

Ideas From the World's Biggest Inventors Show

POPULAR MECHANICS

MAR. 1971
50 CENTS

Polar
Self-
Focusing
Camera



Build the Yellow Jacket

Page 126

**Pinto vs. Vega: Coast-to-Coast
Comparison Run!** Page 76

**Dan Gurney Talks About His
Biggest Thrills and Auto Racing's Future**

Trouble-Shooting Small Gas Engines • Weekend Projects

BOATS

What's New for '71 • Matching Hull to Horsepower
Just-for-Fun 'Water Toys' • Center-Console Boats
The Newest Jets • How to Repair Fiberglass Hulls



The totally tougher truck.

(built to lead a hard life so yours can be easier.)

We've got more power.

Nobody can top Chevy's available 400 V8. They don't come any bigger than Chevy's standard 250 Six, either. Three other available engines. They all get along just great on regular, or new no-lead or low-lead gasolines.



Super Suspension, for the smoothest ride in trucks.



It's fully independent up front with big coil springs to

keep road shock from passing back and forth between the wheels. Or up to the cab and box. In the rear, coil or leaf springs are available—tailored to the loads. So you ride smooth, even when the road isn't. Super Suspension: better because Chevy's built more of its kind. Over a million and a half more than anybody else.



Durable front disc brakes.

They're standard on Chevy. But not on most other pickups. You get resistance to fade, improved brake life. Even with big loads or in heavy use. Power assist is standard, too, on $\frac{3}{4}$ - and 1-ton models. And new finned rear brakes on $\frac{1}{2}$ -tons.

When we say double-wall, we mean it.

We double-wall our wide Fleetside cargo box sides top to bottom, not halfway like some pickups. So dings inside don't show outside. Our cab roof, cowl, body sills and rear wall panels are two walls of steel, too, for added Chevy truck durability.

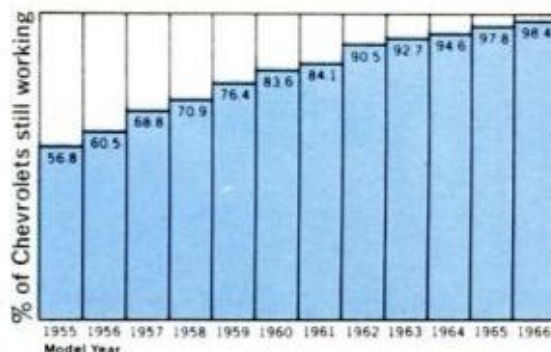
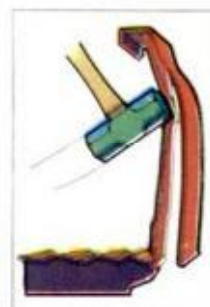

Chevy trucks work longer.

Official figures, based on latest R. L. Polk & Co. statistics, show how Chevrolets outlast other trucks. Going back as far as 1955, for example, over 56% of the Chevrolets of that model year are still on the job. No competitive make has as many as half of its '55 models still working.



Tell your face you love it.



How? By giving it a comfortable shave.

The Spoiler.[®]

(With our miracle plastic coating.)

This One



X4RC-E1P-2JRK

© The Gillette Company, Boston, Mass.

MARCH 1971

1

Материал, защищенный авторским правом



Allstate
life insurance
says if you die,
he gets more
than your name.

Allstate Life Insurance Company

Allstate. The young man's life insurance.

We can help a young father give his new son a future. No high pressure. No appointment. Just walk in. Saturday?

If you're 28 and you pay this much each month:

\$5
\$10
\$15
\$20

Here's how much you get. 20-year decreasing term insurance.

\$13,000
\$32,000
\$64,000
\$88,000

(Even more if you're younger)



You're in good hands with Allstate

Материал, защищенный авторским правом

Since when does a 20 gauge lightweight automatic shotgun pack the power of a 12 gauge?

Since now.

Introducing the lightest 20 gauge gas-operated magnum shotgun made today—the brand-new Remington 1100 Lightweight Automatic 20 Gauge Magnum. It's made for hunters who want the punch of a 12 without the weight and recoil.

Ask a shotgunner to go hunting and, no matter what the game is, the odds are he'll reach for a 12 gauge shotgun. Because with standard factory field loads holding as much as $1\frac{3}{8}$ ounces of shot with $3\frac{1}{4}$ equivalent drams of powder behind it, the 12 has become the big gun in the field. Larger gauges are made, but the 12 is about as much gun as most hunters care to handle.

However, there are some hunters (especially women and youngsters) who prefer to carry a smaller and lighter gun, particularly when they're out all day, up and down hills, across fields, in and out of brush.

They often choose a 20 gauge gun. It's lighter, but with factory-loaded shotgun shells offering $2\frac{3}{4}$ equivalent drams of powder to push 1 ounce of shot, you lose the punch needed for long shots and you have to be darn good to make the close ones.

A better solution is the 3-inch 20 gauge magnum shotgun shell. It packs up to $1\frac{1}{4}$ ounces of shot pushed by $3\frac{1}{4}$ equivalent drams of powder, and the new Remington 1100 Lightweight Automatic 20 Gauge Magnum makes the most of all that power.

The new 1100 is the only lightweight 20 gauge magnum gas-operated shotgun made today. Its solid-steel receiver and other parts are designed to pare away every possible ounce without impairing the 1100's long-established reliability. It weighs only about $6\frac{3}{4}$ pounds, a full quarter pound lighter than our regular 20 gauge 1100, and three-quarters of a pound lighter than our 12.

This means you won't feel your arms growing longer as the day goes on. More important, it's an all-season

gun that's ideal for all kinds of upland hunting.

But what happens to your shoulder when you shoot that much powder in a lightweight gun? Have no fear. In addition to a recoil pad, the new 1100 has the famous gas-operated system that delivers up to 40% less "kick" than any other shotgun action. That alone makes the Model 1100 worth owning.

This new 20 gauge magnum features everything that made the 1100 the world's most popular automatic shotgun including exclusive "vibra-honed" metal parts for less friction, smoother action, richer blueing and Du Pont's RK-W wood finish that protects your gun against rough conditions in the field.

The 20 gauge lightweight can handle, interchangeably, all 20 gauge 3-inch and $2\frac{3}{4}$ -inch magnum shotgun shells. You also have a choice of a plain or ventilated-rib 28-inch full-choke barrel.

One final point. This gun and Remington and Peters shotgun shells are matched by electronic tests to make sure they work well together. These shells can help it perform like a 12 gauge, because their patented

"PowerPiston" one-piece wads put 10% more shot in the pattern area, giving you a 10% better chance of scoring. And their exclusive "Kleanbore" priming will help you to make your gun last longer as well as perform better.

Remington Reports is a series based on information straight from the Remington experts who design and engineer all Remington products. If you'd like to build your own hunting and shooting manual with these Reports, we'll send you a free binder to keep them in. You can also get a free copy of our new 1971 catalog by writing to: Remington Arms Company, Inc., Dept. 132, Bridgeport, Conn. 06602

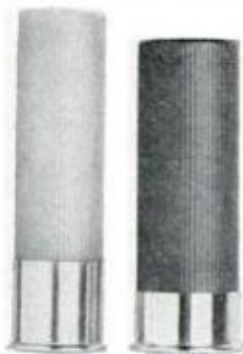

20 ga. 3" mag. 12 ga. 2 $\frac{3}{4}$ " std.



Remington® DU PONT PETERS®

Great guns deserve great ammunition. We make both.

POPULAR MECHANICS®

INTERNATIONAL EDITIONS: AUSTRALIA, BRAZIL, CARIBBEAN, DENMARK, MEXICO, SOUTHERN HEMISPHERE, SWEDEN

AUTOMOBILES AND DRIVING

- 30 Detroit Listening Post
- 44 The Land Rover—Is It Really Indestructible?
- 66 Automobile Clinic
- 76 PM's Coast-to-Coast Test: Pinto vs. Vega
- 86 'I'll Never Quit Racing!'
—Dan Gurney
- 92 The 411 Series: Volkswagen's Luxury Line
- 126 Build the Yellow Jacket for \$400
- 136 Saturday Mechanic: How to Troubleshoot Your Speedometer

HOME AND YARD

- 62 Homeowners' Clinic
- 130 How to Service Small Engines—Part I: Troubleshooting
- 144 Make a Grand Entry (How to Perk Up Your Foyer)
- 152 You Can Build This Early American Gossip Bench
- 160 Exciting New Products
- 164 New Tools You Should Know About
- 166 Solving Home Problems

SCIENCE AND INVENTIONS

- 26 Science Worldwide
- 98 Bright Ideas From the Biggest Inventors Show Yet

PHOTOGRAPHY

- 82 Coming: A Camera That Can Focus Itself!
- 140 Tripods Are Up to New Tricks

REGULAR FEATURES

- 6 Letters

BOATING, OUTDOOR RECREATION

- 14 What's New Outdoors
- 60 On-the-Go Camping
- 104 New Breed of Offshore Fishermen
- 108 New 1971 Boats . . . Houseboats and Sailers Lead the Way
- 112 PM Tests Adaptability of Bertram's Pop-Top Camper to Wake Surfing
- 115 New Jet-Powered Boats
- 116 How to Repair a Fiberglass Boat
- 120 How to Figure Your Planing Speed From Hull and Horsepower
- 122 Water 'Toys'
- 124 New Boating Products

SHOP AND CRAFTS

- 126 Build the Yellow Jacket for \$400
- 148 The Light, Lustrous Look of Glass—Plexiglass Projects You Can Make
- 152 You Can Build This Early American Gossip Bench
- 155 Hints From Readers
- 156 Weekend Projects—3 Quickie Designs That Keep the Sawdust Flying
- 162 A Mini Drill Press for Hobbyists
- 165 Hints From Readers
- 168 Hints From Readers
- 169 How to Make Perfect Bends in Tubing
- 170 Add an Indexing Attachment to Your Lathe

SPACE, AVIATION, MILITARY

- 73 'A-Wax' . . . It Protects the Surface From Six Miles Up!
- 94 How the Airlines Hope to Stop Bombs and Bomb Scares

ENVIRONMENT

- 50 Pollution Fighters' Newsletter

Cover Photo by Danick Studio

Build the Yellow Jacket (The hot little air-cushion vehicle that hovers at 5 inches and goes up to 50 mph)

NEXT MONTH IN POPULAR MECHANICS

- Sublimos: an underwater habitat your diving club can build.
- 10 Lifesaving Driving Tips. Be ready for highway emergencies.
- Coming: Skyshark. First jet amphibian for businessmen and sportsmen.
- Performance vs. Durability: Can you have both in a four-cylinder engine?
- How to Outfit for a Wilderness Canoe Trip: What to take; what to leave behind.

THIS MONTH'S CLASSIFIED ADVERTISING SECTION BEGINS ON PAGE 211

ROBERT P. CROSSLEY

Editor

JAMES M. LISTON
Executive Editor

JOHN A. LINKLETTER
Managing Editor

WAYNE C. LECKEY
Home and Shop
Editor

SHELDON M. GALLAGER
Assistant Executive
Editor

THOMAS G. DAUER
Art Director

Published by The Hearst Corporation
RICHARD E. BERLIN, PRESIDENT

RICHARD E. DEEMS
President, Magazines Division

JOSEPH F. KERN
Publisher

BILL HARTFORD.....Automotive
JOHN F. PEARSON.....Science and Aerospace
GEORGE W. REIGER.....Boating and Outdoors
SHELDON GALLAGER.....Electronics and Photography
HARRY WICKS.....Home Workshop
MICHAEL LAMM.....West Coast Automotive
ROBERT LUND.....Detroit Automotive
GARRY WINTER.....Copy and Production
RICHARD H. FUNK.....Associate Copy and Production
JOHN ADKINS.....Assistant Copy and Production
ALVIN KIETZ.....Assistant Art Director
FRED A. LEERS.....Assistant Art Director
JOSEPH P. BEATON.....Assistant Art Director
DON EVANS.....Technical Art Director
CLIFFORD B. HICKS.....Special Projects
SOPHIE GRONOWICZ.....Director, Bureau of Information
EVERETT JOHNSON.....Cabinetmaker

ADDRESS ALL EDITORIAL COMMUNICATIONS TO: 224 West 57th St., New York, N.Y. 10019. For additional sources of information on the articles and products in this issue, write to Bureau of Information, Popular Mechanics, for free "Where-to-Find-It" list.

DANIEL J. COLEMAN
Director of Advertising

ADVERTISING OFFICES: New York: 224 West 57th St., 765-6850; Chicago: 520 N. Michigan Ave., 527-2400; Detroit: General Motors Bldg., TRinity 5-8711; Cleveland: 20310 Chagrin Blvd., Shaker Heights, 283-7788; Los Angeles: 601 North Vermont Ave., 666-6263.

JOHN A. REGINA.....Advertising Production Manager

SUBSCRIPTION SERVICE: Mail all subscription orders, changes of address, correspondence concerning subscriptions, and Postmaster notices of undeliverable copies to Popular Mechanics, Box 646, New York, N.Y. 10019. Please enclose your latest address label for quickest service when writing about your subscription.

POPULAR MECHANICS IS PUBLISHED MONTHLY by The Hearst Corporation, 57th St. at 8th Ave., New York, N.Y. 10019, U.S.A. Richard E. Berlin, President; George Hearst, V-Pres.; Richard E. Deems, President of Magazines; John R. Miller, Executive V-Pres. of Magazines; Raymond J. Petersen, Senior V-Pres. of Magazines; William S. Campbell, V-Pres. of Magazines; Albert A. Rachoi, V-Pres. and Director of Circulation; Joseph F. Kern, V-Pres. for Popular Mechanics; Frank Massi, Executive V-Pres. and Treasurer; Harvey L. Lipton, Secy. Single copy in the United States and Canada, 50 cents. Subscription prices: United States and Possessions \$5.00 for one year; \$9.00 for two years; \$12.00 for three years. Canada, add \$0.75 for each year. Pan American Postal Union countries, add \$1.00 for each year. All other countries, add \$2.00 for each year. When changing address, give old address as well as the new, with postal-zone number, if any, and allow six weeks for change to become effective. Second-class postage paid at New York, N.Y., and at additional mailing offices. Authorized as second-class mail by the Post Office Department, Ottawa, and for payment of postage in cash. Registered as second-class matter at the Post Office at Mexico D.F., Mexico, June 20, 1950. © 1971 by The Hearst Corporation. All rights reserved. Printed in U.S.A.

After you've sanded, painted and finished the job, admire it with

the good stuff.

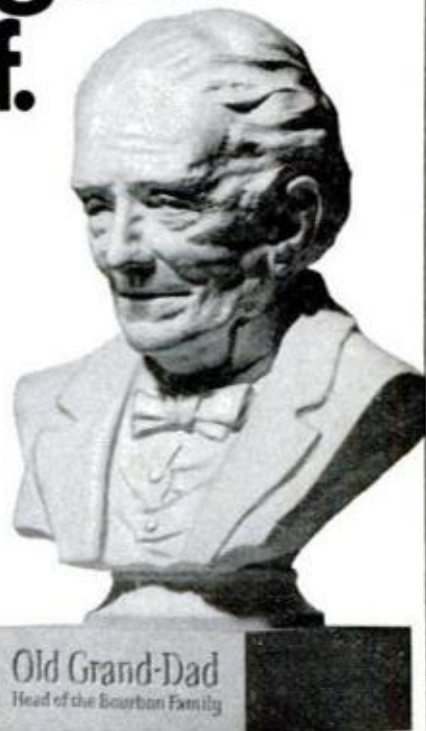

Kentucky Straight Bourbon Whiskeys, 86 Proof and 100 Proof Bottled in Bond. Old Grand-Dad Distillery Company, Frankfort, Kentucky 40601.

If the aroma of
Field & Stream
doesn't remind you
of a great autumn
day in the woods...

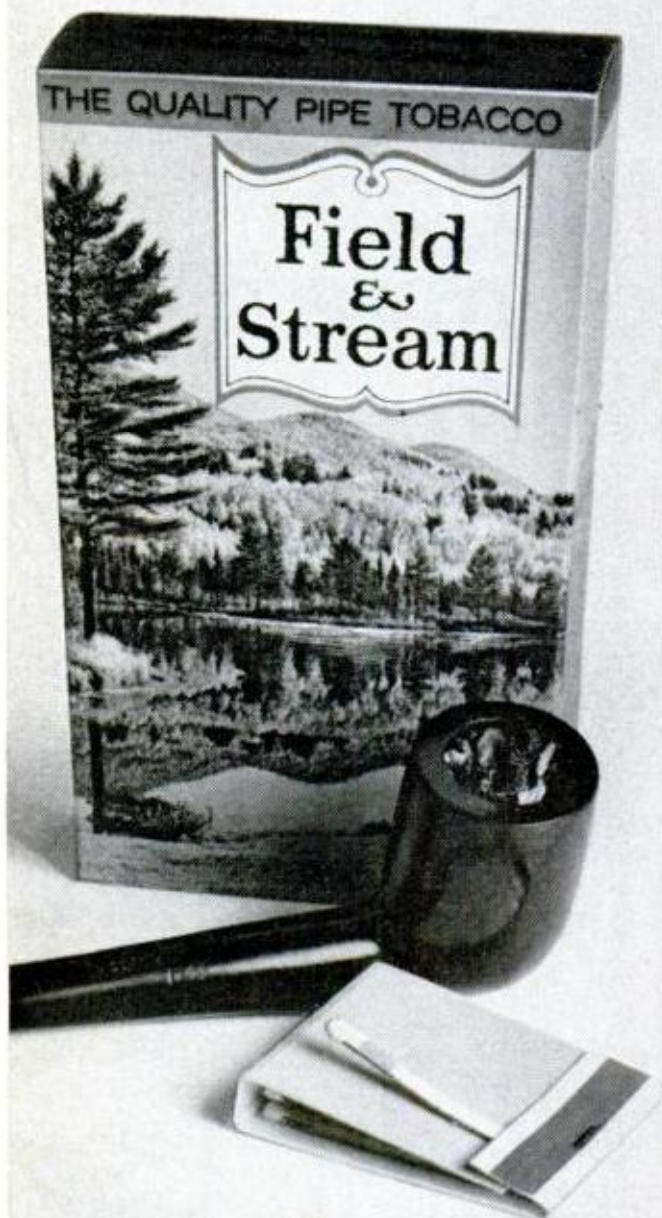

**you forgot
to light it.**

A quality product of Philip Morris U.S.A.

LETTERS TO THE EDITOR

License auto mechanics?

Should Mechanics Have to Have a License? (page 73, Jan. PM) is interesting.

I am an aircraft mechanic, and we have to be licensed by the FAA. An aircraft mechanic must have three years on-the-job training or two years of training at an FAA-approved school. Then he must pass both a written examination and a practical examination. The FAA issues a separate license for airframe work and one for powerplant work.

After three years of holding the license and working full time in the field of maintenance, a mechanic may take an examination to obtain an inspector's rating.

I think that automobile mechanics should be governed by federal laws just as we aircraft mechanics are. They are just as responsible for the safe condition of automobiles as we are for aircraft.

MORO, ILL.

JACK HARMON

No, no, a thousand times no! Mechanics licensed? I agree with Mr. Iacocca.

Is my doctor any better or my dentist or my druggist? Hell, no. It's like professional engineers—just a racket, a tight clique.

People are people. Having a license does *not* change them nor make them good or bad. If I do not like what one does or his prices, I can—and do—go someplace else.

Who the hell brought it up anyway?

NORTH WEBSTER, IND. HAROLD A. LEACH

Middle-aged men on the streets?

In answer to Louis Smith who requested more articles on motorcycles (because "more and more middle-aged men are buying them"), you stated in your January *Letters*: "Really, we're in favor of keeping middle-aged men off the streets."

I surely don't know why! I bought my first "bike" in July 1968, rode it over 5000 miles in a year, traded up two years ago and have over 10,000 miles on this one. I always considered "middle age" about 35 because twice that is what most of us expect to live—and I was 55 before I thought I could afford a motorcycle. I've never had anything that gave me more fun since I learned to ride a bicycle.

So quit trying to run us off the streets. We've paid taxes longer than most of you guys, and we are more sensible riders than the young punks, I'm sure. Any middle-

(Please turn to page 8)

LA SALLE EXTENSION UNIVERSITY

A Correspondence Institution • 417 S. Dearborn Street, Dept. 63-110, Chicago, Illinois 60605

Please send me, without cost or obligation, FREE booklet and full information on the field I have checked below:

ACCOUNTING

- Complete Accounting
- Income Tax
- CPA Training
- Bookkeeping

BUSINESS MANAGEMENT

- Introduction to Business Management

DRAFTING

- Complete Drafting

REAL ESTATE

- Complete Real Estate
- Real Estate Brokerage
- Real Estate Management

LAW COURSES

- Bachelor of Laws Degree
- Business Law
- Insurance Law
- Claim Adjusting Law
- Law for Police Officers

TRAFFIC & TRANSPORTATION

- Complete Traffic Management

RESTAURANT MANAGEMENT

- Complete Executive Training

LANGUAGE INSTRUCTION

- French
- Spanish

COMPUTER PROGRAMMING

- Basic Training

INTERIOR DECORATING

- Complete Training

ART TRAINING

- Commercial Art
- Oil, Water Color Painting
- Complete Training

HIGH SCHOOL

- High School Diploma

HOTEL/MOTEL MANAGEMENT

- Hotel Executive Training
- Motel Management

STENOTYPE

- Machine Shorthand

CAREERS FOR WOMEN

- Accounting
- Bookkeeping
- Computer Programming
- Dental Assistant
- Interior Decorating
- Real Estate
- Secretarial
- Stenotype

Interested in a career not listed? Write here: _____

Mr.

Mrs.

Miss.....

(Circle title and please print)

Age.....

Address..... Apt. No.....

City &

State.....

Zip.....

01D

If you had mailed this coupon a year ago, perhaps your salary would be up too!



WHY NOT MAIL IT TODAY?

Look at these pleased reports from LaSalle students. Many success stories of this kind come to us every year—from people who began their career planning by mailing the LaSalle coupon for information.

Yes, many graduates attribute their increases in income largely to their LaSalle spare-time training.

LaSalle students have one ambition in common—to get out of the ranks of the untrained and earn more money and respect in a better job. Isn't that your goal too?

Without interfering with your present work—and by devoting only a little of your spare time—you too can prepare for advancement in the field of your choice through LaSalle home study. The cost is low.

LaSalle has been a leader in home education for more than sixty years, enrolling over 2,000,000 ambitious men and women in its many courses. You study under the supervision of LaSalle's experienced faculty. Upon satisfactory completion of your study, you receive the LaSalle diploma—a recognized and respected credential.

Check the subject you are interested in—then send the coupon above for FREE booklet. No obligation.



"Since enrolling with LaSalle my salary has doubled."
Robert Kubec,
St. Cloud, Minnesota.

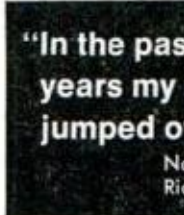

"In the past three years my income has jumped over \$6,500."
Norbert Kaitan,
Ridgewood, N.Y.



"My salary has quadrupled since starting the course."
George R. Kelly,
W. Bridgewater, Mass.

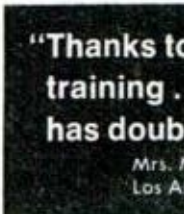

"Thanks to LaSalle training... my salary has doubled."
Mrs. Mary M. Nyberg,
Los Angeles, Calif.

© 1970 LaSalle Extension University

LA SALLE EXTENSION UNIVERSITY

A Correspondence Institution • 417 S. Dearborn Street, Chicago, Illinois 60605

LETTERS

(Continued from page 6)

aged man who wants a motorcycle and can afford it should get it now! It's later than you think. And give us more motorcycle articles!

KANSAS CITY, MO.

W. E. GODFREY

Most of the young people today can't handle a *real* motorcycle. My husband owns both a Harley and an Indian cycle. They are a bit larger than the "toys" the kids today ride, and it takes a good man to handle one. Both my husband and I read and enjoy *PM* very much, and I can't remember that you've shown such apparent bias before.

FARIBAULT, MINN.

MRS. FRANK LEE

All middle-aged men should cancel their subscriptions to your magazine as I am doing, so please send me the balance of my subscription money, thank you, and I never will read your magazine again and I will tell all middle-aged men about this and show them your reply to Mr. Smith.

MARIETTA, N.Y.

FRANK L. WATKINS

Aw, c'mon, folks. We have a collection of mainly 40 and 50-year-olds putting out this magazine (aided up and down stairways, across streets and into wheelchairs by a couple of callow youths in their 30s), and we rank middle-aged men up there with Home, Mother and the Flag. As one colleague puts it: It's lucky there are still magazines around to work on; they keep middle-aged men off the streets.

Hippies are good, too

I enjoy reading *PM*. I was considerably irked, however, to see Wade Mitchell's stupid and bigoted reference to "... potentially troublesome groups (such as hippies) ..." in *On-the-Go Camping* (page 63, Jan. *PM*).

The term "hippie" is right down there with all other ugly terms of prejudice; so is the attempt to shunt the blame for society's bad elements off on one group.

THOUSAND OAKS, CALIF.

ROD SMITH JR.

Your reference to hippies reflects an ignorant and narrow-minded position. Why not mention the criminal who steals from campers or the rapist who takes advantage of unprotected women in our parks? Apparently the discrimination you mention exists and your article supports the fact that it does.

WEST HEMPSTEAD, N.Y.

KEVIN BOBIER

Wade Mitchell, it's people like you who

should be discriminated against if you can't find peace in your mind toward other types of people in this mixed-up, confused world of ours. Not all "hippies" are potentially troublesome groups, but as long as there are people like you around they will never get a fair shake. I hope your mind is not a "hard-hat" in order that this letter may make an impression on your future thoughts about your sons' and daughters' (if you have any) actions and other kids trying to find what they want and what they want to be.

TOWSON, MD.

THOMAS L. CAGLE

Telescope builders

In your *200-Power Telescope* (page 166, Dec. *PM* and page 152, Jan. *PM*), you quoted a price of \$4 for a 6-inch mirror kit from Edmund Scientific. This is incorrect. The kit costs \$13.95.

You also used an aluminum tube. A cardboard tube, designed for concrete forms, works very well for this purpose at a fraction of the cost.

It's nice to see this type of project in *Popular Mechanics*.

MILWAUKEE, WIS.

PAUL A. MURN

That error in price was our mistake. The kit does sell for \$13.95.

Should one be as close as possible to the 96-inch figure [focal length] before beginning to polish? What would be the consequence of grinding too deep? And approximately how long should the mirror be immersed in silvering solution for best results?

MOUNTAIN VIEW, MO.

ORVILLE F. SMITH

If you grind too deep, the curve can be corrected by grinding with the tool on top and the mirror in the barrel. Radius of curvature before polishing should be about 96 inches. Polishing has very little effect on the focal length.

The mirror should be immersed in the silvering solution about two minutes, or until a good coat has appeared. Longer will do no harm, but flecks may begin to deposit on the surface; they can be flushed away with distilled water.

About 40 years ago you had an article which started me on the hobby of telescopemaking. Since then, I have quite a number of scopes to my credit—from 6 to 12½ inches.

But I must say you are falling below par to print a story like the one in your December issue. It is not hard to make a telescope, but you have to have a detailed

(Please turn to page 10)



Mr. Blanton goes to school.

Eugene Blanton is chief mechanic at the First Baptist Church School in Charleston, South Carolina.

It's his job to keep its eight school buses coming to school every day.

"I'm here at eight when the buses start arriving."

Eugene says, "If there are any mechanical problems, I have to have them fixed before school gets out in the afternoon."

In the buses, as well as in his own two cars and boat, he uses Champion Spark Plugs.

"When I tune a car for a friend," he says, "I won't do it unless I can put in Champs."



Toledo, Ohio 43601

**20 million people have switched to Champion Spark Plugs.
This has been one of them.**

EARN BIG MONEY IN AIR CONDITIONING REFRIGERATION & HEATING

25 KITS SENT TO BUILD THIS
COMPLETE REFRIGERATION SYSTEM



APPROVED FOR GI TRAINING
If you served since January 31, 1955 or are
in service, check GI line in coupon

A better job, top pay and steady work are easily within your reach. Learn to repair and install air conditioning systems, refrigerators and freezers. Air conditioning is one of America's fastest-growing industries. Millions of autos and homes are being air-conditioned. The need for trained men is immediate and great.

Make Home Your Training Center—Learn by practicing. CTI sends 25 kits of tools and parts to build a complete refrigeration system—which you later convert into a refrigerator or freezer. The course is easy!

Earn Money As You Train—Since the CTI course includes training with real equipment, many students earn money repairing units soon after enrolling. On completing training they go into top pay jobs. Many get started in their own business.

Mail Coupon Today for FREE book. No obligation. Prove to yourself that the air conditioning, refrigeration and heating field is best for you—the easiest training to master and loaded with top pay opportunities.

Commercial Trades Institute, Chicago, Ill. 60626

COMMERCIAL TRADES INSTITUTE
1400 Greenleaf Avenue
Chicago, Illinois 60626 Dept. PM-371



Send book, Be a Success in Air Conditioning,
Refrigeration & Heating. No obligation.

Name _____ Age _____

Address _____ Zip _____

City _____ County _____ State _____

Check for facts on GI Bill

Accredited Member National Home Study Council

LETTERS

(Continued from page 8)

book on the subject so you don't waste your time and money on something you can't see the moon with, much less the rings around Saturn. You should have copied your previous article; it was much better.

BUFFALO, N.Y.

RUDOLPH NEUHAUSER

Racing Guide

In your 1971 *Auto Racing Guide* (page S1, Jan. PM), you show a painting of a McLaren car in the *Can-Am Cars* section. The caption states that the car is an M8D; if it is, the painting is inaccurate. The McLaren M8D has two fins, one on each side, by which the wing is mounted.

Also: Would the Bond Bug be suitable for conversion to a funny car; could it be run in Trans-Am?

FRANKLIN, IND.

DON ROUTIER

The caption says that Team McLaren won in M8Ds (which is correct). The M8D does have two fins. However, what the caption does not say is that the painting is of an M8E—successor to the D model—which will probably run in 1971.

The Bond Bug could be funny, but it couldn't run in the Trans-Am because it doesn't have four wheels.

Firing those plugs

The importance of filing the electrodes on sparkplugs to reduce the firing voltage required is a point not generally appreciated (*How to Service Sparkplugs*, page 146, Jan. PM). Firing can also be improved during starting by only slightly depressing the accelerator. This decreases the effective pressure in the cylinders, also making the plugs fire at a lower voltage as well as reducing the load on the starter. It may make it possible to start when the ignition is in poor condition.

KENSINGTON, MD.

JAMES O. SPRIGGS

Annual Index

One of my nicest Christmas presents was the announcement that there will be an Annual Index available in December. I would like to thank the person responsible for such a simple, but tremendous, help.

ATLANTA, GA.

JULIUS HUGHES, DDS

It will cover the year 1971 and will include an attractive shelf cover for all 12 issues. Our Special Projects Editor is the guy who's responsible. ★★★

TOM McCAHILL SAYS:

"A Smart Guy Can Really Clean Up in the Appliance Repair Field"

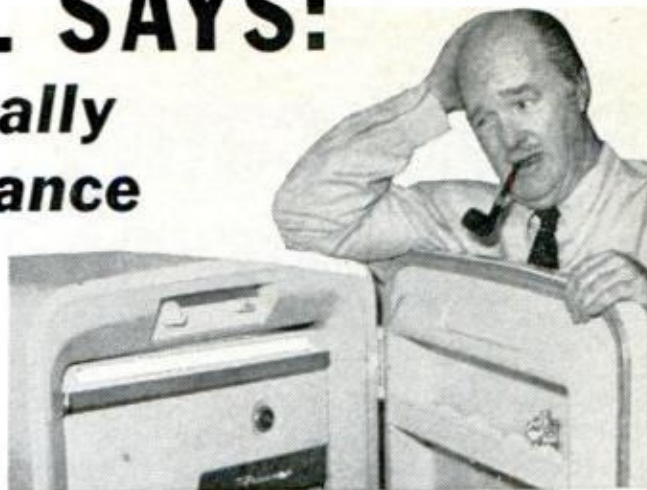

Those electrical gadgets you have around your house are great on convenience, but if you're like a lot of do-it-tomorrow Johnnies, you don't know where to turn when one breaks down. So you call one of the busy Appliance Servicemen in your town, then drink instant until that fancy automatic coffee pot is perking again.

People have so many electrical appliances, it's no wonder Appliance Repairmen are busy as a bear in a bee nest. Count yours. The average home has at least a dozen, maybe more. There are better than 800 million appliances in the U.S.A. right now. No wonder the man who knows how to service appliances properly is pocketing \$4 to \$6 an hour, for as many hours as he cares to work!

If you're interested in making money (and who isn't), here is a job field crying for good men. And it's no sweat at all to get the training you need. Thousands have trained with National Radio Institute's Appliance Division. NRI has a great, low-cost home-study program covering every type of Appliance repair in detail. You study at home, in your spare time, learning through actual practice how to fix home, commercial and farm appliances. And not just the little stuff, either. Besides cantankerous coffee pots and toasters, you can learn how to repair air conditioners, refrigeration equipment, even small gasoline engines—and that's where the big bucks are, in the major appliances you'll fix.

NRI is one of the biggest and best schools in the home-study field. They have this Appliance Servicing course worked out to the most nit-picking detail. Yet, you'll be amazed at how little it costs. You even get a 25-buck professional Appliance Tester without extra cost. With your Tester and a few basic tools you probably have in your house, you'll be doing repair work long before you finish the course. And you can work anywhere—

in a corner of your basement, in the garage, even on the kitchen table.

NRI has been in home-study education since 1914. Experienced, well-trained instructors on the staff of 150 in Washington, D. C., give you all the personal attention a man could ask. You don't even need a high school diploma. Take it from Uncle Tom . . . this can be one of the easiest and most rewarding businesses you'll find today, either full-time or in spare hours. As a matter of fact, knowing how to service Electrical Appliances can pay off even if you don't want to strike out on your own. That coffee pot on the fritz probably needed ten minutes of a repairman's time to be perking again like the mudpots in Yellowstone Park. You can do it yourself with the training NRI gives you. And if you're thinking about Social Security years, this is a great way to pick up some money and keep yourself busy at the same time.

There's nothing to lose except a postage stamp and the energy it takes to walk to the mailbox. What you'll get for your efforts is the newest NRI Appliance Servicing catalog. Nobody is going to ring your doorbell to pressure you into signing an enrollment blank. NRI doesn't employ salesmen.

Do yourself a favor and mail the coupon now—before you turn this page.

Tom McCahill

NATIONAL RADIO INSTITUTE, APPLIANCE DIVISION
3939 Wisconsin Avenue, Washington, D. C. 20016

APPROVED UNDER NEW GI BILL
If you served since January 31, 1955
or are in service, check GI line below.

600-031

OK—I want to see for myself. Send me the free book on Professional Appliance Servicing. No salesman will call.

Name Age.....

Address

City State Zip Code

Accredited Member National Home Study Council.

Check for facts on new GI Bill.

Is your camper pickup built from scuttlebutt?

Most camper pickups are built around campfires and over backyard fences.

That's because almost everyone has a favorite opinion about the way a pickup should be set up for camping. Even if they've never owned one.

Like most information, it loses something in the passage from one person to another. Personal prejudices override the facts and the guy who once read something somewhere begins to sound like an expert.

That's the kind of free advice nobody needs. Because it often winds up costing plenty. But until now, that was the only kind you could get.

What you really need are the facts. A camper pickup is no small investment. And you're going to have to live with it a long time. You need the facts, not scuttlebutt.

They start with the INTERNATIONAL® 1210 Camper Special pickup.

The least important thing about a camper pickup suspension is how smoothly it rides.

Camper pickup suspensions are bought and sold by the seat of someone's pants.

The "Gee, it doesn't ride like a truck" smile on a prospect's face is the car salesman's first foot in the door.

Not that a soft, cushy ride doesn't have its place. It does. In a car.

A truck should ride like a truck for good reasons. Stability, safety and heavy load capabilities are the prime ones. And trucks have leaf spring suspensions.

The International 1210 Camper Special pickup is a truck. So it has leaf springs all around. And what little it loses in the smoothness department, it more than gains back in others.

It's easiest to think of it this way:

A coil spring gives you one point of suspension per wheel. A leaf spring gives you two.

In a pickup with coil springs all around, you get a total of 4 points of suspension. In a pickup with coils in the front and leaf springs in the rear,

you get a total of 6 points of suspension. In the International 1210 Camper Special pickup, with leaf springs all around, you get a total of 8 points of suspension.

At 60 mph, with a stiff crosswind, a GVW of 7,000 pounds and a curve just ahead, how many points of suspension would you want under you...4, 6 or 8?

A lot of pickups and cars have one thing in common: Their engines.

There's a common misconception that any engine, so long as it's bolted in a truck, is a truck engine.

That isn't so.

It's a fact that most camper pickup engines are taken from other assembly lines. If these other lines happen to be automobile assembly lines, the engines are automobile engines. If those other lines have trucks on them, you get a truck engine in your camper pickup.

Our other assembly lines have trucks on them.

Here's what you get:

Manufacturer	Engine	Rated HP:	Net HP:
International	V-304	193.1 @ 4400 rpm	173.0 @ 3900 rpm
	V-345	196.7 @ 4000 rpm	182.3 @ 3900 rpm
	V-392	253.0 @ 4200 rpm	235.9 @ 3600 rpm
Manufacturer "A"	302 V8	205.0 @ 4600 rpm	150.0 @ 4000 rpm
	360 V8	215.0 @ 4400 rpm	177.0 @ 4100 rpm
	390 V8	255.0 @ 4400 rpm	180.0 @ 4000 rpm
Manufacturer "B"	307 V8	200.0 @ 4600 rpm	135.0 @ 4000 rpm
	350 V8	250.0 @ 4600 rpm	170.0 @ 4000 rpm
	402 V8	300.0 @ 4800 rpm	240.0 @ 4400 rpm

International engines lose less horsepower between the test stand and actual use because they're truck engines. They have to be more efficient.

You'll also notice that they develop their power peaks at a lower rpm. They don't have to work as hard, so their chances of lasting longer are better. And they're all set to run on regular

or low-lead content gas.

International V-8's are, in fact, the same engines we use in many of our gas-engined highway rigs. And you know how long they last.

When you buy a pickup, make sure you get a truck.

There's more to a camper special pickup than an engine and a suspension system.

Transmissions, for instance. You can order any one of seven different transmissions—two 3-speed, two 4-speed, and a 5-speed heavy duty, a 5-speed with overdrive, and a rugged 3-speed automatic. Like the engines they're attached to, they're truck transmissions. They're strong.

Special additional equipment items. A front anti-sway bar and over-size electrical and cooling systems are standard on International Camper Special pickups.

Idiot lights. You can't get them with an

International. Gauges are standard equipment. So you always know what's going on.

Fuel tank location. International pickups are the only pickups with the tank outside the cab. Everyone else's tank is right inside, behind the passenger seat.

There's a truckload of other things to consider—power steering and brakes, air conditioning, AM-FM, the works. Your International truck dealer has the facts on them all.

Stop by and see him. Ask him about the 1210 Camper Special pickup. And let him help you separate fact from the fiction.

IH.
INTERNATIONAL® TRUCKS

International Harvester Company, 401 N. Michigan Avenue, Chicago, Illinois 60611.

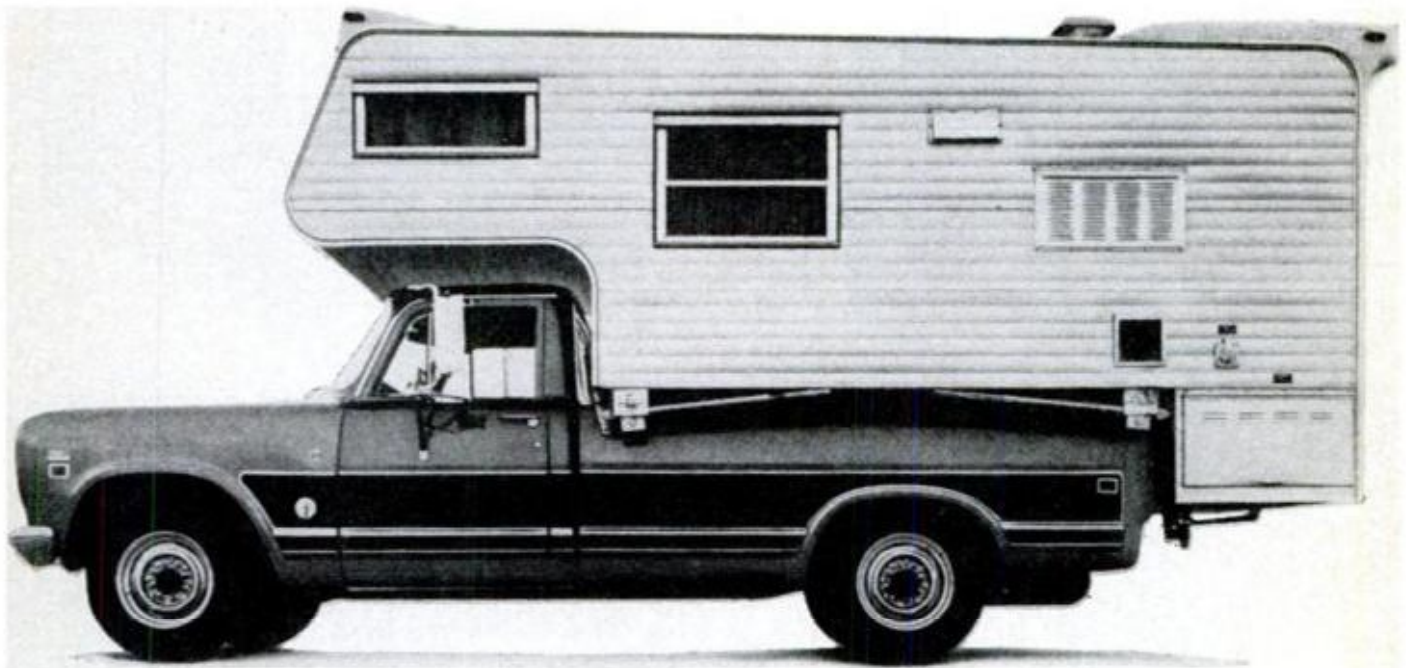



FOR BOATING, camping or vacationing convenience, try the 100 percent self-contained portable toilet, Porta Potti 1000 (above), needing no fresh-water hookup or permanent holding tank. Made in two sections—seat, seat cover, four-gallon water storage; and holding tank with pedal. Just unclamp and carry holding tank to permanent toilet for evacuation. Thetford Corp., Box 1285, Ann Arbor, Mich.



FLUORESCENT LANTERN

made by Burgess will add to your enjoyment of outdoor activities. Available in a beige, blue or gold polystyrene and vinyl case with stainless-steel trim, it operates on heavy-duty batteries or plugs into an a.c. outlet to give shadow free light across a 110° field. A Lucite shield protects 12-in. bulb and enamel reflector increases intensity of the light. Lantern is equipped with rubber feet on base, also has sturdy chain to hang it overhead. It retails for \$39.95 from Burgess Battery Div. of Gould, Inc., Freeport, Ill. 61032.

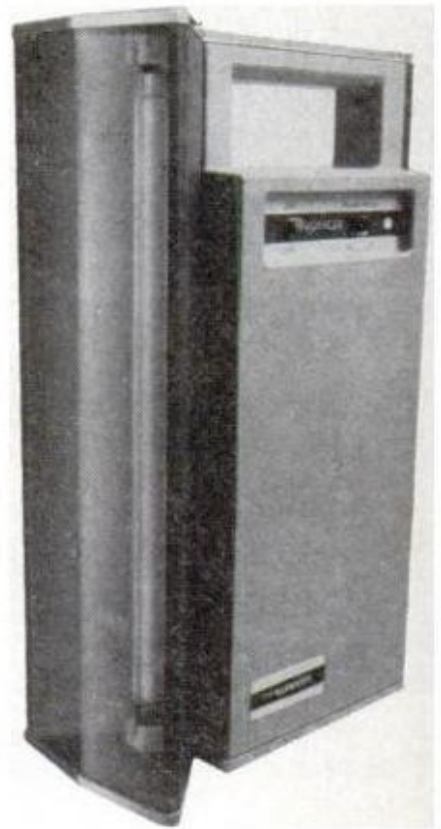

CONVERT YOUR GASOLINE OUTBOARD

into a silent, electric fishing motor with the Electra Pal "Papoose," a permanent-magnet motor that rides piggyback on your motor's anticavitation plate. Less than a foot long and weighing about 9 pounds, it comes with a movable speed-control console you can clamp at any steering position. The motor, made in two models, operates from a 12-volt car battery. You steer it the same way you guide the outboard. For more information, write "Papoose," Osborn Engineering Corp., 1400 East Lafayette St., Bloomington, Ill. 61701.

WHAT'S NEW OUTDOORS

BY ROB KINSON

Taste Symbol

Just about everyone knows what the
7 Crown of Seagram's stands for.

Unquestionable good
taste. Consistent quality. And a
flavor that is consistently
smooth, and always comfortable.

**Say Seagram's 7 Crown
and Be Sure.**



Seagram Distillers Company, New York City. Blended Whiskey. 86 Proof. 65% Grain Neutral Spirits.

COOL it!

The end of
hot taste.

Sterling

Blend
SMOKING TOBACCO

Sterling tobacco
is blended by an
exclusive process
to smoke cool and
dry right to the
bottom of the bowl.

Sterling—A cool idea.

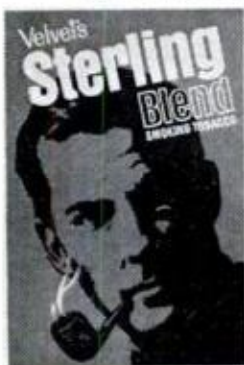

**SIX
GOOD
REASONS**



Why You, Too, Should be an ACCIDENT INVESTIGATOR

1. You become a member of a respected fast growing profession.
2. You meet all kinds of interesting and important people.
3. You are not "chained" to an office desk or assembly line.
4. You render a worthy, **necessary** service (NO SELLING) to the community.
5. There are many opportunities for quick advancement.
6. There are good openings in every state and Canada.

Car furnished—Expenses paid—Work part-time or full time—
Earn as you learn—No selling of any kind—Only average
education required—Mail for Free Information.

■ Jim Edwards, Director, Dept. 53
■ Liberty School
■ 1111 W. Park Ave., Libertyville, Illinois 60048

■ Send me your FREE Brochure Showing how I can quickly get
into the Booming Accident Investigating Field and enjoy the job
security and professional prestige offered Accident Investigators.
■ This does NOT obligate me in any way and no salesman will call.

■ Name _____ Age _____
■ Address _____
■ City _____ State _____ Zip _____

FANTASTIC VALUES WITH THIS COUPON

AMERICAN MACHINE & TOOL CO., Dept. PM-31, Royersford, Pa. 19468
Please send me the units checked. Payment in full enclosed \$.....
or \$3 deposit each item enclosed, balance C.O.D. I MUST BE FULLY
SATISFIED OR WILL RETURN UNIT WITHIN 10 DAYS FOR FULL REFUND.
No questions asked.

- 8" Power Saw at \$19.95
 Standard Rip Fence at \$3.50
 Long Rip Fence at \$4.50
 Precision Ball Bearing Spindle at \$5.00
 Jointer Planer at \$24.95
 Drill Press at \$34.95
G.E. Motor \$19.90 (with other item) \$24.85 (purchased separately)
- Belt Sander at \$14.95
 Disc sander attach. at \$7.95
 Mitre Gauge for sander at \$1.95
 Lathe at \$14.95
 Face Plate at \$2.50
 Turning Chisels at \$4.95

NAME

ADDRESS

CITY STATE ZIP

SAVE AS MUCH AS...
80% WITH
QUALITY 
POWER TOOLS

DIRECT FACTORY OFFER AND REVOLUTIONARY PATENTS decrease costs, increase efficiency. Full scale power tools of heavy duty 100% cast iron and steel. Streamlined design reduces weight, cuts material and production costs. Special patents provide added efficiency, accuracy, savings. Parts made, assembled, tested, packed right in our own factories shipped direct... save store profits.

UNCONDITIONAL MONEY BACK GUARANTEE

You must be fully satisfied. If not, return in 10 days, freight collect. Money promptly refunded in full.

ENDORSED BY AMERICA'S TOP MAGAZINES... Here is what the editors say:

"A good bit of sound—imaginative—engineering." Popular Science; "(saw) boasts many features of bigger brothers." Popular Mechanics; "Amazingly versatile." Workbench; "Highly substantial construction, sturdy enough for production line use."

Industrial Woodworking. And Workbench awarded these tools their coveted "Work Tested" Seal.

OVER A MILLION USERS confirm their precision, versatility and rugged performance.

*10-YEAR FULL SERVICE GUARANTEE... Any part or parts of any AMCO power tool (except motor) which may become inoperative for any reason within ten years after the purchase date will be repaired or replaced by the factory without cost to the purchaser. Your only cost: for postage.

8" TILT ARBOR POWER SAW

DOES WORK OF \$75 BENCH SAW as is. Converts easily to equal any \$300 floor model cabinet units! Crosscuts, rips, mitres, cuts compound angles, dados, makes coves and mouldings.

\$1995 f.o.b. factory. Wt. 25 lbs. Incl. completely assembled cast iron and steel 8" saw with ground cast iron and blade guard, less blade. RIP FENCE, if desired, for easier work alignment, \$3.50 add'l.

PRECISION BALL BEARING SPINDLE for Commercial Service, \$5.00 add'l.

SAW BLADE TILTS... TABLE STAYS LEVEL

• Locks securely at any angle up to 50°, raises, lowers 0"-2 1/4". Patented tilt mechanism, accurate etched scale. Patented motor mount takes std. 1/4 h.p. or larger motor, keeps belt tight, assures perfect alignment at any angle, transmits full power. Takes std. blade, saw insert removes to take dadoe heads, cutters, etc. (not incl.). Accurate mitre gauge assembly. Ground spindle. Enclosed steel base. "Compo" bearings. Accessories available at factory prices. RIP FENCE, if desired for easier work alignment: Std. size (for bench saw) \$3.50; larger fence (for cabinet base, as ill'd.) \$4.50.

FREE CABINET BASE PLANS Use as portable bench saw as received (inset photo) or transform easily and inexpensively into floor model (as shown) guar. to do work of floor models costing \$300. FREE plans... all you'll need are a sheet of 3/4" plywood and 3-4 hours. Use your AMCO saw for cutting. Plans provide 27" x 24" work surface, 33" height, tool storage compartment.

10-YEAR FULL SERVICE GUARANTEE*



6" SWING 3-FOOT LATHE



Optional faceplate for turning bowls, trays, lamp bases, rosettes, etc. \$2.50. **\$1495** f.o.b. factory Wt. 14 lbs.

Set of 3 high speed turning chisels, \$4.95 add'l.
DOES THE WORK OF \$40 UNITS... with same precision and speed. Turns wood, plastic. Sturdy cast iron with tubular steel bed. Ball thrust cup center, spur center, T-rest assembly, lever action tail stock, 2-speed pulley. Fits any motor.

10-YEAR FULL SERVICE GUARANTEE*

PRECISION 4" x 36" BELT SANDER

f.o.b. factory. Wt. 15 lbs.



\$1495 †Disc Sander attachment incl. disc bracket, ground cast table (tilts 0-45°): \$7.95 add'l.

DOES WORK OF \$50 SANDERS... The world's most talented belt sander. Heavy cast sander incl. 4" x 36" sanding belt, V-pulley drive, multi-purpose drive spindle. Changes from horizontal to vertical sanding in secs. Uses 1/2 hp or larger motor.

10-YEAR FULL SERVICE GUARANTEE*

FULL 22" LONG, 4 1/8" JOINTER-PLANER

\$2495



f.o.b. factory. Wt.: 19 lbs. Complete as shown.

100% precision ground cast iron and steel.

DOES THE WORK OF \$60 UNITS... Professional power planing at a hand tool price. Make faster, more accurate joints, rabbetts, bevells for windows, doors, drawers, square tapered legs—Adjustable precision ground cast iron tables. Patent-pending design holds knife to table clearances at any depth. Rabbett depth 3/8". Fence adjustable 0°-50°. Hardened, ground hi-speed steel knives. Dual cutter guards. Balanced cutter head.

10-YEAR FULL SERVICE GUARANTEE*

32" DRILL PRESS

All cast iron and steel

f.o.b. factory **\$3495**

Wt. 30 lbs. 1/2" cap. Jacob's chuck incl.

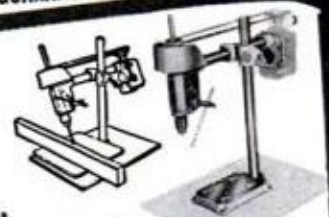

DOES WORK OF \$90 UNITS... and much more. Industrial quality precision unit with all standard features, many extras. Head raises, lowers. Depth of throat up to 16". Pre-set to any angle for on-or-off table drilling, even horizontal drilling. 10-YEAR FULL SERVICE GUARANTEE.*

BRAND NEW  MOTOR

DEVELOPING FULL 1 HP... **\$1990**

F.O.B. FACTORY

FOR ANY OF ABOVE MACHINES. WT. 17 LBS. PURCHASED SEPARATELY, \$24.85

WHAT'S HOLDING YOU

Think of doing something to "better yourself" now!

Make more money. Win respect and promotions. Enjoy your work.

But maybe you've *been* thinking about it—for too long. Don't *just go on* thinking . . . and thinking . . . while the raises and promotions keep going to the other guy. *Every day you wait costs you money*—according to a recent survey the average ICS graduate is making \$1200 more a year within a year of graduation—and many do far better.

Every day you wait is another opportunity lost. The opportunity is here—on this page—*now*. Read the attached booklet. ICS has been successfully training people to move up in the world, for over 80 years. ICS can help you.

ICS is America's most successful teacher. It teaches skills, and teaches success. It can teach *you* success. In any of 266 programs for a brighter, better-paying future.

You've nothing to gain by waiting. You've *everything* to gain by sending the coupon today for *free* information.

You'll get the famous ICS "Success Kit," which includes: a catalog, a lesson "sampler" which shows you what it's like to study at ICS; and a very helpful booklet called "How To Succeed." All free.

If you've been *just thinking*, cut it out—send the envelope *today*—and really start something toward a better tomorrow.

DOWN?

(VETERANS! APPROVED FOR TUITION REFUND!)

Cut along this line, fold and tape—mail as envelope.

ICS[®] International Correspondence Schools Division of Intext

7F054B

Without cost or obligation, send me the Success Kit for the course checked.

ACCOUNTING

- Accounting (U.S. or Can.)
- General Accounting
- Public Accounting

ARCHITECTURE and BUILDING TRADES

- Air Conditioning
- Air Conditioning Maint.
- Architecture
- Arch. Drawing & Design
- Building Contractor
- Carpenter-BUILDER
- Heating and Air Conditioning with Drawing
- House Planning, Int. Design
- Plumbing-Heating
- Reading Arch. Blueprints
- Refrigeration & Air Cond.

ART and DESIGN

- Commercial Art
- Commercial Cartooning
- Interior Decorating
- Sign Painting & Design
- Sketching & Painting

AUTOMOTIVE

- Auto Body Rebuilding & Refinishing
- Auto Mechanic-Techn.
- Diesel-Gas-Motor Vehicle Engines
- Auto. Electrical Techn.
- Engine Tune-Up
- Transmission Specialist

BUSINESS

- Advertising
- Basic Management
- Advanced Management
- Business Administration

- Industrial Psychology
- Managing a Small Store
- Purchasing Agent
- Traffic Management

BUSINESS SALES

- Real Estate Sales
- Sales & Sales Mgmt.

CHEMICAL

- Chemical Engineering
- Chem. Lab Technician
- General Chemistry
- Plastics Technician

CIVIL ENGINEERING

- Civil Engineering
- Sewer Plant Operator
- Surveying & Mapping

COMPUTERS

- Fundamentals of Computer Programming
- COBOL Programming
- Fortran Programming
- Programming for Digital Computers
- Programming the 360
- Programming the 1401

DRAFTING

- Aircraft Drafting
- Architectural Drafting
- Blueprint Reading
- Drafting Technology
- Electrical and Electronic
- Mechanical Structural

ELECTRICAL

- Electrical Engineering
- Appliance Servicing
- Elec. Eng. Technician
- Industrial Electrician

- Industrial Maint. Elect.
- Motor Repairman
- Practical Electrician
- Practical Lineman

HIGH SCHOOL

- High School Business
- High School General
- High School Math.
- High School Secretarial
- High School Vocational
- College Preparatory
- Preparatory Course for H.S. Equivalency Test

MACH. SHOP PRACTICE

- Machine Shop Practice
- Maintenance Mechanic
- Reading Shop Prints
- Welding, Gas & Elec.

MECHANICAL

- Aircraft Mechanic
- Power Plant Engineering
- Quality Control

TV-RADIO-ELECTRONICS

- Cable TV Installer
- Electronics Fundamentals
- Electronic Technician
- General Electronics
- Indust. Electronics Tech.
- Radio Telephone License
- Solid State Electronics
- Telephony
- TV and Radio Servicing

WRITING and ENGLISH

- English and Writing
- Free-Lance Writing
- Reading Improvement

Other (tell us) _____

Name _____ Age _____
(Indicate Mr., Miss or Mrs.)

Home Address _____ Apt. _____

City _____ State _____ Zip _____

Occupation _____

Employed by _____ Working hours _____ A.M. to _____ P.M.

I am a veteran. Tell me how I qualify for tuition refund under the G.I. Bill.
(Residents of Canada should affix postage and mail to Scranton, Pa. Further service handled through ICS Canadian Ltd.)

POSTAGE WILL BE PAID BY—
International Correspondence Schools
Division of Intext
Scranton, Penna., 18515

BUSINESS REPLY MAIL.
No postage stamp necessary if mailed in United States.

FIRST CLASS
PERMIT
NO. 1000
SCRANTON, PA.

Unexpected reactions to nitrous oxide ("laughing gas") by college-aged patients recently aroused the curiosity of two Boston University dentists. They noted that administration of the gas made some patients more placid than was to be expected, caused others to be unusually active while under treatment, and produced prolonged aftereffects in a number of patients. Investigation revealed that all had used marijuana the day of the appointment or the evening before, and that adverse reactions did not occur if marijuana was avoided prior to dental treatment. The researchers also noted that an increase in nitrous-oxide dosage was required for consistent marijuana users, possibly because of a tolerance buildup. The scientists believe that the hallucinatory effect and euphoria produced by marijuana are reinforced by the similar effects of nitrous oxide.

A record simulated wet dive to 1100 feet was recently accomplished by five divers during a test of a new helium-oxygen, closed-cycle breathing rig at the Taylor Diving & Salvage Co., Belle Chasse, La. The test was carried out in a big steel pressure chamber filled with 7000 gallons of salty water cooled to 29° F. At depth, the men breathed a mixture of 99 percent helium and 1 percent oxygen. The old simulated wet-diving record of 1025 feet was established two years ago at the Navy's Experimental Diving Facility in Washington, D.C. The "dry" diving record of 1709 feet, not involving underwater immersion, is held by the French.

Promethium, an unstable element that doesn't exist naturally on Earth, has been identified in the spectrum of a star by University of Michigan astronomers Margo Aller and Charles Cowley. Designated HR 465, the star is in the constellation Andromeda at the edge of the Milky Way and only faintly visible to the naked eye. Promethium was originally discovered in 1947 as a fission product of uranium.

The hazards involved in experimenting with lasers are spelled out in a new 117-page manual issued by the Department of Health, Education and Welfare (HEW). Intended as a safety and experimentation guide for high-school and college instructors, the manual states that even low-power lasers can cause eye damage when improperly used. Since 1965, HEW has received reports of four laser-induced injuries at universities. Copies of Laser Fundamentals and Experiments may be purchased from the Superintendent of Documents, Government Printing Office, Washington, D.C., 20402. Cost: \$1.25 per copy.

Why has the eastern United States and other parts of the world experienced a cooling trend in recent years? Some scientists think air pollution is blotting out sunlight and others suggest that we may be experiencing a cyclical variation in energy output of the sun. A more likely cause, according to Jerome Namias, chief of the Extended Forecast Div. of the National Weather Service, is the oceans, which act as a kind of governor of global climate. Water in the North Pacific has warmed up in recent years, he says, causing shifts in the high-level river of air known as the jet stream. This shift causes cold air to sweep down from the Canadian Arctic and across the eastern two-thirds of the United States. Scientists can't pinpoint the reason for the warming trend in the North Pacific.

SOS from the nursery. This distress signal may be heard in American homes if a new type of diaper fastener catches on. The fastener is an electrified safety pin with its own power supply. When baby wets, moisture closes a circuit to a miniature radio transmitter that sends a signal to a loudspeaker-equipped receiver. A California inventor was recently granted a patent for the fastener. ★★★

**The Swingline
Tacker Gun can
finish off every room
in your house...**



for only \$9.95

Use the Model 800 Heavy-Duty Tacker Gun to install ceiling tile... repair screens... lay carpet... insulate... weather-strip... upholster... you-name-it!
Takes 5 staple sizes, from 1/4" to 9/16" — plus special Loktile® staples for ceiling tile installation. Easy to load — easy to operate.



Model 800

Write for free booklet, TIPS ON TACKING Dept. P-3

Also available:

Model 101 Tacker Gun. Only \$6.95.
Takes 2 Staple Sizes 1/16" and 5/16"

Swingline®

Consumer Products Division, 32-00 Skillman Ave., Long Island City, N.Y. 11101.

UNUSUAL BARGAINS

MANY U.S. GOV'T SURPLUS

**FREE!
GIANT
CATALOG**

1st QUALITY OPAQUE UNDER \$200



Terrific Buy! Top Quality! Projects brilliant, sharp 4 1/2 ft. sq. image from 8" using up to 5"X5" color, b&w illustrations. Retains all original colors, proportions. Enlarges drawings, coins, maps, etc. Revolutionary peanut-size quartz Halogen lamp (50hr. life). 200mm anastigmatic lens (f3.5.8"F.L.), unique internal reflecting system give maximum brightness, entire field focus. Can be used upside down. Turbo-cooled. 5 1/2 ft. cord.

Stock No. 71,272H (Wt. 11 1/4 lbs) \$89.75 Ppd.

AMERICAN MADE OPAQUE PROJECTOR



Projects illustrations up to 3" x 3 1/2" —enlarges them to 35" x 30" if screen is 6 1/2 ft. from projector, larger pictures if screen is farther away. No film or negatives needed. Primarily intended for children. Projects charts, diagrams, color or black-and-white in darkened room. 115 v. A.C. . . . 6 ft. cord and plug included. Size 12" x 8" x 4 1/2" wide. Weight 1 lb. 2 ozs. Plastic case.

Stock No. 70,199H \$8.75 Ppd.

GIANT WEATHER BALLOONS



"Balls of fun" for kids, traffic stoppers for stores, terrific for amateur meteorologists. Create a neighborhood sensation. Great backyard fun. Exciting beach attraction. Amateur meteorologists use to measure cloud heights, wind speed and temperature. Made of heavy duty neoprene. Inflate with vacuum cleaner or auto air hose or locally available helium for high rise.

Stock No. 60,568H (8 Ft. diameter) \$2.00 Ppd.
Stock No. 60,632H (16 Ft. diameter) \$7.00 Ppd.

"FISH" WITH A MAGNET



Go treasure hunting on the bottom! Fascinating fun & sometimes profitable! Tie a line to our 5-lb. Magnet—drop it overboard in bay, river, lake or ocean. Troll it along bottom—your "treasure" haul can be outboard motors, anchors, other metal valuables. 5-lb. Magnet is war surplus—Alnico V Type—Gov't cost \$50. Lifts over 150 lbs. on land—greater weights under water.

Stock No. 70,571H \$14.00 Ppd.
Stock No. 70,570H 3 1/2 lbs. (lifts 40 lbs.) \$ 8.75 Ppd.
Stock No. 85,152H 15 3/4 lbs. (lifts 350 lbs.) \$33.60 FOB

PLASTIC MODEL V-8 ENGINE



Hours of fun! Get thrill of building your own easily assembled engine from over 350 parts. Then push starter and watch it run. Crankshaft revolves, pistons move, valves open and close in sequence with spark plugs. Does everything but burn oil. 1/4 scale, molded in 4 colors. Used in many auto-mechanic courses. Excellent, easy-to-understand "tech manual."

Stock No. 70,448H \$13.50 Ppd.

BLACK-LIGHT MIGHTY MITES



Relatively small (12") fixtures give surprisingly bright blacklight. Mirror-finished reflector makes instant starting 8-watt, high-intensity bulb look like 40-watter. Up to 5,000 hours of safe, long-wave (3660A) blacklight to really turn-on parties, light & theatrical shows, psychedelic decors, holiday decorations. Shockproof end-caps remove for safe, easy replacement of bulb and starter. Stands upright or horizontal. Aluminum case.

Stock No. 71,274H \$14.95 Ppd.
DELUXE OUTDOOR/INDOOR MODEL
Stock No. 71,299H \$19.95 Ppd.

'Bright Ideas' in Unique Lighting Big, new 100-page handbook, packed with facts, loaded with illustrations. All latest developments, applications, equipment. 8 1/2" x 11" looseleaf paper to fit 3 rings. Stock No. 9100 H \$3.00 Ppd.

MAIL COUPON FOR GIANT FREE CATALOG

148 PAGES! MORE THAN 4,000 UNUSUAL BARGAINS.

Completely new 1971 Catalog. Packed with huge selection of telescopes, microscopes, binoculars, magnets, magnifiers, prisms, photo components, unique lighting items, parts, kits, accessories—many hard-to-get surplus bargains. 100's of charts, illustrations. For hobbyists, experimenters, schools, industry.
EDMUND SCIENTIFIC CO.
300 Edscorp Building, Barrington, N. J. 08007
Please rush Free Giant Catalog "H"

Name
Address
City State Zip

EDMUND SCIENTIFIC CO. 300 EDSCORP BLDG. BARRINGTON, NEW JERSEY 08007
ORDER BY STOCK NUMBER - SEND CHECK OR MONEY ORDER - MONEY-BACK GUARANTEE

Residence Schools / Camps Directory

For advertising information on this section, please contact Hildegard K. Esposito, Popular Mechanics, 224 West 57th Street, New York, N.Y. 10019.

Many schools and camps have long waiting lists for 1971-1972 enrollment. POPULAR MECHANICS urges you to write now to the residence school or camp of your choice for more information.

BOYS' SCHOOLS

St. John's Military Academy 1884

A TRADITION OF EXCELLENCE
stressing character, leadership, scholarship. Accredited college preparatory, grades 7-12. Tutorial and developmental reading programs. All sports including hockey, flying, riflery. Own golf course, stable, pool, hospital, lake for crew. Honor ROTC. Band. Interdenominational. Chicago 100 mi. Write: Wm. J. West, Headmaster, Box VMF 321, Delafield, Wisconsin 53018

HOWE MILITARY SCHOOL

Jr. & Sr. Schools. Grades 6-8 & 9-12. Thorough acad. training. Accredited college prep. ROTC. Jrs. have own dorm, sports & activities; housemother. Devel. Reading. Small classes. Testing. New buildings, pool, Episcopal. Est. 1884. Summer Camp. Catalog. Col. R. R. Kelly, Supt., 1211 Academy Pl., Howe, Ind. 46746.

Wentworth Military Academy

Preparation for the rigors of business or higher education. Accred. 4-yr. H.S., separate 2-yr. College Sr. ROTC. New million-dollar field house. Golf course. Pool. FAA flying. Summer school; younger boys' camp. 91st year. Catalog. Col. L. B. Wikoff, 231 Washington Place, Lexington, Mo. 64067

As a service to our readers and their families, we are now including this Schools/Camps Directory, offering listings of the finest schools—college preparatory, technical schools and military academies—we hope their services will be beneficial to the success of today's youngsters so that they might be the strong foundations of tomorrow's world.

Missouri Military Academy

AND SEPARATE JR. SCHOOL

82nd yr. Small classes. College prep. Gr. 4-12. All sports. Golf. Riding. ROTC. 10 beautiful new buildings in 14 yrs. incl. library, dorm, largest field house in state. Catalog. Col. Charles Stribling III, 811 Main, Mexico, Mo. 65265. Tel: 314/581-1776.

Roosevelt Military Academy

"Builders of Men" Fully accred. Gr. 7-12. College prep. General High School Courses. Small classes. Emphasizes fundamentals, how to study. Guidance. ROTC. Sports. Riding. Aviation. Bands. Mod. rate. Catalog. Col. Glen G. Millikan, Box P, Alledo, Ill. 61231. Tel: 309/582-5166.

Kemper Military School & College

Fully accred. Grades 7-12; 2-year college. Ind. instruction. Excellent faculty. Personal counseling. How-To-Study Program, Jr., Sr. ROTC. Sports. Social activities. FAA Flying. Education for leadership since 1844. Catalog: 500 Third St., Boonville, Mo. 65233.

TECHNICAL SCHOOLS

Gradwohl School of Laboratory Technique

Be a medical lab technician! Big demand, good salaries. One-year course for H.S. grads. Enter monthly. Co-ed. Internationally known. M.D. supervised. G.I. approved. Placement service. Catalog: 3530 Lucas Avenue, St. Louis, Missouri 63103.

GET INTO ELECTRONICS

V.T.I. training leads to success as technicians, field engineers, specialists in communications, guided missiles, computers, radar, automation. Basic & advanced courses. Electronic Engineering Technology and Electronic Technology curricula both available. Assoc. degree in 29 mos. B.S. obtainable. G.I. approved. Start Sept., Feb. Dorms, campus. High School Graduate or equivalent. Catalog.

VALPARAISO TECHNICAL INSTITUTE
DEPARTMENT D.
VALPARAISO, INDIANA 46383



What Do You Want in a Lightweight Chain Saw?

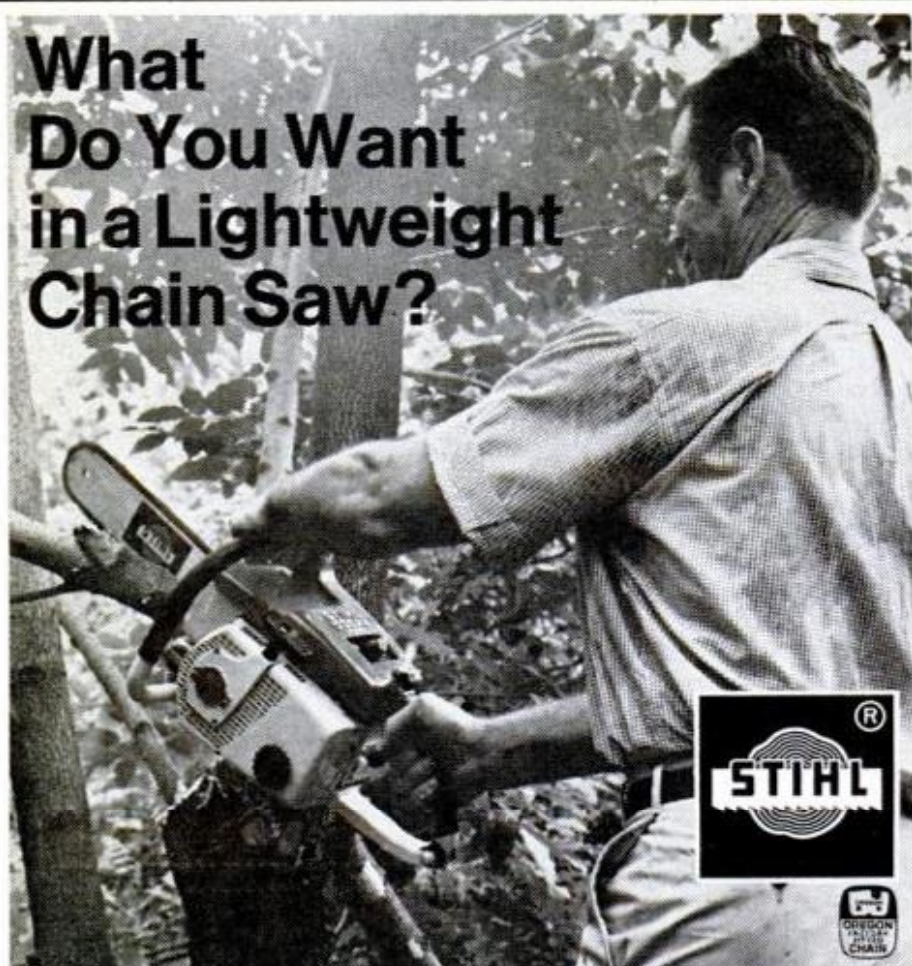

A mini-size saw with mini-power... or a lightweight "professional" saw like our new Stihl 030 AV Deluxe?

This saw is a happy combination of lightweight and cutting power double that of some mini-saws.

The 030 AV Deluxe is a precision made lightweight, which incorporates features costing as much as \$ 50.00 more in other saws. These include the patented Stihl AV antivibration system, automatic chain oiling, silencer-muffler, and a dependable "big" power engine.

See it today at your local Stihl dealer.

STIHL American, Inc.

194 Greenwood Avenue,
Midland Park, N. J. 07 432,
Code 201-445-0890
7364 Lee Industrial Boulevard,
Mableton (Atlanta), Georgia 30059,
Code 404-941-1730
23962 Clawiter Road,
Hayward California 94541,
Code 415-785-9100



The Army can take your hobby and turn it into a career.

Tear down an engine or snap a picture or solder some wires to a speaker to rock the room.

Maybe you call it a hobby or a knack or maybe even your thing.

And, you know, the Army can take that favorite talent of yours and turn it into a rewarding, lifetime career.

We have more horsepower than the Motor City.

We have cameras that can take a portrait of a bird a half mile away.

We have electronic equipment so new that it hasn't even been named yet. The Army needs people to run it all and keep it running.

We can train you to be an expert. What's more, we'll guarantee this training in writing before you enlist.

Send for our free book.

Use the coupon or write:
Army Opportunities, Department 200A, Hampton, Virginia 23369.

It's full of things. Maybe yours is one of them.

Your future, your decision.
Choose ARMY.

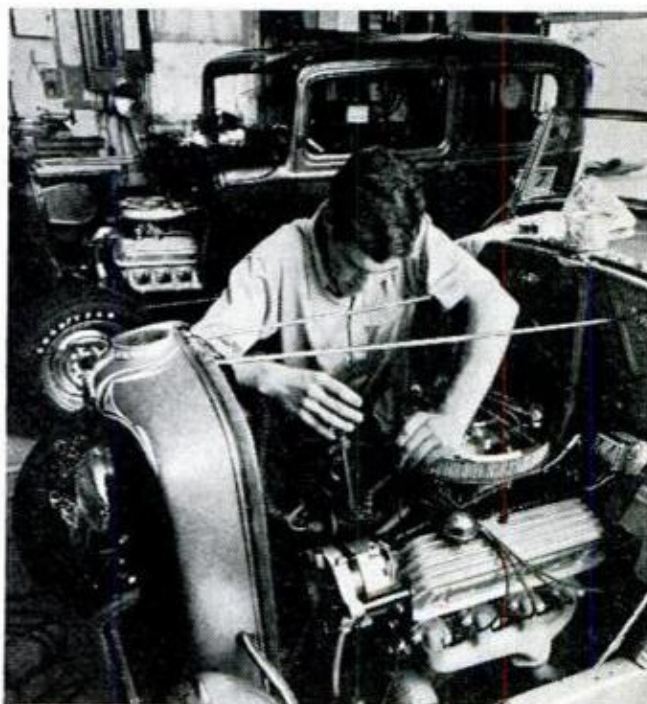

Army Opportunities Date _____
Dept. 200, Hampton, Va. 23369

I'd like to find out more about how the Army can turn my hobby into a career. Please send me your free booklet.

Name _____ Date of Birth _____

Address _____

City _____ County _____

State _____ Zip _____ Phone _____

Education _____

2PM 3-71

DETROIT LISTENING POST

BY ROBERT LUND

WAS VW RIGHT ALL ALONG? Is Detroit finally swinging around to the view that there's something to be said for not changing models every year—staying with the same package as long as a car sells in fair volume? That's one interpretation industry outsiders offer to explain the lack of styling changes on cars coming this fall.

It's true there won't be many major reworkings of '72 cars, but not because Detroit is backing off from the annual model change. The reasons car companies won't spend big money reshaping the metal this year are financial, uncertainty over government standards and, in the case of GM, because it lost three months of '71 model production while closed by a strike. But, as we see it, Detroit's still very much committed to the idea of something new or make-'em-think-it's-new every year.

GM'S EYEING FALL OF 1972 as a target for introducing fuel injection on its cars. Some of 'em. But it could be two years after that (fall of 1974 when the '75s come out) before all GM cars switch over to F.I. And that's assuming something better doesn't come along in the interim.

CHRYSLER DIDN'T TELL ALL in disclosing it has shelved its small car, R-429. As originally envisioned, R-429 was to be more midi than mini. Big C decided to take a second look at the project late last year in the light of reports that Ford and GM are researching cars smaller than Pinto and Vega. The question that has Chrysler hung up for an answer is whether it should bring out a car the same size as Vega and Pinto or go more mini than those makes. What happens to R-429? There's probably some salvage value in the plans for the car, but the original will never go into production.

THERE COULD BE ANOTHER FORD CAR IN A YEAR OR SO, if the company can find manufacturing capacity to produce it and providing the customers are still hot for compacts. If it comes off—and there's a lot of weaseling in that if—it will be a deluxe Pinto; renamed, of course, and sold out of Lincoln-Mercury shops. The price would middle somewhere between Pinto and the current Comet. With Pontiac adding Ventura II to its line, that GM division will have five cars against four for L-M. L-M has a five-car catalog if you count its import, Capri. But Ford believes L-M should match Pontiac domestic car for domestic car to hold its own against GM competition.

DETROIT-STYLE HORSEPOWER RACE FOR THE IMPORTS? Not in large cubic leaps, certainly, but displacement of import engines has been creeping upwards of two liters (122 cu. in.). Among cars with bigger engines is the Fiat 124 Sports series, the Spider model (below). The twin-overhead-cam four is up to 1608 cc from 1438 in '71 models. The extra performance was well received by this driver and will make the 124s



even more appealing than they already are to sports-car enthusiasts operating in the under-\$4000 bracket.—*B.H.*

GM AND FORD, along with several supplier companies, are checking out various nonmetallic materials that might be used to make a new (to private passenger

(Please turn to page 32)

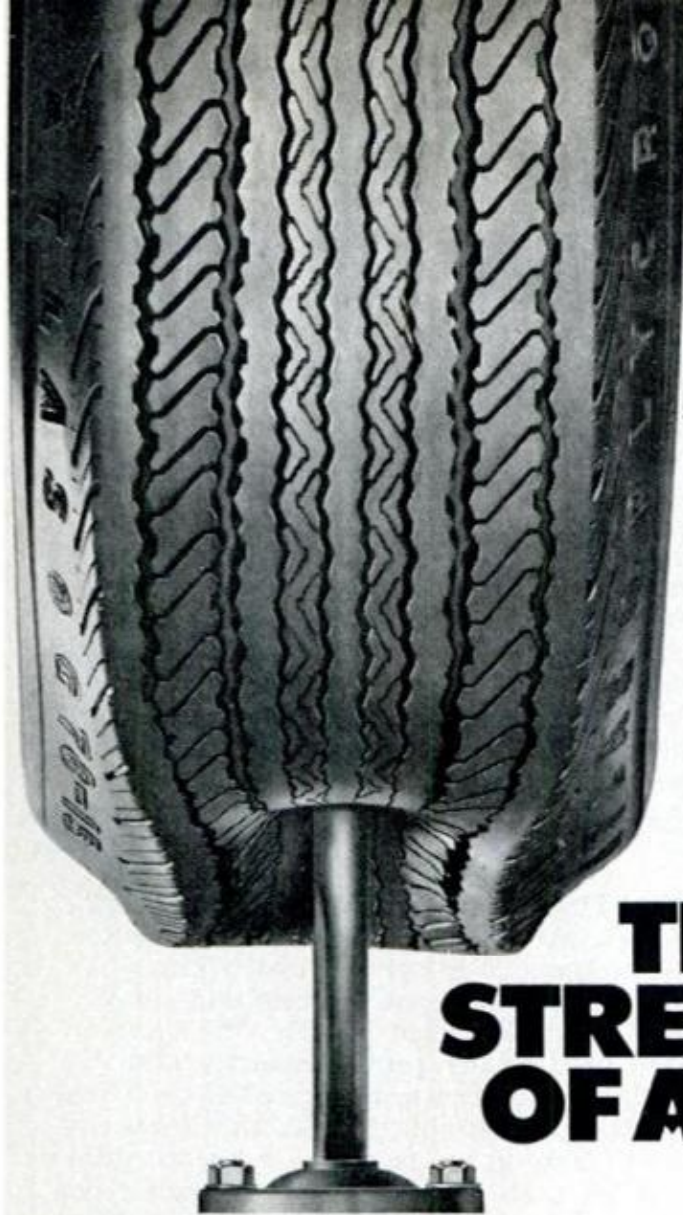

THE STRENGTH OF ATLAS

**We forced a steel plunger
into an Atlas Plycron
2 plus 2 tire at a pressure
of 5372 in. lbs. without
rupturing it.**

Tire rupture can rob you of thousands of miles of tread life. To help prevent it, you need strong tires.

Like Atlas Plycron 2 plus 2 fiberglass belted tires.

They're built with two tough fiberglass belts bonded onto a Vicron polyester cord body. These fiberglass belts, placed under the tread, help resist rupture.

Atlas Plycron 2 plus 2 tires survive one of the industry's toughest testing programs. A program which includes 49 probing laboratory tests and a hard run with a test fleet. On the fleet they're run for thousands of miles.

You're miles ahead riding on the strength of Atlas.

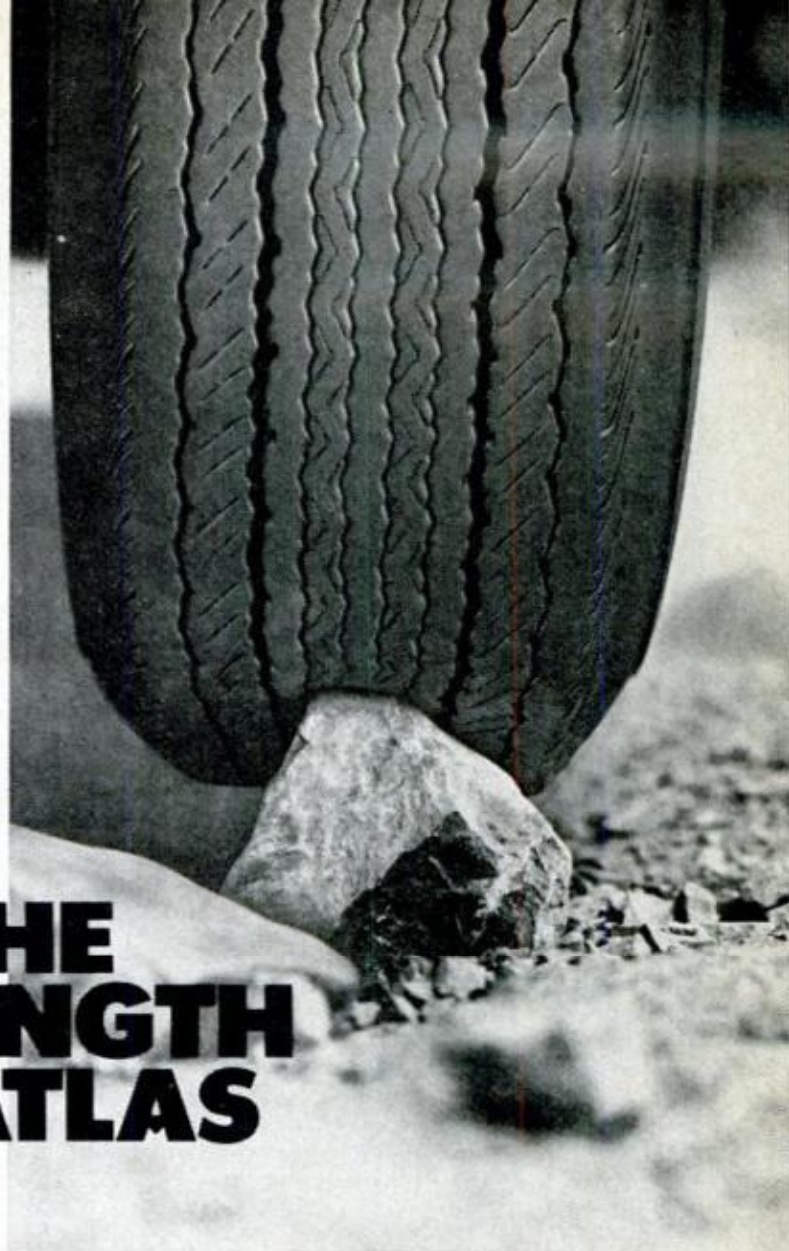

**So you'll feel more secure
riding over any rocks
and ruts you may meet
on the road.**

Over all kinds of roads. Which helps assure that you'll get the mileage that's built into every Atlas Plycron 2 plus 2 tire.

You can get a set at any of the 50,000 leading service stations that carry Atlas tires, batteries and accessories.

Remember, all our products are strong enough to live up to our name. Atlas.

**FIBERGLASS BELTED
ATLAS
PLYCRON 2 plus 2***

Trademarks "Atlas," "Plycron," "Vicron," Reg. U.S. Pat. Off.
*Trademark. © 1971 Atlas Supply Company.



BIG DOLLAR OPPORTUNITY!

THERE'S BIG MONEY TO BE MADE
IN AN AAMCO FRANCHISE . . .

Just ask Bob Steel,
AAMCO franchisee in
Rapid City, South Dakota:

"With what AAMCO has to offer . . .
the only way to go in the company
is up! I like it so well I'm expand-
ing . . ."

AAMCO Transmissions has been making success happen for over seven years! 550 center operators in hundreds of cities across the country make big profits every day. Some gross as much as \$300,000, with earnings in excess of \$50,000.

The AAMCO franchise has been so successful that only a few major market locations are left. However, thousands of cities and towns all across the nation with populations of 80,000 or under have a need for our service. AAMCO operators are making it big in their own local communities with fully equipped transmission centers. Towns like Provo, Utah; Hattiesburg, Miss. and Rapid City, S. D. are now providing modern, reliable and complete AAMCO transmission service.

Bob Steel, owner of the Rapid City AAMCO Center has this to say:

"I don't feel that I could have selected another organization that would have given me the help that AAMCO does. I feel that someone who has the money to invest, and is looking for a way to get into business for themselves would be very smart for looking into an AAMCO franchise."

ACT NOW WHILE THE TIME IS RIGHT!

- Capitalize on your own managerial skill
- Training Course included. No mechanical skills needed
- Annual sales in six figures can be expected
- Profits of as much as \$25,000 and more annually

\$10,000 CASH REQUIRED

Write, wire or call collect Area Code (215) 277-4000

AAMCO TRANSMISSIONS, INC.
Mr. Howard Price, Dept. 31
408 E. Fourth St., Bridgeport, Pa. 19405

NAME _____

ADDRESS _____

CITY _____ STATE _____ ZIP _____

TELEPHONE NUMBER _____

DETROIT LISTENING POST

(Continued from page 30)

cars) type of gas tank. The tank's divided into compartments that seal off in the event of a puncture or fire. The idea has been used in race cars, but hasn't been applied to production automobiles.

FEWER SEDANS for five and six passengers will be built in the mid-'70s than now, predict engineers at work on '74 and '75 cars. Most cars are coming down in size, including interior dimensions. The auto companies aren't abandoning motorists with big families, who need room for more than four people, but they feel they can supply most big-family requirements with station wagons. The predicted trend to four-passenger cars is partially based on the expectation that families will grow smaller as the movement to control population gains ground. Fewer children per family, so there will be less of a demand for oversize cars.

WHAT'S WITH THE WANKEL? Everything out of GM up to now has indicated the company's interested in the engine to power a pint-size car—something smaller than Vega. But that may not be entirely accurate. All the auto companies, GM included, foresee cars shrinking in size. (See previous paragraph.) While the Wankel's most likely to be used in a mini, it might also be used in what will be considered standard-size cars in the mid-1970s. Standard size in 1974-75 could be squeezed down substantially from what it is today.

NEW PONTIAC COMPACT is due in dealer showrooms this month. The car, called the Ventura II, is on a 111-inch wheelbase and eight inches shorter than



the T-37 intermediate. Base engine in the 194.5-in.-long, two or four-door Ventura line-up is a 250-cu.-in. Six. A new 307-cu.-in. V8 is optional. Both engines operate on 91 octane no-lead or low-lead fuel. The standard transmission is a three-speed manual column-mounted.

Available later in the model year will be a Sprint option—a dressed-up version

(Please turn to page 34)



**Comfort on the rocks.
You get it with Jeep guts.**

**The Jeep Wagoneer—
the first family wagon to give you 4-wheel drive safety off the road.**

You've got to have a tough wagon when you're exploring with your family. A wagon with guts you can take for granted—even when you're crunching over granite.

The Wagoneer gives you more comfort and safety than you've ever experienced in any 4-wheel drive vehicle. It has a higher ground clearance and



a lower center of gravity, too.

You'll climb up hills that would stall other wagons. Because you've got traction and strength to make it in the Wagoneer.

— Altogether, it's the family wagon that makes all the competition come out second best. Only the Wagoneer gives you muscle with comfort—and a wide margin of safety for your family.

Today, the Wagoneer has a rock bottom price to keep it the leading 4-wheel drive family wagon. See it

at your Jeep dealer. And for options, choose anything from an air-conditioner to a snowplow. Everything from push to push.

**The toughest
4-letter word on wheels.**

Jeep

Products from American Motors

Versamatic®

Reversible Speed Reducer turns your power drill into a power drive!

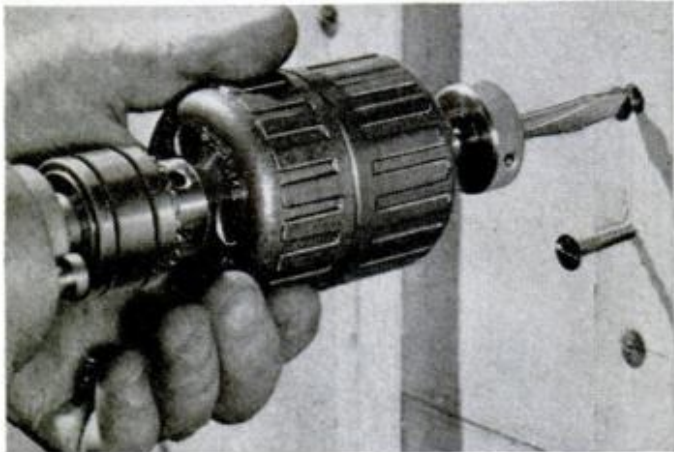

Versamatic increases your drill's power 7 times — power-drives and removes screws and nuts — and helps drill into steel, concrete, masonry, and ceramic tile. Next to your power drill, Versamatic is the most versatile tool you can own!

The Versamatic No. 4100 comes with a medium-duty screw driver bit, a No. 2 Phillips-type bit, 1/4" square drive adapter, and a wrench pin. Optional screw driver bits, 3/8" square drive adapter, and 1/2" RIDGID/Supreme Chuck and Key also available.

See the Versamatic at your nearest quality Hardware Store. And be sure to ask about other RIDGID Pre-Tested Work Saver Tools and parts from The Ridge Tool Company, Elyria, Ohio 44035, U.S.A.

RIDGID

Supreme



Ridge Tool Subsidiary Emerson Electric Co.

EMERSON

34

DETROIT LISTENING POST

(Continued from page 32)

including three-speed floor stick, wide tires, sport steering wheel, and special trim and striping.—B.H.

WHAT WOULD YOU SAY to a car put together from sweepings off the factory floor? That's laying it on stronger than the facts allow, but it makes the point. Scrap dealers who pay the auto firms for the privilege of carting away metal chips and trimmings say there's less and less scrap coming out of GM plants. The reduction in waste is partially due to GM's machining methods. It gets the most of each piece of metal with a minimum of throwaway. But over and above that, GM's coming up with ways of reclaiming metal it used to sell off as scrap. GM hasn't said so, but it's working toward a goal of reusing every last shaving.

WOULD YOU GO FOR OPTIONS of a full four-wheel antiskid braking system and air bags on your next car? Both items are ready now, or nearly so, and could be installed on '72 cars. Could be, but won't. Another instance of Detroit dragging its feet until the government steps in and orders such equipment put on cars? No, it's not the old collective conspiracy theory.

In the case of four-wheel antiskid brakes, every auto manufacturer now has his own unit or one developed by a supplier company. The hardware's ready. But who wants it at \$300 and up? And that's a bargain price, possible only if the item sells in substantial volume. Chrysler gets \$351.50 for the four-wheel antiskid it offers on Imperial—the only domestic car you can buy with a four-wheel system. The number of takers for the Imperial device has been running at a rate of about a hundred a month. Not exactly what you'd call a stampede.

How about air bags? There are so many unresolved questions about them that the auto companies can't even give the gear away so they can conduct research programs. Ford tried to do just that—give 'em away, put them on fleets, police cars or whoever would have them. There's a catch to the Ford offer. If you're injured as a result of the bags popping off, you get the hospital bill. Or your heirs get the bill for the funeral, if it comes to that.

Detroit isn't holding back on anything. The purpose of the game is to sell cars and all the extra gizmos that can be loaded on. If there's a conspiracy against the customer, it's to sell him more machine than he needs, not less. ★★★

POPULAR MECHANICS

NEW RUBBER STAMP BUSINESS PAYS BEGINNERS UP TO \$16.50 AN HR.

**START AT HOME
IN SPARE TIME**
with Table Top Machine!

We Help Finance You
... at less than bank rates!

The multi-million dollar Rubber Stamp business—once controlled by a few big companies—is now being taken over by small operators—one in each community throughout the United States. Men and Women who have this inexpensive machine can turn out huge quantities of Rubber Stamps with special wording that buyers once were forced to buy from big cities. Material costing only 27c makes a stamp that sells for \$2.75. The machine that does the work is simple and easy to operate and it turns out as many as six Rubber Stamps at a time, each with different wording such as names, addresses, notices, stock numbers, prices and other "copy" needed by offices, factories and individuals. Working full capacity, it can earn as much as **\$33.00 an hour for the operator!** Now you can get into the big-pay business yourself, with your own home as headquarters. You don't need experience. We supply everything, including complete instructions and eight ways to get business coming in fast. **We even help finance your start.** Start making up to \$16.50 an hour from the very beginning. Cash in on the profitable Rubber Stamp business in your community, right away. We'll mail full particulars **FREE** and no salesman will call. Be first in your locality. Rush coupon today or send your name on postcard to:

RUBBER STAMP DIV., R-2-AC
1512 JARVIS AVENUE • CHICAGO, ILL. 60626



RUBBER STAMP DIV.
1512 Jarvis Ave., R-2-AC
Chicago, Illinois 60626

FREE!

Please rush full particulars about your financing plan and the little machine that can get me started in the profitable Rubber Stamp business at home in spare time. Everything you send me is **FREE** and no salesman will call.

NAME _____

ADDRESS _____

CITY _____ STATE _____ Zip Code _____

Buy Aluminum Jelly® (it cleans and brightens aluminum)



Use it on aluminum screens, windows, and storm doors, outdoor furniture, bicycles, siding trailers and boats.

Buy NAVAL JELLY® Rust dissolver and let the rust of the world go by.



World's Finest Fix-It Products
Woodhill Chemical Sales Corp., Cleveland, Ohio 44128

MARCH 1971

Who else
**WANTS to be a
LOCKSMITH?**
Train **FAST**
at Home. It's **EASY** Making Up
to **\$10 an Hour**—even while learning!

If you enjoy fixing things, you're a "natural" to make hundreds of **EXTRA DOLLARS A YEAR** as a Locksmith. Need for service, sparked by rising crime, has never been so great and urgent. Easy, illustrated lessons complete with **ALL** practice equipment, personal assistance—**PLUS** professional tools and Key Machine given you free of extra cost—enable you to make **\$5 to \$10 an hour** ... sparetime, or your own fulltime business.

Mail coupon for **FREE** facts—no salesman will

Call Accredited Member
Nat'l Home Study Council.
Approved for Veterans.

BELSAW INSTITUTE
101M Field Bldg., Kansas City, Mo. 64111



**THIS PRO KEY
MACHINE
YOURS
TO KEEP**

BELSAW INSTITUTE 101M Field Bldg., Kansas City, Mo. 64111

Name _____

Address _____

City _____ State _____ Zip _____

Check here if eligible Veteran

**IF YOU CAN SAW,
DRILL, CEMENT & POLISH**

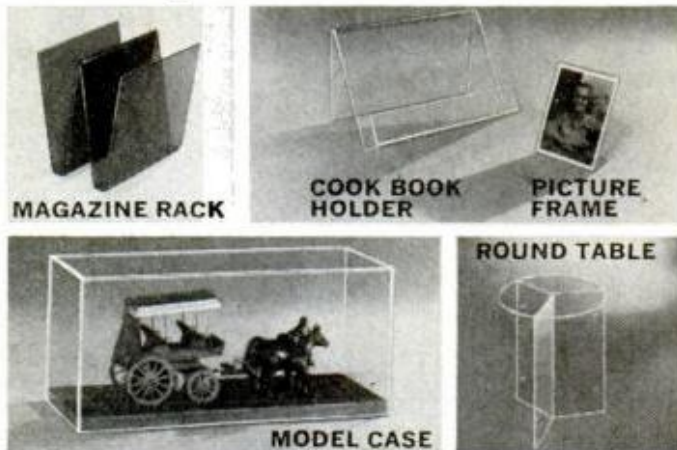

MAGAZINE RACK

COOK BOOK
HOLDER

PICTURE
FRAME

ROUND TABLE

MODEL CASE

**YOU CAN
MAKE THESE
FOR A
FRACTION
OF THE COST
OF READY-
MADE WITH
PLEXIGLAS[®]
ACRYLIC SHEET**

It's easy with Plexiglas sheet. Use hand or small power tools.

The 2nd edition of "Do It Yourself with Plexiglas" has over 40 projects to decorate your home. The "how-to" booklet gives step-by-step instructions for cutting, cementing, drilling, and even building a simple strip heater to bend Plexiglas.

Plexiglas is an approved safety glazing material—use it in storm doors for safety sake. It is a high impact, thermoplastic material with a combustibility rating comparable to wood and should not be exposed to temperatures exceeding 180° to 200° F.

You can get your "how-to" booklet at hardware, glass and building supply dealers displaying the "We Sell Plexiglas" sign. Or write to us enclosing 25c for postage and handling.

**ROHM AND HAAS COMPANY
P.O. BOX 9860H
PHILADELPHIA, PA. 19140**

do it
yourself
with
PLEXIGLAS
acrylic
sheet

**Toughest
oil
in the
block**

Any engine worth its power is tough on oil. Change to the 100% Pure Pennsylvania that's extra-refined to take the rough stuff.

Buy your oil the way you bought your car. Carefully. Wolf's Head Oil Refining Co., Oil City, Pa. 16301

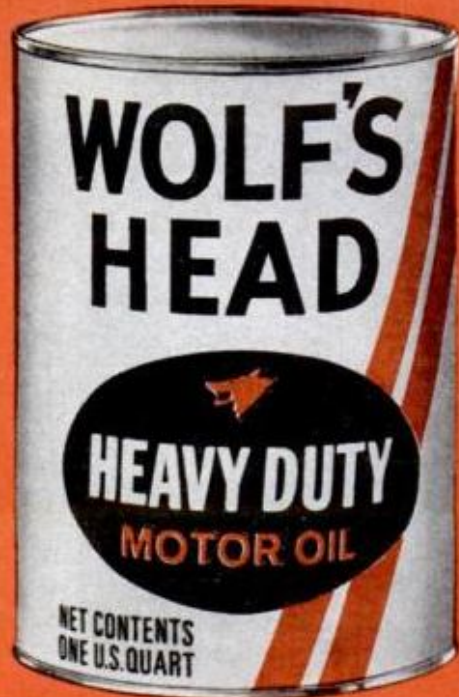

the uncommon motor oil
Exceeds car makers' warranty requirements.

The End Of A Nasty Old Habit

Are you still flicking those messy cigarette ashes all over the house? Burning holes in your favorite wing chair? How would you like to see a full-color photograph of your lungs? Isn't it time you put an end to the nasty old cigarette habit?

Can't do it? Of course you can! Take Nikoban, the remarkable medicated lozenge (or pleasant-tasting gum). Nikoban can really help you cut down or stop smoking—often without gaining weight. Nikoban is a

clinically-tested smoking deterrent that helps satisfy your craving for a cigarette. In fact, 4 out of 5 people replying to a survey reported Nikoban worked for them.

Nikoban can work for *you*. Help break the nasty old cigarette habit once and for all with pleasant tasting Nikoban — medicated lozenges or gum. Nikoban really works.



PUBLICATIONS **WORTH WRITING FOR** BY CATHERINE BILSKI

INVOLVED in a home-improvement project and need simple instructions on how to apply and finish gypsum wallboard? A Georgia-Pacific Corp. brochure contains easy do-it-yourself steps for professional-looking results. Entitled *Do-It-Yourself. . . Gypsum Wallboard Application*, its four pages illustrate planning the job, estimating materials, cutting, nailing, installation and finishing. It's free by writing to G. S. Nelson, Georgia-Pacific Corp., 900 S. W. Fifth Ave., Portland, Ore. 97204.

A BOUNTY of exciting ideas for all ages, talents and tastes is described and illustrated in the booklet *Accent on Crafts*. It presents step-by-step, full-color photographs and easy-to-follow directions. Even the novice craftsman can create projects for all occasions. Available in paint and hardware stores or craft and hobby cen-

ters, the booklet may also be ordered by mail for \$2 from Judy Martion, Creative Crafts Director, Illinois Bronze Powder & Paint Co., Lake Zurich, Ill. 60647.

A POCKET-SIZE 16-page brochure containing filter and film data has been released by Spiratone, Inc. Entitled *Filter and Film Speed Information*, it explains the uses of filters for color and black and white film, of lens attachments such as diffusers, polarizers and special-effect filters, has tables on close-up photography with regular and telephoto lenses and gives speeds of all popular films. For a copy, send 10 cents for handling to Spiratone, Inc., 135-06 Northern Blvd., Flushing, N.Y. 11354.

POROUS METALS are explained and illustrated in a new eight-page booklet, *What You Should Know About Ucar Porous Metals*. A suggested application chart describes the use of Ucar porous metals for abradable seals, filters, bearings, brake linings, acoustic liners, fuel cells and batteries, catalysts and phase mixers. For a copy of booklet CP-4037, write New Business Ventures Dept., Carbon Products Div., Union Carbide Corp., 270 Park Ave., New York, N.Y. 10017.

NEW exciting NRI home training plan BE A COMPUTER TECHNICIAN



PROGRAM INCLUDES COMPLETE, OPERATING DIGITAL COMPUTER WITH MEMORY. AS YOU BUILD IT YOU LEARN ORGANIZATION, DESIGN, OPERATION, CONSTRUCTION, PROGRAMMING, TROUBLE-SHOOTING AND MAINTENANCE. What you see above may well be the most unique educational aid ever developed for home training. Not simply a "logic trainer," but an actual small scale, integrated-circuit, digital computer. It's yours as part of NRI's newest home training in Complete Computer Electronics. NRI is the way to go in the "Computer Age." Qualified men are urgently needed. Exciting NRI program gives you the priceless confidence to step into a Computer Technician's job and know just what to do.

TRAIN WITH THE LEADER. This exceptional new course has been planned from the start to include unique training equipment in the NRI tradition. Training is as much fun as it is education. Mail coupon. NRI Catalog you get tells about new Computer training plus other NRI training plans. No obligation. No salesman will call. NRI, Washington, D.C. 20016.

MAIL FOR FREE CATALOG



NATIONAL RADIO INSTITUTE 90-031
Washington, D.C. 20016
Send me Catalog about NEW Complete Computer Training. (No salesman will call.)

Name _____ Age _____

Address _____

City _____ State _____ Zip _____

ACCREDITED MEMBER NATIONAL HOME STUDY COUNCIL



ACCORDIONS and AMPLIFIERS

BIG SAVINGS up to 1/2 or more on famous make accordions. Over 40 models. Standard and new electronic models. Buy direct at low discount prices. Get five-day home trial. Small down payment, easy terms. Free gifts. Trade in allowance. Money back guarantee. Rush coupon for color catalogs, discount price list. **Accordion Corp. of America, Dept. R-31, 5535 W. Belmont Ave., Chicago, Illinois 60641**

COUPON BRINGS FREE COLOR CATALOG & DISCOUNT PRICES

ACCORDION CORP. of AMERICA—Dept. R-31
5535 W. Belmont Ave., Chicago, Illinois 60641
Send FREE Color catalogs and discount prices. Include special information checked:

Accordion Amplifiers
 Button Type Accordions
Name _____
Address _____
City _____ State _____ Zip _____

ELECTRIC ARC WELDER \$9.99!

NATIONALLY ADVERTISED \$18.95 VALUE!—NOW 1/2 PRICE! WELDS—BRAZES—SOLDS—CUTS—ALL METALS! Plugs into ANY 110 volt socket. **MAKE—REPAIR 1001 items for CAR—HOME—BUSINESS.** Lifetime **BURNOUT GUARANTEE** 10 day money back trial (if retrnd). **HEAVY DUTY** Design—Does \$85. welderwork. No experience needed—**FREE WELDING LESSONS!**
SEND ONLY \$2.00 (cash, ck, M.O.) and pay postman \$7.99 COD postage or send \$9.99 plus \$1.00 postage for paid del. in U.S.A.
COMPLETE READY TO USE—Includes BIG pack steel, Brazing, Solder, Carbon "touch" rods, ELECTROFLAME ARC TORCH! OFFER LIMITED—Order TODAY! MIDWAY WELDER, Dept. EPM-3, Kearney, Nebr. 66847

Career in ELECTRONICS?

Career training at home the new easy way with RCA Institutes. Lab work with first lesson. Easy payment plans. Send for free 64-page book.

RCA Institutes, Dept. 699-003-1
320 W. 31 St., N.Y., N.Y. 10001



LIFETIME "SPIN-ON" OIL CLEANER



Cleans motor oil 100 times cleaner than any other "spin-on" filter. Never drain oil again. Never buy another spin-on filter. Change 15 cent element every 3000 miles, available everywhere. Doubles engine life. Oil is 100% clean 100% of the time. Guaranteed 5 years. \$25.95 post paid. Write for the facts. Save \$8.00 every 3000 miles.

VIRDEN PERMA-BILT
Box 7066 PM, Amarillo, Texas 79109



Mini Bikes—Karts—Parts—Clutches—Torque Converters—Chain—Sprockets—Tires, etc. Send for wholesale catalog #8H. Enclose 50¢.

ROCKEY, Dept. PM
Galveston, Ind. 46932

"LISTEN IN" TO POLICE-FIRE RADIO CALLS IN YOUR CAR!

WORKS with ANY CAR—Portable or HOME RADIO! Just **PLUGS** in—No wiring—3 minute hookup! Switch instantly from regular to **ALL POLICE—FIRE—EMERGENCY—COMMERCIAL—TAXICAB—STATE—CITY—GOV'T** 2 way Radio calls in **YOUR AREA. DUAL—HI-LOW BANDS—OVER A MILLION** Radio Cars/stations. **USE** Everywhere—anytime—always works!

(cash, ck, M.O.) and pay postman \$7.99 plus COD pstg or send \$9.99 for ppd Del in USA. **COMPLETE, ready to use with instructions. One Year service Warranty—10 DAY MONEY BACK TRIAL** (if retrnd). **AMAZING OFFER** good only by mail—**WESTERN RADIO Dept. BPM-3 KEARNEY, NEBR. 68847**



Start Making **BIG MONEY FAST!**

in **UPHOLSTERY** and **SLIP COVERS!**

"LET US SHOW YOU HOW YOU CAN EARN MORE LIKE WE DO" say these prosperous master upholsterers

ONLY accredited course that INCLUDES EVERYTHING YOU NEED

all tools, new wooden frames, materials, fabrics, etc. — at NO EXTRA CHARGE!

NOT 4 — NOT 6
13 FURNITURE KITS included

You build and slip cover a roomful of fine new furniture you can keep, or sell for more than course costs! You get professional, wholesale buying privileges. Furniture re-upholstering, repairing, refinishing, antique restoring, handling plastics, foam rubber, decorating know-how . . . every skill and advantage to make your training pay off in **TOP WAGE, TOP PROFITS IS YOURS FAST!** Thousands of our graduates have done it. Find out how you, too, can secure your future in this enjoyable easy-to-learn skilled trade. Write **TODAY!**



ALL TOOLS AND UPHOLSTERED PIECES YOURS TO KEEP OR SELL



DIPLOMA

ACCREDITED DIPLOMA

Cut Along Dotted Line—Seal (Paste or Tape) and Mail

Took in \$450 while learning—earning \$60 a week in spare time. Words can't express my satisfaction with the better future it has given me.

Leon Master, Troxelville, Pa.



I needed something to help with household expenses. I studied between household chores. During my training program I made \$1200 in part time money. Upholstery Trades School gave me everything promised—plus!

Katharine Shain, Punta Gorda, Fla.



The course was very thorough and worth the investment. My wife learned with me and helps considerably with her sewing skill and talent for color and decorating. I was able to earn \$75 a week while I studied.

Richard Feleay, Topeka, Kansas



THE UPHOLSTERY SCHOOL licensed by N.J. Dept. of Education • Accredited, National Home Study Council • Approved for Veterans and for Vocational Rehabilitation • Established 1939.

FREE BOOK! Fact-filled, illustrated book explains how YOU can make **MONEY** as a Master-Craftsman, full time or part time or in your own business, **PLUS** free sample lesson sheets.

THIS ENTIRE FOLD-OVER COUPON FORMS A NO-POSTAGE-REQUIRED BUSINESS REPLY ENVELOPE

UPHOLSTERY TRADES SCHOOL, Dept. 5110-031
Little Falls, New Jersey 07424

Please send me **FREE BOOK**, "Your New Way to a Successful Career" and **FREE** sample pages. (No obligation. No salesman will call.)



Name (PLEASE PRINT PLAINLY)

Address

City State Zip

Check here if entitled to veteran's benefits.

DO NOT CUT HERE ↑ JUST FOLD OVER, SEAL AND MAIL THIS ENVELOPE — NO STAMP NECESSARY

BUSINESS REPLY MAIL
No postage stamp necessary if mailed in The United States

POSTAGE WILL BE PAID BY:

UPHOLSTERY TRADES SCHOOL
Division of Singer Communications Corporation
Little Falls, N.J. 07424

First Class
Permit No. 137
Little Falls, N.J.



NEW **DYNAMIC** MARK 88
80 AMP INDUSTRIAL TRANSFORMER ARC WELDER

IDEAL GIFT — EDUCATIONAL, ENJOYABLE, PROFITABLE
WELD, BRAZE,
CUT, SOLDER, HEAT
STEEL, BRASS, ALUMINUM,
AND MOST OTHER METALS.

Build and repair anything of metal. Save time & money with this **BRAND NEW, PROFESSIONAL ARC WELDER!** Rugged metal cabinet, baked Hammerloid finish. Ideal for home, shop, farm and industrial use. **POWERFUL** glass insulated transformer welds most metals up to 1/2" thickness with multi-pass weld, with 1/4" rods. 4 heat settings 20 to 80 amps. Operates on 110 Volt AC line fused for 30 amps. Complete with fibre glass helmet, electrode holder, ground clamp and cables, solder, assorted rods and simplified welding manual. **DOUBLE PROTECTION GUARANTEE.** 10 day money back trial plus full 5-yr. warranty. If inoperative return prepaid, we will repair or replace without charge & reship collect. **ORDER TODAY.** Complete ready to weld. Only \$59.50 F.O.B. **SEND ONLY \$6.00.** Pay Balance plus C.O.D. and Delivery Charges or Write for illustrated color literature and Welder details.



DYNAMIC WELDER CO.

1808 S. FEDERAL ST.
Dept. D2-C
CHICAGO, ILL. 60616



On the job
...on the go
...for a
quick lift

The
cologne
spray
face
refresher
for men

New by *ChapStick*

reach for
**the caulk
fixer™**

elastomeric sealant

DAP Architectural Grade Caulk. Fills and seals cracks and joints before painting. Stops drafts and heat loss. Stays flexible.

DAP
fixer™
products

DAP Inc., Dayton, Ohio 45401
Subsidiary of *Plough, Inc.*

Also available in Canada

Electric Razor
1.70



Calendar Watch 2.44



Auto \$954

**START IMPORTING
IN 10 MINUTES**

MEN/WOMEN—BIG MONEY AT HOME First day profits! Make your first import transaction order 10 minutes after you get my plan. Thousands more dazzling products from overseas. Deal direct—below wholesale prices. No product investment. Full or part time. Write for **FREE BOOK** today to...

MELLINGER, Dept. D2253, 1554 S. Sepulveda, Los Angeles, CA 90025

THE DREMEL MOTO-SHOP...

A complete workshop that's 5 power tools in 1

Why struggle with five different power tools when a single Dremel Moto-Shop will do the work of all of them. Handles simple craft projects or "big shop" jobs. Moto-Shop is basically a 15-inch jig saw with a power take-off that converts to all the tools shown below. With the flexible shaft attachment you can grind, drill, polish, sharpen, engrave, carve. Rugged ball-bearing construction lets you buzz through wood up to 1 3/4" thick. So compact you can use it on a table top, store it anywhere. Basic Moto-Shop, \$37.95 — with attachments, \$54.95. Ask your hardware or hobby dealer for a demonstration today.

DREMEL CREATIVE POWER TOOLS

DREMEL MFG. CO., Dept. 901C, Racine, Wis. 53401



WRITE FOR
COMPLETE
POWER TOOL
CATALOG



It's a Jigsaw



It's a Buffing Wheel



It's a Disc Sander



It's a Bench Grinder



It's a Flexible Shaft





Transport 500 Wide Oval, Traction All Season.
—Firestone TMS

Two new truck tires from Firestone. The more you drive, the more you need them.

Bring on the heavy loads. Bring on the ruts and potholes, the mud and snow. And the super-highway speeds. These two new tires from Firestone, the mileage specialist, are the answer. The top of the line for pickups, pickup-campers and other light trucks.

The Transport 500 Wide Oval puts more rubber on the road for more stability and a whisper-smooth ride. And up to 50% more mileage than the Firestone tire it replaces.

The Traction All Season runs cat-sure, cat-quiet on the highway. Now get off the highway and feel its rugged lugs pull your rear wheels through mud or snow.

Get them at your Firestone Dealer or Store. Specify them when you buy a new light truck. The more you drive, the more you need them.

Firestone
The mileage specialist.



LITTLE CHANGED from the first, 1948 model (background) is the current 88-in. wheelbase Land-Rover

The Land-Rover— Is It Really Indestructible?

By DAVID LAMPE

GREAT BRITAIN ended World War II with a stockpile of aluminum sacrificed by patriotic housewives. Steel went to the makers of essential vehicles and to auto producers with the best prewar export figures. This really hit the Rover Car Co. low. In 1947 Rover people began to think about the American Jeep that one of the company's bosses, like a lot of British gentlemen farmers in those days, actually seemed to like to drive. Why not a British Jeep with four-wheel drive for British farmers? Just, of course, to help the factory coast through the austerity period? At the Amsterdam Motor Show in 1948, barely a year after they first got the idea, the Land-Rover—so named because it was modestly intended as a farm vehicle—was

unveiled. Since then it has made its way literally to every corner of the world.

All steelwork, including the hulking ox of a chassis, was heavily galvanized, making it likely to remain free of rust forever. All body work was stamped out of aluminum—in small, bolted-together units, to keep repair and tooling costs down.

Everything was designed to be sturdy and simple because the Land-Rover seemed likely to end up in some colonial backwash where there might be no blacksmiths, let alone mechanics.

From the start the Land-Rover had a transfer case to give it eight forward speeds, two reverses and the option of four-wheel drive. Its power-takeoff facil-

(Please turn to page 46)



CONVERSIONS of Land-Rovers to specialty vehicles have been many; include special wheels, tracks, armor

OREL. The right brush for anything.

Right for any paint or finish.

Paintbrushes made with OREL* tapered polyester filament give you the finest brush performance you've ever seen—whether you use them in oil or water-based paints, or in shellac, varnish, lacquer or stain. OREL is unaffected by water or the chemicals in paints and finishes. So use it for anything. It's the all-in-one paintbrush.



Right for any conditions.

On hot days or cold, in the muggiest weather, even on a hot tin roof under the broiling midday sun—OREL doesn't poop out. Use it for hours on end. It'll stay stiff and smooth-working—won't finger, won't become floppy or hard to paint with.



Right for any surface.

Plaster, wood, masonry, brick, concrete, metal, stucco—nothing fazes OREL. It's tough. Outlasts natural bristle three to one. Does a better all-around job, too. That's why professional painters use it. You should, too.



**When you care about quality, the name is OREL.
You can't buy a better paintbrush.**



* Du Pont registered trademark.
Du Pont makes OREL, not paintbrushes.

DU PONT **OREL®**
REG. U.S. PAT. OFF.

THE LAND-ROVER

(Continued from page 44)

ities, offered as factory-fitted accessories, are unique. The first is on the front of the 2286-cc, four-cylinder engine (petrol or diesel). A second is amidships, working off the transfer case and ideal for powering compressors for such tasks as painting and crop spraying or pneumatic drilling. The third power takeoff point is for a drive-shaft extending from the top of the main transmission to the rear of the vehicle. It powers buzz saws, threshers—even the drive wheels of a special cargo trailer.

Land-Rovers have always been able to negotiate axle-cracking ruts and wade happily through a foot and a half of water. Guaranteed to negotiate 45° slopes, given any kind of footing, they can usually handle 60° ones.

Land-Rovers beat it into the bush so

often that the Solihull factory now runs its own expedition-training school. After a blitz course in basic mechanics they discuss expeditioning: How to drive where the going is awful and, among other things, how to avoid stomach upsets where the food is doubtful, how to pack film for the tropics, how to swap money profitably in native bazaars, and even how to use a Land-Rover as a washing machine (you stuff your clothes into a watertight container, add hot water and soap flakes, then seal. Stow the container behind the driver's seat, and after a hundred bouncy miles your laundry's ready for rinsing).

The British Army has had several amphibious types of Land-Rovers. On the first prototype the exhaust merely discharged into the water, but for the final version someone decided the fumes should be ducted into the pontoons and then out

(Please turn to page 48)

The New Range Rover



HANDSOME, yet utilitarian, the four-wheel-drive Range Rover features a powerful V8 engine with twin carbs. Tailgate window hinges up, tailgate proper hinges down

What do you get when you cross a Land-Rover with a Rover luxury sedan? This all-purpose four-wheel-drive station wagon. Stubby, 14 feet, 9 inches long, the Range Rover has radial tires and everything underneath is neatly tucked up. It's much faster and more comfortable than the Land-Rover.

I drove a Range Rover across plowed fields at 40 mph and easily held a smooth, straight course. I steered deliberately into a steep, slime-filled bomb crater—one of a few left in England—and effortlessly out again. On an unpaved road three feet under water we keep going—pushing ahead a hood-high tidal wave.

The Range Rover's 156-hp aluminum 215-cu.-in. V8 engine is basically that borrowed from Buick to power Rover's most expensive sedans. Compression ratio has been cut to 8.5 to 1 to accept regular fuel. On freeways it does over a hundred, and it cruises comfortably and quietly at 90. Coil springs and telescopic dampers at each corner, plus a self-leveling unit, keep the ride smooth. Aluminum body panels and specially dipped steelwork mean no rusting. The eight forward and two reverse speeds are all synchromesh. Front-wheel drive can't be disengaged, but a third differential between the front and back prevents tire scrubbing on hard roads. For extra road bite you lock this differential with a vacuum switch, even when the wagon is in motion.

The only fault of the Range Rover is a tendency to over-steer in tight corners. You learn to control this in about two minutes. They should arrive in the United States near the end of the year, priced between \$5000 and \$6000.—D.L.

FORD PRESENTS...

The groundskeeper is Ford's fine line of dependable lawn and garden tractors. Seven models altogether. From the 7 hp model 70 lawn tractor to the 14 hp model 140 lawn and garden tractor with hydrostatic transmission. Each one built to keep your lawn and grounds looking estate-clean. Over 50 attachments available for four-season use.

The new assistant is Ford's new line of riding mowers. Three models. 5 hp recoil start, 7 hp recoil start and 7 hp electric start. Like the rest of the Ford line, rugged design complemented by modern styling. A built-in convenience tray on the console. Full running boards and fenders keep your feet off the mower . . . keep grass and dirt off you.

This year add a little class to your home. Add a Ford lawn and garden tractor or one of the new riders. You'll be surprised at what little investment it takes.

FORD TRACTOR



the groundskeeper... and the new assistant.



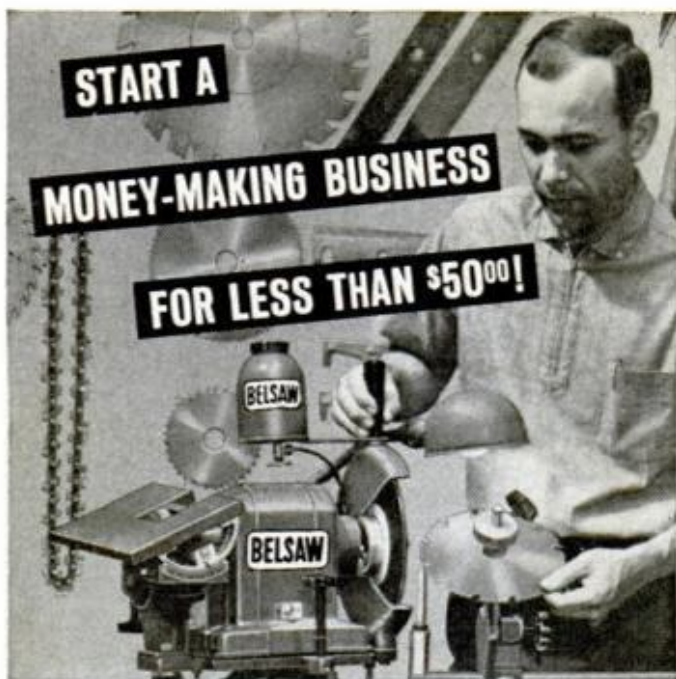

No Selling, No Inventory... All Cash Profits and YOU Set The Hours!

You can have your own lifetime business right at home... work in spare time... and make up to \$200 a month CASH! My FREE PLAN gives you all the facts: How to start, how to grow. You don't need previous experience. You don't have to sell. I'll even finance you. People bring you the work and pay cash. Over 90¢ of every dollar you collect is clear cash profit. And you work when you want to. Let me prove you can't find a more certain, lower cost, higher paying business of your own.

**Does The Belsaw Pay?
YOU BET!**

W. R., Maryland

"My BELSAW is working fine and business is increasing by 20 to 30 customers a month. I've added one employee and am looking for a night man to handle rush jobs."

C. S., Minnesota

"The sharpening business has helped me buy two homes and three motor cars. The nice thing about the Sharp-All is that you get some cash every day."

RUSH COUPON TODAY!

Just Mail Coupon—No Salesman Will Call

BELSAW SHARP-ALL CO.

Stan Field, President
711M Field Bldg., Kansas City, Mo. 64111

Name _____

Address _____

City _____ State _____ Zip _____



LAND-ROVER 109-inch station wagon can be set up as 10 or 12-seater. Engine is six-cylinder, 160-cu.-in.

THE LAND-ROVER

(Continued from page 46)

again through balancing valves. Thus, if the pontoons are punctured by bullets or by anything else, they'll stay inflated as long as the engine keeps running!

Terrible things sometimes happen to Land-Rovers. One got caught in a desert storm in Iran. It emerged five hours later, its crew in a state of abject terror but physically unhurt. Not a scrap of paint was left on the car's aluminum sides and top. It had been sandblasted clean!

Another Land-Rover charged through an Australian bush fire, carrying a dozen foresters on a ride they'll never forget. The heat became so intense that the tires began to melt. The windshield cracked and became almost opaque. And the gas in the tank began to steam and hiss. But the Land-Rover got its passengers to safety.

What of the vehicle's future? "Well," says Tom Barton, Rover technical director, "we can probably go on making them forever, if we want to."

Only cost has kept such luxuries as overdrives and automatic transmissions out of Land-Rovers. The cost of the aluminum for bodies keeps rising, but there's no suitable replacement material. Steel can't be rustproofed to Land-Rover standards, and every plastic Barton has examined has been weakened by fatigue.

Anyway, any drastic change in the Land-Rover would start owners howling all over the world. Most of the 675,000 Land-Rovers so far built are still going strong despite the strange, unique attitude their owners tend to have toward them. Give the most reasonable man a Land-Rover and he won't be happy till he's tried to bash it to death. All over Britain there are Land-Rover-owning farmers who brag—brag, mind you—that they've driven the same one for 20 years and have never had it serviced!

★★★

Von Schrader offers you three ways to a growing income in your own business

Here's your opportunity to have your own very profitable business. One that offers a service badly needed in the home, in offices and public places. A business where how much you earn depends largely upon you. It's an opportunity to be your own boss. Free from layoffs and work restrictions. Free to work any number of hours you wish. And you don't require any special skills or large investment.

Already thousands of men have gained financial independence and personal satisfaction offering this service. Yet the demand is so big—and growing so fast—that your opportunity for success is better than ever before.

If you're a man who wants to work—but in his own way—see if you don't agree that what you are about to read is an opportunity you can't afford to pass up.

Wall-to-wall carpeting, upholstery, walls: 3 great needs for on-location cleaning

Nothing enriches a room like wall-to-wall carpeting. Every year you find it in more homes at every income level. Then there are all the public places with this carpeting. Places like motels, hotels, restaurants, banks, offices, theaters, stores, cocktail lounges, hospitals, reception rooms, etc.

Since this carpeting can't be sent out for cleaning there's a real opportunity for on-location cleaning services. It's faster, easier and inexpensive to clean carpeting on the customers' premises.

This same opportunity exists for upholstered furniture. It's faster, easier and costs less to clean upholstery on-location.

Now, consider wall and ceilings. Cleaning them with a bucket and sponge is slow, tiring and messy. People will welcome a service that does a professional job of cleaning quickly and without mess.

3 Von Schrader Detergers: each does on-location cleaning at its best

With Von Schrader Detergers—professional cleaning equipment—you'll do on-location cleaning that wins repeat customers . . . make as much money part time as many people earn full time . . . enjoy a steady, dependable business of your own . . . watch your income grow to where you are financially independent. Every home, every building, are a potential source of income.

You can start your on-location cleaning service with any one, two or all three Von Schrader Detergers.

Carpet Deterger. Cleans so deeply and completely it helps restore natural beauty—even revives color. Fast drying.

Upholstery Deterger. Gives deep-level cleaning to every inch of fabric upholstery and synthetics. Leaves furniture looking fresh and new.

Wall Deterger. Washes walls and ceilings 6 times faster (and better) than the



Von Schrader Carpet Deterger. Cleans so completely it helps restore natural beauty. Fast drying.



Von Schrader Upholstery Deterger. Gives deep-level cleaning to fabric upholstery and synthetics.



Von Schrader Wall Deterger. Washes walls and ceilings 6 times faster (and better) than hand method.

bucket-and-sponge method. Cleans easily without any mess.

Von Schrader stands for the best in professional cleaning equipment, as it has for over 35 years. All our Detergers are light-weight and easy to operate. Proven reliable and profitable for thousands of users.

You own your equipment

As a Von Schrader Associate you are your own boss. There's no contract to sign. You pay no fees, dues or royalties. Work out of your home part time or full time. Hire help as your customer list grows. (Many men start by working evenings or weekends while retaining their regular jobs.)

You get supplies

Each Deterger you order includes supplies and accessories, operating instructions and promotional material. You can go after on-location cleaning business immediately.

We'll help you get started

As a Von Schrader Associate your success is our success. So we'll help you every step of the way. That includes free consultation and special business-building materials.

Very small investment

You can have your own on-location cleaning business for an investment so small it's hard to believe. Send for complete information. No obligation.

READ WHAT OTHER MEN ARE DOING WITH VON SCHRADER DETERGERS

Carpet: "Averaged \$1000 a month for 12 months."—C.E. Neville. "Grossed \$30,000 the first year."—Father-Son Team. "Have all 3 of your Detergers. Earned \$2500 in one week."—E. Letz

Upholstery: "One day I did a \$135 job. Best week was \$500."—C. Lambert. "We passed over the \$450 mark in five days."—T.E. Baylor

Walls: "Earned the price of Deterger with the work I did the past week."—J. Haws. "I work just 2 or 3 days a week. Best month was \$1200."—J. R. Johnson. "Big motel chain delighted with cleaning results and low cost."—E. Holst

Von Schrader
Detergers

FREE BOOKLET TELLS WHOLE STORY—MAIL COUPON TODAY
VON SCHRADER MFG. CO.

1031 Place, Racine, Wis. 53403

Please send complete information on the Von Schrader Deterger(s)
I have checked: Carpet Upholstery Wall

Name _____

Present Occupation _____

Address _____

City _____ State _____ Zip _____

NEW YORK—Imagine communities without smokestacks! This prediction by Maj. Alexander P. de Seversky (designer of World War II's P-47 fighter plane), now president of Seversky Electronatom Corp., followed his design of Hydro Precipitrol, a precipitator which controls stack emissions (sulfur-dioxide or nitrous oxide) and recovers by-products (sulfuric acid or nitric acid) marketable to fertilizer plants. It operates as follows: Exhaust gases enter the bottom of the precipitator and flow upward where gases are ionized and collected by electrodes, liquid in form. The liquid with particles then flows downward to a sump where entrapped particles become by-products while the liquid recirculates. Hydro Precipitrol has already been installed (January) at the General Battery Corp. in Laureldale Township, Pa.

ALBANY, N.Y.—Preserved fish caught up to 43 years ago and recently studied at the New York Department of Environmental Conservation at Albany have been found to contain more than twice as much mercury as that in fish currently banned from the market. Blue pike (caught in 1939—Irondequoit Bay, near Rochester) had the highest concentration of mercury—1.03 parts per million—of the old fish studied. To learn just how widespread this situation is, Henry L. Diamond, department commissioner, has asked collectors of old preserved fish to contribute their fish to further research. Write to Comm. Henry L. Diamond, New York Department of Environmental Conservation, Albany, N.Y. 12207.

CHICAGO—Virtual elimination of black diesel exhaust smoke has been found to result from the addition of a barium fuel additive. (The Von Brand smoke recorder and a Clayton dynamometer were used in measuring.) The importance of such an additive cannot be emphasized enough when considering that excessive exhaust smoke is the basis for most state and city antipollution regulations. A manufacturer of one additive, Ever-Tops NS, is Robert J. Kerr, Inc. 6600 N. Ogallah St., Chicago, Ill. 60631. The additive also promotes engine cleanliness, extends injector life, reduces engine and ring wear, and improves power and mileage.

WASHINGTON, D.C.—Five patents were recently given to the Union Carbide Corp. for its Unox pure-oxygen process for treatment of sewage. Like conventional processes, Unox also introduces oxygen into sewage activating bacteria to decompose wastes. But, because Unox uses pure oxygen, decomposition is faster. So, the system will be installed at the Newtown Creek waste treatment plant in Brooklyn where the pollution problem is not only municipal sewage, but also, pharmaceutical and brewery outflows.

DO YOU KNOW about some action being taken to fight pollution that we don't know about? In your community? On the job? Tell us about it. Write Environment Editor, Popular Mechanics, 224 W. 57th St., New York, N.Y. 10019.

The secret of teaching yourself music

It may seem odd at first—the idea of teaching yourself music. You might think you need a private teacher at \$4 to \$10 an hour to stand beside you and explain everything you should do—and to tell you when you've made a mistake.

But the fact is, you don't. Thousands have taught themselves to play with the lessons we give by mail. And you can too. Guitar, piano, accordion—you can learn any of ten popular instruments.

The secret lies in the step-by-step way our lessons teach you. Starting right from scratch, they show you with simple words and pictures exactly what to do. You'll learn to play the right way—by note, from sheet music. Without any gimmickry.

But how do you know you're doing it right? Easy. A lot of the tunes you'll practice first are simple songs you've heard many times. Since you know how they're supposed to sound, you can tell right away when you've "got them right."

By the time you go on to more advanced pieces, you'll be able to tell if your notes and timing are right, even without being familiar with the songs. Sooner than you may think you'll be able to play whatever kind of music you like. Popular. Classical. Folk music. Hymns.

For more information, just mail the coupon. We'll send you our free booklet, *Be Your Own Music Teacher* and a free Piano "Note-Finder." No obligation. No salesman will call. *The U.S. School of Music. Estab. 1898. Lic. by N.Y. State.*

©1969 U. S. School of Music



U. S. School of Music

Port Washington, New York 11050

I'm interested in learning to play the instrument checked below. Please send me, FREE, your illustrated booklet, *Be Your Own Music Teacher* and a free "Piano Note-Finder." I am under no obligation. Check the instrument you would like to play: (check only one)

- | | | |
|---|---------------------------------------|------------------------------------|
| <input type="checkbox"/> Piano | <input type="checkbox"/> Steel Guitar | <input type="checkbox"/> Accordion |
| <input type="checkbox"/> Guitar | <input type="checkbox"/> Saxophone | <input type="checkbox"/> Mandolin |
| <input type="checkbox"/> Organ—pipe, electronic, reed | <input type="checkbox"/> Violin | <input type="checkbox"/> Clarinet |
| | | <input type="checkbox"/> Ukulele |

Print Name _____ Age _____

Address _____

City _____

State _____ Zip _____

Accredited Member National Home Study Council

A-303



We've taken the "bite" out of pipe smoking

Your favorite blend never had it so smooth, right from the very first puff because: the world's only pre-smoked pipe needs no breaking-in! What curing does for tobacco, pre-smoking does for your Dr. Grabow.

WORLD'S FINEST IMPORTED BRIAR
 Starfire.....\$5.95
 Viscount.....\$6.95
 Commodore...\$7.95
 Eldorado.....\$10.00

For FREE informative booklet, write
 Dr. Grabow pre-smoked pipes
 Box 21888, Greensboro, N. C. 27420

Dr. Grabow *the World's only Pre-Smoked Pipes*

START A BUSINESS

in your neighborhood



Sharpen Hand or Power Saws with the

FOLEY SAW FILER

Start your business in sparetime and make CASH PROFITS right away. No stock to carry, no selling involved, no experience needed—the Foley Saw Filer does every sharpening job **automatically!** Earn \$3 to \$6 an hour sparetime in your own garage or basement. Profit 90c on every dollar.

Best of all, every saw you sharpen, will be resharpened again and again—watch your repeat business grow! Add cash to your income now, while you build retirement security with the Foley Saw Filer.



FREE BOOK shows how you can make money as thousands of others have. Send coupon today. There's no obligation, and no salesman will call—so write today!

Foley Manufacturing Co.
 343-1 Foley Bldg., Minneapolis, Minn. 55418
 Send for FREE book on Money-Making facts about the sharpening business.

NAME _____
 ADDRESS _____
 CITY _____ STATE _____ ZIP CODE _____



MOWER SHARPENER

Precision-grind all hand and power lawn mowers—a perfect job every time.

NEW - Ninth Edition of the Universally Accepted Small Engines Service Manual



\$495
 9th Edition

Factory "know-how" at your finger tips! Complete repair information on over 1,000 models of small engines that power lawn mowers, tillers, go-karts, etc. 328 pages with hundreds of photos and exploded view drawings. Step-by-step, easy to follow instructions for everything from minor tune-up to major overhaul. Over 300,000 copies sold to mechanics and do-it-yourselfers. Save time... make money. Order your copy today.

Money Back Guarantee
 Send check or money order and we pay postage.

Technical Publications Div., Dept. PM-370
 1014 Wyandotte, Kansas City, Mo. 64105

BEST LOW COST HEAVY DUTY WELDER MONEY CAN BUY \$18.95 POSTPAID

10 DAY MONEY BACK TRIAL—LIFETIME GUARANTEE

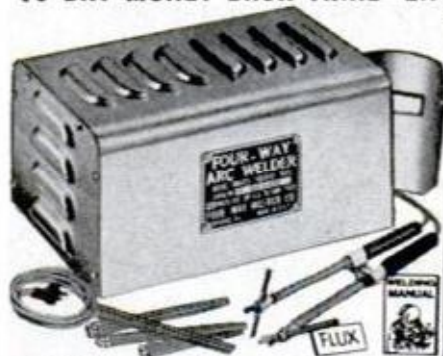

READY TO USE
 NO MORE TO BUY

GET: Welder in rugged metal cabinet, heavy duty cables and ground clamp, full face helmet, adjustable torch and rod holder, simplified welding manual and

FREE TWO BIG PACKS

Instant arc welding rods, brazing rods, 1/4 carbons, solder & flux.

Weld, braze, solder, cut almost anything of metal including aluminum. Use regular 1/8" rods, 1/4" carbons. Operates on ordinary home 110V outlet, 30A fuse. Make or repair cars, boats, toys, furniture, bicycles, farm and garden equipment. Adjustable carbon arc torch to easily regulate heat up to 11,000° for light or heavier welding without changing heats or cables. **HUNDREDS OF THOUSANDS SOLD IN 30 YEARS. PROOF YOU CAN'T BUY A BETTER WELDER FOR LESS. LIFETIME GUARANTEE.** If ever inoperative, return prepaid, we will repair and reship without charge. **FREE TRIAL.** If not completely satisfied, return in 10 days and we will refund purchase price. **SEND ONLY \$2.00,** pay \$16.95 plus C.O.D. and delivery charges or send \$18.95 for prepaid shipment in Continental U.S.A. Ill. res. add 5% sales tax. **FOUR-WAY WELDER CO., 1810 S. Federal St., Dept. M2-C, Chi., Ill. 60616**

MAKE BIG MONEY INSTALLING ALARM SYSTEMS



New plan opens multi-million dollar burglar, fire alarm business to small home operators. Guides beginners step by step. Starts you full or spare time without previous experience or big investment. See how to cash in on invisible web of protection that stops crooks cold, makes big profits. No salesman will call. Free details! **NASCO, 11071 Massachusetts Avenue Dept. E2253, Los Angeles, Calif. 90025**

MENTION POPULAR MECHANICS
 WHEN ANSWERING ADS



LOCKS AND KEYS MADE EASY!

COMPLETE ILLUSTRATED BOOK OF FACTS

Shows how to fit keys, change combinations, master key locks, keys by number, tools to use, etc. Fascinating trade explained in simple words, clear and complete illustrations. Satisfaction guaranteed. Get started! Order today. Dept. B

ONLY
 \$3
 PPD.

I. B. Ancele, P. O. Box 69234, Los Angeles, Calif. 90069

POPULAR MECHANICS

Материал, защищенный авторским правом



THESE 3 BIG DRAFTING KITS* GIVEN TO YOU!



*Precision Drawing Instrument Set, Professional Drafting Board Outfit & Fingertip Tilting Drafting Table are given to you with your complete North American Course in Drafting.

Coast-to-Coast Shortage of Trained Draftsmen Opens Thousands Big Salary Jobs for Beginners!

Now you can take your pick of thousands of big salary jobs open to Draftsmen (see "help wanted" sections of metropolitan newspapers). Huge nationwide demand... U.S. Dept. of Labor reports "42% more Draftsmen needed in next 10 years—not enough applicants to fill drafting jobs available now!" Our easy "Quick-Learn" Method has helped hundreds toward good income, security and prestige as Draftsmen. Why not you?

YOU NEED NO DRAWING SKILL... NO TECHNICAL ABILITY

NASD's staff of Professional Draftsmen guide you step-by-step. With our spare time home-study plan you work on actual projects. Makes learning fun—easy to remember, too. Many graduates have succeeded with only grade school training. Others report good earnings drafting part time while still learning!

...when you train at home with NASD for a HIGH PAY JOB IN DRAFTING!

Earns \$820 Month!

"My first position after completing your course jumped my income from \$350 to \$820 per month."—G. W., Tenn.



Big Promotion!

I was promoted from the production line ahead of 4 others and got a good pay raise."—W. A., Wisc.



ALL 4 FREE!
Rush Coupon today!



RUSH COUPON FOR FREE KIT...

Mail coupon today for FREE "DRAFTING CAREER KIT," Sample Lesson, Drafting Aptitude Test including intriguing new 5-Way Drafting Instrument & 20-page Book "Your Future in Drafting"—jam-packed with revealing facts on your opportunities to win top pay and job security in Drafting. No salesman will call. Everything sent FREE and WITHOUT OBLIGATION. Write today!

North American School of Drafting, Dept. 14173
4500 Campus Dr., University Plaza, Newport, Calif. 92660
Rush "DRAFTING CAREER KIT", including Book, Sample Lesson, Aptitude Test & Drafting Instrument — ALL FREE! No salesman will call. G.I. Approved.

NAME _____ AGE _____
ADDRESS _____
CITY _____ STATE _____ ZIP _____

A home-study program in association with Cleveland Engineering Inst.



Does this look like work?

New Gilson S-14 tractor lets you relax on any lawn and garden chore. Powerful 14 hp engine is teamed up with a new Hydrostatic transmission for smooth, easy control of the toughest job. More, you get almost effortless steering, hydraulic implement control (optional), electric starting, cushioned bucket seat, headlights, even a cigarette lighter. And a complete line of all-season attachments. Ride the smart new Gilson S-14 — it's no work at all. See your dealer. Gilson Brothers Company, Plymouth, Wisconsin 53073, Dept. A.



Gilson®

BELSAW PLANER • MOLDER • SAW

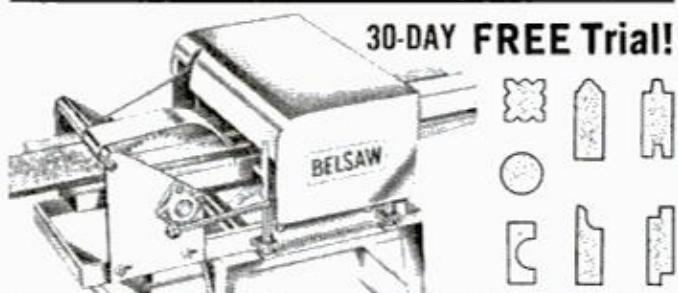

30-DAY FREE Trial!

Now you can use this ONE power-feed shop to turn rough lumber into moldings, trim, flooring, furniture...ALL popular patterns. RIP...PLANE...MOLD—separately or all at once with a single motor. Free 30-Day Trial. Low Cost—only \$35 down. Send Postcard Today — No Salesman Will Call.

BELSAW POWER TOOLS, 901M Field Bldg., Kansas City, Mo. 64111

AN EXCITING JOB

ACCIDENT INVESTIGATOR

Investigators and adjusters are needed to handle the great increase in insurance claims. Top salary, company car and expenses usually furnished. Train for this wide-open field.

**APPROVED FOR VETERANS
MAIL COUPON TODAY
or For Immediate Information
PHONE: (305) 642-2332
(24 hours)**

INSURANCE ADJUSTERS SCHOOLS, Dept. P.M.
1901 N.W. 7 Street, Miami, Fla. 33125

Please Print
Name _____ Age _____
Address _____
City _____ State _____
Phone _____ Zip _____

**NEW - Third Edition
Chain Saw Service Manual**



\$595
3rd Edition

Everything you need to know about chain saw repair. Detailed, step-by-step instructions on tear down, repair, reassembly and adjustment of most popular chain saws. Fundamentals section describes common saw engine failures and outlines troubleshooting procedures. Includes section on sharpening, lubrication, and repair of the cutting chain, 240 pages covering 24 leading brands.

Money Back Guarantee
Send check or money order and we pay postage.
**Technical Publications Div. Dept. PM-370
1014 Wyandotte, Kansas City, Mo. 64105**

**New Discovery
Makes Stuck
Drawer Slide At
Fingertip Touch—
Without Oil!**

A new spray lubricant so clean it won't soil linen or clothes in drawer. One Sw-o-o-sh! And tight stuck drawers, windows and zippers slide easy when you spray new 3-IN-ONE DRY-LUBE. Eliminates friction without oil. The secret is a new spray lubricant so clean it won't soil your best clothes. Get 3-IN-ONE DRY-LUBE at all hardware outlets.



3-IN-ONE®
DRY LUBE

**REFINISH MARRED OR GOUGED
FURNITURE LIKE NEW.**

Fill in wood gouges, nicks and scratches like professional carpenters do with GENUINE PLASTIC WOOD Cellulose Fiber Filler. Handles like putty, hardens like wood. Plane it, sandpaper it, varnish it, paint it for true, professional finish. GENUINE PLASTIC WOOD comes in walnut, oak, mahogany or natural color. At hardware stores and supermarkets.



GENUINE
PLASTIC WOOD®
CELLULOSE FIBER FILLER

WOOD VENEERS • TOOLS
Shop Equipment • Supplies
POWER TOOLS
at Lowest
Discount Prices!

SAVE MONEY on finest domestic and imported hardwoods... all dimensions. Over 1500 items for the home craftsman and woodworking hobbyist. Lamp parts, upholstery supplies, tile, power tools at discounts. **NEW CATALOG READY** 132 pages. Full Color. Send name, address and 35¢ to cover handling, and postage. Write...
**CRAFTSMAN Wood Service Co. Dept. A-31
2729 S. Mary, Chicago, Ill. 60608**

LEARN SURVEYING AT HOME. 1000s big pay jobs open to trained Surveyors.

You Get **BIG 68 PIECE SURVEYING KIT** WHEN YOU ENROLL...

U.S. Bureau of Labor Statistics predicts shortage of 50,000 civil engineering technicians (Surveyors, etc.) by 1975. Our easy step-by-step home-study plans have helped 1000s beginners toward prestige salary, security. Why not you? Send for "SURVEYING CAREER KIT"—ALL FREE! No salesman will call. Write & state age.
**NORTH AMERICAN SCHOOL OF SURVEYING & MAPPING 4500 Campus Drive
Dept. 14173 Newport, Calif. 92660**



The bargain hunter

PORTABLE STEAM CLEANER

STEAM IN 60 SECONDS

Clean—Engines, large & small • Air Filters • Lawn Mowers • Trucks & Tractors • Garbage cans • Kennels

"Big enough to do the job small enough to get there" Freight collect—complete except for propane bottle

\$198.00

Auxiliary pump needed on water pressures below 60 lbs. or on well systems—\$73.50 extra.

Self cleaning coils—uses liquid cleaning compounds—soap by-pass for clear water rinsing—stainless steel firebox for long life—3 year guarantee on coils and firebox—propane fired—weighs only 120 lbs.

WEDCO MANUFACTURING, INC.
Dept. M-2, Box D,
Jackson, Wyoming 83001

REDUCIBLE

RUPTURE

AGONY Removed
(or trial COSTS YOU NOTHING)

WHEN you slip into a low-cost, contour-designed Brooks Patented Air Cushion Appliance! Your reducible rupture will be held in securely yet gently—or the trial costs you nothing! This invention has made millions of sufferers happy. You can enjoy heavenly comfort night and day at work and play—or the Appliance costs you NOTHING. Isn't this worth a no-risk trial by you? If interested, write for free facts now. Brooks Co., Box 346-J, Marshall, Mich. 49068



FREE Catalog 2000 Jokes & Novelties

World famous catalog of novelties, live animals, scientific supplies, hobbies, fun-makers, planes & boats, looms, magic tricks, joke articles, unusual seeds, gadget time-savers, cameras, optical goods, projectors, movies, lucky jewelry, religious novelties, disguises, musical instruments, stamps, coins, puzzles, fortune tellers, radios, auto & bike accessories, telescopes, magnifiers, compasses, banks, smokers' gadgets, artists supplies, printing sets, engine, motors, shockers, knives, billfolds, books, games, etc. Send this ad with coin or stamp for postage. NO LETTER NECESSARY!

Yes—I want FREE Catalog. My Name & Address Attached or on Envelope

Johnson Smith Company
16535 E. Warren Av., Dept. C-103
Detroit, Mich. 48224

GO IN FOR YOURSELF

Seamless Nylons 31¢
Keychain Flashlight 18¢
Woman's Raincoat 15¢
Electric Percolator \$2.60

TAT DISTRIBUTORS

P.O. Box 761
Sparks, Nevada 89431

Plan Your Retirement Future Now

MAKE MONEY in the PROFITABLE RADIATOR REPAIR BUSINESS

Invest As Little As \$1500 to \$3000 . . . and BE YOUR OWN BOSS

- 2 Weeks Free Schooling
- Small Down Payment
- Extended Terms

The radiator repair market is a multi-million dollar business. Write Barbee Co. for complete details.



THE BARBEE CO., Box 323-PM,
Louisville, Ky. 40201

Please send the free catalog and complete information on the Barbee Plan.

Name _____
Address _____
City _____
State _____ Zip _____



Thousands of exciting tool values!

SILVO (BRAND NAME) TOOL CATALOG

Thousands of Exciting Tool Values! Stanley, Millers Falls, Skil, Thor, Wen, Disston, Wiss, Wellsaw, Dremel, Speedy Sprayers, Plumb, Huot, Kennedy, Channellock, Porter-Cable, Rockwell, Helios, Vise-Grip, Crescent, Ridgid, Pony Clamps, Unimat, Foredom and many other Nationally Advertised brands of Tools & Supplies. We ship Coast to Coast at prices Hard to Beat. Send 50¢ for our big 146 page tool catalog today. Silvo Hardware Co., PM-3, 107 Walnut St., Philadelphia, Pa. 19106.



WHAM-O \$150

HITS LIKE A RIFLE—KILLS RABBITS, SQUIRRELS
Powerful, silent, accurate.
For hunting, target, routing posts.
Sportsman's choice sold world over!
NEW! Surgical quality poly gum rubber.
40 heavy extra steel balls 20¢
HUNTING SLINGSHOT
Heavy duty 7" ash stock,
40 heavy steel balls, extra rubber,
adapter for shooting arrows.
GUARANTEED: Professional model of
Nat'l Slingshot Assn. At dealers, or write
WHAM-O MFG. CO., P.O. Box 15-X San Gabriel, Calif. 91778

Kirsten

The pipe that never loses its cool.

Kirsten's exclusive radiator stem tames the smoke . . . makes it milder . . . cooler. It also traps impurities and allows you to remove moisture with a flick of your wrist.



\$8

postpaid.

Imported aged Mediterranean briar. Hand finished vulcanite bit. Order your Kirsten pipe and you'll keep your cool forever.

KIRSTEN PIPE CO., INC.

Dept. PM-3 P.O. Box 5227, Seattle, Wn. 98107

Please send me your 1971 catalog showing all of the Kirsten Pipes and accessories.

Name _____
Street _____
City _____ State _____ Zip _____



Bartlett Flying Saucer ultra-light hovercraft powered by ordinary lawn mower engine—easy to build—fun to fly—complete plans, kit brochure, photos and supply sources \$5.00. All orders returned via airmail. Write:

HERB BARTLETT

Box 3339-M, Scottsdale, Arizona 85257



HoverPacer 2-seat ACV. Build from simple Plans, Kit. Outstanding performance: 50 MPH water, 60 MPH land. Proven design. Available in open (Sport) or closed (All Weather) cockpit design. Send \$1 for photos, tech. specs, prices.

KING TECHNOLOGY

Box 231, Carmel, Indiana 46032

FREE FEL-PRO GASKET MANUAL

... for top performance in all gasket applications

Learn about the latest gasket materials and trouble-free gasket installation techniques from Fel-Pro... for 50 years a leader in gasketing improvements. Improve engine... transmission... and rear end performance with these helpful tips. 36 fact-filled pages.

Write: **FEL-PRO, INC.**

7452 N. McCormick Blvd. Dept. 3PM Skokie, Illinois 60076

FEL-PRO

WESTERN HAIG

.12 CALIBER SPECIAL FACTORY OFFER!



\$300 post-paid

USES POWDER CHARGE

This small bore gun shoots .12 cal. steel bullets fired by small 4.4 mg. powder charge. Not a CO₂ gun. You'll like the handsome lines, grip, and balance. Western in style, but patented ball and cap action allows this low price. 9 1/4" steel barrel cased in knurled styrene stock, overall 13 1/2". Develop pistol form, accuracy at a fraction of cost of large cal. pistols. Comes with 50 steel bullets. Satisfaction guaranteed. Send \$3.00 to:

HAIG MFG. CO., P.O. Box 26-J Alhambra, Calif. 91802



NEARSIGHTED? FARSIGHTED?

No more glasses to wear! Latest discoveries! Fifteen minutes daily eye training course will improve your vision. Are your eyes worth \$2.95?

Mail cheque today to:

GROSSI, Box 1061-E, Postal Station "A", Toronto 1, Ont., Canada.

'KIMBA KAT'

Build this 12 ft Prefabricated Catamaran sailboat in 20 hours. Completed fiberglass hulls & decks ready to fasten together. Dacron Sail, stainless rigging and hardware. Price \$445 f.o.b. Send for free brochure or \$2 for illustrated construction manual. Seahorse Sailboats, Dept. 'A' P.O. Box 1896, Hawaiian Gardens, California, 90715.



5 foreign coins, free

We will actually send you, free, seldom seen coins from Turkey, Spain, Austria, Finland and Somalia. Just to get your name for our mailing list. And we'll include our big free catalog of coins, paper money, collector's supplies. Send name, address and zip to:

Littleton Stamp & Coin Co., Inc. Dept. ST-10, Littleton, N.H. 03561

LEARN UPHOLSTERY! AT HOME



SEND FOR FREE ILLUSTRATED BOOK

on home study course for upholstering sofas, chairs, foot-stools, built-ins. New methods, all styles including fabulous new Naugahydes (above). Free special upholsterer's tools. Fine spare time income, high-paying job opportunities all over. Earn while you learn in spare time. Fascinating. Write for free book, free sample lesson to

Modern Upholstery Institute
Box 899-ECK, Orange, Calif. 92669

Please rush illustrated career book, sample lesson, facts on MUI home training — all FREE, without obligation.

Name _____

Address _____

City _____ State _____ Zip _____

APPROVED FOR VETERANS

THIS IS IT!



Popular Mechanics said in July, 1969 (p. 166):

"Handiest Tool You Can Have in Your Shop"

It sands, grinds, polishes, sharpens. It's portable. Take it on the job. Use with any 1/2 hp motor. Model 165. Factory direct special.

\$24.95 less motor

Quik-Sand

ARCO MFG. CO.

P.O. Box 817, Grand Forks, N. Dak. 58201

"EXCELLENT GIFT"

"Lifetime" water scope for viewing bottom of clear water lakes to locate brush piles.



lost motors, rods, Etc. Wide angle lens, 23 inches long when extended. Only \$4.95 Prepaid, Insurance 30¢ extra. Free brochure. NELSON MFG. CO., 2639 Wilton, Only \$4.95 Dept. M, Dallas, Texas 75211 Prepaid

BUILD YOUR OWN CAMPER

• PLANS • PATTERNS • KITS
Covers to Cabovers
★ FREE CATALOG ★

GLEN



9152 Rosecrans, Dept. PC, Bellflower, Ca. 90706



SAVE HUNDREDS OF DOLLARS . . .

Build this attractive Little Red Barn for work shop, garden tractor, tool storage, play house, dog kennel, motorcycle garage. 8 ft. x 12 ft. x 9 ft. high. Mounted on skids for portability. 4 ft. sliding door. Quick to build using 1/2 in. exterior plywood. No expensive tools needed. Simple step by step plans. Send \$2.50 for barn plans and material list. Also petite 6 ft. x 8 ft. x 8 ft. high with dutch doors for \$2.50. Both plans for \$4.00.

HAMMOND BARN

Dept. PM1, Box 39027 Indianapolis, Indiana 46239

STOP A BURGLARY BEFORE IT STARTS

Protect your family and possessions. Amazing device—Easily installed. Cost \$2 Satisfaction Guaranteed or Money Back. Write:

P.O. BOX 16034

Jacksonville, Fla. 32211 Dept. PM

WATER WATER WATER WATER WATER WATER

"HOW TO DRILL YOUR OWN WATER WELL"

\$1.00 ppd
SATISFACTION GUARANTEED

DEEPROCK CO.
OPELIKA, ALA. 36801

Relic Collectors! Moments of the infamous 3rd Reich 7"x20" Wide. Rugged-cast-Solid-Aluminum NAZI eagle. \$10.00 Postpaid . . .

With our fully illustrated Catalog, Listing Hundreds of Hard-to-find Items.

Catalog Only \$1.00
W.W.#2-M Ltd. Box 2063
St. Louis, Mo. 63158



BOAT PLANS · PATTERNS · FRAME KITS
... especially for amateurs!

BUILD YOUR OWN & SAVE \$\$

New Catalog—nearly 100 pages, over 80 designs—\$1.00. Sail, Inboards, Outboards, Hydros, Houseboats, Hot Boats & boat trailers—includes all styles from 8' to 36'. Glen L plans, patterns and frame kits are specially prepared for amateurs. Books: Inboard Motor Installations In Small Boats \$6.00; Boat Building With Plywood \$7.50; How To Build Boat Trailers \$4.00. Glen L, 9152T Rosecrans, Bellflower, Calif. 90706.

50¢ buys hand-rubbed effect without rubbing



Try this 1/2-pint sample of Pen-Chrome Clear Satin Finish on previously finished or new wood. See how easily this special formulation brings out the deep-down natural beauty.

SPECIAL OFFER!

Limit one can per customer.
Send 50¢ to The O'Brien Corporation,
Dept. P-3, South Bend, Ind. 46621.

Easy to Build PLANS AND INSTRUCTIONS for

Go Kart\$2.00
Mini Bike\$2.00
Mini Car\$3.50
Pedal Boat\$4.00
Sail Boat\$3.00

MINI VEHICLES PLANS "DEPT. C"
P.O. Box 92
Chazy, N.Y. 12921

IMPORTED
LOCK BLADE STILETTO

ONLY \$2.75 Ea.
9" Overall Length
5" When Closed

- Opens instantly
- Sharp and Tough
- Stainless Steel Blade

Flips open instantly and locks automatically to prevent accidental closing. Razor sharp tough stainless steel blade for reliable use and hard, long service. Money back in 5 days if not satisfied. Send \$2.75 plus 25¢ to cover postage and handling.

WESTBURY SALES CO.
P.O. BOX 415 WESTBURY, N.Y. 11591
DEPT. L-105-PM

MACHINISTS BUILD YOURSELF:

A small plastic injection molding machine—An O. D. grinding attachment for surface grinders—A thread grinding attachment—And other items. Send 25¢ for illustrated brochure with prices of complete plans to:

**NORM SELSTAD, Box 2169,
Westminster, Calif. 92683**

KLEEN-LINE BOTTLE CUTTER

Make your own glasses. Sell for profit—Give as gifts. Cuts any round glass bottle in less than five minutes. Do your bit for ecology. \$10.50

**KLEEN-LINE CO., 2591 Circle Dr.,
Newport Beach, Calif.
Dealer inquiries invited.**

NEW \$50 A DAY
HAND & CIRCULAR SAW SHARPENER
INDUSTRIAL TYPE PROFESSIONAL DESIGN

25 YEARS of know-how
FAST ACCURATE SHARPENING
3" to 48" circular saws

Factory-To-You prices.
EST. 1946. Quality performance guaranteed.
Write — Free Booklet

TREYCO PRODUCTS, INC.
332-A NIAGARA ST.
N. TONAWANDA, N. Y. 14120

POLARITY INDICATOR FOR BOOSTER CABLES EMERGENCY TROUBLE LIGHT

• SAVE COSTLY REPAIR BILLS DON'T DESTROY YOUR ALTERNATOR

Light provides positive proof of jumper cable hook-up. Illuminates battery and engine areas. Fits all size cable 6 or 12 volt syst. Rigid connection between cables eliminates tangling. Same day mail service. U.S. Pat No. 3259754 Send \$2.00 to:

**Polarity Indicator Inc.
Box 1047, Miami, Fla. 33157**

SHOP MEN

Qualify as a SHOP PLANNER or become a Numerical Control PROGRAMMER on the Tape Cont. machines for Shop. Only State Cert. Voc. Instr's. (Home) (NO salesmen) non-profit (Diplomas)

MFG. CONSULTING ENGR'S ASSOCIATION EDUCATIONAL SERVICES DIV.
100 Aloha Seattle, Washington 98109

BUILD YOUR OWN MODEL ENGINE. Got a lathe? You can do it!! From high quality castings & drawings you can machine beautiful high performance engines. A wide selection is available including 9 gas & 3 steam engine designs. Single cylinders, twins, four's, & a V-8 with HP ranges from .25 to 3 HP. Air cooled and water cooled in both 4 cycle & 2 cycle designs. Send \$1.25 for catalog.

**Lancer Engineering,
P.O. Box 544, Pekin, Illinois 61554**

DETROIT APPROVED—PICKUP TANKS

Original equip. type poly. now avail. in aux. tanks for pickups. Increase gas capacity 40 gals. Easy 1 hour installation—completely hidden—no body work necessary. Let truck discounts pay for tanks.

**R.P.M. INC., Dept. PM-3
P.O. BOX 7936, Waco, Texas 76710**

NEW MINI FLASHLIGHT KEY RINGS

Comes with one mono-cell battery and lasts as long as one (1) year with normal use. Price Each \$1.39
Send Check or Money Order To:

**Whitley Brothers
Department PM-3 1695 Barrett Drive, N.W.
Atlanta, Georgia 30318**

HOW MANY HANDY DANDYS CAN YOU USE?

Handy Dandys are plastic caps that hook onto 1/8" pegboard and hold quarter-twist glass jars, such as used for baby food. Suggestions for getting FREE JARS in every package. Nothing better for storing supplies, parts and small tools. Keeps workshop neat. Sample pack 10 for \$1.00 36 for \$3.50 72 for \$6.00 144 for \$11.50. Caps only. No jars. Postpaid U.S.A. No C.O.D.'s. **WICKLIFFE INDUSTRIES, Box 286-PM3, Wickliffe, Ohio 44092**

KITES, KITS, PLANS! KYTE TALES

KYTE TALES IS:

1. An introduction to new & novel kite designs.
2. A kite catalogue.
3. A kite "textbook".
4. Written for both adults & children.
5. Cartooned and illustrated.
6. Only 25¢

**KYTEHOUSE, Box 145-X
Richardson, Texas 75080** **25¢**



FREE MUSCLE COURSE!
Want a new Jet-Charged body? In 15 minutes I'll prove you can snap on 4" of muscles to your chest—3" to each arm—give you life-guard shoulders, trim your waist to athletic size—give you speedy athletic legs. I don't care if you're short or tall (skinny or fat) young or not so young, expect a muscle building miracle when you send for my free course. Send only 25¢ to cover postage and handling to Joe Weider, Dept. 38-31-D2, 531 32nd St., Union City, N.J.

MAKE BIG MONEY IN AN IMPORT BUSINESS OF YOUR OWN
Our genuine stone jewelry novel ics, gfts, premiums are terrific sales and profit makers—all Formosa imports. Sensationally low priced—unusual values—excellent profit margin. Send \$3.00 Postal Money Order or American Express Money Order for 15 different samples plus catalogs featuring 300 items. Satisfaction guaranteed.

**TAIWAN VARIETY
P.O. Box 24029
Dept. 91 TAIPEI,
TAIWAN, FORMOSA**

GRANDFATHER CLOCKS

SAVE 50% BUILD YOUR OWN GRANDFATHER AND GRANDMOTHER WEIGHT DRIVEN CLOCKS

- Highest Quality Imported
- Movements from Germany
- Tubular or Rod Chimes
- Moving Moon Dials
- Pre-cut Semi-assembled Handcrafted Case Kits (No power tools required)
- Dials, Barometers, Hygrometers, Templates and Case Plans.

All movements and dials in stock.
Send 50¢ for complete catalog

**H. DeCOVNICK & SON,
P.O. Box 68, Dept. M3
Alamo, Calif. 94507
EST. 1947**

YOUR OWN RADIATOR BUSINESS

**"\$70,000
LAST YEAR"**

says D. Carter,
Lemoine, Pa.



Complete turn-key package: training school in radiator repair technology and business management plus special power-equipped auto radiator shop.

Don Carter writes: "Averaging \$30 an hour, expect to hit \$80,000 next year." Mail this coupon for complete story.

NAME _____
ADDRESS _____
CITY _____ STATE _____
ZIP _____ PHONE _____

INLAND MFG. CO. Dept. PM-3
1108 Jackson Street • Omaha, Nebr. 68102



FREE!!! POWERFUL MUSCLES FAST!

Fantastic New Discoveries in the science of bodybuilding. Now, in the privacy of your bedroom, our method will add inches of powerful muscles to arms, chest, shoulders & legs. Learn secrets on trimming the waist with ultra-modern methods—fast! Results Guaranteed! Send for free brochure, Universal Bodybuilding, Box 485-M1, Dearborn, Mich. 48121.

**SHOW YOU'RE FOR PEACE
BY WEARING THIS TIME PIECE**

**AUTHENTIC
PEACE™
WATCH**

Watch the fingers turn to point . . . it's time for Peace! Swiss made in living color. Only \$19.95 Ppd. Add \$1.10 tax for Calif. Res. 2 Year Guarantee



PEACE ENTERPRISES, Dept. 10 PM
P.O. BOX 10731, San Diego, 92110

DRILL PRESS VISE

- Self Centering
- 3" capacity
- Hardened Steel Jaws
- Precision Lead Screw
- Weights 4 Lbs.

\$995

+ 50¢ shipping

Send for our catalog of hundreds of tools 35¢!

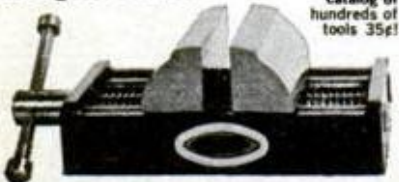

SCHLESINGERS FOR TOOLS LTD.
1020 East 54th Street, Brooklyn, N.Y. 11234
TEL.: (212) 241-7482

MAKE DRAWERS EASILY!



FOR WORKSHOPS... GARAGES... FACTORIES... FARMS... HOMES

Workbench drawers are a snap to make with this kit. Simply cut three pieces of 1/2" or 3/4" plywood (not included) to size and assemble with Side-n-Slides. Heavy gauge steel parts make sturdy drawer 24" front to back by 5" deep by any width. Supports weight of heavy tools. Built-in rails provided to carry inner tray for small items. Safety drawer stop prevents accidental spilling. Tamper-proof lock plate included for securing with padlock. Padlock not furnished. Satisfaction guaranteed. Postpaid \$8.95 (\$9.95 west of Rockies). No C.O.D.'s.

John Robert, P.O. Box 391, McHenry, Ill. 60050

COUNTERFEIT GUNS

**AUTHENTIC MACHINED METAL
REPLICAS OF FAMOUS FIREARMS
DISASSEMBLE LIKE ORIGINALS.**

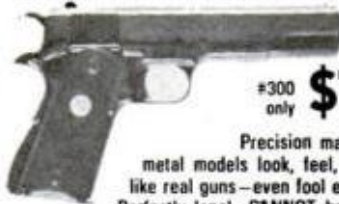

#300 only **\$17**

Precision machined metal models look, feel, weigh like real guns—even fool experts. Perfectly legal—CANNOT be fired.

Great for decorating den, office, rec. room. Send 25¢ for color brochure of 28 models of famous historical to modern military firearms. Dealer inquiries welcome.

REPLICA MODELS, Inc.

Dept. PM-3, 610 Franklin Street
Alexandria, Virginia 22314



**EARN
HIGH
WAGES
as a HEAVY
EQUIPMENT
OPERATOR**

Train your way to high pay in the booming construction industry! Learn the skills you need to qualify, by actual field training on machines like the ones used by the industry. Huge training grounds in North Carolina, a million dollars worth of school-owned diesel-engined machines, experienced instructors, full 220-hour and 440-hour courses. National, the original school of heavy equipment operation, is a recognized leader. Member American Road Builders Assn., Services and Supply Division. Associate Member A.G.C. Full-time Job Advisory and Counseling Director on staff. VA approved. For men ages 17 to 56. Train Now-Pay Later plan . . . other payment plans also available. Write TODAY for FREE catalog and FREE copy of school newspaper reporting news of National School graduates. Accredited member National Association of Trade and Technical Schools.

**NATIONAL SCHOOL
OF HEAVY EQUIPMENT OPERATION, Dept. D-48**
P. O. Box 8529, Moores Chapel Road, Charlotte, N. C. 28201

Please send me FREE illustrated school catalog and complete information. I understand there's no obligation.

Name _____ Age _____
Address _____ Phone _____
City _____ State _____ Zip Code _____

PASSENGER CAR AIR HORNS!



16 times louder than your electric horns! Complete: dual horns, vacuum powered air compressor, air storage tank, solenoid and all fittings. Toggle switch for city or country driving. Compact, easily installed under the hood of any car. With these horns, you drive defensively at turnpike speeds. Regularly \$53.55; special purchase price only \$29.95. Send check or money order. Satisfaction guaranteed or your money back.

GIBBONS TUBEWELD COMPANY

P.O. Box 38, Carey, Ohio 43316

BURGLAR & FIRE ALARM

ONLY
\$39.50
COMPLETE

PEACE-OF-MIND, ROUND THE CLOCK PROTECTION



NOW you can protect yourself, your home, your business with a PROFESSIONAL HIGH SECURITY ALARM SYSTEM. Save \$100's in parts & installation. Same fully "CLOSED CIRCUIT" system as used by alarm installers. Provides electrical supervision at all means of entry. Attempted entry or cutting of wires sounds loud alarm—cannot be silenced except by authorized personnel. COMPLETE with large Steel locked cabinet, Closed Circuit Panel, Dual loud Bell & Horn, Magnetic Contacts, Entrance lock, Heat Sensor, all switches, wires, etc. Easy illus. Manual. COMPLETE—only \$39.50 ppd. Send ONLY \$5.00 now, balance COD. 7 day MONEY BACK GUARANTEE.

SAFEGWAY PRODUCTS, 92 Brighton 11th St., Bklyn., N.Y. 11235
Dept. S-1

HOW TO GET RICH

Secret Mail Order business brings cash by mail. Pyramid profits. No investment. Start at home in spare time. Write for full details and Free Book.

MAIL ORDER ASSOCIATES, INC.

Dept. 5, Montvale, New Jersey 07645

How to get your hands on more money fast and have a good time doing it

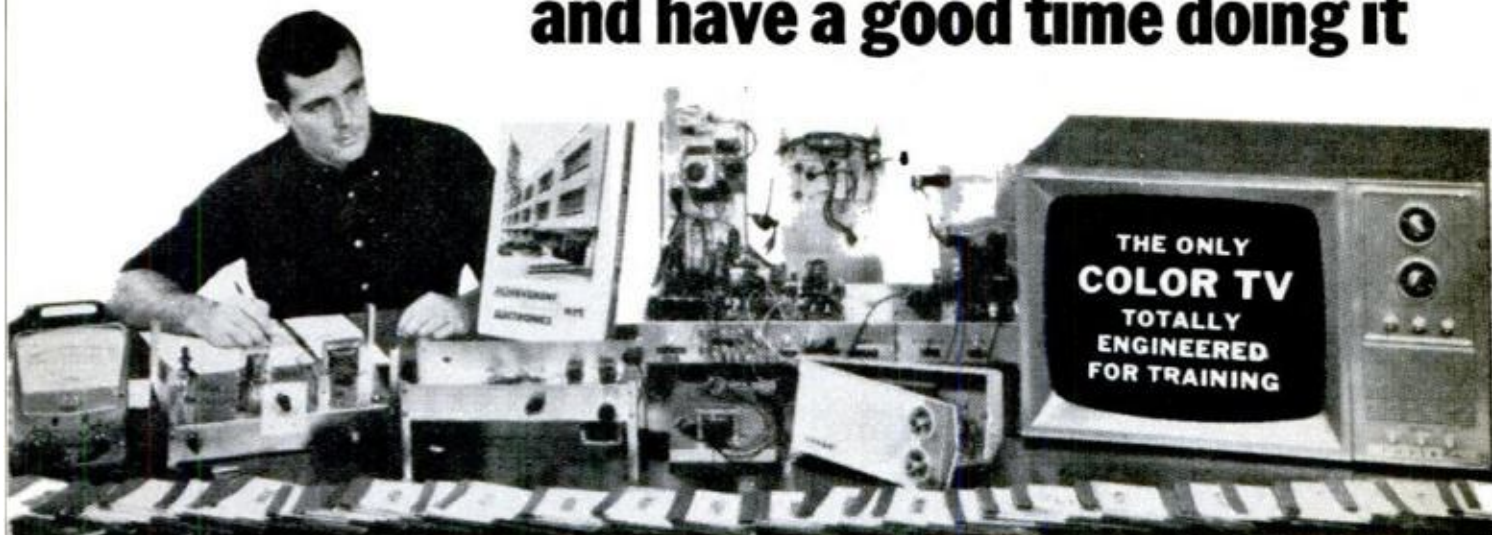

BUILD • TEST • EXPLORE All this is yours — from Achievement Kit, to solid state Radio, to training-engineered Color TV set—when you enroll for NRI's TV-Radio Servicing course. Other courses equally complete. Unique training methods, "bite-size" texts, many personal services have made NRI the leader in its field for over 50 years.

NRI Programmed Equipment Gives You Priceless Confidence, Makes Learning TV-Radio, Electronics Fast and Fascinating

NRI pioneered the idea of supplying home-study students with custom designed training kits to give practical on-the-job experience as you learn. Today, NRI's "3-Dimensional" training can't be equalled. You get more value—from the exclusive Achievement Kit sent the day you enroll, to "bite-size" texts and custom training equipment. Learning TV-Radio, Electronics or Communications at home is easy, exciting, the NRI simplified, dramatized way.

BE A SKILLED TECHNICIAN IN AMERICA'S FASTEST GROWING INDUSTRY

Regardless of your educational background, you can learn the Electronics field of your choice the practical NRI way. The NRI color catalog, sent to you free and without obligation, tells you how you can qualify quickly to be a part of the fast growing Electronic Age; about engineering jobs in business, industry, broadcasting, government, now offered to men without college degrees. It will open your eyes to the great number of success opportunities available right now in the high-pay world of TV-Radio Servicing, Broadcasting-Communications and Industrial-Military Electronics. With NRI technical training, you can take your choice of a wide variety of career

openings or have a business of your own. And if you choose one of five NRI courses that include FCC License preparation, you must earn your FCC License or NRI refunds your tuition!

MAKE \$5 TO \$7 AN HOUR EXTRA IN SPARE TIME STARTING SOON

Tens of thousands of NRI graduates are proof it is practical to train at home in your spare time. Keep your present job while preparing for a better one, and earn \$5 to \$7 an hour extra in spare time while you train, fixing sets for friends and neighbors. NRI shows you how. Equipment you build and keep becomes useful in your work.

STEP UP TO BETTER PAY, A BRIGHTER FUTURE

NRI can help you, but the decision to act must come from you. Decide now to move ahead . . . mail the postage-free card today for your FREE NRI color catalog. No obligation. No salesman will call. NATIONAL RADIO INSTITUTE, Electronics Division, Washington, D.C. 20016.

APPROVED UNDER GI BILL

If you served since January 31, 1955, or are in service, check GI line on postage-free card or in coupon.

CASH IN ON THE BOOM IN COLOR TELEVISION



The NRI TV-Radio Servicing course includes your choice of black and white or color TV training equipment. Color TV needs thousands of trained men to keep pace with millions of sets being sold every year. NRI prepares you quickly. Cash in on the boom.

Mail insert card for
your **FREE NRI**
color CATALOG

No salesman will call



NEW MUF-LER-FIX

REPAIR YOUR OWN



No need to scrape, buff nor clean area to be repaired. Muf-Ler-Fix adheres to rusty or even oily metal. Anyone can apply Muf-Ler-Fix using simple directions. Muf-Ler-Fix lasts as long as metal to which applied. Useful on trucks and tractors or for household items such as gutters, buckets, gasoline cans, garbage cans, etc.

STOP NOISE AND FUMES

To obtain Muf-Ler-Fix, send \$3.00 cash, check or money order to:
HARDCAST, INC.,
 P.O. Box 19167, Louisville, Ky. 40219

Your name: _____
 Address: _____
 City: _____ State: _____ Zip: _____
 (Please print plainly)

"POP" RIVET TOOL

MAKES NUTS & BOLTS OLD FASHIONED!

Now fasten things in seconds. Permanently. From one side of the work!

- 1 Insert "POP" Rivet in holes
- 2 Pump Rivetool handle
- 3 "POP" it's fastened forever!

Kit includes tool and assorted rivets. At hardware dealers.



USM Corporation
 Consumer Products Division

WHAT'S HE DOING!

Making a Concrete Flower Pot! . . . and SO CAN YOU!



Make and sell your own Ornamental Concrete items. Rush \$2.00 for book about Aluminum Molds with prices and production trade secrets direct from world's largest mold manufacturer. Over 350 designs to select from.

Send \$2.00 **CONCRETE MACHINERY COMPANY**
 Today To → P. O. BOX 99 • HICKORY 2, N. C. 28601

REAL ESTATE BE A BROKER

PAYS BIG! SEND FOR BIG FREE CATALOG NOW! Graduates report making substantial incomes. Operate your own business quickly. Men, Women, all ages, learn easily. Course covers Sales, Appraising, Loans, Mortgages, & related subjects. **STUDY AT HOME** or in classrooms in leading cities. **Diploma Awarded. Write Today for FREE Book!** Accredited Member National Home Study Council. (Est. 1936) G. I. Approved.
WEAVER SCHOOL OF REAL ESTATE
 3521-P Broadway Kansas City, Mo. 64111

FREE BOOK TELLS HOW

5-in-1 METAL LATHE

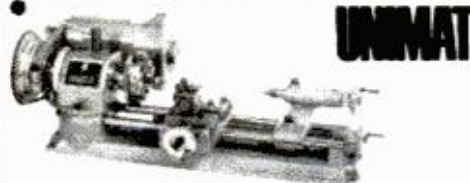

Easy for modelmakers, gunsmiths, inventors to precision machine small parts. Lathe converts in seconds to vertical mill, drill press, grinder & polisher. AC/DC motor, 11 speeds, 3" swing, 17" overall. 90,000 in use. \$149.50. Send for free details, or \$1 for 48-page "Miniature Machining Techniques" handbook. (Available in Canada.)

AMERICAN EDELSTAAL, INC. DEPT BC-1
 1 ATWOOD AVE., TENAFLY, N. J. 07670



FREE!

Learn how you can buy used engines \$15 up, new engines \$30 with FREE confidential list and coupons when you order your plans

- **BUILD THIS MINI-BIKE!** Plans reveal step by step details!
- **BUILD A RACING KART!** Build frame for less than \$10!



RUSH \$2 for plans (indicate type) or send 25¢ for circular describing plans
PLANS, Box 651, Valley, Nebr. 68064

TREASURE & COIN DETECTOR

MONEY BACK GUARANTEE

New electronic detector penetrates deep into earth to locate gold, silver, coins, minerals. More penetrating power than ever before. Sensitive enough to locate a single coin or small nugget. Works through earth, wood, vegetation, water, rock, etc. Not a "probe" type but a fully electronic detector that is guaranteed to have at least twice the detection ability of any detector in this price range or return in 10 days for refund. Uses inexpensive 9V battery. Fully transistorized. Weighs only 2 pounds. Loudspeaker signals when object is detected. Has plug-in earphone for treasure hunting in privacy. **NOTHING ELSE TO BUY!**

29⁹⁵
PER UNIT



Comes complete, ready for operation. Shipping container has compartments for detector and all accessories, serves as a carrying case. Send only \$29.95 check, cash or M.O. for postpaid shipment or \$2.00 and pay \$27.95 plus small C.O.D. when delivered. **Viking Detectors, Dept. V-2, Box 10680, Houston, Texas 77014**

Evinrude Sportwin gives you more chances to get "lucky."



The smartest fishermen have the most "luck." Evinrude designed the Sportwin to help make them even luckier — by making it easier to be in the right place, at the right time, doing the right thing.

Sportwin is short — just 34 inches prop to top. Easy to carry and stow. On the boat, it hides down low. You fish over it, not around it.

It's rated at 9½ horsepower, which qualifies it in the "under 10 hp" class — so you can use it just about anywhere.

But its big 15.2 cu. in. displacement makes it the strongest, fastest "under 10" around. It really moves a load.

Sportwin has 16 quick-trim positions — eight for running in weeds and shallows — and eight for fitting hard-to-fit rental boats.

You can run in a tilt-out position in weeds without having to run that way all the time.

The motor is isolated on rubber mounts, so fish-spooking vibration isn't transmitted by the boat. It's so smooth and quiet when you're trolling, you may wonder whether it's even running.

Sportwin has Evinrude's Safti-grip propeller clutch protection. And it's salt-water designed, like all Evinrudes.

All in all, it's quite a motor. So it's not surprising that this sporty little shorty has become the most popular fishing motor ever made.

Fishermen are getting smarter all the time.

Write for Catalog, Evinrude Motors, 4075 North 27th Street, Milwaukee, Wisconsin 53216.

power for the performance generation

EVINRUDE  **first
in
outboards**
Div. of Outboard Marine Corporation

ON-THE-GO

CAMPING

BY V. LEE OERTLE

CASINO-STYLE RV RESORT COMING! Camper Ranches, Ltd., has acquired a former casino in Las Vegas, Nev., and is transforming it into the first gambling RV resort. Paved campsites by the casino, shops, baby-sitters, and mechanical services are expected to lure the RV traveler who wants to gamble. Rates are tentatively set at \$50 a week or \$10 daily. Camper Ranches, Ltd. (Box 4507, Las Vegas, Nev. 89106), is also adding other parks to its chain in Idaho, New Mexico, Florida, California and in Sonora, Mexico. Preregistration is said to be necessary to gain entry.

BE FUSSY ABOUT RV INSURANCE. There's a great difference in benefits offered by various insurance companies. Some companies view a trailer, camper or motor home as a higher-than-average risk, while others treat RVs with preferred-rate premiums. Be sure to ask these key questions: Does the insurance cover personal effects within the insured unit? Is it guaranteed renewable? Does it provide coverage while the coach is separated from the towing vehicle? Does it provide special payments for on-site fire department service, or for emergency expense allowances when you're involved in an accident far from home? New RV policies are available. Shop around!

GOLDEN EAGLE POLICY ESTABLISHED. The Golden Eagle Passport, an annual permit for use at public recreation sites operated by the National Park Service, Bureau of Sport Fisheries, Bureau of Land Management, U.S. Forest Service and Department of Agriculture, went on sale last Dec. 15, for a new annual fee of \$10. It is valid Jan. 1 through Dec. 31, 1971.

NEW SADDLE-TYPE CAMPER FOR BRONCO. The world's first overcab camper coach for a 4x4 Bronco station wagon was recently unveiled for *Popular Mechanics*. Called the Hi-Country Camper, the incredibly compact unit rides on the back and top of a 1971 Bronco wagon. It contains two bunks, fully-equipped kitchen and even a toilet compartment. All this luxury fits into a package small enough to attach or remove in 5 minutes, weighing under 500 pounds and costing well under \$1000. Details from Hi-Country Campers, Ber-mack Industries, Box 168, Whittier, Calif. 90603.

WARNING: INSURANCE COSTS ROCKET ON RENTALS. One rental dealer told us privately he must now pay \$60 per season to insure each tent-trailer he rents. Because some rental agencies carry as many as 100 units at the season's peak, insurance is a critical expenditure. As a result, rental rates will doubtless be higher this year.

Some dealers just "take a chance" and rent *without* insurance. Renters of units damaged while in their possession could be stuck for repair or replacement costs. Insist that the rental agent explain all insurance provisions. One camping family lost a rental tent-trailer when a cheap bumper-hitch broke. The dealer sued and made them pay. The bumper-hitch was inadequate; hence, negligence could be charged. Get insurance provisions written into your rental form!

CHEVROLET HAS CREATED SEPARATE RV DEPARTMENT to handle RV development and promotion in a bid to wrest the spotlight from Ford and Dodge. Most newsworthy in the announcement from GM was that it "will maintain close liaison with all recreational equipment companies to keep abreast of their present and future requirements for adapting our vehicles to recreational use." Chevrolet's past attitude has sometimes been: "Make use of what we offer." Now it's saying it will custom-build units for special coach duty. That's good news indeed. Head of the new department will be Herb Henry.

★★★

Uncommon carriers

Uncommon cargoes? Don't flip. Datsun gives you two great ways to haul.

Seals to Sasswood—the tough Li'l Hustler Pickup. Penguins to Potentates—try the more luxurious 5-Door Wagon.

Both give you 96 horsepower overhead cam engines. Potent in the short haul, reliable in the long. Both have some six feet of bed and floor space.

The Li'l Hustler, for example, has a flat loading tailgate. Slide on a spinet or generator. Hay bales or surfboards. Tie them down—there are plenty of built-in hooks. Slip into the all-vinyl

upholstered cab, flick the neat 4-speed stick and away you go.

And whatever you stash in the easy-load Wagon, you don't have to worry about the easy-to-clean vinyl upholstery. You just relax in full-reclining front buckets. Cool it under tinted glass (all standard equipment). And if shifting the full-synchro 4-speed isn't your style, liberate a hand and foot with the optional 3-speed automatic.

Carry out your plans in a Datsun. The number one selling import truck's just \$1916.* The perfect-size 5-Door Wagon just \$2350.*

Drive a Datsun...then decide.

DATSUN

PRODUCT OF NISSAN



*PLUS TAX, LICENSE, LOCAL FREIGHT AND DEALER PREPARATION. SPECIFICATIONS AND PRICE SUBJECT TO CHANGE WITHOUT NOTICE.

HOMEOWNERS' CLINIC

BY W. CLYDE LAMMEY

Laying a brick walk

I'd like to lay a brick walk without mortar from my front door to the sidewalk, about 30 feet. Inquiries bring varied advice about how to lay the bricks—lengthwise, crosswise or in a "herringbone" pattern. Can you give me an authentic go-ahead? Is there any preparation other than digging a trench that's brick-thickness deep?—N.H., Nev.

It depends on the soil, the slope (if any), drainage and the kind of bricks you use. For bricks laid "dry," that is, without mortar, you will need to trench at least 3 inches deeper than the thickness of the bricks and then tamp in gravel or crushed stone to a depth of at least 3 inches (4 or 5 inches if the soil tends to be at all unstable). Normally the bricks should be laid lengthwise with the run of the walk, but you can use any pattern that suits your fancy. In any case the edges of the trench must be cut straight so that they serve to hold the bricks in place. In time these bricks will settle, so keep the top of each one slightly above the level of the sod as you lay them. There's no special problem other than keeping the bricks uniformly level as you go. In some cases such a walk is crowned slightly; in others a line of bricks is laid on edge on each side before filling in. This latter step tends to keep the walk from settling unevenly.

Carpeted basement floor

I'm building a small home by myself. I have the basement in, first floor laid and temporary roof on. I'll live in the basement for a year; it's dry—no seepage or flooding. Temporary partitions divide the space into three rooms. I want to carpet the largest as a "living room." Later it will be the rec room. Is this practical? What carpeting should I use?—W.S., Ark.

You might use the new indoor-outdoor carpeting. I would want to be very sure there is no seepage, that flooding is extremely unlikely, and that the floor is absolutely clean and smooth—no dusting, loose material or ridges. I also would coat the masonry foundation walls—block or poured concrete—with a masonry water-proofer and, if necessary, provide adequate ventilation with a small fan installed

in a window. Indoor-outdoor carpet usually is supplied as squares to be cemented or taped to the floor like tiles.

Outside paint problems

You're doing a creditable job of answering questions, but I disagree when you imply that common outside paint problems—blistering and peeling—are due to moisture coming through from the room side. I say that in many instances paint problems are caused by heavy dew and rain filtering into tiny cracks that develop in the paint film, enlarging these breaks and eventually causing the paint to crack and peel. The tiny cracks generally are caused initially by expansion and contraction of the wide, softwood sidings now commonly used. Right?—T.D., Md.

In saying that peeling and blistering are due to moisture coming through walls from the room side I did not mean to imply that all paint problems are due to this cause. Prevailing winds, latitude, location of shade trees and adjacent structures expose painted siding to differing "climates" on sides and ends of any dwelling.

Wide, softwood sidings do shrink and expand with periodic changes in temperature and humidity. Though slight, these variations can cause stresses on the paint film often resulting in fine cracks along the grain. Shrinkage usually causes breaks, or "upsets," in the paint film along the length of the board, resulting in tiny ridges in the form of inverted vees. Eventually these widen and the loose strips of paint fall away, exposing the wood to moisture absorption. Edges of the narrow opening thus formed often loosen and curl. This is especially difficult to deal with by sanding or scraping. Usually it's advisable to take off the defective paint film to the bare wood with a chemical remover. Or, you can remove all the loose material and fill these narrow breaks with spackling compound, sanding it smooth after it has hardened. I don't know that this is an approved practice, but I have done it successfully.

Attaching ornament to brick

How can I attach a fairly heavy cast-iron eagle ornament to the brick above my fireplace mantel?—J.M., Ga.

Perhaps the best way is to make a hole about 3 inches deep in a mortar joint with a star drill, then drive in a slightly oversize dowel. Drill the end of the dowel and turn in a roundhead screw to nearly full depth. Hang the eagle from the screw, centering it to hang level. ★★★



Never hot. Never dry. Always cool.
Come all the way up to KOOL.

©1971, BROWN & WILLIAMSON TOBACCO CORP.

MAKE BIG MONEY

OPERATING HEAVY EQUIPMENT



**BULLDOZERS
CLAMSHELLS
TRENCHERS
DRAGLINES
BACKHOES
SCRAPERS
GRADERS
CRANES**

The Construction Industry is Booming! Earn top money in this fast moving, action-packed field. Keep present job and train at home in spare time followed by practical training on our machines under project conditions at our facilities. Nationwide placement assistance. For FREE information fill out and mail coupon today!
Member American Road Builders' Assn.

APPROVED FOR VETERANS AND INSERVICE PERSONNEL

UNIVERSAL HEAVY CONSTRUCTION SCHOOLS, Dept. PM
1901 N.W. 7 STREET / MIAMI, FLORIDA 33125
Phone: (305) 642-2332 (24 Hours)

Please Print

Name _____ Age _____

Address _____

City _____ State _____

Phone _____ Zip _____



If you can use these simple tools . . . you can air condition your entire home and save \$200 or more

With these simple tools you can add whole-house air conditioning to your forced-air furnace. Our central air conditioning kit is designed for do-it-yourself installations in homes up to 1800 sq. ft. We furnish step-by-step instructions and help you select the right size unit. Complete kits start at approximately \$500.00* Mail the coupon today!

*Cost varies according to home size and construction.

McGraw-Edison Company—Albion Division
703 North Clark Street, Albion, Michigan 49224.
Please send free brochure on Do-It-Yourself central air conditioning kit that can save me \$200 or more installation cost.

NAME _____

ADDRESS _____

CITY, STATE _____ ZIP _____



BLAST CARBON
from every engine with
Fuel Mix Tune-Up Concentrate
New! from **GUMOUT**

WRIST ROCKET

AMERICA'S Pat. HARDEST U.S. HITTING SLING
Range 225 yd. - 232 fps
Matched spare rubbers and pouch assembly, \$1.00.



Write:
WRIST ROCKET®
P. O. BOX 21-B
Columbus, Nebraska 68601

\$3.00 Post Pd.
No C.O.D.'s

locksmithing and key making

PRACTICAL UP-TO-DATE COURSE — ONLY \$7.95



Teaches you how to pick locks, de-code, make master keys, repair, install, service, etc. New self-instruction lessons for every handyman, homeowner, carpenter, mechanic, service station operator, fix-it shop, hardware dealer, gunsmith. 53 easy illustrated lessons. Full price only \$7.95 post-paid. Satisfaction or refund guaranteed. Mail order today!

NELSON-HALL CO., Dept. CZ-2
325 W. Jackson Blvd., Chicago 60606

HYDRAULIC JACK REPAIRS



Earn While You Learn at Home
Earn while you learn at home. Millions of jacks in gas and auto service stations, trucking firms, body shops, riggers, factories and farms need servicing . . . most of which you can learn to repair. We show you HOW. Start spare time in your basement or garage. Big opportunity for mechanics. ACT NOW!
Write for folder No. PM-3 and free bonus offer.

HYDRAULIC JACK REPAIR MANUAL CO., INC.
G. P. O. BOX 3 • STATEN ISLAND, N. Y. 10314

BLAST FURNACE 2400 F



Since 1938
Hobbyists • Schools • Inventors, etc.
Make your own castings of any metal from cast iron, down to lead and zinc. Available in 6 sizes, 1 1/2 to 50 lbs. Complete units from \$50.40 to \$162. Send 25¢ for circular—refundable.

KANSAS CITY SPECIALTIES CO.
Dept. P-3
P.O. Box 193
Middleton, Wisc. 53562

GLASS BLOWERS KIT \$13.95^{pdd}



SPECIAL TRIAL SIZE KIT
Contains assorted crystal and colored glass with complete instructions, diagrams and actual glass model. Learn to make beautiful ships, birds, bottles for fun and profit.

SEND \$13.95 TO
WILLIS GLASS SUPPLY CO.
BOX 3460 — ARTIST STUDIO — A
ANAHEIM, CALIFORNIA 92803

FREE FISHING



CATALOG
170 PAGES
OVER 5,000
FISHING ITEMS

Hard to find Fishing Specialties and Kits
Please don't miss this great 1971 Catalog
NETCRAFT CO.
Toledo, Ohio 43613

POPULAR MECHANICS

The outboard built like a racing car.

We didn't build our Johnson Sea-Horse 125 hp low and fast just so we could say it's low and fast.

Good engineering let us build it low. Like the V-4 design's short, straight-in fuel induction paths. Or the compact cooling and internally tuned exhaust systems. Or the short, rigid crankshaft. Or the Capacitor Discharge ignition system, which has fewer parts, yet is 20 times faster than conventional ignition systems.

Our Sea-Horse 125 is a full one-third shorter than competitive outboards. You can fish over it. See over it. Tow skiers over it. Can you do all that with anybody else's motor? Ask them. And while you're at it, see if their outboard has a low center of gravity for extra turning stability. Or if it takes up less space when tilted forward.

Now you know how and why we built the 125 low. We built it fast so you can set new performance rec-

ords. Like our V-4's did at the last American Power Boat Association Nationals. Or in the world's outboard endurance competitions at Rouen and Paris, France.

And here's the clincher. Power Shifting with single lever remote control is standard.

So visit your Johnson dealer.

Just tell him you want to see the little motor. With big go.

Or maybe you'd like our catalog. It tells all about the 125 and everything else Johnson makes, right down to the 2 hp baby. Write Johnson Motors, Waukegan, Illinois 60085. Dept. PM-371.

Watch for two Johnson NBC-TV specials. March 14, "The Greatest Show on Water... at Cypress Gardens", with host Ed McMahon. April 11, "National Boating Test". Checks your knowledge of the basics of safe boating. And see the Greatest Show on Water at your Johnson dealer's during March-April.



For lots of fast reasons.

THE CAR — FAMOUS LEADER CARD RACER.



Division Outboard Marine Corporation — makers of OMC Stern Drives

SOLUTIONS FOR MECHANICAL HEADACHES

AUTOMOBILE CLINIC

BY MORT SCHULTZ

Rear-end clunk

The rear end of my 1970 Ford truck gives out with a "clunk" when I start off. The service manager says that most Ford trucks are doing this because rear springs are weak and letting the rear end shift up and down. Is he putting me on?—Caron Hotchkiss, Waycross, Ga.

In many cases, the clunk is caused by dirt on the driveshaft splines and lack of lubrication. Tell the dealer to pull the shaft, clean the splines carefully and lubricate them as specified in the car's lubrication chart.

Vibrating shift lever

My 1969 Valiant's stick-shift lever on the steering column jumps up and down, and makes a racket. It is very bad when going over bumps. Can you help me?—E. M. Bowlby, Trenton, N. J.

They all do this to some extent, but if the condition is bad enough to cause "a racket," there is a mechanical reason—like a broken transmission mount or misaligned steering column.

Gas in oil

I have a 1959 Chevrolet Six that's drawing gasoline into the oil. My mechanic has changed the fuel pump twice, overhauled the carburetor and replaced the manifold without success. Where do I go from here?—Leo Tucker, North Hollywood, Calif.

Clean out the crankcase ventilation system to assure good airflow. This should include the valve cover air inlet breather and road draft tube. There are metallic screens in each of these that can become dirty and restrict airflow, which would cause internal pressure, forcing fuel past rings and into the oil. Naturally, with a car this old, there is always the chance of piston and piston ring wear.

Should she downshift?

I would appreciate your opinion on how to descend these steep Connecticut hills in my Volkswagen. My husband says to shift to second gear. My brother-in-law says brakes are cheaper to replace than a

transmission and I should depend solely on foot braking. To whom should I listen?—Mrs. Olga Buttrick, Watertown, Conn.

Your husband and the VW owner's manual which states that when descending a hill you should make full use of the engine's braking power by selecting a lower transmission range. You won't hurt the transmission by using it for a purpose for which it's intended. Just don't select too low a gear and over-rev the engine.

Can't adjust brakes

The adjusting mechanisms for brakes on the Oldsmobile Toronado are out of sight of the slots in the drums. Is there an offset tool I can buy to make this adjustment?—H. G. Thomsen, San Francisco.

No. These are self-adjusting brakes and, theoretically, you shouldn't have to adjust them manually. However, self-adjusting mechanisms can freeze because of dirt and rust—the main reason why auto manufacturers recommend that you exercise self-adjusting mechanisms every so often by backing the car up and applying the brake pedal. If mechanisms in your car have frozen, you will have to pull the drums, free the mechanisms, and lubricate them and the brake guides.

Ford's I-beam headache

I and other people have the same problem with the 1969 Ford Club Wagon—trying to get the right front tire to last more than 6000 miles. Several trips to the dealer and phone calls to Ford's regional office have not led to a solution. I am at my wit's end and, if I could afford to, I would get rid of this vehicle. Ford surely didn't have a better idea making twin I-beam suspension.—John Decker, Paterson, N. J.

I took this one to FoMoCo, which claims the problem will probably be overcome if you adjust toe-in exactly to the specification outlined in the shop manual and rotate tires. I realize this appears too simple, but it's worth a try. If it doesn't work, there's another solution I've heard of: Replace the front springs with a heavier type—part No. C8UZ-5310-F for the left side

(Please turn to page 70)

When your kid starts telling you what oil to use, listen.

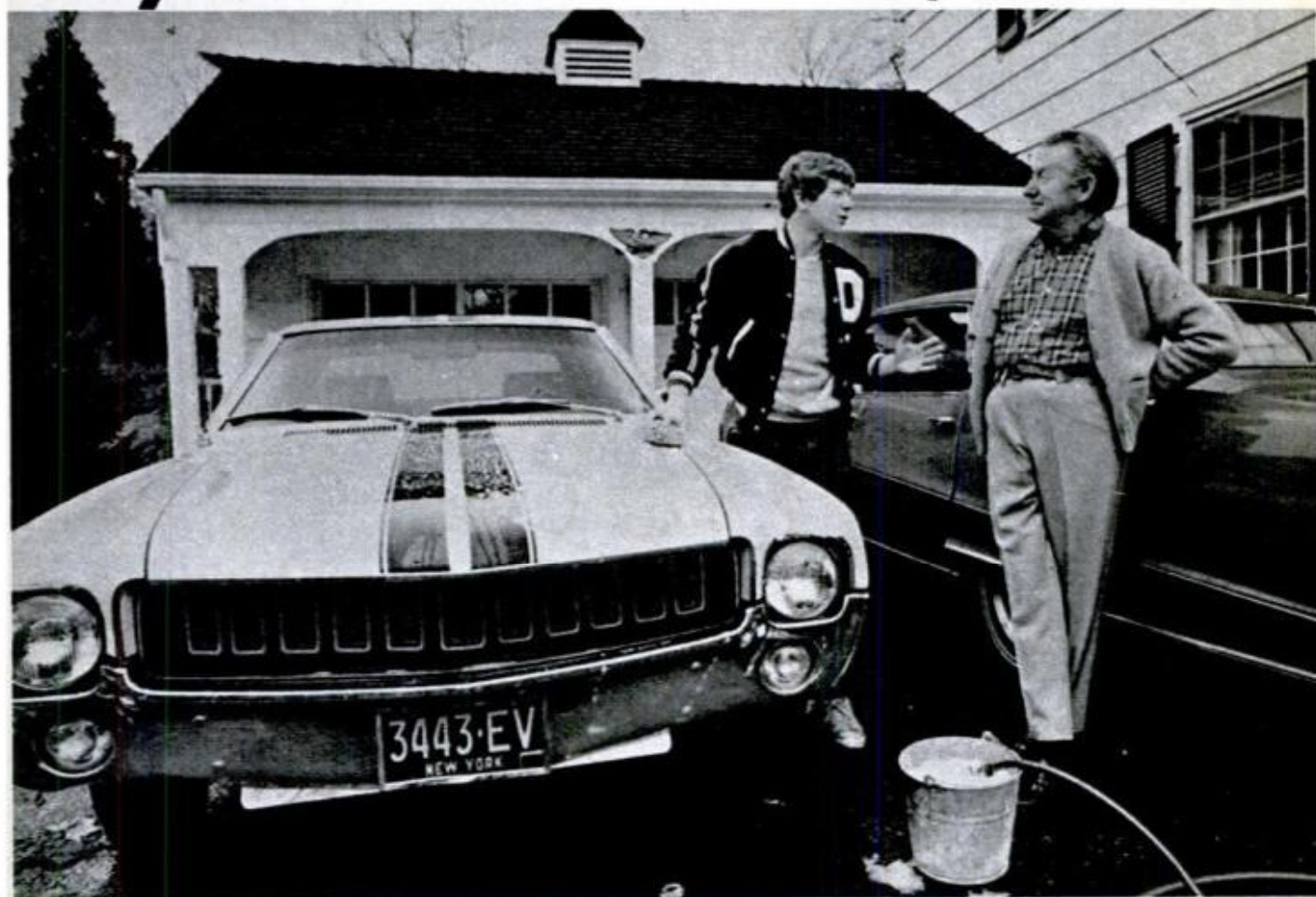

He may be your kid. But that's no kiddy-car he's driving: a 390-cube, 4-barrel V-8, four-on-the-floor muscle machine he has purring like the family kitten.

He knows cars. He knows motor oils. That's why his motor oil is Quaker State. It's refined only from 100% Pure Pennsylvania Grade Crude Oil, the world's best natural lubricant. Then it's fortified to protect an engine even more than any car maker's warranty demands.

Next oil change, do like your resident car expert. Ask for Quaker State wherever they care about cars. It does great things for your engine. And your peace of mind.



Quaker State your car to keep it running young.

BUICK MOTOR DIVISION

**We give you better
reasons to buy a new car
than anybody else.**



The 1971 Buicks offer reasons that will make you feel you've spent your money very wisely. Things you can believe in. Like these:

MaxTrac.

Helps stop fishtailing before it starts. An on-board computer detects rear wheel spin and controls the power fed to the rear wheels. An exclusive Buick feature you can order.

AccuDrive.

A directional stability system with a new forward steering feature that gives you improved, smoother handling, especially on windswept, bumpy roads. An exclusive Buick feature on every Electra and LeSabre.

Balanced braking.

The power braking system is equipped with a unique valve that proportions the braking force from front to rear. Which helps give you smooth, quick, straight-line stops. The standard front disc brakes help, too.

Clean engines that also perform.

The new Buick engine is designed to run efficiently on no-lead or low-lead gas with lower exhaust pollutants. But without sacrificing smoothness or performance. And Buick's exclusive nickel-plated engine exhaust valves lengthen valve life.

Owner loyalty.

Once people buy a Buick, they generally keep coming back. Proof? Ask any Buick owner.

Resale value.

It's one reason our owner loyalty rate is so high.

Our dealers.

Another reason people are loyal to Buick: the dealers are loyal to them.

The 1971 Buicks are waiting for you to test-drive now.

Pictured below are the new Buick LeSabre (left) and the Buick Electra 225.

1971 Buick. Something to believe in.



AUTOMOBILE CLINIC

(Continued from page 66)

of the car and part No. C9UZ-5310-A for the right. Then, bend the twin I-beams until front-end alignment is brought into proper spec.

To preserve tires

Is there something I can put on tires to preserve them? I don't mean tires that are on the go every day, but those on trucks and farm machinery which stay out in the open and stand idle for some time.—Richard Johnson, Geneseo, Kans.

If there is a worthwhile tire preservative, I haven't heard of it. I guess that you are noticing little check marks on the sidewalls—so-called weather checking. The only thing I can recommend is that you keep tire pressure up to normal, jack up the wheels and slip boards beneath the tires. Allowing the tires to rest on boards will protect them against the freezing and thawing of the ground.

The hot one

I have a 1965 Pontiac GTO that has the three two-barrel-carburetor setup. No matter what I try, including carburetor rebuilding, the center carburetor runs rich. I've spoken to many people having this arrangement and they have the same problem. The car runs okay, but isn't as responsive as it should be. Is there a solution?—Jay Keller, Reserve, La.

No. This is the way it is with the three two-barrel setup; the engineers have yet to find a solution. One carburetor, nearly always the center one, has more heat concentrated on it than the other two simply because of its position in the engine compartment. Heat causes the carburetor to overload. Not even smaller size jets will help.

Jumping hood

When I hit a bump, the hood of my 1969 Chevelle Malibu jumps open. Fortunately, the safety latch keeps it from flying up. The bolt has been adjusted a few times, but this hasn't helped. What should I do?—Meyer M. Katz, Brooklyn.

This is what happens when guys at the

gas station get overzealous when closing the hood. They bend the bolt. You have two choices: move the striker plate in the radiator grille or replace the bolt.

Service Tips

If you have recently purchased motor oil and have examined the can, you may have noticed some strange letters you've not seen before—SD, SC, maybe even SB. This is a new way of identifying what an oil is intended to do. It replaces the MS—MM system with a graded system that specifically establishes performance levels. Here's what the letters mean:

● **SD.** Oil bearing this classification on its can, which means that the oil is for service class D, tells you that it has been refined to meet the requirements of automobile manufacturer warranties for passenger cars beginning in 1968. If your car is under warranty and you use any oil other than SD (or MS), you will void your warranty. This oil provides the greatest protection you can get against high and low temperature, wear, rust and corrosion.

● **SC.** Oil bearing this classification is refined to meet the requirements of auto manufacturer warranties that covered the 1964 through 1967 models. It provides protection against temperature, wear, rust and corrosion, but not to the same degree of protection afforded by SD.

● **SB.** Oil intended for service class B is for use in engines which are operated under mild conditions and need minimum protection. This oil provides only anti-scuff capability, and resistance to oil oxidation and bearing corrosion. Naturally, an oil designated SD can be used where oil designated SB or SC is suggested.

● **SA.** This isn't suited for automotive engines. No performance requirements for service class A oils have been established.

Although these new designations are in existence now, for the next year anyway you will still encounter oil cans having the MS and MM classifications. MS means that the oil is designed for severe motor service—stop-go driving, short trips, and long periods of idle as well as high-speed operation. MM means that the oil is designed for moderate service—where there is little stop-and-go, short-trip and long-idling driving. ★★ ★

GOT A PROBLEM WITH YOUR CAR? Ask Mort about it. Send your question to Auto Clinic, Popular Mechanics, 224 West 57th St., New York, N.Y. 10019. Letters cannot be answered individually, but problems of general interest will be published in the column.

Old Crow begins with men who love to work with their hands.

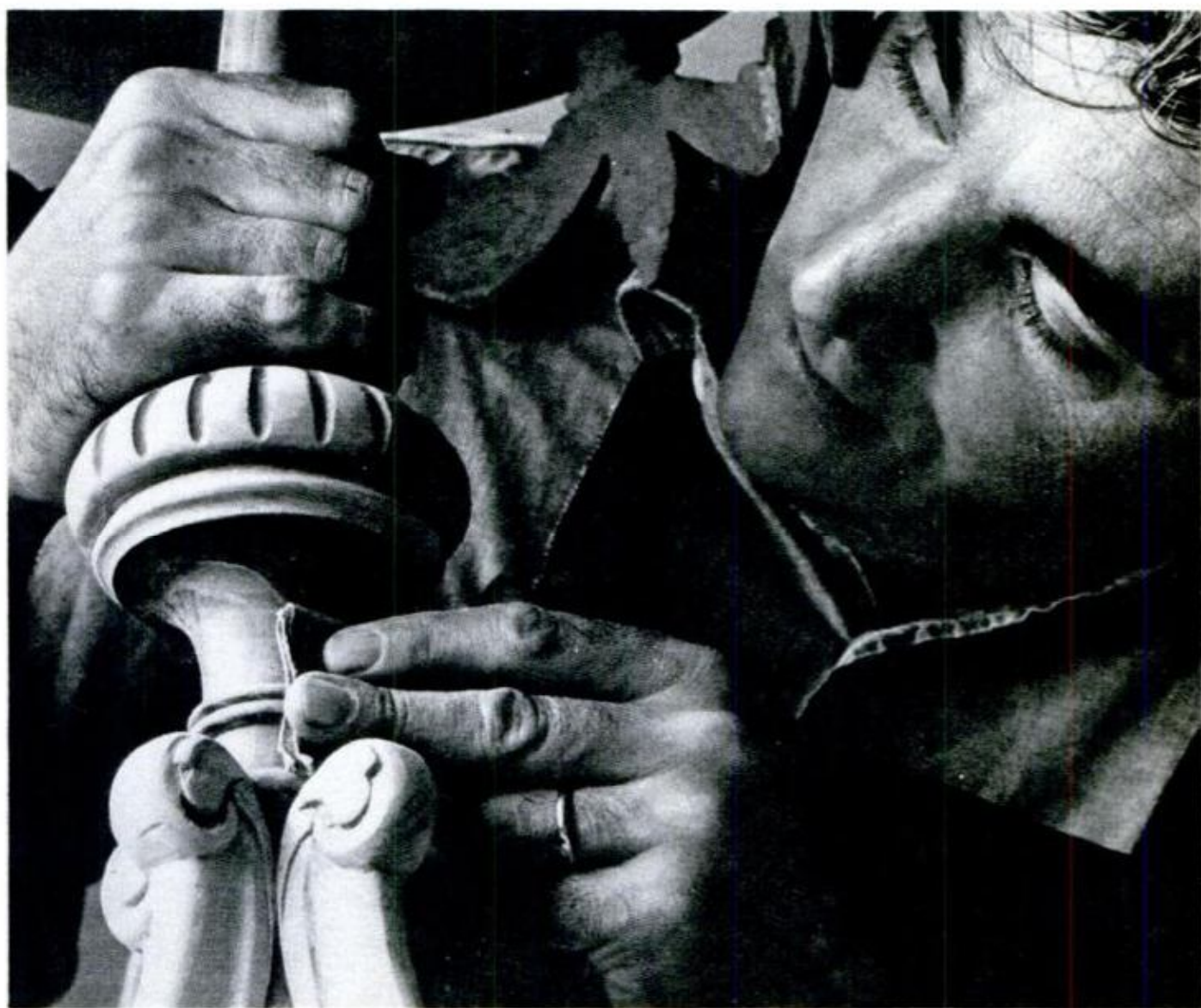

Some of Old Crow's men have been making whiskey so long they can almost find a flaw with their eyes shut. Eyes open, and hydrometer in hand, Ralph Wise analyzes each batch of our Bourbon, making sure it tastes as good as it can be made.

Back in 1835, Dr. James Crow discovered that scientific controls could produce a Bourbon which tasted good bottle after bottle. Later, he handmade the first sour mash Bourbon. We still use our hands in making Old Crow.

"I get peace of mind working with my hands," says Wise, "and some pretty nice furniture, too."

Ralph Wise calls on the same craftsmanship making our country Bourbon as he does refinishing this antique table. For a set of refinishing plans, write: Old Crow, Box 675, Frankfort, Ky. 40601.



Soften table's old finish with remover. Scrape. Use toothbrush to get at crevices.



Wipe wood with fine steel wool soaked in paint remover to avoid scratching. Sand.



Stain. The trick is to follow the grain, use long strokes, work fast.



Old Crow
Made by good Kentucky hands

KENTUCKY STRAIGHT BOURBON WHISKEY. 86 PROOF. DISTILLED AND BOTTLED AT THE FAMOUS OLD CROW DISTILLERY CO., FRANKFORT, KY.

Mr. Victor suggests a much longer cigarette to go with his new hairstyles.

Now everybody will be smoking longer cigarettes to go with their new hairstyles

...almost everybody.



Camel Filters.
They're not for everybody.
(But then, they don't try to be.)





'A-Wax'...

It Protects the Surface From Six Miles Up!

You spell it AWACS—an eight-engined 707 with enough radar, radio and computers to boss a whole battle.

By MERLE E. DOWD

THOUGH IT SOUNDS like something you might polish your car with, it's designed to polish off an enemy. AWACS (pronounced a-wax) stands for Airborne Warning and Control System. It's a flying nerve center—a big jet crammed with the most complex package of communications, display and computer gear ever assembled in a single plane. And it's a full-scale radar station that can operate at 30,000 feet.

AWACS is the Air Force's newest defense system. In its tactical role, it will provide a commanding officer with the best "view" any general ever had of a battle.

From its sky-high position, AWACS monitors the progressing action (see illustration on the following two pages). Radios crackle; an artillery man relays a call through AWACS for an air strike against a stubborn mortar position. Radar picks up a flight of enemy attack fighters as they streak through the hills 100 miles away. As

radar and computers vector the fighters' position, a signal scrambles an interceptor squadron to surprise the attackers. An urgent radio message calls for an air-evac helicopter to pick up wounded. Infrared sensors locate enemy troops infiltrating along a supply route. An observer pinpoints the position and calls for fighter-bombers. Following a tip from an AWACS observer, fire-belching gunships attack a band of guerrillas waiting to ambush a convoy. Navy attack-bombers appear on an AWACS screen as they catapult from carriers off the coast and assemble for a low-level strike at coastal defenses.

Communications form the hub of AWACS activity. Radio, TV, infrared and other sensors, and the all-important radar flood displays and earphones with information as AWACS loiters above the battlefield. Radar blips constantly update map displays. Signalmen hunched over cathode tube (CRT) display consoles or seated with

AIR FORCE
FIGHTER-BOMBERS
PROVIDE
GROUND SUPPORT

MARINE FIGHTER
PLANE COVER

MAIN SUPPLY ROAD
BLOCKED BY ENEMY AMBUSH

U-2 HIGH-ALTITUDE
RECONNAISSANCE PLANE

PUFF THE MAGIC DRAGON
SUPPORTING A BESIEGED
U.S. MARINE PATROL

TACTICAL INFANTRY
PARACHUTE ASSAULT

ARMY
HELICOPTER
GUNSHIPS

AMPHIBIOUS
LANDING

ENEMY INTERCEPTORS

HELICOPTER,
INFANTRY
ASSAULT

ENEMY ROCKET BATTERY
UNDER AIRCRAFT ASSAULT

ENEMY MECHANIZED ATTACK

FIGHTER GROUND-SUPPORT MISSION

headphones in front of maps relay messages back and forth among walkie-talkie-equipped ground troops, field commanders, attack aircraft in the area, and naval gun batteries offshore.

Great gobs of data pour in. The officers aboard AWACS know more about developments on the ground and in the air than any commanders ever knew before—and while it is all happening.



SUB RECON MISSION

B-52
BOMBING
MISSION



U.S. SHIPS MOVE
TO NEW POSITION



NAVY FIGHTER PLANES TAKE
OFF ON INTERDICTION MISSION



TROOPSHIP WITH
MEN FOR ASSAULT



AMPHIBIOUS
LANDING



FIGHTER GROUND-SUPPORT MISSION



AIR-CUSHION
VEHICLES



ARMY INFANTRY PATROL
REQUIRES ARTILLERY SUPPORT

So that land and sea action could be portrayed, the battle scene by artist Ed Valigursky shows AWACS at a much lower altitude than it would normally operate

In its air-defense role, AWACS will extend radar surveillance hundreds of miles beyond U.S. borders. The Air Force doesn't say just how far. In times of low tension, AWACS picket planes could remain on ground alert. OHR-B (Over the Horizon Radar—

Backscatter) monitors could pick up bogies approaching. A signal would scramble the AWACS crews. Once airborne, AWACS immediately enlarges its area of surveillance as it speeds to its lookout station. During periods of high international tension, AWACS would remain on airborne alert.

Dual-purpose equipment will permit

(Please turn to page 198)



On narrow road through redwoods at Navarro, Calif. rack and pinion steering inspired confidence.



Crossing to Vancouver Island, B. C. Pinto compactness was an asset getting the last berth.



Windy Oregon coast has warnings; Pinto is easy to hold



Both cars agile on San Francisco's steep hills



With 4834 miles on Pinto, I switched to Vega at home of PM's West Coast Editor



Ran out of gas in Monterey!



Rest stop. Jackrabbit, Ariz.



Oil okay at Bighorn, Mont., after day of flat-out (86 to 91 mph), no-speed-limit driving.

STOCKTON

PM's Coast-to-Coast Test: Pinto

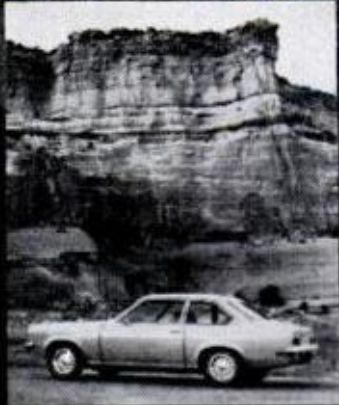

New Mexico is breathtaking; Vega sedan has good visibility

Last October, PM sent Irv Dolin, automotive photographer and car buff, on a journey around this large country, driving first Ford's Pinto from New York to California, and then Chevy's Vega back to New York. Irv (whose expertise in long-distance test driving started several years ago when he co-drove a racing "bird cage" Maserati from New York to Florida) drove the Pinto to Stockton, Calif., home of Mike Lamm, PM's West Coast editor. There he "traded it in" for the Vega and finally, after a month and a half of living in the two cars, arrived in the East with some definite conclusions.

By IRV DOLIN

I PICKED UP THE PINTO at a Ford garage in New York and started home to pack it for the long trip ahead. I thought, "It looks like an American car outside, but inside it has the feel of a small, imported sedan." Smart bucket seats, instruments and controls were well positioned—with one glaring exception: The dimmer switch is way up on the left side of the firewall. Very awkward. In fact, the first time I tried to use it I couldn't find it!

I found the driver's seat a bit low, but a thin cushion put me up where I

POPULAR MECHANICS



Added quart of oil at Dresbach, Minn.



Rest stop in Baraboo, Wis. Thoroughly accustomed to car, no aches or pains



First overnight stop in Pa., stressed need for very organized luggage stowing; trunk opening is narrow.

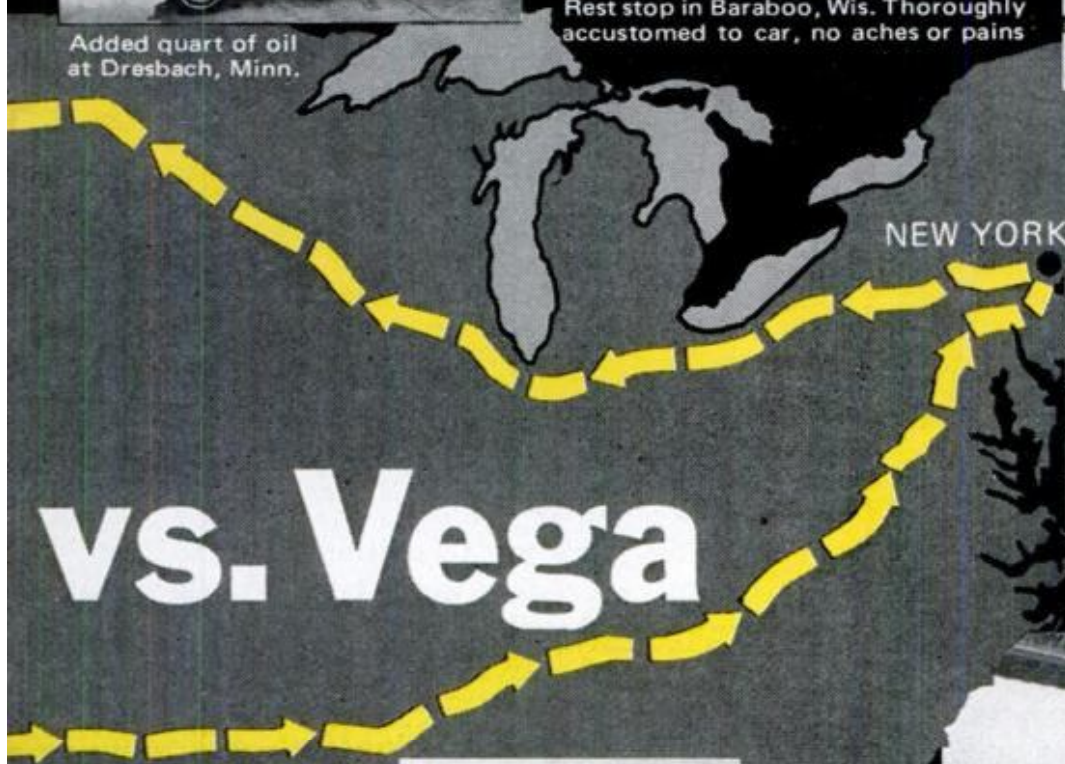

vs. Vega



In New York City, Pinto is ready to go—gas, lubricants topped off

In Shawnee, Okla., Vega styling praised as usual



Suspension shocks get back to the driver on both cars



Back in New York with 4806 miles on Vega. Used only 1/3 quart oil!



Passed Vega coupe on U.S. Rt. 70 near Rockwood, Tenn. Saw few because of GM strike. Car cruised at high speeds effortlessly.

wanted to be. The moderate fastback affords a little less rear visibility than I like but it's very good compared to Ford's bigger fastbacks.

The Pinto's trunk has no mat. With all my gear I needed some sort of padding to keep rough edges and the wingnut that holds the spare from scratching my bags. A large quilt solved the problem. Because of the narrow trunk opening, the trunk seemed smaller than it actually is. Still, it's not huge; a couple or a small family will find storage space inadequate on long

trips. I used the back floor and seat for some things. For its overall dimensions, though, the Pinto does pack quite a bit.

I've encountered a lot of American cars that have been sloppily put together: loose chrome, ragged carpets, bent moldings, screws in askew. But on this Pinto there was none of that. I'd have to rate it high on workmanship.

Before I got off poorly-paved Manhattan Island, I discovered that potholes are the Pinto's worst enemy. A couple of moderate-sized washouts made the



VEGA FILLER NECK is inconvenient to use and the filler pipe angle allows spillage when topping off

rear suspension bottom with a jolt. By the time I neared Williamsport, Pa., 200 miles west of New York on Interstate 80, I had confidence in the stability of the Pinto at high speeds and in the wet. Disconcerting, however, until you get used to it, is its action when you go over small bumps or tar strips on a curve. Expect a little rear-end hop to one side.

On those long stretches through North Dakota and Montana the Pinto cruised comfortably—for a small car—at 70 to 75 mph. Noise level was respectably low (lower than Vega's, I was to discover). Gas mileage on these flat-out stretches dropped as low as 19 mpg—well below the trip average of 25.17. With a slight downgrade and a tailwind I got the Pinto up to 91 mph. This was tops, short of dropping it off a cliff. On the level top speed was in the mid-80s. The manual says it won't go this fast, but that's what the speedometer read.

Just west of Fargo, I looked at the fuel gauge and figured I could make it to Jamestown. Soon, the needle was sitting on empty and for the last six or eight miles I just prayed. Nothing was to be seen on the horizon. I held a steady 60 mph and watched the odometer—mentally subtracting the miles I'd have to walk if I ran out. At last, a gas station! I rolled in with a sigh. We filled the tank to the very top, in-



A MORNING RITUAL was checking tire air pressure. I ran the fronts and rears of both cars at 28 p.s.i.

cluding the inside of the gas cap. The book says the tank holds "approximately 11 gallons." We got 11.8 gallons into it. (Later I ran low enough to get in 12.5 gallons!)

I found that driving fast—full-time work and fatiguing in any car if you're paying attention as you should—had a particular feel in the Pinto. Its rack-and-pinion steering is precise and responsive. It leaves no dead, sloppy play in the steering wheel when you're going straight ahead. And steering corrections due to wind gusts didn't need so much steering-wheel movement. You get a little aerodynamic buffeting from passing trucks on the interstates. Passing double trailer trucks on a two-lane road can be a genuine adventure because it takes a while to build up speed! On long grades, too, the Pinto slowly ran out of breath. In the Rockies I decided that if I lived there and were buying a Pinto, I'd go for the 90-hp engine. And I'd take the four-speed standard transmission over the automatic because I used second and third to good advantage on mountain roads.

I checked the odometer by highway mileage markers. Once for a distance of 50 miles I found the reading three miles high for every 100 traveled. All mileage and mpg figures have been corrected for this three-percent error.

Relaxing on the ferry from Victoria, B.C., to Port Angeles, Wash., I real-



ENGINE COMPARTMENT CHECKS were made often. Vega (above) used only one-third quart of oil on trip!



LUGGAGE STORAGE is tough in both cars—more so in Pinto, however. Luggage rack is a good option

ized that in several thousand miles, the Pinto engine had never skipped a beat, never fluffed and revealed no flat spots in its power curve. It also demonstrated good cold-weather starting, firing up without hesitation so you can drive right off with no coughing or bucking.

On the last leg down the Oregon and California coasts, I determined Pinto's 0-60 mph performance to be in the 18-second range. The gearbox, exceedingly smooth and a pleasure to use, contributes much to this respectable—for a 1600-cc Four—performance figure.

Test Cars—Specifications

	Vega	Pinto
Engine	4-cyl. Ohc	4-cyl. Ohv
Displacement	140 c.i.d. (2300 cc)	97.6 c.i.d. (1600 cc)
Horsepower @ rpm	90 @ 4700	75 @ 5000
Compression ratio	8.0:1	8.4:1
Transmission	4-speed manual	4-speed manual
Rear-axle ratio	2.92:1	3.55:1
Wheelbase	97.0 in.	94.0 in.
Overall length	169.7 in.	163.0 in.
Overall width	65.4 in.	69.4 in.
Shipping weight	2190 lbs.	2008 lbs.
Base price	\$2091	\$1919
Options on test cars	Interior and exterior trim group, 4-speed transmission, wide tires	Interior and exterior trim and protection groups
Price as tested	\$2337	\$2049

Fuel and Oil Consumption

	Vega	Pinto
Total miles driven	4806.3	4834.6
Average gas mileage	25.72 mpg.	25.17 mpg.
Oil consumption	1/3 quart	3 quarts

MARCH 1971

In Stockton I left the Pinto with Mike Lamm, PM's West Coast auto editor, and switched to the Vega which he had driven up from L.A. To my mind, Vega styling has it over Pinto's. With its optional wide tires Vega looks like a mini-muscle car. It also had a four-speed transmission which is optional on the Vega. I found its trunk bigger than Pinto's. But it, too, lacked padding and had plenty of sharp edges, so back went the quilt.

Our test Vega had a loose interior side panel beside the rear seat. I had to

Summary—Pinto

Likes: Good overall workmanship and finish. Good high-level and adjustable vents. Precise rack-and-pinion steering. Smooth gearbox and shift-lever linkage. Good cold-weather starting action. Respectable noise levels. Good economy.

Dislikes: Small trunk opening. Low, thinly padded seats. Poor headlight dimmer switch location.

Summary—Vega

Likes: Superior styling. Good acceleration and high-speed performance. Good economy. Good brakes (front discs standard). Good visibility in sedan. Roomy trunk.

Dislikes: Minor assembly defects. Slow throttle response. Poor headlight dimmer location. Poor gas-tank filler design. No glovebox. Fussy cold-weather starting. Appreciable engine noise.



FRONT ENDS OF THE CARS—the Pinto on the Oregon coast (left) and the Vega on U.S. 66 in New Mexico—are clean, uncluttered. In overall execution of styling theme, however, I definitely preferred the Vega

pound it back in place several times during the trip. The panels on the back of both front seats fit poorly and one of the shoulder-harness anchors was installed backwards so that the buckle pointed inward. After fixing it, I headed for San Francisco and quickly found the dimmer switch to be even higher on the firewall than the Pinto's. Again, the other instruments and controls are nicely laid out. I kept maps in the door pocket, which was handy. (The only glovebox is a small recess in the dash.)

In San Francisco, going down steep Lombard St., I had a "small" problem: The engine quit! It was the only get-out-and-get-under of my whole coast-to-coast-and-back trip. The ignition wire from the coil tower had come out of the distributor cap. The problem never recurred; the lead must simply not have been securely in place. The engine compartment is neat and clean, with everything accessible—even more so than in the Pinto.

Vega with a single-barrel carburetor is rated at 90 hp, and on the run down to the Monterey Peninsula its 0-to-60-mph performance shaved a second or two off the figure for the Pinto. Even so, Vega fuel mileage for the whole trip, 25.72 mpg, beat Pinto's 25.17!

Vega's gas gauge, tank and filler pipe

also had surprises. The tank is supposed to hold "approximately 11 gallons," like Pinto's. The most I ever got into it was 10.8. The filler pipe, behind the license plate on the Vega, is almost horizontal and gas slops out when topping off. After a few tankfuls, I figured out the peculiarities of the fuel gauge, which showed empty with three to four gallons left in the tank—more than a reasonable reserve. The Vega odometer was only 0.3 miles off in 100.

Driving in rain with windows closed, I found Vega's vent system defogs the glass a little slower than Pinto's. The high-level fresh-air vents in the Pinto also give better relief when the going is hot. Both heaters proved more than adequate in freezing temperatures.

Giving the Vega full throttle in the Southwest was exhilarating: It really pulls on long grades and has a top speed genuinely in the 90s. At one point I pinned the needle (over 100 mph indicated) trying to stay up with a Lamborghini. The noise level at high speeds wasn't bad, but Vega is a shade noisier than Pinto.

The Vega has recirculating ball steering and a loose, dead feeling in the center. Because of this it requires more of a wheel movement for response,

(Please turn to page 206)

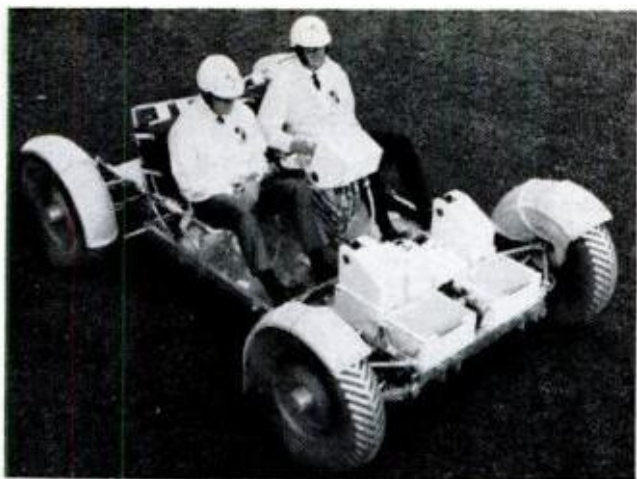

Training wheels

Equipped with rubber tires rather than the wire wheels that it'll have on the moon, this lunar roving vehicle is the trainer U.S. astronauts use to prepare for a moon mission.



New van from Japan

Honda's new "Vamos," a small pickup van equipped with a 30-hp engine, is designed for agricultural and forestry work. Its price is slightly under \$1000.



Food warmer for Skylab

Each crewman in Skylab's Orbital Workshop will prepare his meals in a food tray like this. He'll simply put canned food in the recesses and flip a switch to warm it. The tray measures 13½ by 15 inches.

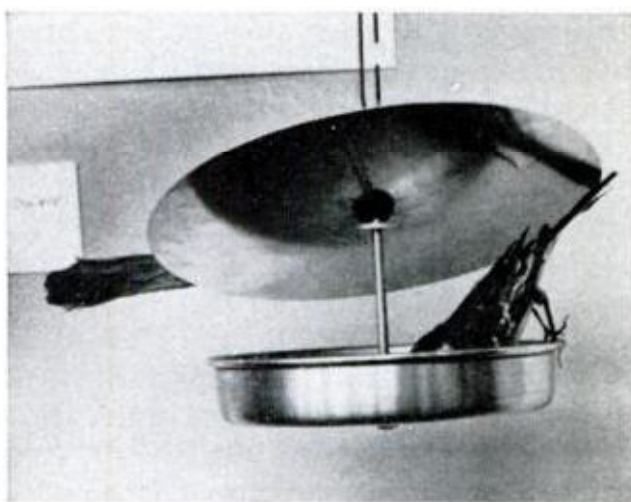

Fair share for little birds

Large birds (which often monopolize a feeder) are discouraged when they light on the tilting top of this one. Small ones don't tilt it, so they stay, finally descend to the tray to eat, says the Norwegian maker.

Renegade II

Painted in a color called "Big Bad Orange," trimmed in charcoal and equipped with padded rollbar, whitewalls and mag-style wheels, Jeep's new Renegade II is a limited-edition model based on the famed four-wheel-drive Jeep Universal CJ-5. Other standard features are rear-mounted tire carrier, V6 power and padded instrument panel. Factory-installed options include Bostrom rear seat, dual padded sun visors, heavy-duty springs and shock absorbers.



Coming: A Camera

By SHELDON M. GALLAGER

CAMERAS have been getting more and more automatic all the time, but until now you still had to do one thing yourself—focus the lens. Now Polaroid has come up with an electronic focusing system that even does this for you. Result: a camera so automatic a blind person could take perfect pictures with it.

Still under development, the ingenious camera “sees” your subject by means of sonic pulses from a miniature sonar-like transmitter. Mounted on top, like two protruding eyes, are twin transducer cones. One beams pulses at your subject; the other picks up reflected echoes. The time it takes the echoes to return indicates how far away your subject is. This generates a signal that drives a tiny servomotor geared to the lens, automatically setting the focus to the proper distance.

Because the focusing process is continuous, it will “track” a moving subject, keeping it constantly in focus. You just trip the shutter whenever you want and your subject will always be sharp. The system also lets you focus in situations where an optical rangefinder can't be used, such as in poor light or at night. Since it requires no light, it functions in total darkness.

How does the servomotor know how far to adjust the lens or which way to turn it? This is the really clever part. As the motor rotates the lens-focusing ring, it also moves a geared wiper contact along a variable resistor. The resistor produces a feedback signal that varies in strength according to the location of the wiper contact, thus indicating the position of the lens at any given moment. This feedback signal is compared with the echo signal from the subject through a bridge circuit. If it's greater than the echo signal, it indicates that the lens is set farther away than the subject. The servomotor then rotates the lens ring until the two signals are the same and cancel each other out. At this point, no current flows, the motor stops and the lens is in focus. If the feedback signal is less than the echo signal, it indicates that the lens is set at too close a distance. Polarity through the bridge circuit is reversed and the servomotor turns the lens ring in the opposite direction until the two signals match.

In addition to the self-focusing feature, the new camera will incorporate automatic exposure control and will take self-developing, instant-print Polaroid film packs. As yet, no date has been announced for its sale, but when it comes it will usher in an exciting new era of truly automatic picture-taking.

★★★

TRANSDUCERS
AND OTHER
ELECTRONIC
CIRCUITRY

BATTERY

PUSHBUTTON
FOCUSING
SWITCH



COMPARTMENT
FOR POLAROID
FILM PACK

That Can Focus Itself!

This ingenious new Polaroid bounces sonic pulses off your subject in the same way sonar spots enemy subs. It just could be the next big step in truly automatic picture-taking

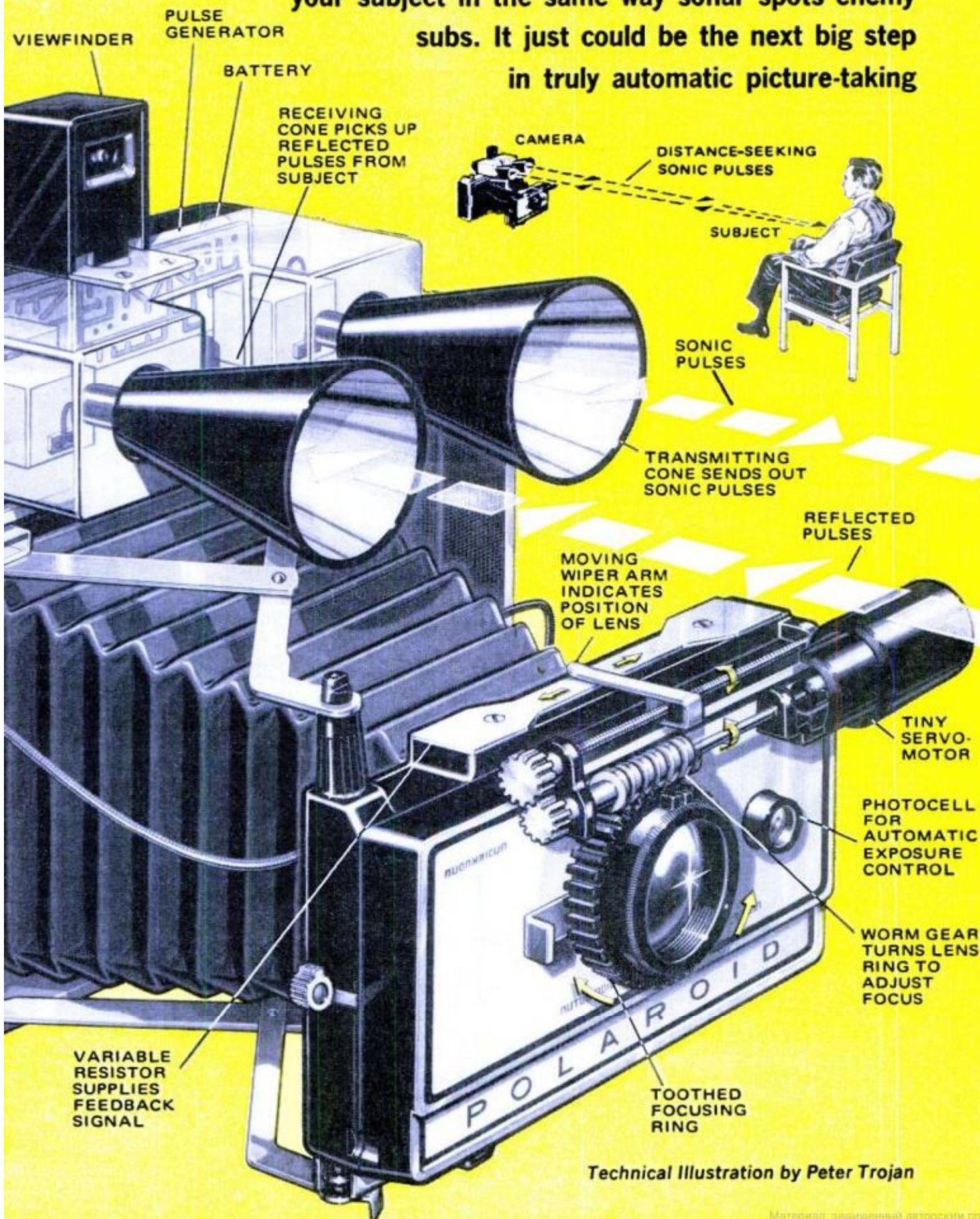

Technical Illustration by Peter Trojan



Facade of friendly faces

Putting people's pictures in their windows started as "conceptual art" but turned out to be a bit of effective social engineering, according to Peter Nemetschek, the artist who did it. He selected an apartment near Munich and convinced the residents not only to have their pictures taken but also to display huge enlargements in windows. Now the apartment looks better—and people who never spoke to one another before are firm friends.

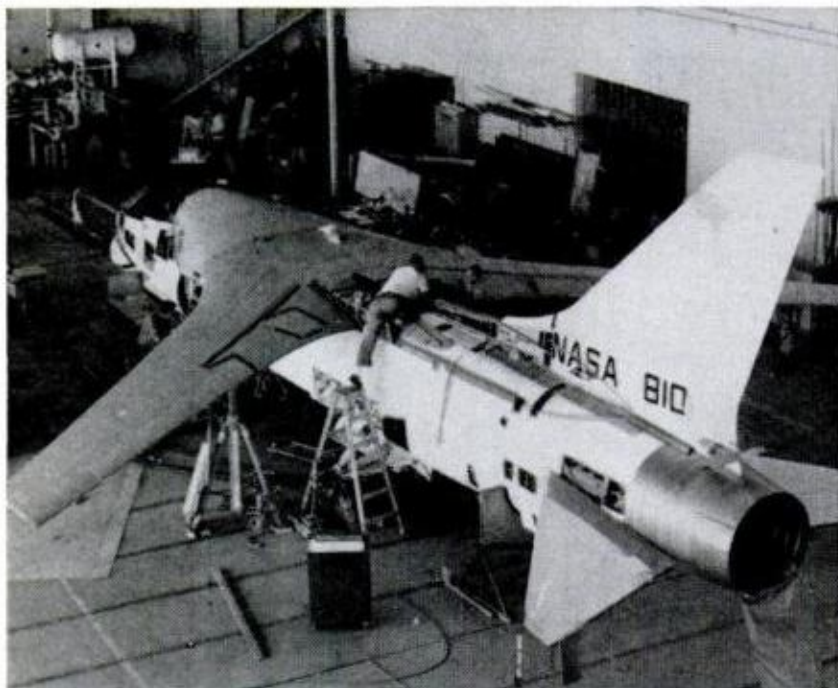

Supercritical wing for better cruise

A new shape in airfoils, the NASA supercritical wing, is shown here installed on a modified F-8 jet. Delivered to NASA by North American Rockwell, the new wing had shown in wind-tunnel tests that it could allow highly efficient cruise flight near the speed of sound (660 mph at 35,000 feet). In actual flight, it's expected to enable planes to cruise faster without an increase in fuel usage.

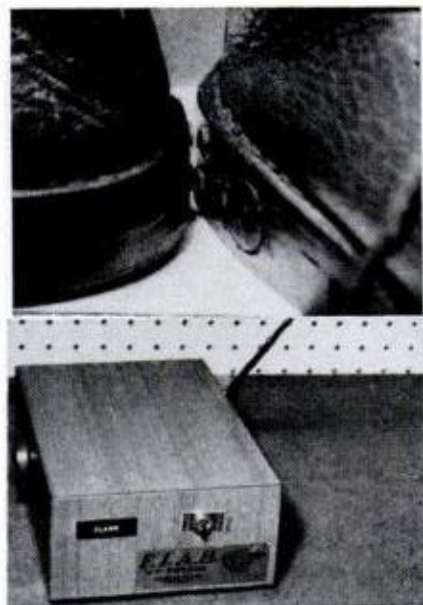

Heels call help

A pair of "alarm shoes" developed by an Italian doctor enable a bank teller—simply by bringing his heels together (top photo)—to send a radio signal that's picked up by a receiver (bottom photo) isolated within a 16-mile radius. Help can thus be summoned in event of a bank robbery.

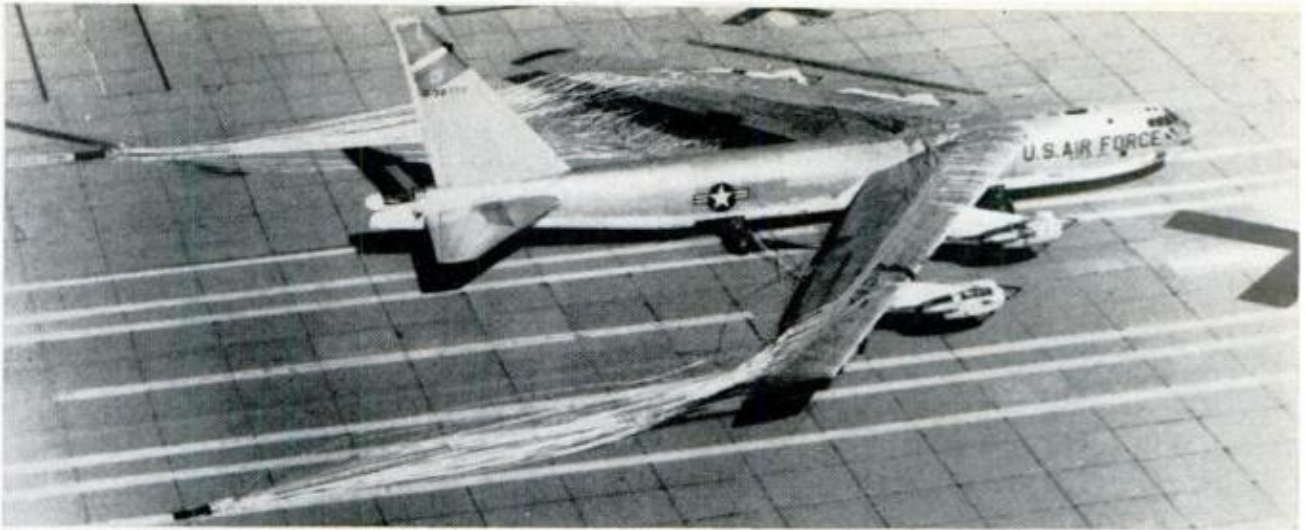

Big net to catch big birds

On electronic command from pilot or control tower, a nylon barrier net pops out of a transverse runway slot and is held erect by pneumatic rubber tubes. A jetliner that has run out of runway on an aborted takeoff or too-fast landing is caught by the net, which wraps around the wings and brings the plane to a stop within 1200 feet. Two rotary hydraulic arresting gear (left), buried at either side of the runway, pay out nylon line as the net is dragged forward. Tests of the system, using a B-52, are being carried out at Edwards Air Force Base, Calif. The developers say the gear can even stop jumbo 747s.

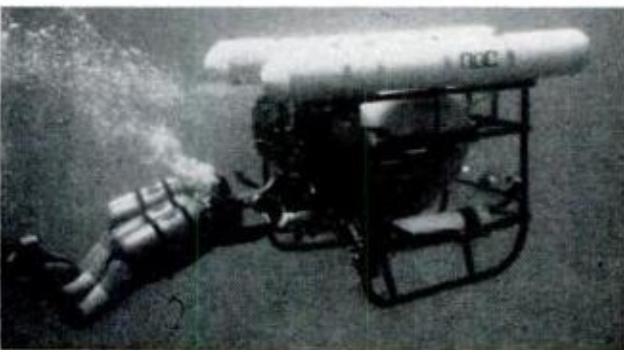

Undersea lifter

An underwater "forklift," developed by the Naval Undersea Research and Development Center, can carry 1000-pound loads. The Buoyancy Transport Vehicle operates to a depth of 850 feet. It contains its own power, lighting and electrohydraulic propulsion systems.

MARCH 1971



Sure-footed speedster for ice

The Ice Cycle is a new recreational vehicle that zips along at 22 mph on ice. BGW Industries, Mansfield, Ohio, makes it.

"I'm retiring from driving,
 but... I'LL NEVER
 QUIT RACING!"
 Dan Gurney

Dan looks back at 15 years of competition in every kind of car, and looks ahead to managing the All American Racers team

PM: When Sterling Moss retired he said it was because he'd lost his reflexes. Freddy Lorenzen had an ulcer. Rodger Ward said racing had ceased to be fun. Do any of these reasons apply to you?

DAN: I suppose all could apply to a small extent. I wanted to do a job I was proud of whenever I raced, and it seemed as though I had less time to stay in shape racing and more responsibility with other things, such as being president of All American Racers.



WHAT A MOMENT for a team manager! Also for Swede Savage who won the Bobby Ball 150 for AAR. He's youngest driver to score a USAC victory

Do you feel you were actually slowing up or just not able to concentrate?

I think I was slowing up, but not necessarily because I wasn't able to go fast anymore. I just wasn't as sharp as I had been at one time.

How could you tell?

I was my own most severe critic and I knew when I felt right. The enthusiasm you need to generate the kind of dedication a race driver must have become more and more difficult to summon. I got older and my interests changed a bit.

Just how are you reappportioning your time?

Well, the main 1971 project for All American Racers is a two-man racing team. We're going to race the Indianapolis series of races—I believe it's 12 races including the Indy 500, the Ontario 500 and the new Pocono 500, July 3. Six will be on national television. It's also going to be the biggest circuit in terms of prize money.

You don't intend to do any guest shots

POPULAR MECHANICS

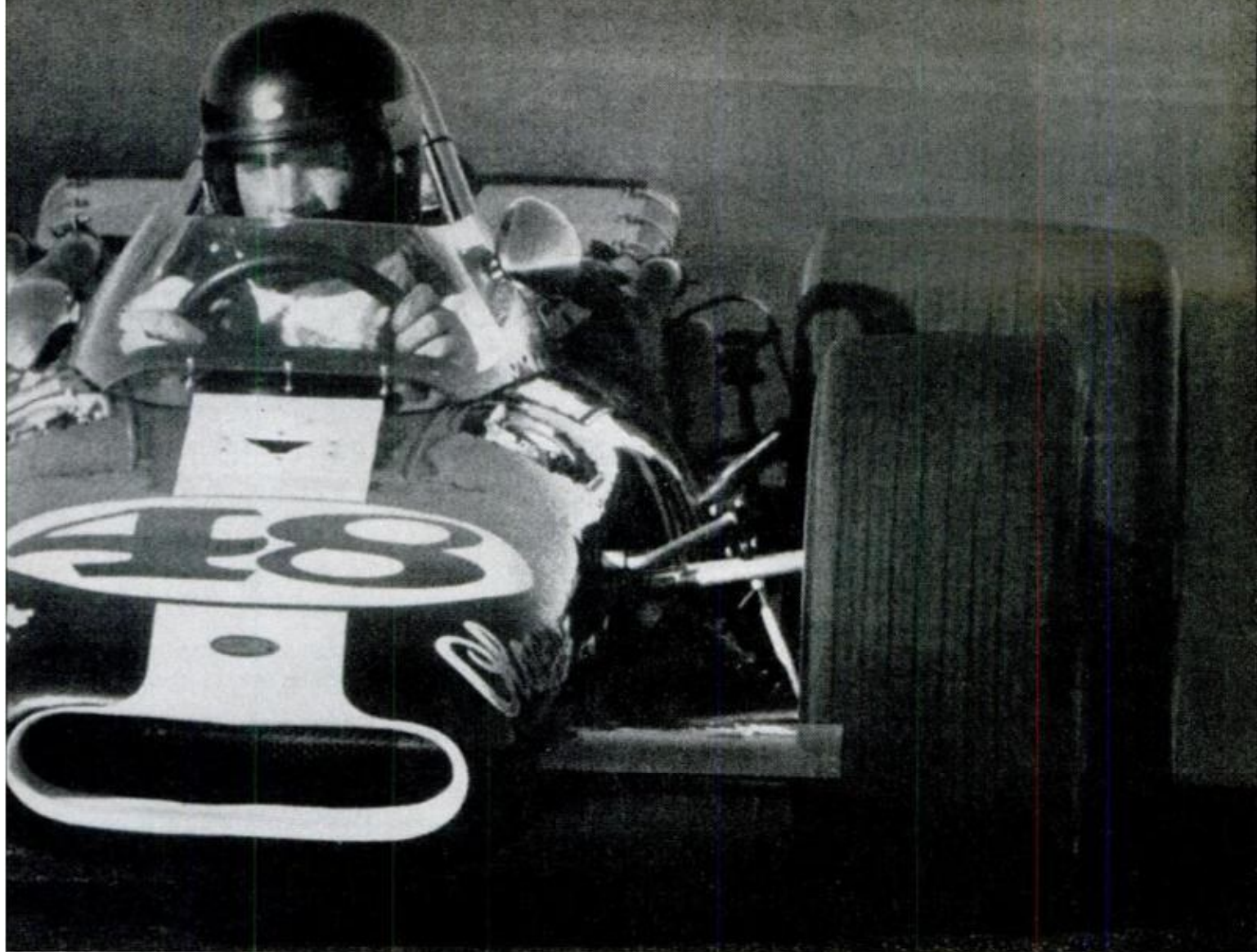

... if somebody calls you up and says, "Would you drive our Can-Am car next week?"

No, I intend to be deeply involved in racing but in a different way.

You used to say that you had two ambitions: to win the Indy 500 and to be World Champion in Formula 1. Do you feel frustrated that you didn't quite make either one?

From a driver's standpoint, yes. On the other hand, one must face disappointments. There's a lot of luck involved in winning the Indy 500. I've been second. I've been third. The second time I was second, Mario Andretti won the race. We were running at a speed for the last 50 or 60 miles that put me in reasonable striking distance, but neither Mario nor I was really *running*. Both of us were running about 10 mph slower than we should have been able to run. He was nursing his car along, and I was nursing mine. It really ceased to be a race. The pinion in his gearbox had one tooth gone and another that was cracked, yet I couldn't put on

any pressure because I had a whole lot of trouble myself.

Just how do you sense trouble with the car? How do you know when to back off and take it easy? Sounds, vibrations?

All of these. You can sense things beginning. For instance, you detect a foreign smell. Or you feel a vibration you know isn't normal. Or you sense a tiny miss or a change in the sounds or different amount of pull or a change in the handling of the car. When you're a race driver and you're running well you're extremely intimate with your car. It becomes an extension of your own nerves and feelings and all the things you use to sense what you're doing, where you are, how fast you're going and how close to the limits you are at any given moment.

Are you able to feel this way about a car you don't drive very often? You drove a Wood Bros. Mercury once a year. This year, you drove a strange Can-Am car two or three times. Do you get so you can "feel" them the way you do your Eagle that you

drive all the time or the Barracuda you drove in Can-Am?

That's a very difficult thing to do, but a good driver can gain a big percentage of this knowledge with a couple days of practice. But if you've been using your head, you try to look into other aspects: Who is preparing the car, what is its background, what its history has been, who designed it, who built it, what it's made out of, just how much strength it has, how hard you can push it, what sort of punishment it will take without falling apart.

Is it true that a good driver is apt to get a new car, a good car, a car built by a good car builder whereas a second-rate driver is apt to take a car that's been around or has been beat up?

Yes, a lot of the time second-rate drivers will take such a car because they don't have any choice. But I think they may be too easily satisfied. In the evolution of racing cars there've been a lot of small steps in improving the cars. Teams try to protect new-found knowledge, regardless of how they found out about it. "Speed secrets" is a good term for want of a better one.

Are you talking about a technique or a piece of mechanical equipment?

No, this is something that makes the car easier to drive. A suspension improvement or any small thing. A driver might say,

"Well, I feel pretty good today," and he'll even have his mechanics thinking, "Now this guy's really something great," when in fact, regardless of how great he is or isn't, the reason is that *they've* done something that's a little bit better mechanically. If a lot of second-rate drivers were not so easily satisfied, they would find out about the subtleties of sensing car setup.

Why is it in this mysterious area of "speed secrets"—setting up a car (suspension mainly)—that no scientific formula has evolved so anyone can set up a car to handle it through the turns at maximum speed?

Well, we have been working on this, and it's one thing I think you'll see coming about. I mentioned this "speed secret" thing, and I think that that explains it right there. If someone were to come up with the formula you're talking about—which I think we're mighty close to—he still wouldn't want to say anything about it because he would want to win with it. It's another tool; you want to protect it. It's one unfortunate thing about racing, but secrets do have a way of leaking out. There's a lot of espionage going on. But as a driver, once you have driven a car that's pretty close, you're never satisfied again until you can get every car you drive to run that way.

With what degree of accuracy can you,



OUT ON THE FIRST LAP in the pileup at Indy in '66! I'd rather run a whole race and go out on the last



I'VE HAD MY SHARE OF CHAMPAGNE, I guess. In fact, at Riverside, it was pretty much an annual event



WINNING THE GRAND PRIX at Spa, Belgium, in my Formula 1 Eagle was definitely my biggest racing thrill

on a road course, sense whether you're down a second on a lap or up a second?

On a track where you have a two-minute lap or a minute-and-a-half lap I think you can tell within a few tenths of a second. It's more difficult to tell when you're several seconds off the pace than when you're running right on your limit. At that point you can tell: "Now there was a good lap." It's very seldom when you go into the pits that you look at your times and are surprised.

Do you think you've just been lucky in the fact that your career has been relatively accident-free?

Well, there's a great deal of luck involved. But I also feel that I was a more conservative driver than many.

How could you be conservative and yet qualify on the pole or in the front row so often?

I'd say that one basic difference was that I drove more on anticipation than on reaction. If you anticipate something is going to happen, you're going to know about it sooner than someone who waits till it actually happens. This applies to the highway as well as the race track.

Won't an owner take a guy out of a car if he doesn't think he's pushing it hard enough?

That's his prerogative. It's part of racing.

Are there some drivers you don't like to drive against?

MARCH 1971

I'd rather race some drivers more than others. As a rule, the predictable ones are best to race against. I'd rather race against the better-known ones and those that have fewer accidents.

Do you think A. J. Foyt will retire?

I really don't know.

In a sense he's doing the same thing you are—building cars.

Yes, he's had a big engine business going with Ford four-cam engines.

Would he have been a great Formula 1 driver if he had really gone in for it?

That's difficult to say. I felt that A.J. didn't take to road racing as quickly as some others—Mario, for instance—but I would never underestimate A.J. If he'd never had any oval experience and had determined to go into road racing, I think he would have become a star.

What was the biggest single disappointment in your racing career?

The first one that comes to mind was when I was leading the Belgium Grand Prix in 1963 and ran out of fuel. Another, the German Grand Prix with three laps to go and a 40-some-second lead and I lost the universal joint. That was in our own car, an Eagle.

What was your biggest win—your biggest thrill?

At the time, it didn't seem that way,

(Please turn to page 210)



Mickey's mini

Built just like a big one—with tubular steel frame and fiberglass body—Mickey Thompson's new mini-dragster is powered with a 3-hp Tecumseh engine. The 150-pound car sells for \$395.



Stripping keeps it cool

Instead of installing airconditioning in a new department store in Stuttgart, Germany, the architects placed 957 movable aluminum strips outside the windows to reflect the heat of the sun away from the building.

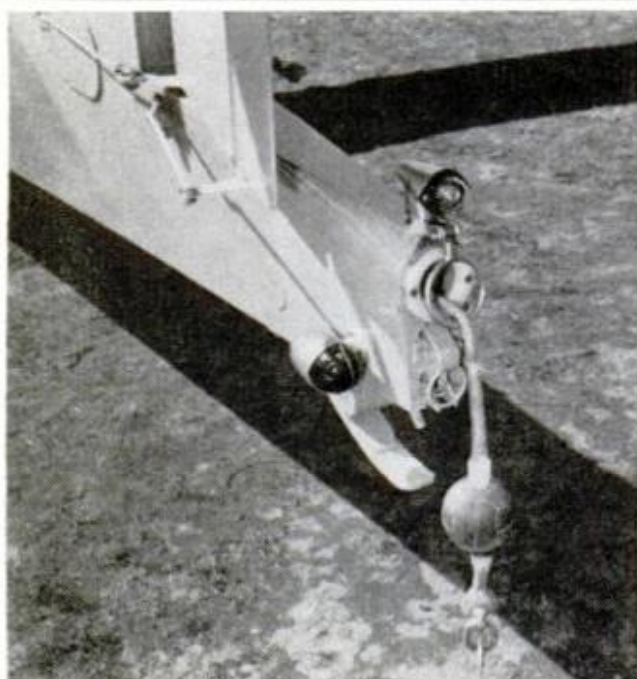
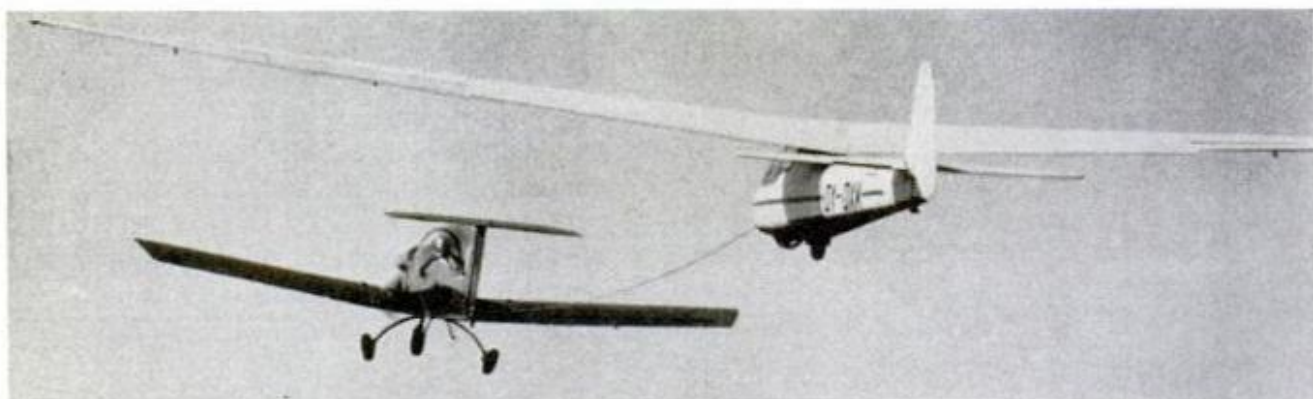

Wood plane for towing

Constructed entirely of wood except for steel fittings, the Poly V is a prototype tug airplane for towing sailplanes. It was designed by a student group at the Technical University of Denmark. An electric winch aft of the pilot pulls in the nylon towline (photo, left) after sailplane release. The plane can perform 7 or 8 launches per hour.



ATV drives like a car

The Wedge 295, a new all-terrain vehicle from the New Holland Group of Sperry Rand, features automotive-type controls, land speeds of 33 mph and water speeds of 6 to 8 mph with an optional jet pump installed.

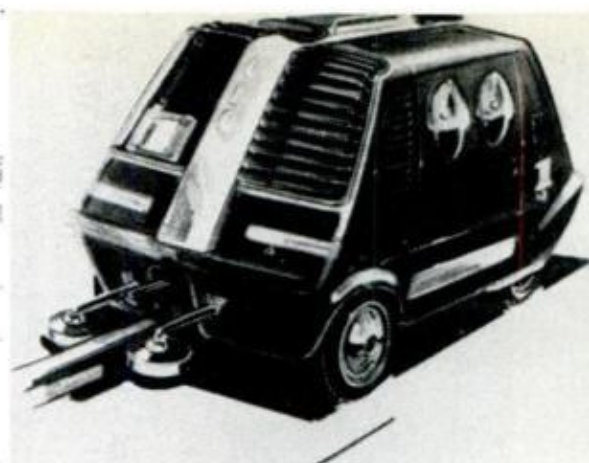

Electric car for Tokyo

A system of computer-controlled electric cars, developed by the Japanese government and Tokyo University, will be tested this spring. One of the designs (above) is a city car that grips a rail with two front "arms."



Soviet catamaran is stable

Even in Force 10 winds, the double hull of this catamaran remained very stable, reported the Russians after the ship completed a 3½-month scientific voyage in the Arctic Ocean.



Spotter for border crossings

A soldier riding in a bucket seat suspended on a steel frame can spot footprints of terrorists who cross the Israeli border. Elevated, he avoids danger of stepping on a hidden mine.

'Dream car'

This "millionaire's dream car" was built by Sidney Carlton, a director of the Explorer Motor Co., in collaboration with Len Bailey, Ford Motor Co. design engineer. The long, low vehicle is powered by a three-liter Ford Zodiac engine. A bigger engine may be used in the production model if public reaction is favorable and the car actually is offered for sale, according to Mr. Carlton.



The 411 Series: Volkswagen's Luxury Line

It's happened: VW has a 4-door sedan with automatic transmission standard!

By BILL HARTFORD, Auto Editor

THE UPHILL BATTLE for VW 411 models won't be in performance—not with a competitive, 85-hp fuel-injected engine—but in acceptance by many Americans. For some strange reason, many of our home-grown automobile drivers feel the only good VW is one with a sticker dead on \$1899. When they learn the 411s are in the \$3000 price range, the reaction will be automatic: Back to Detroit. Does that much money imply exotic foreign machinery? Does it indicate a preference for a domestic compact or intermediate with a sticker of \$2700 that you can have the

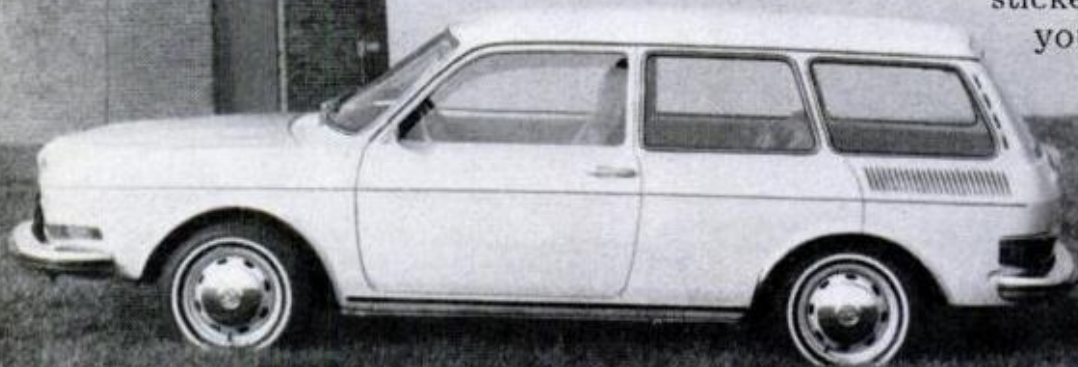

FOUR-CYLINDER ENGINE, under the floor in the three-door (station wagon) model, is fuel injected

LOUVERS IN LID of the four-door sedan are for the air-cooled rear engine. "Trunk" is in the front

dubious pleasure of running up to \$3545 in the wink of an eye?

Whatever the reason, overlooking 411s because "they cost too much for a VW" would be a mistake. My impressions of driving the four-door from Wolfsburg to Hamburg right after the model was introduced in '68 are still quite vivid. Right off, the front bonnet swallowed a huge flight bag and a collection of small packages and could have held more. The two-lane road I took through the North German farmland was not unlike the roads of Martha's Vineyard where John Linkletter, *PM* Managing Editor, drove the first 411 wagon to arrive here (VW calls it the "three-door"—the third door being the tailgate). The big-car feel and ride was a reaction we both shared. (It does have that rear-engine susceptibility to crosswinds, however.)

The 179.2-inch-long 411 is far from a boat, however. On the sometimes winding, undulating and strangely cambered stretches to Hamburg the four-wheel independently suspended, rear-engine sedan exhibited tenacious road-holding and a preciseness of steering not found on large domestic sedans with standard suspensions. Body roll was slight and steering had plenty of feel. The 411 uses McPherson struts up front. Their use marks VW's first departure from torsion-bar front suspension. Now, the Beetle, too, uses this

suspension arrangement (see *It's a Super Beetle!* page 24, Dec. '70 *PM*).

Since its European introduction, the 411 has benefited by several refinements, the most significant of which is Bosch electronic fuel injection. This boosts hp and puts top mph in the mid 90s—the fastest production VW yet! The 411 can cruise all day at this top speed, but performance in the lower ranges with the standard automatic transmission is more sane than sizzling. Regrettably, no four-speed box is available here. Certainly the imports have lost sales in the past because of the lack of an automatic transmission option; now (to a lesser degree VW would hope) it could be the other way around!

Many features of the 411 may not quickly be noticed by someone not used to human engineering. How about seats that adjust for *your* driving position and not that of an anthropomorphic dummy? How about ventless side glass that is ingeniously notched on the leading edge for draft-free ventilation when the window is slightly cracked open? How about map pockets and three-point belts? Separate heater controls for each side of the car?

There's a lot to like about the 411. Too expensive for a VW? Not by today's prices and especially not for a superbly finished car that—being a VW—will probably depreciate at a Beetle's pace! ★★ ★



411 SEDANS and wagons are not in VW showrooms yet, but should start arriving from Germany soon
MARCH 1971

SPECIFICATIONS—VW 411

ENGINE—Four-cylinder, horizontally opposed, overhead-valve, four-stroke, air-cooled rear engine. Displacement: 1679 cc (102.5 cu. in.). Compression ratio: 8.2:1. Bore: 3.54 in. Stroke 2.60 in. Max. SAE hp: 85 @ 5000 rpm. Max SAE torque: 99.4 ft. lbs. @ 3500 rpm.

ELECTRICAL SYSTEM—12 volts

TRANSMISSION—3-speed automatic

CHASSIS—Front suspension: McPherson struts, coil springs, antiroll bar, double-acting telescopic shock absorbers. Rear: Semitrailing arms, coil springs, antiroll bar, double-acting shocks

TURN CIRCLE—37 ft.

TIRES—Tubeless radial ply

BRAKES—Disc front, drum rear

DIMENSIONS—Length: 179.2 in. Width 64.9 in. Height: 58.5 in. Track: front, 54.2 in.; rear, 53.1 in.

CURB WEIGHT—2425 lbs. (sedan); 2469 lbs. (wagon)

FUEL CONSUMPTION—20 to 24 mpg.

How the Airlines Hope to Stop Bombs And Bomb Scares

Chemosensors that sniff out the telltale odor of explosives, and neutron activators that reveal bombs concealed in luggage are promising new developments

By MORT SCHULTZ

HOW SAFE ARE YOU from a bomb when you fly a commercial airliner?

On the surface, the answer seems to be "reasonably so." In all, 173 people have perished in six bombings of U.S. passenger planes. The first fatal explosion was in 1933; the last, in 1962.

Why, then, did Carl Eck of the Airline Pilots Assn.'s Air Safety Committee tell me that the situation has become "very critical"?

Why has the Federal Aviation Administration suddenly shown great interest in bomb detectors, especially chemosensors and neutron activators?

Chemosensors, which literally "sniff out" odors given off by explosives, were developed two years ago by the Illinois Institute of Technology Research Institute in Chicago. Neutron activators, which seek to find bombs by bombarding an area with neutrons, are being worked on primarily by North American Rockwell, Los Angeles.

In short, why all the fuss when there have been only six fatal American air-

Photo by Bruce Nett



craft bombings in the past 37 years?

For two reasons. First, because the number of bombings worldwide has taken a sharp jump of late and, as one FAA official put it, "We're afraid this thing could snowball."

Secondly, because there have been American planes bombed in recent years, but the facts have been hushed up.

On the world scene, 47 people were killed last February when a Swissair jetliner exploded shortly after taking off from Zurich for Israel.

A day earlier, an Austrian Airlines cargo plane bound for Israel had a gaping hole blown into its fuselage by dynamite. The plane managed to land safely.

In May, an Iberian Airlines jet that was about to take off was quickly evacuated and towed to a remote corner of Madrid Airport after a bomb threat was received. Minutes after the towing vehicle disengaged itself from the aircraft and drove away, a bomb in the plane exploded.

In the United States, recent bombings have resulted in no fatalities. One case occurred in late 1968 when a fire broke out in the passenger compartment of a United Airlines jet that was flying over Denver. It was extinguished and the plane landed. Investigation revealed that the fire was started by a fire bomb.

Another bombing involved an American Airlines jet flying over Alamosa, Colo., in 1967. Dynamite exploded, but no one was killed. Since no damage was done to a critical part, such as a control cable, the pilot was able to make a safe landing.

Bombings, of course, are a great danger. But there is another problem that pilots and airlines fear—bomb threats. They are costly, numerous and increasing.

The exact number is tough to pin down. The FAA puts it at about 400 a year. The FBI says it runs into "the thousands."

A pilot, who at the time was flying an Eastern Airlines shuttle from LaGuardia Airport to Washington National, describes what happens when an airline gets a bomb threat:

"The message was relayed to us by the tower as we were about to take the runway. We taxied back in, parked the plane, unloaded the passengers who were questioned by the FBI, and manually searched all the luggage. No bomb was found.

"I wasn't too worried, because we were on the ground. I would have sweated a lot more had we been in the air."

Which was exactly where American Airlines flight 160 was when it got its call last May. It had taken off from Toronto for New York City when the pilot was informed by radio that a bomb threat had been received.

Air traffic in the Buffalo area was cleared away so the plane could make



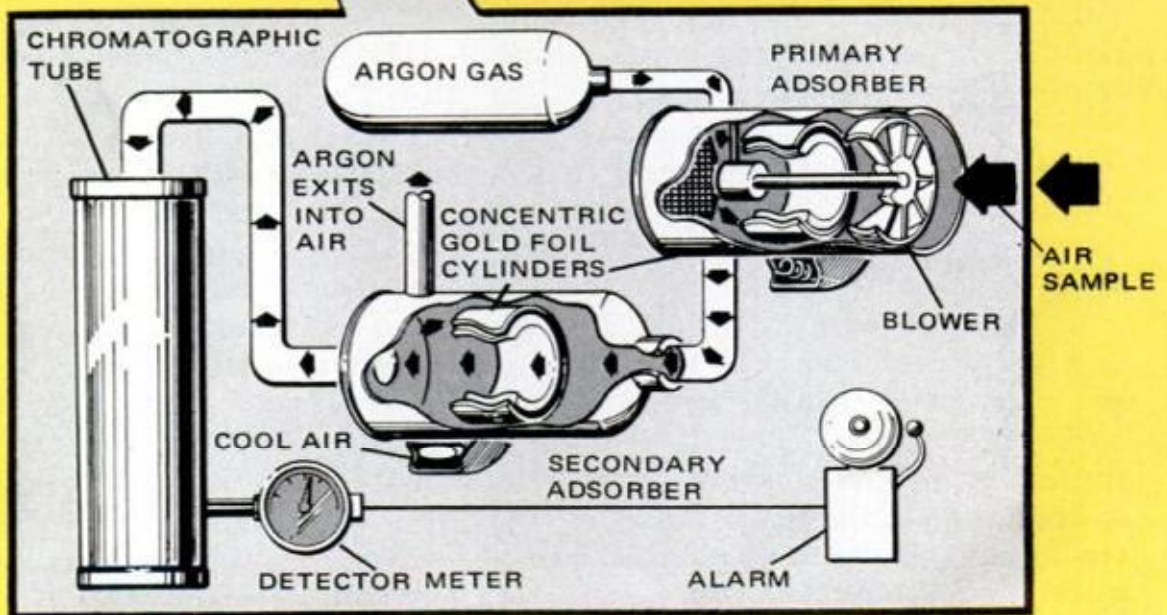
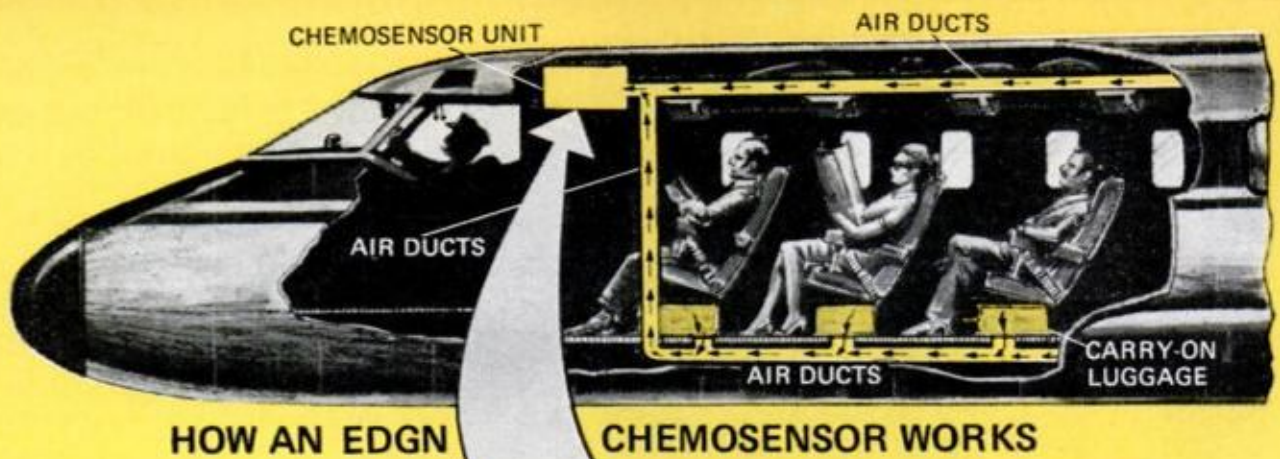

ARTIST'S CONCEPT OF AIRCRAFT INSTALLATION: Air sample is drawn into primary adsorber. Argon transfers adsorbed vapors to secondary adsorber. During the transfer, the cooling element speeds adsorption. After adsorption, vapor is heated for transfer to a gas chromatographic partition tube where it is absorbed to get a time pulse. This is recorded by meter. If any EDGN is present, an alarm sounds

an immediate landing. The 100 passengers were unloaded, and the 727 was allowed to sit for 30 minutes before it was boarded for a search. No bomb.

Can airlines guarantee that a plane on which you are seated isn't carrying a bomb? Chemosensors and neutron activation may make it possible.

A chemosensor recognizes a characteristic vapor emitted by an explosive. It can detect dynamite by recognizing ethylene glycol dinitrate (EGDN), a by-product of nitroglycerin. Dynamite contains nitro and emits EGDN.

Chemosensors would be used to sample the air in a plane's passenger compartment before takeoff. If a vapor emitted by an explosive were present, an alarm would sound in the cockpit.

"But chemosensors aren't sensitive enough to detect vapors given off by an explosive which is placed inside a tightly sealed suitcase," explains Max Collins of the FAA. "That's where neutron activation comes in." Collins is chief FAA troubleshooter in this field of detection equipment.

A neutron activation gun would bombard luggage with neutrons before it was loaded on an aircraft. If neutrons strike inert material—as they would if explosives were present—gamma rays are given off. The density of these rays reveals when the inert material is equivalent in mass to a bomb.

In activation analysis, a neutron source having a specific energy output must be used to amplify the presence

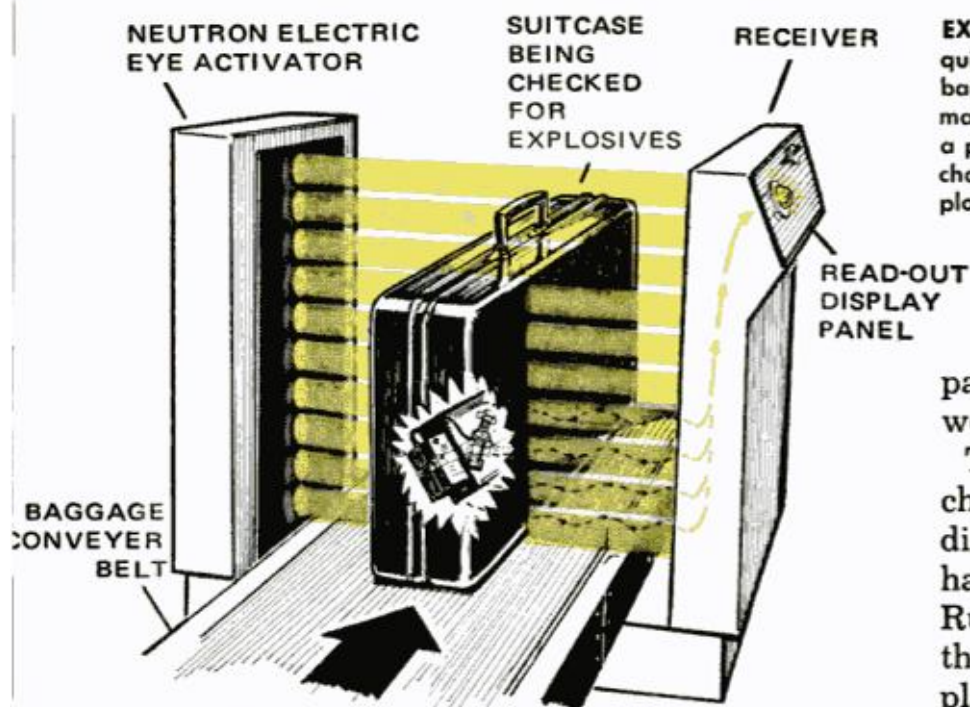

NEUTRON EXPLOSIVE DETECTOR

Art Concept by Fred Wolff

EXAMINATION OF LUGGAGE can be quick, conclusive. Activator bombards bag with neutrons. Contents emit gamma rays; their energy is measured by a photo-multiplier tube. Density of rays characteristic of dynamite or other explosive gives instant read-out on panel

of the element being sought while suppressing the activity of other elements.

Looking for a mineral, such as silicon, a geologist will shoot a specific number of neutrons in the Mev range into sand and rock. This might be a beam of 14-Mev neutrons. (A Mev is equal to one million electron volts.)

The irradiated (activated) atoms become radioactive and emit high-energy electromagnetic radiations called gamma rays. Gamma rays can be analyzed for their energy on an instrument having a photo-multiplier tube. This output can then be read on an oscilloscope.

Since the energy output of the gamma rays given off by one element differs from that given off by other elements, you can locate that element in a table of data.

The geologist will know that silicon is present if the gamma rays he gets have an energy output of 1.78 Mev, which is that of aluminum 28, one of the trace elements of silicon.

Neutron activators would be used to examine luggage carried on by passengers as well as that being loaded into the cargo compartment. Neutron activators could also be used to scan

passengers, but probably won't be.

The principle upon which chemosensing is based was discovered in 1906 by Mikhail Semenovitch Tsvett, a Russian botanist. He found that the different parts of plant pigmentation could be distinguished by the way in which they clung to and flowed down an adsorber—

in this case, limestone. Adsorption is the adhesion of molecules to a surface.

This process of separating parts of pigmentation by their flow characteristics is called chromatography. A vapor, too, can be separated into its distinctive parts (or gases) by running it over an adsorber. Molecules of various gases have different rates of flow.

A vapor acts much like a liquid consisting, say, of oil and water. If you poured this down the side of sheet metal, the two would separate and each would reach the bottom at a different time.

The first chemosensor developed by the Illinois Institute of Technology Research Institute (IITRI) for the FAA was for the detection of dynamite, since this explosive is the easiest for a bomber to obtain. Jay Fischman of IITRI, who was chief engineer on the project, told me how this chemosensor works.

With the aid of a small fan, air from an airliner cabin is scooped into a cylinder containing three concentric gold foil cylinders that adsorb EGDN. Gold is used because it is an excellent surface for adsorption of EGDN.

(Since the dynamite chemosensor was

(Please turn to page 188)

WEIRD, WILD and WONDERFUL

Bright Ideas From The Biggest Inventors Show Yet

On these six pages, PM brings you exciting highlights from the huge International Patents Exposition held last month in New York. Sponsored by Patents International Affiliates, Ltd., the annual event—largest of its kind—draws thousands of new inventions from all over the world. Here are some of the brainiest and zaniest. Most are not yet on the market. For more information, write Patents International at 680 Fifth Ave., New York, N.Y. 10019.

By **SHELDON M. GALLAGER**

Illustrations by Roy Grinnell

IT'S A BOAT! IT'S A DOCK! Well, actually it's both. The clever pontoon float cruises along pushed by an outboard with its bow fitted into a recess in the deck. Anchored, it becomes a swimming raft, and the outboard

can be detached for use as a runabout. Tied up back at shore, it's a floating dock. In bad weather, the outboard can be stored on top with the canopy lowered for protection. Inventor is Vernon C. Runkel of Kansas City, Mo.

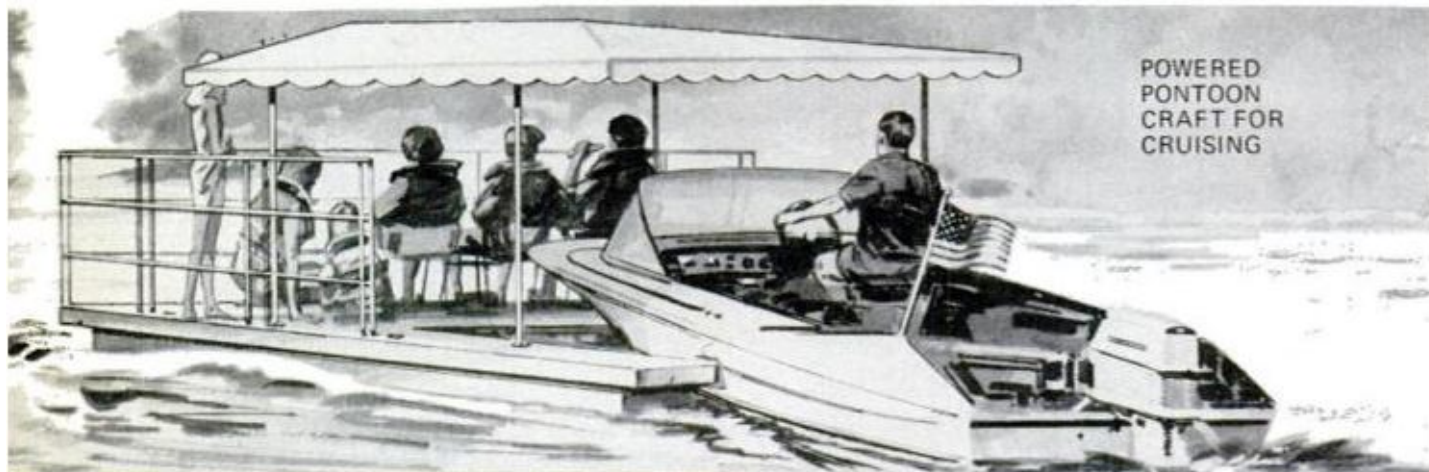

POWERED
PONTOON
CRAFT FOR
CRUISING



SWIMMING RAFT
WITH OUTBOARD DETACHED



BOAT STORAGE SHELTER
WITH CANOPY LOWERED

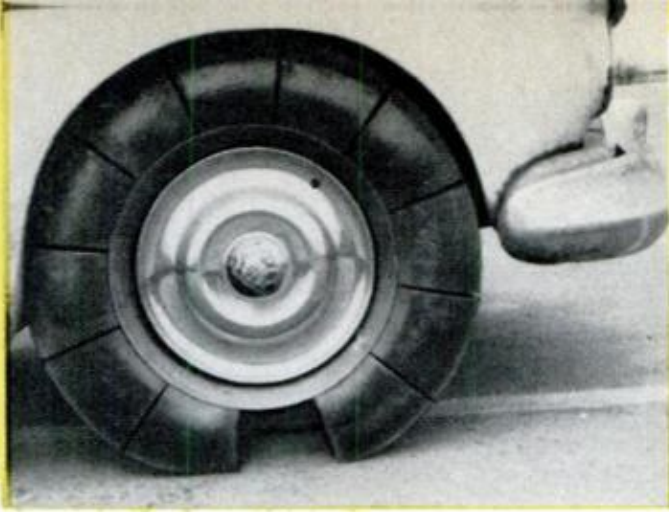

YOU CAN'T HAVE A FLAT with this ingenious sectional tire invented by Samuel C. Pellegrino of Buffalo, N. Y. Each of the 12 segments is self-contained and inflated through its own valve. If one is ruptured, the tire will continue to function normally, eliminating the danger of high-speed blowouts. Instead of a spare wheel, you just carry along a few extra segments for replacement as needed. In winter, the sections can be rotated slightly, as shown at right. This offsets their edges for added traction and eliminates the need for snow tires, Lugs, easily reached behind the hub cap, hold segments on.



INWARD-FOLDING WINDOW is cleaned from inside the house, eliminating the difficulty and danger of having to lean outside to reach it. The two sashes are first slid up and down so they're reversed from their normal positions, with the lower sash at the top and the upper one at the bottom. This slips them off their guide rails so they're free to pivot sideways on hangers at the top and bottom. They're then swung into the room and hooked together at the ends with small catches. Finally, the upper sash is pulled down along its balance tubes, lowering the whole assembly within easy reach. Outer sash is slightly narrower to clear inner tracks. The handy window was invented by Henry J. Hendra of Montreal.

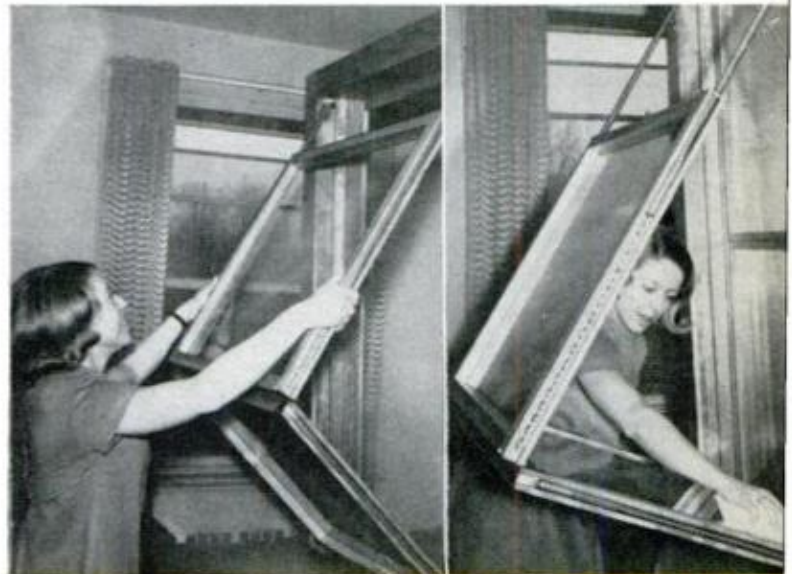

UPPER SASH CLOSED

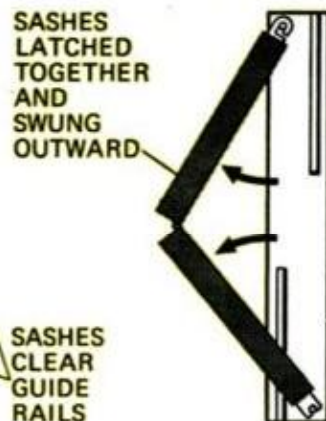



TILTED DOWN FOR QUICK REMOVAL



STOWED FOR TRAVELING



PIGGYBACK BOAT CARRIER for campers is double-hinged so it can swing up and down or sideways. Pivoted sideways, it gives access to the camper's rear door without your having to remove the boat completely. To unload the boat, you lock the horizontal pivot and release the vertical one, allowing the carrier to swing down to the ground. The vertical pivot bar also holds an outboard engine on a separate bracket. Inventor is Gilbert J. Johnson of Seattle, Wash.



TILTING AUTO LIFT enables a mechanic to reach either end of a car easily. Hydraulically operated, the lift is raised by V-shaped arms until the car is well off the ground. Then it pivots at the center to tilt the

car in either direction, tipping up the front or rear as needed. The slanted position provides a more comfortable working angle and eliminates the strain of reaching overhead. Octavio Alvarez Suarez of Gijon, Spain, is the inventor.

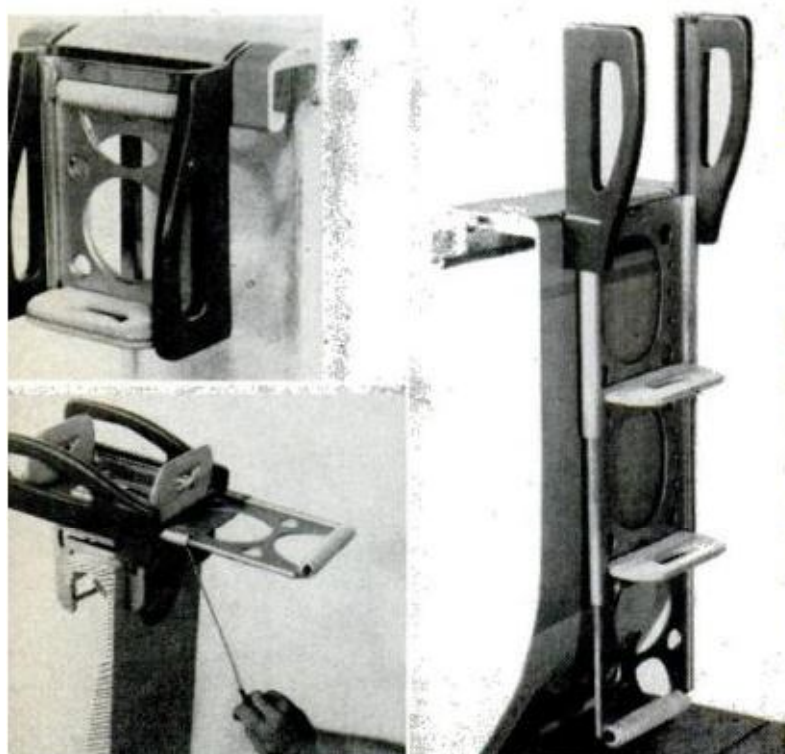

FLIP LADDER stows inside a boat, but can be lowered on the outside by a swimmer in the water. Pulling a cord swings the ladder up and over the gunwale. Telescoping leg sections then slide down the outside of the hull into the water, enabling a swimmer to board the boat easily. Invented by A. O. Akermanis of Orlando, Fla., the ladder stows out of the way inside when not in use.

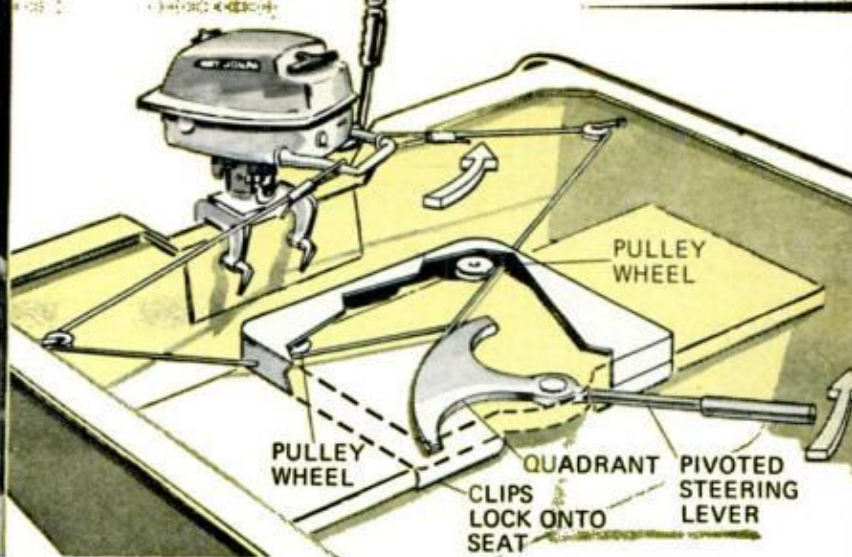
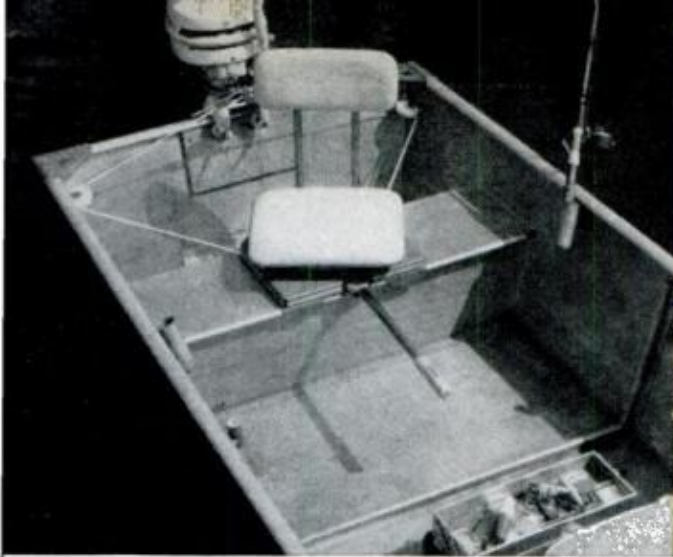

YOU STEER WITH YOUR KNEES

with this no-hands control for fishermen. An auxiliary tiller bar clamps to the seat and turns the engine through a system of pulleys and cables. A swiveling seat is mounted on top of the tiller mechanism so that a slight

twist of your body steers the boat in the direction you want to go, freeing your hands to hold the pole. The tiller can be rigged to move with or opposite to the engine's rotation depending on the action preferred. The inventor is A. O. Akermanis of Orlando, Fla.

TWO-WAY ROPE CADDY

stores a line so it can't slip off, then lets you pay it out at the push of a button. Pivoted lobes at the outer end spring up to hold the coil in place as you wind the rope on. Squeezing a release in the handle then retracts the lobes so the rope slides easily off. Made by New Horizon Enterprises of Largo, Fla., the device is for water-ski tow ropes and anchor lines that must be reeled in and payed out frequently.

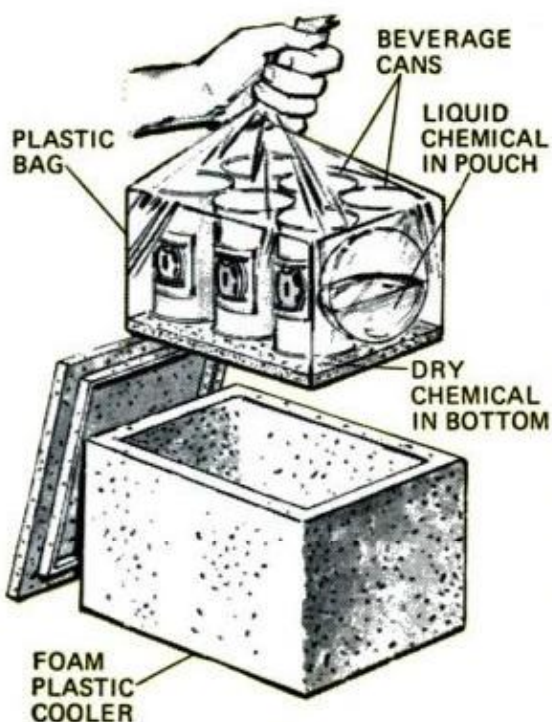
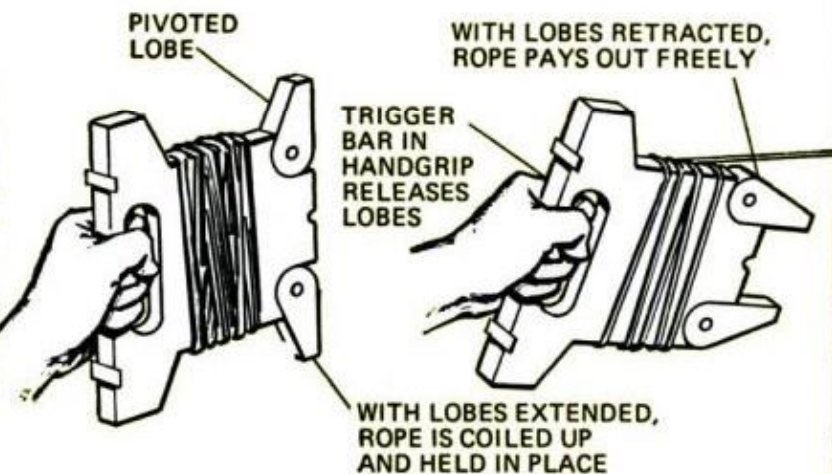

INSTANT COOLER chemically chills a six-pack of beer or soft drinks in minutes for picnics and impromptu parties. The cans are sealed in a plastic bag containing a dry chemical in the bottom and a liquid chemical in a pouch in the side. Squeezing the pouch breaks it, mixing the chemicals to start an endothermic reaction that quickly cools the cans. In an insulated container, they stay cold for hours. Inventor is Marvin Holt of Saugus, Calif.



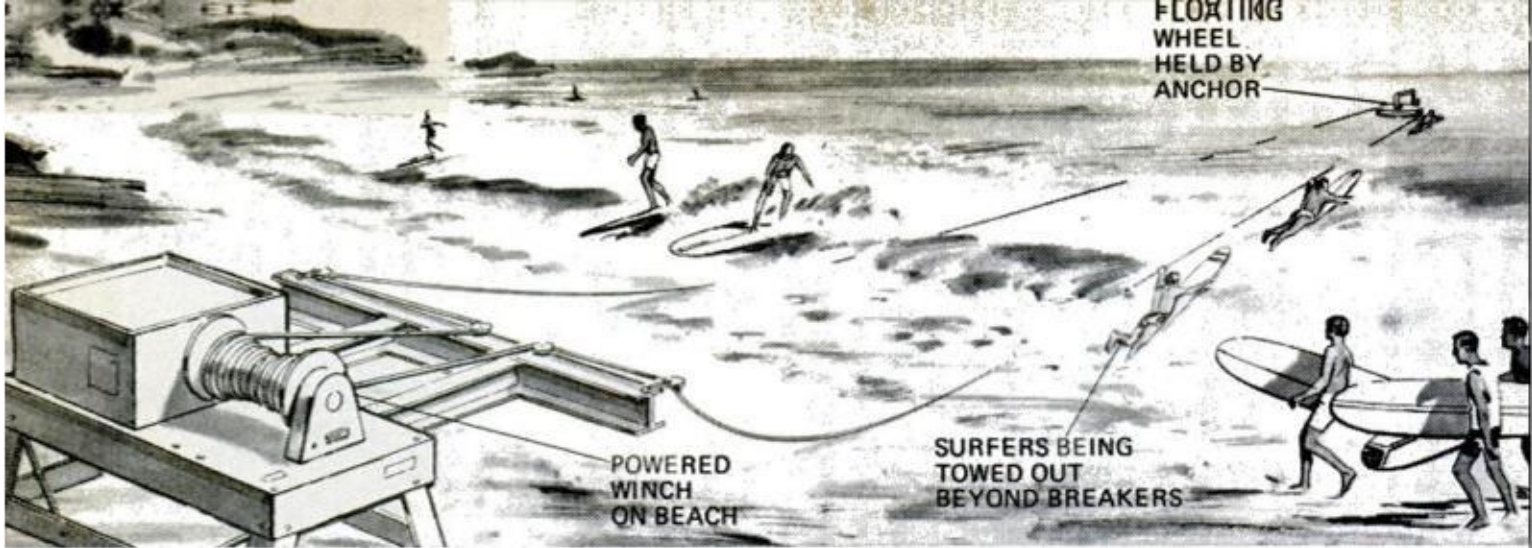

WATER TOW FOR SURFERS is a new switch on the ski-tow idea. You hang onto a rope as it pulls you out into the surf, then let go and ride the waves in. The rope runs out and around a large floating pulley anchored

offshore. Invented by Edwin V. Hanson of Seattle, Wash., the tow not only gives outbound surfers a lift, but also eliminates the danger of their being struck accidentally by inbound surfers since the two are kept apart.

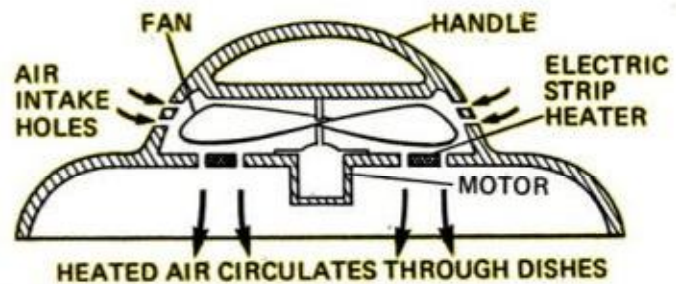
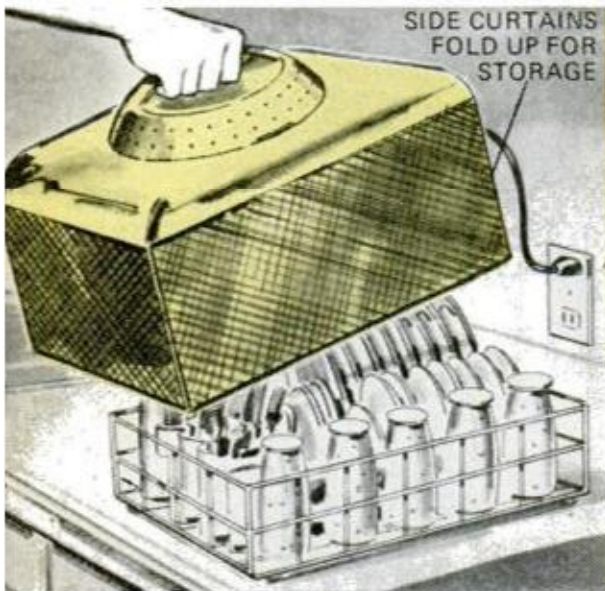

QUICK DRYING OF DISHES is the object of this invention by Sibyl Krausz of Pacific Palisades, Calif. It slips over a standard dish rack and forces heated air downward to speed the drying action and save hand wiping. It can also be used to prewarm dinner plates or keep food hot. When it's not in use, its flexible sides fold inward underneath for easy storage.

PROP-POWERED CARGO BOOM steers itself in and out of tight places using a rotor on the rear end. The remote-controlled rotor can be reversed to swing the boom sideways in either direction for precise position-

ing of construction materials and other loads. Suspended from a crane, the boom slides forward and back, automatically adjusting balance point to keep load level. Logan Greeson of West Palm Beach, Fla. is the inventor.

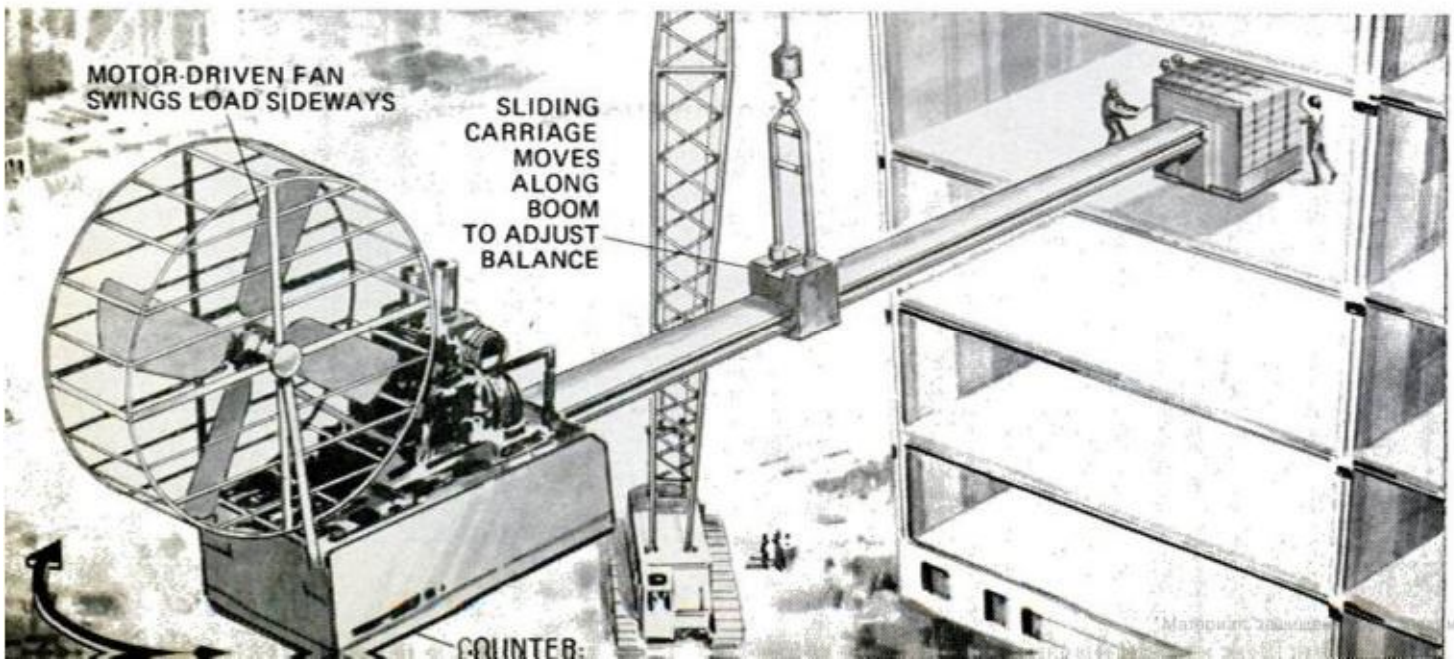

CONVERTIBLE CRAFT

switches quickly from surfboard to sailboard to motorized skimmer depending on your needs at the moment. A well in the center lets you slip in a small outboard engine mounted in a special housing. This gives you a powered surfboard for use where there are no waves to ride. With the engine removed, the well opening is covered with a deck insert, and the craft becomes a conventional surfboard or paddle raft. If a breeze comes up, you just slip a mast into a socket and attach a small canoe-type sail. Bolt-on lee boards give the effect of a keel and stabilize the board for tacking into the wind. Maker is Berkshire Crafts of Media, Pa.



YOU DON'T TRIP OVER any chair legs getting in and out of your seat at this novel dining table invented by Gordon E. Rogers of Boise, Idaho. The seats are suspended from the table on slide-out bars and swivel for easy accessibility. When not in use, they retract out of the way into recesses in the tabletop. Object of the design is to save space and permit easier cleaning underneath.

LADDER WITH A HOLLOW LEG makes it easy for fruit pickers to drop fruit harmlessly to the ground without having to climb up and down themselves. The fruit slides down the tubular leg and pops out at the bottom into crates. It feeds into the leg from a hopper that can be moved from rung to rung depending on how high the picker works. Inventor is A. O. Akermanis of Orlando, Fla.



SEATS RETRACT UNDER TABLE WHEN NOT IN USE

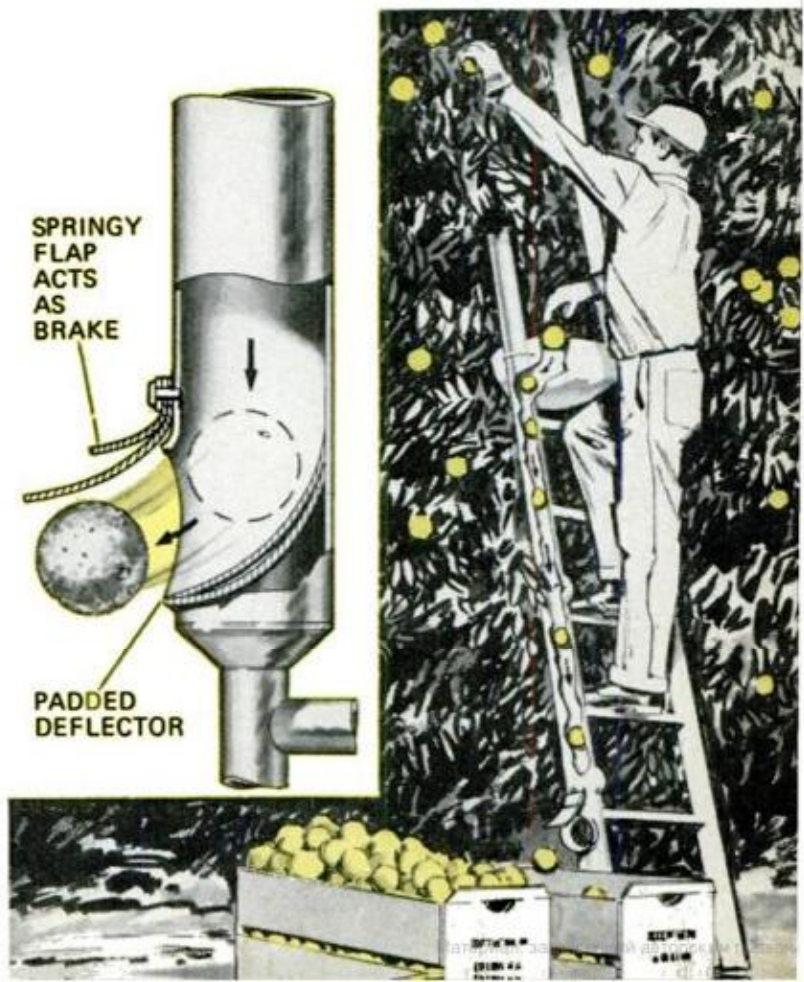
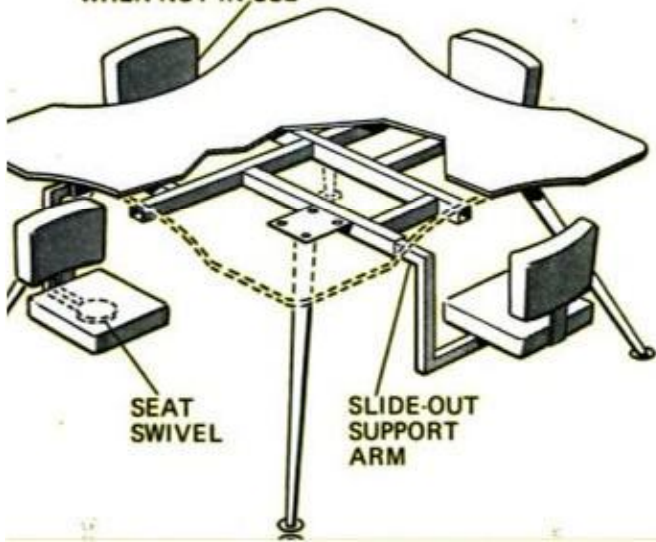



New Breed of Offshore Fishermen

Anyone cruising the coast in such small, open hulls a generation ago would have been called foolhardy. Today, he's the envy of all men who go down to the sea to fish. Here's why . . .

By GEORGE W. REIGER

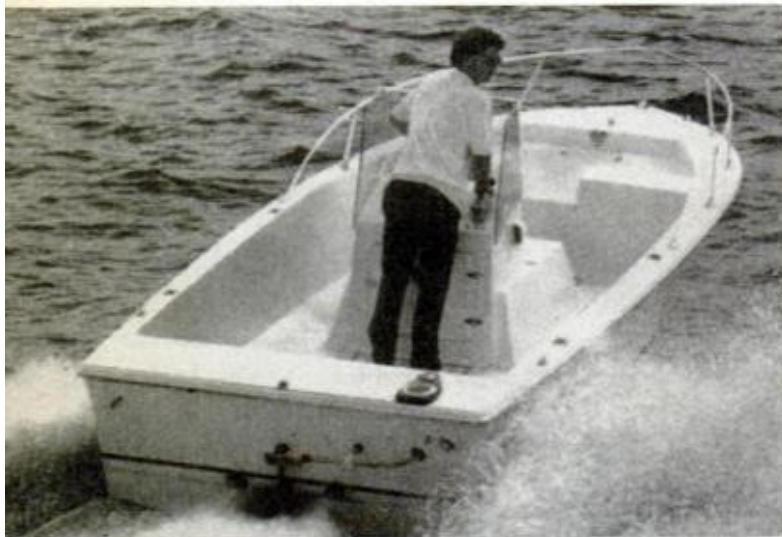

SOME CLAIM the first hull was an accident; manufacturers insist it resulted from careful planning. But everyone agrees that the new stable center-console designs are tailor-made for anglers who like to fish beyond sight of land but can't afford a cruiser.

One story has it the Bahamian Crown Colony Club asked for a boat that could negotiate the shallows for bonefishing, yet handle the Gulf Stream and battles with big marlin. This search for a hull with a two-in-one capability turned out the Aquasport, and the success of this

SOME CENTER CONSOLES stress big water, some the shallows. Sea Lark, above, is a 19-footer with a 115-hp Volvo/Penta in-board and a tunnel stern enabling it to run in water just 6 inches deep. Fisher-Pierce, builder of the Boston Whaler, has come up with the Outrage (at right) for anglers who like to work a turbulent shoreline from a reliable, seaworthy hull. Price of the Sea Lark, \$5595; the Outrage: \$3950





LARGEST of the fleet is Trojan's 25-footer (top left) next to one of Mako's three models (17, 19 and 22 feet). Middle left is an Aquasport, the boat that started the trend, with a Stamas Tarpon charging in from the right. Below is MFG's new Fishing Caprice, modeled from the hull of the 18-foot deep-Vee Caprice. Two captain's chairs behind the console revolve 180° to become fighting chairs in the event of a big one. All these boats are fully trailerable—another plus for the new offshore fishermen



MARINE ALUMINUM is used in a number of "off-shore" models. Above, Chrysler's Fin Runner weighs but 875 pounds, yet can carry 3000 pounds. \$1730



LIVE-BAIT WELL is a bonus feature in many offshore fishermen. This 19-foot center-console model from Cobia has a large one aft; boat sells for \$1700



THIS 19-FOOTER from Glastron boasts high fuel capacity with an integral 18-gal. tank and space for three 6-gal. standard outboard tanks under the seats

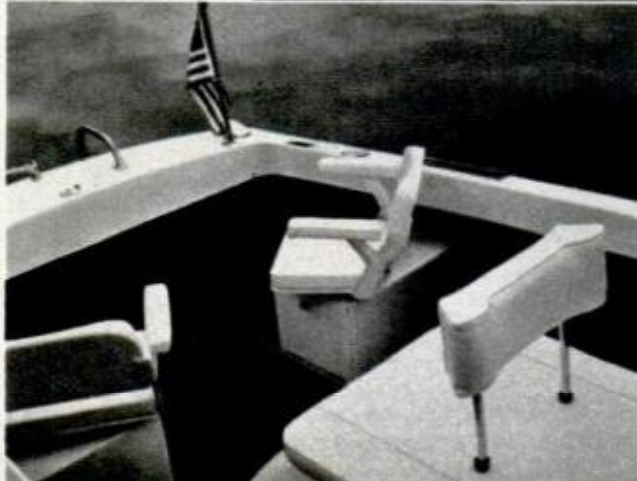
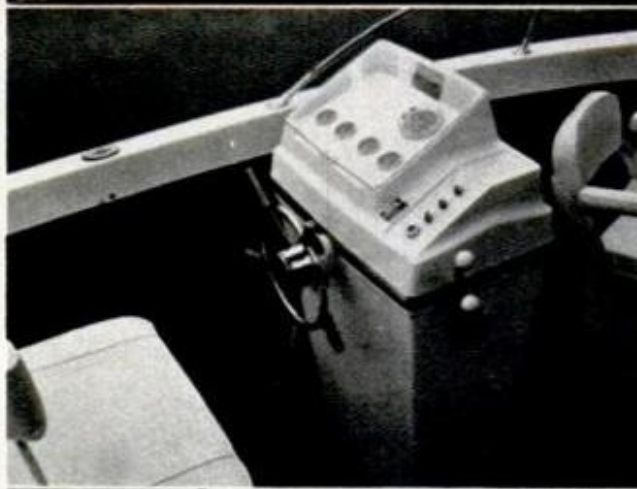

WATER JET UNITS offer unparalleled shallow-water capability, none more so than Buehler's 18-foot Nimrod II with "jet-age" console and roomy cockpit



company sparked other Florida firms to produce their own versions. Today most makers have an "offshore fisherman" model.

What distinguishes this design? It's a boat with enough freeboard and vee to take open water, yet with sufficiently shallow draft to work close inshore. It has a center-console instrument panel for radio/telephone and fathometer, and the console provides maximum cockpit space and casting room. Sometimes there's a built-in live-bait well and usually a large-capacity fuel system for long cruises. The boat has enough power to get there in a hurry, yet is equipped (by running on only one of two outboards or, perhaps by using a small auxiliary) to troll long hours. For a maximum expenditure of \$5000 for boat and motors (more often closer to \$3000), an angler has all he needs to pursue walleye in Minnesota or wahoo in Florida. ★★★

SELF-BAILING COCKPITS and bow-casting platforms appear on many offshore models and are found on this Pro Line 24. Options include marine head and twin 21-gal. fuel tanks



ANOTHER ALUMINUM MODEL, this 18-foot deep-Vee hull from Mirro-Craft has positive flotation. Bow safety rail and running lights are standard equipment. Price is \$1350

SOME CENTER-CONSOLE THINKING has gone into Lund's 14-foot Fish 'n Ski outboard with a 40-hp capacity and ample room for fishing or skiing. Suggested retail: \$695



MINI-MODELS include Shell Lake's 14-foot Nipigon (left). Part "bass boat," part "center-console fisherman," this Shell Lake creation can handle up to a 60-hp motor





New 1971



IMPROVED VERSION of Mossberg's successful Mal-lard Tri-Spar (no boom) design is still only \$399



FOR YOUNG AT HEART, Alcott's new 12-foot Mini-Fish with a 65-sq.-ft. lateen-rig; it costs only \$400

HOUSEBOATS are increasingly the trend in summer homes on the water. For \$16,650 you can have this 37-foot mobile, all-season lodging from Boatel, perfectly designed for family vacations and weekend trips



Boats

Houseboats and sailers lead the way in the colorful season ahead



PUMPKIN-COLORED POWER PACKAGE is MFG's Super Gypsy made especially for water skiers at \$1369



TWIN OR SINGLE Tunnel Drive comes with Penn Yan's 26-foot flying-bridge Vindicator, starting at \$14,500

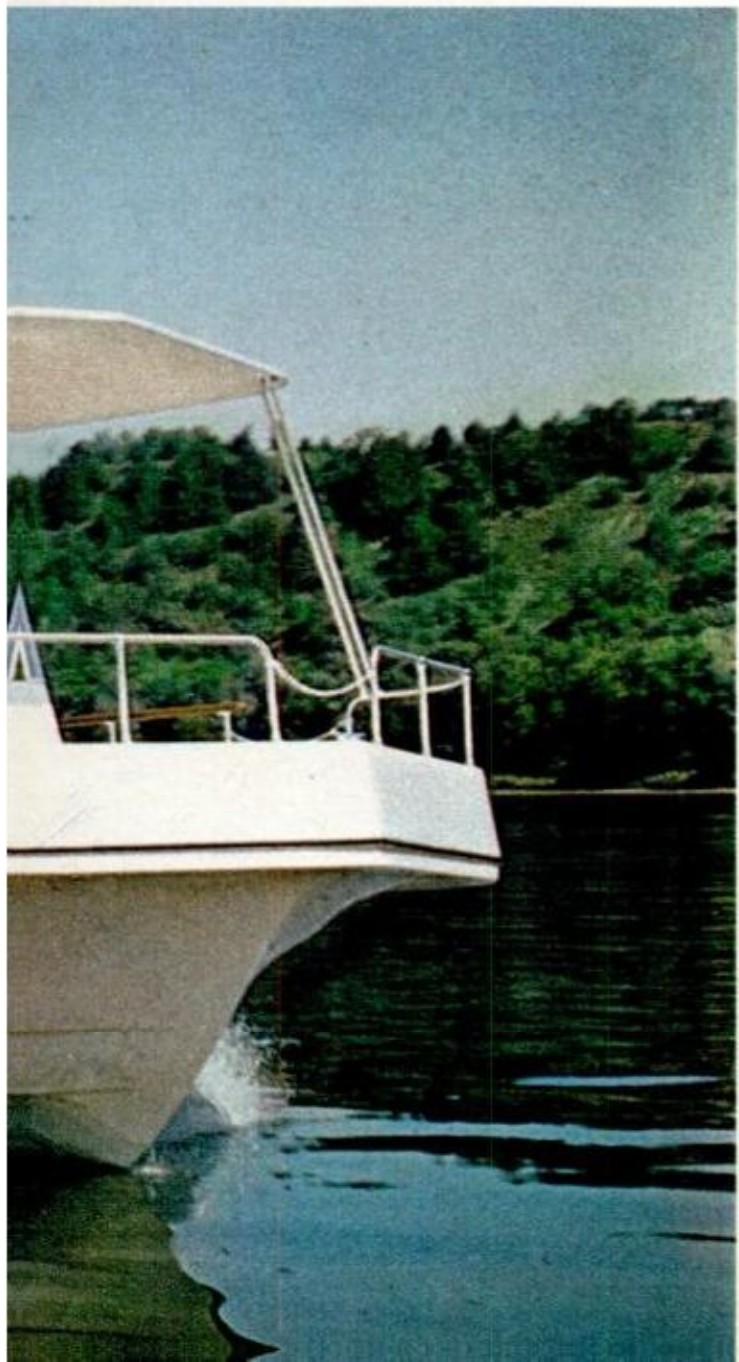

BOW CONTROLS make "bass boat" a great run-about and fine for fishing; this Monark model, \$700



WANT A COLLAPSIBLE tent trailer that runs on water? Sleep ashore in Sea Space Deck-Line; launch it the next day for a cruise. Complete for \$4490



TRADITIONAL DORY DESIGNS never had it so good! This Sea-safe 18-footer made out of plastic needs only a 20-hp outboard to speed up to 25 mph, thereby providing a modern means of transportation in a time-tested hull. Price is \$1195

RACY LINES in Chrysler's all-new 16-foot Conqueror come from its fast-planing shallow-vee hull, wrap-around back-to-back seating, a deeply padded dash with smartly styled instrument cluster and a sweeping, optional windshield. Priced at \$2105



HAZARD OF FIRE AFLOAT in a fiberglass boat has been reduced with new fire-retardant resin (Hetrax) used in Uniflite houseboats and said to be 20 times less flammable than ordinary fiberglass. Price, \$25,000



COMBINE A CRUISER with a home in Larson's new 21-foot Cruiser Home. Some standard features include a vinyl hardtop with fully enclosed cabin and power options from 155 to 215 hp. Priced at \$8500

JET-POWERED HOUSEBOAT (below) from Chris-Craft provides great shallow water maneuverability with wonderful open-water speed from two 230-hp engines. Run Runner (right), Kenner's latest family cruiser, sleeps six, races at better than 34 mph with dual 155-hp engines. Price: \$14,500

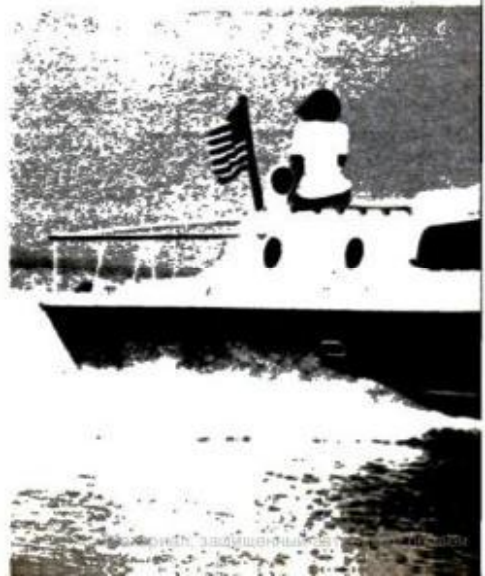



COMPLETE WITH RACING STRIPE is this 16-ft. Mustang from Correct Craft. These popular boats are often used by professional water skiers at Cypress Gardens. Powered by 22 horses; price, \$4738



JUST NINE FEET LONG, the Triumph trimaran from Snark Products has five-foot beam that, with the mast down, converts the little sailer into a swimming, skindiving or sunbathing platform. Price, \$349



NEW LAST YEAR and still going strong is Mark Twain's Snoopy, a bow-riding trihull providing enormous cockpit space for skiing, fishing, cruising—any activity afloat. Priced at \$4520 with 120 hp



LIGHTWEIGHT CATAMARANS, once California's "in sailers" are increasing in popularity across country. Above is the 15-foot Sea Spray from Gen-Mar, Inc. Below, Starcraft's Skylark II offers a one-design Marconi cat-rigged tunnel planing hull and gunwale-walking stability; all in a 14-footer for \$795

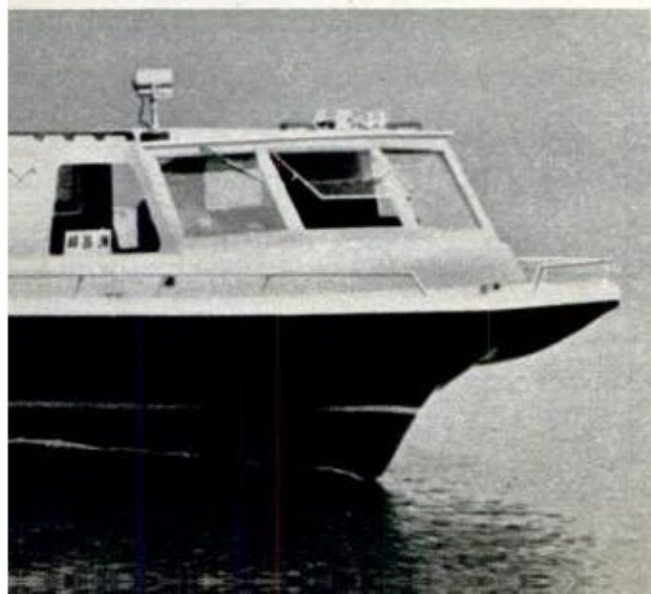

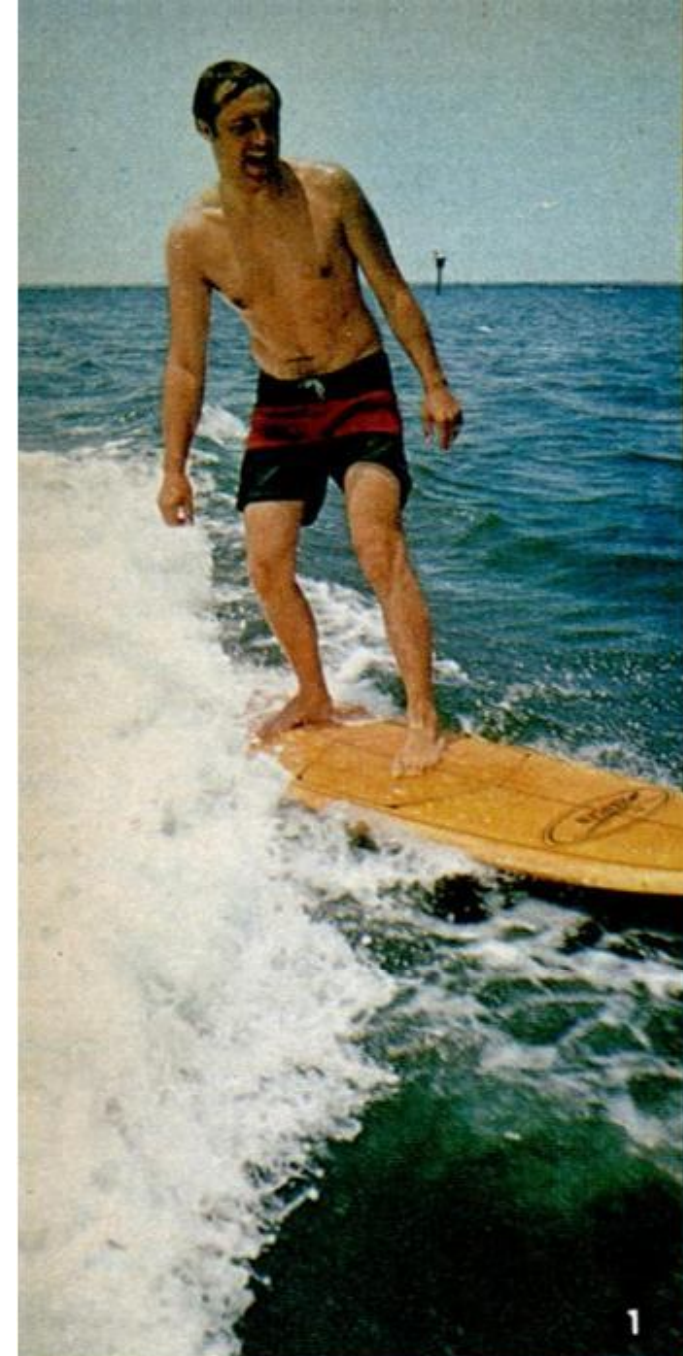



Wake Surfing Is For Anywhere

PM tests the adaptability of Bertram's Pop-Top Camper — and three frustrated surfers.

By GEORGE REIGER, Boating Editor

TAKE THREE BEACH BOYS, season them with saltwater and sunshine, add three surfboards, and what do you have? Ecstasy! And frustration, too, if surfing conditions aren't up to their breezy standards. After all, these three guys—Ron Caragias, Hank Leonard and Al Newbury—have won some 40-odd surfing trophies attesting to near-professional skill with those slippery slivers of fiberglass.

I'm nuts about the Delmarva (Delaware, Maryland, Virginia) peninsula, particularly the unsettled coastline south of Ocean City, Md. When Hank asked me whether any surfers had ever before explored the area, I replied, "Doubtful," and Hank was hooked.

Ron and Al have no trouble finding time off from work. Most beaches along the Long Island and Jersey shores are so well populated by surfers that the mere mention of sandy stretches and cresting combers unknown to others is enough to "inspire" a four-day weekend!

We trailer a Bertram "Pop-Top" camper behind an Inter-

◀ **SHOWING 'EM HOW**, Hank Leonard (1) rides Bertram wake up Chincoteague channel. 2) First morning finds us stranded with tide out, but by the time we had breakfast, we're afloat again. 3) Ron makes the most of modest seaside wave. 4) Even though wind isn't up, Bertram's 40+ knots makes own breeze. 5) Hank (right) pulls up onto wake's crest before releasing towrope while Ron is still seeking his balance

national Travelall from Neptune, N.J., to Chincoteague, Va. Launch and run to the inlet. The big moment: But where's the surf? For three days we wander in and out of inlets from Chincoteague to Wachapreague and back again looking for the "perfect wave." Halcyon weather prevails—great for fishing, sunbathing or boating, but just no surf for my companions. The second morning out, Hank gets an idea: "With this deep-V hull, we should be able to carve a sizeable

wake at moderate speeds. Let's try wake surfing!" It works. The boys have a perfect wave—mile after mile of one continuous crest. It's great fun for a weekend!

The Bertram performs like a dream. Equipped with two 165-hp Mercruiser stern-drives and a 100-gallon fuel tank, it's ideally suited for coastal cruising and camping. It's priced at \$11,190. For further information write the Whitaker Corp., 3663 N.W. 21st St., Miami, Fla. 33142. ★ ★ ★



FIRST STEPS in "popping" camper top for the night are to unhook hatch and ease it over onto foredeck

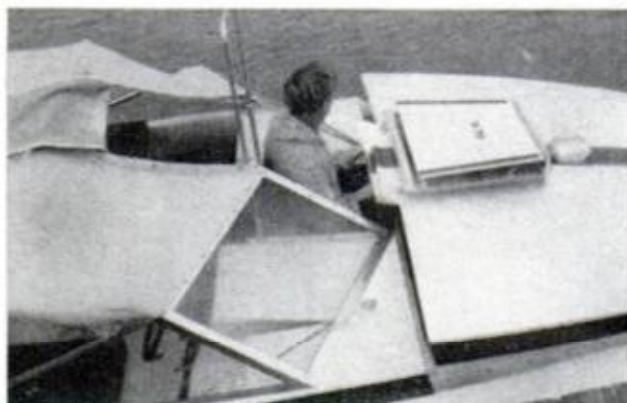

THOUGH FOREDECK LOOKS HEAVY, 5-ft.-long section is easily lifted if firmly gripped in the middle



WHILE STEVE HOLDS foredeck up, Ron slides roof rods along support bars preparatory to tightening



FOREDECK UP, boys begin to snap down vinyl side curtains that'd been rolled up beneath the "roof"



"CORRIDOR CANOPY" snaps around mast light to provide weatherproof passage from cabin to cockpit



FINISHING TOUCHES are provided by the author in tying closed the little openings in mastlight seam



GLASTRON/CARLSON'S NEW CV-21 powered with 350-cu.-in., 265-hp jet engine moves at more than 50 mph

New Jet-Powered Boats

JET POWER is not new. Experiments with water jet systems go back two decades, and jets have been used in family boats for years. They're safe (no props to cut swimmers), maneuverable and have wonderful shallow-water capability since they don't need the draft of prop-driven boats to do their thing. So what's new besides this?

The answer is speed. In any jet system, air or water, great speeds are a result of sleek aerodynamic or hydrodynamic designs coupled with enormous power. The more air or water *impelled* through the system, the faster

the craft will be. But boats must overcome water resistance. And as sheer energy drives nuclear subs along at underwater speeds of 50 knots plus, big engines and jet units are doing the same thing on the surface for a new breed of family power boat. Whereas 40 mph is a kind of sonic barrier for most hull and power combinations, California firms like Checkmate, Sanger and Sidewinder, and now Chris-Craft and Glastron, offer combinations that can keep up with a nuclear sub. Checkmate's Jetmate, for instance, claims 70 mph—and that's moving! ★ ★ ★

BERKELEY JET (below) has moved in to lead competition for civilian users while Jacuzzi is kept busy supplying jet units for the U.S. Navy's patrol boats

CHECKMATE AND CHEETAH feature this 455-cu.-in., 390-hp Olds engine as standard equipment; Ford and Chevy high-performance engines are optional

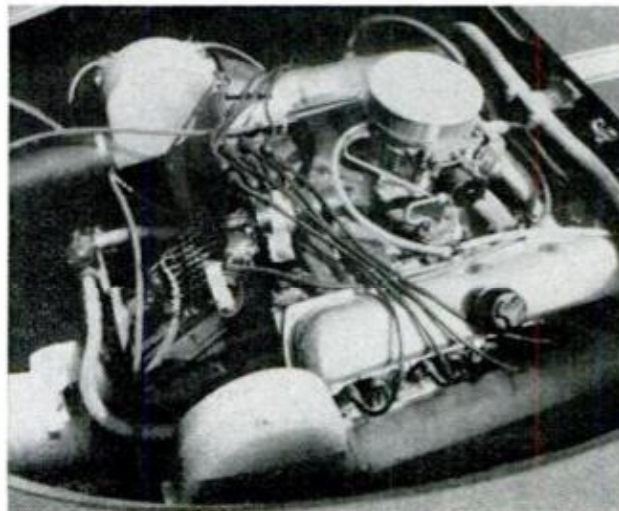
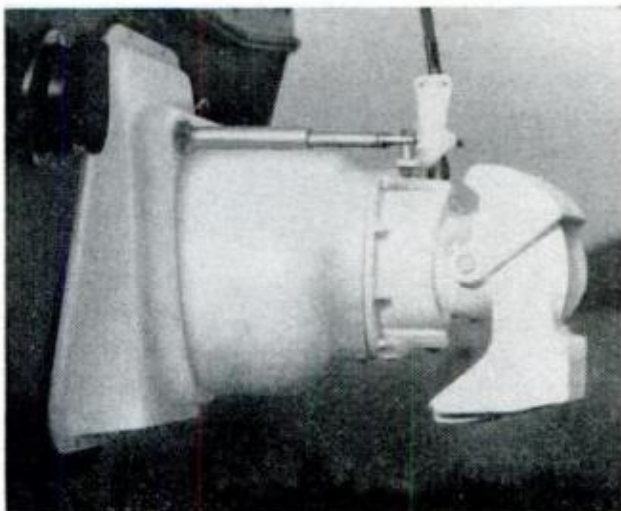



How to Repair A Fiberglass Boat

By MORTON J. SCHULTZ

NO MATTER WHAT ITS SIZE, if your boat is made of fiberglass you can save yourself a bundle of money by repairing it yourself.

Not long ago, for example, a yard wanted to charge a friend \$75 to patch a couple of gouges in his 42-foot ketch. When we got through doing the job ourselves, it cost \$5 for materials and it looked great.

As long as you know how to match the repair procedure to the damage, repairing a fiberglass hull is easy. But a lot of people fall flat on their transoms for too many believe one repair will suffice for all types of damage.

There's another misbelief we should clear up now. Through-

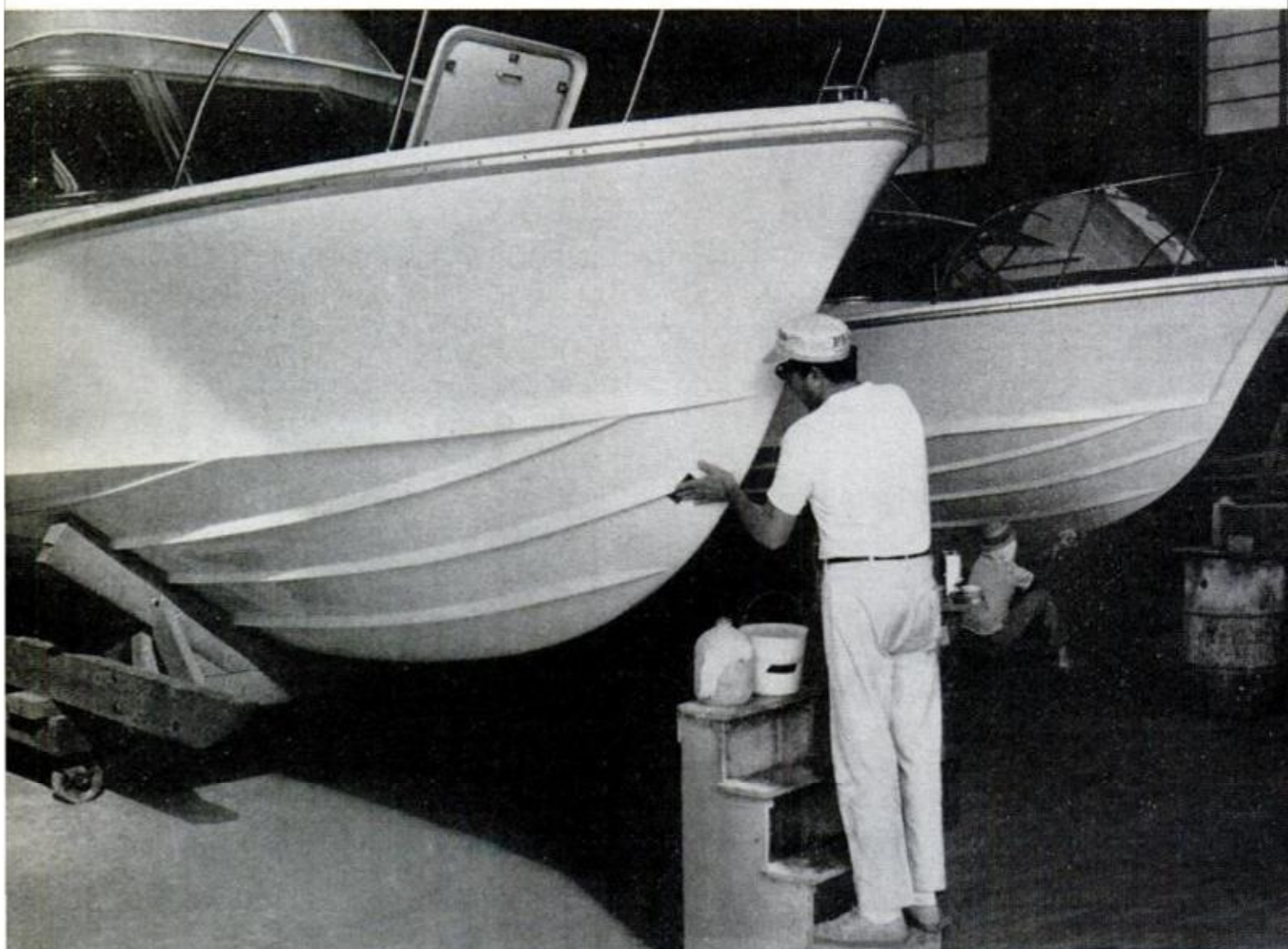

the-hull fractures seldom occur with fiberglass boats. Fiberglass is a high-strength material with superior resistance to impact. Only a direct collision will cause a punctured hull.

Even if a hull is fractured, you stand a good chance of being able to fix it yourself if the puncture isn't spread over a wide area. A good book on fiberglass boats in general that deals with repairing infrequent through-the-hull fractures is *Fiberglass Boats* by Boughton Cobb Jr. He's manager of the Fiberglass Industrial Materials Div., Owens-Corning. The book can be ordered for \$3 from Yachting Publishing Co., 50 W. 44th St., New York, N.Y. 10036.

Our concern here is how to fix damages that occur frequently. This surface distress can be divided into five classes: gouges, scratches, crazed cracks, wrinkles and loss of gloss.

Most fiberglass boats are made of two

layers of material bonded together by chemical action. The outside layer is a colored gel coat, a special resin material containing concentrated color that provides a smooth, finished surface. The layer beneath the gel coat is a polyester resin which adheres to and is reinforced by laminations of fiberglass mat, cloth or woven roving.

Gel coat and polyester resin are cured by a catalyst that allows them to form a hard, strong mass. The only one of the five categories of surface damage which destroys this mass is a gouge, and that's a good place to start.

● *Repairing gouges.* Once the gel coat-polyester resin formulation is gouged, the damaged material has to be cleaned out to reveal the fiberglass. Rout it out with a putty knife or similar tool.

Clean and rough up the fiberglass with a piece of 100-grit sandpaper to



REPAIR PUTTY must have a firm seat on which to hold, so scrape away all loose distressed material

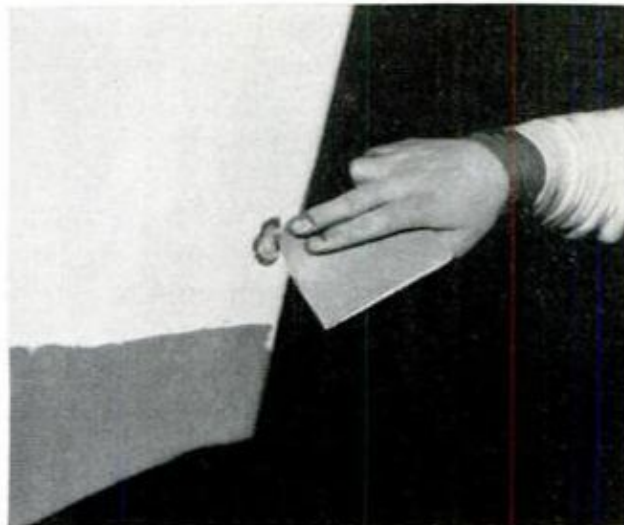

GOUGE is then sanded with 100-grit sandpaper to remove dirt and provide roughened surface for putty

MIX CATALYST and plastic repair putty on a clean piece of scrap just prior to application of putty



OVERFILL THE GOUGE about $\frac{1}{4}$ inch. Press the putty firmly into place to squeeze out all of the air

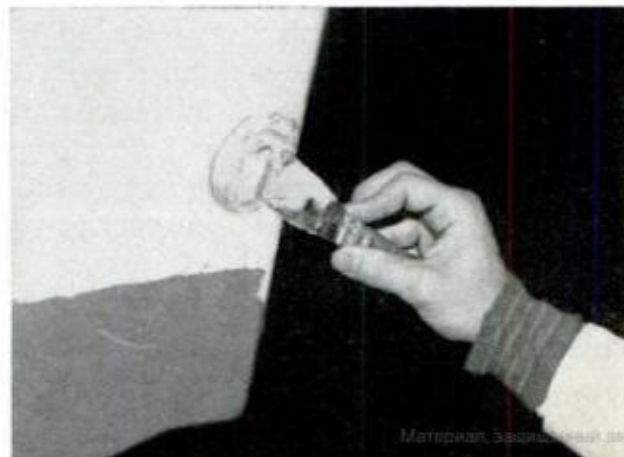

assure that the repair putty will have a good base. Then swab the whole area with a cloth that has been saturated in acetone or lacquer thinner to clean away dirt and grime. The area to be repaired must be clean!

Buy fiberglass plastic repair putty at a boat store—polyester is the most suitable. Mix this thoroughly with the catalyst as instructed on the can and apply very firmly. Press the putty in hard to force out air, and build it up about $\frac{1}{4}$ -inch above the surface.

Now, cover the repair with a piece of cellophane. Press it into place with a single-edge razor blade or rubber squeegee. Cellophane protects the patch from air while it's curing. Hold the squeegee at a low angle so it's almost flat. Don't worry about the excess putty that oozes out around the cellophane.

Mask off the damaged area in preparation for finishing. When the putty becomes hard to the touch, remove the cellophane and sand with 220-grit sandpaper to remove excess putty and to surface the patch. Use a vibrator sander if available. If not, use a sanding block.

Wash away sanding dust with water, then hand-sand the area with *wet* 400-grit sandpaper to remove scratches left by the coarser paper, and repeat using 600-grit paper.

Wash the area again, and buff to remove remaining scratches and to restore gloss. If you have a power buffer, hold it at a 45° angle and use a lightly abrasive rubbing compound, such as Mirro Glaze No. 1. If you buff by hand, use a slightly harsher grit compound, such as DuPont No. 7 or No. 101S.

To complete the repair, apply the gel coat finish; ideally, the same used by the boat manufacturer so the color matches. Request the company to tell you where to get it. This material can be brush-applied if you have no spray equipment, but a spray finish is neatest and should be used if possible.

● *Removing scratches.* A scratch caused by sideswiping the slip is a most

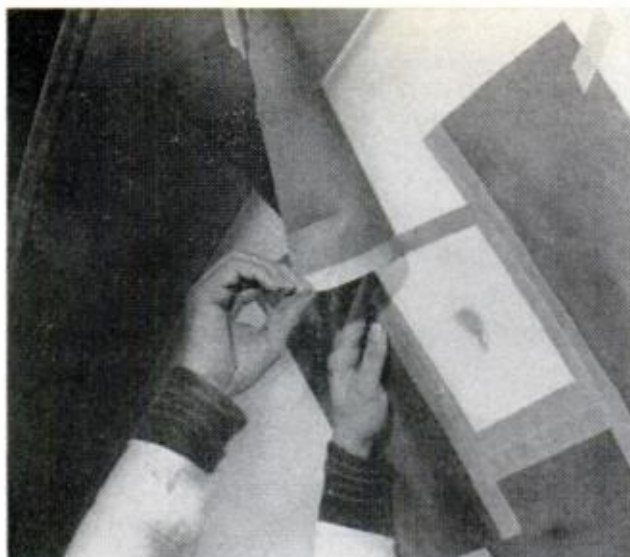

MASKING can be done before or after sanding the repair patch. It's necessary to avoid affecting adjacent areas, especially if gel coat is applied by spray



IF YOU HAVE a vibrating sander, use it. Start with 220-grit paper, wash sanded area frequently with water as you work to keep repair zone free of dust

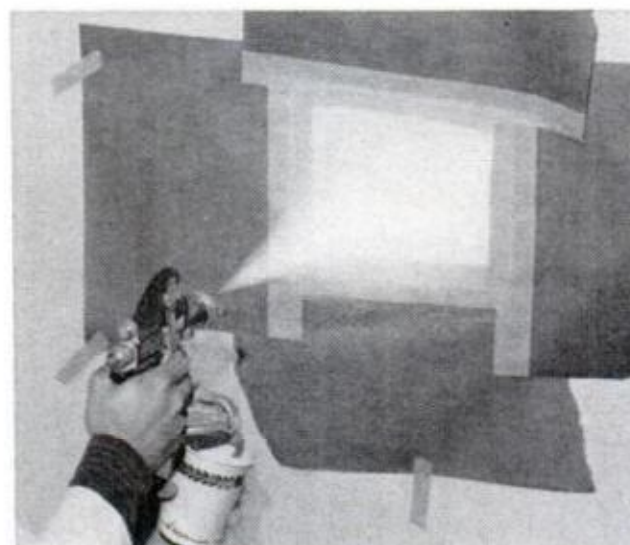

SPRAY FOR BEST OVERALL RESULTS. All you need is the spray head and compressed air. You can use a paper cup for a dispenser as demonstrated above



KEEP SANDPAPER WET while removing scratches. That's what the bucket's for. Keep your eye on the scratch and stop sanding as soon as it disappears



AFTER SCRATCH IS OUT, buff area by hand to finish the repair. Any soft cloth and one heck of a lot of elbow grease should wrap up the job for you



TO ELIMINATE ABOVE STEP, you can buff the entire boat to restore gloss to all dull surfaces. An electric buffer is the ticket for this task

MARCH 1971

common problem for fiberglass boat owners. To get rid of this, first wash down the area with acetone or lacquer thinner to remove grease and grit that can cause additional scratches during the repair.

Now, sand the scratch with wet 400-grit sandpaper. Keep a light hand on the paper and a keen eye on the scratch so you can stop sanding as soon as the scratch disappears. If you go crazy with the paper you could sand right through the gel and have a bigger headache.

Complete the repair by buffing as described above.

- *Handling crazed cracks.* Crazed cracks in the gel coat often look like a spider web. To remove them, block-sand the area with 100-grit sandpaper.

All crazings must be removed. If not, what's left will spread after the boat has been returned to use and you'll be back where you started.

As you sand, try not to make ripples and indentations in the gel coat. If you're lucky and none appear, you can spray or brush on the gel coat after sanding is completed. However, rippling the gel coat is often hard to avoid when you sand crazed cracks. Thus, you'll have to apply plastic repair putty over the area, then sand, buff and finish as described for gouges.

- *Getting rid of wrinkles.* An owner may find gel coat wrinkles over his new boat, a result of sloppy manufacture. Wrinkles look like the "hilly" region of a topographic map.

With a putty knife, scrape off as much wrinkled area as you can. Remove the rest with 100-grit sandpaper. Sand until smooth, and follow by swabbing thoroughly with acetone or lacquer thinner.

Mix a quantity of fiberglass plastic repair putty and apply smoothly with a rubber squeegee. Cover the area with cellophane as explained above until the putty cures. Sand the spot again with (in order) 220, 400 and 600-grit paper

(Please turn to page 206)

How to Figure Your Planing Speed From

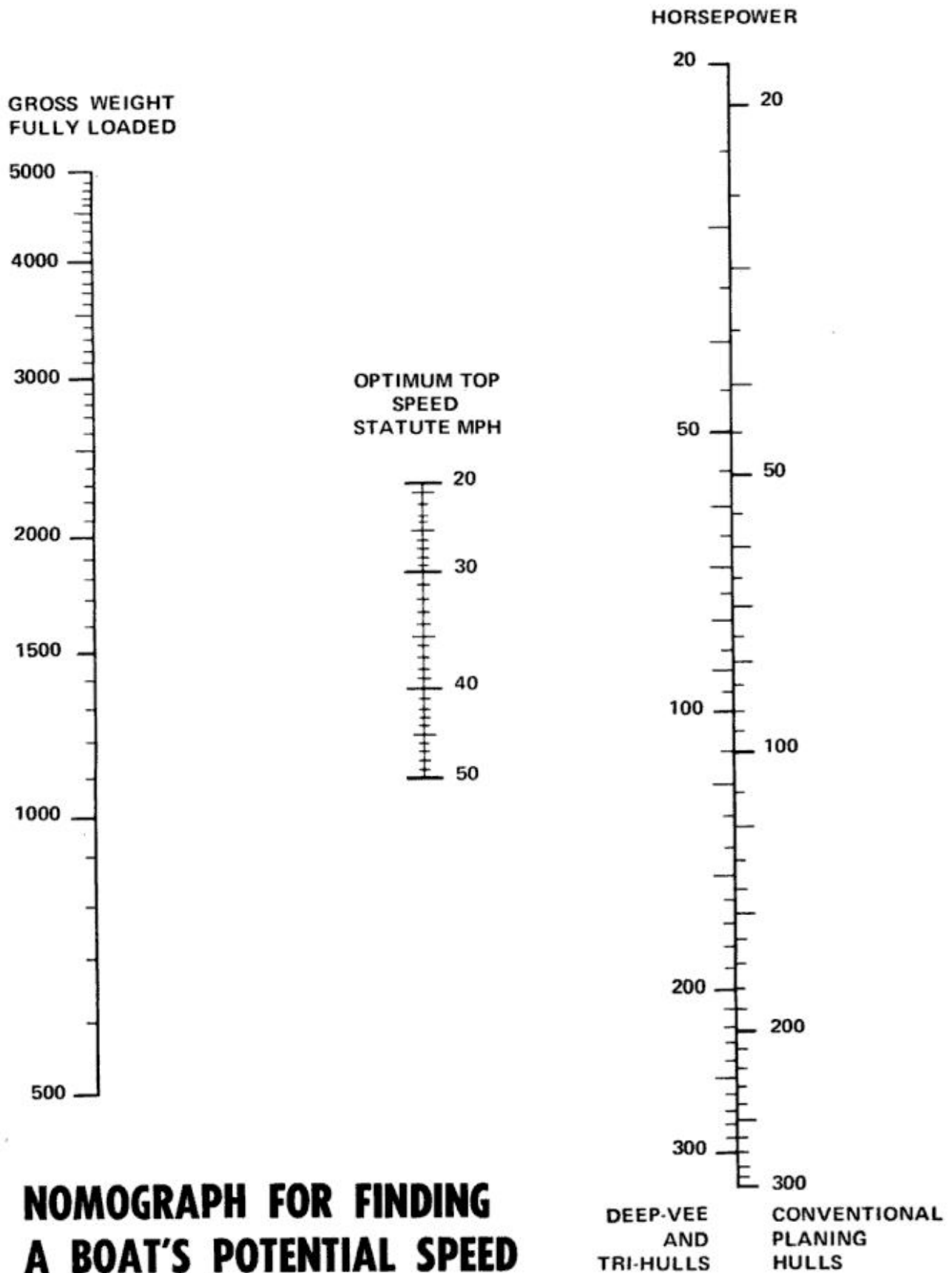



Hull and Horsepower

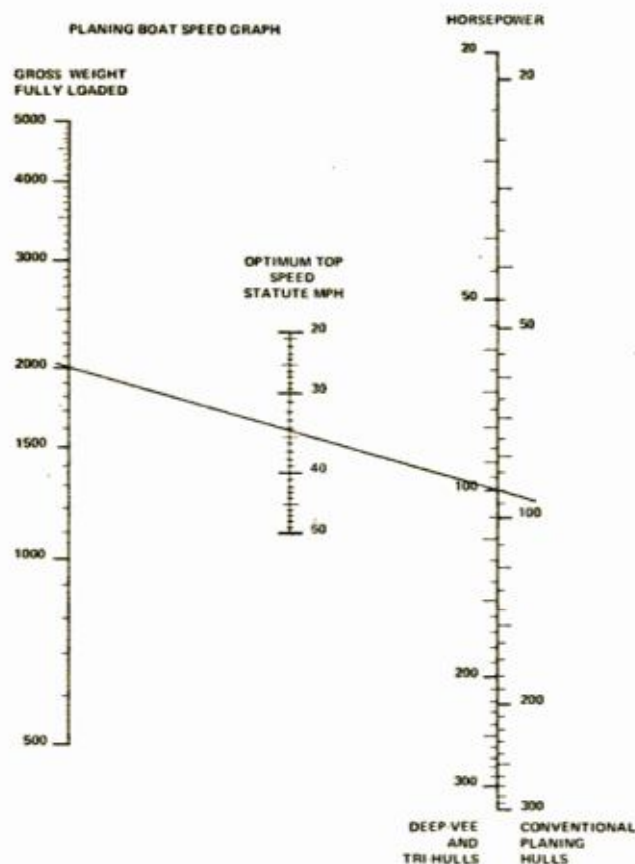

EXAMPLE: A 100-hp engine mounted on a 2000-pound (gross weight) deep-V boat should give 35-mph speed

By **JIM MARTENHOFF**

KNOWING the fully loaded gross weight of a planing boat, and the horsepower, allows you to compute the probable optimum speed—assuming the engine is tuned and delivering its rated hp, correct propeller is fitted, and the boat is properly trimmed.

Here is a nomograph, or slideless slide rule, that tells you what top speed you can expect from your boat. If you know the hp, all you have to do is figure the gross weight, *fully loaded*.

Using a straightedge, connect the gross weight with the hp. Read optimum top speed at point where straightedge intersects speed scale in center.

The hp scale, you'll note, is in two parts: conventional planing hull hp on the right side; deep-vee and tri-hull hp

on the left. (Boats with complex bottom configurations are not ordinarily as efficient as hulls with flat bottoms aft, require slightly more power to attain the same top speed.) Timing your boat over a measured distance and comparing true speed with that obtained from the nomograph does two things:

First, if you fall badly below what you expected, you may have an engine not putting out its rated power, a poor propeller—you may need more pitch—or your boat may be poorly trimmed out for peak performance with, perhaps, too much weight forward.

Second, the nomograph serves as a "rating" of powerboat efficiency, including hull design. If actual speed on a measured mile equals the speed obtained from the scale, then the boat rates at 100 percent, or par. Most boats will reach top speeds at 90 percent of that obtained from the scale, or better.

Boats rating much less than 90 may have performance or even design problems. A rare boat will exceed 100.

The nomograph can be used when buying a boat, providing a clue to what hp you need for the top speed you want. Connect weight with top speed required, read minimum necessary hp where straightedge intersects hp line.

For heavier inboards with weight and hp above those on the scales, take 10 percent to use table. Example: 9000-pound boat, 420 hp; use 900 pounds and 42 hp. Answer from nomograph is optimum speed for that boat.

Forty miles per hour is a sort of "barrier." Efficiency tends to improve sharply above 40 mph, as the boat's bottom "breaks out," gets air under it, has less wetted surface and therefore less drag. It would not be unusual for boats exceeding 40 mph to rate above 100 in performance efficiency. ★★★

WATER 'TOYS'

Whether you want to explore the Florida Keys or merely get out to your mooring, inventors have come up with some pretty wild ways to do it!

WANT A BOAT that's more like a motorcycle or snowmobile? The Hunter Scooter Ski (left) may be just your cup of tea. Or Bombardier's jet-powered Sea-Doo or Turbo Marine's Scorpion. Hydro-Cycle's Barracuda is outboard version of same stable design

FLEET OF YAK-YAKS shows one way to get there. Whether you're a pedaler or a paddler, Fleet Products Co. (1920 E. Pomona St., Santa Ana, Calif. 92705) promises to have something for you. How about a fiberglass Yak-Yak water coupe (top) 10 feet 3 inches long, weighing 250 pounds and with 800 pounds capacity? Or a plastic un-sinkable Yak-Yak Kayak (bottom) just 10 feet long and only 50 pounds? If you're still not satisfied and want something else in a pedal-boat, try the Mustang (fiberglass) by Dolphin Products, Inc., Box 4220, Clearwater, Fla. 33518 or the Aqua-Bike (marine aluminum) by Kayot, Inc., Mankato, Minn. 56001. If you're in the market for either a pontoon boat or a canoe, Kayot has a full range of choices



THIS MAY NOT LOOK LIKE A SKI BOAT, but the Bronco will do 31 mph with a 20-hp engine and is unsinkable even if you flip it! Write Perfection Boats, 4044 N.E. 5th Terrace, Fort Lauderdale, Fla. 33308. Similar designs are the Firefly (FF 300) from Grewe Products and the Scat-A-Boat from Allen-Hayosh



WOULD YOU BELIEVE A "SEASAUCER"? That's what inventor Charles Jennings calls this whatzit. Actually, round boats have been used in the Orient for centuries; only Westerners have trouble steering them. Weighing 55 pounds with a bottle-fed turbine engine for power, the 'Saucer holds 700 pounds

POPULAR MECHANICS

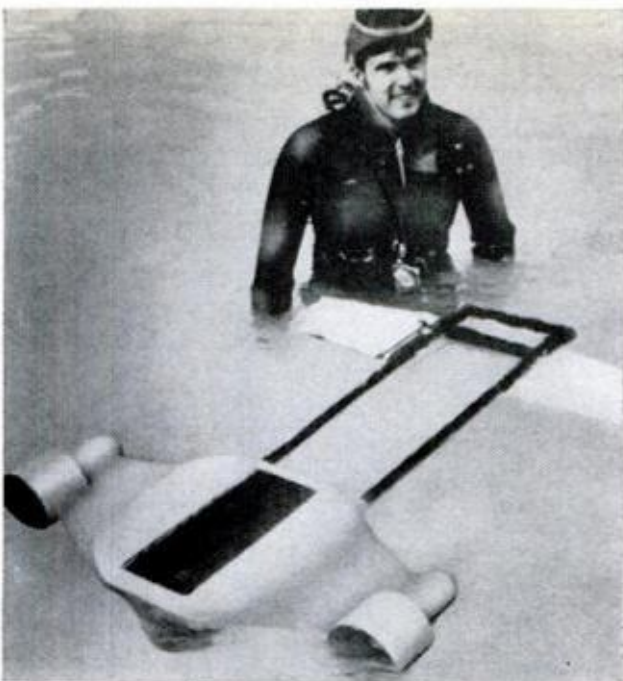

BOY MEETS GIRL (below). He, on Britain's new Hi-Foil runabout; she, on an Aqua-Glider (Box 306, Glassboro, N.J. 08028.) With a 7.5-hp outboard, Aqua-Glider has a tested top speed of 22.7 mph—not bad for mechanized surfing! Similar is the Aero-skimmer from Leisure Products, Menlo Park, Calif.

MINI-MANTA (left) and Sea Scuta (above) are made especially for the growing underwater recreation trade. Think of the fun you could have at a crowded beach! The Mini-Manta tows a diver up to five knots for four hours; the more compact Sea Scuta gives you two hours at three knots. The latter from Underwater Ways, 173 Bleecker St., New York, N.Y. 10012, for \$375; the Manta for less than \$1000 from Leisuredyne, Inc. Another diver propulsion unit (operational to 300 feet) is the DPV MK-I from Farallon Industries, 1333 Old County Rd., Belmont, Calif.

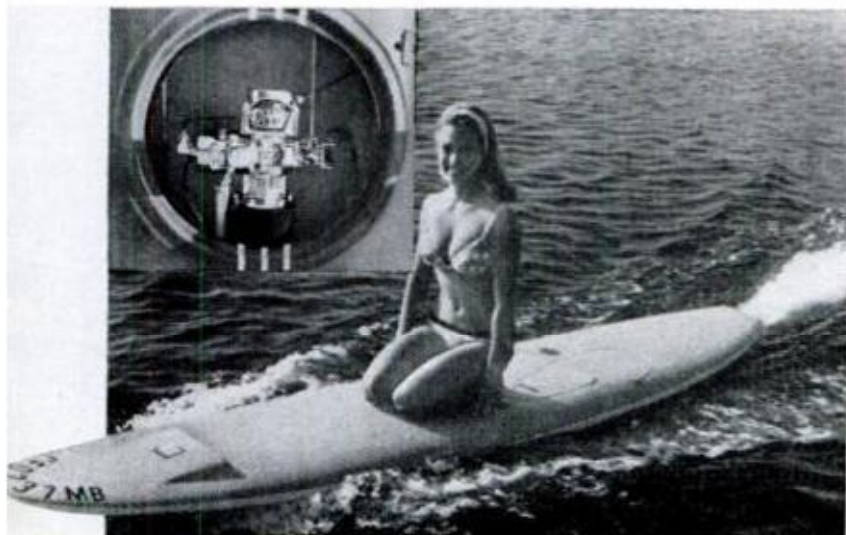
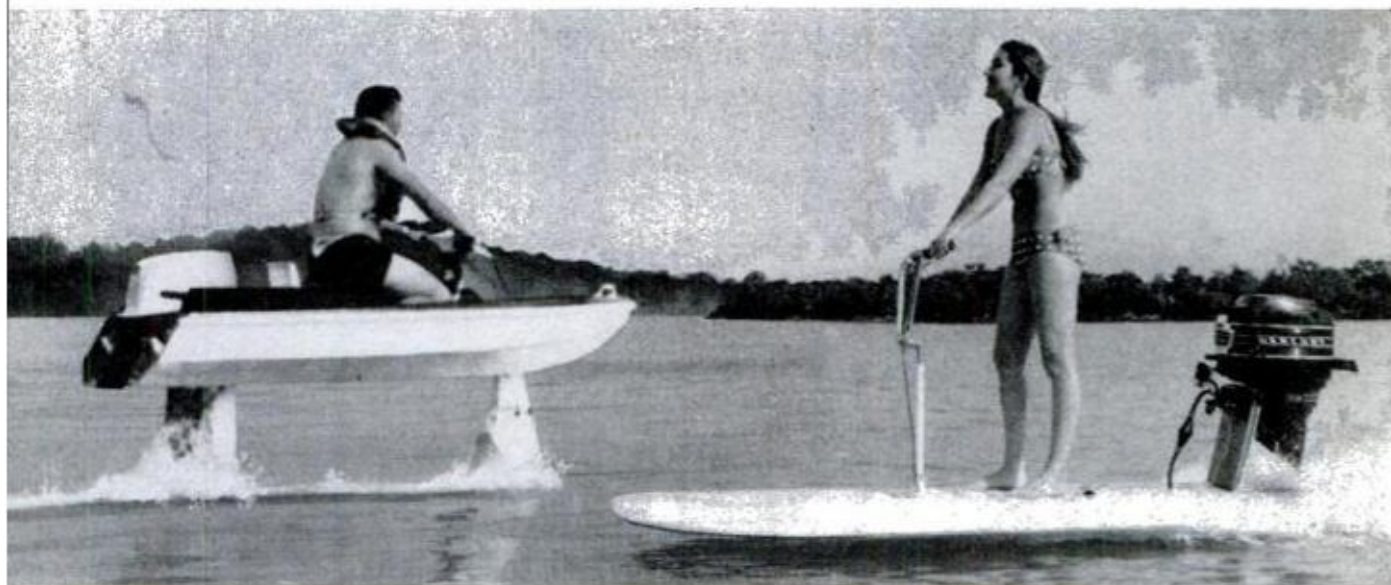

WHO NEEDS SURF TO SURF? This gal (left) doesn't. She has a single-cylinder loop-scavenged, two-cycle, 6.2-hp engine for her Jet Board (9255 Sunset Blvd., Los Angeles, Calif. 90069.) Priced at \$495, this water-jet propelled board runs four hours at 10 mph with such comely cargo. And if she falls off, a safety switch disengages the throttle, so the board won't go to sea without her. Skimmer (Western Recreational Products, Ltd., 5545 97th St., Edmonton 85, Alta., Canada) offers two Chrysler engine options of 3.5 and 7 hp to drive a slightly bulkier board up to 20 mph. Also using waterjet principle, but in kind of toboggan, are Aqua-Jet from Aquasonics, Inc., Rochester, N.Y. 14613, and Aquadart from Leisuredyne, Inc., 166 Ridgedale Ave., Morristown, N.J. 07960.



New Boating

They'll help you to improve your on-the-water living

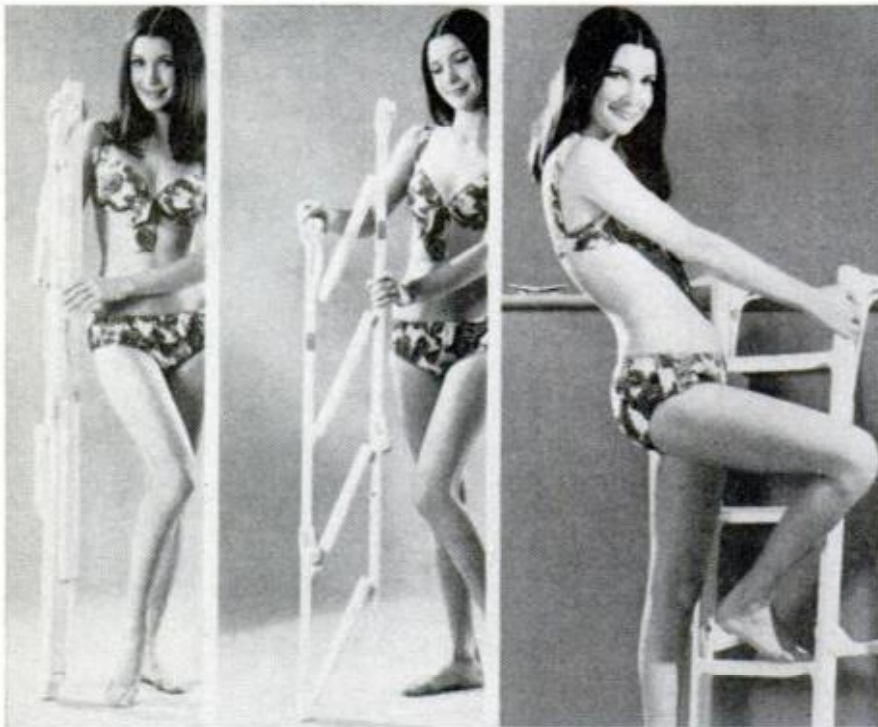

STOWABLE BOARDING LADDERS by Mayfair Marine Corp. (1217 Combermere, Troy, Mich. 48084), made of Union Carbide's "structural foam," are so light they float, yet support 500 pounds. They won't rot or rust and they resist marine growth.

FOR NIGHTTIME BOATERS Allan Marine, Box 120, Deer Park, N.Y. 11729, has a portable set of battery-operated running and emergency lights for bow, stern and waterproof flashlight use.

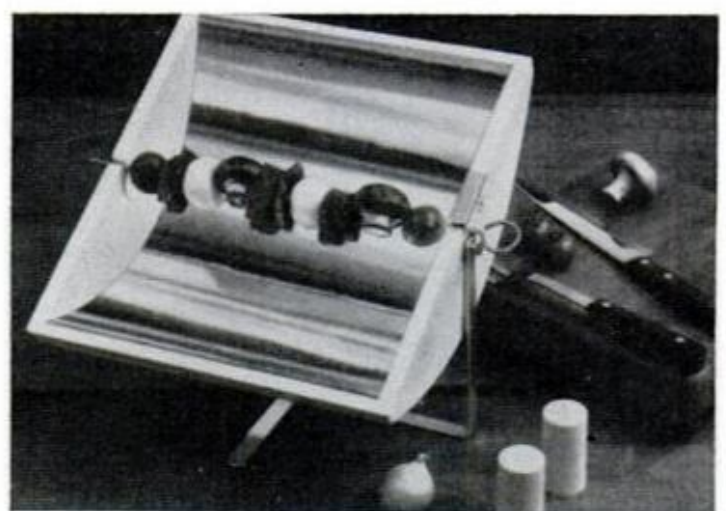

SOLAR COOKER lets sun's rays do the cooking in minutes with this 13 by 13 by 4-inch unit. Davis Instruments, 857 Thornton St., San Leandro, Calif.

PROTECT YOUR BOAT while trailering with a Transom Hold Down made up of chains, hooks, tension springs and lock. Dutton-Lainson, Hastings, Neb.

POPULAR MECHANICS

Products

By ROB KINSON



PORTABLE CUDDY CABIN for cartopper stores in compact pouch. For 12 to 14-ft. boats. Easily put up to protect from sun and rain. From Convert-A-Top, 1827 Los Robles Blvd., Sacramento, Calif. 95838. Price: \$49.95.

BE COOL ABOARD YOUR CRUISER with Aqua-Therm Mark II, water-cooled marine air-conditioner (top right), Repco Products, 7400 State Rd., Philadelphia, Pa. 19136. \$300.

NO MORE METAL NOISE or rust with Gas-Mate, portable 6-gal. polyethylene fuel tank with fuel gauge, bleed valve (right). \$15.95 from Zurn Industries, Erie, Pa. 16512.

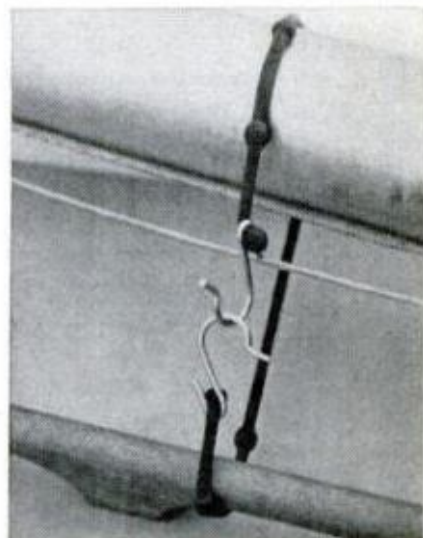
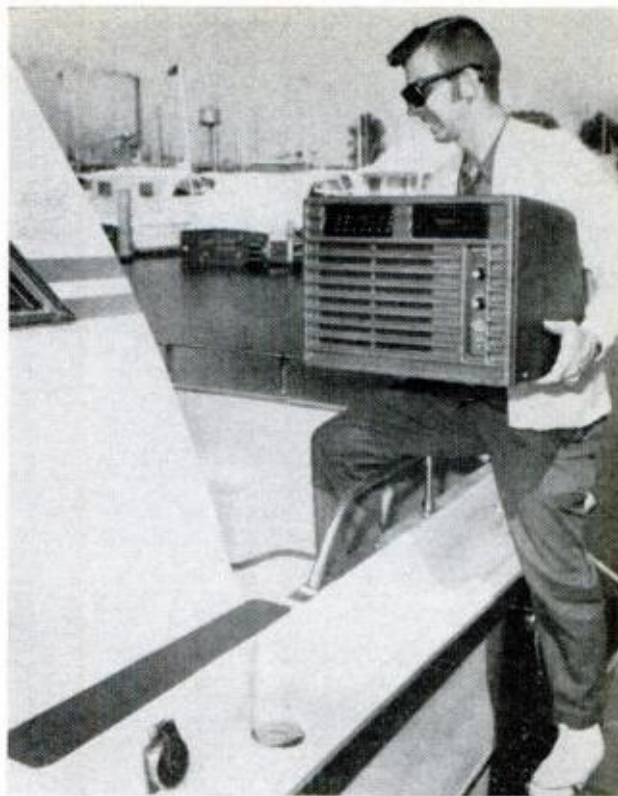

EVEN WITHOUT TIDES, heavy winds and rain can drastically alter water levels and damage your boat. Moor Master Div. of Tomlinson Industries has a device—two steel arms and a concrete block—to hold a pair of plastic-covered steel cables so boat rides free a foot from dock. Write Moor Master Div., 13700 Broadway, Cleveland, Ohio 44125.

FOR ANY TIE-DOWN JOB, this weather-resistant strap will stretch from 4 to 36 inches. It adjusts four ways, costs 89 cents. Tempo Products, 6200 Cochran Rd., Cleveland, Ohio.



BUILD THE 
Yellow Jacket
FOR \$400.

Here's a hot little air-cushion vehicle that hovers at 5 inches and goes up to 50 mph.

By **ROBERT Q. RILEY**

PLANS AVAILABLE. A set of complete plans and instructions for building the Yellow Jacket can be obtained by writing Popular Mechanics Magazine, 224 W. 57th St., New York, N. Y. 10019. Enclose \$15. Specify Yellow Jacket plans.





FLYING THE YELLOW JACKET is quite an experience. You first start the two go-kart engines using the rope starters. Then, after letting the engines warm up a bit, you climb aboard. At about one-third throttle the skirt suddenly inflates like a balloon, and the craft pops up about 5 in. and sits on the edge of the skirt. At about half to three-quarter throttle you are airborne. Once contact with the ground is lost, you are instantly aware of the complete absence of friction. Simply by leaning one way or the other, you can make the Yellow Jacket spin around in a circle, move backwards, sideways, or perform a combination of all these. At low speeds, you use the pedal-operated thrusters for steering; the rudders don't become effective until you reach 20 to 25 mph. At that speed the craft is very stable and the only way to change direction is with the rudders. Over water the craft is no speed demon, but take her over open, flat land and she will really sail.

Yellow Jacket is a result of the engineering know-how of Eugene Gluhareff, former helicopter designer and project engineer at the Sikorsky Aircraft Co.

"The failing with most small air-cushion vehicles," Gluhareff says, "is that the air is not used efficiently. Many times the builder will employ a standard



EXPLODED VIEW

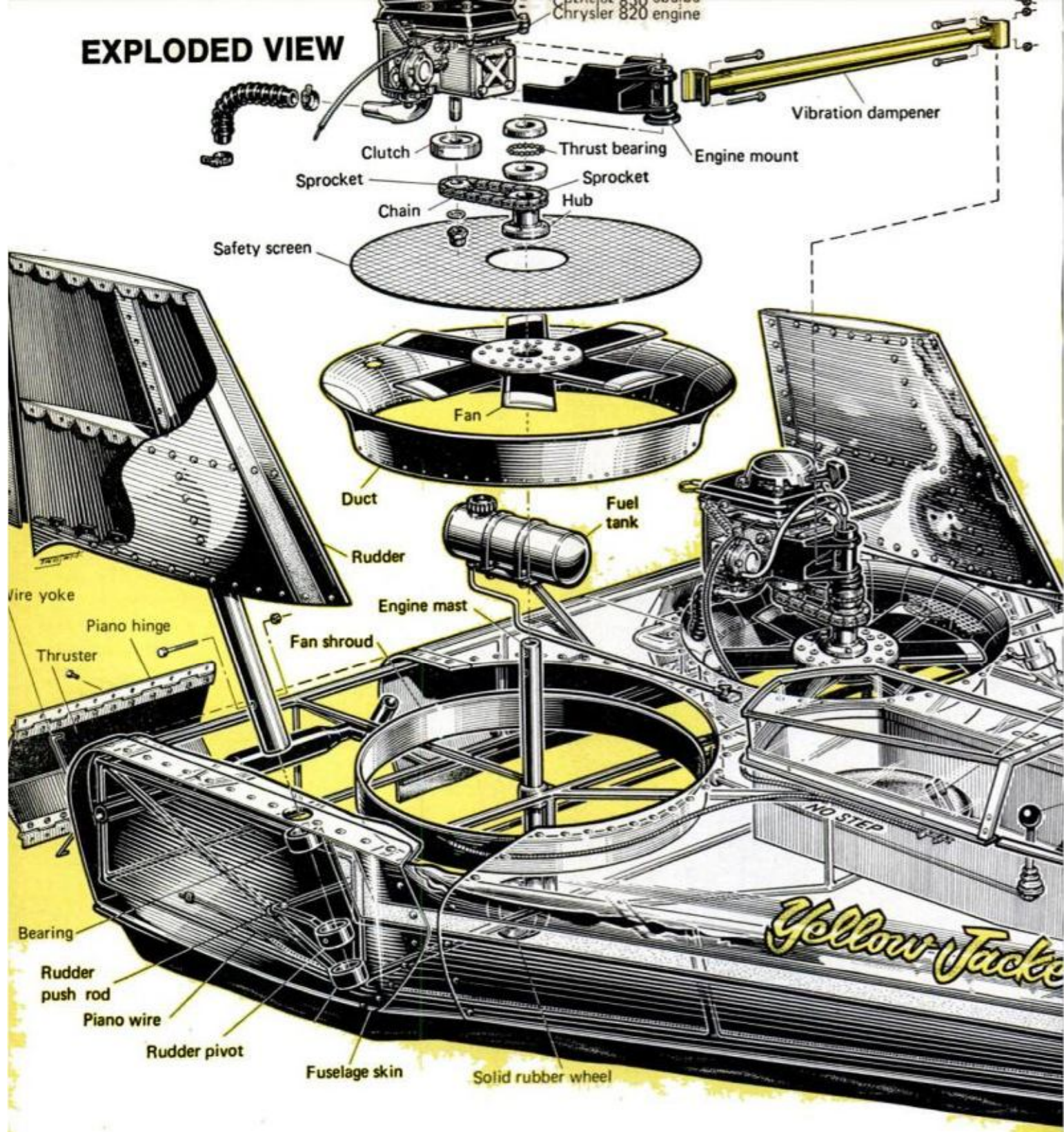

BUILDING the Yellow Jacket is a lot easier than it appears, and the craft is pure fun to operate. The plans offered (see page 126) include a pattern for making the prop. If you lack a router or the patience, you can have a prop maker turn it out. For speediest reply when ordering plans, address your envelope to PM's Reader Service Bureau 128

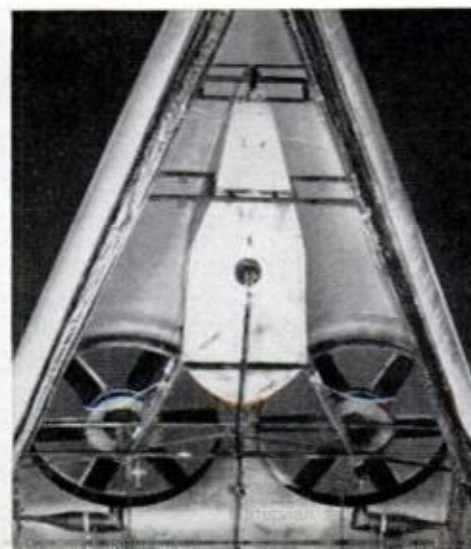

OKWIKIPEDIA

propeller is great until you put it next to the ground. But this creates a strong back-pressure and the propeller loses most of its efficiency." So he started the Yellow Jacket from scratch, designing two very efficient compression fans around the powerful Chrysler 820 go-kart engine. For more lift, he cambered the fan blades like airplane wings. At a 3600-rpm operating speed, the blades act as miniature wings

moving at over 300 mph. "Finally," he continued, "I designed the fuselage in the shape of a flying wing, which creates lift as it moves through the air." (Ed. note: This accounts for increased altitude as Yellow Jacket gains speed.)

To build the Yellow Jacket, Eugene used readily available materials throughout. The frame is, principally, 7/8-in. dia. (Please turn to page 182)

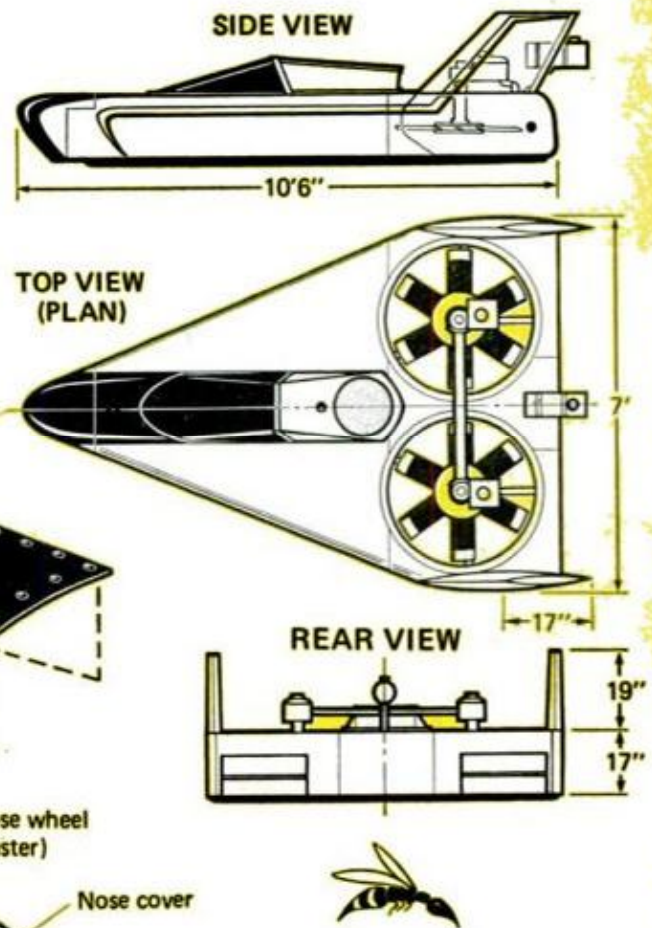
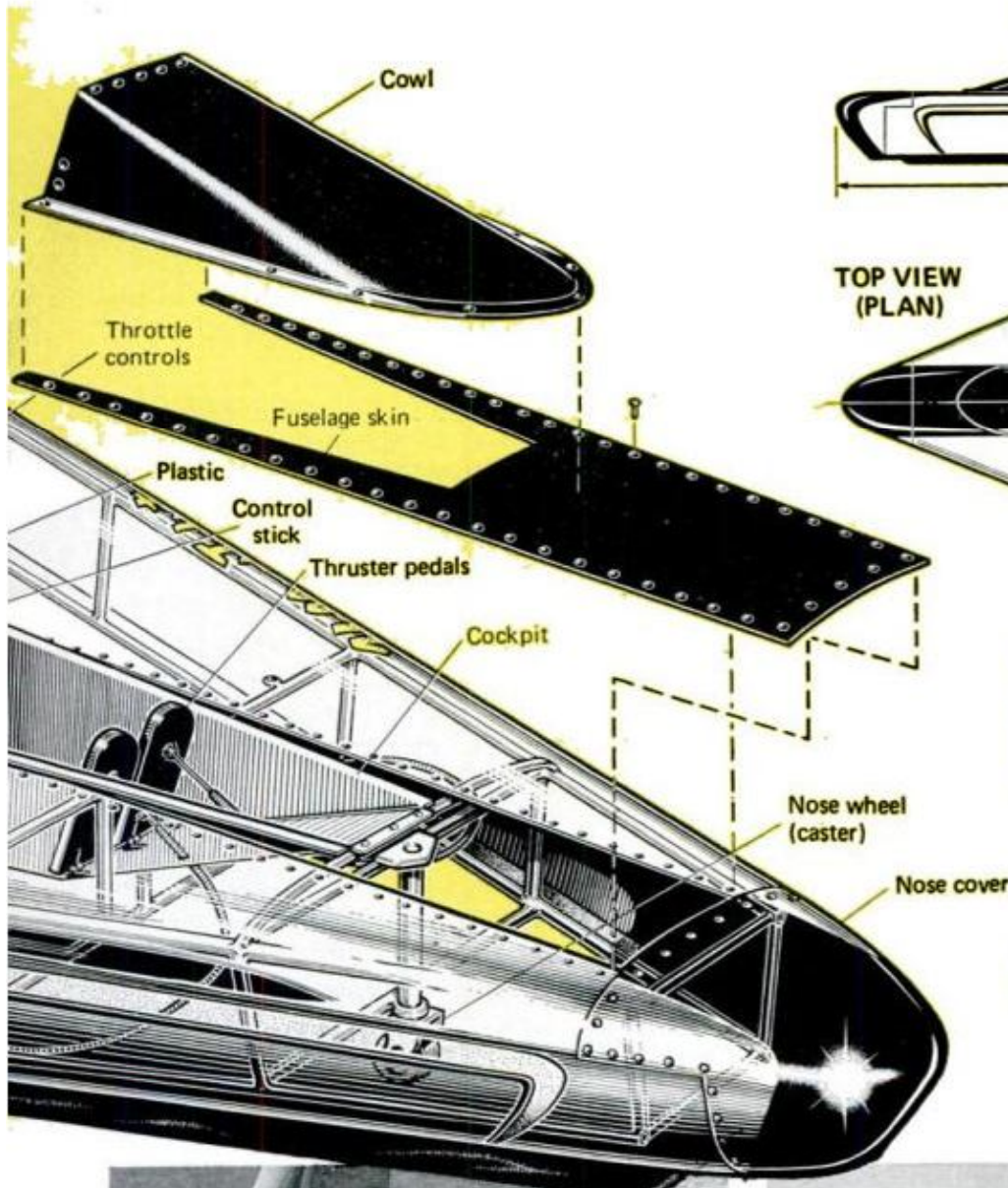

Technical Art Created by Peter Trojan,
Based on Drawings by Dave Carey

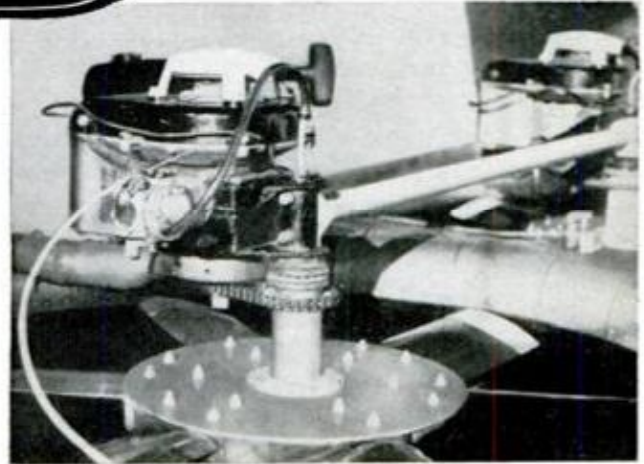
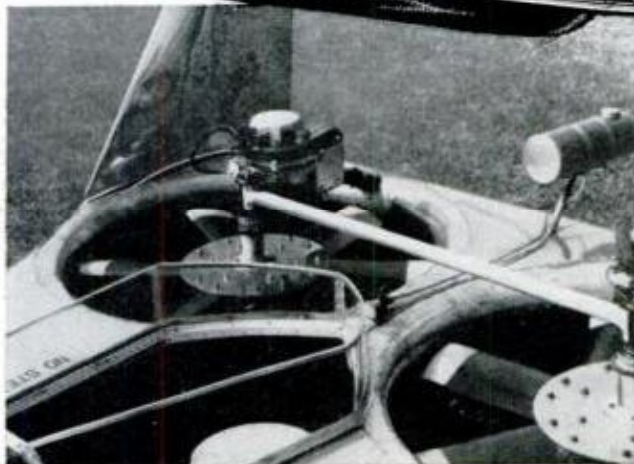

How to Service Small Engines

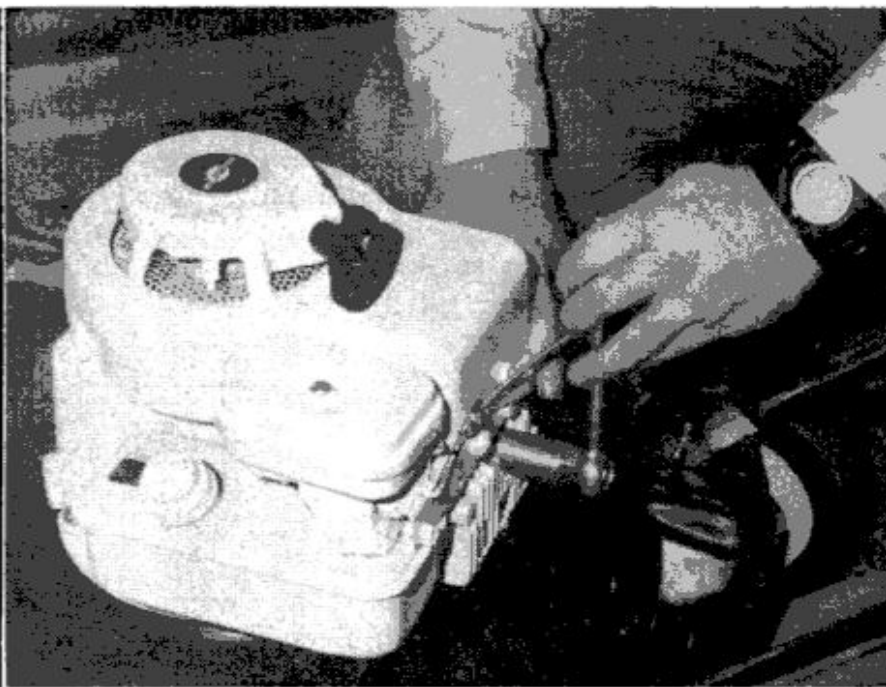

By MORT SCHULTZ

Illustrations by Fred L. Wolff

SPARKPLUG IS ONE OF FIRST CHECKS to make when troubleshooting. When replacing, seat by hand, give half turn with socket

THIS FIRST INSTALLMENT of a two-part article, to be continued next month, deals with troubleshooting, repair and maintenance of single-cylinder gasoline engines. These engines power yard and garden equipment—self-propelled and riding mowers, tillers, leaf blowers, sweepers, tractors, chain saws, trimmers and snow blowers.

Let's start by defining terms. *Troubleshooting*, the single most useful skill to master, means to zero in on a malfunction. Before you can solve a problem, you must find its cause. Even if you don't want to tackle the repair, knowing what's causing the problem allows you to be specific in dealing with a mechanic, thus assuring yourself that unnecessary repairs won't be made. Replacing parts and making adjustments to solve a problem will be considered as repairs.

We won't get into engine overhaul. Practically every case of engine failure can be resolved with minor repairs; we'll concentrate on those.

Maintenance, which includes tune-up, is the care you give a small engine to minimize the chance of breakdown. Replacing parts and making adjustments to forestall a breakdown will be considered as maintenance.

Two other terms you will encounter are *two-cycle* and *four-cycle*. Your single-cylinder engine is one or the other.

Two-cycle engines take in fuel, com-

press and ignite it, and exhaust waste gases in two strokes of the piston—up and down. The ignition (power) stroke occurs during every revolution of the crankshaft.

Four-cycle engines accomplish intake, compression, ignition and exhaust in four piston strokes. If you're not very well acquainted with small engines, here's how to tell two from four-cycle quickly: You mix oil with the gas for a two-cycle; a four-cycle has an oil sump and filler pipe. If your engine is made by Briggs & Stratton, Kohler or Wisconsin, it's four-cycle. If it's a Jacobsen engine, it's two-cycle.

Jacobsen, incidentally, is one of the few manufacturers that makes two-cycle engines for its own equipment. However, where four-cycle engines are used in Jacobsen mowers and other equipment they are made by other companies, such as Lauson-Tecumseh. The manufacturer of the equipment and the manufacturer of the engine are not usually the same. So check the nameplate attached to the engine.

Two-cycle engines used in Lawn Boy mowers are manufactured by the company that makes the mower—Outboard Marine Corp. But Lawn Boy riding mowers use either a Briggs & Stratton or Lauson-Tecumseh four-cycle engine.

If your engine is made by Clinton or Lauson-Tecumseh, it could be two- or four-cycle.

Engines that power chain saws, such as

Be your own serviceman. You can handle most small engine repairs. Here's the guide you need to insure quick-starting, smooth-running gas engines on your yardpower equipment.

McCulloch, Homelite and OR (many Sears chain saws have OR engines) are two-cycle.

Troubleshooting. The following is a list of the major problems that affect small engines:

1. Engine doesn't start or is hard to start.
2. Engine overheats.
3. Engine vibrates excessively.
4. Engine stops running and won't restart.
5. Engine misses under load or lacks power.
6. Engine knocks.
7. Engine surges (gallops).
8. Engine backfires.

Each of these problems, with the exception of engine knock and excessive vibra-

tion, is caused primarily by trouble in one of four areas: ignition, sparkplug, fuel or compression. The sparkplug is, of course, part of the ignition system. However, it's considered separately for two reasons: First, because a bad or "wrong" sparkplug is often a cause of small engine failure; second, because it may be the result of a more serious problem that will not be resolved by simply replacing the plug. An examination of the sparkplug will show what that problem is.

When your engine gives trouble (other than knocking and excessive vibration) first do the following in the sequence given:

1. Check ignition output

Most small engine problems are caused



HARD STARTING of two-cycle engine is often the result of not using gas-oil mixture that's specified
MARCH 1971



FOUR-CYCLE ENGINE OIL is critical in preventing cylinder scoring. Use what manufacturer suggests

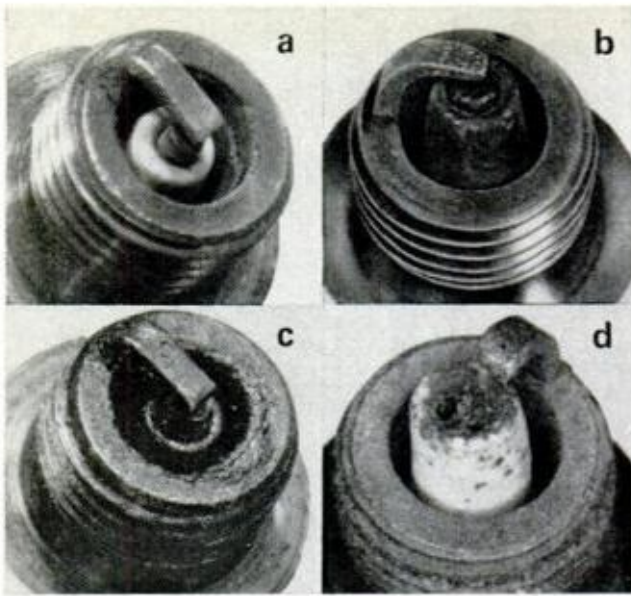

SPARKPLUG CONDITION tells a tale: (a) Normal wear with grayish deposits; (b) fouled with carbon deposits; (c) oil-fouled, and (d) burned electrodes

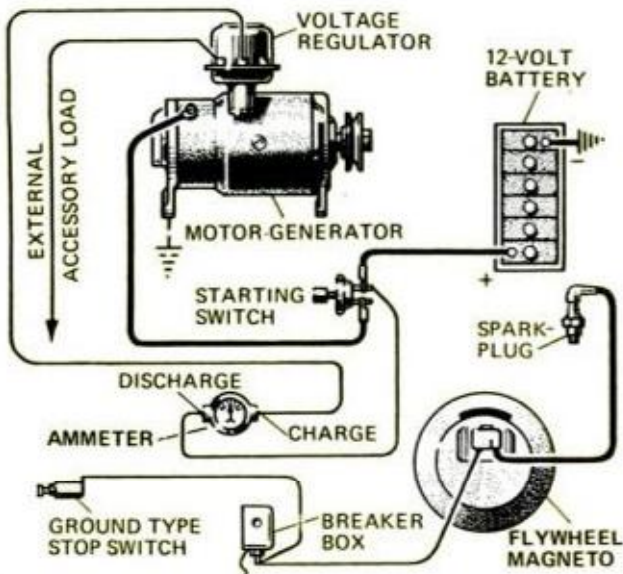
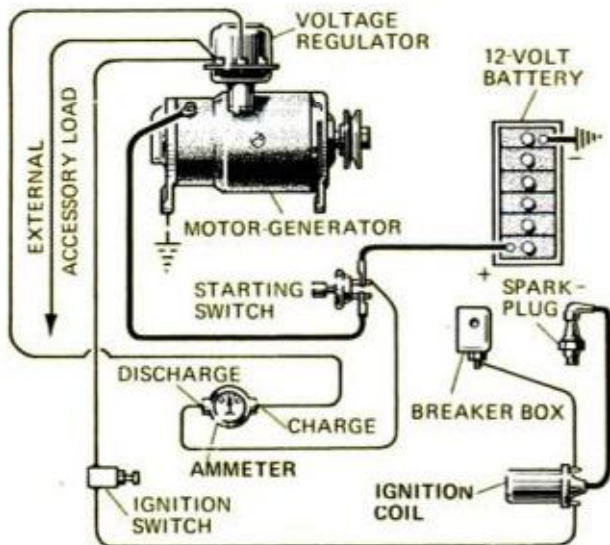

IGNITION SYSTEM of most engines has a magneto. Ignition coil system (top) is generally found on the large four-cycle engines used on garden tractors

by a breakdown in the ignition system. There are two basic types: magneto and ignition coil systems.

Most single-cylinder small engines use magnetos. Exceptions include some of the larger horsepower Wisconsin, Kohler and Lauson-Tecumseh four-cycle engines that are used in garden tractors. They have an ignition-coil system.

The difference between magneto and ignition coil, simply stated, is that once the engine is running, a magneto makes its own electricity. A properly operating magneto system provides about 15 kilovolts to the sparkplug.

In the ignition-coil system, a regular automotive-type ignition coil, which is basically a transformer, replaces the magneto. A modern system has a 12-volt battery (charged by an alternator) providing current to the ignition coil which steps the 12 volts up to approximately 25 kilovolts at the sparkplug.

Both magneto and ignition coil systems employ breaker points which act as a switch to concentrate full voltage at the sparkplug at the exact time that current is needed to fire the fuel mixture. A relatively new innovation used on some garden tractors having Wisconsin, Kohler and Lauson-Tecumseh engines is breakerless ignition, which employs solid-state devices instead of mechanical breaker points.

Breakerless ignition provides current approaching 50 kilovolts at the sparkplug and the timing of the spark is permanently set. With breaker points, timing can get out of adjustment, causing an engine problem until it is reset.

To test a magneto system, buy a 14-mm or 18-mm sparkplug at a gasoline station or automobile parts supply store. Open the electrode gap to $\frac{5}{32}$ to $\frac{3}{16}$ in. Remove the high-tension lead from the engine sparkplug and attach it firmly to the test plug. (The engine plug can stay in place while the output test is being conducted.)

To avoid being shocked during this test, do not hold the test plug or lead in your hand. Instead, place the plug on the engine next to a clean ground, such as a bolt. The plug can be kept from slipping by placing it beneath a cable, such as the choke cable, or by attaching it with a vise clamp.

Crank the engine. If spark jumps the gap, the magneto output is A-1—ignition is not causing your engine problem. If there is no

spark, the engine problem is being caused by a breakdown in ignition. The magneto will probably have to be disassembled and each part tested. How and for what will be discussed next month under *repairs*.

Why use a separate plug for testing magneto output? Why not just pull the plug from the engine and use that? Because the wide gap of the test plug gives a more accurate indication of magneto output.

A 14-mm sparkplug gapped to .028 in. requires a magneto output of only 7 kilovolts for spark to jump the electrode gap. (Most single-cylinder small engines use 14-mm sparkplugs.) But when you open the gap to $\frac{5}{32}$ to $\frac{3}{16}$ in., about 10 kilovolts are required for a spark to jump the gap.

A magneto in good condition supplies approximately 15 kilovolts to a sparkplug. Thus, if your magneto cannot provide a wide-gapped test plug with sufficient voltage to make spark, it tells you that the magneto has broken down or is in process of doing so.

A less accurate indication of output is given with the test you have to employ for the ignition coil system. Conduct the test in the same manner as with a magneto system, but use the engine's sparkplug instead of a test plug.

The ignition coil system is supposed to put out about 25 kilovolts. The comparatively small amount of voltage required to make spark with a wide-gap test plug doesn't justify use of this plug for the test.

If spark occurs as you crank the engine, you can assume for the time being that the ignition system is okay. However, if other tests (sparkplug, fuel and compression) show these areas to be in good condition, then suspect ignition trouble and come back to it. If spark doesn't appear at the plug, try a new plug before ripping into the ignition system.

For solid-state ignition you'll need a spark-intensity tester to check a breakerless system. Spark occurs so rapidly that you can't see it jump the plug gap. Grounding the plug puts a strain on solid-state components and may damage them. One company that makes an intensity tester—Snap-On Tools—sells it for about \$7.50.

To use it, disconnect the lead from the sparkplug and attach the test instrument's lead to the cable's metal terminal. Touch the point of the test instrument to ground



BREAKERLESS IGNITION SYSTEM must be tested with a spark intensity tester connected to the plug lead

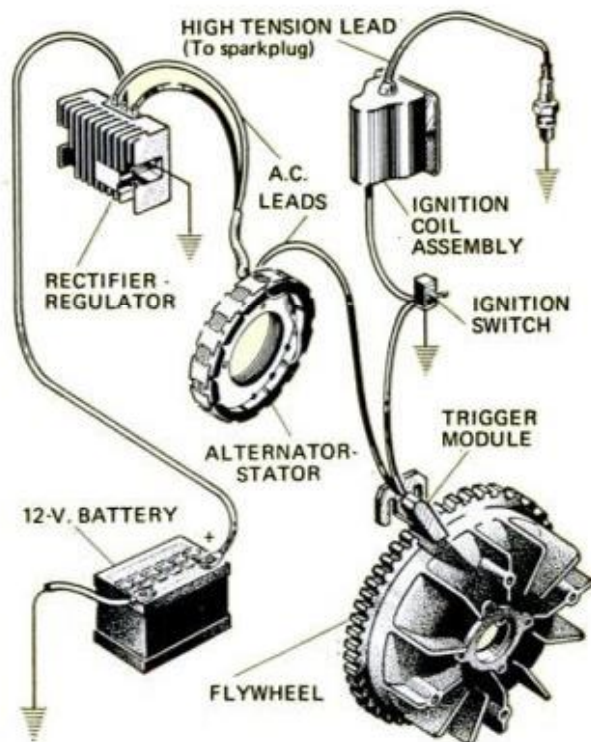

SOLID-STATE IGNITION on some Wisconsin, Kohler and Lauson-Tecumseh tractor engines uses electronic devices that eliminate breaker points. The timing is permanently set and will need no adjustment



DIAPHRAGM-TYPE CARBURETOR is directly coupled to the fuel tank. When fuel stoppage seems to be the cause of trouble, check screens in the fuel pipes

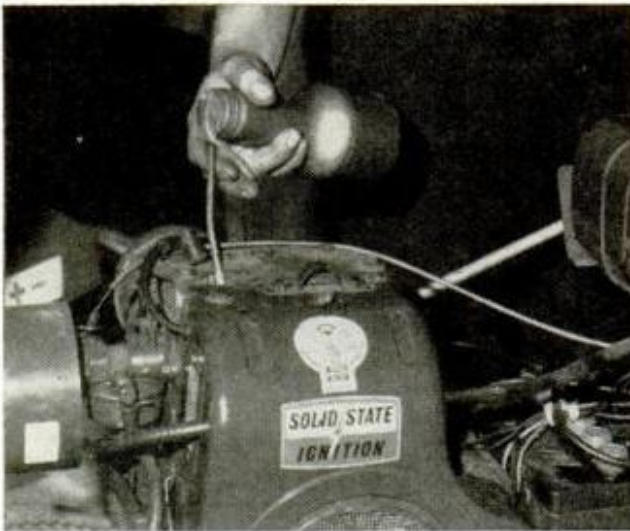

FUEL REACHING CYLINDER? Squirt some in plug hole, replace plug. If engine starts, then stops when this has burned, fuel line or screens are blocked

as someone cranks the engine. If the test light flashes, the ignition system is okay.

2. Check sparkplug condition

If your engine won't start, is hard to start, or misses or lacks power, check the sparkplug. Get a new one if you find a cracked insulator, burned electrodes or heavy carbon deposits.

Make sure that electrode gap conforms to the maker's specifications. For two-cycle engines, gap is set at .028 to .033 in.; for four-cycles, it's .025 to .028 in. Check your engine manual.

Critical examination of a plug's firing end can lead you to the cause of a problem. Here are some most common conditions and what they mean:

- *Normal wear.* If the sparkplug has brown or grayish-tan deposits and there is some electrode wear, the plug is wearing normally. Clean off deposits with a small wire brush, file the electrodes square and bright with an ignition point file, set electrode gap with a sparkplug feeler gauge, and reuse the plug.

If the plug shows extreme electrode wear and a pitted insulator, it's worn out. Get a new one.

- *Carbon fouled.* A carbon-fouled sparkplug will have dry, fluffy black deposits on the tip. This is the usual result when the engine is fed an over-rich fuel mixture. It's caused by overchoking, by a clogged air cleaner restricting air flow to the carburetor, or by an incorrect fuel-mixture adjustment.

Another reason for a carbon-fouled plug is poor ignition output that results in a reduced voltage condition to cause mis-firing. Check for bad breaker points, a weak coil or condenser, or a worn ignition cable.

- *Oil-fouled.* An oil-fouled sparkplug spells internal engine trouble in the form of worn piston rings or valve stems.

- *Burned electrodes.* The chief cause here is an overheated engine; also check for improper ignition timing and a lean fuel mixture.

To install a sparkplug, seat it by hand and then turn it one-half turn with a socket wrench.

3. Check fuel system

Make sure that fuel is getting to the carburetor and, if so, through the carburetor into the cylinder. For a quick check, crank the engine and then remove the sparkplug. If the tip of the plug is wet with fuel, your engine problem is being caused by something other than a fuel-system malfunction.

A more accurate way to see if the fuel system is functioning is to squirt some fuel into the cylinder from a clean, trigger-type can. Only two or three squirts are needed. Insert the sparkplug and try to start the engine. If the engine starts, runs for a few seconds or so, and then stops, trouble is indicated in the fuel system.

Now, where's the stoppage—ahead of the carburetor or in it? Many carburetors

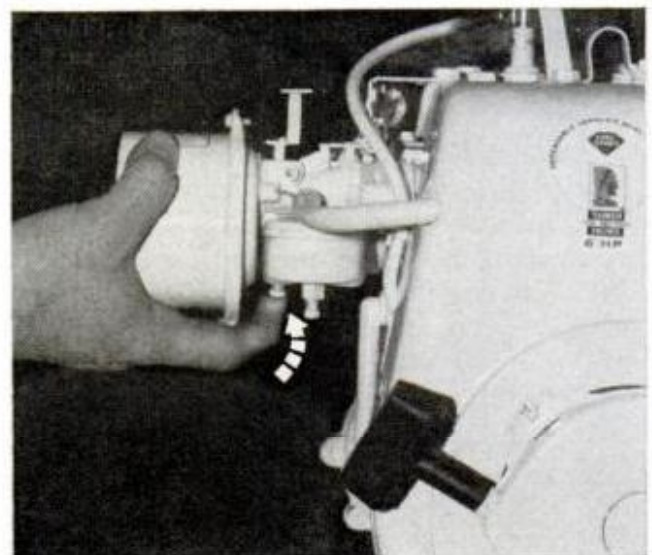

FUEL STOPPAGE IN LINE or carburetor? Press drain valve. If gas doesn't leak out, check line and tank

POPULAR MECHANICS

with bowls have a drain valve in the base of the bowl next to the main adjustment screw, which is larger. Press the drain valve. If fuel doesn't leak out, this indicates there's an obstruction in the fuel tank or fuel line.

If there is no drain valve and the fuel line connects the fuel tank (or fuel pump) to the carburetor inlet, simply unhook the line at the carburetor. If fuel dribbles out, it is getting to, but not through, the carburetor.

If your fuel system is the type in which carburetor and fuel tank are coupled together, fuel is fed directly from tank to carburetor through pipes attached to the carburetor. This is done by the creation of low pressure in the carburetor while the piston is moving on its downward stroke.

If the sparkplug or cylinder-loading test indicates a fuel failure, the carburetor will have to be disconnected from the fuel tank. Check the screens in the fuel pipes to determine if they are clogged. If they aren't, it's evident that the carburetor needs overhauling.

Engine trouble will also result if the fuel system floods the cylinder. If the engine doesn't start after cranking, examine the tip of the sparkplug. If it's wet with fuel, either the engine is flooding or an ignition or compression failure exists. Make ignition and compression tests to determine the problem.

4. Test compression

If your engine has an A-1 ignition and fuel system, and a brand-new sparkplug,

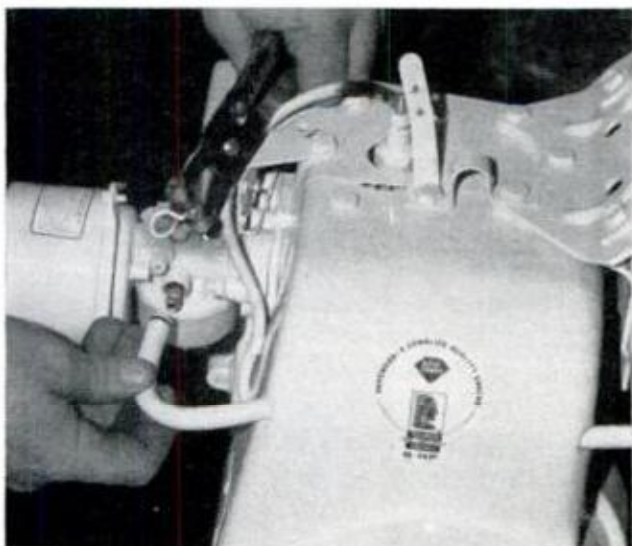

FUEL STOPPAGE AT CARBURETOR? Unhook fuel line at carb. Fuel flows? It's getting to, not through, carb
MARCH 1971

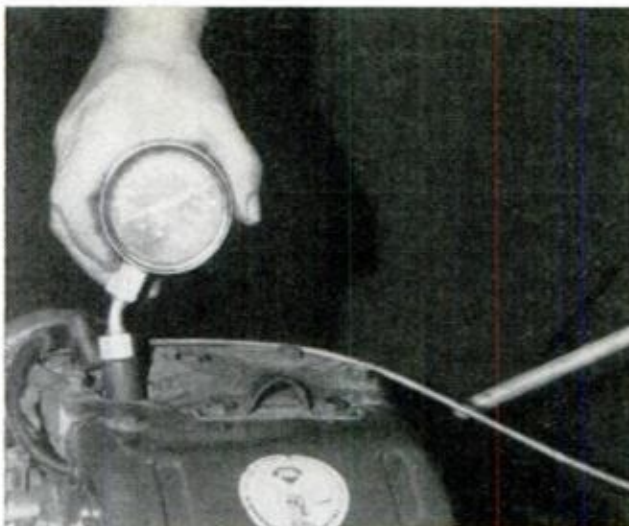

MINIMUM COMPRESSION? Without it, you'll have hard starts, less horsepower. Only a gauge will tell

it won't do much unless it has compression. Compression is the ability of the piston to compress fuel to a point where it will ignite and burn to provide maximum power.

Compression in a single-cylinder engine is extremely important. Without the specified amount, the engine will prove hard to start and will not develop maximum horsepower.

Good compression is a result of engine "tightness." An engine loses compression when it loses its ability to seal. Leaks around worn rings and pistons, cylinder or valves, or a ruptured gasket, for instance, will cause loss of compression.

An accurate check of compression can be made only with a compression gauge. Remove the sparkplug and hold or screw (depending on the type used) the gauge into the sparkplug hole. Crank the engine several times until the gauge gives a maximum reading.

If you are working on a two-cycle engine, the reading should be at least 60 pounds per square inch (p.s.i.). If you have a four-cycle engine of 4½-hp or less, the compression reading should be 65 to 70 p.s.i. If it's above 4½-hp, minimum compression should be 70 p.s.i.

Once the problem area has been isolated, the part (carburetor or magneto, for example) may have to be disassembled and each component checked. But if you're lucky, perhaps only an adjustment is needed.

Next month's article will deal with how to tackle repairs in a logical sequence so you can do the job in the least amount of time.

★★★

How to Troubleshoot Your

SATURDAY MECHANIC

By MORT SCHULTZ

The speedometer head is a delicate instrument that can be tricky to repair, and happily it rarely fails. Most problems are with the connecting cable itself or at one end of it—and they are easily remedied

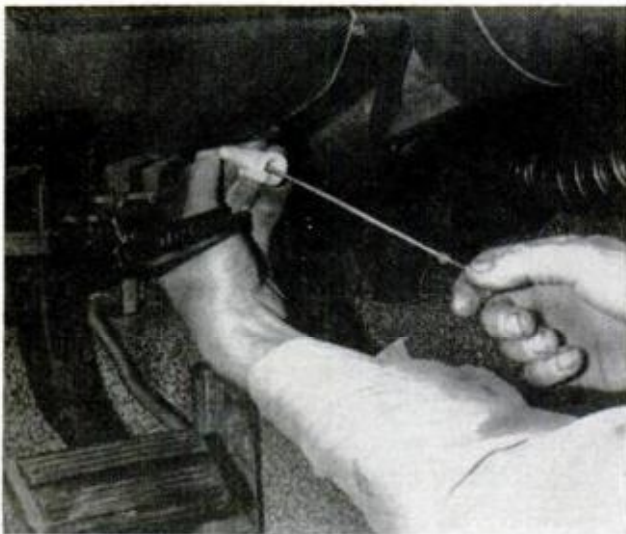

IN TRANSMISSION PINION SYSTEM, detach cable from speedometer head, then pull it from housing



TO REMOVE SNAPPED CABLE you must detach cable housing from the pinion gear at the transmission

YOUR CAR SPEEDOMETER is a delicate instrument that is taken for granted—until it starts acting up.

The instrument, which informs you how fast your car is moving (as opposed to an odometer which records the miles you've traveled), incorporates a permanent magnet, speed cup and a finely calibrated hair spring.

Lucky for you that a speedometer head seldom fails. Repairing the head requires special tools and knowledge. The professional who has both charges a pretty penny. Replacing the speedometer head costs about \$25.

Speedometer problems, however, occur most often from the coupling on the rear of the speedometer head back to the transmission (or to one of the wheels).

The speedometer cable is the one part that gives the most trouble. It transfers car speed, as represented by transmission-shaft (or wheel) rotation, to the speedometer head.

Two general systems

Speedometer systems are of two general types. In most cars, the speedometer head is connected to the output shaft of the transmission by means of the flexible speedometer cable, which is attached to a pinion gear in the transmission.

As the pinion is driven by the transmission output shaft, it drives the cable, which drives the speedometer head that registers speed. Also driven is the geared odometer, recording distance traveled. The speedometer cable is protected by an outer casing (housing), but the two parts—cable and casing—are separate.

In other cars—Volkswagen comes to mind—the speedometer and odometer are driven by a flexible cable that is attached to one of the car's wheels—usually the left-hand front wheel.

Other than this difference, both types of speedometer systems are pretty much the same.

A speedometer problem becomes ap-

Speedometer

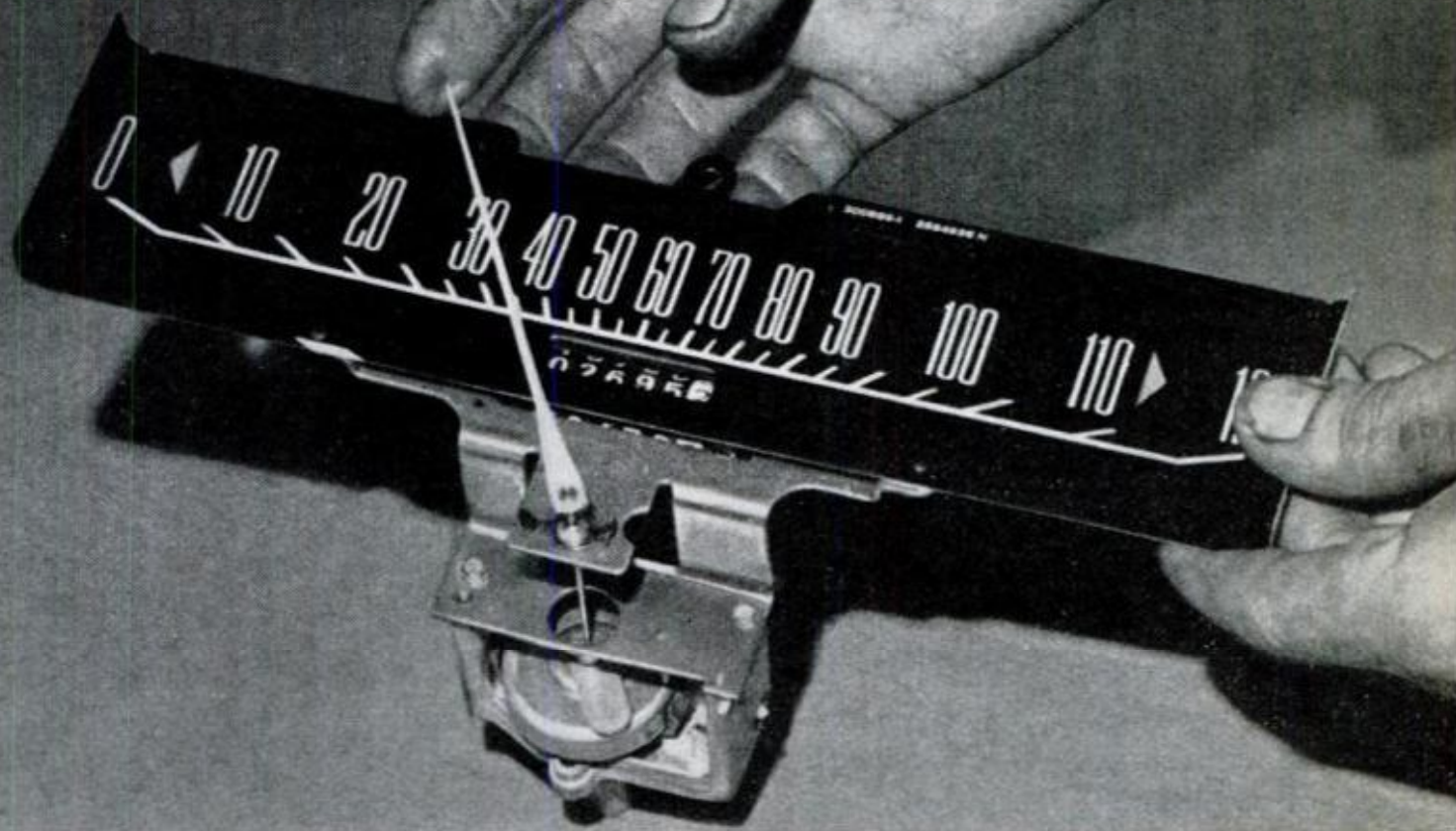

BEFORE REPAIRING or replacing a speedometer head having a needle which hangs up, make sure that the hang-up and the resultant noise aren't due to a bent needle. All you may have to do is unbend it

parent in one of four ways: a ticking or scraping noise is heard; the speed indicator, if it's a needle, moves and then hangs up; the speed indicator doesn't hold steady when car speed is steady; the speed indicator just doesn't work.

Speedometer noise is the most common problem and usually precedes complete failure. In other words, noise coming from the speedometer probably means that the cable is in bad shape and will snap if you don't take action.

Before pulling the cable, though, make sure the cable-to-speedometer head coupling hasn't worked loose.

Disconnecting cable

There are two ways in which speedometer cables are connected to the speedometer head: a conventional coupling nut that you can tighten with a pair of pliers; or a quick-disconnect that you press in to pull the cable from the speedometer head.

The quick-disconnect replaced coupling

nuts in many 1968 and later models, but this isn't true across the board, so check your setup.

There's another problem that you'll run into at this point. How do you get to the rear of the speedometer head so you can get at the cable coupling? The way varies from car to car of even the same make and model year.

With some cars, such as the 1970 Falcon, Fairlane and Montego, you can reach beneath the instrument panel to release the cable. Try this first. It's the easiest.

With others, such as the 1970 Ford, you have to remove the upper section of the instrument panel pad and reach down behind the panel. And with still others, such as the 1970 Mustang and Cougar, you have to remove the instrument cluster.

An examination of your setup should reveal what method you have to use.

If the coupling nut is tight so that it couldn't be the cause of noise, disconnect the cable from the speedometer head and

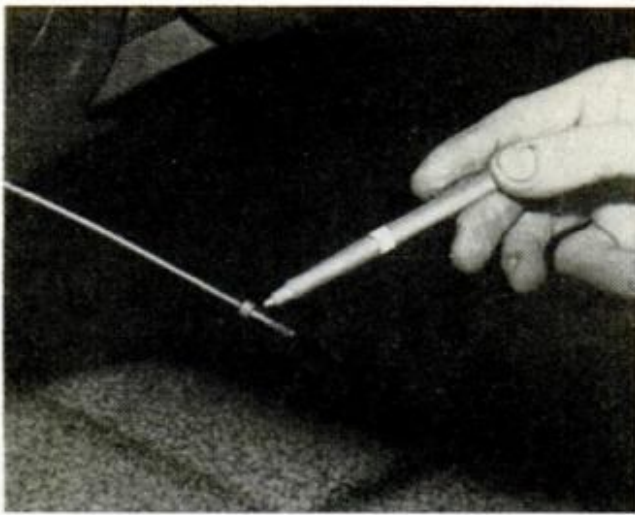

CABLE TIP is the short portion from the end of the cable to knurled stopnut on speedometer head end. If this tip is bent, the cable should be replaced

slowly pull the cable out from its housing.

A cable that is run off the car's front wheel must first be detached from the wheel by removing the outer hub cap and pulling the cotter pin that attaches the cable to the inner hub. Loosen the nut at the speedometer head and pull the cable from place.

If the cable catches as you pull it from the housing, both the cable and housing are damaged. Replace both.

Checking cable

With the cable out of the housing, check it for a bent tip (speedometer head end), kinks and whipping. If the cable tip is bent replace the cable.

Wipe the cable clean with a rag and lay it out straight on a flat surface. Roll it back and forth. If it doesn't roll smoothly, it is kinked and should be replaced.

Pick the cable up and take an end in each hand. Allow the cable to hang in a 9 to 12-inch loop. Twist it between your fingers. If it whips or jumps rather than turns smoothly, replace the cable.

Cable lubrication

The main reason for speedometer noise is a cable that needs lubrication. Most manufacturers call for lubrication on an as-needed basis—that is, when the cable becomes noisy, lubricate it. In lubricating a speedometer cable, remember that too much grease is as bad as too little. Excess lubricant can cause failure of the speedometer head.

To lubricate a cable, apply a very thin film of speedometer cable lubricant or a lubricant such as Lubriplate that is cold-

resistant and waterproof. Then, wipe off excess by running the entire cable length through your fingers.

Caution: Do not lubricate the cable tip. Grease here will damage the speedometer head.

Checking head

Before putting the cable back into its housing, conduct another easy test to determine if the cause of noise is the drive gear in the speedometer head. Get a short piece of cable, insert it into the head and rotate it. If the head drags or makes noise, that's where the trouble is. Have the head repaired, or replace it.

When reinstalling the cable, feed it through the housing slowly and carefully so you don't kink it. When the cable is just about seated, twist it slightly to engage its far end firmly into the seat in the pinion gear at the transmission.

Of course, with a cable that works off the wheel, make sure that the cable goes through the hole in the hub and that the cotter pin is inserted.

The reasons why a speed indicator will flutter are a kinked cable and housing, which are checked as you pull the cable from the housing, and a damaged speedometer cable. If kinking isn't the problem, replace the cable.

A speedometer that doesn't work at all is the result of a cable that has worked loose from the head (check the coupling) or, more likely, by a cable that has snapped. To get a broken cable out of the housing, you have to disconnect it at the speedometer head and pull one end of it out from there.

Now, get beneath the car and detach the cable housing from the pinion gear. The



GO EASY ON GREASE. Apply a light film to cable and remove excess by running cable through your fingers. Do not get any grease on tip of the cable

POPULAR MECHANICS

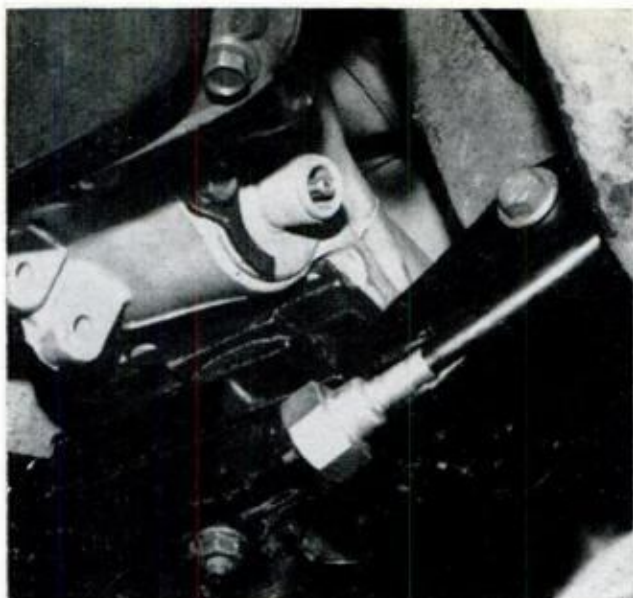

WHEN CABLE HOUSING IS LOOSE, pull the broken cable out of the housing and reconnect the housing to the pinion gear. Then install a new cable

other end of the broken cable can now be pulled from the cable housing.

Reconnect the cable housing to the pinion, and install a new speedometer cable from the speedometer head end as explained before.

Incidentally, you might wonder why you can't remove any but a broken cable from the transmission end rather than from the speedometer head end. The reason you can't is that knurled stopnut on the tip of the cable. It stops the cable from extending itself too far into the pinion. It will also prevent you from pulling the cable through the tail end of the housing.

If the speedometer needle hangs up, the speedometer head is damaged and has to be repaired or replaced, or the speedometer needle is bent and is rubbing against the dial. Check the needle for rubbing first. If it moves freely after you



TEST SPEEDOMETER HEAD FOR NOISE by inserting a piece of cable into shaft, then rotating it. Movement should be free and there should be no noise

MARCH 1971

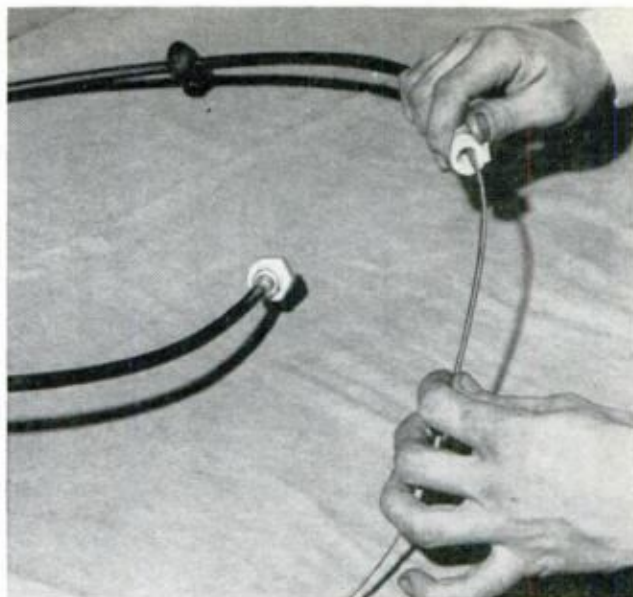

THE SPEEDOMETER CABLE fits into the metal funnel of the housing with close tolerance, so feed the cable into the housing slowly to avoid kinking it

straighten it out, there's no need to hire the expensive services of a repairman.

Checking accuracy

How can you tell if your speedometer is accurate? Run distance-time checks or compare with a speedometer on a friend's car that's known to be accurate.

Be sure that both vehicles are moving at a rate of speed that you and the other driver decide on beforehand. You should stay neck and neck. To check the accuracy of the odometer, drive the car over a measured mile. A handy figure to remember is that 60 mph is a mile a minute. You can take further computations from there.

Speedometers will show an incorrect reading if the car is equipped with over-size or under-size tires or if the pinion in the transmission is not the correct one. Rear axle gear ratio and tire size determine pinion gear size.

Consult the speedometer pinion chart provided in the car's service manual. You can buy the correct part from the parts department of a new car dealer who sells your make of car. Installing the pinion is easy enough.

Detach the speedometer cable from the pinion and remove the retainer that holds the pinion in the transmission. Be prepared to catch transmission fluid as you pull the pinion from place.

Now, simply insert the new gear, making sure it engages firmly and fully in the transmission. Reconnect retainer and hook up speedometer cable housing. ★ ★ ★

Tripods Are Up to New Tricks



You wouldn't think they could do much to change the old three-legged camera support, but today's models are loaded with handy improvements that make shooting easier and more fun. Here's the lowdown on features to look for.

By JACKSON HAND

THE ONLY THING that's the same about tripods is that they still have three legs. Gone are the heavy, hard-to-adjust cumbersome supports that used to make you wish you never had to lug one around. The newest models are trim, light and simple to set up. They stand tall, yet fold small for easy carrying. And they have added conveniences such as invertible center posts, tilting arms, flip-top heads and fingertip controls—all designed to make picture taking easier and more fun.

If you haven't been using a tripod, now's the time to consider adding one of these handy accessories to your photo equipment. Professional photographers have a saying they're fond of passing on

to hobbyists—the best picture you ever took would have been better with a tripod. This is true for several reasons. A tripod not only steadies a camera, producing clearer, sharper pictures, but it lets you concentrate on the scene rather than on trying to hold still. You can take your time composing the picture in the viewfinder until you have exactly what you want. Once you've locked the camera in that position, you can forget it. You can make repeated shots at different exposures, knowing that all will show precisely the same view. You can focus sharply without any chance that the camera will move and change the focus before you shoot. For portrait and tabletop photography, a tripod is indispensable since it frees your hands for arranging lights and posing your subject. It also braces a single-lens reflex camera against the jarring shake of its instant-return mirror—a critical problem at slow shutter speeds.

One important feature you'll want to look for in choosing a good tripod is an adjustable center post. This is a column that can be raised and lowered independently of the tripod legs. It's a tremendously useful convenience since it enables you to change the height of the camera without readjusting the length of the legs each time. You just set the legs to the approximate height you'll need, then make fine adjustments using the column. It used to be that only expensive professional tripods came with a center post. Now you can buy an elevator tripod, as it's often called, for as little as \$20.

One problem you have to watch out for with a center column is that it tends to become unsteady if it's extended too far. The higher you go, the farther away you get from the basic rigidity of the tripod legs and the more your camera is likely to wobble. As a good working rule, it's best not to raise the center post more than halfway. If you find you need more height, reset the legs so you can work with the column lowered.

The stiffer the column, the steadier it

YOU CAN SHOOT HIGH OR LOW with invertible tripods like this Quick-Set Husky. Reversible center column allows camera to be suspended below tripod for low-angle shots close to ground (lower right). Group photo at top of opposite page shows a wide variety of tripods from tiny tabletop Vivitar to unusual Spiratone model with tilting center column

MARCH 1971



Three Smart Ways Tripods Use Their Heads

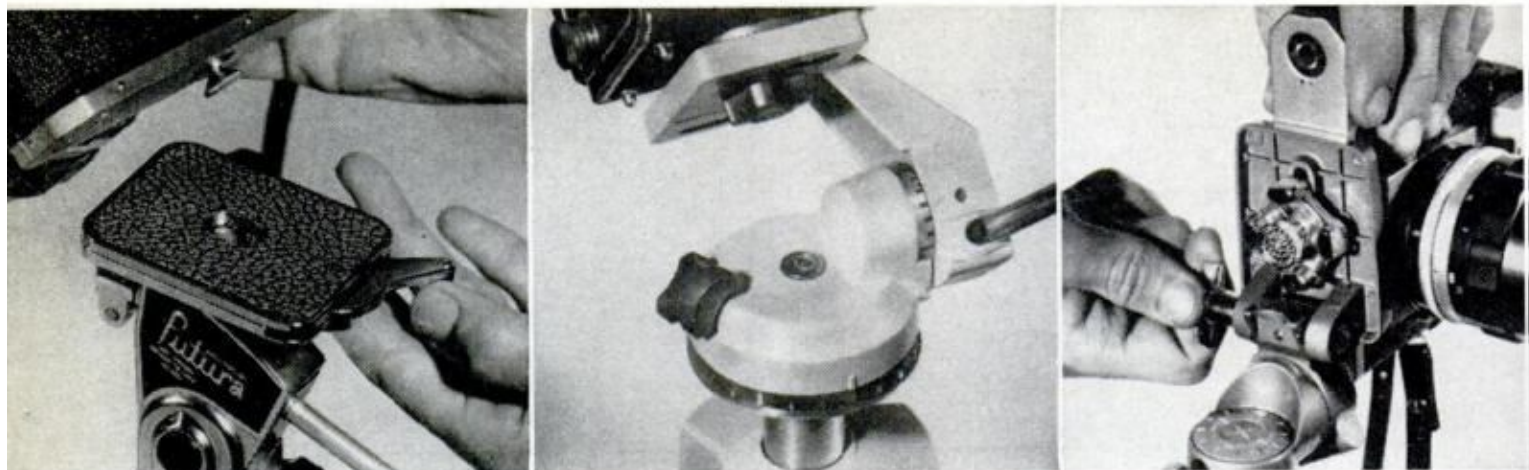

INSTANT-MOUNT FEATURE on Hollywood Futura tripod at left, above, has a cone-shaped fitting that screws into camera. Cone then locks into tripod head with quick flip of lever. At center, calibrated

pan and tilt adjustments on Bilora model permit precise positioning for multiple exposures or panoramic stills. At right, Spiratone's tilt-up head lets you swing camera sideways for vertical shots

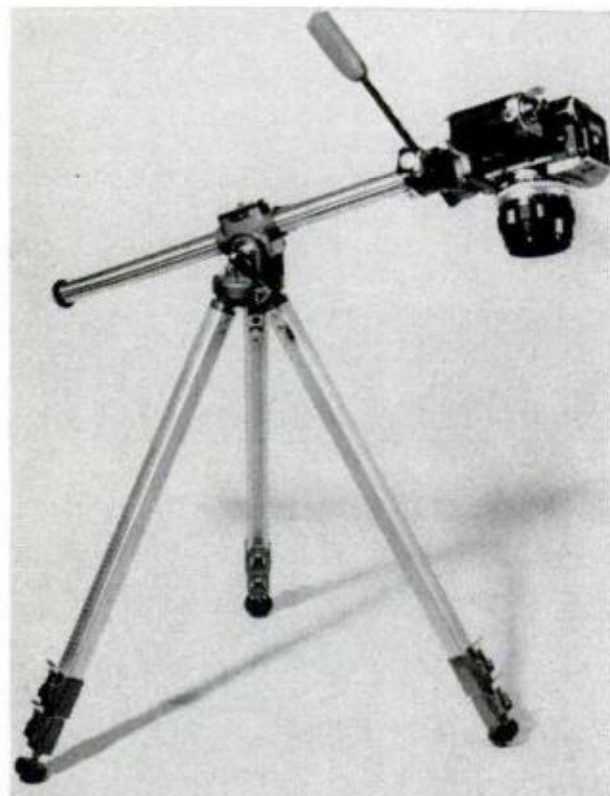

will be. Spindly, light-duty tripods may have center posts that are too springy for good support. Some of the better models have added cross braces that run from the legs to a collar around the center post of the tripod.

Cross braces give considerable rigidity, but they also increase the cost and may make the tripod a little less handy to put up and take down. They're good for heavy professional equipment, but probably aren't needed for amateur use.

Many of today's center columns are reversible—another important feature to look for. You can slide the column out at the top, turn it upside down and insert it from underneath the head. This lets you suspend your camera below the tripod for low-angle shots, such as for photographing flowers or insects close to the ground. Your camera is, of course, upside down, but this isn't hard to get used to since the image appears just as it would if the camera were upright anyway.

If you're likely to be doing a lot of low-angle shooting, be sure the column is invertible—not all are. If you should have a noninvertible model, you can achieve somewhat the same effect by using a special accessory bracket that clamps to the lower end of the center post to hold the camera down low. There are also brackets that clamp onto a leg to lower



TWO RECENT DEVELOPMENTS in tripods are Spiratone's tilting-column model at upper left and palm-size miniatures like the Vivitar shorty at lower left. The tilting column is handy for high-angle shots or overhead copy work. Shorty tripods are excellent for tabletop use, can extend to four feet

Three New Quick and Easy Leg Adjustments

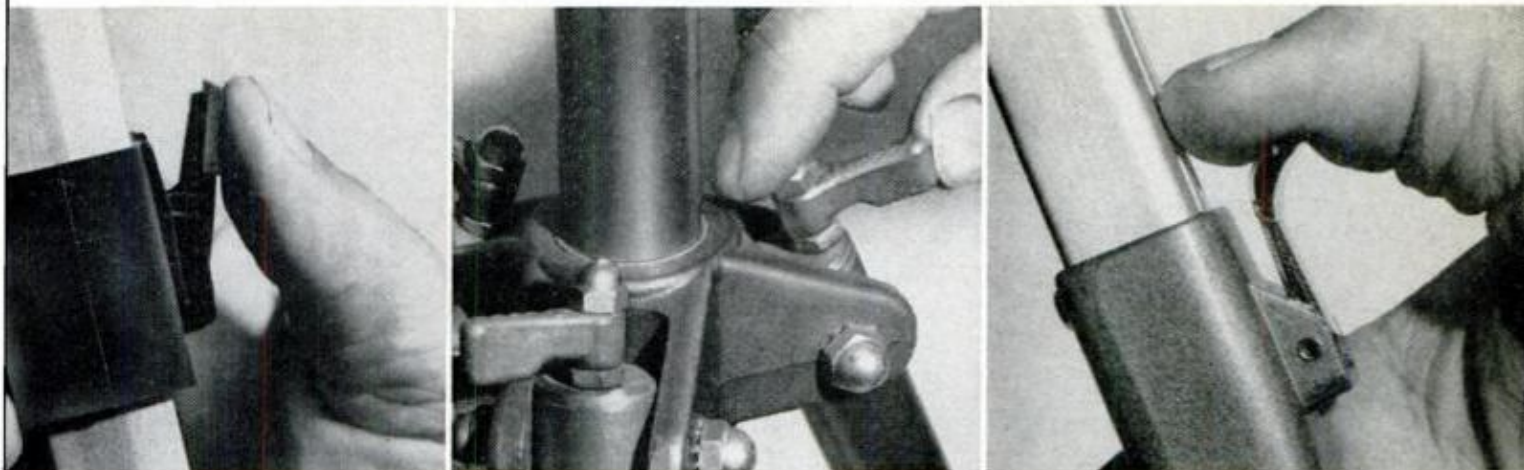

SPEEDY LEG ADJUSTMENTS are found on many new tripods, such as Quick-Set's automatic cam at left, above. You just pull out leg to desired length and it locks by itself. Pressing lever releases cam to

shorten leg. At center is Safe-Lok's lever arrangement at top of each leg. A half turn locks and releases legs. At right is Spiratone's quick-acting finger catch—press in to lock, flip out to release

the camera on tripods having no center columns.

One particularly ingenious new idea in tripod design is Spiratone's tilting center column that swings from vertical to horizontal. This lets you get your camera up and over your subject for straight-down shooting or copying. In the horizontal position, the column can be used like a sliding rail to move the camera forward or back for critical close-up work. Price is about \$23. Somewhat similar rails are available as accessories for regular fixed-column tripods.

One of the biggest improvements in new tripods is the square tube or channel leg with a quick lock-release arrangement for fast setting up. Instead of having to turn a threaded collet, you just flip a finger catch to extend or shorten each leg section. One clever variation is Quick-Set's automatic cam lock. To extend a leg, you slide it out to the desired length and it locks there by itself. The finger latch is pressed only when you want to release the leg to shorten it. Another easy-adjust system is Safe-Lok's lever arrangement at the top of the legs. You simply reach down under the head and flick the lever to lock or release each leg.

Getting a camera onto a tripod has always been a time-consuming nuisance
(Please turn to page 186)

HANDY ACCESSORIES for any tripod are ball-and-socket swivel (near right), sliding extension arm for vertical or horizontal mounting (center) and hinged tilt-up attachment for flipping camera to sideways position (far right). Swivel and tilt-up bracket are by Hollywood, extension arm by Bilora

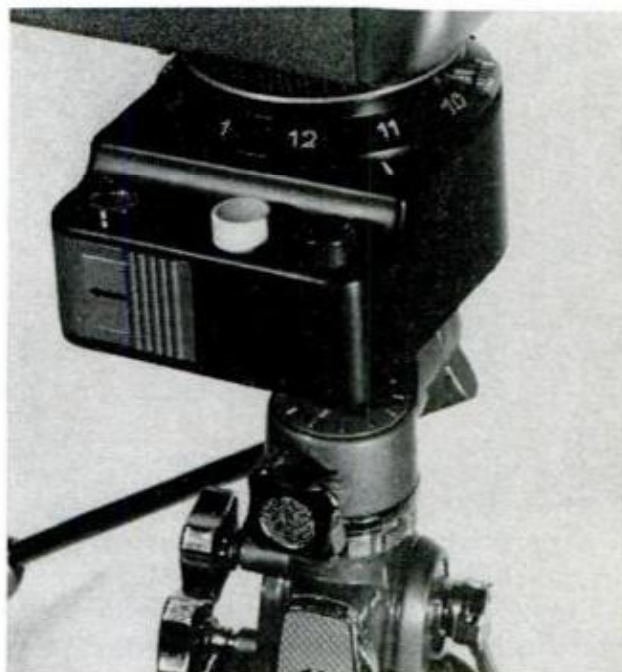

JUST PRESS A BUTTON and this motorized panning attachment swings a movie camera in a slow arc for smooth panorama shots. Powered by batteries, it fits any tripod head, is sold by Bilora for \$49.50

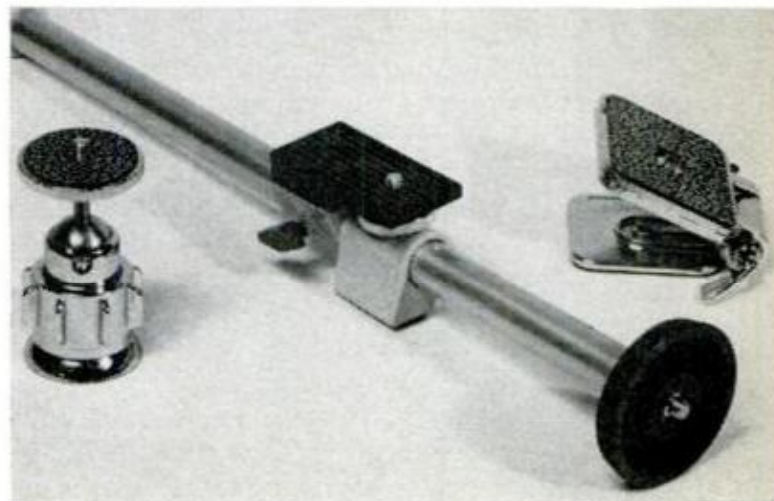

MAKE A GRAND ENTRY

If the foyer in your home looks a little drab, you can perk it up easily and inexpensively by remodeling the door and adding a filigree-paneled archway

By ROSARIO CAPOTOSTO

ARCHITECTURAL STYLES have been changing dramatically since the post-World War II building boom, but there's one design feature that's found in nearly every home built in the last two decades. It's the lackluster front-door foyer. Fortunately, it doesn't take much effort, imagination or money to brighten up a drab entryway.

Starting with the conventional front door shown at right, we ended up with a bright, cheerful entry (see facing page) that really does *welcome* people to our house.

The job can be tackled in two stages, if you desire. But, to assure continuity of design, lay out the *total* project at one time. If you don't, you may be tempted to change style slightly when you start the second stage. The result then is almost certain to show that you changed your mind in mid-project.

Once we settled on our overall design, material selection was a snap. Translucent panels in the door and arch and the filigree are manufactured by Masonite Corp., 29 N. Wacker Drive, Chicago, Ill. 60606. Walls in the foyer were skinned with Tuscan Travertine planks made by Marlite Paneling, Dover, Ohio. All products used in the project are available at well-stocked lumberyards.

● *Customizing the door.* To start, knock out the hinge pins and set the door on sawhorses. Clamp or tack-nail a straightedge to guide your saw and make the four cuts to drop out the opening. A sabre saw will cut right up to a corner; with a portable circular saw, you'll have to stop

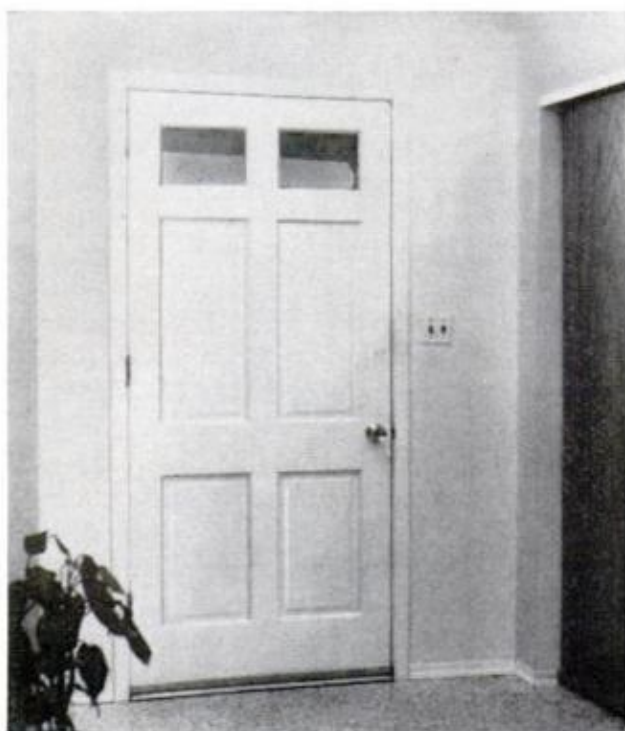

ORIGINAL FOYER was drab, uninteresting. Updated door, arch, Marlite Travertine on walls changed it

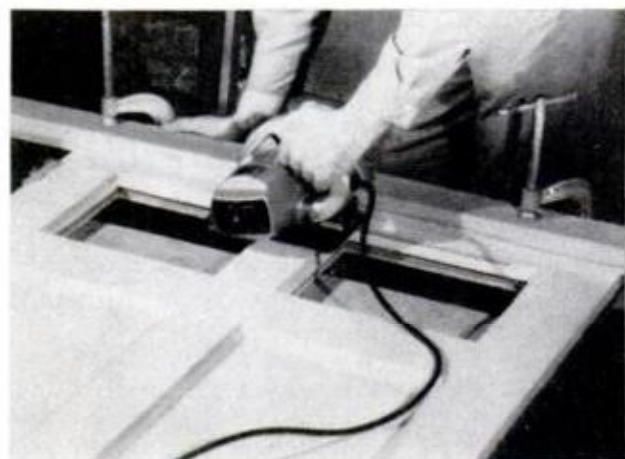

INTERNAL CUT required plunge cut with sabre or circular saw. Use straightedge for the neatest cut



A FRONT ENTRANCE takes on an elegant look with a minimum cash outlay when you tackle the project yourself. The door is adapted from the original; the divider is built of stock items



PANEL ADHESIVE simplifies facing the door interior with flush panel. Apply a thin, flat coat to door

short of each corner and finish them with a handsaw. If you decide (as I did) to panel the door's interior, let the saw blade project as much as possible and cut with the inside of the door facing upward. Paneling will hide the extended corner kerfs. Finish the preparation by scraping off any loose paint.

Apply a piece of $\frac{1}{8}$ -in. luan plywood (or your own choice of paneling) with an insert opening 1 in. smaller *overall* to the door with panel adhesive. Do as the pros

PRECISE ANGLE required for each diagonal piece is determined by positioning before cutting mating dado

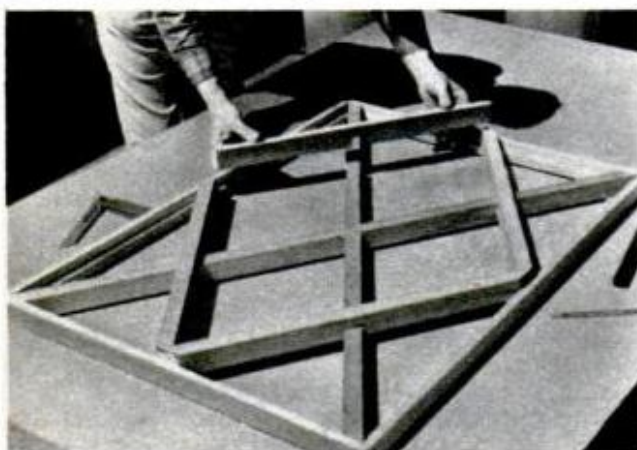

ROUTER AND SHAPED CUTTER dress up strips. Make sure that parts are numbered before disassembling

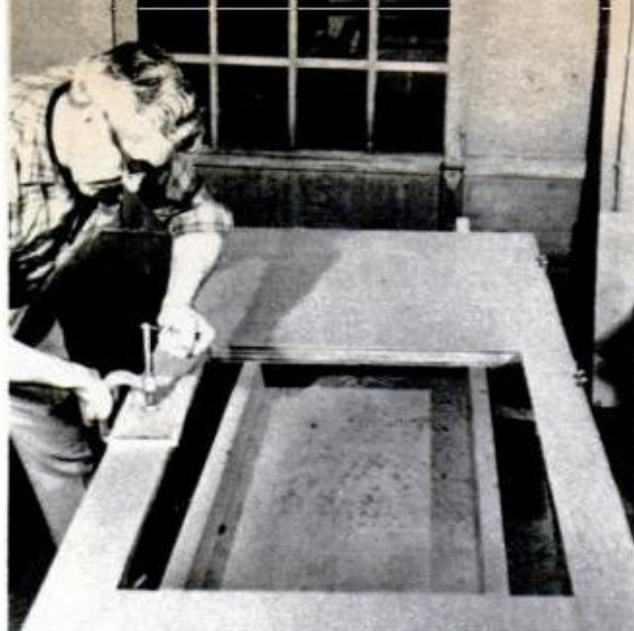

POSITION PANEL and drive a few brads to prevent it from shifting. Use weights until the glue is dry

do and drive a few small brads at random to prevent the panel from sliding. Use clamps or ample weight to make good contact overall. But, do *not* use excessive pressure with the clamps.

The insert plastic-panel framing is made of solid mahogany to match the new interior panel of the door. Make a rectangular frame, butt-jointed and dimensioned to fit snugly into the door opening. Cut the rabbet in the frame members before gluing and screwing them together. Exact

COMBINATION SAW BLADE can be used for dados by making series of cuts. Shift work with each pass



PLASTIC INSERTS are labeled for reassembly identity. GE Silicone Seal keeps the pieces from shifting

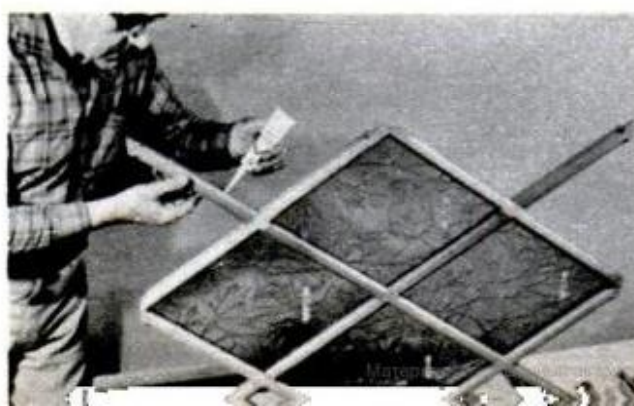

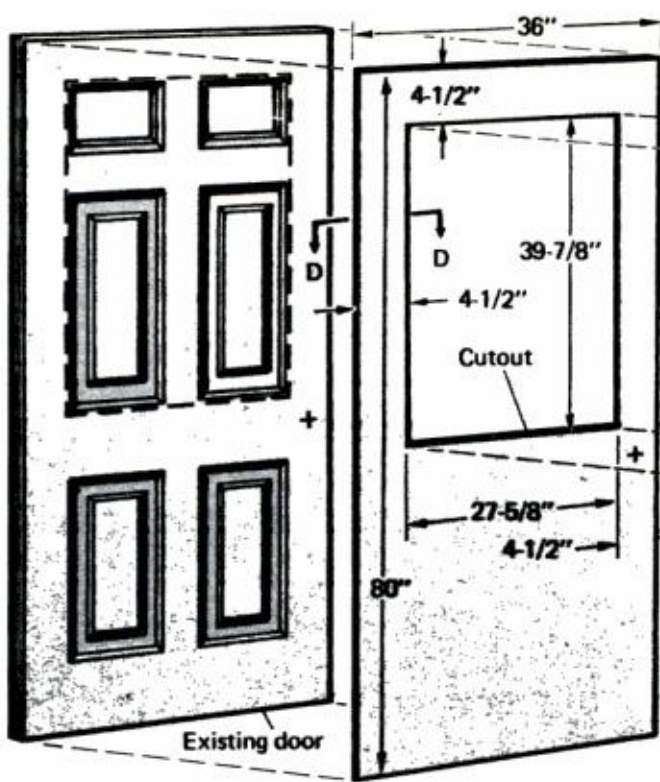

DOOR RESTYLING DETAILS

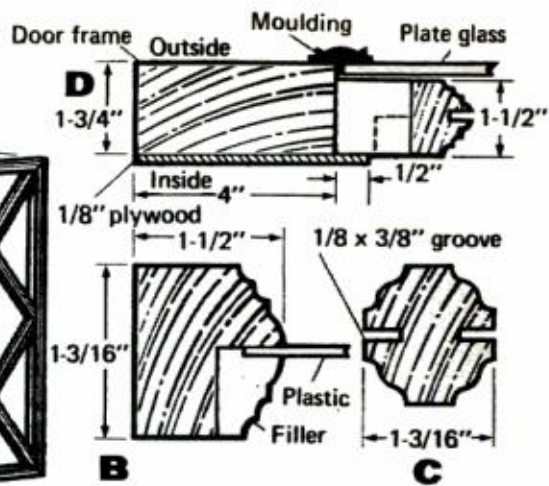
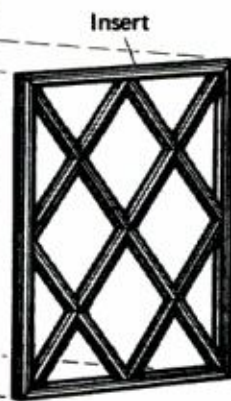

DOOR INSERT

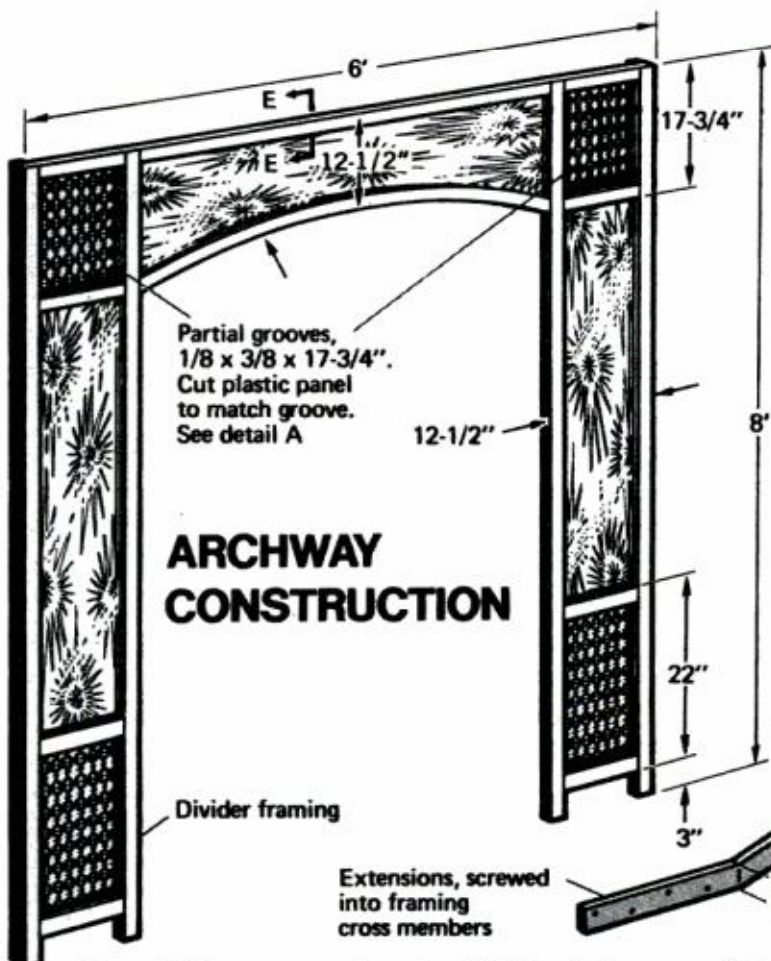
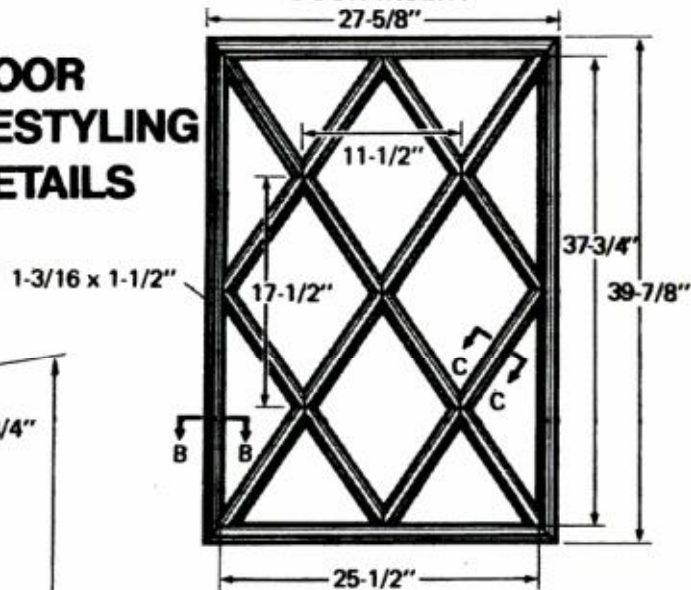

ARCHWAY CONSTRUCTION

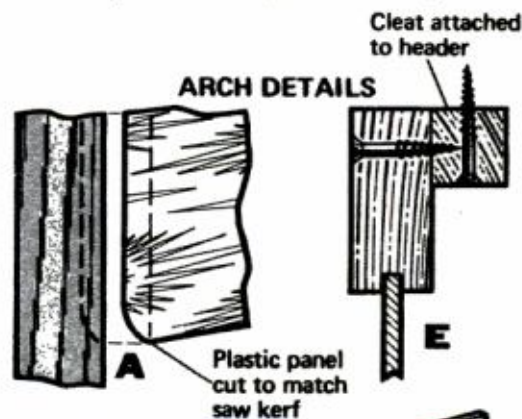

ARCH DETAILS

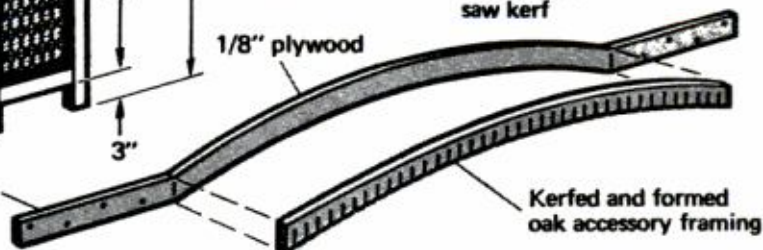

angles of the cross pieces will be determined by the size of your door opening (this varies with different doors). Inasmuch as the plastic panel inserts used are designed for interior use only, we inserted plate glass over the entire insert panel on the exterior. Thus, you must allow for the thickness of the glass (or plexiglass)

when figuring the depth of the insert frame lumber.

The easiest way to lay out the crisscross members is to begin with an X from corner to corner. Draw the angles indicated at the center and the corners and cut them. The center gets a crosslap; the ends

(Please turn to page 178)

The Light, Lustrous Look of Glass—and You Can Make Them

By WAYNE C. LECKEY
Home and Shop Editor

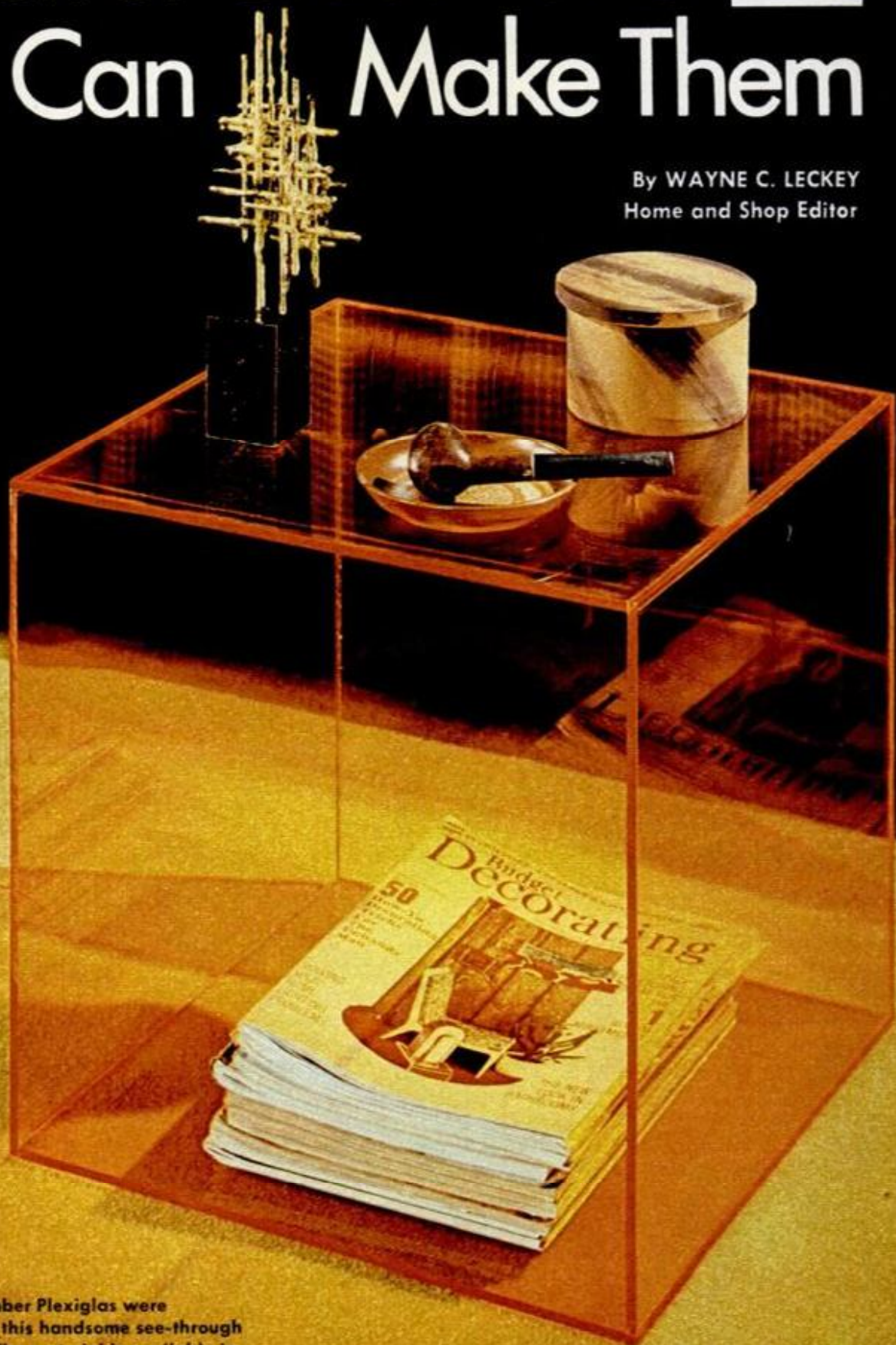

SHEETS of amber Plexiglas were used to make this handsome see-through coffee table. The material is available in translucent and opaque colors as well as clear.

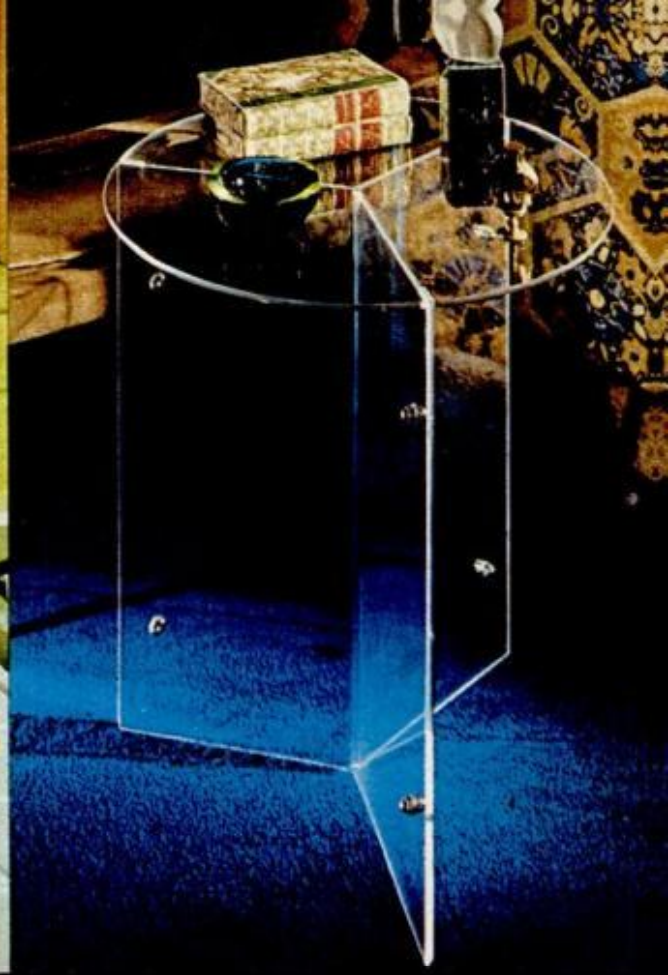

PERHAPS NO OTHER CRAFT MATERIAL can compare with the "factory-made" look you get when a project is made from glass-like sheets of plastic—the finished piece is just too professional looking for one to think it could be made at home. Yet acrylic sheet plastic is as easy to work with as any home workshop material—it can be sawed, drilled and cemented almost as easily as wood. What's more, it even can be heat-formed into interesting shapes, something you can't do readily with wood. You'll find it a fascinating material on your very first try.

The projects shown here were made of Plexiglas, a material that's tougher than

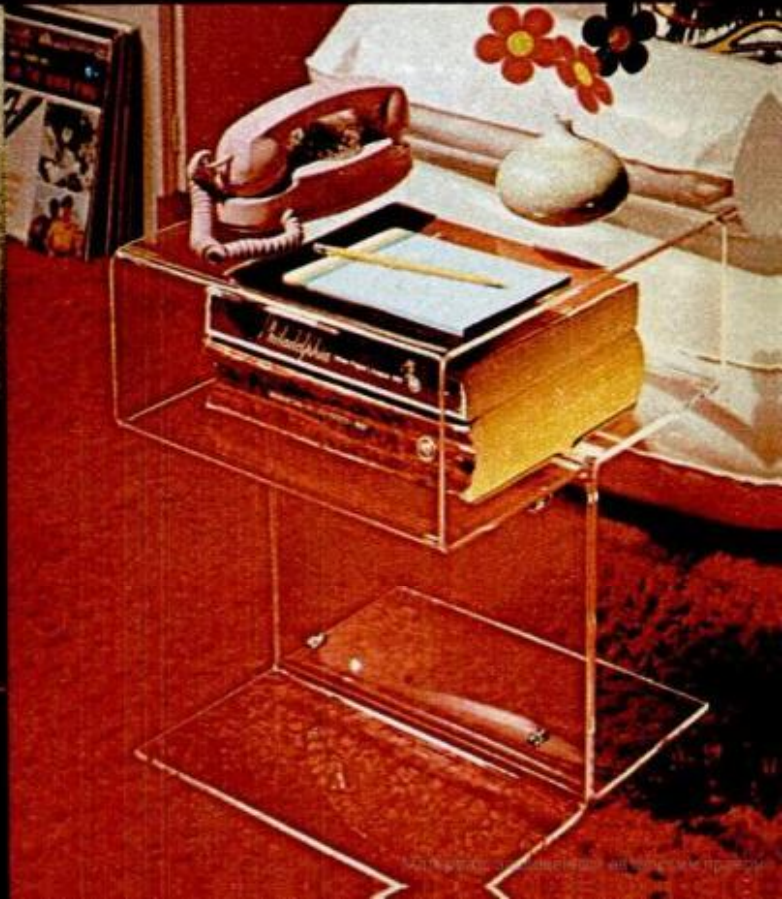

TERRARIUM

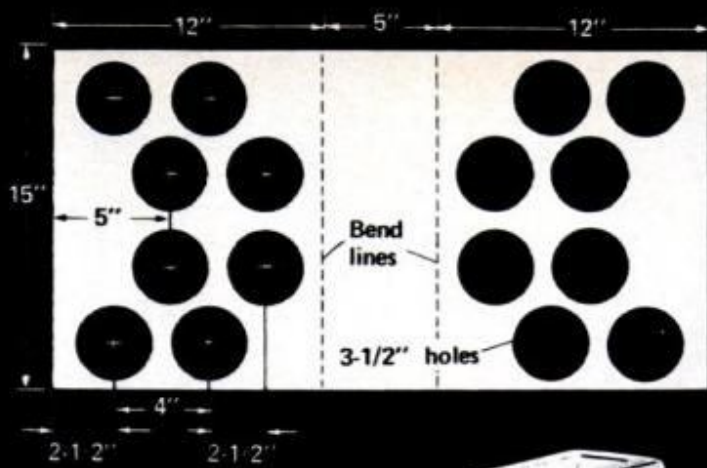
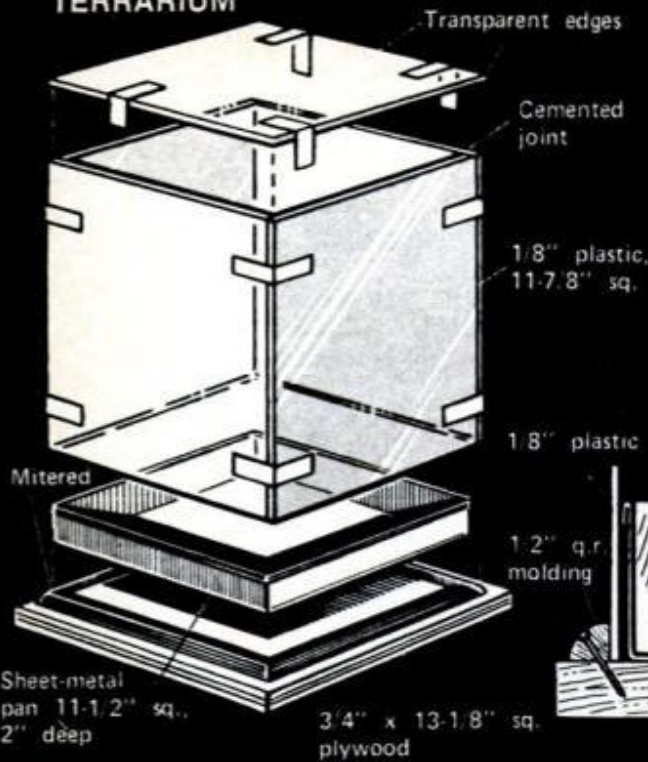

WINE RACK

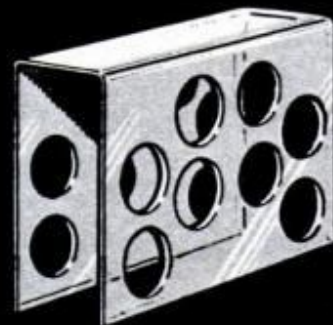

CUBE TABLE

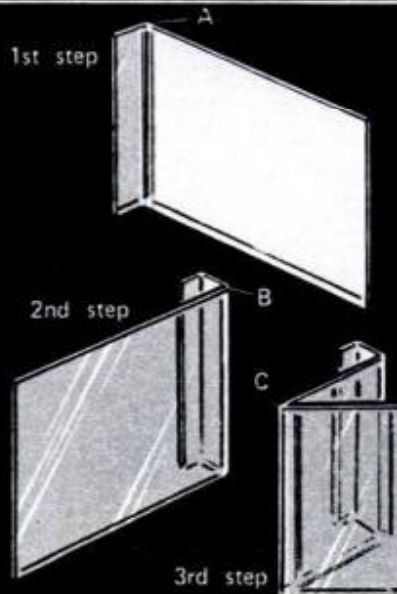
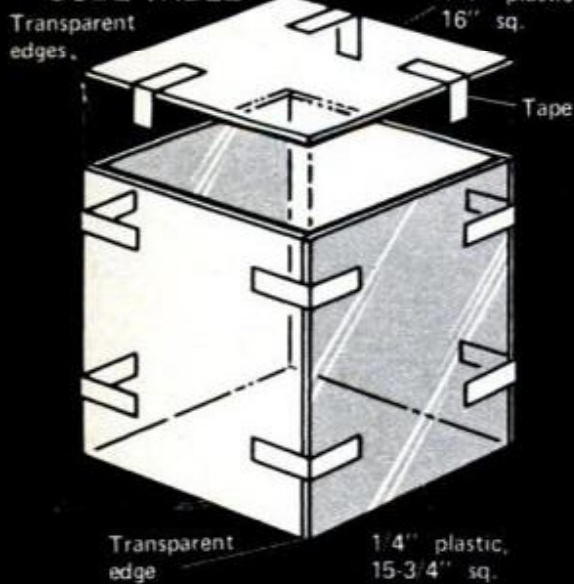

COOKBOOK HOLDER

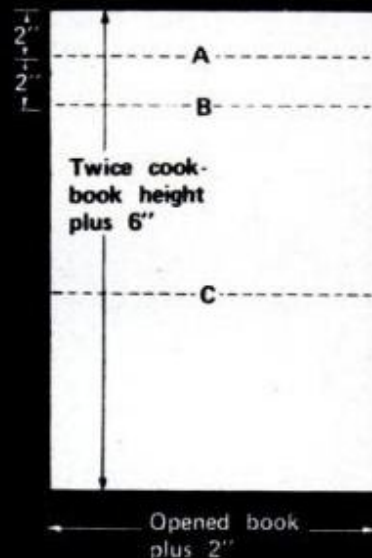

glass, and is a product of the Rohm and Haas Co. The examples represent but a few of the dozens of things that the imaginative home craftsman can create from translucent, opaque and transparent sheets.

Basic fabricating steps for working with acrylic sheet plastic were presented in a previous article (see *How to Work With Plexiglas*, page 176, June '70 PM) which showed how you cut, drill, polish, cement and bend the material.

Three of the projects, the wine rack, cookbook holder and telephone stand, are formed from one piece of plastic by heat-forming. Of the three the telephone stand is the trickiest to make. Each pair of bends must be made alike in the sequence given, otherwise you will wind up with a somewhat cockeyed form. Use a grease pencil to mark the plastic where it is to be bent and center the pencil mark over the heater element. It will take from 8 to 10 min. to heat 1/4-in.-thick plastic to a bendable state. Make the bend slowly, on the line, while the plastic is still on the heater. You'll find that the plastic has a tendency to "spring" back as it cools, so you must compensate a bit when forming a right-angle bend. In the case of the telephone stand

(Please turn to page 184)

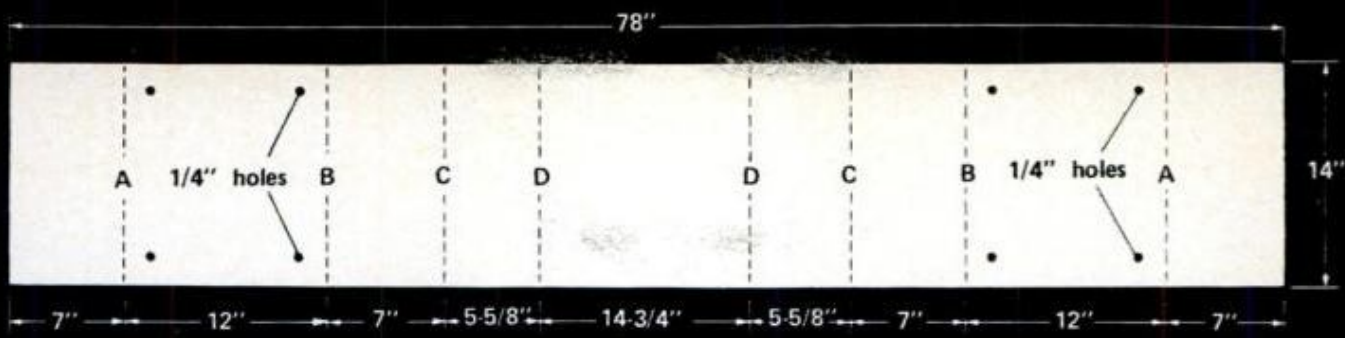

TELEPHONE STAND

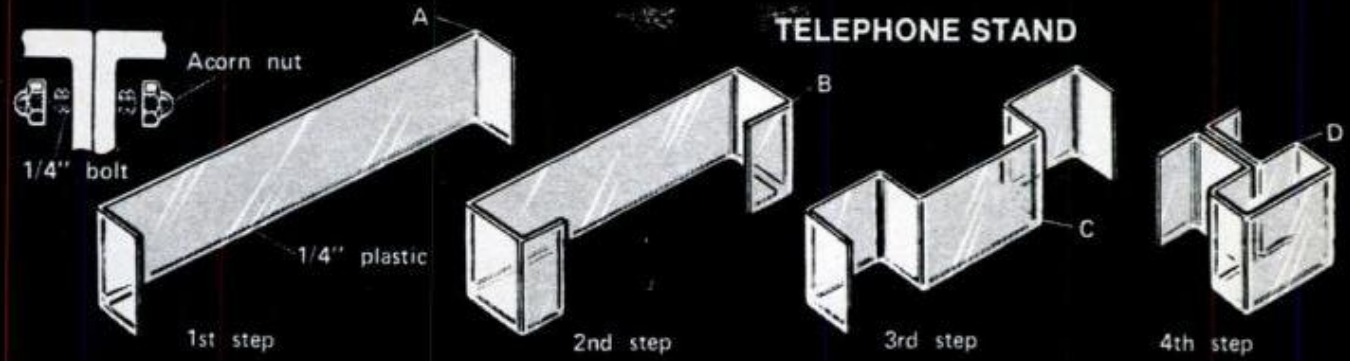

TRISECTED TABLE

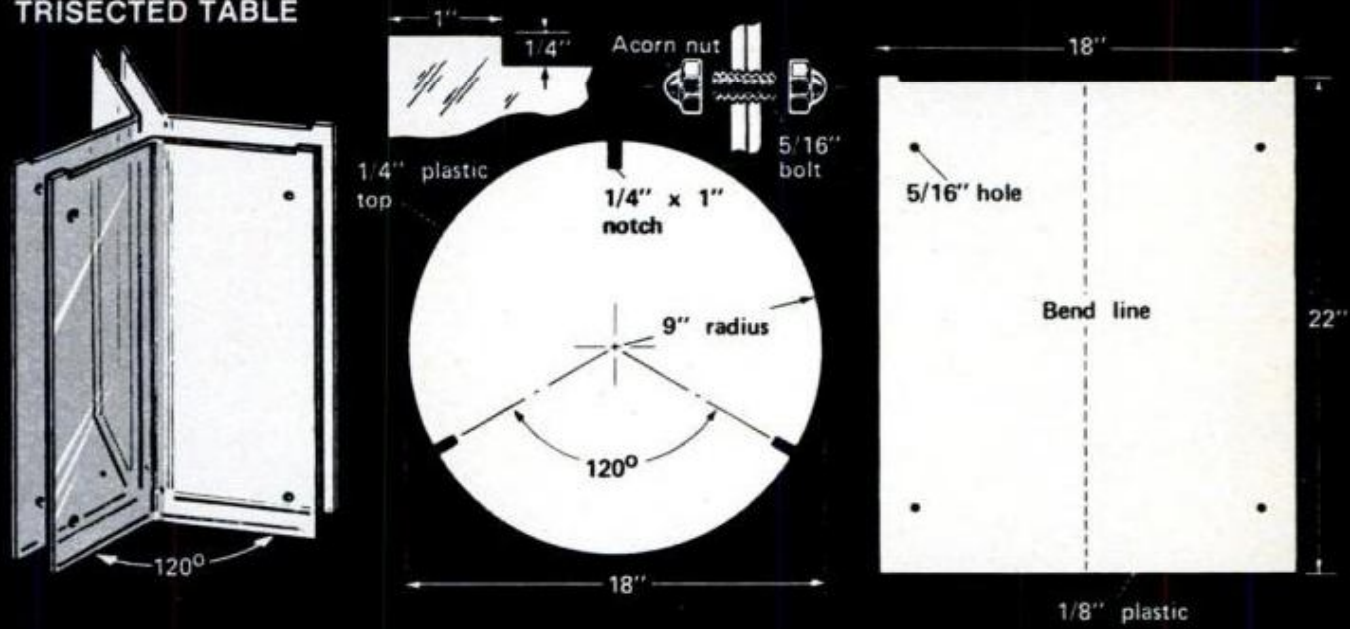

TO BEND PLASTIC, protective paper is removed and plastic is placed over heat tape in homemade heater

"NEEDLE" SPOUT makes special solvent applicator dripless, lets you apply watery cement to seam only

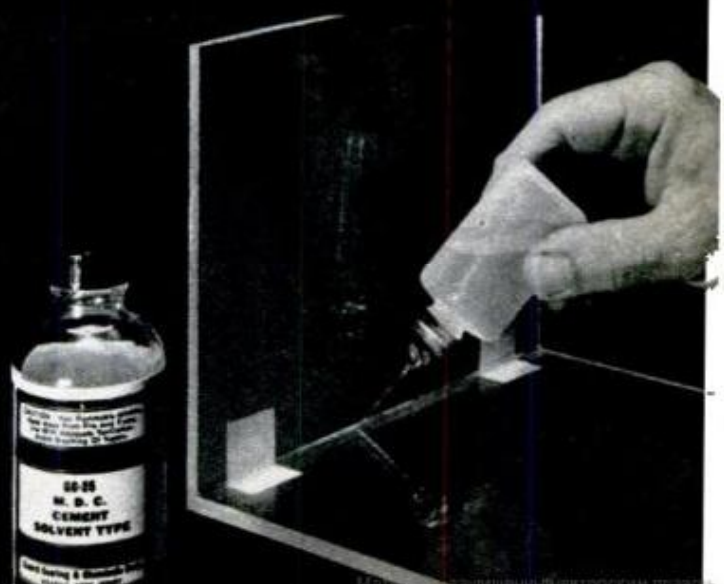



You Can Build This Early American Gossip Bench

Charming colonial piece in warm cinnamon finish provides a convenient place to sit and chat

By WAYNE C. LECKEY, Home and Shop Editor

IF YOU LIKE FURNITURE with a past, you'll like this authentic Early American gossip bench. Crafted in solid cherry in our own cabinet shop, this handsome piece is something you'll cherish for years to come. It has a shelf for the phone and a place below for directories.

To make it you'll need a wood lathe to turn the 4 legs and 13 spindles. The legs are turned from 1 $\frac{3}{4}$ -in. turning squares, 16 in. long. When mounting the blanks between centers, place the unturned end of the leg at the headstock end of the lathe. Turn the first leg by following the pattern

Color Photo by Bill Maris/Styling by Bob Lofgren

given, then use it as a sample in turning the others. Notice that the tops of the legs require a compound cut to provide the proper leg splay. This is done by tilting both the blade and the miter gauge on your table saw. A similar bevel is made at the opposite end of each leg but this is done after the base is completed.

Each of the 13 spindles is turned from 1-in.-sq. stock, approximately 12 in. long. Finish-sand each spindle while in the lathe and turn a $\frac{1}{2}$ -in. tenon at each end. Use the first turning as a sample for the others.

The $\frac{3}{4}$ -in. seat aprons are ripped 2 $\frac{5}{8}$

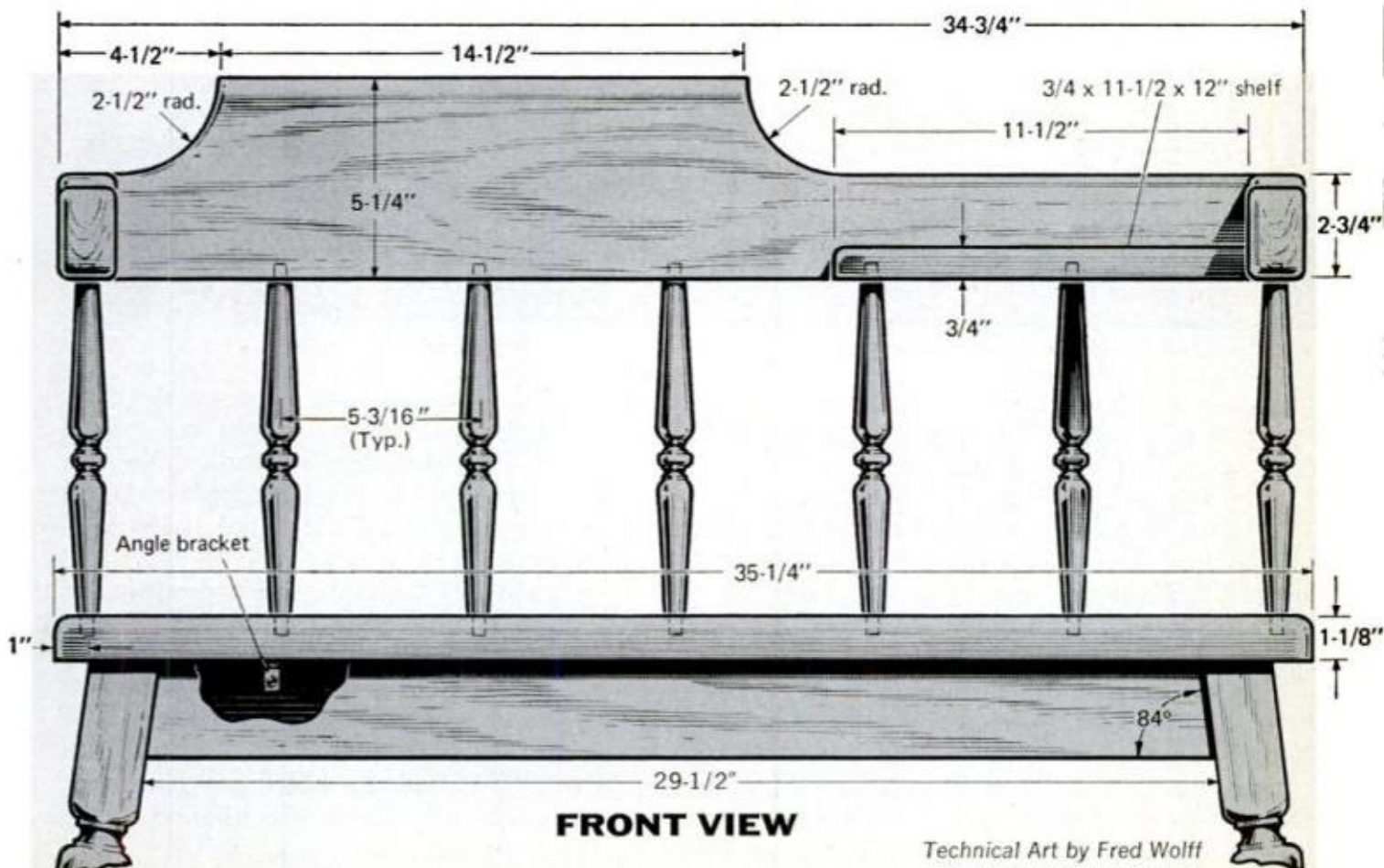

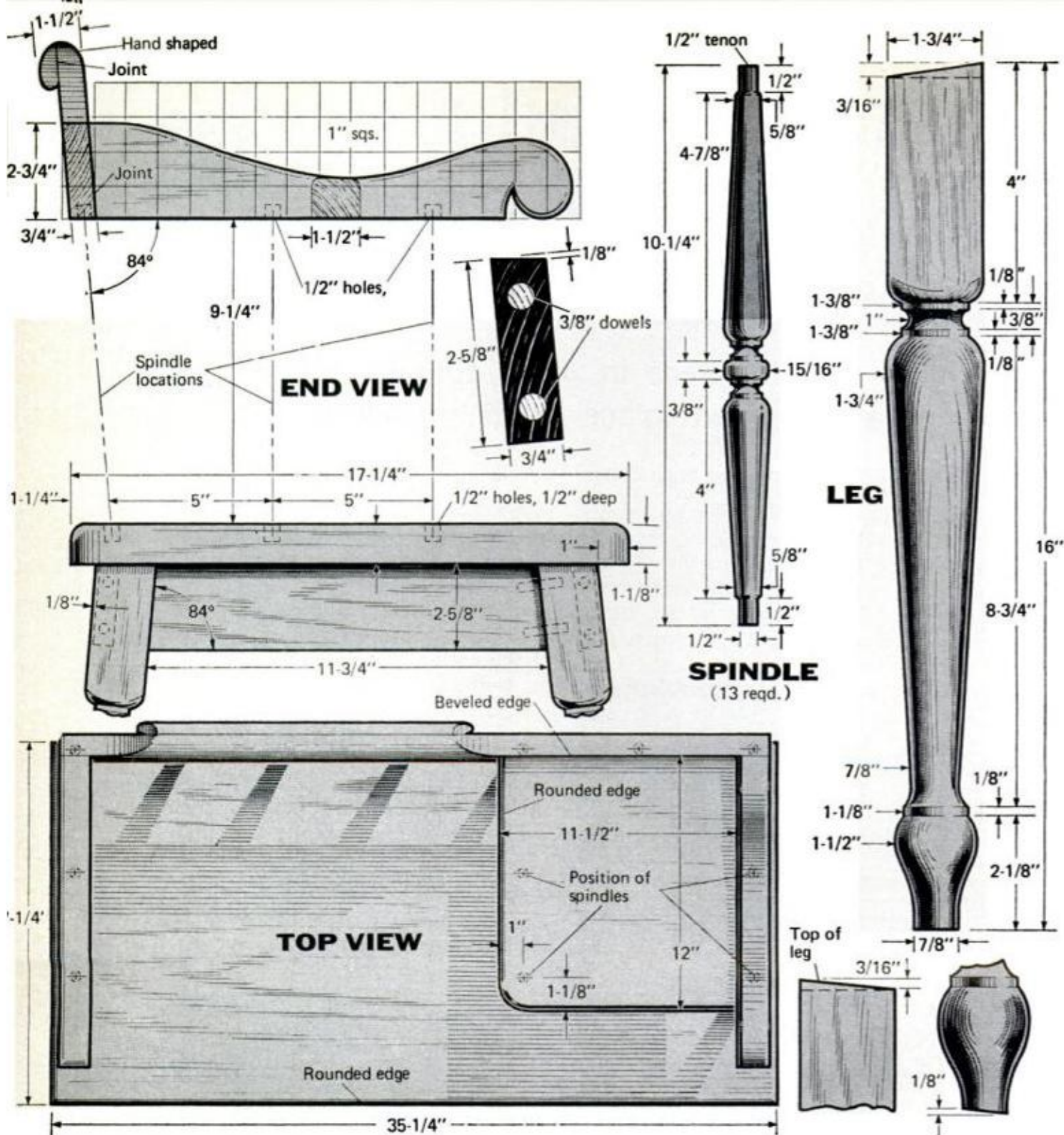

in. wide. Notice that the top edges are beveled and that the ends are cut at an 84° angle. The end aprons are 11³/₄ in. long, the side rails 29¹/₂ in.

The aprons are attached to the legs with ³/₈-in. dowels and are set in ¹/₈ in. Assemble the legs and end aprons in pairs, then add the side aprons. Check for squareness and hold it squarely with a temporary cross brace.

The seat is 1¹/₈-in. solid cherry. If you wish, you can simulate this thickness by adding ¹/₄ x 1¹/₈-in. strips to the edges of a 16³/₄ x 34³/₄-in. panel of veneer-face, lumber-core plywood and mitering the

corners. Use your router to round the top edges of the seat, then lay out and bore the ¹/₂-in. holes for the 13 spindles. Notice that all are bored at a 90° angle except those along the back. Here the holes are bored at an 84° angle.

Next, cut out the back rail according to the dimensions given in the front and end views. You'll notice that the decorative "curl" along the top of the rail is hand-shaped after you double the thickness with a second ³/₄-in. strip.

Seven ¹/₂-in. spindle holes are required in the back rail. These are aligned with

(Please turn to page 198)

HINTS FROM READERS

King-size kite reel

After observing the frustration my youngster endured whenever she attempted to rewind the kite string on the cardboard core it originally came on I made this reel, which works like a charm. I used a 3-in. paint roller for a handle and made the spool from $\frac{1}{4}$ -in. plywood and a short piece of an old tailpipe, although tubing would do.

Simply cut the plywood to the diameter shown and, using a holesaw, cut grooves to receive the tailpipe. Use three $\frac{1}{4}$ -in. bolts through the center of the reel to hold the three components together. (Two would probably do the job but, built as shown, my version has taken all kinds of abuse without weakening.) As can be seen in the sketch, the handle for winding consists of a thread spool and a short bolt that fits its center hole. Though not a must, I sealed the plywood edges and then gave the reel a couple of coats of paint.

—Taylor M. Boyer



Quick way to solder aluminum

Often when soldering to—or on—aluminum, the task is difficult even though you may be using a special aluminum solder and flux. An easy way is to take a strip of aluminum solder and a piece of aluminum-core solder and hold the two together. Then, using an electric iron or gun of at least 135 w., apply the two solders simultaneously. You'll find they will fuse together at a low melting point, but make certain that the aluminum being soldered is hot enough to assure a good bond.

—H. Miller

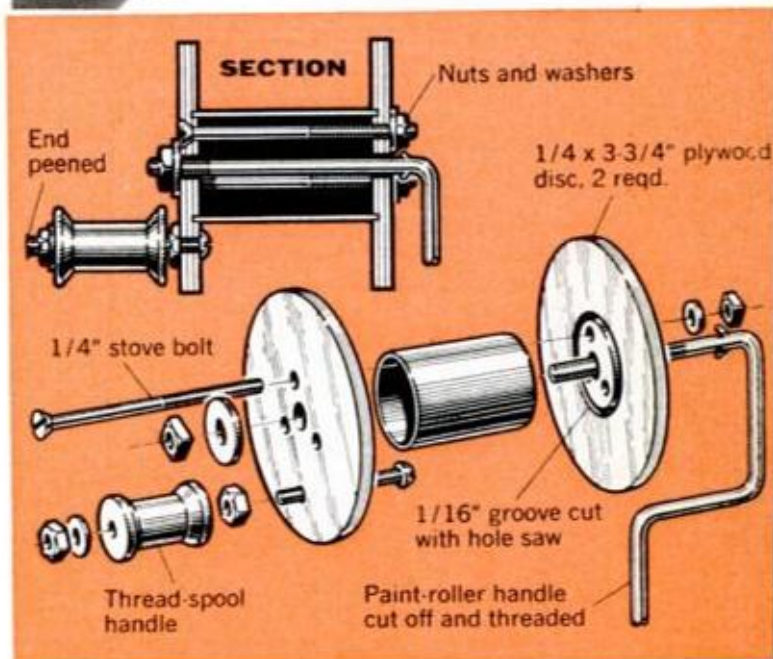

Hose clamp guides layout

A hose clamp installed around a tube or shaft can serve as a guide in scribing a line or spotting hole positions accurately. If you use a gear-type clamp, you'll find that it will have reasonably straight edges and can be adjusted for a true circumference. Thus, you'll obtain a line around the circumference that coincides with a plane perpendicular to the tube or shaft axis.

—B. W. Ervin

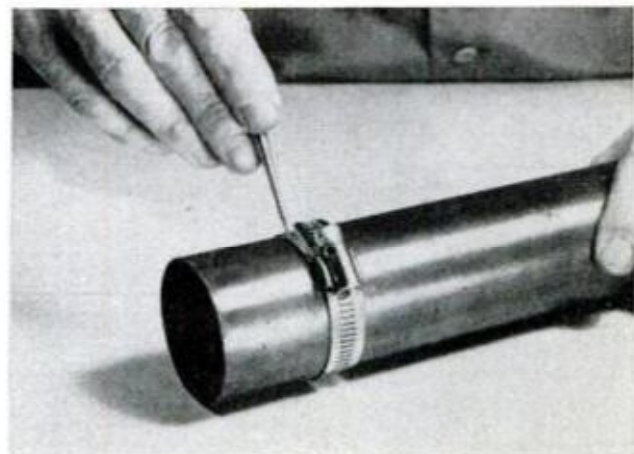

Quickie Designs That

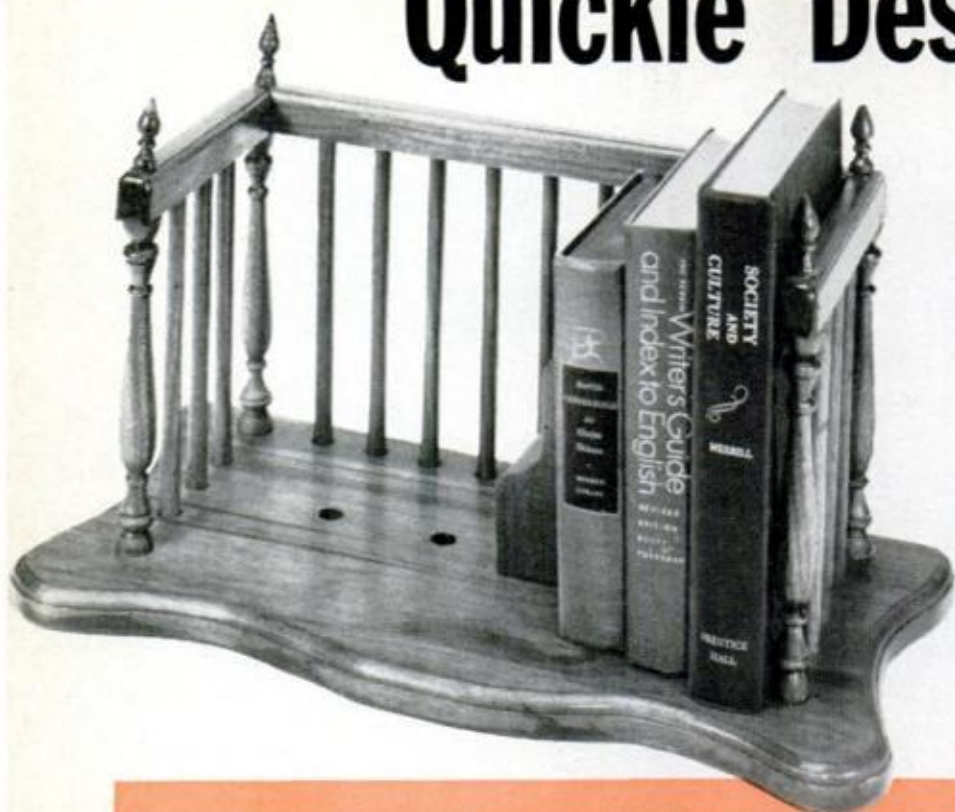

Colonial Bookrack

A handsome but seldom seen piece these days is the small bookrack that was built to be set upon a chest or other piece of furniture. My version is a replica of those that were found in almost every American home a century or so ago.

Except for the spindles and dowels, the entire piece can be made of pine. However, if you prefer, the rack can be cut from hardwood,

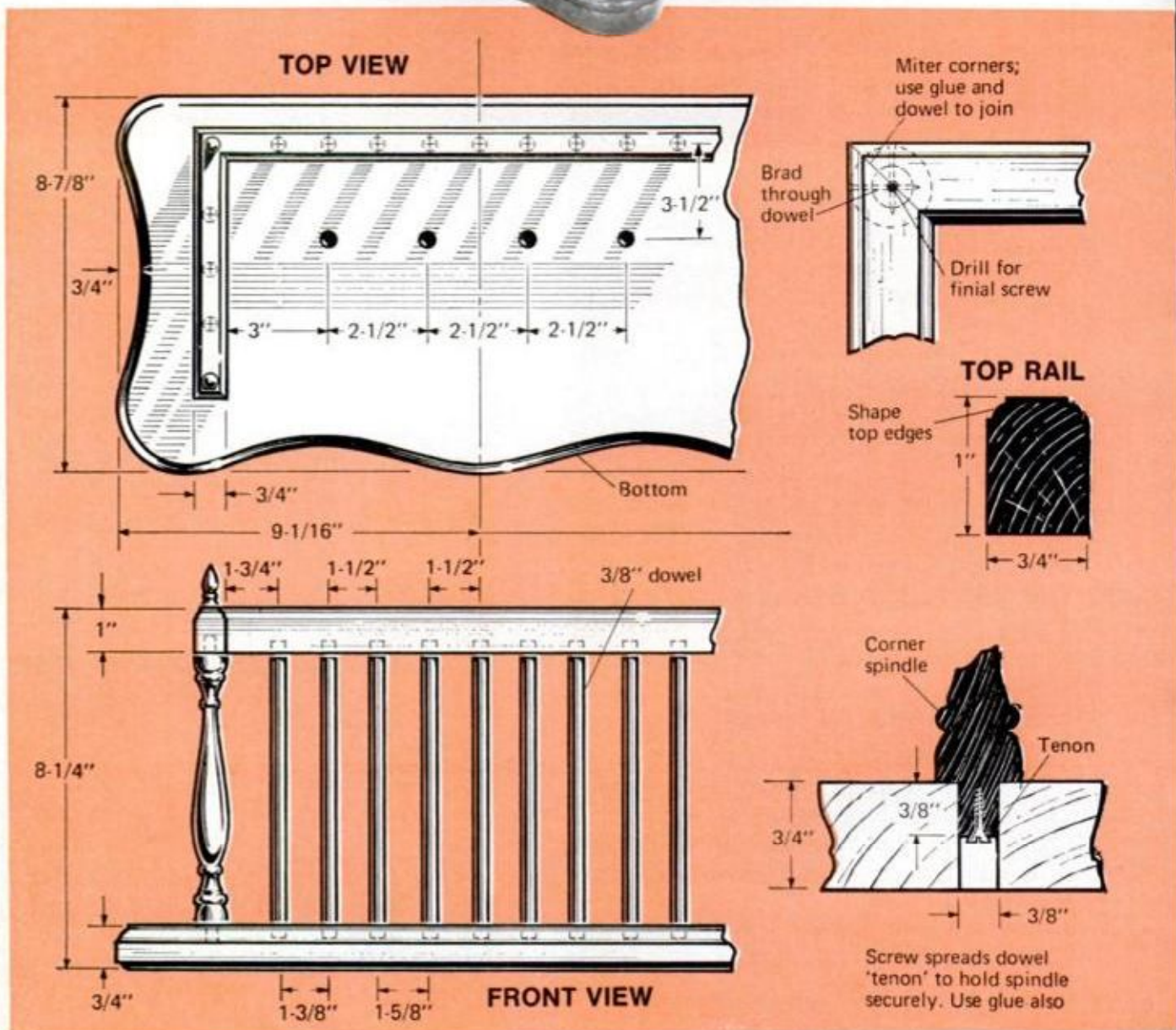

Keep the Sawdust Flying

such as walnut or cherry which have particularly attractive grain patterns.

Start by making a full-size pattern of the base and, after cutting and shaping, lay out the dowel and spindle locations. The dowels can be turned on your lathe, but if you prefer, the commercial hardwood dowels that are available at lumberyards will do the trick; if you use the latter you'll just have to spend a little more time staining to insure a good overall match.

Assembling the rack calls for a little planning ahead. The nature of the project requires that a number of pieces be assembled simultaneously. First, assemble the top rails as one unit. Then, saw kerfs in the lower ends of the dowels and assemble the dowels and corner spindles to the base and top rail. A small screw driven up into each kerfed dowel wedges them securely.—Richard Sickler

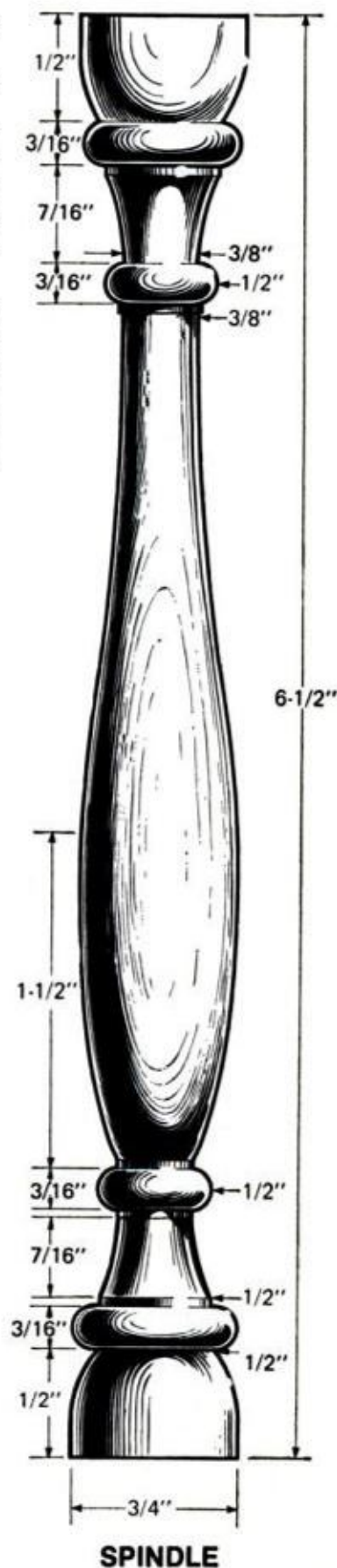
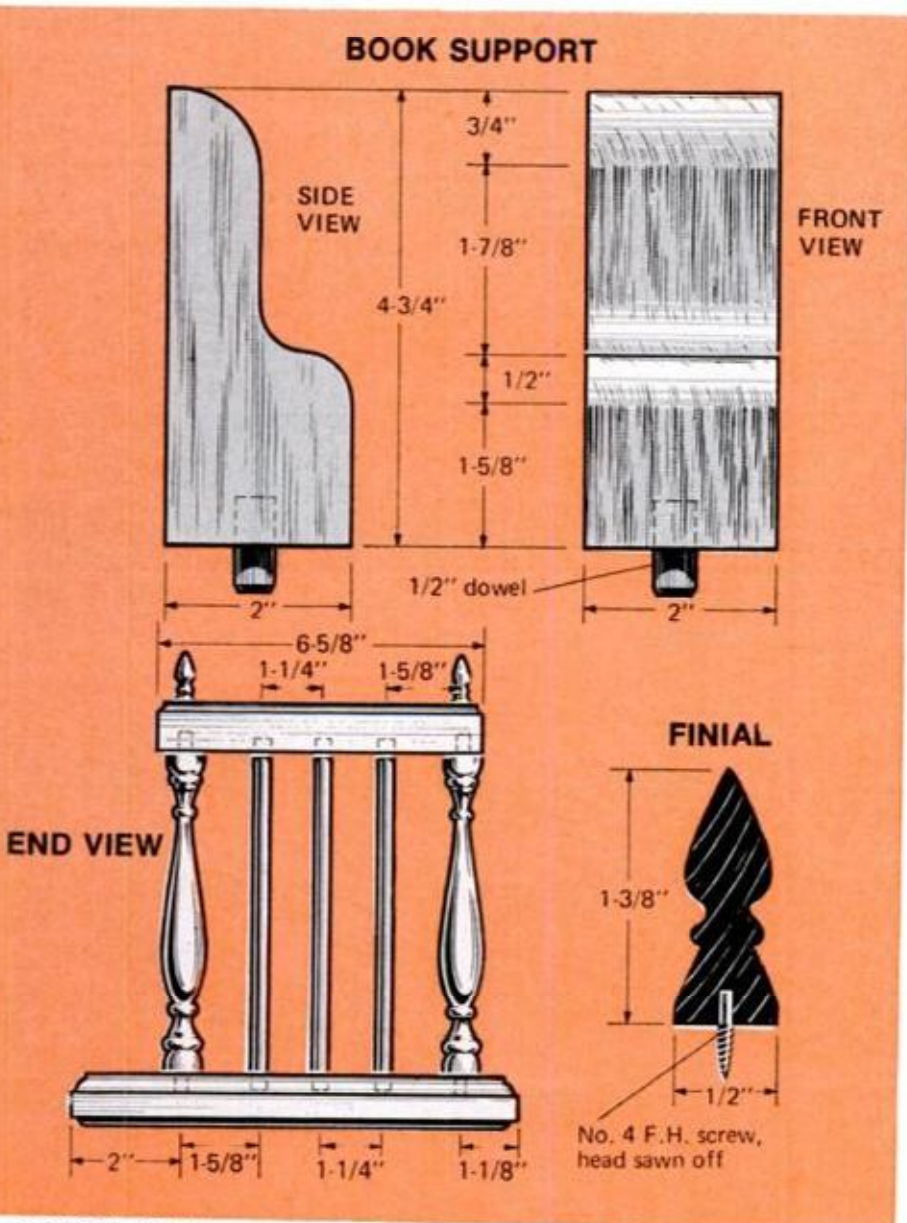

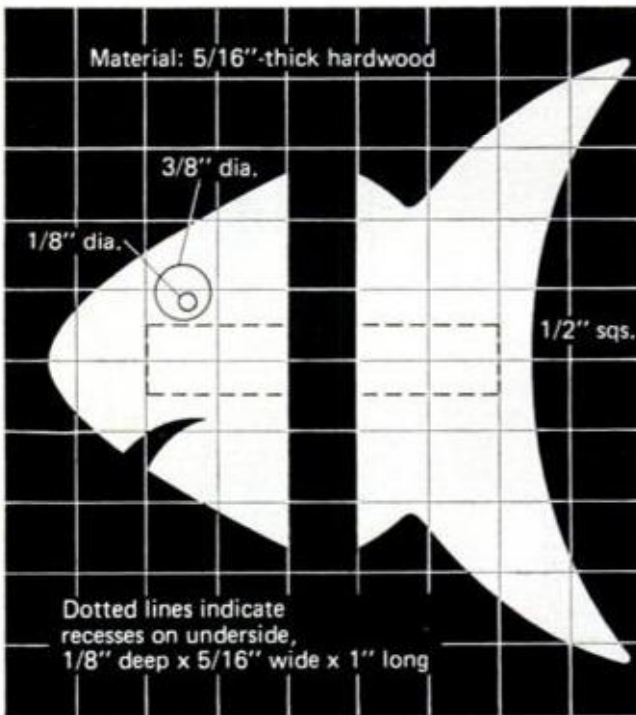
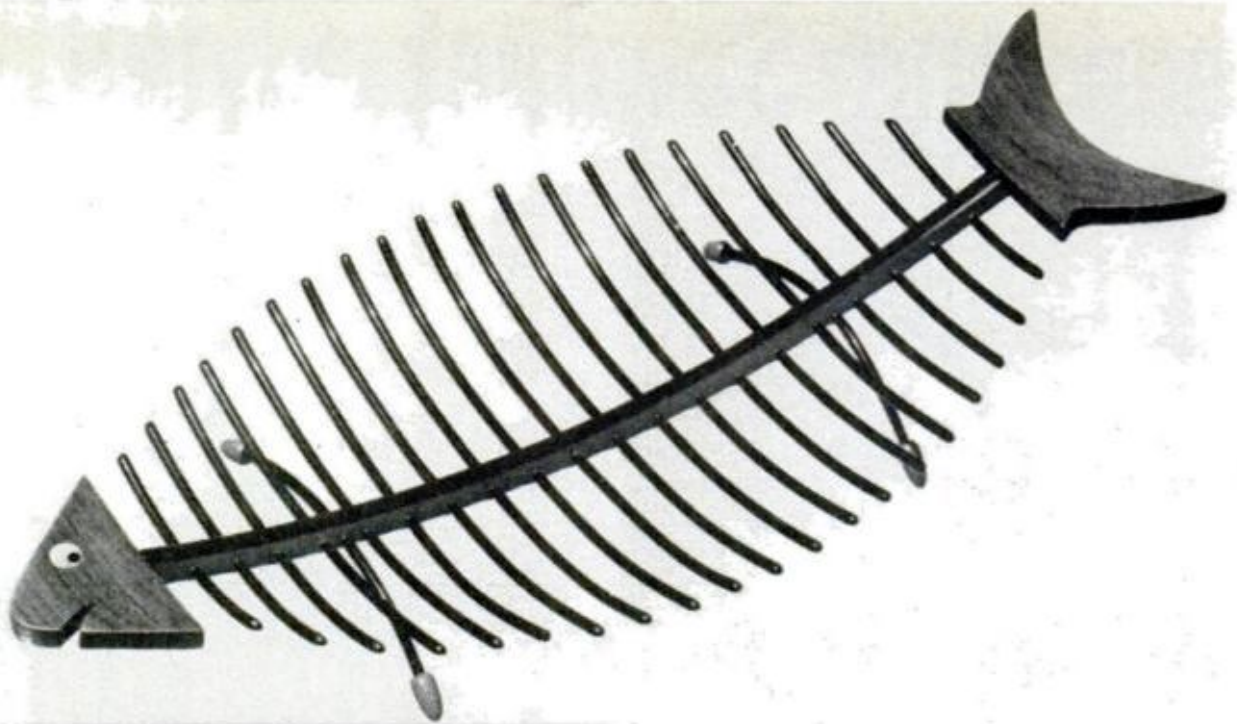

Novel Hors d'Oeuvre Server

Using just a few basic tools and a drill press, you can whip out this skeleton-like "fish dish" in one Saturday work session. To simplify construction, the "ribs" are fixed into the "backbone" without soldering. Use 5/16-in.-sq. mild steel bar for the backbone and, after cutting it to length, saw and file the ends for the head and tail. Mark off and drill the holes on the backbone, deburring all except the head and tail-fixing holes which should be countersunk on the underside. To assemble, it is necessary to use a "setting tool" as shown. Since all ribs are originally cut the same length, after assembly, mark the desired fish shape using a felt tip pen and cut the individual ribs to the desired lengths.

—Kenneth Wells

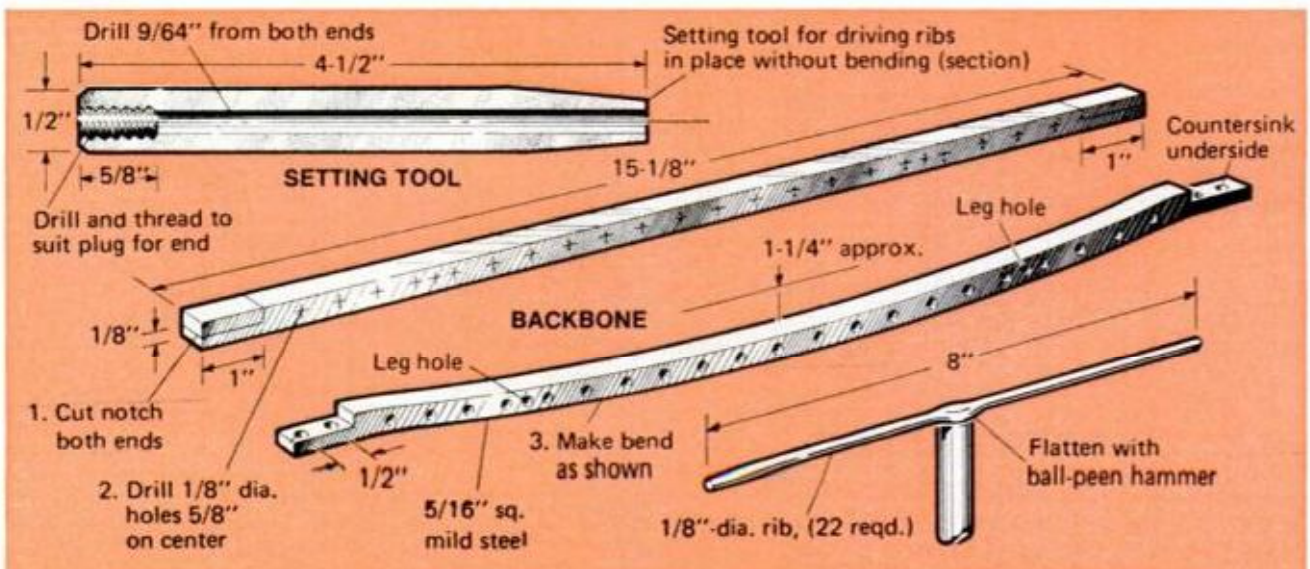

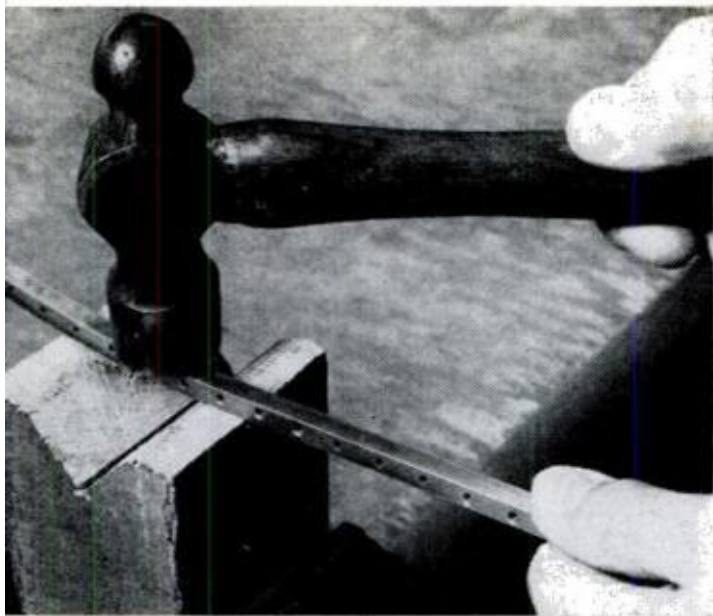

BACKBONE CURVATURE is achieved by placing rod over notch cut in a 4x4 and tapping it with hammer

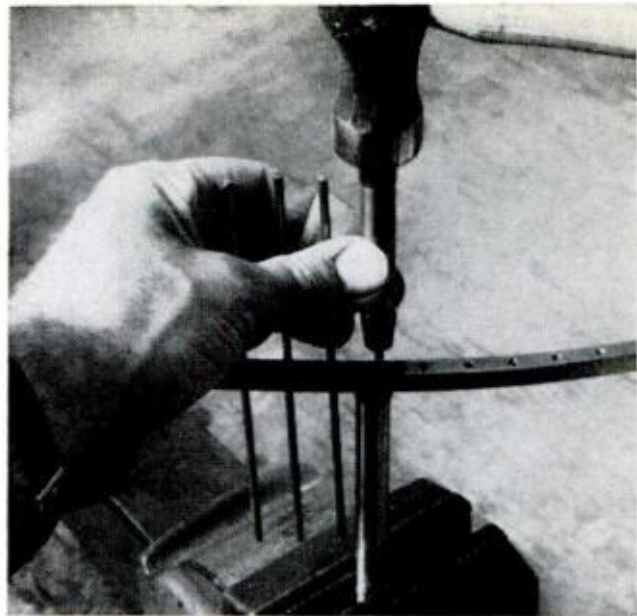

RIBS are driven with special setting tool. After all ribs are in place, cut them to the shape of a fish

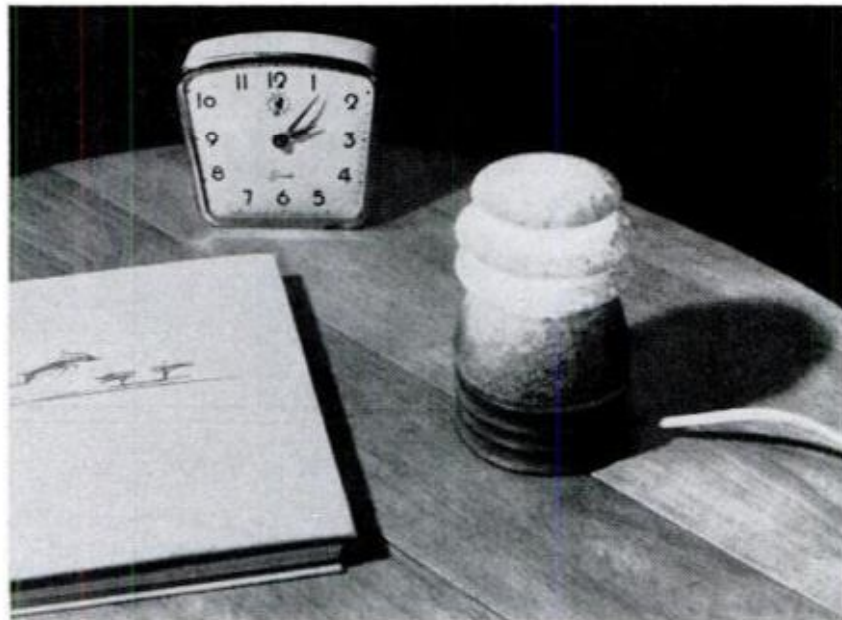

TELEPHONE LINE-INSULATOR makes handsome night light, can be quickly changed if you want another color

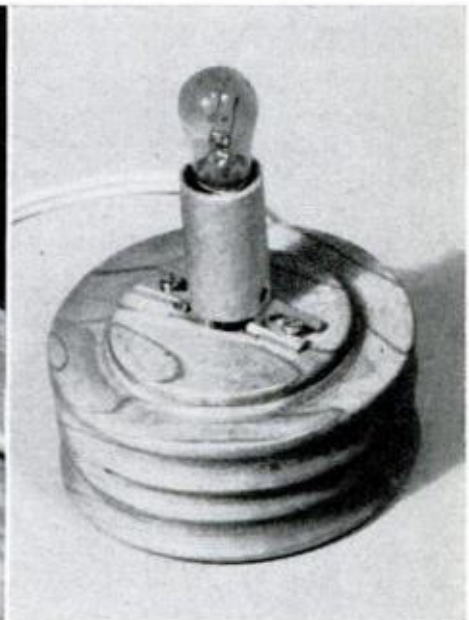

Ornamental Night Light

While I am not a dedicated collector of old telephone-line insulators, the assortment that I've gathered over a period of years has stirred considerable comment from just about every visitor to our home. Blue is the most common color and these sell for about a dollar or so in antique and junk shops. Even the most easily obtainable clear ones can be made attractive by heating in an oven and then dipping them in cold water (this gives a crackle effect). To make the light, first turn a suitable base. Attach a candelabra-size socket to the base and run the cord down through a centerhole and out the side. Attach a line plug and switch to complete the job; the insulator simply rests in place and is not fastened.

—C. Wayne Close



INSULATORS are available in a large variety of interesting shapes and colors. Author found that swap and junk shops are usually the best sources

EXCITING NEW PRODUCTS

BY CATHERINE BILSKI



IS YOUR LADDER causing scrapes and scratches on exterior or interior surfaces? If it is, Eazy Ladder Protectors will solve the problem. Made of durable foam plastic, they slip on or off in seconds and when not on a ladder, they can be used as hand sponges for cleaning walls, car and woodwork. Price is \$1.98 a pair from Rochester Eazy Products, 272 Spencer St., Rochester, N.Y. 14608.

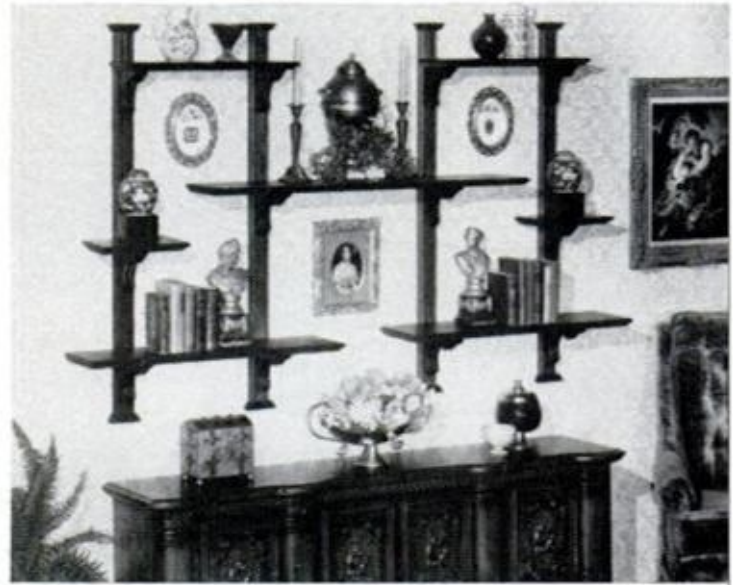

ADD EXCITEMENT to a foot of space or accent an entire wall with these carefully constructed and masterfully finished shelves. They're made of solid native oak, deep stained and finished as fine furniture. They're available in a variety of shelf widths and lengths, as well as in special units for stereo, television and magazines. Made by Kirsch Co., Sturgis, Mich. 49091.



AT NIGHT, disabled cars are often hard for other drivers to see. So be safe—be seen with the Blinki-Lux Warning Signal. Its flashing light switches on automatically at the approach of another vehicle and keeps on flashing until it has passed. \$11.95 from the E. J. Co., Dept. PM-30, 704 S. Fifth Ave., Mount Vernon, N.Y. 10550.

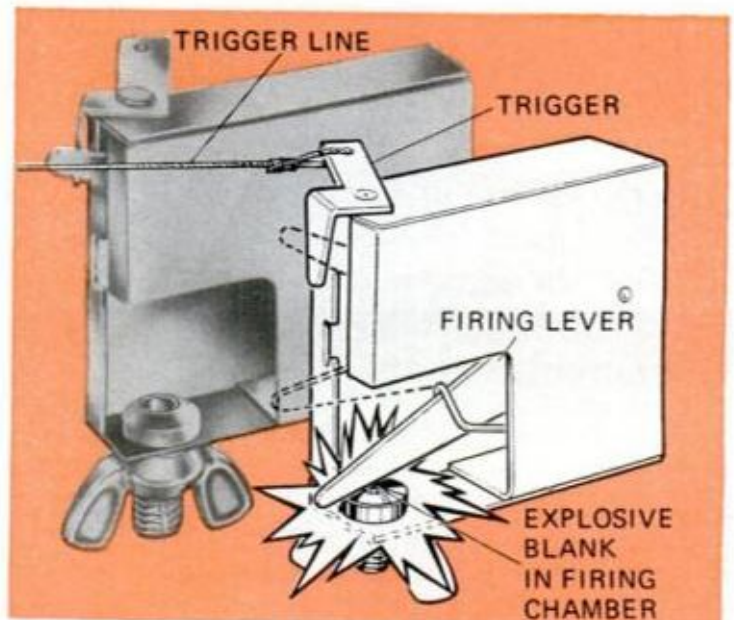

SCARE OFF PROWLERS and burglars with the Snooper-Stopper warning signal. Its positive trigger and spring-action mechanism fires a 22-cal. explosive blank when the firing lever is tripped, producing a loud, "gunshot-like" sound. Heavily plated so it will not rust or corrode in any weather condition, the signal sells for \$5.98 postpaid from Harris International Enterprises, Box 11, Kooskia, Idaho 83539.



WHEREVER YOU'RE GOING—camping, on a picnic, to the beach or sitting out on the patio—take the Porta Lamp along. It's cordless, battery-operated and safe: no fumes, fuel or flames. The shade, base and jacket are molded of polyethylene, making it strong and durable. It sells for \$9.95 (with battery) from the Hipwell Manufacturing Co., 831 West North Ave., Pittsburgh, Pa. 15233.

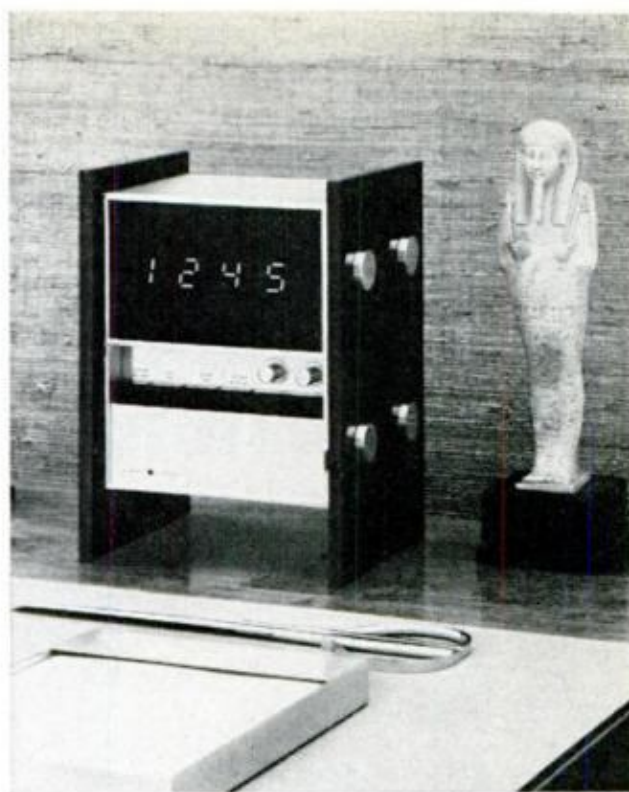

BE AHEAD OF THE TIMES in keeping the time with General Electric's Chronosan ED-3 digital read-out timepiece. It has no hands or dial face, no motors or moving parts, no tick-tock or motor sounds and no clanging or buzzing alarms and it complements any decor. Suggested retail price is \$250 from General Electric, Housewares Div., 1285 Boston Ave., Bridgeport, Conn. 06602.



PUSH OF A BUTTON GLUES IT. USM Bostik Spray Glue quickly and neatly bonds paper, cardboard, fabrics, Styrofoam, plastic, fiberglass, glass and metal. This nonflammable, waterproof and pressure-sensitive adhesive has dozens of uses around the home, at school and on the job. It sells for \$1.49. USM Corp., Consumer Products Div., Box 1139, Reading, Pa. 19603.



TEST YOUR BRAIN POWER and ingenuity with Qwik-Sane, a puzzle of 13 pieces in a tray. With only one space in which to maneuver, the object is to slide the pieces around the tray without removing any of those remaining and solving the puzzle in the prescribed number of moves. It sells for \$1.75 (two for \$3) postpaid from Wff 'N Proof Publishers, Box 71, New Haven, Conn. 06501.

A Mini Drill Press For Hobbyists

A sewing machine motor and a modified portable drill bench stand team up to give maxi small-drilling ease

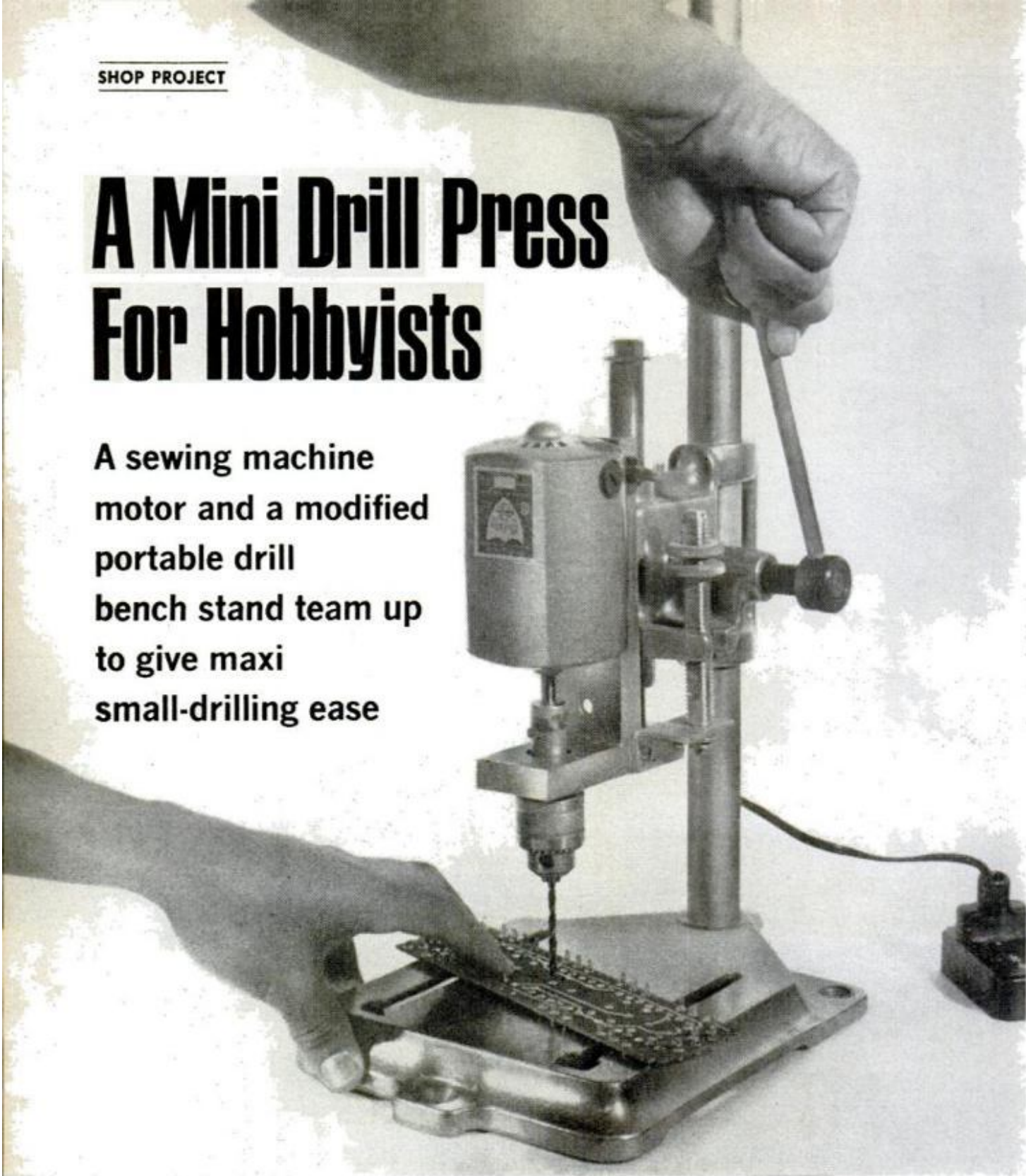

By J. RONALD EYTON

AT ONE TIME or another, all workshoppers who tackle electronic and hobby projects have need for a small drill press. I found this to be true, and, in my case, I also quickly realized that one that featured variable-speed—and more power than any press I could find at retail—would offer even greater workshop convenience. The model shown, which I built in my spare time using a sewing-machine motor, miscellaneous brass scrap

and a couple of store-bought items, filled the bill perfectly.

The press uses a standard chuck which accepts bits up to $\frac{1}{4}$ in. and the motor's variable speed is controlled by a foot switch. The electric motor (catalog No. 41A4006) which generates $\frac{1}{15}$ hp with speed control was purchased from Birstein-Applebee, 3199 Mercier St., Kansas City, Mo. 64111, for \$8.88. Portable electric-drill stands are stocked by hardware

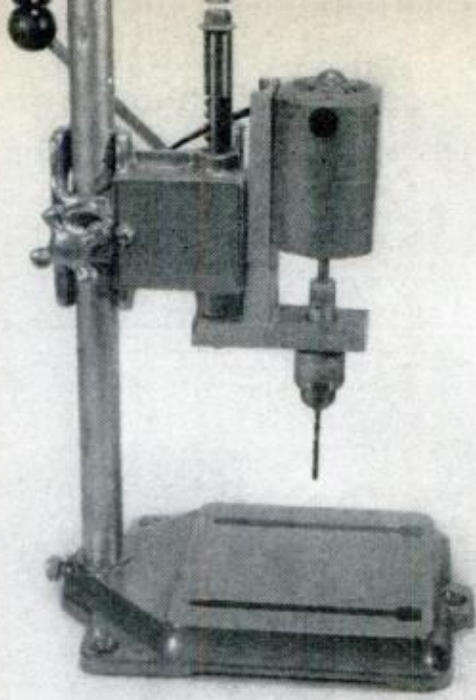

SHOP-BUILT DRILL PRESS has more power than most commercial types, is easily built

DRILL'S MOTOR has variable-speed control activated by a foot switch. Text tells make

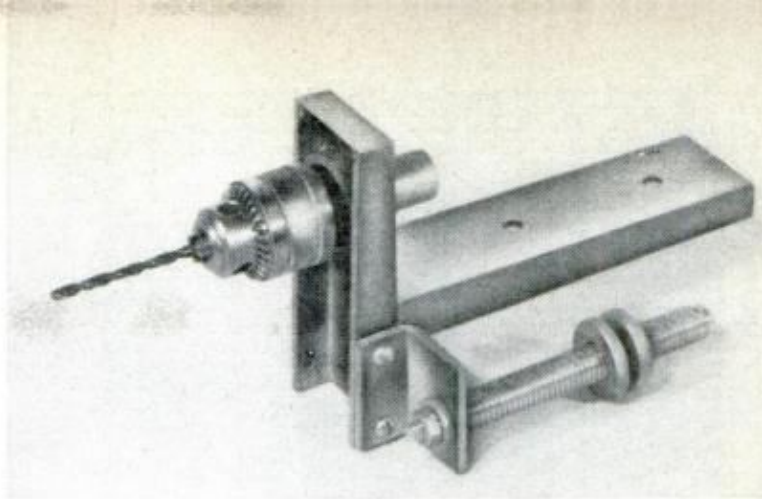
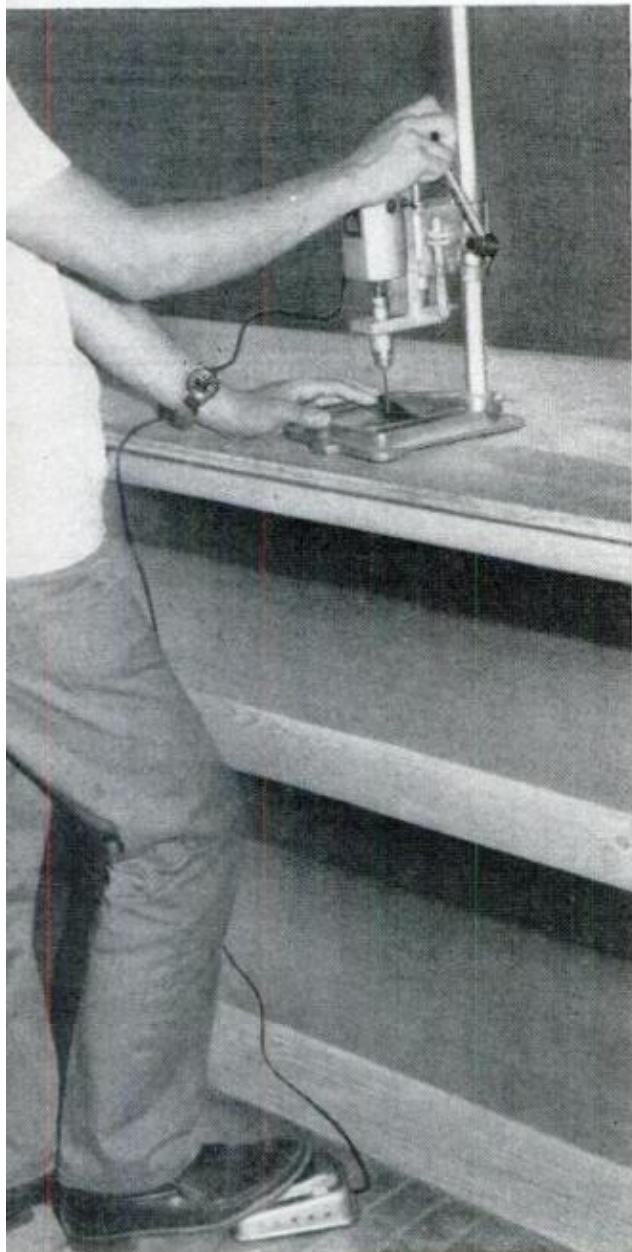

STANDARD CHUCK with 1/4-in. bit capacity was used here. Chuck is available at most well-stocked hardware stores

HOW MOTOR SUPPORT IS MADE

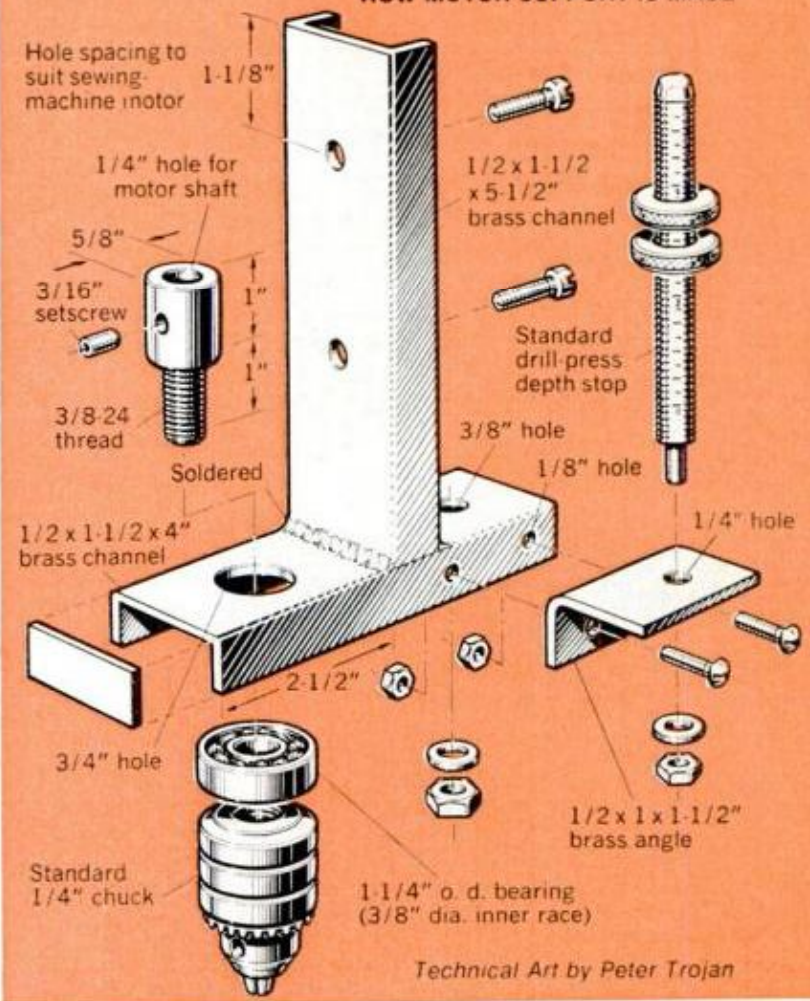

Technical Art by Peter Trojan

stores and any make can be adapted to this setup by making necessary adjustments (Thor's model B-A 37B347 (\$13) was used in this instance).

Dimensions are not critical, and, as with the bench stand, holes can be varied to suit the sewing-machine motor.

Once you have completed the project and mounted the drill press on your workbench, you'll be more than pleased with the tool's efficiency and the convenience it will add to your workshop hours.

★★★

New tools you should know about

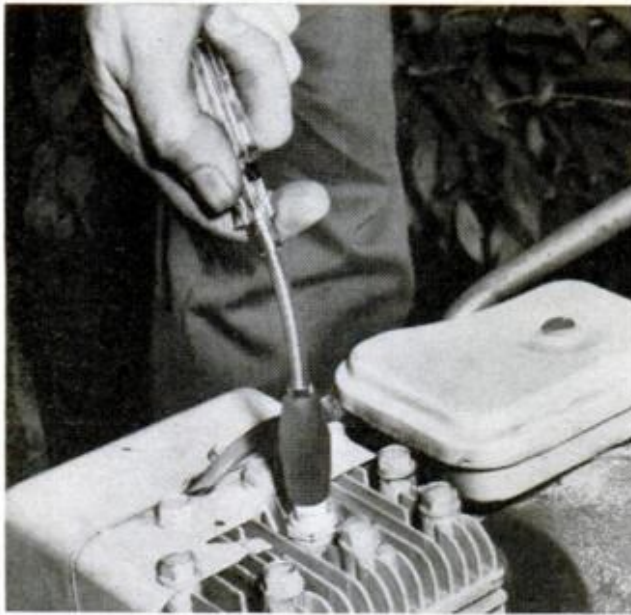

FLEXIBLE SPARKPLUG TOOL, claimed to save time, temper and skinned fingers, consists of a rubber gripper which holds plugs firmly and a $\frac{1}{4}$ -in.-square drive for socket sets. The woven flexible shaft makes it easier to reach hard-to-get-at and recessed places. Tool can also be used on oil-pan bolts; the rubber end will even remove small bulbs safely. \$1.95. L. Crittenden Co., 1201 N.W. 5th St., Oklahoma City, Okla. 73106.



REEL-MOUNTED DROP LIGHT rated at 6 amps, 125 v., comes with a 20-ft., three-wire, grounding-type retractable cord. Cordomatic 500G features a pistol-grip handle of high-impact phenolic, a Levolver toggle-action switch and a built-in convenience outlet for portable power tools and appliances. By mail order from Omar House, 1010 Omar Rd., West Palm Beach, Fla. 33405. The \$15.95 price tag includes the postage.

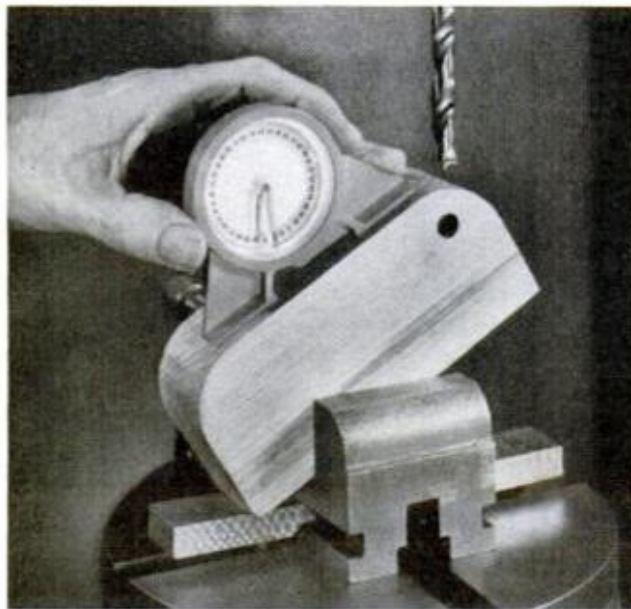

PRECISION INCLINOMETER/LEVEL that's constructed of durable ABS plastic presents the graduations in magnified view. Called PAV model AP Angle Gage, the level features read-out to 1° with 30-minute estimations possible. Gauge feet are V-grooved for use on rounds such as pipe, and the angle indicator rides on a precision pivot. Priced at \$2.98 by Schlesingers For Tools Ltd., 1020 E. 54th St., Brooklyn, N.Y. 11234.

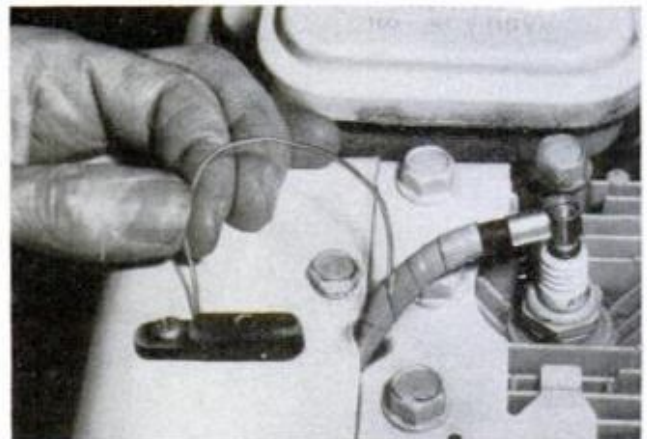

CONTINUOUS ENGINE ANALYZER labeled Spark Bug is easily installed on a 1-cylinder engine and actually monitors the engine's ignition system. Once connected, the indicator glows brightly if sparkplug and wiring system are operating efficiently; light variation indicates faulty plug, inefficient spark or other causes of sputtering. \$1. Dinsmore Instrument Co., Box 595, Flint, Mich. 48501, is the manufacturer.

HINTS FROM READERS

Increase life of sabre-saw blade

Here are two tricks that get more mileage from your portable jigsaw blades. When necessary to make a panel cut on the floor, place the work on a sheet of plasterboard. On the downstroke, the blade enters the "buffer pad" instead of striking the floor. The shim on the shoe brings new, unused teeth into play to extend blade life.—*George Daniels*

Repair wobbly chair legs

It's quite common for the socket holes in legs and spindles of Early American (or old) furniture to wear oversize with usage and cause a general loosening. For an easy way to insure tight joints when re-gluing, first apply a thin film of white glue on the tenon, then sprinkle sawdust evenly on the dowel end and clamp the part in position.—*Harold T. Bodkin*

Easier metal cutting

You'll find that hacksaw blades won't dull or break as fast if you use them this way. Instead of inserting one blade in the frame as usual, position two blades with their teeth pointing in opposite directions. You'll be pleasantly surprised to find that sawing will be easier, especially when you're working with thin sheet metal and tubing.—*Blanche Campbell*

Portable drill depth stop

Here's a simple depth gauge you can make from a hose clamp with a hole drilled through, plus some odds and ends you may have lying about the shop. Make sure the binding post wire-hole clears the drill's casing and then fit the rod with a threaded or soldered washer on the end. Simply clamp the unit onto the spindle casing hub.—*Peter Legon*

Painted oar handles

Aluminum oars are nice to row with because they are easy on the arms, but they do have the objectionable trait of leaving the rower's hands black with aluminum oxide after use. I've licked this problem simply by spraying portions of the oars that the hands contact with a good quality metal paint. For best results, use two coats.—*John Krill*

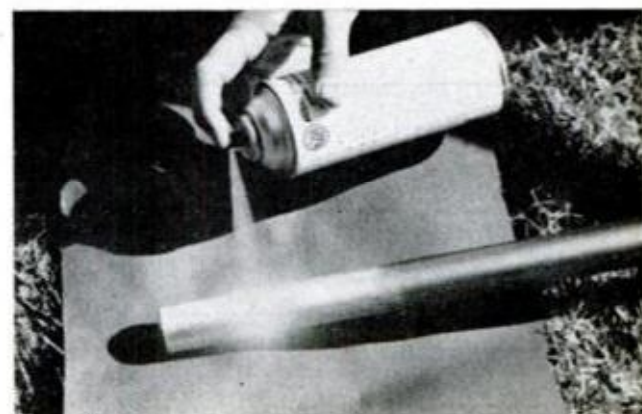
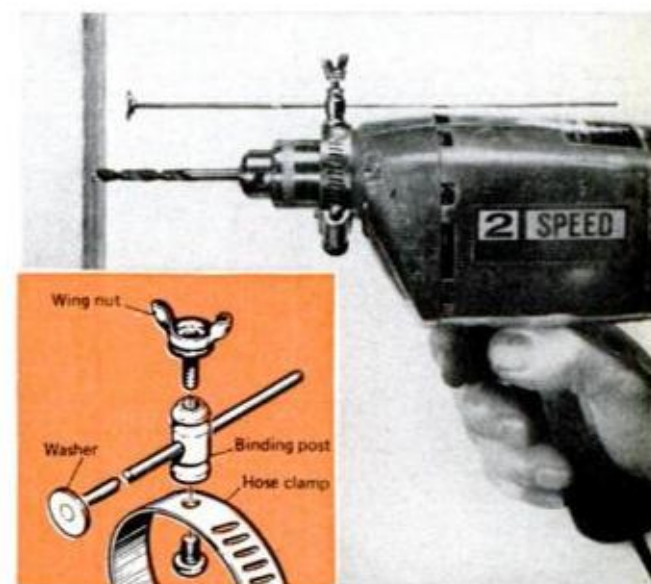
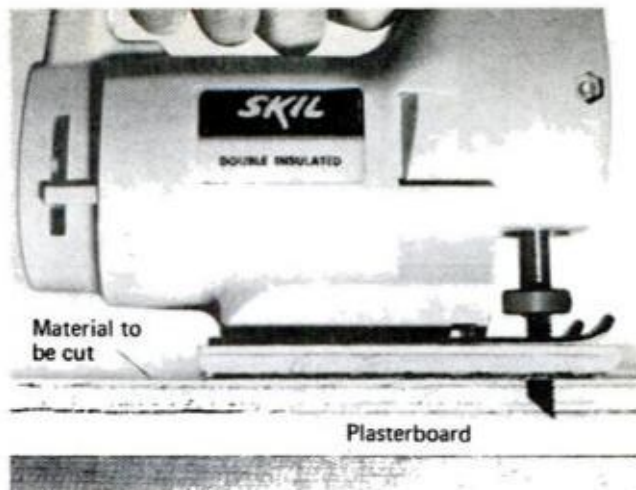



SOLVING



FLIES AROUND GARBAGE CANS are a health hazard during the hot summer months. By bolting a Shell No-Pest insecticide strip inside the cover, I've eliminated these disease carriers completely.—*W. Hitchen*

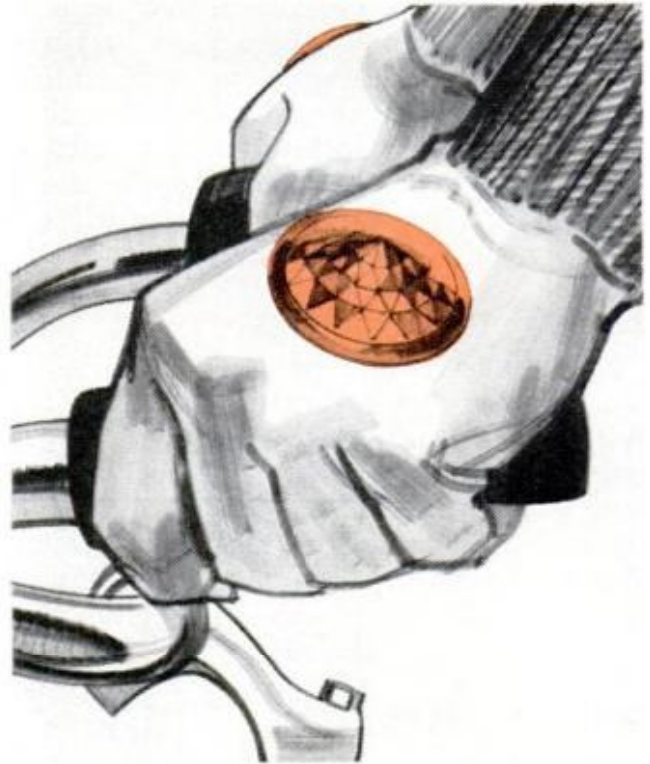

RUBY REFLECTOR, rubber-cemented to the back of each glove, is good safety device for bike and motorcycle night riders. The reflectors make hand signals visible to oncoming vehicles.—*Joseph Braunstein*

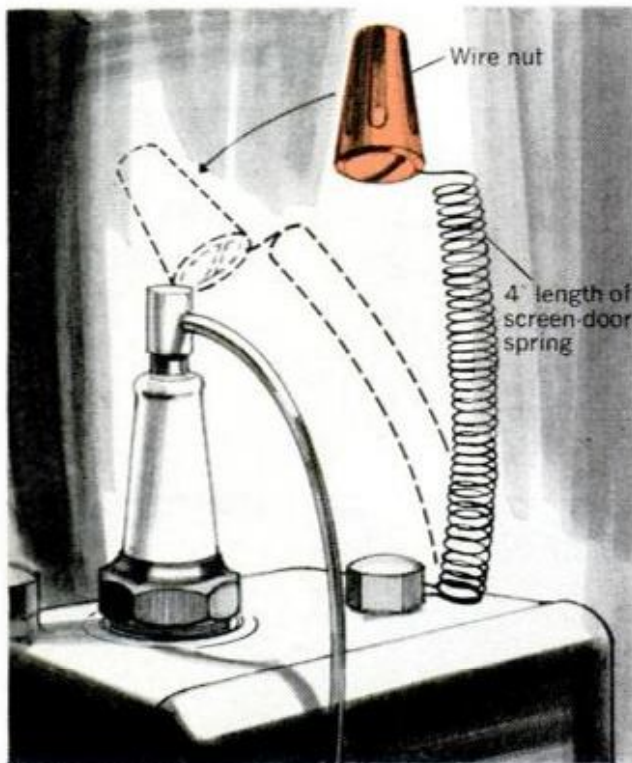

TO SHORT AN OLDER-TYPE GAS MOWER, try a length of screen-door spring. Secure one end under a cylinder-head bolt and the other on a solderless connector to act as a shockproof knob.—*C.H. Hardy*

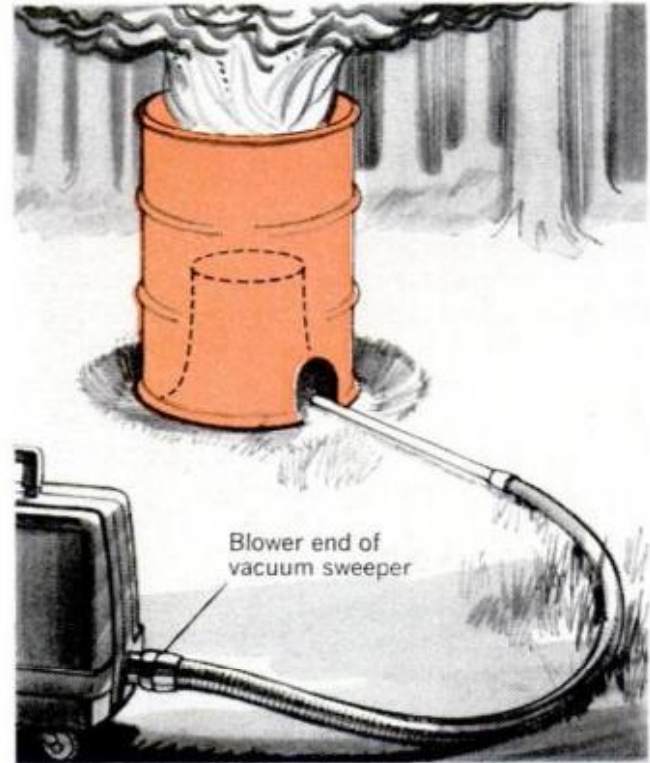

STUMP WILL BURN QUICKER if you cover it with bottomless barrel and rig up a vacuum cleaner with a length of pipe. Use "blow" end of vac to force air around stump to keep fire burning.—*Leroy Marshall*

HOME PROBLEMS

Illustrations by Adolph Brotman, Worman Associates

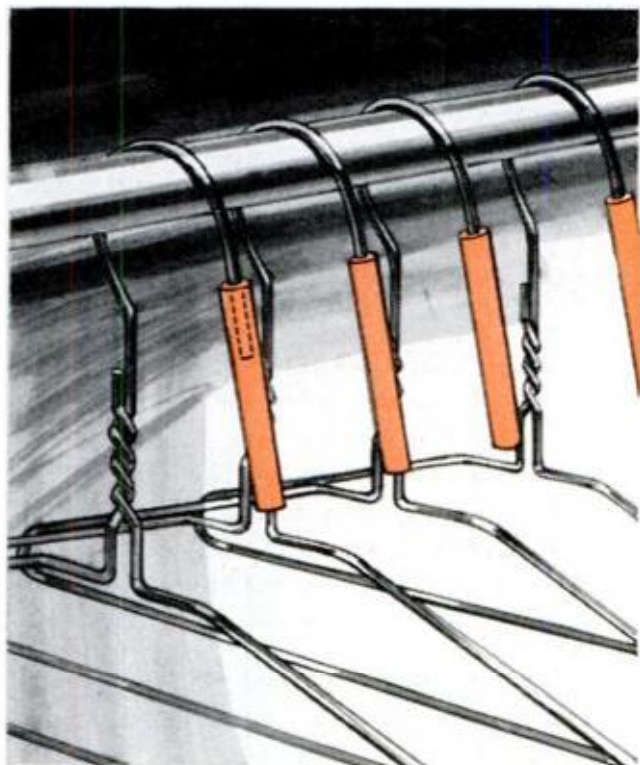

EMPTY COATHANGERS can be kept on closet poles (instead of falling off every time you remove an article of clothing) by simply slipping pieces of small rubber tubing over the hooks.—*Harry Radzinski*



EMERGENCY SCREEN-DOOR "SPRING" can be made when the stores are closed from a narrow section cut from an old inner tube. Screw a hook to jamb, stretch rubber and fasten to door.—*Wilfred Beaver*

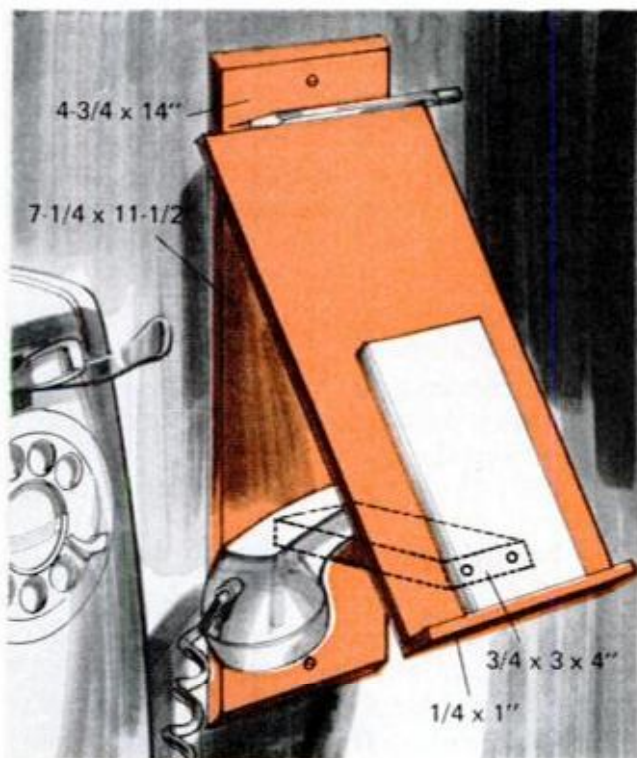

TELEPHONE BRACKET constructed as shown and mounted on the wall near the phone, gives a place to park the receiver. The simple bracket also provides room for memo pad and pencil.—*John F. Dinges*
MARCH 1971



PREVENT CURLED BRISTLES when storing a paintbrush overnight by fastening brush with a rubber band to a slightly longer stick. The stick, not the bristles, will then bear the weight.—*Allen Wilks*



HINTS FROM READERS

Ouchless way to remove pane

Often when you remove a window pane or install a new one, it is necessary to give the glass a few light taps to loosen it or push it in place. If you slip a rubber crutch tip over the putty-knife handle, the latter can be used as a sort of "glazier's hammer" to do the tapping without any danger of breaking the glass.—*William Swallow*

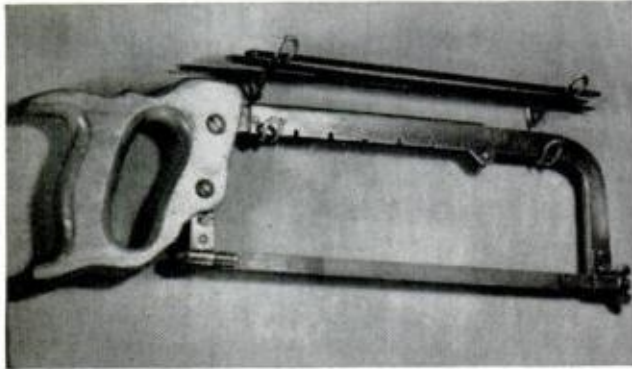

Neat storage rack for hacksaw

A cost-free and easy-to-assemble rack for your hacksaw can be fashioned from a couple of screw-type wire coathooks. Simply position the hooks to suit the saw's frame and screw them in the wall. The bottom hook of each hanger is used to hang the saw, while the upper hook is used to store extra hacksaw blades.

—*William Swallow*

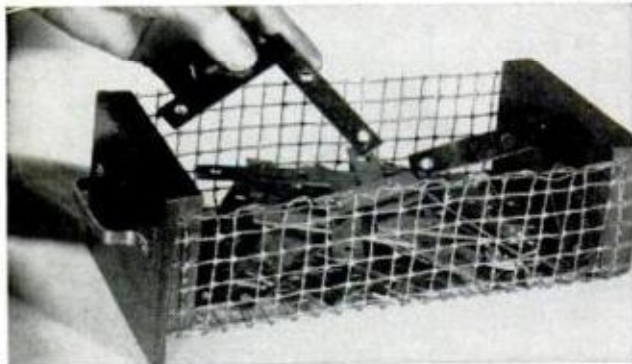

Dust-free storage drawer

If you bend a piece of hardware cloth in the shape of a U and fasten a wood block to each end, you'll have a drawer suitable for holding various shop parts such as those shown. This type drawer is particularly desirable where there is apt to be an accumulation of dirt, dust or rust because it falls through the wire and the contents remain clean.—*B. W. Ervin*

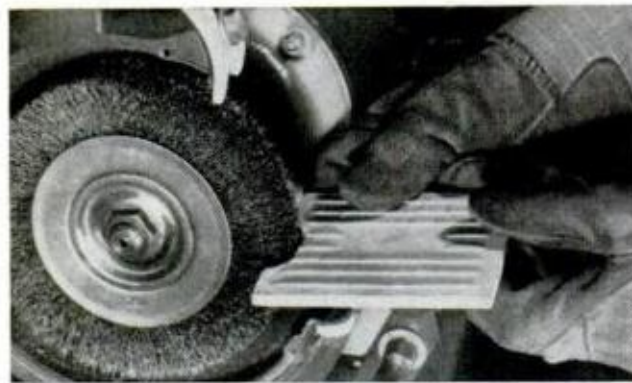

Wire brush 'nibbles' ceramic tile

Lacking a tilesetter's nibbler when I recently tiled my bathroom, I found that a wire brush chucked in my bench grinder does a fine job of cutting tiles to fit around pipes and other odd shapes. The wheel bites the material more readily if you hold the back uppermost and, surprisingly, there is absolutely no flaking or chipping on the glazed side.

—*D. L. Vaughan Jr.*



Pipe fitting serves as small anvil

If you fit a short pipe nipple with a pipe cap and drop it in a dog hole in your workbench, it can be used as a mini-anvil. Because it is not feasible to straighten a nail or the like on the cap's round top, the center of the cap in the photo was "flattened" by machining on a lathe. If the cap has molded letters, these should be filed off.—*William Swallow*

How to Make Perfect Bends In Tubing



MANY HOME INSTALLATIONS call for connections made with small copper or brass tubing. For example, 1/4-in. tubing is frequently used to put a humidifier in an air duct, and oil-pressure and manifold-vacuum gauges usually call for 1/8 or 3/16-in. tubing between engine and dash. Just about any connection you make is sure to need one or more bends.

To make a kink-free bend, you'll need a simple grooved bender like that shown, which can be lathe-turned in minutes from a wood block. Follow the table of dimensions shown below the illustration at the right, for the turning of benders to suit tubing ranging in size from 1/16 through 5/16 in. o.d.

To heat-treat tubing, mark the part of the tube to be bent and heat this area to *dull red* using a propane torch. Then dip it in cold water. (Note: Since copper is a good conductor of heat, handle tubing with tongs or pliers.) To make the bend, clean the surface of the annealed tube by rubbing lightly with fine emery. Place the tubing in the groove of the bender to get the appropriate bend and exert uniform finger pressure to form the tubing around the bender.—*Rudy Kouhoupt*

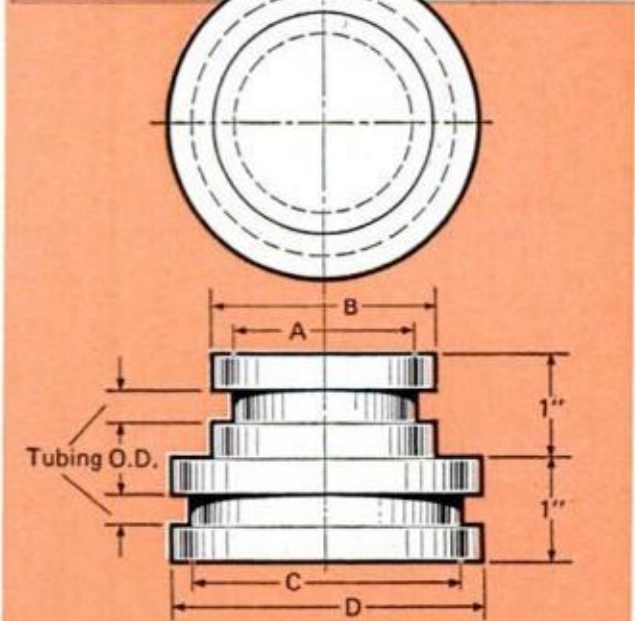
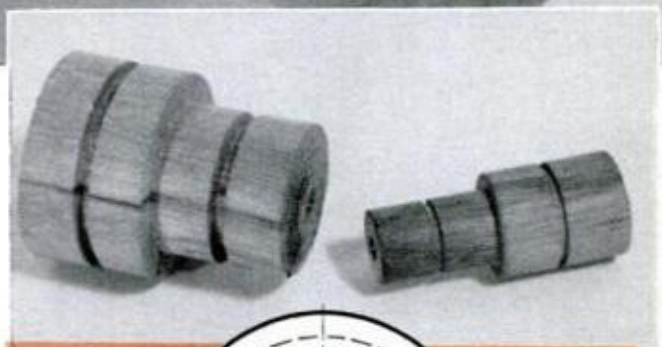

DIMENSIONS (in inches)

Tubing O.D.	A	B	C	D
1/16	1/2	5/8	3/4	7/8
1/8	1	1 1/4	1 1/2	1 3/4
3/16	1 1/2	1 7/8	2 1/4	2 5/8
1/4	2	2 1/2	3	3 1/2
5/16	2 1/2	3 1/8	3 3/4	4 3/8

Add an Indexing

With it, you can precisely space holes around a disc, space holes around the circumference of a ring—and more. Here's how you can make this versatile accessory

By WALTER E. BURTON

IF YOUR LATHE is equipped with a headstock-spindle indexing attachment -- also referred to as a dividing head or index head -- here are just a few of the things you will be able to do accurately.

- Drill precisely spaced holes around the edge of a disc.
- Space holes or lines around the circumference of a cylinder or ring.
- Scribe scale lines on a micrometer collar from a machine-control screw.

The attachment is not difficult to make, even though it involves over three-dozen parts. The headstock-spindle indexer shown here was fitted to a 9-in. (Model A, South Bend) lathe, but its basic design can be adapted to other lathes of various sizes.

The indexer more or less naturally divides itself into two main components: First, an arbor that fits inside the headstock-spindle hole, and supports on its outer end the various gears and discs that en-

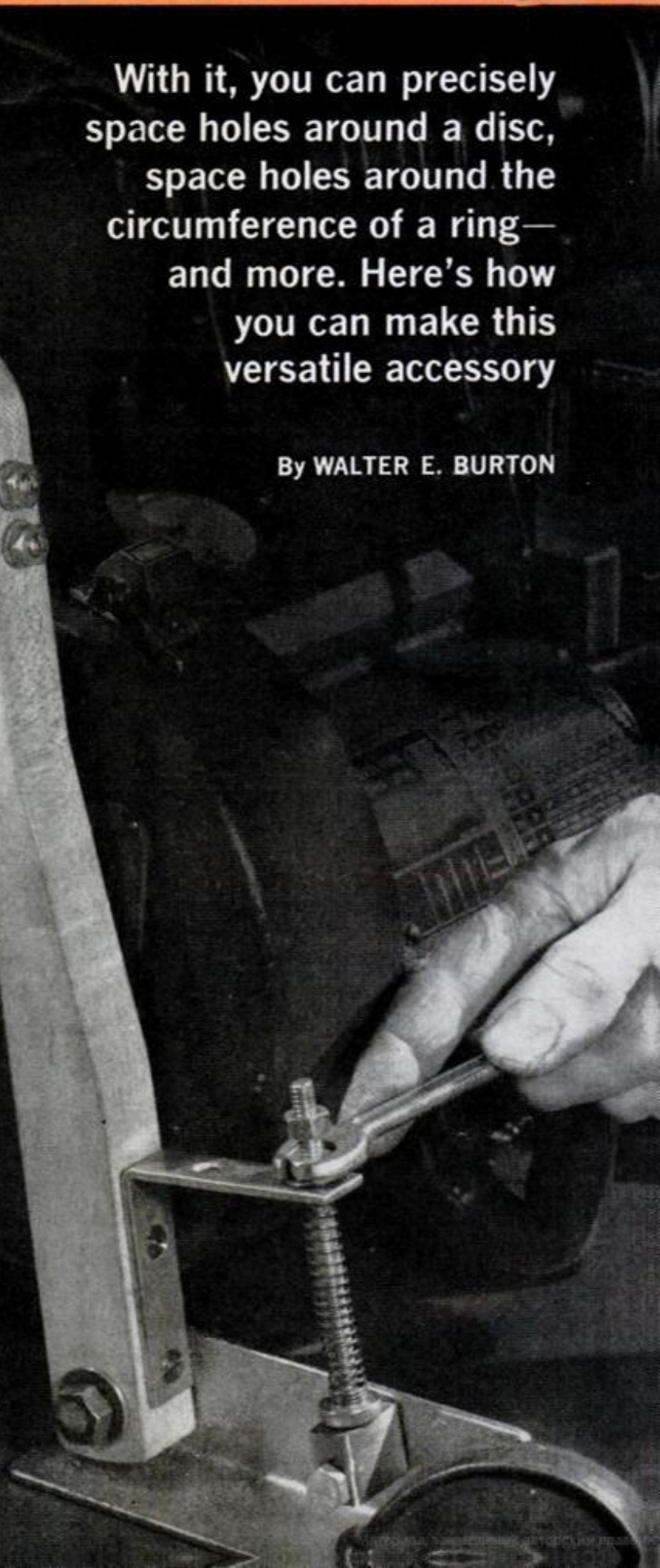

Attachment to Your Lathe

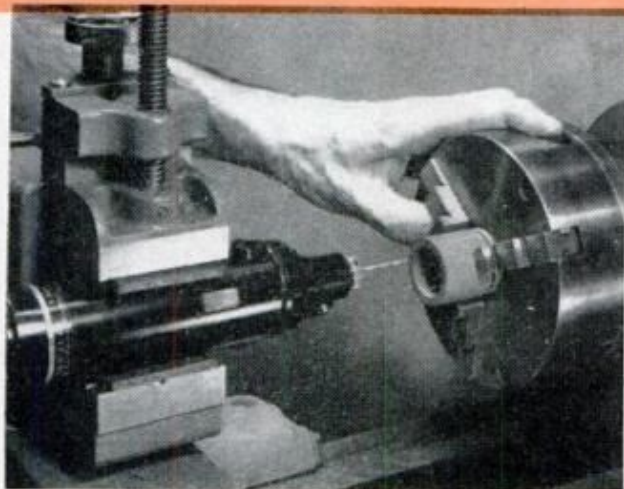

ONE OF MANY JOBS that an indexing attachment enables the lathe to do—drilling precisely spaced holes around end of a Koroseal vinyl-pipe section

able a revolution of the spindle to be divided into, for example, 100 equal parts. Second, a "pawl" (pointer arm), whose job is to provide a latching action for positioning the spindle with respect to the gear teeth. Used with a gear, the arm corresponds to the pawl in a clock-winding mechanism.

These two units work together to provide easy adjustment of the headstock to various angular positions, while the workpiece, in a chuck or between centers, is scribed, drilled, filed, ground or sawed. During such operations, the spindle can be held against turning by gripping the chuck or cone pulley with the hand, engaging the back gears and grasping pulley and applying a spindle brake. When an attempt is made to move the spindle forward and a gear is used as an indexing plate, jamming the gear tooth against the tip of the pawl arm can provide a degree of locking action.

During indexing operations, no power should be delivered to the headstock spindle; the lathe motor should be switched off. When routine machining is to be done, disengage the pawl-arm assembly and, for safety, remove the indexing gear, too.

● *The arbor unit.* To mount, at the outer end of the headstock spindle, a gear or disc providing the indexing divisions, an arbor is inserted into the spindle and locked with an arrangement resembling a collet-chuck setup. The arbor body is

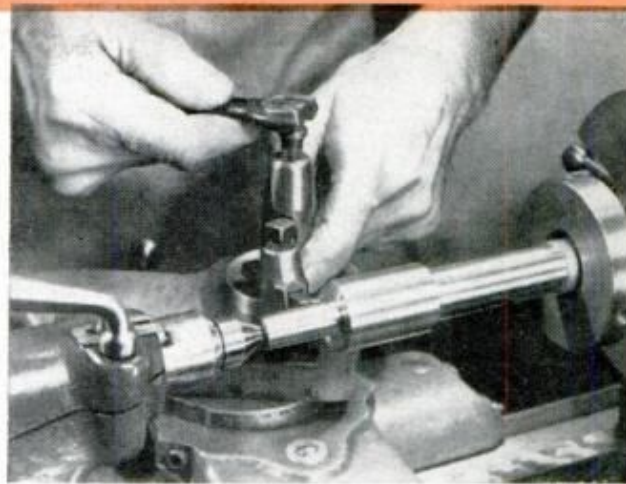

MACHINING ARBOR BETWEEN CENTERS: Tool is working on an end that will be the outside spindle and on which the indexing gear or disc is mounted

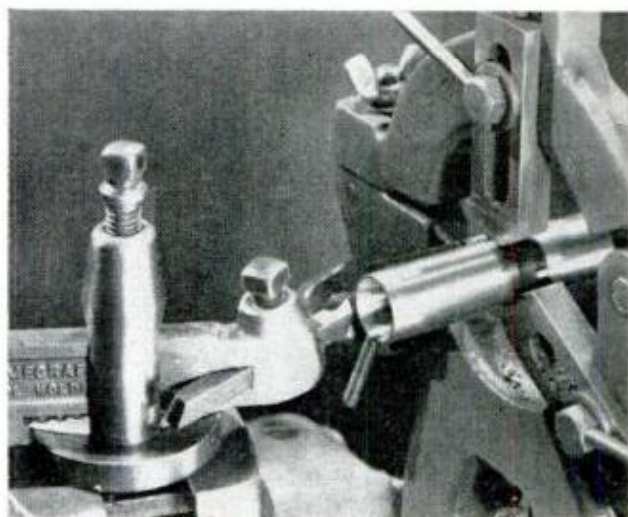

COLLET (INSIDE) END OF ARBOR was bored to the diameter shown in drawing, then a 15° taper was turned using the compound slide to control the tool

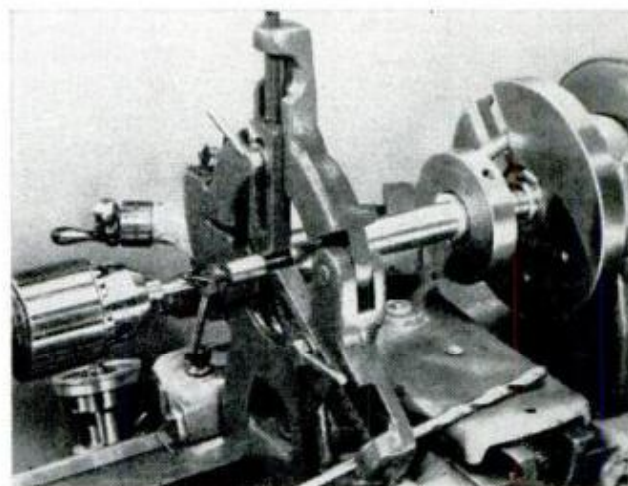

TO DRILL LONGITUDINAL HOLES through arbor, shoulders rotating against steady-rest jaws hold arbor on headstock center. Long ¼-in. bit eased job

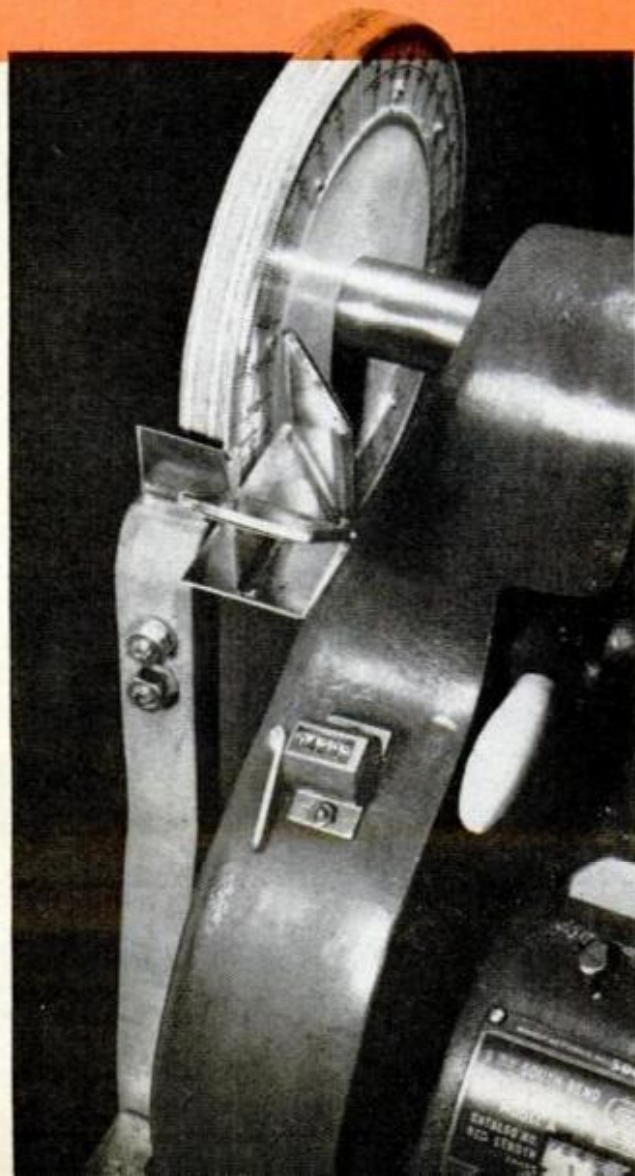
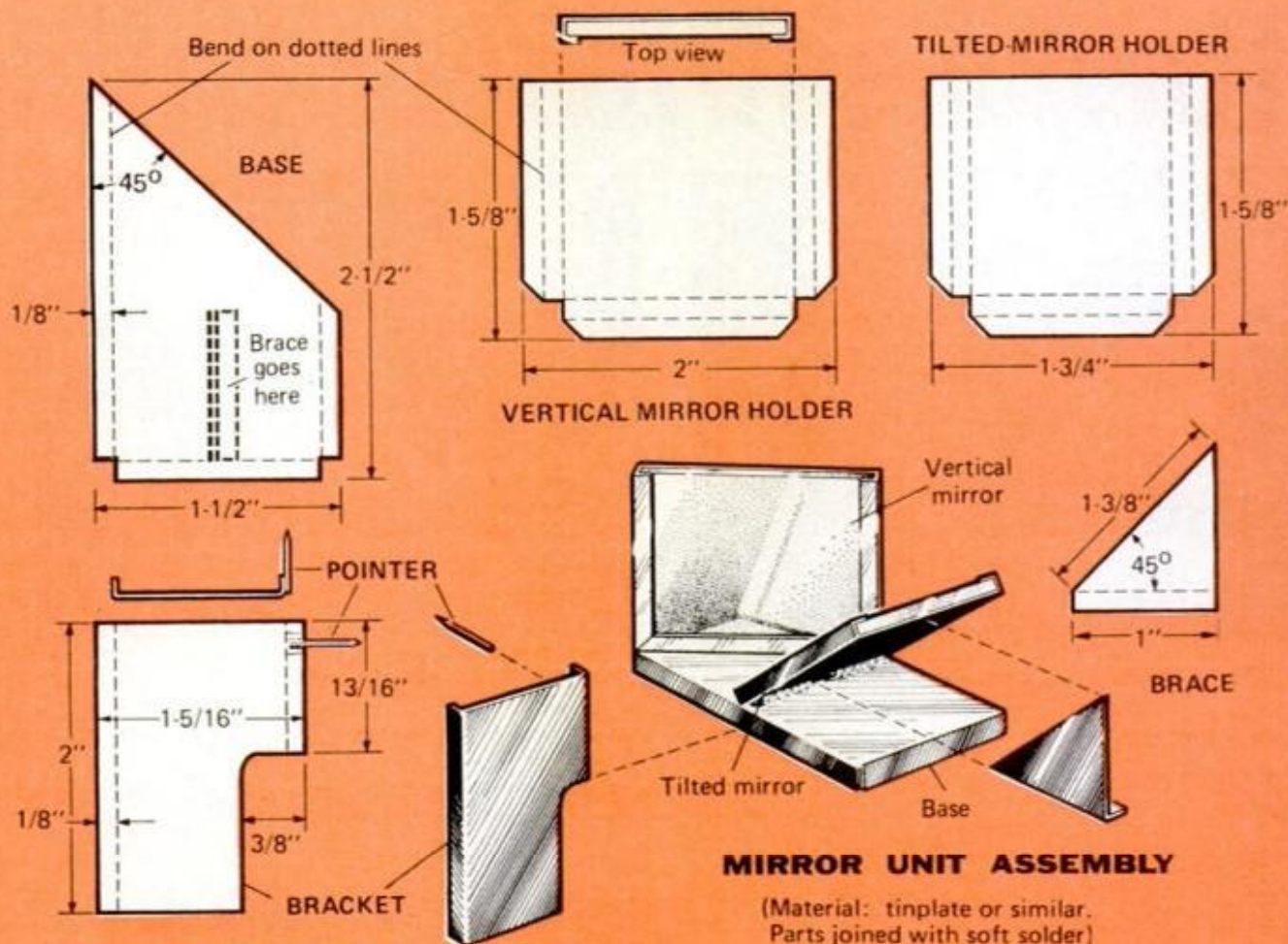

made from cold-rolled or tool steel and shaped as shown in the drawings. The portion that goes into the spindle fits the hole rather snugly, and itself has a bore that ends in a 15° taper. The walls of this bore are divided into four segments by longitudinal saw cuts which extend back for about $1\frac{1}{2}$ in. A machine bolt inserted through the outer end of the arbor has, as a nut, a colletlike "plug" whose larger diameter is machined to a 15° taper. When the bolt is tightened, it draws this collet plug into the bore of the arbor, and the tapered surfaces cause the segments between saw slits to expand against the wall of the headstock spindle, locking the arbor in place.

At the same time, the bolt head clamps the gear or indexing disc tightly against the outer end of the arbor. Make bushings as needed to accommodate gears or discs of various thicknesses.

Projection of the arbor beyond the spindle end should be such that the gear or disc clears all adjacent parts of the lathe—

THIS SETUP USES A MIRROR instead of pointer. Scale is seen by looking down at comfortable angle

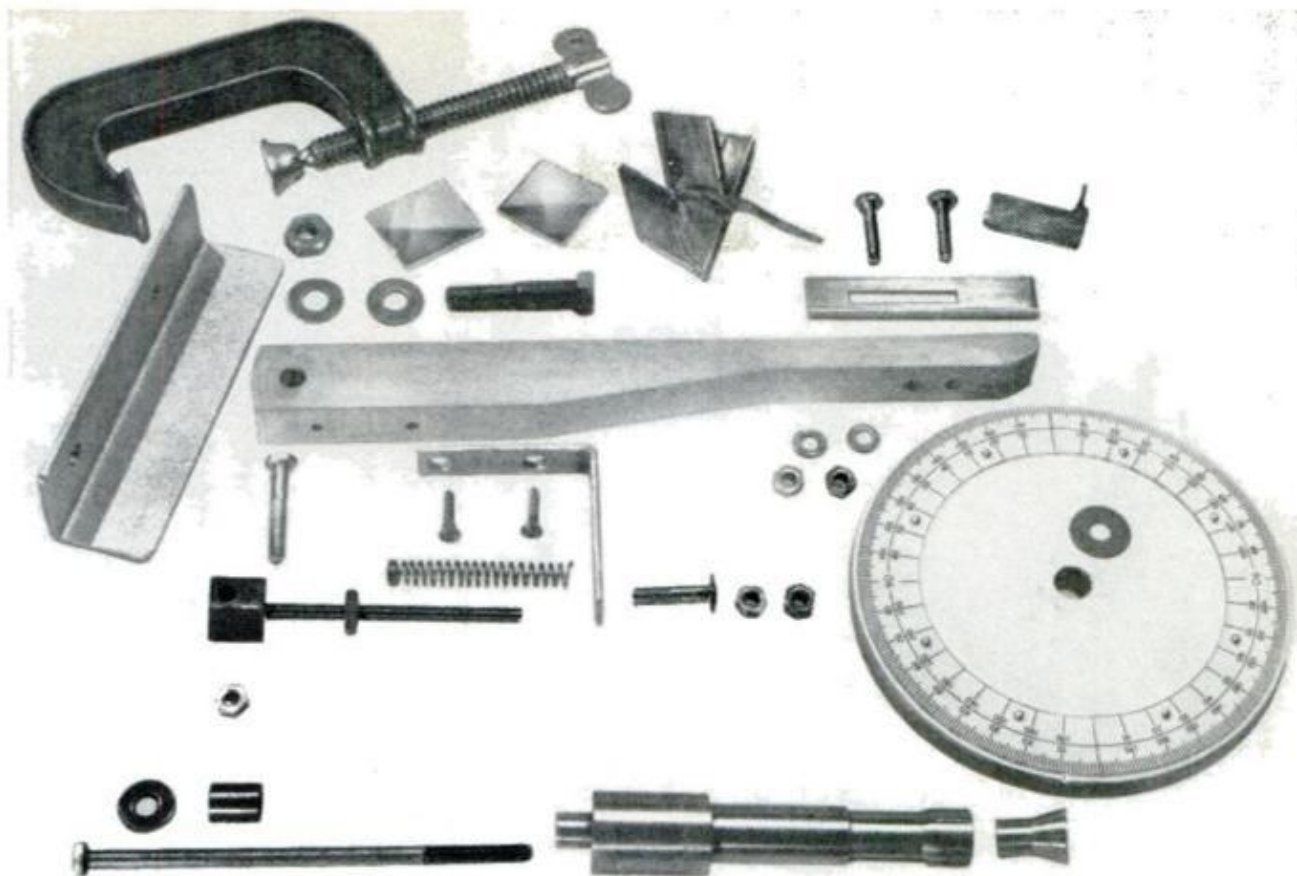

ESSENTIAL PARTS of the indexing attachments are shown above. Notice that they include an angular degree disc that was made from two 10-cent plastic protractors purchased at a five and dime store

such as the safety cover over the lathe-gear assembly.

● *The pawl arm.* It can be called a "pawl arm" because its action against the teeth of a gear is much like that of a pawl in a ratchet arrangement. The unit shown is mounted on the benchtop close to the lathe, but some latches might be of such construction that a similar latching device could be attached directly to the headstock area. It was found desirable to use a C-clamp, rather than bolts or screws, to hold the pawl arm in position; this permits quick adjustment or removal and replacement.

The arm itself, in the model shown, was made from maple with an overall length of 11½ in. (This might vary with different lathes and different angles of inclination of the arm.)

The bottom end of the arm is bolted to a piece of angle iron acting as a base, the bolt fitting snugly in the hole in the wood but the arm being free to swing. The hole could be bushed with brass or bronze. The bolt hole in the angle-iron base is threaded (¾ in.-16), and a locknut used to prevent the bolt from turning. A thin

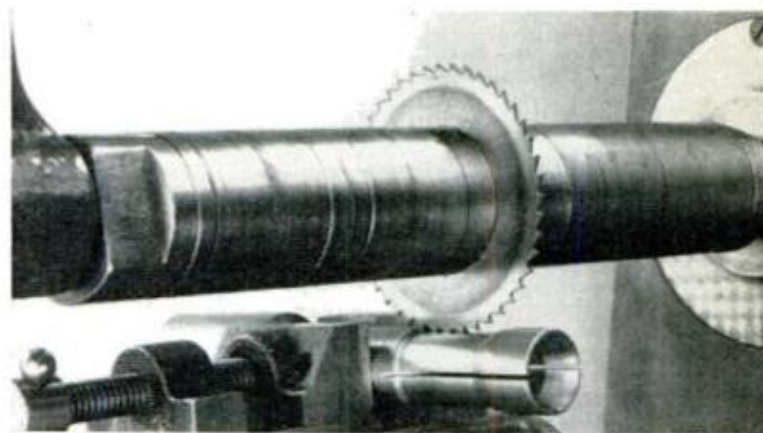

SLITTING SAW used on milling machine separates the collet end of arbor into four longitudinal segments

washer is used between arm and base; it can be a smooth, slightly-curved spring type rather than split.

To maintain pressure of the arm against a gear used as an indexing plate, a coil spring arrangement was devised as illustrated. A conventional ⅝ x 2½ x 2½-in.-steel angle brace was screwed to the wooden arm and its outer hole enlarged to slide freely over a pivoted ¼-in. threaded rod encircled by the coiled compression spring. Nuts on the rod enable the spring pressure to be controlled and

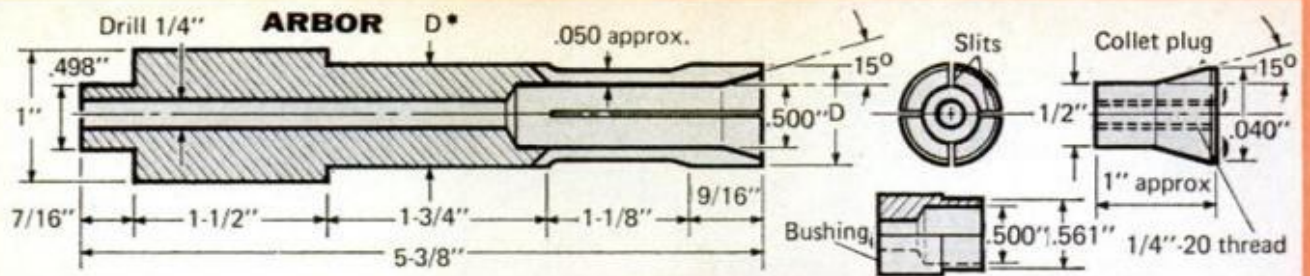

Note: Bushing for gear with 9/16" hole and 3/8" thickness

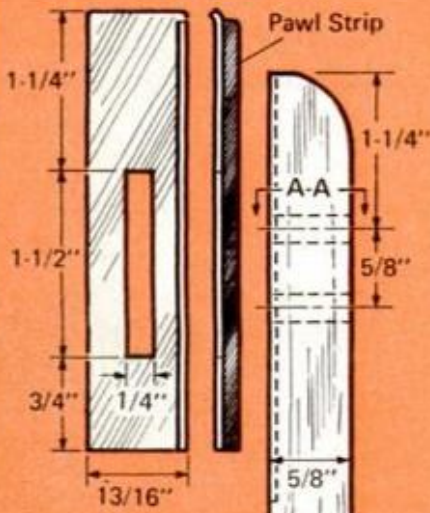
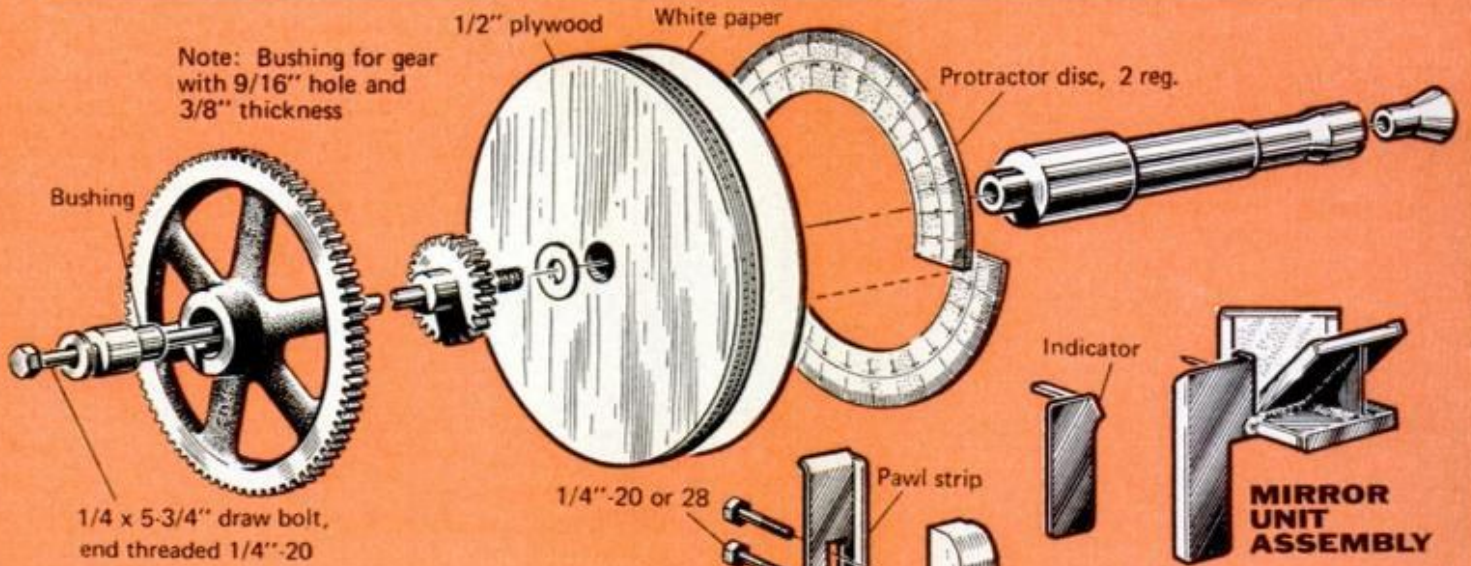

Technical Art by Fred Wolff

SECTION A-A

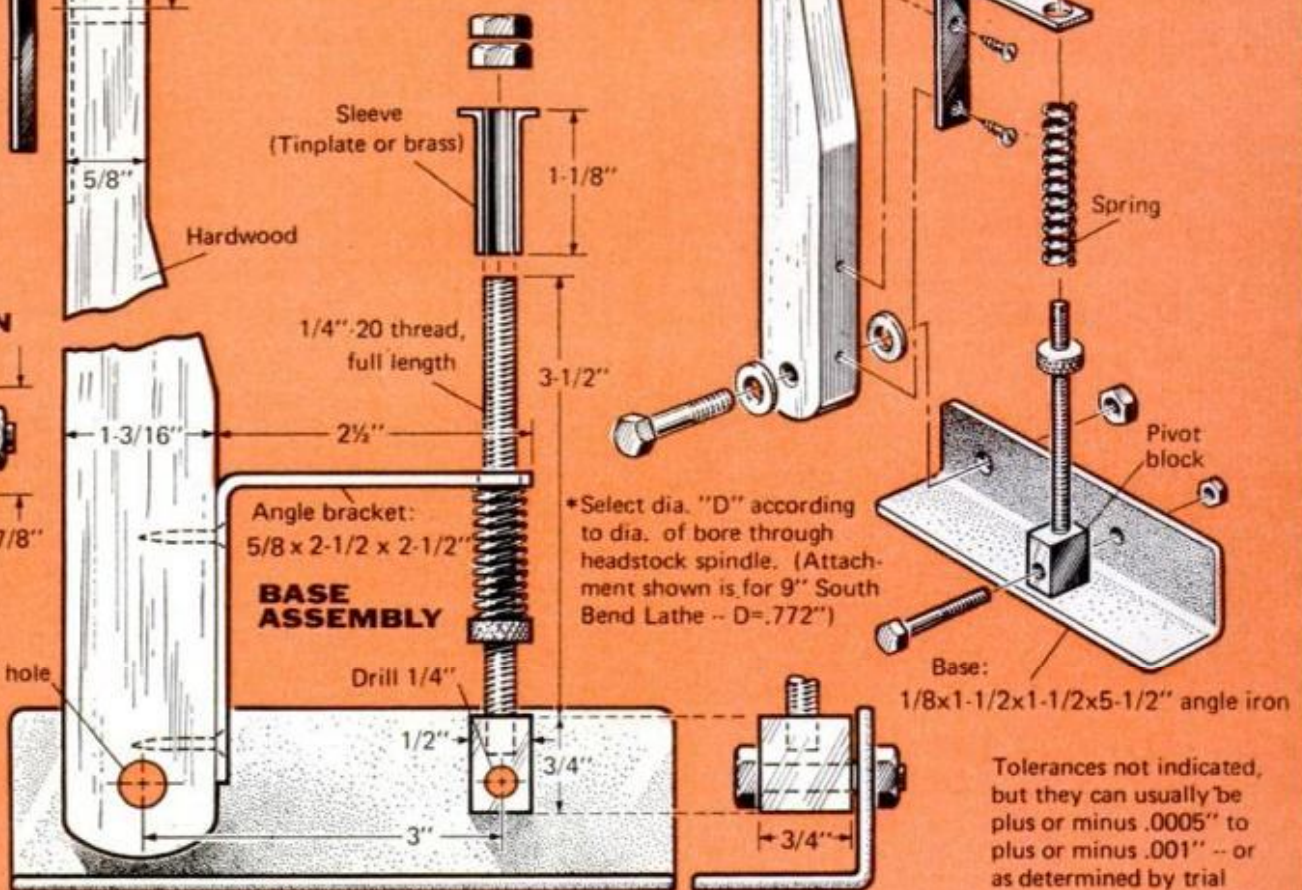

*Select dia. "D" according to dia. of bore through headstock spindle. (Attachment shown is for 9" South Bend Lathe -- D=.772")

Tolerances not indicated, but they can usually be plus or minus .0005" to plus or minus .001" -- or as determined by trial

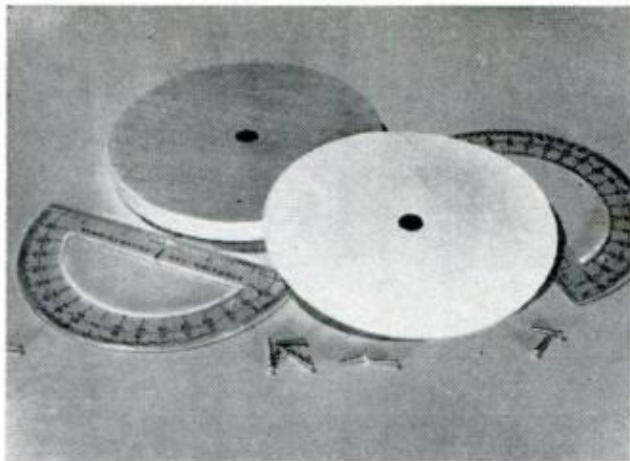

ANGLE-MEASURING DISC consists of two 6-in. 180° protractors; white paper beneath makes reading easy

the arm movement toward the spindle limited. A sleeve made from thin sheet metal is inserted between the threaded rod and hole in the angle bracket, so the bracket can move smoothly instead of being hampered by the threads. The pivoted block from which the threaded rod projects is mounted, on a 1/4-in. bolt (the same as the arm).

The angle to which the arm can be inclined is found by trial; it depends somewhat on the shape and position of the adjustable steel "pawl strip" at the upper end of the arm. This strip—the one shown was cut from a piece of 1/16 x 3/4 x 3/4-in. angle iron—acts as a pawl to engage the indexing-gear teeth. Its upper end is bent or otherwise shaped so it presses firmly against the tooth that is just above it when this end is positioned about level with, or a little below, the headstock-spindle (and gear) centerline. The strip must be adjustable lengthwise so it can be aligned with both large and small gears when the arm is swung to different angles.

Although the "pawl strip" shown was cut from angle iron and has one turned-back edge which helps prevent it from shifting laterally, it could be simply a 1/16- or 1/8 in. flat piece of steel.

In indexing, move the spindle backward by hand until the pawl clicks into the desired space between gear teeth. Then reverse the spindle so the pawl presses firmly against the uppermost tooth and hold it in that position while the workpiece is scribed, drilled and so on. There should be no "give" in the pawl-arm assembly under pressure of a gear tooth against the pawl strip.

● *Degree-measuring disc.* The ability to
MARCH 1971

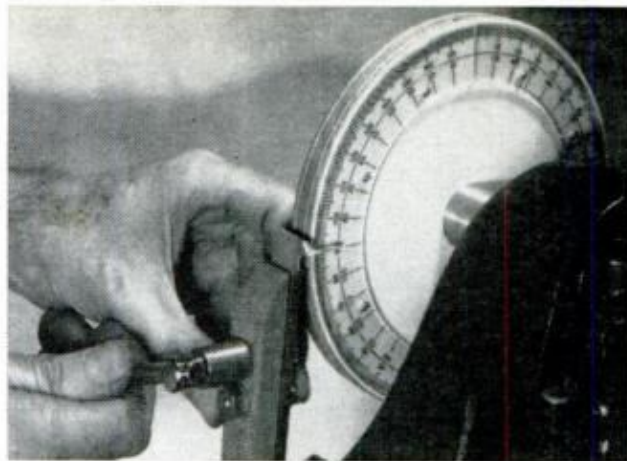

PROTRACTOR EDGES are concentric with a center hole. Simple pointer is cut from a sheet of aluminum

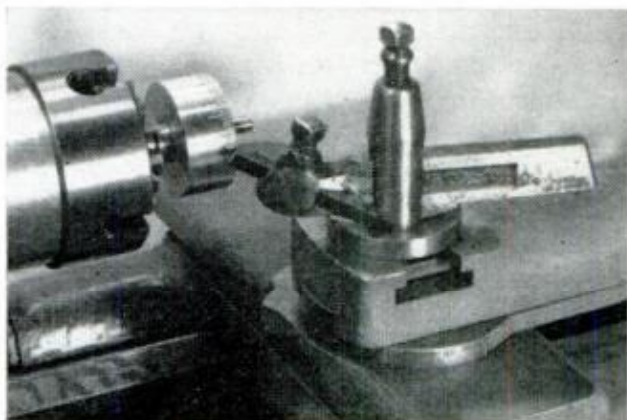

SCRIBING SCALE LINES on micrometer collar is an easy task using the indexing attachment shown here

index lathe work with respect to angular position in degree is handy. For this operation, a disc calibrated in degrees of angle is mounted on the spindle arbor, and a suitable pointer fitted to the tip of the pawl arm.

Two 180° protractors were mounted on one side of a 6-in. disc of 1/2-in. plywood. Unneeded portions of the protractors were carefully cut away with a jeweler's saw. Brass escutcheon pins through drilled holes secure the segments to the wood. A white paper underlay is used to make division marks easier to see. Care was taken to match the protractor halves so the degree divisions remain uniform at the joints.

Perhaps a minor disadvantage of this arrangement is that the scale is on a side of the disc instead of the rim. The simplest indexing pointer for such a scale consists of a piece of sheet metal (such as aluminum) having a projecting point. It is clamped between the tip of the wooden arm and the pawl strip. If you will hold your head at about the same position

each time, the scale readings obtained with this simple pointer can be reasonably uniform.

An optional arrangement that seems more accurate consists of two small mirrors mounted to reflect an image of a pointer (short piece of wire) and a portion of the degree scale, for convenient viewing without your having to stoop and look sidewise. By holding your eye in about the same position each time, you can achieve easy, uniform readings.

If a tiny dot of black lacquer or marking-pen ink is put on the mirror nearest your eye, you'll see two dots close together when you look into the system—one being the original dot and the other its reflection from the mirror back surface. Visually, these dots are a fraction of an inch apart. Each time, if you hold your eye so the indexing pointer seems to be halfway between the dots, you can assume you'll get a negligible variation between readings.

An alternate way of calibrating a disc in degrees is to mark, on the circumference, a scale dividing the space exactly into 360 parts—or it may suffice to divide it into, say, 5° or 10° sections.

Gears suitable for indexing should be new or uniformly worn, so teeth spacing does not vary. Usually there are several loose gears with a screw-cutting lathe, and these can be fitted to the arbor.

To scribe lines on workpieces under control of the indexing attachment, adjust

a pointed bit in the toolpost holder until it will plow a shallow line neatly in the work as the carriage, or cross or compound slide, is moved. Or, for an alternate method, you could clamp a vibrating tool on the carriage and use its point to engrave the lines.

To drill holes, you can: 1. Clamp a small hand grinder (with drill bit in its chuck) in a carriage-mounted milling attachment; or otherwise fasten grinder to carriage; 2. Similarly mount an electric drill; 3. Use a toolpost grinder equipped with drill chuck; 4. Use a hand or electric drill with bit operating through a hole in a jig mounted in fixed position on carriage or slide.

To form flats, as in making a hex on a bolt blank: 1. File the flats with aid of a guide that limits depth of cut; 2. Use a milling attachment having a rotary cutter driven by a motor on the attachment; 3. Use a grinding wheel on a toolpost grinder, electric drill or hand grinder mounted on carriage.

To cut slots and grooves: Use a slitting cutter driven by a toolpost grinder, electric drill or other power unit mounted so length and depth of cut can be controlled by carriage slides.

A scale can be made on flat sheet metal by fastening the blank around the circumference of a cylindrical mandrel and engraving the scale lines on the blank in the same way as you'd calibrate a micrometer collar. ★★★

NEXT MONTH IN SHOP AND CRAFTS

FROM-SEA-TO-SKI VACATION HOMES. More and more of today's families are looking toward a second home as an investment as well as a retreat from everyday living. *PM's* annual round-up this year includes eight houses you can buy or build, as well as an improved version of the house that was most popular with readers last year. Look for these exciting leisure homes in the April issue of *PM*.

BUILD THIS CABANA FOR YEAR-ROUND USE. A trim little lawn house built next to your pool can save your floors from wet footprints because bathers will have a place to change. And if you plan ahead, the same building can be put to storage use in the off season. Pick up an April *PM* and build your own.

ALL-TIME GREAT NO. 5: BUILD THIS OLD-TIME SWING FOR YOUR YARD. It's the same kind that Grandpa did his spooning in, and you'll find this delightful piece of lawn furniture has lost none of its original charm. Complete instructions including how-to-build plans, are in *PM* next month.

BUILD A CONTEMPORARY PEDESTAL TABLE. This project adds a new and interesting technique to your workshop know-how. You'll be able to turn out hi-fi speaker bases, lamps and other fascinating modern furniture. See next month's issue.



Quick. When was the last time you changed your motor oil?

Have you ever looked at your service sticker and found it to be so old you really couldn't tell when you last had your oil changed?

Well, don't feel bad. You're not alone.

Matter of fact, you've got lots of company. Because most people never get around to changing their motor oil when they should.

That's why there's race-proved Valvoline®. The motor oil the pros count on.

And the one that's a lot better than it really has to be.

Valvoline is a unique blend of the finest com-

ponents specifically designed to work harder, longer.

To give you added protection beyond recommended drain intervals.

Naturally, we recommend changing your motor oil at the proper time.

But should you forget (and even if you don't), you'll be glad you remembered Valvoline.

Available at fine service stations, garages and new car dealers everywhere.

Now then. Maybe you'd better go out and take a look at your service sticker.



For people who don't
always remember
to change their motor oil.

VALVOLINE OIL COMPANY, Ashland, Ky.  Division of Ashland Oil, Inc.

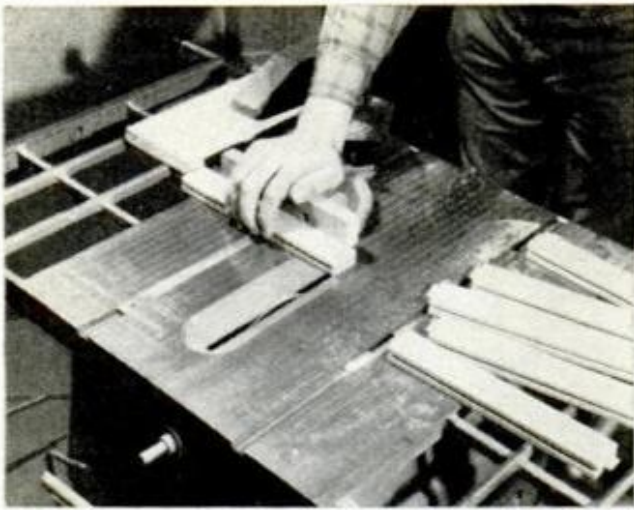

OAK FRAMING PIECES are cut to size on table saw. The new tongue must be formed on the cutoff side

TAPE A PIECE OF PAPER to the plastic panel inserts to facilitate both marking and bandsaw cutting

MAKE A GRAND ENTRY

(Continued from page 147)

require a stepped-lap to fit into the rabbet. Drop the X into the frame and repeat the procedure with the smaller Xs.

Number all of the pieces so that they don't get mixed up, then disassemble them and cut a $\frac{1}{8} \times \frac{3}{8}$ -in.-deep kerf along all the sides to contain the plastic inserts. Reassemble the parts and apply a router to both edges of the inside face with a shaped cutter. Filler strips which lie in the rabbet between the cross pieces should be included in the routing operation.

Cut the plastic inserts oversize so they rest in the grooves and the rabbeted setback of the outer frame. Use a fine-tooth saw blade and sand off any burrs before the final assembly. A dab of General

(Please turn to page 180)

DOWELS are used to beef up corners, and a partial groove must be cut where arched insert intersects



FOR NEAT JOB, paint the grooves before installing plastic. Use a few drops of glue for added strength

OLD TRICK of running many parallel saw kerfs into oak frame for arch makes frame easily bendable

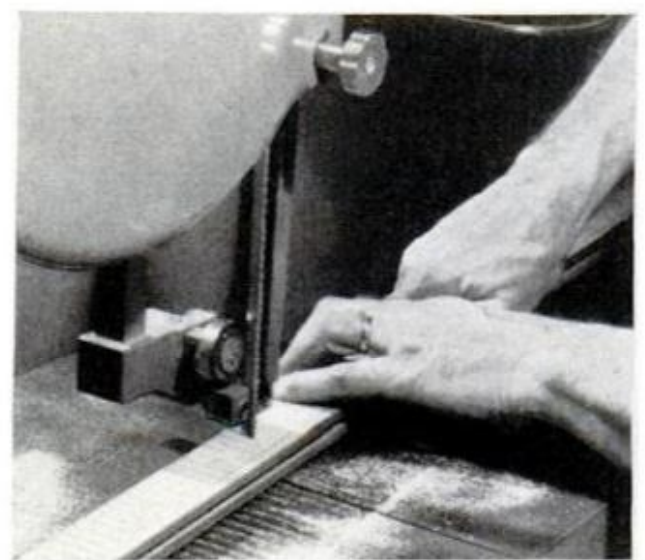

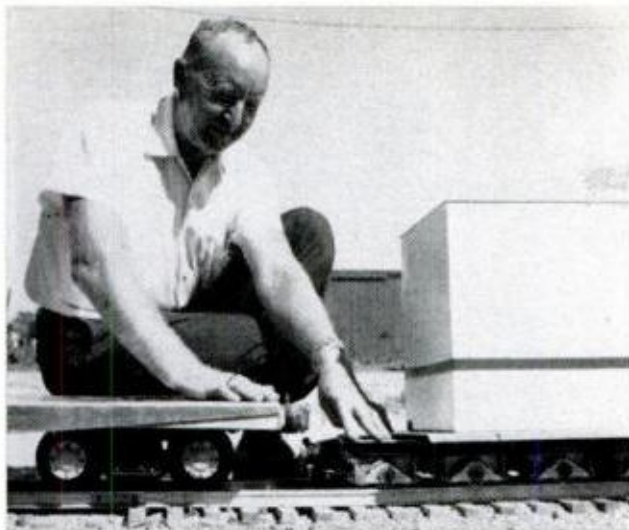

Santa Fe tests coaxial train

An unusual coaxial train, built to one-eighth scale, is being tested at the Santa Fe Research and Development Laboratory in Topeka, Kans. The model features a continuous center "sill" running the length of the train, with no coupling devices. Individually powered wheels are spaced at four-foot intervals, each fastened to the center sill and to a "wheel deck." Among advantages of the design are even weight distribution, less wheel wear and low center of gravity.

think sealants

Life expectancy 10 years! A tough, elastic, one-part waterproof sealant. Seals without drying. Ideal for windows, doors, sinks, showers, expansion joints, masonry, metal, glass, and wood.

See M-D display at your Hardware or Building Supply Dealer.

MACKLANBURG-DUNCAN CO.
BOX 25188
Oklahoma City, Okla. 73125 U.S.A.



Our 50th year.



DOUBLE YOUR INCOME

MAKE CUSTOM ENGRAVED SIGNS AT HOME, IN YOUR SPARE TIME

Anyone can make professional engraved signs in minutes. Scott engraved signs have a markup of up to 500%. Work as little as 2 hours a day and earn up to \$150 a week extra. Complete with accessories—everything you need to start your own engraving shop—at about half the cost of competitive engravers. Write for free catalog. Dept. M70

SCOTT MACHINE DEVELOPMENT CORP.
215 Prospect Ave.
P. O. Box 217
Walton, New York 13856



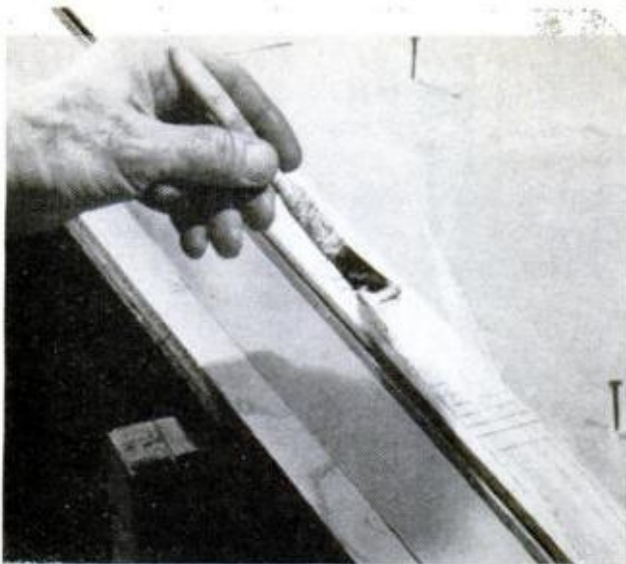

WATER-SOLUBLE GLUE, mixed with fine sawdust, is brushed into the kerfs, serves as an effective filler

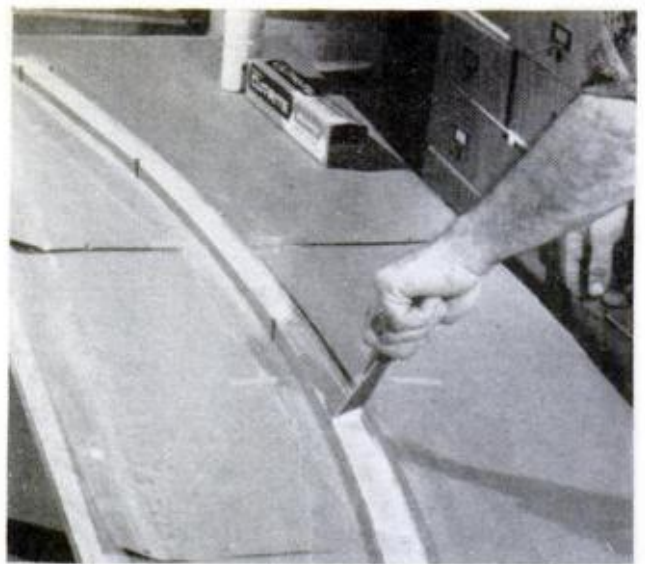

BEFORE GLUE DRIES, flex the strip to desired arch by bridging preset nails. Scrape off glue ooze-out

MAKE A GRAND ENTRY

(Continued from page 178)

Electric's Silicone Seal is used in each groove to keep the plastic inserts from shifting about. This material is pure rubber, which remains flexible, thus preventing any expansion problems. Varnish the inside, paint the outside and then add the plate glass which is secured with a molding frame.

● *New archway.* Similar procedures are used to build the archway. The oak framing is a stock building-supply-house accessory item grooved to accept either the filigree or plastic panels. It is available in 8-ft. lengths and 2-ft. cross pieces. The cross pieces have tongues at both ends to fit into the uprights. Our units require smaller cross members so it will be neces-

(Please turn to page 182)

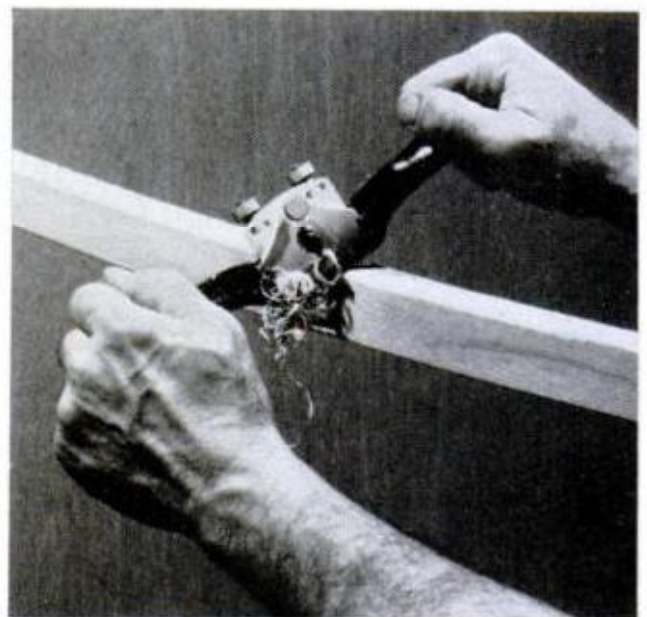

USE A SPOKESHAVE to round off the 1/8-in. plywood facing that must be added to one side of frame

TO MARK CURVED STRIP for an accurate joint, clamp it in place (below left). When satisfied with the fit, apply glue to the groove, force the arch into place and hold with brads well set into predrilled holes



DURACELL® LASTS FAR LONGER THAN ANY ORDINARY BATTERY

IN RADIOS, CAMERAS, TAPE RECORDERS, TOYS, FLASHLIGHTS, ANYTHING THAT RUNS ON BATTERIES!

DURACELL is built better inside, with today's advanced technology. To make it basically a different kind of power source.

About as different from ordinary batteries as a superjet is from yesterday's tri-motor.

The fact is, after you begin using DURACELL, you'll forget all about ordinary whatchamacallits!



DURACELL. THE LONG DISTANCE POWER CELL.

MALLORY

®Registered trademark of P. R. Mallory & Co., Inc.

MAKE A GRAND ENTRY

(Continued from page 180)

sary to cut them down to size and form a new tongue on the cutoff end.

The upright sections are made as separate units, using dowels on all corners to gain extra strength. Before assembling the foyer divider, which was ultimately painted black, it proved to be advantageous to paint the inside edges and the grooves in advance. This permits you to coat the inside of the grooves, which otherwise would show up nonblack through the plastic panel.

Forming the arches

It is not difficult to form the curved section of the arches if you follow a time-honored cabinet-making technique. The $\frac{3}{4}$ x $1\frac{1}{2}$ -in. oak framing is about as rigid as a piece of steel. So the only way to produce the curve is by means of kerfing—a series of saw cuts partially through the wood at close intervals. This “breaks the back” of the wood, rendering it quite flexible. The job is generally done with a circular saw which makes a rather wide kerf. Instead, I used the band saw to produce a finer cut. Make a series of cuts through the solid edge $\frac{3}{8}$ in. apart down to within $\frac{3}{8}$ in. from the grooved edge.

Determine the amount of curve desired and draw the curve onto the worktable. Next, partly drive nails in positions that will hold the piece in this curved condition. Remove the piece and cover the area with wax paper to prevent the workpiece from gluing itself to the table. Make a pasty glue by mixing in some fine sawdust. Brush the mixture well into the crevices, both sides, and place the strip onto the jig bending it around the nails. Use a scraper to remove the excess before it hardens. When it's dry, clamp the piece in place over the upright sections to mark and cut off any excess at the ends.

The $\frac{1}{8}$ -in. plywood backing glued to the curved piece serves two purposes: First, to reinforce it and, second, to provide a simple means for attaching to the uprights. The plywood can be glued on oversize and trimmed in place later. Leave sufficient overhang to form a “wing” on each side. The wings form built-in brackets which are screwed into the uprights.

The corresponding verticals are similarly framed but, for looks, make the inserts of hardboard filigree. Here, again, you'll speed the job if you complete all the carpentry first, mark the pieces as you cut them for easy reassembly later, and then paint the filigree outdoors where you can spray it, rather than spend unnecessary time fussing with a brush. ★★★

BUILD THE YELLOW JACKET

(Continued from page 129)

thinwall steel tubing. With no bends involved, the sections are simply cut to length and welded together.

The thin aluminum skin sections are cut to shape with tin snips, then “Pop”-riveted into place. The duct intakes and nose section are fiberglassed.

To build the fins, you will need to make a few breaks, but you don't need any fancy equipment. Just clamp the aluminum between a pair of 2x4s and bend it over gently with a plastic mallet. Start at one end and work toward the other. By making two or three passes along the edge with the mallet, you can produce the bends cleanly.

Fan blades are laminated spruce

The fan blades are made separately of laminated spruce. Once shaped and finished, they are glued and bolted to a 14-in. aluminum disc. This assembly is then bolted to the hub, which is merely a short section of chrome steel tubing.

If you have money to burn, and you don't want to tackle the job yourself, take the pattern (provided in the plans) to a prop maker. He should make you a set of fans for around \$250. But with a little patience and a rented router, you can shape, assemble and balance your own fans for less than \$60.

The power is provided by two Chrysler 820 go-kart engines. These engines sell new for \$139 each. However, with the popularity of go-karts, used engines are available for less.

Top speed better than 50 mph

“I don't really know the top speed of Yellow Jacket,” Eugene reports. “I usually shut it down between 45 and 50 mph, but it feels like it will keep on gaining speed.” It's very slow to accelerate up to about 25 mph, but at this speed, the aerodynamic lift on the fuselage comes into effect. Then, he adds, “Yellow Jacket suddenly rises about 3 in. and takes off hell-bent for leather.”

Unlike most air-cushion vehicles in this power class, Yellow Jacket gets up high enough to clear small obstacles. Fascinated, I flew it back and forth over a 5-in.-high street curb waiting for a bump that never did come.

So if you don't mind your neighbors thinking you're a little eccentric, and you can accept the limitations of an air-cushion vehicle, building Yellow Jacket might be your cup of tea. It's a jazzy little rig and you'll get more than \$400 worth of fun from it. ★★★

YOURS ABSOLUTELY FREE

This big, practical book of plans, projects, "how-to" ideas from the all-new, profusely illustrated

POPULAR MECHANICS DO-IT-YOURSELF ENCYCLOPEDIA

Let these shopwork experts show you techniques, procedures and short-cuts you need for really satisfying results!



BARBECUES



PLUMBING



SAILBOATS



AUTO REPAIRS

As a do-it-yourselfer, you take genuine pride in what you build, improve and repair with your own hands. Now—with the help of this remarkable FREE BOOK, you'll be able to sharpen your skills...do jobs better, faster, easier—and save a pocketful of cash at the same time.

The moment you open your FREE volume, you'll start reorganizing your workshop...get going on a whole new range of exciting projects for family, house, garden, car, boat, vacation.

Need more room in your home? See how easy it is to turn an unfinished attic or basement into the most striking room in the house. Practical, step-by-step plans help you do a perfect job and pocket savings of \$300 to \$1,500.

Want professional tips on sanding? Discover how to bring out the best finish in woods and metals with both hand and power sanding. 19 hands-at-work photos show clearly how to handle open-grained woods, pad sanders, flexible rubber sanders, disc sanders...answer every question.

Build an auxiliary table to enlarge your band saw. Your 12- or 14-inch band saw will cut anything you can get under the blade guide. The problem is to support and guide a large workpiece while it is being cut. Here's a 3 x 4 foot plywood table that gives any small band saw big-machine capacity and flexibility. Plans help you do it inexpensively.

Learn arc welding basics quickly. No need to shy away from arc welding. Practical tips help you lay a good weld in 6 hours easy practice.

Children love the Free-Flight Parashut Plane. Build this model for your children and you'll get a big hand at any flying competition. It may look like a flying dinner plate, but this way-out model is a rugged performer.

Brazing fixture for band saw blades. You can save half on blade costs if you buy bulk 100-foot rolls and make

your own. But you have to know these steps to silver-solder the joints.

These are just six of more than 6,000 exciting projects, plans and ideas you'll find in the new POPULAR MECHANICS DO-IT-YOURSELF ENCYCLOPEDIA...practical pointers to improve your skills in carpentry metalwork, plumbing, masonry, electrical work, painting and decorating. Best of all, every volume in the set is a practical manual. Experts lead you step-by-step through every project you select. Without question, here is the most helpful, reliable, "how-to-do-it" guide you've ever seen—and Volume 1—a \$3.49 value—is yours ENTIRELY FREE.

You risk nothing on this free book offer!

Mail attached certificate at right, and we'll rush you the first of the 16 volumes of POPULAR MECHANICS DO-IT-YOURSELF ENCYCLOPEDIA as an outright gift. The book is yours to keep. You are not obligated to buy any other book in the set. We are giving you the first volume so you may see for yourself, at our expense, how easily you can do a better job on repairs, improvements, new projects—and save hundreds of dollars as well.

We believe that if you browse through the first volume—select a plan or project—use it at your workbench—try some of its money-saving short cuts—you will be anxious to receive the others. Therefore, we make this unusual offer. You may, if you wish, purchase the remaining volumes, at the low subscriber's price of only \$3.49 per volume.

Each new volume will come to you for 14 days' free examination entirely on approval. If you do not wish to keep it, return it and owe nothing. You may buy one, two, the whole set, or none at all.

Detach and mail the coupon at the right today to be sure of getting your free copy.

POPULAR MECHANICS do-it-yourself ENCYCLOPEDIA

16 outstanding volumes
3,136 how-to-do-it pages
Over 10,000 "show-me-how" illustrations
Instant Index to more than 6,000 ideas
Stain and scuff resistant, washable bindings
Big, easy-to-leaf-through pages
8 1/4" x 11" in size

You get more than 6,000 projects, plans and ideas for better living, greater savings, including...

93 tested projects on home maintenance, repairs, services to save you up to 75% on labor costs, materials.

538 "show-how" photos, drawings, diagrams on auto care and repair.

561 pages, over 1,000 illustrations on additions, remodeling, alterations.

107 money-saving tips on

power tools. Select the best tool for your needs.

68 detailed projects on electronics, radio, TV, hi-fi, tape recorders, stereo. Repair, maintain, install your own equipment.

76 illustrated projects and plans for sail and power boats, docks, moorings, water safety, navigation.

FREE GIFT CERTIFICATE

Popular Mechanics Book Division, Dept. B-013
250 West 55th St., New York, N.Y. 10019

Please send, entirely free, Volume 1 of the new, illustrated POPULAR MECHANICS DO-IT-YOURSELF ENCYCLOPEDIA. I'm not obliged to buy anything—now or later—but am entitled to receive additional volumes (including future Yearbooks), on approval as published each month. After examining each volume free for 14 days, I either return it and owe nothing—or keep it and remit low subscriber price of \$3.49 a volume, plus shipping. I reserve the right to cancel any time—without obligation. Whatever I decide, Volume 1 is mine to keep free!

Name _____

(Please Print)

Address _____

City _____

State _____ Zip _____

Signature _____

This offer available in Canada at a slightly higher price. Canadian residents please mail the coupon to New York address. Shipment of books and all services will be handled within Canada.

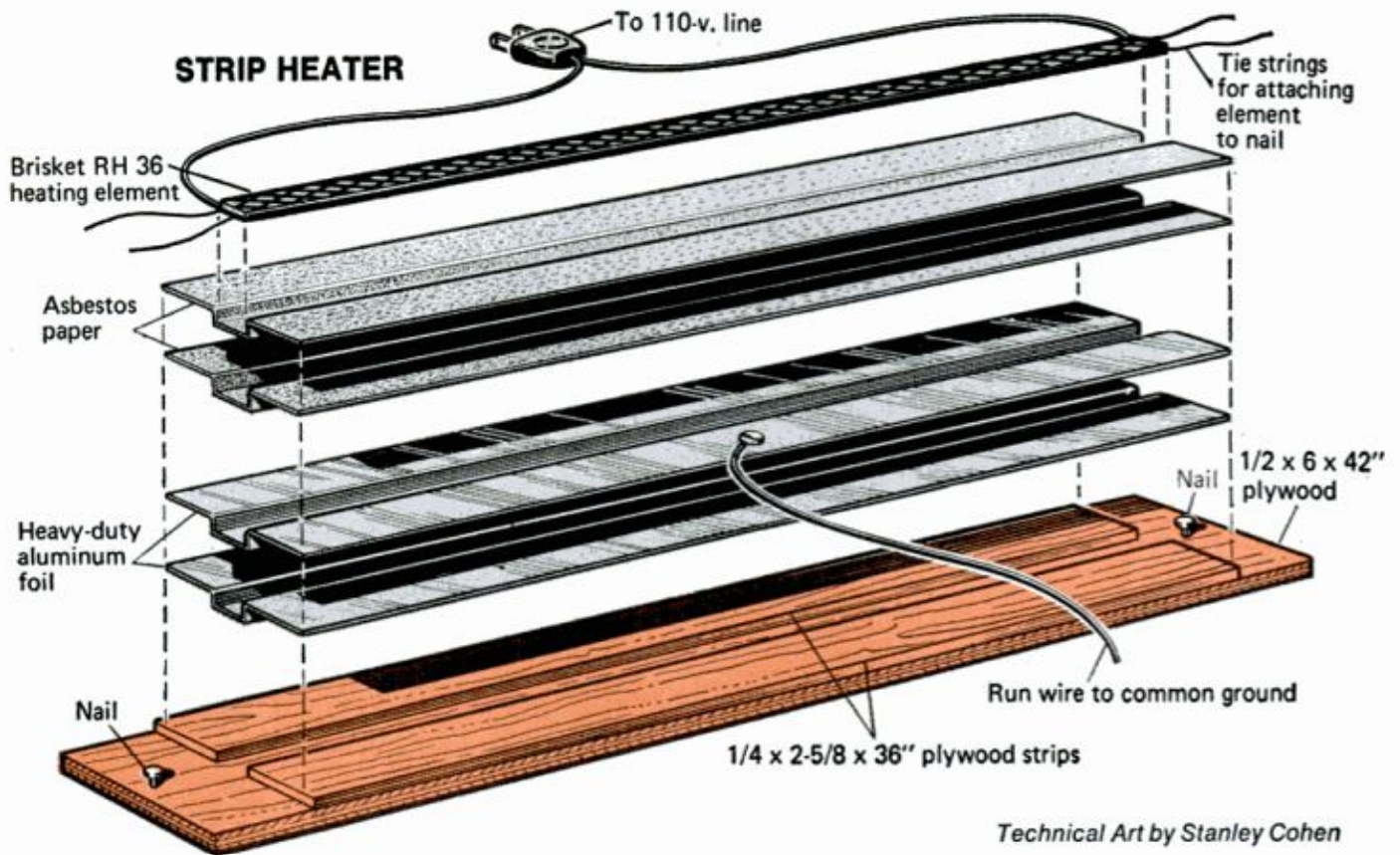

PLEXIGLASS PROJECTS

(Continued from page 150)

it is particularly important that you make accurate 90° bends. Hold the bend until the plastic cools.

All exposed edges of the plastic for whatever project you're making must be polished, which is done by first sanding with a medium-grit (60-80) paper, then with a "wet or dry" (150) grit and progressively finer grits up to 400, and finally, by polishing with a cloth (muslin) wheel charged with jeweler's rouge or fine-grit buffing compound which you can get in bar form at Sears. To save time, bind four panels together and polish the edges simultaneously. The finished edges will look like glass.

Edges to be cemented are sanded *only*, not buffed. Use tabs of masking tape to hold the pieces in position and apply the cement to the joint. The waterlike solvent will flow into the joint by capillary action and immediately fuse the plastic. Let the joint dry for 20 minutes or so, then remove tape.

A new hypodermic-type applicator places the solvent without spilling a drop outside the seam. It sells for \$2 and works much better than the eyedropper I had been using. The element for the strip heater sells for \$8. You can buy both element and applicator from Rohm and Haas Co., Box 9730, Philadelphia, Pa. 19140.

When using the homemade, plug-in

MAGAZINE RACK

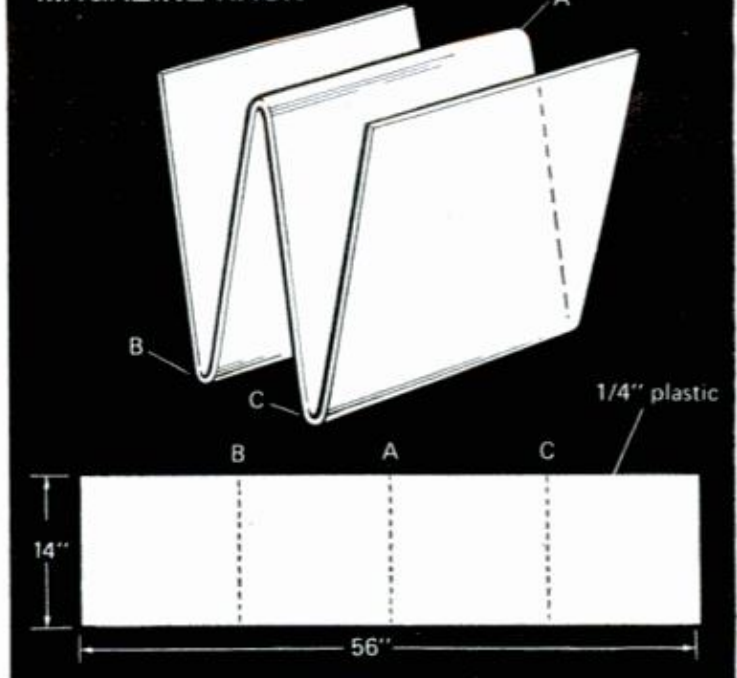

heater detailed above, do not let the plastic sheet touch the heating element and do not heat the material higher than 340° F. since surface overheating will cause scorching and bubbling. In heat-forming the phone stand, I had no trouble when I heated the plastic for 10 minutes. I placed the sheet across the top of the heater and timed each bend with an oven timer. Bending the sheet before it is soft enough will cause stress crazing (small internal fractures) at the bend. Don't try to bend plastic over 1/4 in. thick. ★★★

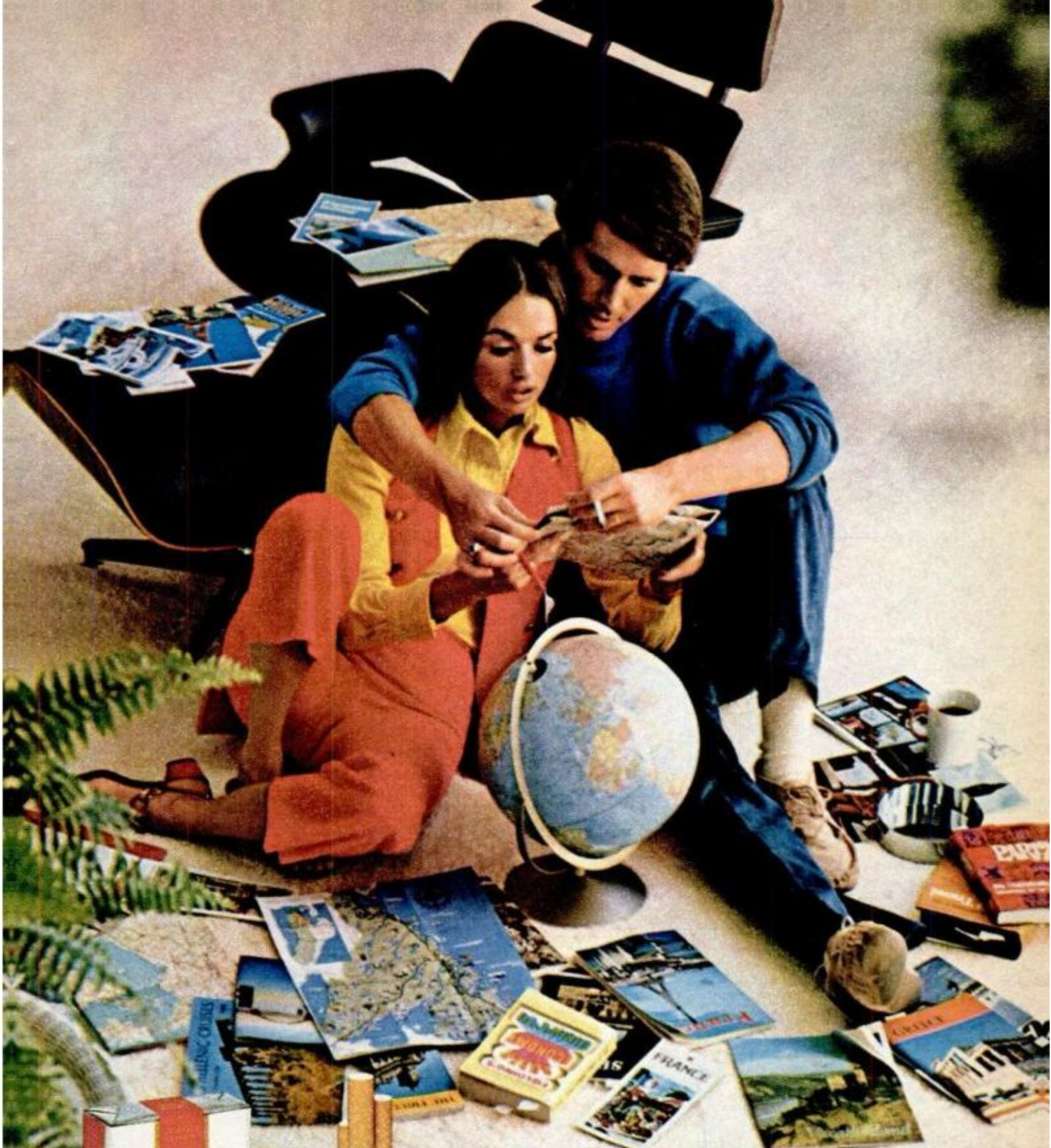

This year they want it different.
A vacation away from the crowds.
An ancient Scottish castle. Or some
remote Aegean island.
Something special and different.
Their cigarette? Viceroy. They won't
settle for less. It's a matter of taste.

Viceroy gives you all the taste, all the time.

TRIPODS UP TO NEW TRICKS

(Continued from page 143)

as you fumble around to thread the mounting screw into the socket. Now there are quick-mount arrangements that speed up the job. On some tripods, you screw the mounting stud only part way into the camera socket—just enough for a good grip. Then you spin a knob with a fast-spiral thread that quickly draws your camera down snugly against the head of the tripod.

Another instant-mount system, used on Hollywood's Futura tripod, is based on a small cone-shaped fitting that's screwed into the camera socket and left there. To attach the camera to the tripod, you just slip the cone into an opening in the head and flip a lever to wedge-lock the cone and camera firmly in place. If you want to mount several different cameras interchangeably, you can buy extra cones, one for each camera used, and leave them attached. Other types of quick

Take your camera to the store and actually try it on several different models.

mounts are available as accessories and can be used on any tripod.

Most tripods have dual-action pan-and-tilt heads that swing up and down for vertical aiming and sideways for panning. On better heads, there's a two-stage adjustment usually controlled by a single handle. Twisting the handle part way locks the tilt pivot, but permits the camera to swivel sideways in an arc. This lets you make smooth pan shots with a movie camera without fear that the camera will shift up or down. Twisting the handle farther then locks the pan pivot as well for still pictures. On some tripods, the handle controls only the tilt, and a separate knob locks rotation. This system is designed mainly for heavy equipment. For average use, the single-handle control is simplest.

For maximum flexibility, a tripod head should tilt a full 90°. This enables you to point the camera straight downward for overhead shots. It also lets you flip a horizontal-format camera over on its side for making vertical shots. Some tripods have an added feature that accomplishes the same thing even more easily. This is a hinged platform on top of the head that swings up to turn the camera sideways. Similar tilt-top attachments are also available as accessories.

You won't find every feature on every tripod—you have to choose the ones that are the most helpful for the particular type of shooting you do. If you always use a square-format camera, for instance, a tilt-top tripod is obviously of no special advantage. At the same time, it's wise to plan ahead for future acquisitions. It's a good idea to buy a tripod a little sturdier than you think you really need. As you add longer lenses and heavier equipment, you'll be happy to have some extra rigidity to spare.

Also pick a model that will give you good height. There will be occasions when you'll want to shoot from on top of a chair or stepladder. You can always shorten a tall tripod, but you can't lengthen a short one. For tabletop work or easy carrying in a gadget bag, there are some excellent shorty tripods that shrink down to a few inches in length. But these are best treated as accessories rather than your main equipment. Also useful is a chest pod that hangs from a strap around your neck. This will help to steady a camera when you're moving around too much to use a conventional tripod.

How much should you pay for a tripod? Some hobbyists wince at the thought of spending \$60 on a tripod for a \$50 camera. Actually, the \$50 camera may need a tripod more than a \$250 camera. It depends on how serious you are about your picture taking. You can buy good tripods in the \$30 to \$45 range. As you go down the price ladder, you have to shop a little more carefully because quality varies widely at the low end of the scale. There are respectable \$20 tripods and there are junky \$20 tripods.

In choosing a tripod, take your camera to the store and actually try it on several different models. Check on ease of operation, set-up time and camera stability. You can test for rigidity by positioning the camera so it picks up a light reflection on a piece of bright metal trim. Trip the shutter's self-timer, then step back and watch the reflection. If it jiggles when the timer goes off, the camera moved. Look for a tripod that shows a minimum of movement.

Most of the tripods shown here are nationally distributed and are readily available in local photo shops. Spiratone models are sold by mail from Spiratone, Inc., 135-06 Northern Blvd., Flushing, N.Y. Bilora tripods and accessories are distributed by Ehrenreich Photo-Optical Industries, Inc., 623 Stewart Ave., Garden City, N. Y. The Tiltall model is available from G. M. Marchioni in Rutherford, N.J. ★★

Direct Charge: such a great idea



we patented* it.

Before we tell you what it is, let us tell you what it does.

Example: the new 135-hp Mercury outboard with Direct Charge has the same size powerhead as the former 125-hp Mercury without Direct Charge. Yet without any increase in fuel consumption, it delivers, at wide-open throttle, ten additional horsepower.

What it is—that's more complicated. It's Mercury's exclusive induction system design for improved flow of intake and exhaust gases. You'd need detailed specifications and drawings (like those we took to Washington to obtain our patent) to have all the facts. But most boaters just want to know if it works.

After thorough testing, we put Direct Charge into our 80 hp two years ago. Instant success! Now it's in our 135, 115, 80 and 40 hp.

Direct Charge, together with Thunderbolt ignition and Perma-Gap spark plugs, gives you more hp per cubic inch and more miles per gallon. To put it another way, the same amount of fuel goes into the cylinders—you just get a lot more out of it.

Ask your Mercury dealer about Direct Charge.

*U.S. Patent No. 3,494,335



MERCURY
OUTBOARDS

Complete range of power: 4, 7½, 9.8, 20, 40, 50, 65, 80, 115, 135 HP.

For nearest Mercury Dealer, see the Yellow Pages under "Outboard Motors."
Kiekhaefer Mercury/Division of Brunswick Corp./Fond du Lac, Wis./Canada, Ltd./Australia Pty. Ltd.

A New Spare Time Income For The Home Handy Man Sharpen Carbide

Saws and Tools
with famous

Foley

Carbide Grinder

Excellent potential in this super growth industry! Manufacturing firms of all sizes are switching to carbide. They use hundreds of different carbide tipped saws and tools. All need sharpening. Amazing profits are yours for just minutes of easy work.

We Will Finance You! Easy finance plan helps you start in this highly profitable field. Part time could lead to full time. No special skills required. Foley shows you how. Write now for full information.



Foley

Carbide Service Center

Room 316-1, 3300 N.E. 5th Street
Minneapolis, Minnesota 55418

ARROW

All-Purpose
STAPLE
GUN

T-50

SHOOTS A STAPLE

WHEREVER YOU'D DRIVE A NAIL!

Uses 6
Staple Sizes
1/4" to 9/16"
including
Ceiltile.

At
Hardware,
Lumber & Building Supply,
Stationery, Variety and
other retail outlets.

ARROW FASTENER COMPANY, INC.
271 Mayhill Street, Saddle Brook, N. J. 07663

BUILD YOUR OWN CAMPER SAVE UP TO 50%



VIKING CAMPER SUPPLY, INC.
99-8P Glenwood Ave.,
Minneapolis, Minn. 55403
Please send _____ for
which I enclose \$ _____
NAME _____
ADDRESS _____
CITY _____
STATE _____ ZIP _____

Complete, easy to follow
plans, instructions, materials list.

Camper Plans\$3.95
Travel Trailer\$3.95
Pickup Cover\$2.00
CONVERSION PLANS:
Econoline Type Van..\$2.95
Passenger Bus or
Delivery Van.....\$2.95
Satisfaction Guaranteed

EQUIPMENT CATALOG \$1.00

Refundable on First Order.
Send Dime for Details.
Save 50% on Camper Kit.
All items from catalog to
build \$1,795. Camper, 8',
10', 10'6" or Chassis Unit.

VIKING

STOPPING AIRLINER BOMBERS

(Continued from page 97)

developed, a new adsorbing material, styrene-divinylbenzene polymer, was found by IITRI. According to Fischman, it can be used in a chemosensor for the detection of most types of explosives, including dynamite, black gunpowder, plastic and tetraethyl.)

After allowing time for adsorption, the gold foil is heated to about 80°C. (176°F.). This releases adsorbed gases.

Argon, an inert gas which will not contaminate the sample, is injected into the cylinder to carry gases to a second smaller cylinder. The inside surface of this cylinder is also lined with gold to permit further adsorption. Heating occurs and adsorbed gases are released and carried into a gas chromatographic partition tube.

Unidentified material is detector

This tube contains a special material that absorbs and desorbs gases. IITRI officials will not reveal what this material is.

Each gas is absorbed by the material at the front of the tube and is desorbed farther down the tube. Since gases entering the tube are traveling at a different rate—much like our oil-water example above—each is absorbed and desorbed at a different time.

This difference in time is recorded on a meter. Thus, if the meter peaks, say, three minutes after an air sample is taken, EDGN is present. If the peak occurs before or after, the vapor is from a source other than dynamite.

A complete bomb-detection system will probably consist of both neutron activators and chemosensors. Neutron activators will scan baggage in the plane's luggage compartment and that carried by passengers.

A number of chemosensors will be installed in the plane and connected to a monitor in the cockpit. As the plane waits to take off, the pilot will sample the air in the cabin. If EGDN is present, the monitor will show it.

Chemosensors can also act as a backup to detect bombs in a piece of carry-on luggage (attache case or small bag) that someone manages to smuggle aboard. EGDN vapors will seep through most pieces of baggage since they aren't well sealed. Besides, by varying cabin pressure before takeoff, the pilot can get luggage to "breathe."

"Chemosensors have other uses," Fischman claims. "For example, they can be employed to find explosives planted in a building, a gas leak in a mine, and drugs being shipped through the mail." ★★★

Now in specially priced special models!

The pickup that works like a truck, rides like a car.

Now, for a limited time, your Ford Dealer is offering special value "Explorer Special" pickups. They are available with a choice of four equipment packages, bringing you special savings on air conditioning, power steering, Cruise-O-Matic transmission, and much more. And all are equipped with the better ideas that make every Ford pickup the better buy:

Biggest cab of any pickup. Combined headroom, legroom, shoulder room and seat-height dimensions exceed those of any other pickup cab.

Exclusive Ford Twin-I-Beam independent front suspension.

Wheels step over bumps independently to smooth the ride.



Levellest, quietest ride of them all. Virtually no nosedive on braking, less sidesway on curves. Independent tests proved Ford is quieter than all other leading pickup makes.



A better idea for safety:
Buckle up.



Most luxurious. Explorer Specials offer a choice of three color-keyed interiors with harmonizing "Random Stripe" seat material. Many special features are included or available at special savings.

I-beam front axles. A Ford exclusive. Both axles are drop-forged I-beam design. Everybody's *big* trucks use I-beam front-axle design for greater strength.

Radius rods help hold alignment better than any other front-suspension system. Only Ford pickups offer radius rods.

Self-energizing brakes stop quickly, smoothly, with little pedal pressure. Self adjusting for lower service costs.

Welded, instead of bolted, pickup box stays strong, resists working loose, means greater quietness, less chance of rust.

Leaf-type rear springs, like all big trucks use, for better stability. Exclusive Flex-O-Matic rear suspension, standard on F-250 and with heavy-duty springs on F-100, keeps the ride smooth, with or without a load.

Limited time only.

Limited production Explorer Special models now available, but you must act now!

**FORD
PICKUPS**



GET UP TO \$50 WIN A RACE DAY \$2 WITH 2 STAKES

MILLIONAIRES CAN'T BUY BETTER!

'HE SAID he'd had wins at tracks on the day of \$874, \$1082, and \$1516. I thought he must be a millionaire. Then I found out he wasn't. He'd simply had \$20 on all predictions of PENCLIFF world's top race computer'

SENSATIONAL—space age—scientific, we supply **FACTS**—over 4,000 latest **CHECKABLE** big win PENCLIFF results. **BIG \$2** pays incl. \$66, \$70, \$82, \$90, \$96, \$104, etc. And **BIG** track wins—\$2 stakes on all predictions in all races incl. \$113, \$118, \$121, \$134, \$141, \$151 etc. **CLEAR PROFIT ON THE DAY**. Over a dozen race experts **BRAINS ARE BUILT INTO PENCLIFF**. Experience the pleasure of seeing this amazing instrument 'think' as it works out wins for you. Not just small ones—many grand, big, **BIG** pays. Later, you'll accept as normal, but at first we're sure you'll find the unique way this remarkable instrument receives race information you feed in, skillfully works it out and **COMPUTES** it, will be one of the most wonderful experiences of your life. We programmed **THOUSANDS** of races to an I.B.M. computer with intensive probes into entrants—equivalent to 50 mathematicians 3 yrs. work. Due to this **COLOSSAL RESEARCH** fantastically successful PENCLIFF was invented. Shipped complete—full easy instructions in a genuine english leather carrying case—so cleverly designed that even if no previous experience of horseracing **EASILY** operated. Get full, **EXCITING** details of world's greatest horserace winning computer, and in future really enjoy the world's most popular sport. *Money refund guarantee*. Mail the coupon NOW. R. H. P. Co. PME16 Box 5715, CARMEL, CALIF. 93921.

R.H.P. Co. PME16 Box 5715, CARMEL, CALIF. 93921

(Tell me everything about exciting PENCLIFF)

Name _____

Address _____

City _____ State _____ Zip _____

LIQUID WRENCH

LOOSENS RUSTED BOLTS, NUTS & PARTS IN SECONDS!



HEAVY DUTY BALL-BEARING PUMP

IRRIGATE-DRAIN-SPRAY-CIRCULATE. All-metal, rust-proof, Type XB. Stainless shaft. Use 1/4 HP or larger. 1 HP 1,200 GPH 60' high or 3,000 GPH 25' well. 5,200 GPH max. 1 1/4" in: 1" out. Belt or direct drive \$12.95
Type P won't rust or clog. Bronze-bearing. Hundreds of thousands in use. Up to 2,400 GPH. 1" inlet. 3/4" outlet. Free coupling..... \$8.95
P'pd. cash with order **MONEY BACK GUARANTEE**
LABAWCO, Box 40, Belle Mead, N. J. 08502

MAGIC MAIL PLAN

that comes with this Little Machine CAN MAKE YOU \$1200 AN HOUR

The machine is turning out a job that will bring operator \$2.58, by mail. Material cost, only 11c



Write today for free facts about the newest and most fascinating of all new home operated businesses. For the first time, a simplified machine brings the fabulous profits of Plastic Sealing and Plastic Laminating within reach of the small operator. Anyone can learn to operate it with a few minutes practice. Then—with our **MAGIC MAIL PLAN**—can get mail orders pouring in daily with cash in every envelope.

No Convassing or Selling

Fill orders at home in spare time to start. Then expand to full time business. We even supply circulars to bring back cash and orders. Rush name for all the facts you need to start. A postcard will do. No charge.

WARNER ELECTRIC CO., Dept. L-2-AC
1512 Jarvis, Chicago, Ill. 60626

SATURDAY MORNING INCOME PLAN!



Earn \$5 to \$20 extra in spare weekend or evening hours, accepting orders from friends and neighbors for our nationally famous shoes. Just show our beautiful full color catalog of over 275 exciting styles, many exclusive comfort features! No experience needed to make extra money, earn prizes, bonuses—even **FREE SHOES** for life! Rush name & address for **FREE Starting Outfit** today.
MASON SHOE, Dept. F-154, Chippewa Falls, Wis. 54729

OPERATE THREE PHASE MOTORS FROM SINGLE PHASE LINES ONLY

The **RELIANCE THREE PHASER** allows you to operate three phase motors, 1/4 thru 7 1/2 horsepower from 220 volt single phase power sources. Rugged—heavy duty—patented unit built to give many years of satisfactory service. Thousands of satisfied users. Free literature on request.
RELIANCE ELEC. MFG. CO., INC. New Albany, Miss. 38652

22 CAL. PELLET FIRING "STINGER AUTOMATIC"



\$1.00

50 22 CAL. PELLETS FREE
Looks and Feels Like Real Pocket Automatic—Loads 15 Shots

Fire 22 cal. pellets just as fast as you can pull the trigger. Great for fast action combat-type target practice. 50 reusable 22 cal. pellets free. Free supply of targets. Money back if not satisfied. Just send \$1.00 plus 25c postage and handling to: Not sold in N.Y.C.

HONOR HOUSE, Dept. 96RA75, Lynbrook, N. Y. 11563

HEARING AIDS

Huge savings on tiny, all-in-the-ear, behind the ear, eyeglass and body models. New space age models are so tiny and well concealed your closest friends may never even notice. **FREE HOME TRIAL**. No down payment. Low as \$10 monthly. Money back guarantee. Order direct and save. Write today for free catalog and confidential booklet. **PRESTIGE, Dept. D-34, Box 10947, Houston, Tex. 77018.**



JEEP OR SCOUT OWNERS

REPOWER with a 6 or V-8. H.D. ADAPTORS for using Car, Compact and some Truck engines. "State year & model, Jeep or Scout." Want fast action? Give us **FULL INFORMATION**. Send \$25.00 Dep. and we will ship correct kit, bal. COD. Send full amount for prepaid shipment. Wire, phone or write today. Details **FREE**

HOOSIER MACHINE PRODUCTS CO.

312 S. E. 8th St., Phone 278-3442, Pendleton, Oregon 97801



LEARN MEAT CUTTING

Train quickly in 8 short weeks at Toledo for a bright future with security in vital meat business. Big pay full-time jobs—**HAVE A PROFITABLE MARKET OF YOUR OWN!** Time payment plan available. Diploma given. Job help. Thousands of successful graduates. **OUR 48th YEAR!** Send now for big new illustrated **FREE**

catalog. No obligation. G.I. Approved. **NATIONAL SCHOOL OF MEAT CUTTING** 20197T
Dept. 50-T, Toledo, Ohio 43604



Springtime!

It happens every Salem.

NATURAL MENTHOL™
Not the artificial kind. That's what
gives Salem a taste as soft and fresh
as Springtime. It's only natural.



Michigan Propellers Economy plus quality

Cast of tough Michalium alloy. Durable yet repairable. Michigan manufacturing method assures top outboard performance at low cost. Send for free '71 Outboarder's Bible.



MICHIGAN WHEEL CORP. A SUBSIDIARY OF  **CORP**
1501 BUCHANAN, S.W., GRAND RAPIDS, MICH. 49502

Evinrude-Johnson-Gale	Year	Mich. Part#	Price	Size
9½ - 10 HP	56-71	PJ11	\$10.00	8¼ x 8
		PJ10	10.00	8¼ x 8½
14 - 20 HP	50-71	PJ17	12.00	9 x 10½
		PJ19	12.00	9 x 9
		PJ18	13.00	9¼ x 11
22 - 40 HP	51-71	PJ41	16.30	10½ x 10
		PJ31	16.30	10½ x 11½
		PJ30	16.30	10½ x 12½
		PJ32	16.30	10½ x 12
		PJ35	16.30	10½ x 13¼
		PJ40	16.30	10½ x 14
		PJ42	16.30	10½ x 13
60 - 90 HP	60-68	PJ74	16.00	10 x 9¼
		PJ75	18.00	10¼ x 10
		PJ78	16.00	9½ x 10
		PJ76	16.00	10 x 11
		PJ73	16.00	10 x 11
		PJ77	16.00	10 x 12
50 - 115 HP Thru Hub Exhaust	68-71	PJ80	29.00	13¼ x 15
		PJ81	29.00	13¼ x 17
		PJ82	29.00	13 x 19
		PJ83	29.00	13 x 21

INVENTORS

**INVENTIONS—NEW PRODUCTS—IDEAS
DEVELOPED & PREPARED**

For Commercial Appeal & Sales

DESIGN—MARKETING—PATENT RESEARCH—DRAWINGS

DIRECTOR: *United States Patent Office former Patent Examiner*

Member: United States Council Int'l Chamber Commerce

Second Decade of Reliable Service to

INVENTORS—MANUFACTURERS—ATTORNEYS

FREE CONSULTATION

THE RAYMOND LEE ORGANIZATION

230-Z Park Ave., New York 10017 (212-MU 6-8500)

SEND FREE "INVENTION RECORD" Form & "PRODUCT MARKETING" BROCHURE

Name _____

Address _____

City _____

State _____

Zip _____



**BUILD
THESE
BEAUTIFUL
CLOCKS**



NOW AT BIG SAVINGS!

Send just \$1 for plans & instructions to build choice of: (A) Grandfather, (B) Steeple, (C) Grandmother—plus information-packed catalog of movements, dials, parts & kits to build these & 16 other fine clocks. All 3 plans—\$2.50. Catalog alone—25¢.

MASON & SULLIVAN COMPANY

Dept. PM, Osterville, Mass. 02655



**110-120 VOLT A.C. LIGHT
PLANTS—60 CYCLES**

Fanbelt driven from pickup or small gas engine. Operates saws, drills, pumps, freezers, T.V. X1000 Watts—Needs No Battery. Now \$70.00. 1500 Watts—6 and 12 volt vehicles. Now \$60.00. 3000 Watts—12 volt vehicles only. Now \$99.50. *Guaranteed. Check or Money Order.*

VIRDEN PERMA-BILT, Box 7060 P.M., Amarillo, Texas 79109



ROTARY FILES

U.S. Surplus High Speed Milling Files going fast. New, in G.I. Packs. Hardened steel, for filing, milling, routing, drilling—any work in light metal or wood. Use in ¼ in. drill, etc. Range in size from ¼ to 1 inch wide. Get these most useful tools now. 16 tool set—government cost \$109..... \$ 9.00 to you! 36 tool set—government cost \$265..... \$15.00 to you! 100% GUARANTEED. WE PAY POSTAGE. A LIFETIME BUY!!

**THE SURPLUS CENTER
LANCASTER, TEXAS 75146**

2 for 1 WAREHOUSE CLEARANCE SALE

©MCMXXIX VIKING



**TWO \$1.98 \$3.96 VALUE 10 Year Guarantee
FOR TWO FOR THE PRICE OF ONE**

Razor sharp lifetime steel blade opens easily and automatically locks in place. PUSH-BUTTON release. Tough, razor steel blade honed and polished to mirror-like finish. Balanced for target throwing. Legal size. Blade GUARANTEED 10 YEARS. If blade breaks we replace free. 30-day MONEY BACK GUARANTEE. A favorite with sportsmen. Priced for quick sale of 200,000 knives. Makes excellent gift for man or boy. Two for \$1.98 plus 50¢ shipping. Send cash, ck. or M.O. to VIKING KNIVES, Dept. K-3, Box 10880, Houston, Tex. 77018.

I-N-V-E-N-T-O-R-S WE NEED INVENTIONS

Sell your invention for cash—need money for Patent?—Are technical problems holding you back? Universal inventions has helped inventors all over the world—just like yourself—why not you? Inventions provide the magic spring-board to sudden riches. REMEMBER, we either sell your invention or pay you a cash bonus. Write for details. **UNIVERSAL INVENTIONS, Dept. 13, Marion, Ohio**

FIND BURIED TREASURE

Powerful electronic detector finds buried gold, silver, coins, etc. 5 new models. Write for free catalog.



RELCO, Dept. D-3 19⁹⁵

BOX 10839, HOUSTON, TEX. 77018



SAILBOAT KITS

Free color catalog of the largest selection of popular sailboats, iceboats, and sail making supplies.

TAFT MARINE CORP.

Dept. PM-3, 636 39th Ave. N.E.
Minneapolis, Minnesota 55421

BASEMENT TOILET FLUSHES UP



TO OVERHEAD SEWER OR SEPTIC TANK. NO DIGGING UP FLOORS. INSTALLS EASY. Write **McPHERSON, INC., BOX 15133, TAMPA, FLORIDA 33614**

The day Bill told off his boss

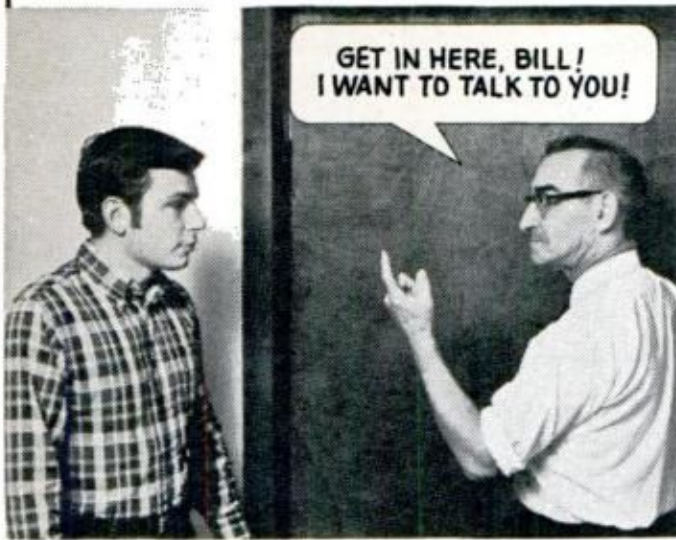

GET IN HERE, BILL!
I WANT TO TALK TO YOU!



YOU PUNCHED IN SEVEN
MINUTES LATE. I'M DOCKING
YOU AN HOUR'S PAY, AND
IT BETTER NOT HAPPEN
AGAIN... OR ELSE!



OH, YEAH? I'VE GOT NEWS
FOR YOU, MR. BEMIS.
I'VE GOT A NEW JOB
OFFER WITH A REAL
FUTURE... AT TWICE
THE MONEY!



HAH! ANYBODY'D
BE CRAZY
TO PAY YOU
THAT MUCH!

THAT'S WHAT
YOU THINK!
I'VE BEEN
LEARNING
ELECTRONICS
IN MY SPARE
TIME AT HOME
FROM **CIE**...
AND NOW I CAN
TAKE MY PICK
OF GOOD JOBS!



YOU GOTTA BE
KIDDING! YOU?
IN **ELECTRONICS**!

YES! NOW I'VE GOT A **CAREER**.
CIE MADE IT EASY. SO GOOD-BY
TO YOU AND YOUR CRUMMY JOB!

ARE YOU WORKING FOR PEANUTS IN A
DEAD END JOB? GET SMART LIKE BILL...
MAIL CARD FOR **2 FREE BOOKS** LIKE HE DID!

If coupon has been removed, write to Cleveland Institute of Electronics
1776 E. 17th St., Cleveland, Ohio 44114

IF CARD IS MISSING, MAIL THIS COUPON

CIE

Cleveland Institute of Electronics
1776 East 17th Street, Cleveland, Ohio 44114

Please send me your 2 **FREE BOOKS** describing the
opportunities in Electronics and how to prepare for them.

Name _____
(Please print)

Address _____

City _____

State _____ Zip _____ Age _____

Veterans and Servicemen:
Check here for G.I. Bill information.

Accredited member National Home Study Council



PM-51



You can make money in

WATCH REPAIR

Learn at home the low cost Sweazey Way

Watch repairing pays up to \$6 an hour, part time watch makers report on survey. Unique and modern Sweazey home study System starts you making repairs right away on Swiss and American watches. Professionally prepared training. No previous experience needed. Special tools provided for practice. Diploma Awarded. Free sample lesson and opportunity book give all facts. Write today. No obligation.

CHICAGO SCHOOL OF WATCHMAKING

Dept. 131 Fox River Grove, Illinois 60021

FREE BOOK and SAMPLE LESSON

CHICAGO SCHOOL OF WATCHMAKING

Dept. 131 Fox River Grove, Illinois 60021

Please rush FREE BOOK and Sample Home Study Lesson.

Name _____ Age _____

Address _____

City _____ State _____ Zip _____

READ THE LAW FOR YOUR OWN BENEFIT

Learn how the law regulates commerce, politics and social activities . . . how your business and economic affairs are affected by the law.

The Blackstone School of Law offers a program of reading assignments for adults planned to familiarize you with the law.

NOT A CORRESPONDENCE COURSE

Suit your program to your special interests and available time.

WRITE FOR FREE BOOKLET

"The People vs. You." Contains complete information on the program. No Salesman Will Call. Write directly to:

BLACKSTONE SCHOOL OF LAW Dept. 53
307 N. Michigan Avenue, Chicago, Illinois 60601



IF YOU CAN SING, WHISTLE, OR HUM A TUNE . . .

you can play the Musical Saw. No notes to read, no musical knowledge required. Since 1921 we have furnished the entire world this unusual, sweet-toned instrument. If you are 10 or 70, you play or no pay. Musical Saw, soft hammer, bow, resin and lessons mailed on 5 days' trial. Write today for details and free copy of "Sawing News of the World," picturing successful saw musicians. **MUSSEHL & WESTPHAL**, 107 Fort St., Fort Atkinson, Wisconsin. 53538.

MAN-SIZE TRACTOR

PRICED WITH THE COMPACTS!

Mows up to 60" swath!



Handles 48" and 60" mowers . . . bigger implements for gardening, dozing, removing snow. Here's why: Big 14 hp . . . extra size and traction . . . all-gear-drive with automatic clutch, transmission and differential. More for your money! Send for free catalog.

ECONOMY TRACTOR

1005 K-3 Anoka Avenue
Waukesha, Wisconsin

NEW Improved Accurate Scope-Shot

SCOPE-SHOT COMPLETE WITH 50 DISINTEGRATING PELLETS They crack like a rifle when they hit—leave mark—pull of smoke! **\$2.50 P.P.**

World's Finest Precision **SLINGSHOT** Scope-type sight! Millions Sold! Patent No. D-178,837

Big Bag of **250 EXTRA Pellets \$1.00 P.P.**

Pure gum rubber slings. Beautifully polished cast aluminum stock. Pistol grip. So powerful it kills small game. Fits pocket perfectly! Guaranteed. **FREE** shooting manual.

EXTRA RUBBER SLINGS, 3 pairs \$1.00 p.p. Leather Pouch & Sling assembly only 50c p.p. Order NOW from:

GENERAL SPORTS
4184-M3 Apple Street Cincinnati, Ohio 45223

ROUTS PESTS! Price without pellets **\$2.00 P.P.** Order Now!

FREE! CAMPER & TRAILER KITS catalog

Save 1/2 over factory built. Anyone can assemble. No experience required. Save \$500 to \$2000 over cost of factory built. Only household tools needed. Everything furnished—nothing else to buy! Just put factory pre-assembled parts together. 12 models—8', 8 1/2', 10 1/2' Pickup Truck Campers, 24', 31', 36' Pickup Truck Covers, 16', 19' Travel Trailers and 4 Soft & Hard Top Tent Trailer Models. Money back guarantee. Rush name, address for 24 page color catalog, **FREE!**

LUGER CAMPER & TRAILER KITS 10% dn, E-Z terms
Dept. TA 31, 1300 E. Cliff Road, Burnsville, Minnesota 55378



DURHAM'S Rock Hard WATER PUTTY

WILL NOT SHRINK STICKS AND STAYS SET

Solves Repair Problems

Durham's fills cracks and holes in plaster, wood and tile. Won't shrink or fall out. Economical, easy to use. Big 4-lb. can, only \$1.80 at lumber, paint, and hardware dealers, or shipped direct postpaid in U. S. for \$2.50. Money-back guarantee. Order now. Donald Durham Co., Box 804, Des Moines, Iowa 50304

Don't change your address without notifying us!

To insure uninterrupted service on your **Popular Mechanics** subscription, please notify us at least six weeks before you move.

1. Attach your address label from a recent issue in the space provided below . . . (if label not available, be sure to give us your old address, including Zip Code)
2. Print your name and new address below (be sure to include your Zip Code).

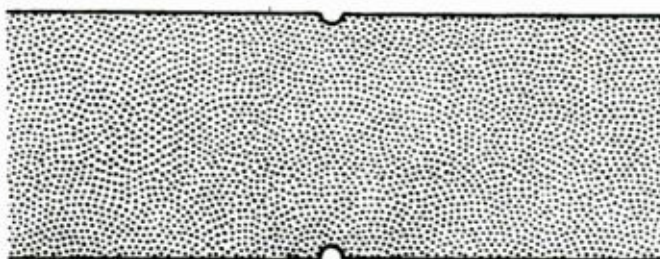

3. Mail entire notice to: **Subscription Service Dept. Box No. 646 New York, N.Y. 10019**

Name _____ *Please Print*

New Address _____

City _____

State _____ Zip Code _____

Throw a little weight around:

'71 Chrysler Lo-Profiles

Suppose the fishing's better or the skiing's smoother elsewhere when you're trapped in Dullsville.

Weighty problem?

Nope. Moving is no problem when Chrysler Makes It Happen, Captain . . . as evidenced by the '71 Chrysler Lo-Profile outboards. 14 Chrysler-engineered models to choose from: in 6, 8, 9.9 and 12.9 horsepower ranges, including manual or Autoelectric models (9.9 and 12.9) with built-in utility dome light for night fishing, Depth-Minder

Drive for shallow water going, stowaway tiller, unique Tote-Tank for fuel, and much more.

All '71 Chrysler Lo-Profiles are light in weight, easy to pick up, carry and stow away in your car trunk.

And their low-profile styling that lets them fit low to a boat transom makes them easy to handle, easy to fish over.

If you'd like to talk about a '71 Chrysler Lo-Profile, find your nearest Chrysler Crew dealer by calling 800-243-6000, free. (In Conn., 800-942-0655.) It's something to throw around.

MARINE PRODUCTS



CHRYSLER CORPORATION



'A-WAX'...

(Continued from page 75)

AWACS to cover both tactical and air-defense roles. In either role, fighters will provide protection. Otherwise, AWACS would offer a fat target. As the next generation warning system, AWACS will replace the aging SAGE (Semi-Automatic Ground Environmental System), BUIC (Back-Up Interceptor Control) and the existing airborne surveillance system.

The key system aboard AWACS will be an advanced pulsed-Doppler radar called ORT (Overland Radar Technology). ORT's prime task is to recognize and track low-flying aircraft among ground clutter. Natural phenomena plus man's activities produce quantities of electronic flak. Ground clutter confuses ordinary radar from the air, and ground-based radar can't see low-flying airplanes, as the United Arab Republic painfully discovered in the war with Israel in 1967. AWACS will utilize ORT to pick up aircraft flying at any altitude from 20 to 60,000 feet.

The Boeing Co., as prime contractor, will adapt two 707-320 jetliner airframes, largest of the 707 series, for AWACS prototypes. Instead of the usual four engines, eight new-technology General Electric TF-34 engines, installed two to a pod, will power AWACS. Each engine delivers 9600 pounds of thrust at takeoff. The high-bypass engines burn less fuel and extend cruise range despite added drag from the huge 30-foot-diameter radome on top of the fuselage. Efficient engines permit use of the big antenna to assure superior radar performance. Eight engine-driven generators will produce up to four times as much electrical power as the 707 uses in regular airline service to operate radar and communications gear aboard an AWACS plane.

Still to be determined is the Overland Radar Technology contractor. Westinghouse Electric and Hughes Aircraft have developed competing laboratory models. A Westinghouse system will be installed in one prototype, the Hughes system in the second. An old-fashioned electronic "shoot out" will determine the winner in a return to "fly before you buy" competition.

When both prototypes are complete, the Air Force plans to rate each system on two performance counts: (1) ability to detect low-flying aircraft over land amidst a variety of ground clutter; (2) accuracy of tracking of aircraft speeding across land areas. Tolerance limits for tracking precision vary with range and speed. Little is known about techniques or tolerances

because of the secrecy shrouding the program.

In addition to the radars, AWACS will pack more electronic and computer equipment into one airframe than any previous system. Multipurpose consoles include CRT displays as key elements. The consoles will be equipped with communications, navigation and data-processing links plus situation and numerical displays. International Business Machines Corp. will design and install the largest capacity airborne computer ever flown.

With so much electronic gear aboard, troubleshooting and maintenance problems could hold AWACS on the ground much of the time. Boeing plans to develop computerized monitors for continuous checking of the thousands of built-in sensors and "black boxes" scattered throughout the airplane. The troubleshooting system will detect malfunctions and isolate faults for quick servicing. Inputs from the checkout computers and stores of spare parts on board will permit electronics specialists to service most of the systems while in the air.

AWACS is planned for wide-ranging, long-endurance flights. Inflight refueling will enable tankers to transfer fuel while AWACS remains on station. Rest areas in the lower hold will allow crews to work in shifts during missions.

Timing for AWACS calls for completion of the two competing prototypes in late 1972. If either Westinghouse or Hughes develops an acceptable system, production of up to 40 AWACS will begin in mid-1973. AWACS will then become operational to plug existing gaps in our defense systems sometime in 1975. ★★ ★

GOSSIP BENCH

(Continued from page 154)

the ones in the seat, centered in the rail thickness and bored at right angles.

The pattern for the two arms is traced on 1½-in. stock, bandsawed and then the top edges rounded. From the top view drawing you'll see that the arms butt against the back rail. Two spindle holes are bored in each arm.

This leaves the 11½ x 12-in. telephone shelf which is beveled along the rear edge to meet the slanting back rail. It's glued to both the rail and arm and is supported by two spindles.

Now go over your bench and sand it glass-smooth. After a coat of maple NGR (nongrain raising) stain, we applied two coats of Wood Lore (a self-rubbing, clear, satin finish) and sanded lightly between coats with a type-4 finishing paper. ★★ ★

THE CHALLENGE.



No beer in the world can touch the combination of ingredients, brewing skill, and exclusive Beechwood Ageing that makes Budweiser the King of Beers®.

In brewing Bud®, our choice is to go all the way. We hope beer matters enough to you that you too will go all the way... with Budweiser.

WHEN YOU SAY

Budweiser.

YOU'VE SAID IT ALL!

ANHEUSER-BUSCH, INC. • ST. LOUIS

Use your router motor profitably with the new
MARLIN 3-D CARVING MACHINE

to produce identical copies of carvings, plaques, mouldings, etc. in wood or plastic. Signs are easily carved by freehand with this precision ball bushing equipped machine. Carves areas as large as 10" in diameter or 8" x 30" in size. Write today for further particulars.

**MARLIN INDUSTRIES, 1655 Cota Avenue,
Dept. PM-2, Long Beach, California 90813**



\$149.50

F.O.B. Factory



SMALL FOUNDRY FURNACES AND SUPPLIES

Ideal for home craftsmen and light commercial use. Make castings of bronze, cast iron, aluminum, copper, gold, silver, brass and other similar metals for hobby or business. Free literature.

PYRAMID PRODUCTS CO.

3736 SOUTH 7TH AVENUE, PHOENIX, ARIZONA 85041

**U. S. Government says a
HIGH SCHOOL
DIPLOMA**



can mean about \$50 a week more pay for the rest of your working life! Find out how you can earn yours. 3 new, shortcut ways at home in sparetime. Top-accredited training. Coupon brings full, free details.

NO SALESMAN WILL CALL. MAIL NOW

FRANKLIN ACADEMY, Dept. 91-031

2000 Euclid Ave., Cleveland, Ohio 44115

Send full details on 3 ways I can finish high school and earn \$2,500 more a year.

Name Age

Address

City State Zip

Give last full grade completed



This miracle plastic fastener is a thermoplastic rod with a memory that expands into a rivet, bolt or plug just by applying heat. Great for hobby-craft or repair jobs. Join metals, leather, wood, plastic . . . just about anything. With RADFAST you make your own fasteners. You'll want RADFAST rods on hand in your home workshop, office, auto glove compartment, tool and tackle box, boat, just about everywhere. For your get-acquainted starter kit of assorted diameters and complete instructions, mail \$1.50 today.

Radiation Technology, Inc
Department P-3, Box 41
Hibernia, New Jersey 07842



Enclosed is \$.....*for.....Radfast Starter Kit(s).

Name.....

Address.....

City.....State.....Zip.....

*\$1.50 per kit, ppd. Distributor inquiries invited.

Radfast™ Fasteners - Patents Pending

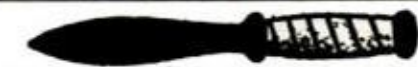

METAL PIERCING THROWING KNIFE

Terrific for hunting game. Balanced and weighted for precise bulls-eye-accurate throwing. Penetrates with a solid smack! EASY TO THROW, VERY FAST. Superb for target thrills, games, hunting, other uses. Made of quality cutlery steel. 10" long, double edged. Leather wrapped handle, \$1.00 ea. (3 for \$2.00) Knife throwing instructions included free. Rush order today.

R. L. Smith Imports, Ltd., Box 42-A, Holland, Mich. 49423

BIG PROFITS FOR YOU!!

**In your own spare-time
PRINTING BUSINESS**



Since 1872 thousands from high school to retirement ages have made important extra money with Kelsey hand presses, supplies, paper and how-to-do-it printing and business management help. Have your own printing business and your present job too. Send 25c (credited against your first order) for big catalog and details. **ACT NOW!! KELSEY PRESSES, Dept. 71-H, Meriden, Conn. 06450**



MINI-BIKE PARTS

Wholesale Prices

"Build your own" kits... Big savings... Repair parts... Welded frames & forks, enameled... Chains... Clutches... Brakes & throttle controls... Wheels... Tires... Bearings... Axles... Engines... etc. Send 50¢ for illustrations and lists... **SAVE DOLLARS!**

BYCO, Dept. B, Box 6241, Omaha, Nebr. 68106

KNOW MORE ABOUT ELECTRICITY

Two weeks seminar, 85 hours of illustrated lecture and laboratory instruction including light industrial, farm, and residential wiring; motors; control devices; and systems. Used as a training program for apprentice electricians, equipment installation and service personnel, and others. State approved school. Write for brochure.

POWER & ELECTRONIC INSTITUTE
Bushnell, Illinois 61422

MAKE YOUR OWN ALUMINUM CASTINGS!

Build this Charcoal Briquet Furnace and all Equipment for less than \$25

Now you can make original machine parts, prototypes, models, tools, ornaments, etc. in your own home workshop. This simple but effective blast furnace and booklet **Pattern Making and Sand Casting for the Home Workshop** will provide you with the capacity to make professional quality aluminum castings.

PLANS & BOOKLET only **\$3** TEAR OUT AD & MAIL TODAY!
Money-Back Guarantee!

DELTA DESIGN CO., Dept. M-3, P.O. Box 1091, Arlington, Texas 76010



**CAREER TRAINING / Engine Specialist
DIESEL • GASOLINE • L. P.**

Write to-day for free bulletin

An endowed non-profit institution
Founded 1907 — VETERANS APPROVED

THE DAVID RANKEN TRADE SCHOOL
4421 FINNEY AVENUE • ST. LOUIS, MISSOURI 63113

**BUILD A LOW COST PONTOON BOAT
WITH THIS KIT...**



FREE CATALOG

It's fun, it's easy too! You can build a rugged pontoon boat that will provide years of fun for your family at an amazingly low cost.

WRITE: PERMA-D MARINE PRODUCTS DIV.
DEPT. 35
1234 Central Ave. N.E. • Mpls., Minn. 55413

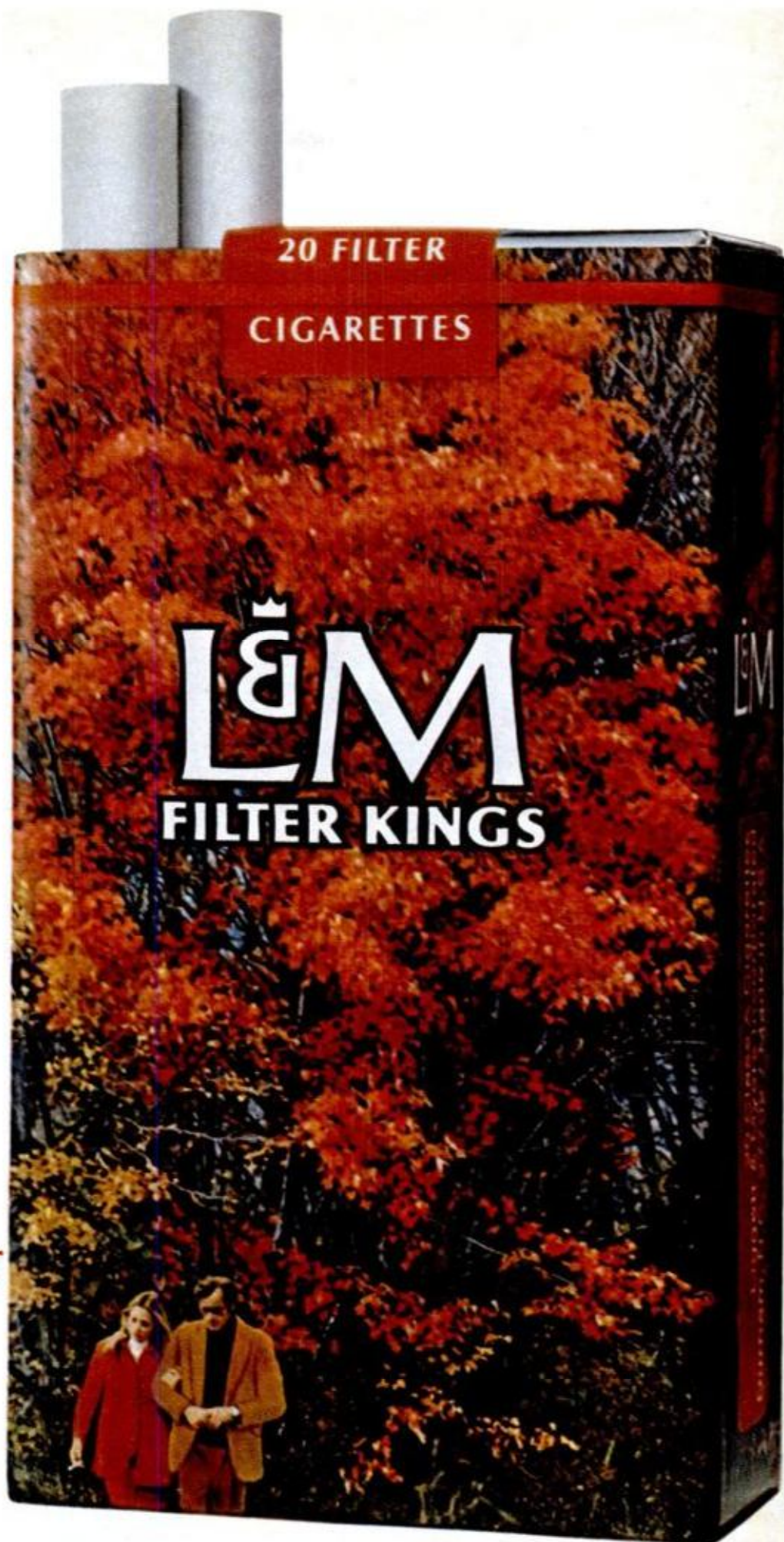

Relax.

Unwind.
Make this the
moment
to take things
easy.

With a whole
new cigarette.

Rich new
blend,
rich new
flavor.

**THIS
IS THE
L&M MOMENT**

3 new Heathkit® home improvement ideas

For the TV room...



New 25" Solid-State Color TV...with exclusive ultra-rectangular MTX-5 matrix picture tube for the biggest and best color viewing ever. Modular plug-in circuit boards for easy assembly and self service.

Kit GR-371MX, less cabinet, 125 lbs.\$579.95*

For the music room...



New 25-Pedal Theater Organ... the Heathkit "Legato" designed exclusively for Heath by Thomas Organ craftsmen. Color-Glo® key system lets you play like a pro from the start. \$100 organ course included free.

Kit TO-101, 299 lbs.\$1495.*

For the kitchen...



New Microwave Oven... the cooking revolution of tomorrow here today in money-saving kit form. Super-size oven cavity. Space-saver countertop design. Exclusive fail-safe dual door interlock.

Kit GD-29, 97 lbs.\$399.95*



HEATH COMPANY, Dept. 17-3
Benton Harbor, Michigan 49022

Schlumberger Company

- Rush my FREE Heathkit Catalog.
 Enclosed is \$_____ plus shipping.

Please send model (s) _____

Name _____

Address _____

City _____ State _____ Zip _____

Prices & specifications subject to change without notice.

*Mail order prices; F.O.B. factory. CL-404

HEAVY DUTY WELDER

with special \$7.00 gift offer to

Popular Mechanics readers

10-DAY FREE TRIAL

Lifetime Guarantee

Brand New 1895

1971 Model 1895

Fits ordinary 110V outlet

Not one - but 3 welding heats



WELD WITH WEL-DEX

Weld, braze, solder or cut most anything made of metal. No experience necessary. Follow simple instructions to make repairs on cars, trailers, farm and lawn equipment, bicycles, appliances, etc. Make campers, boats, furniture, hundreds of valuable items. NOTHING ELSE TO BUY! Comes complete with full face shield, pack of welding and brazing rods, heavy duty power cables, special electric torch attachment, ground clamp, flux, easy-to-follow illustrated instructions, rod holder, etc. Uses standard 1/8" rods to weld iron, steel, brass, bronze, aluminum, other metals. New improved HEAVY DUTY circuit gives more welding power. Gives 4 times the heat needed to melt toughest iron. Plugs into ordinary 110V outlet. 3 WELDING HEATS... Not just one as with other low cost models. Use "high" for tough jobs "medium" or "regular" for lighter work. This important feature saves you money and time. Makes it possible for even beginners to start welding professionally the very first day. Pays for itself quickly. An excellent gift for any occasion. IT'S AUTOMATIC: Current is turned ON when arc is struck, OFF when rod is lifted from work. Eliminates need for troublesome foot switch. Speeds up work.

FREE!

Mention that you saw this ad in Popular Mechanics and receive a \$7.00 gift pack assortment of "touch weld" welding rods, Automatic arc striker. Weld with "push button" ease.

10 day MONEY BACK GUARANTEE. You must be satisfied or return for refund. Send only \$2.00 and pay postman \$16.95 plus postage when delivered or send \$18.95 cash, check or money order for immediate postpaid shipment.

WEL-DEX MFG. CO., Dept. W-203, Box 18778, Houston, Texas 77018

CAN A SHOOTER WHO IS OUT TO SCORE BULLS-EYES FIND HAPPINESS with the NEW BENJAMIN AIR RIFLE?

We think so. Indeed, shooters have told us that the accuracy and performance of our new Super Single Shot are next to fantastic! Just what makes the new Benjamin something all by itself? It's probably the retention of things the owners of its famous predecessor used to brag about. And the painstaking way we build them. For example, it has the same dependable, time-tested action. And the same adjustable firing power. It even has the same bronze barrels, machined brass and steel parts that gave our older model an amazing wallop.

Of course, there are certain new features about the rifle which further enhance shooting fun. For one thing, it has a thumb operated top safety for more efficient fire control.

And a ramp-type front sight plus adjustable stepped leaf rear sight to help bring out the full accuracy potential of the new gun. Safe. Quiet. Odorless. Shoot indoors or out. Model 340 BB. Model 342 Cal. 22 Pellet. Model 347 Cal. 177 Pellet. Find happiness at your dealer's. Use Benjamin Pellets—Sized and Lubricated



PLEASE FULL SAFETY ON TOP OF STOCK WHEN IN STORAGE

BENJAMIN AIR RIFLE COMPANY 896 Marion St., St. Louis, Mo. 63104

FREE CATALOG WRITE

You Can DEPEND on BENJAMIN

RECHARGE ALL BATTERIES

Only Everlite

- Charges 6 batteries
- Charges 3 times faster
- Charges all batteries

Including hearing aid, flashlight, lantern, radio, in fact any battery up to 12V. Save Money and have the convenience of fresh batteries always. Simple and 100% Safe. Plugs into any 115V. outlet. Guar. for one year. Send \$6.95 plus \$.65 for shipping

695



Model 75

MASTER MECHANIC MFG. CO., Dept. A31, Burlington Wis
Southern Customers write Dept. A31, Box 65, Sarasota, Florida

POPULAR MECHANICS

**This fully automatic
ELECTRIC ADDING
MACHINE GIVEN
TO YOU!...**

when you
train at home
with us for a



BIG INCOME CAREER IN ACCOUNTING

**DEMAND FOR ACCOUNTANTS
AT ALL TIME HIGH** Train at home in spare
time for one of 1000s high pay prestige positions open
to Accountants. Or, open your own accounting practice.

Accounting is the most direct road to high level positions in business—more corporation presidents got their start in Accounting than in any other field! And no wonder! As an Accountant you'll be an "insider" on your company's management team... the confidential data you develop will be essential to making major corporate decisions and even to handling day-to-day company affairs. The demand for Accountants already far exceeds the supply, as more than 5 million U.S. firms require financial statements, bookkeeping systems, etc. to operate daily. Whatever your previous experience or education—we show you how! Thousands spare time opportunities, too. Now you can grasp this golden ground-floor opportunity. Mail postpaid card for FREE "Accounting Career Kit."

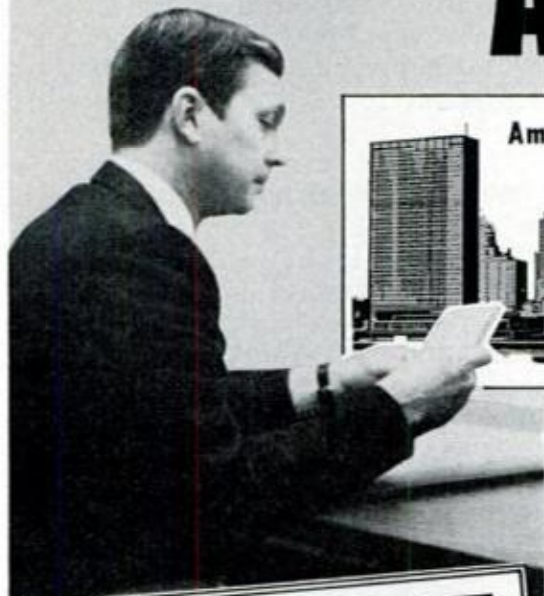

America's Only "Computer Age" Home-Study Course in Accounting

North American is one of America's foremost Correspondence Institutions. And, our home-study course in Accounting is America's newest, most modern and only Computer Age concept of working with figures.

3 BIG ACCOUNTING OPPORTUNITIES...

... choose one or all three!

- 1. ACCOUNTANT** — Over 1/2 million Accountants plus 1 million full & part time Bookkeepers employed today with business, accounting firms, Government, etc. Demand already exceeds supply by far.
- 2. BOOKKEEPING SERVICE** — Make good fees keeping books for small businessmen. Over 5 million businesses in U.S. today. All need financial statements, bookkeeping service, etc. Ideal part time career.
- 3. TAX SERVICE** — Earn \$\$\$\$\$ during tax season, preparing income tax returns at home for friends, neighbors, relatives, referrals, etc.

YOU LEARN BOTH MANUAL & COMPUTER ACCOUNTING.

With our step-by-step method you are shown how computers and other business machines simplify your work... make your financial data more complete... make you more valuable to company management. We show you how to "set up books" to take best advantage of computers. We reveal what computers can and cannot do for you. Through working on actual problems, you'll learn exactly what information you must supply to the "programmers" who "feed" data to computers. And through the actual "print out" reports our IBM 360 computer returns to you, you'll learn how to interpret reports received from computers. In short, we give you all the instructions, help and guidance you'll need to become a Computer Age Accountant, qualified to step into one of the 1000s high pay prestige jobs awaiting those trained in this "big future" field. (In addition, you can make good money doing part time Accounting while still learning with the fully automatic electric adding machine we give you at no extra cost.)

Mail Postpaid Card for FREE "ACCOUNTING CAREER KIT"

... including 20-Page CAREER FACT BOOK "Your Future in Computer Age Accounting" and Self-Scoring Accounting Aptitude Test—ALL FREE. No salesman will call.



Accredited Member, National Home Study Council

IF CARD HAS BEEN DETACHED, MAIL THIS COUPON

BOTH FREE!

Self-Scoring Aptitude Test

NORTH AMERICAN SCHOOL OF ACCOUNTING, Dept. 14173
4500 Campus Dr., Newport Beach, CA 92663
Rush "Accounting Career Kit"—ALL FREE. No salesman will call.

Your Future in **Computer Age ACCOUNTING**

NAME _____ AGE _____

ADDRESS _____

CITY _____ STATE _____ ZIP _____

NORTH AMERICAN SCHOOL OF ACCOUNTING, Dept. 14173
4500 Campus Dr., Newport Beach, CA 92663

GOVT. SURPLUS AND OTHER BARGAINS SAVE UP TO 90%



HIGH VOLUME PUMP
Delivers a whopping 1,000 G.P.H. at up to 23 P.S.I. @ 27 V.D.C. Also runs extremely well @ 12 V.D.C. @ reduced rating. Motor section runs submerged and is explosion-proof. Outlet is 1 1/2" hose fitting. 12" H x 8" Dia. Will pump fuel, light oils, water-based insecticides. GOVT. COST \$503. Like NEW. Shpg. wt. 24 lbs. \$14.75 (Stk #2787).



HEAVY DUTY GEAR MOTOR All ball bearing construction. Rated approx. 3.5 HP @ 24 V.D.C. Turns 400 RPM, no load, on 12 V.D.C. & 800 RPM on 24 V.D.C. Contains instant start-stop magnetic clutch. Reversible. Has 12 tooth, 5/8" shaft. 18 1/2" L x 7" dia. GOVT. COST \$454. Shpg. Wt. 35 lbs. \$32.50. Stk. #2465



ELECTRIC PUMP WITH CONTROL SWITCH For boats, campers & trailers. Output 300 GPH. Can be used in fuel or water. 1/2" pipe bronze inlet. 12 or 24 V.D.C. Explosion-proof motor. Comes with wiring diagram. Approx. GOVT COST \$150. Shpg. wt. 9 lbs. \$14.50 (Stk. #1164)



NEW! BIG 1971 CATALOG

Send 35c for amazing catalog with 1000's of bargains in hydraulics; electrical, marine, automotive items, etc. 90 day guarantee. Order from ad. All prices FOB Culver City. 50% deposit for COD. Cal. res. add 5% sales tax. Include zip. Satisfying customers world-wide since 1945.

AIRBORNE SALES CO.

Dept. PM371

8501 Steller Dr., P.O. Box 2727, Culver City, Calif. 90230

EARN \$20.00/HOUR

Assemble unique vehicles in Kit form for resale at big profits.



MINI-DOZER
Rugged, heavy-duty, high-performance track vehicle. Smooth lawn or cleated dozer tracks. Highly maneuverable — turns 360° in own length — powered by dependable 4-cycle engine. Attachments include dozer blade for snow, sand or dirt, lawn mower, many other lawn and garden tools.

MINI-BEEP
Powerful, compact lawn tractor. Also ideal as a lightweight cross country vehicle. Feather-light articulating steering gives unequalled maneuverability at work or play. The only 4-wheel drive lawn tractor on the market. Economical 2-wheel drive option also available. Complete line of lawn care attachments.



TURF-MASTER
Ideal tractor for lawn and garden use. Powerful 12 H.P. engine handles all chores easily, from mowing to plowing to dozing snow or dirt. Puts raw power where you need it. Outperforms other units costing hundreds of \$\$ more! Complete line of lawn and garden attachments.

MINI-SKAT
Exciting go-anywhere work and recreation vehicle. Use it at home for lawn care or where rugged, six-wheel traction is needed. Then take it out and enjoy the countryside. All six driving wheels tackle most any terrain with ease. Full line of lawn care attachments.



"Build-it-yourself" PLANS for each machine offered @ \$5.00. Any 2 plans — \$7.50. Also available — big colorful 48-pg Catalog of complete line — 75¢. Refunded with any purchase. Send today!

STRUCK CORP., Dept. PM-31, Cedarburg, Wis. 53012

PM'S TEST: PINTO VS. VEGA

(Continued from page 80)

more constant correcting. The rack and pinion of the Pinto is more positive.

Not once on the entire east-to-west Pinto leg of the trip and the west-to-east Vega leg did I detect any brake fade in the course of normal driving, including many long, downgrade runs. I did test the brakes, however, in a series of stops. On a lonely stretch of Oklahoma road I found less increase in pedal pressure required with the Vega after a series of six hard stops than with the Pinto (which I had also tested in the state of Washington).

Back on the more congested Eastern Seaboard, I missed the Pinto's controls—by controls I mean a combination of the precise steering and instant throttle response while shifting. The Vega's controls are not as easy to coordinate as the Pinto's. I rolled into New York, at last, and went directly to PM Auto Editor Bill Hartford's house on Long Island where we checked over the car. After all that driving, engine oil level was down only one-third quart!

Summing up, after living with each car for three weeks and driving coast to coast: Which car do I prefer? As tested, I choose the Pinto. Despite the Vega's terrific style, better brakes and performance, the Pinto has more to offer as a complete package. Everything seems to hang together better: good workmanship, smooth engine and gearbox; nicely finished interior; precise steering—all in all at \$2029 a better dollar buy. If I could load up Vega with all the goodies, running its price up to the \$3000 bracket, maybe I'd prefer it. But as tested, it's Pinto. ★★

REPAIR A FIBERGLASS BOAT

(Continued from page 119)

to remove excess putty and smooth the spot. Then apply the gel coat.

● **Restoring gloss.** You may want to do this after repair work. However, since it takes very little time for the results you get, you may wish to make it a periodic job.

Wash down the boat with acetone or lacquer thinner to remove loose grit and grime. Using a compound with the grit of Mirro Glaze No. 1, buff the craft with polisher at a 45° angle. Apply minimum pressure to corners and edges to save the gel coat.

To complete the job, use a fresh polishing pad lightly held flat against the surface, and buff to restore the boat's lost gloss. ★★★

It only tastes expensive



Popular price

Also available in New large-size container.

MAKE MONEY—ENJOY YOUR WORK. Repair small engines and mowers at home, spare time. Order our kit and get started now. Kit includes technical repair manual, rate book, 5 supply catalogs, bulletins, special sheets, tool catalog, the best wholesale parts supply in the industry. Order RB Kit #1, \$24.95.

SURPLUS PARTS CATALOG, odds and ends, wheels, controls, hardware, fasteners. Something for repair shops. Order catalog #8E at 75¢. Rockey Dept. PM, Galveston, Ind. 46932

handiest handful of all-purpose tools



SERVICE MASTER

23 essential items at your fingertips in roll-up kit. Regular and stubby handles with interchangeable nutdriver, slotted and Phillips screwdriver blades, reamers, extension. Pliers. Cutters Wrench.

Mail coupon: **FREE CATALOG** of professional hand tools and sets precision-made in USA. Nationwide availability thru local distributors, dealers.

No. 99SM

XCELITE®

XCELITE, INC.

162 Bank St. Orchard Park, N.Y. 14127

name _____
address _____
city _____ state _____ zip _____

PUT YOURSELF IN THIS PICTURE:

Your Typewriter is now like new! I'll send a bill for the \$25.

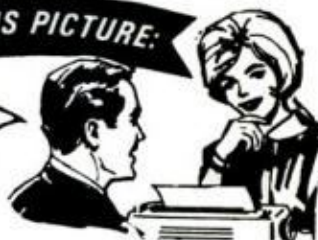

This Can Be YOU Sooner Than You Think!

BECOME A TYPEWRITER MAINTENANCE EXPERT

Quickly—Easily—At Home without risk!

Royal Typewriter for practice



PLUS YOUR PROFESSIONAL TOOLS INCLUDED WITH COURSE



Earn up to \$50 in a week spare time, as a graduate reports, get big pay position, or start your own business

There is a critical shortage of technicians to keep America's 30 million typewriters in repair. Now, regardless of age, education, or present job, you can enter this big-paying field by training in the Office Equipment Industry's only Approved Home Study Course.

Learn fast, and earn money while learning. Diagrams, photos, clear lessons, professional tools, plus benchwork assignments on actual typewriter that we give you, make learning easy.

Send name today for **FREE BOOKLET** telling of your opportunities in this profitable vocation. Full information, no obligation. No salesman will call. Approved for Veterans

MAIL COUPON FOR FREE BOOKLET

Typewriter Repair School, Dept. 3110-31
Little Falls, N. J. 07424

Please rush Booklet entirely FREE. No obligation. No salesman is to call.

Name _____

Address _____

City _____ State _____ Zip _____

"WILL YOU SMOKE MY NEW KIND OF PIPE ... 30 Days at My Risk?"

All I want is your name so I can write and tell you why I'm willing to send you my pipe for 30 days' smoking without a cent of risk on your part. This is not a new model, not a new style, not a new gadget, not an improvement on old style pipes. It's based on an entirely new principle that harnesses four of Nature's immutable laws—contradicts every idea you've ever had about pipe smoking—and delivers a smoking pleasure you've never before experienced. My new kind of pipe smokes cool and mild hour after hour, day after day without rest, without bite, without bitterness. It doesn't have to be "broken in". It never has to be "rested" and it never accumulates sludge! To prove all this, I want to send you a Carey Pipe to smoke 30 days at my risk. Send your name and address today for my complete trial offer. Mail coupon now to

E. A. CAREY, 1920 Sunnyside Ave., Dept. 252-C, Chicago 40

NO MONEY—JUST SEND YOUR NAME

E. A. CAREY, 1920 Sunnyside Ave.
Dept. 252C, Chicago, Ill. 60640

Please mail facts about your 30 day offer of a Carey Pipe postage prepaid. Then I will let you know if I want to try it at your risk. This information is free, no salesman will call.

NAME _____

ADDRESS _____

CITY _____ STATE _____



Now, a level that never takes time off the job.

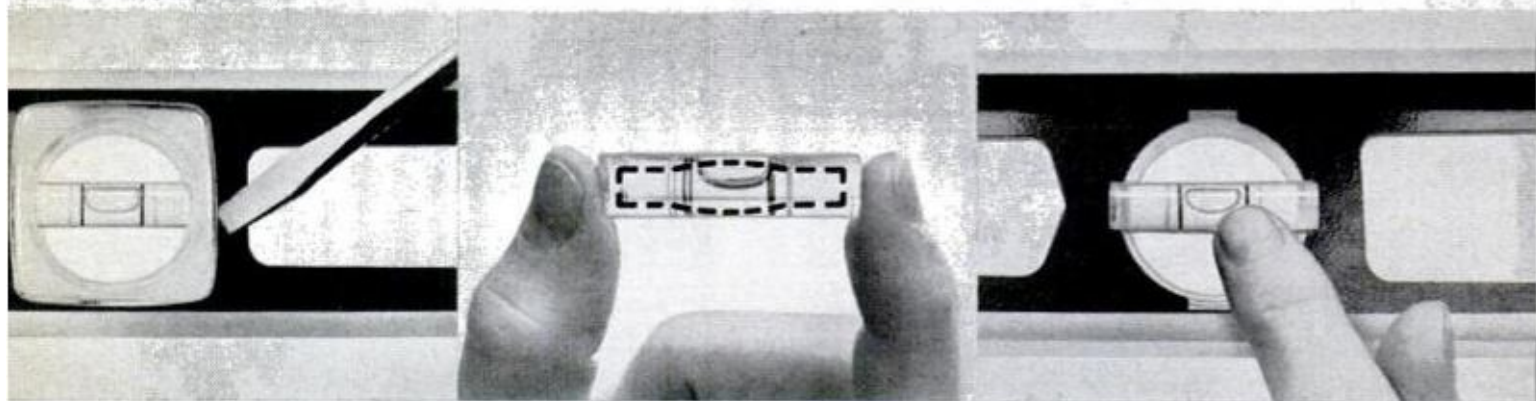

Our Workmaster™: a level to last you a lifetime. One reason: cover plates and vials snap out for replacement – *on the job* – if broken. (A big “if” – since they’re nearly break-proof!)

Snap in the new “360 vial” – vertically *or* horizontally. Notice how one bigger vial does the job of two usual vials. And with all the accuracy of solid set levels.

On goes the cover plate – precisely! The frame itself is lightweight, extra strong aluminum. 18”, 24”, 28” long.

STANLEY
helps you do things right

авторские права

Let MOTOR's Big New **1971** AUTO REPAIR MANUAL

Show You How to

FIX ALMOST ANY PART OF ANY CAR



Quickly... Easily... Right!

**Shows You Where to START...
Which TOOLS to Use...
Exactly What to DO!**

Over 1,000 pages, over 3,000 pictures and diagrams cover 2,300 models (1965-1971)... 225,000 facts that make those "tough" repairs come easy

MOTOR's great new illustrated 1971 AUTO REPAIR MANUAL! Here is the "meat" of over 300 factory manuals, brought together for you in the most complete, up-to-date auto repair guide ever prepared! Here are the easy directions and "see-how" pictures that help you sail through virtually every auto repair... from a simple carburetor adjustment to a complete transmission overhaul! Here are over 1,000 almost-foot-high pages that can lick your toughest problems—quickly, easily, right the first time!

Yes — fix practically any part of any car! This revised, improved 1971 edition immediately identifies 2,300 models (1965-1971) for you. Just look up make, model, and repair in the handy Instant-Reference Index—and go to it! MOTOR's AUTO REPAIR MANUAL takes you all the way—shows where the trouble is, which tools to use, what to do to fix it fast. Over 3,000 pictures and diagrams detail the parts... clear, simple

language puts over 225,000 service and repair facts at your fingertips! A special Trouble-Shooter section and detailed trouble-shooting information thruout help pinpoint in a flash over 4,200 causes of car trouble: Transmissions, brakes, engines, electrical systems.

Saves You Time, Money, Work

You get hundreds of compact tables... over 55,000 essential specifications and dimensions... tune-up and adjustment charts... tables of measurements and clearances... overhauling and replacement facts... adjusting and servicing guidance, and much, much more!

Here is the step-by-step help every beginner needs. And here are the labor-saving methods and shortcuts that get old pros over the "tight spots" and save time and money. No wonder more than

5,500,000 copies of this great book have been sold all over the world — to garages, schools, armed forces!

New Illustrated 1971 Edition



FREE 10-DAY TRIAL
Return and Pay Nothing If Not Delighted

FIX ALL THESE CARS

- | | |
|---------------|----------------|
| Volkswagen | Comet |
| Mustang | Corvair |
| Chevy II | American |
| Pontiac | Oldsmobile F85 |
| Thunderbird | Falcon |
| Buick | Fairlane |
| Imperial | Tempest |
| Cadillac | Corvette |
| Continental | Valiant |
| Dart | Cougar |
| Mercury | Toronado |
| Ford | Front Drive |
| Chevelle | Cadillac |
| Chevrolet | Mark III |
| Chrysler | AMX |
| Plymouth | Javelin |
| Lincoln | Montego |
| Nova | Torino |
| Vega | Barracuda |
| Pinto | Rambler |
| Gremlin | Eldorado |
| Hornet | Challenger |
| Dodge | Maverick |
| Oldsmobile | Camaro |
| Buick Special | |

Same Offer on MOTOR's AUTO ENGINES & ELECTRICAL SYSTEMS



1,300 big pictures. Clear text explains how parts work; principles involved; design; construction; maintenance. Covers all parts of engines & entire electrical system. For FREE trial, check box in coupon.

SEND NO MONEY Use Manual FREE for 10 Days

Put MOTOR's big new AUTO REPAIR MANUAL to work for you. See for yourself how quickly and easily it gets the work done! We'll send you this 1971 edition to use FREE for 10 days. If it doesn't start paying for itself in even this short time, return the MANUAL and owe nothing to MOTOR Book Dept., Desk B013, P.O. Box 2316, F.D.R. Station, New York, N.Y. 10022. (Schools, Bookstores: Write for discounts.)

MAIL COUPON NOW FOR 10-DAY FREE TRIAL

MOTOR BOOK DEPT., Desk B013
P.O. Box 2316, F.D.R. Sta., N.Y. 10022
Rush to me at once (check box opposite books you want):

MOTOR's New AUTO REPAIR MANUAL, \$10.95. If O.K., I will remit \$3 in 10 days; \$3 monthly for 2 months and a final payment of \$1.95 (plus delivery charge and sales tax, if any) one month after that. Otherwise I will return the book postpaid in 10 days.

Also send me for 10-day Free Trial **MOTOR's AUTO ENGINES & ELECTRICAL SYSTEMS**, \$10. If O.K., I will remit \$2.50 in 10 days and \$2.50 monthly for 3 months (plus delivery charge and sales tax, if any.) Otherwise I will return book postpaid in 10 days.

Print Name..... Age.....

Address.....

City.....

State..... Zip Code.....

Check box and save shipping charge by enclosing WITH coupon payment of \$10.95 for AUTO MANUAL (or \$16 for AUTO ENGINES) plus sales tax, if any. Same 10-day return-refund privilege.



COMPLETE AND SIMPLE. "I always rely on my MOTOR Books. They're well illustrated — and complete and simple."
—Mr. Erve Jones, Minnesota (Garage Owner)



DEPENDS ON IT. "MOTOR's Auto Repair Manual is invaluable to me. I depend on it for all makes and models."
—Mr. W. W. Forlines, Virginia (Mechanic)

I'LL NEVER QUIT RACING!

(Continued from page 89)

but in looking back, winning the Belgium Grand Prix in 1967. I know it meant a lot to all of us and certainly has meant more to me as the years have gone by.

What was your biggest disappointment in your having failed yourself, knowing you had bobbed something?

One of the first ones was when I went for an audition—to drive for an owner with a stable of Ferraris and Maseratis. I was one of six drivers he invited. We were to progress from Alfa Giulettas right up to Maserati Grand Prix cars. Well I got as far as a two-liter Ferrari and was going around very, very fast—about three seconds quicker than other drivers who had been in the car—when I came around one turn and was really heavy on it, hanging out the tail. I came over the brow of a hill and it spun around and went off the road backwards. It was one of the most embarrassing blows ever, but it was a great lesson for me. I realized I didn't know everything about driving.

Who's the most underrated driver now competing? Maybe you want to break that down into a couple of different circuits.

In Grand Prix racing I'd say, maybe, Pedro Rodriguez; in championship racing I'd say, maybe, Mike Mosley. I think both, however, lack the understanding of the car that some of their more successful competitors have. It's two strikes against you if you don't have it.

I'm sure you've heard yourself referred to as "Tinker Dan." People say you fiddle and fuss with a car too much. Is that a fair charge?

It's an understandable charge, but not a fair one!

What did you see in Swede Savage that made you think he was worth training as a protege?

Well, he's young and athletic and has a lot of natural talent. He was an outstanding motorcycle rider. His USAC win at Phoenix certainly proves he has what it takes!

Who do you think will be the big names of 1975 in world auto racing?

It's too far for me to see. I would hope Swede will be among the top ones.

Did Swede have any particular problems or faults when he started out?

He needed experience; he had to develop judgment.

Was he brash when he started or was he too brave?

I think every driver has a tendency to be a little bit too brave.

Do they have it more when they start out, when they're young? Or did they acquire it with experience?

It's ignorance more than it is bravery. When they get more experience and have more knowledge, their judgment improves. They're just as brave, maybe braver, but they don't take the same chances. They don't drive into the unknown as blindly.

You had the experience of being eliminated in that first-lap pile-up at Indianapolis in '66, and you've also had the experience of being eliminated in the last lap. Which is most frustrating?

I'd say on the first lap. In the case of Indianapolis you've put in at least a year's preparation, and you're all charged up to finally go out and do it. If you are forced out early, it's a big letdown.

Even in a race where you go only half-way and run a good race, do you feel some satisfaction?

Sure.

Al Unser's championship car almost ran away from everybody in championship racing last year. His dirt-track car was almost unbeatable too. How were they able to build him such a good dirt-track car? It really has little in common with the Indy car except the same mechanics.

Well, you shouldn't take anything away from Al. And, of course, George Bignotti and Parnelli and their whole organization were outstanding. They have a great depth of knowledge and certainly used it.

It just surprised us that they were able to do it on both circuits.

Yes. They'll be tough again this year, but they'll be awfully disappointed when we beat 'em!

You don't build a dirt-track car, do you?

No. We would like to go into dirt-track, though, and we have built several engines for Mario Andretti. The engine itself looks very good. It's based on a stock-block Ford.

Are speeds too fast, Dan? Would races be just as exciting to the fans at 150 mph say as at 180 or at 100 as at 120?

That's an old question, and I don't think there is an answer to it.

When a driver's going 200 mph, or even

(Please turn to page 230)

CLASSIFIED ADVERTISEMENTS

Rate: \$2.00 per word payable in advance each insertion. Capitalized words—75¢ per word additional. Minimum insertion ten words. To be inserted under the proper classification, copy must be in our office by the 15th of the second month preceding date of issue. The next available issue to place an advertisement in America's No. 1 Classified Section is May. The closing date is March 15th. Send remittance and order to C. A. Martin, Popular Mechanics, 224 West 57th Street, New York, New York 10019. Please make remittance payable to Popular Mechanics.

WHEN ANSWERING ADVERTISEMENTS PLEASE USE THE ZIP CODE NUMBER.

AUTOMOBILES

YOUR Ad in Popular Mechanics will be seen by more than 5,000,000 active buyers for your products and services. It costs only \$2.00 per word. And, if you wish to run all or part of your ad in capital letters—you can do so for as little as 75¢ per word additional. Act now! Place your Classified ad in Popular Mechanics today.

RCD THE Professional USED CAR GUIDE lists current monthly average RETAIL VALUES on American cars—foreign—light trucks 1964-1970. SAVE when buying or selling. Send \$2.00. RESEARCHED CAR DATA, Dept. P, P.O. Box 27385, Richmond, Virginia 23261.

INCREDIBLE NEW SCIENTIFIC "ANTI-GLARE" DEVICE, As Described in "Science & Mechanics", January Page 63 NOW AVAILABLE! \$18.75 Prepaid. H & T Company, Box 4, Hillcrest Alberta-Canada. Money Back Guarantee. Dealership Available.

AUTO SUPPLIES AND EQUIPMENT

BEAUTIFULLY Colored Hobby Car Murals 20"x30". Striking in den or office. Free Brochure. Write: Hobby, Box 93-ABM3, Lafayette, California 94549.

AUTO DRI-KLEENER! Cleans without soap or water, auto sparkling clean in minutes. Easy to use anywhere. \$2.25 postpaid. Casa Granada—Dept. PM3—501 W. Grand Road, Phoenix, Arizona 85003.

AUTO Parts for old and new Cars, All makes. Catalogue \$1.10. Antique Auto, Milwaukee, Wisconsin 53204.

REPAIR Hydraulic Jacks. Write Wallachs, Box 36, Richland, New Jersey 08350.

TIMING LIGHT Factory closeout guaranteed one year. While they last \$2.98. PP. Alan Enterprises, P.O. Box 1655 Harrisburg, Pennsylvania 17105.

PARTS: Army jeep and truck parts. Spare Parts & Equipment Co., P.O. Box 751, Lexington, Ky. 40502.

"CROSLY (¾ Midget) auto parts, accessories. Service, 616 Burnside, Inwood, L. I., N. Y. 11696."

BURNING Oil?? . . . Smoking?? . . . Pepless?? . . . Hard Starting?? . . . Save with Ring-Valve Job while driving \$6.50. (Special: Two for \$12.00 postpaid.) Results guaranteed!! Motaloy, Grantham, Penna. 17027.

PREVENT Flat Tires! Stop slow leaks! Seal punctures! Fantastic. New Liquid Product! Free information! Xcito Products, Dept. TG-4B, 5715 North Mozart, Chicago, Illinois 60645.

BE YOUR Own Ignition Expert. Install Ignit. Q-Arc, Box 47876, Los Angeles, California 90047.

ELIMINATE Overheating, install Radiator Surge Tank. Complete kit \$4.75 (postpaid). Free information. Gilbert Products, Box 2102, Milwaukee, Wisconsin 53201.

HYDRAULIC Jack repair kits, parts and supplies. Catalog 50¢ (in coin). Hydraulic Jack Packing & Tool Co. Inc., General, P.O. Box 3, Staten Island, N.Y. 10314.

MAGNIFIER LIGHT. Read maps, books anytime. Uses "C" batteries. \$4.95. Alan Smith, 2833 McClellan, Anniston, Alabama 36201.

METRIC Tools Information. 25¢ refundable with order. MediaMetric Inc., Box 461D, Media, Penna. 19063.

JEEP Owners—V8 conversions. Read Jeep Owners' ad, page 190.

STOP AUTO THEFT. Auto-Guard makes car jumper proof. Solid state silicone circuit deactivates ignition. Engine can't start even when battery voltage is jumped to coil. Easily installed. Be protected. Only \$6.95 ppd. 10 day satisfaction guarantee. Send check or M.O. Now! Three Son's Enterprises, 25080 Randolph Rd., Bedford Hts., Ohio 44146.

SNOWMOBILES

SNOWMOBILE Hop up accessory CATALOG. Speed and performance equipment—manifolds, exhaust systems. Send 25¢. G.E.M. PRODUCTS, Box 845, Carol Stream, Ill. 60187.

AUTO TRAILERS

CAMPER Plans and full sized patterns. The most detailed available with written and pictorial instructions. Various models and accessory kits offered. Send for literature—Glen L. 9152—PMC—Rosecrans, Bellflower, California 90706.

PICKUP Camper, Trailer or Pickup—Cover . . . Build yourself. Save! Complete plans \$3.95 each Cover plans \$2.00. Conversion Plans—econoline type van \$2.95; passenger bus or delivery van \$2.95. Satisfaction Guaranteed. Equipment catalog \$1.00 (refundable). Details 10¢. Viking Camper Supply, 99-F Glenwood, Minneapolis, Minn. 55403.

CAMPING Trailer, complete plans with 15 photos \$3.50. Sleeps 6. Kits and parts available. Stratford Trailers, Stony Creek, Connecticut 06405.

BUILD Your Pickup Camper. Precut kits, blueprint and supplies. Literature 25¢. Comstock Camper and Trailer Supply. Dept. 664, Parsons, Kansas 67357.

MOTORCYCLES, BICYCLES, MOTORSCOOTERS AND SUPPLIES

MOTORCYCLE Turn Signals, Accessories Catalog 35¢. Houston PM Lockport, Illinois 60441.

BUILD "Popular Mechanics" MINIBIKE featured June 1967 issue. Detail plans, photographs \$2.50 refundable. Kits, parts, engines; factory discount prices. Catalog 25¢. Gilliom Mfg.; PMC; St. Charles, Missouri 63301.

BARGAIN PRICES. Every part, Kart or Mini-bike. Giant Catalog \$1.00. New, "how to" plans \$1.00. Both, \$2.00. Brown's Motorsports, 19P Central St., Worcester, Mass. 01608.

ILLUSTRATED Catalog 25¢. Parts, Accessories, Custom Stock, most makes, models. Cycle Supply, Box 192M, Fairbury, Ill. 61739.

INDIAN PARTS. Rebuilding. Accessories. Indian Motorcycle Sales, Kansas City, Missouri 64127.

MINI-BIKES, Kart Plans \$1.00. Supply Catalog 25¢. Loren Products, Danville, Illinois 61832.

SERVICE Your own bicycle, or mini-bike. New Books from Sincere Press, Box 10422, Phoenix, Arizona 85016.

SPACE, ROCKETS AND ASTRONAUTS

ROCKET Launcher, Motorized, Electronic. Brochure, 20¢. Lercari Engineering, Box 90894, Los Angeles 90009.

ROCKETS: Real flying models—flights up to 2500 ft. New illustrated catalog 25¢: Singles and multistage kit, cones, engines, launchers, trackers, rocket aerial cameras, technical information. Fast service. Estes Industries, Dept. 7-C, Penrose 7, Colorado 81240.

ROCKETS!! Real flying models—2500 feet altitude with powerful motors. Terrific Science Projects. Tubes—Cones—Parachutes—Launchers—Igniters. Gigantic catalog—rocket data—diagrams—25¢. Fast Delivery. Centuri Rockets, Box 1988, Phoenix, Arizona 85001.

LIQUID Rocket. 10,000' Altitudes! Plans, \$2.98 (Catalog included). Star Space Systems, PM4, P.O. Box 4605, Vancouver 10, British Columbia.

MOON Landing Pictures, other historic space fantasies! Free Brochure! Box 234-PM, Merritt Island, Florida 32952.



AVIATION

AIRBOAT, Propellers, Plans, Kits, Supplies. 90, 125, 150 & 220 H.P. engines. Corvair, V-W, Conversions. Catalog \$1.00. Banks-Maxwell, Box 3301E, Ft. Worth, Texas 76105.

BE A Government licensed aviation mechanic. Practical training. Free information. Aero Mechanics School. Municipal Airport, Kansas City, Missouri 64116.

(Continued on next page)

AVIATION

(Continued from preceding page)

AVIATION Surplus Big Catalogue 50¢ (Refundable). Box 177PM, Spring Grove, Penna. 17362.

BUILD—One-Man jet helicopter. Easy inexpensive. Detailed plans, drawings—\$5.00. Helicopters, Box 7153, Baltimore, Maryland 21218.

HOME BUILT helicopter and airplanes PLANS. Single, two, four seaters. Complete literature \$3.00 (refundable). Genest Aircraft (PM), 6200 Iberville, Montreal 331, Canada.

BUBBLE Canopies—Special \$49.50, New! Other Sizes, Information 26¢. Carl Bouwens, Twing Road, Leroy, New York 14482.

HELICOPTER, One-Man, Portable, Bubble canopy, (also Snowplane, Airboat, Ice-boat), Kits, Plans, Information 10¢. Photos and three-view drawings \$1.00. COMPCOP, Inc., Box 1267, Redwood City, California 94064.



BOATS AND TRAILERS

FREE Catalog! Camping, Boating, Sailing Supplies; Gadgets, Hardware and Gifts. Laacke and Joys, 1439 N. Water St., Milwaukee, Wisconsin 53202.

FIBERGLASS Canoes, Kayaks, and Duck-boats. Many exciting models. Easily assembled kits. \$39.95 up. Free Literature. Riverside Canoes, Box 5595P, Riverside, Calif. 92507.

BOAT Kits, Molded Fiberglass. Save money—assemble yourself. Factory molded sections bond into one-piece craft. 20 models—14' to 32'. Cruisers, Runabouts, Houseboats, Sailboats. Big line accessories, motors, trailers. Easy terms. Free 80 page catalog. Luger, Dept. BC-71, 1300 East Cliff Road, Burnsville, Minnesota 55378.

PLANS, FULL-SIZE PATTERNS, FRAME KITS with step-by-step instructions specially for amateurs. Send \$1.00 for new catalog just off press—nearly 100 pages, over 80 designs 8' to 36': Sail, Jets, Inboards, Outboards, Cruisers, Houseboats, Hot Boats, Catamarans, Hydros. Glen Designs. 9152 Rosecrans, Bellflower, Calif. 90706.

BUILD Your own boat from our large-scale blueprints. Books of plans give how-to-build help. Hundreds of professional designs—motor, sail or auxiliary—for amateur builders. Free catalog. MoToR Boat-ing. 959 Eighth Ave., Dept. PM-RS, New York, N.Y. 10019.

FIBERGLASS Cloth and resin. World's finest cloth and non-run resin, at direct mill prices. Flotation foam. Complete line of plastics, silicon bronze and brass screws, save 60%. No sales tax. Boat Plans. Catalog 25¢. Freight prepaid. Stiles Boat Supply, Box 11P, Linden Ave., Mantua Hts., N.J. 08051.

NEW Outboards 1970 & 1969 McCulloch & others. 4 H.P. \$120, 9 Electric \$295, 18 . . . \$368, 60 Electric \$848, all sizes. Literature 50¢. Electric Marine, 1427 Broadway, Brooklyn, New York 11221.

CANOE! Kayaks! Factory-direct quality kits, from \$25.00. Many different models. Canvas hulls. Strongest construction materials. Free literature. Sportscraft, Box 8280, Columbus, Ohio 43201.

AMATEUR Boat Building Magazine. Plans, Discounts, books, instructions. 3183 Merrill, Royal Oak, Michigan 48072.

FIBERGLASS KITS \$99. Assemble Modern 35 lbs. Fiberglass Kayak from Molded Parts. Free Brochure, Kayaks, P.O. Box 47-G, Hingham, Massachusetts 02043.

OUTBOARD OVERBOARD? Send \$2.95 for "LOST MOTOR MARKER". Box 836, Huntsville, Alabama 35804.

44' CATAMARAN Plans. Fast Cruising Sloop, Details \$1.00, LB Designs, Box 1131, Mountain View, California 94040.

BOAT KITS, FRAME KITS, PLANS AND PATTERNS. World's most complete catalog. Over 200 top designs—New class Sailboat kits, 7' to 20'; Windmill, Snipe, El Toro, Penguin, etc. Trimarans and catamarans, 12' to 34'. Motor sailers to 28'. Power-cruisers, deep V's, fishing boats, houseboats, Hydros—large selection inboard and outboard, all classes. New Hydroplane kit boat, A, B, C class now ready. Ferro Cement-33' to 45' sail and power. Send \$1.00 for large Plan Kit Catalog or \$2.00 for catalog plus Boat Builders Guide to Clark Craft, 16-P Aqua Lane, Tonawanda, New York 14150.

"FIBERGLASS Cloth, math, polyester and epoxy resins. Wholesale catalog 25¢. Boat Molding book 30¢. Seifert's, Box 1206-M, Green Bay, Wisconsin 54305."

BUILD lively lightweight 16 ft. Windmill sailboat. Information free, building plans \$15. Class secretary, Mrs. George Holler, 5399 York Lane South, Columbus, Ohio 43227.

CAMPER AND TRAILERS —KITS—PLANS—

CAMPER & Trailer Kits—Assemble yourself, save 1/2 over factory built. 12 models: Pickup Truck Campers, Pickup Covers, Travel Trailers, Folding Tent Trailers. Big line of accessories. Easy terms, money-back guarantee. Free 24 page color catalog. Luger, Dept. TW-71, 1300 East Cliff Road, Burnsville, Minnesota 55378.

PLANS—Pick-Up Campers \$3.95; Pick-Up Covers \$2.00; Travel Trailers \$3.95; Vanette Conversions \$2.95; Bus Conversions \$2.95; Huge Supplies, Parts and Equipment Catalog at Discount Prices \$1.00 (Refundable). Order Plans, Discount Supply Catalog from this advertisement. Camper, Cover, Trailer Kits available—literature 25¢. CAMPERS, Box 377 C, Savage, Minnesota 55378.

MARINE EQUIPMENT AND SERVICES

FREE Brochure—Engines, Gears, 1/0's, Conversion Kits—Gas—Diesel. StarMarine, 1931 Embarcadero, Oakland, Calif. 94606.

MARINE Engines, conversions, parts. Catalog free. Charles F. Stokes Enterprises, Coldwater, Michigan 49036.

CONVERT Auto engines to marine. 68 Page Catalog, 50¢. Lehman Manufacturing Company, 800 Elizabeth Avenue, Linden 4, New Jersey 07036.

MARINE Supplies, Ignition Parts. Free literature. Michael's, 991 Broadway, Bayonne, New Jersey 07002.

FLOATING DOCK AND SWIMMING RAFT PLANS. \$3.00. Dock and board your boat with ease independent of water level changes. Build your own from readily available materials using easy to follow drawings and material list. Rugged, stable, puncture and corrosion resistant. Plans, 5 Harrison Avenue, Waldwick, New Jersey 07463.

ATHLETIC AND BODY BUILDING COURSES

SHORT STATURED? Growth, Height, Increase Facts, Medical details, Adults, Youngsters. 25¢ to: Physical Culture-PM1, Box 1548, Pompano Beach, Florida 33061.

POWERFUL Muscles fast! Free brochure! Universal Bodybuilding, Box 4327-C, Dearborn, Michigan 48126.

"GIANT Arms." Dr. Young's, D.C. revolutionary discovery. \$2. Satisfaction or refund. Gaucho, 1769-S7, Chicago 60690.

FEAR No Bully! Master Authentic Chinese Kungfu Unbeatable Techniques! Defeat Within Seconds Any Attacker Including Giant Judo-Karate Experts. Free Details By Air. Write Asia's Greatest Master, Leongfu (MI/48) 119, Anderson Road, Ipoh, Malaysia.

BE TALLER! Yes, grow man grow! Gain 2-6 inches actual height in few short weeks! Proven, safe method. Special one time offer: 25¢ Coin. Height Increase Bureau, P.O. Box 146-PM, Brampton, Ont. Canada.

GAIN Weight! Yes, Build Muscles! Get big in a few short weeks with Fantastic, New TENSILE CONTRACTION. Special one time offer: 25¢ Coin. Bodybuilding Center, P.O. Box 146-PM, Brampton, Ont. Canada.

REVOLUTIONARY New Books by Doctors!—"Giant Muscles"—"Skin Remedies"—"Jogging"—"Reducing"—"Quick Diet". Rush \$1.00 each (Guaranteed!): Fitness-books, 15242-C, Atlanta 30333.

SPORTING GOODS AND EQUIPMENT

GOLF . . . Discount Prices. Carts, Balls, Bags, Nets, and Accessories. Free Brochure. Renco, Box 1755, Anniston, Alabama 36201.

FREE . . . Wholesale Catalog. Arrow Shafts, Broadheads, Fletchings Fisharrow Parts, Tools, Bows, Finnyports. (22G), Toledo, Ohio 43614.

FREE 1971 Catalog. Guaranteed Lowest Prices! Rods Reels, Lures, Accessories—Thousands of Item. Cabela's Inc., Dept. S. Sidney, Nebraska 69162.

FREE Catalog low direct factory prices, fishing, Hunting, Archery, reloading Camping supplies. Send today Herfers Inc., Dept. CPM, Waseca, Minn. 56093.

DERRINGER 44 Caliber, Make Yourself Easy, complete, pre-machined kit with instructions \$10.50. Complete instructions only \$2.00. Fernwood, 1725 Springbrook, Walnut Creek, California 94596.

FREE Shotgun bag, send 50¢ postage, handling. Spencar, Box 51181, Tulsa, Okla. 74151.

CHANGE Inner tube into safe plaything for snow, beach, or backyard. Flush mounted valve \$2.50. Box 730, Claremont, California 91711.

ARCHERY Lowest Discount Prices. All top brands. Orders shipped same day received. Money-back guarantee. World's Largest Supplier. Free catalog. Anderson Archery Corporation, Grand Ledge, Michigan 48837.



FISHING, TACKLE, LURES

MOLDS For fisherman's sinkers, jigs, squids, casting and spinning lures. Free catalog. Sweet Molds, Tonawanda 1, New York 14150.

SEND For FREE Wholesale Catalog. The most complete and fully illustrated catalog of reels, rods, beads, spinners, jigs, bodies and parts, sinker molds, feathers, tools, hooks, rod blanks, rod parts, swivels, wire, etc. FINNYSPTS, ME Sports Bldg., Toledo, Ohio 43614.

MOLDS—For casting your own fishing sinkers. Free illustrated booklet. Reading Instrument Co., Box P78, Reading, Pa. 19603.

FISHERMAN'S DREAM BOOK—FREE, 170 Pages, pocket size and loaded with Hard To Find Fishing Specialties and Do-It-Yourself Goodies. Our 27th year. NETCRAFT, Inc., Box 5510, Toledo, Ohio 43613.

FISHERMEN WANTED AT ONCE. Field test and sell patented BIG BASS LURE. Combine Pleasure with Profit. Sample lure and starter kit \$7.50. Sherman Bryant Lures, Lewisport, Ky. 42351.

GAMECOCK Necks-Lifelike Minnow Molds, Plastic, Tying Materials, Instructions. Tackle Craft, Box 489-6 Chippewa Falls, Wisconsin 54729.

LETHAL Hook Method For Catching Fish. Deadly accurate. A nibble or a strike and you've "got-em"! Send two dollars for instructions. Catch, Box 936, Rock Island, Illinois 61201.

EARTHWORMS, LIVE BAIT

GROW Fishworms. Outstanding new breed. Free Literature. Fain's Hatchery-31, Edison, Georgia 31746.

MORE Profit: Better-Bred Fishworms. Important Information Free. Lee's, Box 326-M, Queen City, Texas 75572.

EARN Money raising fishworms for us! Exciting details free! Oakhaven-56, Cedar Hill, Texas 75104.

HYBRID Redworms 5000 \$10.00, 20,000 \$20.00 Postpaid with Raising Instructions, Worms, Route 9, Waco, Texas 76705.

\$15,000 YEARLY Raising Fishworms! Three outstanding breeds! Free Literature, Instructions. Breeder Redworms: 5,000-\$19.75. Georgia Hatcheries, Dawson, Georgia 31742.

BIG Profits Raising Nightcrawlers, Redworms, Soilless Method. Three Oaks, Dresden, Tenn. 38225.

FROGS, FISH, REPTILES

MAILORDER Records help get increased business! Complete 32 Page Record Book shows your inquiries orders, advertising, expense, etc. Only \$1.00. C. A. Martin, Popular Mechanics, Dept. PM, 224 West 57 Street, New York, N.Y. 10019.



HUNTING, GUNS, DECOYS

GUN SILENCER—Build on Your Stove in 1 Hour. Very Effective. Literature \$1.00. P.O. Box 19097, Sacramento, Calif. 95819.



DOGS AND KENNELS

DACHSHUNDS. For Information Write: Moonglow Kennels, 1318 West Second Street, Madison, Indiana 47250.



POULTRY & GAME BIRDS

QUAILS, Incubators, cages, supplies catalog. Marsh, 14216 Brookhurst, Garden Grove, Calif. 92643.

EGGS, chicks (started & adult). Pheasant, quail, chukar, waterfowl, turkey—game & ornamental. Bantams & chicken. Free price list. Northwest Farms, Inc. Box 3003 (PM), Portland, Oregon (503) 233-4659.

RABBITS—FUR BEARING ANIMALS

\$625—\$900 MONTHLY. Raise small laboratory-breeding animals for us. Also chinchilla. We supply breeders, equipment, instructions. Fox River Valley Research Farms, Department PMR-031, McHenry, Illinois 60050.

RAISE Rabbits successfully by knowing facts. 48 page illustrated book describing 25 breeds. Housing, breeding, feeding, markets, marketing etc. 25 cents. American Rabbit Association, 36 Arba Building, Pittsburgh, Penn. 15217.

INFORMATION 25¢/Raise for Staloch's Rabbitry, Box 6302, Rochester, Minn. 55901.

AMAZING PROFITS! \$10,000 Yearly Raising Rabbits for Wool and Breeding. Details 25¢ coin. American Angora, Malta 12, Montana 59538.

RAISE Rabbits for us on \$500 month plans. Free details. White's Rabbitry, Mt. Vernon, Ohio 43050.

MAKE Big Money raising chinchillas, rabbits, guinea pigs for us. Catalog 25¢. Keeney Brothers Farms, Inc., New Freedom, Pa. 17349 or Summerfield, Fla. 32691.

\$500-\$800 MONTHLY Part-Time. Raise Small Laboratory-breeding stock for us. We supply equipment, breeders, and instructions. Illinois Research Farms, Dept. MPB-2, Barrington, Illinois 60010.

"MAKE Guaranteed earnings raising Chinchillas for us. Catalog-50¢. DeShon Chinchilla Ranch, Dept. PM, 3722 South Park Drive, Fort Wayne, Indiana 46806."

PETS—BIRDS, CATS, HAMSTERS, ETC.

FLYING Squirrels, Gray, Fox Squirrels, Chipmunks. Send 25¢ For Brochure, Pictures, Prices. Pets, Neches, Texas 75779.

LIVE Seahorses, marine specimens, aquarium supplies. Illustrated catalog 25¢. Marine, Box 248-010, Dania, Florida 33004.

HAWKS, Reptiles, raccoons, skunks, squirrels. Catalog 25¢. Trails End Zoo, St. Stephens, S.C. 29479.

SEAHORSES, Animals, Aquariums and Pet Supplies, Catalog 25¢, Aqualand Box 130, Miami, Fla. 33145.

950 PICTURE Pet Hobby Catalog 50¢. "Everything—You Name It." Stromberg's Pets Unlimited, Fort Dodge 25, Iowa 50501.

TROPICAL FISH And Aquarium Supplies. Complete Catalog \$25. Aquarium Center, 172 S. Center Street, Orange, N.J. 07050.

HORSES, LIVESTOCK

"HOW To Train Horses"—Everyone who likes horses or ponies should have this book; Free. Write Beery School, 1103, Pleasant Hill, Ohio 45359.

CAMPING EQUIPMENT AND TENTS

PROFITS FROM CLASSIFIED ADVERTISING! Booklet shows you how to start your own business with Classified Advertising. Only \$1.00 (Refundable with first order.) C. A. Martin, Popular Mechanics, Dept. PM, 224 West 57 Street, New York, N.Y. 10019.

TRAVEL AND RESORTS

CANOE Trips—Canadian Outpost Cabins. Rom's Outfitters, Ely, Minnesota 55731.

WHERE To retire or vacation at rock bottom prices! Norman Ford's 100,000 Word Book, "Off the Beaten Path" covers Hundreds of low cost Vacation and Retirement Paradises. Only \$2.50. Fena Enterprises, 2045 North West 2nd St., Miami, Florida 33125.

ELECTRICAL SUPPLIES

LAMP Parts. Catalog, prices, wiring instructions. 50¢. Refunded first order. Gyro, 5218P N.W. 35 Ave., Miami 42, Florida 33142.

METERS—Surplus, new, used, panel and portable. Send for list. Hanchett, Box 5577, Riverside, Calif. 92507.

LAMP Parts for building, repairing converting. Catalog 40 cents. Refunded first order. Brown Lamp Co., Box 12511, Creve Coeur, Missouri 63141.

BATTERIES, GENERATORS

BATTERY Reconditioning Kit. Includes molds, material, instructions. Battery Shop, Route 1-188D, Blythe, Calif. 92225.

10 GUARANTEED 9-Volt Transistor batteries, \$1.95. David Tomich, 136 N. Marion, Oak Park, Illinois 60301.

ENGINES, MOTORS, MAGNETS

WINDING Data. 275 motors. \$1.20. Data Company, 512 Kensington, Kansas City, Mo. 64124.

SIMPLIFIED INSTRUCTIONS! Motors! Generators! Batteries! Electroplaters! Modequip, Box 7266, Kansas City, Missouri 64113.

MACHINERY, TOOLS AND SUPPLIES

MICROMETERS — Indicators — Steel — Aluminum — Brass Maximat, Unimat Lathes, Accessories. Lists free: Complete mailing—50¢. Campbell, 1424 Barclay, Springfield, Ohio 45505.

POWER-HONE To sharpen fishhooks, knives, model making and tool & die making. Vercon Supply, Box 316, Brockport, N.Y. 14420.

SMALL Foundry furnaces. Supplies. Free literature. Pyramid Products, 3736 South 7th Avenue, Phoenix, Arizona 85041.

BUILD Your Own Tool Post Grinder, Casting With Blueprint \$9.95. Specifications Free. General Devices Inc., 861 West 66th Street, Hialeah, Florida 33012.

ROUTER Bits, 1/4" shank, high speed, used; excellent condition, \$2.50 dozen postpaid. Lillian's, Box 17165, Chicago, Illinois 60617.

LATHE Milling attachments. Blueprints too! Write. Potter, Box 73, Cedar Rapids, Iowa 52406.

NEW Portable sandblaster \$21.00 (Air-compressor required). Free brochure. Inka, 2621-A Persa, Houston, Texas 77006.

ROTARY FILES Set 24, Various Shapes for 1/4" drill, use on metal, wood, leather. Send \$12.95. F. H. Potthoff, 1814 Pine Village, Houston, Texas 77055.

FREE Catalog . . . Calipers . . . Micrometers . . . Optical Comparator . . . Shop Microscopes . . . Illuminators . . . assorted Magnifiers . . . Unimat . . . Mototools . . . ultrasonic cleaners . . . Victor Peterzell Company, 305A Webster Avenue, Rochester, New York 14609.

ECONOMICAL Bench Mill, Plans \$2.50. Microm, Box 2313-A, Santa Ana, California 92707.

FREE Catalog—Micrometers, Dial Calipers, Indicators, Unimat Lathes—Raymond Leung, Rm. 136, 664 King's Road, Hong Kong.

LATHES, Millers, \$60. Build chucks, machines cheap. Machine, Newfane, Vermont 05345.

SHOPSMITH ACCESSORIES. Repair service, parts. Free catalog. Hobbymodels, Peoria, Ill. 61602.

RUST Protection for small tools, tackle. New. No dipping or painting. \$1.00. Janus I, Box 163, Cuyahoga Falls, Ohio 44222.

WELDING, SOLDERING, PLATING

WELDERS—110/220, 150 Amperes, \$53.50. Morris, 1070 Inner, Schenectady, New York 12303.

PLATING Equipment, supplies and "know-how". Build your own tanks for nickel, chrome, etc. Easy-to-install PVC liners. Rectifier components—all sizes. Schematics, parts lists, formulas, operating instructions for all plating. \$5.00 postpaid. Guaranteed to save you 25%-75% or immediate refund. Platers Service Company, 1511-A Esperanza, Los Angeles, California 90023.

GOVERNMENT SURPLUS

JEEPS \$50.00 Thousands items your area. Catalog \$1.00 Bargains, Hawthorne, New York 10532.

SURPLUS BARGAINS—War, government, Industrial surplus at savings to 80%! Clothes, boots, cots, tents—bargains for farm, home, outdoors. SEND FOR FREE CATALOG—must give zip code. SURPLUS STORE, Sioux Falls, S. D. 57102.

1971 SURPLUS Army, Navy store illustrated catalog. Send 50¢ (refundable with first \$5.00 order). Ruvel, 3037 North Clark, Dept. 3-J, Chicago, Illinois 60614.

(Continued on next page)

GOVERNMENT SURPLUS

(Continued from preceding page)

JEEP And Gov't. Surplus Buying Manual (Jeeps Pictured) 50¢. Surplus Bargain Catalogue 50¢. Both \$1. Surplus Bargains, Box 789PM, York, Penna. 17405.

JEEPS Typically From \$53.90 . . . Trucks From \$78.40 . . . Airplanes, Typewriters, Boats, Clothing, Camping, Sporting, Photographic, Electronics Equipment. Wide Variety, Condition. 100,000 Bid Bargains Direct From Government Nationwide. Complete Sales Directory and Surplus Categories Catalog \$1.00 (Deductible First \$10.00 Order From Our Separate Included Catalog). Surplus Service, Box 820-A, Holland, Michigan 49423.

NO CATCHES. Buy any surplus direct from U.S. gov't. All information \$2.00. Bridgworth, P.O. Box 2292-C, Vancouver, Washington 98661.

GOVERNMENT Lands . . . Low as \$1.00 Acre! Millions Acres! For exclusive "Government Land Buyer's Guide" . . . plus "Land Opportunity Review" listing lands available throughout U.S., send \$1.00. Satisfaction Guaranteed! Surplus Lands, Box 19107-AO, Washington, D.C. 20036.

GOVERNMENT SURPLUS. How and Where to buy in your area. Send \$1.00. Surplus Information, Headquarters Bldg., PM, Washington, D. C. 20036.

SAVE \$\$\$! Buy Gov't Surplus. How and Where to buy directory. Plus Income opportunities manual. \$1.00 to Bri-Mel Distributors, Box 93PM, Dayton, Ohio 45405.

JEEPS From—\$52.50; Typewriters from—\$4.15; Cars from—\$31.50. Walkie-talkies, motorcycles, airplanes, boats, Typical "As Is" bid bargains from Uncle Sam. Tremendous variety. Exciting free list. Write: Enterprises, Box 402X66, Jamaica, New York 11430.

HOBBIES AND COLLECTIONS

SEA SHELLS! Colorful collection of 100 beauties. \$2.95 postpaid. Refund if not delighted. Chappell, 801—30th St. NW-11, Roanoke, Virginia 24017.

FREE: German Medal; send 50¢ postage, get illustrated catalog; Iron Cross, \$1.50; 3 Regimental Crests, 50¢. Insignias, Box 71-P, Rockaway, New York 11694.

NEW Guide for Avon Bottle Collectors, 1971 printing over 150 photographs, including title, date issued, market price, \$3.95 plus .25 handling. Kenneth Mathes Sr., Box 322-M, Alliance, Ohio 44601.

COLLECTOR'S ITEM, Authentic scale replica, 1910 Maxwell Roadster \$13.95. Free Gift Catalog. Write: Pat Russell, 665 East 181st Street, 7D, Bronx, New York 10457.

HOW To Make Money Collecting Coins. Booklet \$1.00. Duffy-Day, 152 North Broadway, Red Hook, New York 12571.



STAMP COLLECTING

100 DIFFERENT Large, \$2.00. Keep wanted; credit for balance. Ask for auction list. Stamp Box, 9104 Veteran's, Tacoma, Washington 98498.

63 DIFFERENT U.S. commemoratives 10¢! Approvals. Gordon Davison Henniker, New Hampshire 03242.

KOREA 25 different 10¢. Approvals. Hijop, Box 505, Norristown, Pa. 19404.

FREE 300 Genuine postage stamps! Worth \$10.00 at catalogue prices. Africa, Europe, Asia, British Emp.—a fascinating valuable mixture from foreign convents—banks—etc. Who knows what you will find. Also free valuable booklet. "Get-acquainted" offer to Adults only. Approvals enclosed. Frasek Co., Inc., PM3, White Plains, New York 10601.

ITALY 25 Diff 10¢ To Introduce our Approvals. Atlas Stamp Co., Dept. 270, 5485 Edgelawn, Grand Rapids, Michigan 49508.

19th CENTURY Included in our Packet of 30 different Canada to serious applicants to our worldwide approval service . . . only 25¢. Modern Stamps, Dept. 57Ca, Ferrysburg, Michigan 49409.

RUSSIA—Paintings, Airmails, Rockets, Sports, 25 others, 10¢. Attractive packet approvals. Gouge, Box 88-MC, Elizabethton, Tennessee 37643.

FREE! BIG Bargain Catalog—New Edition listing thousands of bargains including U.S. & B.N.A. stamps, packets, albums, accessories and supplies. Also, fine stamps from our approval service which you may return without purchases and cancel service at any time. Jamestown Stamp, Dept. E31PM, Jamestown, New York 14701.

SURPRISE COLLECTION! Exotic mint British Colonials absolutely free with approvals. VIKING, Great Neck, 8, New York

FAMOUS PAINTINGS "50 different 50¢" when requesting worldwide approvals. C.&F. Stamps, 655 Forbes Street, East Hartford, Connecticut 06118.

505 DIFFERENT Stamps \$1.00. Paschall, 3035 McGowan Blvd., Marion, Iowa 52302.

72 DIFFERENT US or 25 different South American, 10¢ with approvals. Album Service, Soledad 6, California.

WOW! 110 All Different Germany 10¢. Commemoratives, Airmails, High Values, Big catalog, bargain lists. Also, fine stamps from our approval service, which you may return without purchases and cancel service at any time. Jamestown Stamp, Dept. A31PM, Jamestown, New York 14701.

HIGHER PRICES PAID For Stamps. For details write, Federal Stamp Exchange, Box 15088 Civic Center Sta., Columbus, Ohio 43215.

BEAUTIFUL \$4.00 Value. 100 different large Russia \$1.00. Approvals. White, Box 26265-FB, Indianapolis, Indiana 46226.

DOUGLAS MAC ARTHUR Memorial stamp on lovely first day cover addressed in your name. 35¢ each, 3 for \$1. K. M. Walsh, Box 308D, TUCKAHOE, N. Y. 10707.

VATICAN Xmas Set (1967) 50¢. Approvals. Barricks, Box 7154, Detroit, Mich. 48202.

U.S. MINT Specials! Flag set, complete \$1.00. 1¢, 2¢, 3¢ famous Americans (21 different) \$1.00. Free list. Brooks, 2601 Avenue "U," Brooklyn, N.Y. 11229.

"AFRICA." 25 Beauties, 10¢. Approvals. Gorliz, Box 1915PM, Naples, Florida 33940.

FREE 50 Worldwide, Approvals. University Stamps, P.O. Box 1471, Lake Worth, Florida 33460.

ONE CENT A Stamp. Write for a jumbo book of Foreign stamps at 1¢ each, mounted in Scott order. PP, Bullot, 6815 Bay Parkway, Bklyn., N.Y. 11204.

PENNY! Approvals! Regardless catalogue! Kloster, 4164 52nd St., San Diego 5, Calif. 92105.

50 YEARS Old, fifteen different United States, over fifty years old—10¢ with approvals. Jaxon, Box 145-P, Brooklyn, New York 11230.

UNITED STATES Commemorative collection containing 33 different—10¢. Approvals. White, 516-A Avenue L, Brooklyn 30, New York.

U.S. BARGAIN, 50 Different 10¢, with beautiful worldwide, approvals. Stamp Center, Kennebunk, Maine 04043.

"INVERTED ERROR" Dag Hammarskjold. 6¢ with approvals. Belmont Stamps, Washington, D.C. 20015.

50 DIFFERENT Old U.S. Revenue stamps 50¢. Winchester Stamps, Box 1592, Mansfield, Ohio 44907.

FREE Surprise collection sent with approvals. Gould, 1784 Union, San Francisco 94123.

PENNY Stamps! 1000 Mounted in book at 1¢ each! Trast Stamp Company, P.O. Box 100-P, Jamaica, New York 11435.

ABSOLUTELY Free United States Mint Souvenir Sheet When Requesting United States Approvals. K.&B, Box 70, Brooklyn, N.Y. 11223.

100 DIFFERENT United States, only 25¢ with Approvals. Shelton, Box 547C, North Miami, Florida 33161.

100 OLD United States between 1861 and 1935. \$1.00. Roush Stamps, 423 Shepard, Mansfield, Ohio 44907.

225 STAMPS For only 10¢! Airmails. Pictorials: stamps from strange countries cataloging up to 25¢ each! Plus unusual stamps to examine. Buy any or none return balance, cancel service anytime. Mystic Stamp Co., Camden 80, New York 13316.

QUALITY AND LOW PRICE. EXCELLENT For advanced or beginner. Mounted approvals 2¢ up, all countries in Scott's Order. Preview Stamps, P.O. Box 9809M, San Diego, California 92109.

500 DIFFERENT Stamps, \$1.00. Smith, 508-A Brooks, College Station, Texas 77840.

RUSSIA High-Value Collection. 32 different Russia—some over 50 years old! Commemoratives, Czarist Issues, Airmails, Catalog price \$2.50. Special Get Acquainted Offer—all for only 10¢! H. E. Harris, Dept. GG 49, Boston, Mass. 02117.

NEW Issues—Free Weekly Illustrated list. Brooks, 2601N Avenue "U," Brooklyn, N.Y. 11229.

210 DIFFERENT U.S. Commemoratives \$1.00. Stamps, 7607 Larchview, Dallas, Texas 75240.

RUSSIAN Space collection 10¢. Russian Approvals, Snedco, Box 68-P, Waldwick, N.J. 07463.

14,000 DIFFERENT! AMAZING New plan builds your collection systematically, country by country. Only 50¢ weekly. Ware, Monroe, Conn. 06468.

TEN Different Nudes: 20¢. Approvals, Stamp Farm, 2M28, Oxford, Wis. 53952.

MILLIONS Foreign Stamps! 2¢ each! Send for gigantic approvals! ABC, Box 6000-MB, San Francisco, California 94101.

AMERICANS On foreign stamps, Presidents, Kennedy, Roosevelt, Lincoln, U.S. Spacemen, Princess Grace and others. 10¢ with approvals. Roseland Stamps, Dept. 57, Spring Lake, Michigan 49456.

YOURS FREE! 20 Almost Rare Stamps from 12 Lost Nations—Most a Half-Century Old! Nations overrun by invaders and never freed again. Stamps so appealing that experienced and beginning collectors alike will want them. You get 110 other stamps from Britain's Lost Empire plus illustrated Album to keep as a Bonus should you buy \$1 from our Approval Selection. Or return Album and 110 stamps with selection and buy nothing. Cancel Service anytime. But Lost Nations stamps are yours to keep! Send 10¢ for mailing while supplies last. Kenmore, Milford LN-676, New Hampshire 03055.

FREE!! 25 U.S. Commemoratives, 2" Diameter Magnifier. Postage—10¢. Approvals. Mixdrak, 5630 Wilson, Chicago 60630.

VIETNAM 25 Different 10¢ approval. Sam Chazen, Box 95, Ozone Park, N.Y. 11417.

50 DIFFERENT U. S. Commemoratives. 15¢. Approvals. Cambridge, Box 2311, Heath, Ohio 43055.

TOPICAL Treasure: Thousands of huge multi-colored stamps, 2¢ each. Belden, Box 4175B, Dearborn, Michigan 48126.

APPROVALS, International, up to 90% off. No gimmicks. Dryz, Box A9209, Treasure Island, Florida 33740.

"SPACE" Pictorials, others. 110 Different—10¢! Approvals. Shaw, Drawer E-64, Montevallo, Alabama 35115.

25 MALAYSIA, 10¢ With approvals. Campbell, Box 5295-P3, Phoenix, Arizona 85010.

NOW Rockets, Paintings, Giant beauties, others. 10¢. Approvals. Tiquet, Box 1496 Denver, Colorado 80201.

(Continued on next page)

STAMP COLLECTING

(Continued from preceding page)

CLOSEOUT SALE: Unbelievable low prices. Generous lot \$1.00. High value packet \$2.00. List Free. Persile, 436 N.Y. Ave., Brooklyn, N.Y. 11225.

OLDER UNITED STATES Approvals to adults only. Intriguing, worthwhile. Engle, Box 208P, Lowell, Michigan 49331.

FREE Russian To Approval Customers. Stroud, Box 8133, Montgomery, Alabama 36110.

CANADA Sports Complete 15¢. Canada approvals. Valley Stamps, Little Valley, New York 14755.

U.S. TIPEX Souvenir Sheet 50¢ With U.S. Approvals. Jester Stamps, Box 425M, Georgetown, Delaware 19947.

RUSSIA—25 Beauties plus Space set. Only 10¢! Approvals. Robert Carlson, Box 16135, Long Beach, California 90806.

FAR EAST ASSORTMENT—VIET NAM, JAPAN, KOREA, Formosa and others only 10¢ with world wide approvals. Clark Stamps, Dept. 57V, Muskegon, Michigan 49444.

RARE Stamp Free! Also new packet Aden to Urundi, with Kennedy, Triangles, Space, Sports, Ships, Dogs, Cats, Reptiles Plus Others. All Free. Send 10¢ for mailing. Empire Stamp Co., Dept. 1, Toronto, Canada.

SEND Only 10¢ for the most wonderful catalog of stamp offers in America. You will also receive a special bonus collection of over 150 different stamps from Congo, Nigeria, Mauritius, etc. Littleton Stamp, Dept. MN-1, Littleton, N. H. 03561.

VALUE PACKED Approvals On Requesting Our World-Wide Selections. Stamp A Nanza, 1904 Broad Street, Schenectady, New York 12306.

ROMANIA 50 Different 10¢ Approvals. Lansdowne Stamp Company, Box 257, Lansdowne, Pennsylvania 19050.

15 IRELAND Commemoratives 25¢. Penniston, Box 5502, Arlington, Va. 22205.

FREE 50 Different with Approvals. Polze, Box 5215, Milwaukee, Wisconsin 53204.

FREE 10 Japan War Stamps. Approvals. Schroeder, 1486½ Sherburne, St. Paul, Minnesota 55104.

400 FINE Mixed U.S. 15¢. Wright, Box 753-M, Hagerstown, Maryland.

225 DIFFERENT U.S. Commemoratives \$1.00. 500 Mint and Used \$2.00. Superior, Avon Lake, Ohio 44012.

WASHINGTON BI-Centennial! Lake Placid Arbor Day! All Mint!!! Two Dimes! Request Approvals! Box 361, Eagle River, Wisconsin 54521.

HIDDEN British Colonies: Antigua, Cayman, British Honduras, Grenada "Moon Walk", Turks-Caicos. Multi-colored beauties. Free with approvals. Laffal, Box 691, Silver Spring, Maryland 20901.

JOIN The World Mail Club for World mail direct. Plus, How to Become a Stamp Dealer. Free details. Alfred Fahsing, Atascadero, California 93422.

5000 USA. Contains airs, dues, presidentials, revenues, 19th Century, high values, etc. \$3.00. 300 pre-1940 USA commemoratives \$2.00; 700 \$4.00. 1500 foreign \$1.00; 5000 \$3.00; 9000 \$5.00. No approvals. Meyers, 5321 Fleming, Richmond, California.

FANTASTIC!!! Astonishing Surprise Stamp Collection—10¢!!! Approvals. Box 4155M, Tulsa 74104.

I PAY \$250 Each For 1924 1¢ Green Franklin Stamps, Rotary Perforated Eleven (\$2.500 Unused). Send 25¢ For Illustrated Folders Showing Amazing Prices Paid For Old Stamps, Coins, Collections. Vincent, 85PM, Bronx, New York 10458.

FIFTY Spanish Pictorials 35¢ for Approval Applicants. John Swenson, Box 46, Occoquan, Virginia 22125.

FREE Stamp Wallet with approvals. Wide choice collections by Countries. Clark, Box 38, Wilmette, Illinois 60091.

BEGINNERS 100 Different World 10¢. Approvals. Moonstone Stamps, Box 343, Fontana, California 92335.

307 DIFFERENT Triangles, Sports, Topicals, etc. Worth near \$8.00. Only 25¢. Bargain approvals. Jayto Stamps, East Syracuse, New York 13057.

MINT United States. 5 Early Commemoratives 25¢. Approvals. Stamps, 3835 42nd Street, Meridian, Mississippi 39301.

FREE!—1000 HINGES. Approvals Accompany, 12¢ postage, Ohlsen, B103, Fairfield, Illinois 62837.

U.S.—Worldwide Colonies—4¢ each approvals. Faye Zoeller, Troy, Missouri 63779.

APPROVALS: Plus Collections By Year Martus, Box 251 Bushkill, Pennsylvania 18324.

FREE \$1.00 CREDIT When You Request Beautiful—Commemorative And Worldwide Pictorial—Stamp Packet Approvals! Donaldson, 9410 Lansford Street, Philadelphia, Pennsylvania 19114.

FREE African set. Approvals. Chapman Stamps, 61 Division, Galesburg, Michigan 49053.

60 DIFFERENT U.S. (30 Commemoratives) 25¢. Seidenberg, Salem 169, Oregon 97308.

TRADE Seven your duplicates plus \$1.00 for 82 (75 without trade) large Polish pictorials. Happy Traders, Box 700, Commerce, Texas 75428.

AUSTRALIA—Fifty Different 10¢ With Approvals! Value Stamp Company, Tenbrooke, Silver Spring, Maryland 20901.

"WALT Disney" Commemoratives—San Marino's latest—Free! Approvals plus 101 Bonus Sets. William Deems, 226X Race, Ravenswood, West Virginia 26164.

500 DIFFERENT World, \$1.00. 1000 different, \$2.50. Free price lists, U.S. and Foreign. Faville, Box 4164, Madison, Wis. 53711.

500 STAMPS 25¢. Approvals. Eric's, Box 1444, Kitchener, Ont., Canada.

255 DIFFERENT Worldwide: 15¢. Approvals. Tibbets, 8675 Meadow, Downey, Calif. 90242.

TWO Cent Approvals. The Best. Scotty Stamp Co., Box 155, Staten Island, New York 10301.

125 STAMPS FREE To New Customers Requesting Our Top Quality Stamps On Approval. Edward Roth, Box 4252, Parkersburg, West Virginia 26101.

APPROVALS: Plus 100 different foreign with pictorials 10¢. Bragg, 110 Lynnhaven Drive, Hampton, Virginia 23366.

SPACE Pictorials 25¢ with approvals. Satellite Stamp Company, Box 6268B, Buena Park, California 90620.

PACKET Bargains! Sample 25¢. F. Ross, Box 152, Wayne, Penna. 19087.

50 DIFFERENT Latin America 10¢ with approvals. Quynn's, Scotland, Penna. 17254.

FREE 149 Flag Stamps with approvals. W-B Stamp Company, Wilkes-Barre, Penna. 18703.

"WHOLESALE" U.S.—Foreign Pricelist and catalog Free! Everything Guaranteed. Schneider, Box 1240, Grand Rapids, Michigan 49501.

ASIA—100 Different, including pictorials. 10¢. Approvals. Tarheel Philatelics, Siler City, North Carolina 27344.

COINS, TOKENS, CURRENCY

DIMES: 2 Different Silver Roosevelts. 25¢. Stevens, Box 546F, North Miami, Florida 33161.

PENNIES S Mints—22 Different Plus 1943PDS—\$1.75 List. 10¢. Krietlich, Box 34273, San Francisco, California 94134.

COMPLETE U.S. List: Cents to Silver Dollars + Supply List + \$1000.00 bank-note 25¢. Schuitheis, Box 151-M, New Hyde Park, New York 11040.

"S" LINCOLNS, 1941S Through 1970S \$1.25. Morehead, 208B Houston, Thousand Oaks, Calif. 91360.

BOTTLES Are Valuable! Free Information—Bottle Treasures. 7311 Van Nuys, Van Nuys, California 91405.

JEFFERSON Nickels (Fine) 1938-D, \$1.40; 1938-S, \$3.00; 1939-D, \$5.00; 1939-S, \$1.50. Catalog 25¢. Free With Order. Village Coin Shop, Dept. P, Plaistow, N.H. 03865.

COINS Reduced! Bargain List, 10¢ (Refundable). Economy Sales, Mansfield, Massachusetts 02048.

ROOSEVELT Dime Specials. All Very Good Or Better. 1949S—80¢, 1955—\$1.50. 1955D—65¢, 1955—40¢. All Other Dates Are 25¢ Each. Complete Set Of 55 Different With Album For \$14.50. Satisfaction Guaranteed. Bryson Inc., 612A White, Toledo, Ohio 43605.

SILVER Dimes: All Different: 30 For \$5.50. Hobby Shop, 179 Mass. Avenue, Arlington, Mass. 02174.

BARGAINS! Rare Coins Pricelist! 25¢ (Refundable) Premiere, Box 7776PM, Spokane, Washington 99208.

25 DIFFERENT Foreign Coins \$1.00. Hoffman, PM-3, Box 98, Clarence, New York 14031.

NICE 1939-S Nickel and Giant List only 50¢ and 6¢ Stamp. Sims, Box 12175P, Richmond, Va. 23241.

SCARCE 1958-d Apostrophe 8 Error Cent Uncirculated 25¢. Bargain Lists Free. Sayers, 1000 Unaka, Johnson City, Tennessee 37601.

SILVER DOLLARS Uncirculated, 1880-81—1883-84-85 \$4.00 Ea. Catalogue 50¢. Shultz, Salt Lake City, Utah 84110.

SPECIAL! Silver Dollars \$2.75; Terrific List! Fairway 121-K Rye, New York 10580.

INDIANHEAD Cents. Good and Better. 3 different \$1.00. Send stamped, self-addressed envelope. B.U.D., P.O. Box 188, Novi, Michigan 48050.

SENSATIONAL Packet Clearance. Twenty Different Packets 50¢. Norge, Wyckoff, New Jersey 07481.

RUSSIA, 25 different only 10¢ with approvals. FREE NUDE SET also included. EXTRA ADDED SERVICE: FREE EXCHANGE PLAN for your duplicates. Markwell Stamp Mart, P.O. Box 921, Schenectady, New York 12301.

GOLD COINS Of The World. Beautiful. Low prices. Plus thousands of United States Coins. Free price list. Please send long, airmail envelope, self-addressed, stamped. Silver Center, Box 22171-M, San Francisco, California 94122.

22 "S" LINCOLNS, including 1955S, \$1.60. 26 1909-1939, \$1.60. 10 "S" Jeffersons, \$1.60. All different. All three \$4.50. HARRIS, 2775P Park, Santa Clara, California 95050.

BEAUTIFUL Uncirculated Silver Dollars—Ten different Dates 1880 to 1902 \$34.75. Bargain Lists 15¢. Bebee's Incorp., Omaha, Nebraska 68111.

FREE! One Indian Cent. Write. Tobey, Box 3061, Glendale, California 91201.

"OLD STUFF!"—3 Different Indians, \$1.00. 11 Different Buffalo's, \$1.65. 11 Different Mercury's, \$2.40. Hobbyist's Village, Box: 781, Lynbrook, N.Y. 11563.

UNCIRCULATED 1955-S Lincoln, 50¢; three, \$1.00. FREE bargain lists. Ron Farley, Metamora, Illinois 61548.

JUMBO Assortment, 100 different Lincoln cents, 1909 and up—\$5.00. Sprague, Kingston Drive, Muskego, Wisconsin 53150.

\$10 PER Pound! Thousands of Indian & Lincoln cents from 1850's thru 1920's. Sample mixture of 20—\$2. Mrs. A. Fisher, Box 1778, Encino, California 91316.

MARCH 1971

ANTIQUES, RELICS, INDIAN GOODS & CURIOS

AUTHENTIC Old Indian Pottery. Excavated in East Texas. \$2.00 Petri, P.O. Box 432, Jacksonville, Texas 75766.

LIST Indian relics. 10 Arrowheads \$3.00. Hyde's, Box 2304, Santa Fe, New Mexico 87501.

TONS Of antique gun parts and supplies. All reproduction muzzle loading guns. Send \$1.00 for enlarged illustrated catalog No. 120. Dixie Gun Works, Union City 12, Tennessee.

EVERYBODY LIKES DIXIE GUN WORKS.

10 PERFECT Arrowheads \$4.00. Smith, 9825 Conway Drive, Indianapolis, Indiana 46236.

INDIAN Relic list. Arrowheads \$4.00, doz. Folsom. \$5.00 each. C. Secrist, Muscatine, Iowa 52761.

10 BEAUTIFUL Arrowheads \$2.00. Guajardo's, 8713 Shaver, El Paso, Texas 79925.

MODELS—CARS, SHIPS, TRAINS, PLANES ETC.

ROCKETS: Real flying models—flights up to 2500 ft. New illustrated catalog 25¢. Single and multistage kits, cones, engines, launchers, trackers, rocket aerial cameras, technical information. Fast service. Estes Industries, Dept. 2-C, Penrose, Colorado 81240.

SHIP Models Kits, fittings, plans, books, tools, engines, motors. Big illustrated catalog 50¢. Mass. residents add 3% tax. James Bliss & Co., Dept. SM, Route 128, Dedham, Mass. 02026.

SHIP And yacht model fittings: Pine construction hull kits: blueprints. Send 50¢ for illustrated catalog. A. J. Fisher, Inc., 1002 Etowah Avenue, Royal Oak, Michigan 48067.

SHIP Models catalog 25¢. Scientific, Inc., 100 Monroe, Newark, N.J. 07105.

MODEL Airplanes—Big 220 Page Catalog 50¢. Sig Company, Montezuma, Iowa 50171.

LIVE Steam powered backyard railroads! All sizes. Complete "bolt-together kits," and rough castings. Excellent drawings. 100 page catalog \$1.00. Little Engines, Lomita, California 90717.

SHIP and Cannon Models: Wood and Metal. Books, Tools, Accessories. Send 75¢ for Catalog. Marine Model Co., Inc., Dept. PC, Halesite, New York 11743.

GAMES, TOYS, PUZZLES, NOVELTIES

AMAZING Hypnotic Disk! Great Fun At Parties. \$1.00 each. 2-\$1.50, 3-\$2.00. Keevil's Gift's, Dept. 1A3, 6041 Washington, Chicago Ridge, Illinois 60415.

RENO Slot Machine Mechanical Bank. Write. Meredith's, 2475 Dyer, Reno, Nevada 89502.

MAGIC TRICKS, JOKES, VENTRILOQUISM

MAGIC MAGAZINE—Monthly since 1936. 44 pages. All phases. 3 month trial \$1.00. Genii, P.O. Box 36068, Los Angeles, Calif. 90036.

COMPLETELY Illustrated catalog. 84 pages, 25¢. Manhattan Magic, Box 334-M, N.Y.C. 10011.

BE A Magician! Two booklets explaining sixty-eight tricks plus large professional catalog. \$1.00. Magic Inc., 5082 Lincoln, Chicago, Illinois 60625.

HOUDINI'S Original Magic Shop. Established 1856. Send 25 cents for illustrated Catalog containing 5000 Tricks. Mindreading, Puzzles, Hypnotism and Jokes. Flosshornmann, 304 West 34th St., N.Y. 10001.

WORLD'S Finest professional magic tricks. Joker's Novelties. Giant illustrated catalog 10¢. Top Hat, Evanston, Illinois.

FABULOUS MAGICS New 1971 catalogue 25¢. Our specialty orders shipped same day no substitutes. Fabulous Magic, 3319 East Charleston, Las Vegas, Nevada 89104.

FREE! World's Leading Catalog 2000 Novelties, Jokes, Tricks, Scientific Gadgets, Hobbies. Johnson-Smith, C-10, Detroit, Michigan 48224.

500 TRICKS, Douglas famous Magic Catalog, only 10¢. Better Magic for pocket, club, stage. Fastest mail service. Douglas Magicland, Dept. 11, Dallas, Texas 75221.

MAGIC Catalog. World's finest 3000 tricks. (340) pages \$2.50. Beginners, amateurs, professionals. Kanter's, A-200 South 13th St., Philadelphia, Pa. 19107.

HOUDINI'S Greatest Magic!! You can now do them!! Giant Illustrated Catalog 25¢ with Free trick. Vick Lawston, Box 2026-P, Pompano Beach, Florida 33061.

VENTRILOQUISM! Information free! Dummy catalog 25¢. State age. Maher, Studio C, Box 9037, Denver, Colorado 80209.

LEARN VENTRILOQUISM with our Home Study Course. FREE information. Write Izzy Rizzy's School of Ventriloquism, 3635 W. 63rd Street, Chicago, Illinois 60629.

BOOKS, CATALOGS, NEWSPAPERS

HOW TO GET 20 TO 90% Off On Everything You Buy. \$2.00 No C.O.D. Mark Books, 31 Commerce Street, Newark, New Jersey 07102.

LEGITIMATE Australian Books, Magazines, Newspapers—36 pounds—all different, relevant, uncirculated—\$35.00 Postpaid USA (Canada-\$42.00). Australasian News, Box 6428, Torrance, California 90504.

FREE Circular "Self Development" and "How To". Garrett Associates, 1110 Fidler Lane, Silver Spring, Maryland 20910.

FREE Circular "Self Development" and "How To". Garrett Associates, 1110 Fidler Lane, Silver Spring, Maryland 20910.

VALUABLE Booklet! Vital Information! "How To Protect Yourself and Family Against Crime." \$1.00. Xcito Products, Dept. 51, 5715 North Mozart, Chicago, Illinois 60645.

FREE List How-To, Educational books. Marney Enterprises, 3138 North Drake, Chicago, 60618.

FREE BOOK. Prophet Elijah Coming Before Christ. Megiddo Mission, Dept. 63, 481 Thurston Road, Rochester, N. Y. 14619.

NATIONAL Geographic Magazines, 1888-1967, any issue. Buxbaum, Box 465-PM, Wilmington, Delaware 19899.

FIVE Golden keys to health, wealth, and happiness. Details free. Glenn A. Gerber and Associates, 311 A. Jefferson; Morton, Illinois 61550.

APPLIANCE Service Manuals. Washers, Dryers, Dishwashers, etc. \$2.75 Each Ppd. Magna Enterprises, Mt. Vernon, Ohio 43050.

FREE FILMS, Posters, sporting goods, product samples etc. Can be yours when you have this 170 Page Directory of things that are yours for the asking. This is the original Directory used by people in the know to order thousands of free items. Send \$1.00 (includes postage). Return directory if not completely satisfied. IMAGE, Box 691, New York, New York 10022.

SEND 50¢ For Giant New Color Navy Arms Catalog Reference Book featuring America's largest selection of Muzzle Loading Replica Firearms & Accessories, which can be purchased by mail. Complete instruction on how to handle a Muzzle Loader and kits to build your own. Address: Navy Arms Company, 689 Bergen Blvd., Ridgefield, New Jersey 07657.

PLAYS, SONGS, MANUSCRIPTS

SONGWRITER! Poets! Spiritual and religious poems, songs wanted for recording by Chapel Symphony Orchestra and Choir. We pay all recording costs! Dept. PM, Chapel Recording, P.O. Box 162, Wollaston, Mass. 02170.

SONGS, SONGPOEMS Wanted for Radio Show. Hollywood Music Productions, 6425-PM Hollywood Boulevard, Hollywood, California 90028.

"FOR Choirs, Harmony Groups, Soloist, New Hymn Entitled "Marvelous Love." Sheet Music Copy \$1.00. Hank Meadows, Box 11401, Winston-Salem, N.C. 27106."

BUSINESS OPPORTUNITIES

MAILORDER—Profitable products, drop-shipped. No merchandise investment. Everything supplied—catalogs, ads, mailing lists. Gift-Guide, 1137½ Crenshaw, Dept. 283, Los Angeles 90019.

MAILORDER Business. Dime brings literature. Andrews, Box 485, New York, New York 10013.

SELL Gifts and household items—Make extra money. Toys, Jewelry, Stationery, Wrappings, All Occasion, Easter Card Assortments. Salable Samples on Approval, Free Color Catalog. Bonus Plan. Write Hedenkamp, 361 Broadway, Dept. PM-109, New York 10013.

INSTALL Burglar Alarm Systems. Big profit home business. Beginners start spare time, without mechanical experience or costly equipment. Free starter plan. Nasco, Dept. E2703, 11071 Massachusetts, Los Angeles 90025.

HOW To Finance A Business. Get \$500 to \$2 million. Free information Capital-17, Kerrville, Texas 78028.

MAILORDER! . . . \$8,000.00 Year! . . . Starting Capital \$6.00 at Home! . . . Free Proof! Alvin Whitmire, Clinton, South Carolina 29325.

EXTRA Cash Workhome men, women!! Successful mailorder yours!! Easily!! Proof . . . Free!!! Williams, POB44646A, Los Angeles 90044.

SECRETS! Mail Order Success. Internationally famous expert reveals how to make home business fortunes. Beginners: Get free copy "Make Money By Mail." Discloses free advertising, profitable products. Mailco, 1554 Sepulveda, Dept. E2703, Los Angeles 90025.

PREPARE Tax Returns—Policeman Albert Myers made \$2000 his very first season. Train at home. VA Approved. National Tax School, Monsey, 2EC, N.Y. 10952.

\$625—\$900 MONTHLY. Raise small laboratory-breeding animals for us. Also chinchilla. We supply breeders, equipment, instructions. Fox River Valley Research Farms, Department PMO-031, McHenry, Illinois 60050.

EARN BIG MONEY. Thrilling HOME mail-order business. Details \$1.50. Andrew Sales, Box 152A, Blue Island, Illinois 60406.

NEW Plan! Pays up to \$25.00 an hour! Little as 4 hours weekly. Place Luxko self-service displays in stores. No cost to merchants. No experience needed. Free details. Lux Company Incorporated, Dept. 1600, Elkhart, Indiana 46514.

PROCTOR & GAMBLE ANALYSIS Of Major Canadian Independent Postal System discloses how to earn \$30,000.00 yearly and up. Owner Operators in major Canadian cities that have adopted this unique delivery system Guarantee Success first year. No capitol required, work from home. Send \$5.00 for complete operation information. No follow up charges. Testimonials from major Canadian firms supplied. Non-Franchise affiliation offered by affiliated Cross Canada companies delivering for International Department, Chain and Mail Order Houses. Recent Post Office rate increases make this a natural for Family Business in cities and towns. P.O. Box 1043, Edmonton, Alberta, Canada.

(Continued on next page)

BUSINESS OPPORTUNITIES

(Continued from preceding page)

IMPORT-Export opportunity, profitable world-wide, mail order business from home, without capital; or travel abroad. We ship proven plan for no risk examination. Experience unnecessary. Free details. Mellinger, Dept. E2703, Los Angeles 90025.

MAIL LETTERS Featuring real merchandise. Get \$12.00 orders every mail. \$8.00 Profit! Everything furnished! Write: BONELL, 20260-A Bensley, Chicago Heights, Illinois 60411.

FREE Millionaire Book. Get Plans, Set-Ups, Little-Known Businesses. Work home! National-7, Kerrville, Texas 78028.

SELL Books By Mail. Complete Dealer Set-Up—20¢. Midwest Mail Sales, Box 44R2-PM, Shawano, Wisconsin 54166.

\$128.00 IN SALES FROM \$12.00 MATERIAL. New . . . Different. Everything Furnished. Write: Sierra's, 162 Main, Amador City, Calif. 95601.

STRIKE IT RICH AT HOME! 622 Proven Plans. Details free. Opportunity, Box W-22, La Mesa, Calif. 92041.

1,000,001 PROFITABLE Mailorder Opportunities. Free list! Specialty, Box 45PM, Lakeside, Iowa 50588.

"MAILORDER LAWS and Regulations." \$2.00. Wonderful drop-ship proposition. Neil H. Tasker, Shamokin, Pennsylvania 17872.

MAKE Gorgeous original candles for all holidays and special occasions. Learn expert Candle decorating, candlemaking, use of professional molds. Free details on home instruction method. Candle Institute, Dept. B-23, 1600 Cabrillo, Torrance, Calif. 90501.

HOW Much does being your own boss or making \$25,000.00 per year interest you? The Warner breakthrough in the Engraving field could be your future. Write: Warner, Room EC-2-AC, 1512 Jarvis, Chicago, Ill. 60626.

MAILORDER. How to prepare your own catalog for pennies. Free Catalog! Obie-MKP, Brooklyn, New York 11219.

MAKE Up To 900% Profit with your own Magnetic Sign Shop! Rapidly growing demand for 3-Dimensional Magnetic Signs on cars and trucks! Start in garage, workshop, or kitchen. Full or spare time. Write today for free details. Nationwide Plastics, Dept. 35, 4200 Panamint, Los Angeles, Calif. 90065.

CLIP Newspaper items, \$1.00-\$5.00 each. Details free. Walter, Box 1360-PA, Erie, Pa. 16512.

FREE REPORT!! 609 Unusually successful businesses, indoor-outdoor, evenings!! Write: Associated, Box 238-B31, Lafayette, California 94549.

PIANO Tuning Learned Quickly At Home! Tremendous field! Musical knowledge unnecessary. GI approved. Information free. Empire School, Box 327, Miami, Florida 33145.

SPARE Time Cash—Sell Advertising Book Matches—every business a prospect—no investment—no experience needed—build steady, repeat business. Power-house selling kit with new complete catalog free. Quick sales—big cash commissions. Dept. MX-371, Superior Match, 7530 S. Greenwood, Chicago, 60619.

\$400.00 MONTHLY Raising giant fishworms. Soilless method. Charlie Morgan, Bushnell, Florida 33513.

EARN Money raising fishworms for us! Write: Oakhaven-38, Cedar Hill, Texas 75104.

400,000 BARGAINS Below wholesale! Many free. Liquidations . . . closeouts . . . job lots . . . single samples. Free details. Bargainhunters Opportunities, Box 730A, Holland, Michigan 49423.

WANT To make big money at home? \$10.00 profit in an hour possible with invisible mending. Make tears, holes disappear from clothing, fabrics. Steady year-round demand from cleaners, laundries, homes. Details free. Fabricon, 1585 Howard, Chicago 60626.

ADVERTISING BUSINESS—YOU Own It. \$350 First Week or Money Back. Electric Neon Action Ad Clock, 229 W. Illinois, Chicago 60610.

SELL Lifetime, Metal, Social Security Plates. Big Profits! Sample and Sales Kit Free. Russell, Box 286-PM, Pulaski, Tennessee 38478.

COPUBLISH "Mail Sale Advertiser," leading mailorder paper. Copy and details 25¢; U.S.A. only. Vanroy Shirk, Lebanon, Pa. 17042.

\$200.00 DAILY in your mailbox! Your opportunity to do what mailorder experts do. Free details. Associates, Box 136-A, Holland, Michigan 49423.

DRAFTSMEN! Operate own DRAFTING SERVICE! Full, Part Time; Experience unnecessary; Details: Roberts Drafting, 1741 Circle Road, Baltimore, Maryland 21204.

RAISE Rabbits for us on \$500 month plan. Free details. White's Rabbitry, Mt. Vernon, Ohio 43050.

MAIL ORDER Sell books. Fascinating, profitable, details. Jobre, Box 27, Great Neck, N.Y. 11023.

WORLD'S Largest supply. Merchandise 25% to 40% under wholesale. Bankrupts, Closeouts 10¢ on dollar. Imports. Hongkong clothes. Automobile discounts. Free details. International Buyers, Box 16386-MM, Portland, Oregon 97233.

HOLLYWOOD CEMENTCRAFT: Offers Highly Profitable Home Business. Experience Unnecessary. Unlimited Unique Pottery Designs Easily Made Without Moulds. Bird-baths, Fountains, Wishing-Well, Waterfalls, etc. Chemical Coloring Formulas. Marble-glazing. FREE Illustrated Brochure. CONCRETE FACTS, 602 Athens Street, Altadena, California 91001.

SELL Books by mail. 400% profit. Royal, Box 450-X, Cleveland, Ohio 44127.

FREE Catalogs. Repair air conditioning refrigeration. Tools, supplies, full instructions. Doolin, 2016 Canton, Dallas, Texas 75201.

VENDING Machines. No selling. Routes earn amazing profits. Big catalogue free. Parkway Corporation, 715PBM Ensor Street, Baltimore, Maryland 21202.

ADDRESSERS And mailers needed. Send stamp for information. Lindbloom, 3636 West Peterson, Chicago 60645.

SELL Beautifully colored Social Security Plates. Big Profits! Free Sample, Paul Wright, 1075 Ringwood Avenue, Pompton Lakes, N.J. 07442.

CLIP Short newspaper items. To \$10.00 each. Details free. Foster, 272-M2, Brooklyn 11235.

BUILD Custom Cases at home for profit. Get orders by mail. We supply materials, instruction—everything. Free home business details. Custom Case Supply Co., 6961 CPC Hayvenhurst Avenue, Van Nuys, California 91406.

TAKE Catalog orders. We drop-ship 1001 best selling specialty products. Guaranteed lowest below wholesale prices. Fantastic spare-full time home business. Free book shows you how. SMC, 6963 SPC, Hayvenhurst Avenue, Van Nuys, California 91406.

VENDING Machine big catalog. Rake, 523 A Spring Garden, Philadelphia, Pa. 19123.

I MADE \$40,000.00 Year by Mailorder! Helped others make money! Start with \$10.00—Free Proof. Torrey, Box 318-Y, Ypsilanti, Michigan 48197.

MAIL Baby Catalogs Imprinted with your address to New Mothers for Big Profits! Details 25¢. Volz PM, Ypsilanti, Michigan 48197.

MAIL Order Collection Agency can make you \$1000.00 monthly. Free Details. Continental, Box 2023-A, Des Moines, Iowa 50310.

MAKE Money from old tires. Operators clearing \$800, weekly. Equipment costs \$1500. Get facts, S & S Patents, Inc., 3752 N. Damen, Chicago 60618.

BIG Money-making new greaseless do-nuts in kitchen. Everything furnished. Sell stores. Free recipes. Montgomery Ray, Waseca, Minn. 56093.

EARN \$60.00 Daily Manufacturing Concrete Fence Posts. Practically no investment. Send stamped, addressed envelope. American, Excelsior Springs, Mo. 64024.

MAKE \$46 From square foot plywood: jigsaw or bandsaw necessary. Free details. Woodard, Bridgewater, Mass. 02324.

MAKE Fortune in Mailorder! Easy! Advances, Box 24, La Grange, Illinois 60525.

I MADE \$2,000.00 Monthly by mailorder—evenings only. You can too! Free Proof! Kingman, Box 723D, Montclair, New Jersey 07042.

BOOKKEEPERS Earn \$500.00 week. Operate Bookkeeping Tax Service. Details free. Universal, Box 664-M, Springfield, Missouri 65801.

\$70.00 WEEKLY—Home, spare time. Simplified mail bookkeeping. Immediate income easy. Auditax, 34741A, Los Angeles 90034.

\$60.00 DAY. Manufacturing concrete Posts. Blocks. Mold Equipment Catalog \$1.00 refundable. Carlayne, Route One Box 95, Rapid City, South Dakota 57701.

TREMENDOUS \$1,000.00 Profit From 1,000 Mailings! Exciting. New Products! Tested! Everything Furnished! Free Guidance, Proof! George, Box 2188-PM, Cypress, California 90630.

FRANCHISING? Amazing New Way to own your own business. Send for free copy. Modern Franchising Magazine—P, Des Plaines, Ill. 60016.

CALIFORNIA MANUFACTURER NEEDS Man to assemble our product and be local agent, experience unnecessary. May start while presently employed. Five-figure income for responsible applicant. S.K.R.M. Manufacturers, 2347 West 238 Street, Torrance, California 90501.

MAKE A year's income in 8 weeks camping. No capital investment, no selling, no land ownership necessary. 9 different ways. Write EDU'S, Rt. 5, Box 5733, Gig Harbor, Washington 98335.

1000% PROFIT Bronzing Shoes. Free Literature—N.B.C., Box 11069-PM, Kansas City 64119.

HUGE Profits! Mail order importing. Free information. ITIS, PM-3, Box 454, Hollywood, Calif. 90028.

JEWELRYCRAFT—It's easy! Big profits! Catalog, 25¢. Modern Craft, Box 4796, Clearwater, Florida 33518.

BOTTLES Are Valuable! Free Information—Bottle Treasures, 7311 Van Nuys, Van Nuys, California 91405.

MAIL Galore! Money-making offers! Your name on national mailing lists. 25¢. Three months, 50¢. Sullins, Box 206-M, Forsyth, Georgia 31029.

MAILORDER Book Publisher Wants Dealers. Jan Enterprises, 76P, Wild Rose, Wisconsin 54984.

SUPERIOR Auction School. Nation's top Auctioneers own and instruct. Box 1281, Decatur, Ill. 62525.

SENSATIONAL Car Thief Signal. Lightning Seller. Samples for trial. Northwest Electric, Ave. 691 Mitchell, South Dakota 57301.

\$200.00 SPARE Time earnings with your Tablesaw. Write: Workshop Five, 3800 Harney, Vancouver, Washington 98660.

VINYL REPAIRING A golden opportunity. The world is knocking at your door. Free information. AMH Industries, P.O. Box 5386, Santa Ana, Calif. 92704.

MAKE Magnetic car signs. Write Route 1, Box PM-49A, Bardstown, Ky. 40004.

(Continued on next page)

BUSINESS OPPORTUNITIES

(Continued from preceding page)

RAISE Baby Black Widows! Safe, Fascinating, Profitable! Spiderlings, food, instructions \$2.98 (guaranteed). NBWC, Box 260PBM 3, Brigham City, Utah 84302.

MONEY MAKING MAIL ORDER. Free details. Leatham, Box 1027, Mission, Kansas 66222.

MAIL Baby Or Gift Catalogs. Imprint, Big Profits! Details \$1.00. Krefski, 609-A Lee, Plymouth, Penna. 18651.

MAKE Money Selling Men's Wigs, Details Free. F & N Fashions, Box 34-A, Glencoe, Minnesota 55336.

\$25.00 HUNDRED Addressing, possible Year 'round. Gift (\$3.00), instructions 25¢. Cove, 629-BE Franklin, Clearwater, Florida 33517.

\$25.00 HOURLY! Repair business at home. Details. Baron, Box 863, Portales, New Mexico 88130.

LEARN About amazing spare time businesses. Details free. Home Income Reports, Box 263, Wheeling, Illinois, 60090.

\$25.00 HUNDRED Addressing, Possible Year 'round. Complete instructions 25¢ for registration, postage. Cove, Box 1348-B, Clearwater, Florida 33517.

101 BUSINESSES YOU CAN START AND RUN WITH LESS THAN \$1,000. FIRST EDITION ONLY \$8.95. Friedland Associates, 10522 Fernglen, Tujunga, California 91042.

FREE Sample Kit. Sell Lifetime Beautiful Social Security Cards. Bilbrey Sales, Route #1, Crossville, Tennessee 38555.

\$2000.00 MONTHLY, Easily Done. Ropchan, Box 5341-P, Sherman Oaks, California 91413.

\$75.00 THOUSAND, Home Addressing! Longhand, Typewriter. Information, send stamped, self-addressed envelope. Brewster "TF" Box 1348, Clearwater, Fla. 33517.

AGES 17-60. Learn profitable WATCH REPAIRING at home. Free sample lesson. Sweazey, YPA, Fox River Grove, Illinois 60021.

MAILORDER! Make big money working home. Free report reveals millionaire's secrets! Executive (IA3), 333 North Michigan, Chicago 60601.

"VACUUM Sign Machines 14" x 26" \$65.00. Homecraft, 2350 W47, Denver, Colorado 80211.

MAKE RUBBER STAMPS! Easy profitable hobby or full time business, low starting cost package, free details, Barco Type, 237 S. Evergreen, Bensenville, Ill. 60106.

BIG Profits in your own wholesale business. Complete Program Starts You With Little Capital. Details. R&R Enterprises, Box 1317M, Running Springs, Calif. 92382.

\$300.00 WEEKLY Possible!!! Photograph Beautiful Models. No experience needed. Everything explained. Write today. Photocolor, Box 273K2, Burlington, Vermont 05401 or Box 83K2, Verdun, Quebec, Canada.

BIG PROFITS "Secrets of Wall Street Operators", tells how. \$2.00. Investment Research, 11 Westerly, Thornwood, New York 10594.

EASY Profits—Worldwide Products (Sources—Plans) \$1.00 (Refundable). CBS-CO-10, Marksville, Louisiana 71351.

MAILORDER. Home Business. Wonderful Method guarantees Success for Beginners. Valuable lists, concrete information, detailed steps, guidance. Capital unnecessary. Free Details. Prudential, Box 327, Boston 02199.

VACUUM Plastic Molding & Liquid Plastic Casting—At Home! Make Hundreds of full 3-D plastic products. Big profit in spare time. Facts. Nationwide Plastics, Dept. CV, 4140 Eagle Rock Blvd., L.A., California 90065.

MAIL Baby Catalogs To New Mothers For Big Profits, Details Free. Parks, 1736 South Queen Street, York, Penna. 17403.

\$500-\$800 MONTHLY Part-Time. Raise Small Laboratory-breeding stock for us. We supply equipment, breeders, and instructions. Illinois Research Farms, Dept. MPD-3 Barrington, Illinois 60010.

PROFIT With Popular Mechanics' subscription plan. No investment, no experience needed. Earnings begin immediately when you obtain subscription for Popular Mechanics, Good Housekeeping and others. High commissions, bonus. No experience needed. Deal directly with the publisher. Write Popular Mechanics, Room 3B, 250 West 55th St., New York 19, N.Y.

FANTASTIC Opportunity. Your own catalog business. Gifts, books, auto accessories, etc. No inventory. Up to 100% profit. Details free. Tiffanias, Box 3348-P3B1, Vancouver, British Columbia.

AMAZING Mailorder secrets explained. Fantastic \$25,000 home business. Free particulars. Write today. Time means money! RAF-Enterprises, Dept. PM3, Remsen, New York 13438.

MAILORDER Records help get increased business! Complete 32 Page Record Book shows your inquiries, orders, advertising, expense, etc. Only \$1.00. C. A. Martin, Popular Mechanics, Dept. PM, 224 West 57 Street, New York, New York 10019.

\$600.00 PROFIT! Mailing 100 Catalogs. Sample, complete instructions, only \$1.00. Digest, Box 839-PMP, Long Beach, New York 11561.

HOMEWORKERS—Mailing wanted. Free Details. Allen, 2418A Lori, Santa Ana, California 92706.

EARN \$20.00/Hour. Assemble unique vehicles in Kit form for resale at big profits. Or, keep and enjoy yourself. Complete "Build it Yourself" plans also available. Lawn Tractors, Dozers, Snowmobiles, Trail Bikes, ATV's, etc. Send 50¢ for colorful Catalog. Struck Corp., Dept. PM-31A, Cedarburg, Wisconsin 53012.

SELL Watchdog Fire-Burglar Alarms. 200% Profit. Watchdog-PM3, Williamsburg, Ohio 45176.

"BARGAINS GALORE: Buy WHOLESAL and below. DROPSHIP—IMPORT. FREE details. NEWTRON, 510A, Arthur, Middleville, Michigan 49333."

YOUR Own Business in home improvement, send 25¢ for facts. Lynn's, 2907 Plover, Sacramento, California 95815.

ESTABLISH Profitable Mailorder Business. Everything furnished. Vikari's, Box 1312PM, Salt Lake City, Utah 84110.

UNLIMITED Mailorder Profits Yours!! Full, sparetime. Easy! Everything explained. Write: Waters, 40-N McIntyre, Gibbsboro, New Jersey 08026.

MAILING BABY CATALOGS Imprinted With Your Name & Address To New MOTHERS Brings Big Profits! Details Free. Drasher Enterprises, Box 4637, Phila., Pennsylvania 19127.

CONTINUOUS PROFITS!! Always a market. Mail your own imprinted baby catalogs. Sample plus profit, details, 25¢. Brighton House, 5200N Greenfield, New Brighton, Minnesota 55112.

YOUR Very Own Gift Catalog. Big Profits. Operate full or part time. No investment in products; Write for free information. House of Michaels, 303 W. Frazee, Detroit Lakes, Minnesota 56501.

BOOK Publisher wants mailorder dealers. Excellent opportunity! Free details. Advisor, Box J-25, Hallandale, Florida 33009.

\$400.00 OR More weekly in Spare Time. Operate your own business. Free Details. Box 733-C, Holland, Michigan 49423.

WE NEED GINSENG GROWERS! \$3,000—\$30,000 Annually! We Buy Your Crop. Send \$2.00 For Seed Sample And Information. Glass' Ginseng Exchange, Box 336, Rochdale Station, Jamaica, New York 11434.

EASY Ways to secure capital you need. Details free. Koren Enterprises, Route 1-A, Emory Road, Corryton, Tennessee 37721.

MAKE MONEY IN MAIL ORDER IMPORTS, Profitable, Exciting business from your own home. Report reveals foreign dropship sources, World Trader's Digest, ideal mailorder items. Send \$1.00 P. F. Carter, 623-A West Fern Drive, Fullerton, Calif. 92632.

ALERT YOURSELF! Unique Report covering business opportunities impartially flashes signals. New, different. Write: Sherwood Publications, P. O. Box 517A, Brundidge, Alabama 36010.

FREE Report—Work Home \$1500 Yearly. Roney, 18 Oneida, Centereach, New York 11720.

SECONDHAND Business, How to Start your own. Free Information. Empire, Rio Nido, California 95471.

TRIPLE YOUR INCOME. Assemble Woodwards PATENT Furniture and other Products. Free Details. John Woodward Engineering Services Registered, 65 Tremblay, Iberville, Quebec, Canada.

MAKE Money Sparetime. Home Operated Mailorder Business. News-Messenger, South Lancaster, Massachusetts 01561.

START BIG-PAY Business at home in spare time. No experience needed to operate little tabletop machine for bronzing baby shoes. Make \$7.95 profit on every pair. Full particulars free! Send postcard to: Mason, Room MC-2-AF, 1512 Jarvis, Chicago, Illinois 60626.

\$48,000.00 YEAR! No Investment. Free Details. Idrach, Box 10067-C, San Antonio, Texas 78210.

ALTERNATORS — GENERATORS — STARTERS. Be first in your area to cash in on real money maker. You've heard of rebuilding transmissions & engines & carburetors. Alternators & starters are more in demand & more profitable. A small One-Man operation can be worth more than \$30,000.00 a year. For money making details send \$4.50 to: Victor Electronics, P.O. Box 8295, West Palm Beach, Florida 33407.

MOLDING Rubber Liquid Plastic. Hobby Supplies. Details 10¢. Chaney's, 5415-L San Jose Blvd., Jacksonville, Fla. 32207.

MAKE MONEY AT HOME METALLIZING. Baby Shoes, Plastics, Novelties, Gold, Silver, Bronze. Free Facts. Kiktavi, Box 2127-A, Inglewood, Calif. 90305.

HUNDREDS, Profitable, Part Time, Business Opportunities. Free Details. Mack Publishing, Box 254, Milton, Mass. 02187.

FREE FRANCHISE JOURNAL Magazine with over 100 franchise opportunities in every issue. Franchise Journal, Dept. G, Box 1790, Newport Beach, Calif. 92663.

MONEYMAKING OPPORTUNITIES

\$625—\$900 MONTHLY. Raise small laboratory-breeding animals for us. Also chinchilla. We supply breeders, equipment, instructions. Fox River Valley Research Farms, Department PMM-031, McHenry, Illinois 60050.

MAKE Money Easily. Information \$1.00. S. Rudolph, Evesboro Road, Marlton, New Jersey 08053.

\$100 WEEKLY Possible—addressing envelopes and typing for firms. Start now! Details, send self-addressed, stamped envelope—Edward, Box 50160PM3, Tulsa, Oklahoma 74150.

BE YOUR OWN BOSS—Sell Home Products, Cosmetics in spare time. You buy wholesale. We send 4 full-size products plus sample rug cleaner for FREE TRIAL. Great profits. Rush name, address to BLAIR, Dept. 31LC, Lynchburg, Va. 24505.

EARN MONEY Building patio furniture. Sample, Plan list, 25¢. Barlow's, 1166 West 4800 So. Murray, Utah 84107.

MAKE Money mailing circulars for us from your home. Free details! Alexander's, 4101 Wadsworth, # 202-PM, Annandale, Virginia 22003.

(Continued on next page)

MONEYMAKING OPPORTUNITIES

(Continued from preceding page)

MAKE \$1,000,000 Within Ten Years. Start with \$10.00. Free Trial. Imperial, Dept. AAO, 501 Wayoata, Winnipeg 25, Canada.

FREE. 206 Easy Ways to make money taking orders for exciting new products—spare time. Send name, age for 5 months free subscription. Opportunity Magazine, 1460 Hancock Center, Dept. 17-CM, Chicago 60611.

HOMEWORK—Steady income! Experience unnecessary. Send stamped envelope. Atzo, Box 6033, Los Angeles, Calif. 90055.

INTERNATIONAL Trade. Sources, bank references, etc. Details \$1.00. Laval International, Box D126, St. Clair Shores, Mich. 48083.

OVER \$16.50 An Hour. Spare time at home! Rubber Stamp industry needs small manufacturers. We furnish all equipment and know-how! Particulars free! Write: Roberts, Room RC-2-AC, 1512 Jarvis, Chicago, ILL. 60626.

MAKE Big Easy Profits making costume jewelry at home. Spare time. Quick, easy to make; easier to sell! Details Free! Donbar, 2934 Fullerton, Dept. A-201 Chicago, Illinois 60647.

SELL Lifetime Metal Social Security Plates. Sample and Sales Kit FREE. Lady McGuire, Box 3333PM, Anderson, S.C. 29621.

CIGARETTES 12¢ a pack. Improved roller makes 20 filtertip, plain, king or regular for 12¢. Facts free. Green River Tobacco, Box 953, Owensboro, Kentucky 42301.

EARN \$240.00 a month at home, spare time, doing only two \$5.00 invisible mending jobs a day. Big money paid for service that makes cuts, tears disappear from fabrics. Steady demand. Details free. Fabricon, 1532 Howard, Chicago 60626.

MAKE Statuettes, novelties, imitation marble. Sell to stores or start gift shop. Free details. Marbleizing, 41 Waverton, St. Louis, Mo. 63124.

HOW To Make money writing short paragraphs. Information free. Barrett, Dept. C-27-01, 6216 N. Clark, Chicago 60626.

FREE Copy of world's leading contest magazine! Write Prizewinner, Box 11569, St. Petersburg, Fla. 33733.

SCIENTIFIC Messages: Big Earnings uncrowded profession. Learn spare time at home. Diploma awarded. Free catalog. Write Anderson School, Dept. C-1, Princeton, Illinois 61356.

CLIP Newspaper items. \$1.00-\$5.00 each. Details free. Walter, Box 1360-P, Erie, Pa. 16512.

HOW TO GET RICH!! Free "Money-making Brochure"! Success International, Box 2447-C, Livonia, Mich. 48151.

\$200.00 FROM Sheet 1/4" plywood (scrap). Details 25¢. Novelties, 610 So. 24th, Elwood, Indiana 46036.

VENDING Machines. No selling. Routes earn amazing profits. Big catalogue Free. Parkway Corporation, 715PMM Ensor Street, Baltimore, Maryland 21202.

LEARN The secrets of repairing junk batteries "Fabulous Profits" at home. Battery Shop, Route 1-188 D, Blythe, Calif. 92225.

MAKE \$5,000 Yearly, sparetime, raising mink, chinchilla, nutria, etc. Free booklet reveals proven plan. Write: Furs, Dept. E, Bewdley, Ont., Canada.

MAKE \$12.00 Dozen Lacing Billfolds. Details Free! (Stamp Appreciated.) Redikut's 40, Richland Center, Wis.

INSULATORS, Profitable, unique gift items made from insulators. Booklet only \$2.00 (complete details, drawings, photographs.) R. St. Pierre, 82 Bowditch Avenue, Peabody, Mass. 01960.

SKETCH Photos—(Home Goldmine!) Details. Gem, 365-F Longhill, Shelton, Conn. 06484.

GET World's Biggest Wholesale Import-Merchandise Catalog. Write: Worldwide-K, Medina, Washington 98039.

STRIKE IT RICH, Enter U.S. Government Oil Lease Drawings. Details free. Petroleum Research Associates, Box 249, Westlake Village, California 91360. Licensed Mineral Oil Gas Broker.

BLACK Widow Spider embalmed specimen and exciting moneymaking plan \$1.25 (Returnable). NBWC, Box 260PAM3, Brigham City, Utah 84302.

FREE Starting stock worth \$15.00 given our associates. Up to 200% profit for you. Information and samples, \$1.00. Master Research, 115 Garner Road, Lilburn, Georgia 30247.

DOGS, For fun and profit. Successful breeder tells how. \$1.00. Flynn, 17733 Cliffbourne Lane, Derwood, Maryland 20855.

\$10,000.00 INCOME Producing Items at home. Complete Instructions \$2.00. Lockett, 4153-P Lancaster Ave., Philadelphia, Pa. 19104.

GREATER Stock Profits. Free Details. Box 383, R.D. 4, Cortland, Ohio 44410.

MAKE Rubber Stamps. Easy Profitable Business. Starting Outfits, Presses, Manufacturers Supplies. Free Catalog. Roll, 15930 Trask River, Tillamook, Oregon 97141.

BOOST Earning power to a new dimension. Amazing "Money-Tree" concept. Anyone can do it. Free details. Leader, Box 44718-D8, Los Angeles 90044.

\$100 A DAY Possible! Wholesale Business! Free Information! Xcito Products, Dept. W-1 5715 N. Mozart, Chicago, Illinois 60645.

MAKE SPARE MONEY. We teach you how to make GLASS BOTTLE LAMPS for LESS than \$3.00. Complete detailed instructions with illustration. Rush \$2.00. Southern Enterprises, Box 5082, Huntsville, Alabama 35805.

\$500-\$800 MONTHLY Part-Time. Raise Small Laboratory-breeding stock for us. We supply equipment, breeders, and instructions. Illinois Research Farms, Dept. MP-2 Barrington, Illinois 60010.

MAKE Hunting Bows—\$2.00 wood enough for \$78.00 bow. Master Craftsman construction secrets. \$3.00. Woodlawn, Dept. P, 333 Catherine, Ottawa 4, Canada.

BECOME RICH. Send your ideas to Travel-Aids Manufacturing Company. Include \$1.00 for processing and evaluation. Box 47, Pomona, California 91769.

ASSEMBLE A boat in a morning and make \$100 a day. Costs less than \$20. Sell easily for \$125. New commercial FAST plans \$3.00. Woodlawn, Dept. P, 333 Catherine, Ottawa 4, Canada.

RECORDING STUDIO Equipment! Catalog \$1.00. DSS-R, Box 633, Scarsdale, New York 10583.

PENNY STOCKS Have big profit potential. Free information. Penny Stock Reporter, 608 N. Guadalupe, PM, Redondo Beach, California 90277.

BIG Profits electrifying camps with wind generated power. \$40.00 in parts gets you a \$200 profit. Plans \$3.00. Woodlawn, Dept. P, 333 Catherine, Ottawa 4, Canada.

"BLAB-OFF" Increases TV pleasure 1,000-fold, sells on sight! Every home needs one or more. Build for self and market. Send \$1 (refundable) for details. Jobcraft, Box 46325, Cincinnati, Ohio 45246.

EARN \$100.00 Weekly. Postage, envelopes, etc. furnished. Details \$1.00. Service, P.O. Box 1573, Worcester, Massachusetts 01601.

PROFITS From Your Camera Shots— Booklet \$1.00. Redwood Lodge, 3405-32 Street Court, Rock Island, Illinois 61201.

FREE! 182 "Your-Own-Business" government publications! List \$1. Dittofax, 5815-PM Compass, Los Angeles 90045.

BIG Profits, Sell Lifetime Social Security Plates. Sample Goldthwaite, 220-PM, Lawrenceburg, Tennessee 38464.

PROFITABLE Rewarding home business. Sell books by mail. Free details. San Tusca Sales, Box 235, Greencastle, Pa. 17225.

49 WAYS To make money at home. Send \$2.00. Satisfaction Guaranteed. Coach Publishers, Box 834, Bangor, Maine 04401.

MONEY MAKING OPPORTUNITIES—Free listing of books on how to start and operate many profitable businesses. Informative Publications, Box P-187, Painted Post, New York 14870.

\$50-200 for short paragraphs. Information: Dane, Box 5353-D3, Walnut Creek, California 94596.

GET Our Free Gifts and Business Opportunities From 987 Firms Making Big Money. Rush \$1.00 To: Brokers Associates, Box 10067, San Antonio, Texas 78210.

HEADLONG Plunging Fatal. Mailorder Is Strictly Business. Read Our Story. Stationers, Drawer 5350 C, San Antonio, Texas 78201.

MAKE \$20,000 Year! With Mailorder Insurance Promotion. Booming Market. Wholesaling By Mail! Promotions, R7, Rome, Georgia 30161.

SECRETS Of wedding photography. Profit-making details: Dane, Box 5353-C3, Walnut Creek, California 94596.

LYRIC Writers write songs with Writers who write hits for top Nashville Artists. Globe, 1313 Dickerson Road, Nashville 37207.

PROFITABLE OCCUPATIONS

\$625—\$900 MONTHLY. Raise small laboratory-breeding animals for us. Also chinchilla. We supply breeders, equipment, instructions. Fox River Valley Research Farms, Department PMP-031, McHenry, Illinois 60050.

MAKE \$300 CLEAR MONTH Few hours from 10 customers, representing us in your community. No individual selling. Repeats forever. Customers waiting. \$1 for sample, details. Our 40th year. Progressive, Box 1302, Springfield, Illinois 62705.

LEARN GUN REPAIR GUNSMITHING in spare time. Book, details 10¢. Modern Gun Repair School, Dept. 508, Twenty E. First Ave., Scottsdale, Arizona 85251.

FREE!! FREE!! FREE REPORT!! 609 Little-known, successful businesses. Written by consultant. Indoor . . . outdoor, work home! Start small, grow big . . . many others have. Experience unnecessary, easily done!! Write: Report, Box 238-BA3, Lafayette, California 94549.

FREE Book "999 Successful, Little-Known Businesses." Work Home! Plymouth-47W, Brooklyn, New York 11218.

FT. SMITH Auction School. Ft. Smith, Ark. Residents & Home study. Veteran approved.

BECOME A mortgage broker, earn \$10,000 to \$50,000 a year. Details free. United, Box 6284A, Marietta, Georgia 30060.

SHARPEN Scissors, Pinkers, inexpensive equipment, tools, supplies. Blackhawk's, Sheldahl, Iowa 50243.

HOW To Make Money writing short Paragraphs. Information Free. Barrett, Dept. C-27-02, 6216 N. Clark, Chicago 60626.

BAKE New greaseless doughnuts in kitchen. Sell stores. Free recipes. Michael Ray, Waseca, Minn. 56093.

EARN \$240.00 A month at home, spare time, doing only two \$5.00 invisible mending jobs a day. Big money paid for service that makes cuts, tears disappear from fabrics. Steady demand. Details free. Fabricon, 1586 Howard, Chicago 60026.

\$500-\$800 MONTHLY Part-Time. Raise Small Laboratory-breeding stock for us. We supply equipment, breeders, and instructions. Illinois Research Farms, Dept. MPA-3, Barrington, Illinois 60010.

(Continued on next page)

PROFITABLE OCCUPATIONS

(Continued from preceding page)

FREE Details. "Home Business Opportunities" Neshotah, 2908-41st, Two Rivers, Wisconsin 54241.

\$2-\$5-\$10-\$50 PAID For your jokes, stories, recipes, etc. Instructions \$2.00. Smithco, Box 292-C, Syracuse, New York 13201.

FREE INFORMATION. "Specific Method For Developing Ideas Quickly". "Make Extra \$\$\$\$\$" (DON'T DELAY). Seaside House PA-Route 3, Box 99, Port Orchard, Washington 98366.

SALESMEN—DISTRIBUTORS

MAKE Extra \$25 to \$75 spare time! Double air cushion shoes. Men's, women's line. Dress, work, play. Highest commissions. Shoes for yourself. Outfit Free. Bronson, Dept. H-31, Minneapolis, Minnesota 55408.

HOUSEHOLD Products Route. Earn \$25.00 or more daily. Larger repeat orders. Man, woman. Full, part time. McNess, Freeport 2631, Illinois 61032.

47 MONEY-Making Specialties. Latest conveniences for home, car. Send no money. Just your name. Kristee 168, Akron, Ohio 44308.

SALES OPPORTUNITY FOR MEN OVER 35! Work to suit your convenience showing our new 1971 Line of Advertising Specialties, Gifts and Calendars to business firms in your area. We are a low-pressure, small town firm, in our 62nd year, rated AAA-1. No investment, collections, quotas or reports. Weekly commissions. Liberal bonus arrangement. Can be developed into a full-time business, with long range security. Costs nothing to investigate. Write John Mc Neer, Dept. PM-3, Newton Mfg. Co., Newton, Iowa 52028.

SELL HERTEL BIBLES—Part Time. Finest reference Bible available. Demonstrator and supplies furnished. Excellent commissions. Write International Book, Dept. PM, Box 118, Wichita, Kansas 67201.

LONG Needed Invention. Man contact service stations. Full or part time. Huge profits. Write Cyclo Mfg., 3816 Dahlia, Dept. 123, Denver, Colorado 80207.

SELL America's biggest value wedding ine! Big 40% profit showing wedding invitations and over 50 exciting accessory items. Sideline for printing, Christmas card salesmen. Send \$1.00 for album, refundable on first order. Elmcraft, 7201 S. Cicero, Dept. EW-169, Chicago, Illinois 60629.

100% PROFIT—Sweet Georgia Brown Cosmetics sell fast. Write for Sample Case offer. Valmor, Dept. H, 2411 Prairie, Chicago 60616.

EARN Big Commission Full or Part Time. Show America's largest line Low Priced Business Printing and Advertising Specialties Plus calendars in season. No experience. No investment. No collections or deliveries. On-the-spot commissions. Big Free Sales Kit samples hundreds items used daily by businessmen. Merchandise bonuses for you. Build profitable repeat business. Start now. National Press, Dept. 11D, North Chicago, Ill. 60064.

THERE'S Money in selling office supplies and equipment, full or part time. Steady repeat commissions. Free selling outfit. Write. Oseco, 3505-PM North Elston, Chicago 60618.

PERSONAL Protective Devices Now In Big Demand due to increased crime rate. Proven. Sell easy to Drive-Ins, Stores, Nurses, Night Workers, Motorists. Sales experience unnecessary. Get profit details now. Hagen Supply, Dept. CLA-31, St. Paul, Minnesota 55107.

SALESMEN Needed Fast. Best selling Toy ever made. \$100.00 per day commission not unusual. Send \$2.00 for Samples. Barber's Inc., 111 W. 6th St., Tusculumbia, Alabama 35674.

SELL Advertising Specialties, Printing. 60% Profit. Brochures .25c. Marketing-C44, 147 Vivyan, Bergenfield, N.J. 07621.

SALESMEN'S Delight "CLAMSTER" patented combination Clam and Oyster opener. \$12.95 ppd. For details. T.R. Berry Corp., Box 26, Lake Hiawatha, N. J. 07034.

PROFITS GALORE! Sell New Chemical Specialty. Prospects Everywhere. Hoben's, Box 4852, Columbus, Ohio 43202.

LIMITED Number of exclusive distributorships available. No other like it. Enjoyable, Easy, Dignified and Very Profitable. Write today before your area is taken. BTC Franchise, 2789 Montauk Highway, Brookhaven, N.Y. 11719.

60% PROFIT Distributing new item to service stations, stationery, department stores. Samples. Auto-Memo, Box 1125, Norwich, Connecticut 06360.

MAKE \$10.80 Hour Spare Time, introducing offices to fantastic Dura-Copy, successor to carbon paper. Guaranteed 100 copies per sheet, or we replace free. Can't rip or tear. Give free samples to prospects, sells itself. Details Free. Write Merlite, 114 East 32nd, Dept. M102N, New York 10016.

AGENTS WANTED

MAKE Extra Money—Show friends, neighbors, others—All Occasion, Easter Cards, Assortments, Stationery, Wrappings, Gifts, Toys, Jewelry, Salable Samples on Approval, Free Color Catalog, Bonus Plan. Write Hedenkamp, 361 Broadway, Dept. PM-110, New York 10013.

WILL You test new items in your home? Surprisingly big pay. Latest conveniences for home, car. Friends buy on sight. Send no money. Just your name. Kristee, 125 Akron, Ohio 44308.

REPRESENT Fine Line Of Quality Flowerbulbs Write: Bulbhome, P.O. Box 29, Sassenheim, Holland, Europe."

SAVE ON FEED COSTS. Users of Rawleigh livestock premix feeding program report extra profits. Farm product dealerships available. Factory prices. Write: Rawleigh Farm Director, Dept. PM-371, Freeport, Illinois 61032.

WANT TO MAKE UP TO \$100 A WEEK Spare time, and get free shoes for life, too? No investment. Rush card for free details. Mason Shoes, K-824, Chippewa Falls, Wisconsin 54729.

PRINTING. Advertising Salesmen—Excellent moneymaking sideline selling Decalcomania Name Plates, small quantities. Advertising Specialties, sign letters. Free Samples. Ralco XL, Boston, Mass. 02119.

EVERY Man a prospect. Refundable sales kit offer showing line belt buckles, tie clasps, money clips, cuff links, labels, identification badges, individualized with customer's name and emblems. Cap badges for trucking, bus, taxi, police, firemen, also postal, letter carriers and heavy construction emblems. Choice 4000 emblems. Hook-Fast, Box 1088PM, Providence, R.I. 02901.

LIFETIME Income. Business Loan Representative Write: Financial, 28 E. Jackson, Suite 1204-X3, Chicago 60604.

PROFITABLE! FULL OR PART TIME. Represent largest manufacturer of magnetic signs for cars and trucks. TRIMETRIC, 2640 Saddle, Oxnard, California 93030.

ESTABLISH Your own business. Low prices on used clothing, shoes, household goods. Unlimited profits. Free catalog. Northwestern Distributors, 2129 No. Western Avenue, Chicago, Illinois 60647.

EMPLOYMENT INFORMATION

FREE DETAILS AUSTRALIA!!! Government assisted transportation!! Jobs Galore!! Latest Handbook. Free Details. Write: Associated, Box 17-B31, Lafayette, California.

LEGITIMATE Australian Books, Magazines, Newspapers—36 pounds—all different, relevant, uncirculated—\$35.00 Postpaid USA (Canada-\$42.00). Australasian News, Box 6428, Torrance, California 90504.

BIG MONEY! Jobs for anyone living anywhere. Send 12¢ stamps. International Employment Services, P.O. Box 24, Colrain, Massachusetts 01340.

AUSTRALIA NEEDS YOU!!! Free Transportation!! 65,000 Jobs—Construction—Mechanical—Clerical!! "Australian Employment Handbook" includes Giant "Employers' List—Application Forms . . . Details about Wages, Rental Housing, Prices, Land!! \$1.00 (Refundable) "Australian Employment Services," Box 5211E, Akron, Ohio 44313.

FOREIGN And USA job opportunities available now. Construction, all trades. Earnings to \$3,000.00 monthly. Paid overtime, travel bonuses. Write. Universal Employment, Woodbridge, Conn. 06525

HIGH Paying overseas jobs. Construction, other projects. Bonuses. Travel Expenses, Extras. International Information, 124, Cortez, Florida 33522.

FLORIDA Employment Opportunities Booklet \$1.00. Sun, 4512N Jamaica, Tampa, Florida 33614.

OVERSEAS OPPORTUNITIES . . . Higher Pay! Free Transportation! Complete information including Directory of 135 companies hiring thousands of Americans overseas . . . all occupations! Send \$1.00. International Opportunities, Box 19107-AO, Washington, D.C. 20036.

OVERSEAS JOBS. High Pay, Travel, Adventure. Directory of Over 100 American Firms Now Hiring for Overseas Projects. \$1.00. TRANSWORLD, Box 90802-E, International Airport, Los Angeles, California 90009.

LAS VEGAS NEEDS YOU!!! Earn \$10,000 to \$30,000 yearly. Exciting, glamorous career opportunities available. No experience or educational requirements necessary. Overseas employment. COMPLETE information . . . \$1.00. DYNAMICS, A-3 Box 15127, Las Vegas, Nevada 89114.

AUSTRALIA WANTS YOU!!! Government Assisted Passage. 1971 Government Information and Forms—Most Complete Information Available—\$1.00. Reports on Employment, Business, Taxes, Education, Teaching, Housing, Ranching, Maps, etc. AUSTCO, Box 3623-E, Long Beach, California 90803.

"AUSTRALIAN Business Directory"—Over 300 Companies Seeking Help—50,000 Jobs—\$1.00. "Australian Private Employment Agencies Directory"—All Professions—\$1.00. AUSSIE, Box 91018-E, Los Angeles, California 90009.

JOBS—Men, women, professions, trades, clerical, executive. U.S.A.—overseas. Homeworkers also. Free bulletin. Hoppe, 44-D Wales, Thousand Oaks, Calif. 91360.

OUT OF WORK? Willing to relocate overseas? We have immediate openings in all fields. Write—Interploy, P.O. Box 279, Monterey Park, California 91754.

JOBS ON SHIPS! Good Pay! Europe, Asia. Worldwide! Who to see and Where—\$1.00 Seaways, PM, Box 121, Ellicott City, Maryland 21043.

HELP WANTED

\$220 WEEKLY Mailing. Send quarter. OpSCO, 1311 Huntington, Huntington, West Virginia 25701.

WORLD-WIDE. . . U.S.A. Jobs Galore!! Students, all professions and occupations. Enjoy Paris, Rome, Tokyo, Mexico City, Miami, San Francisco. \$700.00 to \$3,000.00 monthly. Paid Overtime, Travel Allowance, Sightseeing. Free Details!! Write: Global Employment, Box 706-B31, Orinda, California 94563.

OVERSEAS Jobs—Europe, South America, Australia, Far East, etc. 2000 openings all trades. Construction, Office, Engineering Sales, etc. \$700 to \$3,000 month. Expenses paid. Free Information. Write Overseas Jobs, International Airport, Box 536-M, Miami, Florida 33148.

OVERSEAS EMPLOYMENT . . . Australia, Europe, South America, Asia! All Occupations! \$700-\$3,000 monthly! Write: Employment International, Box 29217-AC, Indianapolis, Indiana 46229.

(Continued on next page)

HELP WANTED

(Continued from preceding page)

"AUSTRALIAN OPPORTUNITIES HAND-BOOK" . . . Latest information about Government Paid Transportation, Employment, Business, Farming, Housing . . . plus "Employers List" and Forms. Send \$1.00. International Services, Box 19107-AC, Washington, D.C. 20036.

OVERSEAS Jobs—Australia, Europe, South America, Far East, Openings, in all trades and professions. \$400. to \$2,500 Monthly, free information. Write Foreign Jobs, Box 2235 A.M.F. Miami, Florida 33159.

REAL ESTATE & FARMS

CANADIAN Lands, seized and sold for taxes. Our 54th annual series of lists, describe many choice properties, situated from coast to coast, acquired by us through Tax Sale. Priced as low as ten dollars per acre, guaranteed perfect title, small monthly payments, no mortgage. Beautifully situated hunting and fishing camps, where there is real sport, summer cottage sites, heavily wooded acreages. Now is the time to invest in Canada's minerals, forest and farms. Write today for free booklet with full explanation. Tax Sale Service, Room 301-D, 85 Bloor St., East, Toronto 5, Canada.

CANADIAN LAND INVESTMENT. FROM \$9.00 an acre. Choice properties across Canada. Low monthly payments. Ideal hunting, fishing, investment, timber, cottages. FREE CATALOGUE. Canadian Estate Land, Department PMC-3, 194 Wilson Avenue, Suite 101, Toronto 380, Canada.

ARIZONA. Walden Village. 2-acre parcels near Prescott National Forest. Ideal climate. Homesite or retirement. \$1,995 with low terms. Mrs. Young, Glenarm Co., 2233 No. 7th St., Phoenix 85006.

OCALA FOREST CAMPSITES Deep in the heart of the Great Ocala National Forest. Excellent hunting and fishing. Free maps and photos. (Unavailable in states requiring separate registration) AD70LB710E. W. H. Vernor, Inc., Dept E, DeLand, Florida 32720.

GOVERNMENT LANDS Low as \$3.50 acre. Millions Acres! For exclusive "Copyrighted Report" . . . plus "Land Opportunity Digest" listing lands throughout U.S.; and VALUABLE 17 X 22 TREASURE MAP OF U.S.; send \$1.00. Land Disposal, Box 9091-PM, Washington, D.C. 20003. Satisfaction Guaranteed.

CANADIAN Vacation lands: Full price \$385.00. 40 acres. \$10 month. Suitable cottage sites, hunting, fishing, investment. Free information. Land Corporation, 3768-C Bathurst, Downsview, Ontario, Canada.

LAND! EASY TERMS LESS THAN BANK RATES. NORTHWEST TIMBERED ACREAGES As low as \$1,250 Total Price. 5-10-20-40 Acres. For people who love the land—A tract of Recreation Land to have for your very own! In Northern Idaho, Northeastern Washington, and Western Montana. In the heart of lakes and big game country. All covered with growing timber. Access and Title insurance with each tract. This is select land with natural beauty, recreational and investment values. Plan for the future and retirement recreation. We have tracts of many types and sizes from which to choose, including beautiful Northwest Waterfront property. Your inspection is welcomed. Write us for free list, maps, and complete information. Write to: Dept. PC, Reforestation, Inc. P.O. Box 106, Opportunity Station, Spokane, Wash. 99214.

\$1 ACRE—Canadian Border—hundreds campsites, islands, farmlands, directly from tax authorities. (Non-profit). Lists, photographs mailed. Register. Room 10, 110 Church Street. Toronto 1, Canada.

CENTRAL Ontario—Choice 640 acre Sportsmen's paradises still available—\$20.00 plus \$6.50 taxes yearly. Maps, pictures. \$2.00 (Refundable). Information Bureau, Norval 4, Ontario, Canada.

GOVERNMENT LANDS. . . . Low as \$3.50 acre! Millions Acres throughout U.S. . . . Canada. Free Details! Land Digest, Box 11071-P, Indianapolis, Ind. 46201.

GOVERNMENT LANDS . . . low as \$1.00 Acre! Millions Acres! For exclusive "Government Land Buyer's Guide" . . . plus "Land Opportunity Review" listing lands available throughout U.S., send \$1.00. Satisfaction Guaranteed! United Lands, Box 19107-AC, Washington, D.C. 20036.

FREE! New 1971 Spring catalog! Hundreds of bargains, homes, farms, resort, businesses, investment property in many states. Actual property photos! Your copy FREE! (Zip code, please.) SAFE-BUY Real Estate, Box 589-PM, Little Rock, Ark. 72203.

\$1 ACRE—U.S.A.—CANADA Millions Acres. Direct from Government Agencies. No middlemen. . . . Family vacationing. Fishing, Hunting, Homesteading, Investing. . . . For amazing "where" and "how" "ALL STATES—ALL CANADA GOV'T LANDS DIGEST" . . . plus invaluable Canadian maps. Rush \$1.00 (Guaranteed): Can-Am-Lands, P.O., Box 1147, Buffalo, New York 14240.

FREE CATALOG! Big SPRING edition! Over 4,600 properties described, pictured—Land, Farms, Homes, Businesses—Recreation, Retirement. Selected Best thru-out the U.S.! 71 Years' service, 548 Offices, 40 states Coast to Coast. Mailed FREE from the World's Largest! STROUT REALTY, 60-MX E. 42nd St., NY, NY 10017; 7-MX S. Dearborn, Chicago, Ill. 60603; 521-MX E. Green, Pasadena, Cal. 91101.

FREE! Real Estate Catalog! Farms, Ranches, Business, Recreational and Investment Property. 18 states, pictures galore. Note State Desired. Banner Advertising, Box #3333, 19-A, Springfield, Missouri—65804—"Real Estate Our Specialty".

FREE . . . SPRING 1971 Catalog. All types real estate coast to coast! UNITED FARM AGENCY, 612-PM West 47th St., Kansas City, Missouri 64112.

ARIZONA—Beautiful 2½ acres, \$995, easy terms. For vacation, retirement or investment. Lake Havasu-Kingman area. Ev King, Broker, 316-M East Ocotillo Road, Phoenix 85012.

MICHIGAN 10 TO 160 ACRE TRACTS Lake Superior—Marquette area from \$99.00 Acre. Any terms A-OK. Cabins, trailers, camping welcome. (Land Anywhere in Michigan). FREE PICTURES write Lake Acres, 3650 Dixie, Drayton Plains 16, Michigan 48020.

FARM & GARDEN EQUIPMENT

CATFISH Farming, profits!, fun!, plans \$1.00, Leisuretime, Box 582, Livermore, California 94550.



FLOWERS, PLANTS & NURSERY SUPPLIES

600 ASSORTED Sweet onion plants with free planting guide \$4.20 postpaid. Tonco, "home of the sweet onion." Farmersville, Texas 75031.

"TOMATOES, ROMANOSKI GIANTS". Immense fruits, mouth-watering, full-flavored, meaty, delicious. 25 seeds \$1.00. J. Romanoski, 473 Johnson Ave., Bohemia, New York 11716.

LEARN Landscaping and the growing of plants. Start a profitable business part or full time. Free information without obligation. Lifetime Career Schools, Dept. A-958, 2251 Barry Avenue, Los Angeles, California 90064.

GINSENG Bringing \$20.00 pound. Have seeds, roots. Goldenseal. Full information. K. Collins, Viola, Iowa 52350.

GROW OVER 300 TOMATOES. Only Five plants. Amazing easy method. Complete instructions \$1.00. Barkham Associates, Youngstown, New York 14174.

CONSTRUCTION PLANS, BLUEPRINTS

BUILD THREE BEDROOM HOME UNDER \$7,000. Beat high interest, labor, down payments. Save thousands. No experience necessary. Send \$3. Step by step instructions, blueprints, material prices. Dougherty Products, RD #3, Box 285, Hummelstown, Pa. 17036.

HOME CRAFTSMEN

101 PATTERNS Of smart Gifts, Novelties, Shelves, Action Windmills, plus "Make Money Jig Sawing". \$1.25. Mastercraft, 35M, 7041 Olcott, Chicago 60631.

BUILD GRANDFATHER CLOCKS. Send \$1.50 for detailed plans of two beautiful designs. We have ample stock of movements and guarantee prompt shipment. Emperor Clock Co., Dept. 3, Fairhope, Alabama 36532.

LAMICUT FORMICA KNIFE. Handknife cuts Formica, Glass etc. Easily cuts curves. No need for power tools. \$4.50 Postpaid. Lamicut Products, P.O. Box 43166, Cleveland, Ohio 44143.

CABINETMAKING MADE EASY And "How to Make Formica Counter Tops." Two excellent guides let you build kitchen cabinets and counter tops like professionals. Extraordinary guides bring master craftsmen's shortcut methods. Satisfaction guaranteed. Write: Japs, 126-P Seventh North, Hopkins, Minn. 55343.

WOODWORKING Catalog and Manual 25¢ Plus free "101 Project Ideas." World's most beautiful veneers, lumber plywood! Wood finishing, upholstery supplies, Cane Lamp parts. Furniture hardware. Animal whittling blocks, 2,000 workshop products. Constantine, 2051-C Eastchester Road, Bronx 10461.

MAKE Money Building and selling Bird Houses. Send \$1.90 for 39 page book of plans covering 19 projects. Yeager, 1665 Linden, Homewood, Ill. 60430.

WALNUT, Bowls, Legs, Round Picture Frames, Gun-Stocks Lumber Moulding, Midland Walnut, Box 262, Savannah, Missouri 64485.

FULL SIZE FURNITURE PLANS. Traditional, Early American, Danish Modern. Catalog 50¢. Furniture Designs, Dept. P-31, 1425 Sherman, Evanston, Illinois 60201.

PICTURE Framing—Profitable full or spare-time business. Easy to learn with handbook-course "Guide To Picture Framing Profits." \$1.50 Guaranteed. Free framing-supplies catalog included. Japs, 126-PM Seventh North, Hopkins, Minnesota 55343.

JIGSAW Profits, new, unusual full size pattern \$1.25. Werts, Box 41097, Cincinnati, Ohio 45241.

"WOODEN LANTERN PLANS—Circular 25¢ (refundable with purchase). Bingaman Plans, P.O. Box 74, Langhorne, Pa. 19047."

HOME HOBBIEISTS: Fine veneers available for "facelifting" furniture. Many other uses for woodworking hobbies. Veneer Kits, 100 South Kentucky, Evansville, Indiana 47717.

PICTURE MOULD—Large selection. Will miter. Catalog 25¢. Samples \$2.00. Bauerle Cabinet, Box 1838-M3, Hammond, Louisiana 70401.

SAUNA—7½' X 5½'—Redwood Elisauna Heater. Complete U-Do-It \$499. 212-753-1239 Collect.

POPULAR MECHANICS MASTER SHOP GUIDE. Greatest product offered to a man with a workshop. All information printed on heavy boards, punched and ready to hang above his workbench. Covers wall fasteners, nails, screws, bolts, twist drills, abrasives, lumber, moulding patterns, plywood grades, hardboard, drywall, plumbing supplies, electrical supplies. Plus information on scores of other subjects. Send \$3.95 to: POPULAR MECHANICS, 224 West 57th Street, New York, New York 10019.

(Continued on next page)

HOME CRAFTSMEN

(Continued from preceding page)

100 JIGSAW Patterns for Pleasure—Free—\$1.00. Lynds, Medway, Mass. 02053.

WOODTURNERS: Build latheturning duplicator. Less than \$10.00. Plans \$2.00. Jenks Craft Shop, Rt. 2, Bolivar, Missouri 65613.

HOME HOBBYIST: Make money, assemble for your own use or sell to friends. Big demand for this beautiful 10" quarter-hour CUCKOO CLOCK. Comes in natural colors, with moving bird, weights and pendulums. Simple, detailed instructions included. Educational and fun. Suggested retail price \$21.95. Your price only \$9.95 ppd. Direct from Holland. Small customs duty collected on delivery. Quantity prices on request. ORDER NOW from The Ashworth Co. Importers/Exporters, P.O. Box 547, Sand Springs, Oklahoma 74063.

FREE Catalog Clocks, Movements, Dials, Hands. Newport, Box 6848A, Burbank, California 91505.

BEAUTIFUL Ships wheel—plans \$2.00. For table, clock etc. Easy. Harrington, Box 262, Tarrytown, New York 10591.

SAVE Hundreds Of Dollars. Build own kitchen cabinets. Step by step instructions. Drawings \$2.00. Paul Schermerhorn, Marathon, New York 13803.

FASTEN Your fence with new method Eliminates nails, rust. Adds new style to home. Adaptable to existing wood fence. Booklet illustrates how—\$2.00. Dell Products, 512 West 5th St., Cheney, Washington 99004.

BABYCRADLE—Complete Plans—Easy To Build—\$1.00. J. Armstrong, 3636 East 1st Street, Long Beach, California 90803.

MAKE Money Repairing Small Appliances! New Manual. Rush \$1.00 (Guaranteed): Bookcorp, 15242-B, Atlanta 30333.

DO-IT-YOURSELF

LEARN, The Secrets of Refinishing and Restoring Antiques. Send \$1.00 to Pringles, Box 945, Norwich, Connecticut 06360. For 190 page book.

PSYCHEDELIC LIGHTING MANUAL! Make strobes, kaleidoscopes, organs, etc. Send \$2.95—Lightrays, 1315-H Weaver, Philadelphia, Pennsylvania 19150.

HYDRAULIC Shop Press 8 ton capacity. Complete plans \$2.00. Plans, Box 723, Niceville, Florida 32578.

BURGLAR-FIRE Alarm Supplies and Information. Free Catalog. Protecto Alarm Sales, Box 357, Birch Run, Michigan 48415.

"BUILD Log Cabins, rustic furniture, fireplaces!!! Complete manual, \$3.00 . . . "A" Frame plans, \$2.00 . . . Guaranteed . . . Beels, 956 Springdale, Atlanta, Georgia 30306."

"HOW TO" Books. Catalogue 25¢. Elston House, 35 Stonycliff, Centerville, Mass. 02632.

REFRIGERATOR Door gaskets—Electric Range Washer Parts. Send Make and model for cost. Box 5465, Hamden, Conn. 06518.

CONVERT MOWER Engines into air compressors. Write Showalter, Box 409, Abilene, Kansas 67410.

APPLIANCE Parts, REFRIGERATOR door gaskets. Send make and model cost. Spaceage 83, Box 4438, Hollywood, Florida 33023.

BURGLAR ALARM. PLANS for RELIABLE Alarm systems for home or automobile. \$3.00 each. Both for \$5.00. Plans, Box 54, Bronxville, New York 10708.

ELECTRIC WALL CALENDAR. Complete, \$2.25. Check, Moneyorder. West, 7940 Guilford, Dayton, Ohio 45414.

"HOW To start your Car when its wet. \$2.00. Also 1 idea free". Automobiles-Proven, P. O. Box #14, Pontiac, Michigan 48053.

BURGLARY PROTECTION—Professional alarm system components, locks, safes, accessories. Free catalog. TPC, Box AE-3, Cupertino, California 95014.

DO IT YOURSELF Colorful Plastic Coating. Gives metals lasting protection & beauty. As a hobby or profitable business. 1/2 pt. with instructions—\$3.00. Bonita & Company, 4349 E. 10th Lane, Hialeah 1, Florida 33012.

SLIDING SCREEN DOOR CLOSER PLANS. Keep out flying insects with simple, low cost mechanical device. Harmless to children. \$1.00. MARGAY Corporation, Department 1100, Box 827, Redlands, California 92373.

SHIP In a bottle—do yourself kit \$10.00. Landlubber, Box 2524, St. Louis, Missouri 63114.

ENJOY Your music! Transducer converts walls, ceilings into omnidirectional speaker. Inexpensive. Guaranteed. Limited offer. Reply today! Particulars 20¢. Tradewind, Box 8866-PM3, Stockton, Calif. 95204.

APPLIANCE REPAIRS. Rush \$1.00 (guaranteed!) New Book, Box 15242 M, Atlanta, 30333.

DO IT YOURSELF Income Tax Kit \$1.95. Lumpy, 182 Fairburn Road SW, Atlanta, Georgia 30331.

PSYCHOLOGICAL Tests. Self administered. I.Q., personality, job aptitudes, marriage, etc. Booklet containing over 30 different tests \$5.25. Institute of Applied Psychology, Box 1021-B, Cuyahoga Falls, Ohio 44223.

ARTS AND CRAFTS

LEARN Decorative Arts & Crafts—Excellent opportunities for starting part or full-time business. Great hobby, too! Free booklet. Lifetime Career Schools, Dept. E-540, 2251 Barry Avenue, Los Angeles, California 90064.

FREE: New 136 page handicraft catalog. Supreme Handicrafts, Box 395-PM, Sioux Falls, South Dakota 57101.

MAKE Figurines, plaques, lawn ornaments. Molds, plastercraft kits, liquid rubber. Sample and catalogue 10¢. Wooley Company, Box 29-B, Peoria, Illinois 61601.

"GETTING Started in Stained Glass" 25¢. Whittemore, Box 2065Y, Hanover, Mass. 02339.

300 FIBERGLASS Molds for casting ornamental concrete products. Catalog \$1.00. Plycrete Molds—Elk Rapids, Michigan 49629.

CRAFTS, Hobby, Woodworking books. Catalog 25¢. R. House, 2407S Drake Ct., Hillsboro, Oregon 97123.

BINOCULARS, TELESCOPES, MICROSCOPES, MAGNIFIERS

BINOCULAR Sale! Free color catalog 100 models \$9.95-\$250.00. Write United, 9043 So. Western, BCAT-3208, Chicago 60620.

SCIENCE Bargains! Lenses, telescopes, binoculars, microscopes, kits, parts, war surplus. Send \$1.50 for beginner's 10-lens kit with instruction booklet. Order Stock 2-CH. Request free 148 page Catalog CH. Edmund Scientific Co., 300 Edscorp Bldg., Barrington, New Jersey 08007.

BINOCULARS Direct From Manufacturer. Finest Quality. Tremendous Savings! Catalog 50¢, Refundable. Koyu, 4116 Crenshaw Blvd., Los Angeles, Calif. 90008.

NEW Approved Interocular design simplifies making new true image reflecting binocular, illustrated instruction \$2.50. Serite, Box 63, Galiano, B.C., Canada.

TELESCOPES (Reflectors) complete kits. Other accessories, request free literature. Criterion Manufacturing, Dept. PM-15; Hartford, Connecticut 06101.

MANON Means fine binoculars! Get the best! MANON, Dept. 16, Box 1386, Huntington Beach, California 92647.



CAMERAS AND EQUIPMENT

MONTHLY Newspaper, Used Photo Equipment. Free Copy. Shutterbug Ads, Dept. P, P.O. Box 730, Titusville, Florida 32780.

WORLD'S Largest Buying Guide—800 Illustrations—50¢—Deductible With Your Order—Olden Camera—1265 Broadway, New York, N.Y. 10001.

STEREO Camera and viewer kit \$19.95, cameras included, assemble, it yourself. Or will furnish plans for \$3.00. Direct Sales Co., Box 835, Huntsville, Ala. 35804.

SPY CAMERA: Hide it Completely in one hand! Takes Secret Photos, only \$1.50! Spy Film-60 Exposures, \$1.00! (Plus Kenrus Catalogue Free!) Kenrus-SC, Box 158M, Staten Island, New York 10309.

PHOTO & PHOTO SUPPLIES

NEW Film Catalog. Write Chai Photo Supply Co., 14-03 Berdan Avenue, Fair Lawn, New Jersey 07410.

NOW—Sell Your Photo's, How, Where? Booklet, \$1.00. Northwest Merchandising, P.O. Drawer 100A, Rio Linda, Calif. 95673.

PHOTO FINISHING

CAMERA FANS! Expert photofinishing by one of Country's largest labs at lowest prices. Fast service and free "Foto-Fan" Stamps you quickly redeem for valuable Photo Supplies. 8MM Kodachrome \$1.29; 8 Exp. Kodacolor \$1.79; 35MM Kodachrome. 20 Slides \$1.39; 8 Exp. Black White 69¢. Satisfaction guaranteed. Send exposed film or request free mailers, complete Price List and Gift Catalog. Direct Mail Photo, Box 8352-PM, Pittsburgh, Pa. 15218.

KODACOLOR FILM Developed and twelve jumbo color prints \$1.49; twenty \$2.49. Black & White 12-exposure 60¢. Trial offer. Young Photo Service, 45C, Schenectady, N.Y. 12301.

COLOR SLIDES

35MM COLOR Slides, 10,671 Individually sold. Described, Encyclopedia catalog 10¢. Wolfe Worldwide, Dept. 14-31, Los Angeles, Calif. 90025.

MOTION PICTURES AND SOUND EQUIPMENT

8MM-16MM FILM And Accessory Catalog 16MM Sound Projectors \$99.00 (16MM Sound 1000 Ft. Featurette \$7.95 with Ad). IMPERIAL, 34 Parkrow, New York 10038.

FREE! 64-Page catalog. 8-16mm film, supplies, processing equipment. Superior, 448 N. Wells, Chicago 60610.

8MM-16MM MOVIE BARGAINS! Free Catalog! Cinema Eight, Box 245-PM, NYC 10028.

16MM SOUND Features, Shorts, New, used for Sale. Free Catalog. National Cinema, 333 W 57th St.—N.Y.C., N.Y. 10019.

UNUSUAL Movie supplies. Free circular. Esor, 47th Holly, Kansas City, Missouri 64112.

RADIO, TELEVISION AND HAM EQUIPMENT

TUBES—Lowest prices. Foreign-American, obsolete, receiving, special purpose, transmitting tubes. Send for tube, parts catalog. United Radio Company, 56-PM Ferry St., Newark, N. J. 07105.

36¢ RADIO & TV tubes. Free catalog. Cornell, 4213-17 University, San Diego, California 92105.

GOVERNMENT Surplus receivers, transmitters, snooperscopes, parts. Catalog. 25¢. Meshna, Nahant, Mass. 01908.

FREE Electronics Catalog. Tremendous bargains. Edu-Kits, Department C-735B, Hewlett, New York 11557.

(Continued on next page)

RADIO, TELEVISION AND HAM EQUIPMENT

(Continued from preceding page)

HEAR Police/Fire/Railroad/Aero radio stations. Stamp brings catalog of receivers and "confidential" directories of dispatcher channels. Communications, Box 56-PM, Commack, New York 11725.

HIFI, TAPES, RECORDS AND ELECTRONICS

FREE—FREE—FREE—FREE—Send in for your FREE one year subscription to Olson Electronics' fantastic value packed catalog—unheard of low, low prices on brand name speakers, changers, tubes, tools, stereo amplifiers, tuners, CB and other values. Credit plan available. If you have a friend interested in electronics, send his name and address for a FREE subscription also. Olson Electronics, Dept. JO-260 S. Forge St., Akron, Ohio—44308.

FREE Catalogues, 2000 hard to find unusual records. Rose's Records, Box 7216, Louisville, Ky. 40207.

BUILD AM Wireless transmitter kit. Broadcasts to any AM radio 50 feet away. Simple, educational to build, \$8.95 + 15¢ postage. Free Catalog. D. Electronics, 4725 45th NE, Seattle, Wash. 98105.

FREE Catalog—Electronic kits—amplifiers—preamplifiers—psychedelic strobes—metal detectors—color organs—digital instruments—guitar amplifiers. FREE Subscription, SWTPC, Box PM32040, San Antonio, Texas 78216.

OLD TIME RADIO SHOWS on Tape. Send \$2.00 for 1 hour. Wireless Trader, P.O. Box 6866, Birmingham, Alabama 35210.

RECORDING Tape 2400' Reels. 12 for \$15.00 postpaid, Sample \$2.00, Guaranteed. Mitchell, Box 444, Flushing, New York 11367.

STEREO TAPES 4 Track, 8 Track, Reel-to-Reel, and Cassettes. Your Choice \$3.99. Send 50¢ stamps for catalog of 500 titles. Tape Confederation, Dept. PM-3, Box 153, Balboa Island, California 92662.



MUSIC AND MUSICAL INSTRUMENTS

GUITARS, Save up to \$300.00! Buy authentic copies of most famous brand name guitars. Send 12¢ stamps. Guitars, P.O. Box 24, Colrain, Massachusetts 01340.

ACCORDIONS And Amplifiers! Excelsior and other Famous Makes. Save 50%. Buy Direct. Factory Distributor. Terms. Trades. New—Used. Free Home Trial. Free Catalog and Discount Prices. Excelsior, Dept. R, 3147 North Luna, Chicago 60641.

POEMS And Songs wanted by America's most popular studio. Tin Pan Alley. Broadway Productions Division, PM, Lake Grove, New York 11755.

LEARN Musical instrument of your choice—easy! New home study tape course. Write for free brochure. Carver School, 7 West 1st, Dept. M, Hinsdale, Illinois 60521.

30% DISCOUNT Name Brand Musical Instruments. Free Catalog. Freeport Music, 127 F. Sunrise Highway, Freeport, New York 11520.

FREE, Song Selling Information. Peerless Publications, Box 193-A, Bloomfield, Conn. 06002.

ACCORDION Manufacturing. 6846-P North Avenue, Chicago, Illinois 60635. Concertinas, Hohners, Chromatics, Guitars, Drums. New, Used. Tuning, Repairing. Wholesale Catalogs Free.

PLAYER Piano Rebuilding—get details from: Vestal Press, Vestal 11, N.Y. 13850.

ELECTRIFY Player Planos, Pump Organs Quickly, Inexpensively with Lee Silent Suction Units. Write Lee Music, 525F Venezia Avenue, Venice, California 90291.

LEARN Banjo. 5-String Bluegrass. No music. Makes learning easy. Free details. Blaylock, Box 25-M, Marietta, Georgia 30060.

POEMS Wanted for new songs, records. FIVE STAR MUSIC, 6M Beacon, Boston, Mass. 02108.

GUITAR, Banjo Making books, Plans, woods, necks, tools. List 25¢. Satinwood, 510 East 11th Street, New York, N.Y. 10009.

ACCORDION Top brands. Buy direct. Tremendous discounts. Trade accepted. Free brochure PM. Accordion-O-Rama, 874 Broadway, N.Y.C. 10003.

WHOLESALE Professional Guitars, Amplifiers, PA Systems, Free Catalog. CARVIN, Escondido, Calif. 92027.

GUITAR MAKING Books. Imported Woods, Supplies, Accessories. Catalog 25¢. Guitar Center, Box 15444, Tulsa, Okla. 74115.

GUITARISTS—Busy? Five minutes weekly, teaches strums, barres, melody. Beginner—advanced. Samples, 10¢. Steele's, Box 114, San Raphael, Calif. 94902.

VIOLINS, Guitars, String Instruments. Old or New. Instant Strad Tone. Worldwide. Certified. Do-it-Yourself \$10.00. Superlative Formula, 90 Day Trial \$3.00. Sgt. Rorex U.S.A.F. "Ret." P.O. Box 2381, Las Vegas, Nevada 89104.

POEMS Set to music. Songs recorded. Send poems, songs, Crown Music, 49-C West 32, New York 10001.

30% TO 50% DISCOUNT. Guitars, Amps, Drums. Any Model. Free Catalog. WAREHOUSE P8, Box 9352, Fort Worth, Texas 76107.

VALUABLE Recording, Publishing. Promotional Information \$2.00. Free Demonstration Record Included! Mother Cleo Productions, Box 521, Newberry, South Carolina 29108.

SWISS Music Boxes. Highest quality. Spielman, 131 West 42nd, New York 10036.

POEMS Wanted For songs, Nashville Music Productions, Box 9001-P, Nashville, Tennessee 37204.

SONGPOEMS Urgently Needed, Possible Recording/Publishing, 50-50 Agreement, Betty's Music Makers, 945B Central, St. Petersburg, Florida 33705.

SONGWRITERS—50-50 Offer. Newart Pubs, Box 693, Syracuse, New York 13201.

CONSERVATION TRAINING

GAME WARDEN, Government Hunter, Forestry, Park & Wildlife Service announce job openings regularly. Prepare at home for outdoor work, good pay, security. Complete information Free! Write North American School of Conservation MPW, Newport, California 92663.

MOTEL HOTEL MANAGEMENT TRAINING

MOTEL MANAGER TRAINING — Men, women, couples wanted by leading resorts, motels-hotels everywhere. Enjoy free rent, plenty of free time. Easy home-study plan. Free! "Motel Career Kit." No salesman will call. North American School of Motel-Hotel Management, AZW, Newport, California 92663.

EDUCATION AND INSTRUCTION

EARN University Degrees through Experience—Many Subjects—Details \$1.00—St. Matthew University, 1394 Kelton Ave., Columbus, Ohio 43206.

COMPLETE YOUR HIGH SCHOOL At home in spare time. Texts furnished. No classes. Diploma. Approved for Veteran Training. Founded 1897. Free Brochure. American School, Dept. X345, Drexel at 58th, Chicago, Illinois 60637.

FINGERPRINTING—Investigation. Exciting, secure career. Learn at home. Free book. State age. Institute of Applied Science, 1920 Sunnyside, Dept. 163, Chicago, Illinois 60640.

MAGIC Easily learned with home study course. Inexpensive. Magic Masters, P.O. Box 774M, Bowie, Maryland 20715.

GRAPHOANALYSIS — Learn scientific handwriting analysis for profit, pleasure. Free sample lesson, catalog, reveals plan. Write: Igas Inc., 325 Jackson, Dept. 2AZ-2, Chicago 60606.

BE A Real Estate Broker. Big earnings. Prepare quickly, easily. GI approved. Free Catalog. Weaver School, 3519-P Broadway, Kansas City, Missouri 64111.

MISSOURI Auction School. Veteran Approved. Free catalog. 1600-03 Genesee, Kansas City, Mo. 64102.

LIFETIME ORDINATIONS. Send stamp for information. Church, 2207 Cardinal, Rolling Meadows, Ill. 60008.

PENMANSHIP Corrector. Improve Poor penmanship quickly. Details free. Ozment, Box 2344, St. Louis, Mo. 63114.

LEARN Auctioneering. Term soon. Free catalog. Reisch Auction College, Box 850, Mason City, Iowa 50401.

PIANO Tuning quickly learned with home study course. Diploma granted. American Tuning School, Gilroy, Calif. 95020.

EARN \$125 A week and up. Learn a trade with a future. Learn auto diesel mechanics in our shops. You learn with tools on real equipment. Earn while you learn. Many of our graduates earn \$125 a week and up. Write for free bulletin: Dept. 256, Auto Diesel College, Nashville, Tennessee 37219.

HIGHLY EFFECTIVE Home study courses in Electronics Engineering Technology and Electronics Engineering Mathematics. Earn your Degree. Write for Free Descriptive Literature. Cook's Institute of Electronics Engineering. (Dept. 10). P.O. Box 10634, Jackson, Miss. 39209. (Established 1945).

EXTENSION And Post-Graduate Awards in Philosophy, Arts, Sciences, Botanic Medicine, Homeopathy, Radionics and others. 30 subjects. Curricular free (air-mail \$1.00 refundable). Registrar, Sussex College of Technology. Highfield, Danehill, Sussex, England.

DETECTIVE Course. Free Information. Universal Detectives, Box 8180-F, Universal City, California 91608.

HIGH SCHOOL Diploma at home. Licensed teachers. Send age, highest grade completed for free details. No salesman will call. Southern States Academy, 5300 W. Bellfort, Dept. 16-03, Houston, Texas 77035.

OWN Collection agency. "Little Gold Mine!" Franklin Credit, Roanoke, Virginia 24004.

USED CORRESPONDENCE Courses and Books sold and rented. Money back guarantee. Catalog free. (Courses bought.) Lee Mountain. Pisgah, Alabama 35765.

AUCTIONEERING. Resident or Home Study Course Free Catalog. Nashville Auction School, 2004 West End, Nashville, Tennessee 37203.

AUTOSUGGESTION. Sleep-learning headquarters! Tapes, records, books. Gigantic catalog free. Research Association, Box 24PM, Olympia, Washington.

ANSWERED GOD'S CALL. Become an Ordained Minister of the Gospel for Christ. We Ordained Worthy Christians. Calvary Grace Christian Church, Post Office Box 1674, Fort Lauderdale, Florida 33302.

EARN College degrees at home. Many Subjects. FLORIDA STATE CHRISTIAN COLLEGE, Post Office Box 1674, Fort Lauderdale, Florida 33302.

POLICE Correspondence Courses and diplomas \$10.00. National Police Studies, Box 112, Pleasant Grove, Alabama 35127.

PROFITABLE Camera service training at home. National Camera, Dept. PM, Englewood, Colo. 80110.

PIANO Technology—Electronic organ servicing, learned easily at home. G.I. Approved. Free booklet. Niles Bryant School, Dept. P, 3631 Stockton, Sacramento, California 95820.

(Continued on next page)

EDUCATION AND INSTRUCTION

(Continued from preceding page)

LEARN Asleep or awake! Records, tapes, equipment! Free catalog! Drawer PM-400, Ruidoso, New Mexico 88345.

\$100.00 PER Day plus expenses possible for Detectives. Details Free. Detectives, Box 185, Fairfield, Alabama 35064.

REPAIR MINIBIKES, LAWNMOWERS, BICYCLES, Sewing Machines, Auto Engines. Build concrete, Plywood, boats, trailers. Ten additional How-To-Do books. Free brochure. Sincere, Box 10422, Phoenix, Arizona 85016.

MAKE MONEY In real estate! Complete home study course designed to start you on new career. Opportunities waiting! Write: Career School of Real Estate Studies, 1301PM S. Glenstone, Springfield, Missouri 65804.

WATCH REPAIRING. Learn to repair American and Swiss watches in spare time at home. Diploma awarded. Free sample lesson. No obligation. Chicago School, Dept. YP, Fox River Grove, Illinois 60021.

MEMORY improvement—simple, easy, way using little known ECRIT facts send \$1.00 to P.O. Box 122, Bell, California 90201.

BARGAINHUNTERS CORRESPONDENCE Courses rented. Listing \$1. Jakutis, 415 East 3rd, Long Beach, 90812.

FREE List, used courses, books. Ellie, 1002 Central, Lowell, Massachusetts 01852.

COLLEGE Degree at Home. Law, other subjects. Easy tuition. Williams College, Riverview, Arizona 85334.

MAKE Money writing short articles. Order "Ten Lesson Writing Course" only \$4.95. Kit's Korner, PM 1, 671 Davis Avenue, Staten Island, New York 10310.

CERTIFIED HIGH SCHOOL DIPLOMA Earned by examination only. Send stamped, self-addressed envelope for information and application: Bedford Academy, Box 221, Bedford, Virginia 24523.

\$85.00 A DAY Tuning pianos? Easy! Free Booklet. ABC School of Piano Tuning, P.O. Box 3215, Shreveport, Louisiana 71103.

DRAFTING Booklet. Inside tips on getting first job, training, requirements, career potential, much more. Satisfaction Money Back Guaranteed. \$2.00. John Rybicki, Box 5124B, Anaheim, California 92804.

LEARN New way to get more out of life. Powerful book explains new science of Self-image psychology. \$2.00. Dunlavy's, Dept. 251, 5231 Simpson Rd., Mechanicsburg, Pa. 17055.

COLLEGE Degrees thru extension. State Chartered, Prospectus Free, Box 688, Palm Beach, Florida 33480.

HOW To Get that CIVIL SERVICE Job. Free folder lists 285 classifications. Tomar, 1760 South Brentwood, St. Louis, Missouri 63144.

SERVE God. Lifetime Ordination. Free D.D. Dept. 25, Box 333, Rillton, Pa. 15678.

AUTOMATIC Transmissions. Ticket to \$13,000.00 year. Free brochure. Idrach Institutes, Box 10067-C, San Antonio, Texas 78210.

FOR INVENTORS

INVENTOR'S Service. Everything. Booklet. Reasonable. Pen-Ink, 50 East 42, New York City 10017.

INVENTIONS Wanted immediately for promoting on cash or royalty. Patented, Un-Patented. Free booklet outlines royalty rates, requirements. Write Kessler Corporation, C-53-F1, Fremont, Ohio 43420.

PATENT Application Financing. Free patent search plan. Global Patent Division. 2420 77th, Oakland, Calif. 94605.

U.S. PATENT Office Searches, 234 Broadway, Room 3615, New York. Free invention certificates.

PATENT SEARCHES Including maximum speed, full airmail report and closest patent copies. \$6.00. Quality searches expertly administered with complete secrecy guaranteed. Free Invention Protection forms and "Patent Information." Write Washington Patent Office Search Bureau, Dept. 15, 711 14th St., N.W. Washington, D.C. 20005.

PATENT And invention development by licensed professional patent engineer and U.S. Patent Office former examiner, and engineering specialists. Your inventions and ideas engineered for patent protection and commercial value. Inventions developed by us negotiated for cash or royalties with our nationwide contacts. Send for free protection "Invention Certificates" and further interesting, valuable patent information. George Spector, Licensed Professional Patent Engineer, Woolworth Building, New York 10007.

IMMEDIATE Cash, for patent applications. Free patent searches. Write for details. Universal Patents, 184-D, Marion, Ohio 45750.

INVENTORS: Your ideas and inventions (patented/unpatented) expertly searched, developed for commercial appeal and cash/royalty sales to manufacturers by professional Invention Developer with excellent record of experience. B.S. Industrial Engineering; United States Patent Office former Patent Examiner. United States Government former Patent Advisor. Second decade reliable service! Member: United States Council International Chamber Commerce. Free "Invention Record" and "Recommended Protection Procedure." Airmailed! Write: Raymond Lee, Invention Developer, 230P-Park Ave., New York City 10017.

FREE PAMPHLET: "Tips on Safeguarding Your Invention." Write: United States Inventors Service Company, 501P Thirteenth Street N.W., Washington, D.C. 20004.

PATENT Searches, including copies of related U. S. patents. Inventors, attorneys, manufacturers use our "worldwide" airmail service! "Invention Record" form and "Information Every Inventor Needs". Sent Free! Hayward Company, 898P National Press Building, Washington, D. C. 20004.

MANUFACTURERS NEED New Products! FREE Literature explains "How to Submit Your Invention." Congress Invention Company, 911-C Warner Building, Washington, D.C. 20004.

INVENTORS WOULD You like names and addresses of where to write for books pertaining to patents, copyrights and trademarks? SEND \$1.50 to ALVAH T. And R. CLOUGH, POST OFFICE Box 89, SOMERVILLE, MASSACHUSETTS 02145.

INVENTIONS WANTED

INVENTIONS Wanted immediately for promoting on cash or royalty. Patented, Un-Patented. Free booklet outlines royalty rates, requirements. Write Kessler Corporation, C-53-IW, Fremont, Ohio 43420.

INVENTIONS Wanted. Patented: unpatented. Tremendous manufacturers lists. Global Marketing Service, 2420G 77th, Oakland, California 94605.

INVENTORS! Sell your invention for cash or royalties! Our client manufacturers eagerly seek new items. Patented, Unpatented. Financial assistance if needed. 25 years proven performance. For free information, write Dept. 15, Gilbert Adams, Invention Broker, 81 Wall St., New York, N.Y. 10005.

INVENTORS! We will develop, sell your idea or invention patented or unpatented. Our national manufacturer-clients are urgently seeking new items for highest outright cash sale or royalties. Financial assistance available. 10 years proven performance. For free information write Dept. 47, Wall Street Invention Brokerage, 79 Wall Street, New York, N.Y. 10005.

WE Either sell your invention or pay cash bonus. Write for details. Universal Inventions, 28-E, Marion, Ohio.

INVENTORS! Don't sell your invention, patented or unpatented until you receive our offer. Eagle Development Company, Dept. H, 83 Wall Street, New York, New York 10005.

FREE "Directory of 500 Corporations Seeking new Products." For information regarding development, sale, licensing of your patented/unpatented invention. Write: Raymond Lee Organization, 230-N Park Avenue, New York City 10017.

INVENTORS! Protect your ideas! Free "Recommended Procedures." Washington Inventors Service, 422F, Washington Building, District of Columbia 20005.

INVENTIONS Promoted. No-Risk Percentage Basis. Detail. INSECO, Box 200, Monroe, Ohio 45050.

PATENTS FOR SALE

PROFITS FROM CLASSIFIED ADVERTISING! Booklet shows you how to start your own business with Classified Advertising. Only \$1.00 (Refundable with first order.) C. A. Martin, Popular Mechanics, Dept. PM, 224 West 57 Street, New York, N.Y. 10019.

MANUFACTURING

INVENTORS Ideas developed. Research. Models. Manufacturing. Sales. Free brochure. Since 1942. William Parker, Box 209, Worcester, Mass. 01601.

BUYING AND SELLING

MAILORDER Records help get increased business! Complete 32 Page Record Book shows your inquiries orders, advertising, expense, etc. Only \$1.00. C. A. Martin, Popular Mechanics, Dept. PM, 224 West 57 Street, New York, N.Y. 10019.

BUY IT WHOLESALE

WHOLESALE—Buy 40% To 50% Off Retail—same prices retailers pay! Thousands of name brands! Watches, cameras, jewelry, radios, phonographs, tape recorders, etc. Buy for yourself or resell at fat profit. Big wholesale catalog. Confidential Wholesale Price List. Free details. Wholesale Merchandise Club of America, Dept. 410, 154 Jericho Turnpike, Floral Park, N.Y. 11001.

LIVE Catch Traps. Free Literature. National Live Trap Corp., Tomahawk, Wis. 54487.

AUTOMATIC Fishhooks. 400% Profits. Free Details. 2 Models. Samples \$2.00. Aron, 61-PM Mastic Beach, New York 11951.

HEARING Aids. Batteries. Wholesale. Catalog 25c. Flston, Box 1444, New Preston, Conn. 06777.

WORLD'S Largest wholesale dropship sources. U.S., foreign. Factory suppliers dropship direct to you or customers. Now! have your own catalog for pennies. Free details. International Buyers, Box 16386-M, Portland, Oregon 97233.

BARGAINS! Buy wholesale and below. Name brands. Appliances, furniture, sports equipment, televisions, cameras, watches, jewelry thousands more. Huge discounts to \$1,000.00 on new automobiles. All makes. Free details. Write today: Worldwide Bargainhunters, Box 730-A, Holland, Michigan 49423.

1970 FORDS, Dodges, \$799; 1969 Cars only \$599. For free catalog. Associated Dealers, 50 Swalm, Dept. 6, Westbury, New York 11590.

10 GUARANTEED 9-Volt Transistor Batteries, \$1.95. David Tomich, 136 North Marian, Oak Park, Illinois 60301.

LOWEST Importer Prices New York Directory \$2.00. Free Brochure. Winchester Enterprises, 2807 PM Hargrave Street, Philadelphia, Pennsylvania 10136.

POLYETHYLENE BAGS—New wholesale catalog. 300 stocked sizes. Lowest ever prices. Catalog 20c. Dealers wanted. Milvan, 7921D Enterprise, Newark, Calif. 94560.

(Continued on next page)

BUY IT WHOLESALE

(Continued from preceding page)

800,000 PRODUCTS Wholesale! Free catalog offer! Wholesalers, 1265-MP Broadway, New York, N.Y. 10001.

EXPORT-IMPORT

JAPAN: 1200 Products Directory. Illustrated Manufacturers' names, addresses. \$3.00. Send cash. Yamagata Office, 814 Togin Bldg., Marunouchi, Tokyo.

ORIGINAL Oil Paintings 16X20" \$72 Dozen. Details 25c. McDaniel, 3632 Topax, Claymont, Delaware 19703.

MAILORDER IMPORTS, Report reveals foreign drop-ship sources World Trader's Digest, ideal mailorder items only \$1.00 P. F. Carter, 623 West Fern Drive, Fullerton, Calif. 92632.

FOR PARENTS

PROFITS FROM CLASSIFIED ADVERTISING! Booklet shows you how to start your own business with Classified Advertising. Only \$1.00 (Refundable with first order.) C. A. Martin, Popular Mechanics, Dept. PM, 224 West 57 Street, New York, N.Y. 10019.

OF INTEREST TO WOMEN

STYLE Wigs, Kit and Instructions, \$14.95. Robertsons Wigs, 4900 Birchman, Fort Worth, Texas 76107.

CHURCHES, School Groups, Civic clubs, Scouts! \$50.00 cash is yours everytime 10 members each sell 10 canisters of Nationally Advertised Candy at \$1.00 a can using our "50-50" Funds Raising Plan. Fun, Fast, Easy. Send no money. 30 days to pay. Write Verne Collier, Dept. PM-6, 900 North 19th Birmingham, Alabama 35203.

DRIVE New car, wear new clothes, buy color TV. Get daily cash income. Put spare hours to work. Write for 5 months free subscription Opportunity Magazine, see hundreds easy ways to make money. Opportunity, 1460 Hancock Center, Dept. 17-CO, Chicago 60611.

\$6.00 PROFIT Per Dozen Lacing Beautiful Baby Boots, Baby Moks! Cowboy, Warsaw 9, Indiana 46580.

\$500.00 MONTHLY Possible—clipping news at home. No experience. Send stamped-addressed envelope. American, Excelsior Springs, Mo. 64024.

WOMEN! Make big money at home. \$10.00 profit in an hour possible with invisible mending. Make holes, tears disappear from clothing fabrics. Steady year-round demand from cleaners, laundries, homes. Details free. Fabricon, 1533 Howard, Chicago 60626.

HOW To make money writing short paragraphs. Information free. Barrett, Dept. C-27-03, 6216 N. Clark, Chicago 60626.

HOME Newspaper clippers needed, \$500 monthly possible. Details free. Foster, 272-MA2, Brooklyn 11235.

\$46.00 DAILY Possible—addressing—stuffing envelopes (typewriter or longhand). Information: Send stamped, addressed envelope. American, Excelsior Springs, Mo. 64024.

WANTED! Addressers — Commission Mailers. Stamp required. Ooton Distributors, 4120-P Duke Drive, Portsmouth, Virginia 23703.

HOMEWORKERS! \$100.00 Weekly addressing for firms. Begin immediately. Details—send stamped, addressed envelope. Hamilton, 272-TM2, Brooklyn 11235.

"DRAPERY AND DRESSMAKING FABRICS. WHOLESALE Prices in small quantities, Edwards, Dept. B., 130 Burlwood Drive, Santa Cruz, California 95060."

\$75.00 THOUSAND, HOME Addressing! Longhand, Typewriter. Information, send stamped, self-addressed envelope. Brewster "YL" Box 1348, Clearwater, Florida 33517.

GUARANTEED, \$20.00 EVERY 80 ENVELOPES you stuff. No postage, addressing required. Information, send 30c with stamped, self-addressed envelope. Econ, "CX", 629 Franklin St., Clearwater, Florida 33517.

WEDDING Consulting, Party Planning, Catering, cake decorating & candymaking all provide profitable spare or full-time businesses. Membership in world-wide club gives you 5 Free Professional Courses, advice of Experts, Business Plan & Money-Making Projects-Of-The Month! Write for Free details to: R. S. V. P. —Internationale, Dept. 36, 1600 Cabrillo Avenue, Torrance, California 90501.

WEAVE RUGS—Make Good Profits—No experience necessary! Free Catalog, sample card, and low prices on carpet warp, rug filler, looms, parts, inexpensive beam counter. If you have loom—advise make, weaving width please. Or. Rug Company, Dept. 319, Lima, Ohio 45802.

LOSE WEIGHT Spot Reduce Exerciser, Weight Charts, Diet, Menus, Recipes Included. \$2.98. CONVENIENT MAIL ORDER. General Delivery, Jellico, Tennessee 37762.

HOUSEWIVES, Teachers, students, office workers. If you need extra cash each week but household or other duties prevent you from taking a part-time job, learn how you can earn by accepting orders to Popular Mechanics, Good Housekeeping and all other magazines. No experience needed. Write Popular Mechanics Room 3W, 250 West 55th St., New York 19, New York.

GIRLS—Write for Waitress Course Information. Goldstreet, Drawer 17005, Wichita 67217.

HOMEWORKERS' Paint novelties. Good profits. Free details. Roland, 10-V Lakeview, Hammonton, New Jersey 08037.

CORDLESS "ELECTRIC-SCISSORS" Cut fast! accurate! Safe! \$2.98 plus 60c shipping. "FOUR" J'S. Wholesalers" 914 South Helen Street, Sioux City, Iowa 51106.

I WANT HOMEWORKERS: Excellent Earnings, Interesting, No Experience Needed. Send Stamped Envelope: Beret Enterprises, P.O. Box 2436-F, Renton, Wash. 98055.

\$100 WEEKLY POSSIBLE Addressing mailing circulars, sparetime. Free details. Send stamped addressed envelope. Newby Enterprises, Box 20431-PM, San Antonio, Texas 78220.

FREE CATALOG. With fantastic gift ideas. Creston House, 751 Crotona Park North, Bronx, New York 10457.

ATTENTION: HOMEWORKERS. Stuff letters in already addressed stamped envelopes supplied you free. No experience needed. Golden Rule Mailorder, Dept. Pms 962 Eva Ave., Akron, Ohio 44306.

HOMEWORKERS DIRECTORY! 262 National Firm seeking help. Send stamped, self-addressed envelope. Economy "AD", 629 Franklin, Clearwater, Fla. 33517.

\$25.00 HUNDRED Home Mailing Possible! Everything supplied. Instructions 35c postage, handling. Diximailco, POB 38-PMC, Hallandale, Florida 33009.

\$350 MONTH Addressing! Details, mail stamped addressed envelope. WRITE! Happy, Box 1161-CC, Battle Creek, Michigan 49016.

GIFT SHOPPING

FREE FANTASTIC New catalog of useful gifts and novelties. J & L Co., Dept. P-718, 1761 Lacombe Ave., Bronx, New York 10472.

EXCITING Gifts, all occasions, free catalog. Harvey Company, Box 3846, Wilmington, Delaware 19807.

"MOVING" Ring (adjustable) Unique—attractive—\$2.00 postpaid. Crystalcrafts, Cologne, Minnesota 55322.

HIDDEN TIE TAC. Original! Enhance your Appearance. Eliminate Unsightly Holes. Satisfaction Guaranteed! \$1.50 (Three for \$4.00). Postpaid. Free Unusual Gift Catalog. Tac-Les Tie Tac, Box-67332, Century City, California 90067.

FREE Gift Brochure, with over 100 Items. John Harris, 1743 Roosevelt Avenue, Indianapolis, Indiana 46218.

RARE FOSSIL GIFTS—500,000,000 year old Trilobite Fossil in matrix, display stand, \$9.50. 40,000,000 year old Fossil Fish 4" long, display stands, \$17.50. Perfect trilobite tie tack, \$2.50. The Bug House, Box 102, Delta, Utah 84624.

NEW! Watch Band Calanders' Years Supply; \$1.00 Postpaid; Satisfaction Guaranteed. Bolton, 5955 Linden, Long Beach, California 90805.

FREE! 32 Page Distinctive Gifts Catalog. Send Post card. Barber, 811 Delray, Nashville, Tenn. 37209.

HAND CARVED Meershaum Pipes, Free Catalog. Ronco, Dept. 51, 106 Glenside Trail, Sparta, New Jersey 07871.

WATCHES, OLD GOLD, JEWELRY

HIGHEST CASH for Gold, Jewelry, Gold Teeth, Rings, Diamonds, Watches, Silver, Platinum. Mail Articles Today. Free gift with information. Chicago Gold & Precious Metals, 6E. Monroe, Dept. 758, Chicago 60603.

WANTED: Gold, silver, platinum (any form). Information free. Wilmot's, 1067 Bridge St., Grand Rapids, Mich. 49504.

CASH Immediately for old gold, jewelry, gold teeth, watches, diamonds, silverware, spectacles, platinum, mercury. Free information. Rose Industries, 29-A East Madison, Chicago 60602.

WATCH And clock repairing books. Free catalog. North American, Box 77-AC, Fox River Grove, Illinois 60021.

COMPLETE Watchmakers'—Jewelers' Catalog \$1.00. Bengal's, 17942 Ventura, Encino, California 91316.

WEARING APPAREL

MAILORDER Records help get increased business! Complete 32 Page Record Book shows your inquiries orders, advertising, expense, etc. Only \$1.00. C. A. Martin, Popular Mechanics, Dept. PM, 224 West 57 Street, New York, N.Y. 10019.

HEARING AIDS

HEARING Aids below wholesale. Regular, eyeglass, completely hidden models. Smallest, most powerful. Free home trial. No Salesman will call. Free details. Write Prestige-C6, Box 10880, Houston, Texas 77018

SAVE To \$500.00. Rhodes Hearing Aids, Box 518, Paducah, Ky. 42001.



SCIENCE AND CHEMISTRY

LASER PISTOL—\$1.00. How to build PHASER PISTOL—\$1.00. MOON MAN (ROBOT), Build now. Complete plans \$2.00. (add 25c postage.) New catalogue—25c. Roy Davis Laboratories, Dept. PM, 118 West Adams Street, Jacksonville, Florida 32202.

CHEMICALS And apparatus for industrial, analytical, and private laboratories. Catalog 50c. Dept. M-50. Biological Supply Co., 1176 Mt. Hope Ave., Rochester, N.Y. 14620.

CHEMICALS Apparatus, Biology and Model Rockets. Both Catalogs for 50c. Sheard Science, Dept. PM, Columbus, Wisconsin 53925.

EVERYTHING You Want And Need—Chemistry, Biology, Astrology Catalog 35c. Boulevard Laboratories, 3114 East 83rd Street, Chicago, Illinois 60617.

SEARCHING For Economically Priced Laboratory Supplies? Conversion Charts And Catalogue—35c. Hagenow Laboratories; Manitowoc, Wisconsin 54220.

LABORATORY Supplies at discount prices. Catalogue—35c Deluxe Scientific; Manitowoc, Wisconsin 54220.

CATALOGUE Of Those Ver-ry Hard-To-Find Products in Chemistry, PLUS things that Go Boom, Rockets, Transistor Radios, —More. (Price Refundable—1st Order) 50c. Kenrus-C, Box 158M, Staten Island, New York 10309.

FORMULAS, PLANS, ETC.

SEVENTY-FIVE One and two Ingredient Marketable Formulas, Complete Instructions. Satisfaction Guaranteed. \$1.00 Gamfields'-A, Box 1746, Indianapolis, Indiana 46206.

ANY FORMULA—\$5.00. Catalog—Manufacturing Treatise 25¢. Belfort, 192 N. Clark, Chicago 60601.

PLASTICS

PLEXIGLAS Plastic supplies, tools catalog 25¢ refundable. COSAS, Box 5768, San Francisco 94101.

CASTOLITE Pours like water, hardens like glass. Without heat. Embed natural flowers, photos, coins. Many other money-making projects. Manual 25¢. CASTOLITE, 71/101C, Woodstock, Illinois 60098.

PLASTIC, DECORATIVE, Mother-of-Pearl Chips Wholesale. Use for plastic embedments. Use in making beautiful table tops, wall paneling, Decorative Novelties. Send .25 cents for Price List. Apco, P.O. Box 282, Metropolis, Illinois 62960.

TREASURE FINDERS

TREASURE Detector's From \$49.50 to \$500.00. Professional Advice On Your Choice! Ask For FREE 24 Page TREASURE Hunter's PAPER, Treasure Map and Book Bargains. Ask For Free List. Write: TREASURE HELP, 300 State Street, Oscoda, Michigan 48750.

BURIED Treasure Is Everywhere! New Map Book Shows Over 400 U.S. Locations. Details Free. Cummings & McIlvain, 922 Melrose Avenue, Santa Cruz, California 95060.

FREE TREASURE GUIDE! Fact-filled collectors edition; send 50¢ for postage. Also request free literature on ultrasonic, professional Fisher Detectors. FISHER RESEARCH, Dept. PM-3, Palo Alto, California 94303.

FREE 128 Page detector catalog. General Electronic Detection Co., Box 67, Bellflower, California 90706.

"FIND Buried treasure with revolutionary patented, analytical metal detector. Features push button and automatic tuning, negligible ground pickup, greatest range. Free catalogue. Gardiner Electronics, Dept. 9, 4729 N. 7th Avenue, Phoenix, Arizona 85013."

POWERFUL Metrotech locator detect gold, silver, coins, relics. Moneyback guarantee. terms. Free information. Underground Explorations, Dept. A, Box 793, Menlo Park, California 94025.

TREASURE Hunters! Prospectors! Relco's new instruments detect buried gold, silver, coins, minerals, historical relics. Transistorized. Weighs 3 pound. \$19.95 up. Free catalog. Relco-A40, Box 10839, Houston, Texas 77018.

TREASURE, Gold, silver, relics. New 1971 detectors now available. Free information. Excelsior Electronics Company, 7448 Deering Avenue, Canoga Park, California 91303.

TREASURE LOCATORS MOST COMPLETE LINE. FREE INFORMATION. TESOROS, APARTADO 7-948, MEXICO 7, MEXICO.

GOLDAK Treasure locators—Pleasure and profit in a hobby you'll enjoy. Find coins, relics, gold, silver. Charge on BankAmericard. GOLDAK, Dept. PM 1101-A Air Way, Glendale, California 91201.

"TREASURE BOOKLET. Excellent information on treasure hunting and metal detectors. Send 25¢. BOOKLET, Dept. PM-3, Box 243, San Gabriel, California 91778.

REALLY Want Treasure? Get "Selectmatic"! Differentiates Money—Iron—Tinfol. Patented. Literature—\$1.00. Treasuretronics, Plain Dealing, La. 71064.

SEARCH Metal Detectors. Solid state. Sensitive. Operate underwater. Free literature. Search Electronics, Box 8396-A, St. Petersburg, Florida 33738.

PRECIOUS STONES AND MINERALS

500 POLISHED Gemstones \$5.00. Tumblecraft, 5401 James North, Minneapolis, Minn. 55430.

EARTH Science Rockhound Magazine. Subscription \$3.00. Sample \$4.00. Box-550-PM, Downers Grove, Ill. 60515.

500 BEAUTIFUL POLISHED GEMSTONES \$1.50. Floodstones, P.O. 1673, Fremont, California 94538.

GET Free catalog no serious rockhound, gem cutter, jewelry maker, hobbyist or craftsman can be without. Full of bargains, exclusive items, low prices from largest suppliers and authorities in the field. Free new catalog just off the press, yours for the asking. Write Grieger's, Dept. C-12, 1633 E. Walnut, Pasadena, California 91106.

NEW! Brilliant multicolored Twotone quartz baroque—1/4" to 2" tumblepolished—25 for \$1.00 postpaid. Crystal Gems, Cologne, Minnesota 55322.

POLISHED Agates, 15 Banded Lake Superior \$1.00. H. Palm, 6119 Perry North, Minneapolis, Minnesota 55429.

CARTOONING, COMMERCIAL ARTS, SHOWCARD & SIGN PAINTING

"HOW TO MAKE MONEY WITH SIMPLE CARTOONS"—Everyone who likes to draw should have this book; FREE. Write Cartoonists' Exchange, 93, Pleasant Hill, Ohio 45359.

\$200.00 MONTHLY Sparetime possible making signs, posters, silkscreen printing. Learn quickly—easy instructions. Information free! Hampton 111PM, Box 112, New York, N.Y. 10012.

COMPACT 23 lesson Cartoon Course and Cartoonist's Magazine. \$2.00. Hartman, Box 30367, Lincoln, Nebraska 68510.

LEARN Sign painting at home. Free talent test. Ben Kerns, Box 812-PM, Greenville, S.C. 29601.

MODERN Cartooning taught by mail. Write for free brochure. Cartoonorama—Box 263-5B, Branford, Conn. 06405.

LEARN Sign painting—low cost books. Free information. Sign Book Company—PMF, 470 Oak Street, St. Louis, Missouri 63119.

SIGN Painting—\$1000 per Month Part-Time. Free Catalogue. Kaufmann Supply, Centertown, Missouri 65023.

"PROFESSIONAL Art Instructions, Tips, Tricks." Deluxe Edition \$1.25 (Airmailed). Harris, Box 1567-PMA, Portland, Oregon 97207.

CHALK Talks. 40 page Catalog 10¢. Balda The Cartoonist, Oshkosh, Wis. 54901.

ADVERTISING AGENCIES, ADV. SERVICE, MAILING LISTS

ADVERTISING Ratebook leading newspapers, magazines, 25¢. Chicago Advertising Agency. 28-E Jackson, Chicago 60604.

MAILING Lists most all kinds 1000 \$5.00. Free folder Your circulars mailed \$4.00 1000. Dixie Mailers, King, N.C. 27021.

TYPEWRITERS, DUPLICATORS, OFFICE EQUIPMENT

FREE Plan. Start printing, lettershop. Offset Presses. Mimeograph Copy machines. DixieGraph, King, N. Car. 27021.

RUBBER STAMPS AND OFFICE SUPPLIES

ADDRESS \$1.50. Photo \$5.00. Inker \$1.10. Craig Stamps, Box 511, Mt. Vernon, Illinois 62864.

POCKET Stamp 3 Lines \$1.00 Indelible stamp \$2.00 Martinhouse, 2052 East 24th Brooklyn 11229.

RUBBER Stamps, 3L-2" \$1.90, Catalog R.E.D., 18 Crane, Darien, Connecticut 06820.

ADDRESS Stamp 85¢. Signature \$2.80. Catalog. Carol's, McCloud, Okla. 74851.

FREE 48 Page Catalog. Rubber stamps, printing, office supplies. Youngers Stamp Shop, Princeton, Iowa 52768.

PERSONAL PRINTER 3 Lines in Script \$3.50 Richard Price Jr., 48124 VanDyke, Utica, Michigan 48087.

ADDRESS Stamp 4 Lines \$1.30. Denton's, Box 3594, Albuquerque, N.M. 87110.

HARD TYPE, Machines, supplies for making rubber stamps, buy direct from manufacturer. Barco Type, 237 S. Evergreen, Bensenville, Illinois 60106.

FREE Stamp catalog. 45 type styles. Fast service, low prices. Jackson's, Box 443-A, Franklin Park, Illinois 60131.

PRINTING PRESSES, RUBBER STAMP OUTFITS

RUBBER Stamp manufacturers supplies. Presses, starting outfits. Best prices, service. Catalog. Jackson Supply, Box 443A, Franklin Park, Illinois 60131.

SIMPLE-X RUBBER STAMP PRESSES, Hydraulic operated, electrically heated. Sizes 5"x8", 8"x12", 10"x15". Starting outfits. Orders for presses, supplies shipped day received. Free catalog low supply prices. Custom Manufacturers, 406-P East Elm, Springfield, Mo. 65801.

PRINTING Presses, type, supplies. Lists. 5¢. Turnbaugh Service, Mechanicsburg, Pennsylvania 17055.

TYPE Catalog No. 12, 120 pages. Send One Dollar. Deductible First Order. Acme Type. 732 Federal, Chicago, Illinois 60605.

SAME Day shipment on rubber stamp supplies. Revised wholesale price list No. 7 free. Star Stamp Supply, 732 Federal, Chicago, Ill. 60605.

RUBBER Stamp outfits, supplies. Kiewiet, 2025 Barney Road, Kalamazoo, Michigan 49007.

MAKE Your Own self-molding rubber stamps and printing cuts. Plexirubber, Argyle (1), Wisconsin 53504.

BIG SAVINGS On printing with new, unique mimeograph! Only \$29.95. Free sample printing and details. Rohler, 611 Central, Lafayette, Ind. 47905.

PRINTING AND SUPPLIES

BUSINESS Cards . . . \$4.99*! (Thousand!); Bicoloreds . . . \$6.99*! (*Refundable!). Discountagraphics, Pfhlieughiersville, Texas 78660.

QUALITY Business Forms, letterheads, envelopes. Economical. Samples, Burnfin, Weaubleau, Mo. 65774.

AMAZING Business printing values. Quotations. Print Shop. Box 576, Greenville, R.I. 02828.

FREE Literature. Address Labels, Business Cards, Printing, Rubber Stamps: Jordan's. 552 West O'Connor, Lima, Ohio 45801.

8 HOUR PRINTING—Free Booklet "Secrets of Cutting Printing Cost." Nationwide Printing, Atlanta, Illinois 61723.

BUSINESS CARDS Raised Letters \$5.65 Thousand. Like Engraved. Free Samples. Kavanagh, Box 1222, Brooklyn, N.Y. 11202.

QUALITY PRINTING—Offset. Since 1945. Free 24 page catalog! Napco Press, 1744-P Bath Avenue, Brooklyn, N.Y. 11214.

FREE Catalog, samples. Top quality printing, bargain prices. Wilco, P.O. Box 6176, New Orleans, Louisiana 70114.

100 TWO-Color Kromekote Finish Business Cards \$2.00. Eslick's, Delavan, Wisconsin 53115.

FANTASTIC 3-D Action Business Cards. Samples 25¢. Scholler, 1747 Selby, Saint Paul, Minnesota 55104.

FREE—100 Personal cards, with 100 5 1/2"x7 letterheads, envelopes, 3 lines each. \$4.75. Buddy's, 711 So. Hampton, Dallas, Texas 75208.

(Continued on next page)

PRINTING AND SUPPLIES

(Continued from preceding page)

PRESTIGE: New and beautiful, 250 enameled business cards. Printed in two brilliant colors and bordered \$3.00 postpaid. Samples airmailed \$1.00 (deductible). Lefty Gandy, Lyons, Georgia 30436.

SEND Stamp for Printing Catalog. Gables—405 Clifton, Glenshaw, Pa. 15116.

PRINTING—8 Hour service. 100 8 1/2 x 11 \$1.95, 1000—\$6.95. Allstate Press, 120-PM South LaSalle, Chicago 60603.

GUMMED LABELS

1,000 GUMMED Address Labels \$1.00. Walt's, Box 966A, South Bend, Indiana 46624.

1000 PERSONALIZED Labels 50¢. 3 Sets \$1.25. Free Catalog!! Fabrico—Dept. MC-1, 1512 N.E. 29th Street, Ocala, Florida 32670.

1000 GOLD Stripe Address Labels \$1.00. Free brochures. Vernon House, 158 W. Sandford Blvd., Mt. Vernon, N.Y. 10550.

1000 TWO-COLOR Address Labels, \$1.00. Free Gift Catalog. R&R Enterprises, Box 1317M, Running Springs, Calif. 92382.

2000 GOLD Stripe Address Labels \$1.75. Reckards, 2829 Idaho, Camden, New Jersey 08104.

REMAILING SERVICE

NEVADA Remails, Confidential, 25¢. \$3.00 monthly. Souvenir postcards 25¢. D.D., Box 5321, Las Vegas, Nevada 89102.

FIRST Month's receiving-forwarding free. Wright, Box 2112-M, Asheville, North Carolina 28802.

SAN JUAN Remails 25¢ each. \$3.00 monthly. Confidential. Rob, Box 787, San Juan, Texas 78589.

SCOTTSDALE Remails 25¢ \$3 monthly. Remfor, Box 1541, Scottsdale, Arizona 85252.

MIAMI Remails 25¢. Monthly rates. Marie, Box 1266, Coral Gables, Fla. 33134.

CONFIDENTIAL New York City mail address \$3.00 month. Remails 25¢. Details Free. Birnhan, 152 W. 42, New York City 10036

SECRET, Receiving—forwarding. Discreet and confidential. Remail 25¢ single. Mail Forwarding Service, 8050 S. Main, Houston, Texas 77025.

RECEIVING—Forwarding. Monthly Rates. Hedgpeh, 406-M South Second, Alhambra, Calif. 91802.

ONEIDA Remails 25¢ Each. Confidential-Dependable. Box 506, Oneida, Tennessee 37841.

PHOENIX, Remailing, Forwarding, Confidential Valley of the Sun address. Troen, Box 2386, Phoenix, Ariz. 85002.

CINCINNATI Receiving, Forwarding, Confidential. Hahn, 2621-M-Ida, Cincinnati, Ohio 45212.

SAN FRANCISCO Remails 25¢, \$3.00 Monthly. Scotts, Box 5446-P, Redwood City, California 94063.

HOME of DISNEYLAND—Anaheim Remails—25¢. Venson Vaughn, Dept. 301A, 2519 Hartford Avenue, Fullerton, California 92631.

CONFIDENTIAL Remails 25¢—\$3.00 Monthly. Bodewig, Box 381, Coos Bay, Oregon 97420.

MICHIGAN—Complete service. Information, write: Motor City, Drawer 890, Dearborn, Michigan 48121.

DENVER Remails, 25¢, \$3.00 monthly. Confidential. Rich, Box 26099, Denver, Colorado 80226.

NYC Remails, Fast, Reliable \$3.50 Monthly, Singles—25 cents. Garco, 507 Fifth Avenue, New York, N.Y. 10017.

NORTHEASTERN Remails. Confidential. Free Information. Knortheastern, 39 Woodland Street, Sharon, Mass. 02067.

CALIFORNIA Remails 25¢—Special Services. Fitzgerald, Box 3194, Santa Monica, California 90403.

MINNEAPOLIS Remails 25¢, Confidential Mail Address, \$3 Monthly. Details Free. TPS, Box 442, Rosemount, Minn. 55068.

"MICHIGAN Remails" 25¢ each or \$3.00 per month. P.O. Box #14, Pontiac, Michigan 48053.

REPAIRS AND SERVICING

NEW!!! Appliance Servicing Equipment Catalog, 25¢. Jacknan, Dept. B3, Hattertown Road, Newtown, Connecticut 06470.

SPECIAL SERVICES

INFORMATION On anything. Ferguson Research Specialists, 83-45 Vietor Ave., Elmhurst, N.Y. 11373.

RESEARCH: Most Kinds. E. Voight, 2528 West Wells, Milwaukee, Wisconsin 53233.

MACHINING For Hobbyists, Inventors. Details 25¢. Frans, Box 692, Marion, Ohio 43302.

LOCATING Service Any Item, Product. Jake Barraco, 478 Gardner, South Beloit, Illinois 61080.

TOBACCO

CIGARETTES \$2.00 per Carton, filters \$2.25. Legal. Send \$1.00 (refundable) for details. Tobacco, Box 1403, Winston-Salem, North Carolina 27102.

FREE Samples sweet chewing. 10¢. Jolley Farms, Dresden, Tenn. 38225.

PERSONAL

ORIENTAL Catholic Girls Seek Gentlemen. \$1.00 brings photos, application, complete details. Pacific, 406-M Second St., Alhambra, California 91802.

SECRET Law Wipes Out Your Debts. to \$25,000 in 90 minutes. Clear credit. Free details. Counselor-7, Kerrville, Texas 78028.

MEN, OVERCOME PSYCHOLOGICAL NEGATIVES Affecting family life with "self hypnosis". Rush \$2.00 to Thomas, 12411 Nelson, Garden Grove, California 92640.

PAY Bills! Borrow to \$1500 by mail! Convenient terms! State licensed. Postal Finance, 200 Keeline Building, Dept. 17-A, Omaha, Nebraska 68102.

YOUR Success in STOCK MARKET Astrological expert advise, Belz, AFA-member, Box 21 A, East Detroit 48021. Details free.

MAKE YOUR WILL. Get 4 Will Forms and attorney's informative book. \$1.00. Legal Forms Company, Department 124, 1830 Guardian Building, Detroit, Michigan 48226.

LONESOME? I HAVE thousands of single women. Tell me what you want. I'll send her name and picture. Help Company Club, 4554 Broadway, Chicago, Illinois 60640.

BIBLE Questions answered. Stamped envelope. Bylon, 17167 Bentler, Detroit, Michigan 48219.

INVESTIGATORS. Latest electronic Aids. Free Literature. Clifton, 11500-P NW 7th Ave., Miami, Florida 33168.

RUPTURED. Relief and comfort. No understraps, elastic or steel. Write Hand-Lock Products, Preston 4, Ont., Canada.

ARE YOU REALLY SINCERE About wanting to find a marriage partner? SOCIAL INTRODUCTION SERVICE, P.O. Box 1547, Eugene, Oregon 97401.

TOO Many Debts? Want to lower your payment and pay off the bills? Write Continental, Dept. PM, Box 2116, East Chicago, Indiana 45312.

FOLLOW That Car. Electronic Trailing Equipment. Free Literature, Box 220, Miami, Florida 33168.

SERVE Christ. Become an Ordained Minister. Write Holy Light, Dept. D, Box 4478, Pittsburgh, Pennsylvania 15205.

"SINGLE? 2000 Ladies' Fotos \$2.00. Meet beautiful girls, divorcees, of all ages through world's largest matrimonial catalog. International Contacts: Box 12, STN. "O", Toronto 16, Canada.

"RULE Others With Thoughts." (Telepathy) write: Clarion, Box 1769-S7, Chicago, 60690.

ASK! Improve Yourself. Personality questions answered. You become a winner! \$3.00. Counselor, Success Services, Box 985M, Mason City, Iowa 50401.

AMAZING Money benefits from U.S. Government. Details free. Raphax Publications, P.O. Box 10001-B, Washington, D.C. 20018.

STOP Burglars! Amazing Lokalarm! Write: S&S Sales, Lockbox 35178, Chicago 60635.

FIVE Golden keys to health, wealth, and happiness. Details free. Glenn A. Gerber and Associates, 311 B, Jefferson; Morton, Illinois 61550.

MD "STOP Smoking Kits". Sales are "Snowballing". The time is RIGHT. The time is NOW. Page, Box 117, Sun City, California 92381

FREE INFORMATION WRITE: BETTER HEALTH PRODUCTS, Box 69B, Rt. 2, Danville, Ohio 43014.

BEAUTIFUL Girls—Free Information; International Introductions, Box 1457, Vallejo, California 94590. . . .

COMPUTER DATES by mail. Nationwide. Free Details. House of Hoke, Box 101-PM, Sebring, Florida 33870.

"HAVE Confidence with others get what you want. Book reveals ways. Send \$2.00 DELCAMPO SALES, 1065 N.E. 79 St., Miami, Florida 33138.

HAVE Triple-A credit in thirty days! Get new credit without investigation! Continental, Box J-24, Hallandale, Florida 33009.

"HOW TO STOP SMOKING." Permanently! 96-Page Book Guides You. Results Guaranteed. Send \$1.00, Frank Chandler, Albemarle, North Carolina 28001.

DON'T Die without a will!! Legal form \$2.00. Guaranteed! Robertson Enterprises, 3460 Ridgewood, Akron, Ohio 44313.

OVERWEIGHT? Help For Compulsive Overeaters. Stevens of Federal, Rd. #1-PM, Oakdale, Pennsylvania 15071.

WANT To Feel Better, Live Better, Read "Guide to Successful Living." \$2.00 plus 35¢. Mid-West Gifts, Dept. 2, Columbia City, Ind. 46725.

GET That Old "DRIVE" Back in Your Life! Free Brochure! Write: Huss, 505 Penrhyn, East Chicago, Indiana 46312.

STOP SMOKING! Book Presents Medical and Psychological Method. \$2.00. Free Gift Catalog. Bosman, Box 1056-A, Tupper Lake, New York 12986.

ARE YOU SEEKING Companionship Marriage Partner? Remarkable Introduction Service Now, With Magazine And Details 35¢. Jay's, Box 1301-X, Wausau, Wisconsin 54401.

"NEW Hope for your Health"! Doctor LeCron's Revolutionary Discovery Cures Your: Insomnia, Headaches, Overweightness, Asthma, Fatigue Tension, Smoking!!! Book \$1.00 (Guaranteed!): Healthbook, BX-15242, Atlanta 30333.

WANTED—MISCELLANEOUS

WE Buy Bottles, Coins, Antiques, Books, fruit jars, magazines (anything). Send \$1.00 (refundable) for Huge Buying Lists. Schroeder's, R-4, Paducah, Ky. 42001.

MERCURY, Gold, Silver, Platinum; Ores assayed. Wholesale Terminal, Norwood, Mass. 02062.

MISCELLANEOUS

WANT A POSTER YOU CAN HUG? Your Favorite Photo Blown Up To A Big 11 By 14 Inch On Durable Fabric And Sewn Onto Side Of Decorative Throw Pillow. Perfect Gift! Details. Photo Pillow, 4402 Prasse, Cleveland, Ohio 44121.

(Continued on next page)

I'LL NEVER QUIT RACING!

(Continued from page 210)

190 mph, at Talledega, is that too fast?

If you ask the drivers who've done it, I think they'd prefer racing a little slower.

You'd say that good racing depends on the competitiveness of the racing more than all-out speed?

I'd go along with that, quite a bit.

In road racing the lead doesn't seem to change often enough. In oval racing, particularly stock-car racing, you'll have eight or ten guys, and the lead will change every time they go around the track. In road racing they tend to string out.

Well, yes. I think that's true, although the pit stops are accounting for the lead changes as much as the track itself. When you have road racing with pit stops you'll find the same sort of lead-changing. It is, I think, more man-against-the-track in road racing rather than man-to-man as in oval racing, although that's a broad statement that doesn't always hold true.

Yes, we felt that way after riding around the Nurburgring with John Fitch last year. A driver only goes around about 11 or 13

times in a race, and he doesn't get very familiar with it.

Of course, that's a unique track, but not necessarily the most challenging. I held the record there a few years, by the way.

It's a much more complicated race track than Hockenheim?

Yes, and you're very aware of the tradition. It's an awe-inspiring place. I think most Grand Prix drivers would pick the Nurburgring as one that they'd like to win.

You won there once, right?

Yes, a 1000-kilometer race in 1960, co-driving a Maserati with Stirling Moss. At the Nurburgring they get tremendous crowds. They get really stirred up. I've seen hundreds of thousands of people lining that track in the pouring rain waving their umbrellas at you.

Are Grand Prix fans different in different countries?

Sure. Just like the countries are different, the circuits are completely different and so are the fans.

A little like showbiz: You're well aware of playing to a certain audience?

Yes, that's the way it is!

★ ★ ★

MISCELLANEOUS

(Continued from preceding page)

BURGLAR Alarm Installations \$6.95. Sootin's, 321 Northwest Third Avenue, Miami, Florida 33128.

WINEMAKER'S Supply Catalog, Free, Bacchanalia, 321-Z-7 Saugatuck Station, Westport, Connecticut 06880.

CIGARETTE Shredded Smoking, Snuff, Twists, Free Samples. Stoker's, Dresden, Tennessee 38225.

SUFFERING From Arthritis? Try Ginseng; Information Free. Write Ginseng, Asheville 53, N. C.

CIGARETTES 12¢ a pack. Improved roller makes 20 filtertip, plain, king or regular for 12¢. Facts free. Green River Tobacco, Box 954, Owensboro, Kentucky 42301.

YOUR Name sent to 1000 importers, publishers, mailers, wholesalers, etc. on our mailing list. Year \$1.00. Dixie Mailers, King, N. Car. 27021.

WINEMAKING . . . Grape, Elderberry, Dandelion, Frozen Juices, etc. Brewmasters' secrets revealed! Powerful Methods! Instructions, Recipes, and Supplies Catalog, \$1.00. Continental, Box 11071 PC, Indianapolis, Indiana 46201.

PSYCHEDELIC Catalog of Posters, Lightings, Jewelry, Etc. Send 50¢. Hole, 6055 Lankershim, N. Hollywood, Calif. 91606.

WINEMAKERS Yeast, Recipes & Catalog 25¢; Kraus, Box 451-L, Nevada, Missouri 64772.

ORNAMENTAL Iron designs. Book of 1600 beautiful, practical designs for railings, columns, etc. Free literature. Cunningham, 3881 South 3200 West, Salt Lake City, Utah 84119.

WINEMAKERS. Free illustrated catalog of yeasts, equipment. Semp'lex, Box 12276, Minneapolis, Minn. 55412.

BOOKS On antiques and their prices. Free circular! P. Warman Publishers, Uniontown, Penna. 15401.

HEARING Aid batteries wholesale. Free list. Habs, Box 51, York, Penna. 17405.

WINEMAKING Kit—\$4.98 Free Catalog and recipes. JIMDANDY, Box 30230M, Cincinnati, Ohio 45230.

DRIVER'S License, Birth Certificate, H.S. & College Diplomas, Marriage & Divorce Certificates—Blank Forms. Fill them in yourself. Highest quality you can buy! Confidential. 3 day service! \$2.00 each; any four—\$5.00, postpaid. Formco, Box 834D-H, Warren, Michigan 48090.

BIRTH Certificates, Marriage Certificates, Diplomas! 2 blank forms \$1.00. Sample 10¢. Standard Forms, Box 482-M, Washington, D.C. 20044.

NEWEST "New miracle cleaner" Biodegradable, economical, free details. Leigh of California, Suite 249P, 7240 Lankershim, North Hollywood, California 91605.

WINEMAKING! All varieties. Favorite recipes! Best manual available! Complete, illustrated instructions \$1.00 (free supplies catalog). Namar, Box 6, Dearborn, Michigan 48121.

RECEIVE Exciting Offers In Your Mailbox. New Unique Products 50¢. Mann, 4402 Prasse Road, Cleveland, Ohio 44121.

WINE LOVERS! Learn what the experts know! 60 Minute cassette of concentrated, easy to understand information on how to buy, serve, and cook with wine. \$5.95. JRS Mail Order, Box 9613, San Jose, California 95117.

WINEMAKING—200 Recipes, instructions—\$1.00. E&G Sales, Box 18384-T, Memphis, Tennessee 38118.

CREDIT Cards! Receive all kinds fast, easy. Get new credit without investigation! Continental, Box J-23, Hallandale, Florida 33009.

STRANGE NAZI PHOTOS \$1.00. Hugo Enterprises, 1105 Moore, El Paso, Texas 79902.

NEW! AMAZING TWO-WAY MIRRORS! See through walls, doors, etc. Protect your family. Big 8x10" with instructions. \$2 each. Guaranteed! ORDER TODAY! Venetian Enterprises, Dept. PM-1, 219 Lido Parkway, Lindenhurst, New York 11757.

WINEMAKERS! Fermentation Locks—3 for \$1.00—Free catalogue. Werth Wine, Box 1902L, Cedar Rapids, Iowa 52406.

ANTIQUE Buying Guide. Know the value of what you own; what you want to buy. \$1.98 brings 224 page illustrated handbook of wholesale and retail prices of thousands of antiques, curios and collectibles. Californians add sales tax. Mari Mountgarden, Room 18-A, 320 Elwood Avenue, Oakland, California 94610.

FREE BROCHURE. NEW and UNUSUAL products for Home, Auto, Sportsman. SEND TODAY. Elton's, 1810 PM-2 Pine North Cedar, Cedar Falls, Iowa 50613.

IDENTIFICATION CARDS—Marriage—Birth Certificates. Send stamped self-addressed envelope for samples. E.C.S.M., POB 12117, Las Vegas, Nevada 89112.

FACTS On Living Well In Mexico On \$250.00 Monthly. Send \$1.00 to: D. Owen, Box 381, Fallbrook, California 92028.

MAGNETS. All types. Specials—20 disc magnets, or 2 stick magnets, or 10 small bar magnets, or 8 assorted magnets, \$1.00. Maryland Magnet Company, Box 192-A, Randallstown, Maryland 21133.

MOUTHWATERING Dill pickles. Recipe \$1.00. Dane, Box 5353-B3, Walnut Creek, California 94596.

THROW Away your alarm clock! Don't oversleep. Information: Sleep, Box 5353-A3, Walnut Creek, California 94596.

"SPECIAL!—Blank H.S. and birth certificates—\$1.00. Suttons Sales, 712 Northview, Dalton, Georgia 30720."

POPULAR MECHANICS

Available direct from the publisher
 New edition of the world famous
ENCYCLOPAEDIA BRITANNICA

and introducing

**Britannica's
 PRE-SCHOOL
 Library
 included
 FREE**

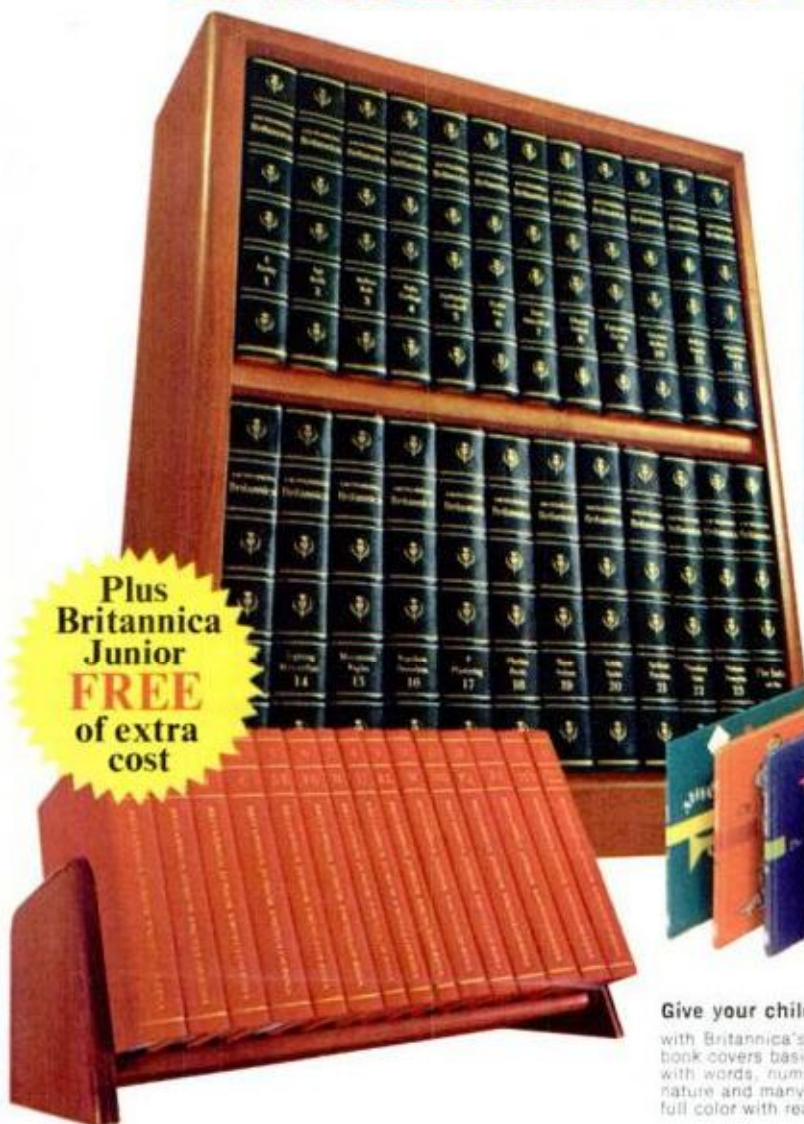

Give your child a head start now

with Britannica's Pre-School Library. Each book covers basic and important childhood experiences—with words, numbers, colors, sounds, signs, shapes, sizes, time, measures, nature and many other things. 13 volumes, beautifully illustrated, entirely in full color with read-aloud passages to help your child discover the world about him.

**Plus
 Britannica
 Junior
 FREE
 of extra
 cost**

You get all volumes now . . . pay later on easy Book a Month Payment Plan.

Yes, the latest edition of Britannica—the greatest treasury of knowledge ever published—is now available on a remarkable Cooperative Offer. Under the terms of this truly amazing offer, you may obtain the latest edition of Britannica Junior at no extra cost when you choose Encyclopaedia Britannica. Also included, free, the new Britannica Pre-School Library—*First Adventures in Learning*. The 3 complete sets will be placed in your home NOW . . . you pay later on convenient budget terms. *It's as easy as buying a book a month.*

The Britannica Pre-School Library—*First Adventures in Learning*—is now available for the first time from Britannica. It represents years of editorial and educational experience and was designed to help provide every child with proper pre-school preparation. This Pre-School Library offers a wealth of exciting and colorful new materials which acquaint the smaller child with the world in which he lives through simple words, pictures and signs.

Britannica Junior is written, illustrated and indexed especially for children in grade school . . . easy to read

and understand, rich in picture interest and carefully matched to school subjects.

Encyclopaedia Britannica offers thousands of subjects of practical value that can save you many dollars. There are 22,000 magnificent illustrations, thousands in vivid color. It's the work of 10,400 of the world's great authorities and its use develops the active, alert minds that bring success in school and later life.

Preview Booklet Offered Free. If you would like to learn more about how your family can get Britannica Junior and our new Pre-School Library—at no extra cost with

Encyclopaedia Britannica on our Cooperative Offer, plus a Free Preview Booklet—simply mail the attached postage-free card now.



FREE!

Mail card now for Special New
Preview Booklet

and complete details on this remarkable offer.

If card is detached, write to Encyclopaedia Britannica, Dept. 103-B, 425 N. Michigan Ave., Chicago, Ill. 60611.

Outboards aren't the only ones that
give you a choice

Get the
**inside
story**



When anybody buys an outboard boat, he puts exactly the make and size of engine he wants on it. Right? Did you know you can do exactly the same thing when you buy a stern drive boat? Many people don't know that—still believe that they must take the brand of stern drive already installed. And that's too bad, because a few are still cheating themselves out of MerCruiser. *You* be smarter. Choose from seven power sizes. With Power Trim, just your finger on a button adjusts trim angle at any speed. Enjoy the economy and the quiet of Jet-Prop exhaust. The instant starts of breakerless Thunderbolt ignition. Everything in the system from prop to steering matched and engineered to work together like the fingers on a hand. MerCruiser powers more boats in North America than any other stern drive. You'll probably find it on the boat of your choice. If not, you're the skipper. It's *your* money, *your* boat, *your* future pleasure. See your dealer for the Inside Story.

MERCRUISER
STERN DRIVES



For the name of your nearest MerCruiser dealer, see the Yellow Pages under "Outboard Motors."
Kiekhaefer Mercury, Division of Brunswick Corp., Fond du Lac, Wisconsin; Canada, Ltd.; Australia Pty. Ltd.