

POPULAR MECHANICS

FEB. 1971
50 CENTS

What's
New In
Pickup
Trucks

Build This 10-Foot Sailboat for \$200

Page 142

Daytona 500 Preview

Big Year for the Little Guys?

Exploring the Scenic New Arkansas Waterway



New, More Versatile Cassette Recorders

How to Raise the Roof On a Camper Van

A Working Model Live-Steam Tractor



MILLER MAKES IT RIGHT!

Miller High Life
is brewed hearty, robust, deep-down good.

It's the Champagne of Beers.

Now, a level that never takes time off the job.

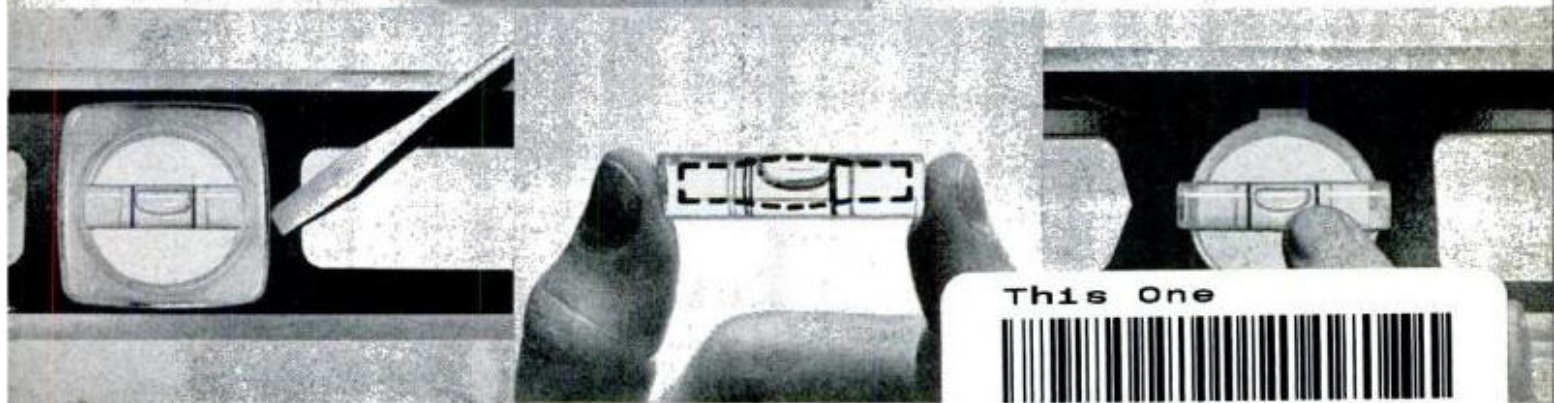
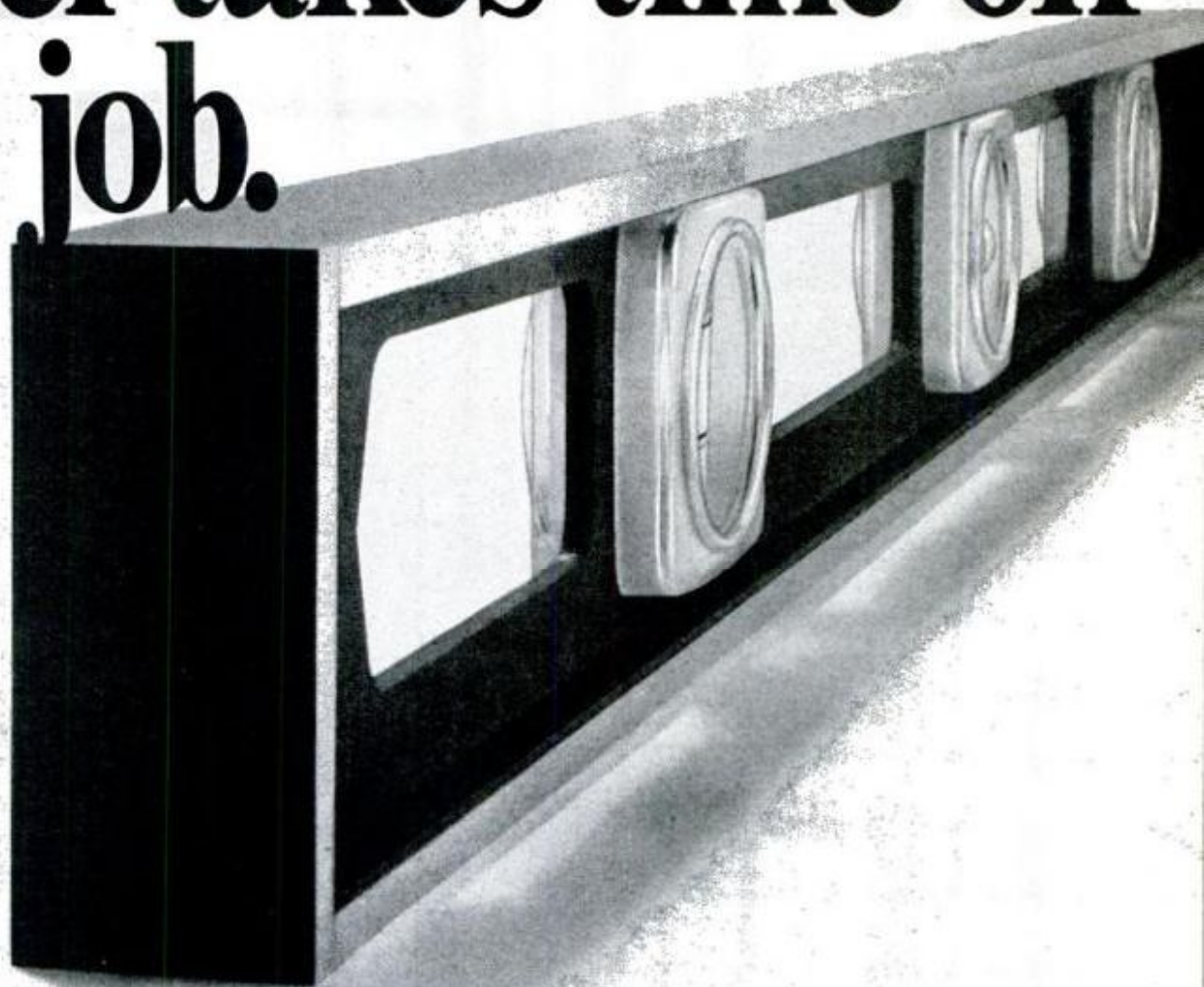

Our Workmaster™: a level to last you a lifetime. One reason: cover plates and vials snap out for replacement – *on the job* – if broken. (A big “if” – since they’re nearly break-proof!)

Snap in the new “360 vial” – vertically *or* horizontally. Notice how one bigger vial does the job of two usual vials. And with all the accuracy of solid set levels.

This One



C8CX-F99-XNGX

On goes the cover plate – precisely! The frame itself is lightweight, extra strong aluminum. 18”, 24”, 28” long.

STANLEY

helps you do things right

It takes guts to roam The Badlands. Jeep guts.



The Jeepster Commando—keeps on going where others quit!

Turn off U.S. 16 into the South Dakota Badlands. Go ahead. Explore.

You've got the Jeep guts to do it!

The Commando will get you over rough spots like nothing else can. Because no comparable 4-wheel drive vehicle has such high ground clearance—



or a lower center of gravity.

This sport is built for endurance. With a welded *and* riveted frame. With 18-gauge steel body panels. And lots more!

But it's not all brute. *Fully* foam-molded bucket seats are just one of many standard Commando comforts. Nobody can equal the Commando's combination of quality—and price.

In coming months we'll take the

Commando to other places—over the most demanding roads and rugged terrain we can find.

The Commando keeps going long after others quit!

**The toughest
4-letter word on wheels.**

Jeep
Products from American Motors



**Allstate
life insurance
says if you die,
your baby is
still babied.**

Allstate Life Insurance Company

Allstate. The young man's life insurance.

**A lot of protection for the money.
And a no-nonsense way to buy it.
No appointment, just drop in.**

If you're 28 and you pay this much each month: Here's how much you get. 20-year decreasing term insurance.

\$5	\$13,000
\$10	\$32,000
\$15	\$64,000
\$20	\$88,000

(Even more if you're younger)



You're in good hands with Allstate

POPULAR MECHANICS®

INTERNATIONAL EDITIONS: AUSTRALIA, BRAZIL, CARIBBEAN, DENMARK, MEXICO, SOUTHERN HEMISPHERE, SWEDEN

AUTOMOBILES AND DRIVING

- 26 Drivin' With Dan
- 46H Detroit Listening Post
- 58 Automobile Clinic
- 63 What Ever Happened to Air Bags?
- 66 The Daytona 500: Big Year for the Little Guys?
- 98 The '71s: Pickups That Pamper
- 114 Let Your Gun Rack Work Year Round
- 122 Those New Gasolines: How to Pick the Right One for Your Car
- 126 Saturday Mechanic: How to Use the Tach-Dwell for Perfect Tune-Ups
- 148 From Van to Camper—\$340
- 180 The Racer's Threads

BOATING, OUTDOOR RECREATION

- 14 What's New Outdoors
- 52 On-the-Go Camping
- 102 Honeymoon on a Houseboat: Exploring America's Newest Waterway
- 106 Surf Fishing With a 4-Wheel Drive
- 114 Let Your Gun Rack Work Year Round
- 115 Boating Tips
- 142 Build PM's Top-Performance Sailboat: the Glen L 10

SCIENCE AND INVENTIONS

- 20 Science Worldwide
- 76 They Like 'Impossible' Jobs
- 80 Danger in the Hospital
- 110 Just Patented: PM's Pick of the New Inventions

PHOTOGRAPHY

- 84 Wrap a Ring Light Around Your Lens
- 119 New in Photography
- 120 Photo Print Dryer You Can Build

ENVIRONMENT

- 50 Pollution Fighters' Newsletter

SHOP AND CRAFTS

- 94 Make This Model Steam Tractor
- 134 Hints From Readers
- 142 Build PM's Top-Performance Sailboat: the Glen L 10
- 147 Hints From Readers
- 148 From Van to Camper—\$340
- 153 Make This Appliance Test Block
- 154 Hints From Readers
- 155 This Die Holder Makes Thread Cutting Easy
- 156 Make Your Own Gemstone Faceting Machine
- 162 Add a Limit Switch to Your Lathe Carriage
- 163 New Tools You Should Know About
- 166 Hints From Readers

HOME AND YARD

- 130 Exciting New Products
- 132 Weekend Projects: Things to Make for the Fun of It
- 138 What an Ugly Radiator Can Do for a Room
- 164 Solving Home Problems
- 182D 'Glass-Top' Wagon-Wheel Table
- 182H Homeowners' Clinic

ELECTRONICS, RADIO AND TV

- 72 Cassette or Cartridge: Which Tape Machine for You?
- 84 Wrap a Ring Light Around Your Lens
- 116 New Quickie Kits for Hi-Fi
- 118 New in Electronics

SPACE, AVIATION, MILITARY

- 90 Coming: A Computerized Collision-Avoidance System

REGULAR FEATURES

- 6 Letters

Cover Photo by Elbert Witt

Build This 10-Foot Sailboat for \$200 (No building form is needed and it's light enough for cartopping)

NEXT MONTH IN POPULAR MECHANICS

The '71 Boats. Center consoles, jets, sails, new products—22 pages in all!
I'm Retiring . . . but I'll Never Quit Racing! Exclusive interview with Dan Gurney.
AWACS: Protection From 6 Miles Up. It's an 8-engined 707 full of electronics.
Pinto vs Vega: A Coast-to-Coast Test. New bantamweights rack up 10,000 miles.

THIS MONTH'S CLASSIFIED ADVERTISING SECTION BEGINS ON PAGE 200

ROBERT P. CROSSLEY

Editor

JAMES M. LISTON
Executive Editor

JOHN A. LINKLETTER
Managing Editor

WAYNE C. LECKEY
Home and Shop
Editor

SHELDON M. GALLAGER
Assistant Executive
Editor

THOMAS G. DAUER
Art Director

Published by The Hearst Corporation
RICHARD E. BERLIN, PRESIDENT

RICHARD E. DEEMS
President, Magazines Division

JOSEPH F. KERN
Publisher

BILL HARTFORD.....Automotive
JOHN F. PEARSON.....Science and Aerospace
GEORGE W. REIGER.....Boating and Outdoors
SHELDON GALLAGER.....Electronics and Photography
HARRY WICKS.....Home Workshop
MICHAEL LAMM.....West Coast Automotive
ROBERT LUND.....Detroit Automotive
GARRY WINTER.....Copy and Production
RICHARD H. FUNK.....Associate Copy and Production
JOHN ADKINS.....Assistant Copy and Production
ALVIN KIETZ.....Assistant Art Director
FRED A. LEERS.....Assistant Art Director
JOSEPH P. BEATON.....Assistant Art Director
DON EVANS.....Technical Art Director
CLIFFORD B. HICKS.....Special Projects
SOPHIE GRONOWICZ.....Director, Bureau of Information
EVERETT JOHNSON.....Cabinetmaker

ADDRESS ALL EDITORIAL COMMUNICATIONS TO: 224 West 57th St., New York, N.Y. 10019. For additional sources of information on the articles and products in this issue, write to Bureau of Information, Popular Mechanics, for free "Where-to-Find-It" list.

DANIEL J. COLEMAN
Director of Advertising

ADVERTISING OFFICES: New York: 224 West 57th St., 765-6850; Chicago: 520 N. Michigan Ave., 527-2400; Detroit: General Motors Bldg., Trinity 5-8711; Cleveland: 20310 Chagrin Blvd., Shaker Heights, 283-7788; Los Angeles: 601 North Vermont Ave., 666-6263.

JOHN A. REGINA.....Advertising Production Manager

SUBSCRIPTION SERVICE: Mail all subscription orders, changes of address, correspondence concerning subscriptions, and Postmaster notices of undeliverable copies to Popular Mechanics, Box 646, New York, N.Y. 10019. Please enclose your latest address label for quickest service when writing about your subscription.

POPULAR MECHANICS IS PUBLISHED MONTHLY by The Hearst Corporation, 57th St. at 8th Ave., New York, N.Y. 10019. U.S.A. Richard E. Berlin, President; George Hearst, V-Pres.; Richard E. Deems, President of Magazines; John R. Miller, Executive V-Pres. of Magazines; Raymond J. Petersen, Senior V-Pres. of Magazines; William S. Campbell, V-Pres. of Magazines; Albert A. Raehol, V-Pres. and Director of Circulation; Joseph F. Kern, V-Pres. for Popular Mechanics; Frank Massi, Executive V-Pres. and Treasurer; Harvey L. Linton, Secy. Single copy in the United States and Canada, 50 cents. Subscription prices: United States and Possessions \$5.00 for one year; \$9.00 for two years; \$12.00 for three years. Canada, add \$0.75 for each year. Pan American Postal Union countries, add \$1.00 for each year. All other countries, add \$2.00 for each year. When changing address, give old address as well as the new, with postal-zone number, if any, and allow six weeks for change to become effective. Second-class postage paid at New York, N.Y., and at additional mailing offices. Authorized as second-class mail by the Post Office Department, Ottawa, and for payment of postage in cash. Registered as second-class matter at the Post Office at Mexico D.F., Mexico, June 20, 1950. © 1971 by The Hearst Corporation. All rights reserved. Printed in U.S.A.

Part of the popular mechanics of making a great drink:

the good stuff.



Kentucky Straight Bourbon Whiskeys, 86 Proof and 100 Proof Bottled in Bond. Old Grand-Dad Distillery Company, Frankfort, Kentucky 40601.

When your daughter says that Field & Stream's aroma reminds her of a great autumn day in the woods...

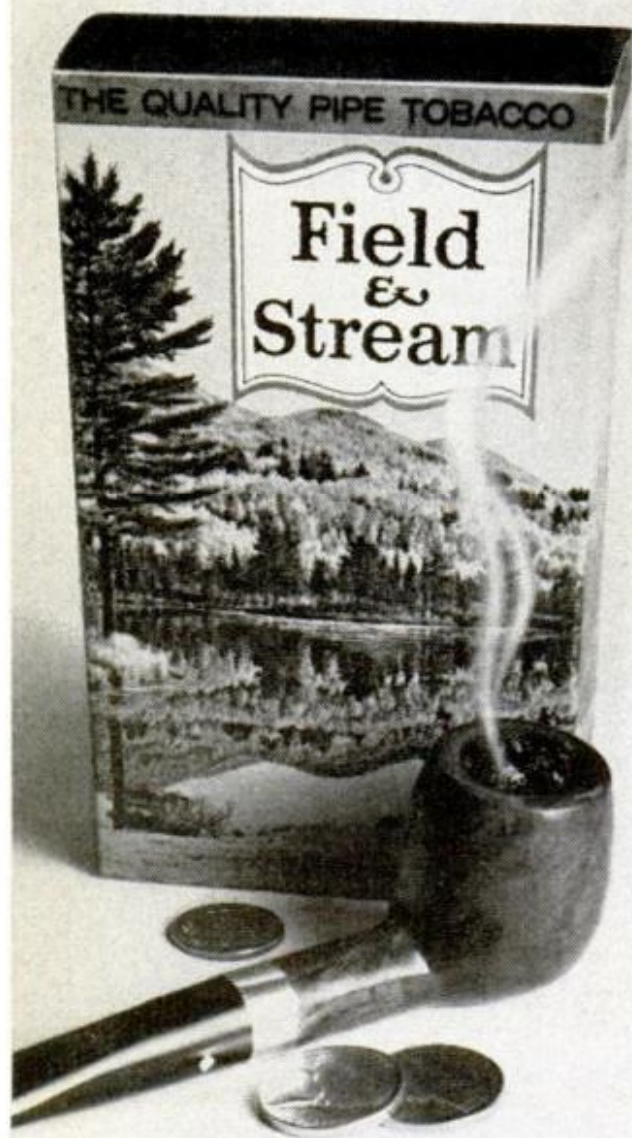

**start
saving up
the dowry.**

A quality product of Philip Morris U.S.A.

LETTERS

TO THE EDITOR

F-15—too late?

Help! The Air Force's proposed F-15 fighter (*A Fighter Pilot's Fighter Plane*, page 75, Dec. PM) due to be operational in 1975 is a dead-ringer for Russia's MiG 23—in production and operational now!

The conclusions to be drawn from this fact are self-evident and fraught with dire forebodings for this country. While the Russians were planning decent, straightforward fighters, the USAF was sold Mr. McNamara's tricky, jack-in-the-box F-111 swing-wing whatzit. Top-heavy with complexities, expensive and difficult to produce, the F-111 was good only for defense industry contractors.

NEW YORK CITY RICHARD MARTIN

Great hints!

Your *40 Great Hints for Your Home and Shop* (page 156, Dec. PM) was great! Let's have more like it.

DAVENPORT, IOWA

H. NEIBERT

How about an index?

I think *Popular Mechanics* is the best. I have a couple of questions. Why don't you have a lifetime subscription rate that would save renewing every few years? And why don't you make an index issue in December that would cover all the articles and projects for the whole year? That way you won't have to look through every issue to find a particular article. I think these ideas would make the best magazine just a little bit better.

PATTON, PA.

GARY CHURELLA

In these days of computers, high production costs and rising postal rates, five years (for \$18) is the longest subscription we can offer. It's not a lifetime—but for 18 bucks it's not bad.

As for your second question: In December, we'll announce the availability of an inexpensive Annual Index (this one covering the year 1971) combined with an attractive shelf cover for all 12 issues.

Carib Queen

Congratulations on your very excellent description of *The Last Flight of the Carib Queen* (page 94, Dec. PM).

I just finished reading it, and haven't got my breath back yet. Let us hope the

(Please turn to page 8)

POPULAR MECHANICS

"Look who's smiling now!"

Sometimes a man sets his ambitions high enough to make skeptics smile. But how often he gets the last laugh! "At the time I started studying with LaSalle, I was working as a factory clerk. Before completing the course I was transferred to cost accounting and my salary was increased by \$1800. Now, having completed the course, I'm in charge of the department and headed for the five figure bracket. LaSalle's course helped me pull myself out of a boring and ill-paid job into a position of almost unlimited opportunity."

The words in quotes come directly from one of the pleased reports that are sent to us by LaSalle graduates. LaSalle files contain many letters from men and women who have increased their earnings with the help of LaSalle training. You, too, can prepare for the career opportunity of your choice through LaSalle home study—without interfering with your present work—and by devoting only a little of your spare time.

LaSalle has been a leader in home education for more than sixty years, enrolling over 2,000,000 ambitious men and women in its many courses. You study under the supervision of LaSalle's experienced faculty. Upon satisfactory completion of your study, you receive the LaSalle diploma—a recognized and respected credential.

Mailing the LaSalle coupon below may be the first step toward preparing yourself for a better job, higher pay, and the many good things that go with success. Simply check the program in which you are most interested, and we will send you a valuable free booklet describing the opportunities in that field. There is no obligation. LaSalle, 417 S. Dearborn Street, Chicago, Illinois 60605.



LA SALLE EXTENSION UNIVERSITY

A Correspondence Institution • 417 S. Dearborn Street, Dept. 62-069, Chicago, Illinois 60605

Please send me, without cost or obligation, FREE booklet and full information on the field I have checked below:

ACCOUNTING

- Complete Accounting
- Income Tax
- CPA Training
- Bookkeeping

BUSINESS MANAGEMENT

- Introduction to Business Management

DRAFTING

- Complete Drafting

REAL ESTATE

- Complete Real Estate
- Real Estate Brokerage
- Real Estate Management

Interested in a career not listed? Write here: _____

LAW COURSES

- Bachelor of Laws Degree
- Business Law
- Insurance Law
- Claim Adjusting Law
- Law for Police Officers

TRAFFIC & TRANSPORTATION

- Complete Traffic Management

RESTAURANT MANAGEMENT

- Complete Executive Training

LANGUAGE INSTRUCTION

- French
- Spanish

COMPUTER PROGRAMMING

- Basic Training

INTERIOR DECORATING

- Complete Training

ART TRAINING

- Commercial Art
- Oil, Water Color Painting
- Complete Training

Mr.
Mrs.
Miss

Address.....
City &
State.....

HIGH SCHOOL

- High School Diploma

HOTEL/MOTEL MANAGEMENT

- Hotel Executive Training
- Motel Management

STENOTYPE

- Machine Shorthand

CAREERS FOR WOMEN

- Accounting
- Bookkeeping
- Computer Programming
- Dental Assistant
- Interior Decorating
- Real Estate
- Secretarial
- Stenotype

Age.....

Apt.No.....

Zip.....

LETTERS

(Continued from page 6)

story will help make further flights safer for all. Those pilots are really heroes.
SYRACUSE, N.Y. MRS. BEATRICE STURGE

Good water from bad

Whenever I am asked for advice and help on a water problem involving a private water supply, I refer the enquirer to *6 Ways to Make Bad Water Good* (page 184, May '69 PM). It is an excellent article and contains very helpful information.

MOUNT CLEMENS, MICH. ROBERT H. HANSEN
SUPT., WATER PURIFICATION AND PUMPING

How deep is the ocean?

In *Questions About the Oceans* (page 121, Nov. PM), your first two questions and answers contradict each other. If the greatest depth is 37,782 feet, then the greatest pressure would be around 18,000 to 19,000 pounds per square inch. Since there is no pressure except the weight of the water and the air above, a rough rule of thumb to determine water pressure in an open vessel—or river or ocean—is to multiply the depth in feet by one-half. At 3000 feet, the pressure would be something around 1500 p.s.i., not 8100 as stated in the article.

PASCAGOULA, MISS. B. L. WHITE

You say that the ocean's greatest depth is 37,782 feet. I have checked in a number of recently printed encyclopedias, and they indicate that this reading is incorrect. The most commonly agreed upon depth is 36,198 feet, in the Challenger Depth of the Marianas Trench, southeast of Guam.

WHITBY, ONT. VELLO VOOGJARV

The errors are explained and resolved in this letter from Robert W. Taber, head of the Production Control and Quality Assurance Branch of the National Oceanographic Data Center:

"I was interested to see the article in *Questions About the Oceans* based on the book of the same name by Harold W. Dubach and myself. Unfortunately, there were two factual errors in the first printing, on which your article is based.

"The deepest confirmed sounding of the oceans was made by the Soviet vessel *Vityaz*, which reported a depth of 36,200 feet in the Marianas Trench off Guam in 1959. The depth of 37,782 feet observed in 1962 by the British survey ship *Cook* in the Mindanao Trench near

the Philippines was later retracted as erroneous.

"In the second question, the pressure at a depth of 3000 feet is 1350 pounds per square inch, rather than 8100. This pressure is sufficient to squeeze a block of wood to half its volume so it will sink.

"These errors have been corrected in later printings and the 121-page book is still available from the Government Printing Office, Washington, D.C. 20402, at 55 cents for the paperback edition and \$2 for the clothbound edition. There are more than 100,000 copies in print.

Potshot at George

George Reiger must be stupid to publish such an article as *How to Keep Your Shooter's Eye Sharp the Year Round* (page 116, Dec. PM), about hunting pigeons, blackbirds, etc., the way our wildlife status is now. I am going to complain to *Popular Mechanics* about that article because of its sickness to kill helpless birds looking for food or a home. I hope he gets fired.

NORTH OLDMSTEAD, OHIO UNSIGNED

There! That'll keep old George on his toes.

Shop Guide

I'm writing concerning the *Popular Mechanics Shop Guide* which you advertised in your pages. I read your magazine in the braille edition, and, unfortunately, there was no price listed for the guide. Could you tell me how much they cost and if they're still available.

PITTSBURGH, PA. HERMAN ALLWEIN

I just received my Shop Guide set (No. B1252) today and am so pleased with it I want four more sets to give as gifts.

ENGLEWOOD, COLO. R. S. WILTSHIRE

The Shop Guide continues to be one of PM's most popular offerings. Yes, indeed, the Guide is still available at \$3.95 per set from Popular Mechanics, Dept. JL, 224 W. 57th St., New York, N.Y. 10019.

Those Japanese drivers

I read with great interest the article, *They Said I Was Crazy to Drive in Japan* (page 126, Oct. PM). The Sunny [Datsun] 1200 is a sharp-looking automobile. The Japanese automobile industry builds many fine, small cars. However, I take exception to the remarks by the author [PM editor Bob Crossley] about Japanese

(Please turn to page 10)

Here's a left-hand shotgun some right-hand shooters should use.

Introducing the brand-new Remington Model 870 "Wingmaster" Left-Hand Pump Shotgun ... the only pump shotgun made with the ejection port located on the left side of the receiver.

The advantage this offers left-handed shooters is important: no more ejected shell hulls flying past his face. And this could be very important for some right-handed shooters as well!

How come? Because scientists have found that people tend to have a dominant or master eye. Just because you're right-handed, it does not automatically follow that your right eye is your master eye. It could be your left one.

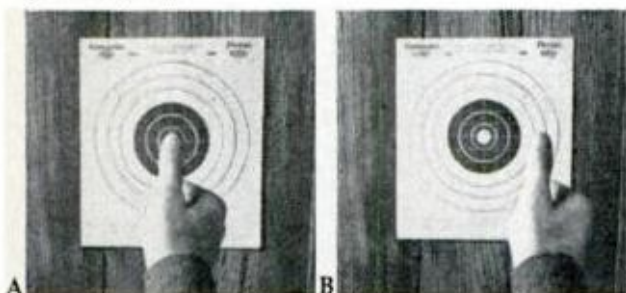

Here's how to tell which is your master eye. If you're right-handed, hold out your right arm to its full length and sight with your thumb on some distant object, *keeping both eyes open* (see photo A). Now, close your left eye. If your thumb seems to move off target, (see photo B) then your left eye is your master eye. To check on it, close your right eye and open your left—without moving your hand. If your thumb is now back on target, it proves you used your left eye to sight with—even when both eyes were open.

Naturally, if your left eye is your master eye, you're better off using that one to shoot with even though you may be right-handed. If you're an experienced shooter, you may not want to learn new habits, but it's wise for beginners to learn to use their master eye. And the left-hand 870 is an easy gun to start with since the pump action can be operated with either hand. Incidentally, it's a good idea for parents to learn the correct master eye of their

children before buying them their first gun. If they are left-eyed, this "Wingmaster" is the gun for them.

The new 870 is a good bet, because it meets the high standards of dependability set by the right-hand Model 870's. It has a receiver machined from a solid piece of steel. Double action bars permit you to pump the gun twice as smoothly—without twisting or binding. Exclusive "vibra-honing" finish makes the action easier to work and permits a deeper, richer blueing. The stock and fore-end have an exclusive Remington RK-W finish that will protect them against the rigors of the weather and the field for years.

The Model 870 Left-Hand Pump Action comes in both 12 and 20 gauge with optional barrel lengths of 26" improved cylinder, 28" full or modified, and 30" full chokes, plain or with ventilated ribs. There is also a 12 gauge magnum model with a 30" full choke with either a plain or ventilated-rib barrel. Both trap models are 12 gauge with a 30" full-choke ventilated-rib barrel, and one has a Monte Carlo stock.

Whichever model you select, we suggest that for best results you always use either "Remington" or "Peters" shotgun shells. Our testing procedure matches the guns and ammo to each other. In addition, you get the benefits of our famous "Kleanbore" non-corrosive priming for faster, surer ignition along with a clean, bright barrel. Our patented "Power Piston" one-piece wads deliver 10% more shot in the pattern area.

Remington Reports is a series based on information straight from the "Remington-Peters" experts who design and engineer all Remington products. If you'd like to build your own hunting and shooting manual, we'll send you a free binder to keep them in. You'll also get a free copy of our new, 48-page color catalog by writing to: Remington Arms Company, Inc., Department 114, Bridgeport, Connecticut 06602



Remington® DU PONT PETERS®

Great guns deserve great ammunition. We make both.

"Wingmaster", "Power Piston", "Kleanbore", "Remington" and "Peters" are trademarks registered in the U. S. Pat. Off.

EARN BIG MONEY IN AIR CONDITIONING REFRIGERATION & HEATING

25 KITS SENT TO BUILD THIS
COMPLETE REFRIGERATION SYSTEM



APPROVED FOR GI TRAINING
If you served since January 31, 1955 or are
in service, check GI line in coupon

A better job, top pay and steady work are easily within your reach. Learn to repair and install air conditioning systems, refrigerators and freezers. Air conditioning is one of America's fastest-growing industries. Millions of autos and homes are being air-conditioned. The need for trained men is immediate and great.

Make Home Your Training Center—Learn by practicing. CTI sends 25 kits of tools and parts to build a complete refrigeration system—which you later convert into a refrigerator or freezer. The course is easy!

Earn Money As You Train—Since the CTI course includes training with real equipment, many students earn money repairing units soon after enrolling. On completing training they go into top pay jobs. Many get started in their own business.

Mail Coupon Today for FREE book. No obligation. Prove to yourself that the air conditioning, refrigeration and heating field is best for you—the easiest training to master and loaded with top pay opportunities.

Commercial Trades Institute, Chicago, Ill. 60626

COMMERCIAL TRADES INSTITUTE
1400 Greenleaf Avenue
Chicago, Illinois 60626 Dept. PM-271



Send book, **Be a Success in Air Conditioning,
Refrigeration & Heating.** No obligation.

Name _____ Age _____

Address _____ Zip _____

City _____ County _____ State _____

Check for facts on GI Bill
Accredited Member National Home Study Council

LETTERS

(Continued from page 8)

drivers being skillful, law-abiding and courteous. They are skilled at driving recklessly. The author must have been very fortunate to meet drivers of the caliber he mentioned in his article.

I have lived in Japan for the past 18 months. I have driven in other countries, but Japanese drivers have to be the most impatient, oblivious in the world. They are constantly taking chances, such as passing on curves. The only group of drivers worse than taxi drivers are the so-called professional truck drivers. They literally plow through traffic by their sheer size, with their horns constantly blaring to clear a path.

YOKOHAMA

M. S. SMITH

Editor's note: I have also driven in any number of other countries, and the Japanese drivers I saw were skillful, law-abiding and courteous.—R.P.C.

Assistant Editor's note: On the other hand, Mr. Crossley himself may drive like a Japanese truck driver.—Anon.

Not in the garbage

The hint, *Eliminates Pail Cleaning* (page 193, Nov. PM), suggests throwing away waste crankcase oil.

Please don't discard any petroleum product by dumping it in the garbage. They are environmental pollutants and should be brought to an auto service station or oil company for disposal.

HARTSDALE, N.Y.

IRA GULKER, DDS

Candle stand

In *Holiday Candle Stand* (page 182, Nov. PM), there's a slight error in the plans. When you make an enlarged pattern of the arms, you should use half-inch squares instead of the inch squares that are indicated in the pattern. This way, it will turn out to be 8½ inches high.

LAMBERTVILLE, N.J.

RICHARD GOCCIA

Attention, Mongoose owners

I think your magazine is just great. I read it every month. I especially like your road tests on new cars. How about doing a test on a Mangusta Mongoose. I've heard it cruises at 140 mph and gets 28 miles per gallon.

SALINAS, CALIF.

BRENT BALL

Hmmm. We'll look into that one. Everybody who owns a Mongoose: Please send us a report.

★★★

WITCHCRAFT

Complete guide to the weird ways of modern witchcraft. Learn the Witch Manifesto. Visit Witchcrafters of the World. Discover the secrets of Voodoo. Get information on occultism. Warlocks, wizards, black mass, demons, table magic, tarot, handjumps, etc. Big 224 pages, 13 chapters. Over 100 pictures.

7010 Price Only... **\$1.00**

MIDGET SPY CAMERA



Take social or register pictures. Size of pocket watch. Controls in hand. Inexpensive bargain. Precision made with the finest, solid metal construction. Chrome trim, rapid zoom finder, guaranteed economical, good pictures. Fine enlargements, 2 1/2". Takes 35 pictures on each roll.

4017. Camera & Leather Case... **\$1.00**
4088. Film 2 rolls (20 pictures)... **.40**

HERCULES WRIST BAND

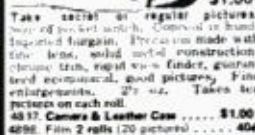

Insta-Magic Power Instantly gives wrist grip and arm more power. Relieves strain on wrist. Concentrates muscles. Adjustable Double strap.

Get two for both arms.
2112. Set of 2, \$1.50... Each **\$1.00**

Automatic Hypnotizing Record



Learn hypnotizing in minutes. Amazing weather forecasting. By world famous hypnotist hills subject into deep hypnotic sleep then turns control over to you. Second recording induces self-hypnosis. Hand time and regularly with one use. For the lot of the month.

No. 6930. Complete Set... **\$5.00**

HOME WINEMAKING SET

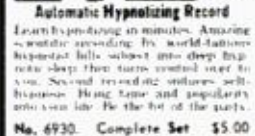

Makes better wine for less money. Federal law allows you to make 100 gallons wine at home each year. All new set includes complete equipment. Use cedar, brass jugs, trays, etc. With booklet for all your recipes.

7058. Complete winemaking outfit... **\$3.95**

1001 THINGS FREE

Get FREE articles, novelties, books, stamps, coins, show tickets, games, films, products, maps, toys, food-drag samples, science materials, records, jewelry, books, travel info, etc. Mammoth directory of over 1000 free offers with names and addresses.

1018. "Things Free" Directory... **50¢**
1029. With 2 Mail Kit... **\$1.00**

X-RAY GLASSES SCIENTIFIC WONDER

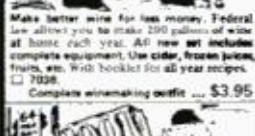

Attention of the century! Apparently see through your skin, see through clothes, etc. You will never trust you with these. But let them look for themselves and apparently see legs right through your pants. Amaze and embarrass everyone! Regular size glasses with built-in optical device.

3762. (2 pair, \$1.75)... **Pair, 95¢**

GIANT 10 Ft. BALLOONS



SUPER-SIZE, BRAND NEW GOVERNMENT SURPLUS BALLOONS. Durable heavy-duty neoprene rubber. Easy to inflate with vacuum cleaner, auto air hose or fill with helium to give it tremendous lifting power when soaring into air! Lift signs, objects. Do entertaining stunts, advertising effects, crowd getter. See far miles. Inflates to 10 feet high... over 30 feet diameter.

3010. 10' BALLOON... **\$1.75**
3082. 25' GIANT... **\$2.95**

LIVE SEA-MONKEYS



Watch a family of Sea-Monkeys in only 5 minutes. Born in sea, you can raise an entire family in ordinary glass of water (only three quantities of which fully grown). Easy to care for. Watch them anytime, close watch after plentiful game of tag. FREE literature!

Instant Life! Handbook of tricks, training and amazing history of Sea-Monkeys. PLUS A FULL YEAR'S SUPPLY of special Sea-Monkey growth food. Guaranteed to live and grow.

3760. Complete set only... **\$1.00**

Black Light Bulb



Psychodelic, Fluorescent Effects See in Dark! ONLY \$1.95

Black Light (invisible ultra violet ray bulb) Makes many objects, posters, paints, make-up, minerals, etc. fluoresce in dark in brilliant, vivid colors. Create psychodelic "trippy" and supernatural effects. Many practical and scientific uses. 40 watt, 110 volt, long lasting bulb fits any socket. For greater effects get two or more.

4356. Black Light Bulbs, 2 or more \$1.95 each... **\$1.95 each**

POCKET SPY TELESCOPE



Magnifies 64 times area. 8 Power. Terrific power yet a small fountain pen. Precision lenses. All metal chrome finish. Reverse and use as microscope magnifying 900 times!

6724. Super Spy Scope... **\$1.50**

POCKET MICROPHONE TRANSMITTER



Try microphone picks up sounds at about any place. Use as dictaphone, phone pickup, amplifier, telephone, etc. Complete except for battery & cigarette or speaker.

2980. Midget Mike... **\$1.00**
2986. Earphone, Each... **\$1.00**

POCKET RADIO & TRANSMITTER

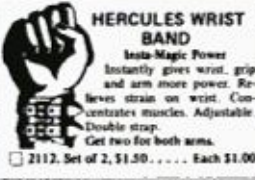

Broadcast Talking, music, etc. over regular AM band. Also receive all AM radio stations. Complete with speaker & microphone. Wind, just connect & use. Also use as walkie-talkie, intercom, dictaphone to monitor sounds in private places, etc. Sample bargain (retail \$20.00).

6249. Each \$2.95 Postpaid... 2 for \$5.75

10" THROWING KNIFE



PIERCES METAL. Heavy weighted & balanced metal gives positive accuracy, hard hitting, deep penetration. Easy throwing. Non-slip handle. Double edge, culinary steel.

K8284 \$1.25. Matched Set... 2 for \$2.25
8409. Knife Strength... Each 65¢
1096. Professional Knife Throw. Bk... 50¢

PEDESTAL



How Far You Walk or Run!

Accurately measures distance you walk. 1 mi & useful for bikers, sportsmen, golfers, etc. All metal, precision made, easy-reading dial. Retail \$10.00.

8001. Guaranteed Only... **\$1.00**

MAGNET LIFTS 100 POUNDS!



Lifts up to 100 Pounds. SOLID STEEL! Even more powerful. GO TREASURE HUNTING. Do amazing stunts. 1000 uses. Newly developed alloy. Pocket size.

4006. Lifts 90 lbs... **\$1.50**
4066. Lifts 100 lbs... **\$2.95**

German Cuckoo Clock



Red pops out & cuckoo every 15 minutes. Expertly made, guaranteed timepiece.

14" high... **\$9.95**
9117... **\$9.95**

FLESH EATING PLANTS



Bites Fingers. Eats flies & meat! Obeys your command where to bite. Beautiful plant snaps shut on anything. Finger, pencil, bug, 1 inch stick, fly, hair, pen, and eating insects. "Mud" animal plant as world's... easy to grow indoor house plants. 6 to 10 traps per plant. 12" high.

5019. Venus Fly Trap Plants... **\$1.00**

BEAT UP BIG BULLIES!



Unbeatable, unatoned self-defense. Includes KARATE, JUDO, JIU JITSU, SAVATE, AIKIDO, YANARA, AYE-WAZA. Newest most complete book! All the latest ideas, new exercises. Proven points make it possible for weaklings to beat up and control big bullies in seconds. Over 200 illustrations, anatomical charts. Your hands become more powerful weapons than clubs, knives, even guns in close fighting. Valuable for ladies.

5006. Oriental Kenjutsu... **\$1.00**

Silent Dog Whistle



Nobody can hear except dog. Visible range. Dogs respond instantly as if by magic. Used by dog trainers.

4091... **\$1.00**

SOQUIRELL CALL



Bring them right to you. Hand operated. 4290 Only \$1.50

UNBELIEVABLE U.S. NICKELS



6076. Real Nickel 2 Heads... **\$1.95**
6079. Real Nickel 2 Tails... **\$1.95**

POCKET MUSCLE BUILDER



Pocket size, heavy rubber exercising with grip on ends. Build biceps, neck, hand muscles. Carry anywhere. Amaze friends with feats of strength anytime.

6623. He-Man Pocket Gym... **\$1.25**
1048. "How to Perform Strong Man Stunts" Book on Secrets of Strong Men... **50¢**

POLICE HANDCUFFS



Regulation size and style. Heavy duty steel with lock and keys. Chrome plated.

9043. Set Postpaid... **\$2.95**

Electric Laughing Bag



Roan with Laughter! Happy hilarious joke get surprise. Battery operated. Lasts indefinitely.

3070... **\$2.95**

STINKY SMOKE JOKE!



Give off clouds of smelly and stinky odor.

2001. Pkg. of 8 - 25¢
3. Page - \$1.00

Hunting Slingshot



WORLD'S FINEST SLINGSHOT. Hard hitting! Repeater action! Rifle-style peep sight. Bull's eye accuracy. Heavy, non-sprung, molded non-slip grip with built-in magazine & push button ammo release for rapid shooting. Heavy duty, pure gun rubber slings. Leather "H" Shooter. BB's, pellets, etc. Not sold in firing pouch.

3002. Slingshot... **\$2.50**
X9062. Del. Case Repeating Slingshot... **\$2.50**

Exploding Shot



Disintegrating Pellets Hit target with loud crack pull back and target bounces right while you sit in comfort outdoors.

3272. Pkg. of 250 Exploding Pellets... **\$1.00**

Hear Police, Fire, Aircraft Calls on ANY Radio



Tuner-Converter Module. Use with standard radio. Solid state circuit. Uses 9 v. transistor battery.

6126. Police, Fire Calls (30-50 MHz)... **\$6.95**
6117. Police, Fire Calls (150-160)... **\$5.95**
6118. Airport & Tower (118-128)... **\$5.95**

LEATHER PEACE RING



Combines warm natural feeling of genuine leather band with polished silver-like Peace emblem. Beautiful appearance, extremely comfortable. Listed in fashionable masculine jewelry.

Price Only... **\$1.00**
8256... **\$1.00**

\$1000 SAFE



Regged home vault holds \$1000 & valuable. Combination lock. Blazing fast. Built with gold trim. Rolls on rubber wheels.

6491... **\$3.50**

LEATHER BULL WHIP



Hard Hitting. LOOD - cracks like shot-gun. Made by hand.

6762. 6 ft. \$1.95... 6763. 8 ft. \$2.95
6758. 10 ft. \$3.95... 6760. 12 ft. \$4.95

SURPRISE PACKAGE



Pleasant surprise & bargain. Fun or useful. Includes new sampler, factory surplus, special novelties, etc. Most worth much more. Money back if not delighted.

2997. Surprise Bargain... **\$1.00**

POWERFUL RAM JET ENGINE



Only \$1.00

Drive boats, cars, planes, rockets. Do anything you want. Amazingly modern plastic of action. Powerful, continuous forward thrust. More energy than any other light weight engine. Operates on high compression air fuel. Use over 200 different types of fuels. Duration of burn depends on Amount of fuel used.

7431. \$1.00 each... 2 for \$1.85
7432. Fuel, 75¢ pack 2 packages... **\$1.25**

With Hair! Rubber Masks



Natural, life-like, hairlike. Thin latex rubber. Clings where you want. Amazingly realistic. Eat, drink, smoke, talk!

4637. Full Size Wild Cave Man... **\$2.95**
4717. Full Size Monkey... **\$2.95**
4620. Full Size Ape... **\$2.95**

Comic Bald Head Rubber Mask



Change an ordinary head into a comic bald head. Use with rubber mask. No need for hair. Use for parties, school plays, etc. For a real laugh, use with hair.

4620. Price Postpaid... **\$1.00**

Pocket Electronic Sound Detector



Newly developed, high gain magnet. 3-transistor circuit amplifies 100,000 times. Powered by penlight cell. Listens on tiny earphone or feeds into tape recorder. Complete with crystal microphone, earphone, all parts for easy assembly. Smaller than pack of cigarettes - only 3 1/2".

6121. Sound Amplifier Postpaid Only... **\$3.95**

UGLY BLACKHEADS OUT IN SECONDS!



Eliminates Pimples! Be Good Looking! removes blackheads in seconds, cleanly and safely. No pinching. Guaranteed.

No. 4641... **\$1.00**

SECRET

Looks like attractively bound book but opens to reveal combination lock made. Keep valuable papers, jewelry, money, etc. hidden away. 4 1/2 x 1 1/2".

4012. Price Postpaid... **\$1.00**

CANNON



REALLY SHOTS! Replica famous 24-pounder Cannon. Fits in starting gun. Useful 4th of July noisemaker, etc. Heavy in looks. Ruggedly built, all metal, chrome & black.

8086. 2 for \$4.50... Each **\$2.50**
8084. Ammo, 80 shots 75¢... 3 Boxes **\$2**

COMBAT SURVIVAL KNIFE



Complete survival "Kit" on your hip. Rugged, finest quality knife, 9 1/2" long, 3" wide sharp blade. Perfectly balanced. Sharp saw tooth on back of blade. Solid, blunt end. Use as hammer, saw, file, scaler, hatchet, skinning knife, etc. Laminated leather handle for positive grip. Genuine leather sheath with leg ties and sharpening stone included.

8420. Armed Forces Survival Knife... **\$4.95**

SWISS COMPUTER WATCH



Carry this computer on your wrist, ready to perform money-saving calculations. Useful for shopping, calculations problems, etc. Precision Stop Watch, Timer, Measurement speed dial, distance, production. Multiples, Divides, Calculates. Slide rule on rim for computations. Swiss made. With band. Fully guaranteed.

8012. Slide Rule Watch... **\$1.95**

Slot Machine



Replica of Las Vegas Machine. Take a Chance! Insert coin, pull "one arm bandit" and watch dial spin. BIG FAVORITE if you hit jackpot. Collect money for your "bank". Precision made. 6" high. Not to be used for gambling purposes.

4362. Price Postpaid... **\$2.50**

POCKET HUNTING KNIFE



Quick silent opening. Positive locking blade. Push button release. Razor sharp, heavy duty stainless cutting steel blade.

K8284. Each... **\$1.50**

"BROKEN ARM" JOKE CAST

LOOKS REAL. White moulded rubber appears like genuine plaster cast. Slips over hand into wrist and part of arm. On or off in seconds. Either arm.

2665. Price Only... **\$1.25**

"PEN" RADIO



Listen in Secret Almost Anywhere

Hear SPORTS, MUSIC, NEWS in bed, office, school, etc. Featured on NBC-TV. Wear on pocket like fine pen. Tiny capsule for secret listening. Self-powered, solid state circuit. No electricity. No batteries. Plays forever at no cost. Full range - tunes. Money back guarantee.

7082. Complete. Ready-to-Wear. Postpaid... **\$1.95**

Free New Catalog 2000 Novelties

World famous catalog of novelties, for animals, babies, scientific supplies, fashionables, plants & books, maps, books, joke articles, unusual plants, gadgets, interesting photo & optical goods, jewelry, daguerres, model trains, stamps, coins, puzzles, fortune teller, radios, tape & recorders, telescopes, books, office & artist supplies, airplane models, sports, books, games, tools, emblems, etc.

CHECK HERE YES - I want FREE Catalog. My Name & Address Attached or on Envelope
Please RUSH to me the following things:

Name	Number or Name	Price Each	Total

Send check or money order. If cash, wrap **ADD POSTAGE** 35¢
will (no tape or glue please). No C.O.D. **POSTAGE** 35¢
Canada & Foreign add \$1.00 handling. **POSTAGE** 35¢
Add 10¢ for personal check.

Name
Address
City
State Zip

Johnson Smith, Dept. 102, Detroit, Mich. 48224

Mail Orders for All Items On This Page To
Money Back Guarantee **JOHNSON SMITH CO.,**
16535 E. Warren, Dept. 102, Detroit, Mich. 48224



Your Job
as an
**ACCIDENT
INVESTIGATOR**

Make big money investigating accidents. Car furnished, expenses paid. No selling. No tedious study. Full or spare time. I train you directly by mail and provide free placement service. (Liberty School is State Licensed and fully approved for Veteran Educational Benefits).

Mail For Free Information

Jim Edwards, Director, Dept. 52
Liberty School
1111 W. Park Ave., Libertyville, Illinois 60048

Send me your FREE Brochure Showing how I can quickly get into the Booming Accident Investigating Field and enjoy the job security and professional prestige offered Accident Investigators. This does NOT obligate me in any way and no salesman will call.

Name _____ Age _____
Address _____
City _____ State _____ Zip _____



HEAVY DUTY WELDER
with special \$7.00 gift offer to
Popular Mechanics readers
10-DAY FREE TRIAL
Lifetime Guarantee
Brand New 1895
1971 Model POST PAID
Fits ordinary 110V outlet
Not one • but 3 welding heats

Weld, braze, solder or cut most anything made of metal. No experience necessary. Follow simple instructions to make repairs on cars, trailers, farm and lawn equipment, bicycles, appliances, etc. Make campers, boats, furniture, hundreds of valuable items. **NOTHING ELSE TO BUY!** Comes complete with full face shield, pack of welding and brazing rods, heavy duty power cables, special electric torch attachment, ground clamp, flux, easy-to-follow illustrated instructions, rod holder, etc. Uses standard 3/8" rods to weld iron, steel, brass, bronze, aluminum, other metals. New improved HEAVY DUTY circuit gives more welding power. Gives 4 times the heat needed to melt toughest iron. Plugs into ordinary 110V outlet. **3 WELDING HEATS** . . . Not just one as with other low cost models. Use "high" for tough jobs "medium" or "regular" for lighter work. This important feature saves you money and time. Makes it possible for even beginners to start welding professionally the very first day. Pays for itself quickly. An excellent gift for any occasion. **IT'S AUTOMATIC:** Current is turned ON when arc is struck. OFF when rod is lifted from work. Eliminates need for troublesome foot switch. Speeds up work.

FREE! Mention that you saw this ad in Popular Mechanics and receive a \$7.00 gift pack assortment of "touch weld" welding rods. Automatic arc striker. Weld with "push button" ease.

10 day MONEY BACK GUARANTEE. You must be satisfied or return for refund. Send only \$2.00 and pay postman \$16.95 plus postage when delivered or send \$18.95 cash, check or money order for immediate postpaid shipment.

WEL-DEX MFG. CO., Dept. W-203, Box 10776, Houston, Texas 77018

**WOOD
VENEERS • TOOLS**
Shop Equipment • Supplies
POWER TOOLS
at Lowest
Discount Prices!

SAVE MONEY on finest domestic and imported hardwoods . . . all dimensions. Over 1500 items for the home craftsman and woodworking hobbyist. Lamp parts, upholstery supplies, tile, power tools at discounts. **NEW CATALOG READY** 132 pages. Full Color. Send name, address and 35¢ to cover handling, and postage. Write . . .

CRAFTSMAN Wood Service Co. Dept. A-21
2729 S. Mary, Chicago, Ill. 60608



SAILBOAT KITS

Free color catalog of the largest selection of popular sailboats, iceboats, and sail making supplies.

TAFT MARINE CORP.
Dept. PM-2, 636 39th Ave. N.E.
Minneapolis, Minnesota 55421

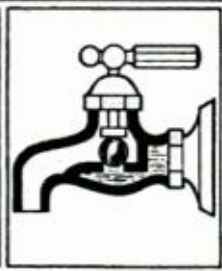
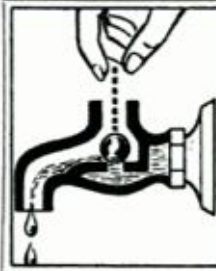

**INSTANT
DRIP
STOPPERS**

Self-installing neoprene ball sealers. Just drop into any faucet—no more washers to replace! Forget the bevelled washers, the screws, and the fitting to size. Money back guarantee, of course! Set of 12 in 4 standard sizes, just \$2.00 per dozen, post paid from Sullivan's Plumbing Shop, 1199 Broadway, New York 10001

HEAVY DUTY BALL-BEARING PUMP

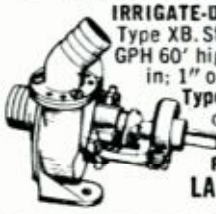

IRRIGATE-DRAIN-SPRAY-CIRCULATE. All-metal, rust-proof, Type XB. Stainless shaft. Use 1/4 HP or larger. 1 HP 1,200 GPH 60' high or 3,000 GPH 25' well. 5,200 GPH max. 1 1/4" in; 1" out. Belt or direct drive. **\$12.95**
Type P won't rust or clog. Bronze-bearing. Hundreds of thousands in use. Up to 2,400 GPH. 1" inlet. 3/4" outlet. Free coupling. **\$8.95**
P'pd. cash with order **MONEY BACK GUARANTEE**
LABAWCO. Box 40, Belle Mead, N. J. 08502

BIG PROFITS FOR YOU!!
In your own spare-time
PRINTING BUSINESS



Since 1872 thousands from high school to retirement ages have made important extra money with Kelsey hand presses, supplies, paper and how-to-do-it printing and business management help. Have your own printing business and your present job too. Send 25c (credited against your first order) for big catalog and details. **ACT NOW!!** **KELSEY PRESSES, Dept. 71-E, Meridan, Conn. 06450**

FIND BURIED TREASURE

Powerful electronic detector finds buried gold, silver, coins, etc. 5 new models. Write for free catalog.



RELCO, Dept. D-3 19⁹⁵
BOX 10839, HOUSTON, TEX. 77018

MOLDS

for making
Ornamental Concrete
Items . . .



Book about Aluminum Molds with prices and production trade secrets direct from world's largest mold manufacturer.

**SEND
\$2.00**

CONCRETE MACHINERY COMPANY, INC.

P. O. BOX 99 • HICKORY 2, N. C. 28601

TOM McCAHILL SAYS:

“You can pocket \$5 to \$7 an hour if you’re good enough to fix these things.”

The coming of the automobile built a multimillion dollar service industry in a few, short gas-eating years. The same thing has happened in the electrical appliance field. Manpower is desperately needed now to repair appliances.

But there is one big difference. Anybody with a few simple tools can get started in appliance repair. No expensive equipment is needed.

What is needed is the right kind of training. You can't strike it rich in today's job market with nothing more than muscle. Nor can you hang onto an old-time job skill while an electronic monster with buttons replaces men around you. It's like driving a buckboard down the Jersey Turnpike. The fuzz would locate you fast and send you out to pasture.

If you want an up-to-date job skill with good opportunity—why not take a look at the Electrical Appliance Repair field?

This field is loaded with opportunity because every house in our high speed land is loaded with appliances. There are about four times as many appliances as we have men, women, children and babies in the good old U.S.A. There are over a billion of these electrical gadgets being used, abused and broken. If you know how to do fast repair jobs on them, how much you can earn can well depend on how much you want to earn.

The opportunities in this field are all the better because you can prepare for them fast. There's one short, sweet course you can take right in your own home and it covers everything. I'm referring to a home-training course offered by the Appliance Division of National Radio Institute—one of the biggest and oldest home study schools of its kind.

NRI gives you the whole works. Their training covers basic electricity and how to use test instruments. They cover the electrical and mechanical operation of every type of appliance from toasters and coffee-makers to dishwashers; from vacuum cleaners and automatic laundry equipment to air conditioners and refrigerators. They even show you how to fix farm and commercial appliances and small one-lung engines.

The training is designed to be interesting, practical and fast. You can make \$5 to \$7 an hour extra fixing



appliances in spare time starting soon after you enroll. They give you all you need to know to do fast, profitable repair service. They even include equipment without charging you extra. And the full cost of the training is surprisingly low.

If you are driving a buckboard in today's job market, at least find out what the Appliance field can do for you. NRI sends you a fancy, illustrated book about their training so you can judge for yourself. There's no obligation and they don't send a salesman to pressure you. All I say is get the facts and see for yourself. Send the coupon today while you are thinking about it.

Tom McCahill

AVAILABLE UNDER NEW GI BILL

If you served since January 31, 1955 or are in service, check GI line below.

APPLIANCE DIVISION, NATIONAL RADIO INSTITUTE 600-021
3939 Wisconsin Avenue, Washington, D.C. 20016

- OK—I want to see for myself. Send me the free book on Professional Appliance Servicing.
- Check for facts on new GI Bill.
- NO SALESMAN WILL CALL.**

Name _____ Age _____

Address _____

City _____ State _____ Zip Code _____

**ACCREDITED MEMBER
NATIONAL HOME STUDY COUNCIL.**

WHAT'S NEW OUTDOORS

BY ROB KINSON

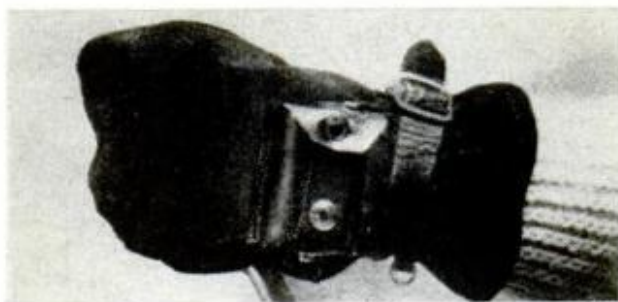

HEAT YOUR HANDS AND FEET with Lectra-Mits and Lectra-Sox, newly designed to provide comfort for outdoor winter sports fans. The heat is supplied by one D-size flashlight battery that's located in a small pouch attached to each sock or mit. A thin wire sewn inside the material leads from battery clip to a concealed heating element. The Ski Lectra-Sox battery pouch has a spring-metal clip that fits on the back of your boot. Socks, of white or blue wool and nylon, are available in 9-11 or 10-13 stretch sizes, are washable and retail for \$9.95 per pair. Mits, made of double reinforced, black-suede leather with wool liners, come in small, medium and large sizes for \$16.95 per pair. They are made by Timely Products Corp., 210 Eliot St., Fairfield, Conn. 06430.



DISPLAY YOUR FIREARMS handsomely and safely with Outers Safety Guard. Lock and wall mount, shaped like a door-knob and fitted through the trigger guard, prevent children and curious novices from playing with or mishandling your guns. Molded of Cyclac, the gun guard is attached with a screw that's invisible when lock is engaged. Metal locking pin prevents "picking" or accidental opening. A barrel bracket keeps gun from sliding off the mount. Gun Guard may also be used in closets to mount and lock guns at any angle, allowing you to use closets and still keep firearms safe. From Outers Laboratories, Onalaska, Wis. 54650.

REPAIR YOUR SNOWMOBILE track or body at the point of breakdown with the new USM Snowmobile Repair Kit, which features a heavy-duty "Pop" Rivetool. This kit is packaged in a self-locking plastic carrying case and consists of the tool, interchangeable nosepieces and 200 steel or aluminum rivets in two lengths. Instructions are included for replacing broken drive-belt cleats as well as for repairing the vehicle's housing, cowling and underframe. For details, write USM Corp., Consumer Products Div., Box 1139, Reading, Pa. 19603.

START YOUR NEW CAREER NOW! WITHOUT OVERHEAD! ANY PLACE! ANY AGE!

UPHOLSTERING JUST ONE

you don't even have to quit your present job!!!

Start learning now. At home, or in the garage, in your spare time — no outside classes to attend. If you can tie a knot and drive a tack, you can learn this business, quickly, easily. You start learning the basics **right away** through the proven MUI Home Training Plan. And before you're barely into it, you can start doing the simple upholstery jobs that are all around you waiting to be done. Chairs, cushions, seats, footstools. Even before MUI students finish their training, people start bringing upholstery jobs to them, and remember—the world is full of furniture that needs fixing and re-upholstering and more is wearing out all the time!

CHAIR can pay you as much as your present weekly paycheck!

"What started as a hobby, now pays me \$10 an hour"

Yes, many MUI graduates make better than \$10 an hour turning old wornout furniture into bright new decorator pieces! **Stack it up against what you're doing now!** Are you making \$150 a week? \$200? \$250? Do you put in long hours of dull work, with small raises? Is that the way you want to spend the rest of your life? Just imagine, you can make \$150, \$200, \$250 upholstery just **one chair or sofa** these days! And if you're the kind of person who likes to work and earn, you can sometimes finish a job like this in a day. That's pay... and it beats what most college graduates make!

AS YOU LEARN, YOU JUST SLIP INTO THE IMMENSE FLOW OF UPHOLSTERY WORK! Think of all there is! . . . Sofas, lounging chairs finished in beautiful fabrics, which MUI tells you how to get at the right price — even leather and all the new vinyls. And then you have built-ins and breakfast nooks, boats, trailers and all the millions of automobiles in America. Yes, you learn all this and more! When we finish teaching you, (in your own home in your spare time) and when you get our California state approved diploma, you **know** this business . . . as a **real professional!** You will then have one of the most fantastic moneymaking skills in America built into your head and hands! No one can ever take this skill away from you . . . and no one can ever fire you, because **you're the boss** of a business that you can take with you . . . You can make big money from then on . . . any time, anyplace you want to put out your shingle!

When you read the papers you see there's a strike here, a lockout there. Detroit lays off 150,000 men. A plant is shut down and moved out of state. A new automated machine eliminates 5,000 jobs. They talk about dislocated workers and try to do something about it. What pays the bills if you get caught up in one of these situations? When you know upholstery, life gets very simple and lots of fun. It's simple because where there are people, there are upholstery jobs and lots of them. It's fun because life is fun when the bills are paid and there's money in the bank, even enough to buy those things you've always wanted for yourself.

MUI IS APPROVED BY THE CALIFORNIA SUPER-INTENDENT OF PUBLIC INSTRUCTION AND IS AUTHORIZED TO ISSUE A DIPLOMA IN UPHOLSTERY.

MODERN UPHOLSTERY INSTITUTE
Box 899-DTG Orange, Calif. 92669

FEBRUARY 1971

YOU GET SIX BIG FURNITURE KITS FREE



YOU GET THIS AUTHORIZED DIPLOMA WHEN YOU GRADUATE



Name _____ Age _____
Address _____
City _____ State _____ Zip _____

WORK THE HOURS YOU LIKE TO WORK!!

If you favor a regular 35 hours a week, upholstery lets you do it and make a really fine living. On the other hand, if you're really ambitious and want to work 60 or 70 hours a week, **you are starting to talk about some big, big money!** The important thing is that the choice is yours, not somebody else's! (Not like when you're working for someone else.) Many students of retirement age just do a few pieces now and then just to keep things nice and comfortable.

TO GET STARTED, JUST GET THE COUPON IN THE MAIL... TODAY!

It costs you nothing to get the information and there's no obligation. No salesman is going to call you. This much and this much only, every successful MUI graduate must do for himself — **send the coupon today!**

YOU'LL GET A BIG ILLUSTRATED 32 PAGE BOOK ON UPHOLSTERY and the upholstery business, and an actual free sample lesson showing how the fabulously successful MUI system is taught. For your sake and the sake of your future, do it now. Cut out the coupon, fill it out, put it in an envelope and mail it now. Air mail reaches MUI about two days sooner!

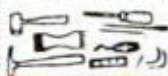

ALL THE SPECIAL "TOOLS OF THE TRADE" ARE YOURS... **FREE**

THIS FREE UPHOLSTERY BOOK may be the most important information you ever read.

MAIL COUPON NOW!

MODERN UPHOLSTERY INSTITUTE, Box 899-DTG Orange, Calif. 92669

Please send the **FREE UPHOLSTERY CAREER BOOK**, the **FREE SAMPLE LESSON**. I understand I am under no obligation whatever and am just sending for the free facts on job and career opportunities in Upholstering and the MUI home training program. I understand that no salesman will call.



APPROVED FOR VETERANS

BURIED ALIVE!



SIX YEARS ON THE SAME JOB WITH NEVER AN ACCIDENT... AND THEN ONE MORNING...

2 A CAVE-IN PUT ME SIX FEET UNDER FOR SIX LONG MINUTES

QUICK! GET HIM OUT OF THERE!

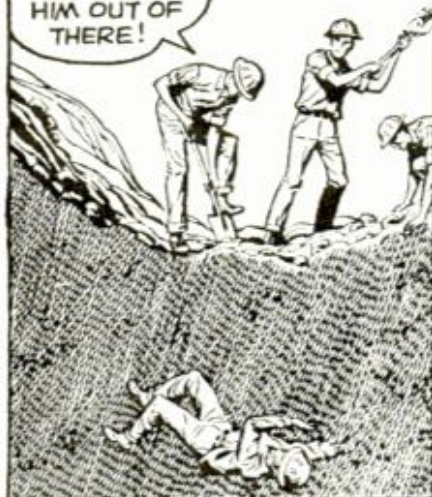

3 IN THE HOSPITAL, I HAD PLENTY OF TIME TO THINK

SIX YEARS I'VE BEEN BURIED ALIVE IN THAT SAME OLD JOB, JANE!

WELL, NOW'S A GOOD TIME TO DO SOMETHING ABOUT IT



4 I'D PASSED OVER DOZENS OF I C S ADS IN POPULAR MAGAZINES. BUT I SAW THIS ONE IN A NEW LIGHT

I C S SUCCESS PLAN... SPARE-TIME TRAINING... 266 COURSES TO CHOOSE FROM... THIS COULD BE THE ANSWER... WON'T HURT TO FIND OUT



FREE!

I C S CAREER KIT
Send coupon now...
get all three books

HOW'S IT GOING, DARLING?

FAST! I'M INTO HYDRAULICS ALREADY. AND I THOUGHT I WAS TOO OLD TO LEARN

5 SIGNING UP FOR THAT I C S COURSE WAS THE SMARTEST THING I EVER DID

6 ONE MONTH LATER...

GOOD TO SEE YOU BACK ON YOUR FEET, JIM. IT'LL BE AWHILE BEFORE YOU'RE BACK IN THE FIELD. SO WE'LL FIX A TEMPORARY DESK FOR YOU IN THE OFFICE WHEN YOU'RE READY

I'M READY NOW, MR. WALSH

7 THEY GAVE ME SOME SIMPLE ASSIGNMENTS... AND I SURE SURPRISED THEM!

SAY, WHERE DID YOU LEARN ABOUT PUMPS?

SAME PLACE YOU DID, JOE... I C S

8 THEN A FEW DAYS LATER, MR. WALSH CALLED ME IN...

JIM, I'M KEEPING YOU HERE AND PUTTING YOU ON SALARY. YOU'LL BE GETTING ABOUT \$20 MORE A WEEK. AND AT THE RATE YOU'RE GOING, I EXPECT I'LL HAVE TO RAISE THAT IN SIX MONTHS

9 THAT EVENING, JANE AND I WENT HOUSE HUNTING

OH, JIM! IT'S A DREAM HOUSE!

AND THANKS TO I C S IT'S A "DREAM" THAT CAN COME TRUE!

HERE'S WHERE YOU COME IN! LET I C S SHOW YOU THE WAY TO MORE PAY, RAPID ADVANCEMENT, REAL JOB SECURITY! MAIL THIS COUPON TODAY!

- 1 "HOW TO SUCCEED" A gold mine of ideas
- 2 CAREER CATALOG Opportunities in the field that interests you most
- 3 SAMPLE LESSON Shows the famous step-by-step I C S teaching method



ICS[®] International Correspondence Schools

Division of Intext

ICS, Scranton, Pa. 18515
 Canadian residents: Send coupon to Scranton. Our affiliate in Canada will reply.

Take your first step... mail this coupon today... ICS, Scranton, Pa. 18515.

I'm interested in a program of independent study. Send me your free 3-booklet Success Kit: (1) "How to Succeed," 30 pages of valuable job tips, (2) Sample text demonstrating famous ICS method, (3) Catalog for subject checked below...

Miss _____
 Mrs. _____
 Mr. (Please print) _____ Age _____

Address _____ Apt. _____
 City _____ State _____ Zip Code _____

Occupation _____ Employed by _____ Working Hours _____ A.M. to _____ P.M.

ACCOUNTING <input type="checkbox"/> Accounting (U.S. or Can.) <input type="checkbox"/> Cost Accounting <input type="checkbox"/> General Accounting <input type="checkbox"/> Practical Accounting <input type="checkbox"/> Public Accounting	<input type="checkbox"/> Commercial Cartoning <input type="checkbox"/> Interior Decorating <input type="checkbox"/> Sign Painting & Design <input type="checkbox"/> Sketching & Painting	<input type="checkbox"/> Retail Business Mgmt. <input type="checkbox"/> Traffic Management	<input type="checkbox"/> Programming for Digital Computers <input type="checkbox"/> Programming the 360 <input type="checkbox"/> Programming the 1401	<input type="checkbox"/> High School General <input type="checkbox"/> High School Math. <input type="checkbox"/> High School Secretarial <input type="checkbox"/> High School Vocational <input type="checkbox"/> College Preparatory <input type="checkbox"/> Preparatory Course for H.S. Equivalency Test	SECRETARIAL <input type="checkbox"/> Clerk-Typist <input type="checkbox"/> Secretary, Legal <input type="checkbox"/> Secretary, Medical <input type="checkbox"/> Secretary, Professional <input type="checkbox"/> Shorthand <input type="checkbox"/> Stenographic <input type="checkbox"/> Typist
ARCHITECTURE and BUILDING TRADES <input type="checkbox"/> Air Conditioning <input type="checkbox"/> Air Conditioning Maint. <input type="checkbox"/> Architecture <input type="checkbox"/> Arch. Drawing & Design <input type="checkbox"/> Building Contractor <input type="checkbox"/> Carpenter-Building <input type="checkbox"/> Carpentry & Millwork <input type="checkbox"/> Heating & Air Conditioning with Drawing <input type="checkbox"/> House Planning, Int. Design <input type="checkbox"/> Plumbing <input type="checkbox"/> Plumbing & Heating <input type="checkbox"/> Reading Arch. Blueprints <input type="checkbox"/> Refrigeration & Air Cond.	AUTOMOTIVE <input type="checkbox"/> Auto Body Rebuilding & Refinishing <input type="checkbox"/> Auto Mechanic-Techn. <input type="checkbox"/> Diesel-Gas-Motor Vehicle Engines <input type="checkbox"/> Auto. Electrical Techn. <input type="checkbox"/> Engine Tune-Up <input type="checkbox"/> Transmission Specialist	BUSINESS: SALES <input type="checkbox"/> Creative Salesmanship <input type="checkbox"/> Real Estate Sales <input type="checkbox"/> Sales & Sales Mgmt.	DRAFTING <input type="checkbox"/> Aircraft Drafting <input type="checkbox"/> Architectural Drafting <input type="checkbox"/> Blueprint Reading <input type="checkbox"/> Design Drafting <input type="checkbox"/> Drafting Technology <input type="checkbox"/> Electrical and Electronic <input type="checkbox"/> Mechanical <input type="checkbox"/> Structural	MACH. SHOP PRACTICE <input type="checkbox"/> Machine Shop Practice <input type="checkbox"/> Maintenance Mechanic <input type="checkbox"/> Reading Shop Prints <input type="checkbox"/> Tool & Die Maker <input type="checkbox"/> Welding, Gas & Elec.	TV- RADIO-ELECTRONICS <input type="checkbox"/> Cable TV Installer <input type="checkbox"/> Electronics Fundamentals <input type="checkbox"/> Electronic Technician <input type="checkbox"/> General Electronics <input type="checkbox"/> Indust. Electronics Tech. <input type="checkbox"/> Radio Telephone License <input type="checkbox"/> Solid State Electronics <input type="checkbox"/> Telephony <input type="checkbox"/> TV and Radio Servicing with Equip. Training
ART and DESIGN <input type="checkbox"/> Commercial Art	BUSINESS <input type="checkbox"/> Advertising <input type="checkbox"/> Advanced Management <input type="checkbox"/> Basic Management <input type="checkbox"/> Business Administration <input type="checkbox"/> Business Law <input type="checkbox"/> Industrial Psychology <input type="checkbox"/> Inventory Control <input type="checkbox"/> Managing a Small Store <input type="checkbox"/> Personnel-Labor Rel'n's <input type="checkbox"/> Purchasing Agent	CHEMICAL <input type="checkbox"/> Chemical Analyst <input type="checkbox"/> Chemical Engineering <input type="checkbox"/> Chem. Lab Technician <input type="checkbox"/> General Chemistry <input type="checkbox"/> Plastics Technician	ELECTRICAL <input type="checkbox"/> Electrical Engineering <input type="checkbox"/> Appliance Servicing <input type="checkbox"/> Elec. Eng. Technician <input type="checkbox"/> Industrial Electrician <input type="checkbox"/> Industrial Maintenance Electrician <input type="checkbox"/> Motor Repairman <input type="checkbox"/> Practical Electrician <input type="checkbox"/> Practical Lineman	MECHANICAL <input type="checkbox"/> Mechanical Engineering <input type="checkbox"/> Aircraft Mechanic <input type="checkbox"/> Boiler Inspector <input type="checkbox"/> Hydraulic, Pneumatic Power <input type="checkbox"/> Industrial Engineering <input type="checkbox"/> Industrial Instrumentation <input type="checkbox"/> Machine Design <input type="checkbox"/> Power Plant Engineering <input type="checkbox"/> Quality Control <input type="checkbox"/> Tool Design	WRITING and ENGLISH <input type="checkbox"/> English and Writing <input type="checkbox"/> Free-Lance Writing <input type="checkbox"/> Reading Improvement <input type="checkbox"/> Other (tell us)
	CIVIL ENGINEERING <input type="checkbox"/> Civil Engineering <input type="checkbox"/> Highway Eng. Tech. <input type="checkbox"/> Sewer Plant Operator <input type="checkbox"/> Structural Eng. Tech. <input type="checkbox"/> Surveying & Mapping <input type="checkbox"/> Water-Works Operator	COMPUTERS <input type="checkbox"/> Fundamentals of Computer Programming <input type="checkbox"/> COBOL Programming <input type="checkbox"/> Fortran Programming	HIGH SCHOOL <input type="checkbox"/> High School Business		

Approved for veterans for tuition refund.
 Accredited member, Nat'l Home Study Council.
 Easy pay-as-you-learn plan.
 Special rates to members U.S. Armed Forces.
 ICS has over 266 career-related courses
 C3054A

A cure for the common cold has been with us for years, according to Stanford University chemist Linus Pauling. Heavy doses of vitamin C, he claims, will prevent many colds or decrease the intensity of the symptoms. "The people of the United States spend about \$500 million per year on cold medicines," says Prof. Pauling. "These medicines do not prevent colds. They may decrease somewhat the misery of a cold, but they also do harm because of their toxicity and side effects." Vitamin C—ascorbic acid—is a natural food with extremely low toxicity. Though it has been commercially available for decades, it usually is taken only in amounts too small to do any good, Pauling declares, a practice that he attributes in part to the average physician's ignorance of nutrition. The chemist, who won a Nobel prize in 1954, cites scientific studies and his own experience in backing up his contention.

Seventeen amino acids have been found in a meteorite that fell on Australia last year. This report comes from a team of American scientists—Dr. Cyril Ponnampereuma of NASA's Ames Research Center, Dr. Ian R. Kaplan of UCLA and Dr. Carleton Moore of Arizona State University—who say the crystalline structures of many of the acids show them to be forms rarely found on Earth. This is regarded as the strongest evidence yet obtained that conditions suitable for the evolution of life exist in space. Amino acids compose the proteins needed for maintaining life.

Feet and inches are getting competition from meters and centimeters at NASA. From now on, certain of NASA's technical publications will use metric units to express measurements, making the space administration the first federal agency to take this sensible step. Since it uses decimals and multiples of 10, the metric system is far simpler than the English system (feet, inches) that we inherited centuries ago. It may not be long before the United States will be the only industrial nation to continue to use the English system. Even Great Britain, a long-time holdout, is switching to metric units.

Common table sugar is a "wonder drug" for cut roses, prolonging their vase life for as long as 10 days. Researchers at Cornell University mix sugar with distilled water that has been treated with a germ killer. The sugar is a vital source of plant food, say the scientists, and the germ killer keeps the water-conducting system in the plant from being plugged by microbial infections. Ordinarily, cut roses last about six days.

A throw-away clinical thermometer, costing but a few cents, has been developed by a New Jersey research firm. The instrument consists of a strip of aluminum with a series of chemical dots fixed to it. The strip and dots are encased in plastic to permit the thermometer to be used in the customary way, under the tongue. The dots react to heat, turning from white to blue to indicate specific temperatures. Reaction time is in seconds compared to the several minutes required by a glass thermometer. The throw-away feature eliminates the possibility of cross-infection caused by a "dirty" thermometer.

Air pollution has doubled over the North Atlantic since the early 1900s while the cleanliness of the South Pacific atmosphere has not changed. This finding was made by scientists of the National Oceanic and Atmospheric Agency who compared data on the electrical conductivity of the early-century atmosphere—gathered on Carnegie Institution expeditions—with similar information obtained during a recent global research cruise. Conductivity is related to amounts of particulate matter in air. The vast ocean regions and limited land masses of the southern hemisphere, say the scientists, have not seen the enormous increase of sources of manmade pollution experienced by the northern hemisphere. ★★

PALL MALL GOLD 100's

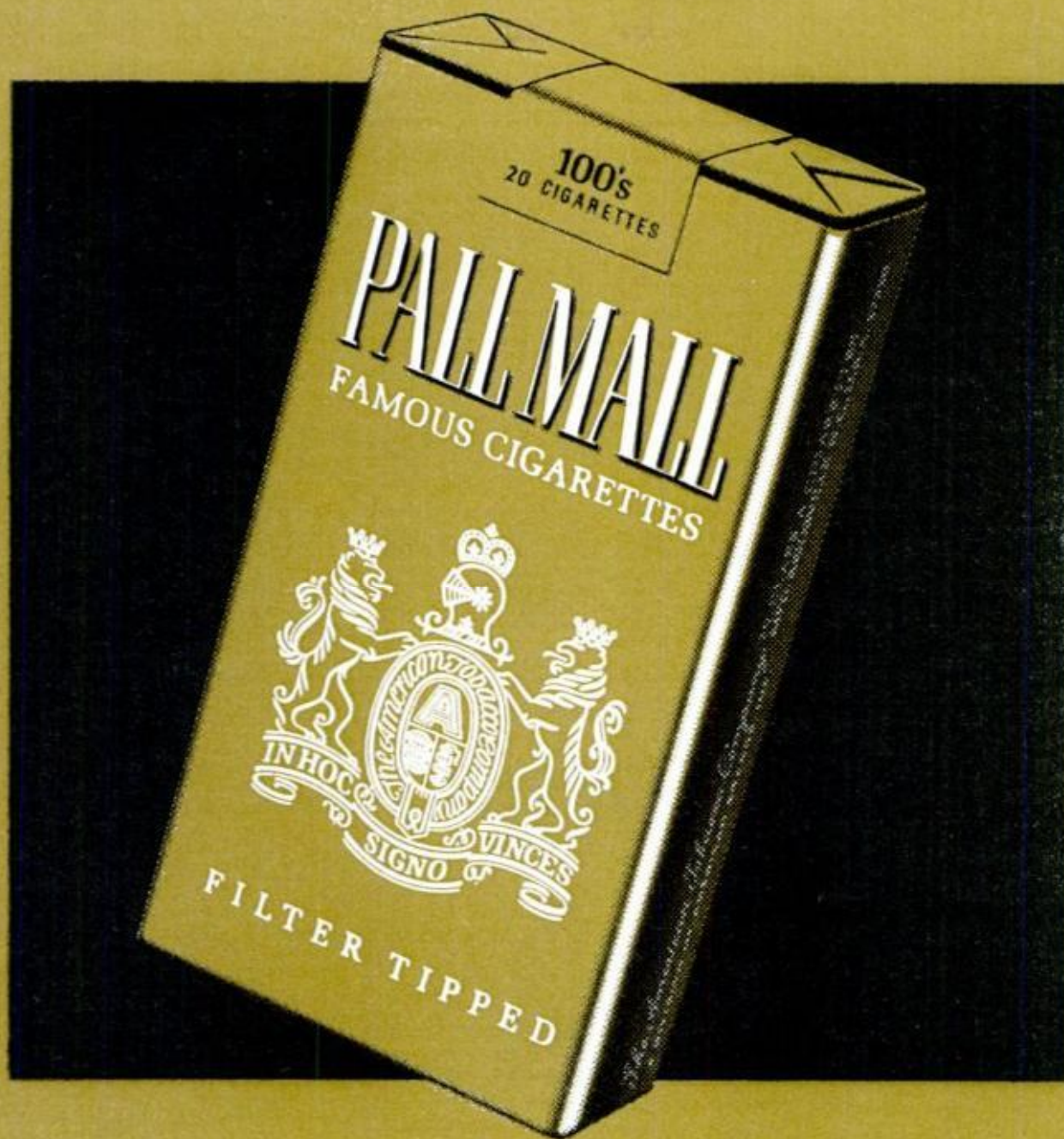

Longer...yet milder

longer length - milder taste.

You get both with

PALL MALL GOLD 100's

Residence Schools / Camps Directory

For advertising information on this section, please contact Hildegard K. Esposito, Popular Mechanics, 224 West 57th Street, New York, N.Y. 10019.

Many schools and camps have long waiting lists for 1971-1972 enrollment. POPULAR MECHANICS urges you to write now to the residence school or camp of your choice for more information.

BOYS' SCHOOLS

St. John's Military Academy 1884

A TRADITION OF EXCELLENCE

stressing character, leadership, scholarship. Accredited college preparatory, grades 7-12. Tutorial and developmental reading programs. All sports including hockey, flying, riflery. Own golf course, stable, pool, hospital, lake for crew. Honor ROTC. Band. Interdenominational. Chicago 100 mi. Write: Wm. J. West, Headmaster, Box VMF 321, Delafield, Wisconsin 53018

HOWE MILITARY SCHOOL

Jr. & Sr. Schools. Grades 6-8 & 9-12. Thorough acad. training. Accredited college prep. ROTC. Jrs. have own dorm, sports & activities; housemother. Devel. Reading. Small classes. Testing. New buildings, pool, Episcopal. Est. 1884. Summer Camp. Catalog. Col. R. R. Kelly, Supt., 1211 Academy Pl., Howe, Ind. 46746.

Wentworth Military Academy

Preparation for the rigors of business or higher education. Accred. 4-yr. H.S., separate 2-yr. College Sr. ROTC. New million-dollar field house. Golf course. Pool. FAA flying. Summer school; younger boys' camp. 91st year. Catalog. Col. L. B. Wikoff, 911 Washington Place, Lexington, Mo. 64067

As a service to our readers and their families, we are now including this Schools/Camps Directory, offering listings of the finest schools—college preparatory, technical schools and military academies—we hope their services will be beneficial to the success of today's youngsters so that they might be the strong foundations of tomorrow's world.

Missouri Military Academy

AND SEPARATE JR. SCHOOL

82nd yr. Small classes. College prep. Gr. 4-12. All sports. Golf. Riding. ROTC. 10 beautiful new buildings in 14 yrs. incl. library, dorm. largest field house in state. Catalog. Col. Charles Stribling III, 811 Main, Mexico, Mo. 65265. Tel: 314-581-1776.

Roosevelt Military Academy

"Builders of Men" Fully accred. Gr. 8-12. College prep. Small classes. Emphasizes fundamentals, how to study, Guidance, ROTC. Sports. Riding. Aviation. Bands. Mod. rate. Catalog. Col. Glen G. Millikan, Box P, Aledo, Ill. 61231. Tel: 309/582-5166.

Kemper Military School & College

Fully accred. Grades 7-12; 2-year college. Ind. instruction. Excellent faculty. Personal counseling. How-To-Study Program. Jr., Sr. ROTC. Sports. Social activities. FAA Flying. Education for leadership since 1844. Catalog: 500 Third St., Boonville, Mo. 65233.

TECHNICAL SCHOOLS

Gradwohl School of Laboratory Technique

Be a medical lab technician! Big demand, good salaries. One-year course for H.S. grads. Enter monthly. Co-ed. Internationally known. M.D. supervised. G.I. approved. Placement service. Catalog: 3530 Lucas Avenue, St. Louis, Missouri 63103.

GET INTO ELECTRONICS

V.T.I. training leads to success as technicians, field engineers, specialists in communications, guided missiles, computers, radar, automation. Basic & advanced courses. Electronic Engineering Technology and Electronic Technology curricula both available. Assoc. degree in 29 mos. B.S. obtainable. G.I. approved. Start Sept., Feb. Dorms, campus. High School Graduate or equivalent. Catalog.

VALPARAISO TECHNICAL INSTITUTE
DEPARTMENT D.
VALPARAISO, INDIANA 46383



A cure for nail biters.



We call it Elmer's® Heavy Grip™ Cement.

It's a heavy duty cement for where a nail or screw won't do.

You can use it to hang shelf brackets, towel bars, hooks, soap dishes, you name it.

A couple of drops gives you all the support you need. Almost instantly.



Elmer's Heavy Grip. From the makers of Krylon Coatings and Mystik Tapes.

 BLACK FOREST CLOCK Handcarved in Bavaria. Weight driven movement. \$1.84	 ELECTRIC MASSAGE SET Special attachments for scalp, body and face. \$1.50	 8mm MOVIE CAMERA Electric powered no winding! Loads in seconds. \$5.50	 JADE RING 79¢ Hand set in delicate mounting. Men's styles also available.	 DUTCH MOTORCYCLE Deluxe Springmaster model for sporty appeal. \$113.00	 ELECTRIC GUITAR Rugged construction for true amplification. Great electronic sound. \$7.40	 CASSETTE TAPE UNIT Snap in cartridge ready to play. From \$7.50	 FLASH CAMERA 55¢ For indoors or out. Black and White or Color.
 REAL SAPPHIRE RING Sterling Silver mounting. Men's styles also available. \$3.50	 LAMP RADIO Combination Hi-Intensity Lamp and six transistor radio. \$5.95	 INTERPHONE SET Closed circuit telephones for home or office. \$2.40 for two	 CALENDAR WATCH Swiss movement. Tells time and date. \$2.10	 FIELD GLASSES 7 x 35 G.C.F. Clear and powerful. Center focusing. \$2.10	 ELECTRIC HAIR DRYER Feather weight. Whisper quiet. Great for men, too. \$1.50	 FRENCH PERFUME Many delicate fragrances to choose from. 1/3 to 1/2 oz. bottles. 85¢	 MEN'S BRIEFCASE Executive style with compartments. Light weight, easy action zipper. \$1.00
 30 POWER TELESCOPE & TRIPOD Sturdy Metal Construction. \$1.94	 ELECTRIC RAZOR Product of Swiss Craftsmanship. Maker guarantees one full year. \$1.70	<h1>67 FANTASTIC VALUES!</h1> <h2>Buy Below Wholesale</h2> <h3>AT PRICES SHOWN HERE</h3>			 RIVIERA BIKINI American girls go wild over European Bikinis. Exclusive styling from continental designers. \$1.75	 FISHING KITS Sectional bamboo spinning and fly rod. Flies, hooks and lures in wooden carrying case. \$3.30	
 ELECTRIC CARVING SET Self contained power. Two stainless steel blades. \$1.50	 MINK COAT Full length Mink coat from Scandinavia. \$333				 SIMULATED PEARLS 7¢ Fourteen inch strands. Translucent quality. With clasp.	 AUTO VACUUM Compact car Vacuum works off cigarette lighter. Adjustable nozzle. \$1.80	
 58¢ TENNIS RACKETS Laminated hard wood. Nylon strung. Precision balanced.	 WIRELESS INTERCOM Amazing set operates thruout home, office, farm without wire. \$4.95	 ADDING MACHINES Famous design for home and personal use. 9¢	 10¢ FLASHLIGHTS Bright reflector ideal for outdoor or recreational use.	 \$1.85 TIGER EYE RING Genuine Sterling Silver mounting.	 OLD WORLD CLOCK \$5.00 Clear plastic dome guards German craftsmanship. Great decorator item.	 PHONOGRAPH Portable battery operated. Great for mountains or beach. Three speeds. \$3.50	 \$3.45 ELECTRIC CAN OPENER Powerful. Automatic. Opens any size can.
 BEDFORDFLEX CAMERA Twin lens reflex. Ready to shoot in seconds. 50¢	 ELECTRIC TRAIN SET Sixteen piece set. Battery operated. Great for kids. \$1.50	 RAINCOATS Plastic Raincoats for men and women. Clear or color. Carry in your pocket. 9¢	 HI-INTENSITY LAMP Rotates in full circle. Ideal for reading, hobby work, sewing. \$1.85	 TELEPHONE AMPLIFIER Transistorized. Hear phone conversation across room. \$3.10	 CAR SPOT LIGHT For six or twelve volts. Extra long cord. Pistol grip. 50¢	 BURGLAR ALARM For office or home. 39¢	 BICYCLE Man-size, latest style, powerful frame. \$16.
 NYLON TIP PENS Fast seller at a fraction of the regular cost. All colors available. 10¢	 HAND-BEADED SWEATER From Hong Kong. Beautifully fashioned. \$5.85 ea.	 TEAKWOOD BOX .90¢ Handcarved from India. Beautiful finish, lift up lid.	 STEAK KNIFE SET Six pieces. Stainless steel serrated blades. Only 31¢ set of six.	 BLACK FOREST WEATHERHOUSE Handcarved weather station. Predict bright, sunny or rainy days. 75¢	 ELECTRIC TOOTHBRUSH Four nylon bristle brushes. Battery operated. Up and down action. 45¢	 BEADED HANDBAGS Delicate hand-beading on satin bag. Many colors. 89¢	 8mm MOVIE PROJECTOR Projector. Battery operated. Built-in screen. \$1.60

1000's of dazzling imports like these help you, spare or full time, start your own BIG PROFIT HOME IMPORT BUSINESS

Start fast! See how easy I make it for you! Without previous experience or product investment I'll start you in your own big profit Home Import Business. Cash in quickly. Import bargains I locate for you give profit opportunities beyond your wildest dreams. You can make your first import transaction 10 minutes after you get my proven drop ship plan. Everything done for you;

nothing left to chance. These fantastic bargains go fast to stores, mail order operators, premium users, friends, others. Start anywhere; age no barrier. You've seen amazing import bargains I have shown in my "Passport to Profit" TV series ... now I'll tell you how to cash in on my import "finds" from overseas!

DISCOVER PROFITS of IMPORT!

You keep all the profits yourself! My Plan reveals everything you need to step into your own home business at once. You get free membership in International Traders—exclusive world-wide organization that puts you in direct personal contact with suppliers abroad. It is easy to buy below wholesale for yourself or for profit when I show you how. Rush coupon for my FREE BOOK, "How to Import and Export." Get details on amazing buys. No salesman will call. Airmail reaches me overnight.

Mail This Coupon Today! Get My Free Book!

More examples of 1000s of import bargains you can get to make fantastic profits up to 200% and more.

- | | |
|-------------------------------|---------------------------------|
| Transistor Radio \$1.50 | Singing Bird Cage \$3.75 |
| Fishing Rod50 | Golf Balls09 |
| Movie Title Kit 1.00 | Badminton Set60 |
| Water Pistol05 | Beer Stein28 |
| Swords 3.00 | 20 pc. Dinnerware 1.25 |
| Spinning Reel96 | Leather Ball Glove 1.25 |
| Cardigan Sweater 2.00 | AM FM SW Radio 10.50 |
| Walkie Talkie 2.50 | Rifle Scope 1.85 |
| Cigarette Lighter20 | Diamond per Ct. 90.00 |
| Model Boat Kit65 | Electric Shoe Shiner 1.50 |

Prices subject to availability, price fluctuation.



B. L. Mellinger, Jr.
Famous World
Trader, President,
The Mellinger Co.

Send No Money!

Do not order from us. I show you how to get these bargains and hundreds of others. Prices shown are direct from suppliers abroad.

Coupon brings details about
8 FREE IMPORTS

THE MELLINGER CO., Dept. E2252

1554 S. Sepulveda Blvd., Los Angeles, CA. 90025

Send free Book showing how I can buy imports below wholesale. Show me how to start a business of my own and make big profits. (If under 21, state age).

Name _____ Age _____
Address _____
City _____
State _____ Zip _____

Save 3 Days... Give Zip No. For Fastest Reply



EARN HIGH WAGES as a HEAVY EQUIPMENT OPERATOR

Train your way to high pay in the booming construction industry! Learn the skills you need to qualify, by actual field training on machines like the ones used by the industry. Huge training grounds in North Carolina, a million dollars worth of school-owned diesel-engined machines, experienced instructors, full 220-hour and 440-hour courses. National, the original school of heavy equipment operation, is a recognized leader. Member American Road Builders Assn., Services and Supply Division. Associate Member A.G.C. Full-time Job Advisory and Counseling Director on staff. VA approved. For men ages 17 to 56. Train Now-Pay Later plan... other payment plans also available. Write TODAY for FREE catalog and FREE copy of school newspaper reporting news of National School graduates. Accredited member National Association of Trade and Technical Schools.

NATIONAL SCHOOL OF HEAVY EQUIPMENT OPERATION, Dept. D-47
P. O. Box 8529, Moores Chapel Road, Charlotte, N. C. 28201

Please send me FREE illustrated school catalog and complete information. I understand there's no obligation.

Name _____ Age _____
Address _____ Phone _____
City _____ State _____ Zip Code _____



This point lets you bore holes up to 1 1/2" with small electric drill

IT'S HOLLOW GROUND to bore cleaner, faster at any angle

Now step-up the boring range of your small electric drill or drill press to 1 1/2" with Irwin Speedbor "88" wood bits. 1/4" shank chucks perfectly. No wobble. No run-out. Sharp cutting edges on exclusive hollow ground point start holes faster, let spade type cutters bore up to 5 times faster. You get clean, accurate holes in any wood at any cutting angle.

Each Irwin Speedbor "88" forged from single bar of finest tool steel. Each machine-sharpened and heat tempered full length for long life. 17 sizes, 1/4" to 1 1/2", and sets. See your Irwin hardware or building supply dealer soon.

\$.90 each **\$1.00 each** **\$1.50 each**
1/4" to 5/8" 5/8" to 1" 1 1/8" to 1 1/2"

IRWIN SPEEDBOR "88" WOOD BITS
at Wilmington, Ohio 45177, since 1885

Be a SURVEYOR & MAP MAKER

Join a Surveying Team—get in on planning of America's highways, bridges, dams, subdivisions, etc. Wonderful outdoor work. Ideal for those who like to work with their hands. 1000s exciting big pay jobs open now to qualified men. U.S. Bureau of Labor Statistics predicts shortage of 50,000 civil engineering technicians (Surveyors, etc.) by 1975 as construction of highways, airfields, waterways skyrockets upward. Our easy step-by-step home-study plans have helped 1000s beginners toward prestige salary, security. Big 68-piece Surveying Kit (training transit, drawing, instruments, etc.) given to you when you enroll. Thousands of Surveyors got their start through home-study. You can too! Send for "SURVEYING CAREER KIT"—ALL FREE! No salesman will call. Write & state age.

NORTH AMERICAN SCHOOL OF SURVEYING & MAPPING
4500 Campus Dr. • Dept. 14172, University Plaza, Newport, Calif. 92660

MAKE MONEY in MAIL ORDER



B. L. Mellinger, Jr.
"Mr. Mail Order" My FREE REPORT shows you how. Men-Women start SPARE TIME or FULL TIME! My Plan reveals how I made a mail order fortune, starting in my garage with less than \$100. I cover secrets of getting best mail order products, free advertising, operating without product investment. No salesman will call. Write for Free Report now. MAILCO, Dept. E2252 1554 South Sepulveda, Los Angeles, CA 90025

BLAST FURNACE 2400 F



Since 1935
Hobbyists • Schools • Inventors, etc.
Make your own castings of any metal from cast iron, down to lead and zinc. Available in 6 sizes, 1 1/2 to 50 lbs. Complete units from \$50.40 to \$162. Send 25¢ for circular—refundable.

KANSAS CITY SPECIALTIES CO. Dept. P-2
P.O. Box 193
Middleton, Wisc. 53562

Don't change your address without notifying us!

To insure uninterrupted service on your Popular Mechanics subscription, please notify us at least six weeks before you move.

1. Attach your address label from a recent issue in the space provided below... (If label not available, be sure to give us your old address, including Zip Code)
2. Print your name and new address below (be sure to include your Zip Code).

3. Mail entire notice to: **Subscription Service Dept.**
Box No. 646
New York, N.Y. 10019

Name _____ Please Print
New Address _____
City _____
State _____ Zip Code _____

The road.
Play it, feel it, know it, sense it, command it.
Take of it what it has to offer.

The Renault 16. Front-wheel drive.
4-wheel independent suspension.
Torsion bars. Rack and pinion steering.
Front-wheel disc brakes.

Up to 30 mpg. Top speed, 90 mph.
Net effect: Total adhesion to
the road and a whole new way to
communicate with it. \$2,495.*



*SUGGESTED P.O.E. PRICE
TAXES, FREIGHT, OPTIONS (SUCH
AS AUTOMATIC TRANS., SUN ROOF, ETC.)
AND DEALER DELIVERY CHARGES ADDITIONAL.
FOR OVERSEAS DELIVERY INFORMATION SEE YOUR
NEAREST DEALER OR WRITE TO: RENAULT, INC.
100 SYLVAN AVE., ENGLEWOOD CLIFFS, N. J. 07632.

ROAD LOVE

RENAULT 

Drivin' with Dan

What's the best procedure for approaching a hairpin turn? What is c.i.d. and how is it measured? Will changing wheel size affect speedometer reading? Dan Gurney answers these and other automotive questions

Q. Isn't it correct procedure, when you approach a hairpin turn (unless it's banked) to let off the gas and downshift when coming in, then shift back into high when going out of the turn? My brother says I'm wrong. What do you say?—Bill Ohl, Albany, N.Y.

A. You are correct, basically. Depending on the gearbox and the gear ratios, you might go all the way down to first gear and then back up through second, third, fourth and so forth upon leaving the turn.

Q. What does "destroyed" mean?—Ken Lewis, Richvale, Calif.

A. Stroking a crankshaft means regrinding the throw off center to lengthen the stroke of the piston. Destroying means regrinding to shorten the stroke.

Q. I've heard that you have won in every category of racing. What about drag racing?—John Virge, Plymouth, Mich.

A. I have not won in every category of racing. I did, however, drag race in earlier days and I even beat a few cars. You surely can't

win them all. I've managed to win in sports cars, G.T. cars, production cars, stock cars, Indy cars and G.P. cars. I've led a few oval races, but never won one. I've never raced on dirt, though I love to watch dirt racing.

Q. Since Swede Savage is replacing you in the racing scene, will he also drive the Can-Am circuit, along with the other circuits that you participated in?—Johnny Hahn, Indianapolis.

A. He'll drive in everything that we (All American Racers) participate in. 1971 should be an exclusive USAC Indy-car racing season for the A.A.R. Bobby Unser will also be driving for us.

Q. A friend recently said that because of WW II gasoline shortage, many people ran their cars on a gas which he believed to be methane (swamp gas). Is this true? Could an internal combustion engine be made to run on gas?—Mark Eghers, Cincinnati.

A. Yes, this has been done. Now propane conversions are becoming popular. Propane is an economical, efficient and clean fuel for internal combustion engines. See *Propane Power! Should You Switch to LP-Gas?*, page 85, Oct. '70 PM.

Q. Could you explain what c.i.d. displacement is? I'm curious as to how it is measured or determined.—Rudy Zweetzig, Franklin Park, Ill.

A. C.i.d. stands for cubic-inch displacement. You can determine this mathematically by applying the formula for measuring the volume of a container. In this case, it's the volume of the space within the cylinder walls between the points reached by the top of the pistons at their highest and lowest points of travel (stroke). Try to visualize the shape

(Please turn to page 28)

SWEDE SAVAGE in the Gurney Eagle scored his first USAC championship victory at Phoenix at 116 mph. Win was Dan's first as All American Racers team manager



You can't always tell when your spark plugs are misfiring.

PERCENTAGE OF GASOLINE LOST DUE TO SPARK PLUG MISFIRING

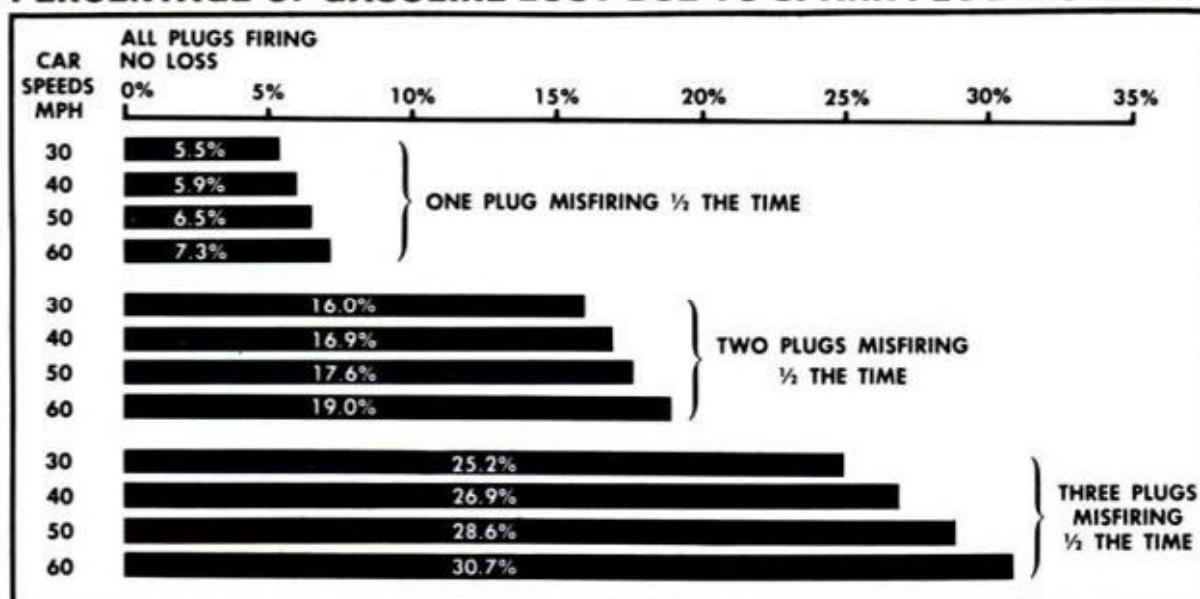

How spark plug fouling and misfiring reduces gasoline mileage in tests conducted at the General Motors Proving Grounds.



Automatic transmissions tend to cover up engine roughness due to spark plug misfiring.

Engine misfire can cost you plenty in wasted gasoline.

That's why it's important to keep your car on a

regular maintenance schedule. A well maintained engine with properly tuned carburetion and ignition systems can give you improved mileage and performance.

When you install new spark plugs, make sure you get the best . . . AC Fire-Ring Spark Plugs. AC's self-cleaning hot tip fires hotter, burns cleaner. A fresh set in your engine will help assure you many miles of top economy and performance.



AC SPARK PLUG DIVISION OF GENERAL MOTORS



**"Let me
show you
how to add
\$300
per week
to your
income"**

Does an extra \$300.00 per week sound "just too good to be true"? If you're willing to invest about 10 hours per week in your own future, I assure you that profits like these are very definitely within reach. Let me give you some real-life examples.

A Florida housewife, with no selling experience whatsoever, spent "maybe 5 minutes" talking to the purchasing agent of her local newspaper about a revolutionary new product. The result: a \$785 sale—including a \$215 commission for the housewife. A famous New York university purchased two sample packages of this same product from a student. After trying it, they reordered in the amount of \$1,285—including a \$450 commission. Another part-timer in Florida earned over \$10,000 in profits in his first five months, and has now been able to quit a dull, no-future job to pursue this extraordinary opportunity on a full-time basis.

The product that makes success stories like these possible is called COPYFAX. COPYFAX is a patented, totally new concept in multiple copying that renders old-fashioned carbon paper obsolete—and carbon paper is a big, big, multimillion-dollar business.

What's more, COPYFAX is just one of a complete line of "Office Products of Tomorrow" produced and distributed by American Unifax. Collectively, UNIFAX products embrace an annual market of a quarter of a BILLION dollars. They are used by business offices around the world, ranging in size from your local accountants, lawyers, and banks to companies like Sears, Westinghouse, Firestone, and General Electric.

A substantial share of this gigantic market can be YOURS, when you become an independent UNIFAX Products Distributor. Even starting part-time and without previous experience in the office-products field, you can quickly launch an exciting, prestige business of your own that can pay off in a lifetime of profits and prosperity.

Write your own success story. Send today for a complimentary copy of a detailed report called HOW TO SUCCEED IN A BUSINESS OF YOUR OWN. There's no cost or obligation, so mail the coupon TODAY.



AMERICAN UNIFAX, INC.
95 Madison Avenue
New York, N.Y. 10016
Dept. PMA2



1970 AMERICAN UNIFAX, INC.

AMERICAN UNIFAX, INC. DEPT. PMA2
95 Madison Avenue • New York, N.Y. 10016

YES! I want to get in on the ground floor with American Unifax! Rush the information checked below:

// RUSH FREE SAMPLE AND MONEY-MAKING DETAILS.

// \$6.00 enclosed. Rush 2 sample demonstrator packs of COPYFAX (worth \$9.00 retail) and all details.

Name _____

Address _____

City _____ State _____ Zip _____

DRIVIN' WITH DAN

(Continued from page 26)

of the "container" scribed by the piston as it makes one complete stroke.

So, figure the area of the circle (bore of the cylinder) by multiplying 3.1416 by the square of its radius (πR^2), then multiply this total by the stroke to get volume of the cylinder. Multiply this volume by the number of cylinders to get the c.i.d.

Q. Why did your Trans-Am Cuda have a front spoiler? To qualify a device like that, I thought it had to be homologated into 2500 street Cudas, and I don't know of any street Cudas with spoilers.—Thomas Kee, Ellendale, N.D.

A. Yes, it did. Apparently the rules allowed it. It helped, also.

Q. If a car originally had 14-inch wheels and you changed them to 15-inch, how would this affect the speedometer reading, if at all?—Randy James, Macomb, Ill.

A. It depends entirely on the circumference of the tire. When a tire makes one revolution, it covers so much distance. If the tires had the same circumference, the wheel size wouldn't affect the speedometer reading.

Q. I would like to be a race driver and wonder how you got started in racing.—Bill Glass, Lancaster, Pa.

A. I began racing with a Triumph TR-2 sports car in amateur road-racing with the California Sports Car Club in 1955 at Torrey Pines, Calif. Before that I was hooked on hot rods.

Q. Is the 289 Ford engine just as good as the 302? I say it is, but my friends disagree.—David Householder, Ellwood City, Pa.

A. What do you mean by good? They are both good. The 289 is, possibly, a bit smoother and should get a little better mileage. It's a bit lighter. The 302 is newer and slightly more powerful.

Q. Can foreign nationals, as from India, enter Grand Prix races? If so, is there an age limit?—S.K. Malmotra, Gandigarh, India.

A. You must be 21 years old and be able
(Please turn to page 30)

Defending America is one of the jobs we teach.

In fact, it's our main job,
and we teach it well.

Infantry, Armor, Artillery,
Engineers, Signal Corps. These
are the outfits that serve up front.
No effort is spared to train the
men who serve in them.

And when you have that
training behind you, you're a pro-
fessional, respected and needed
by the others on your team.

If you have what it takes,
you can expect to advance
in rank. Promotions will come
as fast as you can handle them.

An Army career is worth
thinking about. Your Country
takes good care of the men
who take care of her.

Send for more information
about the outfits that serve
up front. Use the coupon or
write to Army Opportunities,
Department 200A,
Hampton, Virginia 23369.

Your future, your decision.
Choose ARMY.



Army Opportunities
Dept. 200, Hampton, Va. 23369

Date _____

I'd like to know more about soldiering and service to my
Country. Please send me your free book.

Name _____ Date of Birth _____

Address _____

City _____ County _____

State _____ Zip _____ Phone _____

Education _____

2PM 2-71

RIDGID

Extractors

The fast, easy, professional way to remove broken pipe, fittings, screws, studs and bolts.

RIDGID Pipe Extractors

9 sizes for 1/8" through 2" pipe



Available singly or in sets. Tough, hardened alloy tool steel. Squared end for non-slip wrench grip. Straight flutes grip entire length of work to be removed. Each extractor marked with drill size to be used when solid ends of plugs or fittings must be drilled to receive extractor.



RIDGID Screw Extractors

8 sizes for 1/4" through 1" Screws or Bolts

Sliding turnuts on small sizes for wrench grip. Available singly or in sets, including drills and drill guides.

See the complete line of RIDGID professional Extractors at your quality Hardware Dealer's. For free booklet No. E-S-R, write The Ridge Tool Company, Dept. KG, Elyria, Ohio 44035 U.S.A.

RIDGID

 Ridge Tool Subsidiary
Emerson Electric Co.
EMERSON

DRIVIN' WITH DAN

(Continued from page 28)

to qualify for the race by going fast enough in practice. Often there are more cars trying than there are positions open and then it gets tough. Each G.P. organizer has his own rules on eligibility and entry fee.

Q. What was the purpose of the orange light in the rear side window of your AAR Cuda which I saw in the Trans-Am last year?—Joseph Hibbard, Jr., West Chester, Pa.

A. The light was on when the reserve gasoline supply was being used. We knew the car would soon have to pit, or else the driver could be signaled to shut off his auxiliary pump if it was still turned on right after a fuel stop.

Q. My friends and I often argue about Ford and GM cars. I say GM cars rust out and they say that Fords fall apart. Which would you rather have?—Ricky Braun, New Orleans, La.

A. They are both very good. I'd say it boils down to old loyalties (or new ones) and personal relationships with dealers. I am neutral. If you take care of your car properly, it won't rust or fall apart for a long time, no matter what make it is.

Q. In your opinion will the turbine engines ever replace the reciprocating engines in passenger cars?—E.H.M., Wilmington, N. C.

A. In my opinion, not for 8 or 10 years. Then a replacement may be something besides a turbine. A turbine works best at a constant speed. It is really good at high altitude in an airplane, but it's not so good idling around town.

Q. I know all about Bobby Unser and "his mountain." Would you ever drive Pikes Peak?—Paula Haine, Indianapolis, Ind.

A. Yes. I have often considered the possibility of giving it a try. Maybe some day I will—not in competition, however. ★★

If you have questions on racing, high-performance and everyday driving techniques, send them to "Drivin' with Dan," c/o Popular Mechanics, 224 West 57th St., New York, N.Y. 10019. Questions cannot be answered by individual letters. Questions on maintenance and repair should be addressed to the Auto Clinic (see page 58).

**With every tune-up, you change points
and plugs because they're worn out, pitted,
not doing their job.**

**What makes you think your air filter, fuel filter,
PCV valve haven't had it too.**

**They could be dirty, clogged,...
choking the life out of your engine.**

And that's bad.

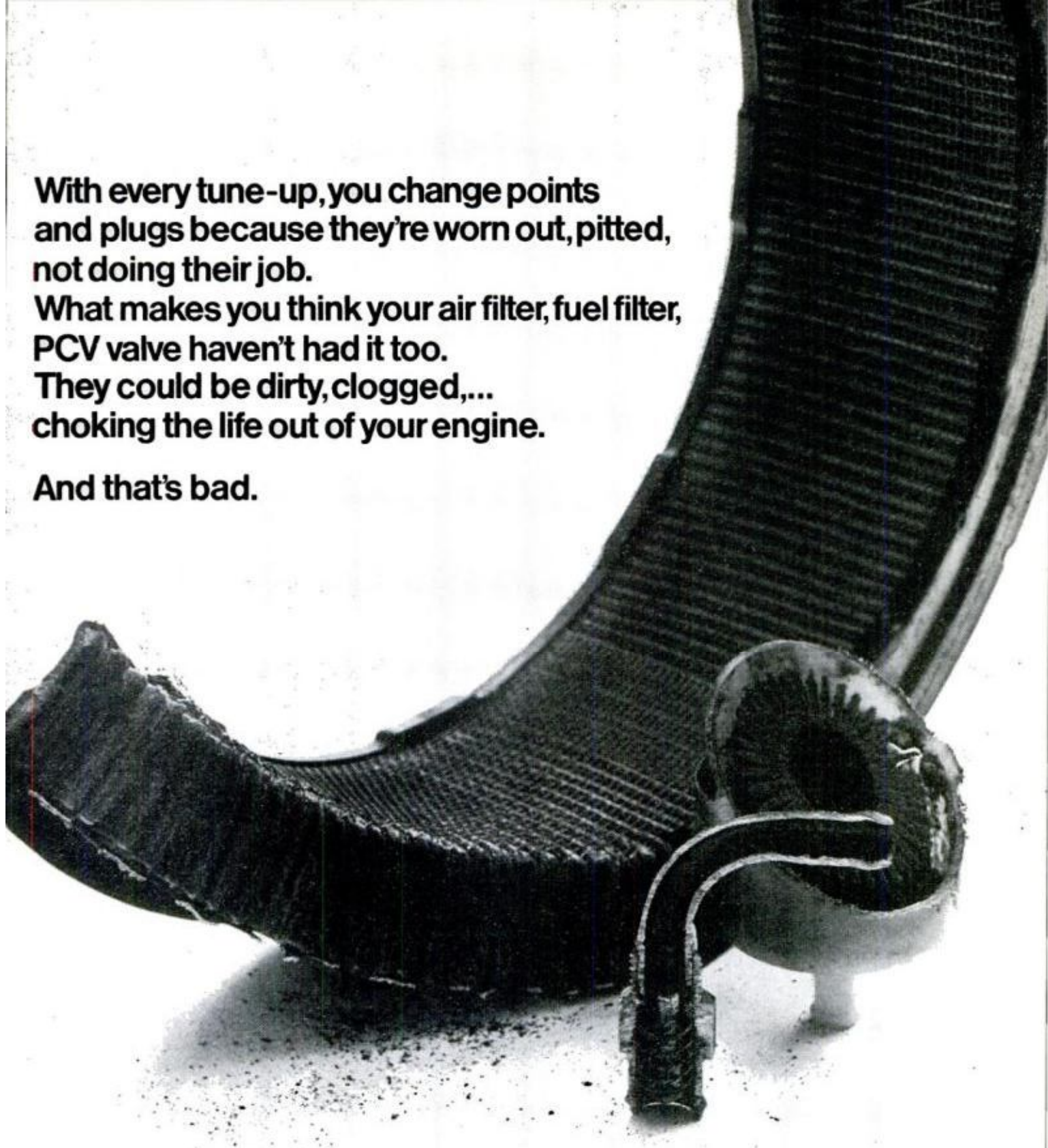

**Next tune-up, replace with fresh Fram parts...
Air filter, fuel filter, pollution control valve.**

That's good.

**Fram Automotive Division
Providence, R.I.**





**START A
MONEY-MAKING BUSINESS
FOR LESS THAN \$500!**

**No Selling, No Inventory... All
Cash Profits and YOU Set The Hours!**

You can have your own lifetime business right at home... work in spare time... and make up to \$200 a month CASH! My FREE PLAN gives you all the facts: How to start, how to grow. You don't need previous experience. You don't have to sell. I'll even finance you. People bring you the work and pay cash. Over 90¢ of every dollar you collect is clear cash profit. And you work when you want to. Let me prove you can't find a more certain, lower cost, higher paying business of your own.

**Does The Belsaw Pay?
YOU BET!**

W. R., Maryland

"My BELSAW is working fine and business is increasing by 20 to 30 customers a month. I've added one employee and am looking for a night man to handle rush jobs."

C. S., Minnesota

"The sharpening business has helped me buy two homes and three motor cars. The nice thing about the Sharp-All is that you get some cash every day."

RUSH COUPON TODAY!

Just Mail Coupon — No Salesman Will Call

BELSAW SHARP-ALL CO.

Stan Field, President
711F Field Bldg., Kansas City, Mo. 64111

Name _____

Address _____

City _____ State _____ Zip _____



The Easy Way to Build
BEAUTIFUL CLOCKS
Send 25¢ for 48-page catalog of easy patterns, fine clock movements, dials and hardwood kits.
CRAFT PRODUCTS
ELMHURST (1) ILL. 60126

MORE POWER FOR BIG JOBS

man-size **ECONOMY TRACTOR**
Mow 2-3 acres/hour, plow acreage fast. Big 14 hp engine, all-gear drive for more work-power. No belt or fluid-drive loss. Over 20 implements, 48" dozer, 32" tiller, 48" snow-blower. Write:
ECONOMY TRACTOR
1005 K-2 Anoka Avenue
Waukesha, Wis. 53186

DON'T QUIT SMOKING
before giving my pipe a 30 Day Trial

New principle that contradicts every idea you've ever had about pipe smoking. I guarantee it to smoke cool and mild hour after hour, day after day, without rest, without bite, bitterness or sludge. To prove it, I'll let you try a new Carey Pipe. Send your name and address today for my free complete trial offer. Write:
E. A. CAREY, 1920 Sunnyside Ave., Dept. 252-B, Chicago 40

BUILD REFINISH RESTORE
... anything of wood

LET Constantine's picture-packed Catalog-Manual help you build new furniture — help you restore and refinish beat-up cabinets, chairs, chests, tables. Find instantly whatever you need. Newest materials plus plans, instructions. Largest selection of beautiful woods. Specialty tools. Products not found in stores or by mail elsewhere. *Unsurpassed values.* Send for vast, illus. catalog NOW!

2,000
CRAFTSMAN PRODUCTS
Woods — Veneers — Inlays
Newest Workshop Tools
Wood Finishes — Moldings
Carving Woods & Patterns
Cane Kits — Lamp Parts
Hard-to-find Hardware

CONSTANTINE
2051 Eastchester Rd., Bronx, N.Y. 10461

Tear out ad. Mail with 25¢ for vast new CATALOG Plus New "101 Project Ideas"

GLASS BLOWERS KIT \$13.95⁹⁵ pdd

SPECIAL TRIAL SIZE KIT
Contains assorted crystal and colored glass with complete instructions, diagrams and actual glass model. Learn to make beautiful ships, birds, bottles for fun and profit.
SEND \$13.95 TO
WILLIS GLASS SUPPLY CO.
BOX 3460 — ARTIST STUDIO — A
ANAHEIM, CALIFORNIA 92803

Cash in on your Air Force years.

Maybe you really thought you were making the right decision when you decided to get out. Maybe you really believed you could use your service skills to carve out the good life on the outside. But now, as you look back, maybe you have to admit that you've overlooked something that could make it all a little easier. Something called the Air Force Reserve.

Well, if that's where it's at with you, remember, it's not too late. By putting in one weekend a month

and 15 active duty days a year, you can still enjoy all the reserve benefits. Things like a second income and the chance to train yourself to do your job better.

So, if you've still got the skills the service taught you, you've still got a chance for a future you can look forward to, in the Air Force Reserve.

For all the facts, just mail in the coupon. Or, write to Hq Air Force Reserve (DPBC), Robins AFB, Georgia 31093.

HQ AIR FORCE RESERVE (DPBC)
Robins AFB, Ga. 31093 PM271

Please send me information about joining the Air Force Reserve.

I was a member of AIR FORCE NAVY
COAST GUARD MARINES ARMY

My grade was _____

My specialty was _____

NAME _____

ADDRESS _____
(PLEASE PRINT)

CITY _____ STATE _____ ZIP _____

PHONE _____

(AREA CODE)

I understand there is no obligation.

Find yourself in the Air Force Reserve.

NEW FREE BOOK DISCUSSES HOW TO SELL YOUR INVENTION

If you have an invention (whether patented or unpatented) that you believe has commercial value, our Free Booklet entitled "How to Go About Selling Your Invention" may help you save time and money.

We are specialists in representing inventors and submitting their inventions to manufacturers. We work with scores of manufacturers who are seeking new products or new product ideas, and we therefore know which firms may be interested in your particular invention. Our service is designed to do all those things the average inventor lacks the knowledge or facilities for doing, or does not have time to do. We prepare your sales letters, folios, duplicate drawings, handle correspondence, select the firms.

We charge the standard commission (on sales) and a modest fee for the submitting service. This fee is refunded if a manufacturer buys your invention through our efforts. We are a nationally known concern with an impeccable reputation for ethics and integrity.

The Free Booklet we have prepared especially for inventors contains such information as current royalty rates being paid by manufacturers, discusses many types of inventions, the possible market for them, tells the effective methods of presenting your invention for sale, whether you employ us or do it yourself, and outlines how we may be able to help you.

You can obtain this booklet "How to Go About Selling Your Invention" by mailing the coupon below. And if you wish to write us for comments on your invention, please do so. We make no charge for consultation. But please do NOT send drawings or models. Just describe the purpose and nature of your invention. Mail the coupon to K. O. Kessler, Pres., Kessler Sales Corporation, Dept. D-52, Fremont, Ohio 43420.

You are welcome to ask your lawyer, local Bank, Chamber of Commerce to carefully check on our reputation for honesty and fair-dealing.

MAIL THIS COUPON

Mr. K. O. Kessler, President, Dept. D-52
Kessler Sales Corp., Fremont, Ohio 43420

Please mail me a copy of your Free Booklet "How to Go About Selling Your Invention." It is understood that this does not obligate me in any way to use your Service.

My Name

Street Address

City State Zip

Train at Home for a BIG INCOME Career in ACCOUNTING

Train now at home in spare time for 1000s

high pay prestige positions open to Accountants. Or, open your own accounting practice. As an Accountant you'll do important work — and get important pay! Accountants move up fast in business... more corporation presidents got their start in Accounting than in any other field. As an Accountant you'll be an "insider" on your company's management team... the confidential data you develop will be essential to making corporate decisions and handling daily affairs.

This Electric Adding Machine GIVEN TO YOU!



BIG DEMAND FOR TRAINED PEOPLE!

Demand for Accountants far exceeds supply as 5 million U.S. firms need financial statements, bookkeeping services to operate. Our exclusive "Computer Age" Accounting Course is the only home-study plan that shows you step-by-step how to take advantage of computers to simplify work... to make your financial data more complete... to make you more valuable to company management.

Whatever your previous experience or education — we show you how! Send for FREE "Accounting Career Kit." No salesman will call!

Accredited Member, National Home Study Council

NO. AMERICAN SCHOOL OF ACCOUNTING Dept. 14172, 4500 Campus Dr., Newport Beach, CA 92663
Rush FREE "Accounting Career Kit." No salesman will call.

NAME _____ AGE _____

ADDRESS _____

CITY _____ STATE _____ ZIP _____

BOTH FREE! Self-Scoring Aptitude Test. Your Future in Computer Age ACCOUNTING.

INSTALL ALARM SYSTEMS

Beginners Make Big Money — Your Own Boss

New plan opens multi-million dollar burglar fire alarm business to small home operators. Guides beginners step by step.

Starts you full or spare time without previous experience or big investment. See how to cash in on invisible web of protection that stops crooks cold, makes big profits. No salesman will call. Write for free details!

NASCO, 11071 Massachusetts Avenue, Dept. E2252 Los Angeles, Calif. 90025



IS YOUR LIFE WORTH ONE DOLLAR?

Now-New safety all-weather warning sign 24" x 20". If you're stuck, have a flat, in a ditch, whatever, NEED-HELP, just display easily attached to any part of vehicle in seconds. Easy to see over 200 yards away. Beautiful 2-color Dayglow conveniently kept glove compartment for immediate use.

Send \$1.00 (Tax inc.) to:

PHIL-GRAY ENT.

Box 144, River Road, Fairlawn, New Jersey, Zip 07410



name _____

address _____

city _____ state _____ zip _____

SEND FOR BIG, NEW ILLUSTRATED FREE CATALOG

of Health and Exercise Products
Shop at discount savings from wide selection of top-brand equipment... reducing aids... vitamins and nutrition supplements... health cooking appliances... faucet water filters... and many more. FREE GIFTS with all purchases! Send name, address, zip code to: IBEM SALES CORP., 24-08 Jackson Ave. Dept. PM-1 Long Island City, N.Y. 11101



Learn Profitable Profession in few months at Home

MEN AND WOMEN, 18 TO 60

Earn big pay as a skilled operator in Scientific Massage. Many employment opportunities. Easy to learn and do. Diploma awarded. Open your own office or earn good income from Doctors, Hospitals, Clubs and other health or recreational centers. Wonderful part-time profession. Low monthly payments. Write today for free Anatomy Charts and catalog. No obligation.



ANDERSON SCHOOL OF SCIENTIFIC MASSAGE
Dept. B-1, Princeton, Illinois 61356

We've equipped a lot of men to make a lot of money. (you're next)

Open to you — thousands of good-paying jobs in the professional technical fields below. No matter what your education or background — take your pick! A little spare time and NTS home-training can make your future secure. Find out how easy and enjoyable it is to train the professional way with our classroom-tested "Project Method" lessons. Learn with the professional

tools and equipment we supply (much of it offered *only* by NTS.) Follow our personal development tips. Take advantage of our 65 years experience in gathering the latest know-how and using it to turn out the best-trained technicians. Just send the card for your free illustrated catalog. No obligation. No salesman will call.



NTS ELECTRONICS DIVISION

Train with the biggest, most exciting package of electronics kits ever offered! Big color TV included with color TV courses. Other equipment includes solid-state 74 sq. in. B & W TV, Lo-Silho superhet radio, electronic tube checker, F.E.T. Volt-Ohmmeter, 5" wide-band oscilloscope, desk-top Computer Trainer and more. Send the coupon. We'll rush you a free color catalog and all the facts.



NTS MECHANICS DIVISION

These courses include professional tools and engine analysis test instruments at no extra cost! Special Engine Diagnostic and High Performance lessons included. Learn to handle everything from engine trouble-shooting to electrical systems. Industry needs 20,000 trained auto and diesel mechanics. You can be one of them, if you send the coupon today! We'll rush you the catalog and the facts. Free!



NTS AIR CONDITIONING, REFRIGERATION DIVISION

There's a big job waiting for you if you learn this field the *professional* way. We give you the tools, tester and instruments you need, including hermetic unit analyzer, leak detector, soldering kit. Show you how to service commercial and industrial cooling systems, refrigeration installation, and household A/C and refrigeration equipment. What are you waiting for? Send the coupon.

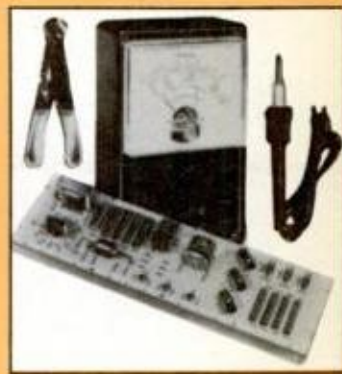

NTS HOME APPLIANCES DIVISION

Every day, someone buys a new home appliance. And someone, maybe *you*, will make money fixing it. We'll send you the new, exclusive NTS CIRCUIT-TRAINER. It'll help you learn *faster*, and qualify for employment *sooner*! Let the NTS *Project-Method of Home Training* put you in line for a big piece of the billion-dollar appliance repair field.

Send post card for colorful catalog and sample lesson in field checked



Tear out and mail this card today.

Check one only.

ELECTRONICS DIVISION

- MASTER COURSE IN COLOR TV SERVICING
- COLOR TV SERVICING
- MASTER COURSE IN TV & RADIO SERVICING
- PRACTICAL TV & RADIO SERVICING
- MASTER COURSE IN ELECTRONIC COMMUNICATIONS
- FCC LICENSE COURSE
- MASTER COURSE IN ELECTRONICS TECHNOLOGY
- INDUSTRIAL AND AUTOMATION ELECTRONICS
- COMPUTER ELECTRONICS
- BASIC ELECTRONICS

AUTOMOTIVE DIVISION

- MASTER COURSE IN AUTO, DIESEL & TRUCK MECHANICS
- AUTOMOTIVE MECHANICS
- TRUCK, HEAVY DUTY & DIESEL MECHANICS
- ENGINE TUNE-UP & ELECTRICITY

AIR CONDITIONING/REFRIGERATION/HEATING DIVISION

- MASTER COURSE IN AIR CONDITIONING, REFRIGERATION & HEATING
- AIR CONDITIONING & HEATING
- REFRIGERATION

HOME APPLIANCE DIVISION

- HOME APPLIANCE MASTER TECHNICIAN COURSE
- HOME APPLIANCE SERVICING
- HANDYMAN APPLIANCE REPAIR

HIGH SCHOOL DEPARTMENT

- HIGH SCHOOL AT HOME

Dept. 201-021

APPROVED FOR VETERANS

NAME _____ AGE _____

ADDRESS _____

CITY _____ STATE _____

Please fill in Zip Code for fast service _____

- Check if interested in veteran training under the new G.I. Bill.
- Check if interested **ONLY** in classroom training at Los Angeles.

NATIONAL TECHNICAL SCHOOLS

WORLD-WIDE TRAINING SINCE 1908

4000 So. Figueroa St., Los Angeles, Cal. 90037

Копия, защищенный авторским правом

10 testimonials to the "success-ability" of NTS home training

Let The Next Testimonial Be Yours—Send The Postage-Paid Card *Now*.

They're all around you. Thousands of successful men who once read a message like this and wondered if National Technical Schools

Thanks again to your school. It has made me a man in demand for the first time.

*Osbourne C. Williams,
Jamaica, W.I.*

Thanks to NTS, I have an extra income now and plan to go into business full time very soon.

Gary Wernette, Michigan



I advanced from auto accessory mechanic to auto leadman within three month's time.

Harry E. Repine, Washington

I am now a TV repairman at Sears... I heartily endorse your course.

W. M. Firestone, Jr., Texas

Today I passed the four tests required for the 1st Class Radio-Telephone license.

*Richard Morgan,
Massachusetts*



could really open up a new future for them. Read what they found out. Then take *your* turn. Send the postage-paid card for the free illustrated catalog in the field you find most interesting.

I'm now earning \$11,000 a year as an electronics mechanic at Bell Helicopter Company.

Elijio Guzman, Texas

Your course has gotten me from climbing poles to a position as technician and crew chief in flight simulation.

Leonard B. Barfield, Texas

Not knowing anyone, I went looking for work in commercial refrigeration and was immediately hired as a service man.

Charles Greaser, Washington



I have been operating the Ace Appliance Repair Shop here and have been getting more and more to repair all the time.

Frank J. Mercier, California

I work for Haynes' Radio and Refrigeration Service and can repair any major appliance on the market.

*Vernon Helmick,
West Virginia*



**FILL OUT
AND MAIL
CARD TODAY**

NTS also offers:
High School at Home
Accredited high school programs. Take only subjects you need. Everything included at one low tuition. Check special High School Box in Coupon for free catalog.

Classroom Training at Los Angeles
Train in sunny Southern California. NTS occupies a city block with over a million dollars in training facilities.

Accredited member, National Association of Trade & Technical Schools; National Home Study Council

FIRST CLASS
Permit No. 3087
Los Angeles,
Calif.

VIA AIR MAIL

BUSINESS REPLY MAIL

No Postage Stamp Necessary if Mailed in the United States

POSTAGE WILL BE PAID BY

NATIONAL TECHNICAL SCHOOLS

4000 South Figueroa Street

Los Angeles, California 90037

Approved for veterans

FANTASTIC VALUES WITH THIS COUPON

AMERICAN MACHINE & TOOL CO., Dept. PM-21, Royersford, Pa. 19468
Please send me the units checked. Payment in full enclosed \$.....
or \$3 deposit each item enclosed, balance C.O.D. I MUST BE FULLY
SATISFIED OR WILL RETURN UNIT WITHIN 10 DAYS FOR FULL REFUND.
No questions asked.

- | | |
|---|---|
| <input type="checkbox"/> 8" Power Saw at \$19.95 | <input type="checkbox"/> Belt Sander at \$14.95 |
| <input type="checkbox"/> Standard Rip Fence at \$3.50 | <input type="checkbox"/> Disc sander attach. at \$7.95 |
| <input type="checkbox"/> Long Rip Fence at \$4.50 | <input type="checkbox"/> Mitre Gauge for sander at \$1.95 |
| <input type="checkbox"/> Precision Ball Bearing Spindle at \$5.00 | <input type="checkbox"/> Lathe at \$14.95 |
| <input type="checkbox"/> Jointer Planer at \$24.95 | <input type="checkbox"/> Face Plate at \$2.50 |
| <input type="checkbox"/> Drill Press at \$34.95 | <input type="checkbox"/> Turning Chisels at \$4.95 |
| G.E. Motor <input type="checkbox"/> \$19.90 (with other item) <input type="checkbox"/> \$24.85 (purchased separately) | |

NAME

ADDRESS

CITY STATE ZIP

SAVE AS MUCH AS...
80% WITH
QUALITY 
POWER TOOLS

DIRECT FACTORY OFFER AND REVOLUTIONARY PATENTS decrease costs, increase efficiency. Full scale power tools of heavy duty 100% cast iron and steel. Streamlined design reduces weight, cuts material and production costs. Special patents provide added efficiency, accuracy, savings. Parts made, assembled, tested, packed right in our own factories shipped direct... save store profits.

ENDORSED BY AMERICA'S TOP MAGAZINES... Here is what the editors say:

"A good bit of sound—imaginative—engineering." Popular Science; "(saw) boasts many features of bigger brothers." Popular Mechanics; "Amazingly versatile." Workbench; "Highly substantial construction, sturdy enough for production line use." Industrial Woodworking. And Workbench awarded these tools their coveted "Work Tested" Seal.

UNCONDITIONAL MONEY BACK 10-DAY GUARANTEE
You must be fully satisfied. If not, return in 10 days, freight collect. Money promptly refunded in full.

OVER A MILLION USERS confirm their precision, versatility and rugged performance.

***10-YEAR FULL SERVICE GUARANTEE...** Any part or parts of any AMCO power tool (except motor) which may become inoperative for any reason within ten years after the purchase date will be repaired or replaced by the factory without cost to the purchaser. Your only cost: for postage.



8" TILT ARBOR POWER SAW

DOES WORK OF \$75 BENCH SAW as is. Converts easily to equal any \$300 floor model cabinet units! Crosscuts, rips, mitres, cuts compound angles, dadoes, makes coves and mouldings.

\$1995 f.o.b. factory. Wt. 25 lbs. Incl. completely assembled cast iron and steel 8" saw with ground cast iron table, blade guard, less blade. RIP FENCE, if desired, for easier work alignment, \$3.50 add'l.

PRECISION BALL BEARING SPINDLE for Commercial Service, \$5.00 add'l.

SAW BLADE TILTS... TABLE STAYS LEVEL

• Locks securely at any angle up to 50°, raises, lowers 0"-2 1/4". Patented tilt mechanism, accurate etched scale. Patented motor mount takes std. 1/4 h.p. or larger motor, keeps belt tight, assures perfect alignment at

any angle, transmits full power. Takes std. blade, saw insert removes to take dadoe heads, cutters, etc. (not incl.). Accurate mitre gauge assembly. Ground spindle. Enclosed steel base. "Compo" bearings. Acces-

ories available at factory prices. RIP FENCE, if desired for easier work alignment. Std. size (for bench saw) \$3.50; larger fence (for cabinet base, as ill'd) \$4.50.

FREE CABINET BASE PLANS Use as portable bench saw as received (inset photo) ... or transform easily and inexpensively into floor model (as shown) guar. to do work of floor models costing \$300. FREE plans ... all you'll need are a sheet of 3/4" plywood and 3-4 hours. Use your AMCO saw for cutting. Plans provide 27" x 24" work surface, 33" height, tool storage compartment.

10-YEAR FULL SERVICE GUARANTEE*

6" SWING 3-FOOT LATHE



Optional faceplate for turning bowls, trays, lamp bases, rosettes, etc. \$2.50. **\$1495** f.o.b. factory. Wt. 14 lbs.

Set of 3 high speed turning chisels, \$4.95 add'l.

DOES THE WORK OF \$40 UNITS... with same precision and speed. Turns wood, plastic. Sturdy cast iron with tubular steel bed. Ball thrust cup center, spur center, T-rest assembly, lever action tail stock, 2-speed pulley. Fits any motor.

10-YEAR FULL SERVICE GUARANTEE*

FULL 22" LONG, 4 1/8" JOINTER-PLANER

\$2495



f.o.b. factory. Wt.: 19 lbs. Complete as shown.

100% precision ground cast iron and steel.

DOES THE WORK OF \$60 UNITS... Professional power planing at a hand tool price. Make faster, more accurate joints, rabbetts, bevells for windows, doors, drawers, square tapered legs—Adjustable precision ground cast iron tables. Patent-pending design holds knife to table clearances at any depth. Rabbett depth 3/8". Fence adjustable 0°-50°. Hardened, ground hi-speed steel knives. Dual cutter guards. Balanced cutter head.

10-YEAR FULL SERVICE GUARANTEE*

PRECISION 4" x 36" BELT SANDER

f.o.b. factory. Wt. 15 lbs.



Mitre gauge: \$1.95 add'l.

\$1495 †Disc Sander attachment incl. disc bracket, ground cast table (tilts 0-45°): \$7.95 add'l.

DOES WORK OF \$50 SANDERS... The world's most talented belt sander. Heavy cast sander incl. 4" x 36" sanding belt, V-pulley drive, multi-purpose drive spindle. Changes from horizontal to vertical sanding in secs. Uses 1/2 hp or larger motor.

10-YEAR FULL SERVICE GUARANTEE*

32" RADIAL DRILL PRESS

All cast iron and steel
f.o.b. factory **\$3495**
Wt. 30 lbs.
1/2" cap.
Jacob's chuck incl.

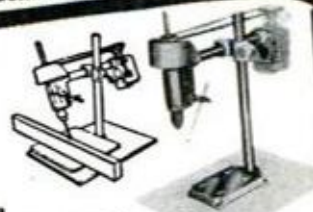

DOES WORK OF \$90 UNITS... and much more. Industrial quality precision unit with all standard features, many extras. Head raises, lowers. Depth of throat up to 16". Pre-set to any angle for on-or-off table drilling, even horizontal drilling. **10-YEAR FULL SERVICE GUARANTEE.***

BRAND NEW MOTOR

DEVELOPING FULL 1 HP... **\$1990**

F.O.B. FACTORY

FOR ANY OF ABOVE MACHINES. WT. 17 LBS. PURCHASED SEPARATELY, \$24.85

ACCORDIONS

SAVE 1/2 Big Discounts

off retail prices of comparable accordions



BUY DIRECT

IMPORTER-TO-YOU PRICES

E-Z TERMS LOW DOWN PAYMENT

Low as \$7.95 a month

NO RISK 5 DAY HOME TRIAL!

42 "NEW SOUND" Electronic and Standard Models

Choose your "new sound" accordion from world's biggest selection of Famous Imported Italian Makes... for beginners, hobby players, professionals. Totally new styling and startling new features—plus an exciting new sound! Buy direct from world's largest dealer at fantastic Importer-to-You savings of 1/2 or even more. Easy terms... low down payment, up to 3 years to pay. **NO RISK PLAN—5 Day No Obligation Home Playing Trial.** Lifetime performance policy. Satisfaction guaranteed or money back.

FREE! Color Catalogs Selection Guide Discount Prices. Beautiful New Color Swatches

Rush coupon today. Get full details, pictures and low discount prices on over 40 models... plus big savings on Amplifiers and accessories. All FREE. No obligation. Write:

TRY BEFORE YOU BUY!

FREE BONUS GIFTS

for promptness in ordering
E-Z LESSONS • MUSIC PORTFOLIO
• MUSIC STAND • DELUXE CASE
YEAR'S SUPPLY OF MUSIC Many More



NOW—Popular "Button Type" Accordions! Full line at discount prices. Check coupon below.



Big discounts on Accordion Amplifiers and Reverb Units. Finest makes—custom designed for Accordions.

MONEY BACK GUARANTEE

TRADE-INS! BIG ALLOWANCE on anything of value!

ACCORDION CORP. of AMERICA, Dept. R-21
5535 West Belmont, Chicago, Illinois 60641

FREE
Color Catalogs
Discount Prices
Rush Coupon

Accordion Corp. of America, Dept. R-21
5535 West Belmont, Chicago, Illinois 60641

Send FREE Color Catalogs and Discount prices. Includes special information checked.

Accordion Amplifiers Button Type Accordions

Name _____

Address _____

City _____ State _____ Zip _____

I have a trade-in

REFINISH MARRED OR GOUGED FURNITURE LIKE NEW.

Fill in wood gouges, nicks and scratches like professional carpenters do with **GENUINE PLASTIC WOOD Cellulose Fiber Filler**. Handles like putty, hardens like wood. Plane it, sandpaper it, varnish it, paint it for true, professional finish. **GENUINE PLASTIC WOOD** comes in walnut, oak, mahogany or natural color. At hardware stores and supermarkets.

GENUINE PLASTIC WOOD®

CELLULOSE FIBER FILLER



Prevent rust on mowers, garden tools!

When storing for the winter, get 3 way protection in just 3 minutes with famous **3-IN-ONE® Household Oil** and add years of extra life. A simple rub-down with **3-IN-ONE** cleans, lubricates, and protects against rust. In the spring tools and mowers work like new. But insist on genuine **3-IN-ONE**. Still at the same low price, wherever hardware is sold.

3-IN-ONE®

HOUSEHOLD OIL



22 Cal. Blank Cartridge
8 Shot Revolver
No Permit Required
Imported from ITALY

VENDETTA II

SALE PRICE \$3.95



Not sold to Calif. or N. Y. res.

Latest model. not a toy. Gun is of solid steel construction. Lightweight and perfectly balanced. Fires 8 rounds in 2 seconds! Double or single action. Precision crafted, 5 1/2 inches long. Ideal for stage, sporting events, boating, protection. Revolver \$3.95, quick-draw deluxe leather holster \$2.25. Send cash, check or M.O. and save C.O.D. charges, \$1.00 deposit on C.O.D. orders. Satisfaction Guar.

BIG 3 ENT., 34 Garfield Pl., Dept. PM-2, B'klyn, N.Y. 11215

Make a full time income—part time

VON SCHRADER OFFERS YOU
THREE WAYS TO A GROWING INCOME
IN YOUR OWN BUSINESS

Here's your opportunity to have your own very profitable business. One that offers a service badly needed in the home, in offices and public places. A business where how much you earn depends largely upon you. It's an opportunity to be your own boss. Free from layoffs and work restrictions. Free to work any number of hours you wish. And you don't require any special skills or large investment.

Already thousands of men have gained financial independence and personal satisfaction offering this service. Yet the demand is so big—and growing so fast—that your opportunity for success is better than ever before.

If you're a man who wants to work—but in his own way—see if you don't agree that what you are about to read is an opportunity you can't afford to pass up.

Wall-to-wall carpeting, upholstery, walls: 3 great needs for on-location cleaning

Nothing enriches a room like wall-to-wall carpeting. Every year you find it in more homes at every income level. Then there are all the public places with this carpeting. Places like motels, hotels, restaurants, banks, offices, theaters, stores, cocktail lounges, hospitals, reception rooms, etc.

Since this carpeting can't be sent out for cleaning there's a real opportunity for on-location cleaning services. It's faster, easier and inexpensive to clean carpeting on the customers' premises.

This same opportunity exists for upholstered furniture. It's faster, easier and costs less to clean upholstery on-location.

Now, consider wall and ceilings. Cleaning them with a bucket and sponge is slow, tiring and messy. People will welcome a service that does a professional job of cleaning quickly and without mess.

3 Von Schrader Detergers: each does on-location cleaning at its best

With Von Schrader Detergers—professional cleaning equipment—you'll do on-location cleaning that wins repeat customers . . . make as much money part time as many people earn full time . . . enjoy a steady, dependable business of your own . . . watch your income grow to where you are financially independent. Every home, every building, are a potential source of income.

You can start your on-location cleaning service with any one, two or all three Von Schrader Detergers.

Carpet Deterger. Cleans so deeply and completely it helps restore natural beauty—even revives color. Fast drying.

Upholstery Deterger. Gives deep-level cleaning to every inch of fabric upholstery and synthetics. Leaves furniture looking fresh and new.

Wall Deterger. Washes walls and ceilings 6 times faster (and better) than the



Von Schrader Carpet Deterger. Cleans so completely it helps restore natural beauty. Fast drying.



Von Schrader Upholstery Deterger. Gives deep-level cleaning to fabric upholstery and synthetics.



Von Schrader Wall Deterger. Washes walls and ceilings 6 times faster (and better) than hand method.

bucket-and-sponge method. Cleans easily without any mess.

Von Schrader stands for the best in professional cleaning equipment, as it has for over 35 years. All our Detergers are light-weight and easy to operate. Proven reliable and profitable for thousands of users.

You own your equipment

As a Von Schrader Associate you are your own boss. There's no contract to sign. You pay no fees, dues or royalties. Work out of your home part time or full time. Hire help as your customer list grows. (Many men start by working evenings or weekends while retaining their regular jobs.)

You get supplies

Each Deterger you order includes supplies and accessories, operating instructions and promotional material. You can go after on-location cleaning business immediately.

We'll help you get started

As a Von Schrader Associate your success is our success. So we'll help you every step of the way. That includes free consultation and special business-building materials.

Very small investment

You can have your own on-location cleaning business for an investment so small it's hard to believe. Send for complete information. No obligation.

READ WHAT OTHER MEN ARE DOING WITH VON SCHRADER DETERGERS

Carpet: "Averaged \$1000 a month for 12 months."—C. E. Nevin. "Grossed \$30,000 the first year."—Father-Son Team. "Have all 3 of your Detergers. Earned \$2500 in one week."—E. Kurtz

Upholstery: "One day I did a \$135 job. Best week was \$500."—C. Lambert. "We passed over the \$450 mark in five days."—T. E. Baylor

Walls: "Earned the price of Deterger with the work I did the past week."—J. Hews. "I work just 2 or 3 days a week. Best month was \$1200."—J. R. Johnson. "Big motel chain delighted with cleaning results and low cost."—E. Holst

Von Schrader Detergers

FREE BOOKLET TELLS WHOLE STORY—MAIL COUPON TODAY

VON SCHRADER MFG. CO.

1021 Place, Racine, Wis. 53403

Please send complete information on the Von Schrader Deterger(s) I have checked: Carpet Upholstery Wall

Name _____

Present Occupation _____

Address _____

City _____ State _____ Zip _____

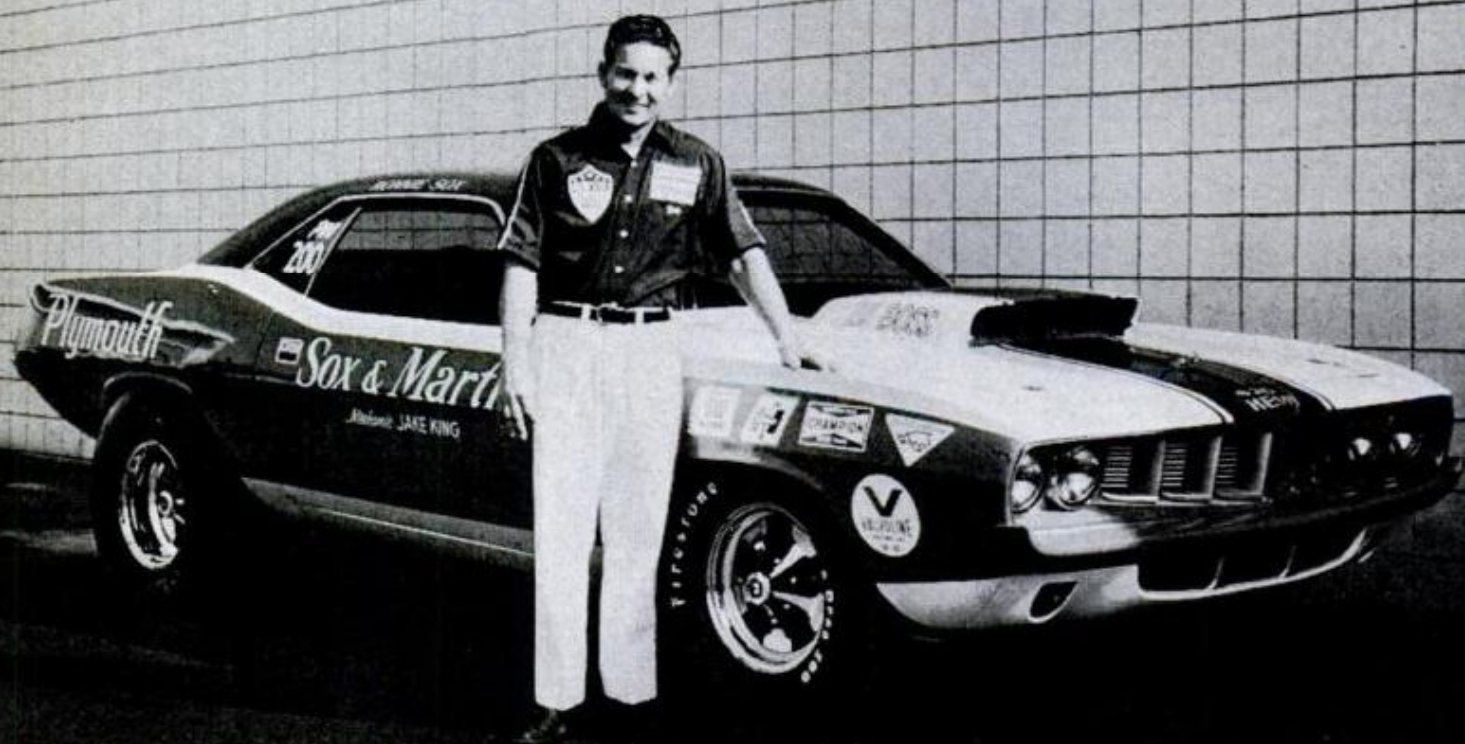

The secret of Sox & Martin.

Jake King may be the most successful racing mechanic in the country.

We asked if he had any "secret" tricks. "I just put 'em

together real careful and Ronnie drives 'em real fast."

We asked if he used Champion Spark Plugs.

"Who told you that?"



Toledo, Ohio 43601

**20 million people have switched to Champion Spark Plugs.
Sox & Martin don't have to.**

Start Making **BIG MONEY FAST!**

in **UPHOLSTERY** and **SLIP COVERS!**

"LET US SHOW YOU HOW YOU CAN EARN MORE LIKE WE DO" say these prosperous master upholsterers

ONLY accredited course that INCLUDES EVERYTHING YOU NEED

all tools, new wooden frames, materials, fabrics, etc. — at NO EXTRA CHARGE!

NOT 4 — NOT 6
13 FURNITURE KITS included



You build and slip cover a roomful of fine new furniture you can keep, or sell for more than course costs! You get professional, wholesale buying privileges. Furniture re-upholstering, repairing, refinishing, antique restoring, handling plastics, foam rubber, decorating know-how . . . every skill and advantage to make your training pay off in **TOP WAGE, TOP PROFITS IS YOURS FAST!** Thousands of our graduates have done it. Find out how you, too, can secure your future in this enjoyable easy-to-learn skilled trade. Write **TODAY!**

ALL TOOLS AND UPHOLSTERED PIECES YOURS TO KEEP OR SELL



DIPLOMA

ACCREDITED DIPLOMA

Cut Along Dotted Line—Seal (Paste or Tape) and Mail

Took in \$450 while learning—earning \$60 a week in spare time. Words can't express my satisfaction with the better future it has given me.

Leon Master, Trozeville, Pa.



I needed something to help with household expenses. I studied between household chores. During my training program I made \$1200 in part time money. Upholstery Trades School gave me everything promised—plus!

Katharine Shain, Punta Gorda, Fla.



The course was very thorough and worth the investment. My wife learned with me and helps considerably with her sewing skill and talent for color and decorating. I was able to earn \$75 a week while I studied.

Richard Feleay, Topeka, Kansas



THE UPHOLSTERY SCHOOL licensed by N.J. Dept. of Education • Accredited, National Home Study Council • Approved for Veterans and for Vocational Rehabilitation • Established 1939.

FREE BOOK! Fact-filled, illustrated book explains how YOU can make MONEY as a Master-Craftsman, full time or part time or in your own business, PLUS free sample lesson sheets.

THIS ENTIRE FOLD-OVER COUPON FORMS A NO-POSTAGE-REQUIRED BUSINESS REPLY ENVELOPE

UPHOLSTERY TRADES SCHOOL, Dept. 5110-021

Little Falls, New Jersey 07424

Please send me **FREE BOOK**, "Your New Way to a Successful Career" and **FREE** sample pages. (No obligation. No salesman will call.)



Name

(PLEASE PRINT PLAINLY)

Address

City

State

Zip

Check here if entitled to veteran's benefits.

DO NOT CUT HERE ↑ JUST FOLD OVER, SEAL AND MAIL THIS ENVELOPE — NO STAMP NECESSARY

BUSINESS REPLY MAIL

No postage stamp necessary if mailed in The United States

POSTAGE WILL BE PAID BY:

UPHOLSTERY TRADES SCHOOL

Division of Singer Communications Corporation

Little Falls, N.J. 07424

First Class
Permit No. 137
Little Falls, N. J.





More like flying

The Link Trainer looks and acts more like an airplane than ever before. The new version, the GAT-1, produces the sounds and feel of real flight—including the bump and tire squeal of a landing.

Blood-flow 'speedometer'

To determine the velocity of blood flow without breaking the patient's skin, researchers at the University of California, Berkeley, measure the flow magnetically. The device "flips" protons in the blood stream, then records how long they take to arrive at a point some centimeters farther on.

ZEBCO will

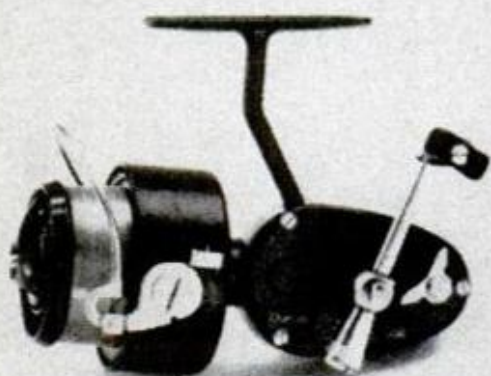

this is a great reel, but...

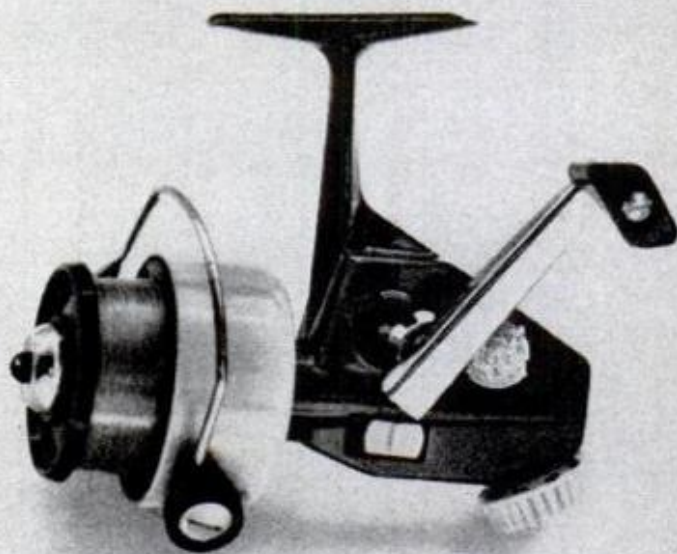

Cardinal 4 is Better!

Indoor shooting

One-ounce hollow ice balls are the targets that are shattered (inset photo, far right) by shooters in the new Wingo indoor shooting range in San Diego. In the photo at right, a lady awaits her iceball target while teammates and opponents sit at the control console. The targets are propelled by air pressure from launch ports at the far end of the range. In developing the Wingo game, the Winchester Group of the Olin Corp. also produced a 20-cal., single-shot, lever-action shotgun with "Qwik-Point" sight (below) and 20-cal. shotshell (lower right).

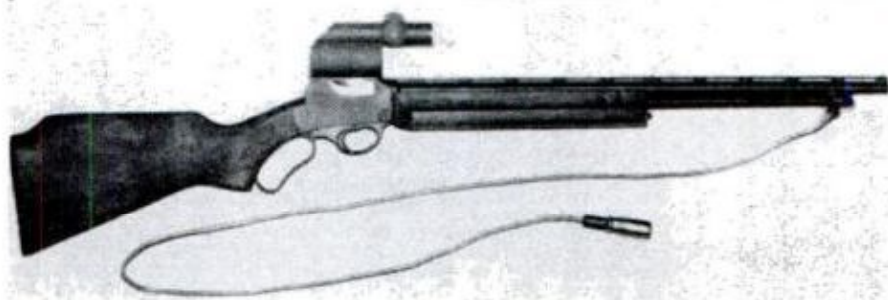
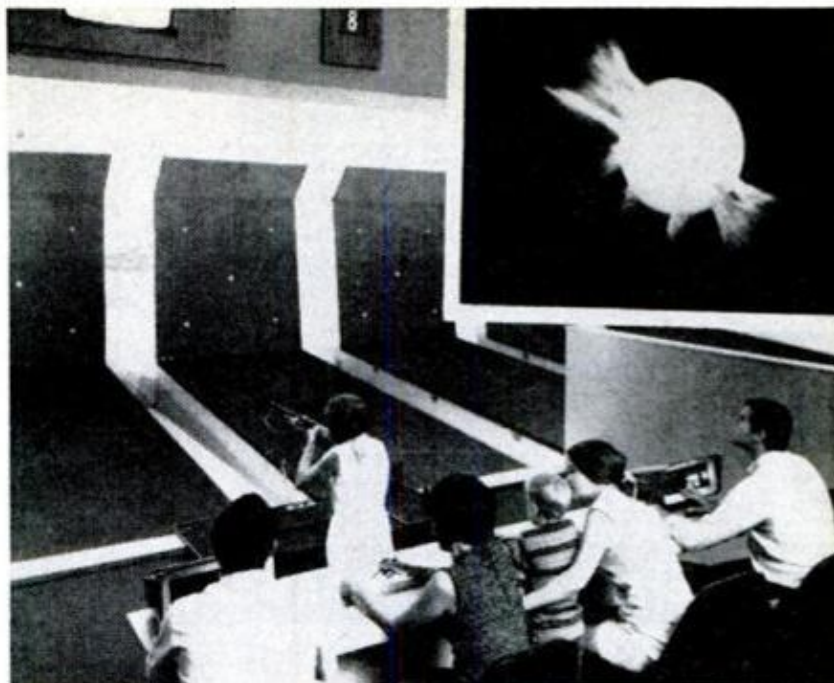

send you \$2

...when you buy a Zebco Cardinal 4 Reel

OFFER REPEATED BY POPULAR DEMAND!

In Spring, 1970, we made this offer and invited fishermen to compare Cardinal 4 with the current best seller.

RESULT: Thousands of fishermen made the actual comparison, and Cardinal 4 was sold out before some of you got the chance to wet a plug.

Now your dealer has a new supply of Cardinal 4 Reels and Reel/Rod combinations. So hurry and take advantage of our special offer before it's too late again!

ZEBCO **SPECIAL \$2.00 REFUND**
WHEN YOU BUY CARDINAL 4
 Dept. PM2-1, Box 270, Tulsa, Oklahoma 74101

Yes! I want the better deal on the better reel! Enclosed is my sales receipt along with the two end flaps from my new Cardinal 4 reel box...or the top portion of my Cardinal 4 Reel/Rod combination package. Please send my check for \$2.00!

NAME _____

ADDRESS _____

CITY _____ STATE _____ ZIP _____

Offer expires June 30, 1971.

Coupon redeemable only on Cardinal 4 Reels purchased on or before June 30, 1971. Offer void where taxed or limited by law.

Compare for yourself

COMPARE CARDINAL 4 TO THE CURRENT BEST SELLER. SEE... FEEL... HEAR THE DIFFERENCE! And notice these exclusive Cardinal 4 features.

(1) **Stern Drag** has ten calibrated click stops. Easy to operate while playing a fish. Six braking surfaces for smooth power. No comparable drag on any competitive reel. (2) **Anodized and Enameled Finish** is double tough, twice as handsome. (3) **Two Ball Springs** give perfect bail action every time. No loss of fishing time if a bail spring breaks. (4) **Swedish Stainless Steel Worm Gear** is precision milled and supported at both ends for perfect alignment. (5) **Stainless Steel Ball Bearings** for super-smooth, quiet running. (6) **Cardinal 4 is guaranteed by Zebco...you can't say it any better!**

Facts are facts, but there's no proof like your own experience. Take a Zebco Cardinal 4 out where it belongs and hang into an old mossback. Then you'll know. **Cardinal 4 is better!**

ZEBCO

Consumer Division Brunswick Corporation
 P. O. Box 270 • Tulsa, Oklahoma 74101



Excitement! Security! Good Pay! CRIME DETECTION

LEARN AT HOME IN SPARE TIME—START NOW!
Crime everywhere is on the rise! Learn now, in your own home, the profitable profession that enables you to track down criminals and bring them to justice! Hundreds of Identification Bureaus employ I. A. S. graduates . . . trained in fingerprinting, police photography, handwriting identification, firearms and investigation. Our 44th year! FREE "Blue Book of Crime" . . . packed with crime facts and the full story of famous I. A. S. training. State exact age. No salesman will call. Rush Coupon! A Correspondence School Founded in 1918.

APPROVED UNDER
G.I. BILL

FREE
Blue Book
of Crime
MAIL
COUPON

INSTITUTE OF APPLIED SCIENCE, Dept. 1352
1920 Sunnyside Avenue, Chicago, Ill. 60640
Rush Blue Book of Crime . . . FREE!

NAME Age
ADDRESS
STATE ZIP



PLANER • MOLDER • SAW

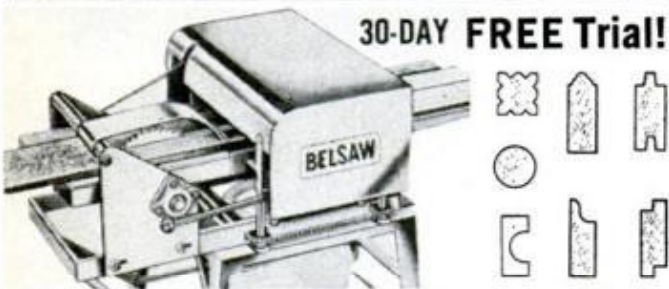

30-DAY FREE Trial!

Now you can use this ONE power-feed shop to turn rough lumber into moldings, trim, flooring, furniture . . . ALL popular patterns. RIP . . . PLANE . . . MOLD—separately or all at once with a single motor. Free 30-Day Trial. Low Cost—only \$35 down.

Send Postcard Today — No Salesman Will Call.

BELSAW POWER TOOLS, 901-F Field Bldg., Kansas City, Mo. 64111

reach for the finish fixer™ wood sealer

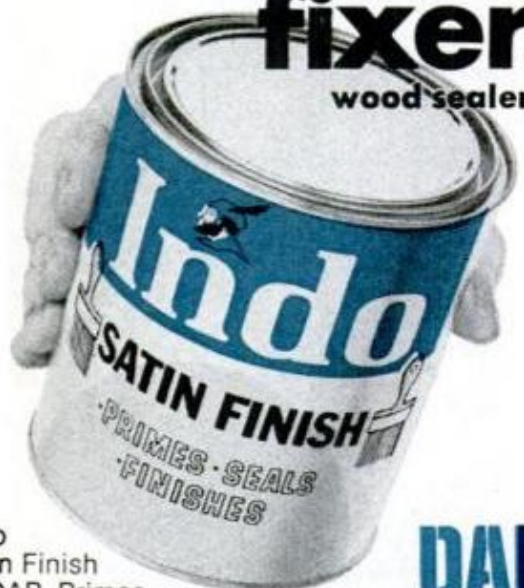

Indo Satin Finish by DAP. Primes, seals and finishes. Gives a rich, satin lustre to wood cabinets and furniture. Dries in 2 hours . . . highlights natural wood grain.

DAP
fixer.
products

DAP Inc., Dayton, Ohio 45401
Subsidiary of *Pittsburgh, Inc.*

Also available in Canada

New 1971 HEAVY DUTY ARC WELDER

LIFETIME
GUARANTEE

10 DAY
MONEY BACK
TRIAL



Only \$18.95 Prepaid Complete Ready To Use

Every home, shop and hobbyist needs this quality metal working machine. Weld, Braze, Solder, cut almost anything metal. Follow simple instructions to make or repair 1001 items including furniture, toys, auto bodies, fenders, trailers, boats, farm and garden tools and equipment. Operates in 110 V. 30A. for pennies—Adjustable Twin Carbon Arc Torch easily REGULATES HEAT FOR EACH JOB. Eliminates changing cables—replaces gas torches—no tanks or refills to buy—produces to 11,000° heat. **YOU CAN PAY MORE BUT YOU CAN'T GET A BETTER LOW COST WELDER.** Over 500,000 in use. Manufacturers of welders for over 30 years. **LIFETIME GUARANTEE.** Simply return prepaid. We will repair and reship FREE of charge. **YOU GET:** heavy duty welder in rugged metal cabinet, ground clamp, cables, combination torch and rod holder, welding manual, helmet, Free \$2.00 pack "TOUCH WELD" rods for instant automatic arc, brazing rods, 1/4" carbons, solder, flux.

PLUS EXCLUSIVE ON/OFF SAFETY FOOT SWITCH
\$3.95 VALUE INCLUDED AT NO EXTRA COST

ORDER TODAY ON MONEY BACK TRIAL. IF NOT COMPLETELY SATISFIED, RETURN IN 10 DAYS AND WE WILL REFUND PURCHASE PRICE. SEND ONLY \$2.00 and pay \$16.95 plus C.O.D. and delivery charges, or send only \$18.95 for postpaid shipment in Continental U.S.A. FOUR-WAY WELDER CO., 1810 Federal St., Dept. R2-B, Chicago, Ill. 60616

Free rent, resort living, great food, unlimited recreation . . . and plenty of time to enjoy them! Easy home-study plan. 1000s men, women, couples needed. Age no barrier. (Or, own your own motel.) Send for FREE "Career Kit." No salesman will call.

MOTEL-HOTEL CAREER

NORTH AMERICAN SCHOOL OF MOTEL-HOTEL MANAGEMENT
4500 Camous Dr., Dept. 14172,
Newport, Ca. 92660

NAME _____ AGE _____
ADDRESS _____
CITY _____ STATE _____ ZIP _____

YOUR FUTURE IN MOTEL-HOTEL MANAGEMENT
YOURS FREE

110-120 VOLT A.C. LIGHT PLANTS—60 CYCLES
Fanbelt driven from pickup or small gas engine. Operates saws, drills, pumps, freezers, T.V. X1000 Watts—Needs No Battery. Now \$70.00. 1500 Watts—6 and 12 volt vehicles. Now \$60.00. 3000 Watts—12 volt vehicles only. Now \$99.50. *Guaranteed.* Check or Money Order.

VIRDEN PERMA-BILT, Box 7066 P.M., Amarillo, Texas 79109

HEADQUARTERS FOR EVERY TYPE & SIZE AT REAL DOWN-TO-EARTH MONEY SAVING PRICES!

TIRES! ALL FAMOUS BRANDS!

AUTO TRUCK SPORT CAR FARM TRAILER

TREMENDOUS SAVINGS!
LET US PROVE IT TO YOU!
... WRITE US TODAY ...

Send for your FREE catalog!

RELIABLE TIRE CO. 1111 Chestnut St. Camden, N. J. 08103

GET THE FACTS!
Magnetic Sign Machine
20" X 30" Model Only \$595
Complete Shop \$785

MASCO
1148 Acoma Street
Denver, Colorado 80204

FREE INFORMATION WRITE:

300 Heathkit® Winter Projects you'll enjoy for years to come

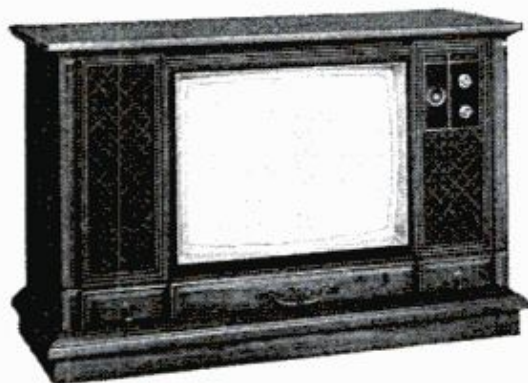

NEW Heathkit GR-371 Solid-State Ultra-Rectangular 25" Color TV...only \$579.95*

More convenience and performance features than any set at any price. Exclusive 315 sq. in. MTX-5 square-corner matrix picture tube . . . 25" diagonal measurement . . . the largest picture in the industry with brighter picture, better contrast, more natural colors. Modular plug-in circuit board construction for easy assembly and service. Solid-state VHF & UHF tuners for greatest sensitivity; 3-stage IF for higher gain. AFT, standard. VHF power tuning, standard. "Instant-On" circuitry; automatic color control; adjustable noise limiting. Plus exclusive Heath self-servicing for total owner service capability. Also available: new solid-state 23" & 20" solid-state color TV's... and a 14" portable solid-state color TV. **Kit GR-371**, 125 lbs.

NEW Heathkit "Legato" 25-Pedal Theater Organ . . . just \$1,495*

The world's most versatile musical instrument designed by Thomas organ craftsmen—exclusively for Heath... here today in money-saving, easy to assemble kit form. All solid-state. Features 15 manual voices, 4 pedal voices... any or all at the flip of a tab. 25-note heel & toe pedal board, range 16' & 8' C0 to C3. Color-Glo® key lights show you correct notes and chords. Unique Color-Glo and comprehensive organ course included will have you playing professional-sounding songs in minutes. Two 44-note keyboards; accompaniment range 8'... F1 to C5. Solo manual 16', 8', 4', 2'... F1 to C7. 200 watts peak power from two separate solid-state amplifiers... one for the unique 2-speed rotating Leslie speaker plus one for the two 12" speakers in the main system. Unique tape recorder/playback jack on amplifier. Band Box & Playmate accessories available. Put a universe of sound at your fingertips... order your **TO-101** now. 299 lbs.

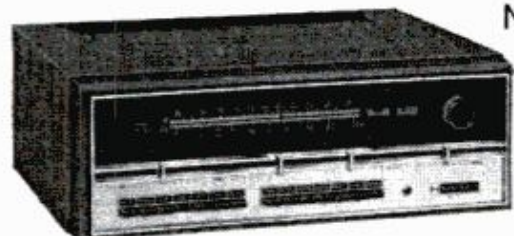

NEW AR-29 100-watt Stereo Receiver...only \$299.95*

The world's finest medium-power stereo receiver. 100 watts IHF output @ 8 ohms; less than 0.25% harmonic & IM distortion. Pre-assembled & aligned FM tuner has 1.8 μ V sensitivity; advanced L-C filter delivers over 70 dB selectivity, eliminates IF alignment. All solid-state. Modular plug-in circuit board design for easy assembly & service. Separate FM Stereo Tuner and Stereo Amplifier kits from the AR-29 are also available. Put the sound of music in your home... order your **AR-29** now, 33 lbs.

Heathkit Solid-State Metal Locator . . . \$69.95*



Detects down to 6'. Induction balance circuitry signals thru built-in speaker only when metal is detected. Portable, battery operation. Headphone jack; meter. **Kit GD-48**, 4 lbs.

The Amazing Heathkit "Boonie-Bike" . . . \$199.95*



Giant 18 x 8.50 rear tire gives positive traction in mud, sand, gravel, snow . . . goes where other bikes can't. 2-speed. 5-HP 4-cycle engine. Up to 30 mph. **Kit GT-18**, 140 lbs.

Heathkit Solid-State Fish Spotter . . . \$89.95*



Spots fish, vegetation, underwater terrain to 200 ft. Portable. Waterproof, floating case. Noise Rejection eliminates ignition noise. Portable transducer incl. **Kit MI-29**, 9 lbs.

Plus 294 other projects in this FREE catalog

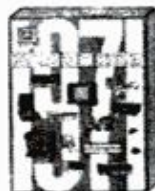

NEW FREE 1971 CATALOG!

Now with more kits, more color. Fully describes these along with over 300 kits for stereo/hi-fi, color TV, electronic organs, guitar amplifiers, amateur radio, marine, educational, CB, home & hobby. Mail coupon or write Heath Company, Benton Harbor, Michigan 49022.

HEATH COMPANY, Dept. 17-2
Benton Harbor, Michigan 49022



Enclosed is \$ _____, plus shipping.

Please send model (s) _____
 Please send FREE Heathkit Catalog. Please send Credit Application.

Name _____

Address _____

City _____ State _____ Zip _____

*Mail order prices; F.O.B. factory. Prices & specifications subject to change without notice. CL-401

The bargain hunter

REDUCIBLE

RUPTURE

AGONY Removed
(or trial COSTS YOU NOTHING)



WHEN you slip into a low-cost, contour-designed Brooks Patented Air Cushion Appliance! Your reducible rupture will be held in securely yet gently—or the trial costs you nothing! This invention has made millions of sufferers happy. You can enjoy heavenly comfort night and day at work and play—or the Appliance costs you **NOTHING**. Isn't this worth a no-risk trial by you? If interested, write for free facts now. **Brooks Co., Box 346-J, Marshall, Mich. 49068**



Bartlett Flying Saucer ultra-light hovercraft powered by ordinary lawn mower engine—easy to build—fun to fly—complete plans, kit brochure, photos and supply sources \$5.00. All orders returned via airmail. Write:

HERB BARTLETT

Box 3339-M, Scottsdale, Arizona 85257

MINIATURE AIRCRAFT RECEIVER

- Amazing voice clarity. Hear a/c movements.
- Fits easily in pocket. Little larger than fountain pen.
- Range up to 75 miles to flying aircraft. 15 miles to Control Tower.
- Operates on 108-136 MC, Operates on hearing aid battery (supplied). Send for our free catalog.

\$13.49

DELECTO ELECTRONICS, Dept. PM
4725 45th NE—Seattle, Wash. 98105

"SKY SPY"



FREE MUSCLE COURSE!

Want a new Jet-Charged body? In 15 minutes I'll prove you can snap on 4" of muscles to your chest—3" to each arm—give you life-guard shoulders, trim your waist to athletic size—give you speedy athletic legs. I don't care if you're short or tall (skinny or fat) young or not so young, expect a muscle building miracle when you send for my free course. Send only 25¢ to cover postage and handling to Joe Weider, Dept. 38-21-D2, 531 32nd St., Union City, N.J.

FIX CLOCKS, WATCHES

FOR FUN & PROFIT! Fascinating new Handbook by master craftsman H. Harris gives you the knowledge skilled watch-makers learn.

OVER 200 ILLUSTRATIONS show how to install hands, dials, crystals, main-springs, stems—rehouse old movements in modern cases—clean timepieces, etc.

INSTRUCTIONS COVER every popular watch and clock, chimes, grandfathers, cuckoo, every-day alarm and electric clocks. Handbook tells you where to buy parts . . . where to send "overflow" work for repairs at wholesale prices as business expands!

Friends gladly pay \$5 to \$50 for restoring cherished timepieces. Try the **HANDBOOK OF WATCH AND CLOCK REPAIRS**. Rush only \$4.95, plus 25¢ handling, on 10-day money-back guarantee. **EMERSON BOOKS, Inc., Dept. 996-S, 251 West 19 St., New York, N. Y. 10011.**



100 STYLES FOR WIDE FEET

and HIGH INSTEPS
EE to EEEE Only
Sizes 5 to 13

Men only Casual, dress, work shoes that really fit. Top quality, popular prices. Money-back guarantee.



Not sold in stores

Write Today for **FREE CATALOG**
HITCHCOCK SHOES, INC.
Hingham 28-A, Mass. 02043

"EXCELLENT GIFT" (Bottom Viewer)

for Father's Day, Graduation, or Birthday

"Life-time" water scope for viewing lakes to lost motors, rods, Etc. Wide angle lens, 24 ft. circle at 20 feet. Rustproof, 23 inches long when extended. Only \$4.95 Prepaid. Insurance 30¢ extra. Free brochure.

NELSON MFG. CO., 2639 WILTON, DEPT. M, DALLAS, TEXAS 75211
Only \$4.95 Prepaid
National advertised \$8.95. Special \$4.95 Prepaid.



HOW MANY HANDY DANDYS CAN YOU USE?

Handy Dandys are plastic caps that hook onto 1/8" pegboard and hold quarter-twist glass jars, such as used for baby food. Suggestions for getting **FREE JARS** in every package. Nothing better for storing supplies, parts and small tools. Keeps workshop neat. Sample pack 10 for \$1.36 for \$3.50 or 72 for \$6.14 for \$11.50. Caps only. No jars. Postpaid U.S.A. No C.O.D.'s. **WICKLIFFE INDUSTRIES, Box 286-PM-2, Wickliffe, Ohio 44092**



CHOOSE PATRIOTIC FLAG LABELS OR OUR FAMOUS CUSTOM LABELS

Printed with your name, address and zip code—or any message up to 3 lines. Use them on stationery, envelopes, photos, records, checks, books, greeting cards—almost anything you wish to personalize. Patriotic Flag Labels show your All-American spirit in colorful red, white and true-blue. Our popular Custom Labels are clear black-on-white. Both come in handy plastic boxes. We pay the postage. *Specify wording.*

Flag Labels Pack (500) \$1.49
Custom Labels Pack (1,000) \$1.00

Sunset House, 456 Sunset Building
Beverly Hills, Calif. 90213

SUNSET HOUSE

USE ZIP CODES
WHEN ANSWERING ADS

FIRE EXTINGUISHER

BUY NOW . . . SAVE 40%

Special: Am. La France 2 1/2 lb. dry chemical type BC U.L. Coast Guard, ICC, FAA, & Factory Mutual approved, Reg. \$11.95 NOW ONLY \$8.95 . . . 2 for \$16.50 ppd. All other types available. Send for quotes. **Fendrock Enterprises, Box 489 Carbondale, Pa. 18407**



Build this beautiful clock and many others for fun or profit. Send for free catalog "P"

Armor Company
Box 290
Deer Park, N. Y. 11729

GO FLY A KITE!



A Gigantic 5 1/2 ft. Space Bird

This giant kite stopped the World Series. It was flown by JFK and won first prize. It soars, climbs and glides and needs no running or tail. Made of tear proof acetate. Complete with 500 ft. heavy cord and wooden winding reel. For adults only. May lift small child into the air. Adult Space Kite \$7.98

Smaller 4 ft. version of the above kite, \$4.98. Send to **Acadia Gifts, Winter Harbor, Maine 04693**. . . . Maine residents only add 5% sales tax.

QUIT WORRYING

Why be at the mercy of layoffs and overtime cutbacks? Now is your time for ACTION

LEARN HOW
Sharpening
PAYS OFF
BIG



Neighbors, hobbyists, barbers, beauty and pet shops, farmers, sportsmen, markets, restaurants, contractors, rental shops—everybody is your cash customer. TREYCO 6-in-1 MACHINE hollow-grinds knives, saws, tools, scissors, pinkie shears, skates, clippers, planer and Dado blades, etc. Make as much as \$6 an hour. 6 MACHINES IN 1 for price of one. World-wide-satisfaction since 1946. Write for FREE CATALOG AND Factory-To-You Prices.

TREYCO 322-A Niagara St.
N. Tonawanda,
N.Y. 14120

WESTERN HAIG

.12 CALIBER
SPECIAL FACTORY
OFFER!



\$300
post-paid

USES POWDER CHARGE

This small bore gun shoots .12 cal. steel bullets fired by small 4.4 mg. powder charge. Not a CO₂ gun. You'll like the handsome lines, grip, and balance. Western in style, but patented ball and cap action allows this low price. 9 1/4" steel barrel cased in knurled styrene stock, overall 13 1/2". Develop pistol form, accuracy at a fraction of cost of large cal. pistols. Comes with 50 steel bullets. Satisfaction guaranteed. Send \$3.00 to:

HAIG MFG. CO., P.O. Box J-26 Alhambra, Calif. 91802

WIN

UP TO \$3,000.
MONTHLY
WORKING PUZZLES

FREE MEMBERSHIP DETAILS

Hundreds of our members are competing for cash prizes from \$2,000 to \$3,000 every month. Clip this coupon and we will send you membership particulars plus a free copy of the puzzle magazine. No obligation of course.

INTERNATIONAL CONTEST CLUB
1502 Las Vegas Blvd. So. Dept. PM25
Las Vegas, Nevada 89104
If convenient please enclose 25c to cover mailing costs.

HEARING AIDS

UP TO **65% OFF** DEALER'S PRICES ★

• BUY DIRECT • 20 DAYS FREE TRIAL
Body Aids \$29.95 up. Tiny All-in-the-Ear; Behind-the-Ear; Eye Glass Aids. Low as \$10 monthly. No interest. One of largest selections. Very low Battery Prices. No salesman will call. Write: ★ LLOYD Corp. ★
Dept. PM, 905 9th St., Rockford, Ill. 61108

Relic Collectors! Ver-r-r-ry Interestink!

German-Wehrmacht-Style HELMETS. Rugged-cast-metal. (not thin sheet steel) Cleaned by sandblasting & finished in black. Authentic S-S emblems. New chin strap & adjustable liner. While-they-last \$25.00 post-paid—With our fully illustrated Catalog. Listing Hundreds of items. Catalog Only—\$1.00.

W.W. #2-M Ltd.
Box 2063, St. Louis, Mo. 63158

WATER WATER "HOW TO DRILL YOUR OWN WATER WELL"
WATER WATER \$1.00 ppd
WATER WATER SATISFACTION GUARANTEED
DEEPROCK CO.
OPELIKA, ALA. 36801

FEBRUARY 1971



POLARITY INDICATOR FOR BOOSTER CABLES EMERGENCY TROUBLE LIGHT

• SAVE COSTLY REPAIR BILLS DON'T DESTROY YOUR ALTERNATOR

Light provides positive proof of jumper cable hook-up. Illuminates battery and engine areas. Fits all size cable 6 or 12 volt syst. Rigid connection between cables eliminates tangling. Same day mail service. Send \$2.00 to

Polarity Indicator Inc.
Box 1047, Miami, Fla. 33157

FIRE & BURGLAR ALARMS

Save Hundreds of Dollars
1971 HAND BOOK & CATALOG



Professional Closed-Circuit equipment from famous manufacturers. Easy, illustrated instructions. No special tools required. Save up to 75%. A must for every homeowner and businessman. Send just \$1.00 to

ALARM COMPONENT DIST. 33 NEW HAVEN AVE., MILFORD CONN. 06460



FREE!!! POWERFUL MUSCLES FAST!

Fantastic New Discoveries in the science of bodybuilding. Now, in the privacy of your bedroom, our method will add inches of powerful muscles to arms, chest, shoulders & legs. Learn secrets on trimming the waist with ultra-modern methods—fast! Results Guaranteed! Send for free brochure. Universal Bodybuilding, Box 485-M1, Dearborn, Mich. 48121.

KITES, KITS, PLANS!

KYTE TALES IS:

1. An introduction to new & novel kite designs.
2. A kite catalogue.
3. A kite "textbook".
4. Written for both adults & children.
5. Cartooned and illustrated.
6. Only 25c

KYTE HOUSE, Box 145-t
Richardson, Texas 75080

25c



Thousands of exciting tool values!

SILVO (BRAND NAME) TOOL CATALOG

Thousands of Exciting Tool Values! Stanley, Millers Falls, Skil, Thor, Wen, Dixon, West, Welisaw, Dremel, Speedy Sprayers, Plumb, Huot, Kennedy, Channellock, Porter-Cable, Rockwell, Helios, Vise-Grip, Crescent, Ridgid, Pony Clamps, Unimat, Freedom and many other Nationally Advertised brands of Tools & Supplies. We ship Coast to Coast at prices Hard to Beat. Send 50c for our big 146 page tool catalog today. Silvo Hardware Co., PM-2, 107 Walnut St., Philadelphia, Pa. 19106.

STUTTERING? STAMMERING? LISPING?

Micro Wave Voice aid can help you stop these and other speech impediments.

Send \$10.00

Full 100% money back guarantee

MICRO WAVE VOICE CORP.



433 DURNAM ST.
ROCHESTER, NEW YORK 14617

RAZOSHARP®

Pat. Pend.

\$2.25
p.p.



PRECISION TOOL
HANDLE FOR
INJECTOR RAZOR BLADES

IDEAL POCKET KNIFE—EXCELLENT OFFICE AND HOUSEHOLD UTILITY TOOL—Only holder to use standard injector type razor blades. Only holder allowing for carrying blade length exposure. Only holder allowing blade to be completely sheathed and protected. Only razor blade holder to give precision tool feel.

ALWAYS RAZOR SHARP—When blade dulls—pop in new blade. Re-use injector type razor blades. SHAVE and SAVE. Inexpensive injector type razor blades available. To expose new sharp edge—reverse blade or clip dull edge. Excellent for cutting clippings, cardboard, trimming. Ideal for opening packages, cartons, boxes. Use for carving, whitening, sharpening, erasing, etc. Shape blade to suit use—snip edge, grind or break with pliers. Nothing to break or wear out.

RAZOSHARP® 421 Stockholm Street,
Brooklyn, New York 11237

IMPORTED LOCK BLADE STILETTO

ONLY \$2.75 Ea.

9" Overall Length

5" When Closed

- Opens instantly
- Sharp and Tough
- Stainless Steel Blade



Flips open instantly and locks automatically to prevent accidental closing. Razor sharp tough stainless steel blade for reliable use and hard, long service. Money back in 5 days if not satisfied. Send \$2.75 plus 25c to cover postage and handling.

WESTBURY SALES CO.
P.O. BOX 415 WESTBURY, N.Y. 11591

DEPT. L-92-PM

46C

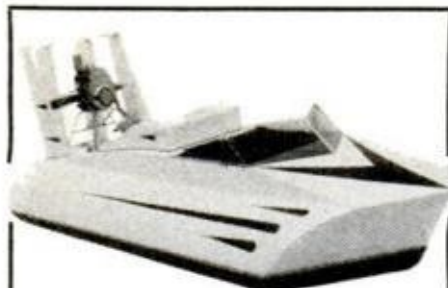

HoverPacer 2-seat ACV. Build from simple Plans, Kit. Outstanding performance: 50 MPH water, 60 MPH land. Proven design. Available in open (Sport) or closed (All Weather) cockpit design. Send \$1 for photos, tech. specs, prices.

KING TECHNOLOGY
Box 231, Carmel, Indiana 46032

BUILD YOUR OWN

CANOE AND SAVE!

MOLDED FIBERGLASS OR WOOD & CANVAS

MANY MODELS TO CHOOSE FROM

• NOW! EARLY BIRD SPECIAL
Perfect Wintertime Project
NEW LOW PRICES FROM **\$29.50**
Leader in Canoe Kits Since 1967
WRITE FOR FREE CATALOG
P.O. BOX 60679 PH. 913-243-1313
TRAILCRAFT INC. CONCORDIA, KANS. 66901

"\$33,000 LAST YEAR"

OPERATING AUTO RADIATOR SHOP

—Mercier Bros., Lowell, Mass.

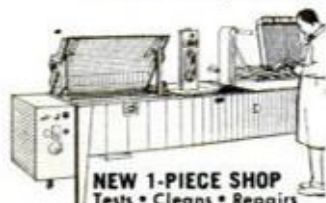

NEW 1-PIECE SHOP
Tests • Cleans • Repairs

START SHOP OR ADD TO BUSINESS. Market growing. More cars each year. Packaged radiator shop incl.: equipment, training, 98-page manual, initial supplies. Proven merchandising attracts business. Pay-as-you-profit plan. Write.

INLAND MFG. CO., Dept. PM-2
1108 Jackson St., Omaha, Neb. 68102

DETROIT APPROVED—PICKUP TANKS

Original equip. type poly. now avail. in aux. tanks for pickups. Increase gas capacity 40 gals. Easy 1 hour installation—completely hidden—no body work necessary. Let truck dis. counts pay for tanks.



R.P.M. INC., Dept. PM-2
P.O. BOX 7936, Waco, Texas 76710

SAVE UP TO 92%



LOOK
JEEP and Gov't. Surplus Buying Manual (Jeeps Pictured) 50c. Surplus Bargain Catalogue 50c. Both for \$1. Surplus Jeeps, Dept. P, Box 1563, York, Penna. 17405

BUILD YOUR OWN CAMPER

• PLANS • PATTERNS • KITS
Covers to Cabovers
★ FREE CATALOG ★



9152 Rosecrans, Dept. PB, Bellflower, Ca. 90706

FEAR NO MAN!



Amazing **KARATE** Self Defense "Instructor". Now in Your Own Home You Can Turn Your Fingers, Hands Into Powerful Weapons! Relieves Tension!

Within minutes in the privacy of your own home master the secret Karate Black Belt self defense chop that can render a 200 lb. bully helpless, almost instantly. No powerful muscles needed. Turns each finger and hand into powerful weapons like a professional. Fast results guaranteed! Karate instructor enables you to perfect Karate chop from any angle. Breaking strength adjusts from 5 to 150 lbs. as you progress. High impact plastic quickly resets for next blow. Never get weak knees or be caught off guard again in the street. Self defense for the whole family.

WORLD COMPANY, Dept. 2PM
1 Park Avenue, New York, New York 10016

Please rush me..... Amazing Karate self defense "instructor" for only \$3.98 postpaid on money back guarantee if not delighted.

Name.....
Address.....
City..... State..... Zip.....

AUTOMATIC 100-SHOT PELLET STINGER

Animals, Assailants Instantly Repulsed. The pellet is harmless but STINGS. Holds and fires 100 pellets automatically as fast as you can pull the trigger to knock most stubborn assailants off guard. Portable. Fits easily in pocket or purse. Made of high impact styrene for long life, trouble-free use. Keeps dogs and animal pests off your property. Send **\$1.98** cash, check or money order plus 27c to cover handling and we include 50 stinging pellets. Not sold in N.Y.C. or if under 16 (State age with order), (100 pellets \$1) (250 pellets \$2) (1000 pellets \$5). **WORLD CO. Dept. 2 PM, 1 Park Ave., N.Y.C. 10016**



PERMANENT MATCH

AMAZING INVENTION SELLS LIKE MAD!



Lights up to 15,000 times. Pull this ingenious metal wonder out of its case, strike on side, and presto!—it's lit. Amazes everyone who sees it. **MAKE BIG PROFITS.** Show to friends, fellow-workers, in stores, offices, taverns, factories. Sells on sight for \$1.00. Order at low wholesale prices ONLY \$4.90 per doz.; \$14.25 for 3 doz.; \$49.20 for 12 doz. 12 samples \$1.00. Catalog of 100 other fast sellers included free! Lakeside Company, Dept. PP-21, 6800 N. Campbell Ave.; Chicago, Ill. 60645.

Easy to Build **PLANS AND INSTRUCTIONS** for
Go Kart\$2.00
Mini Bike\$2.00
Mini Car\$3.50
Petal Boat\$4.00
Sail Boat\$3.00



MINI VEHICLES
PLANS "DEPT. C"
P.O. Box 92
Chazy, N.Y. 12921

FACTORY CLOSEOUT!

Air Pistol **\$4.95** ppd.

Shoots both pellets and darts. This fine, well made .177 cal. German air pistol is just the ticket for target or Varmints.

Accurate. No CO2 cartridges to replace, either. Once in a lifetime bargain. Order several. Supply limited. Only \$4.95 ppd. (Secret leather holster, \$2.95 ppd.)

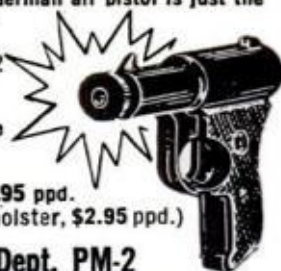

AIR PISTOL, Dept. PM-2
4535 Huntington Dr. South
Los Angeles, Calif. 90032

'KIMBA KAT'

Build this 12 ft Prefabricated Catamaran sailboat in 20 hours. Completed fiberglass hulls & decks ready to fasten together. Daeron Sall, stainless rigging and hardware. Price \$445 f.o.b. Send for free brochure or \$2 for illustrated construction manual. Seahorse Sailboats, Dept. 'A' P.O. Box 1896, Hawaiian Gardens, California, 90715.

GRANDFATHER CLOCKS

SAVE 50%
BUILD YOUR OWN GRANDFATHER AND GRANDMOTHER

WEIGHT DRIVEN CLOCKS

- Highest Quality Imported
- Movements from Germany
- Tubular or Rod Chimes
- Moving Moon Dials
- Pre-cut Semi-assembled Handcraft ed Case Kits (No power tools required)
- Dials, Barometers, Hygrometers, Templates and Case Plans.

All movements and dials in stock.

Send 50c for complete catalog

H. DeCOVNICK & SON,
P.O. Box 68M,
Alamo, Calif. 94507
EST. 1947



BLANK GUN

(NO FED. LICENSE REQ.)
AUTOMATIC 6 SHOT 6.95 CHROME 7.95 REVOLVER 8 SHOT 5.95 CHROME 7.95 100 BLANKS 1.25
FREE CATALOG \$1
SHIPPING PER ORDER

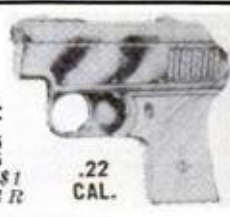

BARBER #74C
10333 Northfield Northfield Ohio 44067

Build your own Surfboard!

The Surfboard Builders' Yearbook

90 actual production photos, concise text. Excellent for school or shop project; home-builder; or training manual for the industry. Whether you are building, buying, or riding a surfboard

Send \$4.00 to **TRANSMEDIA**
9811 Edgelake Road, Dept. 3
La Mesa, California 92041

WHAM-O \$150

HITS LIKE A RIFLE—KILLS RABBITS, SQUIRRELS. Powerful, silent, accurate. For hunting, target, routing pests. Sportsman's choice sold world over!



HUNTING SLINGSHOT

Heavy duty 7" ash stock, 40 heavy steel balls, extra rubber, adapter for shooting arrows.

GUARANTEED. Professional model of Nat'l Slingshot Assn. At dealers, or write

WHAM-O MFG. CO., P.O. Box X-1, San Gabriel, Calif. 91778

- Salary
- Commissions
- Quota Bonus
- Car
- Car Expense
- Health Insurance
- Life Insurance
- Expenses
- Educational Assist.
- Vacation
- Holidays
- Sick Leave
- Christmas Bonus
- Pension
- Profit Sharing
- Stock Options
- Major Medical

MAYBE YOU SHOULD SWITCH TO TYPEWRITER AND OFFICE MACHINE SERVICE & REPAIR

OR WOULD YOU RATHER HAVE
YOUR OWN PART TIME OR
FULL TIME BUSINESS

LEARN AT HOME: 

That impressive list of benefits comes from *Geyer's, the office equipment and stationery dealers' magazine*, from an article on getting and keeping good machine servicemen. Not all firms offer all benefits, of course, but the shortage of trained men makes this a most attractive profession. Full and part time *go-in-business for yourself* opportunities, too.

You can learn at home at your own pace, from the course that is the Official Training Center for the National Association of Office Machine Dealers. Even earn as you learn, with real typewriter, sub-assemblies, professional tools, easy-to-follow lessons, **ALL INCLUDED**. Send for full information—no obligation, no salesman will call.

TYPEWRITER REPAIR SCHOOL

Division of Singer Communications Corporation
Dept. 3110-21 Little Falls, N.J. 07424

COURSE INCLUDES 
ROYAL TYPEWRITER
AND PROFESSIONAL TOOLS...

Last year I made (net) \$1400 from repair rental and sales of typewriters and adding machines. (This year, in 7 months) I have grossed nearly \$6000 in sales and service from a part time business.

Francis "Pete"
Davey, Jr.
Alton, Ill.



By the time I reached Lesson 7, I earned my first fee. Since then I have earned over \$500 part time.

Joseph E. Randall
Fairbanks,
Alaska



Licensed State of New Jersey. Accredited Member, National Home Study Council. Approved National Association of Office Machine Dealers

↓ CUT OUT. Ready to Mail Coupon Below. ↓

TYPEWRITER REPAIR SCHOOL
Dept. 3110-21
Little Falls, N.J. 07424

RUSH

me full information on typewriter and business machine service opportunities and on the Typewriter Repair School Course which I can take, at home, at my own pace. No obligation. No salesman is to call.

Name _____

Address _____

City _____

State & Zip _____

Check here if eligible for Veteran's Benefits.

BUSINESS REPLY MAIL
No Postage Stamp Necessary if Mailed in the United States

POSTAGE WILL BE PAID BY

Typewriter Repair School Division of
SINGER COMMUNICATIONS CORPORATION
Little Falls, New Jersey 07424

First Class
Permit Number 137
Little Falls, N.J.



↑ DO NOT CUT BUT FOLD HERE—Seal, Stamp and Mail. ↓

DEVCON[®] "5 Minute" Epoxy

NEW! SUPER-FAST GLUE

Now! All the advantages of epoxy adhesives *plus* quick setting. Used by industry for repairs and bonding. Also by the military for repairing pontoon bridges, pipelines, etc. Now available for the home and hobbyist. Contains no water, no solvent. Can't shrink. Achieves terrific strength through chemical reaction with hardening agent. Bonds almost any material including iron, steel, aluminum, glass, wood, concrete and many others. Clear. Easy to use. The strongest, fastest setting epoxy glue on the market today.

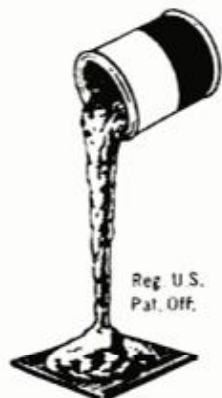

THIS AD WORTH 25¢ Tear it out. Take it to any Devcon dealer and receive 25¢ off the regular price of one twin-tubed "5 Minute" Epoxy with hardener. Offer good through March 31, 1971 in the U.S.A. only.

DEVCON CORPORATION

12 Endicott Street, Danvers, Mass. 01923

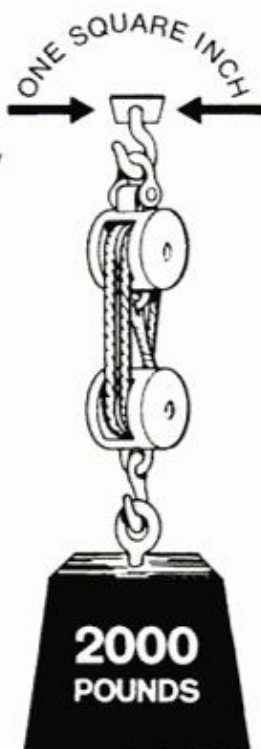

Supports 200 lbs. in 5 minutes...
over 2000 lbs. after full cure.

PUBLICATIONS **WORTH WRITING FOR**

BY CATHERINE BILSKI

EVERYTHING a do-it-yourselfer needs to know about selection, carpentry and installation of prefinished wood moldings is contained in a new information folder entitled *How to With Prefinished Wood Mouldings*. Illustrated with both close-up detail sketches and comprehensive room scenes, it contains profiles of all the most popular prefinished molding patterns and includes the basic steps in paneling installation. It's available for 10 cents from Western Wood Moulding & Millwork Producers, P.O. Box 25278, Portland, Ore. 97225.

TOYS PLAY AN IMPORTANT ROLE in your child's life, and toys wisely chosen can help develop his abilities. The booklet entitled *Choosing Toys for Children of All Ages* clearly describes and illustrates the four main kinds of play and what toys are of interest to babies and children up

to 12 years of age. There's also a guide for selecting toys and a little chart to help you remember what you've given your favorite children. It's free by written request to the Toy Manufacturers of America, Inc., 200 Fifth Ave., New York, N.Y. 10010.

FIBERS, FABRICS, TIRES and adhesives are the subjects of the first three of a series of consumer information booklets to help the consumer make better-informed purchases in the market place. The first, *Fibers and Fabrics* (65 cents) provides information for selection and care of fabrics and apparel. The second, *Tires, Their Selection and Care* (65 cents) provides information needed to obtain maximum safety, wear and performance of tires. The third, *Adhesives for Everyday Use* (40 cents) describes the adhesives now available and lists their major uses. The three booklets can be purchased from the Superintendent of Documents, U.S. Government Printing Office, Washington, D. C. 20402.

SEND FOR *Popular Mechanics'* new 32-page catalog crammed full of fascinating and useful projects you can build yourself. Send 25 cents to *Popular Mechanics*, 224 W. 57 St., New York, N.Y. 10019.

If you can't come to the world's newest, largest and most exciting electronics department store, we'll mail the store to you!

Exclusive!
Knight-Kit and Science-Fair Kits.

Exclusive!
Realistic Lifetime Tubes.

Exclusive!
Battery-A-Month Club.

World's finest selection of famous brands—in one book!



New! 1971 Allied Radio Shack Catalog
460 pages—thousands of electronic values!



Big Choice of Audio Items . . . Factory-Direct Savings!
Allied TD-1099, 3-Head Stereo Tape Deck. Walnut-grain case. \$179.95



Realistic STA-120. Wideband AM, FET-FM Stereo Receiver. 140 Watts. With case. \$269.95

MAIL COUPON . . . or bring to Allied Radio Shack store.

ALLIED RADIO SHACK, 100 N. Western Avenue, Chicago, Illinois 60680 **FE**

Yes! I want your big new 1971 Catalog. I enclose \$1 for mailing and handling (refundable with my first purchase of \$1 or more).

NAME _____
First Middle Last

ADDRESS _____
Street or Route and Box No.

CITY _____ STATE _____ ZIP _____

I enclose check money order cash.

ALLIED RADIO SHACK

DIVISION OF TANDY CORP.

WORLD'S LARGEST! OVER 800 STORES IN 48 STATES. SEE YOUR PHONE BOOK.

MAKE EXTRA \$\$\$ EVERY DAY!
Get into the big, year-round
EXTRA MONEY BUSINESS
that's EASY to learn—EASY to do—and EASY ON YOU!

Be a LOCKSMITH!

You Can Make Up to \$10 an Hour—even while learning!
Train FAST at Home!

Never before have money-making opportunities been so great for qualified Locksmiths. Now lucrative regular lock and key business has multiplied a thousandfold as millions seek more protection against zooming crime. Yet there's only one Locksmith for every 17,000 people!

Start Collecting CASH PROFITS Right Away

You're "in business" ready to earn \$5 to \$10 an hour a few days after you begin Belsaw's shortcut training. Take advantage of today's unprecedented opportunities in Locksmithing for year-round EXTRA INCOME in spare-time—or fulltime in a high-profit business of your own. Hundreds we've trained have done it. So can YOU! All tools plus professional Key Machine given you with course. These plus practice materials and equipment,

THIS PRO KEY MACHINE—YOURS TO KEEP—

can add \$25 to \$40 a week to your income . . . and it won't cost you a cent with your training.

ALL TOOLS, MATERIALS AND PRACTICE EQUIPMENT COME TO YOU WITH YOUR COURSE.



FREE



Tells how to make money in Locksmithing almost from the start!

"War injuries left me badly handicapped, but now I'm a financial success as a Locksmith, thanks to your training. Besides, the work is fascinating. If I can do it anybody can."—Glen Johnson, Larned, Kan.



plus simple, illustrated lessons, plus expert supervision, plus business-building guidance will enable you to KEEP THE MONEY COMING IN! Ideal for retirement—good jobs, too.

SEND FOR EXCITING FACTS—No Obligation

Discover what's in Locksmithing for you—how Belsaw's master-locksmith-approved training can give you the skill you can depend on to EARN MORE—ENJOY LIFE MORE. Just fill in and mail the coupon below to receive full information by return mail. Do it TODAY!

BELSAW INSTITUTE, 101F Field Bldg., Kansas City, Mo. 64111
Accredited Member National Home Study Council
Approved for all Veteran Training

MAIL THIS COUPON—NO SALESMAN WILL CALL

BELSAW INSTITUTE, 101F Field Bldg.
Kansas City, Missouri 64111

Please send me free of cost or obligation your publication "Keys to Your Future" on how Belsaw can quickly train me to make money in Locksmithing and how all tools and Key Machine are given me to keep.

Name _____

Address _____

City _____ State _____ Zip _____

Check here if eligible Veteran.

DETROIT LISTENING POST

BY ROBERT LUND

ANY BIG MONEY THE AUTO COMPANIES SPEND on changes on the '72 cars will go into meat and potatoes, rather than cake frosting. Emphasis will be on engineering improvements, making parts more durable and safety devices. Detroit has really slammed the lid on spending for non-necessities on the next crop of cars. From a what's-visible-to-the-eye standpoint, the '72s won't be much changed.

IS GM'S INTEREST IN THE WANKEL (reported first in DLP, page 22, Nov. '70 PM) an admission the company has abandoned hope of cleaning up the reciprocating internal combustion engine? "Not on your life!" a source in GM engineering snaps back. GM believes the piston engine will remain the main source of power for American-made cars for the foreseeable future—until 1980—and that by the second half of this decade, it will meet any antipollution standard that can be written for it.

WHAT'S FORD GOING TO DO with all the money it will save as a result of its withdrawal from racing? The company isn't saying how much it spent, but you can pick a number between \$2 and \$12 million a year. The reason it got into racing in the first place—after all automakers signed a pledge not to—was to shove it down the throats of detractors who said Ford products were all right for getting to the drive-in movie or hauling groceries, but they didn't really have it in get-up-and-go engineering durability. Ford answered by letting fly with everything it had. The company made its point long ago: Ford cars can hold their own against the best machines both U.S. and foreign. It isn't about to let the competition or public forget that, despite its racing pull-out. So a portion of the money Dearborn will save by canceling its racing program will go into developing highly styled, innovative, one-of-a-kind cars for display at leading auto shows. If the showpieces or features of the vehicles attract enough attention, they'll be put on production cars.

CAR SIZE ISN'T THE ONLY THING Detroit's whittling down these days. The auto firms are also reducing the number of models in their catalogs. All of 'em cut back on the number this year vs. last. The retrenchment isn't over yet. Chrysler's already decided to drop one of its slow-sellers at mid-year.

TWO-WHEEL ANTISKID braking system—the first planned as an option for light duty trucks and large wagons—is shown being tested by International-Harvester on its Travelall wagon. The rooftop generator powers test instruments during straight-line "panic stop" tests on the low friction surface. The system, essentially the Bendix unit

available on some high-priced passenger cars, uses a small computer to control brake-line pressures. Sensors and pressure modulators on the rear wheels prevent the wheel lockups that cause skids. The system operates independently of the driver's control for as long as the pedal is depressed. The Adaptive Braking System, as In-

[\(Please turn to page 48\)](#)





Pigskin?
Or calf's hide?
One thing for sure...
for them it won't be an
imitation.
Their cigarette? Viceroy.
They won't settle for less.
It's a matter of taste.



Viceroy gives you all the taste, all the time.

DETROIT LISTENING POST

(Continued from page 46H)

ternational calls it, applies automatic judgment and exact timing, preventing wheel lockup that ordinarily occurs when the driver jams the brake pedal to the floor. The system will become available in late 1971 as an optional extra on International's light pickup trucks and Travel-all wagons.

GM HAS REPORTEDLY EQUIPPED test cars with bumpers, doors and other exterior panels made of a highly resilient material that resumes its original shape after minor impact. The material is apparently the same as that in the "Endura" bumper used by Pontiac. The Pontiac bumper returns to its original shape after a collision (providing you don't smack it too hard), won't chip, rust or pit from stones flying up from the road. The process is probably practical for exposed sheet metal, other than bumpers, but it's costly and is not too likely to make its appearance on any production cars in the near future.

SPEAKING OF NO-DENT BUMPERS, the insurance companies say they will reduce rates when producers bring out cars able to withstand a five-mile-an-hour front or rear collision without crinkling the bumper. Four leading insurers have said they'll cut premiums 20 percent when Detroit meets this requirement. The no-dent bumper is coming. It will be on most '73 cars. But the auto companies are betting beefed-up bumpers won't reduce insurance premiums for two reasons: (1) inflation in what it costs to have a car repaired and, (2) because there's a shortage of body and paint shops and manpower to operate them. The only way to attract manpower, Detroit seers say, is to increase wages. You can't increase wages if the insurance companies reduce premiums and pay less to have cars repaired. It's an oil-and-water situation. Detroit believes the insurance industry will see the light as cars become more crashproof and back down from the promise to cut premiums.

FRONT-WHEEL DRIVE has never lived up to GM's expectations at the counter where the customers pay. Olds had it first, in 1965, and instead of 60,000 Toronados the division expected to sell, the count was an anemic 17,000. Cadillac took the item on at the start of the '67 model run and pushed out just under 20,000 front-wheel Eldorados. The count for '70 models was 25,500 Toronados and 24,000

Eldorados—small numbers by GM standards. As a result, there's always a rumor that GM will abandon front-wheel drive. Don't believe it. GM engineering remains high on fwd, so much so that the company is now looking over an idea for a one-seat, two-person car being worked up for 1974-75.

WHAT DO YOU EXPECT TO SPEND for your next new car? Two thousand dollars, \$2500, something over \$3000? If your answer is in the \$2500 range, you're figuring low. This year and next may be the last time ever you'll be able to buy any car now on the market for less than \$2500.

Starting clean, without a trade, there's no such animal as a \$2000 American-made car. There are a couple that "list" for less than \$2000. But try to buy one. There's a two-seat Gremlin at \$1899 and Pinto at \$1919. But by the time you tack on the mandatory extras—taxes, freight, dealer makeready and license plates—there's no Detroit product you can drive home for \$2000. Add on a couple of the common comforts, such as a radio and automatic transmission, and there are very few cars you can buy for less than \$2500—maybe six or seven out of the 335 different models offered by domestic automakers. And the \$2500 car is fast going the way of the \$2000 car.

The reason the \$2500 car can't survive in its present form is because of all the new gear coming out over the next few years. Take just the major items, safety and antipollution devices the government wants installed as standard equipment on everything that comes off the line. The list includes shockproof bumpers, air bags, catalytic converters (with or without electronic fuel injection) and a roadside warning light for use when cars are disabled. Uncle would also like the automakers to put antiskid systems on all cars, but that hasn't been put in the form of a decree—yet. The package comes close to \$1000. And that's without allowing a cent for inflation and higher labor costs.

The \$2500 car won't disappear entirely. Detroit will still make a few machines to sell at that price. But they won't be the same size, nor will they carry the same appointments as the \$2500 car of today. They'll be scaled-down, stripped-down vehicles that will make the current minis look like the gunboat Packards, Cadillacs and Lincolns of 20 years ago by comparison. If you want the same amount of car you're driving today come 1974, you'll find the starting price will be something over \$3000. ★★

How can a pickup work like a truck, ride like a car?

Consider these facts:

Ford pickups give you better ideas. And better ideas are what make a Ford a better buy. For example:

Biggest cab of any pickup. Combined headroom, legroom, shoulder room and seat height dimensions exceed those of any other pickup cab.

Only Ford has Twin-I-Beam independent front suspension. Wheels step over bumps independently to smooth the ride.

Levellest, quietest ride of them all. Virtually no nosedive on braking, less side-sway on curves. Independent tests proved Ford is quieter than all other leading pickup makes.



Most luxurious. Choose from four levels of luxury . . . all the way up to the unique Ford Ranger XLT, most luxurious pickup ever built. Distinctive good taste marks the XLT: wood-tone accents, thick-pile carpeting, deep-cushioned seats upholstered in pleated cloth and vinyl, plus luxury options like AM/FM stereo and air conditioning.



I-beam front axles. A Ford exclusive. Both axles are drop-forged I-beam design. Everybody's *big* trucks use I-beam front axle design for greater strength.

Radius rods help hold alignment better than any other front suspension system. Only Ford pickups offer radius rods.

Self-energizing brakes stop quickly, smoothly, with little pedal pressure. Self adjusting for lower service costs.

Welded, instead of bolted, pickup box stays strong, resists working loose, means greater quietness, less chance of rust.

Leaf-type rear springs, like all big trucks use, for better stability. Exclusive Flex-O-Matic rear suspension, standard on F-250 and with heavy-duty springs on F-100, keeps the ride smooth, with or without a load.



Make sure your next pickup includes the better ideas you get only from Ford. See your Ford Dealer for the pickup that works like a truck, rides like a car.



A better idea for safety: Buckle up.

**FORD
PICKUPS**



NEW BRUNSWICK, N.J.—An automatic, forced-air multiple chamber incinerator for industrial, commercial and institutional solid waste is called Radicator by its manufacturer, Ross Engineering Corp. The design consists of a semi-cylindrical, grateless combustion chamber, an aerodynamically-inclined breeching which serves as a mixing chamber, an afterburning chamber and an automatic rear loader. The programmed operating sequence provides positive control of combustion, temperature and smoke. Smokeless and odorless, the device has passed government antipollution standards and can dispose of 600 pounds of solid waste per hour.

SACRAMENTO, CALIF.—"Smog sniffers," devices for making roadside measurements of hydrocarbon emissions from automobiles, are being used by California highway patrolmen. Developed by Autoscan, Inc., of Los Angeles, the analyzer is about the size of a portable TV and, if approved for general use, could be employed by smog inspection stations set up at service stations or repair garages.

TAMPA, FLA.—The possibility of using warm water for aquaculture, or sea farming, is being investigated by the Tampa Electric Co. as part of a broad ecological study. Experiments will be conducted to produce new yields of oysters, clams, shrimp and other food in an artificially heated seabed. If a new industry can be developed, the problem of food for our growing population may be eased.

HAUPPAUGE, N.Y.—The first law banning the sale or distribution of detergents was passed here recently and will go into effect March 1. Although it is aimed at two foaming, dirt-loosening agents, alkyl-benzene sulfonate and alcohol sulfate, it does not ban phosphates. The purpose of the law is to reduce the amount of the substances entering Suffolk County's groundwater, causing cloudy and bad-tasting tap water.

SALT LAKE CITY—A junk-car "shredder" is under construction by Pepper Allied Metals and Learner Co. of Oakland, Calif. to provide a pollution-free, economical means of disposing of the growing number of old hulks. Whole or compressed cars are shredded by "teeth" powered by a 1500-hp motor. Iron and steel fragments are recovered by an electromagnet while nonferrous metals and combustibles are burned off in a closed furnace. All residue of the burning is contained in a bath of water.

DO YOU KNOW about some action being taken to fight pollution that we don't know about? In your community? On the job? Tell us about it. Write Environment Editor, Popular Mechanics, 224 W. 57th St., New York, N.Y. 10019.

✓ *Ted Williams*
QUALITY

When you see this brand name, you know the equipment has been tested and approved by a Sears Sports Advisory Staff member. Ted Williams, Chairman, tested this rod personally. You know you can count on it for quality, value and performance.

Your rod's probably made with fiber glass cloth. The criss-cross fibers work against each other and break.

It's a different story with a Ted Williams rod. Thousands of glass fibers run the length of it. That's why you can shake Ted's rod by the tip without breaking it.

But it's when you hook a lunker you really feel the difference—the power, the uniform action of the rod from tip to butt.

Try Ted's "Tip-Tested™" rods at a Sears Sports Center. Or see the Sears Catalog.

FREE FISHING CATALOG. For a free copy of Sears 1971 Fishing and Boating Equipment Catalog, mail to: Sears, Roebuck and Co., Dept. 139-P3, 925 S. Homan Ave., Chicago, Ill. 60607.

Name.....
Address.....
City.....State.....Zip.....

Sears 
SPORTS CENTER
home of the Ted Williams brand



Ted Williams
"Tip-Tested™" rods.

Try this with yours.
Odds are you'll be
picking up the pieces.

ON-THE-GO

CAMPING

BY V. LEE OERTLE

COACHMAKER PROVIDES FREE CAMPING TRIPS. Boise-Cascade, parent company for several recreational vehicles and owner of thousands of acres of forest, is now handing its buyers a recreation guide that tells them how to reach its free private forest lands. Another manufacturer has predicted the day will come when campers must prove access to outdoor facilities before they can enter a recreational region. This move by Boise-Cascade may be the first step in that direction. It means that coachmakers must assume a broader responsibility for the products they sell and how they are used.

WITHIN THREE YEARS, ALL TENT TRAILERS WILL HAVE HARD TOPS. That's the surprising trend indicated by tent-top makers. Though many buyers select a tent-trailer because of lightweight features, research reveals that the primary motivation is the fold-down design which allows low-silhouette towing. Reasons cited for switching to all-hardtop trailers included freedom from maintenance, improved security for campers and their cargo (in lockable compartments), more protection from weather, ease of heating interior with hard top and hard walls, and increased longevity.

NEW 1971 FORD PICKUP IN 1-TON RATING WITH 9-FOOT BOX. That's right, the new Ford model looks almost identical to the popular $\frac{3}{4}$ -ton Camper Special—but on a larger scale. This move will permit greater flexibility now in new designs for slide-in camper coaches weighing up to 3500 pounds or more. For those buyers who like the freedom inherent in slide-in models, yet need more space and more interior facilities, the new 1-ton series may be the answer. (See "Pickups That Pamper," page 98).

LESS DEMAND FOR HOOKUPS IN CAMPGROUNDS? Many private campground operators claim that up to 90 percent of their customers seldom demand sewer, water and electricity. Given a choice at less cost, virtually all travelers this past season selected the standard nonself-contained sites. Most campers prefer an electrical hookup over water and sewer. Reason: water tanks can be filled every few days from a central supply source and holding tanks can be emptied for a modest charge about once weekly, but electric power is required to operate such appliances as airconditioners and refrigerators and, in some models, heaters.

NEW ATV IN KIT FORM FOR UNDER \$700. They call it the Gnat. Dimensions when completed are 75 inches long and 47 inches wide, with weight about 245 pounds. The new High-Flex tires from B.F. Goodrich are utilized. The maker claims the ATV speeds up to 40 mph on flat terrain. A key-operated ignition system, chromed bumpers, fold-back headlights and heavy upholstery and padding are said to make the Gnat unusually comfortable. It's being marketed by American Pride of Troy, Mich.

CHEAP MATTRESSES PLAGUE SOME RVs. Few buyers pay enough attention to the fact that mattresses range in thickness from 2 inches for bunk pads to 5 inches in deluxe units, while length varies from 74 to 90 inches. So measure before you buy. A 6-foot body cannot rest comfortably on a 6-foot mattress, as many have learned too late.

CROSS-COUNTRY CAMPGROUND DEVELOPMENTS will boom faster than ever. Unless our predictions are all wrong at least a score of large motel, hotel and restaurant chains will build campgrounds at a fantastic rate during the next 36 months. As one motelman told me privately, "Your readers haven't seen anything yet! Our own company is talking about 400 new overnight parks within the first two years. If they do well, the sky's the limit." Another chain already operating, Red Arrow Industries, Inc., now has campgrounds in 30 states. Within five years, the number of private campgrounds could very well double from the present 7000 or so. ★ ★ ★

Vantage. The new filter cigarette that doesn't cop out on flavor.

Until now a full flavor cigarette was a high 'tar' cigarette.

Until now any cigarette that held back on 'tar' copped out on taste.

But now there is Vantage, an all-new filter cigarette that's not just a lot of hot air.

If you like the authentic tobacco taste

of a full flavor cigarette then you owe it to yourself to smoke Vantage.

Only Vantage has the ingenious Vantage filter geometrically shaped to increase filtration.

It lets you give up those high 'tar' cigarettes without asking you to cop out on flavor.



©1971-R. J. REYNOLDS TOBACCO CO.

NEW exciting home training from NRI

ACT NOW! BE A COMPUTER TECHNICIAN

NRI program includes a complete integrated circuit, operating computer, with memory, to make you thoroughly familiar with computer organization, design, operation, construction, programming, troubleshooting and maintenance.

What better way to learn all about computers than to actually build and use one? That's exactly what you do in NRI's new Complete Computer Electronics home training program.

What you see illustrated may very well be the most unique educational aid ever developed for home training. It is literally a complete, general purpose, programmable digital computer that contains a memory and is fully automatic. It's a small-scale model of larger, expensive commercial computers. Once you build it and it is operational, you can define and flow-chart a problem, code your program, store your program and data in the memory bank. Press the "start" button and, before you can remove your finger, the computer solves your problem and displays the results.

The computer industry continues to leap ahead. Qualified men are urgently needed, not only as digital technicians and field service representatives, but also to work on data acquisition systems in such fascinating fields as telemetry, meteorology and pollution control. Office equipment and



ANOTHER

FIRST

You build your own digital computer step-by-step, circuit-by-circuit. You really get involved as you learn computer organization, operation and programming with this remarkable new training aid. It performs the same functions as bigger commercial computers—and it's yours to keep and use.

test instruments also demand the skills of the digital technician. This exciting NRI program can give you the priceless confidence you seek to walk into a technician's job and know just what to do and how to do it.

YOU LEARN WITH YOUR HANDS AS WELL AS YOUR HEAD

Planned from the beginning to include training equipment in the pioneering NRI tradition, this exceptional new course combines kits with educator-acclaimed NRI "bite-size" texts in an easy-to-understand package. But, unlike other home training, this is not a general electronics course. Lessons have been specifically written to stress computer repair. You perform a hundred experiments, build hundreds of circuits, use professional test equipment. You build and use your own solid-state, transistorized voltohmmeter and other kits in addition to your digital computer. Because you work with your hands as well as your head, your training is as much *fun* as it is education.

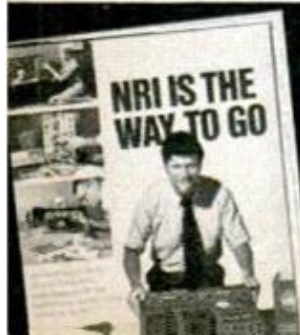

Mail insert card for
your **FREE NRI**
color CATALOG

No salesman will call



**TRAIN AT HOME
WITH THE LEADER**

Get the full story of Complete Computer Electronics and the amazing digital computer you build and use as you learn. Use the postage-free card. There is no obligation. No salesman will call on you. NATIONAL RADIO INSTITUTE, Washington, D.C. 20016.

You get more for your money from NRI

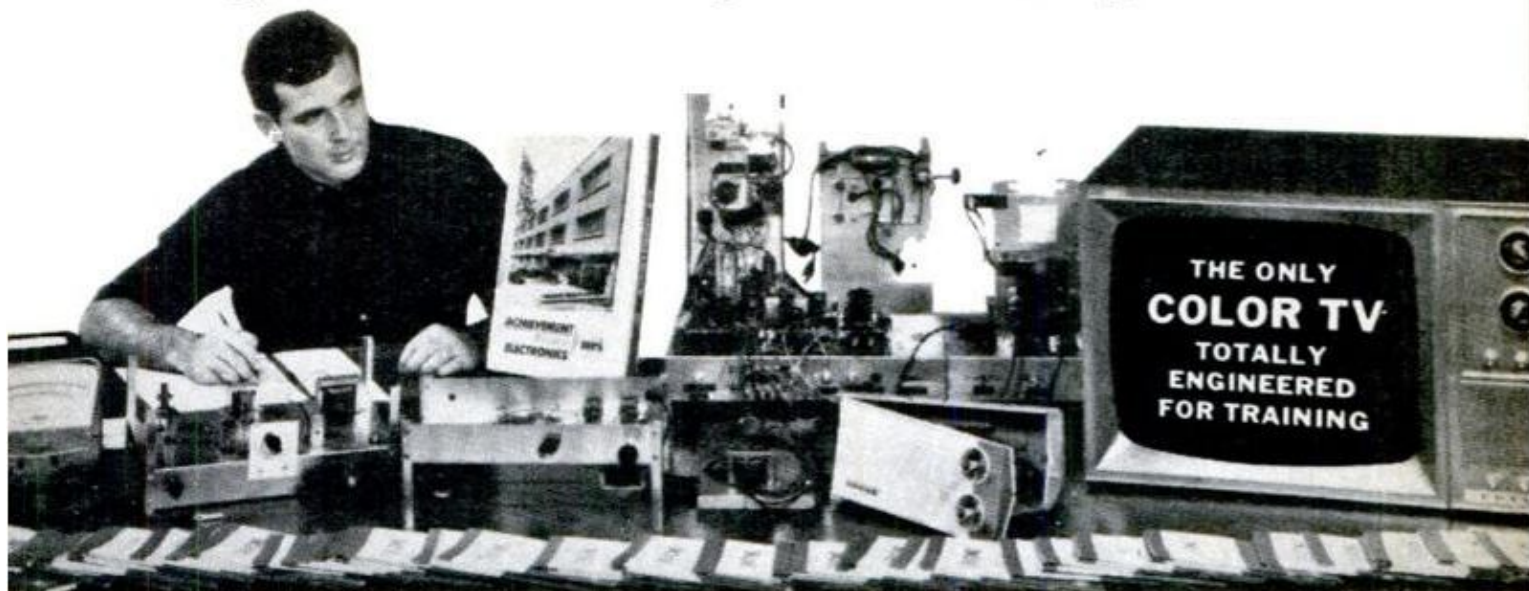

BUILD • TEST • EXPLORE All this is yours — from Achievement Kit, to solid state Radio, to training-engineered Color TV set — when you enroll for NRI's TV-Radio Servicing course. Other courses equally complete. Unique training methods, "bite-size" texts, many personal services have made NRI the leader in its field for over 50 years.

NRI Programmed Equipment Gives You Priceless Confidence, Makes Learning TV-Radio, Electronics Fast and Fascinating

NRI pioneered the idea of supplying home-study students with custom designed training kits to give practical on-the-job experience as you learn. Today, NRI's "3-Dimensional" training can't be equalled. You get more value — from the exclusive Achievement Kit sent the day you enroll, to "bite-size" texts and custom training equipment. Learning TV-Radio, Electronics or Communications at home is easy, exciting, the NRI simplified, dramatized way.

BE A SKILLED TECHNICIAN IN AMERICA'S FASTEST GROWING INDUSTRY

Regardless of your educational background, you can learn the Electronics field of your choice the practical NRI way. The NRI color catalog, sent to you free and without obligation, tells you how you can qualify quickly to be a part of the fast growing Electronic Age; about engineering jobs in business, industry, broadcasting, government, now offered to men without college degrees. It will open your eyes to the great number of success opportunities available right now in the high-pay world of TV-Radio Servicing, Broadcasting-Communications and Industrial-Military Electronics. With NRI technical training, you can take your choice of a wide variety of career

openings or have a business of your own. And if you choose one of five NRI courses that include FCC License preparation, you must earn your FCC License or NRI refunds your tuition!

MAKE \$5 TO \$7 AN HOUR EXTRA IN SPARE TIME STARTING SOON

Tens of thousands of NRI graduates are proof it is practical to train at home in your spare time. Keep your present job while preparing for a better one, and earn \$5 to \$7 an hour extra in spare time while you train, fixing sets for friends and neighbors. NRI shows you how. Equipment you build and keep becomes useful in your work.

STEP UP TO BETTER PAY, A BRIGHTER FUTURE

NRI can help you, but the decision to act must come from you. Decide now to move ahead . . . mail the postage-free card today for your FREE NRI color catalog. No obligation. No salesman will call. NATIONAL RADIO INSTITUTE, Electronics Division, Washington, D.C. 20016.

APPROVED UNDER GI BILL

If you served since January 31, 1955, or are in service, check GI line on postage-free card or in coupon.

CASH IN ON THE BOOM IN COLOR TELEVISION



The NRI TV-Radio Servicing course includes your choice of black and white or color TV training equipment. Color TV needs thousands of trained men to keep pace with millions of sets being sold every year. NRI prepares you quickly. Cash in on the boom.

Mail insert card for
your **FREE NRI**
color **CATALOG**

No salesman will call



How to build an investment you can live in

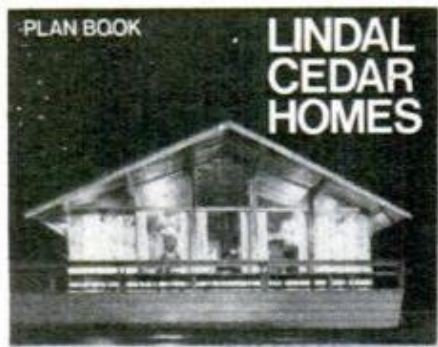

A Lindal ever-last cedar home is one of the best investments today. Lindal, world's largest manufacturer of cedar homes offers 88 imaginative, family-tested home designs, all in a full-color, 36-page book with easy-to-read floor plans. Each home is made of solid Canadian cedar, pre-cut to exacting standards. Part-numbered for quick, easy assembly. Each detail carefully finished, with quality craftsmanship. Wide range of sizes and prices with shipping costs tailored to meet competition anywhere. Send \$1 today for your "Portfolio of Plans" for better living.

Lindal Cedar Homes, Dept. PM72
18601 Pacific Hwy. S., Seattle, Wa. 98188
Enclosed is \$1 for my Lindal Cedar Homes Plan Book.

Name _____ Phone _____
Address _____
City _____ State _____ Zip _____

CAN A HIGH SCHOOL DIPLOMA mean A BETTER JOB? A BETTER LIFE? BETTER PAY?

This one can — and you can get it at home in less than one hour a day!

Send name, address & zip for **FREE** booklet —

FRANKLIN ACADEMY

Accredited Member National Home Study Council



FRANKLIN ACADEMY

Dept. 91-021
2000 Euclid Ave., Cleveland, Ohio 44115

Mr. _____
Mrs. _____ Age _____
Miss _____
Address _____
City _____ State _____ Zip _____
Circle highest grade completed 9 10 11 12

"LISTEN IN" TO POLICE-FIRE RADIO CALLS IN YOUR CAR!

WORKS with ANY CAR—Portable or **HOMERADIO!** Just **PLUGS** in—No wiring—3 minute hookup! Switch instantly from regular to **ALL POLICE-FIRE-EMERGENCY-COMMERCIAL-TAXICAB-STATE-CITY-GOV'T** 2 way Radio calls in **YOUR AREA. DUAL-HI-LOW BANDS—OVER A MILLION** Radio Cars/stations. **USE Everywhere—anytime—always works!**
SEND ONLY \$2.00 (cash, Ck., M.O.) and pay post-man \$7.99 plus COI postg or send \$9.99 for ppd Del in USA. **COMPLETE**, ready to use with instructions. One Year service Warranty—**10 DAY MONEY BACK TRIAL** (if retnd). **AMAZING OFFER** good only by mail—**WESTERN RADIO Dept. BPM-2 KEARNEY, NEBR. 68847**



BUILD THESE BEAUTIFUL CLOCKS

NOW AT BIG SAVINGS!

Send just \$1 for plans & instructions to build choice of: (A) Grandfather, (B) Steeple, (C) Grandmother—plus information-packed catalog of movements, dials, parts & kits to build these & 16 other fine clocks. All 3 plans—\$2.50. Catalog alone—25¢.

MASON & SULLIVAN COMPANY

Dept. PM, Osterville, Mass. 02655



LEARN MEAT CUTTING

Train quickly in 8 short weeks at Toledo for a bright future with security in vital meat business. Big pay, full-time jobs — **HAVE A PROFITABLE MARKET OF YOUR OWN!** Time payment plan available. Diploma given. Job help. Thousands of successful graduates. **OUR 47th YEAR!** Send now for big new illustrated **FREE** catalog. No obligation. **G.I. Approved.**
NATIONAL SCHOOL OF MEAT CUTTING
Dept. 50-S, Toledo, Ohio 43604



IF YOU CAN SING, WHISTLE, OR HUM A TUNE...

you can play the Musical Saw. No notes to read, no musical knowledge required. Since 1921 we have furnished the entire world this unusual, sweet-toned instrument. If you are 10 or 70, you play or no pay. Musical Saw, soft hammer, bow, resin and lessons mailed on 5 days' trial. Write today for details and free copy of "Sawing News of the World," picturing successful saw musicians. **MUSSEHL & WESTPHAL, 107 Fort St., Fort Atkinson, Wisconsin. 53538.**



MINI-BIKE PARTS

Wholesale Prices

"Build your own" kits...Big savings...Repair parts...Welded frames & forks, enameled...Chains...Clutches...Brakes & throttle controls...Wheels...Tires...Bearings...Axles...Engines...etc. Send 50¢ for illustrations and lists...**SAVE DOLLARS!**

BYCO, Dept. B, Box 6241, Omaha, Nebr. 68106

TREASURE & COIN DETECTOR

MONEY BACK GUARANTEE

New electronic detector penetrates deep into earth to locate gold, silver, coins, minerals. More penetrating power than ever before. Sensitive enough to locate a single coin or small nugget. Works through earth, wood, vegetation, water, rock, etc. Not a "probe" type but a fully electronic detector that is guaranteed to have at least twice the detection ability of any detector in this price range or return in 10 days for refund. Uses inexpensive 9V battery. Fully transistorized. Weighs only 2 pounds. Loudspeaker signals when object is detected. Has plug-in earphone for treasure hunting in privacy. **NOTHING ELSE TO BUY!**

29⁹⁵
POST PAID

Comes complete, ready for operation. Shipping container has compartments for detector and all accessories, serves as a carrying case. Send only \$29.95 check, cash or M.O. for postpaid shipment or \$2.00 and pay \$27.95 plus small C.O.D. when delivered.
Viking Detectors,
Dept. V-2,
Box 10680,
Houston, Texas 77016



AUDEL

LEARN MORE
EARN MORE!

• SKILL-BUILDING PRACTICAL GUIDES

POPULAR AUTOMOTIVE GUIDES



Auto Engine Tune-up

Complete tune-up procedures for all types of auto engines. Full adjustment data for carburetors, ignition, valves, etc. For the car owner who wants to do his own tune-up, as well as for the experienced mechanic. Fully illus. 416 pages. \$5.95
Circle 103 in Coupon



Diesel Engine Manual

Complete practical guide to modern Diesel engines. Explains principles, operation, and maintenance. Covers starting and scavenging air compressors; fuel injection; valve timing; air starting and fuel valves, etc. Illus. 544 pgs. \$6.95
Circle 024 in Coupon

Truck and Tractor Guide

A guide for mechanics, drivers and maintenance men. Gas & Diesel repair, service and operation. Illus. 928 pages. \$6.95
Circle 020 in Coupon

Foreign Auto Repair Manual

Up-to-date service data for all popular imports: English, French, German, Italian, Swedish. Illus. 592 pages. \$5.95
Circle 078 in Coupon

PRACTICAL AUTO GUIDE

Biggest \$7.95 Value!

FIX ANY CAR FAST!

STEP-BY-STEP REPAIR GUIDE COVERS:

Troubleshooting—unique symptoms-and-causes charts • Spark Plugs • Batteries • Tune-up • Distributors • Ignition Testing • Starters & Generators • Lighting • Tire Servicing • Brakes • Power Brakes • Front Suspension • Steering Systems • Wheel Alignment • Chassis, Springs & Shocks • Fuel Pumps • Carburetors • Cooling Systems • Lubricating Systems • Pistons & Rings • Crankshafts and Connecting Rods • Camshafts • Valves • Clutches • Automatic & Manual Transmissions • Drive Shafts & Universal Joints • Rear Axle Assemblies—ABSOLUTELY EVERYTHING YOU SHOULD KNOW TO FIX ANY CAR! Hundreds of illus. 736 p. \$7.95
Circle 015 in Coupon

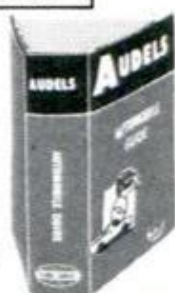

Home Appliance Servicing

How to test, service, and repair all modern gas & electric appliances such as refrigerators, washers, dryers, ranges, irons, hot water heaters. Gives up-to-date methods, wiring diagrams, complete servicing data. Fully illustrated. 608 pages. \$6.95
Circle 016 in Coupon



Home Refrigeration & Air Conditioning

Complete and practical information on installing, servicing, and maintaining gas and electric refrigerators and all types of home and auto air conditioners, water coolers, freezers. Many tables of useful data. Illustrated. 576 pages. \$6.95
Circle 133 in Coupon



Electric Library

10 volume electrical encyclopedia. Presents basic principles, rules and applications of applied electricity. Answers questions on thousands of electrical problems. Fully illustrated with diagrams and tables. 5600 pages. Set \$35.00
Circle 030 in Coupon



TV-Radio Library

Two vols. of practical and theoretical knowledge including basic electronics, basic radio receiver repair. Covers entire subject of television, both black & white and color, from theory thru repair. Illustrated. 960 pages. 2-Vol. Set \$10.95
Circle 161 in Coupon

Outboard Motor Guide

Practical details on all phases of outboard motor repair, maintenance and operation. Up-to-date. Illustrated. 446 pages. \$4.95
Circle 168 in Coupon

Practical Electricity

Complete handbook; practical, simplified ready reference on all electrical subjects. Many illustrations. 496 pages. \$5.95
Circle 160 in Coupon

Mathematics for Mechanics

A complete guide to the mastery of practical math. Simplified method makes learning fast and easy. Illustrated. 704 pages. \$5.50
Circle 026 in Coupon

Blueprint Reading

For mechanics & construction men. Step-by-step explanation of how to read all types of blueprints. 416 pages. \$5.25
Circle 041 in Coupon

Welders Guide

Practical guide to theory; operation; maintenance all types—electric, oxy-acetylene & Thermit. Illus. 626 pages. \$5.50
Circle 025 in Coupon

Masons and Builders Guides

4 practical volumes for bricklayers, masons, cement workers, plasterers. Includes shortcuts and job estimating. 2000 illus. 1488 pages. 4-Vol. Set \$14.95
Circle 076 in Coupon

Plumbers and Pipefitters Guides

3 vols. of ready reference for plumbers, pipe & gas fitters, sheet metal workers. Explains all principle of modern plumbing. 540 illustrations. 928 pages. 3-Vol. Set \$12.50
Circle 155 in Coupon



MACHINISTS LIBRARY

Three volumes of ready reference on all the latest shop practices for machinists and toolmakers. Vol. 1—Practical Fundamentals of Basic Machine Shop Operations. Vol. 2—Setup and Operation of all the widely used, important shop machines. Vol. 3—Toolmakers Handbook with down-to-earth data on layouts, specifications, jigs and fixtures, gear forming, cams, etc. Illus. 1310 pages. 3-Vol. Set \$15.50
Circle 174 in Coupon



CARPENTERS & BUILDERS GUIDES

Four all-inclusive volumes provide latest inside trade information on modern construction. Vol. 1—Tools, Steel Square, Joinery. Vol. 2—Builders Math, Drawings, Specs. Vol. 3—Layouts, Foundations, Framing. Vol. 4—Millwork, Power Tools, Windows, Doors, Roofing, Flooring. Most practical guide available. Thousands of diagrams, charts, graphs and photos. 1612 pages. 4-Vol. Set \$16.95
Circle 169 in Coupon

Millwrights & Mechanics Guide

Practical information on plant installation; operation and maintenance data for foremen & workers. Illus. 1236 pgs. \$7.95
Circle 056 in Coupon

Sheet Metal Pattern Layouts

Modern guide to all phases of sheet metal work, including pattern development. 350 layouts. Illus. 1152 p. \$11.95
Circle 045 in Coupon

MONEY BACK GUARANTEE

SEND NO MONEY! We'll send you any Audel Guides for 10-day FREE examination. If you decide to keep them, use our easy-pay plan. Absolute no-risk MONEY-BACK GUARANTEE!

SEND NO MONEY—10-DAY FREE EXAMINATION!

THEODORE AUDEL & CO.—Self Improvement Publishers Since 1879—

4300 W. 62nd Street, Indianapolis, Indiana 46268

P-021

Please mail me for 10 days' FREE EXAMINATION the books I have circled at right. I agree to mail \$3 in 10 days for each book or set ordered, and to further mail 1/2 of the total purchase price 30 days later, with the balance plus shipping costs to be mailed within another 30 days. If I am not completely satisfied with my Audel Guides I may return them for refund.

SAVE SHIPPING COSTS—Check here if you enclose full payment with order (plus sales tax, if any). We pay postage charges. You have same return privilege.

Name _____

PLEASE PRINT

Address _____

City _____ State _____ Zip _____

015	041	155
016	045	160
020	056	161
024	076	168
025	078	169
026	103	174
030	133	

I have bought Audel books before



THEODORE AUDEL & CO.
division of HOWARD W. SAMS & CO., INC.
Indianapolis, Ind. 46268

SOLUTIONS FOR MECHANICAL HEADACHES

AUTOMOBILE CLINIC

BY MORT SCHULTZ

Wrong battery water

I was shocked the other day to see a service station attendant fill my battery with water from a tap. He explained that it is no longer necessary to use distilled water—that battery manufacturers are using new plates or something. Am I wrong in believing that only distilled water or rainwater caught in a plastic container should be used in a battery?—R. E. Volkert, Dubuque, Iowa.

You are absolutely right. The composition of today's battery plates is the same as it has been for years. Iron in tap water will cause plates to accumulate iron oxide, which will shorten the battery's life. I suggest that car owners check batteries themselves to insure that only distilled water or rainwater is used. The payoff will be maximum battery life.

Strange tire wear

The outside of the right rear tire of my 1969 Chevrolet Malibu wears bald every 7000 miles. The other three tires show no wear. How come?—Spec. 4 D. E. Hayes, APO San Francisco.

Probably because of a bent rear differential housing. See a Chevy dealer when you get home. It isn't news to him.

Dwell awhile

In checking the dwell on my 1968 Dodge Coronet (273-cu.-in. V8 engine), I found a variation of 6° from idle to 1500 rpm. At idle, dwell is 34° and moves to 28° at 1500 rpm. The manual says that a 2° difference indicates a problem, but the dealer tells me my dwell is only off by 1°. He contends that the dwell-angle setting can be anywhere from 28° to 33°, which is the specification spelled out in the manual. However, I always believed that dwell should remain pretty much constant throughout engine operation—for example, that if you got a reading of 29° at idle (or 30°, 31°, and so forth) it should remain about the same at any rpm. Am I wrong?—M. A. LaRocca, Pittsburgh.

No, the dealer is wrong. You are getting a variation of 6°, which is too much. The first thing I would check is the vacuum

advance. If it's okay, then there is wear inside the distributor (cam, shaft).

A squealer

When more than two people ride in my 1969 Ford LTD a high-pitched squeal that resembles a distant whistle or siren is created. My mechanic is at a loss to explain this strange occurrence. Please help.—L. J. Cassidy, Providence, R. I.

An altering of the car's weight may cause a shift in position of a dry transmission extension seal. I suggest lubrication.

Try a new mechanic

I have a problem with a 1967 Pontiac Firebird (OHC-6). It backfires, pings, has a rough idle, and the plugs foul in two cylinders. The car has been to the shop for carburetor adjustments and tune-ups six times in the last year. Now they tell me they can't adjust the carburetor correctly because the PVC unit on '67 and '68 models interferes with it.—Virginia Holland, Fresno, Calif.

Baloney. Tell them they ought to try another trade, and then go find yourself a mechanic who knows what he's doing. For example, one of the first things that should be investigated is the possibility of leaking or sticking valves in those two cylinders which foul.

VW service manual

Can you tell me how to get a service manual for a 1969 Karman Ghia, which was promised to me by the salesman when I bought the car? He now tells me they are hard to get, but several VW owners I know have them.—Harold E. Brown, Woburn, Mass.

This manual should be available through the dealer, but if he is having trouble I suggest you write the director of publications, Volkswagen of America, Englewood Cliffs, N. J. 07632.

To fix a Fiat brake

I have a 1969 Fiat 124 Sports Coupe which has disc brakes. They squeak as
(Please turn to page 60)

Spend a milder moment with the quiet taste of Raleigh.

A special treatment softens the tobaccos for a smoother, milder taste.

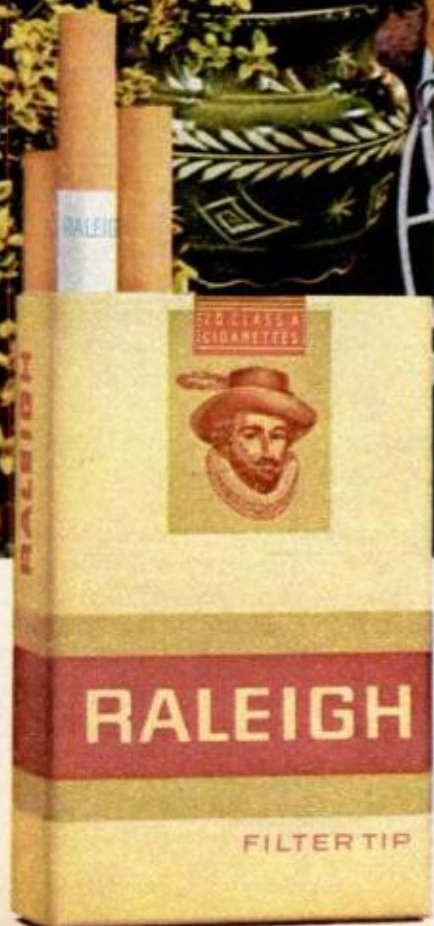

A valuable extra...the famous Raleigh coupon
on both Raleigh Filter Kings and Filter Longs.

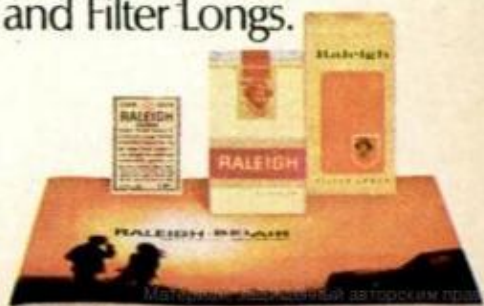

Free Gift Catalog.
Write Box 12, Louisville, Ky. 40201

© BROWN & WILLIAMSON TOBACCO CORP.

Материал подготовлен авторским проектом

AUTOMOBILE CLINIC

(Continued from page 58)

loudly as rusted door hinges. The dealer told me before I was shipped overseas that this is an inherent problem. Is he right?—Sgt. James Aiello Jr., APO New York.

He was, but he isn't anymore. See him when you get home. Word has come down from Fiat to replace the front brake shoes with a new, improved type. The dealer can get the scoop on this by contacting his regional Fiat representative.

Oil-starved

To check a ticking noise in the valve train of my 1968 Buick Riviera, I pulled the valve covers and found that oil wasn't getting to the rear rocker arms. What's wrong?—John R. Rumer, Des Moines.

The rocker arms in this car are fed by drilled passages in the block and heads. These passages connect with the rocker shaft at the front shaft mounting pedestal. Oil then passes back through the rocker arm shaft. Each individual rocker arm is fed by holes that are drilled into the shaft. It's quite possible that in your case one or more of the holes have become plugged. If so, have them unplugged.

The high, hard one

The brake pedal of my 1969 Plymouth becomes high and hard on long trips. What can cause this?—George Hamman, Lawrence, Mass.

A plugged relief port in the master cylinder.

Applying heat

My 1967 Pontiac with 400-cu.-in. engine and four-barrel carburetor practically quits on me in hot weather when the air-conditioner is running. I am unable to unstick the heat-riser valve. Could this cause the problem? What's the solution?—Newman Faulkner, Garland, Tex.

If the heat riser is stuck in the closed position, which seldom happens, it could be causing the trouble. The solution is to tap the counterweight arm with a hammer to try to loosen it up, and then to lubricate each side of the shaft with

graphite or heat-riser lubricant. If this doesn't work, you'll have to replace it. However, since you indicate the trouble occurs only in hot weather, I doubt if it's caused by the stuck valve. Inability of the carburetor to vent itself because of a clogged antipercolation port seems likely.

Halfway fuel gauge

The fuel gauge in my car goes up to the full mark when the tank is filled, but won't go below the halfway mark. I've been keeping one of those magnetic-catch flashlights fastened to the dashboard and wonder if the magnet might have something to do with the problem.—A. P. Wasenaar, Gresham, Ore.

Not at all. The fuel gauge is nonmagnetic. I imagine that the problem is with the sending unit in the gas tank.

Service Tips

● All Chrysler Corp. cars and light-duty trucks for a number of years have had left-hand-thread wheel-mounting nuts and studs on the driver's side and right-hand-thread nuts and studs on the passenger's side. If you have a 1971 model, you'll want to note this has been changed. The wheels have right-hand-thread nuts and studs on both sides.

● Oldsmobile tells us that broken station-wagon tailgate hinge pins have been turning up because lubrication has been denied them. Those pins and hinges should be lubricated periodically with the tailgate in open position. If the pins have started to seize, use a penetrating oil to free them.

● Some 1970 Chevelles and El Caminos came equipped with an incorrect oil dipstick, resulting in a low level of 6/10 to 1½ quarts. The correct stick measures 19-17/32 inches from the bottom of the handle to the FULL mark and 20-11/32 inches from the bottom of the handle to the ADD mark. If yours doesn't, get the right stick (part No. 3925599).

● A tip from FoMoCo: Whenever you have to use a booster battery, turn on the heater or airconditioner blower to keep the small light bulbs in the instrument panel from being blown by the sudden surge of high voltage. Also be sure that engine speed doesn't exceed 1500 rpm when the engine has started and booster cables are disconnected. ★ ★ ★

GOT A PROBLEM WITH YOUR CAR? Ask Mort about it. Send your question to Auto Clinic, Popular Mechanics, 224 West 57th St., New York, N.Y. 10019. Letters cannot be answered individually, but problems of general interest will be published in the column.

less is more.

This new Johnson 50 packs more performance into less space than any mid-range outboard motor. Ever.

The usual thing is to try to make it bigger and better. Johnson engineers set out to make the new Sea-Horse 50 **SMALLER** and better — and achieved a very unusual thing indeed! Its striking silhouette is the most obvious result of this "less is more" approach, but only hints at even more dramatic interior innovations.

First of all, this two-cylinder engine is **LOOP CHARGED** —

a more efficient method of recharging cylinders with a fresh mix of fuel and air, then scavenging the burnt gases from those cylinders.

Loop-charging brings fuel in and exhaust out in one continuous loop through a series of aimed ports. Our design employs lighter, cooler running, flat-topped pistons and domed combustion chambers. It's a hot idea that increases horsepower, decreases weight and fuel consumption.



Johnson's unique **PRESSURE-BACK PISTON RING*** helps to seal the combustion chamber by using compression to force the ring against the cylinder wall. Results,

reduced friction and engine wear, improved fuel economy. There's a new fuel saving system too, which combines a pair of newly designed carburetors with "straight-in" fuel induction and no fuel trapping pockets. Another drain free motor from Johnson.

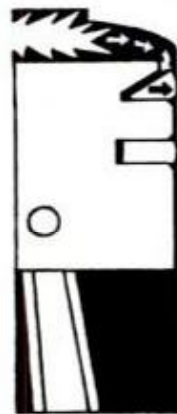

*Patent applied for.

6" lower off the transom than other 50 hp outboards

50 Johnson

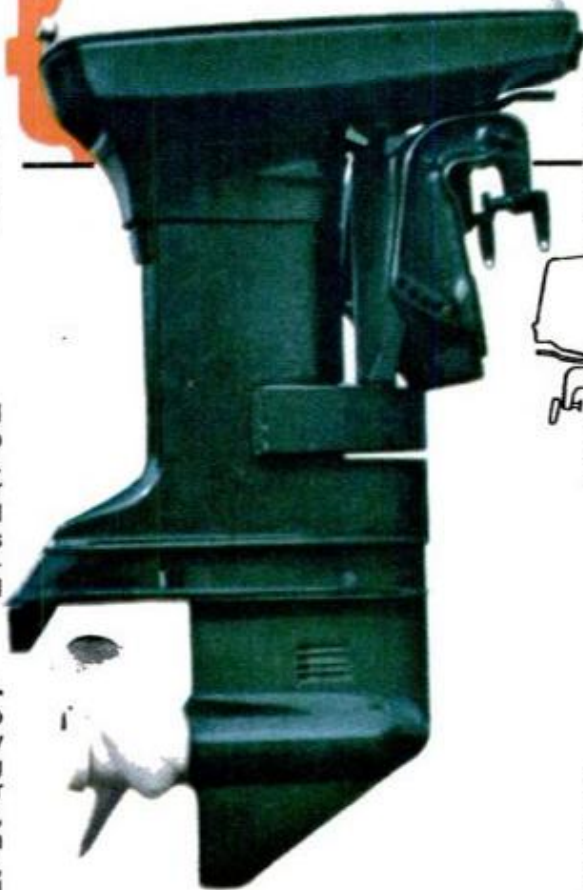

The solid state **CAPACITOR DISCHARGE IGNITION**

system is a new magnetic controlled type.

There are no moving mechanical parts — no distributor, no belts, no breaker points. It will even provide

ignition for the engine without the battery. The spark plugs are a new surface-gap type with tungsten alloy electrodes. They should provide up to 1,000 hours of use in this engine.



THE COOLING SYSTEM is both thermostatically controlled and (for the first time) pressure controlled. At low speeds, the engine is kept warm for smooth running and fuel efficiency. At higher speeds, water circulation is increased. The engine runs appreciably cooler at full throttle than it does at idle, so you get more power at the high

end and increased engine life.

EXHAUST-TUNING is achieved with an internal, closed end megaphone system. It results in more power on less fuel. Power shifting is standard equipment on this motor, along with our exclusive single-lever remote control which combines the key-switch, choke and throttle. Choose from eight standard or six high performance props as optional extras.

From idle to full throttle, this outboard is a new experience. No other motor — in our line or anyone else's — offers so much of tomorrow, today. Your Johnson dealer is showing it right now. Stop in soon. Or write for free catalog: Johnson Motors, Waukegan, Ill. 60085, Dept. PM-271



Johnson
First in Dependability • Division Outboard Marine Corporation

See all the new Johnsons — 2 to 125 hp.

THE ALL NEW OPEL 1900. NO OTHER ECONOMY CAR (FOREIGN OR DOMESTIC) GIVES YOU ALL THIS.

Last year, Opel offered you one wagon, the Model 39, shown at rear.

This year, Opel adds another choice. The all-new Opel 1900 wagon.

It offers many things as standard equipment that other economy cars offer as optional equipment. Or not at all.

For example, the Opel 1900 is the economy car with hydraulic valve lifters, just like the big American luxury cars, for a quiet-running engine and eliminating the need for adjustments.

The Opel 1900 has front power disc brakes for quick, smooth, straight-line stops. As standard equipment.

The Opel 1900 has lots and lots of room. The cargo area is fully carpeted and the luggage compartment is cleverly hidden. And please notice, the Opel has adjustable backs on its front bucket seats and headrests as standard equipment.

The Opel 1900 has a four-speed manual transmission as standard equipment.

And a three-speed, fully automatic transmission is available.

Notice, too, that the Opel 1900 gives you rear, swing-open side windows as standard equipment.

An important comfort in ventilation that we thought you'd like.

But maybe you want an economy car just for the great gas mileage and easy handling. The Opel 1900 gets great gas mileage and we turn tight... 31.8 feet with only three turns of the wheel.

See all the Opel 1900s (1900 sedan, 1900 sport coupe, the zoomy 1900 Rallye and the beautiful 1900 wagon) at your Buick-Opel dealer's. Over 2,000 of them sell and service Opel from coast to coast.

After you've seen all the new Opels, if you can find an economy car that you think gives you more than Opel, congratulations.

You've done a lot more than we could.



BUICK MOTOR DIVISION

Opel 1900 station wagon in antique bronze, foreground.

BUICK'S FOREIGN ECONOMY CAR.

What Ever Happened to Air Bags?

By government order, passive restraint systems are on the way. We'll all foot the bill because we've refused to use those lifesaving lap and shoulder belts!

By ROBERT LUND, Detroit Auto Editor

IT LOOKS GREAT ON PAPER. Everybody—and that takes in the car companies, safety groups, government, the medical profession, police agencies, the insurance industry—one and all agree that the pillow that pops out of the dash to protect the torso in a collision is a great idea. It could save thousands of lives.

But if the idea is such a winner, why haven't the bags been installed on cars? What's the holdup? When will auto producers put the pop-out pillows on production cars? Sooner, later or never?

The straight story on air bags, according to automakers, is that despite all the gung-ho and let's-go you've heard about them, the device is far from foolproof. Instead of saving your life, in certain situations the bags could turn killer. Or, second choice, maim you or make you deaf.

Is this another stall by Detroit, the old hold-'em-off-at-the-pass-trick? Champions of air cushions are convinced that's the case. They accuse the monsters of Motown of dragging their feet

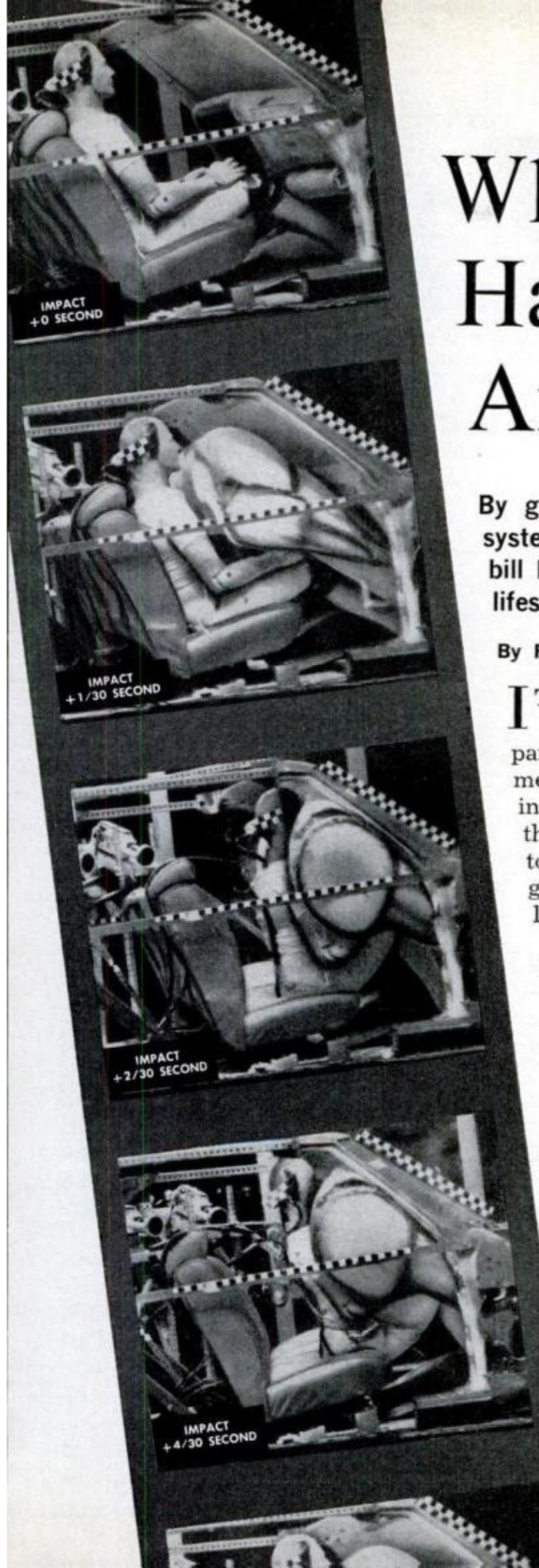

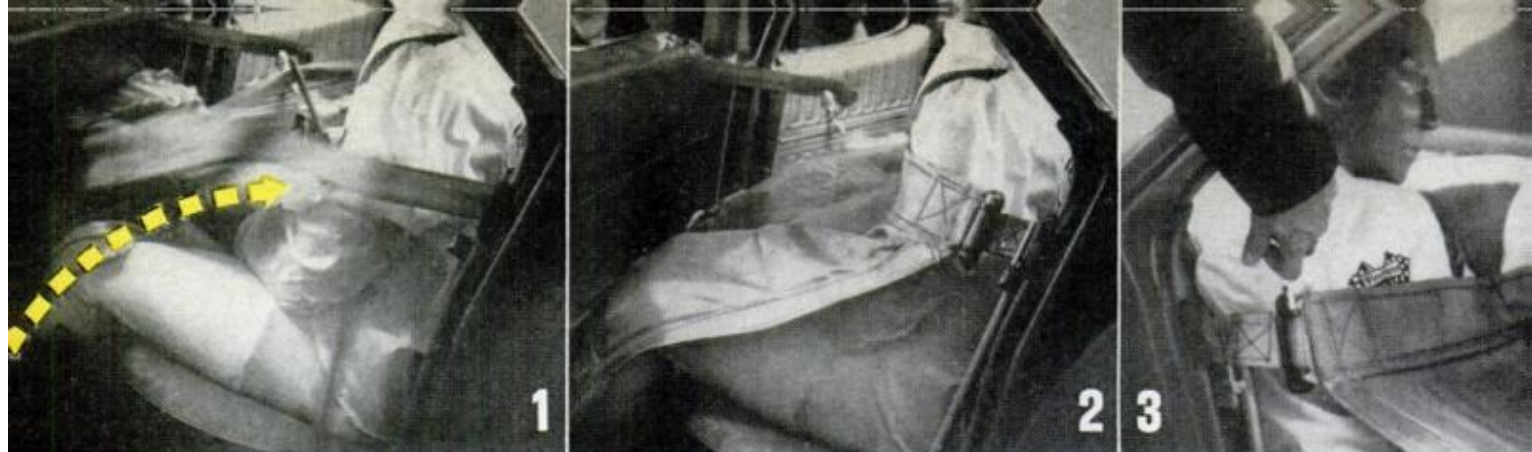

PASSIVE RESTRAINT need not necessarily be the air bag. It can be any device or system that protects drivers and passengers without their having to take any action like buckling a harness. Firestone's research has resulted in a "blanket" system, shown here in a back seat. It snaps into place, pin is pulled for release

on a proven safety development that could prevent thousands of fatalities. It's the familiar accusation that Detroit puts profits above people, the villains gleefully conspiring against the public good.

That's plain stupid. The advocates of air bags who read conspiracy in Detroit's reluctance to put the equipment in cars couldn't be more wrong. The auto companies could actually profit by going along with the idea. Nobody knows what the bags will cost down to the dollar, and it would be an easy matter for the car firms to pad the price and pocket a profit. When air bags come the cost will be factored into the price of cars. You'll pay for them, so Detroit has nothing to gain financially by refusing to install them.

Automakers admit the potential benefits of air bags outweigh the negative risks. They'll definitely do more good than harm. Save more people than they'll kill or cripple. What the auto companies are asking for is time to try to engineer out the harm that does pose a threat or at least minimize it.

The do-it-now-ers make the valid point that air bags aren't a new idea, an untried, untested hypothesis still wet behind the ears. The concept has been around a long time. A research engineer at Martin Aircraft, Carl Clark, captured the interest of the aircraft and auto industries with his idea of a cushion that would automatically pop out to catch passengers in a collision more than a decade ago. In 1965, a Japanese, Yasusaburo Kobori, president of the

Good Idea Center in Tokyo, visited Detroit and demonstrated his inflatable restraint system. The auto companies have been experimenting with the idea off and on for several years.

One drawback of the early bags was the lack of a reliable sensor. A sensing device had to be developed that had the capability of distinguishing between a real collision and a nonaccident impact so the bag would inflate at the right time, only at the right time and soon enough to protect the passengers.

Activating an air bag isn't a simple operation. Inflation is accomplished by a system consisting of six components, the most essential of which is the sensor. Mounted on the car's firewall, the sensor must "decide" when the car has been in a collision equaling a barrier crash of eight miles an hour or more.

Based on the principle that "a body in motion tends to stay in motion," the sensor—a little larger than a golf ball—has a tiny spring that presses against a metal weight that must move forward about a half-inch, thereby completing an electrical circuit. It's a lot like a typical G-switch, except that deceleration must continue long enough.

A couple of electric wires carry this "message" to a high-explosive cap on a bottle of nitrogen gas mounted behind the instrument panel. The gas is stored at a pressure of 3500 pounds per square inch.

When the cap explodes, the nitrogen rushes out into a "distributor," a sort of pipe with slits that quickly distributes



CRASH TESTING and safety research at Volvo has led Karl-Erik Larsson, assistant manager of the passenger car division, to comment that air bags must never *replace* seat belts. Air bags cannot protect occupants in all crash situations—roll overs, for example. One study of auto accidents in Sweden has shown that when belts were worn there were no fatalities at speeds up to 60 mph. When seat belts were not worn, fatalities occurred at speeds as low as 12 mph! Volvo, nevertheless, is working on the air bag since the U.S. federal safety standard requiring a passive restraint in the front compartment by July 1, 1973, will apply to imports, too

the nitrogen to a large coated-nylon bag folded up in the instrument panel.

All the action must occur in a fantastically short time—40 milliseconds, or four percent of a second. In a typical collision, this is the approximate time between the first collision and the start of the passenger's forward movement on the seat that becomes the second collision. To give you an idea of how fast the device must work, a sneeze usually lasts about 500 milliseconds (half a second) and the blink of an eye takes about 100 milliseconds.

In the mid-1960s, a Cleveland-based auto supplier, Eaton, Yale & Towne, launched a \$5 million program to perfect an air bag for automobiles. Now, some six years later, Eaton claims to have a practical system. The guts of the system is a nitrogen bag. Eaton calls the package Auto-Ceptor.

The company achieved the necessary speed to activate the bag in the split second between the first and second collisions partly by using a high explosive to pulverize the plug in the nitrogen bottle. PETN, the explosive agent, burns at a rate of about 3000 meters a second. A quantity about the size of a .22-cal. shell is used.

In the course of its development program. Eaton discovered there is a relatively prolonged impact when a car is in a collision compared with the short impact produced when a vehicle hits, say, a six-inch timber at 60 mph, or when someone slams the hood down hard, or any other nonaccident impact to which cars are subjected. Eaton's

sensor can tell the difference between the prolonged crash that takes place in a collision and a shorter, noncollision impact.

To demonstrate the efficacy of the sensor, Eaton conducted tests showing that even in the most severe noncollision impact, the sliding weight in the sensor never moved more than 10 percent of the distance necessary to trigger the system.

In another test at Holloman Air Base, baboons were strapped in impact sleds and subjected to high-speed stops. A 40-G stop will usually kill a baboon. With the Eaton system, the animals survived 60-G stops with virtually no injuries.

With this wealth of background, history and experience, it's easy to understand why advocates of air bags are impatient with Detroit. Why not now?

Because the auto companies still have some serious misgivings about the device.

"There's no problem building and installing an air bag in a car," John Beltz, the engineer who heads up GM's Oldsmobile Div., told *PM*. "The problem is to install them in nine or ten million cars and have every one work right every time." (From another source, *PM* learns GM has developed its own bag. The GM cushion runs the entire width of the front seat, instead of individual bags popping out to shield each passenger.)

The auto firms want answers to six

(Please turn to page 168)

Big Year for the



Little Guys?

"BIG-GUY" BUDDY BAKER takes hot ride in Dodge Daytona before carb-plate rule. Only driver with Dodge factory ride, he'll run '71 Charger; Richard Petty's in only factory Plymouth. No factory Fords will run

The independents who race in NASCAR's Grand Nationals have always had pretty rough running, but with the factory pullouts and the rule changes this could be their year!

By BILL HARTFORD, Auto Editor

"WOULDN'T IT be something," grinned independent racer-of-fortune James Hylton, "if a \$25,000 operation like mine beat Isaac's million-dollar operation?" That was before the factory axes fell and left Isaac's "million-dollar operation," along with several others, just a bucket of parts and pieces and no big bucks.

Yeah, wouldn't it be something! It

would even be better than last year when Pete Hamilton (who?) streaked out of the blue to out-Petty Richard and all the other hot dawgs. Imagine, an independent, do-it-yourselfer like Hylton, or Neil Castles or Dick Brooks, or any one of a dozen others picking up all the chips at the Big D!

The factories have sworn off fueling those fat Holman & Moody-Matthews-

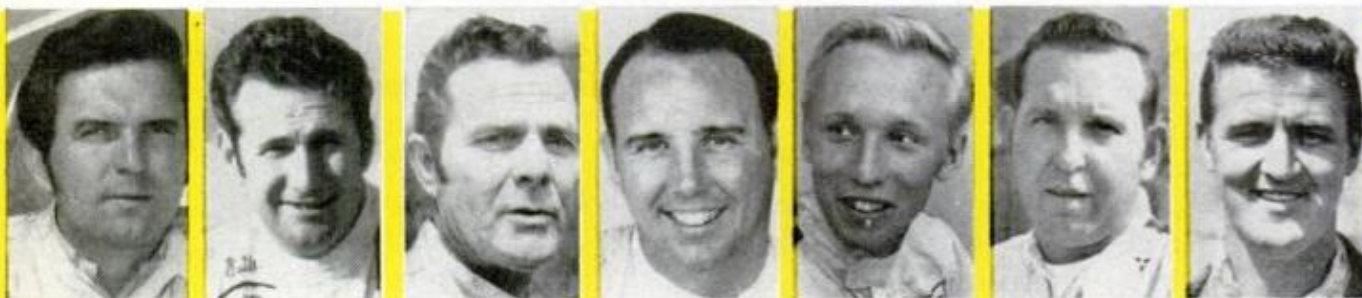

BROOKS

CASTLES

CHAMPION

GLOTZBACH

HAMILTON

HASSLER

HYLTON

Nichels - Hyde - Owens - Rossi - Johnson-Wood operations, folded their programs and gone back to Detroit to worry about safety, ecology, and just plain making cars for the rest of us less speedy drivers. For 1971 Ford and Chrysler are more worried about Volkswagen and the Japanese than they are about each other—or, for that matter, General Motors.

This means, for the little guys, "Daytona's the place if you wanna race!" That's how the bumper sticker reads and that's how NASCAR boss Bill France feels about the factory pullouts: good for the independents.

Despite factory pullouts in the past, stock-car racing has done nothing but grow. The 1971 season will see the total GN purse hitting almost \$3 million—up again for the 21st consecutive year. The Daytona 500 (along with the inaugural Golden State 500 at Ontario and the World 600 at Charlotte) gets a lion's share of this total. France regards the loss of auto-company money as only opening the door for sponsorship from companies not in the automotive field—a trend that has steadily been gaining ground. He also anticipates better competition because, as he says, "More owners and drivers will have an opportunity to be competitive at a much reduced cost."

Cost is always an all-important consideration. In fact, there is probably some secret, extraordinarily complex equation that relates car reliability and mph to m-o-n-e-y. The top teams and drivers will still have more bucks for more bang because *someone* will kick in where the factories have bowed out. K & K Insurance, for example, will

still back Bobby Isaac, last year's GN champ, and his car handler, Harry Hyde, but Dodge won't be helping him this year. (What profiteth the Grand National champion if he win the crown but loseth his sponsor!)

Nichels Engineering will probably continue to field a car with Dow Chemical support but will have to scrounge, now that Chrysler decided not to renew Nichels' contract to distribute high-performance parts, blueprint hemi engines and build stock cars. Ray Nichels and former star Paul Goldsmith prepared Charlie Glotzbach's Dodge last year.

Other top teams scrapped by Dodge include Cotton Owens/Buddy Baker and Mario Rossi-Bobby Allison. Ford Motor's four-car factory effort written off last November included Holman-Moody/David Pearson, Banjo Matthews/Donnie Allison, Junior Johnson/Lee Roy Yarbrough and Wood Brothers/Cale Yarbrough. This sparked Cale to abandon NASCAR for USAC. Lee Roy may do the same.

Pete Hamilton, fair-haired hero of last year's down-to-the-wire duel with fast and foxy David Pearson, became an instant independent with Chrysler's consolidation of one Dodge and one Plymouth into Petty hands. Buddy Baker got the Dodge driving assignment, and Richard Petty the Plymouth. (Richard was recently appointed by President Nixon to the Advisory Conference on Physical Fitness and Sports.) Buddy, son of the former stock-car driver, Buck Baker, held the world's closed oval record with 200.447 mph until topped by Bobby Isaac's 201.104 mph.

At this writing (right after the Ford



LANGLEY

MARCIS

PARSONS

SCOTT

SEIFERT

THOMAS

WARREN



DAVID PEARSON in Holman-Moody Ford was testing a '71 when Ford announced it wasn't buying the gas

announcement and the Tidewater 300, last GN event of the '70 season), the orphaned teams are looking for "investors" to replace Big Daddy Detroit. Now *everybody's* an independent. The little guys, who have been independents for years, may actually have an edge. Most of them have been getting along on a shoestring for years. They are used to fabricating their own parts and skipping lunch now and then.

The other big factor this year is the rule changes, the effects of which are yet to be revealed. The most important part concerns engines. The Automobile Competition Committee of the United States (ACCUS) has set the maximum engine size at six liters, or 366 cu. in., to maintain an equality of competition. The 366s will run with

one four-barrel carb with 1-11/16-inch venturis in a car weighing 3800 pounds minimum.

Additions to this rule make allowances for teams with investments in existing engines and bodies. The 426 hemis and 429 Fords (within the old seven-liter, or 430-cu.-in., limit) can still run this year, but with a carburetor-restrictor plate which cuts the venturi to 1¼ inches. Minimum weight for them is 3900 pounds.

And, get this, those 200-mph special cars—aerodynamic Daytonas, Superbirds, Talladegas, Cyclones—are also eligible, but their engine size is limited to a piddling five liters, or 305 cu.in.! They can run 100 pounds lighter this year (3800 pounds) and don't need the plate under a four-barrel 1-11/16-in. carb.

These rules are in keeping with ACCUS's intentions, announced two seasons ago, to establish the 366 rule without causing hardship on car owners who have an investment in exotic equipment.

By newsstand time it will be known who's running with what, but right now (Nov. '70), testing has only begun. Petty Enterprises has been running a '71 Charger with its hemi destroyed to the 366-cube displacement. Very likely, with the Holley four-barrel, it is getting as much or more horsepower as it would from the 426 with restrictor plate. The 366 free-breathing configuration should crank out over 500 hp while the plate has the effect of dropping hp of the big



CARBURETOR PLATE must be installed on 426 Hemis, 429 Fords. The 1¼-in. venturi, being checked with go/no-go gauge, restricts fuel/air flow to cylinders



CALE YARBOROUGH in the Wood Brothers Mercury Cyclone is an ex-factory driver. He's switched to USAC

displacement engines from around 600 to a bit under 500.

The "bit" varies from engine to engine as was found out during the 1970 season—the plate having been made mandatory by NASCAR just before the 400-mile race at Michigan International Speedway.

Teams will decide the way to go depending on their investment in engines and bodies and what they determine they can get from a 366 free-breathing versus an engine of 430-cube limit with the plate. The decreased venturi with the plate creates eddies in the flow of air and fuel through the intake manifold to the cylinders. Manifold design can help minimize, or straighten, the eddies, which has the effect of upping the hp.

Teams that elect to run the hemi may have an advantage over the 429 Fords in that the plate penalizes the higher revving Fords (greater air consumption), compared to the hemi with its higher torque and lesser need for air. Junior Johnson, one of stock-car racing's all-time greats, complained of this inequity after the National 500 at Charlotte last October—even though his driver, Lee Roy Yarbrough, won the race. Lee Roy "stood on it" all the way, but couldn't really run with the Dodges and Plymouths. He inherited the lead when they dropped out.

In the two short months between the end of the '70 season and Daytona (the first '71 NASCAR event, the Riverside 500, just run, is a road race) all the teams will have done intensive

development and testing for the best engine/chassis set-up for the super-speedways. But even near the end of last November, not all the programs were in full swing: David Pearson and A. J. Foyt, top Ford driver on the United States Auto Club stock circuit, had their testing of '71 Super Cobras squelched when they had to pack it in on orders issued from Ford. At least the independents won't have *that* happen to them.

In 1970 points standings, Bobby Isaac (first), Bobby Allison (second) and Richard Petty (fourth) were the only factory stars at the top. The rest of the point leaders were all independents: James Hylton (Ford), Neil Castles (Dodge), Elmo Langley (Mercury), Jabe Thomas (Plymouth), Benny Parsons (Ford), Dave Marcis (Dodge), Frank Warren (Plymouth), Cecil Gordon (Ford), Richard Brooks (Plymouth), John Sears (Dodge), Wendell Scott (Ford), Bill Champion (Ford). Steady finishers all, but only one triumph among them: James Hylton at the Richmond 500, and that only after running 188 GN events without a win!

Meanwhile, the list of top money winners for 1970 season includes only the big guys who've gone after the big-purse races in FACTORY cars. Will they win again this year? Or will the factory pullouts and ACCUS engine rulings, indeed, as Bill France predicts, equalize competition for all contestants? The starting grid for the Daytona 500 is anyone's guess. ★★



Leg stretcher

Two boards mounted on rollers and joined with two flexible cables make up a new exercise device that's intended to keep the user's legs in shape. The unit is called Shape-O-Matic, and, judging from the lady in the picture, lives up to its name.



Shark Hunter lives up to name

A 16½-foot tiger shark hangs above the submersible from which it was shot during a shark tournament off the Florida coast. The 1430-pound shark, largest of 69 killed during the contest, was shot by Pete Chase riding in a Perry Cubmarine *Shark Hunter*, with John Perry Jr., its inventor, at the controls. (See *Should Your Next Boat Be a Submarine?* page 75, Aug. '70 PM.)



Rubber bullets for rioters

British soldiers now are using rubber bullets to help stop riots. The large projectiles are fired from the same "gun" that they use for firing CS tear gas. The rubber shell is aimed at a depressed angle so that it bounces upward and tends to sweep the feet from under the rioter. The rubber bullets were first used in Hong Kong.



Tube for 250,000 talkers

The waveguide, a two-inch tube, will someday carry 250,000 telephone calls simultaneously. Buried, Bell's waveguide system will guide high-frequency radio waves carrying voice, data, TV and Picturephone signals.

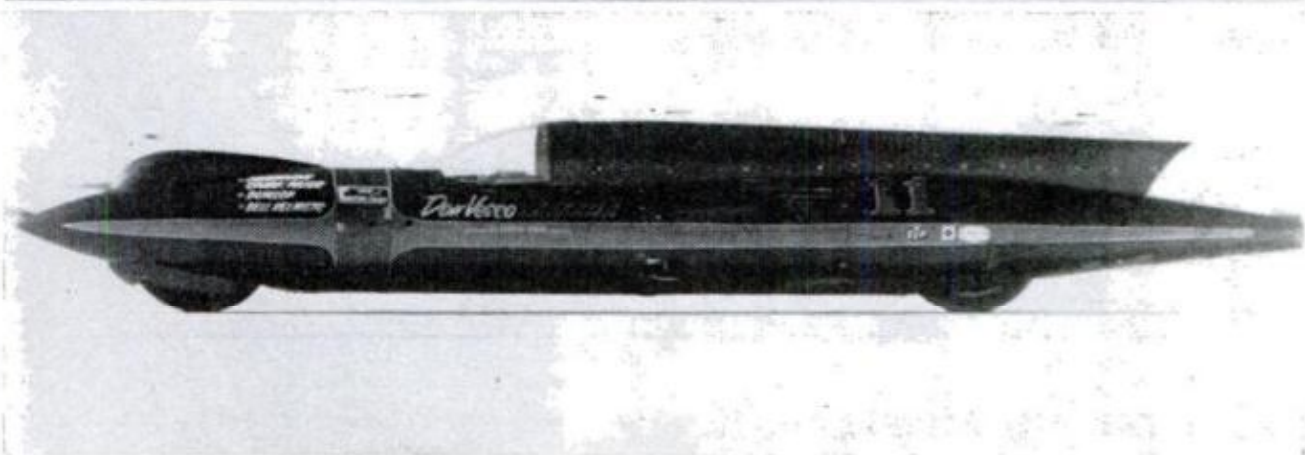

Fast and faster . . . and Harley holds the world record

Shortly after the Yamaha machine (bottom photo) set a land speed record for motorcycles of 251.924 mph, the Harley-Davidson (top photo) zipped over the Bonneville flats at a new world record of 265.492 mph. The Yamaha, powered by two in-line 350-cc Yamaha engines, was driven by Don Vesco. The Harley-Davidson, powered by one 89-cu.-in. Sportster engine, was driven by Cal Rayborn. The streamlined record-holder was designed and built by Dennis Manning, Long Beach, Calif. Its monocoque shell is 19 feet long.



Strap-in radio console

The Two-Way Consolette, designed by Lt. Arliss Boothe of the Iowa Highway Patrol, is simply strapped into the seat beside the driver to provide accessibility of radio and police equipment. It's made of Royalite.

FEBRUARY 1971



Midget car for town

A new German "city car" comes in two-seat and four-seat versions and features an aluminum frame covered with plastic-coated sheet metal. Engine options are 14 and 20 hp. The car was designed and will be produced by Walter Schatzle (shown).

Cassette or Cartridge: Which Tape



The battle still rages, with exciting new developments on both sides. Here's a look at some of the latest models with tips on which system may suit your needs best.

CARTRIDGE CHANGER

plays 12 8-track tapes consecutively—up to 13 hours' uninterrupted music. Qatron is priced at \$329.95, also comes in model for use in cars

HOW FAR CASSETTES HAVE COME is indicated by highly sophisticated 3M/Wollensak recorder designed especially for synchronizing sound tracks with slides. It's \$299.95



THE INTRIGUING MACHINES you see above on these pages are just two of the many exciting, imaginative designs manufacturers are coming up with to entice hi-fi buyers to either cassette or cartridge tape. On the left you have Qatron's slick, rotary cartridge changer capable of playing up to 12 eight-track tapes nonstop—13 hours of uninterrupted music without your lifting a finger. On the opposite page is Norelco's ingenious flop-over cassette changer that plays a whole stack of tapes on both sides, also providing a virtually endless music source.

Such highly sophisticated machines are an example of today's rapidly growing trend toward deluxe cassette and cartridge equipment. Whichever system you choose, one

Machine for You?

By WALTER G. SALM



FLIP-OVER ATTACHMENT for cassette changers (above) turns each tape as it's played so opposite side will play without your having to reverse the stack. Cassettes feed up and over a small ramp, returning to the stack upside down. This ingenious plastic accessory, sold by Norelco for \$19.95, fits several Norelco, Ampex and Bell & Howell changers

thing is clear—mini tapes have grown up from curiosities to serious hi-fi. The better machines rival reel-to-reel recorders in sound excellence and far surpass them in convenience. Many fine receivers and compacts now include a cassette or cartridge player as a basic part of the entertainment package. You can also get trim, tabletop tape decks that play cassettes or cartridges through your existing hi-fi system. Prices in the \$200 to \$300 range are not unusual for such high-performance equipment.

Cassettes and cartridges have fought valiantly to overcome inherent disadvantages in their respective designs. The problem has been one of basic

NEW 4-CHANNEL SYSTEM, developed by RCA, feeds four speakers simultaneously for rich, room-filling sound. Tapes are standard 8-track cartridges, but with four tracks recorded in each direction. Diagram at upper right shows how tape head shifts sideways to play each set of tracks. Idea is expected to spark new interest in 8-track cartridge format

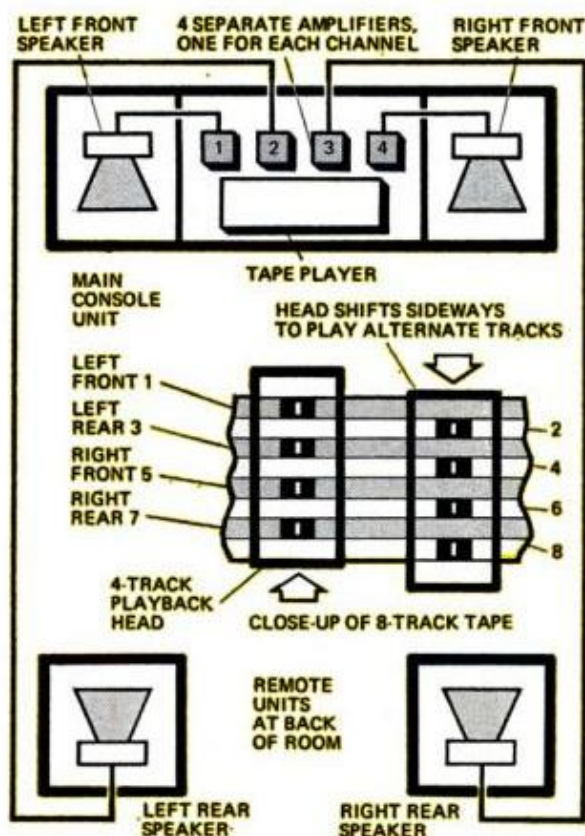



POCKET MODELS
GET SMALLER AND SMALLER

NOT MUCH BIGGER than a pack of cigarets, these mini-cassette recorders slip into a coat pocket for easy carrying, are ideal for camping and travel use. Westinghouse at left and Admiral at right are both \$89.95. Both also operate on batteries or a.c.



ADAPTERS
LET YOU PLAY
BOTH CASSETTES AND CARTRIDGES

BRIDGING THE GAP between cassettes and cartridges are adapters like these that let you play both. You slip a cassette into the adapter, then insert the adapter into a cartridge player. One at top is made by Boman-Astrosonix, one at bottom by Panasonic

FANCY NEW TABLE MODELS OFFER
ADDED FEATURES



Harman-Kardon CAD5
Cassette Deck



Panasonic
Essex Compact
with Cassette
Recorder



Panasonic
Manchester
Cassette Changer



Craig 3303
Receiver with
Cartridge Recorder

differences in concept and application. Cartridge machines were designed primarily for playing, not recording, and became popular when Detroit started building them into the dashboards on cars. Cassettes originated mainly for voice recording in small, portable models you could sling over a shoulder. Cartridges, readily reversible for playing in both directions, offered the multiple tracks needed for stereo; the early two-track cassette was basically monaural and not reversible. Cassettes were big for recording, cartridges for playing. It simply came down to which you wanted most.

Now both cassettes and cartridges are borrowing tricks from each other. You can record on eight-track cartridges and listen to stereo on four-track cassettes. Which you pick depends, somewhat, on what you already have. If you've invested in cartridges for a car player and want to hear them at home, you'll consider one of the many attractive cartridge decks or self-contained cartridge players that

TYPICAL OF TODAY'S high-quality cassette and cartridge systems are those swank, versatile table models designed for hi-fi installations. Harman-Kardon CAD5 cassette deck at top incorporates new Dolby noise-suppression circuitry, is \$229.95. Panasonic's Essex is complete entertainment center with cassette recorder, record changer and AM/FM stereo receiver. It's \$349.95 with speakers. Manchester model, also by Panasonic, is stack-loading automatic cassette changer for \$229.95. Craig model at bottom combines AM/FM stereo receiver with 8-track cartridge recorder that both plays and records in stereo. It's \$249.95, including speakers



GO-ANYWHERE PORTABLES COMBINE RADIO WITH TAPE

NEW HYBRID PORTABLES offer both AM/FM radio and built-in tape units in trim, play-anywhere models powered by batteries. All three shown here record as well as play cassettes. Ampex Micro-34 at left is \$119.95. Craig Model 2609 at center features a

swing-out right-channel speaker that can be removed for greater stereo separation. It's \$179.95. Panasonic Royal-Aire at right has optional bracket for car installation, is \$125. Adapters are available for operating portables at home on a.c. house current

include their own amplifier and speakers. Makers like Craig, Panasonic and Lafayette offer eight-track machines that both play and record in stereo—relatively new for cartridges. Prices range from under \$100 to about \$250.

If you're starting from scratch, you'll find a wider selection among cassette machines. Cassettes, steadily rising in popularity, have brought significant advances in technology. New record/playback heads with higher frequency response, improved tapes designed especially for the narrow cassette track width, and smoother transport drives powered by house current instead of batteries have all combined to give cassettes a strong boost over cartridges. Cassettes are also smaller, handier and hold considerably more material. Because of these characteristics, many ex-

perts believe cassettes will eventually elbow cartridges off the market.

Cartridges still hold an edge in one important respect, however—their frequency range is greater. They go up to about 15,000 cycles, compared to 12,000 or so for cassettes. This added response is generally unappreciated in the noisy surroundings of a car, but can be a plus in a hi-fi system. Manufacturers are still playing it cool. Most offer a variety of models in both cassette and cartridge formats as a safe hedge.

One recent development that's giving cartridges a shot in the arm is four-channel stereo, known as quadraphonic sound. Here, four tracks are recorded simultaneously. Each feeds one of four separate speakers—two at the front of the room, as in conventional stereo, and

(Please turn to page 172)

NEW IDEAS IN UNDER-DASH CAR PLAYERS

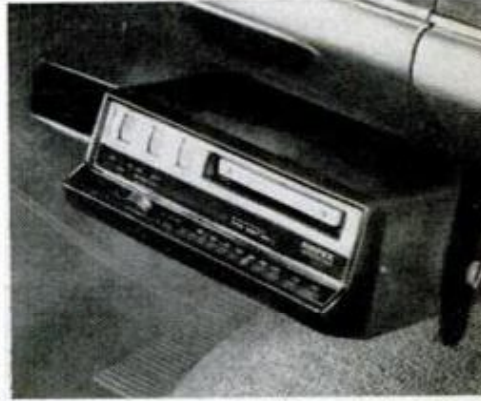

YOU CAN PLAY BOTH cassettes and cartridges interchangeably on the versatile two-way Aiwa model at left, above. Price is \$159.95. Novel floor-mounted Craig stereo cartridge player at center can be

locked against theft, is \$179.95 with optional FM stereo radio or \$119.95 without radio. At right, Ampex Micro-44 combines stereo cassette player and FM radio in one under-dash unit priced at \$199.95

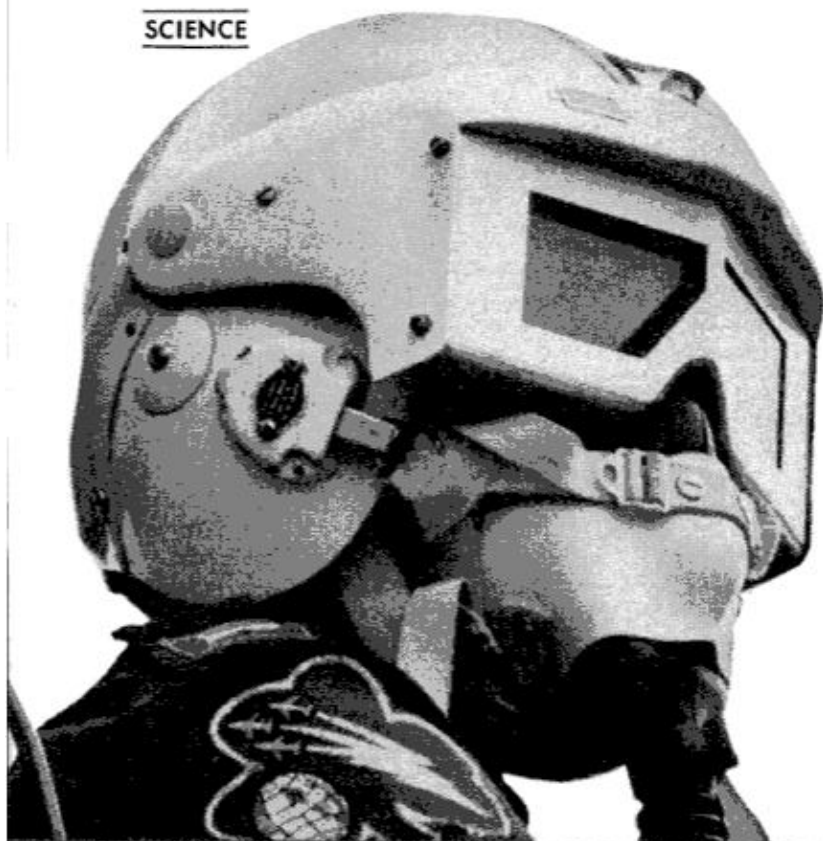

They Like 'Impossible' Jobs

EG & G spells 'Egg' in scientific circles, a company whose can-do eggheads will take on the tough ones whether they're deep down, close up or far out.

TO PROTECT AGAINST NUCLEAR FLASH, EG&G developed goggles with lenses that automatically darken

By NORMAN CARLISLE

A 175-POUND MAN, at least 10 pounds overweight, has finished a tough day at the office. On the way home he has a bad scare when a wild driver barely misses his car.

How does the man's heart react? What does the sudden stress do to his blood pressure? In a laboratory near Washington, D.C., scientists and engineers have whipped up a machine that shows exactly how the human circulatory system reacts in this situation.

- Off the coast of Massachusetts, a mile down in the dark waters of the Atlantic, lies the lost *Alvin*, a tiny research sub that sank in an accident. Hopeless search? Not at all. Men aboard surface craft have a marvelous seeing eye—a camera and light system that takes thousands of brilliantly detailed shots of the sea floor and spots the lost sub.

- Neil Armstrong and Edwin Aldrin rise from the moon's lonely surface to rendezvous with the spacecraft that will take them back to earth. How do they spot the command module? By a

brilliant light that's on it, a powerful space beacon put together by a group of scientists in Massachusetts.

Remarkable as these scientific activities and achievements are in themselves, even more remarkable is the fact that all the scientists and technicians work for the same research organization. And 10 to 1, it's an outfit you've never heard of, though it represents one of America's biggest aggregations of scientific brainpower, with 10,000 employees in labs and installations across the country, from Bedford, Mass., where it's headquartered, to Santa Barbara, Calif. It's EG&G—called, understandably, "Egg" in scientific circles. The initials are those of three electrical engineers from MIT—Harold Edgerton, Kenneth Germeshausen, Herbert Grier—who founded an instrument firm after World War II.

It really began with a hobby of Edgerton's—photography, a field in which the adventurous scientist started probing two new realms, high-speed

and underwater picture taking. He and his associates developed a superpowerful stroboscopic photography system that amazed the world with its millionth-of-a-second exposures using flashes of electronic light.

As use of the equipment spread, the three found themselves so busy helping out fellow scientists that they decided to set up a company. Soon government and industry were tossing all kinds of instrumentation problems at the can-do scientists and the bright young men they had gathered around them.

One thing led to another. Jobs EE&G took on demanded special hardware, complicated stuff no one was making. So, the company found itself producing mechanical sealing units for use in submarines, spacecraft, and the savage environments of chemical plants; acoustic transducers that pick up undersea sounds; medical devices, like an electronic artificial arm (*The Amazing "Boston Arm,"* page 102, Mar. '69, PM).

Today, highly sophisticated EG&G strobe systems are versatile tools of modern scientific photography. They played the key role in the greatest sea search in history, when 40 ships with 6000 men scoured the Atlantic in 1963 for the lost submarine, *Thresher*. With hardly a hint as to its location, predictions had been made that the sub would never be found.

When Adm. Thomas Moorer made the terse announcement, "The submarine's location has been confirmed by means of remotely controlled underwater photography," he was referring to EG&G's underwater camera, strobe and seismic system. Housed in a shell that can withstand the pressures of the ocean deeps, the unit can take 4000 underwater pictures without being brought up for reloading. What makes it possible at all is the powerful strobe that lights up the sea. This same rig spotted the *Alvin* (*How We Raised the Alvin From 5000 feet,* page 92, Jan. '70 PM), and the ill-fated *Scorpion*.

Another EG&G strobe enabled the astronauts of Apollo 11 to take stereo-



ARMED WITH COMPUTER and \$150,000 worth of instruments, scientists in plane study the atmosphere

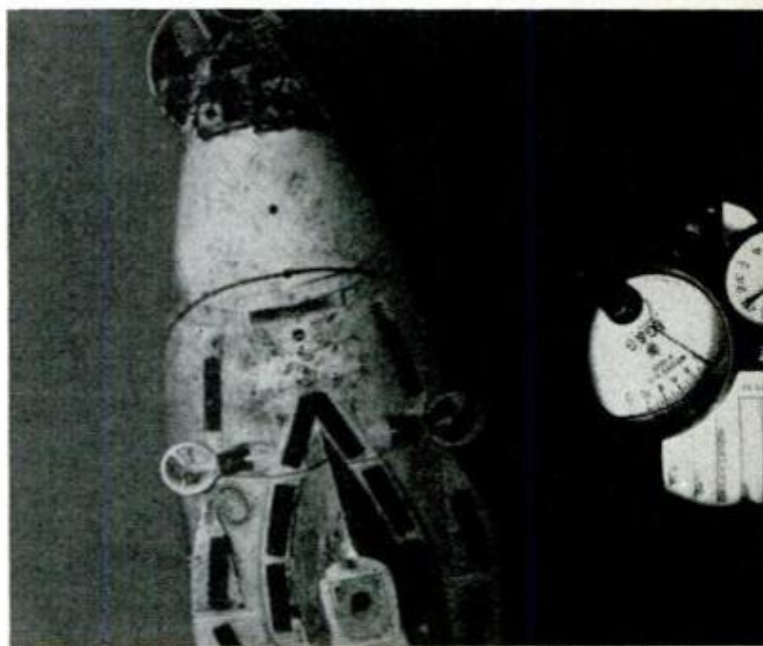

SHARP-EYED CAMERA spotted *Alvin* at 5000 feet. Camera's time and position dials appear at right

SHOT OF SEA FLOOR at 10,000 feet was made by EG&G's amazing camera during search for *Scorpion*



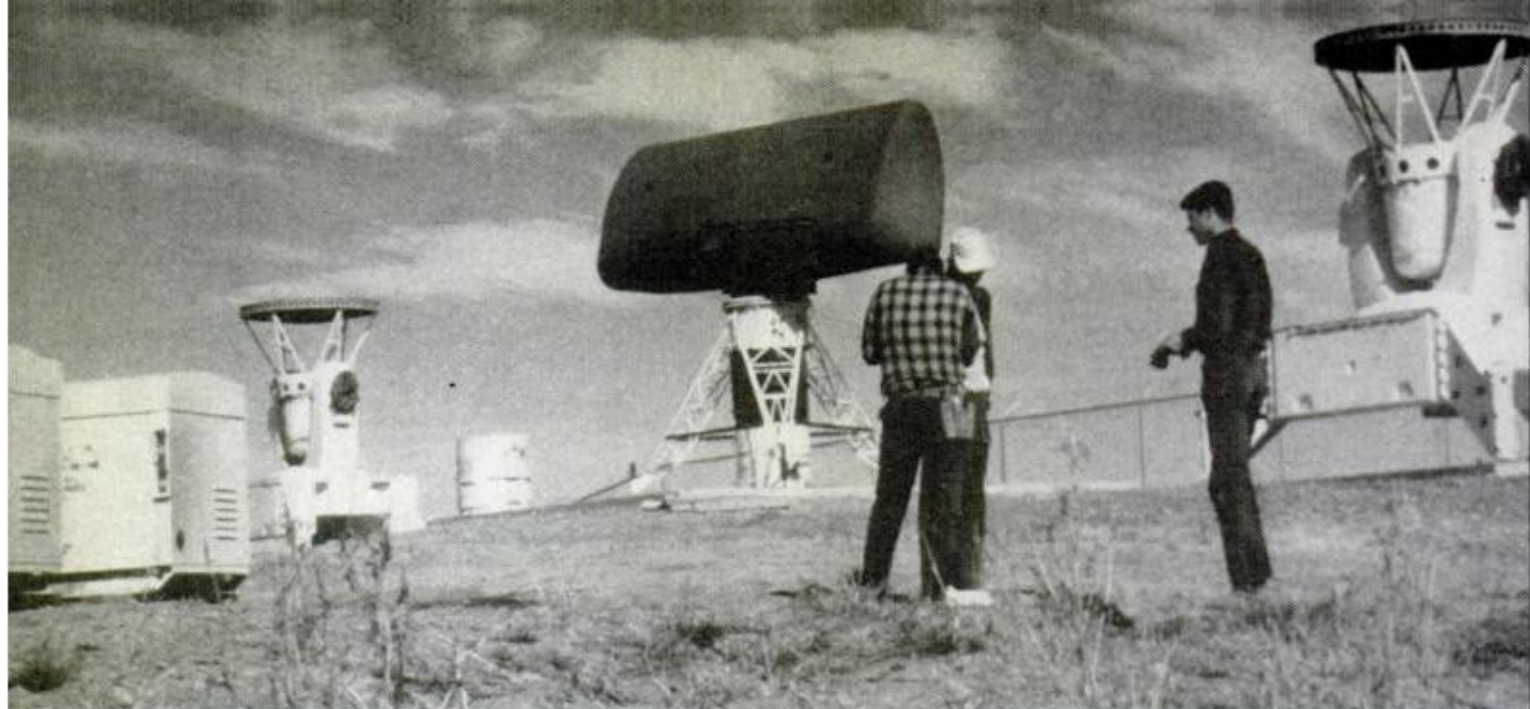

RADAR INSTALLATION IN COLORADO is used to track high-flying balloons for wind computations and to scan for precipitation echoes. Work is part of research involving the seeding of wintertime snow clouds

scopic close-up pictures of the moon's surface. Shortly before the epic flight EG&G got a rush call. NASA scientists had decided that for the close-ups that would be taken by a Kodak-designed camera they'd need a controlled light source with known conditions of color, quality and intensity. Did EG&G have a strobe that would serve the purpose? One weighing no more than a pound?

"We don't have one, but we'll make one," promised Claude Brenner, general manager of the Bedford labs.

In 90 days, NASA had its strobe—a tiny item that weighed in at exactly one pound. On the historic moon flight it did its job, delivering 400 footcandles of illumination onto a three-inch square of lunar surface in flashes lasting 250 millionths of a second.

The EG&G engineers had more time to develop another strobe that played a big part in making the Apollo 11 rendezvous in space possible. From the days of Gemini on, powerful strobes have provided the flashing beacons that help guide spacecraft. The beacons can easily be spotted up to 50 miles away, showing as brilliant points of light much brighter than the stars.

Off Sandy Hook, N. J., where a lightship once was anchored, stands a tower topped by a new kind of light that guides ships toward New York

harbor. It's an EG&G strobe, which, from dusk to dawn, flashes 20,000 times with 600,000 candlepower. That's on clear nights. When the fog clamps down, the brilliance automatically steps up to 6 million candlepower. The complicated arrangement of xenon flash tubes, reflectors and controls, which took years of development, works so well that the Coast Guard is replacing all other types of beacons with strobes.

Brilliant as this light is (the most powerful earlier lights could produce only 2.5 million candlepower) it can't hold a candle to EG&G's greatest triumph of brilliance—the superpowerful strobe beacons at Woods Hole, Nantucket and Martha's Vineyard, Mass. These lights, which guide ferries across narrow, treacherous channels in the heaviest fogs, turn out an amazing 60 million candlepower!

One of the most difficult jobs EG&G ever undertook was that of finding a means, not of creating brilliant light, but of keeping it out. The Air Force needed goggles that would automatically close when subjected to the light from a nuclear detonation. A man could easily be blinded by such a flash at distances much greater than those at which he'd be harmed by shock waves or radiation.

"This was a tough one," says slow-

spoken, thoughtful Kenneth J. Foster, engineer who started the project. "We had to go into a lot of fields—ophthalmology, optics, atmospheric transmission of light, chemistry, electronics, mechanics, nuclear effects and even human engineering."

Requirements were exacting. Needed was a shutter that would close within 100 microseconds of the detonation and open within a few seconds afterwards so the man with the goggles could continue with his work. The shutter had to be reliable under all light conditions, from full sunlight to darkness. It had to tell between light from nuclear sources and ordinary light.

EG&G came up with a goggle system employing chemistry and electronics. The active material in the shutter is a small quantity of a photochromatic chemical in solution. The solution, ordinarily clear, becomes colored when exposed to ultraviolet light emitted by two xenon flashtubes responding to the flash of a nuclear detonation.

The goggles are a relative of an earlier device that rates as one of the most complex pieces of gadgetry in the EG&G arsenal. After World War II, during which Edgerton, Garmeshausen and Grier applied their electrical wizardry to the Manhattan Project, the AEC wanted pictures of nuclear bombs at the moment of explosion. But the blinding light of a nuclear blast makes a conventional camera useless.

EG&G solved the problem by inventing a shutter called the Rapatronic. The shutter includes a coil of wire wrapped around a cylinder of glass placed in front of the camera lens. When the nuclear weapon is triggered, a pulse of current is released from a strobe condenser unit. The current rotates the polarized glass cylinder, allowing light to pass through for as little as one microsecond. Using this device, EG&G scientific crews went to Eniwetok Atoll to take the first pictures of an H-bomb being detonated.

With their expertise in sensitive trig-

(Please turn to page 114)

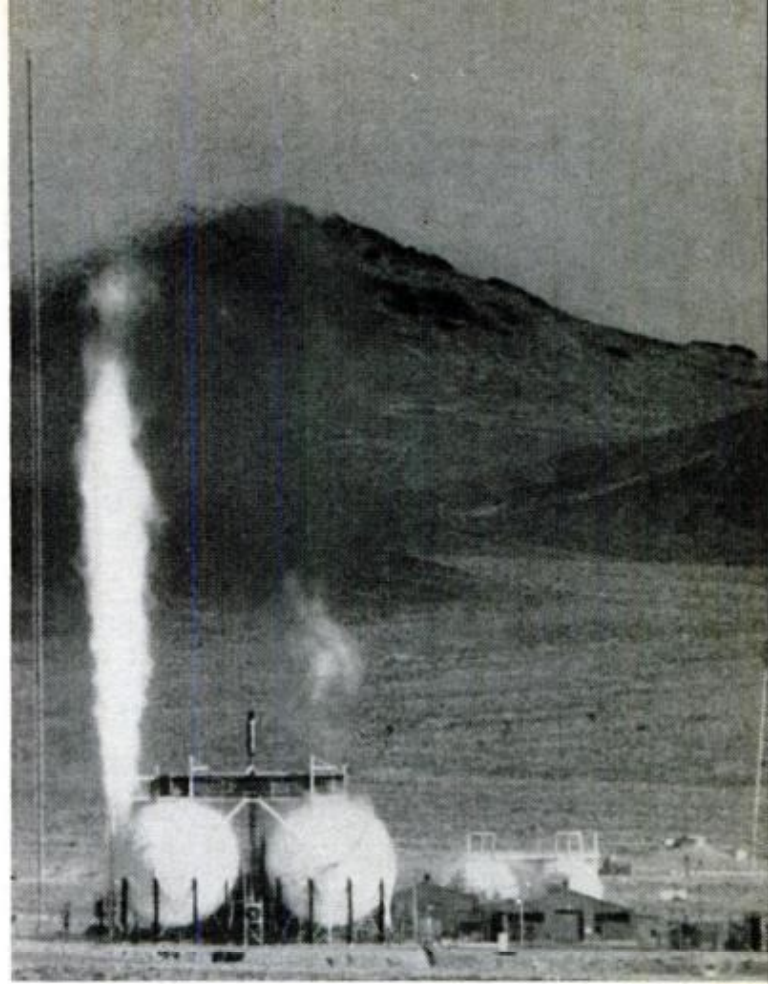

EXHAUST ROARS SKYWARD in desert during test in program to develop atomic power for space flight

BATTERY OF SENSITIVE DETECTORS on plane can pinpoint radioactive sources hundreds of feet below





DANGER IN THE HOSPITAL

In the growing field of medical devices, there are no standards of safety or performance. Until they are established, hospitals will have no guarantee that equipment will operate properly—or even that it won't kill you

By ARTHUR S. FREESE

Technical Art by Fred Wolff

THE MAN was in his mid-forties and the doctors were fighting his cancer with radiation. Now he lay on the table awaiting a treatment. The massive X-ray machine was ponderously lowered over his chest—only this time the unit didn't stop when the switch was thrown. Before the technician could get across the room to the circuit breaker, the patient had been crushed to death.

the operating room of a hospital in the Washington, D. C., metropolitan area. Her routine thyroid surgery had been successfully completed and the surgeon was sewing up the wound. The doctor turned off the anesthesia machine. But there was an electrical spark—and an explosion whose full force hit the woman. Four-and-a-half hours later she was dead.

A woman in her mid-sixties was in

On the West Coast, a whole series

CALIBRATING AND TESTING operating room equipment at Downstate Medical Center, Brooklyn, N.Y., is daily occurrence. Seymour Ben-Zvi, director of Scientific and Medical Instrumentation, checks the TV monitor

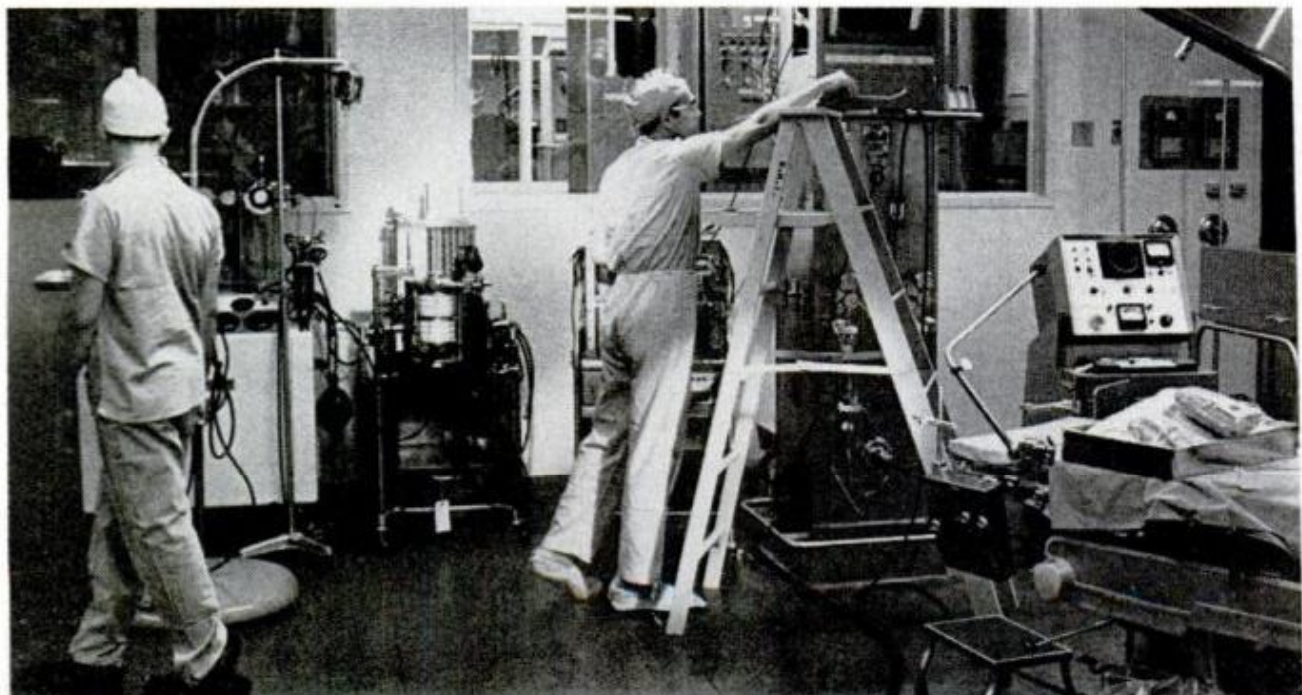

of broken hips was repaired with a ball-pin device in which the ball was nylon. The plastic reacted with body tissues to form abscesses that failed to heal. Additional surgery was required.

A patient in a large East Coast hospital was operated on with an electrocautery while an electrocardiograph was attached to monitor the heart. When the operation was satisfactorily completed and the electrocardiograph leads removed, deep third-degree burns were discovered underneath one of the leads. It was even difficult to tell the extent of the burn at first because these tend to mushroom out and form a cone whose broad base is deep inside the tissues while the opening on the skin remains small—slow and hard to heal.

A large operating-room monitoring oscilloscope was recently returned from a factory-authorized service station. When first turned on, it caught fire.

There have been artificial kidney machines which poured distilled water into the veins of patients, artificial heart valves with surface defects so that blood clots formed in these faults, metal implants—bone plates and screws—that broke or corroded in the body tissues, mechanical hip-joint replacements of such poor quality that additional corrective surgery was required. The plastics doctors use—both

inside and outside you—are only commercial-grade—none are specially made for medical purposes. Dr. Joseph Davis, director of Div. of Clinical Medical Devices of the Food and Drug Administration, told me he believes this is definitely dangerous and the reason patients get toxic reactions from plastic implants.

Even hospitals in major medical centers have admitted they have no central surveillance and testing by trained engineering personnel of medical equipment when it is delivered to the hospital. So it's not surprising that the experts speak of accidents in terms of 5000 patients being electrocuted annually—others of 10,000, 25,000—pick your own figure, no one can really dispute it. As Dr. Davis explained to me: "We know there are at least 5000 different medical devices, perhaps as many as 25,000. So out of 25,000 different type devices with X number of each in use, I think you would be hard put to say an occurrence couldn't occur with each device."

Yet in only a very few hospitals across the country (some say in only *one*) is there a department with trained personnel who routinely check every piece of medical equipment when it arrives and before use, then follow up with proper, regular maintenance. In

DEFECTIVE OXYGEN FLOWMETER on new equipment delivered to hospital as discovered by Ben-Zvi team. Defect allowed oxygen to bypass meter. Patient would have received 36 times more gas than meter indicated

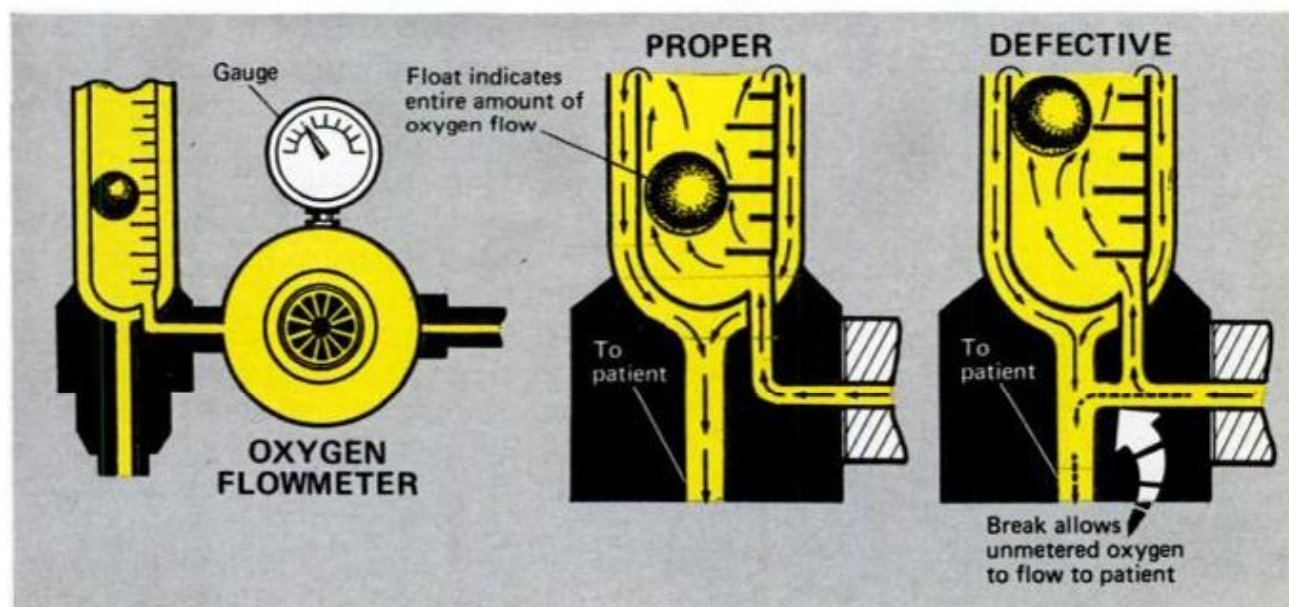

this one hospital's department, for example, technicians obtain the operating-room schedule for the coming day and go over every unit of sophisticated surgical equipment to be used.

This unusual department is located at New York's Downstate Medical Center where Seymour Ben-Zvi is director of scientific and medical instrumentation. His department of two dozen people, including five engineers, tests every piece of equipment, when it arrives, to make certain it meets manufacturer's specifications and is safe and in good working condition. His precautions have repeatedly paid off.

Not long ago a shipment of 10 defibrillators arrived. These are electrical devices which literally "shock" a wildly beating heart back into its normal rhythm by delivering a 7500-volt short-duration pulse. Actually a simple instrument, it consists of a circuit which charges an oil-filled capacitor. The physician or nurse presses two paddles against the patient's chest. Pressing the discharge button causes a relay to switch the capacitor from the charging circuit and pour its full voltage into the patient. All 10 devices were de-

ELECTRONIC EQUIPMENT simulates patient in test of electroencephalograph (brain wave analyzer) in lab

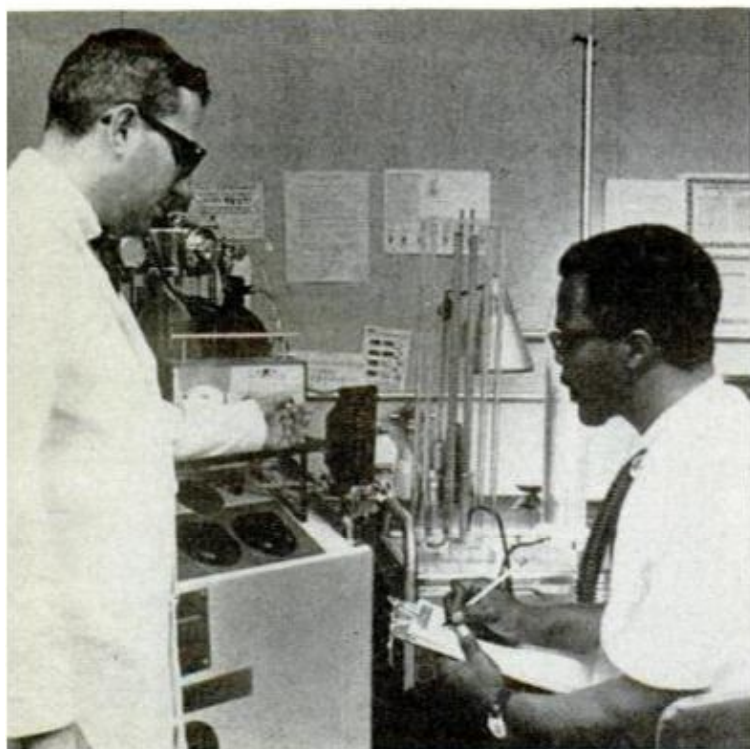

fective—and dangerous! They had improperly degassed vacuum relays and their capacitors discharged without having the discharge button depressed. The devices could have been fatal to both operator and patient. One manufacturer's representative assured Ben-Zvi that the company stood behind these machines and would be happy to replace any defective ones.

"But how will they replace the dead patient, or physician, or nurse?" asked Ben-Zvi.

Dr. Joel J. Nobel—scientific director of Philadelphia's Emergency Care Research Institute, also an authority in this field—points out that every one of the estimated 50-million people who annually enter U.S. hospitals has contact with medical instrumentation. If you have a heart attack you will be in close contact with nearly 400 different medical devices during your three or four-week hospitalization. If you are an average adult and enter a hospital for gall bladder surgery, you will be directly involved with over 600 devices, and if your child has his tonsils out he will be in contact with almost 200.

Dr. Nobel says that 30 to 40 percent of device failures are operator errors. There are more problems than just accidents—electrocardiographs which, in private offices, don't provide correct tracings because they're not calibrated, and instrumentation which gives incorrect diagnostic information. But Nobel believes it is possible "to set up failure systems so that when things do fail they fail in a safe position rather than in a dangerous position" and "to do many things to make instrumentation much safer, both on the part of industry and on the part of the hospitals and designers."

Ben-Zvi's unit at Downstate Medical Center checked several thousand pieces of incoming scientific and medical equipment in the past two years. About 40 percent of all those delivered were defective. These ranged from simple, but dangerous, inadequacies, such as lamps on extendable arms

CONTROL ROOM adjoining operating room of Downstate Medical Center contains array of electronic monitoring equipment typical of that found in most modern hospitals. Ben-Zvi and technician run daily maintenance checks on equipment before operating room is used

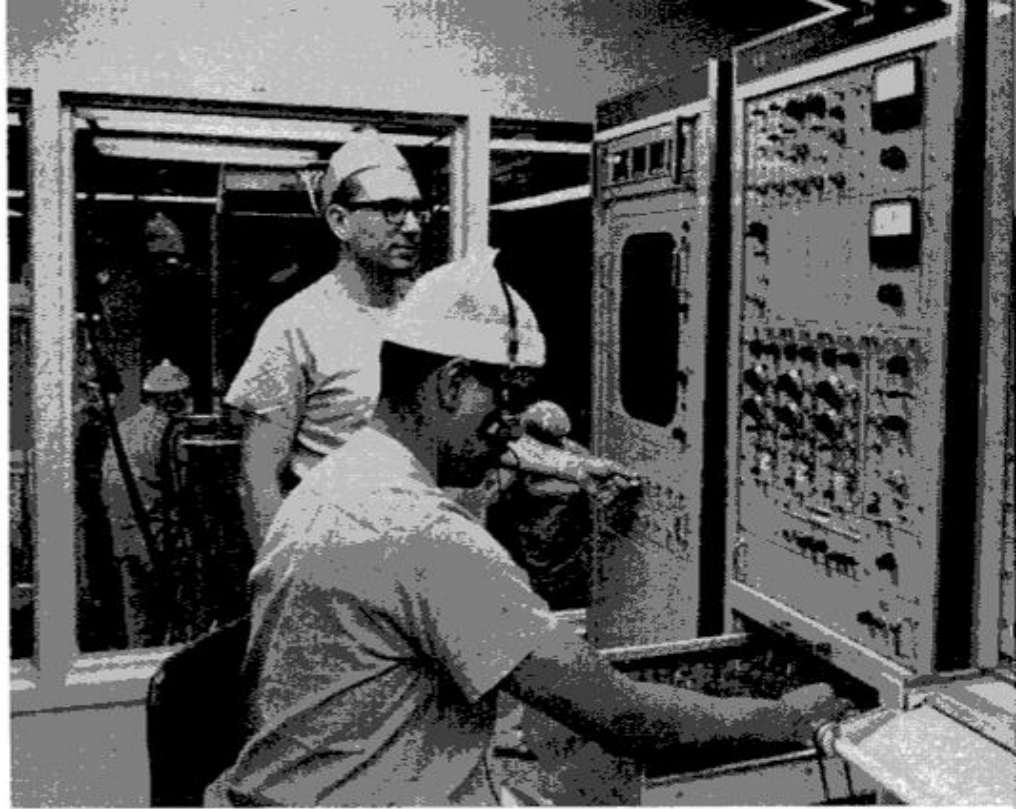

whose strut mechanism eventually severed its own electrical cord, to defective flowmeters which delivered 36 times more oxygen than the meter indicated—enough to explode a patient's lungs or do other damage, depending on the use to which this versatile equipment is put. Mechanical failures included devices not properly assembled, castings not checked before delivery, and other problems due to inadequate quality control—the same slipshod quality we find in our everyday lives, except that in medical devices this becomes a matter of life and death.

As Ben-Zvi explained it, there are two types of electrical hazards—the macro and the micro-electrical shock. The macro-shock is the big jolt you get when you touch an exposed power line in your house. It electrocutes by actual tissue damage and heart fibrillation—an uncontrolled wild runaway beating which is so inefficient that the body cannot be adequately supplied with blood. In a minute or so, permanent brain damage can result and in about three, death. Micro-shock, predominant in the medical environment, is a newer hazard. It has been proven that as little as 20 microamps. (millionths of an amp., really a microscopic amount of current) of leakage current flowing through the heart is enough to

produce fibrillation even though it takes a thousand times this current to light the smallest incandescent bulb.

Ben-Zvi describes micro-shock as “an evasive sort of shock—evasive to the medical person who is not knowledgeable about the technical causes.” But a patient may die if fibrillation is not detected in time, as often happens. Most scientists working in this field agree that this internal electric shock is a subtle hazard that escapes recognition by most physicians. Accurate statistics on the accidents caused by medical devices will not be available until the law requires reporting of these deaths and injuries in every instance.

Responsibility for the lack of medical instrumentation safety is said by those in the field to be shared equally by government, manufacturers and medical profession. There is general agreement that federal legislation is essential but many are pessimistic about the chances for passage of current legislation. As Ben-Zvi puts it: “It always gets bogged down somehow.” In the last analysis it will be the public's demand for protection that will determine the fate of any effective legislation to insure the safety of medical devices and equipment. Until passage of such laws, you are in danger nearly every time you enter a hospital. ★★★

Wrap a Ring Light Around

These circular electronic flash attachments are just great for giving an even, shadowless light, but they aren't for all shooting. Here's what you ought to know about them

ONE OF THE STRANGEST-LOOKING PIECES of photographic equipment is a small, circular electronic flash tube, called a ring light, that literally wraps itself around the front of your camera lens. The effects it produces are as startling as its appearance. Harsh shadows, a major shortcoming of conventional top and side-mounted flashguns, magically disappear with a ring light. The result is a soft, smooth, uniform illumination that can eliminate many of the problems of ordinary flash.

Ring lights are made in models to fit most 35-mm single-lens reflex cameras. While they're not the answer for all flash shooting, they can be a handy aid if you do a lot of close-range photography. Regular flashguns throw their light downward or sideways across the subject, causing irregularities like a nose, chin or ear to cast deep shadows on the unlighted side. Such shadows block out detail and create a harsh, contrasty picture.

Because a ring flash surrounds the lens, it floods the subject with light from all directions at once. Light from one side automatically cancels out shadows that would normally be cast by light from the other side. Since the light encircles the subject, virtually no shadows can form at any point. The beam is also spread out instead of being concentrated in one spot. This avoids the washed-out detail and hot spots you frequently get with conventional flash at close range. Thus a ring light is ideal for shooting close-ups at two to four feet. The even, shadowless illumination brings out detail and is perfect for small tabletop objects, models, insects, flowers, coins, stamps and similar subjects. It's also useful for certain types of portrait photography. Four typical ring-light models



THREE TYPICAL FLASH RINGS are, left to right: Prinz Minicam Multi-Pak, \$59.95; Nikon SR-1, \$82.50; and Honeywell Prox-O-Lite 6A, \$49.50. Both Nikon and Honeywell units require a separate power supply, while the Prinz Minicam comes with self-contained power supply operating from batteries or house current

Your Lens

By **BURT MURPHY**

Photos by Robert D. Borst

CIRCULAR FLASH TUBE, fitted over camera lens, bathes subject in light from all directions at once. Drawings at lower right show how this cancels out shadows normally produced by conventional top or side-mounted flashgun. Model shown on camera here is Aimes-Hershey Sun Ring priced at about \$50

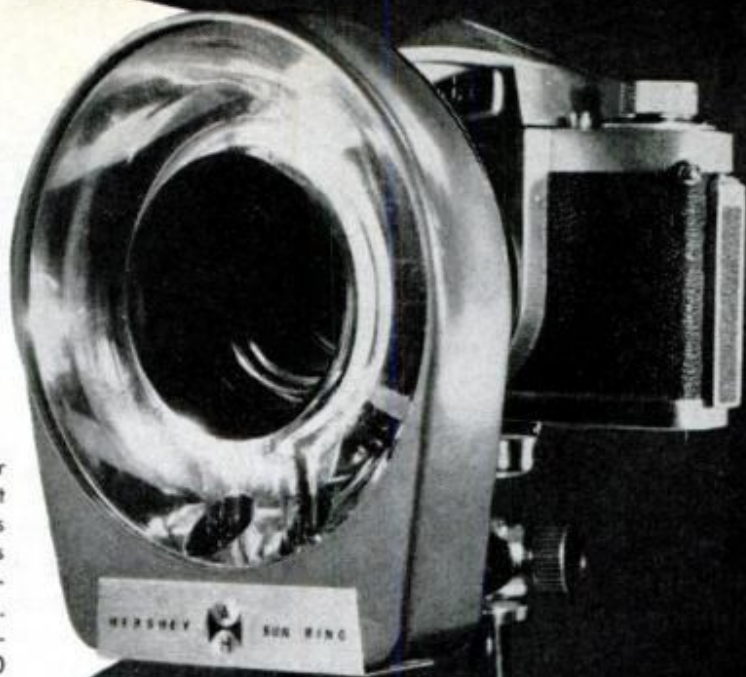

are shown here. These are the Nikon SR-1, Honeywell Prox-O-Lite 6A, Prinz Minicam Multi-Pak and Aimes-Hershey Sun Ring. Prices range from about \$50 to \$85. Each ring screws directly into, or slips onto, the end of the camera lens to hold it in place. For this reason, it's important to pick a model that will fit the lenses you have. The Nikon SR-1 is designed primarily for use with Nikon cameras and the Honeywell Prox-O-Lite for use with Pentax

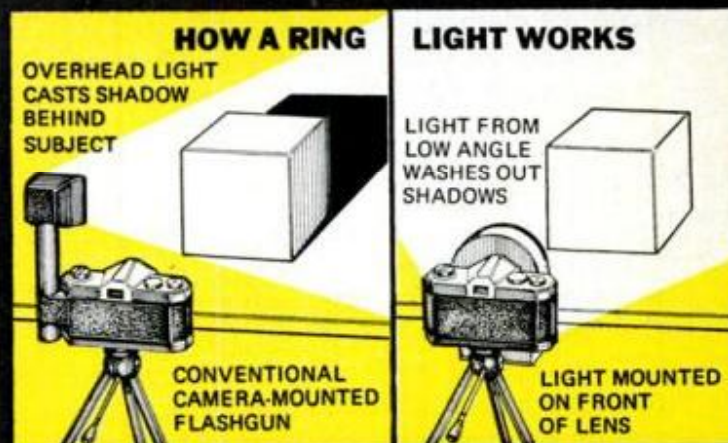

cameras. Both, however, can be fitted to some other makes with adapter rings. Before choosing either model, be sure that such adapters are available for your camera. The Nikon SR-1 fits



HOW RING FLASH COMPARES with regular flash is shown above. Photo at left, made with conventional top-mounted flashgun, shows strong contrast with deep shadows under boy's chin and ear. Ring flash (center) eliminates shadows, but is still contrasty. For a softer effect, ring can be used as fill light (right)

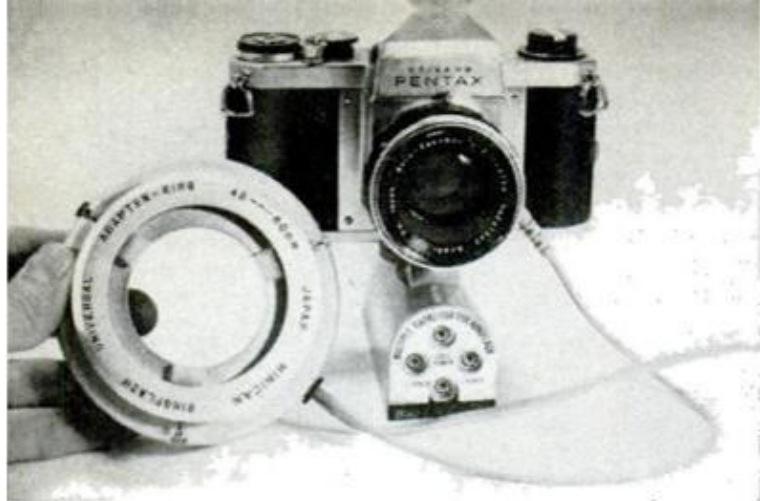

MINICAM RING LIGHT has its own power supply, shown attached to base of camera in photo at left.

52-mm lens threads with a Nikon F mount. The Honeywell Prox-O-Lite is sized for 41-mm lens threads.

The Prinz Minicam and Aimes-Hershey Sun Ring are both designed to fit a variety of cameras. The Minicam has an adjustable clamping arrangement that can be varied to suit lenses 48 to 60 mm in diameter. The Sun Ring is threaded to fit a standard Series 7 or Series 9 filter holder. With adapter rings, it can also be mated to a Series 5, 6 or 8 filter mount. Series mounts are, in turn, available to fit most common lens sizes, either by screwing them in or slipping them over the barrel.

Your choice will also be determined, to some extent, by what electronic flash equipment you already have. This is because all but one of the units require a separate power supply. If you own a conventional strobe flash, you may be able to use its power supply to operate a ring light. If not, you'll have to purchase a power supply suited to the ring you select.

The Nikon SR-1, for instance, must be used with a conventional Nikon SB-1 Speed Light flashgun as the power source. The Honeywell Prox-O-Lite can be used



Plug-in jacks give choice of full, half or quarter output. Adapter for a.c. is shown in photo at right

with either a standard Strobonor flashgun as the power source or a separate power pack. However, the power pack is expensive—about \$80—and probably not worth the investment for occasional use. You're better off powering the ring from a conventional gun so you have both to work with.

The Aimes-Hershey Sun Ring can be operated from several battery or a.c. power supplies made by Aimes-Hershey or from some power supplies made by other manufacturers. It's designed for a 450-volt source with a 25 to 200 watt/second range. If you already own a power supply, check its specifications to see if it is suitable for use with the Sun Ring. The ring's connecting plug may fit other makes of power supplies, or you may find you need an adapter.

The one exception to the separate power requirement is the Prinz Minicam—a free bird, not tied to other units. It has its own power supply—a capacitor in a small housing that screws onto the base of the camera and a battery pack. You can also operate it on house current with an a.c. adapter. The Minicam is thus a good choice if you don't already have a



HOW SHADOWLESS LIGHTING improves appearance of small objects is shown here. In close-up of coin at left, details stand out clearly. In comparative

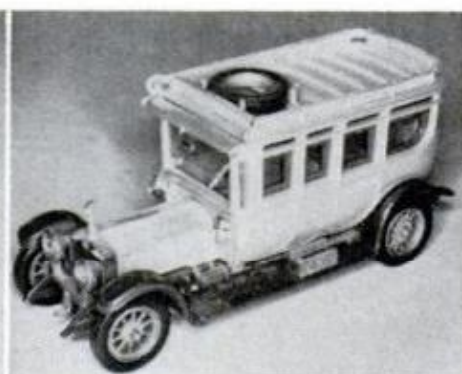
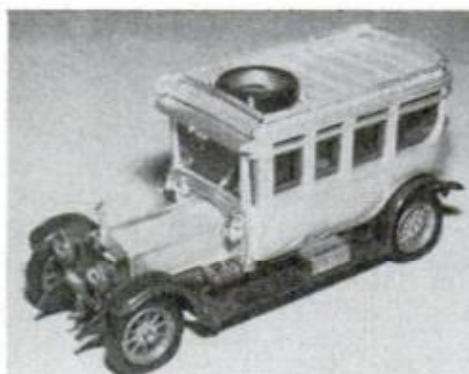

shots of model car, left-hand one, made with photo-flood, shows distracting shadows, while right-hand one, made with a ring light, is free from shadows



HONEYWELL PROX-O-LITE can operate from Strobunar flashgun (center) or a power pack (upper left)

conventional strobe flash or other power source.

The amount of light you get from a ring flash can be varied with most of the units, and this is a handy feature to have. It lets you reduce the brilliance of the flash at very close ranges to avoid overexposing the subject and washing out detail. A switch on the Nikon SR-1 gives you a choice of full or quarter output depending on your shooting distance. The Prinz Minicam has interchangeable connections that offer full, half or quarter output. The Aimes-Hershey Sun Ring can be operated at three or four different intensities depending on which power supply you use. Honeywell's Prox-O-Lite can be regulated for high, medium and low output when used with a power pack, but is limited to full output only when powered from a Strobunar flashgun.

Exposures with a ring light are determined in the same way as for conventional flash except that they become a little trickier at very close ranges. Manufacturers supply guide numbers for different ASA film speeds and different levels of light output. You select the appropriate number for the film speed and output level you're using, then divide it by the lens-to-subject distance in feet. The result is the correct lens f/stop to use. Shutter speed always remains fixed at the X synchronization setting as with regular strobe flash.

At close ranges below four feet, it's wise to bracket the indicated exposure by at least one f/stop on each side. For maximum depth and sharpness, it's usually best to use the smallest lens openings you can. However, if your exposure calculations work out to require a smaller

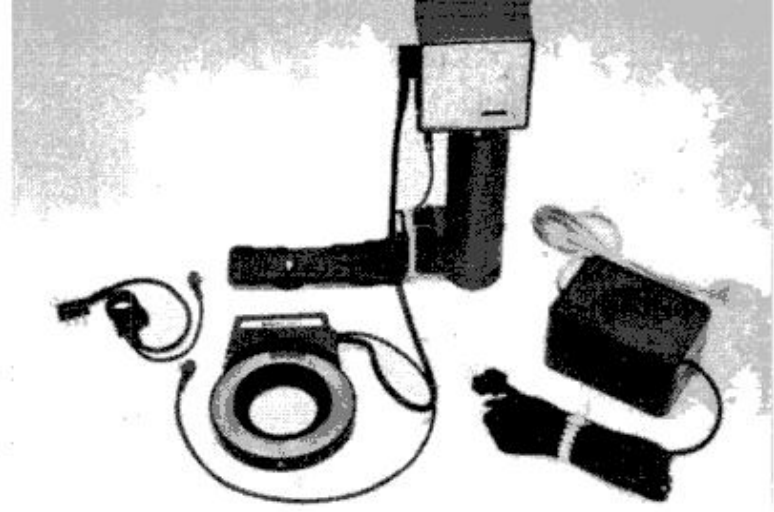

NIKON RING LIGHT plugs into a regular Nikon gun for power. Adapter for house current is at right

lens opening than you have available, it indicates that your light output is too high and that your subject will be overexposed. In this case, drop down to the next lowest output level and recalculate the exposure to find the appropriate opening.

A ring flash is ideal for candid close-ups where a conventional flash would be too overpowering. Its light is cool and instantaneous. Pets and children who won't sit still under hot, glaring floodlights can be caught informally and spontaneously with a ring flash. Delicate things that melt or wilt under intense heat, like plastic objects or flower petals, are other good candidates.

Ring lighting does have some drawbacks, though. By its nature, it tends to be flat, cold and clinical. It's good for recording precise details, but not for adding warmth and depth. By eliminating shadows, it also eliminates delicate modeling. Where you need highlights and shadows for contrast and character, you must go to floodlights or off-camera flash.

Ring lights also have a peculiar effect on eyes. The circular flash is reflected back into the lens, giving the pupils a strange, unnatural look. This makes a ring light unsuitable for formal portrait photography. For candid shots, you can solve the problem by catching your subjects at an angle or asking them to look away from the lens. You can also use ring flash as a fill-in along with sunlight or other light source for the main illumination. In this case, you expose for the main light rather than the ring. The ring light will soften shadows without flattening the whole picture.

A ring light can be fun to experiment

(Please turn to page 198)



Japanese electrics

Battery-powered vehicles bearing the names of some of Japan's largest manufacturers made a strong showing at the recent Tokyo Motor Show. Honda displayed an electric three-wheeler (upper left). Toyo Kogyo's EX005 (lower left) is a hybrid experimental car with electric power for the city and a rotary engine for highways. At top right is Toyota's Commuter three-wheeler; at lower right is the Nissan 315-A, both built for two.



Smile for the camera

If you were 140 times smaller—or ants were 140 times larger—this is how one of the little beasts would appear in a face-to-face confrontation. This remarkable portrait was made with a scanning electron microscope at the General Electric Research and Development Center, Schenectady, N.Y. It shows the ant 140 times natural size.



Press box on wheels

Finding it impractical to build a permanent press box, officials of Northwestern High School, Darlington, Pa., built this portable model. They store it behind the stands between games.

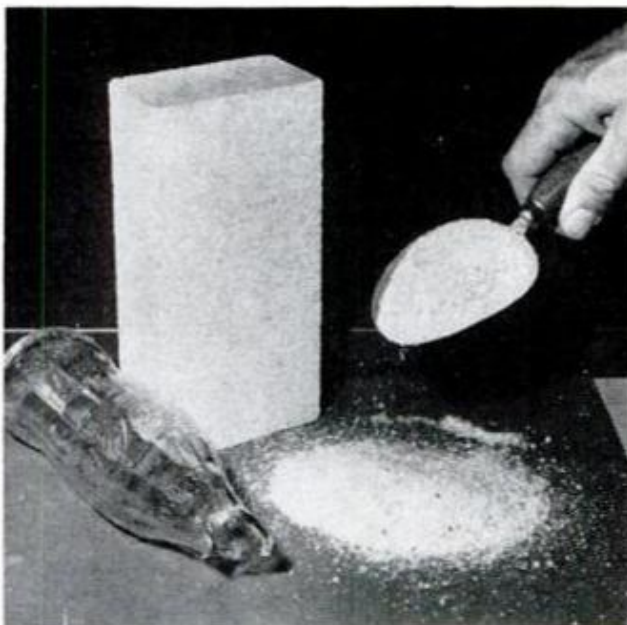

Bricks from bottles

Bricks are being made from glass bottles by a new process developed by T-A Materials, Palisades Park, N.J. Ground-up glass is mixed with cement, treated in a chemical bath, then pressed in a high-compression mold. Bricks air-cure in a couple of days.

FEBRUARY 1971



Awfully high C

There wasn't much of an audience for this concert by the Falcons, the RAF's parachute team. They played for 60 seconds, opened their chutes and landed in a 30-foot circle.



The running board's back

The Metro-Cab, a new taxicab being tried out by London General Cab Co., has a fiberglass body and a Perkins diesel engine. And for those who miss such things, it has a running board to make access easier.



Undersea research sub

Two divers can descend to a depth of 100 feet in a new 10½-foot-long submarine built by Kawasaki Heavy Industries, Japan. The craft has a speed of two knots. An unusual feature is a set of rollers on its bottom which enable it to crawl along the ocean floor.

89

Coming: A Computerized Collision-Avoidance System

With jumbo jets flying, a single mid-air collision could take a thousand lives. Two amazing cockpit instrument systems are vying for the chance to prevent disasters

By MORT SCHULTZ

BY THE END of the decade, there could be as many as 10 mid-air collisions per year involving commercial airliners, and the number could soar to between 30 and 40 per year by 1985. So warns the Air Traffic Advisory Committee of the Department of Transportation.

A recent study by the National Transportation Safety Board foresees the

toll of future collisions. Because of a sharp increase in the number of aircraft and the advent of jumbo jets, "it is conceivable that in the near future a single mid-air collision could result in the loss of a thousand lives," it states.

What's being done to avert disaster?

The most reassuring step as far as airline passengers are concerned is a black-box system that will automatic-

COLLISION-AVOIDANCE SYSTEM cockpit instrument (Bendix) shows traffic situation, gives vertical escape maneuver commands. When aircraft is descending or climbing and is hazard to another (1), instrument advises the pilot to fly level. If an aircraft is below (2), the pilot is warned. If collision is possible (3), the pilot is told to prepare to climb. If on a collision course (4), pilot is immediately told to climb

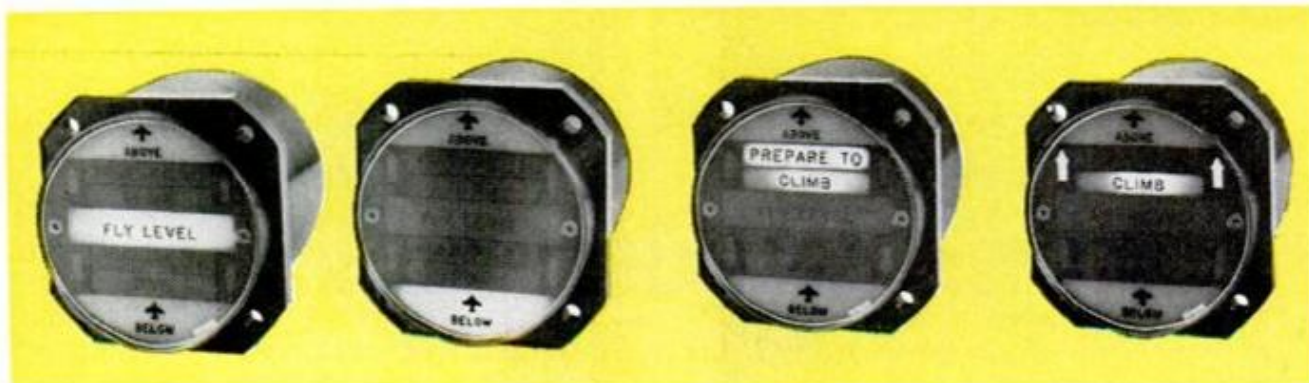

ally warn a pilot when collision with another aircraft is imminent and indicate what he must do to avoid it.

According to the Air Transport Assn., which represents virtually all scheduled airlines in the United States, commercial aircraft could begin receiving this collision-avoidance system (called CAS) sometime next year. The cost of equipping an aircraft will be about \$40,000. Thus, cost of installing the CAS in existing aircraft will be approximately \$12 million.

The new CAS system is a time-frequency setup that allots a time slot of 1500 microseconds for each plane, in turn, to transmit important data to other planes in its vicinity. The system can accommodate and sample 2000 aircraft in just three seconds.

Calculations are made by a computer that will be installed aboard each airliner to determine if aircraft are on a collision course. If they are, pilots are issued both an audio and visual signal by an instrument that tells them how to avoid a collision—climb, dive, or fly level.

The airborne CAS will supplement air-traffic-control (ATC) equipment. As matters now stand, the ability of ground-based equipment to keep planes off a collision course is in question. Last September, for example, when an Allegheny Airlines DC-9 and a single-engine lightplane collided over Indianapolis with a loss of 83 lives, the radar controller said that the small plane just didn't show up on his scope although the weather was clear.

This tended to confirm what had been known about ATC radar for some time—that it is not always able to provide adequate signals in precipitation, including periods when the weather is clear but the humidity is high.

In all, there were 303 mid-air collisions from 1956 to 1969, resulting in 989 deaths. Airliners were involved in 24. Fifteen of these were between an airliner and a general-aviation aircraft.

General aviation is a designation that takes in all aircraft which aren't com-



MODIFIED vertical speed indicator, CAS cockpit display by McDonnell Douglas, orders one plane (above) to climb; other, to dive. Each pilot limits the rate of climb or descent so that the pointer does not reach lighted area

mercial of military, and includes privately owned planes, business aircraft, air taxis and trainers.

According to William G. Osmun of ATA, the first objective is to get time-frequency into airliners.

“Our immediate concern is to keep the big guys away from the big guys,” he says.

CAS equipment to keep the little guys away from other little guys and from the big guys is currently too expensive. A mini version of the system would cost an owner of a general-aviation plane about \$4000. It's inconceivable that most small-plane owners would spend this unless forced to do so by the government, and that doesn't appear likely at present. This means that those planes most frequently involved in mid-air collisions—general aviation aircraft—would not have a collision-avoidance system.

This is a major objection that one critic of time-frequency offers. That critic is RCA, which is being represented in this controversy by staff engineer Jack Breckman.

Breckman is the main designer of a

type of anticollision system called SECANT which, like radar, sends out probing signals to interrogate the environment. If it passes its tests, SECANT could be available to general and commercial aircraft by 1974.

"SECANT would cost owners of general aviation aircraft anywhere from \$500 to \$1000, depending on how sophisticated the owner wants the system to be," Breckman says. "It would cost the airlines about \$6 million to install the system in all existing aircraft."

"And it's more accurate and reliable than time-frequency," he declares.

In what way? To understand what Breckman means, you first must have some idea of how time-frequency and SECANT differ.

Let's take time-frequency first. During that 1500-microsecond period mentioned above, a plane transmits digital data of its altitude. Range and range-rate are derived from this transmission by the other plane since the signal travels at a known time and frequency.

Range is the distance between two (or more) aircraft. It's determined by the length of time it takes the signal sent by one aircraft to reach the other. For example, knowing that a signal travels at 6 microseconds per mile, if it takes your signal 36 microseconds to be received by my aircraft, it means you're six miles from me.

Range-rate is the rate at which this range is changing. It's obtained by the Doppler shift in electromagnetic frequency as one aircraft approaches another. Simply put, each plane using time-frequency is transmitting at a

known frequency. As aircraft approach each other, it changes pitch.

It's like what happens when a train blowing its whistle approaches you. The Doppler shift in pitch of the whistle is a measure of the speed at which the train is coming toward you.

Time until possible collision, called "Tau", is determined by the formula—

$$\frac{\text{Range}}{\text{Range-Rate}} = \frac{\text{Miles} \times 3600 \text{ (i.e. 36 microseconds)}}{\text{MPH}} = X \text{ seconds}$$

For instance, suppose the range is 6 miles and the range-rate is 400 mph. Tau would be 54 seconds.

$$\frac{6}{400} = \frac{6 \times 3600}{400} = 54 \text{ seconds}$$

At 30 seconds, collision is confirmed or denied. It's confirmed if the protective umbrella of space around the aircraft has been violated. This umbrella allows for 700 feet of unviolated air during level flight and 3500 feet during takeoff and landing.

Once collision is confirmed, the instruments in the cockpit of both planes warn pilots and tell them what to do.

The success of time-frequency depends on accurate timekeeping, since the system relies on measurement of time differences from the start of a transmission by one aircraft to the receipt of that transmission by another. The ATA contends that timekeeping

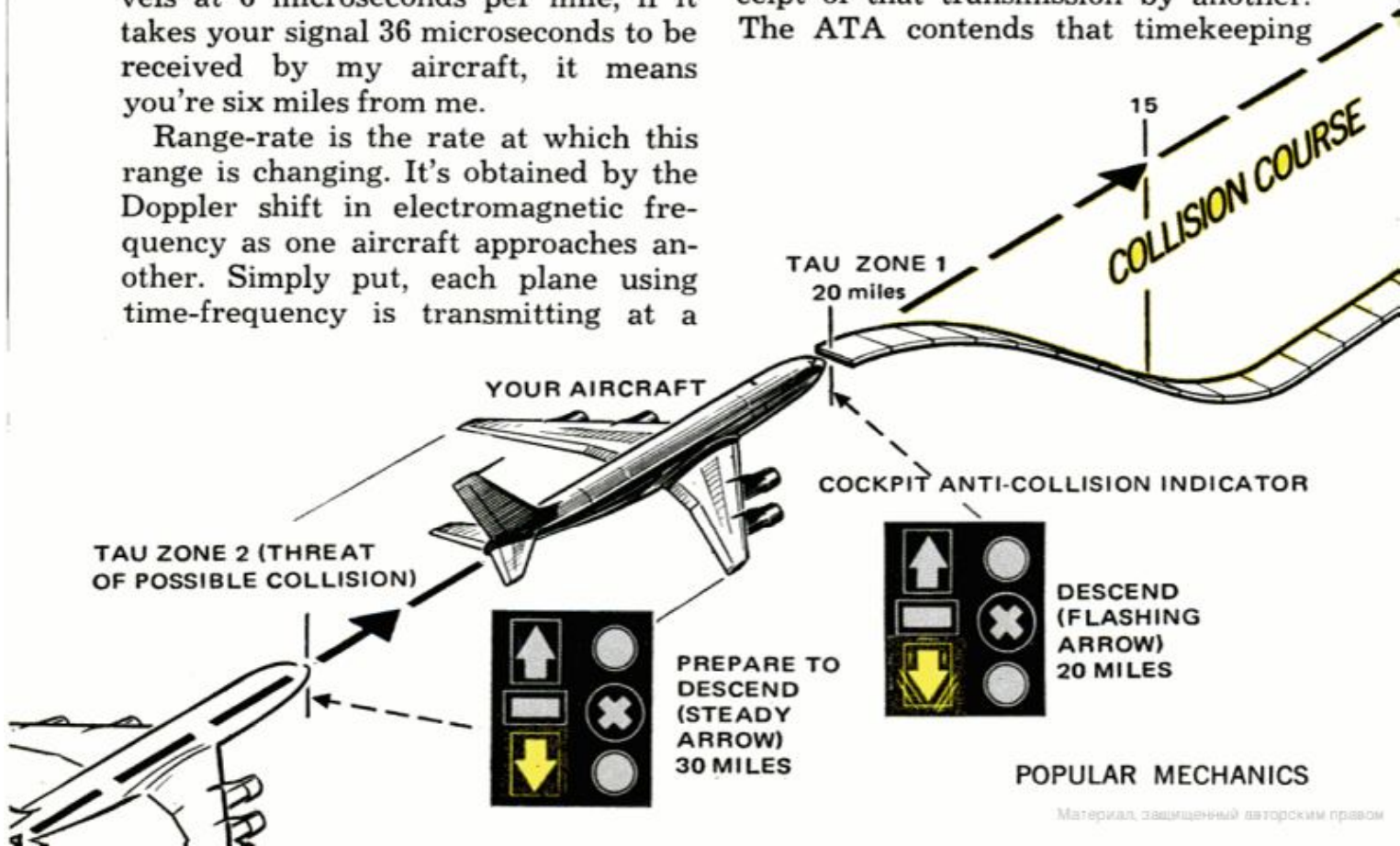

TIME-FREQUENCY TYPE COLLISION-AVOIDANCE SYSTEM (CAS)

How time-frequency works when two aircraft are headed on a collision course is shown below. While this is a head-on example, the same computations and cockpit warnings apply in other hazardous situations. When a plane penetrates the Tau Zone 2 (Tau: time until collision), the instrument shows a steady red arrow indicating Prepare to Descend or Prepare to Climb. In Tau Zone 1, the arrow will flash red, which is the command to Descend or Climb

COCKPIT ANTI-COLLISION INDICATOR



CLIMB
(FLASHING
ARROW)
20 MILES



PREPARE TO
CLIMB
(STEADY
ARROW)
30 MILES



NO THREAT
(NOT
ILLUMINATED)

INTRUDER
AIRCRAFT

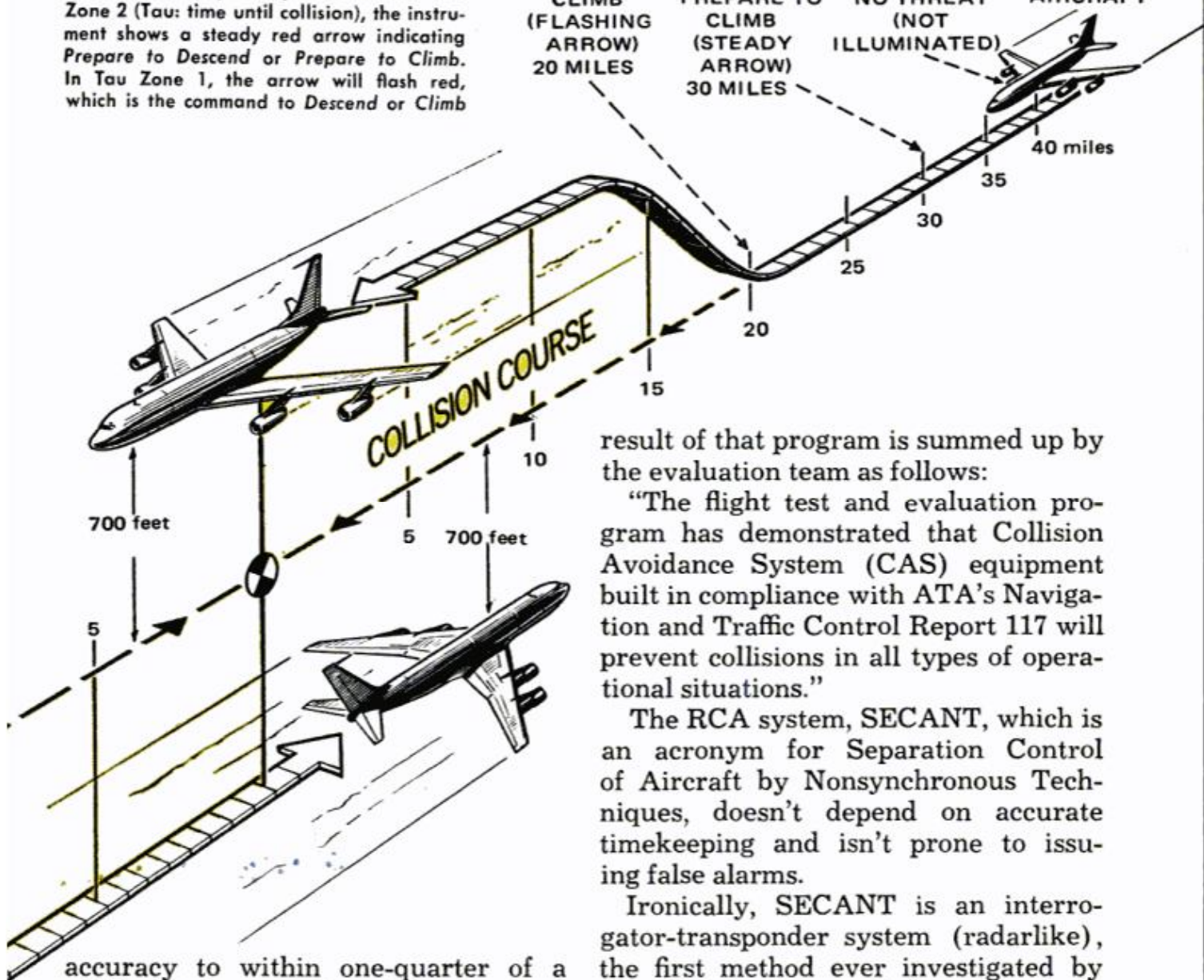

accuracy to within one-quarter of a millionth of a second can be maintained by atomic clocks.

Breckman says it can't be. He also argues that data signals around an airport, where hundreds of planes could be stacked up at a time, would by flying so fast and furious that there would be no way of avoiding false alarms.

"The hardware works," Osmun reports.

This seems to be confirmed by a flight test and evaluation program of time-frequency equipment that was completed by the Martin Marietta Co. as this article was being prepared. The

result of that program is summed up by the evaluation team as follows:

"The flight test and evaluation program has demonstrated that Collision Avoidance System (CAS) equipment built in compliance with ATA's Navigation and Traffic Control Report 117 will prevent collisions in all types of operational situations."

The RCA system, SECANT, which is an acronym for Separation Control of Aircraft by Nonsynchronous Techniques, doesn't depend on accurate timekeeping and isn't prone to issuing false alarms.

Ironically, SECANT is an interrogator-transponder system (radarlike), the first method ever investigated by the ATA in its search for an anticollision system. It was dismissed as impractical back in 1955 because of the "fruit" problem.

Fruit results when more than two aircraft in an area are probing and transmitting at the same time. Only the signals of the plane that is on a collision course with your plane is of importance. However, you receive the signals of other planes, too. That's fruit, and up to now no one has been able to develop an interrogator-transponder system that could weed out the fruit and

(Please turn to page 198)

You Can Make This MODEL STEAM TRACTOR

Built to a three-quarter-inch scale and patterned after the famous J. I. Case threshing-machine tractor, this modelmaker's beauty actually runs

By RUDY KOUHOPT

Color Photo by Robert D. Borst

IF MODELMAKING is your cup of tea, you won't want to wait to start this museum masterpiece which represents a page out of history.

Big on American farms at harvest time more than a half century ago, the steam-traction tractor with its familiar canopy top was an exciting, self-propelled, hissing, smoke-belching monster which traveled from farm to farm to drive a stationary threshing machine by belt and pulley. You'll find it just as exciting in model form when under its own head of steam.

Though remarkably akin to the well-known Case farm tractor which roamed farmlands at the turn of the century,

my model is not an exact scale replica. To simplify construction, I rearranged some of the parts to insure dependable operation.

While limited editorial space prohibits detailing this beautiful model in the magazine, complete step-by-step directions and a set of full-scale plans are available. See page 96.

The framework. Most steam-traction tractors did not have a separate framework or chassis. Instead, they relied upon the shell of the boiler to serve as sort of external frame to which the cylinder, front axle, smokestack and other parts were attached by rivets or bolts. I found that a short length of

CONT'D P9-136

IT'S EXCITING JUST TO LOOK AT, and more so when you see it hissing and puffing under its own power

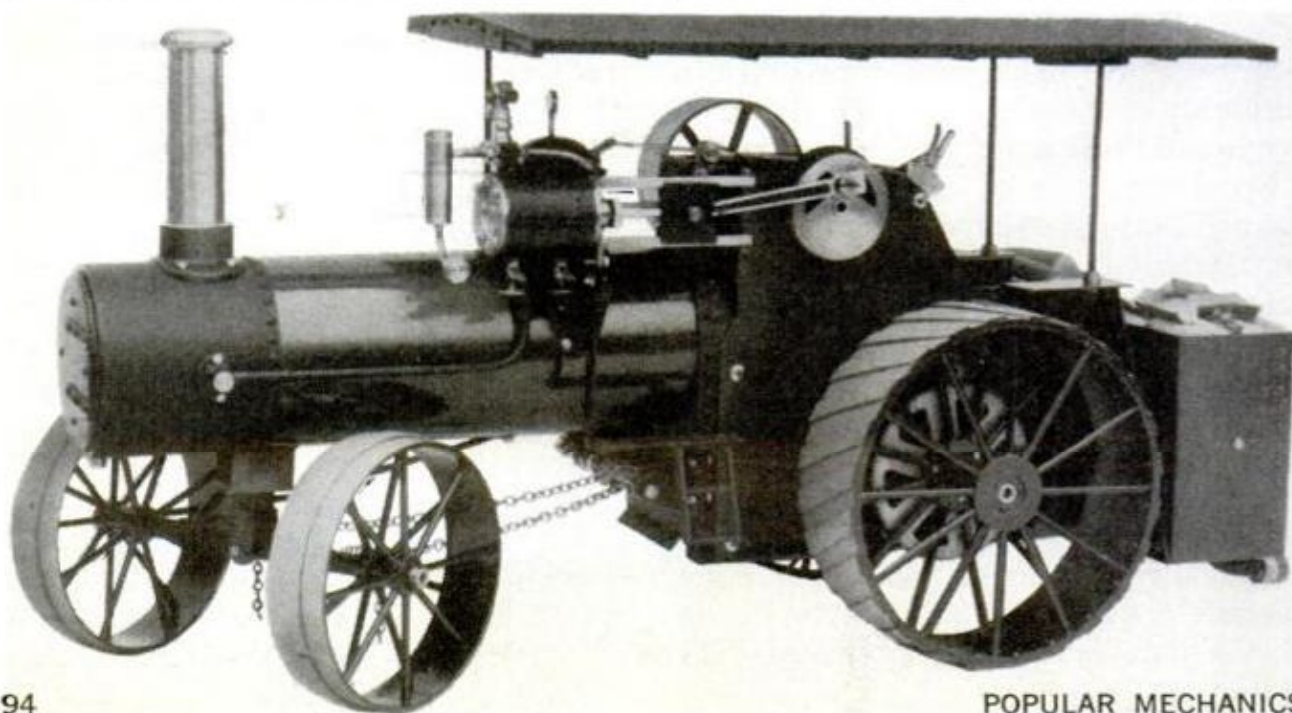

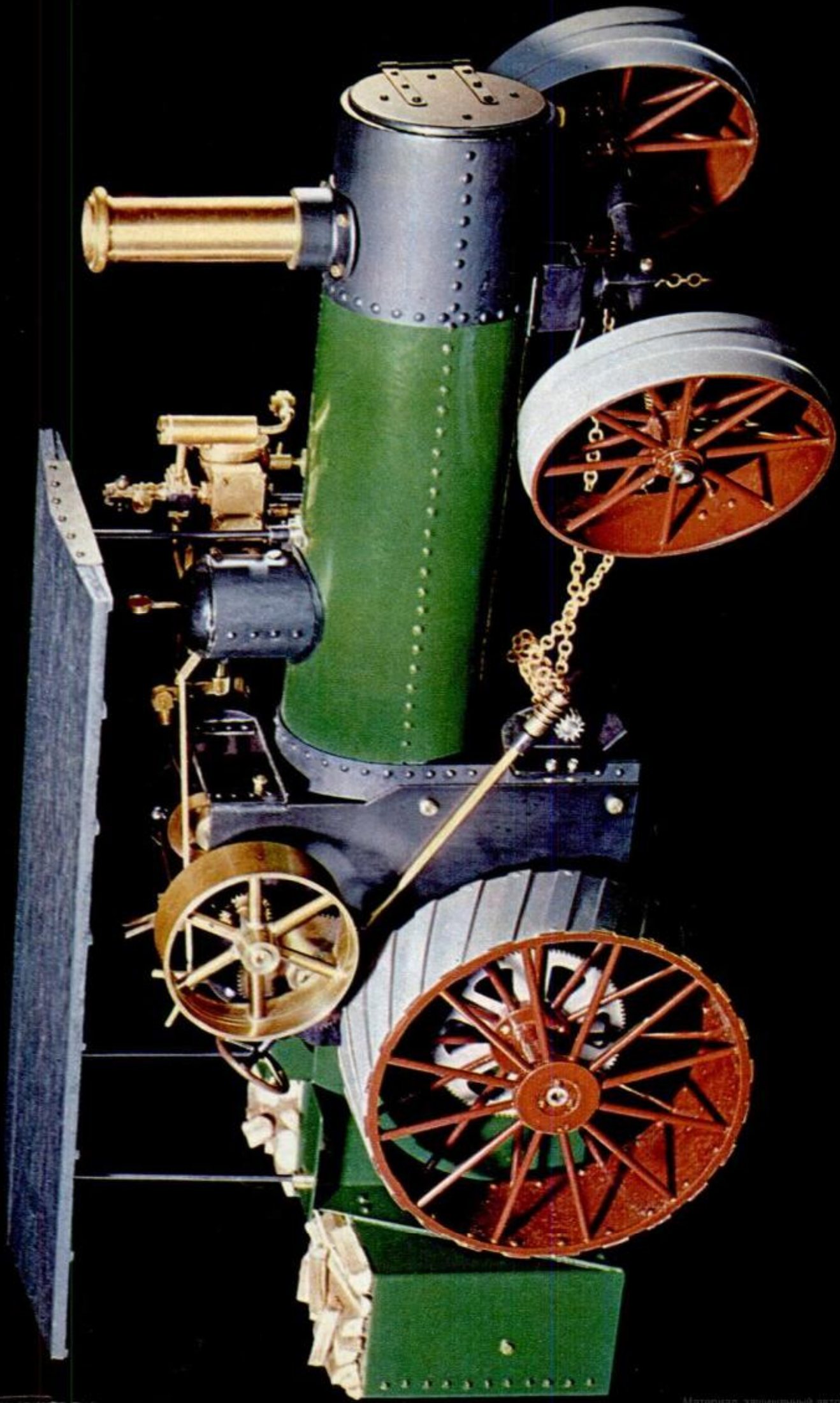

Pull-Apart Assembly View

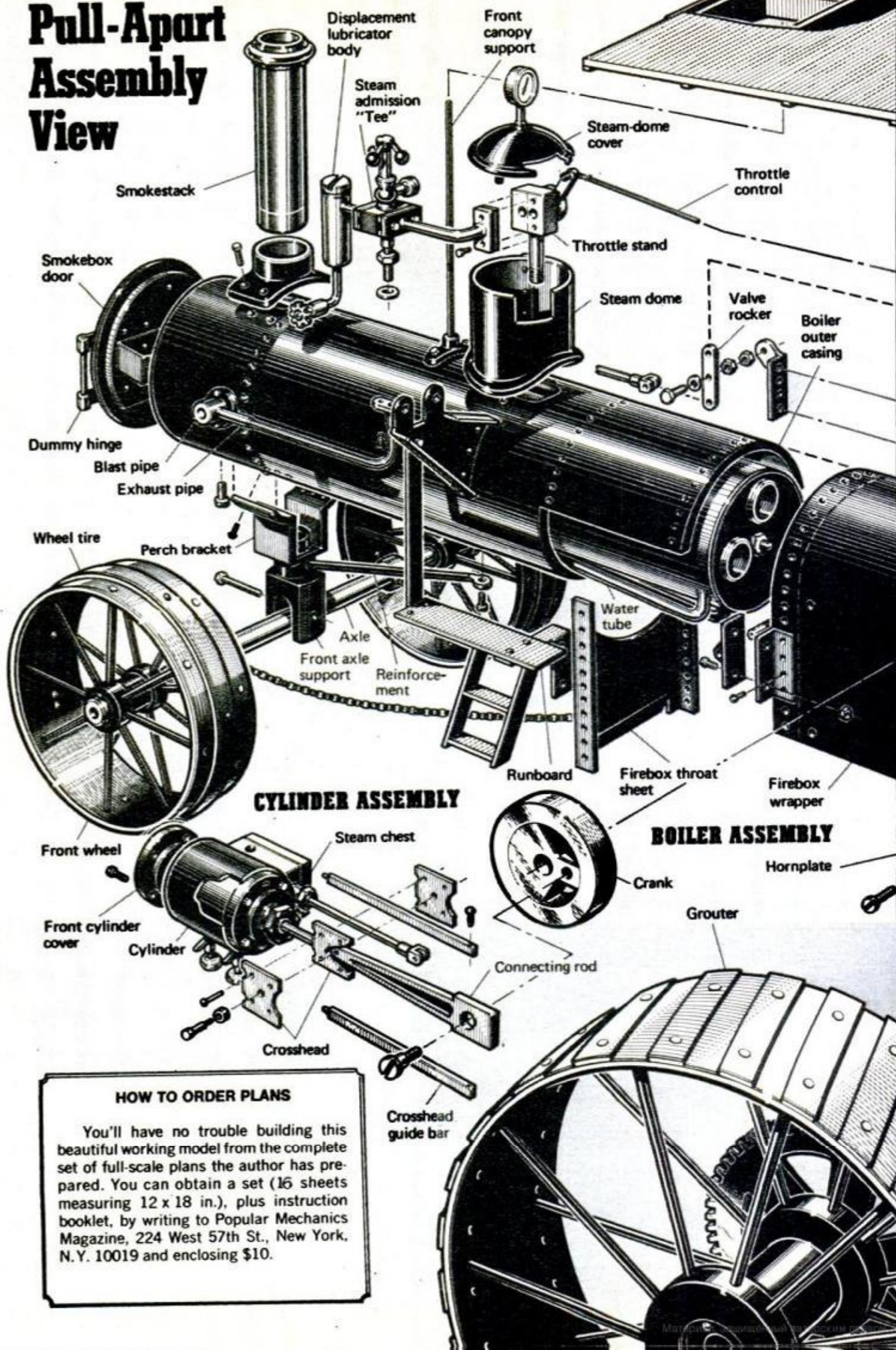

CYLINDER ASSEMBLY

BOILER ASSEMBLY

HOW TO ORDER PLANS

You'll have no trouble building this beautiful working model from the complete set of full-scale plans the author has prepared. You can obtain a set (16 sheets measuring 12 x 18 in.), plus instruction booklet, by writing to Popular Mechanics Magazine, 224 West 57th St., New York, N.Y. 10019 and enclosing \$10.

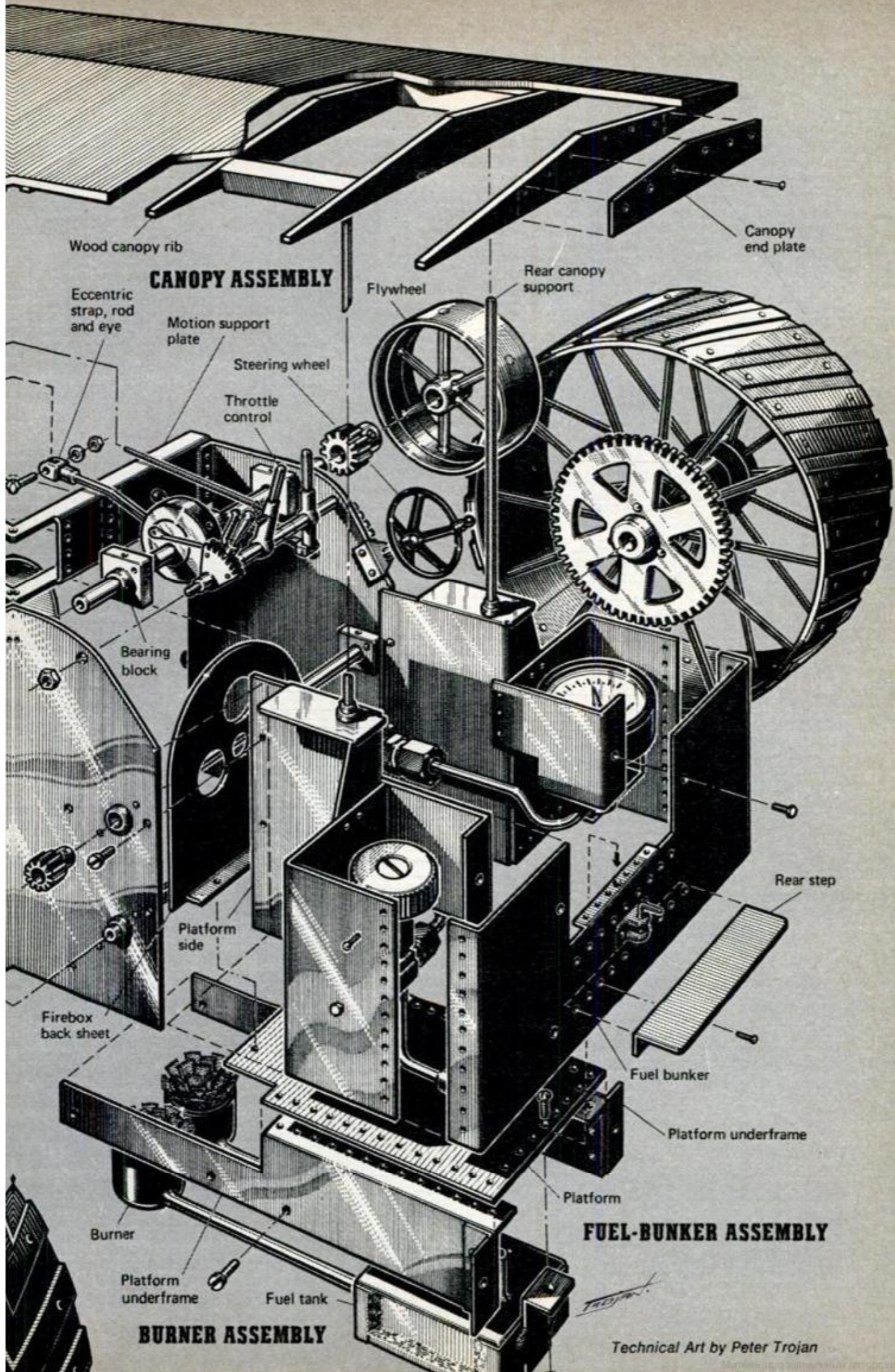

CANOPY ASSEMBLY

FUEL-BUNKER ASSEMBLY

BURNER ASSEMBLY

Wood canopy rib

Canopy end plate

Eccentric strap, rod and eye

Flywheel

Rear canopy support

Motion support plate

Steering wheel

Throttle control

Bearing block

Platform side

Rear step

Firebox back sheet

Fuel bunker

Platform underframe

Burner

Platform

Platform underframe

Fuel tank

Technical Art by Peter Trojan

AUTOMOTIVE



Jeep Gladiator



Ford Ranchero

The '71s: Pickups



Chevrolet Cheyenne 10



**GMC
Sierra Grande
2500**

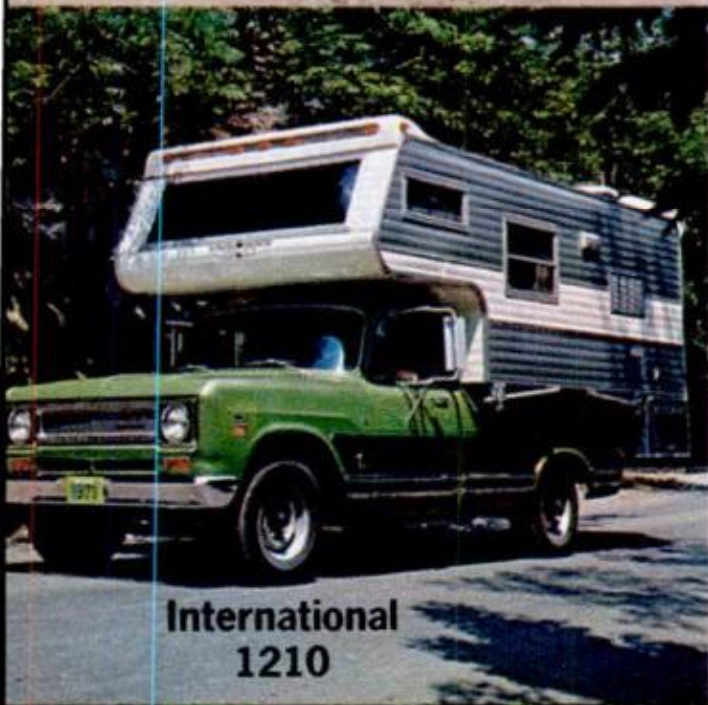

**International
1210**

Every year the all-purpose pickups get classier, more comfortable and more suited to serve as both workhorse and recreational vehicle.

By **MICHAEL LAMM**
West Coast Auto Editor

EACH YEAR, pickups become a little more like cars. Ford's Ranchero and Chevy's El Camino are obvious examples, but even the ones that still look like pickups now feel, ride, sound, handle and pamper you almost the way cars do—in some cases even like luxury cars.

Today, pickups are called on to perform every task cars do, *plus*: become a camper on the weekend after hauling hay all week after taking the missus to the store every night after helping dad move the neighbor's furniture after towing the boat home from the lake after delivering a load of shingles to the summer cabin—and so on, ad infinitum. There's no end to the pickup's versatility.

You're as likely to see a housewife behind the wheel of a new pickup as you are a businessman. That's because airconditioning, power steering, power disc brakes, automatic transmission,

That Pamper



Dodge 100

bucket seats, console, vinyl roof, stereo and hosts of other refinements go into pickups today on a regular basis. A "loaded" pickup no longer means in the cargo bed. Today it's in the cab and under the hood.

Nearly all manufacturers offer jazzy top-of-the-liners that turn heads and influence buying decisions . . . in big-town showrooms, not just out in the country. Dodge offers the Adventurer and Dude, Ford the Ranger XLT, Chevy the CST, International a Custom series, and GMC the Sierra. But, of course, you can still get a good, basic, not-too-expensive workhorse, the lowest-priced half-tonners beginning around \$2500 base. Three-quarter-ton models begin about \$2700; one-ton pickups around \$2900 stripped. You can easily work your way above \$4000, though, and that *excludes* the camper. Two economical alternatives to full-size pickups are the Datsun and Toyota pickups—both in the half-ton range.

These "ton" designations now mean relatively little. They used to refer to payload; that is, a one-ton pickup used to be able to carry a maximum payload of 2000 pounds in its bed. Now a full one-tonner most often carries two tons with ease—with heavy-duty suspension, even more. Tires and other components have been upgraded, with manufacturers recommending specifics for various loads.

Each line and series of pickups offers several styles and sizes of boxes. Styles are either slab-sided or have outjutting fenders. There's more total room in slab-sided models, but they cost more and sometimes space is chopped up.

Matching your needs to a specific pickup might take some long, hard thought. Despite appearances, there's a lot more to a pickup than to a car—factors and features that tailor them to individual jobs. Lists of noncomfort options alone are staggering. You have to get deeply involved in such things as weights, spring rates, capacities, load shapes, tire ratings, axle and transmission ratios, wheelbases and height. So

when you buy a pickup, especially your first, take it easy. Study the entire field — all makes and models. They're hard to compare, because all makers use slightly different standards. Our chart will dispel some of the confusion.

Pickup sales have soared these last few years. The rise began when campers started to become popular. Last year, Detroit sold over 1.5-million pickups—one for every five cars. Ford alone sold more pickups than all Mavericks, Mustangs, Thunderbirds and Falcons put together. During the first six months of 1970, Chevy led Ford slightly in total light-truck sales, followed respectively by Dodge, International, GMC and Jeep.

JEEP GLADIATOR

As you probably know, Kaiser Jeep Corp. recently merged with American Motors Corp. This means there are bound to be changes in the Gladiator, although there have been few formal announcements. Actually, it's been Jeep's policy *not* to make annual model changes, but to incorporate running improvements when necessary. This policy will continue, but coincidentally some of the Gladiator's most important changes will happen just in time for 1971. (All Jeep vehicles built during calendar 1970 are called 1970 models; those built during calendar 1971 will be 1971 models, and so forth.)

Gladiators have long used AMC's 232-c.i.d. 6-cylinder engine and will keep it as *the* base powerplant. AMC's new-for-1971 258-c.i.d. Six will likely be optional. But Buick's 350-inch V8 will no longer be offered, and in its place the Gladiator will use AMC's 360-inch V8 at 245 bhp after Jan. 1. Another change will be to swap the optional Turbo Hydra-Matic for AMC's automatic.

Jeep Gladiators are the only U.S. pickups that have four-wheel drive as standard. This gives them the highest base prices in their class, but it also makes them at home in the roughest

country. Snow, mud and the end of the road hardly faze a Gladiator. All Jeeps share a reputation for ruggedness.

All luxury and convenience options are available for the Gladiator. You can also order power takeoff, a dumper body, snowplow, wrecker package and front-mounted winch. A special camper package has a payload capacity of 3930 pounds, extra-heavy-duty suspension, four-speed all-synchro trans, H-D cooling and 10-ply tires.

INTERNATIONAL

International pickups offer more wheelbases and different transmissions

than any other. Basic engine, as in the Gladiator, is AMC's 232-c.i.d. Six. There are four V8s in addition, plus three, four, and five-speed manual gearboxes (even a five-speed with top gear being overdrive); also an automatic on either two or four-wheel-drive models.

The 1010 and 1110 series, rated as half-tonners, are virtually identical except for differences in front suspension. The 1010 uses independent torsion-bar front suspension; the 1110 and all bigger International pickups, I-beam solid axles up front.

All I-H series above the 1010 can be

(Please turn to page 188)

SPECIFICATIONS OF THE 1971 PICKUPS

Make Model	Ton	Std. Suspension		H-D Suspension		WB. (in.)	Lgth. (in.)	Box Size (cu. ft.)	Engine*	Bhp @ rpm	Torque @ rpm	Avail. Trans.*	
		GVW (lbs.)	Payload (lbs.)	GVW (lbs.)	Payload (lbs.)								
CHEVROLET El Camino CS/CE-10	1/2	4100	n.a.	n.a.	n.a.	116	201.2	n.a.	6-250	145 @ 4200	230 @ 1600	3-man.	
	1/2	4400	1230	5000	1400	115	188.5	58.4	6-292	165 @ 4000	270 @ 1600	4-man.	
						127	207.8		6-292	170 @ 4000	270 @ 1600	2-auto.	
	3/4	6200	3500	7500	n.a.	127	207.8	74.3	V8-307	200 @ 4600	300 @ 2400	3-auto.	
						133	213.8		V8-307	215 @ 4000	300 @ 2400		
CS/CE-30	1	6600	3700	14000	n.a.	133	213.8	82.5	V8-350	215 @ 4000	n.a.		
									V8-350	245 @ 4800	350 @ 3000		
									V8-350	250 @ 4600	350 @ 3000		
									V8-350	270 @ 4800	375 @ 2800		
									V8-400	300 @ 4800	400 @ 2400		
								V8-454	365 @ 4800	500 @ 3200			
DODGE D-100	1/2	5200	1600	5200	n.a.	114	188.1	75.0	6-225	145 @ 4000	215 @ 2400	3-man.	
						128	208.8		V8-318	212 @ 4000	322 @ 2800	3-auto.	
	3/4	7500	2500	7500	n.a.	128	208.8	75.0	V8-383	258 @ n.a.	375 @ n.a.	4-man.	
						160	208.8						
D-300	1	8000	3750	8000	n.a.	133	218.6	66.0					
						159							
FORD Ranchero F-100	1/2	4000	850	4950	1250	114	209.0	39.1	6-240	150 @ 4000	234 @ 2200	3-man.	
						115	187.8	82.3	6-250	155 @ 4000	240 @ 1600	3-auto.	
	3/4	6100	1950	7700	3500	131	205.4	82.3	6-300	165 @ 3600	294 @ 2000	4-man.	
						131	205.4	82.3	V8-302	220 @ 4600	300 @ 2600	3-o.d.	
	1	6600	2400	10000	6060	135	217.4	82.3	V8-351	250 @ 4600	355 @ 2600		
						159	237.2		V8-351	300 @ 5400	380 @ 3400		
									V8-360	215 @ 4400	327 @ 2600		
									V8-390	255 @ 4400	376 @ 2600		
									V8-429	370 @ 3400	450 @ 3400		
GMC CS/CE-1500	1/2	4400		5400		115	188.5	58.4	6-250	145 @ 4200	230 @ 1600	3-man.	
						127	207.8		6-292	165 @ 4000	270 @ 1600	4-man.	
	3/4	6200		7500		127	207.8	74.3	V8-307	200 @ 4600	300 @ 2400	2-auto.	
						133	213.8		V8-350	250 @ 4600	350 @ 3000	3-auto.	
CS/CE-3500	1	6600		1400		133	213.8	82.5	V8-400	300 @ 4800	400 @ 3200		
INTERNATIONAL 1010, 1110	1/2	4800	1600	5400	2200	115	184.0	66.0	6-232	145 @ 3200	215 @ 1600	3-man.	
						119	to		V8-266	155 @ 4400	227 @ 2800	3-auto.	
	3/4	6100	3700	7500	n.a.	131	202.0		V8-304	193 @ 4400	272 @ 2800	4-man.	
						115	184.0	66.0	V8-345	197 @ 4000	309 @ 2200	5-man.	
	1	7000 to 8000	3900	10000	5925	119	to		V8-392	236 @ 4000	354 @ 2600	5-o.d.	
						131	235.0						
						149							
						164							
						134	214.0	66.0					
						149	to						
					156	244.0							
JEEP J-2000 J-4000	1/2	5000	1462	n.a.	n.a.	120	189.0	38.6	6-232	145 @ 3200	215 @ 1600	3-man.	
						132	206.0	44.4	6-258	160 @ 4000	245 @ 1600	3-auto.	
	3/4-1	5000	1305	8000	3633	132	206.0	44.4	V8-360	245 @ 4400	365 @ 2400	4-man.	

*Not all engines and all transmissions available in all models

BOATING

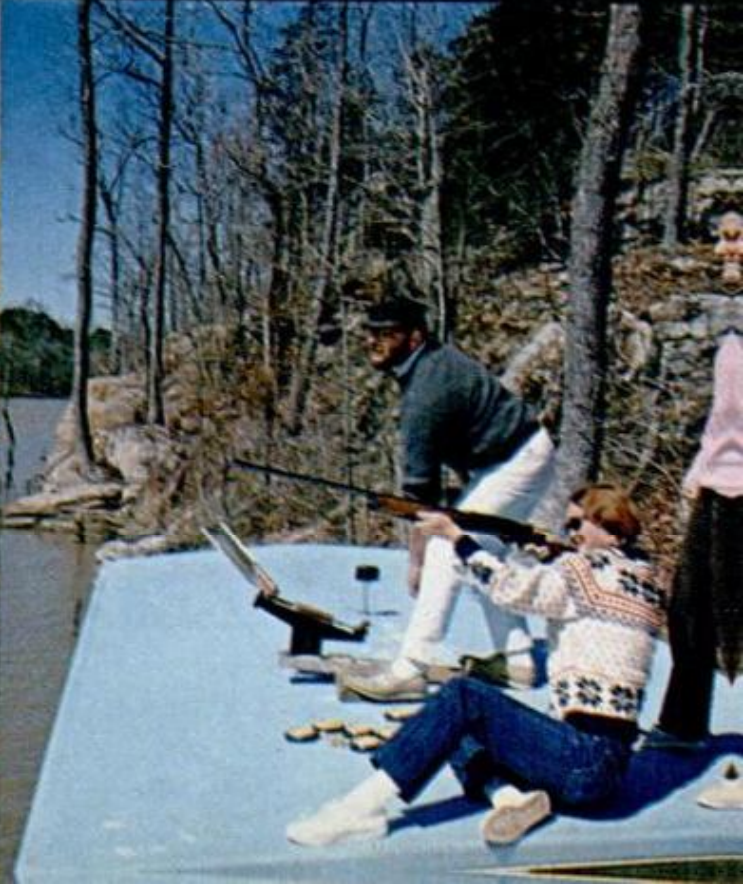
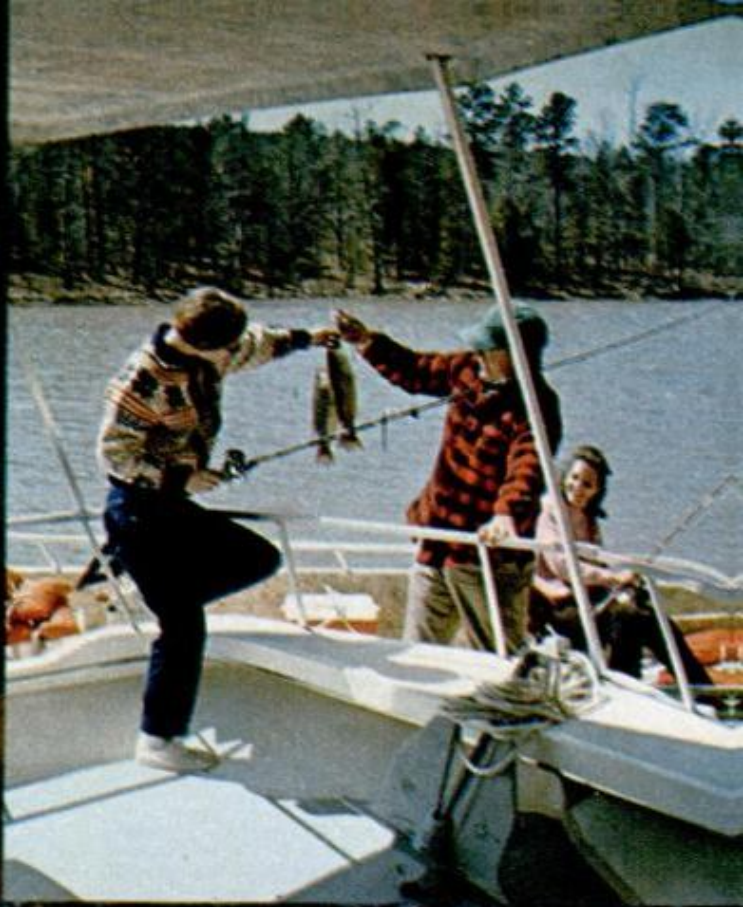
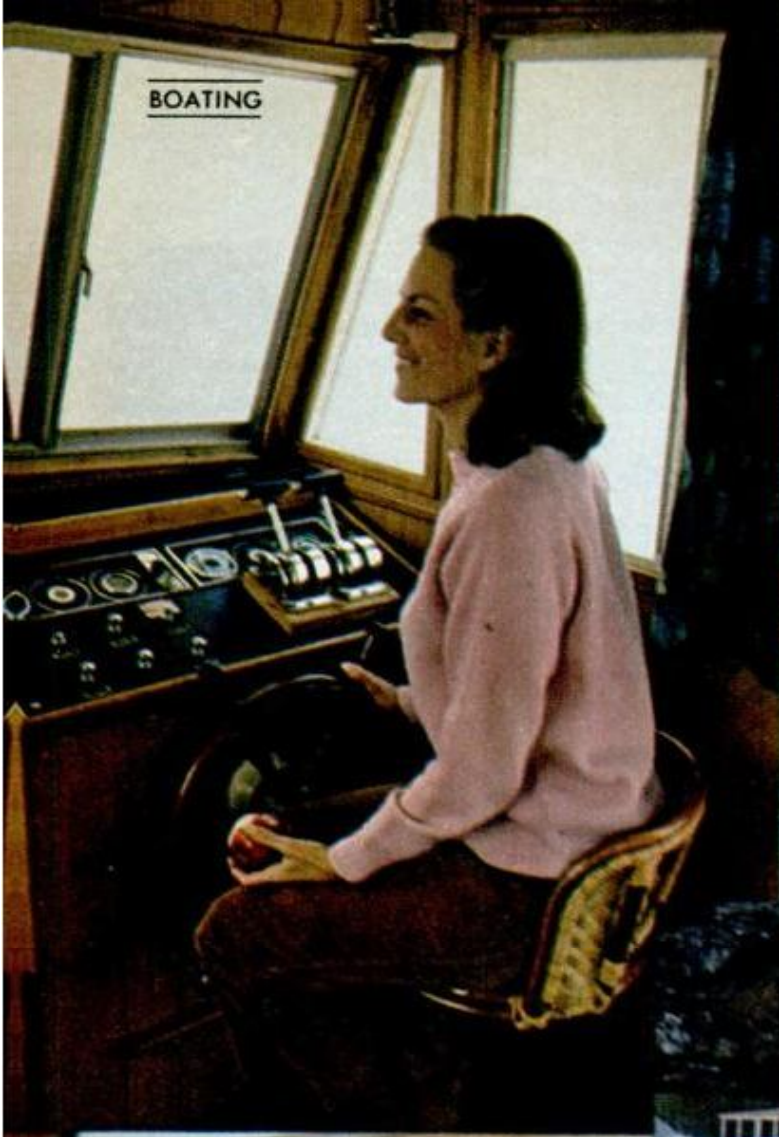

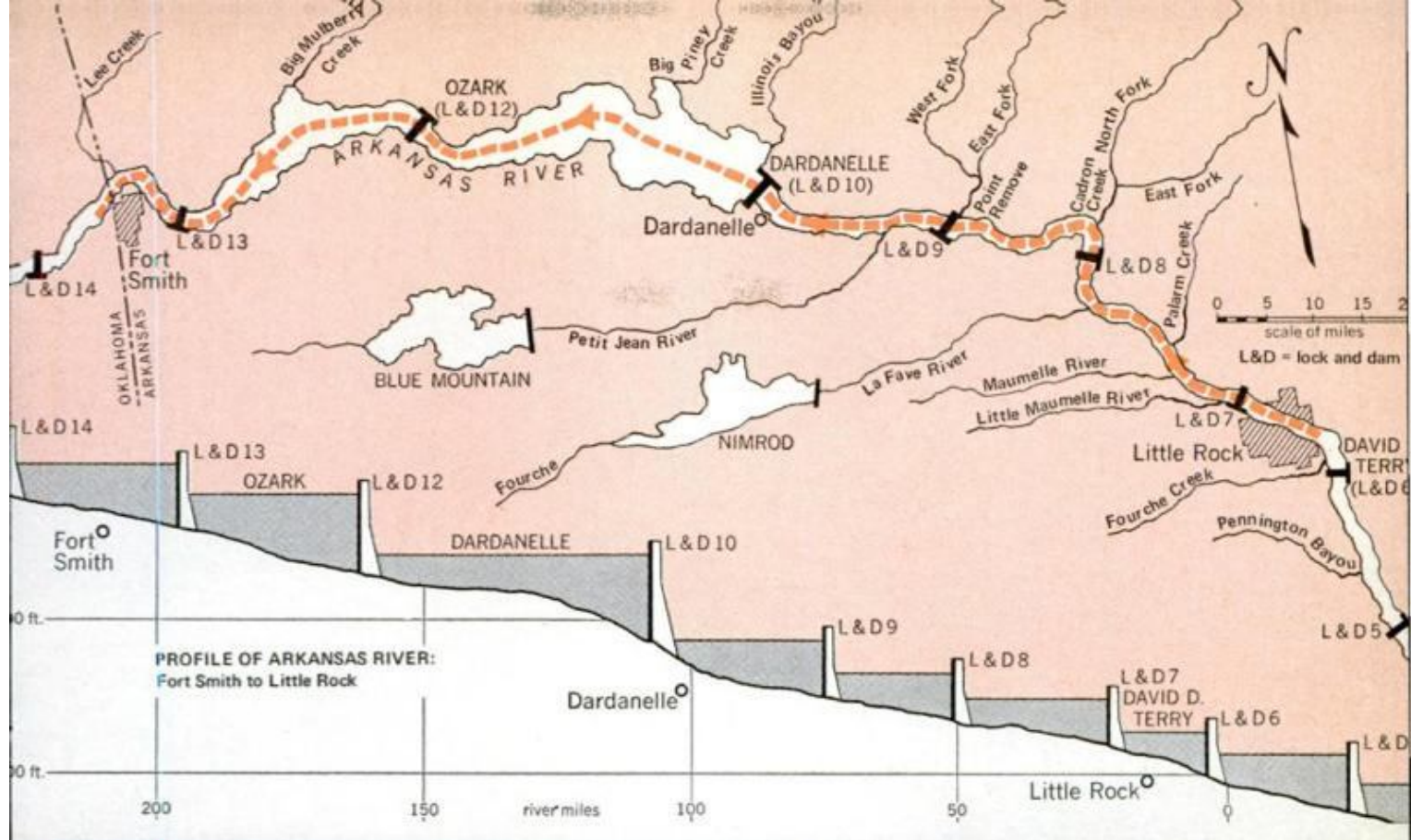

Honeymoon On a Houseboat

PM's Boating Editor and his bride explore
America's newest waterway.

By GEORGE REIGER

ARKANSAS IS BOOMING! And much of the boom is in the dynamite used in the greatest waterway project since the Panama Canal was built. In fact, damming and diking the Arkansas River has been a *bigger* job than the dredging of that Latin-American ditch—and far more expensive. If \$1.2 billion is hard to comprehend, consider instead that enough stone has been dropped between Fort Smith and the Mississippi River to build a 77-story pyramid covering 19 city blocks

and enough pilings driven to reach from Little Rock to Washington, D.C.!

This pile-driving and rock-dumping has provided a dependable commercial waterway between Oklahoma (particularly Tulsa's port of Catoosa) and the Gulf States, and then abroad. Grain, coal, cattle and bauxite will go downstream while the goods of the world flow up. It is anticipated that eventually 13.5 million tons of cargo will be shipped annually over this route.

Hydroelectric power, water supply and recreation are additional benefits. Recreation will boost another of the area's "booms." Not that the state's boating industry needs it—Arkansas is already No. 1 in total boat production, from lazy johns to sleek cruisers

1) **LOOK MA, ONE HAND!** Barbara demonstrates houseboat's ease of handling. 2) Hot coffee underway. 3) Pair of fresh-caught bass the girls quickly converted to lunch. 4) Running beneath wooded bluffs of Big Piney Creek. 5) Jack pulls trap for Carolyn while Barbara cheers on the girls' team



TUMBLING TORRENTS below dams are in striking contrast to the quiet rise of water in the locks



BEDMAKING and dishwashing are done in spaces slightly smaller than those in our city apartment



Ten Tips For Locking Through

- Approach at reduced speed, staying between red and black channel buoys.
- Boats carrying a whistle or horn should signal one long blast (3 to 10 seconds) at a distance not exceeding one-half mile.
- Small craft without whistles or horns should use the manual signal chains located at each end of the lock.
- Wait for lockman to signal entry; either a blinking green light or one long blast on an air horn.
- Boats going downstream should stay at least 400 feet upstream from the end of lock wall until entry signal is received. Larger craft may be about to leave the lock heading in your direction.
- Carry at least 50 feet of mooring line.
- Dock at floating mooring bits only; do not tie to ladders or mooring posts.
- Use fenders to spare hull and lock walls.
- Don't leave your engine on during lockage; no smoking or open flames allowed.
- Remember your priority (pleasure boat) is fifth after U.S. government vessels, commercial passenger boats, commercial tow and rafts. Lockmen are like traffic policemen. Obey their instructions.

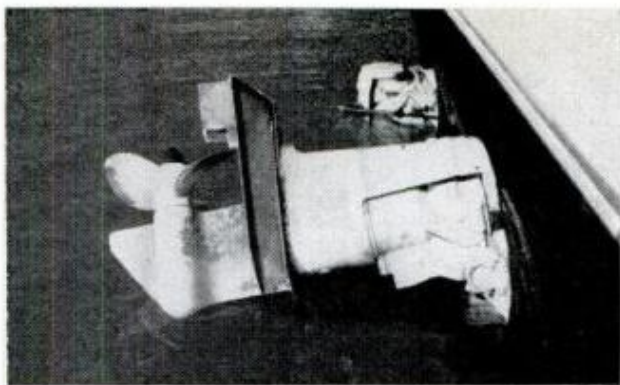

ONE ADVANTAGE of OMC's stern-drive system is that entire lower unit can be raised out of the water

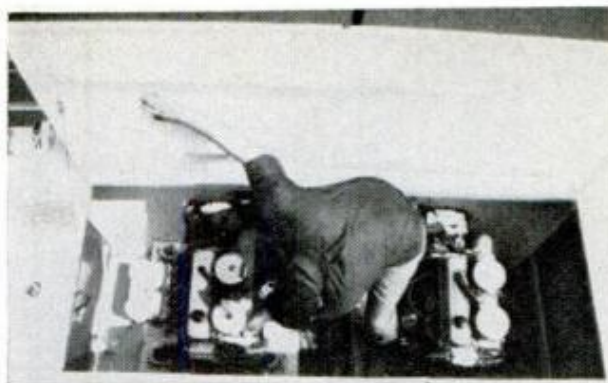

JACK PRUDENTLY CHECKS oil, fuel supply and other mechanicals each morning before getting underway

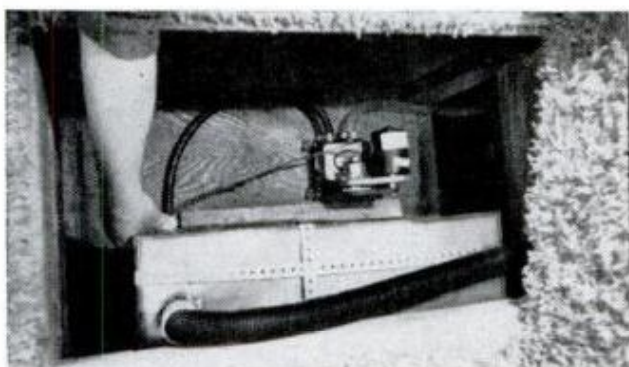

WATER PUMP, easily accessible, is neatly hidden from view under cutaway section of carpeted deck

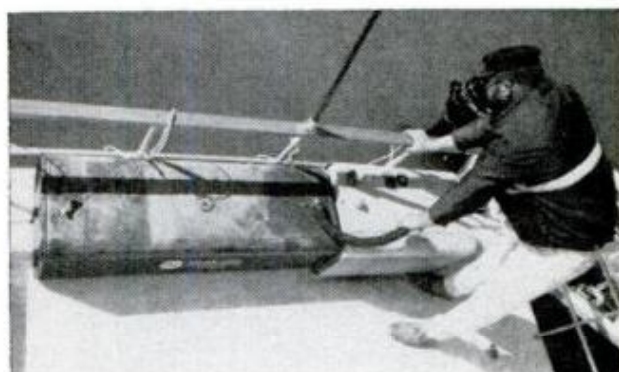

MARINAS ARE FEW between Dardanelle and Fort Smith, so we carried two fuel tanks as "insurance"

and houseboats. Hearing of all this activity, my bride and I decided a trip up the "new" river in Arkansas's latest houseboat would be an exciting way to spend our honeymoon. We weren't disappointed.

Sales Manager Jack Seastrom of Kenner Boats located at Knoxville, half-way up the river, met us in Little Rock and quickly got us settled aboard a handsome Suwanee 35-footer. Making sure we were well provisioned for the first leg of the journey, he bade us farewell and said he'd look us up at Dardanelle.

The run upstream to this major reservoir is an eight-hour effort, but since we wanted to explore and putter along the way, we left well before noon.

Navigating the Arkansas used to turn up shifting channels, sudden shallows and flooding. Today the channel is stable, well marked and averages 9 feet deep and 250 feet wide for its 466-mile length from Catoosa to Rosedale, Miss. Yet minor hazards persist in the many pieces of driftwood (some quite siz-

able). The solid fiberglass construction of the Kenner hull turned aside all the small pieces; it was just the thought of meeting an errant piling drifting off to New Orleans that worried me! When pounding upstream with a pair of 120-hp OMC sterndrives at better than 20 knots, you could make a pretty healthy hole in your hull if you hit just the right snag.

Barbara prepares lunch as we run. Regular meals are a refreshing change from the odd hours of bachelor life. The idea of eating a hot steak at the helm of a speeding boat while Barbara makes the coffee and tidies up the kitchen—and later, when she takes the helm while I rig tackle or read—is hard to imagine in most small boating situations. Our houseboat suffers with rather noisy vibrations at low speeds, but at better than 4000 rpm, our surroundings seem every bit as familiar as our apartment back in the city—with a far more pleasant view!

A note from my diary: "The feeling

(Please turn to page 190)

Surf Fishing With a 4-Wheel Drive

By GEORGE W. LINNANE



With one of these rugged vehicles you can extend your range and increase your catch.

STRIPED-BASS ANGLERS have been doing it since the first Model A was converted to a beach buggy. Nowadays, modern off-the-road four-wheelers make beach driving easy and increasingly popular. And so many mobile anglers use New York and New England beaches that they have organized voluntary associations to regulate themselves.

The three basic categories of four-wheel-drive vehicles are: 1) short wheelbase, highly mobile, on-and-off-the-road, multiuse passenger carriers like the Jeep, Scout, Broncho, Blazer, Toyota Land Cruiser and Land Rover; 2) station wagons, not much different in appearance from their two-wheel-drive counterparts; 3) pickup campers, which mount a living-space camper on a truck pickup body like Jeep's Gladiator and Dodge's Power Wagon.

They're all basically trucks and are sold like trucks. The newcomer may be astonished to find that top, rear seat and even bumpers are

part of a lengthy list of optional extras.

Vehicles in the first category rarely bog down. Their short wheelbase (88 to 104 inches), high clearance and light weight permit them to ride the sand and avoid being trapped. With the tires deflated to 10 or 15 pounds pressure they go just about anywhere. They'll carry four anglers with surf rods mounted on the roof or front bumper. There's little space left over, however, and this is their chief disadvantage. In addition, highway performance is only fair.

Four-wheel-drive wagons are closer to being all-around cars. Their longer wheelbase makes them a bit less nimble on the sand than the Jeep-type vehicles, but they'll carry passengers and baggage with ease. The Jeep Wagoneer has the shortest wheelbase (110 inches). The largest is the Chevrolet Carryall and GMC Suburban with the International Travelall a close second. Interiors may be rigged for sleeping and limited cooking. Highway performance is adequate.

Pickup campers, the third category, look like their two-wheel-drive cousins, but the four-wheel drive transfer case makes them more dependable and versatile on the dunes. The 4x4, 3/4-ton model is the best choice for highway stability and hard pulling in deep sand. It can sleep four and serve as a family camper. When not on the beach, the truck can be driven out from under the camper and put into service for everyday hauling.

All these vehicles are exposed to the corrosive effects of salt air and water. Driving in saltwater is disastrous to metal and should be avoided at all costs. Frequent washings, undercoating and care in selecting a dry trail are musts.

Beach driving is regulated by federal, state and local governmental agencies. Typical regulations are those prescribed by the Cape Cod National Seashore

(Please turn to page 192)

TALK ABOUT FRESH FISH! Advantage of camper fishing is that mere minutes elapse from catch to dinner
FEBRUARY 1971



CAPE COD CAMPER-ANGLERS overlook beach and relax while waiting for the striped bass to show up



SOON AFTER LEAVING BEACH, reinflate your tires to save unnecessary wear driving over paved roads



IT'S EASIER to follow feeding, moving fish in a four wheeler than to run along behind them on foot



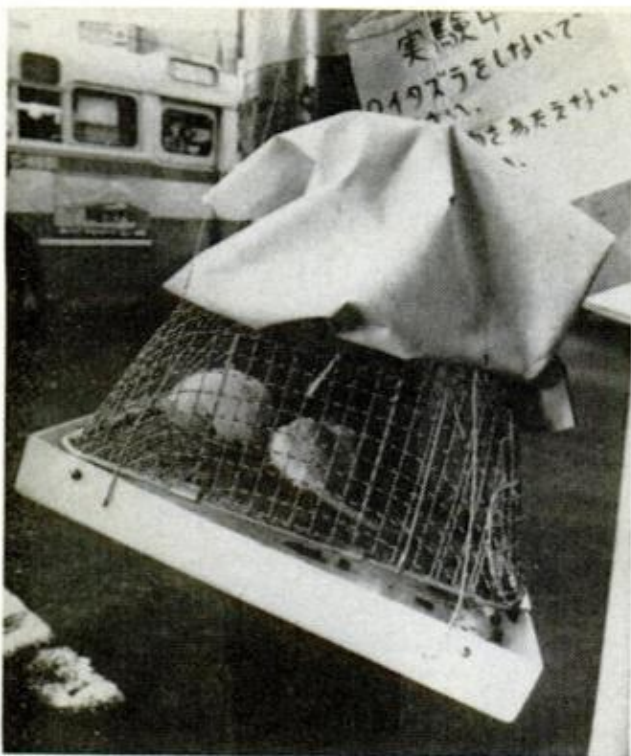

Rats are pollution warning

Caged white rats are being used on busy Tokyo streets to check the amount of air pollution caused by passing motor vehicles. If the pollution becomes severe enough, it will kill the rats.



Timber stacker's masterpiece

Stacking lumber so it takes up a minimum of space, remains accessible and still has air circulating around it is an art. John Clark of London, a master of the art, arranged this 4000-ton stack with a passage for trucks.



Russian air-cushion vehicle

Shown during a trial run is the new Russian air-cushion vehicle, the Sormovich. The 50-seat vessel, designed and manufactured at the Krasnoye Sormovo Works, can travel at speeds of between 50 and 60 mph.



Three-quarter-scale Bugatti

Car buff Geoffrey Sutton, who feels that many people would like to own a Bugatti (as he does), built this three-quarter-scale "Weston Bugatti" at his Lancashire factory where he hopes to turn out about 100 a year. Project engineer Tom Lawrence is shown driving the car in a test run.

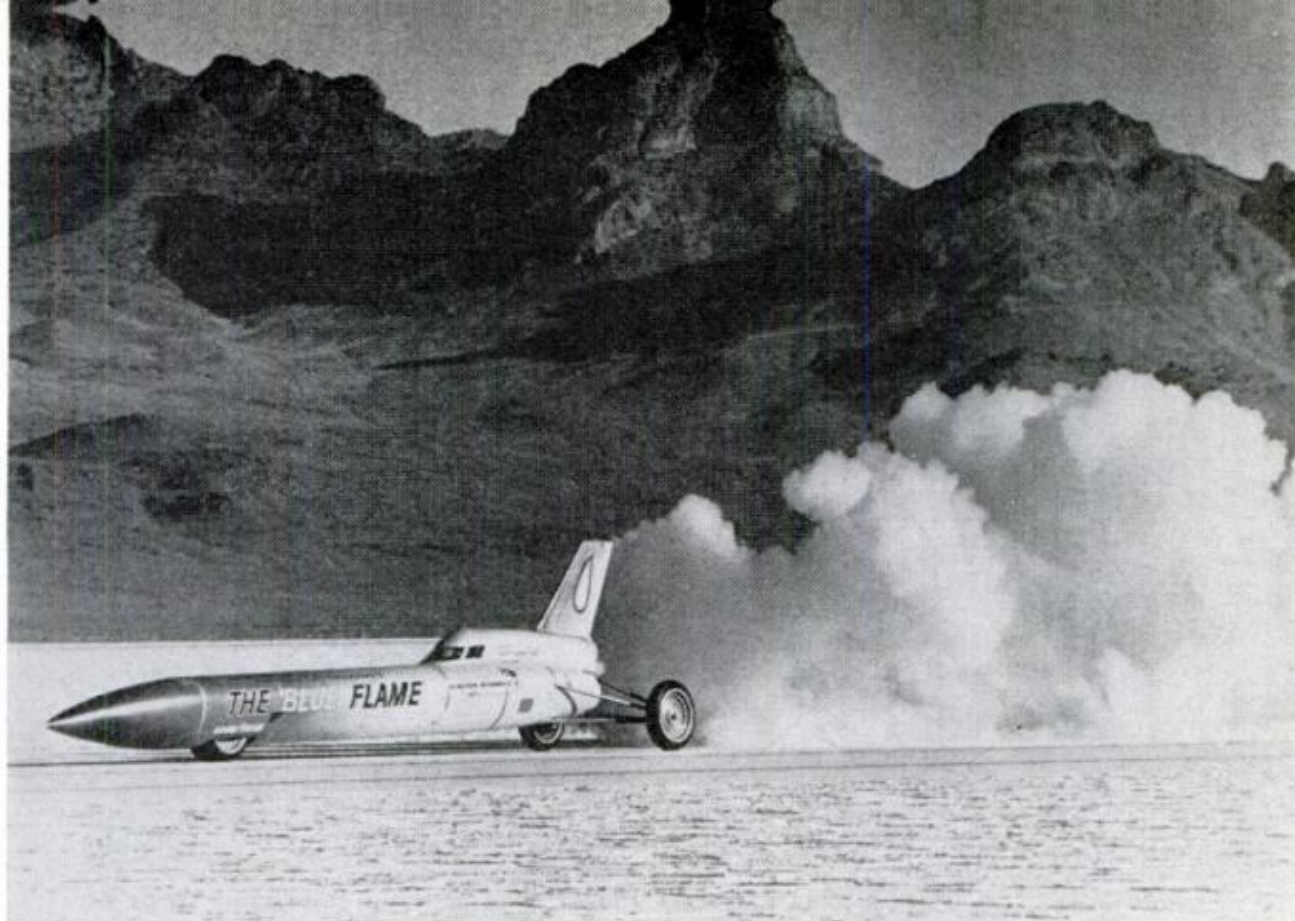

Gary Gabelich sets world land record in The Blue Flame

The Blue Flame blasts off at the start of one of its runs when it set a world land speed record of 622.407 mph on Oct. 23. Driven by Gary Gabelich, 30, of Long Beach, Calif., the rocket-propelled vehicle topped the previous land speed record by over 21 mph. (The record had been held since 1965 by Craig Breedlove.) *The Blue Flame*, which is sponsored by the natural gas industry and was built by Reaction Dynamics, Inc., Milwaukee, uses liquefied natural gas and hydrogen peroxide as propellants.

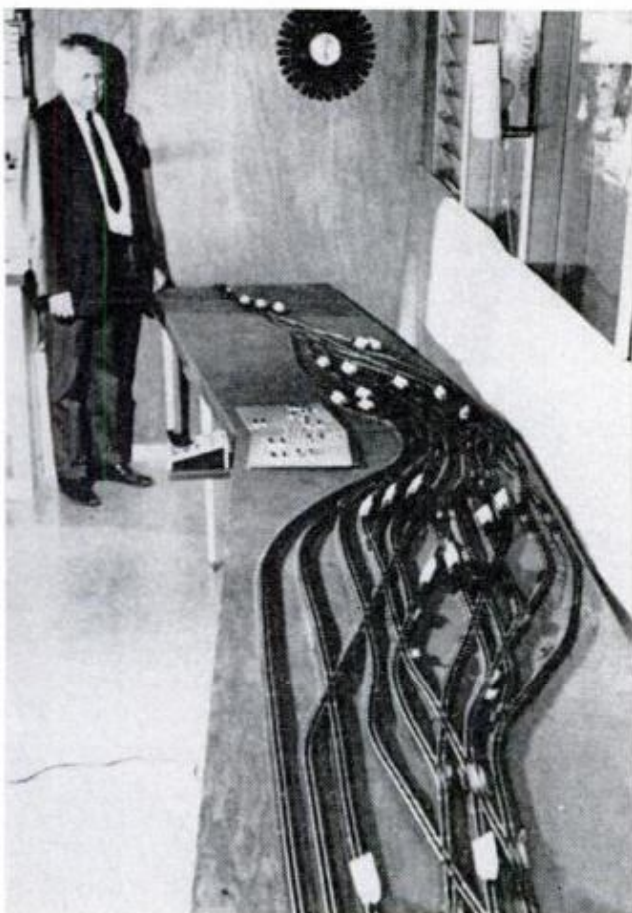

Space station simulator

Space engineers spend up to a week in this giant spinner to provide information for building an Earth-orbiting space station. The spinning of the North American Rockwell unit creates artificial gravity similar to that of a rotating space station.

'Train of Thought'

William H. Miller, professor of English at Diablo Valley College, Pleasant Hill, Calif., uses an N-gauge train layout to make the teaching of English sentence structure more graphic—and more fun for elementary pupils. Pupils push buttons to select various options; the programmed locomotive then picks up words in the correct order and form. Prof. Miller calls it the "Train of Thought."

Just patented

PM'S PICK OF THE NEW INVENTIONS

Prepared in cooperation with Roger S. Shashoua, Director, International Inventors Assn., Inc.

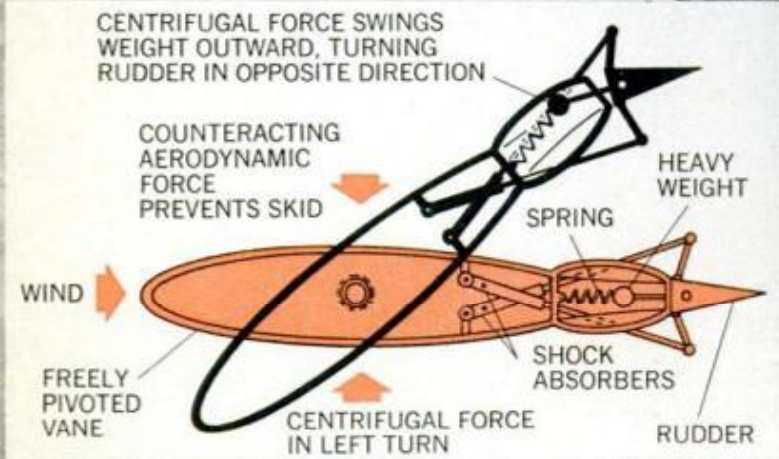
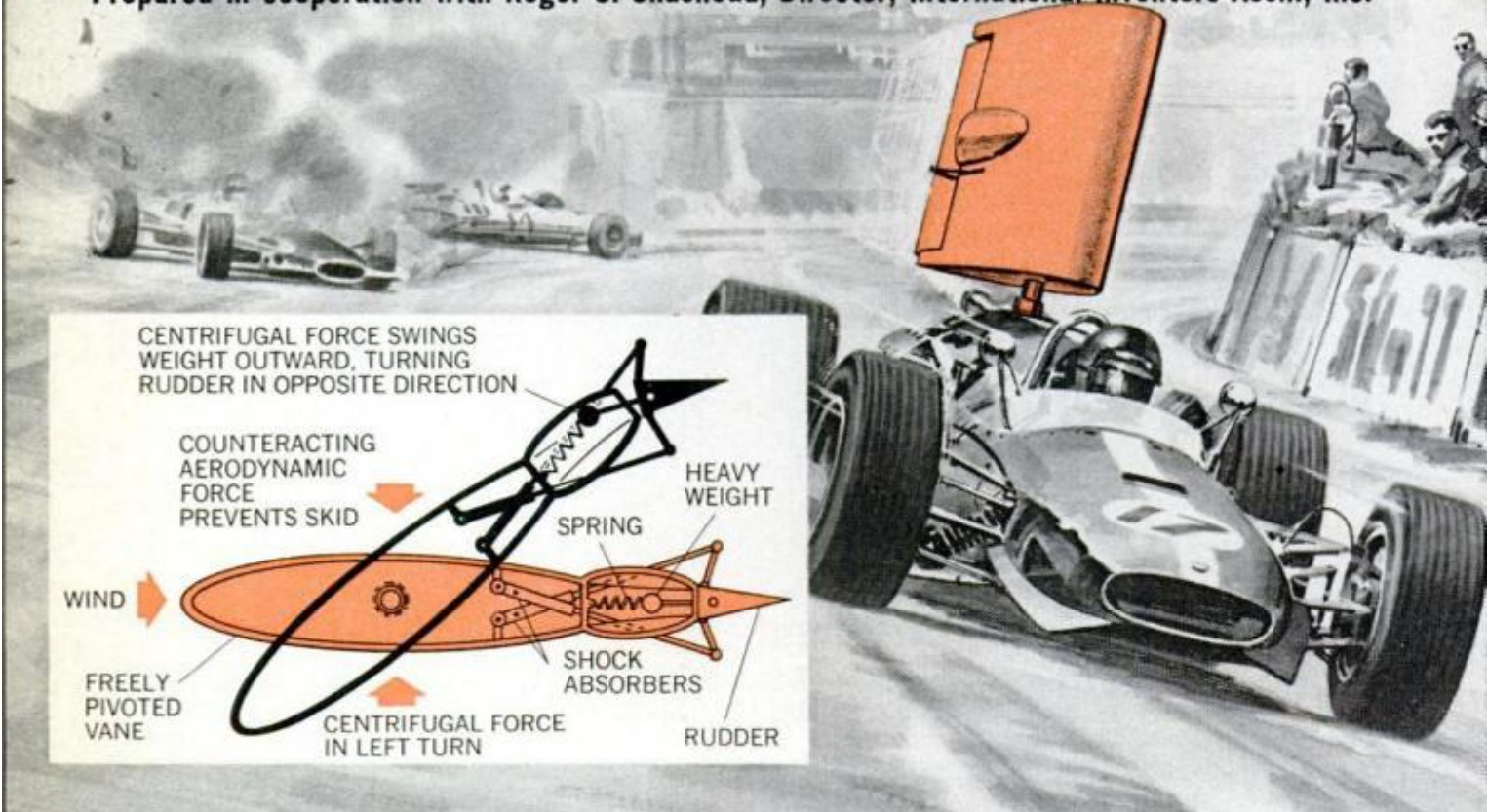

1. FASTER TURNS FOR RACING CARS are the object of this sail-like antiskid device. Unlike steerable fins, it is free to pivot like a weathervane. On a straightaway, it automatically lines up with the relative wind, eliminating drag, even in a direct crosswind. A small rudder vane at the trailing edge is controlled by a counterweight. On a turn,

centrifugal force throws the weight outward, turning the rudder inward. This forces the main fin to bite into the wind, putting air pressure on its outer face—the side away from the turn. The outer force keeps pushing the car into the turn to counteract a skid. By contrast, the steerable fins do not allow for prevailing wind and frequently cause drag

2. YOU HAVE TO PAY this parking meter or you can't take your car. As you pull in, your wheels strike a treadle switch, actuating a hydraulic mechanism that flips up a hinged barrier behind the wheels to lock the car in place. When you're ready to leave, the meter shows the time expired and the

amount you owe. When you deposit the correct coins, the barrier retracts and you're free to go. This prevents motorists from sneaking in and parking free at meters with unexpired time on them. However, you can park as long as you like without getting a ticket since you simply pay for the time you use

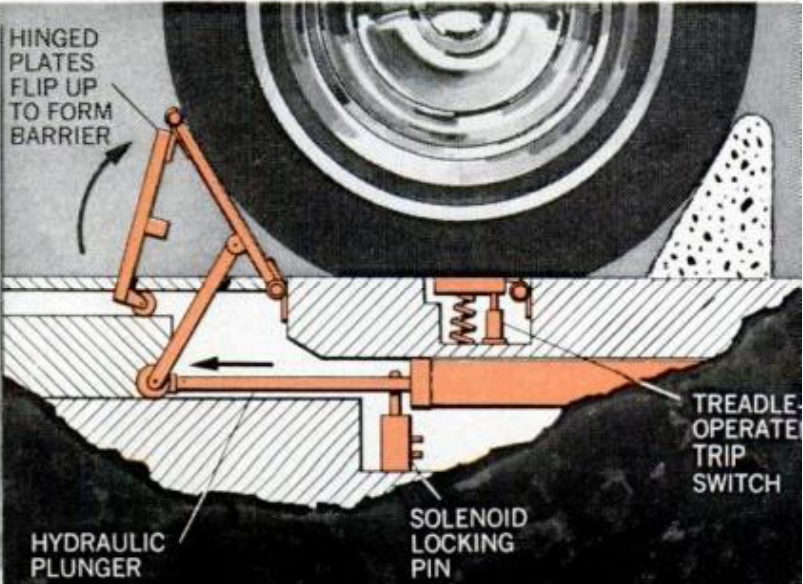

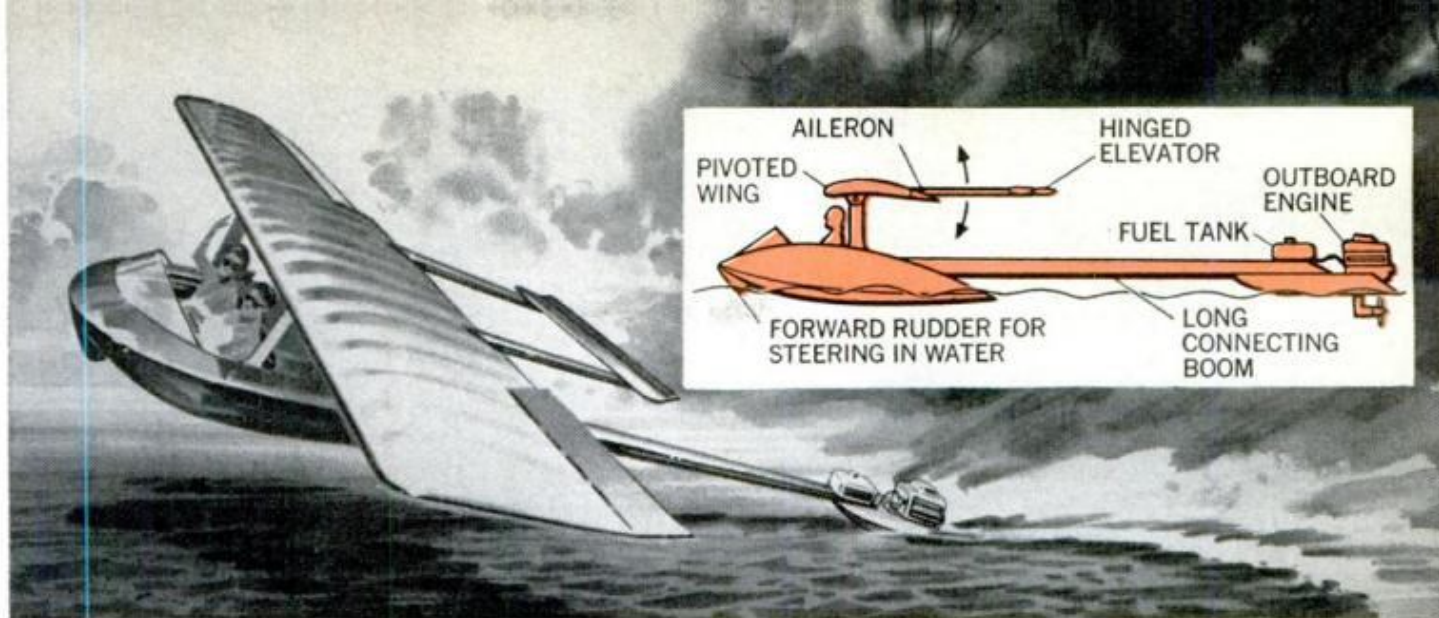

3. FLYING OUTBOARD gives you the thrill of soaring through the air without ever leaving the water. The wing and cockpit section is propelled by a conventional outboard engine at end of a long boom. As speed increases, the cockpit lifts a few feet

off the surface, while the outboard unit remains in the water. Airplane-type ailerons and elevator let you bank, climb and dive just as if you were really flying. The wing is pivoted so it assumes a level attitude in flight, even with the cockpit tilted up

4. YOUR HAND is a wrench with glove at right. Ribbed plastic inserts attached to both the thumb and forefinger form hexagonal jaws when you wrap your hand around a nut. The glove is designed for use in hard-to-reach places where a conventional wrench would be difficult to handle, such as opening a plumbing drain under a sink. It can also serve as a second wrench where you need to hold one end of a bolt or pipe from turning while threading nut or fitting on the other end

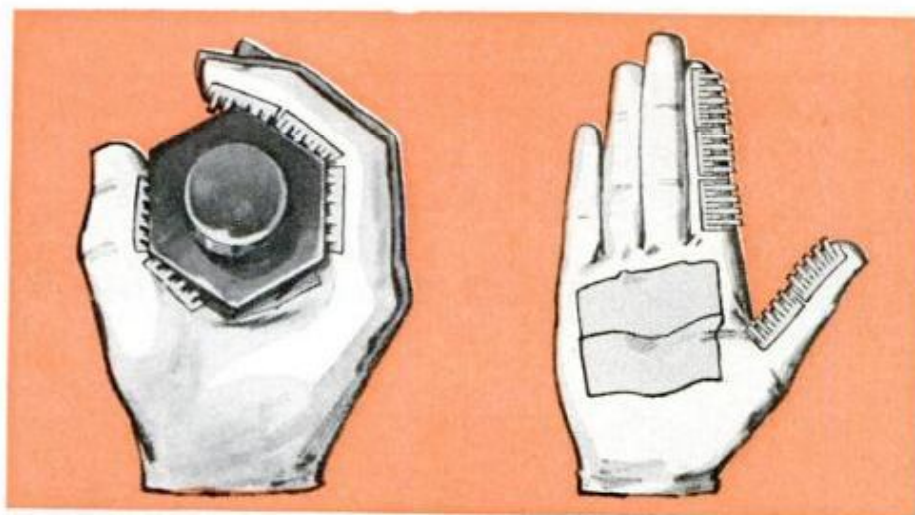

5. YOU SLEEP ON WATER in this novel bed. The water-filled plastic mattress is said to provide a firm, yet soft, support with a pleasant, sleep-producing floating sensation. A built-in heater keeps

the water at any desired temperature and is thermostatically controlled like an electric blanket. The bed is filled from a faucet through a hose. Stiffness is adjusted by varying the amount you put in

Inventors of the items shown on these pages are as follows: 1. Robert D. Green, Ethiopian Air Lines, Box 1755, Addis Ababa, Ethiopia (No. 3,512,825); 2. Clark L. Selby, Jr., 9543 Walmer Lane, Overland Park, Kans. (No. 3,503,480); 3. David F. Thompson, 204 Wildwood Ave., West

Chester, Pa. (No. 3,522,785); 4. Albert B. Meszaros, 24 Eastern Ave., Ossining, N. Y. (No. 3,500,477); 5. Inner-space Environments, Inc., 584 Pacific Ave., San Francisco, Calif. Roger S. Shashoua is located at the International Inventors Assn., Inc., 680 Fifth Ave., New York, N. Y. 10019.

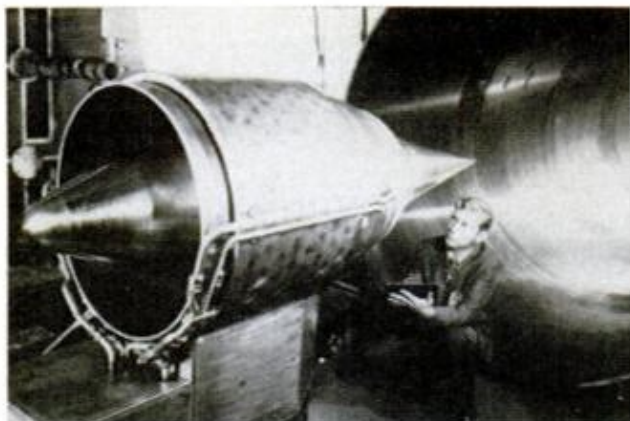

Mach 7 engine

A stream of hot gases moving more than seven times the speed of sound was blasted at NASA's Hypersonic Research Engine in its first wind-tunnel tests. The tests are intended to demonstrate that the liquid-hydrogen-cooled engine can withstand Mach 7 flight.



Plans to fly his car

Erwin Stockwell, a retired toolmaker who has flown for 37 years, plans to continue his flying in his aeromobile—a standard car with wings, propeller and an extra engine added. Stockwell is assembling the vehicle in his back yard in Orange, Mass.

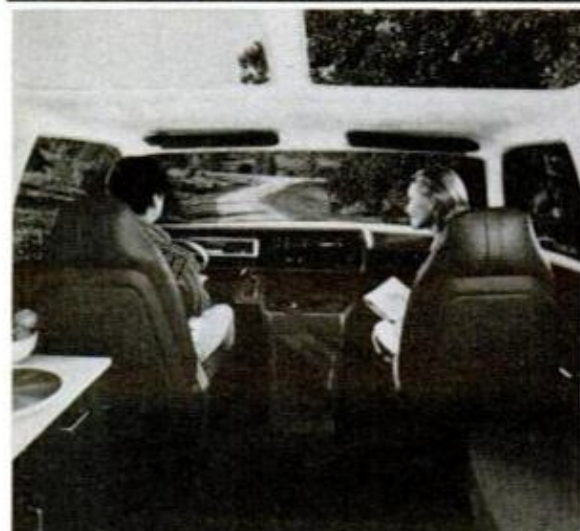

Two new Discoverer motor homes; one model has front drive

Two sleek motor-home models are being produced by Rectrans, Inc., a new recreational vehicle company. The Discoverer 25 (above) is mounted on a standard 159-inch-wheelbase, motor-home chassis. The Discoverer 27 is on a 180-inch-wheelbase chassis and uses a front-wheel-drive Olds 455-c.i.d. V8. Both models have panoramic windshields, L-shaped dinettes, and sleep six. Side and roof panels are of Dynafoam "sandwich" construction with fiberglass reinforced plastic used as outside skin and aluminum inside.



New hovercraft ferry to start work this year

A new hovercraft, the 85-ton VT1-001, built by Vesper Thornycroft, will go into ferry service on the English coast this year. The 40-knot craft can carry 146 passengers and 10 cars.

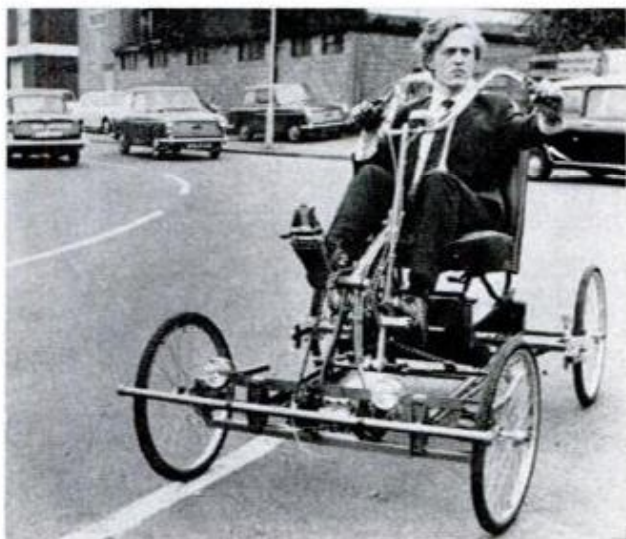

And it doesn't produce smog, either

When a bicycle is crossed with a car, you get a pedal car—in this case, a vehicle that was able to travel from London to Paris in 28 hours (not counting the Channel crossing). Built by factory apprentices, it has 10-speed derailleur gear, rear-wheel brakes and lights.



Vauxhall stylists show how they think a car should look

Just 41½ inches high, the Vauxhall SRV (Styling Research Vehicle) is a four-seat, four-door car that incorporates such ideas as an airfoil in the nose for trimming the car at high speeds and an electric leveling system. Too bad, though; it won't be for sale.

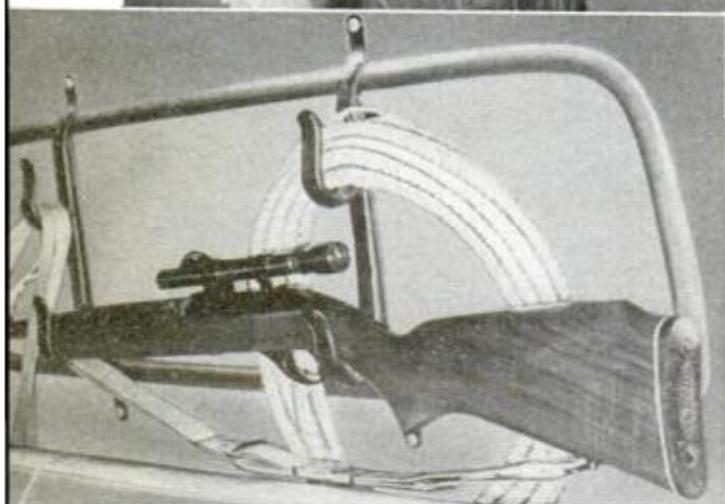

EVEN DURING GUN SEASON rack can be handy hanger for rope, lights and other outdoor gear



A LOCKING DEVICE is a must these days if you live near a big city. It's also helpful for securing any loose gear you may carry in the off season

Let Your Gun Rack Work Year Round

By L. A. WILKE

GUN RACKS in trucks and wagons have many uses other than holding firearms. They're supporting everything from rolled blueprints to diaper bags!

Originally intended for pickup trucks and fastened over the back window, gun racks are now being installed in station wagons lengthwise in the luggage area and in passenger cars under the trunk lid, or behind the driver's seat. Most are adjustable, with spring-steel clips or hooks covered with a plastic material to prevent marring.

The standard rack has three clips and prices start at \$3.95. Metal screws sold in some packages will occasionally work loose with heavy loads and over rough roads, but ordinary lagbolts should hold permanently.

If your wife balks at having a rack in the family car, point out how convenient the hooks are for carrying parasols or kiddies' playthings. And, of course, you'll need 'em for your fishing tackle in the spring! ★★★

BOATING TIPS

A CONVINCING ARGUMENT for trading up from a runabout to a small, hardtop cabin cruiser is the windshield with side curtains—protection to keep charts and cockpit dry, even in choppy weather. But beware the salt if you're a coastal boater! Big solid splashes of seawater are easily cleared by windshield wipers, but intermittent splashes of fine spray dry to leave a film impervious to unmoistened wiper blades. You'll have to either reach around to splash fresh water on the blades, or open the windshield. Either "solution" defeats the purpose of a windshield in the first place.

For less than \$10—starting with a \$4.95 automotive windshield washer from an auto supply store—I solved the seawater problem. A suction and pressure pump is easier to install than a battery type, but both work well. Plastic tubing from an aquarium-supply store provided me with a water connection from the solvent bag. Spray heads were set above the windshield wipers, tubing disguised against the aluminum windshield frame with aluminum-colored Scotch tape, and solvent supply concealed in a sliding cabinet in the head, providing easy access for filling. For that \$10 outlay and an afternoon's efforts, you can insure clearer, safer vision wherever you boat.—*D. W. Smith*



MOST OUTBOARD MOTORS are sold with a 6-gallon gas tank, and that's hardly enough for water skiing or extended cruising. Most boaters need a larger, permanently installed fuel system. A number of firms (such as Tempo Products below) make auxiliary units, or with a little work you may find that a salvaged auto tank does the trick for half the cost.—*T. J. Jackson*



New Quickie Kits

Prewired subassemblies and a clever all-purpose cabinet make this low-cost line of amplifiers easy and fun to build. You can also use the parts to design your own circuits.

WHEN YOU BUY one of these new hi-fi kits, you get it half-assembled for you. The main controls, transistors, resistors, capacitors and other small parts are neatly mounted on a prewired printed-circuit board. All you do is make a few additional connections and the unit is ready to play. Low in cost and easy to assemble, the kits are ideal for putting together an inexpensive hi-fi system, musical-instrument amplifiers or public-address equipment.

The Callectro-Amperex kits are designed for maximum flexibility—you buy only what you want. You can purchase the prewired subassemblies separately for developing your own sound system, or you can get all the parts needed for building a complete piece of audio equipment. The kits are based on preassembled modules for five different solid-state amplifiers, all designed to fit into a trim, walnut-finished enclosure about 12 inches long by 3½ inches high. The five modules include an 8-watt stereo amplifier for \$29.95, 20-watt stereo amplifier for \$39.95, 10-watt guitar amplifier for \$27.95, 30-watt guitar amplifier for \$44.95 and 20-watt ultralinear monaural power amplifier for \$26.95. The output ratings are for peak power; RMS ratings are about half.

The two stereo amplifiers have built-in volume, tone and balance controls as part of the basic module. The two guitar amplifiers have volume, tone and tremolo controls. The 20-watt power amplifier, without controls, is designed for use with a separate control preamp.

To complete each module, you need a

POPULAR MECHANICS



SECRET OF LOW COST is clever aluminum chassis stamped out to take any amplifier module used. Interchangeable front panels hide unused holes, and walnut-finished cover gives trim appearance. Stacked at top are 30-watt guitar amp, 20-watt power amp and 20-watt stereo amp all boxed in same enclosure

for Hi-Fi

By SHELDON M. and
SCOTT M. GALLAGER

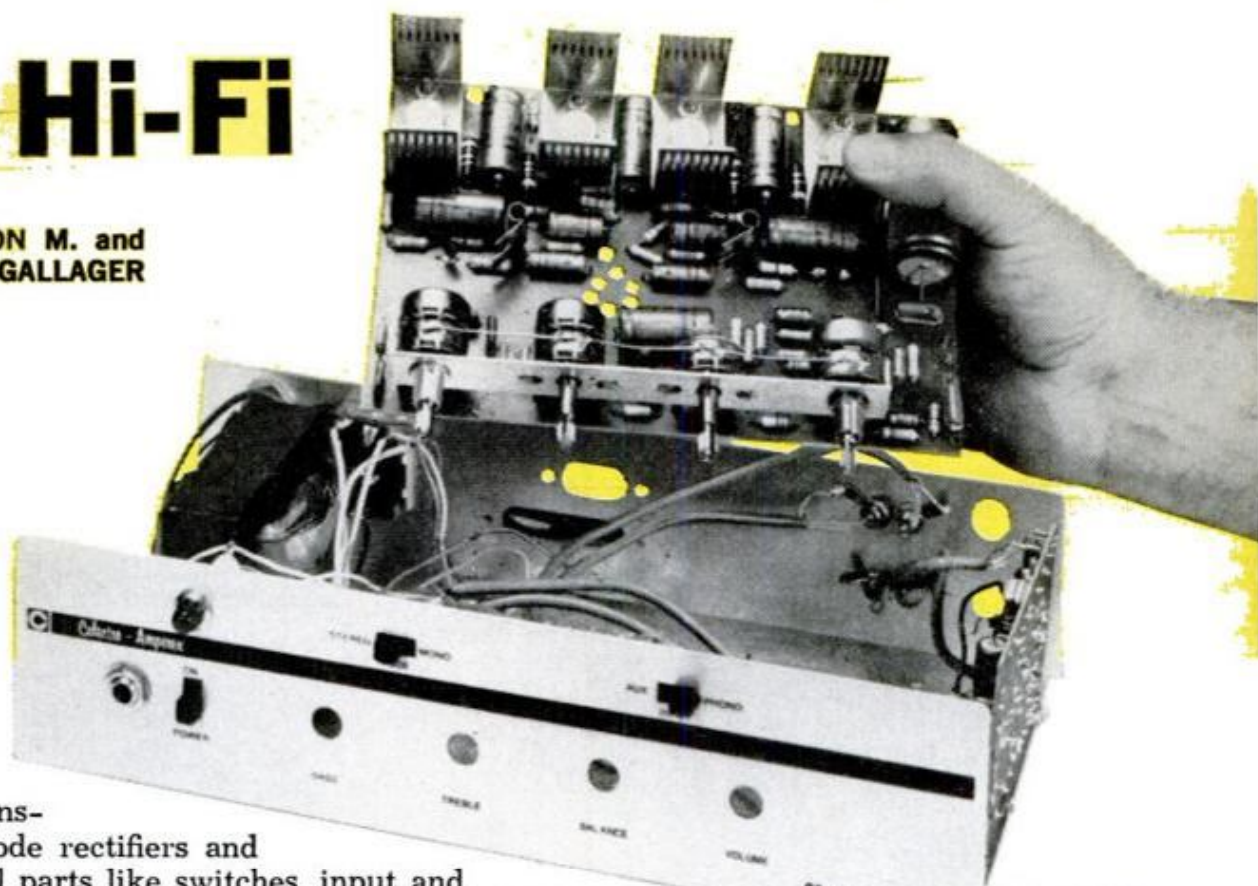

power trans-
former, diode rectifiers and
other small parts like switches, input and
output jacks, fuse holders and pilot lights.
You can add these yourself or buy them
in a handy accessory kit (\$7.95 to \$11.95).

The walnut-finished enclosure is also
available as an accessory for \$11.95. It in-
cludes a prepunched aluminum chassis
with holes to suit any of the basic ampli-
fier modules. To cover the front, you paste
on an attractive, gold-toned, self-adhe-
sive panel supplied with each module.
This conceals the unused holes and pro-
vides the correct openings for the particu-
lar module you've selected. One enclosure
serves all five modules interchangeably.

Except for the power amplifier, all
modules have output connections for
standard 8-ohm speakers. Any conven-
tional music source—phonograph, tuner
or tape deck—can be plugged into inputs
on the two stereo hi-fi amplifiers. If you're
using a magnetic phono pickup, a small
preamp is required in addition to the
main amplifier. This is available as a
separate prewired module for \$14.95. The
two guitar amplifiers have inputs for both
normal and solo instruments and are
wired for foot-switch tremolo control.

The sound you get from these packaged
modules is surprisingly clean and power-
ful, and the kits offer a lot of value for the
money. Sold under the Calectro-Amper-
ex name, they're made by GC Electronics,
400 S. Wyman St., Rockford, Ill. ★★★

FEBRUARY 1971

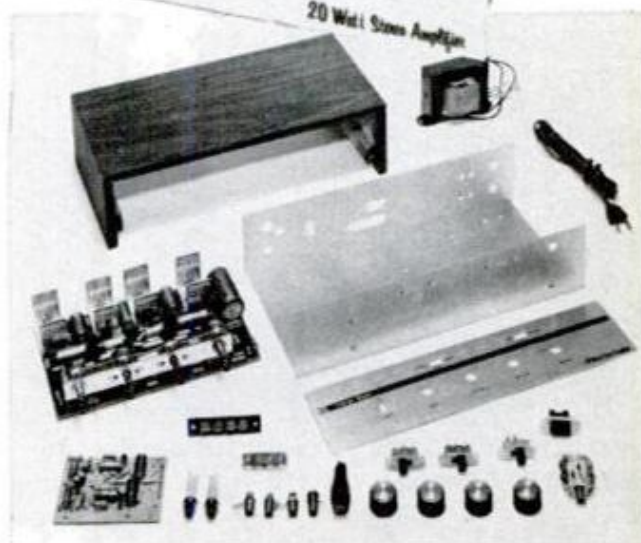

AMPLIFIER MODULES come bubble-packed in a va-
riety of types and sizes. At center is universal en-
closure designed to fit all. A typical module, com-
plete with volume and tone controls, is shown be-
ing inserted in a stereo amplifier at top of the page

117

NEW IN ELECTRONICS

TINY 2-WAY CB TRANSCEIVER works anywhere—as a base station at home, as a mobile unit in a car or boat or as a portable walkie-talkie. Only five inches wide, it has five watts of power—the maximum FCC limit—and offers up to 12 Citizens Band channels. The 12-volt Micro-12 is \$79.95. For home use, an accessory a.c. power supply is \$19.95. For portable use, there's a handy carrying case with built-in battery pack, also \$19.95. Lafayette Radio, 111 Jericho Turnpike, Syosset, N.Y. 11791.

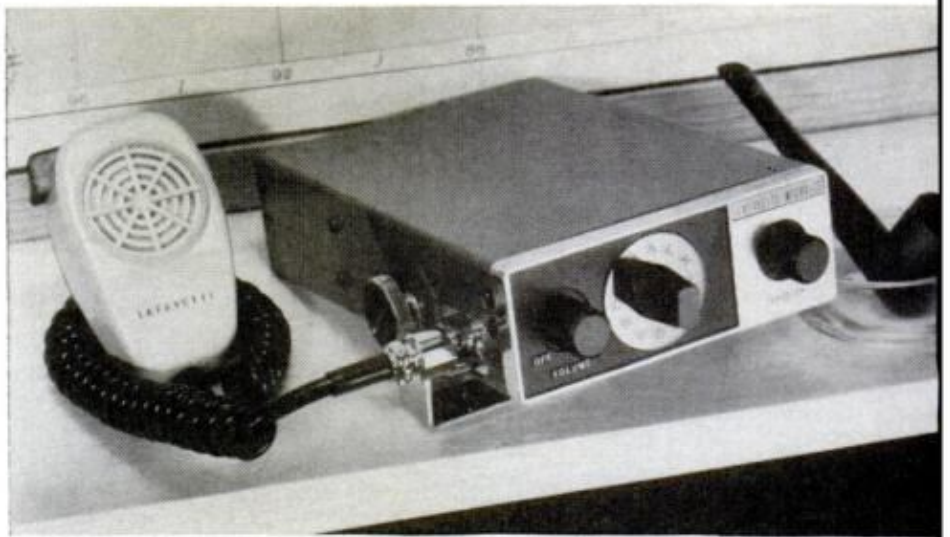

MINIATURE RADIO, developed by the Russians as a by-product of space research, is one of the world's smallest. No bigger than a matchbook, it receives long-wave commercial stations and some medium-wave special broadcasts. Its battery gives up to 15 hours of continuous use. A tiny earphone is used for private listening. The Russians plan to sell the radio in England, possibly in the United States.

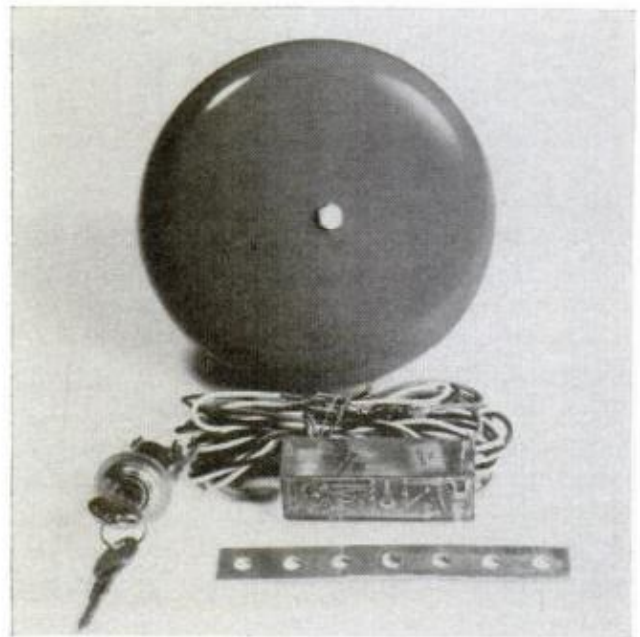

ANTITHEFT ALARM FOR CARS installs in minutes with no special tools. Unlike systems requiring tripping switches, it simply hooks into the ignition wiring and detects any slight current drain on the battery. If someone opens a door, turning on the dome light, or tries to start the car, the device senses the voltage drop and sounds a loud warning. \$29.95, GC Electronics, 400 S. Wyman St., Rockford, Ill.

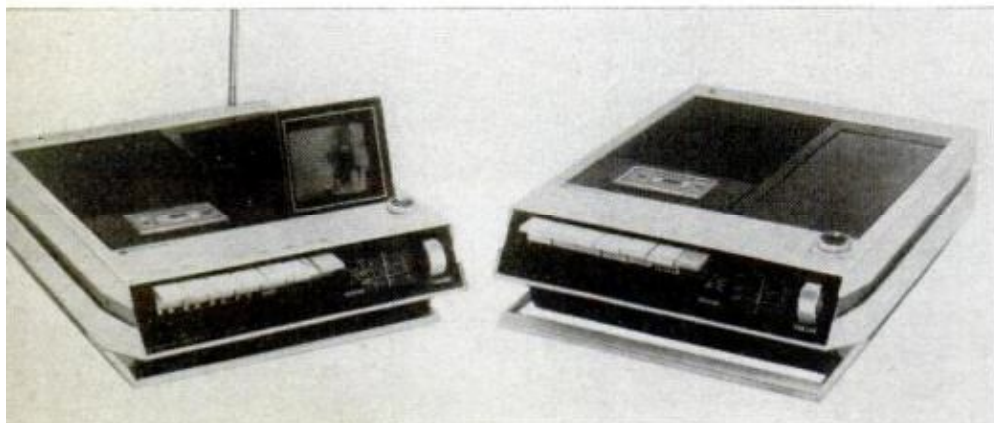

FIRST COMBINATION of TV set and tape recorder will be in this novel Panasonic hybrid, due later. The battery-powered portable packs a 3-inch mini TV screen and a cassette recorder into a slim, compact carrying case weighing only 10 pounds. The screen pops up for viewing (far left) and retracts for carrying. Price has not yet been announced.

POPULAR MECHANICS

New in Photography



YOU CAN PUT SOUND ON FILM with this packaged system designed for low-cost home use. It consists of a Super-8 movie camera, a special synchronized cassette tape recorder and a Super-8 sound projector. During filming, sound is recorded on tape in step with the camera. But unlike other systems, the tape is

used only for the original sound track. During processing, the film is magnetically striped at the factory and the sound is added from the tape. The sound is then played back through the projector when the movie is shown. Price is \$320 for the complete system. Synchronex Corp., 635 Madison Ave., New York, N. Y.



ROLLEI'S LONG-AWAITED ENTRY in the 35-mm single-lens reflex field is expected to be on the market this month. Said to be lighter and more compact than many current SLRs, the new Rolleiflex SL35 has a through-the-lens metering system and a self-starting frame counter that needn't be set at the start of each roll. Six interchangeable lenses, 25 to 200 mm, will be available. Price, around \$300.

FEBRUARY 1971



POLAROID OWNERS can add electronic flash to their cameras with this special adapter for a Model 180 Vivitar strobe. The adapter mates the strobe to most Polaroid models and permits Polacolor close-ups to be made at 3½ to 6 feet with the flash set on low intensity. On high intensity, shots can be made at up to 10 feet. Price of PFA-1 adapter is \$6.95. Ponder & Best, 11201 W. Pico Blvd., Los Angeles, Calif.

119

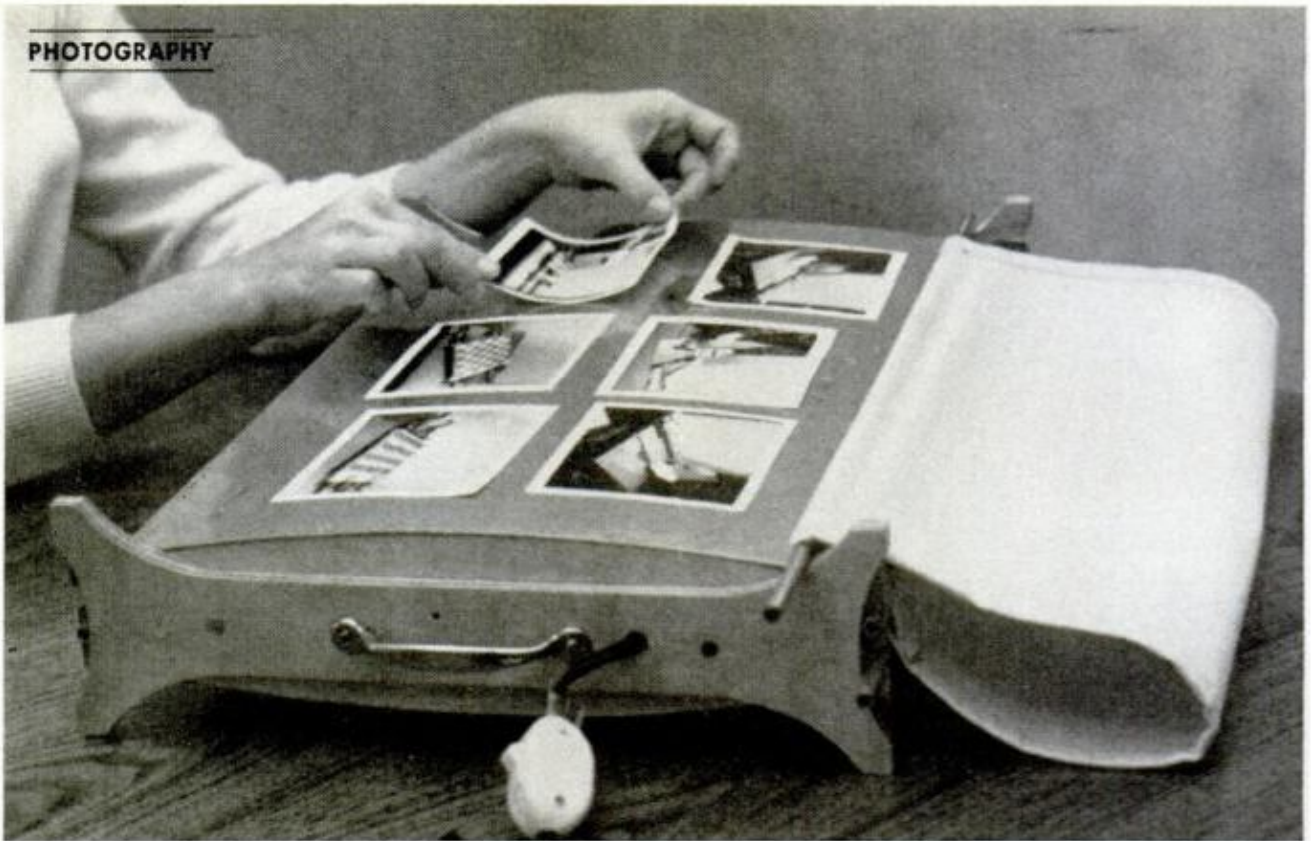

Photo Print Dryer You Can

A simple plywood frame and an old heating coil will speed your dark-room work for only a few dollars

IF YOU'RE TIRED of waiting hours for your prints to dry on a ferrotype plate, you can build this electrically heated dryer and have them ready in a fraction of the time. The double-sided design provides drying surfaces on both sides. Wet prints are laid out on metal sheets and held flat by canvas retaining strips hooked over the ends and pulled taut. There's room for two 8x10s on each side or four 4x5s.

The frame is made of plywood scrap. Two sidepieces serve both as legs for the dryer and hooks for stretching the canvas over the prints. Screwed to the frame are metal sheets to conduct heat. These can be thin aluminum, stainless steel or galvanized—almost any sheet metal will do. Reynolds aluminum is readily available at hardware stores in $\frac{1}{16}$ -inch sheets. You can size the dryer to take ready-made cookie sheets or stock ferrotype plates.

Supported inside the frame is the heating element from an old space heater. Wired

in series with the coil is a bimetallic thermostat from an electric coffeemaker to keep the heat constant. If you can't scrounge these items from around the house, replacement heating coils and thermostats can be purchased at electrical appliance stores. Measure the length of coil you need, then buy one as close as possible to this length. A coil can be stretched or shortened slightly to adjust its length, but

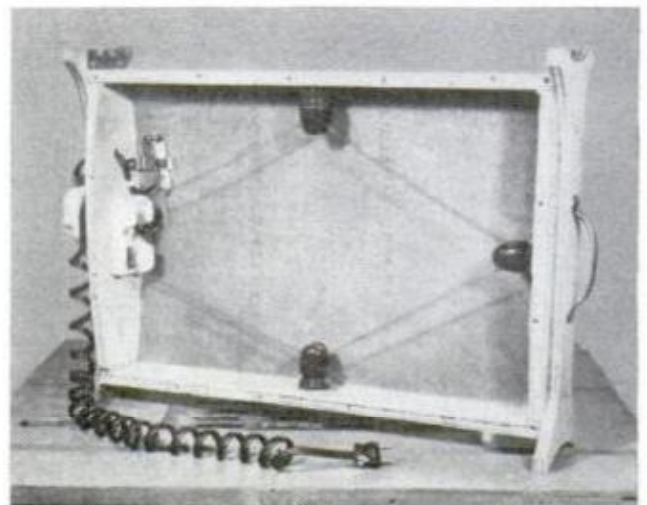

HEATING COIL inside the dryer is strung through glass or porcelain insulators of the type used to anchor radio antennas. Be sure that the coil doesn't sag and touch the metal drying plates at any point

POPULAR MECHANICS

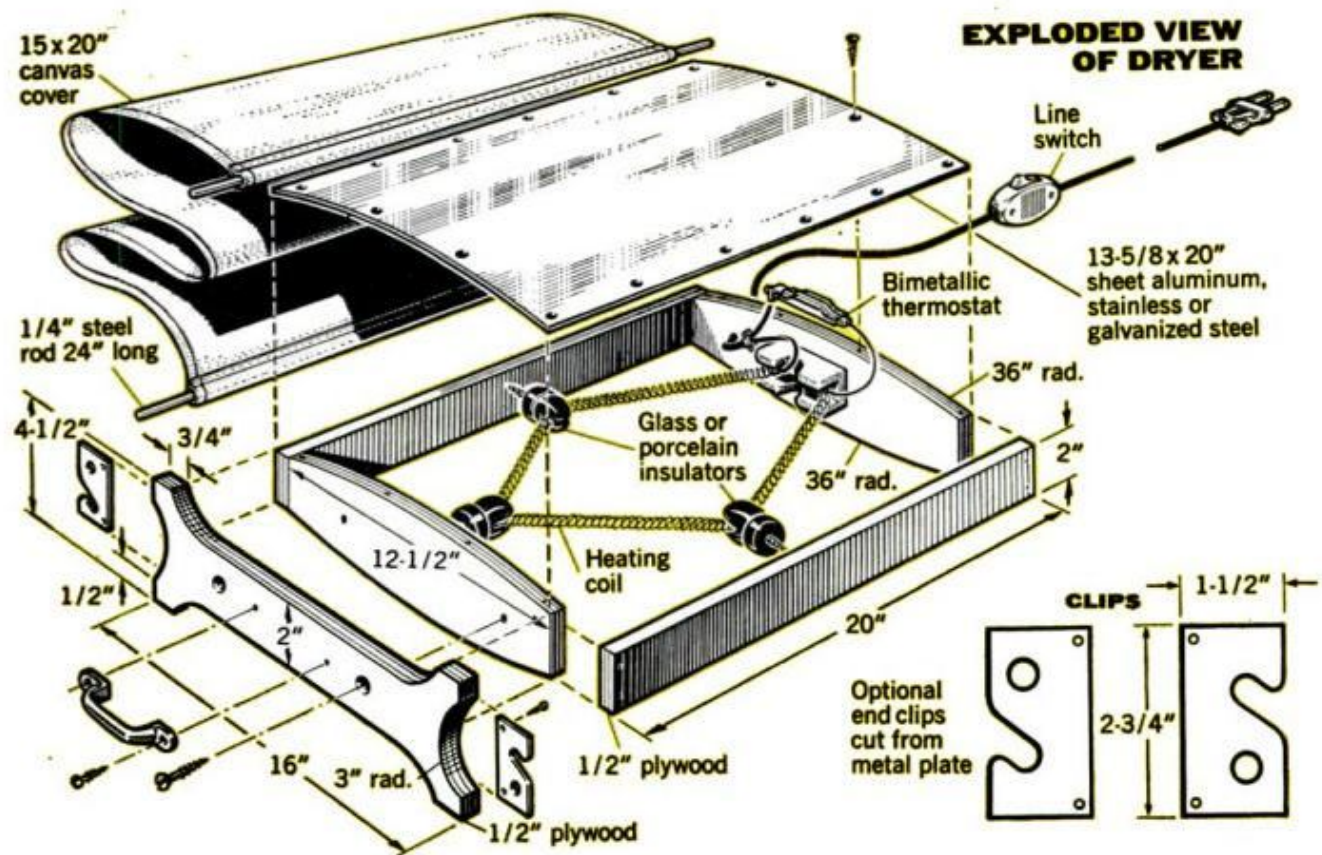

Build for Peanuts

By JAMES A. JOYNER

don't cut off much or you will change its electrical resistance.

String the coil through insulators as shown. The ends are connected to screws on a large porcelain fuse holder serving as a terminal block. Any similar insulated terminal block will do. One lead of the power cord is connected directly to one end of the coil on the block. The other is attached to the thermostat, which is

connected to the other end of the coil.

The canvas covers are held in place by metal rods. Have your wife sew pockets in the ends to hold the rods. The rods can be hooked over the legs or, for a neater arrangement, you can make the metal rod holders shown in the drawing above. In use, the dryer is loaded one side at a time in the flat position, then it's stood upright during the drying period. ★★★

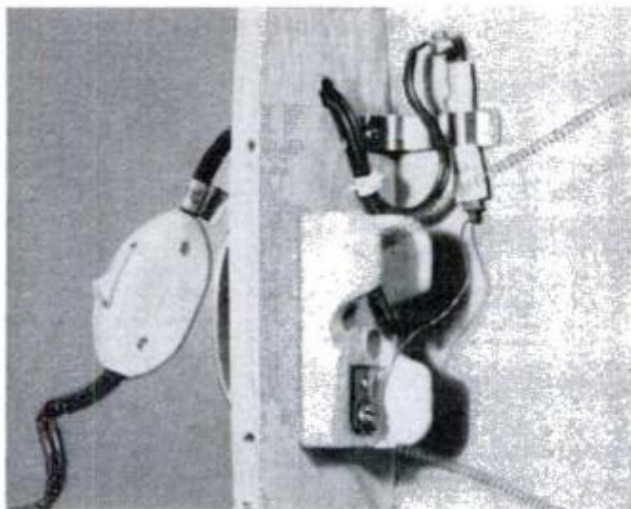

FUSE HOLDER serves as insulated terminal block for fastening ends of heating coil. Note how tubular thermostat is mounted against one of the metal drying plates with small clip bent from metal strap

FEBRUARY 1971

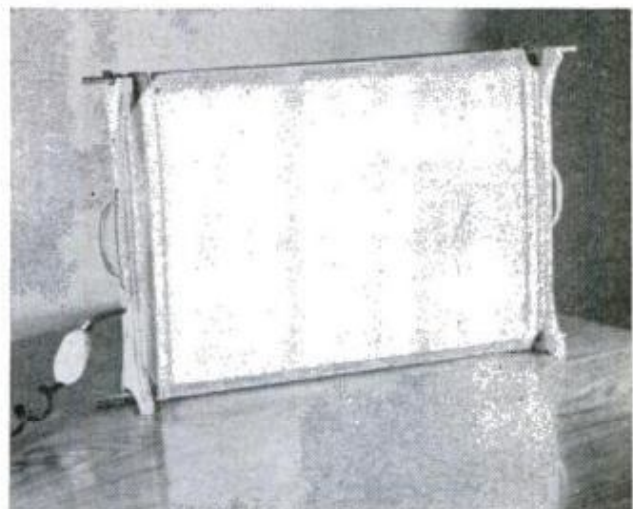

IN UPRIGHT POSITION, dryer is well ventilated and both sides receive heat evenly. Screen-door handles at ends facilitate turning and carrying it. Line switch in the power cord is within easy reach

Those New Gasolines:

How to Pick the Right One for Your Car

By MORT SCHULTZ

Illustrations by Peter Trojan

THE GASOLINE GUESSING GAME has been with us for a long time. Because most oil companies do not post octane numbers on their gas pumps, about all you have been able to do is to resort to trial and error and keep your own record of which fuels knock in your car and which do not.

Now, with nearly every oil company selling no-lead or low-lead gasoline, the guessing game is more confused than ever. Why no lead? What are the advantages of leaving it out? Disadvantages? The answer depends on to whom you're talking. No-lead gas is supposed to reduce air pollution—not so much by reducing lead in the air as by extending the life of the new, experimental catalytic mufflers (which now cost about \$200) from approximately 10,000 miles of operation to 50,000 miles. In a catalytic muffler, which is the most effective exhaust emission-control device yet developed, the exhaust reacts chemically with a catalyst to convert pollutants to harmless carbon dioxide, nitrogen and water

vapor. The real benefit of unleaded gasoline on air pollution, then, won't be realized until 1975, at the earliest, when General Motors says it will equip all of its new vehicles with catalytic mufflers.

So why push lead-free gas now? One reason is because it will take time to introduce unleaded fuel on a nationwide basis. Another is to obtain some secondary benefits of unleaded fuel at once, such as a reduction in lead emissions.

A vice-president of the Continental Oil Co. argues there is little point in omitting lead from gasoline until the catalytic muffler is in wide use. Lead, he insists, is an insignificant pollutant.

This may be true, but where *does* the lead go? To what extent does it get into the human body and what are its effects? We can't assume that lead emissions are harmless until they're proven otherwise.

Still, the high-compression engines on the majority of cars of 1970 and earlier vintage aren't able to burn unleaded fuel without knocking. While there are exceptions, most gasolines have lower octane ratings than comparable grades of leaded

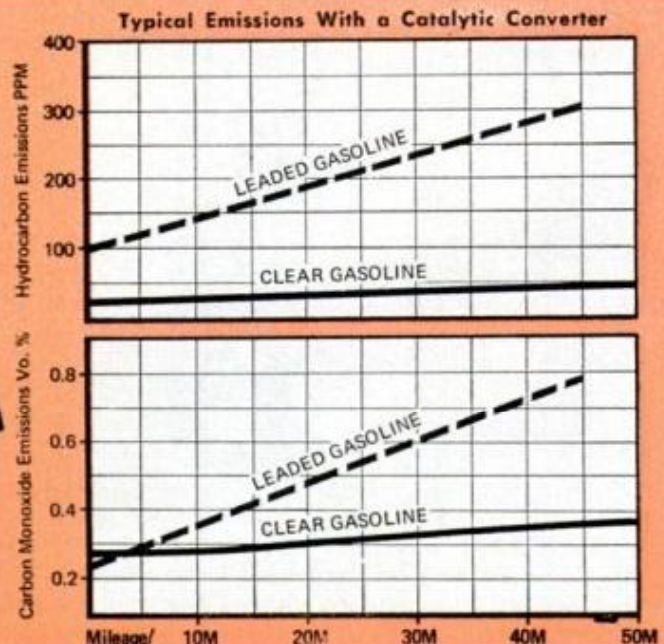
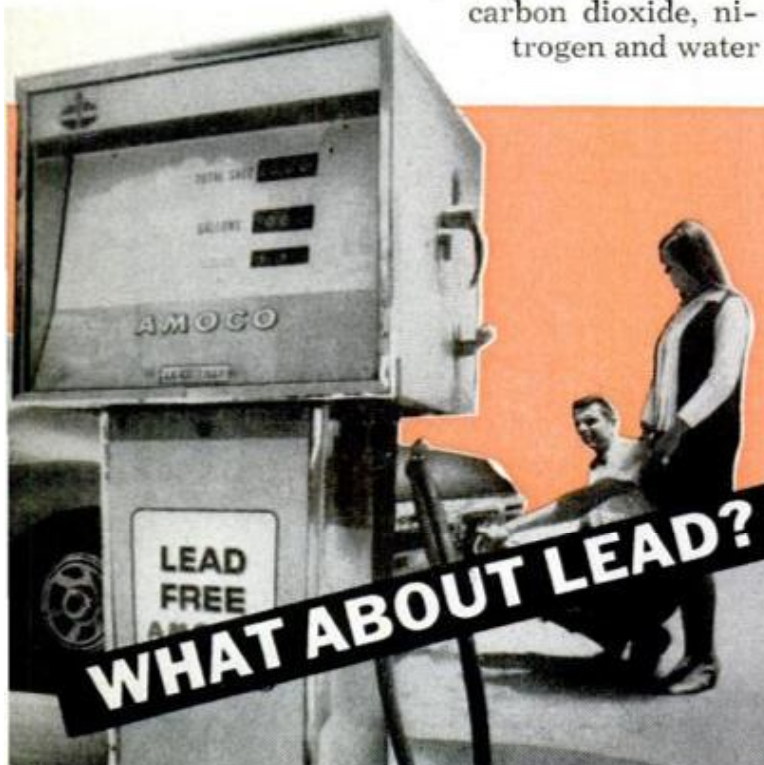

fuel. Lead additives, particularly tetraethyl lead, have been mixed into gasoline since 1923 to increase the fuel's resistance to combustion-chamber heat and pressure. In the absence of lead (or sophisticated, expensive refining to increase a fuel's resistance to heat and pressure), gasoline will explode rather than burn smoothly. This is called detonation (or knock).

The more lead you add to gasoline, the greater will be its resistance to detonation. This resistance is reflected by the fuel's octane rating. Thus, 100-octane leaded gas has greater resistance (and more lead) than 96-octane leaded gas.

Octane rating is obtained by comparing a gasoline's resistance to detonation with a blend of isooctane and n-heptane (the *n* stands for normal). Isooctane has maximum resistance to detonation and an octane number of 100. N-heptane has no resistance to detonation and an octane number of 0.

Thus, if gas is rated at 94 octane, it has the same resistance to detonation as a mixture of 94 percent isooctane and 6 percent n-heptane.

Octane ratings of leaded gasolines differ widely from one section of the country to another and from brand to brand. The number for regular fuel ranges from 90 to 96, that of premium, from 97 to 103.

The octane rating of today's *unleaded* gasoline, on the other hand, is about the same from brand to brand: 91. But some oil companies have taken a middle-of-the-road position. They sell a low-lead gasoline, claiming that you need some lead

Pressure-Time Relationships for Combustion

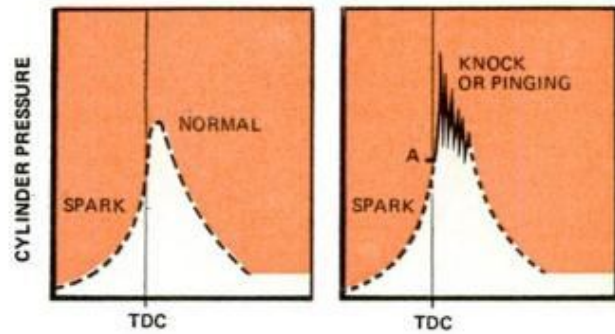

RESISTANCE OF FUEL to self ignition from heat in cylinder depends on octane number. Fuel should burn smoothly and evenly as flame front advances through combustion chamber. Self ignition creates sharp pressure changes that result in knocking

to prevent valve problems. The octane rating of low-lead gas is from 94 to 96.

Incidentally, most regular leaded gasolines contain up to 2.5 grams of lead per gallon, while low-lead gas has a maximum of 0.5 gram of lead per gallon.

Whether lack of lead does lead to valve trouble is another question. The Chrysler Corp. contends that lead protects engine valve seats. American Oil Co., on the other hand, which has been selling no-lead premium in the eastern half of the United States for almost 50 years, replies that it has never had a complaint about valve problems in cars using its lead-free fuel.

One thing is certain. If valve failure becomes a problem because of no lead in gas (in theory, lead helps eliminate valve pounding by acting as a buffer between valve and seat), a different chemical

LEAD FOULING is evident on plug which was run for 12,000 miles in engine using leaded fuel. Plug at the right was run 50,000 miles on unleaded gasoline

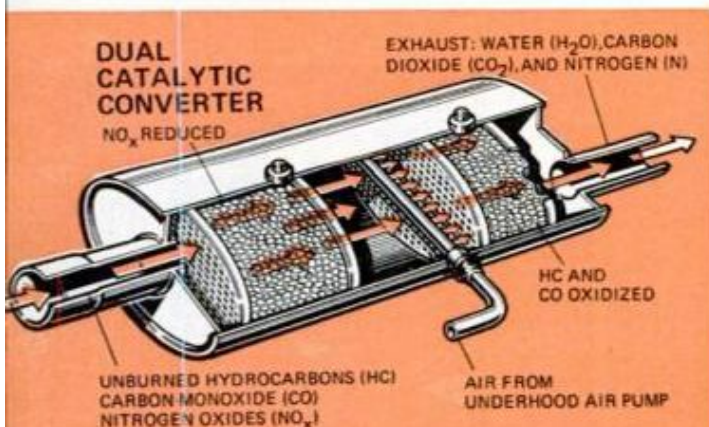

GETTING LEAD OUT is mainly to halt rapid disintegration of expensive catalysts in exhaust-cleaning converters to be original equipment on production cars in few years. Charts show rise in HC and CO emissions using leaded fuel with converter. Also under study: health hazard of lead in the air

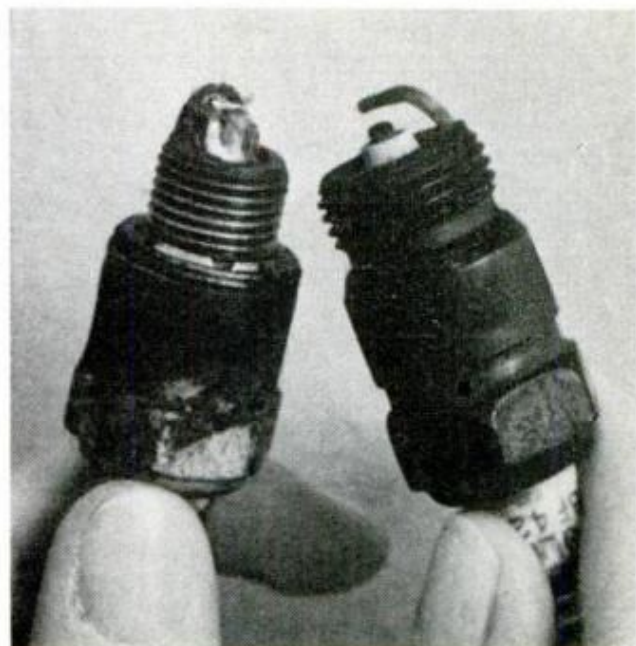

additive may be tried or more durable valve materials developed.

When you buy leaded gasoline you are getting increased resistance to detonation. How can this resistance be obtained if lead is "outlawed"?

Most oil companies, whether producing no-lead or leaded gasoline, start with a "regular" having an octane level ranging from 86 to 90. To increase this rating the refiners can add lead. Or they can use more intricate and expensive refining methods. An oil company can get any octane level it wants by refining and re-refining a gasoline to alter its molecular structure. But lead is cheaper. For that reason, unleaded (and low-lead) gasoline is costing customers from one to six cents per gallon more than leaded fuel with comparable octane.

What does all this mean as far as your car is concerned?

Practically every pre-1971 car requires gas with an octane rating of at least 92. An exception is Volkswagen, which will run okay on 91-octane.

This year's models are different. Almost all engines have been redesigned to allow use of lower-octane fuel. Every 1971 General Motors car, 1971 FoMoCo cars except those having 429 and 460-cu.-in. engines, and 1971 AMC cars except those with a 401-cu.-in. engine will operate without knocking on 91-octane fuel.

Chrysler says 93 percent of its 1971 models will operate on 91-octane gas, but recommends that low-lead (not no-lead) fuel be used because of the valve problem.

If 91-octane fuel is recommended, it means that unleaded regular gas can be used (Chrysler notwithstanding). However, keep in mind this important fact: These 1971 engines will perform just as well on low-lead and fully leaded gasoline.

Octane requirement is the name of the game. The octane requirement of an engine depends on compression ratio, ignition timing and combustion-chamber design. The lack of just one octane unit can cause knock.

Actually, knocking can occur without your hearing it. But if you can't hear it, there's nothing to worry about. "Detonation per se is not harmful to engines as long as it is of light intensity," says Bernard Rosen, director of product and process research for Cities Service.

A heavy knock is something else, however. So what do you do? The answer to this question offers the logical way to select gas with the correct octane level for your car.

Start with the grade (regular or premium) of fuel suggested by the manufacturer of your vehicle. If a knock becomes audible, switch to a different brand of the same grade.

Within a geographical area, octane ratings differ from brand to brand and, unfortunately, ratings are seldom posted. In the east, for example, Sunoco 200 (leaded) has an octane rating of 94, Phillips 66 regular (leaded) has an octane rating of 95 and American regular (leaded) has an octane rating of 96.

In the Los Angeles area, the octane

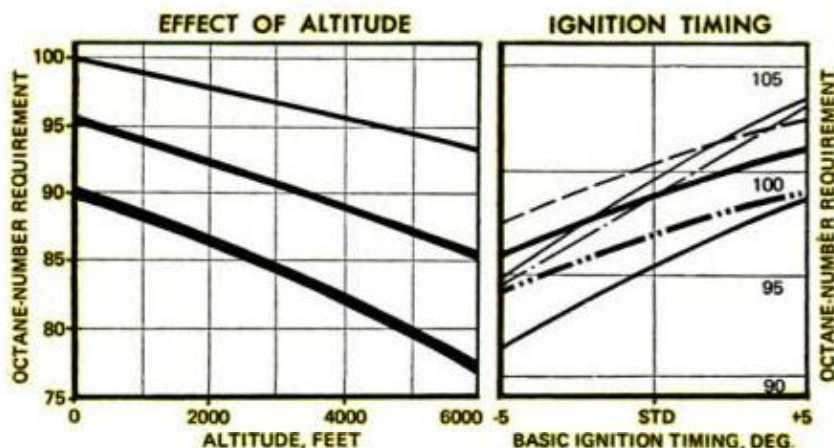

POSTING OF OCTANE NUMBER is not required by law, so only a few oil companies post this measure of fuel's resistance to detonation. Engine's octane-number requirement depends on more than compression ratio. It decreases with altitude, for example, as shown in graph at left for engines needing 90, 95 and 100 octane at sea level. Graph at right shows need for higher octane in six different engines as ignition is advanced

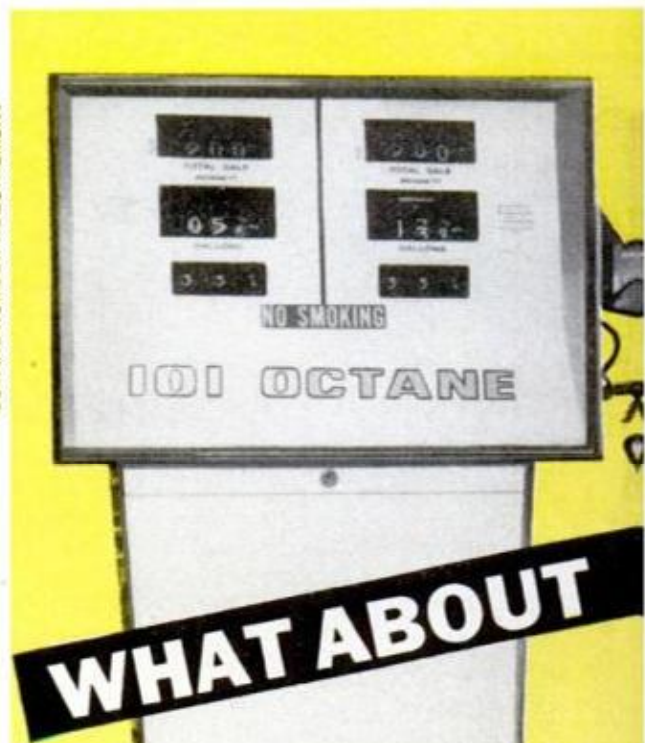

rating of Esso Extra (leaded premium) is 99 while that of Texaco Sky Chief (leaded premium) is 100.

This is not intended to suggest that a gas having a lower octane may not be as good as one having one or two octane units higher. *Excess* octane is of no value. It doesn't give an engine more power. It doesn't keep an engine clean. In fact, says J. H. MacPherson, vice-president of Chevron Research Co., you should use gasoline having the lowest octane rating that doesn't produce knock in your car.

When you switch your brand of gas, it won't take you long to determine if it's of the octane level your engine needs. An engine burning fuel too low in octane begins to knock when that fuel enters its cylinders. Similarly, once the engine gets a gas that allows it to resist detonation, it will stop knocking.

Bear in mind, however, that high-octane gas isn't always the solution to detonation. Overadvanced ignition timing, high cooling-system temperature, and a lean air/fuel mixture—any of these can make an engine designed to operate on regular fuel knock even when premium is used.

A proposal before the Federal Trade Commission—if it passes—will make it easier for you to determine the octane rating of the gas you buy. It calls for posting of the octane ratings on the pumps.

Now, what about those 1971 engines designed to run on 91-octane unleaded gas? As we said, unleaded gasoline won't really begin to reduce air pollution until cars have catalytic mufflers. Even so, there are



CATALYTIC CONVERTER to be installed on 50 of Chicago's city-operated automobiles is described to H. W. Poston, Chicago's commissioner of environmental control, by J. O. Logan, president of Universal Oil Products. UOP is a leading company in research and development of catalytic processes for industry

several real benefits in using unleaded gasoline now: You'll eliminate lead fouling of sparkplugs and minimize deposits that build up on valves, pistons and other engine parts. And you'll reduce the corrosion of your present, regular noncatalytic muffler. ★★★



EFFECTS OF REFINING AND LEAD ADDITIVES ON OCTANE

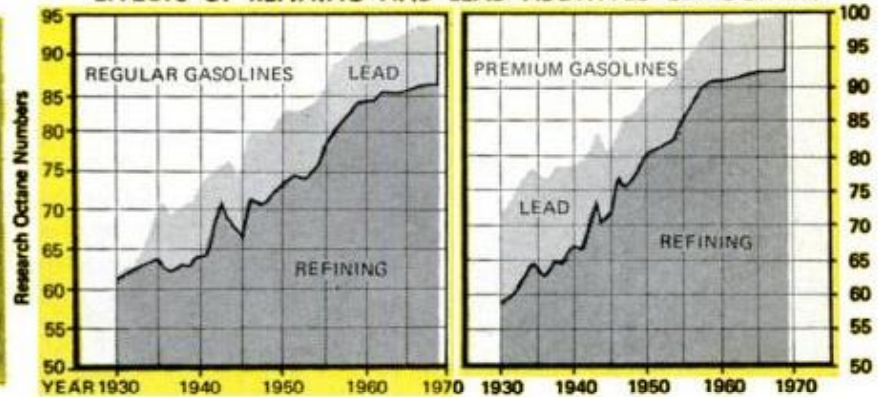

REFINING TECHNIQUES over the years have raised the resistance of fuels to detonation and made possible the modern high-compression internal-combustion engine. In the 1920s it was found that a pinch of tetraethyl lead raised octane number without further refining and it has been used for that purpose since then. Always use gasoline of the minimum octane (and therefore price) that you can. There's no benefit to using a higher octane number

How to Use the TACH-DWELL for Perfect Tune-Ups

You can get an acceptable tune-up 'by ear' but if you want to be right on spec, you'll invest in a good measuring instrument.

By MORT SCHULTZ

WHEN YOU DO your own engine tune-ups you really need a tach-dwell tester, which measures engine speed and the time that distributor breaker points remain closed.

You could probably get along without the distributor or dwell-test part. A feeler gauge is not 100-percent accurate, especially if points are slightly corroded, but it will put you somewhere in the ballpark on point adjustment.

However, you can't measure engine revolutions per minute by ear, eye or feel, and since most engine adjustments must be made at a specified speed, there's no way to get around the need for a tachometer.

There's another reason why a tach is necessary. A modern engine requires that speed be set to within 10-15 rpm of specification at idle to insure proper operation of an automatic transmission and carburetion. You can't get this close without a tach.

So why not buy only a tach? Because you can buy a tach-dwell for practically the same price.

The circuitry necessary for both functions is practically the same. For both rpm and dwell readings the circuit allows a preset amount of charge through the meter each time distributor points open and close.

Distinction between rpm and dwell is made primarily by a switch that allows

you to transfer from rpm (tach) scale to dwell scale. This switch adds a few dollars to the cost of the instrument, but it's worth the extra money to get the dwell feature.

The dwell meter portion of the instrument measures the percent of time that points remain closed and converts this into a scaled reading which multiplies the percent of time by 360° divided by the number of cylinders in the engine. For example, if points in an eight-cylinder engine remain closed two-thirds of the time, the dwell reading would be $\frac{2}{3} \times 360^\circ$ divided by 8, or 30°. On a six-cylinder engine, it would be 40°—on a four, 60°.

If point dwell is excessive—that is, if points remain closed too long—too much current would flow through them at low engine rpm and arcing would occur that would reduce point life. Conversely, if dwell is set too low, not enough current would flow in the coil at high speeds to provide sufficient spark to fire sparkplugs. Poor high-speed performance would be the result.

To check dwell, warm the engine to operating temperature, calibrate the meter using the zero adjustment button, screw or switch on your unit and connect the leads. The hookup for all tests done with the tach-dwell is the same.

The unit's black lead is connected to a clean ground on the engine. The red lead is connected to the distributor primary

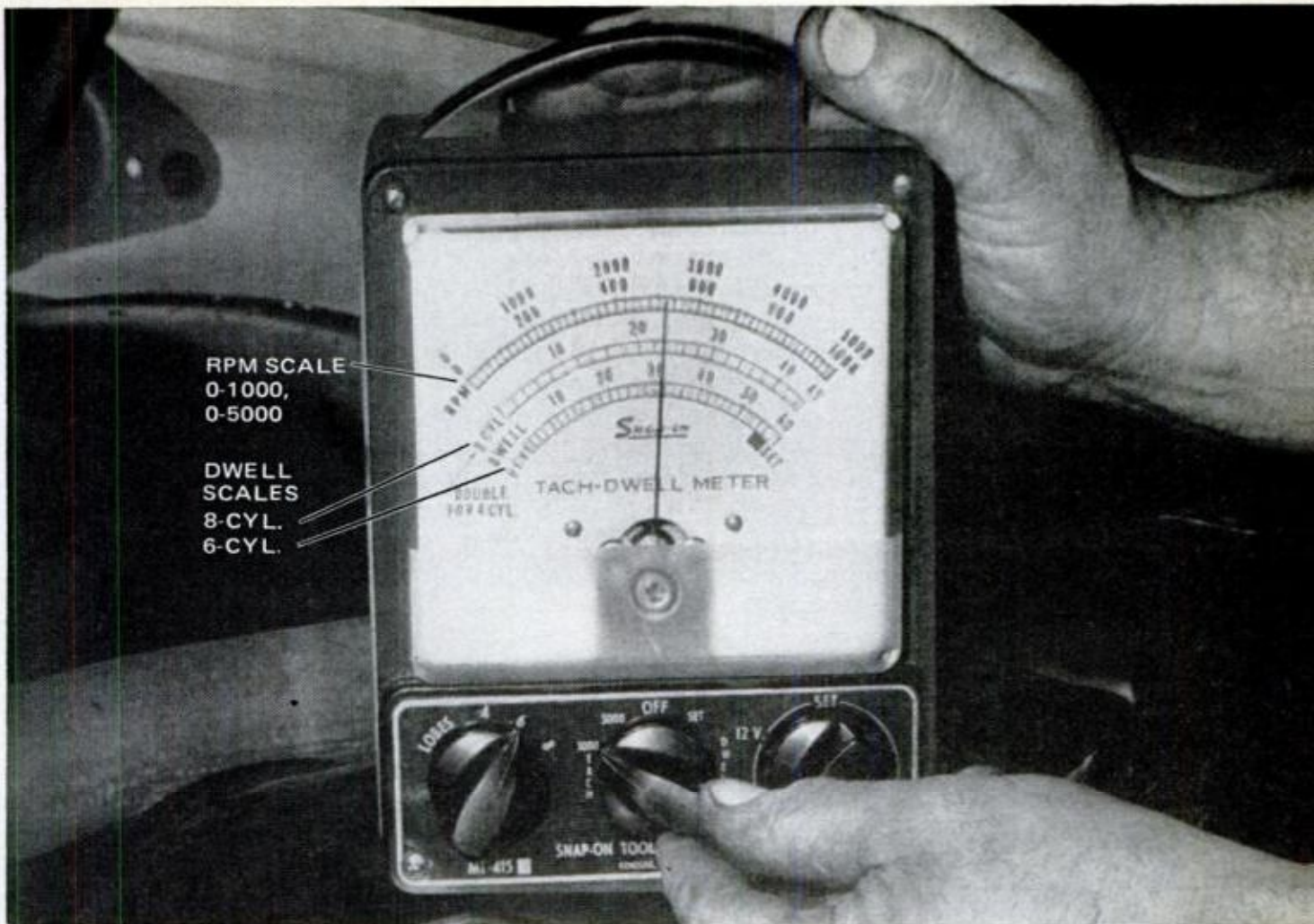

TYPICAL TACH-DWELL METER has high and low rpm ranges, and scales for six, eight cylinders. For four cylinders, the eight-cylinder scale is used and reading doubled. Connections for dwell-tach (below) are simple (see text). Points are adjusted (below right) to bring dwell reading within the manufacturer's specification

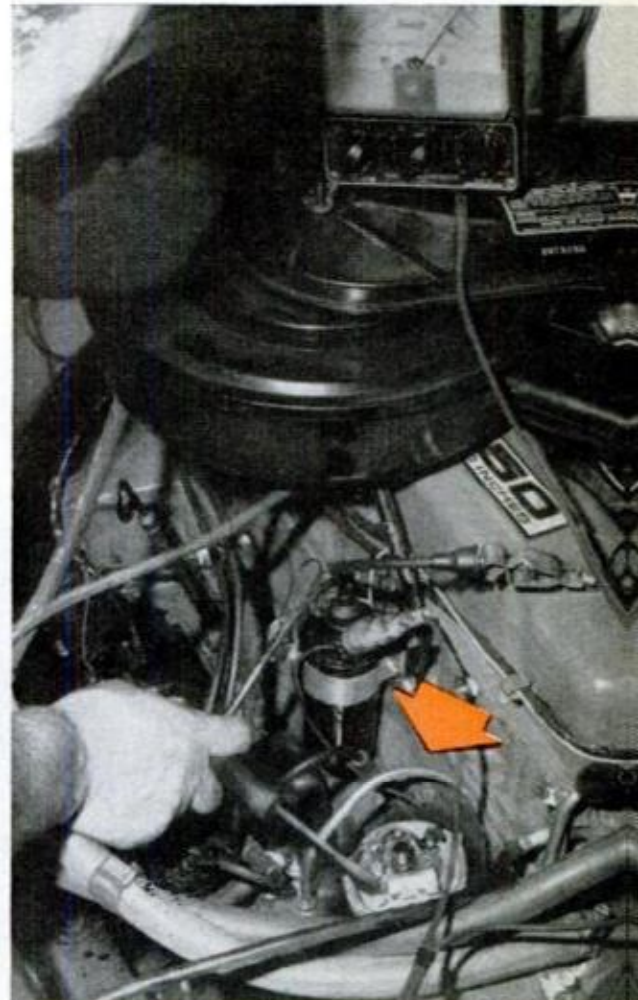
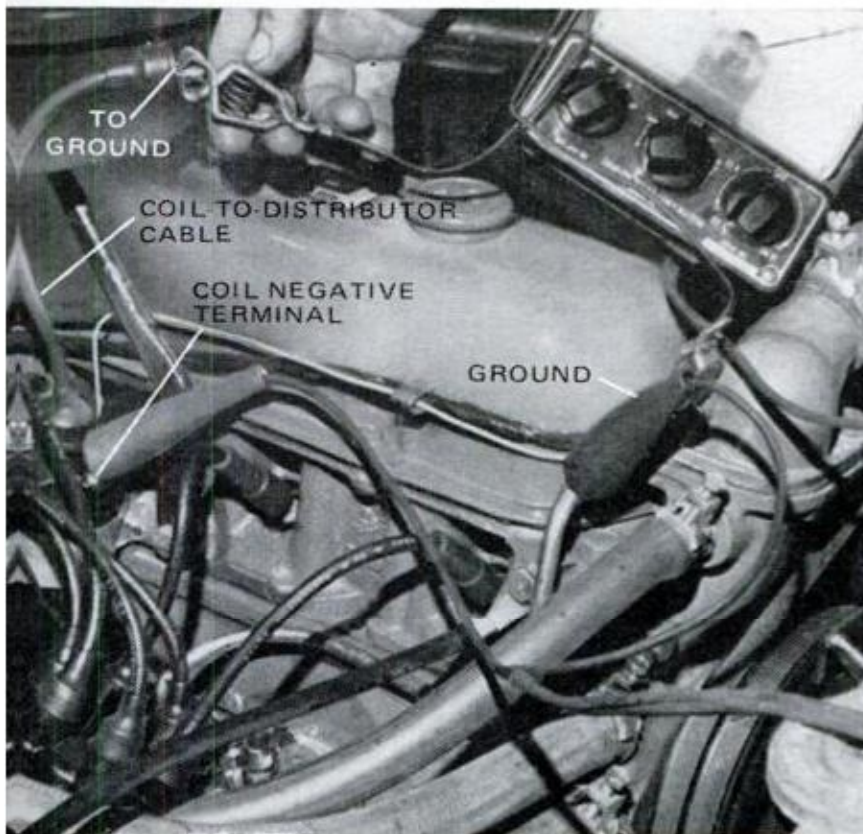

terminal at the coil. This is assuming that the car's electrical system is negative ground, as most are. If by some chance you should have a positive-ground system, reverse the leads.

Make sure the tester's selector switch is on *dwell* and start the engine, running it at idle speed. Observe the meter and compare the reading to manufacturer's specifications, which are provided in owner's and service manuals.

This specification is probably given as a range, such as 28°-32°. A reading within this range is normal. However, if the meter shows a higher or lower reading, you'll have to adjust the points.

Shut off the engine and remove the distributor cap and rotor. Remove the coil high-tension cable from the center tower of the distributor cap and connect it to ground by means of a jumper lead. Leave the tach-dwell hooked up as it was before.

Now, turn on the ignition switch and have someone crank the engine as you adjust the breaker points to obtain correct dwell. When this has been done, button everything up and make the dwell test again.

If correct dwell cannot be achieved or maintained, you have a problem inside the distributor with a worn point rubbing block (replace the points) or a worn cam (replace the cam).

With dwell properly set, use the tach-

SET IDLE SPEED on cars with throttle-stop solenoid by turning the adjusting screw while watching tach



dwell tester to check dwell variation, which is the total difference in the meter reading between idle and 1500 rpm. Start by noting dwell at idle.

Switch the tester to the *tach* mode and increase speed to 1500 rpm. Hold it there and switch back to *dwell* position.

Note the dwell reading. It should not have changed by more than 2° from the idle reading on most engines, but make sure that you check the manufacturer's dwell variation specification before condemning the distributor.

Suppose, for example, that the dwell specification for your engine is 28°-32° at idle, and you obtained a reading of 28° at idle. This means that at 1500 rpm your reading should be 26°-28°. If it isn't, you have a bad vacuum advance, worn or loose distributor shaft, worn distributor bushings, or a worn distributor breaker plate.

A word should be said about engines that have dual point distributors. The number of degrees of dwell measured with the engine running is the combined total of both sets of points. However, when adjusting dual distributor points, one set of points should be blocked open while the other set is being adjusted.

To use the tachometer part of the tach-dwell tester for making tests to manufacturer-specified rpm, hook up the instrument's leads as mentioned before. Some test instruments have a selector switch for four, six and eight-cylinder engines. Others have individual scales on the instrument dial—one for eight and one for six-cylinder engines. If you are testing a four-cylinder engine, use the eight-cylinder scale and multiply whatever reading you get by two.

One of the most important uses you can make of a tach is to adjust engine idle speed and mixture. Specifications for your engine can be obtained from the service manual, or in *Motor's* or *Chilton's* auto repair manuals, which can be found in most libraries.

With the tach-dwell hooked up, the selector in *tach* mode, and the engine at operating temperature and idling, adjust the throttle stop or idle adjusting screw to get the idle speed specified by the manufacturer.

Now, turn the idle mixture adjusting screw out until engine speed starts to decrease. Then turn it in until speed in-

creases and continue turning it in until engine speed again begins to decrease. At this point, back out the screw just enough to get the highest engine rpm and the smoothest idle.

If you're working with a two and four-barrel carburetor, repeat the procedure for each mixture adjusting screw (there are two).

Okay, place the transmission shift lever in the position recommended by the car manufacturer (some require neutral—others, drive). If the tachometer now shows engine rpm to be less than specification, readjust the throttle stop or idle adjusting screw and, if necessary, the idle mixture screw(s). For optimum results, this final test should be done with the air cleaner installed and the engine at operating temperature if these conditions weren't present to begin with.

You can buy a tach-dwell for \$12.95, \$75, or anywhere in between. Shop around and compare. By "shop," I mean just that. See what professional auto-supply stores, discount department stores, regular department stores and mail-order houses have to offer. Get specification sheets and study them to see what each instrument offers.

Don't overlook instruments that come in kit form which you put together yourself. They offer good value.

In making comparisons, there are a few things to look for which are more important than others:

- The instrument should have an accuracy of at least 5 percent—2 percent or 3 percent would be better. Anything less accurate makes the dwell function virtually useless.
- Make sure the meter is large and easy to read.
- The unit should be capable of providing readings for at least six and eight-cylinder engines—and four-cylinder, too, if there's a Vega, Pinto, Gremlin, VW, Opel, Datsun or similar car in your future.
- Make sure that a comprehensive instruction booklet is furnished with the instrument.
- Make sure the unit will provide readings at cranking speeds and that it can be used with the ignition system in your car. Many makes of instruments won't work with transistorized and capacitor discharge ignition systems.
- If the unit is powered by battery, de-

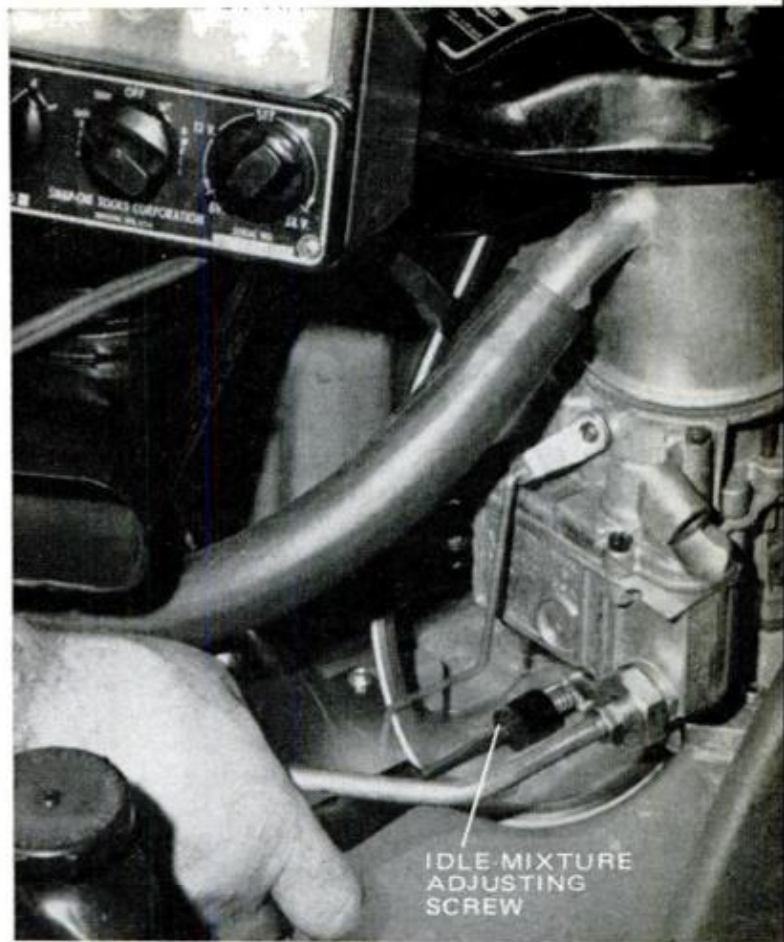

CARBURETOR ADJUSTMENT is made using tachometer to get right idle mixture for optimum performance

termine whether it's a battery that is easily obtainable.

- The impedance of the tester's circuit must be great enough to keep it from altering the electrical properties of the ignition system. This has been a problem with low-priced units, so watch it.
- Check that guarantee and repair service. Tach-dwells have a way of falling off fenders or getting caught in fan belts. Does the manufacturer of the unit provide a practical repair service? And what will it cost?

Following is a list of some instrument manufacturers. To get started in your hunt for a tach-dwell, write and ask them about the units they make:

Accurate Instrument Co., 2435 White Plains Road, Bronx, N.Y. 10467; Fox Valley Instrument Co., 8627 Straits Highway, Cheboygan, Mich. 49721; Heath Co., Benton Harbor, Mich. 49022; Kal-Equip Co., 411 Washington, Otsego, Mich. 49078; Marquette Corp., 3800 North Dunlap, St. Paul, Minn. 55101; Snap-On Tools Corp. 8028 28th Ave., Kenosha, Wis. 53140; Sun Electric Corp., Harlem and Avondale Aves., Chicago, Ill. 60631. ★★



IF YOU'RE GOING AWAY, or looking for a gift for someone about to make a trip, remember the Mini-Valet. This grooming kit offers a fine assortment of high-quality personal essentials and hygiene preparations in compact travel-size containers. Perfect for use at home, in the office or the car, it's priced at \$3.98 plus 50 cents for postage. Head-To-Toe Products, 1697-1725 Elizabeth Ave., Rahway, N.J. 07065 is the maker.

EXCITING NEW PRODUCTS

BY CATHERINE BILSKI



WANT YEAR-ROUND CHARCOAL COOKING? Majestic's Fire-B-Q grill (above) fills the bill—in the fireplace on a cold wintry evening, outdoors on the patio or at a picnic in balmy weather. Designed to hold an adequate supply of charcoal, the unit has a generous 13 by 20-inch surface for cooking. The grill is raised and lowered easily with a crank-type handle. It folds flat for storing and sells for \$18.95 from the manufacturer, the Majestic Co., Inc., Huntington, Ind. 47651.



END THE HAZARDS of slippery rugs and carpets by making them slip-resistant with Rug Gripper Adhesive. It's easy to apply—just dab it onto the back of rugs or carpets with handy dispenser and let it dry. To remove, just peel a rug gradually, starting from one corner. The product, offered in 4-oz. (\$1.25) and 32-oz. (\$3.50) sizes, is manufactured by Carpet Products Co., Box S, Central Square, New York, N.Y. 13036.

130



NAUTICAL FLAGS imprinted on sets of oyster-white cups, mugs, tumblers and trays, as well as on a matching ice bucket, shaker/decanter and coffee service, make this jaunty Ship 'N Shore collection of Acca Ware ideal for a boater. Each set is sold individually. A special acetate-covered gift set, consisting of server and six cups, retails for \$18. Available from David Douglas Co., 20 Frederick St., Plymouth, Wis. 53073.

POPULAR MECHANICS

GO IN SNOW with the Novoslei Snow Go-Cart. Besides its attractive, streamlined design, it features a double safety-brake system, step pedals for speed control, angled steering for excellent edging and turning, movable rear skis and a double shock absorber built into the steering device. This easy-to-handle snow vehicle is safe, lightweight and durable, provides hours of winter fun for the entire family. Suggested retail price is \$98. Available from Novelty Imports, Box 53, Cessford, Alta., Canada.

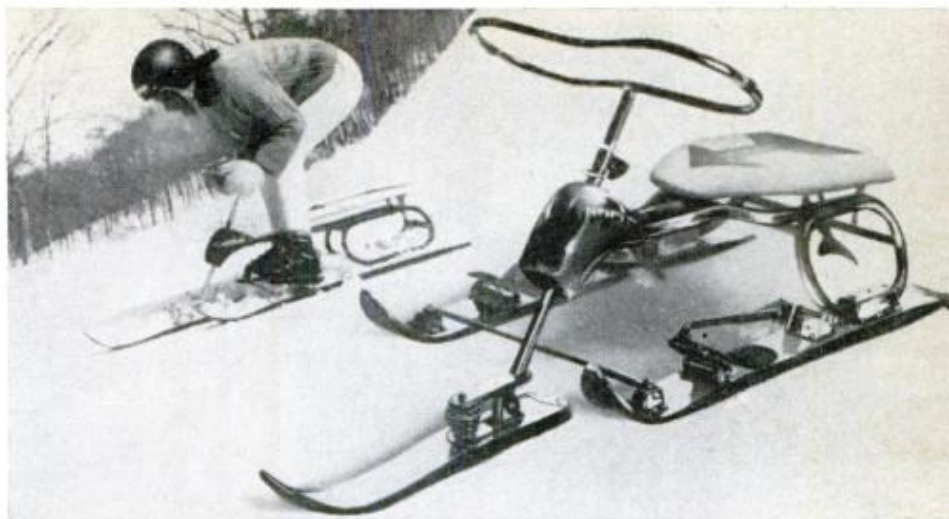

MODEL CAR BUFFS will really go for this rough-terrain Dune Buggy (above). Powered by a Cox .049 Babe-Bee engine, this rugged model can overcome sand, grass, water hazards, jumps and inclines. It measures 14 inches overall and has an adjustable throttle, recoil starter and gearshift. Priced at about \$20, it's made by the L. M. Cox Manufacturing Co., Inc., 1505 E. Warner Ave., Santa Ana, Calif. 92702.

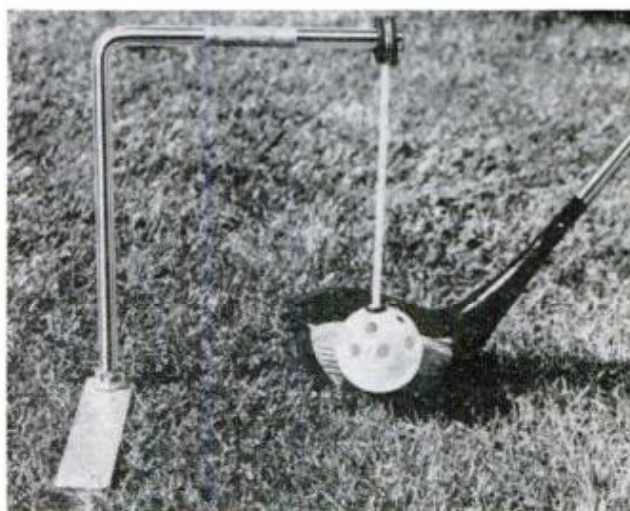

IMPROVE YOUR GOLF GAME at home with a Tee-Off Golf Practice Aid which you can install on the ground wherever there's room to swing a club. It tees itself, there's no ball chasing, and it indicates how you hit the ball: straight, hook or slice. The device is priced at \$5.95, plus 90 cents for shipping and handling, from F. J. Kielian, Specialty Merchandise, 130 Drake Ave., South San Francisco, Calif. 94080.

PERSONALIZE YOUR HOME by spelling name or address with Snap-A-Word letters. These are impossible to misalign because slots engage pegs to eliminate a spacing problem. Tab snapped off last letter (B) is flopped to fill hole (A) in first lower-case letter. Easy to install, letters are weatherproof, and priced at 49 cents each for lower case units, or 59 cents for capitals. Letter House, 8 W. Mineola Ave., Valley Stream, N.Y. 11580.



Things to

Jewelry Keeper

You can quickly build a surefire "corral" to keep your wife's small jewelry—earrings, pins, rings and the like—in one handy spot. The keeper shown is a project you can easily whip out in one day.

The "tree" at the back keeps the earrings in pairs: the clamp types on the crossbars, and those for pierced ears in the small drilled holes. Rings are neatly stacked on the short pole at front and pendants and pins can be stored in the scooped-out portion of the base.

I recommend using hardwood, such as walnut. The two posts and the dished-out section are turned on a lathe (the latter on the lathe faceplate).

Sand the turnings on the lathe, using a fine-grit sandpaper before making the cutoffs. Then assemble the stand using glue, and let dry.

Finish with a coat of stain and wipe off the excess. Allow the keeper to dry for 24 hours, and apply wood paste filler. (This is necessary only if you used an open-grain wood such as walnut, mahogany or oak). Finally, spray on two coats of clear lacquer. After a two-week "curing" period, bring the piece to a hand-rubbed luster using double-0 steel wool and Butcher's wax.

—Harold Jackson

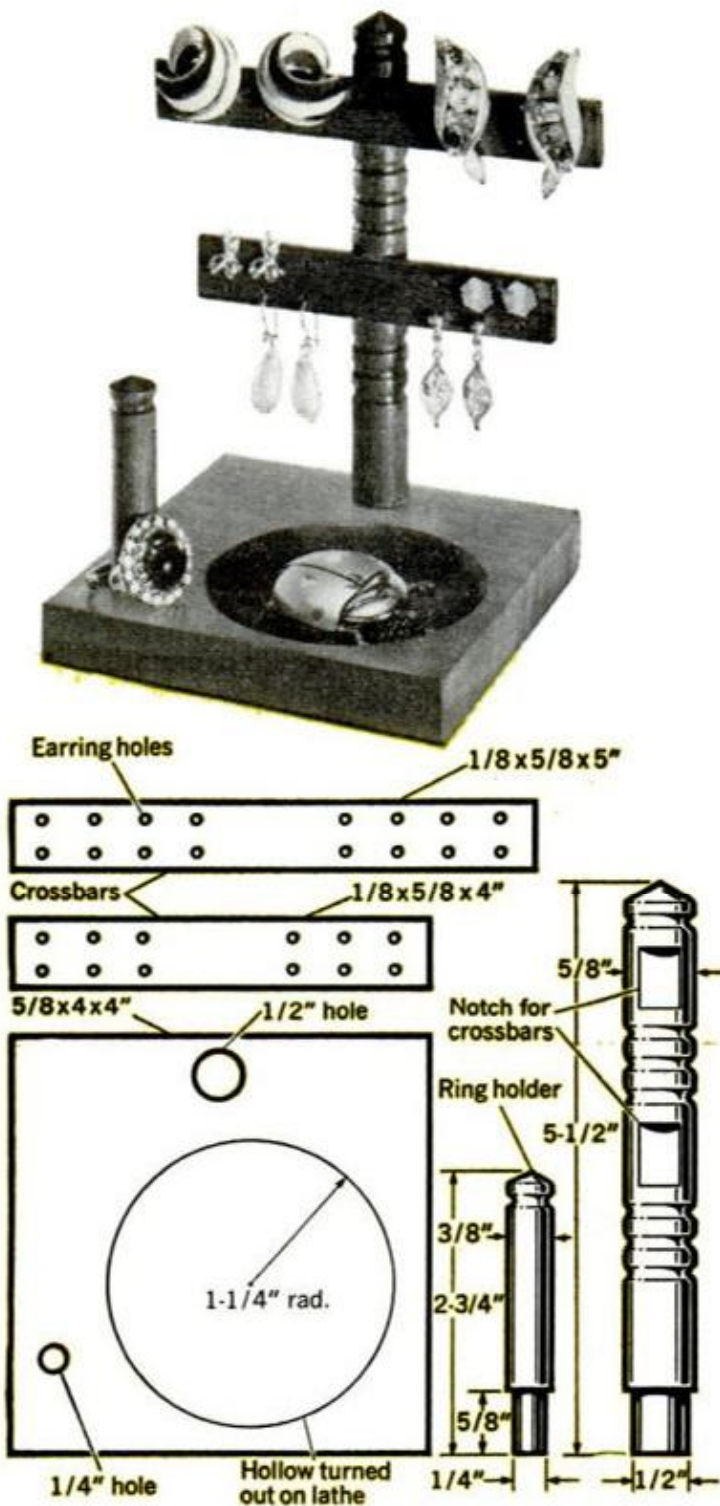

A Baffling Puzzle

Here's a puzzle that you—and no one else but you—will be able to solve unless you reveal its secret. Made as shown in the drawing, the smaller piece (with the dowel glued in) fits into the larger one. The object is to engage the notch in the rubber band which appears to be in the large piece.

The illusion that *you can* engage a rubber band is created by the way you withdraw the smaller part. To

Make for the Fun of it

Key House Number

Looking for a novel way to display our house number, my wife and I hit on the idea of making a replica of a keymaker's sign. It's easy to make, and when it's hung from the roof overhang, the early American touch enhances the look of the house.

The turned section is six glued-up 1x5s. While this piece is "square," cut the two 1/2-in.-wide dados for the handle and key sections. Then cut two blocks to fill the dados and glue them in place with water-soluble glue and use paper in the joint. Next, the turning is made. After completing the lathe work, the glued-in blocks can be easily pried out with a slight dampening and a chisel. Sand the turned section and set it aside. Now jigsaw the decorative handle and key sections and, after sanding the edges, glue these pieces in place on the turned section with waterproof glue.

The house numbers are jigsawed from 1/2-in. stock and are glued to a 3/4-in. mounting strip fitted with screw eyes to accept the chain as shown. All parts are then assembled with a decorative chain. Though expensive, a solid brass chain is the best choice. But, if you prefer a less expensive chain, you can paint it with flat black enamel.

To finish, stain or paint the key to suit your home's exterior. If you prefer, the key can be antiqued (make distress marks with gouge, chisel or by beating with a chain). Since the key will be exposed to the weather, apply at least two coats of exterior varnish for maximum protection and long life.

—C. Wayne Close

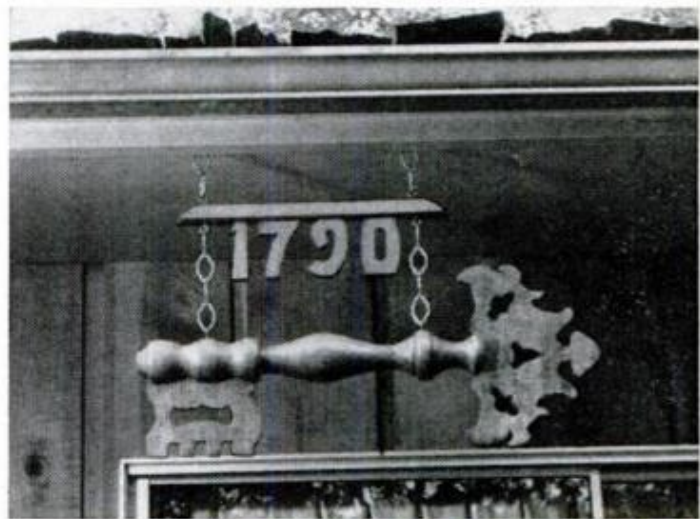

pull off the gag, you slide the plunger out an inch or so by gripping the tapered end between thumb and forefinger. Then, when you squeeze it, it will snap from your fingers and literally fly back into the block. Then, pass the puzzle to a challenger and sit back and watch as he finds it impossible to hook the band as you seem to do so effortlessly.

It's important to be sure that the ends of the "rubber band" are clearly visible when the dowel is inserted.

—Kenneth Wells

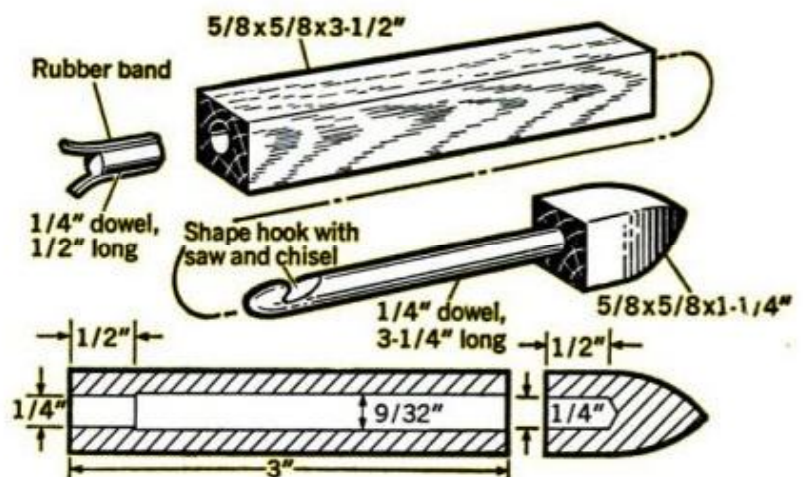

HINTS FROM READERS

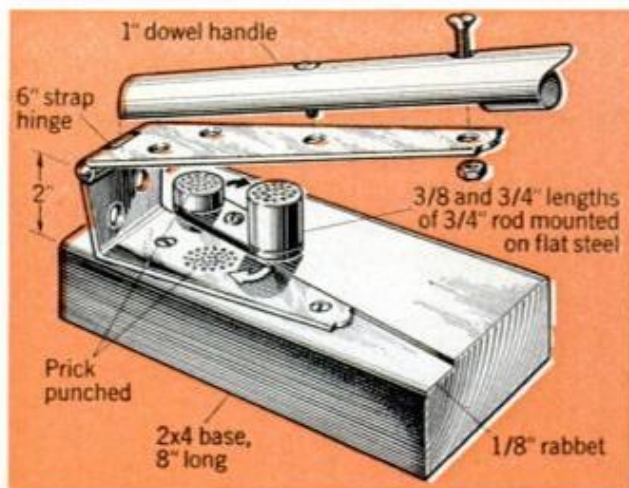

Nutcracker made from strap hinge

Here's a small item you can turn out by the score for fun or profit. The nutcracker is simply a 6-in. strap hinge with one leaf bent at a 90° angle at a point where it will take the largest nut. The "turret-head" feature is simply two different lengths of 3/4-in. rod epoxied, or soldered, to a short section of flat metal that flips into position to handle various-size nuts. Finish the 2x4 base as desired and, if you would like to introduce a personalized note, why not rout in or burn in the recipient's initials?—*William Waggoner*

Emergency resistance-wire repair

When the resistance-wire coil on our toaster burned in two, I used a brass tube from a ballpoint pen to fix it. Simply cut a short length of the tube, insert the burned-off ends of the wire in each end of this tube and crimp them with pliers.

—*G. R. Boulden*

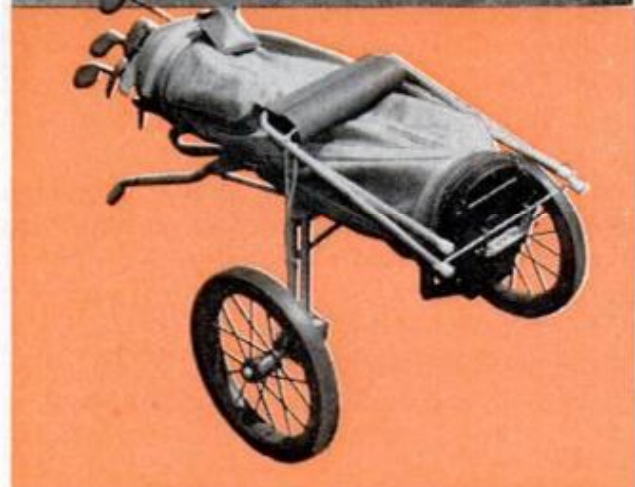

Rest before driving

Here's one way you can beat fatigue while waiting for an opportunity to tee off or for a slow foursome to clear the green ahead. It's an inexpensive campstool that's attached to your golf cart by means of two strands of rubberized rope that are looped through the legs and fastened to a cart member. Use a length of 1/4-in. threaded rod through two of the legs at the bottom to insure stability, and mount a metal clip on the cart-bottom to secure it when the stool is folded.

—*William Waggoner*

String-marker spaces fenceposts

For a low-cost way to insure equal spacing between fenceposts, without constantly measuring, try marking the desired intervals on a length of mason's line. If you use a red felt-tip pen, the post locations will be easier to spot.

—*Herbert E. Serold*

1971 18-111888

**"I want to taste the tobacco in my cigarette.
I get what I want.
I smoke Old Gold Filters."**

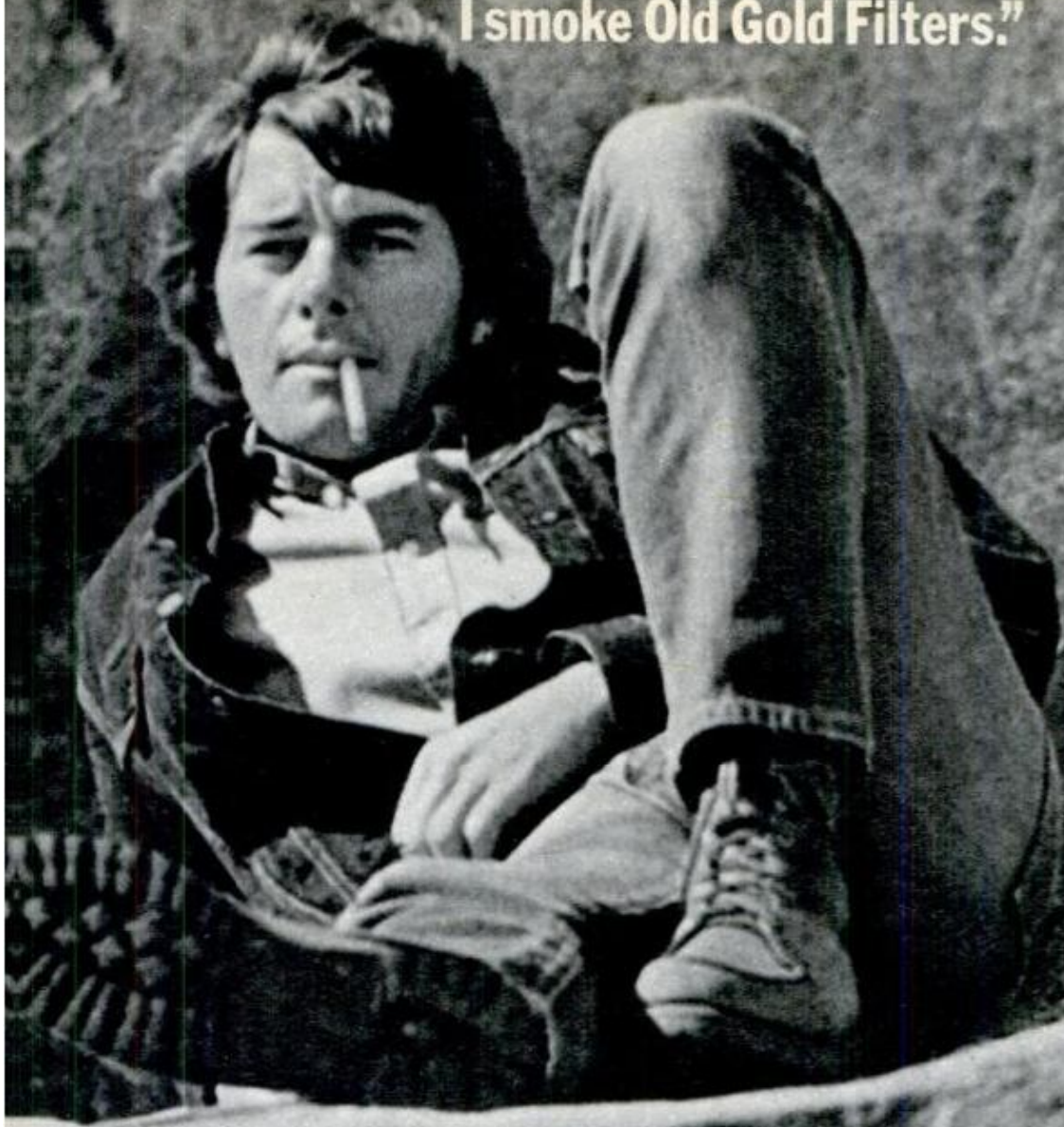

Old Gold Filters. The cigarette for independent people.

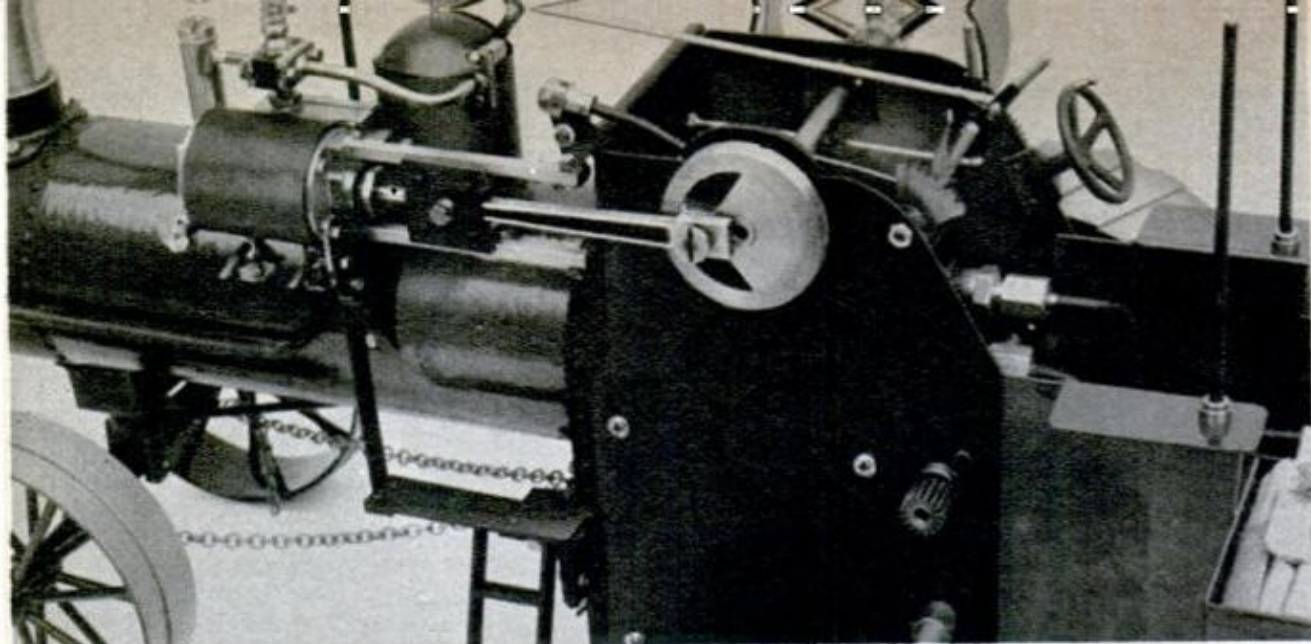

TWO GEARS are used on model's left side. Notice the connections leading from steam dome to cylinder

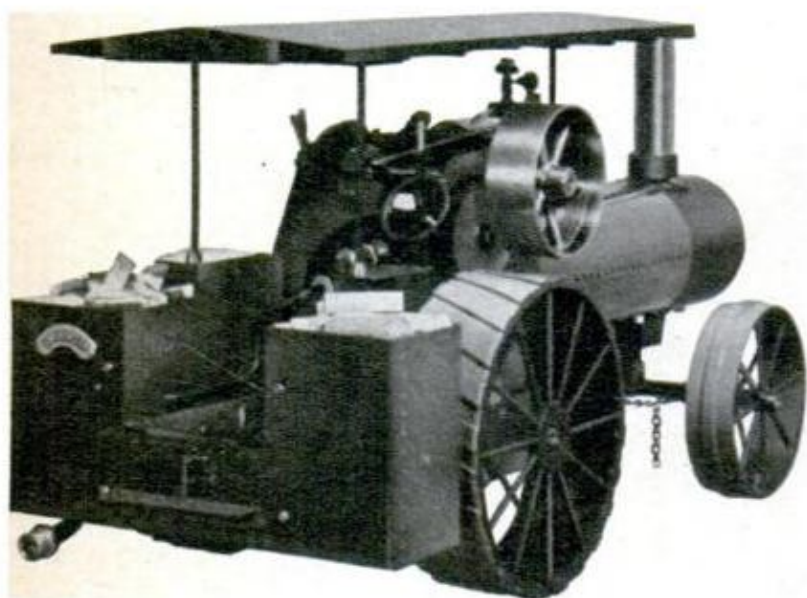

WITH FIREWOOD stacked in the fuel bunkers, model appears ready to roll. The unit is actually fueled by alcohol

MODEL STEAM TRACTOR

(Continued from page 94)

nominal 2-in. steel water pipe makes a good boiler outer casing. The pipe wall is thick enough to give good depth of thread for bolt-on components and more than adequate to meet strength requirements.

Power transmission. Nine gears are used: seven spur gears to move power from the crankshaft to the rear wheels, and a worm-and-pinion for steering. *Ed. Note:* Since many will want ready-made gears, rather than make their own, the full-scale plans tell where to buy commercial sets.

The valve gear fitted to the tractor, generally called the slip-eccen-

GEARS on the right side transmit power from the crankshaft to rear wheels. Note the slip-eccentric gear

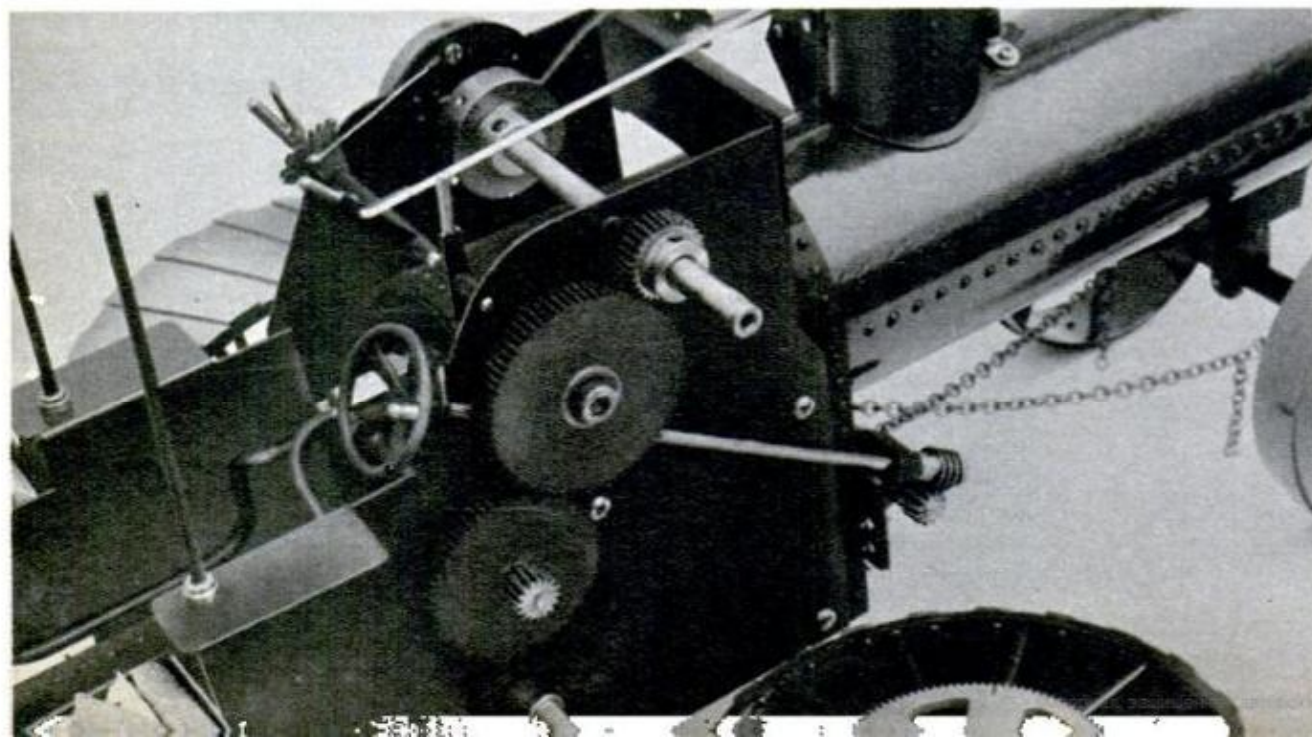

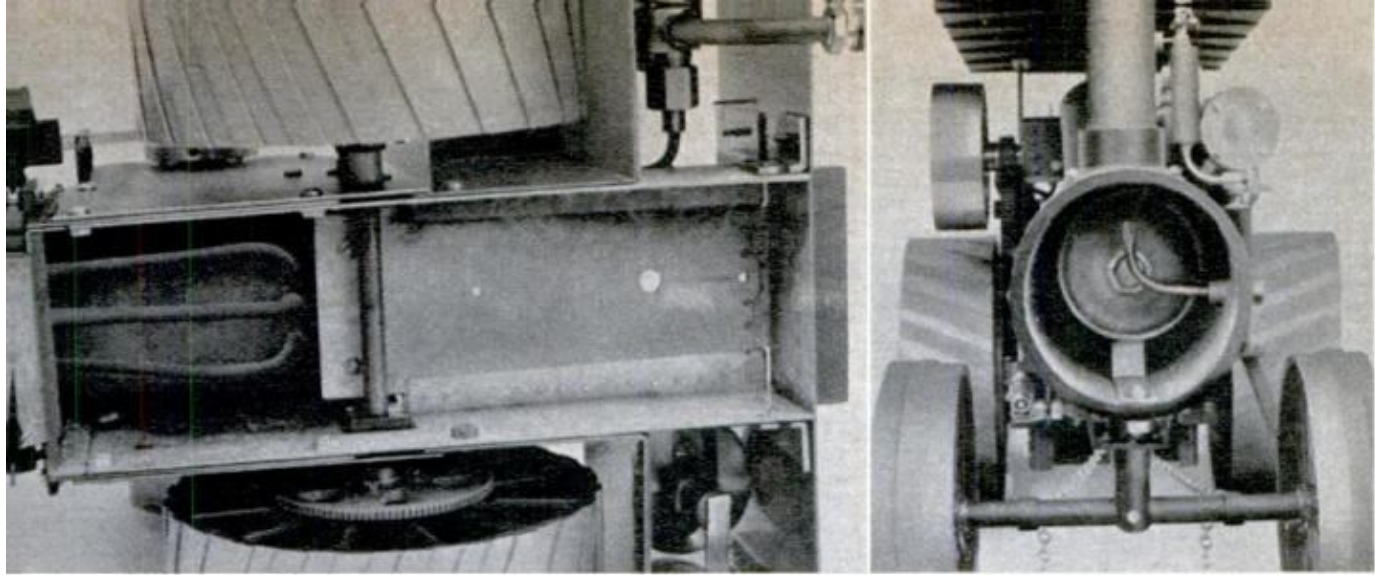

UNDERSIDE of model, with the fuel tank and burners removed, details how plate work at rear is assembled

tric type, is a relatively simple arrangement that lets the engine run either way, while requiring but one eccentric.

For adequate strength, all attachments to the cylinder should be silver-soldered. Before you start, all parts must be scrupulously clean so the solder will flow into the joints. Follow standard soldering practice; use emery cloth to clean all surfaces to be joined and be sure the mating parts are a close fit because you cannot build up a fillet with silver solder.

The canopy. Built of $\frac{3}{16}$ -in. plywood, eight ribs hold the two canopy halves securely together. End plates are cut from 22-ga. sheet metal and attached to the roof sections with small nails through pre-drilled holes. Bear in mind that the canopy should be easily removable for access to working parts of the engine should it ever be necessary to engage in a little repair work.

To finish. Dummy piles of firewood fitted to the fuel bunkers add a realistic

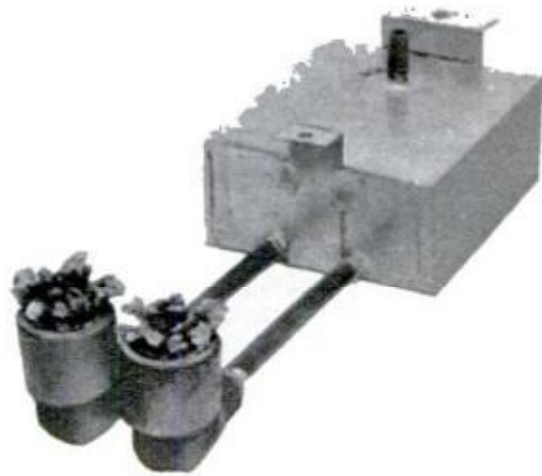

BEST HEATING will be obtained when the burners fill the entire firebox with a soft and steady flame

finishing touch. Though just about any paint combination will look well, it should be mentioned that at the height of their popularity most steam-traction tractors were painted black or green. Thus, my choice of finish ([see color photo, page 95](#)) is accurate and good to copy. ★★★

DISPLACEMENT LUBRICATOR supplies oil to inner "works" of cylinder. Small valves are for let-off

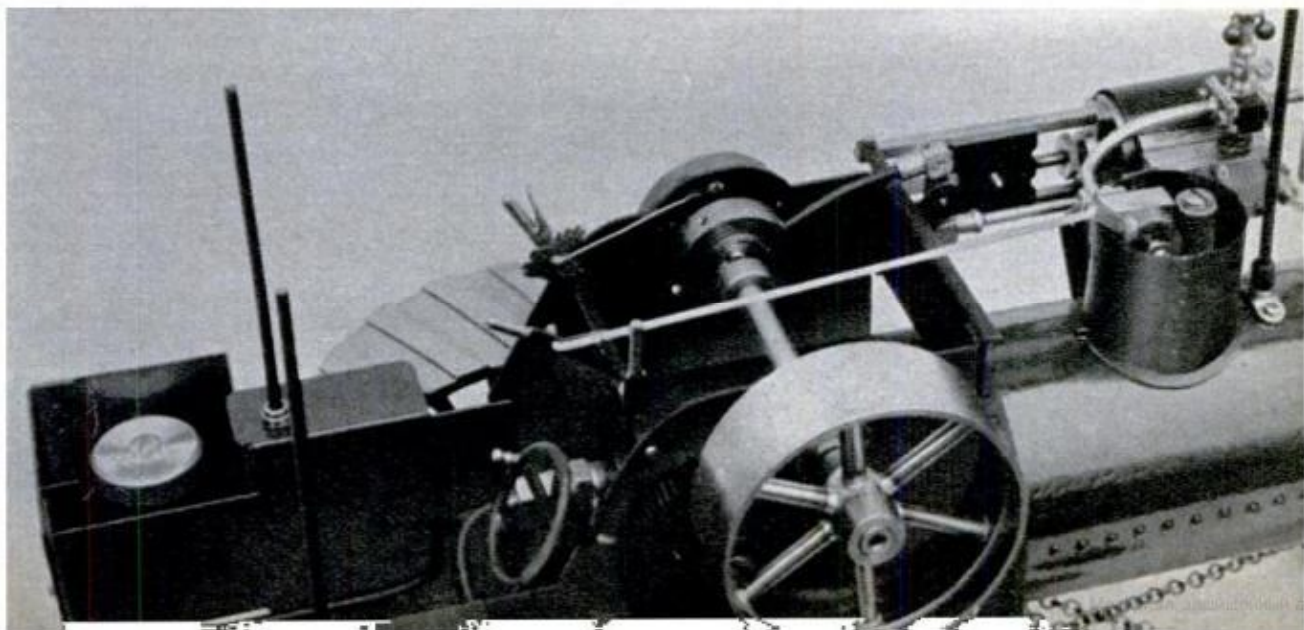

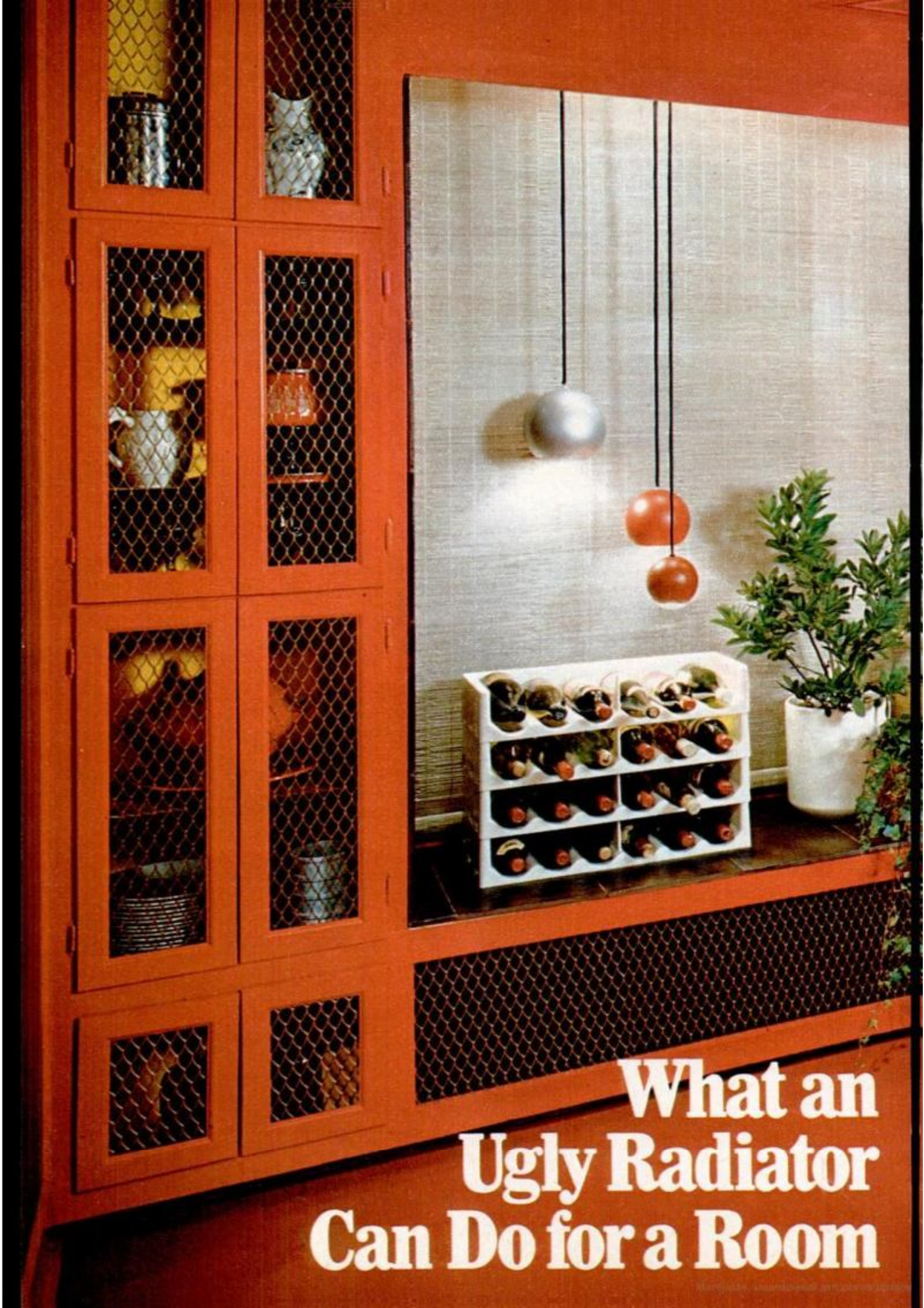

**What an
Ugly Radiator
Can Do for a Room**



PLEASE TURN PAGE

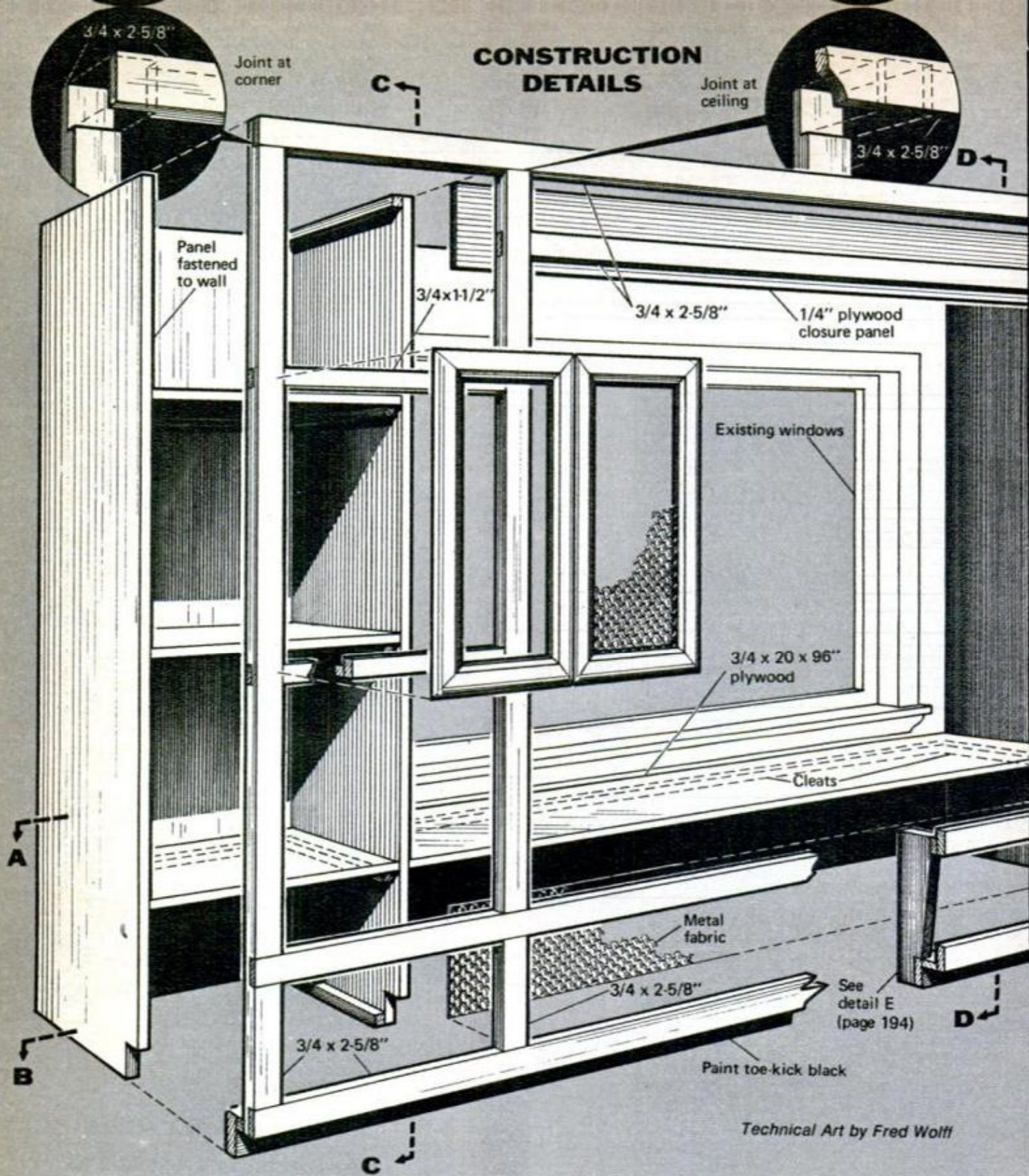

How would you conceal a radiator and make use of the wall space around it? Here's one handsome wall-and-window treatment that 'makes' the room

By **WILLIAM E. SCHREMP**

Color Photo by Bill Maris/Styling by Robert Lofgren

OLDER HOMES, in many cases, have two problems in common: 1. Protruding, hefty radiators that contribute a boiler-room look, and 2. a lack of storage space to handle the needs of today's busy family. Happily, with some careful plan-

ning and a little imagination, you can solve both problems with one project.

The attractive, functional wall on the preceding two pages started out as such a problem. The radiator was (and still is) beneath the double-mullion windows and

3/4 x 1-1/2"

1/4" quarter-round molding

Joint at wall

3/4 x 2-5/8"

Shelves, 3/4" plywood

3/4 x 20" panels. Length cut to suit floor-to-ceiling height

Shelf cleat

A

B

Joint at window seat

3/4 x 2-5/8"

SECTION C

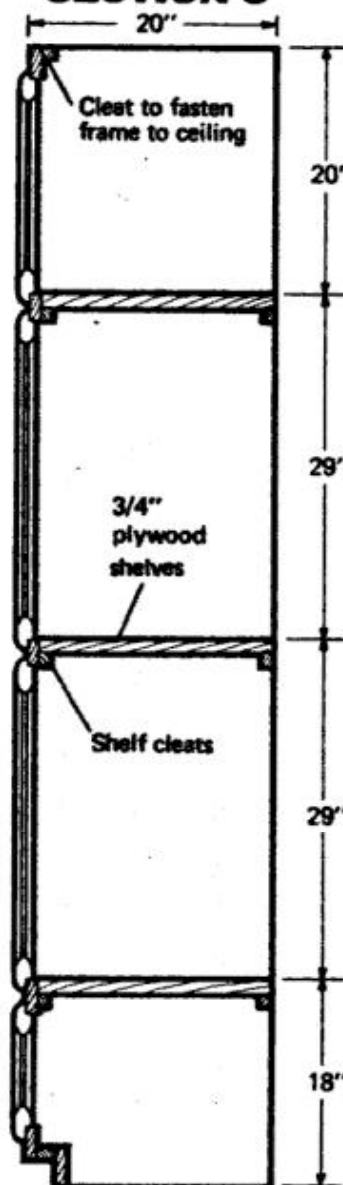

SECTION D

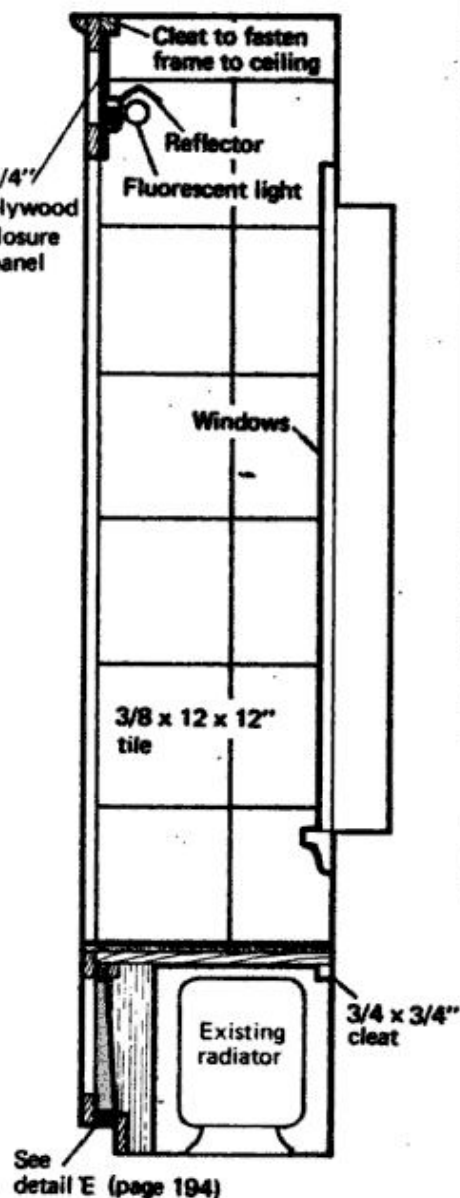

HINGING DETAIL

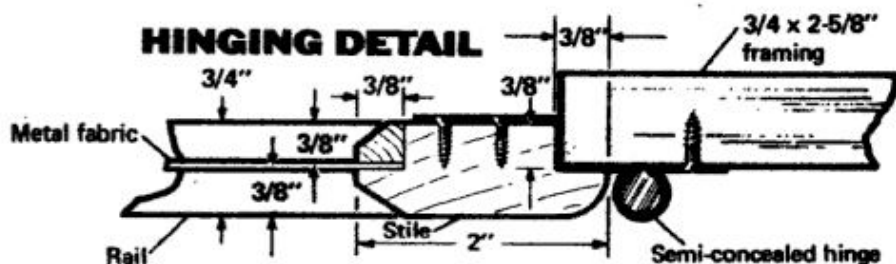

—as is usually the case—it's centered on the wall. The result was wall space which left little choice when placing furniture, plus a dust-collecting heat source which was a nuisance to clean.

Since the built-in shown occupies one end of a dining room, the radiator enclosure was built at window-seat height from wall to wall. And the cabinets flanking the enclosures were built extra deep to provide ample storage for glass-

ware, dishes and games used when entertaining.

The window seat, which covers the radiator, serves as an indoor garden. It's lit from above with special bulbs for growing indoor plants. And for protection against moisture, I lined this space with 12-in. ceramic tiles.

Hiding the radiator. To allow free circulation of the heated air, the radiator

(Please turn to page 194)

Build PM's Top-Performance Sailboat: The *Glen L10*

Light enough for cartopping, this trim craft doesn't even require a form to build the hull

By HARRY WICKS, Workshop Editor

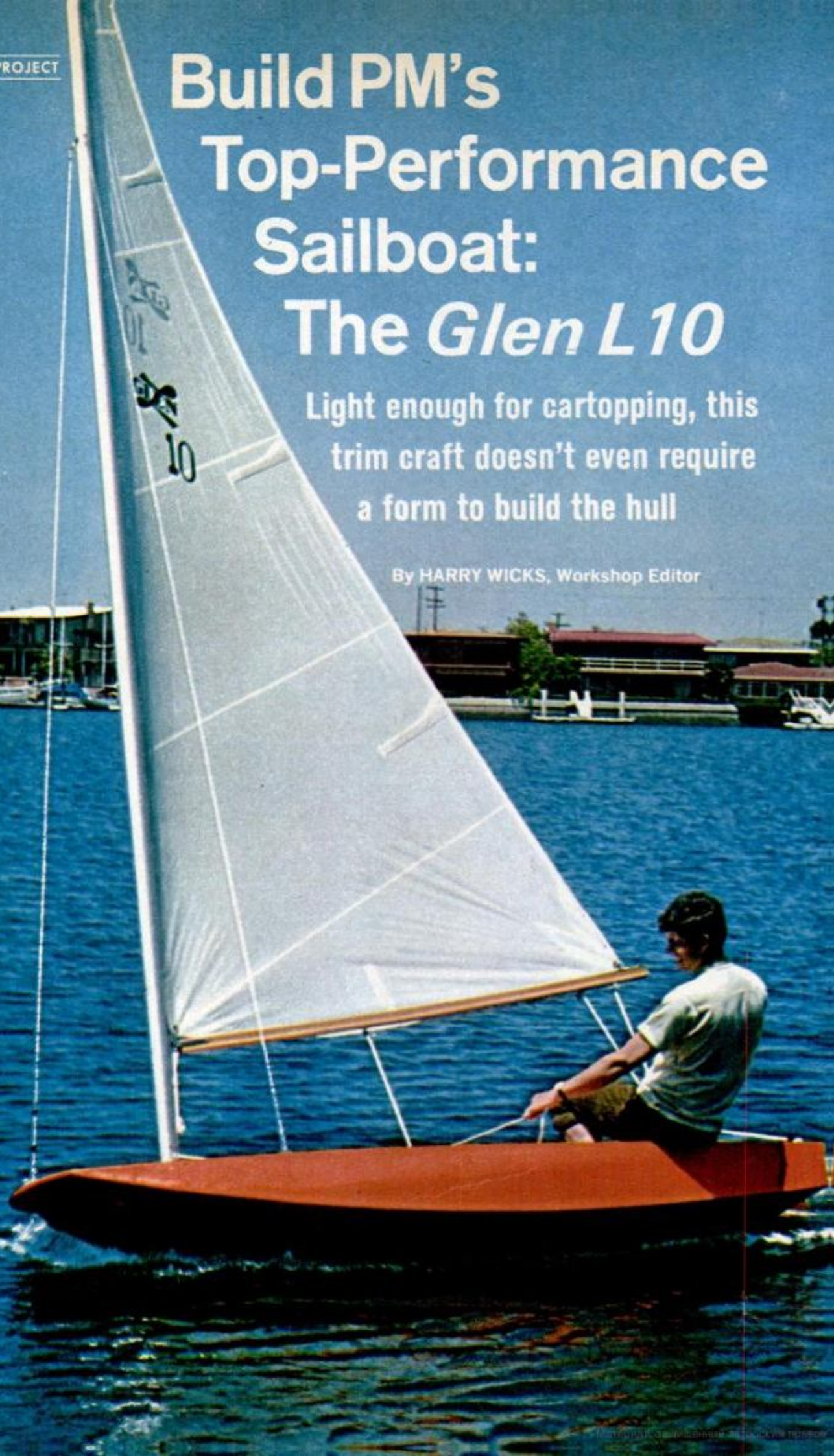

IF YOU'RE a sailing buff you'll spot this trim craft as a pure fun boat. Take her out on a breezy day, and it's almost a sure bet that it will be hours before you'll want to return to the dock.

Designed by Naval Architect Glen L. Witt, the Glen L 10 is a cat-rigged, daggerboard sailboat that weighs less than 90 lbs., making it a natural for cartopping or station-wagon hauling. The mast is light enough to be stepped by one person, and the standing rigging consists simply of forestay with turnbuckle and two shrouds with stay adjusters.

The craft will easily accommodate two adults and perform beautifully; she comes about readily and points well. The designer says that in light air she seems to outperform most boats her size. And in heavy air, she is guaranteed to provide thrills though it does require hiking out to windward and keeping passenger weight as far aft as possible.

Since total weight is the prime concern when building a small boat that is intended to give top performance, Witt utilized $\frac{1}{8}$ -in. plywood for the most part when he designed the boat. It's possible that in many areas it will be difficult to purchase marine plywood of that thickness. But the boat can still be built of one of the more commonly available plywood thicknesses ($\frac{3}{16}$ or $\frac{1}{4}$ in.); the hull will just weigh more.

All joints in the construction of the boat are made using a hard-setting glue—either plastic-resin or resorcinol. And the designer recommends using either hot-dipped galvanized or bronze fittings. The second is superior, but, of course, costs considerably more than the galvanized. Witt makes a point of not advocating plain brass because of its tendency to fracture under stress.

Assembly. Since no building form is used, assembly sequence is extremely

PLAN AND PATTERN INFORMATION

PM PLANS. Complete plans plus instruction booklet for the Glen L 10 are available by sending \$7.50 to Popular Mechanics Boat Plans, 224 W. 57th St., New York, N.Y. 10019. To order, specify Glen L 10 Boat Plans No. B 1265.

PATTERNS. If you prefer, you can obtain the plans and instruction book (above) plus full-size cutting patterns for the stem, daggerboard trunk, rudder, tiller, transom, frames, stem and side planking. To order this complete package, simply send \$11 to Glen L Marine Designs, Dept. PM, 9152 East Rosecrans, Bellflower, Calif. 90706.



BREEZY-DAY SAILING calls for keeping the weight as far aft as possible. Two people make this a snap

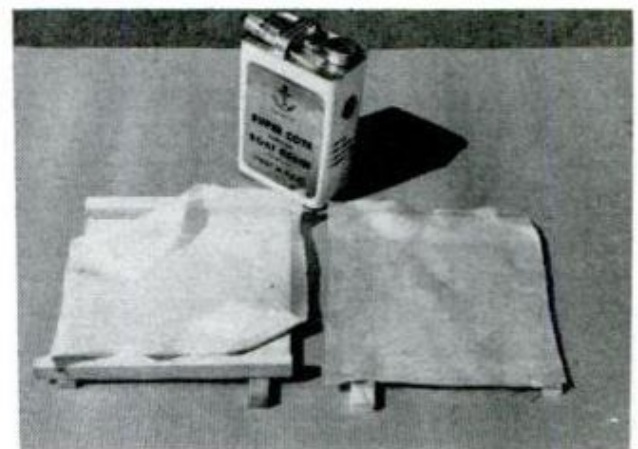

DAGGERBOARD TRUNK is fiberglassed inside before assembly. Below: Bed logs must be carefully aligned

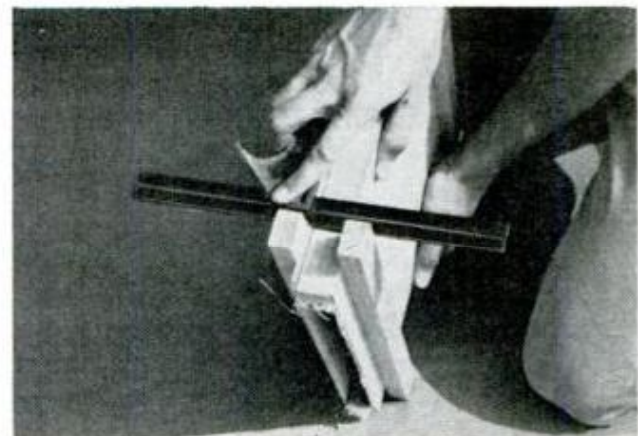



PLANKING-SHEER-CHINE fits into bow-piece notch. Notice plywood members fastened to the underside

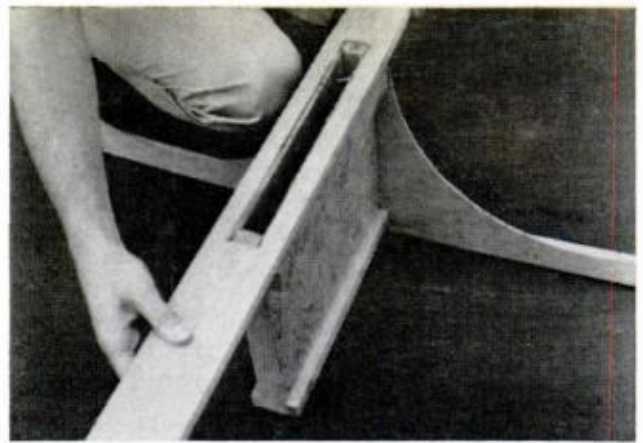

KEEL IS PRECUT to fit over the daggerboard trunk. Both ends are left oversize for custom fitting

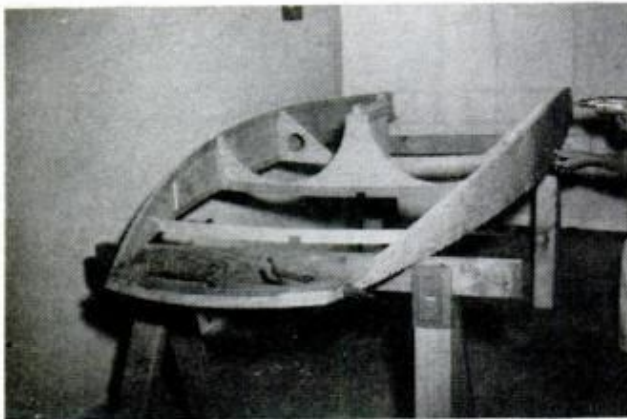

BOAT CAN BE BUILT on two sawhorses with top members parallel; use cord to hold the side planking

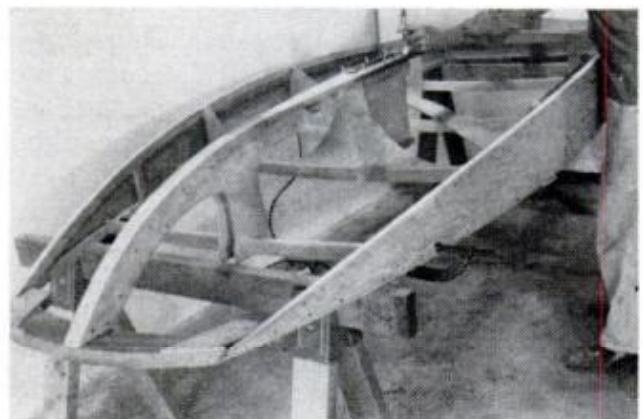

GLUE IS APPLIED and keel is sprung into position. Use clamps to hold forward deck-beam blocking



FAIRING is started by filing a series of equally spaced grooves all along the stem, keel and chine

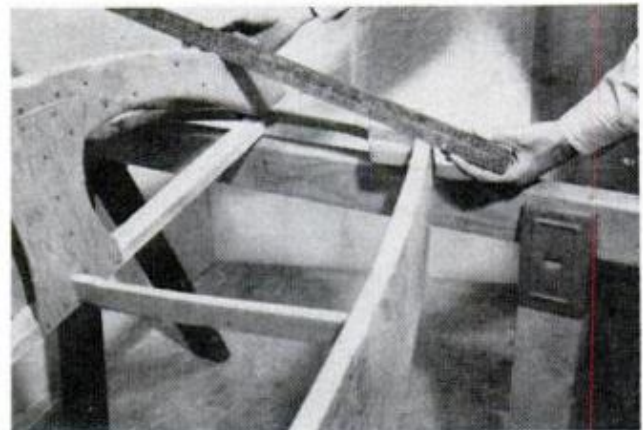

YARDSTICK is used to simulate planking which must rest on both keel and chine and not just one edge

important. Actually, the precut side planking is used to hold the various frames in their relative positions. Each of the frames and the transom must be carefully fit to the side planking by cutting the notches in the frames to fit the assembled side planking with sheer clamp and chine logs attached.

Fairing. All of the framework must be beveled or faired so that the plywood planking will rest on *all surfaces* and not just one edge. Along the forward part of

the chine, a considerable amount of beveling is necessary. In the long run you'll save time (and your arms) if you sharpen your plane-iron before tackling the beveling operation.

Three $\frac{1}{2}$ x $1\frac{1}{2}$ -in. battens are used on either side of the centerline. They're fitted into notches in the transom and rest at the designated position on frame No. 1.

To finish, Witt recommends trimming the hull and filling all imperfections with

SPECIFICATIONS

Length overall: 9' 11"
Beam extreme: 3' 10"
Hull weight: 88 lbs.
Maximum hull depth: 19"
Cockpit size: 2' x 4' 3"

Sail area: 64 sq. ft.
Hull type: V-bottom hull developed for sheet plywood planking
Sail type: Cat rigged with daggerboard

Designer: Glen L. Witt, Naval Architect

THE GLEN L 10

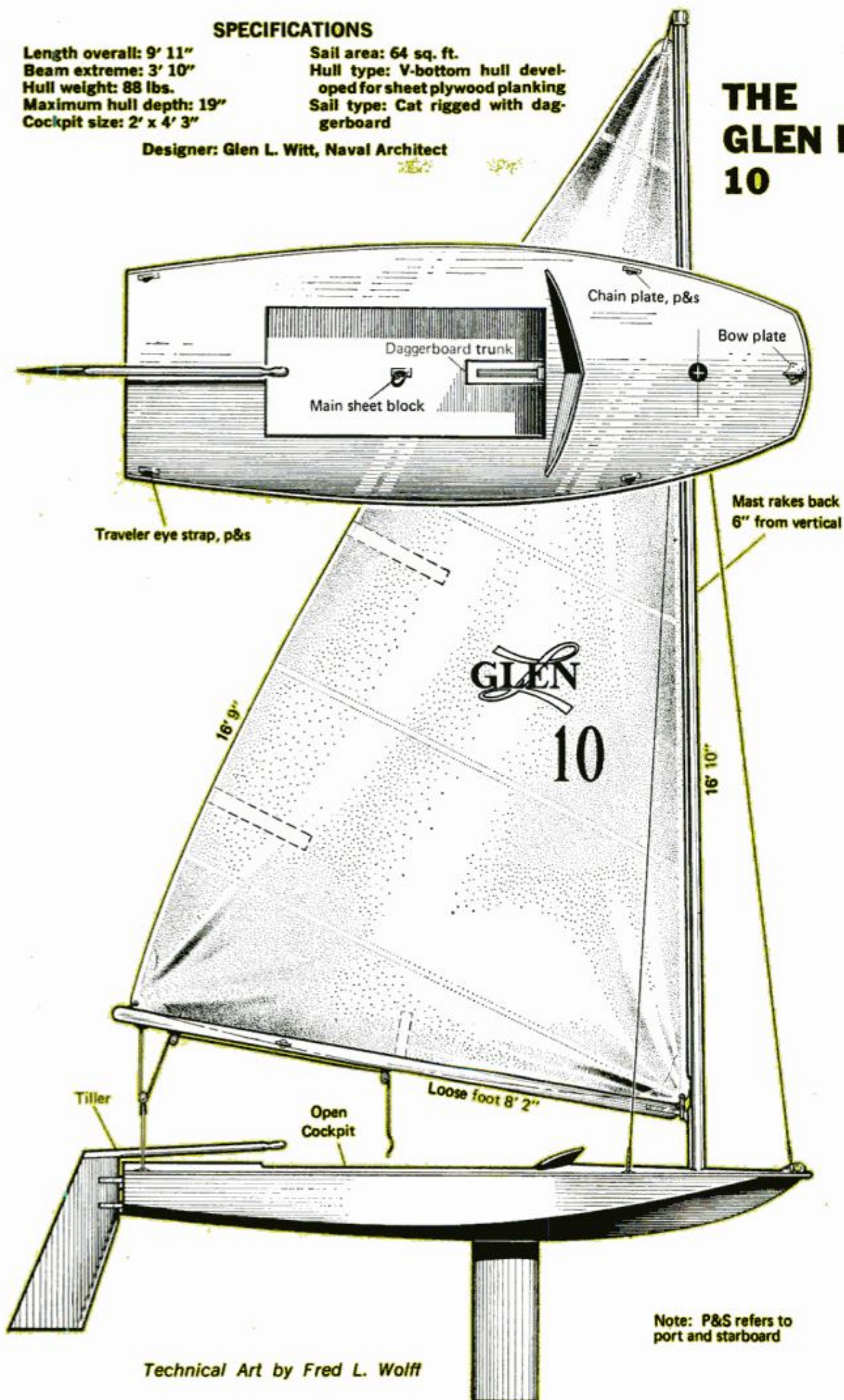

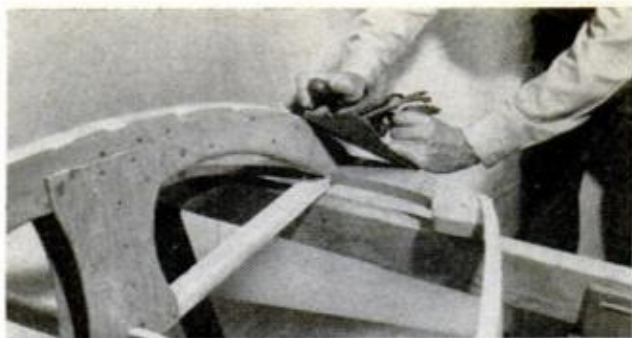

AREAS BETWEEN GROOVES are removed in a smooth, sweeping curve to eliminate any humps or dips



GOOD METHOD of insuring a smooth fairing job on aft section is sandpaper glued to a length of 2x4



BATTENS ARE NOTCHED into transom and rest on the frame. Next, bottom panel is trimmed in place



BUTT-BLOCKS are fitted between the battens before the planking is permanently fastened to hull



INTERIOR of the boat should be painted prior to applying the decking. Use a quality marine paint



PINE BLOCKING needed on bow extends from sheer to sheer, must be faired to form crown of decking



DECKING is butt-joined and fitted to frame in the same manner as bottom planking was accomplished



ALUMINUM ANGLE BRACKET holds cam cleat and the pin on a chain to hold daggerboard in down position

a hard-setting putty. Fiberglassing the hull is optional, but if you do decide to do it, it should be put on the bare wood with a 6 to 8-oz. cloth used with resin. Make certain you follow the manufacturer's application instructions on the can.

Most step. Two types of mast steps are detailed in the plans. But if you prefer, a

cast-aluminum type can be purchased from Glen L Marine Designs for \$6. Additionally, the marine design firm also has a complete line of accessories which have been custom-made for this particular craft. So if you want to get your boat in the water in a hurry, write to the firm at the address shown in the box on page 143 for details and prices. ★★★

HINTS FROM READERS

Apply center clamping pressure

To provide clamping pressure at the center when laminating two or more plywood panels, you can do it with common C-clamps, according to the folks at 3M Co. After spreading glue on mating surfaces, position the panels and run a cleat down each edge and a third, thicker, cleat down the center. Use scrap to span the cleats.

—Bob Brightman

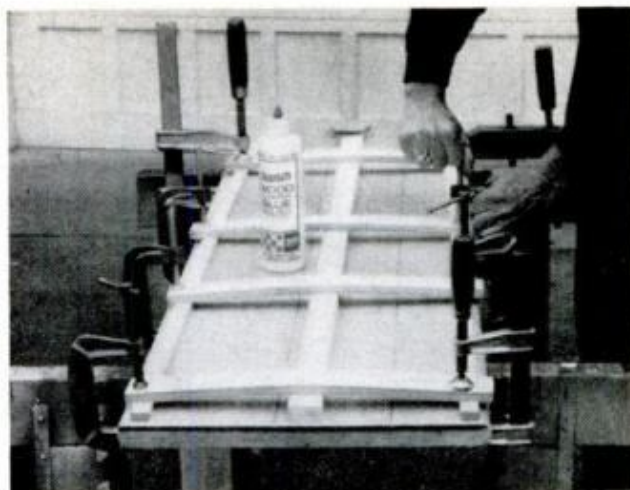

Concealed tabletop fastener

The drawing at right illustrates a method of fastening tabletops I've used for years with great success. The important point to keep in mind is the clearance that must be allowed between table and rail. Also, when installing the fastener, leave about 1/8-in. clearance so that the screw will pull the parts together snugly.

—Harold R. Crawford

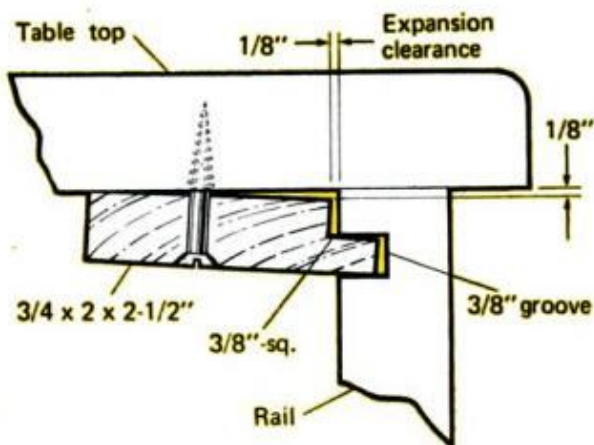

Pointer guides sabre saw

When cutting with a sabre saw, most persons find it hard to follow a line free-hand. To make this task easier, I added an adjustable pointer to the saw shoe as shown. Simply start the saw on the line you want to cut, turn off the saw and set the pointer on the line. The attachment will let you make a much neater cut.

—H. C. Anderson

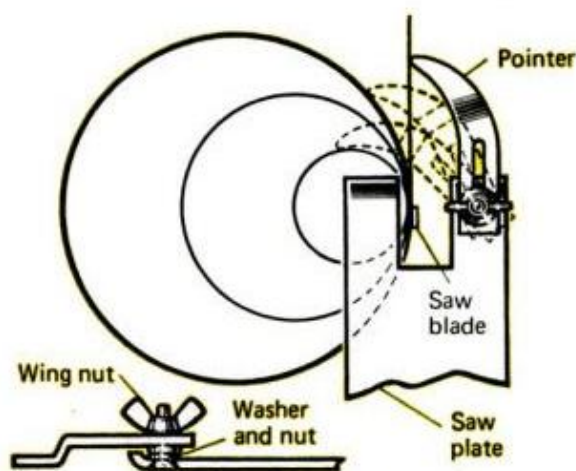

Kill weeds in pavement joints

Unightly weeds growing up out of the cracks and joints in concrete pavement or walks can be killed by squirting a small amount of kerosene on them. Use a squirt-type oil can to get the stream exactly where you want it. *Caution:* Do not use this method around any treasured plants or trees or they, like the weeds, will soon be gone.—Andrew Vena

Add an instant outlet

Needing a receptacle at one end of my workbench, I hit upon the idea of simply splicing into a BX cable strung below a joist and installing an outlet box. After cutting off power, cut the cable and install the box on the joist. You'll find there is plenty of slack in the line to permit the installation. Finish by adding the plate cover.—Bob Brightman



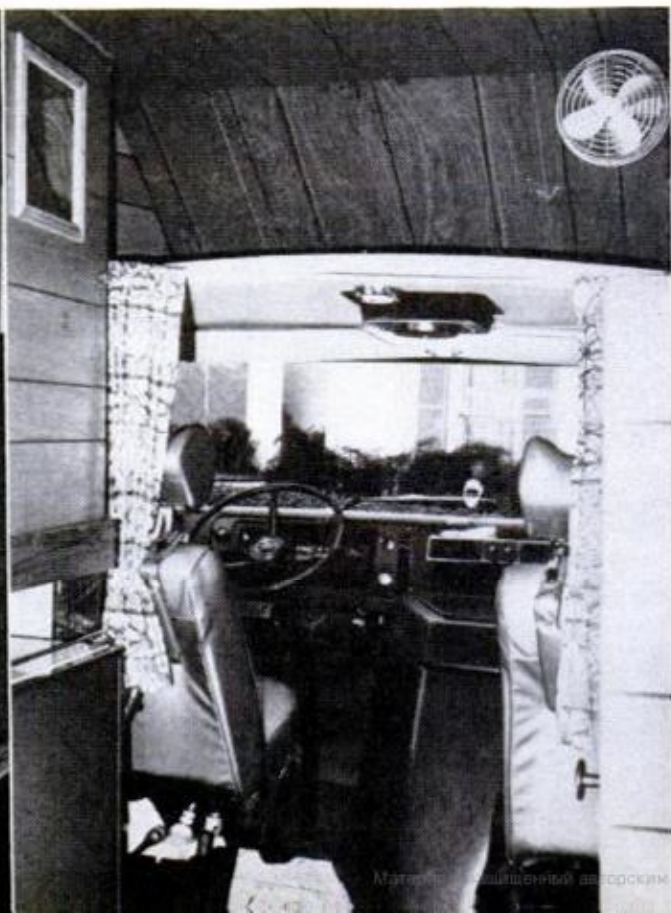

From Van to Camper —\$340

By raising the roof on a Ford Econoline we got a motor home with full headroom. The idea works for a Chevy or Dodge too

By JEFFREY W. DAUM

LIKE MOST FOLKS who enjoy spending their vacation time traveling, economy motivated our decision to invest in a motor home. But, we soon learned that commercial jobs that would provide the minimum comforts we desired were priced in the neighborhood of \$7000. So instead, we purchased a new Ford Econoline complete with airconditioning. And for a total additional cash outlay of \$340,

LOOKING TOWARD FRONT of van (two photos at bottom of opposite page), left mid-side shows sink, two-burner stove and refrigerator next to cabinet. Middle photo shows closet and storage area over driver and passenger seats. Below, looking toward rear, bed is in sofa position with two bed-boards stacked under the mattress. Notice the storage area beneath the bed; access to it is via the rear doors. Hinged skylight provides light and ventilation

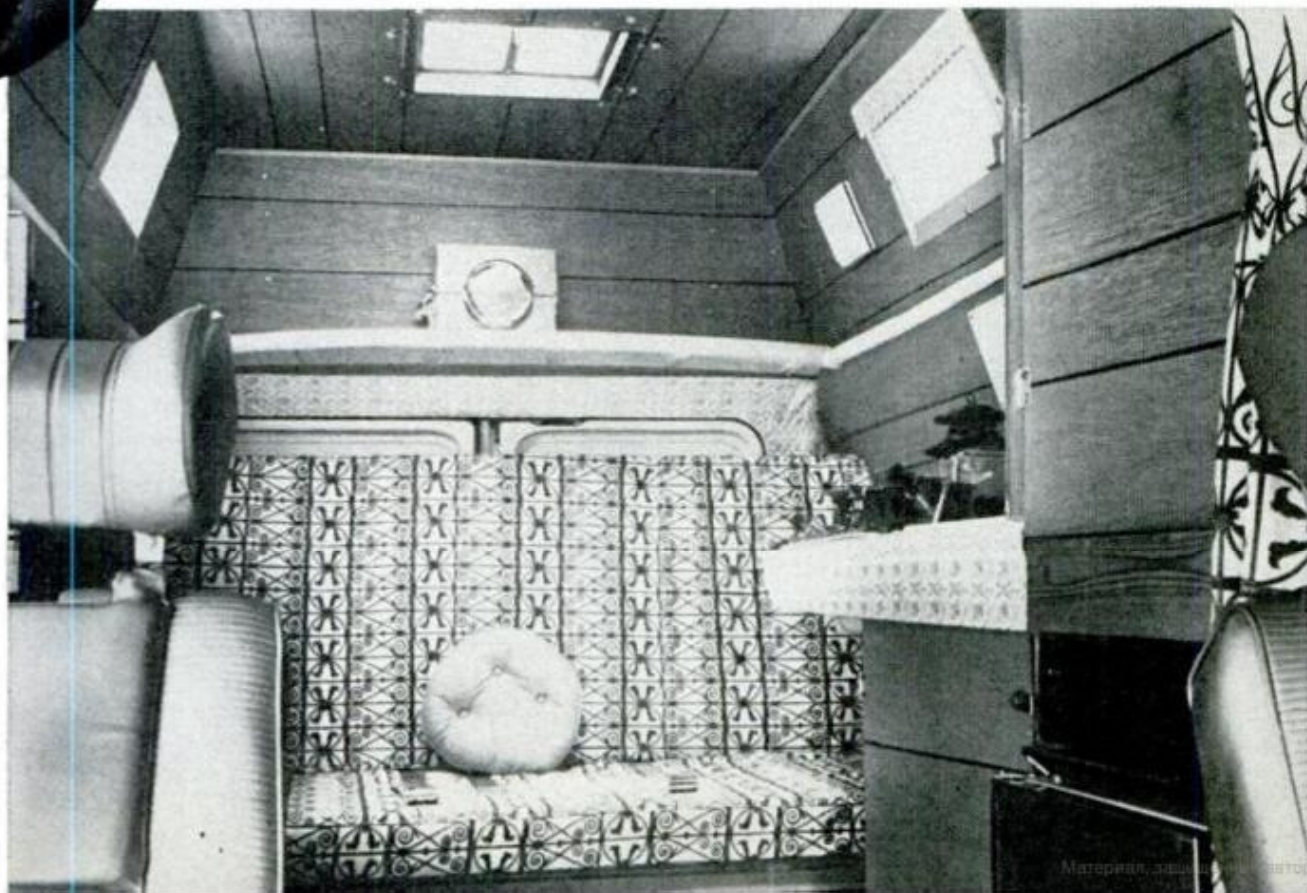

Cutaway of Roof

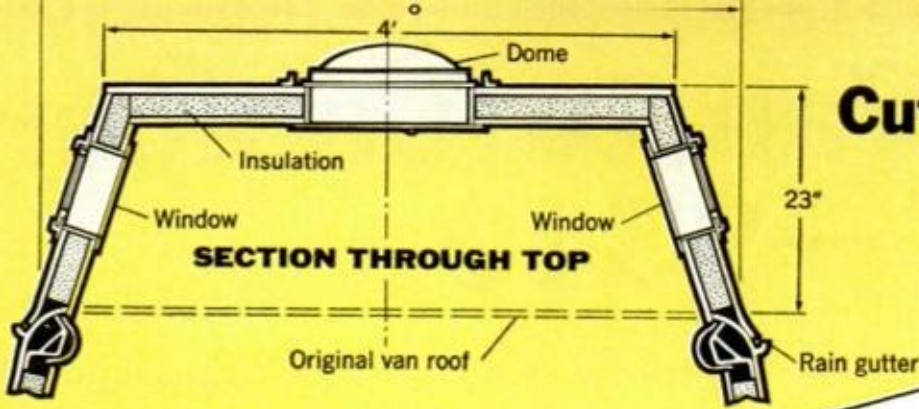

Angle iron fastened to roof for protection. (See section B-B)

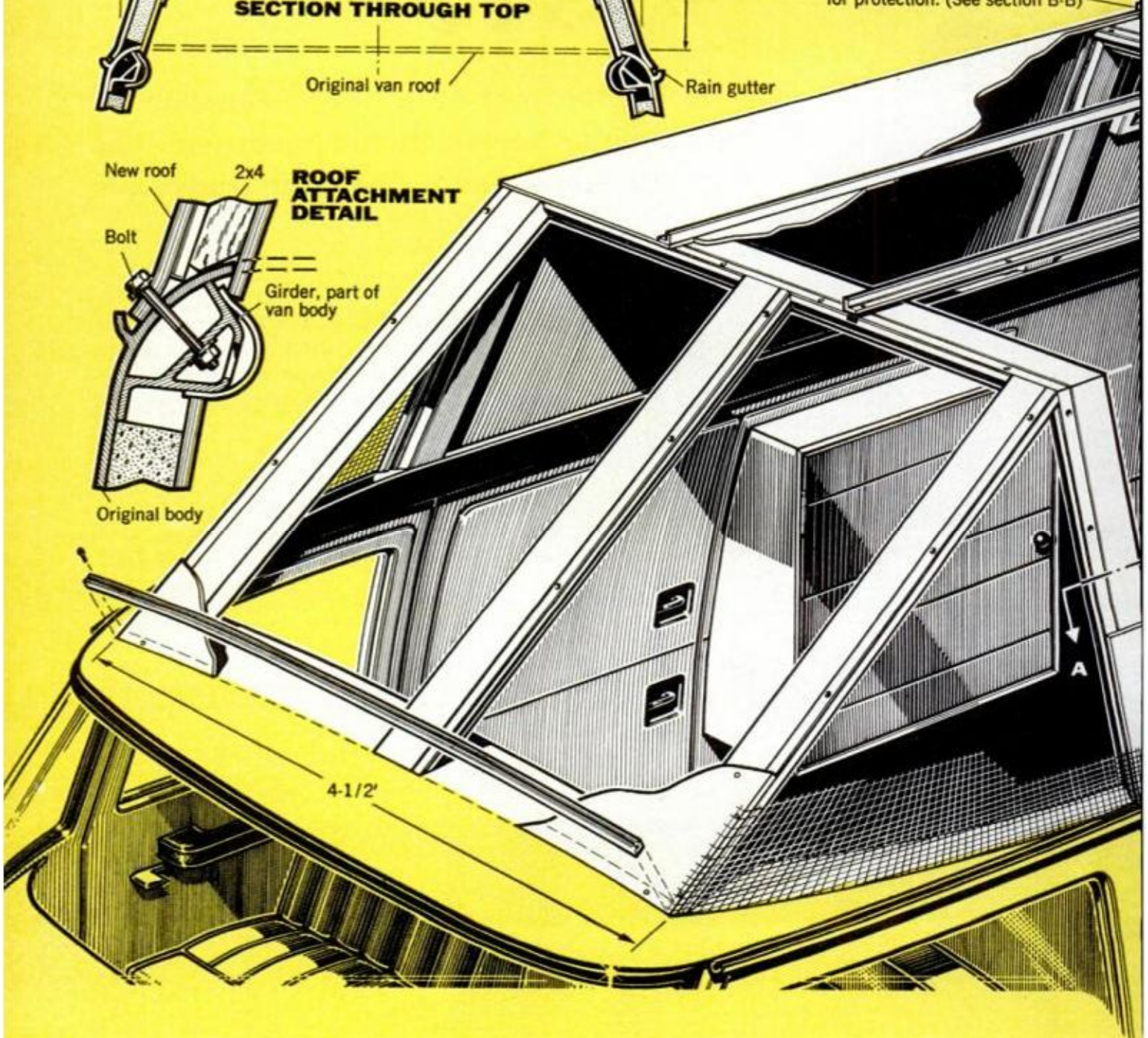
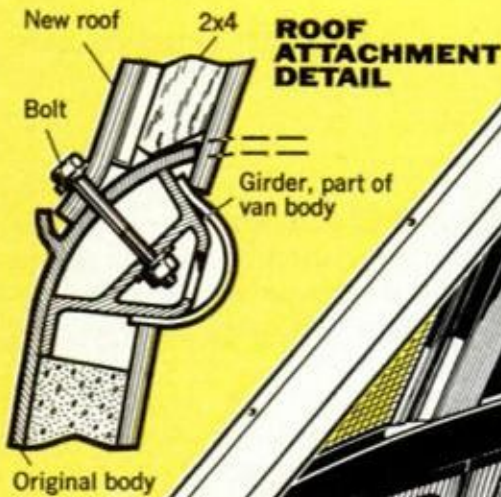

we came up with *Tumbleweed*, our motor home that cruises at turnpike speeds and is economical to operate.

After buying the van, our first step was to take complete interior and exterior measurements. The roof's sloping design minimizes wind resistance and continues the aerodynamic lines of the existing body. The crucial line is the angle of the front of the extension. Here we used the windshield slope to determine the best angle.

In a similar way, the taper (curve) of

the sides of the van served as guides for the slope of the extended roof sides.

The roof is constructed of 1/4-in. marine sheet plywood. Its height can be determined after taking into account the thickness of the insulation and interior paneling that you plan to install.

Each section is fitted with three lengths of 1/2-in. steel channel at both ends and in the middle, running across the short length of the section. These are drilled and then epoxied to the inside. The channels in the sides are then bolted to the

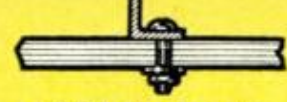
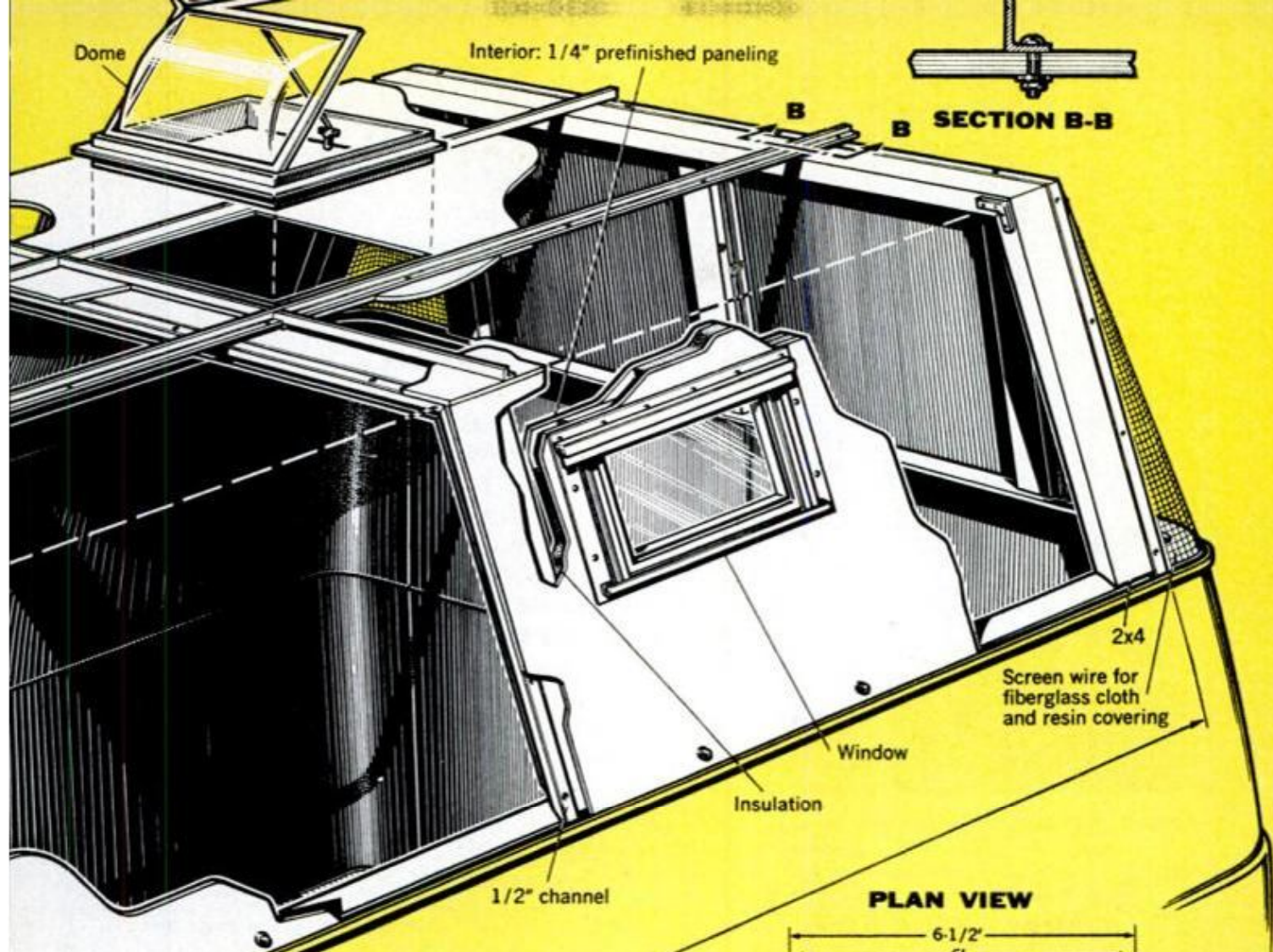

B SECTION B-B

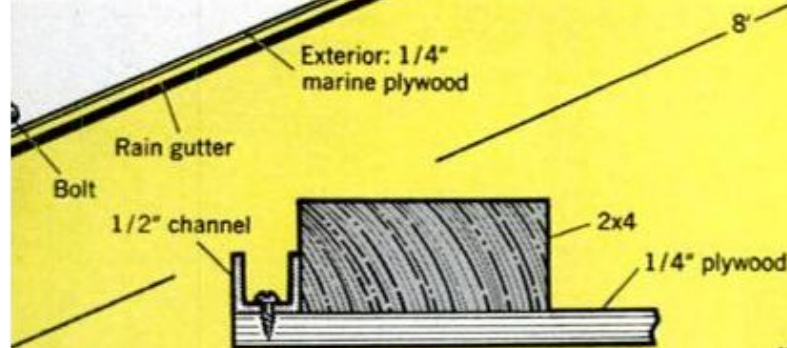

SECTION A-A

Technical Art by Peter Trojan

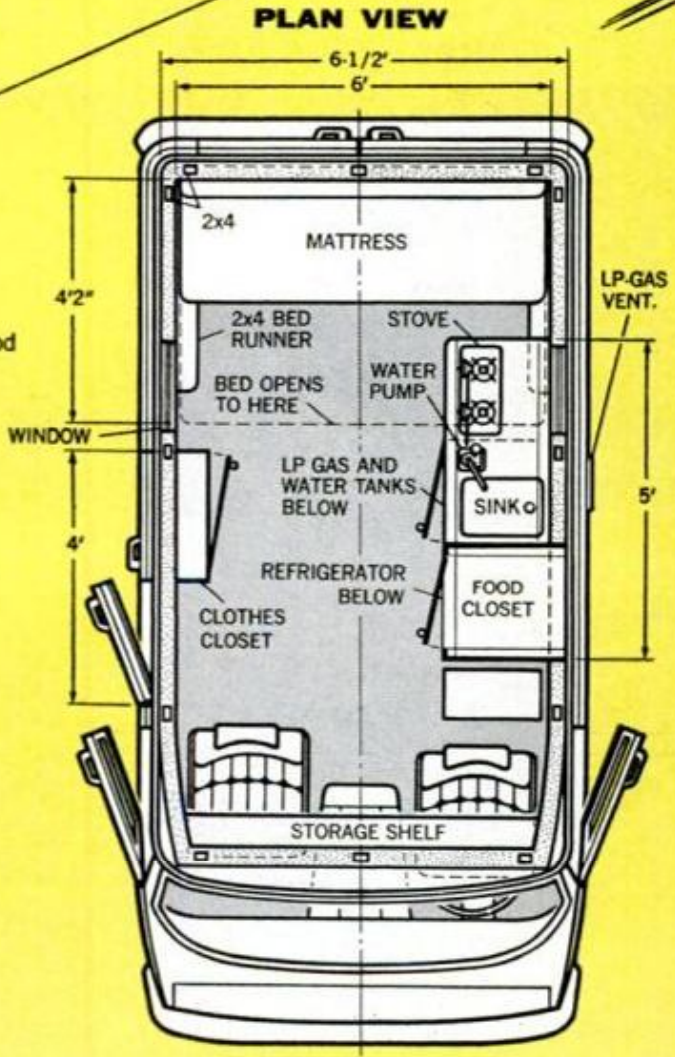

channels in the top, using preformed steel angles. These are bent at the respective slopes determined earlier from existing body lines.

After the roof is bolted together, 2x4s are placed parallel to all the steel channels on the inside. Joints are mitered and then bolted through the roof. These go the full width of the top section but stop 3 in. from the bottom edge of the extension sides, front and back to allow for a flush fit to the body. The 2x4s give additional reinforcement and serve as spacers

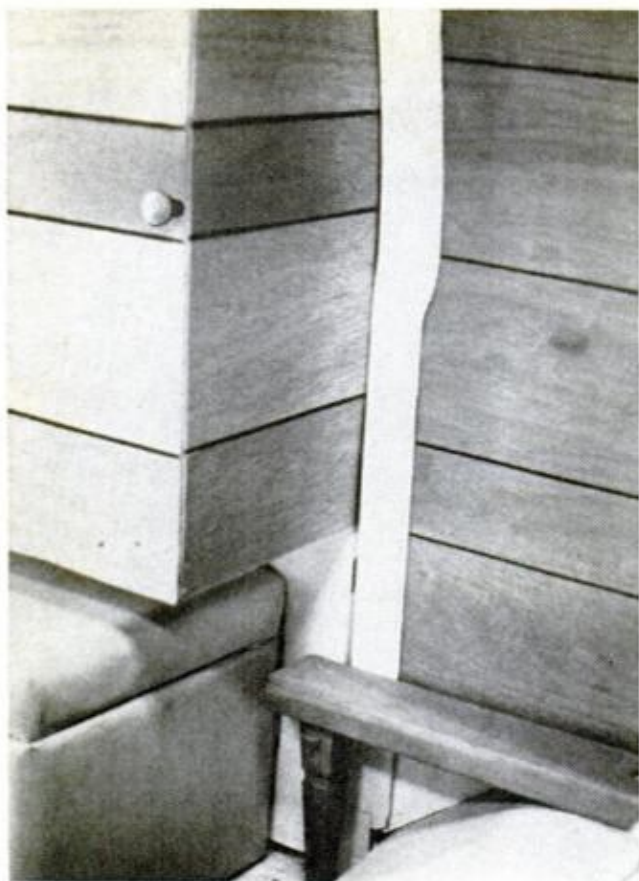

RIGHT MID-SIDE showing 2x4 runner which bed rests upon. At top left is door-mounted clothes closet. The portable chemical-toilet fits neatly below

for the insulation and interior paneling material.

The skylight and windows were installed next. These are standard trailer items and come with complete instructions for installation. Finally, a $\frac{3}{16}$ -in. angle-iron brace, 8 ft. long and in the shape of an elongated "H," is bolted on top of the roof to provide protection against falling branches.

The original van roof was cut out down to 3 in. above the rain gutter. The latter must be left completely intact to serve as the ridge on which the extension sits (see drawing, page 151). Be careful to cover your van seats and interior when applying the torch, to guard against damage from sparks.

Leave the front part of the original roof intact so it can serve as the shelf of the storage area under the sloping front.

The new top should fit snugly into the rain gutter of the original roof. Drill through the base of the new roof at an angle so the drill bit will go through the girder, which is on the inside of the van's original body at that point. Drill in this

(Please turn to page 196)

COMPLETED TUMBLEWEED stands 100 in. high. Louvers on side of van vent the LP-gas storage area

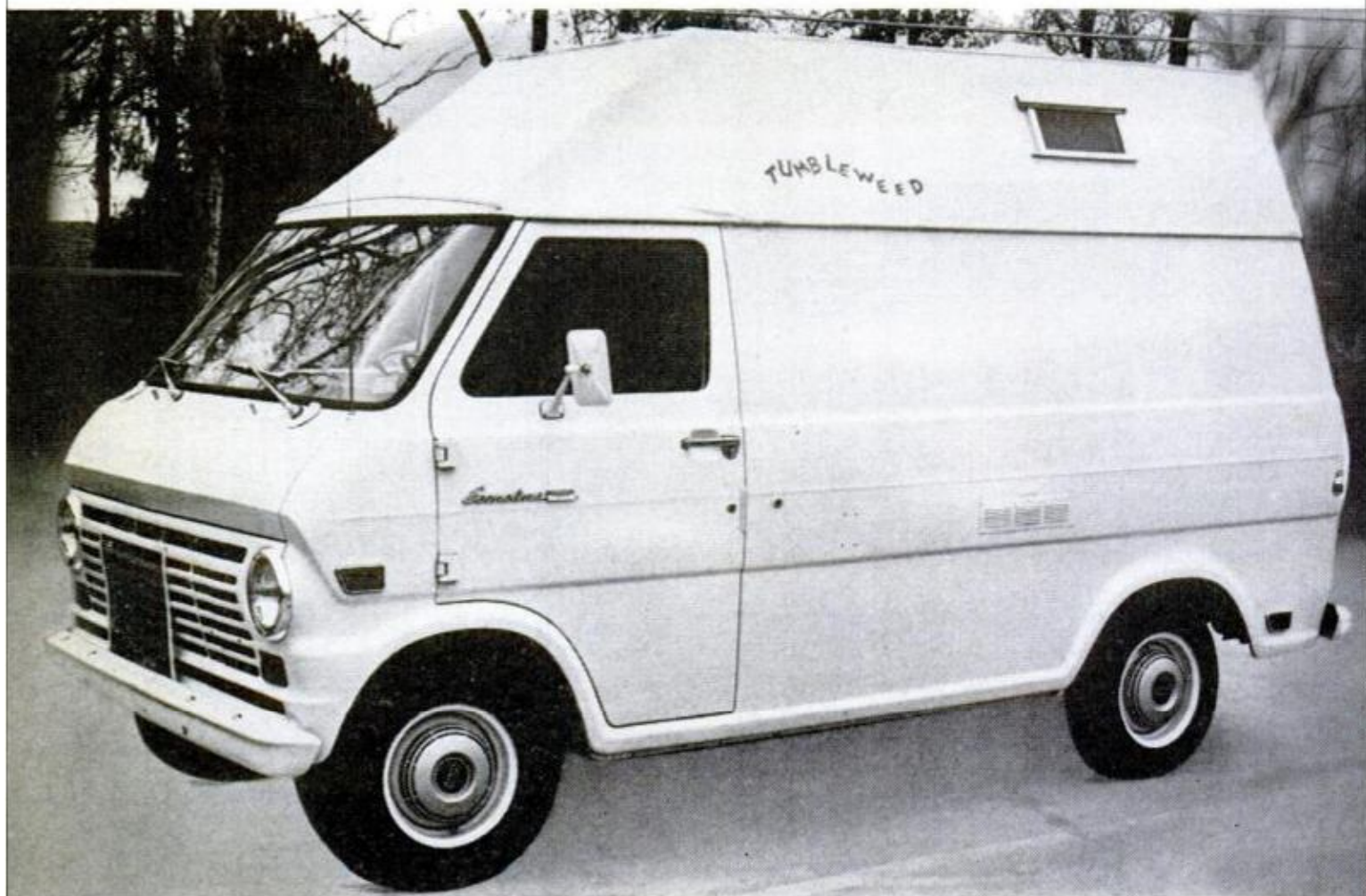

Make This Appliance Test Block

THE SCARCITY of servicemen (and the big bill when you can get one) makes it just plain common sense to be able to do most appliance-testing yourself. You can do it with the test block shown, which offers full line-load with an indicator, series resistor, test lamp and a neon tester for checking voltage leaks.

A 6-v. panel lamp used in series with outlet No. 1 is bridged by about 11 turns of $\frac{3}{16}$ -in. o.d. by .028 resistance wire such as that used in open-coil hot plates. With a high-load appliance such as a waffle iron, which can draw as much as 1200 w., the lamp glows moderately bright.

To test an appliance, first check for breaks in elements and grounds to the case with test leads in No. 3 (a safety test.) Next, plug appliance in the same outlet for a continuity check. Then, plug it into No. 2; if cone heater element glows red, the appliance is shorted; if not, switch to No. 1 and watch lamp to see that the thermostat is cycling if appliance is so equipped.—W. H. McClay

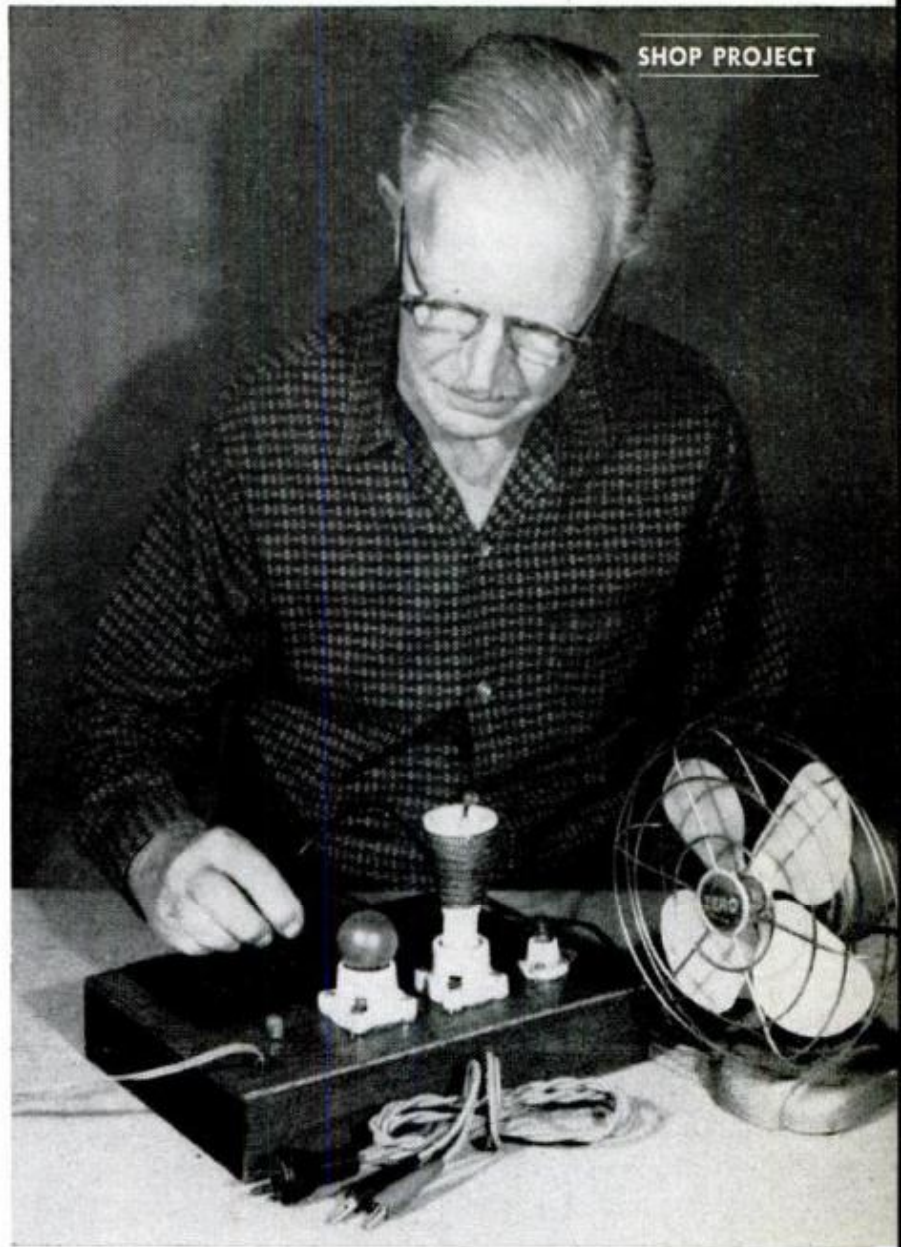

TEST-BLOCK WIRING DIAGRAM

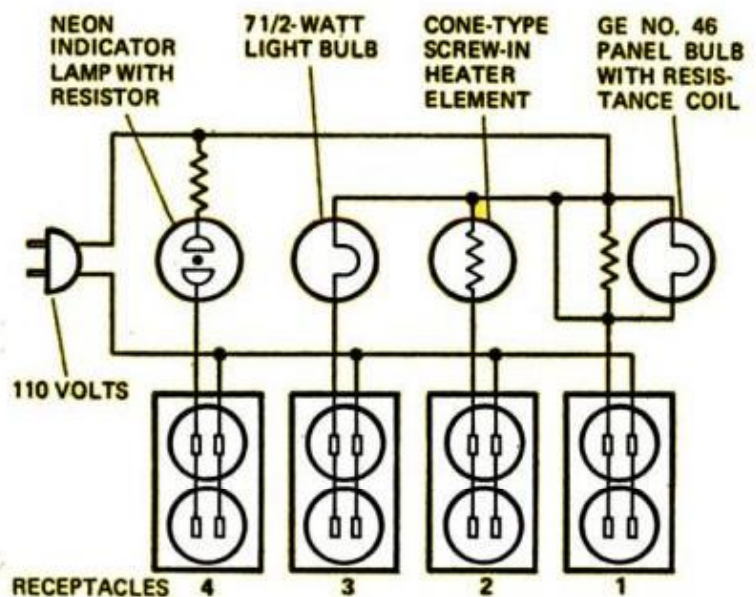

TEST BLOCK has four test outlets; text tells the sequence in which to use them. Always check the appliance ground first

HINTS FROM READERS

Sponge-mop speeds car wash

Since neither car washing nor window washing are chores I particularly look forward to, I devised this handy accessory to make those tasks easier. It consists of a viscose sponge, hose connection and length of 1/2-in. pipe. No fancy attachments are needed; just poke a small hole halfway through the sponge and insert the pipe.—*W. H. McClay*

Jig for tightening screw eyes

Next time you have a batch of screw eyes and hooks to install, you'll prevent sore fingers if you make this little jig for turning them in. It's nothing more than two strips of wood taped tightly together, with a separating strip of proper thickness between them. Insert hook in its hole and slip the notch over it to tighten.—*H. N. Webster*

Continued life for ballpoint case

Next time a ballpoint pen runs dry, instead of throwing it away, save it for future use as a small-tool handle. Just remove filler, pour some epoxy into cavity and insert the tool. The idea works fine for all kinds of miniature tools with shanks and for shop-made screwdrivers and scribes you may make for hard-to-reach locations.—*C. W. Reynolds*

Opener tags along on paint can

It's time-consuming if you have to set paint tools aside to hunt for an implement when you want to open a can of paint. If you take an ordinary punch-type opener and drill and slot one end as shown, you'll avoid that nuisance. Most openers have a hole at one end, but in either case, saw a slot to the hole so opener can be slipped on and off the bail.—*H. N. Webster*

Nut-stop eliminates file jamming

By preventing the large-diameter end of a file from entering the hole, you can keep it from sticking while reaming a hole. Just select a nut slightly smaller than the hole to be enlarged, slip it on the file and tighten it with pliers. If workface must be protected from mars, glue a small piece of felt or rubber to the work side of the stop.—*H. N. Webster*

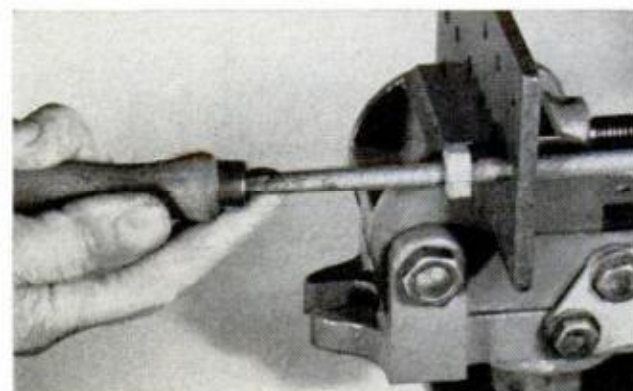
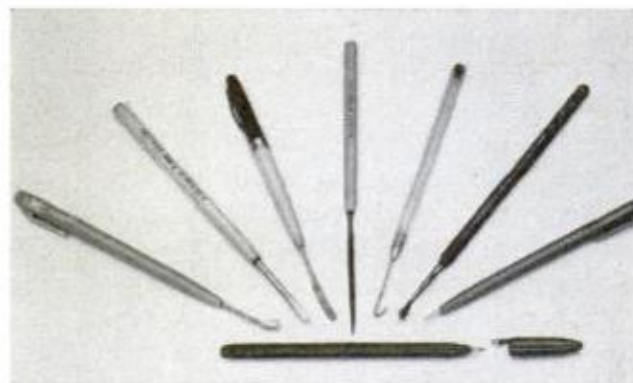
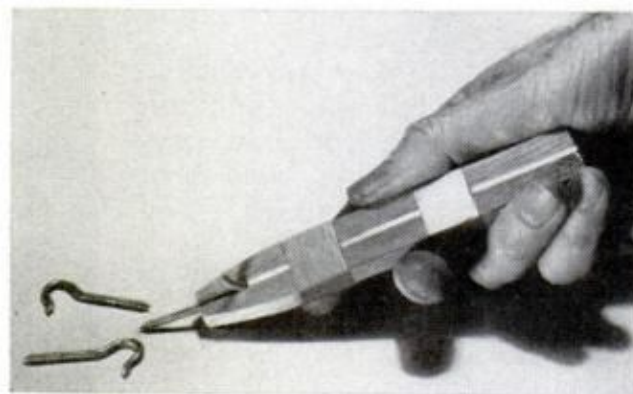
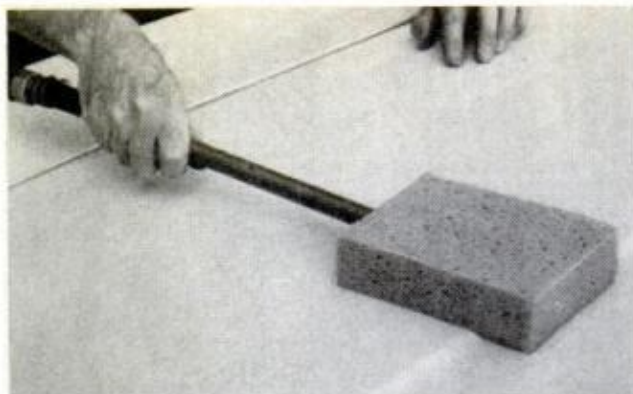

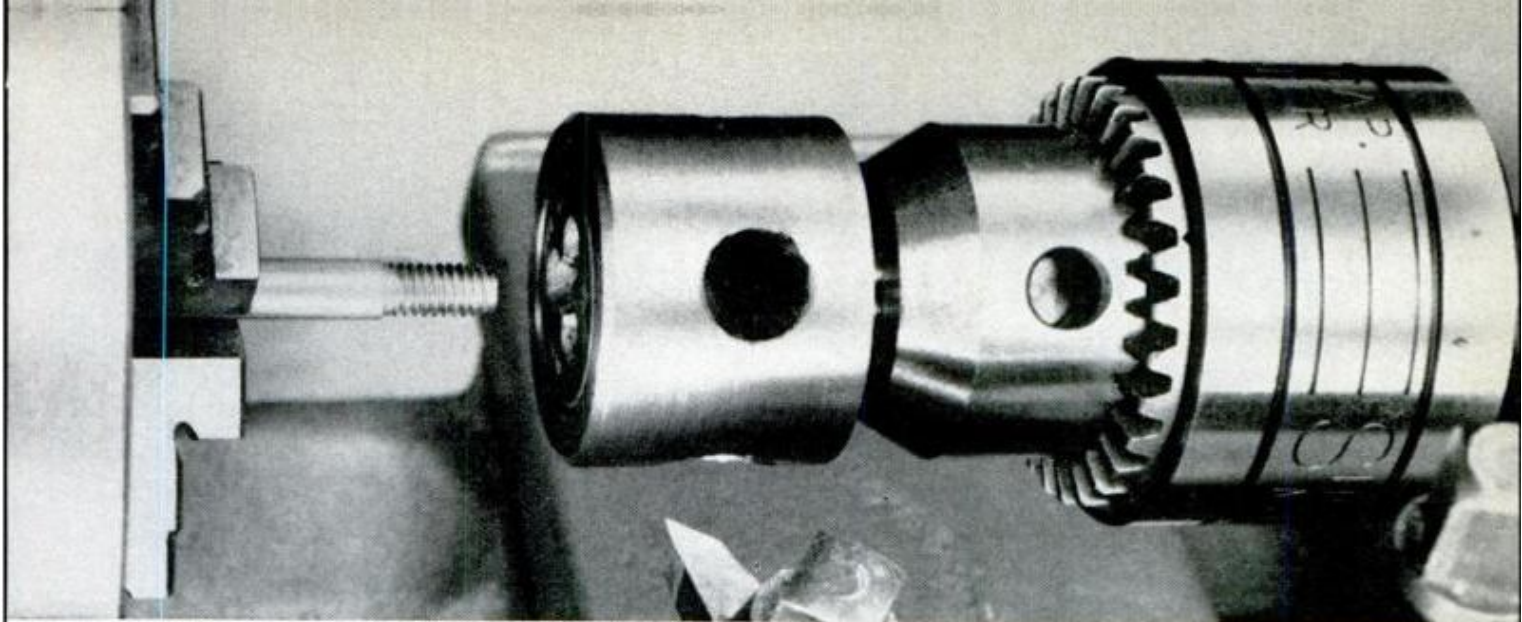

METALWORKING

This Die Holder Makes Thread Cutting Easy

By ANTON M. BARKEY

WITH THIS TAILSTOCK die holder you will find it a lot easier to cut No. 12 or smaller-size threads in your lathe. It's easy to tighten the holder in a 1/2-in. drill chuck so that it will cut the threads you want. When the die hits a shoulder on the workpiece, the 3/8-in.-dia. shaft slips in the brass sleeve and stops the threading operation.

Alignment of the threading die and the workpiece is automatic with a three-jaw lathe chuck. The two cross holes give you full view of the back of the die and come in handy when you have to remove a jammed die.

The holder is turned primarily of mild steel and brass. Drill the 3/8-in. hole through the brass, then slit the sleeve with a hacksaw. Next, turn the die holder and drill the cross holes. The setscrew locks the die in place. Make certain that it's spaced between the cross holes as shown. ★★★

DIE HOLDER

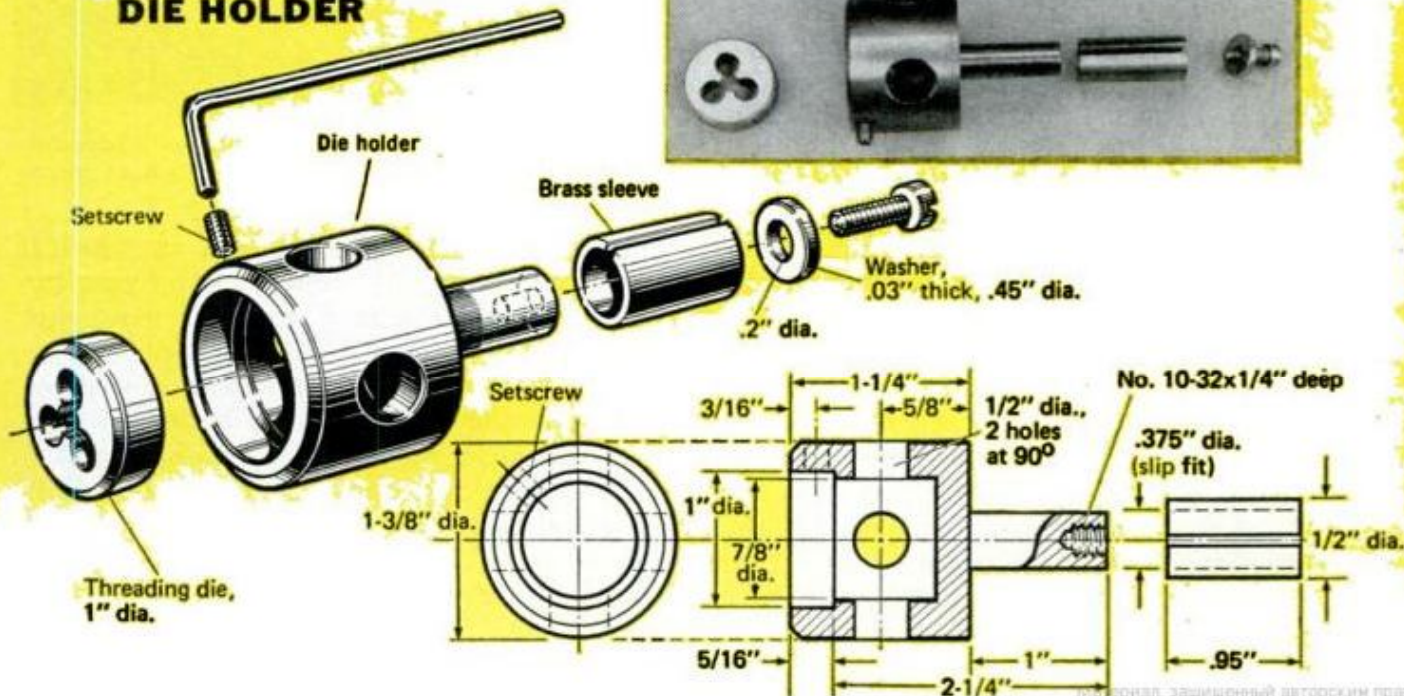

Make Your Own Gemstone Faceting Machine



The art of lapidary—polishing stones to best display their qualities—is an ancient one. With this motor-driven machine, you can do it effortlessly

By MOODIE E. BRAUN JR.



LAP PLATE can be of copper, tin or plastic, depending on faceting step. Pie tin acts as splash guard

UNLESS YOU HAVE SEEN someone cutting and polishing a stone, or tried it yourself, you'll be amazed at the satisfaction you get from bringing out the inherent beauty of a stone. The art of lapidary has fascinated man for centuries, and many methods have been devised for doing it.

Nowadays, all you need is a faceting machine like the shop-built version described here, plus a set of cutting and polishing laps, polishing powders, a selection of dops (tools) for holding stones, a dop transfer kit and the patience to follow step-by-step instructions. (These can be found in any good gem-faceting book. One that I recommend is *Gemcraft* by LeLande Quick and Hugh Leiper, F.C.A., published by Chilton Co., Philadelphia, Pa.)

Though a detailed explanation of lapidary methods is beyond the scope of this

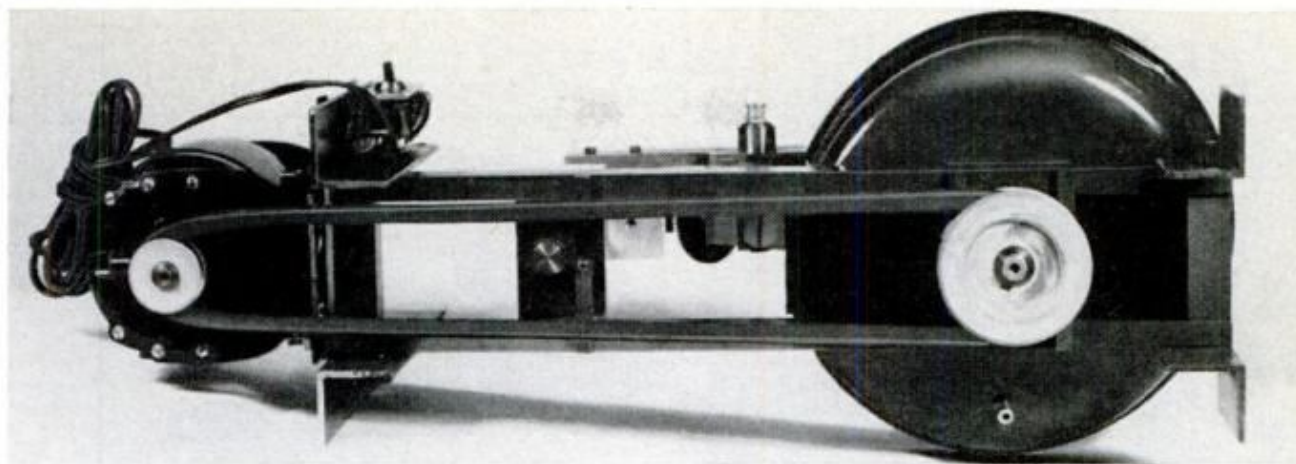

BOTTOM VIEW of faceting machine shows relationship of work end of rig to the motor. Lap plate itself is commercially available item and usually has a 1/2-in. mounting hole which is placed over the shaft

article, a description of some basic steps is necessary in order to understand the functions of the various machine components. For example, with a round, brilliant cut stone the first stage is preparation of the preform. This is simply the process of grinding the stone to a general shape to permit easier and more accurate finishing. With a round brilliant, the first preform shaping is to grind and polish the top or table by hand, using the lap plate and holding the stone with your fingers. The next step is to grind the outer circumference of the top, to the largest circular diameter possible. The final step is to shape the stone so that it resembles a turnip.

The stone is then mounted on a cone-shaped dop using a transfer jig. The transfer jig is a simple, inexpensive accessory which enables a stone to be placed accurately on a dop or to be transferred from one dop to another. (Use and selection of dops is described in the book mentioned on the preceding page). The dop is then mounted in the machine's index head and the facets are ground and polished according to the shape and type of stone.

During all cutting steps a small but steady drip of water is required on the lap plate to cool the stone and to wash away the cuttings.

A faceting machine must be capable of holding a stone at any given preset angle from 0° to 90° in a plane perpendicular to the revolving lap plate. At the same time, the machine must allow rotation of the stone relative to the lap plate surface in up to 64 accurately spaced divisions. Finally, you need a pan surrounding

the lap plate to collect and drain away the cooling water and cuttings.

Begin construction with the machine bed. Make the bed ways as shown and separate them with two 1-in.-square steel spacers. Assemble the frame first by clamping the spacer to the ways. These strips will align the frame and hold it accurately for drilling the two large 1/4-28 bolt holes in each corner. Make the four bed feet from angle iron and finish the bottom ends accurately by milling, turning or careful filing. The bolt holes in the feet should be carefully laid out and then spot-faced after drilling. When the bed is completely fabricated, check the parallel alignment of the ways carefully before proceeding, and eliminate any rocking tendency the bed may have. The motor mounting holes should be drilled after the lap-plate bearing assembly is completed and mounted to insure accurate belt alignment.

Next, machine the lap-plate, bearing-housing assembly. The bearing housing itself can be made from hard aluminum or brass, and its machining is straightforward turning and boring. The top bearing is a radial thrust-type (Boston No. 704) necessary to support the weight of the lap plate while the two lower bearings (Boston No. 3003DS) absorb the belt tension load. All bearings should be a tight push-fit in the housing. A nut and lock-nut on the bottom of the lap-plate shaft can be adjusted to eliminate any bearing play.

The bearing housing is mounted to the frame with the large center mounting hole in the plate, bored 1 1/4 in. using a lathe faceplate or four-jaw chuck. The

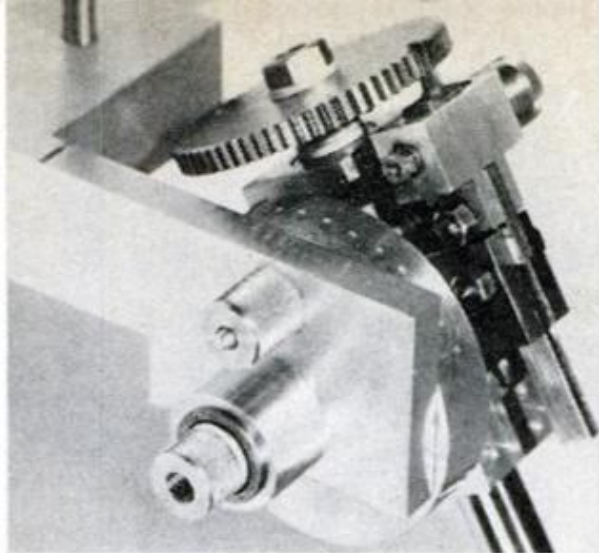

FACETING MACHINE must be capable of holding a stone at any angle from 0° to 90° from perpendicular. Text tells which bearings to use and where to get them. Cheater (right) is advised as addition

bearing and 1½-in. pulley on the motor. With the frame assembled, the motor mounted and the lap plate running satisfactorily, construction can proceed on the vertical column and height adjusting mechanism.

The vertical column is made with the ends faced in the lathe to an overall length of 12 in. and a hole drilled ½ in. from one end with a ¼-in. center drill to receive a locking setscrew in the column base. The column base has deep insets milled in each side leaving the center 2½ in. wide (to fit smoothly between the bed ways). The base is clamped to the bed from one edge by a knurled clamp screw.

The two fine-feed mechanism blocks which operate on the vertical column to raise and lower the index head are also machined from 1-in. hard aluminum. A ¾-in. hole for fitting on the column should be bored or reamed ¾ in., then an expansion cut made with a slitting saw in the lathe or milling machine, or cut carefully with a thin hacksaw. The ¼-in. hole in the upper block serves as a bearing for the lowering screw and should be reamed. The rest of the work on the feed blocks is straightforward requiring no special instructions. The fine-feed adjusting screw is made from ⅝-in. drill rod and must be machined to close diameter tolerance in order to minimize any play. *Both clamping screws are always locked while actually cutting the stone.*

The only critical work on the index-head mounting plate is the distance between the ¼-in. hole, the No. 25 hole immediately above it and the index mark

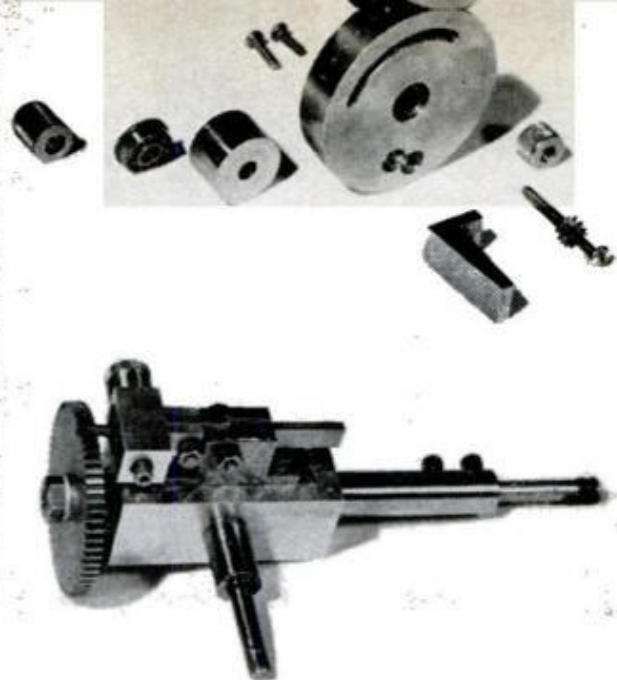

on the top edge. The center of the two holes *must* be exactly in line with the index mark and at a right angle to the horizontal axis of the mounting plate.

The index-head assembly is the heart of the faceting machine and considerable care should be taken in constructing it. Excessive play in any direction will show up as inaccuracies in the finished stone. Machine the index-head body and face each end to an overall length of 2½ in., then accurately lay out the center on one end. Make a deep "pop" with a center punch, and adjust to run truly in a four-jaw chuck. Start with a center hole, then drill all the way through ⅝ in.

A recess is then bored out 1⅛ in. in dia. by ¼ in. deep to hold (with a tight push-fit) one of the index-head shaft bearings (Boston No. 160DS). Remove the body and chuck a scrap piece of ½-in., or larger, steel rod with about 2 in. protruding. Turn this rod to a diameter which fits tightly in the ⅝-in. hole in the index-head body. Twist the end of the body with the bored recess onto the rod and machine the second bearing recess. Mark out the pivot shaft hole on one side of the body and drill with a No. 3 drill right through to the ⅝-in. center hole. Before tapping, drill into the No. 3 hole with a 1⅛-in. drill to a depth of ⅜ in., then tap 14-28. This will enable the pivot shaft to be locked when tightened up to the ¼-in. shoulder of the threaded end. To finish, lay out, drill, and tap the index lever base mounting holes.

The index-head pivot shaft should be

(Please turn to page 170)

Add a Limit Switch To Your Lathe Carriage

IN TURNING OPERATIONS where it is necessary to run the cutting tool as close to the headstock as possible, there's usually a risk of running the compound rest into the chuck or dog. While a micrometer stop is satisfactory when hand-feeding, extra caution should be exercised when you use power feed, because if the feed isn't disengaged before the stop is reached, damage to lead screw and gears could occur. With this attachment, the carriage can be fed without attention since the lathe automatically shuts off when the compound rest hits a switch of the attachment.

To minimize the chance of damage to the ways, make the clamp of aluminum. The pair of $\frac{1}{4}$ -in. setscrews is simply intended to insure parallelism between the two clamping members. Two hex-head machine screws are used to secure the clamp to the ways.

Though you can use several types of microswitches, I found that the one indicated on the drawing performs adequately. It has a rating of 15 amps., plus the capability of handling the current needed for my Atlas lathe motor. It also permits enough free travel to take up any carriage overrun. (There is always a slight carriage overrun after power is cut, especially when using a chuck, light cut or combination of both.) The switch shown permits a carriage overrun of approximately .25 in.

To attach the switch to the angle, drill and tap two holes and fasten with machine screws. To prevent shorted connections, separate switch and angle with insulating material. The aluminum case should also be lined with the same material.

—Arthur Volz

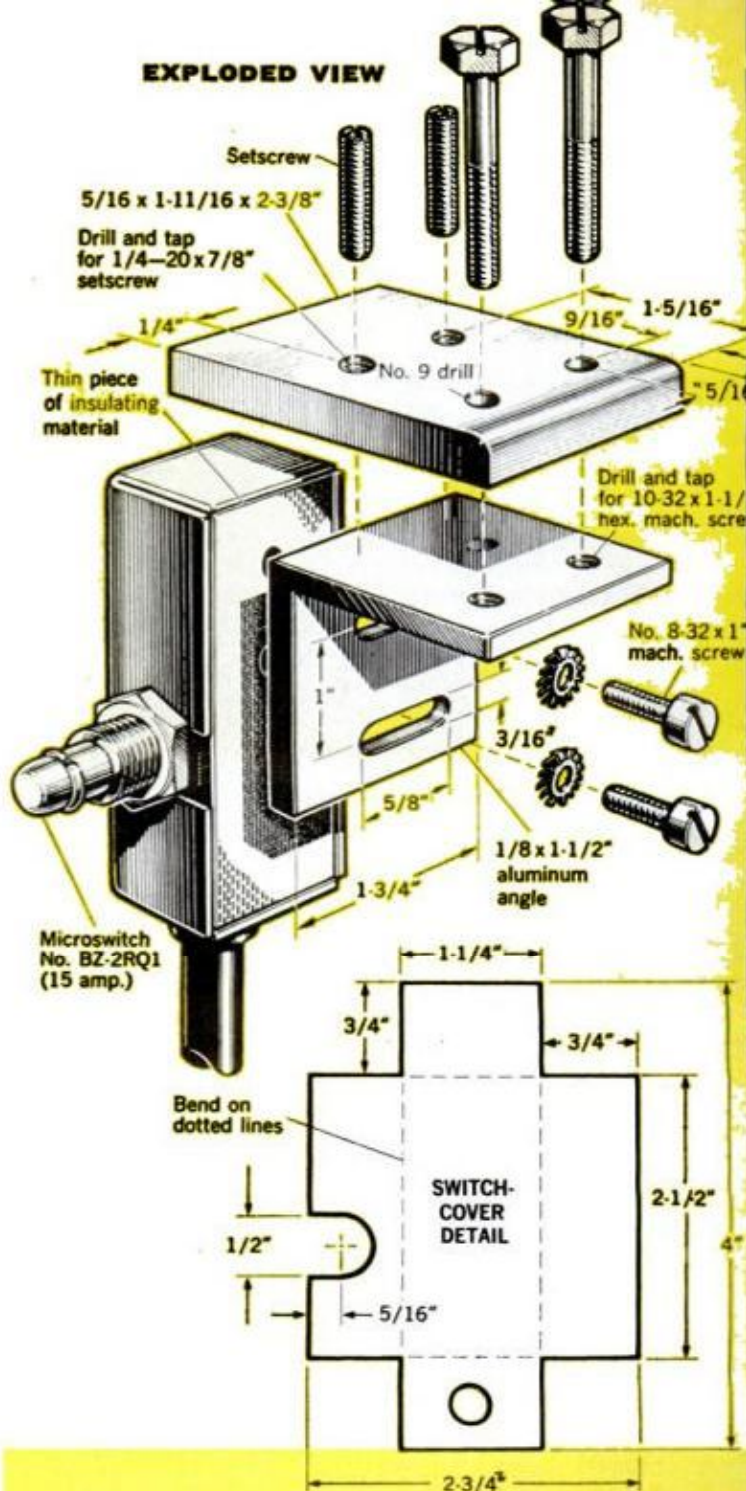

ELONGATED HOLE, obvious in photo but not used in art, is for adapting clamp to other uses as needed

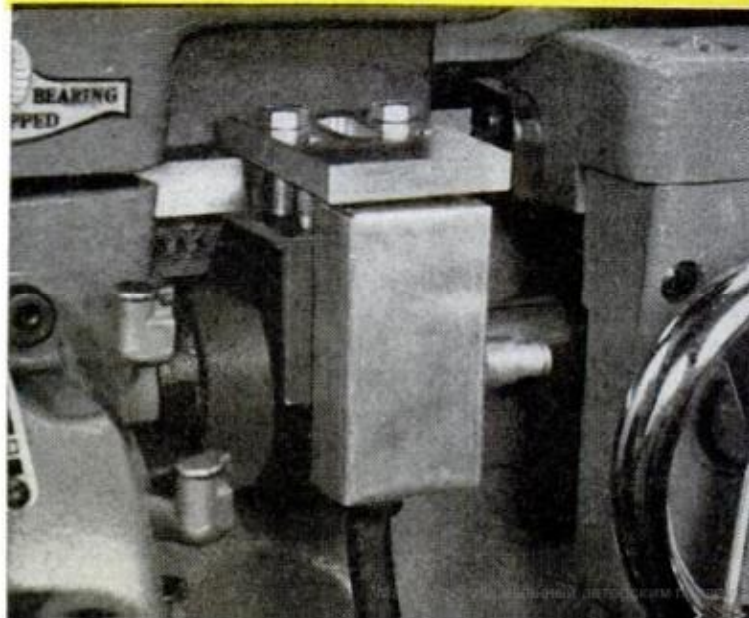

New tools you should know about



PORTABLE SAWHORSE labeled Trojan can be stored under a workbench or hung on the wall because when not in use it folds to a compact 6 in. sq. by 42 in. long. When opened, it automatically locks in a rigid position and gives a generous work surface with a 1000-lb. capacity. Sold at retail or by mail order, \$18 per pair. For information, write Trojan Folding Sawhorse, 2229 Jefferson Ave., S.E., Grand Rapids, Mich. 49507.



DRIVEN BY COMPRESSED AIR, the 1 $\frac{3}{4}$ -lb. Speed Ratchet Wrench is claimed to spin loosened fasteners on and off 90 percent faster than a conventional ratchet. Designed primarily for automobile work, the tool accommodates sockets up to 13/16 in. and uses a 3-in. extension for easy sparkplug changing. \$127.50. For nearest dealer, write Chicago Pneumatic Tool Co., 6 East 44th St., New York, N.Y. 10017.

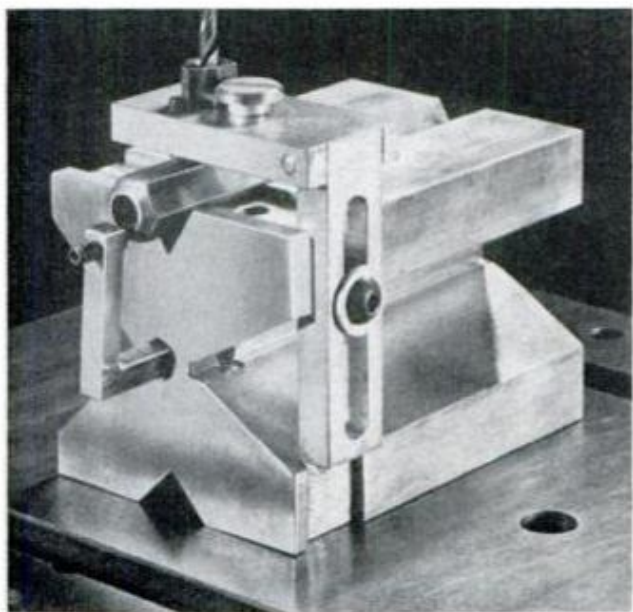

MULTIPURPOSE V-BLOCK measures 3x3x4 in., is designed to accommodate round, square or hexagonal workpieces from $\frac{1}{4}$ to 1 $\frac{1}{2}$ in. Each aluminum block has one bracket to drill from No. 80 to 5/16-in. holes using slip renewable bushings. The block also features a stop that enables you to control the distance of the hole from end of the part. \$18.50. NuDres Tool Co., 1534-F E. Chestnut Ave., Santa Ana, Calif. 92701.

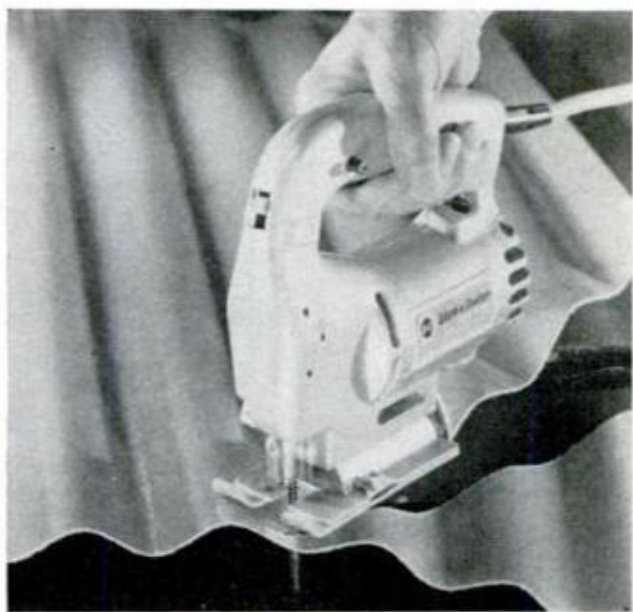

THREE-SPEED JIGSAW boasts 3000 rpm for cutting wood and compositions, medium (2500 rpm) for soft sheet metal and pipe, and a low speed (2250) for hard metal, plastics and tile. Model 7545 has a calibrated tilting shoe for bevel cuts up to 45° and accepts a rip-fence, circle-cutting guide attachment. Available at hardware stores for \$35, the jigsaw is made by Black & Decker Manufacturing Co., Towson, Md. 21204.



SOLVING

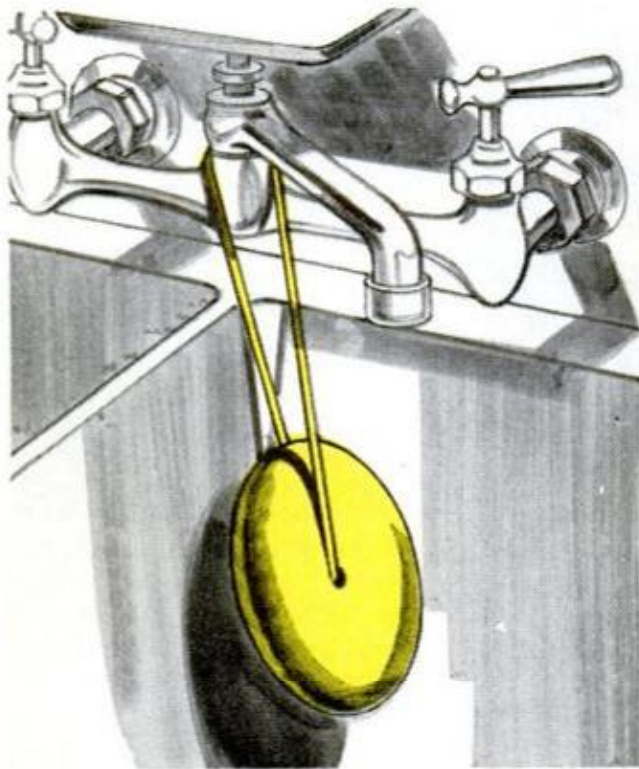

KEEP BAR SOAP from wandering by drilling a $\frac{1}{8}$ -in. hole through one end of the cake and inserting shoestring. With string looped over your laundry-tub faucet, soap is always at hand.—*Harry Wheeler*



A NEAT BIRD FEEDER can be quickly and inexpensively made from a plastic cottage-cheese container and three short lengths of wire. Fill it with wild bird seed and hang it from a branch.—*W. H. McClay*

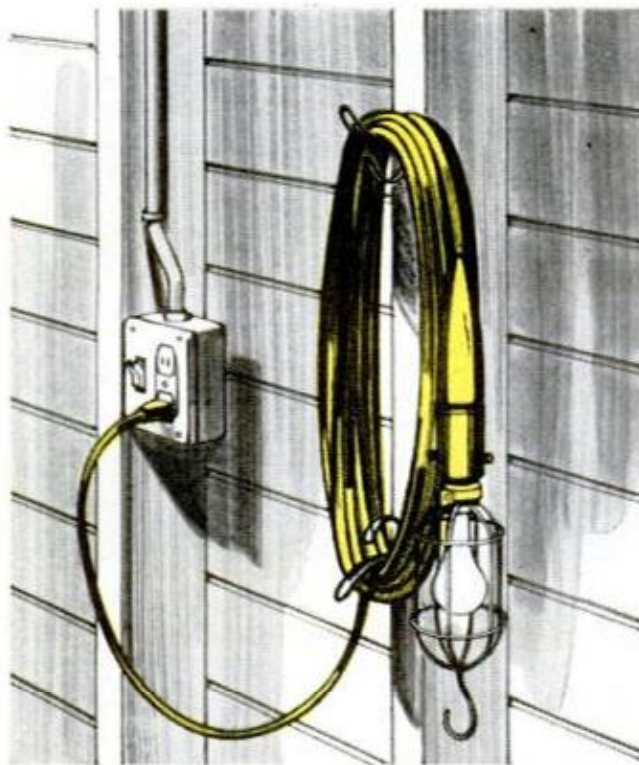

TWO COATHANGER HOOKS fastened to a garage wall stud will do a neat job of storing a drop light. If light has a built-in switch, locate hangers so that the line can be kept plugged in.—*John F. Pilznienski*



DRIED-OUT, FELT-TIP PENS can still serve a function if you use them to hold the seed packets to mark the plantings in your garden. Leave the marker in place until plants are identifiable.—*Charles Hardy*

POPULAR MECHANICS

HOME PROBLEMS

Illustrations by Adolph Brotman, Worman Associates

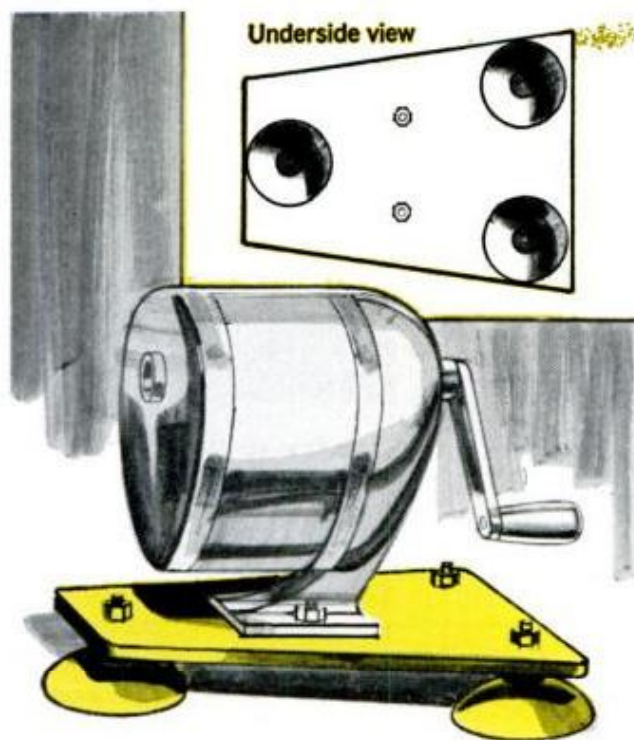

YOUR PENCIL SHARPENER can be carted to wherever you're working if you first mount it on a small piece of hardboard. Simply affix three or four small suction cups to the underside.—*Harry Radzinsky*



SAVE BB AND PELLET AMMO by rigging up a target that will trap any shot that hits the mark. To do it, fill a milk carton with cardboard or rags and hang it where shooting is safe.—*George Mayerchak*



EASEL FOR WEEKEND ARTISTS can be rigged by nailing a crossbar to an ordinary stepladder at any height desired. If removal is a must, fasten crossbar with screws instead of nails.—*Gordon Ligocki*

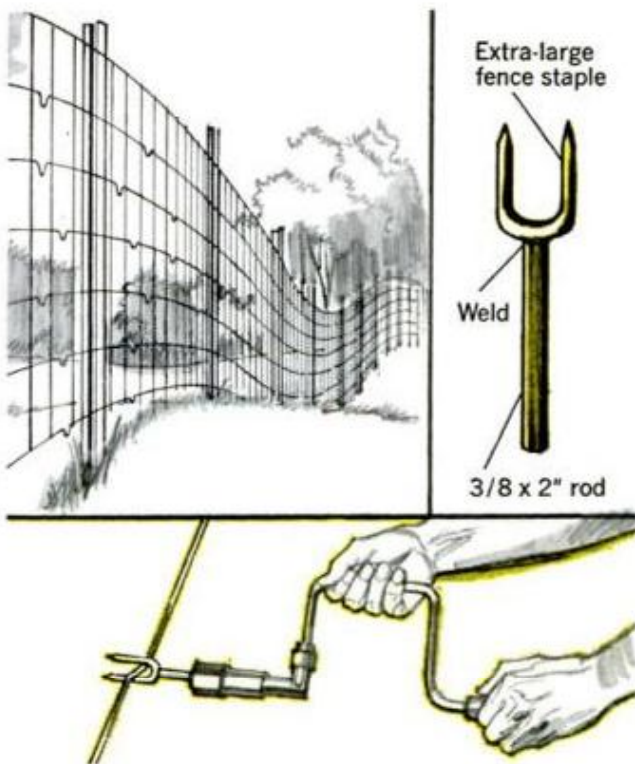

WAVY WIRE FENCES can be aligned with ground contour by welding a short rod to a heavy-duty staple. Easy way to use "tool" is to insert it in carpenter's brace and give it a quarter turn.—*Albert T. Pippi*

HINTS FROM READERS



Leaf-bag sleeve

You can make leaf raking and other yard cleanup easier with this method of keeping the disposal-bag mouth open for one-man stuffing. My wife and I use an old bottomless trashcan as a sleeve. For looks, I gave it a coat of paint and added cloverleaf designs.

—W. Robert Proctor



Funnel pouring aid

Pouring liquids from one container through a funnel and into a small-neck bottle can be wearying. Should your eye wander, the liquid might overflow. If you solder a piece of wire to the funnel spout, air can escape from the bottle and the pouring goes faster.

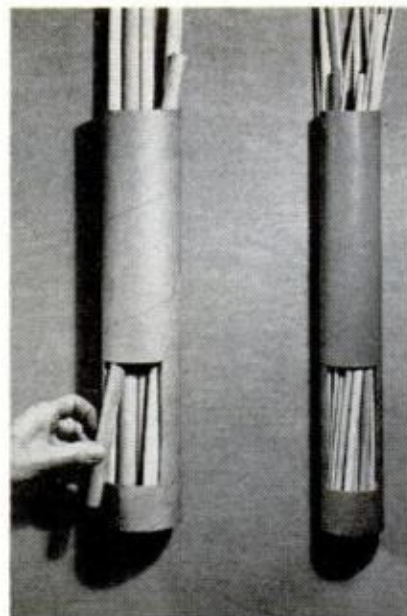

Neater dowel storage

A cardboard tube provides compact storage for various-size dowels. Simply cut a wood plug to fit the inside diameter and tack in place to serve as the bottom. Cut an opening in the tube to accept your hand and fasten the holder to the wall with two hefty screws.

'Welding' plexiglass on a drill press

Next time you have to join cylindrical plastic to a flat piece, try this stunt for speed. Simply chuck the rod in your drill press and clamp the flat to the table. Lower the press until parts meet, then switch on medium-high speed. Friction causes the material to melt, but turn off drill the instant the flow starts.

NEXT MONTH IN SHOP AND CRAFTS

EARLY AMERICAN GOSSIP BENCH. A handy place to sit and gab, this handsome spindle-back bench makes for comfortable conversation. Reproduced from an authentic Early American piece in our own cabinet shop, it captures the warmth and charm that colonial pieces offer and is something you'll want to add to your Early American collection. Watch for it in the March PM.

MAKE A GRAND ENTRY. If your foyer looks a little drab, you can perk up its appearance by remodeling the existing door and updating the entryway with a paneled room divider. You'll find one homeowner's attractive solution in the March PM.

HANDSOME PROJECTS OF PLEXIGLASS. They look as if they're molded of glass, and you won't believe you can make them yourself—but you can from sheets of lustrous acrylic plastic. This striking group of home furniture and accessories includes a telephone stand, magazine rack, cookbook holder, wine bottle rack, terrarium and chairside table. They are projects you'll be eager to make as soon as you pick up the March issue.

PLUS: A mini drill press for hobbyists, how to add an indexing attachment to your lathe, easy way to bend tiny tubing, and much, much more.

CHANNELLOCK

Gives You More In Hand Tools Including



HAMMERS
with

EPOXY-LOKT
HANDLES

(never loosen...never need wedging)

The unmatched feel and balance of a hickory handle hammer PLUS THIS NEW ADVANTAGE: a handle that **never** loosens, **never** needs wedging. It's Epoxy-Lokt for life. Yours with better-than-ever CHANNELLOCK hammers (and we've been forging hand tools since 1886). Look for the bright red enamel finish, the high polished pisen and face and the name CHANNELLOCK. Your best buy at any price.

Want more information? Our catalog is yours for the asking.

TOOLS BY
CHAN NEL LOCK[®]

MEADVILLE, PA. 16335

WHAT ABOUT AIR BAGS?

(Continued from page 65)

key questions before they install air cushions in cars.

1. What happens to passengers who are not in an upright, head-on position when the pillow inflates? In simulated crashes with dummies, a mannequin's legs were crushed as it "braced" itself in anticipation of a collision. What happens if a child is kneeling on the seat or standing on the floor? What happens if driver or passenger are leaning forward so they receive the full impact of the exploding bag on the head? In an airtight car, the force of the bag going off can blow out the windows and doors. What happens to passengers who aren't wearing seat belts when the doors fly off?

2. What about damage to the ears of car occupants from the sound and pressure of a bag inflating? Tests carried out by the car companies indicate about 75 percent of motorists can take the full force of

What happens to passengers who aren't wearing seat belts when the doors fly off?

the sound pressure waves with no ill effect. If the sound grazes the ear—that is if the passenger is facing the source of the noise—about 95 percent of the population can tolerate the sound without any lasting injury to the ears. But what if the head is turned slightly so the full force of the explosion hits one ear? GM estimates that somewhere between 5 and 25 percent of the population would suffer severe hearing damage from the explosive noise of the bag going off.

3. What happens if a bag blows in a noncrash situation? The auto manufacturers say the present hardware used in air bags just isn't good enough to prevent this from happening.

4. How reliable will the air pillows be after being stored in the dash for four or five years? Will they still function?

5. Air bags provide protection only in head-on collisions or at angles of about 30° left and right of straight-on. This covers about 50 percent of all accidents. But what about the other 50 percent—side-on collisions, rear impacts, sideswipes and rollovers? Would air cushions help or hinder drivers involved in nonfrontal collisions?

6. Chrysler raises the question of what happens to passengers smoking pipes or cigars, people wearing glasses and false

teeth, the driver whose arm is upraised in front of his face when the bag blasts off. Does he get the stem of his pipe shoved down his gullet? Are his glasses smashed against his eyes?

Eaton, Yale & Towne, the pioneer producer of air pillows, argues that the auto companies are overcautious and overconcerned on several points.

"We were also concerned about the noise factor," an Eaton executive explains. "We conducted a comprehensive series of tests on this at Wright Field. Dr. Charles Nixon, the impulse noise expert at Wright, ran 84 tests involving 91 human volunteers and found they suffered no damage to their hearing."

Using a car with a small passenger compartment, Eaton's tests showed its system has about the same peak sound pressure as a shotgun. All participants in the tests were healthy adults. (There is little concern about damage to the eardrums of children because their drums are smaller and more flexible than adults'.) But questions still remain about the ears of older people and motorists with ear trouble.

Eaton also doubts there's much danger of an accidental triggering of the mechanism. "In more than two million miles of testing the sensor over all kinds of roads and obstacles, we haven't experienced a single accidental triggering," a company engineer declares. "But even if the unit was accidentally detonated, there would be no safety calamity because it operates at such terrific speed that it doesn't have much opportunity to incapacitate the driver."

Finally, Eaton is confident its system would function properly after being stored for five years. After five years or so, major components might have to be replaced. They'd also have to be replaced after a collision. Replacement costs, the company estimates, would be in the area of \$40 to \$50 per pillow.

The auto manufacturers have a lot of respect for Eaton. But, "We don't question their findings," declares a safety engineer for a Big Three company. "But all the research in the world isn't going to get us off the hook if we become embroiled in lawsuits because the air bags we install on cars fail or malfunction."

Despite all the dangling question marks, the Federal government has ordered auto firms to install air bags or some type of passive restraint in front seats starting July 1, 1973 and in rear seats a year later—July 1, 1974.

Ford and GM say they will put a few hundred air bags on cars this year on a

(Please turn to page 170)

It's the same truck. Same load-lovin' overhead cam engine. Same torsion bar front and heavy-duty rear suspension. Same steel girder frame. And a split personality.

The Datsun busy body picks up on all the tough assignments.

A six foot all-steel bed and flat-loading tailgate take on surfboards, bikes, hay bales and branding irons. Tie down hooks all 'round see that they stay on.

Your Datsun dealer will show you a variety of campers that snuggle right in there, too. Switching loads is simple. You can take this

busy body on vacation over the weekend and put it back to work bright and early Monday morning.

Slip into the comfortable, hi-visibility cab. Latch onto the smooth shifting 4-speed stick.

Up to 25 miles per gallon economy and load-proven reliability.

About the best thing you can do with the Datsun Pickup is haul off and buy one. A lot of haulers have. It's the number-one selling import truck. And there's no two ways about that.

At just \$1916*, no wonder.

Busy body



DATSUN 
Drive a Datsun... then decide.

*Plus tax, license, local freight, dealer preparation. Specifications and price subject to change without notice.

WHAT ABOUT AIR BAGS?

(Continued from page 168)

trial basis. (The cars will not be sold to the general public.) Ford says it will step up installations to 2000 to 4000 cars in 1972 and offer the item as an option in 20,000 to 40,000 vehicles in 1973. GM has volunteered to install 25,000 units in 1972, make the equipment optional on some '73 cars and standard equipment on '75 models. American Motors says it's game to offer air bags as an option on one car line in '73 and put the device on all '76 models. Chrysler also favors a program of progressive installation, beginning with a few hundred units and culminating with 100 percent installation rate by Jan. 1, 1975.

The National Highway Safety Bureau still has some questions of its own on air bags. The Bureau recently awarded a \$500,000 contract to Cornell Aeronautical Laboratory to evaluate designs and to develop new passive protection systems.

The auto firms are resigned to the fact they are going to have to install some type of passive restraint on cars sooner or later. They just aren't convinced air bags are the only or best answer. But there's no conspiracy to scuttle air bags.

"Give us time to improve it," the auto-makers are saying, "or give us time to come up with something else that'll do the job without the risks."

Something else? There are a lot of ideas kicking around—blankets; nets and movable curtains that drop down in front of the body; Toyota's radar sensor to deploy the bag at the instant before a crash; pop-out instrument panels that shoot forward to cushion the head and chest (technically the panel is called an articulated dash); seats that curve around the shoulders combined with a chest protector that encases the body; and, from Ford, a device that prevents you from starting the car unless you're wearing the seat belt and/or shoulder harness.

You'll see air bags or one or more of these gadgets as standard equipment on all new cars before 1974. ★★

GEMSTONE FACETING MACHINE

(Continued from page 161)

machined with accuracy with both ends reduced to $\frac{1}{4}$ in. diameter for $\frac{3}{8}$ in. and $1\frac{1}{8}$ -in. lengths. Tighten the shorter end into the index head body. The index-head dop shaft also requires careful machining to insure a play-free fit in the bearings. This shaft should be machined with one end turned to $\frac{1}{4}$ -in. dia. for a length of $3\frac{1}{4}$ in. and thread the tip $\frac{1}{4}$ -28 for $\frac{5}{16}$ in.

Then drill a $1\frac{5}{64}$ -in. hole $1\frac{1}{4}$ in. deep in the $\frac{1}{2}$ -in. dia. end and follow by reaming $\frac{1}{4}$ in. Use a tail-stock "V" drill pad and drill two No. 36 holes in the $\frac{1}{2}$ -in. dia. part of the shaft $\frac{1}{8}$ and $\frac{5}{8}$ in. respectively from the end. Drill right through into the $\frac{1}{4}$ -in. reamed hole and tap 6-32. Two $\frac{3}{8}$ -in. 6-32 knurled screws with 45° tips are machined to engage the groove found in dop shafts.

The index gear I selected is a Boston No. S3264, 64-tooth, 32-pitch, $\frac{3}{16}$ -in.-face steel gear with a $\frac{3}{8}$ -in. hole. Since the majority of stones are cut in multiples of 8 facets, this 64-tooth gear will permit indexing a wide selection of facets.

The index lever and base is machined using a lathe milling attachment or milling machine. Any vertical play of the lever is not important but there should be *no side play*. Also, the gear end of the lever should be carefully ground for a play-free fit in the gear teeth. A simple, non-adjustable index lever could be used but experience proves that an adjustable lever (called a cheater) is useful. As with most mechanical devices, things are never absolutely perfect and a cheater enables minute adjustments to be made. Its construction is fairly simple. The spring-loaded gear-tooth piece eliminates play, and, as with the simple lever, careful grinding is required for a close fit with the gear teeth to eliminate play and to bring the lever level when it's engaged.

In order to eliminate lateral play of the index head, compensate for pivot shaft wear and to adjust index head lowering tension, the index head which pivots in the index-head mounting plate is also supported by a friction adjusting mechanism. This device consists of a brass bearing holder which serves as an additional $\frac{1}{4}$ -in. bearing surface for the index head-pivot shaft and holder for a friction adjusting ball bearing. The purpose of the ball bearing is to provide a friction-free surface which will allow the adjusting nut to be tightened to any setting without being loosened by shaft rotation.

The final major component to make is the angle stop. The rough shape is cut by hacksaw, and after you mark the center and scribe to interesting lines 90° apart, a $\frac{1}{2}$ -in. hole is reamed in the center of the rough piece. The stop is then mounted on a mandrel and turned to a $2\frac{3}{8}$ -in. dia.

To finish, mount a switch on one of the legs, connect the motor in series with the switch and a power cord, arrange for a water supply, and cut a 2-in. length of $\frac{5}{32}$ -in. drill-rod steel for a clamping screw tightening lever. Finally, paint all non-working steel surfaces on the bed with two coats of rust-resistant enamel. ★★



I'd like to give this to my fellow men... while I am still able to help!

I was young once, as you may be—today I am older. Not too old to enjoy the fruits of my work, but older in the sense of being wiser. And once I was poor, desperately poor. Today almost any man can stretch his income to make ends meet. Today, there are few who hunger for bread and shelter. But in my youth I knew the pinch of poverty; the emptiness of hunger; the cold stare of the creditor who would not take excuses for money. Today, all that is past. And behind my city house, my

summer home, my Cadillacs, my winter-long vacations and my sense of independence—behind all the wealth of cash and deep inner satisfaction that I enjoy—there is one simple secret. It is this secret that I would like to impart to you. If you are satisfied with a humdrum life of service to another master, turn this page now—read no more. If you are interested in a fuller life, free from bosses, free from worries, free from fears, read further. This message may be meant for you.

By Victor B. Mason

I am printing my message in a magazine. It may come to the attention of thousands of eyes. But of all those thousands, only a few will have the vision to understand. Many may read; but of a thousand only you may have the intuition, the sensitivity, to understand that what I am writing may be intended for you—may be the tide that shapes your destiny, which, taken at the crest, carries you to levels of independence beyond the dreams of avarice.

Don't misunderstand me. There is no mysticism in this. I am not speaking of occult things, of innumerable laws of nature that will sweep you to success without effort on your part. That sort of talk is *rubbish!* And anyone who tries to tell you that you can *think* your way to riches without effort is a false friend. I am too much of a realist for that. And I hope you are.

I hope you are the kind of man—if you have read this far—who knows that anything worthwhile has to be *earned!* I hope you have learned that there is no reward without effort. If you have learned this, then you may be ready to take the next step in the development of your karma—you may be ready to learn and use the secret I have to impart.

I Have All The Money I Need

In my own life I have gone beyond the need of money. I have it. I have gone beyond the need of gain. I have two businesses that pay me an income well above any amount I have need for. And, in addition, I have the satisfaction—the deep satisfaction—of knowing that I have put more than three hundred other men in businesses of their own. Since I have no need for money, the greatest satisfaction I get from life is sharing my secret of personal independence with others—seeing them achieve the same heights of happiness that have come into my own life.

Please don't misunderstand this statement. I am not a philanthropist. I believe that charity is something that no proud man will accept. I have never seen a man who was worth his salt who would accept something for nothing. I have never met a highly successful man whom the world respected who did not sacrifice something to

gain his position. And, unless you are willing to make at least half the effort, I'm not interested in giving you a "leg up" to the achievement of your goal. Frankly, I'm going to charge you something for the secret I give you. Not a lot—but enough to make me believe that you are a little above the fellows who merely "wish" for success and are not willing to sacrifice something to get it.

A Fascinating and Peculiar Business

I have a business that is peculiar—one of my businesses. The unusual thing about it is that it is needed in every little community throughout this country. But it is a business that will never be invaded by the "big fellows." It has to be handled on a local basis. No giant octopus can ever gobble up the whole thing. No big combine is ever going to destroy it. It is essentially a "one man" business that can be operated without outside help. It is a business that is good summer and winter. It is a business that is growing each year. And, it is a business that can be started on an investment so small that it is within the reach of anyone who has a television set. But it has nothing to do with television.

This business has another peculiarity. It can be started at home in spare time. No risk to present job. No risk to present income. And no need to let anyone else know you are "on your own." It can be run as a spare time business for extra money. Or, as it grows to the point where it is paying more than your present salary, it can be expanded into a full time business—overnight. It can give you a sense of personal independence that will free you forever from the fear of lay-off, loss of job, depressions, or economic reverses.

Are You Mechanically Inclined?

While the operation of this business is partly automatic, it won't run itself. If you are to use it as a stepping stone to independence, you must be able to work with your hands, use such tools as hammer and screw driver, and enjoy getting into a pair of blue jeans and rolling up your sleeves. But two hours a day of manual work will keep your "factory" running 24 hours turning out a product that has a steady and

ready sale in every community. A half dollar spent for raw materials can bring you six dollars in cash—six times a day.

In this message I'm not going to try to tell you the entire story. There is not enough space on this page. And, I am not going to ask you to spend a penny now to learn the secret. I'll send you all the information, free. If you are interested in becoming independent, in becoming your own boss, in knowing the sweet fruits of success as I know them, send me your name. That's all. Just your name. I won't ask you for a penny. I'll send you all the information about one of the most fascinating businesses you can imagine. With these facts, you will make your own investigation. You will check up on conditions in your neighborhood. You will weigh and analyze the whole proposition. Then, and then only, if you decide to take the next step, I'll allow you to invest \$15.00. And even then, if you decide that your fifteen dollars has been badly invested I'll return it to you. Don't hesitate to send your name. I have no salesmen. I will merely write you a long letter and send you complete facts about the business I have found to be so successful. After that, you make the decisions.

Does Happiness Hang on Your Decision?

Don't put this off. It may be a coincidence that you are reading these words right now. Or, it may be a matter that is more deeply connected with your destiny than either of us can say. There is only one thing certain: If you have read this far you are interested in the kind of independence I enjoy. And if that is true, then you must take the next step. No coupon on this advertisement. If you don't think enough of your future happiness and prosperity to write your name on a postcard and mail it to me, forget the whole thing. But if you think there is a destiny that shapes men's lives, send your name now. What I send you may convince you of the truth of this proverb. And what I send you will not cost a penny, now or at any other time.

VICTOR B. MASON
1512 Jarvis Ave., Suite M-2-AB
CHICAGO, ILLINOIS 60626

CASSETTE OR CARTRIDGE?

(Continued from page 75)

two more at the back. The added rear speakers create a rich, reverberant, room-filling sound simulating the realism and spaciousness of concert-hall listening. RCA now offers such a system, complete with four speakers, for under \$200. Motorola has another, for car installation.

Eight-track cartridges are ideally suited to four-channel sound since they can provide four tracks in each direction. The tracks can also be arranged so they're compatible with regular two-channel stereo cartridges. While cassettes can be adapted to quadrasonic sound, they don't lend themselves as readily to this new format. Norelco and Ampex are experimenting with a four-channel cassette system, but have nothing on the market yet. If quad tapes become popular in the eight-track configuration, they could keep cartridges alive for a good long time.

Meanwhile, cassettes are getting a big

Soon . . . you'll play all selections on a cassette without removing or turning it . . .

lift from another spectacular development: the so-called Dolby system for suppressing background tape noise. Mini tapes have long been plagued by a high level of hiss because of their narrow track width and slow speed. To avoid overloading the tape, it's necessary to record the original signal at low volume, then boost it in playback to proper loudness for listening. The trouble is, noise created in the recording gets boosted in playback with the music.

In the Dolby system, low-volume, high-frequency signals—where the hiss problem is greatest—are boosted *before* they're recorded. Because they're naturally low in volume anyway, they can be amplified without overloading the tape. In playback, these high-frequency signals are then cut back to proper listening volume, reducing hiss as well. The result is a cleaner, quieter tape.

At the moment, Harman-Kardon, Fisher and Advent lead the way with Dolby-equipped cassette decks. They're premium-priced—about \$200 to \$260—but offer top-quality hi-fi. High-performance cassette decks without Dolby circuitry are sold by Panasonic, Craig, Concord, Sony, Ampex, Aiwa, 3M/Wollensak, RCA, TEAC, Toshiba, Allied and Lafayette for about \$90 to \$130.

The problem of reversing a cassette is

also getting attention. The sticker is that a cassette has only three slots in its plastic housing—one for the pinch roller that presses the tape against the driving capstan, one for the record/playback head, and one for the erase head. To reverse a cassette, you need a second pinch roller at the other end to drive the tape in the opposite direction. This takes up the hole normally used for the erase head, leaving only one center opening for record, playback and erase functions. For a four-track stereo cassette, this calls for shoe-horning eight heads—four for record/playback and four for erase—into an opening the size of a keyhole.

Head designers have actually accomplished this prodigious feat and reversible cassette machines will be appearing soon. You'll be able to play everything on a cassette without having to turn it over.

Jumping the gun, Craig has already marketed an automatic-reversing cassette changer—Model 2805 for \$189. The catch is it's a playback-only machine and thus needs no erase head or combined record/playback head. The second pinch roller is in the unused erase-head slot, and a simple four-track playback head goes in the center gap.

Norelco has gotten around the reversing problem with its clever flip-over arrangement that actually turns the cassettes instead of playing them in both directions. The device is in the form of a separate plastic chute attachment that will fit on several Norelco, Ampex and Bell & Howell cassette changers. It's \$19.95.

For the cartridge user, the Qatron rotary changer is a marvelous piece of machinery despite its somewhat hefty \$329.95 price tag. It can be mounted vertically or horizontally, and its rotary magazines are removable so you can store cartridges easily like trays of slides.

Stack-loading cassette changers are available from several makers. In addition to Craig's reversible machine, there are models by Panasonic, Norelco, Ampex, Bell & Howell and Denon (Nippon Columbia). The Panasonic, Ampex and Norelco units are about \$230, the Denon \$250. All are decks designed to play through an existing hi-fi system. Coming soon from Panasonic is a 20-cassette changer that will have automatic reversing similar to Craig's. Also in the works is a rotary changer by Benjamin that will hold cassettes in circular trays like Qatron's for cartridges. Most experts are convinced that the slick, handy tape changer will become the next big add-on hi-fi accessory, taking a place alongside the record changer as a major source of home entertainment. ★ ★ ★

Take this \$3.49 book FREE!

Let these 257 experts show you how to attain the skills of a real pro!

You get this giant 8¼" x 11" illustrated volume of exciting "how-to" projects for your family, home, garden, car, boat, vacation—as an outright gift—nothing to buy. It is crammed with reliable shop-tested, do-it-yourself techniques and practical show-how pictures. Use these hundreds of do-it-yourself plans, projects, tips and hints to polish your own shopwork and hobby skills! Here is a brief glimpse of all your FREE Volume brings:

- Having car engine trouble? Fix 8 common problems quickly without having to pay a garage mechanic anything he chooses to charge you.
- Professional tips for expert sanding show how to bring out the best finish in woods and metals with power and hand tools.
- Complete plans help you build an inexpensive 3 x 4 foot plywood table to give any small band saw big-machine capacity and flexibility.
- Need extra space? Turn an unfinished attic or basement into handsome, usable areas with practical, money-saving plans.
- Save on band saw blade costs. Build brazing fixture to make your own blades.
- Do your own auto body repair expertly with simple tools and methods.
- Build a boat designed just for fun. Step-by-step plans and materials list included.
- Home too hot for comfort? Follow complete directions for air conditioning your home.



• Bothered by a wet basement? Cure it yourself and save \$200 to \$2,000 under what professionals charge.

- Need better burglar protection? Build effective power alarm for a safer home.
- Refinish furniture perfectly. Hands-at-work pictures show you how.
- You'll wonder how you ever got along without an air supply in your shop once you've built and used the "foot-bellows" system.
- Build a gas-fired barbecue for more back-yard fun.
- New soundproofing techniques enable you to relax in quiet.
- Anyone can hand-letter signs with the "Project-A-Plan" method.
- Special trouble-shooting chart pin points malfunctions in an auto electrical system so you can fix it quickly.
- Target practice in the living room? Believe it or not you can blast away indoors without harming anything.
- Build your children model planes that fly higher than any others.
- Special tricks-of-the-trade save you time and effort in handling power tools.
- Save hundreds of dollars on buying and servicing appliances. Plus hundreds of other exciting plans and do-it-yourself ideas to save you big money and add thousands of hours of pleasure to your hobby, sport and vacation projects.

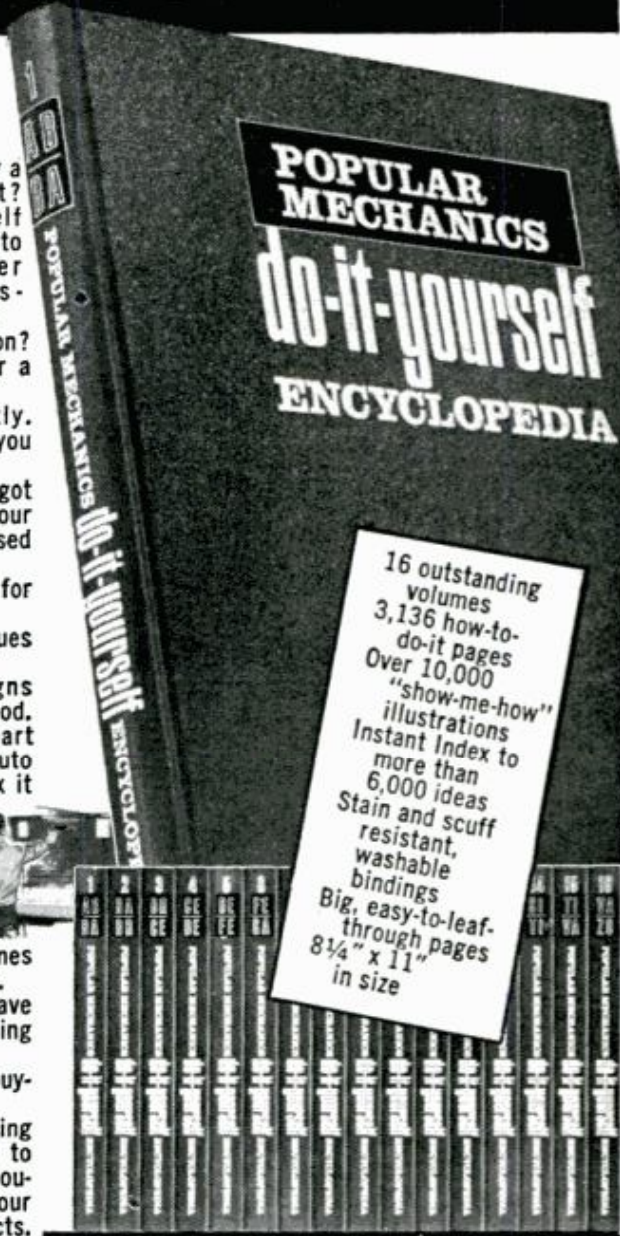

Why you receive this practical do-it-yourself handbook ABSOLUTELY FREE!

The reason you get this brand-new \$3.49 book as an outright gift is simple. This gold mine of "how-to" projects and money-saving plans is the first volume in POPULAR MECHANICS DO-IT-YOURSELF ENCYCLOPEDIA—an amazingly useful guide created by the editors of *Popular Mechanics*—experts in do-it-yourself techniques for over 65 years. The Encyclopedia gives you over 6,000 projects, repairs and improvements you can do by yourself to save hundreds of dollars on labor and materials. 257 experts lead you through every step of every project you select. They give you thousands of practical pointers to sharpen your skills in carpentry, car repair, metalwork, plumbing, masonry, electrical work, electronics, hi-fi, stereo, painting and decorating.

We believe that if you browse through the first volume—select a plan or project—use it at your workbench—try some of the money-saving shortcuts, shop-tested methods—you will be anxious to receive the others. Therefore, you may enjoy future volumes as they are published for 14 days' FREE EXAMINATION. You may buy one, two, the whole set, or none at all. But the first volume is yours to keep without obligation, no matter what you decide. Mail coupon today, to be sure of getting your FREE Volume.

FREE GIFT CERTIFICATE

Popular Mechanics Book Division, Dept. B-012
250 West 55th St., New York, N.Y. 10019

Please send, entirely free, Volume 1 of the new, illustrated POPULAR MECHANICS DO-IT-YOURSELF ENCYCLOPEDIA. I'm not obliged to buy anything—now or later—but am entitled to receive additional volumes (including future Yearbooks), on approval as published each month. After examining each volume free for 14 days, I either return it and owe nothing—or keep it and remit low subscriber price of \$3.49 a volume, plus shipping. I reserve right to cancel any time—without obligation. Whatever I decide, Volume 1 is mine to keep free!

Name _____
(Please Print)

Address _____

City _____

State _____ Zip _____

Signature _____

This offer available in Canada at a slightly higher price. Canadian residents mail coupon to New York address. Shipment of books and all services will be handled within Canada.

THEY LIKE 'IMPOSSIBLE' JOBS

(Continued from page 79)

gering mechanisms, EG&G engineers perform many nuclear tasks. As contractors to the AEC, they're in on every atomic explosion. They drill the holes in which explosives are placed. They set up the devices that touch off the blast. They monitor the results.

They have a record of complete safety, though in the early days of testing, when devices were placed atop steel towers, Grier and Bernard O'Keefe, the smiling Irishman who is now president of EG&G, had a hair-raising experience. When the detonating apparatus was put into operation, nothing happened. No explosion. There was an atomic bomb sitting up there atop the tower, so somebody had to go up and disconnect the triggering apparatus.

"I'll go," Grier volunteered.

O'Keefe argued that he should do it.

... EG&G is checking out the nuclear engine that will propel spaceships to Mars.

They tossed a coin. Grier "won" and O'Keefe climbed the 300-foot tower.

"Well, I'm still here to tell about it," O'Keefe says with a twinkle in his eye. "Actually, I wasn't worried. Those were our instruments and I knew they were fail-safe." Since then, EG&G instrumented blasts have all gone off perfectly.

Within the desolate reaches of the Nevada test site is the barren ground known as Jackass Flats. Here EG&G is checking out the nuclear engine that may propel spaceships to Mars.

In the engineering world work being done on NERVA—Nuclear Engine for Rocket Vehicle Application—is considered as about the toughest of all testing jobs. There's no sweat up to the time the 23-foot-high engines are hauled to the test stand aboard a giant flatcar of the "Jackass & Western." And no sweat in particular about the elaborate instrumentation that tells EG&G engineers what's going on as the nuclear engine roars into life. Monitoring remote events which create an environment too hellish for humans is old stuff.

The problem comes when the engine, sizzling with radiation, is hauled back to a huge concrete test cell, a "den of robots" full of remote-control manipulative devices. There, mechanical arms take the engine apart—fuel elements, pipe connec-

tors, all the thousands of parts, right down to the tiniest bolts. And each part has to be studied by EG&G instruments which feed their findings into a computer system. How radioactive are the parts? How have they stood up during their fiery ordeal?

The complex system of TV cameras, sensors and readout instruments contrived by EG&G engineers will determine whether nuclear propulsion is going to get us on our way to Mars and beyond.

In the sprawling research center of Hydrospace, Inc., an EG&G subsidiary in Rockville, Md., engineers are carrying out a complicated monitoring job that may someday save your life. You can see a weird network of pipes, tubes, valves, dials, wires and transistors which, you may be surprised to learn, simulates the human circulatory system.

When the National Institutes of Health wanted a way to test the mechanical hearts it was developing, it turned to EG&G. The engineers figured they would build up a system of tubes into which you'd hook the "heart," letting it pump blood, or a bloodlike liquid, all the while monitoring its performance.

It wasn't easy. "You wouldn't believe how much sweat went into this one," says Lee Custer, the project manager.

In the first place, just how does the human circulatory system operate? Surprisingly, the engineers found wide gaps in that knowledge. For example, they had to know exact pressures at every point of the body—in the big toe, say. They had to know exactly what happened to these pressures under all the different circumstances that might affect the human heart. This required long searches of hospital records. Eventually, they had a pretty good idea how the human system works. But could they make their artificial one operate the same?

The problem of finding a plastic with exactly the elasticity of human arteries involved experiments with hundreds of possibilities.

The third problem was no cinch either. How do you get your man-made system to react just the way the human physiology does to a variety of conditions? First you find out what these reactions are; then you program them into a computer that tells your plastic system when to contract, tells the "heart" when and how much to speed up, when and how much to slow down.

After three years' hard work, the EG&G engineers triumphed. Medical experts say the mock circulatory system has brought closer the day when an artificial heart will be popped into place like a spare part into an automobile engine. ★★★

1.

Did you know
Winston tastes
good like a
cigarette
should?

2.

That's
bad
grammar.

3.

Everybody
knows
that!

4.

But did you
know that
you're
getting in
the wrong
car?

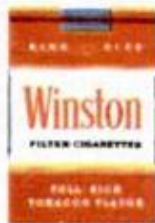

© 1971 R. J. REYNOLDS TOBACCO CO., WINSTON-SALEM, N. C.

Whenever you go on a weekend trip take along an extra pack of WINSTONS. They come in very handy at parkway picnics.

WINSTON may not say it right, but they sure know how to make it right with specially processed **FILTER BLEND** tobaccos.



TO YOUR OWN DOCTOR'S PRESCRIPTION



**EYEGLASSES
BY MAIL AT
GREAT SAVINGS!**

Mail orders filled by **\$10⁹⁵**
licensed optician from

(Including single vision lenses, frame and case).

Doctor's prescription will be filled by a skilled, approved and licensed optician or your own prescription duplicated. Lenses are ground and manufactured to U.S. optical standards. Choose from complete catalog of men's, women's and children's glasses. Bifocals, trifocals, sunglasses or SAFETY HARDENED LENSES at low additional cost. We guarantee accuracy, perfect fit.

SEND FOR YOUR FREE CATALOG TODAY
PRISM OPTICAL INC.

Dept. PM-53, 135 W. 41st St., New York, N.Y. 10036

EVERLITE[®] World's THRIFTIEST Light Plants



THE CHAMPION \$149.50

**The Champion—1200 watts
115 volts AC for only \$149.50**
Unbelievable but true—Brand new production methods now make possible free alternator design in a service free alternator light plant at this unprecedented price. Plant puts out a steady 1200 watts of 115 volt AC power to run power tools, oil burners, pumps, TV, or anything that requires up to 1200 watts. Powered by a rugged 3 HP, 4 cycle, easy start gas engine with 1 Year factory warranty. Complete with carry handle and shock mounts. Why fool with short life 2 cycle plants when you can buy this rugged top quality machine at our factory price.
Item # 1265
wt. 65 lbs. \$149.50

MASTER MECHANIC MFG. CO., Dept. A-21 Burlington, Wis.
Southern Customers write Dept. A-21, Box 65, Sarasota, Florida

Bean's Free Spring Catalog

Ready February 15



Fully illustrated 112 pages of camping specialties, fishing tackle, clothing and footwear for men and women. Featuring practical outdoor items, many of our own manufacture.

Send Free Catalog

Name _____

Address _____

Zip _____

L. L. Bean, Inc.

625 Main St., Freeport, Maine 04032
Fishing, Camping and Hunting Specialties

ELECTRIC ARC WELDER \$9.99!



**NATIONALLY ADVERTISED
\$18.95 VALUE!—Now 1/2
PRICE! WELDS—BRAZES
SOLDERS—CUTS—ALL MET-
ALS! Plugs into ANY 110 volt
socket. MAKE—REPAIR 1001
items for CAR—HOME—BUSI-
NESS. Lifetime BURNOUT
GUARANTEE 10 day money
back trial (if retnd). HEAVY DUTY Design—Does \$85.00 welder
work. No experience needed—FREE WELDING LESSONS!**

SEND ONLY \$2.00 (cash, ck. M.O.) and pay postman \$7.99
COD postage or send \$9.99 plus \$1.00
postage for paid del. in U.S.A. COMPLETE READY TO USE—In-
cludes BIG pack steel, Brazing, Solder, Carbon "touch" rods.
ELECTROFLAME ARC TORCH! OFFER LIMITED—Order TODAY!
MIDWAY WELDER Dept. EPM-2 Kearney, Nebr. 68847

WORLD WAR II STYLE COMBAT KNIFE Only \$2.75



Replica of the hated Nazi COMBAT KNIFE of World War II. Now made into a real man's hunting knife. 5 1/2" blade, 9 3/4" over all length. Razor sharp high quality cutlery steel blade. Comes with Leather Sheath. Your treasure for only \$2.75 plus 25¢ handling charge.

WESTBURY SALES CO. Dept. NM-2
P.O. Box 434, Westbury, N.Y. 11590



REPOWER with a 6 or V-8. H.D. ADAPTORS for using Car, Compact and some Truck engines. "State year & model, Jeep or Scout." Want fast action? Give us FULL INFORMATION. Send \$25.00 Dep. and we will ship correct kit, bal. COD. Send full amount for prepaid shipment. Wire, phone or write today. Details FREE

HOOSIER MACHINE PRODUCTS CO.

312 S. E. 6th St., Phone 278-3442, Pendleton, Oregon 97801

TURN AN ENTIRE WALL INTO A LOUDSPEAKER \$9⁹⁵

Postpaid

Attach the tiny 2 inch-8 oz. ASHWORTH SOUND REPRODUCER to practically anything, autos included, and the entire object becomes a Hi-Fidelity speaker. Connects like speaker to any radio, phono, tape player, or amplifier. Seen on the TODAY and TONIGHT T.V. shows. Winner of Popular Mechanics Magazine "Scientific Achievement Award." Literature on request. Dealer plan and displays available.
RELIANCE ELEC. MFG. CO., INC. New Albany, Miss. 38652

MAIL ORDER ADVERTISING AGENCY

Now, get professional advertising at rates you can afford, even if you're just starting...we specialize in helping beginners and small mail-order advertisers. We do all the work: copywriting, layout, production, media selection, and placement of your ad. Send for FREE details today.
MOADCO Advertising Agency, 1554 S. Sepulveda Blvd., Suite E, Los Angeles, CA 90025

NEW Improved Accurate Scope-Shot

SCOPE-SHOT COMPLETE WITH 50 DISINTEGRATING PELLETS \$2.50 P.P. They crack like a rifle when they hit—leave mark—puff of smoke!

Big Bag of 250 EXTRA PELLETS \$1.00 P.P.

World's Finest Precision SLINGSHOT Scope-type sight! Millions Sold! Patent No. D-178,837

Pure gum rubber slings. Beautifully polished cast aluminum stock. Pistol grip. So powerful it kills small game. Fits pocket perfectly! Guaranteed. FREE shooting manual.

EXTRA RUBBER SLINGS, 3 pairs \$1.00 p.p. Leather Pouch & Sling assembly only 50¢ p.p. Order NOW from:

GENERAL SPORTS 4184-M2 Apple Street Cincinnati, Ohio 45223

POPULAR MECHANICS

The clean team

When it comes to
gas treatments or
carburetor cleaners
nothing works like Gumout.

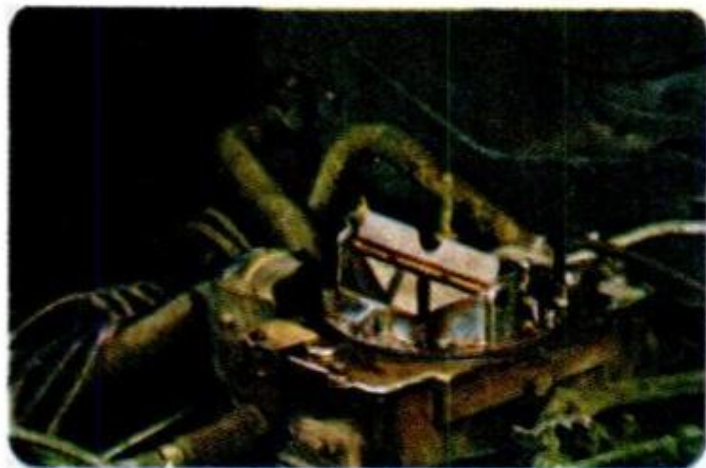

HERE'S PROOF . . . Remove the air cleaner and you'll probably see your carburetor covered with a gummy, dirty coating like this. A quick application of GUMOUT from the jet-spray aerosol can cleans it right down to the bright bare metal in a jiffy. Professional mechanics use GUMOUT because they know it takes much more than an ordinary "gas treatment" to cut the tough build-up of gum and dirt found outside *and* inside most carburetors.



The powerful cleaning action of GUMOUT does the same fast efficient job on the **INSIDE** of your carburetor, too. Just add a can of GUMOUT to your gas tank. In just a few hours of driving GUMOUT dissolves and removes the gum and varnish deposits that cause hard starting, stalling and gasoline waste. You'll feel the big difference. Get smoother idling . . . Faster response . . . A better running engine. Buy both cans.

GUMOUT Division
PENNSYLVANIA REFINING COMPANY, Cleveland, Ohio 44104

UNUSUAL BARGAINS

MANY U. S. GOV'T SURPLUS

FREE!
GIANT
CATALOG

1st QUALITY OPAQUE UNDER \$200



Terrific Buy! Top Quality! Projects brilliant, sharp 4 1/2 ft. sq. image from 8" using up to 5"X5" color, b&w illustrations. Retains all original colors, proportions. Enlarges drawings, coins, maps, etc. Revolutionary peanut-size quartz Halogen lamp (50hr. life), 200mm anastigmatic lens (f3.5.8"F.L.), unique internal reflecting system give maximum brightness, entire field focus. Can be used upside down. Turbo-cooled. 5 1/2 ft. cord.

Stock No. 71,272H (Wt. 11 1/4 lbs) \$89.75 Ppd.

AMERICAN MADE OPAQUE PROJECTOR



Projects illustrations up to 3" x 3 1/2" —enlarges them to 35" x 30" if screen is 6 1/2 ft. from projector, larger pictures if screen is farther away. No film or negatives needed. Primarily intended for children. Projects charts, diagrams, color or black-and-white in darkened room. 115 v. A.C. . . . 6 ft. cord and plug included. Size 12" x 8" x 4 1/2" wide. Weight 1 lb. 2 ozs. Plastic case.

Stock No. 70,199H \$8.75 Ppd.

GIANT WEATHER BALLOONS



"Balls of fun" for kids, traffic stoppers for stores, terrific for amateur meteorologists. Create a neighborhood sensation. Great backyard fun. Exciting beach attraction. Amateur meteorologists use to measure cloud heights, wind speed and temperature. Made of heavy duty neoprene. Inflate with vacuum cleaner or auto air hose or locally available bellum for high rise.

Stock No. 60,568H (8 Ft. diameter) \$2.00 Ppd.

Stock No. 60,632H (16 Ft. diameter) \$7.00 Ppd.

"FISH" WITH A MAGNET



Go treasure hunting on the bottom! Fascinating fun & sometimes profitable! Tie a line to our 5-lb. Magnet—drop it overboard in bay, river, lake or ocean. Troll it along bottom—your "treasure" haul can be outboard motors, anchors, other metal valuables. 5-lb. Magnet is war surplus—Alnico V Type—Gov't cost \$50. Lifts over 150 lbs. on land—greater weights under water.

Stock No. 70,571H \$14.00 Ppd.

Stock No. 70,570H 3 1/2 lbs. (lifts 40 lbs.) \$ 8.75 Ppd.

Stock No. 85,152H 15 1/4 lbs. (lifts 350 lbs.) \$33.60 FOB

PLASTIC MODEL V-8 ENGINE



Hours of fun! Get thrill of building your own easily assembled engine from over 350 parts. Then push starter and watch it run. Crankshaft revolves, pistons move, valves open and close in sequence with spark plugs. Does everything but burn oil. 1/4 scale, molded in 4 colors. Used in many auto-mechanic courses. Excellent, easy-to-understand "tech manual."

Stock No. 70,448H \$13.50 Ppd.

WAR SURPLUS ELECTRIC GENERATOR



Brand new Signal Corps Electric Generator. Generates up to 90 volts by turning crank. Use in high impedance relays. Charge ground & bring up night crawlers for bait or study. 2 Alnico Magnets alone now worth more than original gov't cost of \$15. Wt. 2 lbs.

Stock No. 50,225H \$8.50 Ppd.

'Bright Ideas' in Unique Lighting Big, new 100-page handbook packed with facts, loaded with illustrations. All latest developments, applications, equipment. 8 1/2" x 11" looseleaf paper to fit 3 rings. Stock No. 9100 H \$3.00 Ppd.

MAIL COUPON FOR GIANT FREE CATALOG

148 PAGES! MORE THAN 4,000 UNUSUAL BARGAINS. Completely new 1971 Catalog. Packed with huge selection of telescopes, microscopes, binoculars, magnets, magnifiers, prisms, photo components, unique lighting items, parts, kits, accessories—many hard-to-get surplus bargains. 100's of charts, illustrations. For hobbyists, experimenters, schools, industry.

EDMUND SCIENTIFIC CO.
300 Edscorp Building, Barrington, N. J. 08007
Please rush Free Giant Catalog "H"

Name
Address
City State Zip

EDMUND SCIENTIFIC CO. 300 EDSCORP BLDG. BARRINGTON, NEW JERSEY 08007
ORDER BY STOCK NUMBER SEND CHECK OR MONEY ORDER MONEY BACK GUARANTEE

With PLEXIGLAS® acrylic sheet

you can make each of these for less than \$20.00

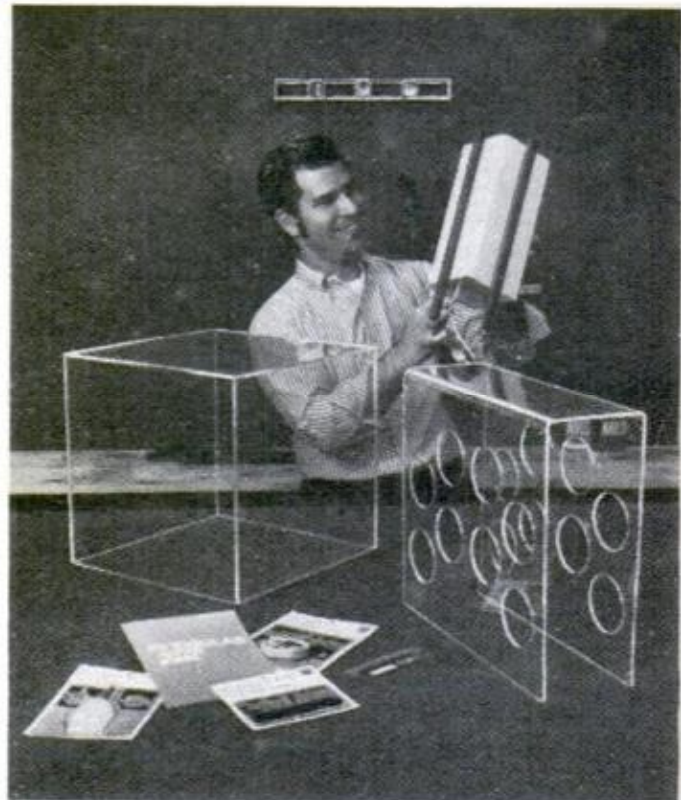

It's easy to work with Plexiglas sheets. Use hand or small power tools.

The second edition of "Do It Yourself With Plexiglas" tells how to make these and 40 more projects. The "how-to" booklet gives step-by-step instructions for cutting, cementing, drilling, and even shows how to build a simple strip heater to bend Plexiglas.

Plexiglas is an approved safety glazing material—use it in storm doors, for safety's sake. It is a high impact, thermoplastic material with a combustibility rating comparable to wood and should not be exposed to temperatures exceeding 180° to 200°F.

You can get your copy of the new "how-to" booklet at hardware, glass and building supply dealers displaying the "We Sell Plexiglas" sign. Or, write to us enclosing \$.25 for postage and handling.

ROHM AND HAAS COMPANY
P.O. BOX 9730H
PHILADELPHIA, PA. 19140



"Changed My Whole Life!"

Says WM. A. TARNELLI, SR., Ossining, N.Y.
"I was a postal clerk, but I soon left the postal service to devote fulltime to Locksmithing. I now have my own shop in the main section of Ossining with plenty of work."

Be a LOCKSMITH

Train at HOME—Earn While You Learn. Add 50%-100% to YOUR INCOME with easy spare time earnings. Cash in on the nation-wide shortage—trained locksmiths in great demand! Quickly step into a big pay opportunity job or start a high-profit shop of your own.

Earn Extra Money RIGHT AWAY! All Master Locksmiths Special Tools, Equipment and Supplies Furnished FREE for use with course.

Age, education, minor physical handicaps don't matter in this growing trade. You can quickly qualify as a skilled locksmith. It's like a fascinating hobby. Study at home as little as one hour a week. Gain practical experience through complete well-illustrated lessons. Do real jobs on car locks, house locks, padlocks and safe locks, under the guidance of experts. FREE Illustrated Book, write now.

LOCKSMITHING INSTITUTE,

(Div. of Singer Communications Corp.)

Dept. 1110-21 • Little Falls, New Jersey 07424

306
pieces of professional equipment
for use with course.

Professional Equipment includes
LOCKS - PICKS - PARTS - KEYS
SPECIAL TOOLS & SUPPLIES
all FREE for use with course.

MAIL COUPON for FREE ILLUSTRATED BOOK

For a future as your own boss or in a high-pay job, write now for FREE Illustrated Book. Only school of its kind. Licensed by State of New Jersey. Approved for Veterans.

Accredited, Nat'l Home Study Council.

MAIL COUPON NOW

LOCKSMITHING INSTITUTE, Dept. 1110-21
Little Falls, New Jersey 07424

Please send FREE Illustrated Book—"Your Big Opportunities in Locksmithing," complete Equipment folder and sample lesson pages—FREE of all obligation—(no salesman will call).

Name _____

Address _____

City _____ State _____ Zip _____



MAKE SMALL PRECISION PARTS ON UNIMAT

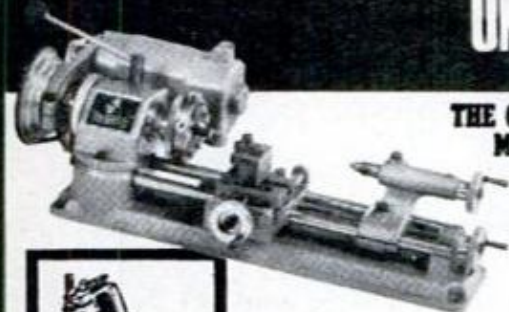

THE COMPLETE
MINIATURE
MACHINE
SHOP

\$149.50
Fab. N.J.

Make the parts you need—when you need them—at practically no cost. For models, guns, tools, cameras, inventions—on amazing UNIMAT—the world's most versatile miniature machine tool. Even a beginner can use it like a pro!

5-in-1 UNIMAT converts in seconds from precision lathe (3" swing, 7" centers) to vertical mill, drill press, grinder & polisher! Small as a typewriter, versatile as a whole shop of machines. Over 90,000 in use in precision labs & shops the world over. Write for free folder or send \$1 for 40-page "Miniature Machining Techniques" handbook. Also available in Canada.

AMERICAN EDELSTAAL, INC. DEPT BB-1
1 ATWOOD AVE., TENAFLY, N. J. 07670

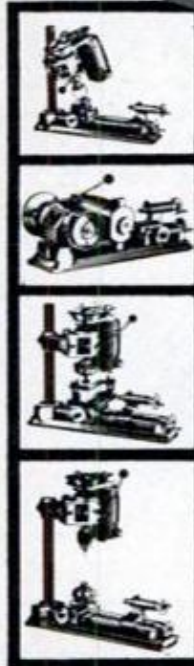

We tell it Like it is...

OVER \$30,000.00 PER YEAR

"My income from my Warner Shop now exceeds \$30,000.00 annually. And, my supply orders to your firm will bear me out." S.D.M.

Interested? If a business of your own, which you can:

- Operate part time,
- Expand into full time,
- Start on the proverbial shoestring,
- Learn to operate easily... and get
- Full revelation of all the facts before you buy

interests you... send me your name with the coupon below, and you be the sole judge. FREE facts. No salesman will call.

Jim B. Warner, Dept. L-2-AB
1512 Jarvis Avenue, Chicago, Illinois 60626

Jim B. Warner, Dept. L-2-AB SEND NO MONEY
1512 Jarvis Ave., Chicago, Ill. 60626

Please rush your FREE illustrated brochure to:

Name _____

Address _____

City, State, Zip _____



The Racer's Threads

STRIPPED THREADS in sparkplug ports of aluminum-head engines have long been a headache—with the cure always something less than perfect. Kelox Industries of Dover, N.H., a subsidiary of Phillips Screw Co., however, feels that its precision-locking, threaded steel insert and installation tool offers the right answer. The "Newports," as they're called, were developed for aerospace applications, then tested in Formula Vee racers and adapted for automotive and small air-cooled engines like those in motorcycles, lawnmowers, snowmobiles and snow throwers.

...Do-It-Yourself Sparkplug-Port Repair Kit

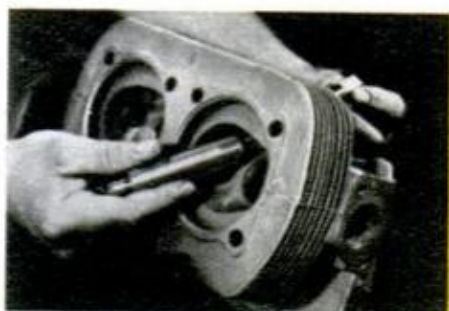
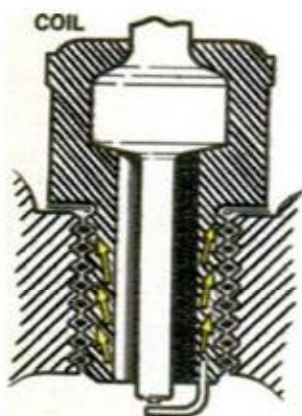

TAP GUIDE is threaded onto the reamer-tap after the nose of the reamer-tap protrudes through the underside of the sparkplug port. Continue to thread the guide until it becomes snug against the cylinder head. The guide not only assists the reamer-tap in cutting the new threads but also helps to keep tool straight in the sparkplug port while cutting

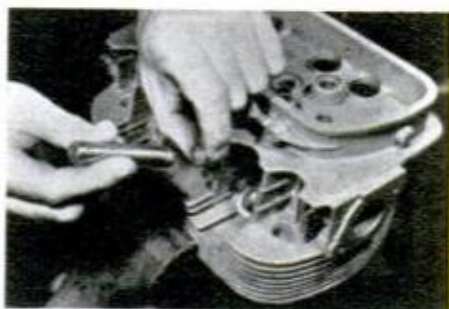
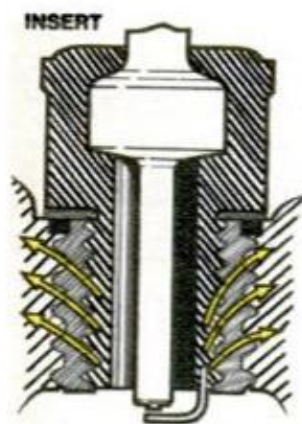

INSERT INSTALLATION TOOL is used to thread the insert into the newly tapped port. The inserts were fitted in several Formula Vee cars and a Porsche racer so that they could be tested by Engine Technology, Inc. Such inserts, which are now available to fit all 14 and 18-mm plugs in any engine, have saved racing cylinder heads which cost as much as \$400



WIRE COIL repair, top, can leave small air spaces that block dissipation of heat of combustion (air being a poor conductor). One advantage of inserts is good heat dissipation for safe, efficient engine operation, cool plugs

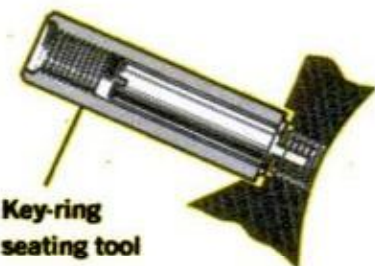

KEY-RING SEATING TOOL is designed to slide over the insert installation tool so that its lead end will be flush with the locking key ring. You then strike the end of the seating tool with a hammer in order to seat the ring flush with the insert, the two tangs broaching the newly cut threads in the port to keep the insert locked against rotation

A cowboy wearing a light-colored cowboy hat, a brown jacket with a yellow fur collar, and a red shirt is riding a dark brown horse. He is holding a lasso and has a lit cigarette in his mouth. The background is a snowy, hazy landscape. The text 'Come to Marlboro Country.' is overlaid on the right side of the image.

Come to Marlboro Country.

Marlboro Red or Longhorn 100's - you get a lot to like.



Marlboro, Longhorn 100's and the chevron are registered trademarks of Philip Morris Inc.

Check the Kind of Body You Want

Charles Atlas

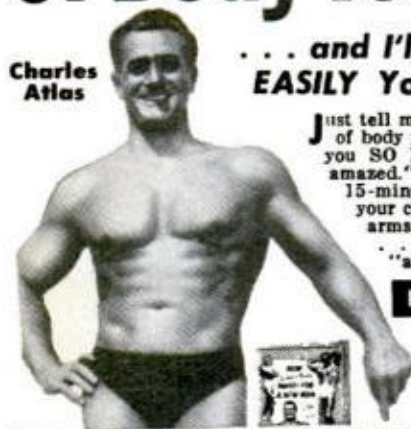

... and I'll Show You How EASILY You Can Have It!

Just tell me, in coupon below, the kind of body you want—and I'll give it to you SO FAST your friends will be amazed. "Dynamic-Tension," my easy, 15-minute-a-day method, will make your chest and shoulders bulge... arms and legs surge with power... you: whole body feel "alive!"

FREE BOOK Learn how I became "World's Most Perfectly Developed Man"—Mail coupon! CHARLES ATLAS, Dept. 8P, 115 East 23rd Street, New York City, N. Y. 10010

CHARLES ATLAS, Dept. 8P
115 East 23rd St., New York, N. Y. 10010

Dear Charles Atlas: Here's the Kind of Body I want:
(Check as many as you like)

- | | |
|--|--|
| <input type="checkbox"/> Broader Chest, Shoulders
More weight—Solid—
in the Right Places | <input type="checkbox"/> Powerful Arms, Legs, Grip
Slimmer Waist, Hips
Better Sleep, More Energy |
|--|--|

Send me absolutely FREE a copy of your famous book showing how "Dynamic-Tension" can make me a new man—32 pages, crammed with photographs, answers to vital questions, and valuable advice. No obligation.

PRINT NAME..... AGE.....

ADDRESS.....

CITY..... ZIP.....

STATE..... CODE.....

In England: Atlas, 21 Poland St., London, W. 1

BUILD YOUR OWN CAMPER SAVE UP TO 50%



Complete, easy to follow plans, instructions, materials list.

Camper Plans \$3.95
Travel Trailer \$3.95
Pickup Cover \$2.00
CONVERSION PLANS:
Econoline Type Van... \$2.95
Passenger Bus or
Delivery Van..... \$2.95
Satisfaction Guaranteed

EQUIPMENT CATALOG \$1.00

Refundable on First Order.
Send Dime for Details.
Save 50% on Camper Kit.
All items from catalog to
build \$1,795. Camper, 8',
10', 10'6" or Chassis Unit.



VIKING CAMPER SUPPLY, INC.

99-8P Glenwood Ave.,

Minneapolis, Minn. 55403

Please send _____ for

which I enclose \$_____

NAME.....

ADDRESS.....

CITY.....

STATE..... ZIP.....

READ THE LAW FOR YOUR OWN BENEFIT

Learn how the law regulates commerce, politics and social activities... how your business and economic affairs are affected by the law. The Blackstone School of Law offers a program of reading assignments for adults planned to familiarize you with the law.

NOT A CORRESPONDENCE COURSE
Suit your program to your special interests and available time.

WRITE FOR FREE BOOKLET

"The People vs. You." Contains complete information on the program. No Salesman Will Call. Write directly to:

BLACKSTONE SCHOOL OF LAW Dept. 53
307 N. Michigan Avenue, Chicago, Illinois 60601

At Last a New Amazingly Simple

GAS TURBINE JET ENGINE

Build from easy to follow plans. Length 15", Dia. 8 1/2", Wt. 15 lbs. Fuel: Gasoline or Kero.



"Screamin Demon" develops 20 H.P. Ideal project for serious-minded hobbyists, students; scientific and industrial arts classes. Make on 9" metal cutting lathe with milling attachment. For use on small racing boats, midget cars, etc. Full size assembly drawings with critical dimensions, bill of materials and photos. Price \$5.00. No C.O.D.

SAVOY SCIENTIFIC, BOX 1398, SANTA MONICA, CALIF. 90406

FREE!

Learn how you can buy used engines \$15 up, new engines \$30 with FREE confidential list and coupons when you order your plans

BUILD THIS MINI-BIKE!

Plans reveal step by step details!

BUILD A RACING KART!

Build frame for less than \$10!



RUSH \$2 for plans (indicate type) or send 25¢ for circular describing plans PLANS, Box 651, Valley, Nebr. 68064



ROTARY FILES

U.S. Surplus High Speed Milling Files going fast. New, in G.I. Packs. Hardened steel, for filing, milling, routing, drilling—any work in light metal or wood. Use in 1/4 in. drill, etc. Range in size from 1/4 to 1 inch wide. Get these most useful tools now.

16 tool set—government cost \$109..... \$ 9.00 to you!
36 tool set—government cost \$265..... \$15.00 to you!
100% GUARANTEED. WE PAY POSTAGE. A LIFETIME BUY!!

THE SURPLUS CENTER
LANCASTER, TEXAS 75146

LIQUID WRENCH

LOOSENS RUSTED BOLTS,
NUTS & PARTS IN SECONDS!



Newest Idea In Home Decor!

FANTASTIC MONEY-MAKER!

Exciting new Decorator Floral Bowl. Exquisite beauty. Glass decanter jar holds array of Empress Roses... artificial, but amazingly true to life! Remove lid... delicately scented rose aroma refreshes air. Use in living room, bedroom, kitchen, bath, den, or office. Ideal gift. Anyone can make easy money just showing it! Ideal Fund Raiser. Rush your name for facts, or send \$1. for introductory Offer Regular Size Sample (\$1.95 value). Double your money-back if you aren't delighted, amazed! Unique Products, Dept. R-1412, 426 S. Clinton, Chicago, Ill. 60607.

6 DECORATOR APPROVED COLORS
Wide color choice
Blend with any decor

Magic Capsule
is Secret of long lasting fragrance.
REFILLS AVAILABLE.

MYLER FILM TAKES PLACE OF CARBON PAPER

Guaranteed 100 clear copies from every sheet, or replaced free.
2000 copies from every 20 sheet package compared to 500 copies from a package of regular carbon paper. Regular size 8 1/2 x 11 1/2 \$4.95. Legal size \$5.45.

A. Schell 435 Thompsonville Rd. McMurray, Pa. 15317

You're a pretty important guy

...when you know Electronics. And now you can learn enough to break into this exciting field right at home in your spare time.

How would you like to be the kind of guy other men come to for advice and "know-how"?

The kind of guy businessmen and scientists lean on—and listen to?

With a salary that can bring a guy respect? And an impressive title like Communications Officer, or Customer Engineer?

People admire a man like that. His success shows in his bearing. He doesn't have to be timid in business or social situations any more...he's important!

And you can be that man!

How? By cashing in on one of the hottest growth fields of all time: Electronics.

Today, whole industries are built upon Electronics. It's Electronics that makes computers and automated production lines and modern aerospace developments possible. And to keep all these electronic miracles running—to see that problems don't occur, and to solve them when they do—the world depends on a new breed of professional: the Electronics specialist.

But there just aren't enough trained Electronics specialists to go around! By 1975, the booming Electronics industry will need an estimated 4 million of these men.

With this kind of demand for

qualified people, you can earn the kind of salary you've always dreamed about. Once you have some experience, you can make up to \$5, \$6, \$7 an hour. \$200, \$225, \$250 a week. \$8,000, \$10,000, \$12,000 a year—doing work you'll really enjoy!

You might think you need college to break into this great field. But you don't. You don't even have to leave home to go to technical school.

The Cleveland Institute of Electronics can teach you all you need to know in your spare time at home.

CIE is the largest school in the country specializing exclusively in Electronics home training. The Institute's methods make learning Electronics easy, even for men who once had trouble studying.

It's all spelled out in two informative books that CIE will send you FREE. To get them, just mail the bound-in card. If card is missing, use the coupon below or write Cleveland Institute of Electronics, 1776 E. 17th St., Cleveland, Ohio 44114.

It could be your first step toward becoming a mighty important guy in this world.

ENROLL UNDER NEW G.I. BILL
All CIE courses are available under the new G.I. Bill. If you served on active duty since January 31, 1955, or are in service now, check box on card for G.I. Bill information.



CIE Cleveland Institute of Electronics
1776 East 17th Street, Cleveland Ohio 44114

Please send me 2 FREE books describing opportunities in Electronics and how to prepare for them.

Name _____ Age _____
(Please print)

Address _____

City _____ State _____ Zip _____

Check here for G.I. Bill information.

Accredited Member National Home Study Council 
A Leader in Electronics Training... Since 1934

PM-50

Build This 'Glass-Top' WAGON-WHEEL TABLE

An old farm-wagon wheel and clear plastic provide the top for this rustic piece

By ELMA and WILLARD WALTNER

ALL KINDS OF ANTIQUES are being converted from their original purposes to new uses in home decorating. An old wagon wheel becomes a handsome coffee table when it's placed horizontally under a see-through top so that evidences of its age and hard use are displayed. You may have to do some scouting to find a wheel, but antique shops and swap shops usually have one or two lying about.

A 44-in. wheel was used for the table shown, so dimensions are sized accordingly. But there are no fancy or unusual construction techniques used to build the piece; thus, a different-size wheel won't rule out the project because dimensions can be altered.

Getting the wheel ready is not an instant process. Use a wire brush in a drill to remove the first layer of dirt, peeling paint and crumbling wood. When you get

to sound wood replace the brush with a coarse sanding disc and go over the spokes, felloes (wooden parts of the rim) and the wood parts of the hub.

Clean the hub of grease and use carving chisels, knife or pointed tool to finish cleaning out the cracks in the wood. Hand-sand to smooth the surface and bring out the grain of the wood, but don't worry about the cleaned-out cracks or repaired places; they add character to the wheel. To remove rust from the metal parts, use steel wool.

Give the wood parts two coats of varnish or lacquer but leave the iron parts "as is." If desired, metal can be given one coat of flat black paint rubbed lightly before it dries.

Since the base spoke placement may vary with different wheels, make a cardboard template for the legs and custom-

WIRE BRUSH chucked in drill is fast way to clean off heavy dirt. Follow with a coarse sandpaper

DIRT-FILLED crevices and cracks must be hand-cleaned with an awl, ice pick, fine-grit sandpaper

PAPER TEMPLATE is made for the legs. Variance may exist, so top cutout for each must fit spokes

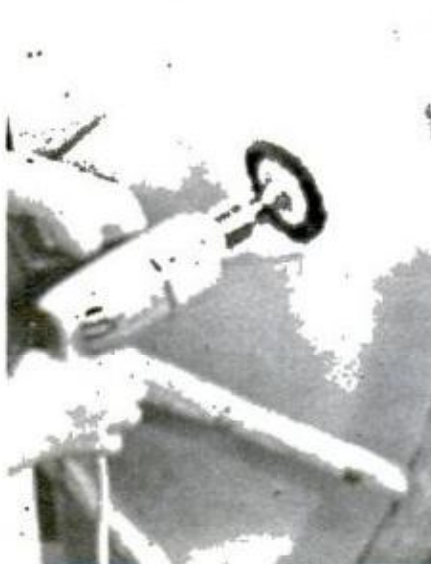



Plastic collar
Glued together with epoxy



1/4" clear plexiglass

44" farm wagon wheel

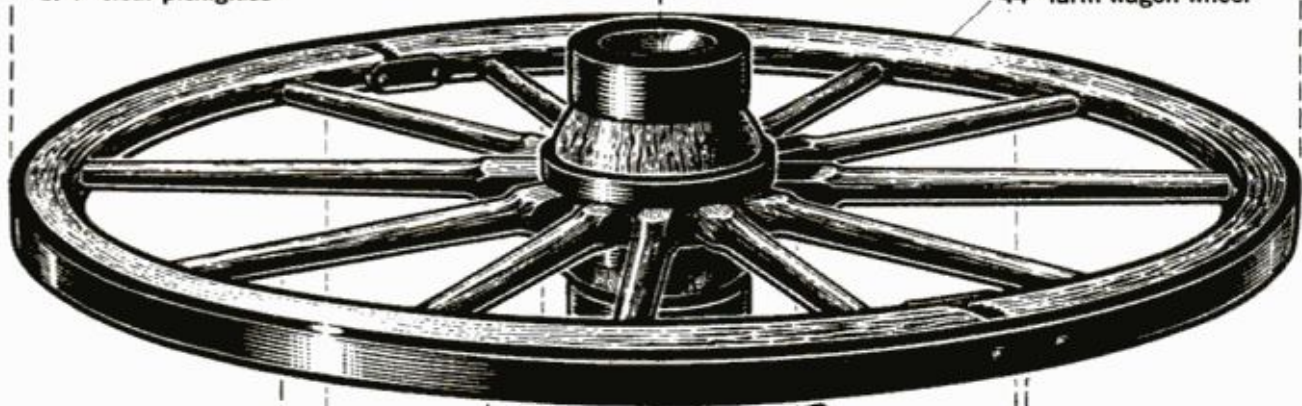

WAGON-WHEEL TABLE

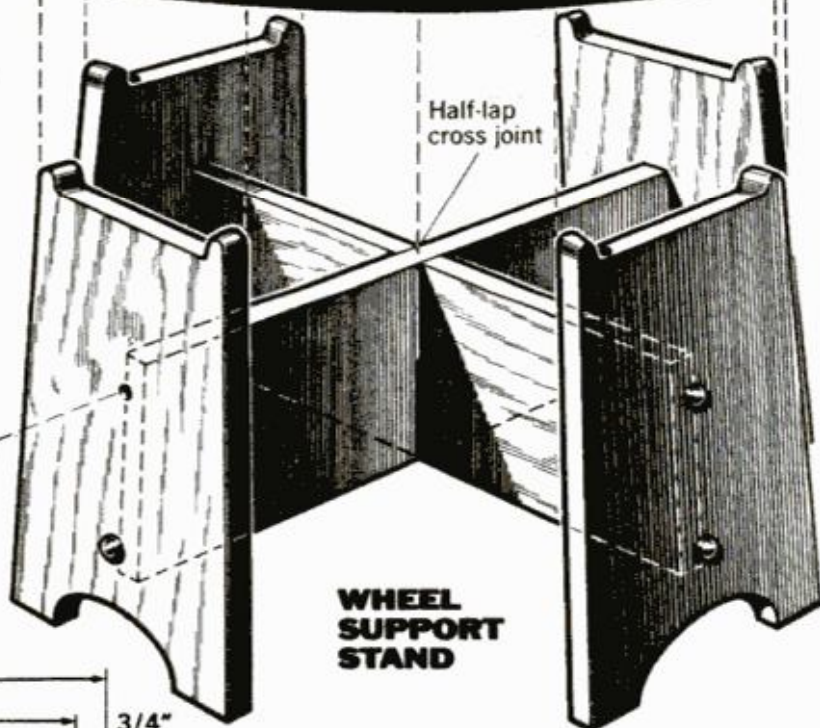

Half-lap cross joint

No. 8-2-1/2" FH screw

Wood screw-head button

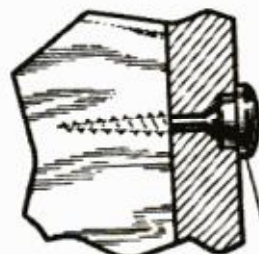

Screwhead countersunk 1/8"

WHEEL SUPPORT STAND

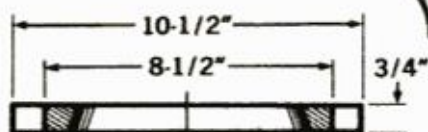

LEG PATTERN (make 4)

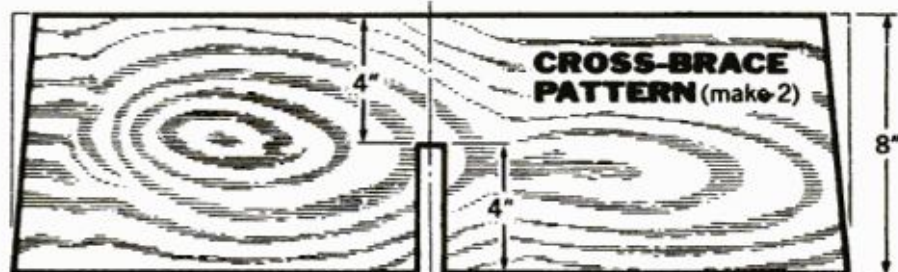
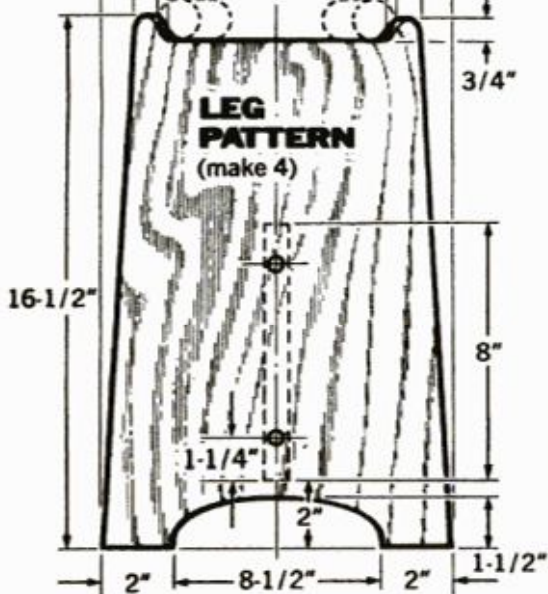

CROSS-BRACE PATTERN (make 2)

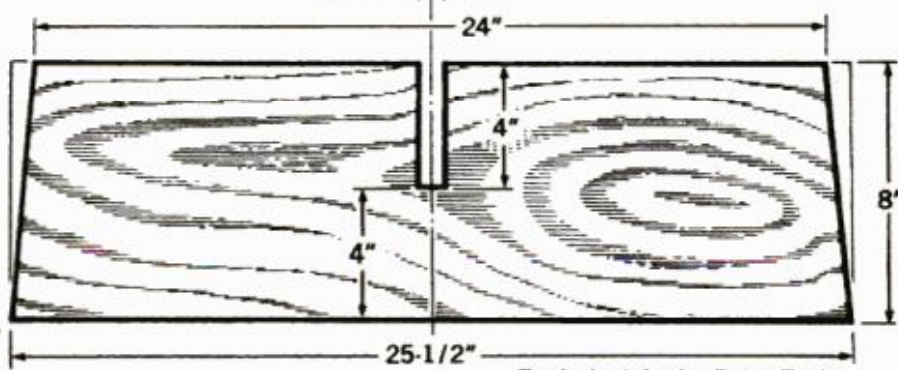

Technical Art by Peter Trojan

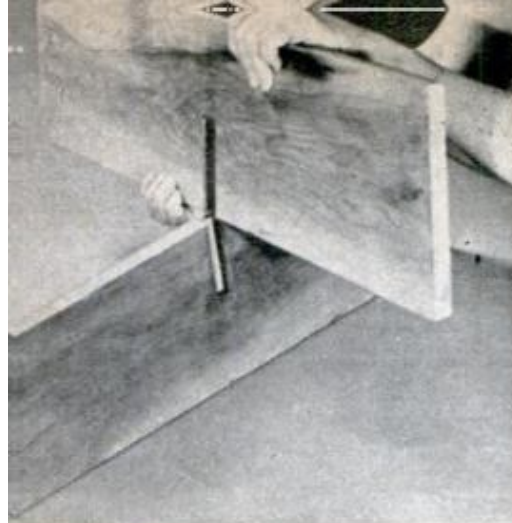

CROSS BRACES are joined, using a snug half-lap joint. Apply glue generously to the mating surfaces

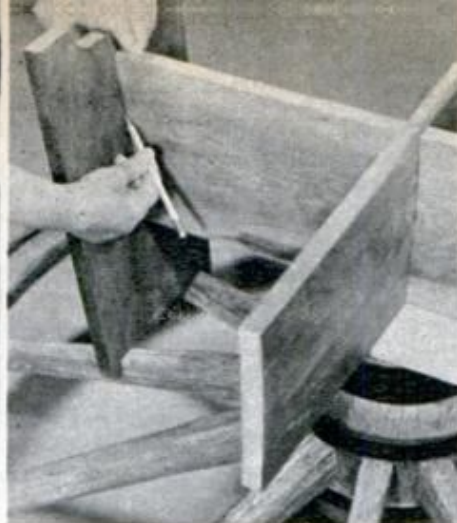

EACH LEG is marked, drilled and attached to cross brace individually to assure its proper location

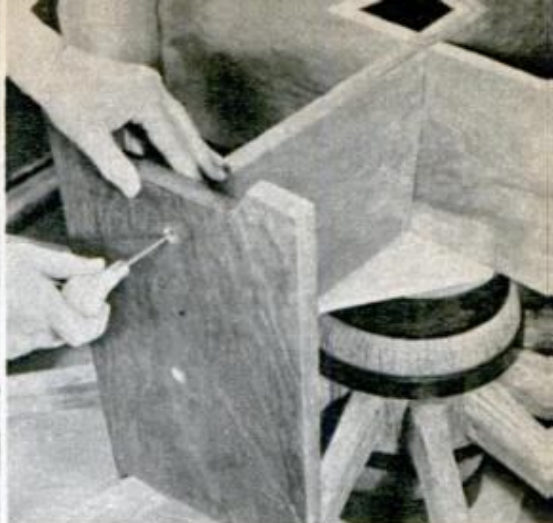

COUNTERBORE the legs about $\frac{1}{8}$ -in. deep to conceal the screw-head, finishing actual assembly

fit the top recess to suit. Cut the slots (half-lap joint) in the two cross-frame pieces to insure a tight fit.

Next, lay the wheel on the floor top-side down. Cover the hub with a square piece of $\frac{1}{2}$ -in.-thick wood for the frame assembly to rest on. Fit two opposite legs against the ends of one of the cross-frame pieces, make match-marks and scribe the outline of one end on the inside of one leg to serve as a guide for drilling the screw holes through the leg. Drill the screw pilot-holes into the cross-frame end at an angle matching the slant of the leg as it is fitted against the cross frame. Legs must be fitted individually because the spokes may vary. Use glue and counter-bored screws to assemble. Before lifting the assembly frame off the wheel, mark the legs 1, 2, 3, 4 and make match marks on the wheel spokes for alignment later. Give the base the same finish you used on the wheel.

The tabletop. Clear plastic ($\frac{1}{4}$ in. thick) was used for the top because it's easy to work with (see *How to Work With Plexi-*

glass, page 176, June '70 PM), is durable and gives the glasslike look this table needs. First, draw the center circle just large enough to fit the hub. (Do not make the cutout at this time.) Then outline the circle's circumference (as shown). You can now cut both circles sawing the larger one first.

Lay the tabletop on the wheel and measure the distance between the plastic and the points where spokes go into the hub at the center. (The outer edge of the plastic is supported by the rim which is higher than the spokes at the center.) At the hub, it will need support. A plastic collar around the hub resting on the spokes gives that support. Make it by cutting two strips of plastic to the necessary width and half the length of the hub circumference plus $\frac{1}{2}$ in. With masking paper removed, place the strips on a cookie sheet and heat in a 200° oven until pliable. To shape the strips, bend them around the cutout of center hole and file the ends at an angle to butt against each other. Finally, glue the two together with epoxy. ★★★

SCREWS are hidden by turned buttons, or you can use dowel ends cut to fit and then sanded flush

COMPASS for marking top circumference is strip of wood with holes drilled for nail and pencil

SUPPORT COLLAR, on which top rests at center, has two shaped plastic strips glued together

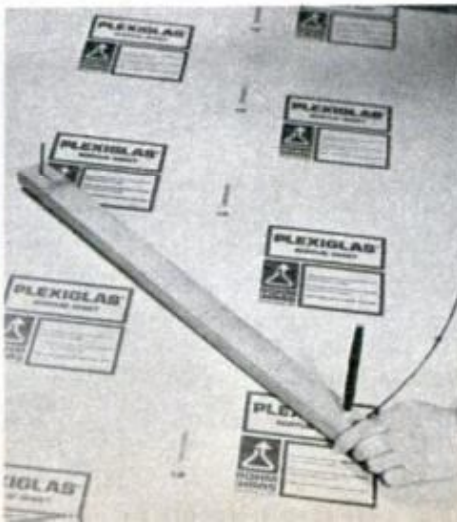
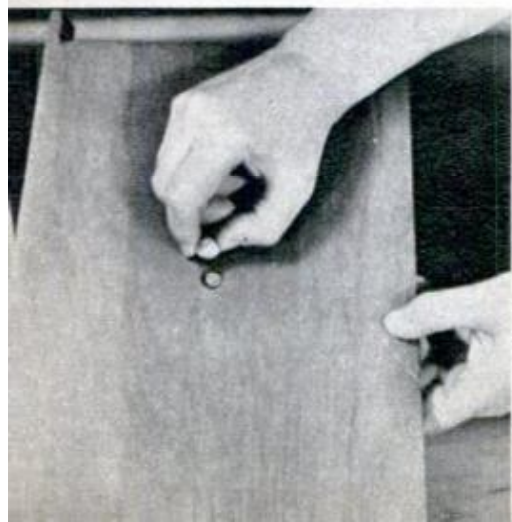

HOMEOWNERS' CLINIC

BY W. CLYDE LAMMEY

Frost-clogged chimney

I'm building my small home and living in the basement. I have an oilburning space heater vented to a temporary "block" chimney capped with a clay chimney pot. In cold weather the flue fills with frost which gradually builds up until the burner goes out, often with a loud "bang." In warmer weather the frost melts and runs into the basement through the smokepipe opening. What causes this? What's the remedy?—N.Y., Minn.

One of the products of combustion of concentrated fuels is water vapor. When the burner is operating you will see what appears to be "smoke" issuing from the chimney pot. But this is not smoke; it's water vapor. When the temperature is much below freezing this tends to collect in the flue as frost. This builds up to narrow the flue opening and eventually causes the burner to "plop" out. You are fortunate the burner has not "exploded" and caused you more trouble. Probably you have the pipe damper—on some installations this is an atmospheric damper—very nearly closed, thus releasing minimum heat to the smokepipe and flue.

Usually you can prevent this buildup by opening the turn damper half way, or a trifle more, to release more heat to the flue and prevent frost from forming. If the damper is of the atmospheric type, set it to remain more nearly closed, which will have essentially the same effect. A little experimenting will determine the best setting for either damper.

Leaky shower stall

My basement shower stall has a concrete rim 5 in. high, is neatly curved at the corners and encloses a floor space about 30 in. square. Plastic curtains form the enclosure of the stall. This rim is cracked away from the floor and water runs out on the floor when the shower is in use. Any suggestions?—E.C., Nev.

Ordinarily, new concrete will not bond to old and this, undoubtedly, is the cause of leakage at floor level. Rather than break up the present rim and replace it, first raise it 5 or 6 in., clean away dirt and loose particles and lay two or more lines of caulking under the rim. Then lower the

rim onto this, pressing it down all around to spread the lines of caulking evenly. If you can do this without breaking the rim, the leakage may be halted.

Otherwise, you might break up the present rim, drill holes in the concrete floor to take lead screw anchors, then turn long round or flathead screws into the anchors, allowing the heads to project $\frac{3}{4}$ or 1 in. Then make a form and pour new concrete, preferably using hydraulic cement in a sand mix. The projecting screws should hold the pouring in place.

Installing a bathroom fan

I want to install a ventilating fan in my bathroom but I'm confused about whether to place it in the ceiling or in the wall. I thought the ceiling was the logical location but I'm told it makes little difference. Can you set me right?—L.A., Miss.

Natural convection of warm, moist air would be through the ceiling, of course, but when you install a fan these conditions are altered somewhat. The fan exhausts a given amount of air from the room in a given length of time according to its rated capacity. Assuming that the bathroom is of average size, that one side is an outside wall, and that other governing factors are average, you would put the fan wherever installation would be easiest: in the ceiling or in the wall, preferably near the ceiling. Ordinarily, you'll get efficient operation either way. If the fan is installed in the ceiling, the warm, moist air should be conducted to the outside through a duct, rather than exhausted into the attic where the moist air might create a condensation problem.

'No-see-through' window screens

I understand there's a way to treat window screens so that persons outside the room cannot see inside. Can you describe how it's done?—D.S., Mich.

One way is to paint the inside of the screen black and the outside white. First, the screen must be scrubbed with a mild soap solution, hosed down to remove all loosened dirt and debris, and allowed to dry. Apply the black paint lightly to the inside of the screen with an applicator made for the purpose, or make one by stapling a piece of carpeting to a small block of wood. Let this black paint dry thoroughly, then apply white paint to the outside of the screen in the same manner. This is effective only during daylight hours; not at night when the room is lighted. ★★★

Can't take hot taste?



Come all the way up to KOOL,
the only one with extra coolness.

© 1971, Brown & Williamson Tobacco Corp.

Turn any car into the toughest car in town

Whether your baby is a 'Vette or a VW, you can have her humming like a little atom-smasher, every part doing its job with laser-beam cleanness. Just grab onto the giant 1971 MOTOR's AUTO REPAIR MANUAL.

Brand New 1971 Edition Now Available

Shrewd racing mechanics bank on MOTOR's AUTO REPAIR MANUAL to give them every last fact about the cars they're handling and to make the most of their car sense. Whatever it takes to get top performance, from a simple carb adjustment to a complete tune-up, MOTOR's 1971 MANUAL gives you the know-how of a pit pro.

225,000 Repair Facts for 2,300 Car Models

The big 1971 edition has more than 1,000 double-size pages featuring 55,000 specs and over 300 quick-check spec charts, 225,000 service and repair facts, and over 3,000 "this-is-how" photos and diagrams. They get you into the guts of 2,300 domestic models—Standards, Compacts, and Intermediates—including all the hot '71's, plus the Volkswagen.

Detailed Trouble-Shooter Section, plus trouble-shooting information throughout, helps you to pinpoint 4,200 car troubles. Then you're shown exactly how to quickly fix almost any part of these cars made in



America from 1965 to 1971: Toronado, Mustang, Barracuda, Pinto, Vega, Chevy II, Pontiac, Thunderbird, Buick, Imperial, Cadillac, Continental, Dart, Ford, Mercury, Chevelle, Chevrolet, Chrysler, Plymouth, Rambler, Dodge, Oldsmobile, Buick Special, Comet, Corvair, American, Olds F-85, Falcon, Ford Fairlane, Nova, Tempest, Corvette, Front-Drive Cadillac, Lincoln, Mark III, AMX, Camaro, Valiant, Cougar, Maverick, Montego, Javelin, Torino, Challenger, Hornet, etc. They're all included—plus Volkswagen. And you get tune-up and front-end alignment specifications for all cars built from 1946 thru 1964.

And all this information is authoritative. It comes from the car manufacturers themselves. MOTOR's editors distill more than 300 official factory manuals and hundreds of service bulletins to make sure your auto repair questions are answered, your service problems are solved. That's why over 5½ million copies have been sold—to auto buffs, beginner and professional mechanics, students—making MOTOR's AUTO REPAIR MANUAL the all-time best seller in the field.

If you really want to keep your machine mean, we'd like you to make a test run with the big '71 MOTOR's AUTO REPAIR MANUAL.

10-Day Free Home Trial

Just fill in and mail the coupon on this page, and we'll send you a copy of the '71 MOTOR's MANUAL to look over and use, free, for ten days. Then, if you're satisfied, simply pay \$10.95 plus a few cents handling. Otherwise, return the book and owe nothing. MOTOR Book Dept., 250 West 55th Street, New York, N. Y. 10019.

SAME 10-DAY FREE TRIAL ON MOTOR's Auto Engines & Electrical Systems.



Ideal basic book for enthusiasts, students, engineers, mechanics. Explains engines and electrical systems thoroughly, showing exactly how and why they work. Over 700 pages, 1,300 illustrations. Only \$10.00.

MOTOR BOOK DEPT., Desk B-012 250 W. 55th St., N.Y., N.Y. 10019

Please send me the book(s) checked below, for 10-day free examination. If I decide to keep them, I will remit payment as indicated.

MOTOR's Auto Repair Manual, \$10.95, for which I will remit \$3.00 in ten days, \$3.00 monthly for two months, and a final payment of \$1.95 (plus delivery charge and sales tax, if any).

MOTOR's Auto Engines & Electrical Systems, \$10.00, for which I will remit \$2.50 in ten days and \$2.50 monthly for 3 months (plus delivery charge and sales tax, if any).

Print Name _____ Age _____

Address _____

City _____ State _____ Zip Code _____

SAVE MONEY! Check here if you are including payment in full for book(s) ordered, in which case we pay postage. Same 10-day trial applies; you can return book(s) for prompt, full refund.

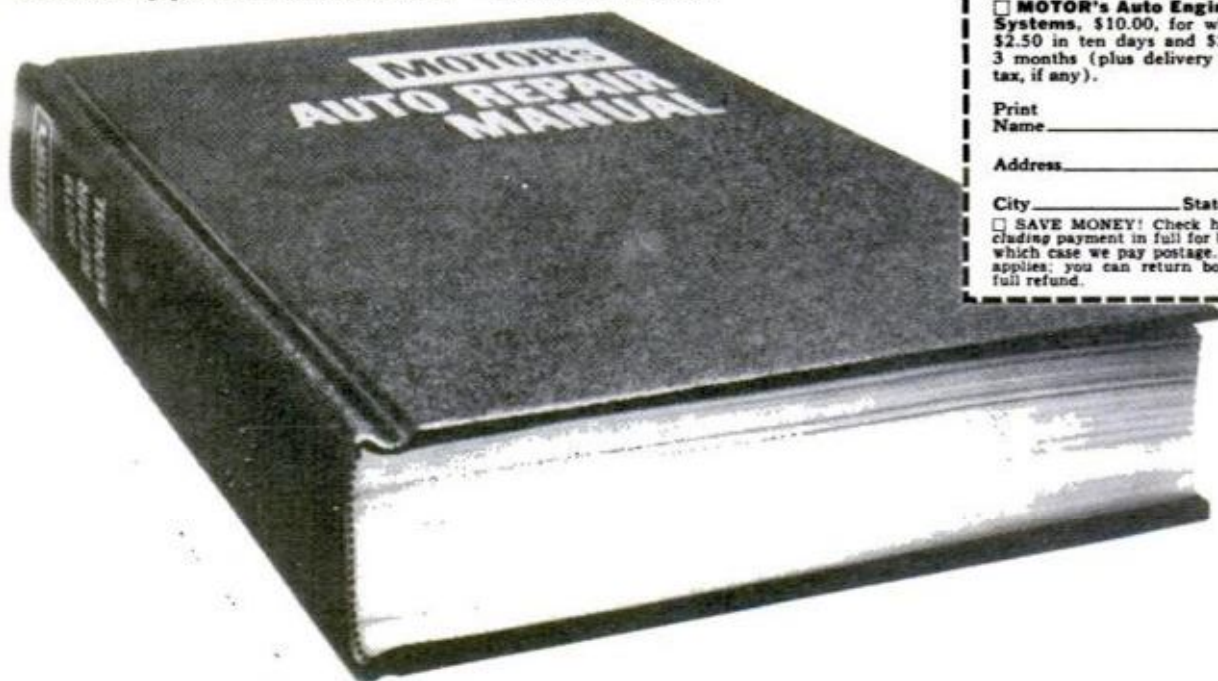

TAKE ANY 3 FOR ONLY \$1

when you join the Popular Science Book Club



054



1008



293

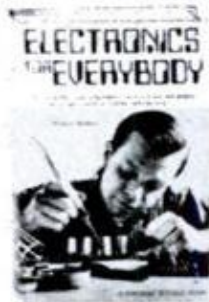

038



313



312

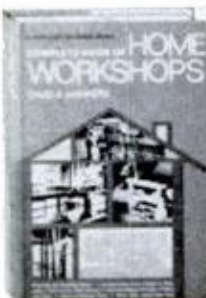

044



286

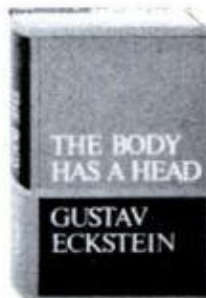

315

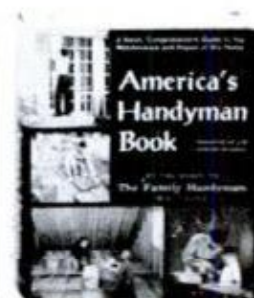

311



630



1005

054. COMPLETE BOOK OF HOME IMPROVEMENT. How to improve floors, walls, doors, windows, bathroom, kitchen, electrical system, storage areas, more. Retail: \$11.95

038. ELECTRONICS FOR EVERYBODY. All about do-it-yourself electronics. How to build kits or your own projects — simple printed circuits to complete systems. Retail: \$6.95

044. COMPLETE BOOK OF HOME WORKSHOPS. How to design, build, improve or expand your home workshop, build equipment, select tools, more. Retail: \$8.95

311. AMERICA'S HANDY-MAN BOOK. How to maintain and repair floors, stairs, walls, ceilings, windows, doors, house exterior, plumbing, electricity, heating. Retail: \$8.95

1008. SET OF 3 SKILL BOOKS. Includes *Painting and Wallpapering*, *Concrete and Masonry*, *Recreation and Hobby Rooms*. Hard-gloss paper covers. Counts as one. Retail: \$5.85

313. SMALL APPLIANCE REPAIR GUIDE. How to service dozens of small appliances. How they work. How to troubleshoot, make repairs like a pro. Retail: \$7.95

286. CRIME & SCIENCE. A superb fact-crime book that reveals science in the cause of justice. Amazing detection techniques, lab tests, real cases. Retail: \$8.95

630. GUINNESS BOOK OF WORLD RECORDS. The biggest, smallest, fastest, slowest. You get all the up-to-date world records in every human activity. Retail: \$5.95

293. WHAT WOOD IS THAT? How to identify wood, select and use it. How wood is processed. 40 actual wood samples are included in the book. Retail: \$7.95

312. THE NEW INTELLIGENT MAN'S GUIDE TO SCIENCE. Covers virtually every scientific discovery, invention, breakthrough in the history of modern science. Retail: \$12.50

315. THE BODY HAS A HEAD. All about the human body—its organs, systems, voluntary and involuntary nervous systems, the senses, the body's defenses, the brain. Retail: \$12.50

1005. SET OF 3 SKILL BOOKS. Includes *Build Your Own Furniture*, *Hand and Power Tools*, *Be Your Own Home Electrician*. Hard-gloss paper covers. Counts as one. Retail: \$5.85

HOW YOUR CLUB WORKS

First, you choose any three of these 12 best-selling books for only \$1 to start your PSBC membership. Thereafter, you'll be offered a book a month from the very best books published today on all your favorite subjects. You need accept only one more selection in the next year to retain all membership privileges. And every single Club selection you accept comes to you at your special reduced member's price. (Discounts range from 30% on up to 70% for the books you like to read best.)

EXTRA MONTHLY BONUS! With every selection you accept from the Club, you'll receive an exciting surprise gift —compact tool, science chart, key ring, or some equally handy, practical item.

MAIL THE POSTPAID CARD TODAY
or write to address below

POPULAR SCIENCE BOOK CLUB · 44 Hillside Avenue, Manhasset, N. Y. 11030

GET UP TO \$15 WIN A RACE DAY \$2 WITH 2 STAKES

BE A WINNER!

EXPERIENCE the pleasure of being a WINNER—the joy of seeing your horses romp home at big, big odds. Get PENCLIFF world's top race computer which predicts wonderful wins on the day, up to \$151 with just \$2 stakes.

SENSATIONAL—space age—scientific, we supply FACTS—over 4,000 latest CHECKABLE big win PENCLIFF results. BIG \$2 pays incl. \$66, \$70, \$82, \$90, \$96, \$104, etc. And BIG track wins—\$2 stakes in all predictions in all races incl. \$113, \$118, \$121, \$134, \$141, \$151 etc. CLEAR PROFIT ON THE DAY. Over a dozen race experts BRAINS ARE BUILT INTO PENCLIFF. Experience the pleasure of seeing this amazing instrument 'think' as it works out wins for you. Not just small ones—many grand, big, BIG pays. Later, you'll accept as normal, but at first we're sure you'll find the unique way this remarkable instrument receives race information you feed in, skillfully works it out and COMPUTES it, will be one of the most wonderful experiences of your life. We programmed THOUSANDS of races to an I.B.M. computer with intensive probes into entrants—equivalent to 50 mathematicians 3 yrs. work. Due to this COLOSSAL RESEARCH fantastically successful PENCLIFF was invented. Shipped complete—full easy instructions in a genuine english leather carrying case—so cleverly designed that even if no previous experience of horseracing EASILY operated. Get full, EXCITING details of world's greatest horserace winning computer, and in future really enjoy the world's most popular sport. Money refund guarantee. Mail the coupon NOW. R. H. P. Co. PME15 Box 5715, CARMEL, CALIF. 93921.

R. H. P. Co. PME15 Box 5715, CARMEL, CALIF. 93921
(Tell me everything about exciting PENCLIFF)

Name _____
 Add. _____
 City _____ State _____ Zip _____

ARROW All-Purpose STAPLE GUN T-50

SHOOTS A STAPLE

Uses 6 Staple Sizes 1/4" to 9/16" including Ceittile.

WHEREVER YOU'D DRIVE A NAIL!

At Hardware, Lumber & Building Supply, Stationery, Variety and other retail outlets.

ARROW FASTENER COMPANY, INC.
271 Mayhill Street, Saddle Brook, N. J. 07663

POWER HACKSAW KIT ONLY \$24.95



Also 51 other money-saving projects to be built in the home workshop. Lathes, drill presses, vises, etc. Send 50¢ for 28 pg. Catalog.

C.F. STRUCK CORP., Dept. 788, Cedarburg, Wis. 53012

Career in ELECTRONICS?

Career training at home the new easy way with RCA Institutes. Lab work with first lesson. Easy payment plans. Send for free 64-page book.

RCA

RCA Institutes, Dept. 699-002-1
320 W. 31 St., N.Y., N.Y. 10001

CASH BY MAIL



Most fortunes, as you know, are made by people who own their own business. And Mail Order is the fastest growing, most profitable business in the U.S.

home. In fact, no one will know how you're earning so much money!

The Secret

The secret of making big money fast, is financial leverage. Use other people's money to make money for you! You mail beautiful gift catalogs offering hundreds of dollars worth of quality gifts—yet you don't invest a penny of your own money in merchandise! When the postman brings your mail each day, you keep up to HALF of all the money! Send the rest to us, and we ship all the orders for you.

It's ideal. No door to door selling. No driving in traffic. Everything is done by mail . . . right from your

Free

We are now accepting a limited number of charter members in our new Mail Order Program. No previous experience is required, but you must be over 21.

If you are sincerely interested in starting a profitable business of your own . . . if you can see the tremendous advantages which Mail Order offers . . . then ACT NOW!

Mail the coupon today, or simply send your name and address on a postcard. No salesman will call. We will send you a free book—gift catalog, reprints of feature articles, plus complete facts about our program. Write to:

**MAIL ORDER ASSOCIATES, Inc., Dept. 18
Montvale, New Jersey 07645**

**Work at Home—
Get Cash by Mail!**

Looking for a way to make extra money in your spare time? Have you ever thought of running a profitable little Mail Order business, right from your home? It's a fascinating business!

You mail catalogs to people, and by return mail, you get back stacks of letters stuffed with cash, checks and money orders!

No other business offers such fast, easy profits. It's simple! The more catalogs you send out—the more money you make!

RUSH COUPON FOR FREE BOOK

Plus reprints of Mail Order Articles

**MAIL ORDER ASSOCIATES, Inc., Dept. 18
Montvale, New Jersey 07645**

Please rush complete details on your Mail Order Program. I understand everything is free and there is absolutely no obligation. I am over 21.

Name _____
 Address _____
 City _____ State _____ Zip _____

GIANT STEREO 8 OFFER

Any **5**

STEREO 8 TAPE CARTRIDGES

For Only **\$6.95**
Worth up to \$49.90 at regular Club prices!

You merely agree to buy as few as six more cartridges at regular Club prices within a year.

NOW! Enjoy top Stereo 8 hits by top stars at top savings! Choose from renowned labels in every music category.

Save **NOW!** Choose FIVE tapes for only \$6.95 (worth up to \$49.90 at regular Club prices.) After trial membership, you may choose one tape of equal value FREE for every two you buy at regular Club price (usually \$6.98). That's a 33 1/3% average saving!

Keep posted! Illustrated music guide brings news of over 300 Stereo 8 releases, featuring a Selection of the Month. If you want this tape, do nothing — it will be shipped automatically. If you want other tapes, or no tapes, indicate your choice on the card always provided, and return it by the date specified.

All tapes guaranteed for 1 year! **Charge them!** Pay only after receiving tapes. **Send no money!** Choose 5 of 50 hits shown here; we'll bill you \$6.95 plus small shipping charge later. You can cancel membership after accepting 6 more, or continue to enjoy savings of one-third for years! Mail coupon right **NOW!**



13359 03419 02318



03996 03512 03578



03944 00046 03316



00267 04118 03840



04068 03727 03266



04124 04040 03472



04073 10280 03346 11349



03695 03731 03395 03753 03652



03682 03639 03843 03277 00363



10523 03878 04105



00222 12141 03933



03292 04024 03478



03875 03692 03997



03415 04107 03802



03842 00100 10235

SEND NO MONEY — MAIL COUPON TODAY!

RCA STEREO 8 TAPE CLUB, P.O. Box 26878, Lawrence, Ind. 46226
Yes, please accept my application for membership in the RCA Stereo 8 Tape Club, and send me the 5 cartridges I have selected for only \$6.95. I understand I may refuse the automatic shipment of each month's Main Selection, or order other selections by returning the dated card always provided. I agree to buy as few as six more cartridges within a year at regular Club prices to fulfill my trial membership. (A small shipping-service charge is added to each order.)

MAIL ME THESE FIVE CARTRIDGES

--	--	--	--	--

I am most interested in the following type of music: (check one only)

Popular (Instrumental/Vocal Moods) Classical
 Country & Western Today's Sound (Rock/Soul/Folk)

Mr. }
 Mrs. }
 Miss } (Please Print)

Address _____
 City _____ State _____

Phone (_____) _____ Zip _____
 Area Code

Limited to new members; Continental U.S.A. only; one membership per family.



TRADEMARKS USED IN THIS ADVT. ARE PROPERTY OF VARIOUS TRADEMARK OWNERS. TM/RS © RCA CORPORATION

'71S: PICKUPS THAT PAMPER

(Continued from page 101)

ordered with 4wd. Again, there are wide ranges of H-D options, varying GVWs, box sizes, payload capacity and special-purpose vehicles. International fully realizes the importance of versatility and caters to all tastes.

Cabs can be had with exterior and interior trim packages, sliding rear window, full-width bench seat, airconditioning, vinyl roof, and wood-grain sides. Crew cabs (six-passenger) are available in the 1210 series.

FORD F-100/250/350

Someone at Ford figured out that the company offers 69 different '71 pickup models, *excluding* the Ranchero.

The Torino-based Ranchero continues relatively unchanged this year, using the intermediate's 114-inch wheelbase and much of its sheet metal. Last year there were three different 429-inch V8s; now there are only two. Otherwise, the engine lineup is the same. Rancheros have three model designations: 500, GT and the wood-paneled Squire. Options include everything you can get in a car, even a four-way power seat.

In the regular Ford line are three series: F-100, F-250 and F-350—all with either two or four-wheel drive. The 2wd versions continue Twin-I-Beam front axles and a unique adjustable rear-spring system called Flex-O-Matic. This incorporates a handle to adjust the rear spring shackles for light or heavy loads.

Models are called Custom, Ranger, Sport Custom and Ranger XLT. These become progressively fancier. You get a choice of wheelbases in the F-100 and F-350 and different box sizes in all series. Among Ford pickups' clevernesses are a sliding rear window that opens or locks shut. An electric power-pack option uses an auxiliary, aircooled gasoline engine mounted under the hood of F-100 and F-250 pickups. This drives a 2500-watt a.c. generator to run tools and appliances.

Ford pickups also offer various special camper, heavy-duty, farm, ranch and contractor packages. The F-250 and F-350 can be ordered with power front disc brakes and/or heavy-duty drums.

DODGE D-100/200/300

Dodge's fancy job, the Adventurer, introduced in late 1968, has been doing well ever since. Available in both D-100 and D-200 2-wheel-drive series, it comes in Standard, Sport and Special Edition versions. Among the niceties are added sound-deadening, six-way adjustable seat,

door pockets, plusher upholstery, nylon carpeting. You can order the gamut of driver-assist and luxury options.

There's a new 1971 Dude—for tough, fast going; not expensive but with distinctive striping and interiors. The A-100 compact pickup has been dropped.

Dodge offers 4wd in all three series, but this changes the designations to W-100, W-200, and W-300. The larger two are available with six-man cabs.

Dodge's 2wd pickups come with "Cushioned Beam" front suspension, which means an I-beam axle with longitudinal leaf springs. The trick, though, comes in putting plastic liners between leaves to remove most interleaf friction, thus smoothing the ride and getting rid of traditional squeaks and groans. Dodge pickups also have front sway bars for added cornering stability and resistance to side winds. You can, of course, get all sorts of heavy-duty suspension mods to fit various loads and roads.

The Camper Special package includes an easy-off tailgate, increased cooling and electrical capacity, and heavy-duty components throughout.

CHEVROLET AND GMC

Chevy and Jimmy pickups have become twins. You can still tell them apart by their grilles and trim, but otherwise they're virtually identical. Both pickups use the same engines, although Chevrolet offers three more horsepower ratings. Both offer three series in three trim groups, also three different wheelbases (see chart).

Most notable addition to 1971 Chevy and GMC pickups are standard disc brakes. These make long downhill runs a lot safer, especially with heavy loads, because discs resist fading much more than drums. Discs also aren't affected by water. Both GMC and Chevrolet include a vacuum booster with all but half-ton pickups; it's optional on those. Front-rotor diameters are 11.86 inches on half-tonners; 12.5 inches on $\frac{3}{4}$ and one-ton models. A delay valve correlates front-disc application with that of the new, finned rear drums. A proportioning valve balances brake pressure front-to-rear, regardless of load. With the better braking, all GMC and Chevy pickups get wider wheels.

Variable-ratio power steering is optional on 4wd models, with a two-speed transfer case standard on GMC 4wd pickups. Four-speed floorshift gearboxes are standard on one-ton versions; optional on others. Airconditioning and those other comfort and camping options are available. ★★★

BIG

YACHT-SMART
Sail Rig
DACRON
from
\$114

WINTER SAVINGS NOW

FOLBOT

TRAVEL CRAFT
fits in every
home or car

FOR YOUR SPORT AND FAMILY FUN

and
**RECORD
FISHING**

GENUINE Folbot RECREATION for just ONE small investment, WITHOUT the continuous burdens of complicated 'big rig' operation. You GO CAREFREE anytime with COMPACT Folbot . . . rocky streams, lakes, marsh, surf & open sea. Superior non-sinkable designs provide SAFEST low gravity center, balanced low & high seating, substantial construction, protective decks & EXCLUSIVE swivel-back COMFORT. ALL within your reach. In handy Folbot YOU GLIDE smoother, faster & NOISELESS with paddles, oars, or sails and ride softly w. 1 to 10 HP. motors. Many styles & sizes from 1 to 4 seaters, FOLDING or rigid PORTABLE come in PREFAB KIT, or expertly FACTORY BUILT

Just a few Dollars start
YOU right away. From

ONLY \$19 NOW
for BASIC KIT

16 feet long
'CAYAT'
car top
YACHT.



NEW
Fabulous
16 foot
\$117

Factory BUILT
FREE
ACTION CATALOG
**STARTLING
FACTS & FIGURES**
Mail coupon or address

to: FOLBOT CORP.
Dept. PM-271, Charleston, S. C. 29405

Name _____

Address _____

City _____ State _____

CAREER TRAINING / Engine Specialist DIESEL • GASOLINE • L. P.

Write to-day for free bulletin
An endowed non-profit institution
Founded 1907 — VETERANS APPROVED

THE DAVID RANKEN TRADE SCHOOL
4421 FINNEY AVENUE • ST. LOUIS, MISSOURI 63113

locksmithing and key making

PRACTICAL UP-TO-DATE COURSE — ONLY \$7.95



Teaches you how to pick locks, de-code, make master keys, repair, install, service, etc. New self-instruction lessons for every handyman, homeowner, carpenter, mechanic, service station operator, fix-it shop, hardware dealer, gunsmith. 53 easy illustrated lessons. Full price only \$7.95 post-paid. Satisfaction or refund guaranteed. Mail order today!

NELSON-HALL CO., Dept. BZ-2
325 W. Jackson Blvd., Chicago 60606

HEARING AIDS

Huge savings on tiny, all-in-the-ear, behind the ear, eyeglass and body models. New space age models are so tiny and well concealed your closest friends may never even notice. **FREE HOME TRIAL.** No down payment. Low as \$10 monthly. Money back guarantee. Order direct and save. Write today for free catalog and confidential booklet. **PRESTIGE, Dept. D-34, Box 10947, Houston, Tex. 77018.**



INVENTORS

**INVENTIONS—NEW PRODUCTS—IDEAS
DEVELOPED & PREPARED**

For Commercial Appeal & Sales
DESIGN—MARKETING—PATENT RESEARCH—DRAWINGS
DIRECTOR: United States Patent Office former Patent Examiner
Member: United States Dept. of Army former Patent Adviser
Member: United States Council Int'l Chamber Commerce
Second Decade of Reliable Service to

**INVENTORS—MANUFACTURERS—ATTORNEYS
FREE CONSULTATION**

THE RAYMOND LEE ORGANIZATION
230-Z Park Ave., New York 10017 (212-MU 6-8500)

SEND FREE "INVENTION RECORD" Form & "PRODUCT MARKETING" BROCHURE

Name _____

Address _____

City _____ State _____ Zip _____

ORDER TAKERS WANTED

. . . in your neighborhood!



We're looking for men and women who can show our giant full color shoe catalog, accept orders from friends and neighbors for nationally famous Mason Shoes. Earn \$5 to \$20 extra in a few spare hours each week, much more if you can devote full time. Over 275 styles. Many comfort features. Prizes, bonuses, **FREE SHOES** for life! Rush name and address for **FREE Starting Outfit** today.

MASON SHOE, Dept. F-153 CHIPPEWA FALLS, WIS. 54729

compact double duty tool sets unsurpassed for precise work

*Made for the skilled mechanic
and craftsman who appreciate
professional quality*

Five different sets with variety of 6 to 10 midget drivers for delicate work with hex head screws and nuts; slotted, Phillips, hex socket, and Scrulox screws.

Each contains unique, slip-on, torque amplifier handle for added reach and driving power. Lets you do more jobs with fewer tools. Slim, trim, vest-pocket size case.

Nationwide availability through local distributors-dealers. Write for **FREE HAND TOOL CATALOG.**

XCELITE, INC., 162 Bank St., Orchard Park, N.Y. 14127



HONEYMOON ON A HOUSEBOAT

(Continued from page 105)

of movement, space and working opportunity on a houseboat is unparalleled in any other kind of family conveyance, even including a motor home. I'm sitting, relaxed, writing, reflecting on the green and gold of the Arkansas bluffs moving by while snacking on cake and coffee. Do that on water with any other design of comparable size, and you might end up with coffee in your lap! This is honest leisure."

We arrive after dark at the Ramada Inn Marina near Dardanelle. Charlie Smith meets us, and we're off to dinner at Russellville's Marina Restaurant. Imagine, genuine Thai food in the Arkansas heartland!

Next morning Jack Seastrom and his wife, Carolyn, join us. Jack wants to show us the Kenner plant at Knoxville and since neither he nor Carolyn has seen the river above Dardanelle, they ask to hitchhike on the rest of the run to Fort Smith.

Dardanelle Lake is pretty and we could spend days doing nothing but fishing for greedy largemouth bass in just one of its tributaries, Big Piney Creek. And if we tire of angling, we could shoot trap off the houseboat roof or take a Kenner Ski Barge into the tiny creeks nearby.

Finally we push on through soft, rolling countryside as we near the Oklahoma border, and we can see even farther from the river. Not that the river itself doesn't offer scenery enough: we're always sighting birds, most notably a bald eagle sitting near the houseboat and a flock of white pelicans on a sandbar.

We make Fort Smith in fine time and celebrate with an excellent seafood dinner (fresh from the Gulf) at Jimmie Little's. When Jack and Carolyn turn downstream for the run back to Knoxville, Barbara and I long to go with them. While a mite cramped for permanent living, the Suwanee 35 proved a perfect weekender and a memorable honeymoon boat.

For more information about it and other Kenner boats, write Box 16, Knoxville, Tenn. 72845. For river maps and charts and brochures about recreation in Arkansas, write U.S. Army Engineer Dist., Box 867, Little Rock, Ark. 72203; Arkansas Game & Fish Commission, State Capitol, Little Rock, Ark. 72201; Arkansas Publicity and Parks Commission, also at the State Capitol; or local chambers of commerce along the waterway. For information about reservoirs in eastern Oklahoma, write U.S. Army Engineer Dist., Box 61, Tulsa, Okla. 74102. ★★

REAL ESTATE BE A BROKER

PAYS BIG! SEND FOR BIG FREE CATALOG NOW! Graduates report making substantial incomes. Operate your own business quickly. Men, Women, all ages, learn easily. Course covers Sales, Appraising, Loans, Mortgages, & related subjects. **STUDY AT HOME** or in classrooms in leading cities. **Diploma Awarded. Write Today for FREE Book!** Accredited Member National Home Study Council. (Est. 1936) G. I. Approved.

**FREE
BOOK
TELLS
HOW**

WEAVER SCHOOL OF REAL ESTATE
3521-P Broadway Kansas City, Mo. 64111

I-N-V-E-N-T-O-R-S WE NEED INVENTIONS

Sell your invention for cash—need money for Patent?—Are technical problems holding you back? Universal Inventions has helped inventors all over the world—just like yourself—why not you? Inventions provide the magic spring-board to sudden riches. **REMEMBER**, we either sell your invention or pay you a cash bonus. Write for details. **UNIVERSAL INVENTIONS, Dept. 13, Marion, Ohio**

1¢ SALE
GUARANTEED
10 YEARS



The knife for hunting, fishing and all around use. Mirror polished, imported stainless steel blade honed to a razor's edge. Rugged. Opens with flick of finger. Locks into position. Blade will not close when in use. Press button in handle to close. Safety finger guard. Sure-grip handle. Balanced for target throwing. **IF BROKEN WITHIN 10 YEARS WE WILL REPLACE AT NO CHARGE!** Use 30 days. Money back if not pleased. Special 1¢ sale.

REG. PRICE \$1.98. Send \$1.99 & receive 2 knives. Add 49¢ postage, handling. **Remit TOTAL \$2.48 for 2 knives.** **ORDER NOW!** Midwest Knife Co., 9043 S. Western Ave., Dept. DD-2808, Chicago, Ill. 60620. Est. 1936.

LIFETIME "SPIN-ON" OIL CLEANER



Cleans motor oil 100 times cleaner than any other "spin-on" filter. Never drain oil again. Never buy another spin-on filter. Change 15 cent element every 3000 miles, available everywhere. Doubles engine life. Oil is 100% clean 100% of the time. Guaranteed 5 years. \$25.95 post paid. Write for the facts. Save \$8.00 every 3000 miles.

VIRDEN PERMA-BILT
Box 7066 PM, Amarillo, Texas 79109

NEW RUBBER STAMP BUSINESS PAYS BEGINNERS UP TO \$16.50 AN HR. START AT HOME IN SPARE TIME

The multi-million dollar Rubber Stamp business—once controlled by a few big companies—is now being taken over by small operators—one in each community throughout the United States. Men and Women who have this inexpensive machine can turn out huge quantities of Rubber Stamps with special wording that buyers once were forced to buy from big cities. Material costing only 27c makes a stamp that sells for \$2.75. The machine that does the work is simple and easy to operate and it turns out as many as six Rubber Stamps at a time, each with different wording such as names, addresses, notices, stock numbers, prices and other "copy" needed by offices, factories and individuals. Working full capacity, it can earn as much as **\$33.00 an hour for the operator!** Now you can get into the big-pay business yourself, with your own home as headquarters. You don't need experience. We supply everything, including complete instructions and eight ways to get business coming in fast. **We even help finance your start.** Start making up to \$16.50 an hour from the very beginning. Cash in on the profitable Rubber Stamp business in your community, right away. We'll mail full particulars FREE and no salesman will call. Be first in your locality. Rush coupon or send your name on postcard now to:

RUBBER STAMP DIV., Dept. R-2-AB
1512 Jarvis Ave. • Chicago, Illinois 60626

**THIS LITTLE TABLE TOP MACHINE
MAKES EVERYTHING SIMPLE & EASY**

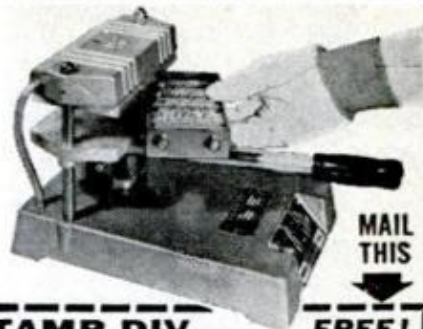

MAIL
THIS
↓

RUBBER STAMP DIV. FREE!
1512 Jarvis Avenue Dept. R-2-AB, Chicago, Ill. 60626

Please rush full particulars about your financing plan and the little machine that can get me started in the profitable Rubber Stamp business at home in spare time. Everything you send me is FREE and no salesman will call.

Name _____
Address _____
City _____
State _____ Zip Code _____

BASEMENT TOILET FLUSHES UP



TO OVERHEAD SEWER OR SEPTIC TANK.
NO DIGGING UP FLOORS. INSTALLS EASY. Write
McPHERSON, INC., BOX 15133, TAMPA, FLORIDA 33614

2 for 1 WAREHOUSE CLEARANCE SALE

©MCMXXIX Viking



TWO \$1.98 \$3.96 VALUE 10 Year Guarantee
FOR 1 TWO FOR THE PRICE OF ONE

Razor sharp lifetime steel blade opens easily and automatically locks in place. PUSH-BUTTON release. Tough, razor steel blade honed and polished to mirror-like finish. Balanced for target throwing. Legal size. Blade GUARANTEED 10 YEARS. If blade breaks we replace free. 30-day MONEY BACK GUARANTEE. A favorite with sportsmen. Priced for quick sale of 200,000 knives. Makes excellent gift for man or boy. Two for \$1.98 plus 50c shipping. Send cash, ck. or M.O. to VIKING KNIVES, Dept. K-3, Box 10880, Houston, Tex. 77018.

McCulloch introduces the new Mini Mac 6. The world's lightest chain saw. 6½ lbs. At the world's lightest price. \$139.95.*

Extra teeth give smoother cuts, for delicate building jobs.

All controls are grouped beneath handle for finger-tip control.

Exclusive Master-Grip handle, right over center of gravity, gives perfect balance.

Narrower bar lets you slice through hardest woods.

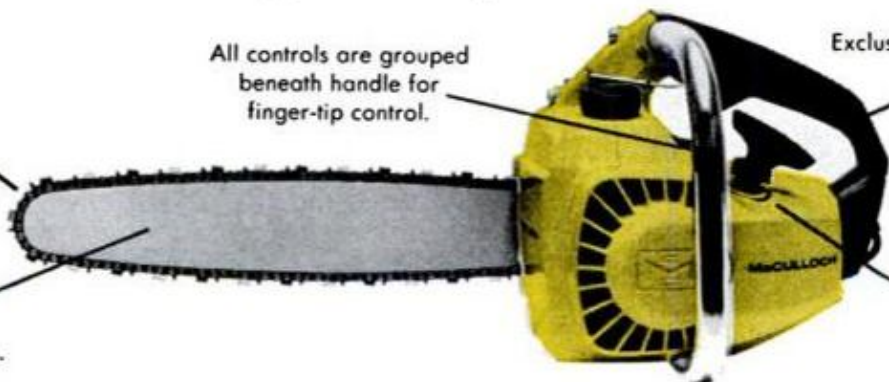

Starts easily and safely.

Cut the cost of living with the Mini Mac 6! It's so maneuverable, you can build tables, benches, sheds and planters, as well as cut firewood with it. It's nearly 25% lighter and has more exclusive features...yet costs 22% less than the next lightest competitive direct drive saw. Test-cut the new Mini Mac 6 yourself. Or the new Mini Mac 6 Automatic which oils its own bar and chain as you cut.

For your nearest McCulloch Dealer, call: 800-243-6000, toll-free, any hour. (In Conn. only, call 800-942-0655). Or see the Yellow Pages under "saws"

McCulloch really gets the job done.

*Manufacturer's suggested list price. Weight given is less cutting attachments. McCulloch Corporation, Los Angeles, Calif. 90045 / McCulloch of Canada, Malton, Ontario



You can make money in

WATCH REPAIR

Learn at home the low cost Sweazey Way

Watch repairing pays up to \$6 an hour. part time watch makers report on survey. Unique and modern Sweazey home study System starts you making repairs right away on Swiss and American watches. Professionally prepared training. No previous experience needed. Special tools provided for practice. Diploma Awarded. Free sample lesson and opportunity book give all facts. Write today. No obligation.

CHICAGO SCHOOL OF WATCHMAKING
Dept. 121 Fox River Grove, Illinois 60021

FREE BOOK and SAMPLE LESSON

CHICAGO SCHOOL OF WATCHMAKING
Dept. 121 Fox River Grove, Illinois 60021
Please rush FREE BOOK and Sample Home Study Lesson.

Name _____ Age _____
Address _____
City _____ State _____ Zip _____

WRIST ROCKET

AMERICA'S Pat.
HARDEST U.S.
HITTING SLING
Range 225 yd. - 232 fps
Matched spare rubbers
and pouch assembly, \$1.00.
Write:



WRIST ROCKET®
P. O. BOX 21-B
Columbus, Nebraska 68601 **\$300 Post Pd.**
No C.O.D.'s

MAKE BIG MONEY

OPERATING HEAVY EQUIPMENT



- BULLDOZERS
- CLAMSHELLS
- TRENCHERS
- DRAGLINES
- BACKHOES
- SCRAPERS
- GRADERS
- CRANES

The Construction Industry is Booming! Earn top money in this fast moving, action-packed field. Keep present job and train at home in spare time followed by practical training on our machines under project conditions at our facilities. Nationwide placement assistance. For FREE information fill out and mail coupon today!
Member American Road Builders' Assn.

APPROVED FOR VETERANS AND INSERVICE PERSONNEL

UNIVERSAL HEAVY CONSTRUCTION SCHOOLS, Dept. PM
1901 N.W. 7 STREET / MIAMI, FLORIDA 33125
Phone: (305) 642-2332 (24 Hours)

Please Print
Name _____ Age _____
Address _____
City _____ State _____
Phone _____ Zip _____

FOUR-WHEELER SURF FISHING

(Continued from page 107)

Park. These include an inspection of all "privately-owned over-sand vehicles" and issuance of a permit. The following equipment is required by law: jack, shovel, tow-rope or chain, and board or similar jack support. Camping is prohibited, which is the case on most beaches. (You'll find that nearby campsites are usually provided, however.)

Many ingenious devices utilize all available beach-buggy space. Roof boxes are mounted on carriers and hold an assortment of tools, tackle and fresh water. Rods are carried in front-bumper rod holders and even outboards are mounted on the bumpers while small, light boats are carried on the roofs for launching in mild surf when the fish are feeding beyond casting range.

Driving problems on the beach are best avoided with a little common sense. Never park below the high-tide mark, and it's unwise to drive below it. A mechanical breakdown, even a flat tire could be disastrous in an incoming tide. Follow the Jeep trails on the high and dry side and watch out for driftwood with tire-piercing nails. Big tires are better than small ones, and they should be deflated in deep sand. (Tube tires are better than tubeless ones for this reason.) Remember that your vehicle will ride on a highway most of the time, and tires must serve a dual purpose. The regular tread will do, although I prefer the mud and snow treads for year-round use.

If you get stuck, avoid digging in. Shift to low gear, deflate the tires to minimum pressure, straighten the wheels and shovel a path for them. Then ease out by rocking back and forth. There is no bottom to beach sand and spinning wheels won't help. If one wheel gets a grip, chances are you can grind out. If you're sunk in wet sand or quicksand, bumper jacks and planks are a must. A tow is even better, and you'll discover that most beach buggy men are helpful compatriots who never know when it might become their turn for assistance.

Deep sand, eroded gullies and traps require a firm hand on the wheel. Loose sand on a slope may cause the buggy to sideslip. Hillocks and eroded dunes are treacherously deep and may cause the vehicle to stall. Turning 180° should be done by backing rather than circling; crossing ruts can be difficult.

Most driving is in low gear, and remember: The beach is a close relative of the sea, and like the sea, it should always be treated with caution. ★★★

MAKE MONEY!

REPAIR HYDRAULIC JACKS



Earn while you learn at home. Millions of jacks in gas and auto service stations, trucking firms, body shops, riggers, factories and farms need servicing... most of which you can learn to repair. We show you HOW. Start spare time in your basement or garage. Big opportunity for mechanics. ACT NOW!

Write for Folder PM-2 and Free Bonus Offer

Hydraulic Jack Repair Manual Co., Inc.

G.P.O. BOX 3 • STATEN ISLAND, N.Y. 10314



make your own Gems \$39.50
F.O.B.

The Gem Maker comes complete with all necessary equipment, including a super-charged diamond blade for sawing, and all the wheels for grinding, shaping and polishing; also complete instructions. The complete equipment as shown, less motor and belt for only \$39.50. f.o.b., Burlington, Wisconsin. Write today for information and literature.

B & I MANUFACTURING CO.
Dept. P, Burlington, Wis. 53105



BE A LANDSCAPE CONTRACTOR

LEARN MODERN LANDSCAPING for exciting hobby or profit. Thousands of spare or full time money making opportunities. Start a profitable business—we show you how. Study and earn your certificate at home.

Write today for Free Book.

LIFETIME CAREER SCHOOLS

Dept. A-979

2251 Barry Ave.

Los Angeles, Calif. 90064

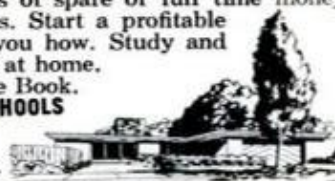

FREE!

LAFAYETTE'S 1971 Golden Jubilee Catalog

Your 1st Guide To Everything in Electronics

Stereo Hi-Fi • Citizens Band • Ham Gear • Tape Recorders • Test Equipment • TV and Radio Tubes and Parts • Cameras • Auto Accessories • Musical Instruments • Tools • Books

Lafayette Radio Electronics, Dept. 15021
P.O. Box 10, Syosset, L.I., N.Y. 11791

Send me the FREE 1971 Lafayette Golden Jubilee Catalog

Name _____ 15021

Address _____

City _____

State _____ Zip _____

FINISH CORNERS • CUT MOULDING

WITH ANY ELECTRIC DRILL

NO \$50 ROUTER OR \$6 BITS NEEDED!

You don't have to buy an expensive Router to finish corners, moulding & trim. ARCO Corner Finishing & Moulding Cutters do the work at a fraction of the cost. Simply slip the Cutter's 1/4" shank in any drill chuck and it's ready to produce! Special Dual Guides assure accurate cuts along entire length & width of workpiece. Cuts wood, plastics, soft metals. Quality-made in U.S.A. of hardened steel. These Cutters will fit & work with all Electric Routers.

No. 6—3 PIECE CUTTER SET

CUTS 3/8" CONTOURS

\$3.95



FANCY COVE-CUTTER



ROMAN OGEE-CUTTER



RABBET-CUTTER

No. 7—3 PIECE CUTTER SET

CUTS 3/8" CONTOURS

\$3.95



BEADING-CUTTER

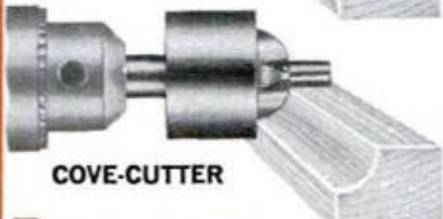

COVE-CUTTER

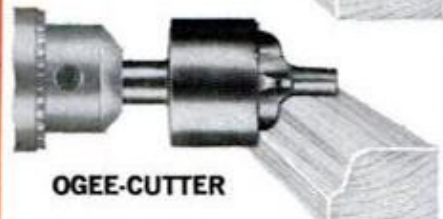

OGEE-CUTTER

SPECIAL SAVING!

Order all of above 3 Sets at our Special Money-Saving Price. No. 6715, total **\$11.95** of 10 Cutters, only

These & over 300 other Arco Tools available at Hardware Depts. everywhere, or order direct on 20-day Money Back Guarantee

No. 15—4 PIECE RADIUS & BEVEL CUTTER SET

\$5.75



ADJUSTABLE BEVEL-CUTTER cuts 45° bevels from 1/2" to 3/4" wide.



RADIUS CUTTERS 3 SIZES for 1/8", 3/16", 1/4" Radius Cuts.

MAIL THIS COUPON TODAY!

ARCO TOOLS, INC. Dept. PM-2
421 West 203rd St., N.Y., N.Y. 10034

Ship on your 20-day Money Back Guarantee:

- No. 6, 3-Piece Cutter Set \$ 3.95
- No. 7, 3-Piece Cutter Set 3.95
- No. 15, 4-Piece Cutter Set ... 5.75
- No. 6715, All 10 Cutters 11.95
- I enclose Check. M.O.—SHIP PPD. (No COD's)

Name _____

Address _____

City _____ State _____ Zip _____

UGLY RADIATOR

(Continued from page 141)

itself must be covered with a relatively open grille. Before enclosing the radiator, spray it with black paint and it will be virtually invisible behind the brass screen. *Another tip:* Line the wall behind the radiator with two layers of kitchen-type foil (or a piece of sheet aluminum). If you use the former, make certain that both layers are glued securely to the wall, or the moving, heated air will cause "crinkling" noises. The foil effectively reflects and bounces the maximum amount of heat into the room.

The cabinets are easy to build; no fancy or intricate cabinetry was employed here. And to make the job even easier, I utilized discarded, inexpensive kitchen-cabinet doors. Your local kitchen-cabinet contractor will gladly sell you all you need at nominal cost since any kitchen remodeling job he tackles requires removing the old cabinets anyway.

When you have your cabinet doors in hand, lay out the cabinet frame to suit the door opening sizes. The inserts are a matter of personal choice but we chose to stick with brass grille throughout. A trip to your local lumberyard will reveal an almost staggering variety of grilles and plastic inserts that are available at relatively low cost.

If you're using doors removed from old cabinets, you'll first have to remove the plywood inserts by routing a rabbet around the frames on the rear side. This will let you lift the wood inserts and replace them with decorative brass grilles. ★★★

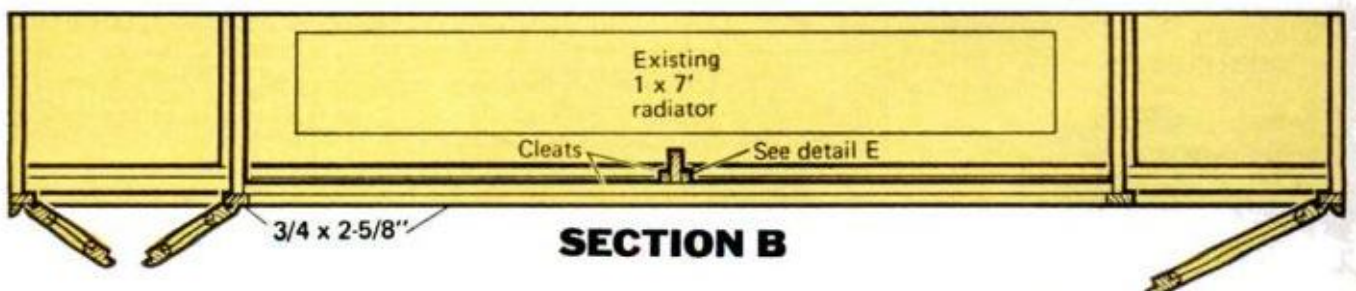
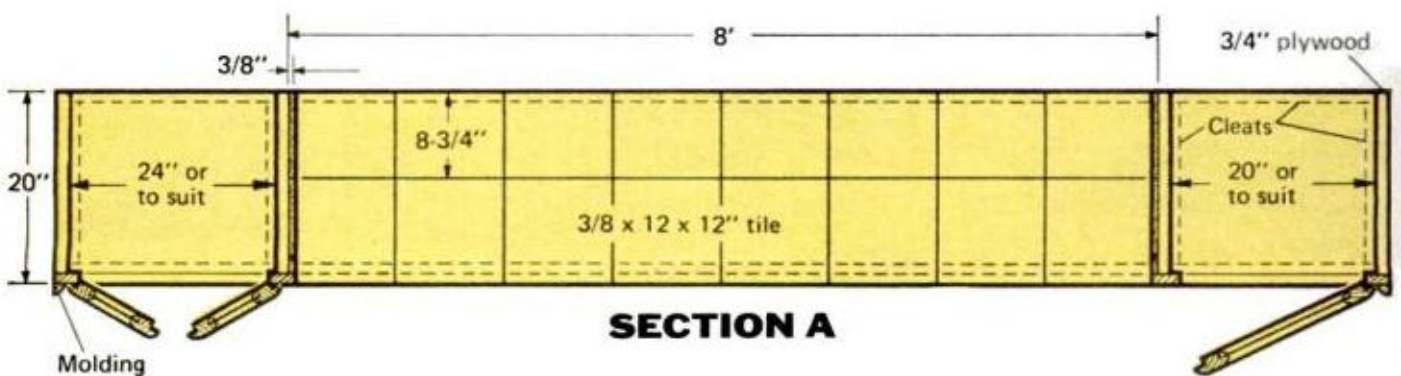
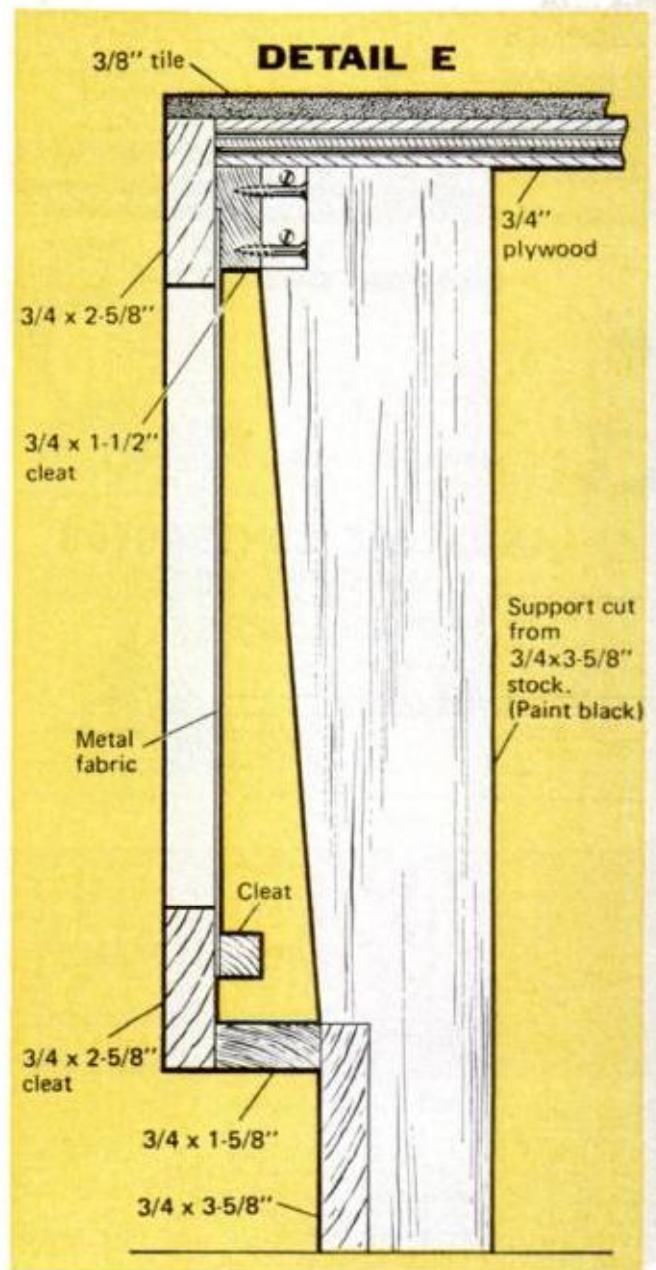

Need More Money? Want to Be Your Own Boss?

START SAW SHARPENING BUSINESS

Of Your Own - in Your Sparetime



Turn your spare hours in the evening or week-ends into extra dollars, this proven practical way—start your own money-making sharpening business—No selling or canvassing—No experience required. You can do it automatically with the Foley Saw Filer or Lawn Mower Sharpener.

Beginners Earn \$3 to \$6 an Hour

People, just like yourself, all over the United States are making extra cash—\$20 to \$30 a week—right now in their spare time. "My sparetime saw filing business has made me \$952 these first ten months," says R. T. Chapman. Many start part-time, find it so profitable that they build year-round service business. You can, too, simply by following easy Foley plan.

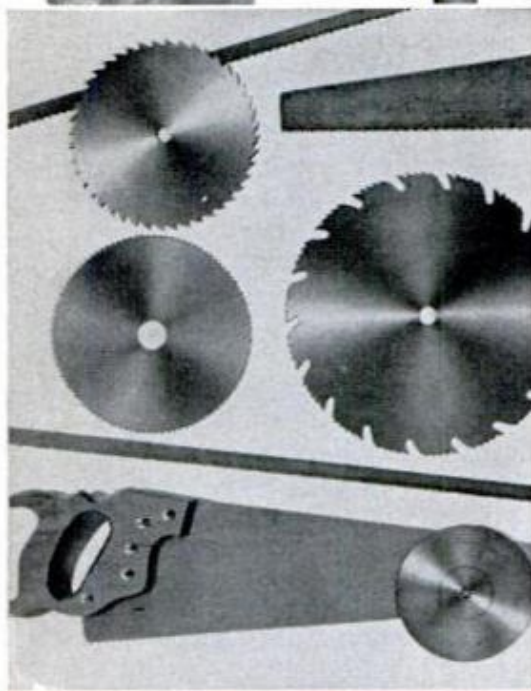

Town of 150 Supports Profitable Business

Here's the story from Dick and Jo Ann Koester after being in business less than a year. "We have acquired another Foley Saw Filer and for the past two months we have been in full-time operation. As we live in a small town of 150 population in farm area we use our truck to pick up saws in five nearby towns. With a family to support and plans for building to our house we had to pick up a business fast and already sharpen an average of 15-20 saws a day. Business for the future looks even better as good machine filing is our best advertising."

CASH for Sharpening Mowers

Every neighbor with a lawn needs his lawn mower sharpened at least once a year. No experience is needed to start—anyone can operate and turn out professional jobs. All operations are handled quickly, easily and accurately.



Sharpen These Professionally
with amazing
Foley Saw Filer

You can sharpen combination (rip and crosscut) circular saws, band saws, hand saws, crosscut circular saws—and do a perfect job every time without experience or special training. The precision Foley Filer does it for you automatically! A complete repair shop in one machine! Set up in basement or garage, work your own hours in your own way and earn big sparetime profits.



FREE

BOOKLET TELLS HOW! Free Book "Money Making Facts" shows just how you can start at home in spare time. Small investment—time payments if desired. Get this booklet—study it! Send coupon today. No salesman will call on you.

Foley Manufacturing Co., 216-1 Foley Bldg.
Minneapolis, Minnesota 55418

Send Free Booklet on Saw Sharpening Business Lawn Mower Sharpening

Name _____

Address _____

City _____ State _____ Zipcode _____

radfast™ FASTENERS

PUTS IT ALL TOGETHER

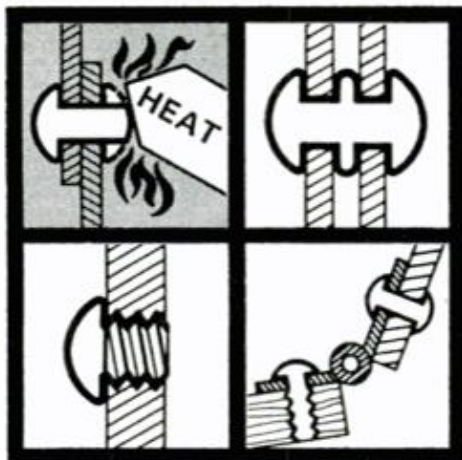

ALMOST ANYTHING THAT TAKES RIVETS, SCREWS, BOLTS AND NUTS CAN BE JOINED OR SECURED BY RADFAST FASTENERS.

Get the amazing new thermoplastic "with a memory" that expands under heat to its original size and shape, creating tough rivets, plugs, all kinds of fastening devices. Radfast comes in flexible rods of modified polyethylene in a range of diameters, is easily cut to any desired insert length. No tool except a common heat source is needed...a soldering iron, hot air gun, cigarette lighter, even a match will do. Join metals and other materials simply by heating one end to form a fastener head, insert the other rod end, snip and re-apply heat. Radfast quickly expands in place to a tight, self-lubricating, non-corroding and noiseless fastener with a 3500 psi shear strength! Form threaded inserts by heat-expanding into tapped holes, make fasteners with spacers or create your own custom "Radfasteners."

You'll want Radfast rods on hand in your home workshop, office, auto glove compartment, tool and tackle box, boat, just about everywhere. They're ideal for hobbycrafts, everyday fixing jobs, all kinds of unexpected emergency repairs. In fact, with only a little imagination you'll find endless new uses and ways to "Radfasten." For your get-acquainted Radfast starter kit, mail \$1.50 today. Kits with detailed working instructions contain 18" of rod material in 1/8", 3/16" and 1/4" diameters, enough for dozens of jobs.

Radiation Technology, Inc
Department P-2, Box 41
Hibernia, New Jersey 07842



Enclosed is \$____*for____Radfast Starter Kit(s).

Name _____

Address _____

City _____ State _____ Zip _____

*\$1.50 per kit, ppd. Distributor inquiries invited.

Radfast™Fasteners - Patents Pending

FROM VAN TO CAMPER—\$340

(Continued from page 152)

manner around the extension at 1-ft. intervals. Use both epoxy and bolts with lock washers and nuts to fasten this roof securely in place.

To finish the open corners, cover them with heavy wire screening. Screw the screen to the roof in several places. This will serve as a base for the fiberglassing. Finally, cover the entire new roof with fiberglass resin, and cover the screen molds and all edge joints with fiberglass cloth and resin. Take special care that you cover the joint where the new roof meets the body. We used four coats of acrylic enamel to finish the outside. If you paint the roof a light color, it will reflect sunlight and keep the van cooler during the summer months.

The interior can be completely designed and appointed to suit your own taste and needs. But try to use the existing steel spars as much as possible to support any additions. Another hint: Plan your design to keep the center of gravity as low as possible.

If desired, you can supplement existing spars, by adding a framework of 2x4s to the body with epoxy.

Along the left wall we built a 20x60-in. counter topped with a laminated particle board. Here we placed an LP-gas stove, sink with food strainer (for drainage we used a PVC pipe that leads from the sink through the floor) and a hand water pump.

The 20-in. space behind the driver's seat is filled by a food closet designed with an ample number of shelves.

When you have decided where to place all your fittings, you can install the fiberglass expandable insulation (with vapor barrier) throughout the interior—on all walls and the ceiling. We used about 180 sq. ft. The wood paneling which is bolted to the steel body spars, and screw-fastened to the roof 2x4s, holds the insulation in place.

Other items we added include an AM/FM radio with front and rear speakers, high-intensity electric light as well as a gas lantern, a chemical toilet, a two-speed fan, carpeting and an all-door and engine-compartment burglar alarm. All the equipment that we installed was bought at either a local camping supply store or from Sears.

The total weight of the converted van is 3900 lbs. It cruises at 65-70 mph and averages about 14 mpg, even with the air-conditioning running full blast. Actual building time was about 70 concentrated hours.

★★★

train for Machine Design Technology in two years

Graduates of our six quarter Machine Design Technology Program are employed by leading companies. Trained in everything from basic technical drawing to machine and product design, they have entree into responsible positions in important industries. Tri-State also offers four year programs in five fields of engineering . . . four areas of business administration . . . two-year programs in computer technology, arts, and science. Accredited. Approved for veterans. Moderate total costs. Enter March, June, Sept., Jan. Write Director of Admissions for Catalog, indicating career you prefer. Excellent placement record!



TRI-STATE COLLEGE

421 College Avenue, Angola, Indiana 46703

GOVT. SURPLUS AND OTHER BARGAINS SAVE UP TO 90%



HYDRAULIC PUMP & MOTOR Miniature hydraulic unit consists of pump & 26 V.D.C. motor. Pump output 1000 PSI @ 3/4 GPM. Runs well on 12 V.D.C. @ 1000 PSI @ 1/4 GPM. Inlet port 1/2" - 18. Outlet port 7/16" - 20. Gear type intermittent duty. Exc. for small hydraulic tail gates, automotive lowering systems, etc. 8" L x 3 1/2" H x 5" W. Tested prior to shipment. GOVT COST \$184. Shpg. wt. 7 lbs. \$17.50 (Stk. #2467)



HEAVY DUTY GEAR MOTOR All ball bearing construction. Rated approx. 3.5 HP @ 24 V.D.C. Turns 400 RPM, no load, on 12 V.D.C. & 800 RPM on 24 V.D.C. Contains instant start-stop magnetic clutch. Reversible. Has 12 tooth, 5/8" shaft, 18 1/2" L x 7" dia. GOVT. COST \$454. Shpg. Wt. 35 lbs. \$32.50 Stk. #2465

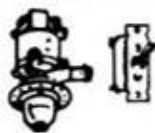

ELECTRIC PUMP WITH CONTROL SWITCH For boats, campers & trailers. Output 300 GPH. Can be used in fuel or water. 1/2" pipe bronze inlet. 12 or 24 V.D.C. Explosion-proof motor. Comes with wiring diagram. Approx. GOVT COST \$150. Shpg. wt. 9 lbs. \$14.50 (Stk. #1164)



NEW! BIG 1971 CATALOG

Send 35c for amazing catalog with 1000's of bargains in hydraulics; electrical, marine, automotive items, etc. 90 day guarantee. Order from ad. All prices FOB Culver City. 50% deposit for COD. Cal. res. add 5% sales tax. Include zip. Satisfying customers world-wide since 1945.

AIRBORNE SALES CO.

Dept. PM271

8501 Steller Dr., P.O. Box 2727, Culver City, Calif. 90230



"Buy auto air conditioning now? You're kidding."

"When you can save \$200 or more - why not? Write Comfy Kit, Box 8585, Dallas, Tex."



NEW DYNAMIC MARK 88 80 AMP INDUSTRIAL TRANSFORMER ARC WELDER

IDEAL GIFT - EDUCATIONAL, ENJOYABLE, PROFITABLE WELD, BRAZE, CUT, SOLDER, HEAT STEEL, BRASS, ALUMINUM, AND MOST OTHER METALS.

Build and repair anything of metal. Save time & money with this BRAND NEW, PROFESSIONAL ARC WELDER! Rugged metal cabinet, baked Hammeroid finish. Ideal for home, shop, farm and industrial use. POWERFUL glass insulated transformer welds most metals up to 1/2" thickness with multi-pass weld, with 3/8" rods, 4 heat settings 20 to 80 amps. Operates on 110 Volt AC line fused for 30 amps. Complete with fibre glass helmet, electrode holder, ground clamp and cables, solder, assorted rods and simplified welding manual. **DOUBLE PROTECTION GUARANTEE.** 10 day money back trial plus full 5-yr. warranty. If inoperative return prepaid, we will repair or replace without charge & reship collect. **ORDER TODAY.** Complete ready to weld. Only \$59.50 F.O.B. **SEND ONLY \$6.00.** Pay Balance plus C.O.D. and Delivery Charges or Write for "PAY AS YOU WELD" Easy Low Down Payment Plan. Welder details FREE.



DYNAMIC WELDER CO.

1808 S. FEDERAL ST.
Dept. D2-B
CHICAGO, ILL. 60616

Use your router motor profitably with the new MARLIN 3-D CARVING MACHINE

to produce identical copies of carvings, plaques, mouldings, etc. in wood or plastic. Signs are easily carved by freehand with this precision ball bushing equipped machine. Carves areas as large as 10" in diameter or 8" x 30" in size. Write today for further particulars.

MARLIN INDUSTRIES, 1655 Cota Avenue, Dept. PM-1, Long Beach, California 90813

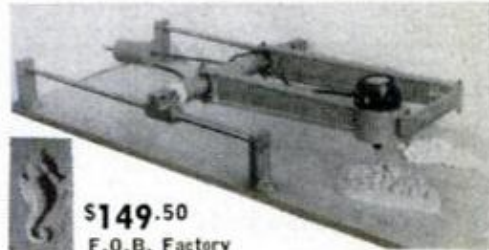

\$149.50

F.O.B. Factory



IT'S ALMOST LIKE PRINTING YOUR OWN MONEY!

and have the personal satisfaction, and independence, that comes with operating a business of their own.

Now, a revolutionary new machine makes it possible for an Independent Business Man with no "PULL" . . . **No Big Money to Invest . . . and, No Experience**—to start a business of his own, at home in his spare time. Here's what J. H. of Pennsylvania says:

\$7,280.00 for 1 to 1 1/2 hours work an evening in my spare time—and without advertising. When I start to advertise I will have my own full-time business. Now the extra income gives my family the luxuries my present job does not afford.

Now you can get into this highly lucrative business, using your home as headquarters. No experience needed because we supply

FEBRUARY 1971

9c WORTH OF RAW MATERIAL becomes \$1.25 in less than 60 seconds—and ANYONE can LEARN to do it in a FEW SHORT HOURS!

everything. The new Warner Success Program, "Engraving as a Profitable Business," is now ready for you. Send for your FREE illustrated brochure. No salesman will call. Send your name and address on the coupon or a postcard. Be first in your area to cash in on this ground floor opportunity. **SEND NO MONEY**

WARNER ELECTRIC CO., DEPT. E-2-AB
1512 Jarvis Ave., Chicago, Ill. 60626

Engraving Division, Dept. E-2-AB
1512 Jarvis Ave., Chicago, Ill. 60626

Please rush your free illustrated brochure to:

Name _____

Address _____

City, State, Zip _____



So stable it
flies hands off!

EASY TO BUILD AND FLY — MOST FUN, TOO!

Enjoy the exhilarating thrill of personal flying in the world's most popular homebuilt aircraft, the Bensen Gyrocopter. Store it in your garage, go aloft when you like—high and fast or low and slow. Send \$5 for Copter (\$3 for Glider) colorful "Info Packet", with 3-View Drawings; General Specifications; Design Information; Construction Hints; in-flight photo; 6-page "Bulletin" with numerous pictures plus descriptions of Plans, Kits, Engines; Condensed Price List . . . and a Certificate for \$5 (or \$3) toward the purchase of Construction Plans.

SEND
\$5
OR
\$3

BENSEN AIRCRAFT CORP., Dept. PM-21
RDU Airport, P. O. Box 2746, Raleigh, N. C. 27602
NAME _____
ADDRESS _____

BUILD YOUR OWN POWER TOOLS

METAL PARTS KITS AT LOW SAVE

FACTORY DISCOUNT PRICES FOR: \$50 OR MORE

- 10-IN. TILT/ARBOR SAW
- COMB. DRILL PRESS-LATHE
- 12-IN. BAND SAW
- 18-IN. BAND SAW
- 6-IN. BELT SANDER
- SPINDLE SHAPER

PLANS \$1.00 EACH DEDUCTIBLE

Kits from \$17.99 to \$45.99. Satisfaction guaranteed. Built and sold for 24 years. 50,000 units in use. Send \$1.00 for Plans or 25c for Catalog!

GILLIOM MFG. CO. Dept. PMT-2, St. Charles, Mo. 63301

LICKITY SPLITTER

Splits Big Profits from toughest woods — Ends Splitting Drudgery with 18 ton hydraulic power!

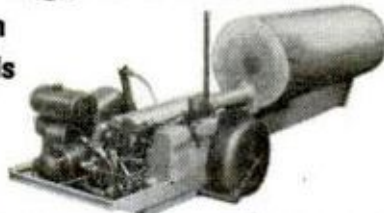

7 H.P. trailer unit squats under power to load logs without dead lift. Has 2 speeds, auto-shift, auto-stroke. 26" ram travel splits logs up to 34", any diameter — with extended frame and adjustable wedge splits up to 60". **NEW LOW COST** Economy model for farmers and small wood lots. Also ask about the 60L Series for logs up to 8½ ft. long—Details free.

Piqua Engineering Inc., Dept. P, Box 605, Piqua, Ohio

20 COURSE HOME STUDY PROGRAM

KARATE

FREE NERVE CENTER CHART

Jiu Jitsu

JUDO • BOXING
• SAVATE
• ISOMETRICS
• STUNTS

Only
\$1.00

Here is what you get!

- 20 best KARATE Blows and Chops
- SAVATE French foot fighting
- JUDO throws, Jiu Jitsu holds
- Isometric muscle building course
- Endurance Exercises and lots more

Satisfaction guaranteed or money back. Send just \$1.00 plus 25c for postage and handling to: **GUARANTEED DISTR. DEPT. 96KR74 LYNBROOK, N.Y. 11563**

COLLISION-AVOIDANCE SYSTEM

(Continued from page 93)

keep the hits. Breckman says that's what he's done.

The box is called, simply enough, a processor. Other primary parts of SECANT are a remitter (compound of the words receiver and transmitter) and a prober.

To interrogate its environment, an aircraft transmits a probe-pulse, which is a short burst of radio-frequency energy. All aircraft receiving a probe acknowledge by transmitting a return pulse. Probes and returns are on a one-to-one basis—one return sent for one probe received.

Since all aircraft are interrogating and responding at the same time and over the same frequencies, without synchronization, it now falls on the processor to separate the meaningful signals from the fruit. It succeeds in doing this, essentially, by measuring the strength of the received signals.

Weak signals are fruit. They're being transmitted by distant aircraft, which pose no collision threat. But strong signals indicate an aircraft which has intruded into prohibited air space.

These signals are fed to direction-finder equipment that finds the intruder and calculates its angle of approach. If aircraft are on a collision course, instruments in the cockpits of both planes sound a signal to tell pilots what evasive action they should take.

Today, SECANT consists of a feasibility study and laboratory model. The first prototype is being built and is targeted for testing in May, 1971.

"We'll be glad to take a look at it when it's ready," Osmun says.

Until then, ATA feels that it has found the best answer to the collision problem—for the time being anyway. And that's time-frequency. ★★★

RING LIGHT AROUND YOUR LENS

(Continued from page 87)

with, but it should not be purchased as a substitute for a regular flash. Prices for those shown here are \$49.50 for the Honeywell Prox-O-Lite, Honeywell, Inc., 4800 E. Dry Creek Rd., Denver, Colo.; \$49.95 for the Aimes-Hershey Sun Ring, Aimes Industries, Inc., 2231 Lockport Rd., Lockport, Ill.; \$59.95 for the Prinz Minicam, Bass Camera Co., 179 W. Madison St., Chicago, Ill.; and \$82.50 for the Nikon SR-1, Ehrenreich Photo-Optical Industries, 623 Stewart Ave., Garden City, N.Y. ★★★

FIND BURIED TREASURE



1971 MODELS

**GUARANTEED FOR 60 DAYS
TO EQUAL \$200.00 DETECTORS OR YOUR MONEY BACK**

NEW PATENTED DESIGN DETECTS BURIED GOLD, SILVER
COINS, JEWELRY INDIAN ARTIFACTS AND
CIVIL WAR SOUVENIRS



U. S. PATENT
NO. D214-915

29⁹⁵

POSTPAID

MARK IV WITHOUT METER

39⁹⁵

POSTPAID

METERMASTER WITH METER
DEALER INQUIRIES INVITED

NOW AVAILABLE
WITH 3
SEARCH HEADS

3" SEARCH HEAD \$8⁹⁵

DEPTH RANGE MIN. 0" MAX. 9" POST PAID

Exceptionally sensitive to small nuggets, coins and rings, even when buried on edge. Useful for searching walls of old homesteads and crevices where larger heads cannot enter.

5" SEARCH HEAD INCLUDED WITH DETECTOR

DEPTH RANGE MIN. 1" MAX. 24"

Will detect large coins, watches, lighters and pens. Best general purpose head for beach combing, searching old farm fields and circus lots.

10" SEARCH HEAD \$10⁹⁵

DEPTH RANGE MIN. 4" MAX. 60"

Best sensitivity on large objects, buried deep; like chests, tools, jars of coins, bars or veins of gold, silver and other precious metals. Can also be used to search large areas quickly.

OUTSTANDING FEATURES FOUND IN OUR INSTRUMENTS AND OTHERS SELLING FOR UP TO \$200.00

- FIVE SILICON PLANAR TRANSISTORS
- PRINTED CIRCUIT BOARD construction throughout
- FIVE-INCH DIAMETER SEARCH HEAD included with each unit for general purpose use. Three and ten-inch diameter Search Heads may be purchased with unit or added later.
- THREE COARSE TUNERS and switch in each unit for maximum sensitivity and minimum drift when using.
- SEPARATE THUMBWHEEL CONTROLS for tuning and volume allows one-hand operation.
- DYNAMIC 2 1/4-INCH, 8-OHM SPEAKER, internal and plug-in earphone included in each unit.
- 100 MICRO AMPERE METER that will deflect when audio signal is not detectable included in Metermaster along with extra diode and sensitive, full view meter.
- HEAVY DUTY ANODIZED TELESCOPING ALUMINUM TUBES with single lock nut to set best length for user's height, adjustable from sixteen to thirty inches.
- COMPLETELY WIRED (not a kit and no radio necessary for operation).
- NINE-VOLT BATTERY, Everready 216 or equivalent, included with each unit.
- ATTRACTIVELY STYLED high impact molded case and Search Heads balanced for long use.
- WEIGHT LESS THAN 2 POUNDS.

OPERATING PRINCIPLES

Operates by comparing the frequencies of two colpitts oscillators and amplifying the audio frequency which is the sum of the difference. The fixed oscillator is controlled by the thumbwheel tuner. The variable oscillator changes its inductance when the Search Head is brought into close proximity of any metal. This difference when amplified is heard in the earphone or speaker, as an audio signal tone.

\$14.95 TREASURE HUNTER'S BAG FREE

Carries your metal detector, search heads, battery, earphone, maps, books and magazines. An ebony black Unilite case, braced with handsome aluminum closures. Smooth "slide action" nickel plated locks and two keys, secures your equipment in a fitted charcoal grey foam and protects it from the rough handling. The interior lid contains a wide folio pocket. Included is a

BIG 196-page book, "Lost Treasures And How To Find Them", describing hundreds of famous treasure caches in almost every state, with suggestions on how to get started.



TREASURE HOUSE

A Division of SOLIDTRONICS MFG. CORP.
DEPT. PA-1A TENNET, N.J. 07763 © 1970

TO ORDER: Send Cash, Check or Money Order. In N.J. add 5% State Tax. \$2.00 deposit for C.O.D. To Order on credit send no money. But fill in coupon with charge card and number.

I AM ORDERING A DETECTOR AND 2 EXTRA SEARCH HEADS. SEND MY FREE TREASURE HUNTER'S COMPLETE BAG. IF I AM NOT SATISFIED AFTER 60 DAYS I WILL RETURN THE INSTRUMENT AND MY MONEY WILL BE REFUNDED. THE ATTACHE CASE AND BOOK WILL BE MINE TO KEEP.

- Send 3" SEARCH HEAD 8.95
- Send 10" SEARCH HEAD 10.95
- Send MARK IV DETECTOR 29.95
Includes sensitive earphone and 9V battery
- Send METER MASTER DETECTOR 39.95
Includes meter, sensitive earphone and 9V battery

TREASURE HOUSE
A Division of SOLIDTRONICS MFG. CORP.
DEPT. PA-1A TENNET, N.J. 07763 © 1970

CHECK ONE TO CHARGE
 MASTER CHARGE AMERICAN EXPRESS
 BANK AMERICARD DINERS
 CARTE BLANCE

CHARGE NO. _____
Name _____
Address _____
City _____
State _____ Zip _____

CLASSIFIED ADVERTISEMENTS

Rate: \$2.00 per word payable in advance each insertion. Capitalized words—75¢ per word additional. Minimum insertion ten words. To be inserted under the proper classification, copy must be in our office by the 15th of the second month preceding date of issue. The next available issue to place an advertisement in America's No. 1 Classified Section is April. The closing date is February 15th. Send remittance and order to C. A. Martin, Popular Mechanics, 224 West 57th Street, New York, New York 10019. Please make remittance payable to Popular Mechanics.

POPULAR MECHANICS

WHEN ANSWERING ADVERTISEMENTS PLEASE USE THE ZIP CODE NUMBER.

AUTOMOBILES

FOR The lowest price in the Nation on 1971 New Pontiacs, including the Hot New Firebird. Write Earl Shell, Jim Causley Pontiacs, 17677 Mack, Detroit, Michigan 48224—313-886-1700.

YOUR Ad in Popular Mechanics will be seen by more than 5,000,000 active buyers for your products and services. It costs only \$1.85 per word. And, if you wish to run all or part of your ad in capital letters—you can do so for as little as 75¢ per word additional. Act now! Place your Classified ad in Popular Mechanics today.

RCD The Professional USED CAR GUIDE lists current monthly average RETAIL VALUES on American cars—foreign—light trucks 1964-1970. SAVE when buying or selling. Send \$2.00, RESEARCHED CAR DATA, Dept. P, P.O. Box 27385, Richmond, Virginia 23261.

AUTO SUPPLIES AND EQUIPMENT

SAVE Money. Tune-up your own car. Anyone can by following easy step-by-step instructions. \$2.00 Each for all American cars. State make, year, engine size. Washington residents add 10¢ tax. Vanus, Box 7503 Bitter Lake, Seattle, Washington 98133.

PARTS: Army Jeep and truck parts. Spare Parts & Equipment Co., P.O. Box 751, Lexington, Ky. 40502.

"CROSLY (¾ Midget) auto parts, accessories. Service, 616 Burnside, Inwood, L. I., N. Y. 11696."

BURNING OIL?? . . . Smoking?? . . . Pepless?? . . . Hard Starting?? . . . Save with Ring-Valve Job while driving \$6.50. (Special: Two for \$12.00 postpaid.) Results guaranteed!! Motaloy, Grantham, Penna. 17027.

PREVENT Flat Tires! Stop slow leaks! Seal punctures! Fantastic, New Liquid Product! Free information! Xcito Products, Dept. TG-8, 5715 North Mozart, Chicago, Illinois 60645.

DWELLMETER/TACHOMETER. Plug-In Adapter For Your Voltmeter. Guaranteed Accuracy. \$5.95. Free Literature. Auto-Data, P.O. Box 9253, Stanford, California 94305.

BE YOUR Own Ignition Expert. Install Ignit. Q-Arc, Box 47876, Los Angeles, California 90047.

SERVICE STATIONS Write for SPECIAL FREE Price List Containing Spark Plugs, Contact Sets, Tire Valves, Bulbs, Flashers, Thermostats, Coils, Caps, Rotors, UNIVERSAL BERNAL, 117-18A Rockaway Boulevard, Ozone Park, New York 11420.

EASIER STARTS. Improved combustion, mileage. Chrysler-built cars. Instructions \$1.00. M. LaRock, 167 Davis Avenue, Bellevue, Pa. 15202.

AUTO Parts for older models and antiques. All makes. Catalogue \$1.10. Antiques Auto Parts, Milwaukee, Wis. 53204.

ELIMINATE Overheating, install Radiator Surge Tank. Complete kit \$4.75 (postpaid). Free information. Gilbert Products, Box 2102, Milwaukee, Wisconsin 53201.

JEOP Owners—V8 conversions. Read Jeep Owners' ad, page 176.

SNOWMOBILES

SNOWMOBILE Hop up accessory CATALOG. Speed and performance equipment—manifolds, exhaust systems. Send 25¢. G.E.M. PRODUCTS, Box 845, Carol Stream, Ill. 60187.

SNOWMOBILE Kits \$25. Plans and photos \$1.00. Information 10¢. Compco, Box 1267, Redwood City, Calif. 94064.

AUTO TRAILERS

CAMPER Plans and full sized patterns. The most detailed available with written and pictorial instructions. Various models and accessory kits offered. Send for literature—Glen L. 9152—PMB—Rosecrans, Bellflower, California 90706.

PICKUP Camper. Trailer or Pickup—Cover . . . Build yourself. Save! Complete plans \$3.95 each Cover plans \$2.00. Conversion Plans—econoline type van \$2.95; passenger bus or delivery van \$2.95. Satisfaction Guaranteed. Equipment catalog \$1.00 (refundable). Details 10¢. Viking Camper Supply, 99-F Glenwood, Minneapolis, Minn. 55403.

BUILD Your Pickup Camper. Precut kits, blueprints and supplies. Literature 25¢. Comstock Camper and Trailer Supply, Dept. 664, Parsons, Kansas 67357.

MOTORCYCLES, BICYCLES, MOTORSCOOTERS AND SUPPLIES

MINI-BIKES. Snowmobiles. Chain Saws. Wholesale. Catalogs 25¢. Loren Products, Danville, Illinois 61832.

MINIBIKES, KARTS. Parts, engines, wheels, clutches, transmissions, etc. Wholesale bikes from \$69.50. Free catalog. Rockey, Galveston, Indiana 46932.

BUILD "Popular Mechanics" MINIBIKE featured June 1967 issue. Detail plans, photographs \$2.50 refundable. Kits, parts, engines; factory discount prices. Catalog 25¢. Gilliom Mfg.; PMC; St. Charles, Missouri 63301.

BARGAIN Prices. Every part, Kart or Mini-bike. Giant Catalog \$1.00. New, "how to" plans \$1.00. Both, \$2.00. Brown's Motorsports, 19P Central St., Worcester, Mass. 01608.

ILLUSTRATED Catalog 25¢. Parts, Accessories. Custom Stock, most makes, models, Cycle Supply, Box 192M, Fairbury, Ill. 61739.

MOTORCYCLE Turn Signals, Accessories Catalog 35¢. Houston PM Lockport, Illinois 60441.

INDIAN PARTS. Rebuilding. Accessories. Indian Motorcycle Sales, Kansas City, Missouri 64127.

FABULOUS All electric mini-bike. Noiseless. No gas required. Operates for pennies a day. Easily built from complete construction plans and booklet. All parts available locally. Send \$4.25 postpaid. Lectra-Bike, P.O. Box 82 PM, Washington, New Jersey 07882.

HONDA \$25.00. Other Bargains. Send 50¢. Motorscooter, P443, Bend, Oregon 97701.

METRIC Tool Information taps dies 25¢ refundable with order. MediaMetric, Box 461B, Media, Penna. 19063.

SPACE, ROCKETS AND ASTRONAUTS

HISTORIC Apollo Moon Slides, 10/\$3.00. 45 Huxley, Newport News, Virginia 23606.

LIQUID Rocket, 10,000' Altitudes! Plans, \$2.98. Catalog, 25¢. Star Space Systems, PM3, P.O. Box 4605, Vancouver 10, B.C.

ROCKETS: Real flying models—flights up to 2500 ft. New illustrated catalog 25¢; Singles and multistage kit, cones, engines, launchers, trackers, rocket aerial cameras, technical information. Fast service. Estes Industries, Dept. 7-B, Penrose 7, Colorado 81240.

ROCKETS!! Real flying models—2500 feet altitude with powerful motors. Terrific Science Projects. Tubes—Cones—Parachutes—Launchers—Igniters. Gigantic catalog—rocket data—diagrams—25¢. Fast Delivery. Centuri Rockets, Box 1988, Phoenix, Arizona 85001.

MOON Landing Pictures! Other historic unusuals! Free brochure! Box 234-PM, Merritt Island, Florida 32952.



AVIATION

AIRBOAT, Propellers, Plans, Kits, Supplies. 90, 125, 150 & 220 H.P. engines. Corvair, V-W, Conversions, Catalog \$1.00. Banks-Maxwell, Box 3301E, Ft. Worth, Texas 76105.

(Continued on next page)

AVIATION

(Continued from preceding page)

BE A Government licensed aviation mechanic. Practical training. Free information. Aero Mechanics School, Municipal Airport, Kansas City, Missouri 64116.

AVIATION Surplus Big Catalogue 50¢ (Refundable). Box 1TFPM, Spring Grove, Penna. 17362.

HELICOPTER, One-Man, Portable, Bubble canopy, Kits, Plans Information 10¢. Photos and three-view drawings \$1.00 COMPCOP, Box 1267PM, Redwood City, California 94064.

AERO-CAR. Amazing Hovercraft built easily with ordinary tools. Lawnmower engine power. Carries one man plus. Hovers, flies forward, backward, sideways over land/snow/water. Complete construction plans and brochure. \$5.25. Aero-Projects, Box 5118PM, Clinton, New Jersey 08809.

BUILD—One-Man jet helicopter. Easy inexpensive. Detailed plans, drawings—\$5.00. Helicraft, Box 7153, Baltimore, Maryland 21218.

TWIN engine Hovercraft. Three Passengers. 50 MPH over land, water, snow. Plans \$10.00. 3V Drawing \$1.00. Airboat, gyroplane, small hovercraft plans, \$5.00 each. Catalog \$2.00 listing supplies, engines, propellers, plans. Esco-M, Box 3379, Sarasota, Florida 33578.



BOATS AND TRAILERS

FIBERGLASS Canoes, Kayaks, and Duckboats. Many exciting models. Easily assembled kits. \$39.95 up. Free Literature. Riverside Canoes, Box 5595P, Riverside, Calif. 92507.

BOAT Kits. Molded Fiberglass. Save money—assemble yourself. Factory molded sections bond into one-piece craft. 20 models—14' to 32'. Cruisers, Runabouts, Houseboats, Sailboats. Big line accessories, motors, trailers. Easy terms. Free 80 page catalog. Luger, Dept. BC-71, 1300 East Cliff Road, Burnsville, Minnesota 55378.

PLANS, FULL-SIZE PATTERNS. FRAME KITS with step-by-step instructions specially for amateurs. Send \$1.00 for new catalog just off press—nearly 100 pages, over 80 designs 8' to 36': Sail, Jets, Inboards, Outboards, Cruisers, Houseboats, Hot Boats, Catamarans, Hydros. Glen Designs. 9152 Rosecrans, Bellflower, Calif. 90706.

BUILD Your own boat from our large-scale blueprints. Books of plans give how-to-build help. Hundreds of professional designs—motor, sail or auxiliary—for amateur builders. Free catalog. MoToR Boat-ing, 959 Eighth Ave., Dept. PM-RS, New York, N.Y. 10019.

BOAT PLANS, FRAME KITS, BOAT KITS. World's largest catalog—Over 200 top design for the amateur builders. New catalog includes Cruisers, Runabouts, Deep vee's, Catamarans, Trimarans, Houseboats, Sailboats from small sail fish to 34 ft. motor sailers, large selection of inboard and outboard Hydroplanes. Send \$1.00 for large new plan & kit catalog or \$2.00 for catalog plus Boat Builder's Guide. Clark Craft Boat Company, 16-P Aqua Lane, Tonawanda, New York 14150.

FIBERGLASS Cloth and resin. World's finest cloth and non-run resin, at direct mill prices Flotation foam. Complete line of plastics, silicon bronze and brass screws, save 60%. No sales tax. Boat Plans. Catalog 25¢. Freight prepaid. Stiles Boat Supply, Box 11P, Linden Ave., Mantua Hts., N.J. 08051.

NEW Outboards 1970 & 1969 McCulloch & others. 4 H.P. \$120, 9 Electric \$295. 18 " " \$368, 60 Electric \$848, all sizes. Literature 50¢. Electric Marine, 1427 Broadway, Brooklyn, New York 11221.

CANOES! Kayaks! Factory-direct quality kits, from \$25.00. Many different models. Canvas hulls. Strongest construction materials. Free literature. Sportscraft, Box 8280, Columbus, Ohio 43201.

BOAT Plans, Patterns, Kits, Catalogs: Sailboat, 50¢, Powerboat (3) \$2.00, condensed, \$1.25. Marinecraft, Box 161-M, Brighton, Mass. 02135.

AMATEUR Boat Building Magazine. Plans, Discounts, books, instructions. 3183 Merrill, Royal Oak, Michigan 48072.

CAMPER AND TRAILERS —KITS—PLANS—

CAMPER & Trailer Kits—Assemble yourself, save 1/2 over factory built. 12 models: Pickup Truck Campers, Pickup Covers, Travel Trailers, Folding Tent Trailers. Big line of accessories. Easy terms, money-back guarantee. Free 24 page color catalog. Luger, Dept. TW-71, 1300 East Cliff Road, Burnsville, Minnesota 55378.

PLANS—Pick-Up Campers \$3.95; Pick-Up Covers \$2.00; Travel Trailers \$3.95; Van-Ette Conversions \$3.95; Bus Conversions \$2.95; Huge Supplies, Parts and Equipment Catalog at Discount Prices \$1.00 (Refundable). Order Plans, Discount Supply Catalog From this advertisement. Camper, Cover, Trailer Kits available—literature 25¢. CAMPERS, Box 377-C1, Savage, Minnesota 55378.

MARINE EQUIPMENT AND SERVICES

MARINE Engines, conversions, parts. Catalog free. Charles F. Stokes Enterprises, Coldwater, Michigan 49036.

CONVERT Auto engines to marine. 68 Page Catalog, 50¢. Lehman Manufacturing Company, 800 Elizabeth Avenue, Linden 4, New Jersey 07036.

ALUMINUM Masts, booms, for sailboats 8'-50'. Catalogue available. Zephyr Products, Wareham, Mass. 02571.

ATHLETIC AND BODY BUILDING COURSES

POWERFUL Muscles fast! Free brochure! Universal Bodybuilding, Box 4327-C, Dearborn, Michigan 48126.

"GIANT Arms." Dr. Young's, D.C. revolutionary discovery. \$2. Satisfaction or refund. Gaucho, 1769-S7, Chicago 60690.

SPORTING GOODS AND EQUIPMENT

FREE . . . Wholesale Catalog. Arrow Shafts, Broadheads, Fletchings Fisharrow Parts, Tools, Bows, FinnySports. (22G), Toledo, Ohio 43614.

ARCHERY Lowest Discount Prices. All top brands. Orders shipped same day received. Money-back guarantee. World's Largest Supplier. Free catalog. Anderson Archery Corporation, Grand Ledge, Michigan 48837.

FREE 1971 Catalog. Guaranteed Lowest Prices! Rods Reels, Lures, Accessories—Thousands of Item. Cabela's Inc., Dept. S. Sidney, Nebraska 69162.

FREE Catalog low direct factory prices, fishing, Hunting, Archery, reloading Camping supplies. Send today Harters Inc., Dept. CPM. Waseca, Minn. 56093.

DERRINGER 44 Caliber. Make Yourself! Easy, complete, pre-machined kit, with instructions \$10.50. Complete instructions only \$2.00. Fernwood, 1725 Springbrook, Walnut Creek, California 94596.

UNDERWATER SAUCER: Sea Sled: you submerge, maneuver, surface at will. Detailed plans, photograph, decal. \$1.00. Michigan Water Specialties, Inc. 249 Albany; Ferndale, Michigan 48220.

FREE Shotgun bag, send 50¢ postage, handling. Spencar, Box 51181, Tulsa, Okla. 74151.

CROSSBOWS Pistols \$7.95. Catalog 25¢. Crossbowman, Box 723-PM, Manteca, California 95336.

BILLIARD CUES & Accessories Details Free. Mike Murphy Cues, Box 5352, Santa Monica, California 90406.



FISHING, TACKLE, LURES

MOLDS For fisherman's sinkers, jigs, squids, casting and spinning lures. Free catalog. Sweet Molds, Tonawanda 1, New York 14150.

SEND For FREE Wholesale Catalog. The most complete and fully illustrated catalog of reels, rods, beads, spinners, jigs, bodies and parts, sinker molds, feathers, tools, hooks, rod blanks, rod parts, swivels, wire, etc. FINNYSPTS, ME Sports Bldg., Toledo, Ohio 43614.

MOLDS—For casting your own fishing sinkers. Free illustrated booklet. Reading Instrument Co., Box P78, Reading, Pa. 19603.

LETHAL Hook method for catching fish. Deadly accurate. Send two dollars for information. CATCH, Box 936, Rock Island, Illinois 61201.

FISHERMAN'S DREAM BOOK—FREE, 170 Pages, pocket size and loaded with Hard To Find Fishing Specialties and Do-it-Yourself Goodies. Our 27th year. NETCRAFT, Inc., Box 5510, Toledo, Ohio 43613.

FISHERMEN WANTED AT ONCE. Field test and sell patented BIG BASS LURE. Combine Pleasure with Profit. Sample lure and starter kit \$7.50. Sherman Bryant Lures, Lewisport, Ky. 42351.

EARTHWORMS, LIVE BAIT

EARN Money raising fishworms for us! Exciting details free! Oakhaven—56. Cedar Hill, Texas 75104.

HYBRID Redworms 5000 \$10.00. 20,000 \$20.00 Postpaid with Raising Instructions, Worms, Route 9, Waco, Texas 76705.

FROGS, FISH, REPTILES

MAILORDER Records help get increased business! Complete 32 Page Record Book shows your inquiries orders, advertising, expense, etc. Only \$1.00. C. A. Martin, Popular Mechanics, Dept. PM, 224 West 57 Street, New York, N.Y. 10019.



HUNTING, GUNS, DECOYS

HUNTERS—Free 34 Page Wingshooter's Handbook—The most widely circulated shotgun book in the world—Get the experts advice on pointing, lead; chapters on ballistics. Write Poly Choke, 239 Tunxis St., Hartford, Conn. 06101.



POULTRY & GAME BIRDS

QUAILS, Incubators, cages, supplies catalog. Marsh, 14216 Brookhurst, Garden Grove, Calif. 92643.

GOSLINGS, Ducklings, Guineas, Gamebirds galore! Sunny Creek, Red Lake Falls, Minnesota 56750.

RABBITS—FUR BEARING ANIMALS

RAISE Rabbits successfully by knowing facts. 48 page illustrated book describing 25 breeds. Housing, breeding, feeding, markets, marketing etc. 25 cents. American Rabbit Association, 36 Arba Building, Pittsburgh, Penn. 15217.

INFORMATION 25¢/Raise for Staloch's Rabbitry, Box 6302, Rochester, Minn. 55901.

AMAZING PROFITS! \$10,000 Yearly Raising Rabbits for Wool and Breeding. Details 25¢ coin. American Angora, Malta 12, Montana 59538.

RAISE Rabbits for us on \$500 month plans. Free details. White's Rabbitry, Mt. Vernon, Ohio 43050.

(Continued on next page)

RABBITS—FUR BEARING ANIMALS

(Continued from preceding page)

MAKE Big Money raising chinchillas, rabbits, guinea pigs for us. Catalog 25¢. Keeney Brothers Farms, Inc., New Freedom, Pa. 17349 or Summerfield, Fla. 32691.

\$500-\$800 MONTHLY Raise small Laboratory-breeding stock for us. We supply equipment, breeders, and instructions. Illinois Research Farms, Dept. MPB-2, Barrington, Illinois 60010.

PETS—BIRDS, CATS, HAMSTERS, ETC.

FLYING Squirrels, Grey, Fox Squirrels, Chipmunks. Send 25¢ For Brochure, Pictures. Prices. Pets, Neches, Texas 75779.

LIVE Seahorses, marine specimens, aquarium supplies. Illustrated catalog 25¢. Marine, Box 248-010, Dania, Florida 33004.

HAWKS, Reptiles, raccoons, skunks, squirrels. Catalogue 25¢. Trails End Zoo, St. Stephens, S.C. 29479.

SEAHORSES, Animals, Aquariums and Pet Supplies. Catalog 25¢, Aqualand Box 130, Miami, Fla. 33145.

BIRD Feeders. Unique. Attractive. Descriptive Literature. Logan Valley Sales, 116 River Road, Pender, Nebraska 68047.

HORSES, LIVESTOCK

"HOW To Train Horses"—Everyone who likes horses or ponies should have this book: Free. Write Beery School, 1102 Pleasant Hill, Ohio 45359.

CAMPING EQUIPMENT AND TENTS

FREE Catalog! Camping, Boating, Sailing Supplies; Gadgets. Hardware and Gifts, Laacke and Joys, 1439 N. Water St., Milwaukee, Wisconsin 53202.

PROFITS FROM CLASSIFIED ADVERTISING! Booklet shows you how to start your own business with Classified Advertising. Only \$1.00 (Refundable with first order.) C. A. Martin, Popular Mechanics, Dept. PM, 224 West 57 Street, New York, N.Y. 10019.

TRAVEL AND RESORTS

MAILORDER Records help get increased business! Complete 32 Page Record Book shows your inquiries orders, advertising, expense, etc. Only \$1.00. C. A. Martin, Popular Mechanics, Dept. PM, 224 West 57 Street, New York, N.Y. 10019.

CANOE Trips—Canadian Outpost Cabins. Rom's Outfitters, Ely, Minnesota 55731.

ELECTRICAL SUPPLIES

LAMP Parts. Catalog, prices, wiring instructions. 50¢. Refunded first order. Gyro, 5218P N.W. 35 Ave., Miami 42, Florida 33142.

METERS—Surplus, new, used, panel and portable. Send for list. Hanchett, Box 5577, Riverside, Calif. 92507.

LAMP Parts for building, repairing converting. Catalog 40 cents. Refunded first order. Brown Lamp Co., Box 12511, Creve Coeur, Missouri 63141.

"APPLIANCE SERVICE Shop equipment catalog, free. Jacknan Electric, Hattertown Road, Newtown, Conn. 06470."

BATTERIES, GENERATORS

BATTERY Reconditioning Kit. Includes molds, material, instructions. Battery Shop, Route 1-188D, Blythe, Calif. 92225.

ELECTRIC Generator sets, 5-KW to 60-KW, gasoline and diesel. K. A. Weimer, 1300 Richard Road, Decatur, Georgia 30032.

COMPLETE Hydraulic Jack Repairing manual \$3.00. Satisfaction guaranteed. Bayerco, 938-AG Betty Avenue, Neenah, Wisconsin 54956.

ENGINES, MOTORS, MAGNETS

WINDING Data, 275 motors. \$1.20. Data Company, 512 Kensington, Kansas City, Mo. 64124.

SIMPLIFIED INSTRUCTIONS! Motors! Generators! Batteries! Electroplaters! Modequip, Box 7266, Kansas City, Missouri 64113.

MACHINERY, TOOLS AND SUPPLIES

MICROMETERS — Indicators — Steel — Aluminum — Brass Maximat, Unimat Lathes, Accessories. Lists free: Complete mailing—50¢. Campbell, 1424 Barclay, Springfield, Ohio 45505.

POWER-HONE To sharpen fishhooks, knives, model making and tool & die making. Vercon Supply, Box 316, Brockport, N.Y. 14420.

SMALL Foundry furnaces, Supplies. Free literature. Pyramid Products, 3736 South 7th Avenue, Phoenix, Arizona 85041.

BUILD Your Own Tool Post Grinder. Casting With Blueprint \$9.95. Specifications Free. General Devices Inc., 861 West 66th Street, Hialeah, Florida 33012.

ROUTER Bits, 1/4" shank, high speed, used; excellent condition. \$2.50 dozen postpaid. Lillian's, Box 17165, Chicago, Illinois 60617.

LATHE Milling attachments. Blueprints too! Write. Potter, Box 73, Cedar Rapids, Iowa 52406.

WOODWORKERS. New two wing hardened production shaper cutters. 3-1/4 inch diameter x 1/2" to 3/4" bore x 3/4" straight cutting edge. \$3.75 each. Check or money order. Postage paid. For complete industrial woodworking catalog send \$2.00 for postage and handling. Woodworkers Tool Works, 222 South Jefferson, Chicago, Illinois 60606.

PORTABLE Sandblaster \$21.00 (Air-Compressor Required). Free Brochure. Inka Industries, 2621-A Persa, Houston, Texas 77006.

WELDING, SOLDERING, PLATING

WELDERS—110/220, 150 Amperes. \$53.50. Morris, 1070 Inner, Schenectady, New York 12303.

PLATING Equipment, supplies and "know-how". Build your own tanks for nickel, chrome, etc. Easy-to-install PVC liners. Rectifier components—all sizes. Schematics, parts lists, formulas, operating instructions for all plating. \$5.00 postpaid. Guaranteed to save you 25%-75% or immediate refund. Platers Service Company, 1511-A Esperanza, Los Angeles, California 90023.

GOVERNMENT SURPLUS

GOVERNMENT SURPLUS—How and Where to buy in your area. Send \$1.00. Surplus Information, Headquarters Building, Box 8225-PM, Washington, D. C. 20024.

SURPLUS BARGAINS—War, government, industrial surplus at savings to 80%! Clothes, boots, cots, tents—bargains for farm, home, outdoors. SEND FOR FREE CATALOG—must give zip code. SURPLUS STORE, Sioux Falls, S. D. 57102.

GENUINE Surplus Arctic Clothing and Equipment Special Field Gear, Survival Equipment. Catalog 10¢. Arctic Outfitting Company, Box 8138, Anchorage, Alaska 99504.

1971 SURPLUS Army, Navy store illustrated catalog. Send 50¢ (refundable with first \$5.00 order). Ruvel, 3037 North Clark, Dept. 2-J, Chicago, Illinois 60614.

JEEP And Gov't. Surplus Buying Manual (Jeeps Pictured) 50¢. Surplus Bargain Catalogue 50¢. Both \$1. Surplus Bargains, Box 789PM, York, Penna. 17405.

JEeps Typically From \$53.90 . . . Trucks From \$78.40 . . . Airplanes, Typewriters, Boats, Clothing, Camping, Sporting, Photographic, Electronics Equipment, Wide Variety, Condition, 100,000 Bid Bargains Direct From Government Nationwide. Complete Sales Directory and Surplus Categories Catalog \$1.00 (Deductible First \$10.00 Order From Our Separate Included Catalog). Surplus Service, Box 820-A, Holland, Michigan 49423.

NO CATCHES. Buy any surplus direct from U.S. gov't. All information \$2.00. Bridgeworth, P.O. Box 2292-C, Vancouver, Washington 98661.

GOVERNMENT Lands . . . Low as \$1.00 Acre! Millions Acres! For exclusive "Government Land Buyer's Guide" . . . plus "Land Opportunity Review" listing lands available throughout U.S., send \$1.00. Satisfaction Guaranteed! Surplus Lands, Box 19107-AN, Washington, D.C. 20036.

CAMERAS, Typewriters, Sporting Goods, Tools, Jeeps, Trucks, Etc. Tremendous Assortment. Up To 80% Savings. Booklet Explains Surplus Buying Procedures—\$1.00. Smithco, Box 292-B, Syracuse, New York 13201.

HOBBIES AND COLLECTIONS

FREE: German Medal; send 50¢ postage, get illustrated catalog; Iron Cross, \$1.50; 3 Regimental Crests, 50¢. Insignias, Box 71-P, Rockaway, New York 11694.

FORMOSAN Butterflies. 200 DIFFERENT varieties. Complete listing plus 3 samples \$1.00. Allen Imports, Box 5551, Long Beach, Calif. 90805.



STAMP COLLECTING

SEND Only 10¢ for nice collection of U. S. stamps including "\$5.00." Issue and scarce mint Sipex Souvenir Sheet. You will also receive the most wonderful catalog of stamp offers in America. Littleton Stamps, Dept. SS1, Littleton, N. H. 03561.

SEND Only 5¢ for Worldwide Collection of over 50 different Singapore, Grenada, Chad, etc. Contains old and new issues, sports, animals, etc. You will also receive interesting lists and a certificate worth 50¢ toward purchases. Goliath Co., Dept. TP-1, Bethlehem, N. H. 03574.

JAPAN 25 different 10¢ Approvals. Hijop, Box 505, Norristown, Pa. 19404.

FREE — Mint British Colonials from Sabah, Seychelles, Tristan Cunha, Sarawak, Negri Sembilan, Caymans, South Georgia. Free with approvals. Viking, Great Neck, N. Y.

HITLER—Infamous Commemorative Set 10¢. Approvals. Iannuzzi, Box 76241-C, Los Angeles 90005.

PAINTING—Souvenir Sheet, 10¢ with approvals. Bragg, 110 Lynnhaven Drive, Hampton, Virginia 23366.

1000 WORLDWIDE Stamps \$1.00. Approvals. White, Box 26265-FA, Indianapolis, Indiana 46226.

5,000 DIFFERENT \$1.00. P. Destounis, 160 Trenton # A, Montreal 304, Quebec.

STAMPS Free! New issues—New Countries — Triangles — Rockets — Olympics — Scouts — Birds — Flowers — Animals — Also old Canadian and U.S. Stamps. Plus complete illustrated Canadian Stamp Catalog. Send 10¢ for mailing. Gray Stamp Co., Dept. A, Toronto, Canada.

U. N. 10 DIFFERENT Mint 25¢. Approvals. Gordon Davison, Henniker, New Hamp. 03242.

DOUGLAS MAC ARTHUR Memorial stamp on lovely first day cover addressed in your name. 35¢ each, 3 for \$1. K. M. Walsh, Box 308D, TUCKAHOE, N. Y. 10707.

200 DIFFERENT With approvals. Polze, Box 5215, Milwaukee, Wisconsin 53204.

(Continued on next page)

STAMP COLLECTING

(Continued from preceding page)

1500 FOREIGN \$1.00; 5000 \$3.00; 9000 \$5.00. 5000 USA. contains airm. dues, presidentials, revenues, 19th Century, high values, etc. \$3.00. 300 pre-1940 USA commemoratives \$2.00. 200 pre-1926 USA \$1.00; 700 \$3.00; 3000 ~12.00 No approvals. Meyers, 5321 Fleming, Richmond, Calif. 94804.

VATICAN Xmas Set (1967) 50¢. Approvals. Barricks, Box 7154, Detroit, Mich. 48202.

U.S. MINT Specials! Flag set, complete \$1.00. 1¢, 2¢, 3¢ famous Americans (21 different) \$1.00. Free list. Brooks, 2601 Avenue "U," Brooklyn, N.Y. 11229.

100 DIFFERENT British Empire 10¢. Approvals. Gibson, Box 34, Lansdowne, Pa. 19050.

"AFRICA." 25 Beauties, 10¢. Approvals. Gorliz, Box 1915PM, Naples, Florida 33940.

FREE 50 Worldwide. Approvals. University Stamps, P.O. Box 1471, Lake Worth, Florida 33460.

ONE CENT A Stamp. Write for a jumbo book of Foreign stamps at 1¢ each, mounted in Scott order, PP. Bullock, 6815 Bay Parkway, Bklyn., N.Y. 11204.

PENNY! Approvals! Regardless catalogue! Kloster, 4164 52nd St., San Diego 5, Calif. 92105.

50 YEARS Old, fifteen different United States, over fifty years old—10¢ with approvals. Jaxon, Box 145-P, Brooklyn, New York 11230.

FREE! Big Bargain Catalog—New Edition listing thousands of bargains including U.S. & B.N.A. stamps, packets, albums, accessories and supplies. Also, fine stamps from our approval service which you may return without purchases and cancel service at any time. Jamestown Stamp, Dept. E-21PM, Jamestown, N.Y. 14701.

WOW! 110 All Different Germany 10¢. Commemoratives, Airmails, High Values. Big catalog, bargain lists. Also, fine stamps from our approval service, which you may return without purchases and cancel service at any time. Jamestown Stamp, Dept. A-21PM, Jamestown, N.Y. 14701.

UNITED STATES Commemorative collection containing 33 different—10¢. Approvals. White, 516-A Avenue L, Brooklyn 30, New York.

U.S. BARGAIN, 50 Different 10¢, with beautiful worldwide, approvals. Stamp Center, Kennebunk, Maine 04043.

"INVERTED ERROR" Dag Hammarskjold, 6¢ with approvals. Belmont Stamps, Washington, D.C. 20015.

50 DIFFERENT Old U.S. Revenue stamps 50¢. Winchester Stamps, Box 1592, Mansfield, Ohio 44907.

FREE Surprise collection sent with approvals. Gould, 1784 Union, San Francisco 94123.

APPROVALS: Plus collections by year. Martus, Box 158, Centuck, Yonkers, New York 10710.

PENNY Stamps! 1000 Mounted in book at 1¢ each! Trast Stamp Company, P.O. Box 100-P, Jamaica, New York 11435.

ABSOLUTELY Free United States Mint Souvenir Sheet When Requesting United States Approvals, K&B, Box 70, Brooklyn, N.Y. 11223.

100 DIFFERENT United States, only 25¢ with Approvals. Shelton, Box 547C, North Miami, Florida 33161.

100 OLD United States between 1861 and 1935. \$1.00. Roush Stamps, 423 Shepard, Mansfield, Ohio 44907.

225 STAMPS For only 10¢! Airmails, Pictorials: stamps from strange countries cataloging up to 25¢ each! Plus unusual stamps to examine. Buy any or none return balance, cancel service anytime. Mystic Stamp Co., Camden 80, New York 13316.

QUALITY AND LOW PRICE. EXCELLENT For advanced or beginner. Mounted approvals 2¢ up, all countries in Scott's Order. Preview Stamps, P.O. Box 9809M, San Diego, California 92109.

500 DIFFERENT Stamps, \$1.00. Smith 508-A Brooks, College Station, Texas 77840.

RUSSIA High-Value Collection. 32 different Russia—some over 50 years old! Commemoratives, Czarist Issues, Airmails, Catalog price \$2.50. Special Get Acquainted Offer—all for only 10¢! H. E. Harris, Dept. GG 49, Boston, Mass. 02117.

NEW Issues—Free Weekly Illustrated list. Brooks, 2601N Avenue "U," Brooklyn, N.Y. 11229.

210 DIFFERENT U.S. Commemoratives \$1.00. Stamps, 7607 Larchview, Dallas, Texas 75240.

RUSSIAN Space collection 10¢. Russian Approvals, Snedco, Box 68-P, Waldwick, N.J. 07463.

14,000 DIFFERENT! AMAZING New plan builds your collection systematically, country by country. Only 50¢ weekly. Ware. Monroe, Conn. 06468.

"WHOLESALE" U.S.—Foreign Pricelist and catalog Free! Everything Guaranteed. Schneider, Box 1240, Grand Rapids, Michigan 49501.

FREE 149 Flag Stamps with approvals. W-B Stamp Company, Wilkes-Barre, Penna. 18703.

PICK From thousands—2¢ and up. Stamp-A-Nanza, 1904 Broad, Schenectady, N.Y. 12306.

100 CANADA 25¢. Excellent value. Approvals. Continental, Limehouse, Ontario, Canada.

50¢ FOR 10¢! SEND Us a dime and take choice of first 50¢ from our approvals. Modern Stamps, Dept 57W, Ferrysburg, Michigan 49409.

TEN Different Nudes: 20¢. Approvals. Stamp Farm, 2M27, Oxford, Wis. 53952.

ASIA—100 Different, including pictorials, 10¢. Approvals. Tarheel Philatelics, Siler City, North Carolina 27344.

MILLIONS Foreign Stamps! 2¢ each! Send for gigantic approvals! ABC, Box 6000-MB, San Francisco, California 94101.

AMERICANS On foreign stamps, Presidents, Kennedy, Roosevelt, Lincoln, U.S. Spacemen, Princess Grace and others 10¢ with approvals. Roseland Stamps, Dept. 57, Spring Lake, Michigan 49456.

704 U.S.A. (PLENTY COMMEMORATIVES) —35¢. Approvals. Horace Gatewood, Winston-Salem, N.C. 27102.

YOURS FREE! 20 Almost Rare Stamps from 12 Lost Nations—Most a Half-Century Old! Nations overrun by invaders and never freed again. Stamps so appealing that experienced and beginning collectors alike will want them. You get 110 other stamps from Britain's Lost Empire plus illustrated Album to keep as a Bonus should you buy \$1 from our Approval Selection. Or return Album and 110 stamps with selection and buy nothing. Cancel Service anytime. But Lost Nations stamps are yours to keep! Send 10¢ for mailing while supplies last. Kenmore, Milford LN-676, New Hampshire 03055.

FREE!! 25 U.S. Commemoratives, 2" Diameter Magnifier. Postage—10¢. Approvals. Mixdrak, 5630 Wilson, Chicago 60630.

FANTASTIC!! Unbelievable!! Gigantic Surprise Stamp Collection—10¢. Approvals. Hurry!! Box 4155M, Tulsa 74104.

SENSATIONAL Clearance. Forty Different Packets \$1.00. No Approvals. Norge Company, Wyckoff, New Jersey 07481.

MAGIC Stamp Release. Removes stamps without harm, easily. 500 stamp supply \$1.25. Guaranteed. Daufeldt PM-2, Atalissa, Iowa 52720.

FREE Stamp Wallet with approvals. Wide choice collections by Countries. Clark, Box 428, Northbrook, Illinois 60062.

SEND \$1.00: Receive 2—\$5.00 stamps used #834 Coolidge + #1053 Hamilton. Free pricelist. Giant Stamp Store, 122 Brighton 11 Street, Brooklyn, New York 11235.

JOIN The World Mail Club and receive mail from around the World. Only \$2.00, or send for free details. Alfred Fahsing, Atascadero, Calif. 93422.

VIETNAM 25 Different 10¢ approval. Sam Chazen, Box 95, Ozone Park, N.Y. 11417.

50 DIFFERENT Latin America 10¢ with approvals. Quynn's, Scotland, Penna. 17254.

50 DIFFERENT U. S. Commemoratives, 15¢. Approvals. Cambridge, Box 2311, Heath, Ohio 43055.

500 STAMPS 25¢. Approvals. Eric's, Box 1444, Kitchener, Ont., Canada.

25 U.S. FREE With Approvals. Collier, Box 755, Folkston, Georgia 31537.

AUSTRALIA—Fifty Different 10¢! With Approvals. Value Stamp, Tenbrooke, Silver Spring, Maryland 20901.

COLORFUL Pictorial Collection—Birds, Flowers, Animals, Paintings, Rockets, 10¢. Approvals. Dealing, Box 185, Long Lake, Minnesota 55356.

FREE Mammoth Collection, Scott's International Master Global Albums when you buy Approvals. Bargain Service, Box 506, LaPuente, Calif. 91747.

100 DIFFERENT Italy—10¢. Approvals. Gobestamps, Box 402, Biddeford, Maine 04005.

TOPICAL Treasure: Thousands of huge multi-colored stamps, 2¢ each. Belden, Box 4175B, Dearborn, Michigan 48126.

FREE Mint set. Approvals accompany. Stamps, Box 22092, Memphis, Tenn. 38122.

FREE—\$1.00 Credit when you request beautiful, commemorative, stamp approvals. Fred Donaldson, 9410 Lansford Street, Philadelphia, Penn. 19114.

FREE! 50 Stamps including Dominica, Maldiv Islands, Monaco, Approvals. Moumbow, 1834-R Bassett, Anaheim, California 92805.

APPROVALS, International, up to 90% off. No gimmicks. Dryz, Box A9209, Treasure Island, Florida 33740.

CANADA Outdoor Recreation Set, 40¢ Value, Only 15¢. Approvals. Rheume, 6591 11th Avenue, Montreal, Canada.

"SPACE" Pictorials, others, 110 Different—10¢! Approvals. Shaw, Drawer E-64, Montevallo, Alabama 35115.

PERSIA 25 Different 10¢ Approvals. Lansdowne Stamp Co., Box 257, Lansdowne, Pennsylvania 19050.

25 MALAYSIA, 10¢ With approvals. Campbell, Box 5295-P, Phoenix, Arizona 85010.

"SPACE STAMPS" 25 Different, 10¢ Approvals. Hunt, Box 628, Stony Brook, New York 11790.

500 DIFFERENT World, \$1.00. Packets, sets, singles of Europe, British Commonwealth, U.S. Free Lists! Faville, Box 4164, Madison, Wis. 53711.

CLOSEOUT SALE: Unbelievable low prices. Generous lot \$1.00. High value packet \$2.00. List Free. Persile, 436 N.Y. Ave., Brooklyn, N.Y. 11225.

TWENTY Malta Pictorials 50¢. Penniston, Box 5502, Arlington, Virginia 22205.

307—ALL—Different triangles, sports, topicals, etc. Worth near \$8.00. Only 25¢. Bargain Approvals, Jayto Stamps, East Syracuse, New York 13057.

PACKETS By country on approval. Select only needed stamps at pennies each. Premium plan. Patton, 18636 Benfield, Lake Oswego, Oregon 97034.

(Continued on next page)

STAMP COLLECTING

(Continued from preceding page)

25 SPACE Stamps 10¢! Approvals. Global, Box 427, Livermore, Calif. 94550.

NOW Rockets, Paintings, Giant beauties, others. 10¢. Approvals. Tiquet, Box 1496 Denver, Colorado 80201.

OLDER UNITED STATES Approvals to adults only. Intriguing, worthwhile. Engle, Box 208P, Lowell, Michigan 49331.

FREE Lists, US, UN, Foreign. Discounts. Welles, 35-K Maidenlane, NYC 10038.

FREE Russian to Approval Customers. Stroud, Box 8133, Montgomery, Alabama 36110.

TRADE Seven your duplicates plus \$1.00 for 82 (75 without trade) large Polish pictorials. Happy, Box 700, Commerce, Texas 75428.

GIGANTIC Bicolored "Gorillas"—Rwanda's latest Commemoratives—Free! Approvals plus 101 Bonus Sets. William Deems, 226 Race, Ravenswood, West Virginia 26164.

MALAYSIA, Intriguing mini-collection native states, 10¢. Approvals. Arno, St. David, Arizona 85630.

CANADA Sports Complete 15¢. Canada approvals. Valley Stamps, Little Valley, New York 14755.

FREE! Beautiful Poland Painting Stamp Set. Approvals. Leo Nebesio, 3148 Hollywood, Dearborn, Michigan 48124.

EXCITING World Collection, 200 Different, 25¢ with Approvals. Stamps Unlimited, E. 10112—18th, Spokane, Wash. 99206.

U.S. TIPEX Souvenir Sheet 50¢ With U.S. Approvals. Jester Stamps, Box 425M, Georgetown, Delaware 19947.

U.S.—WORLDWIDE COLONIES—4¢ EACH APPROVALS. FAYE ZOELLER, TROY, MISSOURI 63379.

MYSTERY Conglomeration. Packets, Mixtures, Mint Sheets, Supplies, \$2.00. Norge, Wyckoff, New Jersey 07481.

FREE—Old Set. Approvals. Chapman Stamps, Box 487, Galesburg, Michigan 49053.

RUSSIA—25 Beauties plus Space set. Only 10¢! Approvals. Robert Carlson, Box 16135, Long Beach, California 90806.

WORLDWIDE Packet Free. Penny approvals. Froehlick, Box 7, Waukegan, Illinois 60085.

FAR EAST ASSORTMENT—VIET NAM, JAPAN, KOREA, Formosa and others only 10¢ with world wide approvals. Clark Stamps, Dept. 57V, Muskegon, Michigan 49444.

COINS, TOKENS, CURRENCY

SEND Only 5¢ for valuable booklet "How To Collect Coins" which is loaded with expert advice. You will also receive 5 different foreign coins and your copy of the most unusual and interesting collectors catalog available anywhere. Littleton Coins, Dept. VB-1, Littleton, N.H. 03561.

FIVE Indianheads \$1.50; Free Lists! Coins Wanted! Fairway, 121-K, Rye, New York 10580.

BRILLIANT Proof Sets—1957, 1960, each \$5.98, 1961, 1962, 1963 each \$4.69, 1964 \$6.48, 1968s \$7.89, 1969s \$7.49, 1970s \$9.89. List Other Bargains 15¢. Bebee's Incorp., Omaha, Nebraska 68111.

SILVER DOLLARS UNCIRCULATED, 1880-81-1883-84-85 \$4.00 Ea. Catalogue 50¢. Shultz, Salt Lake City, Utah. 84110.

COMPLETE U.S. List: Cents to Silver Dollars + Supply List + \$1000.00 bank-note 25¢. Schultheis, Box 151-M, New Hyde Park, New York 11040.

"S" LINCOLNS, 1941S Through 1970S \$1.25. Morehead, 208B Houston, Thousand Oaks, Calif. 91360.

BOTTLES Are Valuable! Free Information—Bottle Treasures, 7311 Van Nuys, Van Nuys, California 91405.

JEFFERSON Nickels (Fine) 1938-D, \$1.40; 1938-S, \$3.00; 1939-D, \$5.00; 1939-S, \$1.50. Catalog 25¢. Free With Order. Village Coin Shop, Dept. P, Plaistow, N.H. 03865.

COINS Reduced! Bargain List, 10¢ (Refundable). Economy Sales, Mansfield, Massachusetts 02048.

ROOSEVELT Dime Specials. All Very Good Or Better. 1949S—80¢, 1955—\$1.50, 1955D—65¢, 1955—40¢. All Other Dates Are 25¢ Each. Complete Set Of 55 Different With Album For \$14.50. Satisfaction Guaranteed. Bryson Inc., 612A White, Toledo, Ohio 43605.

BARREL Of Pennies found on ranch! All before 1956 (mostly "S")—includes Indianheads! 50 mixed \$2.00. 22 different "S" Lincolns, including 1955S, \$1.60. 26 different Lincolns 1909-1939, \$1.60. 10 different "S" Jeffersons, \$1.60. All four \$6.50. HARRIS, 2775P Park, Santa Clara, California 95050.

SILVER Dimes: All Different: 30 For \$5.50. Hobby Shop, 179 Mass. Avenue, Arlington, Mass. 02174.

"FREE!": 1918-S Lincoln Cent. Also receive Bargain Price List. Hobbyist's Village, P.O. Box 781, Dept. M2, Lynbrook, New York 11563.

BARGAINS! Rare Coins Pricelist! 25¢ (Refundable) Premiere, Box 7776PM, Spokane, Washington 99208.

25 DIFFERENT Foreign Coins \$1.00. Hoffman, PM-2, Box 98, Clarence, New York 14031.

NICE 1939-S Nickel and Giant List only 50¢ and 6¢ Stamp. Sims, Box 12175P, Richmond, Va. 23241.

100 INDIAN and Lincoln Cents, 1920's and older \$5.00. 40 Mixed Buffalo Nickels \$5.00. 100—1943 Steel Cents \$5.00. Wes Road, West Union, Iowa 52175.

2-S LINCOLN. Your choice 1944S, through 1954S and catalogue 10¢. Rich. Box 34133, San Francisco, California 94134.

SCARCE 1958-d Apostrophe 8 Error Cent Uncirculated 25¢. Bargain Lists Free. Sayers, 1000 Unaka, Johnson City, Tennessee 37601.

20 UNCIRCULATED World Coins \$1.00. Coins, Box 35041, Minneapolis, Minnesota 55435.

LARGE Cent, 2¢ 3¢ Piece, each \$1.98. Free Pricelists. Edel's, Carlyle, Illinois 62231.

2-HEADED Kennedy Half Dollar. Impossible to detect. Genuine. Legal. \$3.95. Lincoln Cent 1970S Two-Headed, \$1.25—10 for \$9.50. Guaranteed. Serendipity, Box 2037P, Santa Cruz, California 95060.

WILL Pay up to \$500 for Joseph Barr dollar bills. 5 lists avail. Serial numbers beginning with B, E, G, J, L. Send 50¢ for ea. list. Elgin, Dept. DPM, P.O. Box 112, Sewell, N.J. 08080.

THREE 1971pds cents, 25¢ postpaid. Sprague, Kineston Drive, Muskego, Wisconsin 53150.

ANTIQUES, RELICS, INDIAN GOODS & CURIOS

LIST Indian relics. 10 Arrowheads \$3.00. Hyde's, Box 2304, Santa Fe, New Mexico 87501.

TONS Of antique gun parts and supplies. All reproduction muzzle loading guns. Send \$1.00 for enlarged illustrated catalog No. 120. Dixie Gun Works, Union City 12, Tennessee.

EVERYBODY LIKES DIXIE GUN WORKS.

10 PERFECT Arrowheads \$4.00. Smith, 9825 Conway Drive, Indianapolis, Indiana 46236.

INDIAN Relic list. Arrowheads \$4.00, doz. Folsom, \$5.00 each. C. Secrist, Muscatine, Iowa 52761.

10 BEAUTIFUL Arrowheads \$2.00. Guajardo's, 8713 Shaver, El Paso, Texas 79925.

REFINISHING And Restoring Antiques, 190 page handbook, \$1.00. Lubar's, 210-P Fifth Ave., New York, N.Y. 10010.

MODELS—CARS, SHIPS, TRAINS, PLANES ETC.

ROCKETS: Real flying models—flights up to 2500 ft. New illustrated catalog 25¢. Single and multistage kits, cones, engines, launchers, trackers, rocket aerial cameras, technical information. Fast service. Estes Industries, Dept. 2-B, Penrose, Colorado 81240.

SHIP Models Kits, fittings, plans, books, tools, engines, motors. Big illustrated catalog 50¢. Mass. residents add 3% tax. James Bliss & Co., Dept. SM, Route 128, Dedham, Mass. 02026.

SHIP And yacht model fittings: Pine construction hull kits: blueprints. Send 50¢ for illustrated catalog. A. J. Fisher, Inc., 1002 Etowah Avenue, Royal Oak, Michigan 48067.

SHIP Models catalog 25¢. Scientific, Inc., 100 Monroe, Newark, N.J. 07105.

SHIP Model kits and fittings; clippers, frigates, etc. Catalog paint-tool list, 1969 catalog 50¢. Models Shipways, Box 65, Bogota, N.J. 07603.

MODEL Airplanes—Big 220 Page Catalog 50¢. Sig Company, Montezuma, Iowa 50171

LIVE Steam Engine Kits. Fascinating Hobby for Model Mechanics. Boilers, Fittings, Accessories. Pictured Catalog \$1.00. H.P.K. Models, Centuck 34, Yonkers, Z New York 10710.

LIVE Steam powered backyard railroads! All sizes. Complete "bolt-together kits," and rough castings. Excellent drawings. 100 page catalog \$1.00. Little Engines, Lomita, California 90717.

GAMES, TOYS, PUZZLES, NOVELTIES

RENO Slot Machine Mechanical Bank. Write. Meredith's, 2475 Dyer, Reno, Nevada 89502.

YOUR Photograph turned into a PUZZLE. \$2.98. Catawaba House, Dept. PM271, 1102 Twelfth Street, North East, Hickory, North Carolina 28601.

MAGIC TRICKS, JOKES, VENTRILOQUISM

HOUDINI'S Greatest Magic!! You can now do them!! Giant Illustrated Catalog 25¢ with Free trick. Vick Lawston, Box 2026-P, Pompano Beach, Florida 33061.

MAGIC MAGAZINE—Monthly since 1936. 44 pages. All phases. 3 month trial \$1.00. Genii, P.O. Box 36068, Los Angeles, Calif. 90036.

COMPLETELY Illustrated catalog, 84 pages, 25¢. Manhattan Magic, Box 334-M, N.Y.C. 10011.

BE A Magician! Two booklets explaining sixty-eight tricks plus large professional catalog. \$1.00. Magic Inc., 5082 Lincoln, Chicago, Illinois 60625.

WORLD'S Finest professional magic tricks. Joker's Novelties. Giant illustrated catalog 10¢. Top Hat, Evanston, Illinois.

FABULOUS MAGICS New 1971 catalogue 25¢. Our specialty orders shipped same day no substitutes. Fabulous Magic, 3319 East Charleston, Las Vegas, Nevada 89104.

HOUDINI'S Original Magic Shop. Established 1856. Send 25 cents for Illustrated Catalog containing 5000 Tricks, Mindreading, Puzzles, Hypnotism and Jokes. Flosshornmann, 304 West 34th St., N.Y. 10001.

FREE! World's Leading Catalog 2000 Novelties, Jokes, Tricks, Scientific Gadgets, Hobbies. Johnson-Smith, C-10, Detroit, Michigan 48224.

(Continued on next page)

MAGIC TRICKS, JOKES, VENTRILOQUISM

(Continued from preceding page)

500 TRICKS, Douglas famous Magic Catalog, only 10¢. Better Magic for pocket, club, stage. Fastest mail service. Douglas Magicland, Dept. 11, Dallas, Texas 75221.

MAGIC Catalog. World's finest 3000 tricks. (340) pages \$2.50. Beginners, amateurs, professionals. Kanter's, A-200 South 13th St., Philadelphia, Pa. 19107.

CARD MAGIC—Original, amaze your friends, \$1.00, A. Caprio, 147 Mansfield Blvd., Cherry Hill, New Jersey 08034.

BOOKS, CATALOGS, NEWSPAPERS

FREE BOOK. Prophet Elijah Coming Before Christ. Megiddo Mission, Dept. 63, 481 Thurston Road, Rochester, N. Y. 14619.

PUBLISH Your book! Join our successful authors: All subjects invited. Send for free appraisal and detailed booklet. Carlton Press, Dept. PMN, 84 Fifth Avenue, New York 10011.

SEND 50¢ For Giant New Color Navy Arms Catalog Reference Book featuring America's largest selection of Muzzle Loading Replica Firearms & Accessories, which can be purchased by mail. Complete instruction on how to handle a Muzzle Loader and kits to build your own. Address: Navy Arms Company, 689 Bergen Blvd., Ridgefield, New Jersey 07657.

NATIONAL Geographic Magazines, 1888-1967, any issue. Buxbaum, Box 465-PM, Wilmington, Delaware 19899.

FREE Brochure! 87 Low cost, "How To", "Self Improvement" Books. Avron, 9315 Avenue "A", Brooklyn, New York 11236.

STOP Smoking! New Book presents Medical and Psychological Step-By-Step Method. Money Back Guarantee. Send \$2.00. Jansen's, Box 296-PM2, Florham Park, N.J. 07932.

HIGH PAY, SECURITY With Civil Service Jobs! Expert books prepare you. Free Literature. Aquarian, 234-K West 13 St., New York 10011.

MAIL ORDER COURSE. New, condensed edition. Send \$5.00 to: New Mail Order Company, Box 121-T, Plainfield, Illinois 60544.

ZIP CODE Directory, 128 pages, over 50,000 listings. \$1.25 postpaid. Free gift catalog. Lee Enterprises, Box 1353A, Southfield, Michigan 48075.

PLAYS, SONGS, MANUSCRIPTS

SONGWRITER! Poets! Spiritual and religious poems, songs wanted for recording by Chapel Symphony Orchestra and Choir. We pay all recording costs! Dept. PM, Chapel Recording, P.O. Box 162, Wollaston, Mass. 02170.

BUSINESS OPPORTUNITIES

FREE Book "996 Odd, Unusual, Successful Businesses" on request! Work home. National-7, Kerrville, Texas 78028.

SELL Gifts And Household Items—Make extra money. Toys, Jewelry, Stationery, Wrappings, All Occasion, Easter Card Assortments. Salable Samples on Approval. Free Color Catalog, Bonus Plan. Write Hedenkamp, 361 Broadway, Dept. PM-109, New York 10013.

IMPORT-Export Opportunity, profitable world-wide, mail order business from home, without capital; or travel abroad. We ship proven plan for no risk examination. Experience unnecessary. Free details. Mellinger, Dept. E2702, Los Angeles 90025.

279 FAST, Easy ways to make money! Free! Rush name, address, zip. Perry, 13263 EN Ventura Blvd., Studio City, Calif. 91604.

MILLION Jobs Vanished since 1960 from automation, mechanization, mergers. Shouldn't you start your own business Now... while employed? Business profits increase your salary. We train... help finance... guide... back you. Seven "on-location," urgently needed services... homes, stores, offices, motels, institutions. Successful worldwide. No shop, no experience needed. Little over \$1000 establishes "nationally advertised," lifetime business. Gross \$30,000 yearly with first serviceman. We furnish servicemen's machines. Interesting, exciting career. Inquire Today while territory open. We'll mail information. Duraclean, C1-162, Deerfield, Illinois.

SELL Books By Mail. Complete Dealer Set-Up—20¢. Midwest Mail Sales, Box 44R2-PM, Shawano, Wisconsin 54166.

HOMEWORK. Steady employment. Guaranteed income. Details 25¢. Beecompany, Dansville, N. Y. 14437.

MAKE \$1,000,000.00 in 10 years. \$10.00 start. Free proof! Wallace, Box 288P2, Gladstone, Oregon 97027.

SECRETS! Mail Order Success. Internationally famous expert reveals how to make home business fortunes. Beginners: Get free copy "Make Money By Mail." Discloses free advertising, profitable products. Mailco, 1554 Sepulveda, Dept. E2702, Los Angeles 90025.

\$1,000 MONTHLY Business. Details free. Homecraft, 2350 West 47th, Denver, Colorado 80211.

\$128.00 IN SALES FROM \$12.00 MATERIAL. New... Different. Everything furnished. Write: Sierra's, 162 Main, Amador City, Calif. 95601.

BECOME Tax consultant. Our students earn \$1,000-\$3,000 every tax season preparing returns evenings. State approved. National Tax School, Monsey 2DC, New York 10952.

NEW Plan! Pays up to \$25.00 an hour! Little as 4 hours weekly. Place Luxko self-service displays in stores. No cost to merchants. No experience needed. Free details. Lux Company Incorporated, Dept. 1600, Elkhart, Indiana 46514.

STRIKE IT RICH AT HOME! 622 Proven Plans. Details free. Opportunity, Box W-22, La Mesa, Calif. 92041.

EXTRA Cash Work Home men, women!! Successful mailorder yours!! — easily!! Proof... Free!!! Williams; POB44646A, Los Angeles 90044.

\$128.00 IN SALES FROM \$12.00 MATERIAL. New and different. Everything furnished. FRIEDLAND ASSOCIATES, 10522 Fernglan Avenue, Tujunga, California 91042.

SELL Books By Mail. Fascinating! Profitable! Details Free. Fred Smith, Chestnut Grove-M, Kinz, North Carolina 27021.

FANTASTIC Opportunity—Your Own Gift Catalog Business. No merchandise investment! Free Sample Catalog! Mail Marketing Services, Benton, Illinois 62812.

HOW And Where To Get Capital. Get \$500 to \$2 million. Free information. Counselor-17, Kerrville, Texas 78028.

1,000.001 PROFITABLE Mailorder Opportunities. Free list! Specialty, Box 45PM, Lakeside, Iowa 50588.

WATCHMAKING Makes every day a payday. Learn this cash business at home. Free details. Sweazey, YOA, Fox River Grove, Illinois 60021.

CELEBRITY Murders! Judge slain! Officials kidnapped! People desperate for protection. Make large profits installing burglar alarms. Full, part time. Free plan. NASCO, Dept. E2702, 11071 Massachusetts, Los Angeles 90025.

"MAILORDER LAWS and Regulations." \$2.00. Wonderful drop-ship proposition. Neil H. Tasker, Shamokin, Pennsylvania 17872.

MAKE Gorgeous original candles for all holidays and special occasions. Learn expert Candle decorating, candlemaking, use of professional molds. Free details on home instruction method. Candle Institute, Dept. A-93, 1600 Cabrillo, Torrance, Calif. 90501.

FREE HOME DECORATING-CUSTOM DRAPERY BOOK Tells how to get started learning & earning Big \$\$\$ at home doing interior decorating, custom drapes, slipcovers, bedspread ensembles. Turn sewing machine into money making machine—supply HUGE endless demand. Delightful hobby too! Learn, earn, work right at home. No experience needed. WE SHOW YOU HOW! Fabrics wholesale—save big money on your own decorating & drapes. Write for FREE four color book today! Custom Drapery Institute, Box 555-RJ, Orange, Calif. 92669.

HOW Much does being your own boss or making \$25,000.00 per year interest you? The Warner breakthrough in the Engraving field could be your future. Write: Warner, Room EC-2-AC, 1512 Jarvis, Chicago, Ill. 60626.

MAILORDER. How to prepare your own catalog for pennies. Free Catalog! Obie-MKN, Brooklyn, New York 11219.

MAIL Baby Catalogs To New Mothers For Big Profits, Details Free. Parks, 1736 South Queen Street, York, Penna. 17403.

MAKE Up To 900% Profit with your own Magnetic Sign Shop! Rapidly growing demand for 3-Dimensional Magnetic Signs on cars and trucks! Start in garage, workshop, or kitchen. Full or spare time. Write today for free details. Nationwide Plastics, Dept. AC, 4200 Panamint, Los Angeles, Calif. 90065.

BE YOUR Own boss in Mail Order. New concept. 2 facets. Send large, addressed, stamped envelope to: NATIONWIDE, Box 2974-PM GPO, New York, N.Y. 10001.

CLIP Newspaper items. \$1.00-\$5.00 each. Details free. Walter, Box 1360-PA, Erie, Pa. 16512.

COMPLETE Mail Order Set-up \$2.00 Proven. BarCo, Box 30256, Bethesda, Md. 20014.

FREE REPORT!! 609 Unusually successful businesses, indoor-outdoor, evenings!! Write: Associated, Box 238-B1, Lafayette, California 94549.

PIANO Tuning Learned Quickly At Home! Tremendous field! Musical knowledge unnecessary. GI approved. Information free. Empire School, Box 327, Miami, Florida 33145.

FREE FRANCHISE JOURNAL Magazine with over 100 franchise opportunities in every issue. Franchise Journal, Dept. G, Box 1790, Newport Beach, Calif. 92663.

SPARE Time Cash—Sell Advertising Book Matches—every business a prospect—no investment—no experience needed—build steady, repeat business. Powerhouse selling kit with new complete catalog Free. Quick sales—big cash commissions. Dept. MX-271, Superior Match, 7530 S. Greenwood, Chicago, 60619.

\$400.00 MONTHLY Raising giant fishworms. Soilless method. Charlie Morgan, Bushnell, Florida 33513.

EARN Money raising fishworms for us! Write: Oakhaven-38, Cedar Hill, Texas 75104.

400,000 BARGAINS Below wholesale! Many free. Liquidations... closeouts... job lots... single samples. Free details. Bargainhunters Opportunities, Box 730A, Holland, Michigan 49423.

ADVERTISING BUSINESS—YOU Own it. \$350 First Week or Money Back. Electric Neon Action Ad Clock, 229 W. Illinois, Chicago 60610.

SELL Lifetime, Metal, Social Security Plates. Big Profits! Sample and Sales Kit Free. Russell, Box 286-PM, Pulaski, Tennessee 38478.

(Continued on next page)

BUSINESS OPPORTUNITIES

(Continued from preceding page)

WANT To make big money at home? \$10.00 profit in an hour possible with invisible mending. **Make tears, holes disappear** from clothing, fabrics. Steady year-round demand from cleaners, laundries, homes. Details free. Fabricon, 1585 Howard, Chicago 60626.

COPUBLISH "Mail Sale Advertiser," leading mailorder paper. Copy and details 25¢. U.S.A. only. Vanroy Shirk, Lebanon, Pa. 17042.

\$200.00 DAILY in your mailbox! Your opportunity to do what mailorder experts do. Free details. Associates, Box 136-A, Holland, Michigan 49423.

DRAFTSMEN! Operate own **DRAFTING SERVICE!** Full, Part Time; Experience unnecessary; Details: Roberts Drafting, 1741 Circle Road, Baltimore, Maryland 21204.

RAISE Rabbits for us on \$500 month plan. Free details. White's Rabbitry, Mt. Vernon, Ohio 43050.

MAIL ORDER Sell books. Fascinating, profitable, details. Jobre, Box 27, Great Neck, N.Y. 11023.

WORLD'S Largest supply. Merchandise 25% to 40% under wholesale. Bankrupts. Closeouts 10¢ on dollar. Imports. Hongkong clothes. Automobile discounts. Free details. International Buyers, Box 16386-MM, Portland, Oregon 97233.

HOLLYWOOD CEMENTCRAFT: Offers Highly Profitable Home Business. Experience Unnecessary. Unlimited Unique Pottery Designs Easily Made Without Moulds. Bird-baths, Fountains, Wishing-Wells, Waterfalls, etc. Chemical Coloring Formulas. Marble-glazing. **FREE Illustrated Brochure. CONCRETE FACTS.** 602 Athens Street, Altadena, California 91001.

SELL Books by mail. 400% profit. Royal, Box 450-X, Cleveland, Ohio 44127.

FREE Catalogs. Repair air conditioning refrigeration. Tools, supplies, full instructions. Doolin, 2016 Canton, Dallas, Texas 75201.

VENDING Machines. No selling. Routes earn amazing profits. Big catalogue Free. Parkway Corporation, 715PBM Ensor Street, Baltimore, Maryland 21202.

ADDRESSERS And mailers needed. Send stamp for information. Lindbloom, 3636 West Peterson, Chicago 60645.

SELL Beautifully colored Social Security Plates. Big Profits! Free Sample. Paul Wright, 1075 Ringwood Avenue, Pompton Lakes, N.J. 07442.

CLIP Short newspaper items. To \$10.00 each. Details free. Foster, 272-M2, Brooklyn 11235.

BUILD Custom Cases at home for profit. Get orders by mail. We supply materials, instruction—everything. Free home business details. Custom Case Supply Co., 6961 CPB Hayvenhurst Avenue, Van Nuys, California 91406.

TAKE Catalog orders. We drop-ship 1001 best selling specialty products. Guaranteed lowest below wholesale prices. Fantastic spare-full time home business. Free book shows you how. SMC, 6963 SPB, Hayvenhurst Avenue, Van Nuys, California 91406.

VENDING Machine big catalog. Rake, 523 A Spring Garden, Philadelphia, Pa. 19123.

I MADE \$40,000.00 Year by Mailorder! Helped others make money! Start with \$10.00—Free Proof. Torrey, Box 318-Y, Ypsilanti, Michigan 48197.

MAIL Baby Catalogs Imprinted with your address to New Mothers for Big Profits! Details 25¢. Volz PM, Ypsilanti, Michigan 48197.

MAKE \$10.00 Hourly Demonstrating portable sandblaster. Inka, Box 66573, Houston, Texas 77006.

MAIL Order Collection Agency can make you \$1000.00 monthly. Free Details. Continental, Box 2023-A, Des Moines, Iowa 50310.

MAKE Money from old tires. Operators clearing \$800. weekly. Equipment costs \$1500. Get facts. S & S Patents, Inc., 3752 N. Damen, Chicago 60618.

BIG Money-making new greaseless donuts in kitchen. Everything furnished. Sell stores. Free recipes. Montgomery Ray, Waseca, Minn. 56093.

EARN \$60.00 Daily Manufacturing Concrete Fence Posts. Practically no investment. Send stamped, addressed envelope. American, Excelsior Springs, Mo. 64024.

MAKE \$46 From square foot plywood: jigsaw or bandsaw necessary. Free details. Woodar, Bridgewater, Mass. 02324.

MAKE Fortune in Mailorder! Easy! Advances, Box 24, La Grange, Illinois 60525.

I MADE \$2,000.00 Monthly by mailorder—evenings only. You can too! Free Proof! Kingman, Box 723D, Montclair, New Jersey 07042.

\$500-\$800 MONTHLY Raise small Laboratory-breeding stock for us. We supply equipment, breeders, and instructions. Illinois Research Farms, Dept. MPD-2, Barrington, Illinois 60010.

BOOKKEEPERS Earn \$500.00 week. Operate Bookkeeping Tax Service. Details free. Universal, Box 664-M, Springfield, Missouri 65801.

\$70.00 WEEKLY—Home, spare time. Simplified mail bookkeeping. Immediate income easy. Auditax, 34741A, Los Angeles 90034.

\$60.00 DAY. Manufacturing concrete Posts, Blocks. Mold Equipment Catalog \$1.00 refundable. Carlayne, Route One Box 95, Rapid City, South Dakota 57701.

TREMENDOUS \$1,000.00 Profit From 1,000 Mailings! Exciting. New Products! Tested! Everything Furnished! Free Guidance. Proof! George, Box 2188-PM, Cypress, California 90630.

FRANCHISING? Amazing New Way to own your own business. Send for free copy. Modern Franchising Magazine—P, Des Plaines, Ill. 60016.

CALIFORNIA MANUFACTURER NEEDS Man to assemble our product and be local agent, experience unnecessary. May start while presently employed. Five-figure income for responsible applicant. S.K.R.M. Manufacturers, 2347 West 238 Street, Torrance, California 90501.

MAKE A year's income in 8 weeks camping. No capital investment, no selling, no land ownership necessary. 9 different ways. Write EDRU'S, Rt. 5, Box 5733, Gig Harbor, Washington 98335.

1000% PROFIT Bronzing Shoes. Free Literature—N.B.C., Box 11069-PM, Kansas City 64119.

HUGE Profits! Mail order importing. Free information. ITIS, PM-2, Box 454, Hollywood, Calif. 90028.

JEWELRYCRAFT—It's easy! Big profits! Catalog. 25¢. Modern Craft, Box 4796, Clearwater, Florida 33518.

BOTTLES Are Valuable! Free Information—Bottle Treasures, 7311 Van Nuys, Van Nuys, California 91405.

MAIL Galore! Money-making offers! Your name on national mailing lists. 25¢. Three months, 50¢. Sullins, Box 206-M, Forsyth, Georgia 31029.

MAKE MONEY AT HOME METALLIZING. Baby Shoes, Plastics, Novelties, Gold, Silver, Bronze. Free Facts. Kiktavi, Box 2127-A, Inglewood, Calif. 90305.

EARN EXTRA CASH! Free catalog lists thousands of business opportunities. Informative Publications, Box 187, Painted Post, New York 14870.

MAILORDER Book Publisher Wants Dealers. Jan Enterprises, 76P, Wild Rose, Wisconsin 54984.

SUPERIOR Auction School. Nation's top Auctioneers own and instruct. Box 1281, Decatur, Ill. 62525.

SENSATIONAL Car Thief Signal. Lightning Seller. Samples for trial. Northwest Electric, Ave. 691 Mitchell, South Dakota 57301.

HOMEWORKERS—Mailers Wanted. Free details P.M. Allen, 2418 Lori, Santa Ana, Calif. 92706.

\$200.00 SPARE Time earnings with your Tablesaw. Write: Workshop Five, 3800 Harney, Vancouver, Washington 98660.

\$15,000 YEARLY. Home Mail Business. Raney, 18 Oneida Avenue, Centereach, New York 11720.

VINYL REPAIRING A golden opportunity. The world is knocking at your door. Free information. AMH Industries, P.O. Box 5386, Santa Ana, Calif. 92704.

MOLDING Rubber Liquid Plastic. Hobby Supplies. Details 10¢. Chaney's, 5415-L San Jose Blvd., Jacksonville, Fla. 32207.

MAKE Magnetic car signs. Write Route 1, Box PM-49A, Bardstow, Ky. 40004.

NEW Mailorder item, terrific appeal, big profit. Everything supplied. Harvey Company, Box 3846, Wilmington, Delaware 19807.

MAILORDER Offers Galore, receive opportunities, catalogs etc. Your name listed nationwide 25¢. Doorbar-PM, 3364 Northwest 35th Street, Fort Lauderdale, Florida 33309.

SECOND Income. . . Mailorder! Work Home!!! Bates, Box 3223-AF, Detroit, Michigan 48214.

ESTABLISH Profitable Mailorder Business. Everything furnished. Vikari's, Box 1312PM, Salt Lake City, Utah 84110.

FANTASTIC Opportunity. Your own catalog business. Gifts, books, auto accessories, etc. No inventory. Up to 100% mark up. Details free. Tiffanies, Box 3348-P2A1, Vancouver, B.C.

RAISE Baby Black Widows! Safe, Fascinating, Profitable! Spiderlings, food, instructions \$2.98 (guaranteed). NBWC, Box 260PBM 2, Brigham City, Utah 84302.

MONEY MAKING MAIL ORDER. Free details. Leatham, Box 1027, Mission, Kansas 66222.

OWN MAJOR FRANCHISE
BE Your own boss. High volume profits. No overhead. Plus, annual renewal overrides on all business sold by every a to dealer and insurance agent miles around where you live. National industry advertising campaign. Road Aid Auto Club exclusive franchises now available—several multi-million dollar firms participating. Thousands of members, guaranteed leads system. You must qualify: ambition, drive, and honest reputation. Area franchise \$400. covers costs of supplies and lists to start immediately. Send \$5 for complete Road Aid Franchise Kit—start building a prestige lifetime business today. ROAD AID AUTO CLUB, National Headquarters, 909 Broad Street, Newark, N.J. 07102.

START 1971 Right! Operate your own Sauna business spare time, full time. Make extra money. Experience not essential. Literature free. Erlander's, Box 183-N, Richmond, N.Y. 10306.

MAIL Baby Or Gift Catalogs. Imprint. Big Profits! Details \$1.00. Krefski, 609-A Lee, Plymouth, Penna. 18651.

MAKE Money Selling Men's Wigs. Details Free. F & N Fashions, Box 34-A, Glencoe, Minnesota 55336.

\$50,000 PROFIT in mailorder. Free details. Martin Mailorder, 409 Inglewood Drive, Savannah, Georgia 31406.

\$25.00 HUNDRED Addressing, possible Year round. Gift (\$3.00), instructions 25¢. Cove, 629-BE Franklin, Clearwater, Florida 33517.

\$25.00 HOURLY! Repair business at home. Details. Baron, Box 863, Portales, New Mexico 88130.

(Continued on next page)

BUSINESS OPPORTUNITIES

(Continued from preceding page)

LEARN About amazing spare time businesses. Details free. Home Income Reports, Box 263, Wheeling, Illinois, 60090.

TEN To \$48,000.00 Year! No Investment, detail free. Idrach, Box 1067, San Antonio, Texas 78210.

400% PROFIT Selling famous "antiqued" reproductions!! Documents—Posters—Money!!! Garen's, Xenia, Ohio 45385.

\$25.00 HUNDRED Addressing, Possible Year 'round. Complete instructions 25¢ for registration, postage. Cove, Box 1348-B, Clearwater, Florida 33517.

GIANT Catalog—Gift Items—Novelties—Toys Carded Merchandise. Fabulous sellers, Amazing Profits. Send \$2.00 Refundable. LeMoyné, 151 Kingston, Lemont, Illinois 60439.

NET Over \$400. 1st week or money back. Your own display neon clock ad business. PAM Services, 416 Chez Patee, Hazelwood, Missouri 63042.

EARN To \$50,000.00 yearly. Amazing businesses. Spare or full time. Unlimited potential. Paslow Co., 306 Hays Ave., Pittsburgh, Pa. 15210.

YOUR Dealership awaits. Solid opportunity selling information by mail. Catalogs, stationery, etc. with your name imprinted. Free details—samples. Agora, Box 1001-F, Albany, New York 12207.

\$128.00 IN SALES FROM \$12.00 MATERIAL New . . . Different. Everything Furnished. Free Details. Palm Beach Gifts, 644 Snead Circle, W. Palm Beach, Fla. 33406.

101 BUSINESSES YOU CAN START AND RUN WITH LESS THAN \$1,000. FIRST EDITION ONLY \$8.95. Friedland Associates, 10522 Fernglan, Tujunga, California 91042.

FREE Sample Kit. Sell Lifetime Beautiful Social Security Cards. Bilbrey Sales, Route #1, Crossville, Tennessee 38555.

ALERT Yourself! Learn how unique report presents business opportunity concepts. New, different! Write: Sherwood Publishing, P.O. Box 517A, Brundidge, Alabama 36010.

\$2000.00 MONTHLY, Easily Done. Ropchan, Box 5341-P, Sherman Oaks, California 91413.

100 LOW-Capital Businesses; sources financing \$1.10. Equity Associates, Box 7541-A, Birmingham, Alabama 35223.

\$75.00 THOUSAND, Home Addressing! Longhand, Typewriter. Information, send stamped, self-addressed envelope. Brewster "TF" Box 1348, Clearwater, Fla. 33517.

SHORT Articles DO Sell. Copyrighted Report Now Available with Details and Ideas. \$1.00. Bowman Studios, 152 West 42nd Street, Suite 536-A, New York, N.Y. 10036.

MONEYMAKING OPPORTUNITIES

TEAR OUT THIS AD. Mail with name, address for big box of home needs and cosmetics, FREE to reliable men and women. Tell and show friends, make good money spare time taking their orders. Write today. BLAIR, Dept. 31LB, Lynchburg, Virginia 24505.

RETIRE Before Fifty! Haikey did with seven "on-location," urgently needed services. Nationally advertised. Successful worldwide. Serve homes, shops, motels, offices, institutions. No shop, no experience needed. We train . . . help finance . . . guide . . . back you. Gross \$30,000 yearly with First serviceman. We furnish servicemen's machines. Large profit Each serviceman. (Starting spare time, business profits increase your job salary.) Little over \$1000 establishes your growing, lifetime business. Interesting, exciting, prestige career. Inquire Today while territory open. We'll mail information. Duraclean, C1-162B, Deerfield, Illinois.

HOW TO MAKE CANDLES FOR FUN AND PROFIT for booklet send \$1.00 to: LEECAR Enterprises, 13251 N. 15th Drive, Phoenix, Ariz. 85029.

MAKE Money Collecting Coins. Booklet \$1.00. Darsi Products, 43-34 Union, Flushing, L.I. 11355.

INTERNATIONAL Trade. Sources, bank references, etc. Details \$1.00. Laval International, Box D126, St. Clair Shores, Mich. 48083.

SHARP \$\$\$ Opportunity! One low-cost machine sharpens, serrates, knives, scissors, pink shears. Earn \$6-\$9 hourly in spare time. Professional results without experience. Free details. Beaver Grinder, 700F Nielsen Building, Eugene, Oregon 97402.

TURN Your Spare Time Into Instant Money. Details Free. Capitol, Box 9363-M, Austin, Texas 78757.

PENNY STOCKS Have profit potential. Free information. Reporter PM, 608 N. Guadalupe, Redondo Beach, Calif. 90277.

WORK WHEN YOU PLEASE. Prosperous HOME MAILORDER business. Details 25¢. Andrew Sales, Box 152A, Blue Island, Illinois 60406.

GET SMART. Start your own mailorder business. FREE information. Mailorder, P.O. Box 63, West Bend, Wisconsin 53095.

NOVELTY IMPORTS Sell like mad! Make huge profits. Nine samples and large wholesale catalog — \$1.00. Lakewood Imports, 6800 North Campbell, Chicago, Ill. 60645.

OVER \$16.50 An Hour. Spare time at home! Rubber Stamp industry needs small manufacturers. We furnish all equipment and know-how! Particulars free! Write: Roberts, Room RC-2-AC, 1512 Jarvis, Chicago, Ill. 60626.

MAKE Big Easy Profits making costume jewelry at home. Spare time. Quick, easy to make; easier to sell! Details Free! Donbar, 2934 Fullerton, Dept. A-201 Chicago, Illinois 60647.

SELL Lifetime Metal Social Security Plates. Sample and Sales Kit FREE. Lady McGuire, Box 3333PM, Anderson, S.C. 29621.

PENNY STOCKS Have big profit potential. Free information. Penny Stock Reporter, 608 N. Guadalupe, PM, Redondo Beach, Calif. 90277.

CIGARETTES 12¢ a pack. Improved roller makes 20 filtertip, plain, king or regular for 12¢. Facts free. Green River Tobacco, Box 953, Owensboro, Kentucky 42301.

EARN \$240.00 a month at home, spare time, doing only two \$5.00 invisible mending jobs a day. Big money paid for service that makes cuts, tears disappear from fabrics. Steady demand. Details free. Fabricon, 1532 Howard, Chicago 60626.

MAKE Statuettes, novelties, imitation marble. Sell to stores or start gift shop. Free details. Marbleizing, 41 Waverton, St. Louis, Mo. 63124.

HOW To Make money writing short paragraphs. Information free. Barrett, Dept. C-27-01, 6216 N. Clark, Chicago 60626.

FREE Copy of world's leading contest magazine! Write Prizewinner, Box 11569, St. Petersburg, Fla. 33733.

SCIENTIFIC Messages: Big Earnings uncrowded profession. Learn spare time at home. Diploma awarded. Free catalog. Write Anderson School, Dept. B-1C, Princeton, Illinois 61356.

CLIP Newspaper items. \$1.00-\$5.00 each. Details free. Walter, Box 1360-P, Erie, Pa. 16512.

HOW TO GET RICH!! Free "Money-making Brochure"! Success International, Box 2447-C, Livonia, Mich. 48151.

\$200.00 FROM Sheet 1/4" plywood (scrap). Details 25¢. Novelties, 610 So. 24th, Elwood, Indiana 46036.

VENDING Machines. No selling. Routes earn amazing profits. Big catalogue Free. Parkway Corporation, 715PMM Ensor Street, Baltimore, Maryland 21202.

LEARN The secrets of repairing junk batteries "Fabulous Profits" at home. Battery Shop, Route 1-188 D, Blythe, Calif. 92225.

\$500-\$800 MONTHLY Raise small Laboratory-breeding stock for us. We supply equipment, breeders, and instructions. Illinois Research Farms, Dept. MP-2, Barrington, Illinois 60010.

MAKE \$5,000 Yearly, sparetime, raising mink, chinchilla, nutria, etc. Free booklet reveals proven plan. Write: Furs, Dept. E, Bewdley, Ont., Canada.

AMAZING Information, 315 magazines free. MacMillan, 133-R Holly Drive, Cleveland, Ohio 44135.

MAKE \$12.00 Dozen Lacing Billfolds. Details Free! (Stamp Appreciated.) Redikut's 40, Richland Center, Wis.

INSULATORS, Profitable, unique gift items made from insulators. Booklet only \$2.00 (complete details, drawings, photographs.) R. St. Pierre, 82 Bowditch Avenue, Peabody, Mass. 01960.

SKETCH Photos—(Home Goldmine!) Details. Gem, 365-F Longhill, Shelton, Conn. 06484.

GET World's Biggest Wholesale Import-Merchandise Catalog. Write: Worldwide-K, Medina, Washington 98039.

STRIKE IT RICH, Enter U.S. Government Oil Lease Drawings. Details free. Petroleum Research Associates, Box 249, Westlake Village, California 91360. Licensed Mineral Oil Gas Broker.

FORTUNE In Classified Ads! Free Details. Milton, Box 1836, Sumter, South Carolina 29150.

\$10.00 DAILY Writing Short Articles at Home. Begin Immediately! Copyrighted Report Reveals How and Where. Send \$1.00. Sunstate Exchange, PM-12, 675 Badger Drive, Palm Bay, Florida 32901.

NO Overnight Bonanza. Mailorder Is Strictly Business. Read Our Story. Stationers, Drawer-5350C, San Antonio, Texas 78201.

START A profitable subscription business in spare time! We need men and women (young and old) as representatives for all leading national magazines. Liberal commissions on all subscriptions. Supplies free. No experience needed. Send this ad with your name and address to Popular Mechanics, Room 2-0, 250 W. 55th St., New York, N.Y. 10010.

HIGHER INCOME, Security, Prestige and Power! 256 page book "Thinking Big" reveals inside facts, case histories and the secrets that make men rich. Send \$2.00. Ell-Mer Company, Box 598, Teaneck, New Jersey 07666.

BLACK Widow Spider embalmed soecimen and exciting moneymaking plan \$1.25 (Returnable). NBWC, Box 260PAM2, Brigham City, Utah 84302.

DOLLAR Making Tips-Book Loaded With Valuable Information And Opportunities. Write For Free Details. Vince Morton, 1543 Bermuda, Cincinnati, Ohio 45231.

SWEEPSTAKES Contests. How to Win. Write for free particulars. General Contests, 1609-18 East Fifth, Duluth, Minnesota 55812.

WANT A new car, color TV, new clothes? Learn hundreds of ways to make money. 5 month subscription Free. Write: Salesman's Opportunity Magazine, Dept. 17-BM, 1460 Hancock Center, Chicago 60611.

FREE Starting stock worth \$15.00 given our associates. Up to 200% profit for you. Information and samples, \$1.00. Master Research, 115 Garner Road, Lilburn, Georgia 30247.

(Continued on next page)

MONEYMAKING OPPORTUNITIES

(Continued from preceding page)

DOGS, For fun and profit. Successful breeder tells how. \$1.00. Flynn, 17733 Cliffbourne Lane, Derwood, Maryland 20855.

MONEY MAKER! Easy Using my Method. Spare Time at Home. No Selling. Special Ability nor Equipment required. Complete Instructions \$1.00. Income, 1874-A Skyland Road, Atlanta, Georgia 30319.

MAKE Big money at home! Fabulous opportunities now available. Golden Rule Mailorder, 962 Eva Ave., Akron, Ohio 44306.

LYRIC Writers write songs with Writers who write hits for top Nashville Artists. Globe, 1313 Dickerson Road, Nashville 37207.

MAKE Money Writing Short fillers, ten lesson writing course \$4.95. Mid-West Gifts, Columbia City, Indiana 46725.

HOME Addressers Wanted! \$100.00 weekly! Details 20¢. Wood, Box 226-PM, Irvington, New Jersey 07111.

\$10,000.00 INCOME Producing Items at home. Complete Instructions \$2.00. Lockett, 4153-P Lancaster Ave., Philadelphia, Pa. 19104.

GREATER Stock Profits. Free Details. Box 383, R.D. 4, Cortland, Ohio 44410.

MAKE Rubber Stamps. Easy Profitable Business. Starting Outfits. Presses, Manufacturers Supplies. Free Catalog. Roll, 15930 Trask River, Tillamook, Oregon 97141.

PROFITABLE OCCUPATIONS

LEARN GUN REPAIR GUNSMITHING in spare time. Book, details 10¢. Modern Gun Repair School, Dept. 508, Twenty E. First Ave., Scottsdale, Arizona 85251.

FREE!! FREE!! FREE REPORT!! 609 Little-Known, successful businesses. Written by consultant. Indoor . . . outdoor, work home! Start small, grow big . . . many others have. Experience unnecessary, easily done!! Write: Report, Box 238-BA2, Lafayette, California 94549.

LOCKSMITHING—Fifty Page Illustrated Automotive Lock Manual Special, \$4.95. Glenstone, Box 3127, Springfield, Missouri 65804.

TRASH To Cash, complete book tells how. Send \$3.95. G. Meyers, 2815 Lincoln, Chicago, Illinois.

FREE Book "999 Successful, Little-Known Businesses." Work Home! Plymouth-47T, Brooklyn, New York 11218.

FT. SMITH Auction School. Ft. Smith, Ark. Residents & Home study. Veteran approved.

BECOME A mortgage broker, earn \$10,000 to \$50,000 a year. Details free. United, Box 6284A, Marietta, Georgia 30060.

SHARPEN Scissors, Pinkers, inexpensive equipment, tools, supplies. Blackhawk's, Sheldon, Iowa 50243.

HOW To Make Money writing short Paragraphs. Information free. Barrett, Dept. C-27-02, 6216 N. Clark, Chicago 60626.

BAKE New greaseless doughnuts in kitchen. Sell stores. Free recipes. Michael Ray, Waseca, Minn. 56093.

\$500-\$800 MONTHLY Raise small Laboratory-breeding stock for us. We supply equipment, breeders, and instructions. Illinois Research Farms, Dept. MPA-2, Barrington, Illinois 60010.

EARN \$240.00 A month at home, spare time, doing only two \$5.00 invisible mending jobs a day. Big money paid for service that makes cuts, tears disappear from fabrics. Steady demand. Details free. Fabricon, 1586 Howard, Chicago 60026.

EXCITING Opportunities: With your Camera; In Mail-order Imports; Writing fillers; Collecting coins; Government Surplus. Each booklet \$1.00. Five for \$4.50. Redwood Lodge, 3405-32 Street Court, Rock Island, Ill. 61201.

START A magazine subscription business. Earn generous commissions on Popular Mechanics, Good Housekeeping and all others. Best commissions, bonus, all material sent free. No experience needed. Write Popular Mechanics, Room 2-P, 250 West 55th St., New York, N.Y. 10019.

FREE! Profitable Home Business Opportunities. Neshotah, 2908—41st, Two Rivers, Wisconsin 54241.

\$2.00—\$5.00—\$10.00—\$50.00 PAID For Your Jokes, Stories, Recipes, Etc. Instructions—\$2.00. Smithco, Box 292-C, Syracuse, New York 13201.

JANITORS—Cleaners—Custodians—Get a Better Job—Make more money. Become a maintenance Supervisor. Homestudy Details Free: Maintenance Training, 907 Beachpoint—Ajax, Ontario.

RECORDS Control Consultant. Study at home. Start your own business, earn extra \$\$\$ while learning. Details free. Systems, Box 929-BM, Estes Park, Colorado 80517.

SALESMEN—DISTRIBUTORS

SELL America's biggest value wedding line! Big 40% profit showing wedding invitations and over 50 exciting accessory items. Sideline for printing, Christmas card salesmen. Send \$1.00 for album, refundable on first order. Elmcraft, 7201 S. Cicero, Dept. EW-168, Chicago, Illinois 60629.

WILL You test new items in your home? Surprisingly big pay. Latest conveniences for home, car. Friends buy on sight. Send no money. Just your name. Kristee, 167 Akron, Ohio 44308.

MAKE Extra \$25 to \$75 spare time! Double air cushion shoes. Men's, women's line. Dress, work, play. Highest commissions. Shoes for yourself. Outfit Free. Bronson, Dept. H-21, Minneapolis, Minnesota 55408.

IMPORT Outstanding novelties, gifts, premiums from Formosa. Sensationally low price. Fifteen different samples. \$3.00 money order. Satisfaction guaranteed. Taiwan Variety, Box 24029-BD, Taipei, Formosa.

BIG Earnings selling Hertel Bibles. New 3-dimension cover, finest reference edition sells fast. Demonstrator furnished. Big commissions. International Book, Dept. PM, Box 118, Wichita, Kansas 67201.

LONG Needed Invention. Man contact service stations. Full or part time. Huge profits. Write Cyclo Mfg., 3816 Dahlia, Dept. 117, Denver, Colo. 80207.

100% PROFIT—Sweet Georgia Brown Cosmetics sell fast. Write for Sample Case offer. Valmor, Dept. H, 2411 Prairie, Chicago 60616.

EARN Big Commission Full or Part Time. Show America's largest line Low Priced Business Printing and Advertising Specialties Plus calendars in season. No experience. No investment. No collections or deliveries. On-the-spot commissions. Big Free Sales Kit samples hundreds items used daily by businessmen. Merchandise bonuses for you. Build profitable repeat business. Start now. National Press, Dept. 11D, North Chicago, Ill. 60064.

TOP 119 Advertising Specialty Manufacturers. Directory \$1.00. Marketing—C30, 147 Vivyan, Bergenfield, New Jersey 07621.

THERE'S Money in selling office supplies and equipment, full or part time. Steady repeat commissions. Free selling outfit. Write. Oseco, 3505-PM North Elston, Chicago 60618.

EARN Big money calling on business-professional men. Send us their delinquent accounts for collection. General Finance, Dept. PM-11, Columbia Bank Bldg., Kansas City, Mo. 64106.

PERSONAL Protective Devices Now In Big Demand due to increased crime rate. Proven. Sell easy to Drive-Ins, Stores, Nurses, Night Workers, Motorists. Sales experience unnecessary. Get profit details now. Hagen Supply, Dept. CLA-21, St. Paul, Minnesota 55107.

AGENTS WANTED

47 MONEY-Making Specialties. Latest conveniences for home, car. Send no money. Just your name. Kristee 124, Akron, Ohio 44308.

MAKE Extra Money—Show friends, neighbors, others—All Occasion, Easter Card Assortments, Stationery, Wrappings, Gifts, Toys, Jewelry, Salable Samples on Approval. Free Color Catalog, Bonus Plan. Write Hedenkamp, 361 Broadway, Dept. PM-110, New York 10013.

WANT TO MAKE UP TO \$100 A WEEK Spare time, and get free shoe; for life, too? No investment. Rush card for free details. Mason Shoes, K-824, Chippewa Falls, Wisconsin 54729.

PRINTING. Advertising Salesmen—Excellent moneymaking sideline selling Decalcomania Name Plates, small quantities. Advertising Specialties, sign letters. Free Samples. Ralco XL Boston, Mass. 02119.

EVERY Man a prospect. Refundable sales kit offer showing line belt buckles, tie clasps, money clips, cuff links, lapels, identification badges, individualized with customer's name and emblems. Cap badges for trucking, bus, taxi, police, firemen, also postal, letter carriers and heavy construction emblems. Choice 4000 emblems. Hook-Fast, Box 1088PM, Providence, R.I. 02901.

LIFETIME Income. Business Loan Representative Write: Financial, 28 E. Jackson, Suite 1204-X3, Chicago 60604.

YOUR Own business—Used Suits \$1.50; Overcoats 65¢; Mackinaws 35¢; Shoes 12½¢; Ladies' Coats 30¢; Dresses 15¢. Enormous profits. Catalog Free. Nathan Portnoy Assoc., 2109-AA Roosevelt Road, Chicago, Illinois 60608.

3-D MAGNETIC Signs by Jay. Most complete line in the industry. 150 stock signs. Jay's 3-D Signs, G-8, Gorham, Maine 04038.

PROFITABLE! FULL OR PART TIME. Represent largest manufacturer of magnetic signs for cars and trucks. TRIMETRIC, 2640 Saddle, Oxnard, California 93030.

FIRE-BURGLAR ALARM. Retail \$2.98; \$18.00 dozen. Sample \$2.00. Hillard, Box 442, Frankfort, Kentucky 40601.

EMPLOYMENT INFORMATION

ELECTRICIANS Needed, \$1.00 for information on breaking into this lucrative field. C. White, 3436 Moyer Drive, Franklin, Ohio 45005.

JOBS—Men, women, professions, trades, clerical, executive, U.S.A.—overseas. Homeworkers also. Free bulletin. Hoppe, 44-B Wales, Thousand Oaks, California 91360.

JOBS ON SHIPS! Good Pay! Europe, Asia, Worldwide! Who to see and Where—\$1.00 Seaways, PM, Box 121, Ellicott City, Maryland 21043.

FOREIGN And USA job opportunities available now. Construction, all trades. Earnings to \$3,000.00 monthly. Paid overtime, travel bonuses. Write. Universal Employment Woodbridge, Conn. 06525.

HIGH Paying overseas jobs. Construction, other projects. Bonuses. Travel Expenses. Extras. International Information, 124, Cortez, Florida 33522.

FLORIDA Employment Opportunities Booklet \$1.00. Sunny, 4512N Jamaica, Tampa, Florida 33614.

(Continued on next page)

EMPLOYMENT INFORMATION

AUSTRALIA WANTS YOU!!! Government Assisted Passage. 1971 Government Information and Forms—Most Complete Information Available—\$1.00. Reports on Employment, Business, Taxes, Education, Teaching, Housing, Ranching, Maps, etc. AUSTCO, Box 3623-E, Long Beach, California 90803.

OVERSEAS OPPORTUNITIES . . . Higher Pay! Free Transportation! Complete information including Directory of 135 companies hiring thousands of Americans overseas . . . all occupations! Send \$1.00. International Opportunities, Box 19107-AN, Washington, D.C. 20036.

OVERSEAS JOBS. High Pay, Travel, Adventure. Directory of Over 100 American Firms Now Hiring for Overseas Projects. \$1.00. TRANSWORLD, Box 90802-E, International Airport, Los Angeles, California 90009.

OREGON—Live—work—play in Pacific Northwest. Classified Advertisements Section from Portland, Oregon Newspaper \$1.00. Opportunity, Box 67, Newberg, Oregon 97132.

"AUSTRALIAN Business Directory"—Over 300 Companies Seeking Help—50,000 Jobs—\$1.00. "Australian Private Employment Agencies Directory"—All Professions—\$1.00. AUSSIE, Box 91018-E, Los Angeles, California 90009.

AUSTRALIA!! AUSTRALIA!! AUSTRALIA!! Government assisted transportation!! Growing Australia needs you!! Fully illustrated Handbook explains employment, housing (buying-renting), education, ranching (capital required) how to start a business. Lists hundreds of American companies in Australia and employment agencies. Explains Government Assisted Transportation. **FREE DETAILS!!** Write: Associated, Box 17-B21, Lafayette, California 94549.

HELP WANTED

WORLD-WIDE. . . U.S.A. Jobs Galore!! Students, all professions and occupations. Enjoy Paris, Rome, Tokyo, Mexico City, Miami, San Francisco. \$700.00 to \$3,000.00 monthly. Paid Overtime, Travel Allowance, Sightseeing. Free Details!! Write: Global Employment, Box 706-B21, Orinda, California 94563.

OVERSEAS Jobs—Europe, South America, Australia, Far East, etc. 1000 openings all trades. Construction, Office, Engineering Sales, etc. \$700 to \$3,000 month. Expenses paid. Free Information. Write Overseas Jobs, International Airport, Box 536-M, Miami, Florida 33148.

OVERSEAS EMPLOYMENT . . . Australia, Europe, South America, Asia! All Occupations! \$700-\$3,000 monthly! Write: Employment International, Box 29217-AB, Indianapolis, Indiana 46229.

"AUSTRALIAN OPPORTUNITIES HANDBOOK" . . . Latest information about Government Paid Transportation, Employment, Business, Farming, Housing . . . plus "Employers List" and Forms. Send \$1.00. International Services, Box 19107-AB, Washington, D.C. 20036.

OVERSEAS Jobs—Australia, Europe, South America, Far East, etc. Openings in all trades and professions. \$400. to \$2,500 Monthly. free information write FOREIGN JOBS DIRECTORY, Box 2235 A.M.F. Miami, Florida 33159.

MAILERS WANTED. Gross up to \$500.00 mailing 1000 circulars. Detail's 25c. Smyre's, 953PM, Newark, N.J. 07101.

REAL ESTATE & FARMS

NEW!—FREE CATALOG! Big SPRING edition! Over 4,600 properties described, pictured—Land, Farms, Homes, Businesses—Recreation, Retirement. Selected Best thruout the U.S.! 71 Years' service, 548 Offices, 40 states Coast to Coast. Mailed FREE from the World's Largest! STROIT REALTY, 67-MX E. 42nd St., N.Y. N.Y. 10017; 7-MX S. Dearborn, Chicago, Illinois 60603; 521-MX E. Green, Pasadena, Cal. 91101.

CANADIAN Lands, seized and sold for taxes. Our 54th annual series of lists, describe many choice properties, situated from coast to coast, acquired by us through Tax Sale. Priced as low as ten dollars per acre, guaranteed perfect title, small monthly payments, no mortgage. Beautifully situated hunting and fishing camps, where there is real sport, summer cottage sites, heavily wooded acreages. Now is the time to invest in Canada's minerals, forest and farms. Write today for free booklet with full explanation. Tax Sale Service, Room 301-D, 85 Bloor St., East, Toronto 5, Canada.

CANADIAN HUNTING/FISHING PROPERTIES, From \$9.00 an acre. Choice properties across Canada. Low monthly payments. Ideal hunting, fishing, timber, investment. **FREE CATALOGUE.** Canadian Estate Land, Department PMC-2, 2200 Avenue Road, Suite 103, Toronto 380, Canada.

CANADIAN LAKEFRONT PROPERTY! \$10.00 PER Shoreline Foot. Well wooded acreage on lakes teeming with fish. Suitable for hunting, fishing, investment. Small monthly payments. **FREE BOOKLET.** Canadian Shoreline, 2200 Avenue Road, Suite 103, Dept. PMC-2, Toronto 380, Canada.

OCALA FOREST CAMPSITES Deep in the heart of the Great Ocala National Forest. Excellent hunting and fishing. Free maps and photos. (Unavailable in states requiring separate registration) AD701.B710E. W. H. Vernor, Inc., Dept E, DeLand, Florida 32720.

GOVERNMENT LANDS Low as \$3.50 acre. Millions Acres! For exclusive "Copyrighted Report" . . . plus "Land Opportunity Digest" listing lands throughout U.S.; and VALUABLE 17 X 22 TREASURE MAP OF U.S.; send \$1.00. Land Disposal, Box 9091-PM, Washington, D.C. 20003. Satisfaction Guaranteed.

CANADIAN Vacation lands: Full price \$385.00. 40 acres, \$10 month. Suitable cottage sites, hunting, fishing, investment. Free information. Land Corporation, 3768-C Bathurst, Downsview, Ontario, Canada

LAND! EASY TERMS LESS THAN BANK RATES. NORTHWEST TIMBERED ACRES. As low as \$1,250 Total Price. 5-10-20-40 Acres. For people who love the land—A tract of Recreation Land to have for your very own! In Northern Idaho, Northeastern Washington, and Western Montana. In the heart of lakes and big game country. All covered with growing timber. Access and Title insurance with each tract. This is select land with natural beauty, recreational and investment values. Plan for the future and retirement recreation. We have tracts of many types and sizes from which to choose, including beautiful Northwest Waterfront property. Your inspection is welcomed. Write us for free list, maps, and complete information. Write to: Dept. PC, Recreation, Inc. P.O. Box 106, Opportunity Station, Spokane, Wash. 99214.

>1 ACRE—Canadian Border—hundreds campsites, islands, farmlands, directly from tax authorities. (Non-profit). Lists, photographs mailed. Register, Room 10, 110 Church Street Toronto 1, Canada.

CENTRAL Ontario—Choice 640 acre Sportsmen's paradises still available—\$20.00 plus \$6.50 taxes yearly. Maps, pictures. \$2.00 (Refundable). Information Bureau, Norval 4, Ontario, Canada.

GOVERNMENT Lands. . . Low as \$3.50 acre! Millions Acres throughout U.S. . . . Canada. Free Details! Land Digest, Box 11071-P, Indianapolis, Ind. 46201.

GOVERNMENT Lands . . . low as \$1.00 Acre! Millions Acres! For exclusive "Government Land Buyer's Guide" . . . plus "Land Opportunity Review" listing lands available throughout U.S., send \$1.00. Satisfaction Guaranteed! United Lands, Box 19107-AB, Washington, D.C. 20036.

NEW: Canadian Oil Leases: \$1.00 acre. Free information. Northern, Box 70-FR, Montreal 206.

10 TO 80 ACRES—Lake Superior, Marquette, Michigan area. \$99 acre. Any terms A-OK. Cabins, Trailers, Camping welcome. Hiawatha Forest Lake Acres, 3650 Dixie, Drayton Plains 16, Michigan 48020.

FREE! New 1971 Spring catalog! Hundreds of bargains, homes, farms, resort, businesses, investment property in many states. Actual property photos! Your copy FREE! (Zip code, please.) SAFE-BUY Real Estate, Box 589-PM, Little Rock, Ark. 72203.

\$1 ACRE—U.S.A.—CANADA Millions Acres. Direct from Government Agencies. No middlemen. . . . Family vacationing. Fishing, Hunting, Homesteading, Investing. . . . For amazing "where" and "how" "ALL STATES—ALL CANADA GOVT LANDS DIGEST" . . . plus invaluable Canadian maps. Rush \$1.00 (Guaranteed): Can-Am-Lands, P.O., Box 1147, Buffalo, New York 14240.

NOW: Benefit from Canada's most profitable natural resource. Timber Leases. \$1.00 acre. Free information. Timberland, Box 70-FR, Montreal 206.

FREE . . . SPRING 1971 Catalog. All types real estate coast to coast! UNITED FARM AGENCY, 612-PM West 47th St., Kansas City, Mo. 64112.

ARIZONA. Sunny Frontier Valley. Choice investment or retirement property. Lake Havasu City area. 2½ acres, \$895, low terms. Mrs. Young, Glenarm Co., 2233 No. 7th St., Phoenix 85006.

ARIZONA—Beautiful 2½ acres, \$995, low down, easy terms. For vacation, retirement or investment. Lake Havasu-Kingman area. Ev King, Broker, 316-M East Ocotillo Road, Phoenix 85012.

FREE! Real Estate Catalog! Farms, Ranches, Business, Recreational and Investment Property. 18 states, pictures galore. Note state desired. Banner Advertising, Box #3333, 19-A, Springfield, Missouri—65804—"Real Estate Our Specialty."



FLOWERS, PLANTS & NURSERY SUPPLIES

TOMATOES Year around. Learn growing in or out side. Instructions and 2 packets Seeds \$1.00; Barker's, Box 3261-C; Fort Worth, Texas 76105.

600 SWEET Onion plants with free planting guide \$4.20 postpaid. Tonco, "home of the sweet onion." Farmersville, Texas 75031.

LEARN Landscaping and the growing of plants. Start a profitable business part or full time. Free information without obligation. Lifetime Career Schools, Dept. A-957, 2251 Barry Avenue, Los Angeles, California 90064.

GINSENG Bringing \$1.20 pound. Have seeds, roots. Goldenseal. Full information. K. Collins, Viola, Iowa 52350.

FIBERGLASS And Plastic Greenhouses—from \$89.95! (12' Long!) Accessories. Free catalog. Greenhouseman, Box 2666-M, Santa Cruz, California 95060.

CONSTRUCTION PLANS, BLUEPRINTS

FULL SIZE Blueprints, Drafting Table—Desk Combination, \$3.50. List Free. Kieberts, 1575 Meadow, Galesburg, Illinois 61401.

HOME CRAFTSMEN

CABINETMAKING MADE EASY And "How to Make Formica Counter Tops." Two excellent guides let you build kitchen cabinets and counter tops like professionals. Extraordinary guides bring master craftsmen's shortcut methods. Satisfaction guaranteed. Write: Japs, 126-P Seventh North, Hopkins, Minn. 55343.

HOME CRAFTSMEN

(Continued from preceding page)

LAMICUT FORMICA KNIFE. Handknife cuts Formica, glass, etc. Easily cuts curves. No need for power tools. Lamicut Products, P.O. Box 43166, Cleveland, Ohio, 44143.

101 PATTERNS Of Smart Gifts, Novelties, Shelves, Action Windmills, plus "Make Money Jig Sawing." \$1.25. Mastercraft, 25M, 7041 Olcott, Chicago 60631.

BOOKLETS: Items From Coat Hangers \$1.00; Handcraft Ideas \$1.00; Catalog 25¢. Leisure Products, R.D. # 1, Freeland, Penna. 18224.

WOODWORKING Catalog and Manual 25¢ Plus free "101 Project Ideas." World's most beautiful veneers, lumber plywood! Wood finishing, upholstery supplies, Cane Lamp parts, Furniture hardware, Animal whittling blocks, 2,000 workshop products. Constantine, 2051-C Eastchester Road, Bronx 10461.

SKIL-CRAFTS New 200 page catalog with world's largest, finest selections of hobby-craft, leather-craft, artist supplies. Send 50¢ (refunded plus free gift with first \$5 minimum catalog order). Skil-Crafts, Box 105-P, Joplin, Mo. 64801.

MAKE Money Building and selling Bird Houses. Send \$1.90 for 39 page book of plans covering 19 projects. Yeager, 1665 Linden, Homewood, Ill. 60430.

WALNUT, Bowls, Legs, Round Picture Frames, Gun-Stocks Lumber Moulding. Midland Walnut, Box 262, Savannah, Missouri 64485.

FULL SIZE FURNITURE PLANS. Traditional, Early American, Danish Modern. Catalog 50¢. Furniture Designs, Dept. P-21, 1425 Sherman, Evanston, Illinois 60201.

CONTRACTORS, Do-It-Yourselfers, buy your ornamental iron columns and railings direct from manufacturer and save. Send 25¢ for catalog, refundable. Duley Steel Fabricators, Advance, Mo. 63730.

PICTURE Framing—Profitable full or spare-time business. Easy to learn with handbook-course "Guide To Picture Framing Profits." \$1.50 Guaranteed. Free framing-supplies catalog included. Japs, 126-PM Seventh North, Hopkins, Minnesota 55343.

JIGSAW Profits, new, unusual full size pattern \$1.25. Werts, Box 41097, Cincinnati, Ohio 45241.

WROUGHT IRON WORKSHOP. Make Lamps, tables, chairs for home or for sale our versatile quality tools perform seven metal operations without heat or electricity. Featured Editorially this magazine March 1970. Free color brochure or send \$1.00 for design book & sample metal. Creative Metalcraft, Dept. A, Box 663, West Caldwell, New Jersey 07006.

SCREW CHECK'R Measures length, diameter, size, etc. of screws, cotter pins, rivets. Instructions. Plastic (\$1.79) or Steel (\$4.98) models. Money-Back Guarantee. Value Valley, 2141-M Sherwood Avenue, St. Paul, Minnesota 55119.

LARGE SELECTION—Picture mould, Wild miter. Catalog 25¢, Bauerle Cabinet, Box 1838-M2, Hammond, La. 70401.

ELECTRICAL WALL CALENDAR. Complete, \$2.25, check, moneyorder. West, 7940 Guilford, Dayton, Ohio 45414.

"WOODEN LANTERN PLANS—Circular 25¢ (refundable with purchase). Bingaman Plans, P.O. Box 74, Langhorne, Pa. 19047."

FREE Catalog, Clocks, Movements, Hands, Gifts. Newport, Box 6848A, Burbank, Calif. 91505.

HOME HOBBYISTS: Fine veneers available for "facelifting" furniture. Many other uses for woodworking hobbies. Veneer Kits, 100 South Kentucky, Evansville, Indiana 47717.

BEAUTIFUL Lamps—from old wagon and buggy wheels, plans, pictures \$1.00. S Enterprises, Naples, Illinois 62669.

DO-IT-YOURSELF

ADD Air Conditioning to your forced-air furnace. Save \$200 or more. Free step-by-step brochure. McGraw-Edison Company, 707A N. Clark St., Albion, Michigan 49224.

DO-IT-YOURSELF Books written by Better Homes and Gardens. Hundreds of ideas, illustrations and instruction. Titles: Planning the Best Bathroom; Basement/Rec Rooms; Add-a-Room; Patios and Fences; Bookshelves; Fireplaces; Project Plans; Painting, Finishing and Decorating; Storage; Gardening and Landscaping; Kitchens; Handyman Tips. All 12 titles \$6.80—6 titles \$3.50—3 titles \$1.80—single titles 65¢. Write to National Plan Service, Dept. 105, 1700 W. Hubbard, Chicago, Illinois 60622.

BURGLAR-FIRE Alarm Supplies and Information. Free Catalog. Protecto Alarm Sales, Box 357, Birch Run, Michigan 48415.

"BUILD Log Cabins, rustic furniture, fireplaces!!! Complete manual, \$3.00 . . . "A" Frame plans, \$2.00 . . . Guaranteed . . . Beels, 956 Springdale, Atlanta, Georgia 30306."

SAVE Hundreds Of Dollars. Build own kitchen cabinets. Step by step instructions. Drawings \$2.00. Paul Schermerhorn, Marathon, New York 13803.

"HOW TO" Books. Catalogue 25¢. Elston House, 35 Stonycliff, Centerville, Mass. 02632.

REFRIGERATOR Door gaskets—Electric Range Washer Parts. Send Make and model for cost. Box 5465, Hamden, Conn. 06518.

CONVERT MOWER Engines into air compressors. Write Showalter, Box 409, Abilene, Kansas 67410.

BURGLARY PROTECTION—Professional alarm system components, locks, safes, accessories. Free catalog. TPC, Box AE-3, Cupertino, California 95014.

BUILD Colonial Barbie Doll Wardrobe—Plans \$2.00. G. G. Enterprise, 2750 Elk Lane, Grants Pass, Oregon 97526.

"FIX That Drip" NEW Booklet reveals "Trade Secrets." homeowners plumbing problems. \$2.00. Brighton House, 5200M Greenfield, New Brighton, Minn. 55112.

WOOD LATHE With DUPLICATOR, Plans \$3.00. Lathe, 500 North Main, Fort Branch, Indiana 47533.

"LOUD, Quick, small, safe, permanent fire alarms made easily at home for half cent each. Selling \$7.50 per dozen. Better than best electrical system. Hang on walls. Send \$2.00 for material, tools and simple directions to Bang Co., P. 115 New Montgomery St., San Francisco, Calif. 94105."

WATERLESS Hand Cleaner Concentrate. \$2.00 pound. Shanahan, 380 West Main, Waterbury, Conn. 06702.

ARTS AND CRAFTS

LEARN Decorative Arts & Crafts—Excellent opportunities for starting part or full-time business. Great hobby too! Free booklet, Lifetime Career Schools, Dept. E-539, 2251 Barry Avenue, Los Angeles, California 90064.

FREE: New 136 page handicraft catalog. Supreme Handicrafts, Box 395-PM, Sioux Falls, South Dakota 57101.

MAKE Figurines, plaques, lawn ornaments. Molds, plastercraft kits, liquid rubber. Sample and catalogue 10¢. Wooley Company, Box 29-B, Peoria, Illinois 61601.

"GETTING Started in Stained Glass" 25¢. Whittemore, Box 2065Y, Hanover, Mass. 02339.

BINOCULARS, TELESCOPES, MICROSCOPES, MAGNIFIERS

"NEW Approved interocular design, simplifies making new true image reflecting binocular, illustrated instruction. \$2.50. Serite, Box 63, Galiano, B.C., Canada."

BINOCULAR Sale! Free color catalog 100 models \$9.95-\$250.00. Write United, 9043 So. Western, BCAT-3108, Chicago 60620.

SCIENCE Bargains! Lenses, telescopes, binoculars, microscopes, kits, parts, war surplus. Send \$1.50 for beginner's 10-lens kit with instruction booklet. Order Stock 2-CH. Request free 148 page Catalog CH. Edmund Scientific Co., 300 Edscorp Bldg., Barrington, New Jersey 08007.

BINOCULARS Direct From Manufacturer. Finest Quality. Tremendous Savings! Catalog 50¢, Refundable. Koyu, 4116 Crenshaw Blvd., Los Angeles, Calif. 90008.

SCIENTIFIC Combination microscope, telescope, magnifier \$1.00. Caloptics, Dept. 22, 1446 8th Avenue, New Brighton, Pa. 15066.

TELESCOPES (Reflectors) complete kits. Other accessories, request free literature. Criterion Manufacturing, Dept. PM 13, Hartford, Connecticut 06101.



CAMERAS AND EQUIPMENT

PHOTOGRAPHY For Pleasure or profit. Learn at home. Practical basic training. Long established school. Free booklet. American School of Photography, 835 Diversey Parkway, Dept. 674-022, Chicago, Illinois 60614.

WORLD'S Largest Buying Guide—800 illustrations—50¢—Deductible With Your Order—Olden Camera—1265 Broadway, New York, N.Y. 10001.

STEREO Camera and viewer kit \$19.95, cameras included, assemble, it yourself. Or will furnish plans for \$3.00. Direct Sales Co., Box 835, Huntsville, Ala. 35804.

PHOTO FINISHING

CAMERA FANS! Expert photofinishing by one of Country's largest labs at lowest prices. Fast service and free "Foto-Fan" Stamps you quickly redeem for valuable Photo Supplies. 8MM Kodachrome \$1.29; 8 Exp. Kodacolor \$1.79; 35MM Kodachrome, 20 Slides \$1.39; 8 Exp. Black White 69¢. Satisfaction guaranteed. Send exposed film or request free mailers, complete Price List and Gift Catalog. Direct Mail Photo, Box 8352-PM, Pittsburgh, Pa. 15218.

KODACOLOR FILM Developed and twelve jumbo color prints \$1.49; twenty \$2.49. Black & White 12-exposure 60¢. Trial offer. Young Photo Service, 45C, Schenectady, N.Y. 12301.

COLOR SLIDES

35MM COLOR Slides, 10,671 individually sold. Described, Encyclopedia catalog 10¢. Wolfe Worldwide, Dept. 14-21, Los Angeles, Calif. 90025.

MOTION PICTURES AND SOUND EQUIPMENT

DISCOUNT FILM Catalog Saves Dollars 8MM/Super 8, Sportlite-PM, P. O. Box 24-500, Speedway 46224.

FREE! 64-Page catalog, 8-16mm film, supplies, processing equipment. Superior, 448 N Wells, Chicago 60610.

8MM-16MM MOVIE BARGAINS! Free Catalog! Cinema Eight, Box 245-PM, NYC 10028.

16MM SOUND Features, Shorts, New, used for Sale. Free Catalog, National Cinema, 333 W 57th St.—N.Y.C., N.Y. 10019.

UNUSUAL Movie supplies. Free circular. Esor, 47th Holly, Kansas City, Missouri 64112.

RADIO, TELEVISION AND HAM EQUIPMENT

TUBES, "Oldies", Latest. Lists for Stamp. Steinmetz, 7519 Maplewood, Hammond, Indiana 46324.

(Continued on next page)

RADIO, TELEVISION AND HAM EQUIPMENT

(Continued from preceding page)

TUBES—Lowest prices. Foreign-American, Obsolete, receiving, special purpose, transmitting tubes. Send for tube, parts catalog. United Radio Company, 56-PM Ferry St., Newark, N. J. 07105.

36¢ RADIO & TV tubes. Free catalog. Cornell, 4213-17 University, San Diego, California 92105.

GOVERNMENT Surplus receivers, transmitters, snooperscopes, parts. Catalog. 25¢. Meshna, Nahant, Mass. 01908.

HIFI, TAPES, RECORDS AND ELECTRONICS

FREE—FREE—FREE—FREE—FREE—FREE—Send in for your FREE one year subscription to Olson Electronics' fantastic value packed catalog—unheard of low, low prices on brand name speakers, changers, tubes, tools, stereo amplifiers, tuners, CB and other values. Credit plan available. If you have a friend interested in electronics, send his name and address for a FREE subscription also. Olson Electronics, Dept. JN-260 S. Forge St., Akron, Ohio 44308.

NOSTALGIC Radio is still available. Six hours of highest fidelity, \$7.00 or catalog for 25¢. Nostalgic Radio, Box 29, Peoria, Illinois 61601.

CASSETTES Ready for recording, C-60—\$1.50, C-90—\$2.25. Vista, 2842 Whaleneck Dr., Merrick, N.Y. 11566.

FREE Catalogues, 2000 hard to find unusual records. Rose's Records, Box 7216, Louisville, Ky. 40207.

BUILD AM Wireless transmitter kit. Broadcasts to any AM radio 50 feet away. Simple, educational to build, \$8.95 + 15¢ postage. Free Catalog, D. Electronics, 4725 45th NE, Seattle, Wash. 98105.

FREE Electronics Catalog. Tremendous bargains. Edu-Kits, Department C-734B, Hewlett, New York 11557.

FREE Catalog—Electronic kits—amplifiers—preamplifiers—psychedelic strobes—metal detectors—color organs—digital instruments—guitar amplifiers. FREE Subscription, SWTPC, Box PM32040, San Antonio, Texas 78216.



MUSIC AND MUSICAL INSTRUMENTS

ACCORDIONS and Amplifiers! Excelsior and other Famous Makes. Save 50%. Buy Direct. Factory Distributor. Terms. Trades. New—Used. Free Home Trial. Free Catalog and Discount Prices. Excelsior, Dept. R, 3147 North Luna, Chicago 60641.

POEMS And Songs wanted by America's most popular studio. Tin Pan Alley. Broadway Productions Division, PM, Lake Grove, New York 11755.

WE Pay All Recording Costs on accepted material! Need new Song Material for immediate recording! Grand Recording. 1354-PM Hancock St., Quincy, Mass. 02169.

TEACH Yourself instruction book amazing method of learning to read notes, and to play accordion. Send \$1.50. Jaworski, 2809 Eastern Avenue, Baltimore, Maryland 21224.

LEARN Musical instrument of your choice—easy! New home study tape course. Write for free brochure. Carver School, 7 West 1st, Dept. L; Hinsdale, Illinois 60521.

SWISS Musical Movements. Mechanical-Electrical, Spielman, 131 West 42nd, New York 10036.

30% DISCOUNT Name Brand Musical Instruments. Free Catalog. Freeport Music, 127 F. Sunrise Highway, Freeport, New York 11520.

FREE, Song Selling Information. Peerless Publications, Box 193-A, Bloomfield, Conn. 06002.

ACCORDION Manufacturing. 6846-P North Avenue, Chicago, Illinois 60635. Concertinas, Hohners, Chromatics, Guitars, Drums, New, Used, Tuning, Repairing. Wholesale Catalogs Free.

PLAYER Piano Rebuilding—get details from: Vestal Press, Vestal 11, N.Y. 13850.

ELECTRIFY Player Pianos, Pump Organs Quickly, Inexpensively with Lee Silent Suction Units. Write Lee Music, 525F Venezia Avenue, Venice, California 90291.

LEARN Banjo. 5-String Bluegrass. No music. Makes learning easy. Free details. Blaylock, Box 25-M, Marietta, Georgia 30060.

POEMS Wanted for new songs, records. FIVE STAR MUSIC, 6M Beacon, Boston, Mass. 02108.

GUITAR, Banjo Making books, Plans, woods, necks, tools. List 25¢. Satinwood, 510 East 11th Street, New York, N.Y. 10009.

ACCORDION Top brands. Buy direct. Tremendous discounts. Trade accepted. Free brochure PM. Accordion-O-Rama, 874 Broadway, N.Y.C. 10003.

WHOLESALE Professional Guitars, Amplifiers, PA Systems, Free Catalog. CARVIN, Escondido, Calif. 92027.

GUITAR MAKING Books. Imported Woods, Supplies, Accessories. Catalog 25¢. Guitar Center, Box 15444, Tulsa, Okla. 74115.

GUITARISTS—Busy? Five minutes weekly, teaches strums, barres, melody. Beginner—advanced. Samples, 10¢. Steele's, Box 114, San Raphael, Calif. 94902.

VIOLINS, Guitars, String Instruments. Old or New. Instant Strad Tone. Worldwide. Certified. Do-It-Yourself \$10.00. Superlative Formula. 90 Day Trial \$3.00. Sgt. Rolex U.S.A.F. "Ret." P.O. Box 2381, Las Vegas, Nevada 89104.

ELECTRONIC DRUMMER—\$24.95, Free catalog. Mele 'Ohi, Box 24410M, New Orleans, La. 70122.

SONGPOEMS Needed, 50-50 RECORDING Agreement, Betty's Music Makers, 945B Central, St. Petersburg, Florida 33705.

POEMS Set to music. Songs recorded. Send poems, songs, Crown Music, 49-C West 32, New York 10001.

VIOLIN And Guitar makers—send for latest Free Catalogue of woods & accessories. International Violin, PM1. 414 East Baltimore St., Baltimore, Md. 21202.

CONSERVATION TRAINING

GAME WARDEN, Government Hunter. Forestry, Park & Wildlife Service announce job openings regularly. Prepare at home for outdoor work, good pay, security. Complete information Free! Write North American School of Conservation MPW, Newport, California 92663.

MOTEL HOTEL MANAGEMENT TRAINING

MOTEL MANAGER TRAINING — Men, women, couples wanted by leading resorts, motels-hotels everywhere. Enjoy free rent, plenty of free time. Easy home-study plan. Free! "Motel Career Kit." No salesman will call. North American School of Motel-Hotel Management, AZW, Newport, California 92663.

EDUCATION AND INSTRUCTION

FINGERPRINTING—Investigation. Exciting, secure career. Learn at home. Free book. State age. Institute of Applied Science, 1920 Sunnyside, Dept. 162, Chicago, Illinois 60640.

WATCH REPAIRING, Unique course develops skills at home. Free sample lesson. Chicago School, YO, Fox River Grove, Illinois 60021.

"WATCHMAKING"—Approved Correspondence Courses. Watchmaking Institute, Box 426-A, Encino, California 91316.

ANNOUNCING HOME Study course in commercial baking. Practical basic training. Good field for those with aptitude. Free booklet, "Opportunities in the Baking Industry." National Baking School, 835 Diversey Pkwy., Dept. 674-022, Chicago (60614).

"INCOME TAX Complete home-study course in 6-10 weeks. Earn up to \$3,000.00 before April 15th! Become a professional tax specialist. Send \$1.00 for first lesson and complete details. Total guaranteed course only \$70.00. Easy terms and diploma. CERTIFIED TAX INSTITUTE, 10825 N. W. 27th Ave., Miami, Fla. 33167."

COMPLETE YOUR HIGH SCHOOL At home in spare time. Texts furnished. No classes. Diploma. Approved for Veteran Training. Founded 1897. Free Brochure. American School, Dept. X245, Drexel at 58th, Chicago, Illinois 60637.

MATHEMATICAL Topics For Tradesmen, Businessmen. Improve your ability, write: Lee's Service, 1862 Andrews Avenue, Bronx, New York 10453.

GRAPHOANALYSIS — Learn scientific handwriting analysis for profit, pleasure. Free sample lesson, catalog, reveals plan. Write: Igas Inc., 325 Jackson, Dept. 2A2-2, Chicago 60606.

BE A Real Estate Broker. Big earnings. Prepare quickly, easily. GI approved. Free Catalog. Weaver School, 3519-P Broadway, Kansas City, Missouri 64111.

MISSOURI Auction School. Veteran Approved. Free catalog. 1600-03 Genesee, Kansas City, Mo. 64102.

LEARN Real Estate At Home. Get your license. Become a Salesman or Broker. Approved for Veterans. Write National Institute of Real Estate, Inc., 3330-M Peachtree Rd., Atlanta, Ga. 30326.

LIFETIME ORDINATIONS. Send stamp for information. Church, 2207 Cardinal, Rolling Meadows, Ill. 60008.

PENMANSHIP Corrector. Improve Poor penmanship quickly. Details free. Ozment, Box 2344, St. Louis, Mo. 63114.

LEARN Auctioneering. Term soon. Free catalog. Reisch Auction College, Box 850, Mason City, Iowa 50401.

PIANO Tuning quickly learned with home study course. Diploma granted. American Tuning School, Gilroy, Calif. 95020.

EARN \$125 A week and up. Learn a trade with a future. Learn auto diesel mechanics in our shops. You learn with tools on real equipment. Earn while you learn. Many of our graduates earn \$125 a week and up. Write for free bulletin: Dept. 256, Auto Diesel College, Nashville, Tennessee 37219.

HIGHLY EFFECTIVE Home study courses in Electronics Engineering Technology and Electronics Engineering Mathematics. Earn your Degree. Write for Free Descriptive Literature. Cook's Institute of Electronics Engineering, (Dept. 10), P.O. Box 10634, Jackson, Miss. 39209. (Established 1945).

EXTENSION And Post-Graduate Awards in Philosophy, Arts, Sciences, Botanic Medicine, Homeopathy, Radionics and others. 30 subjects. Curricular free (air-mail \$1.00 refundable). Registrar, Sussex College of Technology, Highfield, Danehill, Sussex, England.

DETECTIVE Course. Free Information. Universal Detectives, Box 8180-F, Universal City, California 91608.

HIGH SCHOOL Diploma at home. Licensed teachers. Send age, highest grade completed for free details. No salesman will call. Southern States Academy, 5300 W. Bellfort, Dept. 16-R, Houston, Texas 77035.

OWN Collection agency. "Little Gold Mine!" Franklin Credit, Roanoke, Virginia 24004.

(Continued on next page)

EDUCATION AND INSTRUCTION

(Continued from preceding page)

USED CORRESPONDENCE Courses and Books sold and rented. Money back guarantee. Catalog free. (Courses bought.) Lee Mountain, Pisgah, Alabama 35765.

AUCTIONEERING. Resident or Home Study Course Free Catalog. Nashville Auction School, 2004 West End, Nashville, Tennessee 37203.

AUTOSUGGESTION. Sleep-learning headquarters! Tapes, records, books, Gigantic catalog free. Research Association, Box 24PM, Olympia, Washington.

ANSWERED GOD'S CALL. Become an Ordained Minister of the Gospel for Christ. We Ordained Worthy Christians. Calvary Grace Christian Church, Post Office Box 1674, Fort Lauderdale, Florida 33302.

EARN College degrees at home. Many Subjects. FLORIDA STATE CHRISTIAN COLLEGE, Post Office Box 1674, Fort Lauderdale, Florida 33302.

ASK! Improve Yourself. Personality questions answered. You become a winner! \$3.00. Counselor, Success Services, Box 985M, Mason City, Iowa 50401.

POLICE Correspondence Courses and diplomas \$10.00. National Police Studies, Box 112, Pleasant Grove, Alabama 35177.

PIANO Tuning pays. Big money in spare time. Learn at home. No musical knowledge necessary. Phonograph, records, tools and instructions furnished. Electronic tuning also taught. Free catalog. Capital Tuning School, 3160 S.W. 16th Court, Ft. Lauderdale, Fla. 33312.

PROFITABLE Camera service training at home. National Camera, Dept. PM, Englewood, Colo. 80110.

PIANO Technology—Electronic organ servicing, learned easily at home. G.I. Approved. Free booklet. Niles Bryant School, Dept. P, 3631 Stockton, Sacramento, California 95820.

LEARN Asleep or awake! Records, tapes, equipment! Free catalog! Drawer PM-400, Ruidoso, New Mexico 88345.

\$100.00 PER Day plus expenses possible for Detectives. Details Free. Detectives, Box 185, Fairfield, Alabama 35064.

CATALOGUE Of Those Ver-ry Hard-To-Find Products in Chemistry, PLUS Things That Go Boom, Rockets, Transistor Radios, More. (Price Refundable-1st Order) 50¢ Kenrus-C, Box 158M, Staten Island, New York 10309.

DRAFTING (Electronic, Mechanical Architectural). Home Courses \$25.00. Send \$2.00 first lesson. Prior, Inc., 2309-169 Street, Whitestone, New York 11357.

WOULD YOU LIKE TO BE A DETECTIVE?? Learn exciting profession at home in spare time. Write: Global Detectives, Box 415-B21, Lafayette, California 94549.

REPAIR MINIBIKES, LAWNMOWERS, BICYCLES, Sewing Machines, Auto Engines. Build concrete, Plywood, boats, trailers. Ten additional How-To-Do books. Free brochure. Sincere, Box 10422, Phoenix, Arizona 85016.

GET A British Degree, Divinity, Philosophy, Radionics. 35 Courses. Prospectus free. Brantridge Forest School, Highfield, Dane Hill, Sussex, England.

HOW To Get That CIVIL SERVICE Job. Free folder lists 285 classifications. Tomar Enterprises, 1760 South Brentwood, St. Louis, Missouri 63144.

"LEARN Drafting For Industry, Quickly, Inexpensively, Authentically. Write For Particulars." "A206, 1020 Des Plaines, Forest Park, Illinois 60130."

FOR INVENTORS

INVENTORS—Do you want to sell or license your invention on cash or royalty basis. Write Kessler Corporation, C-52-F1, Fremont, Ohio 43420.

PATENT SEARCHES Including maximum speed, full airmail report and closest patent copies. \$6.00. Quality searches expertly administered with complete secrecy guaranteed. Free Invention Protection forms and "Patent Information." Write Washington Patent Office Search Bureau, Dept. 15, 711 14th St., N.W. Washington, D.C. 20005.

ATT: INVENTORS. A major corporation, NYSE listed, is interested in acquiring unique inventions which have industrial or consumer product applications. No investment required. For immediate action enclose particulars and forward them to INNOVATION ASSOCIATES, P.O. Box 546, Westfield, New Jersey 07091.

PATENT Application Financing. Free patent search plan. Global Patent Division. 2420 77th. Oakland, Calif. 94605.

U.S. PATENT Office Searches, 234 Broadway, Room 3615, New York. Free invention certificates.

PATENT And invention development by licensed professional patent engineer and U.S. Patent Office former examiner, and engineering specialists. Your inventions and ideas engineered for patent protection and commercial value. Inventions developed by us negotiated for cash or royalties with our nationwide contacts. Send for free protection "Invention Certificates" and further interesting, valuable patent information. George Spector, Licensed Professional Patent Engineer, Woolworth Building, New York 10007.

IMMEDIATE Cash, for patent applications. Free patent searches. Write for details. Universal Patents, 184-D, Marion, Ohio 45750.

INVENTORS: Your ideas and inventions (patented; unpatented) expertly searched, developed for commercial appeal and cash/royalty sales to manufacturers by professional Invention Developer with excellent record of experience. B.S. Industrial Engineering; United States Patent Office former Patent Examiner. United States Government former Patent Advisor. Second decade reliable service! Member: United States Council International Chamber Commerce. Free "Invention Record" and "Recommended Protection Procedure." Airmailed! Write: Raymond Lee, Invention Developer, 230P-Park Ave., New York City 10017.

FREE PAMPHLET: "Tips on Safeguarding Your Invention." Write: United States Inventors Service Company, 501P Thirteenth Street N.W., Washington, D.C. 20004.

PATENT Searches, including copies of related U. S. patents. Inventors, attorneys, manufacturers use our "worldwide" airmail service! "Invention Record" form and "Information Every Inventor Needs". Sent Free! Hayward Company, 898P National Press Building, Washington, D. C. 20004.

MANUFACTURERS NEED New Products! FREE Literature explains "How to Submit Your Invention." Congress Invention Company, 911-C Warner Building, Washington, D.C. 20004.

INVENTIONS Protected by U.S. Patent Office for only \$10. Complete details \$1. Dittofax, 5815-PM Compass, Los Angeles 90045.

INVENTIONS WANTED

IF Your Invention is adaptable to promoting we will contract for selling on cash or royalty. Free booklet outlines royalty rates, requirements. Kessler Corporation, C-52-IW, Fremont, Ohio 43420.

ATTENTION: INVENTORS. A major corporation, NYSE listed, is interested in acquiring unique inventions which have industrial or consumer product applications. No investment required. For immediate action enclose particulars and forward them to INNOVATION ASSOCIATES, P.O. Box 546, Westfield, New Jersey 07091.

INVENTIONS Wanted. Patented; unpatented. Tremendous manufacturers lists. Global Marketing Service, 2420G 77th, Oakland, California 94605.

INVENTORS! Sell your invention for cash or royalties! Our client manufacturers eagerly seek new items. Patented. Unpatented. Financial assistance if needed. 25 years proven performance. For free information, write Dept. 15, Gilbert Adams, Invention Broker, 81 Wall St., New York, N.Y. 10005.

INVENTORS! We will develop, sell your idea or invention patented or unpatented. Our national manufacturer-clients are urgently seeking new items for highest outright cash sale or royalties. Financial assistance available. 10 years proven performance. For free information write Dept. 47, Wall Street Invention Brokerage, 79 Wall Street, New York, N.Y. 10005.

INVENTORS! Don't sell your invention, patented or unpatented until you receive our offer. Eagle Development Company, Dept. H, 83 Wall Street, New York, New York 10005.

FREE "Directory of 500 Corporations Seeking new Products." For information regarding development, sale, licensing of your patented/unpatented invention. Write: Raymond Lee Organization, 230-N Park Avenue, New York City 10017.

INVENTORS! Protect your ideas! Free "Recommended Procedures." Washington Inventors Service, 422F, Washington Building, District of Columbia 20005.

WE Either sell your invention or pay cash bonus. Write for details. Universal Inventions, 28-E, Marion, Ohio.

MANUFACTURING

INVENTORS Ideas developed. Research. Models. Manufacturing. Sales. Free brochure. Since 1942. William Parker, Box 209, Worcester, Mass. 01601.

BUY IT WHOLESALE

WHOLESALE—Buy 40% To 50% Off Retail—same prices retailers pay! Thousands of name brands! Watches, cameras, jewelry, radios, phonographs, tape recorders, etc. Buy for yourself or resell at fat profit. Big wholesale catalog. Confidential Wholesale Price List. Free details. Wholesale Merchandise Club of America, Dept. 409, 154 Jericho Turnpike, Floral Park, N.Y. 11001.

LIVE Catch Traps. Free Literature. National Live Trap Corp., Tomahawk, Wis. 54487.

STEREO 8 Tracks & Cassettes. New in boxes, 3 for \$12.00. Send for list. Tapes-4638, Irvine, Calif. 92664.

AUTOMATIC Fishhooks. 400% Profits. Free Details. 2 Models. Samples \$2.00. Aron, 61-PM Mastic Beach, New York 11951.

HEARING Aids, Batteries, Wholesale. Catalog 25¢. Fiston, Box 1444, New Preston, Conn. 06777.

WORLD'S Largest wholesale dropship sources. U.S., foreign. Factory suppliers dropship direct to you or customers. Now!, have your own catalog for pennies. Free details. International Buyers, Box 16386-M, Portland, Oregon 97233.

BARGAINS! Buy wholesale and below. Name brands. Appliances, furniture, sports equipment, televisions, cameras, watches, jewelry thousands more. Huge discounts to \$1,000.00 on new automobiles. All makes. Free details. Write today: Worldwide Bargainhunters, Box 730-A, Holland, Michigan 49423.

POLYETHYLENE BAGS—New wholesale catalog. 300 stocked sizes. Lowest ever prices. Catalog 20¢. Dealers wanted. Milvan, 7921D Enterprise, Newark, Calif. 94560.

FANTASTIC Free catalog—Watches, general merchandise. Department Forty, 100 North Greene Street, Baltimore, Md. 21201.

(Continued on next page)

BUY IT WHOLESALE

(Continued from preceding page)

BARGAIN DIRECTORY INTERNATIONAL. Over 100,000 low cost imports. \$2.00. Winchester Enterprises, 2807PM Hargrave Street, Philadelphia, Penna. 19136.

EXPORT-IMPORT

JAPAN: 1200 Products Directory. Illustrated Manufacturers' names, addresses. \$3.00. Send cash. Yamagata Office. 814 Togin Bldg., Marunouchi, Tokyo.

HEY! Importer, Exporter, Wholesaler, Distributor, Manufacturer, discover what International Export Association can do for you, Write Box 819, Sun Valley, Cal. 91352.

FOR THE HOME

SENSATIONAL Bargain! 30 Big beautiful lint-free towels only \$1.98. Satisfaction guaranteed. Golden Rule Mailorder, Dept. PMT, 962 Eva Ave., Akron, Ohio 44306.

FOR PARENTS

YOUR CHILD Can learn the SECRET of better reading. Learn phonics, EASY kit, \$2.50 Guaranteed. Learning House, 806 South Robertson, Room 301, Los Angeles, California 90035.

OF INTEREST TO WOMEN

\$6.00 PROFIT Per Dozen Lacing Beautiful Baby Boots, Baby Moks! Cowboy, Warsaw 9, Indiana 46580.

DOLLS Make Big Money! Start your own hobby-business dressing, making, repairing and selling dolls. Send for Free booklet describing the excellent opportunities open to you. Doll Hospital School, Dept. D-856, 2251 Barry Avenue, Los Angeles, California 90064.

\$100 WEEKLY Possible—typing, addressing, immediate income! Details, send self-addressed, stamped envelope: EDWARD, Box 50160, PM2, Tulsa, Oklahoma 74150.

\$500.00 MONTHLY Possible—clipping news at home. No experience. Send stamped-addressed envelope. American, Excelsior Springs, Mo. 64024.

WOMEN! Make big money at home. \$10.00 profit in an hour possible with invisible mending. Make holes, tears disappear from clothing fabrics. Steady year-round demand from cleaners, laundries, homes. Details free. Fabricon, 1533 Howard, Chicago 60626.

HOW To make money writing short paragraphs. Information free. Barrett, Dept. C-27-03, 6216 N. Clark, Chicago 60626.

HOME Newspaper clippers needed. \$500 monthly possible. Details free. Foster, 272-MA2, Brooklyn 11235.

\$46.00 DAILY Possible—addressing—stuffing envelopes (typewriter or longhand). Information: Send stamped, addressed envelope. American, Excelsior Springs, Mo. 64024.

WANTED! Addressers — Commission Mailers. Stamp required. Ooton Distributors, 4120-P Duke Drive, Portsmouth, Virginia 23703.

HOMEWORKERS! \$100.00 Weekly addressing for firms. Begin immediately. Details—send stamped, addressed envelope. Hamilton, 272-TM2, Brooklyn 11235.

HOW To make money working at home addressing envelopes. \$50-\$100 weekly possible. Start immediately. Exciting details free. Send stamped, self-addressed envelope. Enterprises, Box 16143-PM, Phoenix, Arizona 85011.

"DRAPERY AND DRESSMAKING FABRICS. WHOLESALE Prices in small quantities, Edwards, Dept. B., 130 Burlwood Drive, Santa Cruz, California 95060."

FREE. Learn dozens of easy ways to make money full or part time. Write for Free 5 month subscription. Salesman's Opportunity Magazine, Dept. 17-B0, 1460 Hancock Center, Chicago 60611.

\$150.00 WEEKLY Possible. Addressing, Mailing. 55 firms need homeworkers. Instructions, \$2.00. Schoen, Box 1963-P, Chicago, Illinois 60690.

WRITE For waitress course information. Goldstreet, Box 17005, Wichita 67217.

\$75.00 THOUSAND. HOME Addressing! Longhand, Typewriter. Information, send stamped, self-addressed envelope. Brewster "YL" Box 1348, Clearwater, Florida 33517.

MEXICAN Handbags. Big Profits. Color catalog \$1.00 refundable. L & M, Box 376-M, Wyandotte, Michigan 48192.

25¢ EACH. Stuffing envelopes. No postage required. No addressing necessary. Complete instructions \$1.00. Economy, 629-BT Franklin, Clearwater, Fla. 33517.

GUARANTEED. \$20.00 EVERY 80 ENVELOPES you stuff. No postage, addressing required. Information, send 30¢ with stamped, self-addressed envelope. Econ. "CX", 629 Franklin St., Clearwater, Florida 33517.

GIFT SHOPPING

FREE CATALOG Many new and unusual items. Tobi, 3211 West Campus Drive, Visalia, Calif. 93277.

FANTASTIC! New Flashlight Keyring comes with battery, send \$1.29 to Whitley Brothers # 24, 1695 Barrett Drive, Northwest, Atlanta, Ga. 30318.

UNIQUE Catalog: Free Gifts. Lillian Moline, Box 352A, Carpentersville, Ill. 60110.

LADY'S Combination Butane lighter with built in Swiss Watch \$19.95. C. A. Roberson's, Dept. K Box 6404, Anaheim, California 92806.

AMAZING GIFTS For sick friend or shutin GLASS GARDEN 6 plants will grow in any gallon container. Easy instructions included. \$2.00. CONVENIENT MAIL ORDER, General Delivery, Jellico, Tenn. 37762.

PRACTICAL Attractive Gifts. Free Catalog. Zeromski, Box 3795, Grand Central Sta., New York, New York 10017.

WATCHES, OLD GOLD, JEWELRY

HIGHEST CASH For Gold, Jewelry, Gold Teeth, Rings, Diamonds, Watches, Silver, Platinum, Mail Articles Today. Free gift with information. Chicago Gold & Precious Metals, 6 E. Monroe, Dept. 658, Chicago 60603.

WANTED: Gold, silver, platinum (any form). Information free. Wilmot's, 1067 Bridge St., Grand Rapids, Mich. 49504.

CASH Immediately for old gold, jewelry, gold teeth, watches, diamonds, silverware, spectacles, platinum, mercury. Free information. Rose Industries, 29-A East Madison, Chicago 60602.

WATCH And clock repairing books. Free catalog. North American, Box 77-AB, Fox River Grove, Illinois 60021.

HEARING AIDS

HEARING Aids below wholesale. Regular, eyeglass, completely hidden models. Smallest, most powerful. Free home trial. No Salesman will call. Free details. Write Prestige-C6, Box 10880, Houston, Texas 77018

SAVE To \$500.00. Rhodes Hearing Aids, Box 518, Paducah, Ky. 42001.



SCIENCE AND CHEMISTRY

LASER PISTOL—\$1.00. How to build PHASER PISTOL—\$1.00. MOON MAN (ROBOT). Build now. Complete plans \$2.00. (add 25¢ postage.) New catalogue—25¢. Roy Davis Laboratories, Dept. PM, 118 West Adams Street, Jacksonville, Florida 32202.

CHEMICALS And apparatus for industrial, analytical, and private laboratories. Catalog 50¢. Dept. M-50. Biological Supply Co., 1176 Mt. Hope Ave., Rochester, N.Y. 14620.

CHEMICALS Apparatus, Biology and Model Rockets. Both Catalogs for 50¢. Sheard Science, Dept. PM, Columbus, Wisconsin 53925.

EVERYTHING You Want And Need—Chemistry, Biology, Astrology Catalog 35¢. Boulevard Laboratories, 3114 East 83rd Street, Chicago, Illinois 60617.

FREE Periodic classification of elements and conversion tables with catalog 50¢. Chemicals, apparatus, biology, Midstates Scientific, 7053 N. Clark, Chicago, Ill. 60626.

SEARCHING For Economically Priced Laboratory Supplies? Conversion Charts And Catalogue—35¢. Hagenow Laboratories: Manitowoc, Wisconsin 54220.

LABORATORY Supplies at discount prices. Catalogue—35¢ Deluxe Scientific; Manitowoc, Wisconsin 54220.

COMPLETE Chemistry catalog, 25¢. Laboratory Sales, Box 161-A, Brighton, Mass. 02135.

SPY CAMERA: Hide it Completely in one hand! Takes Secret Photos, only \$1.50! Spy Film-60 Exposures, \$1.00! (Plus Kenrus Catalogue Free!) Kenrus-SC, Box 158M, Staten Island, New York 10309.

BELL JARS, Vacuum tested, acrylic plastic, 7 1/2" I.D. 5" high, \$10.50 each, 5 1/2" I.D. 3 1/2" high, \$8.50 each, post paid in U.S. LESAIR Incorporated, Box 23053, San Diego, Cal. 92123.

FORMULAS, PLANS, ETC.

SEVENTY-FIVE One and two Ingredient Marketable Formulas, Complete Instructions. Satisfaction Guaranteed. \$1.00 Camfields-A, Box 1746, Indianapolis, Indiana 46206.

ANY FORMULA—\$5.00. Catalog—Manufacturing Treatise 25¢. Belfort, 192 N. Clark, Chicago 60601.

TREASURE FINDERS

BURIED Treasure Is Everywhere! New Map Book Shows Over 400 U.S. Locations. Details Free. Cummings & McIlvain, 922 Melrose Avenue, Santa Cruz, California 95060.

FREE TREASURE GUIDE! Fact-filled collectors edition; send 50¢ for postage. Also request free literature on ultrasensitive, professional Fisher Detectors. FISHER RESEARCH, Dept. PM-2, Palo Alto, California 94303.

FREE 128 Page detector catalog. General Electronic Detection Co., Box 67, Belflower, California 90706.

"FIND Buried treasure with revolutionary patented, analytical metal detector. Features push button and automatic tuning, negligible ground pickup, greatest range. Free catalogue. Gardiner Electronics, Dept. 9, 4729 N. 7th Avenue, Phoenix, Arizona 85013."

POWERFUL Metrotech locator detect gold, silver, coins, relics. Moneyback guarantee, terms. Free information. Underground Explorations, Dept. A, Box 793, Menlo Park, California 94025

TREASURE Hunters! Prospectors! Relco's new instruments detect buried gold, silver, coins, minerals, historical relics. Transistorized. Weighs 3 pound. \$19.95 up. Free catalog. Relco-A40, Box 10839, Houston, Texas 77018.

TREASURE. Gold, silver, relics. New 1971 detectors now available. Free information. Excelsior Electronics Company, 7448 Deering Avenue, Canoga Park, California 91303.

TREASURE LOCATORS MOST COMPLETE LINE. FREE INFORMATION. TESOROS, APARTADO 7-948, MEXICO 7, MEXICO.

GOLDAK Treasure locators—Pleasure and profit in a hobby you'll enjoy. Find coins, relics, gold, silver. Charge on BankAmericard. GOLDAK, Dept. PM 1101-A Air Way, Glendale, California 91201.

(Continued on next page)

TREASURE FINDERS

(Continued from preceding page)

"TREASURE BOOKLET. Excellent information on treasure hunting and metal detectors. Send 25¢. BOOKLET, Dept. PM-2, Box 243, San Gabriel, California 91778.

PRECIOUS STONES AND MINERALS

500 POLISHED Gemstones \$5.00. Tumblecraft, 5401 James North, Minneapolis, Minn. 55430.

EARTH Science Rockhound Magazine. Subscription \$3.00. Sample \$4.00. Box-550-PM, Downers Grove, Ill. 60515.

500 BEAUTIFUL POLISHED GEMSTONES \$1.50. Floodstones, P.O. 1673, Fremont, California 94538.

GET Free catalog no serious rockhound, gem cutter, jewelry maker, hobbyist or craftsman can be without. Full of bargains, exclusive items, low prices from largest suppliers and authorities in the field. Free new catalog just off the press, yours for the asking. Write Grieger's, Dept. C-12, 1633 E. Walnut, Pasadena, California 91106.

ROCK Polisher—twin tumblers, easily built from scrap materials, plans, pictures \$1.00. S Enterprises, Naples, Illinois 62669.

CARTOONING, COMMERCIAL ARTS, SHOWCARD & SIGN PAINTING

\$200.00 MONTHLY Sparetime possible making signs, posters, silkscreen printing. Learn quickly—easy instructions. Information free! Hampton 109PM, Box 112, New York, N.Y. 10012.

COMPACT 23 lesson Cartoon Course and Cartoonist's Magazine, \$2.00. Hartman, Box 30367, Lincoln, Nebraska 68510.

LEARN Sign painting at home. Free talent test. Ben Kerns, Box 812-PM, Greenville, S.C. 29601.

"HOW TO MAKE MONEY WITH SIMPLE CARTOONS"—Everyone who likes to draw should have this book: FREE. Write Cartoonists' Exchange, 92 Pleasant Hill, Ohio 45359.

MODERN Cartooning taught by mail. Write for free brochure. Cartoonorama—Box 263-6A, Branford, Conn. 06405.

SIGN Painting—Latest Free Catalogue explains everything. write: Kaufmann Supply, Centertown, Missouri 65023.

LEARN Sign painting—low cost books. Free information. Sign Book Company—PMF, 470 Oak Street, St. Louis, Missouri 63119.

ADVERTISING AGENCIES, ADV. SERVICE, MAILING LISTS

ADVERTISING Ratebook leading newspapers, magazines, 25¢. Chicago Advertising Agency, 28-E Jackson, Chicago 60604.

MAILING Lists most all kinds 1000 \$5.00. Free folder Your circulars mailed \$4.00 1000. Dixie Mailers, King, N.C. 27021.

GUARANTEED FRESH MAILING LIST! 200 Plain paper, \$1.00. 1000 Buyers, Gummed labels, \$10.00. Smyre's, Box 953-PM, Newark, N.J. 07101.

TYPEWRITERS, DUPLICATORS, OFFICE EQUIPMENT

FREE Plan. Start printing, lettershop. Offset Presses. Mimeograph Copy machines. DixieGraph, King, N. Car. 27021.

RUBBER STAMPS AND OFFICE SUPPLIES

RUBBER Stamps, 3L-2" \$1.90, Catalog R.E.D., 18 Crane, Darien, Connecticut 06820.

ADDRESS Stamp 85¢. Signature \$2.80. Catalog. Carol's, McCloud, Okla. 74851.

FREE 48 Page Catalog. Rubber stamps, printing, office supplies. Youngers Stamp Shop, Princeton, Iowa 52768.

3 LINES \$1.00. Extra lines 25¢. Knob Handle. Daufeldt-PM, Atalissa, Iowa 52720.

PERSONAL PRINTER 3 Lines in Script \$3.50 Richard Price Jr., 48124 VanDyke, Utica, Michigan 48087.

"FIRST CLASS", etc. \$1.10 (\$11.00 dozen). Stamps, 511, Mt. Vernon, Illinois 62864.

ADDRESS Stamp 4 Lines \$1.30. Denton's, Box 3594, Albuquerque, N.M. 87110.

PRINTING PRESSES, RUBBER STAMP OUTFITS

RUBBER Stamp manufacturers supplies. Presses, starting outfits. Best prices, service. Catalog. Jackson Supply, Box 443A, Franklin Park, Illinois 60131.

SIMPLE-X RUBBER STAMP PRESSES, Hydraulic operated, electrically heated. Sizes 5"x8", 8"x12", 10"x15". Starting outfits. Orders for presses, supplies shipped day received. Free catalog low supply prices. Custom Manufacturers, 406-P East Elm, Springfield, Mo. 65801.

PRINTING Presses, type, supplies. Lists. 5¢. Turnbaugh Service, Mechanicsburg, Pennsylvania 17055.

TYPE Catalog No. 12, 120 pages. Send One Dollar. Deductible First Order. Acme Type. 732 Federal, Chicago, Illinois 60605.

SAME Day shipment on rubber stamp supplies. Revised wholesale price list No. 7 free. Star Stamp Supply, 732 Federal, Chicago, Ill. 60605.

RUBBER Stamp outfits, supplies. Kiewiet, 2025 Barney Road, Kalamazoo, Michigan 49007.

LOW Priced Rubber Stamp Manufacturing Supplies, Starting Outfits. Martin, 1432 Major, Jefferson City, Missouri 65101.

RUBBER Stamp Makers. Supplies, Presses Free Catalog. Roll, 15920 Trask River, Tillamook, Oregon 97141.

PRINTING AND SUPPLIES

QUALITY Business Forms, letterheads, envelopes. Economical. Samples. Burnfin, Weaubleau, Mo. 65774.

AMAZING Business printing values. Quotations. Print Shop, Box 576, Greenville, R.I. 02828.

FREE Literature. Address Labels, Business Cards, Printing. Rubber Stamps. Jordan's, 552 West O'Connor, Lima, Ohio 45801.

8 HOUR PRINTING—Free Booklet "Secrets of Cutting Printing Cost." Nationwide Printing, Atlanta, Illinois 61723.

BUSINESS CARDS Raised Letters \$5.65 Thousand. Like Engraved. Free Samples. Kavanagh, Box 1222, Brooklyn, N.Y. 11202.

PRINTING. Reasonable prices. Samples free. Fowlco, 3515 Walnut, Muncie, Indiana 47302.

QUALITY PRINTING—Offset. Since 1945. Free 24 page catalog! Napco Press, 1744-P Bath Avenue, Brooklyn, N.Y. 11214.

SMALL Order Printing—Free Price List. Wahle, 1947 Cornelia, Chicago, Illinois 60657.

FREE Catalog, samples. Top quality printing, bargain prices. Wilco, P.O. Box 6176, New Orleans, Louisiana 70114.

100 TWO-Color Kromekote Finish Business Cards \$2.00. Eslick's, Delavan, Wisconsin 53115.

OFFSET Printing. Top Quality, Fast Delivery. Thousand 20 Bond \$6.75. Free Delivery. Write For Catalog. Interstate Printing Company, 1574 39th Street, Brooklyn, New York 11218.

DISTINCTIVE "Embossed" Letterheads. Inexpensive. Postpaid. Universal, 226-F Myrtle, Scotch Plains, New Jersey 07076.

"SAVE" On Printing! Free Estimates. Longwood Press, 4721, Fort Johnson, New York 12070.

TOP 110 Wholesale Printing Sources. Directory \$1.00. Marketing—C36, 147 Vivyan, Bergenfield, New Jersey 07621.

GUMMED LABELS

1,000 GUMMED Address Labels \$1.00. Walt's, Box 966A, South Bend, Indiana 46624.

1000 PERSONALIZED Labels 50¢. 3 Sets \$1.25. Free Catalog!! Fabrico—Dept. WB1, 1512 N.E. 29th Street, Ocala, Florida 32670.

1000 GOLD, Gummed Address Labels, \$1.00. JRS Mail Order, Dept. A, Box 9613, San Jose, Calif. 95117.

1000 GOLD Stripe Address Labels \$1.00. Free brochures. Vernon House, 158 W. Sandford Blvd., Mt. Vernon, N.Y. 10550.

1000 GOLD Stripe Address Labels. Up to four lines. \$1.50. No finer label at this price. Robert Witt, 813-B Laramie, Wilmette, Illinois 60091.

REMAILING SERVICE

INDIVIDUALS . . . Quarter! (Seven . . . Dollar!); Verisimilitudinizations Furnished. "Nationwide Facilities," Pflieughersville, Texas 78660.

NORTHEAST Remails. All types, confidential. Knothead, 39 Woodland, Sharon, Mass. 02067.

SCOTTSDALE Remails 25¢ \$3 monthly. Remfor, Box 1541, Scottsdale, Arizona 85252.

MIAMI Remails 25¢. Monthly rates. Marie, Box 1266, Coral Gables, Fla. 33134.

CONFIDENTIAL New York City mail address \$3.00 month. Remails 25¢. Details Free. Birnhan, 152 W. 42, New York City 10036

SECRET. Receiving—forwarding. Discreet and confidential. Remail 25¢ single. Mail Forwarding Service, 8050 S. Main, Houston, Texas 77025.

RECEIVING—Forwarding. Monthly Rates. Hedgpath, 406-M South Second, Alhambra, Calif. 91802.

ALASKA Remails 25¢. Scenic postcards. M. Carlson, P.O. Box 552, Kodiak, Alaska 99615.

"CALIFORNIA Remails—25¢ Anaheim-Disneyland. Watkins, Box 2431, Anaheim, California 92804.

LOS ANGELES Remails 25¢. 5/\$1. Receiving-forwarding. Dittofax, 5815-PM Compass, Los Angeles 90045.

NEVADA Remail, guaranteed, indicate Las Vegas or Boulder postmark, 25¢, souvenir postcards, Box 5321, Las Vegas, Nevada 89102.

ANAHEIM! Home of DISNEYLAND 25¢. P.O. Box 3203, Anaheim, California 92803.

NEW HAMPSHIRE. Maine, Mass., 25¢. Scenic cards 6/\$1.00. FREE details. Glenrow, Box 234, Worcester, Mass. 01602.

ONEIDA Remails 25¢ Each. Confidential-Dependable. Box 506, Oneida, Tennessee 37841.

PHOENIX, Remailing, Forwarding, Confidential Valley of the Sun address. Troen, Box 2386, Phoenix, Ariz. 85002.

CINCINNATI Receiving, Forwarding, Confidential. Hahn, 2621-M-Ida, Cincinnati, Ohio 45212.

SAN FRANCISCO Remails 25¢. \$3.00 Monthly. Scotts, Box 5446-P, Redwood City, California 94063.

TEXAS Remailing 25¢, Mexico 35¢. Confidential. Repp, Box 1351, San Juan, Texas 78589.

(Continued on next page)

SPECIAL SERVICES

INFORMATION On anything. Ferguson Research Specialists, 83-45 Vietor Ave., Elmhurst, N.Y. 11373.

AUTHORITATIVE Information On Anything! \$2.00 (deductible). Metzler Research, Box 2206PS, Long Island City, New York 11102.

MACHINING And other services. Information 25¢., Frans, Box 692, Marion, Ohio 43302.

TOBACCO

SMOKERS: Remove 30% Nicotine Mechanically—(No filters or Chemicals) New Device \$1.95. Details Free: Atlanta Co., 907 Lakecrest, Ajax, Ontario.

PERSONAL

PAY Bills! Borrow to \$1500 by mail! Convenient terms! State licensed. Postal Finance, 200 Keeline Building, Dept. 17-A, Omaha, Nebraska 68102.

HEMORRHOIDS! Relieve discomfort! Preparation cools, soothes, and promotes healing. Non-Toxic. Send \$2.00. Aros Industries, P.O. Box 517, Media, Penna. 19063.

NEED CASH? For debts, car, vacation. Learn how. Details Free. Your Golden Years, 3145-A N. Sioux Avenue, Tucson, Ariz. 85705.

'MY WIFE And I now share an extra \$60.00 a month we didn't know we had. And the double bonus is—WE DON'T SMOKE ANYMORE. Our method \$3.00. Walkabout, Box 7551, Ft. Worth, Texas 76111.'

NEW False Dental Plate, low as \$29.95. 24 Hour Service. No impression. Lightweight DuPont Beauty Pink Plastic. Satisfaction or money back. Our 20th year. Free details, shipping box, West, Dept. B-203, 3816 W. Lawrence, Chicago, Illinois 60625.

SECRET Law Wipes Out All Debts. Immediate relief. Clear credit. Free details. Counselor-7, Kerrville, Texas 78028.

"LONELY? 200 Names, Addresses, Descriptions, either sex. \$1.00. Free Membership. Mention Popular Mechanics, receive 50 extra names. California Club, Box 314, Long Beach, California 90801."

PROTECT Your Family. Blank Will Forms. Be Secure. 2 Copies \$2.00. Guaranteed. ET, 11720 S. Harding, Alsip, Illinois 60658.

SAVE MONEY! HOMEOWNERS Insurance benefits explained. Major policies compared. Write Alco, Box 11594, Phoenix, Arizona 85015.

ORGANIC Supplements for health, vitality. Details. B. Bodewig, Box 381, Coos Bay, Oregon 97420.

MAKE YOUR WILL. Get 4 Will Forms and attorney's informative book. \$1.00. Legal Forms Company, Department 124, 1830 Guardian Building, Detroit, Michigan 48226.

LONESOME? I HAVE thousands of single women. Tell me what you want. I'll send her name and picture. Help Company Club, 4554 Broadway, Chicago, Illinois 60640.

BIBLE Questions answered. Stamped envelope. Bylon, 17167 Bentler, Detroit, Michigan 48219.

INVESTIGATORS. Latest electronic Aids. Free Literature. Clifton, 11500-P NW 7th Ave., Miami, Florida 33168.

RUPTURED. Relief and comfort. No understraps, elastic or steel. Write Hand-Lock Products, Preston 4, Ont., Canada.

ARE YOU REALLY SINCERE About wanting to find a marriage partner? SOCIAL INTRODUCTION SERVICE, P.O. Box 1547, Eugene, Oregon 97401.

TOO Many Debts? Want to lower your payment and pay off the bills? Write Continental, Dept. PM, Box 2116, East Chicago, Indiana 45312.

FOLLOW That Car. Electronic Trailing Equipment. Free Literature, Box 220, Miami, Florida 33168.

SERVE Christ. Become an Ordained Minister. Write Holy Light, Dept. D, Box 4478, Pittsburgh, Pennsylvania 15205.

WIGS For Men, details free. F & N Fashions, Box 34-A, Glencoe, Minnesota 55336.

"SINGLE? 2000 Ladies' Fotos \$2.00. Meet beautiful girls, divorcees, of all ages through world's largest matrimonial catalog. International Contacts: Box 12, STN. "O", Toronto 16, Canada.

FOR Better Health and longer life, write for free information to: Better Health Products, Box 69 RD2, Danville, Ohio 43014.

"RULE Others With Thoughts." (Telepathy) write: Clarion, Box 1769-S7, Chicago, 60690.

ARE YOU SEEKING Companionship Marriage Partner? Remarkable Introduction Service Now, With Magazine And Details 35¢. Jay's, Box 1301-X, Wausau, Wisconsin 54401.

STOP Burglars With Lokalarm. Write: S&S Sales, 35178-A Lockbox, Chicago 60635.

COMPUTER Dates by mail. Nationwide. Free Details. House of Hoke, Box 101-PM, Sebring, Florida 33870.

MIND Conditioning Sleep-learning Records—books. Dr. Fowler, Drawer 2297, Woodbury, New Jersey 08096.

RECORD Telephone conversations automatically. Leave recorder unattended. Write—Robert's, Box 49PM, Parkridge, Illinois 60068.

INCREASE TAX REFUND. Itemize your deductions. Simple, easy to understand guide guarantees cash savings. Only \$1.25. ABC Enterprises, 6240 Woolwood, Bell, Calif. 90201.

WIN AT DICE! Copyrighted systematic approach offers "guaranteed satisfaction" \$2.00 to Thomas, 12411 Nelson, Garden Grove, California 92640.

HYPNOTISM! Amazing new discovery. Now anyone can become an expert hypnotist in thirty minutes. Double your money back if not satisfied \$3.00. Box 248, Laird Hill, Texas.

SHORT-WINDED? WANT TO STOP SMOKING? New Book Presents Medical and Psychological Step-By-Step Method. 96-Page Book #WB-106 Only \$1.00. Money Back Guarantee. F. Chandler, Box 365, Albemarle, N.C. 28001.

WANTED—MISCELLANEOUS

WE Buy Bottles, Coins, Antiques, Books, fruit jars, magazines (anything). Send \$1.00 (refundable) for Huge Buying Lists. Schroeder's, R-4, Paducah, Ky. 42001.

MERCURY, Gold, Silver, Platinum: Ores assayed. Wholesale Terminal, Norwood, Mass. 02062.

MISCELLANEOUS

WINEMAKER'S Kit!! Includes: Yeast, Chemicals, Fermentation Locks, Corks, Recipe Manual, Catalog!! Everything—\$3.00. Satisfaction guaranteed. Winekit, 2121 Conger, Olympia, Washington 98501.

EXCITING Contests! Cash prizes! News and ideas for healthier, better living. Extra income opportunities. Send 35¢ and large, addressed, stamped envelope to: ALAMOSSCO, Dept. PMA, Box 1196 GPO, New York, NY 10001.

CIGARETTE Shredded Smoking. Snuff, Twists. Free Samples. Stoker's, Dresden, Tennessee 38225.

SUFFERING From Arthritis? Try Ginseng: Information Free. Write Ginseng, Asheville 53, N. C.

CIGARETTES 12¢ a pack. Improved roller makes 20 filtertip, plain, king or regular for 12¢. Facts free. Green River Tobacco, Box 954, Owensboro, Kentucky 42301.

YOUR Name sent to 1000 importers, publishers, mailers, wholesalers, etc. on our mailing list. Year \$1.00. Dixie Mailers, King, N. Car. 27021.

WINEMAKING . . . Grape, Elderberry, Dandelion, Frozen Juices, etc. Brewers' secrets revealed! Powerful Methods! Instructions, Recipes, and Supplies Catalog, \$1.00. Continental, Box 11071 PB, Indianapolis, Indiana 46201.

PSYCHEDELIC Catalog of Posters, Lighting, Jewelry, Etc. Send 50¢. Hole, 6055 Lankershim, N. Hollywood, Calif. 91606.

WINEMAKERS Yeast, Recipes & Catalog 25¢: Kraus, Box 451-L, Nevada, Missouri 64772.

ORNAMENTAL Iron designs. Book of 1600 beautiful, practical designs for railings, columns, etc. Free literature. Cunningham, 3881 South 3200 West, Salt Lake City, Utah 84119.

WINEMAKERS. Free illustrated catalog of yeasts, equipment, Sempex, Box 12276, Minneapolis, Minn. 55412.

BOOKS On antiques and their prices. Free circular!! P. Warman Publishers, Uniontown, Penna. 15401.

HEARING Aid batteries wholesale. Free list. Habs, Box 51, York, Penna. 17405.

WINEMAKING Kit—\$4.98 Free Catalog and recipes. JIMDANDY, Box 30230M, Cincinnati, Ohio 45230.

WINEMAKERS! Special! Leading University Winemaking Booklet—Supplies Catalogue—10¢. Werth Wine, Box 1902H, Cedar Rapids, Iowa 52406.

IDENTIFICATION CARDS, Send stamped self-addressed envelope for samples. ECSM, P.O. Box 12117, Las Vegas, Nevada 89112.

DRIVER'S License, Birth Certificate, H.S. & College Diplomas, Marriage & Divorce Certificates—Blank Forms. Fill them in yourself. Highest quality you can buy! Confidential. 3 day service! \$2.00 each: any four—\$5.00, postpaid. Formco, Box 834D-G, Warren, Michigan 48090.

BIRTH Certificates, Marriage Certificates, Diplomas! 2 blank forms \$1.00. Sample 10¢. Standard Forms, Box 482-M, Washington, D.C. 20044.

WATCH Secretly without being seen! See-thru Mirror. Fun!! Front-door Protection. \$2.00. Curliis, 12 Howe, Hot Springs, Arkansas 71901.

WINEMAKERS. . . Free Illustrated Supply Catalog of Yeasts, Equipment, Recipes. Winemaker, Box 11211-PM, Indianapolis, Ind. 46201.

NEWEST "New miracle cleaner." Biodegradable, economical, free details. Leigh of California, Suite 249P, 7240 Lankershim, North Hollywood, California 91605.

ECOLOGIST'S DELIGHT! Two way flush Control Helps save our precious water. Details Free. Watr-Savr, Box 481C Altadena, Calif. 91001.

KNIVES—101 Imported Novelty Knives, Catalogue 50¢, Friedmar Imports, Box 533 PM, Montebello, California 90640.

KAHLUA—Delicious coffee flavored liquor made inexpensively at home. For recipe send \$1.25. Box 8024, Hualapai Br., Kingman, Arizona 86401.

WINEMAKING! All varieties. Favorite recipes! Best manual available! Complete, illustrated instructions \$1.00 (free supplies catalog). Namar, Box 6, Dearborn, Michigan 48121.



Coast-to-Coast Shortage of Trained Draftsmen Opens Thousands Big Salary Jobs for Beginners!

Now you can take your pick of thousands of big salary jobs open to Draftsmen (see "help wanted" sections of metropolitan newspapers). Huge nationwide demand... U.S. Dept. of Labor reports "42% more Draftsmen needed in next 10 years—not enough applicants to fill drafting jobs available now!" Our easy "Quick-Learn" Method has helped hundreds toward good income, security and prestige as Draftsmen. Why not you?

You Need No Drawing Skill—No Technical Ability

NASD's staff of Professional Draftsmen guide you step-by-step. With our spare time home-study plan you work on actual projects. Makes learning fun—easy to remember, too. Many graduates have succeeded with only grade school training. Others report good earnings drafting part time while still learning. Rush postpaid card today for **FREE "DRAFTING CAREER KIT," Sample Lesson, Drafting Aptitude Test** including intriguing new **5-Way Drafting Instrument** and **20 page Book "Your Future in Drafting"**—jam-packed with revealing facts on your opportunity to win top pay and job security in Drafting. Everything mailed to you **FREE** and **WITHOUT OBLIGATION**. No salesman will call.

...when you train at home with NASD for a

HIGH PAY JOB IN DRAFTING!

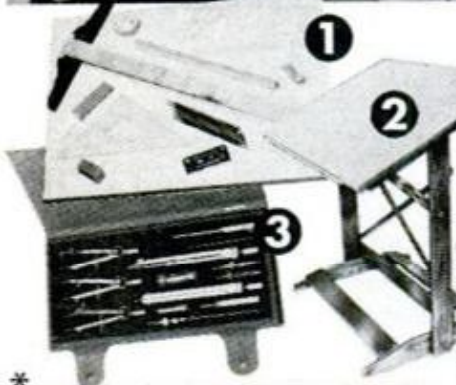

* Precision Drawing Instrument Set, Professional Drafting Board Outfit and Fingertip Tilting Drafting Table are given to you with your complete North American Course in Drafting.

U. S. LABOR DEPT. REPORTS SERIOUS SHORTAGE OF DRAFTSMEN

(The following quotes from U. S. Labor Dept. point out nationwide shortage for Draftsmen):

"The dearth of qualified applicants has resulted in increasing calls for trainees, as employers in many areas relaxed hiring specifications. Experience requirements have been virtually eliminated, along with age barriers."

"Steadily growing employer requirements... were accompanied by marked reductions in the supply of draftsmen available."

TOP AMERICAN EMPLOYERS WELCOME NASD GRADUATES

"We would be interested in interviewing your grads as potential employees." **REMINGTON**

"At the present time we have several openings available for qualified Draftsmen. I look forward to considering graduates of your institution." **WESTINGHOUSE**

"We have immediate openings for designers and Draftsmen and have a definite interest in interviewing candidates immediately."

AMERICAN MACHINE & FOUNDRY

(3) High School Draftsmen

NO EXPERIENCE REQUIRED!

NO EXPERIENCE REQUIRED!

Students who satisfactorily complete a field, part and shop requirement will receive an AUTOMATIC SALARY ADJUSTMENT.

JOE PASKOWSKI

FLUOR

Corporation, Ltd. INTERNATIONAL ENGINEERING CORP. 1108 S. ANAHEIM BLVD. LOS ANGELES, CALIF. 90022

Design Draftsmen

Requires experience in design and drafting of small mechanical devices.

CALL OR APPLY ABOUT GENERAL CORP. 11711 Woodruff Ave.

DRAFTSMAN Architectural

WESTERN GEAR

Take Your Pick of 2 EXCITING FIELDS

1 Architectural Drafting

Today's population explosion guarantees boom in building of homes, churches, schools, factories, office buildings & warehouses is just starting. Thousands Architectural Draftsmen needed NOW because drawings must be made of every part of every building before ground can be broken.



2 Mechanical Drafting

Skyrocketing U.S. mass production requires millions of drawings & thousands of Mechanical Draftsmen all along the way. Drawings must be made of every PART of every product used in the U.S. (as well as of the machines that make these parts) before production can be started.



HERE'S WHAT STUDENTS SAY



Earns \$820 Month!
"My first position after completing your course jumped my income from \$350 to \$820 per month." —G. W., Tenn.



Big Promotion!
"I was promoted from the production line ahead of 4 others and got a good pay raise." —W. A., Wisc.

Gets 50% Raise!
"Shortly after I completed your course I was made shop foreman. My pay was increased by half." —W. R., New York

No Layoffs!
"Strikes and layoffs are nightmares of the past. Your training has opened the door to a wonderful future for me." —H. O., Ohio

Authorized to issue diplomas by California Superintendent of Public Instruction.

Accredited Member, National Home Study Council.



Veterans, Servicemen you may be eligible for Gov't education benefits in association with Cleveland Engineering Institute.

ALL 4 FREE! Rush Postpaid Card Now

Your FUTURE in DRAFTING

APTITUDE TEST

SAMPLE LESSON

- 1 5-Way Drafting Instrument—yours to keep as a FREE GIFT without obligation.
- 2 20-Pg. Drafting Career Fact Book — packed with details about career opportunities.
- 3 Self-Scoring Drafting Aptitude Test — tells if you are suited for high-pay Drafting Career.
- 4 Sample Lesson — a "sneak preview" of things to come.

NORTH AMERICAN SCHOOL OF DRAFTING
4500 Campus Dr., Dept. 14172 University Plaza, Newport, Calif. 92660

IF CARD HAS BEEN DETACHED, MAIL THIS COUPON

NORTH AMERICAN SCHOOL OF DRAFTING, Dept. 14172
4500 Campus Dr., University Plaza, Newport, Calif. 92660

Rush "DRAFTING CAREER KIT" including Book, Sample Lesson, Aptitude Test & Drafting Instrument — ALL FREE! No salesman will call.

NAME _____ AGE _____

ADDRESS _____

CITY _____ STATE _____ ZIP _____