



SPECIAL: Tear-Out Section—Complete Records and Schedules
AUTO RACING GUIDE FOR 1971

POPULAR MECHANICS

JAN. 1971
50 CENTS

Build This Motor Home for \$3900

Should Mechanics Have to Have A License?

Make the Fantastic Fold-A-Majig —The World's Most Flexible Furniture

Page 140

Those TV Cartridge Tape Systems — Which Does What?

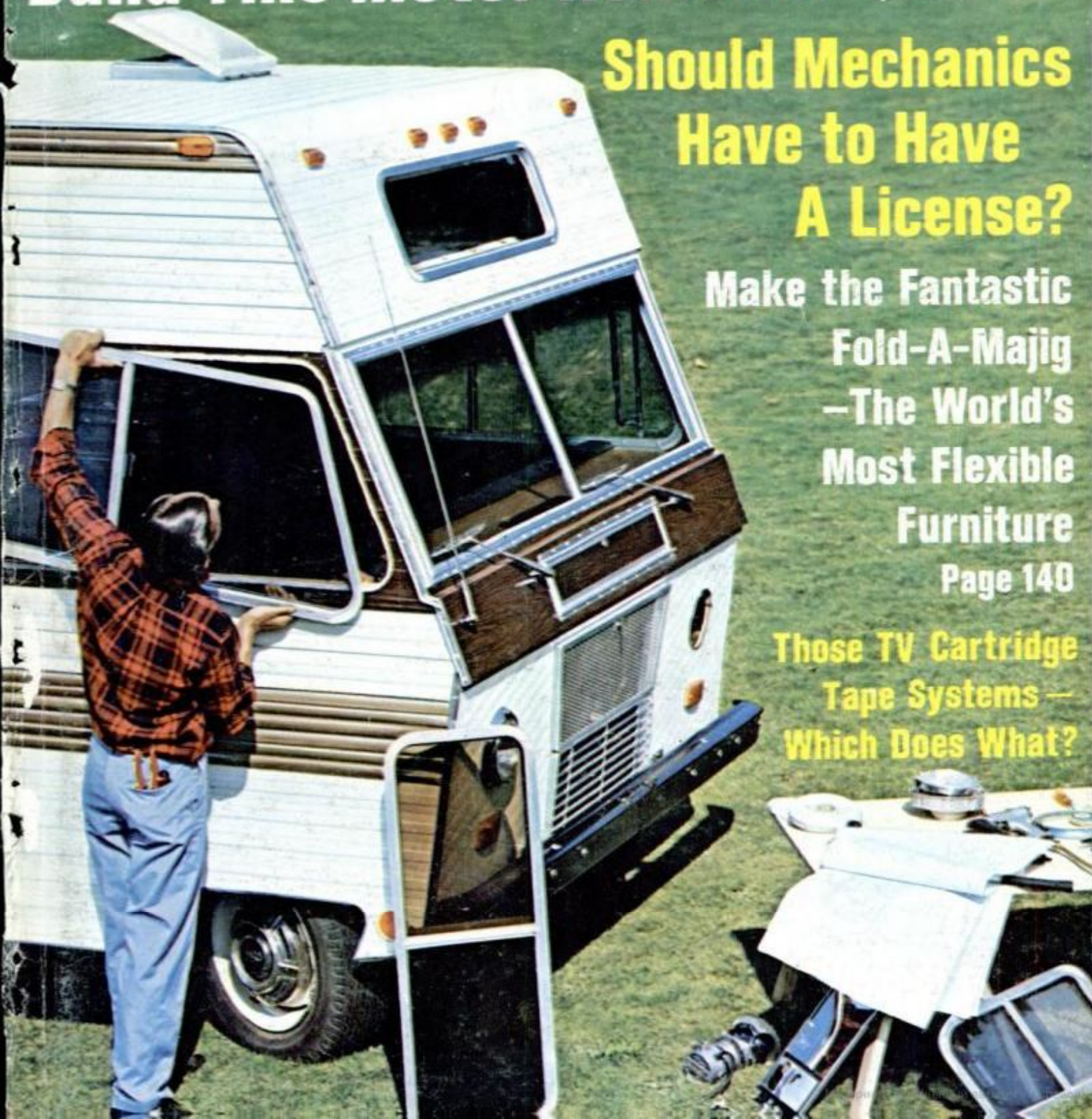

The better small car. 1971 Mercury Comet GT.



1. Start with the best small-car ideas.

Simple maintenance, for example. Comet GT is an ideal car for the do-it-yourselfer. A handy repair manual is available containing dozens of tips on how to adjust the automatic choke, set idle speed, change filters, etc.

2. Add the best sports-car ideas.

A racy look coming and going with special GT striping. Hi-back buckets in "upbeat" cloth and vinyl or lively woven vinyl. Big, hooded, easy-to-read dials. Outside racing mirror right and left. Plus much more. See below.



3. Result: a better sporty small car.

With hood scoop, black-out grille and headlamp doors, special hubcaps and trim rings. Comet comes with a 100 hp "6." Or you can order 115 or 145 hp. Or a 210-hp V-8. It takes better ideas to make better cars. Mercury makes better cars — to buy, rent, or lease. See your nearby Mercury dealer soon.

Better ideas make better cars.

MERCURY

LINCOLN-MERCURY DIV.





**POPULAR
MECHANICS**

1971



**Auto
Racing Guide**

TO REMOVE SECTION, lift gently along this edge.



478S-RDH-C59Z

The inside story of NGK.

An ordinary looking plug with extraordinary performance.
How come?

A better grade of porcelain. More internal gaskets.

A bigger electrode with a long-life nickel alloy tip. Those are some good reasons.

And—a copper core. That's the biggest reason.

Let's examine this expensive, highly conductive "Heart of Copper." Its primary advantage is rapid heat dissipation... much faster than with ordinary steel cores. This means a wide heat range. And top performance at either end of the temperature scale.

Under light driving, NGK's fire with less fouling. Under heavy driving, the dissipation rate cuts hot spots; cures pre-ignition.

So whether you drive with a hot or cold engine, go fast or slow... NGK's perform at peak efficiency.

And they last longer, deliver better fuel economy, more horsepower and easier starting.

Performance may be all you need to know about NGK's. Try a set in your imported car, bike, or off-road vehicle. Great for domestic cars, too. NGK's cost no more than ordinary plugs.

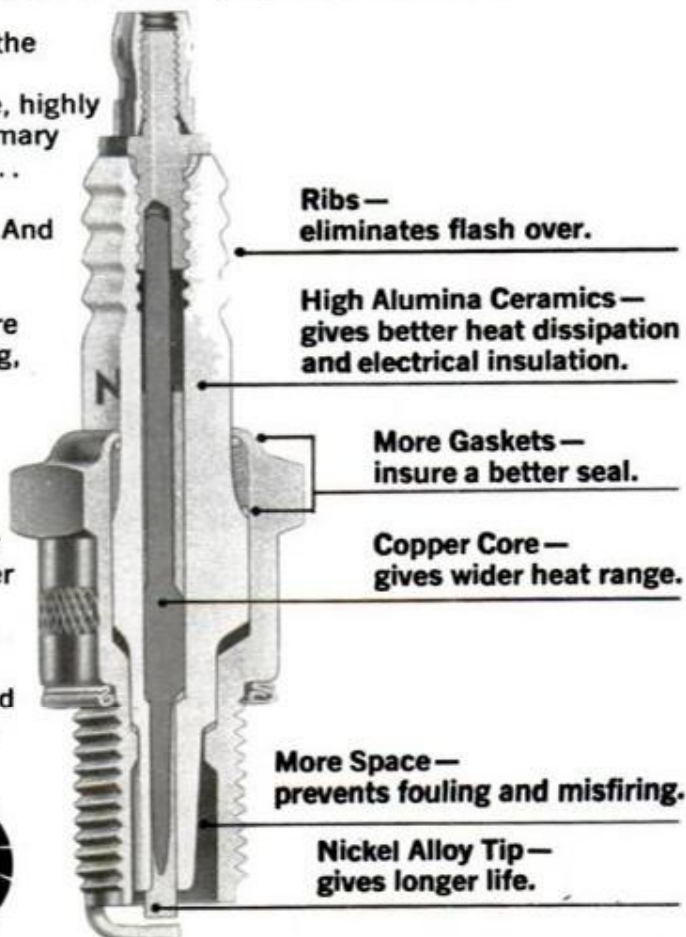

NGK SPARK PLUGS (U.S.A.) INC.,
4010 SAWTELLE BLVD.
LOS ANGELES, CALIF. 90066.



Still the Greatest Sport

Last year we said automobile racing—in all of its many forms—was the greatest sport in the world. We still think so.

Auto racing is Al Unser's Johnny Lightning Special running away from everyone at Indianapolis and stopping dead with 14 laps to go at Ontario. It's young Pete Hamilton, charging out of obscurity and Massachusetts, to win \$46,000—and us a watch because we were one of only two "experts" who picked him to upset the Southern hot dogs at Daytona. (The other was *PM's* Auto Editor, Bill Hartford, who did most of the work on our 1971 *Auto Racing Guide*.)

But auto racing is more than winning the big ones at places like Indianapolis and Daytona.

It's Don Garlits, seriously injured at Long Beach, coming back at Bristol to show the younger generation how to go through the traps at 225 mph. It's A. J. Foyt, the greatest competitor in sport—any sport—hammering away at his sick Coyote in a 22-minute pit stop to keep it and himself in the California 500—with no chance to win it. It's Jim McElreath, rewarding his boss's tenacity by putting A. J.'s other car in Victory Circle after starting eighteenth. It's Dan Gurney turning over his one Trans-Am Barracuda to protege Swede Savage, and it's Swede putting it on the pole at Bridgehampton. It's Smokey Yunick traveling to Ontario to run the pit crew for a thirty-third-place qualifier named Jim Hurtubise. It's Johnny Rutherford and mechanic Mike Devin almost grabbing the Indy pole with a four-year-old Eagle. It's Ralph Liguori who never beat anyone important, skidding and sliding to second in the Hoosier 500—ahead of Foyt and Mario Andretti. It's Andretti turning Ontario's fastest lap while running well back in the pack. It's 44-year-old Jack Brabham, announcing his retirement and coming back to win the first Grand Prix of 1970. It's hundreds of drag-race mechanics, like Vic Teranzio, reboring 1958 DeSoto hemis in back-yard garages all over America.

Racing is big guys and little guys, and it's the greatest sport because they are great sportsmen.



Editor

BILL HARTFORD

Auto Editor

MICHAEL LAMM

West Coast Auto Editor

FRED A. LEERS

Art Director

DON O'REILLY

Racing Rules, Sprints and
Midgets

DALE GUSTAFSON

Race-Car Illustrations

Popular Mechanics is published monthly by The Hearst Corporation, 57th St. at 8th Ave., New York, N. Y. 10019, U.S.A. Richard E. Berlin, President; George Hearst, V-Pres.; Richard E. Deems, President of Magazines; John R. Miller, Executive V-Pres. of Magazines; Raymond J. Petersen, Senior V-Pres. of Magazines; William S. Campbell, V-Pres. of Magazines; Albert A. Rachol, V-Pres. and Director of Circulation; Joseph F. Kern, V-Pres. for Popular Mechanics; Frank Massi, Executive V-Pres. and Treasurer; Harvey L. Lipton, Secy. Single copy in the United States and Canada, 50 cents. Subscription prices: United States and Possessions, \$5.00 for one year; \$9.00 for two years; \$12.00 for three years. Canada, add \$0.75 for each year. Pan American Postal Union countries, add \$1.00 for each year. All other countries, add \$2.00 for each year. When changing address, give old address as well as the new, with postal-zone number, if any, and allow six weeks for change to become effective. Second class postage paid at New York, N.Y., and at additional mailing offices. Authorized as second-class mail by the Post Office Department, Ottawa, and for payment of postage in cash. Registered as second-class matter at the Post Office at Mexico D.F., Mexico, June 20, 1950. © 1970 by The Hearst Corporation. All rights reserved. Printed in U.S.A. VOL. 135, NO. 1

CHAMPIONSHIP

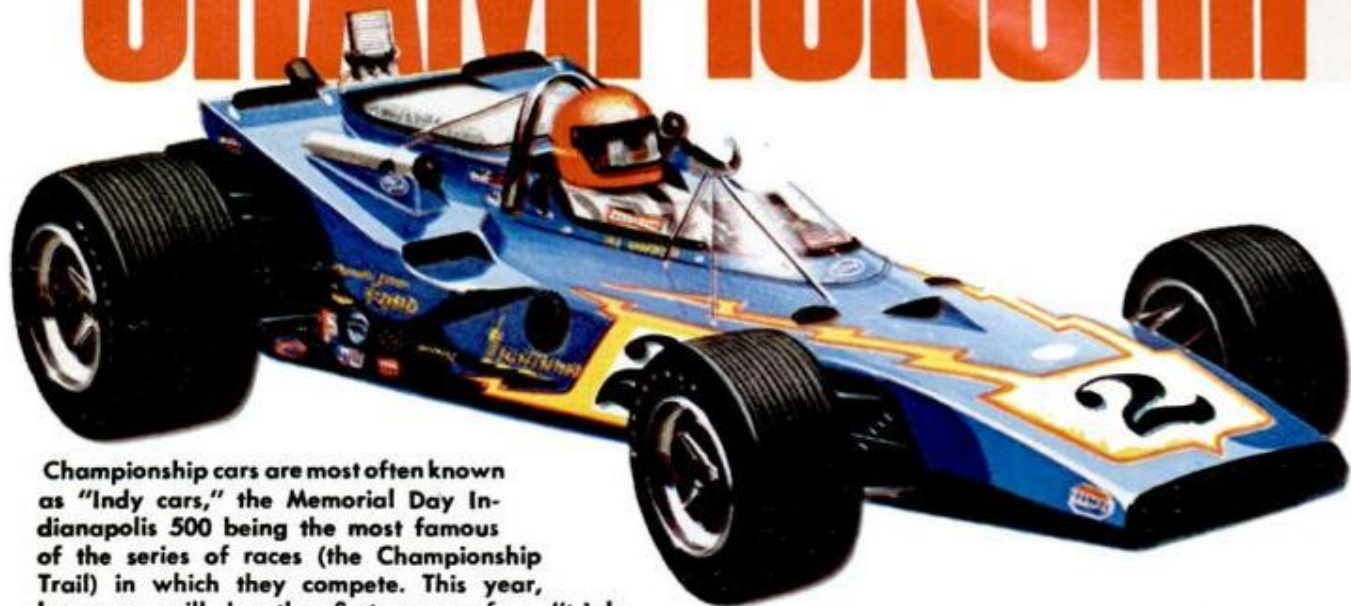

Championship cars are most often known as "Indy cars," the Memorial Day Indianapolis 500 being the most famous of the series of races (the Championship Trail) in which they compete. This year, however, will be the first year of a "triple crown"—three 500 milers: Indy, Pocono and Ontario. Design of the cars and the events in which they run are conducted by the United States Auto Club, which also sanctions three other classes of auto racing: midgets, sprints and stocks. On the Championship Trail, in addition to the 500-milers, roughly a dozen shorter events—from 100 to 300 miles—are run on paved or dirt ovals; about 10 are run on road courses. Events on dirt run a championship car of front-engine configuration. Point-scoring system decides national driving champion, champs on road courses, dirt, other classes.



MARIO ANDRETTI—Winner of the 1969 Indy 500, he also took the National Driving Championship for the third time in that year. He started in modified stocks in 1958, drove his first USAC race in 1964 and was champion in '65 and '66. Won NASCAR's Daytona 500 and competes in Can-Am and F1. Had disappointing 1970 season in McNamara car.



LLOYD RUBY—Veteran USAC driver. Has driven more miles in Indy 500 events than any other active driver; always missed victory due to bad luck. Consummate driver. Won '65 and '66 Daytona Continental with Ken Miles in Ford GT, Sebring 12-hour in '66. Won the 150 and 200-milers at Milwaukee in '68. Took 1970 Ontario 500 pole at 177.567 mph.



A. J. FOYT—Only five-time winner of National Championship and a three-time winner of the Indy 500. To that achievement add over 40 wins on the Championship Trail for an incredible record. Strictly a USAC driver, he has more championship points than any other. Has driven every Indy 500 since '58. Aims to be the only four-time winner.



JOHNNY RUTHERFORD—Started in first row at both Indy and Ontario last year running sizzling qualifying speeds. Started at Indy in '63, drove all Championship Trail races that year, finished 10th in points. Sprint-car champion in 1965, he was grounded for '66 after over-rail flip early in season. Ran strong in '70 Indy 500 until header pipe broke.



GORDON JOHNCOCK—Started racing in stocks in the Great Lakes area in 1955. Went on to log outstanding record in popular modified competition. Went sprint and championship in '64. In his first Indy competition ('65) he started in 15th slot, finished 5th. Was a close-trailing 4th in '66. Consistently high placing in championship point standings.



AL UNSER—The 1970 national driving champion and winner of the Indy 500 arrived at the top with sure and deliberate steps: Was fifth in point standing in '66 and '67, third in '68 and second in '69. Was rookie of the year at Daytona in 1968 after finishing the 500 in fourth position. Was leading '70 California 500 until engine quit on 186th lap.



JIM McELREATH—Winner of first California 500 at Ontario Speedway at 160.106 mph, has been running Indy 500 since '62. That year was rookie of the year. First USAC championship win in 1965, the year he finished third in the point standings. Finished second in points in 1966. Charged from 33rd position to finish 5th in 1970 Indy 500.



BOBBY UNSER—Started racing in 1949 when he was 15. Moved to midgets and sprints after winning modified stocks championship in home state of New Mexico in 1950, '51. 1968 USAC national champion and winner Indy 500. Known as "King of the Hill" from repeated wins of Pikes Peak Hill Climb. Among top three drivers in point standings for past four years.

OTHER STARS: Donnie Allison, Sonny Ates, Keven Bartlett, Gary Bettenhausen, Jack Brabham, Ronnie Bucknum, Wally Dallenbach, Larry Dickson, Mark Donohue, George Follmer, Jerry Grant, Bobby Grim, Bob Harkey, Graham Hill, Denis Hulme, Jim Hurtubise, Mel Kenyon, Arnie Knepper, Steve Krisiloff, Joe Leonard, Ralph Liguori, Jim Malloy, Roger McCluskey, Al Miller, Mike Mosley, Rick Muther, Art Pollard, Peter Revson, Swede Savage, Sammy Sessions, Dick Simon, George Snyder, Bud Tinglestad, Bob Veith, Bill Vukovich, Bruce Walkup, Gregg Weld, Bob Wente, Carl Williams, Lee Roy Yarbrough.

It still goes beep-beep.

And it still has fat tires, high-flow cylinder heads, 4-barrel carburetion and heavy-duty brakes and suspension.

And it's still, well . . . still everything you've come to know and love it for. In other words, a low-priced honest-to-goodness high-performance car with the right equipment built right in.

It's the 1971 Road Runner. Beep-Beep.

The Rapid Transit System. Coming through.

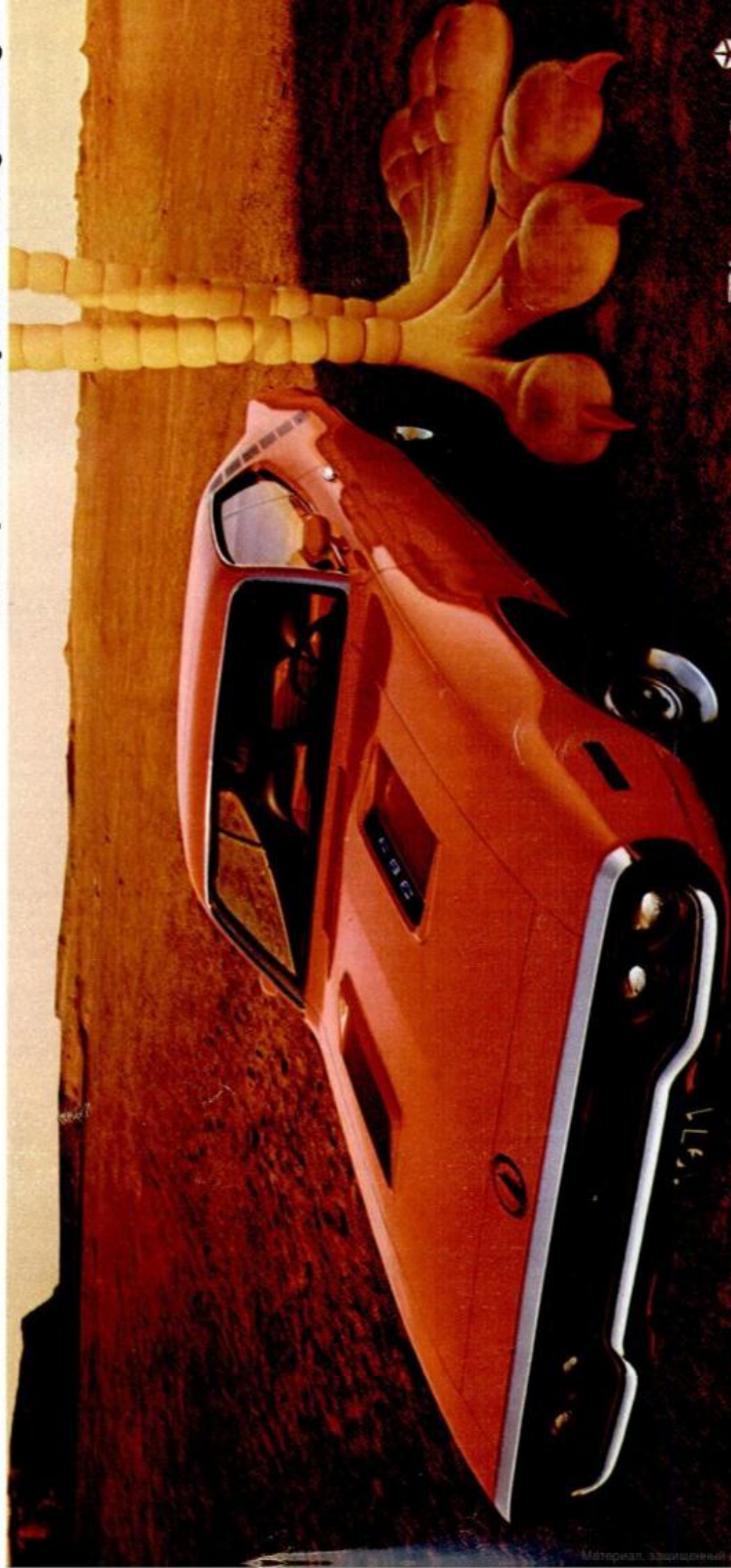

Plymouth



CHRYSLER
WORLDWIDE CORPORATION

SPRINTS AND MIDGETS

SPRINT CARS look like old-fashioned, front-engine Indy racers. Smaller than USAC Championship cars for dirt, they run on half-mile dirt tracks, are extremely fast with their 305-cu.-in. fuel-injected Chevy V8s or 256-cu.-in. overhead-cam Meyer-Drake Offys.

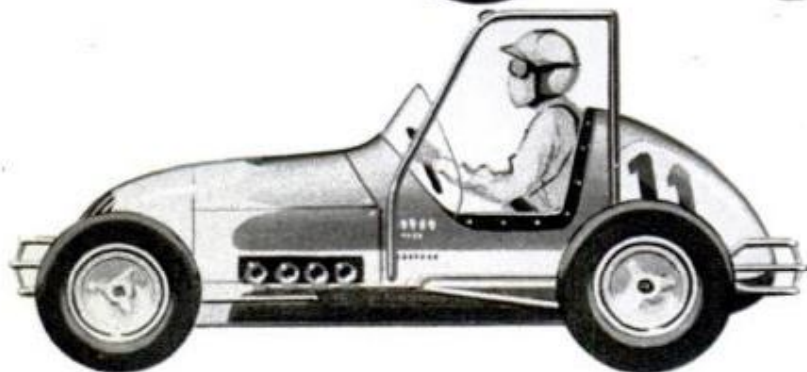

MIDGET CARS, scaled down further from the championship/sprint cars, are the smallest of the USAC racers. Run on one-quarter and one-half mile tracks. Largest engine displacement in USAC midgets is 153 cu. in. (with overhead-cam, 114 CID; supercharged 76 CID).

WHEELS SPINNING AND SLIDING around short, paved or dirt oval tracks—hundreds of them from coast to coast—the open cockpit sprints and midgets are no less exciting with the addition of roll cages (to be mandatory on USAC cars in '71). USAC sprint and midget races are usually scheduled the night before a major league National Championship race for Indy cars. Run at nearby smaller tracks, they give the fans a double-header attraction, and give younger Indy car drivers a better chance to make a buck on the trip.

The sprints and midgets no longer produce as great a percentage of new Indianapolis drivers, but do provide a living for those Indy drivers who've yet to hit the big time consistently. Although USAC is nationwide, most of its sprint and midget races are on midwestern tracks (because of its Indianapolis headquarters) and, in fall and winter, on Pacific Coast tracks. This is where the action is for the fans who want their auto racing once a week. Lots of local color, close-up seating, maybe a little mud in the eye.

The annual midget race at the Houston Astrodome, featured on home television, has further boosted the success of the mighty mites. Increases in attendance have benefited the smaller midget and sprint associations throughout the country. There are the International Motor Contest Assn. (IMCA), United Racing Club (URC), American Racing Drivers Club (ARDC), California Racing Assn. (CRA), American Midget Racing Assn. (AMRA) and more.



Gary Bettenhausen
USAC Sprint



Jerr Blundy
IMCA Sprint



Jimmy Caruthers
USAC Midget



Larry Dickson
USAC Sprint



Darl Harrison
IMCA Sprint



Eddie Leavitt
IMCA Sprint



Chuck Lynch
IMCA Sprint



Benny Rapp
IMCA Sprint



Perry Richert
IMCA Sprint



Dave Strickland
USAC Midget



Dick Sutcliffe
IMCA Sprint



Jay Woodside
IMCA Sprint

STOCK CARS



Most popular form of U.S. auto racing. Ranges from Detroit's latest to severely cobbled, much modified cars dating back to mid-'30s. Cars classified as Grand National, Late Model, Late Model Sportsman, Modified, Hobby. Racing conducted by NASCAR, USAC, ARCA, IMCA, plus regional, local organizations. Big hotbeds are Midwest, South (where stock-car racing is a major sport). Frequency of events means more overall prize money than any other form of racing. Purses range from a few hundred dollars to more than \$50,000 for such major events as the Daytona 500, which draws crowds of up to 100,000.



BOBBY ALLISON—One of NASCAR's most popular stars. Started in jalopies in '55; big winner in modifieds from '62 through '65. Entered first GN—Daytona 500—in '60. Big win was 500-miler at Rockingham in '68. In '69 took 250-milers at Bristol, Wilkesboro, Richmond, Middle Georgia. Last season won Atlanta 500 in '69 Dodge at speed of 139.554.



ROGER McCLUSKEY—The 1969 USAC stock-car champion clinched a repeat in '70 with his second-place finish at Milwaukee in September. USAC sprint-car champion in '63 and '66, just missed in '62. Championship Trail driver since 1960, he's been plagued by mechanical difficulties and bad luck in eight of his nine starts at Indy since 1961.



PETE HAMILTON—Personable young charger joined NASCAR GN ranks in '68 after winning '67 national sportsman championship. Won rookie of year. Won 12 NASCAR GT races in '69—record wins for single season. Joined the Petty Plymouth team in '70 and made his first GN win Daytona 500, followed that with a 500 win at Talldega.



DAVID PEARSON—Three Grand National championships—'66, '68 and '69—highlight his 10-year career in NASCAR. Three championships tie Lee Petty's record of '50s. Rookie of the Year in '60, he was a graduate of the Sportsman ranks. Is No. 2 driver in record of career victories. Big win on '70 Grand National circuit was Rebel 400.



JAMES HYLTON—Joined GN scene as top wrench on cars of Rex White, Ned Jarrett. GN rookie of the year in '66 and runner-up in standings in '66 and '67. Third in '69. Finished in top five 28 times in 52 races. Consistent and determined driver, was second in point standings near end of '70. Still looking for his first big win.



RICHARD PETTY—Stock-car great, winner of more Grand National races than any driver in NASCAR history. GN champ in '64, '67, runner-up three times. Won 27 of 48 races in '67, a record. Son of racing great Lee Petty, "Richard" began in '58. Has won most big ones, including Daytona 500 in '64, '66. Took Carolina and Dixie 500s in '70.



BOBBY ISAAC—Started in sportsman modifieds in '55, South Carolina champ in '58. Ran first GN in '63 at Daytona. Compiler of outstanding record on shorter tracks. Second in points in '68. Won 16 races in '69 including first superspeedway win, Texas 500. Soft-spoken, rugged, always in thick of GN points race, '70 no exception. Tops in points near end of season.



CALE YARBOROUGH—Soapbox racer at age 10, has been racing ever since. Became sportsman star while in teens, ran first GN at 17 (illegally). Won Firecracker 400 in '67 for immediate superspeedway stardom. NASCAR money winner in '68. Won Atlanta 500 in '69, Motor State 500 at Michigan International Speedway in 1969 and 1970.

OTHER STARS: Donnie Allison, Buddy Arrington, Buddy Baker, Jack Bowsher, Richard Brickhouse, Dick Brooks, Neil Castles, Hoss Ellington, Paul Feldner, A.J. Foyt, Charlie Glotzbach, Butch Hartman, Friday Hassler, Elmo Langley, Fred Lorenzen, Dave Marcis, Norm Nelson, Benny Parsons, Art Pollard, Billy Ries, Johnny Rutherford, Wendell Scott, Bugs Stevens, Don Tarr, Jabe Thomas, Frank Warren, Dave Whitcomb, Don White, Lee Roy Yarborough.

Winners of Major NASCAR Races

Alabama Intl. Motor Speedway

ALABAMA 500			
YEAR	DRIVER	CAR	AV. MPH
1970	Pete Hamilton	'70 Plymouth	152.321
TALLADEGA 500			
1969	Richard Brickhouse	'69 Dodge	153.778
1970	Pete Hamilton	'70 Plymouth	158.517

Atlanta International Raceway

ATLANTA 500			
1960	Bobby Johns	'60 Pontiac	108.624
1961	Bob Burdick	'61 Pontiac	124.172
1962*	Fred Lorenzen	'62 Ford	101.983
1963	Fred Lorenzen	'63 Ford	130.582
1964	Fred Lorenzen	'64 Ford	132.959
1965	Marvin Panch	'65 Ford	129.410
1966	Jim Hurtubise	'66 Plymouth	131.266
1967	Cale Yarborough	'67 Ford	131.238
1968	Cale Yarborough	'68 Mercury	125.564
1969	Cale Yarborough	'69 Mercury	132.191
1970	Bobby Allison	'69 Dodge	139.554

*328 1/2 miles because of rain

DIXIE 500			
1960*	Fireball Roberts	'60 Pontiac	112.653
1961	David Pearson	'61 Pontiac	125.384
1962	Rex White	'62 Chevrolet	124.896
1963	Junior Johnson	'63 Chevrolet	121.139
1964	Ned Jarrett	'64 Ford	112.535
1965	Marvin Panch	'65 Ford	110.120
1966	Richard Petty	'66 Plymouth	130.244
1967†	Dick Hutcherson	'67 Ford	132.286
1968	Lee Roy Yarborough	'68 Mercury	127.068
1969	Lee Roy Yarborough	'69 Ford	133.001
1970	Richard Petty	'70 Plymouth	142.712

*Dixie 300 †Race changed from 400 to 500 miles

Darlington International Raceway

REBEL 400			
1957	Fireball Roberts	'57 Ford	107.940
1958	Curtis Turner	'58 Ford	109.624
1959	Fireball Roberts	'59 Chevrolet	115.903
1960	Joe Weatherly	'60 Ford	102.646
1961	Fred Lorenzen	'61 Ford	119.529
1962	Nelson Stacy	'62 Ford	117.864
1963	Joe Weatherly	'63 Pontiac	122.745
1964	Fred Lorenzen	'64 Ford	130.013
1965	Junior Johnson	'65 Ford	111.849
1966*	Richard Petty	'66 Plymouth	131.993
1967	Richard Petty	'67 Plymouth	125.738
1968	David Pearson	'68 Ford	132.699
1969	Lee Roy Yarborough	'69 Mercury	131.572
1970	David Pearson	'69 Ford	129.668

*Race changed from 300 to 400 miles

SOUTHERN 500			
1950	Johnny Mantz	'50 Plymouth	76.26
1951	Herb Thomas	'51 Hudson	76.90
1952	Fonty Flock	'52 Oldsmobile	74.51
1953*	Buck Baker	'53 Oldsmobile	92.78
1954	Herb Thomas	'54 Hudson	94.93
1955	Herb Thomas	'55 Chevrolet	92.281
1956	Curtis Turner	'56 Ford	95.067
1957	Speedy Thompson	'57 Chevrolet	100.100
1958	Fireball Roberts	'57 Chevrolet	102.590
1959	Jim Reed	'59 Chevrolet	111.836
1960	Buck Baker	'60 Pontiac	105.901
1961	Nelson Stacy	'61 Ford	117.880
1962	Larry Frank	'62 Ford	117.965
1963	Fireball Roberts	'63 Ford	129.784
1964	Buck Baker	'64 Dodge	117.757
1965	Ned Jarrett	'65 Ford	115.924
1966	Darel Dieringer	'66 Mercury	114.830
1967	Richard Petty	'67 Plymouth	130.423
1968	Cale Yarborough	'68 Mercury	126.132
1969†	Lee Roy Yarborough	'69 Ford	105.612
1970	Buddy Baker	'69 Dodge	128.817

*Track changed 1 1/4 to 1 3/8 mi. †316 1/4 miles due to rain

Riverside International Raceway

RIVERSIDE 500			
1963	Dan Gurney	'63 Ford	84.965
1964	Dan Gurney	'64 Ford	91.154
1965	Dan Gurney	'65 Ford	87.708
1966	Dan Gurney	'66 Ford	97.946
1967	Parnelli Jones	'67 Ford	91.080
1968	Dan Gurney	'68 Ford	100.598
1969	Richard Petty	'69 Ford	105.516
1970	A. J. Foyt	'70 Ford	97.450

Charlotte Motor Speedway

WORLD 600			
1960	Joe Lee Johnson	'60 Chevrolet	107.752
1961	David Pearson	'61 Pontiac	111.634
1962	Nelson Stacy	'62 Ford	125.552
1963	Fred Lorenzen	'63 Ford	132.418
1964	Jim Paschal	'64 Plymouth	125.772
1965	Fred Lorenzen	'65 Ford	121.772
1966	Marvin Panch	'65 Plymouth	135.042
1967	Jim Paschal	'67 Plymouth	135.832
1968*	Buddy Baker	'68 Dodge	104.207
1969	Lee Roy Yarborough	'69 Mercury	134.361
1970	Donnie Allison	'69 Ford	129.680

*382 1/2 miles because of rain

NATIONAL 500			
1960	Speedy Thompson	'60 Ford	112.760
1961	Joe Weatherly	'61 Pontiac	119.800
1962	Junior Johnson	'62 Pontiac	132.085
1963	Junior Johnson	'63 Chevrolet	132.105
1964	Fred Lorenzen	'64 Ford	134.559
1965	Fred Lorenzen	'65 Ford	119.118
1966*	Lee Roy Yarborough	'66 Dodge	130.743
1967	Buddy Baker	'67 Dodge	130.317
1968	Charlie Glatzbach	'68 Dodge	135.324
1969	Donnie Allison	'69 Ford	131.271
1970	Lee Roy Yarborough	'69 Mercury	123.246

*Race changed from 400 to 500 miles

Daytona International Speedway

DAYTONA 500			
1959	Lee Petty	'59 Oldsmobile	135.521
1960	Junior Johnson	'59 Chevrolet	124.740
1961	Marvin Panch	'60 Pontiac	149.601
1962	Fireball Roberts	'62 Pontiac	152.529
1963	Tiny Lund	'63 Ford	151.566
1964	Richard Petty	'64 Plymouth	154.334
1965*	Fred Lorenzen	'65 Ford	141.539
1966†	Richard Petty	'66 Plymouth	160.627
1967	Mario Andretti	'67 Ford	146.926
1968	Cale Yarborough	'68 Mercury	143.251
1969	Lee Roy Yarborough	'69 Ford	157.950
1970	Pete Hamilton	'70 Plymouth	149.601

*332 1/2 miles due to rain †495 miles due to rain

FIRECRACKER 400			
1959	Fireball Roberts	'59 Pontiac	140.581
1960	Jack Smith	'60 Pontiac	146.847
1961	David Pearson	'61 Pontiac	154.294
1962	Fireball Roberts	'62 Pontiac	153.688
1963*	Fireball Roberts	'63 Ford	150.927
1964	A. J. Foyt	'64 Dodge	151.451
1965	A. J. Foyt	'65 Ford	150.046
1966	Sam McQuagg	'66 Dodge	153.813
1967	Cale Yarborough	'67 Ford	143.583
1968	Cale Yarborough	'68 Mercury	167.247
1969	Lee Roy Yarborough	'69 Ford	160.875
1970	Donnie Allison	'69 Ford	162.235

*Race changed from 250 to 400 miles

North Carolina Motor Speedway

CAROLINA 500			
1966	Paul Goldsmith	'66 Plymouth	100.072
1967	Richard Petty	'67 Plymouth	104.682
1968	Donnie Allison	'68 Ford	99.338
1969	David Pearson	'69 Ford	102.569
1970	Richard Petty	'70 Plymouth	116.117

AMERICAN 500			
1965	Curtis Turner	'65 Ford	101.943
1966	Fred Lorenzen	'66 Ford	104.348
1967	Bobby Allison	'67 Ford	98.420
1968	Richard Petty	'68 Plymouth	105.060
1969	Lee Roy Yarborough	'69 Ford	111.938
1970			

Michigan International Speedway

MOTOR STATE 400			
1969	Cale Yarborough	'69 Mercury	139.254
1970*	Cale Yarborough	'69 Mercury	138.302

*Race changed from 500 to 400 miles

YANKEE 400			
1969*	David Pearson	'69 Ford	115.508
1970	Charlie Glatzbach	'69 Dodge	147.571

*330 miles because of rain

Texas International Speedway

LONE STAR 500			
1969	Bobby Isaac	'69 Dodge	144.277
1970			



**Professional race drivers
stake a lot on their cars.
And 9 out of 10
choose Fram filters.**

**You have a lot
at stake in your car too.
So don't chance anything
but the best.**

**Replace with Fram...
every time you change filters.**

Fram Automotive Division
Providence, R.I.



TRANS-AM

NASCAR Grand American Challenge



Professional racing in two classes—over and under two-liter-CID engines. The former involves so-called "pony" (e.g., Mustang-type) cars, the latter small sedans of both U.S. and foreign manufacture (e.g., Alfa Romeo, Pinto). Trans-Am series, run on road courses, is sanctioned and administered by SCCA. NASCAR runs, sanctions its Grand American Challenge series on oval tracks, sometimes combined with a road course, often as prelude to Grand National events. Type of racing is new, growing. Many entries are factory-backed or at least benefit from factory "cooperation." NASCAR crowns an annual finish-points champion, also honors owner of overall points-winning car. SCCA conducts Trans-Am series as manufacturers' championship: drivers, teams win races, prize money; point standings go to manufacturers.



BUCK BAKER—Legendary NASCAR driver, was third in Grand American points near end of '70. Was Grand National champ in '56 and '57, competed in first GN in '49 in Charlotte, won Southern 500 three times. His last Darlington win was in '64 when he was a hard-charging 46-year-old. His son Buddy won there last September.



TINY LUND—NASCAR GT champion in '68. Was headed for same title in renamed Grand America series near end of '70. Started in sprints, entered Grand Nationals in '55. Biggest win: Daytona 500 in '63. Drove in Japan and Germany last year. Holds Carnegie medal for aiding in the rescue of Marvin Panch from his burning car.



MARK DONOHUE—Consummate road racer, he began career in 1959, was a national sports-car champion in '61. Won two national championships in '65, named SCCA's Driver of the Year. USRRC champion in '67, '68. Trans-Am champ '68 and '69. Finished second in '70 Indy 500. Was running American Motors Javelin team in close second near end of '70.



JIM PASCHAL—Started racing on Daytona's old beach course in 1947. One of few active drivers to have competed in first Southern 500 at Darlington in '50. Winner of World 600 in '64 and '67. In '69 won five of 22 races entered, finished in top five 11 times. Was second in Grand American points near end of '70 with a four-race win streak going.



PARNELLI JONES—An all-time racing great, won Indy 500 in '63, second in '65, far ahead in '67 when turbine car failed. Began career in '52 in stocks, outstanding record in many types of cars—championship, sprint, midget, even off-road. He and George Follmer, driving Bud Moore Mustangs, gave Ford the championship for the '70 season.



SAM POSEY—Moved up to professional racing fast. Five years ago started in Formula Vees, advanced to Porsches and honors at Watkins Glen, Sebring. Third in final standings for '67 USRRC, dropped to seventh in '68, but took fourth and fifth in Can-Am. In '69 Formula A finished close third in points. Dodge Challenger pilot in '70 Trans-Am.



ED LESLIE—Veteran SCCA competitor well-known for his competition record in Ford Cobras. As team driver for Shelby-American, drove Cobras to third place at Sebring and Daytona in '65. Drove Lola in '68 Can-Am. In '69 drove on Penske team scoring many points toward Chevy's Trans-Am win. Ran Camaro for Chapparral team in '70 Trans-Am.



SWEDE SAVAGE—Started at age nine in quarter-midgets, then go-karts, motorcycles. Protege of Dan Gurney, he drove Dan's second car in '68 USRRC and Can-Am. Finished fourth at Bridgehampton. In stocks has several good finishes, drove impressively in '69 Daytona 500 until engine blew. Put Barracuda on pole twice in '70 Trans-Am.

OTHER STARS: (Trans-Am) Maurice Carter, John Cordts, Vic Elford, George Follmer, David Hobbs, Horst Kwech, Lee Midgley, Milt Minter, Peter Revson, Ted Roberts, Peter Schuster, Jerry Thompson, Roy Woods; (NASCAR) Wayne Andrews, David Boggs, Richard Childress, Bobby Fleming, T.C.Hunt, Ken Rush, Frank Sessoms, Ernie Shaw, Jimmy Vaughn, Phil Wills.

CAN-AM CARS



The Canadian-American Challenge Cup is a series of SCCA and Canadian Automobile Club-sanctioned FIA international events for sports racing (Group 7) cars. Unlike other formulas, the rules for the car design place almost no restrictions on weight or overall size. There is no limit on engine displacement. Fantastic power-to-weight ratios are the result of teaming 7 and 8-liter engines putting out 600 to 700 hp with cars weighing as little as 1500 pounds. Since the series began in 1966, the number of races annually has increased from 6 to 10 in 1970 with purse now over \$1 million. The 1970 season was dominated again by "Team McLaren"—Denis Hulme, Dan Gurney and Peter Gethin winning in McLaren M8Ds. Most revolutionary car of '70 season was Jim Hall's Chapparral 2J—an unlikely looking creation with dual exhaust fans giving it a "ground effect" to hold the road better.



BOB BROWN—Racing since 1961 driving Camaros, Corvettes and Cobras. In Lola-Chevrolet he ranked third on final standings for 1968 FA. Three strong second-place finishes at Thompson, Lime Rock and Donnybrooke gave him most of 23 points for position. Ran fifth in '69 FA Series; in top five running McLaren M6B near end of '70.



LOTHAR MOTSCHENBACHER—A force in U.S. road racing since 1966 when he moved from 33 straight formula victories in a junior car to big machines. That year he scored a fifth-place finish at Las Vegas Can-Am, driving a McLaren Mk. 2. He finished seventh in standings in '69 Can-Am series. Was a competitive second near end of '70.



GEORGE EATON—Began racing in Sunbeam Alpine in native Canada at 19. Before his first Can-Am in 1967 in McLaren Mk. 3 he was Ontario's big-sedan champion. His best finish in '68 series was third at Laguna Seca. Steady finisher in the '69 11-race series, he was among handful of drivers at top in point standings. Ran BRM in '70.



JACKIE OLIVER—Started racing in '61. Drove F1 car on Lotus team in 1968. Co-drove GT-40 Ford with Jackie Ickx in '69, won 12 Hours of Sebring, Le Mans. Ran BRM in '70 F1 events, and started '70 Can-Am season in titanium Autocoast Ti-22. Took second in opening race. In second race at St. Jovite, car became airborne, flipped.



PETER GETHIN—Leader in British Guards series for Formula 5000 cars in 1969. An Englishman who visited the United States to run a McLaren in the Continental, he promptly won at Lime Rock. Made F1 debut in '70 Dutch Grand Prix; qualified well but DNF. Finished the '70 season in Can-Am as a member of Team McLaren.



CHUCK PARSONS—High in standings for 1969 season, won U.S. road-racing championship in 1966. That year best Can-Am finish was third in McLaren Mk. 2 at Mosport. For three consecutive years (1966-68) at Elkhart Lake, he took Road America 500 in SCCA's now-discontinued U.S. road-racing championship series. Ran '70 in Lola.



DENIS HULME—New Zealander based in London, is international driving star who has won more Can-Am races than any other man. World Driving Champion in 1967 in a Brabham-Repco, he remains a tough competitor in Formula 1 events and in Indy 500 where he finished fourth in 1967 (his first year there) and in '68, 1970 Can-Am champion.



PETER REVSON—Up from sports-car ranks, he drove superbly to finish fifth in '69 Indy 500. Began in '60, learned trade in F3, F2, F1 in Europe. Drove Cougar in '67 Trans-Am, Javelin in '68 Mustang in '69, Javelin in '70. Ran '70 Can-Am in Lola. Took second at Mid-Ohio. Almost won inaugural California 500 but for unlucky pit stop.

OTHER STARS: Mario Andretti, Dave Causey, Tony Dean, Gordon Dewar, Brooke Doran, Dick Durant, Vic Elford, Leonard Janke, Oscar Koveleski, Roger McCaig, Bob Nagel, Jo Siffert, Gary Wilson.

The high-rev oil.



We didn't design Quaker State Racing Oil just for high-rev racers.

Any high-performance engine that accelerates past 4000 revs a minute is a candidate for it. Race-car engines shoot far beyond 4000 rpm, while your passenger car may only top it during rapid acceleration to expressway speeds. But in each engine, intense temperatures will prevail.

Quaker State Racing Oil is specially formulated to keep its oily film strength in the fiercest engine temperatures. It resists foaming; minimizes piston scuffing; and reduces cam, lifter and ring wear.

Quaker State Racing Oil is best for any high-performance car, because it's refined from 100% Pure Pennsylvania Grade Crude Oil. We start with the world's choicest. And improve it.

Give your high-performance engine the high-rev protection of Quaker State Racing Oil. It's the finest.

**Quaker State your car
to keep it running young.**

FORMULA 1

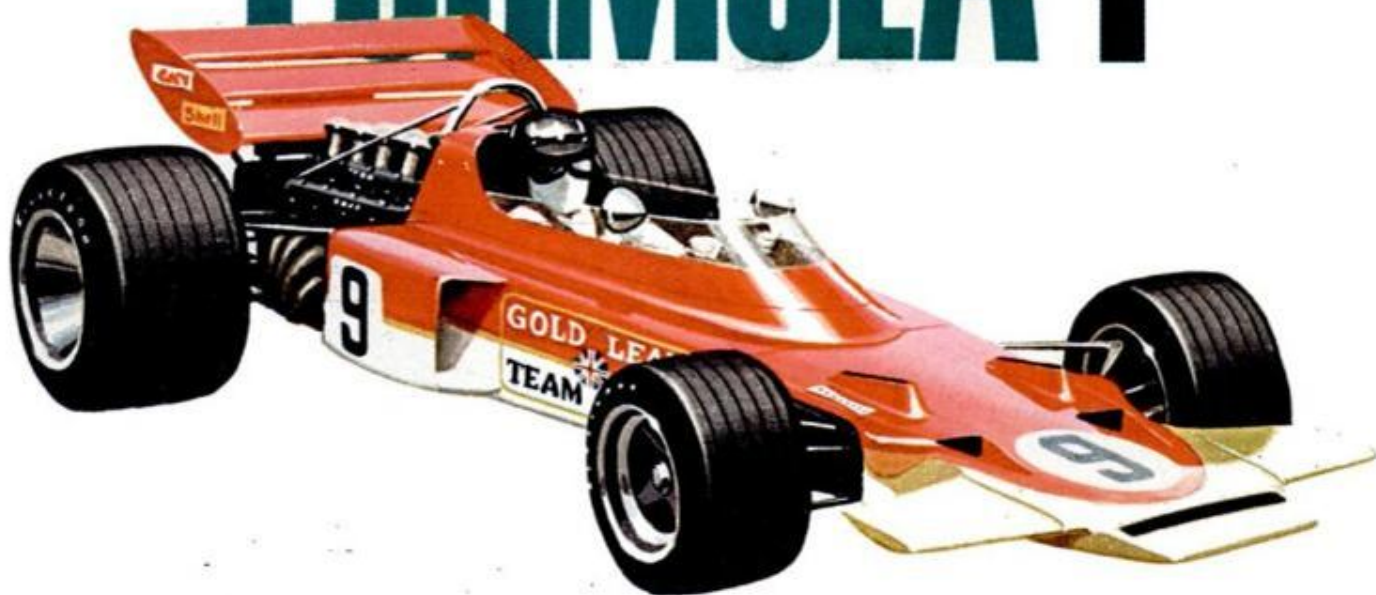

Traditional Grand Prix racing, Formula 1 events are run over road courses, principally in Europe. The U.S. Grand Prix for F1 cars is held each fall at Watkins Glen, N.Y. Originally, races were conducted on city streets; now most are run on special circuits. An exception—the Grand Prix of Monaco. Series each year crowns a "world champion" on a points-finish basis. Only American to win the world championship was Phil Hill in 1961. Two U.S. cars have won Grand Prix events—Jimmy Murphy's Duesenberg the Grand Prix of France in 1921, Dan Gurney's Eagle the Grand Prix of Belgium in 1967. Few American cars or drivers compete in F1 events. Grand Prix racing is rich in a tradition of great cars and outstanding drivers.



CHRIS AMON—A New Zealander, only 27 years old, got his first F1 ride at 19, youngest ever to do so. Joined Ferrari in '67 and co-drove winning Ferrari in 24 Hours of Daytona that year. Reputation as fast but unlucky in F1 competition. Was 12th in '69. Tied for seventh in points near end of '70 season, with seconds at Belgian and French GPs.



JACKY ICKX—Belgian is youngest driver on F1 circuit. Began F1 career in 1967 (won F2 title that year) in a Cooper, went to Ferrari in 1968, switched to Brabham in '69, placed second in points. Won '68 French GP in pouring rain, won German GP in '69, co-winner of '69 24 Hours of LeMans, won '70 Austrian and Canadian GPs in Ferrari.



JEAN-PIERRE BELTOISE—Won 11 championships in France on motorcycles before winning French F3 title in '65. Won the European F2 title in '68, also campaigned in F1. In '69 was second in French GP, third in Spanish, Italian GPs. A charger, very fast, but still seeking first GP win. In '70 was third at Belgian, Italian Grands Prix.



PEDRO RODRIGUEZ—International driver, he began racing in his native Mexico. Was motorcycle champion in '54 and '55. Won South African GP in '67 and took a second and two third places in the 1968 F1 races for BRM. Winning co-driver in 24 Hours of Le Mans. Drove Ferrari in '69 Can-Am. Won Belgian GP last season in BRM, ran second in U.S. GP.



JACK BRABHAM—Top designer and driver. Makes more formula cars than any builder. First to win world championship in his own marque. World champion in '59, '60 and '66. Started career on Australian dirt tracks in 40s, started the rear-engine trend at Indy. Won South Africa GP in '70, was second at Monaco and England.



JACKIE STEWART—The 1969 World Champion from Scotland, began career in '61. In two years he had won more amateur races than anyone in Britain. Was F3 champ in '64, won first F1 event in '65. Twice in contention at Indy, was foiled by mechanical failure. Driving a March-Ford in '70, he won Spanish GP, second in Holland and Italy.



GRAHAM HILL—Ultimate professional in every way. Winner of more Grand Prix races than any other active driver. Began in F3 in '54. Was world champion in '62 and '68, lost by one point in '64. Won Indy 500 as rookie in '66, successfully threading way through first lap pileup. Back driving for Lotus in '70 after accident in '69 U.S. GP.



JOHN SURTEES—Veteran motorcycle star, won seven cycle world championships. Driving a Ferrari, won F1 World Championship in '64. Swept first Can-Am series in '66 in Lola. In '69 drove for BRM in F1, Chapparral in Can-Am. Driving for Cooper, Honda, brought both a GP victory. Runner-up for F1 title in '66. Began running own TS7 Surtees-Ford in '70.

OTHER STARS: Mario Andretti, Francois Cevert, George Eaton, Ignazio Giunti, Denis Hulme, Emerson Fittipaldi, John Miles, Jackie Oliver, Henri Pescarolo, Clay Regazzoni, Johnny Servoz-Gavin, Jo Siffert, Rolf Stommelen.

Grand Prix Racing

At Watkins Glen in October, 1969, PM saw Austrian Jochen Rindt win his first Formula 1 Grand Prix race. He not only won the race at a record 126.36 mph but set the fastest lap record doing it: 130.15 mph. The Formula 2 star was on his way. Last season, in the new Lotus 72, the 28-year-old driver came into his own—he won Monaco, then four straight: the Dutch, French, British and German Grands Prix. He led the World's Driver Championship with 45 points. Then, in practice at Monza, he was killed. No other driver bettered his 45 points, and as this *Racing Guide* goes to press the word is that the international sanctioning body for F1 has decided to award the World Driving Championship to this driver posthumously. Jochen Rindt earned the title.

Grand Prix racing is international—a complex combination of man, machine, mechanics and money. Driving skill is rewarded grandly when an F1 pilot gets a strong car that will go the distance. To see if it will, fans flood the circuits from Australia to Zandvoort. Strong stuff. Only one to a country.

1970 WINNERS

Grand Prix of South Africa, March 7

1. Jack Brabham, Australia (Brabham-Ford)
2. Denis Hulme, New Zealand (McLaren-Ford)
3. Jackie Stewart, Scotland (March-Ford)

Grand Prix of Spain, April 19

1. Jackie Stewart, Scotland (March-Ford)
2. Bruce McLaren, N. Zealand (McLaren-Ford)
3. Mario Andretti, U.S.A. (March-Ford)

Grand Prix of Monaco, May 10

1. Jochen Rindt, Austria (Lotus-Ford)
2. Jack Brabham, Australia (Brabham-Ford)
3. Henri Pescarolo, France (Matra-Simca)

Grand Prix of Belgium, June 7

1. Pedro Rodriguez, Mexico (BRM)
2. Chris Amon, New Zealand (March-Ford)
3. Jean-Pierre Beltoise, France (Matra-Simca)

Grand Prix of Holland, June 21

1. Jochen Rindt, Austria (Lotus-Ford)
2. Jackie Stewart, Scotland (March-Ford)
3. Jacky Ickx, Belgium (Ferrari)

Grand Prix of France, July 5

1. Jochen Rindt, Austria (Lotus-Ford)
2. Chris Amon, New Zealand (March-Ford)
3. Jack Brabham, Australia (Brabham-Ford)

Grand Prix of England, July 18

1. Jochen Rindt, Austria (Lotus-Ford)
2. Jack Brabham, Australia (Brabham-Ford)
3. Denis Hulme, New Zealand (McLaren-Ford)

Grand Prix of Germany, Aug. 2

1. Jochen Rindt, Austria (Lotus-Ford)
2. Jacky Ickx, Belgium (Ferrari)
3. Denis Hulme, New Zealand (McLaren-Ford)

Grand Prix of Austria, Aug. 16

1. Jacky Ickx, Belgium (Ferrari)
2. Clay Regazzoni, Switzerland (Ferrari)
3. Rolf Stommelen, Germany (Brabham-Ford)

Grand Prix of Italy, Sept. 6

1. Clay Regazzoni, Switzerland (Ferrari)
2. Jackie Stewart, Scotland (March-Ford)
3. Jean-Pierre Beltoise, France (Matra-Simca)

Grand Prix of Canada, Sept. 20

1. Jacky Ickx, Belgium (Ferrari)
2. Clay Regazzoni, Switzerland (Ferrari)
3. Chris Amon, New Zealand (March-Ford)

Grand Prix of the United States, Oct. 4

1. Emerson Fittipaldi, Brazil (Lotus-Ford)
2. Pedro Rodriguez, Mexico (BRM)
3. Reine Wisell, Sweden (Lotus-Ford)

Grand Prix of Mexico, Oct. 25

(Race held too late for guide deadline)

1971 Grand Prix Schedule

South Africa March 7
Spain April 18
Monaco May 9
Belgium June 6

Holland June 20
France July 4
England July 18
Germany Aug. 1

Austria Aug. 15
Italy Sept. 5
Canada Sept. 19
United States Oct. 3
Mexico Oct. 24

World's fastest spark plug

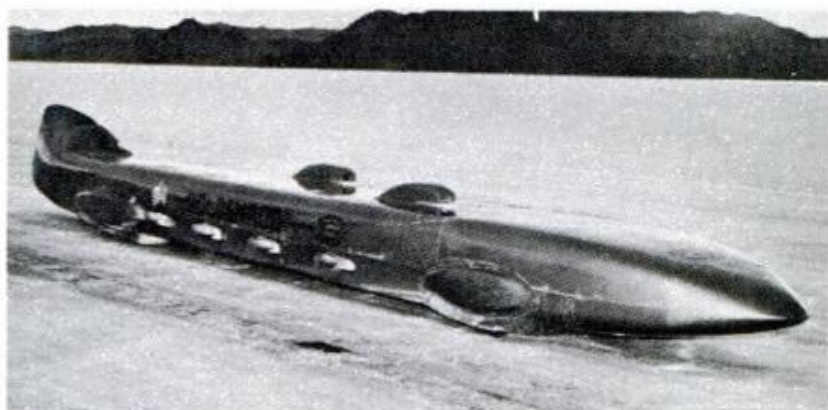

409.277 mph—world land speed record for piston engines is captured by the Summers brothers' Chrysler-powered "Goldenrod"—equipped with Champion spark plugs.



200.419 mph — world water speed record for propeller-driven boats is set by Roy Doby in U.S. Equipment Company's Champion-fitted, Rolls-Royce powered "Miss U.S. 1"



483.041 mph—world air speed record for piston engines is captured by Darryl Greenamyer in his Champion-equipped, Pratt & Whitney-powered Bearcat!

on land, on sea and in the air!

These world speed records were sparked by Champions, giving more proof Champions deliver maximum performance in every engine. Good reason for you to specify Champions for your engines.



The heart of a tune-up!



CHAMPION
SPARK PLUG COMPANY
TOLEDO, OHIO 43601

FORMULA A



The SCCA Continental Championship, America's Grand Prix, is open to open-wheeled, open-cockpit Formula A cars, most powerful of formula cars, and to the nimble, but smaller Formula B-C cars. Emphasis is on driving skill; cars themselves are closely competitive: stock-block V8s limited to 5 liters; no supercharging allowed; two-wheel drive mandatory. Cars often hold outright lap records and show wide variety of design. Continental Championship, only begun in 1967, is up to 13 races from five. A success here and abroad: England, for example, has Formula 5000 (for 5000 cc or 5 liters).



JOHN CANNON—Driving with increasing success since 1960. In '66, he was fifth in the USRRC; in '68, was sixth in Can-Am standings. Took opener at Laguna Seca in '68 driving three-year-old McLaren in steady downpour. In '69, he won Continental opener at Riverside in his Eagle. He clinched the championship last season at Mid-Ohio.



DAVID HOBBS—An Englishman who invaded the FA series in mid-season 1969 and promptly chalked up four wins, a second and a third and missed the championship by a point. A leader in the F5000 in his home country, he's logged an excellent record at Le Mans and in other endurance races. Drives a Surtees Formula A car.



GEORGE FOLLMER—Started in sports cars in 1960. In '65 drove Lotus/Porsche of own design, won six of nine races and U.S. Road-Racing Championship. Drove at Le Mans, competed in Can-Am to finish sixth in '67. Competes in USAC championship events, had brilliant season on Ford team in Trans-Am last year. Runs a Lotus in FA.



GUS HUTCHISON—Impressive record in Formula cars began in '64 with divisional championship in Formula Junior car. In '67, inaugural year for SCCA Grand Prix Championship forerunner to the Continental, he took championship. With victories at Lewisville and Sonoma, he was second in points only to Cannon near end of '70 season.



RON GRABLE—Driving since 1962, he took the ARRC Formula A title in 1968. Drove on Javelin team in 1969 Trans-Am. Returned to open-wheelers running in the down-under Tasman series in a McLaren-Chevy. A former engineer, with wins at Edmonton and Monterey, he was fourth in points standing near end of last season in Continental series.



DICK SMOTHERS—Despite other endeavors, is serious race driver. Earned SCAA national license in '68 and competed in most of the Formula B events with Chevron/Ford. In '69 best finish was third at Sears Point in FB. Teamed with George Wintersteen last season, was running well in top 10 driving Formula A Echlin Lotus-Chevrolet.



JOHN GUNN—Racing in SCCA competition since 1964, he has scored impressively in divisional and national events. Won in his class in '68 and '69 in 24-Hour Daytona Continental. In Formula A competition for two years, best showing was fourth at Elkhart Lake in '69. Consistent finisher last year, he was fifth in points near end of season.



GEORGE WINTERSTEEN—Outstanding young driver who has won regional and national "most improved driver" awards since 1963. Was Northeast FB champ in '67 and moved to SCCA Grand Prix series in 1968 when he drove to second place behind champ Lou Sell. Steady finisher, he tied for fourth in FA in '69. Ran Lotus-Chevrolet last year.

OTHER STARS: Fred Baker, Bill Brack, Dow Byers, Jacques Couture, Nicholas Craw, Mark Donohue, Mike Eyerly, Hiroshi Fushida, Mike Goth, Eric Haga, Dave Jordan, Horst Kroll, Allan Lader, John Martin, Rex Ramsey, Sandy Shepherd, Spence Stoddard, Eppie Weitzes.

Racing Rules

ENGINES

Late Model Stocks (ACCUS-FIA, NASCAR GN, USAC—U.S. factory production, '69, '70, '71. At least 2500 (or 1/250th of previous year's production, whichever is larger) of '70, '71 models built and at least 500 engines installed in any chassis/body model approved for racing by ACCUS-FIA. No half-year models approved. NASCAR: New '71 engines limited to 366 CID with 1-in. overbore allowed. One 4-bbl. carburetor, 1 11/16-in. throttle bore. Previously approved ('69, '70) 430-CID engines may be used, even in '71 models, but with restrictor plate under the one 4-bbl. carb, the hole size to be determined (in late 1970 was 1 1/4-in. diameter). Existing "special" cars (as '69 Ford Talladega, Dodge Daytona, '70 Plymouth Superbird) may be raced, limited to maximum 305 CID, one 4-bbl., 1 11/16-in. throttle bore, no restrictor plate required. USAC: Maximum engine size remains at 429.999 CID, as in 1970, one 4-bbl. carb with no restrictor plate, including '71 engines and existing special cars. In USAC, pony cars run in same race with larger cars, engines limited to 305 CID. Allowed two 4-bbl. carbs, new in 1971. Both: no supercharger or fuel injection. All parts stock except pistons, camshafts. Heads, certain parts may be modified within specified limits. NASCAR: Engine may not be relocated. USAC: Engine may be moved fore or aft 1 1/2-in. ARCA: Maximum 430 CID with .030 overbore, two 4-bbl. carbs. IMCA: No CID limit. Models '69, '70, '71 with minimum 500 built and sold to public. Pony cars welcomed.

Grand American (NASCAR)—U.S. and imported factory production compact cars '69, '70, '71. At least 2500 or 1/250th previous year's production, at least 500 engines installed in any chassis/body model approved. Maximum 305 CID, plus 1-in. overbore. Engine displacement may be increased or decreased to reach 305-CID limit. One 4-bbl. carb, 1 11/16-in. throttle bore. Other rules similar to NASCAR GN. (In USAC, the pony cars run in the same race with standard-size cars, limited to 305 CID, allowed two 4-bbl. carb.)

Late Model Sportsman (NASCAR)—U.S. cars, '52 through '68, engine year optional. No OHCs, certain CID restrictions pertaining to specific makes, years. Parts may be altered within limits. Gasoline only.

Modified (NASCAR)—U.S. cars, '35 through '68. No OHCs, unlimited CID. Engines may be interchanged within the manufacturer's line. Superchargers, fuel injection allowed. Any carburetion, pistons and camshafts.

Hobby (NASCAR)—U.S. cars '36 through '60, any engine except no OHCs. Maximum 335 CID. Multiple carbs allowed on flatheads, one carb for OHV engines. No fuel injection, superchargers.

Cadet (NASCAR)—U.S. cars '55 through '63. Standard U.S. production engine for make and model. No OHV V8s, no OHCs. Six-cylinder maximum 300 CID with .010-in. allowed for wear.

Championship (USAC Indianapolis cars)—OHC 256.284 CID; super or turbocharged OHC 161.703; (Please turn to page S37)

JANUARY 1971

S17

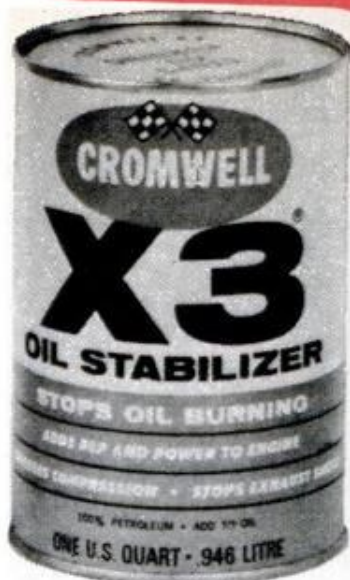

Just ask
**Tom
McCahill**



... "Cromwell X3 Oil Stabilizer... is guaranteed to stop your car's smoking and oil burning... or you get your money back!"

"It's not a mechanic in a can, but it does the job... I've tested Cromwell X3 Oil Stabilizer and it works!"

Cromwell X3 Oil Stabilizer's unique formula is compounded to stop excessive engine wear, oil burning and compression loss.

It forms an oil seal in the compression chamber preventing blow-by and compression loss; an oil barrier on piston and cylinder walls preventing oil burning and smoking.

Cromwell X3 Oil Stabilizer is permanent in the oil and is not a detergent. Like all Cromwell X3 Products, Oil Stabilizer is sold only at service stations and is 100% guaranteed.

**EXCLUSIVE DISTRIBUTORSHIP-FRANCHISES
IN SELECTED AREAS ARE AVAILABLE.
WRITE OUR FRANCHISE DIRECTOR.**



CROMWELL OIL COMPANY
1737 Cordova Street • Los Angeles, California 90007

For 2 sharp Cromwell X3 Decals and valuable information booklet on Cromwell X3 products... send 25c

Other Formulas and Classes

Even football fans have heard of "Indy" and Daytona. But unless they're auto racing fans, too, they probably don't know that for every Indy or Daytona 500 that's run there are hundreds of races run in cars other than those known as Championship and Grand National Stocks. As with any other sport, motor sport has its big leagues and little leagues—lesser leagues is a better term. Not lesser to the skilled participants to be sure, but the machinery is a little less powerful, a little less sophisticated—scaled down from the big-time, big-car, big-purse spectacles. The cars go by a little less blurred, with a little less roar, and there may be fewer spectators.

Still other classes of auto racing, too numerous to detail, are not scaled-down forms of anything, but are unique events in themselves. The only thing the many variations have in common is the contest of getting from start to finish in the shortest time and therefore at the fastest speed.

FORMULA B All such cars have single seat, open wheel, open cockpit; use pump fuel, on-board starters and dual braking systems. Engines are between 1101 and 1600 cc, fuel capacity is 19 gallons and minimum weight 848 pounds, as formulated by the Sports Car Club of America. Races run on some road courses as FA events, with winners averaging around 100 mph. Mike Eyerly in a Chevron B17 was a repeat champion in the 1970 Formula B-C championship series.

FORMULA C SCCA formula allows engines up to 1100 cc, with no mechanical restrictions. Fuel capacity is 16 gallons; minimum weight, 750 pounds. Run with Formula B cars in Formula B-C Championship that is part of Continental Championship.

FORMULA VEE AND SUPER VEE "Vee" is for Volkswagen in the vee formula for single-seat, open-wheel cars, based on VW sedan engines of 1200-cc maximum displacement. Minimum weight of an F/V, less fuel and driver, is 825 pounds. Wheelbase must be 81.5 to 83.5 inches. One of SCCA's most popular racing formulas, Formula Vee attracts devoted fans, is a growing participant sport. Super Vee is new, based on the 1600-cc VW engine and with fewer restrictions.

FORMULA F The "F" is for Ford. This is a new formula that was first established for the 1969 season by the SCCA for single-seat, open-wheel cars with 1600-cc English Ford Cortina engines. More expensive for the participant than F/V racing, but with attendant increases in acceleration and speed. Next step up for F/V drivers with aspirations, it's extremely popular.

CLUB RACING This term means amateur racing with no cash rewards; in the United States it also means the SCCA. At the club level are interdivisional, national, divisional and regional events in which SCCA members participate in their own cars. There are also drivers' schools and so-called Solo 1 events in which cars run one at a time against the clock—in hill climbs, for example, cars in a popular SCCA category are production sports. Production classes A through H place mass-produced sports cars with same racing potential in same category. A-Production includes cars like Corvettes, Shelby GTs; H-Production, cars such as MB Midgets, Fiat 850 Spiders.

OFF-ROAD RACING Growing by leaps and bounds. Start of a race looks like a free-for-all; a couple of hundred anything-goes vehicles are off in a cloud of dust. Actually, under the auspices of either the National Off-Road Racing Assn. or the International Desert Racing Assn., it is strictly organized. Vehicles fall into many classes. The basic types competing (all in one event!) are: two-wheel drives, dune buggies, four-wheel drives and motorcycles. Two big events are Mint 400 in Nevada and the Mexican 1000, which is down the Baja Peninsula.

FORMULA 2 The international F2 class limits engines to two liters—up from 1.6—with six cylinders maximum. Minimum weight of single-seat, open-wheel cars is 924 pounds in running order without fuel. No. F2 races are run in the United States. The Formula 2 cars also compete in the Tasman series, a popular seven-race series run in Australia and New Zealand during January and February. The engine limit in the F2 chassis for the Tasman Series is 2.5 liters: Some competitors (who can afford it) use 3-liter F1 engines reduced to 2.5 liters as powerplants.

FORMULA 3 Smallest of the international formula cars. Engine is limited to a single liter which must be derived from a mass-produced touring-car engine. Minimum weight is 880 pounds. As with the lesser American formula cars, F3 is the training ground of potential Grand Prix drivers.

International Manufacturers' Championship

A series of international endurance events for sports cars, sports prototypes, grand touring and touring cars with points going to the winning marque. Last year Porsche swept the series. Events in the United States, with their dates for 1971, include: The 24 Hours of Daytona, Jan. 30-31; 12 Hours of Sebring, March 19-20; and 6 Hours of Watkins Glen, July 10. Among the other races in the series are Le Mans, France; Monza, Italy, and Targa Florio, Sicily.

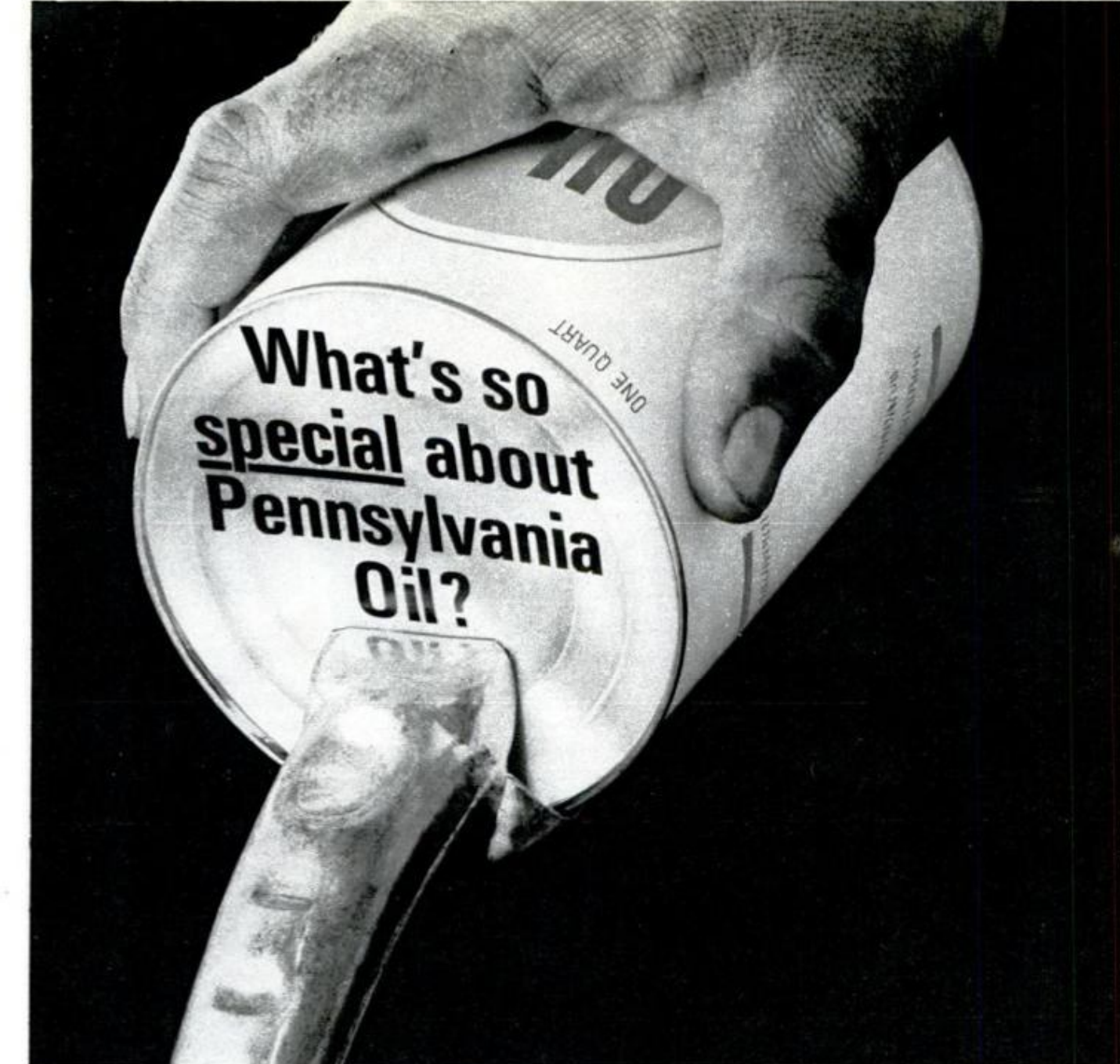

What's so
special about
Pennsylvania
Oil?

There's a big difference between motor oils refined from pure Pennsylvania Grade crude and those made from other crude oils.

Scientists attribute the difference to the unique geologic conditions that existed in the Pennsylvania region millions of years ago. These conditions resulted in a crude oil possessing superior qualities of viscosity and lubricity.

The Pennsylvania motor oil story is contained in a free booklet, "Pride of Performance." This booklet is a handy guide to the grade of oil that's best for *your car, your driving habits, your climate.* Write for your copy today.

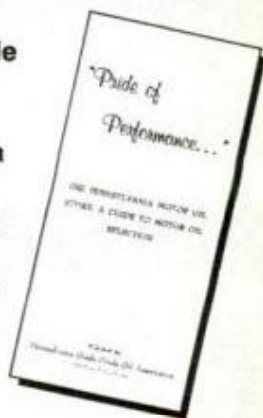

Oils that *stay oilier* are made from

PENNSYLVANIA GRADE CRUDE

PENNSYLVANIA GRADE CRUDE OIL ASSOCIATION
P. O. Box 250, Oil City, Pennsylvania 16301

DRAG RACING



Fuel Dragster

Strictly professional, Top Fuel Eliminators are the fastest cars going. Here we have the all-out rails, with no holds barred. They burn exotic fuels, their engines pulling upwards of 1500 hp, their costs ranging from \$10,000 to \$25,000. These cars turn speeds of 225 mph in the quarter mile, and they're what the crowds strain to see. As in NHRA's Pro Stock and Funny Car, there's only one class—AA/F. Basic rules: Any engine, two allowed, all mods permissible, any location. Any frame as long as it meets SEMA specs. Two-wheel spot brakes on rear wheels mandatory, as is a braking chute. Body must extend forward to firewall and can be of any flameproof material. Minimum wheelbase 90 inches, with no maximum. Rules also specify a large number of safety regulations to protect drivers and spectators.



DON COOK—A Californian known as "The Spoiler." Though he wasn't able to win a major championship in 1970, he counted in the spoiler role by knocking out many favorites in AHRA's top fuel category to keep pro point standings in constant turmoil. The saying in the pits is, "If Cookie ever gets lucky, look out!"



JIM NICOLL—Won AHRA's Grand American National Championships in Boston in 1970. He's from California, best known as a tough competitor anywhere. His top e.t. to date is 6.53, with top speed in excess of 230 mph. His car is used by Firestone to test tires, and he's set up for AHRA's Grand American Professional Series in 1971.



DON GARLITS—Won the NHRA Nationals three times ('64, '67, '68), the Winternationals, Springnationals, almost every other NHRA honor. He topped the AHRA Winternationals in 1970, holds current e.t. record of 6.57. Garlits, known as "Big Daddy," lost part of foot in March, 1969, accident, but this hardly slowed him.



BENNIE OSBORN—Nicknamed "The Wizard"; NHRA's only two-time world champion. Quiet and modest, he's probably one of the sport's most successful independents. He isn't tied to any main sponsor and receives no factory support, yet his ability as a driver/builder has carried him to the NHRA world title in both 1967 and 1968.



CHRIS KARAMESES—A Chicagoan and one of the sport's superstars from the beginning. He drives in AHRA competition and was first dragster pilot to officially clock 200 mph in 1958. The fueler in which he made that run is now on display at Chicago's Museum of Arts and Sciences—a final checker for the car but not the driver.



JIM PAOLI—Virtually grew up in auto racing. His parents owned Indy cars in the 1950s. One of his greatest wins came at the NHRA Gatornationals in 1970. Jim's also a water-skiing champ, an accomplished mechanic and race-car builder. His fueler is Dodge-powered and uses an engine prepared by none other than Don Garlits.



JIMMY KING—Driving half of the King-Marshall team, won AHRA's recent Grand American Nationals, Grand Nationals, and Smoker's Dragster Meet. From Providence, he tours the country professionally. King, considered the "giant killer" of fuel dragster events, promises to keep hauling down more than his share of cups.



DON PRUDHOMME—Fondly known as "The Snake," traditionally battles Tom "Mongoose" McEwen. Started as a fuel dragster pilot, switched to funny cars and now keeps both going after records. Wins include three NHRA top fuel titles at Nationals plus wins at Winter and Springnationals. Don, 27, has raced professionally six years.

OTHER STARS: Garry Biggins, Richard Broughton, Jim Davis, Preston Davis, Larry Hendrickson, Walt Johnson, Tony Nancy, Tom Raley, Ed Renck, Pete Robinson, Richard Tharp, Jim Walther, John Wiebe.

Only one fights acid,



the most destructive element in oil.

LEE the acid fighter...costs less too!

Any one of these four top-rated oil filters will do a good job of cleaning your oil. But one of them . . . and *only one* . . . fights the destructive acids that can build up in your engine. That one filter is Lee. Only Lee has an acid-fighting Feridium Anode to give you double protection. Yet a Lee Oil Filter costs less than any of the other three!

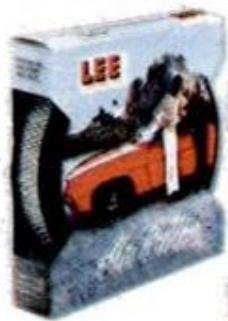

Lee filters are manufactured exclusively for the man who takes personal care of his car. A man who demands top quality and performance. And does not mind saving money. They're sold in discount and auto supply stores. You can install a Lee filter yourself in a matter of minutes. That saves you time and money.

LEE FILTERS

For the man who takes personal care of his car

Lee Filter Division  Filter Dynamics International

DRAG RACING

DRAG RACING has become this country's fastest accelerating sport. It attracts over seven million paid spectators annually. That's 8.5 times as many as in 1955. The number of sanctioned events has more than septupled, and the number of contestants is up over 1500 percent.

There are two sanctioning bodies. Largest and oldest is the National Hot Rod Assn. (NHRA), based in Los Angeles. The American Hot Rod Assn. (AHRA), also growing quickly, is based in Kansas City.

For purposes of simplicity, we've compiled this Drag Racing Guide using NHRA categories of racing, with explanations of AHRA categories where possible. We've included drivers from both sanctioning bodies. Ofttimes they overlap anyway.

The NHRA recently established a World Championship Series. In this, two broad groups run side by side. Group I is called Professional and takes in drivers who participate for money. Cash and prizes come via wins and also via factory and dealer sponsorship. Pro drivers are the nationally known superstars of drag racing, and fans turn out just to see them.

The second group, Group II, is "Amateur," which means both nonprofessional and semiprofessional. They also compete for prizes, and Group II includes its own roster of stars.

In Group I Professional, there are four categories of racing: 1) Top Fuel Eliminator, 2) Funny Car Eliminator, 3) Top Gas Eliminator, and 4) Pro Stock Eliminator. All categories are explained farther along in this section.

Group II's amateur categories are: 1) Competition Eliminator, 2) Modified Eliminator, 3) Super Stock Eliminator and 4) Stock Eliminator. In these categories the racers come up through the ranks.

Most categories also run various classes. Classes are set up according to complicated and elaborate rules. Both NHRA and AHRA publish rule books (see addresses below).

Adding to the confusion, NHRA runs seven regional divisions for each of eight categories in Groups I and II, plus a Travelers Division. Divisions go according to sections of the country. Professionals, for example, have to establish so many points in each regional division; thus fans at events all over the country get chances to watch the superstars.

Categories corresponding to NHRA's Group I Professional fall into AHRA's Grand American Series of Professional Drag Racing. All AHRA categories correspond except Pro Stock, which AHRA calls Super Stock. Also, AHRA lists no Top Gas Eliminator category.

This short guide can't hope to explain all the intricacies of American drag racing. There's simply too much to it. But a devoted fan can puzzle out the finer points after attending a few races—at least enough to thoroughly enjoy the sport.

For more information on drag racing, contact:

National Hot Rod Assn.
10639 Riverside Dr.
North Hollywood, Calif. 91602

American Hot Rod Assn.
8133 State Line
Kansas City, Mo. 64114

NHRA 1971 EVENTS CALENDAR

Feb. 5-7	Winternationals	Pomona, Calif.
Mar. 19-21	Gatornationals	Gainesville, Fla.
June 11-13	Springnationals	Dallas, Tex.
July 16-18	Summernationals	(pending)
Sept. 2-6	Nationals	Indianapolis, Ind.
Oct. 23-24	World Finals	Dallas, Tex.
Nov. 20-21	Supernationals	Ontario, Calif.

AHRA 1971 EVENTS CALENDAR

Feb. 18-21	Winternationals	Scottsdale, Ariz.
Jan. 8-10	Grand American Nationals	Long Beach, Calif.
Apr. 2-4	Spring Championships	Dallas, Tex.
Apr. 16-18	Pro-Am	Rockingham, N.C.
May 21-23	Grand Nationals	Detroit, Mich.
June 4-6	Springnationals	Bristol, Tenn.
July 16-18	Summernationals	Gary, Ind.
July 30-Aug. 1	Grand American Championships	Boston, Mass.
Aug. 20-22	Nationals	Center Moriches, N.Y.
Mid-August	World Championships	Bristol, Tenn.
Labor Day	Labor Day Championships	Dallas/Fort Worth, Tex.

POPULAR MECHANICS 'RACING SHOPPING GUIDE'

START YOUR OWN SPEED SHOP

If you are thinking of starting your own speed shop you will find this book invaluable. Tells how to obtain all licenses, buying at wholesale, getting letterheads, etc. Lists all major wholesalers, manufacturers and cost of set up. Lets you even know how to operate from a garage or basement. Helpful hints. Free trade publications and much more for only \$3.95. Send check or money order to: Start Your Shop, P. O. Box 4283, Minneapolis, Minn. 55414



PROTECTOR OF LIVES & PROPERTY! JUST PLUG IT IN! NO BATTERIES OR INSTALLATION NECESSARY!

Simply plug the compact into any household or shop outlet 110-120v. The Ultra-Alert Sensor activates the buzzer when room temperature reaches 135° F in plenty of time for effective action!

For business trips or holidays—take your protection along!

Great for homes, offices, warehouses, stores, motels, hotels, etc. where high efficiency protection against fire is needed.

FA-100 COMPACT FIRE ALARM—\$6.95—(OH. Res. add 4% S.S.T.)

REX—GIFTS DEPT. PML

844 S. 8th ST. HAMILTON OHIO 45011

U.S. LIST of United States government land for A public sale. Send one dime and a self addressed envelope with a stamp on it to—List—Box 6509, St. Paul, Minn. Zip Code 55106.

LEARN GUN REPAIR



at home quickly, correctly
10¢ brings book, full facts.
APPROVED FOR VETERANS.
MODERN GUN REPAIR SCHOOL

Twenty East First Ave
Dept. 408 Scottsdale, Ariz 85251
Estab. 1946



TESTER IS SELF-POWERED

Will test Alternator circuit including Diodes and coils to find trouble. TESTS CIRCUIT with power OFF, Ignition, Light circuits, Heater & Air conditioner, Starter, Generator, Turn Signal, Brake and Back up light circuit.
THE TRADE LIKES THEM Only \$2.98
Ask your dealer or send to factory

BURNWORTH TESTER CO.
815 Pomona Avenue, EL CERRITO, CALIF 94530

BEVERAGE HOLDER

(Dash Mounting)

HOLDS: GLASSES-

BOTTLES-CUPS-

CANS-ETC. FOR:

CARS-TRUCKS-

AIRPLANES-

BOATS-TRAILERS.

Made of an anodized aluminum ring, 3"

diameter, with supporting straps of vinyl.

Mounting Bracket has self-adhering glue

on back, for permanent attachment to any

flat surface. \$1.25 PPD. (U.S.A.)

"THE HOUSE OF GIFTS"

Dept. 446 A Faison, North Carolina 28341



DEALERS WANTED!

Run new \$6.00 pulling ad over your name in any publication or circular. Keep \$5.00 of each \$6.00 you receive. We fill orders for \$1.00. Rush \$6.00 for sample circulars and copy of ad.

WM. TROWBRIDGE

**35-PM WOODCREST AVE.
DAYTON, OHIO 45405**

POPULAR MECHANICS 1971 AUTO RACING GUIDE

**When you
see this mark
you've seen
the product in
Popular Mechanics.**

**POPULAR
MECHANICS
PRODUCT FEATURE**

\$100,000 REWARD!

If adding a solid automotive mechanic skill can add \$2500 to your annual income—that adds up to a flat \$100,000 over 40 working years. And, this is putting it conservatively.

Trained men are always in demand! To get that training, come to us. We've trained thousands of men successfully and we can train you. Find out more—no obligation—send the coupon today!

ICS International Correspondence Schools
Division of Intext

Mail to ICS, Scranton, Pa. 18515

I want that reward! Rush me information on the course I've checked below.

B2037A

Name _____
(Please print)

Address _____

City _____ State _____ Zip _____

- | | |
|--|---|
| <input type="checkbox"/> Automotive Mechanic | <input type="checkbox"/> Automatic Transmission Specialist |
| <input type="checkbox"/> Engine Tune-Up | <input type="checkbox"/> Automotive Air Conditioning Specialist |
| <input type="checkbox"/> Body Rebuilding and Refinishing | <input type="checkbox"/> Other (specify): _____ |
| <input type="checkbox"/> Automotive Technician | |

Accredited Member, National Home Study Council
Approved for Veterans for tuition refund

DRAG RACING



**'Funny'
Car**

When they began to appear at Deep South drag strips in the mid-1960s, announcers thought they looked funny, so that's what they named them. Underneath, they're tantamount to all-out dragsters, but outwardly they're sheathed-in-fiberglass replicas of U.S. production cars. Drivers are professionals, and there are two classes, blown and unblown (AA/FC and A/FC). NHRA rules state that Funny Cars have to look like 1965 or later models, may use any make or year of engine (one maximum), positioned anywhere, altered any way. Transmissions are recommended but not mandatory. Cars must have at least two-wheel brakes, parachute, stock-type differentials. Wheelbase minimum is 100 inches, with up to 200 pounds of ballast allowed. Suspension can be anything, and so can fuel. Funny Cars consistently hold the fans' interest, with runs usually at around 210 mph and 6.80 seconds e.t.



LEROY GOLDSTEIN, 1970 Challenger—Nicknamed the "Israeli Rocket," Leroy piloted fuel dragsters many years before signing on with famed Ramchargers team. He ran his Dodge Funny to first official 6-second e.t. in class, which was recorded in August, 1970, at AHRA's New York National Racing Facility on Long Island.



DICKIE HARRELL, 1970 Chevrolet—AHRA 1969 Grand American Points Champ in Funny Cars, Harrell also owns cars that compete in Super Stock and GT categories. He's from Kansas City and compares closely with Garlits when spectator appeal is considered. His safety and performance clinics have drawn thousands at every appearance.



LEONARD HUGHES, 1970 Barracuda—His Funny Car times border on creditable AA/Fuel Dragster marks: 6.80 e.t. and 214 mph. Without doubt the most feared driver during qualifying sessions at national events, Hughes scored a major win at the NHRA Gatornationals in 1970, has driven for 10 years and works out of Houma, La.



JIM LIBERMAN, 1970 Camaro—Among the nation's most popular touring Funny Car drivers, "Jungle Jim" was the first to begin matching Chevy horsepower and times against the mighty MoPars and Fords. He won the 1969 NHRA Winternationals and has campaigned two cars recently, the other being driven by Pete Williams.



ED McCULLOCH, 1970 Duster—This newcomer to Funnies came from a distinguished career in Top Fuel. It's barely his second year for AA/FC, but Ed romped to an NHRA Nationals record at a screaming 7.11 seconds, 211.76 mph. Based in Forest Grove, Ore., he races mostly in the Northwest, yet he's known nationally.



TOM McEWEN, 1970 Duster—The "Mongoose" does more than banter with "Snake" Don Prudhomme—on the same team at the moment. One of the most colorful and knowledgeable drivers in AA/FC, McEwen, despite his consistently good times, has never scored a major win. He remains extremely popular with the crowds.



DANNY ONGAIS, Ford—One of the few Ford men left in Funnies, Danny ruled AA/FC in 1969, with major wins at the NHRA Springnationals and Nationals. He's a veteran of more than eight years in dragsters, plus two in Funny Cars. Dragging is not his only talent—this Hawaiian also broke nearly 300 records at Bonneville in '68.



GENE SNOW, Chrysler—Gene's long line of Rambunctious Dodge Funny Cars has been known for blistering speeds and low e.t. Texan Snow holds the AHRA world record at 6.93 and 213.77 mph. He was also winner in Funny Car Eliminator at the NHRA Summernationals in 1970 plus runner-up at the Winter and Springnationals.

OTHER STARS: Ray Alley, Vic Brown, Phil Castronovo, Kenny Goodell, Shirl Greer, Frank Hall, J. Howell, Jake Johnston, Huston Platt, Gas Ronda, Mike Snively, Bob Steakly.

DRAG RACING



Altered Roadster

Until 1970, the Competition Eliminator amateur category was known as Super Eliminator in NHRA. AHRA also calls it Competition Eliminator. It consists of mixed classes of vehicles, which makes a handicap-start system necessary. To explain the handicap start: If one car or class qualifies at 11.0 seconds and another at 10.5, the faster has to wait an extra half second at the starting line. Then, theoretically, if both cars are equally matched, they'll cross the finish line in a dead heat. The delay (handicap) is computed electronically and is signaled by the flashing of the "Christmas tree" (starting lights). Anyway, in Competition Eliminator, all smaller dragsters compete, as do the altered roadsters, sedans, Funny Cars, and the so-called competition cars. Supercharged gas burners run against un-blown fuelers. Rules and classes are extremely complicated in both the NHRA and AHRA.



JACK DITMARS, A/FA—Drives Opel "Mini Brute" that switches between A/FA and Funny Cars. Grabbed competition honors at NHRA Winternationals in 1970, then was runner-up at Gatornationals. Currently holds both A/FA and A/FC NHRA records, he resides in Harvey, Ill., where he is employed as a mechanic in a Buick agency.



JERRY GWYNN, AA/A. Gwynn marched his "Baby Huey" AA/Altered into the 1969 world champion winner's circle with a clean sweep of Super Eliminator, his biggest win in eight years. His ability to wring the last ounce of energy from a Chevy 427 has made his 1923 T a national record holder for the past three years.



KEN DONDERO, BB/GS—Ken's wizardry with four-speed helped him wheel his candy-red blown Anglia to an impressive win at NHRA 1969 Winternationals. In a class where an automatic is virtually a must, his unusual set-up baffles competition. Led NHRA's Div. VII WCS Super Eliminator bracket for more than five years.



ROY RASTETTER, A/C—NHRA national record holder, Roy reached peak of career driving his Plymouth-powered dragster to big Competition Eliminator win at 1970 Springnationals in Dallas. Since he's a Texas boy, the fans couldn't have been prouder. One of Div. IV's big guns, Rastetter is looked upon to take World Champ honors in 1971.



GEORGE FINA, A/D—"Fina the Finalist" vaulted into drag-racing limelight during 1970 at National Hot Rod Assn. World Finals when his twin-engined A/Drags captured eliminator category and established new national record—8.03 seconds elapsed time for the quarter mile. George makes his home in Oklahoma City.



NORM RIES, BB/GD—A self-made millionaire at 30, Ries was crowned NHRA world champion in Super Eliminator in 1968. His Chevy-powered dragster is always in contention for "Best Appearing" as well as being a past national record holder. Norm calls Cincinnati home, but he tours the entire national circuit in pursuit of speed.



RICH GALLI, A/FD—One of the real pros of un-blown fuel dragster competition, Galli captured his first Super Eliminator crown in 1968 at NHRA Winternationals. In 1970, he was in the thick of the world championship series action as the leading contender for points in Competition Eliminator within the NHRA's Div. VII.



TOMMY SHINHOLSTER, CC/GS—When it comes to making small-block Chevys run, this Floridian has been virtually unbeatable. He's captured Super Eliminator in the NHRA's Southeast Div. two years going. His screaming Chevrolet-powered 1941 Willys romped to a decisive victory in his own back yard, the 1970 Gatornationals.

OTHER STARS: Dave Bolz, Harold Gunderson, Jack Harris, Carl Heichel, Gary Koehler, Dana McLorn, Tom Manner, John Mistrich, Jim Spotts, Gene Teranzio, Hank Wilko, Steve Woods.

DRAG RACING (Other Categories)

Pro Stock Eliminator

This new NHRA category for 1970 has proved exceptionally popular. It's an offshoot of Modified Production and corresponds to Super Stock in AHRA. Drivers are professional, factory and dealer-backed in 90 percent of all cases. NHRA's Pro Stock cars have to be 1968 or later U.S. models with 1965 or later engines of same type as factory-original. There's only one class in Pro Stock (designated "P," preceded by car number), which means it's a heads-up free for all, like Funny Car racing. Basic rules: Any internal engine modification permitted; gasoline the only fuel; carburetion limited to two 4-barrels or four 2-barrels; stock suspension, four-wheel brakes and full interior required. Body must use original steel shell but rules permit lightweight fenders, hood, rear deck. Speeds range to 140 mph, with e.t.'s around 9.90 seconds.



BILL HIELSCHER, 1970 Chevrolet—Bill is known as the biggest little man in drag racing. He and the Mr. Bardahl Chevys have established more official AHRA world records than any other. Hielscher also holds Bonneville land speed records and finds time to compete in speed and drag boats. He makes his home in Irving, Tex.



HERB McCANDLESS, 1970 Duster—"Mr. 4-speed" campaigned for quite a time with independent entries before being chosen No. 2 driver for Sox and Martin. Herb's mount, a 426 Hemi-powered Duster, runs in the 9s. Before teaming with the factory, he pushed a Barracuda to a Modified Eliminator win at Gator-nationals, won 1970 NHRA Nationals.



BILL JENKINS, 1970 Camaro—Known as "King of the Chevrolets" and "Grumpy." Has raced 17 years, won NHRA Winternationals and Gator-nationals in 1970. One of sport's biggest superstars, Jenkins takes a scientific approach, got schooling in mechanical engineering at Cornell. Little time for small talk, hence "Grumpy." Shop in Malvern, Pa.



RONNIE SOX, 1970 Barracuda—Full-time pro from Burlington, N.C. Made history in 1969 by winning Super Stock crown at NHRA Spring-nationals, Nationals and World Finals. With Buddie Martin, forms one of most potent partnerships in class. Upholds reputation as one of finest four-speed handlers. AHRA's "Driver of the Year."



DICK LANDY, 1970 Dodge—A nonsmoker, "Dandy" Landy pioneered Funny Cars, switched to stockers in 1967. Won Street and Modified Eliminator titles in 1968-69 NHRA Winternationals and a Pro Stock victory at this year's first Summernationals. Landy gained fame for his heft, unlit cigar, grin and violent power shifts. He's a Californian.



BILL TANNER, 1970 Dodge—Counterpart of Dick Landy in the South, Tanner began the year with a new Dodge Super Car Clinic and immediately led Pro Stock category in points in Div. 2. One of the South's hardest running drivers, Tanner has been experimenting with both four-speed and "clutch-flite" transmissions in search of faster times.



DON NICHOLSON, 1970 Maverick—Young at 43, "Dyno Don" made a brilliant comeback in 1970 after relinquishing his "King of the Funny Cars" title in 1969. He's the first Funny driver to dip into the 7s, doing that with his renowned Comet. His new Maverick was by far the fastest of all Ford Pro Stocks, setting 16 new track records last year.



ARLEN VANKE, 1970 Duster—Not only famous as an expert driver and engine builder, Vanke is chief tester for Firestone Tire & Rubber Co., and specializes in stockers. Won 1968 NHRA Nationals Super Stock Eliminator title. Presently his Plymouth Duster turns in the 9.80s at nearly 140 mph. Vanke makes his home in Akron, Ohio.

OTHER STARS: Darrell Droke, Dave Strickler, Mike Fons, John Hagen, Bob Lambeck, Jim Hayter, Dick Oldfield, Wally Booth, Dick Humbert, Melvin Yow, Reid Whisnant, Robert Nance, Ed Hedrick.

Super Stock Eliminator

One of the most popular categories—with perhaps the greatest impact on auto manufacturing—Super Stock consists of late-model, high-performance machines we usually call "muscle cars." Theoretically you can drive Super Stocks on the street, but it's not often done. This is an amateur category; most cars are factory or dealer-sponsored. Eight classes are for manual-transmission cars (designated SS/A through SS/H); another eight for cars with automatics (SS/AA-SS/HA.) Rules call for a minimum of 50 cars factory-produced, stock bodies, engines stock per factory specs and mods, any cam, big tires but must fit without external wheel-well modifications, stock suspension. No blowers, any headers, but must have full exhaust system.

Stock Eliminator

Essentially, this is the category Super Stock grew from. Stock remains the backbone of drag competition and accounts for biggest percentage of grass-roots racing. Stock means both early and late-model cars—the bread-and-butter variety owners drive daily and then race on weekends. Some don't drive them daily, of course—those who take sport more seriously. Stockers fall into 36 NHRA classes, 20 for standard transmissions and 16 for automatics. As in Super Stock, cars must conform to factory specifications in all major respects. Some differences from Super Stock: Cam must be factory grind, tires seven inches wide and grooved. And a whole lot more.

Top Gas Eliminator

This professional category is much like Top Fuel, but instead of using nitromethane or other blended mixes, standard pump gasoline is the only fuel allowed. The single class is dubbed AA/GD, and there's just as much excitement in Top Gas as in Top Fuel. This last of NHRA's four professional categories is also hotly contested and closely watched. Top Gas involves heads-up (even-start) racing of rail against rail; the cars are built for one purpose—to cover the quarter-mile in the shortest possible time at the greatest speed. Times range in the 7s, with speeds to 200 mph. Rules that apply to Top Fuel apply to Top Gas, and fuel checks are made regularly to assure that these cars use only pump gasoline. Top Gas Eliminators are usually supercharged and often run twin engines. Displacement, as in Top Fuel, is limited to 850 cu. in.

Modified Eliminator

Another new NHRA designation for 1970—a catchall for machines that somehow didn't make it into other categories. Handicap starts are once more the norm. Cars involved are extensively modified coupes, roadsters and dragsters, along with modified and semi-modified "streetable" machines. All run on pump gas; no superchargers allowed. Classes include Dragster, Altered, Gas, Street Roadster and Modified Production. Class requirements are based on Competition Eliminator, similarly complicated. Pre-1960 flathead V8s and oddball engines have a special class.

Other Drag Racing Stars

As must be obvious, drag racing is a vast, complex undertaking with literally thousands of participants in every part of the country. It would be impossible within the limits of this guide to mention all the sport's outstanding performers. So only a few are listed, and if we appear to have overlooked a particular favorite, be assured the omission is simply for lack of space.



John Bartlett
Stock



Paul Blevins
Modified



Dave Boertman
Stock



Earl Britt
Modified



Larry Brown
Top Gas



Bob Burkett
Stock



Don Cain
Top Gas



Steve Carbone
Top Fuel



Carroll Caudle
Modified



R. Charbonneau
Stock



Gordon Collett
Top Gas



Pat Dakin
Top Gas



Low Downing
Super Stock



John Elliot
Super Stock



Al Guerrero
Modified



Dave Grassi
Top Gas



Ray Hadford
Top Gas



Frank Iacono
Stock



Jack Jones
Top Gas



Gary Kimball
Super Stock



Pete Kost
Stock



Bob Lambeck
Super Stock



Judy Lilly
Super Stock



Ray Motes
Top Gas



Bob Muravez
Top Gas



Gene Norris
Stock



Hubert Platt
Super Stock



Barrie Poole
Super Stock



Marv Ripes
Stock



Pete Robinson
Top Fuel



Gas Ronda
Funny Cars



D. Santucci
Top Gas



Shirley Shahan
Super Stock



Fred Teixeira
Modified



Richard Tharp
Top Fuel



Ken Van Cleve
Modified

THE TOP TRACKS

1971 schedules of main events, 1970 winners and track record holders at major raceways in the United States and Canada. *(Some dates tentative at press time. Write tracks for firm dates, ticket information.)*



ALABAMA INTERNATIONAL MOTOR SPEEDWAY

Talladega, Ala. Asphalt, 2.66 mi., 33° banks, 4-mi. road course. Seats 70,000, infield 50,000. Opened 1969.

1971 SCHEDULE

MAY 16—ALABAMA 500: GN. ('70—Pete Hamilton, '70 Plymouth, 152.321 mph.)

AUG. 22—TALLADEGA 500: GN. ('70—Pete Hamilton, '70 Plymouth, 158.517 mph.)

SEPT. 1—BAMA 200: NASCAR GA, 500 mi. ('70—Bill Ward, '70 Mustang, 147.382 mph.)

RECORDS

Alabama 500: 1970 (see above). **Talladega 500:** 1970 (see above). **One Lap:** 1970, Buddy Baker, Dodge Daytona, 200.49 mph. (World's closed course record.)

ATLANTA INTERNATIONAL RACEWAY

Asphalt, 1.522-mi. oval, 24° banks. Seats 38,500, infield 30,000. Opened 1960.

1971 SCHEDULE

APR. 4—ATLANTA 500: GN. ('70—Bobby Allison, '69 Dodge, 139.554 mph.)

AUG. 1—DIXIE 500: GN. ('70—Richard Petty, '70 Plymouth, 142.712 mph.)

RECORDS

Atlanta 500: 1970 (see above). **Dixie 500:** 1970 (see above). **One Lap:** 1970, Cale Yarborough, Mercury, 159.929 mph.

BRIDGEHAMPTON RACE CIRCUIT

Bridgehampton, N.Y. Asphalt/concrete, 2.85-mi. road course. Field seating. Opened 1958.

1971 SCHEDULE

DATE NA—TRANS-AM: GT ('70—Mark Donohue, Javelin, 90.55 mph.)

DATE NA—CAN-AM: Group 7. (Not run in '70. '69—Denis Hulme, McLaren/Chevy, 118.949 mph.)

RECORDS

Trans-Am: 1969, George Follmer, Mustang, 96.535 mph. **Can-Am:** 1969 (see above). **One Lap:** 1969, Denis Hulme, McLaren/Chevy, 118.949 mph.

BRYAR MOTORSPORT PARK

Loudon-Laconia, N.H. Asphalt, 1.6-mi. road course. Seats 7500, unlimited field seating. Opened 1965.

1971 SCHEDULE

JULY 18—TRANS-AM: GT ('70—George Follmer, Mustang, 71.93 mph.)

RECORDS

Trans-Am: 1969, Mark Donohue, Camaro, 76.35 mph. **One Lap:** 1970, Swede Savage, Barracuda, 79.120 mph.

CHARLOTTE MOTOR SPEEDWAY

Charlotte, N.C. Asphalt, 1.5 mi., 24° banks. Seats 51,558, infield 40,000 plus. Opened 1960.

1971 SCHEDULE

MAY 30—WORLD 600: GN. ('70—Donnie Allison; '69 Ford, 129.680 mph.)

OCT. 10—NATIONAL 500: GN. ('70—Lee Roy Yarborough, Mercury, 123.246 mph.)

RECORDS

World 600: 1967, Jim Paschal, '67 Plymouth, 135.832 mph. **National 500:** 1968, Charlie Glotzbach, '68 Dodge, 135.324 mph. **One Lap:** 1969, Cale Yarborough, '69 Mercury, 162.162 mph.

CONTINENTAL DIVIDE RACEWAYS

Castle Rock, Colo. Asphalt. 2.66-mi. road course, drag strip, oval. Grandstand, field seating.

1971 SCHEDULE

JUNE 27—ROCKY MOUNTAIN 150: Championship. ('70—Mario Andretti, McNamara/Ford, 84.013 mph.)

RECORDS

Rocky Mountain 150: 1969, Gordon Johncock, Gerhardt/Ford, 88.44 mph. **One Lap:** 1969, Dan Gurney, Eagle/stock Ford, 90.5 mph.

DARLINGTON RACEWAY

Darlington, S.C. Asphalt, 1¾ mi., 26° banks. Seats 50,000, infield 30,000 (approx.). Opened 1950.

1971 SCHEDULE

MAY 8—REBEL 400: NASCAR GN. ('70—David Pearson, '69 Ford, 129.688 mph.)

SEPT. 6—SOUTHERN 500: NASCAR GN. ('70—Buddy Baker, '69 Dodge, 128.817 mph.)

RECORDS

Rebel 400: 1968, David Pearson, '68 Ford, 132.000 mph. **Southern 500:** 1967, Richard Petty, '67 Plymouth, 130.000 mph. **One Lap:** 1970, Charlie Glotzbach, '69 Dodge, 153.822 mph.

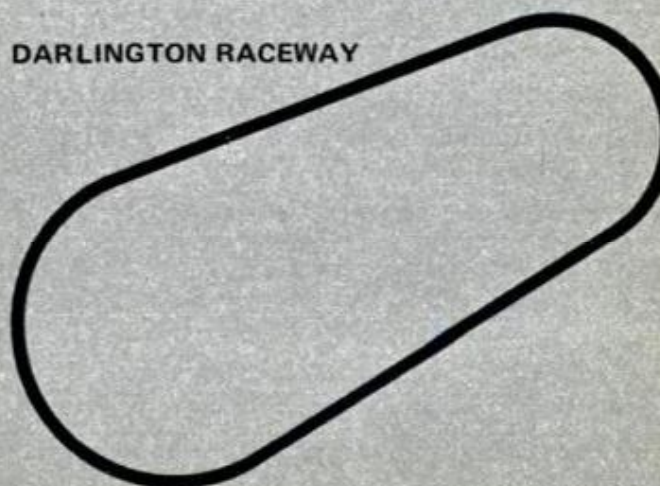
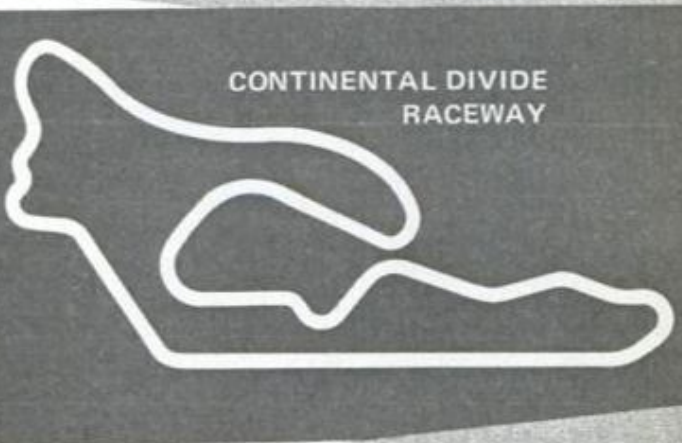
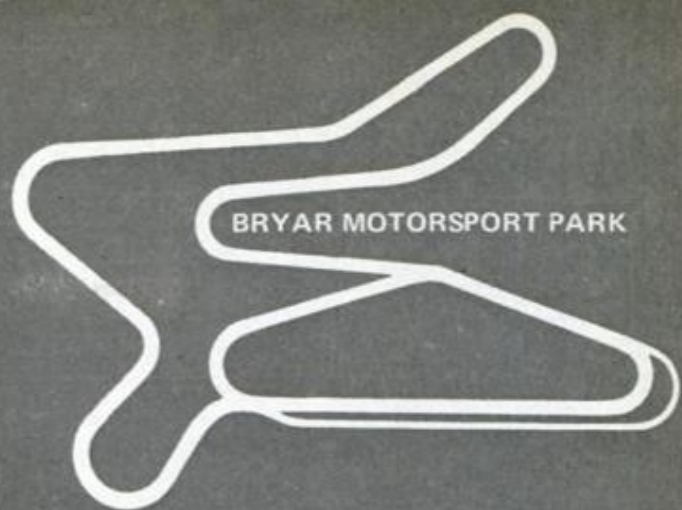

DAYTONA INTERNATIONAL SPEEDWAY

Asphalt, 2.5-mi., 31° banks. Road courses: 3.81, 3.10, 1.63 mi. Seats 50,000, infield 50,000 (approx.). Opened 1959.

1971 SCHEDULE

JAN. 30-31—24 HOURS OF DAYTONA: Sports, Sports Protos., GT, Touring. ('70—Pedro Rodriguez/Leo Kinnunen, Porsche 917, 114.866 mph.)

FEB. 14—ARCA LATE MODEL RACE: Stocks, 300 mi. ('70—Ramo Stott, '70 Plymouth, 142.086 mph.)

FEB. 19—FLORIDA CITRUS 250: NASCAR GA. ('70—James Hylton, '69 Camaro, 101.241 mph.)

FEB. 22—PERMATEX 300: Late Model Sportsman. ('70—Tiny Lund, '66 Ford, 133.316 mph.)

FEB. 21—DAYTONA 500: NASCAR GN. ('70—Pete Hamilton, '70 Plymouth, 149.601 mph.)

JULY 4—FIRECRACKER 400 (Medal of Honor): NASCAR GN. ('70—Donnie Allison, '69 Ford, 162.235 mph.)

RECORDS

24 Hours of Daytona: 1970 (see above). **ARCA Late Model Race:** 1968, Andy Hampton, '67 Dodge, 152.730 mph. **Florida Citrus 250:** 1969, Don Yenko, '69 Camaro, 104.363 mph. **Permatex 300:** 1967, Jim Paschal, '64 Plymouth, 148.188 mph. **Daytona 500:** 1969, Lee Roy Yarbrough, '69 Ford, 157.950 mph. **Firecracker 400:** 1970 (see above). **One Lap:** 1969, Cale Yarborough, '69 Mercury, 190.706 mph.



DAYTONA
INTERNATIONAL SPEEDWAY



DONNYBROOKE
INTERNATIONAL

DONNYBROOKE INTERNATIONAL

Brainerd, Minn. Asphalt, 3-mi. road course. Field seating (5000 grandstand). Opened '68.

1971 SCHEDULE

JULY 4—TRANS-AM: GT, 250-mi. ('70—Milt Minter, '69 Camaro, 96.673 mph.)

AUG. 15—DONNYBROOKE GP: FA, 200 mi. ('70—David Hobbs. Surtees TS5A/Chevrolet, 110.928 mph.)

SEPT. 26—CAN-AM: Group 7, 250 mi. ('70—Denis Hulme, McLaren/Chevy, 117.570 mph.)

RECORDS

Trans-Am: 1969, Parnelli Jones, Mustang, 98.94 mph. **Donnybrooke GP:** 1970 (see above). **Can-Am:** 1970 (see above). **One Lap:** Can-Am, 1970, Denis Hulme, McLaren/Chevy, 120.670 mph; Trans-Am, 1970, George Follmer, Mustang, 101.887 mph; FA, 1970, David Hobbs, Surtees/Chevy, 113.924 mph.

EDMONTON SPEEDWAY PARK

Edmonton, Alta., Canada. Asphalt, 2½-mi., 1½-mi. road courses, ⅞, ¼-mi. ovals. Seats 20,500. Opened May, 1967.

1971 SCHEDULE

JULY 25—KLONDIKE 200: Group 7, 200 mi. ('70—Denis Hulme, McLaren/Chevy, 106.4 mph.)

MAY 23—CONTINENTAL SERIES: FA, 200 mi. ('70—Ron Grable, Lola/Chevy, 101.282 mph.)

RECORDS

Can-Am: 1970 (see above). **Continental:** 1970 (see above). **One lap:** 1970, Denis Hulme, McLaren/Chevy, 108.81 mph.



EDMONTON SPEEDWAY PARK

INDIANAPOLIS MOTOR SPEEDWAY

Asphalt, 2.5 mi., 9+° banks. Seats 225,000, infield 100,000. Opened 1909.

1971 SCHEDULE

MAY 29—INDIANAPOLIS 500: USAC Championship. ('70—Al Unser, PJ Colt/Turbo-Charged Ford, 155.749 mph.)

RECORDS

Indianapolis 500: 1969, Mario Andretti, Hawk/Turbo-Charged Ford, 156.867 mph. **One Lap:** 1968, Joe Leonard, Lotus/Turbine, 171.953 mph.

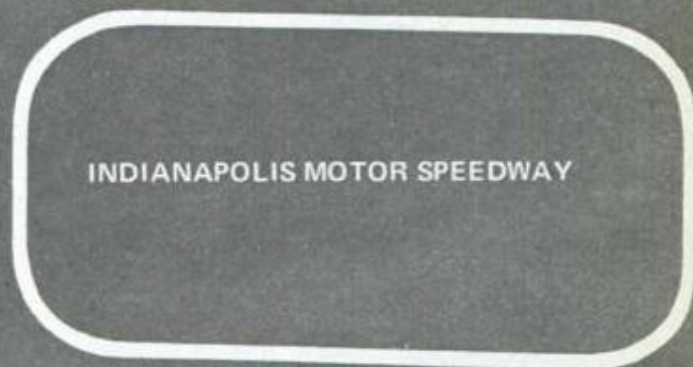

INDIANAPOLIS MOTOR SPEEDWAY

INDIANAPOLIS RACEWAY PARK

Asphalt, ⅝-mile oval, 17° banks max. 2½-mi. road course, 4500-ft. drag strip. Seats 30,000, infield 20,000. Opened 1960.

1971 SCHEDULE

MAY 2—YANKEE 250, USAC Late Model Stocks; 250 mi. ('70—A.J. Foyt, '70 Ford Torino, 83.839 mph.)

JULY 24—INDY 150, Championship, 150 mi. ('70—Al Unser, Colt/Ford, 92.799 mph.)

SEPT. 1-6—National Championship Drag Races.

RECORDS

Yankee 250: 1970 (see above). **Indy 200:** 1968, Al Unser, Lola/Ford 4wd, 200 mi., 96,800 mph. **One Lap:** Championship, 1969, Dan Gurney, Eagle/Ford, 101.408 mph; **USAC Stock,** 2½-mi. road course, 1970, A.J. Foyt, '70 Ford Torino, 88.609 mph.

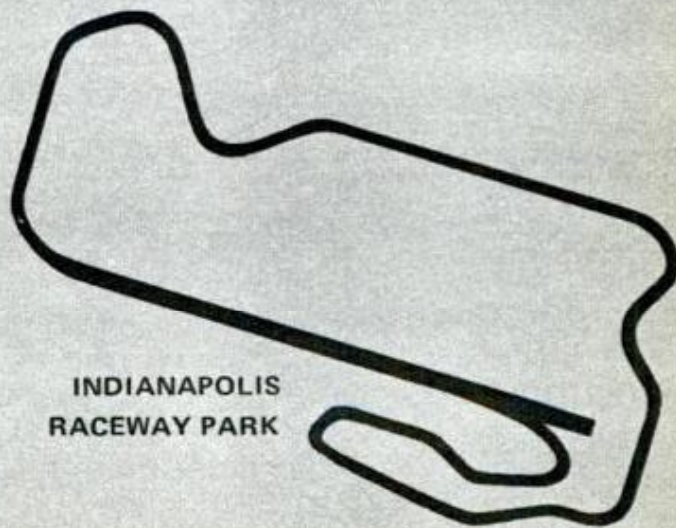

INDIANAPOLIS RACEWAY PARK



LAGUNA SECA RACEWAY

LAGUNA SECA RACEWAY

Monterey, Calif. Asphalt, road course 1.9 mi. Field seating. Opened 1957.

1971 SCHEDULE

APR. 25—TRANS-AM: GT, 225 mi. ('70—Parnelli Jones, Mustang, 91.38 mph.)

DATE NA—CONTINENTAL SERIES: FA, 100 mi. ('70—Ron Grable, Lola/Chevy, 99.708 mph.)

OCT. 17—CAN-AM: Group 7, 152 mi. ('70—Denis Hulme, McLaren/Chevy, 104.107 mph.)

RECORDS—Continental GP: 1969, Sam Posey, Eagle/Chevy, 102.1 mph. **Trans-Am:** 1970 (see above). **Can-Am:** 1970 (see above). **One Lap:** 1969, Bruce McLaren, McLaren/Chevy, 114.9 mph.

LIME ROCK PARK

Lime Rock, Conn. Asphalt, road course 1.53 mi. Field seating. Opened 1957.

1971 SCHEDULE

MAY 8—TRANS-AM: GT ('70—Parnelli Jones, Mustang, 88.91 mph.)

SEPT. 6—CONTINENTAL SERIES: FA, 70 laps '70—David Hobbs, 103.44.)

RECORDS—Continental: 1970 (see above). **One Lap:** 1970, David Hobbs, Surtees TS5, 108.42 mph.

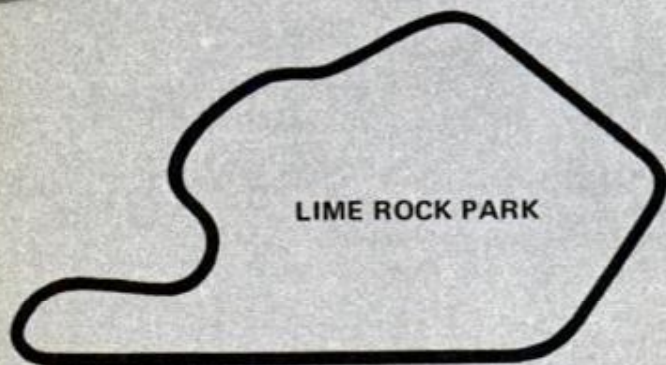

LIME ROCK PARK

MICHIGAN INTERNATIONAL SPEEDWAY

Irish Hills, Mich. Asphalt, 2-mi. oval, 18° banks. 3-mi. road course. Seats 25,000, infield 50,000 plus. Opened 1968.

1971 SCHEDULE

JUNE 6—MOTOR STATE 400: GN. ('70—Cale Yarborough, '69 Mercury, 138.302 mph.)

AUG. 15—YANKEE 400: GN. ('70—Charlie Glotzbach, '69 Dodge, 147.571 mph.)

RECORDS—Trans-Am: 1969, Parnelli Jones, Mustang, 82.122 mph. **Championship:** 1968, Ronnie Bucknum, Eagle/turbo-Offy, 163.043 mph. **Motor State 500:** 1969, Cale Yarborough, '69 Mercury, 139.254 mph. **Yankee 600:** 1969, David Pearson, '69 Ford, 115.508 mph. **One Lap:** Championship, 1968, Mario Andretti, Hawk/Offy, 183.67 mph; GT, 1969, Parnelli Jones, '69 Mustang, 91.72 mph; GN, 1970, Pete Hamilton, '70 Plymouth, 162.737.



MICHIGAN INTERNATIONAL SPEEDWAY

MID-OHIO SPORTS CAR COURSE

Lexington, Ohio. Asphalt, 2.5-mi. road course. Field seating. Opened 1962.

1971 SCHEDULE

JUNE 6—TRANS-AM: GT ('70—Parnelli Jones, '70 Mustang, 83.118 mph.)

AUG. 22—BUCKEYE CAN-AM: Group 7 ('70—Denis Hulme, McLaren/Chevy, 95.163 mph.)

RECORDS—Trans-Am: 1969, Ronnie Bucknum, '69 Camaro, 83.53 mph. **Can-Am:** 1970 (see above). **One Lap:** Can-Am, 1969, Chris Amon, Ferrari, 100.0 mph.



MID-OHIO SPORTS CAR COURSE

It's Here! The handiest
"tool" you'll ever own!

- 12 handy hang-up boards!
- 56 charts—scores of illustrations!
- Wipe-clean-plastic laminated to last for years!
- Authoritative answers to 1001 shop questions!

NEW!

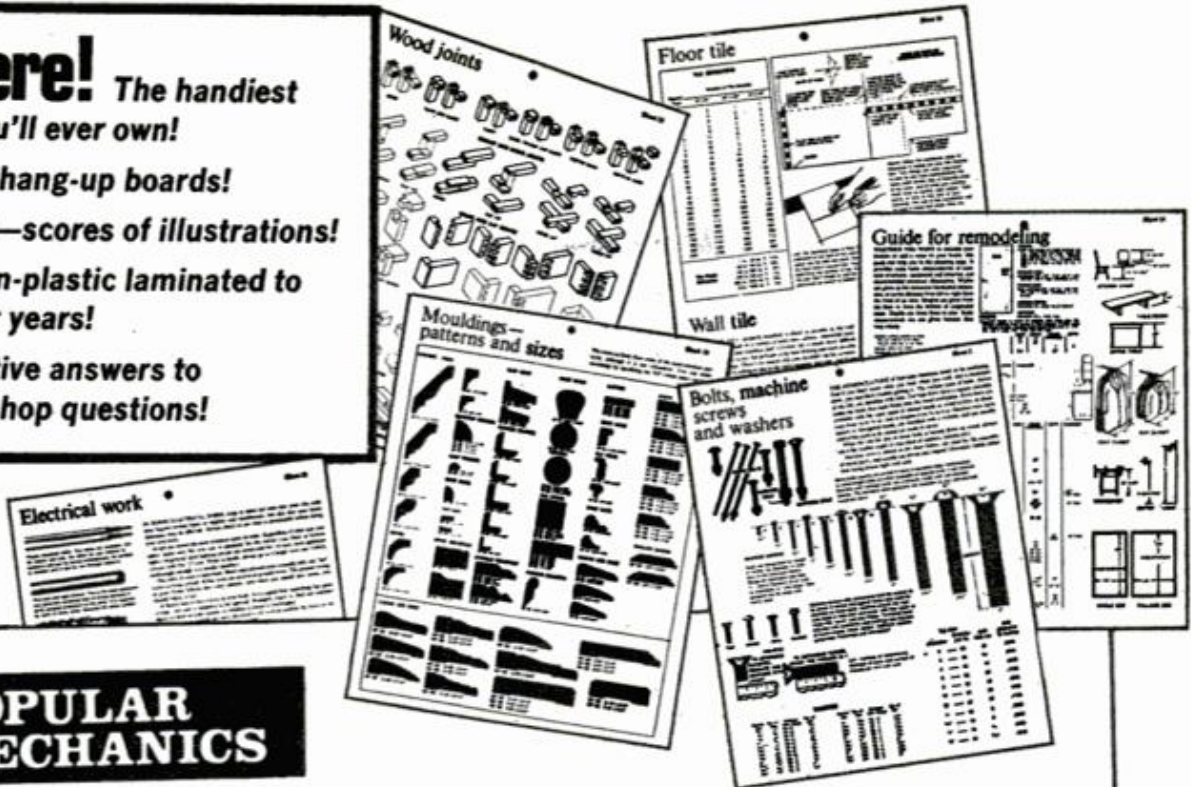

**POPULAR
MECHANICS**

MASTER SHOP GUIDE

Save hundreds of dollars! Save hours of time!

Everything you need to know about: what nails, screws, bolts, wall-fasteners, drills, abrasives to use and why. How to order and use lumber, hardwoods, moldings, plywood, hardboard, gypsum, adhesives, plumbing, electrical work, floor and wall tile, glass. Plus the facts on remodeling measurements, gutters and downspouts, concrete work, lawn and garden chemicals! Plus—all on one "take-right-to-the-job" board—a ruler, centimeter rule, protractor, 45-degree triangle, and a compass for accurate circles up to 19½" diameter.

You'll reach for the MASTER SHOP GUIDE for every job you tackle!

What nail should you use for underlayment? What's the diameter of a No. 12 screw? What types and sizes of sheet-metal screws are available? How many pounds will a ¼-in. toggle bolt hold? How can you save money ordering lumber? What size quarter-rounds are available? How do you bleach close-grained hardwoods? What glue is best for cementing metal to wood?

All the answers on repairs, too! Illustrations of most-used plumbing and electrical fittings. How to fix dripping faucets, how to lay out a room for floor or wall tile, how to cut and apply plastic laminates, how to replace a pane of glass. Remodeling? All the basic dimensions you'll need to plan the job. Leaking gutters? Best way to patch them. What chemical controls which weeds and diseases? Best mixing ratio for concrete work? Just look it up.

One sheet even shows how to solve those puzzling math problems you often encounter in shop work.

By the editors of *Popular Mechanics*—order yours now—you'll use it the rest of your life!

MAIL COUPON TODAY!

\$3.95 complete set of 12
8½" x 11" boards!

PARTIAL LIST OF CONTENTS

Nail and screw sizes and uses	Bolts, machine screws, washers	Plumbing guidance
Useful mathematics	Wallpaper	Lumber sizes
Masonry	Wall fasteners	Mouldings—patterns and sizes
Lawn and garden chemicals	Plastic laminates	Properties of common woods
Stair construction	Glass	Glues and adhesives
Gutters and downspouts	Floor and wall tile	Wood joints
Guide for remodeling	Drill sizes	Plywood grades and uses
	Electrical work	Wood finishes
	Abrasives	

Popular Mechanics, Dept. SG-1-R
224 West 57th St., N.Y., N.Y. 10019
Rush me ___ sets of MASTER SHOP GUIDE.
 I enclose check or money order for \$3.95 for each set ordered.

Name _____

Address _____

City _____ State _____ Zip _____



MONT TREMBLANT



MOSPORT PARK

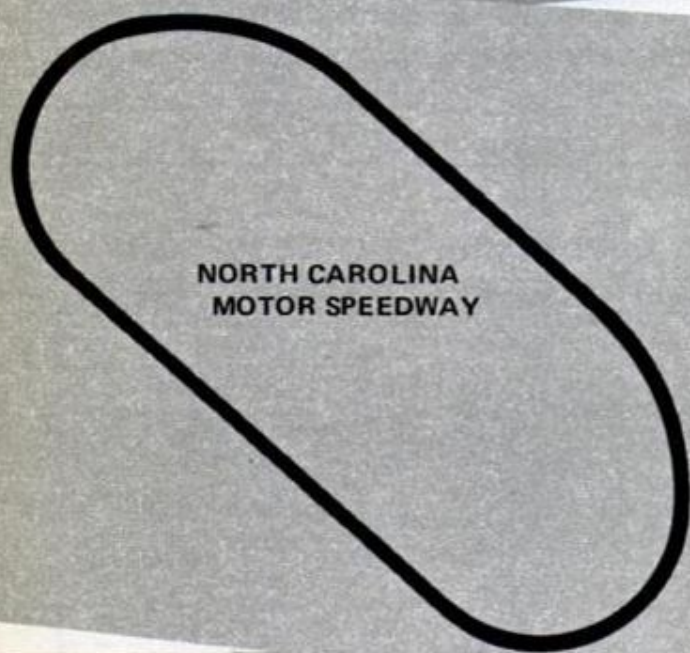

NORTH CAROLINA
MOTOR SPEEDWAY



ONTARIO MOTOR SPEEDWAY

MONT TREMBLANT

St. Jovite, Que., Canada. Asphalt, 2.65-mi. road course, 4° banks max. Seating 1000, unlimited field seating. Opened 1964.

1971 SCHEDULE

JUNE 27—CAN-AM: Group 7, 75 laps. ('70—Dan Gurney, McLaren/Chevy, 97.95 mph.)

AUG. 1—TRANS-AM: GT, 70 laps. ('70—Mark Donohue, Javelin, 85.18 mph.)

JULY 31—CONTINENTAL SERIES: FA. ('70—George Follmer, Lotus Ford, 96.38 mph.)

CANADIAN GRAND PRIX: F1, 90 laps. ('70—Jacky Ickx, Ferrari, 101.27 mph.) (Run alternately at Mosport and Mont Tremblant.)

RECORDS—Can-Am, Trans-Am, Continental: 1970 (see above). **One Lap:** 1970, Clay Regazzoni, Ferrari, 103.467 mph.

MOSPORT PARK

Bowmanville, Ont., Canada. Asphalt, 2.5-mi. road course. Seats 7500, unlimited field seating. Opened 1961.

1971 SCHEDULE

JUNE 13—CAN-AM: Group 7, ('70—Dan Gurney, McLaren/Chevrolet, 110.24 mph.)

SEPT. 12—CONTINENTAL SERIES: FA. ('70—Mark Donohue, Lola/Chevy, 78.377 mph.)

DATE NA—CANADIAN GRAND PRIX: F1. ('69—Jacky Ickx, Brabham/Ford, 112.76 mph.)

RECORDS—Can-Am: 1970 (see above). **One Lap:** 1970, Dan Gurney, McLaren/Chevrolet, 115.27 mph.

NORTH CAROLINA MOTOR SPEEDWAY

Rockingham, N.C. Asphalt, 1 mi., 22° banks, turns 1 and 2; 25°, turns 3 and 4. Seats 30,000, infield 15,000 plus. Opened 1965.

1971 SCHEDULE

MAR. 14—CAROLINA 500: GN ('70—Richard Petty, '70 Plymouth, 116.117 mph.)

OCT. 24—AMERICAN 500: GN. ('69—Lee Roy Yarbrough, '69 Ford, 111.932 mph.)

RECORDS—Carolina 500: 1970 (see above). **American 500:** 1969 (see above). **One Lap:** 1970, Bobby Allison, '70 Dodge, 139.048.

ONTARIO MOTOR SPEEDWAY

Ontario, Calif. Asphalt, 2.5 mi., 9° banks; 3.23-mi. road course, ¼-mi. drag strip plus shutdown. Seats 140,000, infield 60,000 plus. Opened Sept. 6, 1970.

1971 SCHEDULE

FEB. 28—500-MILE STOCK CAR: NASCAR GN. Not run in 1970.

SEPT. 5—CALIFORNIA 500: USAC Championship. ('70—Jim McElreath, Coyote Ford, 160.106 mph.)

NOV. 20-21—NHRA SUPER NATIONALS ('70—Held too late for Guide deadline.)

RECORDS—California 500: 1970 (see above). **One Lap:** Championship, 1970, Lloyd Ruby, Mongoose-turbo Offy, 178.042 mph.

PHOENIX INTERNATIONAL RACEWAY

Asphalt, 1 mi., 13° banks, 2.9-mi. road course, 1320-ft. drag strip plus shutdown. Seats 14,000, infield 4000. Opened 1964.

1971 SCHEDULE

MAR. 28—PHOENIX 150, USAC Championship. ('70—Al Unser, Lola-Turbo-Ford)

DATE NA—BOBBY BALL 200, USAC Championship. ('69—Al Unser, Lola-Turbo-Ford, 110.0 mph. '70—Held too late for Guide deadline)

RECORDS—Bobby Ball 200: 1969 (see above). **One Lap**: 1969, Al Unser, Ford, 129.8 mph.

POCONO INTERNATIONAL RACEWAY

Long Pond, Pa. Asphalt, ¾-mi. oval, 6° banks; 2.5-mi. tri-oval, 14° banks max.; 1.8, 3.3-mi. road courses. Seating 75,000 plus due 1971. Opened 1969.

1971 SCHEDULE

JULY 3—POCONO 500, USAC Championship. Not run in '70.

OCT. 10—500-MILE RACE, USAC Late Model Stocks. Not run in '70.

RECORDS—One Lap: ¾-mi. oval, modified stock cars, 1970, Dutch Hoag, 97.122 mph; sprint cars, 1969, Gary Bettenhausen, 97.826 mph; super modifieds, 1969, Jack Conely, 102.661 mph; 1.8-mile road course, Formula A, 1970, Steve Durst, 102.0 mph.

RIVERSIDE INTERNATIONAL RACEWAY

Riverside, Calif. Asphalt, road courses 2.54, 2.62, 3.3 mi., 8° banks max. Seats 24,000, infield 80,000 plus. Opened 1957.

1971 SCHEDULE

JAN. 17—RIVERSIDE 500: GN ('70—A.J. Foyt, '70 Ford, 97.450 mph.)

APRIL 18—CONTINENTAL GP: FA, 100 mi. ('70—John Cannon, McLaren/Chevy, 114.041 mph.)

JUNE 13—FALSTAFF 400: GN. ('70—Richard Petty, '70 Plymouth, 101.120 mph.)

OCT. 3—MISSION BELL 200: Trans-Am, GT, ('70—Parnelli Jones, '70 Mustang, 99.22 mph.)

NOV. 1—L.A. TIMES GP: Group 7, 200 mi. ('70—Held too late for Guide deadline)

DEC. 5—REX MAYS 300: Championship. (Not run in '70.)

RECORDS—Riverside 500: 1969, Richard Petty, '69 Ford, 105.516 mph. **Continental GP**: 1970 (see above). **Mission Bell 200**: 1970 (see above). **LA Times GP**: 1969, Denis Hulme, McLaren/Chevy, 120.08 mph. **Rex Mays 300**: 1968, Dan Gurney, Eagle/Ford, 108.391 mph. **One Lap**: Championship, 1968, Dan Gurney, Eagle/Ford, 118.556 mph; Group 7, 1969, Denis Hulme, McLaren/Chevy, 126.342 mph; GN, 1970, Parnelli Jones, '70 Mercury, 112.337 mph.

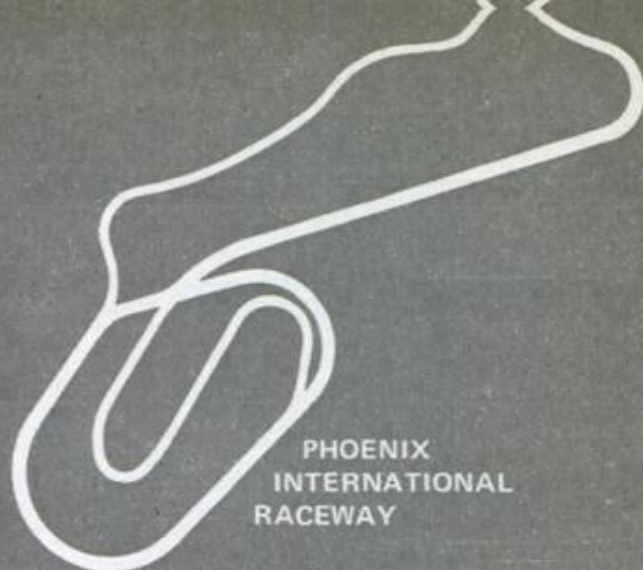

PHOENIX INTERNATIONAL RACEWAY



POCONO INTERNATIONAL RACEWAY

RIVERSIDE INTERNATIONAL RACEWAY



A white line drawing on a dark background showing the layout of the Road America race track. The track is an irregular shape with several curves and a long straight section.

ROAD AMERICA

ROAD AMERICA

Elkhart Lake, Wis. Asphalt, 4-mi. road course. Field seating, 2000 grandstand. Opened 1955.

1971 SCHEDULE

JULY 17—CONTINENTAL SERIES: FA. ('70—John Cannon, McLaren/Chevy, 106.901 mph.)

JULY 18—TRANS-AM: GT. ('70—Mark Donohue, Javelin, 91.839 mph.)

AUG. 29—ROAD AMERICA CAN-AM: Group 7. ('70—Peter Gethin, McLaren/Chevy, 105.016 mph.)

RECORDS

Continental: 1970 (see above). **Trans-Am:** 1970 (see above). **Can-Am:** 1969, Denis Hulme, McLaren/Chevy, 107.479 mph. **One Lap—**1969, Denis Hulme, McLaren/Chevy, 114.014 mph.

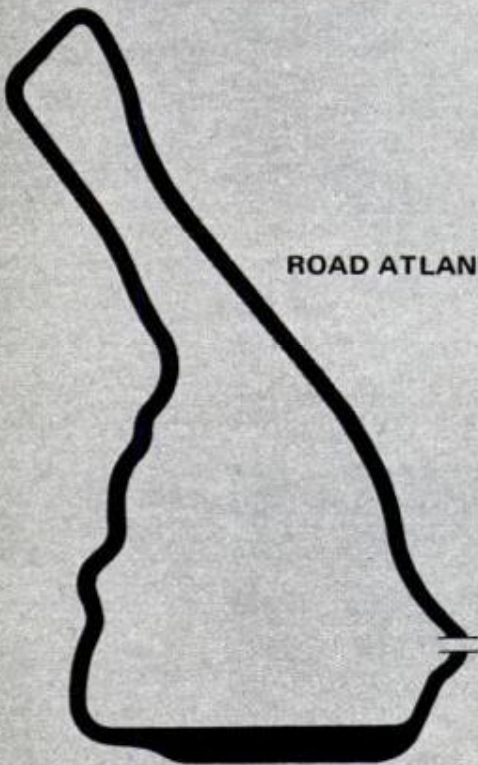
A black line drawing on a light gray background showing the layout of the Road Atlanta race track. The track is an irregular shape with several curves and a long straight section.

ROAD ATLANTA

ROAD ATLANTA

Gainesville, Ga. Asphalt, 2.52-mi. road course. 50,000 field seating. Opened 1970.

1971 SCHEDULE

JULY 12—CAN-AM: Group 7. ('70—Tony Dean, Porsche 908, 103.45 mph.)

OCT. 24—TRANS-AM: GT. Not run in '70.

RECORDS

Can-Am: 1970 (see above). **One Lap:** 1970, Vic Elford, Chaparral/Chevy, 117.35 mph.

A white line drawing on a dark background showing the layout of the Seattle International Raceway. The track is an irregular shape with several curves and a long straight section.

SEATTLE
INTERNATIONAL
RACEWAY

SEATTLE INTERNATIONAL RACEWAY

Kent, Wash. Asphalt, 2.25-mi. road course, 1-mi. drag strip. Seating 3500, unlimited field seating. Opened 1959.

1971 SCHEDULE

APRIL 10-11—NORTHWEST NATIONAL OPEN: NHRA-sanctioned drag races.

MAY 23—TRANS-AM: GT. ('70—Parnelli Jones, '70 Mustang, 90.40 mph.)

SEPT. 19—CONTINENTAL SERIES: FA ('70—John Cannon, McLaren/Chevy, 103.8 mph.)

DATE NA—DAN GURNEY 200: Championship. ('70—too late for Guide deadline).

RECORDS

Trans-Am: 1970 (see above). **Continental:** 1970 (see above). **One Lap:** 1969, Dan Gurney, Eagle/stock Ford, 109.31 mph.

Racing Rules

(Continued from page 17S)

stock block 320.355 or supercharged 203.4; special rocker-arm engine, no OHC, no supercharger, 305.1; two-cycle 170.856; diesel 305.1 or supercharged 203.4; turbines 11.999-sq.-in. annulus area at first moving compressor stage. USAC has appointed a committee to define a "stock block engine" for future. For 1971, USAC has three separate Championship Div. groups: (1) the three 2½-mile tracks and other ovals, (2) dirt tracks, (3) road racing. It was expected road racing will be limited to 305-CID pushrod engines as in SCCA Formula A Continental.

Sprint (USAC)—OHC 256.284 CID or supercharged 170.856; stock block, no OHC, 305.1 or supercharged 203.4; two-cycle 170.856. One percent overbore allowed all engines. Wheelbase minimum 84-in. IMCA: sprints unlimited CID. URC (United Racing Club): sprints unlimited CID, minimum wheelbase 84-in., no gasoline permitted.

Midget (USAC)—OHC 114, CID or supercharged 76; two-cycle 105; stock block, no OHC, 155 CID and engine must be part of production line passenger-car engine with 5000 produced, sold and licensed by public. SESCO engine eligible as a 153-CID four-cylinder portion of a 283-CID Chevrolet V8, using one bank of the cylinders with special case, but must use stock cylinder head. Stock block supercharged 104 CID. ARDC: Offy 4-cylinder maximum 110 CID or supercharged 70 CID; stock block push-rod 155 CID; single OHC 135.

Can-Am (SCCA)—Unlimited CID, optional carburetion. Full international, Group 7 sports cars, rated most powerful road racers in action, unique, experimental.

Trans-Am (SCCA)—U.S. and imported production sedans, "pony cars," maximum 305 CID. Engine displacement may be increased or decreased to reach 305 limit. Racing in two classes, over and under two liters, 122 CID. Carburetion, over two liters one 4-bbl., under two liters production specs. Production: over two liters, at least 2500 or 1/250th of previous year's production, at least 500 engines installed in any chassis/body model approved by ACCUS-FIA; under two liters, at least 5000 produced. All road races. Similar cars run NASCAR Grand American and in USAC and IMCA compete in the same stock-car races with the larger intermediates and standards.

Formula A (SCCA Continental)—U.S. and imported production pushrod engines maximum 305 CID. Admission of imported engines new in 1971. Minimum production 1000 engines, must use original cylinder blocks and heads, but may be modified within specified limits. No superchargers. Engines of unrestricted origin 183 CID or supercharged 91½ CID. USAC Championship road-racing division expected to implement similar 305-CID engine regulations.

Formula 1 (FIA)—International Grand Prix, maximum 183 CID or supercharged 91½ CID.

Other Formulas—See page S19.

Drag Racing—Many classes, extensive list of rules, very complex. Best bet is to check NHRA and AHRA rule books.

JANUARY 1971

Soup for nuts

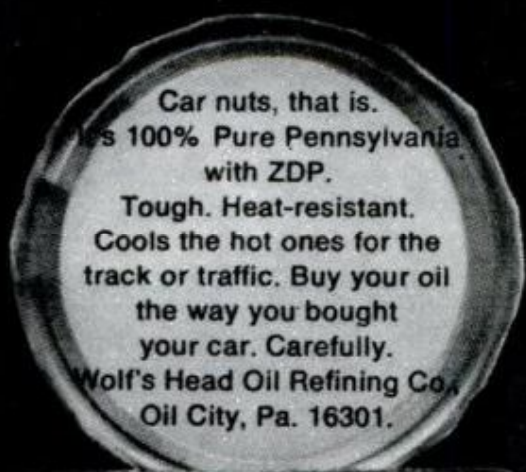

the uncommon motor oil
Exceeds car makers'
warranty requirements.

S37



SEBRING



TEXAS
INTERNATIONAL
SPEEDWAY



TRENTON SPEEDWAY

SEBRING

Sebring, Fla. Concrete and asphalt, 5.2-mi. road course. Seats 15,000, infield 50,000. Opened 1950.

1971 SCHEDULE

MARCH 19-20—12 HOURS OF SEBRING: Proto, Sports, GT, Touring. 12 hrs. ('70—Mario Andretti, Nino Vacarella, Ignazio Giunti, Ferrari 512S, 107.029 mph.)

OCT. 24—CONTINENTAL SERIES (L&M GP): FA, 100 mi. ('69—David Hobbs, Surtees TS5; First heat: Hobbs, 116.642 mph. Record. Second heat: Hobbs, 116.363 mph. Record. ('70 held too late for Guide deadline.)

RECORDS—12 Hours of Sebring: 1970 (see above). **Continental—1969** (see above). **One Lap:** Leo Kinnunen, Gulf-Porsche 917, 122.537 mph.

TEXAS INTERNATIONAL SPEEDWAY

College Station, Tex. Asphalt, 2 mi., 22° banks. Road course 3 mi. Seats 26,000, infield 25,000 plus. Opened 1969.

1971 SCHEDULE

JUNE 20—NASCAR GN: 400 mi. (Not held in '70.)

DATE NA—CAN-AM: Group 7, 210 mi. ('70—too late for Guide deadline; '69—Bruce McLaren, McLaren/Chevy, 109.84 mph.)

DEC. 5—NASCAR GN: 400 mi. ('70—too late for Guide deadline; '69—Bobby Isaac, '69 Dodge, 500 mi., 144.27 mph.)

RECORDS—Can-Am: (see above). **NASCAR GN:** (see above). **One Lap:** 3-mi. road course, 1969, Denis Hulme, McLaren/Chevy, 117.9 mph; 2-mi. oval, 1969, Buddy Baker, '69 Dodge, 176.28 mph.

TRENTON SPEEDWAY

Trenton, N.J. Asphalt, 1.5-mi., 10° turns 1 and 2, 15° turns 3 and 4. Seats 22,000, paddock 10,000. Present track opened 1969.

1971 SCHEDULE

DATE NA—TRENTON 200: USAC Championship. ('70—Lloyd Ruby, Mongoose Offy, 135.967 mph.)

DATE NA—TRENTON 300: NASCAR GN. ('70—Ricard Petty, '70 Plymouth, 120.709 mph.)

DATE NA—TRENTON 300: USAC Championship. ('70—Al Unser, turbocharged Ford 137.500 mph.)

RECORDS—Trenton 200: 1969, Mario Andretti, Hawk/Ford, 139.591 mph. **Trenton 300 (GN Stocks):** 1969, David Pearson, '69 Ford, 121.088 mph. **Trenton 300 (Championship):** 1970 (see above). **One Lap; Championship,** 1969, Bobby Unser, Eagle/turbo-Offy, 154.710 mph; **GN Stocks,** 1969, Bobby Isaac, '69 Dodge, 132.668 mph.

WATKINS GLEN GRAND PRIX CIRCUIT

Watkins Glen, N.Y. Asphalt, 2.3-mi. road course. Seats 11,000, unlimited field seating. Opened 1956.

1971 SCHEDULE

JULY 11—THE GLEN CAN-AM 200: Group 7. ('70—Denis Hulme, McLaren/Chevy, 118.56 mph.)

AUG. 15—GLEN TRANS-AM: GT, 2 hrs. ('70—Vic Elford '70 Camaro, 103.8 mph.)

OCT. 3—GRAND PRIX OF U.S.: F1, 250 mi. (approx.) ('70—Emerson Fittipaldi, Lotus/Ford, 126.79 mph.)

DATE NA—WATKINS GLEN 6-HOUR: Sports, Sports Protos., GT, Touring. ('70—Pedro Rodriguez/Leo Kinnunen, Porsche 917, 117.81 mph.)

RECORDS—Can-Am 200: 1969, Bruce McLaren, McLaren/Chevy, 125.99 mph. **GLEN TRANS-AM:** 1969, Mark Donohue, Camaro, 107.33 mph. **Grand Prix of U.S.:** 1970 (see above). **One Lap:** F1, 1970, Jacky Ickx, Ferrari, 131.28 mph; Can-Am, 1969, Bruce McLaren, McLaren/Chevy, 133.10 mph; GT, 1970, Mark Donohue, Javelin, 111.89 mph.

WISCONSIN STATE FAIR PARK SPEEDWAY

West Allis (Milwaukee), Wis. Asphalt, 1-mi., 9° banks. 1.9-mi. road course. Seats 40,000, infield 10,000. Opened 1903.

1971 SCHEDULE (Dates NA)

REX MAYS CLASSIC: USAC Championship, 150 mi. ('70—Joe Leonard, Colt/turbo-Ford, 108.300 mph.)

MILLER 200—USAC Stocks ('70—Roger McCluskey, '70 Plymouth, 98.160 mph.)

FAIR WEEK 150: USAC Stocks.

FAIR WEEK 200: USAC Stocks. ('70—A.J.Foyt, '69 Ford, 98.071 mph.)

TONY BETTENHAUSEN 200: USAC Championship. ('70—Al Unser, Lola/Ford, 114.307 mph.)

USAC STOCKS: 250-mi.

RECORDS—Rex Mays Classic: 1969, Art Pollard, STP-Offy, 112.157 mph. **Miller 200:** 1970 (see above). **Tony Bettenhausen 200:** 1970 (see '69 Dodge, 98.369 mph. **Fair Week 200:** 1970 (see above). **Tony Bettenhausen 200:** 1970 (see above). **One Lap:** 1969, Al Unser, Turbo-Ford, 119.600 mph

OTHER TRACKS

Action Track—Terre Haute, Ind.
Beltsville Speedway—Beltsville, Md.
Bristol International Speedway—Tenn.
Dallas International—Lewisville, Tex.
Davenport Fairgrounds—Davenport, Iowa
Dover Downs International Speedway—Del.
DuQuoin Fairgrounds—DuQuoin, Ill.
Hanford Speedway—Hanford, Calif.
Langhorne Speedway—Langhorne, Pa.
Marlboro—Marlboro, Md.

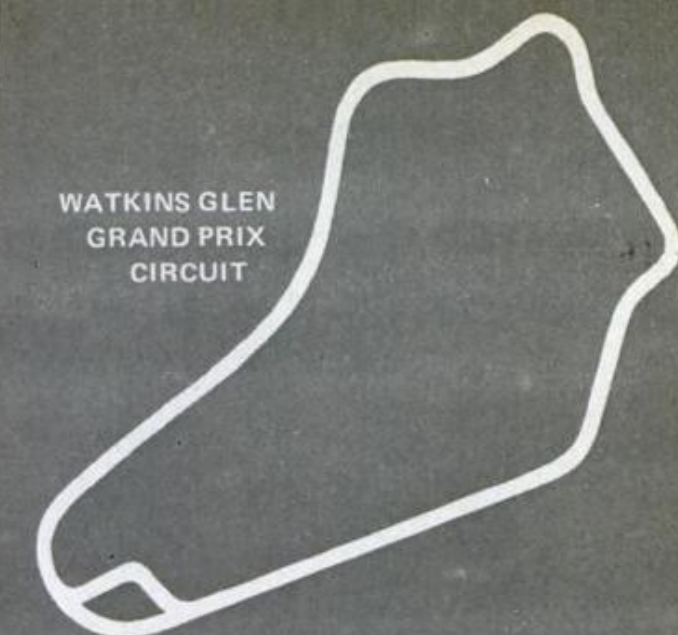

WATKINS GLEN
GRAND PRIX
CIRCUIT

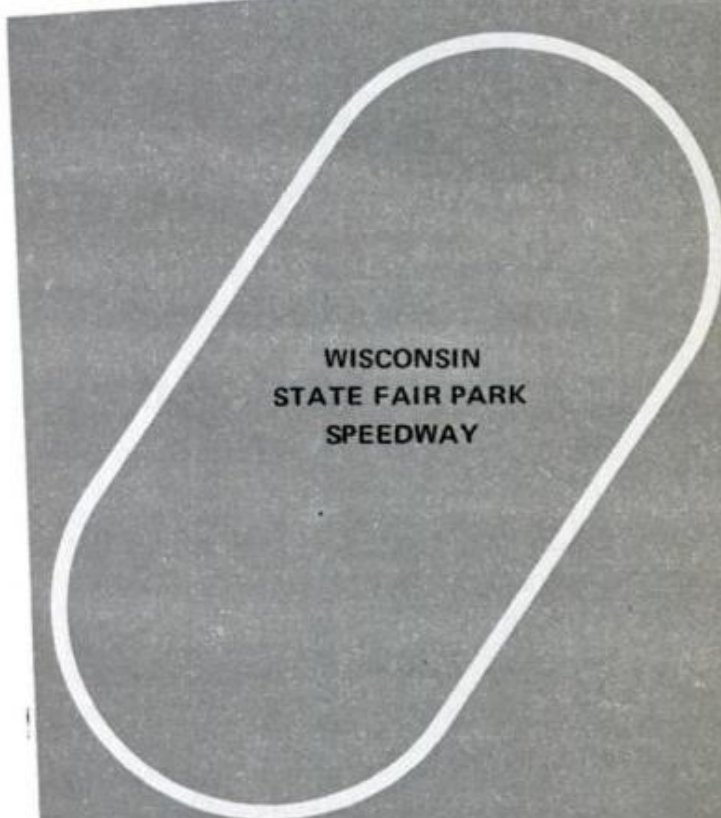

WISCONSIN
STATE FAIR PARK
SPEEDWAY

Martinsville Speedway—Martinsville, Va.
Nazareth Speedway—Nazareth, Pa.
New Asheville Speedway—Asheville, N.C.
New Thompson Speedways—Thompson, Conn.
Pikes Peak—Colo.
Sedalia Fairgrounds—Sedalia, Mo.
Springfield Fairgrounds—Springfield, Ill.
State Fairgrounds—Indianapolis, Ind.
Tri-County Speedway—Cincinnati, Ohio
Winchester Speedway—Winchester, Ind.

Dodge

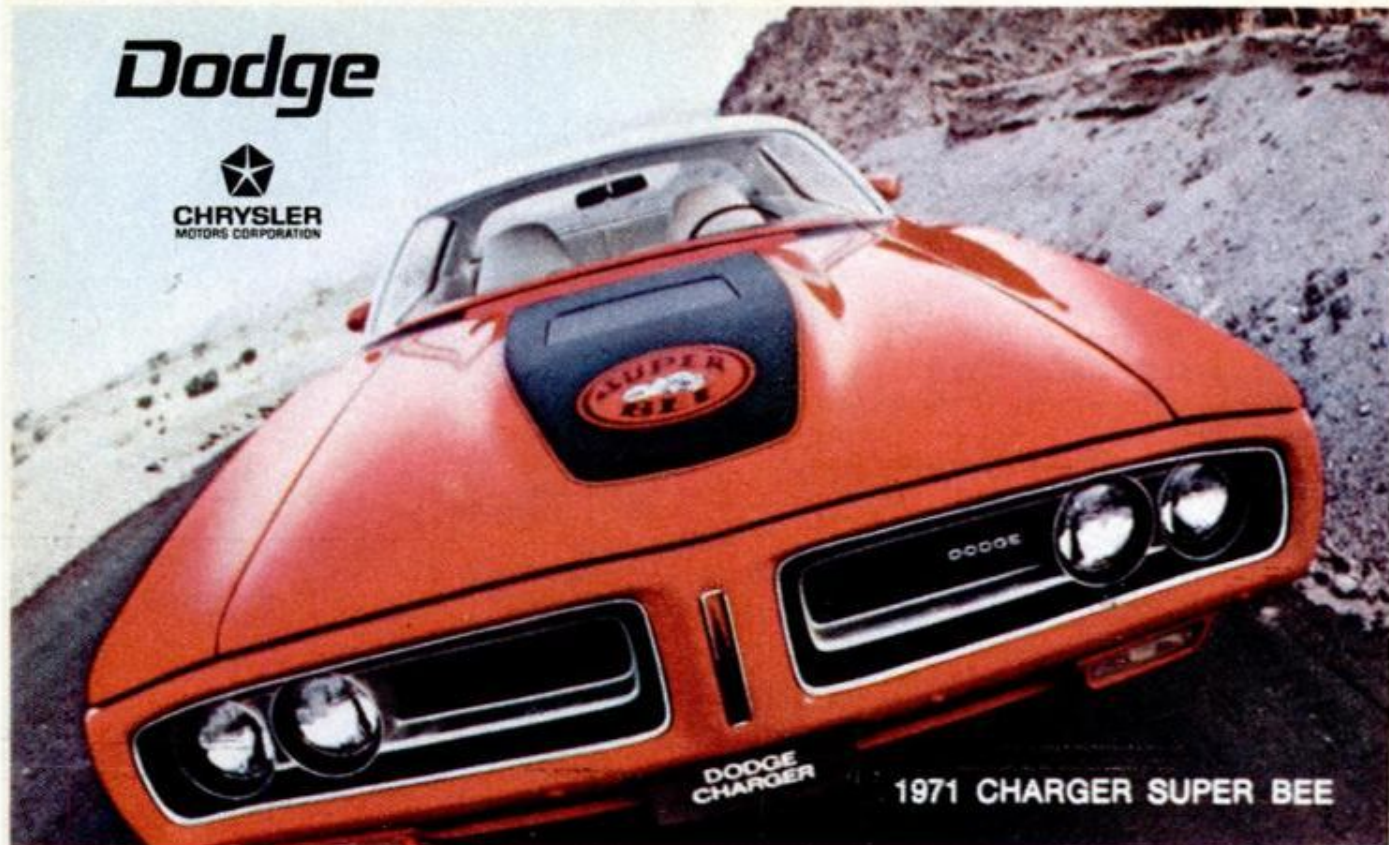

1971 CHARGER SUPER BEE

The run of the mills is anything but run of the mill.

One great shape. Two great ways to go. First, Charger Super Bee (above), the budget way. Budget, yes—austerity, no. Super Bee's standard mill is the 383 Magnum V8 with free-breathing heads right off the 440 Magnum. It thrives on regular-grade gas and delivers all its energy through a slick, three-speed, all-synchro three-on-the-floor. Yes, Super Bee also has heavy-duty suspension and brakes; Rallye Instrument Cluster; plus F70x14 wide-tread, whitewall, bias-belted tires; and a bench-type front seat. And what's wrong with that? Now let us proceed to the "all-stops-out" Charger R/T below. This one's a bit different. Its standard mill is the formidable Dodge 440

Magnum—the transmission, the three-speed TorqueFlite automatic. And you know all about them. Charger R/T gives you bucket seats up front; extra-heavy-duty suspension; heavy-duty brakes; G70x14 wide-tread, raised white letter, bias-belted tires; special paint and stripes. So you see that if you have the urge, we have the Charger for you. Super Bee or R/T. Check your budget again. Then try them both at your nearby Dodge Dealer's. Either way, you can't lose.

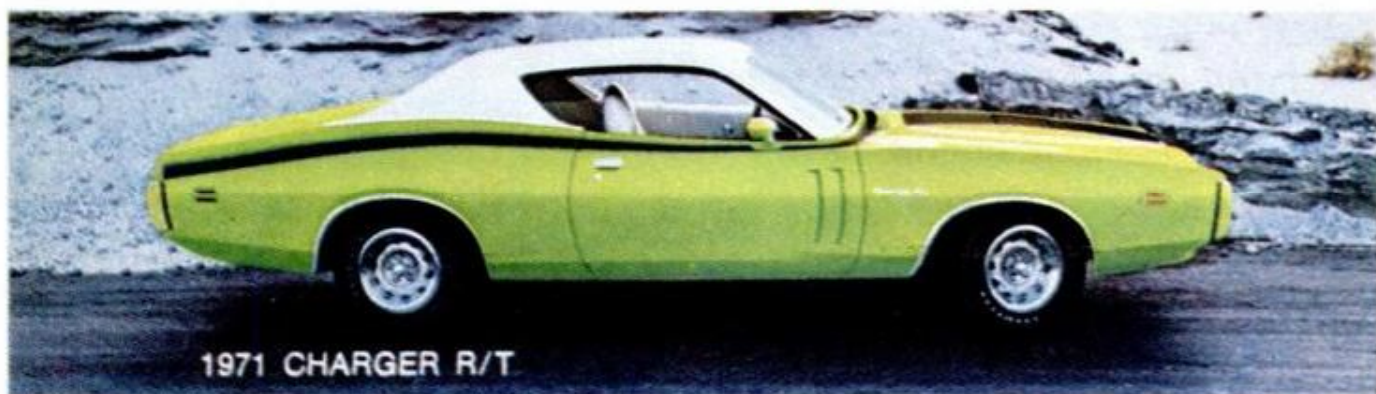

1971 CHARGER R/T

On his last outing, Studs Merkel wowed the gang with his own special, triple-filtered cigarette.

Now everybody will be smoking special, triple-filtered cigarettes.

...almost everybody



Camel Filters.
They're not for everybody
(But then, they don't try to be.)



Shaves time.



This is the shave cream to use for that dreaded morning rush hour shave (when you shave faster than you should—without giving the lather enough time to really soak in).

Why? Because it heats up right under your nose. And takes less time to soften tough whiskers than ordinary cold shave cream. Making it entirely possible for you to get a close, comfortable shave in the morning. And still catch the 7:47.

The Hot One—when you shave too fast for comfort.

SPECIAL OFFER!

Buy this specially equipped Dodge pickup now — get the automatic transmission at no extra cost.*



***That's the same as having \$247.70 taken off the manufacturer's suggested retail price.**

The special low price of this specially equipped Custom Sweptline Automatic pickup D100 model also includes these most-wanted features: ■ Power brakes. ■ Dual electric horns. ■ Radio. ■ Tinted glass all around. ■ Full depth foam seat cushion and seatback. ■ Bright front and rear bumpers. ■ Dual bright 5" x 7" outside rearview mirrors.

■ G78-15B (4 PR) whitewall tires. ■ Undercoating. ■ Body side upper moulding package. ■ Lower wheel lip and sill moulding package. ■ Cigar lighter. ■ Your choice of any standard color or one of four special colors for this model only—medium blue metallic, medium green metallic, moss green metallic, or tan metallic.

TAKE ADVANTAGE OF THIS GREAT OPPORTUNITY TO GET A NEW PICKUP AT A BARGAIN PRICE.

ACT NOW! THE TIME IS LIMITED!



New lightweight engine of Reynolds Aluminum powers McLaren team to Can-Am win.

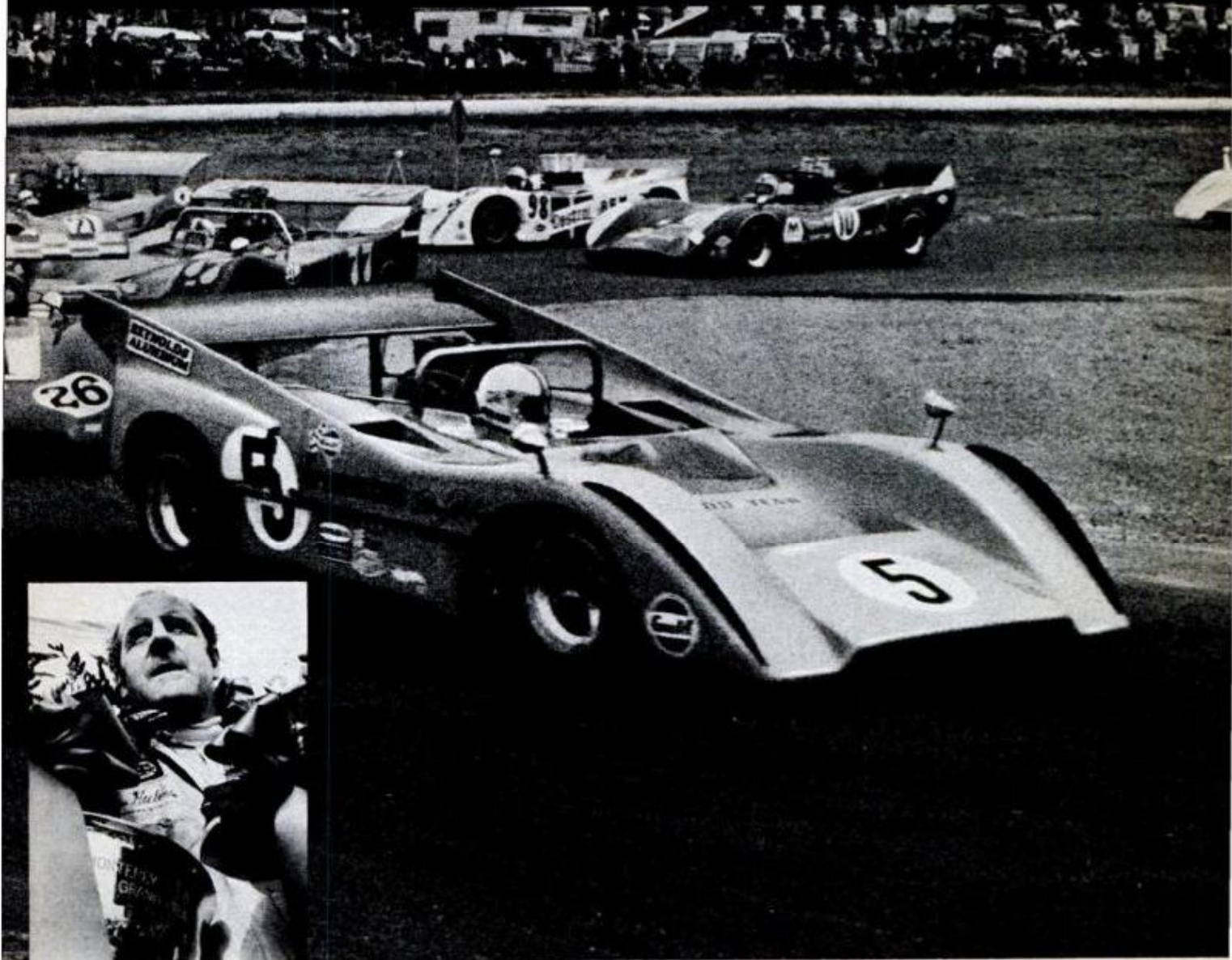

Championship team switches to new engine made with Reynolds Aluminum for Oct. 18 victory at Laguna Seca.

On the Canadian-American racing circuit, the announcement of a McLaren team victory is not earth-shaking. After all, the team was the undisputed champion last year and the year before, winning all 11 racing events in 1969.

Driver Denis Hulme's Laguna Seca win for the team is news because he did it with a new engine, made with a new Reynolds Aluminum alloy which eliminates cylinder liners and saves even

more dead weight. It's news because a championship team had the confidence to change a winning design to make it even better.

And it's news because it puts a big "proved" stamp on a major development in automotive aluminum.

The Reynolds Automotive Team, the RAT Patrol, put years of development work into this new high silicon alloy. Their aim was to help make the aluminum engine a practical reality, not only for racers like McLaren's, but for passenger cars as well. It is, in fact, the same alloy being used in the engine of a new U.S. family car, the Vega 2300... proving

that the weight-saving abilities of aluminum can pay dividends anywhere.

Lighter engines mean better performance, improved handling, and efficiency. A lighter car starts faster and stops quicker.

And the McLaren team has proved it for the RAT Patrol and for every car owner.

Reynolds Metals Company, leading supplier of aluminum to the automotive industry, P.O. Box 27003-LAK, Richmond, Virginia 23261.



REYNOLDS
where new ideas take shape in
ALUMINUM

POPULAR MECHANICS®

INTERNATIONAL EDITIONS: AUSTRALIA, BRAZIL, CARIBBEAN, DENMARK, MEXICO, SOUTHERN HEMISPHERE, SWEDEN

PM'S 1971 AUTO RACING GUIDE (Inside Front Cover)

- | | |
|---|---|
| S3 Still the Greatest Sport | S13 Formula 1 Cars |
| S4 Championship Cars | S14 Grand Prix Racing |
| S6 Sprints and Midgets | S16 Formula A Cars |
| S7 Stock Cars | S17 Racing Rules—Engines |
| S8 Winners of Major NASCAR Races | S18 Other Formulas and Classes |
| S10 Trans-Am Cars | S20 Drag Racing |
| S11 Can-Am Cars | S28 The Top Tracks, Plus Schedules |

AUTOMOBILES AND DRIVING

- 24 Drivin' With Dan
- 32 Test Driving Colt and Cricket
- 54H Detroit Listening Post
- 66 Automobile Clinic
- 73 Should Mechanics Have to Have a License?
- 86 How I Became a Racing Driver in 3 'Easy' Lessons
- 100 PM Owners Report: Mercedes-Benz
- 106 Is There a Three-Wheeler in Your Future?
- 114 Homebuilt Steam Car Takes to Road!
- 130 Maybe You Need an Overdrive
- 136 You Can Build This Motor Home for Under \$3900
- 146 Saturday Mechanic: Servicing Sparkplugs

PHOTOGRAPHY

- 118 Built-In Light Meters
- 124 Make Your Own Electronic Enlarging Meter
- 128 Hold-Down Arm for Photo Trimming

ELECTRONICS, RADIO AND TV

- 76 Big Boom in Cartridge TV
- 110 Wanted: Electronic Detectives
- 124 Make Your Own Electronic Enlarging Meter
- 129 New in Electronics

SPACE, AVIATION, MILITARY

- 96 So You Want to Fly Slow?

ENVIRONMENT

- 60 Pollution Fighters' Newsletter

Cover Photo by Joe Munroe—Build This Motor Home for \$3900

SHOP AND CRAFTS

- 150 Internal Carving: Little-Known Art
- 152 200-Power Telescope (Part 2)
- 158 How to Make a Better Rug Hook
- 159 Hints From Readers
- 160 Spoonholder Rack for Your Lamp
- 168 Hints From Readers
- 169 New Tools You Should Know About
- 170 How to Pick the Drill to Fit the Tap
- 174 Homemade and Handy
- 176 Hints From Readers

HOME AND YARD

- 38 New Ideas From the Hardware Show
- 134 Exciting New Products
- 140 Build the Marvelous Fold-A-Majig
- 162 Solving Home Problems
- 164 How the Pros Use Copper Tubing
- 172 Painting and Papering Tips
- 182 Homeowners' Clinic

SCIENCE AND INVENTIONS

- 20 Science Worldwide
- 82 Putting the Lid on Oil Spills
- 92 Mechanics of Medicine
- 122 Just Patented: PM's Pick of the New Inventions

BOATING, OUTDOOR RECREATION

- 14 What's New Outdoors
- 34D 'All-Terrain' Takes in Snow
- 34F Spunky, New Snowmobile Engine
- 63 On-the-Go Camping

REGULAR FEATURES

- 6 Letters

NEXT MONTH IN POPULAR MECHANICS

Cassette or Cartridge: Which tape machine for you?
Whatever Happened to Air Bags? They once seemed the best bet for car safety.
Dangerous Hospital Equipment. We need performance standards in medical electronics.

ROBERT P. CROSSLEY

Editor

JAMES M. LISTON
Executive Editor

JOHN A. LINKLETTER
Managing Editor

WAYNE C. LECKEY
Home and Shop
Editor

SHELDON M. GALLAGER
Assistant Executive
Editor

THOMAS G. DAUER
Art Director

Published by The Hearst Corporation
RICHARD E. BERLIN, PRESIDENT

RICHARD E. DEEMS
President, Magazines Division

JOSEPH F. KERN
Publisher

BILL HARTFORD _____ Automotive
JOHN F. PEARSON _____ Science and Aerospace
GEORGE W. REIGER _____ Boating and Outdoors
SHELDON GALLAGER _____ Electronics and Photography
HARRY WICKS _____ Home Workshop
MICHAEL LAMM _____ West Coast Automotive
ROBERT LUND _____ Detroit Automotive
GARRY WINTER _____ Copy and Production
RICHARD H. FUNK _____ Associate Copy and Production
JOHN ADKINS _____ Assistant Copy and Production
ALVIN KIETZ _____ Assistant Art Director
FRED A. LEERS _____ Assistant Art Director
JOSEPH P. BEATON _____ Assistant Art Director
DON EVANS _____ Technical Art Director
CLIFFORD B. HICKS _____ Special Projects
SOPHIE GRONOWICZ _____ Director, Bureau of Information
EVERETT JOHNSON _____ Cabinetmaker

ADDRESS ALL EDITORIAL COMMUNICATIONS TO: 224 West 57th St., New York, N.Y. 10019. For additional sources of information on the articles and products in this issue, write to Bureau of Information, Popular Mechanics, for free "Where-to-Find-It" list.

DANIEL J. COLEMAN
Director of Advertising

ADVERTISING OFFICES: New York: 224 West 57th St., 765-6850; Chicago: 520 N. Michigan Ave., 527-2400; Detroit: General Motors Bldg., TRinity 5-8711; Cleveland: 20310 Chagrin Blvd., Shaker Heights, 283-7788; Los Angeles: 601 North Vermont Ave., 666-6263.

JOHN A. REGINA _____ Advertising Production Manager

SUBSCRIPTION SERVICE: Mail all subscription orders, changes of address, correspondence concerning subscriptions, and Postmaster notices of undeliverable copies to Popular Mechanics, Box 646, New York, N.Y. 10019. Please enclose your latest address label for quickest service when writing about your subscription.

POPULAR MECHANICS IS PUBLISHED MONTHLY by The Hearst Corporation, 57th St. at 8th Ave., New York, N.Y. 10019, U.S.A. Richard E. Berlin, President; George Hearst, V-Pres.; Richard E. Deems, President of Magazines; John B. Miller, Executive V-Pres. of Magazines; Raymond J. Petersen, Senior V-Pres. of Magazines; William S. Campbell, V-Pres. of Magazines; Albert A. Rachoi, V-Pres. and Director of Circulation; Joseph F. Kern, V-Pres. for Popular Mechanics; Frank Massi, Executive V-Pres. and Treasurer; Harvey L. Lipton, Secy. Single copy in the United States and Canada, 50 cents. Subscription prices: United States and Possessions \$5.00 for one year; \$9.00 for two years; \$12.00 for three years. Canada, add \$0.75 for each year. Pan American Postal Union countries, add \$1.00 for each year. All other countries, add \$2.00 for each year. When changing address, give old address as well as the new, with postal-zone number, if any, and allow six weeks for change to become effective. Second-class postage paid at New York, N.Y., and at additional mailing offices. Authorized as second-class mail by the Post Office Department, Ottawa, and for payment of postage in cash. Registered as second-class matter at the Post Office at Mexico D.F., Mexico, June 20, 1950. © 1970 by The Hearst Corporation. All rights reserved. Printed in U.S.A.

After you've sanded, painted and finished the job, admire it with

the good stuff.



Kentucky Straight Bourbon Whiskeys. 86 Proof and 100 Proof Bottled in Bond. Old Grand-Dad Distillery Company, Frankfort, Kentucky 40601.

When your daughter says that Field & Stream's aroma reminds her of a great autumn day in the woods...

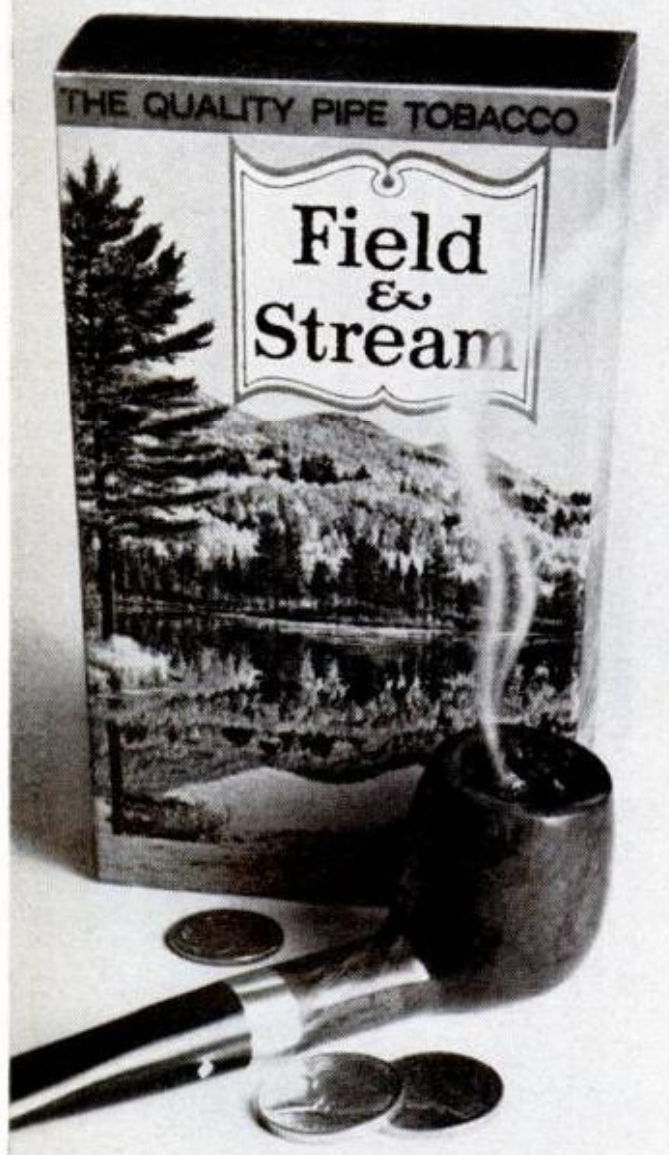

**start
saving up
the dowry.**

A quality product of Philip Morris U.S.A.

LETTERS TO THE EDITOR

Most remarkable people

My hat is off to you for printing *The Most Remarkable People* (page 104, Nov. PM), a most appropriate and dynamic speech by Dr. Eric A. Walker.

Members of Dr. Walker's audience must surely have been inspired and strengthened by his message. The address places things in their proper perspective.

I'd welcome articles in the future that offer words of encouragement to build, rather than tear down, a great nation that we all too often fail to appreciate.

CRESTWOOD, MO. GENE E. STROH

Thank you for printing Dr. Eric Walker's address. As you said, it makes sense and needed to be said.

CLARKS GREEN, PA. L. W. JANSEN

If you did the research on this article as you normally do on your own articles, you would find that Dr. Walker's basic presumptions as set forth in the following paragraph are completely untrue:

"These—your parents and grandparents—are the people who within just five decades (1919-1969) have by their work increased your life expectancy by approximately 50 percent—who while cutting the working day by a third, have more than doubled per capita output."

All that is wrong with this statement is the following:

1. Life expectancy has not increased by 50 percent between 1919 and 1969.
2. The working day has not been cut by a third between 1919 and 1969.
3. Output per capita has not been doubled between 1919 and 1969.

Other than that, the good Dr. Walker can be permitted his conclusions based upon a false premise.

May I hope that in the future when your desire arises to talk about how good your and my generation are, you will let your good editorial judgment prevail upon you to question the article as closely as one written by your own writers.

LAFAYETTE, CALIF. ROBERT KAHN

Where's the phone?

In *Telephone Table Lamp* (page 194, Oct. PM), your author says that old telephones are available from surplus firms for \$8 to \$10 each. For quite some time,

(Please turn to page 8)

POPULAR MECHANICS

Материал, защищенный авторским правом

LEARN THE PROFESSIONAL METHOD OF APPLIANCE REPAIR

For extra income, a job skill in demand, a business of your own — or to save money on your own appliance repairs.

SEND FOR FREE CATALOG

Appliance Division, National Radio Institute
Washington, D.C. 20016

600-011

Send me your illustrated free book that tells about opportunities in Servicing Electrical Appliances, and gives details of NRI's simplified training plan. I understand there is no obligation, no salesman will call.

Name _____ Age _____

Address _____

City _____ State _____ Zip _____ Code _____

Check here for facts on New GI Bill.

Accredited Member National Home Study Council

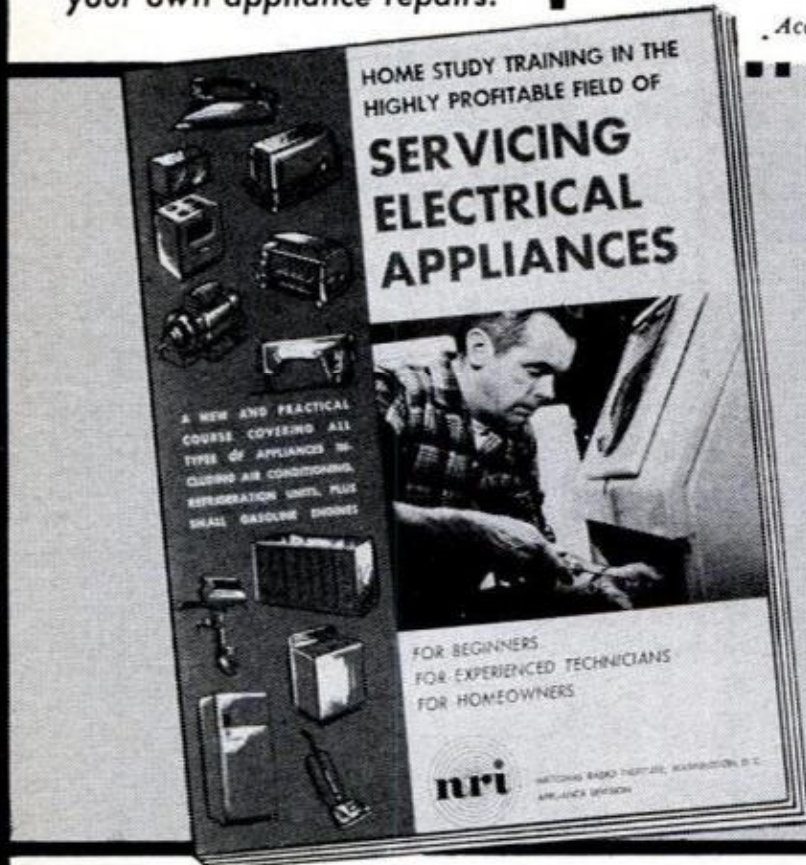

MAIL COUPON ABOVE FOR THIS
FREE NRI CATALOG

AVAILABLE UNDER NEW GI BILL
if you served since January 31, 1955,
or are in service now, check GI line
in coupon above.

A new, short, easy course trains you at home

Now you can prepare quickly to do professional appliance servicing at home in your spare time.

You are ready to start servicing appliances after only a few lessons. The entire course can be finished in a matter of months.

This is the fastest way to a new job or skill or extra income or a business of your own. Wherever you live or want to live, you'll find a demand for top-notch appliance servicemen.

There are probably thousands of broken appliances right in your neighborhood. These can mean cash profits for you starting soon. Use your spare time

to make \$5 to \$7 an hour fixing appliances for friends and neighbors.

Low-cost training plans cover —

- Small and large home appliances
- Farm and commercial equipment
- Portable electric tools
- Small gasoline engines

— there is even special training to prepare you for air conditioning and refrigeration.

Special NRI appliance testing equipment is included in your course at no extra cost. Mail coupon for your FREE NRI Catalog. No salesman will call.



NATIONAL RADIO INSTITUTE • APPLIANCE DIVISION
Washington, D. C. 20016

EARN BIG MONEY IN AIR CONDITIONING REFRIGERATION & HEATING

25 KITS SENT TO BUILD THIS
COMPLETE REFRIGERATION SYSTEM



APPROVED FOR GI TRAINING

If you served since January 31, 1955 or are in service, check GI line in coupon

A better job, top pay and steady work are easily within your reach. Learn to repair and install air conditioning systems, refrigerators and freezers. Air conditioning is one of America's fastest-growing industries. Millions of autos and homes are being air-conditioned. The need for trained men is immediate and great.

Make Home Your Training Center—Learn by practicing. CTI sends 25 kits of tools and parts to build a complete refrigeration system—which you later convert into a refrigerator or freezer. The course is easy!

Earn Money As You Train—Since the CTI course includes training with real equipment, many students earn money repairing units soon after enrolling. On completing training they go into top pay jobs. Many get started in their own business.

Mail Coupon Today for FREE book. No obligation. Prove to yourself that the air conditioning, refrigeration and heating field is best for you—the easiest training to master and loaded with top pay opportunities.

Commercial Trades Institute, Chicago, Ill. 60626

COMMERCIAL TRADES INSTITUTE
1400 Greenleaf Avenue
Chicago, Illinois 60626 Dept. PM-171



Send book, Be a Success in Air Conditioning,
Refrigeration & Heating. No obligation.

Name _____ Age _____

Address _____ Zip _____

City _____ County _____ State _____

Check for facts on GI Bill

Accredited Member National Home Study Council

LETTERS

(Continued from page 6)

I have been trying to get four of these phones for the purpose of making lamps. Can you tell me where I can get them?
NEW BEDFORD, MASS. FRANK BETTENCOURT

Our author suggests Surplus Saving Center, Waymart, Pa. 18472. Those upright phones, though, are becoming collector's items, and prices are edging up.

Likes the truth

The Truth About Pet Foods (page 123, Oct. PM) was extremely good and informative. I appreciate your writing the story, for I am a dog owner.

CRANFORD, N. J.

MILTON BROSS

Wanted: more reports

I hope you'll be doing an Owners Report soon on Vega.

AURORA, COLO.

BRUCE CURVIN

We will. Keep watching.

Why don't you start a regular monthly column on motorcycle care, repairs and the like? More and more middle-aged men are buying them. One of the reasons is the high cost of gasoline and repairs for cars. On my car, I get 12 to 14 miles per gallon. On my motorcycle, I get 69 miles.
LOWER BURRELL, PA. LOUIS SMITH

Really, we're in favor of keeping middle-aged men off the streets, but if enough of them want to know about motorcycles, maybe we can oblige.

'Handling is superb'

This is my version of *The PM Houseboat* (page 160, Dec. '59 PM). Minor modifications include a flying bridge and a single 50-hp outboard, rather than the two 18s recommended. Cruising speed is approximately 10 mph; handling is superb.

This was my first attempt at boat build-



(Please turn to page 10)

START YOUR NEW CAREER NOW! WITHOUT OVERHEAD! ANY PLACE! ANY AGE!

UPHOLSTERING JUST ONE

you don't even have to quit your present job!!!

CHAIR can pay you as much as your present weekly paycheck!

Start learning now. At home, or in the garage, in your spare time — no outside classes to attend. If you can tie a knot and drive a tack, you can learn this business, quickly, easily. You start learning the basics right away through the proven MUI Home Training Plan. And before you're barely into it, you can start doing the simple upholstery jobs that are all around you waiting to be done. Chairs, cushions, seats, footstools. Even before MUI students finish their training, people start bringing upholstery jobs to them, and remember—the world is full of furniture that needs fixing and re-upholstering and more is wearing out all the time!



"What started as a hobby, now pays me \$10 an hour"

Yes, many MUI graduates make better than \$10 an hour turning old wornout furniture into bright new decorator pieces! **Stack it up against what you're doing now!** Are you making \$150 a week? \$200? \$250? Do you put in long hours of dull work, with small raises? Is that the way you want to spend the rest of your life? Just imagine, you can make \$150, \$200, \$250 upholstering just one chair or sofa these days! And if you're the kind of person who likes to work and earn, you can sometimes finish a job like this in a day. That's pay, ... and it beats what most college graduates make!

AS YOU LEARN, YOU JUST SLIP INTO THE IMMENSE FLOW OF UPHOLSTERY WORK! Think of all there is! . . . Sofas, lounging chairs finished in beautiful fabrics, which MUI tells you how to get at the right price — even leather and all the new vinyls. And then you have built-ins and breakfast nooks, boats, trailers and all the millions of automobiles in America. Yes, you learn all this and more! When we finish teaching you, (in your own home in your spare time) and when you get our California state approved diploma, you **know** this business . . . as a real professional! You will then have one of the most fantastic moneymaking skills in America built into your head and hands! No one can ever take this skill away from you . . . and no one can ever fire you, because **you're the boss** of a business that you can take with you . . . You can make big money from then on . . . any time, anyplace you want to put out your shingle!

When you read the papers you see there's a strike here, a lockout there. Detroit lays off 150,000 men. A plant is shut down and moved out of state. A new automated machine eliminates 5,000 jobs. They talk about dislocated workers and try to do something about it. What pays the bills if you get caught up in one of these situations? When you know upholstery, life gets very simple and lots of fun. It's simple because where there are people, there are upholstery jobs and lots of them. It's fun because life is fun when the bills are paid and there's money in the bank, even enough to buy those things you've always wanted for yourself.



YOU GET SIX BIG FURNITURE KITS FREE



YOU GET THIS AUTHORIZED DIPLOMA WHEN YOU GRADUATE

MUI IS APPROVED BY THE CALIFORNIA SUPER-INTENDENT OF PUBLIC INSTRUCTION AND IS AUTHORIZED TO ISSUE A DIPLOMA IN UPHOLSTERY.

MODERN UPHOLSTERY INSTITUTE
Box 899-DTF Orange, Calif. 92669

Name _____ Age _____
Address _____
City _____ State _____ Zip _____

WORK THE HOURS YOU LIKE TO WORK!!

If you favor a regular 35 hours a week, upholstery lets you do it and make a really fine living. On the other hand, if you're really ambitious and want to work 60 or 70 hours a week, you are starting to talk about some big, big money! The important thing is that the choice is yours, not somebody else's! (Not like when you're working for someone else.) Many students of retirement age just do a few pieces now and then just to keep things nice and comfortable.

TO GET STARTED, JUST GET THE COUPON IN THE MAIL . . . TODAY!

It costs you nothing to get the information and there's no obligation. No salesman is going to call you. This much and this much only, every successful MUI graduate must do for himself — send the coupon today!

YOU'LL GET A BIG ILLUSTRATED 32 PAGE BOOK ON UPHOLSTERY

and the upholstery business, and an actual free sample lesson showing how the fabulously successful MUI system is taught. For your sake and the sake of your future, do it now. Cut out the coupon, fill it out, put it in an envelope and mail it now. Air mail reaches MUI about two days sooner!

ALL THE SPECIAL "TOOLS OF THE TRADE" ARE YOURS . . . FREE

THIS FREE UPHOLSTERY BOOK may be the most important information you ever read.

MAIL COUPON NOW!

MODERN UPHOLSTERY INSTITUTE, Box 899-DTF Orange, Calif. 92669

Please send the FREE UPHOLSTERY CAREER BOOK, the FREE SAMPLE LESSON. I understand I am under no obligation whatever and am just sending for the free facts on job and career opportunities in Upholstering and the MUI home training program. I understand that no salesman will call.



APPROVED FOR VETERANS

**MY SPARE TIME HOBBY
MAKES ME**

**\$500 an hour
CASH PROFIT**

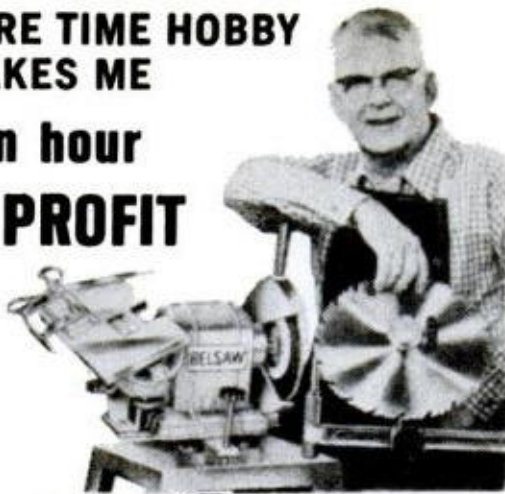

START YOUR OWN SPARE TIME BUSINESS
You can turn your spare time into Big Cash Profits with your own COMPLETE SHARPENING SHOP... Grind saws, knives, scissors, skates, lawn mower blades... all cutting edges. Your Own Cash Business with no inventory... right at home... no experience needed. **FREE BOOK** tells how you can start your own spare time business while you are still working at your regular job. Low Cost—time payments. **FREE BOOK**

BELSAW SHARP-ALL CO., 711J Field Bldg., Kansas City, Mo. 64111
Send Free Book, "LIFETIME SECURITY." No obligation.

Name _____
Address _____
City _____ State _____ Zip _____

**THE
WALL
FIXER®**

BEST HELP YOU CAN FIND FOR FAST PATCHING JOBS. READY-MIXED. WHITE. SMOOTH SANDING, **DAP SPACKLING** SPREADS EASILY, FILLS CRACKS, HOLES, JOINTS IN PLASTER, WOOD AND WALLBOARD.



**vinyl-paste
SPACKLING**

DAP Inc., Dayton, Ohio 45401 / SUBSIDIARY OF Plough, Inc.
In Canada: DAP-DURATITE LTD., Toronto 10, Ontario

LETTERS

(Continued from page 8)

ing, and the fact that only six months of spare time was required to complete it attests to the fine quality of PM plans.
INGLESIDE, ONT. MORRIS MASTERMAN

Any other readers who'd like to build that houseboat can still get plans for \$10. (Ask for plan B201A.) There's another plan, too—B1247—for \$24.50. That boat appeared in our Jan. '69 issue, page 158. Order either plan from Popular Mechanics, Dept. JL, 224 West 57th St., New York, N.Y. 10019.

Nothing quite like it

After reading the *AMC Hornet Owners Report* (page 124, Sept. PM), I have a feeling that the author took a couple of samples and made up the rest while he sipped some martinis.

No Hornet could be half as good as he pictured it, but then, maybe those on the West Coast were assembled by capable Japanese hands in Japan while mine on the East Coast was slapped together in Canada. So far, my \$2800 mess has been in the shop seven full weeks and four full days.

In my 60 years, I have never had a new car quite like it.
NEW CASTLE, DEL. CHARLES HOFMANN

Right to fly

As a private pilot, I appreciated very much your article, *Will You Lose Your Right to Fly?* (page 88, Oct. PM). Having read many biased and inaccurate articles elsewhere, it is refreshing to find this one so accurately and succinctly presented.

Of course, I can understand public hysteria resulting from very tragic aviation accidents, yet I cannot believe these same critics of private aviation would propose, as the result of an auto-bus collision, that our paved highways be exclusively used by commercial transportation.
NASHVILLE, TENN. ROY A. MILES JR.

Too fast in fog

Your article, *Too Fast In Fog* (page 84, Sept. PM) brought back painful memories of the time I too got caught up in the chain-reaction collision in a fog.

Your article said something should be done. It seems not much is being done about the dangerous fogs on the highways. The accident I was in happened almost two years ago!
BIRMINGHAM, ALA. ROSEBELLE GREENBERG

THIS IS A TRUE STORY*

All details in our file #3789. Only the name of the Universal graduate has been changed to respect his desire for privacy . . . Ed.

HOW TED VERNON AVERAGES \$20,000 WORKING 6 MONTHS A YEAR

**NO COLLEGE!
NO EXPERIENCE!
NO SELLING!**

When Ted Vernon* walked to a mailbox that day, the things he wanted seemed far beyond his reach. Like lots more money, freedom from his dead-end job, independence and security, a new future.

Chances looked dim. Ted had no college. His only experience was his old job. And he was already past 40.

Yet, when Ted Vernon mailed his envelope, everything he dreamed of became possible. All he did was mail a coupon like the one below.

Free book put Ted on road to big income

The coupon brought Ted the same fascinating Free Book you can have in just a few days. It tells about opportunities all around you in the booming Accident Investigation field.

It was all new to Ted. He'd hardly even heard of Accident Investigation. Yet he felt he had found his perfect opportunity.

And he had! His first full year he made \$14,768.72. Since then he's averaged \$20,000 working about six months a year. The rest of the time he just relaxes and takes it easy.

He learned secrets of success in 30 minutes

Ted skimmed through Universal's Free Book in 30 minutes. He learned three big points that changed his life.

- Accident Investigation is a \$19 billion dollar industry safe from layoff, recessions and automation.
- More and more men are urgently needed to investigate and settle some 22 million accidents each year.

● Universal's training-by-mail has been the path to success for thousands of men in this high-pay field, mostly men with no college and no experience.

It was the opportunity of a lifetime. Ted enrolled for Universal's correspondence training at the mere cost of cigarette money.

It was easy. Ted simply studied his brief, interesting lessons at home in his spare time. He kept right on with his old job until he could start making money quickly in Accident Investigation.

Ted Vernon's income is unusually high and not typical of the industry. He's a busy specialist in storm loss adjusting. But it does show the big potential in this great field even for men with no college and no experience.



READ WHAT RECENT STUDENTS SAY:

"My income averages \$1,200 to \$2,000 a month."

—Ed Crouch of California.

"Thanks to you, I was contacted by 17 top companies."

—Donald Doris of Illinois.

"A raise every three months for the next two years, plus new car and expense account."

—Oscar Singletary of Georgia.

Send for your free opportunity book today

Mail coupon below to get your copy of the Free Book that started Ted Vernon to new big-money success. Read about the exciting full time or part time opportunities, about other successful Universal students, about Universal's Free Placement Service, and how to start your own full or part time business.

But act quickly. Take the first step to the big money field. Mail your coupon today.

MAIL NOW FOR YOUR BIG, FREE BOOK

Universal Schools, Dept. PM-1
6801 Hillcrest, Dallas, Texas 75205

Please rush my Free Book on earnings and opportunities in Accident Investigation. No obligation. No salesman will call.



Name _____ Age _____

Address _____

City _____ State _____ Zip Code _____



APPROVED FOR VETERANS' TRAINING
Accredited Member National Home Study Council

This Fully Automatic ELECTRIC ADDING MACHINE

GIVEN TO YOU! when you train at home with us for a **BIG INCOME CAREER in ACCOUNTING**



Train now at home in spare time for one of 1000s high pay prestige positions open to Accountants. Or open your own accounting practice.

Accountants move up fast in business... more corporation presidents got their start in Accounting than in any other field. As an Accountant you'll be an "insider" on your company's management team... the confidential data you develop will be essential to making major corporate decisions and even to handling daily company affairs. The demand for Accountants far exceeds the supply as more than 5 million U.S. firms need financial statements, bookkeeping systems, etc. to operate daily. Our exclusive "Computer Age" Accounting Course is the *only* home-study plan that shows you step-by-step how to take advantage of computers to simplify work... to make your financial data more complete... to make you more valuable to company management.

You Learn both Manual and Computer Accounting



You work actual problems with our IBM Computer to learn exactly what information you must "feed" the computer... you learn how to interpret "print out" data our computer returns to you... you qualify for one of 1000 "Big Future" Careers awaiting trained Accountants. Whatever your previous experience or education... we show you how!



Mail Coupon for FREE "ACCOUNTING CAREER KIT"

... including 20-Page CAREER FACT BOOK, "Your Future in Computer Age Accounting" and Self-Scoring Aptitude Test—ALL FREE! No salesman will call.

NORTH AMERICAN SCHOOL OF ACCOUNTING, Dept. 14171
4500 Campus Dr., Newport Beach, CA 92663

Rush "Accounting Career Kit" — ALL FREE.

NAME _____ AGE _____
ADDRESS _____
CITY _____ STATE _____ ZIP _____

WOOD EVERYTHING FOR THE WOODSHOP TOOLS-SUPPLIES



World's Largest Selection of Finest Domestic and Imported Hardwoods, Veneers, Hardware—
at MONEY SAVING PRICES

Over 2000 items! Your money saving hardwood and woodshop buying guide. We've added new Clock kits, wood picture kits, musical instrument kits, many more. Complete selection of hard-to-find hardware, lamp and upholstery supplies, etc. Big savings on name brand power tools. Send name, address and 35¢ for handling and postage to:

CRAFTSMAN WOOD SERVICE CO.
DEPT. A-11
2729 S. Mary St., Chicago, Illinois 60608

New Catalog!
Write Today!...



LEARN SURVEYING — PUT YOURSELF ON THIS HIGH PAY SURVEYING TEAM! Get in on planning of highways, bridges, dams, etc. U.S. Bureau of Labor Statistics predicts shortage of 50,000 civil engineering technicians (Surveyors, etc.) by 1975. Easy home-study plan trains you. Send for FREE "SURVEYING CAREER KIT." State your age. North American School of Surveying & Mapping, 4500 Campus Drive, Dept. 14171, Newport Beach, CA 92663.

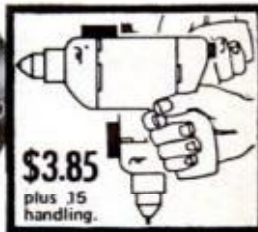

DRILL IT STRAIGHT EVERY TIME WITH DRILL-ALIGN

- WORKS ON ANY DRILL
- VERTICAL OR HORIZONTAL
- EASILY MOUNTED
- SHOCK PROOF
- NOTHING ELSE TO BUY

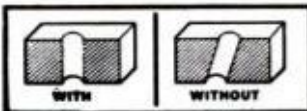

PROVEN PRODUCTS CO. 19644 Ventura Blvd Tarzana, Calif 91356.

"LISTEN IN" TO POLICE-FIRE RADIO CALLS IN YOUR CAR!

WORKS with ANY CAR—Portable or HOME RADIO! Just PLUGS in—No wiring—3 minute hookup! Switch instantly from regular to ALL POLICE-FIRE-EMERGENCY-COMMERCIAL-TAXICAB-STATE-CITY-GOV'T 2 way Radio calls in YOUR AREA. DUAL-HI-LOW BANDS—OVER a MILLION Radio Cars/stations. USE Everywhere—anytime—always works!



SEND ONLY \$2.00 (cash, Ck., M.O.) and pay postman \$7.99 plus COD. pstg. or send \$9.99 for ppd Del in USA. COMPLETE, ready to use with instructions. One Year service Warranty—10 DAY MONEY BACK TRIAL (if retnd). AMAZING OFFER good only by mail—WESTERN RADIO Dept. BPM-1 KEARNEY, NEBR. 68847



BEFORE AFTER

Beautiful any wall in your home with our easy to use brick design kit. Ideal for accenting walls, recreation rooms, entire basements; uses unlimited. So fast and easy to use, anyone can do it. Average wall can be done in your choice of color for less than \$3.00. with texture like that of real brick. Limited supply. Send \$8.00 immediately for your designing kit and instructions.

DAVID LAND, DECORATING DEPT.
2005 Belle Ave., Davenport, Iowa, 52803

SAVE HUNDREDS OF DOLLARS

 BLACK FOREST CLOCK Handcarved in Bavaria. Weight driven movement. \$1.84	 ELECTRIC MASSAGE SET Special attachments for scalp, body and face. \$1.50	 8mm MOVIE CAMERA Electric powered no winding! Loads in seconds. \$5.50	 JADE RING 79¢ Hand set in delicate mounting. Men's styles also available.	 DUTCH MOTORCYCLE Deluxe Springmaster model for sporty appeal. \$113.00	 ELECTRIC GUITAR Rugged construction for true amplification. Great electronic sound. \$7.40	 CASSETTE TAPE UNIT Snap in cartridge ready to play. From \$7.50	 FLASH CAMERA 55¢ For indoors or out. Black and White or Color.
 REAL SAPPHIRE RING Sterling Silver mounting. Men's styles also available. \$3.50	 LAMP RADIO Combination Hi-Intensity Lamp and six transistor radio. \$5.95	 INTERPHONE SET Closed circuit telephones for home or office. \$2.40 for two	 CALENDAR WATCH Swiss movement. Tells time and date. \$2.10	 FIELD GLASSES 7 x 35 G.C.F. Clear and powerful. Center focusing. \$2.10	 ELECTRIC HAIR DRYER Feather weight. Whisper quiet. Great for men, too. \$1.50	 FRENCH PERFUME Many delicate fragrances to choose from. 1/3 to 1/2 oz. bottles. 85¢	 MEN'S BRIEFCASE Executive style with compartments. Light weight, easy action zipper. \$1.00
 30 POWER TELESCOPE & TRIPOD Sturdy Metal Construction. \$1.94	 ELECTRIC RAZOR Product of Swiss Craftsmanship. Maker guarantees one full year. \$1.70	<h1>67 FANTASTIC VALUES!</h1> <h2>Buy Below Wholesale</h2> <h3>AT PRICES SHOWN HERE</h3>		 RIVIERA BIKINI American girls go wild over European Bikinis. Exclusive styling from continental designers. \$1.75	 FISHING KITS Sectional bamboo spinning and fly rod. Flies, hooks and lures in wooden carrying case. \$3.30		
 ELECTRIC CARVING SET Self contained power. Two stainless steel blades. \$1.50	 MINK COAT Full length Mink coat from Scandinavia. \$333			 SIMULATED PEARLS 7¢ Fourteen inch strands. Translucent quality. With clasp.	 AUTO VACUUM Compact car Vacuum works off cigarette lighter. Adjustable nozzle. \$1.80		
 58 TENNIS RACKETS Laminated hard wood. Nylon string. Precision balanced. \$1.50	 WIRELESS INTERCOM Amazing set operates thruout home, office, farm without wire. \$4.95	 ADDING MACHINES Famous design for home and personal use. 9¢	 FLASHLIGHTS Bright reflector ideal for outdoor or recreational use. 10¢	 TIGER EYE RING Genuine Sterling Silver mounting. \$1.85	 OLD WORLD CLOCK \$5.00 Clear plastic dome guards German craftsmanship. Great decorator item.	 PHONOGRAPH Portable battery operated. Great for mountains or beach. Three speeds. \$3.50	 ELECTRIC CAN OPENER Powerful. Automatic. Opens any size can. \$3.45
 BEDFORDLEX CAMERA Twin lens reflex. Ready to shoot in seconds. 50¢	 ELECTRIC TRAIN SET Sixteen piece set. Battery operated. Great for kids. \$1.50	 RAINCOATS Plastic Raincoats for men and women. Clear or color. Carry in your pocket. 9¢	 HI-INTENSITY LAMP Rotates in full circle. Ideal for reading, hobby work, sewing. \$1.86	 TELEPHONE AMPLIFIER Transistorized. Hear phone conversation across room. \$3.10	 CAR SPOTLIGHT For six or twelve volts. Extra long cord. Pistol grip. 50¢	 BURGLAR ALARM For office or home. 39¢	 BICYCLE Man-size, latest style, powerful frame. \$16.
 NYLON TIP PENS Fast seller at a fraction of the regular cost. All colors available. 10¢	 HAND-BEADED SWEATER From Hong Kong. Beautifully fashioned. \$5.85 ea.	 TEAKWOOD BOX 90¢ Handcarved from India. Beautiful finish, lift up lid.	 STEAK KNIFE SET Six pieces. Stainless steel serrated blades. Only 31¢ set of six.	 BLACK FOREST WEATHERHOUSE Handcarved weather station. Predict bright, sunshiny or rainy days. 75¢	 ELECTRIC TOOTHBRUSH Four nylon bristle brushes. Battery operated. Up and down action. 45¢	 BEADED HANDBAGS Delicate hand-beading on satin bag. Many colors. 89¢	 MOVIE PROJECTOR 8mm Movie Projector. Battery operated. Built-in screen. \$1.60

1000's of dazzling imports like these help you, spare or full time, start your own **BIG PROFIT HOME IMPORT BUSINESS**

Start fast! See how easy I make it for you! Without previous experience or product investment I'll start you in your own big profit Home Import Business. Cash in quickly. Import bargains I locate for you give profit opportunities beyond your wildest dreams. You can make your first import transaction 10 minutes after you get my proven drop ship plan. Everything done for you;

nothing left to chance. These fantastic bargains go fast to stores, mail order operators, premium users, friends, others. Start anywhere; age no barrier. You've seen amazing import bargains I have shown in my "Passport to Profit" TV series...now I'll tell you how to cash in on my import "finds" from overseas!

Mail This Coupon Today! Get My Free Book!



B. L. Mellinger, Jr.
Famous World Trader, President, The Mellinger Co.

Send No Money!

Do not order from us. I show you how to get these bargains and hundreds of others. Prices shown are direct from suppliers abroad.

Coupon brings details about **8 FREE IMPORTS**

DISCOVER PROFITS of IMPORT!

You keep all the profits yourself! My Plan reveals everything you need to step into your own home business at once. You get free membership in International Traders—exclusive world-wide organization that puts you in direct personal contact with suppliers abroad. It is easy to buy below wholesale for yourself or for profit when I show you how. Rush coupon for my FREE BOOK, "How to Import and Export." Get details on amazing buys. No salesman will call. Airmail reaches me overnight.



THE MELLINGER CO., Dept. E2251
1554 S. Sepulveda Blvd., Los Angeles, CA. 90025
Send free Book showing how I can buy imports below wholesale. Show me how to start a business of my own and make big profits. (If under 21, state age).

Name _____ Age _____
Address _____
City _____
State _____ Zip _____

Save 3 Days... Give Zip No. For Fastest Reply

- More examples of 1000s of import bargains you can get to make fantastic profits up to 200% and more.
- | | |
|-------------------------------|--------------------------------|
| Transistor Radio . . . \$1.50 | Singing Bird Cage . . . \$3.75 |
| Fishing Rod50 | Golf Balls09 |
| Movie Title Kit . . . 1.00 | Badminton Set60 |
| Water Pistol05 | Beer Stein28 |
| Swords3.00 | 20 pc. Dinnerware . 1.25 |
| Spinning Reel96 | Leather Ball Glove . 1.25 |
| Cardigan Sweater . . 2.00 | AM FM SW Radio . .10.50 |
| Walkie Talkie 2.50 | Rifle Scope1.85 |
| Cigarette Lighter . . .20 | Diamond per Ct. . .90.00 |
| Model Boat Kit65 | Electric Shoe Shiner 1.50 |
- Prices subject to availability, price fluctuation.

The Mellinger Co., Dept. E2251, 1554 S. Sepulveda Blvd., Los Angeles, CA. 90025

WHAT'S NEW OUTDOORS

BY ROB KINSON

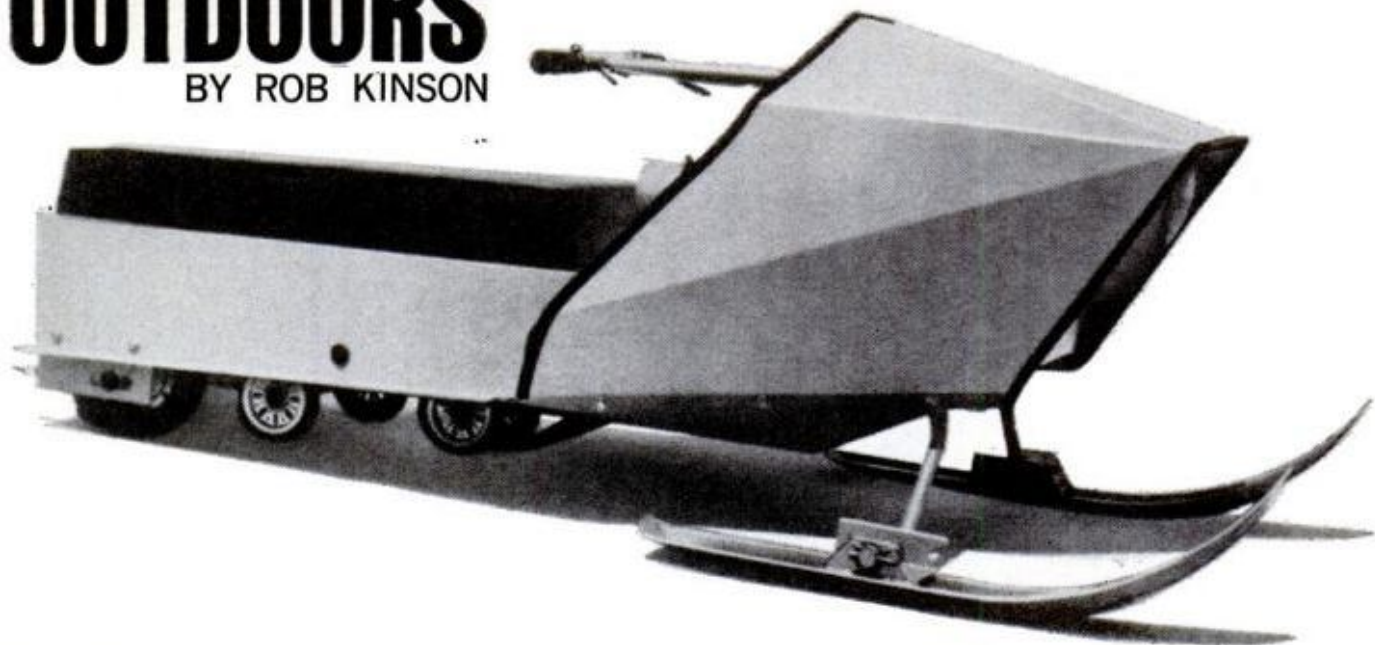

PUT TOGETHER your own snowmobile with the "Sno-Skoot" kit by C. F. Struck Corp., Cedarburg, Wis. Available only by mail, the vehicle can be put together at home in less than three hours. It weighs approximately 180 pounds, runs on a 15-

inch urethane track and will carry an adult or two mature children at 20 mph. With four-cycle engine, the kit is priced at \$275 (5 hp) or \$298 (7 hp). Plans illustrating construction with kit parts or local materials, \$5 per set.

AN INSULATED rescue sheet, "Soehngen," could save a life in an outdoor emergency. The tearproof foil has a silver metalized surface on one side and is coated yellow on the other to conserve body temperature, protect from all weather and sun radiation and reflect light to aid rescue or protect from cars on a highway. The "disposable blanket" is 86 in. x 55 in., weighs only 1 $\frac{3}{4}$ oz. and folds up to the size of a pack of cigarets. The rescue sheet is available from Allen International, 1352 Murray Ave., Plainfield, N.J. 07060, for \$3.



GOLFING ENTHUSIASTS now can put to good use those long winter weekends waiting for the snow to melt on the greens. With "Golf Iron Pro Shine" you can clean dirt, stain, grass, corrosion and contamination from your irons, thus restoring the shine of the plating. The light blue liquid comes in a 12-oz. (\$2.95 ppd.) or trial-size plastic container (\$1.25 ppd.), and the package includes a pure bristle brush—the only tool needed to do the job. From Elless Co., Ltd., 5849 Ranchito Ave., Van Nuys, Calif. A leaflet, *Care and Maintenance of Golf Clubs*, is free for the asking.

A TIP from noted outdoorsman Pete Alport: Don't envy the hunter with the \$60 down-filled outer coat. The best deal is the proven system of layers—mesh underwear next to your skin, then an old tee shirt, then a turtleneck and a wool shirt. Add thin wool sweaters, an outside windproof, water-repellent jacket and you're set for conditions from 40° above to 40° below. You can start out in the morning when it's really cold with everything on, and gradually peel off layers as the sun warms you. You have comfort flexibility without an expensive jacket that doesn't change with temperature. ★★★

HOW WE WON THE AIR WAR IN WORLD WAR II

The story of the B-17's and the men who flew them

TO MOST MEN who flew her in World War II, the B-17 was "lady luck" herself. They gave her names like Susie-Q and Rosie. But to the enemy she was a devil in the sky. You'll see why — in this gripping story of the plane and her scrappy brave flyers . . . illustrated with hundreds of photographs. (If you were in the Air Force, many startling candid shots will have personal meaning for you.)

Flying Fortress takes you on bombing missions over Europe and the Pacific . . . on day and nighttime air raids of Leipzig, Cologne, Cassino, Berlin, Tokyo. You'll find out • How a personality clash almost kept the first B-17 from getting off the drawing board • Why one of the best spare parts for the B-17 was an empty tin can • What happened when the German high command marked the U.S. 100th Bomb Group for special extermination . . . for breaking the "gentlemen's agreement" of aerial combat • How a B-17 crew member found himself hurtling through space in a flying tail section — without a plane — and *glided safely to the ground!* • How a B-17 returned from a bombing mission in one piece — *but without a pilot!*

Flying Fortress illuminates the history of the air battles of the Second World War as no other book can. Take it, if you wish, as one of your 4 introductory books, along with trial membership.



B-17 TAIL-GUNNER READY FOR ACTION



CREW MEMBERS OF "ROSIE'S RIVETERS"



B-17's CROSSING THE ENGLISH CHANNEL

U.S. AIR FORCE PHOTOS



EXTRA FEATURES:
 ■ Original Blueprint Drawings of the B-17, from wings and fuselage to engines and guns.
 ■ Pilot's Training Manual—how to fly the B-17. Even how to ditch it.

FLYING FORTRESS
 The Illustrated Biography of the B-17's and the Men Who Flew Them • by EDWARD JABLONSKI

875. FLYING FORTRESS. Edward Jablonski. Pub. ed. \$9.95

The Military Book Club invites you to take

Any 4 books for only 98¢

if you join now and agree to accept only 4 selections or alternates during the coming year



895. The United States Marine Corps in World War II. Ed. by S. E. Smith. 965 page anthology. illus. Pub. ed. \$17.95
 893. A Leap to Arms. Jack Cameron Dierks. Incredible story of our "splendid little war" with Spain. Pub. ed. \$6.95
 307. Marshal Zhukov's Greatest Battles. Outspoken memoirs detail big U.S.S.R. W.W.II victories. Pub. ed. \$6.95
 871. The Two-Ocean War. Samuel Eliot Morison. Story of U.S. Navy in action from 1939 to V-J Day. Pub. ed. \$15.00
 026. The Arms of Krupp. William Manchester. Rise and fall of Germany's munitions dynasty. Pub. ed. \$12.50



894. The Mighty Endeavor. Charles B. MacDonald. W.W. II battles from North Africa to V-E Day. illus. Pub. ed. \$12.50
 887. Richthofen: A True History of the Red Baron. William E. Burrows. Exploits of W.W. I air ace. Pub. ed. \$6.50
 213. The Longest Day. Cornelius Ryan. Hour by hour account of D-Day invasion, from both sides. Pub. ed. \$7.95
 874. Battles Lost and Won. Hanson Baldwin. N.Y. Times military editor analyzes W.W. II campaigns. Pub. ed. \$10
 885. Iron Coffins. Herbert A. Werner. German U-boat captain's memoirs of submarine warfare in W.W.II. Pub. ed. \$7.95

Look over the books described on this page. You won't find a listing like it in any other book club. THE MILITARY BOOK CLUB offers you an exciting range of books on hot wars and cold ones. Important combat biographies and revealing memoirs. Significant books on military history and international affairs. Savings are always substantial, too. On the average, 30% below publishers' edition prices, plus shipping and handling.

You're invited to try the Club on a trial-membership basis. Simply choose any 4 books (including, if you wish, *Flying Fortress*). They are worth up to \$50 in the original publishers' editions. Take them all for only 98¢, plus shipping and handling. But send no money now. Examine the books for 10 days without charge and keep them *only if you're delighted*. The Military Book Club, Garden City, N.Y. 11530.

Book Club editions are sometimes reduced in size, but they are all full-length, hard-cover books you will be proud to add to your permanent home library.

The MILITARY BOOK CLUB
 Dept. 11-PTX, Garden City, N. Y. 11530

Please accept my application for membership in The Military Book Club and send me the 4 books whose numbers I have printed below. Bill me 98¢ (plus shipping and handling) for all 4 volumes.

Each month new selections will be described in advance in the Club's monthly bulletin, *Battles and Leaders*. If I do not wish to receive the monthly selection, or prefer an alternate, I simply give instructions on the form provided. I need take only 4 selections or alternates in the coming year, at average savings of 30%, plus shipping and handling, and may resign any time after purchasing 4 books.

NO-RISK GUARANTEE: If I am not delighted with the introductory shipment, I may return it within 10 days and membership will be canceled. I will owe nothing.

Mr. _____
 Mrs. _____
 Miss _____ (please print)
 Address _____
 City _____ State _____ Zip _____

If under 18, parent signs here _____
 Members accepted in U.S.A. only. **1-M8B**

FIX your appliances,
car,
house,

SAVE

on home improvements,
air conditioning,
power tools and more

WITH THIS
FREE \$3.49
VALUE
GIFT VOLUME

Just look back over the past few years and figure how much you have spent on repairs for your home, your car, your appliances. Wouldn't you like to keep these high-priced repair fees for yourself? Well, now you can.

As a reader of *Popular Mechanics* the chances are that you already have a considerable degree of skill with tools. Nevertheless, you may have hesitated to tackle more complicated repairs, improvements or hobby projects.

Now, however, this FREE Book—packed with the combined skill and know-how of 257 *Popular Mechanics* expert editors, consultants and designers—can put a professional edge on your do-it-yourself skills.

The most difficult jobs will soon become easy

Before you know it, you'll be able to fix car engine troubles... transform unfinished attic space into an extra bedroom... catch more fish using homemade lures... learn "tricks-of-the-trade" in handling power tools... save hundreds of dollars when buying and servicing appliances.

These are just a few of more than 6,000 exciting "how-to" ideas, plans, and valuable projects you'll find in **POPULAR MECHANICS DO-IT-YOURSELF ENCYCLOPEDIA**. You'll learn how to get more professional-looking results than ever before in your carpentry, metalwork, plumbing, masonry, electrical wiring, electronics, hi-fi, stereo, car repair, painting, decorating... PLUS exciting new ways to help you get more fun out of your hobbies, sports, vacations. Experts lead you step-by-step through every project you select. Without question, here is the most helpful, reliable, "how-to-do-it" guide you've ever seen—and Volume 1—a \$3.49 value—is yours ENTIRELY FREE!

You risk nothing on this FREE Book offer!

As soon as your gift book comes, browse through it—try some of the exciting ideas—use some of the money-saving tips. We're sure you'll get so much valuable help from this book, you'll want to see the other volumes as they are published. You can see future volumes without risk—on a 14-day FREE TRIAL basis. But this first volume is yours as an outright gift—whether you buy one, two, five, the whole set, or none at all. But please hurry. Our supply of gift volumes is definitely limited. To be sure of getting your copy FREE, mail the coupon today.

Here is a brief glimpse of all your FREE Volume brings you:

- Fix 8 common car engine problems and save garage fees
- Save money air conditioning your entire home
- Cure a wet basement and save \$200 to \$2,000 under what professionals charge
- Burglarproof your home with special power alarm
- Professional tips for expert sanding
- Learn arc welding basics in 6 hours of easy practice
- How to save on band saw blade costs by making your own
- Build a gas-fired barbecue for more back-yard fun

PLUS much, much more

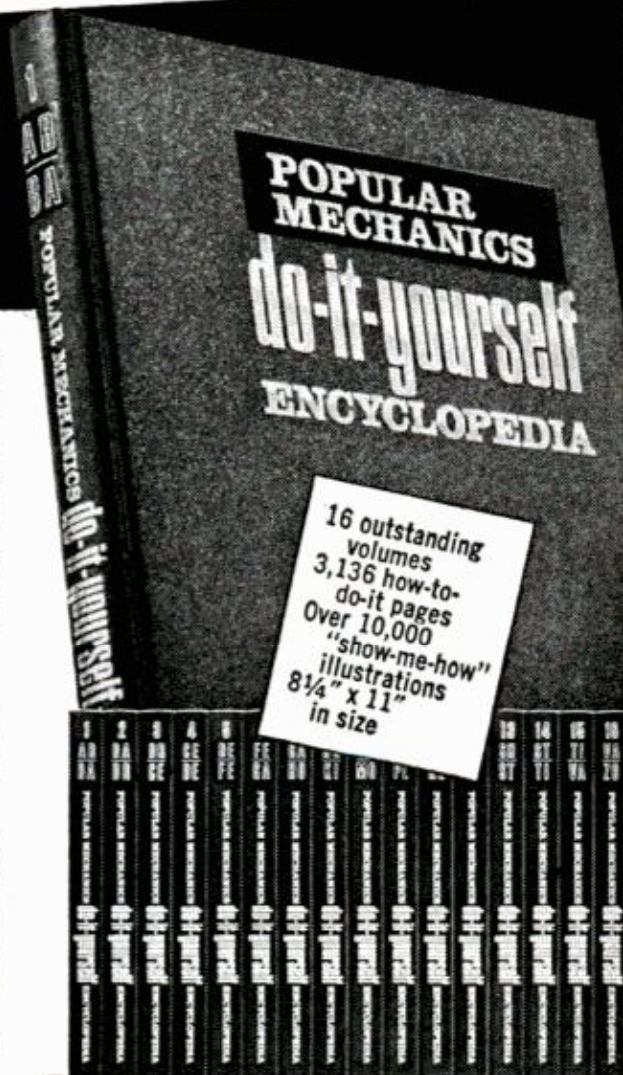

MAIL COUPON TODAY!

Popular Mechanics Book Division, Dept. B011
250 West 55th St., New York, N.Y. 10019

Please send, entirely free, Volume 1 of the new, illustrated **POPULAR MECHANICS DO-IT-YOURSELF ENCYCLOPEDIA**. I'm not obliged to buy anything—now or later—but am entitled to receive additional volumes (including future Yearbooks), on approval as published each month. After examining each volume free for 14 days, I either return it and owe nothing—or keep it and remit low subscriber price of \$3.49 a volume, plus shipping. I reserve right to cancel any time—without obligation. Whatever I decide, Volume 1 is mine to keep free!

Name _____
(Please Print)
Address _____
City _____
State _____ Zip _____
Signature _____

This offer available in Canada at a slightly higher price. Canadian residents mail coupon to New York address. Shipment of books and all services will be handled within Canada.

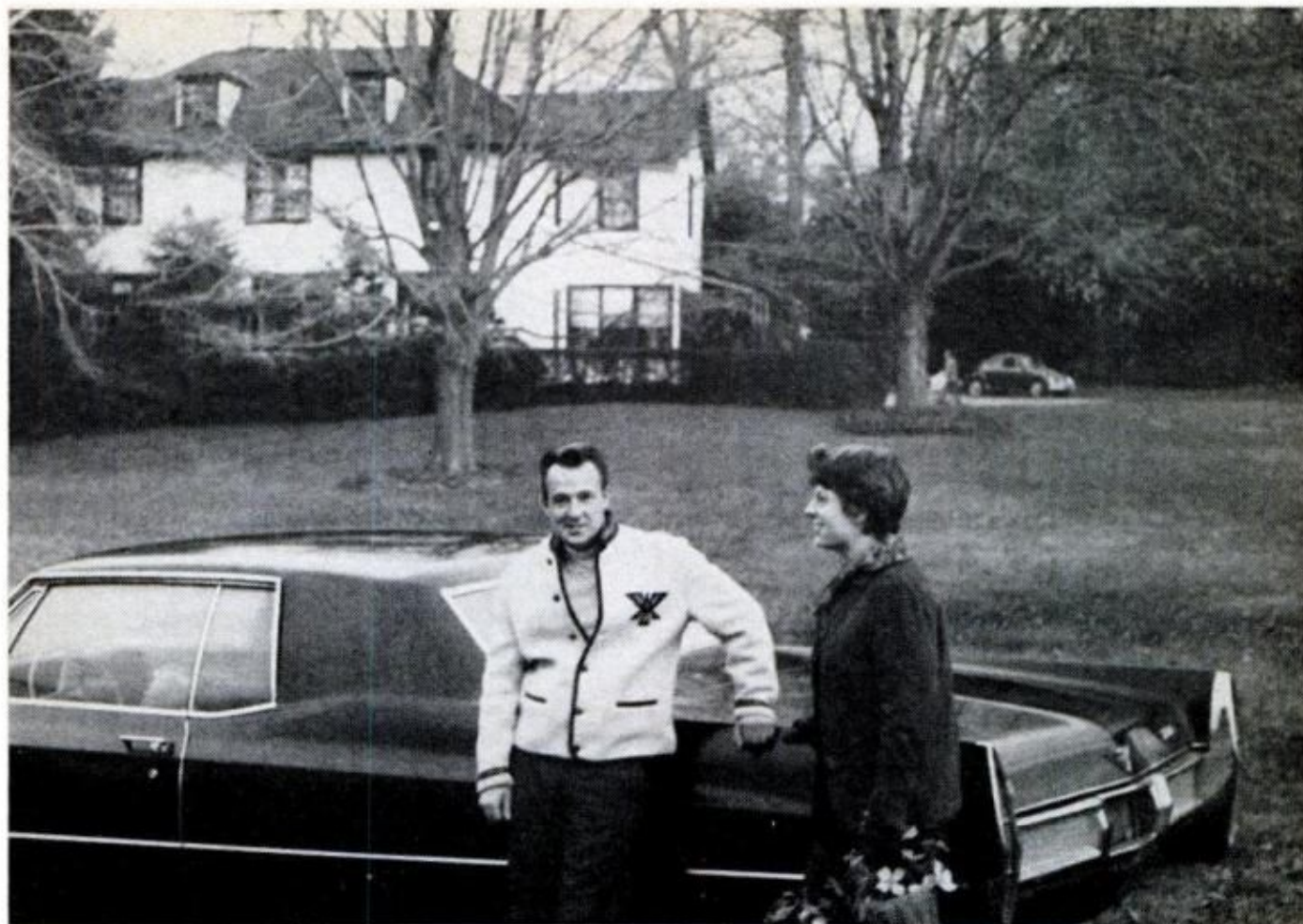

© 1970 LaSalle Extension University, A Correspondence Institution

The Accountant. You should earn his salary.

Learn how to become an Accountant in your spare time.

You are looking at an influential and often envied man in the world of business.

He is a special kind of authority. He usually knows more about a firm's financial affairs than anybody short of the highest company officers. There's hardly a single major decision made without calling on him for advice.

Obviously he is worth a lot of money—and he gets it.

Why don't *you* become an accountant?

Of all the professions, few offer a greater welcome to newcomers than the accounting profession. That's because there are frequently more fine positions open than there are trained people to fill them.

Do you know that, regardless of your present position or previous experience you can learn to be an accountant—or add accounting to your qualifications for advancement—through spare-time home study?

With the low-cost training offered by LaSalle, you study in privacy, during hours of your own choosing, without the need for travel or for taking time from your own job.

Your lessons are mailed to you. LaSalle's CPA-supervised faculty starts you right at the beginning, explains basic accounting principles and methods, gives you actual accounting problems with your lessons, then corrects and grades your work. By the time you are finished, you are well prepared for the major accounting tasks you will be expected to handle in the business world.

LaSalle has been a leader in home study for over 60 years. It has enrolled more than 2,000,000 students in that time. That is why a LaSalle diploma is a recognized and respected credential.

If you are truly seeking a more rewarding career with higher pay, a solid position in the business

world and the good things that affluence can buy, you owe it to yourself to read LaSalle's famous booklet "Opportunities in Accounting." Send for a free copy. You will also receive a free sample lesson in accounting which will demonstrate how LaSalle makes home study interesting and practical. No obligation. Mail attached card or write LaSalle, Dept. 61-056, 417 S. Dearborn Street, Chicago, Illinois, 60605.

Mail card for
FREE booklet
and sample
lesson



Twenty-one small explosions and four bigger ones will be set off on the moon's surface next month if the Apollo 14 landing goes according to plan. The blasts will create seismic waves that will be recorded and measured by automatic devices. Relayed to Earth, the measurements will provide scientists with new information on the shape, structure and thickness of the moon's outer crust. The 21 small explosions will be made by use of a "thumper"—a 42-inch-long tube that will be pressed against the lunar surface, setting off a cartridge at the end of the tube. This task will be handled by lunar module pilot Edgar B. Mitchell while mission commander Alan B. Shepard Jr. sets up other experiments. After the astronauts have returned to the orbiting command module (piloted by Stuart A. Roosa), radio commands from Earth will fire a mortar set up by them. The mortar will hurl four high-explosive grenades as far as 5000 feet to send vibrations through the moon.

A study that rates toothpastes according to abrasive quality has been released by the American Dental Assn. for use by practicing dentists in advising patients. "A dentifrice should be no more abrasive than is necessary to keep the teeth clean—that is, free of accessible plaque (deposits from saliva and bacteria), debris and superficial stain," states the report. "The degree of abrasivity needed to accomplish this purpose may vary considerably from one individual to another." The study reports these dentifrices lowest in abrasive quality: T-Lak, Listerine and Pepsodent with zirconium silicate. Those found to be most abrasive include Walgreen's Smokers' Tooth Paste, Iodent No. 2, and Vote.

A remote-controlled parachute that can be guided to a selected landing site after deployment at transonic speeds has been developed by Atomic Energy Commission researchers. It's guided from a radio console similar to those used by model plane enthusiasts. Four flaps, actuated by cables, control the glide path and the parachute's tendency to roll. Without radio control, such a 'chute goes off target by about 150 feet for every 1000 feet of descent. With control, the error is reduced to 7 feet per 1000. The parachute, which can handle loads up to five tons, could be used to drop emergency supplies in remote areas or survival equipment to shipwreck victims.

The idea of using an icebreaking tanker to ship crude oil from Alaska's North Slope to the "Lower 48" has been "suspended" by the Humble Oil & Refining Co. In making the announcement, company officials said that a proposed trans-Alaska pipeline appears to be a more commercially feasible way to move the oil. Transportation has been the main stumbling block to the exploitation of the Alaska oil discovery made back in '68. In 1969, the Manhattan, a 115,000-ton, icebreaking tanker, made an historic voyage through the Northwest Passage to the North Slope. Though battered, the big ship returned to an East Coast port with a symbolic barrel of oil. The experiment cost about \$30 million.

What is the purest substance on Earth? It's ultra-pure germanium, say General Electric scientists who produce the metallic-looking material for use in devices that detect X-rays, gamma rays and other high energy radiation. The GE researchers claim the germanium has less than one atom of impurity in a trillion (the numeral one followed by 12 zeros). The ratio is comparable to having only one grain of table salt in a freight car full of sugar.

A computerized blood-bank system, which can give physicians instant access to information about donors, has been designed by Stanford University scientists. On command by a blood-bank clerk, the computer can scan the list of available donors, choose those with the right blood type, and print out the names of people to be contacted. ★★ ★

KEEP PACE WITH SPACE AGE! SEE MOON SHOTS—LANDINGS, SPACE FLIGHTS, CLOSE-UP!

AMAZING SCIENCE BUYS

for FUN, STUDY or PROFIT

**FREE
GIANT
CATALOG!**

1st QUALITY OPAQUE UNDER \$200



Stock No. 71.272H (Wt. 11 1/4 lbs) \$89.75 Ppd.

BLACK-LIGHT MIGHTY MITES

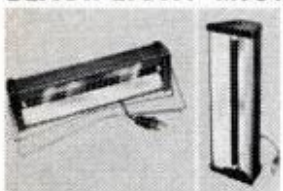

Stock No. 71.299H \$19.95 Ppd.

ECOLOGY KITS FULL OF LIFE!



Stock No. 70.199H \$8.75 Ppd.

AMERICAN MADE OPAQUE PROJECTOR



Stock No. 70.199H \$8.75 Ppd.

HOT-AIR FLYING SAUCER KIT



Stock No. 71.175H \$3.00 Ppd.

"FISH" WITH A MAGNET



Stock No. 85.152H \$33.60 FOB

MAIL COUPON FOR GIANT FREE CATALOG

148 PAGES! MORE THAN 4,000 UNUSUAL BARGAINS. Completely new 1971 Catalog. Packed with huge selection of telescopes, microscopes, binoculars, magnets, magnifiers, prisms, photo components, unique lighting items, parts, kits, accessories—many hard-to-get surplus bargains, 100's of charts, illustrations. For hobbyists, experimenters, schools, industry.

EDMUND SCIENTIFIC CO.
300 Edscorp Building, Barrington, N. J. 08007
Please rush Free Giant Catalog "H"

Name

Address

City State Zip

EDMUND SCIENTIFIC CO.

ASTRONOMICAL TELESCOPE KITS

See Pop. Mech. Feat. Article "The Sky's the Limit"

Grind your own mirror for powerful telescopes. Kits contain fine annealed pyrex mirror blank, tool, abrasives, diagonal mirror, and eyepiece lenses. Instruments you build range in value from \$75 to hundreds of dollars.

4 1/4" Dia. 3/4" Thick = 70.003H \$10.75 Ppd.
6" Dia. 1" Thick = 70.004H \$13.95 Ppd.
8" Dia. 1 1/4" Thick = 70.005H \$21.50 Ppd.
10" Dia. 1 3/4" Thick = 70.006H \$52.50 FOB

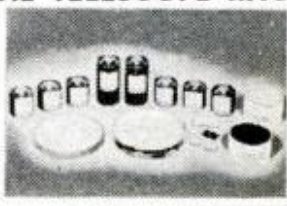

GIANT WEATHER BALLOONS

"Balls of fun" for kids, traffic stoppers for stores, terrific for amateur meteorologists. Create a neighborhood sensation. Great backyard fun. Exciting beach attraction. Amateur meteorologists use to measure cloud heights, wind speed and temperature. Made of heavy duty neoprene. Inflate with vacuum cleaner or auto air hose or locally available helium for high rise.

Stock No. 60.568H (8 Fl. diameter) \$2.00 Ppd.
Stock No. 60.632H (10 Fl. diameter) \$7.00 Ppd.

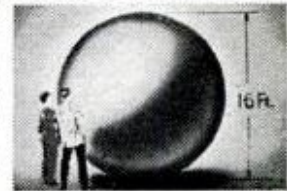

NEW MODEL DIGITAL COMPUTER

Solve problems, teach logic, play games with miniature version of giant electronic brains! Adds, subtracts, multiplies, shifts, complements, carries, memorizes. Colored plastic parts easily assembled. 12" x 3 1/2" x 4 1/2". Incl. step-by-step assembly diagrams, 32-p. instruction book covering operation computer language binary system programming, problems & 13 experiments.

Stock No. 70.683H \$5.98 Ppd.
ANALOG COMPUTER KIT
Stock No. 70.341H \$18.95 Ppd.



\$16.50 AIR POLLUTION TESTER!

1st low-cost survey-type instrument. Quickly provides quantitative results in threshold limit ranges set by Amer. Conf. of Gov't Industrial Hygienists. Sensitive, accurate, wide measuring range. Includes 2 ampoules each to test for CO2, CO, H2S, NO2 and SO2. Sufficient for 2 to 4 tests depending on concentration. Lightweight kit includes sturdy vacuum pump, coupling tubes, complete instructions with scales in determining results. Sets of 4 replacement ampoules available separately for \$4.75.

Stock No. 71.349H \$16.50 Ppd.



PLASTIC MODEL V-8 ENGINE

Hours of fun! Get thrill of building your own easily assembled engine from over 350 parts. Then push starter and watch it run. Crankshaft revolves, pistons move, valves open and close in sequence with spark plugs. Does everything but burn oil. 1/4 scale, molded in 4 colors. Used in many auto-mechanic courses. Excellent, easy-to-understand "tech manual."

Stock No. 70.448H \$13.50 Ppd.

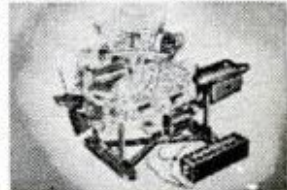

WAR SURPLUS ELECTRIC GENERATOR

Brand new Signal Corps Electric Generator. Generates up to 90 volts by turning crank. Use in high impedance relays. Charge ground & bring up night crawlers for bait or study. 2 Alnico Magnets alone now worth more than original gov't cost of \$15. Wt. 2 lbs.

Stock No. 50.225H \$8.50 Ppd.



1st LOW-COST-VACUUM PUMP!

Nothing like it! Top-quality hand-held pump produces & maintains 25" of vacuum. Has instant release tab. 1 1/2" diam. stainless gauge (0-30"). 100's of uses—siphon noxious fluids, evacuate bell jars and castings, clean, retrieve, lift sterile objects, demonstrate Magdeburg hemispheres, bleed fuel lines, check leaks, etc. Lifts 40 lbs. with included 7" lifter (2 1/2" diam. cap—much more w/ larger cup).

Stock No. 71.301H \$12.00 Ppd.
No. 71.300H (without gauge/lifter) \$5.50 Ppd.



ORDER BY STOCK NUMBER • SEND CHECK OR MONEY ORDER • MONEY-BACK GUARANTEE

300 EDSCORP BLDG. BARRINGTON, NEW JERSEY 08007

Residence Schools / Camps Directory

For advertising information on this section, please contact Hildegard K. Esposito, Popular Mechanics, 224 West 57th Street, New York, N.Y. 10019.

Many schools and camps have long waiting lists for 1971-1972 enrollment. POPULAR MECHANICS urges you to write now to the residence school or camp of your choice for more information.

"These days it's tough to get a good job without a good education . . ." This statement has been made countless times by parents, teachers, and employers. Today, however, schools are more crowded than they've ever been, and the enrollment rosters are continually growing. The well-rounded young man or woman will have a better chance to compete in a complex society with the advantage of a good educational background.

POPULAR MECHANICS readers total more than 7 MILLION . . . many of whom

are youthful readers. We're interested in their future, and we want them to have the best chances for success possible. As a service to our readers and their families, we are now including this Schools/Camps Directory, offering listings of the finest schools—college preparatory, technical schools and military academies—we hope their services will be beneficial to the success of today's youngsters so that they might be the strong foundations of tomorrow's world.

BOYS' SCHOOLS

St. John's Military Academy 1884

A TRADITION OF EXCELLENCE

stressing character, leadership, scholarship. Accredited college preparatory, grades 7-12. Tutorial and developmental reading programs. All sports including hockey, flying, riflery. Own golf course, stable, pool, hospital, lake for crew. Honor ROTC. Band. Interdenominational. Chicago 100 mi. Write: Wm. I. West, Headmaster, Box VMF 321, Delafield, Wisconsin 53018

NORTHWESTERN MILITARY ACADEMY

Fully accredited, purposely small, college prep. Grades 7-12. Concern for individual. Promotes scholarship, ambition, confidence, ROTC. All sports. Scholarships available. Chicago 85 miles. Catalog: 88 South Lake Shore Road, Lake Geneva, Wis. 53147

Obtain Pilot's License

MARINE MILITARY ACADEMY



College Prep. 7-12. PG. Naval Honor School. Accredited. High academic standards. Marine Corps JROTC. Full sports program. Scholarships. Catalog: 700 Iwo Jima

Bldv., Harlingen, Texas. Tele: 512/423-6006.

Wentworth Military Academy

Preparation for the rigors of business or higher education. Accred. 4-yr. H.S., separate 2-yr. College Sr. ROTC. New million-dollar field house. Golf course. Pool. FAA flying. Summer school; younger boys' camp. 91st year. Catalog. Col. L. B. Wikoff, 911 Washington Place, Lexington, Mo. 64067

HOWE MILITARY SCHOOL

Jr. & Sr. Schools. Grades 6-8 & 9-12. Thorough acad. training. Accredited college prep. ROTC. Jrs. have own dorm, sports & activities; housemother. Devel. Reading. Small classes. Testing. New buildings, pool, Episcopal. Est. 1884. Summer Camp. Catalog. Col. R. R. Kelly, Supt., 1211 Academy Pl., Howe, Ind. 46746.

Western Military Academy

Develops a desire to succeed. Emphasis on self-confidence, self-direction, how-to-study. Small classes, guidance. Grades 7 through 12. Career analysis. R.O.T.C. All athletics: riding, pool. 92nd yr. Fully Accred. Near St. Louis. Catalog: Col. Ralph B. Jackson, Supt., Box P-1, Alton, Ill. 62002

Roosevelt Military Academy

"Builders of Men" Fully accred. Gr. 8-12. College prep. Small classes. Emphasizes fundamentals, how to study. Guidance. ROTC. Sports. Riding. Aviation. Bands. Mod. rate. Catalog. Col. Glen G. Millikan, Box P, Aledo, Ill. 61231. Tel: 309/582-5166.

Kemper Military School & College

Fully accred. Grades 7-12; 2-year college. Ind. instruction. Excellent faculty. Personal counseling. How-To-Study Program, Jr., Sr. ROTC. Sports. Social activities. FAA Flying. Education for leadership since 1844. Catalog: 500 Third St., Boonville, Mo. 65233.

Missouri Military Academy

AND SEPARATE JR. SCHOOL

82nd yr. Small classes. College prep. Gr. 4-12. All sports. Golf. Riding. ROTC. 10 beautiful new buildings in 14 yrs. incl. library, dorm, largest field house in state. Catalog. Col. Charles Stribling III, 811 Main, Mexico, Mo. 65265. Tel: 314/581-1776.

MARMION

STRONG COLLEGE PREP

Boarding high school. Benedictine tradition of family atmosphere. Small classes. Accredited. 98% of graduates enter college. ROTC. Eight new buildings. 330-acre campus. Varsity and Intramural Sports. Indoor pool. 38th year. Rev. Superintendent, 500 Butterfield Road, Aurora, Ill. 60504 (312) 897-6936. 45 minutes from Chicago.

GIRLS' CAMPS

Mishawaka On Lake Pokegama near Grand Rapids, Minnesota. Girls 8-16. Experienced leadership. New facilities. Individual development a goal. Sailing, water skiing, riding, 8, 4 wks. Separate 12-day canoe-trip camp for older girls. Adjacent brother camp. Catalog: Mr. & Mrs. Theodore P. Cavins, 1221 Griffith Road, Lake Forest, Illinois 60045. Telephone: 312-234-1793.

BOYS' CAMPS

WENTWORTH SUMMER CAMP AND SCHOOL

Boys 8½ & over. Finest summer fun & training on campus under Academy personnel. Indian tribe. Ozark Mountain Camp. Ride, canoe, swim, fish. Crafts, riflery, military. Optional tutoring in Camp. Summer school includes accredited high school and junior college. Write:

Wentworth Military Academy
811-C Main Street,
Lexington, Missouri 64067

Camp Northwestern

Boys 8-15. 90 acres on Lake. Swim, sail, water-ski. Canoe trips. Red Cross awards. 12 land sports: baseball, golf, tennis, riding, riflery. Complete indoor facilities. Mature counselors. Developmental Reading program optional. 3 wks-\$350. 6 wks. \$600. Write: 88 S. Lake Shore Drive, Lake Geneva, Wis. 53147. Tele: 414/248-4465.

Howe Military Camp

A summer of constructive fun for Juniors (8-14) on lake. July 4 to Aug. 14. Completely modern equipment and facilities. Staff from Winter School faculty. All sports: boating, swimming. Review studies if desired. Low rate. Catalog. Col. R. R. Kelly, 2811 Academy Pl., Howe, Ind. 46746.

TECHNICAL SCHOOLS

GET INTO ELECTRONICS

V.T.I. training leads to success as technicians, field engineers, specialists in communications, guided missiles, computers, radar, automation. Basic & advanced courses. Electronic Engineering Technology and Electronic Technology curricula both available. Assoc. degree in 29 mos. B.S. obtainable. G.I. approved. Start Sept., Feb. Dorms. campus. High School Graduate or equivalent. Catalog.

VALPARAISO TECHNICAL INSTITUTE
DEPARTMENT D.
VALPARAISO, INDIANA 46383



Gradwohl School of Laboratory Technique

Be a medical lab technician! Big demand, good salaries. One-year course for H.S. grads. Enter monthly. Co-ed. Internationally known. M.D. supervised. G.I. approved. Placement service. Catalog: 3530 Lucas Avenue, St. Louis, Missouri 63103.

POPULAR MECHANICS

Материал, защищенный авторским правом



NEW exciting home training to be a **COMPUTER TECHNICIAN**

NRI program includes a complete, operating computer, with memory, to make you thoroughly familiar with computer organization, design, operation, construction, programming, trouble shooting and maintenance.

You build your own digital computer step-by-step, circuit-by-circuit. You really get involved as you learn computer organization, operation and programming with this remarkable new training aid. It performs the same functions as bigger commercial computers—and it's yours to keep and use.

What better way to learn all about computers than to actually build and use one? That's exactly what you do in NRI's new Complete Computer Electronics home training program.

What you see illustrated may very well be the most unique educational aid ever developed for home training. This is not simply a "logic trainer." It is literally a complete, general purpose, programmable digital computer that contains a memory and is fully automatic. It's a small-scale model of larger, expensive commercial computers. Once you build it and it is operational, you can define and flow-chart a problem, code your program, store your program and data in the memory bank. Press the "start" button and, before you can remove your finger, the computer solves your problem and displays the results.

NRI is offering this new course because this is only the beginning of the "Computer Age." The computer industry continues to leap ahead. Qualified men are urgently needed, not only as digital technicians and field service representatives, but also to work on data acquisition systems in such fascinating fields as telemetry, meteorology and pollution control. Office equipment and test instruments also demand the skills of the digital technician. This exciting NRI program can give you the priceless confidence you seek to walk into a technician's job and know just what to do and how to do it.

You learn with your hands as well as your head Planned from the beginning to include training equipment in the pioneering NRI tradition, this exceptional new course combines kits with educator-acclaimed NRI "bite-size" texts in an easy-to-understand package. But, unlike other home training, this is not a general electronics course. Lessons have been specifically written to stress computer repair. You perform a hundred experiments,

build hundreds of circuits, use professional test equipment. You build and use your own solid-state, transistorized voltohmmeter and your own oscilloscope in addition to your digital computer. Because you work with your hands as well as your head, your training is as much *fun* as it is education.

Train at home with the leader

There is so much to tell you about this latest NRI "first" in home training, you must fill out and mail the coupon today. Get the full story of Complete Computer Electronics and the amazing digital computer you build and use as you learn. The free NRI Catalog you receive also tells you about other NRI training plans in Color TV Servicing, Communications, Electronics Technology. There is no obligation. No salesman will call on you. NATIONAL RADIO INSTITUTE, Washington, D.C. 20016.

MAIL NOW FOR FREE CATALOG



NATIONAL RADIO INSTITUTE
Washington, D.C. 20016

Please send me your FREE CATALOG with details about new Complete Computer Electronics training. (No salesman will call)

90-011

Name _____ Age _____

Address _____

City _____ State _____ Zip _____

ACCREDITED MEMBER NATIONAL HOME STUDY COUNCIL

Drivin' with Dan

Should Can-Am racing bar the new Chaparral 2J? Will fuel injection help mileage and cut air pollution? What does a driver do during his rookie test? Dan Gurney answers these and other automotive questions

Q. *I understand many constructors feel the new Chaparral 2J ground-effect car should be banned from Can-Am racing. Where do you stand?—Robert F. Robinson, Monterey, Calif.*

A. The Chaparral's design is revolutionary and its performance phenomenal. There is a good chance that all racing cars will be forced to go this way if the rules allow it. Racing cannot be entirely free. It cannot be pure research. It is still a sport with rules. The ground-effect car, like the fiberglass pole in vaulting, makes old concepts obsolete. And it does escalate cost. But if the rules permit it, then I'm for it.

Q. *Will fuel injection increase mileage and/or decrease air pollution to any significant degree? About what would it cost to put it on my 1970 Eldorado?—J. E. Harper, Oxon Hills, Md.*

A. My experience has been almost entirely with racing applications. Mercedes-Benz in Stuttgart, Germany, probably knows more

about it than anyone else as far as mass-produced normal driving performance and pollution relationships go. It has thousands of fuel-injected cars on the road. My judgment tells me that miles per gallon is probably the most significant aspect of this pollution business. With fuel injection, fuel charge is metered for very efficient burning. I should think if you burn half as much gasoline to get from A to B, you would probably create about half as much pollution. Lighter, smaller cars make a lot of sense and very efficient engines sound good also. It would be a very expensive conversion for your Eldorado.

Q. *If you take your car for a front-end adjustment because of uneven wear on the front tires, won't the worn tires prevent the mechanic from adjusting the camber correctly?—Edward Rovner, Baltimore.*

A. No, this shouldn't keep him from adjusting. *(Please turn to page 26)*



DAN'S LAST RACE was Mission Bell Trans-Am at Riverside in AAR Plymouth Barracuda; he finished fifth

Al Unser & Valvoline win at Indy!

When you're up against the best competition in the world, you want to make sure you have nothing but the best going for you. Like Valvoline® Motor Oil. The winning lubricant used by twenty-nine out of the thirty-three starting drivers at this year's "500." Valvoline Motor Oil. The best thing going for any car. Just ask Al.

Best thing going for any car.

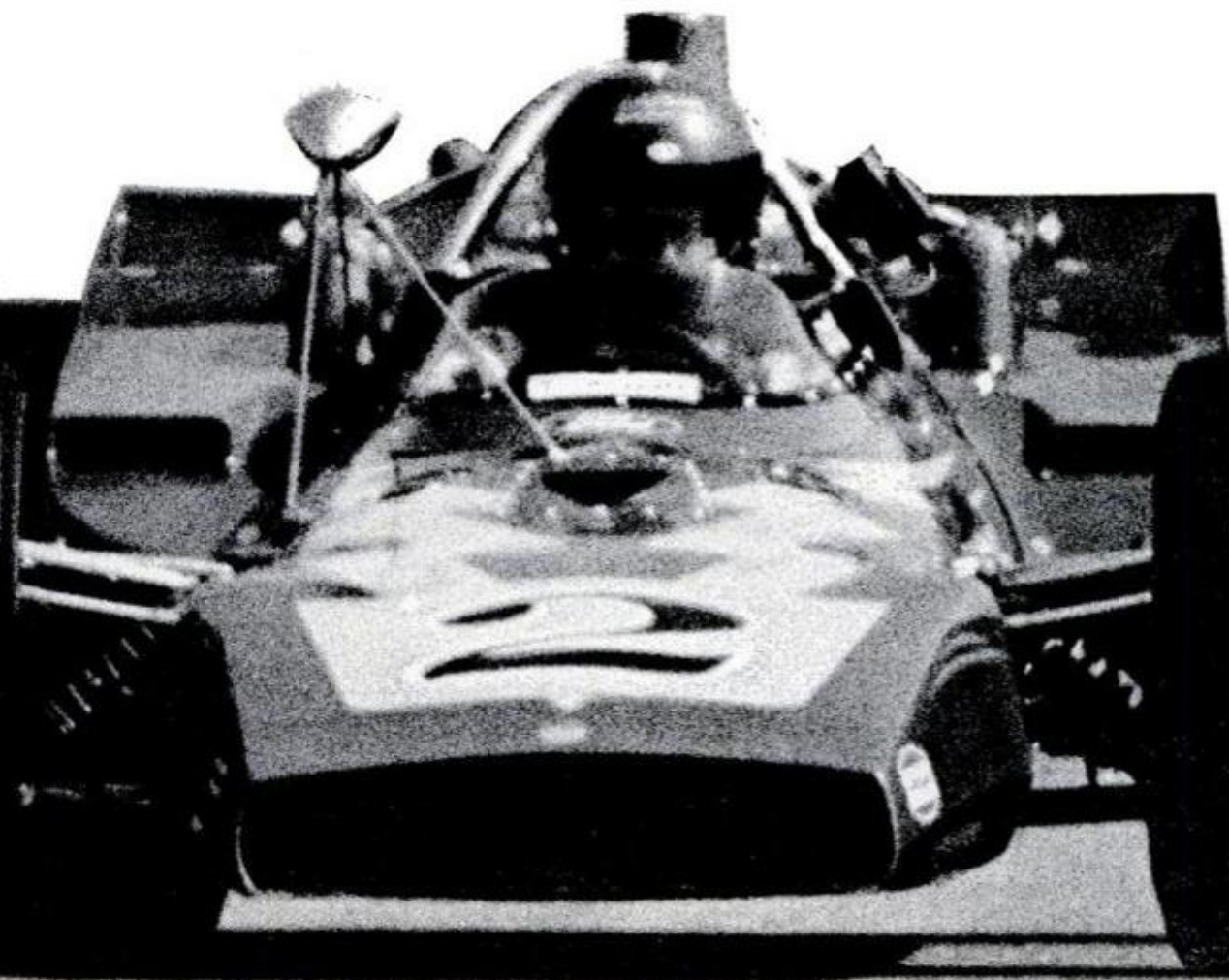

RIDGID

Tubing Cutters give "pro" results!



Midget Tubing Cutters

- No. 103
1 $\frac{5}{16}$ " turning radius
- No. 104
1 $\frac{11}{16}$ " turning radius

For extra-close-quarters cutting of hard and soft copper, aluminum, brass and plastic tubing. Dual rollers opposite hardened cutter wheel center tubing for smooth, fast, accurate cuts.

3 Tools in 1!

- No. 10 — $\frac{1}{8}$ " thru 1" O.D.
- No. 15 — $\frac{3}{16}$ " thru 1 $\frac{1}{8}$ " O.D.

Quickly, smoothly cut copper, brass and aluminum tubing — also thin-wall conduit. Have handy, fold-in reamer with gas cylinder wrench key cut into blade. For larger capacities ($\frac{5}{8}$ " through 4 $\frac{1}{8}$ " O.D.) see Nos. 20, 30 or 40. Cutters for plastic also available.



Enclosed Feed Tubing Cutter

- No. 105 — $\frac{1}{8}$ " thru 1 $\frac{1}{8}$ " O.D.

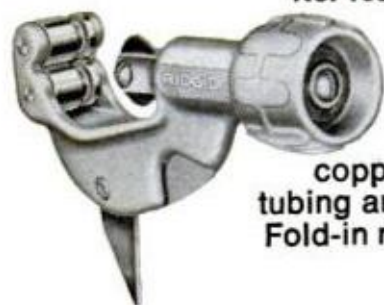

Grooved rolls for close flare cut-offs. Only 5" long! For copper, brass, aluminum tubing and thin-wall conduit. Fold-in reamer. Spare cutter wheel in handle.

Buy RIDGID Tubing Cutters at your quality Hardware Store, and be sure to see the other RIDGID Work Saver Tools from The Ridge Tool Company, Elyria, Ohio 44035, U.S.A.

RIDGID®

 Ridge Tool Subsidiary
Emerson Electric Co.

DRIVIN' WITH DAN

(Continued from page 24)

ing things correctly. On the other hand, it would be a good idea to rotate the tires if you have some good ones on the rear.

Q. I follow you in Popular Mechanics, but here in India there are few tracks and we have mostly rallies. May I ask why you do not drive in any rallies such as the London/Sydney Marathon or other international rallies?—Prince Manvendra Singh, Barwani, India.

A. I have often hoped to be able to do such things but I have just not been able to put it all together. Mostly it has been a question of not enough time or opportunity to learn. I have great respect for the ability and skill of the top rallye drivers. Their techniques are very specialized, varied and demanding.

Q. I have asked several people about motor oil additives. Some say it helps; some say it breaks oil down. Do additives help or hinder a car's engine? Does your company recommend them?—W. N. George, Lakewood, Calif.

A. We don't use them because we don't know if they are good or bad, and we don't have any trouble with the oil we use.

Q. What takes place during a rookie test?—Doug Huffines, Doraville, Ga.

A. A rookie test at Indy starts with a discussion with the rookie; a ride around with a passenger car and veteran driver talking about the lap. Then comes a three-stage test in a race car where the rookie must maintain plus 3, minus 1 mph at 145, 150 and 155 mph for 10 laps at a time with four driver/observers watching at four spots around the track. If he is successful, this is followed by another discussion or critique. Two days are usually required to complete the test.

Q. What is the importance of the CSI rule which prevents drivers from competing in a Grand Prix race within 24 hours after competing in another event?—Steve Slanery, Thunder Bay, Canada.

A. It is a safety precaution for drivers who travel all over the world these days and it also protects the date for the organizer so

(Please turn to page 30)

It takes guts to cut car prices* when others are raising theirs. Jeep guts.

***Now some of our list prices are even less than last year!**

We want to sell more Jeep vehicles in 1971. A lot more. And we're ready to take some strong measures to accomplish this.

Like cut prices. We've taken some of our most popular models and slashed prices down from last year. And we've taken other models and held back increases to a bare minimum.

As a result, the Jeep Universal equipped with our powerful V-6 engine option has a total list price which is \$93 less than last year. That's right, \$93 less.

The prices of the Jeep Gladiator pick-up trucks

have been chopped \$100 to \$110*. And that's not peanuts — especially when the list prices of other competitive pick-up trucks have been raised as much as \$200 to \$300*. And this price reduction goes for every single Gladiator model.

The Jeepster Commando price increase has been held to a bare minimum*. Now it's ready to take on Blazer, Bronco and Scout. Head on. And the same goes for the Jeep Wagoneer.

**THE TOUGHEST
4-LETTER WORD ON WHEELS.**

Jeep

Products from American Motors

It's priced* to insure its place as the vehicle that outsells all other 4-wheel drive family wagons combined.

And they're all still the same durable 4-wheel drive vehicles that are imitated around the world. With the same rugged Jeep construction. And the same well-earned "go anywhere, do anything" reputation.

What it comes down to is this. We're doing our best to hold the line on new car prices*. And that takes guts. Especially with inflation rearing its ugly head. But that's what it takes to get the job done. Guts. Jeep guts.





SAVE 1/2 ON "NEW SOUND" ELECTRONIC ACCORDIONS*

BIG DISCOUNTS!
Importer-to-you Prices

42 STANDARD AND ELECTRONIC MODELS
 for Students, Teachers and Professionals

FREE GIFTS
 E-Z Lesson Course, Year's Music Supply, Music Stand, Straps, and Case... Many More!

Rush Coupon
Free Color Catalog
Discount Price List

Easy Terms • Low as \$7.95 a Month
 ★ Rush coupon for **proof** you save up to 50% off retail prices of comparable accordions! **BUY DIRECT**—Low Importer-to-You prices. World's largest accordion dealer. All famous makes. 42 New **Electronic** & Standard models, Amplifiers. Popular "Button type" accordions, too! Lifetime Performance Policy. Money Back Guarantee. Easy terms. Big Trade-In. Color Catalogs, Selection Guide and Discount Prices—**FREE!**
ACCORDION CORP. OF AMERICA
 Dept. R-11, 5535 W. Belmont Ave., Chicago, Ill. 60641

5 Day Home Trial

Accordion Corp. of America, Dept. R-11
5535 W. Belmont, Chicago, Ill. 60641
 Send **FREE** Catalog of Accordions, Amplifiers—Selection Guide, Color Chart, Discount Prices.

NAME _____
 ADDRESS _____
 CITY _____ STATE _____
 Check here if you have a Trade-in.



Excitement! Security! Good Pay! **CRIME DETECTION**

LEARN AT HOME IN SPARE TIME—START NOW!
 Crime everywhere is on the rise! Learn now, in your own home, the profitable profession that enables you to track down criminals and bring them to justice! Hundreds of Identification Bureaus employ I. A. S. graduates... trained in fingerprinting, police photography, handwriting identification, firearms and investigation. Our 44th year! **FREE** "Blue Book of Crime"... packed with crime facts and the full story of famous I. A. S. training. State exact age. No salesman will call. Rush Coupon!
A Correspondence School Founded in 1916.

APPROVED UNDER G.I. BILL

FREE Blue Book of Crime MAIL COUPON

INSTITUTE OF APPLIED SCIENCE, Dept. 1351
 1920 Sunnyside Avenue, Chicago, Ill. 60640
 Rush Blue Book of Crime... **FREE!**

NAME _____ Age _____
 ADDRESS _____
 STATE _____ ZIP _____



B. L. Mellinger, Jr.
 "Mr. Mail Order"

MAKE MONEY in MAIL ORDER

My **FREE REPORT** shows you how. Men-Women start **SPARE TIME** or **FULL TIME!** My Plan reveals how I made a mail order fortune, starting in my garage with less than \$100. I cover secrets of getting best mail order products, free advertising, operating without product investment. No salesman will call. Write for **Free Report** now. **MAILCO, Dept. E2251**
 1554 South Sepulveda, Los Angeles, CA 90025

MAKE BIG MONEY INSTALLING ALARM SYSTEMS



New plan opens multi-million dollar burglar, fire alarm business to small home operators. Guides beginners step by step. Starts you full or spare time without previous experience or big investment. See how to cash in on invisible web of protection that stops crooks-cold, makes big profits. No salesman will call. Free details!
NASCO, 11071 Massachusetts Avenue
 Dept. E2251, Los Angeles, Calif. 90025



110-120 VOLT A.C. LIGHT PLANTS—60 CYCLES
 Fanbelt driven from pickup or small gas engine. Operates saws, drills, pumps, freezers, T.V. **X1000 Watts—Needs No Battery.** Now \$70.00. **1500 Watts—8 and 12 volt vehicles.** Now \$80.00. **8000 Watts—12 volt vehicles only.** Now \$99.50. *Guaranteed. Check or Money Order.*

VIRDEN PERMA-BILT, Box 7066 P.M., Amarillo, Texas 79109

Free rent, resort living, great food, unlimited recreation... and plenty of time to enjoy them! Easy home-study plan. 1000s men, women, couples needed. Age no barrier. (Or, own your own motel.) Send for **FREE "Career Kit."** No salesman will call.

MOTEL-HOTEL CAREER

NORTH AMERICAN SCHOOL OF MOTEL-HOTEL MANAGEMENT
 4500 Campus Dr., Dept. 14171, Newport, Ca. 92660

NAME _____ AGE _____
 ADDRESS _____
 CITY _____ STATE _____ ZIP _____



POWER THROUGH WOOD, METAL, PLASTICS WITH A DREMEL MOTO-TOOL

It takes over where other power tools leave off

Moto-Tool is a complete power workshop with a multitude of uses. With it you can grind, drill, polish, carve, engrave, rout, you name it. Handles any job with speed and precision. Constant torque, permanent magnet motor produces 30,000 RPM. Moto-Tool. No workshop is complete without it. From \$24.95 to \$39.95. Ask your hardware or hobby dealer for a demonstration.



Moto-Tool Kits complete with 34 accessories and molded storage case. From \$34.95 to \$49.95.



CREATIVE POWER TOOLS
 DREMEL MFG. CO., Dept. 110-A, Racine, Wis. 53401



Write for complete power tool catalog

Von Schrader offers you three ways to a growing income in your own business

Here's your opportunity to have your own very profitable business. One that offers a service badly needed in the home, in offices and public places. A business where how much you earn depends largely upon you. It's an opportunity to be your own boss. Free from layoffs and work restrictions. Free to work any number of hours you wish. And you don't require any special skills or large investment.

Already thousands of men have gained financial independence and personal satisfaction offering this service. Yet the demand is so big—and growing so fast—that your opportunity for success is better than ever before.

If you're a man who wants to work—but in his own way—see if you don't agree that what you are about to read is an opportunity you can't afford to pass up.

Wall-to-wall carpeting, upholstery, walls: 3 great needs for on-location cleaning

Nothing enriches a room like wall-to-wall carpeting. Every year you find it in more homes at every income level. Then there are all the public places with this carpeting. Places like motels, hotels, restaurants, banks, offices, theaters, stores, cocktail lounges, hospitals, reception rooms, etc.

Since this carpeting can't be sent out for cleaning there's a real opportunity for on-location cleaning services. It's faster, easier and inexpensive to clean carpeting on the customers' premises.

This same opportunity exists for upholstered furniture. It's faster, easier and costs less to clean upholstery on-location.

Now, consider wall and ceilings. Cleaning them with a bucket and sponge is slow, tiring and messy. People will welcome a service that does a professional job of cleaning quickly and without mess.

3 Von Schrader Detergers: each does on-location cleaning at its best

With Von Schrader Detergers—professional cleaning equipment—you'll do on-location cleaning that wins repeat customers . . . make as much money part time as many people earn full time . . . enjoy a steady, dependable business of your own . . . watch your income grow to where you are financially independent. Every home, every building, are a potential source of income.

You can start your on-location cleaning service with any one, two or all three Von Schrader Detergers.

Carpet Deterger. Cleans so deeply and completely it helps restore natural beauty—even revives color. Fast drying.

Upholstery Deterger. Gives deep-level cleaning to every inch of fabric upholstery and synthetics. Leaves furniture looking fresh and new.

Wall Deterger. Washes walls and ceilings 6 times faster (and better) than the



Von Schrader Carpet Deterger. Cleans so completely it helps restore natural beauty. Fast drying.



Von Schrader Upholstery Deterger. Gives deep-level cleaning to fabric upholstery and synthetics.



Von Schrader Wall Deterger. Washes walls and ceilings 6 times faster (and better) than hand method.

bucket-and-sponge method. Cleans easily without any mess.

Von Schrader stands for the best in professional cleaning equipment, as it has for over 35 years. All our Detergers are light-weight and easy to operate. Proven reliable and profitable for thousands of users.

You own your equipment

As a Von Schrader Associate you are your own boss. There's no contract to sign. You pay no fees, dues or royalties. Work out of your home part time or full time. Hire help as your customer list grows. (Many men start by working evenings or weekends while retaining their regular jobs.)

You get supplies

Each Deterger you order includes supplies and accessories, operating instructions and promotional material. You can go after on-location cleaning business immediately.

We'll help you get started

As a Von Schrader Associate your success is our success. So we'll help you every step of the way. That includes free consultation and special business-building materials.

Very small investment

You can have your own on-location cleaning business for an investment so small it's hard to believe. Send for complete information. No obligation.

READ WHAT OTHER MEN ARE DOING WITH VON SCHRADER DETERGERS

Carpet: "Averaged \$1000 a month for 12 months."—C. E. Nevin. "Grossed \$30,000 the first year."—Father-Son Team. "Have all 3 of your Detergers. Earned \$2500 in one week."—E. Kurtz

Upholstery: "One day I did a \$135 job. Best week was \$500."—C. Lambert. "We passed over the \$450 mark in five days."—T. E. Baylor

Walls: "Earned the price of Deterger with the work I did the past week."—J. Hews. "I work just 2 or 3 days a week. Best month was \$1200."—J. R. Johnson. "Big motel chain delighted with cleaning results and low cost."—E. Halst

Von Schrader
Detergers

FREE BOOKLET TELLS WHOLE STORY—MAIL COUPON TODAY

VON SCHRADER MFG. CO.

1011 Place, Racine, Wis. 53403

Please send complete information on the Von Schrader Deterger(s)
I have checked: Carpet Upholstery Wall

Name _____

Present Occupation _____

Address _____





City _____ State _____ Zip _____

STOP ERRORS WITH SCREW CHEK'R

SCREW CHEK'R
Ruelle Brothers
SPECIALTY MANUFACTURING
P. O. Box 114
Ferndale, Mich.

SIZE	NO. OF TAPS	NO. OF TAPS	NO. OF TAPS	NO. OF TAPS	NO. OF TAPS
1"	84	32	72	51	36
2"	56	31	64	45	27
3"	48	31	56	45	27
4"	40	31	48	45	27
5"	40	31	44	45	27
6"	32	31	40	45	27
8"	32	31	36	45	27
10"	24	31	32	45	27
12"	24	31	28	45	27
14"	20	31	28	45	27
16"	18	31	24	45	27

CHECKS:

-  MACHINE SCREWS
-  WOOD SCREWS
-  SHEET METAL SCREWS
-  SELF-TAPPING SCREWS
-  DRIVE SCREWS
-  STANDARD RIVETS

TELLS:

- SIZE
- THREADS PER INCH
- LENGTH
- DIAMETER
- TAP SERIES
- BODY DRILL SIZE
- TAP DRILL SIZE

**CUTS SCREWS TO LENGTH
STRAIGHTENS BENT SCREWS
and BATTERED THREADS**

ONLY \$3.98 WITH
SCREW SHEAR, DRILL
CHART & INSTRUCTIONS

Screw Chek'r—3"x5" satin chromed steel
Screw Shear—1/4"x1/4"x4" tool steel

RUELLE BROS., Box 114, Ferndale, Mich. 48220

Send us _____ Chek'rs (Remittance attached)

M-171

(Name)

(Street Address)

(City)

(State)

(Zip Code)

**New 1971
HEAVY DUTY
ARC WELDER**

LIFETIME
GUARANTEE

10 DAY
MONEY BACK
TRIAL



Only \$1895 Prepaid Complete Ready To Use

Every home, shop and hobbyist needs this quality metal working machine. Weld, Braze, Solder, cut almost anything metal. Follow simple instructions to make or repair 1001 items including furniture, toys, auto bodies, fenders, trailers, boats, farm and garden tools and equipment. Operates in 110 V. 30A. for pennies—Adjustable Twin Carbon Arc Torch easily **REGULATES HEAT FOR EACH JOB**. Eliminates changing cables—replaces gas torches—no tanks or refills to buy—produces to 11,000° heat. **YOU CAN PAY MORE BUT YOU CAN'T GET A BETTER LOW COST WELDER.** Over 500,000 in use. Manufactures of welders for over 30 years. **LIFETIME GUARANTEE.** Simply return prepaid. We will repair and reship **FREE** of charge. **YOU GET:** heavy duty welder in rugged metal cabinet, ground clamp, cables, combination torch and rod holder, welding manual, helmet. Free \$2.00 pack "TOUGH WELD" rods for instant automatic arc, brazing rods, 1/4" carbons, solder, flux.

PLUS EXCLUSIVE ON/OFF SAFETY FOOT SWITCH
\$3.95 VALUE INCLUDED AT NO EXTRA COST

ORDER TODAY ON MONEY BACK TRIAL. IF NOT COMPLETELY SATISFIED, RETURN IN 10 DAYS AND WE WILL REFUND PURCHASE PRICE. SEND ONLY \$2.00 and pay \$16.95 plus C.O.D. and delivery charges, or send only \$18.95 for postpaid shipment in Continental U.S.A. FOUR-WAY WELDER CO., 1810 Federal St., Dept. R2-A, Chicago, Ill. 60616

DRIVIN' WITH DAN

(Continued from page 26)

that he has some assurance that important name drivers will show up for his race and his practice.

Q. In determining the advantages, if any, of standard transmission over an automatic, I'm told you get better gas mileage with a standard. Is this true?—Steven Borsch, Jr., Bronx, N. Y.

A. I think it boils down to personal preference. I prefer the automatic. The difference in mileage is probably not significant. I suppose a standard transmission would get better mileage in an all-out economy contest.

Q. What would you think of an Indy car made with the nose wedge shaped like the Lotus Turbine and the radiator mounted behind the driver's head underneath an extended roll bar?—Joe Norris, Wisconsin Rapids, Wis.

A. Mounting the radiator or radiators is certainly a problem, considering the rules at Indy. We must carry 75 gallons of fuel; we must have a streamlined shape, enough water and oil cooling capacity and a low center of gravity. I don't think the ideal location has been determined yet.

Q. Is there a book published that gives statistics about winning drivers of races, the general field of cars and drivers and information such as car type, engine type, high qualifying and winning speeds?—Clinton Tatro, U. S. Coast Guard, Governor's Island, N. Y.

A. The USAC Yearbook does give most of this info on USAC races on a year-to-year basis. *Automobile Year* is a yearly volume on Grand Prix racing (No. 17 covers 1970 season). I also suggest writing to Briggs Cunningham Automotive Museum, 250 Baker St., Costa Mesa, Calif. 92627, for more information.

Q. What would I have to do to get on the Plymouth stock-car team?—John Davlantes, Grosse Point, Mich.

A. You'd have to do something to make them ask you to join! ★ ★ ★

If you have questions on racing, high-performance and everyday driving techniques, send them to "Drivin' with Dan," c/o Popular Mechanics, 224 West 57th St., New York, N.Y. 10019. Questions cannot be answered by individual letters. Questions on maintenance and repair should be addressed to the Auto Clinic (see page 66).



THESE 3 BIG DRAFTING KITS* GIVEN TO YOU!



* Precision Drawing Instrument Set, Professional Drafting Board Outfit & Fingertip Tilting Drafting Table are given to you with your complete North American Course in Drafting.

Earns \$820 Month!
 "My first position after completing your course jumped my income from \$350 to \$820 per month." — G. W., Tenn.

Big Promotion!
 I was promoted from the production line ahead of 4 others and got a good pay raise." — W. A., Wisc.

ALL 4 FREE!
 Rush Coupon today!



Coast-to-Coast Shortage of Trained Draftsmen Opens Thousands Big Salary Jobs for Beginners!

Now you can take your pick of thousands of big salary jobs open to Draftsmen (see "help wanted" sections of metropolitan newspapers). Huge nationwide demand... U.S. Dept. of Labor reports "42% more Draftsmen needed in next 10 years—not enough applicants to fill drafting jobs available now!" Our easy "Quick-Learn" Method has helped hundreds toward good income, security and prestige as Draftsmen. Why not you?

YOU NEED NO DRAWING SKILL... NO TECHNICAL ABILITY

NASD's staff of Professional Draftsmen guide you step-by-step. With our spare time home-study plan you work on actual projects. Makes learning fun—easy to remember, too. Many graduates have succeeded with only grade school training. Others report good earnings drafting part time while still learning!

...when you train at home with NASD for a HIGH PAY JOB IN DRAFTING!

RUSH COUPON FOR FREE KIT...

Mail coupon today for FREE "DRAFTING CAREER KIT," Sample Lesson, Drafting Aptitude Test including intriguing new 5-Way Drafting Instrument & 20-page Book "Your Future in Drafting"—jam-packed with revealing facts on your opportunities to win top pay and job security in Drafting. No salesman will call. Everything sent FREE and WITHOUT OBLIGATION. Write today!

North American School of Drafting, Dept. 14171
 4500 Campus Dr., University Plaza, Newport, Calif. 92660

Rush "DRAFTING CAREER KIT", including Book, Sample Lesson, Aptitude Test & Drafting Instrument—ALL FREE! No salesman will call. G.I. Approved.

NAME _____ AGE _____
 ADDRESS _____
 CITY _____ STATE _____ ZIP _____
A home study program in association with Cleveland Engineering Inst.

MAKE EXTRA \$\$\$ EVERY DAY! Get into the big, year-round EXTRA MONEY BUSINESS that's EASY to learn—EASY to do—and EASY ON YOU!

Be a LOCKSMITH!

You Can Make Up to \$10 an Hour—even while learning!
 Train FAST at Home!

Never before have money-making opportunities been so great for qualified Locksmiths. Now lucrative regular lock and key business has multiplied a thousandfold as millions seek more protection against zooming crime. Yet there's only one Locksmith for every 17,000 people!

Start Collecting CASH PROFITS Right Away

You're "in business" ready to earn \$5 to \$10 an hour a few days after you begin Belsaw's shortcut training. Take advantage of today's unprecedented opportunities in Locksmithing for year-round EXTRA INCOME in spare-time—or fulltime in a high-profit business of your own. Hundreds we've trained have done it. So can YOU! All tools plus professional Key Machine given you with course. These plus practice materials and equipment,

THIS PRO KEY MACHINE—YOURS TO KEEP—

can add \$25 to \$40 a week to your income... and it won't cost you a cent with your training.



FREE



Tells how to make money in Locksmithing almost from the start!

ALL TOOLS, MATERIALS AND PRACTICE EQUIPMENT COME TO YOU WITH YOUR COURSE.

"War injuries left me badly handicapped, but now I'm a financial success as a Locksmith, thanks to your training. Besides, the work is fascinating. If I can do it anybody can." — Glen Johnson, Larned, Kan.



plus simple, illustrated lessons, plus expert supervision, plus business-building guidance will enable you to KEEP THE MONEY COMING IN! Ideal for retirement—good jobs, too.

SEND FOR EXCITING FACTS—No Obligation

Discover what's in Locksmithing for you—how Belsaw's master-locksmith-approved training can give you the skill you can depend on to EARN MORE—ENJOY LIFE MORE. Just fill in and mail the coupon below to receive full information by return mail. Do it TODAY!

BELSAW INSTITUTE, 101J Field Bldg., Kansas City, Mo. 64111
 Accredited Member National Home Study Council
 Approved for all Veteran Training

MAIL THIS COUPON—NO SALESMAN WILL CALL

BELSAW INSTITUTE, 101J Field Bldg.
 Kansas City, Missouri 64111

Please send me free of cost or obligation your publication "Keys to Your Future" on how Belsaw can quickly train me to make money in Locksmithing and how all tools and Key Machine are given me to keep.

Name _____

Address _____

City _____ State _____ Zip _____

Check here if eligible Veteran.



Test Driving Colt and Cricket

PM takes the wheel of Chrysler's new imports and discovers that the domestic minis have still more competition!

By MICHAEL LAMM, West Coast Auto Editor /Photos by the Author

CHRYSLER CORP. got caught with its pants part way down in the subcompact race. To fill the breach, it has decided to import the Japanese Mitsubishi for selected Dodge dealers and the British Hillman for Plymouth dealers. These cars will carry Dodge and Plymouth nameplates until Chrysler can ready a U.S.-built subcompact. It will continue to import the Simca from France.

I had the opportunity to drive the Dodge Colt and Plymouth Cricket briefly (very briefly) last September. Both are good, but I believe the Colt is a little more carefully assembled.

The Colt is also a bit smaller, lighter, slightly more powerful, and offers three body choices to the Cricket's one. Colts come as four-door sedans, wagons and two-door hardtops, while the Cricket is available only as a four-door. Seating space in both is remarkably good, and by clever body engineering the Cricket ends up with an amazingly large trunk—14 cu. ft. of usable space.

Both cars are laid out conventionally: engine up front, rear drive. Both have front disc brakes, the Cricket's brakes vacuum-assisted as standard equipment. Both come with four-speed manual transmissions, three-speed automatics being optional. Both use unit body construction, have MacPherson-strut front suspensions. Colt utilizes leaf springs in the

rear; Cricket has coils, with axle location by trailing arms and diagonal links.

The Colt's engine is rather interesting. It uses a belt-driven overhead camshaft, has hemispherical combustion chambers, a duplex carb and split exhaust manifolds. The water-cooled block is an iron copper alloy; the head an aluminum alloy.

The Cricket comes with conventional but very quick rack-and-pinion steering. The Colt has recirculating-ball, variable-ratio, manual steering as standard equipment, a pleasant and unexpected feature. And the Colt's driver can set the steering wheel at nearly any height he wants.

Driving the two cars, I found them remarkably similar. Both offer good vision all around. They're comfortable to sit in and quick to get used to. The Colt's controls seemed a bit harder to learn—such things as the turn-signal lever that also serves as windshield wiper switch and washer pump. Small matters.

Acceleration of either car proved rather sluggish with the optional automatic transmissions but perked up considerably in cars with manual gearboxes. The Cricket ordinarily comes with a single-barrel carburetor, but there's a duplex optional, as are twin exhausts. This raises output to 83 bhp and gives concomitantly improved acceleration.

Both cars have flow-through ventila-

(Please turn to page 34)

SOLVE THESE PROBLEMS FOREVER:



**RETIREMENT INCOME!
OUR OWN BUSINESS!
TOO OLD!
RA MONEY!
W WAGES!
ESSION!
NFLATION!
MATION!
AYOFFS!**

the key— to your future!

LOCKSMITH SKILLS

Add to your income with easy spare time earnings—cash in on the nationwide shortage of skilled locksmiths. Quickly step into a highly-paid position or a business of your own.

Age, education, minor physical handicaps don't disqualify you. **EARN EXTRA MONEY EVEN WHILE LEARNING.** Study at home, gain **PRAC-TICAL** experience through complete illustrated lessons. Professional equipment, locks, etc., included with your course.

LOCKSMITHING INSTITUTE

Division of Singer Communications Corporation
Dept. 1110-011 Little Falls, N.J. 07424

Only school of its kind: Licensed by N.J. State Dept. of Education; Accredited Member, National Home Study Council; State Approved Diploma; Approved for Veterans.



Everything necessary: locks, picks & tools—supplied with course. State Approved Diploma.

LIKE THESE MEN —LEARN AT HOME!



I now have my own shop ... with plenty of work.
*Wm. A. Tarnelli, Sr.
Ossining, N.Y.*

During my training period ... I earned \$150.

*Paul G. Funes
New York, N.Y.*



I turned to Locksmithing to supplement my pension upon retirement.

*David Osborne
Sydney, N.S. Canada.*

Think it's the "greatest". \$500 ... earned while studying.

*Ernest C. Young
San Francisco, Calif.*



HURRY! MAIL THIS POSTAGE-FREE CARD!

✂ CUT OUT. Ready to Mail Coupon Below. ✂

YES, send me free information on opportunities in Locksmithing

Mail me sample lesson pages, details of the critical need for locksmiths. I understand there is no obligation on my part and no salesman will call upon me.



Name _____
Address _____
City _____
State _____ Zip _____

Check here if eligible for Veteran's Benefits.

✂ DO NOT CUT BUT FOLD HERE—Seal, Stamp and Mail. ✂

BUSINESS REPLY MAIL
No Postage Stamp Necessary if Mailed in the United States

POSTAGE WILL BE PAID BY

**LOCKSMITHING INSTITUTE
SINGER COMMUNICATIONS CORPORATION**
Little Falls, New Jersey 07424
DEPT. 1110-011

First Class
Permit Number 137
Little Falls, N.J.



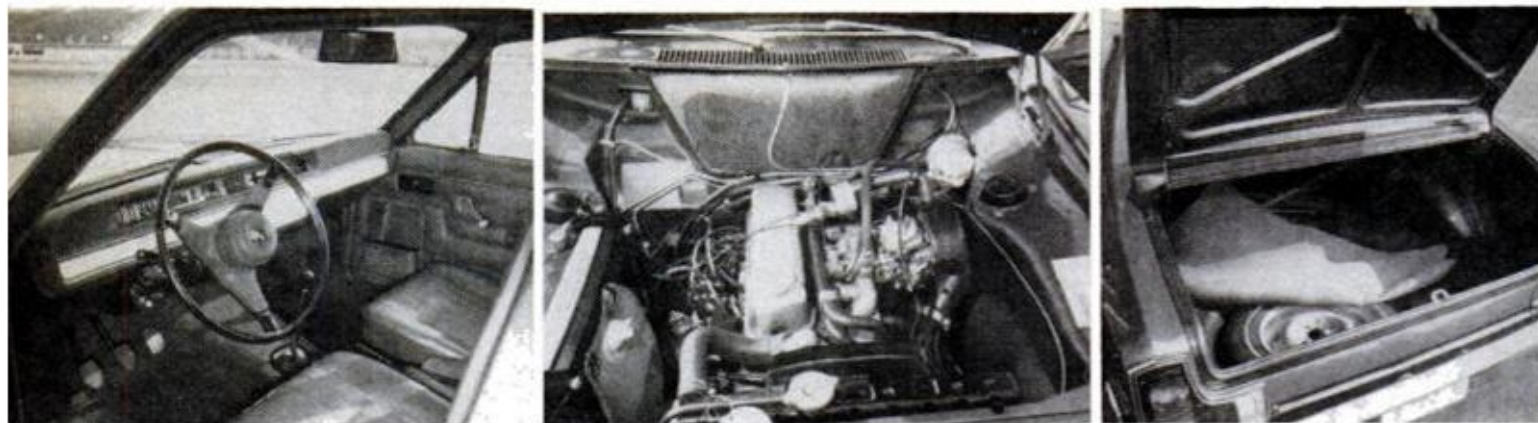

PLYMOUTH CRICKET, made in England, was styled here. Water-cooled ohv Four can be had with optional two-barrel carb, twin exhausts for 13 extra bhp. Trunk has 14-cu.-ft. space compared to 9 in Colt four-door

TESTING COLT AND CRICKET

(Continued from page 32)

tion systems. It was warm the two days we drove these automobiles, and with all windows rolled up, neither circulated enough air for comfort. Completely sealed, though, the Colt proved very quiet, even at high speeds, and the Cricket was only a bit less quiet. The Cricket, however, suffered from a few gentle sympathetic hums that Mitsubishi engineers obviously managed to damp out of the Colt.

Both cars can be flung through sharp turns with good stability. The Cricket seems to show a bit more understeer than the Colt, but it's present in both and surely no more drastic than in any small, front-engine subcompact. I can't say which corners better, because to do that they'd have to be on the same track, same speeds, at the same time.

Cricket comes with radial-ply tires, which makes a difference in traction as well as in wear characteristics. Both cars

have antiroll bars up front. The Colt's rear suspension uses asymmetrical leaves as against the Cricket's coils. I purposely took both cars off the smooth pavement and into the rough. Neither jostled me unduly nor was there any wheel fight or loss of control.

The Cricket's brakes are larger than the Colt's, and they're mildly power assisted. Both cars appear to stop equally well—rapidly, no pull. After repeated high-speed stops, the Cricket's brakes began to smell, but there was no fade. A few years ago, both these braking systems would be judged far superior to anything normal on the road, especially in economy cars, but today we tend to take them for granted.

What sort of acceptance these cars will find in the United States is hard to say, especially since Chrysler seems ready to pop a domestic subcompact in the near future. That will, but shouldn't, affect the fact the Colt and Cricket represent good value in their price classes. ★★★

GENERAL SPECIFICATIONS

Car	Engine	Displ. Cu. In.	Net BHP @ RPM	Wheelbase	Overall Length	Curb Weight
Dodge Colt	Ohc 4	97.5	83 @ 5600	95.3 in.	160.0 in.	1841 lbs.
Plymouth Cricket	Ohv 4	91.4	70 @ 5000	98.0 in.	162.0 in.	1966 lbs.

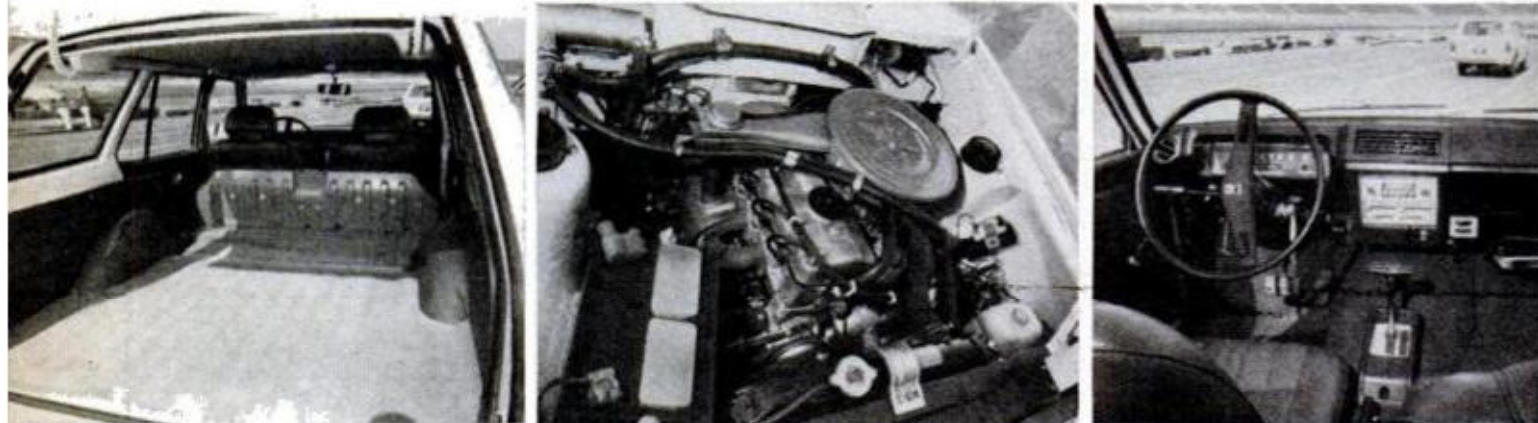

DODGE COLT, made in Japan by Mitsubishi, has three body styles, including a spacious wagon. Overhead-camshaft four uses exotic alloys. Both cars have four speeds, disc brakes. Colt has variable-ratio steering

The bargain hunter

Knots & Splices

By Charles E. Gibson . . . Now tie knots for every purpose—useful, ornamental, fun-to-make! Book gives complete "1-2-3" sketches and instructions for every hitch, splice, bend, lashing, sling or whipping you'll ever need for boating, camping, climbing, fishing, hunting . . . for patio awnings, swings, hammocks, rope fences, "welcome" mats . . . ornamental lamp, vases, bell rope, key chains, buggy whips, cat-o-nine tails, rope handcuffs, play quoits, etc. They're all here . . . over 100 kinds of knots and ropework! From the simple square knot to such fancy numbers as the Manrope, Stopper, Shroud, Crown, Turk's Head and Pine-apple knots. Also covers plaiting, braiding, much more. "Highly recommended"—Library Journal. Profusely illustrated. **ORDER NOW! \$4.95**, plus 25c handling. *10-Day Money-Back Guar.



EMERSON BOOKS, Inc., Dept. 924-S
251 W. 19th Street, New York, N.Y. 10011

COMPACT FIRE ALARM

Protector of Lives And Property Just Plug It In

No Batteries Or Installation Needed
Simply plug the compact into any household or shop outlet 110-120v. The Ultra-Alert Sensor activates the buzzer when room temperature reaches 135°F in plenty of time for effective action. For business trips or holidays—take your protection along.
Great for homes, offices, warehouses, stores, motels, hotels, etc. where high efficiency protection against fire is needed. Send \$6.95 to

ACADIA GIFTS.
WINTER HARBOR, MAINE 04693
Maine Residents add 5% State Sales Tax.

Relic Collectors! Ver-r-ry Interestink!
German-Wehrmacht-Sty'e HELMETS.
Rugged-cast-metal. (not thin sheet steel)
Cleaned by sandblasting & finished in black. Authentic S-S emblems. New chin strap & adjustable liner.
While-they-last \$25.00 post-paid—With our fully illustrated Catalog. Listing Hundreds of items. Catalog Only—\$1.00.
W.W. #2 Ltd.
Box 2063, St. Louis, Mo. 63158

NEARSIGHTED? FARSIGHTED?
No more glasses to wear! Latest discoveries! Fifteen minutes daily eye training course will improve your vision. Are your eyes worth \$2.95? Mail cheque today to:
GROSSI, Box 1061-A, Postal Station "A", Toronto 1, Ont., Canada.

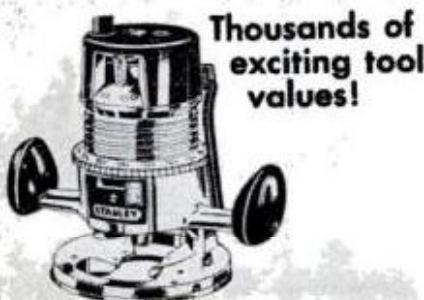

SILVO (BRAND NAME) TOOL CATALOG

Thousands of Exciting Tool Values! Stanley, Millers Falls, Skil, Thor, Wen, Dison, Wiss, Wellsaw, Dremel, Speedy Sprayers, Plumb, Huot, Kennedy, Channellock, Porter-Cable, Rockwell, Helios, Vise-Grip, Crescent, Ridgid, Pony Clamps, Unimat, Foredom and many other Nationally Advertised brands of Tools & Supplies. We ship Coast to Coast at prices Hard to Beat. Send \$5 for our big 146 page tool catalog today. Silvo Hardware Co., PM-1, 107 Walnut St., Philadelphia, Pa. 19106.

CASSETTE RADIO TUNER



CONVERT YOUR CASSETTE RECORDER TO A RADIO!

Simply insert this cartridge into your recorder as you would a tape cartridge. Press the play button, & pick up any AM or FM stations in your area.
Control volume from your recorder. Here's an option that doubles the enjoyment & value of your tape recorder!
CT-101 AM Model Cassette Tuner \$ 9.95
CT-102 FM Model Cassette Tuner \$14.95
Plus 80c post. & hdlg.
GENIE, INC. 102 So. 17, Boise, Idaho 83706

WARNING

THIS PROPERTY IS PROTECTED
BY ELECTRONIC WARNING DEVICES
WITH DIRECT SILENT ALARM
HOOK-UP TO POLICE HEADQUARTERS

PROTECT YOUR HOME AND BUSINESS!
Install this proven warning sign at rear door, side windows, front door, on fences—wherever forcible entry might be attempted. Discourages would-be intruders. Makes them keep their distance. Printed in vivid red on durable aluminum to give you lasting protection. 5"x8", \$1.98; 7"x11", \$2.98; plus 25c postage. **HUNTER INDUSTRIES**, Box 2096, Coral Gables, Florida 33134.



Imagine walking around your office or home and carrying on a phone conversation! This precision compact transistorized unit eliminates the need for being chained to phone while working or waiting for your party to answer. Ideal for conference calls in your office—simply turn up the volume & anyone in the room can hear both sides of the conversation! In the office, secretaries can listen in without disturbing conversation. At home, mother can carry on a conversation while washing dishes or tending baby. Use also as an extension speaker. TA-810 Telephone Amplifier \$9.95. Robert Witt, 813-B Laramie, Dept. 171, Wilmette, Illinois 60091.

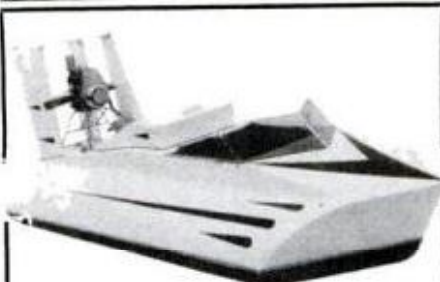

HoverPacer 2-seat ACV. Build from simple Plans, Kit. Outstanding performance: 50 MPH water, 60 MPH land. Proven design. Available in open (Sport) or closed (All Weather) cockpit design. Send \$1 for photos, tech. specs, prices.

KING TECHNOLOGY
Box 231, Carmel, Indiana 46032

QUIT WORRYING

Why be at the mercy of layoffs and overtime cutbacks? Now is your time for ACTION

LEARN HOW
Sharpening
PAYS OFF
BIG



Neighbors, hobbyists, barbers, beauty and pet shops, farmers, sportsmen, markets, restaurants, contractors, rental shops—everybody is your cash customer. **TREYCO** 6-in-1 MACHINE: hollow-grinds knives, saws, tools, scissors, pinking shears, skates, clippers, planer and Dado blades, etc. Make as much as \$6 an hour. 6 MACHINES IN 1 for price of one. World-wide satisfaction since 1946. Write for FREE CATALOG AND Factory-To-You Prices.

TREYCO 332-A Niagara St. N. Tonawanda, N.Y. 14120

PORTABLE STEAM CLEANER

STEAM IN 60 SECONDS

Clean—Engines, large & small • Air Filters • Lawn Mowers • Trucks & Tractors • Garbage cans • Kennels
"Big enough to do the job small enough to get there"
\$198.00 Freight collect—complete except for propane bottle
Auxiliary pump needed on water pressures below 60 lbs. or on well systems—\$73.50 extra.

Self cleaning coils—uses liquid cleaning compounds—soap by-pass for clear water rinsing—stainless steel firebox for long life—3 year guarantee on coils and firebox—propane fired—weighs only 120 lbs.

WEDCO MANUFACTURING, INC.
Dept. M-2, Box D,
Jackson, Wyoming 83001



WALTHER PPK 22 CAL. PELLET FIRING "STINGER AUTOMATIC" 50-22 Cal. Pellets Free.

Looks and Feels Like Full Size "James Bond" style German Automatic 5 1/2 inches long — 4 1/2 inches high. Fires 22 cal. pellets just as fast as you can pull the trigger with realistic moving slide action. Great for fast action combat—type target practice. 50 reusable 22 cal. pellets free. Free supply of targets. Money back if not satisfied. Just send \$1.25 plus 25c Not sold in NY City. HONOR HOUSE, Dept. 96PK74, Lynbrook, N.Y. 11563

Have the time of your life! Register speed, measure distance, check athletic contests. Six dials for precision. Unbreakable mainspring, luminous dial, leather strap. Fully guaranteed for one year.
pm-0087 Sports Watch \$12.95 Mass. residents add 3%
Sando's, 215 Fort Pleasant Avenue Springfield, Mass. 01108.

5 DRILLS AMERICAN MADE
1/4" shank—5" long with plastic case
ONLY \$3.75
CHECK OR MONEY ORDER TO
WOODWORKERS TOOL WORKS
222 S. Jefferson St., Chicago, Ill. 60606



AT LAST! A new TV antenna for VHF/UHF Black and White and Color. Powerful FM Stereo Radio Reception. 360° reception eliminates practically all ghosts and shadows. Install plastic TV Dome on roof or attic in minutes. All parts are sealed in the weather proof dome for protection from wind, ice, snow and damaging corrosive elements. Also ideal for boats and travel trailers. Write for free literature.

**THE SPACE SHIP, Dept. PM-70,
24-08 Jackson Ave., L.I.C., N.Y. 11101**

WHAM-O \$150
HITS LIKE A RIFLE—
KILLS RABBITS, SQUIRRELS
Powerful, silent, accurate.
For hunting, target,
routing pests.
Sportsman's
choice said
world
over!

**HUNTING
SLINGSHOT**
NEW! Superior quality pure gum rubber
40 heavy extra steel balls 20x
Heavy duty 7" ash stock.
40 heavy steel balls, extra rubber,
adapter for shooting arrows.
GUARANTEED. Professional model of
Nat'l Slingshot Assn. At dealers, or write
WHAM-O MFG. CO., P.O. Box 15 - W San Gabriel, Calif. 91778

**DRILL
SHARPENER**
No special skill required
... anyone can quickly
resharpen drills to factory
accuracy. Adjustable for all
common drill angles and
countersinks. Resharpen
drills from 1/8" to
3/4".
Instructions for
lip angles of
various ma-
terials en-
closed

**ONLY
\$5.95**
+ .75¢ P.P.
& Hdlg.

**MONEY-
BACK
GUAR-
ANTEE
(No C.O.D.
orders please)**

Northern Supply Co
Box 378, Walhalla,
North Dakota 58282

**WATER WATER "HOW TO DRILL YOUR
WATER WATER OWN WATER WELL"
WATER WATER \$1.00ppd
WATER WATER SATISFACTION
WATER WATER GUARANTEED**

**DEEPROCK CO.
OPELIKA, ALA. 36801**



Bartlett Flying Saucer ultra-light hovercraft powered by ordinary lawn mower engine—easy to build—fun to fly—complete plans, kit brochure, photos and supply sources \$5.00. All orders returned via airmail. Write:
HERB BARTLETT
Box 3339-M, Scottsdale, Arizona 85257



FREE MUSCLE COURSE!
Want a new Jet-Charged body? In 15 minutes I'll prove you can slap on 4" of muscles to your chest—3" to each arm—give you life-guard shoulders, trim your waist to athletic size—give you speedy athletic legs. I don't care if you're short or tall (skinny or fat) young or not so young, expect a muscle building miracle when you send for my free course. Send only 25¢ to cover postage and handling to Joe Weider, Dept. 38-11-D2, 531 32nd St., Union City, N.J.

AUTOMATIC BLANK GUN
ONLY **\$500**
POSTPAID

Fires 22 calibre blank ammo. Solid metal construction. 6 shot, clip fed. Smooth functioning rapid firing. Comes with instructions and free cleaning rod. Use for self-protection—theatre—dog training—sporting events. Purchaser must be over 21. No shipment to New York or California. Only \$5.00 post-paid. Money back guarantee.

**WESTBURY SALES CO.
P.O. BOX 434 Dept. AT-9-P
Westbury, New York 11590**

POLARITY INDICATOR FOR BOOSTER CABLES EMERGENCY TROUBLE LIGHT

• **SAVE COSTLY REPAIR BILLS DON'T DESTROY YOUR ALTERNATOR**

Light provides positive proof of jumper cable hook-up. Illuminates battery and engine areas. Fits all size cable 6 or 12 volt syst. Rigid connection between cables eliminates tangling. Same day mail service. Send \$2.00 to

**Polarity Indicator Inc.
Box 1047, Miami, Fla. 33157**

**IMPORTED
LOCK BLADE
STILETTO**

ONLY **\$2.75 Ea.**
9" Overall Length
5" When Closed

- Opens instantly
- Sharp and Tough
- Stainless Steel Blade

Flips open instantly and locks automatically to prevent accidental closing. Razor sharp tough stainless steel blade for reliable use and hard, long service. Money back in 5 days if not satisfied. Send \$2.75 plus 25¢ to cover postage and handling.

**WESTBURY SALES CO.
P.O. BOX 415 WESTBURY, N.Y. 11591
DEPT. L-85-PM**

**REDUCIBLE
RUPTURE**
AGONY Removed
(or trial COSTS YOU NOTHING)

WHEN you slip into a low-cost, contour-designed Brooks Patented Air Cushion Appliance! Your reducible rupture will be held in securely yet gently—or the trial costs you nothing! This invention has made millions of sufferers happy. You can enjoy heavenly comfort night and day at work and play—or the Appliance costs you NOTHING. Isn't this worth a no-risk trial by you? If interested, write for free facts now.

BROOKS CO., BOX 346-J, MARSHALL, MICH. 49068

WESTERN HAIG
.12 CALIBER
SPECIAL FACTORY OFFER!

\$300 post-paid

USES POWDER CHARGE
This small bore gun shoots .12 cal. steel bullets fired by small 4.4 mg. powder charge. Not a CO2 gun. You'll like the handsome lines, grip, and balance. Western in style, but patented ball and cap action allows this low price. 9 1/4" steel barrel cased in knurled styrene stock, overall 13 1/2". Develop pistol form, accuracy at a fraction of cost of large cal. pistols. Comes with 50 steel bullets. Satisfaction guaranteed. Send \$3.00 to:
HAIG MFG. CO., P.O. Box 26 - B Alhambra, Calif. 91802

ATTENTION SKIERS!
Build and let the "SKI PROP" push you for your winter fun.

Fun to assemble. Fun to "fly" with 45 lbs. of thrust on your back and speeds up to 50 mph. Get your complete easy to follow plans, instructions, materials list, photos and supply sources. Send \$5.00. Complete kit available. (\$5.00 refundable on first order of one complete kit.) All orders filled by return mail. Use it also with a SKIBOB!

**WRITE TODAY TO DEPT. PM 2
AIR KINETICS, Box 1665, Orange, Calif. 92667**

FREE!!! POWERFUL MUSCLES FAST!
Fantastic New Discoveries in the science of bodybuilding. Now, in the privacy of your bedroom, our method will add inches of powerful muscles to arms, chest, shoulders & legs. Learn secrets on trimming the waist with ultra-modern methods—fast! Results Guaranteed! Send for free brochure. Universal Bodybuilding, Box 485-M1, Dearborn, Mich. 48121.



Metal Piercing Throwing knife

Great for hunting game. Weighted, balanced for sure throwing accuracy. Hits with a hard smack. **FAST, EASY TO THROW.** Use for self defense, hunting, thrills, targets. Razor sharp cutlery steel, 16" long—Double edge. Wrapped leather handle. **\$1.00** (2 for **\$1.85**) (3 for **\$2.75**). Knife-throwing instructions **FREE.** Order Now. **WORLD CO., Dept. 1PM, 1 Park Ave., New York City 10016.**

AUTOMATIC 100-SHOT PELLET STINGER

Animals, Assailants Instantly Repulsed. The pellet is harmless but STINGS. Holds and fires 100 pellets automatically as fast as you can pull the trigger to knock most stubborn assailants off guard. Portable. Fits easily in pocket or purse. Made of high impact styrene for long life, trouble-free use. Keeps dogs and animal pests off your property. Send **\$1.98** cash, check or money order plus 27c to cover handling and we include 50 stinging pellets. Not sold in N.Y.C. or if under 18 (State age with order). (**\$1.00** pellets **\$1**) 250 pellets **\$2** (1000 pellets **\$5**). **WORLD CO. Dept. 1PM, 1 Park Ave. N.Y.C. 10016**



Powerful, New, Transistorized Listening Device

SNOOPER-EAR



- Amplifies Sound
- Complete with Tripod & Earphones

Electronic marvel. Works on same principle as fabulous Missile Tracking antennas. Aim disk reflector, hear jets roar in your special earphones. Pick up voices too distant to hear. Big 18" reflector-disk concentrates sound and amplifies inaudible sounds loud and clear. Sturdy tripod with stethoscope-type earphones. Used by government agencies. Tape recorder can be plugged in. Fully guaranteed. **WORLD CO., Dept. 1PM, 1 Park Ave., N.Y.C. 10016.**

\$1895
plus **\$1.00**
pp. & hdig.

MINIATURE AIRCRAFT RECEIVER

- Amazing voice clarity.
- Hear a/c movements.
- Fits easily in pocket.
- Little larger than fountain pen.
- Range up to 75 miles to flying aircraft. 15 miles to Control Tower.
- Operates on 108-136 MC. Operates on hearing aid battery (supplied).

\$13.49

Send for our free catalog
DELECTO ELECTRONICS, Dept. PM
4725 45th NE—Seattle, Wash. 98105

"SKY SPY"



BUILD THESE BEAUTIFUL CLOCKS



NOW AT BIG SAVINGS!

Send just \$1 for plans & instructions to build choice of: (A) Grandfather, (B) Steeple, (C) Grandmother—plus information-packed catalog of movements, dials, parts & kits to build these & 16 other fine clocks. All 3 plans—\$2.50. Catalog alone—25¢.

MASON & SULLIVAN COMPANY
Dept. PM, Osterville, Mass. 02655

BUILD YOUR OWN POWER TOOLS

- METAL PARTS KITS AT LOW FACTORY DISCOUNT PRICES FOR: **SAVE \$50 OR MORE**
- 10-IN. TILT/ARBOR SAW
 - COMB. DRILL PRESS-LATHE
 - 12-IN. BAND SAW
 - 18-IN. BAND SAW
 - 6-IN. BELT SANDER
 - SPINDLE SHAPER
- PLANS **\$1.00** EACH DEDUCTIBLE
Full Size Patterns

Kits from **\$17.99** to **\$45.99**. Satisfaction guaranteed. Built and sold for 24 years. 50,000 units in use. Send **\$1.00** for Plans or 25c for Catalog!

NO WELDING, NO MACHINING

GILLIOM MFG. CO. Dept. PMT-1, St. Charles, Mo. 63301

JANUARY 1971

BELSAW PLANER • MOLDER • SAW

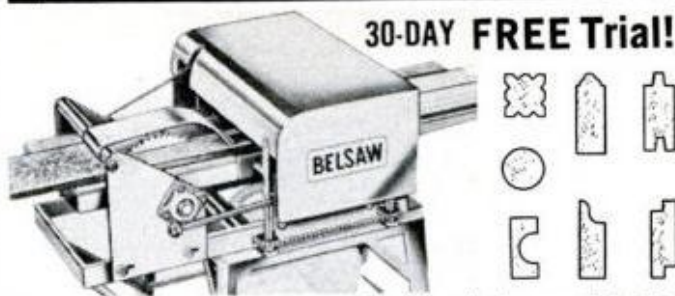

30-DAY FREE Trial!

Now you can use this ONE power-feed shop to turn rough lumber into moldings, trim, flooring, furniture... ALL popular patterns. RIP... PLANE... MOLD—separately or all at once with a single motor. Free 30-Day Trial. Low Cost—only **\$35** down.

Send Postcard Today — No Salesman Will Call.
BELSAW POWER TOOLS, 901-J Field Bldg., Kansas City, Mo. 64111

FREE 2000 NOVELTIES TRICKS * JOKES

FREE! World Famous Catalog of hard-to-get Novelties, Hobbies, Science & Electronics, Sports, Auto-Bike Items, Live Animals, Fantastic Jewelry & Medals, Bargains. Many pages in color. Send 10¢ mailing cost.

No Letter Necessary. Send Ad with Name & Address
JOHNSON SMITH CO., Dept. C-101, Detroit, Mich. 48224
TEAR OUT MAIL TODAY

OPERATE 3 PHASE MOTORS FROM SINGLE PHASE LINES— ONLY \$29.95!

The Reliance 3 phaser allows you to operate 3 phase motors from 220 volt single phase power sources. Rugged-heavy duty-patented unit built to give many years of dependable service. Thousands of satisfied users. Free literature on request.

RELIANCE ELECTRIC MFG. CO. INC.
P. O. BOX 841, DEPT. 37
NEW ALBANY, MISS. 38652

PUT YOURSELF IN THIS PICTURE:

Your Typewriter is now like new! I'll send a bill for the \$25.



This Can Be YOU Sooner Than You Think!

BECOME A TYPEWRITER MAINTENANCE EXPERT

Quickly — Easily — At Home without risk!

Royal Typewriter for practice



PLUS YOUR PROFESSIONAL TOOLS INCLUDED WITH COURSE



Earn up to \$50 in a week spare time, as a graduate reports, get big pay position, or start your own business

There is a critical shortage of technicians to keep America's 30 million typewriters in repair. Now, regardless of age, education, or present job, you can enter this big-paying field by training in the Office Equipment Industry's only Approved Home Study Course.

Learn fast, and earn money while learning. Diagrams, photos, clear lessons, professional tools, plus benchwork assignments on actual typewriter that we give you, make learning easy.

Send name today for FREE BOOKLET telling of your opportunities in this profitable vocation. Full information, no obligation. No salesman will call. Approved for Veterans

MAIL COUPON FOR FREE BOOKLET

Typewriter Repair School, Dept. 3110-011
Little Falls, N. J. 07424

Please rush Booklet entirely FREE. No obligation. No salesman is to call.

Name _____

Address _____

City _____ State _____ Zip _____

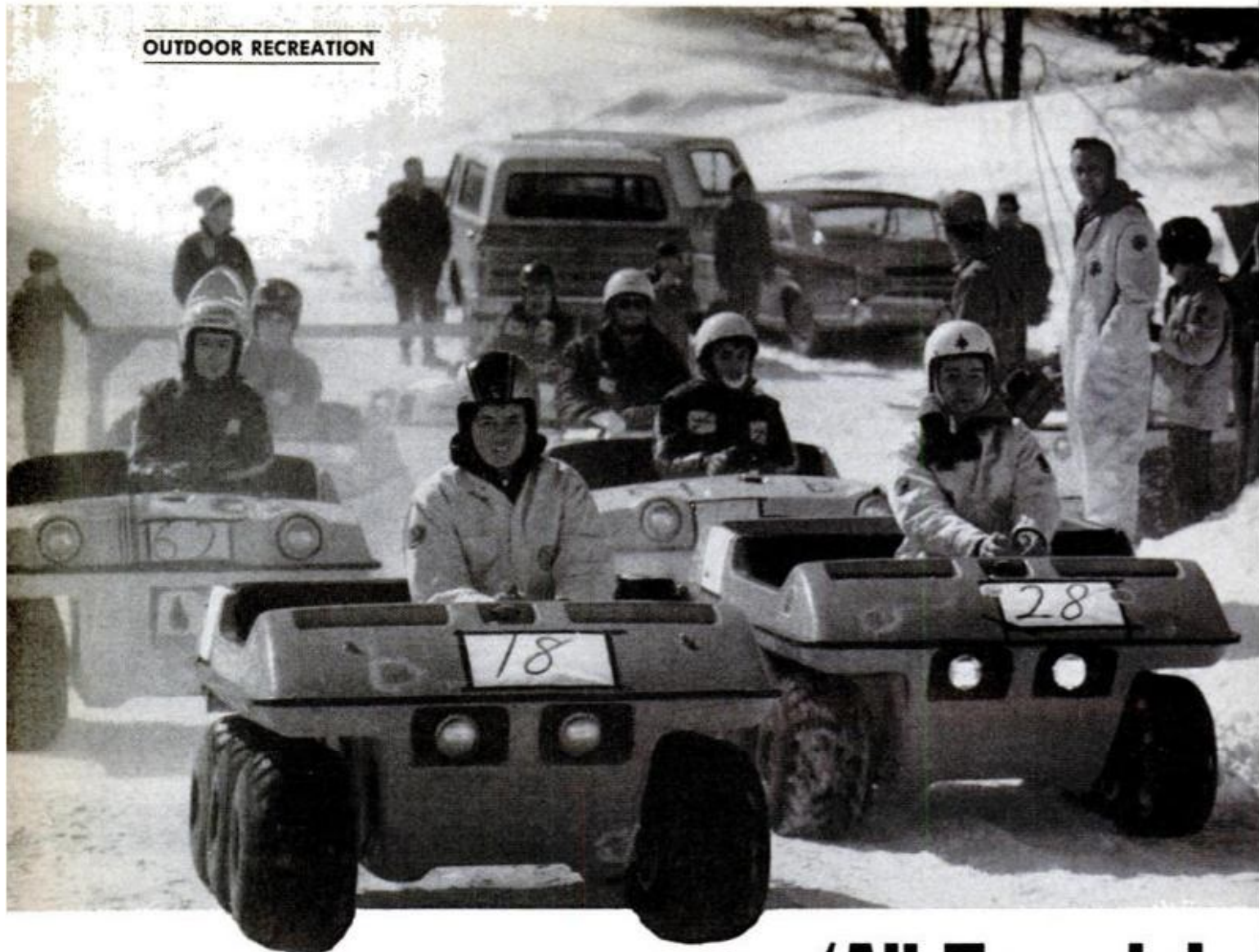

ENGINES ROAR and exhausts rise as drivers ready for the starting gun in the Mount Snow winter rally

INSTRUCTIONS FROM FLAG warn driver to avoid collision with disabled ATVs round the next curve

'All-Terrain' Takes in Snow

By **GEORGE REIGER**, *Outdoors Editor*

Photos by Ernie Gay



NO TROLLEY HOOKUPS, no overhead wires—but still the darn things are like bumper cars at a carnival. That's not really their purpose, but it's the way ATVs act in a snow race, I learned in a frigid ATV rally at Mount Snow, Vt. You're not supposed to collide with the car in front—but you do. And you aren't supposed to fall out while trying to climb a steep grade. But that happens, too. Since you're not really going fast and you land in snow, no harm. As for who wins, come on now, who cares? ★★★

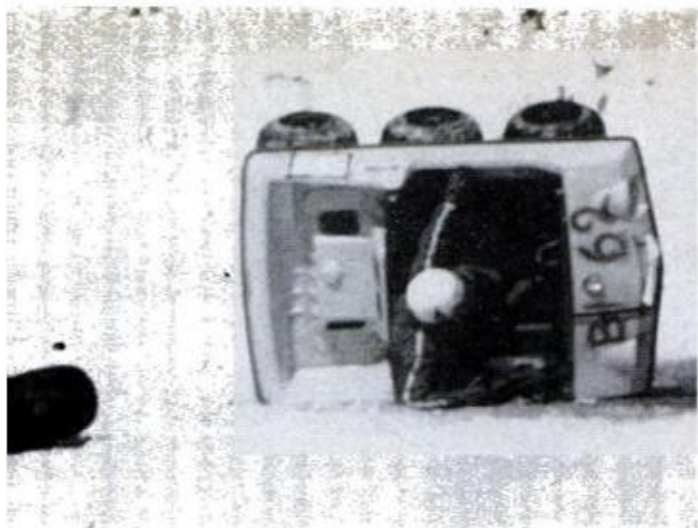

WHILE RACING BUGS frequently spill drivers on sharp turns, wheel losses (above) are rare. Below: ATVs prove themselves on packed, slippery straight-aways, but appear limited in deep, powdery snow



FROZEN FOUNTAIN at Mount Snow (above) provides weird winter backdrop for little obstacles of race. Below: While not typical of Vermont traffic, it shows what happens when one ATV conks out on a curve



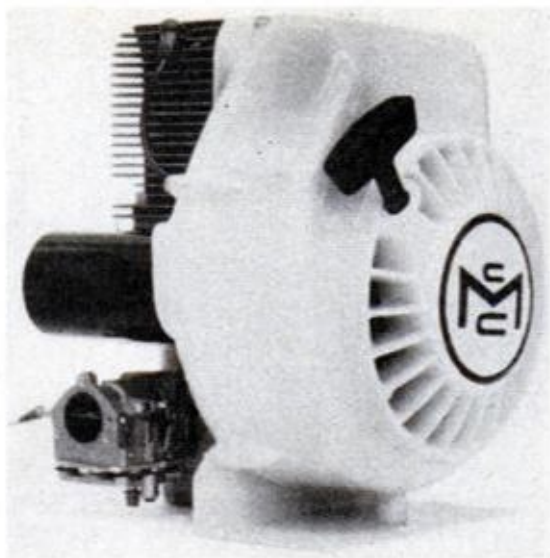
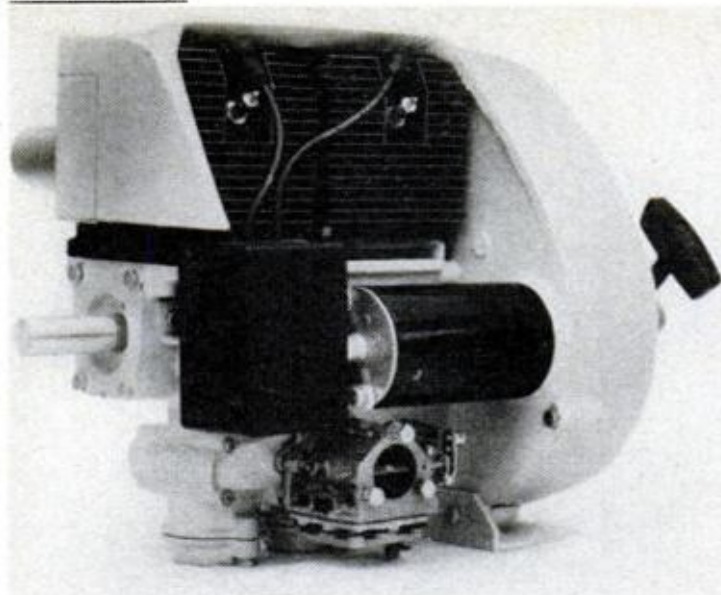

TWO OF McCULLOCH'S LINE of 12 new snowmobile engines are the 399-cc two-cylinder (left) and the 199-cc one-cylinder (right). Both engines boast a speed ranging between 2000 and 7000 rpm and a 2.75-in. bore

A Spunky, New Engine for Snowmobiles

By MICHAEL LAMM, West Coast Auto Editor
 Technical Illustration by Peter Trojan

McCULLOCH CORP. of Los Angeles plans to burn up the snow next year with a new generation of snowmobile engines. These revolutionary powerplants include a lot of very astute engineering.

Since four-stroke engines suffer from cold-weather sluggish starting and lubrication problems, McCulloch uses two-strokes, air-cooled, made mostly from magnesium castings. The superlight-weight powerplants come in one and two-cylinder versions. They can be mounted in or on the vehicle in any position and at any angle. Carb(s) and exhaust systems may be swapped from side to side.

Seven sizes are planned initially, ranging from 147 cc (8.9 cu. in.) to 439 cc (24.6 cu. in.). The McCullochs' horsepower ratings average 24 percent more than their cubic-inch displacements. In other words, a 24-cu.-in. McCulloch twin puts out around 30 bhp. Additional horsepower may be gained by multiple carburetion and tuned exhausts.

(Please turn to page 34H)

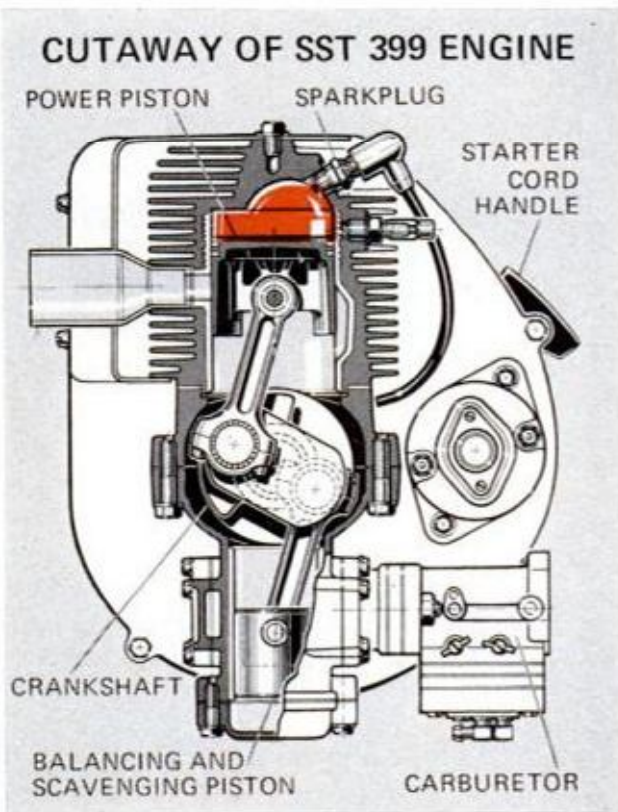

McCULLOCH ENGINES		
Displacement	No. Cylinders	Approx. BHP
147.0 cc	1	11.1
199.0 cc	1	15.0
219.5 cc	1	16.5
294.0 cc	2	22.5
339.0 cc	2	26.1
399.0 cc	2	30.0
439.0 cc	2	33.0
Proposed for 1972-73		
294.0 cc	1	n.o.
399.0 cc	1	n.o.
650.0 cc	2	n.o.
800.0 cc	2	n.o.
1200.0 cc	3	n.o.

when I planned to retire before fifty

this is the business that made it possible

a true story by John B. Haikey

Starting with borrowed money, in just eight years I gained financial security, sold out at a profit and retired.

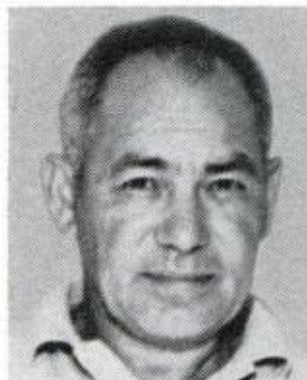

"Not until I was forty did I make up my mind that I was going to retire before ten years had passed. I knew I couldn't do it on a salary, no matter how good. I knew I couldn't do it working for others. It was perfectly obvious to me that I had to start a business of my own. But that posed a problem. What kind of business? Most of my money was tied up. Temporarily I was broke. But, when I found the business I wanted I was able to start it on less than \$1000 of borrowed money.

"To pyramid this investment into retirement in less than ten years seems like magic, but in my opinion any man in good health who has the same ambition and drive that motivated me, could achieve such a goal. Let me give you a little history.

"I finished high school at the age of 18 and got a job as a shipping clerk. My next job was butchering at a plant that processed boneless beef. Couldn't see much future there. Next, I got a job as a Greyhound Bus Driver. The money was good. The work was pleasant, but I couldn't see it as leading to retirement. Finally I took the plunge and went into business for myself.

"I managed to raise enough money with my savings to invest in a combination motel, restaurant, grocery, and service station. It didn't take long to get my eyes opened. In order to keep that business going my wife and I worked from dawn to dusk, 20 hours a day, seven days a week. Putting in all those hours didn't match my idea of independence and it gave me no time for my favorite sport—golf! Finally we both agreed that I should look for something else.

"I found it. Not right away. I investigated a lot of businesses offered as franchises. I felt that I wanted the guidance of an experienced company—wanted to have the benefit of the plans that had brought success to others, plus the benefit of running my own business under an established name that had national recognition.

"Most of the franchises offered were too costly for me. Temporarily all my capital was frozen in the motel. But I found that the Duraclean franchise

offered me exactly what I had been looking for.

"I could start for a small amount—less than \$1000—and that amount I could borrow. I could work it as a one-man business while getting a start. No salaries to pay. I could operate from my home. No office or shop rent or other overhead. For transportation I could use the trunk of my family car. (I bought the truck later, out of profits.) But, best of all, there was no ceiling on my earnings. I could build a business as big as my ambition and energy dictated. I could put on as many men as I needed to cover any volume I could build. I could make a profit on every man working for me. And, I could build this little by little, or as fast as I wished.

"So, I started. I took the wonderful training furnished by the company. When I was ready I followed the simple plan outlined in the training. During the first period I did all the service work myself. By doing it myself, I could make much more per hour than I had ever made on a salary. Later, I would hire men, train them, pay them well, and still make an hourly profit on their time that made my idea of retirement possible—I had joined the country club and now I could play golf whenever I wished.

"What is this wonderful business? It's Duraclean. And, what is Duraclean? It's an improved, space-age process for cleaning upholstered furniture, rugs, and tacked down carpets. It not only cleans but it enlivens and sparkles up the colors. It does not wear down the fiber or drive part of the dirt into the base of the rug as machine scrubbing of carpeting does. Instead it *lifts out* the dirt by means of an absorbent dry foam.

"Furniture dealers and department stores refer their customers to the Duraclean Specialist. Insurance men say Duraclean can save them money on fire claims. Hotels, motels, specialty shops and big stores make annual contracts for keeping their carpets and furniture

fresh and clean. One Duraclean Specialist recently signed a contract for over \$40,000 a year for just one hotel.

"Well, that's the business I was able to start for less than \$1000. That's the business I built up over a period of eight years. And, that's the business I sold out at a substantial profit before I was fifty."

Would you like to taste the freedom and independence enjoyed by Mr. Haikey? You can. Let us send you the facts. Mail the coupon, and you'll receive all the details, absolutely without obligation. No salesman will ever call on you. When you receive our illustrated booklet, you'll learn how we show you STEP BY STEP how to get customers; and how to have your customers get you more customers from their recommendations.

With no obligation, we'll mail you a 24-page brochure explaining the business. Then you, and you alone, in the privacy of your home, can decide. Don't delay. Get the facts before your location is taken by someone else. Mail the coupon, now.

DURACLEAN INTERNATIONAL
1-161 Duraclean Bldg., Deerfield, Ill. 60015



send
name
for
full
facts

DURACLEAN INTERNATIONAL
1-161 Duraclean Building
Deerfield, Illinois 60015

WITHOUT OBLIGATION mail letter and 24-page illustrated booklet explaining how I can increase my income and family security with a Duraclean Dealership. No salesman is to call.

Name _____
Address _____
City _____ State _____ & Zip _____

think foam tape



It's self-adhesive!

Ideal for easy weather stripping of doors and windows and hundreds of other uses. Sticks to any dry, clean surface. Comes in four sizes. Available at the M-D Weatherproofing Center of your Hardware or Building Supply Dealer.



MACKLANBURG-DUNCAN CO.
BOX 25188

Our 50th year. Oklahoma City, Okla. 73125 U.S.A.

ARROW

All-Purpose
STAPLE GUN

T-50

SHOOTS A STAPLE

Uses 6
Staple Sizes
1/4" to 9/16"
including
Ceiltile.

WHEREVER YOU'D DRIVE A NAIL!

At
Hardware,
Lumber & Building Supply,
Stationery, Variety and
other retail outlets.

ARROW FASTENER COMPANY, INC.
271 Mayhill Street, Saddle Brook, N. J. 07663

Nothing by any
other name is even
half the same as

Spackle®



Unique — the painter's smoothing compound — first choice of the pro's — there's just one Spackle®. Works easiest, adheres to anything, dries fast, sands beautifully. Get it — and nothing but it — in the orange and blue can at paint and hardware stores.

the **muralo** company inc.
New York/Bayonne/Chicago/Los Angeles.

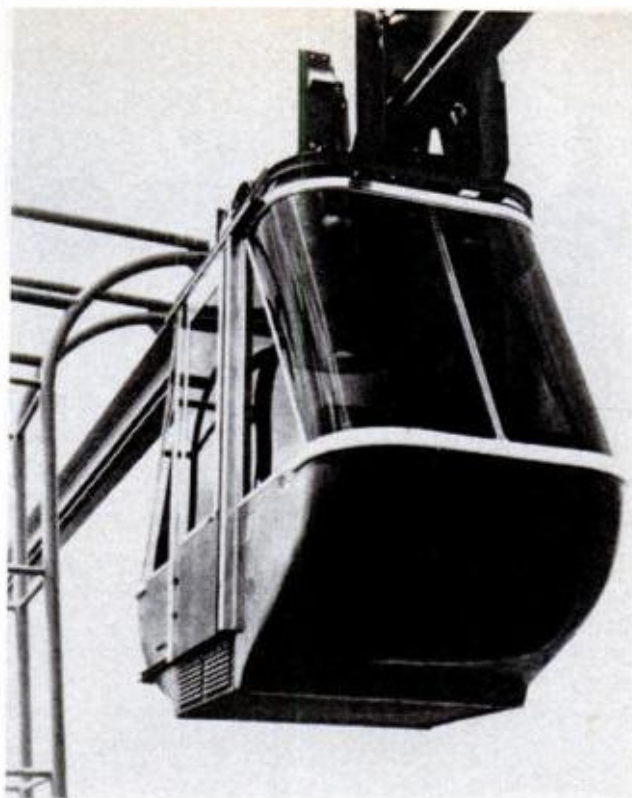

City transporter

An automated, computer-controlled urban transportation system is being tested in Texas by the Sky-Kar Corp. Each car in the system, suspended on a rail, can carry six seated and six standing passengers. The cars are self-powered, airconditioned and heated.

NEW ENGINE FOR SNOWMOBILES

(Continued from page 34F)

Among these engines' clever features is a combined balancing and scavenging piston. This piston mounts opposite the power piston and moves up and down in its own chamber. Thus the "two-cylinder" McCulloch actually has four cylinders and four pistons. Yet two pistons are *not* powered—they have no sparkplugs and do no actual work. They're there to balance the power pistons, but more important, they also serve to draw fuel/air/oil mixture into the crankcase for added scavenging. This gives the McCulloch two-strokes their horsepower advantage over most other designs.

The intake system is designed so one to four carburetors can be mounted by unscrewing baffle plates on a cuboid manifold extension and replacing them with carbs.

With the McCullochs' inherent balance in both the single and twin version, engine mounts can be quite a bit lighter than usual. This plus the engines' light weight does wonders for performance and space.

You'll see a lot of McCullochs on the snow next year.

★★★

How to get your hands on more money fast and have a good time doing it

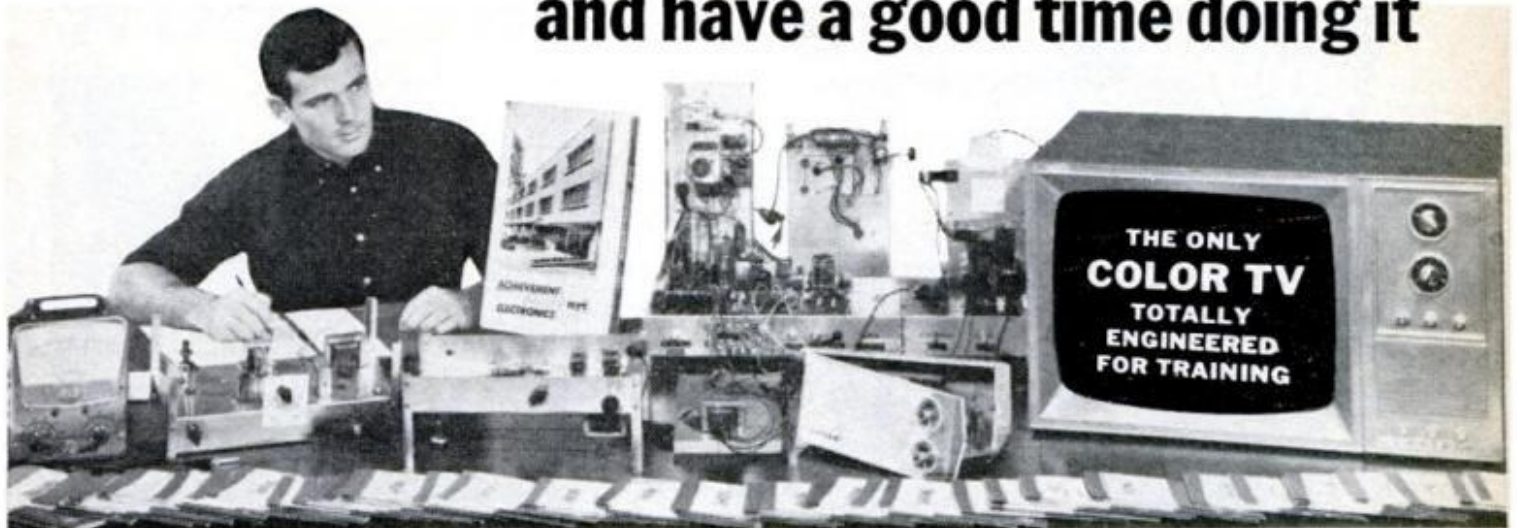

BUILD • TEST • EXPLORE All this is yours — from Achievement Kit, to solid state Radio, to training-engineered Color TV set — when you enroll for NRI's TV-Radio Servicing course. Other courses equally complete. Unique training methods, "bite-size" texts, many personal services have made NRI the leader in its field for over 50 years.

NRI Programmed Equipment Gives You Priceless Confidence, Makes Learning TV-Radio, Electronics Fast and Fascinating

NRI pioneered the idea of supplying home-study students with custom designed training kits to give practical on-the-job experience as you learn. Today, NRI's "3-Dimensional" training can't be equalled. You get more value — from the exclusive Achievement Kit sent the day you enroll, to "bite-size" texts and custom training equipment. Learning TV-Radio, Electronics or Communications at home is easy, exciting, the NRI simplified, dramatized way.

BE A SKILLED TECHNICIAN IN AMERICA'S FASTEST GROWING INDUSTRY

Regardless of your educational background, you can learn the Electronics field of your choice the practical NRI way. The NRI color catalog, sent to you free and without obligation, tells you how you can qualify quickly to be a part of the fast growing Electronic Age; about engineering jobs in business, industry, broadcasting, government, now offered to men without college degrees. It will open your eyes to the great number of success opportunities available right now in the high-pay world of TV-Radio Servicing, Broadcasting-Communications and Industrial-Military Electronics. With NRI technical training, you can take your choice of a wide variety of career

openings or have a business of your own. And if you choose one of five NRI courses that include FCC License preparation, you must earn your FCC License or NRI refunds your tuition!

MAKE \$5 TO \$7 AN HOUR EXTRA IN SPARE TIME STARTING SOON

Tens of thousands of NRI graduates are proof it is practical to train at home in your spare time. Keep your present job while preparing for a better one, and earn \$5 to \$7 an hour extra in spare time while you train, fixing sets for friends and neighbors. NRI shows you how. Equipment you build and keep becomes useful in your work.

STEP UP TO BETTER PAY, A BRIGHTER FUTURE

NRI can help you, but the decision to act must come from you. Decide now to move ahead . . . mail the postage-free card today for your FREE NRI color catalog. No obligation. No salesman will call. NATIONAL RADIO INSTITUTE, Electronics Division, Washington, D.C. 20016.

APPROVED UNDER GI BILL

If you served since January 31, 1955, or are in service, check GI line on postage-free card or in coupon.

CASH IN ON THE BOOM IN COLOR TELEVISION



The NRI TV-Radio Servicing course includes your choice of black and white or color TV training equipment. Color TV needs thousands of trained men to keep pace with millions of sets being sold every year. NRI prepares you quickly. Cash in on the boom.

Mail insert card for your **FREE NRI color CATALOG**

No salesman will call



**SPECIAL
ROUNDUP**

New Ideas From the HARDWARE SHOW

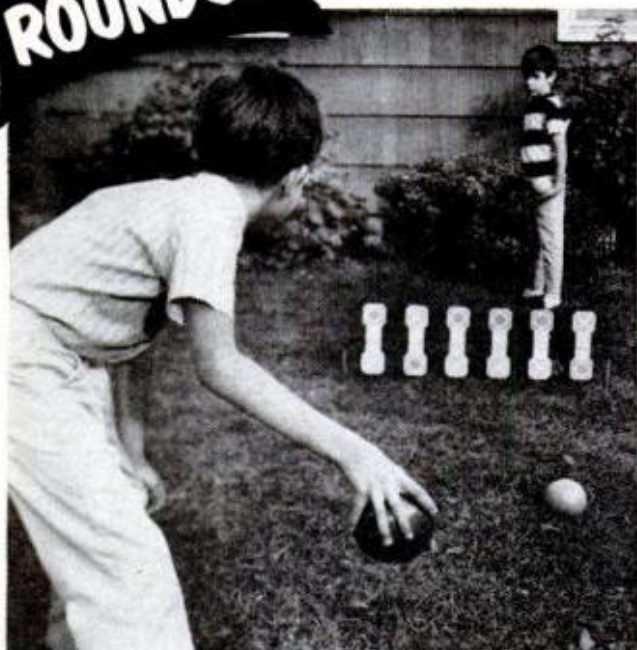

GOOD GAMES NEVER DIE; they just pop up in newer versions. Lawn Tic-Tac-Toe provides outdoor fun for the family, sells for \$12. Eagle Rubber Co., Inc., Ashland, Ohio 44805.

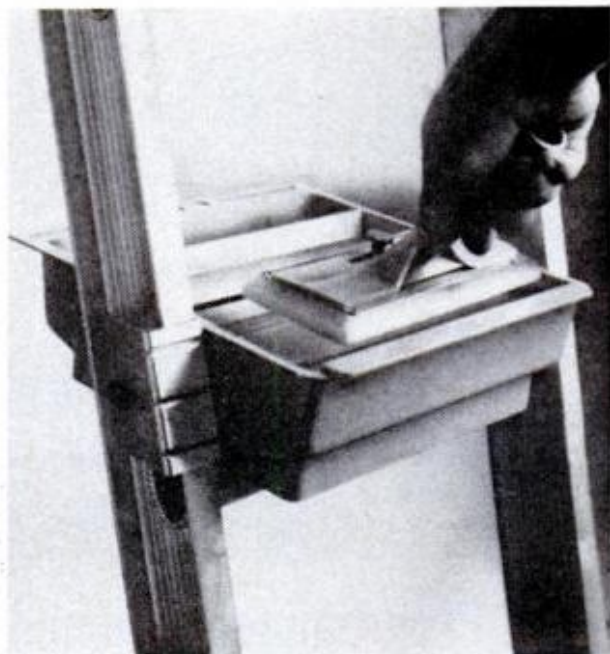

PAINT TRAY for pad applicators, designed to transfer paint evenly, holds $\frac{1}{2}$ gallon of paint. Tough, plastic tray snaps apart for cleanup. \$4.22. Red Devil, Inc., Union, N.J.



LOW-COST FIRE EXTINGUISHER from Bernz-O-matic, Driving Park and Reich, Rochester, N.Y., is priced under \$4. Model No. FE18UL foam puts out oil, grease and gas fires.

ELECTRIC PENCIL-ENGRAVER from Wen Products, Inc., 5810 N.W. Highway, Chicago, Ill. 60631, has superhard tungsten-carbide tip, for use on materials from steel to glass.



GARDEN SHEARS with built-in, nonslip anvil holds flower and shrubbery stems after they're cut. \$3. Stanley Tools, Dept. PID, New Britain, Conn. 06050. At hardware stores.



(Please turn to page 44)



How much do you have riding on your camper's tires?

A lot. In pounds and in people.

So you need a lot of tire. Firestone recommends nylon-cord truck tires with Triple-Strength Construction. For example:

The new Transport 500 Wide Oval truck tire, now original equipment on new pickup campers. This all-wheel tire puts more rubber on the road for more stability and less sway in crosswinds, and a smoother ride.

The new Traction All Season Wide Oval truck tire for rear wheels. Runs smooth and silent on the highway. But get off in the roughest country and this one pulls you through mud, loose gravel or snow.

Both of these tires are Wide Oval truck tires. They'll carry heavy loads. And stop faster. But, most important, they are made with Firestone's exclusive Triple-Strength Construction. That's the special way Firestone bonds the tread to the body, reinforces the sidewalls and insulates every cord.

Get them at your Firestone Dealer or Store. Or specify them on your new camper.

Because you have a lot riding on your camper's tires.



The new Transport 500 Wide Oval truck tire.

The new Traction All Season Wide Oval truck tire.

Transport 500 Wide Oval, Traction All Season Wide Oval—Firestone TM's. Transport®

Firestone
For Triple-Strength Construction.

New Ideas From the HARDWARE SHOW

(Continued from page 38)

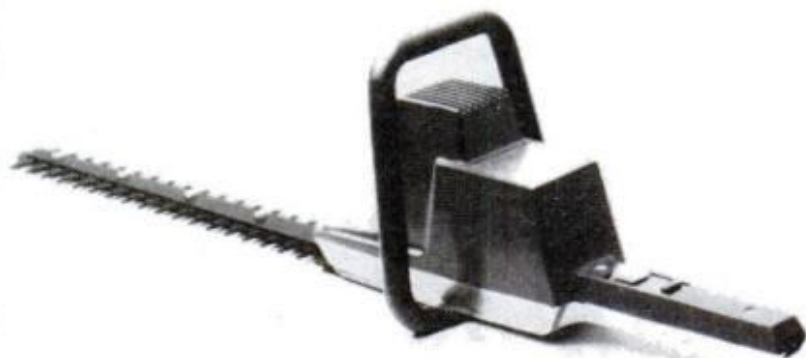

CORDLESS ELECTRIC HEDGE TRIMMER is completely self-contained, features rechargeable batteries for overnight renewal and Teflon-S coated blades. Disston Div., H. K. Porter Co., Inc., Porter Building, Pittsburgh, Pa. 15219, makes it.

MORE LAWN FUN next summer is assured with Posy Pitch. Played like horseshoes by two to eight, the game is quickly set up. \$5. Eagle Rubber Co., Inc., Ashland, Ohio 44805.

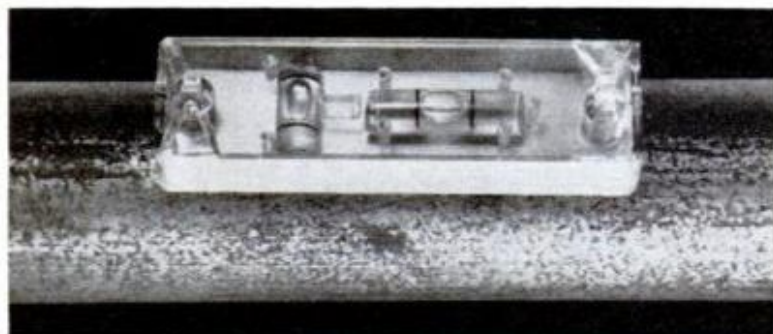
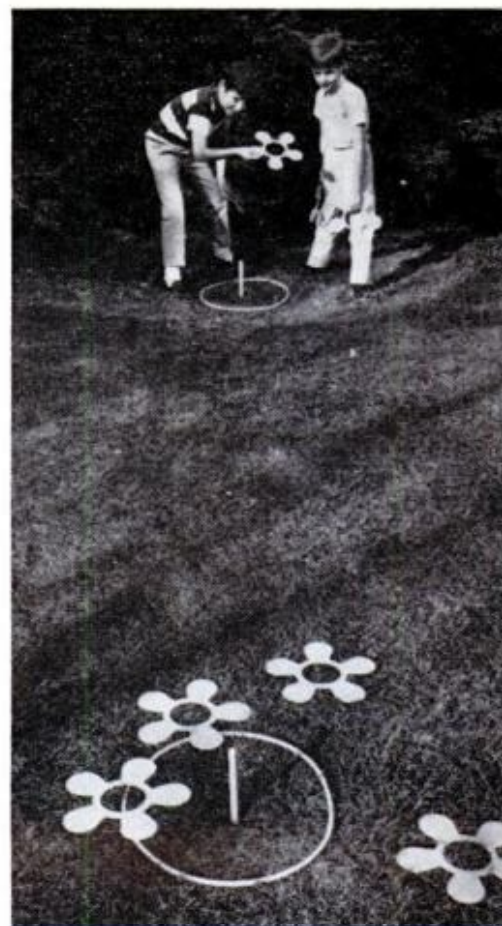

MINI LINE-LEVEL features a magnetized base so that the tool can be used when you work with metals to give instant plumb and level readings at a glance. The level incorporates modular construction features with replaceable tough, plastic Lexan parts which will take all kinds of abuse. Handy for around-the-house chores such as leveling hi-fi turntables and appliances and general carpentry, the 3½-in. instrument

comes in a see-through pouch with a pocket clip for convenient on-the-job toting. It's available at hardware stores for \$1.25. For nearest dealer write Miracle Instrument Co., 1569 Third Ave., New York, N.Y. 10028.



PORTABLE ORGANIZER for drill and all its accessories holds any ¼ or ⅜-in drill, 25 drill bits and features molded slots for wall mounting when not in use. At hardware stores, \$5. Akro-Mils, Akron, Ohio 44309.

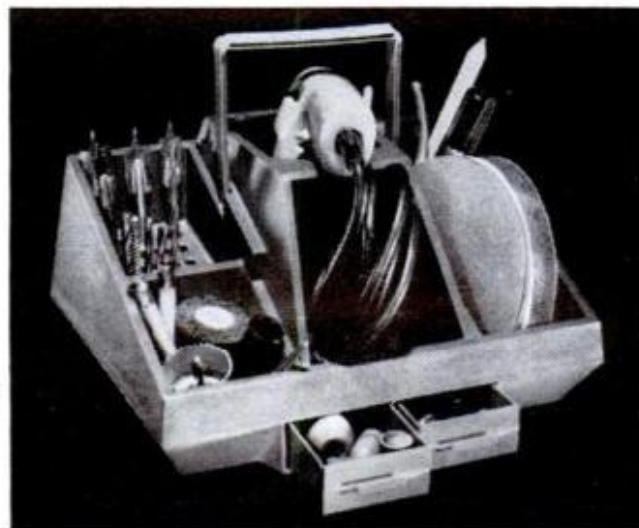

It's Like Having Auto Factory Experts Right Beside You...

when you use this famous illustrated step-by-step guide that shows you

HOW TO FIX ALMOST ANY PART OF ANY CAR

Now—Whether You're a Beginner or Pro Mechanic—You Can "Breeze Through" Almost ANY Repair Job on Any Popular-Make Car—1965-1971!

MOTOR's AUTO REPAIR MANUAL shows in step-by-step words and pictures all the factory-approved repair procedures you'll ever need for fixing practically ANY part of ANY car listed here—1965-1971.

**OVER 1,000 BIG PAGES—
OVER 3,000 PICTURES!**

This GIANT NEW, 1971 edition covers everything you need to know to fix almost any car model from 1965 through 1971. Over 1,000 giant pages. Over 3,000 pictures. Hundreds of "Quick-Check" charts, 55,000 essential repair specifications. Over 225,000 service & repair facts.

PLUS Adjustment Tables, Tune-Up Charts, Tables of Measurements and Clearances, Overhauling and Replacement Facts, Carburetor Adjustment, etc. Special Trouble-Shooter Section and detailed trouble-shooting information throughout help pinpoint the cause of any of 4,200 car troubles in a jiffy.

Same Offer on MOTOR's AUTO ENGINES & ELECTRICAL SYSTEMS

1,300 big pictures. Clear text explains how parts work; principles involved; design; construction; maintenance. Covers all parts of engines & entire electrical system. For FREE trial, check coupon.



No guess-work! Even a green beginner mechanic can do a good job with this giant MANUAL before him. And if you're a top-notch mechanic, you'll profit from the time-saving and work-cutting procedures you'll find.

The MOTOR MANUAL makes almost every operation on any car—from Volkswagen to Cadillac—as easy as A-B-C! Eliminates trial and error — saves you time, work and money.

**OVER 5½
MILLION
COPIES SOLD**

**SEND NO MONEY
Try MANUAL at OUR
Risk—FREE**

See for yourself why U.S. Armed Forces, Schools, and garages everywhere "swear" by MOTOR. Just mail the coupon. Try MANUAL for 10 full days—FREE! If it doesn't pay for itself in those 10 days, just return it and pay nothing, owe nothing. Mail the coupon AT ONCE to MOTOR Book Dept., 250 West 55th Street, New York, N.Y. 10019 (SCHOOLS, BOOKSTORES: Write for discounts.)



FIX ALL THESE CARS

Volkswagen	Maverick
Mustang	Buick
Barracuda	Special
Nova	Cornet
Chryv II	Corvaer
Pontiac	American
Thunderbird	Olds F-85
Buick	Falcon
Imperial	Fairlane
Cadillac	Lancer
Continental	Tempest
Dart	Corvette
Mercury	Valiant
Ford	Cougar
Chevelle	Toronado
Chevrolet	Lincoln
Camaro	Front-Drive
Chrysler	Cadillac
Plymouth	Mark III
Rambler	AMX
Dodge	Javelin
Oldsmobile	Montego
Pinto	Torino
Vega	Hornet
	Challenger



MOTOR'S

**AUTO
REPAIR
MANUAL**

**TROUBLE-SHOOTER Section
Helps Spot 4,200 Car Troubles**
Trouble-Shooter section & detailed trouble-shooting info thruout help pinpoint 4,200 causes of car trouble: transmissions, brakes, engines, electrical systems, much more!

MAIL COUPON NOW FOR 10-DAY FREE TRIAL

MOTOR BOOK DEPT., Desk B 011
250 W. 55th St., New York, N. Y. 10019

Rush to me at once the new MOTOR's AUTO REPAIR MANUAL, \$10.95. If O.K., I will remit \$3 in 10 days, \$3 monthly for 2 months and a final payment of \$1.95 (plus delivery charge and sales tax, if any) one month after that. Otherwise I will return the book postpaid in 10 days.

Print Name Age.....

Address.....

City & Zip
State..... Code.....

Also send me for 10-day Free Trial MOTOR's AUTO ENGINES and ELECTRICAL SYSTEMS, \$10.00. If O.K., I will remit \$2.50 in 10 days and \$2.50 monthly for 3 months (plus delivery charge and sales tax, if any). Otherwise I will return book postpaid in 10 days.

Save shipping charge. Enclose entire payment of \$10.95 for AUTO REPAIR MANUAL (or \$10.00 for AUTO ENGINES and ELECTRONIC SYSTEMS), plus sales tax, if any. Same 10-day return-for-refund privilege.

CLASSIFIED ADVERTISEMENTS

Rate: \$2.00 per word payable in advance each insertion. Capitalized words—75¢ per word additional. Minimum insertion ten words. To be inserted under the proper classification, copy must be in our office by the 15th of the second month preceding date of issue. The next available issue to place an advertisement in America's No. 1 Classified Section is March. The closing date is January 15th. Send remittance and order to C. A. Martin, Popular Mechanics, 224 West 57th Street, New York, New York 10019. Please make remittance payable to Popular Mechanics.

POPULAR MECHANICS

WHEN ANSWERING ADVERTISEMENTS PLEASE USE THE ZIP CODE NUMBER.

AUTOMOBILES

FOR The lowest price in the Nation on 1971 New Pontiacs, including the Hot New Firebird. Write Earl Shell, Jim Causley Pontiacs, 17677 Mack, Detroit, Michigan 48224—313-886-1700.

REPAIR Any American made auto. Trouble shooting charts. Wiring diagrams. Diagnostic service. Details free. GMT, 85 A Jay Street, Newark, N.J. 07103.

YOUR Ad in Popular Mechanics will be seen by more than 5,000,000 active buyers for your products and services. It costs only \$1.85 per word. And, if you wish to run all or part of your ad in capital letters—you can do so for as little as 75¢ per word additional. Act now! Place your Classified ad in Popular Mechanics today.

AUTO SUPPLIES AND EQUIPMENT

HYDRAULIC Jack repair kits, parts and supplies. Catalog 50¢ (in coin). Hydraulic Jack Packing & Tool Co., Inc., General, P.O. Box 3, Staten Island, N.Y. 10314.

PARTS: Army jeep and truck parts. Spare Parts & Equipment Co., P.O. Box 751, Lexington, Ky. 40502.

AUTO Parts for old and new Cars. All makes. Catalogue \$1.10. Antique Auto, Milwaukee, Wisconsin 53204.

"CROSLY (¾ Midget) auto parts, accessories. Service, 616 Burnside, Inwood, L. I., N. Y. 11696."

BURNING Oil?? ... Smoking?? ... Pepless?? ... Hard Starting?? ... Save with Ring-Valve Job while driving \$6.50. (Special: Two for \$12.00 postpaid.) Results guaranteed!! Motaloy, Grantham, Penna. 17027.

WINTER STARTING a problem? Special STARTING PRODUCTS for sub zero weather. Catalog 50¢ for handling & postage. (Refundable) SAVE \$\$\$ in repairs, loss of time and STARTING or SERVICE CALLS by reading our new "COLD WEATHER OPERATING GUIDE": Explains the latest techniques to get ENGINE STARTED, plus ways to prolong engine life and save gas. \$1.95 Postpaid. Automotive Developments, P. O. Box 369, Davenport, Iowa 52805.

VOLKSWAGEN, DUNE BUGGY; CORVAIR PERFORMANCE AIR FILTERS. List 25¢. CC Products, Box 96-M, Rialto, California 92376.

ENGINE OVERHAUL KIT. Thermo-Plates worn engine parts. \$5.25 ppd. Superior Auto Services, P.O. Box 6218, Torrance, Calif. 90504.

"MAKE PEOPLE SMILE. ... With our historical bumper stickers. Free catalogue. Write: Hobby, Box 93-AB1, Lafayette, California 94549.

PERMANENT SPIN-ON OIL FILTER. \$22.45 ppd. Save \$3.50. Superior Auto Services, P.O. Box 6218, Torrance, Calif. 90504.

FOREIGN Cars run on batteries, instructions \$3.00. Bus-Campers, \$4.00. EKERADIO, Box 131, Temple City, Calif. 91780.

TURN Old TV into Automobile Tuneup Scope. Send \$2.00 for instructions. Manchester Sales, Dept. A. Crawfordsville, Ind. 47933.

PREVENT Flat Tires! Stop slow leaks! Seal punctures! Fantastic, New Liquid Product! Free information! Xcito Products, Dept. TG-3, 5715 North Mozart, Chicago, Illinois 60645.

METRIC Bolt gauge. Two piece handy gauge measures diameter and thread of most METRIC bolts. \$5.00 ppd, no cod's. Penna. add 6% tax. MediaMetric, Box 461A, Media, Penna. 19063.

JEOP Owners—V8 conversions. Read Jeep Owners' ad, page 199.

DWELLMETER/TACHOMETER. Plug-In Adapter For Your Voltmeter. Guaranteed Accuracy. \$5.95. Free Literature. Auto-Data, P.O. Box 9253, Stanford, California 94305.

BE YOUR Own Ignition Expert. Install Iglit. Q-Arc, Box 47876, Los Angeles, California 90047.

SNOWMOBILES

SNOWMOBILE Hop up accessory CATALOG. Speed and performance equipment—manifolds, exhaust systems. Send 25¢. G.E.M. PRODUCTS, Box 845, Carol Stream, Ill. 60187.

SNOWMOBILE Kits \$25. Plans and photos \$1.00. Information 10¢. Compco, Box 1267, Redwood City, Calif. 94064.

AUTO TRAILERS

CAMPER Plans and full sized patterns. The most detailed available with written and pictorial instructions. Various models and accessory kits offered. Send for literature—Glen L. 9152—PMA—Rosecrans, Bellflower, California 90706.

PICKUP Camper, Trailer or Pickup—Cover ... Build yourself. Save! Complete plans \$3.95 each Cover plans \$2.00. Conversion Plans—econoline type van \$2.95; passenger bus or delivery van \$2.95. Satisfaction Guaranteed. Equipment catalog \$1.00 (refundable). Details 10¢. Viking Camper Supply, 99-F Glenwood, Minneapolis, Minn. 55403.

BUILD Your Pickup Camper. Precut kits, blueprints and supplies. Literature 25¢. Comstock Camper and Trailer Supply, Dept. 664, Parsons, Kansas 67357.

HOW-TO-Build-Camping-Trailers-Truck Bus-Conversion-Blueprints-Manual-parts catalog-\$2.00. Kamcraft, Box 1153, Milwaukee, Wisc. 53201.

MOTORCYCLES, BICYCLES, MOTORSCOOTERS AND SUPPLIES

ELECTRIC Bicycle. Ride All Day For Nickel. Complete Plans \$3.00. Electro, Box 27203P, Indianapolis, Indiana 46227.

BUILD "Popular Mechanics" MINIBIKE featured June 1967 issue. Detail plans, photographs \$2.50 refundable. Kits, parts, engines; factory discount prices. Catalog 25¢. Gilliom Mfg.; PMC; St. Charles, Missouri 63301.

BARGAIN PRICES. Every part. Kart or Mini-bike. Giant Catalog \$1.00. New, "how to" plans \$1.00. Both, \$2.00. Brown's Motorsports, 19P Central St., Worcester, Mass. 01608.

ILLUSTRATED Catalog 25¢. Parts, Accessories. Custom Stock, most makes, models, Cycle Supply, Box 192M, Fairbury, Ill. 61739.

MOTORCYCLE Turn Signals. Accessories Catalog 35¢. Houston PM Lockport, Illinois 60441.

MOTORIZE Your Bicycle with Lawn Mower Engine. No Welding. Easy Plans \$2.00. Motor's, Box 415, Baraboo, Wisconsin 53913.

INDIAN PARTS. Rebuilding. Accessories. Indian Motorcycle Sales, Kansas City, Missouri 64127.

FABULOUS All electric mini-bike. Noiseless. No gas required. Operates for pennies a day. Easily built from complete construction plans and booklet. All parts available locally. Send \$4.25 postpaid. Lectra-Bike, P.O. Box 82 PM, Washington, New Jersey 07882.

HONDA \$25.00. Other Bargains. Send 50¢. Motorscooter, P443, Bend, Oregon 97701.

MINI-Bikes. Snowmobile. Plans \$1.00. Parts Catalog 25¢. Loren Products, Danville, Illinois 61832.

SPACE, ROCKETS AND ASTRONAUTS

ROCKETS: Real flying models—flights up to 2500 ft. New illustrated catalog 25¢: Singles and multistage kit, cones, engines, launchers, trackers, rocket aerial cameras, technical information. Fast service. Estes Industries, Dept. 7-A, Penrose 7, Colorado 81240.

ROCKETS!! Real flying models—2500 feet altitude with powerful motors. Terrific Science Projects. Tubes—Cones—Parachutes—Launchers—Igniters. Gigantic catalog—rocket data—diagrams—25¢. Fast Delivery. Centuri Rockets, Box 1988, Phoenix, Arizona 85001.

ROCKET Launcher, Motorized, Electronic. Brochure, 20¢. Lercari Engineering, Box 90894, Los Angeles 90009.

(Continued on next page)

SPACE, ROCKETS AND ASTRONAUTS

(Continued from preceding page)

MOON Landing Pictures! Other historic unusuals! Free brochure! Box 234-PM, Merritt Island, Florida 32952.

LIQUID Rocket, 10,000' Altitudes! Plans \$2.98. Catalog, 25¢. Star Space Systems, PM2, P.O. Box 4605, Vancouver 10, B.C.



AVIATION

EXPRESS Air Rider Two-Seater Hovercraft. Complete DIY construction plans \$2.00 The Hover Centre, Box 656, Maple, Ontario.

BE A Government licensed aviation mechanic. Practical training. Free information. Aero Mechanics School. Municipal Airport, Kansas City, Missouri 64116.

AVIATION Surplus Big Catalogue 50¢ (Refundable). Box 1TFFM, Spring Grove, Penna. 17362.

HELICOPTER, One-Man, Portable, Bubble canopy, Kits, Plans information 10¢. Photos and three-view drawings \$1.00 COMPCOP, Box 1267PM, Redwood City, California 94064.

AIRBOAT, Propellers, Plans, Kits, Supplies, 90, 125, 150 & 220 H. P. engines & Parts. Complete airboats. Catalog \$1.00. Banks-Maxwell, Box 3301 E. Ft. Worth, Texas 76105.

ONE-MAN Jet Helicopter—easy, inexpensive to build. Detailed plans, drawings, \$5.00. Helicopter, Box 7153, Baltimore, Maryland 21218.

AERO-CAR. Amazing Hovercraft built easily with ordinary tools. Lawnmower engine power. Carries one man plus. Hovers, flies forward, backward, sideways over land/snow/water. Complete construction plans and brochure, \$5.25. Aero-Projects, Box 5118PM, Clinton, New Jersey 08809.

GUIDE TO SMALL HOVERCRAFT—Most Authoritative Source on Hovercraft available. Covers Subject completely from Construction to Theory. Interesting Reading. Written by noted Hovercraft Experts. \$6.00. Naacve, 801 Poplar Street, Terre Haute, Indiana 47807.



BOATS AND TRAILERS

BOAT Kits, Molded Fiberglass. Save money—assemble yourself. Factory molded sections bond into one-piece craft. 20 models—14' to 32'. Cruisers, Runabouts, Houseboats, Sailboats. Big line accessories, motors, trailers. Easy terms. Free 80 page catalog. Luger, Dept. BC-71, 1300 East Cliff Road, Burnsville, Minnesota 55378.

FREE Catalog! Camping, Boating, Sailing Supplies; Gadgets, Hardware and Gifts, Laacke and Joys, 1439 N. Water St., Milwaukee, Wisconsin 53202.

PLANS, FULL-SIZE PATTERNS, FRAME KITS with step-by-step instructions specially for amateurs. Send \$1.00 for new catalog just off press—nearly 100 pages, over 80 designs 8' to 36': Sail, Jets, Inboards, Outboards, Cruisers, Houseboats, Hot Boats, Catamarans, Hydros. Glen Designs, 9152 Rosecrans, Bellflower, Calif. 90706.

FIBERGLASS KITS \$99. Assemble Modern 35 lbs. Fiberglass Kayak From Molded Parts. Free Brochure, Kayaks, P.O. Box 47-G, Hingham, Mass. 02043.

BUILD Your own boat from our large-scale blueprints. Books of plans give how-to-build help. Hundreds of professional designs—motor, sail or auxiliary—for amateur builders. Free catalog. MoToR Boating, 959 Eighth Ave., Dept. PM-RS, New York, N.Y. 10019.

BOAT PLANS, FRAME KITS, BOAT KITS. World's largest catalog—Over 200 top design for the amateur builders. New catalog includes: Cruisers, Runabouts, Deep vee's, Catamarans, Trimarans, Houseboats, Sailboats from small sail fish to 34 ft. motor sailers, large selection of inboard and outboard Hydroplanes. Send \$1.00 for large new plan & kit catalog or \$2.00 for catalog plus Boat Builder's Guide. Clark Craft Boat Company, 16-P Aqua Lane, Tonawanda, New York 14150.

FIBERGLASS Cloth and resin. World's finest cloth and non-run resin, at direct mill prices Flotation foam. Complete line of plastics, silicon bronze and brass screws, save 60%. No sales tax. Boat Plans, Catalog 25¢. Freight prepaid. Stiles Boat Supply, Box 11P, Linden Ave., Mantua Hts., N.J. 08051.

NEW Outboards 1970 & 1969 McCulloch & others. 4 H.P. \$120, 9 Electric \$295, 18 " " \$368, 60 Electric \$848, all sizes. Literature 50¢. Electric Marine, 1427 Broadway, Brooklyn, New York 11221.

CANOE! Kayaks! Factory-direct quality kits, from \$25.00. Many different models. Canvas hulls. Strongest construction materials. Free literature, Sportscraft, Box 8280, Columbus, Ohio 43201.

AMATEUR Boat Building Magazine, Plans, Discounts, books, instructions. 3183 Merrill, Royal Oak, Michigan 48072.

OUTBOARD MAGAZINE! 12 issues \$6.00. Rooster Tales, Box 810P, Reseda, Calif. 91335.

"FIBERGLASS Cloth, matt, polyester and epoxy resins. Lowest prices. Seifert's, Box 1206-M, Green Bay, Wis. 54305."

BOAT Plans, Patterns, Kits, Catalogs: Sailboat, 50¢, Powerboat (3) \$2.00, condensed, \$1.25. Marinecraft, Box 161-M, Brighton, Mass. 02135.

CAMPER AND TRAILERS —KITS—PLANS—

CAMPER & Trailer Kits—Assemble yourself, save 1/2 over factory built. 12 models: Pickup Truck Campers, Pickup Covers, Travel Trailers, Folding Tent Trailers. Big line of accessories. Easy terms, money-back guarantee. Free 24 page color catalog, Luger, Dept. TW-71, 1300 East Cliff Road, Burnsville, Minnesota 55378.

PLANS—Pickup Campers \$3.95; Pickup Covers \$2.00; Travel Trailers \$3.95; Vanette Conversions \$2.95; Bus Conversions \$2.95; Huge Supplies, Parts and Equipment Catalog at Discount Prices \$1.00 (Refundable). Order Plans, Discount Supply Catalog from this advertisement. Camper, Cover, Trailer Kits available—literature 25¢. CAMPERS, Box 377 C, Savage, Minnesota 55378.

MARINE EQUIPMENT AND SERVICES

MARINE Engines, conversions, parts. Catalog free. Charles F. Stokes Enterprises, Coldwater, Michigan 49036.

CONVERT Auto engines to marine. 68 Page Catalog, 50¢. Lehman Manufacturing Company, 800 Elizabeth Avenue, Linden 4, New Jersey 07036.

FREE Brochure—Engines, Gears, 1/0's, Conversion Kits—Gas—Diesel. StarMarine, 1931 Embarcadero, Oakland, Calif. 94606.

ATHLETIC AND BODY BUILDING COURSES

BASKETBALL—FREE Prototype wrist bands! Order NEW Basketball Booklet. Special drills increase your jumping ability 3 to 6 inches in 6 weeks! Be a great rebounder! Height not important when you know secrets! BONUS—Basketball poster, training aid, \$2.65 postpaid, state age. All Star Sports, 55 Wishing Well, Penfield, N.Y. 14526.

POWERFUL Muscles fast! Free brochure! Universal Bodybuilding, Box 4327-C, Dearborn, Michigan 48126.

ZAKAL, Russian toughening system. \$4.00. Eastview. Book Service, Box 7053, Ottawa, Canada.

FANTASTIC NEW METHOD. Build huge muscles in three months send only \$1.00 to L & F Enterprises, Box 101, Burlington, Mass. 01803.

GIANT Muscles! Rush \$1.00 (guaranteed!) New Book, Box 15242P, Atlanta, 30333.

"GIANT Arms." Dr. Young's, D.C. revolutionary discovery. \$2. Satisfaction or refund. Gaucho, 1769-S7, Chicago 60690.

SPORTING GOODS AND EQUIPMENT

FREE . . . Wholesale Catalog. Arrow Shafts, Broadheads, Fletchings Fisharrow Parts, Tools, Bows, FinnySports, (22G), Toledo, Ohio 43614.

ARCHERY Lowest Discount Prices. All top brands. Orders shipped same day received. Money-back guarantee. World's Largest Supplier. Free catalog. Anderson Archery Corporation, Grand Ledge, Michigan 48837.

FREE 1971 Catalog. Guaranteed Lowest Prices! Rods Reels, Lures, Accessories—Thousands of Item. Cabela's Inc., Dept. S, Sidney, Nebraska 69162.

FREE Catalog low direct factory prices, fishing, Hunting, Archery, reloading Camping supplies. Send today HerTERS Inc., Dept. CPM, Waseca, Minn. 56093.

DERRINGER 44 Caliber. Make Yourself! Easy, complete, pre-machined kit, with instructions \$10.50. Complete instructions only \$2.00. Fernwood, 1725 Springbrook, Walnut Creek, California 94596.

CROSSBOWS Powerful, Accurate. Catalog, 25¢ Crossbowman, Box 1089-PM6, Los Gatos, Calif. 95030.

UNDERWATER SAUCER—Fun, search, explore underwater. You submerge, maneuver, surface at will. Detailed full size plans and decal \$1.00. Michigan Water Specialties, Inc., Dept. M, 249 Albany, Ferndale, Michigan 48220.

FISHING, TACKLE, LURES

MOLDS For fisherman's sinkers, jigs, squids, casting and spinning lures. Free catalog. Sweet Molds, Tonawanda 1, New York 14150.

EASY To make plastic fishing worms. Fun. Cost 3¢. Sell for up to \$1.00. Big profits. Simple instructions \$2.00. Poca Plantation, Dept. 100A, Box 5046, Augusta, Georgia 30906.

SEND FOR FREE Wholesale Catalog. The most complete and fully illustrated catalog of reels, rods, beads, spinners, jigs, bodies and parts, sinker molds, feathers, tools, hooks, rod blanks, rod parts, swivels, wire, etc. FINNYSPOrts, ME Sports Bldg., Toledo, Ohio 43614.

MOLDS—For casting your own fishing sinkers. Free illustrated booklet. Reading Instrument Co., Box P78, Reading, Pa. 19603.

LETHAL Hook method for catching fish. Deadly accurate. Send two dollars for information. CATCH, Box 936, Rock Island, Illinois 61201.

FISHERMAN'S DREAM BOOK—FREE, 170 Pages, pocket size and loaded with Hard To Find Fishing Specialties and Do-It-Yourself Goodies. Our 27th year. NETCRAFT, Inc., Box 5510, Toledo, Ohio 43613.

(Continued on next page)

EARTHWORMS, LIVE BAIT

EARN Money raising fishworms for us! Exciting details free! Oakhaven—56. Cedar Hill, Texas 75104.

HYBRID Redworms 5000 \$10.00, 20,000 \$20.00 Postpaid with Raising Instructions, Worms, Route 9, Waco, Texas 76705.

GROW Fishworms. Outstanding new breed. Free Literature. Fain's Hatchery-31, Edison, Georgia 31746.

FROGS, FISH, REPTILES

MAILORDER Records help get increased business! Complete 32 Page Record Book shows your inquiries orders, advertising, expense, etc. Only \$1.00. C. A. Martin, Popular Mechanics, Dept. PM, 224 West 57 Street, New York, N.Y. 10019.



HUNTING, GUNS, DECOYS

GUN SILENCER—Build on Your Stove in 1 Hour. Very Effective. Literature \$1.00. P.O. Box 19097, Sacramento, Calif. 95819.

HUNTERS—Free 34 Page Wingshooter's Handbook—The most widely circulated shotgun book in the world—Get the experts advice on pointing, lead; chapters on ballistics. Write Poly Choke, 139 Tunxis St., Hartford, Conn. 06101.

CARBINE. New accessories, custom stocks, combos to 60 rds. Scope mounts. New 30 rd. mags., \$2.99 ppd. Muzzle brake, \$6.99 ppd. Free List. Fedord, Box 36032-AK, Los Angeles, Calif. 90036.



DOGS AND KENNELS

REVOLUTIONARY Dog leash Expands. Retracts. Write, Bell, 808 Mark, Hamilton, Ohio 45013.



POULTRY & GAME BIRDS

QUAILS. Incubators, cages, supplies catalog, Marsh, 14216 Brookhurst, Garden Grove, Calif. 92640.

RABBITS—FUR BEARING ANIMALS

\$625—\$900—MONTHLY Raising Rabbits, Chinchillas, other small animals. We supply everything, equipment, instructions, breeders, buyers, big demand, big markets. Fox River Valley Research Farms, Dept. PMR-1, 2727 Justen, McHenry, Illinois 60050.

RAISE Rabbits successfully by knowing facts. 48 page illustrated book describing 25 breeds. Housing, breeding, feeding, markets, marketing etc. 25 cents. American Rabbit Association, 36 Arba Building, Pittsburgh, Penn. 15217.

RAISE Rabbits for us on \$500 month plans. Free details. White's Rabbitry, Mt. Vernon, Ohio 43050.

AMAZING PROFITS! \$10,000 Yearly Raising Rabbits for Wool and Breeding. Details 25¢ coin. American Angora, Malta 12, Montana 59538.

MAKE Big Money raising chinchillas, rabbits, guinea pigs for us. Catalog 25¢. Keeney Brothers Farms, Inc., New Freedom, Pa. 17349 or Summerfield, Fla. 32691.

\$500-\$800 MONTHLY Raise small Laboratory-breeding stock for us. We supply equipment, breeders, and instructions. Illinois Research Farms, Dept. MPB-1, Barrington, Illinois 60010.

PETS—BIRDS, CATS, HAMSTERS, ETC.

FLYING Squirrels, Grey, Fox Squirrels, Chipmunks. Send 25¢ For Brochure, Pictures. Prices. Pets, Neches, Texas 75779.

LIVE Seahorses, marine specimens, aquarium supplies. Illustrated catalog 25¢. Marine, Box 248-010, Dania, Florida 33004.

HAWKS, Reptiles, raccoons, skunks, squirrels. Catalogue 25¢. Trails End Zoo, St. Stephens, S.C. 29479.

SEAHORSES, Animals, Aquariums and Pet Supplies, Catalog 25¢, Aqualand Box 130, Miami, Fla. 33145.

TROPICAL FISH And Aquarium Supplies. Complete Catalog \$.25. Aquarium Center, 172 S. Center Street, Orange, N.J. 07050.

HORSES, LIVESTOCK

"HOW To Train Horses"—Everyone who likes horses or ponies should have this book: Free. Write Beery School, 1101 Pleasant Hill, Ohio 45359.

CAMPING EQUIPMENT AND TENTS

PROFITS FROM CLASSIFIED ADVERTISING! Booklet shows you how to start your own business with Classified Advertising. Only \$1.00 (Refundable with first order.) C. A. Martin, Popular Mechanics, Dept. PM, 224 West 57 Street, New York, N.Y. 10019.

CAMPING

SAVINGS Plus dividends! Campers-fishermen-outdoorsmen cooperative. Free 68-page catalog. Recreational Equipment, Inc., 1525-P 11th, Seattle, Washington 98122.

TRAVEL AND RESORTS

MAILORDER Records help get increased business! Complete 32 Page Record Book shows your inquiries orders, advertising, expense, etc. Only \$1.00. C. A. Martin, Popular Mechanics, Dept. PM, 224 West 57 Street, New York, N.Y. 10019.

ELECTRICAL SUPPLIES

METERS—Surplus, new, used, panel and portable. Send for list. Hanchett, Box 5577, Riverside, Calif. 92507.

LAMP Parts. Catalog, prices, wiring instructions. 50¢. Refunded first order. Gyro, 5218P N.W. 35 Ave., Miami 42, Florida 33142.

LIGHT Bulbs All Types. Specify. Jetronics, Box 67015, Century City, Calif. 90067.

LAMP Parts for building, repairing converting. Catalog 40 cents. Refunded first order. Brown Lamp Co., Box 12511, Creve Coeur, Missouri 63141.

BATTERIES, GENERATORS

BATTERY Reconditioning Kit, includes tools, material, instructions. Battery Shop, Route 1-188D, Blythe, Calif. 92225.

ELECTRIC Generator sets. 5-KW to 60-KW, gasoline and diesel. K. A. Weimer, 1300 Richard Road, Decatur, Georgia 30032.

ENGINES, MOTORS, MAGNETS

LIVE Steam powered backyard railroads! All sizes. Complete "bolt-together kits." and rough castings. Excellent drawings. 100 page catalog \$1.00. Little Engines, Lomita, Calif. 90717.

WINDING Data, 275 motors. \$1.20. Data Company, 512 Kensington, Kansas City, Mo. 64124.

SIMPLIFIED INSTRUCTIONS! Motors! Generators! Batteries! Electroplaters! Modequip, Box 7266, Kansas City, Missouri 64113.

MACHINERY, TOOLS AND SUPPLIES

LATHE Milling attachments. Blueprints too! Write. Potter, Box 73, Cedar Rapids, Iowa 52406.

MICROMETERS — Indicators — Steel — Aluminum — Brass Maximat, Unimat Lathes, Accessories. Lists free: Complete mailing—50¢. Campbell, 1424 Barclay, Springfield, Ohio 45505.

POWER-HONE To sharpen fishhooks, knives, model making and tool & die making. Vercon Supply, Box 316, Brockport, N.Y. 14420.

SMALL Foundry furnaces. Supplies. Free literature. Pyramid Products, 3736 South 7th Avenue, Phoenix, Arizona 85041.

BUILD Your Own Tool Post Grinder, Casting With Blueprint \$9.95. Specifications Free. General Devices Inc., 861 West 66th Street, Hialeah, Florida 33012.

HORIZONTAL MILLING MACHINE, Enjoy Building, SAVE \$200, Castings available, Blueprints ONLY \$2.00. MICROM COMPANY, Box 2313-S, Santa Ana, Calif. 92707.

ROUTER Bits, 1/4" shank, high speed, used; excellent condition. \$2.50 dozen postpaid. Lillian's, Box 17165, Chicago, Illinois 60617.

FREE Catalog—Micrometers, Dial Calipers, Indicators,—R. Leung, Room 136, 664, King's Road, Hong Kong.

WOODWORKERS. New two wing hardened production shaper cutters. 3-1/4 inch diameter x 1/2" to 3/4" bore x 3/4" straight cutting edge. \$3.75 each. Check or money order. Postage paid. For complete industrial woodworking catalog send \$2.00 for postage and handling. Woodworkers Tool Works, 222 South Jefferson, Chicago, Illinois 60606.

WELDING, SOLDERING, PLATING

MICROFLAME Hand-sized gas welding torch, welds, brazes solders. For workshop, electronics, hobby, jewelry making. 5000° pinpoint flame. Self-contained. Full line of torches and accessories. Free Brochure. Write Flo-Pro, Box 26363, Minneapolis, Minnesota 55426.

WELDERS—110/220, 150 Amperes, \$53.50. Morris, 1070 Inner, Schenectady, New York 12303.

PLATING Equipment, supplies and "know-how". Build your own tanks for nickel, chrome, etc. Easy-to-install PVC liners. Rectifier components—all sizes. Schematics, parts lists, formulas, operating instructions for all plating. \$5.00 postpaid. Guaranteed to save you 25%-75% or immediate refund. Platers Service Company, 1511-A Esperanza, Los Angeles, California 90023.

GOVERNMENT SURPLUS

1971 SURPLUS Army, Navy store illustrated catalog. Send 50¢ (refundable with first \$5.00 order). Ruvel, 3037 North Clark, Dept. 1-J, Chicago, Illinois 60614.

JEEP And Gov't. Surplus Buying Manual (Jeeps Pictured) 50¢. Surplus Bargain Catalogue 50¢. Both \$1. Surplus Bargains, Box 789PM, York, Penna. 17405.

JEeps Typically From \$53.90 . . . Trucks From \$78.40 . . . Airplanes, Typewriters, Boats, Clothing, Camping, Sporting, Photographic, Electronics Equipment. Wide Variety. Condition. 100,000 Bid Bargains Direct From Government Nationwide. Complete Sales Directory and Surplus Categories Catalog \$1.00 (Deductible First \$10.00 Order From Our Separate Included Catalog). Surplus Service, Box 820-A, Holland, Michigan 49423.

(Continued on next page)

GOVERNMENT SURPLUS

(Continued from preceding page)

GOVERNMENT Surplus. How and where to buy in your area. Send \$2.00. Surplus Information, Headquarters Box 8225PM, Washington, D.C. 20024.

NO CATCHES. Buy any surplus direct from U.S. gov't. All information \$2.00. Bridgeworth, P.O. Box 2292-C, Vancouver, Washington 98661.

GENUINE Surplus Arctic, Clothing & Equipment Special Field Gear Individual Wilderness, Survival Equipment New 1971 Catalog 10¢. Arctic Outfitting Co., Box 8138, Anchorage, Alaska 99504.

GOVERNMENT Lands . . . Low as \$1.00 Acre! Millions Acres! For exclusive "Government Land Buyer's Guide" . . . plus "Land Opportunity Review" listing lands available throughout U.S., send \$1.00. Satisfaction Guaranteed! Surplus Lands, Box 19107-AM, Washington, D.C. 20036.

HUNDREDS Now earning small fortune through buying/selling surplus! Learn secrets of purchasing direct from government at low, low, low prices. Booklet \$1.00. Smithco, Box 292, Dept. A, Syracuse, New York 13201.

GOVERNMENT SURPLUS. How And Where To Buy. Directory of Surplus Offices. Send \$1.00. Jess Cahill, Mail Order Dept. 16 Windbeam Road, Riverdale, N.J. 07457.

JEEPS \$53.00 Thousands Items Your Area. Catalog \$1.00. Bargains, Hawthorne, New York 10532.

HOBBIES AND COLLECTIONS

SHOULDER PATCHES—Collectors Items. Official Apollo patches one dollar each Postpaid. U. S. Army and Air Corps patches. Special patches made to order. 10 assorted patches, price list and catalog \$3.00. Catalog only 35¢. Springer's, Box 577-PM, El Paso, Texas 79944.

FREE: German Medal; send 50¢ postage, get illustrated catalog; Iron Cross, \$1.50; 3 Regimental Crests, 50¢. Insignias, Box 71-P, Rockaway, New York 11694.

FIND A FORTUNE IN YOUR POCKET—Three official guides 160 pages each. Coins, Currency, Stamps all only \$2.98. Satisfaction or prompt refund. Manchester Gifts, 40B Edgerton St., Manchester, Conn. 06040.

HOBBY MOTORS—DC Permanent Magnet. Operate On Flashlight Batteries 2 1/4" X 1 3/8". 4 For \$1.00. GRAIN OF WHEAT LAMP—Transparent Red. 5 For \$1.00. Add 10¢ Mailing. S&G Enterprises, P.O. Box 4916, Van Nuys, California 91412.



STAMP COLLECTING

RARE Stamp Free! Also new packet Aden to Urundi, with Kennedy, Triangles, Space, Sports, Ships, Dogs, Cats, Reptiles Plus Others. All Free. Send 10¢ for mailing. Empire Stamp Co., Dept. 1, Toronto, Canada.

COMPLETE Set of 6 giant stamps shows Pres. Eisenhower with Kennedy, Nixon, Pope John, Churchill, Adenauer & additional great moments in history. This complete set plus Big Stamp Dictionary is yours for only 10¢! to introduce our bargain approvals. Stampex, Box 47-EM, White Plains, N. Y. 10601.

1500 FOREIGN \$1.00; 5000 \$3.00; 9000 \$5.00. 5000 USA, contains airmails, dues, presidentials, revenues, 19th Century, high values, etc. \$3.00. 300 pre-1940 USA commemoratives \$2.00. 200 pre-1926 USA \$1.00; 700 \$3.00; 3000 \$1.00. No approvals. Meyers, 5321 Fleming, Richmond, Calif.

SURPRISE COLLECTION! Exotic mint British Colonials absolutely free with approvals. VIKING, Great Neck 8, N.Y.

GERMANY 100 different 10¢. Approvals. Hijop, Box 505, Norristown, Pa. 19404.

PICTORIAL COLLECTION Plus Gorgeous topical set! Over \$3.00 catalog value, only 25¢. Other fascinating stamps to examine. Buy any or none, return balance. Romar Stamps, Box 8642, Kansas City, Missouri 64114.

UNBEATABLE. Free Jamaica, British Honduras, British Antarctic Territories, Angola, Rwanda, Iceland, Monaco. Approvals. Moublow, 1834-N Bassett, Anaheim, California 92805.

SEVEN Different 3¢ U.S. Commemorative Plate Blocks \$1.00—Approvals. Gordon, Davison, Henniker, New Hampshire 03242.

2,000,000 STAMPS, 150 Countries, 2¢ Each. Belden, Box 4175B, Dearborn, Michigan 48126.

1500 WORLDWIDE \$1.00 off paper no approvals. Regency Stamps, Box 8854, Pittsburgh, Pa. 15221.

VATICAN Xmas Set (1967) 50¢. Approvals. Barricks, Box 7154, Detroit, Mich. 48202.

TREASURE Mixture, \$2.00. Drew, Box 1388P, Sturgeon Falls, Ontario, Canada.

U.S. MINT Specials! Flag set, complete \$1.00. 1¢, 2¢, 3¢ famous Americans (21 different) \$1.00. Free list. Brooks, 2601 Avenue "U," Brooklyn, N.Y. 11229.

100 DIFFERENT British Empire 10¢. Approvals. Gibson, Box 34, Lansdowne, Pa. 19050.

EISENHOWER MEMORIAL Or APOLLO XI stamp on lovely first day cover addressed in your name. 50¢ each. K.M. WALSH, Box 308A, TUCKAHOE, N.Y. 10707.

FREE Stamp Wallet with approvals. Wide choice collections by Countries. Clark, Box 428, Northbrook, Illinois 60062.

"AFRICA," 25 Beauties, 10¢. Approvals. Gorliz, Box 1915PM, Naples, Florida 33940.

FREE 50 Worldwide. Approvals. University Stamps, P.O. Box 1471, Lake Worth, Florida 33460.

ONE CENT A Stamp. Write for a jumbo book of Foreign stamps at 1¢ each, mounted in Scott order. PP. Bullot, 6815 Bay Parkway, Bklyn., N.Y. 11204.

PENNY! Approvals! Regardless catalogue! Kloster, 4164 52nd St., San Diego 5, Calif. 92105.

50 YEARS Old, fifteen different United States, over fifty years old—10¢ with approvals. Jaxon, Box 145-P, Brooklyn, New York 11230.

FREE! Big Bargain Catalog—New Edition listing thousands of bargains including U.S. & B.N.A. stamps, packets, albums, accessories and supplies. Also, fine stamps from our approval service which you may return without purchases and cancel service at any time. Jamestown Stamp, Dept. E-11PM, Jamestown, N.Y. 14701.

WOW! 110 All Different Germany 10¢. Commemoratives. Airmails. High Values. Big catalog, bargain lists. Also, fine stamps from our approval service, which you may return without purchases and cancel service at any time. Jamestown Stamp, Dept. A-11PM, Jamestown, N.Y. 14701.

UNITED STATES Commemorative collection containing 33 different—10¢. Approvals. White, 516-A Avenue L, Brooklyn 30, New York.

U.S. BARGAIN, 50 Different 10¢, with beautiful worldwide, approvals. Stamp Center, Kennebunk, Maine 04043.

"INVERTED ERROR" Dag Hammarskjold. 6¢ with approvals. Belmont Stamps, Washington, D.C. 20015.

50 DIFFERENT Old U.S. Revenue stamps 50¢. Winchester Stamps, Box 1592, Mansfield, Ohio 44907.

FREE Surprise collection sent with approvals. Gould, 1784 Union, San Francisco 94123.

APPROVALS: Plus collections by year. Martus, Box 158, Centuck, Yonkers, New York 10710.

PENNY Stamps! 1000 Mounted in book at 1¢ each! Trast Stamp Company, P.O. Box 100-P, Jamaica, New York 11435.

ABSOLUTELY Free United States Mint Souvenir Sheet When Requesting United States Approvals. K&B, Box 70, Brooklyn, N.Y. 11223.

100 DIFFERENT United States, only 25¢ with Approvals. Shelron, Box 547C, North Miami, Florida 33161.

100 OLD United States between 1861 and 1935. \$1.00. Roush Stamps, 423 Shepard, Mansfield, Ohio 44907.

225 STAMPS For only 10¢! Airmails. Pictorials: stamps from strange countries cataloging up to 25¢ each! Plus unusual stamps to examine. Buy any or none return balance, cancel service anytime. Mystic Stamp Co., Camden 80, New York 13316.

QUALITY AND LOW PRICE. EXCELLENT For advanced or beginner. Mounted approvals 2¢ up, all countries in Scott's Order. Preview Stamps, P.O. Box 9809M, San Diego, California 92109.

500 DIFFERENT Stamps, \$1.00. Smith, 508-A Brooks, College Station, Texas 77840.

RUSSIA High-Value Collection. 32 different Russia—some over 50 years old! Commemoratives, Czarist Issues, Airmails, Catalog price \$2.50. Special Get Acquainted Offer—all for only 10¢! H. E. Harris, Dept. GG 49, Boston, Mass. 02117.

FREE "Mona Lisa" painting issue. Approvals. Williams Stamps, Box 1281-P4, Pawtucket, R.I. 02862.

NEW Issues—Free Weekly Illustrated list. Brooks, 2601N Avenue "U," Brooklyn, N.Y. 11229.

210 DIFFERENT U.S. Commemoratives \$1.00. Stamps, 7607 Larchview, Dallas, Texas 75240.

FAR EAST ASSORTMENT—VIET NAM, JAPAN, KOREA, Formosa and others only 10¢ with world wide approvals, Clark Stamps, Dept. 57V, Muskegon, Michigan 49444.

RUSSIAN Space collection 10¢. Russian Approvals, Snedco, Box 68-P, Waldwick, N.J. 07463.

14,000 DIFFERENT! AMAZING New plan builds your collection systematically, country by country. Only 50¢ weekly. Ware, Monroe, Conn. 06468.

"WHOLESALE" U.S.—Foreign Pricelist and catalog Free! Everything Guaranteed. Schneider, Box 1240, Grand Rapids, Michigan 49501.

50 DIFFERENT U. S. Commemoratives. 15¢. Approvals. Cambridge, Box 2311, Heath, Ohio 43055.

FREE 149 Flag Stamps with approvals. W-B Stamp Company, Wilkes-Barre, Penna. 18703.

PICK From thousands—2¢ and up. Stamp-A-Nanza, 1904 Broad, Schenectady, N.Y. 12306.

100 CANADA 25¢. Excellent value. Approvals. Continental, Limehouse, Ontario, Canada.

50¢ FOR 10¢! SEND Us a dime and take choice of first 50¢ from our approvals. Modern Stamps, Dept 57W, Ferrysburg, Michigan 49409.

EUROPE, British Commonwealth, U.S. Packets, sets, singles. Free lists. Faville, Box 4164, Madison, Wis. 53711.

(Continued on next page)

STAMP COLLECTING

(Continued from preceding page)

TEN Different Nudes: 20¢. Approvals. Stamp Farm, 2M26, Oxford, Wis. 53952.

SELL Stamps In Spare Time, Make Easily \$4.00 Per Hour. Brochure 25¢. Strobl's Stamps, Box 1221, Thunder Bay P. Ontario.

PACKET Bargains! Sample 25¢! F. Ross, Box 152, Wayne, Pa. 19087.

500 STAMPS 25¢. Approvals. Eric's, Box 1444, Kitchener, Ont., Canada.

ASIA—100 Different, including pictorials, 10¢. Approvals. Tarheel Philatelics, Siler City, North Carolina 27344.

MILLIONS Foreign Stamps! 2¢ each! Send for gigantic approvals! ABC, Box 6000-MB, San Francisco, California 94101.

AMERICANS On foreign stamps, Presidents, Kennedy, Roosevelt, Lincoln, U.S. Spacemen, Princess Grace and others, 10¢ with approvals. Roseland Stamps, Dept. 57, Spring Lake, Michigan 49456.

25 U.S. FREE With Approvals. Collier, Box 755, Folkston, Georgia 31537.

SEND Only 10¢ for the most wonderful catalog of stamp offers in America. You will also receive a special bonus collection of over 150 different stamps from Congo, Nigeria, Mauritius, etc. Littleton Stamp, Dept. MN-1, Littleton, N. H. 03561.

AUSTRALIA—Fifty Different 10¢! With Approvals. Value Stamp, Tenbrooke, Silver Spring, Maryland 20901.

FREE Stamps—\$1.00 credit toward approvals! Donaldson, 9410 Lansford Street, Philadelphia, Pennsylvania 19114.

704 U.S.A. (PLENTY COMMEMORATIVES) —35¢. Approvals. Horace Gatewood, Winston-Salem, N.C. 27102.

NEW! Get Dominica Moon Landing, Burundi Pope stamps PLUS colorful Kennedy and Dickens Memorial issues, many more. Valuable collection of 100 different stamps from the world's far places. Fierce beasts, famous people, rare paintings, pirate treasure. Also stamp collections to examine. Buy any or none, cancel service anytime. Rush 10¢ handling now. Garcelon Stamp Co., PM1P, Calais, Maine 04619.

YOURS FREE! 20 Almost Rare Stamps from 12 Lost Nations—Most a Half-Century Old! Nations overrun by invaders and never freed again. Stamps so appealing that experienced and beginning collectors alike will want them. You get 110 other stamps from Britain's Lost Empire plus illustrated Album to keep as a Bonus should you buy \$1 from our Approval Selection. Or return Album and 110 stamps with selection and buy nothing. Cancel Service anytime. But Lost Nations stamps are yours to keep! Send 10¢ for mailing while supplies last. Kenmore, Milford LN-676, New Hampshire 03055.

FREE!! 25 U.S. Commemoratives, 2" Diameter Magnifier. Postage—10¢. Approvals. Mixdrak, 5630 Wilson, Chicago 60630.

FREE, Japan mint park set. Approvals. Seaside, Box 5645, Redwood City, California 94063.

FANTASTIC!! Unbelievable!! Gigantic Surprise Stamp Collection—10¢. Approvals. Hurry!! Box 4155M, Tulsa 74104.

255 DIFFERENT Worldwide: 15¢. Approvals. Tibbets, 8675 Meadow, Downey, Calif. 90242.

SENSATIONAL Clearance. Forty Different Packets \$1.00. No Approvals. Norge Company, Wyckoff, New Jersey 07481.

EIGHT VATICAN PICTORIALS 25¢. Penniston, Box 5502, Arlington, Virginia 22205.

MAGIC Stamp Release. Removes stamps without harm, easily. 500 stamp supply \$1.25. Guaranteed. Daufeldt PM-2, Atalissa, Iowa 52720.

100 DIFFERENT Italy—10¢. Approvals. Gobestamps, Box 402, Biddeford, Maine 04005.

SEND \$1.00: Receive 2—\$5.00 stamps used #834 Coolidge + #1053 Hamilton. Free pricelist. Giant Stamp Store, 122 Brighton 11 Street, Brooklyn, New York 11235.

TWO Cent Approvals. The Best. Scotty Stamp Co., Box 155, Staten Island, New York 10301.

FREE 300 Genuine postage stamps! Worth \$10.00 at catalogue prices. Africa, Europe, Asia, British Emp.—a fascinating valuable mixture from foreign convents—banks—etc. Who knows what you will find. Also free valuable booklet, "Get-acquainted" offer to Adults only. Approvals enclosed. Frasek Co., Inc., PM1, White Plains, N.Y. 10601.

CHRISTMAS Souvenir Sheet Free! Cook Island, beautiful mint, multicolored paintings. Also fine stamps on approval. Send 25¢ postage and packaging. Rolls, 15900 Trask River, Tillamook, Oregon 97141.

400 FINE Mixed U.S. 15¢. Wright, Box 753-M, Hagerstown, Maryland.

CLOSEOUT: Large Assortment 40 cts. Generous lot \$1.—High value packet \$2. Persile, 436 New York Ave., Brooklyn, New York 11225.

LIQUIDATING Tremendous Accumulation. Collections, Lots, Miscellaneous. Lists free. Alatalo, Maynard, Mass. 01754.

SENSATIONAL! Five multicolored mint complete sets, retail 75¢, only 25¢ with approvals. Bergman, Box 308, Malden, Massachusetts 02148.

WORLDWIDE New Issues, Free illustrated lists. Kahaner, Box 56, Brooklyn, N.Y. 11229.

25 DIFFERENT U.S. Airmails 25¢. 45 Different \$1.00. Free Pricelist. Eberling, 105 Franklin Avenue, Staten Island, New York 10301.

JOIN The World Mail Club and receive mail from around the World. Only \$2.00, or send for free details. Alfred Fahsing, Atascadero, Calif. 93422.

60 DIFFERENT U.S. (30 Commemoratives) 25¢. Seidenberg, Salem 169, Oregon 97308.

THOUSANDS Of Stamps, 1¢ Up. Bonuses. Fisk, Box 35, Elmhurst-A, N.Y. 11373.

COLORFUL Pictorial Collection—Birds, Flowers, Animals, Paintings, Rockets, 10¢. Approvals. Dealing, Box 185, Long Lake, Minnesota 55356.

VIETNAM 25 Different 10¢ approval. Sam Chazen, Box 95, Ozone Park, N.Y. 11417.

I PAY \$250 EACH FOR 1924 1¢ GREEN FRANKLIN stamps, rotary perforated 11 (\$2,500 unused). Send 25¢ for illustrated folders showing amazing prices paid for old stamps, coins, collections. Vincent 85 PM, Bronx, New York 10458.

FREE—29 Different Birds & Animals, to approval applicants. 10¢ postage. Golden Age, Box 86, Station "H", Toronto 13, Canada.

FREE Mammoth Collection. Scott's International Master Global Albums when you buy Approvals. Bargain Service, Box 506, LaPuente, Calif. 91747.

"JAPAN." 25 beauties, 10¢. Approvals. Cohen, 200 East 15 Street, New York, N.Y. 10003.

"SUBMARINES, Destroyers, Battleships"—Poland's Latest Gigantic Commemoratives—10¢. Approvals Plus 101 Bonus Sets. William Deems, 226 Race, Ravenswood, West Virginia 26164.

50 DIFFERENT Latin America 10¢ with approvals. Quynn's, Scotland, Penna. 17254.

FREE German Mints. Approvals. Chapman Stamps, Box 487, Galesburg, Michigan 49053.

22 VALUABLE Sets \$1.00. Approvals Ac-company. Karl Klondike, Harrisburg, Ill. 62946.

COINS, TOKENS, CURRENCY

BRILLIANT Uncirculated Silver Dollars —Ten Different Dates, 1880 to 1902, \$33.85. Bargain Lists 15¢. Bebee's, Incorp., Omaha, Nebraska 68111.

25 DIFFERENT Foreign Coins \$1.00. Hoffman, PM-1, Box 98, Clarence, New York 14031.

SILVER DOLLARS UNCIRCULATED, 1880-81-1883-84-85 \$4.00 Ea. Catalogue 50¢. Shultz, Salt Lake City, Utah. 84110.

COMPLETE U.S. List: Cents to Silver Dollars + Supply List + \$1000.00 bank-note 25¢. Schultheis, Box 151-M, New Hyde Park, New York 11040.

"S" LINCOLNS, 1941S Through 1970S \$1.25. Morehead, 208B Houston, Thousand Oaks, Calif. 91360.

INDIANHEAD Cents 3 Different \$1.00. Coins, Box 35041, Minneapolis, Minnesota 55435.

BOTTLES Are Valuable! Free Information—Bottle Treasures, 7311 Van Nuys, Van Nuys, California 91405.

50 MIXED S-Mint Pennies Uncirculated \$1.00. Bargain Lists Free. Sayers, 1000 Unaka, Johnson City, Tennessee 37601.

JEFFERSON Nickels (Fine) 1938-D, \$1.40; 1938-S, \$3.00; 1939-D, \$5.00; 1939-S, \$1.50. Catalog 25¢. Free With Order. Village Coin Shop, Dept. P, Plaistow, N.H. 03865.

NICE 1939-S Nickel and Giant List only 50¢ and 6¢ Stamp. Sims, Box 12175P, Richmond, Va. 23241.

COINS Reduced! Bargain List, 10¢ (Refundable). Economy Sales, Mansfield, Massachusetts 02048.

25 LINCOLNS, Your Choice 1944-S, through 1954-S and catalogue 10¢. Rich, Box 34133, San Francisco, California 94134.

ROOSEVELT Dime Specials. All Very Good Or Better. 1949S—80¢. 1955—\$1.50. 1955D—65¢. 1955—40¢. All Other Dates Are 25¢ Each. Complete Set Of 55 Different With Album For \$14.50. Satisfaction Guaranteed. Bryson Inc., 612A White, Toledo, Ohio 43605.

BARREL Of Pennies found on ranch! All before 1956 (mostly "S")—includes Indianheads! 50 mixed \$2.00. 22 different "S" Lincolns, including 1955S, \$1.60. 26 different Lincolns 1909-1939, \$1.60. 10 different "S" Jeffersons, \$1.60. All four \$6.50. HARRIS, 2775P Park, Santa Clara, California 95050.

100 INDIAN and Lincoln Cents, 1920's and older \$5.00. 40 Mixed Buffalo Nickels \$5.00. 100—1943 Steel Cents \$5.00. Wes Rood, West Union, Iowa 52175.

ROOSEVELT Dimes: 2 Different "S" Mints, 25¢. Stevens, Box 546F, North Miami, Fla. 33161.

SILVER Dimes: All Different: 30 For \$5.50. Hobby Shop, 179 Mass. Avenue, Arlington, Mass. 02174.

GOLD COINS of the World. Beautiful, Low prices. Plus thousands of United States Coins. Free price list. Please send long, airmail envelope, self-addressed, stamped. Silver Center, Box 22171-M, San Francisco, California 94122.

COLLECT COINS For Profit! How to Start, Where to Sell. Lists of Valuable Coins. Check Your Change! Send \$1.00. Frank Chandler, Box 365, Albemarle, N.C. 28001.

(Continued on next page)

COINS, TOKENS, CURRENCY

(Continued from preceding page)

"FREE!": 1918-S Lincoln Cent. Also receive Bargain Price List. Hobbyist's Village, P.O. Box 781, Dept. M1, Lynbrook, New York 11563.

COLLECT Coins for Investment and Profit—where to buy and sell. Booklet only \$1.00. Elbru, 422 Chester Avenue, Annapolis, Md. 21403.

BARGAINS! Rare Coins Pricelist! 25¢ (Refundable) Premiere, Box 7776PM, Spokane, Washington 99208.

FABULOUS Medals By FRANKLIN MINT. Write Today For Free Catalog. Alico Sales Co., 69-53 Caldwell Avenue, Maspeth, New York 11378.

ANTIQUES, RELICS, INDIAN GOODS & CURIOS

IROQUOIS Masks, Eskimo Sculptures, etc. Catalogue 25¢. Irogrants, RR 6, Ohsweken, Ontario, Canada.

LIST Indian relics. 10 Arrowheads \$3.00. Hyde's, Box 2304, Santa Fe, New Mexico 87501.

TONS Of antique gun parts and supplies. All reproduction muzzle loading guns. Send \$1.00 for enlarged illustrated catalog No. 119B. Dixie Gun Works, Union City 12, Tennessee.

EVERYBODY LIKES DIXIE GUN WORKS.

FREE List, books on Antiques. Beck, Griffin Rd., Hometown, Ind. 46748.

10 PERFECT Arrowheads \$4.00. Smith, 9825 Conway Drive, Indianapolis, Indiana 46236.

INDIAN Relic list. Arrowheads \$4.00. doz. Folsom. \$5.00 each. C. Secrist, Muscatine, Iowa 52761.

10 BEAUTIFUL Arrowheads \$2.00. Guajardo's, 8713 Shaver, El Paso, Texas 79925.

MODELS—CARS, SHIPS, TRAINS, PLANES ETC.

ROCKETS: Real flying models—flights up to 2500 ft. New illustrated catalog 25¢. Single and multistage kits, cones, engines, launchers, trackers, rocket aerial cameras, technical information. Fast service. Estes Industries, Dept. 2-A, Penrose, Colorado 81240.

SHIP Models Kits, fittings, plans, books, tools, engines, motors. Big illustrated catalog 50¢. Mass. residents add 3% tax. James Bliss & Co., Dept. SM, Route 128, Dedham, Mass. 02026.

SHIP And yacht model fittings: Pine construction hull kits; blueprints. Send 50¢ for illustrated catalog. A. J. Fisher, Inc., 1002 Etowah Avenue, Royal Oak, Michigan 48067.

SHIP Models catalog 25¢. Scientific, Inc., 100 Monroe, Newark, N.J. 07105.

MODEL Airplanes—Big 220 Page Catalog 50¢. Sig Company, Montezuma, Iowa 50171.

SHIP Model kits and fittings; clippers, frigates, etc. Catalog paint-tool list. 1969 catalog 50¢. Models Shipways, Box 65, Bogota, N.J. 07603.

LIVE Steam Engine Kits. Fascinating Hobby for Model Mechanics. Boilers, Fittings, Accessories. Pictured Catalog \$1.00 H.P.K. Models, Centuck 34, Yonkers, Z New York 10710.

GAMES, TOYS, PUZZLES, NOVELTIES

LITTLE TEASER Wooden puzzle will intrigue and frustrate you and your friends. Win bets—Send \$1, North 4727 Cannon, Spokane, Washington 99208.

"STOP Midi" Button. Send \$1.00. Box 47, New York, N.Y. 10021.

MAGIC TRICKS, JOKES, VENTRILOQUISM

MAGIC MAGAZINE—Monthly since 1936. 44 pages. All phases. 3 month trial \$1.00. Genii, P.O. Box 36068, Los Angeles, Calif. 90036.

COMPLETELY Illustrated catalog. 84 pages. 25¢. Manhattan Magic, Box 334-M, N.Y.C. 10011.

BE A Magician! Two booklets explaining sixty-eight tricks plus large professional catalog. \$1.00. Magic Inc., 5082 Lincoln, Chicago, Illinois 60625.

WORLD'S Finest professional magic tricks. Joker's Novelties. Giant illustrated catalog 10¢. Top Hat, Evanston, Illinois.

FABULOUS MAGICS New 1971 catalogue 25¢. Our specialty orders shipped same day no substitutes. Fabulous Magic, 3319 East Charleston, Las Vegas, Nevada 89104.

HOUDINI'S Original Magic Shop. Established 1856. Send 25 cents for Illustrated Catalog containing 5000 Tricks. Mindreading, Puzzles, Hypnotism and Jokes. Flossie-Hornmann, 304 West 34th St., N.Y. 10001.

FREE! World's Leading Catalog 2000 Novelties, Jokes, Tricks, Scientific Gadgets, Hobbies. Johnson-Smith, C-10, Detroit, Michigan 48224.

500 TRICKS, Douglas famous Magic Catalog, only 10¢. Better Magic for pocket, club, stage. Fastest mail service. Douglas Magicland, Dept. 11, Dallas, Texas 75221.

SUPERWATER Flows uphill! Quart. Rush \$1.00 (guaranteed!): Hoseless Siphon, Box 15242Q, Atlanta, 30333.

HOUDINI'S Greatest Magic!! You can now do them!! Giant Illustrated Catalog 25¢ with Free trick. Vick Lawston, Box 2026-P, Pompano Beach, Florida 33061.

MAGIC Catalog. World's finest 3000 tricks. (340) pages \$2.50. Beginners, amateurs, professionals. Kanter's, A-200 South 13th St., Philadelphia, Pa. 19107.

BOOKS, CATALOGS, NEWSPAPERS

HOW To Solve Your Problems! "Hypnotism Revealed" only \$1.00. General Service Company, 443 West 8th Street, San Bernardino, California 92401.

FREE CATALOG Featuring Unique Gifts! The Gift Gallery, 407-A Eastwood, Fort Worth, Texas 76107.

FREE BOOK. Prophet Elijah Coming Before Christ. Megiddo Mission, Dept. 63, 481 Thurston Road, Rochester, N.Y. 14619.

NATIONAL Geographic Magazines. 1888-1967, any issue. Buxbaum, Box 465-PM, Wilmington, Delaware 19899.

FREE Bookalogue—Private Library Sale! Bookways, 436-A Center, Fort Lee, N.J. 07024.

WANTED: Old comic books 1930's—1950's). David Weiss, 2072 77th Street, Brooklyn, New York 11214.

AMAZING Book reveals Methods for Developing Psychic Powers! Only \$1.00. Universal Enterprises, 103 Park Avenue, New York, New York 10017.

HIGHER INCOME. Security. Power . . . 256 page Book "Thinking Biz" reveals secrets that make men Rich!!! Send \$2.00. Jansen's, Box 296-PM1, Florham Park, N.J. 07932.

THINK AND GROW RICH. Over 7 Million Readers have made this book one of the best sellers of all time. Read these case histories and money making methods. \$2.00. NO C.O.D. Orders. McRae Sales, 1461 Alice St., Oakland, Calif. 94612 B.

EXAM Secret Book \$1.00! Or free gift catalog. Staron House, 17 Roy St., Fairhaven, Mass. 02719.

"GOVERNMENT Publications and How to Get them". Send \$1.00. L. Battle, Box 9747, Philadelphia, Pa. 19140.

"FREE; 1001 Books, manuals, samples. Yours on request. All listed in 64 page booklet. Only \$1.00 JN Distributor. 99 Featherbed Lane, Boothwyn, Pa. 19061.

AUSTRALIAN Magazines, 12 different—\$3.99, 6 for \$2.50; Melbourne/Sydney Newspapers—\$1.00 each. Perth/Adelaide/Brisbane—75¢, older/mixed—50¢ pound, "Unlimited" 100,000 word report—50¢; Books 25¢—\$10.99, 300 page handbook—75¢; Postpaid Canada/USA. Letters answered. Australasian News, Box 6428, Torrance, California 90504.

BOOKS On All Subjects. FREE Circular. GENERAL SERVICE COMPANY, 443 WEST 8th STREET, PM1, SAN BERNARDINO, CALIFORNIA 92401.

CHECKBOOK TRICKS Save money! Simple, unorthodox. Booklet \$2.00. J. Jaquith, 751 Greenbrier, Orange, Conn. 06477.

FREE Circular "Self Development" and "How To". Garrett Associates, 1110 Fidler Lane, Silver Spring, Maryland 20910.

SEND 50¢ For Giant New Color Navy Arms Catalog Reference Book featuring America's largest selection of Muzzle Loading Replica Firearms & Accessories, which can be purchased by mail. Complete instruction on how to handle a Muzzle Loader and kits to build your own. Address: Navy Arms Company, 689 Bergen Blvd., Ridgefield, New Jersey 07657.

PLAYS, SONGS, MANUSCRIPTS

SONGS, SONGPOEMS Wanted for Radio Show. Hollywood Music Productions, 6425-PM Hollywood Boulevard, Hollywood, California 90028.

SONGWRITER! Poets! Spiritual and religious poems, songs wanted for recording by Chapel Symphony Orchestra and Choir. We pay all recording costs! Dept. PM, Chapel Recording, P.O. Box 162, Wollaston, Mass. 02170.

BUSINESS OPPORTUNITIES

"MAILORDER LAWS and Regulations." \$2.00. Wonderful drop-ship proposition. Neil H. Tasker, Shamokin, Pennsylvania 17872.

\$625-\$900—MONTHLY Raising Rabbits, Chinchillas, other small animals. We supply everything, equipment, instructions, breeders, buyers, big demand, big markets. Fox River Valley Research Farms, Dept. PMB-1, 2727 Justen, McHenry, Illinois 60050.

RETIRE Before Fifty! Haikey did with seven "on-location", urgently needed services. Nationally advertised. Successful worldwide. Serve homes, shops, motels, offices, institutions. No shop, no experience needed. We train . . . help finance . . . guide . . . back you. Gross \$30,000 yearly with First serviceman. We furnish servicemen's machines. Large profit Each serviceman. (Starting spare time, business profits increase your job salary.) Little over \$1000 establishes your growing, lifetime business. Interesting, exciting, prestige career. Inquire Today while territory open. We'll mail information. Duraclean, C1-161, Deerfield, Illinois.

279 FAST, Easy ways to make money! Free! Rush name, address, zip. Perry, 13263EM Ventura Blvd., Studio City, California 91604.

MAKE Gorgeous original candles for all holidays and special occasions. Learn expert Candle decorating, candiemaking, use of professional molds. Free details on home instruction method. Candle Institute, Dept. A-92, 1600 Cabrillo, Torrance, Calif. 90501.

(Continued on next page)

BUSINESS OPPORTUNITIES

(Continued from preceding page)

FREE HOME DECORATING-CUSTOM DRAPERY BOOK Tells how to get started learning & earning Big \$\$\$ at home doing interior decorating, custom drapes, slip-covers, bedspread ensembles. Turn sewing machine into money making machine—supply HUGE endless demand. Delightful hobby too! Learn, earn, work right at home. No experience needed. **WE SHOW YOU HOW!** Fabrics wholesale—save big money on your own decorating & drapes. Write for **FREE** four color book today! Custom Drapery Institute, Box 555-RH, Orange, Calif. 92669.

IMPORT-Export opportunity, profitable world-wide, mail order business from home, without capital; or travel abroad. We ship proven plan for no risk examination. Experience unnecessary. Free details. Mellinger, Dept. E2701, Los Angeles 90025.

HOW To Finance Your Own Business. Get \$500 to \$2 million. Free offer. Capital-17, Kerrville, Texas 78028.

PREPARE Tax Returns—Housewife Jo Ann Netzley made \$5,500 last season. Train at home. VA Approved. National Tax School. Monsey 2CC, New York 10952.

HOW Much does being your own boss or making \$25,000.00 per year interest you? The Warner breakthrough in the Engraving field could be your future. Write: Warner, Room EC-2-AC, 1512 Jarvis, Chicago, Ill. 60626.

MAILORDER. How to prepare your own catalog for pennies. Free Catalog! Obie-MKM, Brooklyn, New York 11219.

MAIL Baby Catalogs To New Mothers For Big Profits. Details Free. Parks, 1736 South Queen Street, York, Penna. 17403.

MAILORDER Business. Dime brings information. Andrews, Box 485, New York, New York 10013.

FREE Millionaire Book. Get 996 Odd, Unusual, Little-Known Businesses. Work home. National-7, Kerrville, Texas 78028.

\$1000.00 FREE! Request Big Money by mail information. Including an 1840 \$1000 Bill. Hillcrest, Box 2445, N. Hollywood, California 91602.

INSTALL Burglar Alarm Systems. Big profit home business. Beginners start spare time, without mechanical experience or costly equipment. Free starter plan. Nasco, Dept. E2701, 11071 Massachusetts, Los Angeles 90025.

MAKE Up To 900% Profit with your own Magnetic Sign Shop! Rapidly growing demand for 3-Dimensional Magnetic Signs on cars and trucks! Start in garage, workshop, or kitchen. Full or spare time. Write today for free details. Nationwide Plastics, Dept. AB, 4200 Panamint, Los Angeles, Calif. 90065.

BE YOUR Own boss in Mail Order. New concept. 2 facets. Send large, addressed, stamped envelope to: **NATIONWIDE**, Box 2974-PM GPO, New York, N.Y. 10001.

CLIP Newspaper items, \$1.00-\$5.00 each. Details free. Walter, Box 1360-PA, Erie, Pa. 16512.

COMPLETE Mail Order Set-up \$2.00 Proven. BarCo. Box 30256, Bethesda, Md. 20014.

FREE REPORT!! 609 Unusually successful businesses, indoor-outdoor, evenings!! Write: Associated, Box 238-B1, Lafayette, California 94549.

PIANO Tuning Learned Quickly At Home! Tremendous field! Musical knowledge unnecessary. GI approved. Information free. Empire School, Box 327, Miami, Florida 33145.

BLACK Widow Spider Ranchers needed! Big guaranteed market! Complete program \$1.00 (Refundable). NBWC, Box 260 CPM4, Brigham City, Utah 84302.

SPARE Time Cash—Sell Advertising Book Matches—every business a prospect—no investment—no experience needed—build steady, repeat business. Powerhouse selling kit with new complete catalog Free. Quick sales—big cash commissions. Dept. MX-171, Superior Match, 7530 S. Greenwood, Chicago, 60619.

FREE FRANCHISE JOURNAL Magazine with over 100 franchise opportunities in every issue. Franchise Journal, Dept. G, Box 1790, Newport Beach, Calif. 92663.

\$400.00 MONTHLY Raising giant fishworms. Soilless method. Charlie Morgan, Bushnell, Florida 33513.

EARN Money raising fishworms for us! Write: Oakhaven-38, Cedar Hill, Texas 75104.

400,000 BARGAINS Below wholesale! Many free. Liquidations . . . closeouts . . . job lots . . . single samples. Free details. Bargainhunters Opportunities, Box 730A, Holland, Michigan 49423.

ADVERTISING BUSINESS—YOU Own it. \$350 First Week or Money Back. Electric Neon Action Ad Clock, 229 W. Illinois, Chicago 60610.

WANT To make big money at home? \$10.00 profit in an hour possible with invisible mending. **Make tears, holes disappear** from clothing, fabrics. Steady year-round demand from cleaners, laundries, homes. Details free. Fabricon, 1585 Howard, Chicago 60626.

SELL Lifetime. Metal, Social Security Plates. Big Profits! Sample and Sales Kit Free. Russell, Box 286-PM, Pulaski, Tennessee 38478.

COPUBLISH "Mail Sale Advertiser." leading mailorder paper. Copy and details 25¢. U.S.A. only. Vanroy Shirk, Lebanon, Pa. 17042.

\$200.00 DAILY in your mailbox! Your opportunity to do what mailorder experts do. Free details. Associates, Box 136-A, Holland, Michigan 49423.

DRAFTSMEN! Operate own **DRAFTING SERVICE!** Full, Part Time; Experience unnecessary; Details: Roberts Drafting, 1741 Circle Road, Baltimore, Maryland 21204.

RAISE Rabbits for us on \$500 month plan. Free details. White's Rabbitry, Mt. Vernon, Ohio 43050.

MAIL ORDER Sell books. Fascinating, profitable, details. Jobre, Box 27, Great Neck, N.Y. 11023.

WORLD'S Largest supply. Merchandise 25% to 40% under wholesale. Bankrupts. Closeouts 10¢ on dollar. Imports. Hongkong clothes. Automobile discounts. Free details. International Buyers, Box 16386-MM, Portland, Oregon 97233.

HOLLYWOOD CEMENTCRAFT: Offers Highly Profitable Home Business. Experience Unnecessary. Unlimited Unique Pottery Designs Easily Made Without Moulds. Bird-baths, Fountains, Wishing-Wells, Waterfalls, etc. Chemical Coloring Formulas. Marble-glazing. **FREE Illustrated Brochure.** **CONCRETE FACTS.** 602 Athens Street, Altadena, California 91001.

SELL Books by mail. 400% profit. Royal, Box 450-X, Cleveland, Ohio 44127.

FREE Catalogs. Repair air conditioning refrigeration. Tools, supplies, full instructions. Doolin, 2016 Canton, Dallas, Texas 75201.

VENDING Machines. No selling. Routes earn amazing profits. Big catalogue Free. Parkway Corporation, 715PBM Ensor Street, Baltimore, Maryland 21202.

ADDRESSERS And mailers needed. Send stamp for information. Lindbloom, 3636 West Peterson, Chicago 60645.

SELL Beautifully colored Social Security Plates. Big Profits! Free Sample. Paul Wright, 1075 Ringwood Avenue, Pompton Lakes, N.J. 07442.

CLIP Short newspaper items. To \$10.00 each. Details free. Foster, 272-M1, Brooklyn 11235.

BUILD Custom Cases at home for profit. Get orders by mail. We supply materials, instruction—everything. Free home business details. Custom Case Supply Co., 6961 CPA Hayhurst Avenue, Van Nuys, California 91406.

TAKE Catalog orders. We drop-ship 1001 best selling specialty products. Guaranteed lowest below wholesale prices. Fantastic spare-full time home business. Free book shows you how. SMC, 6963 SPA, Hayhurst Avenue, Van Nuys, California 91406.

VENDING Machine big catalog. Rake, 523 A Spring Garden, Philadelphia, Pa. 19123.

I MADE \$40,000.00 Year by Mailorder! Helped others make money! Start with \$10.00—Free Proof. Torrey, Box 318-Y, Ypsilanti, Michigan 48197.

MAIL Baby Catalogs Imprinted with your address to New Mothers for Big Profits! Details 25¢. Volz PM, Ypsilanti, Michigan 48197.

MAILORDER Records help get increased business! Complete 32 Page Record Book shows your inquiries, orders, advertising, expense, etc. Only \$1.00. C. A. Martin, Popular Mechanics, Dept. PM, 224 West 57 Street, New York, N.Y. 10019.

MAKE \$10.00 Hourly Demonstrating portable sandblaster. Inka, Box 66573, Houston, Texas 77006.

MAIL Order Collection Agency can make you \$1000.00 monthly. Free Details. Continental, Box 2023-A, Des Moines, Iowa 50310.

MAKE Money from old tires. Operators clearing \$800, weekly. Equipment costs \$1500. Get facts. S & S Patents, Inc., 3752 N. Damen, Chicago 60618.

BIG Money-making new greaseless donuts in kitchen. Everything furnished. Sell stores. Free recipes. Montgomery Ray, Waseca, Minn. 56093.

EARN \$60.00 Daily Manufacturing Concrete Fence Posts. Practically no investment. Send stamped, addressed envelope. American, Excelsior Springs, Mo. 64024.

MAKE \$46 From square foot plywood: jigsaw or bandsaw necessary. Free details. Woodar, Bridgewater, Mass. 02324.

MAKE Fortune in Mailorder! Easy! Advances, Box 24, La Grange, Illinois 60525.

I MADE \$2,000.00 Monthly by mailorder—evenings only. You can too! Free Proof! Kingman, Box 723D, Montclair, New Jersey 07042.

\$500-\$800 MONTHLY Raise small Laboratory-breeding stock for us. We supply equipment, breeders, and instructions. Illinois Research Farms, Dept. MPD-1, Barrington, Illinois 60010.

BOOKKEEPERS Earn \$500.00 week. Operate Bookkeeping Tax Service. Details free. Universal, Box 664-M, Springfield, Missouri 65801.

\$70.00 WEEKLY—home, spare time. Simplified mail bookkeeping. Immediate income easy. Auditax, 34741A, Los Angeles 90034.

\$60.00 DAY. Manufacturing concrete Posts. Blocks. Mold Equipment Catalog \$1.00 refundable. Carlayne, Route One Box 95, Rapid City, South Dakota 57701.

MAKE Magnetic car signs. Write Route 1, Box PM-49A, Bardstown, Ky. 40004.

TREMENDOUS \$1,000.00 Profit From 1,000 Mailings! Exciting. New Products! Tested! Everything Furnished! Free Guidance, Proof! George, Box 2188-PM, Cypress, California 90630.

(Continued on next page)

BUSINESS OPPORTUNITIES

(Continued from preceding page)

FRANCHISING? Amazing New Way to own your own business. Send for free copy. Modern Franchising Magazine—P, Des Plaines, Ill. 60016.

UPHOLSTERY DIRTY? Electro Sprakleen and never see dirt again. New easy method, no messy foam. Buy a kit for your home. Big money sales plan, sell for us. Become a distributor, let others sell for you. Rem-Ko Sales, 3637 S. Loomis Rd., R 4, Mt. Pleasant, Mich. 48858.

CALIFORNIA MANUFACTURER NEEDS Man to assemble our product and be local agent, experience unnecessary. May start while presently employed. Five-figure income for responsible applicant. S.K.R.M. Manufacturers, 2347 West 238 Street, Torrance, California 90501.

MAKE A year's income in 8 weeks camping. No capital investment, no selling, no land ownership necessary. 9 different ways. Write EDRU'S, Rt. 5, Box 5733, Gig Harbor, Washington 98335.

1000% PROFIT Bronzing Shoes. Free Literature—N.B.C., Box 11069-PM, Kansas City 64119.

HUGE Profits! Mail order importing. Free information. ITIS, PM-1, Box 454, Hollywood, Calif. 90028.

JEWELRYCRAFT—It's easy! Big profits! Catalog, 25¢. Modern Craft, Box 4796, Clearwater, Florida 33518.

BOTTLES Are Valuable! Free Information—Bottle Treasures, 7311 Van Nuys, Van Nuys, California 91405.

BECOME Ordained Minister. Free Information. Church, Box 191, Auburn, New York 13021.

DEALERS—Specialty ad salesmen "Bonanza". Write: Garen's Historical Documents, Xenia, Ohio 45385.

MAIL Galore! Money-making offers! Your name on national mailing lists, 25¢. Three months, 50¢. Sullins, Box 206-M, Forsyth, Georgia 31029.

NEW!! "Ideas For Self Support". Details. Eddie's, 4809-P1 North Montclare, Chicago, Illinois 60656.

CASH Benefits. U.S. Government. Free Details. Parks Enterprises, 713-A South Pleasant Street, Jackson, Michigan 49203.

MAILORDER—Home Business Guild. Receive hundreds money-making, business building propositions. Year's membership only 25¢. Digest, Box 839-PMM, Long Beach, New York 11561.

SECRETS! Mail Order Success. Internationally famous expert reveals how to make home business fortunes. Beginners: Get free copy "Make Money By Mail." Discloses free advertising, profitable products. Mailco, 1554 Sepulveda, Dept. E2701, Los Angeles 90025.

IMPORT Low-cost Brazilian products. Cheap labor here. Supplier list in specialty you indicate. \$2.00. Rey. Caixa Postal 447, Santo Andre, S.P., Brazil.

MAILORDER: Catalogs. 100% your choice. \$8/1000 Advance proof, details. 10¢. Specialty. Box 45M, Lakeside, Iowa 50588.

MAKE MONEY AT HOME METALLIZING. Baby Shoes, Plastics, Novelties, Gold, Silver, Bronze. Free Facts. Kiktavi, Box 2127-A, Inglewood, Calif. 90305.

MAILORDER SELLING. What, Where, How. DOORBAR—PM, 3364 Northwest 35th Street, Ft. Lauderdale, Florida 33309.

HIGHER INCOME. Security and Power. 256 page Book "Thinking Big" reveals secrets that make men Rich! Send \$1.95. Lindemann Bros., 1418 N. Mitchell Ave., Arlington Heights, Ill. 60004.

ESTABLISH Profitable Mailorder Business. Everything furnished. Free details. Vikari's, Box 1312PM, Salt Lake City, Utah 84110.

HOW Mail Order Fortunes Are Made! Waters, 40-G McIntire, Gibbsboro, N.J. 08026.

EARN EXTRA CASH! Free catalog lists thousands of business opportunities. Informative Publications, Box 187, Painted Post, New York 14870.

ARE You young? Just married? Expecting a new baby? Then You are going to want THOUSANDS. Be a now businessman. Be your own man. For my informative and very rewarding letter, send \$3.00 and a large, stamped, self addressed envelope to Realert, P.O. Box 174, Exeland, Wisconsin 54835.

MAILORDER Beginners! Send for free Moneymaking Directory. Roman's, 12002 Spanish, St. Louis, Mo. 63138.

MAILORDER Book Publisher Wants Dealers. Jan Enterprises, 76P, Wild Rose, Wisconsin 54984.

SHOVEL DIRT. 3 Hours daily, 12 days month, earn \$12,000 yearly. Write Digger Dan, Box 9974, St. Louis, Mo. 63122.

NEW: Canadian Timber Leases: \$1.00 acre. Free information. Timberland, Box 70-FB, Montreal 206.

SUPERIOR Auction School. Nation's top Auctioneers own and instruct, Box 1281, Decatur, Ill. 62525.

UNBELIEVABLE Spare time profits! Repairing vacuum cleaners at home. New easy method. Free details. Baron, Box 863, Portales, New Mexico 88130.

SELL Gifts And Household Items—Make extra money. Toys, Jewelry, Stationery, All Occasion, Easter, Valentine Card assortments. Salable Samples on Approval. Free color catalog, Bonus Plan. Write Hedenkamp, 361 Broadway, Dept. PM-109, New York 10013.

SENSATIONAL Car Thief Signal. Lightning Seller. Samples for trial. Northwest Electric, Ave. 690 Mitchell, South Dakota 57301.

MAILORDER! Make big money working home. Free report reveals millionaires' Trade Secrets! Executive (IA1), 333 North Michigan, Chicago 60601.

NEW Mailorder item, terrific appeal, big profit. Everything supplied. Harvey Company, Box 3846, Wilmington, Delaware 19807.

SELL Books By Mail. Free Details. Maskell, 357 5th Ave., LaSalle, Quebec, Canada.

GO INTO Business for yourself. Complete book \$1.00. Keith St. George, 16 Keniston Road, Lynnfield, Mass. 01940.

"HOW To Build and Use Customer Mailing Lists". Mail Order Business Aid, \$2.00. Listings, P.O. Box 222, Central Islip, N.Y. 11722.

COMPLETE Mailorder Business rush \$2.00 today. BEGINNER'S BONANZA Opportunity, Box 3536M, Nashville, Tennessee 37217.

BUY Lowest Below Wholesale! 1001 Novelties and Toys. Giant Catalog \$1.00 Refundable First Order. Seekagift 13826 Oro Grande, Sylmar, Calif. 91342.

HOMEWORKERS—Mailers Wanted. Free details P.M. Allen, 2418 Lori, Santa Ana, Calif. 92706.

\$200.00 SPARE Time earnings with your Tablesaw. Write: Workshop Five, 3800 Harney, Vancouver, Washington 98660.

MAIL catalog to engaged girls for big profits! Everything supplied, dropshipped. Details 25¢. Weddings, 354 South Graham, Pittsburgh 15232.

\$15,000 YEARLY. Home Mail Business. Raney, 18 Oneida Avenue, Centereach, New York 11720.

TRIPLE YOUR INCOME. Assemble Woodwards PATENT Furniture and other Products. Free Details. John Woodward Engineering Services Registered, 65 Tremblay, Iberville, Quebec, Canada.

BE THE FIRST! Start a vehicle reconditioning and restoration cooperative, also estimating career. Information Free, Details. Box 23764, Fort Lauderdale, Florida 33307.

AGES 17-60. Learn profitable WATCH REPAIRING at home. Free sample lesson. Sweazey, YNA, Fox River Grove, Illinois 60021.

MAGNETIC SIGN MACHINE 20" X 30" Portable. 110 Volts, \$345.00. Complete Supplies Available. Write: MASCO, P. O. Box 38P, McCalla, Alabama 35111.

MAKE Durable building plastic easily. Waterproof, fireproof, economical. Bays Laboratory, Cedaredge, Colo. 81413.

FREE Booklet, "Publish and Sell Books by Mail," 1200% profit! DRCA Publications, 606 Solana, Tempe, Arizona 85281.

WOULD You Like A Business of your own? High Profit on Low Investment? Full or Part Time Basis? with National Organization? If Yes Call 233-5304 or Write P.O. Box 11987, Atlanta, Ga. 30305.

VINYL REPAIRING A golden opportunity. The world is knocking at your door. Free information. AMH Industries, P.O. Box 5386, Santa Ana, Calif. 92704.

MAILORDER: Professional Profits! FREE Details. Graphics, Box 472-A, LaMirada, Calif. 90638.

FREE BOOK 505 ODD SUCCESSFUL BUSINESSES, WORK HOME. MACK PUBLICATIONS, BOX 254, MILTON, MASS. 02187.

MAKE Quality Paint. Kit containing Formulation, Instructions, Ingredients \$6.50. CFI-Inc., Box 127, North Wales, Pa. 19454.

NOW!!! Second Income. . . . Mailorder! Free details! Bates, Box 3223-AE, Detroit, Michigan 48214.

MOLDING Rubber Liquid Plastic. Hobby Supplies. Details 10¢. Chaney's, 5415-L San Jose Blvd., Jacksonville, Fla. 32207.

MONEYMAKING OPPORTUNITIES

SWEEPSTAKES Contests. How to Win. Write for free particulars. General Contests, 1609-18 East Fifth, Duluth, Minnesota 55812.

OVER \$16.50 An Hour. Spare time at home! Rubber Stamp industry needs small manufacturers. We furnish all equipment and know-how! Particulars free! Write: Roberts, Room RC-2-AC, 1512 Jarvis, Chicago, Ill. 60626.

MAKE Big Easy Profits making costume jewelry at home. Spare time. Quick, easy to make; easier to sell! Details Free! Donbar, 2934 Fullerton, Dept. A-201 Chicago, Illinois 60647.

OWNER-Manager Wanted "Nationally advertised" business in Your area. Seven superior, "on-location" services . . . homes, offices, motels, shops, institutions. Successful worldwide. Gross \$30,000 yearly with First serviceman. Additional servicemen's machines furnished. Large profit Each serviceman. Little over \$1000 establishes urgently needed, growing, lifetime business. No shop, no experience needed. (Starting spare time, business profits increase your job salary.) We train . . . help finance . . . guide . . . back you. Interesting, exciting, gratifying career. Inquire Today while territory open. We'll mail information. Duraclean, C1-161 B, Deerfield, Illinois.

\$625—\$900—MONTHLY Raising Rabbits, Chinchillas, other small animals. We supply everything, equipment, instructions, breeders, buyers, big demand, big markets. Fox River Valley Research Farms, Dept. PMO-1, 2727 Justen, McHenry, Illinois 60050.

(Continued on next page)

MONEYMAKING OPPORTUNITIES

(Continued from preceding page)

SELL Lifetime Metal Social Security Plates. Sample and Sales Kit FREE. Lady McGuire, Box 3333PM, Anderson, S.C. 29621.

101 COMPANIES Offering home employment! Names, addresses, types of employment offered plus application forms, yours for \$1.00. Jobguide, 69-29M Queens Blvd., Woodside, New York 11377.

\$350 MONTH Addressing! Details, mail stamped addressed envelope. WRITE! Happy, Box 1161-CC, Battle Creek, Michigan 49016.

NEED MONEY NOW? I made THOUSANDS in first year spare time at home. You can too! Simple, proven method gives immediate results. Send name and address to: VML, P.O. Box 723, Claremont, California 91711.

HOME Addressers wanted! \$100.00 Weekly! Details 12¢ stamps. Wood, Box 226-F18, Irvington, New Jersey 07111.

EASY Money writing short paragraphs. Booklet tells what to write, where to sell. Send \$1.00. Day's, 200 Mason Road, Milford, N.H. 03055.

PENNY STOCKS Have big profit potential. Free information. Penny Stock Reporter, 608 N. Guadalupe, PM, Redondo Beach, Calif. 90277.

CIGARETTES 12¢ a pack. Improved roller makes 20 filtertip, plain, king or regular for 12¢. Facts free. Green River Tobacco, Box 953, Owensboro, Kentucky 42301.

EARN \$240.00 a month at home, spare time, doing only two \$5.00 invisible mending jobs a day. Big money paid for service that makes cuts, tears disappear from fabrics. Steady demand. Details free. Fabricon, 1532 Howard, Chicago 60626.

MAKE Statuettes, novelties, imitation marble. Sell to stores or start gift shop. Free details. Marbleizing, 41 Waverton, St. Louis, Mo. 63124.

HOW To Make money writing short paragraphs. Information free. Barrett, Dept. C-27-01, 6216 N. Clark, Chicago 60626.

FREE Copy of world's leading contest magazine! Write Prizewinner, Box 11569, St. Petersburg, Fla. 33733.

FREE. 206 Easy Ways to make money taking orders for exciting new products—spare time. Send name, age for 5 months free subscription. Opportunity Magazine, 1460 Hancock Center, Dept. 17-AM, Chicago 60611.

SCIENTIFIC Messages: Big Earnings uncrowded profession. Learn spare time at home. Diploma awarded. Free catalog. Write Anderson School, Dept. A-1C, Princeton, Illinois 61356.

CLIP Newspaper items. \$1.00-\$5.00 each. Details free. Walter, Box 1360-P, Erie, Pa. 16512.

HOW TO GET RICH!! Free "Money-making Brochure"! Success International, Box 2447-C, Livonia Mich. 48151.

\$200.00 FROM Sheet 1/4" plywood (scrap). Details 25¢. Novelties, 610 So. 24th, Elwood, Indiana 46036.

VENDING Machines. No selling. Routes earn amazing profits. Big catalogue free. Parkway Corporation, 715PMM Ensor Street, Baltimore, Maryland 21202.

LEARN The secrets of repairing junk batteries "Fabulous Profits" at home. Battery Shop, Route 1-188 D, Blythe, Calif. 92225.

HOW TO GET RICH! Amazing plan revealed! \$2.00 Refundable. Seco, Box 144, Walkerton, Indiana 46574.

\$2.40 HOURLY Making simple wood novelties. Free details! Gene's, 55 Boxwood, Falmouth, Mass. 02540.

\$500-\$800 MONTHLY Raise small Laboratory-breeding stock for us. We supply equipment, breeders, and instructions. Illinois Research Farms, Dept. MP-1, Barrington, Illinois 60010.

NO Risk \$15.00 stock advanced. Pay wholesale cost when sold. If not sold pay nothing. MASTER RESEARCH, 115 Garner Road, Lilburn, Georgia 30247.

MAKE \$5,000 Yearly, sparetime, raising mink, chinchilla, nutria, etc. Free booklet reveals proven plan. Write: Furs, Dept. E, Bewdley, Ont., Canada.

AMAZING information, 315 magazines free. MacMillan, 133-R Holly Drive, Cleveland, Ohio 44135.

HOW To Get Sound 6%-15%. Amazingly profitable ways to MAKE YOUR MONEY WORK. This new book could be your best investment. Satisfaction Guaranteed. Send \$2.95. Ayyash Caravan, 3121 Princeton, Philadelphia, Penna. 19149.

127 SPARE Time income facts 25¢. Consultant, Box 10288-M, Alameda, N.M. 87114.

ENORMOUS Profits—safe, dry, light, fire-extinguishers for car, home. Laboratory-approved, effective. Harmless to paint, fabrics! Materials cost 39¢! Instructions \$2.00. Rey, Caixa Postal 447, Santo Andre, S.P., Brazil.

MAKE MONEY At Home WRITING Short Articles. Copyrighted Report Reveals How And Where. Send \$1.00. LEE DALE, 1501-A EDITH LANE, COLORADO SPRINGS, COLORADO 80909.

INFORMED Judgment Vital. Mailorder is strictly business. Read our story. Stationers, Drawer 5350-C, San Antonio, Texas 78201.

GET In On LAND RUSH! Let one man's search—acres to lots—help you make money in land! Nothing like this! Satisfaction guaranteed. Send \$2 to Land Rush Report, LR, 2 Van Buren Road, Scotia, New York 12302.

SELL Your Photos. REPORT Tells How. Where. COLOR Slide Markets. ONLY \$1.00. LEE DALE, 1501-A EDITH LANE, COLORADO SPRINGS, COLORADO 80909.

MAKE \$12.00 Dozen Lacing Billfolds. Details Free! (Stamp Appreciated.) Redikut's 40, Richland Center, Wis.

INSULATORS. Profitable, unique gift items made from insulators. Booklet only \$2.00 (complete details, drawings, photographs.) R. St. Pierre, 82 Bowditch Avenue, Peabody, Mass. 01960.

SKETCH Photos—(Home Goldmine!) Details. Gem, 365-F Longhill, Shelton, Conn. 06484.

"MAILORDER Imports report reveals foreign drop-ship sources. World Traders Digest. Ideal mailorder items. \$1.00. Hoy'e W. Helms, 2601 Allen Rd., South, Charlotte, North Carolina 28213.

LEARN Secret inside facts. Case histories of men who have become rich. 256 page book, Only \$2.00. Manchester Sales, Dept. A. Crawfordsville, Ind. 47933.

GET World's Biggest Wholesale Import-Merchandise Catalog. Write: Worldwide-K, Medina, Washington 98039.

STRIKE IT RICH. Enter U.S. Government Oil Lease Drawings. Details free. Petroleum Research Associates, Box 249, Westlake Village, California 91360. Licensed Mineral Oil Gas Broker.

HAVE You received your INHERITANCE! Rich relative not required. Free, write: SRJ-rr, Box 397, Newfield, N.J. 08344.

QUICK Money! Create Decorative Candles at Home! Inexpensive "Manufacturing Manual." Free Particulars! Kaycrafters, 28639 Bartons, Garden City, Mich. 48135.

FORTUNE In Classified Ads! Free Details. Milton, Box 1836, Sumter, South Carolina 29150.

MAKE MONEY Addressing, mailing, etc. Golden opportunity! Send stamp for money-making folder. Hicks Service, 37-215, Los Angeles 90037.

MAIL LETTERS FEATURING REAL MERCHANDISE. Get \$12.00 Orders in EVERY MAIL. \$8.00 PROFIT! Everything Furnished. Write: Brighton House, 5200M Greenfield, New Brighton, Minn. 55112.

RELAX, Let vending machines work for you. How? Write Techage, 5 E. 51 St., NYC 10022.

PROFITABLE OCCUPATIONS

FREE Book "999 Successful, Little-Known Businesses." Work Home! Plymouth-47R, Brooklyn, New York 11218.

\$625-\$900-MONTHLY Raising Rabbits, Chinchillas, other small animals. We supply everything, equipment, instructions, breeders, buyers, big demand, big markets. Fox River Valley Research Farms, Dept. PMP-1, 2727 Justen, McHenry, Illinois 60050.

FT. SMITH Auction School, Ft. Smith, Ark. Residents & Home study. Veteran approved.

BECOME A mortgage broker, earn \$10,000 to \$50,000 a year. Details free. United, Box 6284A, Marietta, Georgia 30060.

SHARPEN Scissors, Pinkers, inexpensive equipment, tools, supplies. Blackhawk's, Sheldahl, Iowa 50243.

MAKE \$300 CLEAR MONTH Few hours from 10 customers, representing us in your community. No individual selling. Repeats forever. Customers waiting. \$1 for sample, details. Our 40th year. Progressive, Box 1302, Springfield, Ill. 62705.

HOW To Make Money writing short Paragraphs. Information Free. Barrett, Dept. C-27-02, 6216 N. Clark, Chicago 60626.

BAKE New greaseless doughnuts in kitchen. Sell stores. Free recipes. Michael Ray, Waseca, Minn. 56093.

\$500-\$800 MONTHLY Raise small Laboratory-breeding stock for us. We supply equipment, breeders, and instructions. Illinois Research Farms, Dept. MPA-1, Barrington, Illinois 60010.

EARN \$240.00 A month at home, spare time, doing only two \$5.00 invisible mending jobs a day. Big money paid for service that makes cuts, tears disappear from fabrics. Steady demand. Details free. Fabricon, 1586 Howard, Chicago 60026.

FREE INFORMATION. "Specific Method For Developing Ideas Quickly". "Make Extra \$\$\$\$" (DON'T DELAY). Seaside House PM-Route 3, Box 99, Port Orchard, Washington 98366.

EXCITING Opportunities: With your Camera; In Mail-order Imports; Writing fillers; Collecting coins; Government Surplus. Each booklet \$1.00. Five for \$4.50. Redwood Lodge, 3405-32 Street Court, Rock Island, Ill. 61201.

FREE!! FREE!! FREE REPORTS!! 609 Little-Known, successful businesses written by Consultant. Indoor . . . Outdoor, work Home. Start small, grow big. . . Many others have. Experience Unnecessary, easy to do. Write! Report, Box 238—BA1, Lafayette, California 94549.

SALESMEN—DISTRIBUTORS

LONG Needed Invention. Man contact service stations. Full or part time. Huge profits. Write Cyclo Mfg., 3816 Dahlia, Dept. 101, Denver, Colo. 80201.

SELL Hertel Bibles—Part Time. Finest reference Bible available. Demonstrator and supplies furnished. Excellent commissions. Write International Book, Dept. PM, Box 118, Wichita, Kansas 67201.

MAKE Extra \$25 to \$75 spare time! Double air cushion shoes. Men's, women's line. Dress, work, play. Highest commissions. Shoes for yourself. Outfit Free. Bronson, Dept. H-11, Minneapolis, Minnesota 55408.

(Continued on next page)

SALESMAN—DISTRIBUTORS

(Continued from preceding page)

NOVELTY IMPORTS Sell like mad! Make huge profits. Nine samples and large wholesale catalog—\$1.00. Lakeshore Imports, 6800 North Campbell, Chicago, Illinois 60645.

THERE'S Money in selling office supplies and equipment, full or part time. Steady repeat commissions. Free selling outfit. Write: Oseco, 3505-PM North Elston, Chicago 60618.

EARN Big money calling on business-professional men. Send us their delinquent accounts for collection. General Finance, Dept. PM-11, Columbia Bank Bldg., Kansas City, Mo. 64106.

100% PROFIT—Sweet Georgia Brown Cosmetics sell fast. Write for Sample Case offer. Valmor, Dept. H, 2411 Prairie, Chicago 60616.

ITEM Sells itself at 100% Profit. \$1.00 Refundable for Sample to Miller, P.O. Box 1918, Indianapolis, Indiana 46208.

BECOME An Advertising Specialty Jobber. Marketing-C12, 147 Vivyan, Bergenfield, N.J. 07621.

47 MONEY-Making Specialties. Latest conveniences for home, car. Send no money. Just your name. Kristee 166, Akron, Ohio 44308.

EARN Big Commission Full or Part Time. Show America's largest line Low Priced Business Printing and Advertising Specialties Plus calendars in season. No experience. No investment. No collections or deliveries. On-the-spot commissions. Big Free Sales Kit samples hundreds items used daily by businessmen. Merchandise bonuses for you. Build profitable repeat business. Start now. National Press, Dept. 11D, North Chicago, Ill. 60064.

AGENTS WANTED

WANT TO MAKE UP TO \$100 A WEEK spare time, and get free shoes for life, too? No investment. Rush card for free details. Mason Shoes, K-824, Chippewa Falls, Wisconsin 54729.

PRINTING, Advertising Salesmen—Excellent moneymaking sideline selling Decalcomania Name Plates, small quantities. Advertising Specialties, sign letters. Free Samples, Ralco XL, Boston, Mass. 02119.

EVERY Man a prospect. Refundable sales kit offer showing line belt buckles, tie clasps, money clips, cuff links, lapels, identification badges, individualized with customer's name and emblems. Cap badges for trucking, bus, taxi, police, firemen, also postal, letter carriers and heavy construction emblems. Choice 4000 emblems. Hook-Fast, Box 1088PM, Providence, R.I. 02901.

LIFETIME Income. Business Loan Representative Write: Financial, 28 E. Jackson, Suite 1204-X3, Chicago 60604.

YOUR Own business—Used Suits \$1.50; Overcoats 65¢; Mackinaws 35¢; Shoes 12½¢; Ladies' Coats 30¢; Dresses 15¢. Enormous profits. Catalog Free. Nathan Portnoy Assoc., 2109-AA Roosevelt Road, Chicago, Illinois 60608.

3-D MAGNETIC Signs by Jay. Most complete line in the industry. 150 stock signs. Jay's 3-D Signs, G-8, Gorham, Maine 04038.

BE The Popular Mechanics representative in your neighborhood and earn big profits in your spare time. Write Popular Mechanics, Room 1A, 250 West 55th St., New York 19, N.Y.

WILL You test new items in your home? Surprisingly big pay. Latest conveniences for home, car. Friends buy on sight. Send no money. Just your name. Kristee, 123 Akron, Ohio 44308.

MAKE Extra Money—Show friends, neighbors—All Occasion, Easter, Valentine Card Assortments, Stationery, Wrappings, Gifts, Toys, Jewelry. Salable Samples on Approval. Free Color Catalog. Bonus Plan. Write Hedenkamp, 361 Broadway, Dept. PM-110, New York 10013.

PROFITABLE! FULL OR PART TIME. Represent largest manufacturer of magnetic signs for cars and trucks. TRIMETRIC, 2640 Saddle, Oxnard, California 93030.

EMPLOYMENT INFORMATION

JOBS ON SHIPS! Good Pay! Europe, Asia, Worldwide! Who to see and Where—\$1.00 Seaways, PM, Box 121, Ellicott City, Maryland 21043.

INTERNATIONAL . . . U.S.A. Jobs Galore!! Free Information!! Write: Employment, Box 249-B1, Lafayette, California 94549.

FOREIGN And USA job opportunities available now. Construction, all trades. Earnings to \$3,000.00 monthly. Paid overtime, travel bonuses. Write, Universal Employment, Woodbridge, Conn. 06525

HIGH Paying overseas jobs. Construction, other projects. Bonuses. Travel Expenses. Extras. International Information, 124, Cortez, Florida 33522.

ADVENTURE And High Pay at Sea! Fact-filled Booklet "How to Get a Job in the Merchant Marine". \$2.00. Mariner, Box 34422, Washington, D.C. 20034.

AUSTRALIA WANTS YOU!!! Government Assisted Passage. 1971 Government Information and Forms—Most Complete Information Available—\$1.00. Reports on Employment, Business, Taxes, Education, Teaching, Housing, Ranching, Maps, etc. AUSTCO, Box 3623-E, Long Beach, California 90803.

AUSTRALIA!! AUSTRALIA!! AUSTRALIA!! Growing Australia needs you!! Latest Handbook explains employment, housing (buy . . . rent) education, ranching (capital required) start a business. Lists hundreds of American companies in Australia and employment agencies. Explains Government Assisted Transportation. Free Details!!! Write: Associated, Box 17-B1 Lafayette, California 94549.

OVERSEAS OPPORTUNITIES . . . Higher Pay! Free Transportation! Complete information including Directory of 135 companies hiring thousands of Americans overseas . . . all occupations! Send \$1.00. International Opportunities, Box 19107-AM, Washington, D.C. 20036.

"AUSTRALIAN Business Directory"—Over 300 Companies Seeking Help—50,000 Jobs—\$1.00. "Australian Private Employment Agencies Directory"—All Professions—\$1.00. AUSSIE, Box 91018-E, Los Angeles, California 90009.

\$100-\$200 WEEKLY—Assembling, packaging small toys, novelties, premiums at home. Easy work using only your hands. Steady earnings. No previous experience necessary. Complete job application instructions, plus actual sample work, and full employment information. \$1.00 Transamerican Toy Manufacturers, Box 31212-M, San Francisco, California 94131.

OVERSEAS JOBS. High Pay, Travel, Adventure. Directory of Over 100 American Firms Now Hiring for Overseas Projects. \$1.00. TRANSWORLD, Box 90802-E, International Airport, Los Angeles, California 90009.

OREGON—Live—work—play in Pacific Northwest. Classified Advertisements Section from Portland, Oregon Newspaper \$1.00. Opportunity, Box 67, Newberg, Oregon 97132.

FLORIDA Employment Opportunities Booklet \$1.00. Sunshine, 4512N Jamaica, Tampa, Florida 33614.

HELP WANTED

WORLD-WIDE . . . U.S.A. Jobs Galore!! Students, all professions and occupations. Enjoy Paris, Rome, Tokyo, Mexico City, Miami, San Francisco. \$700.00 to \$3,000.00 monthly. Paid Overtime, Travel Allowance, Sightseeing. Free Details!! Write: Global Employment, Box 706-B1, Orinda, California 94563.

OVERSEAS Jobs—Europe, South America, Australia, Far East, etc. 2000 openings all trades. Construction, Office, Engineering Sales, etc. \$700 to \$3,000 month. Expenses paid. Free Information. Write Overseas Jobs, International Airport, Box 536-M, Miami, Florida 33148.

OVERSEAS Jobs—Australia, Europe, South America, Far East, etc. Openings in all trades and professions. \$400. to \$2,500 monthly, free information write Foreign Employment Mart, Box 2235 A.M.F. Miami, Florida 33159.

OVERSEAS EMPLOYMENT . . . Australia, Europe, South America, Asia! All Occupations! \$700-\$3,000 monthly! Write: Employment International, Box 29217-AA, Indianapolis, Indiana 46229.

"AUSTRALIAN OPPORTUNITIES HAND-BOOK" . . . Latest information about Government Paid Transportation, Employment, Business, Farming, Housing . . . plus "Employers List" and Forms. Send \$1.00. International Services, Box 19107-AA, Washington, D.C. 20036.

COMING To warm sunny Miami? First check the classifieds for jobs, housing, business opportunities. Send \$1.00 to Miami Information Service, Post Office Box 253M, North Miami Beach, Florida 33160.

REAL ESTATE & FARMS

FREE CATALOG! Exciting Fall-Holidays edition! Over 4,600 properties described, pictured—Land, Farms, Homes, Businesses—Recreation, Retirement. Selected Best thruout the U.S.! 70 Years' service, 541 Offices, 40 States Coast to Coast. Mailed FREE from the World's Largest! STROUT REALTY, 60-RX E. 42nd St., N.Y., N.Y. 10017; 7-RX S. Dearborn, Chicago, Ill. 60603; 521-RX E. Green, Pasadena, Cal. 91101.

CANADIAN LAKEFRONT PROPERTY! \$10.00 PER Shoreline Foot. Well wooded acreage on lakes teeming with fish. Suitable for hunting, fishing, investment. Small monthly payments. FREE BOOKLET. Canadian Shoreline, 2200 Avenue Road, Suite 103, Dept. PMC-1, Toronto 380, Canada.

FREE new spring Journal. Just Off Press! Statewide Realty Co., 507-AE Pyramid Bldg., Little Rock, Ark. 72201.

ARIZONA Ranch: beautiful acreage for homesite or vacation, near Prescott National Forest. 2 acres, \$1,495, low terms. Mrs. Young, Glenarm Co., 2233 No. 7th St., Phoenix 85006.

OCALA FOREST CAMPSITES Deep in the heart of the Great Ocala National Forest. Excellent hunting and fishing. Free maps and photos. (Unavailable in states requiring separate registration) AD70LB710E. W. H. Verner, Inc., Dept E, DeLand, Florida 32720.

GOVERNMENT LANDS Low as \$3.50 acre. Millions Acres! For exclusive "Copyrighted Report" . . . plus "Land Opportunity Digest" listing lands throughout U.S.; and VALUABLE 17 X 22 TREASURE MAP OF U.S.; send \$1.00. Land Disposal, Box 9091-PM, Washington, D.C. 20003. Satisfaction Guaranteed.

CANADIAN Vacation lands: Full price \$385.00. 40 acres, \$10 month. Suitable cottage sites, hunting, fishing, investment. Free information. Land Corporation, 3768-C Bathurst, Downsview, Ontario, Canada.

CANADIAN LAND INVESTMENT. FROM \$9.00 an acre. Choice properties across Canada. Low monthly payments. Ideal hunting, fishing, investment, timber, cottages. FREE CATALOGUE. Canadian Estate Land, Department PMC-1, 194 Wilson Avenue, Suite 101, Toronto 380, Canada.

(Continued on next page)

REAL ESTATE & FARMS

(Continued from preceding page)

CANADIAN Lands, seized and sold for taxes. Our 54th annual series of lists, describe many choice properties, situated from coast to coast, acquired by us through Tax Sale. Priced as low as ten dollars per acre, guaranteed perfect title, small monthly payments, no mortgage. Beautifully situated hunting and fishing camps, where there is real sport, summer cottage sites, heavily wooded acreages. Now is the time to invest in Canada's minerals, forest and farms. Write today for free booklet with full explanation. Tax Sale Service, Room 301-D, 85 Bloor St., East, Toronto 5, Canada.

LAND! EASY TERMS LESS THAN BANK RATES. NORTHWEST TIMBERED ACREAGES As low as \$950 Total Price. 5-10-20-40 Acres. For people who love the land—A tract of Recreation Land to have for your very own! In Northern Idaho, Northeastern Washington, and Western Montana. In the heart of lakes and big game country. All covered with growing timber. Access and Title insurance with each tract. This is select land with natural beauty, recreational and investment values. Plan for the future and retirement recreation. We have tracts of many types and sizes from which to choose, including beautiful Northwest Waterfront property. Your inspection is welcomed. Write us for free list, maps, and complete information. Write to: Dept. PC Reforestation, Inc. P.O. Box 106, Opportunity Station, Spokane, Wash. 99214.

\$1 ACRE—Canadian Border—hundreds campsites, islands, farmlands, directly from tax authorities. (Non-profit). Lists, photographs mailed. Register. Room 10, 110 Church Street, Toronto 1, Canada.

CENTRAL Ontario—Choice 640 acre Sportsmen's paradises still available—\$20.00 plus \$6.50 taxes yearly. Maps, pictures. \$2.00 (Refundable). Information Bureau, Norval 4, Ontario, Canada.

GOVERNMENT Lands. . . . Low as \$3.50 acre! Millions Acres throughout U.S. . . . Canada. Free Details! Land Digest, Box 11071-P, Indianapolis, Ind. 46201.

GOVERNMENT Lands . . . low as \$1.00 Acre! Millions Acres! For exclusive "Government Land Buyer's Guide" . . . plus "Land Opportunity Review" listing lands available throughout U.S., send \$1.00. Satisfaction Guaranteed! United Lands, Box 19107-AA, Washington, D.C. 20036.

10 TO 80 ACRES—Lake Superior, Marquette, Michigan area. \$99 acre. Any terms A-OK. Cabins, Trailers, Camping welcome. Hiawatha Forest Lake Acres, 3650 Dixie, Drayton Plains 16, Michigan 48020.

FREE! New 1971 Spring catalog! Hundreds of bargains, homes, farms, resort, businesses, investment property in many states. Actual property photos! Your copy FREE! (Zip code, please.) SAFE-BUY Real Estate, Box 589-PM, Little Rock, Ark. 72203.

\$1 ACRE—U.S.A.—CANADA Millions Acres. Direct from Government Agencies. No middlemen. . . . Family vacationing. Fishing, Hunting, Homesteading, Investing. . . . For amazing "where" and "how" "ALL STATES—ALL CANADA GOVT LANDS DIGEST" . . . plus invaluable Canadian maps. Rush \$1.00 (Guaranteed): Can-Am-Lands, P.O., Box 1147, Buffalo, New York 14240.

GET In On LAND RUSH! Let one man's search—acreages to lots—help you make money in land! Nothing like this! Satisfaction guaranteed. Send \$2 to Land Rush Report, XS, 2 Van Buren Road, Scotia, New York 12302.

NEW: Canadian Timber Leases: \$1.00 acre. Free information. Timberland, Box 70-FR, Montreal 206.

HOMEBUYERS—Pocketsize Appraiser Selects Best Value. Instructions \$1.00. Clamer, General Nash Drive, Lansdale RD2, Penna. 19446.

FREE! Real Estate Catalog! Farms, Ranches, Business, Recreational and Investment Property. 18 States, pictures galore. Note State Desired. Banner Advertising, Box #3333, 19-A, Springfield, Missouri—65804—"Real Estate Our Specialty".

"INCOME PROPERTY. No personal investment! Send \$1 to: Advisors, P.O. Box 7606, St. Paul, Minn. 55119."

FREE . . . NEW SPRING 1971 Catalog. All types real estate coast to coast! UNITED FARM AGENCY, 612-PM West 47th St., Kansas City, Mo. 64112.

FARM & GARDEN EQUIPMENT

CATFISH Farming, profits! fun! plans \$1.00. Leisuretime, Box 582, Livermore, California 94550.



FLOWERS, PLANTS & NURSERY SUPPLIES

600 SWEET Onion plants with free planting guide \$4.20 postpaid. Tonco, "home of the sweet onion." Farmersville, Texas 75031.

LEARN Landscaping and the growing of plants. Start a profitable business part or full time. Free information without obligation. Lifetime Career Schools, Dept. A-956, 2251 Barry Avenue, Los Angeles, California 90064.

CARNIVOROUS (Insectivorous) Plants. 28 kinds. Illustrated Catalog 25c. Peter Pauls, Macedon, Canandaigua, N.Y. 14424.

GINSENG Bringing \$1.20 pound. Have seeds, roots. Goldenseal. Full information. K. Collins, Viola, Iowa 52350.

RAYNER'S FREE 1971 Strawberry Book. Tells how to grow bigger, tastier berries for table, freezing, market. Book describes 30 virus-free varieties. Illustrates best for your area. Gives complete instructions for planting in simple terms. All plants certified and guaranteed. Lists blueberries, raspberries, grapes, fruit trees, etc. Write today for free copy. Rayner Bros., Inc., Dept. 64, Salisbury, Md. 21801.

CONSTRUCTION PLANS, BLUEPRINTS

PROFITS FROM CLASSIFIED ADVERTISING! Booklet shows you how to start your own business with Classified Advertising. Only \$1.00 (Refundable with first order.) C. A. Martin, Popular Mechanics, Dept. PM, 224 West 57 Street, New York, N.Y. 10019.

HOME CRAFTSMEN

101 PATTERNS Of smart Gifts, Novelties, Shelves, Action Windmills, plus "Make Money Jig Sawing." \$1.25. Mastercraft, J5M, 7041 Olcott, Chicago, 60631.

WOODWORKING Catalog and Manual 25c Plus free "101 Project Ideas." World's most beautiful veneers, lumber plywood! Wood finishing, upholstery supplies, Cane Lamp parts. Furniture hardware. Animal whittling blocks, 2,000 workshop products. Constantine, 2051-C Eastchester Road, Bronx 10461.

SKIL-CRAFTS New 200 page catalog with world's largest, finest selections of hobby-craft, leather-craft, artist supplies. Send 50c (refunded plus free gift with first \$5 minimum catalog order). Skil-Crafts, Box 105-P, Joplin, Mo. 64801.

CABINETMAKING MADE EASY And "How to Make Formica Counter Tops." Two excellent guides let you build kitchen cabinets and counter tops like professionals. Extraordinary guides bring master craftsmen's shortcut methods. Satisfaction guaranteed. Write: Japs, 126-P Seventh North, Hopkins, Minn. 55343.

MAKE Money Building and selling Bird Houses. Send \$1.90 for 39 page book of plans covering 19 projects. Yeager, 1665 Linden, Homewood, Ill. 60430.

POPULAR MECHANICS MASTER SHOP GUIDE. Greatest product offered to a man with a workshop. All information printed on heavy boards, punched and ready to hang above his workbench. Covers wall fasteners, nails, screws, bolts, twist drills, abrasives, lumber, moulding patterns, plywood grades, hardboard, drywall, plumbing supplies, electrical supplies. Plus information on scores of other subjects. Send \$3.95 to: POPULAR MECHANICS, 224 West 57th Street, New York, New York 10019.

WASHER SHOT? Whirlpool Kenmore rebuild kit \$59.95 includes manual. Manual only, \$4.50. A-1 Distributing, 2012 E. Sprague, Spokane, Washington 99202.

SAUNA—7½' X 5½'—Redwood Elisauna Heater. Complete U-Do-It \$499. 212-753-1239 Collect.

TURNING BLOCKS Of Brazilian Parana, 2"x12"—12" blocks \$2.00. 1"x12"—12" blocks \$1.00. Beautiful semi-hardwood colors running from cream to vermilion. Finishes superbly, easy to work. Minimum \$10.00 orders. Send Check with order. Parcel Post charges collect. Write for free pictures. LEE CYPRESS, INC., P. O. BOX 1120, PERRY, FLORIDA 32347.

WALNUT, Bowls, Legs, Round Picture Frames, Gun-Stocks Lumber Moulding, Midland Walnut, Box 262, Savannah, Missouri 64485.

BABYCRADLE—Complete Plans—Easy To Build—\$1.00. J. Armstrong, 3636 East 1st Street, Long Beach, California 90803.

FULL SIZE FURNITURE PLANS. Traditional, Early American, Danish Modern. Catalog 50c. Furniture Designs, Dept. P-11, 1425 Sherman, Evanston, Illinois 60201.

CONTRACTORS, Do-It-Yourselfers, buy your ornamental iron columns and railings direct from manufacturer and save. Send 25c for catalog, refundable. Duley Steel Fabricators, Advance, Mo. 63730.

100 JIGSAW Patterns for pleasure-profit-\$1.00. Lynds, Medway, Mass. 02053.

JIG SAW SCROLL PATTERNS Full size for Window Valances over Doors, Arches. Send \$2.00 to Artist, Box 5375, Fayetteville, N.C. 28303.

PICTURE Framing—Profitable full or spare-time business. Easy to learn with handbook-course "Guide To Picture Framing Profits." \$1.50 Guaranteed. Free framing-supplies catalog included. Japs, 126-PM Seventh North, Hopkins, Minnesota 55343.

JIGSAW Profits, new, unusual full size pattern \$1.25. Werts, Box 41097, Cincinnati, Ohio 45241.

WROUGHT IRON WORKSHOP. Make Lamps, tables, chairs for home or for sale our versatile quality tools perform seven metal operations without heat or electricity. Featured Editorially this magazine March 1970. Free color brochure or send \$1.00 for design book & sample metal. Creative Metalcraft, Dept. A, Box 663, West Caldwell, New Jersey 07006.

ARTS AND CRAFTS

LEARN Decorative Arts & Crafts—Excellent opportunities for starting part or full-time business. Great hobby, too! Free booklet. Lifetime Career Schools, Dept. E538, 2251 Barry Avenue, Los Angeles, California 90064.

SHELLS, Agates, Treasures From The Sea. Sample Packet \$1.00. Island Trader, Box 12, Mukilteo, Washington 98201.

FREE: New 136 page handicraft catalog. Supreme Handicrafts, Box 395-PM, Sioux Falls, South Dakota 57101.

MAKE Figurines, plaques, lawn ornaments. Molds, plastercraft kits, liquid rubber. Sample and catalogue 10c. Wooley Company, Box 29-B, Peoria, Illinois 61601.

(Continued on next page)

Only RCA Institutes offers you all these advantages:

1 A broad range of courses to help you qualify for good-paying jobs in such rewarding fields as communications, color TV servicing, automation, nuclear instrumentation, space electronics, drafting, computer programming.

2 RCA's exclusive Autotext training method—the easy, faster, simplified way to learn electronics at home.

3 Personal supervision throughout your training.

4 Over 300 experiments and up to 25 kits in some programs

5 Easy Monthly Payment Plan

6 Over 60 years of leadership in technical training.

7 Recognition from leaders in the field as an RCA Institutes graduate.

All courses approved for veterans. Licensed by the State of New York. Accredited Member National Home Study Council.

Courses available in Canada too.

If you've ever thought about getting into electronics...

you owe it to yourself to see what RCA home training has to offer.

If reply card is detached send this coupon today.

This entire fold-over coupon makes a no-postage-required business-reply envelope. Fill in your name and address ...then cut out along dotted lines...fold, seal and mail.

700-001-1

RCA INSTITUTES, Inc., Home Study School
320 West 31st St., New York, N. Y. 10001

Please send me free illustrated home study career catalog.

Name _____ Age _____

(please print)

Address _____

City _____ State _____ Zip _____

- Check here if interested in Classroom Training.
 Veterans check here

NO STAMP NEEDED

You must seal (Staple, tape or glue) before mailing.

FOLD HERE

DO NOT CUT HERE

FIRST
CLASS

Permit No. 10662
New York, N. Y.

BUSINESS REPLY MAIL

No Postage Necessary if Mailed in United States

Postage will be paid by

RCA INSTITUTES

Home Study School
320 West 31st St.
New York, N. Y. 10001

700-001-1

ARTS AND CRAFTS

(Continued from preceding page)

"GETTING Started in Stained Glass" 25¢. Whittemore, Box 2065Y, Hanover, Mass. 02339.

BONANZA Packet! 225 Silhouettes for Decorators, Teachers, Craftsmen. Details 10¢. Geecraft, Box 391M, Blue Earth, Minn. 56013.

FREE Catalog. Clocks, Movements, Hands, Gifts. Newport, Box 6848A, Burbank, Calif. 91505.

DO-IT-YOURSELF

SAVE Hundreds Of Dollars. Build own kitchen cabinets. Step by step instructions. Drawings \$2.00. Paul Schermerhorn, Marathon, New York 13803.

"FIX That Drip." Master Plumber Reveals Trade Secrets. Brand New Booklet \$2.00. Brighton House, 5200K Greenfield, New Brighton, Minn. 55112.

"HOW TO" Books. Catalogue 25¢. Elston House, 35 Stonycliff, Centerville, Mass. 02632.

REFRIGERATOR Door gaskets—Electric Range Washer Parts. Send Make and model for cost. Box 5465, Hamden, Conn. 06518.

CONVERT MOWER Engines into air compressors. Write Showalter, Box 409, Abilene, Kansas 67410.

21 PLEXIGLASS Projects for your home or resale. Illustrated Plans \$1.00. Trend Industries, Box 4573-D, Toledo, Ohio 43620.

EASY Built Hobbyist's Rock Tumbler, Plans \$1.00. Turn Beautiful Stones For Key Chains, Jewelry. Profit. Fun. Calcote's, Rt. 2, Box 30, McCall Creek, Mississippi 39647.

PSYCHEDELIC LIGHTING MANUAL! Make strobes, kaleidoscopes, organs, etc. Send \$2.95—Lightrays. 1315-H Weaver, Philadelphia, Pa. 19150.

BURGLARPROOF Windows less than 50¢. Also Simple Burglar-Fire Alarm System installed with hand tools. Illustrated Instructions. Parts List \$1.00. Protection, 519 Chateaugay Lane NE, Atlanta, Ga. 30342.

MAKE Your own Varnish and Lacquer Brushes from Squirrel Tails, simple, easy instructions, fully illustrated, \$1.00. Craftsman, Box 5375, Fayetteville, N.C. 28303.

BURGLAR Proof Your Home. Free Literature. MEM Distributions, 890 South Los Robles, Pasadena, Calif. 91106.

BASEBALL Bat Kit—Make Your Own Big League Bat. Great School or Scout Project. Kit Includes Ash Turning. Complete Instructions. Costs \$2.00 F.O.B. Catalogue 35¢. Wood Products, Box 51, Tappan, New York 10983.

HYDRAULIC Shop Press. 8 ton capacity. Complete plans \$2.00. Plans, Box 723, Niceville, Fla. 32578.

APPLIANCE Repairs. Rush \$1.00 (guaranteed!) New Book, Box 15242M, Atlanta, 30333.

EASY-TO-BUILD Patio furniture. Plan list, 25¢. Barlow's, 1166 West 4800 So. Murray, Utah 84107.

BURGLARY PROTECTION—Professional alarm system components, locks, safes, accessories. Free catalog. TPC, Box AE-3, Cupertino, California 95014.

BUILD Cantilever Boat Dock. Complete drawing, specifications, material. Send \$3.00. R. Hudson's Docks, 3920 Dill Rd., Drayton Plains, Michigan 48020.

BINOCULARS, TELESCOPES, MICROSCOPES, MAGNIFIERS

BINOCULAR Sale! Free color catalog 100 models \$9.95-\$250.00. Write United, 9043 So. Western, BCAT-3008, Chicago 60620.

SCIENCE Bargains! Lenses, telescopes, binoculars, microscopes, kits, parts, war surplus. Send \$1.50 for beginner's 10-lens kit with instruction booklet. Order Stock 2-CH. Request free 148 page Catalog CH. Edmund Scientific Co., 300 Edscorp Bldg., Barrington, New Jersey 08007.

BINOCULARS Direct From Manufacturer. Finest Quality. Tremendous Savings! Catalog 50¢. Refundable. Koyu, 4116 Crenshaw Blvd., Los Angeles, Calif. 90008.

BINOCULARS Illustrated price list 25¢. Joe Richardson, Mid-America Optics, Box 94672F, Lincoln, Nebraska 68509.

SCIENTIFIC Combination microscope, telescope, magnifier \$1.00. Caloptics, Dept 12, 1446 8th Avenue, New Brighton, Pa. 15066.

TELESCOPES (Reflectors) complete kits. Other accessories, request free literature. Criterion Manufacturing, Dept. PM-10, Hartford, Connecticut 06101.



CAMERAS AND EQUIPMENT

PHOTOGRAPHY For Pleasure or profit. Learn at home. Practical basic training. Long established school. Free booklet. American School of Photography, 835 Diversey Parkway, Dept. 674-021, Chicago, Illinois 60614.

STEREO Camera and viewer for under \$20.00. Make your own. Adapter and plans \$5.00. Direct Sales Co., Box 835, Huntsville, Alabama 35804.

WORLD'S Largest Buying Guide—800 Illustrations—50¢—Deductible With Your Order—Olden Camera—1265 Broadway, New York, N.Y. 10001.

MAKE Money with your camera. Report reveals how and where. Booklet 54-D only \$1.00. Laris, 19 Lenape Road, Wanaque, New Jersey 07465.

EXPOSURE Meter, Shockproof, Jeweled, F1.4 to F22. All Speeds, Battery, Case. Complete \$9.95 PPD. Cookes, 4639 Spruce, Bellaire, Texas (77401).

PHOTOS AND PHOTO SUPPLIES

MAILORDER Records help get increased business! Complete 32 Page Record Book shows your inquiries orders, advertising, expense, etc. Only \$1.00. C. A. Martin, Popular Mechanics, Dept. PM. 224 West 57 Street, New York, N.Y. 10019.

PHOTO FINISHING

CAMERA FANS! Expert photofinishing by one of Country's largest labs at lowest prices. Fast service and free "Foto-Fan" Stamps you quickly redeem for valuable Photo Supplies. 8MM Kodachrome \$1.29; 8 Exp. Kodachrome \$1.79; 35MM Kodachrome. 20 Slides \$1.39; 8 Exp. Black White 69¢. Satisfaction guaranteed. Send exposed film or request free mailers, complete Price List and Gift Catalog. Direct Mail Photo, Box 8352-PM, Pittsburgh, Pa. 15218.

KODACOLOR FILM Developed and twelve jumbo color prints \$1.49; twenty \$2.49. Black & White 12-exposure 60¢. Trial offer. Young Photo Service, 45C, Schenectady, N.Y. 12301.

COLOR SLIDES

35MM COLOR Slides. 10.671 Individually sold. Described, Encyclopedia catalog 10¢. Wolfe Worldwide, Dept. 14-11, Los Angeles, Calif. 90025.

MOTION PICTURES AND SOUND EQUIPMENT

FREE! 64-page catalog. 8-16mm film, supplies, processing equipment. Superior, 448 N. Wells, Chicago 60610.

8MM-16MM MOVIE BARGAINS! Free Catalog! Cinema Eight, Box 245-PM, NYC 10028.

UNUSUAL Movie supplies. Free circular. Esor, 47th Holly, Kansas City, Missouri 64112.

16MM SOUND Features, Shorts. New, used for Sale. Free Catalog. National Cinema, 333 W 57th St.—N.Y.C., N.Y. 10019.

16MM FILMS For sale. Free catalogue. Cinematics, 1431 West Edgewater, Chicago, Illinois 60626.

RADIO, TELEVISION AND HAM EQUIPMENT

TUBES—Lowest prices. Foreign-American, Obsolete, receiving, special purpose, transmitting tubes. Send for tube, parts catalog. United Radio Company, 56-PM Ferry St., Newark, N. J. 07105.

36¢ RADIO & TV tubes. Free catalog. Cornell, 4213-17 University, San Diego, California 92105.

GOVERNMENT Surplus receivers, transmitters, snooperscopes, parts. Catalog. 25¢. Meshna, Nahant, Mass. 01908.

FREE Electronics catalog. Tremendous bargains. Edu-Kits, Department C-7338, Hewlett, New York 11557.

HIFI, TAPES, RECORDS AND ELECTRONICS

FREE — FREE — FREE — FREE — FREE — FREE — FREE Send in for your FREE one year subscription to Olson Electronics' fantastic value packed catalog—unheard of low, low prices on brand name speakers, changers, tubes, tools, stereo amplifiers, tuners, CB and other values. Credit plan available. If you have a friend interested in electronics, send his name and address for a FREE subscription also. Olson Electronics, Dept.-JM 260 S. Forge St., Akron, Ohio—44308.

CASSETTES Ready for recording, C-60—\$1.50, C-90—\$2.25. Vista, 2842 Whaleneck Dr., Merrick, N.Y. 11566.

FREE Catalogues, 2000 hard to find unusual records. Rose's Records, Box 7216, Louisville, Ky. 40207.

STEREO TAPES Big Discounts, Catalog 25¢. Stereo Tapes Unlimited, 2318 Sheffield, Chicago, Illinois 60614.

CLOSEOUT—Factory sealed 8 track stereo tapes; Major artists, labels—Sample and list \$2.98. Somers House, Drawer E1, Boston, Mass. 02145.

BUILD AM Wireless transmitter kit. Broadcasts to any AM radio 50 feet away. Simple, educational to build, \$8.95 + 15¢ postage. Free Catalog. D. Electronics, 4725 45th NE, Seattle, Wash. 98105.



MUSIC AND MUSICAL INSTRUMENTS

ACCORDIONS and Amplifiers! Excelsior and other Famous Makes. Save 50%. Buy Direct. Factory Distributors. Terms. Trades. New-Used. Free Home trial. Free Catalog and Discount Prices. Excelsior, Dept. R, 3147 North Luna, Chicago 60641.

30% DISCOUNT Name Brand Musical Instruments. Free Catalog. Freeport Music, 127 F. Sunrise Highway, Freeport, New York 11520.

LEAD/Rock Guitar Course. Lead Chords, Tricks, Improvisation, Diagrams, Copying, Patterns, More! \$1.00. Vern, 18 Redcoat, Lexington, Mass. 02173.

FREE. Song Selling Information. Peerless Publications, Box 193-A, Bloomfield, Conn. 06002.

(Continued on next page)

MUSIC AND MUSICAL INSTRUMENTS

(Continued from preceding page)

ACCORDION Manufacturing. 6846-P North Avenue, Chicago, Illinois 60635. Concertinas, Hohners, Chromatics, Guitars, Drums, New, Used, Tuning, Repairing. Wholesale Catalogs Free.

PLAYER Piano Rebuilding—get details from: Vestal Press, Vestal 11, N.Y. 13850.

ELECTRIFY Player Pianos, Pump Organs Quickly, Inexpensively with Lee Silent Suction Units. Write Lee Music, 525F Venezia Avenue, Venice, California 90291.

LEARN Banjo, 5-String Bluegrass. No music. Makes learning easy. Free details. Blaylock, Box 25-M, Marietta, Georgia 30060.

POEMS Wanted for new songs, records. **FIVE STAR MUSIC**, 6M Beacon, Boston, Mass. 02108.

GUITAR, Banjo Making books, Plans, woods, necks, tools. List 25¢. Satinwood, 510 East 11th Street, New York, N.Y. 10009.

ACCORDION Top brands. Buy direct. Tremendous discounts. Trade accepted. Free brochure **PM**. **Accordion-O-Rama**, 874 Broadway, N.Y.C. 10003.

WHOLESALE Professional Guitars, Amplifiers, PA Systems. Free Catalog. **CARVIN**, Escondido, Calif. 92027.

GUITAR MAKING Books. Imported Woods, Supplies, Accessories. Catalog 25¢. **Guitar Center**, Box 15444, Tulsa, Okla. 74115.

GUITARISTS—Busy? Five minutes weekly, teaches strums, barres, melody. Beginner—advanced. Samples, 10¢. Steele's, Box 114, San Raphael, Calif. 94902.

POEMS Wanted For Songs. Nashville Music Productions, Box 9001-P, Nashville, Tennessee 37204.

VIOLINS, Guitars, String Instruments. Old or New. Instant Strad Tone. Worldwide. Certified. Do-it-Yourself \$10.00. Superlative Formula, 90 Day Trial \$3.00. Sgt. Rolex U.S.A.F. "Ret." P.O. Box 2381, Las Vegas, Nevada 89104.

ELECTRONIC DRUMMER—\$24.95. Free catalog. Mele 'Ohi, Box 24410M, New Orleans, La. 70122.

SONGPOEMS Needed, 50-50 **RECORDING** Agreement, Betty's Music Makers, 945B Central, St. Petersburg, Florida 33705.

CONSERVATION TRAINING

GAME WARDEN, Government Hunter, Forestry, Park & Wildlife Service announce job openings regularly. Prepare at home for outdoor work, good pay, security. Complete information Free! Write **North American School of Conservation** MPW, Newport, California 92663.

MOTEL HOTEL MANAGEMENT TRAINING

MOTEL MANAGER TRAINING — Men, women, couples wanted by leading resorts, motels-hotels everywhere. Enjoy free rent, plenty of free time. Easy home-study plan. Free! "Motel Career Kit." No salesman will call. **North American School of Motel-Hotel Management**, AZW, Newport, California 92663.

EDUCATION AND INSTRUCTION

MAKE MONEY In real estate! Complete home study course designed to start you on new career. Opportunities waiting! Write: **Career School of Real Estate Studies**, 1301PM S. Glenstone, Springfield, Mo. 65804.

GRAPHOANALYSIS — Learn scientific handwriting analysis for profit, pleasure. Free sample lesson, catalog, reveals plan. Write: **Igas Inc.**, 325 Jackson, Dept. 2AZ-2, Chicago 60606.

HIGH SCHOOL At home-5 week course-\$60. Prepares you for a state High School Equivalency Diploma. Free Booklet. No salesman will call. **Roberts Schools**, Dept. M, 517 West 57th St. N.Y., N.Y. 10019.

FINGERPRINTING — Investigation, Exciting, secure career. Learn at home. Free book. State age. **Institute of Applied Science**, 1920 Sunnyside, Dept. 161, Chicago, Illinois 60640.

CERTIFIED HIGH SCHOOL DIPLOMA Earned by examination only. Send stamped, self-addressed envelope for information and application: **Bedford Academy**, Box 221, Bedford, Virginia 24523.

BE A Real Estate Broker. Big earnings. Prepare quickly, easily. GI approved. Free Catalog. **Weaver School**, 3519-P Broadway, Kansas City, Missouri 64111.

MISSOURI Auction School. Veteran Approved. Free catalog. 1600-03 Genesee, Kansas City, Mo. 64102.

LEARN Real Estate At Home. Get your license. Become a Salesman or Broker. Approved for Veterans. Write **National Institute of Real Estate, Inc.**, 3330-M Peachtree Rd., Atlanta, Ga. 30326.

LIFETIME ORDINATIONS. Send stamp for information. **Church**, 2207 Cardinal, Rolling Meadows, Ill. 60008.

PENMANSHIP Corrector. Improve Poor penmanship quickly. Details free. **Ozment**, Box 2344, St Louis, Mo. 63114.

LEARN Auctioneering. Term soon. Free catalog. **Reisch Auction College**, Box 850, Mason City, Iowa 50401.

PIANO Tuning quickly learned with home study course. Diploma granted. **American Tuning School**, Gilroy, Calif. 95020.

EARN \$125 A week and up. Learn a trade with a future. Learn auto diesel mechanics in our shops. You learn with tools on real equipment. Earn while you learn. Many of our graduates earn \$125 a week and up. Write for free bulletin: **Dept. 256, Auto Diesel College**, Nashville, Tennessee 37219.

HIGHLY EFFECTIVE Home study courses in Electronics Engineering Technology and Electronics Engineering Mathematics. Earn your Degree. Write for Free Descriptive Literature. **Cook's Institute of Electronics Engineering**, (Dept. 10), P.O. Box 10634, Jackson, Miss. 39209. (Established 1945).

EXTENSION And Post-Graduate Awards in Philosophy, Arts, Sciences, Botanic Medicine, Homeopathy, Radionics and others. 30 subjects. Curricular free (air-mail \$1.00 refundable). Registrar, **Sussex College of Technology**, Highfield, DaneHill, Sussex, England.

DETECTIVE Course. Free Information. **Universal Detectives**, Box 8180-F, Universal City, California 91608.

HIGH SCHOOL Diploma at home. Licensed teachers. Send age, highest grade completed for free details. No salesman will call. **Southern States Academy**, 5300 W. Bellfort, Dept. 16-P, Houston, Texas 77035.

LEARN Asleep or awake! Records, tapes, equipment! Free catalog! **Drawer PM-400**, Ruidoso, New Mexico 88345.

LEARN Massage. Home study course. Free details. **Massage**, Box 190-PM, Quincy Mass. 02169.

USED CORRESPONDENCE Courses and Books sold and rented. Money back guarantee. Catalog free. (Courses bought.) **Lee Mountain**, Pisgah, Alabama 35765.

EARN College degree at home. All subjects. **Alpha Psi Omega**, 1161 South Yearling Road, Columbus, Ohio 43227.

GET A British Degree. Divinity, Philosophy, Radionics, 35 Courses. Prospectus free. **Bradridge Forest School**, Highfield, Dane Hill, Sussex, England.

COLLEGE Degrees thru extension. State Chartered, Prospectus Free, Box 688, Palm Beach, Florida 33480.

AUCTIONEERING. Resident or Home Study Course Free Catalog. **Nashville Auction School**, 2004 West End, Nashville, Tennessee 37203.

AUTOSUGGESTION. Sleep-learning headquarters! Tapes, records, books. Gigantic catalog free. **Research Association**, Box 24PM, Olympia, Washington.

ANSWERED GOD'S CALL. Become an Ordained Minister of the Gospel for Christ. We Ordained Worthy Christians. **Calvary Grace Christian Church**, Post Office Box 1674, Fort Lauderdale, Florida 33302.

EARN College degrees at home. Many Subjects. **FLORIDA STATE CHRISTIAN COLLEGE**, Post Office Box 1674, Fort Lauderdale, Florida 33302.

OWN Collection agency. "Little Gold Mine!" **Franklin Credit**, Roanoke, Virginia 24004.

HOME STUDY SCHOOL SUPPLIES. Start your own business. Complete setup. Write **SS-4**, Box 2122, Westminster, Calif. 92683.

BECOME Ordained Minister. Free Information. **Church**, Box 191, Auburn, New York 13021.

ASK! Improve Yourself. Personality questions answered. You become a winner! \$3.00. **Counselor, Success Services**, Box 985M, Mason City, Iowa 50401.

POLICE Correspondence Courses and diplomas \$10.00. **National Police Studies**, Box 112, Pleasant Grove, Alabama 35127.

BACHELOR Degree in Business Administration. By examination. Details \$5.00; refundable. **Buckeye University**, P.O. Box 8497, Parma, Ohio 44134.

COMPLETE YOUR HIGH SCHOOL At home in spare time. Texts furnished. No classes. Diploma. Approved for Veteran Training. Founded 1897. Free Brochure. **American School**, Dept. X145, Drexel at 58th, Chicago, Illinois 60637.

LEARN Self-help tricks; details. **Walker**, 1PM, 5302 1st Street, NW., Washington, D.C. 20011.

DEGREE-Granting Correspondence School Directory; Secret Societies Guide; Government Publications Catalog. Free Details. **Aureap**, Allenhurst, New Jersey 07711.

WATCH REPAIRING. Learn to repair American and Swiss watches in spare time at home. Diploma awarded. Free sample lesson. No obligation. **Chicago School**, Dept. YN, Fox River Grove, Illinois 60021.

COLLEGE Degree at Home. Law, other subjects. Easy tuition plan. **Williams College**, Parker, Arizona 85344.

UNIVERSITY Degrees via experience—free catalog. All subjects. **SMCOG**, 1394 Kelton Ave., Columbus, Ohio 43206.

PIANO Tuning pays. Big money in spare time. Learn at home. No musical knowledge necessary. Phonograph, records, tools and instructions furnished. **Electronic tuning** also taught. Free catalog. **Capital Tuning School**, 3160 S.W. 16th Court, Ft. Lauderdale, Fla. 33312.

ANNOUNCING Home Study course in commercial baking. Practical basic training. Good field for those with aptitude. Free booklet, "Opportunities in the Baking Industry." **National Baking School**, 835 Diversey Pkwy., Dept. 674-021, Chicago (60614).

PROFITABLE Camera service training at home. **National Camera**, Dept. PM, Englewood, Colo. 80110.

THE Exam Secret. Pass every Exam. Book gives you Astonishing New Study Techniques. Hit Target every Time. Only \$1.00. Add 65¢ postage and handling. Refundable. **Universal Products**, 507 Fifth Avenue, New York 10017.

PIANO Technology—Electronic organ servicing, learned easily at home. G.I. Approved. Free booklet. **Niles Bryant School**, Dept. P, 3631 Stockton, Sacramento, California 95820.

FOR INVENTORS

PATENT Application Financing. Free patent search plan. **Global Patent Division**, 2420 77th, Oakland, Calif. 94605.

(Continued on next page)

FOR INVENTORS

(Continued from preceding page)

PATENT Searches complete and thorough. Related copies Air Mailed with maximum speed \$6.00. Free "Protection Forms" and "Patent Information." Write American Patent Search Company, Dept. 27, 711 14th St., N.W. Washington, D.C. 20008.

U.S. PATENT Office Searches, 234 Broadway, Room 3615, New York. Free invention certificates.

PATENT And invention development by licensed professional patent engineer and U.S. Patent Office former examiner, and engineering specialists. Your inventions and ideas engineered for patent protection and commercial value. Inventions developed by us negotiated for cash or royalties with our nationwide contacts. Send for free protection "Invention Certificates" and further interesting, valuable patent information. George Spector, Licensed Professional Patent Engineer, Woolworth Building, New York 10007.

IMMEDIATE Cash, for patent applications. Free patent searches. Write for details. Universal Patents, 184-D, Marion, Ohio 45750.

INVENTORS: Your ideas and inventions (patented; unpatented) expertly searched, developed for commercial appeal and cash/royalty sales to manufacturers by professional Invention Developer with excellent record of experience. B.S. Industrial Engineering; United States Patent Office former Patent Examiner, United States Government former Patent Advisor. Second decade reliable service! Member: United States Council International Chamber Commerce. Free "Invention Record" and "Recommended Protection Procedure." Airmailed! Write: Raymond Lee, Invention Developer, 230P-Park Ave., New York City 10017.

FREE PAMPHLET: "Tips on Safeguarding Your Invention." Write: United States Inventors Service Company, 501P Thirteenth Street N.W., Washington, D.C. 20004.

PATENT Searches, including copies of related U. S. patents. Inventors, attorneys, manufacturers use our "worldwide" airmail service! "Invention Record" form and "Information Every Inventor Needs". Sent Free! Hayward Company, 898P National Press Building, Washington, D. C. 20004.

MANUFACTURERS NEED New Products! **FREE** Literature explains "How to Submit Your Invention." Congress Invention Company, 911-C Warner Building, Washington, D.C. 20004.

INVENTIONS Needed immediately for manufacturers. For additional information write Kessler Corporation, C-51-F1, Fremont, Ohio 43420.

"LEISURE PRODUCT IDEAS Wanted. Contact—New Product Division, P.O. Box 3274, Stamford, Conn. 06905."

FREE Information: Idea to production including patent, licensing, royalties. Inventors' Manuals—P.M. Box 3387 Norland, Miami, Florida 33169.

MANUFACTURERS Located—\$1.00. Any type product. Dittofax, 5815-PM Compass, Los Angeles 90045.

INVENTIONS WANTED

INVENTORS! Sell your invention for cash or royalties! Our client manufacturers eagerly seek new items. Patented, Unpatented. Financial assistance if needed. 25 years proven performance. For free information, write Dept. 15, Gilbert Adams, Invention Broker, 81 Wall St., New York, N.Y. 10005.

INVENTIONS Wanted. Patented; unpatented. Tremendous manufacturers lists. Global Marketing Service, 2420G 77th, Oakland, California 94605.

INVENTORS! We will develop, sell your idea or invention patented or unpatented. Our national manufacturer-clients are urgently seeking new items for highest outright cash sale or royalties. Financial assistance available. 10 years proven performance. For free information write Dept. 47, Wall Street Invention Brokerage, 79 Wall Street, New York, N.Y. 10005.

INVENTORS! Don't sell your invention, patented or unpatented until you receive our offer. Eagle Development Company, Dept. H, 83 Wall Street, New York, New York 10005.

FREE "Directory of 500 Corporations Seeking new Products." For information regarding development, sale, licensing of your patented/unpatented invention. Write: Raymond Lee Organization, 230-N Park Avenue, New York City 10017.

INVENTORS! Protect your ideas! Free "Recommended Procedures." Washington Inventors Service, 422F, Washington Building, District of Columbia 20005.

WE Either sell your invention or pay cash bonus. Write for details. Universal Inventions, 28-E, Marion, Ohio.

INVENTORS—If you have an invention for sale, patented or unpatented, write for free brochure outlining manufacturers requirements, royalty rates. Kessler Corporation, C-51-IW, Fremont, Ohio 43420.

PATENTS FOR SALE

PROFITS FROM CLASSIFIED ADVERTISING! Booklet shows you how to start your own business with Classified Advertising. Only \$1.00 (Refundable with first order.) C. A. Martin, Popular Mechanics, Dept. PM, 224 West 57 Street, New York, N.Y. 10019.

MANUFACTURING

INVENTORS Ideas developed. Research. Models. Manufacturing. Sales. Free brochure. Since 1942. William Parker, Box 209, Worcester, Mass. 01601.

BUYING AND SELLING

WANTED Rubberstamp, Plastic Laminating, Printing, Varytyping Machines, DixieGraph, King, N.C. 27021.

BUY IT WHOLESALE

AUTOMATIC Fishhooks. 400% Profits. Free Details. 2 Models, Samples \$2.00. Aron, 61-PM Mastic Beach, New York 11951.

1970 FORDS. Dodges, \$999; 1969 Cars Only \$699. For free catalog. Associated Dealers, 50 Swalm, Dept. 6, Westbury, N.Y. 11590.

HEARING Aids, Batteries, Wholesale. Catalog 25¢. Flston, Box 1444, New Preston, Conn. 06777.

WORLD'S Largest wholesale dropship sources. U.S., foreign. Factory suppliers dropship direct to you or customers. Now! have your own catalog for pennies. Free details. International Buyers, Box 16386-M, Portland, Oregon 97233.

BARGAINS! Buy wholesale and below. Name brands. Appliances, furniture, sports equipment, televisions, cameras, watches, jewelry thousands more. Huge discounts to \$1,000.00 on new automobiles. All makes. Free details. Write today: Worldwide Bargainhunters, Box 730-A, Holland, Michigan 49423.

POLYETHYLENE BAGS—New wholesale catalog. 300 stocked sizes. Lowest ever prices. Catalog 20¢. Dealers wanted. Milvan, 7921D Enterprise, Newark, Calif. 94560.

BARGAIN ENCYCLOPEDIA. 50,000 low cost items. \$2.00 Postpaid. Winchester Enterprises, 2807PM Hargrave Street, Philadelphia 19136.

FANTASTIC Free catalog—Watches, general merchandise. Department Forty, 100 North Greene Street, Baltimore, Md. 21201.

WHOLESALE—Buy 40% To 50% Off Retail—same prices retailers pay! Thousands of name brands! Watches, cameras, jewelry, radios, phonographs, tape recorders, etc. Buy for yourself or resell at fat profit. Big wholesale catalog. Confidential Wholesale Price List. Free details. Wholesale Merchandise Club of America. Dept. 408, 154 Jericho Turnpike, Floral Park, N.Y. 11001.

EXPORT-IMPORT

JAPAN: 1200 Products Directory. Illustrated Manufacturers' names, addresses. \$3.00. Send cash. Yamagata Office, 814 Togin Bldg., Marunouchi, Tokyo.

LOWEST Priced Imports. Listing \$2.00. Write: Francis Noble White, Import-Export, 3513 West Dickens Street, Chicago, Illinois 60647.

FOR THE HOME

PROFITS FROM CLASSIFIED ADVERTISING! Booklet shows you how to start your own business with Classified Advertising. Only \$1.00 (Refundable with first order.) C. A. Martin, Popular Mechanics, Dept. PM, 224 West 57 Street, New York, N.Y. 10019.

OF INTEREST TO WOMEN

DOLLS Make Big Money! Start your own hobby-business dressing, making, repairing and selling dolls. Send for Free booklet describing the excellent opportunities open to you. Doll Hospital School, Dept. D-855, 2251 Barry Avenue, Los Angeles, California 90064.

LEARN Expert cake decorating, catering, candymaking. Free details on home instruction. Candy & Cake, Dept. BEP, 1600 Cabrillo, Torrance, Calif. 90501.

\$100 WEEKLY Possible—typing, addressing, immediate income! Details, send self-addressed, stamped envelope: EDWARD, Box 50160, PM1, Tulsa, Oklahoma 74150.

\$350 MONTH Addressing! Details, mail stamped addressed envelope. WRITE! Happy, Box 1161-CC, Battle Creek, Michigan 49016.

\$150.00 WEEKLY Possible Addressing Mail For Firms Start Now! Send Stamped Self Address Envelope. Davis, Box 6992-PM, Phoenix, Arizona 85005.

MAKE MONEY AT HOME . . . ADDRESSING AND MAILING OUR SALES LETTERS! EVERYTHING FURNISHED! DETAILS 10¢. SMITH, BOX 2469-AA6, NEWARK, NEW JERSEY 07114.

\$100 WEEKLY Possible addressing mailing circulars. Send self address stamped envelope. Details Free! Ayers Opportunities, Box 1591PM, Denton, Texas 76201.

\$500.00 MONTHLY Possible—clipping news at home. No experience. Send stamped-addressed envelope. American, Excelsior Springs, Mo. 64024.

WOMEN! Make big money at home. \$10.00 profit in an hour possible with invisible mending. Make holes, tears disappear from clothing fabrics. Steady year-round demand from cleaners, laundries, homes. Details free. Fabricon, 1533 Howard, Chicago 60626.

HOW To make money writing short paragraphs. Information free. Barrett, Dept. C-27-03, 6216 N. Clark, Chicago 60626.

DRIVE New car, wear new clothes, buy color TV. Get daily cash income. Put spare hours to work. Write for 5 months free subscription Opportunity Magazine, see hundreds easy ways to make money. Opportunity, 1460 Hancock Center, Dept. 17-AO, Chicago 60611.

HOME Newspaper clippers needed. \$500 monthly possible. Details free. Foster, 272-MA1, Brooklyn 11235.

\$6.00 PER DOZEN Paid Lacing Baby Boots. Baby Moks! Write: Cowboy, Warsaw 9, Indiana. 46580.

(Continued on next page)

OF INTEREST TO WOMEN

(Continued from preceding page)

\$46.00 DAILY Possible—addressing—stuffing envelopes (typewriter or longhand). Information: Send stamped, addressed envelope. American, Excelsior Springs, Mo. 64024.

WANTED! Addressers — Commission Mailers. Stamp required. Ooton Distributors. 4120-P Duke Drive, Portsmouth, Virginia 23703.

HOMEWORKERS' Paint novelties. Good profits. Free details. Roland, 10-V Lakeview, Hammonton, N.J., 08037.

HOMEWORKERS! \$100.00 Weekly addressing for firms. Begin immediately. Details—send stamped, addressed envelope. Hamilton, 272-TM1, Brooklyn 11235.

\$150.00 WEEKLY! Firms need home workers immediately! Listings, Instructions, \$2.00. Schoen, Box 1963-P, Chicago, Illinois 60690.

HOW To Make Money working home addressing envelopes. \$50-\$100 weekly possible. Start immediately! Exciting details free. Send stamped, self addressed envelope. Enterprises, Box 16143-PM, Phoenix, Arizona 85011.

PROTECTION! Sleep safely when traveling. Installs in seconds. No tools needed. Hotel, Motel, Home can't be opened with pass key. Can't mar door or frame. Satisfaction guaranteed. \$1.50, we pay postage. Edmar Gifts, 27 Prangs Lane, New Castle, Delaware 19720.

\$500.00 MONTHLY Home addressing. Send stamped self addressed envelope. Davis, Box 6992-P.M., Phoenix, Arizona 85005.

Doctors' Answers to Skin Problems. Rush \$1.00 (guaranteed!): New Book, Box 15242N Atlanta, 30333.

GIFT SHOPPING

AMAZING Offer! Illustrated gift catalogue. FREE. \$1.00 off on first order. Mail this clipping, to Holiday House, Clinton, S.C. 29325.

FREE CATALOG Many new and unusual items. Tobi, 3211 West Campus Drive, Visalia, Calif. 93277.

GIFTS—Family Friends all Occasions. FREE CATALOG P&C Associates, P.O. Dept. 628, Clifton, New Jersey 07012.

CUCKOO CLOCKS Only \$4.95 ppd. Powell, Postfach 9, 6079 Buchschlag, Germany.

FREE CATALOG. Gifts and Gadgets. Lillian Moline, Box 352, Carpentersville, Ill. 60110.

WATCHES, OLD GOLD, JEWELRY

HIGHEST CASH For Gold, Jewelry, Gold Teeth, Rings, Diamonds, Watches, Silver, Platinum. Mail Articles Today. Free gift with information. Chicago Gold & Precious Metals, 6 E. Monroe, Dept. 558, Chicago, 60603.

COMPLETE Watchmakers' — Jewelers' Catalog \$1.00. Bengal's, 17942 Ventura, Encino, California 91316.

WANTED: Gold, silver, platinum (any form). Information free. Wilmot's, 1067 Bridge St., Grand Rapids, Mich. 49504.

CASH Immediately for old gold, jewelry, gold teeth, watches, diamonds, silverware, spectacles, platinum, mercury. Free information. Rose Industries, 29-A East Madison, Chicago 60602.

WATCH And clock repairing books. Free catalog. North American, Box 77-AA, Fox River Grove, Illinois 60021.

HEARING AIDS

HEARING Aids below wholesale. Regular, eyeglass, completely hidden models. Smallest, most powerful. Free home trial. No Salesman will call. Free details. Write Prestige-C6, Box 10880, Houston, Texas 77018.

SAVE To \$500.00. Rhodes Hearing Aids, Box 518, Paducah, Ky. 42001.



SCIENCE AND CHEMISTRY

SEARCHING For Economically Priced Laboratory Supplies? Conversion Charts And Catalogue—35¢. Hagenow Laboratories; Manitowoc, Wisconsin 54220.

LASER PISTOL—\$1.00. How to build PHASER PISTOL—\$1.00. MOON MAN (ROBOT). Build now. Complete plans \$2.00. (add 25¢ postage.) New catalogue—25¢. Roy Davis Laboratories, Dept. PM, 118 West Adams Street, Jacksonville, Florida 32202.

LABORATORY Supplies at discount prices. Catalogue—35¢ Deluxe Scientific; Manitowoc, Wisconsin 54220.

CHEMICALS And apparatus for industrial, analytical, and private laboratories. Catalog 50¢. Dept. M-50. Biological Supply Co., 1176 Mt. Hope Ave., Rochester, N.Y. 14620.

CHEMICALS Apparatus, Biology and Model Rockets. Both Catalogs for 50¢. Sheard Science, Dept. PM, Columbus, Wisconsin 53925.

EVERYTHING You Want And Need— Chemistry, Biology, Astrology Catalog 35¢. Boulevard Laboratories, 3114 East 83rd Street, Chicago, Illinois 60617.

CATALOGUE OF THOSE VERY HARD-TO-FIND PRODUCTS AND BOOKS. 35¢. THINGS that go boom. Things that go Zoom, plus other GOODIES. Kenrus-C, Box 158M Staten Island, New York 10309.

10,000 FORMULAS. Gigantic reference. 800 pages, 2½" thick, hard cover. Every conceivable mixture, compound in Industry and Science. Only \$6.50. Kenrus-H, Box 158, Staten Island, New York 10309.

ELECTRONIC PISTOL Shoots Electricity. Plans \$2.00. Kilmer, Pinos Altos Road, Silver City, New Mexico 88061.

FREE Periodic classification of elements and conversion tables with catalog 50¢. Chemicals, apparatus, biology. MidStates Scientific, 7053 N. Clark, Chicago, Ill. 60626.

HIGH Vacuum Systems. Build your own. Plans: \$2.00 S.B.E., Box 3306, Lawrence, Kansas 66044.

BELL JARS, acrylic plastic 7½" in diameter, 5" high, \$10.50 each postpaid in U.S. LESAIR Incorporated, Box 1734, San Diego, California 92112.

COMPLETE Chemistry catalog, 25¢. Laboratory Sales, Box 161-A, Brighton, Mass. 02135.

FORMULAS, PLANS, ETC.

SEVENTY-FIVE One and two Ingredient Marketable Formulas, Complete Instructions. Satisfaction Guaranteed. \$1.00 Camfields'-A, Box 1746, Indianapolis, Indiana 46206.

ANY FORMULA—\$5.00. Catalog—Manufacturing Treatise 25¢. Belfort, 192 N. Clark, Chicago 60601.

PLASTICS

MAILORDER Records help get increased business! Complete 32 Page Record Book shows your inquiries orders, advertising, expense, etc. Only \$1.00. C. A. Martin, Popular Mechanics, Dept. PM, 224 West 57 Street, New York, N.Y. 10019.

TREASURE FINDERS

HOW To stake your own mining claim. Send for Treasure Hunters Guide To The Law. Exstone Co., Box 90717, Los Angeles, California 90009. \$2.75 ppd.

FREE TREASURE GUIDE! Fact-filled collectors edition; send 50¢ for postage. Also request free literature on ultrasonic. professional Fisher Detectors. FISHER RESEARCH, Dept. PM-1, Palo Alto, California 94303.

FREE 128 Page detector catalog. General Electronic Detection Co., Box 67, Bellflower, California 90706.

"FIND Buried treasure with revolutionary patented, analytical metal detector. Features push button and automatic tuning, negligible ground pickup, greatest range. Free catalogue. Gardiner Electronics, Dept. 9, 4729 N. 7th Avenue, Phoenix, Arizona 85013."

POWERFUL Metrotech locator detect gold, silver, coins, relics. Moneyback guarantee. terms. Free information. Underground Explorations, Dept. A, Box 793, Menlo Park, California 94025

TREASURE Hunters! Prospectors! Relco's new instruments detect buried gold, silver, coins, minerals, historical relics. Transistorized. Weighs 3 pound. \$19.95 up. Free catalog. Relco-A40. Box 10839, Houston, Texas 77018.

TREASURE, Gold, silver, relics. New 1971 detectors now available. Free information. Excelsior Electronics Company, 7448 Deering Avenue, Canoga Park, California 91303.

TREASURE LOCATORS MOST COMPLETE LINE. FREE INFORMATION. TESOROS, APARTADO 7-948, MEXICO 7, MEXICO.

TREASURE LOCATORS—Powerful, Detects Coins, Minerals, Treasures. Catalog. Hunting Tips Free. Dajco, Dept. G-3, Box 2812, Santa Clara, California 95051.

GOLDAK Treasure locators—Pleasure and profit in a hobby you'll enjoy. Find coins, relics, gold, silver. Charge on BankAmericard. GOLDAK, Dept. PM 1101-A Air Way, Glendale, California 91201.

"TREASURE BOOKLET. Excellent information on treasure hunting and metal detectors. Send 25¢. BOOKLET, Dept. PM-1, Box 243, San Gabriel, California 91778.

PRECIOUS STONES AND MINERALS

500 POLISHED Gemstones \$5.00. Tumblercraft, 5401 James North, Minneapolis, Minn. 55430.

EARTH Science Rockhound Magazine. Subscription \$3.00. Sample \$.40. Box-550-PM, Downers Grove, Ill. 60515.

500 BEAUTIFUL POLISHED GEMSTONES \$1.50. Floodstones, P.O. 1673, Fremont, California 94538.

GET Free catalog no serious rockhound, gem cutter, jewelry maker, hobbyist or craftsman can be without. Full of bargains, exclusive items, low prices from largest suppliers and authorities in the field. Free new catalog just off the press, yours for the asking. Write Grieger's, Dept. C-12, 1633 E. Walnut, Pasadena, California 91106.

GOLD 10 Small nuggets panned from Oregon Streams \$1.00. Robert Brandt, Sweethome, Oregon 97386.

POLISHED Agates, 15 Lake Superior or Mexican Pastel \$1.00. Palm's, 6119 Perry North, Minneapolis, Minn. 55429.

CARTOONING, COMMERCIAL ARTS, SHOWCARD & SIGN PAINTING

\$200.00 MONTHLY Sparetime possible making signs, posters, silkscreen printing. Learn quickly—easy instructions. Information free! Hampton 109PM, Box 112, New York, N.Y. 10012.

COMPACT 23 lesson Cartoon Course and Cartoonist's Magazine. \$2.00. Hartman, Box 30367, Lincoln, Nebraska 68510.

LEARN Sign painting at home. Free talent test. Ben Kerns, Box 812-PM, Greenville, S.C. 29601.

MAKE MONEY IN ART. Free brochure outlines 15 ways. Write American Studios, Dept. P6, Spring Park, Minn. 55384.

(Continued from preceding page)

CARTOONING, COMMERCIAL ARTS, SHOWCARD & SIGN PAINTING

(Continued from preceding page)

"HOW TO MAKE MONEY WITH SIMPLE CARTOONS"—Everyone who likes to draw should have this book; FREE. Write Cartoonists' Exchange, 91 Pleasant Hill, Ohio 45359.

MODERN Cartooning taught by mail. Write for free brochure. Cartoonorama—Box 263-3A, Branford, Conn. 06405.

SIGN Painting Matthews' big new 18 lesson course \$5.00 postpaid. Circulars free. Sign Book Co., 470 Oak Street, St. Louis, Mo. 63119.

SIGN Painting—Latest Free Catalogue explains everything. write: Kaufmann Supply, Centertown, Missouri 65023.

DISTINCTIVE Letter Patterns For Sign Making Purposes. Paulow, 1935 Stardust, Waukesha, Wisconsin 53186.

ADVERTISING AGENCIES, ADV. SERVICE, MAILING LISTS

ADVERTISING Ratebook leading newspapers, magazines, 25¢. Chicago Advertising Agency, 28-E Jackson, Chicago 60604.

MAILING Lists most all kinds 1000 \$5.00. Free folder Your circulars mailed \$4.00 1000. Dixie Mailers, King, N.C. 27021.

MAILING—List's—Fresh—Free Details. THAD, 195 Riverside, Thompson, Manitoba, Canada.

TYPEWRITERS, DUPLICATORS, OFFICE EQUIPMENT

FREE Plan. Start printing, lettershop. Offset Presses. Mimeograph Copy machines. DixieGraph, King, N. Car. 27021.

RUBBER STAMPS AND OFFICE SUPPLIES

ADDRESS Stamp 85¢. Signature \$2.80. Catalog. Carol's, McLoud, Okla. 74851.

FREE 48 Page Catalog. Rubber stamps, printing, office supplies. Youngers Stamp Shop, Princeton, Iowa 52768.

PAID, FRAGILE, Etc. \$1.10 each. Craig Stamps, Box 511, Mt. Vernon, Illinois 62864.

3 LINES \$1.00. Extra lines 25¢. Knob Handle. Daufeldt-PM, Atalissa, Iowa 52720.

RUBBER Stamps, 3L-2" \$1.90. Catalog, R.E.D., 18 Crane, Darien, Connecticut 06820.

PRINTING PRESSES, RUBBER STAMP OUTFITS

RUBBER Stamp manufacturers supplies. Presses, starting outfits. Best prices, service. Catalog. Jackson Supply, Box 443A, Franklin Park, Illinois 60131.

SIMPLE-X RUBBER STAMP PRESSES. Hydraulic operated, electrically heated. Sizes 5"x8", 8"x12", 10"x15". Starting outfits. Orders for presses, supplies shipped day received. Free catalog low supply prices. Custom Manufacturers, 406-P East Elm, Springfield, Mo. 65801.

PRINTING Presses, type, supplies. Lists. 5¢. Turnbaugh Service, Mechanicsburg, Pennsylvania 17055.

TYPE Catalog No. 12, 120 pages. Send One Dollar. Ductible First Order. Acme Type, 732 Federal, Chicago, Illinois 60605.

SAME Day shipment on rubber stamp supplies. Revised wholesale price list No. 7 free. Star Stamp Supply, 732 Federal, Chicago, Ill. 60605.

RUBBER Stamp outfits, supplies. Kiewiet, 2025 Barney Road, Kalamazoo, Michigan 49007.

MAKE Your own self-molding rubber stamps and printing cuts. Plexirubber, Argyle (-1-), Wisconsin.

PRINTING AND SUPPLIES

QUALITY Business Forms, letterheads, envelopes. Economical. Samples. Burnfin, Weaubleau, Mo. 65774.

AMAZING Business printing values. Quotations. Print Shop, Box 576, Greenville, R.I. 02828.

FREE Literature. Address Labels, Business Cards, Printing, Rubber Stamps: Jordan's, 552 West O'Connor, Lima, Ohio 45801.

QUALITY PRINTING—Offset. Since 1945. Free 24 page catalog! Napco Press, 1744-P Bath Avenue, Brooklyn, N.Y. 11214.

8 HOUR PRINTING—Free Booklet "Secrets of Cutting Printing Cost." Nationwide Printing, Atlanta, Illinois 61723.

BUSINESS CARDS Raised Letters \$5.65 Thousand, Like Engraved. Free Samples. Kavanagh, Box 1222, Brooklyn, N.Y. 11202.

PERSONALIZED Notepads, 100 5 1/2 x 4 1/4 sheets, \$1.00 postpaid. Send to: APS, 8329 Regent, Milwaukee, Wis. 53217.

1000 EMBOSSED Two Color Business Cards \$7.00. Free Samples. Stewart Printing Service, Box 19284, Dallas, Texas 75219.

100 8 1/2 x 11 COPIES \$1.95; 1,000—\$6.95. 150 Business Cards \$1.95. 100 Shipping labels \$1.95. Allstate Press, 120-PM South LaSalle, Chicago 60603.

ENVELOPE Printing, free price list and typestyles. J. W., Box 106, Viroqua, Wis. 54665.

PRINTING. Reasonable prices. Samples free. Fowico, 3515 Walnut, Muncie, Indiana 47302.

GUMMED LABELS

1000 GOLD Stripe address labels \$1.00. Free brochures. Vernon House, 158 W. Sanford Blvd., Mount Vernon, N.Y. 10550.

1000 GUMMED Address Labels \$1.00. Wall's, Box 966A, South Bend, Indiana 46624.

1000 PERSONALIZED Labels 50¢. 3 Sets \$1.25. Free Catalog!! Fabrico—Dept. WA1, 1512 N.E. 29th Street, Ocala, Florida 32670.

REMAILING SERVICE

HOLLYWOOD—Burbank—Universal City Remails 25¢. Postcards, Kelly, 6434 Radford, North Hollywood, California 91606.

HOLLYWOOD, LOS ANGELES Remails, 25¢. Fast, private. Burks, 622 South Serrano Avenue, Los Angeles, Calif. 90005.

SCOTTSDALE Remails 25¢ \$3 monthly. Remfor, Box 1541, Scottsdale, Arizona 85252.

MIAMI Remails 25¢. Monthly rates. Marle, Box 1266, Coral Gables, Fla. 33134.

CONFIDENTIAL New York City mail address \$3.00 month. Remails 25¢. Details Free. Birnhan, 152 W. 42, New York City 10036.

SECRET. Receiving—forwarding. Discreet and confidential. Remail 25¢ single. Mail Forwarding Service, 8050 S. Main, Houston, Texas 77025.

RECEIVING—Forwarding. Monthly Rates. Hedgpath, 406-M South Second, Alhambra, Calif. 91802.

SEATTLE Remails 25¢. Dependable, confidential. Toppers, P.O. Box 897, Seattle, Washington 98111.

NIAGARA FALLS—BUFFALO, NEW YORK—Remails 25¢. MULTI-Colored Cards Niagara Falls—7—\$1.00. Receiving—Forwarding—Special Services—Inquiries Invited. S. S. Sprague, 260 Prospect Avenue, Buffalo, New York 14201.

NEVADA Remail, guaranteed, indicate Las Vegas or Boulder postmark, 25¢. souvenir postcards, Box 5321, Las Vegas, Nevada 89102.

ALASKA Remails 25¢. Scenic postcards. M. Carlson, P.O. Box 552, Kodiak, Alaska 99615.

DETROIT Remails 25¢. Motown, 5651 Newberry, Detroit, Michigan 48209. Confidential.

MEMPHIS Remail 25¢. Receiving-Forwarding. EGS, Box 18384-R, Memphis, Tenn. 38118.

IOWA Remails, 25¢ Singles. Longwood House, Box 202, Cedar Rapids, Iowa 52402.

NEW YORK CITY 1/25¢ 6/\$1.00 Additional services. Snow-M-319 East 78th, New York 10021.

CALIFORNIA Remails 25¢—\$3.00 month. Fitzgerald, Box 3194, Santa Monica, California 90403.

DISCREET, Confidential, Dependable, Forwarding, Holding. 25¢ singles, \$3.00 monthly. Maclaurin, Box 46, Key West, Florida 33040.

"CALIFORNIA Remails—25¢ Anaheim-Disneyland. Watkins, Box 2431, Anaheim, California 92804.

NYC REMAILS Confidential, Reliable \$4.00 Monthly, Singles-25 cents. Ro-PA Mailing Services, Box 483, Madison Square Station, NYC, NY 10010.

LOS ANGELES Remails 25¢. 5/\$1. Receiving-forwarding. Dittofax, 5815-PM Compass, Los Angeles 90045.

DETROIT — Fast — efficient — confidential. Remails 25¢/\$3 Monthly. Qwik-Serv Associates, P.O. Box 22, Birmingham, Michigan 48012.

MIAMI BEACH Remails 25¢ Special Services. Reeves, Box 67, Miami Beach, Florida 33139.

"FT. WORTH, Texas Remail 25¢. Box 731, Hurst, Texas 76053."

AUSTRALIA Remail \$1.00. McMillan, Box 308, Yeppoon Old, Australia 4701.

SPECIAL SERVICES

INFORMATION On anything. Ferguson Research Specialists, 83-45 Vietor Ave., Elmhurst, N.Y. 11373.

AUTHORITATIVE Information On Anything! \$2.00 (deductible). Metzler Research, Box 2206PQ, Long Island City, New York 11102.

ARE YOU THINKING OF RELOCATING and WORKING in another part of the country? Send \$1.00 for details of unique club and newsletter. P.O. Box 713, Monterey Park, California 91754.

BEAUTIFUL Monogrammed stationery, 100-sheets, 50-envelopes—\$1.75. Robby House, 2268 Carpenter, Brunswick, Ohio 44212.

PERSONAL

PAY Bills! Borrow to \$1500 by mail! Convenient terms! State licensed. Postal Finance, 200 Keeline Building, Dept. 17-A, Omaha, Nebraska 68102.

SECRET Law Wipes Out All Debts. Immediate relief. Clear credit. Free details. Counselor-7. Kerrville, Texas 78028.

"SUCCESS-Oriented" Luck Date and Cycle Information, \$1.00 with complete Birthdate. College of Universal Truth, Madrid 7, Nebraska.

BEAUTIFUL Girls—Free Information: International Introductions, Box 1457, Vallejo, California 94590.

DIVORCE Obtain a LEGAL DIVORCE with or without the other's consent and save. Send only \$5.00 today to Personal Services, Box 2445, Providence, R.I. 02906.

IRELAND Remails \$1—postcards, souvenirs supplied. A. R. W., 14 Clarence St., Dunlaoire, IRELAND.

ORIENTAL Catholic Girls Seek Gentlemen. \$1.00 brings photos, application, complete details. Pacific, 406-M Second St., Alhambra, California 91802.

SAVE MONEY! HOMEOWNERS Insurance benefits explained. Major policies compared. Write Alco, Box 11594, Phoenix, Arizona 85015.

PERSONAL

(Continued from preceding page)

ORGANIC Supplements for health, vitality. Details. B. Bodewig, Box 381, Coos Bay, Oregon 97420.

MAKE YOUR WILL. Get 4 Will Forms and attorney's informative book. \$1.00. Legal Forms Company, Department 124, 1830 Guardian Building, Detroit, Michigan 48226.

LONESOME? I HAVE thousands of single women. Tell me what you want. I'll send her name and picture. Help Company Club, 4554 Broadway, Chicago, Illinois 60640.

BIBLE Questions answered. Stamped envelope. Bylon, 17167 Bentler, Detroit, Michigan 48219.

SECRET LOANS BY MAIL. Borrow \$100 to \$1500 for any good reason in absolute privacy. No interviews, no endorsers, no co-signers. Fast service. Write Dial Finance Co., Dept. A-214, 410 Kilpatrick Bldg., Omaha, Nebraska 68102.

INVESTIGATORS. Latest electronic Aids. Free literature. Clifton, 11500-P NW 7th Ave., Miami, Florida 33168.

RUPTURED. Relief and comfort. No understraps, elastic or steel. Write Hand-Lock Products. Preston 4. Ont., Canada.

ARE YOU REALLY SINCERE About wanting to find a marriage partner? SOCIAL INTRODUCTION SERVICE. P.O. Box 1547, Eugene, Oregon 97401.

TOO Many Debts? Want to lower your payment and pay off the bills? Write Continental, Dept. PM, Box 2116, East Chicago, Indiana 45312.

SUBCONSCIOUS Conditioning remakes personality while you sleep. Free details. Sleep-Learning, Box 24N, Olympia Washington 98501.

FOLLOW That Car. Electronic Trailing Equipment. Free literature, Box 220, Miami, Florida 33168.

SERVE Christ. Become an Ordained Minister. Write Holy Light, Dept. D, Box 4478, Pittsburgh, Pennsylvania 15205.

HANDWRITING Reveals hidden character and personality traits! 208 page course shows how you can analyze handwriting. Fascinating, try it for parties. Send \$2.00 to Acadia Gifts, Winter Harbor, Maine 04693. Maine residents add 5% sales tax.

ELECTRONIC LISTENING DEVICES. Miniature transmitters, microphones, telephone devices, recorders, wall amplifiers, bug locators, etc. from \$7.95. Complete catalog. PCP Electronics 27597-P-1 Bahama, Hayward, Calif. 94545.

ARE YOU SEEKING Companionship Marriage Partner? Remarkable Introduction Service Now, With Magazine And Details 35c. Jay's, Box 1301-X, Wausau, Wisconsin 54401.

\$1,000,000 IN DEBTS wiped out without borrowing. Immediate relief. Write Legal Aid, Box 63, Stratford, New Jersey 08084.

PROBLEMS Overcoming You? Looking for an escape? Face Reality, TRY GOD! Information free upon request! SRJ-tg, Box 397, Newfield, N.J. 08344.

COMPATIBLE DATES by computer. Free Details, House of Hoke, Sebring, Florida 33870.

WIGS For Men, details free, F & N Fashions, Box 34-A, Glencoe, Minnesota 55336.

HIGH PAY, SECURITY with Civil Service Jobs! Expert books prepare you. Free literature. Aquarian, 234-K West 13 St., New York City 10011.

HANDWRITING Analyzed—for self-understanding, self-improvement. Scientific method. Send sample (unlined paper), including signature. \$5.00. Joy, Box 4707, Baltimore, Maryland 21211.

DEATH . . . Unpleasant, but coming. Avoid death and live longer. \$2. Postpaid. LONGER LIFE, Box 834-PM, Janesville, Wisconsin 53545.

STUTTERING? STAMMERING? LISPING? NEW Device Designed To Improve Speech! A Great Aid To Stop Stuttering. Stammering and LISPING Speech Impediments. 100% Money Back Guarantee. SEND \$10.00 To: J. W. Rundans, MICRO WAVE VOICE CORP., 433 Durnan Street, Rochester, New York 14621.

"SINGLE? 2000 Ladies' Fotos \$2.00. Meet beautiful girls, divorcees, of all ages through world's largest matrimonial catalog. International Contacts: Box 12, STN. "O", Toronto 16, Canada.

FOR Better Health and longer life, write for free information to: Better Health Products, Box 69 RD2, Danville, Ohio 43014.

FREE Circulars On Self-Improvement Books. Write: House Of LaVerne, Route 2, Box 538A, Tacoma, Washington 98424.

"RULE Others With Thoughts." (Telepathy) write: Clarion, Box 1769-S7, Chicago, 60690.

EXCELLENT Money-Saving Do-It-Yourself and Educational Books—every interest. Free List. Aquarian, 234-J West 13 St., New York City 10011.

NEW False Dental Plate, low as \$29.95. 24 Hour Service. No impression. Lightweight DuPont Beauty Pink Plastic. Satisfaction or money back. Our 20th year. Free details, shipping box. West, Dept. A-203, 3816 W. Lawrence, Chicago, Illinois 60625.

WANTED—MISCELLANEOUS

OLD Toy trains. Electric, clockwork, steam. Braem, 4086 Cody, Sherman Oaks, Cal. 91403.

WE Buy Bottles, Coins, Antiques, Books, fruit jars, magazines (anything). Send \$1.00 (refundable) for Huge Buying Lists. Schroeder's, R-4, Paducah, Ky. 42001.

MERCURY. Gold, Silver, Platinum; Ores assayed. Wholesale Terminal, Norwood, Mass. 02062.

MISCELLANEOUS

COOKS! \$1.00 Brings deliciously different recipe for Syd's Chili, Box 866, Clute, Texas 77531.

93,000 CANDLEPOWER Flashlight can shine one mile. PR-18 bulb focuses to bullseye spot. Uses standard batteries. DYNALITE \$9.00 postpaid, Holliday House, PMA, Clinton, S.C. 29325.

WINEMAKER'S Kit!! Includes: Yeast, Chemicals, Fermentation Locks, Corks, Recipe Manual, Catalog!! Everything—\$3.00. Satisfaction guaranteed. Winekit, 2121 Conger, Olympia, Washington 98501.

EXCITING Contests! Cash prizes! News and ideas for healthier, better living. Extra income opportunities. Send 35c and large, addressed, stamped envelope to: ALAMOSSCO, Dept. PMA, Box 1196 GPO, New York, NY 10001.

CIGARETTE Shredded Smoking. Snuff, Twists. Free Samples. Stoker's, Dresden, Tennessee 38225.

SUFFERING From Arthritis? Try Ginseng; Information Free. Write Ginseng, Asheville 53, N. C.

CIGARETTES 12c a pack. Improved roller makes 20 filtertip, plain, king or regular for 12c. Facts free. Green River Tobacco, Box 954, Owensboro, Kentucky 42301.

YOUR Name sent to 1000 importers, publishers, mailers, wholesalers, etc. on our mailing list. Year \$1.00. Dixie Mailers, King, N. Car. 27021.

WINEMAKING . . . Grape, Elderberry, Dandelion, Frozen Juices, etc. Brewmasters' secrets revealed! Powerful Methods! Instructions, Recipes, and Supplies Catalog. \$1.00. Continental, Box 11071 PA, Indianapolis, Indiana 46201.

PSYCHEDELIC Catalog of Posters. Lighting, Jewelry, Etc. Send 50c. Hole, 6055 Lankershim, N. Hollywood, Calif. 91606.

WINEMAKERS Yeast, Recipes & Catalog 25c; Kraus, Box 451-L, Nevada, Missouri 64772.

ORNAMENTAL Iron designs. Book of 1600 beautiful, practical designs for railings, columns, etc. Free literature. Cunningham, 3881 South 3200 West, Salt Lake City, Utah 84119.

WINEMAKERS. Free illustrated catalog of yeasts, equipment. Semplex, Box 12276, Minneapolis, Minn. 55412.

BOOKS On antiques and their prices. Free circular!! P. Warman Publishers, Uniontown, Penna. 15401.

HEARING Aid batteries wholesale. Free list. Habs, Box 51, York, Penna. 17405.

CREDIT CARDS! Receive all kinds, fast, easy. Get new credit without investigation! Continental, Box 996-P, Hallandale, Florida 33009.

WINEMAKING Kit—\$4.98 Free Catalog and recipes. JIMDANDY, Box 30230M, Cincinnati, Ohio 45230.

MEXICAN MARRIAGE LICENSE, U.S. Marriage License, Drivers License, H.S. Diploma, Birth Certificate, Wills—Blank Forms—Finest Available! Only \$2.00 each! Order Today!!! Buy 2, Get 1 Free!!! Lee Forms, 441-A Truman NE, Albuquerque, NM 87108.

SENSATIONAL New "Pocket" Check Protector. Write Brighton House, 5200G Greenfield, New Brighton, Minn. 55112.

ALABAMA CAVES—32 Page Book 70 Color Photographs \$1.00. Manitou Cave, Fort Payne, Ala. 35967.

EXOTIC Brazilian colored post-cards, airmailed. Three for \$1.00. Also air mails. \$1.00. Rey, Caixa Postal 447, Santo Andre, S.P., Brazil.

MAGNETS. All types. Specials—20 disc magnets, or 2 stick magnets, or 10 small bar magnets, or 8 assorted magnets, \$1.00. Maryland Magnet Company, Box 192-A, Randallstown, Maryland 21133.

WINEMAKING—200 Recipes, instructions—\$1.00. E&G Sales, Box 18384-T, Memphis, Tenn. 38118.

"LAS VEGAS Genuine casino dice key chain. Limited supply—\$1.00 . . . Universal Imports, Dept. P., P.O. Box 5697, Las Vegas, Nevada 89102."

DRIVERS License, birth, marriage certificates, high school, college diplomas, with gold seal. \$1.00 each, any 3 for \$2.00. Apex Productions Inc., 648 East 75th Street, Chicago, Illinois 60619.

WINEMAKERS! Special! Leading University Winemaking Booklet—Supplies Catalogue—10c. Werth Wine, Box 1902H, Cedar Rapids, Iowa 52406.

IDENTIFICATION CARDS. Send stamped self-addressed envelope for samples. ECSM, P.O. Box 12117, Las Vegas, Nevada 89112.

WINEMAKING: Simple, inexpensive. Complete manual \$1. Namar-d, Box 6, Dearborn, Michigan 48121.

DRIVER'S License, Birth Certificate, H.S. & College Diplomas, Marriage & Divorce Certificates—Blank Forms. Fill them in yourself. Highest quality you can buy! Confidential. 3 day service! \$2.00 each; any four—\$5.00, postpaid. Formco, Box 834D-F, Warren, Michigan 48090.

BUILD NOW, PROFIT LATER! Beat the races this year with electronic computer break-through. Analog computer handles every track and performance variable. Parts, kits, or completed. Free details. Unimac, 372P, La Canada, Calif. 91011.

FREE BROCHURE. NEW and UNUSUAL products for Home, Auto, Sportsman. SEND TODAY. Elton's, 1810 -PM- Pine, North Cedar, Cedar Falls, Iowa 50613.

NEVER Again go home to a dark house. Electronic eye automatically turns a light on at sunset \$5.98. Timm Enterprises, 901-A Zinnia Lane, Palatine, Illinois 60067.

DETROIT LISTENING POST

BY ROBERT LUND

REAL VW-SIZE CARS out of Detroit, possibly three-wheelers (see page 106), could come within six years. Not that the auto firms are gung-ho to build small cars. The auto companies are cool to mini-machines because they're low-profit pieces. But the industry's own economists predict that if inflation continues at the present rate, auto prices will be out of reach of the bottom third of buyers by 1976. The only solution is to bring out cars below Vega, Pinto and Gremlin in size. That means two-seaters. The factory forecasters also note that prices have already reached a point where millions of car owners couldn't afford to replace their current cars if they didn't have equity in a trade-in.

More on the junior editions: GM has at least 6 and maybe as many as 10 cub cars in various stages of development, all equipped with versions of the Wankel engine. The engine modifications were reportedly made in Japan. GM used to say it wasn't interested in building components in Japan, but with Ford and Chrysler busting down the doors trying to make a connection to produce cars, engines and parts in that country, GM may be experiencing a change of heart.

And still more on minis: There'll be no mistaking the big Plymouths and Dodges from Chrysler's answer to Vega and Pinto when Chrysler's shavetail car comes out late this year. The standard-size cars will become even bigger, via a stretch-out of the rear-quarter panel and deck, at the time the little one's launched.

HOW DO YOU WANT YOUR GRILLE—made of plastic or metal? There's a small war going on between suppliers of aluminum, zinc, a combination of zinc-aluminum and plastic to decide the question. There'll be some switching around on the '72 cars, mostly with metal taking over from plastic. But overall, plastic's still gaining in automaking. On small parts and low-volume cars in particular. The metalmakers are winning back a few bits and pieces they gave up to plastics during the 1960s, but you'll never see an all-metal, plastic-free production car out of Detroit again.

CHRYSLER'S CONSIDERING A SINGLE, UNIFORM INTERIOR for all its '72 cars. But you'll have to have a pretty sharp eye to detect it. Trim, colors, knobs, handles and gauge needles will differ from car to car. But the interior pieces—dashboard and panels—may be identical under the cosmetics. This will give the company more money to spend on exterior styling and that's what catches the eyes of most buyers.

A STEP AHEAD OF DETROIT with safety belts and now with increased use of fuel injection: The hot, new 1971 Volvo 142E sedan is powered by the two-liter B20 four like the '70s, but with the addition of computerized fuel injection (first introduced in the P1800E sports car) which gives it good fuel economy with improved performance over the dual-carb 142S. The stronger engine (130 hp @ 6000 rpm, 0-60 in the 10-to-11-second range) is accompanied—*a la* the Volvo philosophy—by stronger drive train and chassis components: Thicker brake discs, larger pads, five-inch wheel rims with radial tires and front suspension tuned for radials and strengthened gearbox are standard. The f.i. is the well-tested Bosch unit supplied to VW and Saab. Seats are



(Please turn to page 56)



Hand-painted pottery?
They collect it on their
vacations, too.
Sometimes they even get
their own hand in it.
Their cigarette? Viceroy.
They won't settle for less.
It's a matter of taste.

Viceroy gives you all the taste, all the time.



**Your Job as an
ACCIDENT
INVESTIGATOR**

Make big money investigating accidents. Car furnished, expenses paid. No selling. No tedious study. Full or spare time. I train you directly by mail and provide free placement service. (Liberty School is State Licensed and fully approved for Veteran Educational Benefits).

Mail For Free Information

■ Jim Edwards, Director, Dept. 51
 ■ Liberty School
 ■ 162 E. Cook, Libertyville, Illinois 60048
 ■ Send me your FREE Brochure Showing how I can quickly get into the Booming Accident Investigating Field and enjoy the job security and professional prestige offered Accident Investigators.
 ■ This does NOT obligate me in any way and no salesman will call.

Name _____ Age _____
 Address _____
 City _____ State _____ Zip _____

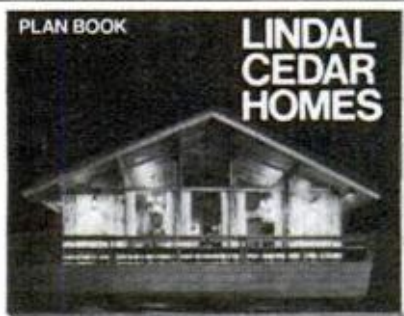

Your leisure home is in this book.

88 imaginative, family-tested designs in dramatic color!

This handsome 36-page book is chock-full of ideas for your vacation home. Full-color interiors and exteriors with easy-to-read floor plans. Lindal Cedar Homes are masterpieces of good taste, with the careful attention to detail and craftsmanship you'd expect of the world's largest cedar-home maker. Wide range of sizes and prices. Every home is pre-cut, ready for quick, easy assembly on your site. Shipping costs tailored to meet competition anywhere.

Lindal Cedar Homes, Dept. PM71
 18601 Pacific Hwy. S.
 Seattle, Wa. 98188
 Enclosed is \$1 for my Lindal Cedar Homes Plan Book

Name _____
 Address _____
 City _____ State _____ Zip _____
 Phone _____

DETROIT LISTENING POST

(Continued from page 54)

leather and the prominent new grille is shared by all '71 140s including the 144 four-door sedan and 145 four-door station wagon. The 140s have increased cooling capacity (for ready accommodation of air-conditioners), temperature sensors in carburetors that correct fuel/air mixture for variations in fuel viscosity with temperature; and on the 145, flow-through ventilation replaces rear, hinged vent window.—B.H.

WHAT'S UP SAFETYWISE? Detroit would like to know, because until it has a reading on what's coming in the way of new safety standards, the auto companies can't go ahead with future models. As a result of the uncertainty, auto producers are trying to develop basic bodies that can be reworked for two to three years to give the appearance of newness without the expense of tooling up for new bodies that might not pass muster when the safety decrees are handed down. GM styling, for example, has come up with a string of striking looking cars for the next three years, all designed around existing bodies. That's not a prediction GM will stay with its current shapes for three years. That decision hasn't been made.

WHEN WILL DETROIT switch over to the metric system? Probably about the same time the nations of the world give up their native languages in favor of Esperanto. Meaning not soon. There's some gear on Pinto that indicates Ford may be thinking of going to metrics gradually over a period of years, although when the Auto Mfrs. Assn. polled the car companies on the proposition last summer, the vote was overwhelmingly against it.

One reason the auto firms are reluctant to tinker with the numbers is because the industry has enough problems now getting people to understand Detroit math. For example, there's talk from time to time of dropping references to cu.-in. displacement of engines in information supplied to the general public because industry critics, including some members of Congress, tend to confuse c.i.d. with horsepower. Thus a car with a 225-cube engine turning out a modest 125 to 135 hp becomes a monster machine because the math dropouts latch onto the idea that 225 refers to horsepower. It's like the old gag of asking someone to express twelve thousand, twelve hundred and twelve in numerals. Try it on your non-mathematician friends and see how they struggle to write it the wrong way. ★★

How to get rich

How can you get rich some day? Make a hit record . . . a killing on the stock market . . . or invent a gadget like the hula hoop?

For most of us, these are just dreams. But have you ever stopped to think that there is a way to get rich—possibly only one sure way? Most fortunes, as you know, are made by people who own their own business.

Perhaps you've thought of starting a small business of your own . . . a franchised drive-in, or maybe a service business. Trouble is, you need \$10,000 to \$15,000 to get started and even then it's a gamble—with slim chances of ever making really big money.

But there is *one* business which could make you rich—almost overnight! And the beauty of it is, you can start on a shoestring during your spare time, even while holding your regular job.

Cash by Mail

The business is Mail Order—and it's fabulous! Come up with a 'hot' new item . . . and WHAM!

It strikes like a bolt of lightning! Suddenly, you are deluged with cash orders from all over the country . . . MORE MONEY than you could ever make in a lifetime!

Like the Vermont dealer who ran one ad in Sports Afield Magazine. His ad pulled 22,000 orders—over A HALF MILLION DOLLARS IN CASH!

There is no other business where you can make a fortune so quickly!

● A beginner from Newark, N.J. ran his first small ad in House Beautiful—offering an auto clothes rack. Business Week reported that his ad brought in \$5,000 in orders. By the end of his first year in Mail Order, he had grossed over \$100,000!

● Another beginner—a lawyer from the midwest, sold an idea by mail to fishermen. Specialty Salesman Magazine reveals, "he made \$70,000 the first three months!"

Proof

It's a fascinating business! Running ads in newspapers and magazines . . . mailing gift catalogs . . . getting cash orders in your daily mail—steady as clockwork.

There is no other business where you can start on a shoestring and pyramid your profits—without investing in merchandise! One husband and wife mail order team took in \$40,000 selling one item. They obtained FREE ads in national magazines . . . didn't invest a cent in merchandise, and even got the supplier to ship all orders for them!

These exceptional cases are absolute proof that you can get rich in your own Mail Order business. Very rich. Even a U.S. Gov. Report stated: "A number of

one-man Mail Order enterprises make up to \$50,000!"

Pick up any magazine. Notice how the same mail order ads are repeated . . . month after month? That's concrete proof! You know those ads wouldn't be repeated over and over again—unless they were bringing in big cash profits to their owners.

The Secret

The secret of getting rich in Mail Order lies in *financial leverage*. It's a little-known, almost secret method—using other people's capital to make money for you!

You can get thousands of dollars worth of advertising in big national magazines—without investing your own money! And you don't have to write a single ad. Tested and proven ads are prepared for you by experts. Reinvest the profits from your first successful ad—to get more, larger ads, and the profits begin to snowball! It's like building a chain of stores . . . each new store puts more money in your pocket.

You mail out beautiful catalogs which offer hundreds of dollars worth of fine, quality gifts—yet you don't invest one



The thrill of receiving money in your mail is one you'll never tire of!

cent of your own money in merchandise! Your catalogs are printed with your name and address, so all orders come to you. Everything is "drop-shipped" for you, and there's up to 100% mark-up! You pocket the cash profits immediately—even before the orders are shipped to your customers!

Repeat orders alone, just from mailing catalogs, could bring you a steady income for the rest of your life!

Yes, Mail Order is the fastest-growing, most profitable business in America! And now, with more people moving to the suburbs . . . the population explosion . . . and the expanding teenage market . . . we are on the verge of the BIGGEST BOOM in Mail Order history!

Now, with the help and backing of Mail Order Associates, Inc., of Montvale, N.J., you can follow the same proven steps to Mail Order success—using the 'secret' of financial leverage!

Start Now

We supply you with beautiful gift catalogs throughout the year. All products are dropshipped for you, with up to 100% mark-up! You get free samples of top-selling mail order items, plus monthly trade reports on 'hot' new products . . . tested, successful ads are sent to you monthly. You get advertising directories, postal laws, complete courses, expert guidance—EVERYTHING you need to practically guarantee YOUR SUCCESS. Why? Because *our* business depends upon your success. It's mutually profitable!

A recent feature article in Income Opportunities Magazine stated, "Mail Order Associates Inc., offers the most comprehensive Mail Order program ever offered to beginners." They go on to say, "This could be the opportunity you've been looking for. A chance to get in on the ground floor in a little-known business which we believe is on the verge of a new boom."

Free

We are now accepting a limited number of charter members in our new Mail Order Program. No previous experience is required but you must be over 21.

If you are sincerely interested in starting a profitable business of your own . . . if you can see the tremendous advantages which Mail Order offers . . . then ACT NOW!

Mail the coupon today, or simply send your name and address on a postcard. No salesman will call. We will send you a free book—gift catalog, reprints of feature articles, plus complete facts about our program. Write to:

Mail Order Associates, Inc., Dept. 317
Montvale, New Jersey 07645

Rush Coupon for
FREE BOOK!

plus reprints of
Mail Order
articles

Mail Order Associates, Inc., Dept. 317
Montvale, New Jersey 07645

Please rush complete details on your Mail Order Program. I understand everything is free and there is absolutely no obligation. I am over 21.

Name.....

Address.....

City..... State..... Zip.....

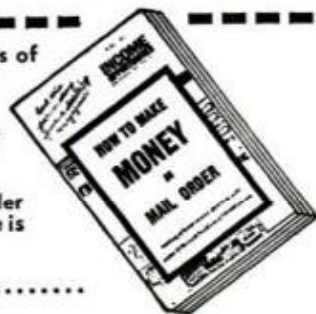



I'd like to give this to my fellow men... while I am still able to help!

I was young once, as you may be—today I am older. Not too old to enjoy the fruits of my work, but older in the sense of being wiser. And once I was poor, desperately poor. Today almost any man can stretch his income to make ends meet. Today, there are few who hunger for bread and shelter. But in my youth I knew the pinch of poverty; the emptiness of hunger; the cold stare of the creditor who would not take excuses for money. Today, all that is past. And behind my city house, my

summer home, my Cadillacs, my winter-long vacations and my sense of independence—behind all the wealth of cash and deep inner satisfaction that I enjoy—there is one simple secret. It is this secret that I would like to impart to you. If you are satisfied with a humdrum life of service to another master, turn this page now—read no more. If you are interested in a fuller life, free from bosses, free from worries, free from fears, read further. This message may be meant for you.

By Victor B. Mason

I am printing my message in a magazine. It may come to the attention of thousands of eyes. But of all those thousands, only a few will have the vision to understand. Many may read; but of a thousand only you may have the intuition, the sensitivity, to understand that what I am writing may be intended for you—may be the tide that shapes your destiny, which, taken at the crest, carries you to levels of independence beyond the dreams of avarice.

Don't misunderstand me. There is no mysticism in this. I am not speaking of occult things, of innumerable laws of nature that will sweep you to success without effort on your part. That sort of talk is *rubbish!* And anyone who tries to tell you that you can *think* your way to riches without effort is a false friend. I am too much of a realist for that. And I hope you are.

I hope you are the kind of man—if you have read this far—who knows that anything worthwhile has to be *earned!* I hope you have learned that there is no reward without effort. If you have learned this, then you may be ready to take the next step in the development of your karma—you may be ready to learn and use the secret I have to impart.

I Have All The Money I Need

In my own life I have gone beyond the need of money. I have it. I have gone beyond the need of gain. I have two businesses that pay me an income well above any amount I have need for. And, in addition, I have the satisfaction—the deep satisfaction—of knowing that I have put more than three hundred other men in businesses of their own. Since I have no need for money, the greatest satisfaction I get from life is sharing my secret of personal independence with others—seeing them achieve the same heights of happiness that have come into my own life.

Please don't misunderstand this statement. I am not a philanthropist. I believe that charity is something that no proud man will accept. I have never seen a man who was worth his salt who would accept something for nothing. I have never met a highly successful man whom the world respected who did not sacrifice something to

gain his position. And, unless you are willing to make at least half the effort, I'm not interested in giving you a "leg up" to the achievement of your goal. Frankly, I'm going to charge you something for the secret I give you. Not a lot—but enough to make me believe that you are a little above the fellows who merely "wish" for success and are not willing to sacrifice something to get it.

A Fascinating and Peculiar Business

I have a business that is peculiar—one of my businesses. The unusual thing about it is that it is needed in every little community throughout this country. But it is a business that will never be invaded by the "big fellows." It has to be handled on a local basis. No giant octopus can ever gobble up the whole thing. No big combine is ever going to destroy it. It is essentially a "one man" business that can be operated without outside help. It is a business that is good summer and winter. It is a business that is growing each year. And, it is a business that can be started on an investment so small that it is within the reach of anyone who has a television set. But it has nothing to do with television.

This business has another peculiarity. It can be started at home in spare time. No risk to present job. No risk to present income. And no need to let anyone else know you are "on your own." It can be run as a spare time business for extra money. Or, as it grows to the point where it is paying more than your present salary, it can be expanded into a full time business—overnight. It can give you a sense of personal independence that will free you forever from the fear of lay-off, loss of job, depressions, or economic reverses.

Are You Mechanically Inclined?

While the operation of this business is partly automatic, it won't run itself. If you are to use it as a stepping stone to independence, you must be able to work with your hands, use such tools as hammer and screw driver, and enjoy getting into a pair of blue jeans and rolling up your sleeves. But two hours a day of manual work will keep your "factory" running 24 hours turning out a product that has a steady and

ready sale in every community. A half dollar spent for raw materials can bring you six dollars in cash—six times a day.

In this message I'm not going to try to tell you the entire story. There is not enough space on this page. And, I am not going to ask you to spend a penny now to learn the secret. I'll send you all the information, free. If you are interested in becoming independent, in becoming your own boss, in knowing the sweet fruits of success as I know them, send me your name. That's all. Just your name. I won't ask you for a penny. I'll send you all the information about one of the most fascinating businesses you can imagine. With these facts, you will make your own investigation. You will check up on conditions in your neighborhood. You will weigh and analyze the whole proposition. Then, and then only, if you decide to take the next step, I'll allow you to invest \$15.00. And even then, if you decide that your fifteen dollars has been badly invested I'll return it to you. Don't hesitate to send your name. I have no salesmen. I will merely write you a long letter and send you complete facts about the business I have found to be so successful. After that, you make the decisions.

Does Happiness Hang on Your Decision?

Don't put this off. It may be a coincidence that you are reading these words right now. Or, it may be a matter that is more deeply connected with your destiny than either of us can say. There is only one thing certain: If you have read this far you are interested in the kind of independence I enjoy. And if that is true, then you must take the next step. No coupon on this advertisement. If you don't think enough of your future happiness and prosperity to write your name on a postcard and mail it to me, forget the whole thing. But if you think there is a destiny that shapes men's lives, send your name now. What I send you may convince you of the truth of this proverb. And what I send you will not cost a penny, now or at any other time.

VICTOR B. MASON

1512 Jarvis Ave., Suite M-2-AA
CHICAGO, ILLINOIS 60626

THE ALL NEW OPEL 1900. NO OTHER ECONOMY CAR (FOREIGN OR DOMESTIC) GIVES YOU ALL THIS.

The Opel story is simple.

The new Opel 1900 offers many things as standard equipment that other small cars offer as optional equipment. Or not at all.

For example, the Opel 1900 is the economy car with hydraulic valve lifters, just like the big American luxury cars, for a quiet-running engine and eliminating the need for adjustments.

The Opel 1900 has front power disc brakes for quick, smooth, straight-line stops. As standard equipment. Some small cars don't even have disc brakes, let alone power ones.

The Opel 1900 has lots and lots of room. About 5 inches more hip room in our back seat than the widest of the new small domestic cars. And please notice, the Opel has adjustable backs on its front bucket seats as standard equipment.

The Opel 1900 is one of the very few economy cars with dual front headlights.

The Opel 1900's trunk is 11.4 cubic feet big. That's bigger than some larger American cars. And if you've seen the trunk opening on any of the new small cars, you'll appreciate the new Opel 1900. You can get big things into the trunk without scraping your knuckles and elbows.

The Opel 1900 has a four-speed stick shift as standard equipment. And a three-speed, fully automatic transmission is available.

Things like wheel trim rings, chrome drip rails, window trim moldings and fancy vinyl upholstery can really dress up a car. And they're all standard equipment on an Opel 1900.

But maybe you want an economy car just for the great gas mileage and easy handling. The Opel 1900 gets great gas mileage and we turn tight . . . 31.8 feet with only three turns of the wheel.

See all the Opel 1900s (1900 Sedan, 1900 Sport Coupe, the zoomy 1900 Rallye and the beautiful 1900 Wagon) at your Buick-

Opel dealer's. Over 2,000 of them sell and service Opel from coast to coast.

While you're there, see the other new Opels, too. Available this year is a new four-door sedan, in addition to a two-door sedan and an economy wagon. And they've got many of the things the 1900s have. Plus one other wonderful advantage — they're less expensive.

After you've seen all the new Opels, if you can find an economy car that you think gives you more than Opel, congratulations.

You've done more than we could.

BUICK MOTOR DIVISION



Opel 1900 Rallye in Chrome Yellow and Black.

BUICK'S FOREIGN ECONOMY CAR.

DETROIT—As a result of toxicity studies to determine the amount of heavy metals in our lakes and streams, fishing bans or warnings now exist in 20 states. Scientific data on heavy-metal toxicity are scarce, but the Food and Drug Administration has set a level of 0.5 parts per million as the danger point for human consumption. Microorganisms in water use mercury, the main poisoner, in food cycles and pass it on to fish. It accumulates in their muscle tissue where cooking and cleaning cannot remove it. Mercury is a cumulative poison like lead, but, unlike lead, the symptoms of mercury poisoning disappear when the source of mercury contact is removed—all of which means that you can be slowly poisoned without knowing it.

WOODLAND, ME.—A \$5 million lime recycling process for water pollution control has been installed by Georgia-Pacific Corp.'s pulp and paper mill. The process, actually an integrated complex of several types of waste-water treatment, is the first attempt in the industry to remove even the dark color from mill effluent. The process also removes up to 96 percent of the remaining solids that formerly escaped into the nearby St. Croix river, reduces oxygen demand by 82 percent to improve the fish and shellfish habitat, and provides an additional quantity of fuel for a new powerplant equipped with its own pollution controls.

RIVERSIDE, CALIF.—Scientists have discovered geothermal fields in the Imperial Valley that could produce 20,000 megawatts of pollution-free electrical energy annually for at least three decades and perhaps three centuries. The underground steam fields, a power source 15 times greater than the Hoover Dam, were formed when hot rock, seeping up from the center of the earth, met cold underground water. This could restructure the economy and environment of the southwestern United States.

CHICAGO—PM 100 Sensor is a 12-pound portable analyzer using U.S. Public Health Service-accepted methods to sample sulfur dioxide, nitrogen dioxide and nitric oxide. The balanced-beam colorimeter by Pollution Monitors, Inc., reads color formation from the pollutant which the machine chemically extracts from the airstream and transfers into a liquid reagent. Can be carried by one person into normally inaccessible places; operates unattended for extended periods.

DO YOU KNOW about some action being taken to fight pollution that we don't know about? In your community? On the job? Tell us about it. Write Environment Editor, Popular Mechanics, 224 W. 57th St., New York, N.Y. 10019.

If you can't come to the world's newest, largest and most exciting electronics department store, we'll mail the store to you!

Exclusive!
Knight-Kit and
Science-Fair
Kits.

Exclusive!
Realistic
Lifetime
Tubes.

Exclusive!
Battery-A-
Month
Club.

World's finest
selection of
famous brands
—in one book!



New! 1971 Allied Radio Shack Catalog
460 pages—thousands of electronic values!



Realistic STA-120. Wideband AM, FET-FM Stereo Receiver. 140 Watts. With case. \$269.95

Big Choice of Audio Items . . . Factory-Direct Savings!
Allied TD-1099. 3-Head Stereo Tape Deck. Walnut-grain case. \$179.95



MAIL COUPON . . . or bring to Allied Radio Shack store.

ALLIED RADIO SHACK, 100 N. Western Avenue, DW
Chicago, Illinois 60680

Yes! I want your big new 1971 Catalog. I enclose \$1 for mailing and handling (refundable with my first purchase of \$1 or more).

NAME _____
First Middle Last

ADDRESS _____
Street or Route and Box No.

CITY _____ STATE _____ ZIP _____

I enclose check money order cash.



WORLD'S LARGEST! OVER 800 STORES IN 48 STATES. SEE YOUR PHONE BOOK.

GE's new Plus 25's give you 25 extra feet where every inch counts.

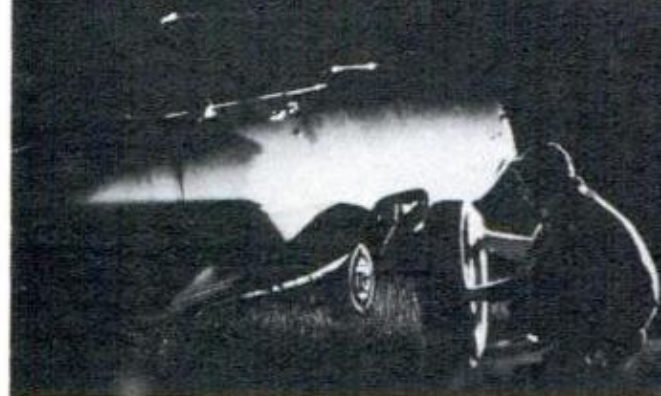

Too many night accidents are the kind that wouldn't have happened if there had been a little more light—and a few more feet to stop in. General Electric has done something about them. We've developed "Plus 25" headlamps. "Plus 25's" put 30% more light in the beam, which lets you see more clearly within the range of your headlamps. But that's not all. They actually extend your range of vision by 25 important feet. Without blinding other drivers. "Plus 25" headlamps are interchangeable. Install them today. It could make all the difference tonight.

GENERAL ELECTRIC



Relax.
Unwind.
Make this the
moment
to take things
easy.
With a whole
new cigarette.
Rich new
blend,
rich new
flavor.

**THIS
IS THE
L&M MOMENT**

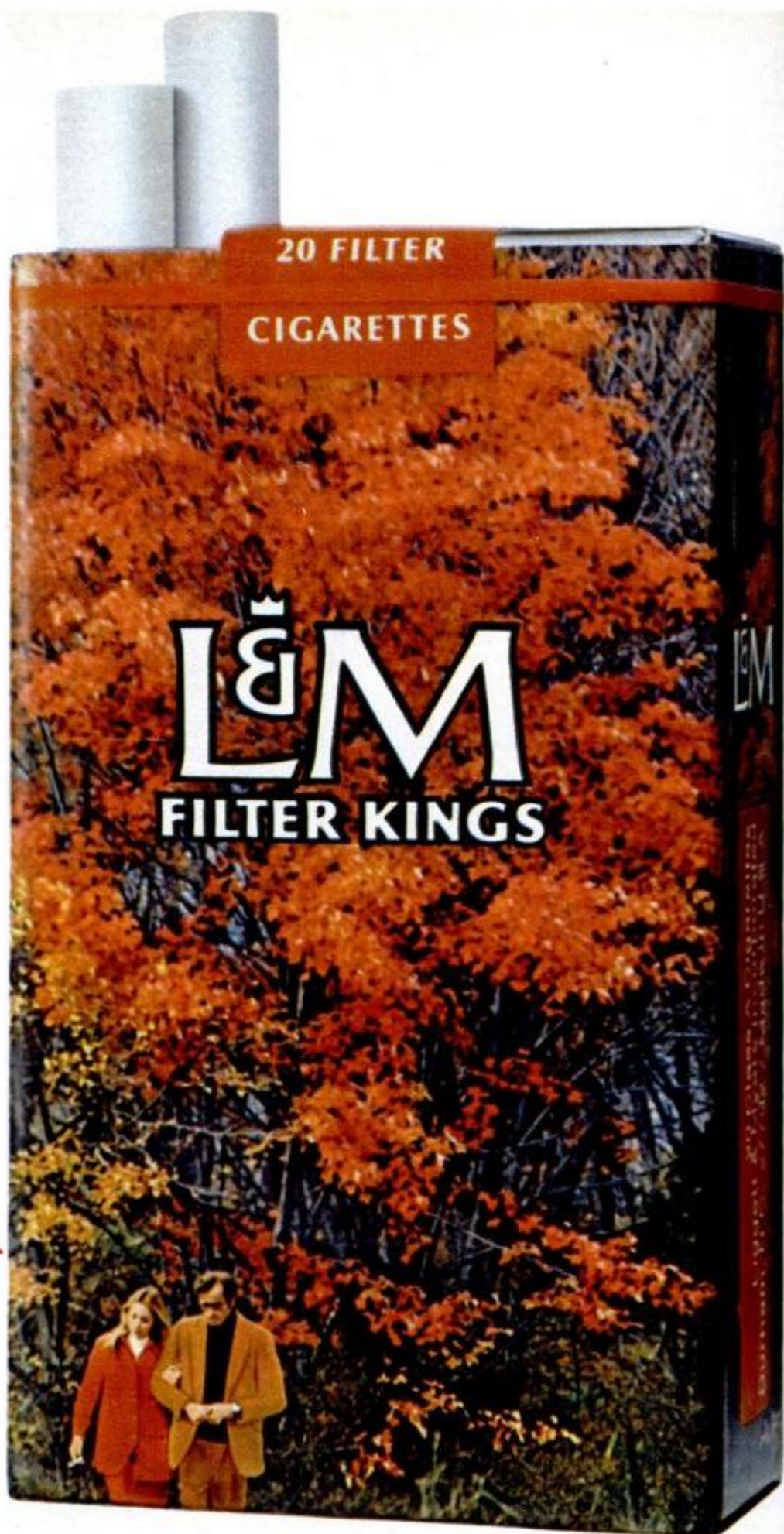

ON-THE-GO

CAMPING

BY WADE MITCHELL

ARE PRIVATE CAMPGROUNDS SAFER THAN NATIONAL PARKS? Many persons believe so, pointing to deteriorating security inside national parks. Public park policy makes it difficult for rangers to refuse admittance to potentially troublesome groups (such as hippies) for fear of starting riots or of being legally accused of "discrimination." Private campground operators, moreover, generally patrol the campsite and have more freedom to bar anyone, or any group, who appears willing or able to make noise, or vandalize equipment or facilities. Private camp operators may call for local law enforcement. Rangers in state and national parks may not have such help close by. A common question in private campgrounds these days is: "Are your premises patrolled by police?" It's an important issue.

NEW ANTISWAY HITCH KICKS OUT AT LOW SPEEDS. Yes, the new Derr Sway-Control Device operates on the principle of a detent assembly and permits the slight play necessary to handle rough highway surfaces—yet it is said to dampen trailer sway. At low speed the Derr hitch "kicks out" to allow tight turns inside campgrounds without pinching or binding. This is accomplished by a slight deflection allowed by rubber bushings which mount the device to the trailer frame. The same company (Travel-Safe, Box 484, Orinda, Calif. 94563) has also developed a new load-equalizing hitch said to be "revolutionary" in design.

WARNING SIGNALS! Chevrolet Div. cautions trailer-towers that whenever you remove a hitch from a car be sure to seal any remaining holes in the underbody to keep exhaust fumes from entering the car. Drafts, water and salt can also enter, unwanted and unannounced, through such holes. Many who trade trailers forget this simple detail. In summer when windows are rolled down it makes little difference. But when winter drives up the windows those unsuspected exhaust fumes could be lethal. Be sure to check for such mounting holes whenever you sell or trade your hitch or trailer.

COMBINATION HEATER-AIRCONDITIONERS FOR RVs? They've been available for homes—now you can install one in your camper, trailer or motor home. It's a rooftop cooler and heating unit made by Intertherm, Inc., 3800 Park Ave., St. Louis, Mo. 63110. It puts out 12,300 B.T.U. at maximum refrigeration efficiency, or 10,500 B.T.U. at low sound levels. For heating, it provides 4800 B.T.U. of warm and filtered air. Five controlled speeds are possible with the unit, which is designed for roof-mounting.

SPECIAL IHC MOTOR-HOME CHASSIS A SURPRISE. International Harvester has scored a direct hit with its new line of chassis models designed specifically for motor-home usage. Longer wheelbase, automatic leveling jacks, and use of the Mor-Ryde rubber-sandwich suspension system gives the new chassis many advantages. Other features include standard power steering, fuel capacity up to 90 gallons, special heavy-duty frame and a sealed cooling system with overflow protection. The entire line, designated 1310 MHC and 1510 MHC will undoubtedly attract wide attention this year.

MORE FIBERGLASS-ALUMINUM MIXING IN COACHES TO COME. Airstream, Ken-Craft, and other trailermakers have used this technique successfully. Now Grumman Motor Homes of Garden City, N.Y., has announced plans to market a motor home with a fiberglass front end and heavy-gauge aluminum body. Reasons for use of two construction materials on the exterior are related to "extra strength and greater freedom in styling." Many other top-line companies are known to be considering a switch to fiberglass this season.

★★★

It's Here! The handiest "tool" you'll ever own!

- 12 handy hang-up boards!
- 56 charts—scores of illustrations!
- Wipe-clean-plastic laminated to last for years!
- Authoritative answers to 1001 shop questions!

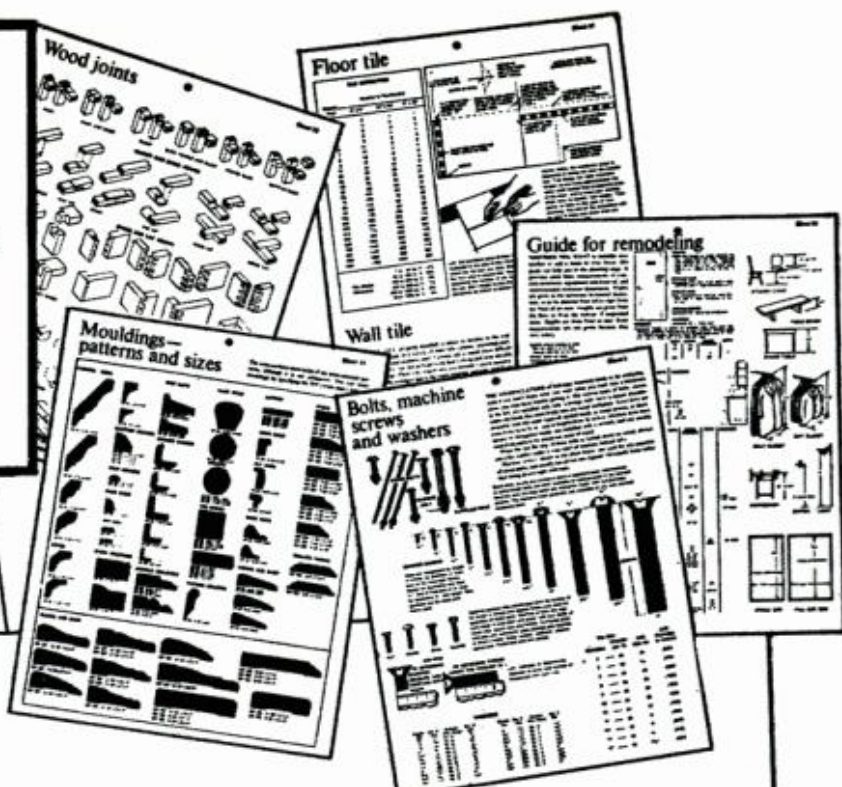

NEW!

POPULAR MECHANICS

MASTER SHOP GUIDE

Save hundreds of dollars! Save hours of time!

Everything you need to know about: what nails, screws, bolts, wall-fasteners, drills, abrasives to use and why. How to order and use lumber, hardwoods, moldings, plywood, hardboard, gypsum, adhesives, plumbing, electrical work, floor and wall tile, glass. Plus the facts on remodeling measurements, gutters and downspouts, concrete work, lawn and garden chemicals! Plus—all on one "take-right-to-the-job" board—a ruler, centimeter rule, protractor, 45-degree triangle, and a compass for accurate circles up to 19½" diameter.

You'll reach for the MASTER SHOP GUIDE for every job you tackle!

What nail should you use for underlayment? What's the diameter of a No. 12 screw? What types and sizes of sheet-metal screws are available? How many pounds will a ¼-in. toggle bolt hold? How can you save money ordering lumber? What size quarter-rounds are available? How do you bleach close-grained hardwoods? What glue is best for cementing metal to wood?

All the answers on repairs, too! Illustrations of most-used plumbing and electrical fittings. How to fix dripping faucets, how to lay out a room for floor or wall tile, how to cut and apply plastic laminates, how to replace a pane of glass. Remodeling? All the basic dimensions you'll need to plan the job. Leaking gutters? Best way to patch them. What chemical controls which weeds and diseases? Best mixing ratio for concrete work? Just look it up.

One sheet even shows how to solve those puzzling math problems you often encounter in shop work.

By the editors of *Popular Mechanics*—order yours now—you'll use it the rest of your life!

MAIL COUPON TODAY!

\$3.95 complete set of 12 8½" x 11" boards!

PARTIAL LIST OF CONTENTS

Nail and screw sizes and uses	Bolts, machine screws, washers	Plumbing guidance
Useful mathematics	Wallpaper	Lumber sizes
Masonry	Wall fasteners	Mouldings—patterns and sizes
Lawn and garden chemicals	Plastic laminates	Properties of common woods
Stair construction	Glass	Glues and adhesives
Gutters and downspouts	Floor and wall tile	Wood joints
Guide for remodeling	Drill sizes	Plywood grades and uses
	Electrical work	Wood finishes
	Abrasives	

Popular Mechanics, Dept. SG-1
224 West 57th St., N.Y., N.Y. 10019

Rush me ___ sets of MASTER SHOP GUIDE.

I enclose check or money order for \$3.95 for each set ordered.

Name _____

Address _____

City _____ State _____ Zip _____



The Easy
Way to
Build



BEAUTIFUL CLOCKS

Send 25¢ for 48-page catalog of easy patterns, fine clock movements, dials and hardwood kits.

CRAFT PRODUCTS
ELMHURST (1) ILL. 60126



SAILBOAT KITS

Free color catalog of the largest selection of popular sailboats, iceboats, and sail making supplies.

TAFT MARINE CORP.
Dept. PM 1-1, 636 39th Ave. N.E.
Minneapolis, Minnesota 55421



BLAST FURNACE 2400 F

Since 1935
Hobbyists • Schools • Inventors, etc.
Make your own castings of any metal from cast iron, down to lead and zinc. Available in 6 sizes, 1 1/2 to 50 lbs. Complete units from \$50.40 to \$162. Send 25¢ for circular—refundable.

KANSAS CITY SPECIALTIES CO.
Dept. P-1
P.O. Box 193
Middleton, Wisc. 53562

HEAVY DUTY BALL-BEARING PUMP



IRRIGATE-DRAIN-SPRAY-CIRCULATE. All-metal, rust-proof, Type XB. Stainless shaft. Use 1/4 HP or larger. 1 HP 1,200 GPH 60" high or 3,000 GPH 25" well. 5,200 GPH max. 1 1/4" in; 1" out. Belt or direct drive \$12.95

Type P won't rust or clog. Bronze bearing. Hundreds of thousands in use. Up to 2,400 GPH. 1" inlet. 3/4" outlet. Free coupling \$8.95

P'pd. cash with order **MONEY BACK GUARANTEE**
LABAWCO, Box 40, Belle Mead, N. J. 08502

REAL ESTATE
BE A BROKER

PAYS BIG! SEND FOR BIG FREE CATALOG NOW! Graduates report making substantial incomes. Operate your own business quickly. Men, Women, all ages, learn easily. Course covers Sales, Appraising, Loans, Mortgages, & related subjects. **STUDY AT HOME** or in classrooms in leading cities. **Diploma Awarded. Write Today for FREE Book!** Accredited Member National Home Study Council. (Est. 1936) G. I. Approved.

WEAVER SCHOOL OF REAL ESTATE
3521-P Broadway Kansas City, Mo. 64111

FREE BOOK TELLS HOW

BE A TAX CONSULTANT



Earn big money in ever growing profession. Our students are earning lucrative fees in dignified full or part time home-office business preparing income tax returns. Pays BIG in a very short time! No bookkeeping experience necessary. We train you at home and help you start. Licensed by N.Y. Education Dept. Write for free literature. Accredited Member NHTC. Vet. Approved. National Tax Training School Monsey, 20CC, N.Y. 10952

BIG PROFITS FOR YOU!!
In your own spare-time
PRINTING BUSINESS



Since 1872 thousands from high school to retirement ages have made important extra money with Kelsey hand presses, supplies, paper and how-to-do-it printing and business management help. Have your own printing business and your present job too. Send 25c (credited against your first order) for big catalog and details. **ACT NOW!!** **KELSEY PRESSES, Dept. 71-B, Meridan, Conn. 06450**

CAN A HIGH SCHOOL DIPLOMA mean A BETTER JOB? A BETTER LIFE? BETTER PAY?

*This one can —
and you can get it
at home in less than
one hour a day!*

Send name, address & zip
for **FREE** booklet —

FRANKLIN ACADEMY

Accredited Member National Home Study Council



FRANKLIN ACADEMY

Dept. 91-011

2000 Euclid Ave., Cleveland, Ohio 44115

Mr. _____ Age _____
Mrs. _____
Miss _____
Address _____
City _____ State _____ Zip _____
Circle highest grade completed 9 10 11 12

MAKE BIG MONEY

OPERATING HEAVY EQUIPMENT

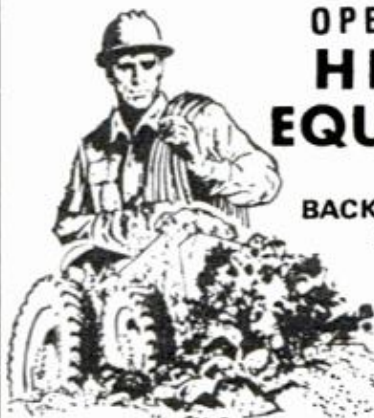

BACKHOES CRANES
DRAGLINES
CLAMSHELLS
SCRAPERS
BULLDOZERS
GRADERS
TRENCHERS

The Construction Industry is Booming! Earn top money in this fast moving, action-packed field. Keep present job and train at home in spare time followed by practical training on our machines under project conditions at our facilities. Nationwide placement assistance. For **FREE** information fill out and mail coupon today!
Member American Road Builders' Association

APPROVED FOR VETERANS AND INSERVICE PERSONNEL

UNIVERSAL HEAVY CONSTRUCTION SCHOOLS, Dept. PM
1901 N.W. 7 STREET / MIAMI, FLORIDA 33125

Please Print
Name _____ Age _____
Address _____
City _____ State _____
Phone _____ Zip _____

SOLUTIONS FOR MECHANICAL HEADACHES

AUTOMOBILE CLINIC

BY MORT SCHULTZ

This plus that equals shimmy

My 1968 Dodge Sport Van shimmies badly after hitting bumps on cement highways. My dealer has checked front-end alignment and wheel balance and cross-switched wheels without success. Do you have a cure?—M. Miller, Charlotte, Mich.

A shimmy is usually the result of a combination of problems. Incorrect front-end alignment and wheel balance, and play in the steering box are most common. But don't overlook the possibility of weak shock absorbers and, in the case of this vehicle, play in the kingpins. Incidentally, two service bulletins your dealer should consult when working on this problem are 68DT-28 (5/16/68), *Effective Procedures for Correcting Front-Wheel Shimmy*, and 68DT-65 (12/26/68), *Caster and Toe-In Specifications*.

Seeks helper help

I want to install helper (stabilizer) springs on my 1970 Chevy II. Auto store dealers tell me this is not recommended for my car, but they can't tell me why. Can you?—A. Vincinitz, Stratford, Conn.

No I can't. It's true that adding helper springs will give a harder ride. At the same time, though, the vehicle's handling characteristics will be improved. If this is what you want, then I would forget auto supply stores. Unless a part is readily available they can't help you. Consult a company listed in your local classified directories under "Springs—Automotive." If a ready-made helper isn't available, these outfits can usually fabricate one.

Curing the creeping crud

My 1967 LTD has a white vinyl top that's gradually being blackened by mildew. I've tried scrubbing with several kinds of detergents, but it hasn't helped and the dealer says he doesn't know what to do. Any ideas?—Frank Stephenson, Dothan, Ala.

The cure is simple. Mix a mildew-killer consisting of $\frac{2}{3}$ of a cup of trisodium phosphate (see your hardware store), $\frac{1}{3}$ of a cup of household detergent, one quart of household bleach, and enough warm

water to make a gallon. Using a soft bristle floor brush, scrub the vinyl top with the solution and then rinse thoroughly with water from a hose.

Starters stop

My 1968 Chrysler Town and Country has busted three starters in 35,000 miles. Each would work for a time—then, bingo, they stopped right in their tracks. What do you think the trouble is?—Cliff Schultz, Clearwater, Minn.

Sounds like you've got a busted torque converter ring gear which, sooner or later, leads to unsequential meshing between it and the starter. The strain this puts on the starter is enough to damage the Bendix drive.

Bug noise

Since it's been 500 miles old, my 1969 Volkswagen has made a loud squealing noise whenever its clutch pedal has been depressed. At 1000 miles the dealer told me the cause was the Teflon throwout bearing and that the noise would eventually go away. At 6000 miles it hadn't, so he replaced the bearing. Now, at 7000 miles, the squealing is back again as annoying as ever. Any suggestions?—Jerry Molnar, Buffalo.

First let me say that your dealer has been doing right by you all along—the noise is in the throwout bearing. Most times it disappears by itself, and when it doesn't a new bearing gets rid of it. What's happened in your case? I have a hunch a misalignment condition exists in the clutch area and believe that the dealer should do the job again, but this time with extreme care.

Capping a gusher

Can you tell me why oil from the crankcase of my 1966 Chevrolet Caprice keeps coming into the air cleaner? We've replaced the PCV valve many times and have cleaned and recleaned the whole smog-control system. It's a 283-cu.-in. engine.—Lawrence Nall, San Diego.

In May of 1967, Chevrolet issued a ser-
(Please turn to page 68)

Spend a milder moment with the quiet taste of Raleigh.

A special treatment softens the tobaccos for a smoother, milder taste.

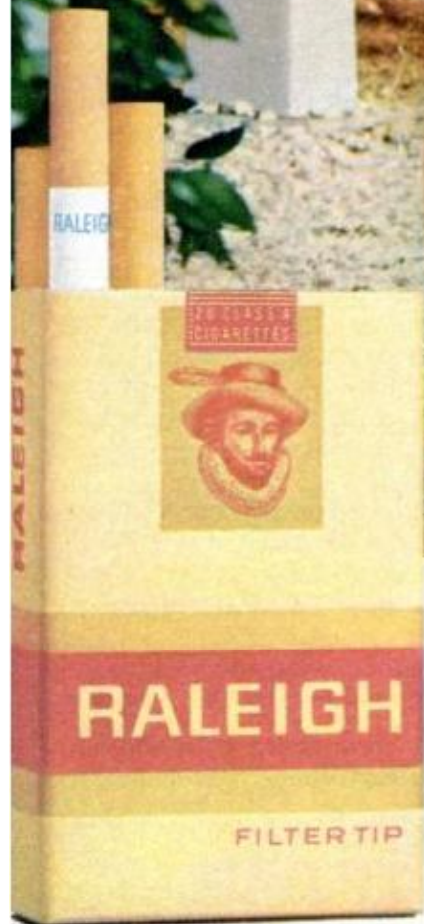

A valuable extra...the famous Raleigh coupon
on both Raleigh Filter Kings and Filter Longs.

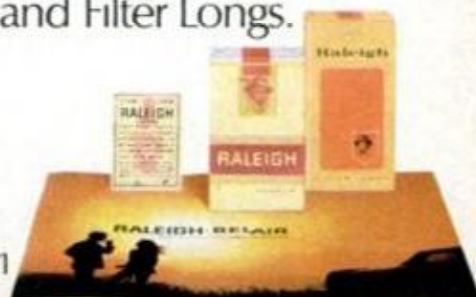

Free Gift Catalog.
Write Box 12, Louisville, Ky. 40201
© BROWN & WILLIAMSON TOBACCO CORP.

AUTOMOBILE CLINIC

(Continued from page 66)

vice air cleaner that decreases engine crankcase oil vapors which enter the smog control system and foul up the air cleaner. Contact a Chevy dealer about this.

No drive

I, along with a couple of other owners of 1969 Ambassadors, am having starter motor troubles. Very often the starter gear won't engage the flywheel, but just spins and makes noise. The dealer has serviced the starter and put in a new Bendix drive. Please help.—Fred G. Stebbins, South Glen Falls, N.Y.

Have the dealer put in another, and another, and another Bendix drive until you finally hit one that's strong. This is the same problem Ford had with its 1969 models until the company issued a stronger drive assembly. I wouldn't be surprised if the Rambler and Ford starters came from the same place.

Hot tip for a hot 383

Owners of Chrysler Corp. cars with 383-cu.-in. engines, please tune in on this. Many of you, such as Bob King of St. Louis ('70 Plymouth) and George Johnson of Eau Claire, Wis. ('68 Dodge), are experiencing hard-to-start-when-hot trouble. Well, I can't tell you why this engine's loading up as it is, but I can tell you how to overcome the problem pure and simple. Just keep that gas pedal all the way to the floor as you crank.

Boiling coolant

The radiator cap of my 1968 Buick Special allows coolant to boil out when I kill the engine. I've replaced that cap three or four times. What now?—Richard Geier, Rose Hill, Kans.

Obviously, the problem is not with the radiator cap, but elsewhere. Either the seat in the filler neck is distorted or bent, or the filler neck is distorted. This can be corrected by a Buick dealer.

Olds engine knock

Here's a cute one for you. I'm getting a high-speed knock that no one can cure. They have checked the distributor vacuum

advance and ignition timing. I have used nothing but premium fuel. Now, a mechanic wants to rip the engine down to clean out "carbon," but before I let him do that I want to know what else the cause might be. The car is a 1969 Oldsmobile.—Jon Sweeney, Lincoln, Neb.

That high-speed detonation could be caused by a faulty thermostatic vacuum switch (TVS), which helps to advance the spark and keeps an idling engine from overheating. It's found on the intake manifold. Check it by running the engine to operating temperature and connecting a vacuum gauge with a tee into the vacuum hose from the top port on the distributor vacuum advance. Hook up a vacuum gauge that has a hose long enough to allow you to bring the gauge into the car. Drive the car and watch the gauge. It should drop immediately when the throttle is depressed. If vacuum drops slowly, the TVS is leaking and should be replaced.

Drumming up work

Is it necessary to turn brake drums whenever new brake linings are installed?—Dr. Lester J. Schultz, Ruskin, Fla.

Necessary? No! Advisable? Yes! Drums wear out-of-round and score during use. It's a good idea to take a thin cut on them to smooth and clean them and to remove high spots. Be careful of that cut, though. Generally, you shouldn't take off more than .060 inch. A thin drum is dangerous.

Service Tips

● 1970 Mercury Montegos equipped with 429 CJ and SCJ engines may have a valve train squeal. If so, the rocker arm fulcrum seats and push rod guide plates should be replaced as pointed out in service bulletin 41 (7/6/70).

● 1971 Chevy Vega electric fuel pump is protected by two fuses, and both should be checked if the pump poops. One is a 20-amp. fuse marked "fuel pump" on the fuse block. The other is a 10-amp. fuse marked "Gage-TCS" on the fuse block.

● On 1970 FoMoCo cars with 351-4V engines there's a switch in sparkplugs. Don't use AF 32 any longer. Switch to AF 42. And the torquing spec for 14 MM plugs in FoMoCo's 351 C-2V and 4V, Boss 302, 429 CJ and SCJ, and Boss 429 engines has been upped to 10-15 ft.-lb. from 5-10 ft.-lb. ★★ ★

GOT A PROBLEM WITH YOUR CAR? Ask Mort about it. Send your question to Auto Clinic, Popular Mechanics, 224 West 57th St., New York, N.Y. 10019. Letters cannot be answered individually, but problems of general interest will be published in the column.

AUDEL

LEARN MORE
EARN MORE!

SKILL-BUILDING PRACTICAL GUIDES

POPULAR AUTOMOTIVE GUIDES

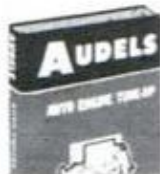

Auto Engine Tune-up

Complete tune-up procedures for all types of auto engines. Full adjustment data for carburetors, ignition, valves, etc. For the car owner who wants to do his own tune-up, as well as for the experienced mechanic. Fully illus. 416 pages. \$5.95
Circle 103 in Coupon



Diesel Engine Manual

Complete practical guide to modern Diesel engines. Explains principles, operation, and maintenance. Covers starting and scavenging air compressors; fuel injection; valve timing; air starting and fuel valves, etc. Illus. 544 pgs. \$6.95
Circle 024 in Coupon

PRACTICAL AUTO GUIDE

Biggest Value! **\$7.95**

FIX ANY CAR FAST!

STEP-BY-STEP REPAIR GUIDE COVERS:

Troubleshooting—unique symptoms-and-causes charts • Spark Plugs • Batteries • Tune-up • Distributors • Ignition Testing • Starters & Generators • Lighting • Tire Servicing • Brakes • Power Brakes • Front Suspension • Steering Systems • Wheel Alignment • Chassis, Springs & Shocks • Fuel Pumps • Carburetors • Cooling Systems • Lubricating Systems • Pistons & Rings • Crankshafts and Connecting Rods • Camshafts • Valves • Clutches • Automatic & Manual Transmissions • Drive Shafts & Universal Joints • Rear Axle Assemblies—ABSOLUTELY EVERYTHING YOU SHOULD KNOW TO FIX ANY CAR! Hundreds of illus. 736 p. \$7.95
Circle 015 in Coupon



Home Appliance Servicing

How to test, service, and repair all modern gas & electric appliances such as refrigerators, washers, dryers, ranges, irons, hot water heaters. Gives up-to-date methods, wiring diagrams, complete servicing data. Fully illustrated. 608 pages. \$6.95
Circle 016 in Coupon



Home Refrigeration & Air Conditioning

Complete and practical information on installing, servicing, and maintaining gas and electric refrigerators and all types of home and auto air conditioners, water coolers, freezers. Many tables of useful data. Illustrated. 576 pages. \$6.95
Circle 133 in Coupon

Truck and Tractor Guide

A guide for mechanics, drivers and maintenance men. Gas & Diesel repair, service and operation. Illus. 928 pages. \$6.95
Circle 020 in Coupon

Foreign Auto Repair Manual

Up-to-date service data for all popular imports: English, French, German, Italian, Swedish. Illus. 592 pages. \$5.95
Circle 078 in Coupon

Outboard Motor Guide

Practical details on all phases of outboard motor repair, maintenance and operation. Up-to-date. Illustrated. 446 pages. \$4.95
Circle 168 in Coupon

Practical Electricity

Complete handbook; practical, simplified ready reference on all electrical subjects. Many illustrations. 496 pages. \$5.95
Circle 160 in Coupon

Mathematics for Mechanics

A complete guide to the mastery of practical math. Simplified method makes learning fast and easy. Illustrated. 704 pages. \$5.50
Circle 026 in Coupon



MACHINISTS LIBRARY

Three volumes of ready reference on all the latest shop practices for machinists and toolmakers. Vol. 1—Practical Fundamentals of Basic Machine Shop Operations. Vol. 2—Setup and Operation of all the widely used, important shop machines. Vol. 3—Toolmakers Handybook with down-to-earth data on layouts, specifications, jigs and fixtures, gear forming, cams, etc. Illus. 1310 pages. 3-Vol. Set \$15.50
Circle 174 in Coupon



CARPENTERS & BUILDERS GUIDES

Four all-inclusive volumes provide latest inside trade information on modern construction. Vol. 1—Tools, Steel Square, Joinery. Vol. 2—Builders Math, Drawings, Specs. Vol. 3—Layouts, Foundations, Framing. Vol. 4—Millwork, Power Tools, Windows, Doors, Roofing, Flooring. Most practical guide available. Thousands of diagrams, charts, graphs and photos. 1612 pages. 4-Vol. Set \$16.95
Circle 169 in Coupon



Electric Library

10 volume electrical encyclopedia. Presents basic principles, rules and applications of applied electricity. Answers questions on thousands of electrical problems. Fully illustrated with diagrams and tables. 5600 pages. Set \$35.00
Circle 030 in Coupon

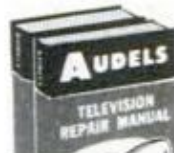

TV-Radio Library

Two vols. of practical and theoretical knowledge including basic electronics, basic radio receiver repair. Covers entire subject of television, both black & white and color, from theory thru repair. Illustrated. 960 pages. 2-Vol. Set \$10.95
Circle 161 in Coupon

Blueprint Reading

For mechanics & construction men. Step-by-step explanation of how to read all types of blueprints. 416 pages \$5.25
Circle 041 in Coupon

Welders Guide

Practical guide to theory; operation; maintenance all types—electric, oxy-acetylene & Thermit. Illus. 626 pages. \$5.50
Circle 025 in Coupon

Masons and Builders Guides

4 practical volumes for bricklayers, masons, cement workers, plasterers. Includes short-cuts and job estimating. 2000 illus. 1488 pages. 4-Vol. Set \$14.95
Circle 076 in Coupon

Plumbers and Pipefitters Guides

3 vols. of ready reference for plumbers, pipe & gas fitters, sheet metal workers. Explains all principle of modern plumbing. 540 illustrations. 928 pages. 3-Vol. Set \$12.50
Circle 155 in Coupon

Millwrights & Mechanics Guide

Practical information on plant installation; operation and maintenance data for foremen & workers. Illus. 1236 pgs. \$7.95
Circle 056 in Coupon

Sheet Metal Pattern Layouts

Modern guide to all phases of sheet metal work, including pattern development. 350 layouts. Illus. 1152 p. \$11.95
Circle 045 in Coupon

MONEY BACK GUARANTEE

SEND NO MONEY! We'll send you any Audel Guides for 10-day FREE examination. If you decide to keep them, use our easy-pay plan. Absolute no-risk MONEY-BACK GUARANTEE!

SEND NO MONEY—10-DAY FREE EXAMINATION!

THEODORE AUDEL & CO.—Self Improvement Publishers Since 1879—
4300 W. 62nd Street, Indianapolis, Indiana 46268 P-011

Please mail me for 10 days' FREE EXAMINATION the books I have circled at right. I agree to mail \$3 in 10 days for each book or set ordered, and to further mail 1/2 of the total purchase price 30 days later, with the balance plus shipping costs to be mailed within another 30 days. If I am not completely satisfied with my Audel Guides I may return them for refund.

SAVE SHIPPING COSTS—Check here if you enclose full payment with order (plus sales tax, if any). We pay postage charges. You have same return privilege.

Name _____

Address _____

City _____ State _____ Zip _____

015	041	155
016	045	160
020	056	161
024	076	168
025	078	169
026	103	174
030	133	

I have bought Audel books before

THEODORE AUDEL & CO.
division of HOWARD W. SAMS & CO., INC.
Indianapolis, Ind. 46268

"WILL YOU SMOKE MY NEW KIND OF PIPE..."

30 Days at My Risk?"

New principle that contradicts every idea you've ever had about pipe smoking. I guarantee it to smoke cool and mild hour after hour, day after day, without rest, without bite, bitterness or sludge. To prove it, I'll let you try a new Carey Pipe. Send your name and address today for my FREE complete trial offer. Write to: **E. A. CAREY**, 1920 Sunnyside, Dept. 252-A, Chicago, 60640.



5-in-1 METAL LATHE

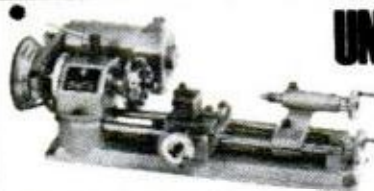

UNMAT

Easy for modelmakers, gunsmiths, inventors to precision machine small parts. Lathe converts in seconds to vertical mill, drill press, grinder & polisher. AC/DC motor, 11 speeds, 3" swing, 17" overall. 90,000 in use. \$149.50. Send for free details, or \$1 for 48-page "Miniature Machining Techniques" handbook. (Available in Canada.)

AMERICAN EDELSTAAL, INC. DEPT BA-1
1 ATWOOD AVE., TENAFLY, N.J. 07670

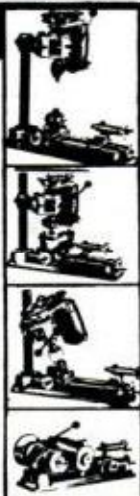

LEARN MEAT CUTTING

Train quickly in 8 short weeks at Toledo for a bright future with security in vital meat business. Big pay full-time jobs — **HAVE A PROFITABLE MARKET OF YOUR OWN!** Time payment plan available. Diploma given. Job help. Thousands of successful graduates. **OUR 47th YEAR!** Send now for big new illustrated FREE catalog. No obligation. G.I. Approved.

NATIONAL SCHOOL OF MEAT CUTTING
Dept. 50-R, Toledo, Ohio 43604

1¢ SALE

GUARANTEED 10 YEARS



The knife for hunting, fishing and all around use. Mirror polished, imported stainless steel blade honed to a razor's edge. Rugged. Opens with flick of finger. Locks into position. Blade will not close when in use. Press button in handle to close. Safety finger guard. Sure-grip handle. Balanced for target throwing. **IF BROKEN WITHIN 10 YEARS WE WILL REPLACE AT NO CHARGE!** Use 30 days. Money back if not pleased. Special 1¢ sale. **REG. PRICE \$1.98. Send \$1.99 & receive 2 knives. Add 49¢ postage, handling. Remit TOTAL \$2.48 for 2 knives. ORDER NOW!** Midwest Knife Co., 9043 S. Western Ave., Dept. DD-2708, Chicago, Ill. 60620. Est. 1936.

BE A LANDSCAPE CONTRACTOR

LEARN MODERN LANDSCAPING for exciting hobby or profit. Thousands of spare or full time money making opportunities. Start a profitable business—we show you how. Study and earn your certificate at home. Write today for Free Book. **LIFETIME CAREER SCHOOLS**
Dept. A-884
2251 Barry Ave.
Los Angeles, Calif. 90064

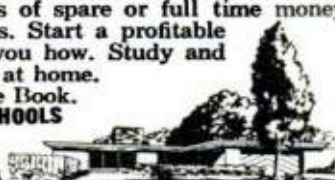

MAN-SIZE TRACTOR

does tough jobs faster

More pull-power, more tool-power with 14 hp and all-gear drive (no belts, no fluid power loss). Bigger frame, bigger wheels, more weight and traction. 20 big attachments—32" tiller, 48" snow blow, 48" and 60" mowers, loader, dozer, plow, harrow, seeder, etc. More for your money. Write for free catalog.

ECONOMY TRACTOR

1005 K-1 Anoka Avenue
Waukesha, Wis. 53186

CAREER TRAINING / Engine Specialist

DIESEL • GASOLINE • L. P.

Write to-day for free bulletin

An endowed non-profit institution
Founded 1907 — VETERANS APPROVED

THE DAVID RANKEN TRADE SCHOOL
4421 FINNEY AVENUE • ST. LOUIS, MISSOURI 63113

Secrets of VENTRILOQUISM

Now Revealed!



Easy to learn in 60 to 90 days with our Home Study Course. **RESULTS GUARANTEED** Make Money! Be Popular! Have Fun! Big Opportunity! Radio, Television, Stage Appearances! For FREE Information regarding price and terms **WRITE**. You must state your age. Dummy Catalog 25c. **MAKER HOME COURSE OF VENTRILOQUISM**
Box 9037, Studio PM-1,
Denver, Colorado 80209



MASONS!

Send today for free catalog of Masonic & Eastern Star books and rituals

EZRA A. COOK PUBLICATIONS, INC.
P.O. BOX 796, DEPT. A-109, CHICAGO 60690



make your own Gems 39.50

The Gem Maker comes complete with all necessary equipment, including a super-charged diamond blade for sawing, and all the wheels for grinding, shaping and polishing; also complete instructions. The complete equipment as shown, less motor and belt for only \$39.50, f.o.b. Burlington, Wisconsin. Write today for information and literature.

B&I MANUFACTURING CO.
Dept. P, Burlington, Wis. 53105



MINI-BIKE PARTS

Wholesale Prices

"Build your own" kits...Big savings...Repair parts...Welded frames & forks, enameled...Chains...Clutches...Brakes & throttle controls...Wheels...Tires...Bearings...Axles...Engines...etc. Send 50¢ for illustrations and lists...**SAVE DOLLARS!**

BYCO, Dept. B, Box 6241, Omaha, Nebr. 68106

Hard-to-Find TOOLS



New, Expanded 1971 Catalog contains unique collection of hand tools, small power tools, rarely found in stores or other catalogs. Hundreds of items to make projects easier. All top quality. Money back guarantee on all orders. Send 25¢.

BROOKSTONE COMPANY
1124 Brookstone Bldg., Peterborough, N.H. 03458

We've equipped a lot of men to make a lot of money. (you're next)

Open to you — thousands of good-paying jobs in the professional technical fields below. No matter what your education or background — take your pick! A little spare time and NTS home-training can make your future secure. Find out how easy and enjoyable it is to train the professional way with our classroom-tested "Project Method" lessons. Learn with the professional

tools and equipment we supply (much of it offered *only* by NTS.) Follow our personal development tips. Take advantage of our 65 years experience in gathering the latest know-how and using it to turn out the best-trained technicians. Just send the card for your free illustrated catalog. No obligation. No salesman will call.



NTS ELECTRONICS DIVISION

Train with the biggest, most exciting package of electronics kits ever offered! Big color TV included with color TV courses. Other equipment includes solid-state 74 sq. in. B & W TV, Lo-Silho superhet radio, electronic tube checker, F.E.T. Volt-Ohmmeter, 5" wide-band oscilloscope, desk-top Computer Trainer and more. Send the coupon. We'll rush you a free color catalog and all the facts.



NTS MECHANICS DIVISION

These courses include professional tools and engine analysis test instruments at no extra cost! Special Engine Diagnostic and High Performance lessons included. Learn to handle everything from engine trouble-shooting to electrical systems. Industry needs 20,000 trained auto and diesel mechanics. You can be one of them, if you send the coupon today! We'll rush you the catalog and the facts. Free!



NTS AIR CONDITIONING, REFRIGERATION DIVISION

There's a big job waiting for you if you learn this field the *professional* way. We give you the tools, tester and instruments you need, including hermetic unit analyzer, leak detector, soldering kit. Show you how to service commercial and industrial cooling systems, refrigeration installation, and household A/C and refrigeration equipment. What are you waiting for? Send the coupon.



NTS HOME APPLIANCES DIVISION

Every day, someone buys a new home appliance. And someone, maybe *you*, will make money fixing it. We'll send you the new, exclusive NTS CIRCUIT-TRAINER. It'll help you learn *faster*, and qualify for employment *sooner*! Let the NTS *Project-Method of Home Training* put you in line for a big piece of the billion-dollar appliance repair field.

Send post card
for colorful
catalog and
sample lesson
in field checked



ELECTRONICS DIVISION

MASTER COURSE IN COLOR TV SERVICING
COLOR TV SERVICING
MASTER COURSE IN TV & RADIO SERVICING
PRACTICAL TV & RADIO SERVICING
MASTER COURSE IN ELECTRONIC COMMUNICATIONS
FCC LICENSE COURSE
MASTER COURSE IN ELECTRONICS TECHNOLOGY
INDUSTRIAL AND AUTOMATION ELECTRONICS
COMPUTER ELECTRONICS
BASIC ELECTRONICS

AUTOMOTIVE DIVISION

MASTER COURSE IN AUTO, DIESEL & TRUCK MECHANICS
AUTOMOTIVE MECHANICS
TRUCK, HEAVY DUTY & DIESEL MECHANICS
ENGINE TUNE-UP & ELECTRICITY

AIR CONDITIONING/REFRIGERATION/ HEATING DIVISION

MASTER COURSE IN AIR CONDITIONING, REFRIGERATION & HEATING
AIR CONDITIONING & HEATING REFRIGERATION

HOME APPLIANCE DIVISION

HOME APPLIANCE MASTER TECHNICIAN COURSE
HOME APPLIANCE SERVICING
HANDYMAN APPLIANCE REPAIR

HIGH SCHOOL DEPARTMENT

HIGH SCHOOL AT HOME

Dept. 201-011

APPROVED FOR VETERANS

NAME _____ AGE _____

ADDRESS _____

CITY _____ STATE _____

Please fill in Zip Code for fast service _____

- Check if interested in veteran training under the new G.I. Bill (зачислен в авторский проект)
 Check if interested ONLY in classroom training at Los Angeles

10 testimonials to the "success-ability" of NTS home training

Let The Next Testimonial Be Yours—Send The Postage-Paid Card *Now*.

They're all around you. Thousands of successful men who once read a message like this and wondered if National Technical Schools

Thanks again to your school. It has made me a man in demand for the first time.

*Osbourne C. Williams,
Jamaica, W.I.*

Thanks to NTS, I have an extra income now and plan to go into business full time very soon.

Gary Wernette, Michigan



I advanced from auto accessory mechanic to auto leadman within three month's time.

Harry E. Repine, Washington

I am now a TV repairman at Sears... I heartily endorse your course.

W. M. Firestone, Jr., Texas

Today I passed the four tests required for the 1st Class Radio-Telephone license.

*Richard Morgan,
Massachusetts*



I'm now earning \$11,000 a year as an electronic mechanic at Bell Helicopter Company.

Elijio Guzman, Texas

Your course has gotten me from climbing poles to a position as technician and crew chief in flight simulation.

Leonard B. Barfield, Texas

Not knowing anyone, I went looking for work in commercial refrigeration and was immediately hired as a service man.

Charles Greaser, Washington



I have been operating the Ace Appliance Repair Shop here and have been getting more and more to repair all the time.

Frank J. Mercier, California

I work for Haynes' Radio and Refrigeration Service and can repair any major appliance on the market.

*Vernon Helmick
West Virginia*



**FILL OUT
AND MAIL
CARD TODAY**

NTS also offers:
High School at Home
Accredited high school programs. Take only subject you need. Everything included at one low tuition. Check special High School Box in Coupon for free catalog.

Classroom Training at Los Angeles
Train in sunny Southern California. NTS occupies a city block with over a million dollars in training facilities.

Accredited member, National Association of Trade & Technical Schools; National Home Study Council

FIRST CLASS
Permit No. 3087
Los Angeles,
Calif.

VIA AIR MAIL

BUSINESS REPLY MAIL

No Postage Stamp Necessary if Mailed in the United States

POSTAGE WILL BE PAID BY

NATIONAL TECHNICAL SCHOOLS

4000 South Figueroa Street

Los Angeles, California 90037

Approved for veterans

SHOULD MECHANICS HAVE TO HAVE A LICENSE?

Has the time come to make a 'professional' out of the guy who grinds your valves? Here's a report on the hottest controversy in the auto business and what it means to you

By MORT SCHULTZ

YOUR DOCTOR has to have a license.
Your dentist has to have a license.
Even your barber.

Should the man who works on your car have to have one too?

Representative Seymour Halpern, of New York, thinks so. Senator Philip A. Hart, of Michigan, did think so. Now he says it would be enough to license repair shops and one master mechanic in each. The master mechanic would supervise a crew of unlicensed but *certified* mechanics.

Most mechanics to whom I've talked say licensing would weed out incompetents, protect car owners, elevate their own status and increase their income.

It sounds good. Just about everyone agrees that some sort of regulation is desirable: mechanics who will be regulated, trade associations or legislators who will do the regulating and customers who are fed up with shoddy repairs. But not everyone agrees that regulation necessarily requires licensing.

Many trade groups—new car dealers, independent garage owners, gas-station operators—and some mechanics believe certifying mechanics would be better than licensing them.

The difference is that certification would be voluntary and administered by non-official trade associations. A mechanic wouldn't have to be certified to work at his trade. Licensing would be mandatory and administered by the state. A mechanic couldn't be a mechanic unless he passed prescribed training and testing require-



'You spend more money with a mechanic than with a barber. If the barber goofs your hair grows back in two weeks. But an automobile—you've got \$4000 invested in it and you're at the mercy of some hit-or-miss guy.'

CLINT BRAWNER
Top Race-Car Builder and Mechanic



'Licensing would reduce the number of garages and the number of mechanics and increase the cost of car repairs.'

JOHN C. BATES
Director, Service Section,
General Motors Corp.



'I'd be glad to have something that says I know my job. But I wouldn't want to be certified in a single specialty.'

GENE TERANZIO
Auto Service Mechanic
and Drag Racer

ments. To head off licensing, the Independent Garage Owners of America, National Congress of Petroleum Retailers and Automotive Service Industry Assn., have set up their own program: the National Automotive Technicians Certification Board.

Under the provisions of NATCB, a mechanic who passes a written test gets a certificate attesting to his proficiency in one of 15 specialties. A mechanic can take as many tests as he wants, but each one he passes qualifies him as an expert in a single field. The likely result would seem to be an increase in specialists and the disappearance of the all-around general mechanic. Some people think the latter is inevitable and a good thing. Others don't.

Either way, licensing or certifying, means stricter regulation. Mechanics are traditionally an independent lot. So why aren't they objecting? Because many of them (in fact, all of the 50-some I asked) *want* to be regulated.

"A mechanic who can advertise that he's passed a test that makes him a specialist in some area of the automobile—brakes, transmission, front end, ignition, or what have you—can charge specialist prices," says Bob Cook, service manager of Hinrichs Oldsmobile in Somerville, N. J.

Most car owners would probably look for a shop whose mechanics had certificates. The mechanic without one would be at a disadvantage. The guy with one could command more pay.

But as mechanics' wages rise, won't repairs cost you more? By the hour, quite likely. But not necessarily in total if the job is done right by a man who knows what he's doing, works fast, and doesn't make mistakes.

It is important to note, though, that one major group of mechanics has refused to go along with NATCB. These are the ones who work for new-car dealers, members of National Automotive Dealers Assn. (NADA).

NADA is setting up its own certification program. According to a NADA spokesman, "The NATCB is too lax in its certification requirements."

Rep. Halpern thinks *all* certification proposals are too lax. His proposed licensing law would require each state to establish standards and tests and an effective method of policing.

"Effective policing is a 'must,'" he insists, "if the public is to be fully protected."

No certification proposal provides for real policing.

Neither licensing nor certification by itself guarantees that the gyp artist won't still be in business. Knowledgeable mechanics—those who are sure to pass licensing or certification tests—are the ones best able, if they're crooks at heart, to multiply simple malfunctions into expensive repairs.

How can anyone police a skilled trade? One way might be to study the way California polices TV repairing.

There the state requires repairmen to provide each customer with a written estimate and an itemized list of parts used and services performed, and to return parts which have been removed from the set. If a customer believes he has been cheated, he has evidence to present to the state's complaint bureau.

What arguments do the advocates of certification offer? One is "choice."

Barry McNulty, executive vice-president of the Independent Garage Owners of America, says, "Under certification you can take your car to either a certified or noncertified mechanic. The noncertified mechanic would probably charge lower rates."

Advocates of certification also say licensing would lead to an even worse shortage of mechanics than we have now. According to the Automobile Manufacturers Assn., we now have some 115,000 mechanics to care for 96 million registered vehicles. This is one mechanic for every 835 cars or trucks.

"Government control would drive many mechanics out of business," Barrie Vreeland, of the Commerce and Industry Assn. of New York, contends. "They are the ones who are qualified technicians, but would have trouble passing tests because of language and reading difficulties."

The idea of certifying mechanics is not new. According to Mel Turner, director of Vocational Education for the Automotive Service Industry Assn., "The need for some type of certification for automotive mechanics and/or shops has been pretty well established for at least 15 years."

But nothing much was done until a Senate subcommittee headed by Sen. Hart took the licensing of mechanics under advisement in 1968. NATCB was formed in August, 1969, about the time Rep. Halpern introduced his licensing bill.

At least NATCB has a program. It provides for tests in 15 specialties: engine overhaul, electrical system, carburetion, cooling system, braking

(Please turn to page 192)



'You can't legislate skill and honesty. That's why we favor certification, not licensing.'

MAGNUS von BRAUN
Director, Product and Customer
Service, Chrysler Corp.



'It sounds all right going in, but it's not the answer. There is too much chance it would become a tight clique, like the construction trade unions, and this would restrict the supply just when we need them most.'

LEE IACOCCA
President, Ford Motor Co.



'We'd know more about the guy we were hiring for our garage. And as a customer you'd have more confidence that your car would be fixed right.'

GLEN WOOD
Lincoln-Mercury Dealer and
Stock-Car Mechanic

Big Boom in Cartridge TV

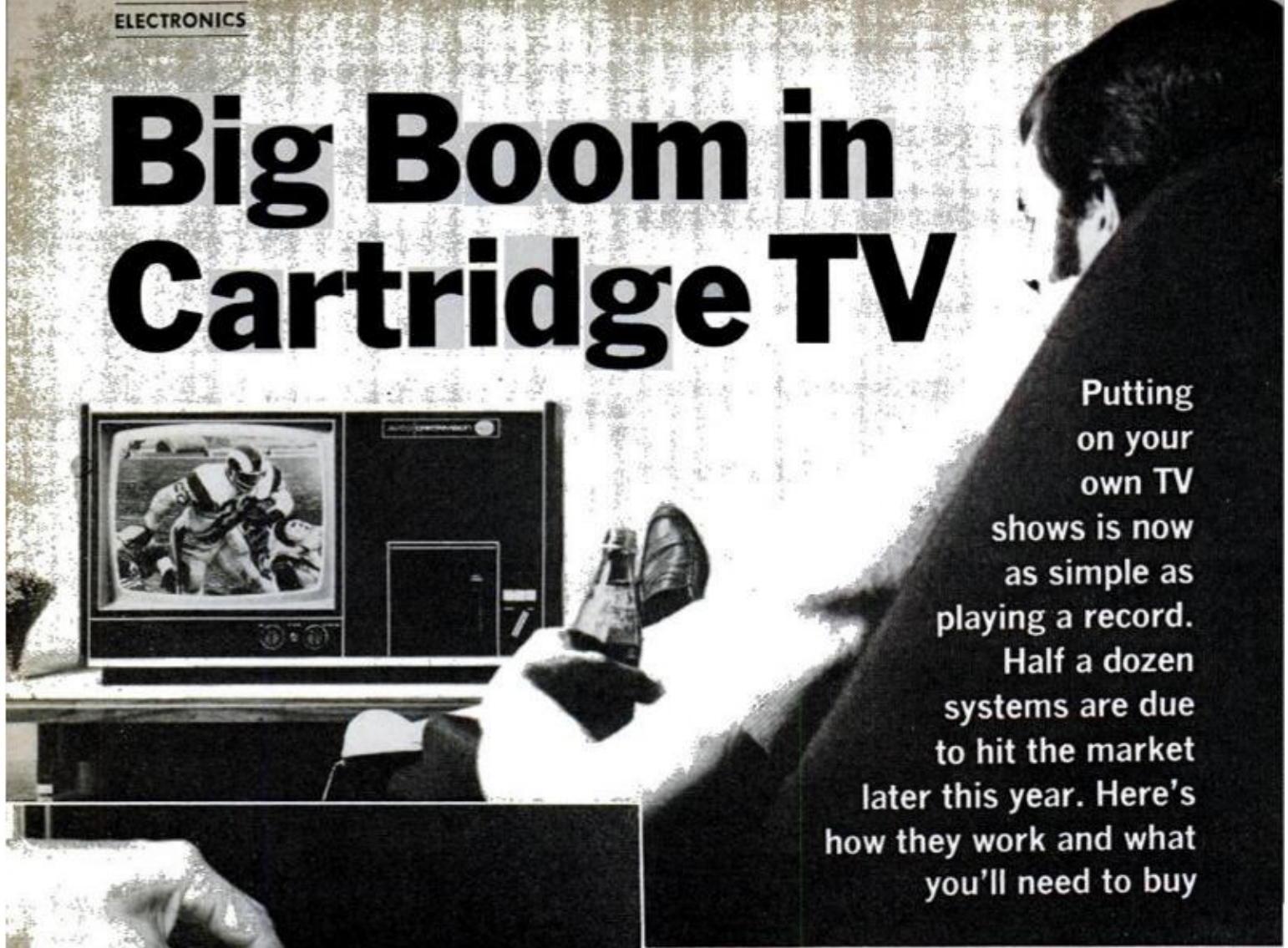

Putting on your own TV shows is now as simple as playing a record. Half a dozen systems are due to hit the market later this year. Here's how they work and what you'll need to buy

By SHELDON M. GALLAGER

AT LAST COUNT, just before *PM* went to press, there were no fewer than a dozen different systems for playing your own TV programs. By the time you read this, there may be more. Developments are breaking so fast in this booming new bonanza of home entertainment that it's hard to keep track of them.

Some systems are a mere gleam in their makers' eyes; some are in the actual hardware stage. By the end of 1971, half a dozen may be competing at dealers. So anxious are manufacturers to win swift public acceptance that all have scrapped plans to start modestly with black-and-white models and are now rushing full-steam-ahead for color.

In this dramatic new form of TV viewing, you become the program director. You put on the show. When you tire of conventional TV, you slip a



SLIP A CARTRIDGE in a slot and almost magically a picture appears on your TV screen. This Cartrivision console combines a video recorder/player and color TV in one unit priced at less than \$900

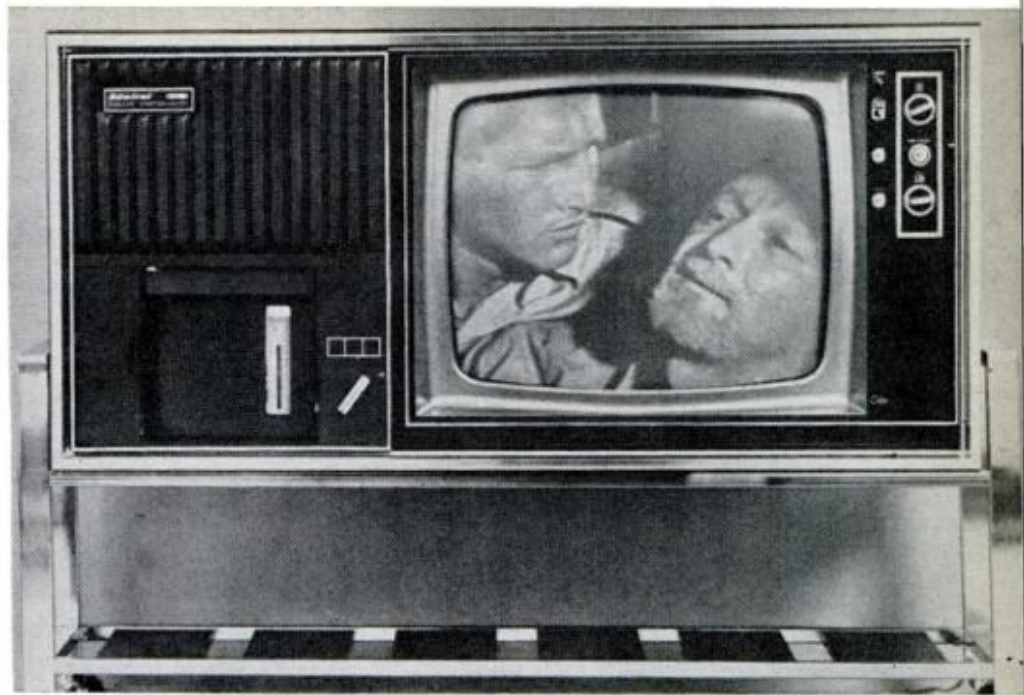

small plastic cartridge into a slot, press a button and watch your own program come magically to life on the same screen. It can be virtually anything you want to see—an exciting movie, a colorful stage show, spectacular sports events, even a course in learning to ski or play golf.

The cartridges play through any TV receiver. They show full-color pictures on color sets and the same pictures in black-and-white on noncolor sets. The machines that play the cartridges are, in most cases, trim, compact units, about the size of a phonograph, that sit on a table or shelf. What makes them so easy to use is that they require only two connections to the antenna terminals on your TV set. While the systems differ internally, they all end up producing TV signals similar to those broadcast over the air. The only dif-

ADMIRAL CONSOLE, priced at under \$1000, uses same basic video player as Cartrivision system so you'll be able to play tape cartridges interchangeably on both. Both will also permit home recording



EXOTIC RCA SYSTEM uses tiny laser gun inside player to convert holographic patterns on plastic tape into visual images for display on TV screen



VIDEO DISC, most unconventional of new systems, resembles ordinary phonograph record except that grooves are much smaller and closer together—about 3500 to the inch compared to 390 for a standard LP. The Teldec disc spins at a fantastic 1500 rpm as stylus picks up high-frequency oscillations, converts them into electronic signals and feeds them to TV set



3 TYPES OF TAPE TRANSPORT MECHANISMS

SINGLE REEL WITH SEPARATE TAKE-UP

SINGLE SUPPLY REEL is used in EVR system and in some magnetic-tape players. In EVR, film passes transducer that converts coded images into TV signals. In magnetic systems, tape feeds around helical-scan drum. In both cases, the original supply reel is rewound before removal

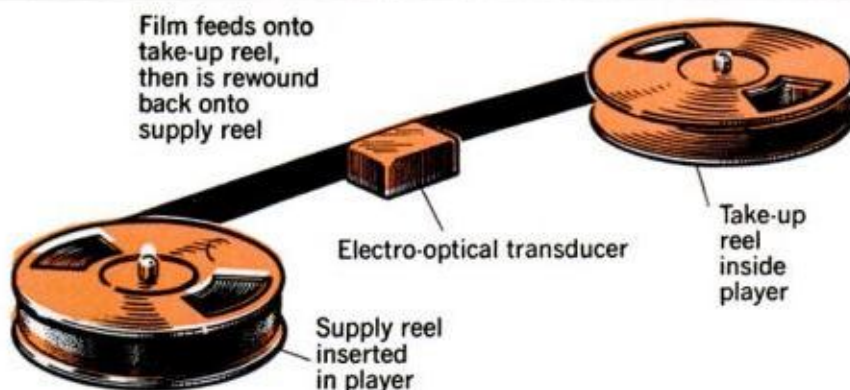

2 REELS STACKED TOGETHER

OVER-UNDER ARRANGEMENT is found in Avco and Admiral systems. Tape feeds out from upper supply reel, runs around helical-scan drum, then winds back into cartridge on lower reel. Rotating scanning head inside drum converts tape's magnetic patterns to TV signals

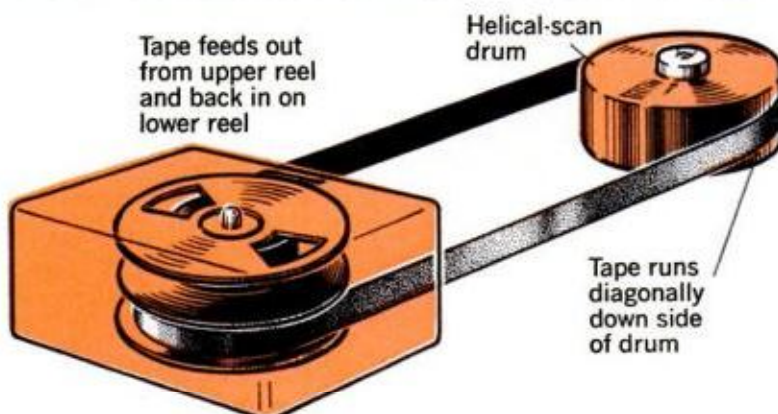

2 REELS SIDE BY SIDE

TWIN-REEL CARTRIDGES look like standard audio cassettes. In this ingenious Sony system, mechanical fingers reach out to pluck the tape from its cartridge, spread apart to form a loop, then drop the loop neatly over the helical-scan drum and retract out of way

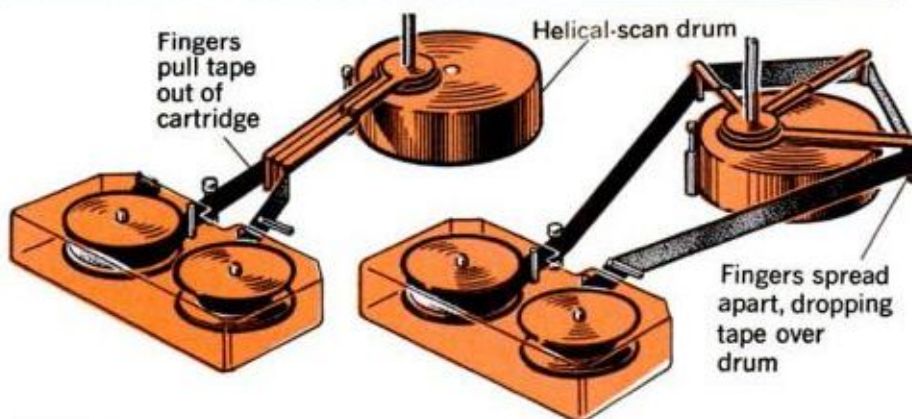

FIRST PORTABLE MODEL is this 15-pound, battery-powered Ampex due next year. About a foot square and only 4½ inches thick, it can be carried with you wherever you go for on-the-spot recording, then connected to your TV set for viewing at home. In addition to its built-in batteries, it can also operate on house current or on 12-volt d.c. from a car or boat. It will be made available in four versions: black-and-white player only, black-and-white recorder/player, color player only and color recorder/player. Prices will range from \$800 to \$1000. An accessory camera for black-and-white recording is expected to sell for about \$400



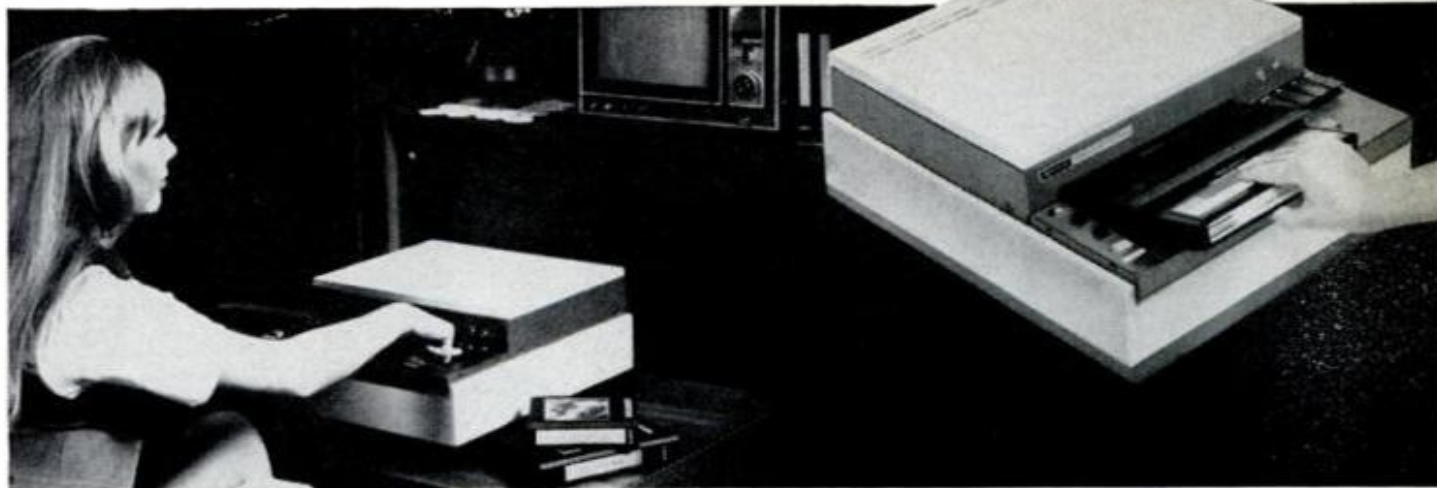

AS SLIM AS A PAPERBACK BOOK, Sony cartridges slip into a trim tabletop player for viewing on any TV

ference is that the signals are fed to your set over wires. To watch the program, you simply tune your set to an unused channel. This gives you, in effect, a closed-circuit system free from outside interference and weak fringe reception. Thus cartridge TV pictures are likely to be considerably clearer and sharper than those on regular TV.

Most systems also permit home recording. You can copy programs right off the air and store them for viewing later. In this case, TV signals are fed from the antenna into the recording unit instead of the reverse. Full-color programs are recorded just as they appear on a color set.

With an accessory TV camera, you

WATCHING YOURSELF ON TV will be possible with many systems like this Cartrivision console. Small black-and-white video camera, sold as an accessory

can even make your own live video recordings of family activities just as you would home movies—with the added advantage of being able to see the results immediately. However, you'll have to settle for black-and-white for the moment. Color TV cameras are still too costly for home use. As an extra bonus, most of the systems are capable of producing stereo sound. While present TV sets aren't equipped for stereo, future models might be, vastly improving the quality of TV sound.

Of the dozen systems currently being readied, all but four are based on the use of standard videotape. Here, signals from a TV camera are recorded on magnetic tape. In playback, the

for about \$200, plugs into set for home recording. Simultaneous monitoring permits you to watch the picture at the same instant it is being recorded



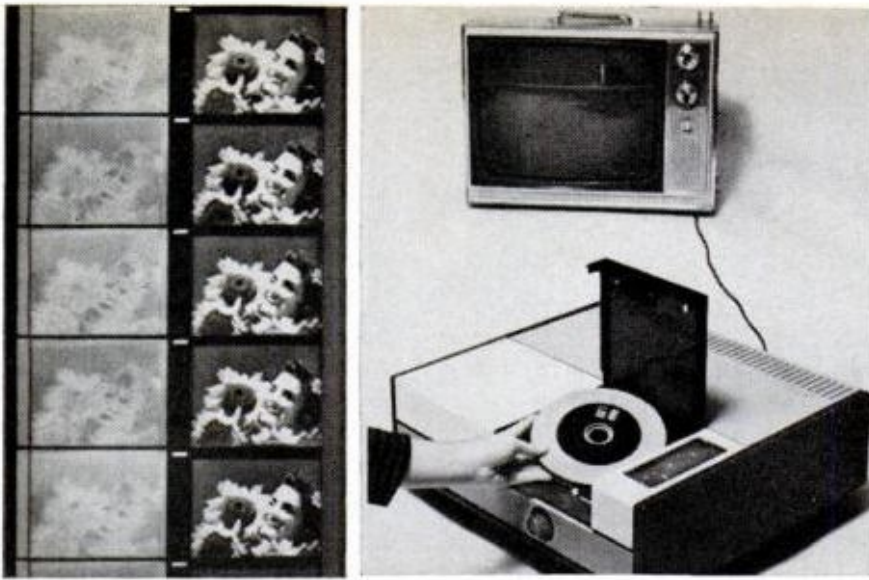

YOU SEE NO COLOR when you look at EVR film, but it is there. Secret lies in unusual split-image arrangement shown enlarged about four times at far left. Right-hand channel carries black-and-white images similar to conventional movie frames. Left-hand channel contains coded color information, also in black-and-white. When two channels are scanned and electronically blended in playback, you get full-color pictures. Twin audio tracks run along edges to provide accompanying stereo sound. Playback unit (near left) looks like a small phonograph, connects to antenna terminals of nearby TV set



SEPARATE VIDEO DECK UNIT, without built-in TV, will be sold by Cartrivision for those who already own color sets. It will play through any existing color set and record live TV in black-and-white

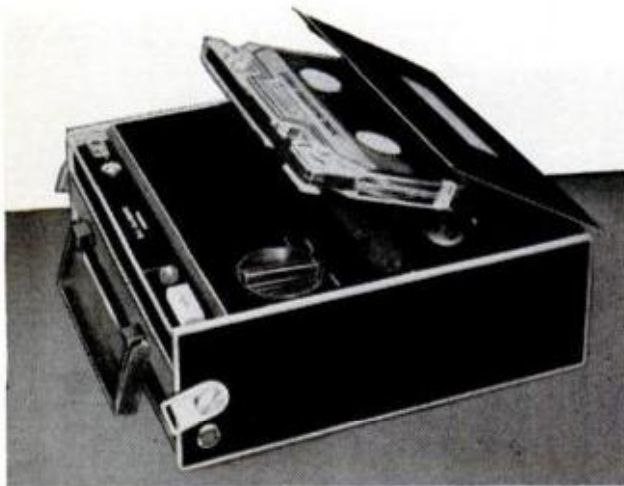

PANASONIC VIDEO PLAYER resembles reel-to-reel tape recorder except that reels are encased in a plastic magazine for easy handling. It will let you record TV programs off the air for viewing later

signals are picked up by a high-speed rotary scanning head and converted back into visual images for display on a TV screen.

The first such system to appear will be Avco's Cartrivision, due shortly. It will combine a videotape player/recorder and a color TV in a single console priced about \$895. Admiral, licensed to use the same Avco player/recorder, will also market a similar console. Later, Avco plans to offer a separate add-on player/recorder that will cost substantially less and work with any existing TV set. Sony, Ampex, Magnavox, Panasonic and Philips (Norelco in the United States) have all announced add-on videotape units for use with a separate TV set. Some are expected to sell for as little as \$400.

Prerecorded cartridge tapes already available for Cartrivision include a wide range of subjects from facial care to professional football to old Humphrey Bogart film classics like *Casablanca* and *The Maltese Falcon*. The initial cost will be high—as much as \$25 for a two-hour movie. But most companies are planning rental libraries on the theory that few will buy an expensive cartridge for one-time viewing. You may be able to rent a cartridge for the weekend for \$3 or \$4.

Theoretically, any videotape system will permit home recording, live or off the air, but not all makers have an-

(Please turn to page 184)

POPULAR MECHANICS

Chopper with wings

The sleek, low-drag profile of Sikorsky's new S-67 high-speed helicopter is graphically shown in this head-on photo. The pilot (rear) and gunner-copilot are seated in tandem beneath a single canopy. The craft can be equipped with a variety of weapons, including guns, cannon, grenade launchers, rockets and missiles. The 28-foot-span wing, which will hold some of the weapons, takes over some of the lift from the main rotor system. Powered by two GE T-58-5 turboshaft engines, the S-67 has flown at 167 knots.



New design for shrimp boats

About 60,000 pounds of aluminum will be used in this 76-foot shrimp trawler designed by Alcoa. Among parts to be built of the light metal are deckhouse, hull, rigging and the shrimp-stowage system.



'Sports car' for snow

Two automotive engineers, in their first venture into snowmobile design, came up with the Raider, a double-track, fiberglass machine that has twin-ski steering and a JLO two-cycle engine. Designed for "advanced snowmobilers," it's made by Leisure Vehicles, Inc., which also makes a family model.

JANUARY 1971

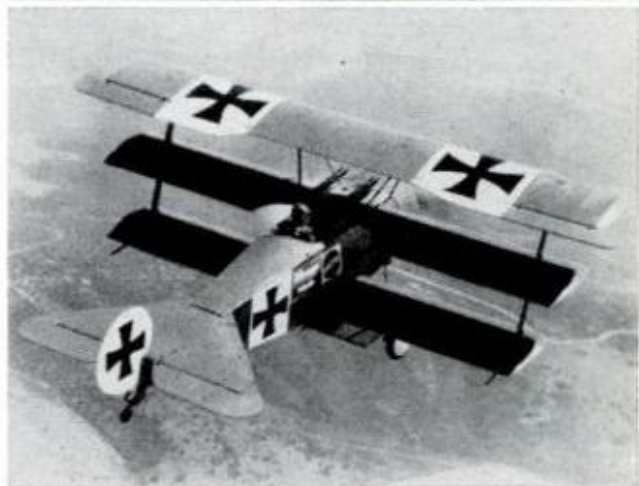

Well, if it isn't . . .

Snoopy (well, not really—it's John Bagley) in his Sopwith Camel (well, not really, it's a fixed-up Nieuport) and the Red Baron (well, not really—it's James Appleby) in his Fokker Triplane (really!) had a transcontinental air race recently to benefit the United Fund and, incidentally, to publicize the Monogram Div. of Mattel, Inc., which makes a plastic model kit of Snoopy and his plane. The planes above are authentic World War I craft from Tallmantz Aviation.

Putting the Lid on Oil Spills

Oil pollution caused by blowouts of offshore wells and wrecked tankers is still a threat. Here are the ingenious new methods and equipment being developed to solve the problem.

By JOHN F. PEARSON
Science Editor

NEAR RAGING BLAZE, in oil blowout, fire fighters weld dynamite holder to end of boom. Later, the device was used to push 300 pounds of TNT into inferno.

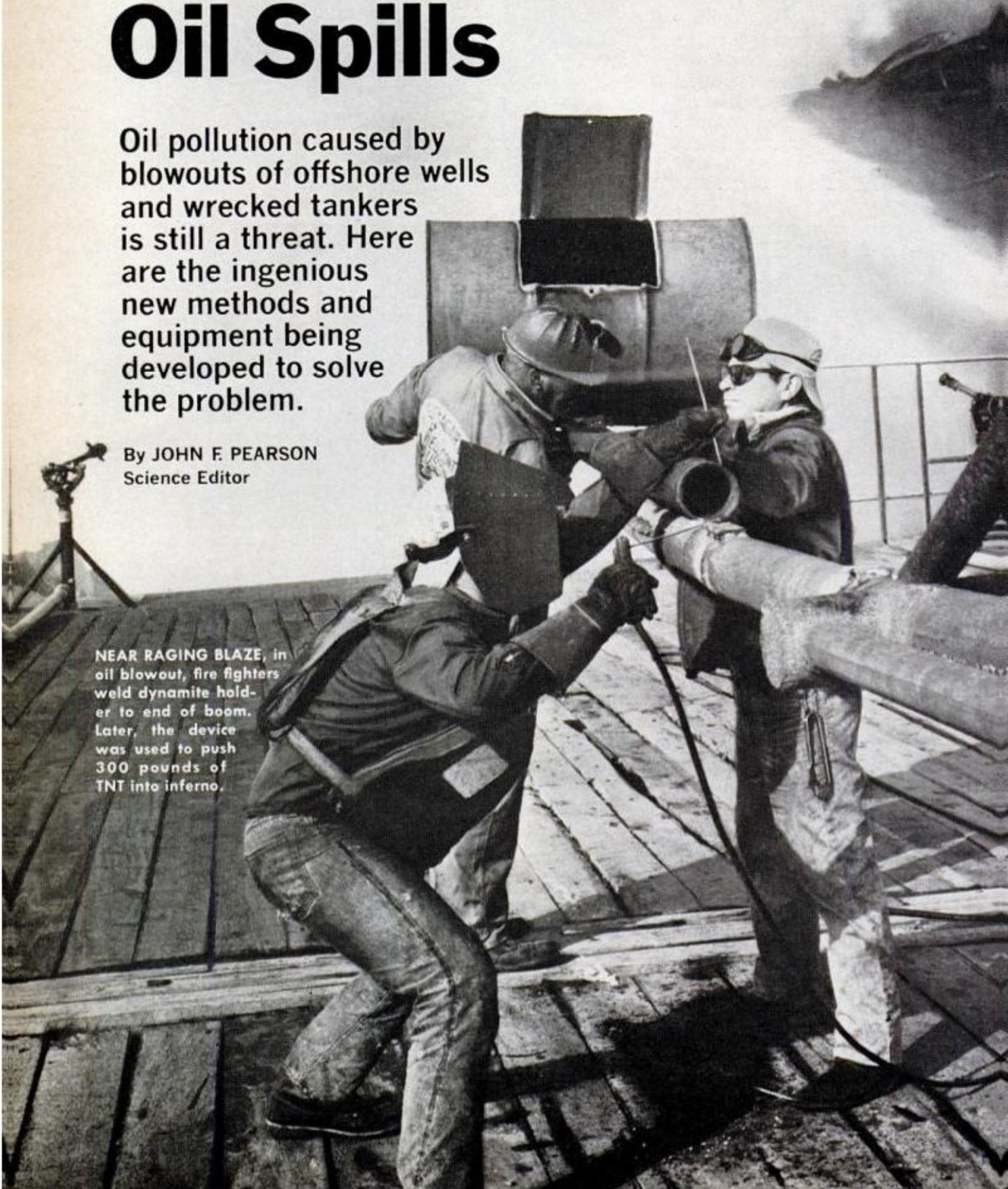



IT TOOK TWO BIG BLASTS to snuff out the fire on platform "Charley." But before the wild-well fighters could do the job, they had to build a big work platform (seen at bottom of the top photo). The intense heat of the month-long, gas-and-oil fire left Charley (below) a wreck of bent and twisted steel

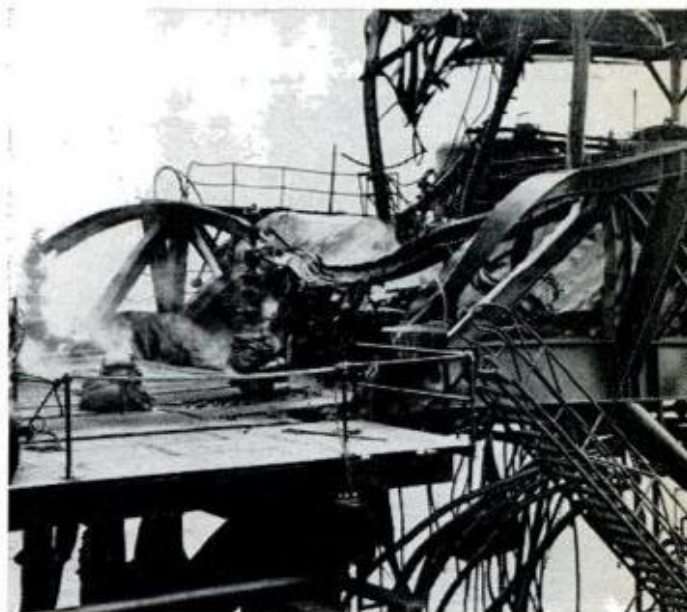
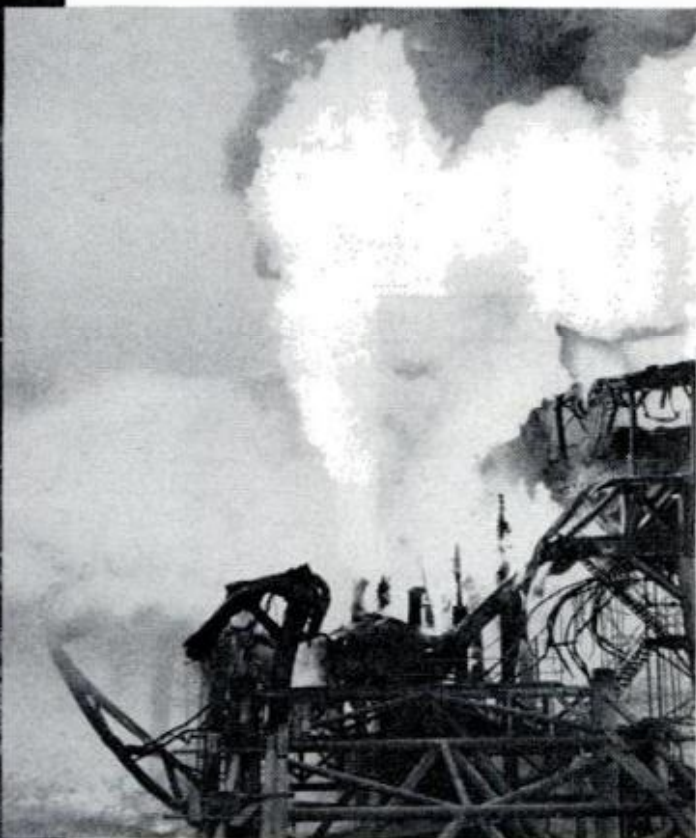

IN YOUR CRANKCASE, it's the dark, rich stuff that makes the world's wheels go 'round. But on water it's a life-choking ooze that ruins beaches, fouls harbors, kills birds and wipes out marine life.

Oil, a boon to auto-happy mankind, became recognized as a dangerous pollutant after the super-tanker *Torrey Canyon* cracked up off the English coast in 1967 and dumped 700,000 barrels of petroleum into the sea. In 1968, there was a series of lesser spills from tanker groundings and sinkings in various parts of the world. In 1969, a well blowout off the coast of Santa Barbara created headlines across America.

The spectacular spills make the newspapers and TV news programs, but thousands of others go virtually unreported. The U. S. Coast Guard estimates that 10,000 spills of pollutants occur annually in American waters and that oil exceeds other categories by a ratio of three to one.

Scientists and engineers have been working on the problem for very few years. They're experimenting with mechanical systems, air curtains, chemicals and items as exotic as glass beads. But so far they haven't come

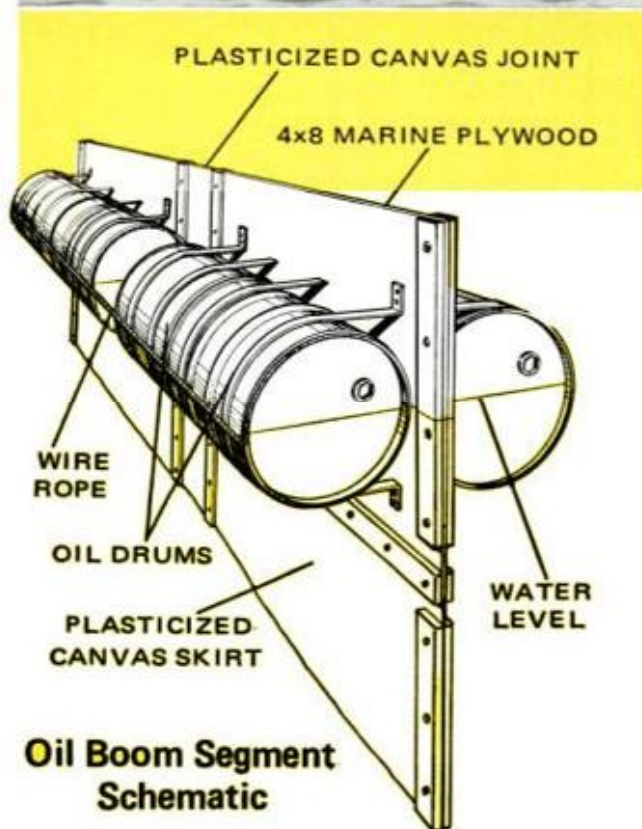
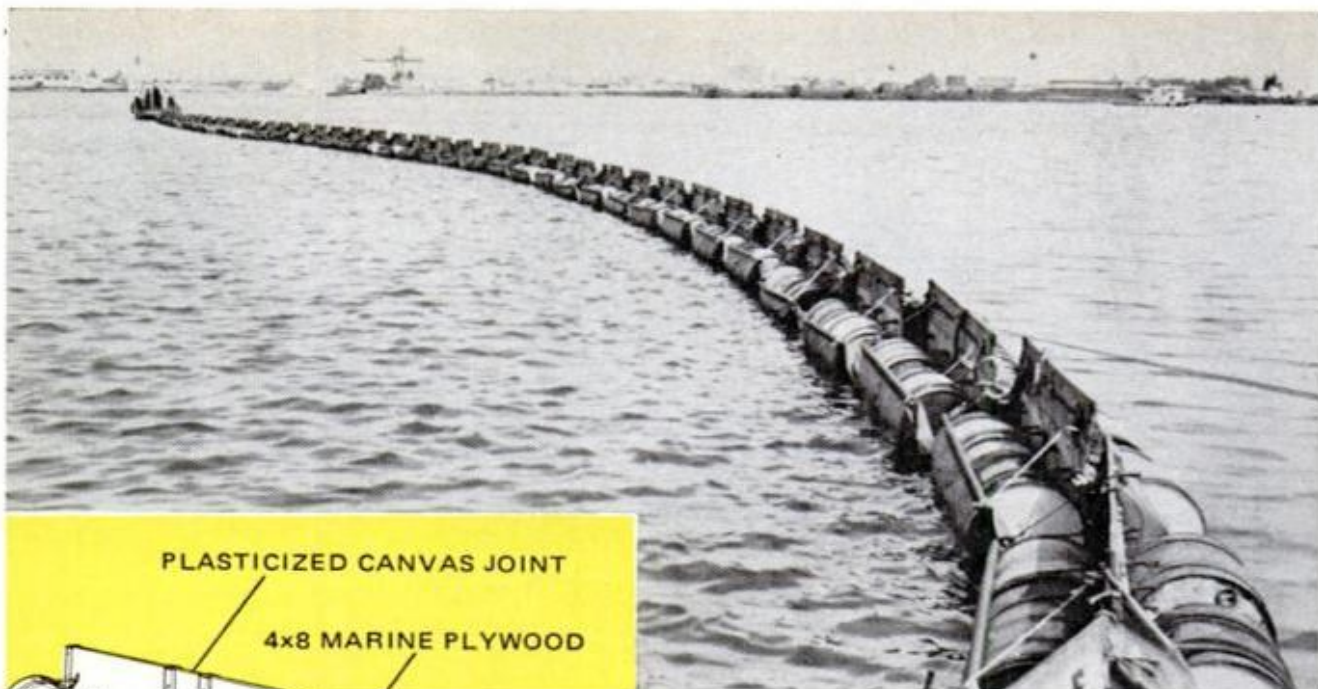

HEFTY BOOM developed by Murphy Pacific is deployed in the Gulf of Mexico to contain oil in Chevron spill. As drawing at left shows, there's nothing fancy about this oil drum and plywood barrier

up with any surefire cleanup methods.

What it takes to fight a major spill with the best available methods was demonstrated last year when a production platform in the Gulf of Mexico, 75 miles southeast of New Orleans, was hit by fire. Platform "C" (Charley) was one of 22 long-legged steel platforms in an area known as Main Pass Block 41. Leased to the Chevron Oil Co., Block 41 daily produces 67,000 barrels of oil and a huge volume of natural gas.

There were 12 well heads on Charley, each connected to pipes running 40 feet down to the surface of the Gulf; then about 50 feet to the bottom and some 9000 into the Earth's crust, where they entered oil-bearing sands.

How the fire started on the unmanned platform is not known. It's fairly certain that three wells had burst into flame, creating heat intense enough to melt valves and ignite other wells.

The fire started on Feb. 10 and raged until March 10, when it was snuffed out with dynamite. From then until March 31, when the last well was capped, the platform belched black oil into the Gulf, up to 1000 barrels a day, creating a slick 52 miles square.

While the fire was raging, Chevron

SHELL'S SAND-SINK METHOD is run through test (below) off the Netherlands coast. Sand treated to attract oil is sprayed on slick. As they sink, the sand particles carry oil with them to bottom





OILEVATORS WERE USED to sop up oil off Nova Scotia after tanker Arrow ran aground and broke up

mobilized 300 men and a fleet of 65 workboats and barges, stockpiled 30,000 bales of hay for beach-cleaning, and prepared 6300 feet of containment booms. The booms were the main line of defense against shoreline pollution. They worked best when strung out to form a huge V. A boat equipped with skimmers was stationed inside the point of the V to suck up oil pushed toward it by the current. Other skimmer boats chased "islands" of oil that escaped the boom, sucking oil and water into separation tanks on deck.

While the weather remained calm, Chevron reported the booms were 80

percent effective in containing the slick. But heavy weather—10-foot waves and wind gusts of 40 mph—ripped the booms apart and scattered the oil. When it was calm again, heavy, brown oil patches were seen 10 miles from platform Charley. Thinner slicks were spotted 20 miles away.

Yet, the operation can be regarded as a qualified success. No oil reached the mainland, though Breton Island, about 12 miles northwest of the blowout, was hit. A Chevron crew sopped up the oil with straw and lit a bonfire. Most birds escaped damage. Waterfowl, which winter on Breton and other islands, had already headed north. Oystermen were happy the 400 acres of oysterbeds in the Breton Sound area appeared clean.

The major strategy in the Chevron blowout was to fence in the oil, then scoop it up. Various kinds of booms are available or in an experimental stage. Whether made of plastic, rubber, reinforced fabric or aluminum, they're basically alike. They have a flotation section (inflated or foam-filled) riding on the water and a skirt hanging in the water to stop the oil. They work well in calm waters, but not in heavy seas.

The type proving most effective in *(Please turn to page 194)*

POROUS GLASS BEADS—a fourth of an inch in diameter—act like wicks on slick. Ignited, they soak up additional oil to feed fire. Dipped in water after test fire, white napkin shows no oil traces



How I Became A Racing Driver In 3 'Easy' Lessons



You, too, can learn the trick of getting in a formula car and finding the pedals! . . . understand the fundamentals of road racing and run laps against the clock in competition!

By **BILL HARTFORD**, Auto Editor/Photos by Irv Dolin

LE CIRCUIT-MONT TREMBLANT, near St. Jovite, Que., in Canada's beautiful Laurentian Mountains, is one of the most difficult road-race courses in North America. The 2.65-mile, 14-turn course was the scene of last year's Canadian Grand Prix. Clay Regazzoni set a new lap record of 1:32.2 or 103.467 mph. The amazing thing about the accomplishment was that, like any pro, he did it so smoothly and effortlessly.

It looks easy when you watch a professional athlete exhibit the grace, coordination, timing, balance and stamina that are his stock in trade. The only way to really appreciate his talent, however, is to try doing the same thing yourself—which is exactly what I did!

Located at *Le Circuit* is the Jim Russell International Racing Drivers School where young enthusiasts (and advanced students) can get expert and personal instruction in road racing. Driving is



POPULAR MECHANICS



FIRST DAY of the three-day program at the Jim Russell Racing Drivers School at Le Circuit-Mont Tremblant starts by getting to know school's Lotus Formula Fords, practicing driving at designated rpm limit, braking and downshifting at cutoff points. Jacques Couture, Canadian racing star and instructor, then moves his charges to classroom for cornering theory. After studying diagrams, it's out to walk track on best "line"

done in Lotus Formula Fords under the conscientious and critical eye of chief instructor Jacques Couture, Montreal racing star who last year took third place in the SCCA Continental Championship for Formula B-C cars. Another Montreal racer, David McConnell, is a second instructor and Lucien LeComte is the general manager whose warm, wide grin makes new students feel part of the racing fraternity right off. The school owns a half-dozen Formula Fords which are maintained by top wrench Hubert Zimone, who was factory-trained at Lotus in England. The school is the second branch (first is in California) of the original Jim Russell school operating in England since '57.

First day out I found myself the old man among students who were a bit plus or minus 20 years of age. Enthusiasts Joel Godet and David Griffith are both licensed airplane pilots. Robert Fortier is strictly a car buff, but he, too, almost gets airborne—in his Mini Cooper S! David and Robert enrolled with a rather clear idea of getting sponsor-

ship or their own car and entering competition. Joel was mostly curious to find out what road racing was all about.

Jacques is aware of the overwhelming desire of his students to get into the cars right away rather than endure a classroom lecture. So he fitted us with helmet, goggles and driving suit and took us right out to the circuit and assigned us our cars. After explaining the basics of a formula car and how an extra kind of delicacy is required to handle a machine that is so finely balanced and how it transmits any out-of-balance condition suddenly, Jacques taught us how to get in the car! One foot on the seat, hands behind your back, grasp the roll bar, other foot in, slide down into seat and buckle up.

After hunting for the pedals, feeling their spacing and getting used to the pressures required, we searched for the gearshift lever—that small-knobbed, short-throw rod hiding on the right side of the car among the struts of the tubular frame! Conventional four-speed, but operating a "crash" box—no

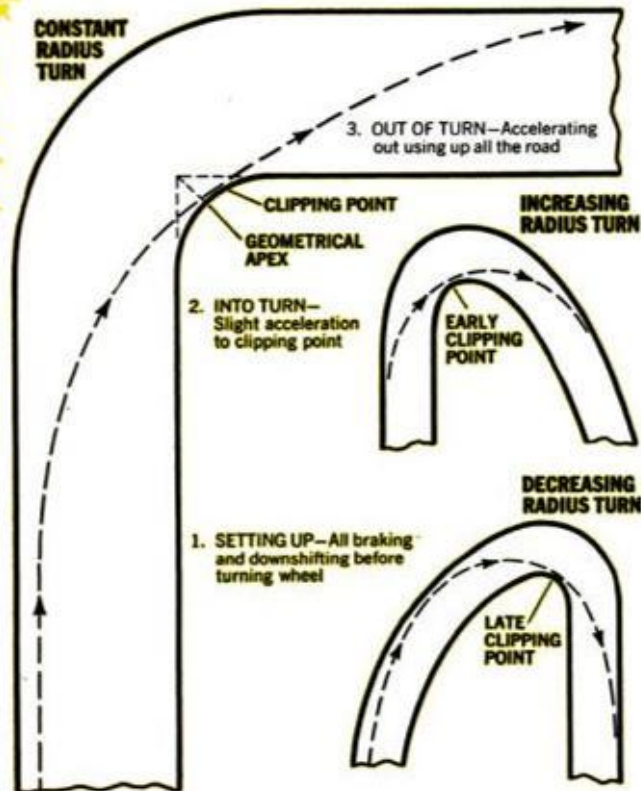

IN ROAD RACING the straights are there only to connect the corners. It's an art and a science to get through a corner in the shortest possible time. The greater your ability, the "deeper" you go into a corner (losing speed, braking and downshifting at the last possible moment before turning steering wheel). Radius of turn, road camber, proximity of next turn (in esses, for example) all determine line through turn and point at which you "clip" corner. It's just as important to come out as fast as possible; speed out determines how fast you get to next corner. Jacques and school manager, Lucien LeComte, use CB to coordinate practice

synchromesh. That means double clutching: into neutral between gears, clutch out, blip throttle then into next lower gear. Not very difficult for a normally coordinated human being, but doing it smoothly, precisely and consistently in a split second going into a high-speed corner requires naturally superior, or at least highly developed, coordination.

We were ready to start making practice runs on the long straight: up through the gears, run at steady rpm to the first pylon. Then, in the distance between the first two pylons, brake, downshift to third; same procedure again into second. A few missed or sloppy shifts were par for the course.

Next stop was the school's classroom and office at the Villa Bellevue. Jacques

discussed the best line through all the turns and why. Anyone can charge down the straights, but it's in the corners where races are won or lost. Instruction here was confined to going around on "rails," that is, with full traction. Drifts and slides, especially in a formula car, are not for novices. A formula car is delicate and nervous and—unless you mean to—you "scrub" off speed anytime you slide.

Jacques concentrated on teaching the fastest line *through* a corner: clipping point close to the geometrical apex of the turn, the line pretty much a constant radius. There are variations on this technique, of course. For example, speed through the turn can be sacrificed for better speed *out* of the turn. You go in a little slower to get a

PRACTICE SESSION LAP TIMES (Minutes)
—1.68-Mile Road Course

RUN	RPM	LAP 1	LAP 2	LAP 3	LAP 4	LAP 5	LAP 6	LAP 7	LAP 8	LAP 9
Second Day										
1st	3000	2.11	2.10	2.20	2.16	2.18	2.16	2.14	2.17	2.14
2nd	3500	1.49	2.11	1.47	1.56	1.48	2.00	2.03	2.00	2.00
3rd	3500	1.51	Stop	1.53	1.53	1.52	1.48	1.48	1.48	1.47
Third Day										
1st	3000	2.09	2.02	2.03	2.03	2.08	2.09	2.08	2.07	2.07
2nd	3500	1.48	1.46	1.51	1.45	1.45	1.45	1.43	1.42	1.43
3rd	3500	1.47	1.43	1.42	1.44	1.43	1.46	1.42	1.43	1.39
4th	3500	1.49	1.50	1.56	1.50	1.47	1.47	1.46	1.45	1.45
5th	3500	1.49	1.50	1.49	1.47	1.47	1.44	1.45	1.43	1.43
6th	4000	1.47	1.40	1.39	1.39	1.39	1.39	1.35	1.35	1.42
7th	4000	1.35	1.36	1.33	1.33	1.34	1.34	1.37	1.35	1.33
Long Course										
8th	3500	2.55	2.54	2.53	2.50	2.47	2.48	2.48	2.48	2.51



LAP TIMES, recorded by Micheline Couture, are measure of my performance. Goal is not solely to lap circuit as fast as possible within rpm limit, but to develop rhythm and technique that shows up in consistent times

straighter line going out and hence earlier application of full power. Decisions about handling corners are subtle ones based on gear ratios, competition, changing road surface (sand blowing on the circuit during a Grand Prix at Zandvoort for example!) We had enough to worry about just getting through at a respectable speed.

We worked Namerow, the circuit's hairpin (No. 14 on circuit diagram), that is hairy enough to have special markers to assist drivers in determining shut-off point (usually trees, fences and such are sufficient markers for a

driver to use as a guide for getting off throttle and onto the brake). We kept at the corner, increasing rpm until we were attacking it at 4000. At the greater speeds you really have to stand on the brakes, which are designed with no pedal play at all. At first the tendency is to be cautious: So you're not driving over your head, you drop speed fast to turn into the apex and find yourself loafing through. When you bobble a downshift, though, all the novice can do is stand on the brakes and miss the turn. Embarrassing, but not dangerous.

We all became aware of the impor-

FINDING THE LINE through turn takes practice and more practice. As configuration of Le Circuit's 14 turns became memorized, all students were able to go in with later shutoff point, get more speed coming out





CONCENTRATION can't be let up for a split second while racing a road circuit. David Griffith, one of the most controlled drivers in the class, with an excellent sense of recognizing where a corner starts and where it finishes, dipped a rear wheel in the grit coming out of a 90° right-hander and right smartly spun out. Unhappily for Dave, who was embarrassed enough, intrepid photographer Irv Dolin was right there to record event

tance of being smooth as we pushed ourselves to—for us at that stage of the game—our limit. You can feel the car get twitchy if you're not smooth. If you take off the "pressure" on the rear wheels—back off on the throttle abruptly and thereby lose traction—you can feel the rear end start to go out. Still, not a single spin out in Namerow! That didn't prove we were ace drivers, but at least it proved we all had the good sense not to overdrive our abilities. We were ready to race: run timed laps on the short, 1.68-mile course (dotted line on circuit diagram).

We ran 10-lap practices starting at 3000 rpm. We left from the pits so the first lap was not timed and we were spaced out for safety. Jacques moved from corner to corner watching how we set up for the turn, how we executed it and how we went out. At first, each corner held its own challenge, but as I locked onto a line—and especially as the speed went up and we were running at 4000 rpm—I became intoxicated with the *rhythm* of road racing. So much concentration was needed, I had no sense of roaring engines. I was doing all the hard braking, downshifting, cornering and accelerating with a sense of timing and coordination akin to that

required in other sports where a "vehicle" is used for motion: slalom skiing and flying rings in gymnastics, for example. Drivers talk of putting their "foot in it" when they apply the power. This brute expression belies the fact that the application of power is as controlled as when a quarterback throws a perfect pass or a gymnast kips up on the rings. Too little power and fractions of a second are lost; too much and you get wheel spin.

I found the three-day course at Jim Russell only the beginning—as it's designed to be—for anyone who wants to go the route, but during those last laps, and especially when for the first time I overtook and passed another car, I *felt* like a racing driver! ★ ★ ★

WHEW! As I peeled my fingers off the wheel and slumped in the cockpit of the Lotus, muscles aching after three days of living the glamorous life of a racing driver, I realized—and I must say, a little sadly—that it was now back to being a desk jockey!



For more information about formula racing, write:
 Jim Russell International Racing Drivers School: (East) 11,933 Boul. Laurentien, Montreal 389, P.Q., Canada; (West) Box 911, Rosamond, Calif. 93560.
 Formula Ford Register, Box 665, Dearborn, Mich. 48121.
 Formula Vee International, 1347 Fairmont Ave., East Wenatchee, Wash. 98801.
 Canadian Automobile Sport Clubs, 310 Victoria Ave. Suite 305, Montreal 215, P.Q., Canada.
 Sports Car Club of America, Box 791, Westport, Conn. 06880.



'Underground art' for Paris Metro station

Underground commuters in Paris have no trouble recognizing the Louvre station—it looks like a room in the museum itself. Reproductions of famous statues, made of stone, glass and copper, are on display for the enjoyment of Metro passengers.



Executives' runabout

This little battery-powered runabout, a British invention, is designed for the use of executives who must move through large factories or across decks of large ships.

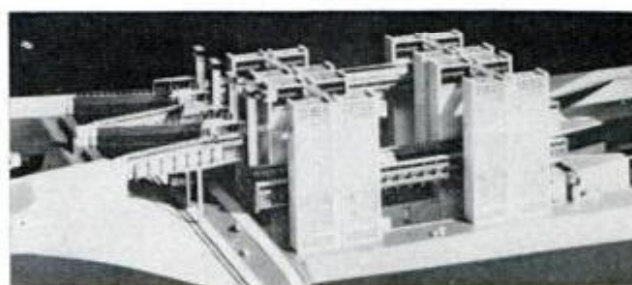

Ship-lifter for Hamburg

Shown in model form is a ship-lift that is being built at Hamburg, Germany, as part of a new canal that leads to the Elbe River. The lift, scheduled for completion in 1975, overcomes a 124-foot difference in elevation. It will lift a ship in 3 minutes.

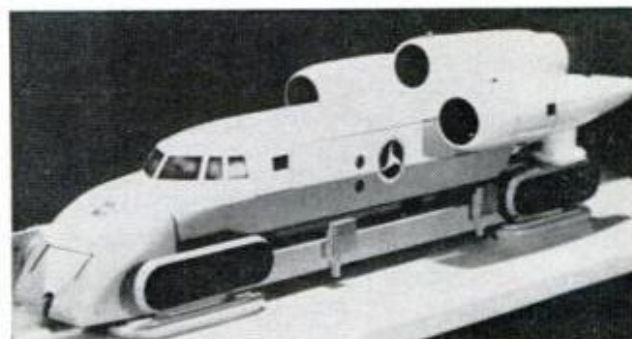

Speedy air-cushion vehicle

Grumman Aircraft Corp. is developing a 300-mph tracked air-cushion vehicle to link cities as much as 250 miles apart. The project is financed by the Dept. of Transportation.

The Breath of Life... **New Old**... Radio Transmitter for Helmet Puts the X on Brain

WILMA GRAY was only four months old when she made history in space-age electronic medicine. Following her heart surgery the doctors performed a tracheostomy, a procedure widely used in those terrifying emergencies when an accident, injury or disease blocks the throat air passages through which you breathe. Dr. Samuel Abraham, director of research at Children's Hospital Medical Center of Northern California, Oakland, explained:

"Tracheostomies are commonly performed to ease breathing for seriously ill patients, even though there may not be complete blockage of the windpipe. The operation involves cutting an opening through the front of the neck into the windpipe or trachea, below the obstruction, to provide a new passageway to the lungs and restore a free flow of air."

But an unconscious adult or child cannot signal for help when, as often happens, the tracheostomy tube becomes plugged with mucus or other material. To prevent suffocation a 24-hour nursing watch must be maintained. Both the risks and the financial costs of thousands of hours of constant surveillance are high and so Dr. Abraham and his colleagues were joined by researchers of NASA's Ames Research Center in devising an automatic monitoring system.

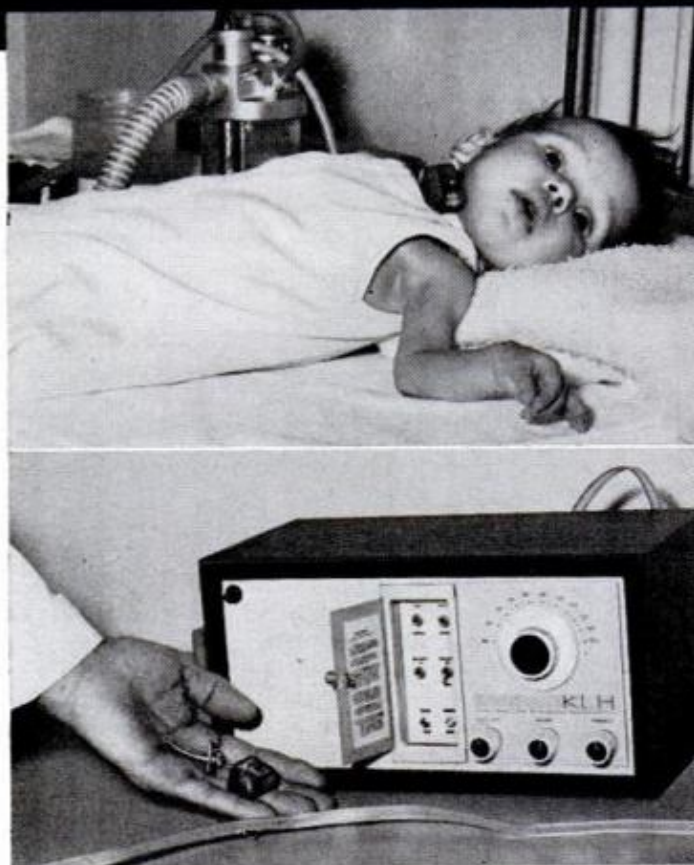

MINIATURIZED TRANSMITTER contained in tracheostomy tube monitors child's breathing with FM tone

The result is a unique device (first used on tiny Wilma) weighing about an ounce, and half the size of a small matchbox. An integrated circuitry FM transmitter the size of a sugar cube was combined with a thermistor (a temperature sensor) the size of a match head. To this was added a battery the size of an aspirin tablet. The tiny transmitter had been developed by Ames in mid-1967 to radio electrocardiograms of subjects who were undergoing a

POPULAR MECHANICS

Joints for Teeth...Giant Tissue

By ARTHUR S. FREESE

simulated reentry from outer space.

The thermistor responds to the passage of cool and warm air with different signals which the transmitter broadcasts—a higher frequency for cool air, lower for warm. Air inhaled into the lungs is at room temperature (some 70°F.), but it's about body temperature (near 99°) when exhaled. An antenna in the room picks up the signals and sends them to an FM receiver (at nurses' station) which puts out a continuous warbling tone whose steadiness indicates evenness of the breathing.

A solid-state timer actuates a switch within 10 seconds if there is either a lessened warbling (indicating reduced breathing) or a cutoff of sound (no breathing). The switch, in turn, sets off a buzzer. The timer will also set off a different alarm if power fails. If there are several patients at the same time, different frequencies would be used for each.

Dr. Abraham says the device could also flash warning lights in the hospital corridors, and a modified version could monitor ordinary nose-mouth breathing in the very ill.

radiosurgery

Dr. Lars Leksell, professor of neurosurgery at the world-famous Karolinska Hospital in Stockholm, Sweden, has just developed a "gam-

JANUARY 1971

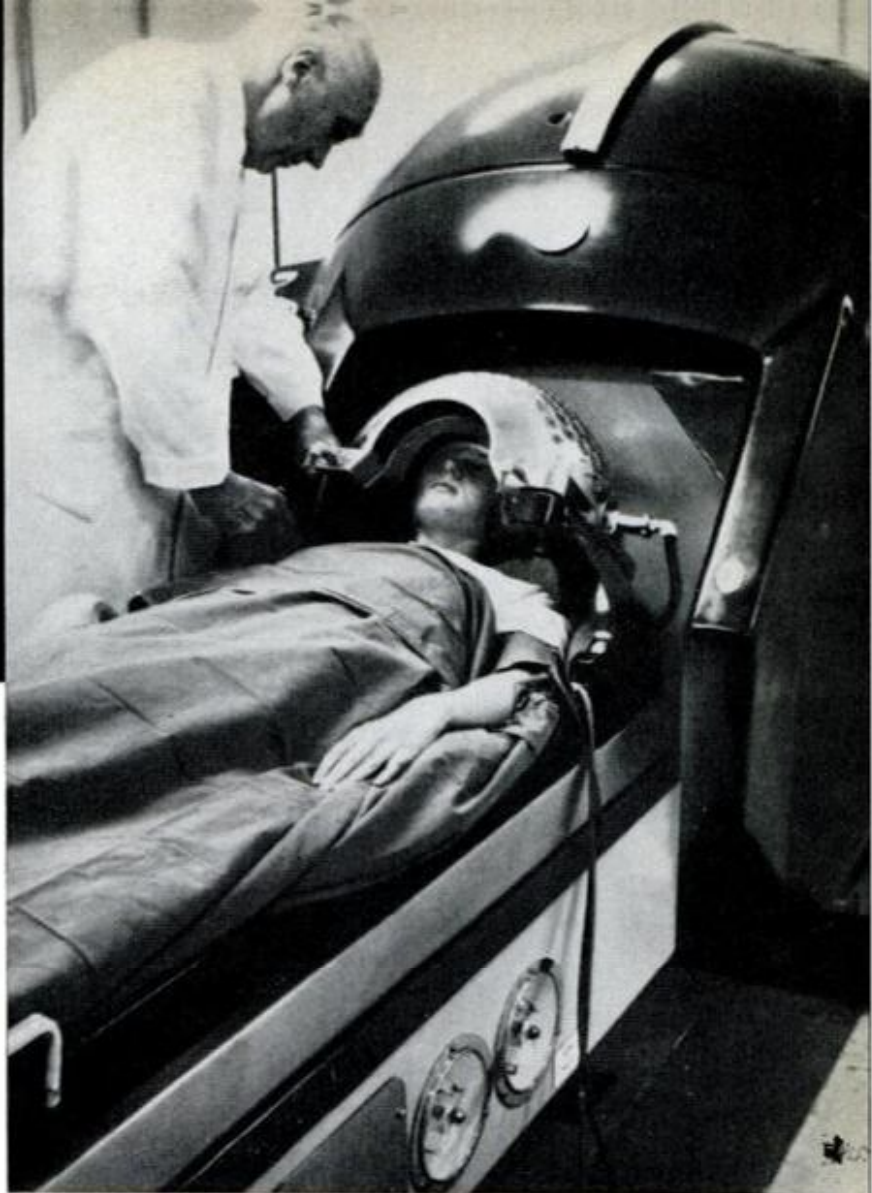

HELMET of radiosurgery apparatus focuses 179 gamma rays for a painless, bloodless removal of brain tissue

ma knife" with which he performs brain operations (radio-surgery) without touching a scalpel or other cutting instrument. He has already used this on 60 or more patients. A radical departure from the traditional surgery in which the doctor improvises his way along by sight and touch, the new operation proceeds on a carefully programmed plan with all the precision and accuracy of modern sophisticated mechanics and electronics.

The patient's skull is covered with a plaster cap, then placed in a metal frame with three metal rods, each in a different axis. Special X-rays locate the brain tissue to be destroyed (whether to relieve the pain of cancer, eliminate the source of Parkinson's disease or some mental disorder such as schizophrenia). The surgeon uses transparencies over the X-rays to determine the amount of radiation

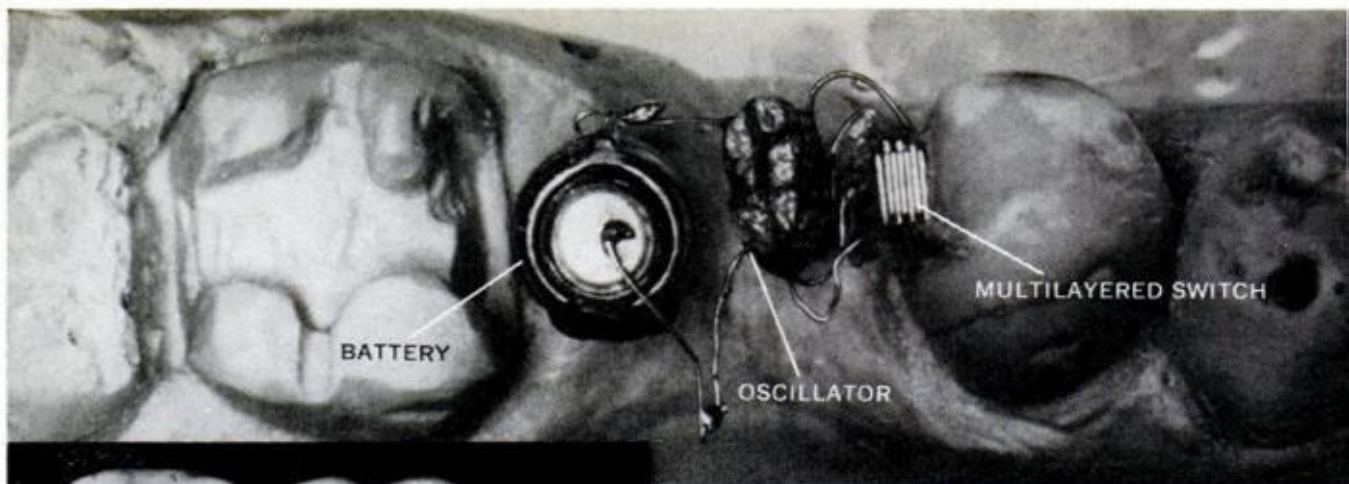

DENTAL TELEMETRY SYSTEM reveals how teeth meet in chewing. Telemetry elements, are shown (above) arranged on model before processing into acrylic resin bridge. Only a multilayered switch is left exposed (left) in artificial molar. Transmitter is activated when gold inlay on tooth in opposing jaw hits one of switch's layers, each with own frequency

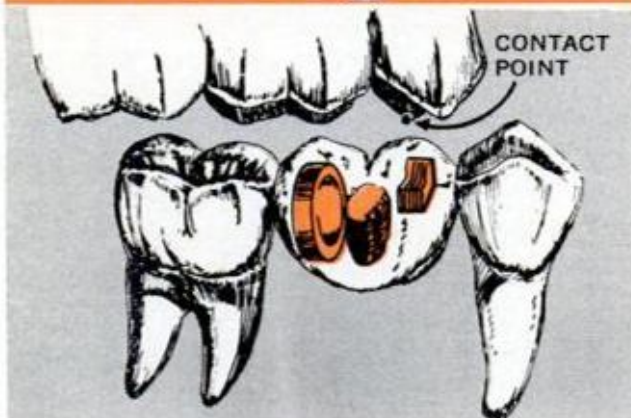
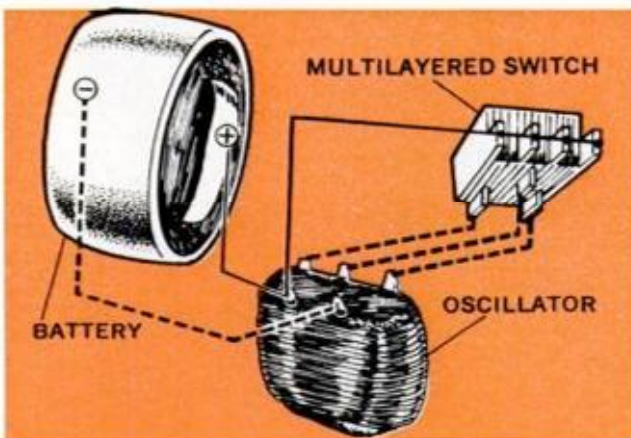

RADIO SIGNALS from elements in molar are picked up by antenna and fed by receivers to oscillograph

and the precise location to be attacked. The patient is placed on a moving operating table which has a perforated metal hat with holes located with mathematical precision and accuracy. The subject's head is locked into position in this cap as it was in the original examination frame so that the doctor knows just where the brain tissue is.

The whole table, patient's cap and

all, is hydraulically moved into a hemispherical unit that resembles a giant football helmet.

Inside the "helmet" are 179 rods of radioactive material (cobalt 60), each about 1/25th of an inch in diameter and 4/5th of an inch long. These rods are so placed that they send their gamma rays (just like X-rays except more powerful and produced differently) accurately through the perforations on the metal cap. Only at the exact spot where all these beams meet, deep in the brain, is tissue destroyed—in principle somewhat like focusing of sun's rays in one spot to burn paper.

Tooth Transmitter

Dr. Irving Glickman, dental specialist and Tufts University professor of periodontology (the study of the diseases of supporting structures around the teeth: tissues, gums and bone), has developed a miniaturized radio transmitter small enough to fit inside of a natural tooth. Dr. Glickman's dental team, which includes a physicist, has developed this unique space-age intra-oral telemetry system to learn how you chew and how, in swallowing, your teeth meet (your "occlusion" or "bite"). From these tests, the Boston dental scientist believes he has proven that the pressures and injuries of chewing

are the source of periodontal disease (what your dentist calls "gum diseases" or, in an older term, "pyorrhea").

The transmitter consists of a Hartley oscillator circuit, a Mallory mercury battery and a multilayered switch with sections less than 3/100th of an inch apart. Embedded in a dental bridge replacing a single tooth, the elements of the device all fit into the artificial molar (just the size of your natural one). The transmitter is activated when a pinpoint gold inlay on the high point ("cusp") of a tooth in the opposing jaw hits one of the switch's individual layers, each of which emits at a different frequency. The signals are then picked up by an antenna and fed to a six-channel oscillograph.

The oscillograph recordings tell the dental investigators where the opposing teeth actually make contact while the radio-equipped subject is chewing foods of different consistencies—apples, bananas, hamburgers or peanuts. This method can locate up to five spots that touch in chewing on that molar, and also distinguishes between single contacts and gliding or rubbing movements.

The subjects are also fitted with what looks like a dog collar except that it has built-in sensors for strain measurements. These are connected through a Sanborn transducer amplifier to another channel of that same oscillograph. The dentists are also studying how your teeth come together every time you swallow.

This information, hopefully, will help your dentist in his understanding of gum conditions—and lead to saving more teeth than ever before.

New Joints for Old

The importance of your knee joint can only be appreciated after you make an attempt to hold it stiff for a part of the day. The effect of even one stiff knee is drastic. So important is this joint that people with rheumatoid arthritis, the most common cause of overwhelming damage to the knees,

(Please turn to page 196)

WALLDIUS KNEE

This mechanical knee joint has been successfully used as a replacement in severe cases of osteoarthritis. The stems of the artificial joint are driven into the soft centers of the thighbone and shinbone. A bolt is inserted to provide axis for rotation and held in place by a locking screw. The range of movement is from 5° hyperextension to 90° of flexion—adequate for walking, climbing stairs and stooping.

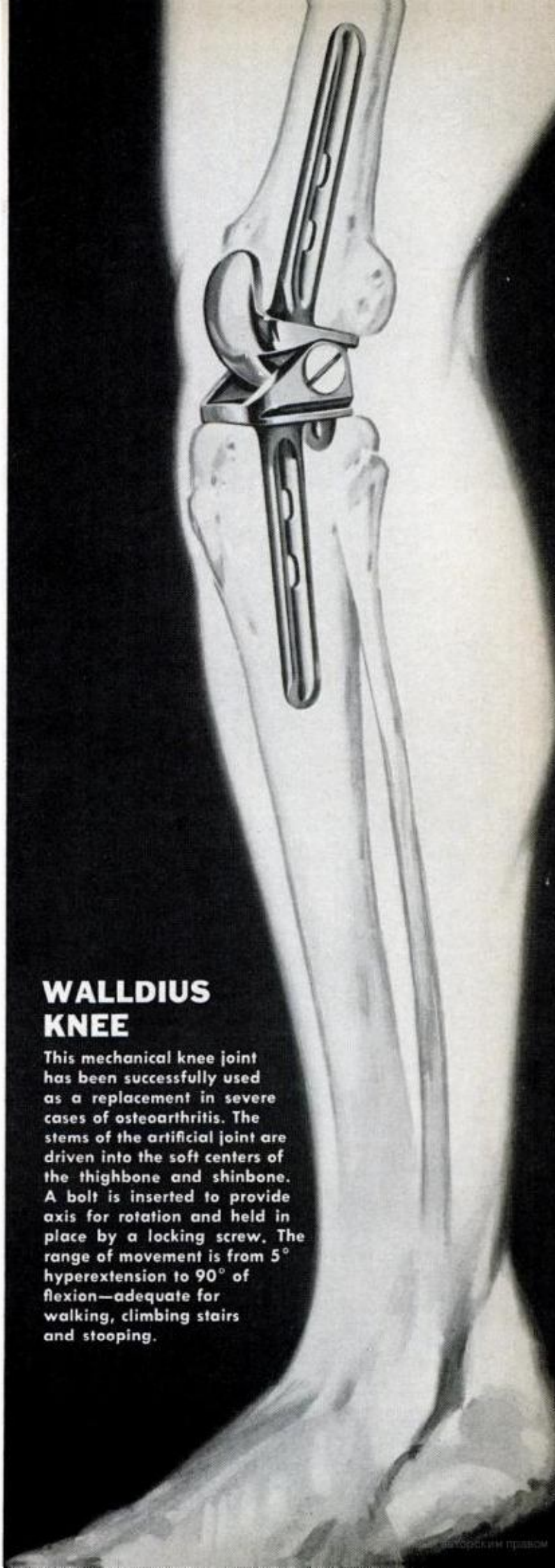



So You Want to

Add the Robertson STOL package to a Piper Cherokee and it will take off and land at less than 50 mph—and use runways half the length required by a standard Cherokee

By **MERLE E. DOWD**

Technical Art by Fred Wolff

A PROSPEROUS RANCHER has just shelled out about \$11,000 for a spanking new Piper Cherokee. Though delighted, he wastes no time admiring it. Instead, he flies the Cherokee to the Robertson Aircraft Corp. in Bellevue, Wash., and orders some \$4000 worth of modifications.

Is the rancher daft? Hardly. He knows what he wants in a plane. He frequently has to use pastures and unimproved fields for takeoffs and landings, and he wants to be able to do so with maximum safety. What he wants is a STOL capability built into his plane.

A factory-fresh Cherokee, say a Model 140, normally takes off at a speed of about 75 mph and needs 1920 feet to get off the ground and clear a hypothetical 50-foot-high obstacle at the end of the runway. With STOL modifications, according to Robertson, the same plane can take off at 46 mph and needs but 975 feet of runway.

The standard plane has a normal approach speed of 70 mph and requires 1080 feet in which to land (after once again clearing that 50-foot obstacle). In this case, the Robertson-STOL figures are 47 mph and a landing distance of 525 feet.

In short, the modified plane takes off and lands in half the distance required by the standard plane. It reportedly handles as well or better than the unmodified version, recovers from stalls more handily, and its high-lift-to-drag ratio increases efficiency.

The modified version flies as slowly as 40 mph. When you're approaching an airfield at 20 mph slower than normal, you have more time to correct for position, altitude and glide slope. More than one flyer has commented that Robertson-STOL forgives his errors and turns him into a smoother pilot.

Most of the components in the typical Robertson package, which adds only 28 pounds to the plane, are shown in



Fly Slow?

STEEP CLIMB (far left) is easy after STOL components are added to Cherokee. Low fin halfway out on each wing is a "stall fence." Left: Raked wing tip adds lift. Above: Triangular piece added to fin increases stability in cruise and slow flight

the drawing. The dorsal fin adds more area for directional stability. A full-length cuff is bonded to the leading edge of the wing to increase its radius. The recontoured edge spreads the wing stall over several degrees, "gentles" stalls and simplifies recovery.

The fuselage flap adds lift for take-off and provides lift plus drag for steep-angle landing approaches. The drooped ailerons help to increase lift.

On each wing, midway out from the fuselage, there's a stall fence—a low

"fin" that starts halfway back on the wing and runs to the trailing edge. The two fences are further protection against stalls, coming into play when the smooth flow of air around the wing breaks down to create what aviators call "burbles."

Burbles result in a loss of lift and an increase in drag.

The pieces in the Robertson conversion package are simple enough. It's the way they work together that produces the payoff: slow, easy flight. ★★

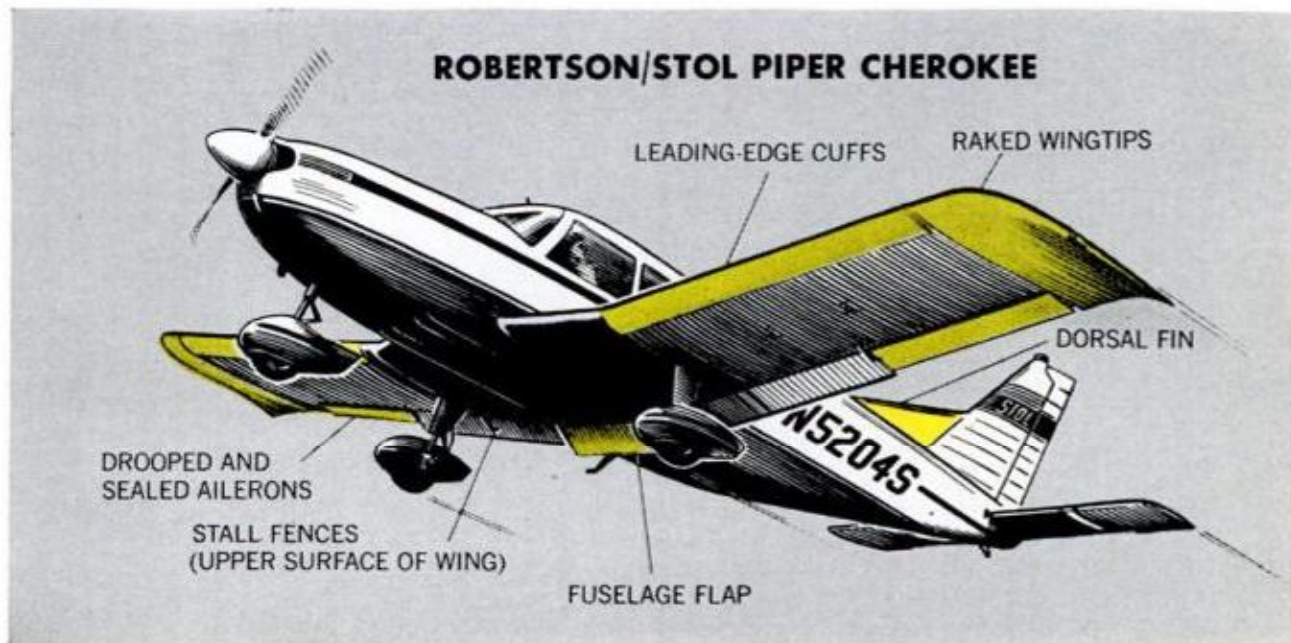

NEWS BRIEFS



Snowmobile fits in trunk

The Ski Lark is a scaled-down, 106-pound snowmobile that'll carry an adult at 25 mph, yet still fit in the trunk of a car. It's made by Larkin Aircraft Co.



Look quick!

A pulse of laser light, described as the world's fastest moving object, has been photographed for the first time by Bell Laboratories scientists. Shown (left) as it travels from right to left through a rectangular bottle of water, the pulse was stopped in flight by a camera with a new ultrafast shutter. Triggered by laser signals rather than electrical pulses, the shutter opens and closes in 10 trillionths of a second. From tip to tip, the pulse measures about one-fifth of an inch. Shutter designers are Michel Duguay and John Hansen.

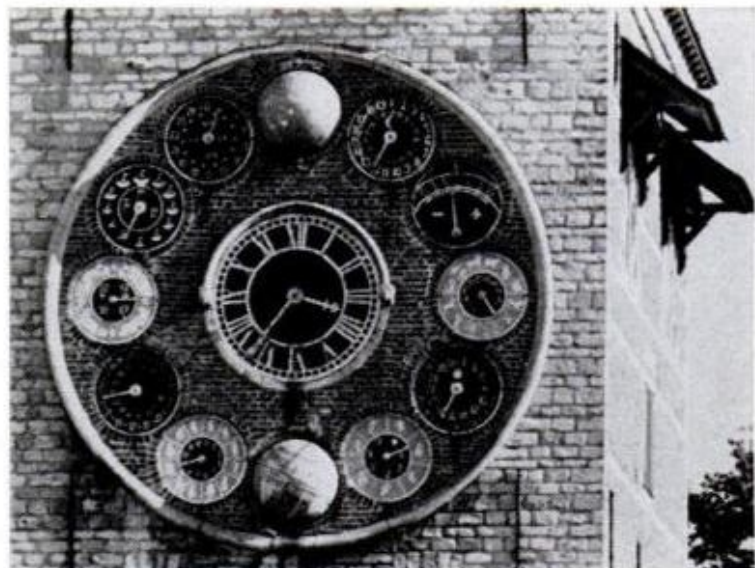

Everything you always wanted to know about time

The Zimmer Tower and an adjoining building in Lierre, Belgium, house some of the most remarkable timepieces in the world. In the tower are the Centenary Clock and the Astronomic Studio; in the adjoining building is the Wonder Clock. The Centenary Clock on the outside of the tower (above) tells the time of day, phases of the moon, the Metonic cycle, time difference between Greenwich and solar—and the like. Inside the tower, and powered

Landlocked

It looks like the answer to a sailor's prayer—a brand-new, beautifully appointed marina. The only problem is that it's miles from open water. However, the marina serves its purpose well: It's a showcase for the boats and other recreational vehicles built by companies of the Bangor Punta Corp. Located at Disneyland in Anaheim, Calif., the marina covers 3½ acres and holds 2 million gallons of water.

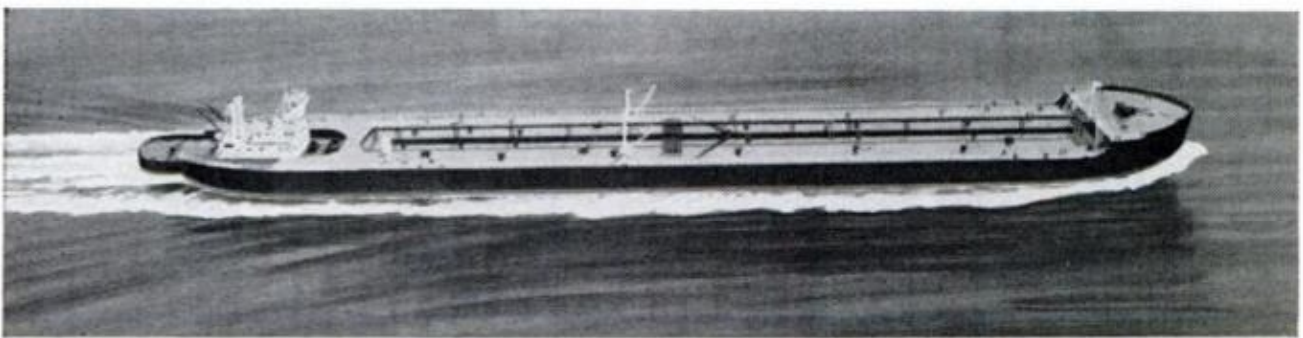

Tug nestles in stern of tanker barge

This drawing shows how the world's largest tug-barge will look when it goes into operation early next year. It's a combination of a powerful tugboat nestled in the notched stern of a 532-foot tanker barge. The oceangoing vessel is built of Armco steel.

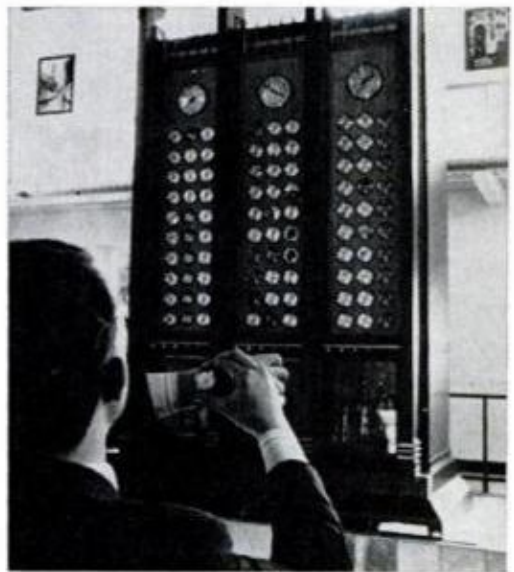
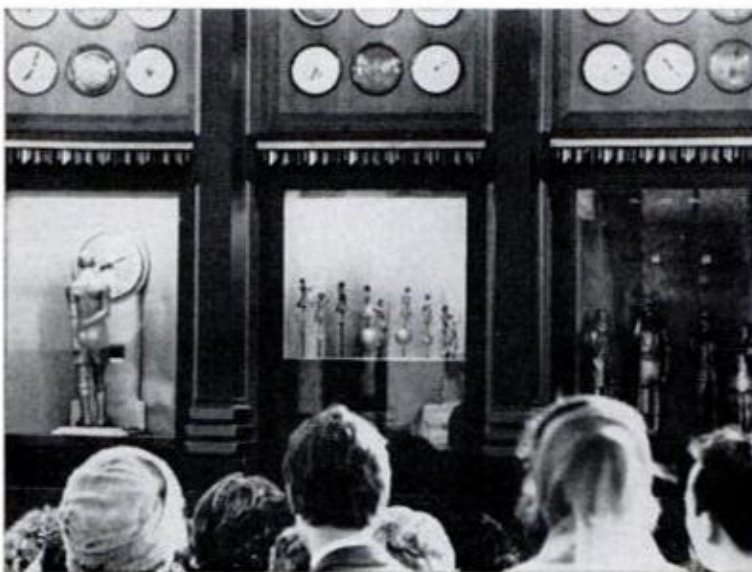

by the same pendulum and mechanism, is the Astronomic Studio with 64 dials, all giving different information. The Wonder Clock (above) has a single pendulum that runs 93 dials and 14 automatons. The automatons illustrate such things as man's relative weight on different planets. The many dials show times throughout the world, rotation of planets and the like. Genius behind the clocks is Louis Zimmer.



A Nationwide Survey Based on 2,034,000 Owner-Driven Miles

Handling Is Superb, Workmanship Great, But Where's Power?

By MICHAEL LAMM, West Coast Auto Editor/Photos by the Author

COULD NOT FIND an American-built car that can match the snug-fitting doors, trunk lid, paint job and overall quality of assembly throughout." So said an Illinois store manager. And an owner of the lowest-priced Mercedes 220 sedan reasoned this way: "After driving VWs for over 12 years and looking at U. S. cars, it seemed a natural move." Mercedes and VW, in fact, are the only two cars ever to receive insignificant workmanship complaints in *PM* owner surveys.

People fed up with Detroit workmanship are willing to pay the extra costs of owning and maintaining a

Mercedes which is among the few full and intermediate-sized cars imported to the United States. And while many owners complain that M-B prices are too high, they do pay them. Not only does initial ownership come steep, periodic dealer service is also expensive, usually \$45 to \$70 a visit for normal inspections and care. Parts and labor likewise run high, but to most Mercedes owners these costs are worth it. Says a retired Michigan auto service manager, "After seven new Cadillacs in 11 years, I've sworn off American junk."

In addition to admiring the way their

cars are put together, owners also have good things to say about handling, roadability, riding comfort, and safety. A New York aero engineer: "A great car to drive. Steering superb. Roadholding excellent. Brakes [4-wheel discs] very good. It goes where I point it [250 series] with great assurance." An Ohio farmer: "To one who had grown tired of driving, it has restored the pleasure of the road." A New Jersey salesman: "Handles like a sports car. Best brakes, most comfortable seats, no oversteer or understeer." And the owner of a 280-SE V8 coupe (one of the few around): "Very, very, VERY safe."

Along with all these self-congratulatory praises (a record high of 97 percent said they would buy another Mercedes, and 44 percent were already on their second) came a few discouraging words. Complaints weren't especially strong, nor were they made by the majority of owners. But some were persistent enough to form patterns.

For example, quite a few owners were displeased with their dealers. It should be pointed out that a certain percentage of owners of any car make will always be at odds with their dealers. But in Mercedes' case, the gripes centered on cost and availability of service. "Not enough service in this area." "Service poor due to shortage of qualified mechanics." "High prices of normal tune-ups are unbelievable." "Extremely hard to find service—needs more locations." "Appointments for service entail long waits."

On the other side, though: "So far treatment and service have been up to my highest expectations." And a Mississippi insurance broker says, "Unlike American car salesmen, M-B takes great pride in its product, and after the sale seems interested in how you like your car."

Turning again to complaints, a fairly strong one centered on horsepower. Not enough of it, said 10.7 percent of owners. Most vocal were drivers of the 220-D diesel. The D gets up a bare 65



DOORS ARE NOT BULBOUS like those found on most American cars. The reclining seats are standard



REAL WOOD graces 280 dashboard, which has plenty of glovebox plus extra storage inside central console

SCREW JACK fits into body side, has so much mechanical advantage that it's very slow to get car up

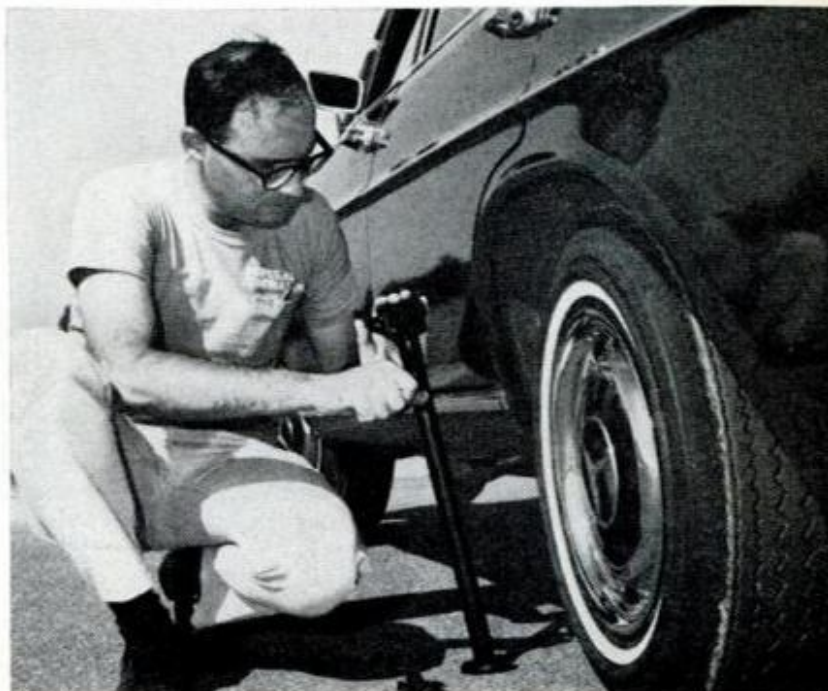



OWNERS SAY nothing but good things about M-B's ride, handling, brakes but many would prefer more power



PACKED ENGINE COMPARTMENT, metric wrench sizes, fuel injection (SE) scare owners off home repairs

SOME 10 PERCENT of all Mercedes come with sunroof. Most are opened electrically, but some are manual

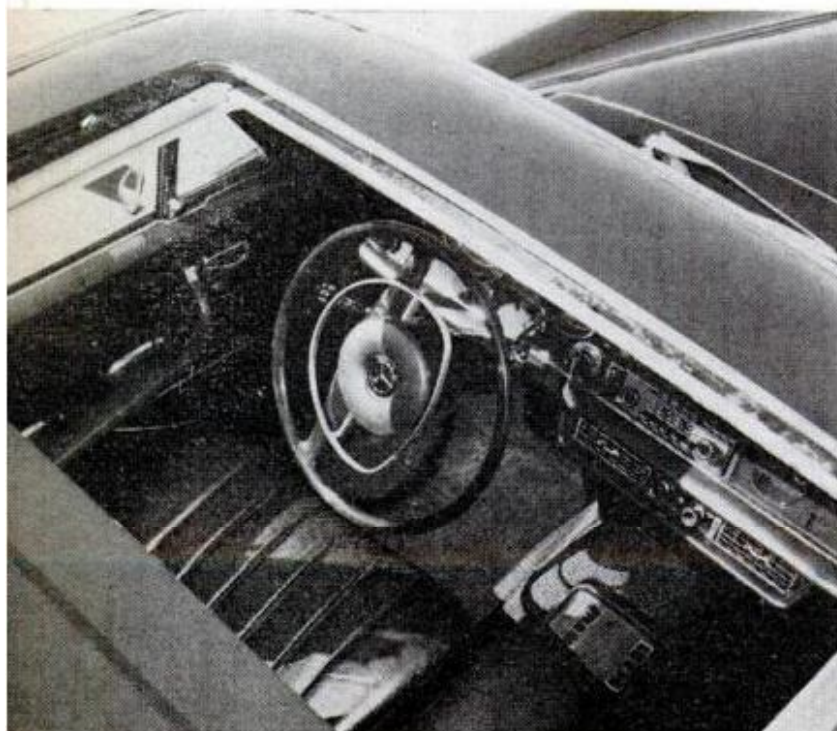

bhp, yet weighs 3230 pounds, same as, say, a 1970 Dodge Charger V8. This puts it at a considerable disadvantage at the stoplight. More than that, it makes pulling up even the gentlest hill quite a struggle.

Beyond the four-cylinder 220 and 220-D series, though, owners of other Mercedes also felt the lack of power. The non-fuel-injected six-cylinder 250 and 280 series develop 146 to 157 bhp, while the injected 280-SE, 280-SEL, and 280-SL get 180 bhp. Owners complain of paying large increases in price for small increases in horsepower. But the road handicap with these higher powered series isn't nearly so bad as in the 220s because all Mercedes weigh within a few hundred pounds of one another.

Quite a number of owners remarked that it was too bad the 3.5-liter V8 costs so much. A shame, they said, because their cars' handling and brakes could certainly stand that extra power, as could their many accessories.

Styling, which plays so large a part in owners reports of U. S. cars, got relatively little comment from M-B faithful. A New York management consultant said simply, "It's not a thing of beauty—functional, yes, and color choices, yes, but most Mercedes still have that same dull drabness." A Chicago fireman: "The fact that they don't go in for many styling changes keeps my car looking new." A Newport doctor: "Big, expensive grille and not much bumper protection for it."

About comfort: A New York violin-



280 SERIES has big, carpeted trunk, with jack and tools out of sight on right side behind spare tire



MOST OWNERS praise styling and appreciate lack of yearly model changes. Vision is good all around

ist: "The only car that equalled my 220 was a 1942 Packard 180 I owned long ago, and that was quite a car." A Westfield housewife: "Rides a bit stiff, but that's okay." A Chicago investor: "I like the front seats, but passengers complain about curved seat-backs on long trips."

General gripes: "High cost of service." "Radial tires should be standard." "Transmission jerky." "Tappet noise excessive for such a high-quality machine." "Brakes squeak terribly in re-

verse." "Constant troubles with turn signals."

About diesels: "It vibrates too much at low rpm; also a six-cylinder diesel sure would help pickup." "Great fuel economy. I drive 30,000 miles a year, get 22-25 mpg at 25 cents a gallon." "Gasoline engines aren't nearly so dependable." "I like my 220-D because it never needs tune-ups, gets terrific tire mileage." "Acceleration is very poor." "You just about have to go back

(Please turn to page 199)

Summary of 1970 Mercedes-Benz Owners Reports*

Total miles driven 2,034,994

Average miles per gallon:

134-cu.-in. 4 (220)	
local driving	17.6
long trips	21.5
134-cu.-in. 4 (220-D)	
local driving	24.8
long trips	27.6
152-cu.-in. 6 (250)	
local driving	15.6
long trips	19.0
170-cu.-in. 6 (780-S)	
local driving	15.4
long trips	18.7
170-cu.-in. 6 (280-SEL)	
local driving	15.1
long trips	17.8
170-cu.-in. 6 (280-SL)	
local driving	14.6
long trips	18.3

(N.B.: Samplings for V8 models too small to tabulate.)

Series:

220	6.4%
220-D	25.8
250	24.3
280-S	7.6
280-SE	16.7
280-SEL	8.0
280-SE 3.5	0.4
280-SL	9.1
300-SEL 3.5	0.0
300-SEL 6.3	1.9
600	0.0

Transmissions:

Automatic	73.3%
4-speed manual	26.7

*Percentages might not equal 100% due to rounding and/or insufficient data.

Why did you choose this car?

Quality	40.6%
Operating economy	14.2
Reputation	10.0
Workmanship	8.8
Performance	8.4
Past experience	8.1

Specific likes:

Handling	50.8%
Comfort	42.8
Economy	26.1
Workmanship	21.6
Styling	20.1
Roadability	17.1
Brakes	15.9
Quality	15.5
Performance	13.6
Ride	10.2

Specific dislikes:

Dealer service	22.1%
Lack of power	10.7
Gas mileage	6.9
Airconditioning	5.7
Brakes	3.8

What changes would you like?

More power (220-D)	8.1%
Styling	5.8
Better airconditioning	5.8
Lower price	5.4
Seat style	4.9
Better dealer service	4.5

Had any mechanical trouble?

No	62.9%
Yes	37.1

What kind of trouble?

Airconditioning	20.2%
Transmission	12.8
Power steering	9.6
Soakolugs	8.5
Electrical	7.5

Did you repair it yourself?

No	99.0%
Yes	1.0

Dealer repairs satisfactory?

Yes	68.8%
No	31.2

Is this your only car?

Yes	34.8%
No	65.2

Other cars owned:

Another Mercedes	19.2%
Chevrolet products	17.4
Volkswagen	15.7
Ford products	11.6
Oldsmobile	11.0
Dodge	5.2

Age distribution of owners:

15-29 years	9.5%
30-49 years	49.3
50-plus	41.2

Would you buy another Mercedes?

Yes	97.0%
No	3.0

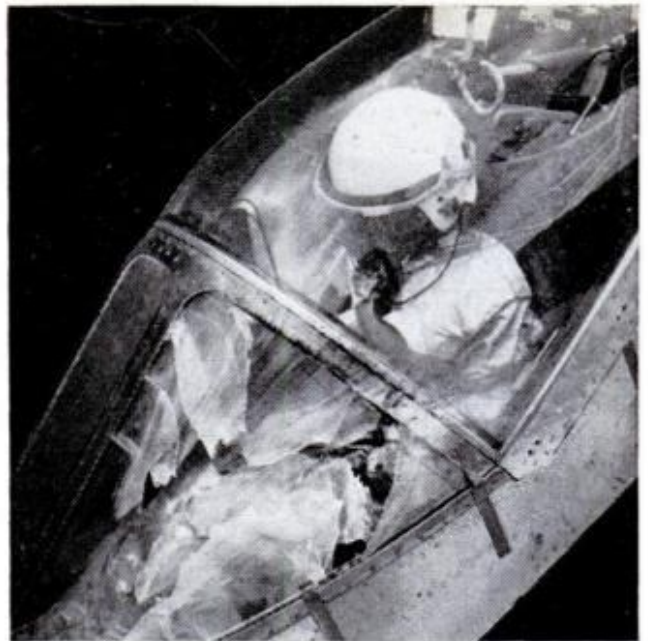
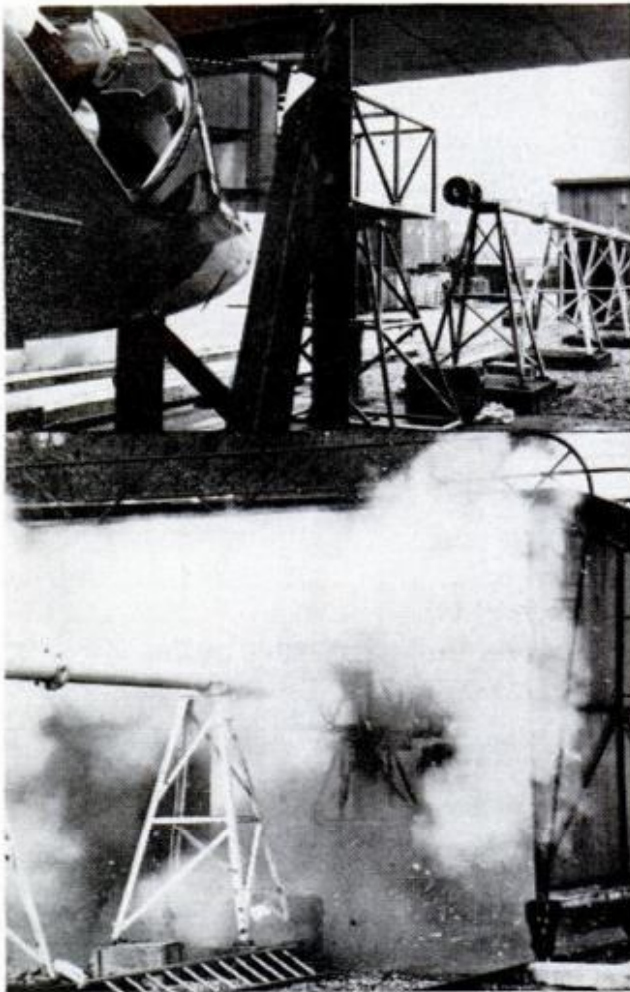

700-mph chicken in flight

To study—and perhaps prevent—the damage that a bird can cause to a high-speed jet plane, scientists at Britain's Royal Aircraft Establishment fire dead 3½-pound chickens at the windscreens of aircraft. The "bird gun" uses compressed air to launch the chickens at a speed of 700 mph. At upper left, a jet fighter is positioned before the gun, the gun fires (left), and a hole appears in the windscreen (above). At 700 mph, even a pigeon can break a ¾-inch windscreen.



Schizophrenic house

Two German brothers, who had been in complete agreement about everything until they decided to build a house for the joint use of their families, came up with quite different tastes in architecture. The brothers are dead, but the house still stands in Zeyern.



Her own monorail

Marianne Schenck of St. Louis, who is afflicted with multiple sclerosis, uses a steel beam and pulley system to move from her front porch to the sidewalk below. Her father, a mechanical engineer, designed the system for her.



Hefty lock

Still in use in Nurnberg, Germany, is a 460-year-old lock that weighs nearly 450 pounds. The key alone weighs $4\frac{1}{2}$ pounds. The job took the lockmaker nearly two years.



Measuring cap

A plastic cap, the Meterette, seals, measures and dispenses liquids. The user dials desired quantity, presses the bulb to draw up the liquid, then presses again to dispense it.



Watch those hands

For some now-unknown reason, the town clock of Regensburg, Germany, has big hands pointing at the hour and small hands at the minutes. (Above: It's 10:23, not 4:53.)



Big shot

Known as a rampart gun, this 9-foot-long, 100-pound weapon fires a handful of marble-sized shot. It was made in India about 1770 and is now owned by a London antiques dealer.

IS THERE A THREE- WHEELER IN YOUR FUTURE?

The Bond Bug has bitten teens in England and could spread to the United States. Like other three-wheelers, it shows up best in city driving

By MICHAEL LAMM
West Coast Auto Editor

A VERY SUCCESSFUL THREE-WHEELER is now being built and marketed in England. It's the Bond Bug, a car which the magazine *Autocar* predicts will become "... the Mustang of its class."

The Bug stands out in any crowd as a cute, sporty, economical gadabout that's aimed primarily at Great Britain's younger drivers. It might just catch on with ours as well.

Most people think of three-wheelers as unstable, far out and tricky, but they're not necessarily so. Actually, you see more of them around than you realize. Your postman likely drives a Cushman three-wheeled mailster. Golfers scoot around on three-wheeled electrics.

Three wheels can never equal four, but they're coming closer. The world's first car, the Cugnot steam tractor of 1769, was a three-wheeler. Since then, plenty of trikes have come along but few have stayed. Most succumbed to tipsiness. Improperly engineered, they tend to fall over at the most embarrassing moments.

Yet their advantages are undeniable. Three-wheelers are easier and less expensive than four-wheelers to build, easier to streamline, they turn and maneuver more sharply, and they resist frame flexing totally.

This country has never had much use for three-wheelers. GM and other major automakers are working half-heartedly on mini-commuter cars, and some have only three wheels. In the past, several developers tried to

BOND BUG'S perky wedge-shaped styling appeals to kids. It can be driven by 16-year-old with motorcycle driver's license

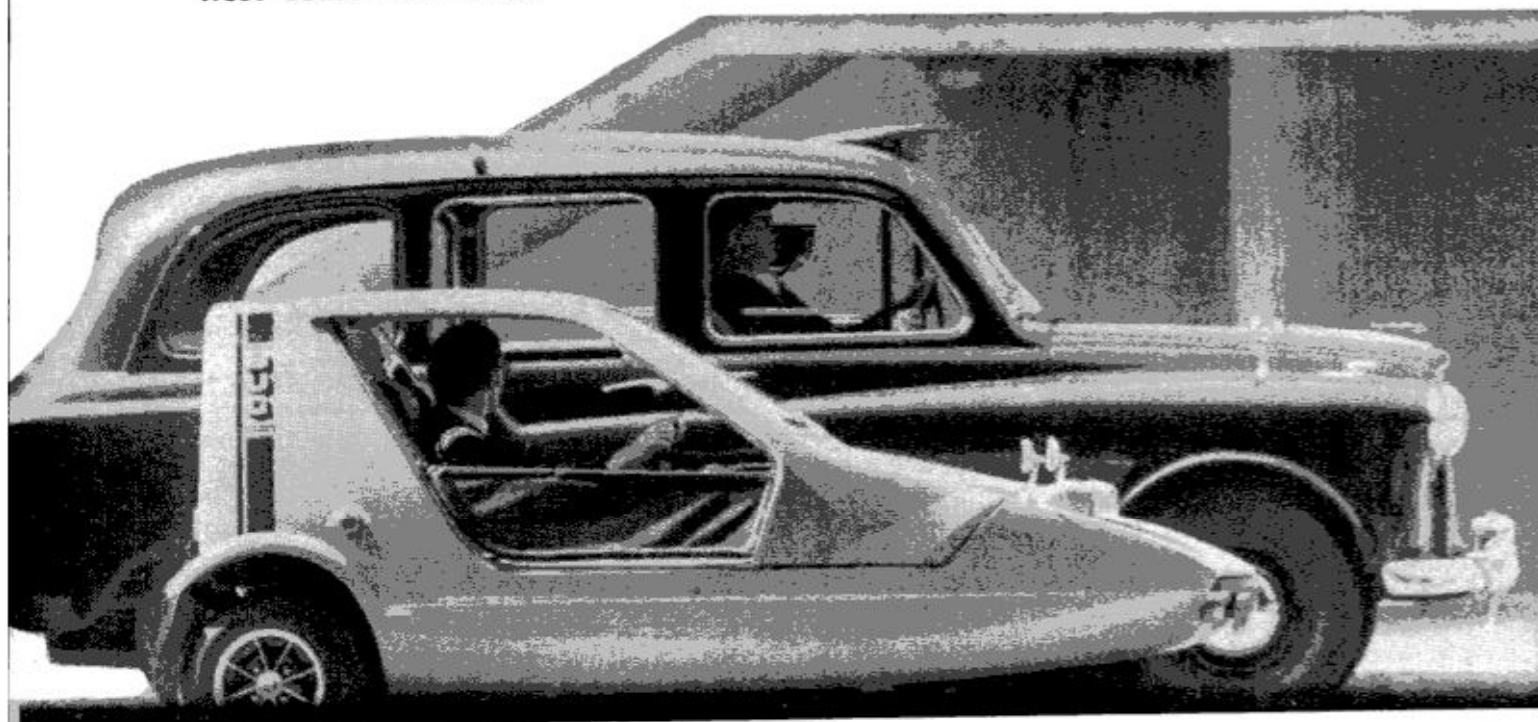

produce three-wheelers—among them Paul Lewis in 1937 with the Airo-mobile (he's planning a comeback) and Glen Davis in 1948 with the Davis.

Davis's latest idea is to make a *practical safety car*. The triangular body shape of a three-wheeler "makes it bounce off" objects run into. Head-on collisions would result in glancing blows rather than dead stops if two Davis cars hit, or if a Davis hit a conventional car. But more interesting is how Davis proposes to build.

First, while he uses the three-wheel configuration, he's talking about a six-wheeler—each wheel with two tires. This gives a higher load capacity and guards against blowouts.

The body is made up of air-filled module sections that fit inside a steel frame completely surrounding the car—all sides as well as forming a rollbar over the roof. Pumping up these modules with air holds them in place inside the frame. Thus passengers sit surrounded by air and rubber. Meanwhile, the outer face of the perimeter frame is edged with high-bounce plastic.

The seats, also inflated, stand just ahead of the rear axle. Steering comes by a handlebar arrangement on an extensible stalk. This extends from the

BODY is made of two pieces of fiberglass. Entire canopy/roof lifts for access. There's even a trunk

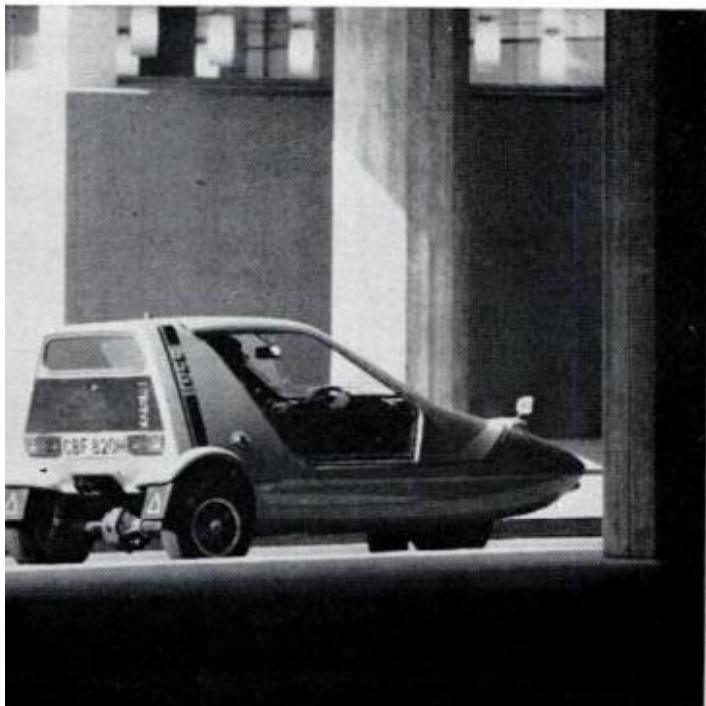

Three-Wheeler Maneuverability

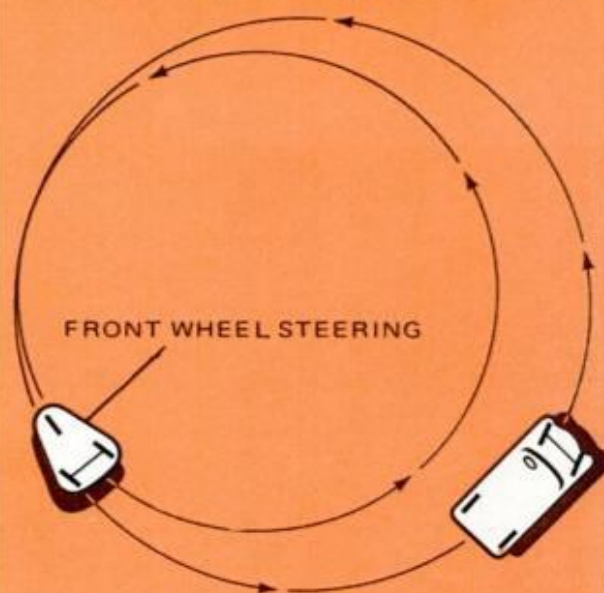

TWO-FRONT-WHEELS configuration with the front wheels steering allows a smaller turning radius than a four-wheel vehicle because of the shorter wheelbase and, usually, larger wheelwells

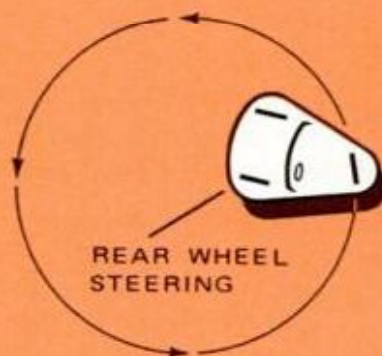

SINGLE REAR-WHEEL STEERING theoretically allows vehicle to turn in twice its own length if rear wheel can be cocked 90°. Hard to park, however, because front can't be maneuvered easily

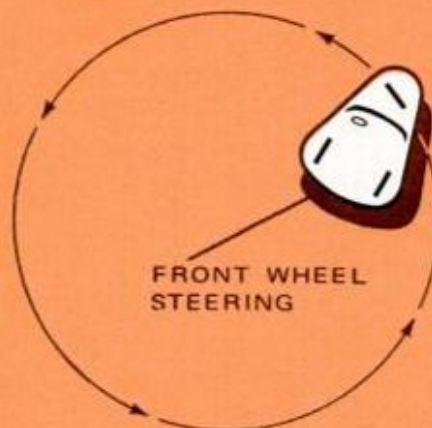

SINGLE FRONT-WHEEL STEERING gives a turning circle that is between that of double front-wheel steering and single rear-wheel steering. This type of vehicle has good maneuverability



BUG'S SNAP-OUT UPHOLSTERY makes washing easy in sporty 700ES. Lesser versions are more spartan

central strengthening chamber — another air-filled module that runs full length between the two seats. On impact, the steering stalk swings back toward the center of the car, out of the driver's way. The windshield is so far ahead of the driver that, with lap belts, his head could never touch it.

What about an engine? Davis says that any lightweight powerplant will do. He mentions the VW flat Four as fitting nicely, either in front or behind.

Davis has no government contract or grant to pursue this project. He developed his ideas privately. Whether he can launch production depends on overcoming lots of hurdles.

The Bond Bug, though, appears to have possibilities, even for the United States. Styled by Tom Karen of Ogle Ltd., it grew from scratch-pad doodlings to reality and now seems likely to end up as a national British craze.

In England, the Bug can legally be driven by anyone with a motorcycle license, which means 16-year-olds. At age 18 you can buy a Bug Budget Package for roughly \$500 down. This gets you the car, insurance, license and warranty for two full years.

The Bug comes in three versions: a standard 700, which excludes such frills as spare tire, side curtains and heater;



LOW SEATING, cramped cockpit merely add to three-wheeler's appeal, as does its good maneuverability

the mid-range 700E; and at the top, the hot and fancy 700ES. Factory prices range from \$1304 to \$1497.

The Bond Bug is wedge-shaped and open looking. Its ohv, four-cylinder, in-line, aluminum, water-cooled engine stands just behind the single front wheel and drives the rear wheels through a four-speed floor-shift transmission. Power output is 29 bhp in the standard 700/700E, 32 bhp at 5000 rpm for the 700ES.

There's a stubby square-tube frame that ties front and rear wheels together. Other than that, the body consists of two halves, both fiberglass and both molded in one piece. The upper half forms the roof canopy and part of the hood. This hinges upward from the front and gives access to the passenger compartment. Two rather recumbent "lounge" seats carry ribbed black upholstery that snaps out for washing.

When first seeing the Bug (or any other three-wheeler) everyone asks: "Is it safe?" Yes, according to every British magazine testing it, but you have to know how far not to push it.

To quote *Autocar*: "Adopting the technique of slow-in, fast-out and never stamping on the throttle before the apex, a sporty driver can hustle the little bug through corners very fast

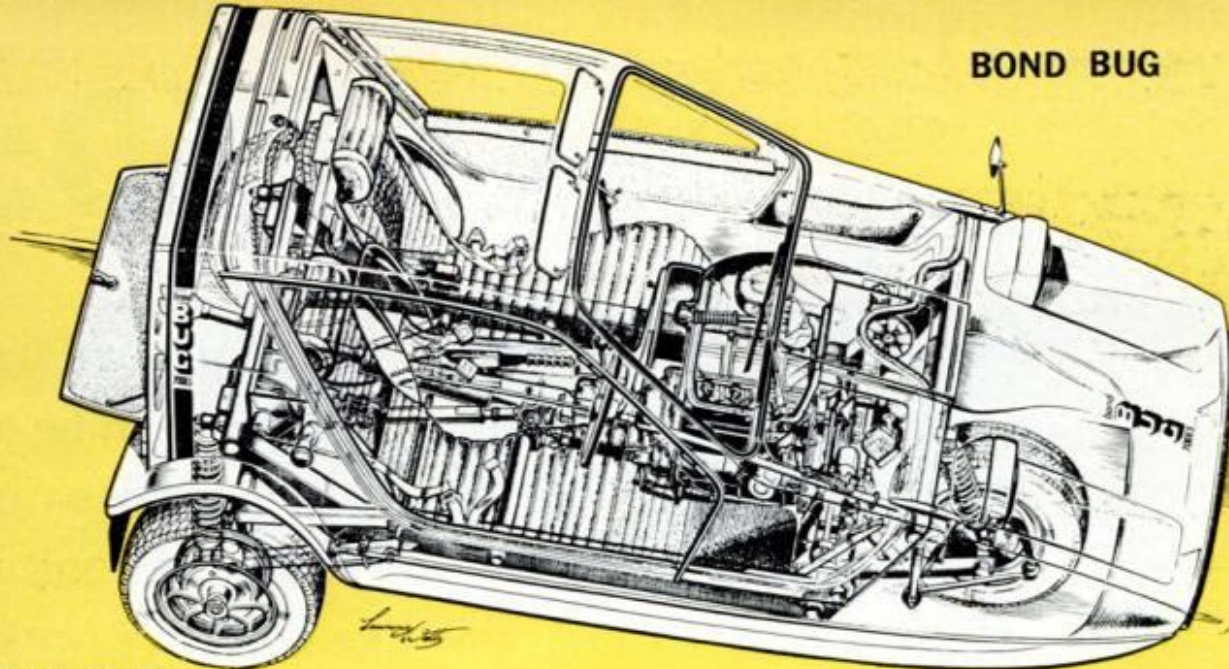

© Autocar 1970

ALL IS SIMPLE, accessible. Stubby square-tube frame lashes front, rear wheels together. Aluminum four-banger rests alongside passenger's legs, connects to four-speed gearbox, shaft drive to differential

and much faster than anything else with three wheels. There is an inherent feeling that at the limit the Bug will topple before it slides, and that alone is the biggest deterrent to youthful indulgence."

Britains honed their trike-driving techniques in such cars as the famous Morgan three-wheeler. The little Mog survived from 1910 through 1951 and was quite fast. Yet it was completely unlike the Bug, having the single driving wheel behind. Other three-wheelers are still being made in England, notably the Reliant. The Bond Bug shares many of the Reliant's parts but not its staid appearance.

Performance lets the Bug keep up with normal traffic, yet its nearness to the ground makes it feel much faster. Top speed approaches 76 mph, while 0-60 mph takes 23 seconds. The quarter mile comes up a bit sooner. Fuel consumption runs around 30 mpg in normal driving. Whether the Bug can catch on here the way it has in England remains to be seen. Three-wheelers have the great advantage of maneuverability, so for suburban housewives, commuters and others who make short trips in tight quarters, they might be the answer. So yes, there could be a three-wheeler in your future. ★★ ★

BOND BUG SPECIFICATIONS (Front engine, rear-wheel drive)

ENGINE	
Cylinders	4 in line
Main bearings	3
Cooling system	Water pump, fan and thermostat
Bore	2.38 in.
Stroke	2.4 in.
Displacement	43 cu. in.
Valve gear	Overhead pushrod and rockers
Compression ratio	8.4 to 1, 95 octane
Carburetor	Zenith 301Z
Fuel pump	AC mechanical
Oil filter	AC full-flow renewable element
Max. power	31 bhp @ 5000 rpm
Max. torque	38 ft.-lb. @ 3000 rpm
TRANSMISSION	
Gearbox	4-speed, no synchro on 1st
Gear ratios	Top, 1.0 Third, 1.45 Second, 2.46 First, 4.27 Reverse, 5.49
Final drive	Hypoid bevel, 3.55 to 1
CHASSIS, BODY	
Construction	Separate steel chassis, fiberglass body
SUSPENSION	
Front	Leading arm, coil spring, telescopic damper
Rear	Live axle, double trailing arms each side, coil springs, Panhard rod, telescopic dampers and antiroll bar
STEERING	
Type	Worm and peg
Wheel diameter	12 in.
BRAKES	
Type	Drum front and rear
Swept area	88 sq. in.
WHEELS	
Type	Pressed steel, 3.5 in. standard Cast alloy extra, 5-in. wide rim
TIRES	
Size	155-10 in.
Type	Decathlon bias-belted

WANTED:

Locating "bugs" planted by industrial spies can be a profitable business—if you know electronics and like detective work

By MORT SCHULTZ

THE SMALL ADVERTISEMENT tucked away in *The Wall Street Journal* read:

"Elimination of electronic eavesdropping devices." That was all, plus, of course, the identification of the company offering the service.

Why would someone offer a service for a problem that had been eliminated by law? The Omnibus Crime Control and Safe Streets Act of 1968 outlaws the use of electronic eavesdropping equipment ("bugs") by other than law enforcement agencies and calls for a stiff fine of \$10,000 and a five-year jail term if violated.

Apparently the law hasn't stopped eavesdroppers. This conclusion was verified later by William LaHiff of Sapan Engineering, New York City, the company that had placed the ad.

"Legislation to the contrary, much industrial eavesdropping is going on," he told me. One estimate is that approximately \$2 billion a year in secrets is stolen from industry via the electronic bug route. This means that the law has a big bark but no bite.

Electronic bugs are wireless. An eavesdropper can relax and listen over a receiver that looks like a radio in the safety of his car or a nearby room.

In the early days of bugging, mi-

POPULAR MECHANICS



COUNTERMEASURES EQUIPMENT includes models used with headsets or hand-held like that above



ELECTRICAL OUTLET in office of Wall Street firm contained a "bug" (right) hooked to tape recorder

Electronic Detectives

crophones were used. The eavesdropper needed time to plant a mike and run its wires to a pickup device, such as a tape recorder. If uncovered, the wires could be traced to the pickup, almost surely leading to identification of the eavesdropper.

Today's electronic transmitters are tiny and readily concealed. When an eavesdropper gains access to an office on one pretext or another—for example, claiming to be a telephone repairman—he can hide a bug in the phone or in such places as light fixtures, plants, bookcases, rugs, plastic tape dispensers and cigar humidors. Only one transmitter per room is needed. Modern bugs can pick up and transmit normal conversation for a distance of one mile. Companies pay handsomely for someone who can find hidden transmitters. Ben Jamil of Continental Telephone Supply Co., New York City, says his fee is \$100 per room.

"When I'm hired on a yearly basis, I get from \$3000 to \$5000 for sweeping a company clean every two or three months," he claims.

Although the money is attractive, the field isn't overcrowded. Even in the highly industrial Northeast, I found only the two companies mentioned plus one other, Criminal Research

Products, Inc., of Conshohocken, Pa., that said it had a debugging service.

If there are more, they aren't talking. A spokesman for one company that once dealt in debugging explained, facetiously I thought, that "since the law makes bugging illegal, there's no need for debuggers."

Richard F. Sirchie, president of Criminal Research Products and a noted authority on bugging, offers a more valid explanation for the apparent scarcity of debuggers:

"Many outfits that once offered a debugging service also sold bugging equipment. This is now illegal, and these companies have gone underground so they can continue in this lucrative business. To avoid attention, they no longer engage in debugging which requires advertising."

The fact that industry needs debugging specialists was verified by several industrial officials.

"Law or not, we can't afford to take the chance that we're not being bugged," a spokesman for an electronics firm told me. "That's why we retain someone to inspect offices and conference rooms."

The companies I asked are those that eavesdroppers consider as prime targets. They are in electronics, textiles,



"CIGAR" found in executive dining room of pharmaceutical company gave away secrets until located
JANUARY 1971

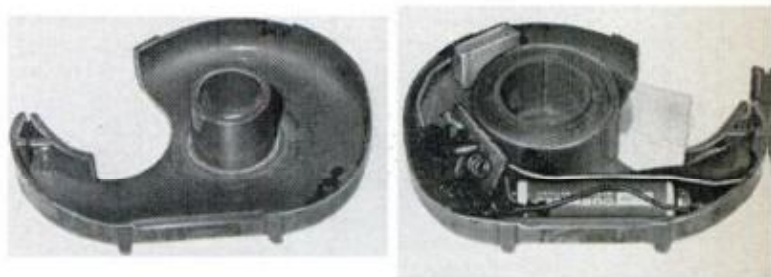

PLASTIC TAPE DISPENSER on executive's desk was hiding place for this battery-powered transmitter

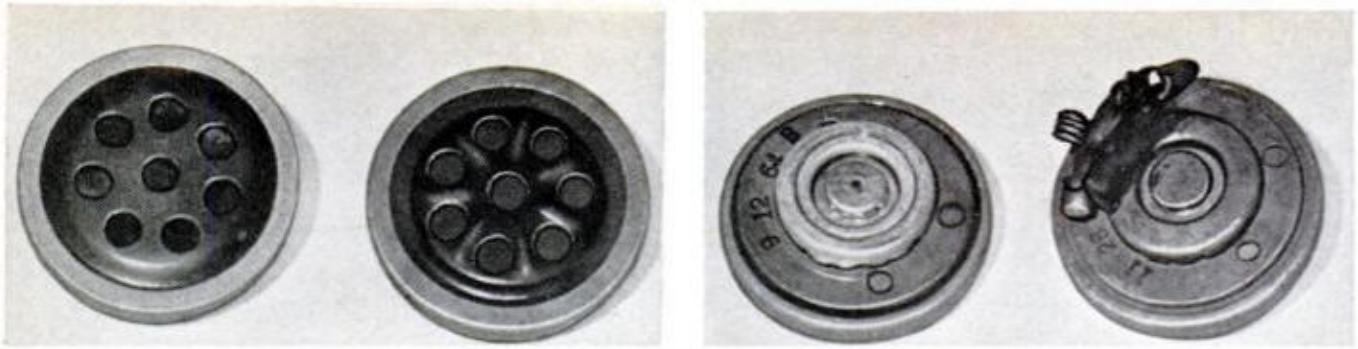

TWO TELEPHONE MOUTHPIECES at left seem identical when unscrewed from instrument. Debugging specialists check these first to look for the kind of tiny transmitter discovered on back of one (far right)

fashions, chemicals, pharmaceuticals, and other businesses that depend upon new ideas and processes for existence.

How does one become a debugger? A background in electronics, especially theory of alternating current, is essential. This gives a basic understanding of how transmitters work.

Sophisticated bugs don't need self-contained batteries for power. One bug I saw not only looks and acts like a telephone transmitter, but uses phone power for its operation.

To plant this bug, the eavesdropper unscrews the phone's mouthpiece, removes the real transmitter and drops the bug into its place. When the receiver is lifted, the bug is activated. The eavesdropper need never worry about a dead battery.

A background in electronics also allows a debugger to save a sizable chunk of cash by providing him with the mechanical knowledge he needs to build his detection equipment. The basic detector used by a debugger operates in the 72 to 108-megacycle range. It costs \$175 and can be purchased from most electronic supply houses. However, someone who has the knowledge can build it for less than \$20.

A debugging specialist must be patient and meticulous. Bugs do not yield to a haphazard search. Each part of a room must be examined with extreme thoroughness.

Hooshang Eliasi of Continental Telephone, who learned debugging in his native Iran before coming to the United States, told me of a case that

demonstrates the need for persistence. It involved a famous pharmaceutical company in New York that had lost several secrets to a competitor.

A two-day search of offices and conference rooms revealed nothing. On the third day, Eliasi examined the executive dining room.

After scanning utensil bins, tables, light fixtures, walls, ceiling and rugs, he was about to leave when he spotted a cigar humidor on a shelf in the back of the room. Opening it, he pointed his detection meter's probe at the cigars and got a reading.

Eliasi proceeded to unwrap each stogie until he found the bug inside the tobacco wrapper of a cigar that was lying on the bottom of the box. Since the humidor was refilled every few days, with new cigars placed on top of those on the bottom, there was little likelihood of someone "smoking" the bug.

To get a feel for how difficult it is to debug a room, I asked a New Jersey private detective agency to give me a brief indoctrination. I started by doing what I had seen on TV. I ran my fingers around picture frames. That exterminated one bug.

The detection meter the detective had loaned me uncovered others. One was taped beneath the desk. Others were found inside a lampshade, in a potted plant, pinned to the drapery and taped to a volume of an encyclopedia. These were all obvious spots that someone looking for bugs would examine.

It took me 20 minutes to find these transmitters, but my self-satisfaction

was shattered when the detective said, "There are more."

Two hours later when I finally gave up, the detective looped the telephone cord around the detector's probe, called the number on another phone and lifted the receiver. The meter showed a reading. The phone was bugged.

I had probed the phone, too, but had simply scanned the case. My method had not simulated calling conditions that activate this bug so I had no indication of a transmitter on my meter.

The detective now walked to a wall. Holding the probe downward so it almost touched the wall, he practically crept along the wall. After several minutes, there was a rise of the meter's needle.

The detective then slowly scanned back and forth until the maximum reading of the needle showed that he had keyed on the bug. It turned out to be the wall outlet; that is, a bug that looks like a wall outlet and allows the person being bugged to use it as such.

Examining the lower part of the wall took the detective a full 10 minutes. "That's how carefully it must be done," he commented.

When a man is ready to start as a debugging specialist, he lets industry know of his availability by advertising in trade journals.

If you wish to read more about debugging, *The Electronic Invasion* by Robert M. Brown (1967, John F. Rider, New York, publisher) is an excellent source. Brown is a leading authority on electronic transmitters and offers an encouraging word for someone who thinks that debugging affords a potentially good business opportunity.

Brown says that since industrial eavesdroppers don't usually use the extraordinarily sophisticated and very expensive bugs that international espionage agents employ, a good industrial debugger will almost always uncover the bug. Debugging offers a legitimate, possibly lucrative, business opportunity to those who know electronics and like detective work. ★★★

JANUARY 1971

Keep Those Copies of Popular Mechanics!

WHERE did you see that article on constructing a power hacksaw? Now that you're ready to build a screened patio, where's the *PM* article that tells you how? You vaguely recall seeing a great idea for lifting a tilted section of concrete sidewalk—but in what issue?

If you already are saving copies of *PM* (as a good many readers do), then it sometimes may be frustrating to have such authoritative information and useful ideas stored right there on your shelves, yet have difficulty finding a particular article when you're ready to go to work.

In the December, 1971, issue, *PM* will announce the availability of an inexpensive *Annual Index* (this one covering the year 1971) combined with an attractive shelf cover that will hold all 12 issues. You simply slip this beautiful cover right over those 12 copies. Then, whenever you want to refer to any article or find information on any subject, you slip off the cover and check the "Instant Index" that's bound inside. It will be thoroughly cross-referenced and will enable you to find any of the hundreds and hundreds of valuable *PM* articles in seconds.

The *Annual Index*—and shelf cover—will multiply the usefulness of your copies of *PM* many times over.

If you're not already saving *PM*:

- Start saving your copies this month.
- Watch for the announcement of the *Annual Index* in the December issue.



Homebuilt Steam Car Takes to the Road!

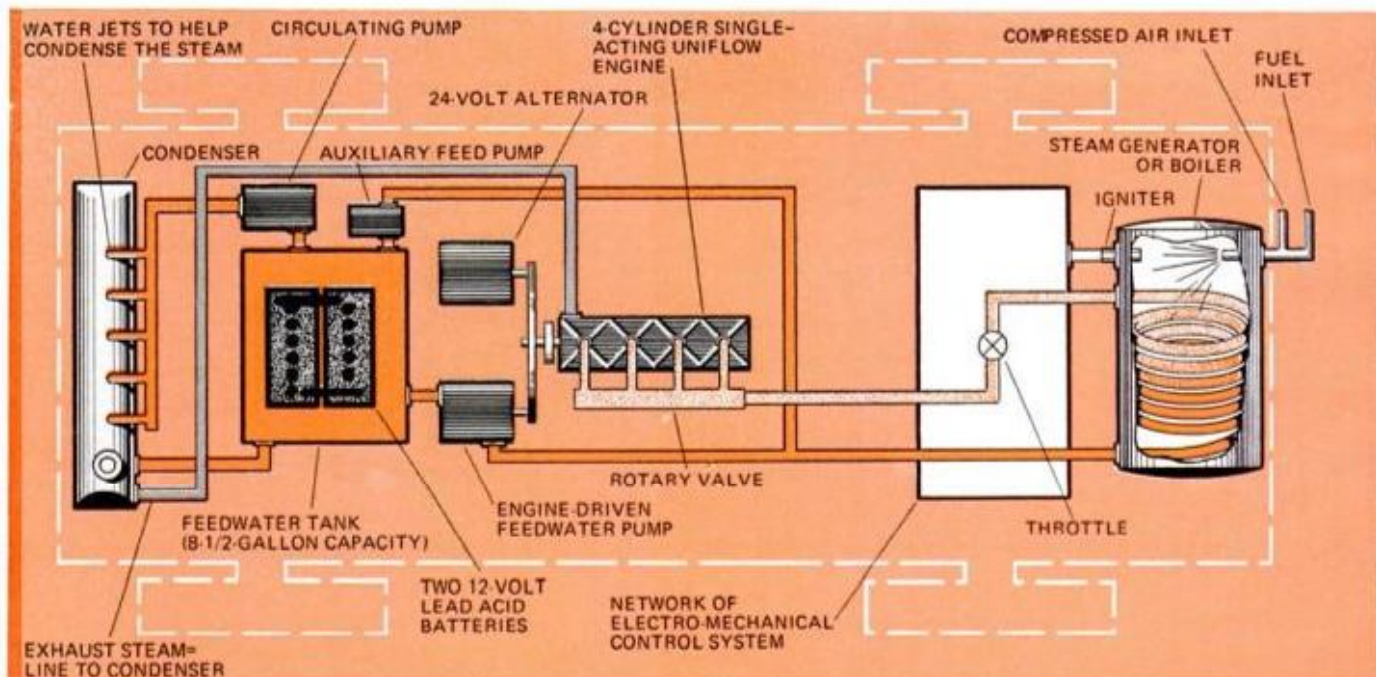

The Barretts didn't wait for an alternative to the infernal internal combustion engine. They made their own!

By JOSEPH ZMUDA

STEAM POWERPLANTS emit very low levels of pollutants, so mechanical engineer Peter Barrett and his son Philip took a Triumph TR-2 chassis and built a steam car. Simple. Except it wound up being a several-year project.

They started with a basic steam-plant design of consulting engineer Richard J. Smith who developed a working rotary valve and previously converted a Volkswagen sedan to steam. Heart of the Barrett steamer is a four-cylinder Mercury outboard marine engine, which was converted with the aid of castings supplied by Smith and then machined to fine tolerances by Philip.

The steam is produced in ample quantities by a specially-designed once-through boiler or vapor generator that consists of 400 feet of copper and steel tubing wound in pancakelike coils stacked upon each other and connected in series to provide a continuous circuit from end to end. Water is pumped from a storage or feed tank into the



STEAM GENERATOR or boiler operation is explained to crowd by Philip Barrett (above), who with his father built the steam car on an old Triumph chassis. Condenser that converts supersaturated steam back to water is mounted on front end of car (below)

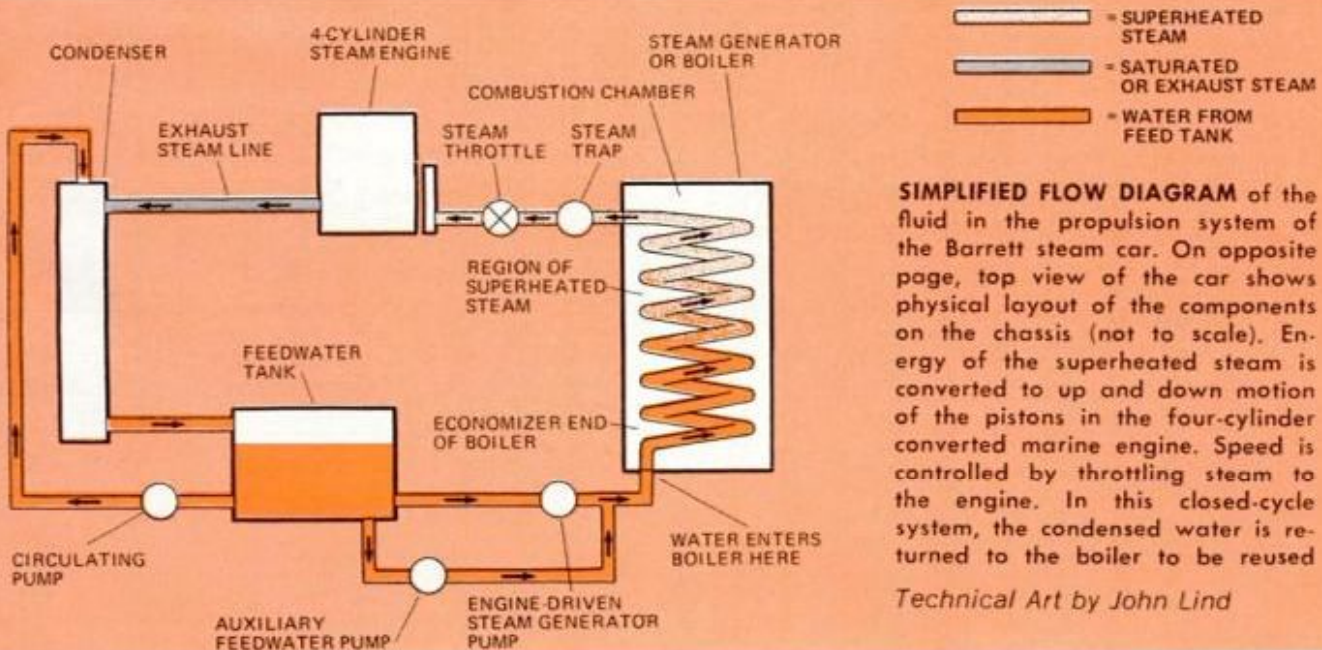
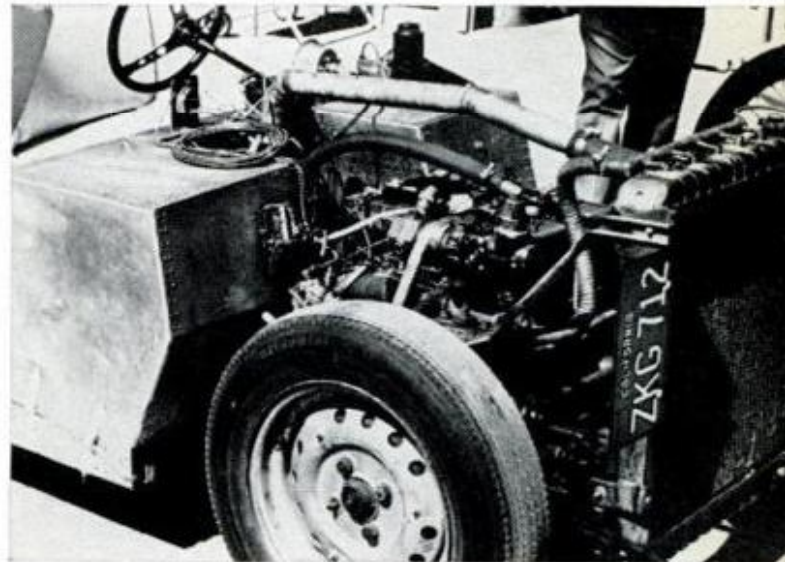

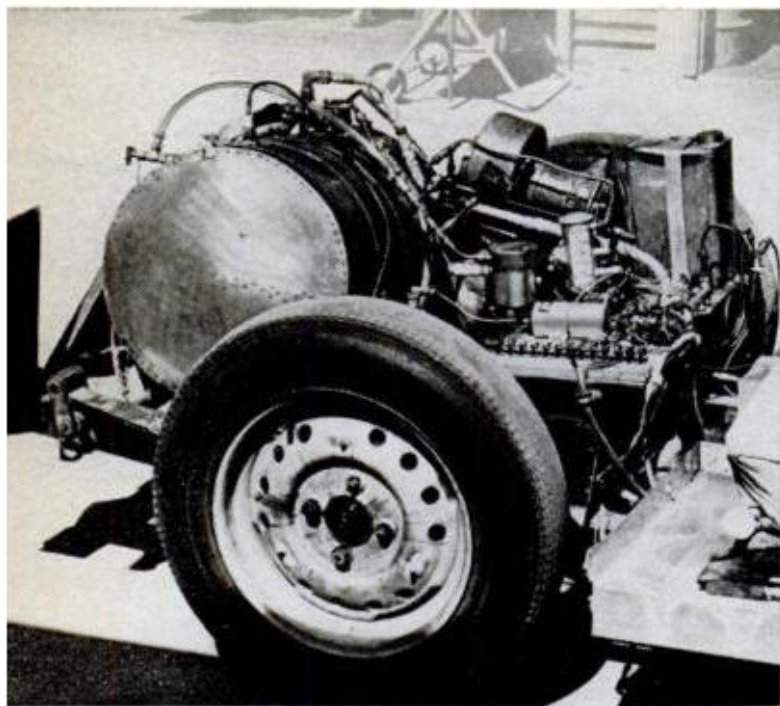

HIGH-PRESSURE STEAM is 700 psi and 650°F. as it leaves rear-mounted boiler on its way to the engine

vapor generator. Fuel is mixed with air in a combustion chamber (the burner), and the ignited flame is swept across the water-filled tubes. In 10 to 15 seconds the water turns to steam at 650° F. and 700 pounds of pressure per square inch. This high-pressure steam forces its way out of the opposite end of the boiler and is directed to the engine inlet.

Steam is admitted to the cylinders by a rotary valve which consists of specially-machined castings with stationary ports. An outer sleeve is driven by a timing chain connected to the engine. A normally, fixed-position inner sleeve can be rotated 128° from the forward running position in order to put the engine into reverse.

Once the superheated steam has performed its useful work, it must be converted back to water in order to conserve the operating fluid and begin the cycle again. This is the function of the condenser, which is a radiatorlike device that's mounted on the front of the car for better access to cooling air.

Major complaint of steam engineers for decades is that often what appears to be simple gives designers the biggest headaches. Philip stresses that

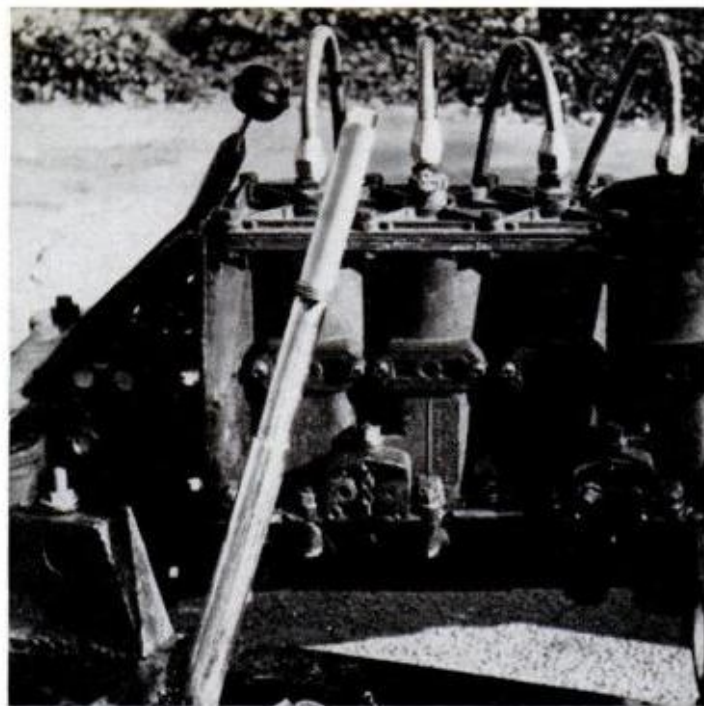

CONVERTED ENGINE, with pistons driven by steam, puts out between 30 and 50 hp. Car has gone 50 mph

they would have been lost without the technical advice supplied by Richard Smith and by engineer Karl Peterson.

Innovations are many in the Barrett steamer. To begin with, the large quantity of air used in combustion is not admitted directly to the burner but is preheated by passing it between the hot walls of the boiler. This assures a more complete burning of the fuel, cuts down on emissions, and it also gets a higher heat value out of the steam.

Ignition in steam cars is usually achieved by a simple sparkplug, but Peter Barrett designed a more efficient electrode igniter. Paint thinner is used as fuel because it is cheap and has a good heat release. Of course, kerosene, diesel oil or any liquid fuel will also work.

Because condensing the large quantities of steam produced by a once-through boiler has always been considered the chief drawback of modern steam plants, the Barretts turned to a Smith-inspired radiator design that utilizes a water spray to help condensation.

Smith's explanation of just how the "jet condenser" works has been scoffed

(Please turn to page 200)



Temporary skyline

This cluttered skyline was, fortunately, only a temporary addition to Le Bourget Airport near Paris. It's "Expomat," a display of equipment used in the building trades.



Soviet electric truck

Photographed alongside a conventional car is the Soviet Electromobile, an electric truck that can carry 1000 pounds at 30 mph to a distance of 50 miles on one charge.

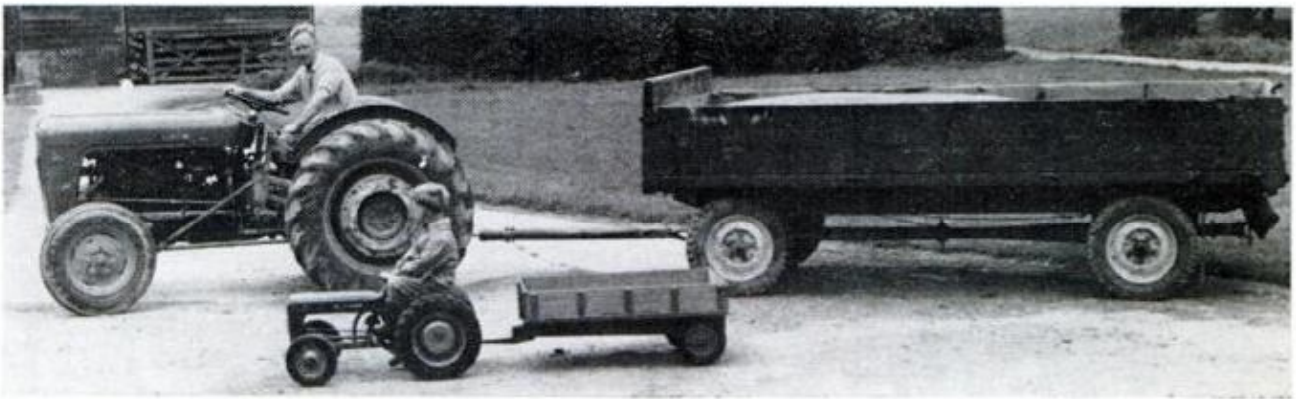

Here's one way to put a 5-year-old in the driver's seat

When his 5-year-old son kept begging to drive his farm tractor, J. G. Hynard built him a miniature replica of the full-size machine, complete with a wagon.



'Auto destructive art'

Trixi Kent calls her art "auto destructive art," which is literally true because she begins by blowing up an old car. She then selects pieces she wants and takes them back to her studio to be painted (right). The results are hung or sold to dealers.





LIKE TWO SMALL EYES, twin light meters in a Nikon nestle behind prism on either side of viewfinder, as indicated by arrows on photo. The two meters backstop each other to insure an accurate reading

Built-In Light Meters *...Eyes That See*

Highly accurate, but not foolproof, these handy aids are made in three types. Here's what you should know about what they can—and can't—do

By PHIL GERACI

Technical Art by Peter Trojan and John Lind

ONE OF THE BIGGEST photographic aids to come along in recent years is the built-in exposure meter—the tiny electronic light-measuring device that hides right inside your camera. Today, nearly all makes of single-lens reflex cameras offer some kind of behind-the-lens (BTL) metering. The added cost is surprisingly little—often less than what you'd pay for a good hand-held light meter.

The advantages are considerable. You don't have to figure your exposure by

guesswork or fuss with a separate meter. The built-in meter sees the scene just as you see it in the viewfinder and instantaneously records the amount of light available. Because it's behind the lens, it automatically compensates for any accessories you add in front, such as filters, lens extenders or extension tubes.

A BTL meter consists of a pea-sized cadmium sulfide (CdS) cell, usually hidden behind the prism on top of the camera. Powered by a small battery, it acts as a light-sensitive variable resistor, regulating the amount of current flowing through the circuit depending on how bright or dim the scene is. This moves a meter needle up or down in the viewfinder. The exposure is correct when you adjust the camera's settings so the needle is centered. Some cameras use two CdS cells, one on each side of the prism, so they act as a check on each other for maximum accu-

How Three Different Metering Systems Work

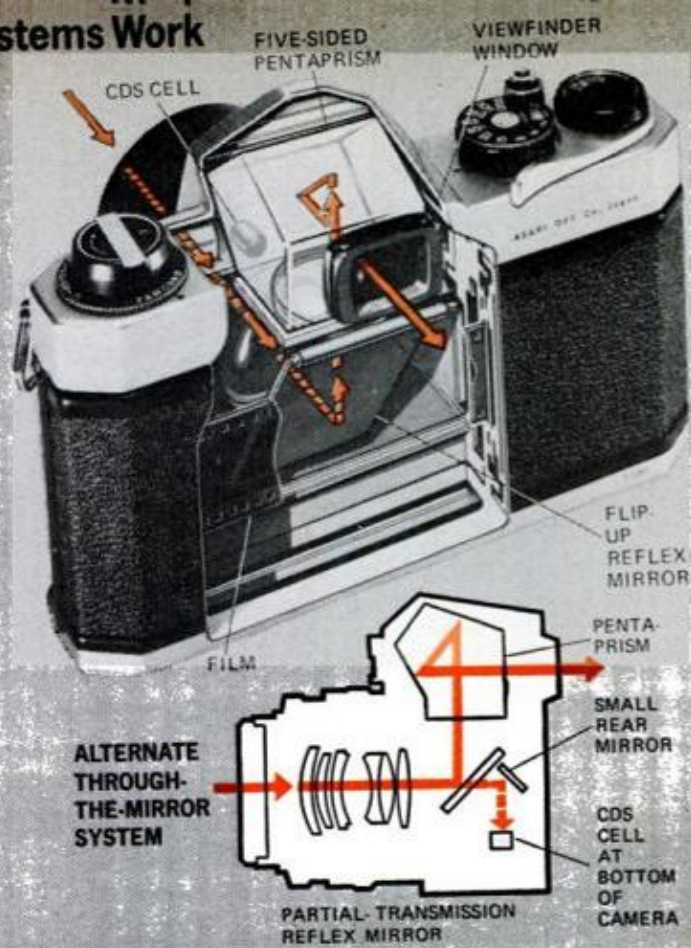
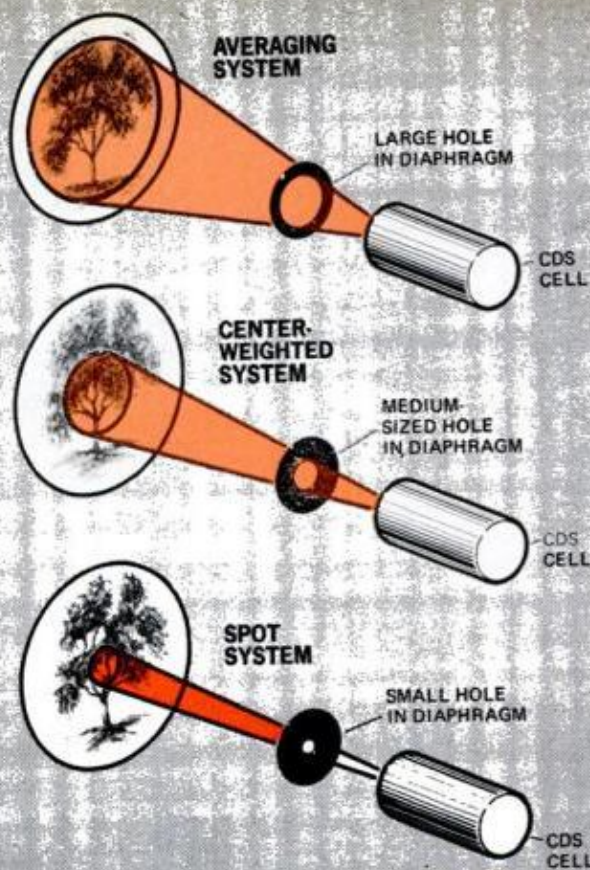

METER COVERAGE is determined by size of hole in disc placed in front of a light-sensitive CdS cell. Angle of view varies from broad in averaging meter to pinpoint in spot meter. The narrower the angle,

the more accurate the meter reading, but the smaller the area sampled. CdS cell is usually located behind the prism, but in some cameras it is behind the mirror, receiving light through a small hole

What You Can't

What You See in the Viewfinder



NEEDLE POINTS HIGH—TOO MUCH LIGHT



NEEDLE POINTS LOW—TOO LITTLE LIGHT



NEEDLE CENTERS—EXPOSURE NOW CORRECT



METER NEEDLE shows up inside the viewfinder window along one edge, making it easy to adjust exposure settings without even removing the camera from your eye. If pointer is low, it indicates too little light; if high, too much. All you do is turn either the speed or diaphragm control until the needle is centered in the window and you have the correct exposure for that picture-taking situation

JANUARY 1971

the light; if high, too much. All you do is turn either the speed or diaphragm control until the needle is centered in the window and you have the correct exposure for that picture-taking situation

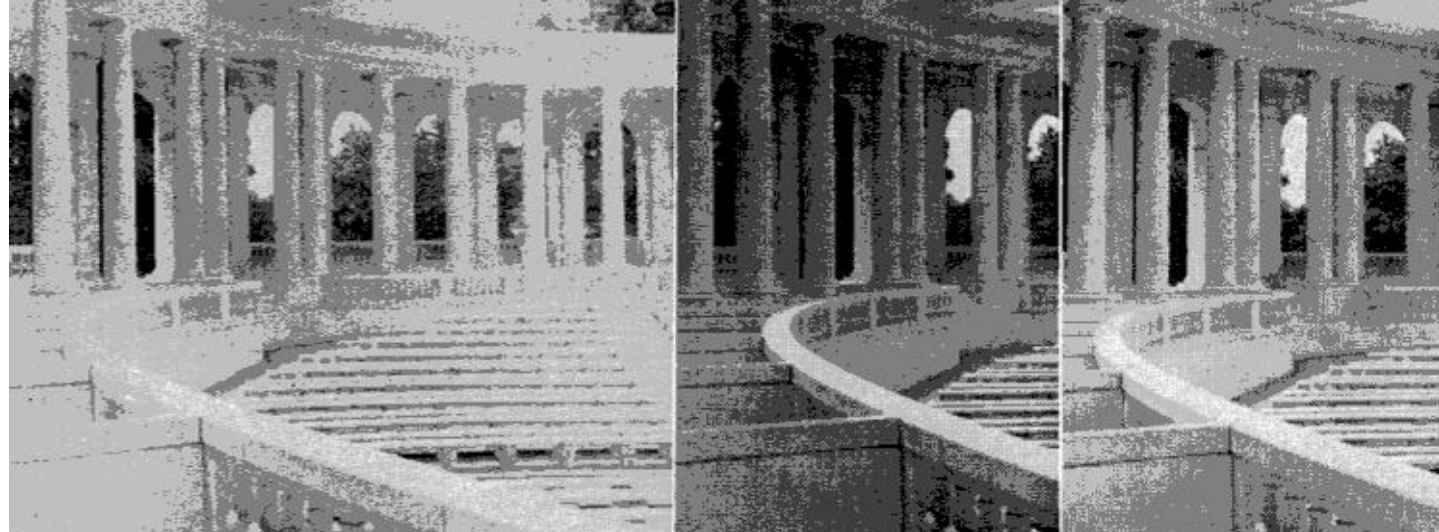

HOW SPOT METER gives different readings depending on where it's pointed is shown above. At left, it reads shadows behind columns, indicating exposure of 1/250th at f/11 for Tri-X. This washes out

racy. In most systems, simply set your ASA film speed into the circuit by turning a dial, then watch the meter needle. You can select the desired shutter speed, then vary the diaphragm opening until the needle centers, or you can start with the opening you want and adjust the speed until the needle centers. Either way, the exposure will be the same.

This independent control of both shutter and aperture is important because it lets you shoot at high speeds and large openings when you want to stop motion or at small openings and slower speeds when you need maximum depth of field and sharpness. In some systems, the speed and/or aperture settings are adjusted automatically for you. This offers simple point-and-shoot convenience, but it may also limit your choice of settings. In some automatics, the speed is fixed and only the aperture is varied, or the aperture may be fixed and the speed varied.

Such systems are handy, but don't offer the flexibility of manual control. If you choose an automatic, be sure there's a manual override that lets you select your own combinations of settings. Many fixed-lens, rangefinder cameras also incorporate built-in meters, but these do not operate through the lens and thus do not offer all the advantages of an SLR with true through-the-lens metering.

There are three BTL metering systems used by different manufacturers—averaging, center-weighted and spot. The type you choose affects, to some extent, the way you use your camera. Averaging meters have a broad angle of coverage, taking in the whole scene. Their readings are a compromise of all the light and dark

lighter foreground areas. At center, it reads high-light areas and underexposes the scene at f/22. At right, center-weighted meter correctly balances shadows and highlights to give proper exposure of f/16

areas electronically averaged out to one optimum exposure.

Averaging meters work fine on scenes where the lighting is reasonably even and uniform. They can be fooled, however, by unusually bright or dark areas. The typical back-lighted beach scene with the subject in shadow against a brilliant expanse of sand or water is tough for an averaging meter. It tends to read too much surrounding brightness and to underexpose.

By contrast, spot meters have a very narrow angle of coverage, seeing only a small portion of the scene at the center. They're much more accurate for the particular area they're aimed at, but are also more difficult to use. If they're pointed at a small dark area surrounded by a lot of brightness, they may correctly read the dark spot but ignore the brightness and end up overexposing the rest of the picture. Also, your subject may not always be at the center of the scene.

Professional photographers like a spot meter because they can read highlight and shadow areas separately and then adjust their exposure for the particular effect they want—say for maximum shadow detail at the cost of some washing out of highlights. But this calls for pointing the camera in different directions, studying the various readings and then making mental adjustments—a time-wasting nuisance for the casual snapshotter.

To get around the problem, a few cameras like the Mamiya offer dual metering. You can change from averaging to spot at the flip of a switch depending on what the scene calls for. Another approach to the problem is the center-weighted system used in the Nikon and other cameras. In

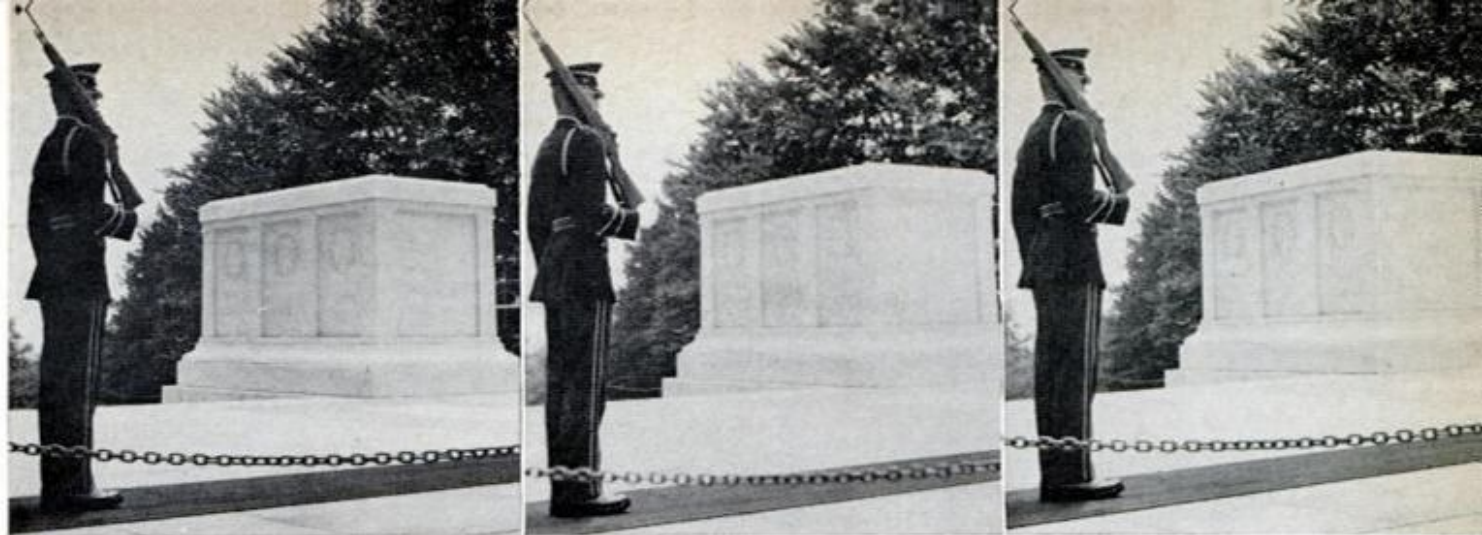

AVERAGING METER can be fooled by large light or dark areas in a scene. At left, it overcompensates for bright glare from marble monument, making the soldier go dark. At center, spot meter aimed at

the soldier's head correctly lightens the face and uniform at the cost of some detail in monument. At right, center-weighted meter gives good detail in both soldier and background despite marble's glare

this, the meter takes two readings—one near the center of the scene and one of the surrounding area farther out. The center reading is given somewhat more weight on the theory that this is the most important part of the picture, but the surrounding area is also taken into account.

Cameras with center-weighted metering are easy to use and avoid many of the drawbacks of spot and averaging systems, but they aren't foolproof—no meter is. Strongly back-lighted scenes are a challenge for any system. Here, the answer is to do exactly what you would if you were using a separate hand-held meter. You have to move in close, take a reading directly on your subject, set your camera, then back off and snap the picture. This way, you can keep extraneous light from

entering the lens and throwing your meter reading off.

As a rule of thumb, set your shutter to no less than 1/125th of a second to insure action-stopping speed, then vary the diaphragm until the meter needle centers to get your aperture. This combination should cover about 80 percent of all picture-taking situations. If the light is weak, open your lens to one stop below wide open and adjust the shutter speed instead. This will give you maximum speed at an opening that is still reasonably sharp. Even center-weighted meters must occasionally be shifted around to sample various portions of the scene, just like a spot meter. If readings vary widely, strike a happy medium between the extremes and bracket this a stop or two on both sides. ★★★

SHOOTING IN DEEP SHADE is good example of where averaging or center-weighted meter does better than spot. At left, spot meter reading sunny opening in trees underexposes foreground. At center, same me-

ter reading soldiers' faces gives good detail here, but still underexposes uniforms. At right, averaging meter correctly exposes foreground, even though wider opening makes background go out of focus

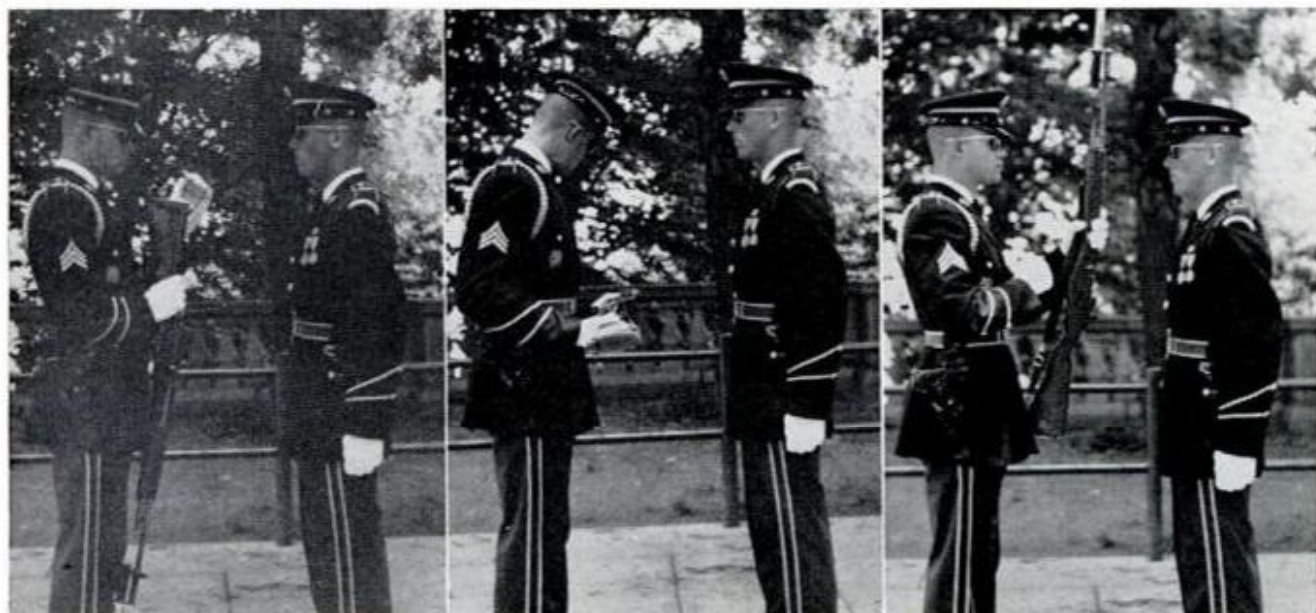

Just patented

PM'S PICK OF THE NEW INVENTIONS

Prepared in cooperation with Roger S. Shashoua, Director, International Inventors Assn., Inc.

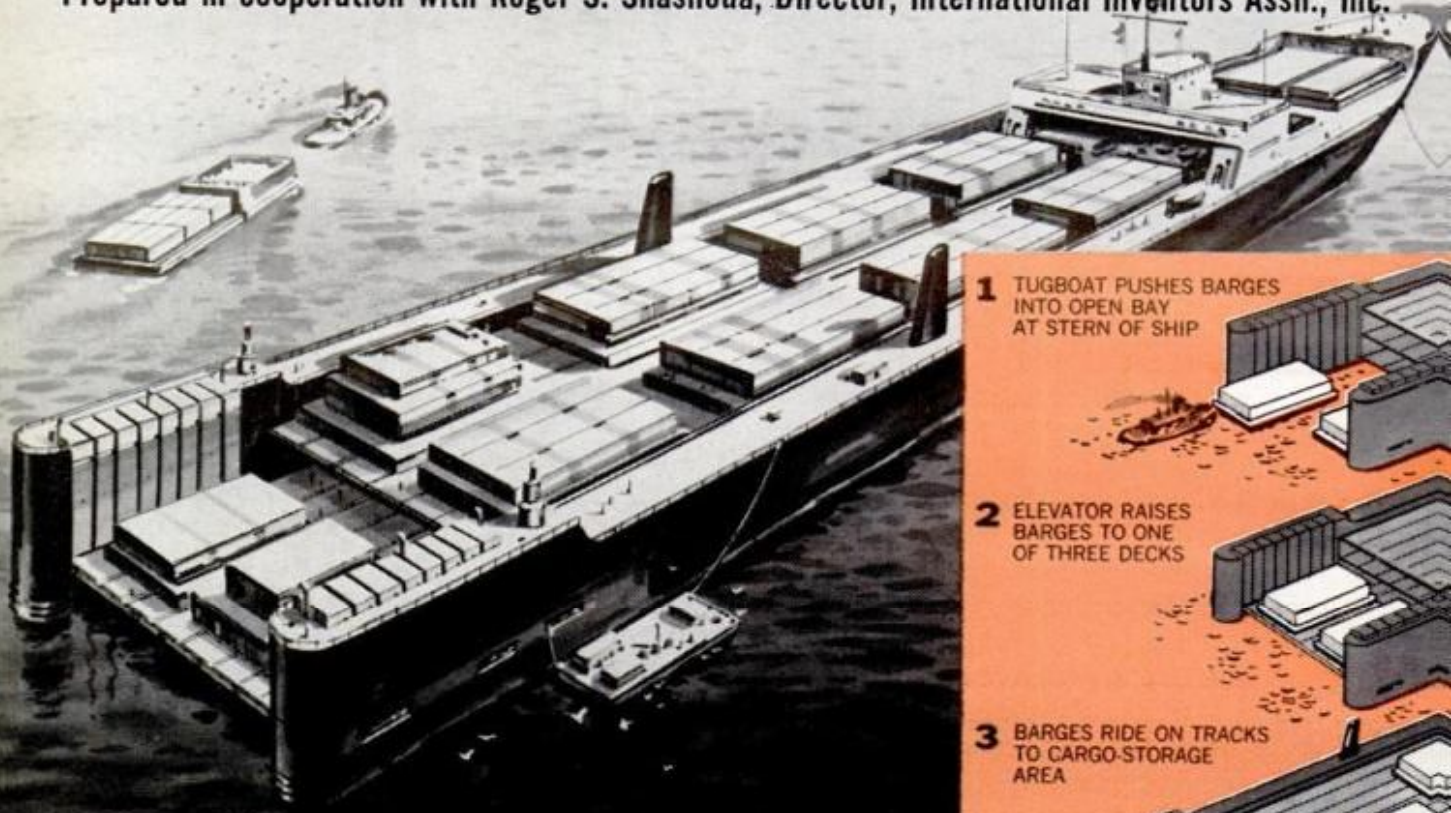

1. FULLY LOADED BARGES are carried piggyback by this giant ocean-going transporter. The idea is to speed overseas shipments by eliminating the tedious job of transferring cargoes from barges to larger freighters. The barges are floated into a water-filled bay at the stern of the transporter, then a huge elevator lifts them to one of three storage decks. There, they're rolled along on tracks and stacked in rows for the trip. At their destination, the loaded barges are launched by the elevator and continue on to foreign ports through inland waterways

1 TUGBOAT PUSHES BARGES INTO OPEN BAY AT STERN OF SHIP

2 ELEVATOR RAISES BARGES TO ONE OF THREE DECKS

3 BARGES RIDE ON TRACKS TO CARGO-STORAGE AREA

Illustrations by Roy GE

2. REVOLVING PLATFORMS on the novel railroad cars below are designed to permit fast loading and unloading of military vehicles, cargo vans and heavy construction equipment. Hydraulically operated

ramps at the ends of the platforms swing down to the ground so vehicles can be driven easily on and off the cars. When they're retracted, the ramps become barriers to help keep the vehicles in place



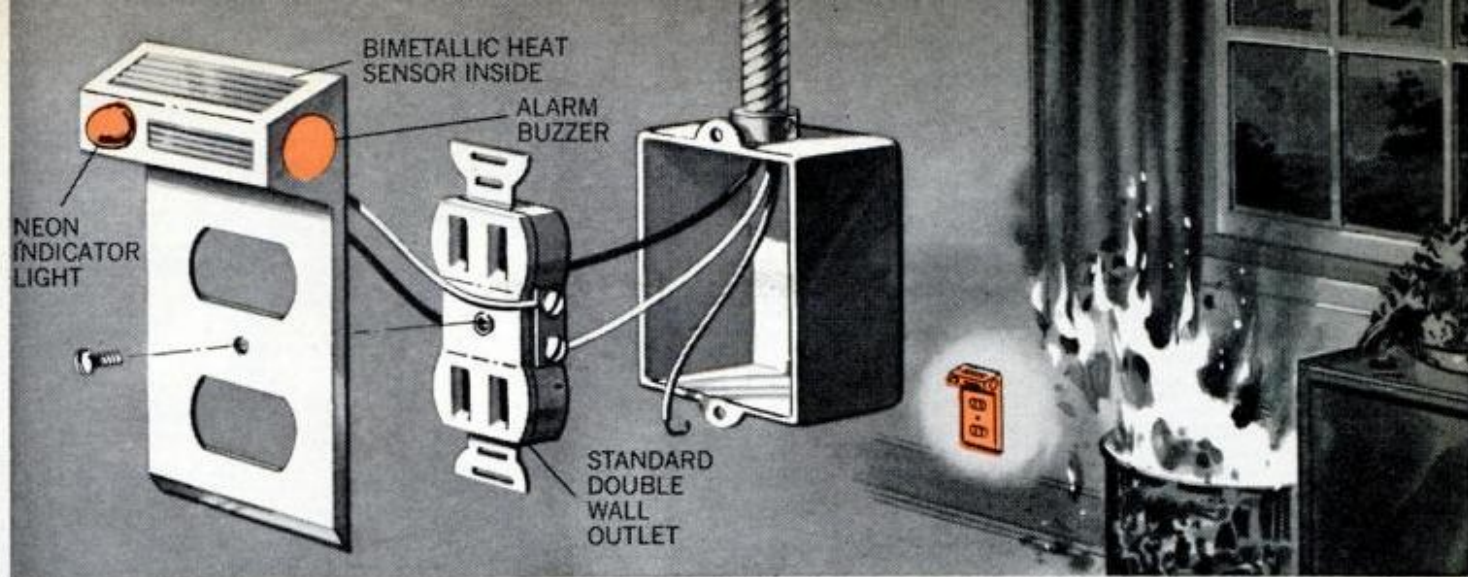

3. EASY-TO-INSTALL FIRE ALARM attaches in seconds to any wall outlet. You just remove the regular cover plate, connect two wires to terminals on the receptacle for power, then fasten the alarm's plate over the outlet. A bimetallic heat sensor

sounds a warning buzzer if there's a sudden rise in temperature. A neon indicator light goes out to signal a power failure or other malfunction. The alarm is said to sense fire within a wall that otherwise might become dangerous before being detected

4. STRAP-ON HAND GAUGE helps you align bricks accurately when building a wall. A metal plate hooked to your thumb runs under the palm of your hand and extends several inches to the rear. You simply set each new brick in mortar and press gently downward until you feel the plate rest on the adjacent brick already in place. This keeps all of the bricks at the same level as you work along the wall

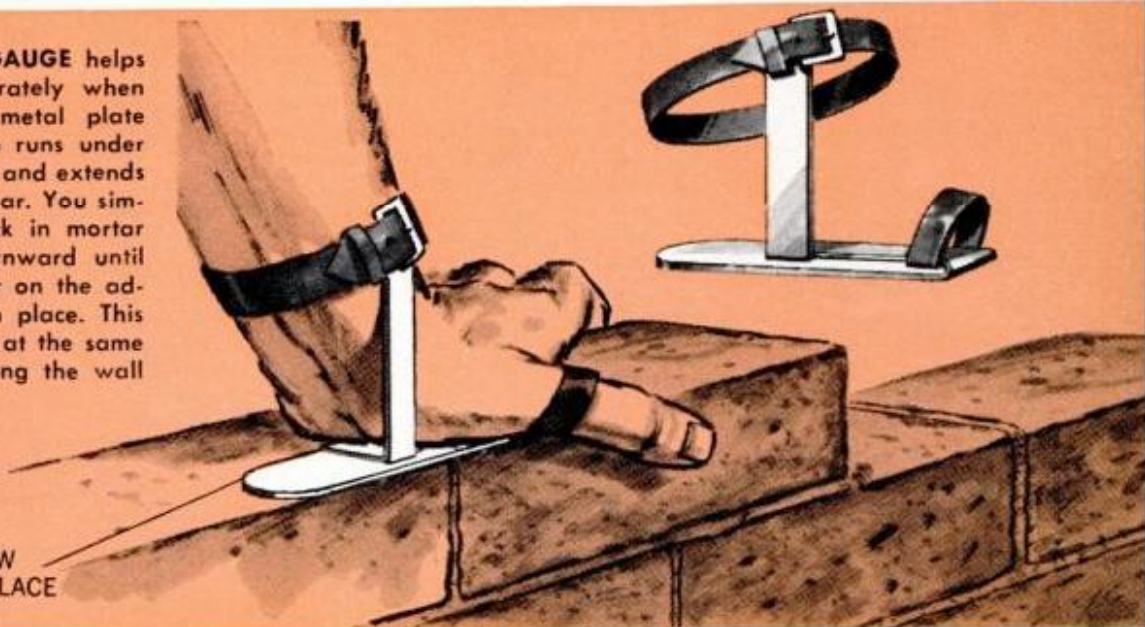

GAUGE STRIP LEVELS NEW BRICK AGAINST ONE IN PLACE

5. INSTANT AIRPORTS are possible with this simple method of putting down plastic runways. The technique is similar to fiberglassing a boat hull or car body. Fiberglass material is laid out flat over grass or dirt, then sprayed with a polyester resin. The resin hardens quickly, forming a tough, smooth landing surface ready for use in a few hours. A moving truck sprays the resin from nozzles like tar on a road to speed the spreading operation. The system is intended mainly for emergency use where conventional concrete runways would take too long to build



Inventors of the items shown on these pages are as follows: 1. General Dynamics Corp., Quincy, Mass.; 2. George H. Brown, 1151 Randolph Rd., McLean, Va. (No. 3,490,389); 3. Donald A. White, Jenn-Air Corp., 3035 Shadeland Ave.,

Indianapolis, Ind.; 4. Granville T. Yarbrough, Box 138, Matthews, Mo. (No. 3,484,943); 5. Dornier, Oberpfaffenhofen, West Germany. The International Inventors Assn., Inc. is located at 680 Fifth Ave., New York, N. Y. 10019.

Make Your Own Electronic Enlarging Meter

By R. S. HEDIN

This handy darkroom indicator will tell you at a glance what grade of printing paper to use for any negative and how long to expose it

JUST AS AN exposure meter can help you take better pictures, an enlarging meter can help you make better prints when you get to the darkroom stage. Commercial enlarging meters are expensive, but you can build this simplified one for less than \$20. It consists of a light-sensitive CdS cell similar to those used in cameras and an ordinary 0-50 d.c. microammeter. What the meter does is measure the amount of light passing through a negative in

LIGHT-SENSITIVE PROBE ON SEPARATE CORD

CALIBRATION CARDS indicate correct exposure times in seconds for any grade of printing paper used. All you do is place the appropriate card over the meter face and read the time designated by the meter needle. Probe is moved around on easel to measure light passing through negative

REAR VIEW OF METER at right shows low-voltage transformer and other parts mounted behind a sloping front panel. Soldered connections are made on two five-lug terminal strips

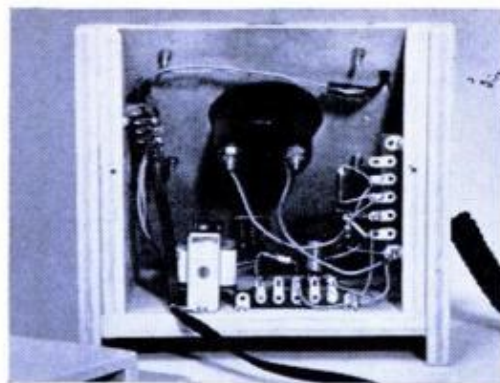

the enlarger. From this you can tell three things—the contrast range of the negative, the right grade of printing paper to use and the proper amount of exposure time.

Many negatives pose problems that must be corrected in printing. A high-contrast negative requires a low-contrast paper and vice versa. Graded papers are numbered from 0, lowest con-

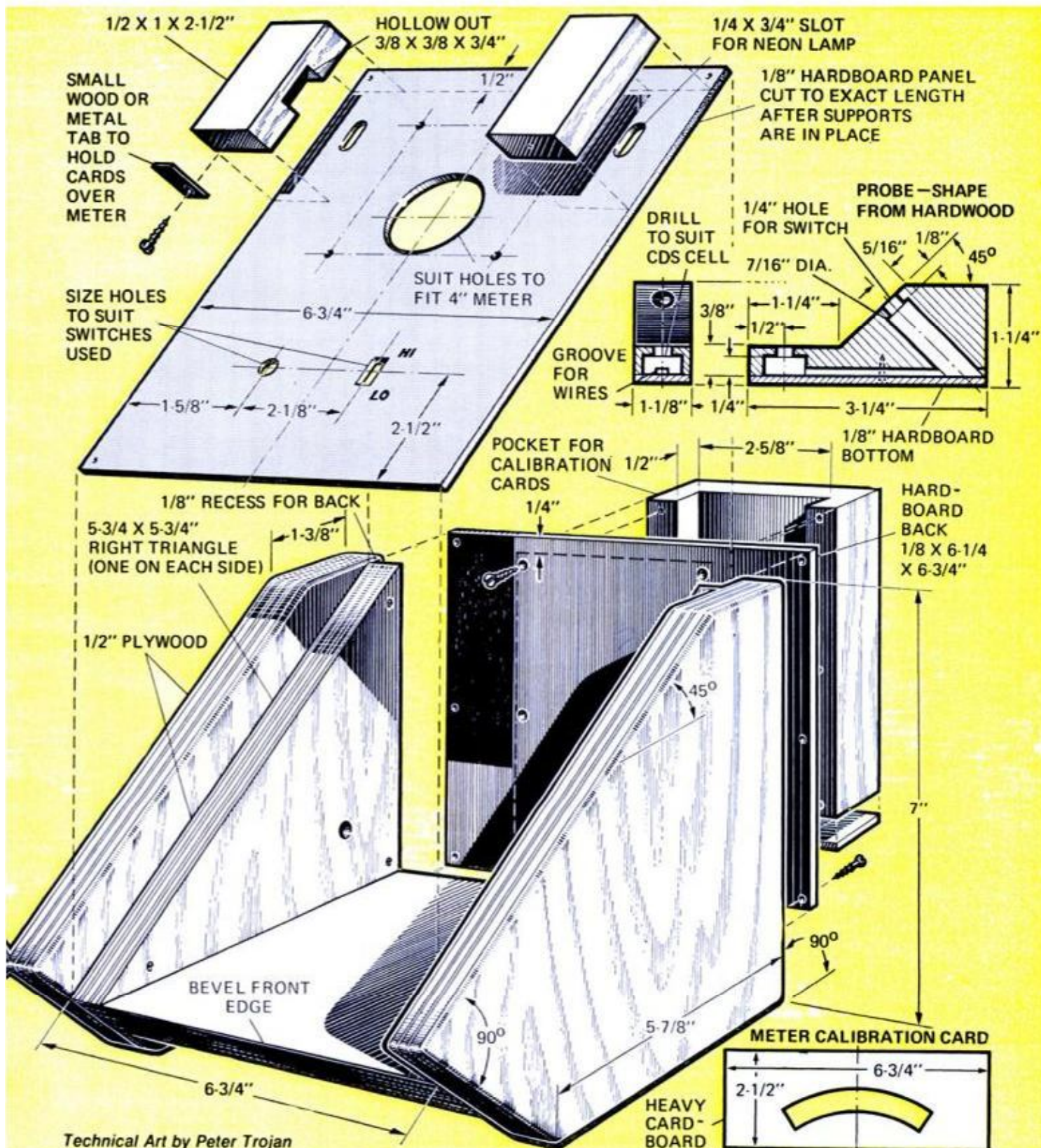

Technical Art by Peter Trojan

trast, to 4, highest contrast. Variable-contrast papers use filters to adjust contrast in similar steps. The meter will work with both types. By helping you to pick the correct paper and exposure time right off the bat, it will speed your printing and prevent waste.

The meter is a standard 4-inch 0-50 d.c. microammeter mounted in a simple slope-front plywood box. If you use a different meter size, merely adjust the dimensions. An ordinary 6.3-volt filament transformer supplies low voltage for the meter circuit, and a diode rectifier converts a.c. to d.c. Be sure to observe proper polarity when connecting them.

Flanking the meter face are two small wood blocks that serve a double purpose. They're hollowed out on the underside to provide recesses for two tiny neon lamps that edge-light the meter dial. The blocks also support calibration cards placed over the face of the meter. Markings on the cards convert the meter readings in microamperes to exposure times in seconds.

The light-sensitive CdS cell is mounted in a separate probe—a small wood block drilled out to take the cell body and a miniature pushbutton switch. The cell window faces upward and the probe is moved around on the printing easel to measure light striking it from above.

A switch on the meter gives you a choice of two levels of light sensitivity depending on the brightness of the image you're working with. Use the low setting for normal enlargements up to about 11x14. For extreme magnifications where the enlarger is racked farther away and light is dimmer, switch to high setting.

Under normal room light at the low setting, the meter should register a full reading of 50. This is a quick test to see that it is working properly. Don't expose the cell to bright light on the high setting; excessive current may damage the meter. Also, switch off your safelight while making measurements or be sure it isn't shining directly on the probe.

A negative's contrast range will determine the grade of paper to use. Start by selecting a negative that appears to have normal contrast and set the enlarger for a moderate blowup of, say, 8x10. Switch the meter to low sensitivity. With the lens wide open, place the probe in a shadow (bright) area of the projected image where detail is just apparent. Press

the probe switch and close down the lens until you just get a maximum reading of 50 on the meter. Now shift the probe to a highlight (dark) area where detail is desired and take another reading. This will be considerably lower since you're measuring a dense portion of the negative. If the meter registers 16, for example, this means the ratio of shadow to highlight is 50 to 16 or nearly 3 to 1. This is the proper ratio for a normal-contrast negative and indicates that you should use a No. 2 paper or no filter with variable paper.

The next step is to make some test prints to establish the proper exposure time. This is done by trial and error or from past experience just as you would normally do without the meter. Cut some 2-inch test strips. Begin with a lens opening of, say, f/8; expose the strips at different intervals until you have a good print.

Now make up some calibration cards from cardboard strips with window cut-

Wiring Diagram For Electronic Enlarging Meter

PARTS LIST

- Meter—4" or similar 0-50 d.c. microammeter
 CdS cell—Clairex CL905L 10K, 100-v cadmium sulfide photocell (Allied No. 751B2409; also Vactec VT-202, Newark No. 61F-1066)
 R1—22K, 1/2-w. resistor
 R2—120-ohm, 1-w. resistor
 R3—250-ohm, 1/2-w. resistor
 R4—1400-ohm, 1/2-w. resistor
 NE1, NE2—neon glow lamps, type NE-2H, 1/4-w. (Allied No. 272B1102)
 C1—50-mfd., 15-v. electrolytic capacitor
 D1—100-P.I.V., 200-ma. diode rectifier
 T1—117-v./6.3-v. filament transformer (Allied No. 273B050)
 SW1—S.p.s.t. toggle switch
 SW2—S.p.s.t. miniature momentary-contact pushbutton switch with 1/4" mounting thread (Allied No. 27581547)
 SW3—S.p.s.t. slide or toggle switch
 Misc.—line cord with plug, 5-lug terminal strips (2), shielded mike cable, hookup wire, solder

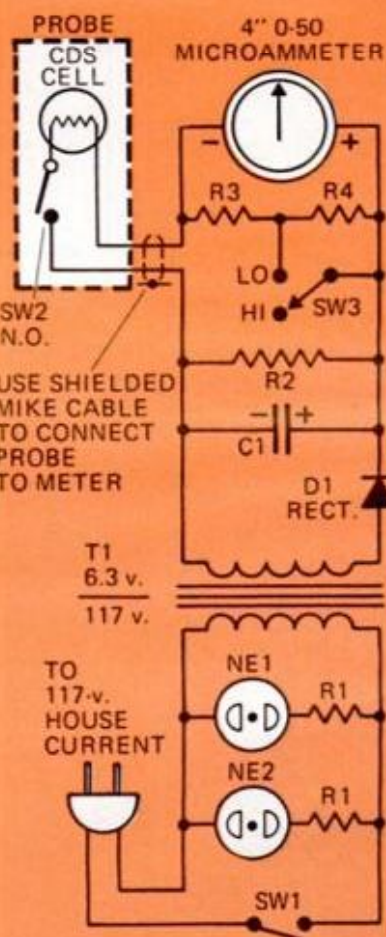

NORMAL

LOW CONTRAST

HIGH CONTRAST



HIGHLIGHT AREA SHADOW AREA

DETERMINING NEGATIVE CONTRAST is first step in using meter. Sample negatives of high, low and normal contrast are shown as guide. Start with a normal one and check contrast ratio by measuring difference in light intensity between two typical highlight and shadow areas. Test print strips are than made, as at right, to determine correct exposure time. Meter can now be calibrated to indicate same exposure for any negative of similar contrast



outs to let the meter dial show through. With the enlarger still set at $f/8$, lay a card over the meter, place the probe in the shadow area of the image and take a reading. Opposite the needle's position, mark the card with the $f/8$ opening and the corresponding exposure time determined from your test strips. This establishes the proper exposure in seconds for No. 2 paper at one lens setting. Repeat the process for other lens settings with additional test strips. A one-stop change in lens opening will double or halve the exposure time. This makes calibration easy once you've determined the initial exposure for one setting.

You now have a completely calibrated series of exposure times for use with any normal-contrast negative on No. 2 paper at any desired lens opening. All you do is select the opening you want, take a reading with the probe, then note the nearest exposure time on the calibration card indicated by the needle's position. For fast bromide papers, always take the reading with the probe in a shadow area. With slower portrait papers, use a skin area or similar medium tone for measurement. Highlight areas are too dense.

Having established exposure times for a normal negative, you can now make up calibration cards for other negatives. The table following lists typical contrast ratios and the correct grade of paper to use with each. Remember that 3 to 1 is normal. Higher ratios indicate higher contrast; lower ratios, lower contrast.

Negative Contrast Ratio

4 to 1 or more
3.5 to 1
3 to 1
2.5 to 1
2 to 1 or less

Paper Contrast Grade

No. 0
No. 1
No. 2
No. 3
No. 4

Selecting negatives of various contrast ranges, keep making exposure tests until you have calibration cards for all five commonly used grades of paper. Once this is done, you simply slip a negative into the enlarger, check its contrast ratio with the meter, put on the proper calibration card for the grade of paper indicated, then take another reading to find your exposure time—all in a few seconds. The markings on the calibration cards can be transferred to clear plastic strips cemented to the underside of the windows for a neater appearance. If you want really big blowups, set your enlarger for an extreme magnification and run through the calibrations with the meter switched to the high-sensitivity setting.

The parts are readily available from local radio stores and mail-order houses. The CdS cell is a Clairex CL905L and sells for \$1.50 from Allied Radio Shack, 100 N. Western Ave., Chicago, Ill. 60680 (No. 751B2409). A similar cell is the Vac-tec VT-202 available from Newark Electronics, 500 N. Pulaski Rd., Chicago, Ill. 60624 (No. 61F-1066). For other components, see the parts list on page 126. ★★★

For Neat Photo Trimming, Add a Hold-Down Arm

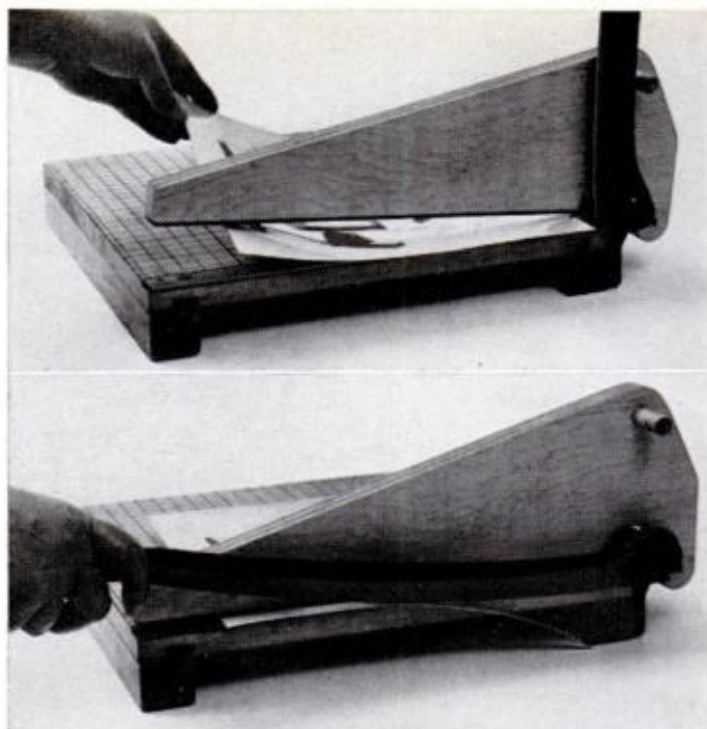

ARM LIFTS AUTOMATICALLY as cutter blade is raised to insert a print (top photo). Then it presses down as blade is lowered to grip print snugly during trimming (bottom)

PHOTO PRINTS are sometimes hard to trim evenly on a paper cutter because their edges are usually curled. Unless you hold the paper firmly, it's likely to slip slightly as the cutter blade comes down, resulting in a crooked or ragged cut. This spring-loaded hold-down arm does the job for you. As you lower the blade, the arm automatically clamps the paper snugly against the cutting board, flattening the edge and preventing it from shifting.

The arm can be fitted to any paper cutter—simply adjust its length to suit the size board you have. The rear end must be shaped to fit over the cutter blade's

pivot. The dimensions shown here will work with most cutters, but you can check the fit first with a cardboard cutout.

As the cutter blade is raised, it engages a dowel run crosswise through the top of the hold-down. This lifts the arm clear of the board so paper can be inserted under it. The other end of the dowel acts as an anchor point for a short, stiff spring. Attach the spring with a small ring bent from coathanger wire. The lower end of the spring is held by a screw eye in the ruled guide strip. Pad the bottom of the arm with cork, felt or rubber to give it a good grip.—R. S. Hedin

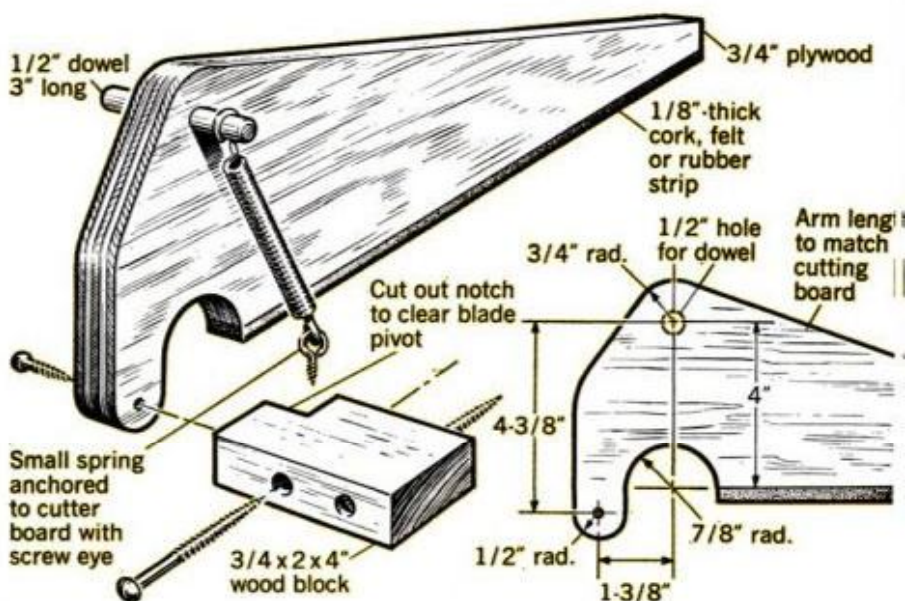

NEW IN ELECTRONICS

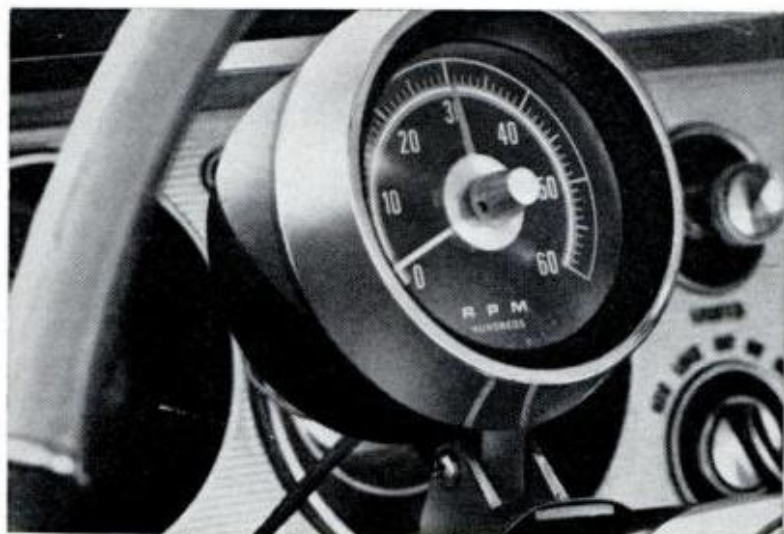

KIT-BUILT TACHOMETER from Heath will work with virtually any car or boat you want to put it on. It can be connected to two-cycle engines of one to six cylinders and four-cycle engines of two to eight cylinders. With rpm ranges of 0-6000 or 0-9000, \$32.95, Heath Co., Benton Harbor, Mich. Flush panel-mount version is \$29.95.



AUXILIARY UHF TUNER for TV sets can be used to replace a defective built-in tuner or to improve UHF reception where the present tuner offers poor sensitivity. It's simply connected between the TV and antenna lead-in. One model, for \$25.95, includes a preamp to boost weak signals in fringe areas. Another model, without booster, is \$19.95. Made by Channel Master, the add-on tuners are designed to save the cost of internal TV repairs.



LOW-COST COPIER for small businesses and home use makes black-and-white reproductions of maps, charts, printed matter, even photographs, on 8½x11 sheets. Copying time is one minute. Made by 3M Co., the desktop machine will be sold in department stores for \$109.95.

NEW LINE OF HOBBYISTS' KITS from RCA (at right) includes a two-channel mike mixer, combination mike/phono preamp, audio oscillator and oscillator-amplifier. The integrated circuit boards can be used with hi-fi, recording and PA equipment or for designing your own experimental circuits. Prices range from about \$5 to \$9. A separate enclosure kit is \$4.75. RCA Electronic Components, Harrison, N. J.





A relatively high axle ratio is fine when you're using your vehicle for pulling power, but when you get out on the open road it's inefficient and uneconomical. So, try an overdrive kit

By CLYDE J. BAKER

IN RECENT YEARS overdrive units have virtually disappeared from American cars. With larger-displacement, high-torque engines and the increasing popularity of automatic transmissions with their efficient torque converters, numerically low rear-axle ratios have become the rule today. Such axle ratios actually make overdrives impractical for the type of operation to which most cars are subjected, because they are almost like a permanent, built-in overdrive.

However, not all cars are used solely for passenger transportation on hard-surfaced roads. Consequently, many owners find it pays to order one of the optional high-ratio axles offered by carmakers to increase the available torque and pulling power at the rear wheels. Vehicles that would benefit include light trucks used for agricultural or construction work; heavily loaded station wagons; pickup trucks fitted with campers, and recreational ve-

1. OVERDRIVE UNIT and shortened driveshaft fit into place without modifying transmission or differential



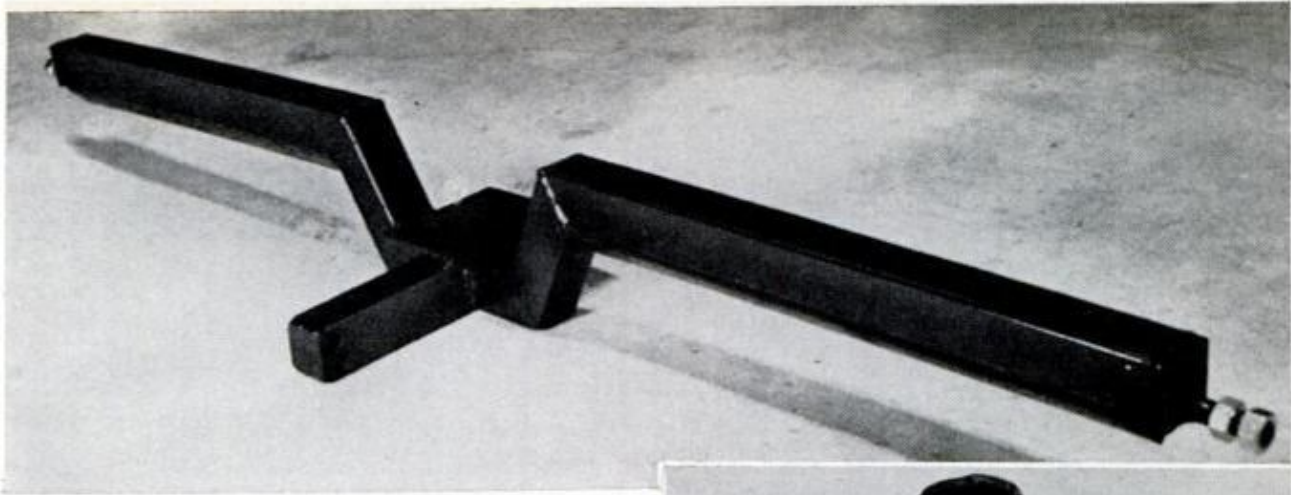

2. OVERDRIVE SUPPORT cross member, made from 1½ in. steel tubing, has dip for most ground clearance

hicles. But these often serve as dual-purpose vehicles and are not used exclusively for jobs that demand extra pulling power. The rest of the time they are used for normal transportation, where the high axle ratio becomes inefficient and uneconomical.

The major drawback of high axle ratios is that engine, transmission, and drive-train operate at a higher speed than those on similar vehicles with low axle ratios. Such continuous high-speed operation increases noise levels, wear, vibration and fuel consumption.

Overdrive is the obvious solution. It will allow you to use a high axle ratio when needed. Then, at the shift of a lever, you can reduce the final drive ratio enough to provide smooth, quiet, economical operation when maximum pulling power is not required.

Ideally, an overdrive unit should be separate from the transmission so that any type transmission can be used with complete compatibility. The overdrive unit can be mounted on the differential, or it can be an entirely separate unit. Unfortunately, such overdrive units are not presently available from Detroit car-makers.

Happily, if you own a dual-purpose vehicle and would like to install an overdrive, one independent firm, the Hone Manufacturing Co. of Santa Fe Springs, Calif., does make a high-quality unit that is adaptable to virtually any vehicle, including four-wheel drive. The unit, called Hone-O-Drive, is offered in two basic kit forms: (1) a differential-mounted unit for Ford products that replaces the pinion-gear bearing housing, but uses the existing pinion gear, bearings, crush washer,

JANUARY 1971

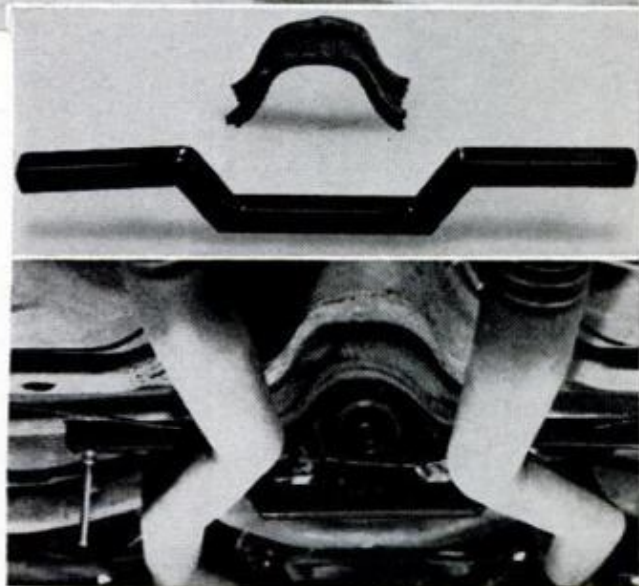

3. SMALL STEEL SUPPORT, made of 1¼ in.-square tubing, passes under unit, replacing section of the floor pan bracing which space dictated be removed

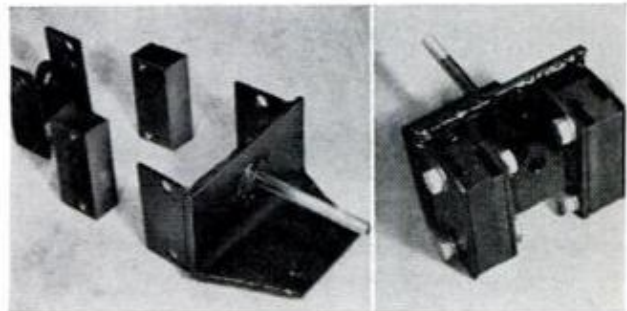

4. FRAME MOUNTS for cross member have two rubber isolators for control under high torque loadings

5. FOR MAXIMUM STRENGTH, horizontal mount is recommended for vehicles with adequate clearance

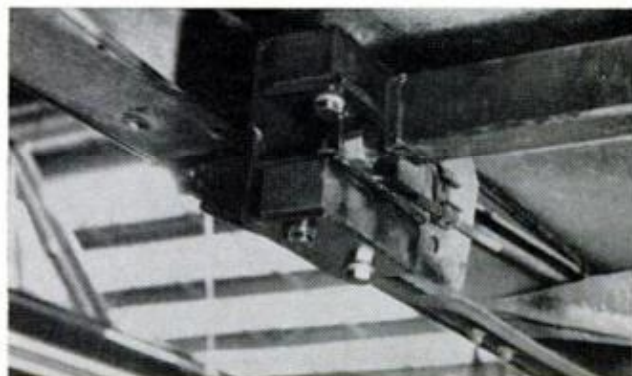

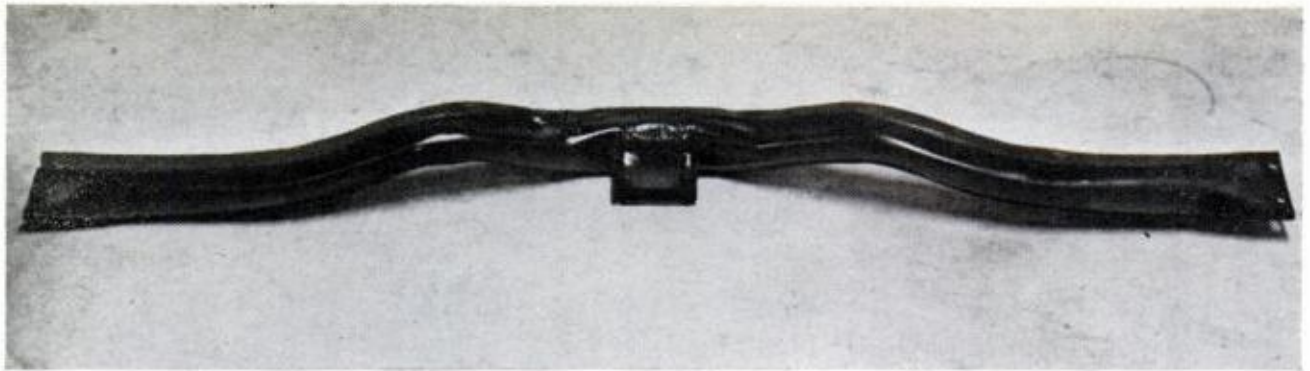

6. **SECOND** transmission support cross member with flange is installed behind the stock transmission support

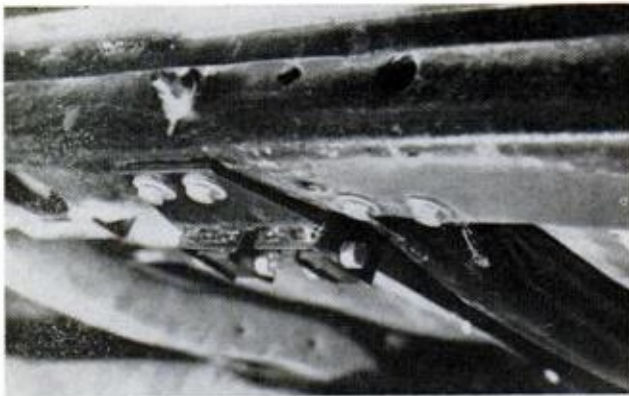

7. **THREE-POINT ATTACHMENT** of cross member to frame is used to prevent flexing of the frame rail

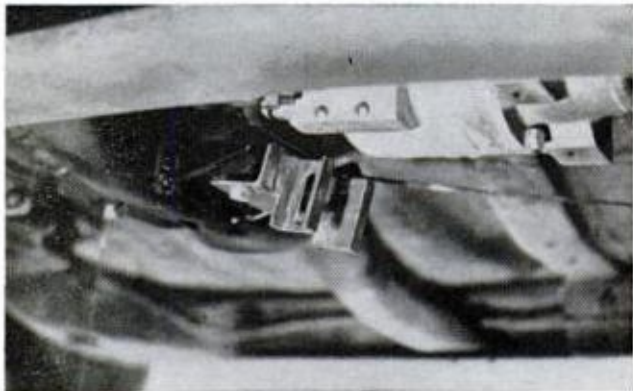

8. **OVERDRIVE** cross member's front tongue attaches at flange. Adjustment slots for static U-joint loading

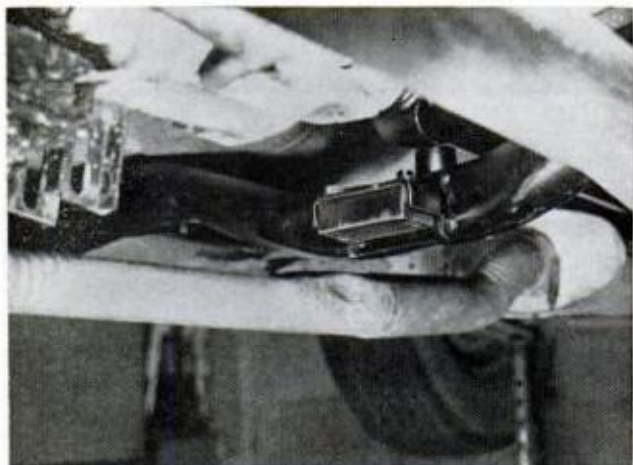

9. **NEW CROSS MEMBER** provides attachment point for the rear tongue of the overdrive cross member

locknut, and universal joint; and (2) a completely self-contained unit which is mounted behind the transmission on virtually any make vehicle that has sufficient tunnel clearance to accept the physical dimensions of the unit. In either case, the driveshaft must be shortened to accept the unit.

The Hone-O-Drive unit is relatively compact, weighing only 35 lbs. and measuring only 6¼ in. in diameter and 17⅞ in. in length. The unit, along with the shortened driveshaft, replaces the existing driveshaft without modification to the transmission or differential (Photo 1).

The unit is actually a fully lubricated, synchromesh, two-speed planetary transmission. Its housing is cast from aircraft-grade 356T6 aluminum. The gears, machined from high-quality steel, have helical teeth for smooth, quiet operation. Moving parts are heat-treated for strength. Shifting, to select either direct drive or a 30 percent reduction of input speed, is accomplished via a chrome-plated shift lever supplied with the kit.

The unit also features a speedometer drive gear and an extended speedometer cable. The new cable is connected to the

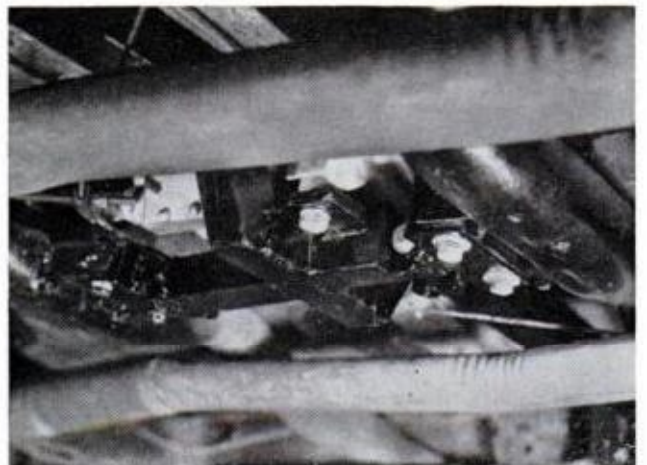

10. **REAR TONGUE** of overdrive cross member attaches same as front tongue, using a rubber isolator

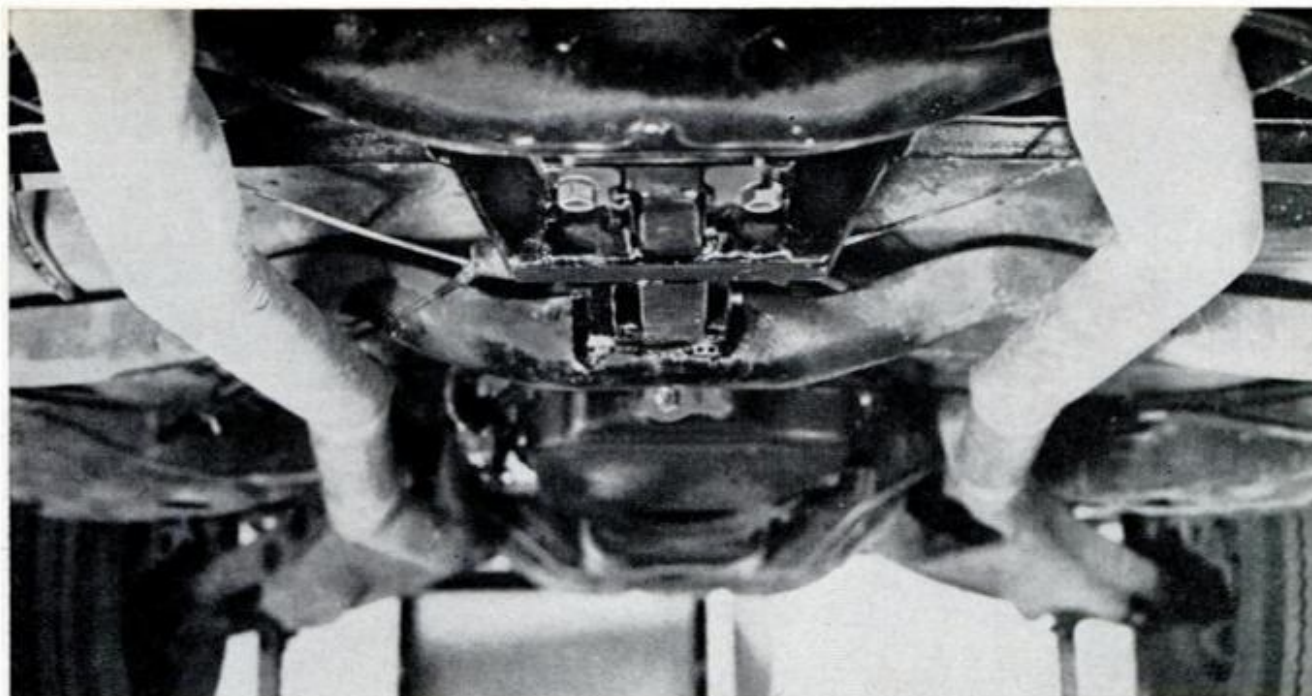

11. AFTER INSTALLATION of the second transmission support, it was necessary to section and reroute the exhaust pipes to provide adequate ground clearance and prevent occurrence of exhaust-pipe rattles

speedometer in place of the existing cable from the vehicle's transmission. This feature provides an accurate speed indication, regardless of whether the unit is in overdrive or direct drive. Complete instructions are included for selecting the right speedometer-driven gear for various ratios and tire diameters.

Time and effort required to install a Hone-O-Drive depend on the make and type of your vehicle and its available clearances. With differential-mounted units, the only critical step is the proper adjustment of the ring and pinion gear lash. Differential-mounted units bypass all possible problems you might encounter in installing a self-contained unit. These can include alignment, control and dampening of drive-train harmonic vibrations, avoiding static loading of the universal joints, control of the torque reaction transmitted to the overdrive case, and providing adequate clearance for components and ground clearance.

Hone claims most installations can be completed in four or five hours. This does not include shortening the driveshaft, but Hone can supply a properly shortened and balanced driveshaft if you supply the correct dimensions. I found Hone's time estimate a bit optimistic but the installation described below is perhaps more difficult than most. I installed an overdrive on a late-model supercar with a large displacement, high-performance engine and an automatic transmission. Com-

JANUARY 1971

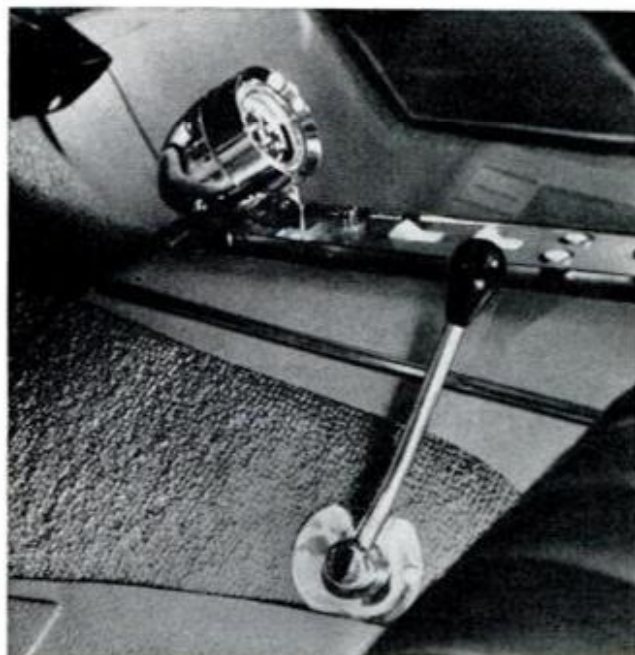

12. OVERDRIVE SHIFT LEVER mounts on side of transmission tunnel (also available for flat floors)

ponent and ground clearances were at an absolute minimum, and the unit and its mounts would be subjected to an extreme torque loading. Installations on vehicles, such as pickup trucks, with more ground clearance and less cramped undercarriages, would certainly be easier. The strength and rigidity of the mountings had to be increased over the manufacturer's recommendation to accommodate the high torque in this particular car, but this should not be necessary on most installations. A special kit offered will

(Please turn to page 198)

EXCITING NEW PRODUCTS

BY CATHERINE BILSKI

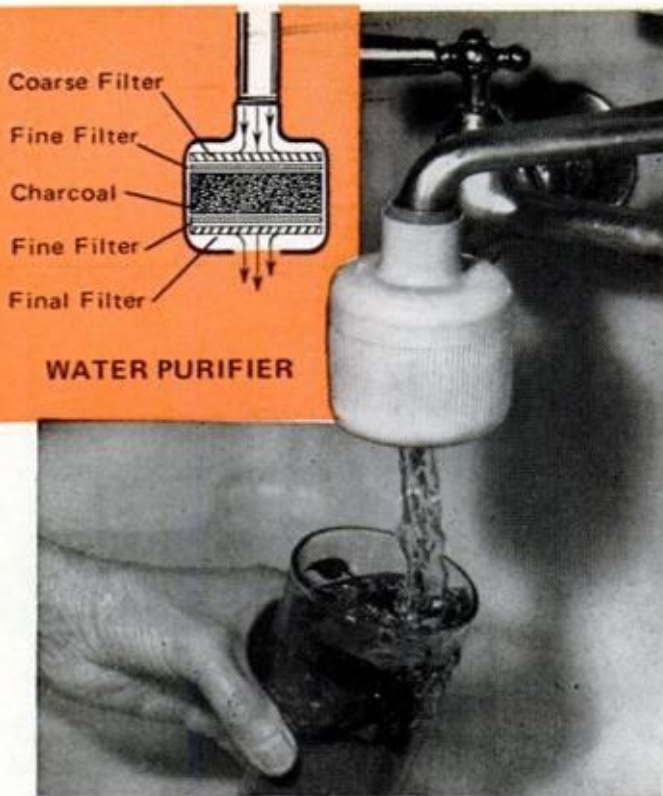

HAVE INSTANT FILTERED WATER from your tap with the Imperial Water Purifier. Utilizing one of the best filtering agents known—activated charcoal—and a series of coarse and fine screens, the unit removes impurities, chlorine, dirt, odors and bad taste, and also stops bacteria. It fits any standard sink faucet, requires no installation or maintenance and lasts an average family about four months before replacement. Sells for \$3.95 by MCS, Box 37, Henderson, Ky. 42420.



CLEAR, PRECISE COPIES can be turned out in minutes with the Press 'N' Print Mimeograph Machine. It's compact and portable, is sturdily constructed of high-impact plastic and metal, uses standard mimeograph stencils and ink and there are no messy drums or rollers to fuss with. It handles sheets up to 8½ x 14 in. and is ideal for offices, churches, clubs, schools. Priced at \$29.95 (with supplies) by Products Unlimited, Dept. P-PM, 1905 Cooper St., Jackson, Mich. 49202.

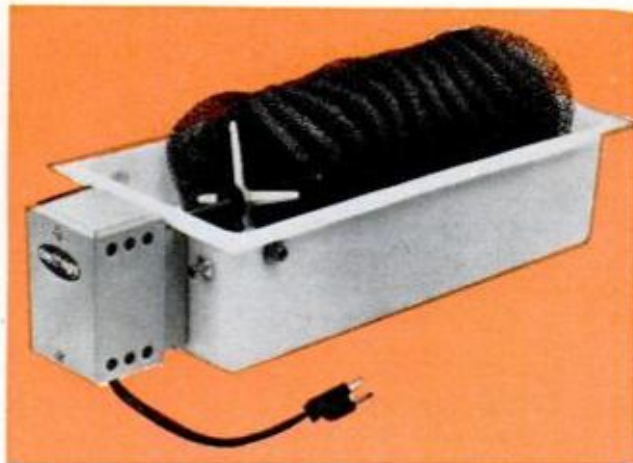

ADEQUATE MOISTURE in your home is important for health reasons as well as for comfort. The Spring Mist Power Humidifier helps maintain the proper level of humidity by adding up to four pounds of moisture per hour to indoor air. It's easily installed inside the main supply duct of any forced warm-air heating system. Manufactured by the Day & Night Co., 855 Anaheim-Puente Rd., City of Industry, Calif., it carries a suggested retail price of \$70.



SWISS-CRAFTED TIMEPIECE gives instant hour and minute readings as well as the date. Dubbed Digital-Dial Calendar Watch, this precision instrument also features a sweep second hand, an unbreakable main-spring, satin dial and a genuine leather strap. Packaged attractively for gift-giving, Model MOA-0021 is sold for \$19.95 (plus 90 cents postage) with a one-year guarantee. For additional information write Robert Witt, 813 Laramie, Dept. A-789, Wilmette, Ill. 60091.



RELAX TAUT NERVES, stimulate circulation and invigorate tired muscles while in the shower with the Body Toner shower-head attachment. Its three rapidly whirling turbines break up water flow into separate, speeding droplets, giving a soothing spray without the familiar sharp sting or annoying splash. A flick of the adjustment handle provides a range of spray settings. This attachment sells for \$19.95, is made by the H. B. Sherman Manufacturing Co., Battle Creek, Mich. 49014.



ADD DECORATIVE CHARM to any room in your home with a Cortez Majestic Electric Fireplace. To install, you merely hang it on the wall and plug it into a standard wall outlet. Unit comes with realistic "flame flickering" electric log and, if heat is desired, a heating unit which can be completely concealed in the fireplace is also available. It's ideal for apartments, mobile homes or wherever space is limited. Made by the Majestic Co., Huntington, Ind. 46750, it sells for \$140.



REPAIR MINOR DENTS, scratches and rust-outs on your car quickly and effectively with the Auto-Pak Body Repair Kit. Everything you need (except paint) is included: eight sheets of assorted sandpaper, plastic sanding block, 10-oz. tube of body filler, 1/2-oz. tube of hardener, mixing stick and spreader and a 1.3-oz. tube of spot putty. Priced at \$5, this handy, auto-body repair kit is made by the 3M Co., Dept. ABO-3, 3M Center, Box 3050, St. Paul, Minn. 55101.



FOR THE MAN WITH EVERYTHING, this handsomely styled Memomatic Electric Memo Pad might be just the thing. It's simple to operate: Just touch the starter bar and the paper glides out automatically. Has concealed storage compartment for standard 3 1/2-in. adding-machine-type refill or roll, uses two "C" batteries (not included). Sells for \$10, plus 50 cents for postage and handling, from Robert's of Rockaway, Dept PM, 758 Caffrey Ave., Far Rockaway, N.Y. 11691.



VISIBILITY from driver's compartment (upper left) is excellent. Bunk above folds out to sleep two. Dinette (top right) seats four, converts to double bed. Galley has a double-bowl sink, range-oven with power exhaust hood. Sofa (left) pulls out to sleep two; and privacy curtain can be drawn to make separate compartments. Lavatory (above) adjoins bath (door ajar). Door at left is a clothes closet. Under it is a butane gas furnace. The vehicle has three hinged skylights



You Can Build This Motor Home For Under \$3900

This 19-footer on a Ford Econoline, Dodge A-100, or Chevy chassis sleeps six and has all the comforts—from furnace to shower—and appearance of factory-built models selling from \$8000 to \$10,000

By JAMES M. LISTON, Executive Editor

Photos by Joe Munro
Illustration by Fred L. Wolff

THE FISHERMAN, the hunter and any man who would like to take frequent weekend trips with the family but can't afford the strain of motels and restaurant meals, now has a 19-foot motor home within reach—if he's willing to work for it.

The ballpark figure is \$3900, which is less than half of what a comparably equipped factory-built motor home of this size sells for today. Your time and labor saves you at least \$4000. The beauty of this project is that it doesn't leave you holding a set of plans and wondering where you're going to get some hard-to-find materials like: aluminum exterior sheeting, the swing-down table hardware, a pressurized water system, a gas-electric refrigerator and a 20-amp. converter. They're available from one source in kits that can be purchased as a complete package (for \$2800) or kit-by-kit as you need and can afford each. (You can

19 FEET OF MOTOR-HOME COMFORT

For detailed plans and instructions that show you how to build this motor home, send \$35 to LariDel Enterprises, Route 2, Box 123, Gaston, Ore., 97119. A list of materials available in kits is included.

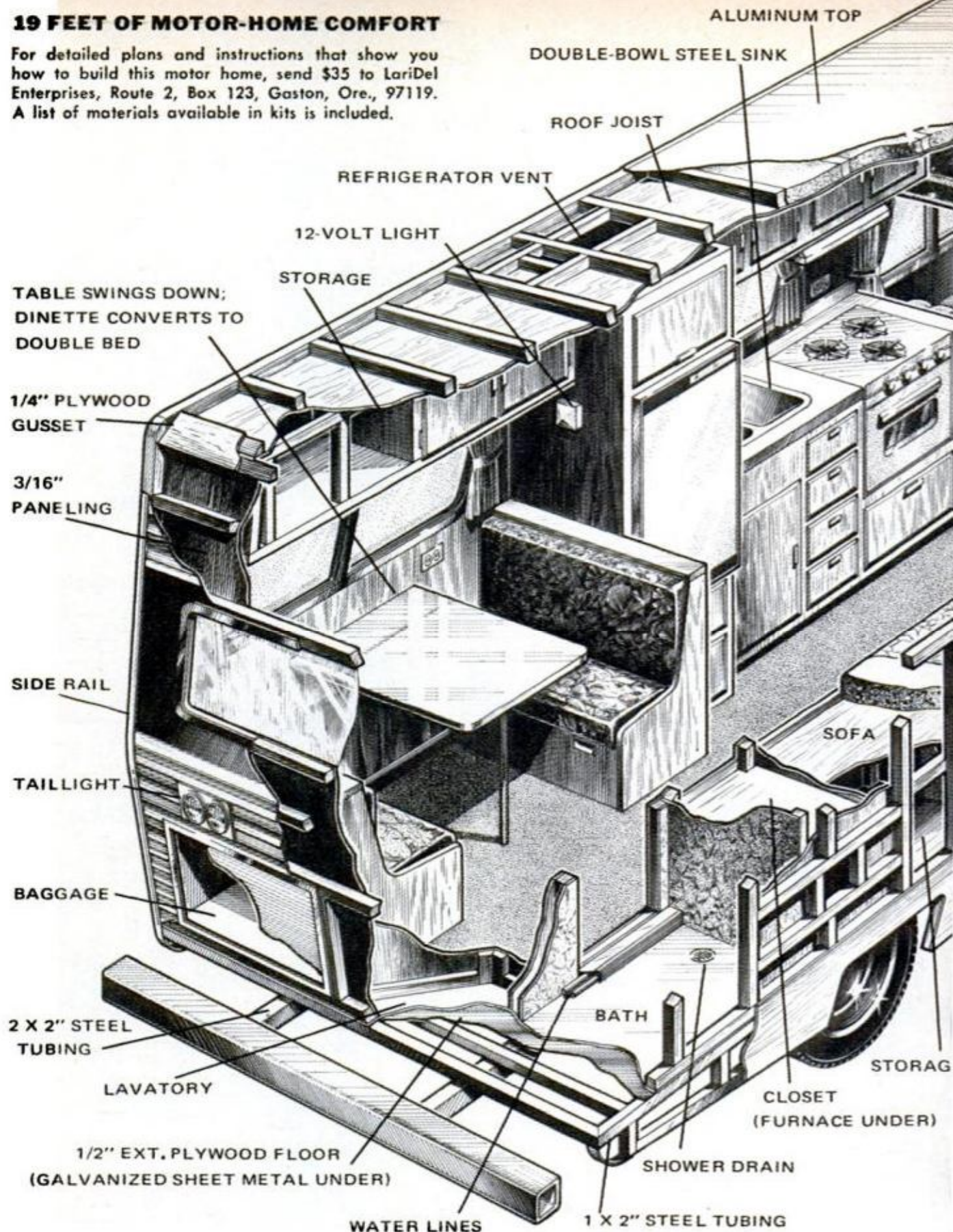

even rent three air-driven staplers for 120 days for \$130.) Exact price for the used chassis (Ford Econoline, Dodge, Chevrolet or GMC-type van with 108-in. wheelbase) can't be quoted in advance. Since the body will be torched off, appearance doesn't matter. Neither does the condi-

tion of tires or wheels; they'll be replaced with heavy-duty equipment. Engine, frame and drive train are all that count. If you shop wrecking yards for a van with a damaged body you can expect to pay from \$600 to \$1100.

If a cutting torch isn't available for re-

POPULAR MECHANICS

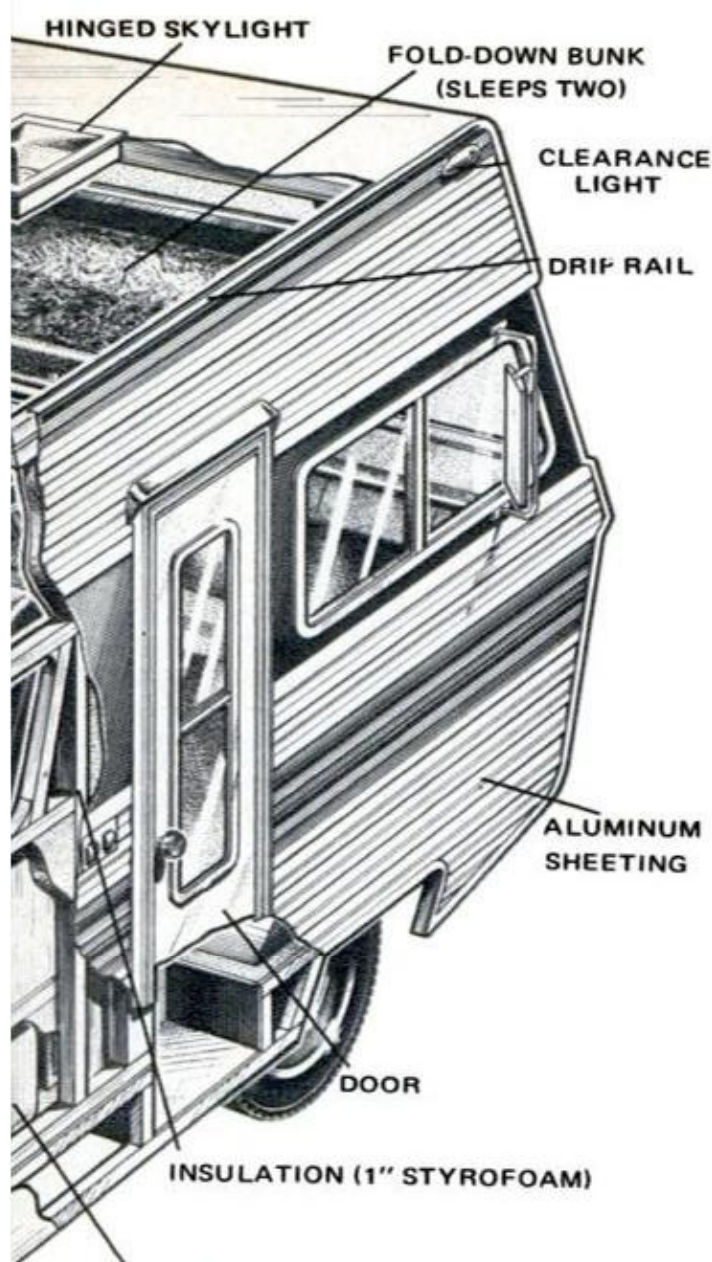

WATER TANK

moving the old body, the job can be done with a chisel and a 3-lb. hammer. Complete instructions and the blueprint for welding the floor frame (18 ft. x 7 ft. 3 in.) make it a simple job for a welder, if you don't have the equipment.

The springs must be beefed up with the addition of two extra leaves. You can do the job right and save money by purchasing from a wrecking yard the main leaf and second leaf for your make of chassis. With a torch, cut off eyes at the ends of the main leaf; keep it as long as possible. The springs are dismantled and an additional leaf inserted between the main and second leaf; another is inserted between the second and third leaf from the top. New U-bolts and center bolts button up this job.

Wheels should be replaced with heavy-duty rims, 8.00x15 in. reversed. Tires may be H 70-15 wide track four-ply nylon or

(Please turn to page 192)

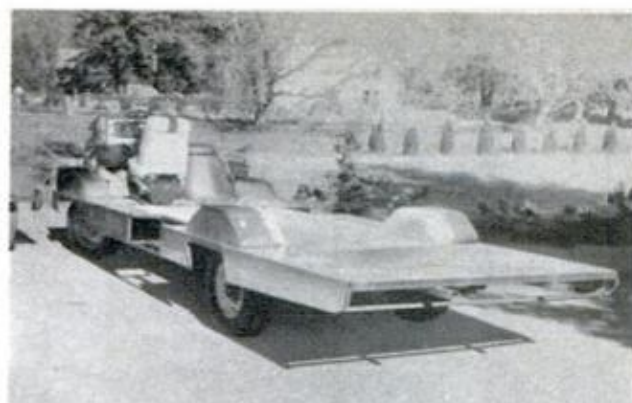

CHASSIS IS READY for sidewalls after old van body has been cut off. Frame is widened and lengthened



SIDEWALLS ARE FRAMED on shop floor. Jig for framing is made on 1/2-in. plywood later used for floor



PREFINISHED PANELING is stapled to sidewall frames after glue bead has been applied to studs



LEFT SIDE WALL ready for aluminum exterior "skin." Styrofoam (1 in. thick) fits snugly between all studs

Build the Marvelous Fold-A-Majig

It's a sofa-bookcase, desk divider-wall or whatever you come up with. Its inventor stopped counting when he reached 100 variations.

By HARRY WICKS, Workshop Editor

Color Photos by Bill Maris/Styling by Robert Lofgren

WHEN a well-designed piece of furniture comes along, one that's basically so simple and ingenious that it prompts the "why-didn't-I-think-of-it" reaction, it's a pretty safe bet that you've stumbled onto an item *PM* readers are sure to get enthused about. "Simple" should be defined more precisely. Though its construction is simple, the Fold-A-Majig's design concept was complex until designer/inventor Charles H. Provost unraveled the hinge mystery.

His versatile desk-bookcase, sofa-counter—or you name it—can be folded or flopped into an almost unlimited number of combinations in a matter of minutes



DESK-BOOKCASE SETUP can be folded to provide wall divider (right) or contained in smaller space (above)

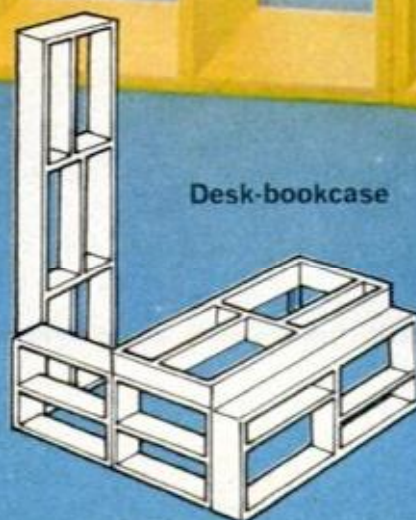

Desk-bookcase

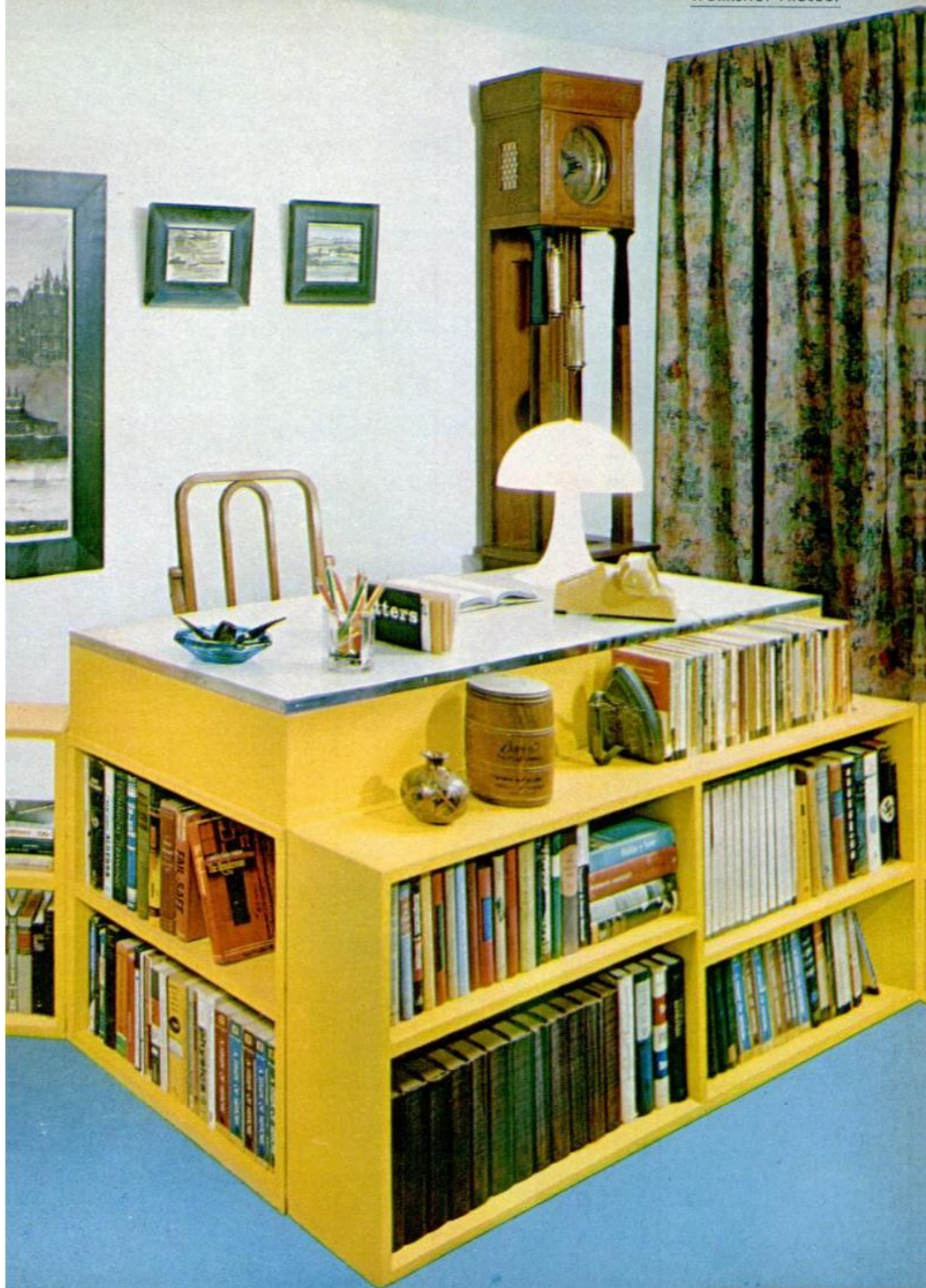

12 POSSIBLE SETUPS

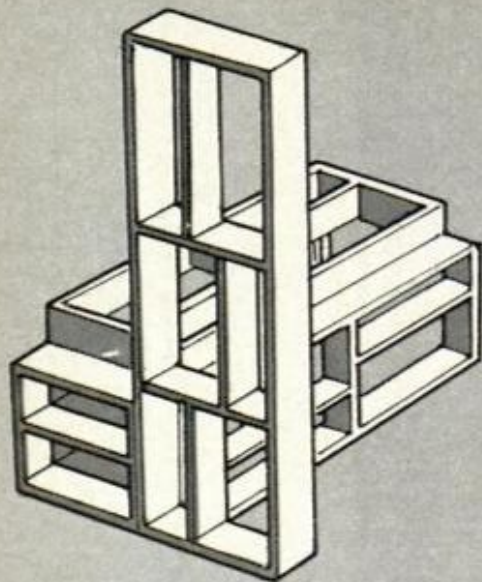

Desk-divider

Twin youth beds

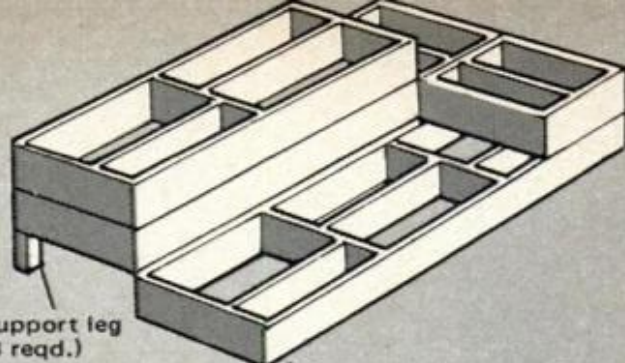

Support leg
(3 reqd.)

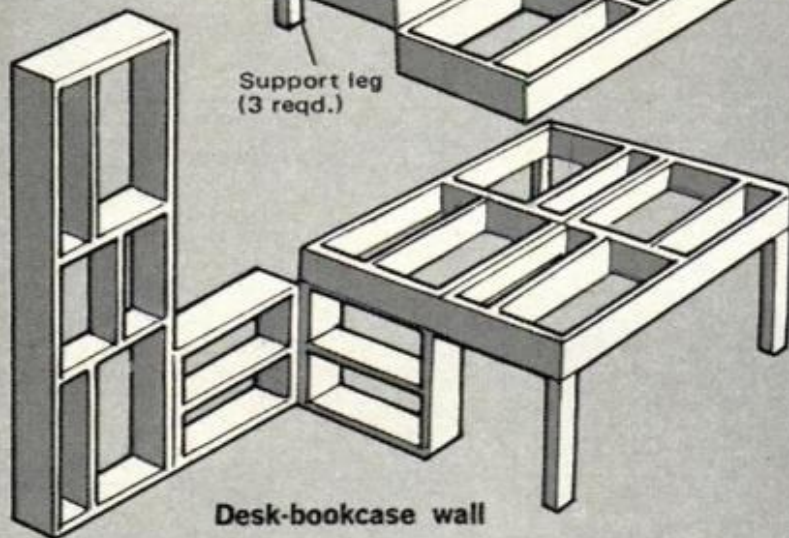

Desk-bookcase wall

without using a single tool. And, if desired, two of the units can be built and used together to achieve even greater versatility.

Happily, "Chick" Provost, who holds a patent on his design, has consented to make construction plans available for *PM* readers to build one for themselves. (It cannot be built for commercial purposes.) Additionally, he has agreed to make available the unique plastic hinge which he calls Kra-Z-Ee hinge. The only other material needed is stock 1x8 select clear

pine and 3/4-in. ring nails available at your local lumberyard.

The skeletonlike framework is actually five boxes—two square-shaped and three rectangular. When the five component parts are folded into a basic rectangular box, overall dimensions are 23x23x84 in. Dimensions were carefully determined for comfort. The "desk," for example, is the standard 30 in. height. Seat height of the "sofa" is also standard.

The secret of the unit is in the placement of the hinges. Thus, you are well

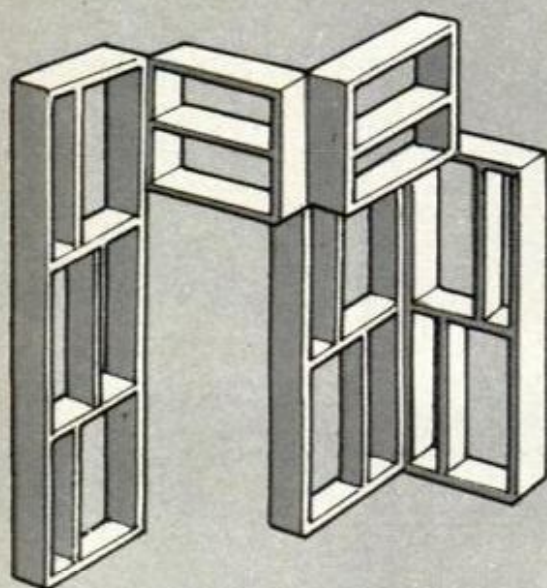

Outside corner

Short divider-wall

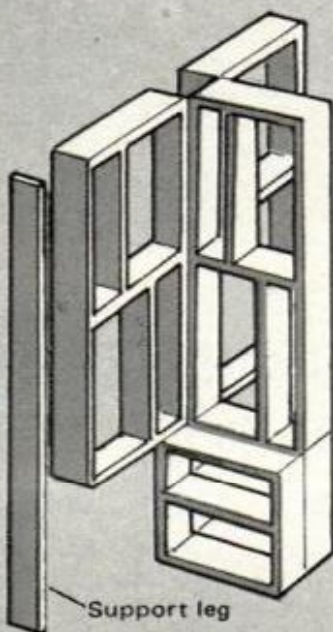

Support leg

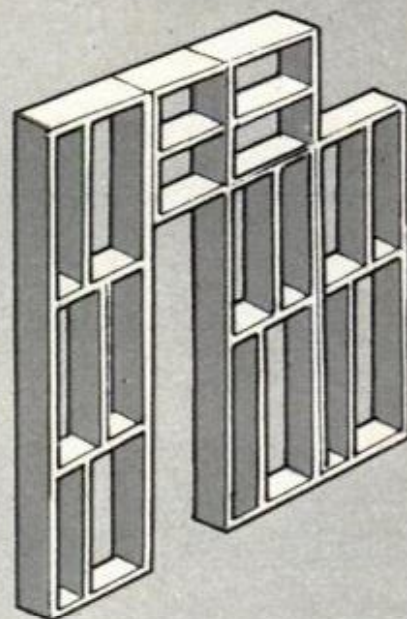

Bookcase wall with pass-through

U-shaped workcenter

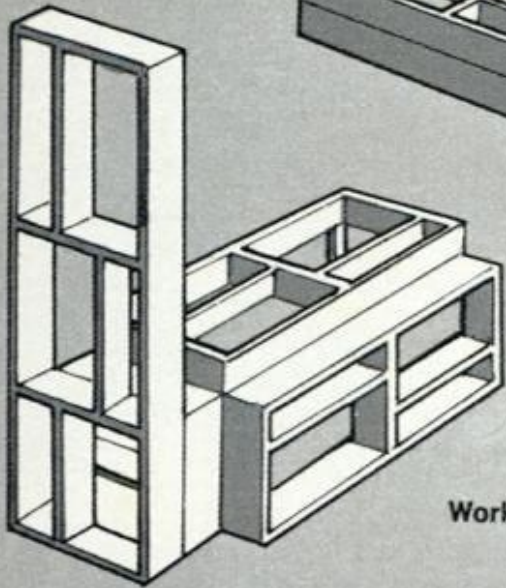
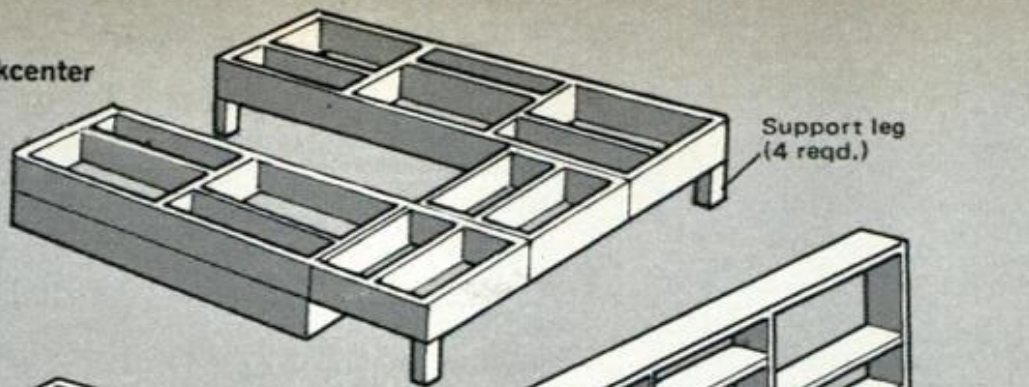

Worktable

Support leg
(2 reqd.)

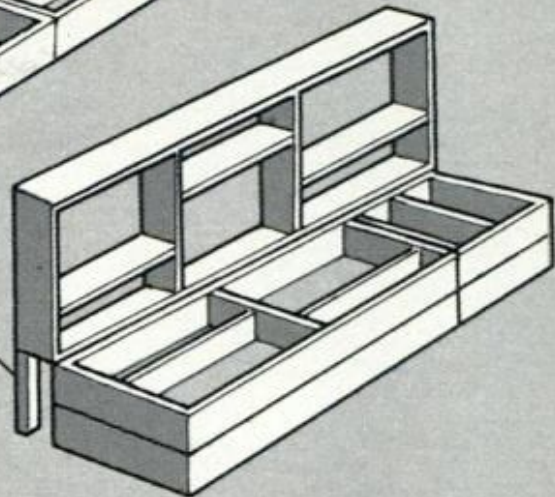

Long sofa-bookcase

advised to build a scale model first and use masking tape to simulate the hinges. This will serve as a guide when assembling your full-size unit. Though continuous hinge and screws could be used, the Kra-Z-Ee hinge is less expensive, easier to install and equally strong. The designer recommends spacing the ring nails 2 in. apart for maximum strength. If they're not available in your area, he will supply the nails as well as the hinge.

In addition to the photos,

we've sketched a dozen most-likely-to-use arrangements for the piece. For clarity's sake, the unit is shown without any finishing surfaces. Once you have arranged the Fold-A-Majig in the setup that you want, you cover any surfaces requiring it with suitable material. In the love seat shown, Provost covered the seat area and "tabletop" with 1/4-in. hardboard which is not permanently attached. The seat was then fitted with a 5-ft. length of 4-in. foam rubber, which in turn was covered with fabric. The tabletop was finished with

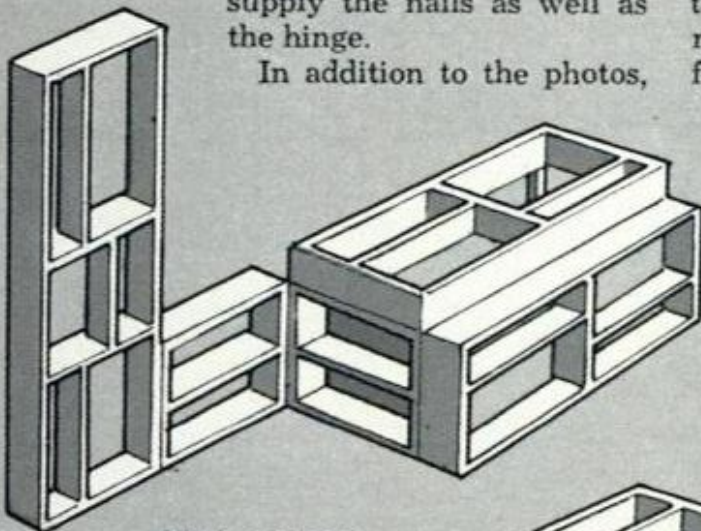

Kitchen island

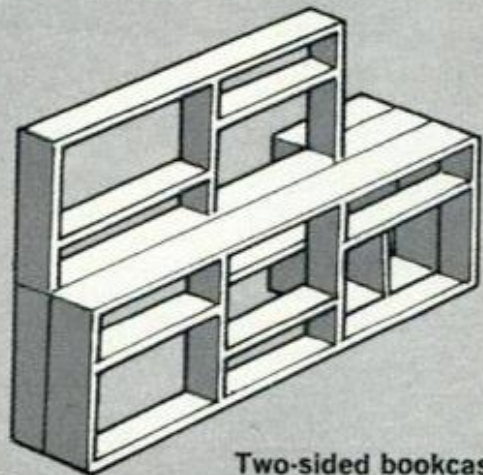

Two-sided bookcase

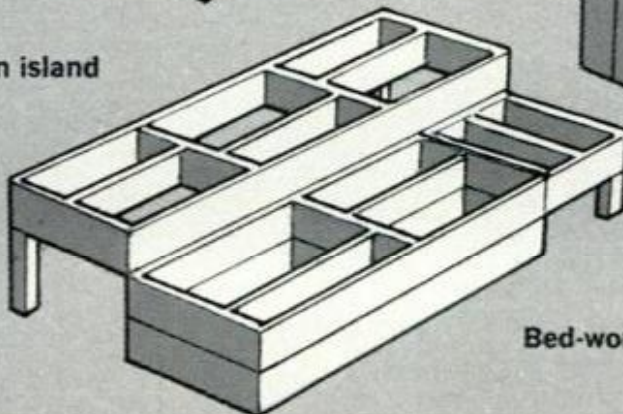

Bed-work center

Support leg
(3 reqd.)





Sofa-bookcase

SOFA ARRANGEMENT provides ample shelving for books and a low table for the display of art objects

THE DESIGNER, Charles Provost, in his workshop, surrounded by the model of his Fold-A-Majig that is featured in the color photographs on facing page

plastic laminate and metal edge molding.

Many arrangements will require an additional piece or two for support (a leg)—a simple hammer and saw task.

There's book storage galore. For rigidity, several cross members in each box are permanently fastened into dados. But for even greater storage, once you have your Fold-A-Majig set up, you can attach vertical shelf standards which will permit installing adjustable shelves to display your books, magazines and art objects.

When asked what prompted the design, Provost, who has been in the scenery design field for over a quarter century, replied, "Actually, I felt there was a need for a contemporary piece of furniture that could serve a number of functions." Thus,

LOVE SEAT-END TABLE gives same seating as upper version but boxes are flopped to provide end table

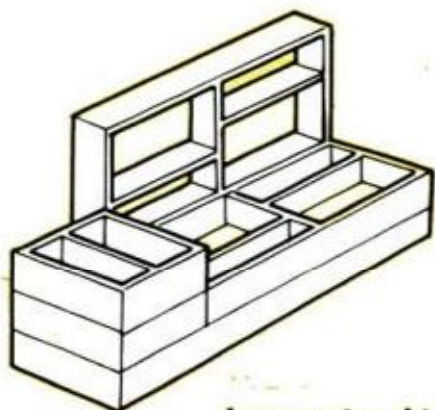

Love seat-end table

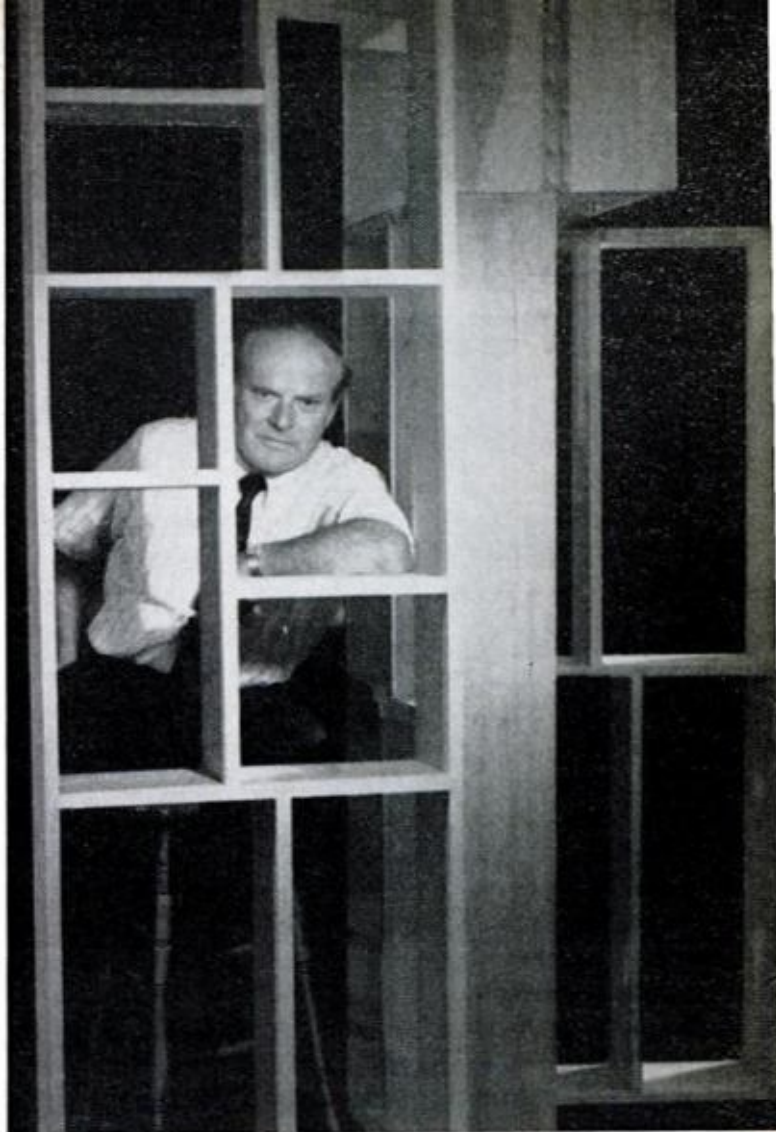

as a family's needs change, the Fold-A-Majig can be converted to suit. That self-imposed restriction plus another—that a change of setup would not necessarily mean a cash outlay—led him to stick with basic shapes. The hinge gave flexibility.

Perhaps the best feature is that the unit can be built for less than \$40. As the designer proudly says, "Where else can you get a desk-bookcase, sofa-end table or any number of furniture combinations at that price?" ★ ★ ★

FOLD-A-MAJIG BUYING INFORMATION

TO ORDER PLANS for the Fold-A-Majig, as well as an instruction pamphlet that details the hinge placement, send \$3 to Fold-A-Majig Plans, Reader Service Bureau, Popular Mechanics, 224 W. 57th St., New York, N. Y. 10019.

HINGES AND NAILS. The flap-type (KRA-Z-EE) hinges and the ring nails used for fastening are available directly from Charles H. Provost Displays, Inc., 618 W. 28th St., New York, N. Y. 10001. You'll need 12 ft. of hinge (\$6.95) and a package of 160 nails (\$1.95) to build the unit. Both prices include postage.

How to Service Sparkplugs

Pick the right plugs to start, service them properly, tune your ignition system and those plugs will last a lot longer

By MORT SCHULTZ

USE CORRECT-SIZE DEEP SOCKET so plugs won't be damaged when you remove them. Take care to keep axis of the socket aligned with that of plug



OILY-TIPPED PLUG is too cold for this engine—hotter plug is needed to burn off deposits. A ghostly white tip indicates a colder plug is necessary

THE ELECTRODE END of a sparkplug in an eight-cylinder engine fires 200 times per second and is exposed to a minimum flame temperature of 3000°F. as fuel burns. How long can a set of plugs last under these conditions?

Sparkplug manufacturers say 10,000 miles. However, this national average takes into account sparkplugs that are never serviced and that operate under conditions for which they're not designed.

Does this mean that you can get more than 10,000 miles from a set of plugs? That's right!

In fact, you should get 20,000 miles if you meet these three conditions:

1. Pick the right plug for your engine.
2. Service plugs every 5000 miles.
3. Make sure that areas allied to sparkplugs (ignition timing, for example) are operating at peak.

The sparkplug recommended by the manufacturer of your car is designed to accommodate a more or less equal amount of idling, slow-speed and high-speed oper-

ation. It's not always the one that's needed. The right sparkplug is one that best meets the thermal conditions which are present most often inside the cylinder head.

If a plug can't get rid of heat fast enough, it can begin to glow and cause preignition—igniting fuel mixture before spark occurs—which can ruin an engine.

Conversely, if a plug doesn't heat up to a temperature that's sufficient to burn away deposits which form on the tip of its insulator, these deposits will eventually cause the plug to short circuit. The engine will then misfire.

Thus, a plug's heat range as determined by the length of its lower insulator is a major consideration. The longer this insulator, the hotter the temperature at which the plug will operate; the shorter the insulator, the cooler the temperature at which the plug will operate.

Each size of sparkplug is manufactured in a number of heat ranges from cold to hot. A cold plug gets rid of heat rapidly. It won't overheat and cause preignition when temperature in the combustion chamber is relatively high—that is, when the engine is under load as, for example, during high-speed operation or when pulling a trailer.

On the other hand, a hot plug gets rid of heat slowly and is used to avoid fouling when combustion chamber temperature is

relatively low, as it would be under stop-and-go city driving.

How do you determine which plug your engine actually needs? Start with the plug that's recommended. Check your owner's manual.

The recommended plug also tells you the size plug your engine needs. Correct size is the thread and reach that match the dimensional requirements of the cylinder head. It's given in code, but that's not important.

For example, if the manufacturer recommends a Champion UJ-12Y, it means that your engine requires plugs having a 14-mm thread and $\frac{3}{8}$ -in. reach. This will always be true even if you switch to a hotter or colder plug.

The auto supply dealer from whom you buy plugs will refer to a size, reach and heat-range chart when you tell him. "I need the next colder plug from UJ-12Y"—which happens to be UJ-10Y.

After operating with the recommended plugs for several days, remove some from the engine and examine their insulator tips. If they are gray or light tan with a light chalky deposit, the plugs are okay for your engine.

However, if tips are sooty or oily, a hotter plug is called for. If tips are ghostly white, try a colder plug.

When going from hotter to colder, or

HEAT FLOW—HOT PLUG vs. COLD

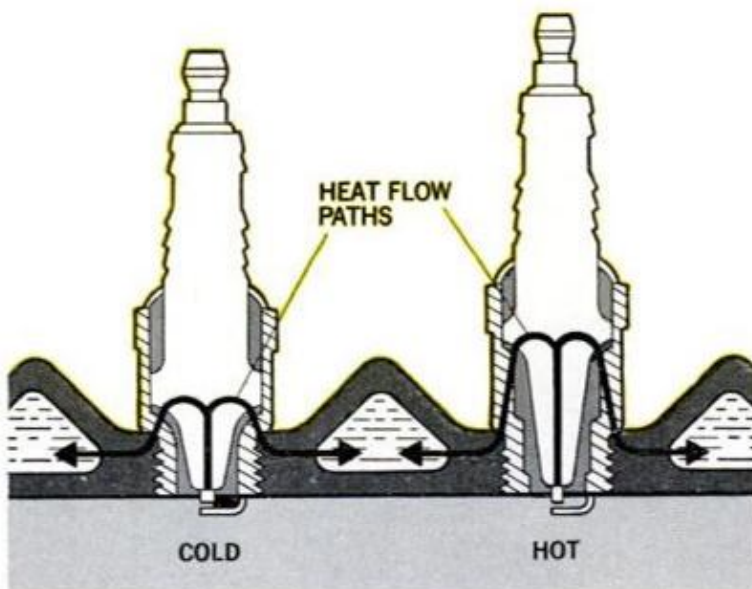

"COLD" SPARKPLUG has short insulator nose, expels heat rapidly; "hot" plug has long nose, holds heat longer. Abrasive cleaning removes deposits on insulator but causes rounding of electrode edges, increasing plug's voltage requirements

JANUARY 1971

FIRING VOLTAGE vs. PLUG CONDITION

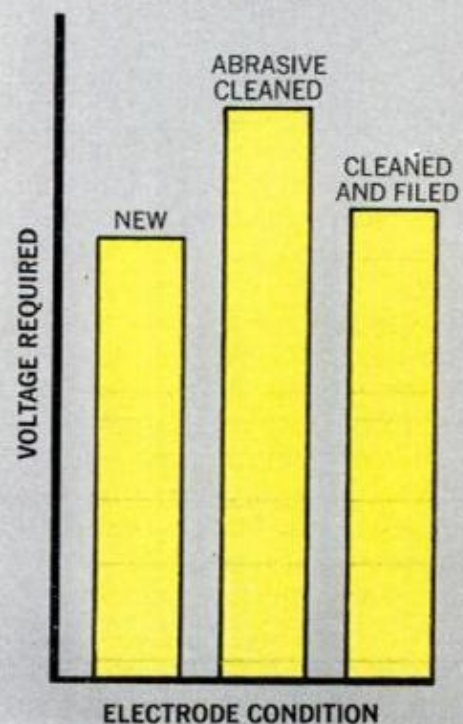

147



FILE ELECTRODES until clean, bright and square. You can buy an ignition file at any auto supply store

vice versa, move up or down the scale one heat range at a time.

You don't need an abrasive cleaning machine to service sparkplugs. In fact, abrasive cleaning causes rounding of electrode edges that will increase a plug's voltage requirements.

You can do a great maintenance job every 5000 miles with nothing more than a small ignition file, a hacksaw blade that's ground to a 1/8-inch wide taper at one end, and a sparkplug feeler gauge.

First, though, plugs have to be removed from the engine. Use a six-point deep socket.

If there are any automotive plugs that can't be removed with a 1 3/16-in. socket, they are few and far between.

Before taking plugs from the engine, use an ear syringe that you can buy in a drug store to blow foreign particles from plug wells. If particles should drop into the cylinder as a plug is being removed, they can damage the cylinder.

As you remove each plug, wipe it clean with a rag and examine it closely for damage. Damaged plugs should be discarded.

Now, inspect the plug's electrode end to determine if any unusual engine condition exists. If plugs (or a plug) are coated with deposits, badly eroded, or have a broken insulator nose, a mechanical condition, such as overadvanced timing, overheating, or a leaking cylinder, exists.

Clean plugs by scraping deposits from the lower insulator with the modified hacksaw blade. Don't be afraid to scrape hard. You won't hurt the insulator.

After cleaning, file the electrodes vigorously to obtain sharp, bright edges. Reset the electrode gap to specification by bending the side electrode only.



IF SIDE ELECTRODE must be bent to gap plug, use gapping gauge bending tool; pliers may mar plug

The sparkplug gap of most engines is set at .035-in. There are exceptions, so check the owner's or service manual.

Naturally, if electrodes are so badly worn that the proper gap can't be obtained, replace the plugs. Incidentally, when installing new plugs, be sure that you check the gap. It's not factory-set.

You don't need a torque wrench to install sparkplugs. Seat them by hand. Then, if plugs are equipped with gaskets, tighten them an extra half turn with the socket to make a gas-tight seal.

Plugs that don't have gaskets—those with a taper-seat design—should be tightened firmly. This does *not* mean rammed down with all your strength.

By the way, if plugs are equipped with gaskets, always use new gaskets when re-installing the plugs. Gaskets that have been compressed once won't make an effective gas-seal when reused.

Several things affect sparkplug perform-

IF NEW PLUGS for your car aren't equipped with gaskets,

SPARK PLUG WITH GASKET

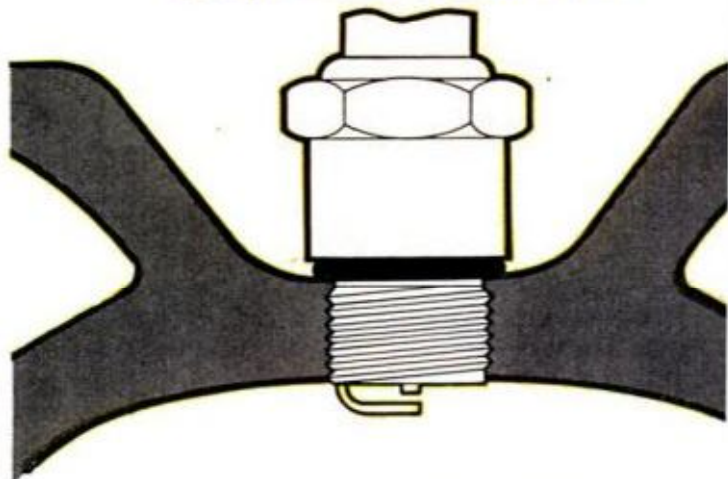

POPULAR MECHANICS

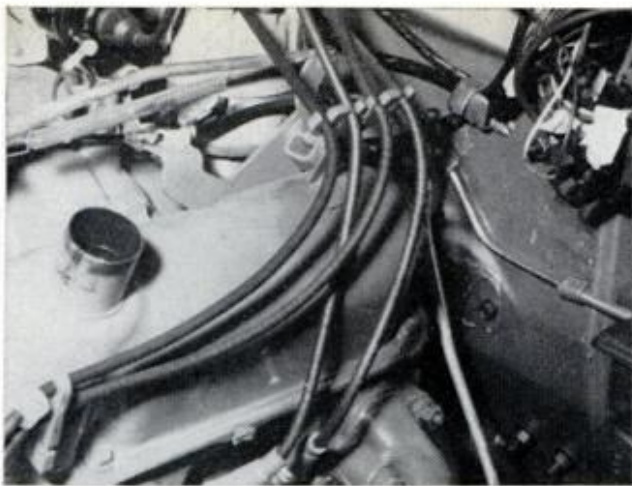

DON'T TRY TO BE NEAT and run wires parallel; keep crisscrossed as shown here to prevent crossfire

ance—for example, fuel-air ratio, engine speed and load, sudden acceleration and reversed coil polarity. However, some factors are more important than others, and we'll deal with them here.

For instance, worn-out ignition cables and sparkplug boots cause problems that lead car owners to throw away good sparkplugs, but the problem isn't discarded with the plugs. Cables that have deteriorated because of high underhood temperature and exposure to grease prevent current from reaching plugs. This causes an engine to misfire.

Inspect each cable carefully and look for cracks in insulation. When replacing cables, select those of the same resistance as the old cable to insure radio and TV suppression. Use copper cable only if recommended for your car.

Incidentally, when dealing with cables be wary of crossfire, which occurs when a sparkplug is fired out of time by induced

they have tapered seats and should be tightened firmly

TAPERED SEAT SPARK PLUG

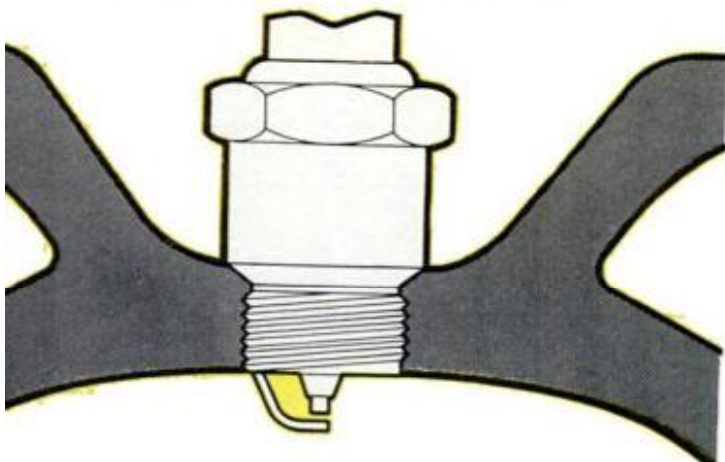

JANUARY 1971

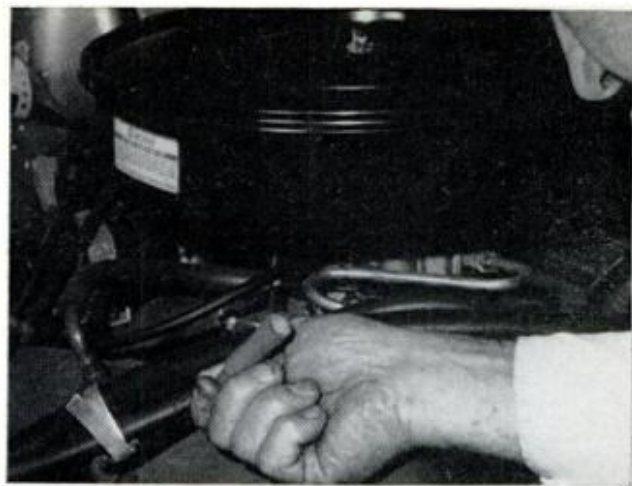

USABLE PLUGS may be blamed for flashover (see text) actually caused by dried-out, cracked boots

voltage. This will result in a rough running engine or backfiring. It can cause major engine damage.

Crossfire occurs when cables are grouped closely together and run in parallel. It is most likely to happen between consecutively firing cylinders located close together in the engine block.

To guard against crossfire, space cables as far apart as possible or crisscross them in their holding grommets so they don't run parallel.

Since electricity takes the path of least resistance, dried out and cracked sparkplug boots will produce a flashover condition. Voltage will short over the outside of the plug's insulator and never reach electrodes, which causes engine misfire. Examine boots and replace those that have seen better days.

Sparkplugs rely on the ignition system for voltage. Obviously, a properly tuned ignition system is necessary to compensate for plugs as they start to wear.

Ignition (spark) timing is a most important factor affecting sparkplug temperature. Engine manufacturers specify timing settings that are generally several degrees retarded from that which will produce maximum power output. They do this to provide a "cushion" against cylinder-to-cylinder variations in timing and to offset the effects of combustion deposits that accumulate in the cylinders.

Keep in mind that timing for maximum power will seldom give you enough output gain to compensate for the fact that your fuel requirements will be increased by several octane numbers and that there will be a sharp rise in plug temperature. Thus, it's best to time your ignition to the recommended setting. ★ ★ ★

149

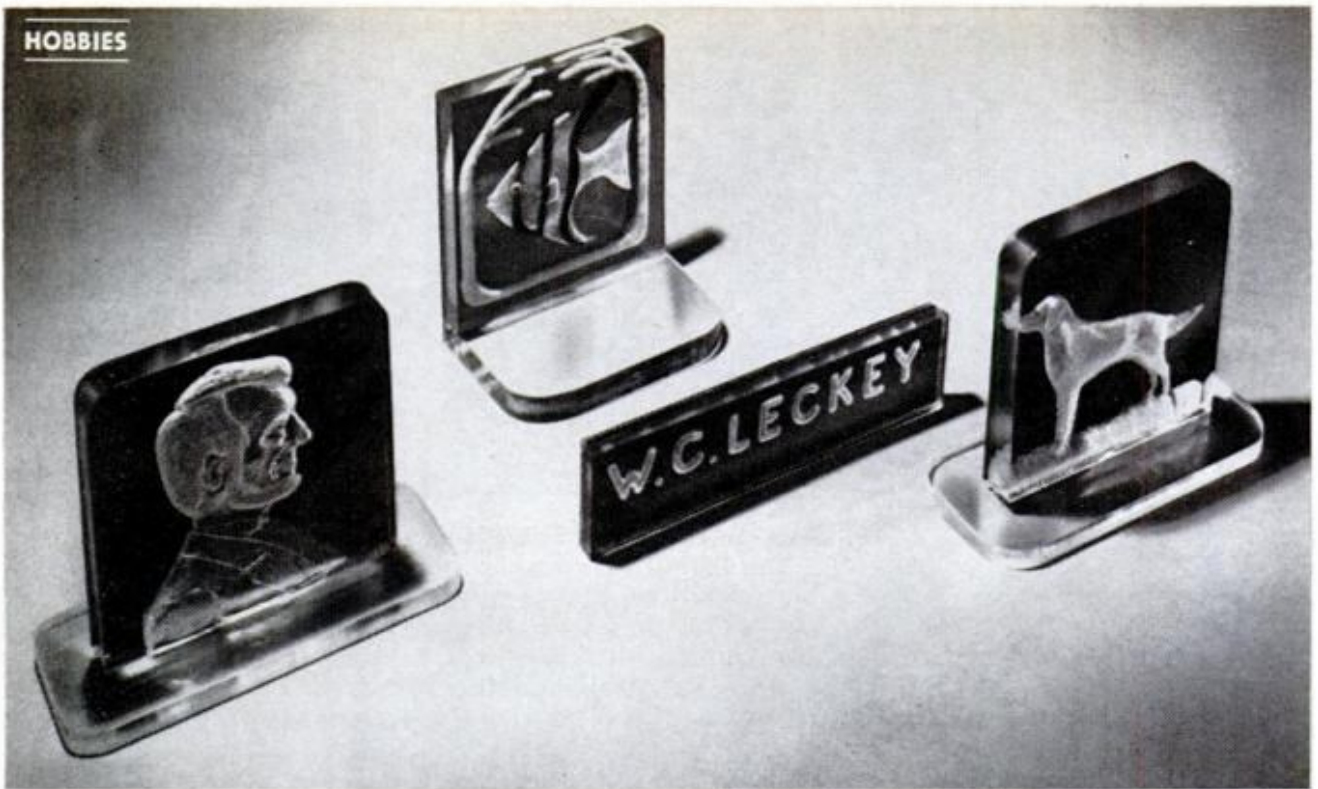

INTERNAL CARVING: LITTLE-KNOWN ART

Development of clear plastics cleared the way for this craft—you carve from the back side instead of the front

By AL WESTERFIELD
And HARRY WICKS

Photos by
Robert D. Borst

DESIGN to be carved in clear plastic is drawn on front of the sheet with a felt-tipped pen or grease pencil. Then an entry hole is made in the back and the carving begins. A large assortment of burrs and cutters is used. You can constantly check depth of the cut by looking through plexiglass sides

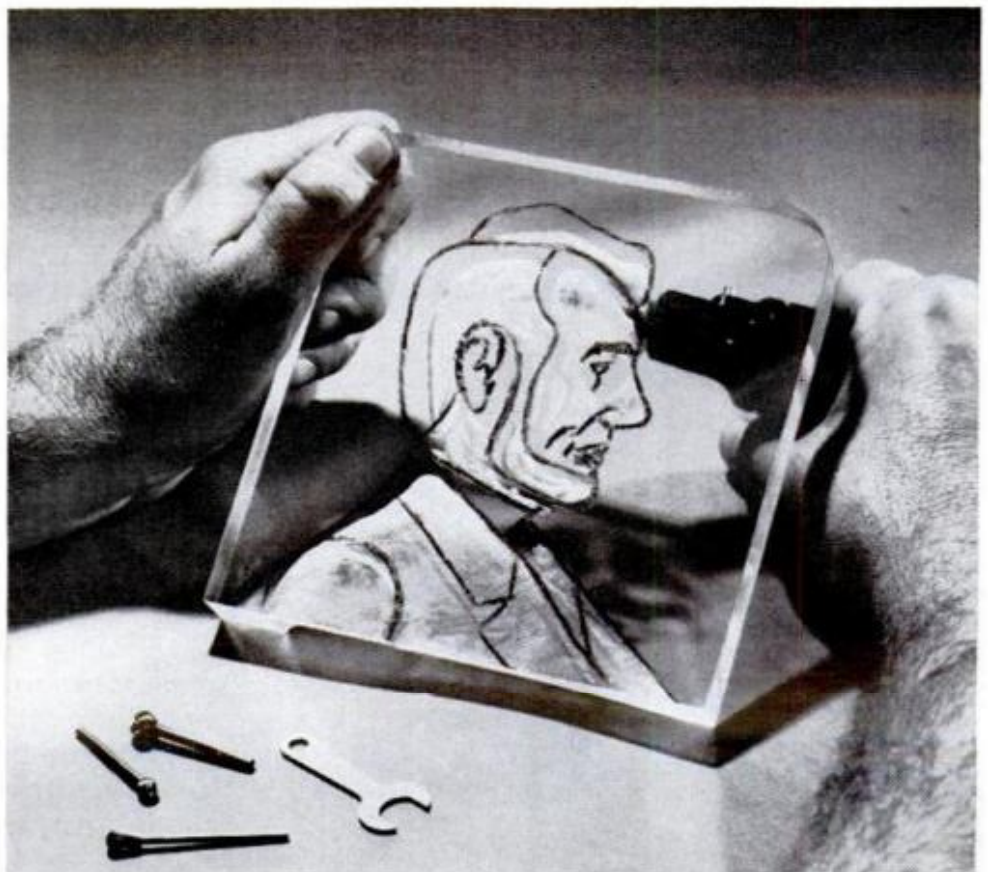

ACCORDING TO EXPERTS in the acrylic plastic field, internal carving was the first popular plastics craft. The fine optical characteristics of clear plastic not only make this art possible, but enable you to create effects that are impossible with any other carving technique.

The biggest delight for most internal carvers, after they have acquired the necessary skills, is to produce objects which are edge-lit. The Lincoln head, for example, when mounted on a wood base containing a 7-w. bulb, produces a striking three-dimensional look when the bulb is lighted. The reason: the light passes through the uncarved area and is not visible to the eye. But, the carved-out portion will reflect every mark that you've made with your cutters.

A fine tool for small carving projects is the Model No. 260 Moto-Tool which Dremel recently introduced (\$24.95). It was used to carve all the projects you see on these pages. With a foot rheostat, the tool performed well on light chores. Though it did require some cooling-off periods when large areas were being ground out, the tool did all the maker claims it will when restricted to the hobbyist-type chores for which it is intended.

If you're a beginner, you should start with simple designs which will keep you

pretty much confined to using round or barrel-type cutters. Don't be disappointed if your first few tries don't even resemble the design you've drawn on the face. It takes practice and more practice to learn the nuances and tricks that the art demands. But once you've mastered the tools of the trade, you'll be more than pleased with what you can turn out.

If you've ever worked with plexiglass, you know it can be handled in much the same manner as wood. If unfamiliar with the stuff, see *How to Work with Plexiglass*, page 176, June '70 PM.

To carve, hold the piece of plastic between thumb and forefinger of your left hand, and the carving tool in your right hand with the drill bit facing up to the bottom of the plastic. As you carve, you will look down into the work. With a round burr, form a cavity in the underside. Don't hurry the job and do let the drill do the work. A good project to start with is a simple shape such as your house number or initials. After a while you'll automatically manipulate the drill expertly enough to take on such sophisticated projects as flowers, birds and fish. For more information on internal carving and the Model 260 Moto-Tool, write Dremel Manufacturing Co., Box 518, Racine, Wis. 53201. ★★★

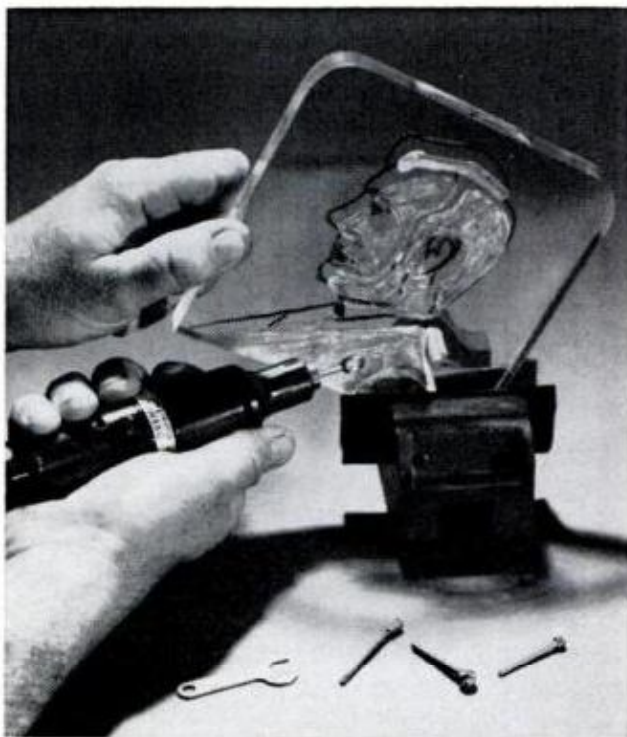

BACK VIEW of carving shows varying depths of cut. When the carving is finished, a colored sheet plastic (right) is affixed to it by means of double-faced tape. If preferred, the carving can be painted



200-Power Telescope

PART 2

Last month you polished the mirror. This month the finishing steps go a lot faster

By ROBERT BRIGHTMAN

WITH THE MIRROR completed, the next step is to make the tube which will hold the optical components. It can be of cardboard or galvanized sheet metal if you decide against the aluminum tube suggested in Part 1.

The cell. This holds the mirror in the bottom of the tube. Cut the two discs and drill three holes through both. The holes should be 120° apart and about 1 in. from the edge. In order to pass $\frac{1}{4}$ -in. bolts freely, one set of holes should be $\frac{1}{4}$ in. dia. (countersunk) while the holes in the second disc should be $\frac{3}{8}$ in. dia. Then pass the three bolts through the disc with the smaller holes and lock them on the other side by means of washers and nuts.

Three springs (auto valve springs cut down to about 2 in. are fine) are placed over the protruding bolts and then the second disc is mounted on the bolts.

The mirror is fastened to the cell by means of three brass clips screwed to the side of the upper disc at 120° intervals. The clips should have $\frac{1}{4}$ -in. flanges at the ends and the flanges should be felt-padded to avoid scratching the mirror. The washers and thumbnuts complete the mirror cell assembly.

When the cell is mounted in the bottom of the tube, you will be able to tilt the mirror in various directions by loosening and tightening the thumbnuts. Three angle irons screwed to the bottom of the

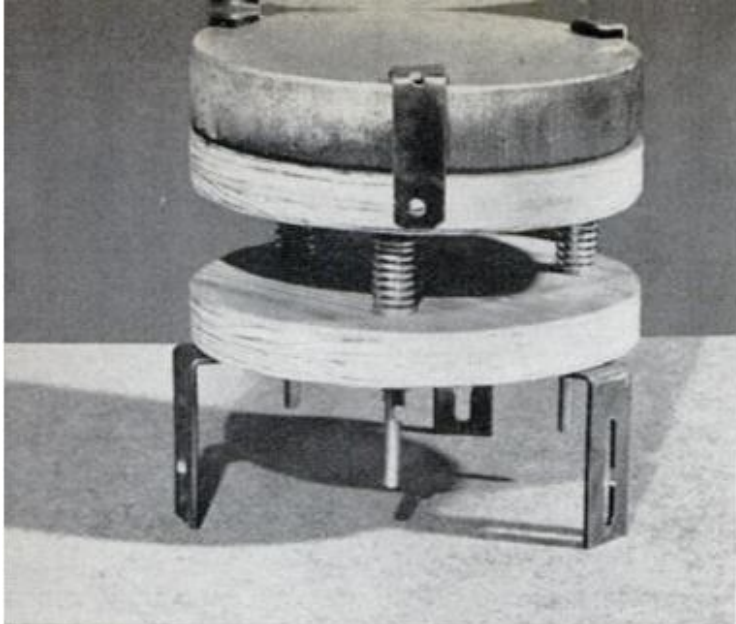

CELL FOR THE MIRROR is made of two plywood discs that are separated by three springs. The mirror is fastened to the top disc by means of three clips

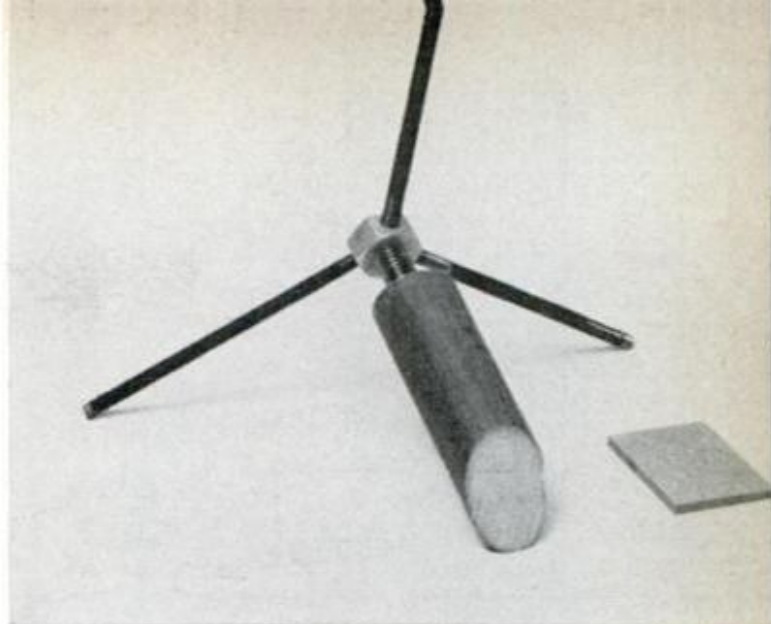

SPIDER for diagonal consists of broom handle cut at 45° miter, a $\frac{3}{8}$ -in. bolt with head cut off and three lengths of threaded rod into $\frac{3}{8}$ -in. tapped nut

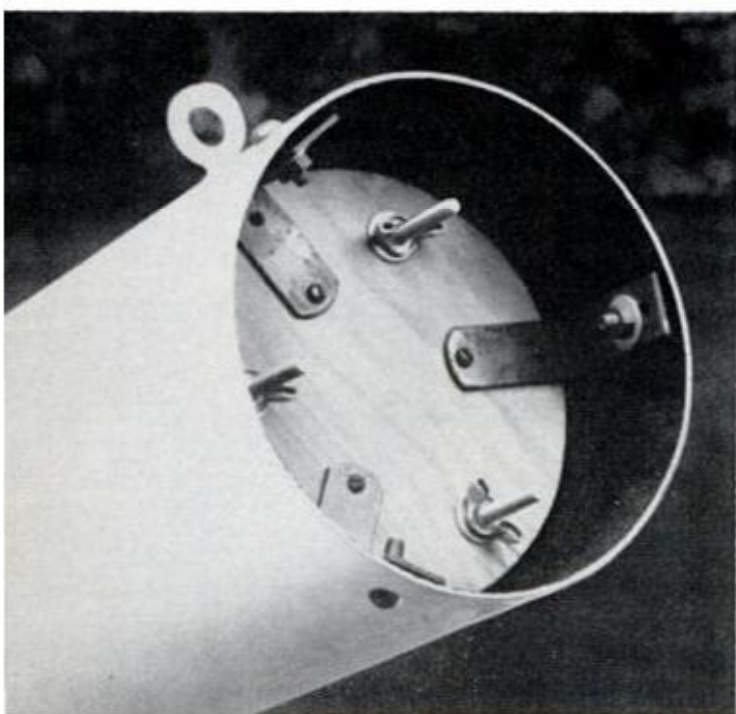

CELL IS INSTALLED in tube using slotted angle irons which permit considerable adjustment to allow for possible errors when the parts are positioned

mirror cell, and in turn fastened to the inside of the tube, hold the mirror and cell assembly securely in place. By cutting slots in one leg of each angle iron, you'll be able to move the entire cell up or down to compensate for any error you may have made in computing focal length of your mirror.

The next step is to position the small diagonal mirror which reflects the light from the main mirror to the eyepiece. This is determined by the focal length of the mirror. You must now determine the true focal length within $\frac{1}{4}$ in. To do it,

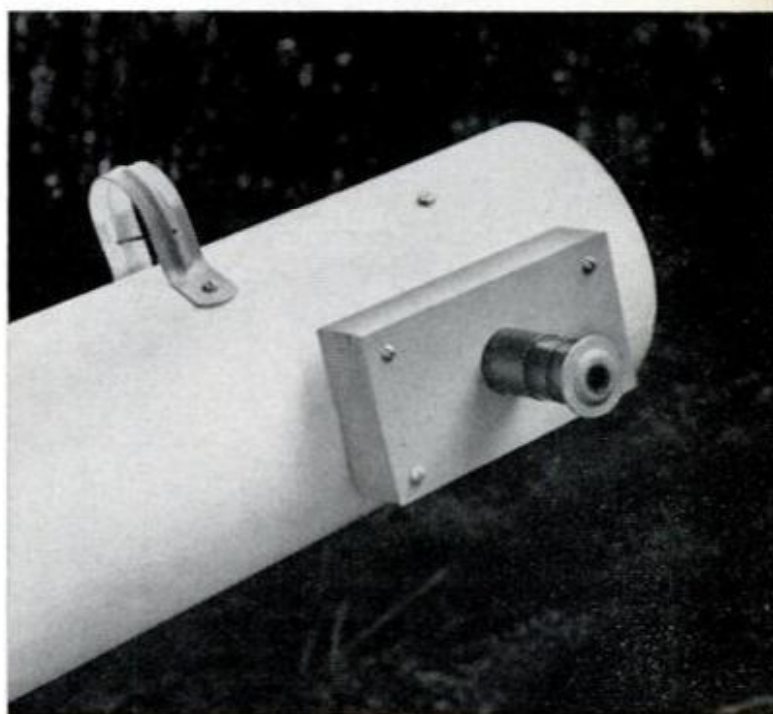

EYEPIECE ADAPTER consists of two pieces of plywood glued together with a $1\frac{3}{8}$ -in. hole at center to accept the telescoping brass tubing and the eyepiece

place the mirror in bright sunlight and direct the reflection of the sun to a business card held about 48 in. away. Move the card nearer or farther away until a sharp image of the sun is obtained. It will be about $\frac{1}{2}$ in. in diameter. Have a helper carefully measure the distance from mirror to card with a steel tape. This distance is the true focal length of the mirror. If grinding was accurate, it should be 48 in.

From this distance (48 in.) deduct the height of the eyepiece adapter (2 in.) plus its distance from the center of the tube to the top of the tube ($3\frac{1}{2}$ in.) This should

Telescope-Tripod Construction

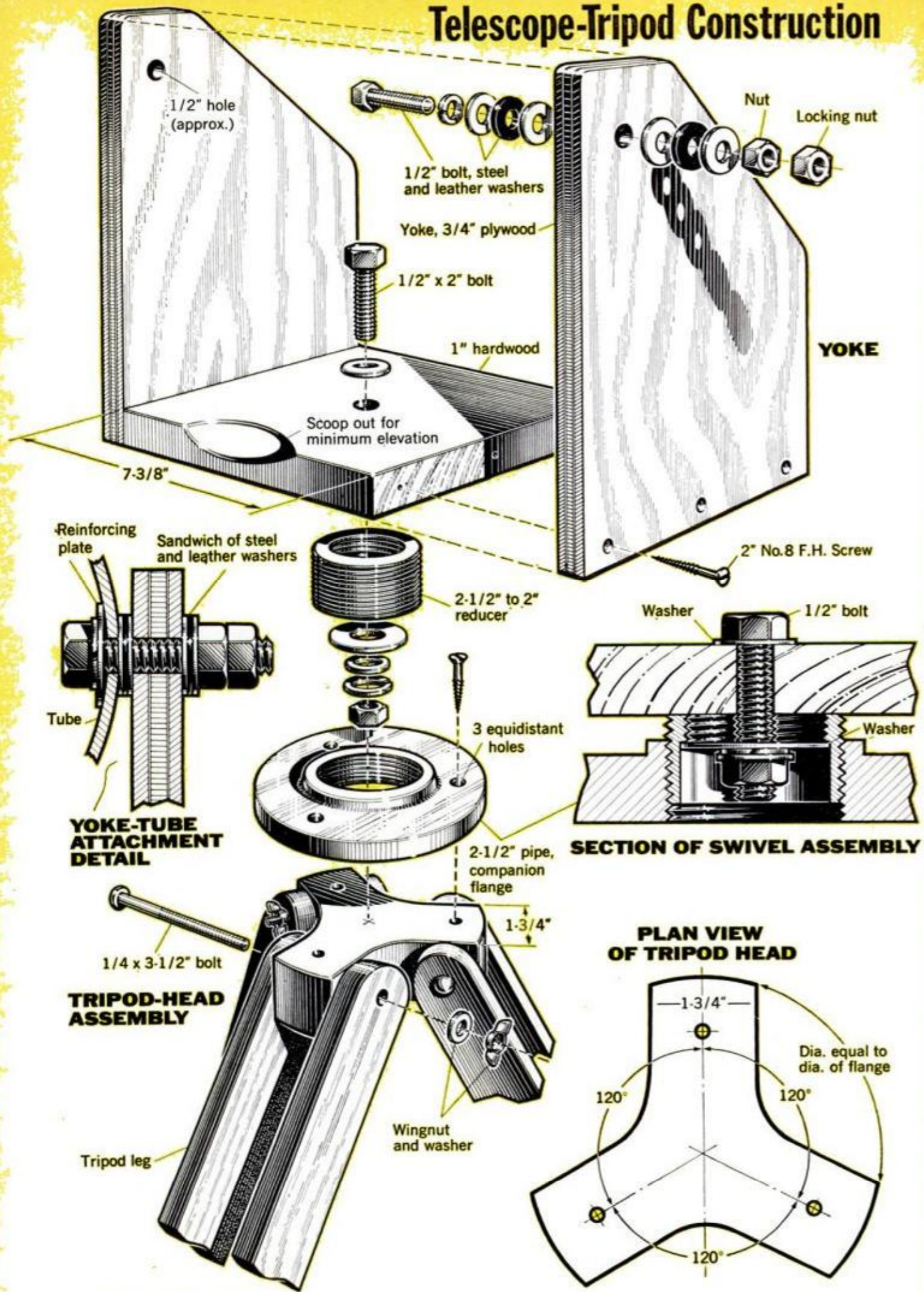

Technical Art by Peter Trojan

LEG PLANS

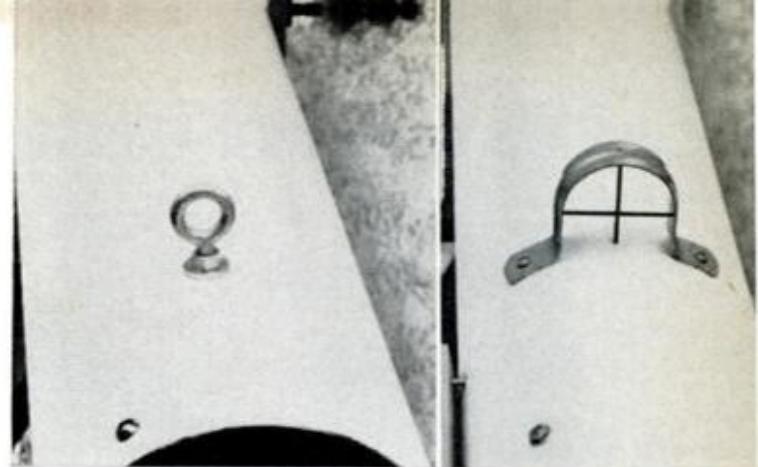
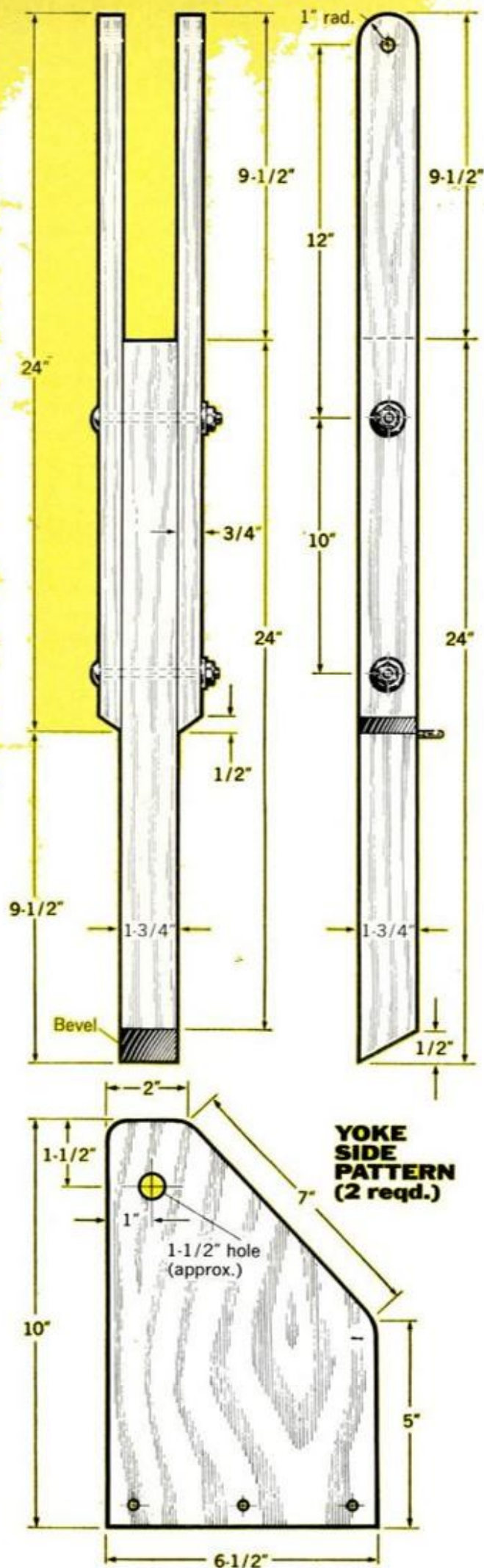

FINDER consists of eyebolt at one end (left) and coathanger wire fitted into holes drilled in pipe strap and tube at the other end. Paint these black

give you about 42½ in., plus or minus ½ in., depending upon the wall thickness of the tube and the actual height of the eyepiece adapter. The slotted angle irons will let you correct any errors. At this point, 42½ in. from the front surface of the mirror, cut the hole for the eyepiece adapter.

The adapter consists of two pieces of plywood glued together to make an oblong block. At each corner drill a hole to pass a 3/16-in. bolt and in the exact center, drill a 1 3/8 in. hole to accept the eyepiece tubing.

To hold the diagonal mirror in the exact center of the tube you will have to make a "spider." Using a broom handle, cut one end at a 45° miter, the other end absolutely square. Next get a 3/8-in. bolt, drill a slightly undersize hole in the square end of the broom handle and screw the bolt into the handle about an inch. Cut off the head, leaving 1½ in. projecting from the end of the handle. Next get a nut to fit the bolt and drill and tap for a 10x32 thread in three alternate sides of the nut as shown in the photo. In addition you will need three 10x32 bolts, each 3½ in. long. Cut off the heads. Glue the diagonal mirror to the mitered end of the broom handle with epoxy cement. *The diagonal is a front-surface mirror, so make certain you apply the epoxy to the back of the mirror.*

The diagonal is positioned directly opposite the eyepiece adapter. Measure the distance from the midpoint of the diagonal to the three 10x32 bolts and drill three holes, each spaced 120° apart, in the tube to accept the spider. Provision for adjusting the diagonal so that it is opposite the eyepiece adapter is possible by screwing the broom handle up or down into the nut

PM's Back-Yard Telescope

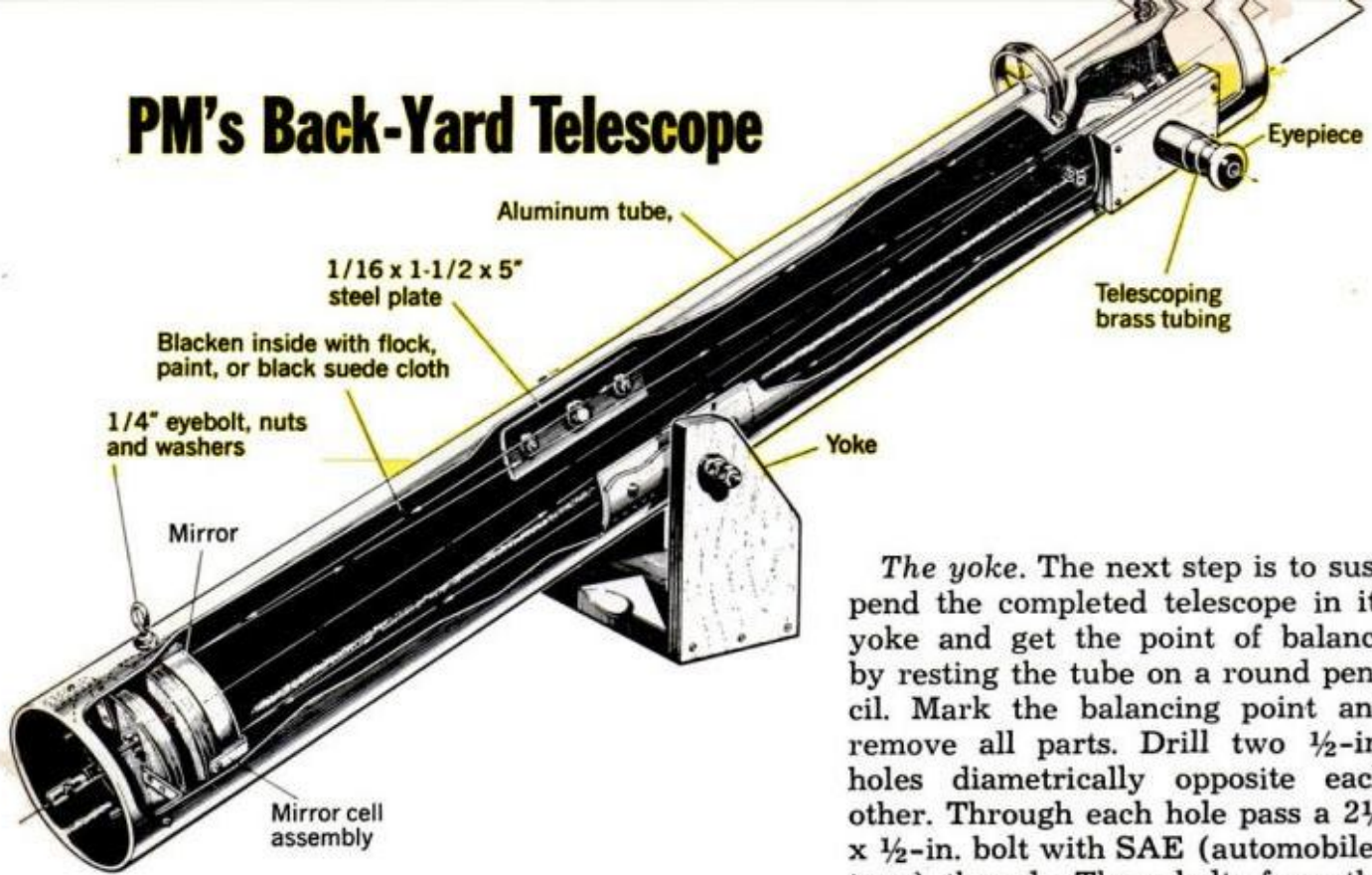

held by the spider. A locknut is not necessary as the three spider legs bear against the $\frac{3}{8}$ -in. bolt.

With the two plano-convex lenses (included in the kit) and three lengths of telescoping brass tubing, you can make a very fine 1-in. focal length Ramsden-type eyepiece with a focusing arrangement that will allow you to focus as close as 100 ft. How to mount and space the lenses is shown in the art. The largest length of brass tubing ($1\frac{3}{8}$ in. o.d.) should be inserted into the hole previously drilled in the eyepiece adapter. Have it project about $\frac{1}{4}$ in. and run a bead of cement around the protruding end so as to anchor it in place.

Finally, paint or spray the inside of the telescope tube flat black to kill reflections.

The yoke. The next step is to suspend the completed telescope in its yoke and get the point of balance by resting the tube on a round pencil. Mark the balancing point and remove all parts. Drill two $\frac{1}{2}$ -in. holes diametrically opposite each other. Through each hole pass a $2\frac{1}{2}$ x $\frac{1}{2}$ -in. bolt with SAE (automobile-type) threads. These bolts form the trunnions on which the telescope is moved up and down. Notice that the bolt holes are offset to get maximum elevation. Oil-soaked leather washers sandwiched between steel washers and then a locknut provide a smooth bearing surface with just enough friction to keep the tube in place at any desired angle.

The tripod. Though the tripod shown is simple, it is rugged and sturdy. Each leg consists of three sections held together by $\frac{1}{4}$ -in. bolts. The tripod head is hardwood and a $2\frac{1}{2}$ -in. pipe flange is screwed to it. A $2\frac{1}{2}$ -in. to 2-in. pipe reducer is fastened to the bottom of the yoke

YOKE is made by fastening two pieces of $\frac{3}{4}$ -in. plywood to a hardwood base. Notice that holes for the bolts are offset to provide maximum elevation

STURDY TRIPOD has $1\frac{3}{4}$ -in.-thick legs plus chains to prevent them from spreading. A $2\frac{1}{2}$ in. flange is bolted to the top. Use two coats of varnish on wood

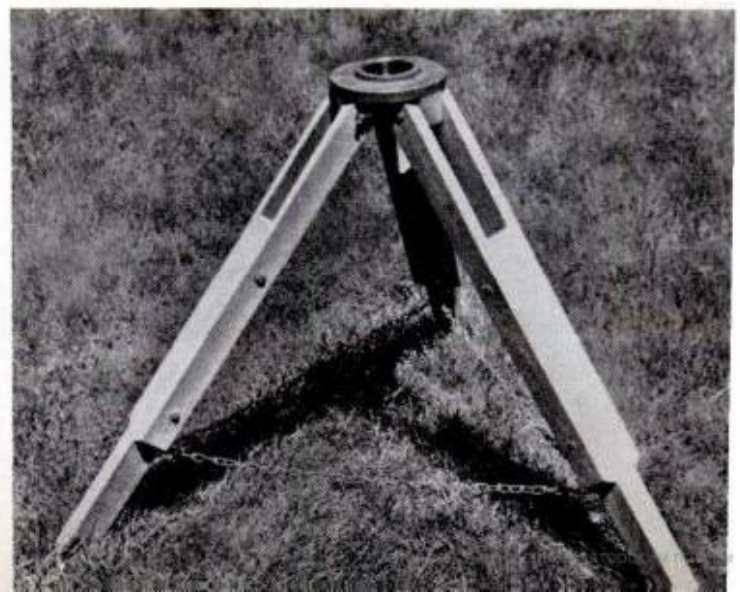
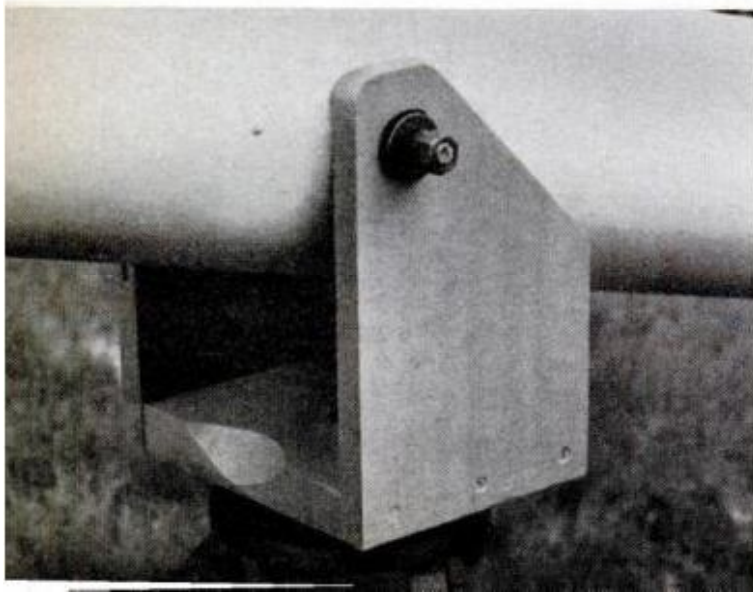

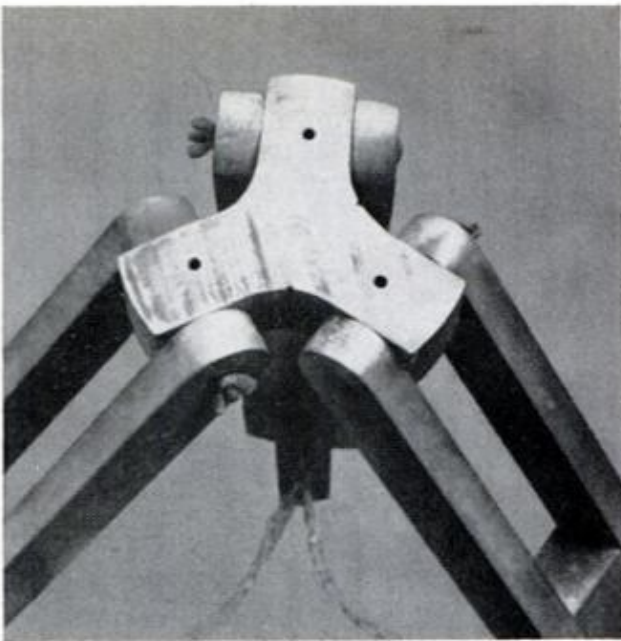

TO KEEP TRIPOD LEGS from spreading and collapsing, use three lengths of inexpensive sash-chain and three eyehooks fastened to the legs at the bottom

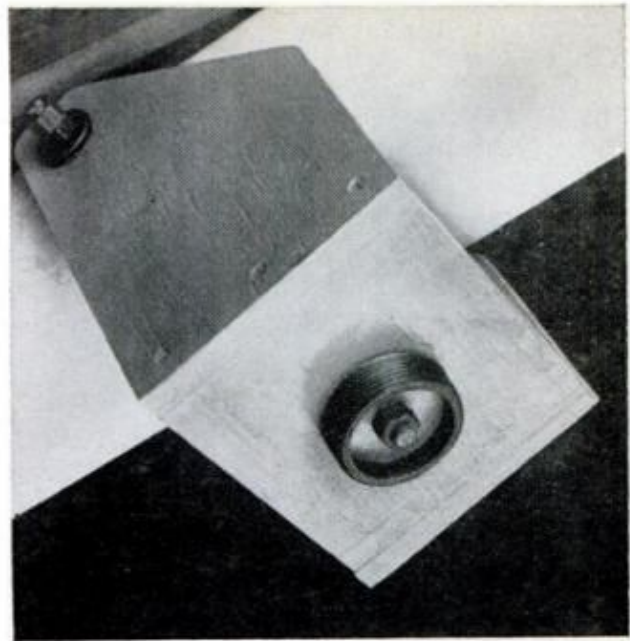

PIPE REDUCER (2½ to 2 in.) is bolted to yoke bottom. For smooth action, lap threads of reducer and flange with grinding compound, apply oil or grease

with bolt and washer. Because American pipe threads are tapered, it is a good idea to lap the pipe reducer to the pipe flange. Apply some of the leftover grinding compound and water to the threads of the reducer. Screw in the reducer as far as you can by hand and keep working it back and forth; a half-turn or so is enough. Keep this up for 15 minutes and you will have a smooth fit between flange and reducer after you have washed out all of the grit and applied a little grease to the threads.

The sighting aid. Unless you have some sort of finder it is impossible to know what you are looking at in the heavens. The finder on this 'scope is a ¼-in. eye-bolt bolted to the other end (aligned, of course). Cross hairs are a couple of wires passing through holes drilled in the pipe hanger.

Optical alignment. Point the tube, with all components in place, at the sky or a brightly illuminated wall. As you look through the adapter you'll see the diagonal mirror. Then, reflected in the diagonal mirror, you'll see the walls of the tube and at the bottom a white disc—the mirror itself. More or less in the middle of the mirror you will see a secondary and smaller image of the diagonal suspended by its three supports. *All of these images should be concentric.*

If the diagonal is not in the exact center of the tube it can be made so by loosening the nuts that hold the spider to the tube

and adjusting each leg of the spider. And the main mirror should be adjusted so the image of the diagonal is in its exact center. To do this best, have a helper turn the thumbnuts at the back of the mirror cell, one or two at a time, while you observe results by peering through the adapter. A good method is to number each thumb nut, and tell your assistant which you want turned.

Astronomical eyepieces are made in standard 1¼ in. o.d. Focusing is done by sliding the eyepiece in and out of the adapter with a twisting motion. The power of our telescope is determined by the focal length of the eyepiece used. The eyepiece we made has a focal length of 1 in. and will give 50-power. With a ½-in. eyepiece you'll get 100-power; with a ¼-in. eyepiece, 200-power. Dividing the focal length of the eyepiece (for example ½-in.) into the focal length of the mirror (50 in.) will determine the power of a telescope.

Your first look. The object most often chosen is the moon. For best viewing, wait until it is at first quarter or last quarter; a look at a full moon will be disappointing. Locate the moon in the approximate field of view with the peep-sight finder, then go to the eyepiece. At first you'll see a giant glob of light. Adjust the eyepiece until this becomes the rills and valleys, mountains and craters of our nearest neighbor in space. From here on you'll be hooked on star-gazing. ★★ ★

HOW TO MAKE A BETTER RUG HOOK



IN COLONIAL DAYS, when rugs were too valuable to discard, housewives scissored them into ¼-in.-wide strips and hooked them into rugs. The cloth strips were drawn up through a burlap backing, loop by loop, with a rug hook to form a thick pile.

You can buy such a hook at a department store for around \$5. But a really good one is a rare tool. One that's designed for the purpose will make the job easier. Happily, you can make it yourself.

A well-designed rug hook should have a tapered shank so that when the hook is pushed through the monk's cloth the shank will spread the weave enough to permit pulling the loop of rag strips or yarn through readily. The hook itself

should have a smoothly rounded barb, and the tool should have an easy-to-grasp handle.

With a little shopwork you can make up a tapered-shank hook of this kind quite easily. The one pictured was turned from a ½-in. stainless-steel bolt. The barb was shaped with a small file, and when polished, the hook was set in a turned walnut handle.

If you lack a metal lathe, you can grind your hook to shape, first rough-grinding with the work hand-held and then finish grinding while the work is chucked in a portable drill. After filing the hook barb, polish with a strip of abrasive paper and buff the steel shank smooth.

—John Burroughs



TURN HANDLE from seasoned walnut and drill lengthwise for hook before removing it from lathe

SHAPE HOOK with a small, three-cornered file, round out the gullet with a hand grinder and polish



HINTS FROM READERS

Protecting paintbrush bristles

Though there are many methods of suspending a paintbrush in thinner without damaging the bristles, the idea shown here is my particular favorite. Select a coffee can or pail that'll accommodate your brush, and hold the brush vertical by clamping it to the container with a C-clamp. Pour in just enough solvent to reach the brush's ferrule.—*Andrew Vena*



Support for bore-sighting a rifle

Here's an adjustable "no hands" support for sighting a rifle that can be made of scrap 1x8 stock. It consists of a base and two hinged arms with notches to cradle the gun stock. For elevation control, long 1/4-in. machine bolts in undersize holes are used. With trigger guard against rear upright, rifle weight keeps assembly firm.—*Robert Hertzberg*

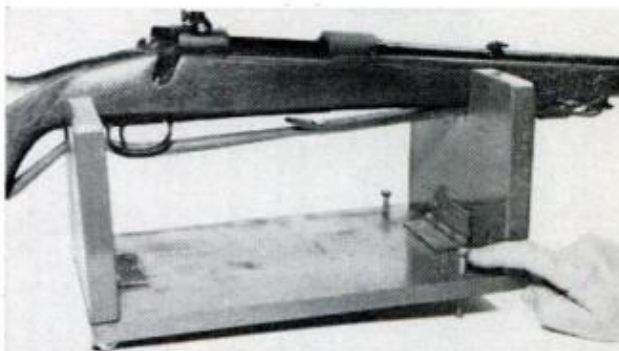

'Carriage' bears weight of gate

A sliding gate in our fenced-in rear yard is a convenience because it doesn't require any swinging room. But its considerable weight caused the inevitable sagging which made it hard to slide. The problem was permanently solved by mounting two pairs of wide-tread wheels on pipe "axles", and clamping them to the bottom rail on the outboard end.—*Norman Redding*

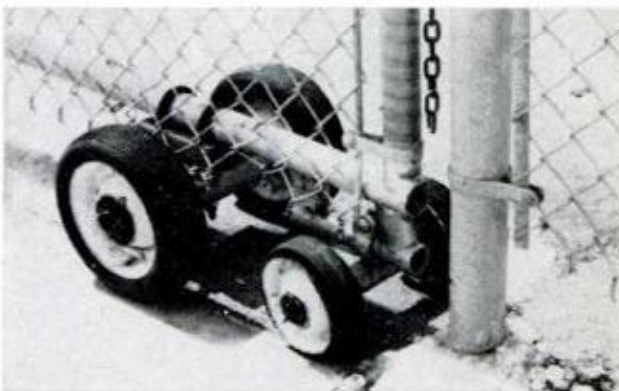

Improve bite of your metal snips

If you hold a file edge at 45° and draw it across the cutting edge of your tin snips, you'll give the tool a better bite. As a result, there is much less chance that the metal will crawl away from the jaws as you cut. This trick, of course, should be used on ordinary snips only; do not file special-purpose, serrated cutters.—*W. H. McClay*



Flowerpot serves as small oven

When heating iron or other metal on a gas stove, half of a clay flowerpot can be used effectively to confine the heat around the workpiece where it's wanted. To cut the pot, use a hacksaw, then place it over the burner. If you use both halves, one over the other as shown, you'll retain even more heat.—*Joe Chinclair*

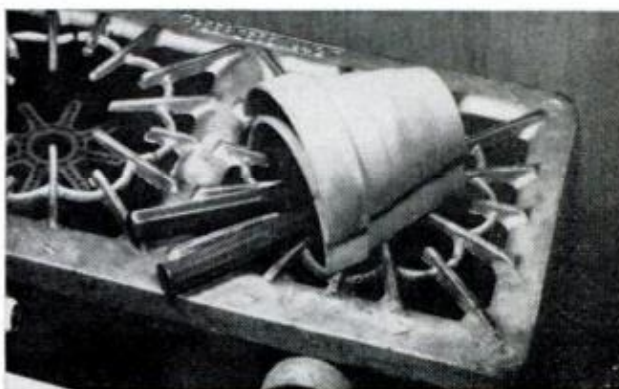

A Spoonholder Rack

By WALTER E. BURTON

A COLLECTION of old or decorative spoons is of little more than sentimental value unless it is attractively displayed. A novel way to keep spoons in view is to suspend them from a spoon-holding lamp on a dining-room table, buffet, or in some other appropriate location. Making such a display is easy and consists mainly of fashioning a slotted disc which is then installed on an existing table lamp.

Lamp design and construction will, of course, pretty much determine the precise position of the disc on the column as well as the size of the center (mounting) hole. When planning the project, bear in mind that it usually is desirable to use a lamp that lets you place the disc at least 3 in. below the bottom of the lamp socket. (Some lamp designs will allow the disc nearer to the socket.)

The lamp shown had a column consisting of a number of metal tubes, washers and glass knobs strung on a length of iron pipe. Thus it was easy to insert the disc below the top tube and above the decorative glass knob.

The disc here is a 6-in. plastic saucer, colored to match the glass knobs, which

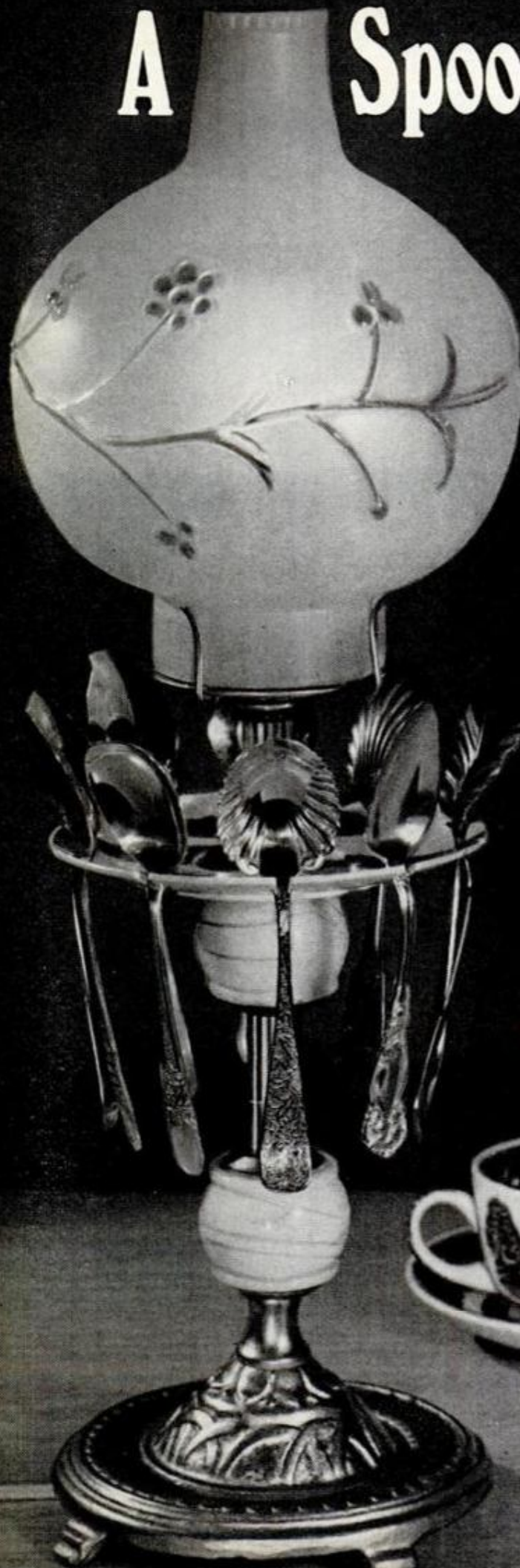

for Your Favorite Lamp

I picked up at a five-and-dime store for less than 15 cents. Before buying one, select your lamp and determine what diameter would harmonize best with the lamp's design.

You can make the spoonholding disc from almost any material having a thickness up to $\frac{1}{4}$ in. if it has a color or can take a paint finish. (Plywood, Plexiglas, Bakelite and the like are all good choices.) You could also use a metal, such as brass, but it might tend to mar the spoons unless the notches are carefully finished and padded with a glued-on felt.

When you cut the notches, size them so the spoons will fit snugly. Since spoon designs may vary, it's wise to cut a test template of cardboard or scrap plywood. Each spoon can then be custom-fitted to its mating notch.

The spoons shown are suspended bowls up. The drawing below shows how the notches were cut in the rather tough plastic saucer. Two holes were drilled side by side, $\frac{3}{8}$ in. from the rim, and two slots were made from each hole to the rim using a hacksaw. The in-between waste was then broken out. To finish, file each notch smooth to contour.

The center hole was made by drilling a pilot hole and using a tapered reamer to enlarge it to fit over the pipe that forms the lamp-column core. ★ ★ ★



SPOON HANDLE NOTCHES are roughed out with drill and saw. A file is used to shape and smooth the cuts

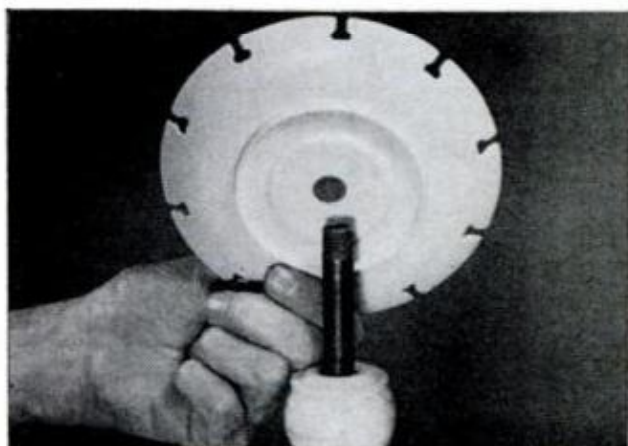

COMPLETED DISC is slipped over pipe. Make certain sufficient clearance is allowed for spoon bowls

HOLDER is sandwiched between glass knob and tubing. Socket is then tightened to hold it firmly in place

NOTCH LAYOUT

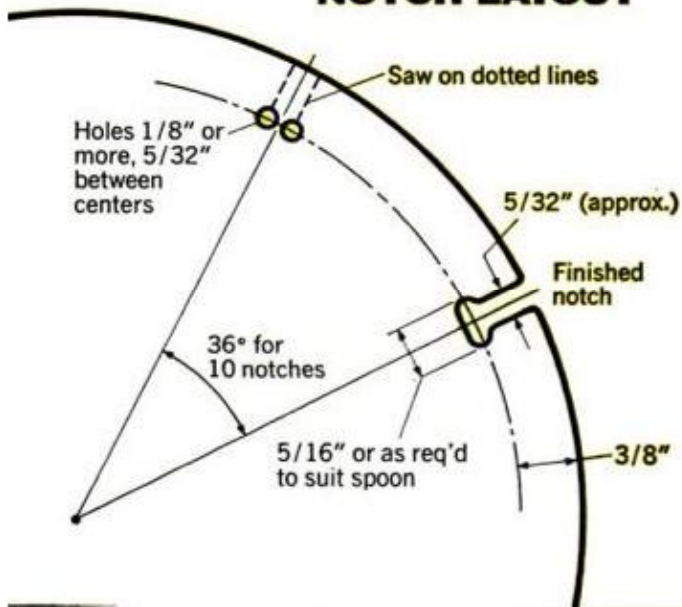



SOLVING



WHEN POURING LEAD SOLDIERS or sinkers, try mixing some tin (an empty toothpaste tube) with the lead. Since tin lowers the melting point, the objects will pour easier and come out cleaner.—Anton M. Barkey

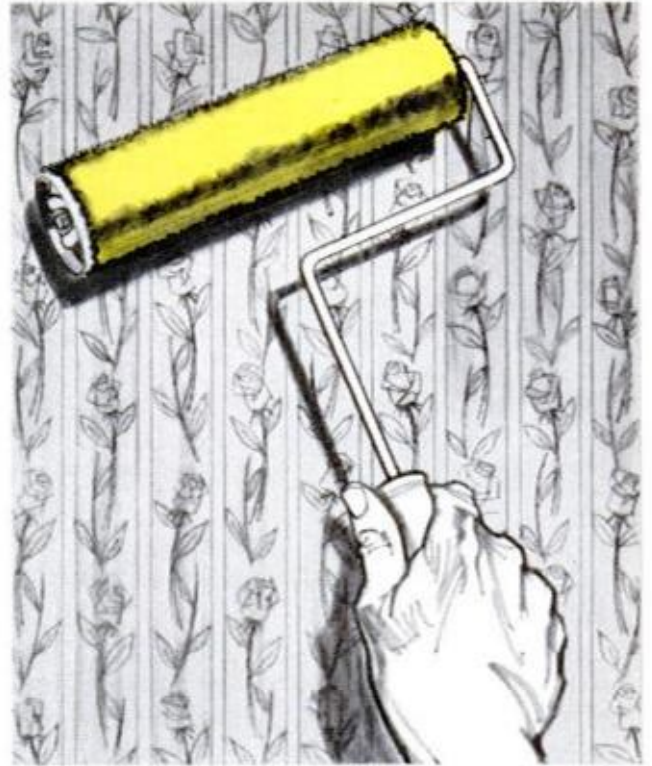

REMOVING WALLPAPER goes a lot faster if you use a paint roller instead of a sponge to dampen it. A roller covers more area faster, and permits you to use hotter water than a hand-held sponge.—I. Cluen

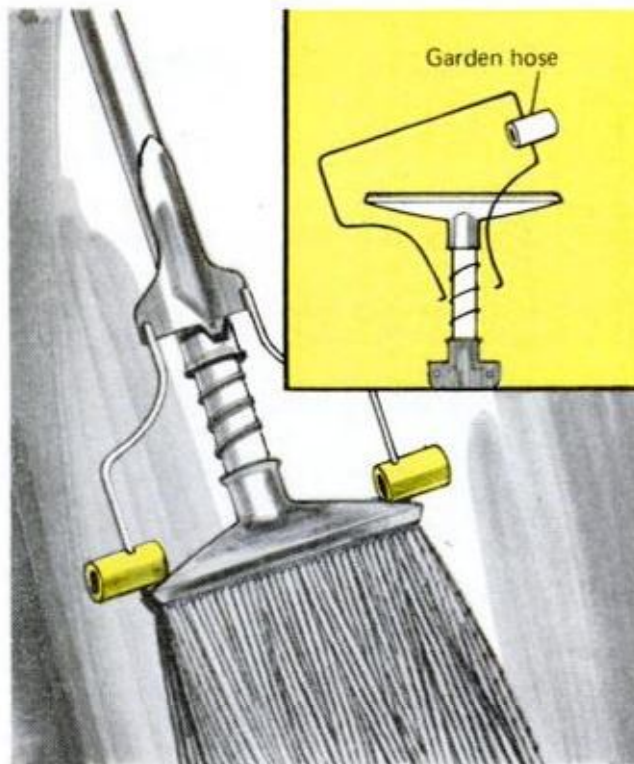

SCRATCH MARKS FROM A MOP can be eliminated if you remove handle and thread a small piece of garden hose onto each end. Punch holes for a force fit with the wire mop handle.—Col. Herbert B. Enderton



TWINE DISPENSER can be made out of a discarded can that comes with a press-on plastic top. Punch a hole in the top to suit the twine stored in the can and then pull the twine through as needed.—J. F. Dinges

HOME PROBLEMS

Illustrations by Adolph Brotman, Worman Associates

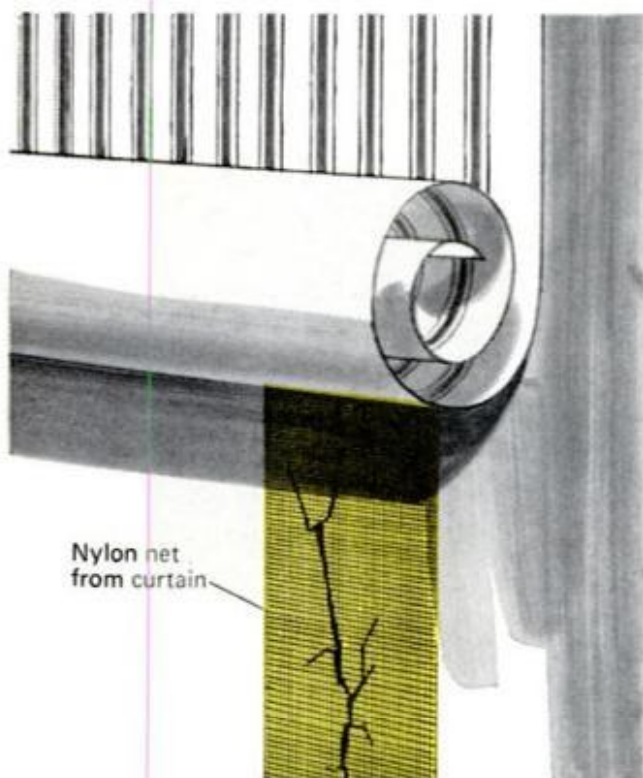

SMALL RAGGED CRACKS in a wall can be easily repaired by pasting a 3-in. strip of nylon mesh over them. When new wallpaper goes on, it's almost impossible to spot the cracked area.—*Ada Landrud*



EMERGENCY PHONE "BOOK" insures getting help in a hurry when it's needed. Stick white tape on inside edge of instrument handle, add numbers and cover with plastic wrap to prevent smudging.—*Paul Brown*

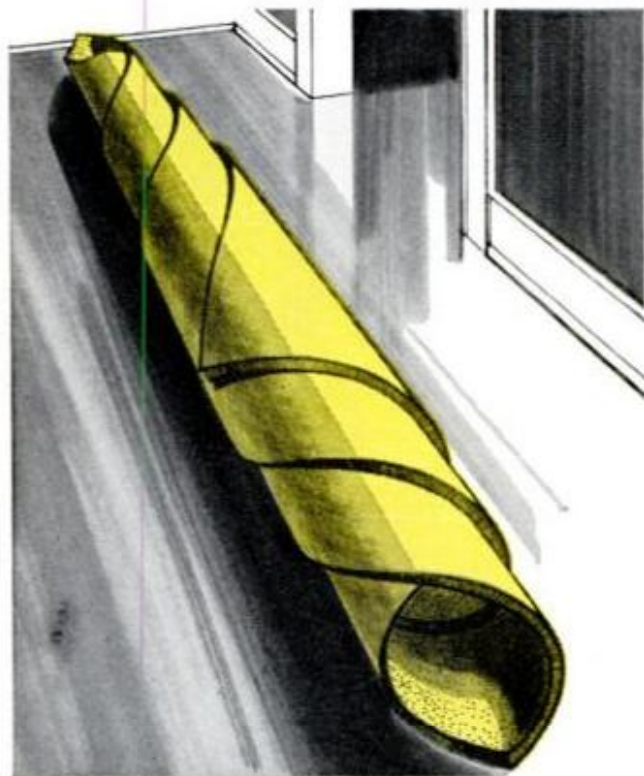

A ROLLED RUG is often difficult to carry because of its tendency to "buckle" in the middle. If you roll the rug diagonally, starting from a corner, the ends are lighter, ending the problem.—*Harold Shanks*

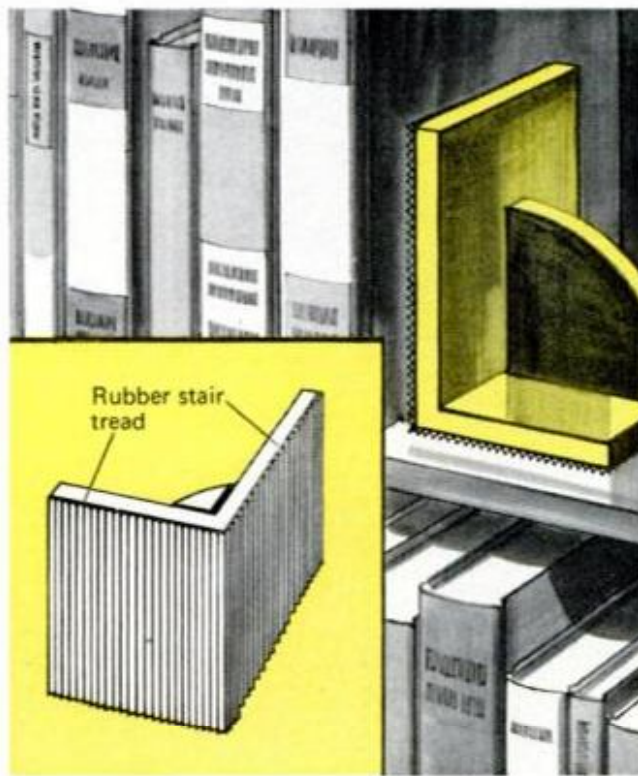

LIGHT OR SMALL BOOKENDS are often easily spread or tipped over when heavy books are placed between them. To prevent this, glue pieces of stair-tread to bookend inside and bottom edges.—*William Swallow*

FOR NEARLY any water, fuel, heating or refrigeration line you plan to install or replace yourself, copper tubing has two advantages over other plumbing materials.

One is that it lasts. Because copper tube never rust-clogs, it's generally considered to be the best standard plumbing material obtainable. The other advantage, particularly for anyone doing installation work himself, is that copper tube is much easier to fit than steel pipe. The tubing can be joined with either of two types of fittings: the soldered type for permanent connections or 45° flare fittings for lines or line-sections that may have to be moved or disassembled.

But copper tubing also has a disadvantage: cost. It's expensive, and the copper or brass fittings to join it are also quite expensive. Except for cutting and flaring

Tools and Tricks the Pros

By JOHN BURROUGHS

BENDING SPRING (above) slips over tube and allows hand-bending without collapsing tubing

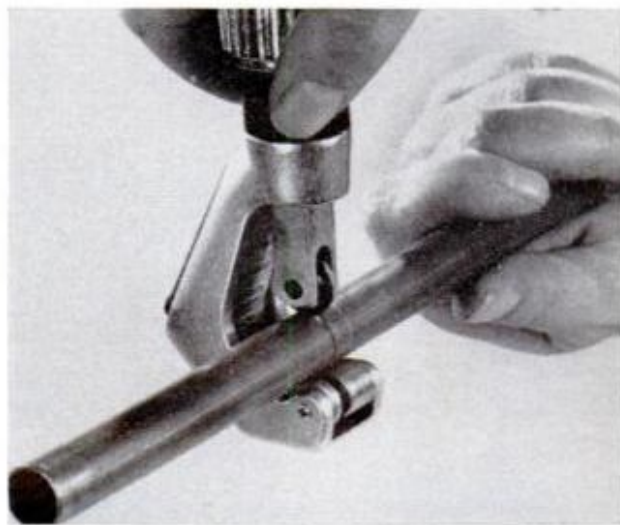

TUBE CUTTER cuts any type copper tube. Burr (below) is reamed out with the cutter's triangular reamer

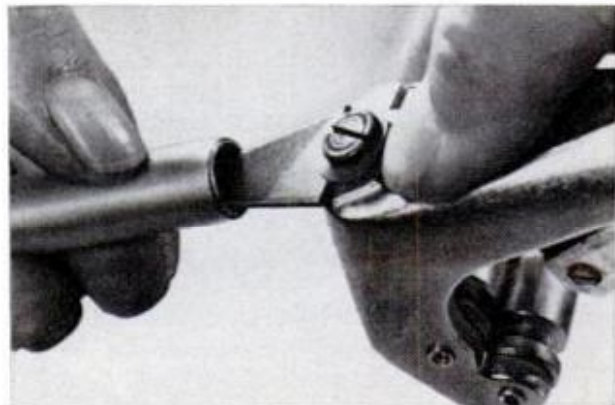

POPULAR MECHANICS

tools, the real purpose of most special tools used to work copper tubing is to cut the cost of the completed job by eliminating the need for costly fittings.

Both hard-temper (rigid) and soft-temper (bendable) tube are commonly used in household plumbing. (Some local plumbing codes do not permit the latter.) Both are available in medium or heavy weight (wall thickness). Medium-weight Type-L tubing is recommended for indoor water lines. Heavyweight Type-K tubing is used for outdoor or buried lines. Rigid Type-M tubing, also available, is a light-weight tube used only for low-pressure air vents.

Copper tubing's size designation—its nominal inside diameter—is really the i.d. of the steel pipe the tube replaces. The actual outside diameter of the tube is its nominal size plus $\frac{1}{8}$ in. Nominal $\frac{3}{8}$ -in.

tube, for example, has an actual o.d. of $\frac{1}{2}$ in. Because this sizing system can cause confusion, tools for flaring and bending tubing are often marked with the actual outside diameter of the tubing they're designed for.

Rigid tubing, which comes in 10 or 20-ft. lengths, makes an especially neat-looking installation, and the straight lengths make it easy to pitch lines a few degrees for drainage. But since hard-temper tubing can't be bent unless torch-annealed, a rigid-tube installation ordinarily requires quite a number of fittings.

Rigid tube can be cut readily with a tube cutter, and the solder-type fittings used with rigid tubing are easily sweated on with a propane torch. When using a tube cutter, advance the cutting wheel gradually, giving the feed screw a quarter-turn for each turn of the cutter around the

Use with Copper Tubing

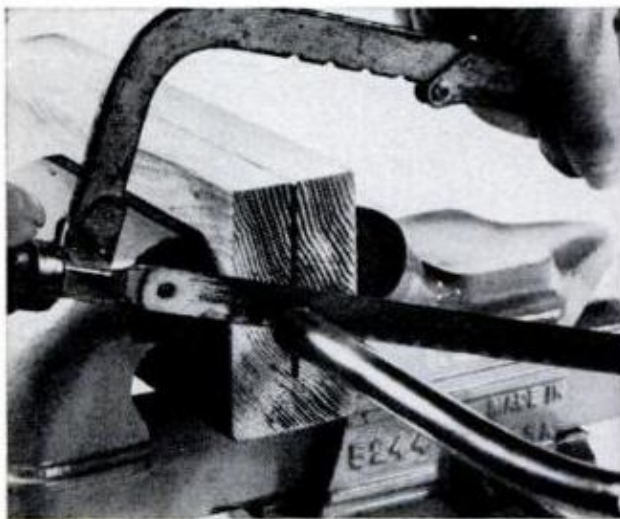

TO PREVENT SQUASHED WALL when tube is gripped in bench vise, use length of 2x4 bored and kerfed its length. Compression-type flaring tool (below) has clamp that grips as cone is screwed to form flare



QUICK AND EASY way to true hacksawed ends square is to twirl end against sanding disc in bench saw. Flare fittings for copper tube have 45° seats. Don't confuse them with the 37° flares on steel fittings

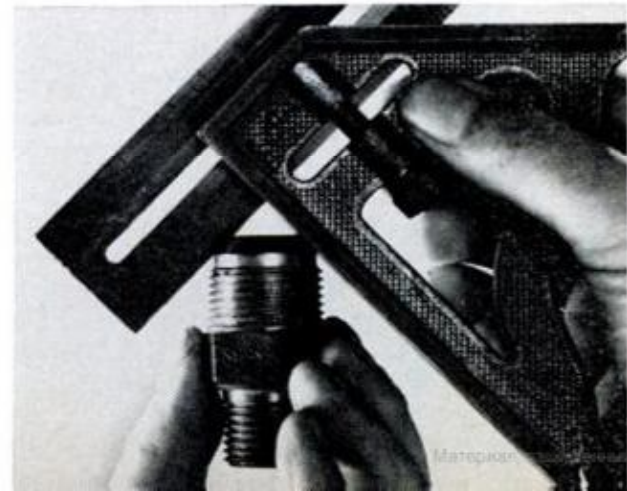
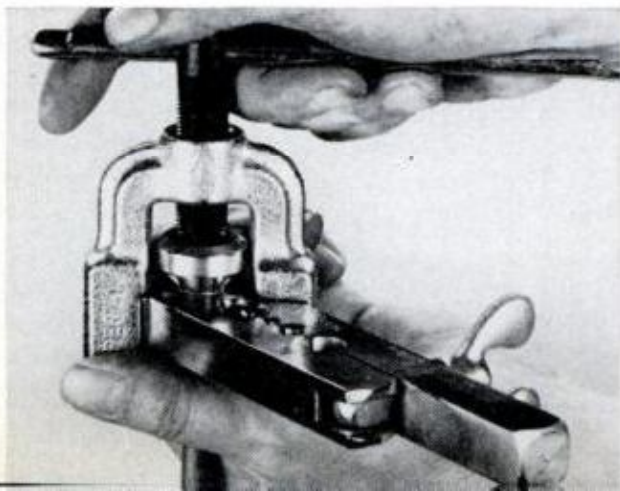

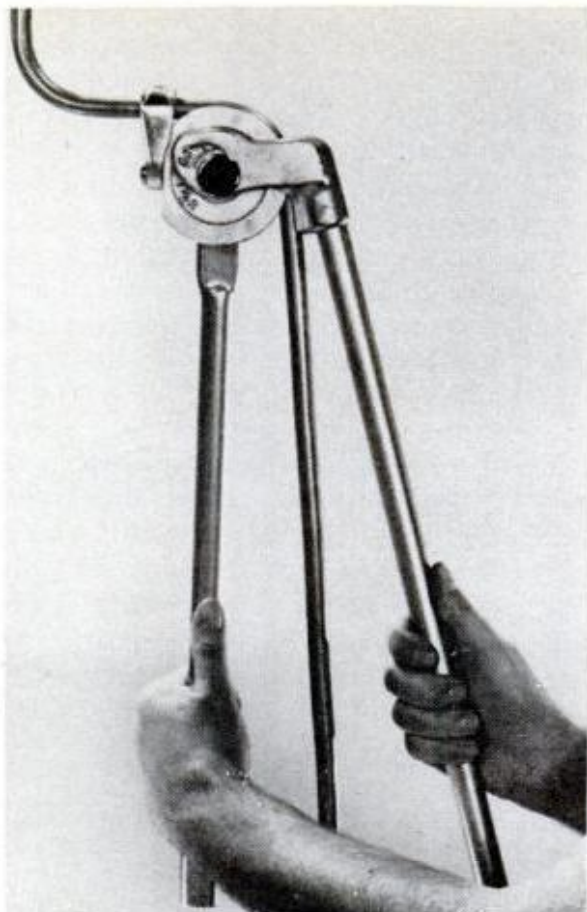

LEVER-TYPE BENDER makes wrinkle-free, short-radius bends. Rigid tube can be bent if torch-annealed

tube. Remember to ream the burr from cut tube before soldering fittings. For successful sweated joints, clean both tube and fitting with abrasive cloth, apply resin flux liberally, then heat fitting and tube evenly until 50-50 wire solder will melt and flow when touched to the joint. Enough solder to fill the joint will be drawn in by capillary action, with excess dripping from the bottom. Let the soldered joint cool undisturbed.

Soft-temper tubing comes in 30 and 60-ft. coils, though you can buy it in cut lengths by the foot. If you avoid kinking the tube as you unroll it from the coil, you can straighten it by hand for exposed straight runs. Exposed soft-temper tubing should be strapped every few feet to prevent sagging. If notched into studs, the tube should be covered with steel plates that are heavy enough to prevent punctures by nails that might later be driven into the wall.

Soft-temper tubing is especially good for remodeling work. Continuous lengths can be snaked through walls or run through holes bored in joists and bent around an obstruction.

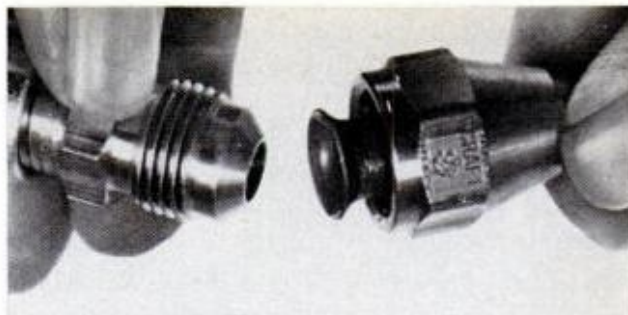

SLIP FLARE NUT on tubing with the threaded end out before forming the flare. Seat must be mar-free



FLARE FITTINGS pictured at top cost twice as much as the solder-type adaptor shown at lower left

Shallow bends won't collapse the tube's walls. Shorter-radius bends can be made with a spring bender (see page 164), which slips over the tube and supports its walls as the bend is made. The trick to making smooth bends with spring benders is to start forming the bend at the middle of the spring and work out. A spring also can be inserted inside the copper tubing when you want to make tight-radius bends near the end.

But the professional tool for making bends in tubing is the lever-type bender, which makes perfect small-radius bends not much larger than elbow fittings. Operating the bending tool's lever draws the tube around a concave-grooved forming wheel.

There are many models of lever-type benders available (one leading manufacturer, Imperial Eastman, 6300 W. Howard St., Chicago, Ill., lists 23 models in its catalog). Lower-priced benders bend only one size of tube. More expensive models have interchangeable forming wheels for bending several sizes. Although ordinarily used to bend soft-temper tubing, lever-type benders bend hard-temper



DON'T OVERTIGHTEN flare fittings or you'll strip the threads. If joint leaks, inspect tube's flare

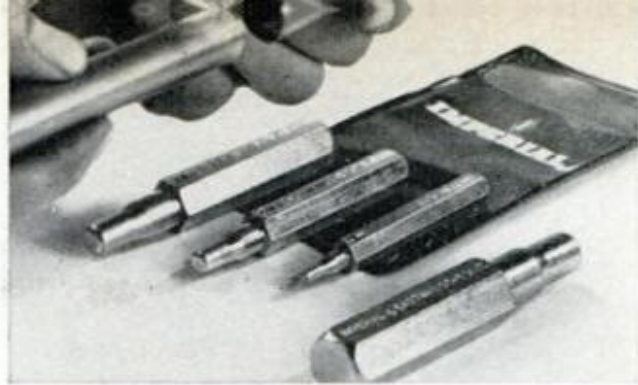

SWAGING PUNCHES enlarge annealed tube i.d. to tube's o.d. for sweat soldering without fittings

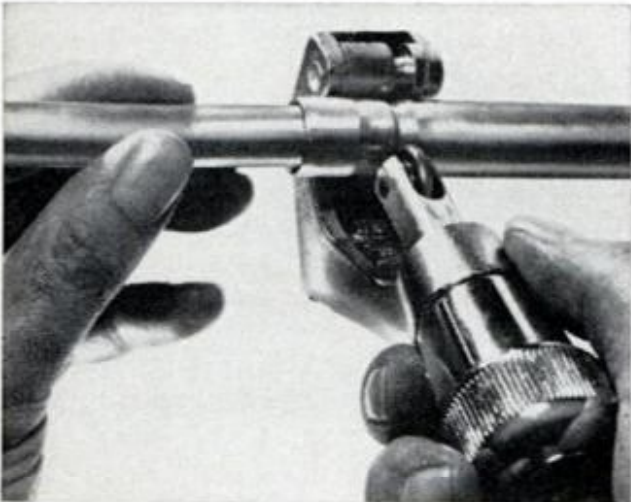

A CONSTRICTOR, a pipe cutter with roller, rolls a groove for sweating small-size tube into a large one

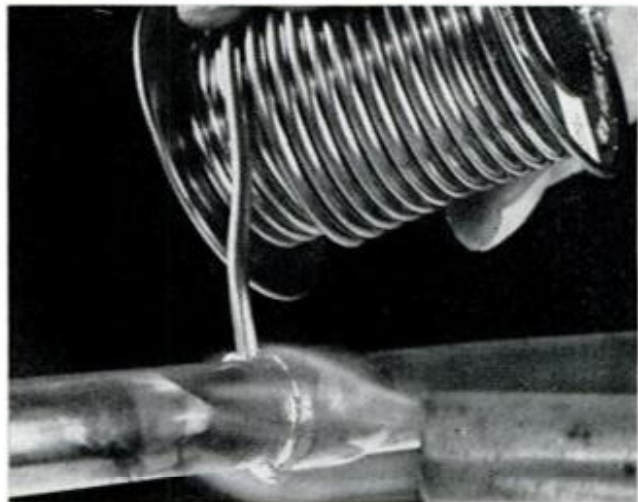

SWAGED OR CONSTRICTED JOINTS are soldered like solder-type fittings. Fill the joints with solder

tube satisfactorily if the tube is first heated dull red with a propane torch at the point of bend.

Another tool widely used by plumbers but not so familiar to home craftsman is the swaging punch, which bells out the end of soft-temper tubing enough to form a self-coupling that can be soldered just as a separate fitting would be soldered. Some care is required when the punch is forced in to prevent it from swaging the tube slightly askew. Gripping the tube in a split bar clamp while the punch is being hammered in will assure an accurately aligned coupling.

A tube constrictor, instead of flaring, reduces the tube-end's diameter. It is simply a tube-cutter equipped with a rounded roller in place of a cutting wheel, which rolls a groove in the tube. Constricting larger diameter tubing permits the soldering of smaller diameter tube into it.

Assembling lengths of soft-temper tubing with flare fittings will present no problem if the tool used to flare the tube ends produces accurate flares. A compression-type tube-flarer, which has a split bar clamp to hold the tube squarely as the

flare is formed, is the best inexpensive flaring tool available. Make sure the tool forms 45° flares (not 37° flares, which are used with steel tubing). The end of tubing to be flared should be squarely cut, carefully reamed and free from dents or nicks. When screwing down the flaring tool's cone, avoid using any more pressure than necessary to form a full, smoothly finished flare on the tube, since excess pressure will only serve to harden the soft copper.

Hard-temper and soft-temper tubing can be coupled together in any combination. For a section of a hard-temper plumbing system that could freeze, soft-temper tube might well be used. Similarly, solder and flare fittings can be used in the same installation, with the flare fittings used for water-heater connection, sink connections or any other connections that later might have to be taken apart. Always use flare fittings with soft-temper Type-K tubing buried underground.

The specialty tools mentioned in this article are available at the larger, well-stocked hardware stores and plumbing supply houses. ★★★

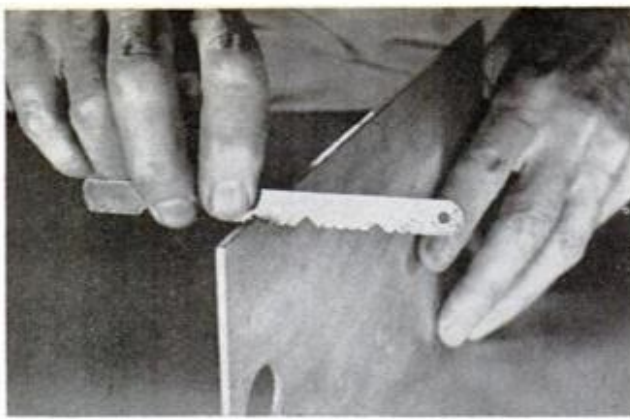

Save those broken hacksaw blades

A five or six-inch length of a broken hacksaw blade can be altered to give continued service as a deburring tool (when you're working with plastics or aluminum). Simply grind a couple of 45° V-notches at the center about halfway up the blade-width as shown. When the ground notch is drawn across the workpiece, the edge will be left perfectly smooth.—*Ernie Wiezorek*

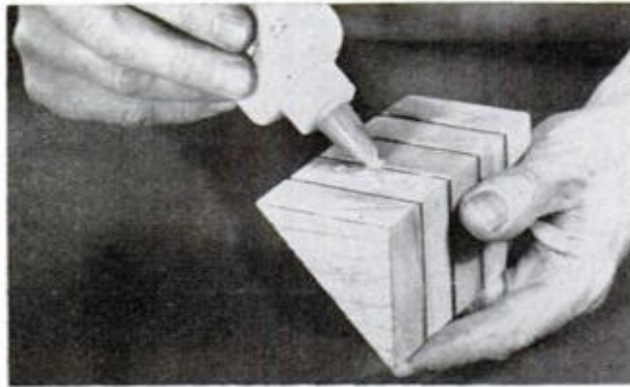

Better-holding glue blocks

Craftsmen who are proud of their cabinetry always use glue blocks on the underside of furniture. A good way to make certain that these blocks stay where they are put is to kerf them in two or three places on each gluing surface. The kerfs should not be more than 1/16 in. deep; they can be cut quickly with either a hand or table saw.—*Bob Brightman*



Quickie kid's snow shovel

Here's a quick way to improvise a snow shovel when your little guy wants to help. It consists of an old dustpan and the handle from a discarded broom. Shape the handle to force-fit the dustpan holder and attach it with a couple of sheet-metal screws. Drill a hole in the other end for hanging the shovel when not in use.

—*Frank Shore*



Cleaning clogged sanding strips

When a tungsten-carbide sanding strip (carbide grains bonded to thin sheet of steel) becomes so gummed up that a bristle brush alone won't clean it, try using a solvent. In some cases, lighter fluid or lacquer thinner will work; in others, an oven-cleaning liquid. Apply, let soak, and then finish cleaning with stiff-bristle brush as shown.—*W. Ervin*



Handy grounding method

You can quickly plug in and remove three-wire tools with this setup—whether the plug has a pigtail (shown) or prong for grounding. Simply solder a length of insulated wire to the grounded outlet box and affix a small alligator clamp to the other end. Then, when plugging in the tool (or adapter), attach the clamp to the ground connection.—*Harold T. Bodkin*

New tools you should know about

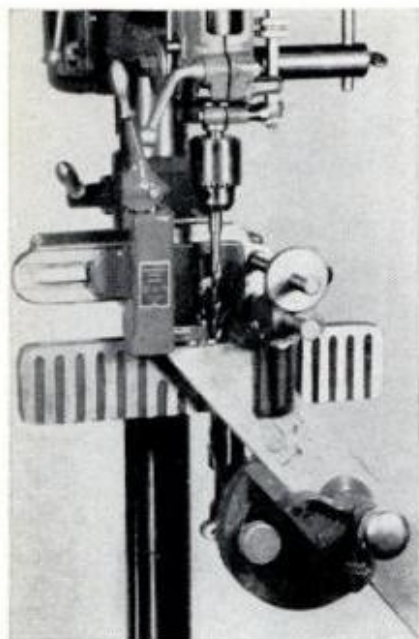

SELF-CENTERING drill press can be used to space dowels up to 3½ in. apart for doweling joints together, drilling holes in doors for locksets and making window sashes. If you lay the press down, it can also be used for long vertical dowel joints. The price is \$200; a long, aluminum table-top is offered for an additional \$50. Schwandt Manufacturing Co., Box 61, 402 Broad St., Weston, Ore. 97886.

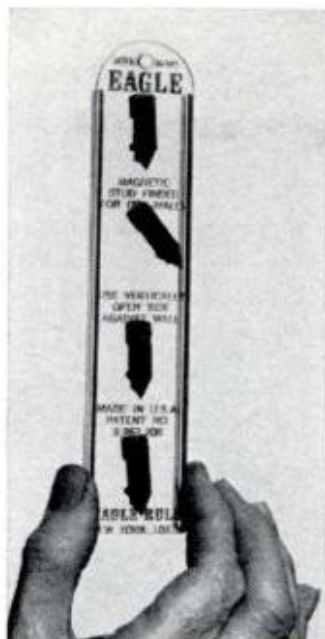

SWINGING stud finder introduced by the Eagle Rule Manufacturing Corp., Bronx, N.Y. 10474, contains four hanging Alnico magnets that are sensitive to nails embedded in plasterboard. As the device is moved, one or more magnets swing to pinpoint nail location, which in turn locates the stud. At hardware stores, \$1.29.



THICKNESS PLANER from the Rockwell Manufacturing Co., Power Tool Div., 400 N. Lexington Ave., Pittsburgh, Pa. 15208, will handle material up to 13 in. wide and 6 in. thick. The planer has the capacity to gang-plane 2x6s on edge and finish 6x12-in. timbers. Because of varying requirements by users, the tool is offered in two versions: one with a 3-hp motor for general applications, the other with a 5-hp motor for heavy work. About \$900.

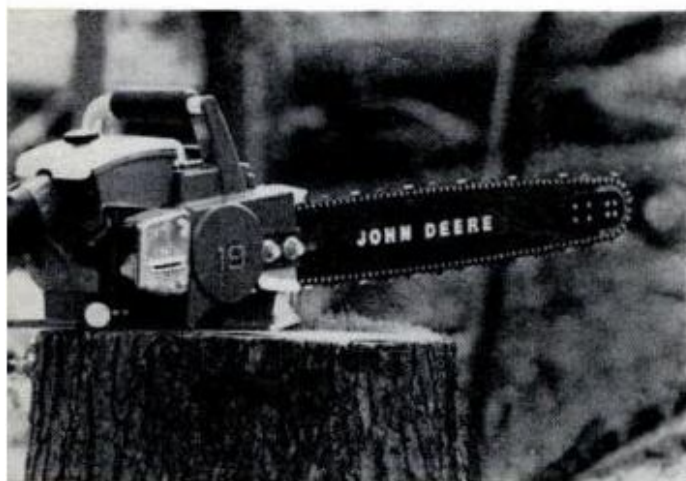

ALL FOUR CHAIN SAWS recently introduced by Deere & Co., John Deere Rd., Moline, Ill. 61265, boast a roller-nose which is claimed to boost cutting power while reducing wear on the guide bar, chain and sprocket. Model 19 (shown above), the largest version (13½ lbs.), is powered by a 4.0-cu.-in. engine and features a 19-in. guide bar. It's priced at \$300 with toolkit and combination sparkplug/mounting-nut wrench.

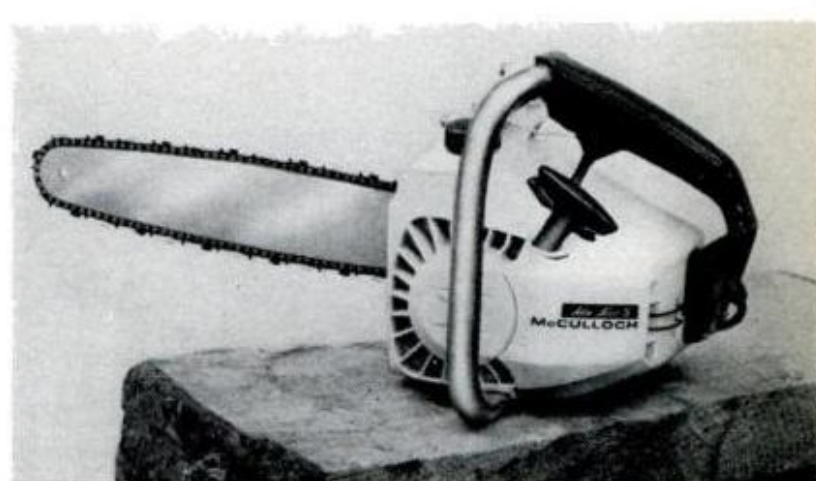

PINT-SIZE CHAIN SAW that weighs in at 6½ lbs., is claimed by the maker to be the world's lightest. Labeled Mini-Mac 6, it features a 12-in. bar and chain powered by a 30-cc, two-cycle engine and a handle location that provides saw control over the tool's center of gravity. The trigger is designed to prevent accidental acceleration. \$140. McCulloch Corp., 6101 W. Century Blvd., Los Angeles, Calif. 90045. ★★★

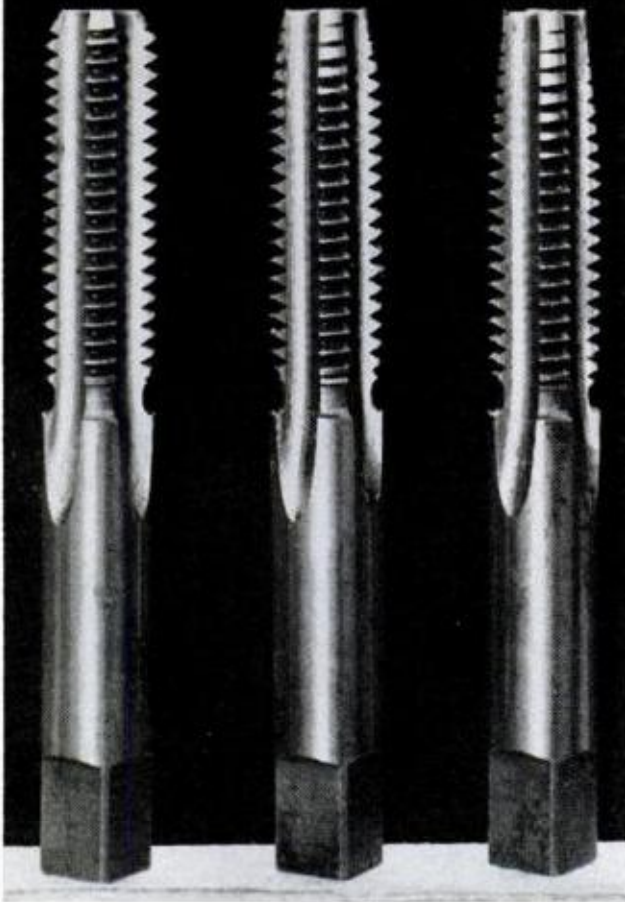

TYPES OF TAPS include (left to right) bottoming, plug and taper. To tap a blind hole, start with the taper, follow with plug and finish with bottom tap

THE TASK of drilling and tapping a hole in a casting to accept a 1/4-in. bolt sounds like a pretty routine chore, especially if you have a rackful of drills from 1/16 through 1/2 in. At first glance you'll figure it simply means a trip to the hardware store for a 1/4 x 20 tap. But you're in for a surprise when you get back to your workshop. At this point you'll learn that not one of the drills in that well-stocked rack is the No. 7 drill that a 1/4 x 20 tap requires.

Though it is hard to believe, more than half of all standard bolts in sizes up to 1/2 in. require what are known as numbered drills. These numbered drills range in size from a No. 80 drill that measures .0135 in. dia. to a No. 1 having a diameter of .2280 in.

But very often, in a pinch, a fractional-size drill can be used—provided you know what the nearest equivalent size is and if the tolerances aren't too close.

Charts on these pages give you that information. Thus, if you do not have a

How to Pick THE DRILL TO FIT THE TAP

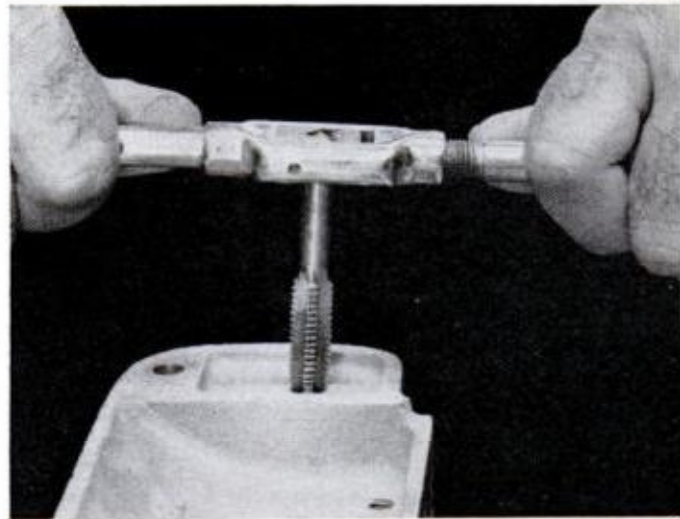

WORK TO BE TAPPED must be secured in a vise; then clamp square end of the tap tightly in proper size wrench and hold the tap perpendicular to workface

TABLE A

18 MOST COMMONLY USED BOLTS AND THE DRILL SIZES THEY REQUIRE FOR TAPPING

Bolt Size	Drill Size	Dia. (inches)
4x36	No. 44	.0860
4x40	No. 43	.0890
6x32	No. 35	.1100
8x32	No. 29	.1360
10x24	No. 25	.1495
10x32	No. 21	.1590
12x24	No. 16	.1770
1/4x20	No. 7	.2010
1/4x24	No. 4	.2090
1/4x28	No. 3	.2130
5/16x18	17/64	.2656
5/16x24	9/32	.2812
3/8x16	5/16	.3125
3/8x24	21/64	.3281
7/16x14	3/8	.3750
7/16x20	25/64	.3906
1/2x13	27/64	.4219
1/2x20	29/64	.4531

AMONG POPULAR BOLTS, note that more than half require a hole made with a numbered drill, while eight of the drill sizes are designated in fractions

POPULAR MECHANICS

TABLE B
EQUIVALENT DRILL SIZES FOR
FRACTIONAL DRILL SET—1/16 to 1/2-INCH

Fraction	Dia. (Inches)	No. Size	Dia. (Inches)
1/16	.0625	52	.0635
5/64	.0781	47	.0785
3/32	.0937	42	.0935
7/64	.1094	35	.1100
1/8	.1250	30	.1285
9/64	.1406	28	.1405
5/32	.1562	22	.1570
11/64	.1719	17	.1730
3/16	.1875	12	.1890
13/64	.2031	6	.2040
7/32	.2187	2	.2210
15/64	.2344	A	.2340
1/4	.2500	E	.2500
17/64	.2656	H	.2660
9/32	.2812	K	.2810
19/64	.2969	M	.2950
5/16	.3125	N	.3020
21/64	.3281	Q	.3320
11/32	.3437	S	.3480
23/64	.3594	T	.3580
3/8	.3750	V	.3770
25/64	.3906	W	.3860
13/32	.4062	Y	.4040
27/64	.4219		
7/16	.4375		
29/64	.4531		
15/32	.4687		
31/64	.4844		
1/2	.5000		

EQUIVALENT DRILL SIZES up to 7/32 in. are known by number, larger-size equivalents by letter. If you lack a lettered drill, consult Table A for equivalent

numbered drill, check the diameter of the recommended drill in table A and consult the list of fractional drill sizes (Table B) for the nearest size.

For example, assume that you want to tap a hole to accept a 10 x 32 bolt. According to Table A this bolt requires a No. 21 drill—which measures .1590 in. in diameter. Then, if you refer to Table B you'll find that the nearest fractional drill is 5/32. This measures .1562 in. in dia., which is just close enough to do the job. However, inasmuch as this drill is slightly undersize, use care when tapping. Be sure to back off the tap a half-turn or so (after each full turn) in order to get rid of the chips.

Quickie tapping lesson. The three taps shown at the top of the facing page are used in the order noted in the caption. The taper is used to get the threads started; it in turn is followed by the plug tap and the bottoming tap is used to cut the threads as close as possible to the bottom of the hole.

—Robert Brightman

HINTS FROM READERS

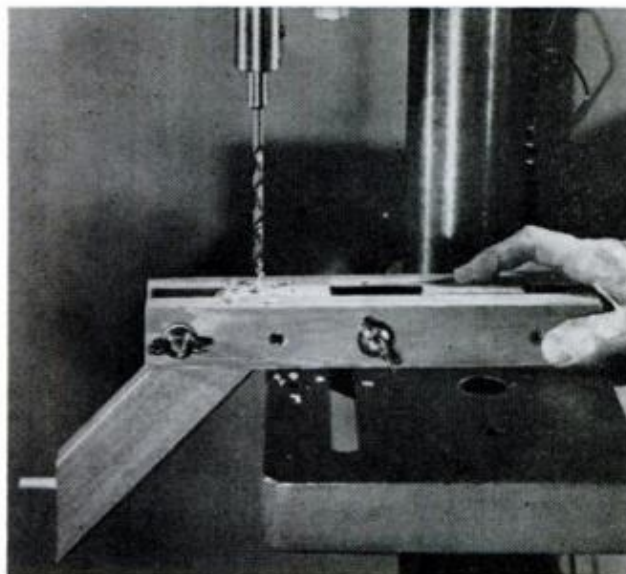

Drilling straight holes in miters

Hand-holding a section of picture frame while drilling the dowel holes is a poor substitute for the accuracy a simple jig will give. It's simply two strips of wood fastened together with a spacer between that equals the workpiece thickness. For fast assembly and disassembly, wingnuts used with carriage bolts and washers are the best bet.—Walter E. Burton

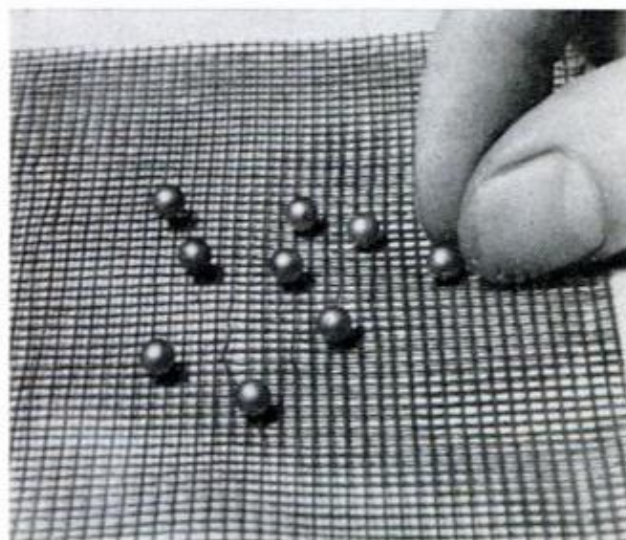

Screen wire serves as parts tray

If you've ever disassembled small parts containing bearings, you know that keeping them all at hand when you need them can be a harder task than the job you're doing. You can keep them corralled with no chance of their rolling off the workbench by using screen wire as shown. It beats bending and hunting for strays.

—William Swallow

Painting and Papering



COLORS THAT HAVE BEEN MIXED often dry somewhat lighter or darker than they appear in the paint can. A wet dab placed on a white blotter "dries" quickly to give you an idea of the exact hue



PLACE A JAR LID under each leg of a chair or table to keep them from sticking to newspapers spread on the floor. When the newly painted furniture dries, simply roll up the papers and lids and throw away



AVOID REMEASURING A ROOM each time you get ready for new wallpaper with this trick. Put all of the data on the back of a wall-hung picture in the room—and the information will always be at hand



NEXT TIME YOU WALLPAPER, insert a toothpick in the hole as you remove each picture hook from the wall. Toothpicks, left in place, will protrude through the new paper, making hook replacement easy

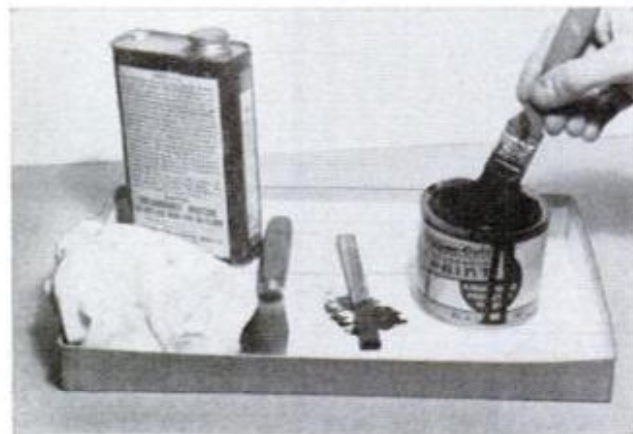

WHEN YOU DO A SMALL PAINT JOB, a good way to keep paint and other equipment together is to place them in a cardboard box cover. All is handy, and you'll save steps going for forgotten items



USE A DISC OF WIRE SCREEN cut slightly smaller than the diameter of your paint can to save yourself the trouble of straining lumpy paint. The round piece of screen takes the lumps with it as it sinks

POPULAR MECHANICS

Tips

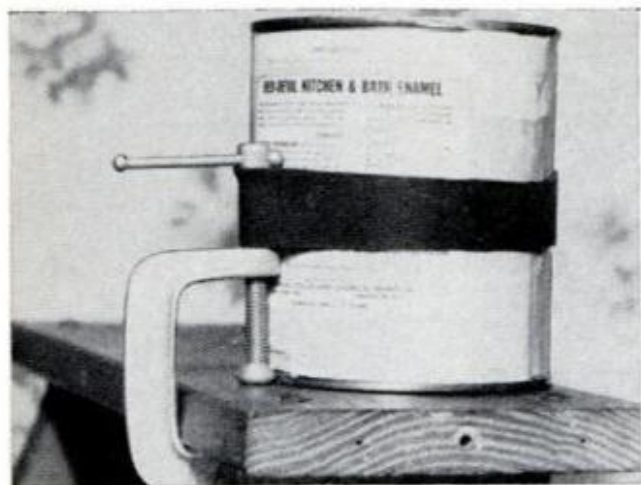

KEEP A PAINT CAN FROM TOPPLING off a stepladder with this simple setup. Fasten a C-clamp to the top of the ladder and secure the can to the clamp with a wide rubber band cut from an old inner tube



A REST FOR A PASTE BRUSH can be improvised by inserting the wire from a coathanger through the bail eyes of the paste bucket. Whenever you want to stir the wallpaper paste, simply withdraw the wire



NEXT TIME YOU USE A SMALL PAINT CAN, keep your fingers and your floor clean by placing the can in a discarded coffee cup. The cup provides a clean handle and catches any drips that run down sides

JANUARY 1971

HINTS FROM READERS



Package flap serves as jar label

When you transfer brads, screws and the like from their packages into storage jars, remove the labels or end flaps and put them in the jars first. You'll have quick and easy identification that comes in handy when it's time to reorder. And, where useful product instructions are on the labels, they'll be conveniently at hand.

—John F. Dinges

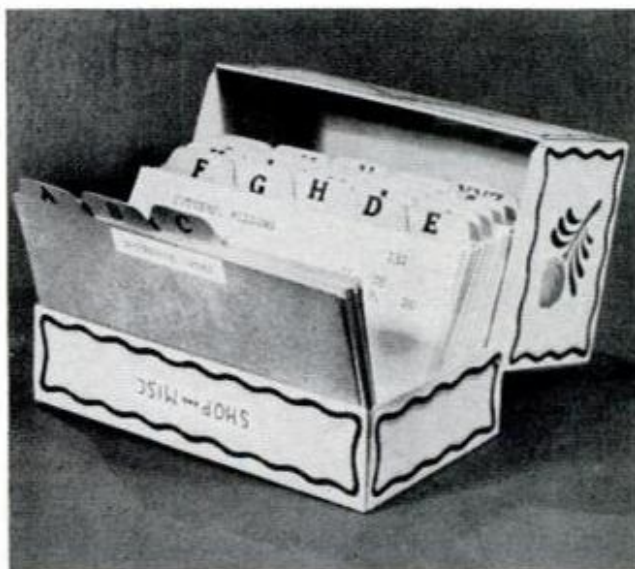

Card trick for index file

When frequent reference to cards stored in a small box-file is necessary, the job is often time-consuming because the index cards are tightly packed. If you lift out the cards (all at one time) and insert them in the top as shown, you can speed up this task. The cards stand well apart, making card removal and replacement quick and sure.—Thomas W. Benson

Homemade

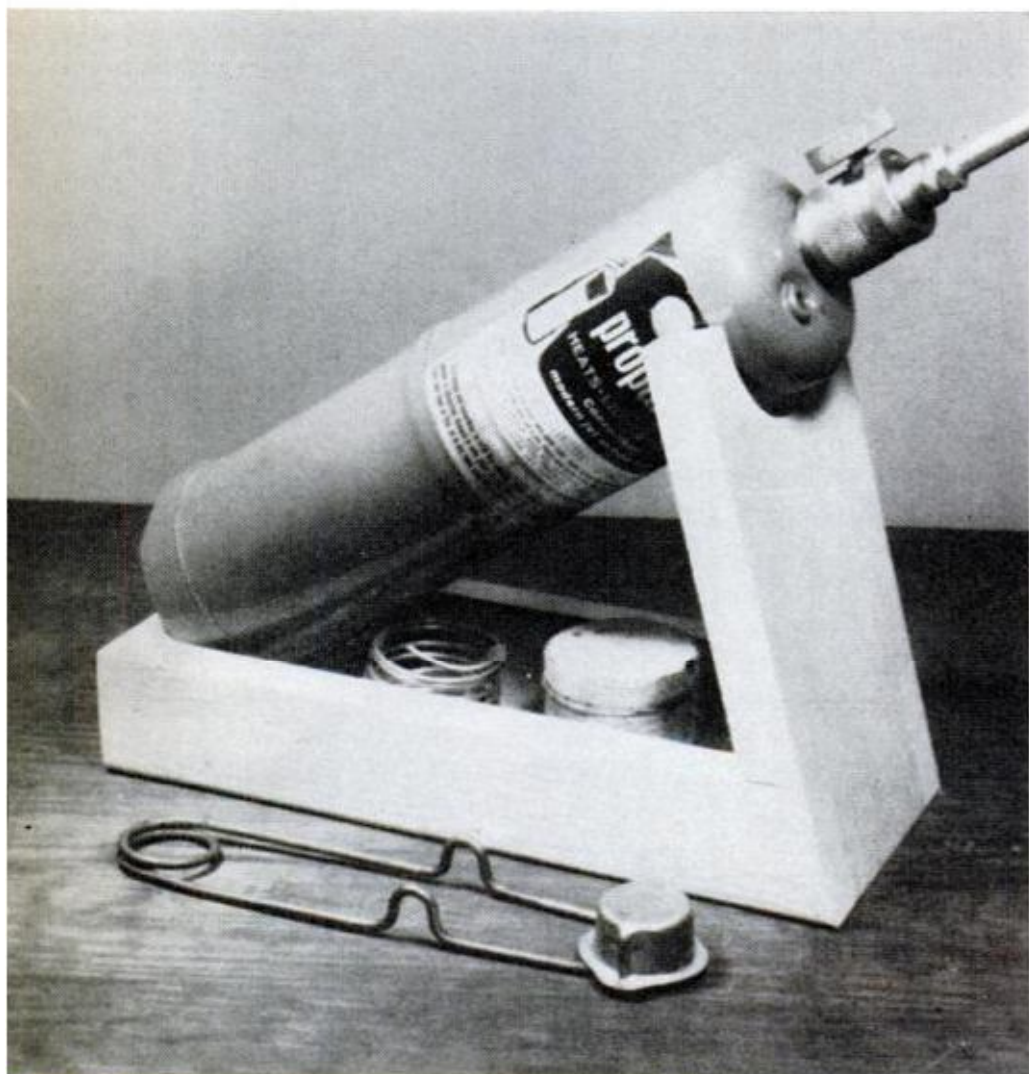

Torch Stand

A propane torch has an important place in every home workshop, but I've found that it is easily tipped over and presents a constant hazard once it is lit. To remedy this, I constructed the simple rack at left. It holds the torch at a convenient angle and leaves both hands free. In addition, when the torch is not in use it can remain in the stand for storage. The torch can be readily lifted out when desired and the tray in the base provides handy storage for the lighter, solder, flux and other torch-related items.

All parts are of nominal one-inch stock and assembly is with glue and 4d finishing nails. You may want to build several stands, altering the angle of the rest so that the torch can be used for special jobs. If you decide to make a rest that will hold the torch nearer to the vertical, I recommend that you notch the small board at the other end in order to cradle the tank bottom securely.

If desired, you can add a torch stand as a permanent fixture to your workbench by attaching it with a large flathead screw. You can turn stand to whatever direction is most convenient for the job at hand.—Harold Jackson

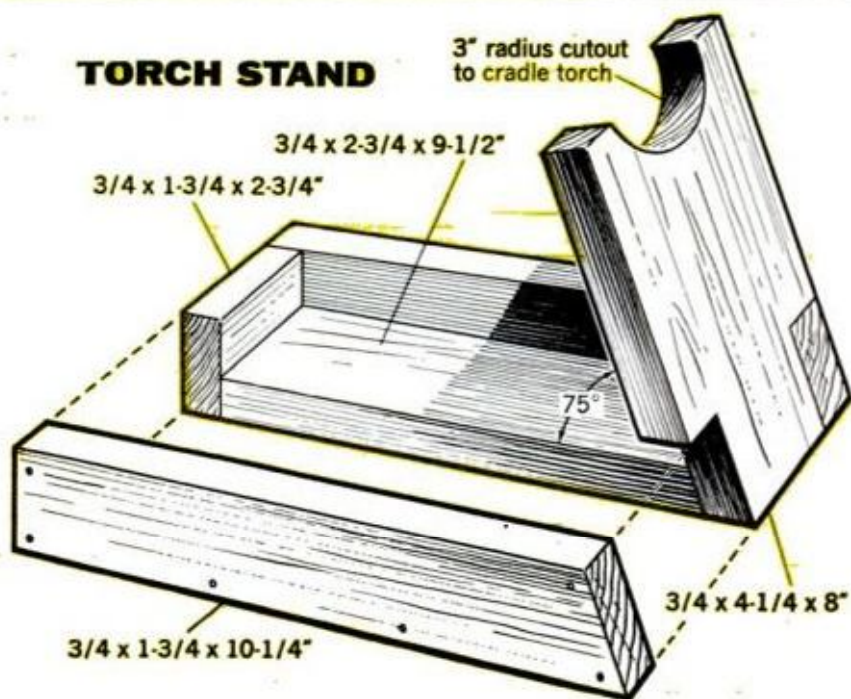

and Handy

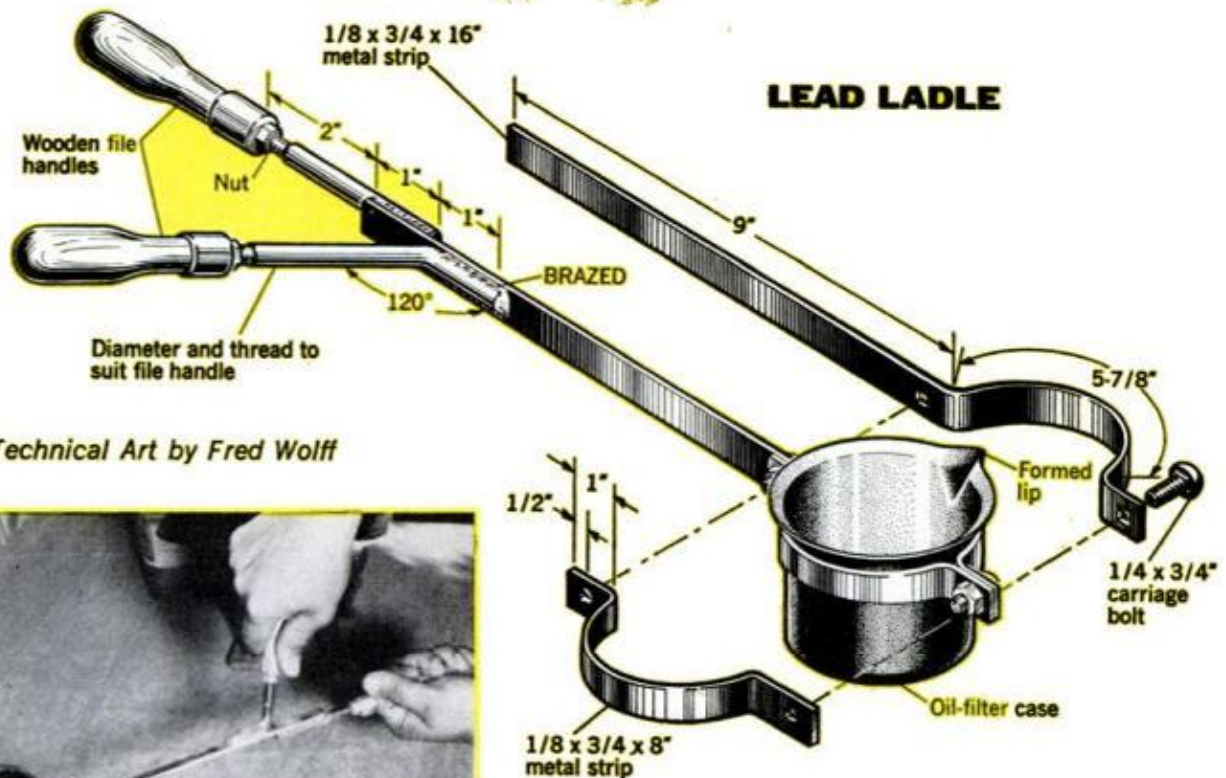

Technical Art by Fred Wolff

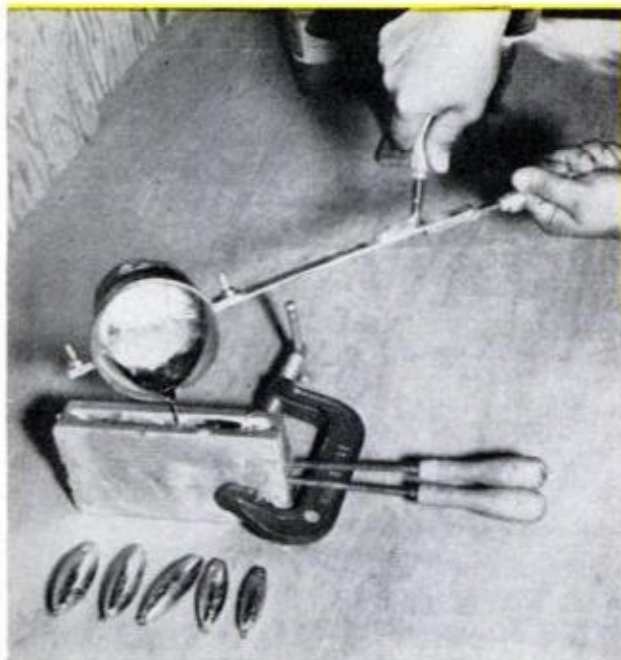

ALUMINUM AND WOOD forming tool serves as an aid in shaping semicircular parts of the ladle's clamp

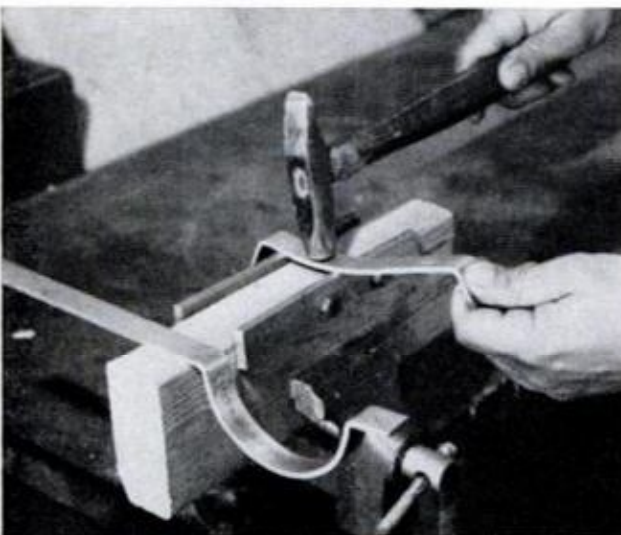

Lead Ladle

Burn the paint and oil residue off an old oil-filter casing and you have the makings of a ladle capable of melting about five lbs. of lead. With its unique Y-branched design and its two file handles, you can easily control the flow of lead into molds for fishing sinkers, lead soldiers, belt weights and the like. The ladle lasts through a dozen or so melting sessions. The used throw-away oil filters are available free at your local gas station.

The handle shown is made to accommodate a 3½-in.-dia. oil filter, but change this diameter if you use a different size filter. Start with the sharp breaks of 75° for the ears of the clamp; this will insure parallel ears when mounted. Then form the semicircular halves in the forming tool as shown at left. Clamp the handle parts together with a C-clamp and drill through two ¼-in.-dia. holes in one handle to receive the carriage bolts. With the ladle assembled, use a torch to melt lead initially, and charcoal to keep it in a molten state.—A. Barkey

HINTS

FROM READERS

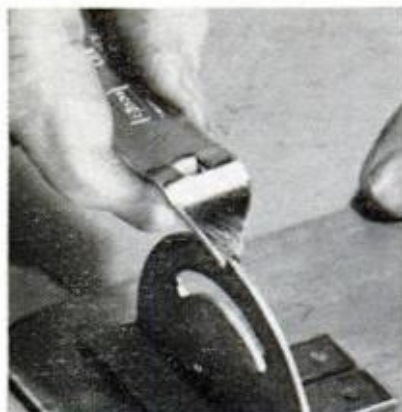

Can-opener deburrer

You can convert a can opener into a handy tool for removing rough edges from sheet metal and plastic by grinding a notch in its pointed end and filing the edges sharp. To use the tool, simply draw it along the edges of the material with firm, downward pressure.—*Frank A. Javor*



Sub for peen hammer

If the nose on your ball-peen hammer is not small enough to produce the dimple pattern you desire when texturing metal, borrow a ball-end pin from a loose-pin door hinge. Used like a punch, the round end of the pin does a neat job, particularly when hammering is done on lead block.



Thread-spool driver

When driving a bullet-type catch into its hole, you'll avoid crushing the sleeve if one end of a wooden spool is held on its flange. After installing the catch, assure trouble-free use by depressing the ball and inserting a drop of oil. Stunt can be used for certain grommets.

Stopping a faucet leak when stores are closed

Though I cannot swear that the idea is original, here's how I stopped an outside faucet leak that couldn't be repaired on a Sunday. I simply removed the rubber washer from a hose connector, inserted a quarter and replaced the washer. When I screwed this connector on the outside bib, the leak stopped. Next day, I picked up a new bib to replace the eroded culprit.—*C. Fowler III*

NEXT MONTH IN SHOP AND CRAFTS

YOU CAN MAKE THIS MODEL STEAM TRACTOR. Built to a scale of $\frac{3}{4}$ in. and patterned after the famous J.I. Case threshing-machine tractor, this modelmaker's beauty actually runs. A set of full-size plans will be available for the lathe buff who wants to build this replica of a farm machine of another era. Watch for it in the February issue.

BUILD PM'S TOP-PERFORMANCE SAILBOAT: THE GLEN L 10. Light enough for cartopping, this trim craft doesn't need a form to build the hull. Designed especially for *PM* readers by Naval Architect Glen L. Witt, it's a fun craft whether piloted by one hand or two. Pick up February *PM* and get in on the fun.

FROM VAN TO CAMPER . . . \$340. Though designed for Ford's Econoline, this nifty home-built version can also be adapted to a Dodge or Chevy. Read *PM* next month and you can have your own on the road well before the camping season starts.

MAKE YOUR OWN GEMSTONE FACETING MACHINE. The art of lapidary—polishing stones to best display their qualities—is an ancient one. With this shop-built faceting machine you'll be able to bring out the brilliance of a stone's color effortlessly. Complete plans for building it are in February *PM*.

PLUS: A wagon-wheel coffee table, appliance test block, lathe limit stop and more.

THIS CAN BE YOUR "BIG BREAK"

if you're a man who's ever said...

**"I'm sick
and tired
of my Job!"**



Read here about the exciting, high-pay careers waiting in one of today's hottest growth fields—and how preparing for these great jobs can be easier than you might ever have imagined.

IT'S A SHAME to go on struggling along in the same old rut—while others around you move up to better jobs, better homes, better cars. Especially when it's now so easy for you to do something about it.

Just mail the coupon to the right and we'll send you, FREE, two books that have started thousands of men on the road to rewarding new careers. Careers they can be proud of. Careers where the work is exciting. And careers where they can earn the kind of money that many men only dream of.

Thousands of career opportunities like this exist right now in America's hottest growth industry—Electronics. It's an industry where you can take your pick of literally scores of different "glamor jobs"—in broadcasting, automation, the aerospace program, and many other areas. And it's an industry where, once you have some experience under your belt, you can earn up to \$5, \$6, \$7 an hour...\$200, \$225, \$250 a week...\$10,000, \$11,000, \$12,000 a year.

You don't need college training to break in. Our free books will show you how you can prepare right at home in your spare time. And they'll show you, too, how we can help you land the "dream job" of your choice.

Mail the postpaid reply card or coupon above today for two FREE books.

CIE Cleveland Institute of Electronics
1776 East 17th Street, Cleveland, Ohio 44114

Cleveland Institute of Electronics
1776 East 17th Street, Cleveland, Ohio 44114

Please send me 2 FREE books describing opportunities in Electronics and how to prepare for them.

Name _____
(Please Print)

Address _____

City _____ State _____

Zip _____ Age _____

Veterans & Servicemen: check here for G.I. Bill information

Accredited Member National Home Study Council

PM-49



You can make money in

WATCH REPAIR

Learn at home the low cost Sweazey Way

Watch repairing pays up to \$6 an hour, part time watch makers report on survey. Unique and modern Sweazey home study System starts you making repairs right away on Swiss and American watches. Professionally prepared training. No previous experience needed. Special tools provided for practice. Diploma Awarded. Free sample lesson and opportunity book give all facts. Write today. No obligation.

CHICAGO SCHOOL OF WATCHMAKING
Dept. 111 Fox River Grove, Illinois 60021

FREE BOOK and SAMPLE LESSON

CHICAGO SCHOOL OF WATCHMAKING
Dept. 111 Fox River Grove, Illinois 60021
Please rush FREE BOOK and Sample Home Study Lesson.

Name _____ Age _____
Address _____
City _____ State _____ Zip _____



FREE!

LAFAYETTE'S 1971 Golden Jubilee Catalog

Your 1st Guide To Everything in Electronics

Stereo Hi-Fi • Citizens Band • Ham Gear • Tape Recorders • Test Equipment • TV and Radio Tubes and Parts • Cameras • Auto Accessories • Musical Instruments • Tools • Books

Lafayette Radio Electronics, Dept. 15011
P.O. Box 10, Syosset, L.I., N.Y. 11791

Send me the FREE 1971 Lafayette Golden Jubilee Catalog
Name _____ 15011
Address _____
City _____
State _____ Zip _____



Learn Profitable Profession in few months at Home

MEN AND WOMEN, 18 TO 60

Earn big pay as a skilled operator in Scientific Massage. Many employment opportunities. Easy to learn and do. Diploma awarded. Open your own office or earn good income from Doctors, Hospitals, Clubs and other health or recreational centers. Wonderful part-time profession. Low monthly payments. Write today for free Anatomy Charts and catalog. No obligation.

ANDERSON SCHOOL OF SCIENTIFIC MASSAGE
Dept. A-1, Princeton, Illinois 61356

locksmithing and key making

PRACTICAL UP-TO-DATE COURSE — ONLY \$7.95



Teaches you how to pick locks, de-code, make master keys, repair, install, service, etc. New self-instruction lessons for every handyman, homeowner, carpenter, mechanic, service station operator, fix-it shop, hardware dealer, gunsmith. 53 easy illustrated lessons. Full price only \$7.95 post-paid. Satisfaction or refund guaranteed. Mail order today!

NELSON-HALL CO., Dept. AZ-2
325 W. Jackson Blvd., Chicago 60606

Don't change your address without notifying us!

To insure uninterrupted service on your Popular Mechanics subscription, please notify us at least six weeks before you move.

1. Attach your address label from a recent issue in the space provided below... (if label not available, be sure to give us your old address, including Zip Code)
2. Print your name and new address below (be sure to include your Zip Code).

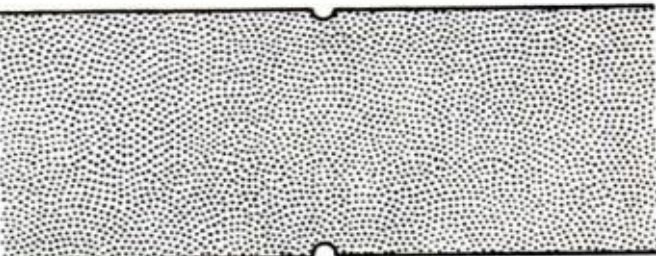

3. Mail entire notice to: Subscription Service Dept.
Box No. 646
New York, N.Y. 10019

Name _____ Please Print
New Address _____
City _____
State _____ Zip Code _____

LIFETIME "SPIN-ON" OIL CLEANER



Cleans motor oil 100 times cleaner than any other "spin-on" filter. Never drain oil again. Never buy another spin-on filter. Change 15 cent element every 3000 miles, available everywhere. Doubles engine life. Oil is 100% clean 100% of the time. Guaranteed 5 years. \$25.95 post paid. Write for the facts. Save \$8.00 every 3000 miles.

VIRDEN PERMA-BILT
Box 7066 PM, Amarillo, Texas 79109

USE ZIP CODES WHEN ANSWERING ADS

2 for 1 WAREHOUSE CLEARANCE SALE

@MCMXLIX VIKING

TWO \$1.98 \$3.96 VALUE 10 Year Guarantee
FOR 1 TWO FOR THE PRICE OF ONE

Razor sharp lifetime steel blade opens easily and automatically locks in place. PUSH-BUTTON release. Tough, razor steel blade honed and polished to mirror-like finish. Balanced for target throwing. Legal size. Blade GUARANTEED 10 YEARS. If blade breaks we replace free. 30-day MONEY BACK GUARANTEE. A favorite with sportsmen. Priced for quick sale of 200,000 knives. Makes excellent gift for man or boy. Two for \$1.98 plus 50c shipping. Send cash, ck. or M.O. to VIKING KNIVES, Dept. K-3, Box 10880, Houston, Tex. 77018.



IF YOU CAN SING, WHISTLE, OR HUM A TUNE...

you can play the Musical Saw. No notes to read, no musical knowledge required. Since 1921 we have furnished the entire world this unusual, sweet-toned instrument. If you are 10 or 70, you play or no pay. Musical Saw, soft hammer, bow, resin and lessons mailed on 5 days' trial. Write today for details and free copy of "Sawing News of the World," picturing successful saw musicians. MUSSEHL & WESTPHAL, 107 Fort St., Fort Atkinson, Wisconsin. 53538.

REVISED EDITION

Popular Mechanics Catalog Plans, Publications, Projects

Want to build a boat, garage, sidewalk classic, plane or a clock, kayak, fireplace, kite, patio, coffee table aquarium, kitchen cabinet, organ, swimming pool, telescope, children's play furniture, camping trailer, science project, electronic project?

Send for the NEW Popular Mechanics illustrated catalog! 32 pages crammed full of fascinating and useful projects you can build yourself!

For more than 67 years, Popular Mechanics has been the world's leading authority on how-to information. In this helpful catalog you'll find the very best of Popular Mechanics plans and publications. In step-by-step text, photos and drawings, these plans show you how to build something for everyone in the family.



Above are shown a runabout boat you can build for less than \$75; a four-place plane you can construct yourself; a patio-garage and the famous sidewalk classic for youngsters that rolls along at 5 m.p.h.

For information on scores of other exciting projects, order the new catalog today! Send only 25c to cover postage and handling.

Enclose 25¢ in coin, no stamps please, to cover postage and handling.

Mail to: **Popular Mechanics Dept JR-1**
224 West 57 Street
New York, New York 10019

Please Print:

Name _____

Address _____

City _____ State _____

Zip _____

HOMEOWNERS' CLINIC

BY W. CLYDE LAMMEY

Fuel-oil stain on concrete

I've replaced my oil-burning furnace with a gas-fired unit. A fuel-oil stain remains on the floor just in front of the new installation. It is about 2 sq. ft. in area and although it is in a small room separate from the rest of the basement, the stain bothers me because of its unsightliness. Can I remove or conceal it?—T.S., Ind.

A fuel-oil stain on concrete, especially if it's more than a month old, is difficult to remove entirely by any ordinary procedure safe for use in the home. Solvents that will do the trick, as a rule, are highly volatile, flammable, and usually toxic in a closed room, so I hesitate to suggest their use in the home. I once had a problem like yours, although the area involved was somewhat less. I used a liquid household cleaner and solvent sold under the trade name of "Amway," applying it full strength with a vinyl sponge and rinsing the area with clean water after each of the several applications necessary to reduce the stain to near invisibility. The procedure appears to have been successful as the stain has not reappeared in several months. At least I'm satisfied with the result. Of course, it takes lots of scrubbing and cleanup and the time necessary to carry out several applications.

Those pesky squirrels!

I've tried everything I know—with pieces of sheet aluminum—to keep squirrels from robbing my bird feeder in winter. The feeder, on a metal post just outside my dining-room window, is festooned with sheets of aluminum of every conceivable shape and looks like a scarecrow. Yet the pests still find a way to scramble up to it, scattering seed all over the place in the process and eating whatever is left in the tray. Is there any way to keep 'em grounded?—A.Y., Pa.

I've had much the same problem with a feeder in the same location. After several failures with discs cut from metal, I contrived a metal bracket made from $\frac{1}{8}$ x 1-in. flat steel and attached this to the window frame at a greater height than the original feeder, which was on a post. You can have such a bracket made at your local welding shop. It consists of a

length of flat steel (also known as flat iron) bent at a right angle and provided with a single brace riveted or welded to the first piece. The ends can be turned to provide ornamentation. At the outer ends of the bracket I attached a piece of heavy wire about 16 in. long and to the lower end of this I attached the feeder, the bottom of the feeder being about 7 ft. above the ground.

That did it. Several squirrels tried to leap from ground to feeder but never quite made it. I solaced these with seeds scattered on the ground below. In time they gave up entirely. Of course, you can buy post-mounted feeders having large discs which are said to be quite effective.

Timing furnace cycles

My oil-burning furnace kicks on and stays on until the temperature rises several degrees, then it kicks off and stays off for a long interval before coming on again. The burner is the gun type and a new thermostat with mercury switch has been installed. Why the long interval?—M.Y., Wis.

Nearly all late-model thermostats have a provision for timing the cycles. If you remove the cover of the stat you will likely see a tiny scale and pointer. Instructions that came with the stat will tell you how to set the pointer to shorten or lengthen the cycling time. Move the pointer accordingly and wait through several cycles to make sure that the pointer is correctly set for the timing you desire. I assume the furnace and controls are otherwise in good operating condition.

Shoddy tile base

Ceramic tile around my bathtub (with shower) has loosened and some of it has fallen off. I've replaced some of the tile. It doesn't adhere although I used the cement recommended. My home is only two years old. What's wrong?—A.J., Calif.

I'd assume right away that the backing, that is, the wall on which the tile is installed, is at fault. Water from the shower may have leaked through the tile joints to the wall and destroyed the adhesion. I think it likely that to cure this trouble permanently you will have to remove the tile, as well as the backing, and reinstall the tile on a cement grouting over wire lath. This is the generally accepted procedure when installing ceramic tile in a shower stall.

If you don't feel up to doing this job yourself then have the work done by a qualified contractor. ★★★

Bothered by hot taste?

A pack of KOOL Filter Kings cigarettes is the central focus, resting on a cross-section of a tree stump. The pack is white with a green band across the middle containing the word "KOOL" in white. Below this, "Filter Kings" is written in a cursive font, and "MILD MENTHOL CIGARETTES" is printed at the bottom. A yellow sticker on the top flap says "78 CLASS A CIGARETTES". Two cigarettes are visible, one standing upright and one lying horizontally. The background is a lush forest scene with a stream and sunlight filtering through the trees. The text "Come all the way up to KOOL" is overlaid on the right side of the image.

Come all
the way
up to
KOOL

78 CLASS A
CIGARETTES

KOOL

*Filter
Kings*

MILD MENTHOL CIGARETTES

© 1970, BROWN & WILLIAMSON TOBACCO CORP.

BIG BOOM IN CARTRIDGE TV

(Continued from page 80)

nounced plans to incorporate the necessary recording heads and TV tuner. So far, Avco, Ampex and Sony definitely plan to provide home recording and will offer accessory black-and-white TV cameras for \$200 to \$400. Cartridges of blank tape will cost about \$13 for a half-hour size and \$25 for two hours.

Two far more exotic systems not based on videotape at all are CBS's EVR (Electric Video Recording) and RCA's SelectaVision. In EVR, an electronic beam prints visual images on special film. Alongside these is a series of unintelligible squiggles that supply coded color information for the images. You see no color when

HOW TV CARTRIDGE SYSTEMS COMPARE

Manufacturer	Type of System	Due to Go On Sale	Approx. Price	Allows Home Recording
Admiral	Videotape	Mid '71	Under \$1000	Yes
Ampex Instavision	Videotape	Mid '71	4 models, \$800 to \$1000	Yes
Avco Cartrivision	Videotape	Mid '71	\$895	Yes
CBS/EVR	Film	Commercial model now available; consumer model due mid '72	Commercial model \$795; consumer model \$350	No
Magnavox	Videotape	Early '72	Not yet announced	Probably
NordMende	Film	Mid '71	\$850	No
Panasonic	Videotape	Late '71	Not yet announced	Probably
Philips (Norelco)	Videotape	Late '71	Not yet announced	Probably
RCA SelectaVision	Plastic tape	Late '72	\$400	No
Sony	Videotape	Early '72	\$400	Yes
Teldec (Telefunken-Decca)	Video disc	Mid '72	\$200	No
Telefunken	Videotape	Not yet announced	Not yet announced	Probably

you look at the film—both images and squiggles are in black-and-white. In playback, another electronic beam scans the film and converts the signals into full-color pictures on the TV screen.

RCA's SelectaVision uses a laser beam to convert visual images into holographic patterns on plastic tape. In playback, a miniature laser inside the home player reconverts the holograms to visual images. These are then transmitted by a small built-in TV camera to your TV set. Seventeen years ago RCA beat out CBS in getting its system for color TV adopted as the national standard. Now it is trying it again with this sophisticated concoction for cartridge TV. This time, however, it is considerably behind CBS—as much as two years, experts estimate.

Compared to videotape, both EVR and SelectaVision have significant advantages.

EVR is capable of extremely high picture resolution—400 lines to the inch in color, 500 in black-and-white—making possible images of striking clarity. By contrast, videotape typically runs about 240 lines per inch in color, 270 to 300 in black-and-white.

The chief advantage of RCA's SelectaVision is the low cost of its cartridges. The plastic tape on which the holograms are printed is almost literally dirt cheap—it's the same stuff butchers use to wrap meat in at the supermarket. Multiple copies can be stamped out inexpensively from a master like phonograph records.

The big drawback of EVR and SelectaVision is that neither permits home recording—their innards are far too complex. How important this will be is hard to say. Proponents point out that you buy disc records without expecting to cut your own. Perhaps so, but a lot of people are going to be irresistibly tantalized by the prospect of putting baby's first steps on videotape or checking their golf swing. This may limit the appeal of the CBS and RCA systems.

One major annoyance is that, except for the similar Avco and Admiral units, no system is compatible with any others—you can't play one maker's cartridges on another's machine. In a way, it is a credit to the industry that it could come up with so many different approaches to the same end, but it is also unfortunate—it will force on buyers a bewildering choice.

The success of some systems may rest not so much on hardware as on what the industry likes to call "software"—the actual cartridges. A gun is no good without bullets. You have to have something to play on your player or the best one is useless.

So far, only a few companies are worrying much about the bullets. Avco, CBS and RCA are seeing to it there will be a good supply available by the time their machines hit the market. Inevitably, however, some represent aging movie titles bought up cheaply to give buyers something to view. Critics grumble that you can watch all the old Humphrey Bogart movies you want on regular TV for free. Why pay to see one?

Against this is the promise of better things as soon as the market widens. In cartridge TV, a subject selling only 2000 copies could be profitable, while a regular TV program with only 2000 viewers would be a disaster. Relieved of having to satisfy mass tastes, cartridge

(Please turn to page 190)

CUT-TO-FIT HOMES SAVE LABOR COSTS UP TO 100%

Save labor cost up to 100%, reducing completed home cost. You can assemble any of 57 designs from easy-to-follow plans. No measuring or cutting . . . every piece precision machine pre-cut and marked. **BUY DIRECT FROM MILL.** Eliminate all between overhead, profit and labor

costs. Nothing to plan or figure. Complete with all lumber, hardware, paint, nails, glass, roofing, etc. Sterling Home quality material throughout. Freight paid most areas. Write today. Send 25c for illustrated, color catalog, floor plans and details.

CHOICE OF 57 DESIGNS

PRICED FROM \$2295 UP

Prices do not include carpentry labor, heating, lighting, plumbing and masonry materials.

FIVE EASY-PAYMENT PLANS,

THIS HOME \$6535



INTERNATIONAL MILL & TIMBER CO. Bay City, Michigan, DEPT. PM-11

A BUSINESS OF YOUR OWN REPAIR HYDRAULIC JACKS



Earn while you learn at home. Millions of jacks in gas and auto service stations, trucking firms, body shops, riggers, factories and farms need servicing . . . most of which you can learn to repair. We show you HOW. Start spare time in your basement or garage. Big opportunity for mechanics. **ACT NOW!** Write for folder PM-1, and free bonus offer

HYDRAULIC JACK REPAIR MANUAL CO., INC.

G. P. O. BOX 3 • STATEN ISLAND, N. Y. 10314

HEARING AIDS

Huge savings on tiny, all-in-the-ear, behind the ear, eyeglass and body models. New space age models are so tiny and well concealed your closest friends may never even notice. **FREE HOME TRIAL.** No down payment. Low as \$10 monthly. Money back guarantee. Order direct and save. Write today for free catalog and confidential booklet. **PRESTIGE, Dept. D-34, Box 10947, Houston, Tex. 77018.**



HOME BOOK OF REFINISHING FURNITURE. All your questions are answered in this authoritative volume. Price \$4.95. Send to: **POPULAR MECHANICS Dept. FA, 224 W. 57th St., New York, N.Y. 10019.**

SATURDAY MORNING INCOME PLAN!



Earn \$5 to \$20 extra in spare weekend or evening hours, accepting orders from friends and neighbors for our nationally famous shoes. Just show our beautiful full color catalog of over 275 exciting styles, many exclusive comfort features! No experience needed to make extra money, earn prizes, bonuses—even **FREE SHOES** for life! Rush name & address for **FREE Starting Outfit** today. **MASON SHOE, Dept. F-152 Chippewa Falls, Wis. 54720**

FIND BURIED TREASURE

Powerful electronic detector finds buried gold, silver, coins, etc. 5 new models. Write for free catalog.



RELCO, Dept. D-3 19⁹⁵
BOX 10839, HOUSTON, TEX. 77018

WHAT'S HE DOING?

Making a Concrete Flower Pot! . . . and **SO CAN YOU!**



Make and sell your own Ornamental Concrete items. Rush \$2.00 for book about Aluminum Molds with prices and production trade secrets direct from world's largest mold manufacturer. Over 350 designs to select from.

Send \$2.00 **CONCRETE MACHINERY COMPANY**
Today To ➔ P. O. BOX 99 • HICKORY 2, N. C. 28601

BUILD YOUR OWN CAMPER SAVE UP TO 50%



Complete, easy to follow plans, instructions, materials list.

Camper Plans\$3.95
Travel Trailer\$3.95
Pickup Cover\$2.00
CONVERSION PLANS:
Econoline Type Van..\$2.95
Passenger Bus or
Delivery Van.....\$2.95
Satisfaction Guaranteed

VIKING CAMPER SUPPLY, INC.

99-87 Glenwood Ave.,

Minneapolis, Minn. 55403

Please send _____ for

which I enclose \$_____

NAME _____

ADDRESS _____

CITY _____

STATE _____ ZIP _____

EQUIPMENT CATALOG \$1.95

Refundable on First Order.

Send Dime for Details.

Save 50% on Camper Kit.

All items from catalog to

build \$1,795. Camper, 8',

10', 10'6" or Chassis Unit.

VIKING

2,000

WOOD CATALOG & MANUAL

Hard-to-find PRODUCTS for easier...better woodworking!

Discover! Enjoy! Benefit from newest products and ideas in Constantine's big picture-packed Manual. Wood headquarters since 1812. Largest selection of world's most beautiful cabinet lumber, veneers, plywood, inlays, moldings. Woods in natural color. Tool bargains. Furn. hdwe. Finishing & upholstery supplies. *Fabulous plus that needs no clamps!* Instructions. Everything. Unsurpassed values. Send 25¢ now for your copy. **TEAR OUT AD.**

ALBERT CONSTANTINE AND SON, INC.
2051 Eastchester Rd., Bronx, N.Y. 10461

Enclosed 25¢ for new Constantine Catalog-Manual



NAME _____
ADDRESS _____

LEADERS IN THE ICS SUCCESS PARADE...

Automobile Engine Tune-Up
Introduction to Programming the IBM System/360 Computer
Business Administration
Accounting
Civil Engineering
Practical Electrician

Radio-TV Servicing
Architectural Drafting
High School Courses
High School Equivalency
Refrigeration and Air Conditioning
Aircraft and Power Plant Mechanics

ACCOUNTING

Accounting (U.S.A.)
Accounting (Canadian)
Accounting for Business Programmers
Accounting for Mgt. Decisions
Auditing
Business Law (U.S.A.)
Canadian Business Courses
Cost Accounting
CPA Review (U.S.A.)
General Accounting
Income Tax (U.S.A.)
Industrial Accounting
Junior Accounting
Office Accounting
Practical Accounting
Public Accounting
Small Business Accounting (U.S.A.)
Starting and Managing a Small Bookkeeping Service (U.S.A.)

ARCHITECTURE AND BUILDING

Architectural Drawing and Designing
Architecture
Building Contractor
Building Estimator
Building Inspector
Building Maintenance
Carpenter-Builder
Carpentry and Millwork
Fundamentals of Urban Planning
House Planning and Interior Design
Mason
Painting Contractor
Reading Architectural Blueprints
Review in Architectural Design and Practice
Review of Mechanical Systems in Buildings

ART

Amateur Artist
Commercial Art
Commercial Cartooning
Illustrating with Options:—Magazine

—Advertising Layout and Illustration
Interior Decorating
Oil Painting for Pleasure
Show Card and Sign Production
Show Card Writing
Sign Painting and Designing
Sketching and Painting

AUTOMOTIVE

Automatic Transmission Specialist
Automobile Air Conditioning Specialist
Automobile Body Rebuilding & Refinishing
Automobile Engine Tune-Up
Automobile Mechanic
Automobile Technician
Diesel-Gas Motor Vehicle Engines

BUSINESS

Advertising
Business Administration
Business Prac. (Cond.)
Canadian Business Course
Direct Mail and Mail Order Advertising
Industrial Psychology
Inventory Control
Magazine & Newspaper Advertising
Managing a Retail Business
Managing a Small Store
Marketing Management
Marketing Research
Modern Exec. Mgt.
Office Automation
Office Management
Production Management
Purchasing Agent
Retail & Local Adv'ting
Retail Bus. Management
Retail Merchandising
Retail Selling
Systems and Procedures Analysis

BUSINESS: SALES

Creative Salesmanship

Real Estate
Salesmanship
Sales Management

BUSINESS: SUPERVISION

Basic Supervision
Industrial Foremanship
Industrial Supervision
Management, Salesmanship and Sales
Modern Woman as a Supervisor
Personality Development
Personnel-Labor Relations (U.S.A.)
Supervision

CHEMICAL

Chemical Analyst
Chemical Engineering
Chemical Laboratory Technician
Chemical Process Equip. Design & Operation
Chemical Process Op.
Elements of Nuclear Energy
General Chemistry
Instrumental Laboratory Analysis

CIVIL ENGINEERING

Civil Engineering
Construction Eng'r'g Tech.
Highway Eng'r'g Tech.
Principles of Surveying
Reading Highway Blueprints
Reading Structural Blueprints
Sanitary Engineering Technician
Sewage Plant Operator
Structural Eng'r'g Tech.
Surveying and Mapping
Water Works Operator

COLLEGE COURSES

American History
Calculus Economics

COMPUTERS

COBOL Programming
Fortran Programming for Engineers
Programming for Digital Computers
Programming the IBM 1401 Computer
Programming the IBM System/360 Computer, Introduction

DRAFTING

Aircraft Drafting
Architectural Drafting
Design Drafting
Drafting Technology
Electrical Drafting
Electronic Drafting
Introductory Mech. Drafting

Mechanical Drafting
Pressure-Vessel and Tank Print Reading
Sheet Metal Layout for Air Conditioning
Structural Drafting

ELECTRICAL

Electrical Engineering—Electronics Option
—Power Option
Electrical Appliance Ser.
Electrical Appliance Ser. with Equip. Training
Electrical Contractor
Electrical Eng'r'g Tech.
Electrical Home Maint.
Electrical Home Maint. with Equip. Training
Electrical Instrument Tech.

Electric Motor Repairman
Industrial Elec. Tech.
Industrial Electrician
Power-Line Design and Construction
Power Plant Operator—Hydro Option
—Steam Option
Practical Electrician
Practical Electrician with Equipment Training
Practical Lineman
Reading Elec. Blueprints

ENGINEERING

(Refresher Courses for Graduate Engineers)
Chemical Civil Electrical
Industrial Mechanical
Sanitary Structural

ENGLISH AND WRITING

Better Business Writing
College English
Composition and Rhetoric
English for Spanish (U.S.A.)

Free Lance Writing for Fun and Profit
Introductory Tech. Writing

Modern Letter Writing
Practical English
Reading Improvement
Short Story Writing

HIGH SCHOOL

High School Business
High School (Canadian)
High School General
High School Math.
High School Secretarial
High School Vocational
High School College Preparatory—Arts
High School College Prep—Engineering and Science
Preparatory Course for High School Equivalency Test

MACHINE SHOP PRACTICE

Grinder Operator
Industrial Metallurgy
Lathe Operator
Mach. Shop Inspection
Mach. Shop Practice
Metallurgical Eng'r'g Tech.

Multicraft Maintenance Mechanic
Practical Millwrighting
Reading Shop Prints
Rigging
Tool & Die Making
Tool Engineering Tech.
Welding Engineering Tech.
Welding Process

MATHEMATICS

Advanced Mathematics
Math and Mechanics for Engineering Techn.
Math and Physics for Engineering Techn.
Modern Elementary Statistics

MECHANICAL

Mechanical Engineering
Aircraft and Power Plant Mechanic
Hydraulic and Pneumatic Power
Industrial Engineering
Industrial Eng'r'g Tech. Instrumentation
Machine Design
Quality Control
Safety Eng'r'g Tech.
Tool Design
Vibration Analysis and Control

PETROLEUM

Natural Gas Production and Transmission
Oil Well Technology
Petroleum Production Operator
Petroleum Production Engineering Tech.
Petroleum Refinery Op.

PLASTICS

Design of Plastic Prod.
Plastics Techn.

PLUMBING, HEATING AND AIR CONDITIONING

Air Conditioning
Air Conditioning Maint.
Domestic Heating with Gas and Oil
Heating
Heating & Air Conditioning with Drawing
Industrial Air Cond.
Pipe Fitting Plumbing
Plumbing and Heating
Plumbing & Heating Est.
Practical Plumbing

COURSES

Refrigeration and Air
Conditioning Serv.

PULP AND PAPER

Paper Machine Operator
Paper Making
Pulp Making
Pulp & Paper
Engineering Tech.

SECRETARIAL

Clerk-Typist Commercial
Secretary, Engineering
Sec'y, Legal Sec'y, Med.
Secretary, Professional
Shorthand Stenographic
Typewriting

STEAM AND DIESEL POWER

Boiler Inspector
Industrial Building Eng'r
Power Plant Engineering
Stationary Diesel Eng's
Stationary Fireman
Stationary Steam Eng'r'g

TEXTILES

Carding and Spinning
Dyeing and Finishing
Loom Fixing
Textile Designing
Textile Mill
Superintendent
Textile Mill Supervision

TRAFFIC

Motor Traffic Man'g'm't
Traffic Management

TV-RADIO-ELECTRONICS

Commercial Radio
Telephone License
Electronics Technician
Fundamentals of
Electronic Computers
General Electronics
General Electronics with
Equipment Training
Hi-Fi Stereo and Sound
System Servicing
Industrial Electronics
Industrial Electronics
Technician
Numerical Control
Electronics & Maint.
Radio & TV Servicing
Radio & TV Servicing
with Equip. Training
Telephony

APPROVED FOR VETERANS FOR TUITION REFUND

Accredited member,
National Home Study
Council.

Easy pay-as-you-
learn plan

Special rates to
members
U.S. Armed Forces.

**We'll send you
complete details
on any one of
them... plus
a sample lesson
FREE!**

ICS is the oldest, largest school of its kind, 266 courses for men and women. High school, business, secretarial, automotive, computers, engineering. One for you. Direct, job-related. Bedrock facts and theory plus practical application. You learn from experts. The ICS diploma is the one recognized throughout industry. Clip and mail the coupon now or write ICS, Scranton, Pa. 18515. You'll receive, absolutely FREE, 3 valuable booklets that have helped thousands. But don't delay. Make your move for a more successful future today.

ICS[®] International Correspondence Schools Division of Intext

ICS, Scranton, Pa. 18515 Canadian residents: Send coupon to Scranton. Our affiliate in Canada will reply.



FREE!
THE ICS SUCCESS KIT!
Three valuable booklets sent
to you free:
1. A new, exciting booklet on
the principles of success.
2. Catalog of your choice.
3. Sample ICS lessons.

Mail this coupon today—ICS, Scranton, Pa. 18515

I'm interested in a program of independent study. Send me, without cost, your booklet on the principles of success, your illustrated brochures on the famous ICS method, and your catalog for _____

(Select from listing)

Interested in another field? Tell us: _____

Name _____ Age _____
(Indicate Mr., Mrs., or Miss)

Address _____

City _____ State _____ Zip Code _____

Occupation _____ Working hours _____ A.M. to _____ P.M.

Employed by _____

I am a veteran, tell me how I qualify for tuition refund
under the new GI Bill. **J7848M**

START A MONEY-MAKING BUSINESS FOR LESS THAN \$50!

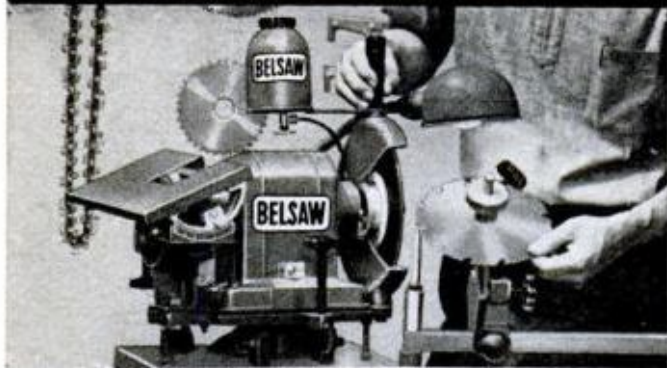

You can have your own lifetime business right at home . . . work in spare time . . . and make up to \$200 a month CASH! My FREE PLAN gives you all the facts: How to start, how to grow. You don't need previous experience. You don't have to sell. I'll even finance you. People bring you the work and pay cash. Over 90% of every dollar you collect is clear cash profit. And you work when you want to. Let me prove you can't find a more certain, lower cost, higher paying business of your own.

Just Mail Coupon—No Salesman Will Call
BELSAW SHARP-ALL CO., Stan Field, Pres.
811J Field Bldg., Kansas City, Mo. 64111

FREE BOOK

Name _____
 Address _____
 City _____ State _____ Zip _____

MAGIC MAIL PLAN

that comes with this Little Machine

CAN MAKE YOU \$1200 AN HOUR

The machine is turning out a job that will bring operator \$2.58, by mail. Material cost, only 11c



Write today for free facts about the newest and most fascinating of all new home operated businesses. For the first time, a simplified machine brings the fabulous profits of Plastic Sealing and Plastic Laminating within reach of the small operator. Anyone can learn to operate it with a few minutes practice. Then—with our MAGIC MAIL PLAN—can get mail orders pouring in daily with cash in every envelope.

No Canvassing or Selling

Fill orders at home in spare time to start. Then expand to full time business. We even supply circulars to bring back cash and orders. Rush name for all the facts you need to start. A postcard will do. No charge.

WARNER ELECTRIC CO., Dept. L2A A
1512 Jarvis, Chicago, Ill. 60626

NEW Improved Accurate Scope-Shot

SCOPE-SHOT COMPLETE WITH 50 DISINTEGRATING PELLETS
 They crack like a rifle when they hit—leave mark—puff of smoke! **\$2.50 P.P.**

Big Bag of **250 EXTRA Pellets**
\$1.00 P.P.

World's Finest Precision **SLINGSHOT**
 Scope-type sight!

Millions Sold! Patent No. 0-178,837
 Pure gum rubber slings.
 Beautifully polished cast aluminum stock.
 Pistol grip. So powerful it kills small game. Fits pocket perfectly!
 Guaranteed. **FREE** shooting manual.

EXTRA RUBBER SLINGS, 3 pairs \$1.00 p.p. Leather Pouch & Sling assembly only 50c p.p. Order NOW from:

GENERAL SPORTS

4184-MX Apple Street Cincinnati, Ohio 45223



ROUTS PESTS!
 Price without pellets **\$2.00 P.P.**
Order Now!

BIG BOOM IN CARTRIDGE TV

(Continued from page 184)

producers could thus cater to highly specialized interests. Opera lovers could have opera; Shakespeare lovers, Shakespeare.

Some videotape makers, nervously eyeing the alarming proliferation of incompatible systems, are beginning to talk about the need for standardized players and cartridges. Those committed to hardware in production are understandably reluctant to start over in the name of conformity. Those not yet committed, however, are likely to go along. When and if this happens, it should open the floodgates to a whole new family of compatible videotape player, insuring a good supply of viewing material.

Meanwhile, other developments may affect the picture, too. Major film companies like Kodak are pushing the use of ordinary Super-8 movies for cartridge TV. The German firm of NordMende has already devised such a system. While details have not been made public, it's easy to guess that it might work on the same principle as Sylvania's system for viewing color slides on TV. Here, the images are broken down into three primary colors by filters. These are scanned separately, converted into TV signals, then recombined in the TV tube to produce full-color duplicates of the original slides.

Presumably, the same could be done with movies. If so, you could view home movies on your TV screen at the push of a button. Commercial programs could easily be put on Super-8 stock as well.

Also coming along are such intriguing developments as flat-screen TV and projection TV. Both promise bigger pictures—literally wall-to-wall images with projection TV. But bigger pictures require a finer resolution for sharpness. This may give a strong boost to CBS's EVR with its remarkably high resolution.

Another eye-popping possibility is three-dimensional holographic TV with images so lifelike they look as if you could walk around them. Here, RCA's SelectaVision may have the edge. Already based on the holographic principle, it could be the logical system to provide actual holographic pictures in 3D.

There's also the sudden appearance of the video disc—one of those they-said-it-couldn't-be-done achievements that's taking everybody by surprise. Developed jointly by AEG-Telefunken and Decca under the name Teldec, it offers a new dimension in home-brewed TV—video discs you play like an ordinary record.

One drawback is that the disc must

(Please turn to page 192)



If someone cares more
for your lips than Chap Stick[®]
Lip Balm, marry her.

Nothing soothes and helps
heal, dry, chapped lips
better than Chap Stick Lip
Balm. Or does a better job
of keeping lips good looking
and comfortable all winter
long.

What you do with your lips
is your business. How you
care for them is ours.



Chap Stick[®]
Care

©MILLER-MORTON COMPANY, Richmond, Virginia, A Subsidiary of A. H. Robins Company



Solves Repair Problems

Durham's fills cracks and holes in
plaster, wood and tile. Won't shrink
or fall out. Economical, easy to use.
Big 4-lb. can, only \$1.80 at lumber,
paint, and hardware dealers, or
shipped direct postpaid in U. S. for
\$2.25. Money-back guarantee. Order
now. Donald Durham Co., Box
804, Des Moines, Iowa 50304

At Last a New Amazingly Simple

GAS TURBINE JET ENGINE

Build from easy to follow plans. Length 15",
Dia. 8½", Wt. 15 lbs. Fuel: Gasoline or Kero.

"Screamin' Demon" develops 20 H.P. Ideal project for serious-minded
hobbyists, students; scientific and industrial arts classes. Make on 9"
metal cutting lathe with milling attachment. For use on small racing
boats, midget cars, etc. Full size assembly drawings with critical
dimensions, bill of materials and photos. Price \$5.00. No C.O.D.

SAVOY SCIENTIFIC, BOX 1398, SANTA MONICA, CALIF. 90406



INSTANT DRIP STOPPERS

Self-installing neoprene ball sealers. Just drop into any
faucet—no more washers to replace! Forget the bevelled
washers, the screws, and the fitting to size. Money back
guarantee, of course! Set of 12 in 4 standard sizes, just
\$2.00 per dozen, post paid from
Sullivan's Plumbing Shop, 1199 Broadway, New York 10001

SMASH
THE LOSING
BARRIER! GET UP TO
\$151 WIN
A RACE
DAY \$2
WITH 2
STAKES

BREAK THROUGH to a wonderful new interest in racing. *Smash*
the losing barrier, and break through to amazing wins up to \$151
profit on the day with \$2 stakes and PENCLIFF, world's top race
computer.

SENSATIONAL—space age—scientific, we supply **FACTS** over 4,000
latest CHECKABLE big win PENCLIFF results, BIG \$2 pays incl.
\$66, \$70, \$82, \$90, \$96, \$104, etc. And BIG track wins \$2 stakes on
all predictions in all races incl. \$113, \$118, \$121, \$134, \$141, \$151 etc.
CLEAR PROFIT ON THE DAY. Over a dozen race experts **BRAINS**
ARE BUILT INTO PENCLIFF. Experience the *pleasure* of seeing
this amazing instrument "think" as it works out wins for you. Not just
small ones—many grand, big, BIG pays. Later, you'll accept as normal,
but at **first** we're sure you'll find the **unique** way this remarkable in-
strument receives race information you feed in, skillfully *works it out*
and **COMPUTES** it, will be one of the most wonderful experiences of
your life. We programmed **THOUSANDS** of races to an I.B.M. com-
puter with intensive probes into entrants—equivalent to *50 mathema-*
ticians 3 yrs. work. Due to this **COLLOSSAL RESEARCH** fantastically
successful PENCLIFF was invented. Shipped complete—full easy in-
structions in a genuine English leather carrying case—so **cleverly**
designed that even if **no previous experience** of horseracing **EASILY**
operated. Get full, **EXCITING** details of world's greatest horserace
winning computer, and in future really *enjoy* the world's most popular
sport. *Money refund guarantee*. Mail the coupon NOW. R. H. P. Co.
PME14 Box 5715, CARMEL, CALIF. 93921.

R.H.P. Co. PME14 Box 5715, CARMEL, CALIF. 93921
(Tell me *everything* about exciting PENCLIFF)

Name _____

Add. _____

City _____ State _____ Zip _____

BIG BOOM IN CARTRIDGE TV

(Continued from page 190)

spin at a fantastic speed—1500 rpm—to produce high frequencies needed to create visual images. This limits viewing time to a few minutes per disc. Good points are easy storage and low cost—video discs can be stamped out as cheaply as conventional records. Telefunken is not putting all its eggs in one basket, however. It is also developing a separate videotape system.

So what's the answer? Unfortunately, there will be few real answers until the industry has had a chance to settle down. If you're considering an early purchase, be sure to check on the availability of cartridges for the system you choose. Also weigh carefully whether you'll want home recording. If the array of choices seems to offer hopeless confusion, there's one compensation—it's the most exciting confusion to come along in ages. ★★★

LICENSING FOR MECHANICS?

(Continued from page 75)

system, automatic transmission, front end, airconditioning, power train and standard transmission, standard and power steering, body and fender, paint, glass, truck repair and frame.

A mechanic can take any or all of them.

NATCB's tests are written examinations. There are no work tests on actual cars. It's on this point, in particular, that NATCB and NADA part company.

"You can't determine a mechanic's ability to fix a car by written examination alone," NADA argues.

This would seem to make good sense. No state will license a dentist until a qualified examiner has watched him fill a tooth. Clint Brawner, the racing mechanic who built Mario Andretti's 1969 Indianapolis winner, thinks mechanics ought to have to diagnose a problem and fix it the way the high-school kids do in Plymouth's annual contest.

This disagreement may have its roots in the type of mechanic at which the tests are aimed. NATCB represents not only mechanics who do major repairs but also those, such as some mechanics in gas stations, who do only minor ones.

NADA doesn't have this problem. Its tests can be aimed at one type of mechanic—those working in dealer garages. It has hired the Educational Testing Service of Princeton, N. J., to develop a series of written and performance tests. The Educational Testing Service has been devising qualifying examinations for voca-

tional and technical groups for 17 years.

So, at this point, where does regulation of mechanics stand?

Only one program exists, NATCB's certification setup. NADA says its program is still a year away. The IGO, incidentally, devised a certification program 15 years ago, but it lay dormant until 1966 when IGO of Arizona adopted it. The NATCB program is, in turn, an adaptation of the Arizona plan. The major difference between the two is that Arizona mechanics who wish to remain certified are required to retake tests every two years. I spoke to Duke Nalon of the Arizona Highway Dept. about his opinion of certification. Nalon drove at Indy from 1938 to 1953 and finished third in 1948. His observation is: "Certification or licensing will protect the tourist. When he has a problem, he can stop anywhere and be assured that the mechanic is certified or licensed and qualified to work on his car."

Rep. Halpern's administrative assistant, Jeff Hodes, says that certification plans have not changed the congressman's thinking. He still believes government licensing is the best way to protect the average car owner. He intends to keep pushing his bill.

However, there is one man who can settle the whole argument. He is Douglas W. Toms, director of the National Highway Safety Bureau. He has the power to regulate mechanics in the name of auto safety without waiting for Congress or anyone else.

"It is possible," he told me last summer, "under the Highway Safety Act of 1966, for the Bureau to issue a Federal standard which would require each state to establish a licensing and certification program for auto mechanics."

Maybe this is what will have to be done. ★★★

BUILD THIS MOTOR HOME

(Continued from page 139)

six-ply commercial. From here on it's all carpentry, cabinetmaking and installing appliances according to manufacturers' directions. The quality of your coach will depend on your craftsmanship; your pride in that will grow as you see the vehicle take shape.

A jig for building sidewall framing is made by laying five 4x8 sheets of ½-in. plywood on the shop floor and tacking a strip along the edge to hold them in place. (These sheets are later used as flooring.) The bottom and top plates and studs of 1½ x 1⅝-in. pine or fir are cut and assembled according to the plans. (Fram-

ing can also be 1x1-in. steel tubing.) When turned over, this frame serves as the pattern for the second wall. Pre-finished wall paneling is glued and nailed to the studs. The walls are bolted to the floor of the vehicle with carriage bolts every two feet. The wall and roof panels are insulated with 1-in. Styrofoam and are then covered with the prefinished aluminum skin. You have your choice of color combinations.

Large glass areas and three hinged skylights make for a cheerful, well-ventilated interior. Rubber-backed, wall-to-wall carpeting is a practical, attractive sound-deadener you can add. Six appliances—a 6-cu.-ft. gas-electric refrigerator, a range hood with light and exhaust fan, a 10,000-B.T.U. butane furnace, a three-burner range with oven, a six-gallon water heater, and a Monomatic recirculating toilet—are all top quality products available in a "kit" (Kit No. 5) for \$691. Purchased individually at retail these would cost \$892.

The roof panels provide a framed opening for adding a Coleman roof-type air-conditioner (\$410). This can be operated only when the vehicle is parked and 110-volt service is available through the exterior electrical supply connection.

The plans and kits for this vehicle come from the little town of Gaston, Ore., because that's where Larry Claridge and his wife, Del, started LariDel Enterprises when Larry perfected his design for a low-cost motor home. He acquired his know-how with a well-known coach builder and has built six motor homes from his own plans. Claridge says that the average builder does the job in 400 man-hours.

When you send \$35 for a set of plans (16 sheets), you receive a step-by-step instruction book as well as a complete materials list that indicates what each kit contains. LariDel does not include in the kits common materials you can obtain locally—like carpeting and steel—to save you the freight. Precut lumber and cabinets (knocked down) are available on special order. All materials, and the quantity of each you'll need, are listed on a separate sheet that carries the helpful footnote: "If there are any items on this list that you cannot locate, write us. We'll do our best to secure the item for you at a reasonable price."

By sticking to the blueprints and the instruction manual, you'll get a custom-built motor home that looks as if it rolled off an assembly line. You'll be proud to park this vehicle anywhere and welcome aboard visitors. And you'll have a lot of them.

★★★

ONLY 36¢-PER-ADVENTURE ON THE Science Fair™ TOUR.

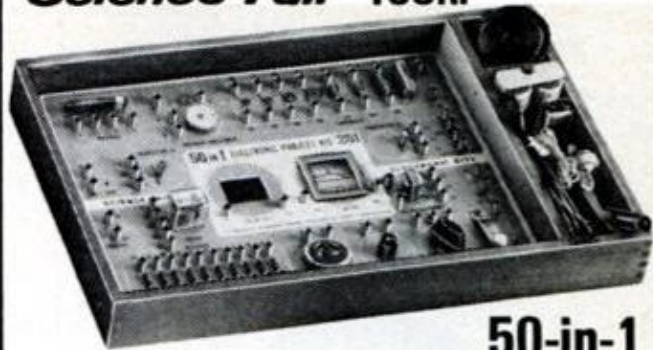

50-in-1 ELECTRONIC PROJECT KIT

For kids of all ages who want to start learning electronics *and have fun doing it!* Safe battery operation, no soldering, 56-page educator-approved manual. Includes speaker, "sun battery," 100's of parts that make each project really work. Build radios, transmitters, alarms, lots more!

\$17.95 AT 850 ALLIED RADIO SHACK STORES COAST TO COAST



FREE COLOR CATALOG ALLIED RADIO SHACK

At your nearest store or mail to:
Allied Radio Shack, Dept. EA
2727 W. 7th, F. Worth, Tex. 76107

Name _____
Street _____
City _____ State _____ Zip _____

FREE! CAMPER & TRAILER KITS catalog

Save 1/3 over factory built. Anyone can assemble. No experience required. Save \$500 to \$2000 over cost of factory built. Only household tools needed. Everything furnished—nothing else to buy! Just put factory pre-assembled parts together. 12 models—8', 8 1/2', 10 1/2' Pickup Truck Campers, 24', 31', 36' Pickup Truck Covers, 16', 19' Travel Trailers and 4 Soft & Hard Top Tent Trailer Models. Money back guarantee. Rush name, address for 24 page color catalog, FREE!



LUGER CAMPER & TRAILER KITS 10% dn, E-Z terms
Dept. TA 11, 1300 E. Cliff Road, Burnsville, Minnesota 55378

I-N-V-E-N-T-O-R-S WE NEED INVENTIONS

Sell your invention for cash—need money for Patent?—Are technical problems holding you back? Universal Inventions has helped inventors all over the world—just like yourself—why not you? Inventions provide the magic spring-board to sudden riches. REMEMBER, we either sell your invention or pay you a cash bonus. Write for details. **UNIVERSAL INVENTIONS, Dept. 13, Marion, Ohio**

Build The BIG ONE For BIG FUN NEW VT-7 Super Bronc



Check these leadership features carefully! 7 h.p., 4-cycle engine plus automatic load-sensing torque converter assures all-terrain, all-season performance. Big 21x21x8 super-trac flotation rear tire puts the power to work on sand, snow, slope. Shock mounted 18x8.50x8 front tire provides easy handling and ride. 2-man cushion seat on heavy-duty shocks and 2 pairs of folding foot pegs. Many accessories. Kits from \$169.95. VT-7 kit, \$269.95. Free literature.

HEALD, Inc. Dept. PM-1, P.O. Box 1148
Benton Harbor, Mich. 49022

Briggs & Stratton — Clinton New Gas Engine Sale

Never before and perhaps never again—this offer of brand new genuine Clinton and Briggs & Stratton engines including 1 yr. factory warranty at less than cost. Perfect power for go-carts, scooters, tractors, mowers, generators, pumps, sprayers, etc. We hauled out 3 big factories who needed cash and the savings are yours while quantities last. Act fast.



Clinton 2 1/2 hp. Mdl. 500—Re-coil starter Std. 3/8 shaft w. keyway—ready to go. Reg. price \$59.50 Special (item 1002)

\$39.95

2 for \$78.95
6 for \$229.50



Briggs & Stratton 2 1/2 hp. Mdl. 81100 clutch start. 3/4 shaft. Sturdy 4 cycle engine. Reg. price \$69.50 Spec Item = 1518

\$39.50

2 for \$78.95
6 for \$229.50

Briggs & Stratton 3 1/2 hp. Mdl. 141002. Re-coil start. Std. 1" shaft w. keyway, and adjustable governor—a rugged big engine ready to tackle any job. Regular price...\$92.60 Special (item 1059) ... **\$74.50**

\$74.50

5 3/4 hp. Briggs & Stratton



Same engine with 12 v. elec. start and battery charging. (item = 1571) **\$99.50**

2 3/4 h.p. Clinton—39.95

Model 400, rugged 4 cycle model. Alum. Block, castiron cylinder Rope start—5/8" std. shaft.

Item 1107 **39.95**
2 for **78.95**

3 1/2 h.p. Clinton—44.95

A big engine with big power. Model 404, 4 cycle, rope start, 3/4" std. shaft, Industrial ball bearing engine.

Item 404 **44.95**
2 for **87.95**

Remember these engines are absolutely perfect and standard and under factory warranty. Money back guarantee. Order now while stocks are complete. Factories—we buy new engines.



STANDARD DIAL PHONES WITH BELL

Bell System late model dial phones same as used by all telephone companies, deal as extensions on any system. Easy to connect. Several may be connected on one line. Easily modified for private inter-com system. Cost \$40.00 new—guaranteed excellent condition.



ITEM 855 NC. Wt. 8 lbs. **\$8.95**

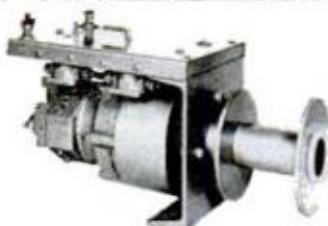

TRUCK OR BOAT WINCH 2000

A powerful, compact winch which installs easily even in limited space. Works with any 12, 24 or 32 volt system. Reverses under power—gear train holds load. Drip proof cover. Remote control if desired. Drum holds 100 ft. of 1/4" cable. Speed 30 ft. per minute. A terrific winch at an economy price. Item 1263 Wt. 55# **\$69.50**

RECHARGE ALL BATTERIES

Only Everlite

- Charges 6 batteries
- Charges 3 times faster
- Charges all batteries

Including bearing aid, flashlight, lantern, radio, in fact any battery up to 12V. Save Money and have the convenience of fresh batteries always. Simple and 100% Safe. Plugs into any 115V. outlet. Guar. for one year. Send \$6.95 plus \$.65 for shipping **695**



Model 75

Send 10c for 100 page Catalog FREE with order. Prices f.o.b. factory—Send check or MO

MASTER MECHANIC MFG. CO., Dept. A11, Burlington, Wis.

Southern Customers write Dept. A11, Box 65, Sarasota, Florida

PUTTING THE LID ON OIL SPILLS

(Continued from page 85)

the Gulf was a heavy-looking affair that employed oil drums for flotation and heavy plywood for a skirt (see page 84). Made by the Murphy Marine Pacific Salvage Co., it was flown in from New York.

Some systems under development, intended for moderate seas, use air as a barrier. One system tested at Santa Barbara employs a pipeline hundreds of feet long. It's placed on the bottom or suspended some distance below the surface. Air forced into it bubbles up through many tiny holes, creating a strong upward surge to form an underwater and surface dike.

Some skimming rigs suck up oil in vacuum-cleaner fashion. Others, like the Oil-evator, sop it up. Made for shoreline work, Oil-evator has a conveyor belt covered with terry cloth that runs down into the water and out again. Oil clinging to the cloth is squeezed into drums by rubber-plated rollers the conveyor belt passes through. Developed in Canada, the device was used with success in a tanker spill off Nova Scotia (*Defusing Canada's Sunken Time Bomb*, page 116, Oct. PM).

Chemical dispersants, which cause oil to break up to form an emulsion, are now thought to be dangerous to marine life. But chemical containment is being explored. Shell Oil has developed a product called Chemical Herder, which reportedly prevents an oil slick from breaking up and makes it easier to skim.

If you can't collect the oil, burn it. That's the thinking behind Pittsburgh Corning's SeaBeads—small, porous glass beads that are spread on a slick to soak up oil. The beads act like a wick when ignited, soaking up more oil to feed the fire.

Shell has developed a method of sinking an oil spill (see page 84). A mixture of water and specially treated sand are sprayed on the spill, the sand particles attracting oil molecules as they sink. In a test, a 100-ton slick was made to disappear in 15 minutes. Shell says the method is relatively harmless to marine life.

The best way to prevent a disabled tanker from causing a spill is to empty it before it breaks up or sinks. The Coast Guard's ADAPTS (Air Anti-Pollution Transfer System) method is designed to do that. Huge rubber-coated bladders, each capable of holding 140,000 gallons of oil, are air-dropped nearby. After loading, the big bags are towed to shore. The system is still under development.

Experts say the oil spill problem won't be solved by any single system. It will take a lot of different methods and equipment—and time and money, too. ★★

It only tastes expensive



Popular price

Also available in New large-size container.

\$12.95 BLACK DIAL TELEPHONES



Complete add \$2.00 for color
Factory rebuilt Western Electric in white, beige, ivory, pink, green or blue. If 4 prong plug is required add \$2.00. Fully guaranteed.

Designs may vary.
Write for free list. All shipments F.O.B.

SURPLUS SAVING CENTER

DEPT. PM-71, WAYMART, PENNA. 18472

ELECTRIC ARC WELDER \$9.99!



NATIONALLY ADVERTISED \$18.95 VALUE!—Now 1/2 PRICE! WELDS—BRAZES—SOLDERS—CUTS—ALL METALS! Plugs into ANY 110 volt socket. MAKE—REPAIR 1001 items for CAR—HOME—BUSINESS. Lifetime BURNOUT GUARANTEE 10 day money back trial (if retrnd). HEAVY DUTY Design—Does \$85.00 welder work. No experience needed. FREE WELDING LESSONS! SEND ONLY \$2.00 (cash, ck, M.O.) and pay postman \$7.99 COD postage or send \$9.99 plus \$1.00 postage for paid del. in U.S.A. COMPLETE READY TO USE includes BIG pack steel, Brazing, Solder, Carbon "touch" rods. ELECTROFLAME ARC TORCH! OFFER LIMITED—order TODAY! MIDWAY WELDER Dept. EPM-1 Kearney, Nebr. 68847

POWERFUL yet gentle, safe

Heathkit Screw-Drive Radio Controlled Garage Door Opener Kit

- giant 8 1/2' screw
- 1/4 hp motor — clutched
- safety switch reverses door when obstructed
- positive locking of door
- easy assembly — no soldering

NEW LOWER PRICE

GD-209A System Shown **\$139.95**

Solid-State Assembled & Tested UHF Transmitter & Receiver Operates Up To 150' Away

components available separately

Send for FREE Catalog, Heath Company, Dept. 17-1, Benton Harbor, Michigan 49022

FOUR POPULAR MECHANICS HANDYMAN BOOKLETS FOR \$1.00

- HANDY GUIDE TO HOUSE PAINTING
- 20 EMERGENCY HOME REPAIRS
- 50 GREAT HINTS FOR HOME & SHOP
- ALL ABOUT LUMBER

SEND \$1.00 to: POPULAR MECHANICS MAGAZINE
DEPT. CH1
224 WEST 57th STREET
NEW YORK, NEW YORK 10019

ITALIAN BLACK BERETTA



22 cal. revolver. Made of solid Black Gun Metal. 6 shots (blanks), double action with simulated pearl grip. Easy loading—Easy firing makes this compact beauty perfect for stage presentations, self-protection, sporting events, holiday celebrations. Lightweight, perfectly balanced. No license required (not sold in N.Y. or Calif.) **\$4.98** ppd

DANCO PRODUCTS

475 Fifth Avenue, Dept. M11, New York 10017

FREE!

Learn how you can buy used engines \$15 up, new engines \$30 with FREE confidential list and coupons when you order your plans

BUILD THIS MINI-BIKE!

Plans reveal step by step details!

BUILD A RACING KART!

Build frame for less than \$10!



RUSH \$2 for plans (indicate type) or send 25¢ for circular describing plans PLANS, Box 651, Valley, Nebr. 68064

NEW **DYNAMIC** **MARK 88**
80 AMP **INDUSTRIAL TRANSFORMER ARC WELDER**

IDEAL GIFT — EDUCATIONAL, ENJOYABLE, PROFITABLE
WELD, BRAZE,
CUT, SOLDER, HEAT
STEEL, BRASS, ALUMINUM,
AND MOST OTHER METALS.

Build and repair anything of metal. Save time & money with this **BRAND NEW, PROFESSIONAL ARC WELDER!** Rugged metal cabinet, baked Hammerloid finish. Ideal for home, shop, farm and industrial use. **POWERFUL** glass insulated transformer welds most metals up to 1/2" thickness with multi-pass weld, with 3/8" rods. 4 heat settings 20 to 80 amps. Operates on 110 Volt AC line fused for 30 amps. Complete with fibre glass helmet, electrode holder, ground clamp and cables, solder, assorted rods and simplified welding manual. **DOUBLE PROTECTION GUARANTEE.** 10 day money back trial plus full 5-yr. warranty. If inoperative return prepaid, we will repair or replace without charge & reship collect. **ORDER TODAY.** Complete ready to weld. Only \$59.50 F.O.B.



SEND ONLY \$6.00. Pay Balance plus C.O.D. and Delivery Charges or Write for "PAY AS YOU WELD" Easy Low Down Payment Plan. Welder details FREE.

DYNAMIC WELDER CO.

1808 S. FEDERAL ST.
Dept. D2-A
CHICAGO, ILL. 60616



Get more
GETUPANDGO
from every engine with
GUMOUT



EARN \$20.00/ HOUR

Assemble the rugged **MINI-DOZER** for resale at big profit. Unique easy-to-assemble kit. Full line of attachments. "Build-it-yourself" Plans \$5.00. 16-page Catalog 50¢. Refunded with any purchase.

C. F. STRUCK CORP., Dept. PM-11, Cedarburg, Wis. 53012

WRIST ROCKET

AMERICA'S Pat. HARDEST U.S. HITTING SLING
Range 225 yd.—232 fps
Matched spare rubbers and pouch assembly, \$1.00.
Write:



WRIST ROCKET®
P. O. BOX 21-B
Columbus, Nebraska 68601 **\$3.00 Post Pd.**
No C.O.D.'s



SMALL FOUNDRY FURNACES AND SUPPLIES

Ideal for home craftsmen and light commercial use. Make castings of bronze, cast iron, aluminum, copper, gold, silver, brass and other similar metals for hobby or business. Free literature.

PYRAMID PRODUCTS CO.

3736 SOUTH 7TH AVENUE. PHOENIX, ARIZONA 85041

BASEMENT TOILET FLUSHES UP



TO OVERHEAD SEWER OR SEPTIC TANK. NO DIGGING UP FLOORS. INSTALLS EASY. Write

McPHERSON, INC., BOX 15133, TAMPA, FLORIDA 33614

MECHANICS OF MEDICINE

(Continued from page 95)

are often confined to wheelchairs. In a desperate attempt to make it possible for these people to walk again, Dr. Borje Walldius, orthopedic surgeon of Stockholm, devised a radical approach to this problem.

If you watch your knees in action, you'll see that, while they can and do rotate, their primary action is hinge-like. So in 1951, Walldius went to work with hammers and chisels and saws (surgical instruments of course, but similar to those used in carpentry). He proved he could cut out the entire knee joint and replace it successfully with a well-designed mechanical one—and it worked. Wheelchair patients could walk again. At first he used an acrylic resin plastic joint but this was soon replaced by Vitallium, an American cobalt-chromium-molybdenum alloy. Many other orthopedic surgeons here and abroad have taken up Walldius's technique and used his Vitallium knees in appropriate cases.

Like a good mechanic, the surgeon disassembles the artificial joint, drives one of the stems (3½ or 4½ inches long) into the cut end of the thighbone and the other into the shinbone. Dr. Frank C. Wilson, University of North Carolina chief of orthopedic surgery, points out that the alignment need only be within 5° or 10° of precision because the knee normally has a fairly wide range and changing the angle a little isn't even perceptible. With a special attachment, the stems are driven into the soft center of the bones, the heavy bolt is then inserted to hold the parts together and it acts as an axis for rotation. Eventually, the stems are locked into the bones by the tissues.

Where Dr. Walldius has been successful with his Vitallium knees since 1958, Dr. Wilson has only been using them for six years, although he has already succeeded with some 30 replacements. As Dr. Wilson said: "This is sort of a last resort—we don't like to throw away a joint completely as long as there's any hope for it."

The result for a person who can't walk because of a bad knee is quite dramatic—he can once more walk, climb stairs, bend and stoop. Of course, as Wilson puts it: "We haven't had anybody go to the Olympics or anything like that." But where your knee can flex as much as 135°, its main functional arc is up to 90° approximately. The Walldius knee can restore some 70° of this really important 90° of function.

★★★

TREASURE & COIN DETECTOR

MONEY BACK GUARANTEE

New electronic detector penetrates deep into earth to locate gold, silver, coins, minerals. More penetrating power than ever before. Sensitive enough to locate a single coin or small nugget. Works through earth, wood, vegetation, water, rock, etc. Not a "probe" type but a fully electronic detector that is guaranteed to have at least twice the detection ability of any detector in this price range or return in 10 days for refund. Uses inexpensive 9V battery. Fully transistorized. Weighs only 2 pounds. Loudspeaker signals when object is detected. Has plug-in earphone for treasure hunting in privacy. **NOTHING ELSE TO BUY!**



29.95
POST PAID

Comes complete, ready for operation. Shipping container has compartments for detector and all accessories, serves as a carrying case. Send only \$29.95 check, cash or M.O. for postpaid shipment or \$2.00 and pay \$27.95 plus small C.O.D. when delivered. Viking Detectors, Dept. V-2, Box 10880, Houston, Texas 77018

New! 3-D Sight Magnifiers ENLARGES CLOSE WORK SMALL PRINT!

ONLY \$1.98

See clearer, work faster, more accurately with less eye strain, less fatigue and tension with **HEAD BAND MAGNIFIER**. Wear like glasses, they'll magnify about 3x and leave hands free to work. Produces a 3-dimensional effect, where each detail appears to stand out. For **CLOSE WORK, REPAIRS, SEWING, HOBBIES**, etc. Sturdy, lightweight, adjusts to all sizes. With or without glasses. Powerful prismatic polished lenses. Only \$1.98 + 50¢ for Post. and Hdlg. PPD. (2 for \$3.50, 3 for \$5.00) worth much more! **MONEY BACK GUARANTEE. Nu Find Products., Dept. HB622, Box 205, Church St., N.Y.C. 10008**



GOVT. SURPLUS BARGAINS SAVE UP TO 90%



HYDRAULIC POWER PACK

Develops up to 8650 PSI. Has its own self-contained reservoir with 12 cu. in. capacity. Hand operated. Displacement .065 per stroke. 1/4" standard pipe fittings. Self-contained valve for pressure return, open or closed. Brand NEW surplus. 14" L x 35 3/8" W. Shpg. wt. 7 lbs. \$19.95. (Stk. #2679)



D. C. JET GENERATOR

Mfg. by G.E. Rated 400 amp., 3700 RPM. Continuous duty @ 30 VDC. Does up to 600 amps intermittent duty. Exc. arc welder. Can use as is with no internal rewiring. Complete with wiring diagram. 16 1/2" L x 7" dia. Govt. overhauled cond. GOVT COST \$464. Shpg. wt. 98 lbs. \$59.50 (Stk. #1795)



SCAVENGE PUMP

Miniature pump unit. 7 1/2" L x 2 3/4" W x 2 5/8" H. Positive displacement, rotary vane-type pump. 27 V.D.C. motor, continuous duty, explosion-proof. Pumps up to 165 GPH @ 8 PSI. Self-priming. Exc. for transfer of gas, diesel fuel, crankcase oil, etc. Pump ports 3/8" tube. Shpg. wt. 5 lbs. Govt. overhauled condition. Approx. GOVT COST \$231. Now \$14.95 (Stk. #2026)



NEW! BIG 1971 CATALOG

Send 35¢ for amazing catalog with 1000's of bargains in hydraulics, electrical, marine, automotive items, etc. 90 day guarantee. Order from ad. All prices FOB Culver City. 50% deposit for COD. Cal. res. add 5% sales tax. Include zip. Satisfying customers world-wide since 1945.

AIRBORNE SALES CO.

Dept. PM171
8501 Stellar Dr., Box 2727 • Culver City, Calif. 90230



"Buy auto air conditioning now? You're kidding."

"When you can save \$200 or more - why not? Write Comfy-Kit, Box 8585, Dallas, Tex."



BIG

YACHT-SMART
Sail Rig
DACRON
from
\$114



WINTER SAVINGS NOW

FOLBOT

TRAVEL CRAFT
fits in every
home or car

FOR YOUR SPORT AND FAMILY FUN

GENUINE Folbot RECREATION for just ONE small investment, WITHOUT the continuous burdens of complicated 'big rig' operation. You GO CAREFREE anytime with COMPACT Folbot . . . rocky streams, lakes, marsh, surf & open sea. Superior non-sinkable designs provide SAFEST low gravity center, balanced low & high seating, substantial construction, protective decks & EXCLUSIVE swivel-back COMFORT. ALL within your reach. In handy Folbot YOU GLIDE smoother, faster & NOISELESS with paddles, oars, or sails and ride softly w. 1 to 10 HP. motors. Many styles & sizes from 1 to 4 seaters, FOLDING or rigid PORTABLE come in PREFAB KIT, or expertly FACTORY BUILT

Just a few Dollars start YOU right away. From

ONLY \$19 NOW
for BASIC KIT
16 feet long
'CAYAT'
car top
YACHT.

and
RECORD
FISHING



NEW
Fabulous
16 foot
\$117

Factory BUILT
FREE
ACTION CATALOG

STARTLING
FACTS & FIGURES
Mail coupon or address

to: FOLBOT CORP.
Dept. PM-171, Charleston, S. C. 29405

Name _____
Address _____
City _____ State _____

NEED AN OVERDRIVE?

(Continued from page 133)

simplify a Camaro or Firebird installation.

The self-contained Hone-O-Drive unit is shipped with a universal mounting kit. This includes two rubber isolators (to prevent drive-train noise from being transmitted to the vehicle's body), two isolator brackets, five feet of 1¼-in.-square thinwall steel tubing, an overdrive attachment clamp, and all necessary spacers, bolts, nuts and washers.

Before beginning the installation, measurements dictated that a section of spot-welded bracing be removed from the floor pan of the car. Although this did not weaken the structure appreciably, a short brace of 1¼-in. square tubing could be fabricated to pass under the Hone-O-Drive unit and replace the removed section (Photo 3).

After clearance had been provided for the unit, a cross member was fabricated

. . . cross member controls all torque reactions transmitted to the overdrive case.

from the 1½-in.-square tubing (Photo 2). A dip was offset in the middle of the cross member to provide maximum ground clearance. These mounts are roughly at the middle of the vehicle where such clearance is most critical.

For extra strength, lengths of 1-in. steel angle were welded to the underside of the tubing to prevent possible flexing. Then grade-six ½-in. bolts were welded to the ends of the tubing and braced with ¼-in. steel caps over the tube ends. Cool these welds properly so as not to weaken these bolts. Oil quenching is acceptable. These bolts extend approximately 2 in. from the ends of the mount to allow lateral adjustment for alignment purposes. The bolts also allow the mount to be pivoted on the ends, assuring that static loading is removed from universal joints on final installation.

Next, tongues were welded to the front and back of the offset in the cross member. These tongues positively locate the cross member after adjustments have been made for static loads on the U-joints, give additional support for the unit and arrest any harmonic vibrations.

The last step in making the cross member was to weld a piece of ¼-in. steel plate to the inside of the offset, providing a platform to hold the overdrive case.

After the cross member was completed,

mounts for attaching it to the frame rails were made. They feature double rubber isolators to assure positive control of the cross member under high-torque loadings (Photo 4). This is important since this cross member controls all torque reactions transmitted to the overdrive case. The mounts also feature three-point attachment to the frame to prevent flexing of the frame rail (Photo 7).

For maximum strength, the mounts should be constructed as shown in Photo 5, but ground clearance limitations prohibited the use of such mounts in our particular installation. On vehicles with adequate clearance, this type of mount is recommended. The double isolators assure that regardless of the direction of the torque reaction, one of the isolators will always be placed in compression—its strongest configuration. This would be especially good for off-road vehicles.

Upon completion of the cross member and its mounts, the Hone-O-Drive was slipped into place with the cross member attached. Correct placement of the mounts was determined, the frame drilled, and the mounts securely bolted into place.

Next, a flange was welded to the rear of the stock transmission support cross member. This flange is used to hold a rubber isolator and the mounting bracket for attaching the front tongue of the overdrive cross member. The attaching bracket is slotted to adjust the cross member for static U-joint loadings (Photo 8).

To provide an attachment point for the rear tongue of the overdrive cross member, a second transmission-support cross member (Photo 6) was installed approximately 20 in. behind the stock transmission support. Since the new transmission support already has a flange welded to its front side, another flange was not required. Attachment of the rear tongue of the overdrive cross member was made in the same manner as the front tongue, using a rubber isolator (Photos 9 and 10). It was then necessary to section the exhaust pipes and reroute them to provide adequate clearance and prevent rattles (Photo 11).

When all attachments had been made, the Hone-O-Drive was adjusted for final alignment. This was done quickly and accurately with three plumb lines, one attached to the rear of the transmission, one to the rear of the Hone-O-Drive and one to the nose of the differential. The driveshaft was rotated by hand to assure that no static loads were on the U-joints; all mounting and attaching bolts were then tightened securely.

The last step of the installation was to mount the overdrive shift lever on the side of the transmission tunnel (Photo

12). Hone offers shift levers for tunnel mounting or for flat floors.

Shifting is quite simple in the manner recommended by the manufacturer. For vehicles with automatic transmission, it is accomplished by synchronizing the speed of the engine to the speed of the driveshaft. For example, when driving in direct gear and a shift to overdrive is desired, let up on the gas pedal and shift to overdrive at the same time. A reduction of 30 percent in engine speed is required to make a smooth shift. Normally the deceleration of the engine is proper to make a correct shift.

To shift smoothly from overdrive back to direct, let up on the gas pedal, shift to the neutral position of the overdrive and then accelerate 30 percent. If the vehicle is not moving, the automatic transmission must be in Park or the engine shut off.

For vehicles with manual transmissions, the shift is made in the same manner as the normal transmission; that is, by using the clutch. Shifting from direct to overdrive is a plain clutch and shift operation. Downshifting to direct from overdrive requires a double clutch with an engine speed increase in the middle of the shift while the clutch is released. While the engine speed is still up, depress the clutch and shift to direct. Shifting sounds complicated at first, but it is really quite easy after you have done it awhile.

The \$300 tab for one of these dual-purpose performers seems high at first glance, but when all the benefits are considered—a 10 percent increase in gas mileage, smoother highway operation, power when you need it, less noise and vibration, longer engine life, and adaptability to another vehicle at trading time—the price may be more than justified.

For more information, write Hone Manufacturing Co., 11748 E. Washington Blvd., Santa Fe Springs, Calif. 90670. ★★★

MERCEDES-BENZ O. R.

(Continued from page 103)

to the dealer for routine service every 3000 miles. It also presents potential repair problem in case of breakdown or accident out in the sticks; e. g. there are only three M-B dealers in the entire state of Iowa." "My only complaint is that it's sometimes hard to get diesel fuel, but that's not the car's fault."

In summing up, Mercedes owners appreciate the quality, workmanship, appointments, handling, braking, and safety of their cars, yet would like more power and less expense of ownership. Overall, they're more than pleased. ★★★

Free



WORLD'S LARGEST ELECTRONIC KIT CATALOG!

The latest edition . . . with more kits and more color. Includes over 300 kits for unique creative fun at 50% savings. You can build your own solid-state color TV, stereo system, electronic organ, home protection system, portable and shortwave radios, ham equipment, marine electronics, metal locator and many more. No special skills or knowledge needed. Millions of others have done it already—you can too! Mail the coupon today and see how easy it is.



HEATH COMPANY, Dept. 17-1 a Schlumberger Company
Benton Harbor, Michigan 49022 CL-388
Please send FREE Heathkit Catalog

Name _____
Address _____
City _____ State _____ Zip _____

Two or
four-wheel drive
**JEEP OR
SCOUT**
OWNERS

REPOWER with a 6 or V-8.
H.D. ADAPTORS for using Car,
Compact and some Truck engines.
"State year & model, Jeep or
Scout." Want fast action? Give us
FULL INFORMATION. Send \$25.00
Dep. and we will ship correct kit,
bal. COD. Send full amount for
prepaid shipment. Wire, phone or
write today. Details **FREE**

HOOSIER MACHINE PRODUCTS CO.

312 S. E. 6th St., Phone 276-3442, Pendleton, Oregon 97801

INVENTORS

**INVENTIONS—NEW PRODUCTS—IDEAS
DEVELOPED & PREPARED**

For Commercial Appeal & Sales
DESIGN—MARKETING—PATENT RESEARCH—DRAWINGS
DIRECTOR: United States Patent Office former Patent Examiner
Member: United States Council Int'l Chamber Commerce
Second Decade of Reliable Service to

**INVENTORS—MANUFACTURERS—ATTORNEYS
FREE CONSULTATION**

THE RAYMOND LEE ORGANIZATION
230-Z Park Ave., New York 10017 (212-MU 6-8500)

SEND FREE "INVENTION RECORD," Form &
"PRODUCT MARKETING" BROCHURE

Name _____
Address _____
City _____ State _____ Zip _____



HEAVY DUTY WELDER

with special \$7.00 gift offer to
Popular Mechanics readers
10-DAY FREE TRIAL
Lifetime Guarantee
Brand New 1895
1971 Model POST PAID
Fits ordinary 110V outlet
Not one • but 3 welding heats



Weld, braze, solder or cut most anything made of metal. No experience necessary. Follow simple instructions to make repairs on cars, trailers, farm and lawn equipment, bicycles, appliances, etc. Make campers, boats, furniture, hundreds of valuable items. **NOTHING ELSE TO BUY!** Comes complete with full face shield, pack of welding and brazing rods, heavy duty power cables, special electric torch attachment, ground clamp, flux, easy-to-follow illustrated instructions, rod holder, etc. Uses standard 1/8" rods to weld iron, steel, brass, bronze, aluminum, other metals. New improved HEAVY DUTY circuit gives more welding power. Gives 4 times the heat needed to melt toughest iron. Plugs into ordinary 110V outlet. **3 WELDING HEATS** . . . Not just one as with other low cost models. Use "high" for tough jobs "medium" or "regular" for lighter work. This important feature saves you money and time. Makes it possible for even beginners to start welding professionally the very first day. Pays for itself quickly. An excellent gift for any occasion. **IT'S AUTOMATIC:** Current is turned ON when arc is struck, OFF when rod is lifted from work. Eliminates need for troublesome foot switch. Speeds up work.

FREE! Mention that you saw this ad in Popular Mechanics and receive a \$7.00 gift pack assortment of "touch weld" welding rods. Automatic arc striker. Weld with "push button" ease.

10 day MONEY BACK GUARANTEE. You must be satisfied or return for refund. Send only \$2.00 and pay postman \$16.95 plus postage when delivered or send \$18.95 cash, check or money order for immediate postpaid shipment.

WEL-DEX MFG. CO., Dept. W-203, Box 10776, Houston, Texas 77018



ROTARY FILES

U.S. Surplus High Speed Milling Files going fast. New, in G.I. Packs. Hardened steel, for filing, milling, routing, drilling—any work in light metal or wood. Use in 1/4 in. drill, etc. Range in size from 1/4 to 1 inch wide. Get these most useful tools now.

16 tool set—government cost \$109 \$ 9.00 to you!
36 tool set—government cost \$265 \$15.00 to you!

100% GUARANTEED. WE PAY POSTAGE. A LIFETIME BUY!!

THE SURPLUS CENTER
LANCASTER, TEXAS 75146

GLASS BLOWERS KIT \$13.95 pdd

SPECIAL TRIAL SIZE KIT

Contains assorted crystal and colored glass with complete instructions, diagrams and actual glass model. Learn to make beautiful ships, birds, bottles for fun and profit.

SEND \$13.95 TO

WILLIS GLASS SUPPLY CO.
BOX 3460 — ARTIST STUDIO — A
ANAHEIM, CALIFORNIA 92803



CAN A SHOOTER WHO IS OUT TO SCORE BULLS-EYES FIND HAPPINESS with the NEW BENJAMIN AIR RIFLE?

We think so. Indeed, shooters have told us that the accuracy and performance of our new Super Single Shot are next to fantastic! Just what makes the new Benjamin something all by itself? It's probably the retention of things the owners of its famous predecessor used to brag about. And the painstaking way we build them. For example, it has the same dependable, time-tested action. And the same adjustable firing power. It even has the same bronze barrels, machined brass and steel parts that gave our older model an amazing wallop.

Of course, there are certain new features about the rifle which further enhance shooting fun. For one thing, it has a thumb operated top safety for more efficient fire control. And a ramp-type front sight plus adjustable stepped leaf rear sight to help bring out the full accuracy potential of the new gun. Safe. Quiet. Odorless. Shoot indoors or out. Model 340 BB. Model 342 Cal. 22 Pellet. Model 347 Cal. 177 Pellet. Find happiness at your dealer's. Use Benjamin Pellets—Sized and Lubricated.

BENJAMIN AIR RIFLE COMPANY **FREE CATALOG**
896 Marion St., St. Louis, Mo. 63104 **WRITE**

You Can **DEPEND** on **BENJAMIN**



HOMEBUILT STEAM CAR

(Continued from page 116)

at by a few thermodynamic engineers, but it is he who has the last words: "It works!"

"In fact, it is working so well," says Philip, "that we don't employ a cooling fan at this time, and our system is still 99 percent condensing. We lost no water except through a few minor leaks, most of which are being eliminated."

One of the biggest breakthroughs on the Barrett steamer is in lubrication. The cylinders of steam engines are usually lubricated by a complex and bulky device that sprays a heavyweight oil in with the steam. This oil coats the cylinder walls and passes out with the exhausted steam. Later, the oil must be separated from the condensed water and returned to the lubricator.

The Barretts make use of a chemical emulsifier that allows both oil and water to coexist throughout the entire system, eliminating the need for cumbersome injectors or separators. Continuing tests show no scaling or deposits, either in the boiler coils or the condenser.

Another piece of original thinking on the Barrett steamer is the "in-out" box, a clutchlike mechanism that directly connects the engine to the driveshaft. Since the car has no gears, speed is controlled by throttling the steam admitted to the cylinders. Using the in-out box is similar to putting a car in neutral. Steam can be admitted to the engine, warming it and at the same time bringing the boiler to near-working temperature and pressure.

Anyone who has doubts about the effectiveness of the total system has only to be taken for a ride. The powerplant generates enough steam to provide 30 to 50 hp, and a gallon of fuel will drive the vehicle 15 to 20 miles. The control system is complex but fully automatic; the operator need worry only about this steering and acceleration.

The car has been driven over 50 mph, but no top speed has yet been designated due to the inadequacy of test-track facilities.

The Barretts want to continue improving their design. They may fit the Triumph chassis with a suitable body or even install the powerplant in another vehicle, maybe double or triple the amount of steam produced by the boiler to raise the horsepower effectively.

They think that a lightweight practical steam plant of 100 to 150 hp—more than enough to run a Mustang or compact car—can be built now. But they're not content to wait for others to do it! ★★

NEW RUBBER STAMP BUSINESS PAYS BEGINNERS UP TO \$16.50 AN HR.

**START AT HOME
IN SPARE TIME**
with Table Top Machine!

We Help Finance You
... at less than bank rates!

The multi-million dollar Rubber Stamp business—once controlled by a few big companies—is now being taken over by small operators—one in each community throughout the United States. Men and Women who have this inexpensive machine can turn out huge quantities of Rubber Stamps with special wording that buyers once were forced to buy from big cities. Material costing only 27c makes a stamp that sells for \$2.75. The machine that does the work is simple and easy to operate and it turns out as many as six Rubber Stamps at a time, each with different wording such as names, addresses, notices, stock numbers, prices and other "copy" needed by offices, factories and individuals. Working full capacity, it can earn as much as **\$33.00 an hour for the operator!** Now you can get into the big-pay business yourself, with your own home as headquarters. You don't need experience. We supply everything, including complete instructions and eight ways to get business coming in fast. **We even help finance your start.** Start making up to \$16.50 an hour from the very beginning. Cash in on the profitable Rubber Stamp business in your community, right away. We'll mail full particulars FREE and no salesman will call. Be first in your locality. Rush coupon today or send your name on postcard to:

RUBBER STAMP DIV., R-2-AA
1512 JARVIS AVENUE • CHICAGO, ILL. 60626



RUBBER STAMP DIV.
1512 Jarvis Ave., R-2-AA
Chicago, Illinois 60626

FREE!

Please rush full particulars about your financing plan and the little machine that can get me started in the profitable Rubber Stamp business at home in spare time. Everything you send me is FREE and no salesman will call.

NAME _____

ADDRESS _____

CITY _____ STATE _____ Zip Code _____

**For Sparetime or Full Time
Income, There's Good**

MONEY IN SHARPENING

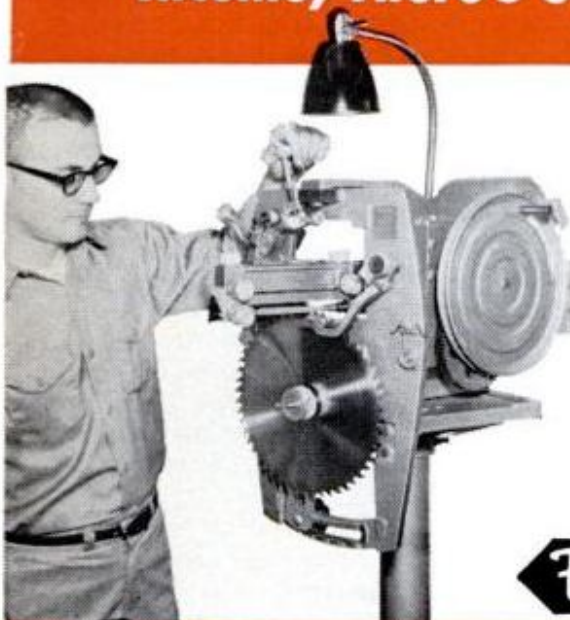

Here's a proven practical way to earn extra dollars in spare time—to develop a money-making repair business of your own. Investment is small. There's no overhead, no stock of goods to carry. No experience needed, no canvassing. You do it with the famous Foley Saw Filer that automatically sharpens all kinds of saws—and the Modern Lawn Mower Sharpener that precision sharpens all types of mowers.

EARN \$3 TO \$6 AN HOUR SPARETIME

Hundreds of people like yourself are making cash like this—\$20 to \$30 a week—right now in spare time. "My spare time saw filing business has made me \$952 these first ten months"—says R. T. Chapman. Many have built a complete sharpening service with such year-around profits. You can too, simply by following the sure, easy Foley Plan.



Foley

MANUFACTURING CO.
MINNEAPOLIS, MINN.

MONEY MAKING FACTS BOOKLET FREE!!!

This valuable book shows you how to start, how to get business from home owners, factories, carpenters, etc., and how to make profits fast. Mail coupon today. No salesman will call.

FOLEY MFG. CO. 116-1 Foley Bldg., Minneapolis, Minn. 55418
 Saw Filer information. Lawn Mower Sharpener information. Money Making Facts booklet.

NAME _____

ADDRESS _____

CITY _____ STATE _____



DEVCON[®] "5 Minute" Epoxy

NEW! SUPER-FAST GLUE

Now! All the advantages of epoxy adhesives *plus* quick setting. Used by industry for repairs and bonding. Also by the military for repairing pontoon bridges, pipelines, etc. Now available for the home and hobbyist. Contains no water, no solvent. Can't shrink. Achieves terrific strength through chemical reaction with hardening agent. Bonds almost any material including iron, steel, aluminum, glass, wood, concrete and many others. Clear. Easy to use. The strongest, fastest setting epoxy glue on the market today.



THIS AD WORTH 25¢. Tear it out. Take it to any Devcon dealer and receive 25¢ off the regular price of one twin-tubed "5 Minute" Epoxy with hardener. Offer good through March 31, 1971 in the U.S.A. only.

DEVCON CORPORATION

10 Endicott Street, Danvers, Mass. 01923

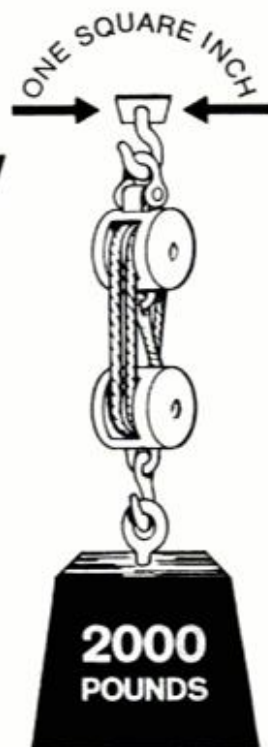

Supports 200 lbs.
in 5 minutes...
over 2000 lbs.
after full cure.

PUBLICATIONS **WORTH** **WRITING FOR** BY CATHERINE BILSKI

DESIGNED FOR SELF-TEACHING, a 28-page booklet, entitled *Arc Welding Short Course*, explains the basic arc-welding skills used by the nonprofessional or occasional welders. It also briefly reviews welding cast iron, brazing, cutting, soldering and the many other jobs that can be done with an arc welder. Available free. Write to the Lincoln Electric Co., Dept. E1, Cleveland, Ohio 44117.

FACTS A CAR OWNER should know to buy a set of new tires or to keep his present tires in safe operating condition are some of the things described in the 20-page *Tire Kicker* booklet. It's free from Owens-Corning Fiberglass Corp., TEAM Div., Toledo, Ohio 43601.

WORKING WITH PLEXIGLAS can be fascinating and fun. The booklet, *Do It Yourself With Plexiglas Acrylic Sheet*, tells

you how you can work with Plexiglas and presents nearly 40 different home-furnishing ideas to make your home a more attractive and safer place to live. For a copy of the booklet, send 25 cents to Rohm and Haas Co., Box 9730, Philadelphia, Pa. 19140.

MAKING IMPROVEMENTS around your home with cement can be fun, and the easy-to-follow instructions in the booklet *Do-It-Yourself Around the Home With Trinity White Portland Cement* tell you about many ways you can add beauty and value to your home. Included are ideas on making driveways, sidewalks and flagstone walks. Get the book free by writing the General Portland Cement Co., 4400 Republic National Bank Tower, Box 324, Dallas, Tex. 75221.

FIREPLACES are becoming more and more popular with homeowners. If you're thinking about installing a fireplace in your home, you're bound to be interested in this 72-page booklet entitled, *Fireplaces*. Included in the contents are numerous designs, plans and ideas plus instructions that will help you to make your dream fireplace a reality. Send \$1.50 to the Majestic Co., Inc., 245 Erie, Huntington, Ind. 46750. ★★★



**This isn't the first time
our name's been dragged
through the mud.**

After over 50 years of rough treatment, we still come up smelling like a rose. Easily. Our high-tenacity polyester and cotton adds muscle for any job. Our dress styling makes you look good. Good and comfortable. And our permanent press and soil release stops tough laundry problems. So don't be afraid to sling a little dirt our way. It won't be the first time our name's been dragged through the mud. And it certainly won't be the last. M. Hoffman & Co., Inc., Boston, Massachusetts 02114. Works hard. Plays hard. Cleans easy:

DUBBLEWARE[®]

FANTASTIC VALUES WITH THIS COUPON

AMERICAN MACHINE & TOOL CO., Dept. PM-11, Royersford, Pa. 19468
Please send me the units checked. Payment in full enclosed \$.....
or \$3 deposit each item enclosed, balance C.O.D. I MUST BE FULLY SATISFIED OR WILL RETURN UNIT WITHIN 10 DAYS FOR FULL REFUND.
No questions asked.

- | | |
|---|---|
| <input type="checkbox"/> 8" Power Saw at \$19.95 | <input type="checkbox"/> Belt sander at \$14.95 |
| <input type="checkbox"/> Standard Rip Fence at \$3.50 | <input type="checkbox"/> Disc sander attach. at \$7.95 |
| <input type="checkbox"/> Long Rip Fence at \$4.50 | <input type="checkbox"/> Mitre Gauge for sander at \$1.95 |
| <input type="checkbox"/> Precision Ball Bearing Spindle at \$5.00 | <input type="checkbox"/> Lathe at \$14.95 |
| <input type="checkbox"/> Jointer Planer at \$24.95 | <input type="checkbox"/> Face Plate at \$2.50 |
| <input type="checkbox"/> Drill Press at \$34.95 | <input type="checkbox"/> Turning Chisels at \$4.95 |
| G.E. Motor <input type="checkbox"/> \$19.90 (with other item) <input type="checkbox"/> \$24.85 (purchased separately) | |

NAME

ADDRESS

CITY STATE ZIP

SAVE AS MUCH AS...
80% WITH
QUALITY 
POWER TOOLS

DIRECT FACTORY OFFER AND REVOLUTIONARY PATENTS decrease costs, increase efficiency. Full scale power tools of heavy duty 100% cast iron and steel. Streamlined design reduces weight, cuts material and production costs. Special patents provide added efficiency, accuracy, savings. Parts made, assembled, tested, packed right in our own factories shipped direct... save store profits.

ENDORSED BY AMERICA'S TOP MAGAZINES... Here is what the editors say: "A good bit of sound—imaginative—engineering." Popular Science; "(saw) boasts many features of bigger brothers." Popular Mechanics; "Amazingly versatile." Workbench; "Highly substantial construction, sturdy enough for production line use." Industrial Woodworking. And Workbench awarded these tools their coveted "Work Tested" Seal.

OVER A MILLION USERS confirm their precision, versatility and rugged performance.

***10-YEAR FULL SERVICE GUARANTEE...** Any part or parts of any AMCO power tool (except motor) which may become inoperative for any reason within ten years after the purchase date will be repaired or replaced by the factory without cost to the purchaser. Your only cost: for postage.

UNCONDITIONAL 10-DAY MONEY BACK GUARANTEE
You must be fully satisfied. If not, return in 10 days, freight collect. Money promptly refunded in full.



8" TILT ARBOR POWER SAW

DOES WORK OF \$75 BENCH SAW as is. Converts easily to equal any \$300 floor model cabinet units! Crosscuts, rips, mitres, cuts compound angles, dadoes, makes coves and mouldings.

\$1995 f.o.b. factory. Wt. 25 lbs. incl. completely assembled cast iron and steel 8" saw with ground cast iron table, blade guard, less blade. RIP FENCE, if desired, for easier work alignment, \$3.50 add'l.

PRECISION BALL BEARING SPINDLE for Commercial Service, \$5.00 add'l.

SAW BLADE TILTS... TABLE STAYS LEVEL
Locks securely at any angle up to 50°, raises, lowers 0"-2 1/4". Patented tilt mechanism, accurate etched scale. Patented motor mount takes std. 1/4 h.p. or larger motor, keeps belt tight, assures perfect alignment at any angle, transmits full power. Takes std. blade, saw insert removes to take dadoe heads, cutters, etc. (not incl.). Accurate mitre gauge assembly. Ground spindle. Enclosed steel base. "Compo" bearings. Accessories available at factory prices. RIP FENCE, if desired for easier work alignment: Std. size (for bench saw) \$3.50; larger fence (for cabinet base, as ill'd.) \$4.50.

FREE CABINET BASE PLANS Use as portable bench saw as received (inset photo) ... or transform easily and inexpensively into floor model (as shown) guar. to do work of floor models costing \$300. FREE plans ... all you'll need are a sheet of 3/4" plywood and 3-4 hours. Use your AMCO saw for cutting. Plans provide 27" x 24" work surface, 33" height, tool storage compartment.

10-YEAR FULL SERVICE GUARANTEE*

6" SWING 3-FOOT LATHE



Optional faceplate for turning bowls, trays, lamp bases, rosettes, etc. \$2.50. **\$1495** f.o.b. factory Wt. 14 lbs.

Set of 3 high speed turning chisels, \$4.95 add'l.
DOES THE WORK OF \$40 UNITS... with same precision and speed. Turns wood, plastic. Sturdy cast iron with tubular steel bed. Ball thrust cup center, spur center, T-rest assembly, lever action tail stock, 2-speed pulley. Fits any motor.

10-YEAR FULL SERVICE GUARANTEE*

PRECISION 4" x 36" BELT SANDER



f.o.b. factory. Wt. 15 lbs. **\$1495** †Disc sander attachment incl. disc bracket, ground cast table (tilts 0-45°): \$7.95 add'l.

DOES WORK OF \$50 SANDERS... The world's most talented belt sander. Heavy cast sander incl. 4" x 36" sanding belt, V-pulley drive, multi-purpose drive spindle. Changes from horizontal to vertical sanding in secs. Uses 1/2 hp or larger motor.

10-YEAR FULL SERVICE GUARANTEE*

FULL 22" LONG, 4 1/8" JOINTER-PLANER

\$2495



f.o.b. factory. Wt.: 19 lbs. Complete as shown.

100% precision ground cast iron and steel.

DOES THE WORK OF \$60 UNITS... Professional power planing at a hand tool price. Make faster, more accurate joints, rabbetts, bevels for windows, doors, drawers, square tapered legs—Adjustable precision ground cast iron tables. Patent-pending design holds knife to table clearances at any depth. Rabbett depth 3/8". Fence adjustable 0°-50°. Hardened, ground high-speed steel knives. Dual cutter guards. Balanced cutter head.

10-YEAR FULL SERVICE GUARANTEE*

32" RADIAL DRILL PRESS

\$3495

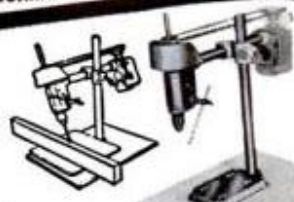

All cast iron and steel f.o.b. factory Wt. 30 lbs. 1/2" cap. Jacob's chuck incl.
DOES WORK OF \$90 UNITS... and much more. Industrial quality precision unit with all standard features, many extras. Head raises, lowers. Depth of throat up to 16". Pre-set to any angle for on-or-off table drilling, even horizontal drilling. **10-YEAR FULL SERVICE GUARANTEE.***

BRAND NEW MOTOR DEVELOPING FULL 1 HP... \$1990 F.O.B. FACTORY / FOR ANY OF ABOVE MACHINES. WT. 17 LBS. PURCHASED SEPARATELY, \$24.85



With a new John Deere Chain Saw, George might have wiped out the whole cherry orchard

Lightweight and lightning fast, a new John Deere Chain Saw will take down your average cherry tree in about 10 seconds. It'll also handle big stuff, 30 or 38 inches in diameter, depending on the model you choose. Roller-nose guide bar boosts cutting power, reduces wear. Balanced, needle-bearing engine design gives your wrists an easier ride. So bury the hatchet and hang up your hand saws. John Deere "chained lightning" comes in four models, with eager-starting, easy handling features our dealer will be proud to show you. Size up your job and see your John Deere dealer now.

Chained 
Lightning

Specifications slightly different in Canada.

For folder, write John Deere, Dept. CS, Moline, Ill. 61265

Springtime!

NO TRESPASSING
HUNTING OR FISHING
VIOLATORS PROSECUTED
UNDER PENALTY OF LAW
J. K. BROWN



It happens every Salem.

NATURAL MENTHOL. Not the artificial kind. That's what gives Salem a taste as soft and fresh as Springtime. It's only natural.

© 1987 B&W T Co. All rights reserved. Salem, Menthol Fresh, and the Salem logo are trademarks of B&W T Co.