

BONUS
Tear-Out Booklet

Money-Saving Emergency Home Repairs

POPULAR MECHANICS

APRIL 1970
50 CENTS

**Build This 3-Stage
VACATION HOME**

See Page 132 for Others
You Could Be in by
Summer

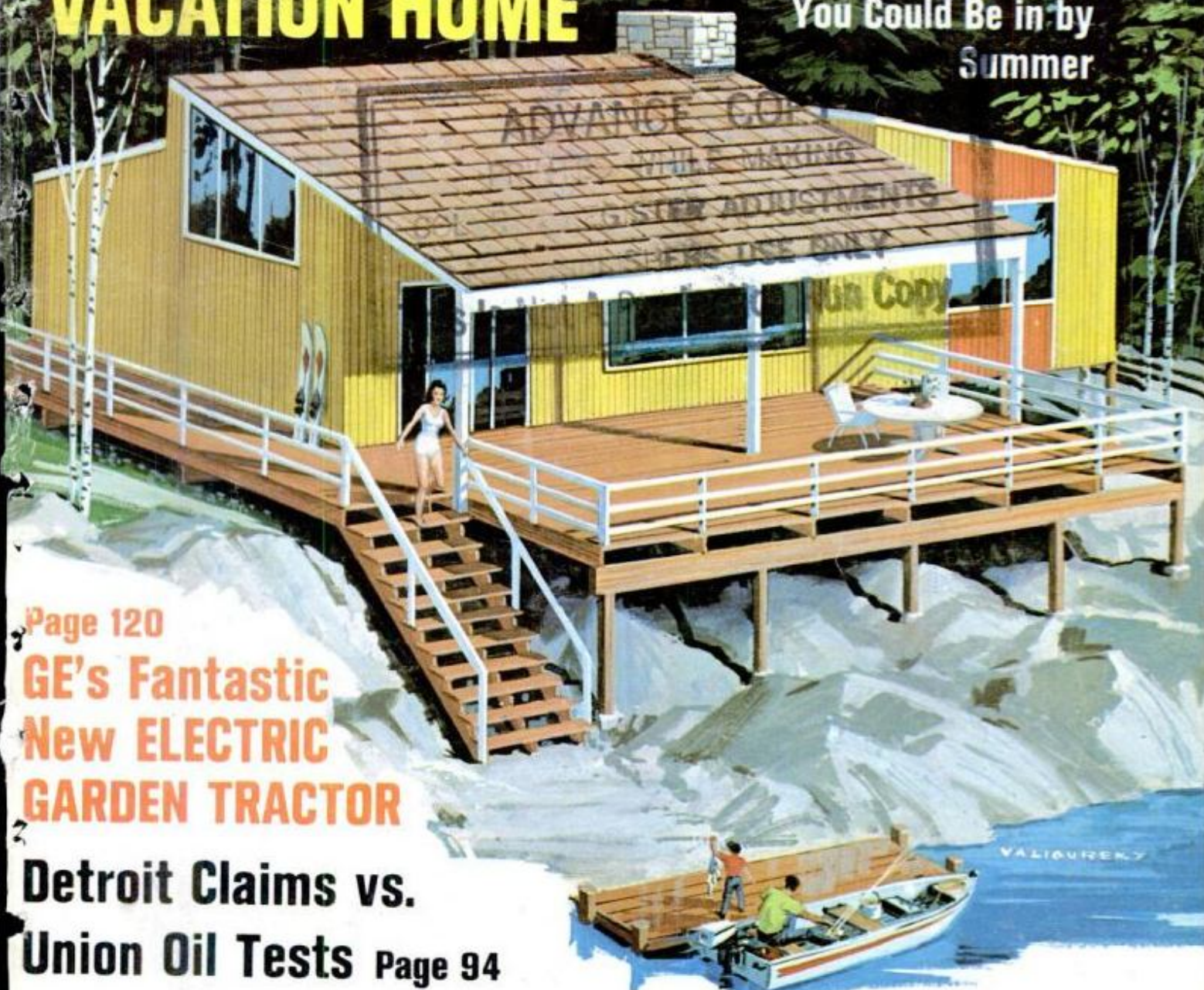

Page 120
**GE's Fantastic
New ELECTRIC
GARDEN TRACTOR**

**Detroit Claims vs.
Union Oil Tests** Page 94

Driving the Gremlin - Detroit's First VW-Size Car

**Best Car Lock Yet • New Low-Smog Gasoline • Apollo's
Fearless Firemen • Weekend Projects • New Electric
Mowers • Dan Gurney's Column • Saturday Mechanic**

the motor
that bridged the



generation gap



new loop-charged 60hp Triumph

To satisfy the young jet set's desire for speed and the biplane generation's desire for smooth trolling you had to have two engines.

Then along came Evinrude with a brand new kind of outboard motor. A trim 3-cylinder job with a unique loop-charged fueling system. No piston deflectors. Lighter pistons. Cleaner combustion. Higher efficiency.

The tremendous increase in power is translated into performance through a lower unit straight out of a computer.

A tuned exhaust system. A gearcase with the best blend of low-drag shape and high-thrust gearing. A thrust accelerator ring that forces water into the cone behind the hollow hub exhaust to reduce drag. And a large, high-rake prop that delivers exceptional thrust

at low speeds without sacrificing high speed efficiency.

The Triumph is a spectacular performer in blasting off with skiers in tow, wringing out a hot runabout, or just idling lazily, smoothly, quietly along.

Any age is the age of Triumph.

See it at your Evinrude dealer. Or send for catalog. Evinrude Motors, 4247 N. 27th St., Milwaukee, Wis. 53216.

power for the performance generation **EVINRUDE**  **first in outboards**
Div. of Outboard Marine Corporation

Caution: The Spoiler[®] is habit-forming.

Not a pill. Not a powder. It's a razor blade. The Gillette Spoiler.

A blade that brings relief to the man with the sensitive skin who feels the slightest tug of blade on whisker, right down to the roots.

Baked on to the edge of this blade is the miracle plastic coating

you've been hearing so much about.

Invented by Gillette, this coated edge reduces the pull to a fraction of what it would be without the coating.

You'll notice the difference especially when you shave those extra sensitive spots, such as under your nose, under your mouth, around the edge of

the chin and on the neck.

Caution: This blade is habit-forming. (The men of America have become so dependent on it, they buy more Gillette Spoilers than all competitive double-edge blades combined.)

Yes—the Spoiler edge is also available for injector blade users.



This One



8NQE-SC4-K1K9

The Gillette Spoilers.

*Manufacturer's suggested retail price, standard Swinger 2-door hardtop. Price excludes state and local taxes, destination charges, optional equipment required by state law, and dealer preparation charges, if any. Reduction includes replacement of fiber-glass-belted tires by polyester-cord, and elimination of day/night rearview mirror as standard equipment.

**Manufacturer's suggested retail price for TorqueFlite automatic transmission on 8-cylinder models—\$191.15; 6-cylinder models—\$175.45.



DODGE DART SWINGER 2-DOOR HARDTOP

FLASH!

DODGE CUTS THE PRICE ON DART

For example, the price of the Dart Swinger, America's lowest priced hardtop going in, now reduced \$187^{00*}

It's true. Dodge has reduced the price of all 1970 Dodge Darts. And that's just the start. Don't forget the Dart Swinger Automatic Sale. Buy the specially equipped Dart Swinger 2-door hardtop shown above, and if you check the sticker, you'll find there's no charge for the automatic transmission. (That's the same as having \$191.15** taken off the sticker price.) Simple addition (\$187.00 + \$191.15)

shows Dodge has reduced the price on this specially equipped car a whopping \$378.15. In addition to Dart's sporty styling and torsion-bar suspension, special sale package includes:

- Vinyl roof
- Whitewall tires
- Deluxe wheel covers
- Deluxe vinyl interior trim
- "Rim Blow" steering wheel
- Left, remote-control mirror
- Carpets
- Vinyl body-side mouldings
- Bumper guards (frt. & rear)
- Wheel lip/belt mouldings

It's the opportunity of a lifetime to get the Dart of your choice at reduced prices. Add to this Dart's traditionally high resale price and you've got it—America's biggest compact value. See your nearby Dodge Boy today!

ACT NOW!

Prices reduced as much as \$378¹⁵



Simoniz[®] Master Wax[®] is tougher than the toughest detergent.



Actual photograph after 44 car washes.
Master Wax still beads, still shines...
it won't wash off.

Master Wax your car and you'll have a detergent-proof shine. And your first wash will prove it. Get out a bucketful of the toughest detergent you'd use on a car. Scrub and clean all you want. After the rinse you'll find Simoniz Master Wax still beading and shining... the wax protection just won't wash off!

Master Wax by Simoniz. (Liquid or pre-softened.)
Tested through 44 consecutive car washes—
without washing off.

Won't wash off!



SIMONIZ is a registered Trade-Mark of Taxize Chemicals, Inc.

POPULAR MECHANICS®

INTERNATIONAL EDITIONS: AUSTRALIA, BRAZIL, CARIBBEAN, DENMARK, FRANCE, MEXICO, SOUTHERN HEMISPHERE, SWEDEN

AUTOMOBILES AND DRIVING

- 14 Detroit Listening Post
- 24 Drivin' With Dan
- 38 World's Most Thiefproof Car Lock
- 44 New Gas Cuts Smog, Cleans Engine, Too!
- 84 Automobile Clinic
- 94 Performance Tests—Detroit vs. Union Oil
- 100 My First Year on a Motorcycle
- 106 The Gremlins Will Get You If You Don't Watch Out!
- 142 PM Owners Report: Chevrolet Monte Carlo
- 148 PM Owners Report: AMC's Rebel
- 170 Saturday Mechanic: How to Do a Complete Brake Job

BOATING, OUTDOOR RECREATION

- 34 On-the-Go Camping
- 128 An \$800 Reel?
- 152 How to Make a Wobbler Minnow Lure
- 155 Blitz Fillets
- 156 Be Your Own Boat Tester—Part 2: On the Water
- 176 You Can Build a Spillproof Canoe

SPACE, AVIATION, MILITARY

- 89 The Hottest Job in the World

SCIENCE AND INVENTIONS

- 12 Science Worldwide
- 98 Just Patented: PM's Pick of the New Inventions
- 110 Mechanics of Medicine: Shirt-Pocket Tape Recorder for Daily Electrocardiograms, Fish-Tank Babies, Shop Tools for the Blind, Market Buoys for Artificial Legs

REGULAR FEATURES

- 6 Letters

HOMES FOR VACATION LIVING

- 132 Hillside Hideaway
- 133 Low-Cost Luxury
- 134 High-Style Living
- 135 All-Purpose A-Frame
- 136 Twofold Savings
- 136 Elegant Chalet in the Woods
- 138 Three-Stage House (Cover)

SHOP AND CRAFTS

- 169 Hints From Readers
- 176 You Can Build a Spillproof Canoe
- 182 Four Projects You Can Finish in a Weekend
- 192 New Tools You Should Know About
- 193 Hints From Readers
- 194 How to Put the Right Finish on Lathe Projects
- 199 Small-Parts Cabinets From TV Dinner Trays
- 200 Hints From Readers

HOME AND YARD

- 88B Homeowners' Clinic
- 114 What You Can Do With Power
- 118 Skil's Powerful Electric Mower
- 119 Black & Decker's Cordless Mower
- 120 GE Introduces the Electric Tractor
- 124 Build Poolhouse for Less Than \$500
- 174 Exciting New Products
- 186 Solving Home Problems
- 188 You Can Drive Your Own Well

PHOTOGRAPHY

- 50 New Projector Shows Slides in a Cube
- 164 Add Motion to Your Photo Slides
- 168 Turn That Camera Carton Into a Fancy Fitted Case

ELECTRONICS, RADIO AND TV

- 160 How to Keep Your Tape Recorder Humming Happily

Cover Illustration by Ed Valigursky
Build This Three-Stage Vacation Home

NEXT MONTH IN POPULAR MECHANICS

Camping '70: Valuable 32-page tear-out section, full of ideas, tips and new camping equipment. You'll want to keep it in your glove compartment.

The Electrolung: Radical new scuba gear that may make 1000-foot dives possible.

Indy 500 Preview: Can the Can-Am kings blitz the Brickyard?

ROBERT P. CROSSLEY

Editor

JAMES M. LISTON

Executive Editor

JOHN A. LINKLETTER

Managing Editor

WAYNE C. LECKEY

Home and Shop
Editor

SHELDON M. GALLAGER

Assistant Executive
Editor

THOMAS G. DAUER

Art Director

Published by The Hearst Corporation

RICHARD E. BERLIN, PRESIDENT

RICHARD E. DEEMS

President, Magazines Division

JOSEPH F. KERN

Publisher

BILL HARTFORD _____ Automotive
JOHN F. PEARSON _____ Science and Aerospace
GEORGE W. REIGER _____ Boating and Outdoors
SHELDON GALLAGER _____ Electronics and Photography
HARRY WICKS _____ Home Workshop
MICHAEL LAMM _____ West Coast Automotive
ROBERT LUND _____ Detroit Automotive
GARRY WINTER _____ Copy and Production
RICHARD H. FUNK _____ Associate Copy and Production
JOHN ADKINS _____ Assistant Copy and Production
ALVIN KIETZ _____ Assistant Art Director
DON EVANS _____ Assistant Art Director
FRED A. LEERS _____ Assistant Art Director
GEORGE W. BLOW _____ Technical Art Director
CLIFFORD B. HICKS _____ Special Projects
SOPHIE GRONOWICZ _____ Director, Bureau of Information
EVERETT JOHNSON _____ Cabinetmaker

ADDRESS ALL EDITORIAL COMMUNICATIONS TO: 224 West 57th St., New York, N.Y. 10019. For additional sources of information on the articles and products in this issue, write to Bureau of Information, Popular Mechanics, for free "Where-to-Find-It" list.

DANIEL J. COLEMAN

Director of Advertising

ADVERTISING OFFICES: New York: 224 West 57th St., 765-6850; Chicago: 520 N. Michigan Ave., 527-2400; Detroit: General Motors Bldg., Trinity 5-8711; Cleveland: 20310 Chagrin Blvd., Shaker Heights, 283-7788; Los Angeles: 601 North Vermont Ave., 666-6263.

SUBSCRIPTION SERVICE: Mail all subscription orders, changes of address, correspondence concerning subscriptions, and Postmaster notices of undeliverable copies to Popular Mechanics, Box 646, New York, N.Y. 10019. Please enclose your latest address label for quickest service when writing about your subscription.

POPULAR MECHANICS IS PUBLISHED MONTHLY by The Hearst Corporation, 57th St. at 8th Ave., New York, N.Y. 10019, U.S.A. Richard E. Berlin, President; George Hearst, V-Pres.; Richard E. Deems, President of Magazines; John R. Miller, Executive V-Pres. of Magazines; Raymond J. Petersen, Senior V-Pres. of Magazines; William S. Campbell, V-Pres. of Magazines; Albert A. Rachol, V-Pres. and Director of Circulation; Joseph F. Kern, V-Pres. for Popular Mechanics; Frank Massi, Executive V-Pres. and Treasurer; Harvey L. Lipton, Secy. Single copy in the United States and Canada, 50 cents. Subscription prices: United States and Possessions, \$5.00 for one year; \$9.00 for two years; \$12.00 for three years. Canada, add \$0.75 for each year. Pan American Postal Union countries, add \$1.00 for each year. All other countries, add \$2.00 for each year. When changing address, give old address as well as the new, with postal-zone number, if any, and allow six weeks for change to become effective. Second-class postage paid at New York, N.Y., and at additional mailing offices. Authorized as second-class mail by the Post Office Department, Ottawa, and for payment of postage in cash. Registered as second-class matter at the Post Office at Mexico D.F., Mexico, June 20, 1950. © 1970 by The Hearst Corporation. All rights reserved. Printed in U.S.A.

APRIL 1970

*Offer valid only where legal—for a limited time only



86 PROOF—EARLY TIMES DISTILLERY CO., LOUISVILLE, KY. © ETDc 1970

What's new Pussycat?

We hereby declare 1970 The Year of the Pussycat. Our national prize-winning drink has become a great success. No wonder. This sunny,

orange-sweet sour makes you want to purr. And mixes up quick as a cat. Just combine a packet of "Instant Pussycat Mix," water and Early Times. Ask for Instant Pussycat Mix at your favorite food or liquor store.



To get a set of 4-10½ oz. Pussycat glasses and 4 packets of Instant Pussycat Mix*, send \$2.95 to:

**EARLY TIMES PUSSYCAT GLASSES,
P.O. BOX 378, MAPLE PLAIN, MINN. 55395**



**Revelation hasn't
changed since Uncle
Ted flew with the
Lafayette Escadrille.**

Revelation's not
made of sugar
and spice, boys.
Just tobacco:
5 great tobaccos.
Revelation's for
the experienced
pipe smoker.



A quality product of Philip Morris U.S.A.

LETTERS

TO THE EDITOR

Are saunas fun anymore?

Tish, tish. Somebody has taken all the fun out of sauna baths as so clearly revealed in your photo on page 155 (*Now: Prebuilt Saunas That Go Together in an Hour*, Feb. PM). No wonder the poor guy has got his arms folded and wears a somewhat detached frown. What the two gals are so glad about I'll never figure out!

MIAMI, FLA.

HAROLD PALLATZ

The gals are happy because they found some towels lying around to wear for the picture. The guy is solemn because he knows he goofed; he forgot to put up the towel rack.

Passing grade

Your article, *A Lot of Railroad in a Little Space* (page 150, Jan. PM) is very interesting as I am working on an N-gauge line.

You forgot to mention an important point in the construction of elevated trackage. To elevate track five-eighths of an inch or more, you must start the grade at least 43 inches from the highest point; this will give a four percent grade—which still requires a great deal of power in the loco to move six cars.

MINEOLA, N.Y.

EDWARD SKILLMAN

Camping in Canada

I have to thank you for the excellent article, *Across Canada in a Motor Home* (page 122, Feb. PM).

During a vacation to your West Coast last year, I was amazed at how many people thought Canada was ice and snow all year. Last summer we had one solid week of in-the-sun temperatures of 120° to 127° F. Canada, and especially Toronto, has so much to offer U.S. tourists.

TORONTO, ONT.

BRUCE W. LOVATT

I can appreciate your fascination with the Trans-Canada Highway. My wife and I traveled it, all but the eastern 700 miles, this summer—but we went much, much farther than you did.

We have a camper—a second-hand Econoline panel job I bought in 1964 and fixed up to suit myself. I built in two bunks with storage underneath a wide seat across the back, a grocery closet and an ice chest. My wife and I, both now 75, live

(Please turn to page 8)

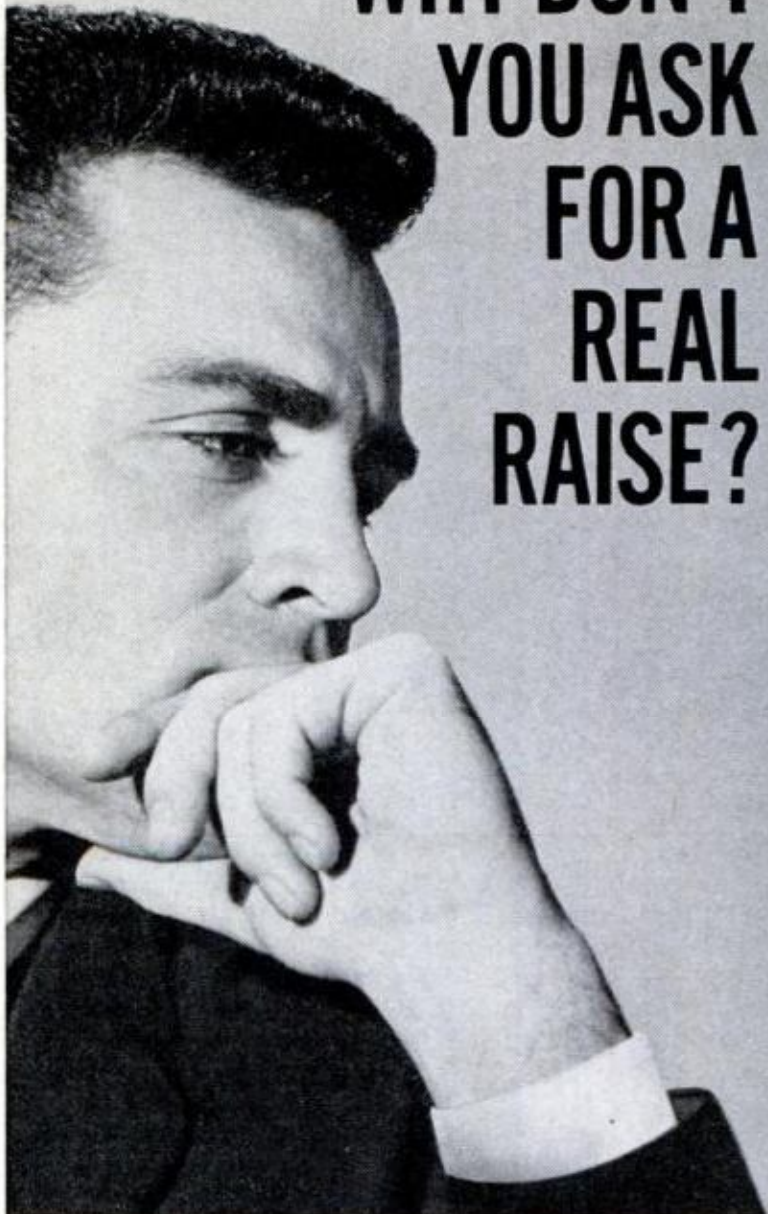

WHY DON'T YOU ASK FOR A REAL RAISE?

Think you may be turned down? Here's how ambitious men get important promotions without even having to ask.

If it's been a long time since you've celebrated a raise in salary, ask yourself why. Are you really worth more money? If you're not sure, look again at men who have moved ahead...men so clearly marked for promotion that when it came it was just what everyone expected.

How did they do it? The most usual answer: *through special training*. Special training is the direct way to increase your personal value, your income, your rate of advancement. Soon other employers are likely to seek you out—because *many important positions today are going begging for lack of qualified people to fill them*.

For more than half a century, LaSalle has trained men and women for higher success in business. More than 100,000 students enroll each year in low-cost LaSalle courses. Why not start today to get out of the ranks of the untrained and prepare for leadership? Without interfering with your present work — using only your spare time — you can qualify for the career opportunity of your choice through home study.

Mail coupon for free booklet describing the training that interests you. LaSalle, 417 S. Dearborn, Chicago, Illinois 60605.

LA SALLE EXTENSION UNIVERSITY

A Correspondence Institution • 417 S. Dearborn Street, Dept. 52-139, Chicago, Illinois 60605

Please send me, without cost or obligation, FREE booklet and full information on the field I have checked below:

ACCOUNTING

- Complete Accounting
- Income Tax
- Accounting Fundamentals
- CPA Training
- Modern Bookkeeping

BUSINESS MANAGEMENT

- Complete Business Management
- Credit and Collections
- Office Management
- Personnel Management
- Sales Management

REAL ESTATE

- Complete Real Estate
- Real Estate Brokerage
- Real Estate Management

Interested in a career not listed? Write here: _____

COMPUTER PROGRAMMING

- Complete Training

LAW COURSES

- Bachelor of Laws Degree
- Business Law
- Insurance Law
- Claim Adjusting Law
- Law for Police Officers

STENOTYPE

- Machine Shorthand

RESTAURANT/CLUB MANAGEMENT

- Executive Training

TRAFFIC & TRANSPORTATION

- Complete Traffic Mgt. Truck, Air, Rail, Sea

DRAFTING

- Complete Drafting

INTERIOR DECORATION

- Professional Training

ART TRAINING

- Commercial Art
- Oil, Water Color Painting
- Complete Training

Mr. _____

Mrs. _____

Miss _____

Address _____

City & State _____

HIGH SCHOOL

- High School Diploma

LANGUAGE INSTRUCTION

- French German
- Spanish Italian
- Other _____

HOTEL/MOTEL MANAGEMENT

- Executive Training

CAREERS FOR WOMEN

- Accounting
- Bookkeeping
- Commercial Art
- Computer Programming
- Dental Assistant
- Hotel/Motel Mgmt.
- Interior Decorator
- Real Estate
- Secretarial
- Stenotype

Age _____

Apt.No. _____

Zip _____

Make your kid a fancy dresser.

If it's battered looking, spray it brand new. With Krylon® spray paint.

Then give it pinstripes. Or pinwheels. Or something personal like initials. With Mystik® tape.

Maybe your kid won't always be neat. But at least he'll have a dressy dresser.



You'll find Mystik® Tapes, Krylon® Spray Paints, and Elmer's® Adhesives at Borden's "Love Thy Neighborhood" displays at your local store.



LETTERS

(Continued from page 6)

and sleep in the camper while traveling.
KERHONKSON, N.Y. ALDRICH L. MUNRO

Fine little camper-boat

Your *Three-Way Travelpod* (page 158, Feb. PM) is about the finest little camper-boat I have ever seen. It'll be just the thing to meet my "once in awhile" camping needs.

GREENWOOD, IND. EARL L. COTTEN

747s for back-yard airlines

Unfortunately, the model of the Boeing 747 you showed (*Styrofoam 747 Is Real Jet*, page 98, March PM) is not the actual scale model (bearing American Airlines



insignia) that will be sold. The plane will retail for \$4.95 without a jet engine; with a jet engine and four CO₂ cartridges, it's \$6.95. Inquiries should be directed to Dymo Special Markets, 280 Madison Ave., New York, N.Y. 10016.

NEW YORK GEORGE KLING, MGR.

Shootin' iron

The *Supersoft Iron Shot* item in *What's New Outdoors* (page 10, Feb. PM) has revived some memories. While I was employed by the Olin-Mathieson Corp., my main research during the years 1946 through 1951 was on lead substitutes. This research was finalized in 1950, and eventually two patents were granted, both assigned to Olin Mathieson.

Disclosures and claims of the two documents give the advantages and some of the disadvantages.

Soft iron shot should be made from ingot iron, melted by an induction furnace. Cost per pound of iron shot would be about one cent. Use of iron shot necessitates use of hardened-steel-choke shotguns. It will "shoot out" swaged chokes.

Use of iron shot on a 100-percent basis would increase wild game waterfowl more than tenfold in 10 years.

ALBUQUERQUE, N.M. LEWIS P. WILSON

POPULAR MECHANICS

TOM McCAHILL SAYS:

"The appliance repair field is so uncrowded it's almost lonely!"

Someone once said that if you build a better mousetrap, the world will beat a path to your door. In the home appliance business, a lot of enterprising companies have gotten rich peddling a list of handy electrical gadgets for the home longer than Wilt Chamberlain's arm. The trouble is, the dozen or more appliances in the average American home can go on the fritz, and men with the proper training to do repairs are as scarce as knee-length skirts on teen-agers.

Good Appliance Repairmen are a rare breed these days. Those with a little ambition are booked so solidly you can wait days to get somebody to fix a balky refrigerator or cantankerous toaster. Sometimes, you have to settle for a bum job from a guy who had no business calling himself an Appliance Repairman in the first place.

This brings me to my point. If you want to make money in a field that's begging for trained technicians, there's a fine, low-cost home-study plan available that teaches you how to handle every type of Appliance repair in detail—including refrigeration, air conditioners, and even small gas engines. The course was prepared by the instructors at National Radio Institute. This is the oldest and largest home-study school in the Electronics/Electrical fields with more than fifty years' experience training men like yourself for new careers or spare-time or full-time businesses of their own.

A few years ago, NRI recognized the increasing demand for trained Appliance Repairmen. They set about preparing well-illustrated, easy-to-understand lessons that teach you how to repair home, commercial and farm Appliances. NRI even added a professional Appliance Tester that's included in their low tuition. With the Tester and a few basic tools you probably already have,

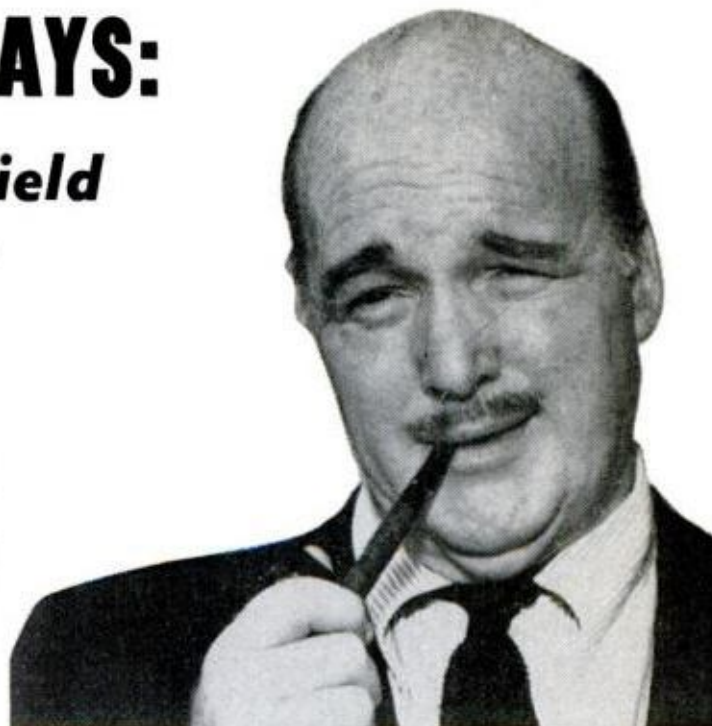

you're equipped to service most Electrical Appliances. If you aren't making as much as \$4 to \$6 an hour in spare time fixing Appliances for friends and neighbors within a few months after enrolling, my name isn't McCahill.

The reason I'm no doubting Thomas, is because the staff at NRI is composed of experienced instructors who guide you through the course with more personal attention than you'd get in many classrooms. With the kind of help they give a student and the kind of course they have, you can be the man in demand in this field—even if you've never tried to rewire a plug, or got fed up with school at the 9th grade.

The best advice I can give you is to clip the coupon below and send for the NRI Appliance Training Catalog. It's free, and there's no obligation. NRI doesn't employ salesmen, so nobody will be knocking at your door. All it will cost you is a postage stamp. Take it from Uncle Tom, the Appliance Repair field needs good men. Now.

Tom McCahill

TOM McCAHILL

APPLIANCE DIVISION, NATIONAL RADIO INSTITUTE
3939 Wisconsin Avenue, Washington, D.C. 20016

APPROVED UNDER NEW GI BILL.
If you served since January 31, 1955, or
are in service, check GI line below.

600-040

OK—I want to see for myself. Send me the free book on Professional Appliance Servicing. No salesman will call.

Name.....Age.....

Address.....

City.....State.....Zip Code.....

Accredited Member National Home Study Council.

Check for facts on new GI Bill.

“We sprung our Firecracker 400 passenger rig. The vibration was really You’re tougher on yours.”—Junior Johnson

Junior Johnson sets up racing cars with the same charging determination that made him a legend as a driver. By mid-1969, his Fords and Mercurys, with Lee Roy Yarbrough driving, had won the Daytona 500, the World 600, the Firecracker 400, and the Darlington 400—all with an Autolite battery under the cowl.

“With two shocks per wheel, a big sway bar, heavy-duty everything, our suspension is really stiff,” says Junior. “The vibration is so

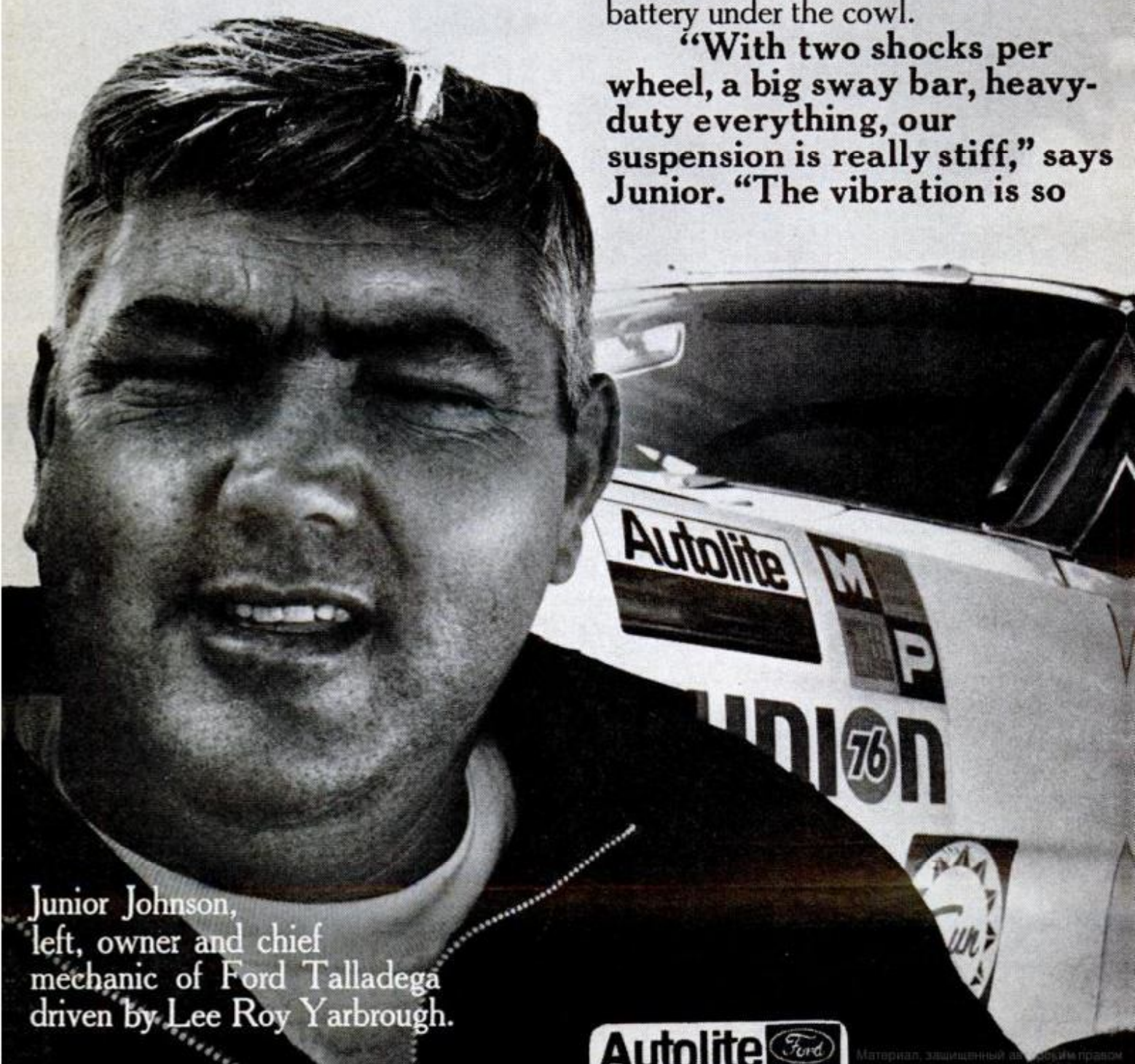

Junior Johnson,
left, owner and chief
mechanic of Ford Talladega
driven by Lee Roy Yarbrough.

Autolite 

Материал, защищенный авторскими правами

winner about 400% stiffer than a tough on our Autolite battery.

bad, Lee Roy can hardly sit down next day. That Autolite battery takes all that vibration right nicely. The plates in my Autolite have never come loose."

Autolite racing batteries have a patented Vibration Guarded design. Plates are mechanically bonded, top and bottom. And press-fitted to stay put, despite 200 mph vibration.

"Racing's tough on batteries. You're tougher. You cold-start a lot. That drains fluid and

power. And then you don't let the gas station fellow take time to refill your battery."

That's okay with Autolite. Its Sta-Ful reservoir has up to 3 times more water above the plates. And, in normal use, needs filling only about three times a year.

"We change batteries like socks. You'd stick with yours for 40,000 miles—and never think about the dust and salt and stuff piling up on the battery, and making a nice little path for electric leaks."

With Autolite, you can forget electric leakage. The one-piece cover construction virtually eliminates self-discharging across the battery top.

Next time get an Autolite battery. It passes the toughest test in racing. And the toughest test there is. Your kind of driving.

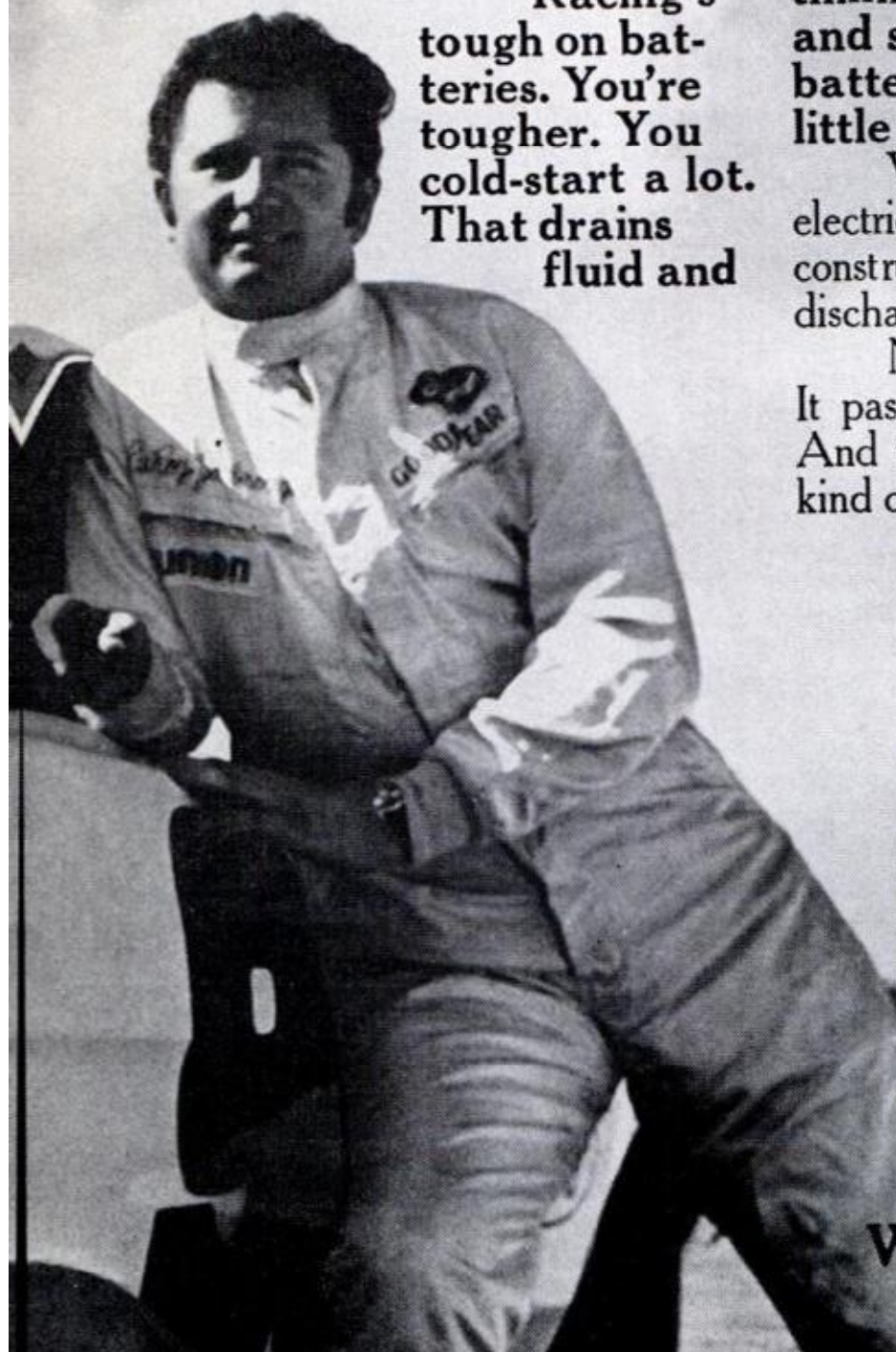

Autolite 



We pass the toughest test.

SCIENCE worldwide

A plastic paint applied to the grinding surfaces of teeth can prevent decay. That report comes from the Eastman Dental Center, Rochester, N.Y., where healthy teeth in 60 children were given a single treatment. Though the treated teeth showed no decay a year later, untreated teeth in the children's mouths had developed cavities. Coating is a simple procedure. After the paint is applied it's irradiated with an ultraviolet lamp, causing the plastic to harden immediately. As yet the materials and equipment used are not commercially available.

A "falling star"—a 22-pound stone meteorite—recently was found within six days of its plunge to earth. It was spotted by cameras in the Smithsonian Astrophysical Observatory's Prairie Network—a system of 16 unmanned camera stations stretching from South Dakota to Oklahoma and from western Nebraska to Illinois. Photos from two widely separated stations permitted scientists to plot a probable impact point. After a three-day search, a Smithsonian field manager found the meteorite on a country road near Lost City, Okla., less than half a mile from the predicted point. Such quick recovery allows scientists to study a meteorite before its low-level radioactivity is dissipated.

Cellulose waste is turned into a low-cost, high-protein food in a pilot plant designed by Louisiana State University engineers. The cellulose is ground, sterilized and fed into a fermenter, where microorganisms metabolize it. The edible end product—a single-cell protein—is straw colored and has the texture of rough flour. The plant can produce 50 pounds of protein per day from 250 pounds of raw material. Sugarcane stalks are the cellulose source used, but scientists think the system can be used to convert grass, hay, cornstalks, wood chips and newspapers.

Beagles with a tobacco habit have helped to establish a closer link between cigaret smoking and lung cancer, according to Dr. E. Cuyler Hammond of the American Cancer Society and Dr. Oscar Auerbach, a pathologist at a New Jersey Veterans Administration hospital. The researchers trained 86 male beagles to smoke up to a maximum of nine cigaretts a day. Through a neck incision, each dog was fitted with a tube into its windpipe that connected with a cigaret holder. The pooches became so addicted they "wagged their tails and whined for a cigaret." Some of the dogs died during the course of the experiment; others were put to death after smoking for over two years. Autopsies showed that 12 dogs had developed lung cancer and that almost all of the "heavy" smokers showed signs of lung problems. Some of the original group are still alive and still puffing.

A dry powder that turns to foam on contact with high heat is used in a new fire extinguisher patented by Britain's Atomic Energy Authority. The powder is made from perlite, an aluminum silicate of volcanic origin that contains about five percent water. Blown on a fire, the powder creates its own steam, which in turn generates a foam that's up to 20 times the original volume. The perlite foam, which kills a fire by cutting off its air, is said to be more stable and viscous than the usual high-expansion foams.

A system that reclaims water from a space crew's urine, perspiration and respiration is slated for a 90-day test at a McDonnell-Douglas Corp. facility at Huntington Beach, Calif. The system, designed for long space voyages, uses nuclear capsules to supply the thermal power needed to work its evaporators. Four men will be involved in the experiment.

Champagne contains little histamine, but burgundy is loaded with it, say French researchers who found varying amounts of the substance in all types of wine. Thus the question: Should antihistamines now be added to that long list of popular hangover cures? ★ ★ ★

KEEP PACE WITH SPACE AGE! SEE MOON SHOTS—LANDINGS, SPACE FLIGHTS, CLOSE-UP!

AMAZING SCIENCE BUYS

for FUN, STUDY or PROFIT



PLASTIC MODEL V-8 ENGINE



Hours of fun! Get thrill of building your own easily assembled engine from over 350 parts. Then push starter and watch it run. Crankshaft revolves, pistons move, valves open and close in sequence with spark plugs. Does everything but burn oil. 1/4 scale, molded in 4 colors. Used in many auto-mechanic courses. Excellent, easy-to-understand "tech manual."

Stock No. 70,448H \$12.95 Ppd.

WOODEN SOLID PUZZLES



Here's a fascinating assortment of 12 different puzzles to provide hours of pleasure and stimulate ability to think and reason. Animals and geometric forms. Take them apart and reassemble them. Lots of fun for the whole family—young and old. Will test skill, patience and ability to solve problems. Order yours now.

Stock No. 70,205H \$5.00 Ppd.

NEW BINOCULAR-TO-CAMERA HOLDER

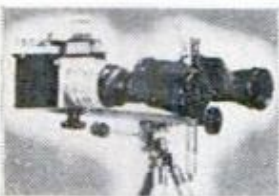

Fits any camera for exciting telephoto pictures. 35-mm camera with 7 x 50 binocular brings distant object 7 times nearer. Ideal for long-range photos of wild life, ships, people, planes, etc. Attaches easily. Use any binocular or monocular—and camera—still or movie, color or black & white. Gray crinkle and bright chrome finish. 10" long. Full directions.

Stock No. 70,223H \$12.50 Ppd.

AMERICAN MADE OPAQUE PROJECTOR



Projects illustrations up to 3" x 3 1/2" —enlarges them to 35" x 30" if screen is 6 1/2 ft. from projector, larger pictures if screen is farther away. No film or negatives needed. Projects charts, diagrams, color or black-and-white. Operates on 115 volts A.C. current . . . 6 ft. extension cord and plug included. Size 12" x 8" x 4 1/2" wide. Weight 1 lb. 2 ozs. Plastic case.

Stock No. 70,199H \$8.75 Ppd.

AMERICAN MADE 7x50 BINOCULARS

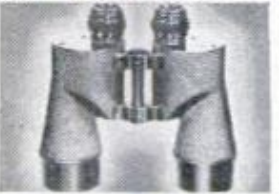

Big savings! Brand new! Crystal-clear viewing—7 power. Every optical element is coated. An excellent night glass—the size recommended for satellite viewing. Individual eye focus. Exit pupil 7 mm. Approx. field at 1,000 yds. is 376 ft. Carrying Case included. American 7x50's normally cost \$274.50. Terrific bargain.

Stock No. 1544H \$99.50 Ppd.

AMERICAN-MADE 6x30's

Stock No. 963H \$65.00 Ppd.

WAR SURPLUS ELECTRIC GENERATOR



Brand new Signal Corps Electric Generator. Generates up to 90 volts by turning crank. Use in high impedance relays. Charge ground & bring up night crawlers for bait or study. 2 Alnico Magnets alone now worth more than original gov't cost of \$15. Wt. 2 lbs.

Stock No. 50,225H \$ 6.95 Ppd.

MOUNTED WITH LIGHT. TO DEMONSTRATE ELECTRICITY.

Stock No. 50,365H \$11.95 Ppd.

3" ASTRONOMICAL TELESCOPE



See moon shots, orbits—stars, phases of Venus, planets close up. 60 to 180 power. Aluminized and overcoated 3" diam. f/10 primary mirror, ventilated cell. Equatorial mount with locks on both axes. 60X eyepiece and mounted Barlow lens. 3X finder telescope, hardwood tripod. FREE: "STAR CHART"; "HANDBOOK OF HEAVENS".

Stock No. 85,050H \$29.95 Ppd.

Stock No. 85,105H 4 1/4" \$94.50 FOB

Stock No. 85,086H 6" \$239.50 FOB

SCIENCE FAIR HEADQUARTERS

GIANT WEATHER BALLOONS

"Balls of fun" for kids, traffic stoppers for stores, terrific for amateur meteorologists. Create a neighborhood sensation. Great backyard fun. Exciting beach attraction. Amateur meteorologists use to measure cloud heights, wind speed and temp. Made of heavy duty neoprene. Inflate with vacuum cleaner or auto air hose; or locally available helium for high rise.

Stock No. 60,568H (8 Ft. diameter) \$2.00 Ppd.

Stock No. 60,632H (16 Ft. diameter) \$7.00 Ppd.

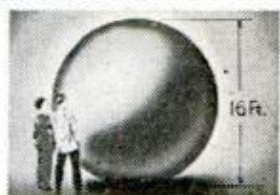

ASTRONOMICAL TELESCOPE KITS

Grind your own mirror for powerful pyrex mirror blank, tool, abrasives, diagonal mirror, and eyepiece lenses. Instruments you build range in value from \$75 to hundreds of dollars.

4 1/2" DIAMETER—3/4" Thick

Stock No. 70,003H \$ 9.75 Ppd.

6" DIAMETER—1" Thick

Stock No. 70,004H \$13.95 Ppd.

8" DIAMETER—1 1/4" Thick

Stock No. 70,005H \$21.00 Ppd.

10" DIAMETER—1 3/4" Thick

Stock No. 70,006H \$34.25 FOB



DIAGNOSE MECHANICAL TROUBLE

Professional Stethoscope. Designed for use by physicians, this super-sensitive Stethoscope is ideally suited for detecting faults in machines and engines, and in fluid, air and gas leakage. Dozens of uses in auto repair shops, labs and for hobby and educational applications.

Stock No. 50,270B \$7.50 Ppd.

BARGAIN PRICE STETHOSCOPE

Stock No. 50,223B \$3.25 Ppd.



"FISH" WITH A MAGNET

Go treasure hunting on the bottom! Fascinating fun & sometimes profitable! Tie a line to our 5-lb. Magnet—drop it overboard in bay, river, lake or ocean. Troll it along bottom—your "treasure" haul can be outboard motors, anchors, other metal valuables. 5-lb. Magnet is war surplus—Alnico V Type—Gov't cost \$50. Lifts over 150 lbs. on land—greater weights under water.

Stock No. 70,571H 3 1/2 lbs. (lifts 40 lbs.) \$14.00 Ppd.

Stock No. 70,570H 3 1/2 lbs. (lifts 40 lbs.) \$ 8.75 Ppd.

Stock No. 70,572H 7 1/2 lbs. (lifts 175 lbs.) \$18.75 Ppd.

Stock No. 85,152H 15 3/4 lbs. (lifts 350 lbs.) \$33.60 FOB



AMAZING "TRICK" PHOTOGRAPHY KIT

Now any amateur can produce all kinds of weird, wild, way-out photo effects. No special knowledges, or equipment required. Unique kit enables you to turn friends into monsters, show house with water to 2nd floor, make psychedelic slides, kaleidoscope photos, impressionistic photo-art . . . unlimited possibilities. Complete instructions reveal the secrets . . . includes all accessories needed.

Stock No. 71,229H \$10.50 Ppd.



NEW MODEL DIGITAL COMPUTER

Solve problems, teach logic, play games with miniature version of giant electronic brains! Adds, subtracts, multiplies, shifts, complements, carries, memorizes. Colored plastic parts easily assembled. 12" x 3 1/2" x 4 3/4". Incl. instruction book covering operation computer language (binary system) programming, problems & 15 experiments.

Stock No. 70,683H \$5.98 Ppd.

ANALOG COMPUTER KIT

Stock No. 70,341H \$18.95 Ppd.



MAIL COUPON FOR GIANT FREE CATALOG

148 PAGES! MORE THAN 4,000 UNUSUAL BARGAINS.

Completely new Catalog. Packed with huge selection of telescopes, microscopes, binoculars, magnets, magnifiers, prisms, photo components, parts, kits, accessories—many hard-to-get surplus bargains. 100's schools, industry. For hobbyists, experimenters,

EDMUND SCIENTIFIC CO.
300 Edscorp Building, Barrington, N. J. 08007
Please rush Free Giant 1970 Catalog "H"

Name

Address

City..... State..... Zip.....



ORDER BY STOCK NUMBER • SEND CHECK OR MONEY ORDER • MONEY-BACK GUARANTEE

EDMUND SCIENTIFIC CO. 300 EDSCORP BUILDING BARRINGTON, NEW JERSEY 08007

DETROIT

LISTENING POST

BY ROBERT LUND

THE SMALLER-THAN-MAVERICK MINI due from Ford in August or September, depending on how soon Ford Div. can get rolling in volume, will offer two engines: 95 horses for the power fiends and a sedate 75-hp plant for the nonperformance crowd. To keep interest stirring, the Official Company Source in Charge of Circulating Rumors continues to come up with new names for the car. You can pick from Phoenix, Special Maverick, Colt, Pony, Pinto or something else.

While everybody's attention is riveted on the mini, Ford has been quietly working up another car in the back room. It will be a senior version of Maverick—larger and higher priced—under the Mercury nameplate. The idea has been kicking around more than a year, but Ford felt no pressure to push it unless GM and Chrysler threatened to move in the same direction. With Chrysler promising a scaled-down Dodge for '71, the car has been reactivated and Mercury will get a new compact. We bet it'll be called Comet. Late flash confirms that, in addition to the Comet, Linc-Merc will be importing the Capri (see page 22).

Speaking of Maverick, this model run will be your last chance to buy one at \$1995 (plus the mandatory extras footnoted in the ads). The same trend to more car, more equipment and higher prices that prevented the original compacts of a decade ago from giving Volkswagen a real run for its money is surfacing again. Maverick gets the Tiffany treatment this summer, including hood scoops and a peppy V8.

WITH THE '71s due to go into production in four to five months, the automakers should be locked in on changes in the new cars. Most of 'em have been buttoned up, but not the standard bread-and-butter Chevys, Fords and Plymouths. There's still a lot of last-minute activity to give the standards more pizzazz. Detroit foreseers fear these cars will be gunned at from up and under come fall. Fire at the top will come from the hot-selling intermediates; the blast at the bottom from the new mini cars. So the search is on for innovations and eye-catchers to give them the stuff they need to fight back.

PORSCHE-AUDI DEALERSHIPS are springing up to market models of two exciting imported cars: front-engine, front-wheel-drive Audi sedans and Porsche 914 mid-engine sports cars. *Porsha Oudy* (rhymes with howdy) is the way it's pronounced and the organization is a division of Volkswagen of America. A four-cylinder, 1679-cc, 85-hp VW engine powers the Porsche 914, in fact. The 914/6 model is essentially the same car except that its powerplant is a two-liter, 125-hp, six-cylinder Porsche. The \$3600 914 is the lowest price Porsche you can buy and shares with the \$6000 914/6 appealing versatility: The roof panel is removable (leaving a built-in roll bar) and stows in the rear trunk (there's a front trunk, too) and a cushion that fits between the bucket seats for an emergency third person. With the engine right behind the passenger compartment and ahead of the rear axle, the cars have extraordinary handling.

Styling of the Audi is plain and straightforward by American standards, but handsome in the tradition of European luxury sedans. Front wheels are driven by an in-line,

(Please turn to page 20)



8 years ago

The French invented match-making by computer. We began aging the whiskeys for today's Schenley.*

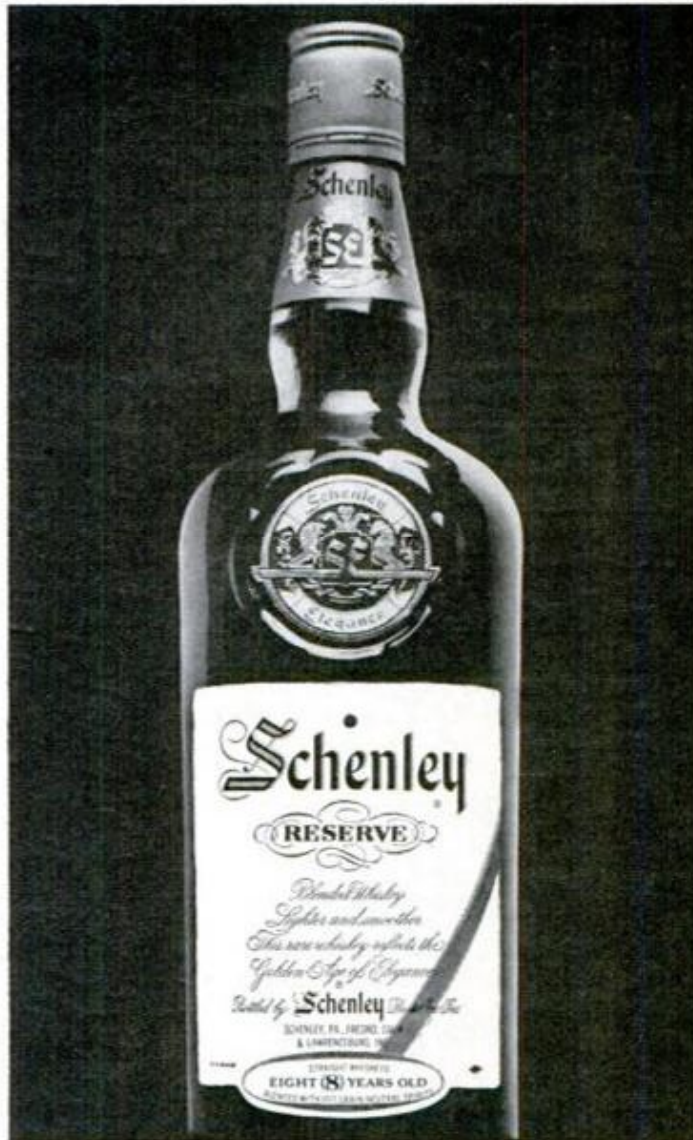
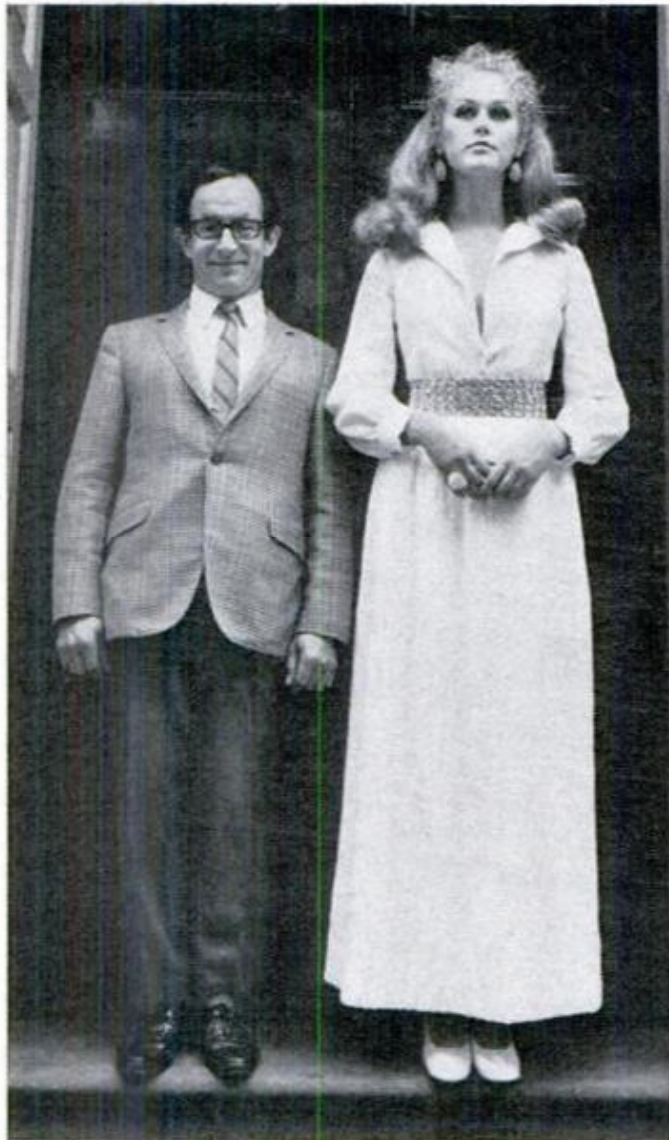

For most people 1962 is just a memory. But for whiskey drinkers it's an important year.

That's when the vigil over the whiskeys for this year's blend began.

We let them mellow for eight long years (the only leading blend that does). Eight long years that lighten-them-up and cool-them-out. Schenley Reserve. Mixed or straight.

When you taste it you'll be glad 1970 started in 1962.

*Blended Whiskey • Eight Year Old Straight Whiskeys (35%) • Grain Neutral Spirits (65%) • 86 Proof © Schenley Distillers Co., N.Y.C.

FLY-FISHERMEN!

4-Piece 'FLY-ROD'

'Perfect-Action' "IDEAL" Taper! Expertly crafted for CORRECT BALANCE! 4-piece 'Split-Bamboo', including EXTRA SPARE Tip Section! Elsewhere you would pay up to \$20.00 for this beauty!

SPECIAL..... only \$5.95



"Superior" FLY REEL

Precision made Light-Weight, Large capacity Fly-Reel. For right or left hand use. Removable Spool! Quick-Take-Apart! A High Quality Reel for Expert and Amateur alike! (Regular \$12.95 value)

SPECIAL..... only \$5.95



"FLOATING" FLY-LINE

Popular size; "D" or "E". It's Unsinkable! Hailed by Fly Fishing Experts! New Bonded Finish... Non-Porous, and completely Water Repellent! Soft, Durable and amazingly Tough! Rides High and Dry on water without kinks or curls! 25-Yards Standard length.

SPECIAL..... only 99¢



"DRY" FLIES or "WET" FLIES

Finest "FLY" Lures we have ever seen! HAND-TIED... all Expertly crafted! NEWEST and most POPULAR Patterns! #10 & #12 Hooks.

SPECIAL... 25-All Different..... only \$1.99



"BUCKTAIL-NYMPH" STREAMERS

Sensational Bass, Trout and Perch getters! Supreme Quality! Shiny-Silk Bodies with Feather Fish-Tails. Flashes like a Live minnow! 12-Different Patterns...

(A \$6.00 Value) SPECIAL..... only \$1.99



SPECIAL!
"JUMBO"
BULK-SPOOLS

FRESH!
NEW
1970 STOCK!

* The BEST! *

TRIPLE 'XXX' MONOFILAMENT

* by DuPONT *

- XTRA SOFT! will not stiffen in any weather!
- XTRA STRONG! small diameter, low stretch!
- XTRA INVISIBLE! Gets more Strikes!

TEST	APPROX YDS	VALUE
4-lb.	2700	\$41.85
6-lb.	2200	\$40.25
8-lb.	1500	\$29.00
10-lb.	1250	\$26.40
12-lb.	1000	\$25.00
15-lb.	750	\$19.50
20-lb.	600	\$18.00
30-lb.	400	\$14.40
50-lb.	275	\$11.25

Special Discount
ALL LB.-TEST: SAME PRICE

\$2.95 each

★ SAVE MORE!
2 Spools \$4.99

10TH
ANNIVERSARY
Lure
SPECIAL

CLOSING-OUT
THOUSANDS and THOUSANDS
FAMOUS LURES!

Last Chance...
GREATEST "LURE-BUY" EVER!

25 FAMOUS
PROVEN
LURES only \$4.95

GUARANTEED CERTIFIED VALUE up to \$25.00

We're loaded with THOUSANDS of the NEWEST and most POPULAR LURES! An assortment of the FINEST QUALITY, well known, Nationally advertised types that sell from 49¢ to \$1.95 each!

Here's your BIG chance to LOAD your Tackle-Box with Outstanding and PROVEN LURES... for a Fraction of their cost!

With this SET of 25 High Quality "Fish-Catchin' Lures" ... Famous Plugs, Spinners, Spoons, etc., you'll be Ready for ANY and ALL Fishing Trips!

ORDER NOW! ... and don't be sorry later that you missed this Last Chance Close-Out SPECIAL! Mail Coupon TODAY! *

Sports LIQUIDATORS
P.O. Box 1434-P, BURBANK, CALIFORNIA 91505

* SATISFACTION GUARANTEED... or Full Refund.

* Add 50¢ for Postage and Co. Insurance

* SPECIAL... 25 Different 'Lure-Set'... only \$4.95

NAME _____

ADDRESS _____

CITY _____ STATE _____ ZIP _____

Please send check Cash or... Money Order
(Because of the amazingly low price, we cannot accept C.O.D.'s)

- 4-Piece 'FLY-ROD' only \$5.95
- 'Superior' FLY-REEL only \$5.95
- "D" size FLY-LINE only \$.99
- "E" size FLY-LINE only \$.99
- 25-different 'DRY' Flies only \$1.99
- 25-different 'WET' Flies only \$1.99
- 12-different 'Nymph-Streamers' only \$1.99
- Triple 'XXX' Bulk SPOOLS only \$2.95

Our Complete CATALOG
sent with every order

Send LB.-TEST:

____lb. _____lb.

(2) \$4.99

Take command of your future...now!

Choose the job you want from 266 ICS Courses

Dozens of new careers are open to you with ICS training. Oldest, largest correspondence institution. 8,000,000 students since 1890. Learn facts, theories, practical applications. Instructors guide

you, answer your questions. Texts, written by authorities, are yours to keep. Famed ICS diploma to graduates. Convenient payment plan. Send our coupon for three FREE booklets.

LEADERS IN THE ICS SUCCESS PARADE...

Automobile Engine Tune-Up
Introduction to Programming the IBM System/360 Computer
Business Administration Accounting
Civil Engineering
Practical Electrician

Radio-TV Servicing
Architectural Drafting
High School General High School
Special Courses
Refrigeration and Air Conditioning
Aircraft and Power Plant Mechanics

ACCOUNTING

Accounting (U.S.A.)
Accounting (Canadian)
Accounting for Business Programmers
Accounting for Man'g'm't Decisions
Auditing
Business Law (U.S.A.)
Canadian Business Courses
Cost Accounting
CPA Review (U.S.A.)
General Accounting
Income Tax (U.S.A.)
Industrial Accounting
Junior Accounting
Office Accounting
Practical Accounting
Public Accounting
Small Business Accounting (U.S.A.)
Starting and Managing a Small Bookkeeping Service (U.S.A.)

ARCHITECTURE AND BUILDING

Architectural Drawing and Designing
Architecture
Building Contractor
Building Estimator
Building Inspector
Building Maintenance
Carpenter-Builder
Carpentry and Millwork
Fundamentals of Urban Planning
House Planning and Interior Design
Mason Painting Contractor
Reading Arch. Blueprints
Review in Architectural Design and Practice
Review of Mechanical Systems in Buildings

ART

Amateur Artist
Commercial Art
Commercial Cartooning

Illustrating with Options:

—Magazine
—Advertising Layout and Illustration
Interior Decorating
Oil Painting for Pleasure
Show Card and Sign Prod.
Show Card Writing
Sign Painting & Designing
Sketching and Painting

AUTOMOTIVE

Automatic Transmission Specialist
Automobile Air Conditioning Specialist
Automobile Body Rebuilding & Refinishing
Automobile Engine Tune-Up
Automobile Mechanic
Automobile Technician
Diesel-Gas Motor Vehicle Engines

BUSINESS

Advertising
Business Administration
Business Practice (Cond.)
Canadian Business Course
Direct Mail and Mail Order Advertising
Industrial Psychology
Inventory Control
Magazine & Newspaper Advertising
Managing a Retail Business
Managing a Small Store
Marketing Management
Marketing Research
Modern Exec. Management
Office Automation
Office Management
Production Management
Purchasing Agent
Retail & Local Advertising
Retail Bus. Management
Retail Merchandising
Retail Selling
Systems and Procedures Analysis

BUSINESS: SALES

Creative Salesmanship

Real Estate Salesmanship
Salesmanship
Sales Management

BUSINESS: SUPERVISION

Basic Supervision
Industrial Foremanship
Industrial Supervision
Management, Salesmanship and Sales
Modern Woman as a Supervisor
Personality Development
Personnel-Labor Relations (U.S.A.)
Supervision

CHEMICAL

Chemical Analyst
Chemical Engineering
Chemical Laboratory Techn.
Chemical Process Equip. Design & Operation
Chemical Process Operator
Elements of Nuclear Energy
General Chemistry
Instrumental Laboratory Analysis

CIVIL ENGINEERING

Civil Engineering
Construction Eng'g Tech.
Highway Engineering Tech.
Principles of Surveying
Reading Highway Bl'pr'ts
Reading Structural Bl'pr'ts
Sanitary Engineering Tech.
Sewage Plant Operator
Structural Eng'g Tech.
Surveying and Mapping
Water Works Operator

COLLEGE COURSES

American History
Calculus
Economics

COMPUTERS

COBOL Programming
Fortran Programming for Engineers
Programming for Digital Computers
Programming the IBM 1401 Computer
Programming the IBM System/360 Computer, Introduction

DRAFTING

Aircraft Drafting
Architectural Drafting
Design Drafting
Drafting Technology
Electrical Drafting
Electronic Drafting
Introductory Mech. Drafting
Mechanical Drafting

Pressure-Vessel and Tank
Print Reading
Sheet Metal Layout for Air Conditioning
Structural Drafting

ELECTRICAL

Electrical Engineering —Electronics Option
—Power Option
Electrical Appliance Ser.
Electrical Appliance Ser. with Equipment Training
Electrical Contractor
Electrical Engineering Tech.
Electrical Home Maint.
Electrical Home Maint. with Equipment Training
Electrical Instrument Tech.
Electric Motor Repairman
Industrial Electrical Tech.
Industrial Electrician
Power-Line Design and Construction
Power Plant Operator —Hydro Option
—Steam Option
Practical Electrician with Equipment Training
Practical Lineman
Reading Elec. Blueprints

ENGINEERING

(Refresher Courses for Graduate Engineers)
Chemical Civil Electrical
Industrial Mechanical Structural
Sanitary

ENGLISH AND WRITING

Better Business Writing
College English
Composition and Rhetoric
English for Spanish (U.S.A.)
Free Lance Writing for Fun and Profit
Introductory Tech. Writing
Modern Letter Writing
Practical English
Reading Improvement
Short Story Writing

HIGH SCHOOL

High School Business
High School (Canadian)
High School General
High School Mathematics
High School Secretarial
High School Vocational
High School College Preparatory—Arts
High School College Prep—Engineering and Science
Preparatory Course for High School Equivalency Test

MACHINE SHOP PRACTICE

Grinder Operator
Industrial Metallurgy
Lathe Operator
Machine Shop Inspection
Machine Shop Practice
Metallurgical Eng'g Tech.
Multicraft Maintenance Mechanic
Practical Millwrighting
Reading Shop Prints
Rigging
Tool & Die Making
Tool Engineering Tech.
Welding Engineering Tech.
Welding Process

MATHEMATICS

Advanced Mathematics
Math and Mechanics for Engineering Technicians
Math and Physics for Engineering Technicians
Modern Elementary Statistics

MECHANICAL

Mechanical Engineering
Aircraft and Power Plant Mechanic
Hydraulic and Pneumatic Power

INDUSTRIAL ENGINEERING

Industrial Eng'g Tech.
Industrial Instrumentation
Machine Design
Quality Control
Safety Engineering Tech.
Tool Design
Vibration Analysis and Control

PETROLEUM

Natural Gas Production and Transmission
Oil Well Technology
Petroleum Production Operator
Petroleum Production Engineering Technology
Petroleum Refinery Oper.

PLASTICS

Design of Plastic Products
Plastics Technician

PLUMBING, HEATING AND AIR CONDITIONING

Air Conditioning
Air Conditioning Maint.
Domestic Heating with Gas and Oil
Heating
Heating & Air Conditioning with Drawing
Industrial Air Conditioning
Pipe Fitting Plumbing
Plumbing and Heating
Plumbing & Heating Est.

Practical Plumbing
Refrigeration and Air Conditioning Servicing

PULP AND PAPER

Paper Machine Operator
Paper Making Pulp Making
Pulp & Paper Eng'g Tech.

SECRETARIAL

Clerk-Typist Commercial Secretary, Engineering Sec'y, Legal Sec'y, Medical Secretary, Professional Shorthand Stenographic Typewriting

STEAM AND DIESEL POWER

Boiler Inspector
Industrial Building Eng'r
Power Plant Engineering
Stationary Diesel Engines
Stationary Fireman
Stationary Steam Eng'r

TEXTILES

Carding and Spinning
Dyeing and Finishing
Loom Fixing
Textile Designing
Textile Mill Superintendent
Textile Mill Supervision

TRAFFIC

Motor Traffic Management
Traffic Management

TV-RADIO-ELECTRONICS

Electronics Technician
Fundamentals of Electronic Computers
General Electronics

General Electronics with Equipment Training
Hi-Fi Stereo and Sound System Servicing
Industrial Electronics
Industrial Electronics Tech.
Numerical Control
Electronics & Maint.
Radio & TV Servicing with Equipment Training
Telephony

APPROVED FOR VETERANS FOR TUITION REFUND

Accredited member, National Home Study Council.
Easy pay-as-you-learn plan.
Special rates to members U.S. Armed Forces.

ICS[®]
International
Correspondence
Schools
Division of Intext

ICS, Scranton, Pa. 18515
Canadian residents use this address for service from ICS Canadian, Ltd. In Hawaii: P.O. Box 418, Honolulu.

TAKE YOUR FIRST STEP... MAIL THIS COUPON TODAY—ICS, SCRANTON, PA. 18515. N1848C

I'm interested in a program of independent study. Send me, without cost, your booklet on the principles of success, sample text demonstrating famous ICS method, and your catalog for _____ (Print name of course. See list.)

Miss _____ Age _____
Mrs. _____
Mr. _____

Address _____

City _____ State _____ Zip Code _____

Occupation _____ Employed by _____ Working Hours _____ A.M. to _____ P.M.

Make stuck shower doors slide the push-button way.

When shower doors get stuck, spray with 3-IN-ONE PENETRATING OIL in the aerosol can—and doors slide at the touch of a fingertip. 3-IN-ONE PENETRATING OIL is the remarkable oil-spray that penetrates deep to help loosen rust . . . and lubricates, so shower doors slide easy. Get 3-IN-ONE PENETRATING OIL at all hardware stores.

3-IN-ONE®
PENETRATING OIL



Refinish marred or gouged furniture like new.

Fill in wood gouges, nicks and scratches like professional carpenters do with GENUINE PLASTIC WOOD Cellulose Fiber Filler. Handles like putty, hardens like wood. Plane it, sandpaper it, varnish it, paint it for true, professional finish. GENUINE PLASTIC WOOD comes in walnut, oak, mahogany or natural color. At hardware stores and supermarkets.

GENUINE
PLASTIC WOOD®
CELLULOSE FIBER FILLER



DETROIT LISTENING POST

(Continued from page 14)

1760-cc, water-cooled, four-cylinder engine that will deliver up to 26 mpg and drive all models a bit better than 100 mph. The two and four-door sedans and station wagon models start at \$3000. Wheelbase of Super 90 models is 98 inches; of 100 LS models, 105.3 inches. The Audi is not new (see *Good Cars You Can't Buy*, page 108, Nov. '67 PM); this German success just took a long time to get here.—B.H.

FORD HAS MOVED UP the deadline it gave De Tomaso on the mid-engine job the Italian car builder is producing to Ford specifications. *Listening Post* said last month that the first edition is due in the United States in July. That's not soon enough. As this is written, Ford hopes to have one show job for display at the International Auto Show in New York in April.

MICHIGAN SENATOR PHIL HART, whose Antitrust and Monopoly Subcommittee has been holding hearings on the cost of repairing cars, tells *PM* he looks for automakers to bring out bumpers that bump under impact, instead of crinkling up, "by 1971." The senator says he thinks we've about seen the end of left-hand-doesn't-know-what-the-right-is-doing engineering, such as hanging bumpers that have to be dismantled before a taillight can be replaced. He also looks for the trend to replacing, instead of repairing, parts to be accelerated. "Many will be replaceable by less-skilled mechanics, often by the motorist himself," he predicts.

THE AUTO COMPANIES periodically work up a froth over publications running stories about cars before the factories have packaged their formal press releases. If you tell the customers what's coming, Detroit contends, they won't buy the current cars. Maybe, maybe not. There have been times when newspapers and magazines have been loaded to their mastheads with stories on forthcoming cars and sales of then-current models managed to balloon into the blue, hitting new highs. But if car builders are as disturbed over peeks and leaks as they claim to be, they might consult their long-time nemesis, Walter Reuther, head of the United Autoworkers Union, on how to keep a secret.

Reuther has been sitting on the best-kept car secret since the Model T—plans for an American version of Volkswagen! As it looks now, the car won't be put into production. Here's how it came about:

(Please turn to page 22)



AN **AC** TION ADVENTURE

HIS ENGINE CAN'T COUGH



When you're a professional stunt pilot, you've got to have equipment you can rely on.

That's why stunt pilot Mike Dewey

uses AC Aircraft Spark Plugs. Mike knows AC's hot tip resists fouling. So when he needs full power, he gets it.

You may never fly like Mike Dewey . . . but the same hot tip that's built into AC Aircraft Spark Plugs is built into AC Fire-Ring Spark Plugs that go into your car.



They fire hotter, burn cleaner. Next tune-up, insist on reliable AC Fire-Ring Spark Plugs. They're original equipment on all GM cars. AC keeps your car in action.



AC SPARK PLUG DIVISION OF GENERAL MOTORS

AC BUILDS MORE PARTS FOR MORE CARS THAN ANYONE ELSE IN THE WORLD. AC FIRE-RING SPARK PLUGS • AC OIL FILTERS • AC AIR FILTERS • AC GASOLINE FILTERS • AC PCV VALVES • AC RADIATOR CAPS • AC GAS CAPS • AC CRANKCASE BREATHERS • AC FUEL PUMPS



Just
ask
**Tom
McCahill**



... "Cromwell X3 Oil Stabilizer... is guaranteed to stop your car's smoking and oil burning... or you get your money back!"

"It's not a mechanic in a can, but it does the job... I've tested Cromwell X3 Oil Stabilizer and it works!"

Cromwell X3 Oil Stabilizer's unique formula is compounded to stop excessive engine wear, oil burning and compression loss.

It forms an oil seal in the compression chamber preventing blow-by and compression loss; an oil barrier on piston and cylinder walls preventing oil burning and smoking.

Cromwell X3 Oil Stabilizer is permanent in the oil and is not a detergent. Like all Cromwell X3 Products, Oil Stabilizer is sold only at service stations and is 100% guaranteed.

**EXCLUSIVE DISTRIBUTORSHIP-FRANCHISES
IN SELECTED AREAS ARE AVAILABLE.
WRITE OUR FRANCHISE DIRECTOR.**



CROMWELL OIL COMPANY

1737 Cordova Street • Los Angeles, California 90007

For 2 sharp Cromwell X3 Decals and valuable information booklet on Cromwell X3 products... send 25c

DETROIT LISTENING POST

(Continued from page 20)

The UAW, like the car manufacturers, has been fretting over the fact that imports have been going gung-ho while sales of domestic makes have dropped. The more VWs, Toyotas, Opels, et al, sold in the United States, the fewer jobs in the auto plants for UAW members. As Reuther watched foreign firms move in to fill the demand for small, low-price cars during the '60s, he came up with the idea of an American "people's car"—Reuther's description. He shipped the plans to Washington, where they've apparently been interred with other best-laid plans of mice and union chiefs.

CAPRI IS COMING OVER from England and will be in Lincoln-Mercury showrooms mid-April. Introduced by Ford of England in Jan. '69, it has been a hot seller since then. Styled in the tradition of European GT coupes, the Capri has a wheelbase of 100.8 inches and a length of 167.8 inches. Basically the same as the European



version which impressed us when we saw it in London last year, the U.S. version has a 1.6-liter (98-cu.-in.), four-cylinder, ohv, 71-hp engine. Four-speed, fully synchronized transmission has a floor-mounted stick. The list of standard equipment including power front discs, sports wheels, radial tires, and carpeting makes the \$2295 price tag of the Capri 1600 that much more impressive.—B.H.

FROM NOSE JOB to distinguished back side—that's the turnabout in styling on the '71 cars. The in idea this year was to outprow the bullet snout pioneered by Pontiac. Emphasis on the '71s will be aft.

Chevy's small car will have a half-door, half-trunk-lid arrangement in the rear. Another Chevy product, a wagon, will have a disappearing tailgate—the glass-top half will roll up into the roof; the solid bottom half fold away into the floor. At Chrysler, Dodge and Plymouth are trying to get corporation clearance to mount Superbird-size wings on the deck lids of a couple of medium-price jobs. If double-breasted suits can come back, why not fins? ★★★

One quart of your new oil change will be dirty oil...

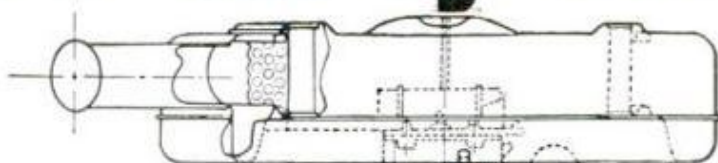

When oil is drained from a crankcase, one quart of dirty oil stays in the filter. This dirty oil combines with grit, dirt and sludge trapped in the used filter to contaminate the new oil. So when you change oil, change your filter, too... and make sure it's a Fram performance-proven filter.

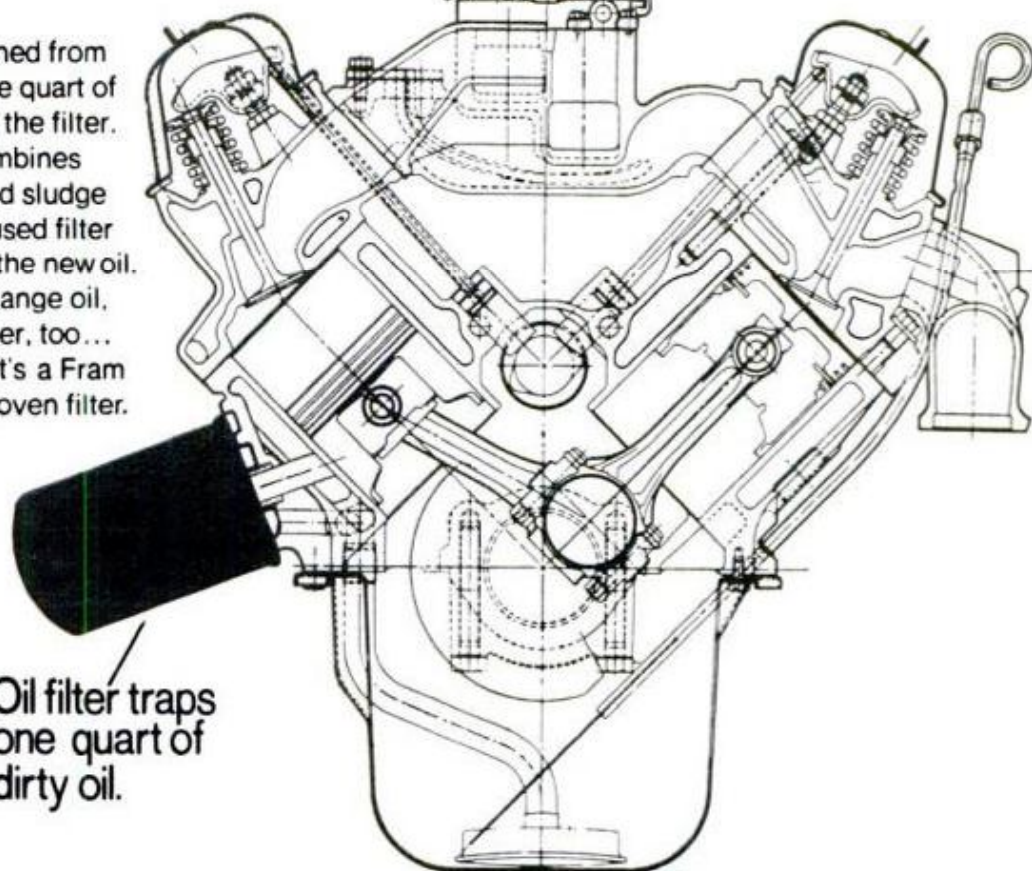

Oil filter traps one quart of dirty oil.

unless you change your oil filter, too

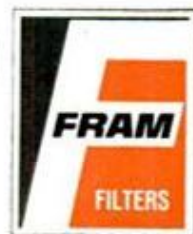

Fram Automotive Division, Providence, Rhode Island 02916

Drivin' with Dan

Would Trans-Am be better with engines of 350 instead of 305 CID? Did you use two-way radio in the Riverside 500? What can happen when speed-shifting a VW? Dan Gurney answers these and other automotive questions

Q. Don't you think Trans-Am racing would be even better if they would allow, say, 350-CID engines instead of 305?—Ben Palmer, Fort Lauderdale, Fla.

A. I believe it would be better because it would be cheaper and more like the popular stock-size engines. On the other hand, a trend toward smaller cars and engines is fine as far as I'm concerned.

Q. Would it be possible for a person to become a race driver without knowledge of engines?—Thomas Kinsel, Champaign, Ill.

A. Yes, of course, but at the same time he would be handicapping himself.

Q. Do you think that electrical or power equipment, such as windows and seat, are items worth taking a chance on when purchasing a used car? How do you feel about the life of these rather

expensive options and whether it would be likely that I could make the repairs myself?—W.S. Ovitt, San Diego, Calif.

A. I wouldn't be afraid to purchase a used car with the options you mention. It would be likely that you could make repairs yourself if you are so inclined and have some tools.

Q. In the Riverside 500, did you use the two-way radio, with which I heard you experimented? Why or why not?—Bill Crosley, New York.

A. No, I didn't use the radio in the race. However, I did try it in practice and I could hear very well. They had some trouble hearing me when I was using full throttle but otherwise it was satisfactory. The installation in the helmet was cumbersome, heavy and crude. It also compromised the helmet's strength and protection so I didn't race with

(Please turn to page 30)

DAN AT THE WHEEL of a Plymouth SuperBird in 500-mile NASCAR Grand National at Riverside. Starting on the pole, Dan finished only sixth. An early rear-brake-system problem forced him to run with front brakes only



*Plus tax, license, &H local freight (except Hawaii).
Prices and specifications are subject to change without notice.



Take a Datsun to launch.

**Spend less for the
hauler—more for the hull.**

Buy a tough Datsun Pickup for \$1875.* Or a neat 5-door Datsun Wagon for \$2265.* Put the extra money into a longer water line, more horsepower, bigger sails. 96 HP overhead cam engines haul outside hulls. Great brakes stop quick and straight. 31 foot turning circle. Panoramic visibility. Standard all-synchro 4-speed stick (optional fully automatic 3-speed in the Wagon) makes launching a cinch.

Six-foot all-steel bed in the Pickup, 6 feet of flat floor space in the Wagon stow lots of gear. Whitewalls and dozens of extras.

Get more than your money's worth...sail off with the savings. Make the Sound Move... Drive a Datsun, *then* decide.

DATSUN 
SEDANS • WAGON • PICKUP • SPORTS CARS

Announcing the Popular Mechanics

DO-IT-YOURSELF YEARBOOK-1970

Just off the press—**Popular Mechanics New Yearbook** gives you the newest do-it-yourself advances that save time, work and money for the home handyman and hobbyist!

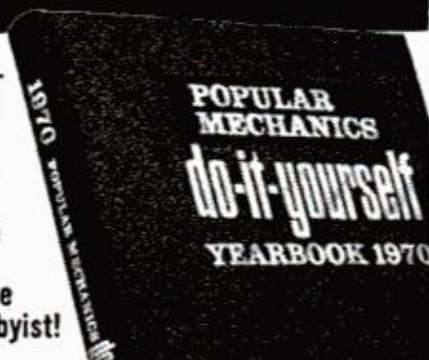

- 14 Big "How-To" Classifications, 63 Section Topics •
- Over 500 "Show-How" Photos and Illustrations • Printed 2-Colors Throughout • Washable, Permanent Hardbound Cover, 196 Big 8½" x 11" Pages • Quick Reference Index

Here at last—a new, ideal way to keep up with the how-to field. The most up-to-date guidebook and workshop companion available: **POPULAR MECHANICS DO-IT-YOURSELF YEARBOOK-1970!**

Whether you're a beginner or an experienced handyman, a hobbyist or sportsman, here are illustrated easy-to-follow, step-by-step instructions on new projects and news of new products sure to increase enjoyment and save money for you and your family this year and every year.

You'll be able to do things that weren't even possible a year ago. Tape your own TV show. Build a whole aquarium in a coffee table. Make a stereo balance meter. Install an inexpensive automatic lawn sprinkling system. Put together your own brush buggy for a few hundred dollars. Put in an alarm system built from a kit. Construct a no-hands telephone amplifier. Select the right gun for the game you seek. Create a child's sidewalk car that looks like a Grand-Prix racer.

You'll be brought up-to-date on the year's new products: building materials, tools, electronic devices, fishing gadgets, boats, recreation vehicles, the 1970 cars, photography equipment. Whatever job you tackle, you'll know about the newest materials and tools to make-it or fix-it better.

**Examine 14 Days On Approval
Available Now Only Through Popular Mechanics**

As a Popular Mechanics reader you can have your copy of the Do-It-Yourself Yearbook-1970 sent to your home by return mail for 14-days no-risk examination. It is not available in stores or from any other source. For hundreds of the best time and money-saving ideas of the year, detach and mail the coupon now. **This is a limited edition.** So please order promptly before supply is exhausted.

Mail for On Approval Examination

Popular Mechanics Book Division, Dept. 0014
250 West 55th Street, New York, N.Y. 10019
Please rush me my copy of **POPULAR MECHANICS DO-IT-YOURSELF YEARBOOK-1970.** I enclose a check or money order for \$4.95. You will pay all postage and handling. I must be completely satisfied or I may return the Yearbook within 14 days for full refund.

Print Name _____
Address _____
City _____
State _____ Zip Code _____

BUILD YOUR OWN CAMPER SAVE UP TO 50%



Complete, easy to follow plans, instructions, materials list.

- Camper Plans \$3.95
- Travel Trailer \$3.95
- Pickup Cover \$2.00
- CONVERSION PLANS:**
- Econoline Type Van.. \$2.95
- Passenger Bus or
- Delivery Van..... \$2.95
- Satisfaction Guaranteed

VIKING CAMPER SUPPLY, INC.
99-BP Glenwood Ave.,
Minneapolis, Minn. 55403
Please send _____ for
which I enclose \$_____
NAME _____
ADDRESS _____
CITY _____
STATE _____ ZIP _____

EQUIPMENT CATALOG \$1.99

Refundable on First Order.
Send Dime for Details.
Save 50% on Camper Kit.
All items from catalog to
build \$1,795. Camper, 8',
10', 10'6" or Chassis Unit.



FREE!

Learn how you can buy used engines \$15 up, new engines \$30 with **FREE** confidential list and coupons when you order your plans

BUILD THIS MINI-BIKE!
Plans reveal step by step details!
BUILD A RACING KART!
Build frame for less than \$10!



RUSH \$2 for plans (indicate type) or send 25¢ for circular describing plans
Box 517, Omaha, Nebr. 68101

DECORATOR FLORAL BOWL

**AIR REFRESHER—
ROOM SCENTER**

Newest Idea in Home Decor

Make up to \$10 an hour in your spare time just showing the amazing new **TRU-SCENT** Decorator Floral Bowl to users and to stores for resale. Sells itself on sight. No sales experience needed. Contains life-like floral arrangement of Empress Roses, 6 radiant colors. Breathtaking beauty. Lift lid and delightful, true-rose aroma refreshes the air... helps banish stale odors. Ideal for ANY room. Perfect gift. 100% plus profits. Terrific fund raiser. **INTRODUCTORY OFFER:** Rush only \$1.00 for postpaid sample (\$1.95 Retail Value). Double-Your-Money-Back Guarantee if you aren't surprised... delighted. **FACTS FREE. UNIQUE PRODUCTS, Dept. R-4204, 216 W. Jackson Blvd., Chicago, Ill. 60606.**



Don't change your address without notifying us!

To insure uninterrupted service on your **Popular Mechanics** subscription, please notify us at least six weeks before you move.

1. Attach your address label from a recent issue in the space provided below... (If label not available, be sure to give us your old address, including Zip Code)
2. Print your name and new address below (be sure to include your Zip Code).

3. Mail entire notice to: **Subscription Service Dept.**
Box No. 646
New York, N. Y. 10019

Name _____
New Address _____
City _____
State _____ Zip Code _____

Please Print

this FREE catalog

shows 300 electronic kits —
world's largest selection

A Kit For Every Interest ... All Described and Illustrated
• Color Television • Stereo/Hi-Fi • Electronic Organs •
Guitar Amplifiers • Shortwave Radio • Portable Radios •
Phonographs • Intercoms • Garage Door Openers • Amateur
Radio • Model Radio Control • Radio Control Cars • Test
Equipment • Trail Bikes • Marine Electronics • Automotive
Electronics • Photographic Aids • Scientific Equipment

this FREE booklet

shows how easy
it is to build kits

Learn how to choose your first kit ... see examples of the easy Heathkit assembly instructions ... see what tools are needed ... learn how to identify parts ... how to solder ... read answers to typical questions. This FREE booklet will convince you that you, too, can build Heathkit electronics ... that no special skills or knowledge are necessary to enjoy this exciting hobby.

HEATHKIT
1970
23rd year of kit leadership

HEATHKIT electronics—the space age hobby. Over 300 different kits—world's largest selection.

FACTORY MAIL ORDER
CATALOG 810/78R
HEATH COMPANY
a Schlumberger company

welcome to the world
of **HEATHKIT**
do-it-yourself electronics

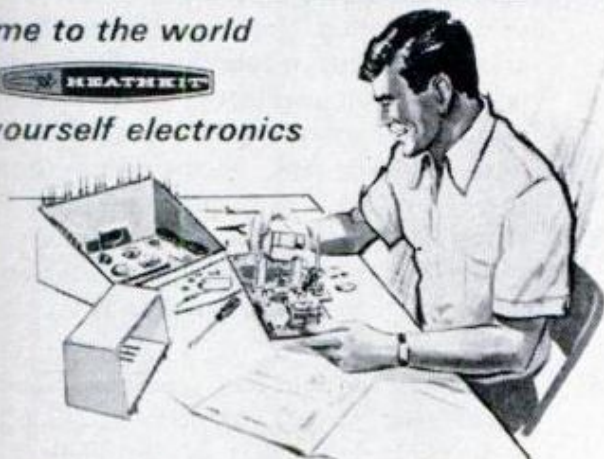

a guide for first-time kit builders

ask for both...

learn how you can get better
equipment at up to 50% savings. It's easy ... it's fun.

Mail today for Complete
FREE information.

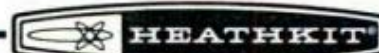

a Schlumberger company

HEATH COMPANY, Dept. 17-4
Benton Harbor, Michigan 49022

Please send FREE 1970 Heathkit Catalog and
Guide for First-Time Kitbuilders.

Name _____

Address _____

City _____ State _____ Zip _____

CL-380

SUPER-POWERED FOR ANY JOB

**Grinds!
Carves!
Drills!
Polishes!
Deburr!
Sands!
Sharpens!
Engraves!
Routs!**



DREMEL MOTO-TOOL

Now you can handle any home, shop, craft or hobby job faster and easier than ever before. Super-powered, 30,000 rpm Moto-Tool belts out twice the power of previous models. Virtually stallproof, even when bearing down. It's compact, lightweight—has a tough, shock-proof Lexan housing. There's a choice of three Moto-Tool models from \$22.95 to \$39.95. Complete kits with storage case and 34 accessories from \$32.95 to \$49.95.

See your dealer or write for free power tool catalog. And 160-page "Dremel Handbook of Hobbies, Crafts and Projects." Only \$1.45.



DREMEL MFG. CO.

Dept. 110-D, Racine, Wis. 53401



DRIVIN' WITH DAN

(Continued from page 24)

it. The next try would probably overcome most of the initial problems.

Q. What is the meaning of letters such as "GT" that are found on some of today's cars?—Paul Whetstone, Cincinnati.

A. G.T. stands for Grand Touring which originated as the name of a racing category for limited-production cars under the rules drawn up by the F.I.A. in Paris, France. I think that Ferrari was the first to attach the "G.T." to a car-model name.

Q. What is the worst thing that could happen to a Volkswagen when speed-shifting? Is it true you get better tire life and better gas mileage if you have larger tires and wheels than those which came with the car?—David Naugher, Amarillo, Tex.

A. It wears out the synchromesh system faster. It's harder on the shift linkage. Of course you can break the gearbox if you butcher it enough. Within certain limits I'd say economy is better with the larger tires. However the bigger tires usually give you a taller gearing (less engine r.p.m. at the same speed) but sometimes they may have more rolling resistance and drag also, so you may not improve the mileage. Maybe your gearing is more ideal with the smaller tires.

Q. It has been said that your stock-block engine went "sour" during the 1969 Indy 500. What was the exact ailment of the engine?—Arthur Siegel, Rego Park, N. Y.

A. The engine was in good shape after the race except for an oil seal at the front of the crankshaft which was leaking (causing the smoke you may have seen). In addition, we played it overly safe on our fuel and sparkplugs, so the engine was down on power, but safe. My big problem was with the brakes and my left-rear shock absorber, which was covered by body work, soon overheated and then failed.

Q. Why aren't the fiberglass-belt-type tires used for racing?—Dana Stahl, Visalia, Calif.

A. They have been used on some racing applications and may be on others. Passenger-

(Please turn to page 32)

The smokeless tobaccos.

They aren't lit, puffed or inhaled. They're too good to smoke.



Put a pinch between gum and cheek, and enjoy it. Without even chewing. The smokeless tobaccos are too good to smoke. You get all the satisfaction of prime aged tobaccos. They cost less, too. Sure beats smoking!



Original



Raspberry

Skool® and Copenhagen® also available in Canada.

For information on how to use smokeless tobaccos, please write: United States Tobacco Company, Dept. PM, 630 Fifth Ave., New York, N.Y. 10020.

DART® ELECTRONICS ANNOUNCES THE ALL NEW GOLDSEYE® SERIES

COPYRIGHT 1969 DART ELECTRONICS U. S. PAT. PEND.

NEW PROFESSIONAL METAL LOCATOR OUTPERFORMS OTHER MODELS

GUARANTEED • Easily detects buried coins, relics, gold, silver, copper and all other metals. Works through dirt, sand, rock, wood, water, etc. New solid state circuit assures maximum performance.



MODEL XL

Fully Transistorized 1970 MODEL

ONLY \$29.95 POSTPAID

Comes complete, ready to use. New powerful circuit for maximum sensitivity. Has both loudspeaker and ear-phone, uses inexpensive 9 volt battery. Lightweight: Only 2 pounds.



VIEW-METER MODEL XXL
New View-Meter model detects objects on the fringe of detectable depths, means more sensitivity.

VIEW-METER MODEL ONLY \$39.95 POSTPAID



NEW POWER-COIL AVAILABLE

Order one now or add it on later. Why buy a detector without this valuable feature?

The all new Dart power-coil will effectively double the penetration depth of the XL and XXL Goldseye Models on larger objects that are buried deeper.

POWER-COIL, ONLY \$12.95 POSTPAID

ORDER NOW FOR IMMEDIATE SHIPMENT!

TO: DART ELECTRONICS P. O. BOX 361 PM
HUNTSVILLE, TEXAS 77340

ENCLOSED THE SUM OF \$_____ FOR THE ITEMS CHECKED BELOW.

CASH CHECK MONEY ORDER

DART MODEL XL \$29.95

DART MODEL XXL, WITH VIEW-METER... \$39.95

POWER-COIL \$12.95

NAME _____

ADDRESS _____

CITY _____ STATE _____ ZIP _____

Take your choice: Both **RIDGID** bench vises are slip-proof.

RIDGID Bench Yoke Vises

Tool steel jaws positively anchor pipe. Malleable iron base and yoke can't break or warp. Benders and rear pipe rest are built in. When work is completed, the vise releases instantly. Available in 8 models, 1/8" through 6" capacity, all equipped for right or left-hand opening.

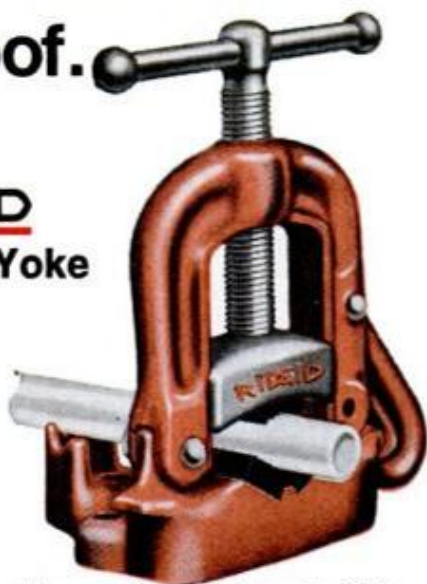

RIDGID Top Screw Bench Chain Vises

Easy to operate. Pipe locks into position quickly and easily. Crank handle is anchored to base — can't pull out. Malleable iron base with tool steel jaws has built-in pipe rest and bender. Five models, 1/8" through 8" capacity.

Buy RIDGID Pipe Vises at your quality Hardware Store, and be sure to see the other RIDGID Work Saver Tools from the Ridge Tool Company, Elyria, Ohio 44035, U.S.A.

RIDGID®

 Ridge Tool Subsidiary
Emerson Electric Co.
EMERSON

DRIVIN' WITH DAN

(Continued from page 30)

car requirements are very different from those of racing cars. Racing-tire research and development is almost entirely classified or secret information so I do not have much access to it. I'm a Polyglas fan myself.

Q. Why don't they put 428s and Hurst shifters in police cars? Wouldn't they get better speed? Do 309s and automatics get that much speed?—Larry Truelove, Albion, Ind.

A. The 428s do give more speed, as a rule. They also use more gas and brakes and tires. I would guess that a smaller engine with an automatic gearbox would be a bit more reliable and less expensive to operate. If you're going to chase bandits, you ought to have the 428 with the Hurst shifter.

Q. I am 17 years old, drive a Meyers Manx and do a lot of road racing with friends on the street although I know this is very dangerous. Did you do much street racing before you were able to get on the tracks?—Bill Burt, Bloomington, Ind.

A. I did a bit of street drag racing in locations we felt safe, also some racing with American and foreign cars against a stopwatch on circuits around deserted housing projects or dirt roads. It all helps.

Q. I have a friend who drives a 1968 Citroen. In appearance it's a real monstrosity but he claims it offers great engineering advances such as aerodynamic body with less drag than any other car resulting in 120 mph with a 103-hp engine; "inboard" disc brakes; hydraulic self-leveling suspension; front-wheel drive; headlights that turn with the front wheels; practically no noise at high speeds. Does it have these features, and if so, why isn't Detroit building something like it for \$3500?—William Young, Harper Woods, Mich.

A. It's all true. It's a good car, but there is more than one way to skin a cat. Fortunately, not everyone likes or dislikes the same things. French driving conditions are considerably different from ours. We have some mighty fine cars here for \$3500. ★ ★ ★

If you have questions on racing, high-performance and everyday driving techniques, send them to "Drivin' with Dan," c/o Popular Mechanics, 224 West 57th St., New York, N.Y. 10019. Questions cannot be answered by individual letters. Questions on maintenance and repair should be addressed to the Auto Clinic (see page 84).



Materialist.

This Atlas tire has what it takes, fiberglass belts, to give you mileage you never thought possible.

The Atlas Plycron 2 plus 2* fiberglass belted tire was subjected to one of the industry's toughest testing programs. Results proved Atlas will deliver outstanding mileage.

New construction puts Atlas ahead. Two fiberglass belts are bonded onto a tough Vicron polyester cord body.

And for traction, the unique wide tread design literally puts hundreds of gripping edges on the road at all times.

These features add up to less tread squirm, extra mileage. And every extra mile you get saves you money.

Sometimes materialism pays off.

Especially at the more than 50,000 leading service stations throughout the country that carry Atlas tires, batteries and accessories.

ATLAS
PLYCRON 2 PLUS 2

Trademarks "Atlas," "Plycron," "Vicron," Reg. U.S. Pat. Off.
*Trademark. © 1970 Atlas Supply Company.

ON-THE-GO

CAMPING

BY WADE MITCHELL

LUXURY IN LIMITED SPACE is quite possible with the new Blazer Sports Camper, as yet just a show-model prototype from Chevrolet. Mounted on the new Chevy Blazer 4x4 utility vehicle, the Sports Camper features fold-out sleeper sections, gas appliances, day couch, full-length closet, utensil racks, transparent plastic skylight and rooftop luggage carrier. Sounds astonishing to have so many accessories in such a small space, but it's true. The Blazer Sports Camper is being displayed this season at shows across the country.

BEWARE DANGEROUS FUMES IN YOUR COACH! Too many fatalities have occurred from such seemingly harmless acts as heating a closed coach with a charcoal stove, allowing a propane lamp to burn all night with windows and doors shut tight, or leaving LP-gas burners going on a cold night without adequate ventilation. *Don't make those mistakes!* The state of Colorado, in investigating the continuing menace of death by asphyxiation, found cases where snow covered the roof and vent stacks of camper coaches. Problems can occur in both homemade and manufactured campers that aren't vented properly. So always leave one window cracked open to guarantee a fresh-air return.

IS OREGON CONSIDERING A NONRESIDENT CAMPING TAX? Just a rumor now, but according to Oregon sources it's nothing to laugh off. A recent editorial in an Oregon paper blasted campers who allegedly clog Oregon's highways and occupy every shady spot. Statistics printed in an RV dealer magazine claimed that about 1,500,000 campers visited Oregon's coastal parks during only nine months of 1969, and one out of every six was turned away. If Oregon *does* declare such a nonresident camping tax will it set a precedent for other overvisited states such as Wyoming, Montana and California? Suppose other states enact "reprisal taxes" against Oregon campers? The outcome may be explosive.

1970 CHEVROLET TRAILERING GUIDE is now available, showing allowable gross trailer weights of 4000 pounds for the Nova; 6000 pounds for the Chevelle, Chevrolet and two station wagons. The maximum allowable trailer weight for the Monte Carlo is listed at 2000 pounds. The new guide also includes special tips to towers and a host of other useful ideas for recreation with a travel trailer.

HIGHER TONGUE-LOAD LIMITS AT FORD. Automakers seem to be competing with each other to prove their vehicles are strongest for towing service. At a special briefing attended by members of the *PM* staff, Ford increased the allowable trailer tongue loads for the Ford Galaxie to 700 pounds on models equipped with the new towing package equipment. This is the highest rating for tongue loads in the field. However, it is true that passenger-car suspension systems, tires and wheels are beefed up to handle the increased loading.

FREE-STANDING BATHROOM ONLY A FEW FEET WIDE, known as the Duomatic Sanitation System, is an amazingly compact, new unit containing a shower, wash basin with faucets, vanity mirror, medicine cabinet, and a toilet that slides in and out of a hidden position. The entire sanitation cabinet is only 9 inches deep, a little over 72 inches tall. The initial six-gallon charge of water provides up to 160 flushes, says the maker. (You can also hook this cabinet directly to a sewer outlet.) This new system should easily convert thousands of old coaches to self-containment. For more information, contact Monogram Industries, Inc., 6537 Arizona Circle, Los Angeles, Calif. 90045. ★★

As featured in Nov. 1969 issue—

Build Popular Mechanics' \$7500 House!

1457 sq. ft.! 3 Bedrooms!
2 Full Baths! 29-Foot Living Room
With Fireplace! Airconditioned!

Sound impossible? The Robert R. Hunts—man, wife and 15-year-old son—did it in about 600 man-hours and figure their savings at over \$30,000 at current mortgage rates. They told all about it in our November 1969 issue. Now—as a service to Popular Mechanics readers—complete do-it-yourself instructions are available.



Complete Plans Only \$25.00

You get everything you need—11 sheets of detailed blueprints, complete instruction booklet, and materials list. If you're a skilled craftsman and can follow instructions, you can do it all. If you're a handyman, you can hire skilled help for some jobs and save a bundle by doing the rest. Even if you plan to hire a builder, you'll still get a lot of house for your money (you'll need 4 sets of plans for a contractor—special price \$35.00). Allow 2 weeks for delivery.



Popular Mechanics, Dept. HPR-4
224 West 57th St., N. Y. 10019

Please rush me complete plans for the \$7500 house.

I enclose \$_____ (Single set \$25.00—
4 sets \$35.00).

NAME _____

STREET _____

CITY _____ STATE _____ ZIP _____

APRIL 1970

learn electronics at home in spare time



*you'll be turning that spare time
into extra money very soon!*

Learn the skills of electronics and help fill the critical shortage of trained electronics personnel. You can keep your present job and still turn spare time into extra money. The home study program of United Technical Institute has been drawn from a resident course taught in our Milwaukee, Boston, and Los Angeles schools; a course that has produced graduates now earning good pay in the electronics industry from coast to coast. UTI is a division of Career Academy, the world's largest private schooling organization. *Mail coupon today for colorful, free booklet with all the details.*

United Technical Institute

division of Career Academy

135 West Wells St. • Milwaukee, Wis. 53203
Dept. N19202



Please rush me your exciting free booklet with all the details of how I can train in the field of electronics.

Name _____ Age _____

Address _____ Phone _____

City/State/Zip _____

I am interested in Home Study Resident

APPROVED BY VETERANS

These 3 BIG DRAFTING KITS GIVEN TO YOU!
... when you train at home with NASD for a **HIGH PAY JOB IN DRAFTING!**



1 Take your pick of 1000s big salary jobs open to Draftsmen. U.S. Labor Dept. reports "42% more Draftsmen needed in next 10 years—not enough applicants to fill jobs available now." Easy home-study plan has helped 100s beginners toward \$\$\$\$\$, security, prestige as Draftsmen—many with only grade school training. Others report good earnings drafting part time while still learning. Why not you?

2 **RUSH COUPON FOR FREE KIT!**
Mail coupon for FREE "DRAFTING CAREER KIT," Sample Lesson, Drafting Aptitude Test including new 5-Way Drafting Instrument & 20-Page Book, "Your Future in Drafting"—ALL FREE. No salesman will call. G.I. approved. Write today.



NORTH AMERICAN SCHOOL OF DRAFTING, Dept. 04174
4500 Campus Drive, Newport, California 92660
Rush "Drafting Career Kit," including Book, Sample Lesson, Aptitude Test & Drafting Instrument—All Free!

NAME _____ AGE _____
ADDRESS _____
CITY _____ STATE _____ ZIP _____

Career in ELECTRONICS?
Career training at home the new easy way with RCA Institutes. Lab work with first lesson. Easy payment plans. Send for free 64-page book.

RCA Institutes, Dept. 699-004-0
320 W. 31 St., N.Y., N.Y. 10001



ACCORDIONS and AMPLIFIERS



BIG SAVINGS up to 1/2 or more on famous make accordions. Over 40 models. Standard and new electronic models. Buy direct at low discount prices. Get five-day home trial. Small down payment, easy terms. Free gifts. Trade in allowance. Money back guarantee. Rush coupon for color catalogs, discount price list. Accordion Corp. of America, Dept. R-40, 5535 W. Belmont Ave., Chicago, Illinois 60641

COUPON BRINGS FREE COLOR CATALOG & DISCOUNT PRICES

ACCORDION CORP. of AMERICA—Dept. R-40
5535 W. Belmont Ave., Chicago, Illinois 60641
Send FREE Color catalogs and discount prices. Include special information checked:

Accordion Amplifiers
 Button Type Accordions

Name _____
Address _____
City _____ State _____ Zip _____

RECHARGE ALL BATTERIES
Only Everlite

- Charges 6 batteries
- Charges 3 times faster
- Charges all batteries

Including hearing aid, flashlight, lantern, radio, in fact any battery up to 12V. Save Money and have the convenience of fresh batteries always. Simple and 100% Safe. Plugs into any 115V. outlet. Guar. for one year. Send \$6.95 plus \$.65 for shipping

695



Model 75

MASTER MECHANIC MFG. CO., Dept. A-40 Burlington, Wis.
Southern Customers write Dept. A-40, Box 65, Sarasota, Florida

MOLDS
for making Ornamental Concrete Items...



Book about Aluminum Molds with prices and production trade secrets direct from world's largest mold manufacturer.

SEND \$2.00

CONCRETE MACHINERY COMPANY, INC.
P. O. BOX 99 • HICKORY 2, N. C. 28601

EARN MONEY FAST!

REPAIR HYDRAULIC JACKS
Earn while you learn at home. Millions of jacks in gas and auto service stations, trucking firms, body shops, riggers, factories and farms need servicing... most of which you can learn to repair. We show you HOW. Start spare time in your basement or garage. Big opportunity for mechanics. ACT NOW!
Write for folder PM-4 and free bonus offer



HYDRAULIC JACK REPAIR MANUAL CO., INC.
G. P. O. BOX 3 • STATEN ISLAND, N. Y. 10314

FOUR-WAY BEST LOW COST ARC WELDER YOU CAN BUY
\$18.95 Complete



WELD, BRAZE, SOLDER, CUT. Tops in performance and value. Ideal gift, educational, profitable, enjoyable. Use 1/8" welding rods and 1/4" carbons to make or repair auto bodies, fenders, trailers, boats, toys, furniture, farm equipment, garden tools, almost anything of metal, even aluminum. Operates on 110V 30A. line. Produces to 11,000". Complete ready to use. **WORLD'S GREATEST WELDER VALUE. BRAND NEW. YOU CAN PAY MORE BUT YOU CAN'T GET A BETTER LOW COST WELDER.** Over 500,000 in use by home owners, farmers, hobbyists and mechanics. **LIFETIME GUARANTEE.** Simply return Prepaid. We will repair and reship free of charge. You Get: **FULL FACE SHIELD,** heavy metal cabinet, ground clamp, 12 ft. heavy cables, **SPECIAL** combination carbon arc torch & rod holder, carbons, welding and brazing rods, flux, solder, welding manual. **ORDER ON 10-DAY MONEY BACK TRIAL.** If not completely satisfied return in 10 days and we will refund purchase price.

SEND ONLY \$2.00 & pay \$16.95 plus C.O.D. & delivery charges.
or send only \$18.95 for ppd. shipment in Continental U.S.A.

FREE Order from this ad & receive extra \$2.00 gift of rods, flux and solder. **FREE**

FOUR-WAY WELDER CO., 1810 S. FEDERAL ST.
Dept. R2-D, Chicago, Illinois 60616

Their NGK is the same.

It's a fact. The beauty and the bug are both turned on by the same NGK spark plug.

That's pretty well pleasing everybody. It just goes to show that NGK's wide heat-range pays off.

Down deep an NGK spark plug is radically different with its central core of copper (instead of commonly used iron). NGK's heart of copper dissipates heat more quickly, more evenly. Thus, regardless of a hot or cold engine, hot or cold weather, or normal or high performance driving, the NGK plug delivers a constant, wide ranging performance. Fouling and misfires are cut way down. Along with gas waste, tip wear, pre-ignition. And you can go longer between tune ups.

And NGK plugs don't cost a cent more.

Remember, no matter how much your car cost, the price of the NGK's stays the same.

NGK Spark Plugs
(U.S.A.) Inc., 4010 Sawtelle
Boulevard,
Los Angeles,
California
90066.



World's Most Thiefproof

No one can outwit this ingenious electronic auto protection system. It's expected to be on the market soon in a handy kit you can install yourself.

By SHELDON M. GALLAGER

ANYONE TRYING TO STEAL a car equipped with this antitheft device would run smack into enough baffling electronic wizardry to drive him up a wall. The first thing he'd see is a trim little 10-push button keyboard under the dash. To start the car, he'd have to press four of the 10 buttons in exactly the right coded sequence. Pressing any of the wrong buttons—or any of the right buttons in the wrong order—causes the device to shut off and nothing happens.

At a time when car thefts are mounting at an alarming rate, this clever new protection system promises a welcome deterrent. What it amounts to is an electronic combination lock. Each car owner has his own four-digit code. If, for instance, you select 7395, you must push the buttons numbered 7, 3, 9 and 5 in that order. As each button is pressed, it causes a combination of transistors and silicon-controlled rectifiers to fire and conduct electricity to the next stage. When all four stages have been properly energized, they trigger a relay that sends power to the car's ignition system. Only then can the engine be started and the car driven away.

The transistors and SCRs are arranged in such a way that no stage will fire unless the right preceding stage has been activated first. Thus even the correct numbers must be pressed in the proper sequence. The keyboard is lighted so you can easily see the buttons even in the dark. When the code has been correctly entered, the lights go out, indicating the engine is ready to be fired up. All the solid-state circuitry is hidden neatly away in the engine compartment in a small box called the decoder unit.

Frantically pushing the buttons at random in an attempt to break the code by chance won't help a would-be thief at all. With the 10-button system, there are more than 5000 different four-digit code possi-

(Please turn to page 42)



KEYBOARD CONTROL mounts under the dash, has 10 numbered pushbutton switches. To start the car, you must press four of the 10 buttons in a coded sequence. Possible number of different codes: 5024

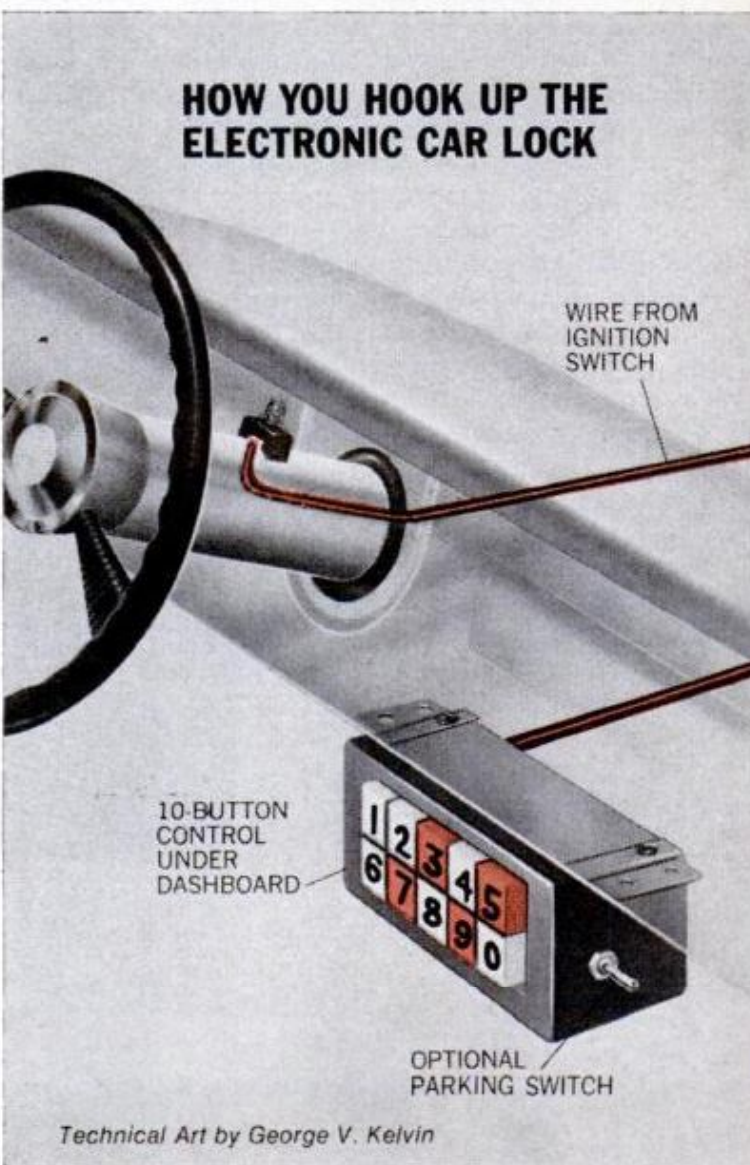

Technical Art by George V. Kelvin

Car Lock

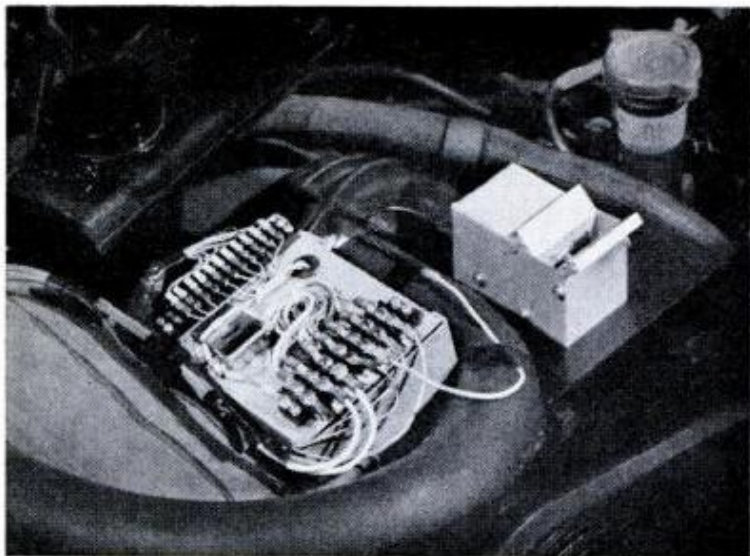

DECODER UNIT and hood latch can mount anywhere in engine compartment, against a side wall or on engine itself with brackets. The code can be changed merely by rearranging connections on the decoder



LATCH STRIKER PLATE is bolted to underside of hood so it slips into a slot in the solenoid-operated latch when the hood is closed. Latch bolt engages hole in the striker plate to lock hood securely





We've taken the "bite" out of pipe smoking

Your favorite blend never had it so smooth, right from the very first puff because: the world's only pre-smoked pipe needs no breaking-in! What curing does for tobacco, pre-smoking does for your Dr. Grabow.

WORLD'S FINEST IMPORTED BRIAR
Starfire.....\$5.95
Viscount.....\$6.95
Commodore...\$7.95
Eldorado.....\$10.00

For FREE informative booklet, write
Dr. Grabow pre-smoked pipes
 Box 21888, Greensboro, N. C. 27420

Dr. Grabow

the World's only Pre-Smoked Pipes

Be a SURVEYOR & MAP MAKER



Join a Surveying Team—get in on planning of America's highways, bridges, dams, subdivisions, etc. Wonderful outdoor work. Ideal for those who like to work with their hands. 1000s exciting big pay jobs open now to qualified men. U.S. Bureau of Labor Statistics predicts shortage of 50,000 civil engineering technicians (Surveyors, etc.) by 1975 as construction of highways, airfields, waterways skyrockets upward. Our easy step-by-step home-study plans have helped 1000s beginners toward prestige salary, security. Big 68-piece Surveying Kit (training transit, drawing, instruments, etc.) given to you when you enroll. Thousands of Surveyors got their start through home-study. You can too! Send for "SURVEYING CAREER KIT"—ALL FREE! No salesman will call. Write & state age.

NORTH AMERICAN SCHOOL OF SURVEYING & MAPPING
 4500 Campus Dr. • Dept. 04174, University Plaza, Newport, Calif. 92660

MEN/WOMEN...

Buy Below Wholesale

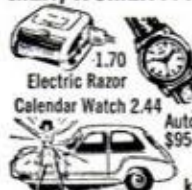

MELLINGER, Dept. D2254, 1554 S. Sepulveda, Los Angeles, CA 90025

BIG PROFIT HOME IMPORT BUSINESS. My plan starts you fast. Deal direct with overseas sources at prices shown. Thousands other dazzling bargains with no investment. Any age or location. Full or part time. You keep all profits. Write for FREE BOOK to...

BLAST FURNACE 2400 F



Since 1937
Hobbyists • Schools • Inventors, etc.
 Make your own castings of any metal from cast iron, down to lead and zinc. Available in 6 sizes, 1 1/2 to 50 lbs. Complete units from \$50.40 to \$162. Send 25¢ for circular—refundable.

KANSAS CITY SPECIALTIES CO.
 Dept. P-4
 P.O. Box 193
 Middleton, Wisc. 53562

ENROLL—EARN YOUR DEGREE

of Bachelor of Bible Philosophy (B.Ph.B.), Master of Bible Philosophy (M.Ph.B.), Graduate of Bible Philosophy (G.Ph.B.), Doctor of Metaphysics (Ms.D.), or Doctor of Divinity (D.D.). Chartered by State, Correspondence Courses only. Please write for FREE BOOKLET.

AMERICAN BIBLE INSTITUTE
 Dept. PM, Post Office Box 8748, Kansas City, Missouri 64114

\$\$ TREASURE \$\$



New revolutionary analytical transistorized metal detector will distinguish a gold bar from a tin can. No more unnecessary digging for tin cans, nails, bottle caps, etc. Also features push button tuning, automatic tuning, loudspeaker. Negligible ground pickup. Greatest detection range, etc. Many models — free catalog.

GARDINER ELECTRONICS CO.
 Dept. 8, 4729 No. 7th Ave., Phoenix, Ariz. 85013

WOOD VENEERS • TOOLS
 Shop Equipment • Supplies
POWER TOOLS
 at Lowest Discount Prices!

SAVE MONEY on finest domestic and imported hardwoods... all dimensions. Over 1500 items for the home craftsman and woodworking hobbyist. Lamp parts, upholstery supplies, tile, power tools at discounts.
NEW CATALOG READY
 132 pages. Full Color. Send name, address and 35¢ to cover handling, and postage. Write...
CRAFTSMAN Wood Service Co. Dept. A-40
 2729 S. Mary, Chicago, Ill. 60608

the finish fixer

wood sealer



Indo Satin Finish by DAP. It primes, seals and finishes. Gives a rich, satin lustre to wood cabinets and furniture. Dries in 2 hours for faster, two-coat finishing.



DAP Inc., Dayton, Ohio 45401/Subsidiary of Plover, Inc.
 Also available in Canada

STOP ALL THOSE CRACKS ABOUT YOUR HOUSE



With two tubes from Dow Corning, you can repair most leaks, breaks, and cracks around your house once and for all.

Because Dow Corning's Clear Sealer and Bathtub Caulk are silicone rubber, they stay completely flexible and waterproof. No crumbling or drying out. They're the best you can buy, and they're both guaranteed for ten full years.

Dow Corning Bathtub Caulk repairs cracks anywhere in the bathroom. It adheres to porcelain, ceramic and plastic tiles, glass, metal, and painted surfaces. And it forms a waterproof seal. In convenient 3-oz. or 5-oz. tubes.

Dow Corning Silicone Rubber Sealer adheres to almost any surface. This clear sealer is just the thing for fixing a basement wall, a drainpipe, roof vents, window frames, or counter tops. Also available in black or aluminum.

To make repair jobs even simpler, get Dow Corning's free brochure by mailing this coupon. It's full of home-maintenance suggestions and advice for the handyman.

Sealants from

DOW CORNING



TO: Dow Corning Corporation
Dept. B-0203
Midland, Michigan 48640

Please send me your free
brochure on home repairs.

Name _____

Address _____

City _____

State _____ Zip _____

If you're judged by your handiwork, let Nicholson give you a hand.

Whatever job you have in the works, Nicholson saws, blades and files can help bring out the best in you.

They help you "cut it" in dozens of jobs around the house. And help you excel at your job if you're a skilled craftsman.

Let Nicholson give you a hand. Pick up the Nicholson tools you need at your hardware store.

As we always say, you get a lot more than great tools from Nicholson. You get a pat on the back, too.

Nicholson  

Nicholson File Co., Providence, R. I.

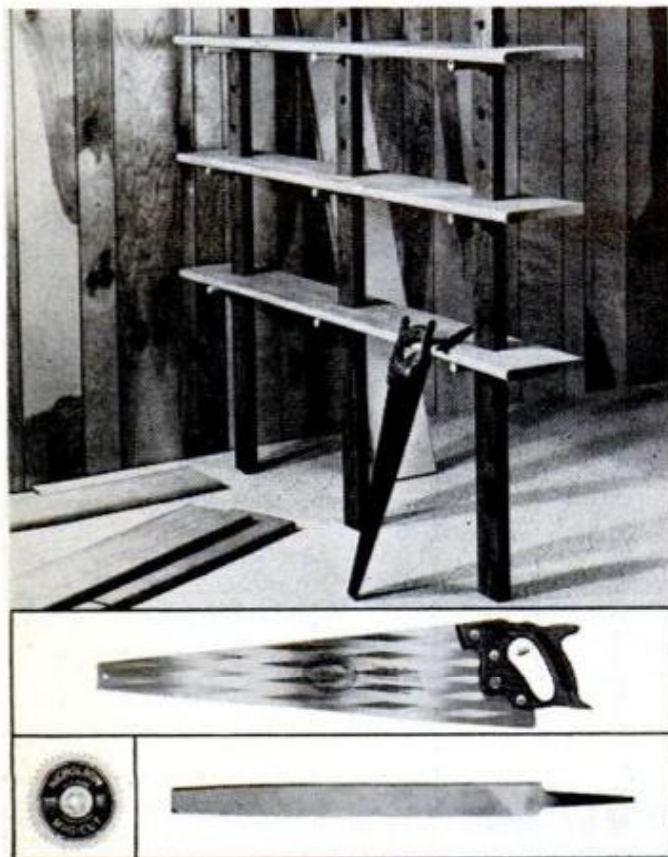

THIEFPROOF CAR LOCK

(Continued from page 38)

bilities, only one of which is correct. Each time a wrong button is pressed, the system automatically deactivates itself and a built-in electronic delay prevents it from being reenergized for 10 seconds. This means that a thief, working at top speed, could try only six combinations every minute or 360 an hour. At this rate it would take him 14 hours to run through all the code possibilities—a hopeless task for even a tenacious thief.

Jumping the ignition wires wouldn't get a thief anywhere, either, since no current flows through the ignition circuit until the decoder unit in the engine compartment has been properly activated. In fact, it doesn't even make any difference if you leave your key in the ignition switch. Since 43 percent of all stolen cars are driven away with keys their owners forgetfully leave in them, this feature is expected to be especially helpful in reducing auto thefts.

Now suppose a thief attempts to open the hood to get at the decoder unit. Foiled again. A solenoid-operated latch prevents the hood from being opened without the code. This consists of a striker plate bolted to the underside of the hood that engages a latch bolt when the hood is closed. The bolt is withdrawn, freeing the hood, only when power is supplied to the solenoid coil from the decoder unit.

The ingenious antitheft system is the brainchild of two young Long Island electronics experts, Marc Hoff and Rod Solomon, of 45B Old Oak Lane, Levittown, N.Y. Hoff and Solomon plan to have a kit of parts for the system on the market by early summer. Priced at about \$35, it will contain all necessary hardware, including a handy preassembled wiring harness.

Anyone concerned that his code might eventually be found out needn't worry. The code can be changed periodically merely by rearranging the wires running from the dashboard control to the decoder unit. The hood latch can be mounted in a variety of locations so that a thief attempting to cut through the hood to disable the latch would not know where to start.

For drivers who park frequently at garages and lots, an optional parking switch is available. This overrides the code control and energizes the ignition circuit so you can leave your car in the hands of a parking attendant without his having to know or use the code. To discourage any temptation there might be to make off with the car, a buzzer sounds loudly from under the locked hood while the parking switch is in use. ★★★

GLASTRON *RUNAWAY* BEST SELLERS!



V-156 Sportster

and no wonder!

In every category — Design, Safety, Flotation, Engineering. In

Price and Way Out Performance, top boating experts and Consumer Test Reports rate Glastron the outstanding buy!

Take your pick of 24 Go-Go models on two great hulls . . . from 14' to 23' . . . priced \$567 to \$9500. There's a Glastron ready for your family's FUN REVOLUTION.



GLASTRON BOAT COMPANY
Dept PM40
P.O. Box 9447
Austin, Texas 78756



Please send new 1970 Glastron Color Catalog.

Name _____

Address _____

City _____ State _____ Zip _____

WOLF BROS. Little Nippers.

The 149-proof cigars.

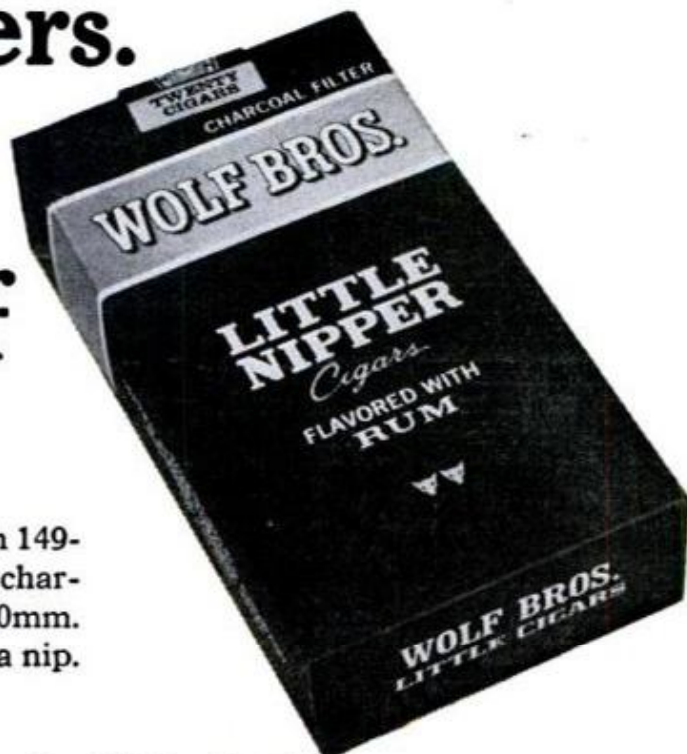

Mild, flavorful tobacco laced with 149-proof rum. And topped off with a charcoal filter. That's Wolf Bros. 100mm. Little Nippers. Go ahead. Have a nip. Enjoy!

Wolf Bros. Division of House of Windsor, Inc., Windsor, Pa. 17366
Subsidiary of United States Tobacco Company

New Gas Cuts Smog, Cleans Engine, Too!

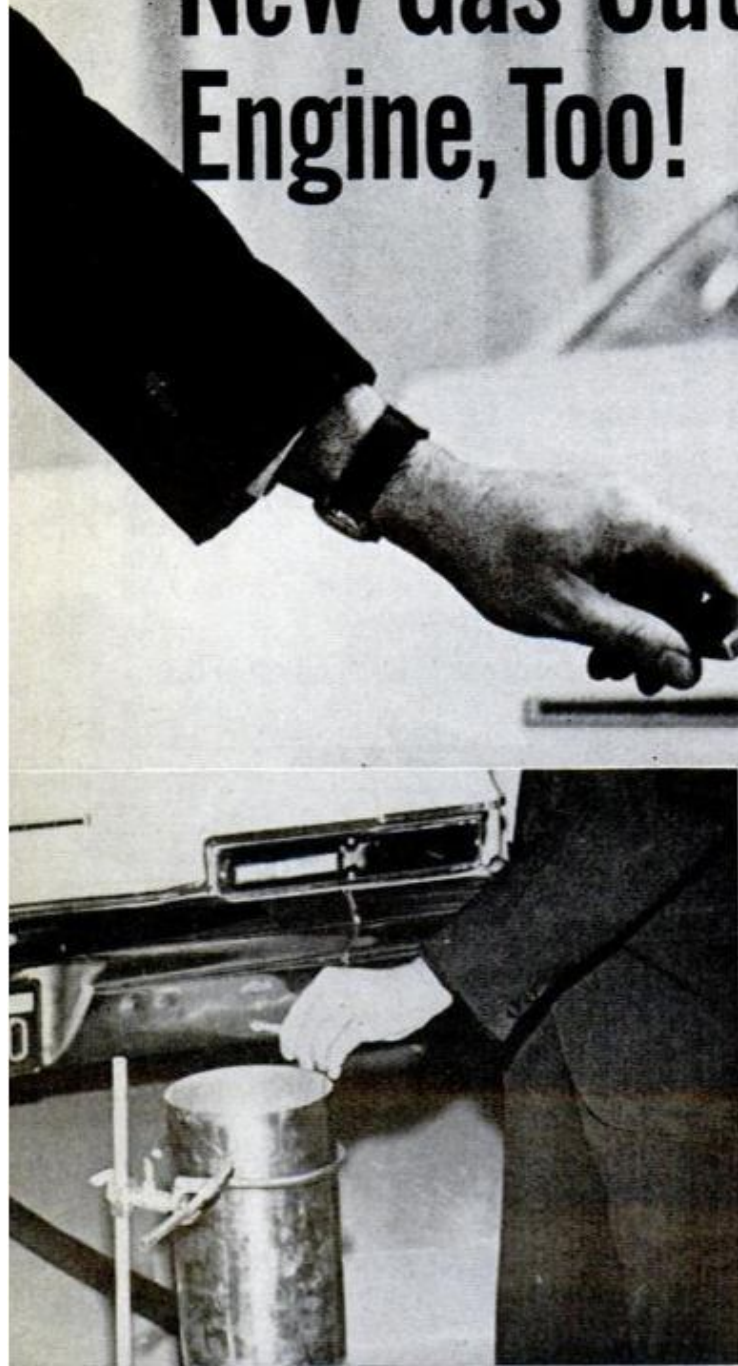

That's what Chevron Research claims for a new additive they've put in their gasoline

By JOSEPH SMUDA

UNBURNED HYDROCARBONS ignite in exhaust. No combustion after 1600 miles of running on F-310 gas

IMAGINE YOUR CAR getting better instead of worse with each passing day: You notice quicker starts, smoother idling, more zip and power, and greater overall drivability. Gasoline mileage has improved slightly while the smog-control system is actually doing its job of reducing harmful emissions without sacrificing engine performance. All this, they say, from nothing more than filling up with gasoline containing Chevron's new F-310 additive.

F-310 acts to reduce hydrocarbon and carbon monoxide emissions to factory-set levels and keep them that way. It's a dispersant, detergent, deposit-inhibiting com-

pound of chemicals that—in new cars—prevents the buildup of harmful carbon deposits in the carburetor, on smog-control positive crankcase ventilation (PCV) valves, and to some extent in the “downstairs” area: rings, piston skirts, crankcase.

An engine that's already belching clouds of black unburned hydrocarbons due to deposit buildup will run like new in less than 2000 miles of driving. While total improvement takes six or seven tankfuls of gasoline, you begin noticing the difference after a few hundred miles.

Chevron's initial tests were performed

(Please turn to page 46)

Springtime IS FIX-IT-TIME all around the house



Time to apply a touch of

magic



to those tough time-consuming nailing chores



ARROW[®] HEAVY DUTY T-50 STAPLE GUN TACKER

SHOOTS A STAPLE
wherever you'd
drive a nail!

FASTER...
BETTER...
CHEAPER...



Uses 6 Staple Sizes:
1/4", 5/16", 3/8", 1/2", 9/16"
And CEILTILE.
\$12.95

One S-Q-U-E-E-Z-E drives a tight-holding staple into the hardest wood, plywood, composition board, plastic—even soft metals! This powerful, all-purpose Arrow automatic tacker is the favorite fastening tool of professional building contractors and do-it-yourselfers alike!

Take advantage of these two Arrow money-saving staple gun values for Spring Hardware/Housewares Week... featured at Hardware, Building Supply, Department Stores and other retail outlets everywhere April 23rd—May 9th.



T-50 Heavy Duty



JT-21 Light Duty

ARROW FASTENER COMPANY, INC.

271 Mayhill Street, Saddle Brook, N. J. 07663

Draw The Lumberjack



YOU MAY WIN A \$795.00 COMMERCIAL ART SCHOLARSHIP

Draw him in pencil, any size (except one that would look like tracing). Scholarship winner gets a complete home study course in all fields of commercial art, taught by one of America's leading home study art schools—Art Instruction Schools.

Every qualified entrant gets a professional estimate of talent.

Imagine: personal attention from professional commercial artists in the fields of advertising art, illustrating, cartooning and painting, to help you develop your talent!

Entries for the contest must be in before May 31, 1970. Amateurs only. Our students not eligible. None can be returned. Contest winner will be notified. Clip the coupon and mail your drawing today!

MAIL THIS COUPON TO ENTER CONTEST.

ART INSTRUCTION SCHOOLS

Studio 0A-2570

500 South Fourth Street • Minneapolis, Minn. 55415

Please enter my drawing in your contest.

(PLEASE PRINT)

Name _____

Occupation _____ Age _____

Address _____ Apt. _____

City _____ State _____

County _____ Zip Code _____

Telephone No. _____



Accredited by the Accrediting Commission of the National Home Study Council. Approved for Veterans Training.

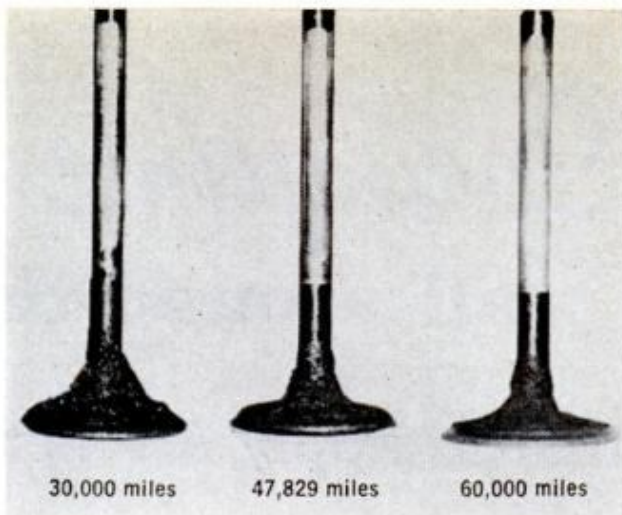

INTAKE VALVE taken from a taxi run 30,000 miles on gas with F-310 additive shows cleansing effect

NEW GAS CUTS SMOG

(Continued from page 44)

on laboratory engines and then in the field on fleet cabs. Late-model, high-mileage cars that manifested the problems of unusual carbon buildup were run on F-310 gasoline. Short-term results were astounding: PCV systems worked like new; carburetor valves looked as if they had been scrubbed with steel wool (see photo at right). Same was true over long periods: Heavy, air-restricting carbon buildup on intake valve-stems was being substantially reduced. Crankcase sludge was actually disappearing.

Chevron employed Scott Research Laboratories of San Bernardino, Calif., to make independent field evaluations of F-310. Late-model used cars were purchased by Scott, properly tuned and cleaned to factory-new condition. The cars were run 5000 to 18,000 miles to dirty up the engines. When the cars began stalling and running poorly, hydrocarbon and carbon monoxide emissions were recorded.

Next, cars went 2000 miles on F-310 gas before the carburetor, PCV system, and emissions were rechecked. Drivers noticed improvement in operation after only 100 to 200 miles. At between 1000 and 2000 miles of test-course driving hydrocarbon emissions were found to be reduced by 50 to 80 percent. Carbon monoxide levels went from an average 2.5 percent to 1.6 percent. PCV and carburetor valves looked like factory replacements rather than used components. Engines ran smoothly, using an average 21 percent less fuel at idle and 11 percent less when driven at a steady 25 mph.

These tests, examination of engine parts and Chevron engineers' demonstrations seem to indicate F-310 is a boon for the car owner and our environment. ★★

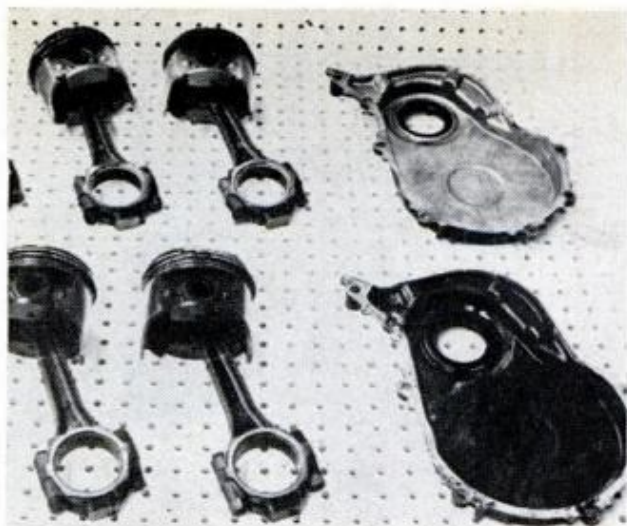

PARTS NOT IN CONTACT with fuel mixture—piston skirts, timing chain cover—are cleaned by blowby

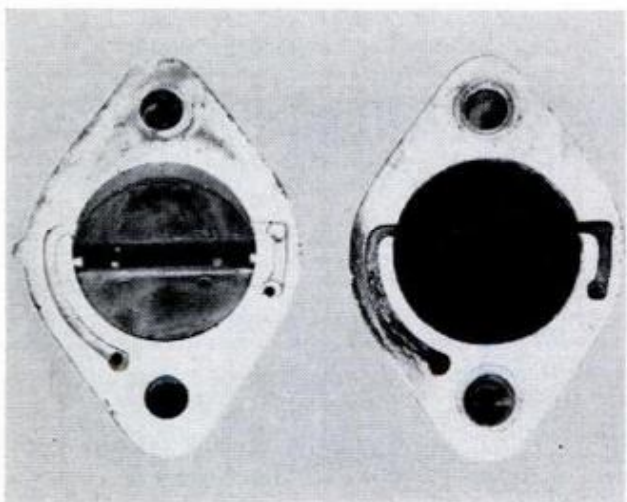

CARBURETOR DEPOSITS are lessened visibly by use of gasoline containing Chevron's additive. Both carbs were removed from engines run in taxi service

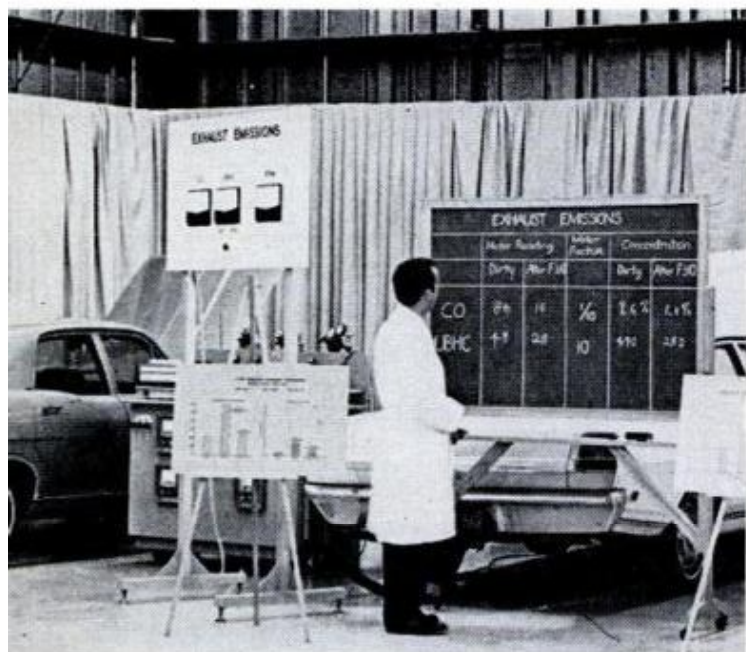

DROP IN LEVELS of unburned hydrocarbons and carbon monoxide is recorded after 1900 miles on F-310

HOW TO REPAIR FIBER GLASS

BOATS: Get this authoritative, 8½" x 11", Fiber Glass Boat repair manual. Here's what's in it:

- Introduction to Fiber Glass (4 pgs.)
- How to Make Surface Repairs (10 pgs.)
- Fracture and Puncture Repairs (16 pgs.)
- Finishing Techniques (3 pgs.)
- 56 close-up, how-to photos
- Tables on tools and materials needed for every type repair
- A great guide for repairing fiber glass tubs, shower stalls and autos.

Price: \$3.00. Publisher: Ferro, world's leading producer of fiber glass and surface color coats for boat construction. So you know this is the right and proven repair data. Order this valuable manual today.



FERRO CORPORATION

Ferro Corporation / Fiber Glass Division
Fiber Glass Road / Nashville, Tenn. 37211

Mail _____ copies of "How to Repair Fiber Glass Boats" @ \$3.00. (No stamps. Check or money order only.)

Name: _____

Address: _____

City: _____

State: _____ Zip: _____

Buy Aluminum Jelly®

(it cleans and brightens aluminum)



Use it on aluminum screens, windows, and storm doors, outdoor furniture, bicycles, siding, trailers and boats.

Buy NAVAL JELLY® Rust dissolver and let the rust of the world go by.



World's Finest Fix-It Products
Woodhill Chemical Sales Corp., Cleveland, Ohio 44128

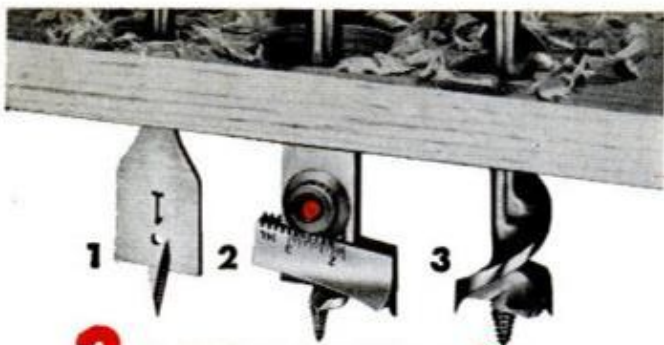

3 easy ways to bore holes faster

1. Irwin Speedbor "88" for all electric drills. Bores faster in any wood at any angle. Sizes $\frac{1}{4}$ " to $\frac{3}{16}$ ", \$.85 each. $\frac{5}{8}$ " to 1", \$.95 each. $1\frac{1}{8}$ " to $1\frac{1}{2}$ ", \$1.50 each.

2. Irwin No. 22 Micro-Dial expansive bit. Fits all hand braces. Just dial your size. Bores 35 standard holes, $\frac{7}{8}$ " to 3". Only \$5.00. No. 21 small size bores 19 standard holes, $\frac{5}{8}$ " to $1\frac{1}{4}$ ". Only \$4.50.

3. Irwin 62T Solid Center hand brace type. Only 16 turns to bore 1" holes through 1" wood. Double-cutter boring action. Sizes $\frac{1}{4}$ " to $1\frac{1}{2}$ ". As low as \$1.45 each.

EVERY IRWIN BIT made of high analysis tool steel, heat tempered, machine-sharpened and highly polished, too. Buy from your independent hardware, building supply or lumber dealer.

Strait-Line Chalk Line Reel Box only \$1.35 for 50 ft. size

New and improved Irwin self-chalking design. Durable aluminum alloy box. Practically damage-proof. Fits pocket or hand. 50 ft. and 100 ft. sizes.

IRWIN every bit as good as the name

of Wilmington, Ohio, since 1885



START A BUSINESS this quick way



Sharpen Hand or Power Saws with the

FOLEY SAW FILER

Start your business in sparetime and make CASH PROFITS right away. No stock to carry, no selling involved, no experience needed—the Foley Saw Filer or mower sharpener does every sharpening job **automatically!** Earn up to \$6 an hour sparetime in your own garage or basement.

FREE BOOK shows how you can make money as thousands of others have. Send coupon today. There's no obligation, and no salesman will call—so write today!



FOLEY MFG. CO.
416-O Foley Bldg., Minneapolis, Minn. 55418
Send for FREE book on Money-Making facts about the sharpening business and Special Combination Offer.

NAME _____

ADDRESS _____



LAWN MOWER SHARPENER

Precision-grind all hand and power lawn mowers—perfect job every time.

Bazooka hub

Outboard Props

Now available in 2-, 3- and 4-blade designs... perfectly matched to any hull, load and service condition. 2 to 3 mph speed increases are common. "Bazooka" style combines with other Michigan features for exceptional performance. No external flares or flanges to cause drag... exhaust sucking action is provided by exclusive Michigan inside or venturi flare. Outer surface is smooth, drag free. Combination of Bazooka hub and Prop-Rider pitch generation principle in our speed wheels results in very substantial increases in boat speed. Available in bronze or aluminum to fit flow-thru exhausts on Johnson, Evinrude and Mercury motors. Write for new Outboard bible.

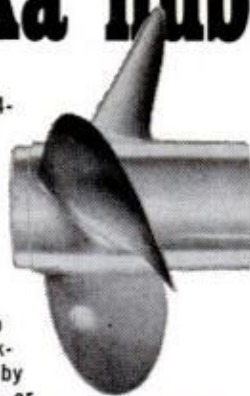

MICHIGAN WHEEL

MICHIGAN WHEEL CO., GRAND RAPIDS, MICH. 49502

YOU CAN'T GET A BETTER VALUE

LINCOLN 225-AMP ARC WELDER FOR 230-VOLT POWER LINE

• UL approved—NEMA rated • 40-225 amps welding range • Cuts and solders, too • Brazing attachment optional • \$95 complete with accessories, Zone 1 List (subject to change).



LINCOLN ELECTRIC, Dept. B, Cleveland, O. 44117

LAW FREE BOOK THE LAW TRAINED MAN

Write today for a FREE copy of illustrated law book, "THE LAW-TRAINED MAN," which shows how to earn the professional Bachelor of Laws (LL.B.) degree through home study of the famous Blackstone Law Course. All necessary books and lessons provided. Moderate cost; convenient monthly terms. Write for FREE law training book today.

Blackstone School of Law, 307 N. Michigan Ave.
Founded 1890 Dept. 54, Chicago, Illinois 60601

BE A COMPUTER PROGRAMMER

Prepare at home in spare time for high pay, prestige, big future as a Computer Programmer. Computers are America's biggest booming field. Every computer requires one or more—sometimes dozens "Programmers" to "write" instructions that put it to work. 50,000 new Programmers needed right now. 500,000 more new jobs by 1975! Easy home-study trains you to get in on ground floor of booming field. No previous experience or technical ability needed. FREE! "Computer Programmer Career Kit." No salesman will call. National Programming School, 4401 Birch, Dept. 04174, Newport, Calif. 92660.



1000s great opportunities to manage motels, resorts, mobile home parks, etc.

"go begging" daily due to lack of trained people. Easy home-study plan shows men, women, couples how to retire to good income, fresh air and fun—20 years ahead of time! Your own area or vacation resort. Free rent, great living and plenty of time to enjoy them as owner or manager. Send for big "Career Kit" plus revealing report, "Owning Your Own Motel"—ALL FREE! No salesman will call.

NORTH AMERICAN SCHOOL OF MOTEL-HOTEL MANAGEMENT
4500 Campus Drive, Dept. 4174, Newport, California 92660



Free Catalog!

TOOL CHESTS of the HIGHEST QUALITY for your PRECISION TOOLS..

GERSTNER TOOL CHESTS
Dept. B-C, 20 Cincinnati Street
Dayton, Ohio 45407

It's Here at last!

CUSHMAN

TRACKSTER

makes the impassable possible

After more than five years of research and testing, Cushman and Outboard Marine Corporation present the Trackster—the all-terrain vehicle with real guts! This rugged machine goes over rocks, sand, mud, snow, you name it, even up 100% grades! This is the vehicle you need to take you into the deepest brush, over the highest country, through the stickiest mud. This is the vehicle that will take you in and take you out again!

The secret is in the remarkable tracks, which take practically everything in their stride. And in the two hydrostatic transmissions that operate each track independently.

The tracks are made of a specially-designed rubber compound reinforced with three layers of polyester cord. They've been tested under highly abrasive conditions including hot desert sand.

A feather-touch T-handle operates the two hydrostats. This

one T-handle steers the vehicle and is also the speed control. You can weave in and out among the thickest forest, just with a light touch on the T-handle. You can climb, or safely descend, with the same light touch. You can even make spin turns by running one track forward and the other in reverse; the vehicle turns in its own length. It has the most responsive steering and speed control you've ever seen!

The Trackster is powered by a lightweight 25-horse diecast aluminum OMC engine—one of the most rugged and dependable two-cycles ever built! A 12-volt electrical system provides lights, key-operated ignition and charging for the standard automotive battery. Gas tank capacity is 10 gallons; enough for an average day's operation.

Test-drive the Cushman Trackster. Send today for free literature and name of nearest dealer!



CUSHMAN MOTORS

Lincoln, Nebraska

A Division of Outboard Marine Corporation

Maker of Evinrude, Johnson and other engine-powered products



Cushman Motors, 991 N. 21st Street, Lincoln, Nebraska 68501

Gentlemen:

I am interested in the new Cushman Trackster. Please rush me all details.

Name _____

Address _____

City _____ State _____ Zip _____

New Projector Shows Slides In a Cube

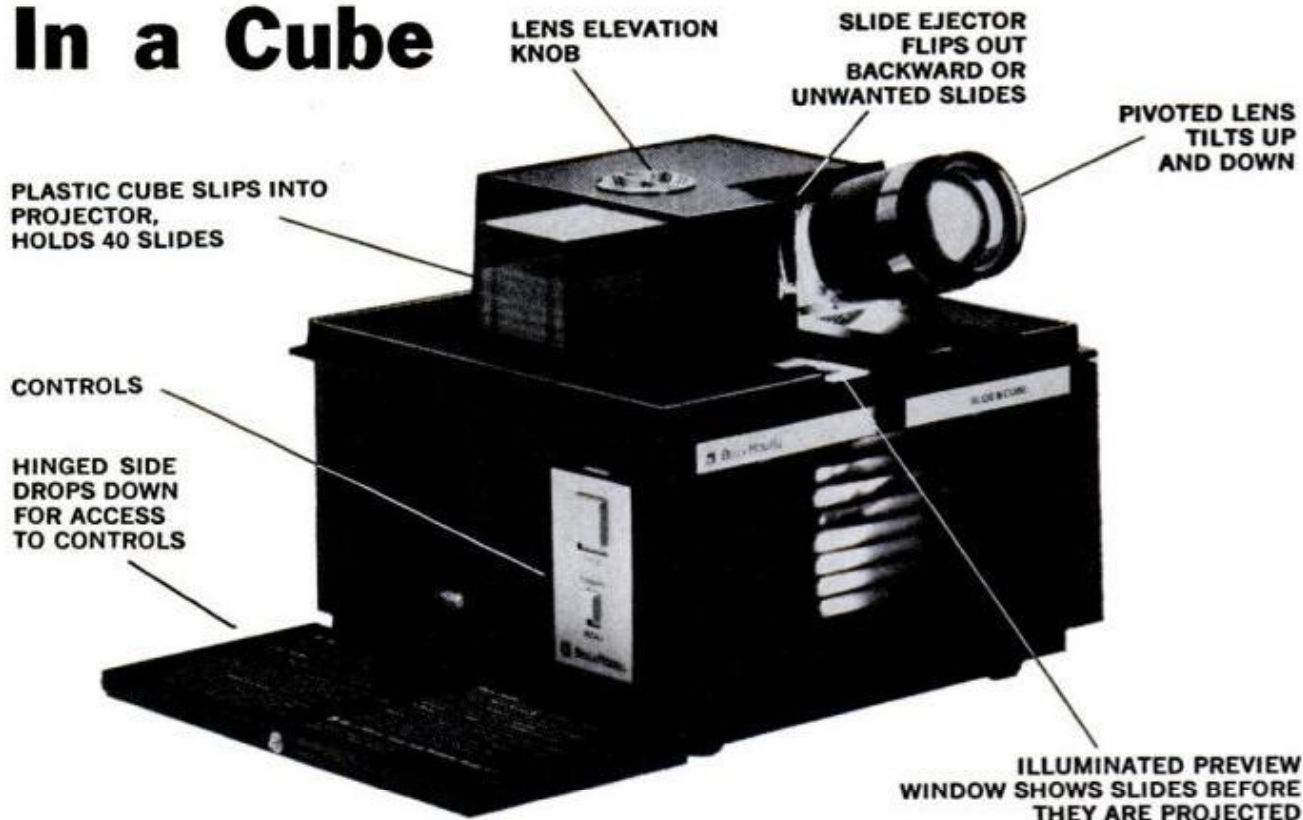

A SMALL PLASTIC CUBE is the heart of a slick new slide projector system by Bell & Howell—the first major change in slide handling since the introduction of the circular storage tray some years ago. The 2-inch cube holds 40 slides. Two cubes hold 80—as many as a full circular tray.

To show the slides, you just slip a cube into the projector. The slides feed out of the cube, through the projector mechanism and back into the cube again. Before each one is shown, it appears in a lighted preview window where you can turn it if it's backward or remove it if you don't want it in the sequence. This makes slide editing a snap. Another nice touch: The lens tilts up instead of your having to raise the entire projector to adjust image height.

The trim, compact projector fits easily on a bookshelf and is smartly styled in a black and wood-grain finish. Prices are \$112.50 to \$184.50 depending on whether you want extra features like automatic focusing, slide recall and a zoom lens. Accessories include a slide-storage lid that replaces the regular cover and holds nine cubes, an automatic slide changer and a slide synchronizer for use with a tape recorder. Bell & Howell, 7100 N. McCormick Rd., Chicago, Ill. ★★★



UP TO 40 SLIDES fit compactly into each of B&H's new cube-shaped magazines. In 16 of the cubes, you can store 640 slides—enough to fill eight conventional round trays stacked nearly two feet high, as shown in the comparison below and at the right. Lighted preview window where each slide appears before its projection is shown in photo at left above



POPULAR MECHANICS

Inventors,



N.Y. Coliseum

strike paydirt!

Announcing **PATEXPO 70, INTERNATIONAL PATENT LICENSING EXPOSITION, N.Y. COLISEUM, OCT. 1-5**

Do you really believe in your idea? If so, your new products, new ideas, unsold patents can make you a fortune by their outright sale or on a royalty basis.

However, to achieve that goal, they first should be shown. More precisely, they must be *exhibited*. Not to just anyone, but to the proper business audience. In an ideal environment created especially for this purpose. At the only patent licensing—new product marketing showcase of its kind in the world.

Now you can reach over 30,000 new products managers, licensing executives, top representatives of major national U.S. and foreign companies—the people who are *looking for* new ideas and technology to expand and diversify, who are anxiously seeking new products to license, manufacture and distribute.

By reserving your space before June 1st, 1970, you can also enjoy numerous benefits of early registration. For example, free advance publicity and promotion for your invention. So don't

miss out, send for your free PATEXPO '70 brochure and application form.

Last year, over \$10 million in licenses, joint venture transactions and new product sales were reported by exhibitors. Creators of new ideas and products became internationally known. And made their fortunes! Is your idea worth a million dollars? Now you can find out!

Act now. Space is limited and is assigned on a first-come-first-served basis. So write, or call today.

Companies that attended PATEXPO 69 include: Alcoa • American Cyanamid • AT&T • Bendix • Black & Decker • Borg Warner • Bristol Myers • Bulova Watch • Burlington • Celanese • Clairol • Coca Cola • E. I. DuPont • Ford Motor • General Electric • General Foods • General Motors • IBM • International Paper • Johnson & Johnson • Lever Brothers • Litton Industries • 3M Company • RCA • Sears Roebuck • Singer • Sperry Rand • Sunbeam • TWA • Uniroyal • Westinghouse • Xerox

Mail coupon or call: (212) 581-7616 or 581-7617

Managing Director, Dept. A, International New Products Center
680 Fifth Avenue, New York, N.Y. 10019

I have a new product, new invention, unsold patent. Please send me an application to exhibit. I am interested in advertising in the Official Catalog.

Name _____

Address _____

City _____

State _____ Zip code _____

PATEXPO 70

A service of PATENTS INTERNATIONAL AFFILIATES, LTD.—a public corporation (OTC)

NOTE:

If you are unable to attend, we will set up, sell and license on your behalf.

CHANNELLOCK

Gives You More In Hand Tools Including

THE
HANDIEST
PLIERS
OF THEM
ALL

Ask any good mechanic. He'll tell you his CHANNELLOCK tongue and groovers are the handiest pliers he owns. Try one . . . you'll agree. A word of caution: be SURE you're getting the original, genuine CHANNELLOCK. It's the only tongue and groove plier with machined, smooth working, undercut channels that never jump out. Look for the CHANNELLOCK trade mark on the handle.

GET ALL THE FACTS. Send for our catalog . . . yours for the asking.



TOOLS BY
CHAN NEL LOCK[®]

MEADVILLE, PA. 16335

THIS CAN BE YOUR "BIG BREAK"

if you're a man who's ever said...

"I'm sick and tired of my Job!"



IF CARD IS MISSING, MAIL THIS COUPON

CIE Cleveland Institute of Electronics
1776 E. 17th St., Cleveland, Ohio 44114

Please send me 2 FREE books describing opportunities in Electronics and how to prepare for them.

Name _____ Age _____
(please print)

Address _____

City _____ State _____ Zip _____

Veterans & Servicemen: check here for G.I. Bill information

Accredited Member National Home Study Council

PM-38



HEAVY DUTY WELDER
10-DAY FREE TRIAL
Lifetime Guarantee
Brand New 18⁹⁵
1970 Model POST PAID
Fits ordinary 110V outlet
Not one • but 3 welding heats

Weld, braze, solder or cut most anything made of metal. No experience necessary. Follow simple instructions to make repairs on cars, trailers, farm and lawn equipment, bicycles, appliances, etc. Make campers, boats, furniture, hundreds of valuable items. **NOTHING ELSE TO BUY!** Comes complete with full face shield, \$2.00 pack of welding and brazing rods, heavy duty power cables, special electric torch attachment, ground clamp, flux, easy-to-follow illustrated instructions, rod holder, etc. Uses standard 1/8" rods and 1/4" carbons to weld iron, steel, brass, bronze, aluminum, other metals. New improved HEAVY DUTY circuit gives more welding power. Gives 4 times the heat needed to melt toughest iron. Plugs into ordinary 110V outlet. **3 WELDING HEATS . . .** Not just one as with other low cost models. Use "high" for tough jobs, "medium" or "regular" for lighter work. This important feature saves you money and time. Makes it possible for even beginners to start welding professionally the very first day. Pays for itself quickly. **10 DAY MONEY BACK GUARANTEE.** You must be satisfied or return for refund.

FREE automatic arc striker. Now weld with push-button ease.
 SEND ONLY \$2.00. Pay postman \$16.95 plus postage when delivered, or send \$18.95 cash, c.k., M.O., for fast postpaid shipment

WEL-DEX MFG. CO., Dept. W-10, Box 10776, Houston, Texas 77018



LEARN UPHOLSTERY AT HOME!
 Men & Women All Ages! Send for free book on learning to reupholster chairs, divans, footstools, all furniture for **BIG MONEY** in spare or full time. No experience needed, no age or educational limits. We show you how and provide **EVERYTHING** needed to start:
 (1) Home training covering all phases, (2) all tools and 6 big furniture kits for practice, (3) free supplies, frames & materials to build \$300 worth of furniture, yours to keep or sell. Write **TODAY** for big free upholstery career book. No obligation, no salesman will call! Veteran Approved. **Modern Upholstery Institute,** Box 899-CYR. Orange, Calif. 92669

FREE BOOK!

WHEN ANSWERING ADS GIVE YOUR ZIP CODE

ALL ABOUT LUMBER booklet.

Price 35¢

This handy reference booklet will give you all you need to know about: How lumber is graded and sized—How it is sold—Plus a glossary of lumber terms. Send 35¢ to:

POPULAR MECHANICS

Dept. LU

224 W. 57th St.

New York, N.Y. 10019



Jumbo earmuffs

Foam-rubber earmuffs have been fitted to elephants at Windsor Safari Park to keep them from being upset by noisy jet traffic at London's Heathrow Airport nearby.

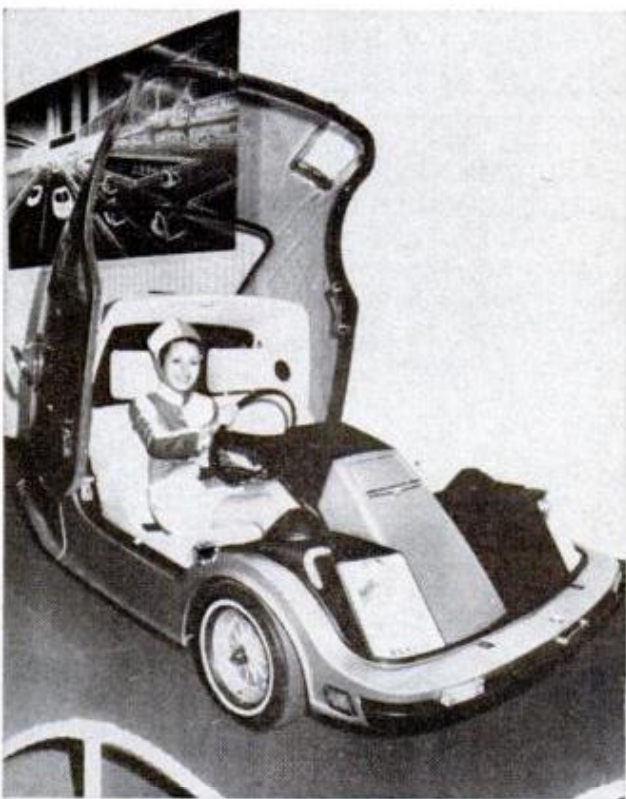

Clamshell commuter car

Toyota's new suburban commuter car with a lift-up cab was shown at the recent Tokyo auto show. At this point, the two-seat vehicle is described as experimental.



Vista[®] gives your car a shine like sterling.

Get real deep-down, hard-wax kind of shine—a dazzling shine like sterling with Simoniz[®] Vista. Vista is a special paste-wax blend of jeweler's polish and high gloss silicones. You clean and wax in one easy step...for a dazzling shine that lasts. Get Simoniz Vista. Paste, Liquid, or new Soft and Easy formula. Give your car a shine like sterling.



NEW! Soft and Easy Vista with handy applicator.

SIMONIZ is a registered Trade Mark of Texize Chemicals, Inc.

3 WAYS

TO A PROFITABLE BUSINESS of your own with small investment

**YOU CAN START WITH ONE DETERGER...
ANY TWO... OR ALL THREE
FULL OR PART TIME!**



■ Von Schrader offers you these three tried and proven money-making businesses. You can start with one Deterger and, by working week-ends, add hundreds of dollars to your monthly income while still employed.

■ Or, you can start your business with any two, or all three Detergers, and build rapidly to a point where helpers and even additional Detergers are necessary. All three Detergers are reasonably priced...and many Associates make more than the price they paid in the first few weeks and from the supplies that came with their original order.

■ You need no shop because all work is done in customers' homes or on their premises. And you have no overhead because you work out of your own home.

■ Full operating instructions come with the Detergers and you need no special skill or training. You can grow as fast as you want to with the assurance that Von Schrader will help you every step of the way. Our Business Manual tells everything you need know, including how to go about getting business, suggested sales letters, tips on keeping books and tax records, suggested ads and radio announcements, etc. Von Schrader assistance is always at your service. Training and consulting with experts is also available... and without charge.

■ Von Schrader is the oldest and largest company manufacturing machines of this type and we are keenly interested in the success of each of our Associates. Our FREE ENTERPRISE PLAN has been developed and fashioned with your future in mind. Your business always belongs to you...no one can ever take it away. You pay no dues or fees or royalties to anyone. All the money you take in belongs to you...you are truly your own boss in your own business.

VON SCHRADER MFG. CO.

READ BELOW what a few of our many Associates have to say about the success of Von Schrader's FREE ENTERPRISE PLAN. Then return the coupon or write today. It costs nothing to get the details. Be sure to check the Deterger you are most interested in starting with.

E. L. McLAINE • New York • Wall—"I'm over 60 years old. In my spare time I make \$125 to \$175 per week."

F. LOTMAN • Canada • Wall—"Our machines have grossed us over \$50,000 for the past 12 months."

R. MORTON • Michigan • Wall—"This last month just working Saturdays and occasional evenings I cleared around \$600."

G. WINTER • Wyoming • Upholstery—"Last year I did \$10,000. This is a one-man operation. Many weeks are now \$250-\$300."

E. ACTON • Oregon • Upholstery—"I don't work very hard at this but in one day my boy and I made \$170."

S. RALLINGS • California • Upholstery—"I'm averaging about \$200 a week... one month went up to \$1000."

T. NORTHRUP • New Jersey • Rug—" \$2000 in two weeks... several weeks over \$1000."

J. THORNTON • Illinois • Rug—" \$90 and \$100 a day is common with your wonderful detergent."

C. LEONARD • Ohio • Rug—"My largest week so far brought me \$1568."

SEND FOR THE FACTS TODAY

VON SCHRADER MFG. CO.

1047 Place, Racine, Wis. 53403

Please rush information about your

_____ DETERGER(S)
(Write in name of detergent(s))

and how I can start my own profitable business.

Name _____

Address _____

City _____ State _____ Zip _____

The bargain hunter



Bartlett Flying Saucer ultra-light hovercraft powered by ordinary lawn mower engine—easy to build—fun to fly—complete plans, kit brochure, photos and supply sources \$4.00. All orders returned via airmail. Write:

HERB BARTLETT

Box 3234-M, Scottsdale, Arizona 85257



NEW SLIM-GARD Trims inches off your middle, waist, hips & lower back without dieting—without exercising! All you do is wear it. Stretches approx. 6". Made of finest, most resistant neoprene rubber. Easy to slip off & on. Sizes: S, M, L. \$9.98. Slim-Gard Co., 531-32nd St., Dept. 38-40D2, Union City, N.J. 07087.



DESIGN PAINT ROLLER

Roll-A-Pattern on Walls, Ceilings... even on Floors
Easy to Use with Any Type of Paint—Send 25¢ for Catalog Showing 40 Designs. DEPT. PM-40

COLOR MART INC. • 4236 So. ARCHER AVE. • CHICAGO, ILL. 60632

One Sharpening Machine Does All This—

Start your sharpening business with Treycos 6-in-1 grinder. No need to buy separate machines for every job. You can hollow-grind scissors, pinkie shears, knives, tools, garden tools, hand and circular saws—all with ONE SIX-IN-ONE Treycos Sharpening Machine at low price of one machine. Safeguard your future—build your own spare or full time sharpening business. Take in as much as \$6.00 an hour—no lay-offs, no cut-backs, no forced retirement—enjoy independence and security! ACT NOW—write for FREE CATALOG and LOW FACTORY-TO-YOU 6-in-1 prices.



TREYCO 332-A Niagara St.
Products, Inc. N. Tonawanda,
N.Y. 14120

MOMENTOS of the infamous 3rd REICH Cast NAZI Eagle-Wall Plaque 7"x20" Wide. Bronze finish. While they last \$5.00 postpaid.

Our fully illustrated collector's CATALOG of... Helmets, Hats, Medals, Pins, Badges, Books, Photos, Posters, Manuals, Stamps, Flags, Decals, Arm Bands & other hard-to-find items. CATALOG free with order or Mailed to you for \$1.00. W.W. 2-M Ltd., Box 2063, St. Louis, Mo. 631 8



HOW MANY HANDY DANDYS CAN YOU USE?

Handy Dandys are plastic caps that hook onto 1/8" pegboard and hold quarter-twist glass jars, such as used for baby food. Suggestions for getting FREE JARS in every package. Nothing better for storing supplies, parts and small tools. Keeps workshop neat. Sample pack 10 for \$1 ** 36 for \$3.50 ** 72 for \$6 ** 144 for \$11.50. Caps only. No jars. Postpaid U.S.A. No C.O.D.'s. WICKLIFFE INDUSTRIES, Box 286-PM-4, Wickliffe, Ohio 44092

IMPORTED LOCK BLADE STILETTO

ONLY \$2.75 Ea.

9" Overall Length
5" When Closed

- Opens instantly
- Sharp and Tough
- Stainless Steel Blade



Flips open instantly and locks automatically to prevent accidental closing. Razor sharp tough stainless steel blade for reliable use and hard, long service. Money back in 5 days if not satisfied. Send \$2.75 plus 25¢ to cover postage and handling.

WESTBURY SALES CO.
P.O. BOX 415 WESTBURY, N.Y. 11591
DEPT. L-3-PM

KLEEN-A-ROLL • Original •

paint roller cleaning device
\$4.74 A FANTASTIC TOOL
This TERRIFIC electric drill attachment SELF-PUMPS clean solvent as it quickly SCRUBS fresh oil or water paint from a 7" or 9" cover. KLEEN-A-ROLL makes it EASY. Spot offer includes DYWIDOR cover on plastic core. (N.J. Residents plus 6% tax.) ORDER THIS AMAZING TOOL BY CHECK OR M.O. TODAY. KLEEN-A-ROLL, P.O. Box 727, Summit, N.J. • 07901 •

Learn music by mail—about \$1 a lesson

Choose Piano, Guitar, Accordion or any of 11 other instruments

Ever wish you could play a musical instrument? Now you can learn for just pennies a day with lessons we give you by mail. No need for an expensive private teacher. Teach yourself with our clear word-and-picture instructions. No gimmicks. Learn to read notes, play regular sheet music. Set your own pace. Sooner than you might think possible, play whatever kind of music you like—classical, popular, hymns. It really works! Thousands now play who never thought they could. For free booklet, mail this ad with your name, address and zip to U.S. School of Music, Studio 304, Port Washington, N.Y. 11050 © 1970 U.S. School of Music



BOAT PLANS

FULL SIZE PATTERNS

FRAME KITS



CATALOG 81

96 PAGES—OVER 80 DESIGNS—\$1.00

Sail, Inboards, Outboards, Hydros, Houseboats, Hot Boats & boat trailers. New \$1.00 catalog includes all styles from 8' to 36'. Glen L. plans, patterns and frame kits are specially prepared for amateurs. Books: Inboard Motor Installations In Small Boats \$6.00; Boat Building With Plywood \$7.50; How To Build Boat Trailers \$4.00. Glen L. 9152T Rosecrans, Bellflower, Calif. 90706.



FREE!!! POWERFUL MUSCLES FAST!

Fantastic New Discoveries in the science of bodybuilding. Now, in the privacy of your bedroom, our method will add inches of powerful muscles to arms, chest, shoulders & legs. Learn secrets on trimming the waist with ultra-modern methods—fast! Results Guaranteed! Send for free brochure. Universal Bodybuilding, Box 485-M1, Dearborn, Mich. 48121.

Searching?

Should you wait years to meet your match?? Establish new friend NOW! The computer has smashed the social time barrier. Request free questionnaire. \$15 fee payable when you return questionnaire.

COM/PAIR SYSTEMS, Inc., PM-X
194 Nassau St., Princeton, N.J. 08540

OR use new West Coast address
234 Cazares Circle, Sonoma, Calif. 95476

Name _____

Address _____

City _____ State _____

© COM/PAIR

APRIL 1970

59

The bargain hunter



Thousands of exciting tool values!

SILVO (BRAND NAME) TOOL CATALOG

Thousands of Exciting Tool Values! Stanley, Millers Falls, Skil, Thor, Wen, Disston, Wiss, Wellsaw, Dremel, Speedy Sprayers, Plumb, Huot, Kennedy, Channellock, Porter-Cable, Rockwell, Helios, Vise-Grip, Crescent, Ridgid, Pony Clamps, Unimat, Freedom and many other Nationally Advertised brands of Tools & Supplies. We ship Coast to Coast at prices Hard to Beat. Send 50¢ for our big 146 page tool catalog, today. Silvo Hardware Co., PM-4, 107 Walnut St., Philadelphia, Pa. 19106.

SPECIAL OFFER



Just \$1.00 for a full Year! (reg. price \$2.00)

REGULAR PRICE \$2.00 per year
\$1.00 per year

Absolutely one of a kind Bi-Monthly magazine! DIFFERENT! UNIQUE! In publication over 15 years! Each issue packed with hundreds and hundreds of exciting offers from all over the country—ANYTHING and ALMOST EVERYTHING you can imagine! Books, cameras, tools, jewelry, machinery, etc., etc., etc. Often at big Bargains Offers! Just one buy brings back the cost of a subscription! (Have YOU anything you want to sell or buy or exchange?) We'll publish it free. (No commercial offers please! Send yours in!). Plenty of other exciting features in every issue (offers from foreign countries, etc.). Just \$1.00 for a full year's subscription. (This is a special 1/2 price sub. Reg. price is \$2.00 per year.) Limited offer only—subject to withdrawal at any time! SAVE \$1.00! Subscribe NOW!

Bargains—Box 412-HA Danvers, Mass.

FIND BURIED TREASURE

\$28.95
60 DAY UNCONDITIONAL MONEY BACK GUARANTEE



ALL TRANSISTORIZED DEALER INQUIRES INVITED

All models find buried coins, gold, silver, war relics and signal thru earphone with loud "beep". Features silicon planar transistors, PC boards, two separated colpits oscillators for maximum stability, thumbwheel tuner allowing one hand operation, 5" search head for most useful range. All complete in "Unilite" black attache case with slide action locks, keys, grey foam interior cushions instrument. Includes a sensitive earphone, battery, fascinating 196-page book "Lost Treasures and How to Find Them" and instructions.

MAIL THIS COUPON TODAY!

- MAVERICK KIT only \$2895 complete do it yourself instrument that we guarantee to work when completed.
- CONTINENTAL only \$3295 completely assembled and ready to use
- IMPERIAL only \$3895 an advanced model that includes a powerful built in speaker that automatically is disconnected when earphone is in use, completely assembled.

TO ORDER: send cash, check or money order. In N.J. Treasure House 7% Sales Tax. \$3.00 deposit for C.O.D. Dept. P4D0 Trenton, N.J. 07763

FREE Catalog 2000 Jokes & Novelties



World famous catalog of novelties, live animals, scientific supplies, hobbies, fun-makers, planes & boats, looms, magic tricks, joke articles, unusual seeds, gadget time-savers, cameras, optical goods, projectors, movies, lucky jewelry, religious novelties, disguises, musical instruments, stamps, coins, puzzles, fortune tellers, radios, auto & bike accessories, telescopes, magnifiers, compasses, banks, smokers' gadgets, artists supplies, printing sets, engines, motors, shockers, knives, billfolds, books, games, etc. Send this ad or post card. NO LETTER NECESSARY!

Yes—I want FREE Catalog. My Name & Address Attached or on Envelope
Johnson-Smith, Dep. C104, Detroit 48224

RAZOSHARP

Pat. Pend.

\$1.89
P.P.



PRECISION TOOL HANDLE FOR

INJECTOR RAZOR BLADES

IDEAL POCKET KNIFE—EXCELLENT OFFICE AND HOUSEHOLD UTILITY TOOL—Only holder to use standard injector type razor blades. Only holder allowing for varying blade length exposure. Only holder allowing blade to be completely sheathed and protected. Only razor blade holder to give precision tool feel.

ALWAYS RAZOR SHARP—When blade dulls—pop in new blade. Re-use injector type razor blades. SHAVE and SAVE. Inexpensive injector type razor blades always available. To expose new sharp edge—reverse blade or clip dull edge. Excellent for cutting clippings, cardboard, trimming. Ideal for opening packages, cartons, boxes. Use for carving, whittling, sharpening, erasing, etc. Shape blade to suit use—snip edge, grind or break with pliers. Nothing to break or wear out.

RAZOSHARP 421 Stockholm Street, Brooklyn, New York 11237

THIS IS IT!



Quik-Sand

Popular Mechanics said in July, 1969 (p. 166):

"Handiest Tool You Can Have in Your Shop"

It sands, grinds, polishes, sharpens. It's portable. Take it on the job. Use with any 1/4 hp motor. Model 165. Factory direct special.

\$19.95 less motor

ARCO MFG. CO.

P.O. Box 817, Grand Forks, N. Dak. 58201

\$50 a Day
With a JB Saw Sharpener



Write For Details

BURNS, INC.
165 Rodman Street
Fall River, Mass. 02721

LICKITY SPLITTER

ENDS WOOD SPLITTING DRUDGERY

New low cost COMPACT MODEL... for farmers, camps, cottagers. 10 ton ram, 2 cycles per min., splits logs 25" x 18". Carried in car trunk, placed upright or hung for storage. For details write:

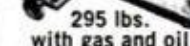

295 lbs. with gas and oil

PIQUA ENGINEERING, INC., Dept. P. Box 605 Piqua, O. 45356

MENTION POPULAR MECHANICS WHEN WRITING TO ADVERTISERS

BEER LOVERS

LEARN THE ART OF BREWING BEER IT'S EASY—IT'S FUN—IT'S CHEAP

The cost is less than 10¢ a quart. For complete instructions send only \$2.00 to

Kraft Supplies, 4078 Kraft Avenue, Studio City, California 91604

"\$23,000 SERVICING RADIATORS"



NEW!
... W. L. Boening, Ferndale, Michigan. Start your own radiator repair shop. Make high profits. Factory training, promotion, guidance. Terms. Send ad with name, address, phone for complete story.

INLAND MFG. CO. Dept. PM-4
1108 Jackson Street • Omaha, Nebr. 68102

BUILD YOUR OWN-SAVE

"BOAT TRAILER"

14'-19' TILTING BED DESIGN BROCHURE 25¢



PLANS \$3.00
GARCEL CO. BOX 612, WALLINGFORD, CT., 06492

POPULAR MECHANICS

CLASSIFIED ADVERTISEMENTS

Rate: \$1.85 per word payable in advance each insertion. Capitalized words—75¢ per word additional. Minimum insertion ten words. To be inserted under the proper classification, copy must be in our office by the 15th of the second month preceding date of issue. The next available issue to place an advertisement in America's No. 1 Classified Section is June. The closing date is April 15th. Send remittance and order to C. A. Martin, Popular Mechanics, 224 West 57th Street, New York, New York 10019. Please make remittance payable to Popular Mechanics.

POPULAR MECHANICS

AUTOMOBILES

DEPRESSION PRICES. No inflation here. All late model police cars. All top condition. Brought in from throughout the USA. Fords, Chevrolets, Plymouths, 1967's, \$495. 1968's, \$595. Deliveries arranged. For order forms and information write Pan American Auto Wholesalers, Dept. PM, 1766 Bushwick Ave., Bklyn, N.Y. 11207 or call 212-342-1700.

1969 AUTOMOBILES \$999.00. Small delivery charge. Catalog \$1.00. Bargains. Hawthorne, N.Y. 10532.

MIDGET CARS

YOUR Ad in Popular Mechanics will be seen by more than 5,000,000 active buyers for your products and services. It costs only \$1.85 per word. And, if you wish to run all or part of your ad in capital letters—you can do so for as little as 75¢ per word additional. Act now! Place your Classified ad in Popular Mechanics today.

AUTO SUPPLIES AND EQUIPMENT

GROSE-JET 2 BALL CARBURETOR needle and seat replacement. ONLY \$3.50-\$9.00 per set. BETTER performance, idle economy, STOPS flooding, stalling & loading. FREE TRIAL—send make of car—no. cylinders & make of carb & no of barrels. Guaranteed 20,000 miles. Herbert C. Grose, 8 Mt. Vernon St., Stoneham, Mass. 02180 Decals .50 ea, 3 for \$1.00.

VOLKSWAGEN and Dune Buggy Accessories. Catalog 50¢. Gem Products, Box 845P, Carol Stream, Ill. 60187.

PARTS: Army jeep and truck parts. Spare Parts & Equipment Co., P.O. Box 751, Lexington, Ky. 40502.

CROSLEY. Foreign, American, Parts. Discounts Accessory Catalog 616 Burnside, Inwood, New York 11696.

AUTO Parts for old and new Cars. All makes. Catalogue \$1.10. Antique Auto, Milwaukee, Wisconsin 53204.

BE Your own ignition expert. Free details. Q-arc, Box 47876, Los Angeles, Calif. 90047.

CAPACITOR Discharge Ignition System, automobiles, motorcycles, snowmobiles, under \$25.00. Sydmar: Midwood Station, Brooklyn 11230.

REVITALIZE—Save your transmission. \$2.50 postpaid. Guaranteed. Profitable for salesmen. Weldtite, 120 N. Fourth St., North Wales, Pennsylvania 19454.

VOLKSWAGEN Replacement Parts. Save 20% to 50% on VW mechanical parts and accessories. Send 25¢ for catalog. Western Distributors, Box 316 E. Cedar Crest, New Mexico 87008.

HIGHWAY Emergency Distress Signal Kit. Signal From Automobile. Immediate Response From Motorists. Send \$2.00. Kaufman Supply Co., P. O. Box 126, Clio, Mich. 48420.

AMAZING new product—Fiberglass— protects against dulling, checking. Ignition system—stops short circuiting and arcing. Waterproof, rustproof, flexible, can be bent to 180 degrees. \$3.25 postpaid. International Material Inc., P.O. Box 1004, Richardson, Texas 75080.

NEW—Emergency Card For Cars. Free Details; Ree Enterprises, Box 667 X, La Puente, Calif. 91744.

UNBELIEVABLE Huge Savings!! (Repairs, Gas, Oil) with Ring-Valve Job while driving. \$6.50 postpaid. Lasts 100,000 miles! Nothing Compares! Motaloy, Grantham, Penna. 17027.

EVERYBODY Needs Portable Air Tanks. You Get Tanks FREE. Fixtures Wholesale, Lynn, Box 863, Stone Mountain, Ga. 30083.

NEW Patented combination tach-dwell and timing lite \$54.50. R. J. Schuler, P.O. Box 8537, Detroit, Michigan 48224.

CONTROLLED Upper-Cylinder lubrication gives easier starting, eliminates costly overhauls. Patented, FAA approved. Details \$2.00. System \$24.95. LeMar Research, 2717 San Lucas Lane, Costa Mesa, Calif. 92626.

AUTOMOBILE STABILIZERS: Thousands sold for \$289.95. Buy direct. \$50.00 Guaranteed. Lynn, Box 863, Stone Mountain, Ga. 30083.

RACING Parts, catalog \$1.00. Speed-O-Motive, Box 1727-PM, South Gate, California 90280.

JEOP Owners—V8 conversions. Read Jeep Owners' ad, page 234.

SNOWMOBILES

SNOWMOBILES—Haul the family in scale-model Canadian Logging Sleigh—Authentic, Tough, Field-Tested Sleigh for the home craftsman—For detailed plans send \$3.75 to: Bobolink, Box 276, Haliburton, Ontario, Canada.

AUTO TRAILERS

BUILD Your Pickup Camper. Precut Kits. Blueprints. Supplies. Literature 25¢. Comstock Trailers, Dept. 664, Parsons, Kansas 67357.

PICKUP Camper, Trailer or Pickup—Cover . . . Build yourself. Save! Complete plans \$3.95 each Cover plans \$2.00. Conversion Plans—econoline type van \$2.95; passenger bus or delivery van \$2.95. Satisfaction Guaranteed. Equipment catalog \$1.00 (refundable). Details 10¢. Viking Camper Supply, 99-F Glenwood, Minneapolis, Minn. 55403

CAMPING Trailer, sleeps 6. 15 photos, complete plans \$3.50. Canvas top and kits available. Circulars 15¢. Stratford Trailers, Stony Creek, Conn. 06405.

CAMPER & Trailer Kits—Assemble your- self, save 1/2 over factory built. 12 models: Pickup Truck Campers, Pickup Covers, Travel Trailers, Folding Tent Trailers. Big line of accessories. E-Z terms, money-back guarantee. Free 24 page color catalog. Luger, Dept. TW-70, 1300 East Cliff Road, Burnsville, Minnesota 55378.

CAMPER plans and full sized patterns. The most detailed available with written and pictorial instructions. Various models and accessory kits offered. Send for literature—Glen L. 9152—PM4—Rosecrans, Bellflower, California 90706.

MOTORCYCLES, BICYCLES, MOTORSCOOTERS AND SUPPLIES

ELECTRIC Bicycle. Ride All Day For Nickel. Complete Plans \$3.00. Electro, Box 27203P, Indianapolis, Indiana 46227.

BUILD "Popular Mechanics" MINIBIKE featured June 1967 issue. Detail plans, photographs \$2.50 refundable. Kits, parts, engines; factory discount prices. Catalog 25¢. Giliom Mfg.: PMC; St. Charles, Missouri 63301.

SNOW VEHICLE & KART Hop up access- ory CATALOG. Speed and performance equipment—manifolds, engine mounts, exhaust systems. Send 25¢. G.E.M. PRODUCTS, Box 845, Carol Stream, Ill. 60187.

ILLUSTRATED Catalog 25¢. Parts, Accessories. Custom Stock, most makes, models. Cycle Supply, Box 192M Fairbury, Ill. 61739.

BUILD Motorbike From Bicycle! Plans \$2: Go-Cart Plans . . . \$2: Snowmobile Plans . . . \$3: Go-Byk Industries, Rothsay, Minn. 56579.

MOTORCYCLE TURN SIGNALS Access- ories. Catalog 25¢. Houston, PM Lockport, Illinois 60441.

BARGAIN PRICES. Every part, Kart or Mini-bike. Giant Catalog \$1.00. New, "how-to" plans \$1.00. Both, \$2.00. Brown's Motorsports, 19P Central St., Worcester, Mass. 01608.

MINI-BIKES. Clutches. Engines. Wholesale catalog 25¢. Loren Products, Danville, Illinois 61832.

MOTORIZED your Bicycle with Lawn Mower Engine. No Welding. Easy Plans \$2.00. Motor's, Box 415, Baraboo, Wisconsin 53913.

MINI-CHOPPER & MINI-BIKE Plans \$3.50. No welding, easy to make. Techna Plans, 3133 Spring Park Road, Jacksonville, Florida 32207.

INDIAN PARTS. Rebuilding. Accessories. Indian Motorcycle Sales, Kansas City, Missouri 64127.

SPACE, ROCKETS AND ASTRONAUTS

"SPACE Jewelry. Complete list 10¢. Space Jewelry, P.O. Box 5191M, Huntsville, Ala. 35805."

ROCKETS!! Real flying models—2500 feet altitude with powerful motors. Terrific Science Projects. Tubes—Cones—Parachutes—Launchers—Igniters. Gigantic catalog—rocket data—diagrams—25¢. Fast Delivery. Centuri Rockets, Box 1988, Phoenix, Arizona 55001.

ROCKETS: Real flying models—flights up to 2500 ft. New illustrated catalog 25¢; Singles and multistage kit, cones, engines, launchers, trackers, rocket aerial cameras, technical information. Fast service. Estes Industries, Penrose 7, Colorado 81240.

ROCKET Engine Performance Handbook. Learn some methods used in NASA Apollo Program \$1.00. Propulsion Associates Division, P. O. Box 58304, Houston, Texas 77058.

TRANSMITTERS And other electronic devices for Model Rockets. Information 10¢. Microdyne Electronics, Box 477, Bozeman, Montana 59715.



AVIATION

PRIVATE Pilots license. New half price plan includes everything. Details \$2.00. Electro, Box 27203P, Indianapolis, Indiana 46227.

BE A Government licensed aviation mechanic. Practical training. Free information. Aero Mechanics School, Municipal Airport, Kansas City, Missouri 64116.

AIRBOAT. Propellers, Engines, Plans, Kits, Supplies. Complete Airboats Outboard Airdrives. Catalog \$1.00. Banks-Maxwell, Box 3301E, Ft. Worth, Texas 76105.

AVIATION Surplus Big Catalogue 50¢ (Refundable). Box 1TFPM, Spring Grove, Penna. 17362.

AERO-CAR. Amazing Hovercraft built easily with ordinary tools. Lawnmower engine power. Carries one man plus. Hovers, flies forward, backward, sideways over land/snow/water. Complete construction plans and brochure. \$5.25. Aero-Projects, Box 5118PM, Clinton, N.J. 08809.

HOMEBUILT. Real enclosed helicopter. 24 pages ideas, information, \$2.50. Build "executive" helicopter, drawing, specifications, \$2.00. Helicopter Development, Box PM147, Washington, New Jersey 07882.

FREE Catalog. Aviation Space Books. Aero Publishers, 329 Aviation, Fallbrook, Calif. 92028.

HOMEBUILT helicopter, gyroplane and airplanes **PLANS** and **KITS**. Complete literature \$3.00 (refundable). Genest Aircraft (PM), 6200 Iberville, Montreal 331, Quebec, Canada.

TWIN-Engine Airboat using 25 H. P. engines. Plans \$5.00. Ice Sled, optional pontoons for water use. Plans \$3.00. Hovercraft Plans \$3.00. Supply Catalog \$1.00. Esco-E, Box 3379, Sarasota, Florida 33578.

HELICOPTER. SNOWMOBILE. HOVERCRAFT. AIRBOAT. Bubble canopy. One-Man, Portable, Kits, Plans, Information 20¢ each. Photos and three-view drawings \$1.00 each. COMPCOP, Box 1267, Redwood City, California 94064.



BOATS AND TRAILERS

AMATEUR Boat Building Magazine. Plans, Discounts, books, instructions. 3183 Merrill, Royal Oak, Michigan 48072.

BOAT BAILER: AUTOMATIC: Small Craft. A check ball does it; and it won't forget! Only \$5.95. Write: De Persia AUTOMATIC BAILER, INC., Grand Haven, Michigan 49417.

CANOE! Kayaks! Factory-direct quality kits, from \$25.00. Many different models. Canvas hulls. Strongest construction materials. Free literature. Sportsraft, Box 8393-PM, Columbus, Ohio 43201.

BOAT PLANS, FRAME KITS, BOAT KITS. World's largest catalog—Over 200 top design for the amateur builders. New catalog includes Cruisers, Runabouts, Deep vee's, Catamarans, Trimarans, Houseboats, Sailboats from small sail fish to 34 ft. motor sailers, large selection of in-board and outboard Hydroplanes. Send \$1.00 for large new plan & kit catalog or \$2.00 for catalog plus Boat Builder's Guide. Clark Craft Boat Company, 16-P Aqua Lane, Tonawanda, New York 14150.

BUILD Your own boat from our large-scale blueprints. Books of plans give how-to-build help. Hundreds of professional designs—motor, sail or auxiliary—for amateur builders. Free catalog. MoToR Boating, 959 Eighth Ave., Dept. PM-RS, New York, N.Y. 10019.

FIBERGLASS Cloth and resin. World's finest cloth and non-run resin, at direct mill prices Flotation foam. Complete line of plastics, silicon bronze and brass screws, save 60%. No sales tax. Boat Plans. Catalog 25¢. Freight prepaid. Stiles Boat Supply, Box 11P, Linden Ave., Mantua Hts., N.J. 08051.

PLANS, FULL-SIZE PATTERNS, FRAME KITS with step-by-step instructions specially for amateurs. Send \$1.00 for new 96 page catalog of over 80 designs: 8' to 36' Sail, Jets, Inboards, Outboards, Cruisers, Houseboats, Hot Boats, Catamarans, Hydros "plus" boat trailers. New "How To Build Boat Trailers" book \$4.00 ppd. Glen Designs, 9152 Rosecrans, Bellflower, Calif. 90706.

BOAT maintenance information. **LIFE-CALK. "GIT"-ROT. LIFE-GLAS.** Finishes & Cleaners. Send for "How to do-where to do" literature. **FREE.** Boatlife, 5-45 49th Av., L.I.C., N.Y. 11101.

PLANS, Kits: canoes, kayaks, sailing rigs, accessories. Free Catalogue. Quicksilver, 115 McGavock Pike, Nashville, Tennessee 37214.

BOAT Kits. Molded Fiberglass. Save money—assemble yourself. Factory molded sections bond into one-piece craft. 20 models—14' to 32'. Cruisers, Runabouts, Houseboats, Sailboats. Big line accessories, motors, trailers. Easy terms. Free 80 page catalog. Luger, Dept. BC-70, 1300 East Cliff Road, Burnsville, Minnesota 55378.

SAIL BOAT KITS. Molded fiberglass and wood for Snipe, Lightning, Penguin, and many others. Free catalogue on sail boats, canoes, ice boats, and fiberglass and sail making supplies. Taft Marine Corp. 636 3/4 39th Avenue, Minneapolis, Minnesota 55421.

KAYAK Kits, inexpensive professional models. Exclusive Nylon hull, aluminum trim. One day assembly. S-T Kayaks, Stony Creek, Conn. 06405.

BUILD AQUA CYCLE, a nine foot outboard powered boat, that rides, controls, and handles like a motorcycle. Send 25¢ for illustrated brochure. Plans set \$5.00. Sprint Marine, Box 7732, Spokane, Washington 99208.

250 PLANS, Some kits. Catalogs: Powerboat \$1.25, sailboat 50¢. Marinecraft, Box 161-M, Brighton, Mass. 02135.

CONVERTIBLE TOPS, Side Curtains. Folding Frames. Save 80%, make your own. Free information. Product Engineering, 1900 Thunderbird, Florissant, Mo. 63033.

NEW 1969 McCulloch and other Outboards. 4 H.P. \$116 9 Electric \$288 18 \$358 25 \$399 55 Electric \$818 85 Electric \$978 All sizes. Literature 50¢. Electra Marine, 1427 Broadway, Brooklyn, New York 11221.

FIBERGLASS Boat covering. Wholesale prices. Free literature and sample. Seifert's, Box 1206-M, Green Bay, Wis. 54305.

FIBERGLASS Canoes, Kayaks, and Duckboats. Many exciting models. Easily assembled kits. \$39.95 up. Free Literature. Riverside Canoes, Box 5595P, Riverside, Calif. 92507.

CAMPER Levelling problems? Free information. Campfire—1, 10943 Hillcrest, Kansas City, Mo. 64134.

MARINE EQUIPMENT AND SERVICES

CONVERT Auto engines to marine. 68 Page Catalog, 50¢. Lehman Manufacturing Company, 800 Elizabeth Avenue, Linden 4, New Jersey 07036.

RELIABLE Electronic fuel gauge \$74.95. Kit \$36.95. Plans \$4.95. Free Brochure. Marine Systems Inc., 1404 Highland, Melbourne, Fla. 32935.

MARINE CATALOG, 1970 Brandname Discounts. \$1—refundable. Northeast. Box 561, Newtown, Conn. 06470.

ATHLETIC AND BODY BUILDING COURSES

"GIANT Arms." Dr. Young's, D.C. revolutionary discovery. \$2. Satisfaction or refund. Gaucho, Box 9309-S7, Chicago 60690.

POWERFUL Muscles fast! Free brochure! Universal Bodybuilding, Box 4327-C, Dearborn, Michigan 48126.

MUSCLES—Without willpower! New research breakthrough. Three month satisfaction refund. Only \$3.00! Science Research Associates, Department 102, Box 1634, Atlanta 30301.

MIGHTY muscles fast! No weights. Complete illustrated course only \$4.00. Free details. Avron, 9315 Avenue "A", Brooklyn, New York 11236.

BAR-BELL Course. \$1.00. Catalogue 10¢. Harry Good, B-228, Cassville, Missouri 65625.

CATALOGUE, KungFu, Karate, Equipment, Supplies, Weapons, Books, all for \$1.00 or free with purchase of Master Wong or Lee's Deadly KungFu Manuals—\$5.95 each; Orient East Weapons Company, 3577 West Lyndale, Chicago, Illinois 60647.

SPORTING GOODS AND EQUIPMENT

FREE Wholesale Catalog. Arrow Shafts, Broadheads, Fletchings Fisharrow Parts, Tools, Bows. Finnysports. (22G), Toledo, Ohio 43614.

FREE 1970 Catalog. Guaranteed Lowest Prices! Rods Reels, Lures, Accessories—Thousands of Item. Cabela's Inc., Dept. S, Sidney, Nebraska 69162.

ARCHERY Lowest Discount Prices. All top brands. Orders shipped same day received. Money-back guarantee. World's Largest Supplier, Free catalog. Anderson Archery Corporation, Grand Ledge, Michigan 48837.

WHOLESALE Pool Tables and Kits. Sportsman, 444 11th, Clarkston, Wash. 99403.



FISHING, TACKLE, LURES

SEND for FREE Wholesale Catalog. The most complete and fully illustrated catalog of reels, rods, beads, spinners, jigs, bodies and parts, sinker molds, feathers, tools, hooks, rod blanks, rod parts, swivels, wire, etc. FINNYSPTS, ME Sports Bldg., Toledo, Ohio 43614.

MOLDS—For casting your own fishing sinkers. Free illustrated booklet. Reading Instrument Co., Box P78, Reading, Pa. 19603.

(Continued on next page)

FISHING, TACKLE, LURES

(Continued from preceding page)

CRAPPIE Jigs \$1.00 per dozen. Buy 5 dozen get dozen free. P.P.D. C.O.D. add 50¢. Assassinator Lures, Box A. Oak Grove, Missouri 64075.

BEST-LUCK-FISHIN'—CATCH MORE FISH. Twelve Bait Recipes \$1.00—Refundable. H. Z. Box-331, Dallas, Texas.

EARTHWORMS, LIVE BAIT

BLACK Widow Ranchers!! Big Guaranteed Market! Free Stock! NBWC, P.O. 260-XPM, Brigham City, Utah 84302.

EARN Money raising fishworms for us! Exciting details free! Oakhaven—56, Cedar Hill, Texas 75104.

SUCCESS for you! Raise red wigglers, crickets, mealworms, 6 inch garden wigglers, 12 inch African worms. We teach you to raise and sell. Make money fast! Free Literature. Carter Redworms, Plains, Georgia 31780.

GROW FISHWORMS. Outstanding New Breed produces great profits! Free Literature. Fain's Hatchery-31, Edison, Ga. 31746.

HYBRID Redworms 5000 — \$10.00, 20,000—\$20.00 Postpaid—with Raising Instructions. Brazos Worm Farms, Route 9, Waco, Texas 76705.



HUNTING, GUNS, DECOYS

"Make A modern Jivaro Blowgun. Send \$2.00 for full construction details. Mountain Products, Box 1922D, Glendale, Cal. 91209."



POULTRY & GAME BIRDS

QUAILS, Incubators, cages, supplies catalog. Marsh, 14216 Brookhurst, Garden Grove, Calif. 92640.

GAME BIRDS. . . Eggs or chicks, Pheasants, Chukars, Ducks, Quail. Write for free price list. Northwest Farms, Inc., Box 3003-PM, Portland, Oregon 97208. 503/233-4695.

RABBITS—FUR BEARING ANIMALS

RAISE Rabbits successfully by knowing facts. 48 page illustrated book describing 25 breeds. Housing, breeding, feeding, markets, marketing etc. 25 cents. American Rabbit Association, 36 Arba Building, Pittsburgh, Penn. 15217.

MAKE Big Money raising chinchillas, rabbits, guinea pigs for us. Catalog—25¢. Keeney Brothers, New Freedom, Pa. 17349.

RAISE Rabbits for us on \$500 month plans. Free details. White's Rabbitry, Mt. Vernon, Ohio 43050.

\$500—\$800 MONTHLY Raise small Laboratory-breeding stock for us. We supply equipment, breeders, and instructions. Illinois Research Farms, Dept. MPB-4, Barrington, Illinois 60010.

AMAZING PROFITS! \$10,000 Yearly Raising Rabbits for Wool and Breeding. Details 25¢ coin. American Angora, Malta 12, Montana 59538.

PETS—BIRDS, CATS, HAMSTERS, ETC.

LIVE Traps, all sizes, mouse to dog. Collapsible or rigid. Carrying Cages. Free literature. National Live Traps, Tomahawk, Wisconsin 54487.

LIVE SEAHORSES, Marine Specimens, aquarium supplies. Illustrated catalog 20¢. Marine, Box 248-310, Dania, Florida 33004.

FREE Collar, book, chain with every monkey \$15.95. Monkeys, animals, birds, snakes. List 25¢. The Bazar, Box 3173, Ft. Worth, Texas 76105.

HAWKS, Reptiles, raccoons, skunks, squirrels. Catalogue 25¢. Trails End Zoo, St. Stephens, S.C. 29479.

SEAHORSES, Animals, Aquariums and Pet Supplies Catalog 25¢. Aqualand, Box 130, M-4 Miami, Fla. 33145.

HORSES, LIVESTOCK

"HOW To Train Horses"—Everyone who likes horses or ponies should have this book: Free. Write Beery School, 1104 Pleasant Hill, Ohio 45359.

VETERINARY Guide to Farmers. The only book of its kind. Send \$6.95 to POPULAR MECHANICS, Dept. VG, 224 West 57 Street, New York, N.Y. 10019.

CAMPING EQUIPMENT AND TENTS

FREE Catalog! Camping, Boating, Sailing Supplies; Gadgets, Hardware and Gifts. Laacke and Joys, 1439 N. Water St., Milwaukee, Wisconsin 53202.

JUMBO 1970 Catalog, 132 pages latest camping equipment, clothing, surplus, at lowest prices. Send 25¢. I. Goldberg, Dept. PM4 902 Chestnut St., Phila., Pa. 19107.

EVERY Camper should have this high-way safety kit containing 2 lb dry chemical fire extinguisher, tire inflator sealer, 2 fusee flares, white emergency help flag and handwipes. \$12.75 PP Ripleys Mail Mart, Dept A-1, Scott Depot, W. Va. 25560.

SWEET-JON Deodorant, the new Toilet Deodorant that really works. Kills odors in all kinds of portable and self-contained toilets. Easy, Pleasant and Economical to use. Won't harm tanks or automatic toilets. Based on formula used by U.S. Forest Service for Years. Send \$1.25 for generous 8-oz. supply. Money back if not Satisfied. Olsen Supply Company, 1783 Cahoon Street, P.O. Box 1636, Ogden, Utah 84402. Dealer Inquiries Invited.

CAMPING

SAVINGS Plus dividends! Campers-fishermen-outdoorsmen cooperative. Free 68-page catalog. Recreational Equipment, Inc., 1525-P 11th, Seattle, Washington 98122.

TRAVEL AND RESORTS

"AMERICA BY CAR" Names Best Places to Eat and Stay. Scenic Routes, Parks, Historic Sights. 170,000 Word Book. \$2.95. Satisfaction Guaranteed. Empire House, 607 East Empire, Bloomington, Illinois 61701.

SEE The U.S.A.—and get paid for it. New cars. All points, one dollar. Write "Travel", Box 72, La Verne, California 91750.

QUETICO-Superior Wilderness Canoe Trips. Write Bill Rom, Ely, Minnesota 55731.

ELECTRICAL SUPPLIES

METERS—Surplus, new, used, panel and portable. Send for list. Hanchett, Box 5577, Riverside, Calif. 92507.

APPLIANCE-LAMP Parts. Wholesale catalogue 25¢. SECO, 109 South 20th Street, Birmingham, Alabama 35233.

LO-VOLT Circuit Tester. Handiest ever! Guaranteed, \$1.75. Mathco, 4256-1 Minmor, Cincinnati 45217.

LAMP Parts. Catalog, prices, wiring instructions. 50¢. Refunded first order. Gyro, 5218P N.W. 35 Ave., Miami 42, Fla. 33142.

LAMP Parts for building, repairing converting. Catalog 40 cents. Refunded first order. Brown Lamp Co., Box 12511, Creve Coeur, Mo. 63141.

BATTERIES, GENERATORS

MINIATURE Storage Batteries \$6.50 6V. 2AH. Allow for postage. Lilly Electronics Co., 14809 Snowden, Detroit, Mich. 48227.

BATTERY Reconditioning Kit, includes molds, material, instructions. Battery Shop, Route 1-188D, Blythe, Calif. 92225.

ELECTRIC Power units. 5-KW to 60-KW, gasoline and diesel. K. A. Weimer, 1300 Richard Road, Decatur, Ga. 30032.

ENGINES, MOTORS, MAGNETS

WINDING Data, 275 motors. \$1.20. Data Company, 512 Kensington, Kansas City, Mo. 64124.

LIVE Steam powered backyard railroads! All sizes. Complete "bolt-together kits," and rough castings. Excellent drawings. 100 page catalog \$1.00. Little Engines, Lomita, Calif. 90717.

PROJECT PLANS! Motors! Generators! Batteries! Electroplaters! Modequip, Box 7266, Kansas City, Missouri 64113.

STEAM Engine Kits, Automotive, Marine, Catalog-Handbook, \$1.00. Reliable Industries, New Baltimore, Michigan 48047.

MACHINERY, TOOLS AND SUPPLIES

SMALL Foundry furnaces, Supplies. Free literature. Pyramid Products, 3736 South 7th Avenue, Phoenix, Arizona 85041.

TWIST Drills, high speed, first quality, reasonably priced. Write for price list. M. Lennon, P.O. Box 95, Little Falls, N.J. 07424.

"FREE Catalog. Imported Micrometers and Precision Measuring Tools. Savings up to 50%. Ralmike's, Springfield, N.J. 07081.

FINEST Woodcarving Tools, Supplies, Catalog 25¢—Woodcarving Shop, 3112 West 28th, Minneapolis, Minn. 55416.

END Mills, High Speed, 2-Flute, 1/4" Shank. Used, Excellent Condition. \$3.50 Dozen Postpaid. Lillian's, Box 17165, Chicago, Illinois 60617.

MICROMETERS—Indicators—Steel—Aluminum—Brass, Maximat, Unimat Lathes, Accessories. Lists free; Complete mailing—50¢. Campbell, 1424 Barclay, Springfield, Ohio 45505.

LATHE Milling attachments. Blueprints too! Write. Potter, Box 73, Cedar Rapids, Iowa 52406.

BIG 170 page tool and hardware catalog \$1.00. Refunded. Elwick, Dept. 123, 230 Woods Lane, Somerdale, N.J. 08083.

WELDING, SOLDERING, PLATING

WELDERS—110/220, 150 Amperes, \$53.50. Morris, 1070 Inner, Schenectady, New York 12303.

CHROME Plating equipment, supplies. All other finishes. Home workshop and production sizes. Send \$2.00 (refundable) for formulas, operating data, equipment guide and catalog. HBS Equipment Division L50, 3543 East 16th, Los Angeles, Calif. 90023.

LINCOLN ARC WELDER. 225 amps AC. Less than \$100 list. Includes holder, helmet, cables, UL approved. Lincoln Electric, Dept. C2, Cleveland, Ohio 44117.

GOVERNMENT SURPLUS

SURPLUS BARGAINS! Government, Industrial, War Surplus at savings to 80%! FREE CATALOG! Write today giving zip code. Surplus Store, PMA, Sioux Falls, S.D. 57102.

GOV'T Surplus. How and where to buy in your area. Send \$1.00. Surplus information, Headquarters Building, P.M., Washington, D.C. 20036.

JEEPS Typically From \$53.90 . . . Trucks From \$78.40 . . . Airplanes, Typewriters, Boats, Clothing, Camping, Sporting, Photographic, Electronics Equipment. Wide Variety, Condition, 100,000 Bid Bargains Direct From Government Nationwide. Complete Sales Directory and Surplus Catalog \$1.00 (Deductible First \$10.00 Order). Surplus Service, Box 820-A, Holland, Michigan 49423.

(Continued on next page)

GOVERNMENT SURPLUS

(Continued from preceding page)

JEEP and Gov't. Surplus Buying Manual (Jeeps Pictured) 50¢. Surplus Bargain Catalogue 50¢. Both \$1. Surplus Bargains, Box 789PM, York, Penna. 17405.

1970 SURPLUS Army, Navy store illustrated catalog. Send 25¢ (refundable with first \$5.00 order). Ruvel, 3037 North Clark, Dept. 9-J, Chicago, Illinois 60614.

JEEPS From—\$52.50; Typewriters from—\$4.15; Cars from—\$31.50. Walkie-talkies, motorcycles, airplanes, boats. Typical "As Is" bid bargains from Uncle Sam. Tremendous variety. Exciting free list. Write: Enterprises, Box 402X57, Jamaica, New York 11430.

NO catches, all information. You can buy any kind of Government Surplus. Send \$2.00, Bridgeworth, Box 2292-C, Vancouver, Wash. 98661.

JEEPS \$53.00, 1969 Autos \$799, Cameras, Guns, Catalog \$1.00. Bargains, Hawthorne, N.Y. 10532.

HOBBIES AND COLLECTIONS

SHOULDER PATCHES—Collectors items: Official Apollo 11 patch \$3.00 postpaid. U. S. Army and Air Corps patches. Special patches made to order. 10 assorted patches, price list and catalog \$2.50. Catalog only, 25¢. SPRINGER'S, Box 577-PM, El Paso, Texas 79944.

COLLECT Regimental Crests: 3 samples and 32 page military catalog, send 50¢ postage, handling. Insignia, Box 71-M Rockaway, N.Y. 11694.

50 GORGEOUS Jungle butterflies \$2.50. Collectors Wonderland, Box 1170, New York 10008.

Old Picture post cards, Colorado scenes only. Send \$2.25 for 100. Kenneth D. Cameron, 2555 Upham, Lakewood, Colorado 80215.

UNUSUAL Very beautiful English Lantern clocks, complete parts, easy assembly. \$1.00 brings colored photograph, details. Traditional Clocks, Box 32032, Cincinnati, Ohio 45232.

"THE CHARGE of the Light Brigade! Imagine, your own shimmering collection of silver, gold badges of famous light brigade regiments! 100% genuine. Hussars! Lancers! Gunners! Velvet plaque, histories, free. \$5 complete. Military Museum, Box 444, Islington, Ontario 100".

EMBLEMS, BRASSARDS, PATCHES

SHOW YOUR PRIDE IN AMERICA. Full color auto bumper sticker depicting American Flag with motto "I'm proud I'm an American." Only \$1.00. Kenneth McMillan, 1220 Duke Way, Cocoa, Florida 32922.



STAMP COLLECTING

POSTMARKED MOON! Valuable Moon Landing First Day Cover postmarked from die taken to Moon and back by Apollo 11 Astronauts. This unique Cover features century-old wood cut from Jules Verne's 1869 novel predicting 3 Americans would be first to land on Moon! We'll give you one Free of extra cost to introduce our famous Approval Service. Buy \$1 worth and get extra bonus of 110 stamps including spectacular Space Issues, plus illustrated Album—or buy nothing, return stamps and album, cancel service anytime. Moon Cover is yours to keep in any case! Send 25¢ for postage and handling today. Kenmore, MC-534, Milford, New Hampshire 03055.

RUSSIAN Space collection 10¢. Russian Approvals, Snedco, Box 68-P, Waldwick, N.J. 07463.

60 DIFFERENT U.S. (30 Commemoratives) 25¢. No approvals. Seidenberg, Salem 169, Oregon 97308.

I PAY \$250 EACH for 1924 1¢ green Franklin stamps rotary perforated 11 (\$2,500 unused). Send 25¢ for illustrated folders showing amazing prices paid for old stamps, coins, collections. Vincent, 85 PM, Bronx, New York 10458.

FREE 400 Genuine postage stamps! Worth \$10.00 at catalogue prices. Africa, Europe, Asia, British Emp.—a fascinating valuable mixture from foreign convents, banks, etc. Who knows what you will find. Also free valuable booklet. Adults only. Approvals enclosed, Frasek Co., PM-4, White Plains, N.Y. 10601.

SURPRISE COLLECTION! Exotic mint British Colonials, absolutely free with approvals. VIKING, Great Neck 8, N.Y.

"UNUSUAL" Set 10¢. with approvals. Gorliz, Box 1915PM, Naples, Florida 33940.

FAR East Assortment—Viet Nam, Japan, Korea, Formosa and others only 10¢ with worldwide approvals, Clark Stamps, Dept. 57 V, Muskegon, Mich. 49444.

ONE CENT a Stamp. Write for a jumbo book of Foreign stamps at 1¢ each, mounted in Scott order, PP, Bullot, 6815 Bay Parkway, Bklyn., N.Y. 11204.

NUDE Collection 10¢ with approvals. George, Box 599; Chicago, Ill. 60690.

DEFECTIVE Old U.S. Approvals. Karl Swartz, Box 373, Venice, Fla. 33595.

PAKISTAN 25 Different 10¢ approvals. Lansdowne Stamp Co., Box 257, Lansdowne, Pa. 19050.

PENNY! Approvals! Regardless catalogue! Kloster, 4164 52nd St., San Diego 5, Calif. 92105.

500 DIFFERENT Stamps, \$1.00. Smith, 508-A Brooks, College Station, Texas 77840.

50 YEARS Old, fifteen different United States, over fifty years old—10¢ with approvals. Jaxon, Box 145-P, Brooklyn, New York 11230.

FREE 50 Worldwide. Approvals. University Stamps, P.O. Box 1471, Lake Worth, Florida 33460.

GIANT Stamp Collection including: Astronauts, Satellites, Moonrocks, Boy Scout issue. Complete U.N. Set, recent Olympic and Sport issues from many countries, etc., Plus Big Stamp Dictionary and approvals. Everything 10¢! Stampex, Box 47-RM, White Plains, N.Y.

ABSOLUTELY FREE 25 different United States Commemoratives when requesting United States Approvals. K & B, Box 70, Brooklyn, N.Y. 11223.

FREE! Big Bargain Catalog—New Edition listing thousands of bargains including U.S. & B.N.A. stamps, packets, albums, accessories and supplies. Also, fine stamps from our approval service which you may return without purchases and cancel service at any time. Jamestown Stamp, Dept. E40PM, Jamestown, N.Y. 14701.

WOW! 110 All Different Germany 10¢. Commemoratives. Airmails, High Values. Big catalog, bargain lists. Also, fine stamps from our approval service, which you may return without purchases and cancel service at any time. Jamestown Stamp, Dept. A40PM, Jamestown, N.Y. 14701.

U.S. Mint specials! Flag set, complete \$1.00. 1¢, 2¢, 3¢ famous Americans (21 different) \$1.00. Free list. Brooks, 2601 Avenue "U," Brooklyn, N.Y. 11229.

100 OLD United States between 1861 and 1935, \$1.00. Roush Stamps, 51 Chestnut, Mansfield, Ohio 44903.

50 DIFFERENT United States Commemoratives only 10¢. Approvals Included. Shelton, Box 547 C, North Miami, Florida 33161.

1500 FOREIGN \$1.00; 5000 \$3.00; 9000 \$5.00; 5000 USA, Contains airm. dues. 19th Century, presidentials, revenues, high values, etc. \$3.00, 300 pre-1939 USA commemoratives \$2.00, 200 pre-1926 USA \$1.00; 700 \$3.00; 3000 \$12.00. No approvals. Meyers, 5321 Fleming, Richmond, Calif.

"GORGEOUS" Sets Free. Request Approvals, Martell, Box 421, Westerly, Rhode Island 02891.

UNITED STATES commemorative collection containing 33 different—10¢. Approvals. White, 516-A Avenue L, Brooklyn 30, New York.

50 DIFFERENT U.S. Commemoratives, 10¢. Approvals, Cambridge, Box 2311, Heath, Ohio 43055.

FREE: Triangles, Scout, 25 others. Approvals, Cambridge, Box 2311, Heath, Ohio 43055.

ONE Pound value Geo. VI Bermuda, plus 100 worldwide 10¢, approvals. Stevens, Box 105A, Homecrest Sta., Brooklyn, N.Y. 11229.

"SPACE" Pictorials, others, 110 Different—10¢! Approvals. Shaw, Drawer E-64, Montevallo, Alabama 35115.

PICTORIAL BONANZA! 10¢ Brings gorgeous collection. Includes sports, space, paintings, animals. Also, other stamps to examine. Buy any or none, return balance. Romar Stamps, Box 8642, Kansas City, Missouri 64114.

UNITED STATES. Fascinating approvals, and lists that are replete with bargains and specialties. Remarkably different. Adult beginner or advanced, you'll be amazed. Engle, Box 8P, Lowell, Mich. 49331.

RYUKYU Turtles complete set 15¢ approvals. Herman Mills, 237 Ashworth Avenue, Toronto 4, Ontario, Canada.

20 GIANT Paintings 25¢ with approvals! Roger Williams Stamp Co., Box 1281-P, Pawtucket, R.I. 02862.

U.S. Bargain, 50 different 10¢, with beautiful worldwide, approvals. Stamp Center, Kennebunk, Maine 04043.

14,000 DIFFERENT! AMAZING new plan builds your collection systematically, country by country. Only 50¢ weekly. Ware, Monroe, Conn. 06468.

CANADA Sports complete, 10¢. Canada approvals. Valley Stamps, Little Valley, New York 14755.

QUALITY AND LOW PRICE. EXCELLENT For advanced or beginner. Mounted approvals 2¢ up, all countries in Scott's Order. Preview Stamps, P.O. Box 9809M, San Diego, California 92109.

EXCHANGE Send 100-200 Different stamps with 25¢. Receive different. Patterson, Lancaster, New York 14086.

"INVERTED ERROR" Dag Hammarskjöld. 6¢ with approvals. Belmont Stamps, Washington, D.C. 20015.

WOW! \$25.00 VALUE! 1000 Different Worldwide \$1.50 with PROFIT SHARING APPROVALS. Universal, Box 6-A, Kenosha, Wisconsin 53141.

RUSSIA High-Value Collection. 32 different Russia—some over 50 years old! Commemoratives, Czarist issues, Airmails, Catalog price \$2.50. Special Get Acquainted Offer—all for only 10¢! H. E. Harris, Dept. GG 49, Boston, Mass. 02117.

225 STAMPS for only 10¢! Airmails, Pictorials: stamps from strange countries cataloging up to 25¢ each! Plus unusual stamps to examine. Buy any or none return balance, cancel service anytime. Mystic Stamp Co., Camden 80, New York 13316.

U.S. Approvals Low prices. Eagle, 2221 Romine Ave., Pittsburgh, Pa. 15226.

(Continued on next page)

STAMP COLLECTING

(Continued from preceding page)

50 DIFFERENT Old U.S. Revenue stamps 50¢. Winchester Stamps, Box 1592, Mansfield, Ohio 44907.

ASIA—100 Different, including pictorials, 10¢. Approvals. Tarheel Philatelics, Siler City, North Carolina 27344.

50 DIFFERENT AFRICA plus SOUVENIR SHEET 25¢—Approvals accompany. Quynn's, Scotland, Penn. 17254.

JUMBO JETS are here and first flight covers like those of early historic Jet flights are becoming scarce. Get yourself one before they go higher. Official post-markings indicate routes they flew. 50¢ each or 5 all different for \$2. K. M. WALSH, Box 308, TUCKAHOE, N.Y. 10707.

FREE duplicate exchange. Details 10¢. approvals. Belden, Box 4175b, Dearborn, Michigan 48126.

UNBELIEVABLE Low Prices: Generous Lot 30 cts., Large Assortment \$1. High Value Packet \$2.—Persile, 436 N.Y. Ave., Brooklyn, N.Y. 11225.

NEW Issues—Free weekly illustrated list. Brooks, 2601N Avenue "U," Brooklyn, N.Y. 11229.

VIETNAM 25 Different 10¢ approval. Sam Chazen, Box 95, Ozone Park, N.Y. 11417.

FREE Surprise collection sent with approvals. Gould, 1784 Union, San Francisco 94123.

MILLIONS Foreign Stamps! 2¢ each! Send for gigantic approvals! ABC, Box 6000-MB, San Francisco, California 94101.

IRELAND! 25 different 10¢. Approvals. John Mullins, 10321 Muskegon, Chicago, Illinois 60617.

255 DIFFERENT Worldwide: 15¢. Approvals. Tibbets, 8675 Meadow, Downey, Calif. 90242.

FREE Stamp Wallet with approvals. Wide choice collections by Countries. Clark, Box 428, Northbrook, Illinois 60062.

DESIRABLE SETS—3 different 10¢ with quality approvals! Cole, Box 223A, Buffalo, N.Y. 14221.

FREE!! Two Beautiful Multi-Colored Complete Mint Sets. Approvals. Hamilton, 1246 Pratt, Chicago OE-4, Illinois 60626.

500 DIFFERENT Stamps 35¢. Approvals. Adults Only, Stamps, Box 4155M, Tulsa, Oklahoma 74104.

MONACO 50 Different all mint \$1.00. Approvals accompany. Wendell Heywood, Box 291, St. Johnsbury, Vt. 05819.

SPAIN 50 different 5¢. Approvals. HIJOP, Box 505, Norristown, Pa. 19404.

HITLER—Mussolini 1941 Axis Commemorative Mint Set \$1.00. Satisfaction Guaranteed. Approvals. Iannuzzi, Box 76241-A, Los Angeles 90005.

100 FRENCH COLONIES \$1.00! Ross, 320 Rockland Road, Wayne, Pa. 19087.

PENNY Stamps! 1000 Mounted in book at 1¢ each. Trast Stamp Company, P.O.B. 100, Jamaica, N.Y. 11435.

STAMPS Free! New issues—New Countries—Triangles—Rockets—Olympics—Scouts—Birds—Flowers—Animals—Also old Canadian and U. S. Stamps. Plus complete illustrated Canadian Stamp Catalog. Send 10¢ for mailing. Gray Stamp Co., Dept. A, Toronto, Canada.

100 DIFFERENT FINE QUALITY Worldwide \$1.00. Approvals if Requested. Robert Heath, P. O. Box 6001, Hannegan Sta., St. Louis, Mo. 63139.

APOLLO Eleven Astronauts, Moonlanding Vehicles, latest Complete mint Paraguay Commemoratives (7 different)—10¢. Approvals. William Deems, 226 Race, Ravenswood, West Virginia 26164.

SOUVENIR Sheet Free. Request approvals. Lee Hoover, Box 3594, Portland, Ore. 97208.

PICTORIALS: 10 Vatican 30¢; 25 Australia 20¢; 20 Malta 50¢. Approvals? Penniston, 5510 Lee, Arlington, Va. 22205.

SENSATIONAL Free offer, 20 outer space stamps, selected approvals, Louis Morrison 1027 Maryland, Cape May, N.J. 08204.

400 FINE Mixed U.S. 15¢. Wright, Box 753-M Hagerstown, Maryland 21740.

NOW Rockets, Paintings, Giant beauties, others, 10¢. Approvals. Tiquet, Box 1496, Denver, Colorado 80201.

APPROVALS: Plus collections by year. Martus, Box 158, Centuck, Yonkers, New York 10710.

210 DIFFERENT U.S. Commemoratives \$1.00. Stamps, 7607 Larchview, Dallas, Texas 75240.

FREE Large Worldwide Collection with Approvals. W. Lamkin, Farmington, Maine 04938.

PAINTINGS—Multicolored set 10¢. Approvals. Philatelics, Box 2061, South Bend, Indiana 46615.

TEN Different nudes: 20¢. Approvals. Stamp Farm, 2M17, Oxford, Wis. 53952.

CONFEDERATE #6 Superb Mint \$1.00. 48 page U.S. Canada List 25¢. Scarlet, 116 Nassau Street, New York 10038.

COINS, TOKENS, CURRENCY

JOIN Coin Exchange \$1.00. Monthly Auctions Providing Excitement, Pleasure, Profit. Traders, 322 N13, San Jose, California 95112.

COMPLETE SET Lincoln Memorial cents uncirculated including 1970 PDS \$1.25. Complete coin list 25¢. J. & J. Enterprise, 749 North St., Meadville, Pa. 16335.

COMPLETE United States Coin List. Coin Stamp Supplies Plus 70S Lincoln Cent 25¢. Schultheis, Box 151M, New Hyde Park, New York 11040.

50 DIFFERENT Lincoln Cents. Beginning with 1909VDB. Nothing later than 1939. Graded Good-Extrafine, \$8.75 postpaid. Free Catalog. Monterey Coins, 311-PM Homeland Northwest, Albuquerque, New Mexico 87114.

SILVER Dollars Brilliant Uncirculated—1880 to 1902. Ten Different Dates \$32.97. 1931-S Cent Ex. Fine \$21.79. Brilliant Uncirculated \$42.87. List Other Bargains 15 cents. Bebee's, Inc., Omaha, Nebraska 68111.

40 GENUINE Coins from 40 countries. Mostly uncirculated. Beautiful, \$2.00. Hindley, Box 708, Aurora, Illinois 60507.

49S LINCOLN Cent and Price list 10¢. Rich, Box 34133, San Francisco, California 94134.

SILVER Dollars, three different uncirculated \$10.00 or 4 different used \$10.00. Illustrated Catalogue 50¢. Shultz, Salt Lake City, Utah 84110.

ROOSEVELT Dime Specials. All Very Good Or Better. 1949S-80¢. 1955-\$1.50. 1955D-65¢. 1955S-40¢. All Other Dates Are 25¢ Each. Complete Set Of 55 Different With Album For \$14.50. Satisfaction Guaranteed. Bryson Inc., 612 A White, Toledo, Ohio 43605.

40-PAGE Illustrated United States and Canadian coin list 10¢. Stoney, 260 Washington, Boston, Mass. 02108.

EXOTIC LIMA, PERU. Currency Packet containing various coin and paper denominations. \$2.50. Santore, Los Abetos 305, Salamanca-Monterrico, Lima, Peru SA.

WE'LL PAY \$125 each for certain Lincoln Pennies! Nickels \$200! Dimes \$2250. We buy all U.S. coins before 1939. All Foreign. 32 page Buyingbook 25¢. BONANZA, 3962P Ross, San Jose, California 95124.

FREE Coin With Approvals. Merlo, 1527 Anderson Ave., Fort Lee, New Jersey 07024.

BUFFALO Nickels, 3 Different, Only 25¢. Stevens, Box 546F, North Miami, Florida 33161.

DISCOUNT JEFFERSON NICKELS, U. S. PRICE LIST 10¢. PCR, BOX 691, ARLINGTON, VIRGINIA 22216.

COIN-BARGAINS Galore! 10¢ brings large price-list. Premiere Coins—Dept. PM—P.O. Box 7776, Spokane, Washington 99208.

UNITED STATES Coins Cheap! Retail Catalog, 25¢. Buying (prices paid) Catalog, 50¢. Currency Valuation Catalog, \$1.50. Max's, Box 11055-BE Minneapolis, Minnesota 55411.

AMAZING Lincoln MOON PENNY! Pictures Lem Module, both Astronauts, Earth in distance, etc. Only 10¢. Offer made to introduce "Coins on Approval" Service. You may return without purchases and stop service at any time. Littleton Stamp & Coin Company, Inc. Dept. A1, Littleton, New Hampshire 03561.

25 DIFFERENT Foreign Coins \$1.00. D. Hoffman, PM3, Box 98, Clarence, New York 14031.

GOLD COINS of the World. Beautiful low prices. Plus thousands of United States Coins. Free price list. Please send long, airmail envelope, self-addressed, stamped. Silver Center, Box 22171-M, San Francisco, California 94122.

ILLUSTRATED Coin Catalog—\$1.00 Postpaid! "How," Box 276-PM, Noble, Oklahoma 73068.

1909-VDB LINCOLN \$1.25. Price list 25¢. Village Coins Shop, Dept. P, Plaistow, N.H. 03865.

FORTUNES? Finding coins. Standard Catalogue of Coin Values \$1.00 (refundable). Prices guaranteed! Camelot, Box 897, Hamilton, Ohio 45012.

500 U.S. PENNIES Made before 1940. Some INDIAN HEADS included. Only \$17.95 prepaid. Send check to Hercaimy, P.O. Box 1125, Walla Walla, Wash. 99362.

BARGAINS—Latest coin price list, 10¢. Ron Farley, Metamora, Ill. 61548.

RARE Coins—over 110 Years old, \$3.95 each. Large Cent, two Cent, Three Cent, Half Dime, all four \$12.95. Guaranteed Coins, Box 1442, Fort Walton, Fla. 32548.

INDIANHEAD Cents 7 Different \$1.98. Coins, Box 35041, Minneapolis, Minnesota 55435.

ANTIQUES, RELICS, INDIAN GOODS & CURIOS

AUTHENTIC PAPAGO BASKETS—NAVAJO RUGS—INDIAN JEWELRY—Retail Only. P.M.M. Western Wear—7740 E. Colfax Avenue, Denver, Colorado 80220.

TONS Of antique gun parts and supplies. All reproduction muzzle loading guns. Send \$1.00 for enlarged illustrated catalog No. 119A. Dixie Gun Works, Union City 12, Tennessee.

LIST Indian relics. 10 Arrowheads \$3.00. Hyde's, Box 2304, Santa Fe, New Mexico 87501.

10 PERFECT Arrowheads \$4.00. George Smith, 9825 Conway Drive, Indianapolis, Indiana 46236.

INDIAN relic list. Birdpoints \$7.50. doz. Folsom, \$5.00 each. C. Secrist, Muscatine, Iowa 52761.

10 BEAUTIFUL Arrowheads \$2.00. Guajardo's, 8713 Shaver, El Paso, Texas 79925.

MODELS—SHIPS, TRAINS, PLANES, ETC.

SCALE Building materials, 1/4" & 1/8" scale. Windows, doors, siding, roofing, lumber and structural shapes. Send 50¢ for catalog. Small Sales Co., P.O. Box 177, Shawnee Mission, Kansas 66201.

SHIP And yacht model fittings: Pine construction hull kits; blueprints. Send 50¢ for illustrated catalog. A. J. Fisher, Inc., 1002 Etowah Avenue, Royal Oak, Michigan 48067.

SHIP Model kits and fittings: clippers, frigates, etc. Catalog paint-tool list, 1969 catalog 50¢. Models Shipways, Box 65, Bogota, N.J. 07603.

SHIP Models catalog 25¢. Scientific, Inc., 100 Monroe, Newark, N.J. 07105.

ROCKETS: Real flying models—flights up to 2500 ft. New illustrated catalog 25¢. Single and multistage kits, cones, engines, launchers, trackers, rocket aerial cameras, technical information. Fast service. Estes Industries, Dept. 2, Penrose, Colorado 81240.

SHIP Models, Kits, fittings, plans, books, tools, engines, motors. Big illustrated catalog 50¢. Mass. residents add 3% tax. James Bliss & Co., Dept. SM, Route 128, Dedham, Mass. 02026.

MODEL Airplanes—Big 220 Page Catalog 50¢. Sig Company, Montezuma, Iowa 50171.

FLYING SAUCER kit. Fly indoors, outdoors. Rubber launched. \$1.00 PP. Saucer Roonie. 1103 Madison, St. Charles, Mo. 63301.

GAMES, TOYS, PUZZLES, NOVELTIES

"ROULETTE DICE" . . . with a unique, "easy-to-learn" Roulette system, only \$1.00. D.E. Products & Co. Box 488, Worcester, Mass. 01601.

WHOLESALE Catalog Hundreds Fast Sellers Send \$1.00 Refundable, Gifts. 3206 Magnolia, Burbank, California 91505.

PUZZLE Unique "Tricky Link" Building Instructions And Solution. Entertaining Challenge To Friends 50¢. Berman, Box 2124, Dearborn, Mich. 48123.

HOROSCOPE Fortune Telling cards liven any party. Nothing to learn. \$2.98. Jaynor, Dept. PM470, 2384 Clearview, Warren, Ohio 44483.

MAGIC TRICKS, JOKES, VENTRILOQUISM

HOUDINI'S Greatest Magic Tricks!! You can do them! Giant Illustrated Catalog and Free Secret Trick. 25¢ House of 1000 Mysteries, Dept. PM70C, Ft. Lauderdale, Florida 33308.

500 TRICKS, Douglas famous Magic Catalog, only 10¢. Better Magic for pocket, club, stage. Fastest mail service. Douglas Magician, Dept. 11, Dallas, Texas 75221.

BE A Magician! Two booklets explaining sixty-eight tricks plus large professional catalog. \$1.00. Magic Inc., 5082 Lincoln, Chicago, Illinois 60625.

COMPLETELY Illustrated catalog. 84 pages, 25¢. Manhattan Magic, Box 334-M, N.Y.C. 10011.

WORLD'S Finest professional magic tricks. Joker's Novelties. Giant illustrated catalog 10¢. Top Hat, Evanston, Illinois.

MAGIC Catalog. World's finest 3000 tricks. (340) pages \$2.50. Beginners, amateurs, professionals. Kanter's, A-200 South 13th St., Philadelphia, Pa. 19107.

FREE! World's Leading Catalog 2000 Novelties, Jokes, Tricks, Scientific Gadgets, Hobbies. Johnson-Smith, D-191, Detroit, Michigan 48224.

FABULOUS MAGIC new 1970 catalogue 25¢. Our specialty orders shipped same day no substitutes. Fabulous Magic, 3319 East Charleston, Las Vegas, Nevada 89104.

VENTRILOQUISM! Information free! Dummy catalog 25¢. State age. Maher, Studio D, Box 9037, Denver, Colorado 80209.

MAGIC MAGAZINE—Monthly since 1936. 44 pages. All phases. 3 month trial \$1.00. Genii, P.O. Box 36068, Los Angeles, Calif. 90036.

"VENTRILOQUISM! Unique "listen-and-learn" method. Write, Show-Biz, 1735-P East 26th Street, Brooklyn, N.Y. 11229.

FREE Trick, Magic Magazine and Catalog 25¢. Magic & Fun, Box 9-PM, New York, N.Y. 10022.

MAGIC Easily learned with home study course. Inexpensive. Magic-Masters, P.O. Box 774M, Bowie, Maryland 20715.

MAGICAL Jokes and club room supplies our specialty literature 25¢. Vine, Hill & Co., Box-35D, Swanton, Ohio 43558.

BOOKS, CATALOGS, NEWSPAPER

PAPERBACK Catalogue, 15,000 titles, \$1.00. Free Listings Publishers' Overstocks, Hardbounds, L.P.s, Savings to 84%. New York Book, 4 P West 43rd Street, N.Y.C.

FREE BOOK. Prophet Elijah Coming Before Christ, Megiddo Mission, Dept. 63, 481 Thurston Road, Rochester, N.Y. 14619.

NATIONAL Geographic Magazines, 1888-1967, any issue. Buxbaum, Box 465-PM, Wilmington, Delaware 19899.

FREE! New List "How To" Books. Elston House, 35 Stonycliff, Centerville, Mass. 02632.

CATALOGUE 500 "How-To-Do-It" Books, 52 Subjects, 35¢. Arthur Kill Publishing, Box 158M, Staten Island, New York 10309.

1001 FREE Items! Full details \$1.00. Fabrico, Dept. PD-2, 1512 N.E. 29th Street, Ocala, Florida 32670.

COLLECTORS! HOBBYISTS! Books you need. Write: free catalog, Cleveland, Box 888H3, San Angelo, Texas 76901.

APPLIANCE Service Manuals. Washers, Dryers, Dishwashers, etc. \$2.75 Each Ppd. Magna Enterprises, Mt. Vernon, Ohio 43050.

GUERRILLA Warfare—Weapons, Demolitions. Book Catalog 25¢ Refundable. Combat Books, Box 395PM, McDonald, Ohio 44437.

THINK BIG! Higher Income, Security and Power. 256 page Book, reveals secrets that make men Rich! Send \$2.00 Kinderman Associates, 3515 W. Market, Louisville, Ky. 40212.

BOOKS On all subjects. Catalog 25¢ refunded first order. Barber's, 3302 Batavia 7PM, Baltimore, Maryland 21214.

HIGHER Income, security and power. 256 page book reveals secrets that make men rich! Send \$2.00 A. Bernier Products, Dept. 7, Oak Ridge, New Jersey 07438.

STOP Worrying. Future, Security plus good pay, with government job. Quick, easy, inexpensive preparation. Score high on test. Free Circular. 285 books to select. Casa-Del, Dept. 171P, Alpine, N.J. 07620.

SELF-Development, autosuggestion books. Free literature. Collinse, B67, Appalachia, Virginia 24216.

PROFITABLE Books, literature, free P-5. Walker's, 5302 First Street Northwest, Washington, D.C. 20011.

"SWEEPSTAKES Can Be Reapstakes" \$1.00. Benro Enterprises, Box 6656-PM, Philadelphia, Pa. 19149.

WANT Your book published? Learn how we publish, advertise, promote, distribute. Many successes. Free booklet PM. Vantage, 120 West 31, New York City.

BOOK Sale. Free List. Hillsdale Gifts, Box 144, Hillsdale, New Jersey 07642.

PLAYS, SONGS, MANUSCRIPTS

SONGS, SONGPOEMS Wanted for Radio Show. Hollywood Music Productions, 6425-PM Hollywood Boulevard, Hollywood, California 90028.

BUSINESS OPPORTUNITIES

I GROSSED OVER ONE MILLION DOLLARS year selling by mail. So can you, at home! Send \$2 (refundable) for success book #PM, Wayne Johnson, Box 12267, Ft. Lauderdale, Fla. 33314.

PIANO Tuning Learned Quickly at home! Tremendous field! Musical knowledge unnecessary. GI approved. Information free. Empire School, Box 327, Miami, Florida 33145.

FREE Book "999 Successful Little-Known Businesses." Work home! Small Business Institute, Dept. 7, Kerrville, Texas 78028.

HOW to make \$1,000,000 in 10 years. Start with \$10.00. Details free. Imperial, 501 Wayoata, Winnipeg 25, Canada.

BIG Profits! Billion Dollar Market! Home Spare Time Mail Order Business. Own Boss, Small Investment. No experience required! Everything Furnished. Send \$1.00 for complete details. H. I. Chanlund, Box 625, Glasgow, Montana 59230.

NEW plan! Pays up to \$25.00 an hour! Little as 4 hours weekly. Place Luxko self-service displays in stores. No cost to merchants. No experience needed. Free details. Lux Company Incorporated, Dept. 1300, Elkhart, Indiana 46514.

AMAZING \$1,000.00 Profit Possible every 1,000 mailings! Complete free details; write today. West, Box 447E, Falls Church, Virginia 22046.

HOW To Finance Your Own Business. Get \$500 to \$2,000,000. Free details. Counselor-17, Kerrville, Texas 78028.

IMPORT-Export opportunity, profitable world-wide mailorder business from home, without capital; or travel abroad. We ship proven plan for no risk examination. Experience unnecessary. Free details. Mellinger, Dept. D2704, Los Angeles 90025.

START Big-Pay Business at home in spare time. No experience needed to operate little table-top machine for bronzing baby shoes. Make \$7.32 profit on every pair. Full particulars free. Send postcard to: Mason, 1512 Jarvis, Room CM-2-F, Chicago, Ill. 60626.

MAKE Money with your camera, REPORT tells how and where to sell photos, slides. \$1.00. FRANCES TREASUREHOUSE, 8400 S.W. 51st Street, Davie, Florida 33314.

SECRETS! Mail Order Success. Internationally famous expert reveals how to make home business fortunes. Beginners! Get free copy "Make Money By Mail" Discloses free advertising, profitable products. Mailco, 1554 Sepulveda, Dept. D2704, Los Angeles 90025.

BUILD Custom Cases at home for profit. Get orders by mail. We supply materials, instruction—everything. Free Home Business Details. Customcase, 6961 CPD Hayvenhurst, Van Nuys, California 91406.

INSTALL Burglar alarms without previous experience or costly equipment. Big profit. Free details. Nasco, 11071 Massachusetts, Dept. D2704, Los Angeles 90025.

BIG PROFITS! Consignment Selling. Full/Spare Time. Others Sell For You. Details FREE. Malone, Box 111-P, New Baltimore, Michigan 48047.

PREPARE Tax Returns—Housewife Jo Ann Netzley made \$5,500 last season. Train at home. VA Approved. National Tax School, Monsey 25B, New York 10952.

(Continued on next page)

BUSINESS OPPORTUNITIES

(Continued from preceding page)

\$15.00 HOURLY Profit—Own Business with one serviceman. Quickly learned. Easy to do. Operate from home. Few hundred dollars builds your own nationally advertised business while continuing present job. Investigate immediately before your territory is taken. Free booklet explains everything. Send today. Then decide. Duraclean, CO-163 Duraclean Building, Deerfield, Illinois 60015.

MAKE Gorgeous original candles for all holidays and special occasions. Learn expert Candle decorating, candlemaking, use of professional molds. Free details on home instruction method. Candle Institute, Dept. ZM, 1600 Cabrillo, Torrance, Calif. 90501.

BE YOUR OWN BOSS. Our instructional manuals show you how. Thousands of business opportunities. Free catalog. Informative Publications, Box 187, Painted Post, New York 14870.

MAILORDER Book publisher wants dealers. Wonderful "drop-ship" proposition. Sample imprint circulars free. Neil H. Tasker, Shamokin, Pennsylvania 17872.

TAKE Catalog orders. We drop-ship 1001 best selling specialty products. Guaranteed lowest below wholesale prices. Fantastic spare-time home business. Free book shows you how. SMC 6963 SPD, Hayvenhurst Avenue, Van Nuys, California 91406.

HUGE Profits! Mail order importing. Free information. ITIS, PM-4, Box 454, Hollywood, Calif. 90028.

\$400.00 MONTHLY Raising giant fishworms. Soilless method. Charlie Morgan, Bushnell, Florida 33513.

EARN Money raising fishworms for us! Write: Oakhaven-38, Cedar Hill, Texas 75104.

400,000 BARGAINS Below wholesale! Many free. Liquidations... closeouts... job lots... single samples. Free details. Bargainhunters Opportunities, Box 730A Holland, Michigan 49423.

ESTABLISH Profitable Catalog Mailorder Business! Vikari's, Box 1312-PMD, Salt Lake City, Utah 84110.

STOP Throwing Away Those Boxtops! They're worth money, some 25¢ each! Write: Boxtops—BO, Cedar Hill, Texas 75104.

ADVERTISING BUSINESS—YOU own it. \$350 First Week or Money Back. Electric Neon Action Ad Clock, 229 W. Illinois, Chicago 60610.

JOIN "MONEY GETTER'S GUILD". Receive hundreds money-making. Business Building Propositions. Year's membership only 25¢. Write: Fourstars, Box 839, Long Beach, New York 11561.

I MADE \$40,000.00 Year by Mailorder! Helped others make money! Start with \$10.00—Free proof! Torrey, Box 318-Y, Ypsilanti, Michigan 48197.

MAIL Baby Catalogs imprinted with your address to New Mothers for Big Profits! Details 25¢. Volz-PM, Ypsilanti, Michigan 48197.

VENDING Machine big catalog. Rake, 523 A Spring Garden, Philadelphia, Pa. 19123.

CLIP Newspaper items, \$1.60-\$5.00 each. Details free. Walter, Box 1360-PA Erie, Pa. 16512.

WANT To make big money at home? \$10.00 profit in an hour possible with invisible mending. Make tears, holes disappear from clothing, fabrics. Steady year-round demand from cleaners, laundries, homes. Details free. Fabricon, 1585 Howard, Chicago 60626.

SELL Lifetime, Metal, Social Security Plates. Big Profits! Sample and Sales Kit Free. Russell, Box 286-PM, Pulaski, Tennessee 38478.

SPARE Time Cash—Sell Advertising Book Matches—every business a prospect—no investment—no experience needed to build steady repeat business. Daily Cash commission in advance. Write today—We'll send your sure-fire selling kit by return mail, Dept. MX-470, Superior Match Co., 7530 S. Greenwood, Chicago, Illinois 60619.

COPUBLISH "Mail Sale Advertiser," leading mailorder paper. Copy and details 25¢. U.S.A. only. Vanroy Shirk, Lebanon, Pa. 17042.

\$200.00 DAILY in your mailbox! Your opportunity to do what mailorder experts do. Free details. Associates, Box 136-A, Holland, Michigan 49423.

BIG Money-making new greaseless donuts in kitchen. Everything furnished. Sell stores. Free recipes. Montgomery Ray, Waseca, Minnesota 56093.

\$75.00 THOUSAND. Home Addressing! Longhand, Typewriter. Information, send stamped self-addressed envelope. Brewster, Box 1348-TF, Clearwater, Florida 33517.

DRAFTSMEN! Operate own DRAFTING SERVICE! Full, Part Time; Experience unnecessary; Details: Roberts Drafting, 1741 Circle Road, Baltimore, Maryland 21204.

JEWELRYCRAFT—It's easy! Big profits! Catalog, 25¢. Modern Craft, 12790 US 19; Clearwater, Florida 33516.

MAIL Baby Catalogs, Imprint, to new Mothers. Big Profits! Details \$1.00. Krefski, 609 Lee, Plymouth, Pa. 18651.

RAISE Rabbits for us on \$500 month plan. Free details. White's Rabbitry, Mt. Vernon, Ohio 43050.

EARN \$60.00 DAILY manufacturing Concrete Fence Posts. Practically no investment. Free information. Send stamp. American, Excelsior Springs, Mo. 64024.

VACUUM Plastic Molding & Liquid Plastic Casting—At Home! Make Hundreds of full 3-D plastic products. Big profit in spare time. Facts. Nationwide Plastics, Dept. OB, 4140 Eagle Rock Blvd., L.A., Calif. 90065.

56 ACTIVE Franchise opportunities available all over USA. Brochure details 56 franchise chances for you to have your own business tied with successful national companies. Send name, address to P. Stewart, 1085 Walnut, Des Plaines, Illinois 60016.

TREMENDOUS \$1,000.00 Profit From 1,000 Mailings! Free Proof! George-PM, Box 2188, Cypress, California 90630.

MAILORDER Records help get increased business! Complete 32 Page Record Book shows your inquiries, orders, advertising, expense, etc. Only \$1.00. C. A. Martin, Popular Mechanics, Dept. PM, 224 West 57 Street, New York, N.Y. 10019.

\$500—\$800 MONTHLY Raise small Laboratory-breeding stock for us We supply equipment, breeders, and instructions. Illinois Research Farms, Dept. MPD-4, Barrington, Illinois 60010.

MAILORDER—Profitable products; drop-shipped. No merchandise investment. Everything supplied—catalogs, ads, mailing lists. Gift-Guide, 1137 1/2 Crenshaw, Dept. 185, Los Angeles 90019.

BOOKKEEPERS Earn \$500.00 week. Operate Bookkeeping Tax Service. Details free. Universal, Box 664-M, Springfield, Missouri 65801.

MAIL ORDER Sell books. Fascinating, profitable, details. Jobre, Box 27, Great Neck, N.Y. 11023.

WORLD'S Largest supply. Merchandise 25% to 40% under wholesale. Bankrupts, Closeouts 10¢ on dollar. Imports. Hongkong clothes. Automobile discounts. Free details. International Buyers, Box 16386-MM Portland, Oregon 97233.

HOLLYWOOD CEMENTCRAFT: Offers Highly Profitable Home Business. Experience Unnecessary. Unlimited Unique Pottery Designs Easily Made Without Moulds. Bird-baths, Fountains, Wishing-Weirs, Waterfalls, etc. Chemical Coloring Formulas, Marble-glazing. FREE Illustrated Brochure. CONCRETE FACTS, 602 Athens Street, Altadena, California 91001.

SELL Books by mail. 400% profit. Royal, Box 450-X Cleveland, Ohio 44127.

FREE "Franchise Profit Letter" tells how unique NR Service is helping thousands seeking profitable businesses. Write today. National Franchise Reports, W-528, 333 North Michigan, Chicago 60601.

QUICK Income with Mail Order Collection Agency. \$1000 monthly and more. We show you how. Continental, Box 2023-A, Des Moines, Iowa 50310.

MAKE Money from old tires. Operators clearing \$800, weekly. Equipment costs \$1500. Get facts. S & S Patents, Inc., 3752 N. Damen, Chicago 60618.

GROW FISHWORMS. Outstanding New Breed produces great profits! Free Literature. Fain's Hatchery-26, Edison, Ga. 31746.

FREE Catalogs. Repair air conditioning refrigeration. Tools, supplies, full instructions. Doolin, 2016 Canton, Dallas, Texas 75201.

CALIFORNIA MANUFACTURER NEEDS man to assemble our product and be local agent, experience unnecessary. May start while presently employed. Five-figure income for responsible applicant. S.K.R.M. Manufacturers, 2347 West 238 Street, Torrance, California 90501.

\$300.00 WEEKLY Profit Possible using our proven mailorder plan. Excellent part time business for either men, women. Details free. Write: Williams, Box 44646A, Los Angeles 90044.

VENDING Machines. No selling. Routes earn amazing profits. Big catalogue Free. Parkway Corporation, 715PBM Ensor Street, Baltimore, Maryland 21202.

MAILORDER books and directories. Free information. E-C Supply, Box 149, N. Olmsted, Ohio 44070.

ADDRESSERS And mailers needed. Send stamp for information. Lindbloom, 3636 West Peterson, Chicago 60645.

MONEY-making plans free. We pay you to help distribute them. Ternes Multi-Mail, Box 115-Garner Road, Lilburn, Ga. 30247.

BECOME PROFESSIONAL DRIVING INSTRUCTOR. Earn \$10.00 Hour. \$400 Week. Part-Full Time. Business Yourself. Free Details. Howard David, 1818 Evarts, Phila., Pa. 19152.

SELL Beautifully colored Social Security Plates. Big Profits! Free Sample. Pop Wright, 1075 Ringwood Avenue, Pompton Lakes, N.J. 07442.

MONOPOLIZE A No-cost waste. Make \$500 week. MEMCO, Box 861, Paradise, Cal. 95969.

PLASTERCRAFT Molds, liquid rubber, plasters, flock, candle supplies. Catalog and manual free. Blue Rapids Supply, Blue Rapids, Kansas 66411.

AMAZING PROFITS! Sell by mail quality self-improvement books. Drop-shipped by reliable publisher. GRAPHIC, 1033-PM S.W. 53rd, Oklahoma City, Oklahoma 73109.

SIMPLE, EASY way to enter mail order. Earn \$12,000 year up. Stamp for details. Emptage, 1033-PM S. W. 53rd, Oklahoma City, Oklahoma 73109.

MAKE \$46 from square foot plywood; jigsaw or bandsaw necessary. Free details. Woodar, Bridgewater, Mass. 02324.

(Continued on next page)

BUSINESS OPPORTUNITIES

(Continued from preceding page)

UNBELIEVABLE extra money can be YOURS through amazingly easy Mail Order method. No inventory. No boss. Work at home YOU can START NOW. Free information. Thank you. River Shores, Box 577-504 Fifth, Crystal River, Florida 32629.

FREE FRANCHISE JOURNAL magazine with over 100 franchise opportunities in every issue. Franchise Journal, Dept. G, Box 1790, Newport Beach, Calif. 92663.

1000% PROFIT Bronzing Shoes. Free Literature—N.B.C. Box 11069-PM, Kansas City 64119.

\$70.00 WEEKLY—home, spare time. Simplified mail bookkeeping. Immediate income easy. Auditax, 34741A, Los Angeles 90034.

FANTASTIC Opportunity—Your Own Gift Catalog Business! No merchandise investment! Free Sample Catalog! Mail Marketing Services, Benton, Illinois 62812.

MAIL Catalogs for big profits. A catalog for all seasons. Send \$1.00 for information. Marlin's, 5801 East 17th Street, Wichita, Kansas 67208.

MAILORDER success plan! "How to Get Rich by Mail." Free copy reveals millionaire's secrets! Executive (1004), 333 North Michigan, Chicago 60601.

MAKE Magnetic car signs. Write Route 1, Box PM-49A, Bardstovon, Ky. 40004.

JANITORS. It's easy to get accounts with help from AMCI. Write for free Brochure. American Maintenance Contractors Institute, Box 4145, Dept. 201, Torrance, Cal. 90503.

TOPLESS Income!!! Amazing Profits in Mailorder-Importing!! New Dropship Plan starts you without merchandise investment. Free Proof! International, Box 1138-AD, Monroe, Louisiana 71201.

INCREASE Your income. Just follow easy instructions. Catalog \$1.00 refundable. Persian, 420 Oakdale Road 1-A, Smyrna, Georgia 30080.

SUCCESSFUL Money-making Opportunities. Thousands. Butler, Box 1521, Anniston, Alabama 36201.

SELL Oil Portraits From Photos. Ness, 83-MB Scarcliffe, Malverne, N.Y. 11565.

OPERATE Restaurant. Free booklet reveals profitable plan. Write Restaurant Business School, Dept. EC-40, 1920 Sunnyside, Chicago, Illinois 60640.

BLACK Widow Ranchers!! Big Guaranteed Market! Free Stock! NBWC, P.O. 260-XPM, Brigham City, Utah 84302.

PROFITABLE WATCH REPAIR. Free information. Watchmaking, Fox River Grove, Illinois 60021.

\$25.00 HUNDRED Addressing. Possible! Year 'round. Special information included. Send 25¢ postage, handling. Cove, Box 1348-BE, Clearwater, Florida 33517.

HOW TO prepare your own Mailorder catalog for pennies... without merchandise investment! Free catalog-proof! Obie, 5711-MKD—14th, Brooklyn, New York 11219.

FREE—\$2.00 Mailorder Lesson. Clayton, 1415 Jefferson Heights, Pittsburgh, Pennsylvania 15235.

MAILORDER Selling: what, where, how. Details 10¢. Doorbar-PM, North West 35th Street, Fort Lauderdale, Florida 33309.

BUY Diamonds from friends. sell us! Free instructions. Send \$2.00 for professional equipment. Olympic, Box 4398, Tyler, Texas 75701.

MAIL Galore! Money-making offers. Name on national mailing lists. 25¢. Box 2064-M, Forsyth, Georgia 31029.

CLIP Short newspaper items. To \$10.00 each. Details free. Foster, 272-M4, Booklyn 11235.

LEARN Money-making methods. Unique monthly newsletter. Money-maker. Box 1835 DD, Philadelphia, Pennsylvania 19105.

MAKE Durable building plastic easily. Waterproof, fireproof, economical. Bays Laboratory, Cedaredge, Colorado 81413.

MAKE A Year's Income in 8 weeks Camping. No capital investment, no selling, no land ownership necessary. 9 different ways. Write Edru's, Route 5, Box 5733, Gig Harbor, Wash. 98335.

PROFITABLE Businesses—Low Investment—Spare Full Time. Details: Value House, 17-M Wilton Terrace, Verona, New Jersey 07044.

MANUFACTURE And sell under your name your own hand and body lotion by using our lotion base. \$1.00 brings details and sample. Bar-Mel, Inc., Box 5201, Winston-Salem, N.C. 27102.

BIG Money dealership. 7 new mailorder offers. Everything dropshipped. Free details. Marnel, Box 485-C, Framingham, Massachusetts 01701.

NEED MONEY??? Our unique catalog (the only one of it's kind in the world), just published, shows 56 ways to get it! Rush 50¢ for your copy today and expect something different! None Free. James J. Paulmann, Dept. AB-4, 70 Argyll Ave., New Rochelle, New York 10804.

MAKE Big Money Growing Ginseng. \$3,000-\$30,000 annually. We buy your crop. Send \$2 for seed sample and information. Glass Ginseng Exchange, Box 336 Rochdale Station, Jamaica, N.Y. 11434.

IMPORT BUSINESS. Details \$1.00. Swiss Import, Box 191, Verona, New Jersey 07044.

START A profitable mail order business immediately. Follow this expert's advice. Let Alfred Stern's latest, greatest book "How Mail Order Fortunes Are Made" be your guide. Well-illustrated, hard-cover book, chock full of down-to-earth information. Rush \$8.95 plus 30¢ postage. Shipstead, Box 231-M Glenville, Greenwich, Connecticut 06830.

STAY HOME. Make money. Thousands Do. Henry Farr, Garnerville, N.Y. 10923.

"START Your own business—from home, part time. Experience unnecessary. Details free. Easy Shopper, Dept. 2270, 6125 W. Spokane Street, Milwaukee, Wis. 53223."

NEW! \$1000. Monthly possible home mailorder business. Free details. Jim Anderson, P.O. Box 944 PM, Anderson, Ind. 46015.

HOW TO build your own Mailorder Business—amazingly easy. Free facts. Advancements, Box 24, La Grange, Illinois 60525.

'TEXAS RANCHER found OIL. Needs help test four sands. GOOD Geology. References. Full Information. R. M. Cooksey, 318 N. 14th St., Corsicana, Texas 75110.'

\$60.00 DAY. Manufacturing concrete Posts. Blocks. Mold Equipment Catalog \$1.00 refundable. Carlavne, Route One, Box 106T, Rapid City, South Dakota 57701.

TINT Windows, Storefronts. High profits low investment. Big demand. VISTRAN, 1368 Court #7, Memphis, Tenn. 38104.

FINANCIAL INDEPENDENCE Manufacture 3-D Magnetic Truck Signs at home. Free information. No selling, investment secured \$2,490.00 complete. Hamilton Industries, 8647 Sepulveda Blvd., Dept. PM, Sepulveda, California 91343.

DROP-SHIPING 1,000,000 Items! Camille, 202-PX Brownell Street, New Bedford, Mass. 02740.

MAKE MONEY IN MAIL ORDER. Sell popular mail order aids. We drop-ship, supply your selling needs. Details free. Martyn, 475 Fifth Avenue, Dept. PM73, New York 10017.

LOWEST Priced Printing Available. Ellichman—(A23), Box 1584, Santa Rosa, California 95403.

EXTRA INCOME THROUGH MAILORDER. Book with large wholesale directory tells how to get started in mailorder. Only \$2. Arlington House, Box 5, Elk Grove, Illinois 60007.

MAILORDER Business. Free literature. ANDREWS, Box 485, New York, New York 10013.

NEW APPROACH TO FINANCIAL INDEPENDENCE. Free details. Collegiate Supply House, 5456 Hartsdale Drive, Jackson, Mississippi 39211.

MONEYMAKING OPPORTUNITIES

MAKE MONEY. GROW SPONGES. Luffa Sponge Seeds. Instructions. \$1.00. Camstan, 2120 North 26th Place, Phoenix, Arizona 85008.

NEW!! Huge "Mailorder Profits" Amazing book!!! \$2.00—guaranteed. Earl Diehl—Route 5—Staunton, Va. 24401.

REAL VALUE Opportunity to make money in your own business. Details Free. SIDENSTICK, 1230 Purcell Ave., Cincinnati, Ohio 45205.

RESEARCH At home. Mail bulletins to merchants, doctors, banks. Big demand. Learn in 7 days. Free details. Datacraft-7, Kerrville, Texas 78028.

HOMEWORKER'S Newsletter explains hundreds ways to start home business. Sample copy free. Homeworker Press, Appalachia, Virginia 24216.

SHARP \$\$\$\$ opportunity! One low-cost machine sharpens serrated knives, scissors, pinky shears. Earn \$6-\$9 hourly in spare time. Professional results without experience. Free details. Beaver Grinder, 340 Nielsen Building, Eugene, Oregon 97402.

BIG PROFIT In antiques and paintings. We will show you how. Send \$1.00 to: Hagen, 1519 Grove Crescent, Delta, B.C., Canada.

MAKE Wooden Picket Fence, woven with wire using new weaving machine. Make sizes and styles to beautify and protect flowers and shrubs of every homeowner. Total machine cost under \$5.00. Money-maker for retired person, clubs and families. Plans, parts list, marketing ideas, send \$2.00. Fencing, Box 41, Longmont, Colo. 80501.

INSTANT Money! Plastics are the wave of the future. Big profits now! At home! Spare time! Materials costing 11¢ bring \$2.58 profits immediately! Free information! Rush name on postcard to: Warner, 1512 Jarvis, Dept. CL-2-F, Chicago, Ill. 60626.

\$80.00 TO \$100.00 weekly profit Part time sign-business. Magnetic Signs, 306 East Sunrise, Fort Lauderdale, Florida 33304.

\$1,000 MONTHLY. Booklet, 10¢. Home-craft, 2350 W47 AP, Denver, Colorado 80211.

WRITE To Sell. Details Free. Novak, 18720 Hatteras, Tarzana, California 91356.

LYRIC WRITERS write songs with writers who write hits for top Nashville artists. Globe, 420 Broad, Dept. PM, Nashville, Tenn. 37203.

"WRITE Persuading Letters. Profitable! Samples. Eljay, 603-B Navarro, San Antonio, Texas 78205

SELL your photos. Booklet tells how. \$1.00 Donald Gorr, Dept. PM-1, 901 2nd St., Farmington, Minn. 55024.

(Continued on next page)

MONEYMAKING OPPORTUNITIES

(Continued from preceding page)

\$15.00 HOURLY Profit—Own Business with one serviceman. Quickly learned. Easy to do. Operate from home. Few hundred dollars builds your own nationally advertised business while continuing present job. Investigate immediately before your territory is taken. Free booklet explains everything. Send today. Then decide. Duraclean, CO-163B Duraclean Building, Deerfield, Illinois 60015.

SKETCH Photos—Home Goldmine! Details. Gem, 365F Longhill, Shelton, Conn. 06484.

"FLESH Eating Moon Plants!!!" Raise Astronomical Profits!!! 3 living plants, tremendous guaranteed program!! \$1.25 (returnable). Biow tics, P.O. 260 BPM3, Brigham City, Utah 84302.

MAKE \$5,000 yearly, sparetime, raising mink, chinchilla, nutria, etc. Free booklet reveals proven plan. Write: Furs, Dept. R, Bewdley, Ont., Canada.

CIGARETTES 12¢ a pack. Improved roller makes 20 filtertip, plain, king or regular for 12¢. Facts free. Moberly, Box 953, Owensboro, Kentucky 42301.

EARN \$240.00 a month at home, spare time, doing only two \$5.00 invisible mending jobs a day. Big money paid for service that makes cuts, tears disappear from fabrics. Steady demand. Details free. Fabricon, 1532 Howard, Chicago 60626.

MAKE Statuettes, novelties, imitation marble. Sell to stores or start gift shop. Free details. Marbleizing, 41 Waverton, St. Louis, Mo. 63124.

HOW To Make money writing short paragraphs. Information free. Barrett, Dept. C-27-D1, 6216 N. Clark, Chicago 60626.

FREE Copy of world's leading contest magazine! Write Prizewinner, Box 11569, St. Petersburg, Fla. 33733.

FREE. 206 Easy Ways to make money taking orders for exciting new products—spare time. Send name, age for 5 months free subscription. Opportunity Magazine, 1460 Hancock Center, Dept. 17-DM, Chicago 60611.

HOMEWORK. Mailing circulars. Free details! Cam Company, Dept. 155-KP, Verona, N.J. 07044.

SCIENTIFIC Messages: Big Earnings uncrowded profession. Learn spare time at home. Diploma awarded. Free catalog. Write Anderson School, Dept. D-1C, Princeton, Illinois 61356.

CLIP Newspaper items. \$1.00-\$5.00 each. Details free. Walter, Box 1360-P, Erie, Pa. 16512.

MAKE: \$12.00 Profit each dozen assembling Belts. Details Free. (Stamp appreciated.) Redikut's-40, Richland Center, Wis.

HOW TO GET RICH!! Free "Money-making Brochure"! Success International, Box 2447-C, Livonia, Mich. 48151.

\$200.00 FROM Sheet 1/4" plywood (scrap). Details 25¢. Novelties, 610 So. 24th, Elwood, Indiana 46036.

MAKE more money—Take orders for Book Matches. Prospects everywhere—every day is payday—no experience needed—no investment. We'll send you power house selling kit with new complete catalog so you can make quick sales and big cash commissions. Superior Match, Dept. MA470, 7528 S. Greenwood, Chicago 60619.

\$500—\$800 MONTHLY Raise small Laboratory-breeding stock for us. We supply equipment, breeders, and instructions. Illinois Research Farms, Dept. MP-4, Barrington, Illinois 60010.

FREE Details. "990 Successful, Little-Known Businesses." Conn, Box 1274-A, Fort Wayne, Indiana 46801.

\$2.40 HOURLY Making simple wood novelties. Free details! Gene's, 55 Boxwood, Falmouth, Mass. 02540.

SELL Lifetime Social Security plates. Free sample, Lady P. McGuire, Rt. #6, Anderson, S.C. 29621.

VENDING Machines. No selling. Routes earn amazing profits. Big catalogue Free. Parkway Corporation, 715PMM Ensor Street Baltimore, Maryland 21202.

GUARANTEED Addressing! Profit \$1000.00 in every thousand mailings! Details. Application—10¢. Troy Company, Dept. 386 PM, Bayonne, N.J. 07002.

YOUR Fortune can be photographing beautiful models. Maybe importing, possibly real estate. Free information. Write: PM-4 Distributors, Box 83, Verdun, Quebec.

SELL Foolproof! Fire-Burglar Alarms. Inexpensive. Write: WATCHDOG, \$40, Williamsburg, Ohio 45176.

REPAIR Clocks. Clock Engineer helps you. McEntire, 323 Tram Road, Columbia, South Carolina 29210.

SWEEPSTAKES Contests. How to Win. Write for free particulars. General Contests, 1609-18 East Fifth, Duluth, Minnesota 55812.

HOMEWORKERS! 200 companies—48 page Directory. FREE details. Quest-14, Box 6029, San Jose, California 95150.

ELECTRONIC Moneymaking Projects. Knowledge unnecessary. Manual 25¢. Barta, Drawer 15083, San Francisco, California 94115.

SPECIAL OFFER—"Streamlined home-study mail order course." You learn all the important facts in twenty-four easy lessons in book form. Shows you how to start a profitable mail order business in spare time. Price only \$2.00. Hunter International, 34 W. 38th Street, Bayonne, N.J. 07002.

SECOND INCOME, sell office supplies. SEB Enterprises, Box 271, Maple Shade, New Jersey 08052.

"MONEY—111 Select Ways For Making It!" plus "Free Item Sources." Guaranteed. \$1.00. Premier Enterprises, Postbox 10597-PM, Pittsburgh, Penna. 15235.

MANUFACTURE Waterless hand cleaner. Easy. Profitable. Concentrate \$2.00 pound. Two ounces, add water, makes four pounds \$1.00. Shanahan, 380 West Main, Waterbury, Conn. 06702.

FUN and Profit collecting old bottles. Details \$2. Box 331PM, Interlaken, N.Y. 14847.

MAKE MONEY! Mail Order Imports—\$1.00. B & H Export-Import, 407 East 22nd, Hays, Kansas 67601.

BIG PROFITS GUARANTEED! 1970's TOP Home Operated Mailorder Offer! Details Free. Minnesota Specialties, Box 1186-M, Minneapolis, Minn. 55440.

REVOLUTION IN MONEY MAKING! HOW TO INVEST \$60 AND LITTLE INTELLIGENCE FOR \$35,000 INSTANT PROFIT—PSYCHOLOGICALLY! \$2.00 For complete information. P. Novak, 926 Bloor W., Toronto, Canada.

PLASTERCRAFT HANDBOOK Illustrated, instructions statuary pouring, finishing, selling and mold making. Also where to obtain all materials. Only \$3.00 postpaid. Guaranteed. Wolfe, Box 561GC, Melbourne Beach, Florida 32951.

QUICK Money! Create Decorative Candles at Home! Inexpensive "Manufacturing Manual." Free Particulars! Kaycrafters, 28639 Bartsens, Garden City, Mich. 48135.

WATCH REPAIRING builds spare time income fast. Free details. Sweazey, YDA, Fox River Grove, Illinois 60021.

BECOME Notary Public! Free particu-lars. Stationers, 405-PM Richardt, Evansville, Indiana 47711.

LEARN The secrets of repairing junk batteries "Fabulous Profits" at home. Battery Shop, Route 1-188 D, Blythe, Calif. 92225.

FORTUNE In your pocket! it's really possible—details in free gift catalogue. Reed Son's Ltd., Dept-1, 1211 East Hernandez, Pensacola, Florida 32503.

"20 SIMPLE Rules on Complete Know How to Install My X-200 All Plastic Water Wells. Clear Profit \$200.00 on each installation. Protected Franchise Territory. Install as many as four in one day. Guaranteed. Send \$10.00 to Payton Water Consultant, P. O. Box 1664, Jackson, Tennessee 38301.

NEW Sign Painting Method. Learn Quick. Easy. Write Simplex Signs, P.O. Box 3059, Hamilton, Ohio 45013.

WE Buy newspaper clippings for 50¢ each. Details \$1.00. Clippings, Box 53, Chalmette, Louisiana 70043.

NEED MONEY??? Our unique catalog (the only one of it's kind in the world), just published, shows 56 ways to get it! Rush 50¢ for your copy today and expect something different! None Free. James J. Paulmann, Dept. AM-4, 70 Argyll Ave., New Rochelle, New York 10804.

"START Moneymaking Mail Order Busi-ness Today!" Roban's, Box 3124, Industry, California 91744.

WORLD'S Greatest Gambling Systems—Free details. Cloverleaf-1, Box 8082, Greensboro, N.C. 27410.

MONEY. Using power handsaw. \$10/hr. Send \$2 for easy plan. Demand waiting. Satisfaction Guaranteed. Profitplans, 128 Third, Wilmette, Illinois 60091.

PUZZLE Contestants Learn sponsors source for difficult tiebreakers. Write: Noel Sowell, 4411 Ellyseway, Pensacola, Florida 32505.

SELL Your photos. Report tells how, where. Color slide market. Send \$1.00. Lucas House, 6429 W. Morris, Indianapolis, Indiana 46241.

FREE Mailorder critique plus exciting home business proposal. MONOGRAPH, Box 661, Cucamonga, California 91730.

\$\$\$\$\$ "1000 SECOND-Income Oppor-tunities!!" Complete. Ready-to-Use Plan! \$1 (Refundable) Matthew, Box 2020-PM1, New York, N.Y. 10017.

ATTENTION SERVICEMEN! Excellent, profitable part-time opportunity. Write: MGR Studios, Box 15036, Fort Worth, Texas 76119.

MAKE Money addressing, mailing, etc. Get on the right track! Send stamp for descriptive folder. Hicks Mailing Service, 37-215, Los Angeles 90037.

HOW TO GET RICH! Amazing plan re-vealed! \$2.00 Refundable. Seco, Box 144, Walkerton, Indiana 46574.

EARN Money with your camera report tells how \$2.00. Scallen, 250 Meadowbrook Court, West Haven, Connecticut 06516.

MONEY For Your Photos. How? Where? Details \$1.00. E-K Enterprises, 1018 Hawk Lane, Fairfield, California 94533.

\$2000.00 MONTHLY. Easily done with my new business. Free details. Send stamp to Ropchan, Box 5341, Sherman Oaks, California 91413.

MAILORDER 24 Lesson Tested Money-making Course Complete \$2.00. Details Free. Ammons, Box 36573-pm, Los Angeles, Calif. 90036.

EARN \$7.00 HOUR Part time while building successful business on side. Proven plan, \$1.00. (Refundable) PERMA SHIELD, Box 44, St. Louis, Missouri 63074.

INVEST IN STAMPS FOR PROFIT! Details of systematic investment program free. Jeffrey Needleman, 2367P East 18th Street, Brooklyn, New York 11229.

(Continued on next page)

MONEYMAKING OPPORTUNITIES

(Continued from preceding page)

MONEY BY MAIL. Mailtrade magazine been telling 40 years. Tips, ideas. Sample 50¢. Year \$4 with bonus offer. Mailtrade, Sheboygan, Wisc. 53082.

HOMEWORKERS Make \$300.00 spare time or up to \$1,000 a month full time. Rush \$1.00 for details. Kronbergs Sales, 1325 So. 27th Street, Omaha, Nebraska 68105.

MAKE Money Mailing our postcards! Work home, full, sparetime. Particulars 10¢. Westley, Dept. 1, Western Springs, Illinois.

SPECIALTY Merchandise Wholesale, gifts, premiums, etc. for catalogues, send \$2.00. M. Zinn, Box 89, Elmwood Park, Ill. 60635.

PROFITABLE OCCUPATIONS

RECESSION? Amazing opportunities in four high income non-degree computer careers! "Computer Technical Jobs," Box 34010, Bethesda, Maryland 20034. \$3.00. Satisfaction guaranteed.

FREE Book "990 Successful, Little-Known Businesses." Work Home! Plymouth 47-A, Brooklyn, New York 11218.

EARN \$240.00 A month at home, spare time, doing only two \$5.00 invisible mending jobs a day. Big money paid for service that makes cuts, tears disappear from fabrics. Steady demand. Details free. Fabricon, 1586 Howard, Chicago 60026.

HOW To Make Money writing short Paragraphs. Information Free. Barrett, Dept. C-27-D2, 6216 N. Clark, Chicago 60626.

CHROME Plating Instructions, equipment and supplies. Platers' Supply, P.O. Box 565, Lugo Station, Los Angeles, Calif. 90023.

FT. SMITH Auction School. Ft. Smith, Ark. Residents & Home study. Veteran approved.

BAKE New greaseless doughnuts in kitchen. Sell stores. Free recipes. Michael Ray, Waseca, Minnesota 56093.

BECOME A mortgage broker, earn \$10,000 to \$50,000 a year. Details free. United, Box 6284A, Marietta, Georgia 30060.

\$500-\$800 MONTHLY Raise small Laboratory-breeding stock for us. We supply equipment, breeders, and instructions. Illinois Research Farms, Dept. MPA-4, Barrington, Illinois 60010.

SHARPEN Scissors, Pinkers. Inexpensive equipment, tools, supplies. Blackhawk's, Sheldahl, Iowa 50243.

LOCKSMITHING—Fifty Page Automotive Lock Manual—\$4.95. Glenstone, Box 3127, Springfield, Missouri 65804.

PAWNSHOPS—Money-makers! Start small or big. Avoid mistakes. Secrets and facts revealed! Enclose \$4.00. CE Smith, Rt. 5, Box 83, Waco, Texas 76705.

PHOTOGRAPHERS—Sell your pictures. 1970 Markets Directory. Send 20¢ for sample list or \$4.95 for complete book: PHOTO MARKETS, Box 956, Bellevue, Washington 98004.

ACT NOW. Rush your name for free list on low cost books for profitables ways to make money. Paradise House, 41-19 52nd Street, Woodside, N.Y. 11377.

MAKE \$300 CLEAR MONTH few hours from 10 customers, representing us in your community. No individual selling. Repeats forever. Customers waiting. \$1 for sample, details. Our 40th year. Progressive, Box 1302, Springfield, Ill. 62705.

SALESMEN—DISTRIBUTORS

SELL Advertising Ball Pens, Calendars, Ad-Specialties—Build Own Repeat Business—Free Kit—Fleming, Dept. A, 6535 Cottage Grove, Chicago 60637.

LONG Needed Invention. Man to Contact Service Stations. Huge Profits. Cyclo Mfg., 3816 Dahlia, Dept. 131, Denver, Colo. 80201.

HOUSEHOLD Products Route. Earn \$25.00 or more daily. Larger repeat orders. Man, woman. Full, part time. McNess, Freeport 2640, Illinois 61032.

BIG earnings selling Hertel Bibles. New 3-dimension cover, finest reference edition sells fast. Demonstrator furnished. Big commission. International Book, Dept. PM, Box 118, Wichita, Kansas 67201.

MAKE Extra \$25 to \$75 spare time! Take orders for double air cushion Bronson Shoes. Men's, women's line for dress, work, play. Highest commissions. Shoes for yourself. Outfit Free. Bronson, Dept. 204, Minneapolis, Minnesota 55408.

EARN Big Commission Full or Part Time. Show America's largest line Low Priced Business Printing and Advertising Specialties Plus calendars in season. No experience. No investment. No collections or deliveries. On-the-spot commissions. Big Free Sales Kit samples hundred items used daily by businessmen. Merchandise bonuses for you. Build profitable repeat business. Start now. National Press, Dept. 01D, North Chicago, Ill. 60064.

DO You wish to use or sell a plant food that is field proven, shows the greatest results at lowest cost? Something different in sales and use. Big monthly income or get your fertilizer FREE. Campbell's Gro-Green, 414 Dewey, Rochelle, Illinois.

FREE. 206 Easy Ways to make money taking orders for exciting new products—spare time. Send name, age for 5 months free subscription. Opportunity Magazine, 1460 Hancock Center, Dept. 17-DS, Chicago 60611.

EARN big money calling on business-professional men. Send us their delinquent accounts for collection. General Finance, Dept. PM-11 Columbia Bank Bldg., Kansas City, Mo. 64106.

100% PROFIT—Sweet Georgia Brown Cosmetics sell fast. Write for Sample Case offer. Valmor, Dept. H, 2411 Prairie, Chicago 60616.

SELL High Profit service station items. Free list. Inka, 2401 Crocker, Houston, Texas 77006.

PERSONAL Protective Devices Now in Big Demand due to increased crime rate. Proven. Sell easy to Drive-ins, Stores, Nurses, Night Workers, Motorists. Sales experience unnecessary. Get profit details now. Hagen Supply, Dept. CLA-40, St. Paul, Minn. 55107.

EVERY BUSINESS NEEDS The proven advertisement value of removable magnetic signs for cars and trucks. Honest 40% commission. Pro-Vac Mfg., 12946 Magnolia, Garden Grove, Calif. 92641.

OLDIES But Goodies—45 rpm's available at .05. No disc jockeys. Records are factory fresh. Excellent assortment—Top Labels such as Atlantic, Buddah, ABC, Tamla-Motown and many others. House of Sounds, Inc., Dept. B, 10 No. 9th St., Darby, Pennsylvania 19023.

AGENTS WANTED

RAZOR blades wholesale. Details free. Madia, 3 Box 324, Egg Harbor, New Jersey 08215.

SELL to industry. Department Stores, Hospitals, Factories, Institutions. Hand trucks, casters, racks, conveyors, air compressors, etc. Simquip, 3490 W. 140, Cleveland, Ohio 44111.

EVERY Man a prospect. Refundable sales kit offer showing line belt buckles, tie clasps, money clips, cuff links, lapels, identification badges, individualized with customer's name and emblems. Cap badges for trucking, bus, taxi, police, firemen, also postal, letter carriers and heavy construction emblems. Choice 3000 emblems. Hook-Fast, Box 1088PM, Providence, R.I. 02901.

PRINTING, Advertising Salesmen—Excellent moneymaking sideline selling Decalcomania Name Plates, small quantities. Advertising Specialties, sign letters. Free Samples, Ralco XL, Boston, Mass. 02119.

LIFETIME Income. Business Loan Representative Write: Financial, 28 E. Jackson, Suite 1204-X3, Chicago 60604.

FREE. 206 Easy Ways to make money taking orders for exciting new products—spare time. Send name, age for 5 months free subscription. Opportunity Magazine, 1460 Hancock Center, Dept. 17-DA, Chicago 60611.

PROFITABLE! FULL OR PART TIME. Represent largest manufacturer of removable magnetic signs for cars and trucks. Trimetric, 2654 Saddle, Oxnard, California 93030.

YOUR own business—Used Suits \$1.50; Overcoats 65¢; Mackinaws 35¢; Shoes 12½¢; Ladies' Coats 30¢; Dresses 15¢. Enormous profits. Catalog free. Superior Jobbing, 2111-AA Roosevelt Road, Chicago, Illinois 60608.

ESTABLISH Your own business. Low prices on used clothing, shoes, household goods. Unlimited profits. Free catalog. Northwestern Distributors, 2129 No. Western Avenue, Chicago, Illinois 60647.

WANT TO MAKE UP TO \$100 A WEEK spare time, and get free shoes for life, too? No investment. Rush card for free details. Mason Shoes, K-768, Chippewa Falls, Wisconsin 54729.

BE The Popular Mechanics representative in your neighborhood and earn big profits in your spare time. Write Popular Mechanics, Room 4A, 250 West 55th St., New York 19, N.Y.

EXTRA Income no selling. Details Free. Box 283, Vienna, Virginia 22180.

PART TIME! \$50.00 DAILY EARNINGS potential. Sell magnetic removable signs for cars/trucks. Send stamped envelope—Freeman's Magnetic Signs, Morristown, Tennessee 37814.

EMPLOYMENT INFORMATION

"NEWSLETTER Hawaii!" Facts on jobs, housing, living, in our booming fiftieth State. \$1.00. Cox's, P.O. Box 131-B, Kaneohe, Hawaii 96744.

AUSTRALIA WANTS YOU! Government Assisted Passage. 50,000 Jobs. Latest Government Information and Forms \$1.00. Special Reports on Employment, Business, Taxes, Housing, Education, Ranching, Farming, Teaching, Maps, Etc. AUSTCO, Box 3623-E, Long Beach, California 90803.

HIGH Paying overseas jobs. Construction, other projects. Bonuses. Travel Expenses. Extras. International Information, 124, Cortez, Florida 33522.

ALASKA. High pay jobs, many with room and board furnished. Send \$3.00 for brochure. H-W ENTERPRISES, Box 4-406 Anchorage, Alaska 99503.

FOREIGN And USA job opportunities available now. Construction, all trades. Earnings to \$3,000.00 monthly. Paid overtime, travel bonuses. Write, Universal Employment, Woodbridge, Conn. 06525

"AUSTRALIAN OPPORTUNITIES HANDBOOK" latest information about Government Paid Transportation, Employment, Land, Farming . . . plus Employers List and Forms. Send \$1.00. International Services, Box 12-A4, Greenfield, Indiana 46140.

(Continued on next page)

EMPLOYMENT INFORMATION

(Continued from preceding page)

ALASKA!! \$400-\$1,000 WEEKLY!! Handy Labor Market shows how. Send \$2.00 to: H.L.M. 702-A Cowles, Fairbanks, Alaska 99701.

JOBS! JOBS! and more Jobs! OVERSEAS. U.S.A. Year-round and Summer Jobs. Jobs with Money, Challenge, Opportunity, Travel. All occupations and trades. For Information, write: "JOBS," Box 475. (PM2), Lodi, California 95240.

AUSTRALIA!! AUSTRALIA!! Government assisted Transportation! Latest Handbook. Free Details!! Write: Associated, Box 17-B40, Lafayette, California 94549.

INTERNATIONAL . . . U.S.A. jobs now!! Free Details!! Write Employment, Box 249B Lafayette, California 94563.

"CANADA CALLS"!! Thousands of excellent job opportunities. Construction, Office, Engineering, Sales etc. Lists hiring organizations. For complete information send \$3.00 to PK Enterprises, Box 2618, P-Stn.-A, Edmonton, Alberta, Canada.

"How To Get Overseas Jobs" — Worldwide — Lists Hiring Organizations — 143 pages — \$4.98 — Refundable. Staydryp — Whitestone, New York.

ALASKA! Due to the interest in the oil industry and construction projects in Alaska, our Research Department has made public their annual report; showing how to obtain employment, cost of living, wages paid, etc. For a copy, send \$3.00 to B & J Surveys, Box 265, Lost Hills, California 93249.

DRAFTSMEN, DESIGNERS, TECHNICIANS, ENGINEERS, COMPUTER PERSONNEL, TECHNICAL WRITERS, MACHINISTS and other technical help earn \$10,000 to \$30,000 per year as **JOB SHOPPERS**. Why work overseas, when you can make overseas pay right here in the U.S.A.? Choose location and length of assignment. (Three months to three years.) Learn secrets of **JOB SHOPPING**. \$3.00. Bruce Panciera, 11 Moss Street, Westerly, Rhode Island 02891.

AUSTRALIAN EMPLOYMENT INFORMATION listing over 600 American Firms employing personnel in Australia. All occupations! \$3.00. Ambrose Publications, Box 2446, Newport News, Va. 23602.

CENTRAL INTELLIGENCE AGENCY employment opportunities U.S., overseas. Free information. Western Distributors, Box 6293-R, San Jose, California 95150.

BOOMING Australia wants You—Application forms and new 1970 Australian Handbook describing Australian assisted passage, family and housing allowances, jobs, business, ranching, teaching, hunting, fishing, etc. \$1.00. Buckeye, Box 1032MK, Fairborn, Ohio 45324.

ARIZONA Information, listings \$1.00. The Stockade, P.O. Box 574, Lakeside, Arizona 85929.

HELP WANTED

OVERSEAS Jobs—Europe, South America, Australia, Far East, etc. 2000 openings all trades. Construction, Office, Engineering Sales, etc. \$700 to \$3,000 month. Expenses paid. Free Information. Write Overseas Jobs, International Airport, Box 536-M, Miami, Florida 33148.

WORLDWIDE . . . U.S.A. jobs now!! \$600.00 to \$3,000.00 monthly. Travel allowance. Paid overtime. Write: Global Employment, Box 706CA40, Orinda, California 94563.

SEX Makes no Difference. You are needed in New York City. You can have more Jobs, Advancement, Money, Security, Opportunity, Future, Travel, Fun, Adventure, Excitement, Romance, Satisfaction, Success and Glamour. Now you will have help. Register now with US by mail. Yourself or with Friends. Details \$1.00 each, sent immediately. Nice Personnel, 181 Broadway, New York City 10007.

OVERSEAS Jobs—Australia, Europe, South America, Far East, Etc. Openings in all trades and professions. \$400 to \$2,500 monthly, free information write Foreign Employment Mart, Box 2235 A.M.F. Miami, Florida 33159.

REAL ESTATE & FARMS

FREE COPY! New spring listings, Arkansas property Journal! Statewide Realty Co., 507-AE Pyramid Bldg., Little Rock, Ark. 72201.

THE Only "No-Risk Land Purchase Plan" in America—10 year money-back guarantee on any Vacation, Retirement or Investment homesite in Boiling Spring Lakes—the multi-million dollar, 14,000-acre development on the Carolina Coast. All facilities, electricity, roads, motel, golf course, country club, already in. Private ocean beach, 50 fresh water lakes. 1/3-acre homesites as low as \$700.00 cash price; \$8.00 down, \$7.70 monthly for 120 months, including interest at an annual percentage rate of 6%. Write for free literature. Dept. 1-Y, Boiling Spring Lakes, North Carolina 28461. (Not offered to residents of California, Florida, New York.)

CANADIAN HUNTING/FISHING PROPERTIES, from \$9.00 an acre. Choice properties available across Canada. Acquired through estate liquidations. Low monthly payments. Ideal hunting, fishing, cottages, farming, timber, minerals, investment. Write for free catalogue. Canadian Estate Land, Department 65A, 194 Wilson Ave., Suite 101, Toronto 12, Canada.

FREE CATALOG. Spring bargains! Homes, farms, ranches, investment, business, retirement property! Actual property photos! Write today! SAFE-BUY Real Estate. Box 589-PM, Little Rock, Ark. 72203.

ARIZONA mountain retreat acreage, near Prescott National Forest. 2 1/2 acres, \$1,295, low terms. Mrs. Young, Glenarm Co., 2233 North 7th St., Phoenix 85006.

CANADIAN Lands, seized and sold for taxes. Our 53rd annual series of lists, describe many choice properties, situated from coast to coast, acquired by us through Tax Sale. Priced as low as six dollars per acre, guaranteed perfect title, small monthly payments, no mortgage. Beautifully situated hunting and fishing camps, where there is real sport; summer cottage sites, heavily wooded acreages. Now is the time to invest in Canada's minerals, forests and farms. Write to-day for free booklet with full explanation. Tax Sale Service, Room 301-D, 85 Bloor St., East, Toronto 5, Canada.

CANADIAN Vacation lands: Full price \$385.00. 40 acres, \$10 month. Suitable cottage sites, hunting, fishing, investment. Free information. Land Corporation, 3768-C Bathurst, Downsview, Ontario, Canada.

\$1 ACRE—Canadian Border—hundreds campsites, islands, farmlands, directly from tax authorities. (Non-profit). Lists, photographs mailed. Register. Room 10, 110 Church Street, Toronto 1, Canada.

CENTRAL Ontario—Choice 640 acre Sportsmen's paradises still available—\$20.00 plus \$6.50 taxes yearly. Maps, pictures. \$2.00 (Refundable). Information Bureau, Norval 4, Ontario, Canada.

GOVERNMENT LANDS . . . Low as \$1.00 acre. Millions acres. For exclusive copyrighted report . . . plus "Land Opportunity Digest" listing land available throughout U.S., send \$1.00. Satisfaction guaranteed. Land Disposal, Box 9091-PD, Washington, D.C. 20003.

BUY CANADA \$10—10 ACRES. Thousands of Tax Sale properties direct from government authorities. Atlantic to Pacific. Good roads. Near border. Sensational investment gains. Lake frontage. Cottages. Hunting, Fishing. Unique researched lists. Maps, Photos. "BUREAU," 16 Quinby Court, Thistletown, Ontario, Canada.

LAND! EASY TERMS LESS THAN BANK RATES. NORTHWEST TIMBERED ACREAGES as low as \$950 Total Price, 5-10-20-40 acres. For people who love the land—A tract of Recreation Land to have for your very own! In Northern Idaho and North-eastern Washington, and Western Montana. In the heart of lakes and big game country. All covered with growing timber. Access and Title insurance with each tract. This is select land with natural beauty, recreational and investment values. Plan for the future and retirement recreation. We have tracts of many types and sizes from which you can choose, including beautiful Northwest Waterfront property. Your inspection is welcomed. Write us for free list, maps and complete information. Write to: Dept. PC, Reforestation, Inc., P.O. Box 8146, Spokane, Wash. 99203.

450,000,000 ACRES Valuable Government Land Now Available Low as \$1.00 Per Acre. Buy, Lease or Homestead Free. For Latest Report Send \$1.00. American Land Disposal, Box 725-A, Holland, Michigan 49423.

GOVERNMENT Land—450,000,000 acres. U.S.A.-ALASKA. \$1.25 acre, up. Buy: Homestead: Vacation, Cabin, Ranch Sites. Copyrighted guide, guaranteed!! Rush \$1.00 today. Surplus Land Bureau, Box 80 GM, Las Vegas, Nevada 89101.

NEW: Canadian oil leases, \$4.00 acre. Free information. Northern, Box 560-F, Westmount, Montreal 215.

10 TO 80 ACRES—Lake Superior, Marquette, Michigan area \$99 acre. Hiawatha Forest Lake Acres. Write H & H Bloch, 1301 E. 6 Mile, Detroit 6, Michigan 48203.

\$1 ACRE—U.S.A.—CANADA Millions Acres. Direct from Government Agencies. No middlemen. . . . Family vacationing. Fishing, Hunting, Homesteading, Investing. . . . For amazing "where" and "how" "ALL STATES—ALL CANADA GOV'T LANDS DIGEST" . . . plus invaluable Canadian maps. Rush \$1.00 (Guaranteed): Can-Am Lands, P.O. Box 1147, Buffalo, New York 14240.

FREE! Real Estate Catalog! Farms, Ranches, Business, Recreational and Investment Property. 18 States, pictures galore. Note State Desired, BANNER Adv. Box 3333, 19-A, Springfield, Mo. 65804. "Real Estate Our Specialty"

FREE . . . 216-page SPRING 1970 real estate catalog. All types property, coast to coast! UNITED FARM AGENCY, 612-PM West 47th St., Kansas City, Mo. 64112.

NEW!—FREE CATALOG! Giant SUMMER edition! Over 4,000 properties described, pictured—Land, Farms, Homes, Businesses—Recreation, Retirement, Selected Best throughout the U.S! 70 Years' service, 518 Offices, 40 states Coast to Coast. Mailed FREE from the World's Largest! STROUT REALTY, 60-RX E. 42nd St. NY, NY 10017; 7-RX S. Dearborn, Chicago, Ill. 60603; 521-RX E. Green, Pasadena, Cal. 90012.

LAKE FRONTAGE. Canadian Shoreline Properties with well wooded acreage on Lakes teeming with fish. Suitable for Hunting, Fishing, and investment. Small monthly payments. Free booklet. Northern Land—Department P 33 Rosehill Avenue, Suite 2507, Toronto 270, Canada.

UTAH—Large Level lots, water, power. Full price \$695. \$10 down, \$10 month, no interest. Hunting, fishing paradise. Free pictures, maps. Write Utah-Arizona Land Co., Box 486, Kingman, Ariz.

FARM & GARDEN EQUIPMENT

PROFITS FROM CLASSIFIED ADVERTISING! Booklet shows you how to start your own business with Classified Advertising. Only \$1.00 (Refundable with first order.) C. A. Martin, Popular Mechanics, Dept. PM, 224 West 57 Street, New York, N.Y. 10019.



FLOWERS, PLANTS & NURSERY SUPPLIES

600 ASSORTED sweet onion plants with free planting guide, \$3.60 postpaid. Tonco, "home of the sweet onion," Farmersville, Texas 75031.

LEARN Landscaping and the growing of plants. Start a profitable business part or full time. Free information without obligation. Lifetime Career Schools, Dept. A-752, 2251 Barry Avenue, Los Angeles, California 90064.

GINSENG Bringing \$18 Pound. Have Seeds Roots. Goldenseal. Full Information. K. Collins, Viola, Iowa 52350.

MAKE MONEY growing valuable ground-covers. Write, Profitplans, 128 Third, Wilmette, Illinois 60091.

CONSTRUCTION PLANS, BLUEPRINTS

HOBBYISTS, EXPERIMENTERS, amateur scientists, students . . . Construction Plans—All complete including drawings, schematics, parts list with prices and sources . . . Laser—Build your own coherent-light optical laser. Operates in the visible light range, pulsed mode—\$6.00 . . . Radar—Build your own ultrasonic doppler radar. Detect motion of people, automobiles, even falling rain drops Transistorized, uses standard small 9-volt battery—\$4.00 . . . Long Range "Sound Telescope"—This amazing device can enable you to hear conversations, birds, other sounds hundreds of feet away. Very directional. Transistorized, uses 9-volt battery—\$3.00 . . . Or send 25¢ coin (no stamps) for complete catalogue . . . Wide range of other plans, including psychedelic lights, color organs, robot man, etc. . . . 38 different plans . . . Technical Writers Group, Box 5994, State College Station, Raleigh, N.C. 27607.

MONEY MAKER-SAVER!! LOW COST HIGH PRESSURE SPRAY CLEANER & CHEMICAL PUMP—500 PSI—2 gal./min. Wash houses—cars—trucks—boats—airplanes furniture—etc. Spray trees—shrubs—lawns—fertilizer or weed killer—rid property of insects etc. Easy assembly—no special tools—portable—115 volts—hot or cold water outlet \$2.00—complete plans—bill material instructions—ideas. "Systems," P.O. Box 18242, Louisville, Kentucky 40218.

HOME CRAFTSMEN

BUILD Stairs instructions \$2.00. Don Haskins, Union Street, R.F.D., Whitman, Massachusetts 02382.

MAKE STONE SIDING from colored concrete for pennies. Simple illustrated instructions \$3.00. Star Enterprises, P.O. Box 1352, Kingston, Penna. 18704.

"DRAW your own scalloped patterns to any size. Send 75¢ for easy method. Scallops, P.O. Box 1782-PM, Hemet, Calif. 92343."

BUILD Electric Ball Game. 25 Page instruction, and information. Picture included. Send \$2.00. Mazzola, 111-48 120th Street, S. Ozone Park 11420.

MAKE your own fine picture frames with our beautiful mouldings and amazing Clamless Assembly Method. Terrific savings! We show how. Free proof, particulars. Japs, 126-PM Seventh North, Hopkins, Minnesota 55343.

CABINETMAKING MADE EASY and "How to Make Formica Counter Tops," two excellent guides let you build kitchen cabinets and counter tops like professionals. Extraordinary guides bring master craftsmen's shortcut methods. Satisfaction guaranteed. Write: Japs, 126-P Seventh North, Hopkins, Minn. 55343.

SKIL-CRAFTS new 200 page catalog with world's largest, finest selections of hobby-craft, leather-craft, artist supplies. Send 50¢ (refunded plus free gift with first \$5 minimum catalog order). Skil-Crafts, Box 105-P, Joplin, Mo. 64801.

PLANS, Bird houses. Send 15¢ for brochure and free feeder plan. Yeager, 1665 Linden, Homewood, Ill. 60430.

FULL SIZE FURNITURE PLANS. Traditional, Early American, Danish Modern. Catalog 50¢. Furniture Designs, Dept. P-40, 1425 Sherman, Evanston, Illinois 60201.

WALNUT And Cherry tapered legs, lumber, gunstock blanks, picture frame moulding. Midland Lumber Company, Box 262, Savannah, Missouri 64485.

PLANS: Dry sink stereo equipment cabinet; colonial corner 12" speaker cabinet; pagoda roof cupola; \$2.00 each. Easyplans, Box 7167, Flint, Michigan 48507.

AMAZING! Combination woodburning fireplace and steak grill. Plans \$3.00, no checks or cod. Box 1413, Las Cruces, New Mexico 88001.

DO-IT-YOURSELF

COMPLETE Home BURGLAR and FIRE alarm system, \$54.95. Satisfaction guaranteed. MRL, Inc. Dept. B, 7227 Lee Highway, Falls Church, Va. 22046.

ROACHES KILLED for less than \$1.00. Not a chemical! Money back guarantee. For amazing secret, send \$1.00 to: Sommerville, 2764 B, Selma, California 93662.

DO-IT-YOURSELF simplified Central Air Conditioning. Approximately \$450 for homes with forced air furnaces. Write for step-by-step brochure. McGraw-Edison Company, 705C N. Clark St., Albion, Michigan 49224.

REFRIGERATOR Door gaskets—Electric Range and Washer Parts. Send Make and model for cost. Box 5465, Hamden, Conn. 06518.

BURGLAR-Fire Alarm Supplies and information. Free Catalog. Protecto Alarm Sales, Box 357, Birch Run, Michigan 48145.

AIR Compressors made from Mower Engines. Write: Showalter, Box 409, Abilene, Kansas 67410.

EXERCISE At home on build-it-yourself physical fitness equipment, including bicycle exerciser, rowing machine, belt massager, and abdominal board. Send \$3.00 for blueprints B1208 and instructions. Popular Mechanics Service Bureau, 224 West 57th St., New York, New York 10019.

HIGH Flying Delta Wing Kite. Easy to make. Outperforms other kites. Plans \$1. L.M., 85 Country Lane, West Seneca, N.Y. 14224.

MANUFACTURE waterless hand cleaner. Easy. Profitable. Concentrate \$2.00 pound. Shanahan, 380 West Main, Waterbury, Conn. 06702.

MAGNETIZE SCREWDRIVERS YOURSELF Equipment and complete instructions with explanations why metal is magnetized \$1.50. Haynes Mfr. Company, Box 39273, Solon, Ohio 44139.

CRIB-Youth bed detailed plans, send \$3.00. R.A.S. Designs, 62 Fairview Avenue, Binghamton, New York 13904.

FREE Literature. Save your OWN money. Avoid commissions selling your home. Guide Publications, Box 151, Yorba Linda, California 92686.

AIR Compressors made from discarded refrigeration units. Instructions \$2.00. Rapid Refrigeration, Box 105, Clarinda, Iowa 51632.

WATER!! How to Drill Your Own Well and Save 75%. Free. DeepRock Co., 2003 Poplar, Opelika, Alabama 36801.

POPULAR MECHANICS MASTER SHOP GUIDE. Greatest product offered to a man with a workshop. All information printed on heavy boards, punched and ready to hang above his workbench. Covers wall fasteners, nails, screws, bolts, twist drills, abrasives, lumber, moulding patterns, plywood grades, hardboard, drywall, plumbing supplies, electrical supplies. Plus information on scores of other subjects. Send \$3.95 to: POPULAR MECHANICS, 224 West 57th Street, New York, New York 10019.

ARTS AND CRAFTS

MAKE Figurines, plaques, lawn ornaments, Molds, plastercraft kits, liquid rubber. Sample and catalogue 10¢. Wooley Company, Box 29-B, Peoria, Illinois 61601.

FREE: New 136 page handicraft catalog. Supreme Handicrafts, Box 395-PM, Sioux Falls, South Dakota 57101.

200 MOLDS For Ornamental Concrete—Catalog 25¢—Plycrete Molds, Elk Rapids, Mich. 49629.

"BUILD Unique COPPER FOUNTAINS inexpensively, easily. Used indoors—outdoors. Complete plans \$5.00. 6001 Blondo, Omaha Nebraska 68104.

"GETTING Started in Stained Glass" 25¢. Whittemore, Box 2065Y, Hanover, Mass. 02339.

BINOCULARS, TELESCOPES, MICROSCOPES, MAGNIFIERS

SCIENCE Bargains! Lenses, telescopes, binoculars, microscopes, kits, parts, war surplus. Send \$1.50 for beginner's 10-lens kit with instruction booklet. Order Stock 2-CH. Request free 148 page Catalog CH. Edmund Scientific Co., 300 Edscorp Bldg., Barrington, New Jersey 08007.

BINOCULAR Specialists. Repairs And Sales. Free Catalog. Tele-Optics, 5514 Lawrence, Chicago, Ill. 60630.

BINOCULARS Direct from manufacturer. Finest quality, tremendous savings! catalog 25¢. Koyu, 3860 Crenshaw Blvd., Los Angeles, Calif. 90008.

TELESCOPES (Reflectors) complete kits, other accessories, request free literature. Criterion Manufacturing, Dept. PM-6, Hartford, Conn. 06101.



CAMERAS AND EQUIPMENT

WORLD'S Largest Buying Guide—800 Illustrations—50¢—Deductible With Your Order—Olden Camera—1265 Broadway, New York, N.Y. 10001.

48 PAGE ILLUSTRATED CATALOG with the low Central Discount price. Send 50¢, get 75¢ CREDIT on order of \$7.50 or more. CENTRAL CAMERA CO., Photographic headquarters for the Amateur and Professional SINCE 1899. Central Camera, Dept. 1AA, 230 S. Wabash Ave., Chicago, Ill. 60604.

PHOTO FINISHING

SPECIAL WITH THIS AD—Kodacolor developed 12 prints \$2.25. Black & White developed 2 prints each Jumbo size—12 exposure 70¢. LENS PHOTOS, Dept. J-4, Janesville, Wis. 53545.

CAMERA FANS! Expert photofinishing by one of Country's largest labs at lowest prices. Fast service and free "Foto-Fan" Stamps you quickly redeem for valuable Photo Supplies. 8MM Kodachrome \$1.29; 8 Exp. Kodacolor \$1.79; 35MM Kodachrome, 20 Slides \$1.39; 8 Exp. Black White 69¢. Satisfaction guaranteed. Send exposed film or request free mailers, complete Price List and Gift Catalog. Direct Mail Photo, Box 8352-PM, Pittsburgh, Pa. 15218.

OLD PHOTOS COPIED RESTORED. High Quality, Special Photo Services. Send Photos, free estimates. Originals Returned unharmed—(enclose 95¢ Special Handling)—(Color-B&W-Enlarging unlimited.) Giant Photos—Camden, Alabama 36726.

TRIAL OFFER. Twelve prints from roll 60¢. Eight enlarged color prints from Kodacolor roll \$1.39; twelve \$1.79; twenty \$2.69. Young Photo Service, 45C, Schenectady, N.Y. 12301.

COLOR SLIDES

MILLIONS of photos bought each year. Make second income with your camera. Booklet reveals how to submit and sell your photos for great profit. Only \$1.00. Mills Mail Mart, Dept. PM470, 130 Herbert Avenue, Elmont, New York 11003.

MOTION PICTURES AND SOUND EQUIPMENT

FREE! 64-page catalog. 8-16mm film, supplies, processing equipment. Superior, 448 N. Wells, Chicago 60610.

16MM SOUND Features, Shorts, New, used for Sale. Free Catalog. National Cinema, 333 W. 57th St.—N.Y.C. N.Y. 10019.

8MM-16MM BARGAINS! Free Catalog! Cinema Eight, Box 245-PM, NYC. 10028.

UNUSUAL Movie supplies. Free circular. Esor, 47th Holly, Kansas City, Missouri 64112.

RADIO, TELEVISION AND HAM EQUIPMENT

TUBES—Lowest world prices. Foreign—American. Obsolete, current, receiving, special purpose, transmitting tubes. Send for tube and parts catalog. United Radio Company, 56-PM Market St., Newark, N.J. 07105.

33¢ RADIO & TV tubes. Free list. Cornell, 4213-17 University, San Diego, California 92105.

BEGINNERS, Experimenters Kits, Parts Catalog. Lectronix, Box 42, Madison Heights, Michigan 48071.

GOVERNMENT Surplus receivers, transmitters, snooperscopes, parts. Catalog. 25¢. Meshna, Nahant, Mass. 01908.

POLICE-FIRE Radio Dispatcher Directories! Exclusive official confidential listings; call signs, frequencies. Catalog; send stamp. CRB Research, Box 56-PM, Commack, New York 11725.

HOME Radio-Television Course. Free literature. Progressive Edu., Department 724B, Hewlett, New York 11557.

CONVERT B&W TELEVISION TO COLOR. Patented System. Free Brochure. Bele Electronics Corp., 111 N.E. Second Avenue, Miami, Florida 33132.

HIFI, TAPES, RECORDS AND ELECTRONICS

SUBMINIATURE microphone extremely sensitive \$2.95, miniature speaker \$1.80. All items guaranteed. Postage prepaid. MICRO-M, Box 251, Hatfield, Pennsylvania 19440.

FREE Catalogues. 2000 hard to find unusual records. Rose's Records, 300 Chelsea, Louisville, Ky. 40207.

RECORDS! Discounts on all LP's. Free details. Citadel Record Club, Symphonette Sq., Dept. 2, Larchmont, N.Y. 10538.

STEREO TAPES! 33% discount! Unavailable elsewhere. Cartridges, cassettes, reels. Latest hits . . . Oldies . . . Professionally recorded, 25¢—catalogs, free offer. Star Recordings—PM, Box 1055, El Paso, Texas 79946.

FREE Circular—Country Western Records and Tape Cartridges—Fiddle Tunes—Waltzes—Blue Grass. Uncle Jim O'Neal, Box A-PMM, Arcadia, Calif. 91006.



MUSIC AND MUSICAL INSTRUMENTS

ACCORDIONS and Amplifiers! Save to 50%. Famous makes. Easiest terms. Trade accepted. Free home trial. Free discount catalog. Accordion Corporation, 5535-R West Belmont, Chicago 60641.

30% DISCOUNT Any Name Brand Musical Instrument. Free Catalog. Freeport Music, 127 West Sunrise H'way, Freeport, New York 11520.

EXCELSIOR Accordions and Amplifiers. Save 50%. Buy Direct. Factory Distributor. Terms, Trades. Free Catalog. Excelsior, 3147 North Luna, Chicago 60641.

VIOLIN and Guitar makers—send for latest Free Catalogue of woods & accessories. International Violin, PMO, 414 East Baltimore St., Baltimore, Md. 21202.

ACCORDION Manufacturing. 6846-P North Avenue, Chicago, Illinois 60635. Concertinas, Hohners, Chromatics, Guitars, Drums, New, Used, Tuning, Repairing. Wholesale Catalogs Free.

POEMS Wanted for new songs and records by America's largest song studio. Send poems. Free examination. Five Star Music, 6M Beacon, Boston, Mass. 02108.

PLAYER Piano Rebuilding—get details from: Vestal Press, Vestal 11, N.Y. 13850.

GUITARS, MANDOLINS, BANJOS, Complete stock of Gibson Martin guitars. Free 100 page catalog, parts and accessories. Big Savings. New York discount prices. Send 50¢ postage handling. Eddie Bell Guitar, Dept. PM, 201 West 49, New York 10019.

SONGWRITERS! London Company now in USA needs poems for new songs. All types wanted. Details free. Musical Services, 715/P. West Knoll, Hollywood, California 90069.

POEMS, Songs, wanted for new songs and immediate recordings. Contracts, royalties. Weiss Music Company, 1472-PM Broadway, New York, New York 10036.

ACCORDION Top brands. Buy direct. Tremendous discounts. Trade accepted. Free brochure PM. Accordion-O-Rama, 874 Broadway, N.Y.C. 10003.

SWISS Musical Movements Mechanical-Electrical. Spielman, 131 West 42nd, New York 10036.

FREE, Song Selling Information. Peerless Publications, Box 193-A, Bloomfield, Conn. 06002.

GET Discounts, Save Money. 426 page catalogue only \$5.00, deductible from first order over Fifty Dollars. Globe Music, 3522 Church Avenue, Brooklyn, N.Y. 11203.

ELECTRIFY Player Pianos, Pump Organs Quickly, Inexpensively with Lee Silent Suction Units. Write Lee Music, 525F Venezia Avenue, Venice, California 90291.

GUITAR, Banjo Making books Plans, woods, necks, tools. List 25¢. Satinwood, 510 East 11th Street, New York, N.Y. 10009.

LEARN Banjo, 5-String Bluegrass. No music. Makes learning easy. Free details. Blaylock, Box 25-M, Marietta, Georgia 30060.

SONGS, Poems wanted by America's most popular studio. Free recording. Bonus for Select Songs. Tin Pan Alley, Dept. PM, Broadway Division, Lake Grove, New York 11755.

PROFESSIONAL 674 Watt Amplifiers. Guitars. Free Wholesale Catalog. Carvin PM70, Escondido, Calif. 92025.

PLAY Organ or Guitar easily! Amazing! Information. Keeley, 1016 Kelly, Joliet, Illinois 60435.

FREE RECORDING, Poem, Song Information. Hollyville, 6565 Fountain, Hollywood, California 90028.

DOBRO Type guitar—world's best acoustical. The Guitar, 4668 Hollywood Blvd., Hollywood 90027.

WE Pay All Recording Costs on accepted material! Need new Song Material for immediate recording! Grand Recording, 1354-PM Hancock St., Quincy, Mass. 02169

RECREATION MANAGEMENT TRAINING

MOTEL MANAGERS Wanted by leading chains, resorts, motels-hotels everywhere! Men, women, couples enjoy free rent, plenty of free time. Easy home-study plan. Free! "Motel Career Kit." No salesman will call. North American School of Motel-Management-AZW, Newport, California 92660.

PLAYGROUND MANAGEMENT TRAINING

PLAYGROUND-PARK, Recreation, Sports, Craft Instructors needed now! Beginners —Get Paid for Having Fun!!! We show you how! U.S. Government says "750,000 new Recreation jobs by 1980." Easy home-study plan. Free! "Recreation Career Kit." North American School of Recreation-AZW, Newport, California 92660.

CONSERVATION TRAINING

GAME WARDEN, Government Hunter, Forestry, Park & Wildlife Service announce job openings regularly. Prepare at home for outdoor work, good pay, security. Complete information Free! Write North American School of Conservation-MPW, Newport California 92660.

TRAVEL TRAINING

TRAVEL AGENTS Make \$\$\$\$\$. Exciting Booming Careers! Easy Home-Study Plan. Free! "Travel Career Kit" Write—North American School of Travel-AZW, Newport, California 92660.

DRAFTING TRAINING

DRAFTING: Learn at Home. U.S. Government reports "42% more Draftsmen needed next 10 years." Send for Free "Drafting Career Kit." No salesman will call. G.I. Bill approved. North American School of Drafting-AZW, Newport, California 92660.

SURVEYING TRAINING

LEARN SURVEYING—join high pay Team . . . help plan highways, bridges, dams, subdivisions, etc. U.S. Government predicts big need for beginners. Easy home-study plan. Free! "Surveying Career Kit." North American School of Surveying-AZW, Newport, California 92660.

EDUCATION AND INSTRUCTION

COLLEGE Degree at home. Law, other subjects. Easy tuition plan. Williams College, 445-PM East 2nd South, Salt Lake City, Utah 84111.

USED Courses, Keenan, 16 Fairview Avenue, Saranac Lake, New York 12983.

COMBINE Bible records. Have conversion information. Box 233, Newport News, Va. 23607.

CONTRACTING pays big money. Free details. Town House Improvements, Brandonwood Dr., Rt. #3A, Johnson City, Tenn. 37601.

EARN University Degrees Through Experience—All Subjects—Details \$1.00—Osmu—Box 9734—Columbus, Ohio—43206.

SELF-Improvement books! Catalog 10¢. Write Jack Butler, 1384-B Monroe Drive, N.E., Atlanta, Georgia 30324.

ART Production. Study this profitable occupation at home. Drawing ability unnecessary. Free information. Box 122, New Canaan, Connecticut 06840.

FINGERPRINTING—Investigation, Exciting, secure career. Learn at home. Free book. State age, Institute of Applied Science, 1920 Sunnyside, Dept. 164, Chicago, Illinois 60640.

BE A Real Estate Broker. Big earnings. Prepare quickly, easily. GI approved. Free Catalog. Weaver School, 3519-P Broadway, Kansas City, Missouri 64111.

LIFETIME ordinations. Send stamp for information. Church, 2207 Cardinal, Rolling Meadows, Ill. 60008.

GRAPHOANALYSIS—Learn scientific handwriting analysis for profit, pleasure. Free sample lesson, catalog, reveals plan. Write: Igas Inc., 325 Jackson, Dept. 2AP-2, Chicago 60606.

(Continued on next page)

EDUCATION AND INSTRUCTION

(Continued from preceding page)

AUTOSUGGESTION. Sleep-learning headquarters! Tapes, records, books. Gigantic catalog free. Research Association, Box 24PM, Olympia, Washington.

USED CORRESPONDENCE Courses and Books sold and rented. Money back guarantee. Catalog free. (Courses bought.) Lee Mountain, Pisgah, Alabama 35765.

LEARN Auctioneering. Term soon. Free catalog. Reisch Auction College, Box 850, Mason City, Iowa 50401.

PIANO Tuning quickly learned with home study course. Diploma granted. American Tuning School, Gilroy, Calif. 95020.

OWN Collection agency. "Little Gold Mine!" Franklin Credit, Roanoke, Virginia 24004.

EARN \$125 A week and up. Learn a trade with a future. Learn auto diesel mechanics in our shops. You learn with tools on real equipment. Earn while you learn. Many of our graduates earn \$125 a week and up. Write for free bulletin: Dept. 256, Auto Diesel College, Nashville, Tennessee 37219.

MISSOURI Auction School. GI Approved. Free Catalog! 424-03 Nichols Road, Kansas City, Mo. 64112.

FCC First Class License in six weeks—Nations highest success rate—Approved for Veteran's Training. Schools in Dallas, Atlanta, Chicago, New Orleans, Minneapolis and Houston. Write Elkins Institute, 2603D Inwood Road, Dallas, Texas 75235.

USED Courses! Books! List 10¢. Smith's, 124 Marlborough, Salem, Mass. 01970.

HIGHLY EFFECTIVE home study courses in Electronics Engineering Technology and Electronics Engineering Mathematics. Earn your Degree. Write for Free Descriptive Literature. Cook's Institute of Electronics Engineering, (Dept. 10), P.O. Box 10634, Jackson, Miss. 39209. (Established 1945).

SUPERIOR Auction School. Nation's top Auctioneers own and instruct. Box 1281, Decatur, Ill. 62523.

AUCTIONEERING Resident or Home Study Course Free Catalog. Nashville Auction School, 2004 West End, Nashville, Tennessee 37203.

DETECTIVE Course. Free information. Universal Detectives, Box 8180-F, Universal City, California 91608.

LEARN To prepare income tax returns. It's easy and profitable. Act today! Write American Tax Training Institute, Dept. PM, Box 4845, Chicago, Ill. 60680.

PROFITABLE Camera service training at home. National Camera, Dept. PM, Englewood, Colo. 80110.

PENMANSHIP Corrector. Improve Poor penmanship quickly. Details free. Ozment, Box 2344-34, St. Louis, Mo. 63114.

EXTENSION And Post-Graduate Awards in Philosophy, Arts, Sciences, Botanic Medicine, Homeopathy, Radionics and others. 30 subjects. Curricular free (air-mail \$1.00 refundable). Registrar, Sussex College of Technology, Highfield, DaneHill, Sussex, England.

PENMANSHIP Improver: Improve penmanship quickly, easily. Write: Tevis, Chillicothe, Mo. 64601.

WATCH REPAIRING. Learn to repair American and Swiss watches in spare time at home. Diploma awarded. Free sample lesson. No obligation. Chicago School, Dept. YD, Fox River Grove, Illinois 60021.

FREE Bible course! Degree! Request information! 708 Bragg, Monroe, North Carolina 28110.

PIANO Technology—Electronic organ servicing, learned easily at home. G.I. Approved. Free booklet. Niles Bryant School, Dept. P, 3631 Stockton, Sacramento, California 95820.

HIGH SCHOOL diploma at home. Licensed teachers. Send age, highest grade completed for free details. No salesman will call. Southern States Academy, 5300 W. Belfort, Dept. 16-D, Houston, Texas 77035.

LEARN Asleep or awake! Records, tapes, equipment! Free catalog! Drawer PM-400, Ruidoso, New Mexico 88345.

GET A British Degree. Divinity, Philosophy, Radionics. 35 Courses. Prospectus free. Brantridge Forest School, Highfield, Dane Hill, Sussex, England.

SHEET-Metal Bend allowance and Bend Deduction Tables for Ferrous and Non-Ferrous Metals, with instructions, \$3.95 Postpaid. Desco Products, Box 395-PM, San Dimas, California 91773.

PIANO Tuning pays. Big money in spare time. Learn at home. No musical knowledge necessary. Phonograph, records, tools and instructions furnished. Electronic tuning also taught. Free catalog. Capital Tuning School, 3160 S.W. 16th Court, Ft. Lauderdale, Fla. 33312.

BECOME Ordained Minister. Free information. Church, Box 191, Auburn, New York 13021.

LEARN Massage. Home study course. Free details. Massage, Box 190-PM, Quincy, Mass. 02169.

COLLEGE degree at home. Free catalog. Canada University, 306-364-99th Avenue SE, Calgary, Alberta.

BECOME Real Estate Broker quickly. Economical Homestudy. Prospectus Free. Howard Schools, Box 8585-A, Kansas City, Missouri 64114.

SELF-HELP through study of top-quality civil service test preparation courses, how-to-do-it, and self-improvement books. For free descriptive brochures, write: Markham's, 95C Dart St., Hartford, Connecticut 06106.

"SELECTIVE SERVICE AND YOU"—an informative booklet giving the meaning of classifications and deferments. A must for draft age males. Send \$1.00 to David Nicholson; 621 Comal, Pearsall, Texas 78061.

STOP Worrying. Future. Security plus good pay, with Government job. Quick, easy, inexpensive preparation. Score high on test. Free circular. 285 books to select. Casa-Dei, Dept. 171, Alpine, New Jersey 07620.

EASY Lifetime Income! Learn Professional Wagering Methods and scientific speculation. Exciting FREE information! Willing Distributors, Box 2208-P, North Hollywood, California 91602.

ABUNDANCE In Success, Prosperity, Health, Happiness. FREE book list. EDIFY ASSOCIATES, Box 341-A, Urbana, Ohio 43078.

EARN Theological Divinity degrees through Correspondence. Catalog! Box 647, Morgantown, Kentucky 42261.

IF TRIG SCARES YOU! IF YOU'RE FLUNKING TRIG! BUT, YOU CAN MULTIPLY 1.23456 x 2. YOU CAN LEARN TRIGONOMETRY IN ONE ENJOYABLE EVENING. \$3.98 FOR NEWLY COPYRIGHTED TRIG OVERNIGHT COURSE. NATIONAL SPEED COURSES, P.O. BOX G D, WILLIAMSBURG, VIRGINIA 23185.

BE A TECHNICIAN Investigate opportunities. 2 year Associate Degree programs in Numerical Control Programming; Power Technology (Small Engine), Food Manufacturing Technology—Canning and Freezing or Dairy. Accredited. Free information available. Fond du Lac Technical Institute, 805 E. Johnson Street, Fond Du Lac, Wisconsin 54935.

\$\$\$ TUNING Pianos. Easily learned at home. Musical knowledge unnecessary. Course. Tools. Business Instructions \$28.00. Free information. Meyco, 4743 North 58th Drive, Phoenix, Arizona 85031.

FOR INVENTORS

1790 PATENT. "Antiqued" reproduction. \$2.00. Jands, Box 743, Lompoc, Calif. 93436.

KNOW before you act!!! Pamphlets now in stock on all aspects of invention development. Free list. "Pamphlets" 139 Longworth, Rochester, N.Y. 14625.

INVENTORS—Do you want to sell or license your invention on cash or royalty basis. Write Kessler Corporation, C-54-F1, Fremont, Ohio 43420.

PATENT Searches complete and thorough. Related copies Air Mailed with maximum speed \$6.00. Free "Protection Forms" and "Patent Information." Write American Patent Search Company, Dept. 27, 711 14th St., N.W. Washington, D.C. 20008.

PATENT Application Financing. Free patent search plan. Global Patent Division, 2420 77th, Oakland, Calif. 94605.

U.S. Patent Office Searches, 234 Broadway, Room 3615, New York. Free invention certificates.

PATENT And invention development by licensed professional patent engineer and U.S. Patent Office former examiner, and engineering specialists. Your inventions and ideas engineered for patent protection and commercial value. Inventions developed by us negotiated for cash or royalties with our nationwide contacts. Send for free protection "Invention Certificates" and further interesting, valuable patent information. George Spector, Licensed Professional Patent Engineer, Woolworth Building, New York.

INVENTORS. Send \$2 for Invention Protection, Patent Procedures and Save \$\$, Inventors Guideline, Box 293, Jacksonville, N.C. 28540.

PATENT Searches, including copies of related U.S. patents. Inventors attorneys, manufacturers use our "worldwide" air-mail service! "Invention Record" form and "Information Every Inventor Needs." Sent free! Hayward Company, 1029P Vermont, Washington 5, D.C.

FREE PAMPHLET: "Tips on Safeguarding Your Invention." Write: United States Inventors Service Company, 501P Thirtieth Street N.W., Washington, D.C. 20004.

INVENTORS: Your ideas and inventions (patented: unpatented) expertly searched, developed for commercial appeal and cash/royalty sales to manufacturers by professional Invention Developer with excellent record of experience. B.S. Industrial Engineering; United States Patent Office former Patent Examiner, United States Government former Patent Advisor. Second decade reliable service! Member: United States Chamber Commerce. Free "Invention Record" and "Recommended Protection Procedure." Airmailed! Write: Raymond Lee, Invention Developer 230P-Park Ave., New York City 10017.

MANUFACTURERS NEED New Products! FREE Literature explains "How to Submit Your Invention." Congress Invention Company, 911-C Warner Building, Washington, D.C. 20004.

IMMEDIATE Cash, for patent applications. Free patent searches. Write for details. Universal Patents, 184-D, Marion, Ohio.

PROFESSIONAL Society for Inventors!!! Details, application form upon request. Write: "Inventors," Membership Department, Box 247A, Webster, New York 14580.

INVENTOR'S Handbook. The Bible for inventors. This invaluable book is now available by mail. our future is at stake. Act now. \$7.50 Postpaid. Catalog 45c. Bilton, River Edge, New Jersey 07661.

INVENTIONS WANTED

WANTED INVENTIONS or Marketable Items to Manufacture. P.O. Box 2563, Muncie, Indiana 47302.

NEW Products wanted for manufacturing, promotion, mass merchandising. Wehner Associates, 210 Fifth Avenue, New York, N.Y. 10010.

(Continued on next page)

INVENTIONS WANTED

(Continued from preceding page)

IF Your Invention is adaptable to promoting we will contract for selling on cash or royalty. Free booklet outlines royalty rates, requirements. Kessler Corporation, C-54-IW, Fremont, Ohio 43420.

INVENTIONS Wanted. Patented: unpatented. Tremendous manufacturers lists. Global Marketing Service, 2420G 77th, Oakland, California 94605.

INVENTORS! Sell your invention for cash or royalties! Our client manufacturers eagerly seek new items. Patented. Unpatented. Financial assistance if needed. 25 years proven performance. For free information, write Dept. 15, Gilbert Adams, Invention Broker, 80 Wall St., New York, N.Y. 10005.

INVENTORS! We will develop, sell your idea or invention patented or unpatented. Our national manufacturer-clients are urgently seeking new items for highest outright cash sale or royalties. Financial assistance available. 10 years proven performance. For free information write Dept. 47, Wall Street Invention Brokerage, 79 Wall Street, New York, N.Y. 10005.

INVENTORS! Don't sell your invention, patented or unpatented, until you receive our offer. Eagle Development Company, Dept. H, 79 Wall Street, New York 5, N.Y.

FREE "Directory of 500 Corporations Seeking new Products." For information regarding development, sale, licensing of your patented/unpatented invention. Write: Raymond Lee Organization, 230-N Park Avenue, New York City 10017.

INVENTORS! Protect your ideas! Free "Recommended Procedures." Washington Inventors Service, 422F, Washington Building, District of Columbia 20005.

WE Either sell your invention or pay cash bonus. Write for details. Universal Inventions, 28-E, Marion, Ohio.

MANUFACTURING

INVENTORS Ideas developed. Research. Models. Manufacturing. Sales. Free brochure. William Parker, 32 Westminster, Worcester, Mass. 01605.

BUY IT WHOLESALE

800,000 BARGAINS! Tremendous Discounts Available! Wholesalers. 1265-MR Broadway, New York, N.Y. 10001.

BARGAINS! Buy wholesale and below. Name brands. Appliances, furniture, sports equipment, televisions, cameras, watches, jewelry, thousands more. Huge discounts to \$1,000.00 on new automobiles. All makes. Free details. Write today: Worldwide Bargainhunters, Box 730-A, Holland, Michigan 49423.

HEARING Aids, Batteries, Wholesale. Catalog 25c. Fiston, Box 1444, New Preston, Conn. 06777.

WORLD'S Largest wholesale dropship sources. U.S., foreign. Factory suppliers dropship direct to you or customers. Now! have your own catalog for pennies. Free details. International Buyers, Box 16386-M, Portland, Oregon 97233.

WHOLESALE—Buy 40% To 50% Off Retail—same prices retailers pay! Thousands of name brands! Watches, cameras, jewelry, radios, phonographs, tape recorders, etc. Buy for yourself or resell at fat profit. Big wholesale catalog. Confidential Wholesale Price List. Free details. Wholesale Merchandise Club of America, Dept. 400, 154 Jericho Turnpike, Floral Park, N.Y. 11001.

1969 FORDS, Dodges, \$799. 1968 cars only \$599. For free catalog. Associated Dealers, 50 Swalm, Dept. L, Westbury, N.Y. 11590.

EXPORT-IMPORT

JAPAN: 1200 Products Directory. Illustrated Manufacturers' names, addresses. \$3.00. Send cash. Yamagata Office. 814 Togin Bldg., Marunouchi, Tokyo.

IMPORT And Save. 1000 Overseas exporters. Many dropship and most send Samples. Directory \$2, 444 Free Magazines. 65 fields of interest. Directory \$2.00. Gray, Rt. 1, Senacaville, Ohio 43780.

REVISED Foreign Suppliers Directory \$4.95. World Shoppers, P.O. Box 151-W, Oklahoma City, Oklahoma 73123.

FOR THE HOME

HOTCHKISS FIRE ESCAPE LADDERS. For Homes, Apartments, Farms. Fires Are Vicious Killers. Free Details. Red Oak Sales, Maple Street, Somersville, Conn. 06072.

FOR PARENTS

DADS, worldwide organization dedicated to restoration of your lost rights and privileges is expanding. For application and exciting details send \$1.00 deposit. Comptroller, Box 705, Port Orange, Fla 32019.

OF INTEREST TO WOMEN

EARN \$100.00 Modeling Garments local areas. Plan \$1.00. Packer, Box 1742, Hollywood Station, Los Angeles, California 90028.

ZIPERS WHOLESALE—20c each in assortments of 10. Several sizes. Many colors. Send \$2.00 Warehouse Sales, P.O. Box 1333, Longview, Wash. 98632.

SELL Memberships. International Franchise Operators League. \$10.00 Commission. Dixon, 421 Center St., Lewiston, New York, 14092.

SKETCH Photos—"Home Goldmine"! Details. Gem, 365-G Longhill, Shelton, Conn. 06484.

FREE SAMPLE, newest stationery. Send name, address. Cornucopia, 1009-C Dorsey, Melbourne, Florida 32901.

WEAVE RUGS—Make Good Profits—No experience necessary! Free Catalog, sample card, and low prices on carpet warp, rug filler, looms, parts, inexpensive beam counter. If you have loom—advise make, weaving width please. Or. RUG COMPANY, Dept. 406, Lima, Ohio, 45802.

HOMEWORKERS Directory! 262 national firms seeking help. Information free. Economy, Box 1348-AD, Clearwater, Florida 33517.

WOMEN: BIG MONEY! Studio Girl Cosmetics needs women in all states including Hawaii, Alaska, Puerto Rico and American Samoa. Full or part time. No experience required. No territory restrictions. Take orders anywhere. Highest profits. 300 Good Housekeeping approved cosmetics, wigs, wiglets and falls. Everything furnished. Credit extended. No stock to carry. No franchise fees. No stock investment. For full information by mail, plus 2 free beauty samples, write HARRY TAYLOR, Chairman, Studio Girl Cosmetics, Dept. BC446, 11461 Hart Street, No. Hollywood, Calif. 91605. Also immediate big profit earnings for experienced city and state managers and for party plan operators. Former Studio Girls please write.

WOMEN! Make big money at home. \$10.00 profit in an hour possible with invisible mending. Make holes, tears disappear from clothing fabrics. Steady year-round demand from cleaners, laundries, homes. Details free. Fabricon, 1533 Howard, Chicago 60626.

HOW To make money writing short paragraphs. Information free. Barrett, Dept. C-27-D3, 6216 N. Clark, Chicago 60626.

DRIVE New car, wear new clothes, buy color TV. Get daily cash income. Put spare hours to work. Write for 5 months free subscription Opportunity Magazine, see hundreds easy ways to make money. Opportunity, 1460 Hancock Center, Dept. 17-D0, Chicago 60611.

\$75.00 THOUSAND. Home addressing! Longhand, typewriter. Information, send stamped self-addressed envelope. Brewster, Box 1348-YL, Clearwater, Florida 33517.

\$500 MONTHLY POSSIBLE—Clipping news at home. No experience. Free information—send stamp. American, Excelsior Springs, Mo. 64024.

\$100 WEEKLY Possible addressing mailing circulars. Send self address stamped envelope. Details Free! Ayers Opportunities, Box 1591PM, Denton, Texas 76201.

\$100 WEEKLY Possible—Home Typing Immediate earnings! Employers list, complete instructions. Details 25 cents. Typing, Box 593, PM-4, Bettendorf, Iowa 52722.

CHURCHES, School Groups, Civic Clubs, Scouts! \$50.00 cash is yours everytime 10 members each sell 10 canisters of Nationally Advertised Candy at \$1.00 a can using our "50-50" Funds Raising Plan. Fun, Fast, Easy. Send no money. 30 days to pay. Write Verne Collier, Dept. PM-5, 900 North 19th, Birmingham, Alabama 35203.

MAILORDER "Pro" reveals secrets for starting profitable home business. Free brochure. Tory, Dept. 884PM, Bayonne, New Jersey 07002.

HOMEWORKERS! \$85 Weekly addressing envelopes for firms. Start immediately! Information: Send stamped, self-addressed envelope. Enterprises, Box 16143-PM, Phoenix, Arizona 85011.

\$100.00 WEEKLY Addressing mail for firms. Start now! Send stamped self-addressed envelope. Davis, Box 6992, Phoenix, Ariz. 85005.

\$25.00 HUNDRED Addressing. Possible! Year 'round. Special information included. Send 25c postage, handling. Cove, Box 1348-B, Clearwater, Florida 33517.

LOSE WEIGHT. Unique diet club for women and girls, combines Bowling or other activities with excellent diet program. Write for free starter kit. Alpha Zeta Chi National Weight Control Sorority, 513 Susana Avenue, Redondo Beach, Calif. 90277.

HOMEWORKERS! Earn \$100 weekly typing, addressing. Begin immediately. Details free. Hamilton, 272-TM4, Brooklyn 11235.

HOME Newspaper clippers needed. \$500 monthly possible. Details free. Foster, 272-MA4, Brooklyn 11235.

HOMEWORK. Mailing circulars! Free details! Cam Company Dept. 155-XM, Verona, N.J. 07044.

EARN Up To \$6.00 per dozen lacing beautiful Baby Boots! Cowboy, Warsaw 9, Indiana 46580.

\$350 MONTH Addressing! Details, stamped self-addressed envelope and 25c. Happy, Box 1161-CC, Battle Creek, Michigan 49016.

GIFT SHOPPING

FREE Catalog. Gifts, novelties, books. Harry Haines, R1, Box 151, Mill Hill, Pennsylvania 17751.

FREE Catalog, write Wood and Company Box 2705—St. Paul, Minn. 55112.

FREE Gift brochure. EXCITING new ideas. FREE gift offer. Koltun's, 60 Willowgreen Drive, Tonawanda, New York 14150.

WATCHES, OLD GOLD, JEWELRY

SPECIAL Deep sea diving watches. Catalog \$1.00. Swiss Import, Dept. W28, Box 191, Verona, N. J. 07044.

HIGHEST Cash For Gold, Jewelry, Gold Teeth, Rings, Diamonds, Watches, Silver, Platinum. Mail Articles Today. Free gift with information. Chicago Gold & Precious Metals, 6 E. Monroe, Dept. 858, Chicago, 60603.

WATCH And clock repairing books. Free catalog. North American, Box 77-AR, Fox River Grove, Illinois 60021.

(Continued on next page)

WATCHES, OLD GOLD, JEWELRY

(Continued from preceding page)

WANTED—gold, silver, platinum (any form), mercury. Information free. Wilnot's, 1067 Bridge Street, Grand Rapids, Michigan 49504.

CASH Immediately for old gold, jewelry, gold teeth, watches, diamonds, silverware, spectacles, platinum, mercury. Free information, Rose Industries, 29-A East Madison, Chicago 60602.

HIGHEST cash immediately for old Gold, Jewelry, Silver, Platinum, Gold teeth, Rings, Diamonds, etc. Mail items today. Prompt payment. Free information. Superior Coin, Dept. GPM, 34 E. 12th, NYC 10003.

MERCURY. Immediate Payment. Free Information. Mercury Supply. PM-52, Fairfield, Ohio 45014.

JEWELRY and HANDICRAFT—Catalogue #10 M 25c (refunded with first order) EVE'S GIFTS, Box 132 Tallman, New York 10982.

CASH Gold Silver Platinum Mercury. Refinery, 43 Ross, Bklyn., New York 11211.

WEARING APPAREL

INTRODUCING Instant Hosiery Wash Case. Profit up to 60%. Selling price \$1.95 Sample \$1.15 prepaid. Comparetto, 34-15 12th Street, New York 11106.

HEARING AIDS

HEARING AIDS—Batteries Wholesale! Brochure—Hearing Center, Box 211, St. Petersburg, Florida.

HEARING Aids below wholesale. Regular, eyeglass, completely hidden models. Smallest, most powerful. Free home trial. No Salesman will call. Free details. Write Prestige-C6, Box 10880, Houston, Texas 77018.

All Type hearing Aids \$89.00. Rhodes, 333 North 9th, Paducah, Ky. 42001.



SCIENCE AND CHEMISTRY

CHEMISTRY, Astronomy, Biology supplies. Catalog. 35c. Xercon, 8542 Oglesby, Chicago, Illinois 60617.

CHEMICALS, Apparatus, Biological Supplies, Microscopes, etc. Catalog 35c. Sheard Science, Dept. PM, Columbus, Wisconsin 53925.

FREE Periodic classification of elements and conversion tables with catalog 35c. Chemicals, apparatus, biology. Mid-States Scientific, 7053 N. Clark, Chicago, Ill. 60626.

CHEMICALS And apparatus for industrial, analytical, and private laboratories. Catalog 50c. Dept. M-50, Biological Supply Co., 1176 Mt. Hope Ave., Rochester, N.Y. 14620.

ILLUSTRATED Catalog: Chemistry, mineralogy, biology 25c. Tracey Laboratories, Evanston, Illinois 60204.

LABORATORY Supplies At Discount Prices. Catalog—35c. Deluxe Scientific, Manitowoc, Wisconsin 54220.

CATALOGUE of ver-ry interesting products 35c. Things that go boom, things that go zoom, and things that make money! Kenrus-C, Box 158M, Staten Island, New York 10309.

LASER PISTOL—\$1.00. How to build PHASER PISTOL—\$1.00. MOON MAN (ROBOT). Build now. Complete plans \$2.00. (add 25c postage.) New catalogue—25c. Roy Davis Laboratories, Dept. PM, 118 West Adams Street, Jacksonville, Florida 32202.

COMPLETE Chemistry catalog. 20c. Laboratory Sales, Box 161-A, Brighton, Mass. 02135.

SEARCHING For Economically Priced Laboratory Supplies? Elements Charts and Catalogue—35c. Hagenow Laboratories, Manitowoc, Wisconsin 54220.

CHEM-CLUB . . . \$5.00 Per Year! BIRCH Laboratories, Sandstone, Minnesota, U.S.A. 55072.

SEARCHING For Economically Priced Chemicals and Apparatus? Conversion Charts with Catalogue—35c. Starr Scientific, Manitowoc, Wisconsin 54220.

FORMULAS, PLANS, ETC.

FOR Proof of what you can do in specialty manufacturing get our literature. It's free! Miller, Chemist, 1517-P, Tampa, Florida 33601.

MAKE CASTING PLASTICS AT HOME WITH MATERIALS FROM DRUG AND GROCERY STORES. SIMPLE. GUARANTEED FORMULA, \$3.00. NO CHECKS UNLESS CERTIFIED. STARMOUNT, 3306 NORTH BOULEVARD, RALEIGH, NORTH CAROLINA 27604.

ANY Formula \$3.00. Catalog—Treatise 10c. Belfort, 192 N. Clark, Chicago 60601.

BEST FORMULAS! Lowest Prices! Catalogue, 10c. Universal Enterprises, 103 Park Avenue, N.Y.C. 10017.

160 THE World's most amazing formulas. Money back guarantee. Only \$10.00. Kronbergs Sales, 1325 So. 27th Street, Omaha, Nebraska 68105.

PLASTICS

CASTOLITE pours like water and hardens like glass at room temperature. Embed natural flowers, coins, special collections Also new molding and casting resins for reproducing originals. Manual 25c. CASTOLITE, 70/101D, Woodstock, Ill. 60098.

PLASTIC Craft Kits—Supplies. New. Enlarged Catalog 50c. (Refundable). Specialty Products, Dept. 7, 731 Brooks Road, Muskegon, Michigan 49442.

PLASTIC Embedders, jewelry workers. We have everything. Findings, moulds. New Catalog 25c. David Co., 861 Broad St., Dept. M, Providence, R.I. 02907.

PLASTIC, DECALS

MOTHER Of Pearl Chips wholesale. Used for plastic imbedment used in making beautiful table-tops, wall paneling and decorative novelties. Send 25c for price list. Apco, Post Office Box 282, Metropolis, Illinois 62960.

TREASURE FINDERS

TREASURE LOCATORS MOST COMPLETE LINE. FREE INFORMATION. TESOROS, APARTADO 7-948, MEXICO 7, MEXICO.

POWERFUL Metrotech locator detect gold, silver, coins, relics. Moneyback guarantee, terms. Free information. Underground Explorations, Dept. A, Box 793, Menlo Park, California 94025.

FREE TREASURE GUIDE! Fact-filled collectors edition; send 50c for postage. Also request free literature on ultrasensitive, professional Fisher Detectors. FISHER RESEARCH, Dept. PM-4, Palo Alto, California 94303.

ULTRA-SENSITIVE AND POWERFUL METAL DETECTORS—Join the many who are finding buried coins, minerals, relics and artifacts. Don't buy till you see our FREE catalog of new models. Write Jetco—Box 132, PM, Huntsville, Texas 77340.

TREASUREPROBES. Patented transistorized detector signals "dig" by earphone "beeping." 5" search head, PC boards, two colpitt oscillators improve stability. Kit \$13.95, assembled \$18.88, with speaker \$24.88. 60 day guarantee. Send for Free bibliography. "Treasure Maps and Books of U.S." Treasurehouse, PA40, Tennent, N.J. 07763.

FIND Buried treasure with new revolutionary analytical metal detector. Features push button tuning, automatic tuning, loudspeaker, negligible ground pickup greatest range. Free catalog. Gardiner Electronics, Dept. 9, 4729 N. 7th Ave., Phoenix, Ariz. 85013.

TREASURE. Gold, silver, relics. New 1970 detectors now available. Free Information. Excelsior Electronics Company, 7448 Deering Avenue, Canoga Park, California 91303.

"TREASURE BOOKLET. Excellent information on treasure hunting and metal detectors. Send 25c. BOOKLET, Dept.—PM-4, Box 243, San Gabriel, California 91778.

TREASURE Hunters! Prospectors! Relco's new instruments detect buried gold, silver, coins, minerals, historical relics. Transistorized. Weighs 3 pound. \$19.95 up. Free catalog. Relco-A40, Box 10839, Houston, Texas 77018.

NEW: Canadian oil leases. \$4.00 acre. Free information. Northern, Box 560-F, Westmount, Montreal 215.

GOLDAK Treasure Locators—Pleasure and profit in a hobby you'll enjoy. Find coins, relics, gold, silver. Charge on BankAmericard. GOLDAK, Dept. PM 1101-A Air Way, Glendale, California 91201.

PRECIOUS STONES AND MINERALS

MOONROCK—Tektite from Thailand. 1 inch \$1.00. Larger \$2.00, \$3.00, \$5.00. Plummer's, 4720 Point Loma Ave., San Diego, Calif. 92107.

EARTH Science Rockhound Magazine. Subscription \$2.50. Sample 35c. Box-550-PM, Downers Grove, Ill. 60515.

100 COLORFUL. Polished gemstones \$1.00. Tumblecraft, 5401 James North, Minneapolis, Minnesota 55431.

GET Free catalog no serious rockhound, gem cutter, jewelry maker, hobbyist or craftsman can be without. Full of bargains, exclusive items, low prices from largest suppliers and authorities in the field. Free new catalog just off the press, yours for the asking. Write Grieger's, Dept. C-12, 1633 E. Walnut, Pasadena, California 91106.

SEMI-Precious uncut gems. Ten different for \$1.00. Request list #35. Prospectors Shop, 201 San Francisco, Sante Fe, New Mexico 87501.

12 POLISH-Gem-Stones-Of-The-World, Names-And-Locations. — Educational — \$1.00. Empire Gem's, Trinidad, Calif. 95570.

500 BEAUTIFUL POLISHED GEMSTONES \$1.50. Floodstones, P.O. 1673 Fremont, California 94538.

150 MANUFACTURED Polished Gemstones. Opaque — clear — swirls — mixed sizes \$1.00. Crystal Gems, Cologne, Minnesota 55322.

CARTOONING, COMMERCIAL ARTS, SHOWCARD & SIGN PAINTING

COMPACT 23 lesson Cartoon Course and Cartoonist's Magazine. \$2.00. Hartman, Box 30367, Lincoln, Nebraska 68510.

LEARN sign painting at home. Free talent test. Ben Kerns, Box 812-PM, Greenville, S.C. 29601.

SIGN Painting. Fascinating System—Straley, 410 So. Western, Springfield, Ohio 45506.

SIGN Painting Matthews' big new 18 lesson course \$5.00 postpaid. Circulars free. Sign Book Co., 470 Oak Street, St. Louis, Mo. 63119.

"HOW TO MAKE MONEY WITH SIMPLE CARTOONS"—Everyone who likes to draw should have this book; FREE. Write Cartoonists' Exchange, 94 Pleasant Hill, Ohio 45359.

(Continued on next page)

CARTOONING, COMMERCIAL ARTS, SHOWCARD & SIGN PAINTING

(Continued from preceding page)

LEARN Profitable tattooing. Illustrated information and instruction \$3.00. Zels, 2220-P Delcy Dr., Rockford, Illinois 61107.

ART Talent? Make money right away. Course may not be necessary. Free brochure. American Studios, Dept. P6, Spring Park, Minn. 55384.

SIGN Painting—Latest methods. Free catalogue explains everything. Kaufmann Supply, Centertown, Missouri 65023.

SIGN Painting secrets, tricks, illustrated booklet \$2.95. Free catalog. Paulow Letter Patterns, 1935 Stardust, Waukesha, Wisconsin 53186.

ADVERTISING AGENCIES, ADV. SERVICE, MAILING LISTS

ADVERTISING Ratebook leading newspapers, magazines, 25¢. Chicago Advertising Agency, 28-E Jackson, Chicago 60604.

MAILING Lists most all kinds 1000 \$5.00. Free folder Your circulars mailed \$4.00 1000. Dixie Mailers, King, N.C. 27021.

EXCLUSIVE! HIGH INCOME LISTS. One thousand names. \$3.00. R.&D., Box 8045-M, Salt Lake City, Utah 84108.

TYPEWRITERS, DUPLICATORS, OFFICE EQUIPMENT

FREE Plan. Start printing, lettershop. Offset Presses. Mimeograph Copy machines. DixieGraph, King, N. Car. 27021.

RUBBER STAMPS AND OFFICE SUPPLIES

FREE Illustrated rubber stamp booklet. Beckley's, 119 DeLong Avenue, Syracuse 2, New York 13208.

ADDRESS Stamp with Handle. Four lines \$1.25. House Tom Henry, Bensenville, Illinois 60106.

FREE 40 Page catalog. Rubber stamps, office supplies. Youngers Stamp Shop, Princeton, Iowa 52768.

ADDRESS stamp, 4 lines. Frank's Stamps, 1701 W. 26th, Erie, Pa. 16508.

RUBBER Stamps—Four lines. \$1.00. Prompt. Huesgen's, 6617 Thurston, St. Louis, Missouri.

ADDRESS Stamp 85¢. Signature \$2.80. Catalog, Carol's, McLoud, Okla. 74851.

PRINTING PRESSES, RUBBER STAMP OUTFITS

SIMPLE-X RUBBER STAMP PRESSES, hydraulic operated, electrically heated. Sizes 5"x8", 8"x12", 10"x15". Starting outfits. Orders for presses, supplies shipped day received. Free catalog low supply prices. Custom Manufacturers, 406-P East Elm, Springfield, Mo. 65801.

PRINTING Presses, type, supplies. Lists. 5¢. Turnbaugh Service, Mechanicsburg, Pennsylvania 17055.

TYPE Catalog No. 12, 120 pages. Send One Dollar. Deductible First Order. Acme Type, 732 Federal, Chicago, Illinois 60605.

SAME Day shipment on rubber stamp supplies. Revised wholesale price list No. 6 free. Star Stamp Supply, 732 Federal, Chicago, Ill. 60605.

MAKE your own self-molding rubber stamps and printing cuts. Plexirubber, Argyle 1, Wisconsin.

RUBBER Stamp outfits, supplies. Kiewiet, 2025 Barney Road, Kalamazoo, Michigan 49007.

PRINTING AND SUPPLIES

OFFSET PRINTING—100 Copies \$3.95. Send copy with money order to: Lamar Printing Co., P. O. Box 52395, Houston, Texas 77052.

AMAZING business printing values. Quotations. Print Shop, Box 576, Greenville, R.I. 02828.

8 HOUR PRINTING—Free Booklet "Secrets of Cutting Printing Cost" Nationwide Printing, Atlanta, Ill. 61723.

50 ADDRESSED Envelopes \$1.00, 500 for \$5.00. Terry's, P.O. Box 817, Ontario, Calif. 91764.

FREE Literature. Address Labels, Business Cards, Printing, Rubber Stamps: Jordan's, 552 West O'Connor, Lima, Ohio 45801.

250 AMERICAS Most beautiful and attractive business Cards. Printed in 2 dazzling color raised letters, glass finish cards. Prompt personal service. \$3.00 postpaid. "Lefty" Gandy, Route 1, Lyons, Georgia 30436.

PRINTED Business Forms—all kinds—Free Illustrated Catalog. Sound Mechanics, Box 1, Bronx, N.Y. 10472.

UNIQUE, attractive Letterheads. Small Quantities. Catalog. EDGEWOOD INDUSTRIES, Box 751, Kernersville, N.C. 27284.

1,000 EMBOSSED Business Cards \$4.75 Postpaid. Robert Gersh, Stetson Street, Hyannis, Massachusetts 02601.

MULTIGRAPH, MIMEOGRAPH

PROFITS FROM CLASSIFIED ADVERTISING! Booklet shows you how to start your own business with Classified Advertising. Only \$1.00 (Refundable with first order.) C. A. Martin, Popular Mechanics, Dept. PM, 224 West 57 Street, New York, N.Y. 10019.

GUMMED LABELS

1,000 DELUXE Address labels. \$1.00. Cleveland, 3108 Ross, Dallas, Texas 75204.

1,000 GUMMED Address labels \$1.00. Walt's, Box 966A, South Bend, Indiana 46624.

1000 TWO Color Address Labels. \$1.00. Pannek, 10202 Pacific, Tacoma, Washington 98444.

1000 GOLD Striped Address Labels \$1.00. Meade Seaman, 1702 Followthru, Tampa, Florida 33612.

1,000 GUMMED address labels \$1.00. Fabrico, PD-1, 1512 N.E. 29th Street, Ocala, Florida 32670.

500 DISTINCTIVE Gold Colored Address Labels, \$1.00. McLean Mailers, 6826-H Poplar, McLean, Virginia 22101.

1,000 DELUXE, Gold Stripe, 2 color, gummed, padded labels printed with any name, address & zip code, \$1.00 for each set. Plastic box available at only 10¢ additional. "The House of Gifts," Dept. 446 AD, Faison, North Carolina 28341.

REMAILING SERVICE

NEW YORK City; United Nations 25¢. Additional Services. Snow-M, 458 Vermont, Brooklyn 11207.

LOUISIANA 25¢ each. \$3.00 month. CROCKETT, P. O. Box 3714, Shreveport, Louisiana 71109.

INSTANT Remail, 25¢. \$3.00/Month. John, Box M 2032; Sunnyvale, California 94087.

ST. LOUIS remails, 25¢. Confidential Ronloe, Box 13432, St. Louis, Missouri 63138.

RECEIVING-Forwarding. Confidential Services. Remails 25¢ single. P. O. Box 3511, Toledo, Ohio 43608.

PRIVATE. Receiving-Forwarding. Remails 25¢. Wellington 3227 Kearny Villa, San Diego, California 92123.

MOTOR CITY Remails Special Services Available. M.C.R.S., Drawer 890, Dearborn, Michigan 48121.

MIAMI Remails 25¢. Monthly rates. Marie, Box 1266, Coral Gables, Fla. 33134.

CONFIDENTIAL New York City mail address \$3.00 month. Remails 25¢. Details Free. Birnhan, 152 W. 42, New York City 10036.

SECRET. Receiving-forwarding. Discreet and confidential. Remail 25¢ single. Mail Forwarding Service, 8050 S. Main, Houston, Texas 77025.

KENTUCKY Remails 25¢. \$3.00 Monthly rates. Smile, Box 203, LaGrange, Ky. 40031.

BEAUTIFUL Lake Huron Resort, Remails 25¢. Monthly \$3.00, post cards. John, 6746 Lakeshore, Lexington, Michigan 48450.

REMAILS, Individual-Business. \$3.00 monthly, 25¢ singles. Gregory, 1121 Palomas, Southeast, #25, Albuquerque, New Mexico 87108.

ALASKA reliable remails 25¢, monthly \$3.00, postcards. Free information. Alaskamail, 4729 Canterbury, Anchorage, Alaska 99503.

RECEIVING—Forwarding. Monthly Rates. Hedgpeth, 406-M, South Second, Alhambra, Calif. 91802.

INDIANAPOLIS Remails 25¢: \$3.00 Monthly. Box 322, Greenfield, Indiana 46140.

LAS VEGAS, Remails 25¢. Monthly rates. RELAY, Box 453, Las Vegas, Nevada 89101.

HAWAII Remails 35¢—Fox, 1642 Kewalo, Honolulu, Hawaii 96822.

WASHINGTON, D.C. Prestige office or personal confidential address. Daily receiving forwarding for dime-a-day. Metro Mailing Services, Suite 714, Warner Bldg., Washington, D.C. 20004.

EXOTIC LIMA, PERU. Confidential reliable re-airmails \$1.00. Santore, Los Abetos 305, Salamanca-Monterrico, Lima, Peru S.A.

ARIZONA CONFIDENTIAL Remailing—Forwarding 25¢. Monthly \$3.00. Colorful Postcards—Remailed Free—7/\$1.00. Nichols, Box 376-0, Salome, Arizona 85348.

NASA Manned Spacecraft Center, Apollo Zip Code, Remail \$1.50. GSE, P. O. Box 58304, Houston, Texas 77058.

YOUNGSTOWN Remails 25¢: monthly \$3.00. Multigroup, Box 3881, Youngstown, Ohio 44505.

LLOYD'S Anchorage Remails 25¢, air-mails 40¢. 1701 Twining, Anchorage, Alaska 99504.

RECEIVING—Forwarding \$4.00 monthly. Wright House, Box 2112-M, Asheville, N.C. 28802.

INDIANA REMAILS 25¢, receiving forwarding \$3.00 monthly. Individual and Business Confidential Reliable. ANDERSON, P.O. Box 944 PM, Anderson, Ind. 46015.

LOUISIANA Remails, 25¢ Singles, Confidential. Lawson, Box 14701, Baton Rouge, La. 70808.

REPAIRS AND SERVICING

LEARN Hydraulic Jack Servicing!! Complete Manual \$3.00. Satisfaction guaranteed. Bayerco, P-938 Betty Avenue, Neenah, Wisconsin 54956.

SPECIAL SERVICES

AUSTRALIAN OPPORTUNITIES" Fact or Fiction? Americans down under tell it like it really is. Details free. Box 6353, Torrance, California 90504.

INFORMATION On anything. Ferguson Research Specialists, 83-45 Viator Ave., Elmhurst, N.Y. 11373.

RETIRED mechanical designer will make complete plans from your ideas. Reasonable. C. A. Moore, Route 1, Box 73, Chandler, Texas 75758.

(Continued on next page)

SPECIAL SERVICES
(Continued from preceding page)

COMMUNICATE with the Universal Plan. Improve your Life. New O-Cult Device allows you to do this in moments. Simple operation. "The First Step Dial." \$1.00. MoonRiver-B, 99 Charles St., Boston, Massachusetts 02114.

COMPUTERIZED Lifetime Listing: Fantastic Mailings—\$1.00! Details, 25¢. Fabian's, Box 154-G, Montreal 130, Canada.

PERSONAL

SECRET Law Wipes Out All Debts. Immediate relief. Clear credit. Free details. Capital-7. Kerrville, Texas 78028.

BORROW Up To \$1,000 By Mail. Money on your signature for any purpose. Write: American Loan Plan, Dept. CA-0135, City National Bank Bldg., Omaha, Nebraska 68102.

BORROW up to \$1500 by mail on convenient terms! State licensed. Postal Finance, Dept. 17-E, 200 Keeline Building, Omaha, Nebraska 68102.

SECRET LOANS BY MAIL. Borrow \$100 to \$1500 for any good reason in absolute privacy. No interviews, no endorsers, no co-signers. Fast service. Write Dial Finance Co., Dept. D-214, 410 Kilpatrick Bldg., Omaha, Nebraska 68102.

SUBCONSCIOUS Conditioning remakes personality while you sleep. Free details. Sleep-Learning, Box 24N, Olympia, Washington 98511.

BEAUTIFUL Girls. Free Information "International Introductions." Apartado 950, Guadalajara, Mexico.

TATTOO Removing. Do-It-Yourself Kit \$14.00. Information Free: Atlanta Co., 907 Lakecrest, Fairport Beach, Ontario.

INVESTIGATORS. Latest electronic Aids. Free Literature. Clifton, 11500-P NW 7th Ave., Miami, Florida 33168.

RUPTURED. Relief and comfort. No understraps, elastic or steel. Write Hand-Lock Products, Preston 4, Ont., Canada.

BIBLE Questions answered. Stamped envelope. Bylon, 17167 Bentler, Detroit, Michigan 48219.

HYPNOTISM SECRETS. Lowest prices. Free information. Merlin Enterprises, P.O. Box 613, Los Gatos, Calif. 95030.

MAKE NEW FRIENDS Worldwide. Meet Marriage minded Girls through our illustrated Catalog. 1200 Ladies' Fotos and Descriptions \$2.00. I. C. B., Box 12, Sta. O Toronto, 375, Ont. Canada.

MAKE YOUR WILL. Get 4 Will Forms and attorney's informative book. \$1.00. Legal Forms Company, Department 124, 1830 Guardian Building, Detroit, Michigan 48226.

ARE YOU REALLY SINCERE about wanting to find a marriage partner? **SOCIAL INTRODUCTION SERVICE.** P.O. Box 1547, Eugene, Oregon 97401.

HIGHER INCOME SECURITY and POWER 256 Page Book **THINKING BIG** reveals secrets that make men RICH. Send \$2.00 Fam-Lee Sales, 703 2nd Street, East Northport, New York 11731.

PEN PALS! Lonely? Send stamped self-addressed envelope: DeAnn Correspondence Club, Box 1492, Albany, Georgia 31702.

GET OUT OF DEBT in 90 minutes, legally without borrowing or bankruptcy, facts so explosive, credit syndicate tried suppressing, free details, Anderson, 5818-E Hamilton, Cincinnati, Ohio 45224.

LOSER At craps? Guaranteed system. Mathematically developed. Big Money. Now! \$5.00. KLM, P. O. Box 58181, Houston, Texas 77058.

FREE! Undenominational Church ordains anyone. No questions asked. "LEGAL" Minister's license sent immediately. Enclose free will donation. "Legal" Church also issues **DOCTOR OF DIVINITY DEGREES** for \$20 donation. Free Life Church—P. Box 4039, Hollywood, Florida 33023.

SAVE Money, proven method, monthly family budget sheets with explanations, \$1.00. Budgetaide, P. O. Box 58304, Houston, Texas 77058.

WEALTHY Ladies Seeking Gentlemen Friends. Particulars Box 2035, Tulsa, Oklahoma 74102.

LIVE Better on less money. 200 ways. \$1.00. Stanton Service, Box 892-H, Binghamton, N.Y. 13902.

NEW PHONE PATCH with automatic switch. Now you can record those important conversations automatically. ONLY \$19.95. Chelco Electronics, 11835 Wilshire Blvd., Los Angeles, Calif. 90025.

FREE Brochure, self improvement books. Kelly, P.O. Box 2225, St. Louis, Mo. 63109.

WANTED—MISCELLANEOUS

MERCURY, Gold, Silver, Platinum; Ores assayed. Wholesale Terminal, Norwood, Mass. 02062.

MERCURY, Immediate Payment. Free information, Mercury Supply, PM-52, Fairfield, Ohio 45014.

MISCELLANEOUS

CANCER! You may be next! **STOP SMOKING!** New 96 page book reveals medical and psychological method. It may save your life! Money back guarantee! WB-106P Denny's Sales, 210 North 6th, Oregon, Illinois 61061.

WIN AT STATE FAIRS. Grow Enormous Sakurajima Radish. 35 seeds \$1.00 Camstan, 2120 North 26th Place, Phoenix, Arizona 85008.

WINEMAKING . . . Grape, Apple, Cherry, Blackberry. Powerful home-tested recipes without expensive equipment! \$1.00. Bates, 5806 Lemay, Detroit, Michigan 48202.

WINEMAKERS Yeast, Recipes & Catalog 25¢; Kraus, Box 451-L, Nevada, Missouri 64772.

DUPLICATE Birdcalls! Entertaining, educational. Mail \$1.00 bill for two Handreck "Birdcallers"; sent airmail. Millions sold in Europe. Guaranteed. Handreck, Box 720B, 43 Essen, Western Germany.

WANT Greatest Cash Crop working for you? Write Ginseng, Asheville 53, N.C.

YOUR Name sent to 1000 importers, publishers, mailers, wholesalers, etc. on our mailing list. Year \$1.00. Dixie Mailers, King, N. Car. 27021.

CIGARETTES 12¢ a pack. Improved roller makes 20 filtertip, plain, king or regular for 12¢. Facts Free. Moberly, Box 954, Owensboro, Kentucky 42301.

BIRTH Certificates, Marriage Certificates, Diplomas! 2 blank forms \$1.00. Sample 10¢. Standard Forms, Box 482-M, Washington, D.C. 20044.

WINEMAKING . . . Grape, Elderberry, Dandelion, Frozen Juices, etc. Brewmasters' secrets revealed! Powerful Methods! Instructions, Recipes, and Supplies Catalog, \$1.00. Continental, Box 11071 PD, Indianapolis, Indiana 46201.

BOOKS On antiques and their prices. Free circular!! P. Warman Publishers, Uniontown, Penna. 15401.

WINEMAKERS. Free illustrated catalog of yeasts, equipment. Semplex, Box 12276, Minneapolis, Minn. 55412.

ORNAMENTAL Iron designs. Book of 1600 beautiful, practical designs for railings, columns, etc. Free literature. Cunningham, 3881 South 3200 West, Salt Lake City, Utah 84119.

WINEMAKING—Grape—Blackberry, Dandelion, Orange—Oldtimers powerful recipes—instructions \$1.00. Oldtimers, Box 110, TORNADO, W. Virginia 25202.

STOP Smoking new easy way. No pills; no gadgets. Proven method. Guaranteed. Mail \$2 to Scientific Publishing Company, Box 1005, Inglewood, California 90308.

POLYETHYLENE Bags. Top quality, lowest prices. 10¢ brings price list with 200 stock sizes. Milvan, 7055B Rich Ave., Newark, Calif. 94560.

HEARING Aid batteries wholesale. Free list. Habs, Box 51, York, Penna. 17405.

BOOMERANGS: Genuine Australian. Free Details, Aleslagle, 1463 Stroop, Kettering, Ohio 45429.

FABULOUS ORIENTAL zodiac horoscope book. \$1.00. Shopper's Fair, 1052 Bristow, Belleville, Illinois 62221.

"EXOTIC Raffia placemat \$1.00 oriental indian recipes book \$4.00 postpaid send cash. Ariff, 104, Lorong 'L', Singapore —15."

MARIJUANA PLANTS. Plastic. Unbelievably natural. Educational. 20" plant \$4.00. 23" plant \$5.00 postpaid. Calif. Residents add 5% tax. Satisfaction guaranteed. Limited supply. Plantorium, Box 3993, San Diego, Calif. 92103.

1001 FREE ITEMS. List 50¢. Shopper's Fair, 1025E Bristow, Belleville, Illinois 62221.

PERMANENT PLASTIC PROTECTION, instantly! No heating, tools. For papers, documents, photos, cards. Four 10"x12" sheets, ready to use at home, office. Introductory offer. Just \$2. Staley Manufacturing Co., Box 322 B, Wayne, N. J. 07470.

ENGRAVED Plastic Nameplates. Color brochure, 10¢. Nameplates, 4901 Perrine, Midland, Michigan 48640.

PSYCHEDELIC Catalog of Posters, Lighting, Jewelry, Etc. Send 25¢. Hole, 6055 Lankershim, N. Hollywood, Calif. 91606.

YOUR Name placed with 1295 mailers, distributors, wholesalers, importers for mailings all year \$1.00. Tayco Mailers, 528-C Sharon, Stockton, Calif. 95205.

40 FOOT Square For Staking out Excavations, Footings, Foundations, Etc. Large enough to do the job Small enough to fit into your tool box. \$15.95. Quick Square, 8 Mechanic St., Pawcatuck, Conn. 02891.

YOUR NAME Sent to 1000 importers publishers, mailers, wholesalers, etc. Receive our business opportunities list. Year \$1.00. Jim Anderson, Box 944 PM, Anderson, Ind. 46015.

"WINEMAKERS: Precision Testing Hydrometer!! Plus: Illustrated Manual! Wine Yeasts Samples!! Catalogue! All—\$2.00—(Applies toward Supplies Order!!) Winekit, 2121 Conger, Olympia, Washington 98501."

MOON Landing pictures, slides, other space unusuals. Free brochure, Box 234-PM, Merritt Island, Florida 32952.

HOMEWORK WANTED receive, assemble & return. Small & medium size parts preferred. Satisfaction guaranteed. Ernest Poitras, Grenierfield Road, Londonderry, N.H. 03053.

STOP Smoking! Medical and Psychological Step-By-Step Method. No gimmicks! Prolong your life. Send \$2.00—Quality Corner, 85-50 159 St., Jamaica, New York 11432.

WINEMAKING Kit—\$4.98 Free Catalog and recipes. JIMDANDY, Box 30230M, Cincinnati, Ohio 45230.

It's Like Having Auto Factory Experts Right Beside You...

when you use this famous illustrated step-by-step guide that shows you



HOW TO FIX ALMOST ANY PART OF ANY CAR

Now—Whether You're a Beginner or Pro Mechanic—You Can "Breeze Through" Almost ANY Repair Job on Any Popular-Make Car—1964-1970!

MOTOR's AUTO REPAIR MANUAL shows in step-by-step words and pictures all the factory-approved repair procedures you'll ever need for fixing practically ANY part of ANY car listed here—1964-1970.

No guess-work! Even a green beginner mechanic can do a good job with this giant manual before him. And if you're a top-notch mechanic, you'll profit from the time-saving and work-cutting procedures you'll find.

The MOTOR MANUAL makes almost every operation on any car—from Volkswagen to Cadillac—as easy as A-B-C! Eliminates trial and error — saves you time, work and money.

FIX ALL THESE CARS

Volkswagen	Ford	Bronco
Mustang	Buick	
Sarracuda	Special	
Jeep	Comet	
Chevy II	Corvair	
Pontiac	American	
Thunderbird	Olds F-85	
Buick	Falcon	
Imperial	Fairlane	
Cadillac	Lancer	
Continental	Tempest	
Bart	Corvette	
Mercury	Valiant	
Ford	Cougar	
Chevelle	Toronado	
Chevrolet	Lincoln	
Camaro	Front-Drive	
Scout	Cadillac	
Chrysler	Mark III	
Plymouth	AMX	
Dodge	Rambler	
Oldsmobile	Montage	
Blazer	Torino	
Bronco	Hornet	
	Rebel	
	Challenger	

**OVER 1,000 BIG PAGES—
OVER 3,000 PICTURES!**

This GIANT NEW, 1970 edition covers everything you need to know to fix almost any car model from 1964 through 1970. Over 1,000 giant pages. Over 3,000 pictures. 365 "Quick-Check" charts. 55,000 essential repair specifications. Over 225,000 service & repair facts.

PLUS Adjustment Tables, Tune-Up Charts, Tables of Measurements and Clearances, Overhauling and Replacement Facts, Carburetor Adjustment, etc. Special Trouble-Shooter Section and detailed trouble-shooting information throughout help pinpoint the cause of any of 4,200 car troubles in a jiffy.

**OVER 5
MILLION
COPIES SOLD**

**SEND NO MONEY
Try Manual at OUR
Risk — FREE**

See for yourself why U.S. Armed Forces, Schools, and garages everywhere "swear" by MOTOR. Just mail the coupon. Try MANUAL for 10 full days—FREE! If it doesn't pay for itself in those 10 days, just return it and pay nothing, owe nothing. Mail the coupon AT ONCE to MOTOR Book Dept., 250 West 55th Street, New York, N.Y. 10019 (SCHOOLS, BOOKSTORES: Write for discounts.)

**TRY BOOK
FOR TEN DAYS
FREE**

Same Offer on

MOTOR's AUTO ENGINES & ELECTRICAL SYSTEMS

1,300 big pictures. Clear text explains how parts work; principles involved; design; construction; maintenance. Covers all parts of engines & entire electrical system. For FREE trial, check coupon.



MOTOR'S

**AUTO
REPAIR
MANUAL**

**TROUBLE-SHOOTER Section
Helps Spot 4,200 Car Troubles**
Trouble-Shooter section & detailed trouble-shooting info through help pinpoint 4,200 causes of car trouble: transmissions, brakes, engines, electrical systems, much more!

MAIL COUPON NOW FOR 10-DAY FREE TRIAL

**MOTOR BOOK DEPT., Desk 0014
250 W. 55th St., New York, N. Y. 10019**

Send me the new MOTOR's AUTO REPAIR MANUAL, \$9.95, for which I will remit \$2 in 10 days, \$3 monthly for 2 months and a final payment of \$1.95 (plus delivery charges and sales tax, if any) one month after that. Otherwise I will return the book postpaid in 10 days.

Print Name..... Age.....

Address.....

City & State..... Zip Code.....

Also send me MOTOR's AUTO ENGINES and ELECTRICAL SYSTEMS, \$10, for which I will remit \$2.50 in 10 days and 2.50 monthly for 3 months (plus delivery charge and sales tax, if any.) Otherwise I will return book postpaid in 10 days.

SAVE MONEY. Check here if you are enclosing payment in full for book(s) ordered (plus sales tax, if any), in which case we pay delivery charges. Same ten day trial applies; you can return book(s) for prompt full refund.

THE GREAT ONES AT DALLAS



THE GREAT ONES AT HOME

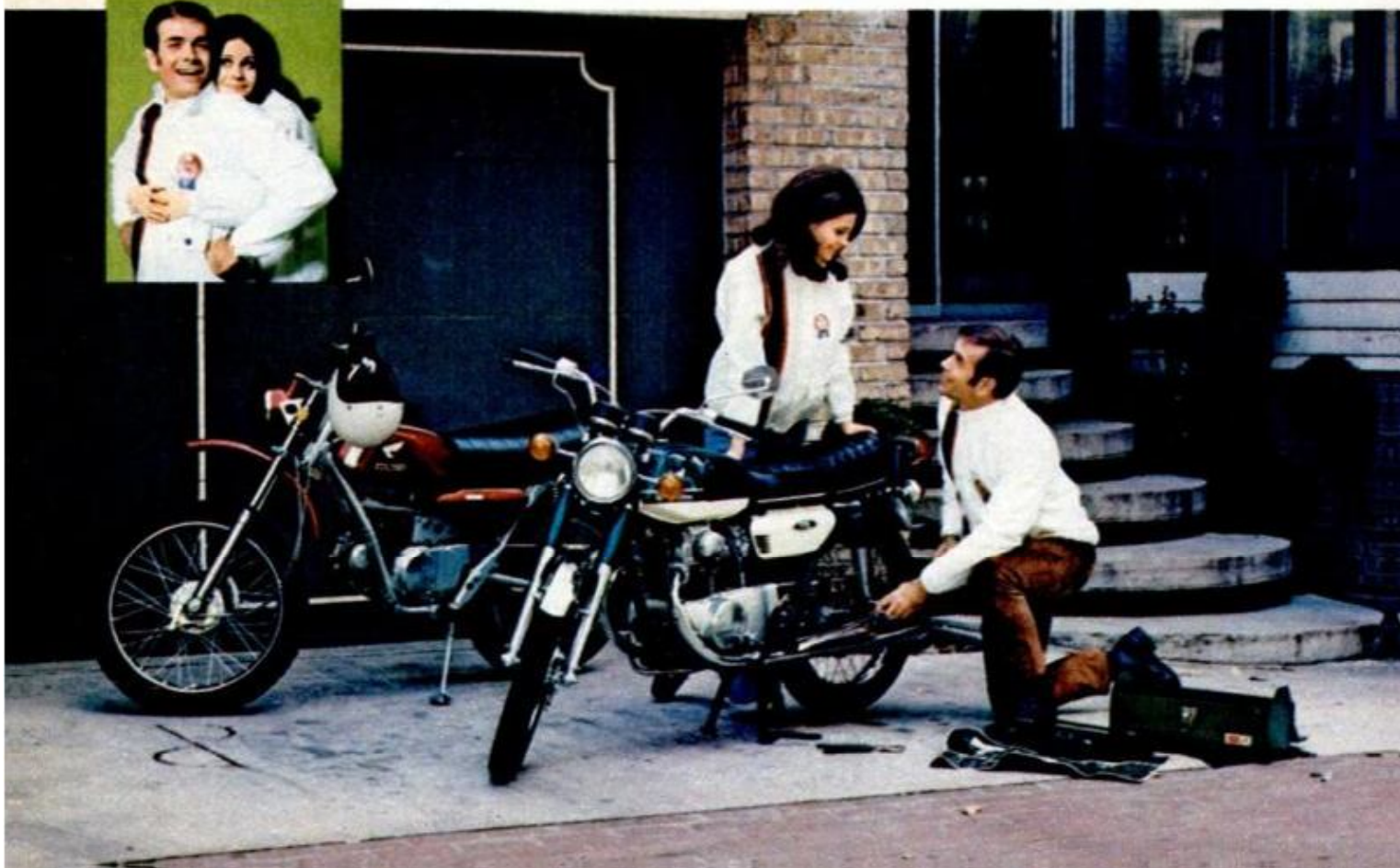

Now, the S-K tools used by the GREAT ONES are on sale at your favorite store!



Head Wrench Amos Satterlee and S-K Tools put the go in the Ongais M/T Funny Car Triumph at NHRA Springnationals!

Danny Ongais drove Mickey Thompson's Mach 1 to victory against a super tough field. He couldn't have won if someone hadn't tamed that Mustang; tuned it, toughened it, and turned it on to mechanical perfection. That took a Great One, head wrench Amos Satterlee.

Under the pressure of big-time racing, professional mechanics must produce top quality work in minute amounts of time. Because of demands on them, the Great Ones demand perfection in hand tools... S-K hand tools... so easy and comfortable to use that they serve as extensions of your brain and hands. It's what you expect from the experts who perfected the famous ratchet wrench.

Save big on Spring Specials!

SAVE \$12.61



No. 4116-9

FAMOUS S-K RATCHET & 1/2" DRIVE SOCKET SET

Regular retail price, if purchased separately: \$36.49. You save \$12.61 during Great Ones Spring Special Sale

"Sweet Sixteen" intermediate set to keep mechanical things in sweet running condition. 16 pieces include 13 standard sockets, ratchet, 5" extension and 17" flex handle. Packed in steel case: 1 1/4" x 17" x 3 3/4".

\$23.88*

LIMITED QUANTITY—SPECIALLY PRICED

*Suggested User Price

Thousands of mechanics rely on S-K Tools to handle jobs easier and faster. If you use tools, why not the best?

You don't have to be a mechanic to need and use S-K tools. That's because there is always a job around the house. If you can't think of one, the little woman will. Point is, why fuss and maybe cuss because you want to do something else, when you can complete jobs in a jiffy with S-K tools? Yep, you can be the Great One at home.

Hold an S-K tool and you'll recognize why they're the choice of the Great Ones. Feels great. Made for your hand. Marvelous balance. Terrific leverage. You couldn't get a sweeter hand-holding tool for love or money. Best of all, you can get them now for less money. Lots less during our Great Ones Sale.

Save big on Spring Specials!

SAVE \$1.00



No. 7510-9

EXPANDABLE 10" TONGUE 'N GROOVE PLIER

Regular retail price: \$3.98. You save \$1.00 during Great Ones Spring Special Sale

The "thin-line" head permits working in tight areas. Machined to micro-tolerances to assure precision jaw operation. Highly polished nickel chrome faces. Cushion grip, green vinyl handles.

\$2.98*

LIMITED QUANTITY—SPECIALLY PRICED

*Suggested User Price

Mechanics: Be proud of your profession. Display this colorful 5" x 7" decal. Enclose 25c for handling and mailing with your request. We'll also send you an illustrated catalog free.

the Great Ones

S-K TOOLS

© 1970 Hand Tool Division, Dresser Industries, Inc.

S-K TOOLS

HAND TOOL DIVISION,
DRESSER INDUSTRIES, INC.
Chicago, Illinois 60604

SOLUTIONS FOR MECHANICAL HEADACHES

AUTOMOBILE CLINIC

BY MORT SCHULTZ

Short stop

If the battery in my car were completely run down, could I get the engine started by connecting a battery from another car by means of jumper cables? One mechanic I asked said yes. Another said it can't be done, because the juice from the good battery would just be absorbed by the dead battery and there wouldn't be enough left to start my car. What do you say?—Art Glaser, McKeesport, Pa.

I say it depends on the condition of your battery. If it's just drained, you will be able to start the engine by jumping another battery. However, if your battery has a dead short in one of the cells, then you probably won't get started. The short would cause grounding of the current coming from the auxiliary battery.

Not many mpg

I have a problem with a 1968 Chrysler with 440 engine and four-barrel Holley carburetor. I get only six miles per gallon. Mechanics tell me there's no adjustment that can be made on this carburetor and that six mpg is all I can expect. Please help.—Clyde D. Nolan, Lilburn, Ga.

This carburetor can so be adjusted, but a mechanic has to know where to look. The mixture adjusting screw, for example, is found inside the air-horn casting. It has a left-hand thread. Frankly, if a mechanic doesn't know this about the four-barrel Holley, I wouldn't let him lay a hand on mine.

Freeze-up

Every time the temperature drops below freezing, the internal linkage of the door locks of my 1968 Mustang hangs up. This isn't outside where I can apply the "hot key," but inside the door panel. I can get the door open, but then the locking jaws won't trip and I have to tie the door shut. Can you offer a solution?—William R. Gardner, Detroit, Mich.

Apply a liberal amount of silicone lubricant spray to the latching mechanism. This will free up the mechanism and will also provide a protective coat to repel an accumulation of moisture. If you get into

a bind again and the door won't close, push the locking button down and slam the door without holding the outside door button in place. This will usually snap the mechanism free.

Hawaiian horrors

No one can solve the problem I'm having with my 1969 Chevelle Six. As I'm driving, the engine will go dead on me. Sometimes it will happen when I'm making a turn; other times when I apply the brake. It always starts immediately afterward. It may not happen for two or three days, and then will occur a few times in one day. What's the trouble?—Candy Candelori, Honolulu, Hawaii.

One of six things: a plugged carburetor gas filter, a misadjusted carburetor float, distributor breaker points that are closed or fouled, a loose connection at the main electrical connector on the firewall, a loose condenser on the breaker-plate attachment, or a primary wire that's grounding against the distributor body. Aloha!

Clogged exhaust

Will engine damage result if the exhaust of a running engine is clogged for even a short time?—Oscar Winkel, Calgary, Alta., Canada.

That depends on what you mean by a "short time." One-half second, for example, will not cause damage. Generally, though, it's damaging. A clogged exhaust causes valves to burn and warp.

What gas?

The owner's manual for my 1968 Opel Rallye says to use premium fuel. Why? The car's engine is only 102 horsepower with a 9.0:1 compression ratio. My V8 Falcon engine has 9.3:1 compression, uses regular.—Wayne Spicer, Arcadia, Calif.

You can use regular, but make sure your ignition timing is on the button. That owner's manual was written in Europe for a European car that uses European gas. That gas has a lower octane rating than American gas. What passes for premium

(Please turn to page 88)

The warranty guarantee.

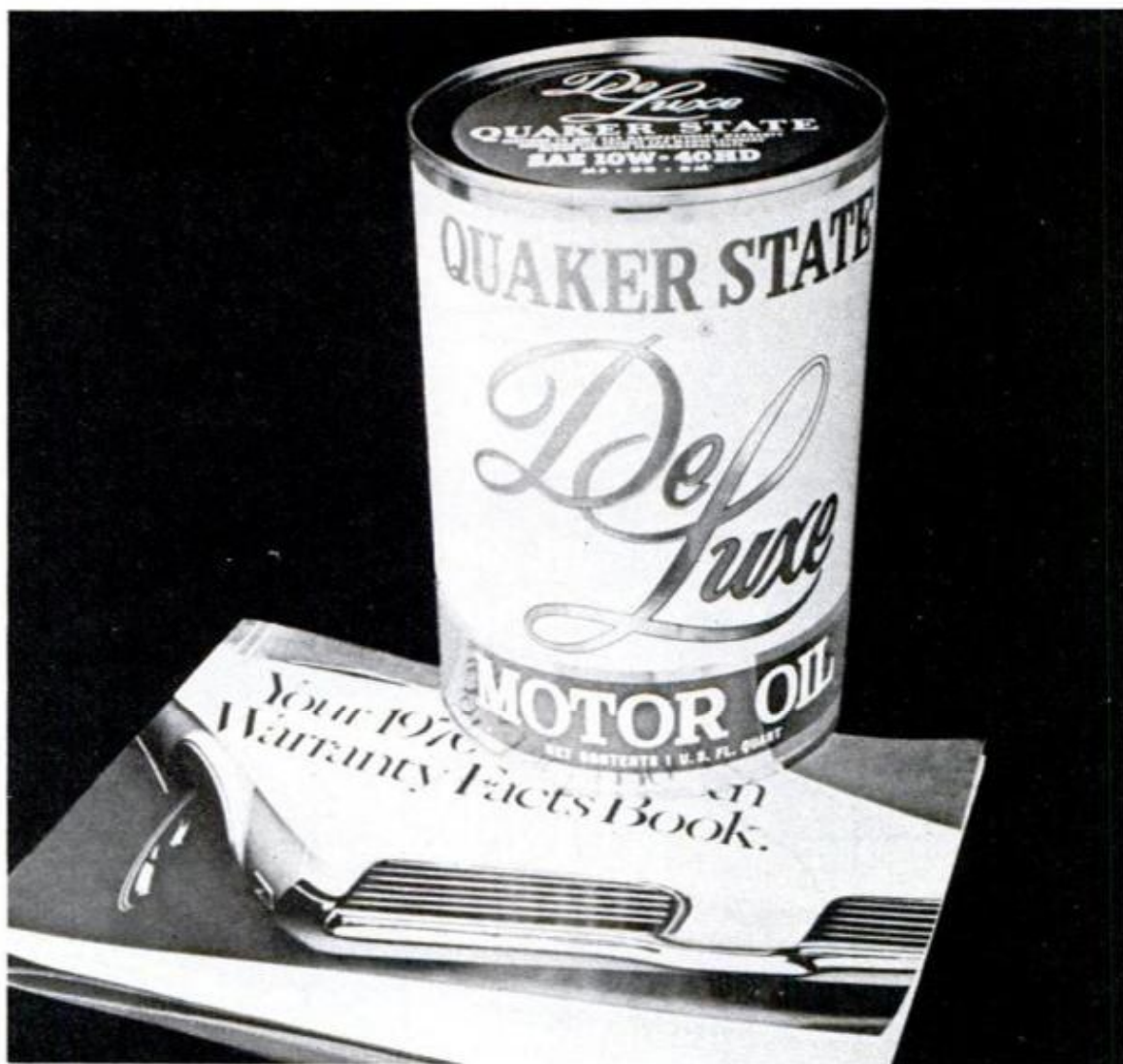

Every new-car maker urges you to use a high-quality motor oil to keep your warranty in effect.

If you use Quaker State, you have the peace of mind of knowing your motor oil does not just meet every car maker's warranty requirements. It exceeds them. Quaker State Motor Oils are your warranty guarantee.

Quaker State is refined only from 100% Pure Pennsylvania Grade Crude Oil. And fortified to protect against rust, sludge and engine deposits.

Read about motor oil in your warranty book. Then buy some peace of mind: Quaker State.

Quaker State your car to keep it running young.



**If you stacked all
the Beechwood Aged
beers in America
on top of each other,
how high would
the stack be?**



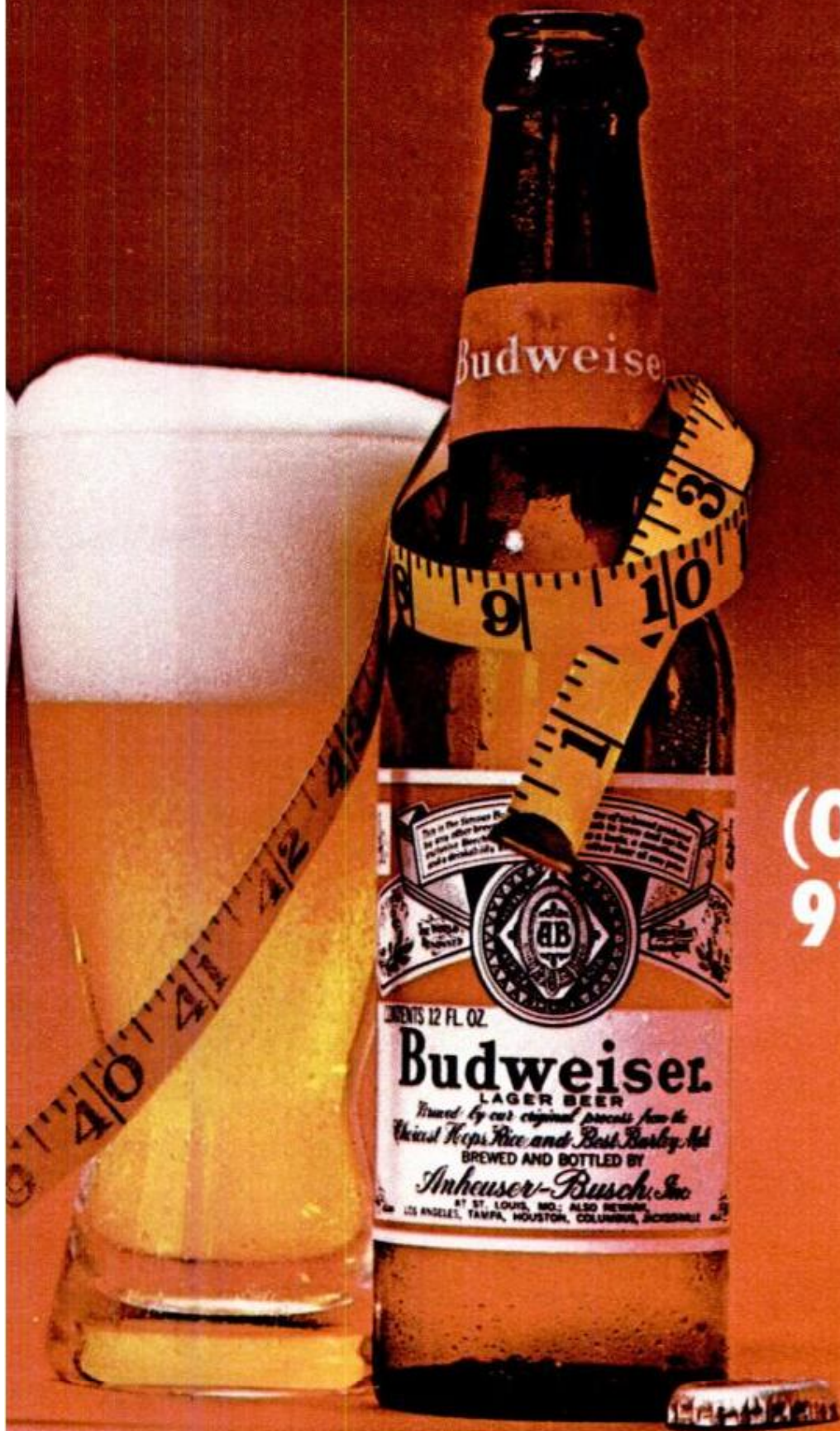

(Oh...about
9½ inches.)

AUTOMOBILE CLINIC

(Continued from page 84)

in Europe is comparable to a good grade of regular gas here. Keep in mind that even American gas differs in octane from company to company. If one brand causes problems, switch—don't fight.

Brake break problem

My dealer tells me that it's normal for my 1969 Plymouth Fury emergency brake to lock, especially in rainy weather and when humidity is high. When I release the brake cable, I have to break the brake loose by accelerating. Any solutions?—Harry Kelman, Central Islip, N. Y.

It's been a problem, and you're not alone, Harry. The emergency brake has been known to hang up with these models. The cable's been binding. To solve, replace the cable. Make sure the new cable is well lubricated with graphite grease before it's installed and grease it periodically.

Shock life

My 1964 Chevrolet station wagon has 50,000 miles on it. When it was new, I had a set of heavy-duty shock absorbers installed in the rear. The car still handles fine—no bounce, switch or sway. My question: How can I determine when the shocks need to be replaced?—Herman H. Eichorst, South Gate, Calif.

I assume you're not beefing, Herm. Anyone who gets 50,000 miles on a set of shocks is doing pretty good. There are two ways to check them. First, visually. If the shocks are leaking, they need replacing. Second, by feel. Take the shocks off the car and activate them by hand. If they aren't stiff, they've seen better days.

Burned up

The points of my 1962 Rambler Classic with 192 engine burn constantly. What causes this?—Tom Austin, Toledo, Ohio.

If points are installed properly and keep burning, more than likely the trouble is a bad ignition resistor. Since the resistor in this car is located in the coil, test for resistance, which should be 3.3 to 4.1 ohms. If this spec isn't met, replace the coil with the right one, which is a Delco-Remy part carrying part No. 1115066.

Also make sure that the ignition switch isn't shorting, that the voltage regulator isn't set too high, that there isn't a bad engine ground, and that there are no loose wires. These, too, can cause points to burn.

Pulley problem

I had an airconditioner installed on my 1963 Fairlane Six by Sears. When I tried to use a timing light on the engine and couldn't set the pointer because it was being blocked by the airconditioner compressor, I took the car back to Sears. They assured me that they didn't touch the damper pulley to install the unit and that the pulley had slipped because it is set in rubber. Are they kidding me?—R. J. Taylor, Detroit, Mich.

No—they're telling you a straight story. This damper is mounted in rubber and it does "give" after awhile. The fact that you've had an airconditioner installed has nothing to do with it. You'll have to replace the pulley to fix the problem.

Service Tips

● **1970 Fords and Mercurys** with 351-cu.-in., 4V engines are experiencing a surge and slight hesitation upon accelerating from speeds below 25 mph. The trouble is easily corrected by discarding the distributor vacuum hose between the distributor secondary diaphragm and the "T" connector in the line. The "T" connector and the secondary diaphragm connector are then plugged. Your serviceman knows about this job, so see him.

● **1968-69 Chrysler and Imperial** headlamps that stay on low beam if you have an automatic headlamp dimmer are probably plagued by an improper connection. The hookup between the automatic headlamp dimmer wiring harness and the automatic headlamp dimmer power relay is not correct. Have your serviceman straighten it out as outlined in SB 69-8-3.

● **Oldsmobile**, starting with the 1969 models, has incorporated a foam-rubber oiler in the distributor to lube the cam. The company advises that this oiler may be installed backward by a serviceman who doesn't know better. This will result in premature rubbing-block wear. Be sure the flat side of the oiler's retainer is toward the cam. The oiler should be relubricated when contact points are replaced or every 12,000 miles with lubricant No. 1948792. ★ ★ ★

GOT A PROBLEM WITH YOUR CAR? Ask Mort about it. Send your question to Auto Clinic, Popular Mechanics, 224 West 57th St., New York, N.Y. 10019. Letters cannot be answered individually, but problems of general interest will be published in the column.



*There's a rhythm to it...
hill after hill... mile after mile.*

The DT-1C Enduro is a 250 single for the back country. Way back, where a bike has to handle like a quarter horse.

It's set up with special Enduro forks designed to smooth out the roughest ground. Autolube

oil injection mixes oil and fuel automatically. And a wide-ratio 5-speed gearbox puts power where you need it. So start up a DT-1C like the one below and on the left, above. Or an AT-1C 125 Enduro, a smaller edition also shown above. You'll hear some great traveling music, maestro.

Yamaha International Corporation
P.O. Box 54540, Los Angeles, Calif. 90054
In Canada: Fred Deeley, Ltd., Vancouver, B.C.



YAMAHA
It's a better machine

HOMEOWNERS' CLINIC

BY W. CLYDE LAMMEY

'Gypsum' odor

My north bedroom has only one window. There is a strong, musty, gypsum-like odor present. The walls are painted. Airing the room seems to help some, but when it's closed the odor is detectable. Other rooms don't seem to be affected. A neighbor tells me it's the plaster. Do you think so? What can I do to eliminate this disagreeable condition?—I.N., Ore.

No, I don't, assuming that the plaster has been properly applied and has "cured." If you examine the walls closely, especially along baseboards and near where walls meet the ceiling, you are likely to find clusters of very fine, brownish spots. This will be mildew and the cause of the odor you describe. It's not so easy to eliminate in a room having inadequate cross ventilation, especially in a relatively warm, damp climate. If there is shrubbery along the north wall or any low branching trees nearby, I would remove both to permit air to circulate more freely. Then I would wash the walls with a medium solution of trisodium phosphate, a tablespoonful or more to the gallon of soft water. Then I would repaint the walls with a mildew-resistant paint. This should eliminate the objectionable odor entirely, or at least make it no longer objectionable. During warmer months drop the top window sash a few inches and raise the lower one about the same to improve air circulation.

Clogged drain

My drain into the sanitary line seems to clog up continually. There are no trees near the drain, so root stoppage cannot be the cause. I have to rod the line frequently, sometimes weekly, to keep it clear. Could a disposal unit in my kitchen sink be the cause?—T.E., Mich.

If the drain clears freely after rodding, this would tend to rule out any breaks or crushing of the tiles as a cause. That leaves either no pitch or too much pitch as the probable cause. In the first instance, movement of waste materials through the drain is sluggish to the point of creating stoppage somewhere along the length of the line. In the second, the pitch, or fall, of the tiles is such that the liquid outruns the solid materials, leaving them behind to

gradually fill the drain to the point of near-complete stoppage. If you flush toilets twice at a short interval and run a quantity of clear water into the sink immediately after using the disposal, the drain may remain clear.

There is also a more remote possibility that one or more tiles may have become tilted due to settling of the grade or other cause. If so, about all you can do until you can get the help of your plumber is to use the stopgap measures suggested, or rod the line frequently as you have done.

Replacing sash cord

I have old-type sash with cords and balancing weights. The cords need replacing. I can see how to replace them on the lower sash, but how do I replace those on the upper sash? That is, how is the upper sash removed?—C.R., Utah.

After you've removed the lower sash you have to pry out one of the two parting strips you'll see between the sashes. On an old window frame these strips may have been "painted in," and you'll have to proceed very carefully to get one out without breaking it or splintering the frame. Perhaps the best way is to break the paint seal on both sides of the strip by tapping the edge of a chisel in lightly at the point where the strip meets the sash frame. Do this at spaced intervals along the exposed length of the strip on both sides. Then tap the edge of the chisel into the strip and pry *very lightly* until it loosens at the lower end. Repeat this along the length until the strip loosens sufficiently for you to lift it out with your fingers. Be especially careful in this step not to break the strip or, worse, splinter the frame. Once the strip is out the sash can be lifted clear without removing the strip on the other side of the frame.

'Cold' siding

I want to cover my old wood siding with new aluminum siding, but I've been told that this siding is "cold"—that my old house will be cold and difficult to heat. Right or wrong?—D.F., Kans.

To me, "cold" is a new term applied to house siding. Much would depend on what your informant meant by it. Perhaps he is right in what he meant to say. But I don't think application of aluminum siding will make your home colder temperaturewise, or more difficult to heat, provided that it is installed according to accepted practice and that your heating installation is adequate to cope with winter temperatures in your locality. ★★

The 1970 GRAVELY Riding Tractor.

We'd sell even more of them if the old Gravelys didn't last so long.



That old tractor is 15 years old and still going strong. Which should come as no surprise to you, if you've ever talked to a Gravely owner. We sell many of our new tractors because of word-of-mouth praise by owners who know how long their old Gravelys last.

As good as our old tractors are, the new Gravely Riding Tractors are even better. You get an all-gear-drive, with no belts to slip or break ...instant forward, neutral or reverse at the flip of a lever. A unique rear-mounted engine for extra traction

when the going's tough. Center or front-mounted mower to suit your needs. Choose from a variety of front, rear or center-mounted attachments—for mowing, gardening, snow removal and many other jobs —on a 10, 12, 14 or 16.5 H.P. tractor that's built better than it has to be.

Please let us send you a new catalog on Gravely Riding and Convertible Tractors, and the name of your Gravely dealer. Write: Gravely Corporation, 5804 Gravely Lane, Clemmons, N.C. 27012.



GRAVELY
CORPORATION

A SUBSIDIARY OF STUDEBAKER-WORTHINGTON INC.

A touch of Turkish
smooths out taste
in a cigarette.

Who's got it? Camel.
Start walking.

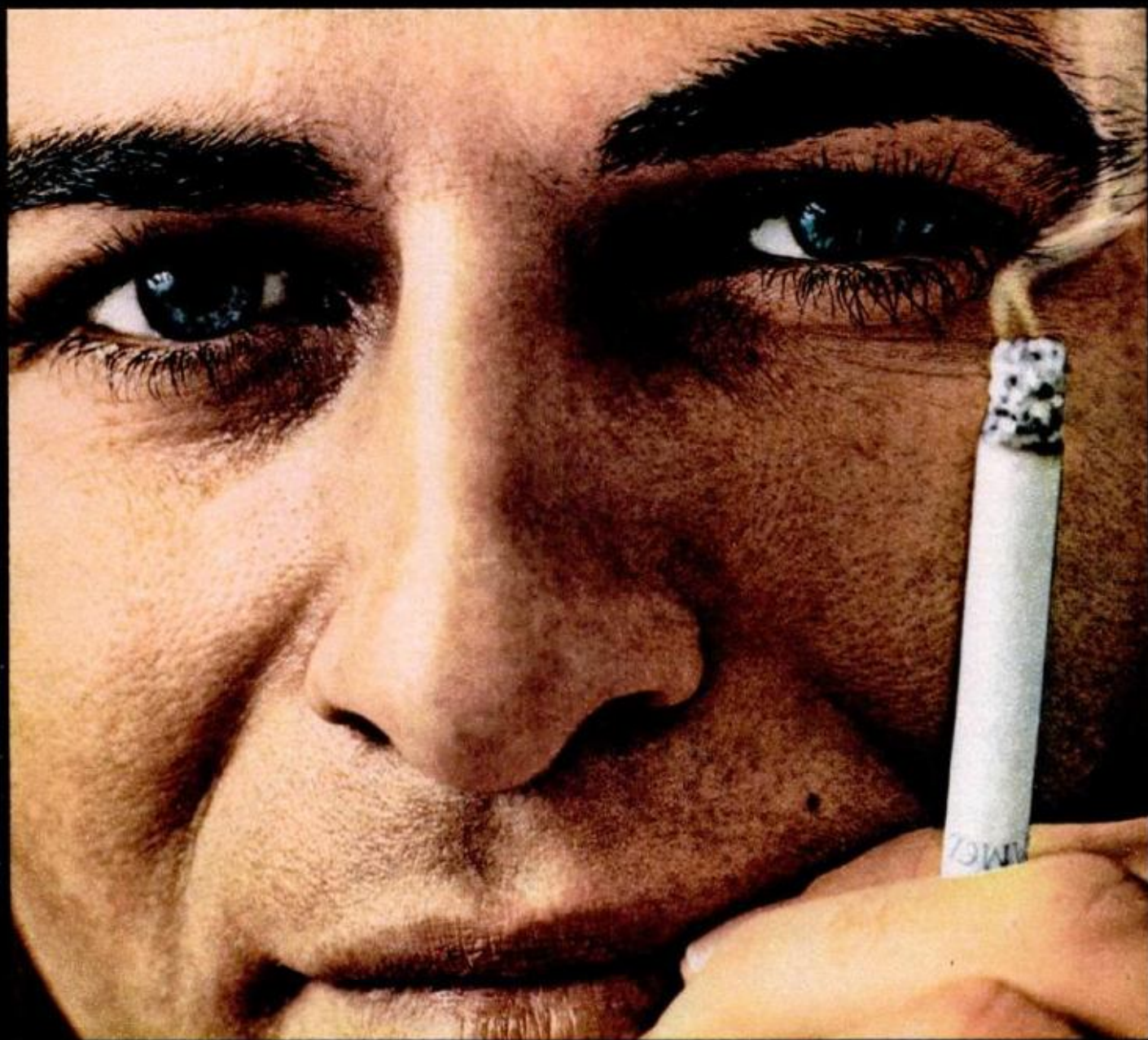

"I'd walk a mile for a Camel."

© 1970 R. J. Reynolds Tobacco Company, Winston-Salem, N. C.

Материал, защищенный авторскими правами

The Hottest Job In The World

Next to the astronauts, the men nearest the fiery blast of an Apollo launch are members of a rescue team. Their job: to get to the astronauts if there's trouble. They'll be on guard when Apollo 13 blasts off this month.

By MARTIN CAIDIN *Author of Marooned*

IT'S THE BIGGEST BOMB EVER MADE. Sixty-five feet across at the base, 33 feet thick through its massive belly. Standing on its ponderous steel launch pedestals, it towers more than 400 feet above the ground.

That's a bomb . . . 6,400,000 pounds of supercold, superhot hell waiting to explode in a titanic blast if just one of several million parts doesn't work exactly as designed.

If it works properly, if the millions of parts mesh in a beautiful blending of energy, it generates more power than Hoover Dam. And it sends three men and 50 tons to the moon.

If it ever explodes, it will be the nearest thing ever to an atomic bomb.

When the Saturn V cooks slowly before coming to life on its pad, and finally erupts in a cataclysmic blast of flame and thunder, a handful of men only 1800 feet away are poised and ready to rush into what would seem to be certain death. They are the 14 men of

At 1800 feet, sound is a cataclysmic shriek

the Astronaut Rescue Team, a select group who make up the toughest, best-trained, fastest-moving and most highly skilled firefighting and rescue force in the world. Their job: to save the lives of the three astronauts who are strapped in and sealed within the thick-hulled Apollo spacecraft atop the Saturn V booster rocket—if there's a pad fire or explosion before, during, or immediately after a launch begins.

The rescue team will stand guard when Apollo 13, scheduled for this month, lifts off with James A. Lovell (commander), Thomas K. Mattingly II and Fred W. Haise Jr. aboard.

The 14 men of the team live, train,

FANTASTIC POWER of Saturn V creates shock waves that feel, at 18,000 feet, like blasts from rapid-fire explosions. Photo shows the Apollo 12 launch

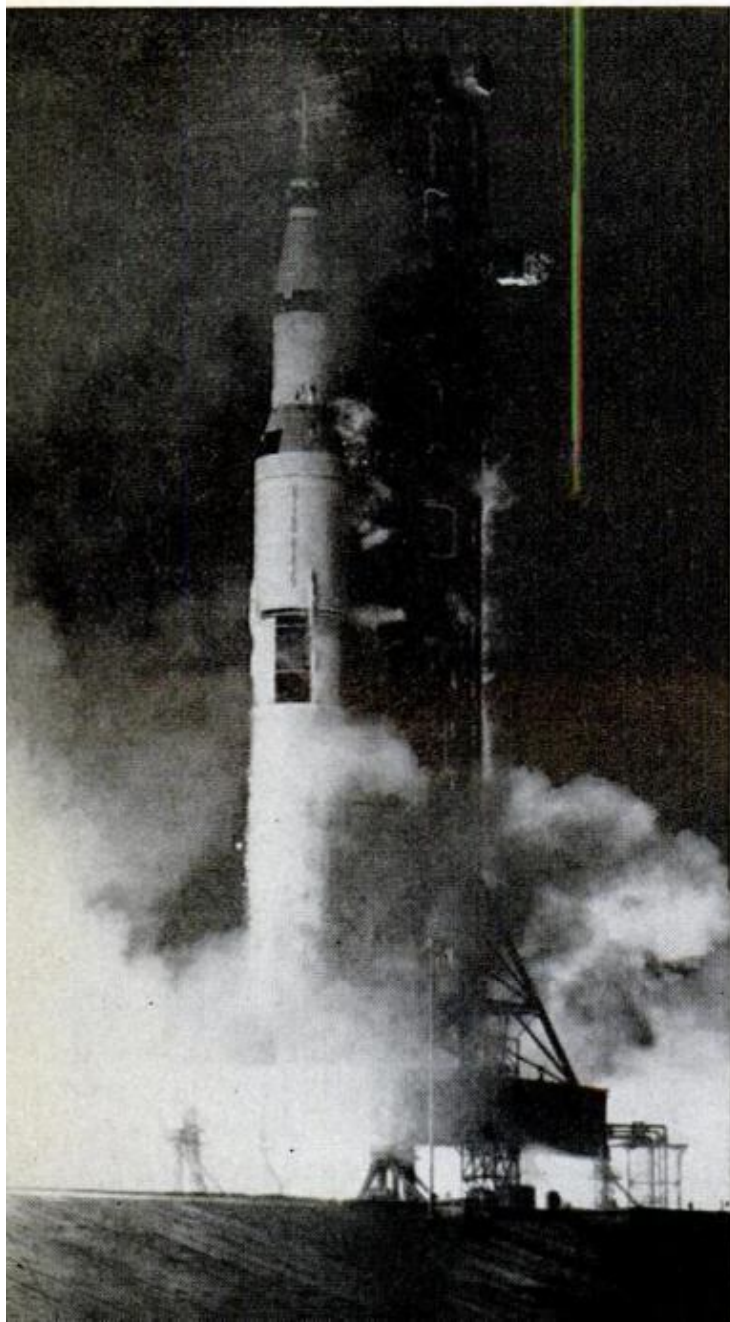

work—and wait—at the Kennedy Space Center in Florida, the world-famed moonport from which four teams of men have left this planet to reach out to the moon. No one knows exactly what would happen if the Saturn V should burn on the pad or explode. It's filled with millions of pounds of kerosene, liquid oxygen and liquid hydrogen, solid-fuel rockets, miles of high-pressure lines and electrical connections. The danger of blast from an explosion is so great that press and TV reporters and VIPs aren't allowed to get closer than 18,000 feet to the launch pad.

Even 18,000 feet isn't much for a Saturn V blast-off. At that distance the shock waves are so great they feel like blasts from a series of rapid-fire explosions. The noise crashes in on you. You can even feel the heat from the nearly 8 million pounds thrust being developed by the five engines of the first stage.

The rescue team for the astronauts waits only a tenth of that distance from the launch pad. At 1800 feet the sound isn't even noise any more. It's a cataclysmic shriek that pounds with painful force against the body. The heat rolls over you like a wave from an open furnace door only a few feet away. It's hot enough to hurt.

During the final moments of a countdown the men of the Astronaut Rescue Team sit or crouch within tanklike vehicles (modified armored personnel carriers, shielded with an ablative material), their senses tuned to *the* signal from the firing room miles behind them. They hope they never receive that signal to *GO!*

Should the rescuers ever receive the word, they would slam their rescue vehicles into gear and pound as fast as they can move to the launch pad. If there's a fire there's imminent danger of an explosion. With a rocket as big as the Saturn V that spells catastrophe. It's a race with the clock, a race where

seconds mean the difference between life and death. At the pad, wearing glistening rescue suits and helmets, they scramble for high-speed elevators that lift them quickly to the 320-foot level of the big bird. Perhaps a fuel line may have ruptured, sending flames cascading across the pad or anywhere along the service tower.

Whatever the danger, once members of the team are committed to the rescue attempt, they don't stop. It's *all the way*, even if the whole pad seems about to go up with the force of 1000 tons of TNT.

They know that three men in that Apollo are counting on them. Back in January, 1967, with an Apollo atop a smaller Saturn 1B, a fire started in the

spacecraft. The space agency didn't have an Astronaut Rescue Team then. They didn't have hair-trigger procedures or skilled personnel. The three men in that Apollo—Gus Grissom, Ed White and Roger Chaffee—burned to death. Nobody at the space center ever forgets that.

At the 320-foot level, the team moves with extraordinary precision. Every man knows what to do and in what sequence. The section immediately outside the spacecraft is known as the White Room. Its normal prelaunch quiet would be shattered by a screaming siren, should an emergency occur. If the rescue team is on the move, there'll be a new sound—booted feet pounding on the catwalk leading from

AFTER ASTRONAUT'S RESTRAINT HARNESS is freed, rescuer "hooks" his man and pulls him from craft

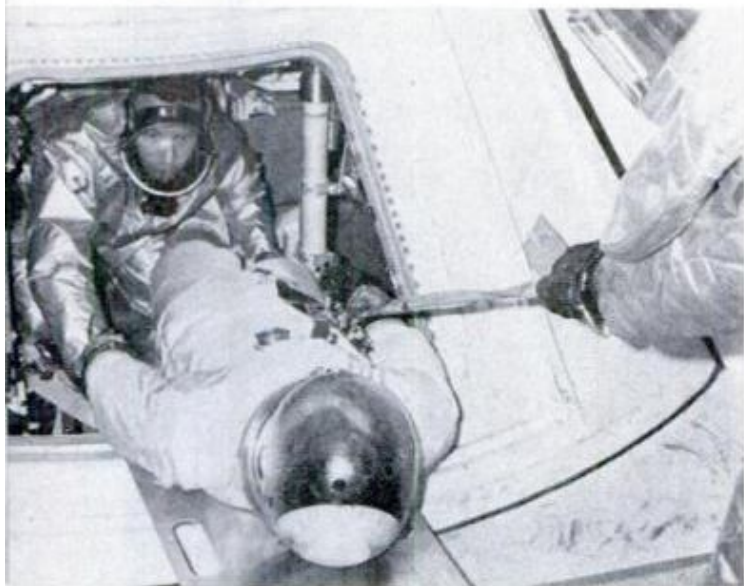

RUSHED TO CAGE, astronauts take 2000-foot, slide-wire ride to safety—one of three escape methods



ALTERNATE SAFETY ROUTE: High-speed elevator to ground, then dash to specially protected personnel carrier



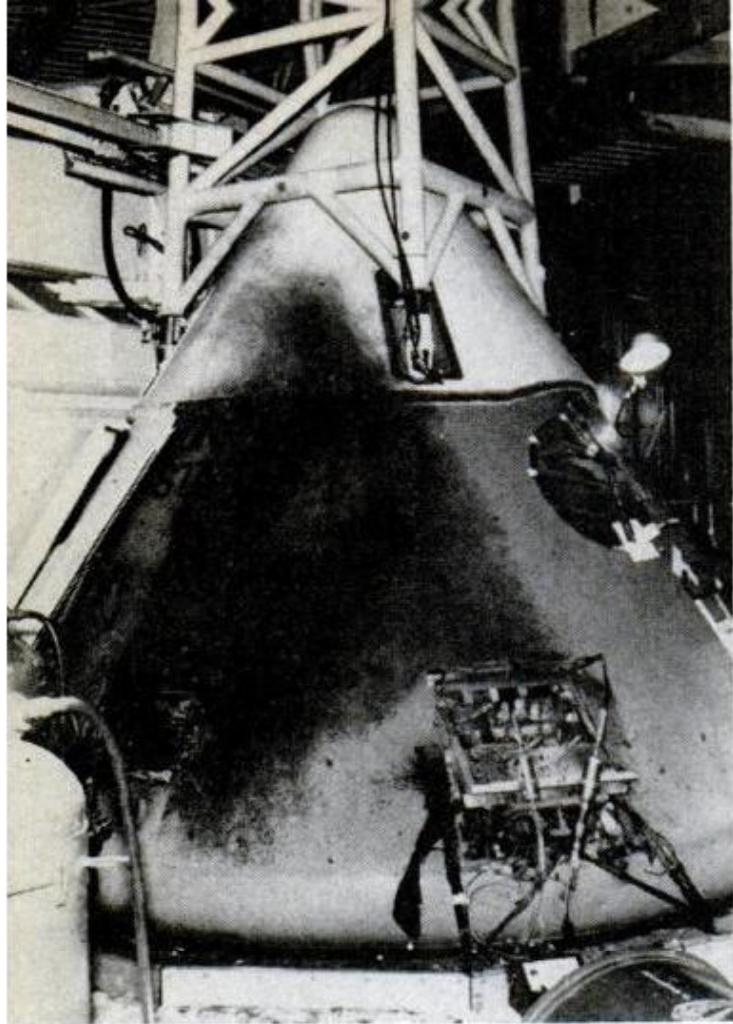

ASTRONAUTS Gus Grissom, Ed White and Roger Chaffee burned to death in this Apollo module in 1967. That tragedy led to new safety procedures and to the formation of the skilled Astronaut Rescue Team

the high-speed elevator to the White Room and the Apollo.

Swinging doors burst aside and the "hot team" of four suited rescuers rush for the spacecraft. If the astronauts inside haven't opened the hatch, or can't open it, the rescue force breaks the seal. One man hauls the hatch out of the way. A second man pushes his way into the spacecraft. Working with a precision born of months of practice, he disconnects oxygen life support, communications and other lines from the Apollo to the astronauts' suits. Then he snaps free their restraint harness, and immediately gets out of the way. A third rescue-team man leans in with a special "gaff hook," snags it on an astronaut's pressure suit, and literally hauls the spaceman from the Apollo the way a fisherman drags a tuna out of a boat. The fourth team member gets the astronaut to his feet even as another man is being hauled from the Apollo, and then the third.

What happens next depends on what the situation is. The rescuers have

(Please turn to page 220)



AS MOON MISSION NEARS, THEIR TRAINING IS ESCALATED. Shown after a practice session are (left to right): G. E. Bidault, Adolph Garza Jr., Al Wozniak, Roderick A. Hobbs, Charles H. Short and Randle Marlow



Spanish tribute to Apollo 11

First statue to honor the Apollo 11 astronauts is this one erected in Malaga, Spain.



Air passengers get a boost

A luxury vehicle designed to load and unload jet-plane passengers at congested airports was recently displayed by the Budd Co., Fort Washington, Pa. The "Plane-Mate" can carry up to 150 passengers between terminals and airliners. It eliminates step climbing by elevating the passenger lounge (top photo) up to 18 feet to the doors of jumbo jets. The lounge is lowered (bottom photo) when the vehicle travels between plane and terminal.



Fiberglass three-wheeler is new all-season sports vehicle

Able to go on snow or dunes, ford low streams, skim over high grass and underbrush, speed 45 mph on level ground and tackle steep slopes, the new SPD Tricart is an all-season, all-terrain sports vehicle. The three-wheeled fiberglass machine, built by the Special Products Div. of Sperry Rand Corp., is essentially a one-man vehicle, but can accommodate a piggyback passenger. Powered by a 230-cc JLO two-cycle engine, Tricart sells for about \$750.



ECONOMY TEST in the Union 76 Performance Trials uses a separate fuel supply mounted on front of the car

PERFORMANCE TESTS—

The automakers rated their '70 cars and submitted their figures to the government; then Union 76 ran its 13th Annual Performance Trials. The results are different

By **BILL HARTFORD**, Auto Editor/Photos by Pal Parker

EVERYBODY'S TESTING CARS these days. Tests have long been the bread and butter of magazines like *PM*. Editors scrutinize a new model and wring it out for their readers' benefit. Test results range from seat-of-the-pants impressions to hard data gathered by sophisticated instruments.

Also in the business is the Union Oil Co. of California. For the last 13 years it has sponsored annual performance trials supervised and sanctioned by NASCAR—the National Assn. for Stock Car Racing. The yardsticks of performance are fuel economy, acceleration and braking. Representative models of domestic passenger cars in nine classes are run through these three series of tests which are set up to minimize driver skill and objectively determine a winner in each class.

Latest to join the ranks of car testers is the federal government. Civil servants clutching steering wheels in panic-stop brake tests is not the way it works, however. The U.S. Department

of Transportation's Federal Highway Administration has established regulations that require auto manufacturers to submit to the agency data that "... reflect actual vehicle performance capabilities."

Last January, almost at the same time the National Highway Safety Bureau was publishing this *Performance Data for New Passenger Cars and Motorcycles*, Vol. 1, No. 1, of its Consumer Information Series, the Union 76 Performance Trials were being held at Daytona International Speedway.

The 304-page government publication (for sale by the Superintendent of Documents, U.S. Government Printing Office, Washington, D.C. 20402 for \$2.25) contains the information the agency regards as vital yardsticks of performance and safety, mainly: 1) acceleration and passing, 2) tire reserve load, and 3) stopping distance. Tire reserve load is the percentage by which the rated load exceeds the actual tire load when the vehicle is loaded to

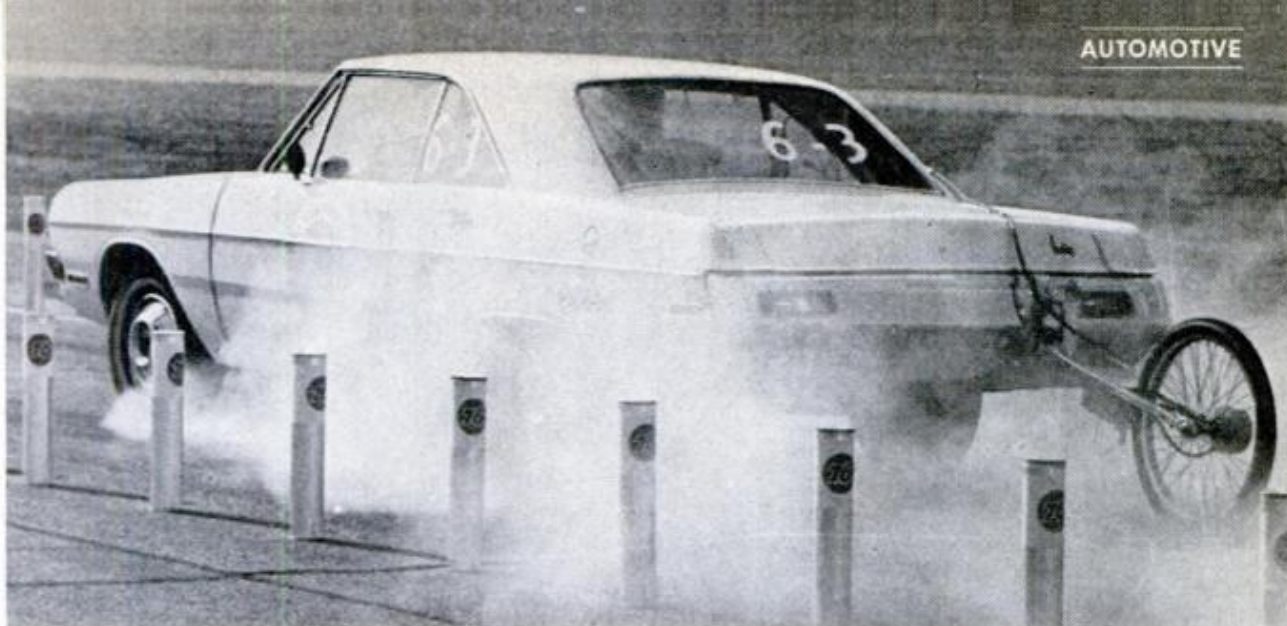

BRAKING TEST in the Union Trials measures distance for emergency stop from 65 mph in 12-foot-wide lane

DETROIT vs. UNION OIL

its maximum recommended capacity.

Fuel consumption figures are not a safety-related aspect of performance and so are not required of the manufacturer by the government. Economy is certainly important to a prospective car buyer and it is determined in the Union 76 Trials. Economy and tire reserve load are, at a glance, the obvious differences between Union 76 data and government-compiled data. The most important difference, however, is the fact that manufacturer-supplied data would seem to protect the manufacturers more than they inform the public. The figures are arrived at and released only after company engineers—and lawyers, probably—feel they can be sure that all cars in a model line will perform within certain limits.

In the Union Trials, on the other hand, a representative model car, purchased unannounced from a dealership and under the watchful eye of NASCAR, is subjected to performance tests. The Union tests *evaluate* the cars in a certain class in a contest.

The accompanying chart of results can be read with the following rules in mind. For the braking test:

Union 76: Emergency stop from 65 mph in a 12-foot-wide lane. Wheels can

be locked. Stop is made after a series of warm-up stops that heat lining or pads to induce fade. Unlimited pedal pressure can be used.

Manufacturers' Data: Emergency stop from 60 mph. Wheels cannot be locked. Brakes are not warmed up. Pedal force cannot exceed 150 pounds.

The Union tests run with driver and one passenger corresponding to "light load" in manufacturers' data. In simulating a highway lane and the danger involved in skidding due to an uneven lockup of brakes, the Union rules provide footage penalties for knocking down lane-marker pylons. Other penalty provisions in the tests minimize driver skill, "cheating," or error.

In the acceleration tests, Union measures time for a car to reach 75 mph from 20 mph. In manufacturers' figures, low-speed pass means passing a 55-foot truck by starting from 40 feet behind, accelerating to 35 mph and finishing 40 feet ahead. In the high-speed pass car starts 100 feet behind, accelerates to 80 mph from 50 mph and finishes 100 feet ahead of the truck—which maintains a steady 20 and 50 mph, respectively, in the two tests.

In the chart, manufacturers' data is given only for cars that ran in the



EMERGENCY STOPPING LANE is 500 feet long marked with pylons. If brakes lock unevenly, car will not stop straight. Penalty imposed is 2 feet per pylon



Union 76 Trials. The government book lists data for all domestic automobiles, imported vehicles and motorcycles. The book also includes further data—braking distance with failure of power-brake system or with partial failure of one brake subsystem, for example. It's not necessary to have a copy of the book, however, since a dealer must make available to a buyer or prospective buyer the data on the cars he sells.

For the official results of the Union 76 Performance Trials, which includes a further description and rules for their tests, write: Union 76, Box 1763, Chicago, Ill. 60604.

Buying a car is still mostly emotion, personal preferences and requirements—style, color, size, price, prestige, brand loyalty and trade-in—but in case you want them, two sets of performance data are in. ★★★



PENALTIES

(DE denotes driver error; first digit in car's number identifies its class, second indicates its order of appearance in class list on opposite page).

Economy: cars 3-4, 9-4, each .3 mpg, average speed, DE.

Acceleration: None.

Braking: car 1-1, 5 ft., decelerometer, DE; car 1-2, 8 ft. (5 ft., decelerometer, DE; 1 ft., qualifying distance, DE; 2 ft., pylons); car 1-3, 10 ft., decelerometer, DE; car 1-4, 9 ft., qualifying distance, DE; car 1-5, 32 ft., pylons; car 1-6, 63 ft. (5 ft., decelerometer, DE; 3 ft., qualifying distance, DE; 7 ft., qualifying time, DE; 48 ft., pylons); car 2-2, 54 ft., pylons; car 2-4, 3 ft., qualifying distance, DE; car 3-1, 42 ft., pylons; car 3-2, 54 ft., pylons; car 3-7, 5 ft., decelerometer, DE; car 4-2, 36 ft., pylons; car 4-4, 73 ft. (3 ft., qualifying distance, DE; 10 ft., qualifying time, DE; 60 ft., pylons); car 4-5, 5 ft., decelerometer, DE; car 5-2, 20 ft., pylons; car 5-3, 4 ft., qualifying time, DE; car 5-5, 10 ft., pylons; car 5-8, 1 ft., qualifying distance, DE; car 7-1, 16 ft., pylons; car 8-1, 2 ft., qualifying distance, DE; car 8-4, 22 ft., pylons; car 8-5, 48 ft., pylons; car 9-2, 2 ft., pylons; car 9-5, 4 ft., pylons; car 9-6, 4 ft. (2 ft., pylons; 2 ft. qualifying distance, DE).

ACCELERATION TEST in Union 76 Trials starts at 25 mph; time to reach 70 mph is measured electronically

1970 UNION 76 TRIALS RESULTS

MANUFACTURERS' DATA

CAR AND MODEL	ENGINE Cu. In.	ECON- OMY Mpg	ACCEL. (25-70mph) Seconds	BRAK- ING (from 65mph) Feet	ACCEL. & PASSING				TIRE LOAD BRAKING		
					(20-35mph) Feet	(50-80mph) Feet	Secs	Secs	Reserve %	Light Load Feet	Max Load Feet
CLASS I—SUPER DELUXE—8-CYLINDER (\$5500-\$6000)											
Buick Electra 225 Custom	455	15.179	9.325	190.9*	421	9.1	1249	13.3	7.7	209	195
• Buick Riviera	455	15.722	8.465	196.8*	421	9.1	1249	13.3	6.5	209	195
Chrysler New Yorker	440	14.581	10.865	232.3*	400	8.5	1180	12.4	2.5	205	205
Oldsmobile 98**	455	15.010	10.80	229.0*	421	9.1	1249	13.3	8.2	205	195
Oldsmobile Toronado**	455	13.388	10.775	213.9*	404	8.5	1200	12.8	6.4	196	200
Thunderbird**	429	14.823	9.14	305.3*	299	8.4	1110	11.4	.77	220	213
CLASS II—DELUXE—8-CYLINDER (\$4900-\$5500)											
Buick Wildcat Custom	455	15.808	9.145	185.5	434	9.6	1385	15.1	4.6	226	228
Chrysler 300	440	15.416	9.745	271.0*	400	8.5	1180	12.4	4.0	205	205
Dodge Monaco	440	14.753	9.310	228.6	400	8.5	1180	12.4	5.2	205	205
Mercury Marquis**	429	13.997	9.59	253.1*	403	8.5	1150	11.9	1.71	234	208
Oldsmobile Delta 88 Custom**	455	15.105	9.935	229.9	434	9.6	1385	15.1	6.2	207	206
• Pontiac Bonneville	455	15.811	9.375	177.8	434	9.6	1385	15.1	2.0	226	228
CLASS III—MEDIUM—8-CYLINDER (\$4500-\$5000)											
Buick LeSabre Custom	350	15.851	12.545	221.8*	434	9.6	1385	15.1	4.6	226	228
Chevrolet Caprice**	350	16.627	11.245	239.8*	434	9.6	1385	15.1	3.5	207	206
Chrysler Newport Custom	383	16.114	11.705	(1)	410	8.8	1315	14.2	4.0	205	205
Dodge Polara Custom	383	16.134*	10.645	230.3	410	8.8	1315	14.2	5.2	210	200
Ford LTD**	351	16.096	11.945	207.6	410	8.9	1272	13.6	2.71	234	208
Mercury Monterey**	390	15.102	11.89	220.2	412	8.8	1240	13.2	1.36	234	208
Oldsmobile Delta 88**	350	15.073	12.86	238.0*	434	9.6	1385	15.1	6.2	207	206
Plymouth Sport Fury	318	16.517	13.555	194.5	435	9.6	1430	15.8	1.0	210	200
• Pontiac Executive	400	16.619	10.590	178.9	434	9.6	1385	15.1	2.0	226	228
CLASS IV—STANDARD—8-CYLINDER (\$3900-\$4300)											
• Ambassador DPL	304	16.717	12.585	173.1	413	8.9	1292	13.9	3.5	249	237
Chevrolet Bel Air	350	17.819	11.255	220.8*	434	9.6	1385	15.1	2.5	226	228
Dodge Polara	318	15.652	15.340	180.5	435	9.6	1430	15.8	5.2	210	200
Ford Custom 500**	302	17.182	14.555	285.6*	414	8.9	1314	14.2	3.83	234	208
Plymouth Fury II	318	17.670	13.770	235.0*	435	9.6	1430	15.8	0.3	210	200
Pontiac Catalina	350	14.930	13.160	185.1	434	9.6	1385	15.1	2.0	226	228
CLASS V—INTERMEDIATE—8-CYLINDER (\$3200-\$3900)											
Buick Skylark Custom	350	16.853	10.87	187.1	427	9.4	1421	15.7	11.1	228	229
Chevelle Malibu	307	17.348	12.33	205.3*	427	9.4	1421	15.7	2.5	228	229
Dodge Coronet 500	318	17.349	11.795	186.7*	405	8.6	1320	14.3	8.2	210	205
• Ford Torino	302	18.082	10.695	170.1	404	8.6	1213	12.8	0.01	254	213
Mercury Montego MX	302	18.165	11.435	212.8*	403	8.5	1222	12.9	3.36	254	213
Oldsmobile Cutlass	350	15.870	11.015	175.6	427	9.4	1421	15.7	5.4	228	229
Plymouth Sport Satellite	318	17.511	11.83	196.3	405	8.6	1320	14.3	5.5	210	205
Pontiac LeMans Sport	350	16.435	10.53	180.4*	427	9.4	1421	15.7	11.8	228	229
Rebel SST	304	16.597	11.475	180.4	406	8.6	1241	13.2	3.0	238	269
CLASS VI—COMPACT—6-CYLINDER (\$2300-\$2800)											
• AMC Hornet SST	232	25.075	14.960	190.9	417	9.1	1502	16.8	5.5	244	262
Chevy Nova 6	230	20.531	18.005	185.4	430	9.5	1316	14.3	4.0	218	219
Dodge Dart Swinger	225	22.487	15.915	159.9	420	9.1	1435	15.9	7.4	215	205
Ford Maverick	200	22.153	17.370	204.7	414	9.0	1493	16.7	0.29	253	220
Plymouth Valiant Duster	225	22.190	19.390	177.2	420	9.1	1435	15.9	14.4	215	205
CLASS VII—SPORT INTERMEDIATE—8-CYLINDER (\$3700-\$4200)											
• Buick GS 455	455	16.325	6.29	189.2*	427	9.4	1421	15.7	11.0	228	229
Chevelle SS 454 (2)	454	—	—	—	427	9.4	1421	15.7	2.5	228	229
Dodge Charger R/T	440	13.279	6.20	183.1	390	8.1	1005	10.0	4.2	200	190
Ford Torino Cobra**	429	14.059	6.38	184.8	385	7.9	1000	9.9	0.43	216	223
Merc Cyclone GT** (3)	429	—	—	—	386	8.0	1010	10.1	5.67	216	223
Oldsmobile 442**	455	15.571	6.11	209.9	427	9.4	1421	15.7	5.5	219	206
Plymouth GTX	440	14.417	6.155	207.7	390	8.1	1005	10.0	4.2	200	190
Pontiac GTO**	455	15.913	6.55	264.1	427	9.4	1421	15.7	11.9	219	206
CLASS VIII—SUPER SPORT COMPACT—8-CYLINDER (\$3500-\$4200)											
Chevy Nova SS**	350	17.503	8.72	197.3*	418	9.2	1316	14.3	4.0	197	202
Dodge Challenger 340	340	16.208	7.21	167.2	400	8.5	1020	10.2	1.7	210	205
Javelin SST	360	17.302	8.69	177.3	392	8.2	1112	11.4	4.5	252	259
Mercury Cougar XR-7**	351	16.978	7.16	193.9*	391	8.2	1104	11.4	2.58	221	213
Mustang Mach I**	351	16.952	7.035	231.0*	390	8.2	1146	11.9	12.00	221	213
• Plymouth Cuda	340	16.260	7.08	164.9	400	8.5	1020	10.2	1.7	210	205
CLASS IX—SPORT COMPACT—8-CYLINDER (\$3000-\$3750)											
Chevy Nova 8	307	19.492	10.72	182.2	418	9.2	1316	14.3	4.0	218	219
Dodge Challenger	318	16.997	10.66	211.95*	400	8.5	1260	13.5	3.3	215	210
Javelin	304	16.681	10.725	162.6	398	8.4	1164	12.2	4.5	252	259
• Mercury Cougar	351	17.233*	8.915	191.1	391	8.2	1104	11.4	2.58	254	213
Mustang	302	18.335	10.25	177.2*	390	8.2	1146	11.9	2.44	237	222
Plymouth Barracuda	318	17.565	10.475	173.6*	400	8.5	1260	13.5	3.6	215	210

• Denotes class winner in Union trials.

* Includes penalty or penalties (see list on opposite page).

(1) Brake test figures disallowed—sudden driver illness.

(2) Car classified but not available for purchase.

(3) Car withdrawn—faulty drive train.

** Disc brakes. All cars in Classes I through IV and Classes VII and VIII equipped with power brakes.

Just patented

PM'S PICK OF THE NEW INVENTIONS

Prepared in cooperation with Roger S. Shashoua, Director, International Inventors Assn., Inc.

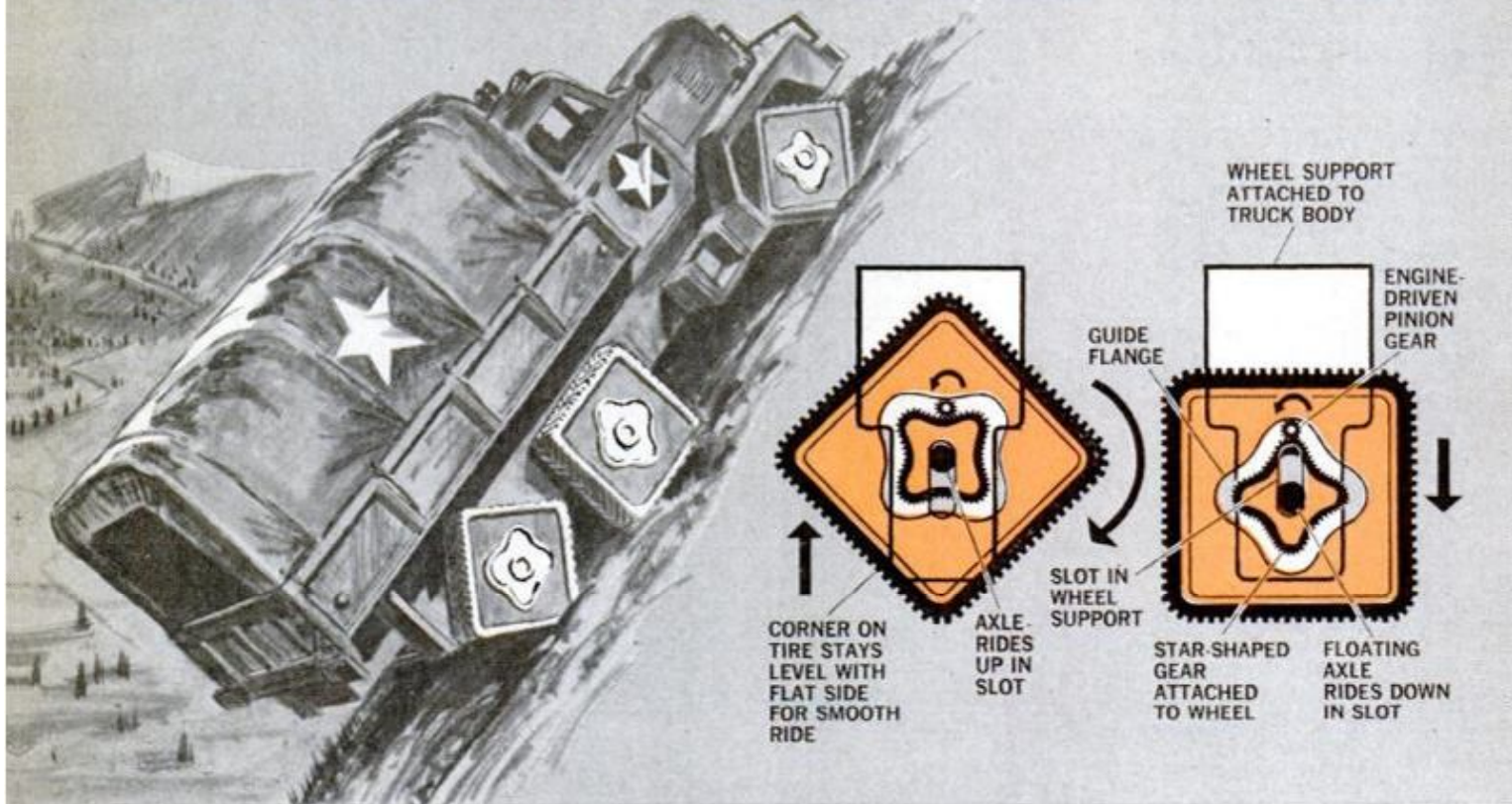

1. SQUARE WHEELS WORK BETTER than round ones in this system for use on rough terrain. The sharp-cornered treads dig in on snow, mud, sand or steep grades, providing increased traction for trucks, tanks and other military vehicles. At the same time, ingenious self-leveling geometry provides a smooth ride on even surfaces. Each wheel is driven by a

pinion gear engaging a star-shaped ring gear. Mounted on a floating axle, the wheel automatically rides upward as the corners approach the ground and downward as the flat segments come around. This produces the effect of a round wheel with all parts of the tread equidistant to the ground, thus permitting the use of high speeds on a level terrain

2. CONVERTIBLE SHOP TOOL is designed to provide the advantages of both a table saw and radial-arm saw in one. For cutting narrow boards, the motor carriage and blade are suspended from an overhead arm, as in a conventional radial saw. For sawing large panels where the column gets in the way, the

arm is slid down into the base cabinet and the motor is rotated upward so the blade projects through a slot in the table. The upper section of column is slipped off for unlimited clearance. A removable fence can be clamped on the table lengthwise or crosswise depending on the type of cutting

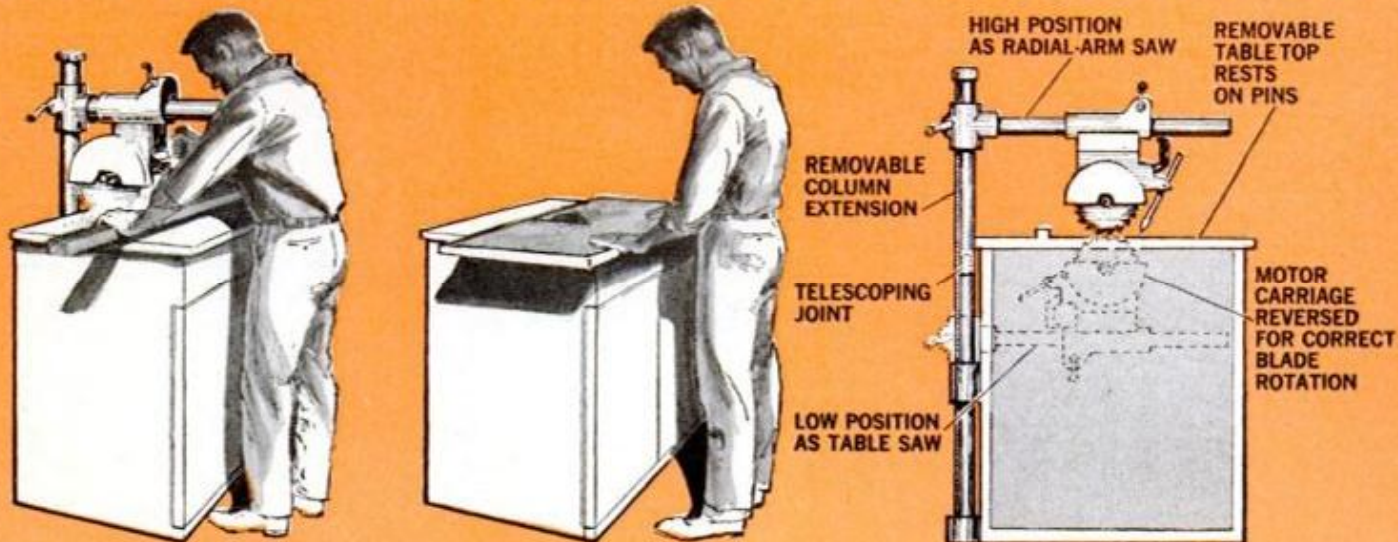

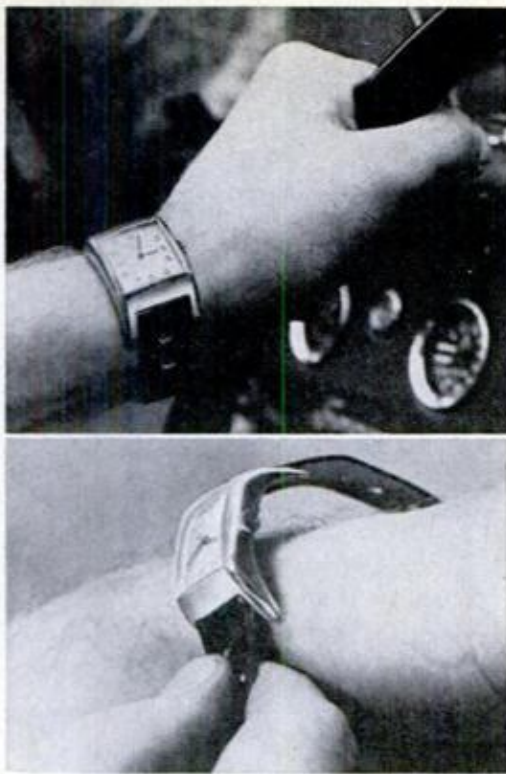

3. CURVED WRISTWATCH is designed to be worn on the side of your wrist so you can see the time while driving without removing your hand from the steering wheel. The case is shaped to fit snugly around the narrow part of the wrist so it can't slip out of place once the strap is tightened. Unusual design is intended especially for rally drivers who find it necessary to check the time frequently while they're racing

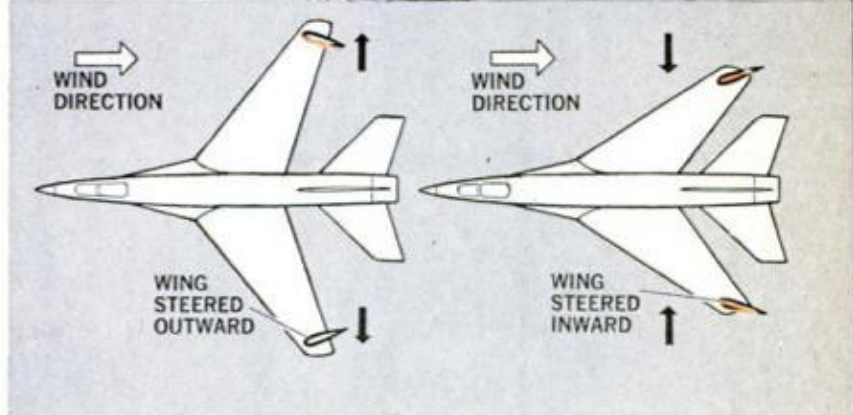
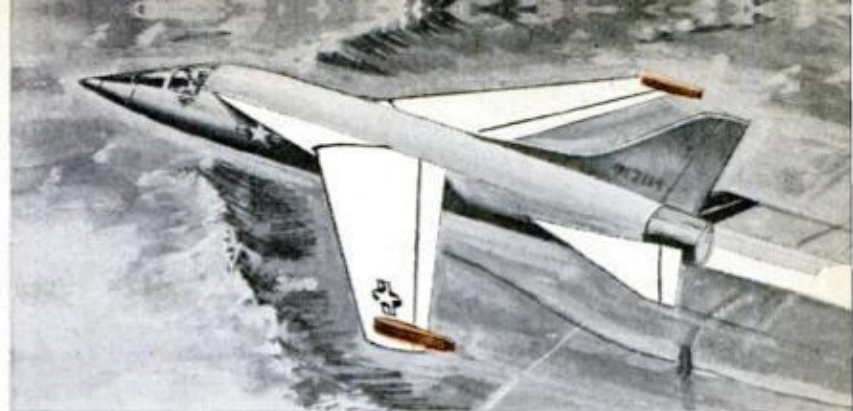

4. TINY WINGTIP RUDDERS on the supersonic plane above do the work of moving the swing wings in and out to vary their angle and lift. The idea behind the clever system is to eliminate the bulky motors and hydraulic gear usually needed on variable-wing aircraft to extend and retract the heavy surfaces. For added lift in low-speed flight and landings, the pilot just pivots the rudders outward, spreading the wings wide. For high-speed flight, he steers the rudders inward, folding the wings back. The rudders are operated by simple control cables running over pulleys, saving crucial weight

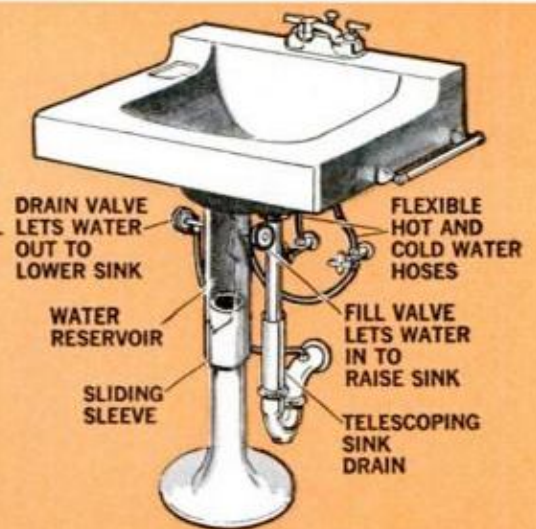
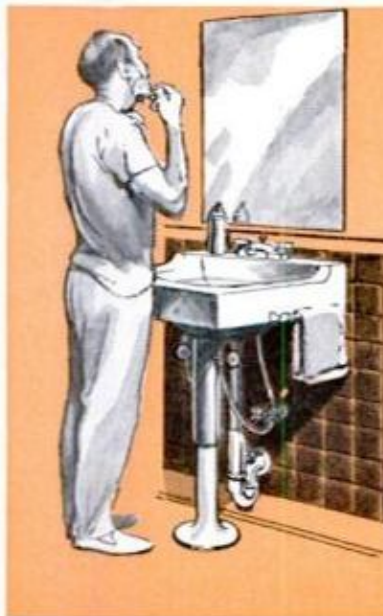

5. ADJUSTABLE SINK can be raised or lowered for easy use by either grownups or children. The sink basin is supported on a column of water that acts like a hydraulic lift. One valve feeds water into the reservoir to raise the basin and another valve lets water drain out to lower it. Flexible hoses

connect the hot and cold-water inlets to the faucets so that the sink is free to move up and down. The sink column and waste drain are sections of telescoping pipe that also allow the basin to slide up and down. Water for the hydraulic lift is piped to the reservoir from the regular cold-water inlet

Inventors of the items shown on these pages are as follows: 1. Albert P. Sfreda, 2106 Iris Pl., Bethlehem, Pa. (No. 2,786,540); 2. Peter Zuk, Cressona, Pa. (No. 3,465,793); 3. Jewellers Supply Co., Ltd., 19-21 Hatton Garden, London, England; 4. Rashid M. Rashidian, Pomona,

Calif. (No. 3,463,419); 5. Michael Flagg, 4345 California St., San Francisco, Calif. (No. 3,456,264). Readers wishing to bring new inventions to the attention of Roger Shashoua can reach him at the International Inventors Assn., Inc., 680 Fifth Ave., New York, N. Y. 10019.



After logging 5000 miles on his first bike—a 100-cc street scrambler—*PM's* Auto Editor reaches some conclusions about motorcycling

MY FIRST YEAR ON A MOTORCYCLE

BY BILL HARTFORD *Photos by Irv Dolin*

COORDINATING SPEED with turning radius in a fast curve on new Honda 175: It takes practice!



NIGHT RIDING requires extra precautions. Amber directionals, standard on some new bikes, are good; hand signals are better in daylight. Wear high-visibility gear

THE FIRST THING I DID was read all the books. That's why I automatically eased over to the inside half of the lane—off the slippery middle stripe of accumulated oil—as I swept into the long, gradual, left-handed curve. The riding weather was perfect: a dry morning, bright and sunny. With almost 2000 miles on my first bike, I was thinking about why it took me so long to discover motorcycling—not only as an inexpensive, exhilarating way to commute to and from the office, but as a great outdoor sport. The parkway I was on is kept in pretty good condition—no commercial traffic allowed—so the hazard of truck-tire carcasses and other debris is at a minimum.

Still riding the inside of the lane, I banked into an underpass on the curve. The combination of the bright sunlight, my sunglasses and the deep shadow underneath created a near blackout. I saw the outline of a gigantic pothole at the same time I went into it. No time to dodge, no time to get up on the pegs. My small bike crunched into the hole and all the air ex-



SNUG HARBOR (right) is in swirl of Manhattan traffic. This free motorcycle parking area is convenient two blocks from PM offices. Openings in traffic (above) are boon to cautious city cyclists



ploded out of my lungs. Dazed, but realizing I was still upright, I eased over to the shoulder.

The damage: Two ruined rims and a cracked rear hub. The road surface had taken its toll. Luckily, I hadn't spilled and the traffic was light; I didn't encounter another big danger to a motorcyclist—the automobile.



The third biggest threat to a motorcyclist is the rider himself. Having settled into my thirties, I figured I was mature enough not to have to prove anything. With a wife, two kids—even a dependent dog—I didn't need a bike just for popping wheelies. I could smugly contemplate that an overwhelming percentage of motorcycle-accident victims are under 25. That's a rough statistic to live with if you're a tender, young motorcyclist or thinking of becoming one. I had thought of becoming one at least once a year for the last dozen years, but somehow I never got around to it.

Last year, something clicked, and, armed with \$400, I set out to pick a brand-new bike. After a lot of looking, I went back to Nassau Cycle Center, near my home. I fell for an orange, 100-cc Suzuki street scrambler. I'm a sucker for style as much as the next guy, and the bike sure had that. Superb craftsmanship from stem to stern and a 12-month 12,000-mile warranty were more rational bases for my decision. Moreover, I found in Otto and Bill two

TYPE AND SIZE of motorcycle you choose depends on intended use. My first bike, 100-cc, is bottom motorcycle at left. Great first bike, but small for doubling up. New machine, a 175-cc Honda (top left) is faster, more comfortable, better size for a passenger. My wife Judy obviously agrees

Some Potholes and Pitfalls of Street Riding

RIDING INTO THE SUNSET is fine if you're on a horse. On a motorcycle, you'd best keep your eyes on the road and the traffic. Even when you do, you can get into some slippery situations—as I found out . . .

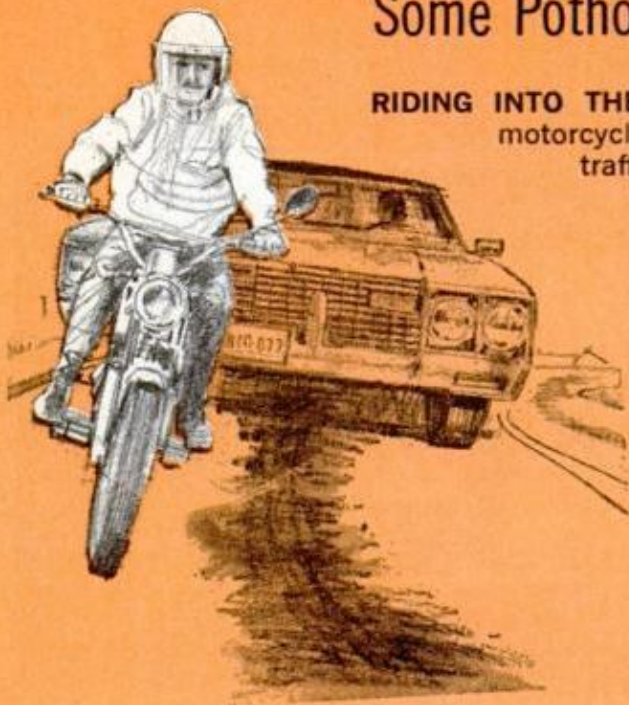

◀ **OIL STREAK** runs down the center of all traffic lanes. On blacktop you can't see it and it can be very slippery when wet. Always ride on either side of it. When in traffic or when you may be overtaken by automobile traffic—riding at the minimum speed limit breaking in a new bike, for example—stay on outside of the lane, not curb side as here. That way cars can't crowd and pass you in your lane.

FLINCH! A motorcyclist's vulnerability forces him to anticipate what automobile drivers are going to do. A car that makes a left in front of you because the driver didn't see you or misjudged speed and distance is a common cause of accidents. It's not fun to always be able to stop, but it's safer. Here, I was sure the driver saw me, yet he kept inching out. Before slowing too much I realized he wanted to cut behind me and ahead of the oncoming car that I saw in my rear-view mirror—a tricky situation that could put all three vehicles on a collision course.



guys who are in the business because they love it. Enthusiasts, mechanics they're the kind of guys who'll give a novice the straight poop.

I figured most of my riding would be on the street. The cruising speed of the Suzuki—50-55 mph—would be okay for highways, and the scrambler design would give me the option of the trail. I bought it. Mistake number one: I should have scraped up another couple of hundred for that 250-cc twin. But I made the most frequent mistake in buying a first bike: Getting one that's too small. Still, it's a mistake that *should* be made. It's easy after you've learned the ropes and survived your

own clumsiness on a smaller bike to come to decide you should have started with a big-time model right off the bat.

I was afraid that a bike as powerful as a 250 and as big (almost 300 pounds) would be too much to handle. I wanted a machine I could physically throw around. The 184-pound Suzuki was perfect for that.

So, last March, helmet-in-hand (law or no law, wear it!), registration-in-wallet and bike-in-garage, I visited the motor vehicle bureau. As a licensed automobile operator, I had only to exchange 75 cents for a motorcycle learner's permit and schedule a road test—and pass it—before the coveted "MC"

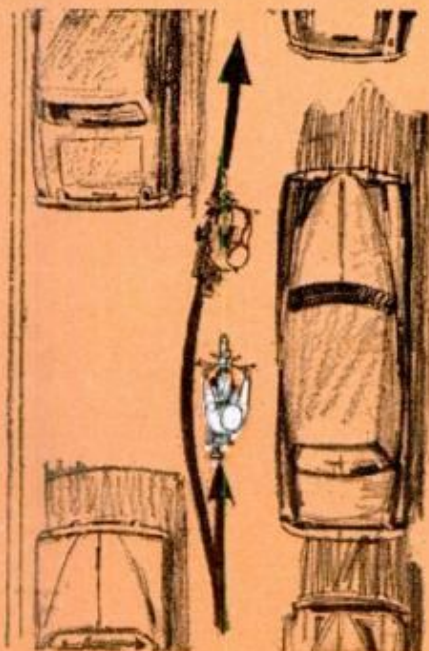

Streaking Between Lanes Is Dangerous and Riles Motorists

DARN MOTORCYCLES! It may appear that I was riding illegally between the lanes of traffic, scaring motorists as I cheated along, but actually I was preparing to move into the right-hand lane. All of a sudden with a startling roar a reckless, hell-bent rider zoomed up between lanes, arced around me and continued on his merry but suicidal way. His speed relative to the automobile traffic was appalling. For more on this controversial subject see the story.

Illustrations by Bill Johnson

LURKING IN THE SHADOWS is a pothole that drove home a lesson—luckily, not too late for the learning. Wearing sunglasses against the bright morning sun, I banked into the shadowed underpass. In the resulting blackout I didn't see the pothole until I went into it with a crunch. A couple of hundred wobbly feet, two bent rims and a cracked rear hub later, on the shoulder of the parkway, I started breathing again. On a bike a lot can happen in the wink of an eye.



would be stamped on my existing license.

On the appointed day I appeared at the test site with permit, road-test appointment stub, motorcycle (and its registration, don't forget). As required, I also brought a licensed auto driver—my wife—and a car so she could chauffeur the examiner while he watched me ride in traffic and perform figure eights and circles. I transported the bike to the test site in my station wagon. With a learner's permit, if you want to ride your bike to the test site, the automobile driver must be a licensed motorcyclist, too! (With a permit in New York State you're supposed

to be always within a quarter mile of a licensed motorcyclist.) On top of all the legalities, I made a point of dressing neatly and smiling politely.

Before I took the test, I rode around and around my home neighborhood. I interpreted the quarter-mile rule as a quarter-mile from home when *not* with another licensed rider. Since I had never given up bicycling for recreation and practical around-town transportation, I didn't have to learn how to balance at slow speed or master the basic characteristics of a two-wheeler. It was just a matter of establishing reflex actions for the Suzuki's controls: **Right**

(Please turn to page 216)



One-wheel cycle

Inventor LaFrance Bressen of Galesburg, Mich., built this one-wheel motorcycle for himself after seeing a picture of a similar machine built in the 1920s. He sits inside a 36-inch wheel that's powered by a 50-cc engine.

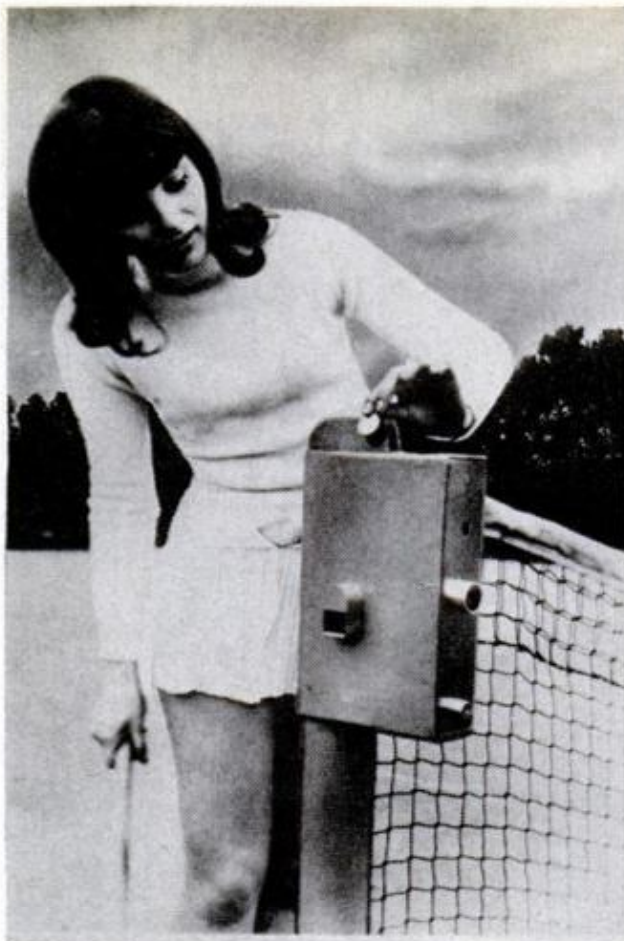

Tennis meter

Tennis meters may one day be as common on tennis courts as parking meters are on streets—and they'll serve approximately the same purpose. A player inserts a coin in the "Tennis Time" meter; the device then raises the net to playing height for a preset time. At the end of playing time, the net drops.

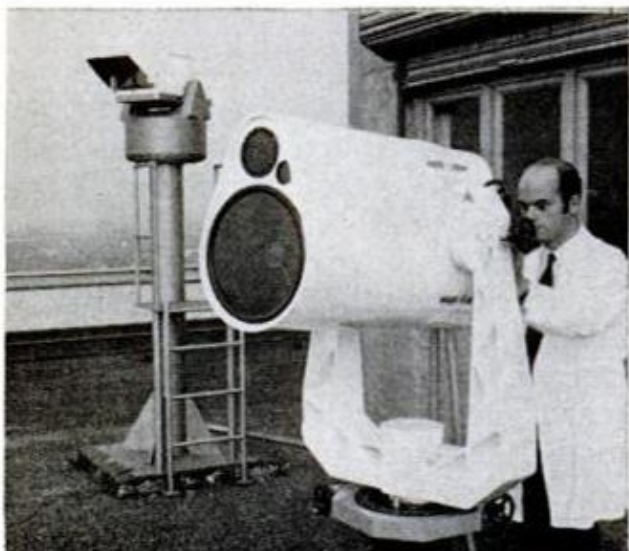

New artillery against smog: TV and Lidar

Television and Lidar (light detection and ranging) have entered the battle against air pollution in Duisburg, Germany. A television system constantly monitors smokestacks, and, when smoke emission appears excessive, a technician shoots a beam from a laser "cannon" (left) at the smoke. Density of the smoke is recorded on the scale next to the TV monitor in the right-hand picture. Photos are taken of the monitor and emission scale for evidence.

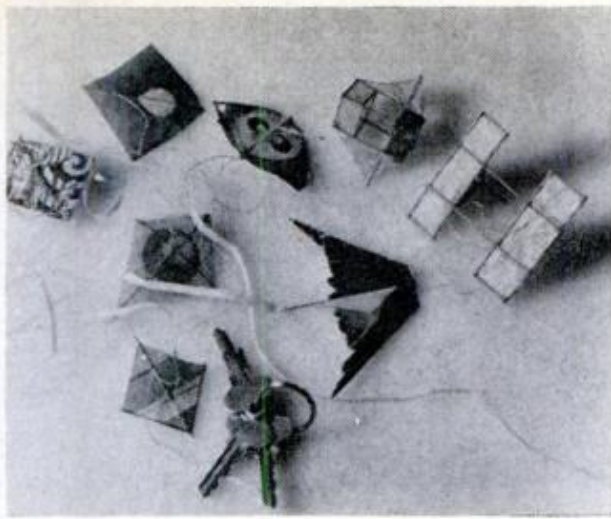

Mini-kites that fly

Kites no longer than a car key—but which really fly—are a specialty of Fumio Yoshimui, New York artist. He makes them of bamboo and paper. Yoshimui occasionally makes big ones, too (photo, right).



Electronic aid for jumpers

A former broad jumper, Prof. Melvin Ramey (left, above), has developed an electronic "force platform" that records the force exerted by a jumper at the moment of takeoff. Purpose of the device is to determine the potential of the athlete and thus guide coaches in training and conditioning the jumper so as to achieve his best jumping form. The electronic platform is used in conjunction with motion pictures that depict the movement of the jumper's center of gravity. Prof. Ramey, who competed at Penn State, now teaches at the University of California at Davis.

APRIL 1970

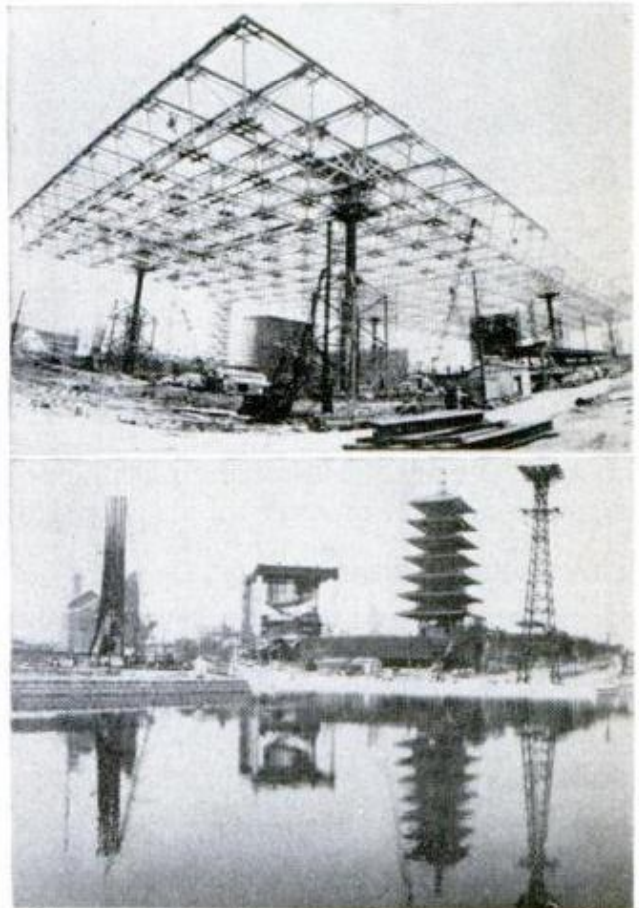

Expo 70 construction

Shown being raised on hydraulic jacks is the world's largest roof (top) which will cover the theme area of Expo 70 in Osaka, Japan. The roof is almost 1000 feet long. Nearly completed pavilions in the lower photo include those of the Japan Gas Assn.; a whiskey maker; electric power producers; and (the tall tower at right) British Columbia.

105

The Gremlins Will Get You If You Don't Watch Out!

By MICHAEL LAMM,
West Coast Auto Editor



Perky looks and plenty of spunk from AMC's latest wee one

SHE'S A CUTIE, no doubt about that—cleverly styled, a touch of the future. She goes pretty well, too, considering the Gremlin's size and price class. With 128 bhp standard and 145 optional, American Motors' new subcompact has the acceleration and passing reserve to dust off most economy imports.

AMC's Hornet and Gremlin offer identical engines and running gear, the base Hornet weighing about 200 pounds more than the Gremmy. This weight accounts in part for a slight acceleration difference in favor of the Gremlin. But to compensate, the Hornet comes in V8 versions. Not so the Gremlin;

WITH 128 BHP STANDARD and 145 optional, Gremlin has enough pickup to dust off most economy imports

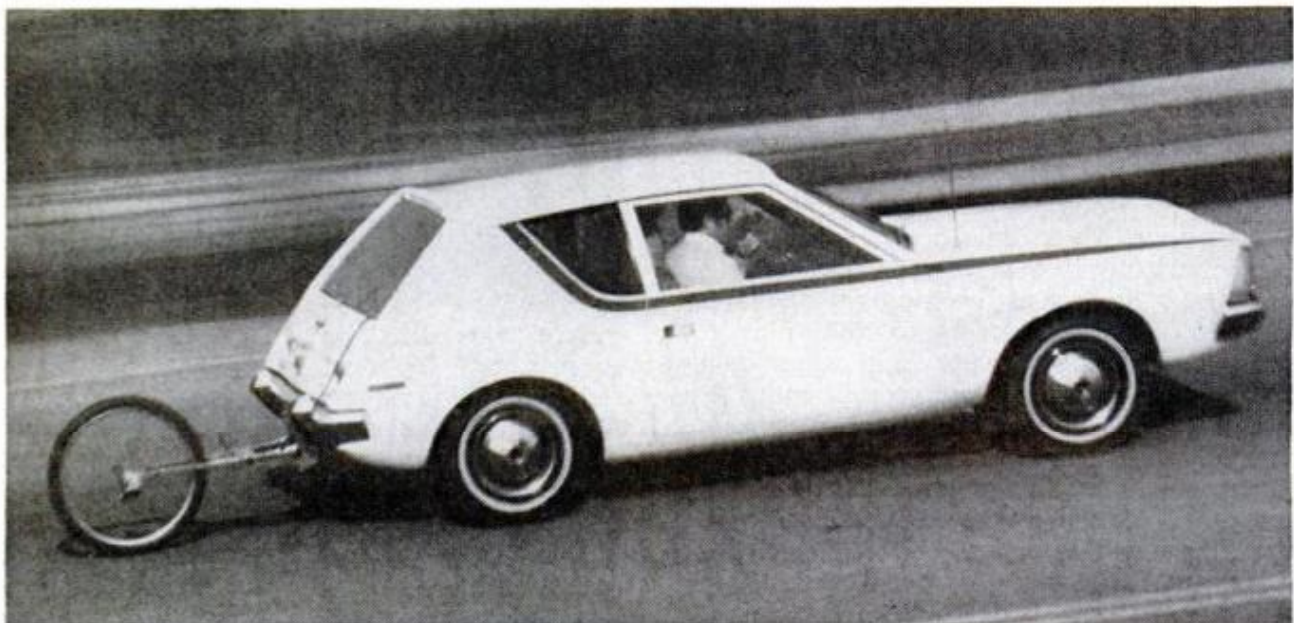

it's offered only with the 199 and 232-cu.-in. Sixes. Yet there's no reason why the 304 V8 (or even the 360/390 V8s, because block dimensions are the same) can't be an option. It'll drop right in.

The Hornet and Gremlin share *everything* forward of the door latches: bumpers, front-end sheet metal, all unit-body components, windshield, dashboard, doors, even suspension, steering and brakes. Among minor differences, the Gremlin has a hood bulge and oblong parking lights. The only major difference between a two-door Hornet and the Gremlin is the body section *behind* the front doors. This leaves the Gremlin's wheelbase a foot shorter (96 inches instead of 108), with 1.5 feet less overall length. The only running-gear component different between the two cars is the driveshaft.

While go-power puts the Gremlin above most economy imports, its cornering power rates so-so and braking leaves quite a lot to be desired. The Gremlin's rear end feels awfully light. AMC spokesmen give weight distribution as 57/43, but that's the Hornet's ratio, so I'd say the Gremlin must be nearer 60/40, because both cars' front-end weights are the same while the Gremlin's rear is much lighter.

Pouring around sharp, graveled turns brings the Gremlin's rear end out with



FOUR-PASSENGER MODEL has a rear seat that folds flat to give a good-sized cargo deck or playpen! The rear window in this model hinges upward for access to the cargo space. Adults would find rear-seat legroom a bit tight; the seat is really for kids. The entire rear area of the four-passenger Gremlin is neatly carpeted, and there's even a cover over the spare tire (it's visible in the top photo)

TASTEFUL, CLEVER DASH has gauges in round dials, controls in center nacelle, locking glovebox at right

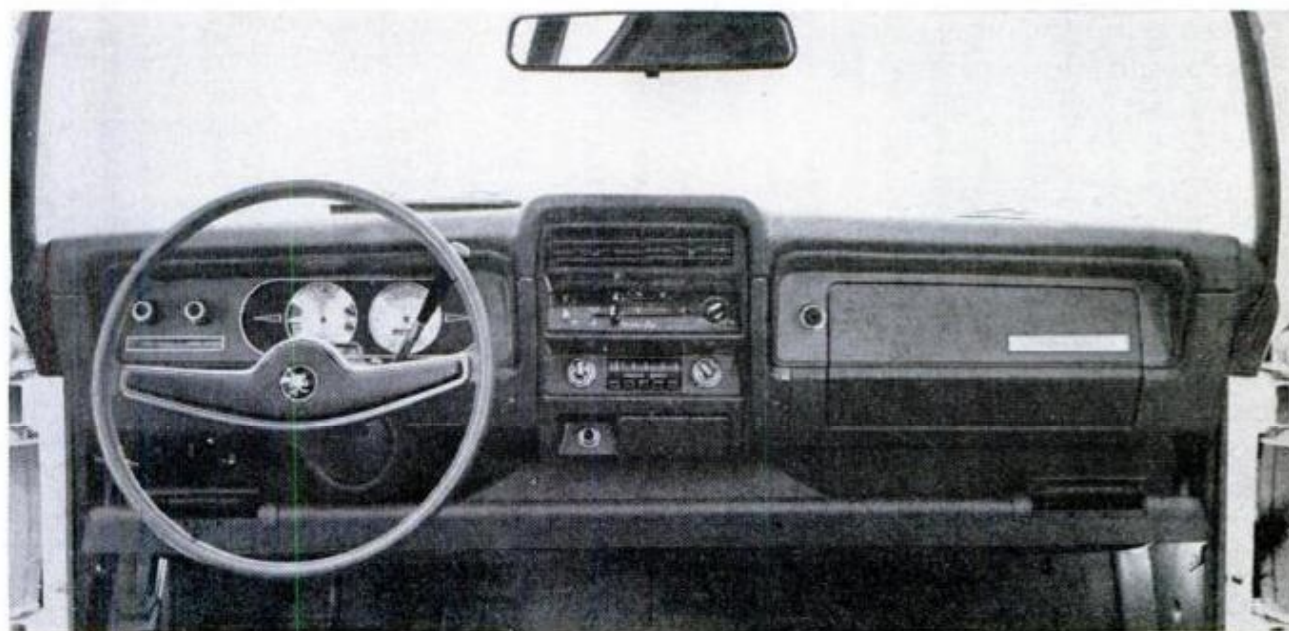

Gremlin



HINGED REAR WINDOW in the four-passenger model raises to gain cargo-area access. Back seat folds flat

fair ease. There's an optional heavy-duty suspension package available that might help here. And one powerful argument for ordering power steering: six wheel turns lock to lock with manual, three with power. The car's general ride, though, lacks the usual chop and rock and roll—it's steady and smooth, little affected by crosswinds.

Hard braking from 60-80 mph takes restraint, because if you cram down the pedal, weight shifts forward and the rear wheels lock up right quick. I made the mistake of trying my first panic stop from about 75 mph and immediately found the rear end trying to pass the front. Better brake-line proportioning would do wonders for this car. However, when I didn't lock wheels, my Gremlin stopped amazingly short—about 135 feet from 60 mph.

The Gremmy comes in either two or four-passenger form, the two being strictly utility. On the four-passenger, the rear window hinges upward and the rear seatback flattens to give a good-sized, carpeted cargo deck. Then there's an optional roof rack for surfboards ("Gremmy," get it?) and extra carrying capacity. The entire rear area of the four-passenger Gremlin is neatly carpeted, and there's even a cover

over the spare. The rear window opens with a simple, lockable twist release, and it's held up by two spring-loaded cylinders. In the two-passenger version, the rear window doesn't open.

Gremlin options run the gamut from airconditioning to rally stripes. And here's one subcompact with enough engine to handle a good load of power equipment—steering, brakes, automatic trans, and air—you can get it all.

Standard transmission in both versions and with both engines is a three-speed manual. With the 199 Six, you get column shift, but with the 232 it's a very handy floor stick. I would have liked synchro on low, but there's certainly no need for four speeds. In fact, the 232 takes off easily in second from a dead stop. Overdrive isn't offered and would be redundant anyway because of the high rear-axle ratios (2.37 to 3.31). The engine loafes even at high road speeds. AMC claims fuel mileage in the 25-mpg range, and I don't doubt it.

The Gremlin's interior is just as cleverly and tastefully done as the outside. Two round dials with brushed aluminum faces house the gauges. Controls for heater, airconditioning, radio, plus lighter and ashtray stand in a central nacelle. Then there's a big glovebox at the right, with its lockable release knob at its left, so the driver can reach it easily. Both kick panels have fresh-air vents, and you can order a full-width under-dash shelf. This has outlets in airconditioned models.

Nothing cheesy-looking about the



CLEVER STYLING should give Gremlin lots of appeal. Among its accessories: a roof rack for surfboards!

upholstery or carpeting, either. The basic Gremlin interior comes in black or white vinyl, with blue, green, or red-pleated bench or bucket seats optional. Those buckets are great. The cockpit area has every bit as much room as any full-sized car, but the rear is a bit abbreviated. It's for kids or short hops. Pinched legroom, as usual.

Like the Maverick, the Gremlin prides itself on being easy to repair. Eleven screws hold the grille in place. Front fenders bolt on. There's plenty of room around the engine to get at plugs, carb, distributor, PCV, filters and accessories. Five screws attach the dash pod, and the main wiring harness has only one plug-in socket. Easy adjustments are built into clutch and parking-brake linkages, front-wheel bearings and headlights.

Gremlin prices weren't available at press time, but guesses hover around \$1850 base. With average accessories, the car should run out at \$2550 or so. It's a lot of automobile for those amounts, especially considering power, styling and durability. If this car catches on with the kids the way the VW did, look out VW! ★★★

GREMLIN SPECIFICATIONS

ENGINES

199-cu.-in. OHV-6 (std.)	
Bore & stroke	3.75 x 3.00 in.
Max. bhp @ rpm	128 @ 4400
Max. torque @ rpm	182 @ 1600
232-cu.-in. OHV-6 (opt.)	
Bore and stroke	3.75 x 3.50 in.
Max. bhp @ rpm	145 @ 4300
Max. torque @ rpm	215 @ 1600

TRANSMISSIONS AND REAR AXLES

With 199-cu.-in. OHV-6	
3-spd. manual, column (std.)	2.73 std. (3.08 opt.)
3-spd. automatic (opt.)	2.73 std. (3.08 opt.)
With 232-cu.-in. OHV-6	
3-spd. manual, floor (std.)	3.08 std. (3.31 opt.)
3-spd. automatic (opt.)	2.37 std. (2.73 opt.)

DIMENSIONS

Wheelbase	96.00 in.
Overall length	161.25 in.
Overall width	70.58 in.
Overall height	51.80 in.
Curb weight (est.)	2633 lb.

BRAKES, TIRES, CAPACITIES

Brake drum diameter	9.00 in.
Brake lining area	153.50 sq. in.
Tire size: std., 6.00x13; opt., 6.45x14, B78x14	
Cargo cap., 6 cu. ft.; fuel tank cap., 21 gal.	



3:00 o'clock and all's well

Driver of Ford's new long-haul Louisville Line trucks can spot malfunctions at a glance, thanks to grouping of instrument gauges in angled panel at his right. Instant recognition of an abnormal condition is facilitated by fact that all gauges except fuel gauge read at 3:00 o'clock when indicating normal operation. This panel also houses heater controls, rocker-type electrical switches and warning lights. Panel directly in front of driver contains speedometer and tachometer only. Left-hand panel groups all air controls in one area. Ford claims new cab has largest glass area in the industry, hence greatest visibility. Truck's fiberglass front end can be tilted 60° so that engine can be worked on easily by mechanic standing on ground. Ford's new Louisville factory, said to be largest truck factory in the world, can turn out 336 trucks a day.

MECHANICS OF MEDICINE:

- *Shirt-Pocket Tape Recorder
For Daily Electrocardiograms*
- *Fish-Tank Babies*
- *Shop Tools for the Blind*
- *Marker Buoys for Artificial Legs*

By ARTHUR FREESE

Heart-Spy! Willy Gray was 16 years old, yet for several years he had suffered from spells of wildly rapid heart-pounding. Even his doctor's powerful drugs had failed to control this, and Willy finally found his way to the Mayo Clinic. Dr. Ralph Zitnik of that institution tells how Willy was fitted with a new electrocardiograph not much larger than a pack of cards. With this in his shirt-pocket and three rubber cups from it on his chest, he left—to return with the first electrocardiogram ever made of this pounding, over 150 beats per minute (the usual is 60 to 80). The spy had worked, and with questioning at the clinic came the diagnosis—just the reaction of any normal teen-ager to a school examination!

William W. Kowalski, project engineer of Marquette Electronics, Inc. of Milwaukee, manufacturer of this device, explained to me how the spy works. Electrical signals from the heart muscles are picked up on the skin and fed into the

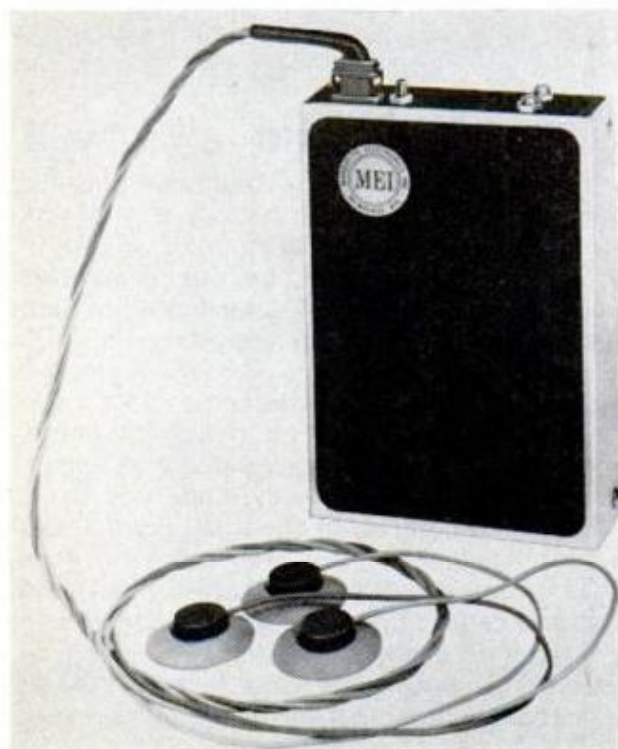

POCKET EKG RECORDER, 3x4½ inches, 11 ounces, is miniature cartridge tape recorder. It transcribes and erases patient's electrocardiogram on endless loop until heart rate limits, or patient-activated push-button (in cases of angina and the like), stops recording process, leaving complete data before and one minute after attack. Paper recording is made on the play-back unit (below) for the physician's analysis. Adult patient (right) carries recorder in shirt pocket

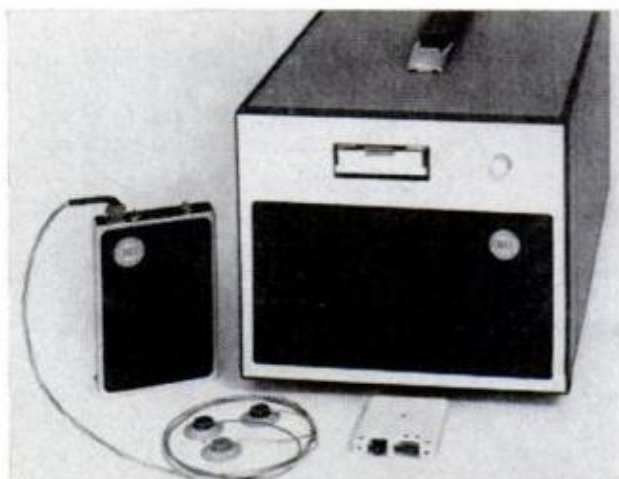

CIRCUIT DIAGRAM OF POCKET RECORDER

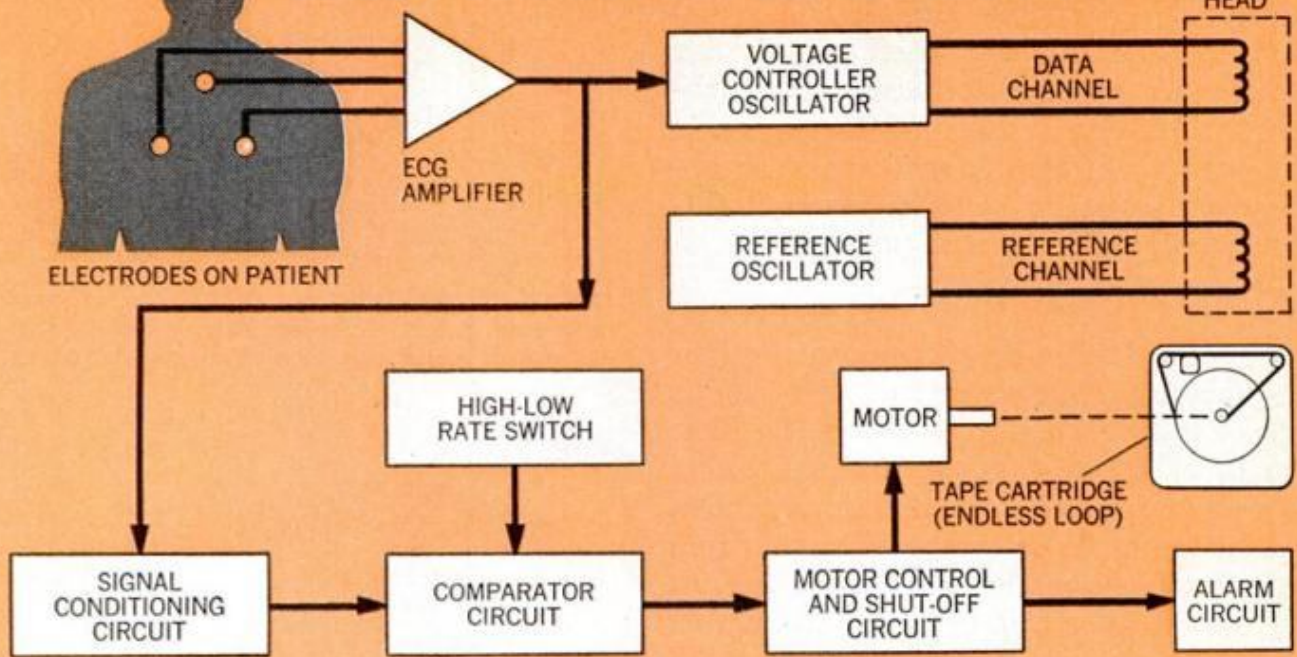

PLAYBACK SYSTEM

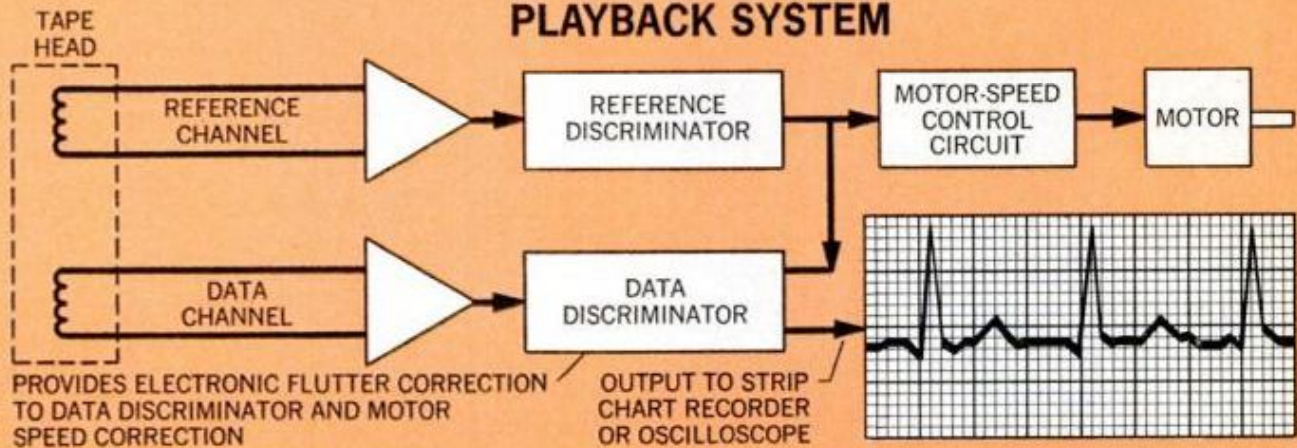

electrocardiograph (ECG) amplifier which converts these from *thousandths* of a volt to actual volts. This in turn is fed into a voltage-controlled oscillator which changes the amplitude variations into frequency modulations which are transcribed on an endless loop of tape in a special cartridge.

The amplified signal has also been fed into signal-processing circuitry which converted the varying heart rates into varying d.c. voltages. These are compared with reference ones selected to correspond to those heart rates the recorder is designed to monitor. When the d.c. voltage from the heart intersects with a reference voltage, high or low, a timing circuit turns on, shutting off the motor after a set time. Then an alarm sounds and the owner replaces the cartridge, keeping the tape for the doctor's examination.

Thus the doctor has the most important part of the incident—the ECG record just before the disturbance, during it, and immediately after. The device is

adjusted to time-out at one-half the time of the cartridge loop—when a five-minute cartridge is used, the motor shuts off 2½ minutes after a disturbance. Dr. Zitnik told me the device is of increasing benefit in diagnosing obscure changes in heart rhythms, fainting spells and chest wall pain.

Fish-Tank Babies

Today, lambs are being “grown” in aquariums! Tomorrow, babies? This is the exciting possibility raised by four medical scientists at the National Heart Institute’s Laboratory of Technical Development. They surgically removed the lambs from the mother’s womb at what would be well before eight months in a human pregnancy. The first 29

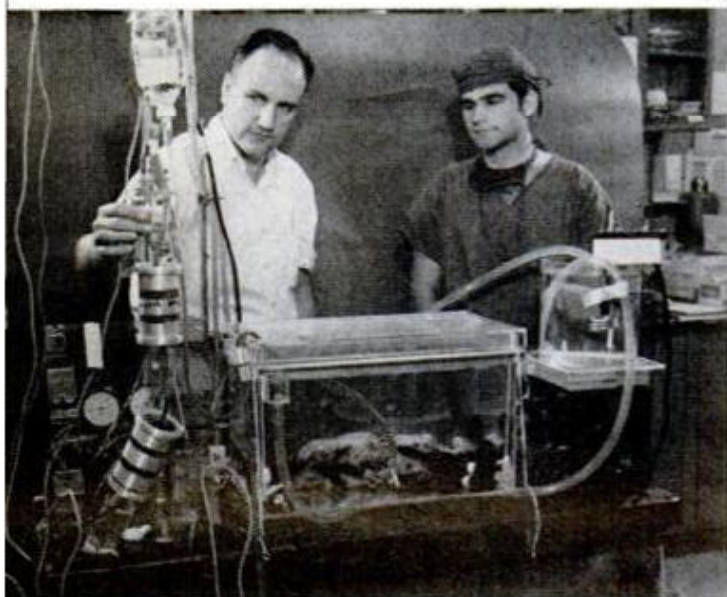

ARTIFICIAL PLACENTA SYSTEM developed by Drs. Kolobow (left) and Zapol at NIH uses new type of artificial lung (pint-sized cylinders) for respiration. Fetal lamb (below) rests in synthetic fluid

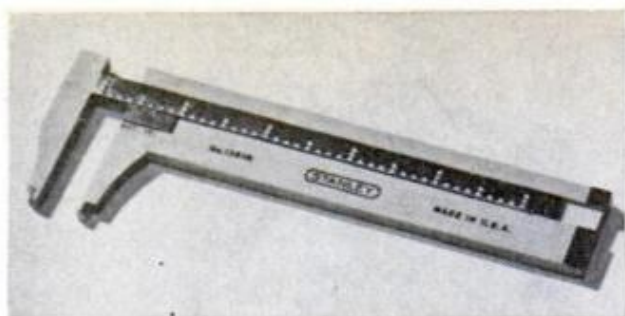
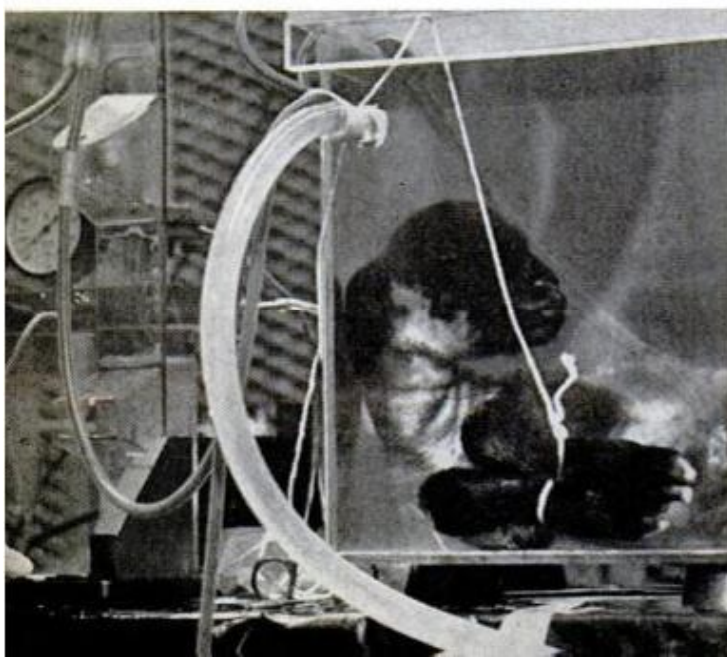

STANLEY CALIPER RULE for sightless can be read with raised dots. Combination square (below), with strip of dots added, can be used as marking gauge

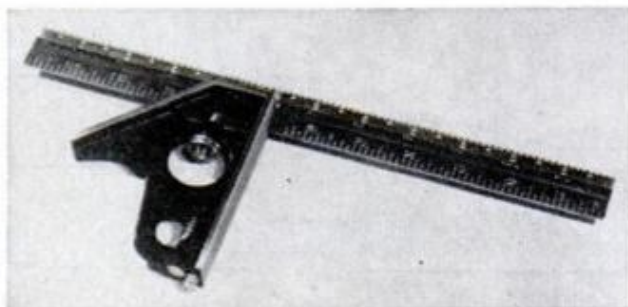

lambs survived up to 56 hours. But then three lambs were weaned away from the artificial womb about May, 1969, and are still living and thriving.

The water in the “fish tank,” which is what the lamb’s artificial womb looks like, contained a mixture of antibiotics, salt, sugar and minerals similar to that contained in the fluid in the placental sac in which the baby grows in the uterus. A man-made umbilical cord provided food and oxygen, took away carbon dioxide. The cord consists of two tiny tubes (inserted into the umbilical blood vessels) of stainless-steel-spring-supported, nonkinking, segmented polyurethane. Even though the walls are only 1/1000 inch thick, the tubes are strong enough to be passed through all the body’s blood vessels. At the navel, they connect to much larger-bore tubing (¼-inch) which passes around a slow roller pump (7-rpm). This gently milks the blood along to the system’s most important innovation, a pint-sized artificial lung in a cylindrical housing. Made of 1/200-inch-thick silicone rubber membrane supported by nylon knit, it’s in the form of a flat tube or envelope, some seven feet long and wound around a central plastic spool. A slight intermittent vacuum brings oxygen in at one

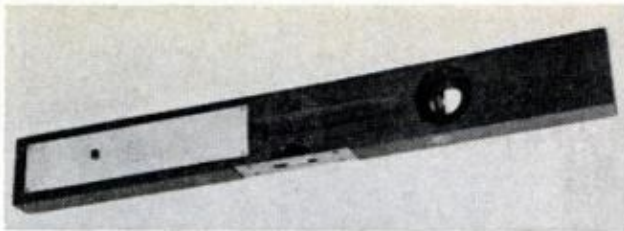

LEVEL WITH AUDIBLE SIGNAL is silent when level or plumb. Modified Starrett micrometer (below) has raised dots for fingernail reading by the blind

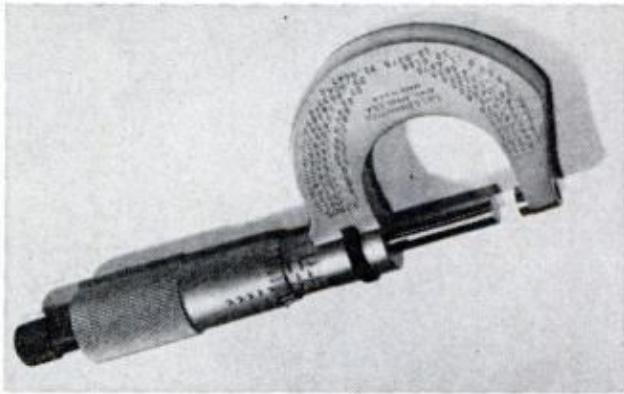

port of the housing and carbon dioxide out at another. The blood flows through this artificial lung, giving up its carbon dioxide and picking up oxygen by diffusion across the silicone membrane. Gentle cyclic suction prevents oxygen bubbles from entering the blood and provides more thorough oxygenation than does the conventional machine.

An equilibration chamber collapses if excessive suction develops, activating a cutoff switch to the roller pump.

The artificial lung alone may provide improved hope for newborn infants with certain breathing difficulties, possibly even for adults. Perhaps some babies too will be "grown" during the last few months of their intrauterine life—in a "fish tank!"

Tools for the Blind

The blind carpenter puts up shelves and partitions with a carpenter's level. But this level is electronically equipped; instead of the standard single horizontal and vertical fluid-filled tube with its air or gas bubble, his tool has a pair of tubes with a ball of mercury in each. A 9-volt battery operates a continuous tone which is controlled through two parallel wires at the ends of each tube. Adjoining tubes are set with their wires at opposite ends. When the level is ab-

solutely true both balls of mercury are centered in their tubes and act as off-switches. When there is no tone, the shelf or post is true.

Obtainable from the American Foundation for the Blind, like this level, are potentiometers—all solid-state in design and with an accuracy of better than 2½ percent. The blind rotate a dial until the tone stops (the same as when your dial reads "0") and then feel the face to "read" its deeply engraved scale. Servo-voltmeters, self-balancing or automatic potentiometers, can be "read" to an accuracy of better than 1 percent.

The foundation also buys blank micrometers and adds deeper markings and tiny steel dots to permit fingernail readings. A caliper rule has raised dots instead of numbers and lines—a single dot for each ⅛ inch, two for each ½-inch mark and three for the inch mark. The stationary jaw has two dots—the first for outside measurements,

(Please turn to page 224)

MARKER BUOYS of vinyl foam (left) were used to form these two legs. Dark limb has been coated with urethane "skin." Leg at right is in an early stage



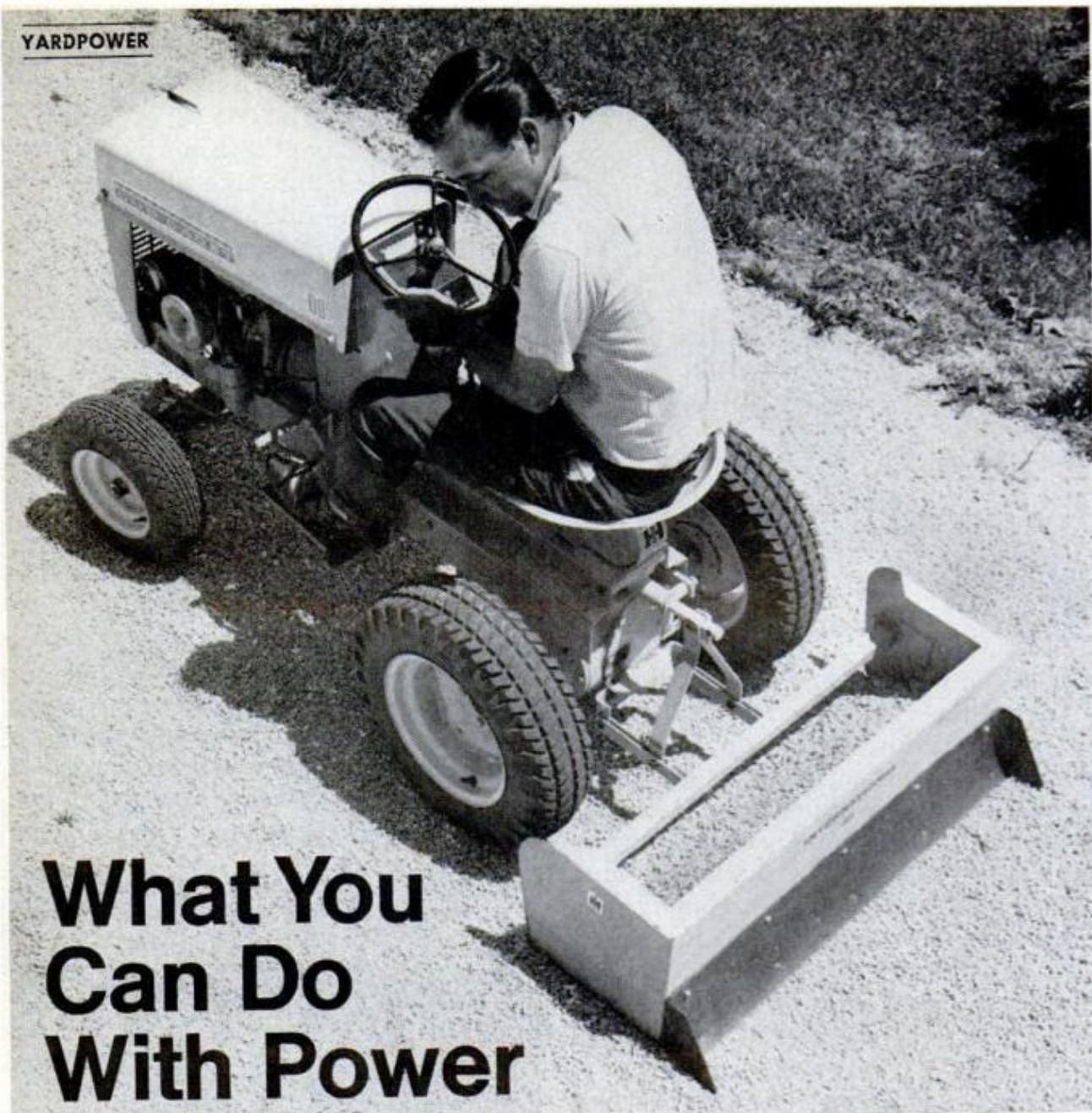

What You Can Do With Power

There's an attachment to do practically every outdoor job

THE BACK-BREAKING JOBS a small gasoline engine can make easy grow in number as new attachments appear for tractors and riding mowers. Many still regard their package of portable power as a mower. If you do, you're not getting your money's worth.

The man in the photo above has a long, gravel drive. He used to spend hours with shovel and rake ridding it of ruts and weeds—while his tractor rested. Now he spruces it up in no time with a box scraper. It's fun. Other jobs being done with power are *work*—but you'll never know it.—James M. Liston

SIMPLE CART is most useful, versatile attachment to speed work and save labor. Cart shown: \$90





COMPOST MILL (above) can be driven to job and powered by tractor's engine designed for all Sears Suburban, SS-12 and Hydro-Trac models. Front-end loader (top right) lifts 500 pounds 65 inches high, is ideal for light earthwork, cleanup. Hydraulically controlled, it's mounted on Economy Power King. Tractor-powered alternator-generator (right) delivers 115 volts where needed to run tools, pumps, light job. Price range: \$185-\$245, depending on wattage



—from tilling to hand-trimming—better, quicker and easier

REAR-MOUNTED TILLER (on Bolens 1256) comes in 25, 30, 33-inch widths with extensions. About \$275

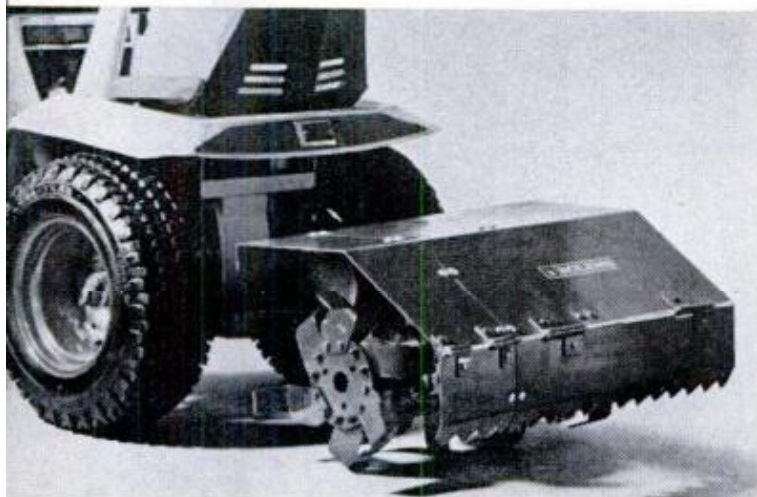

APRIL 1970

ROTARY PLOW (on Gravely 430) prepares seedbed without other preparation; it's \$128, plus adapter kit





LAWN VAC inhales leaves, twigs, litter. Hose gets window wells, tight spots. About \$190; hose \$29

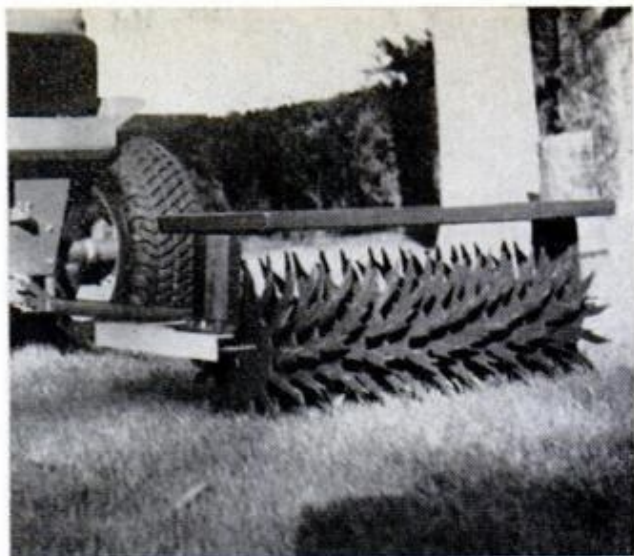

SPIKER AERATOR for Massey-Ferguson has reversible teeth for smooth or rough-spiking 32-inch swath: \$80

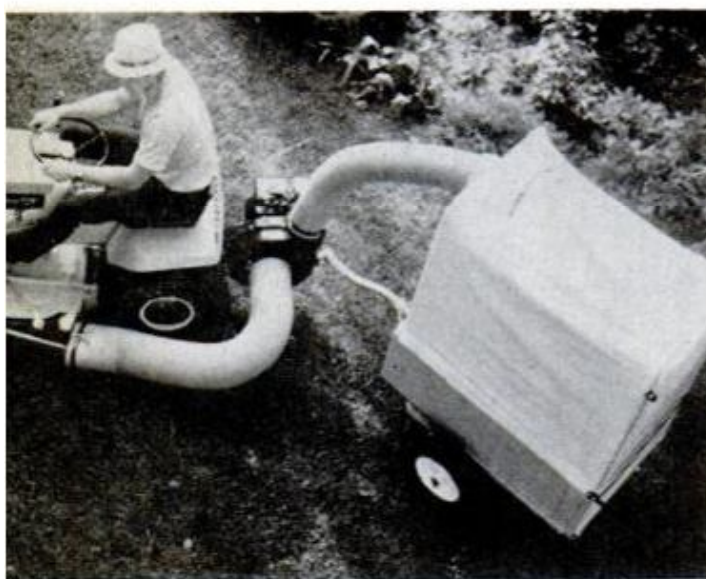

VACUUM COLLECTOR with high profile cover for Simplicity cart has 26-bushel capacity. About \$250



PLANTER-FERTILIZER attachment puts 10 or 12-hp tractor to work on the small farm or acreage: \$90



GRASS CATCHER (on Ariens Emperor) leaves lawn clear of clippings, leaves. Capacity: 2½ bushels. \$45



LAWN-SEEDER-FERTILIZER, 30 inches wide, has 85-pound hopper. Lever at seat starts, stops flow. \$102

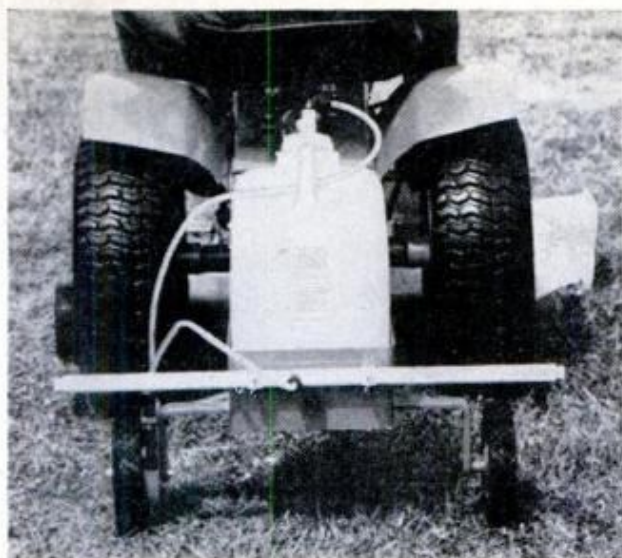

LAWN SPRAYER (Sears) with 42-inch boom covers 20,000-square-foot lawn on one 5-gallon filling. \$60



FIVE GANGPOWER cuts time, trips and a 93-inch swath. Three-gang mower, \$312; five-gang unit, \$579



50-GALLON POWER SPRAYER for orchard work can be run from driver's seat. Sprayer, \$440; hitch, \$16



AIR COMPRESSOR (on Massey-Ferguson) lets you spray paint in the field, inflate tires. About \$165



ROW CROP CULTIVATOR eliminates hand weeding. It adjusts for 6 to 42-inch rows, \$50; hitch is \$30



LAWN ROLLER, 32 inches wide, 415 pounds water-filled with scraper, pulls easily behind Wheelhorse. \$57



Skil's Powerful Electric Mower

If you have the lot for it, this 18-inch rotary has the power. And its grass catcher gives you a clean sweep

EVERYONE can't be happy with an electric mower. If your lot is studded with trees, shrubs and flower beds, you'll spend too much time handling the cord that binds you to an outlet. But if you have clear areas of "picture" lawn—lush growth that responds beautifully to frequent barbering, Skil's 18-inch electric will make you as happy as anyone can be pushing a mower.

The pushing is easy—the mower is light, the handle right—and your wife will like pushbutton starting. The 2-hp, 4300-rpm motor is powerful; it defies overloading, prevents chute clogging. But the high rpm of the blade makes it almost as noisy as a gas mower.

The catcher, not the chute, clogs before it's half full. Compensation for this: a swath so neat it looks vacuumed. Price: \$110.—*J.M.L.*



HANDLE FOLDS EASILY for compact storage. Mower can also be stored off floor using hang-up method

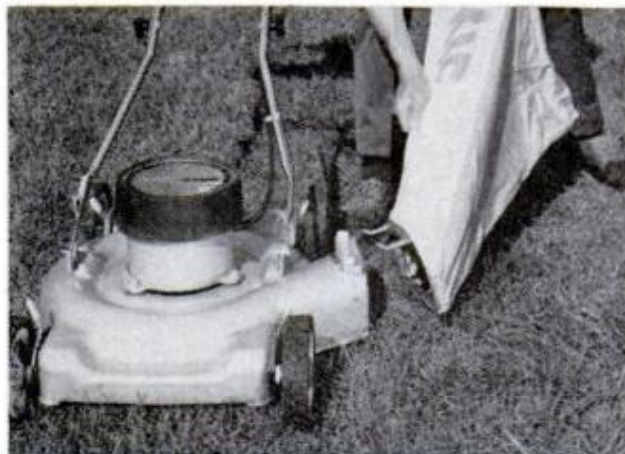

GRASS CATCHER is removed by slipping rod ends out of bracket. Clippings are dumped from zippered end

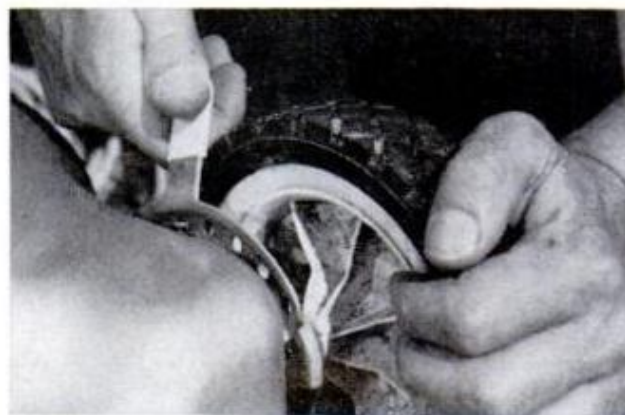

CUTTING HEIGHT ranges from $3\frac{3}{8}$ to $\frac{5}{8}$ in. (for Dichondra). Adjustment levers aren't very cooperative

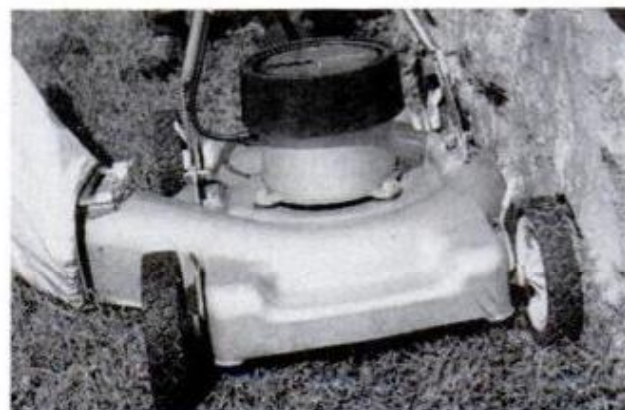

CUTTING NEXT TO A WALL, the mower is excellent; it leaves an uncut strip less than half an inch wide

POPULAR MECHANICS

Black & Decker's Cordless Mower

This 18-inch reel-type unit is safe, quiet and self-sharpening. Power moves the reel, you move the mower

ACCORDING TO Black & Decker engineers, the first cordless electric is "the safest, quietest power mower yet developed." True. But it's a somewhat specialized tool for a small, level lot. It snips lush growth easily, so women will love it. But a slight grade can be disillusioning; it's not self-propelled.

Without battery, the cordless weighs 40 pounds; with battery, 58. (A conventional 18-inch push weighs 46 pounds.) Its powered reel offsets its 12-pound handicap, but you still push uphill. On the plus side: self-sharpening (reverse the reel), easy height adjustment from 1/2 to 3 inches. Price: \$129.95.—J.M.L.



CLEAN-LINED PLASTIC SHROUD conceals motor, battery. Rear wheels replace the conventional roller bar



CONTACT SWITCH is quick-release type. Safety lock prevents accidental starting

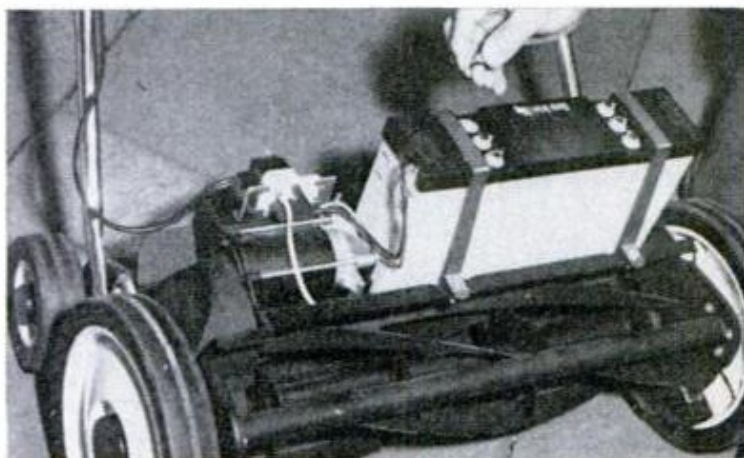

PERMANENT-MAGNET MOTOR and 12-volt battery are under shroud. Both are shockproof. Charger is included with machine

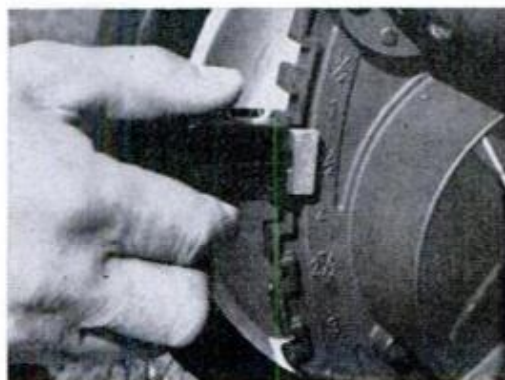

CUTTING-HEIGHT adjustment levers work easily; bed-knife adjustment is also easy



MOWING UPHILL takes leg power, the only drawback. One charge cuts 10,000 square feet. Grass catcher is easy to remove

GE Introduces the Electric Tractor



The first production-line, electric-powered home garden tractor, GE's Electrak, is cool, quiet, safe and vibration-free. Its electric motor develops amazing torque. And it takes the electric plug outdoors to power a complete line of tools—or anything you plug in

By JAMES M. LISTON, Executive Editor

Photos by Burns Photography, Inc.

THIS MONTH GE—yes, General Electric—will introduce an electric-powered home garden tractor that can mow up to 3½ acres without recharging. The Electrak packs plenty of power for plowing, tilling and snowblowing. You can fell trees or shave with it. One of its attachments, a new electric chain saw, plugs into the power takeoff. And—if you use an inverter—an electric shaver or any 115-volt a.c. tool or appliance you choose can be plugged in.

Three models of Electrak will compete with 10, 12 and 14-hp conventional tractors and, while prices haven't yet been announced, "will be priced at mid-range with competing stock."

The Electrak is the brainchild of fast-moving Bruce R. Laumeister, developer of GE's Delta electric car.

"In three years we produced the equivalent of five model years of electric tractors," he says. "We're ready now with three models that will outperform 10, 12 and 14-hp conventional tractors. We developed our own

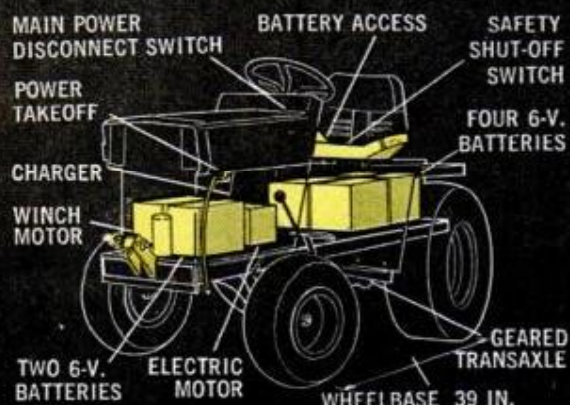

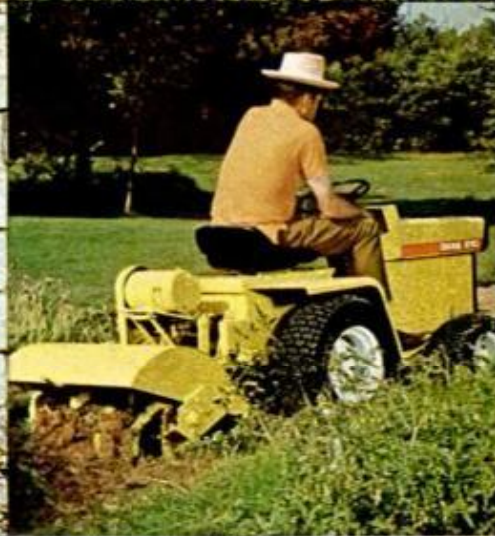
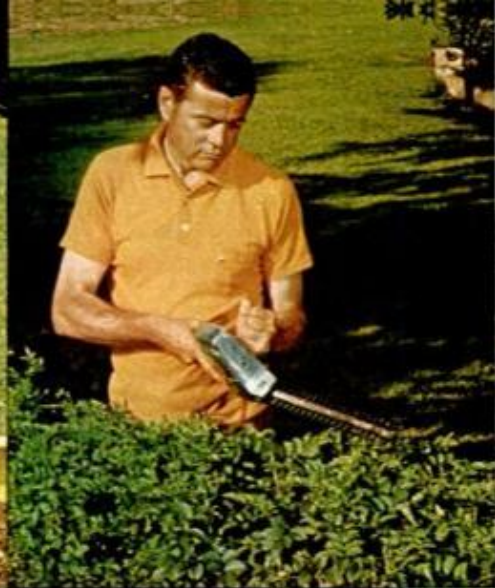
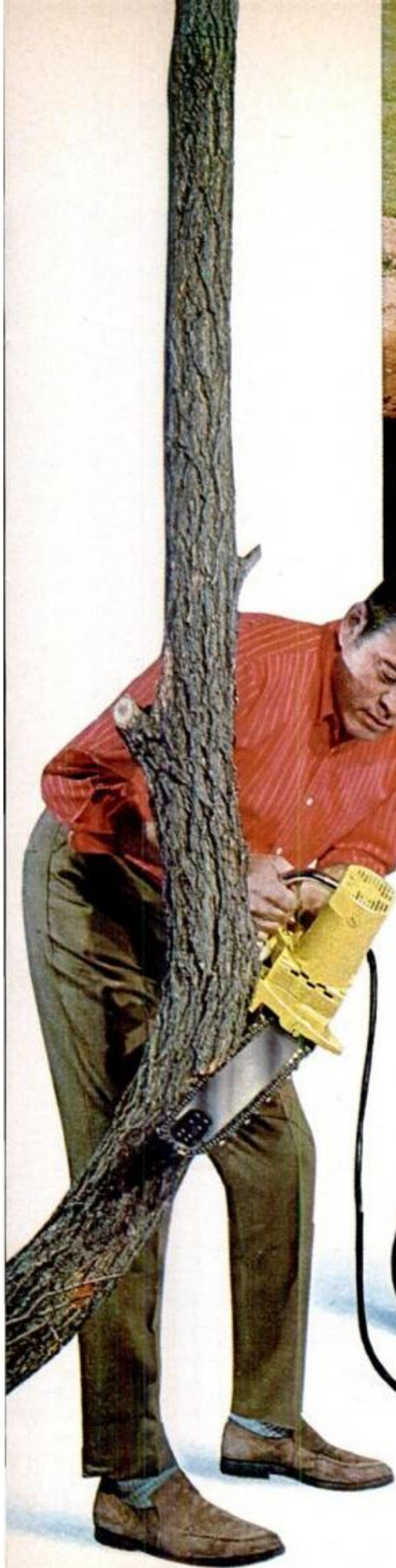

ELECTRAK HAS REAR-DISCHARGE, front-mounted mower (opposite page) with separate motor for each blade. Its weight and torque make it ideal for bulldozing, plowing, tilling. Tools that can be plugged in include drill, hedge trimmer and electric chain saw. Standard 115-volt tools can be used with an inverter that costs under \$100

full line of attachments and believe we have the safest mower and the best snowblower in the industry."

Laumeister, who lives on an acreage, has an engineer's intolerance of poor design and performance.

"I wasn't satisfied with several conventional tractors I wore out," he says. "That's how I got started looking for a better answer."

To avoid questions from his neighbors about the project during the period of field-testing, Laumeister mowed and plowed late at night. He had no complaints from the neighbors—proof that the Electrak was quiet. And proof that GE is convinced he is onto something big is that the corporation has set up a new outdoor power equipment operation which he now manages.

***The mower is shock-mounted;
you can hit a tree . . . and
not break the mower mounts.***

Laumeister believes the cool, quiet, vibration-free ride is an advantage buyers will recognize quickly.

On the dash of the Electrak are two gauges—"Fuel Level" and "Power Use." "Fuel Level" shows the amount of charge in the batteries; "Power Use" indicates the rate at which power is being used. Plowing takes a lot of power; ordinary mowing requires little. At the right of the dash is the drive lever, with forward, neutral and reverse positions. The more you advance the drive lever, the faster you go; it acts as the throttle.

A speed-selection lever offers four speeds: D-2 is the highest, 7 mph, for plowing snow, towing a cart. D-1 is typical mowing speed; L (low) is for heavy pulling, tilling, fast snow-blowing; LL (low low) is for heavy snow-blowing, deep plowing.

The "sound of silence" takes a while to get used to, and men who like a tractor to sound like a tractor may feel let down when they turn the key

starter. I drew a blank the first time I started the Electrak.

"I have the key in the on position," I said to Laumeister. "What am I doing wrong?"

"Nothing," he said. "It's on."

I moved the drive selector forward and took off. There are no neck-snapping starts. You take off smoothly and the tractor accelerates rapidly. If you listen carefully you hear a series of clicks. These are the relays and contacts that program the motor control. The control has a "memory" that won't let you go through the control and apply torque faster than the control will allow. The same thing happens when you shift from forward to reverse. It won't let you jerk-start or jerk-reverse the motor.

"There's a brake pedal on the left," said Laumeister. "You should use it before reversing. If an electric motor is going fast in one direction, it's possible to reverse it, but it does the motor no good. If you try to do this too fast, the circuit breaker will cut out. You'll have to wait a moment for it to come on, so you don't gain anything by 'shifting on the run.'"

I headed the Electrak for a bunker on the grounds of the GE Research Center. I'd been told it was a 40 percent grade. It was covered with an inch of snow; I doubted that I could climb it without chains. I stopped at the foot of the grade and selected D-2. The Electrak climbed the full length of the hill without wheel spin. Heading down, my first inclination was to hit the brake, but the dynamic braking effect of the electric motor held the tractor down to the same speed at which it had climbed.

We mounted a snow blade on the tractor—a simple matter of inserting a few hitch pins—and placed the blade against a concrete curb. Laumeister put the Electrak in Drive and the wheels continued to turn, burning rubber. A 200-pounder added weight by standing on the rear axle. The tires smoked, but the electric motor continued to run. (Try that with a gas engine and it will

stall out.) Laumeister did it to show the tremendous torque developed by the motor. Coupled with ideal weight distribution and a control system, it lets the motor deliver full horsepower—through a conventional geared trans-axle—to the drive wheels.

When GE engineers “started from scratch” to design the Electrak, they worked overtime on new safety features. One of the best—a safety cutoff switch—prevents accidental restarting. When the driver leaves the seat, the mower blades are braked to a stop in less than three seconds; the tractor stops and brakes. It cannot be restarted simply by remounting. To resume operation, you bring the drive lever back to neutral and move it again in the direction of travel. The mower is then restarted by switching the PTO to off and then on again.

Pressing a main power disconnect switch (at the driver’s left) completely disconnects the battery pack from the tractor. It can be used for an emergency stop or to prevent operation when the tractor is stored.

The 42-inch, rear-discharge mower is a three-blade rotary; each blade is powered by its own small d.c. motor. The mower floats on ball joints and is shock-mounted. If the mower hits an obstacle, the shocks absorb the impact. You can hit a tree with it and not break the mower mounts.

The mower lift mechanism is a simple electric winch using a nylon webbed belt as a lifting cable. GE engineers demonstrate its capacity by standing on the mower and being lifted as the winch operates. When raised, the mower can be flipped for cleaning and sharpening.

The Electrak has an unconventionally short wheelbase for its size—39 inches to allow a 47-inch turning radius.

“The short wheelbase was designed to get better maneuverability with the front-mounted mower,” said Laumeister. “If you have a long wheelbase with a front cutter, you end up turning cir-

(Please turn to page 202)

APRIL 1970

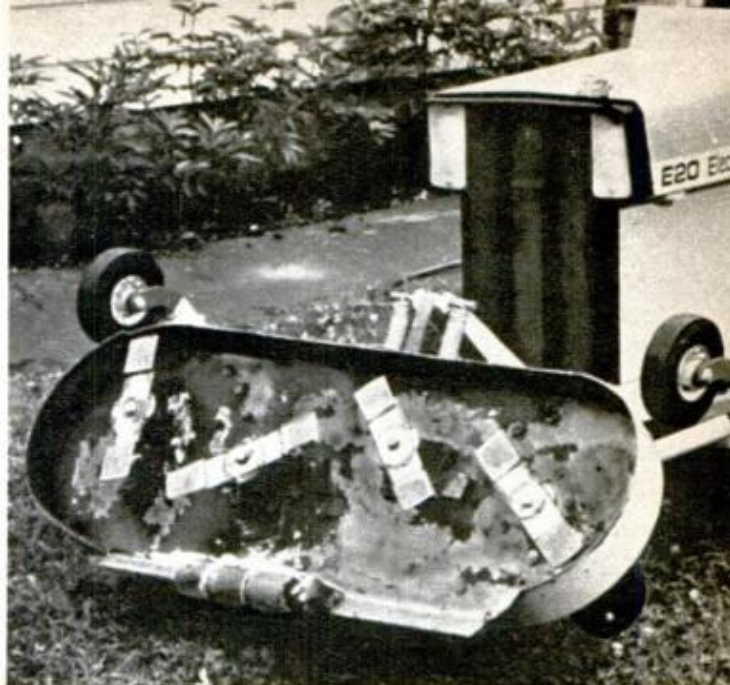

MOWER CAN BE FLIPPED for cleaning, sharpening. A prototype is shown; mower now has three blades

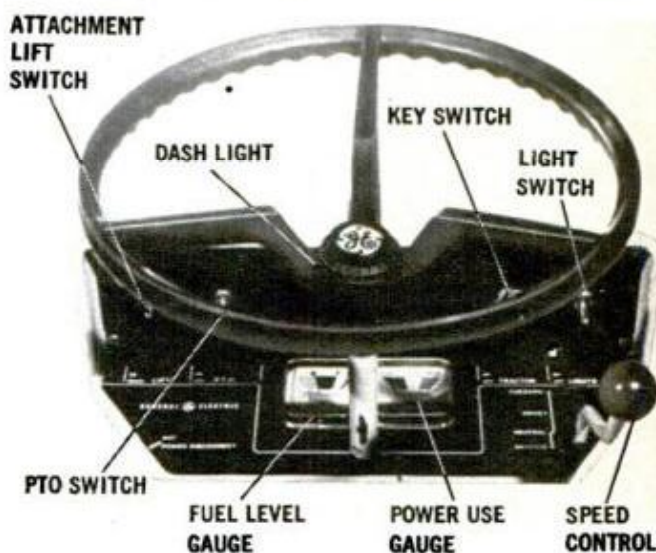

GAUGES ON DASH show amount of charge in batteries, rate at which power is being used. Mower (below) floats on ball joints, and is raised by an electric winch with a rugged nylon belt as cable

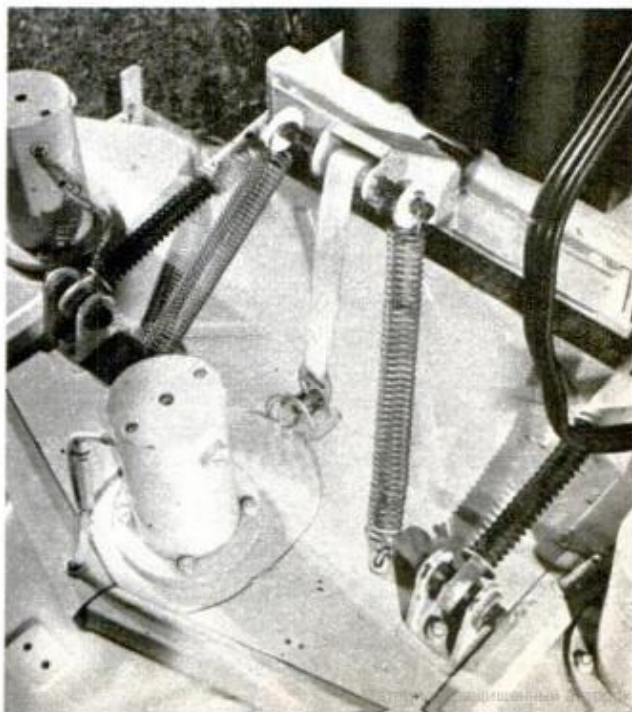

Build This Poolhouse

By SVEN CORSAK as told to HARRY WICKS

Technical Art by Peter Trojan



YOUNGSTERS CAN'T RESIST second-level playhouse, use it frequently for overnight sleep-outs. For contact with house, solid-state intercom is used

for Less Than \$500

Don't let its mini-size fool you. This little house not only is attractive, but also functions five ways to add fun and convenience to any pool

IT DIDN'T TAKE LONG after the christening of our new pool for us to realize that we needed a pool-side cabana to save wear and tear on the main house—which, by the way, is PM's Ranch House (page 154, May '51 PM). Using simplified construction techniques, and inexpensive materials, I built the poolhouse shown here almost two years ago for approximately \$250, although allowing for the current runaway lumber prices, I'd guess the structure today could cost up to twice as much. Prudent shopping, of course, keeps total cost down.

Though small, the house performs five functions. In addition to housing the pool filter and accessories, it offers a screened-in area for bugfree barbecues, a lavatory and dressing room, a deck for sunbathing and an upstairs playhouse for youngsters.

Originally, I had planned to continue the rear roof past the back wall right on down to the ground. My plan was to use this overhang as a "carport" for my garden tractor. But, since my wife was pleased with the little house as is, the idea was shelved. Another optional (but practical) feature is to install a separate septic tank for the lavatory rather than tying the plumbing system into the existing waste system.

The building rests on a 4-in. concrete slab poured on a perimeter footing. For framing I used 2x3s for studs and 2x4s for the joists. The cedar



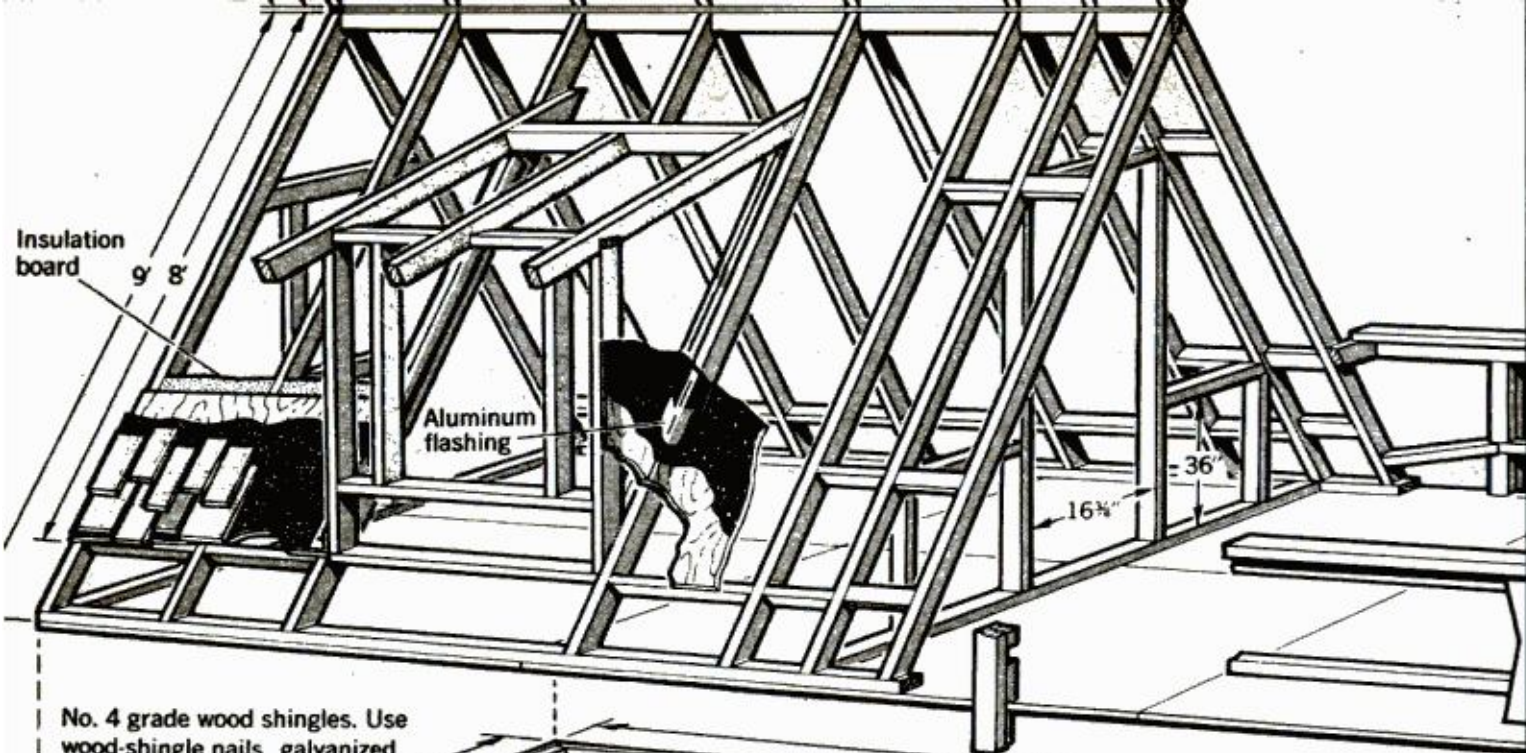

No. 4 grade wood shingles. Use wood-shingle nails galvanized (2 nails per shingle)

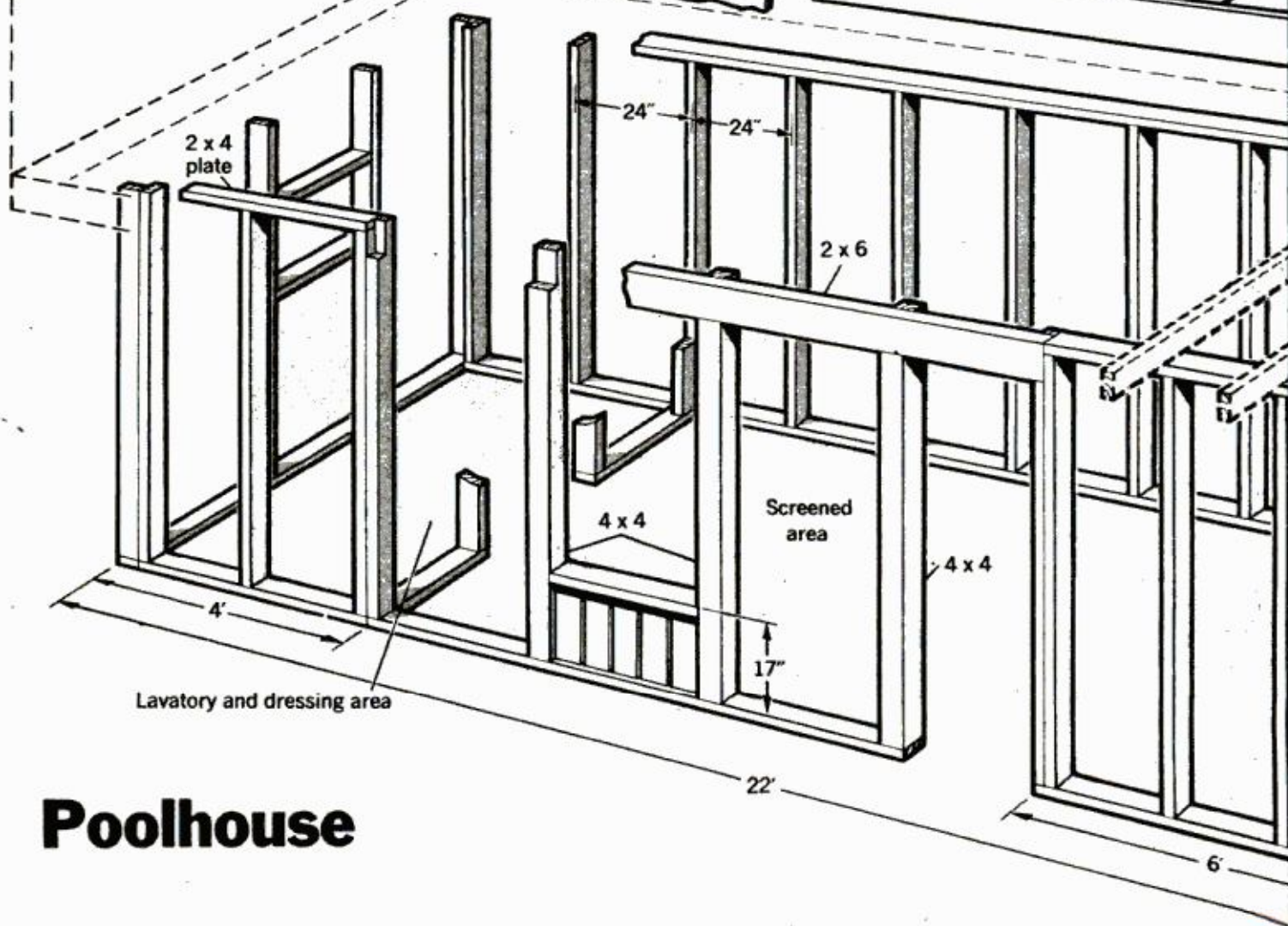
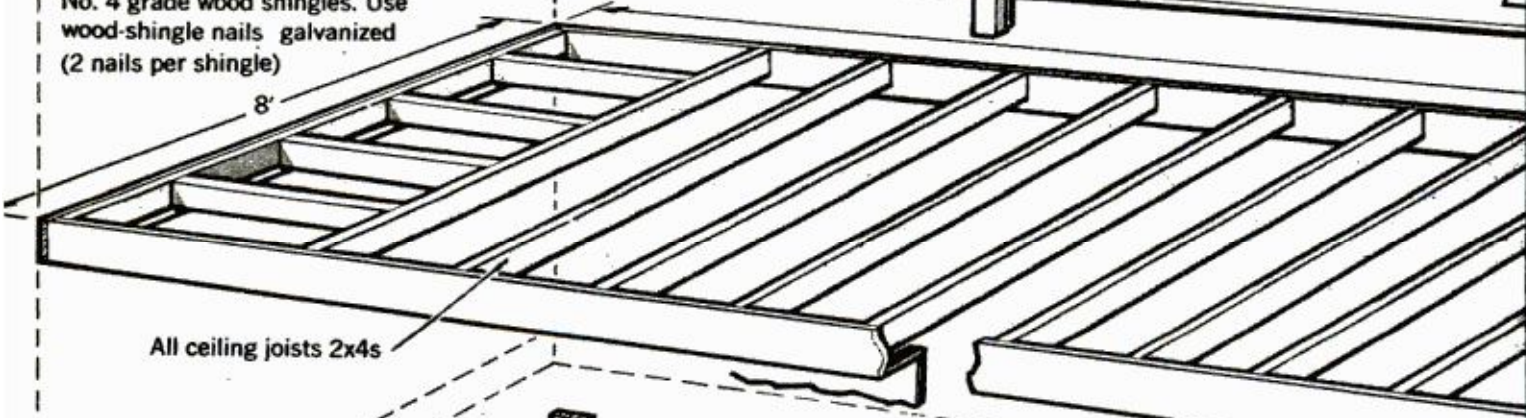

Poolhouse

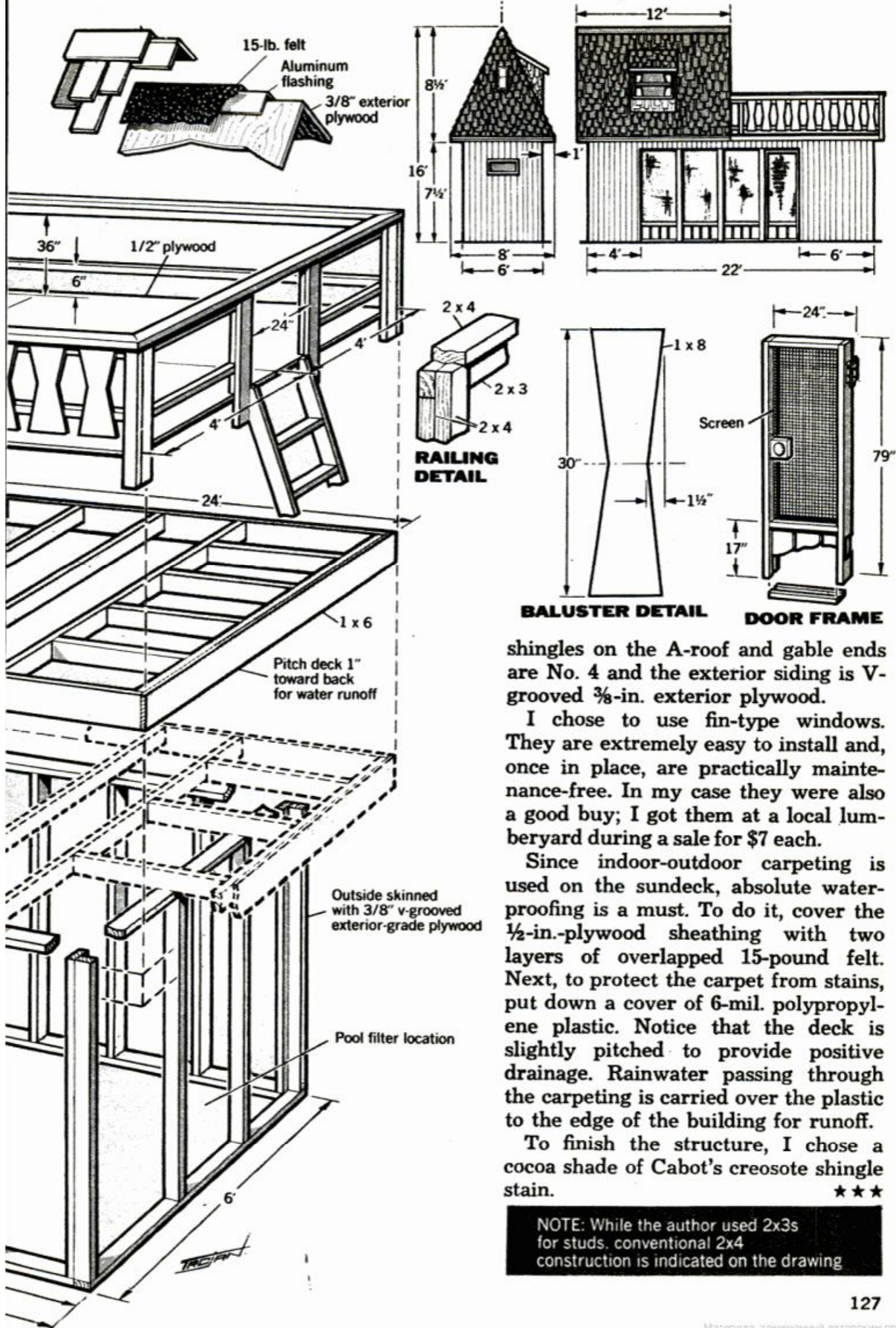

15-lb. felt
 Aluminum flashing
 3/8" exterior plywood

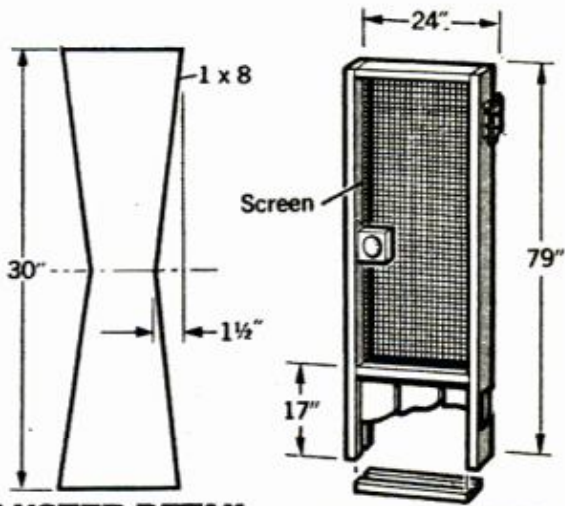
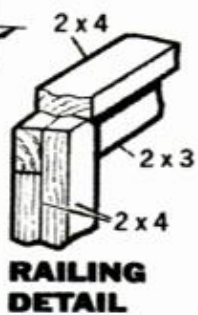
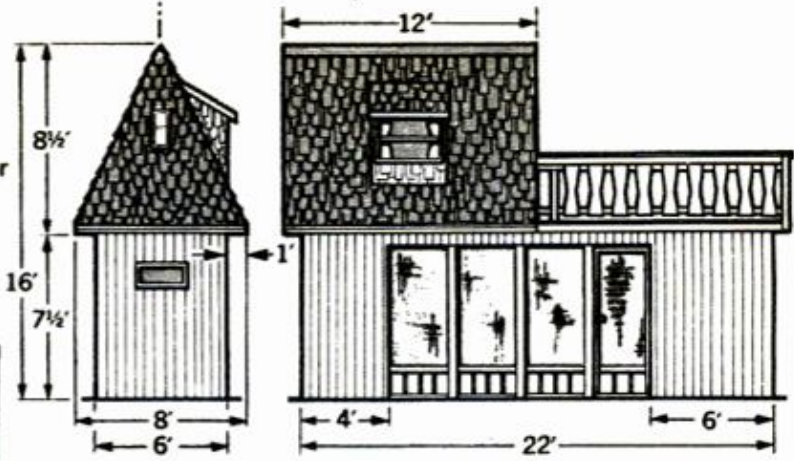

Pitch deck 1" toward back for water runoff

Outside skinned with 3/8" v-grooved exterior-grade plywood

Pool filter location

shingles on the A-roof and gable ends are No. 4 and the exterior siding is V-grooved 3/8-in. exterior plywood.

I chose to use fin-type windows. They are extremely easy to install and, once in place, are practically maintenance-free. In my case they were also a good buy; I got them at a local lumberyard during a sale for \$7 each.

Since indoor-outdoor carpeting is used on the sundeck, absolute waterproofing is a must. To do it, cover the 1/2-in.-plywood sheathing with two layers of overlapped 15-pound felt. Next, to protect the carpet from stains, put down a cover of 6-mil. polypropylene plastic. Notice that the deck is slightly pitched to provide positive drainage. Rainwater passing through the carpeting is carried over the plastic to the edge of the building for runoff.

To finish the structure, I chose a cocoa shade of Cabot's creosote shingle stain. ★★★

NOTE: While the author used 2x3s for studs, conventional 2x4 construction is indicated on the drawing

An \$800 Reel?

Rolls Royce to Rebel, Rolex to Timex. Like cars and watches, fishing reels range widely in price from a \$795 Fin-Nor to a \$7.95 Pflueger. But cost alone is not the point. Reels vary in type and function, and even workaday models are marvelous pieces of engineering and workmanship. This article may not eliminate all your confusion when you confront the variety of a tackle store, but we'll help you decide which reel you want for what kind of fishing.

By **GEORGE REIGER**,
Outdoors Editor

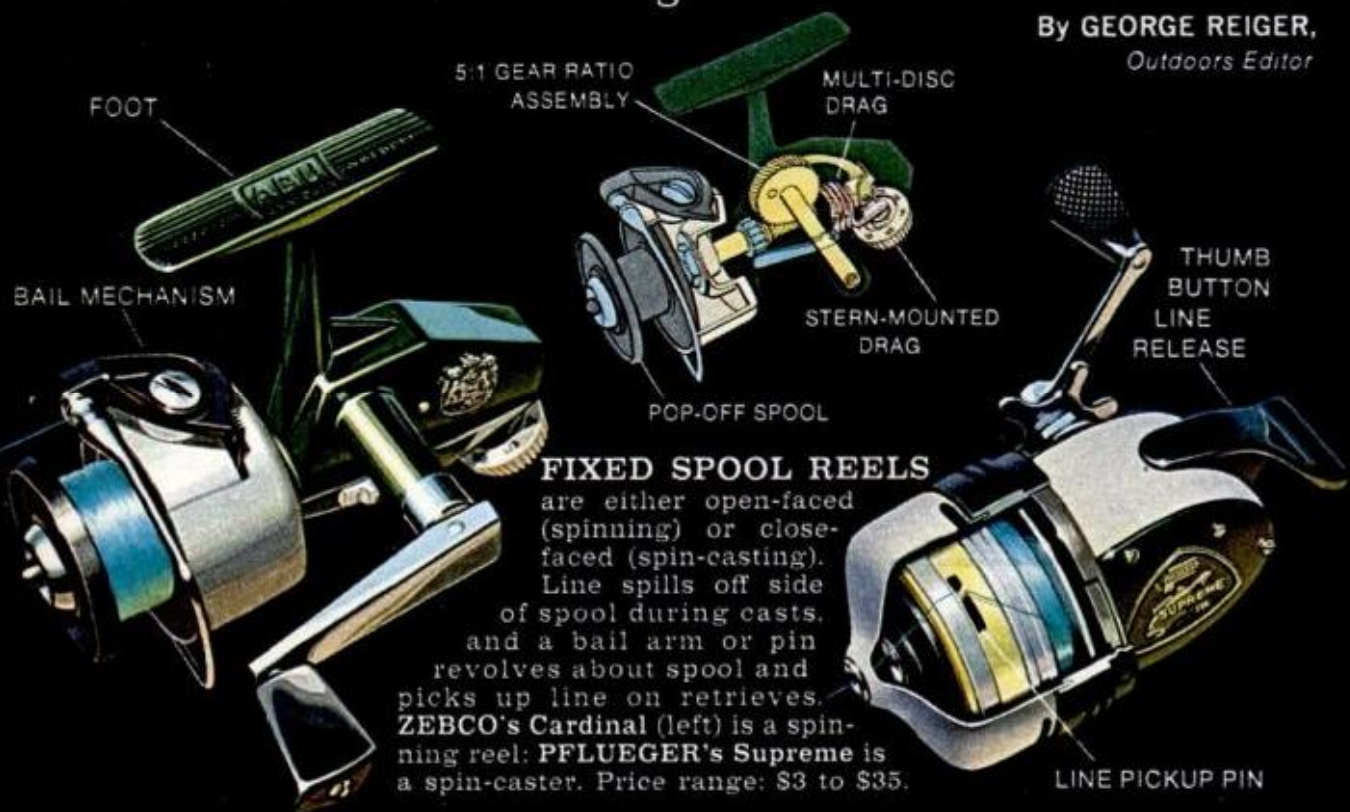

FIXED SPOOL REELS

are either open-faced (spinning) or close-faced (spin-casting). Line spills off side of spool during casts, and a bail arm or pin revolves about spool and picks up line on retrieves. **ZEBCO's Cardinal** (left) is a spinning reel; **PFLUEGER's Supreme** is a spin-caster. Price range: \$3 to \$35.



CASTING REELS

with revolving spools require "educated" thumbs to control rush of line which is paid out according to weight and momentum of cast lures. Cheap imports cost as little as \$1; refined versions run to \$75. **GARCIA's Ambassadeur** (left) is a baitcasting reel; **PENN's Squidder** is for surf casting.

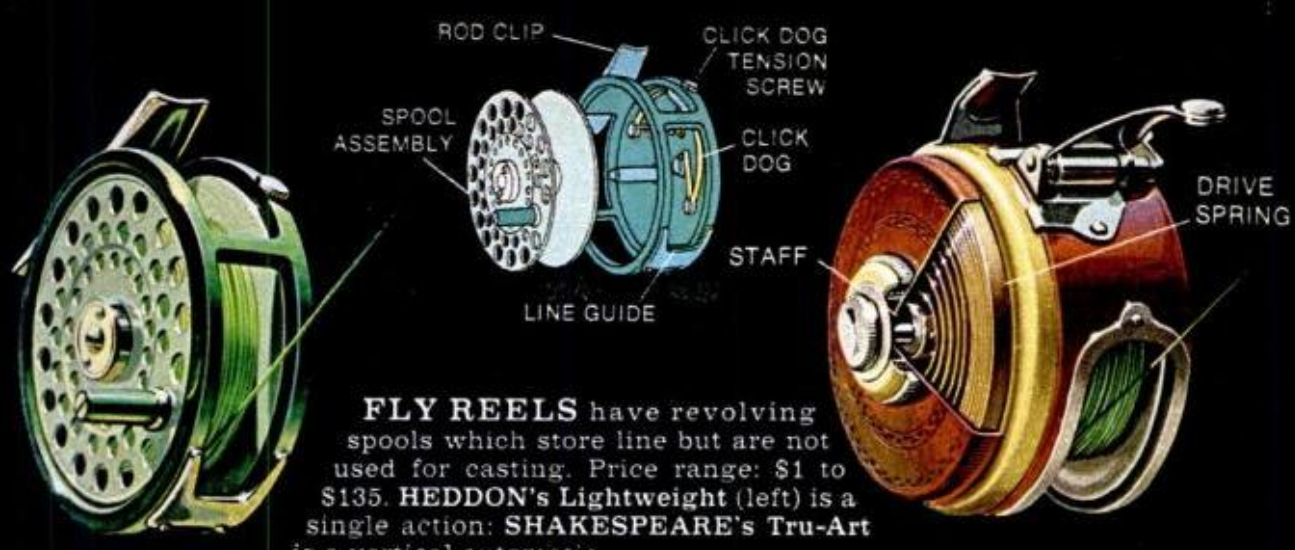

FLY REELS have revolving spools which store line but are not used for casting. Price range: \$1 to \$135. **HEDDON's** Lightweight (left) is a single action; **SHAKESPEARE's** Tru-Art is a vertical automatic.

TROLLING REELS are sturdier versions of the revolving spool casting reel. Used for trailing wire line and big spoons on the Great Lakes for lake trout or drifting six-pound baits in the Gulf Stream for sharks and marlin, these reels are built to take the abuse of an hours-long battle with giant fish. Inexpensive models cost \$25; the **FIN-NOR 12/0** depicted retails for \$795, is over ten inches wide and weighs precisely ten pounds.

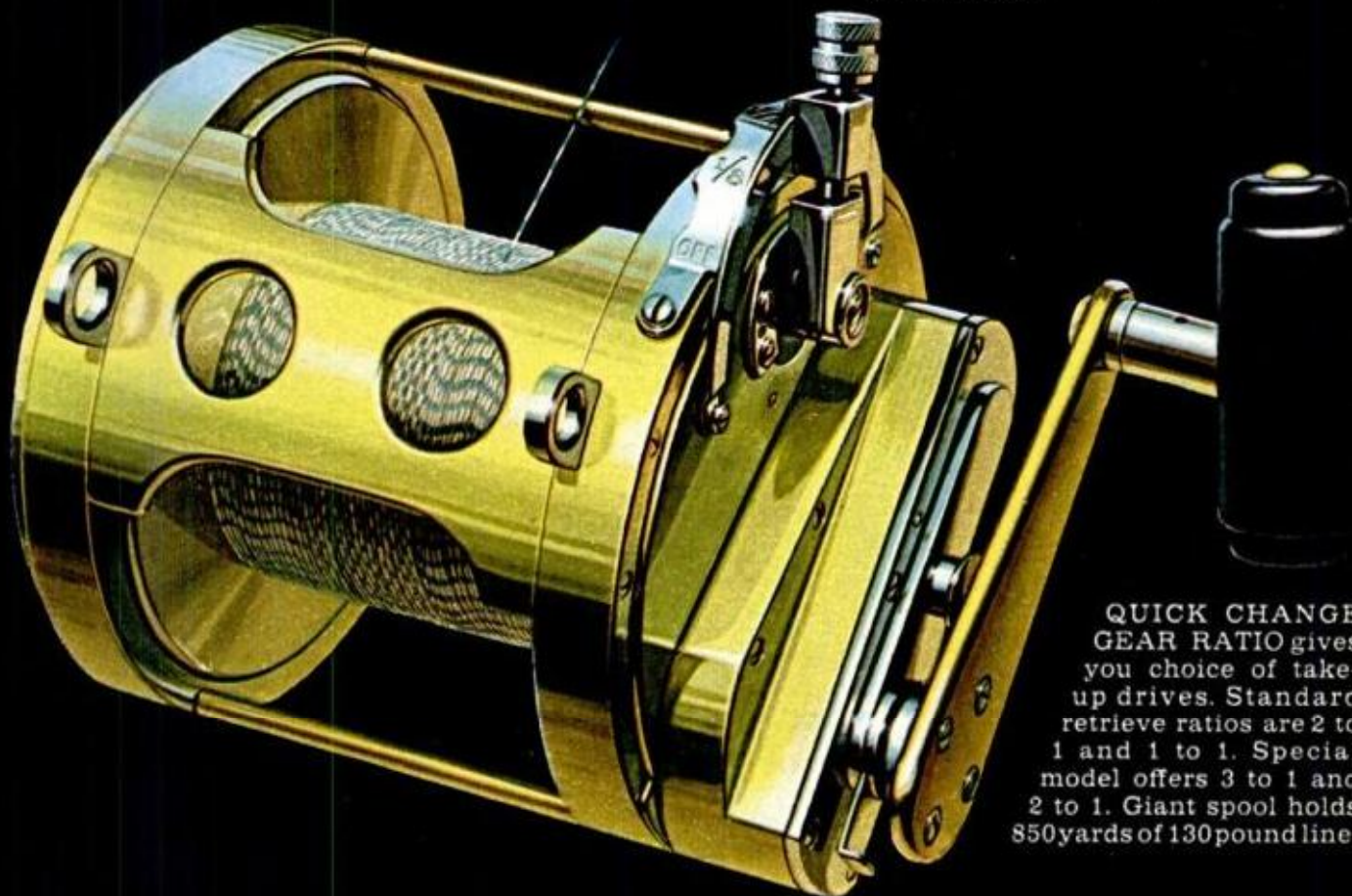
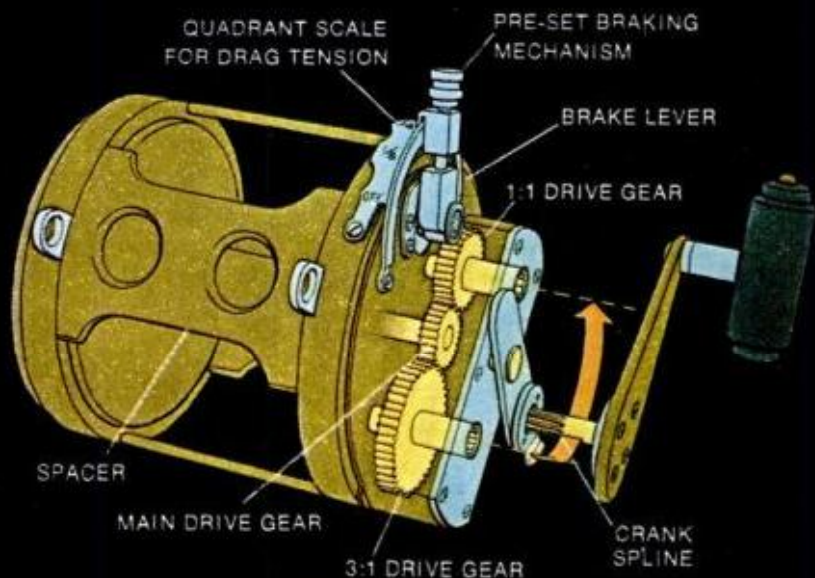

QUICK CHANGE GEAR RATIO gives you choice of take-up drives. Standard retrieve ratios are 2 to 1 and 1 to 1. Special model offers 3 to 1 and 2 to 1. Giant spool holds 850 yards of 130 pound line.

MAYBE you're already a fisherman and figure you know all about reels. And maybe you plan to pack your favorite spinning outfit into the mountains for trout or down to the coasts for striped bass. But will it do the job? You might be better off with tackle adapted to the local fishing. What do you really know about fixed-spool reels versus multiplying revolving-spool reels? Here are a few basic thoughts about four essential designs:

SPINNING was first introduced to America from France in 1935. However, the principle was developed in Great Britain, and we know that a Scotsman, Peter Malloch of Perth, fished with a fixed-spool type reel as early as 1884. Yet spinning didn't really catch on in the United States until after World War II when its facility for lengthy, generally snarl-free casts was appreciated by a host of newcomers to the sport.

Unlike revolving-spool reels in which considerable inertia must be overcome by the momentum of the lure being cast, the fixed-spool type offers

little initial resistance, reducing the likelihood of tangles known as backlashes, bird's nests or, in France, wigs! Also, because there is little inertia to overcome, spinning tackle can cast extremely lightweight lures impossible to throw any distance with revolving-spool outfits. Ultralight spinning, a French development of the 1930s, employs 2 to 4-pound test line and rods weighing 3 ounces to cast lures weighing less than $\frac{1}{16}$ of an ounce 50 feet with little splash and no shadow to alert wary trout in frequently fished waters. At the other end of the spinning spectrum, 30-pound test line and 6-ounce lures are used to take king mackerel and grouper from ocean reefs.

In addition to their versatility, spinning reels are relatively inexpensive,

cast well into headwinds and handle a vast variety of lures for any given outfit.

SPIN-CASTING an American variation on the fixed-spool principle, was first developed by Lloyd E. Johnson of Mankato, Minn. A tool-and-die maker by trade and a fisherman by preference, Johnson liked the ease of spinning but was dissatisfied with what he considered an unorthodox (upside-down) position for the reel and an awkward method of line control. He therefore created a fixed-spool reel with a cone-shaped hood mounted on a plug-casting rod. Though spinning and spin-casting reels may look different, the fixed-spool principle is the same—it has revolutionized fishing and is largely responsible for the 40 million anglers in America today



BAIT-CASTING REELS were created to do precisely that: cast live baits. A watchmaker-angler from Paris, Ky., produced the first *multiplying* revolving-spool casting reel in 1810.

With professional understanding of gear mechanics, George Snyder built a reel in which the spool revolved three times for every turn of the crank handle. The advantage of this multiplying system over *single-action* (1:1) reels for casting and playing fish was immediately appreciated by anglers everywhere. Soon other Kentucky watchmakers began to make bait-casting reels. For close to a century they built precision instruments which, except for latter-day refinements, would compare favorably with today's models. However, these handmade gems are more often collected today than cast.

Since artificial lures are used with



bait-casting reels, this type fishing is often called "plug casting." And here lies the real advantage of the multiply-revolving-spool system. Great accuracy plus good control of a plug's action makes bait casting especially popular with experienced bass fishermen. In addition, bait-casting rods are generally less whippy than those used in spinning, affording a firmer strike into the hard mouths of bass and pike.

SURF CASTING REELS sometimes see triple duty on boat rods for trolling,

bottom fishing, as well as casting. Quick take-apart designs and anti-backlash devices are standard features on almost all quality models. But though these refinements greatly re-

duce maintenance and the aggravation potential of a long day's casting, no device for any revolving-spool reel has supplanted the need for an experienced thumb and a feel for rhythm in casting.

BALANCED ROD AND LINE are what make for effective fly casting. It's the weight of the line that gets the lure out there—not the other way around as in spinning and bait casting. Fly reels are the least important part of a fly-fishing ensemble. Mostly a passive partner, yielding to the stripping action of casts or used to wind up slack, the reel becomes critical only after a sizable fish grabs the feathered hook and rushes off. The reel is then palmed so the click mechanism and hand create an adjustable brake on the fish's run.

A MANUAL FLY REEL is the beginner's best bet. It should be light, easily maintained and inexpensive. For most stream work, the reel should weigh 3½ to 5½ ounces and have a 3 to 3½-inch spool diameter. It should

be single-action and be provided with a click device, either audible or silent, to prevent overruns.

AUTOMATIC FLY REELS offer fingertip retrieval of all loose line, which you may feel is ample compensation for handling heavier pieces of equipment. The spring mechanism creates the extra weight, but it does the work your hand and wrist would normally have to do in cranking line back onto the spool. If you've been reared on 6 or 8-inch trout, you eventually get the urge for salmon or steelhead or even tarpon and snook. While your stream reel may handle small saltwater gamesters, you'd best go to a large-capacity reel with adjustable drag for the larger fish. Fly line's expensive, and it's a pity to lose it on your fish's first rush!

TROLLING may seem like a passive way to fish after you've examined the various other kinds of fishing. But all effective angling requires effort, and successful trollers continually check their lines for weed, change lures or bait, search for diving birds, or run to new grounds.

And their equipment must be in top-flight condition. Don't let the size of trolling reels fool you. Six-nine rods and 4/0 reels may seem unwieldy at first. But they tend to shrink to toothpick-and-thimble dimensions during battle with a determined denizen of the deep. Fishermen who pursue 200-pound alligator gar and giant catfish know what I mean. So do deep-sea anglers.

Not long ago I unpacked a Penn 6/0 reel and what appeared to my smiling, nonfishing friends to be a baseball bat for a rod. "To club the fish to death

(Please turn to page 229)

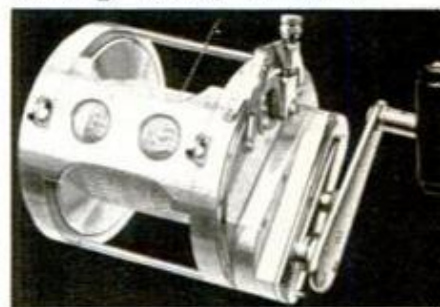



Great Homes

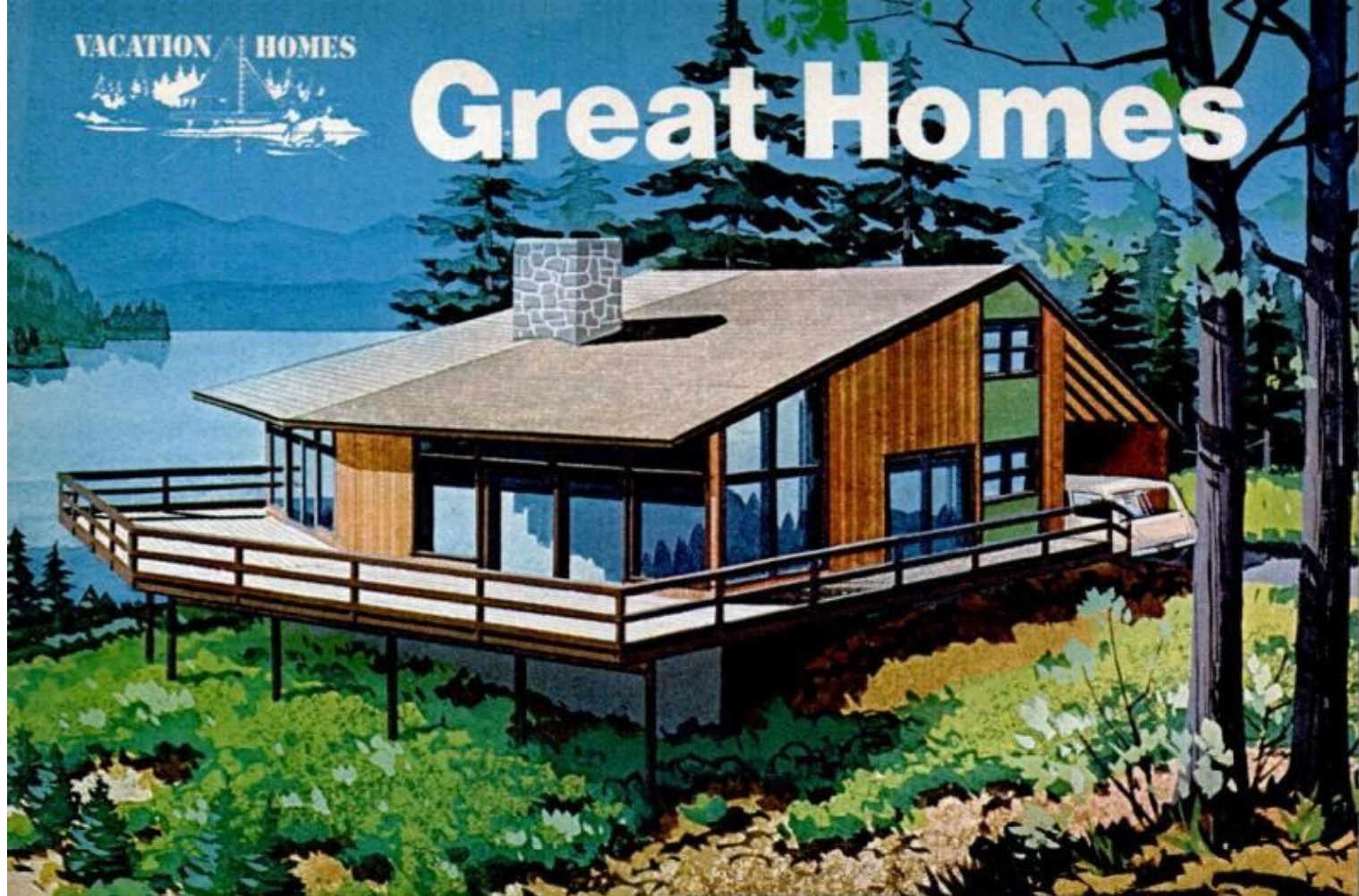

PLAN WWP-13

UPPER LEVEL
(629 SQ. FT.)

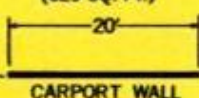

CARPORT WALL

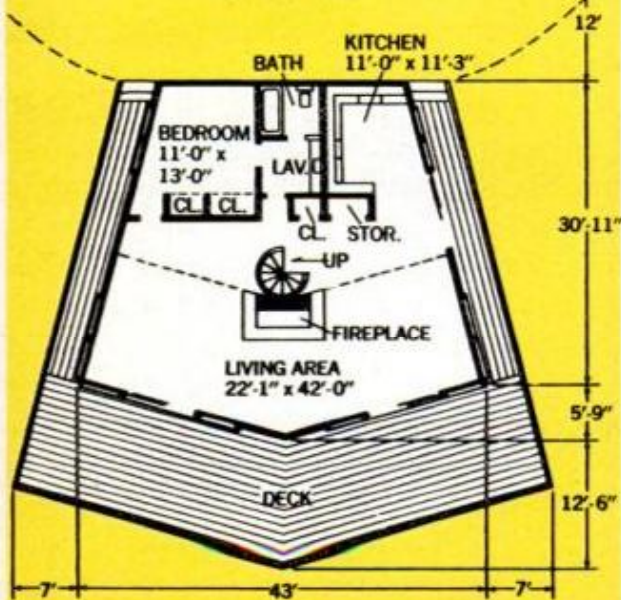

MAIN LEVEL
(1314 SQ. FT.)



Hillside Hideaway

At some time or another, just about everyone has the urge to get away from daily routine, city noises, commuting and the like. And what better place to get away to than a weekend retreat that *you* own? This, the first of seven well-designed homes in *PM's* Vacation Homes section, is a spacious hideaway with a wraparound deck, centrally located fireplace and exterior that blends with its environment. It was designed by Ralph Rittenour for Western Wood Products. To order, specify plan WWP-13. (See page 138.)

for Vacation Living

Today's second homes range from simple to sophisticated structures. Here are seven good designs to choose from

By HARRY WICKS, Workshop Editor



LOWER LEVEL
(276 SQ. FT.)

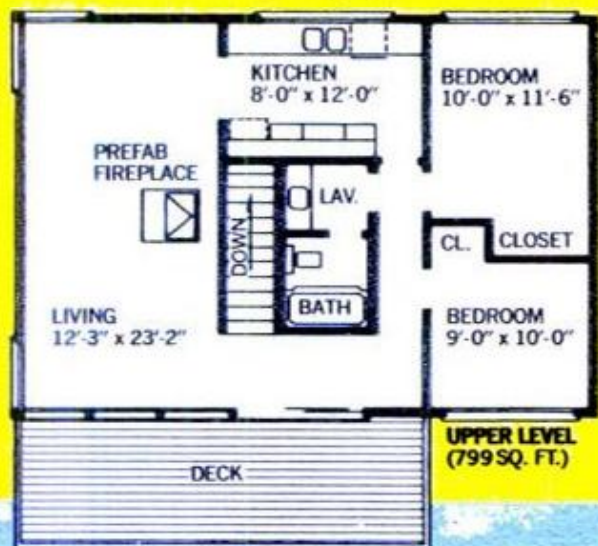

UPPER LEVEL
(799 SQ. FT.)

Low-Cost Luxury

The clean, uncluttered lines of this contemporary-designed second home camouflage the fact that the house has more than 750 square feet of living space. It features a sheltered carport that gives access to the home through the spare room. It can also serve to house your boat during winter dry-dock. Designed for economy in building, the house's rectangular shape allows maximum use of money-saving, standard four-by-eight construction materials. To keep initial cash outlay down, the interior (walls and ceilings) can be left with studs exposed at the start, completed as funds are available. The prefabricated fireplace is an optional extra, but it does let you stretch the vacation season a couple of weekends in spring and fall. Specify plan HBPS 827-1 when ordering.

PLAN HBPS 827-1



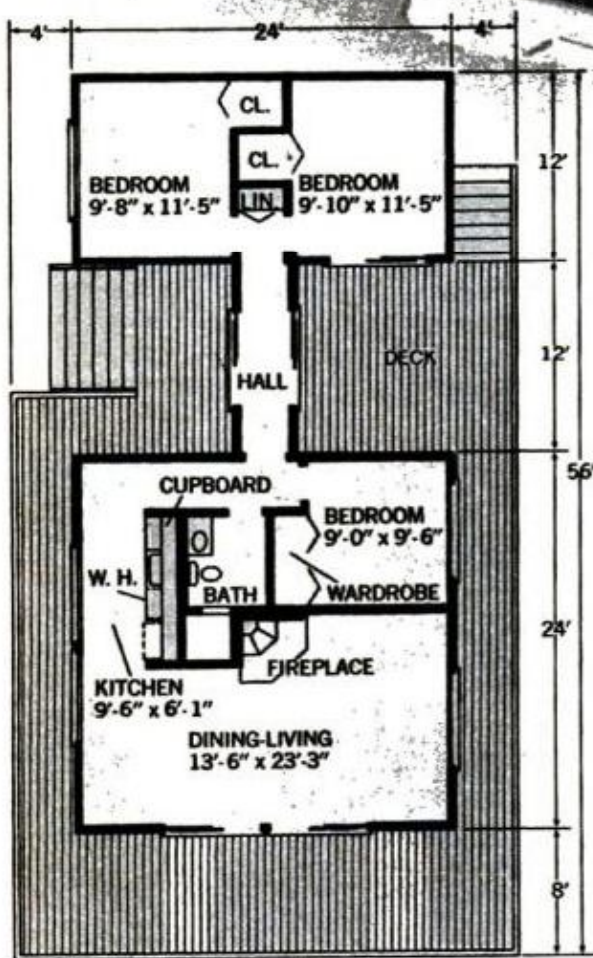
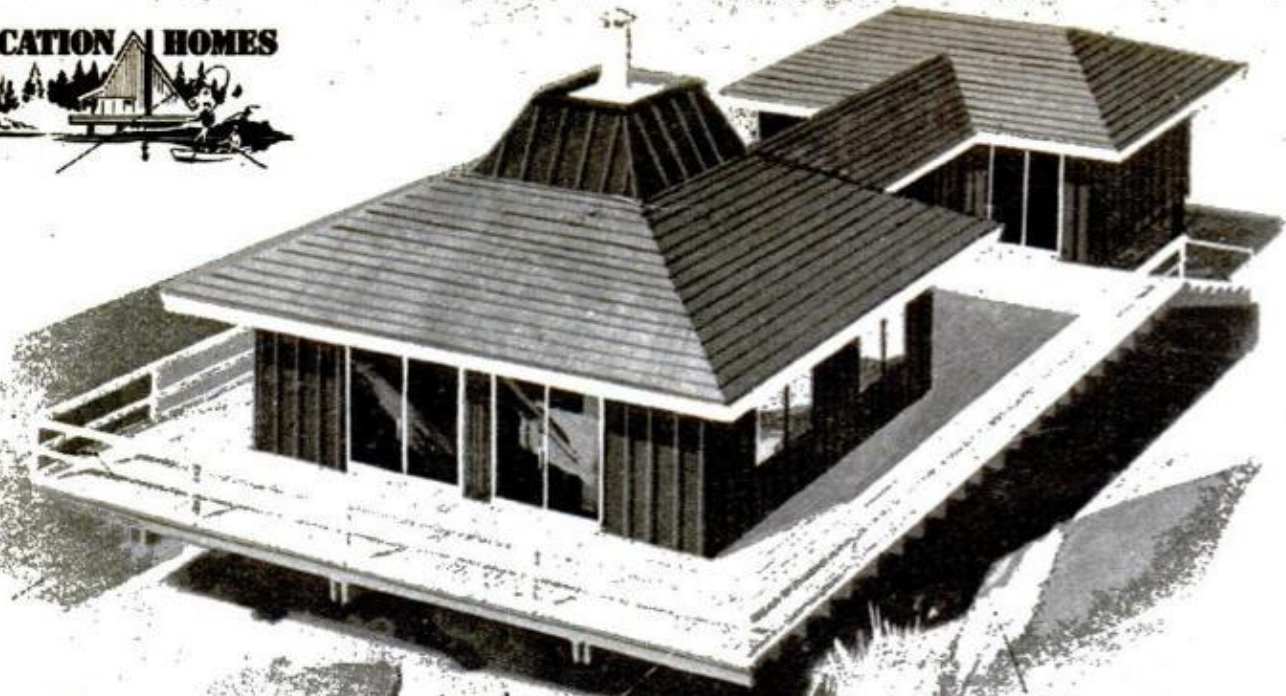

PLAN APA 106

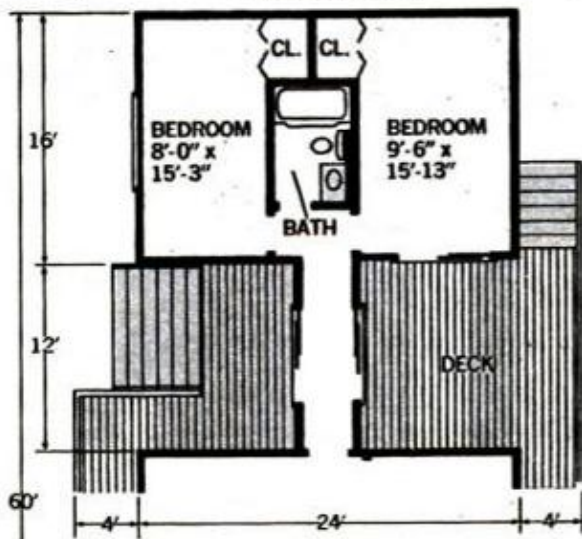

High-Style Living

Here's a compact design that lets you get under cover with a building no more than 24 feet square. The hip roof and spacious deck provide comfortable outside living during the summer months. In chilly weather, the central fireplace warms up the dining-living area. For rustic appeal, battens are used over textured plywood siding and the same rough-sawn paneling is used to cover the indoor walls to carry out the natural wood design. When you need more space, simply add a hallway and two bedrooms. APA plan No. 106.

POPULAR MECHANICS



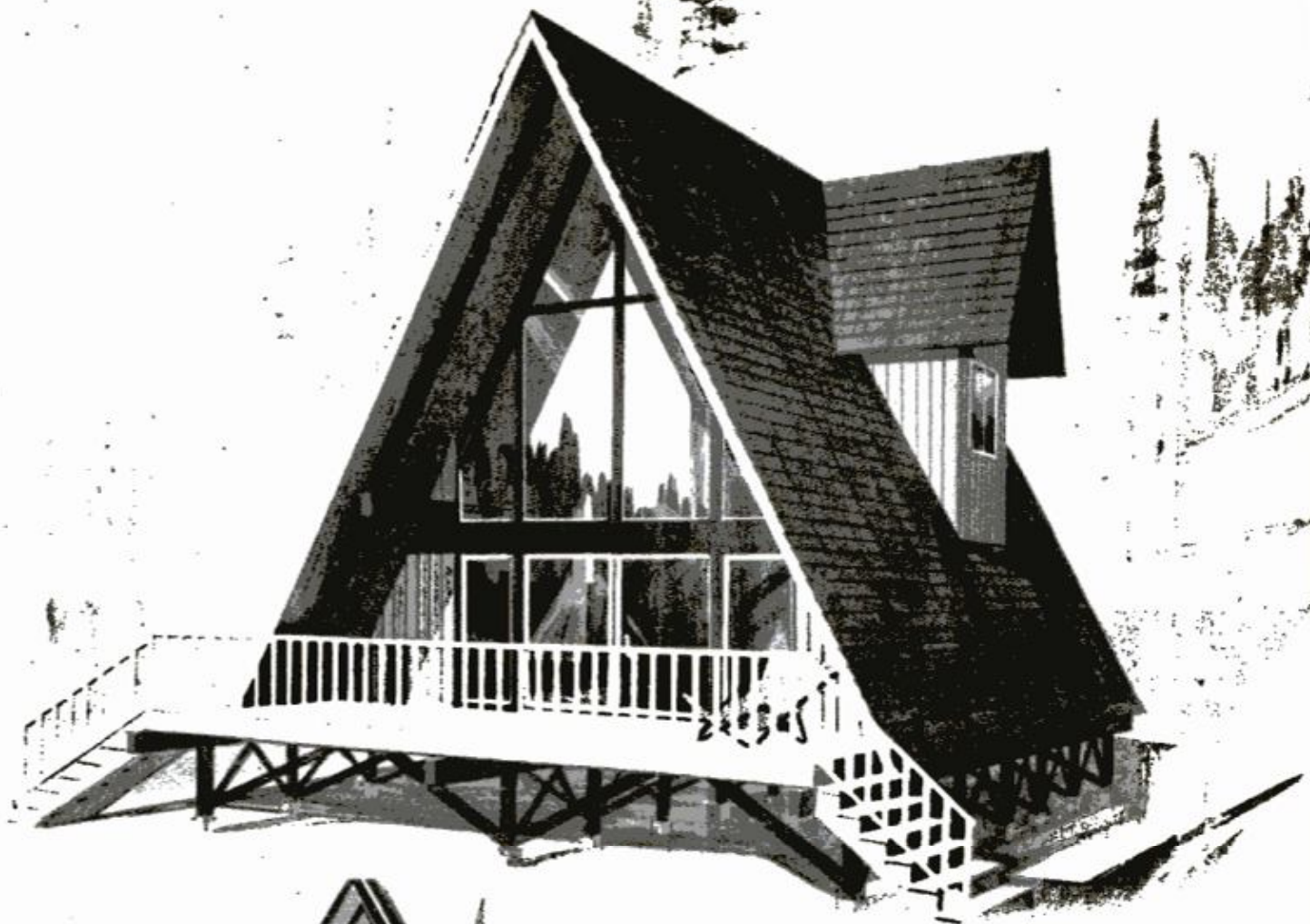

All-Purpose A-Frame

A-frame design has more or less become a standard pattern for a recreation home because walls and ceilings are one and the same—making construction inexpensive. But recently, designers have found that buyers were demanding such creature-comfort extras as access through a rear door, a bathroom near that door, and a second-level lavatory. This updated version boasts all three improvements, as well as exposed beams over a textured plywood

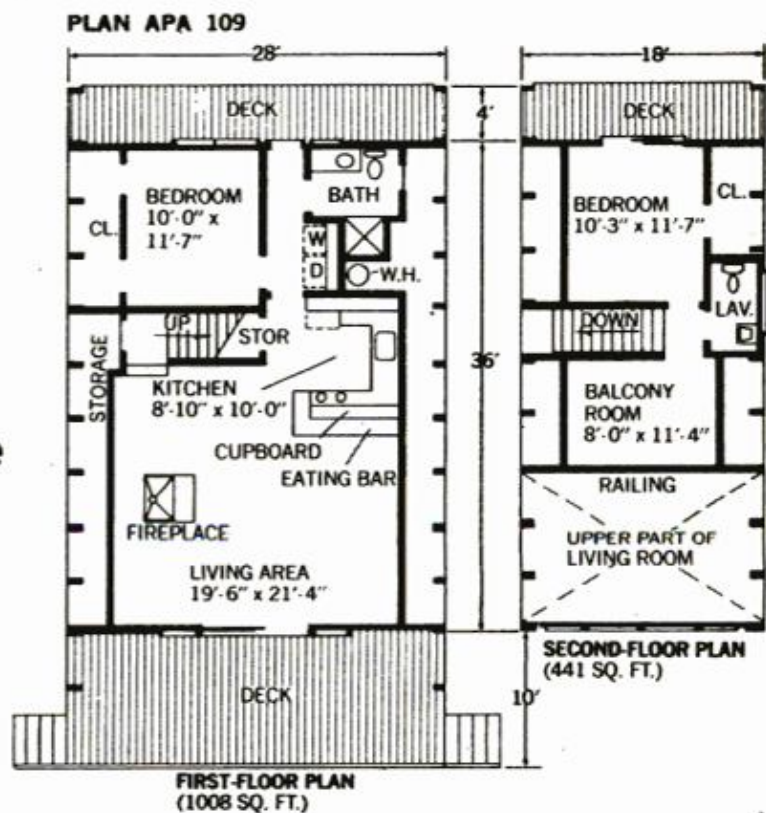

ceiling and space for a washer and dryer. Unexpected guests can be accommodated easily by converting the balcony room—which overlooks the vaulted ceiling—into a sleeping loft. Order APA plan 109.

VACATION HOMES



Twofold Savings

Because vacation-home sites where they wished to locate were premium-priced, two Florida couples halved their property costs by erecting two homes on a single plot. To further reduce expenses, the John Mills and Albert Ayers families then purchased shell homes from the Jim Walter Corp. (Box 9128, 1500 N. Dale Mabry, Tampa, Fla. 33604) and finished the interiors themselves. The homes were constructed as mirror images of each other with decks and stairs between buildings. Thus, the sleeping area (quiet) in each is placed at maximum distance from the living area (noisy) of the other. Starting with Walter's Casual model (floor plan above), both couples added 120 square feet of living space to the shell's basic 640 square feet. Shell cost, about \$6500.

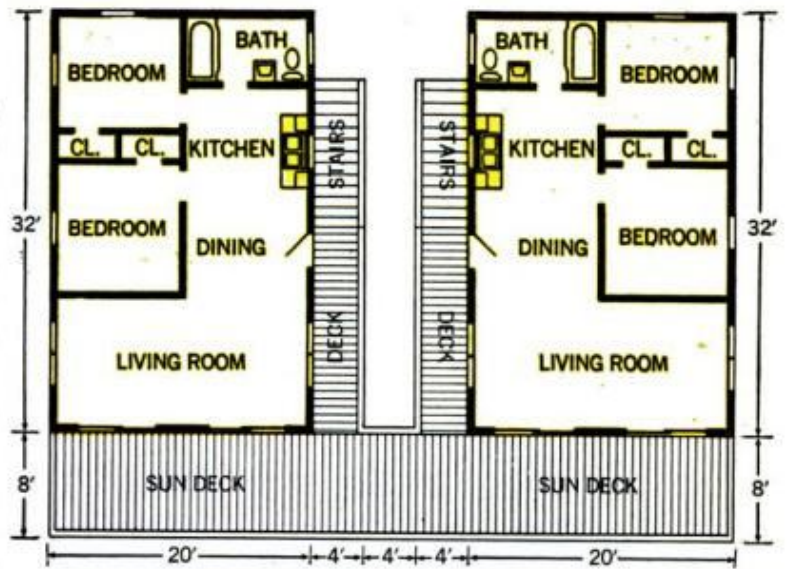

A prefabricated version of a chalet, this 24x30-foot luxury retreat has 1440 square feet of floor space that includes three bedrooms, two baths and a generous-sized dining-living area. Delivered complete to your site, the package includes sink, range (gas or electric), prefinished kitchen cabinets, Formica countertop and 100-ampere elec-

trical service. It can be contractor-erected in one week or owner-built in six to eight weekends, depending upon your carpentry skills. Named Chalet 30, it sells for \$19,500 plus transportation costs based upon mileage from the maker's plant to site. For information, write Stanmar Leisure Homes, Inc., Boston Post Rd., Sudbury, Mass. 01776.

Elegant Chalet In the Woods

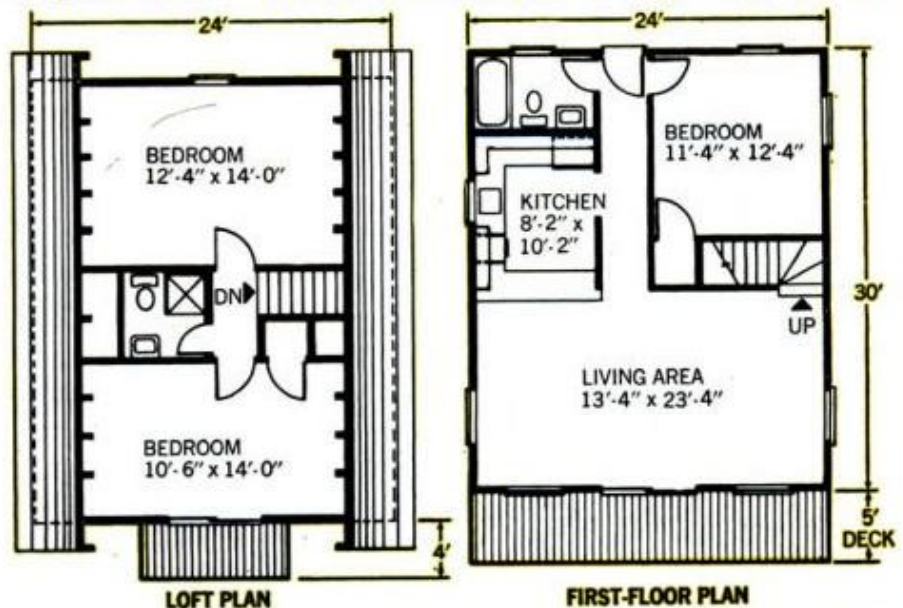



Three-Stage

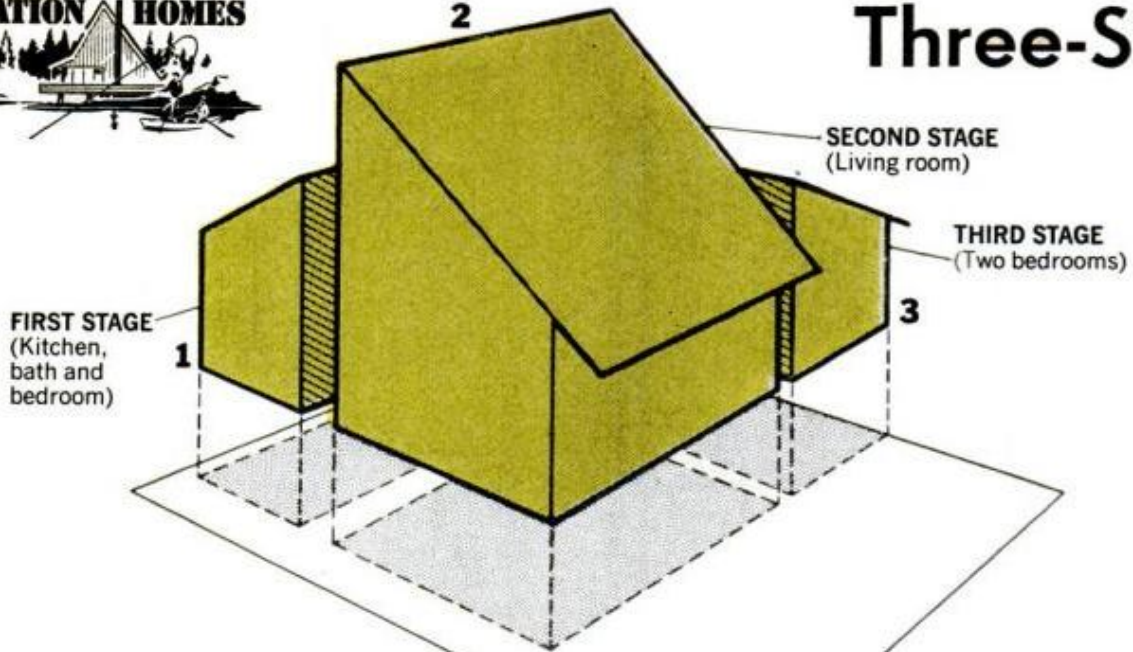

PLAN APA-119

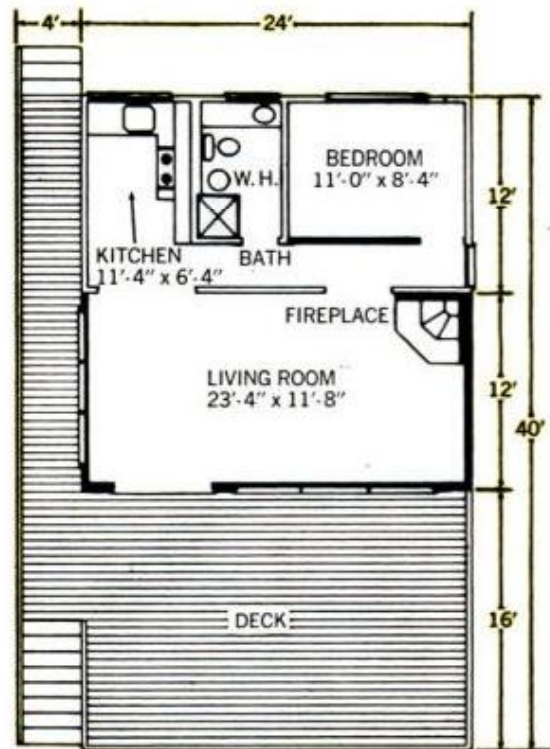
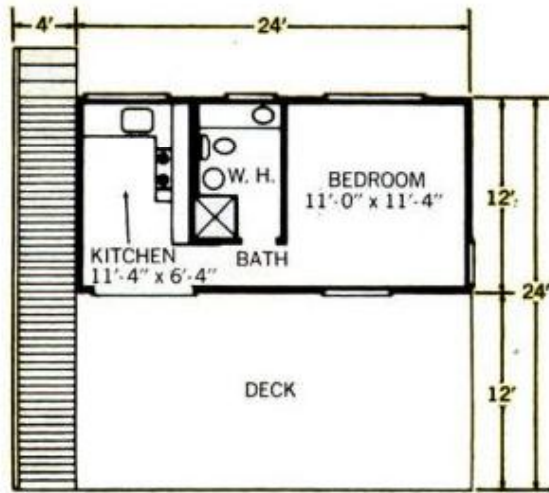

HOW TO ORDER: Plans for five of the homes are \$25 each, or \$35 for four sets of the same plan, from Home Building Plan Service, 2235 N.E. Sandy Blvd., Portland, Ore. 97232. Make certain you specify the plan number that's shown on the floor plan



Cover House

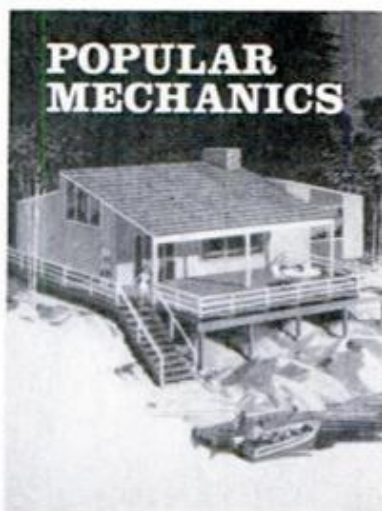

ECONOMY approach to building a second home can be realized with this design because it's especially planned for the add-on building method. With first section enclosed, you can enjoy weekend living, build the second and third sections as time and your budget permit

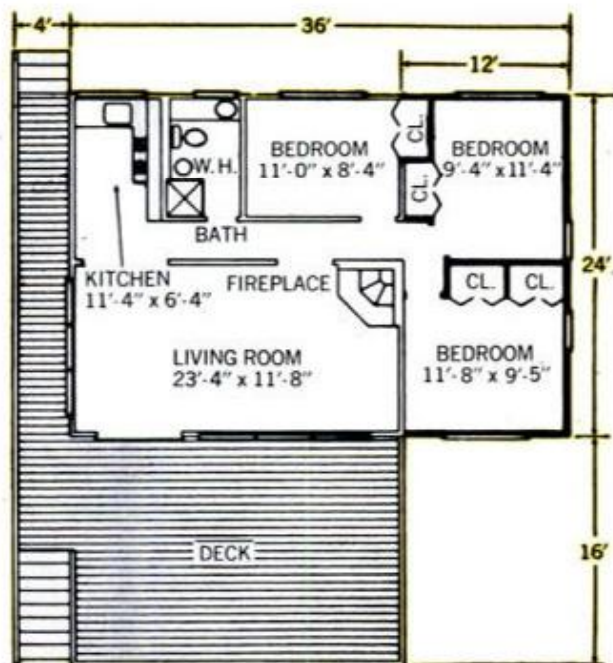

THE COMMON-SENSE WAY to construction of this contemporary beauty is certain to appeal to the do-it-yourselfer who plans to do most of the work himself. The first stage, which gives 288 square feet of living area, can be gotten under cover quickly so you can finish the bathroom and kitchen—the two most expensive rooms in any house—initially. The second and third stages (which double and triple the starter's living area) can be added at your leisure in future seasons. In the meantime, you'll be getting full use from your country property.

When the second stage is added, a new bedroom wall creates a hallway that will eventually provide access, through a door at the end, to the second and third bedrooms. The deck originally placed is sufficient for the first and second modules; additional decking is required after the second stage is built. The generous roof overhang at front can be screened-in for additional outdoor living space. Each stage is skinned, inside and out, with plywood panels. Thus, both installation and future maintenance labor hours are kept to a minimum.

Designed for owner-builders, all five sets of plans offered are more profusely detailed than they would be for a contractor. For example, plans for this three-stager show each of the steps in its completed state. To order, specify plan APA-119. ★★★





Sam has fiberglass lungs

Sucker Sam is a 40-cigarette-a-day man—or, more accurately, robot—whose main function is to provide graphic evidence to reinforce the antismoking theme of Jack Mahon's lectures. Mahon travels about England with Sam, giving talks before young people, lighting Sam's cigarets and squeezing the bulb (above) that draws smoke into Sam's fiberglass-wool lungs. One lung (far left) is cleaned up for each demonstration, while the other (left) is never cleaned—just to show what happens to a smoker's lungs, says Mahon.

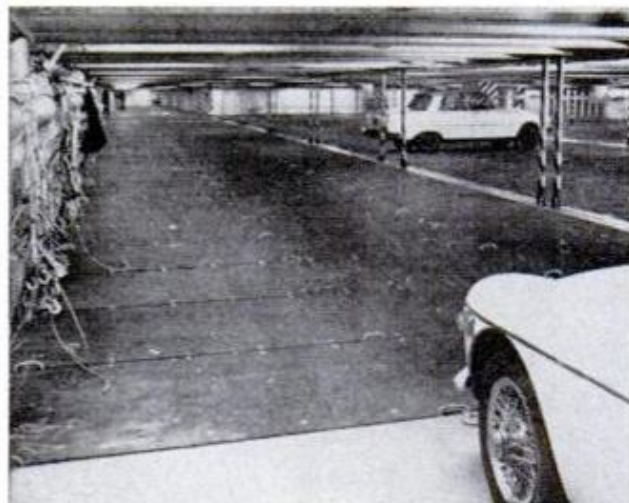

Overseas 'motorway' from England to America

"Motorway to USA" is the sign over the loading ramp (left-hand photo) of the SS *Atlantic Causeway*, one of the Atlantic Container Lines ships that sail weekly between Southampton and America. The 695-foot ship, built by Swan Hunter Shipbuilders, can accommodate 913 cars; the longest car deck (620 feet) is shown in the right-hand photo. (See *Oceangoing Drive-In*, page 100, Nov. '69 PM, for an earlier report on "roll on/roll off" ships.)

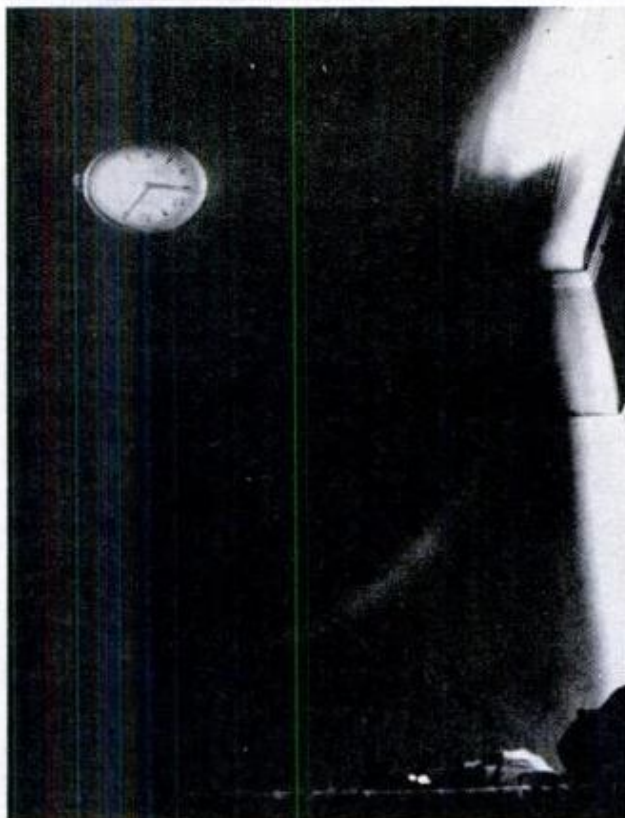
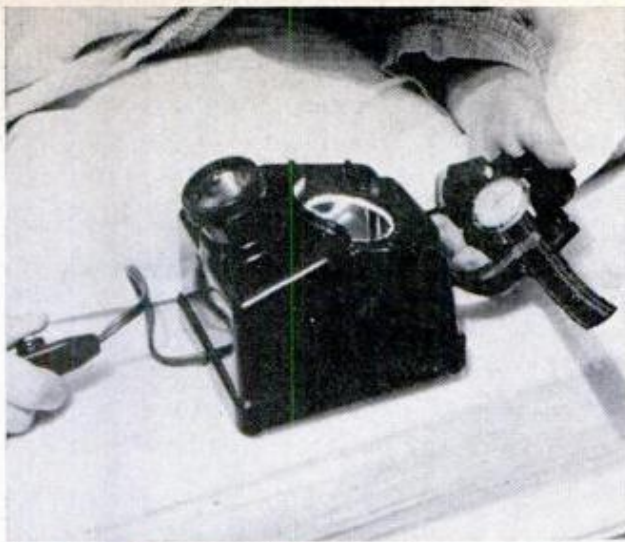

For insomniac clockwatchers

People who wake up at night wondering what time it is now have an answer. All the sleeper need do at bedtime is insert his wristwatch into a bedside projector; a touch of a button projects the dial onto the ceiling.

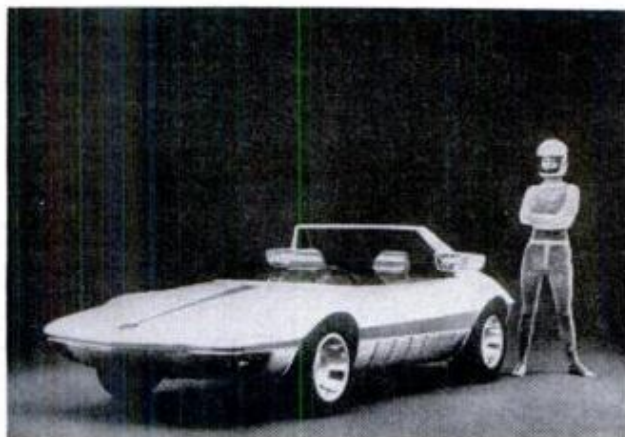

APRIL 1970



Land-Rover that floats

Peter Winter, who lives on the Isle of Wight, has turned his Land-Rover into a water rover with the addition of huge tires that will keep it afloat. The 5½-foot super-soft balloon tires, made of synthetic fabric, can be inflated by the vehicle's exhaust.

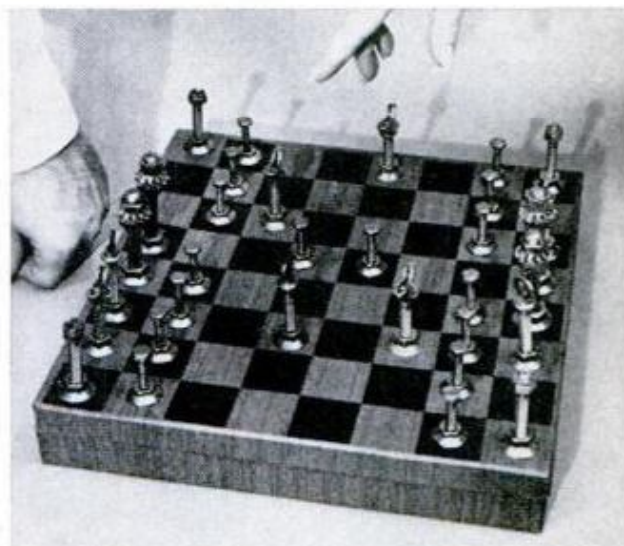

Chess for mechanical mind

A chess player with a mechanical bent would feel himself in familiar surroundings with these chessmen. They're all made up of bronze nuts, bolts and washers that have been given an anodized brass finish.

Lights and engine at rear

One of the newest of Nuccio Bertone's car designs is the Runabout, a sleek, wedge-shaped auto that has its 903-cc engine in the rear and the headlights situated "behind the ears of the passenger and driver." Another unusual feature is the use of stainless steel for the frame.

141

Styling Couldn't Be Greater, but Workmanship Might

By **MICHAEL LAMM** / Photos by *Irv Dolin*



IF YOU DON'T LIKE the looks, you won't like the car." This warning came not from a Monte Carlo owner but from the man who designed it, Chevrolet's chief stylist, David Holls.

Obviously lots of buyers do like the looks, because styling remains the biggest single reason most owners bought Monte Carlos. And sales have been brisk from the start.

"It's a little Eldorado," says an Indiana dairyman. A Boston secretary: "I bought it because it's so beautiful and chic. . . ." A druggist: "I thought it would look newer for the next three years than a Cutlass or Skylark, be-

cause the Monte Carlo will change very little while the others are due for a big face-lift." Or, "Classic design." And, "Interior looks like a Rolls-Royce."

A South Carolina cafe owner exults, "This is the only car I've had that I can say to my wife, 'Honey, you sure do fit into the car perfectly.' In other words, I feel like a king." And a retired Pennsylvanian mentions, "Everywhere I go, people stand by the car and admire it."

Yet while all owners raved about styling, 44.3 percent had encountered mechanical problems. Leakage and other troubles with automatic transmissions and power steering plagued 25

percent of this group, and smaller workmanship complaints ranged from poor paint (more often the dealer's spotter's fault than the factory's) to badly attached chrome, misaligned doors and windows, and generally sloppy assembly. Some owners vented a fair amount of spleen.

Kansas mail carrier: "Mine's terrible—must have been put together in the dark." A New York law student: "Emergency brake fell off three times. Doors and windows don't fit."

Texas foreman: "Rattles and wind noise. Inside trim loose and puckered. Trim around rear window falling out. Many stripped screws. Chrome in wiper cavity loose. All metal screws stripped, some left out."

Indiana fireman: "Poor paint, dents all over car, lousy workmanship."

Roughly half the owners who complained about quality also complained about dealer service. A California housewife grumbled, "Went to dealer a number of times. He would never repair all items. My husband, an engineer, had to finish GM's assembly job." And another owner's rather typical complaint: "Cash customers have priority over warranty work. Out of seven items, two might be gotten to. Had to take taxis to work three days in a row, this after paying \$5000 for the car."

But on the brighter side of dealer service (57.4 percent were satisfied), little things seem to mean a lot. "It was Saturday and they sent an emergency crew out to start it, and then on Monday they picked the car up and put a new alternator on at no extra charge. I call that excellent service," says a Kansas secretary. And a New York engineering technician: "Dealer sent a repairman at 5:00 p.m. Have had no trouble since; 4900 miles on car."

Most owners enjoy driving their new Monte Carlos and give them excellent marks on handling and performance. Two felt they should have ordered a larger engine than the standard 350-incher to cope with airconditioning,



MONTE CARLO OWNERS generally agree car handles well, though some complain of rear-end skittishness

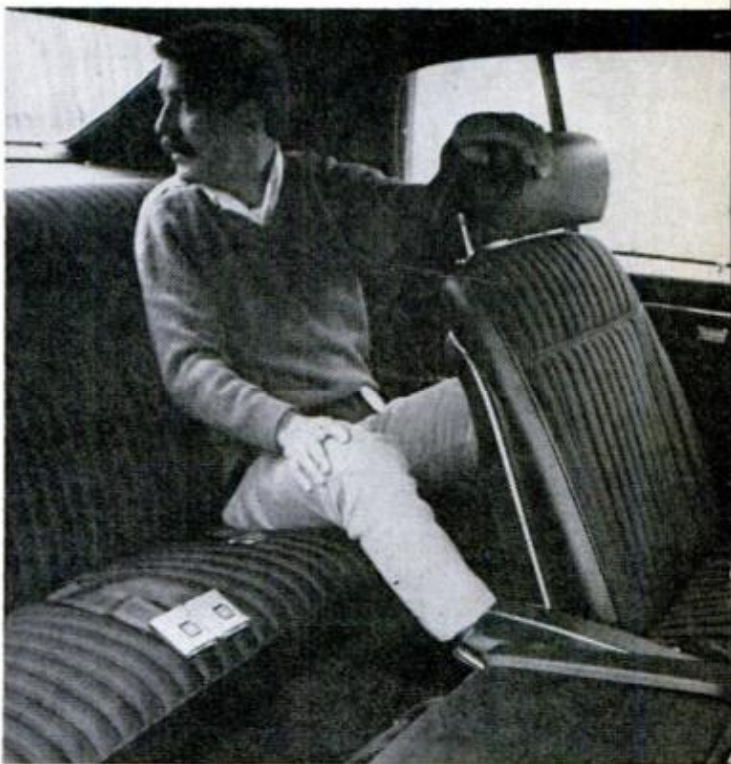

REAR LEGROOM isn't one of car's strong points, but folding front seatbacks, big doors give good access

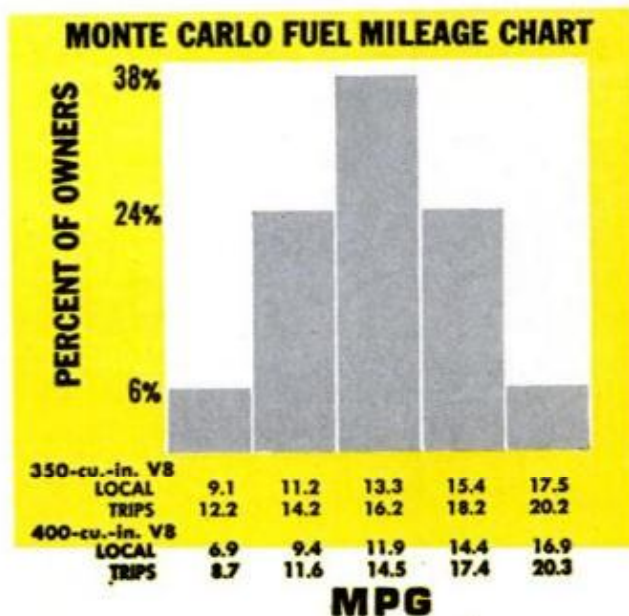

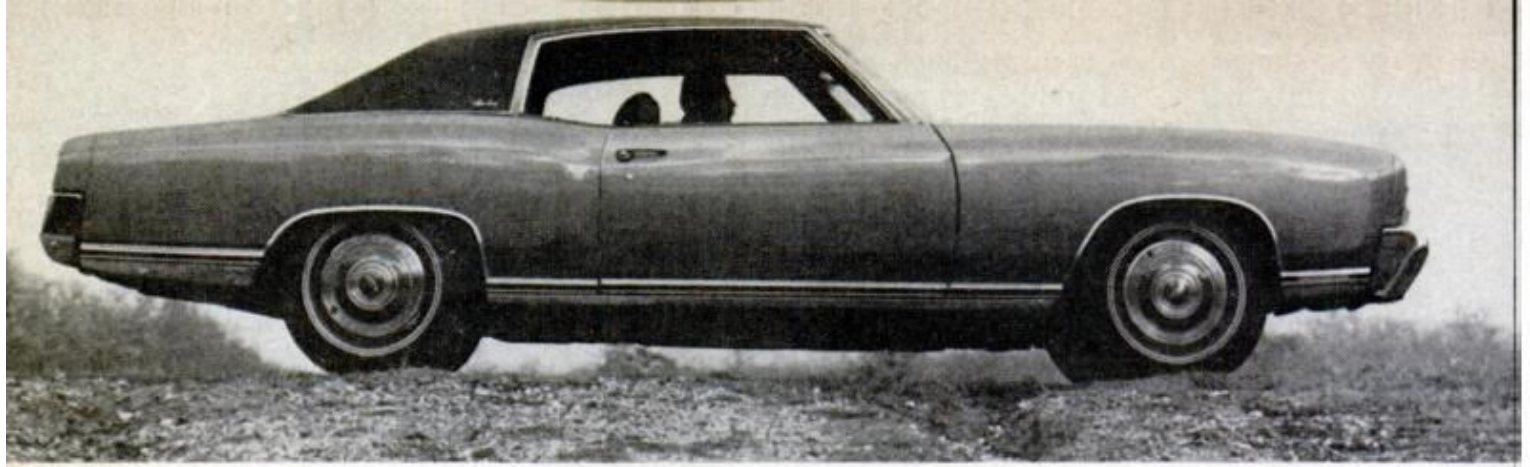

ONE MONTE CARLO owner calls it his baby Eldorado. All concur that styling—inside and out—sells the car

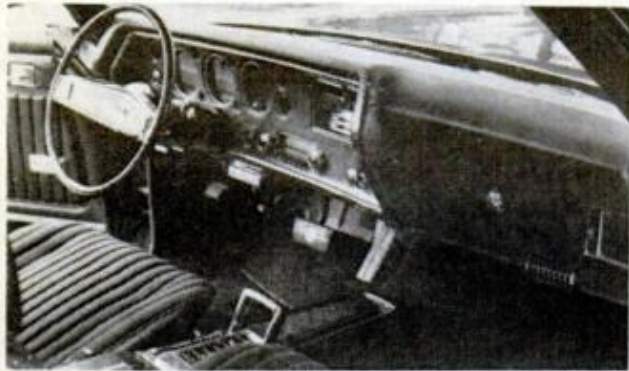

CHEVY'S CHIEF STYLIST, Dave Hollis, studied Packards, Duasies, Rolls, as inspiration for this classic dash

but other than that, no complaints on "stepping out," as one lady put it. An extremely small number had ordered the 454-cu.-in. V8—only 2.3 percent. But since the 454 has only 30 bhp more than the four-barrel 400, owners probably felt the extra cost wasn't worth it. An Ohio glass grinder said, "I might have gotten the 454 V8 if not forced to order the Super Sport option."

Handling, which to many owners means ease of parking and steering in traffic rather than stability in fast cornering, got generally good marks. "Fine stability at freeway speeds. An easy car to control." However, there were a few who thought otherwise. "Rear too light in winter." Or, "No weight on rear wheels. Rear slides even on dry ground; gets stuck too easily in snow"—this from a New Jersey bus driver.

Most owners realize they'd gotten disc brakes as standard equipment, and all but a handful gave the brakes rave reviews.

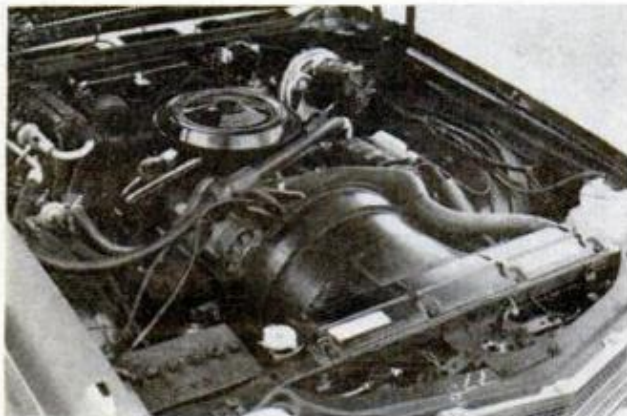

RADIATOR PRECEDES engine 2 feet. Owners like performance, yet some feel 350 V8 too small for air



FAIR NUMBER of wind-noise and rain-leak beefs, apparently because side glass is too big to adjust well



NOT ENOUGH ROOM here (never is), but no owner ordered Space-Saver spare. Several missed trunk light

POPULAR MECHANICS

Summary of 1970 Monte Carlo Owners Reports*

Total miles driven 713,661

Average miles per gallon:
 350-cu.-in. V8, local driving 13.3%
 long trips . . . 16.2
 400-cu.-in. V8, local driving 11.4
 long trips . . . 14.5
 454-cu.-in. V8 . . . n.a.

Engines:
 350-cu.-in. V8 . . . 74.0%
 400-cu.-in. V8 . . . 23.7
 454-cu.-in. V8 . . . 2.3

Transmissions:
 Automatic . . . 98.2%
 4-speed manual . . . 1.8
 3-speed manual . . . none

Why the Monte Carlo?
 Style . . . 82.2%
 Size . . . 11.5
 Handling . . . 8.6
 Price . . . 5.2
 Performance . . . 5.2

Specific likes:
 Styling . . . 68.1%
 Handling . . . 47.2
 Ride . . . 26.4
 Comfort . . . 23.3
 Performance . . . 13.5
 Economy . . . 11.7

Specific dislikes:
 None . . . 23.2%
 Workmanship . . . 15.5
 Rear legroom . . . 10.1
 Dealer service . . . 9.5
 Gas mileage . . . 8.9
 Wind noise . . . 8.9
 Rattles . . . 7.7
 Ride . . . 7.1

What changes would you like?
 More legroom . . . 15.3
 More quality . . . 9.3
 More headroom . . . 8.7
 Bigger trunk . . . 7.3
 Styling . . . 6.7
 Ashtray location . . . 6.7

Had any mechanical troubles?
 No . . . 55.7%
 Yes . . . 44.3

What kind of trouble?
 Transmission . . . 15.8%
 Power steering . . . 10.5
 Oil leaks . . . 9.2
 Electrical . . . 7.9
 Hard starts . . . 7.9
 Brakes . . . 6.6

Dealer repair satisfactory?
 Yes . . . 57.4%
 No . . . 42.6

Is the Monte Carlo your only car?
 No . . . 52.6%
 Yes . . . 47.4

Other cars owned:
 Chevrolet . . . 64.4%
 Buick . . . 8.9
 Ford . . . 8.9
 Pontiac . . . 7.8
 Mercury . . . 5.6

Power options/accessories:
 Power steering & brakes . . . 92.9%
 Radio . . . 57.2
 Airconditioning . . . 55.4
 Tinted glass . . . 20.5
 Vinyl top . . . 20.5
 Rear defroster . . . 16.9
 Tinted windshield . . . 15.7
 Whitewall tires . . . 11.5
 Stereo . . . 9.6
 Bucket seats . . . 9.6
 Power steering (alone) . . . 4.7
 Power brakes (alone) . . . 2.4
 Power windows . . . 1.8

Age distribution of owners:
 15-29 years . . . 34.2%
 30-49 years . . . 33.1
 50 plus . . . 32.7

Would you buy another Monte Carlo?
 Yes . . . 69.8%
 No . . . 30.2

*Percentages may not equal 100 percent due to rounding and/or insufficient data.

On changes they'd like to see in future Monte Carlos, here's a rundown. Many would like a return to front vent panes. Of these, a majority attributed wind noise, rattles, and poor sealing to the size of the glass. Next, there was solid agreement that the inside rear-view mirror blocked forward vision. This mirror, as Chevy proudly points out, is a full foot wide. And the ashtray seems too small—not only that, but the plastic above it discolors when touched by a lit cigaret. More legroom would have been welcome to 15 percent, and

half that number also voted for a larger trunk—one with a light in it.

Monte Carlos are usually sold "loaded," but several owners mentioned that Chevrolet didn't offer enough options. Others would have liked to order single items without having to buy a whole package.

But generally, the unsilent majority agreed they'd simply bought a good new car. They expressed no complaints or very minor ones, and 70 percent vowed they would buy another Monte Carlo. ★★★

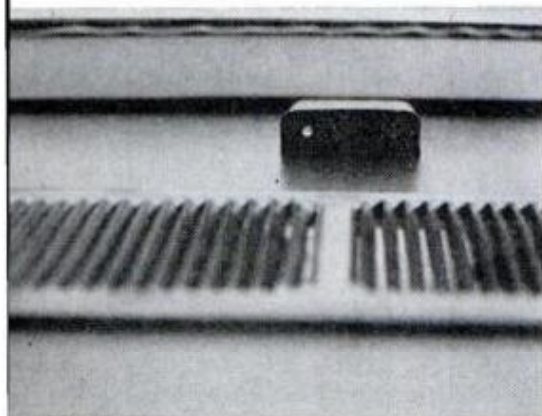

OPTIONAL turn-signal monitor uses fiber optics, winks with exterior lights. It's seen in mirror



SEVERAL OWNERS didn't like the rearview mirror—too big (12 in. wide), blocks their forward vision



SEATING COMFORT is tops. Owners like buckets, console, shift handle; prefer a bigger ashtray

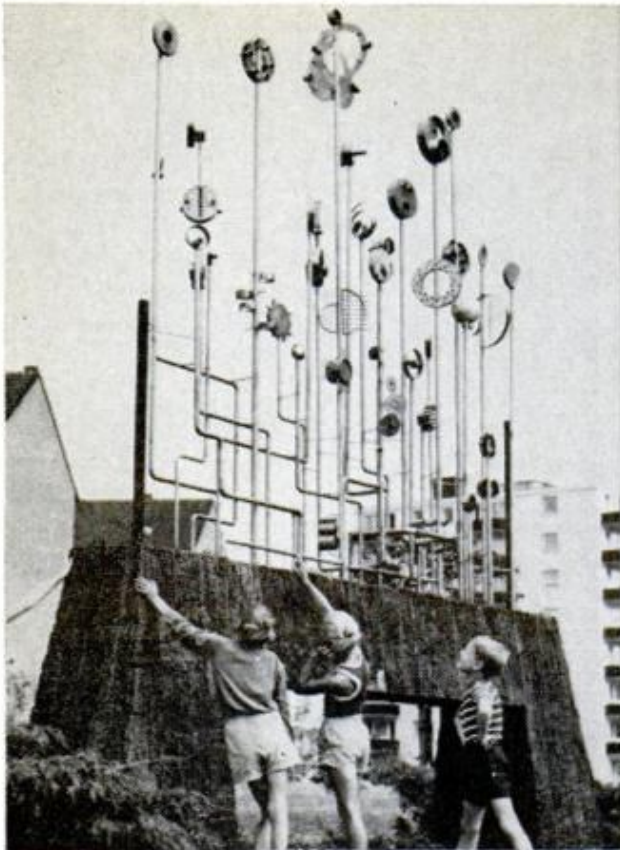

Is an auto part fine art?

Residents of Engelsbu, Germany, aren't quite sure what their new piece of modern sculpture represents—or whether they like it. It was made of pieces of wrecked cars placed on poles. The local sculptor has no comment.



Deadly 'toy'

The Kolibri automatic, now a collector's item, is one of the smallest pistols ever made commercially. It fires a bullet about the size of a ball bearing in a bicycle wheel; cartridge and bullet are less than half an inch long.



Big repair shop

A repair dock recently built at the Sasebo Heavy Industries shipyard in Japan will accommodate the huge new tankers that are now hauling the world's oil (see *The Biggest Thing That Ever Moved*, page 70, May '68 PM). The dock is 370 meters long, 70 meters wide and 15 meters deep.



Let this be a warning

This experimental road sign on the auto-bahn is the result of long study by psychologists and artists. The lines, which crowd together and fragment, warn drivers of the dangers of traveling too close together—even if the sign is seen only fleetingly. The slogan below warns: "Keep your distance!"



Souvenir toy is pattern for back-yard trolley

Using a souvenir model of a San Francisco trolley as a guide, James Anstett, Loveland, Colo., built this kid-carrying vehicle of auto tailpipe (the frame) and hardboard (top and sides). He powered it with a 2-hp mower engine via pulleys and belts from a washing machine.



'Gear down and locked'—and it's a switch engine

Retractable guide wheels fore and aft on the "Shuttle Wagon," a converted four-wheel-drive Dodge truck, keep the vehicle on railroad tracks for use as a switch engine. With guide wheels raised, the Wagon moves onto roads. George Lynch, Clyde, Ohio, does the conversions.



Search for secret TV viewers

In Britain, owners of TV sets must have a license to watch programs. Some folks try to get by without the license, so they become the target of a periodic search by government cars equipped with TV-set-locating antennas.



Homebuilt Formula Ford

The Macon MR7 Formula Ford is a one-of-a-kind. It was built in his garage by Tony Macon, who plans to enter the car in competition. The 1600-cc racer cost Macon just a little over \$3000 to build.



OWNERS OF AMC REBELS usually don't drive their cars this hard, but they like Rebel's steady handling

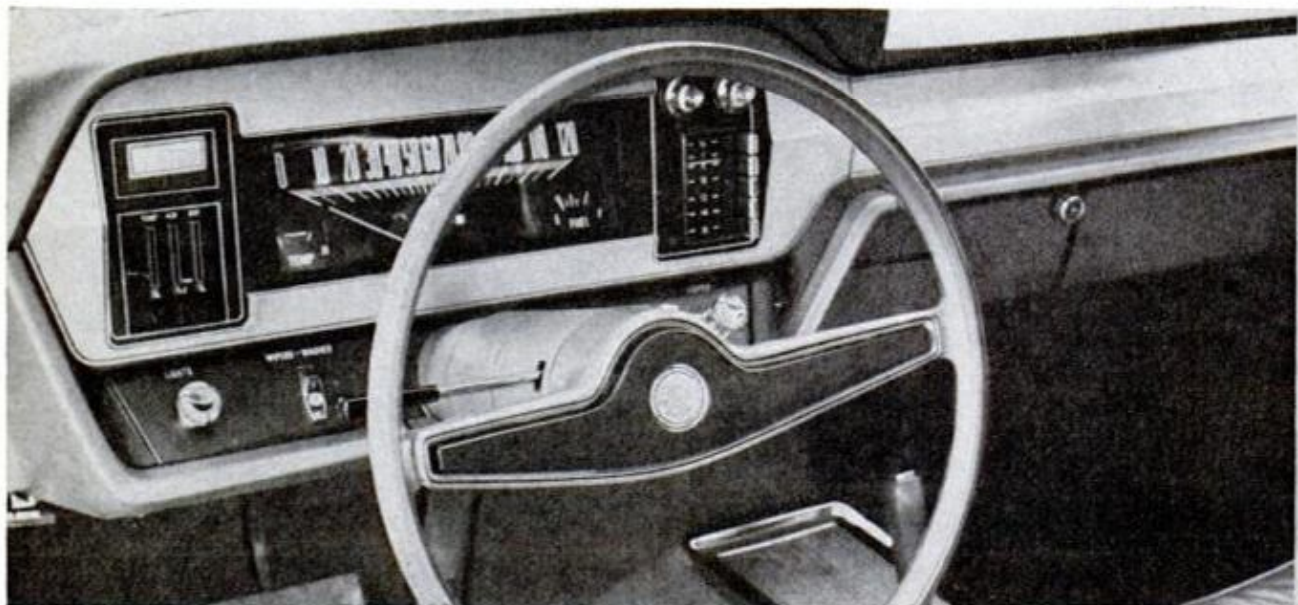

DASH DESIGN brought complaints from 11.3 percent of owners. Too square, sill too high, wheel too low

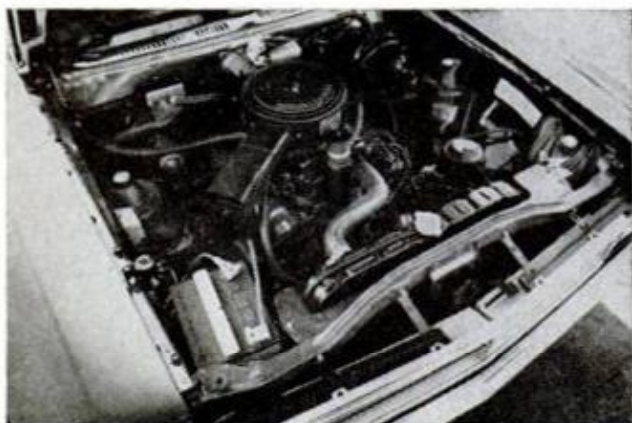

MOST REBEL OWNERS ordered the 304-cu.-in. V8. They like its performance, AMC engine durability



ABOUT THE TRUNK, owners say "lip too high, lots of space but the spare tire should stand upright"

Style, Handling and Comfort Abound; So Do Annoying Rattles

By MICHAEL LAMM, West Coast Auto Editor / Photos by Irv Dolin

Rebel does what it's supposed to, say the buyers. Their complaints are mostly minor, such as that of the guy who dislikes the name. More than half the owners are over 50

REBEL OWNERS TEND to be much more loyal and perhaps a bit fussier than most. As a group, 54.2 percent were over 50 years old, a figure that coincides with American Motors' findings. (Surprisingly, *PM's* 1969 *Ambassador* Owners Report showed only 39.7 percent over 50.)

By and large, Rebel owners have driven AMC products for many years and plan to make their next car another (88.6 percent). "This is my 27th Nash and AMC car since 1936, all new," boasts a Wisconsin mechanic. Several owners similarly cite loyalty from Hudson days. More typically: "Driving Ramblers 11 years, never had any mechanical trouble," says a Kentucky maintenance man.

Flashy looks and runaway performance aren't of primary interest to the average Rebel owner. Workmanship, comfort, fuel economy and freedom from mechanical worries mean much more. Amazingly few owners (2.4 percent), though, had ordered the standard Six. Instead, 85.7 percent took the 304-cu.-in. V8—also standard, but slightly

more expensive to buy and run. The bigger optional V8s—360 and 390—found few buyers in our sampling.

As for freedom from mechanical troubles and workmanship complaints, the Rebel excelled here. Usually, when we poll owners of any car, nearly all say they've had to take it back to the dealer for at least minor adjustments. Not so with the Rebel. Many Rebel

REBEL FUEL MILEAGE CHART

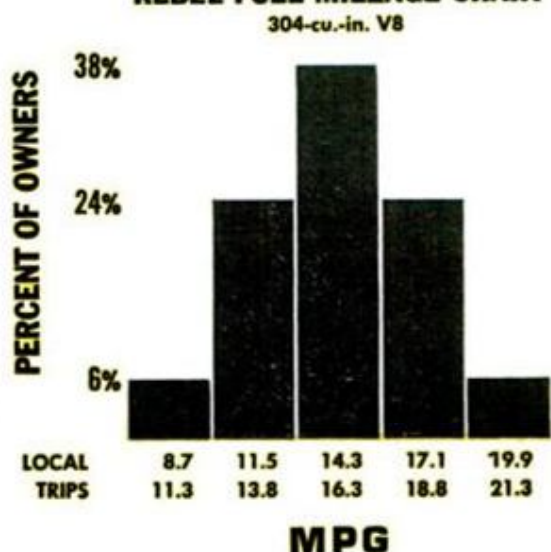



REBEL STYLING was the second-most-cited reason for purchasing the car. Loyalty was first reason



ALL HARDTOPS seem to be short on head and leg-room and owners say that the Rebel is no exception

owners admitted taking delivery of perfectly-put-together cars—quite a remarkable feat.

This isn't to say that Rebel buyers had no complaints. Some 15 percent tended to be unhappy with workman-



GREAT PRAISE from owners for seating comfort, especially for the bucket seats with reclining backs

ship, and of these, most suggested refinements that weren't of the "I'm disgusted" nature. For example, wind noise and rattles bothered 13 percent. Wiper controls, the fact that vacuum wipers were standard (electric optional), airbound gas-tank filler pipes, rough engine idle and incompetent mechanics were frequently mentioned.

On the topic of comfort, a taxi owner/driver from Michigan, aged 70 and holding City Bond Plate No. 1, said, "My Rebel is a taxicab. I'm constantly hearing compliments on comfort. Tried 1968 and 1969 Buicks, but *no service*. I've gone back to American Motors and will stay there." Most other owners likewise rated their Rebels high on comfort. Comments: "Roomy, yet not a large car." "Smooth ride." "Reclining seats, the greatest thing about long trips."

As for handling: "Handles very well in parking," says a Maine dairyman, "and also on the highway." "Ease of handling on open road and in city traffic excellent," echoes an Ohio engineer. Brakes came in for both praise and brickbats, most owners agreeing they were fine but a few complaining of squeaks. One owner said flatly, "My car has the poorest brakes of any I have owned since a 1938 Ford."

Rebel owners and dealers generally get along fine, but not always. "Have dealt with the same dealer five years now, trade each year, haven't had to use his service much, and I pay cash



WHY ONE OWNER BOUGHT: "100,000 miles of troublefree operation from my '67, so why not another?"

for everything." Or, "My dealer is fair and honest. Buying a car from him, I always feel I'm treated squarely at all times." But then again, "Courtesy fair, sales methods very poor, doesn't seem to care." "Mechanics not qualified; small dealers need better mechanics than large ones." "No liaison between sales and service. Once you take delivery, you're stuck." Yet most often: "Most courteous of them all." "My dealer always gives me a much better deal than others offer."

What would Rebel owners like to see next time they buy? "More headroom."

"Less plastic parts." "Hood lock." "Trunk is big, but big things are too hard to lift up so high." "Dash lowered." "Steering wheel raised." "Brake lines to rear wheels badly exposed; could be cut by scraping." "A lot better gas mileage." "I'll order the Six next time—this V8 doesn't give me nearly the economy of my old '64 Classic."

If a single comment has to sum up the general feeling Rebel owners have, perhaps this simple, direct no-nonsense statement by a Massachusetts foreman will do: "I like my car. After 10 Ramblers, I guess a person becomes partial." ★★ ★

Summary of 1970 Rebel Owners Reports*

Total miles driven:316,108

Average miles per gallon:

232-cu.-in. Six n.a.
 304-cu.-in. V8,
 local driving 14.3
 long trips 16.3
 360-cu.-in. V8 n.a.
 390-cu.-in. V8 n.a.

Engines:

232-cu.-in. Six 2.4%
 304-cu.-in. V8 85.7
 360-cu.-in. V8 10.7
 390-cu.-in. V8 1.2

Transmission:

Automatic 98.9%
 4-speed manual 1.1
 3-speed manual 0.0

Why the Rebel?

Past experience 53.0%
 Style 14.5
 Economy 13.3
 Size 12.1
 Service 6.0
 Price 6.0

Specific likes:

Styling 35.4%
 Handling 34.2
 Comfort 34.2

Economy 25.6
 Size 13.4
 Ride 12.2

Specific dislikes:

Workmanship 15.3%
 Fuel economy 14.1
 Rattles 12.9
 Wind noise 12.9
 Brakes 5.9

What changes would you like?

Better workmanship 11.3%
 Dash layout 11.3
 Windshield wipers 8.5

Had any mechanical trouble?

Yes 33.3%
 No 66.7

What kind of trouble?

Battery 19.2%
 Electrical 19.2
 Gas gauge 15.4
 Carburetor 11.5
 Transmission 11.5

Did you repair it yourself?

Yes 0.0%
 No 100%

Dealer repair satisfactory?

Yes 77.8%

No 22.2

Is the Rebel your only car?

Yes 57.5%
 No 42.5

Other cars owned:

AMC products 43.2%
 Dodge 13.5
 Chevrolet 10.8
 Ford 8.1
 Volk wagen 8.1

Power options/accessories:

Power steering 69.4%
 Radio 68.4
 Power brakes 25.9
 Reclining seats 21.1
 Airconditioning 18.4
 Light group 15.8
 Tinted glass 14.5
 Vinyl top 10.5
 Whitewall tires 9.2
 Power windows 1.2

Age distribution of owners:

15-29 years 11.7%
 30-49 years 34.1
 50-p'us 54.2

Would you buy another Rebel?

Yes 88.6%
 No 11.4

Percentages may not equal 100% due to rounding and/or insufficient data.

HOW TO MAKE A WOBBLER MINNOW LURE

By PETER CAMPANER

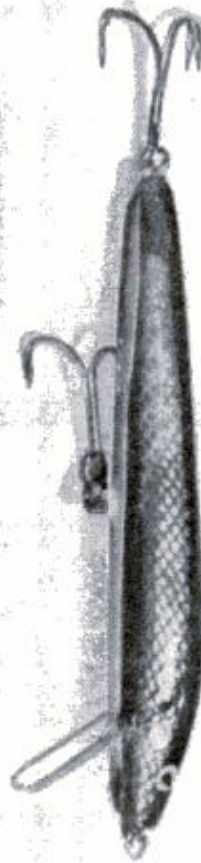
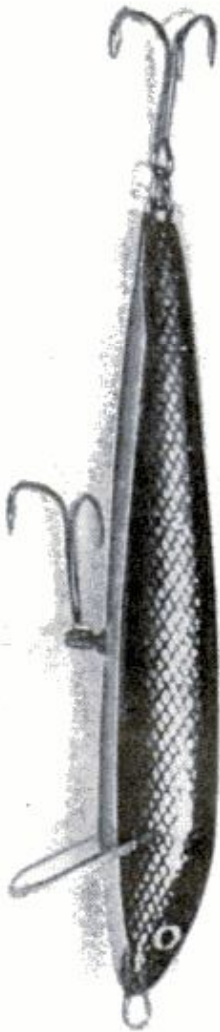

You can produce your own version of the most successful lure in recent angling history for a fraction of the cost of a store-bought model.

THIS LURE not only looks like a baitfish, it imitates the wobbling, darting action of one that's injured. And nothing turns on hungry pike or large-mouth bass like the sight of crippled bait!

Yet these lures are among the most expensive on the market. A good deal of hand labor still goes into the manufacture of some versions of the wobbler, and the loss of two or three of them can really sour the memory of an otherwise pleasant outing.

Since so much of the cost is in manual labor, why not do the work yourself? You can make a dozen or more lures in different sizes and colors at a fraction of the retail cost. Besides the work will give you a chance to use up those nearly empty cans of spray paint you've been saving!

In addition to the satisfaction of turning a dull balsa plug into a bright baitfish replica, you'll experience a kind of pride that can

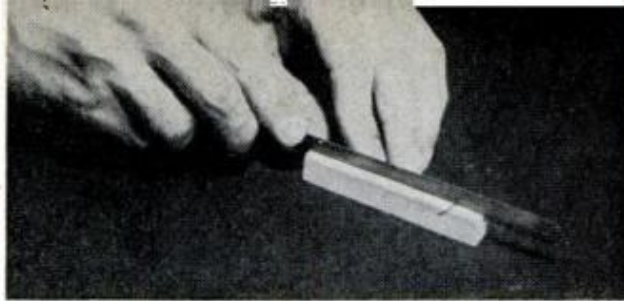

1. **MAKE DIAGONAL CUT** $\frac{1}{4}$ inch deep $\frac{3}{4}$ inch from end. Make another $\frac{1}{4}$ -inch cut down center of block



2. **CUT BALSAWOOD** to basic minnow shape, removing an even amount of the material from each side



3. **TRIM AND SAND SMOOTH**— $\frac{1}{4}$ -inch lengthwise cut is to hold wire prepared per color diagram below



4. **SHAPE AND SOLDER** wire insert; with waterproof glue, fix it in slot. Diagonal cut is for plastic lip



5. **COAT ALL SURFACES** and crevices with red oxide primer. When dry, smooth with No. 400 wet paper



6. **ANY COLOR MAY BE USED**, but glossy black enamel offers the best contrast. Paint the entire lure

never be bought when you land your first fish on a lure you made yourself.

Basically the lure consists of a balsawood body in the shape of a minnow with a wire insert to hold the hooks and a plastic lip to supply the swimming action. Materials available at most hobby shops are: balsawood (stock piece $\frac{1}{2}$ by 3 by 36 inches), 22-gauge (or a substitute approximately this size) brass or copper wire, red oxide primer, spray paint (black, silver or gold), acrylic plastic sheet $\frac{1}{16}$ or $\frac{3}{32}$ -inch, white waterproof plastic tape (type used to repair wading pools), split rings and treble hooks.

You'll need a sharp knife, hacksaw

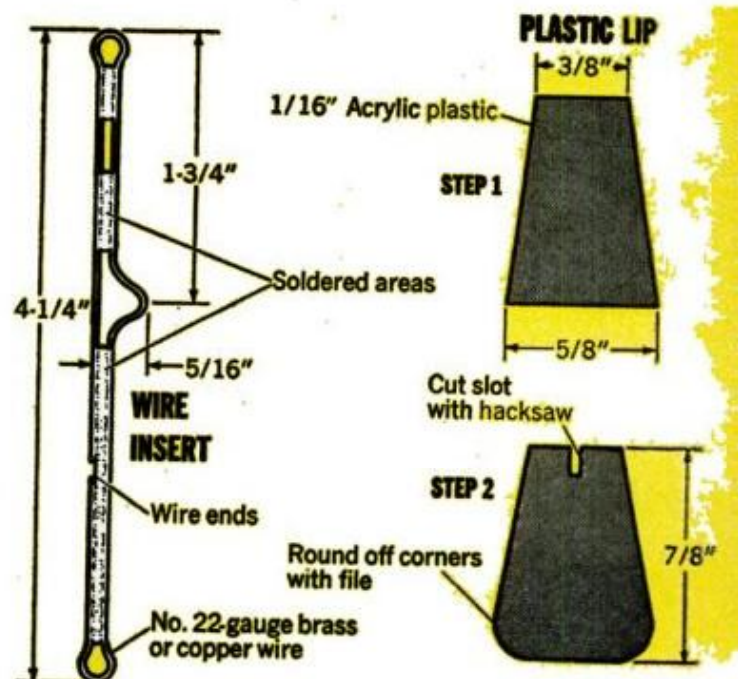

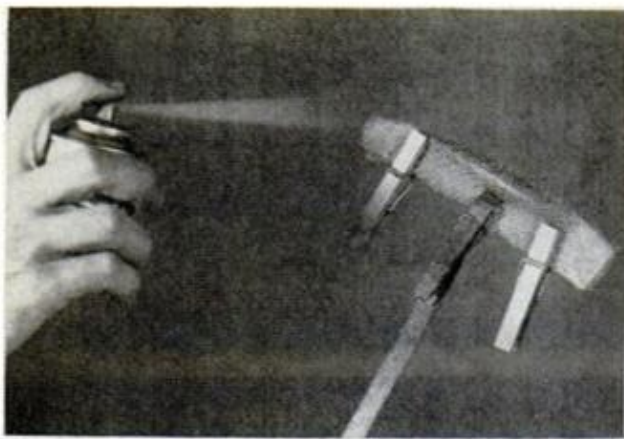

7. FOR SCALE EFFECT, wrap lure in fiberglass window screen. Hold it diagonally with spring-type clothespin and spray it with gold or silver paint



8. CUT WATERPROOF TAPE 4 inches long and $\frac{1}{4}$ inch wide; make slit where wire insert protrudes. Fasten to lure bottom and cut slot for plastic lip



9. PLASTIC MAY BE CUT with soldering gun attachment or by scoring with a sharp knife and breaking along score line. Set in slot with waterproof glue



10. OPTIONS FOR COLOR CONTRAST are as varied as the rainbow, but a combination of painted yellow eyes and red mouth has worked best for the author



11. FOR SHEEN and a permanent bond to protect paint from knocks and fish's teeth, coat entire lure with polyurethane liquid plastic synthetic varnish

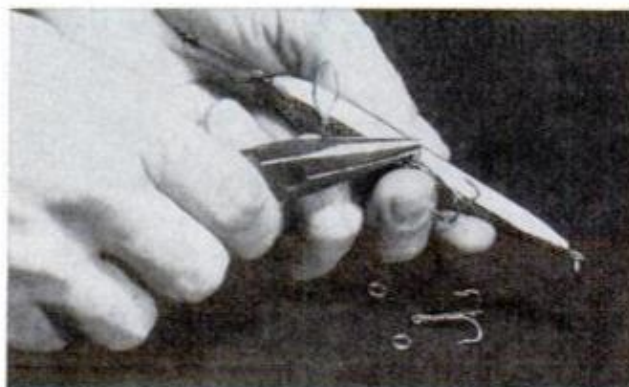

12. FASTEN HOOKS with split rings to wire insert. No. 3 or No. 4 split ring and No. 4 or No. 5 treble hooks seem to offer the best balance for this size lure

blade, soldering gun, fine sandpaper, and No. 400 wet or dry oxide paper.

Instructions are for a 4-inch minnow lure made from a balsa plug $\frac{1}{2}$ by $\frac{5}{8}$ by 4 inches. Alter dimensions and hook size for larger plugs.

After Step 7, the top of the lure can be resprayed with black enamel if gold or silver scaling overlaps too much. The plastic lip is made from acrylic plastic or scrap pieces salvaged from

plastic lids. Action of the lure can be changed by bending the front end of the wire insert. Bend down to increase the wobble; up for less action. If the lure tends to turn over, bend wire in the opposite direction until it runs true.

Best results are obtained with a small snap swivel on a light line. Split shot or a small trolling sinker can be used 18 inches in front of the lure to increase depth. Good luck fishing! ★★★



1. **MAKE FIRST CUT** with a sharp fillet knife just behind gill, stopping when the knife hits backbone



2. **CHANGE DIRECTION** of cut, slice down along backbone, cutting away part of the rib cage as you go

Blitz Fillets

By **GEORGE REIGER**

EVER HAD A FISH DINNER spoiled when your pan-fried catch came out tasting muddy? Don't blame the cook. Perhaps, you need a new way to prepare fish for the skillet. Next time eliminate that tainted taste sensation by filleting and *skinning* your catch with this jiffy method shown to me by Arkansas guide Charles Ray. He can handle a pair of four-pound bass in less than a minute!

When one side is done (steps 1 through 4), flip the fish over and repeat the process. Rib bones can be cut away with a simple slice of the knife. Use a sharp knife with a seven or eight-inch narrow blade. A butcher knife with a wooden, slip-resistant handle will do, but Charlie prefers Rapala's "Fish 'n Fillet" special. ★★ ★



3. **DON'T SEVER SKIN** when knife reaches tail. Flip fillet and start another cut between meat and skin



4. **LIFTING FILLET** from carcass as you work, cut meat from skin as though it were a butter patty on paper

APRIL 1970

155

BE YOUR OWN BOAT TESTER

PART 2: ON THE WATER

By BOB WHITTIER

THOUGH IT'S UNWISE to stand in canoes, much can be learned about stability characteristics of any small craft by leaning cautiously from side to side. At least, you'll be respectful of its limitations in rough water

BEFORE WE SHOVE OFF, first a word about stability. There're two kinds: static and dynamic. The former acts when a boat is at rest or moving slowly; the latter when speed picks up, and water rushes under the hull with great force.

Static stability is created by the volume of water pressing to each side of the hull's centerline. When something makes a boat roll to one side, that side settles deeper, displacing more water. The center of buoyancy shifts to that side. The boat rolls until it has displaced a weight of water equal to the force causing it to roll.

When you first step aboard a new boat move from side to side to feel how it rolls under you. A boat having high static stability is called "stiff"; one that rolls easily and suddenly is called "tender." Cathedral hulls are typical of "stiff" boats, canoes of "tender" ones.

STATIC STABILITY comes into play when a boat is at rest and is important in such activity as fishing

You will encounter all kinds of stability characteristics. A narrow hull with low center of gravity can be just as safe as a wide one with high center of gravity. A round-bottomed boat might be "tender" through the first few degrees of roll, but as more and more of its amply-flared side goes under, the volume of water displaced increases rapidly, and the boat "stiffens up" so that it will be in no danger of capsizing.

The famous Grand Banks dory is a good example of a boat that is "tender" when lightly loaded. But as the load of nets and codfish increases, the boat settles deeper in the water. Due to the ample flare of its sides, the dory's beam at the waterline increases substantially and the boat becomes "stiff."

There is much emphasis on wide beam today. But really, a boat's width across

DYNAMIC STABILITY is created by the pressure of water rushing under hull. Note two men on one side



the gunwales as set forth in specifications is no indication of its stability. Depending on the amount of flare to its sides, a boat that is six feet wide across its gunwales can be six feet wide or only four feet wide down at the waterline. Take a runabout hull and build a cabin on it: with no change in beam or hull shape, you now have a completely different center of gravity, and the beam in inches is no more reliable an indication of stability than engine horsepower is of the number of seats in an airplane.

Exploring this matter of beam, let's take a runabout of conventional, pointed-bow type. Its bottom is very wide at the stern and the part that is actually in water narrows steadily toward the bow. Such a boat is widest across its gunwales at the location of the main passenger seats—but look closely and *consider how narrow the bottom is underneath the seats*, where it touches water! Such a boat may be “cranky” when at rest or moving slowly. When you stand at the aft end of the cockpit and move from side to side, it feels quite stable. But move forward and do the same thing where the bottom is much narrower, and you'll find the boat rolls nervously and disconcertingly under you.

This does not mean such a boat is poor, for actually it will “stiffen up,” thanks to dynamic stability, when under way; you and your passengers will all be seated when crossing rough water, and when fishing somebody will be in the cockpit aft to counter the weight of anyone up forward.

The point of all this is, stability is an involved subject, with many facets to it. You can tell much about any particular boat just by walking around in it, observing its behavior, and noticing the “imprint” its shape makes in the water.

Ideally a fishing boat should have high initial stability, that is, be “stiff” so that occupants can work over the sides without a nervous feeling that they are in imminent danger of toppling overboard. But good things can be overdone, and there are boats that are too wide and stable. They feel reassuringly stiff when at rest on calm water, but when going broadside to waves outside the harbor, they roll so quickly and sharply in obedience to their great stability that it is most uncomfortable.

On the other hand, there are boats that



POWER IS LOST in overcoming water resistance with a heavy boat; it may not lift much from water

WHEN A BOAT IS LIGHT for its power, it lifts well from water and more oomph is available for speed



VISIBILITY BECOMES A PROBLEM in the boat that normally carries its nose in air when fully under way



roll quite easily when at rest, but which stiffen up quickly and substantially when they accelerate and dynamic stability begins to appear. You have noticed how an airplane's wings angle upward—it's called dihedral. Flying level, right and left wings angle upward equally. When a gust of wind rolls the plane a few degrees, the low wing is nearly horizontal and lifts more than the other one, which is angled up even more than before. The difference in lift rolls the plane back to level flight. It works just like that on the bottom of a boat, too. It rolls, and rushing water presses up more on the low side. As pressure increases on the square of the speed, dynamic stability builds up rapidly and can become very powerful.

In fact, a boat can have so much dynamic stability that it will resist banking into turns. The centrifugal force sends it sliding to the outside of the turn. No good, especially on winding rivers and channels. Or if it slides sideways on choppy water, it may hook a wave and flip over. A too-stable boat can be made to turn without skidding by installing assorted bilge keels and experimenting with chine shapes that grab rushing water and resist skidding. Such appendages require much experimenting to get them right. They also generate spray and consume power on the straightaway.

Boat design is an art, the essence of which is an ability to make intelligent compromises between many conflicting requirements. Canoes and sailboats have limited stability, not out of negligence, but as an outcome of the designer having chosen long, slim hull lines for the sake of easy propulsion by limited power. The tenderness of such hulls is compensated for by mechanical means, such as ballast in sailboats, or by depending on the skipper to distribute the load so as to maintain acceptable stability. That's one of the things they mean when they start talking about seamanship. Safety afloat does indeed depend partly on the boat—and partly on the skipper!

Now, before getting underway, look at a boat's side and stern to see what provision has been made to protect the hull from scrapes.

A good boat will have a rubrail of some kind—often called a spray rail by landlubbers—or else the trim stripping on its gunwale will be made to serve well as a dock fender. If there's a metal cap at the aft end of the gunwale stripping, it should be so designed or located that it will not catch on a dock pile and get knocked off.

If the boat to be tested is tied up at a slip and must be backed out, this is an excellent chance to observe behavior when reversing. A propeller turning in reverse will tilt back the lower unit of an outboard or stern drive. If this happens without the driver realizing it and he then opens the throttle, thrust of the accelerating propeller can slam



WATER FLOWS UP SIDES of round bilge boat causing skin friction without adding to hull's lifting ability when on a plane



WATER DOES NOT TOUCH SIDES and shoots clear of hard chine hull's bottom, giving exceptionally dry ride, greater lift



DEEP VEE HULL is a good rough-water design which plows groove in the water, sending it out to sides with much spray



SIMPLE TEST of controls is to release steering wheel when running straight to see what boat will do

the lower unit forward against its stops. So, on stepping aboard, take a look at the motor or the controls to see what is provided in the way of a tilt lock. This is a device, sometimes automatic, sometimes manually released, that holds the lower unit from tilting against the drag of a slowed propeller but which will release and allow the lower unit to tilt if it strikes something in the water.

Moving out of the marina in forward gear, take note of a boat's attitude in the water. The shape of the immersed part of a conventional pointed-bow hull at the waterline is close to triangular, with the narrow end forward. So sometimes there is relatively little buoyancy under the weight of occupants on a seat mounted well forward in the hull. At low speed the boat will progress in noticeably bow-down attitude. This isn't good on a craft that is going to have to slow down to safely negotiate stretches of short, steep waves. It could "submarine"!

The larger a hull is, that much more volume does it have to displace water and afford generous buoyancy to carry a load.

When trying out a new boat you can sense this in a practical sort of way while moving slowly away from the dock area; you feel you are riding "on" a small boat but "in" a larger one. When you start feeling you're riding "in" a boat, you are in a size range that can make sense for open-water use. Boats that make you feel you are riding "on" them are, by and large, best used only on small or protected waters.

Clear of the marina, you can open the throttle. Many things start happening, so

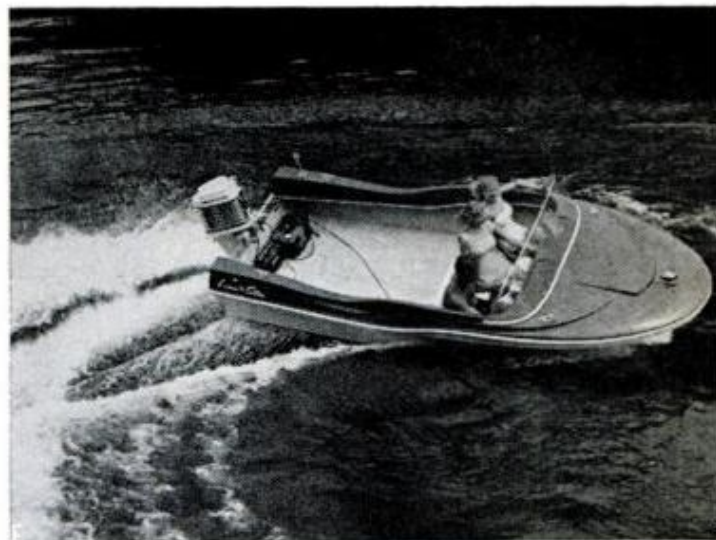

BOATS TURN from stern. Keel area amidships and forward determines how well boat will answer helm

we'll have to digress to explain things that an experienced test driver takes in quickly as his boat accelerates and begins to move along over the water.

There are two basic kinds of hulls—displacement and planing. The former settles into the water until its hull has *displaced* a volume of water that weighs the same as the boat and its load. Water weighs about 64 pounds per cubic foot; a sailboat weighing 190 pounds carrying three persons totaling 450 pounds grosses 640 pounds and so displaces 10 cubic feet of water.

Being supported by the water, any such boat has to progress *through* the water. When it begins to move ahead slowly a small wave angles out from its bow. As speed increases, you can see this get larger—and at the same time a second wave begins to angle out from the bow a short distance back from the first one. As the speed increases, waves get bigger and since they are bigger, the distance between their crests must become greater. So, the second one moves farther and farther back along the hull sides.

Next time you see a tugboat or large sailing yacht moving along at good speed, either in actuality or in pictures, you can see this second wave in its ultimate position, tucked up under the stern. Water piles up at the bow and makes a strong bow wave, it then swoops down well below the painted waterline amidships, and swoops up again under the stern. There, it clings to the hull—and no matter how much more power you add, the boat cannot go faster. It just creates more and

(Please turn to page 230)

How to Keep Your Tape Recorder Humming Happily

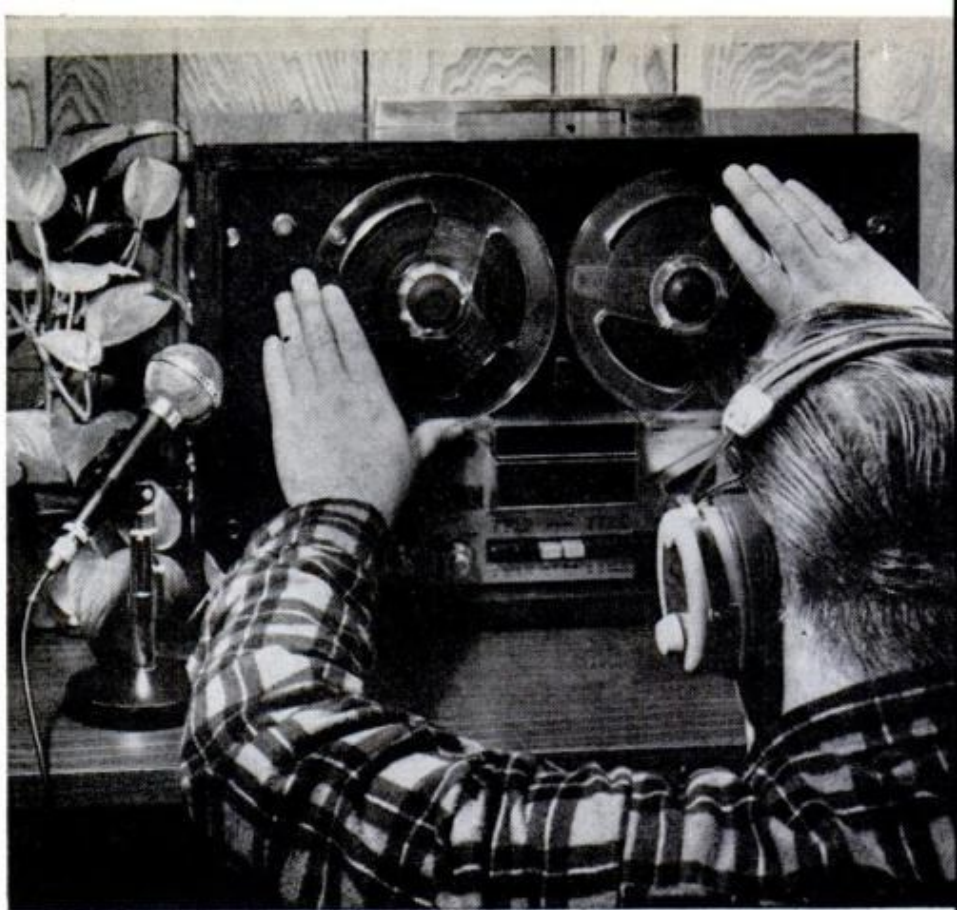

By **WALTER SALM**/Photos by *Robert D. Borst*

Simple periodic maintenance jobs you can do yourself will give you better sound and keep serious trouble from developing. Here's a rundown on products that are readily available to make the task easy and fun

TAPE RECORDERS need more care than you may realize. Two absolute musts, for instance, are regular head cleaning and head demagnetizing. Depending on how much you use your machine, these jobs may have to be done as often as once a week. Keeping the heads in good shape will improve your sound and prevent serious trouble later on.

Hi-fi dealers are stocked with many handy aids for making recorder maintenance quick and simple. In addition, splicers, timing tapes and other accessories can increase the usefulness of your machine and help you have more fun with it. Most techniques described here apply equally to full-size reel-to-reel recorders or their smaller cassette and cartridge cousins.

Frequent head cleaning is important because fine oxide particles rub off the tape, leaving a reddish dust on the heads. As this builds up, it can clog critically tiny head gaps, resulting in poor recordings.

Special head-cleaning fluid is available with an applicator brush attached to the bottle cap. Or you can buy isopropyl alcohol at a drugstore. Apply cleaner with the brush supplied or a cotton swab and rub it gently over the heads. Follow with a dry cotton swab, being careful not to poke too hard at the delicate head gaps.

On most recorders, the heads are easily exposed by pulling off a cover plate. In addition, swab cleaner on the metal tape guides and capstan spindle. Do not get any on the rubber pressure roller; it may cause the rubber to deteriorate.

Demagnetizing the heads, called degaussing, is necessary because they are electromagnets and gradually build up some residual magnetism of their own. This is permanent magnetism—different from the heads' changing electromagnetic fields. It can cause a high level of background noise and spoil your tapes.

To degauss the heads, you'll need a spe-



YOU CAN GET AT THE HEADS EASILY on most recorders by slipping off a cover plate over the tape transport mechanism, as shown at far left, above. With the parts exposed, carefully brush a liquid cleaner on the heads and tape guides, wiping away dust and dirt (second photo from left). Some makes of cleaner come with an applicator brush, as here, or you can use cotton swabs. Keep the cleaner off the large pressure roller or it may deteriorate the

rubber. After this, demagnetize the heads using a special prong-tipped coil (third photo from left). Bring the tip close to each head without actually touching the metal, then slowly back it away. At far right, the pencil indicates tiny felt pressure pads that frequently wear down or fall off. Replace these with fresh felt, available in adhesive-backed sheets. Cut small pieces the same size and just press them gently onto the metal pressure fingers

cial instrument called a head demagnetizer. This is a coil with a pointed pole piece sticking out from the end. Before you plug it into an a.c. outlet, be sure no tapes are within about 20 feet. It will demagnetize everything in sight—including your precious recordings.

Bring the tip of the demagnetizer up to the head gap—almost but not quite touching it. You'll feel and hear a buzzing in the coil as it interacts with the head. Wave the tip in a tiny circle over the gap, then back it away slowly until you're as far from the recorder as the line cord will let you get before disconnecting it. Shutting off the coil abruptly while it's still near the head can leave magnetism in the head.

Repeat the procedure for each head except the erase head. It's not necessary to degauss this, as the bias voltage used for erasing keeps the head demagnetized. The erase head is the first one the tape reaches—the one on the left in recorders where the tape runs from left to right. Also demagnetize metal parts that touch the tape, such as the guide posts and capstan.

You can clean and demagnetize cassette and cartridge recorders the same way as the big machines, but be careful of the tiny, delicate heads. Usually not as accessible, they must be approached cautiously. While cleaning with a liquid solvent is best, you can get a special head-cleaning tape in cassette or cartridge form that

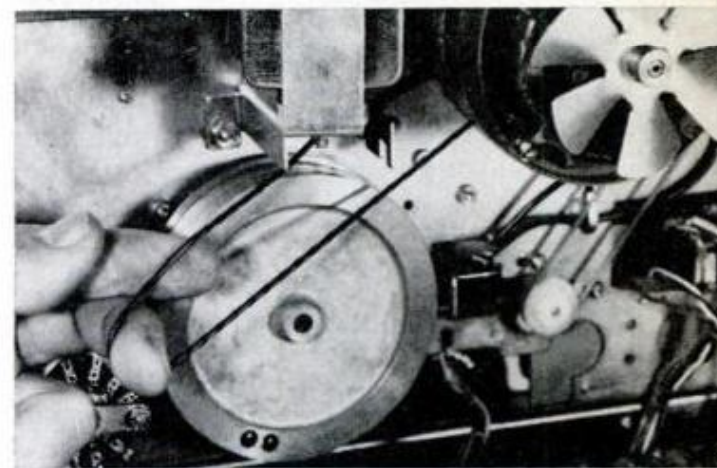

RUBBER DRIVE BELTS stretch with age and slip, causing erratic tape speeds. Check belts to see if tension is good, as above, and replace any that are weak. A stroboscopic speed tester, like one below sold by Robins, can also help you check recorder's accuracy. Special timing tape with black bars is viewed under a small strobe light. Speed is correct if the bars appear to stand still. If they creep forward, machine is fast; if backward, machine is slow

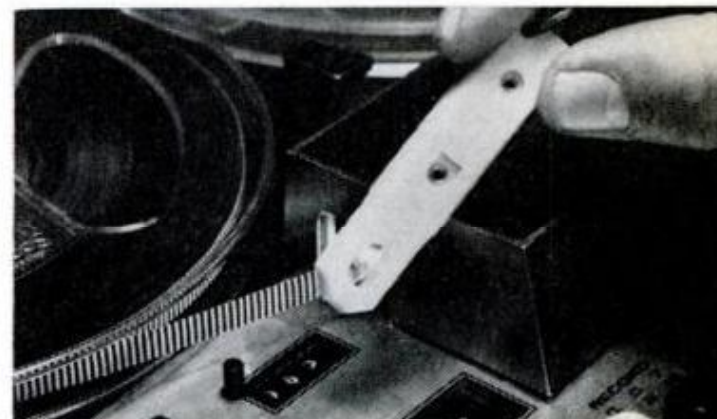

HOW TO USE A SPLICING BLOCK

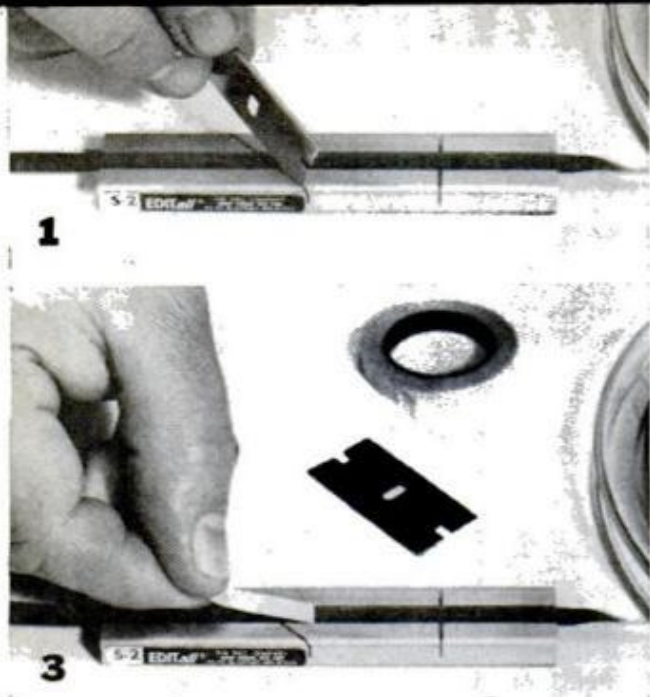

SIMPLEST SPLICING TOOL is a slotted block for making cuts with razor blade. Tape is first cut at desired point, using diagonal slot to guide blade (1). Ends, butted together, are held in block's groove as splicing tape is pressed over joint (3).

wipes away dirt as it passes the heads. You put it on and let it run as if you were playing a regular cassette or cartridge tape. For automobile cartridge players, there's a head demagnetizer that plugs into the cigaret-lighter socket.

While you're working around the transport mechanism, examine the pressure pads that hold the tape against the heads in reel-to-reel recorders. These are small bits of felt cemented onto spring-loaded metal fingers, one for each head. In time,

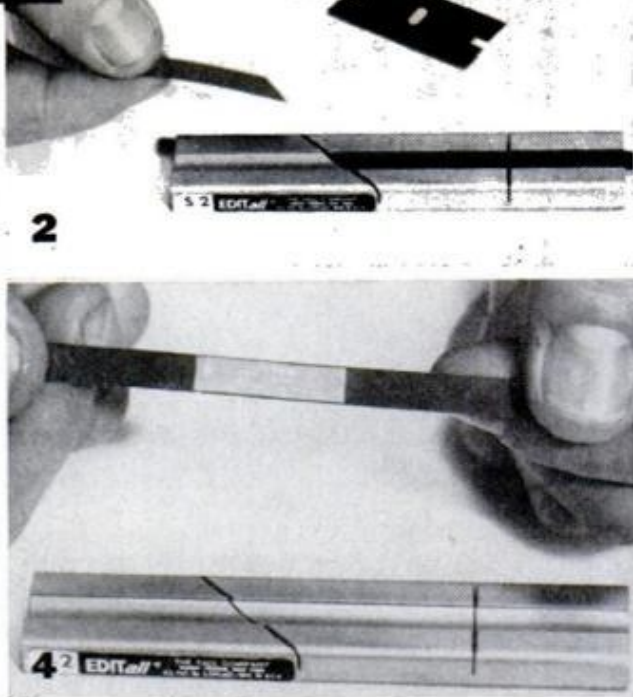

Splicing tape is $\frac{3}{16}$ inch wide—slightly narrower than $\frac{1}{4}$ -inch recording tape—so it can't interfere with transport mechanism (4). It's placed on underside of joint, away from heads. Editall block shown is made by Elpa Marketing, New Hyde Park, N.Y.

the felt wears down or comes off and must be replaced to keep the metal from scratching the tape. Replacement felt is available in a self-sticking, adhesive-backed sheet. You just cut off whatever size pieces you need with scissors and press them onto the metal fingers.

Also subject to periodic failure are rubber drive belts and drive wheels. Heat and age cause the rubber to dry out and lose its resiliency. Belts stretch and slip. Wheels get hard and bumpy. The results

HOW TO USE A TAPE SPLICER

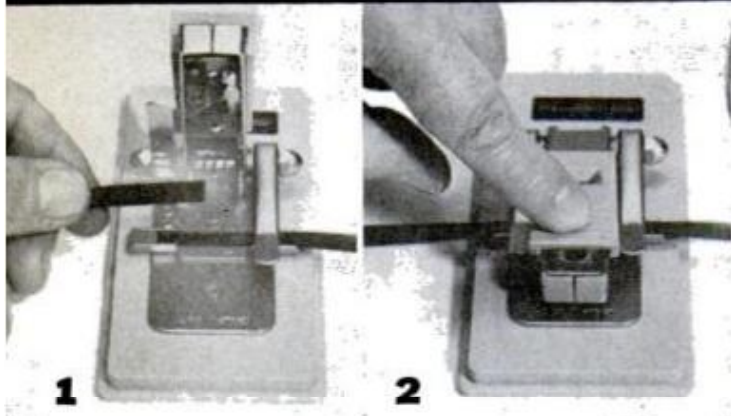

SPLICING MACHINE cuts and joins tape automatically. Tape ends are overlapped under hinged cutter and held in place by spring-loaded fingers (1). Pressing cutter down (2) slices through both tapes, leaving ends butted together. Splicing tape is then

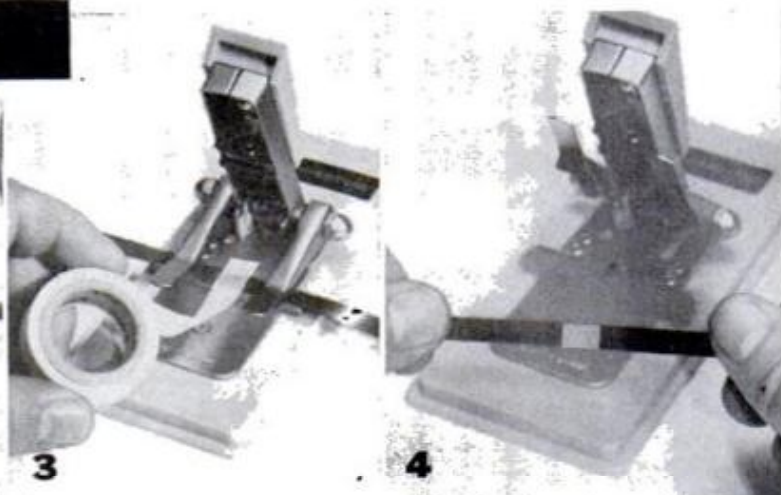

applied to the joint (3) and cutter is pressed again, this time trimming off excess splicing tape to make a neat splice (4). Wide splicing tape is used in this method since it's put on crosswise. The splicer shown is made by Robins, Flushing, N. Y.

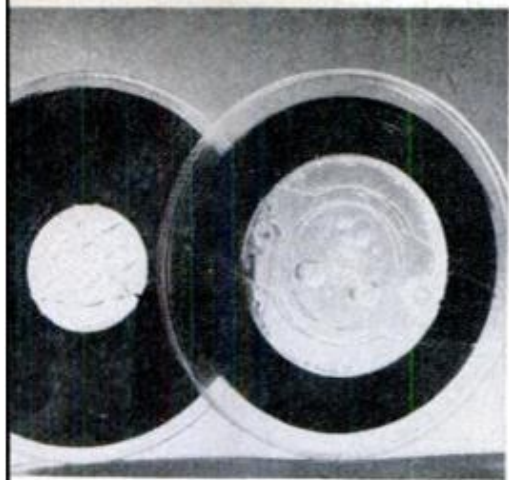

NEW LARGE-HUB REEL at right above offers more even takeup tension, but doesn't hold as much tape as standard reel at left. Not intended for storing tape, it's useful for playing or editing short tape passages



HANDY HEAD-CLEANING TAPES are designed for small cassette and cartridge recorders where heads may not be easily accessible. You just play the tape and it polishes the heads clean. Tapes for making recorder tests are also available



TIMING TAPE made by 3M Co. has identification marks every $3\frac{3}{4}$ and $7\frac{1}{2}$ inches. Marks are one second apart at $3\frac{3}{4}$ and $7\frac{1}{2}$ -inch tape speeds so you can splice in accurately timed pauses between taped passages

are erratic tape speeds, wow and sloppy takeup or rewind.

Replacement belts and wheels are available from recorder manufacturers for most models. Installing them is easier on some machines than others. You will first have to remove the tape chassis from its case or base to get at the back. With the chassis exposed, run the machine through its various functions to see if you can spot which belts or wheels are slipping. On some models, new belts and wheels can be put on without disturbing the rest of the machinery. Others may require a major

disassembly. If you aren't sure how to proceed, leave this job to a repairman.

Worn connector cables are a major source of grief with tape recorders just as with other hi-fi components. Check for fraying or looseness at the plug ends and replace any cables that show wear.

Editing your tapes can add a lot more enjoyment to your recording. You can cut out bad portions and save only the good. You can group similar selections together so a whole collection is instantly available—say, a reel of popular music, a reel of

(Please turn to page 226)



TAPE-CARE KIT at right contains a head cleaner, head demagnetizer, splicer, splicing tape, tape clips, identification labels and extra reels of recording tape all in a handy carrying case. Price is \$33 from Robins Industries, 15-58 127th St., Flushing, N.Y. Also helpful are the inexpensive booklets above. They are, left to right: *Tape Recording the Sounds of Your Life*, \$1.50, Robins; *Tape Editing and Splicing*, 55 cents, Robins; *What You Should Know About Your Tape Recorder*, \$1.30, Robins; *Your Tape Recorder*, \$1, Elpa Marketing Ind., New Hyde Park, N.Y., and *Recording Basics*, 50 cents, 3M Co., St. Paul, Minn.

ANIMATED



SLIDES

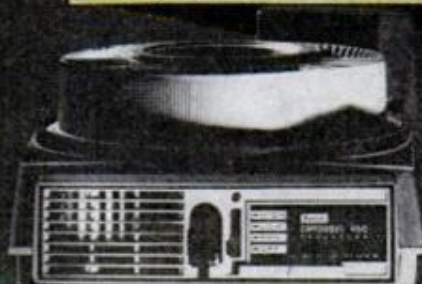
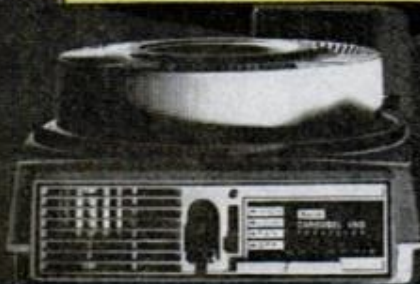

ADD MOTION TO YOUR

A spinning filter in front of your projector can make your transparencies look as if they're really moving. Here's how the ingenious system works and what to buy

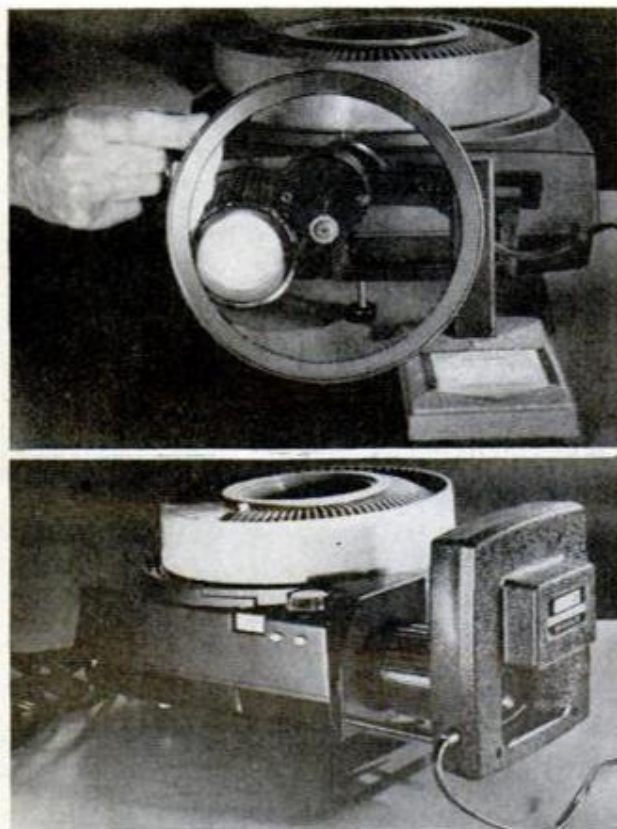

POLARIZING SPINNER is key to creating simulated motion in animated slides. Two types of motor-driven wheels are shown above. At top is inexpensive model made by Technamation, Inc. and sold by Edmund Scientific for \$9. Somewhat more elaborate one at bottom is made to fit Kodak Carousel projectors. It's available at Kodak audio-visual dealers for \$24.50, plus about \$7 for mounting bracket

BLINKING TITLES, lights that flash on and off, water that appears to flow, colors that dance wildly on the screen—these are some of the fascinating effects you can add to your slide shows. Nothing actually moves; the motion is simulated by a trick process, just as the lights running around a theater marquee appear to move but really don't. Such lights are merely turned on and off in a progressive sequence giving an illusion of movement.

Animated slides work in the same way. You "turn off" one portion of the scene and at the same time "turn on" another portion, and the result is apparent motion. The secret lies in polarizing filters. These are sheets of film with fine, closely spaced parallel lines. The lines act like tiny venetian blinds—only light waves vibrating in the same plane as the lines can get through. If you shine light through one filter with the lines horizontal and place another filter in front with the lines vertical, the light is blocked. Turn the second filter so its lines match up with those of the first and light passes easily through.

This is the principle of adding motion to slides. One piece of polarizing material is attached to the slide itself and a second polarizing filter is placed in front of the projector. The front filter is in the form of

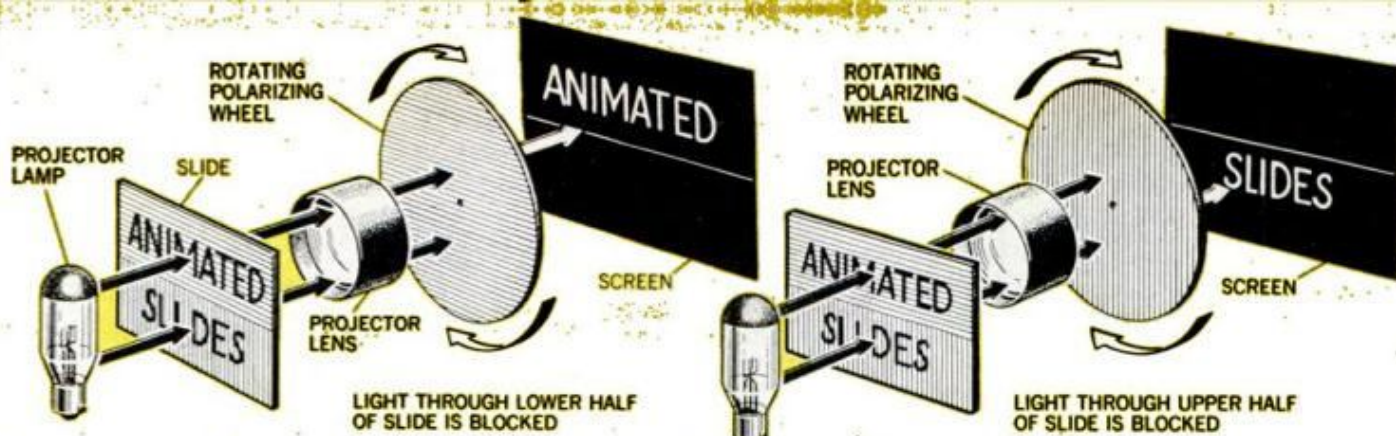

TITLE WORDS FLASH ON AND OFF magically in demonstration setup above and on facing page. Upper word on slide is backed with polarizing material with lines running horizontally. Lower word is backed with the same material but with lines running

vertically. Rotating polarizer wheel in front of projector lens first lets upper word show through while blocking lower one, then lets lower word appear while blocking upper one. Words thus blink on and off alternately for an eye-catching effect

PHOTO SLIDES

By WALTER E. BURTON

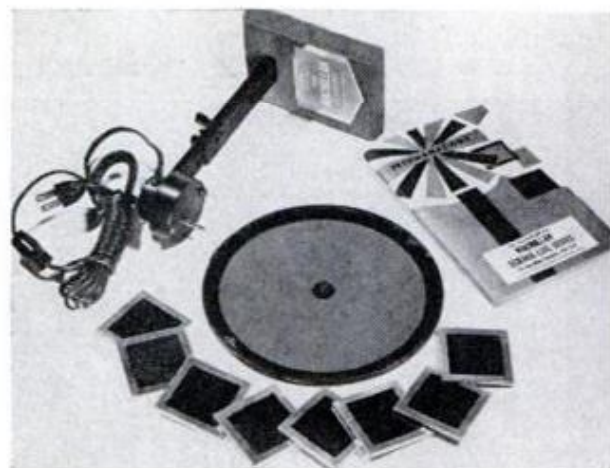

LOW-COST STARTER KIT includes motor-driven polarizer wheel and eight sample motion slides showing workings of ear, heart and other functions. It is \$9 from Edmund Scientific or Technamation, Inc.

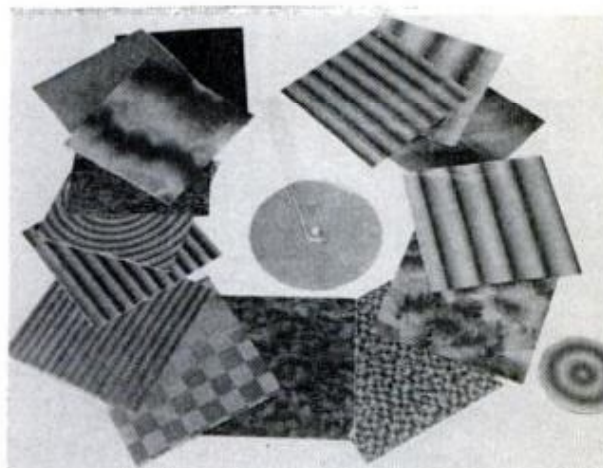

STOCK GEOMETRIC PATTERNS offered by Technamation, Inc. include the array above. A pocket spinner, shown at center, lets you preview each effect by turning the disc slowly as you view the pattern

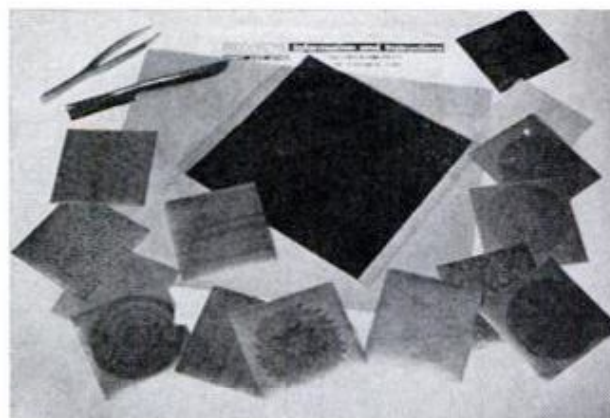

ASSORTED SUPPLIES for adding motion to slides are available in this kit from Edmund Scientific. It contains polarizing material, geometric designs and slide-making tools. Two sizes are \$10 and \$20

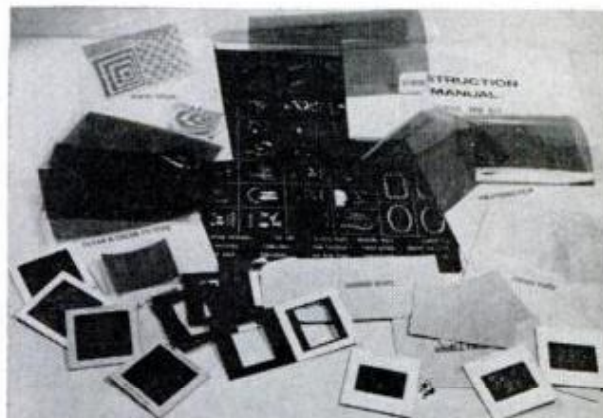

SLIDE-MAKING KIT contains printed words for titles, decorative borders, polarizing material, colored filters and other aids. Available from Polarized Animations, the Series 100 kit costs \$7.95

a motor-driven wheel. As the wheel turns, its polarizing lines change from vertical to horizontal and back to vertical again in rapid succession. The polarizing material on the slide is put on with its lines running in different directions over different areas. Say you make up a title slide having one word backed with vertically polarized film and another word backed with horizontally polarized film. The first word will be visible on the screen only when the spinning filter wheel has its lines vertical, and the second word will be visible only when the lines are horizontal. The two words will thus appear to flash on and off alternately as the wheel rotates, adding an interesting effect to your slide presentation.

Polarizing materials are available in a variety of forms. Some can be applied directly to slides you already have. Others can help you make eye-catching title slides. Still others can be used by themselves to produce novelty slides for livening up an evening's entertainment.

In addition to regular polarizing film in which the lines all run in the same direction, there are also special polarizing materials designed to produce particular motions. Suppose you have a slide that shows a waterfall or fountain. You can get polarizing material that simulates falling water. With a piece of this cut to fit the shape in your scene and pasted over it, the water will actually appear to flow. Other specialty motions that are available include rising vapor, sound impulses and explosion bursts.

One of the handiest polarizing aids is called linear motion material. This is polarizing film in narrow strips with the lines arranged alternately in such a way that they produce motion in a straight line—like the traveling lights on a theater marquee. If you paste strips of this around the edges of a title slide, you can create the effect of a theatrical sign with flashing lights. Two strips running in opposite directions will make the lights appear to



CRUMPLED CELLOPHANE combined with polarizing filter produces striking patterns of changing color. Bind a small piece of each together in a slide mount and insert with filter toward the projector lamp

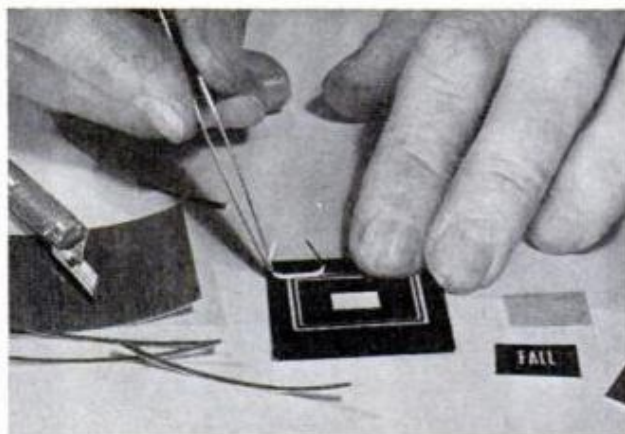

ADDING "MOVIE MARQUEE" BORDER around a title slide is done with narrow strips of linear motion material. Strips are self-sticking. You just peel off backing paper with tweezers and paste them on

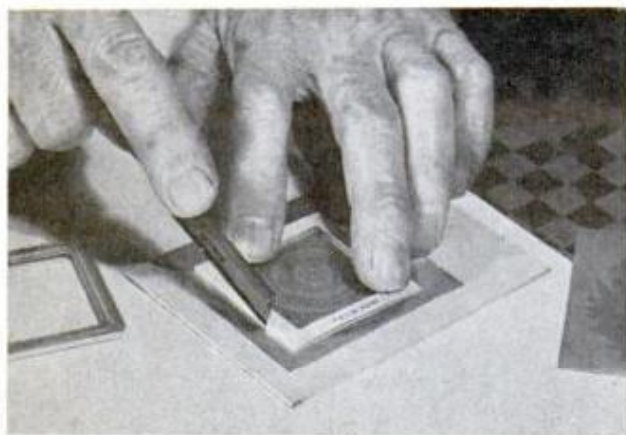

GEOMETRIC PATTERNS—here a whirling pinwheel—come in kit form in many designs to create exciting motion effects. Cut to fit in standard slide mounts, they contain their own polarizing material

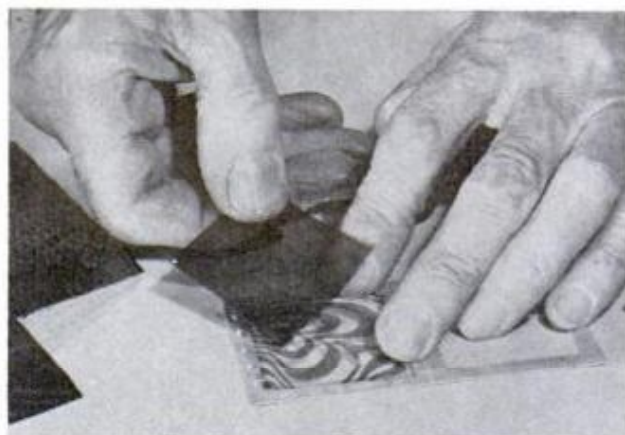

COMBINING A COLOR FILTER with a piece of geometric polarizing material can enhance effect you get. You simply sandwich the two together in a slide mount. The filters are available in many colors

SIX WAYS TO ASSEMBLE MOTION SLIDES

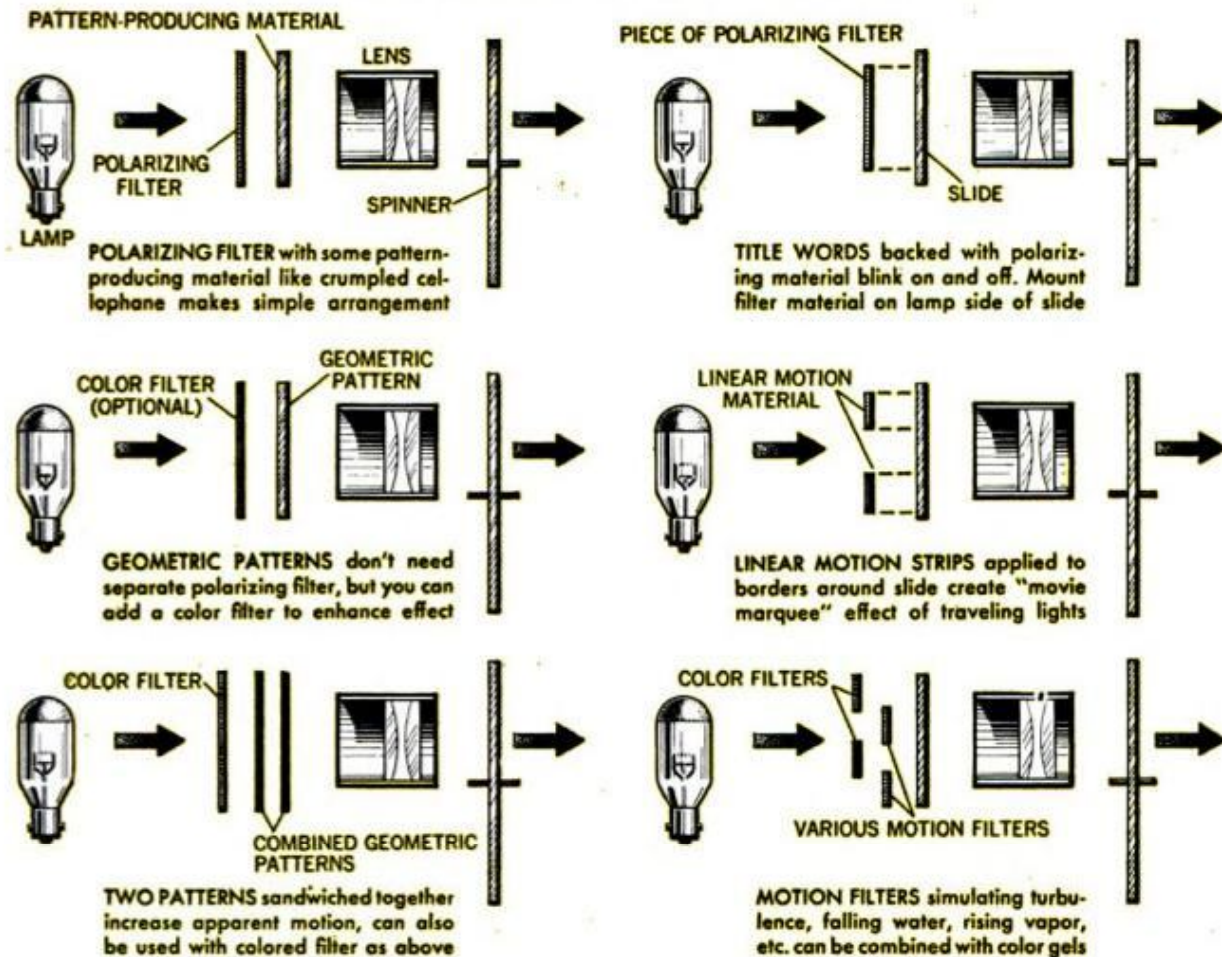

move both clockwise and counterclockwise at the same time. These border effects can be combined with other motions, such as alternately flashing title words. The result can be spectacularly impressive to an audience that has come expecting to watch "stills."

Polarizing filters in the form of geometric patterns are another way to pep up a slide show. In this case, the filters are used by themselves instead of being applied to an existing slide. You can intersperse them through your regular slides to add unusual touches. There are pinwheels that spin, checkerboard designs with shifting squares, exploding sunbursts and so on. The patterns come in sheets and are cut to fit in standard slide mounts. Often you can enhance the effect by combining a geometric pattern and colored filter. An-

(Please turn to page 227)

SPINNING COLOR WHEEL, set up in front of polarizer disc (top right), adds varicolored effects to simulated motion. Wheels are available in several sizes from Edmund Scientific for about \$15 to \$17



Turn That Camera Carton Into a Fancy Fitted Case



MOST NEW CAMERAS today come packed in handsome, contour-molded cushioning material to protect them from damage. These foam-plastic carton liners provide the perfect makings for a custom-fitted camera case. They'll not only keep your equipment in good condition, but will give it a neat appearance as well. In most cases, there are handy pockets for accessory items, or you can add your own cutouts with a knife.

The simplest way to make the case is to build it right around the liner instead of trying to fit the liner into it. You just glue strips of thin material directly to the plastic. Cover each half of the liner separately, then hinge the two together. The case shown here is made of scraps of 1/4-inch veneered plywood, but you could also use plain plywood or hardboard and paint it. Use white woodworking glue to fasten on the pieces, not a solvent cement that might melt the plastic.

Small hinges, catches and decorative metal corners are available at luggage and hardware stores. For a handle, you can use a door pull or a strip of leather. Luggage shops can usually supply metal anchor strips for strap handles. For easier carrying in the field, you might also want to add a shoulder strap. ★★★

SPRING CLAMPS temporarily hold strip of thin plywood against the plastic liner until the glue sets (bottom left). You could also use large rubber bands or string. Use butt joints for simplicity. Covering the exposed plywood edges with paint or stain will make them practically unnoticeable

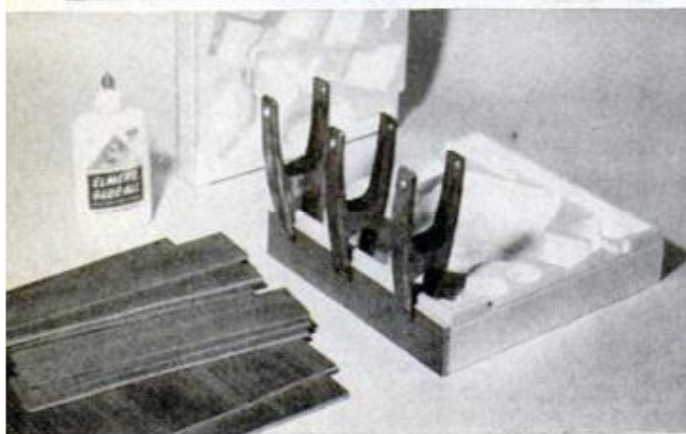
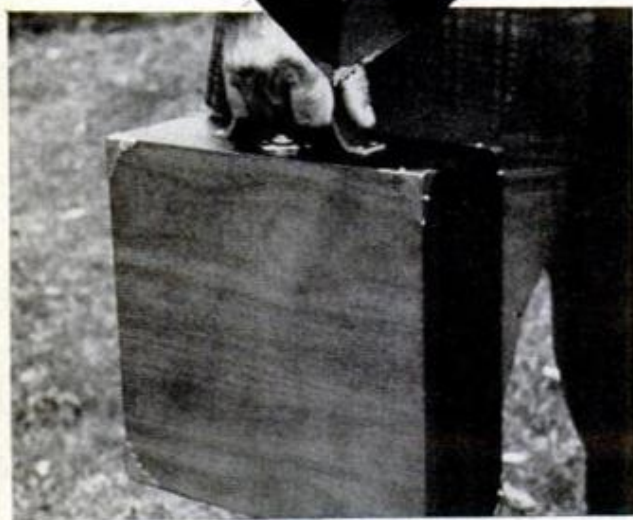

HINTS FROM READERS

Pulley pinch-hits for lathe dog

Lacking the right-size lathe dog for a special job, I used a pulley instead. A cast pulley with its projecting hub works best. Simply thread a shaft to fit the setscrew hole, then bend it to engage the slot in the lathe's faceplate. Clamp the pulley on the workpiece with the L-shape setscrew and lock the setup with a nut. Shims are inserted in the setscrew hole when necessary to bring the tail in line with the slot in the faceplate.—*Peter Legon*

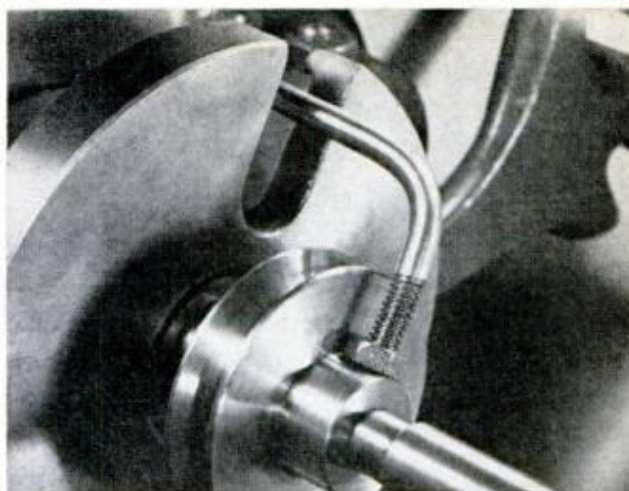

Quickie letter rack

In just minutes you can make a desktop rack for holding letters, cards and the like. Simply cut a piece of Styrofoam to desired size and push in several golf tees to form three rows paralleling the length of the plastic. For eye appeal, try using colored foam and tees of various colors.

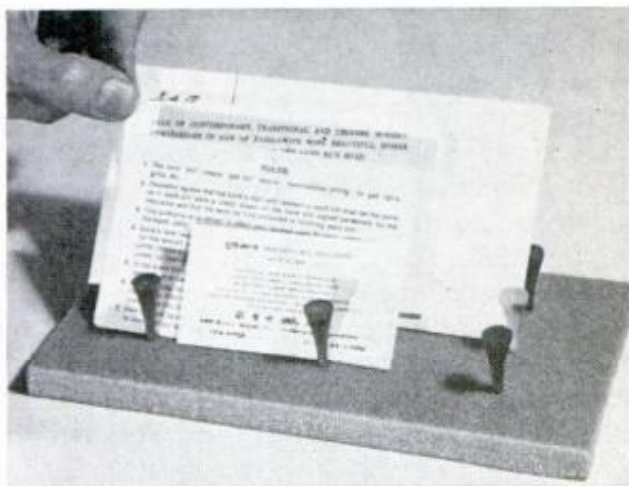

Tired tires put back to work

Recently, while using my portable saw to rip some large sheets of plywood at a friend's house, I was dismayed to learn that he didn't own a sawhorse. Then I hit upon the idea of spreading old tires about and placing the plywood on top. It actually works better than sawhorses, because you can kneel on the sheet and follow the cutting line clear across.—*Harold Miglin*

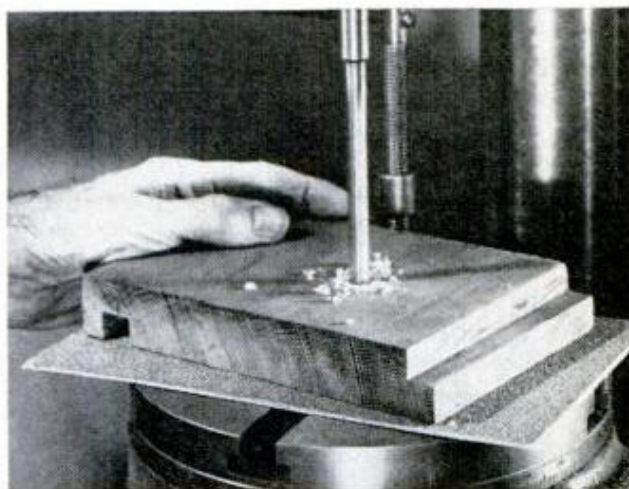

Holding drill-press work

A good stunt sometimes used to help hold wood or other material on a drill-press table is to glue two pieces of sandpaper back-to-back to form a nonskid insert between the work and table. Another good way to provide a means of keeping the work from whirling is to use a single sheet and attach a C-clamp as shown.

—*Walter E. Burton*

Mini-size work clamps

Don't let your wife throw away any earrings she no longer uses; they make dandy clamps when you're involved in modelmaking and other small projects. One type has a spring-action which lets you do fast, one-handed clamping. A second kind is the familiar threaded type which requires two hands to secure.

—*William Slamer*

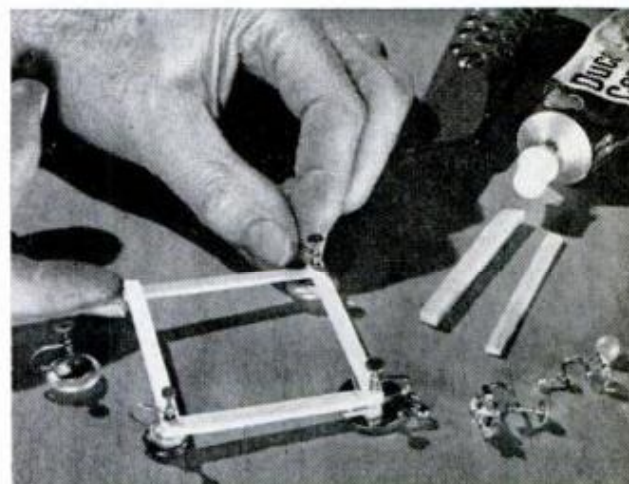

How to Do a Complete

THE TOOLS YOU'LL NEED for a brake job are not unique or expensive. A drum turning machine is an exception, but not all professionals have this large, expensive equipment on hand, either. You can do what they do: Take drums to a professional brake shop that has a machine.

Although all drum-brake setups are essentially the same—consisting of a wheel cylinder, shoes, springs and a drum—differences between them require that you have service instructions for yours. If you don't have these instructions in your car's service manual you can get other manuals for \$1 or \$2. They are published by manufacturers of brake replacement parts. Two especially good ones are the *Delco Moraine Drum Brake Service Manual for American Automobiles* (Delco Moraine Div., GM, Dayton, Ohio) and *Raybestos Brake Service Guide* (Raybestos Div., Raybestos-Manhattan, Inc., Bridgeport, Conn.). Order from the company's publications department.

First determine what tools you'll need. Some tools required to overhaul some systems may not be needed for another system. For example, take a wheel-cylinder hone that costs about \$8. One would think that all wheel cylinders are

overhauled in the same way, but such is not the case.

General Motors does not recommend honing of cylinders originally placed on its cars. Wheel cylinders used on Chrysler Corp. cars may or may not require honing, depending on the degree of damage. Honing of cylinders used on Ford Motor Co. and AMC products is required if damage is present.

As explained in *How to Do a Complete Brake System Checkout* (page 100, March PM), wheel cylinders should be repaired or replaced if fluid leaks out when you pull back the boots. Furthermore, it's a good idea to overhaul cylinders during a complete brake job. Wheel-cylinder overhaul kits are sold at auto supply stores.

Although you may determine that you can rebuild your wheel cylinders while they're on the car, it's better to remove cylinders and work on a bench. You can inspect and clean more thoroughly.

After disconnecting the brake line feeding the cylinder, place tape over the open end of the line to keep out dirt. Don't bend the line.

With the cylinder on the bench, pull off boots and discard them. Press out pistons, cups and expanders. Discard old parts that are duplicated by new parts in the rebuild

DISASSEMBLED WHEEL CYLINDER has these parts: external boots, pistons, cups and spring expanders



170

CROCUS CLOTH can be used to literally polish bore of wheel cylinder from GM car. Don't use pressure



POPULAR MECHANICS

Brake Job

By MORT SCHULTZ

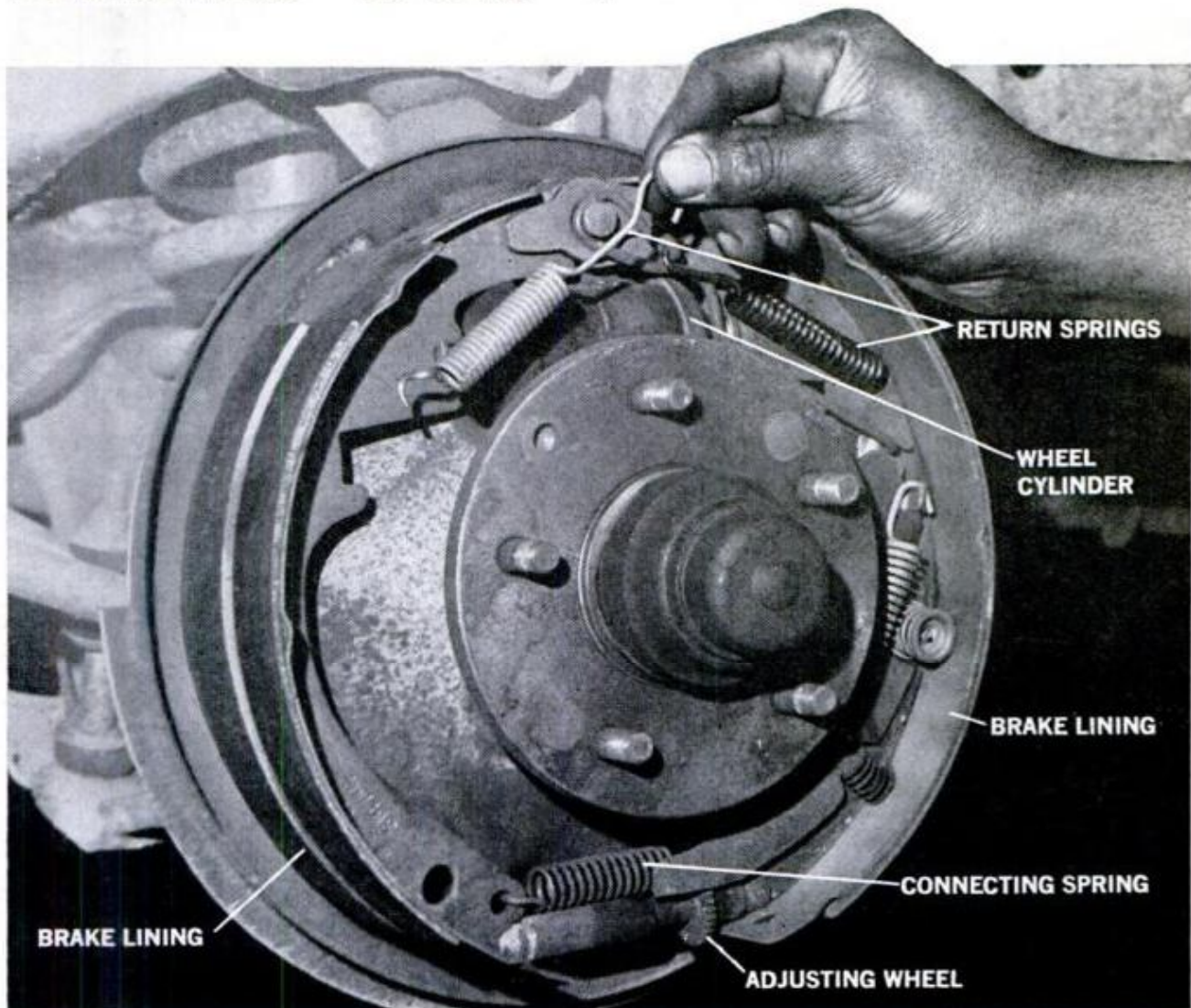

COMPONENTS OF TYPICAL DRUM BRAKE include hydraulic cylinder, springs, linings, "star-wheel" adjuster

kit. Parts generally retained are those made of metal.

Clean retained parts in fresh brake fluid or alcohol. Inspect them for scratches or corrosion. Be sure spring-expanders are not cracked or distorted. If you're working on cylinders off a GM car and you find that the bore is corroded, replace the entire cylinder. Corrosion will show up as pits or roughness in the metal.

If the cylinder is just stained, polish it with crocus cloth. Revolve the cylinder supported by your finger on the cloth. Don't use emery cloth or sandpaper, don't slide the cloth across the bore in a lengthwise manner, and don't use pressure. Clean the cylinder in brake fluid or alcohol after polishing.

Cylinders used in Chrysler Corp. cars can usually be cleaned with crocus cloth

if they have light scratches or show signs of corrosion. Use a circular motion. If cylinders have deep scratches or are scored, they can be honed. However, the diameter of the bore must not be increased by more than 0.002 in. If the cylinder doesn't clean up by then, replace it. To check the bore diameter, insert pistons into the bore. Use a brake or piston gauge, which has extra-long feelers, to check clearance between the piston and bore.

If cylinders of Ford Motor Co. and AMC cars are scored or rusted, hone the bore. However, don't increase the diameter of the bore by more than 0.003 in. Before inserting replacement parts into the bore, coat them with clean brake fluid. This acts as a lubricant.

When you inspect brake linings carefully they will often give a clue to defects

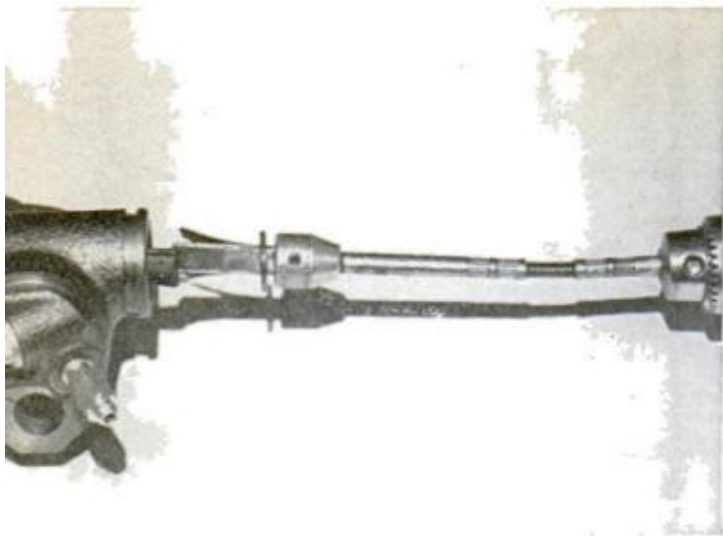

HONING a wheel cylinder removes scratches. Never remove more metal than is recommended (see text)

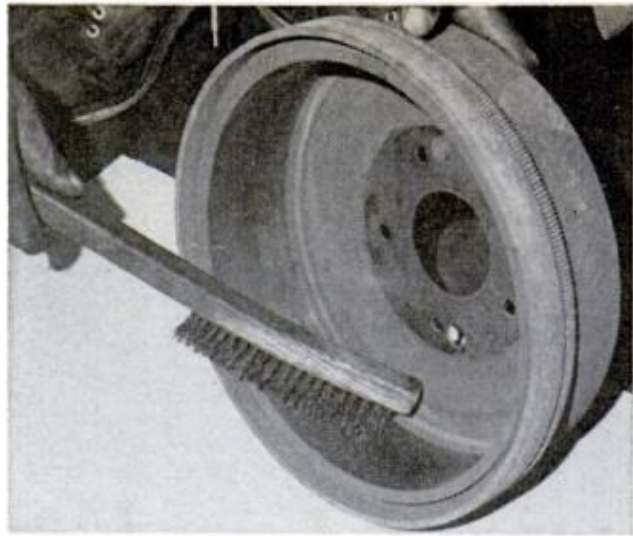

CLEANING BRAKE DRUM with wire brush is slow, but best way if you don't have compressed-air source

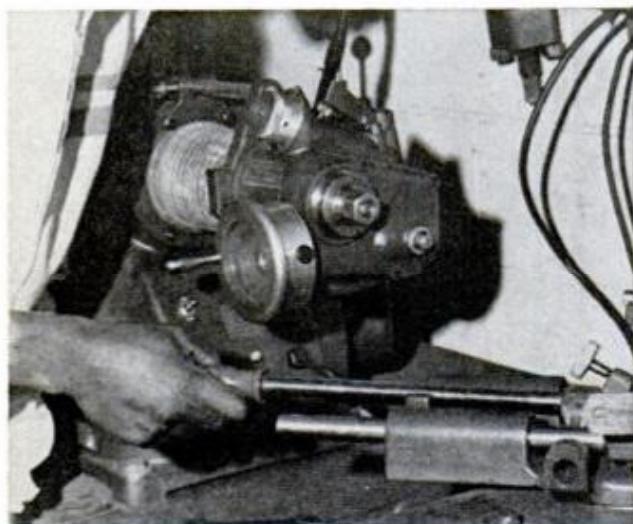

DRUM-TURNING MACHINE is professional equipment. Cost to turn one drum should be about \$2.50

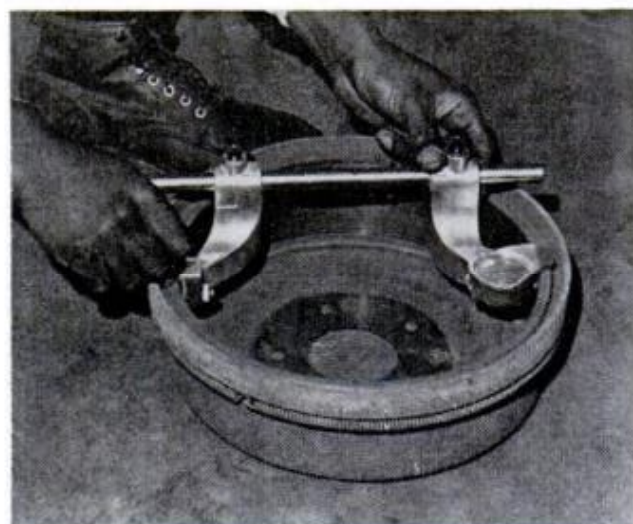

DRUM IS MIKED to check that metal isn't too thin, and to allow matching of new linings to the drum

in the brake drum. If linings of one wheel are worn more than the others, it often means a drum's surface is rough. Uneven wear from side to side on any one set of linings is caused by a tapered drum. Linings that are worn badly at toe or heel indicate an out-of-round drum.

Clean drums thoroughly. Use a stiff brush to remove hard deposits. Then clean the drum's surface with a non-oil-base solvent such as carburetor cleaner or lacquer thinner. If grease or oil is on the drum, find the source and fix the leak.

If a drum is cracked, it must be replaced. Don't attempt to weld it. Most surface defects, such as roughness and scoring, can be removed by having the drums turned. Go to a brake shop to have this done. Only a thin cut is usually necessary. After taking the cut, check the drum with a brake-drum micrometer. If the

maximum diameter reading exceeds a new drum's diameter by more than 0.060 in. (0.030 in. for Chrysler total-contact brakes), replace the drum. If drum metal is too thin, the drum will crack when it gets hot.

Also have the brake shop match the new linings to their respective drums. If linings don't come into full contact with their drums, braking will be difficult and linings will wear rapidly. To match linings to drum, the machine is set to the drum's micrometer reading. The lining is then ground down where necessary.

As you remove return springs from the backing plate, examine each carefully. Weak springs can cause drum scoring and excessive lining wear. Replace any spring that has lost tension, or is damaged.

Examine the raised shoe pads on the backing plate to make sure they're free of

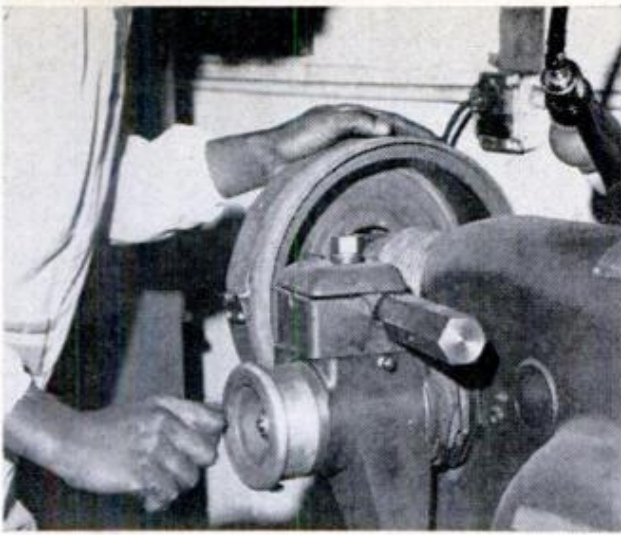

GRINDING BRAKE LINING removes high spots, and insures full contact with the drum for longer life

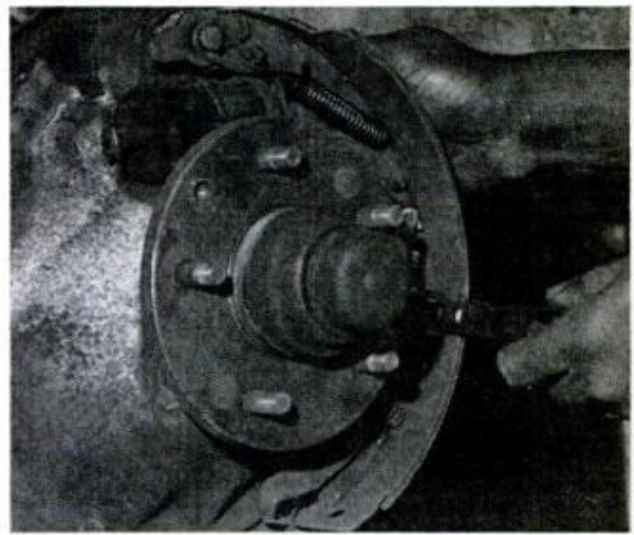

BACKING PLATE should be inspected for damage and then cleaned before you install new brake shoes

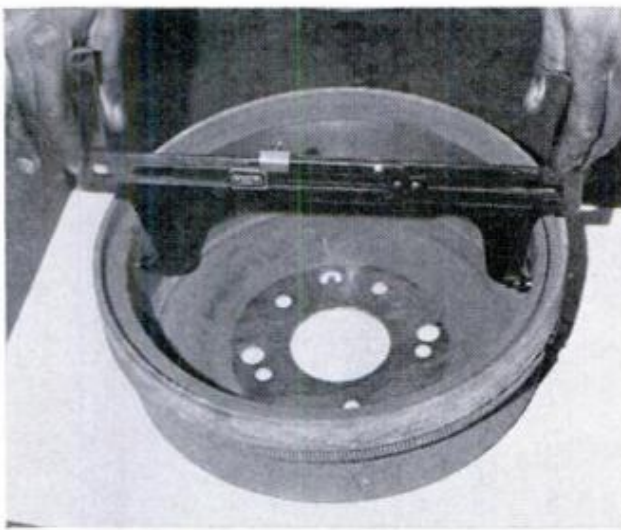

GAUGE METHOD of adjusting brakes is best way. Here, gauge is set to inside diameter of the drum

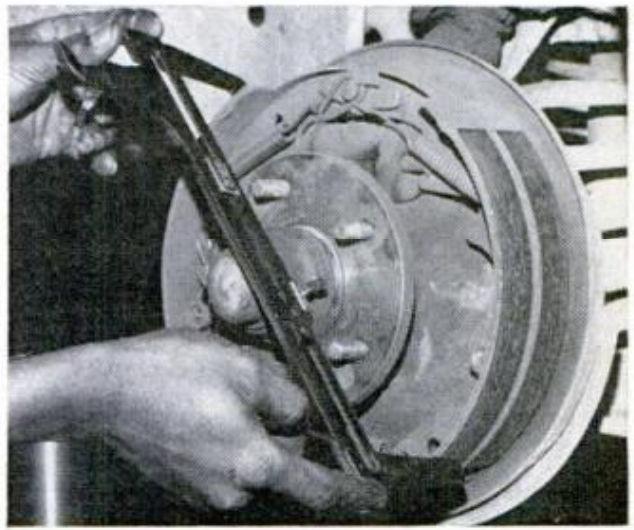

GAUGE IS THEN SET on the linings and heel-to-toe measurement is set by turning the wheel adjuster

corrosion and dirt that can prevent shoes from sliding freely. Use fine emery cloth to remove minor defects on the backing-plate surface.

When new shoes have been installed and the brake reassembled, it's important that brakes be properly adjusted. Adjustment of self-adjusting brakes, which have been in general use since 1963, is made easy and more accurate by using a brake shoe adjusting gauge. Set the tool to the inside diameter of the brake drum and tighten the lock screw.

Turn the tool over and fit it over the brake shoes. Expand the brake shoes by manually turning the star wheel until the gauge just slides over the linings. Rotate the gauge over the lining surface to assure that it has correct clearance from heel to toe.

If you don't have a gauge, adjustment

can be made on most cars with the brake drums installed. Remove the cover over the adjustment hole in the backing plate. On some GM cars, access to the star wheel is made through the drum rather than from the backing plate side.

Insert a star-wheel adjusting tool to engage the teeth of the star wheel. Expand brake shoes until a heavy drag is put on the wheel. Now, back off the star wheel until there is no drag. This takes about 30 notches of the wheel when adjusting Delco brakes, and about 20 notches when adjusting Bendix and Wagner brakes.

After making the adjustment, apply firm pressure to the brake pedal to be sure there's adequate pedal to allow you to drive the car. Now, make a number of alternate reverse and forward stops in order to bring your pedal reserve up to normal. ★★★

EXCITING NEW PRODUCTS

By CATHERINE BILSKI

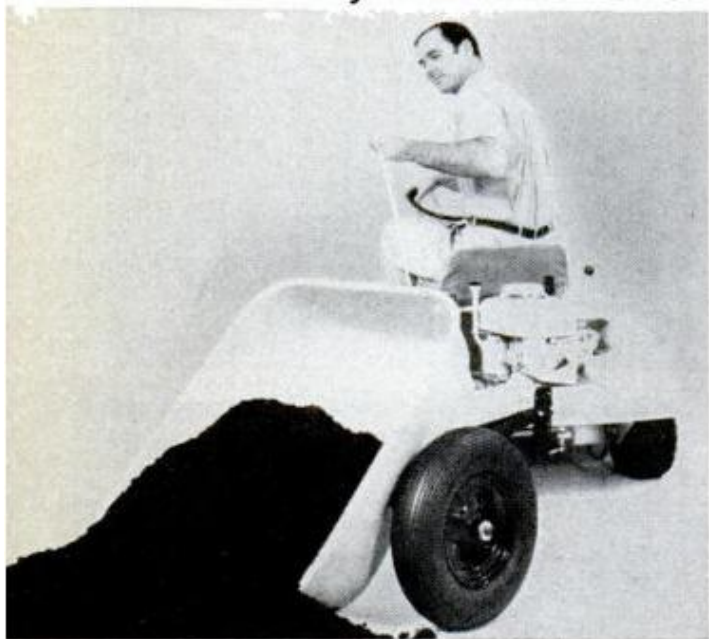

WORKHORSE DUMP TRAILER for garden tractors holds whopping $5\frac{3}{4}$ cu. ft. of sand or dirt. It features one-piece seamless tray, a hitch which is adjustable to six different heights and a latch that releases and catches simply by pulling cord from driver's seat. Dumps automatically and rolls on two rugged 16-in. ball-bearing wheels. Knocked down, sells for \$40. Made by Radio Steel & Manufacturing Co., 6515 W. Grand, Chicago, Ill.

OWNERS OF TRAVEL TRAILERS, truck campers, motor homes, cars, trucks and boats can stay cool in the summer and warm in the winter with the help of a new 12-v. oscillating fan from Kenco Engineering Co., Box 316, Middlebury, Ind. 46540. The fan features 90° side-to-side movement that keeps air on the move in close quarters. The compact fan sells for \$24.95. A remote on-off switch is available for an additional 98 cents.

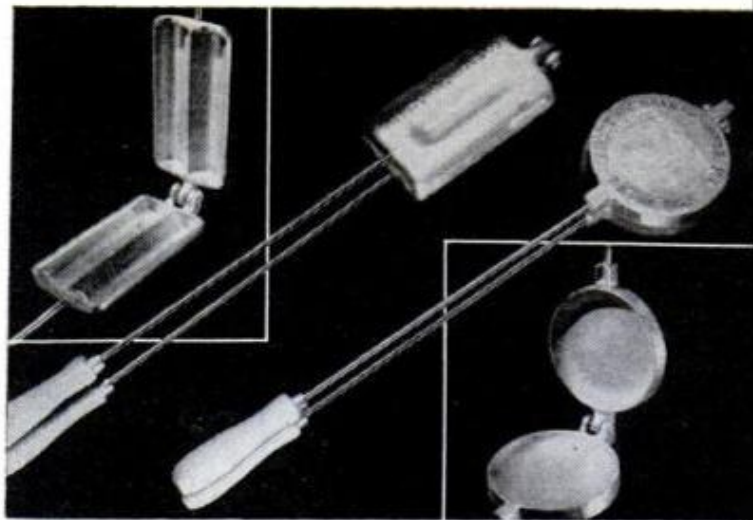

ENJOY CAMPFIRE SNACKS in one minute with either the Minute Pie Mold or Wiener Mold. Use either of these molds in the campfire, on the stove at home, over charcoal or in your fireplace. Just heat the mold, butter the interior surfaces, put in the bread and filling, then heat. Priced at \$4.95 each, post-paid from Minute Pie Mold Co., Box 9221, Cleveland, Ohio 44138.

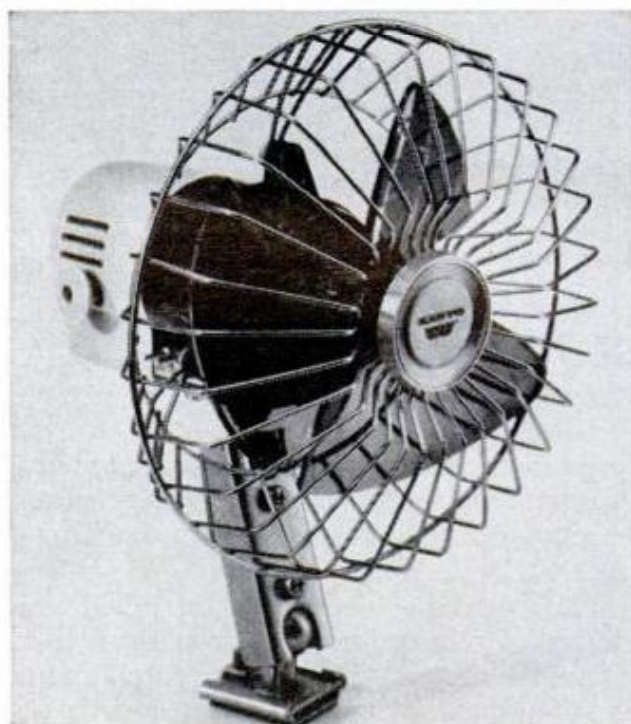

ALL-PURPOSE SILICONE SEAL comes in a new 12-oz. cartridge-size that fits all standard caulking guns. Permanently flexible sealer can be used to mend fabrics and mount objects, also as a permanent caulk for gutters, windshields and in the joints between bathtub and tiles. Available clear or mildew-resistant white, the sealer is sold through hardware and department stores for \$1.98. It's made by General Electric Wiring Service Dept., Providence, R. I. 02907.



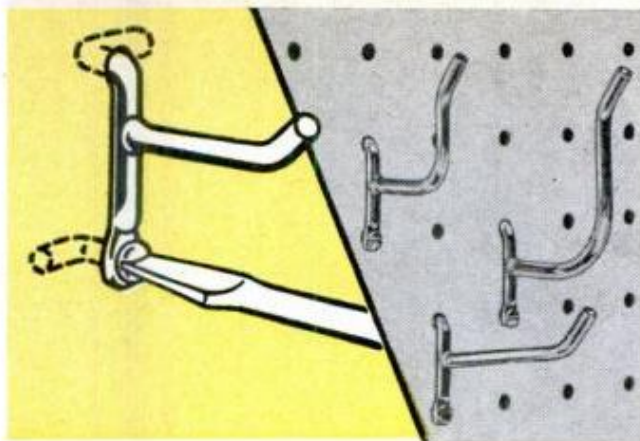

PERFORATED BOARD HOOKS that stay put when you remove a tool, called Hugger Hooks, are made by Roman Products, Box 891, Dept. PM, Golden, Colo. 80401. Positive locking units not only prevent accidental hook fall-out, but let you keep your storage or toolboard unmarred after resetting the hooks. Pack of eight hooks, in $\frac{1}{8}$ or $\frac{1}{4}$ -inch size, sells for \$1.



PROTECT YOUR HOME against forced entry through your sliding doors with the Dalton Katy-Bar. It fits all sliding glass doors and is adjustable from 27 to 48 inches wide. A twist of the wrist locks the telescoping bar at the length required. Adjustable feature allows door to be opened partially for ventilation and still be locked. Made of rustproof aluminum tubing, bar retails for \$4.50 from Dalton Manufacturing Co., 30 S. Central Ave., St. Louis, Mo. 63105.

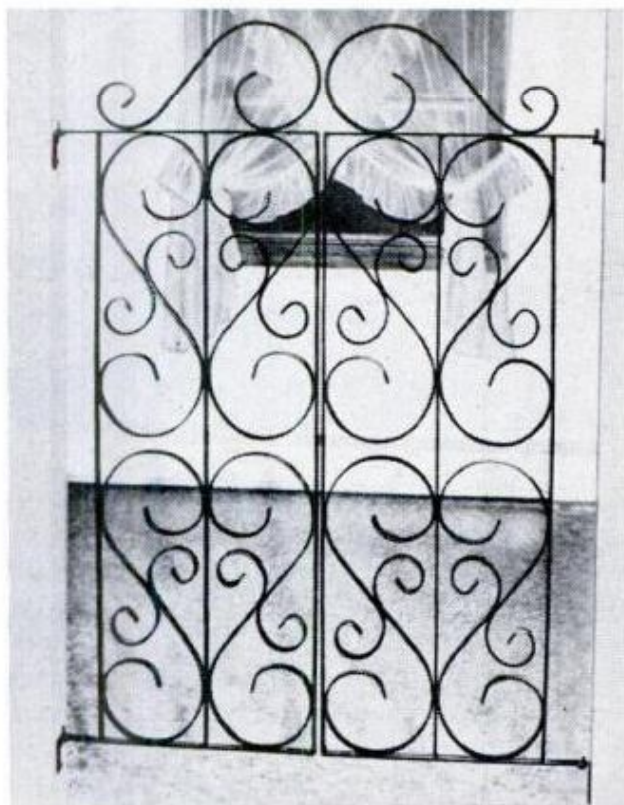

ADD DISTINCTION to the open entryways in your home with wrought-iron cafe doors. They feature a decorator-styled, multiple-scroll design which complements most interior decors. The doors are 48 inches high and will fit doorway widths of 30 to 36 inches. Ideal for entrances to dining room, den, recreation room or as a divider for your kitchen and serving areas. Priced under \$30 and manufactured by Versa Products Co., 2872 W. Market St., Akron, Ohio 44313.

INCREASE THE LIFE of your car's battery and save on maintenance costs with a unique vinyl battery accessory called Battery Savers. The Savers fit all standard battery posts and help prevent corrosion formation. Their honeycomb-core construction suspends standard motor oil and provides a continuous flow of anticorrosive oil by capillary action to area between cable clamp and battery post. Set of two \$1 post-paid from Jacqueline Todd Mail Order, 53 Mondview, Jackson, Tenn. 38301.

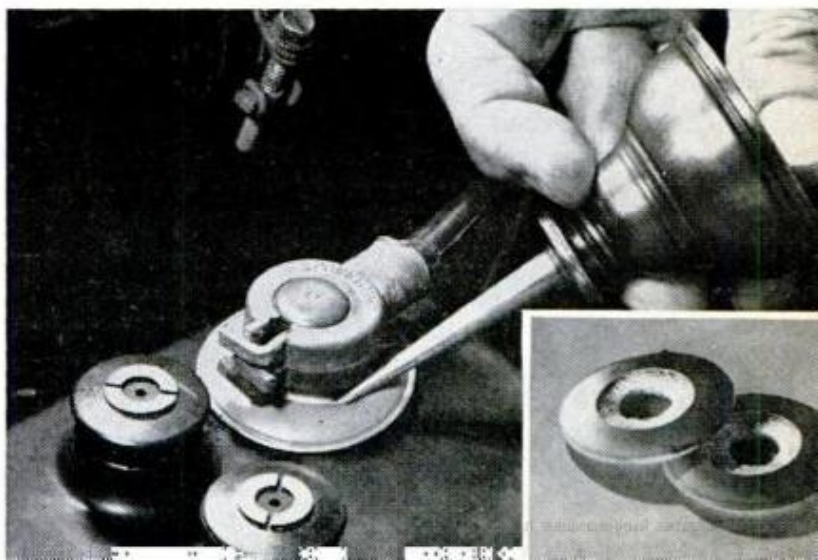

You Can Build A Spillproof Canoe

By GEORGE DANIELS

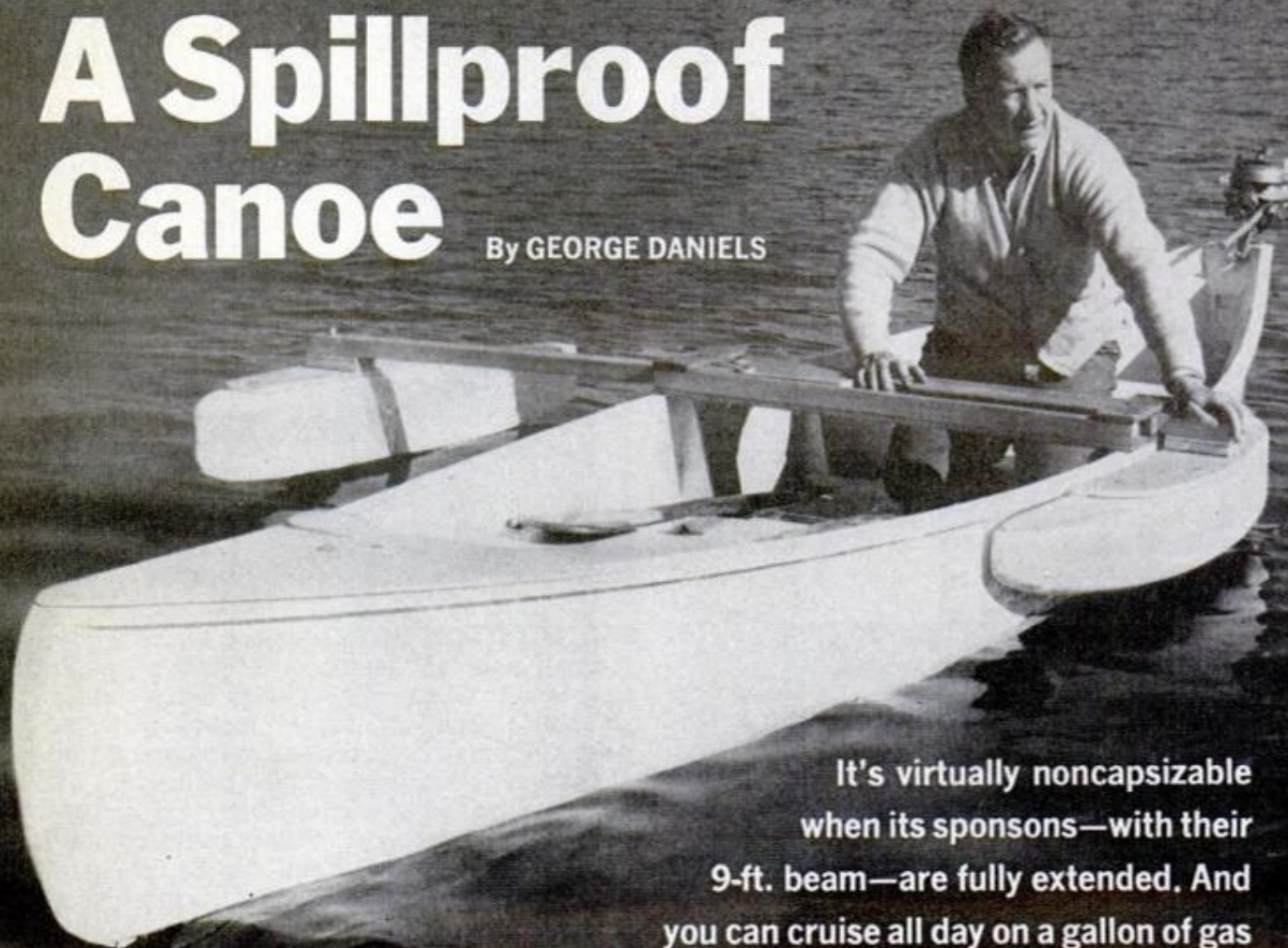

It's virtually noncapsizable when its sponsons—with their 9-ft. beam—are fully extended. And you can cruise all day on a gallon of gas

BUILD THIS CANOE and you will be able to do things you wouldn't dare to attempt with an ordinary one. With sponsons extended full-out, this version lets you stand up to cast a fishing line (or stretch your legs), hang a swimming ladder over the side on the gunwale and swim wherever you choose to anchor. You can take your youngsters out canoeing without the slightest fear of a spill.

Paddling is a breeze. The sponson-pon-toons create no drag whatever as they never touch the water when you're on an even keel. And, when fitted with even the smallest outboard, you'll have full design speed. I've tried motors up to 4 hp, but our 1/8-hp Mighty Mite drives the craft about as fast, and costs only pennies to run.

It's easier to build than most small boats for several good reasons. First, there are no sharp bends or twists in the hull, just gentle curves that stock materi-

als can make without forcing or soaking. Second, your lumberyard can save you work by cutting the 16-in.-wide side planking strips for you. And finally, a time-honored boatbuilding method, brought up-to-date, practically eliminates the chance of a foul-up. The natural bend of a chine is your guide in marking the shape of the hull. Most parts take their form by being fitted on the spot.

Four panels of 1/4-in. exterior plywood, a short list of stock lumber and a quart and a half of Weldwood resorcinol resin glue are all it takes. The glue gives the hull much of its strength and rigidity, so don't build without it.

To start, butt two plywood panels and use scrap wood and some brads to join them temporarily. Then bend one of the chines around blocks on the plywood as shown and mark along the outside of the curve. Cut along the line and use the cut-

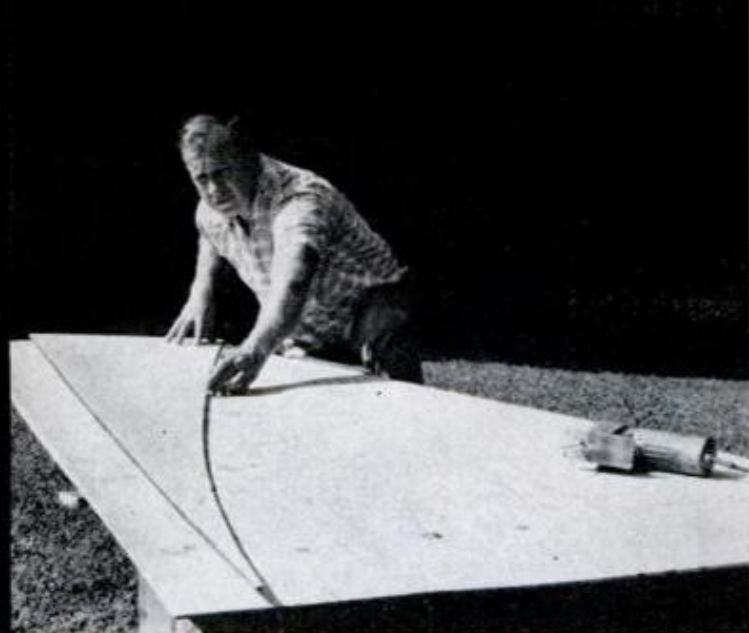

FIRST STEP. Brad two plywood panels together, flex chine in position and draw hull outline with a pencil



REST BOTTOM PANELS (still joined) on raised surface; glue and nail chines in place along edges

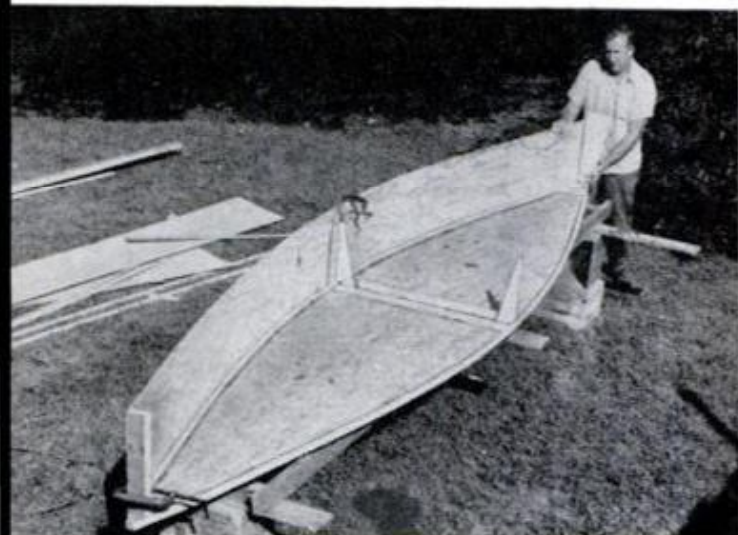

MOUNT SIDE PLANKING DRY, using clamps so glue areas can be pencil-marked. Remove and apply glue

off pieces as templates to mark the cuts on the other side.

Place the cut-out bottom panels on a rigid *raised* support and fasten the chines in place along the edges with glue and 1½-in. finishing nails driven down through the chines into the plywood. Coat both meeting surfaces (chine and plywood) with glue. If dry areas appear before the parts are assembled, apply additional glue. Leave the nailheads slightly above the surface for pulling later. (You fill the nail holes with glue.) Later, when the boat is inverted, "buck" the plywood with another hammer under each location where a nail is being driven, 24 in. apart.

With both chines in place, center the butt piece across the mid-seam between the bottom panels. Mark its position on the bottom, coat both meeting surfaces

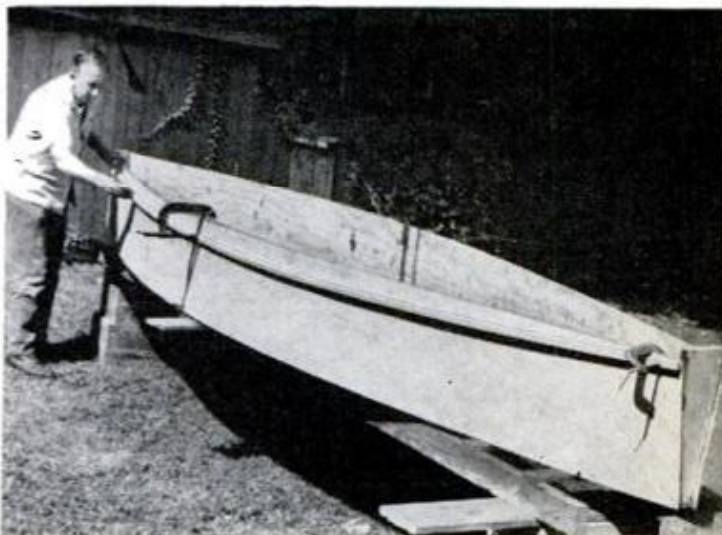

CLAMP THE RUBRAILS 1 ft. above bottom at mid-frame, 16 in. above bottom at stem and transom

with glue and fasten it in place with brads or ½-in. No. 6 flathead brass screws, spaced as needed for thorough contact. (Brads may be pulled or clinched after the glue sets.) Be sure the butt piece fits snugly at the chines.

Join the side planking sections in the same manner, with glued and bradded (or screwed) butt pieces. Next, assemble and glue the midframe. I found that mixing a half pint of glue at a time usually worked well. Also I kept the glue pot in a bowl of cracked ice to stretch out its working time. Keep the glue components handy for extra batches as needed. When bottom, sides and mid-frame have been completed, set them aside to glue-harden overnight at 70° or more.

Next day, use a coarse disc sander to remove any hardened glue squeezed out

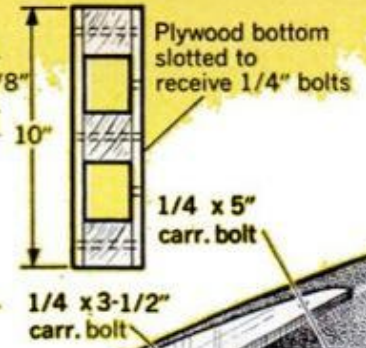
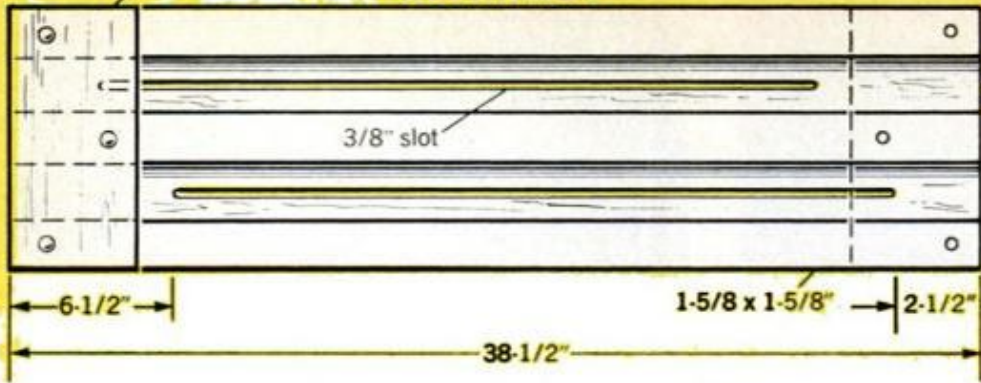

HULL FRAMES

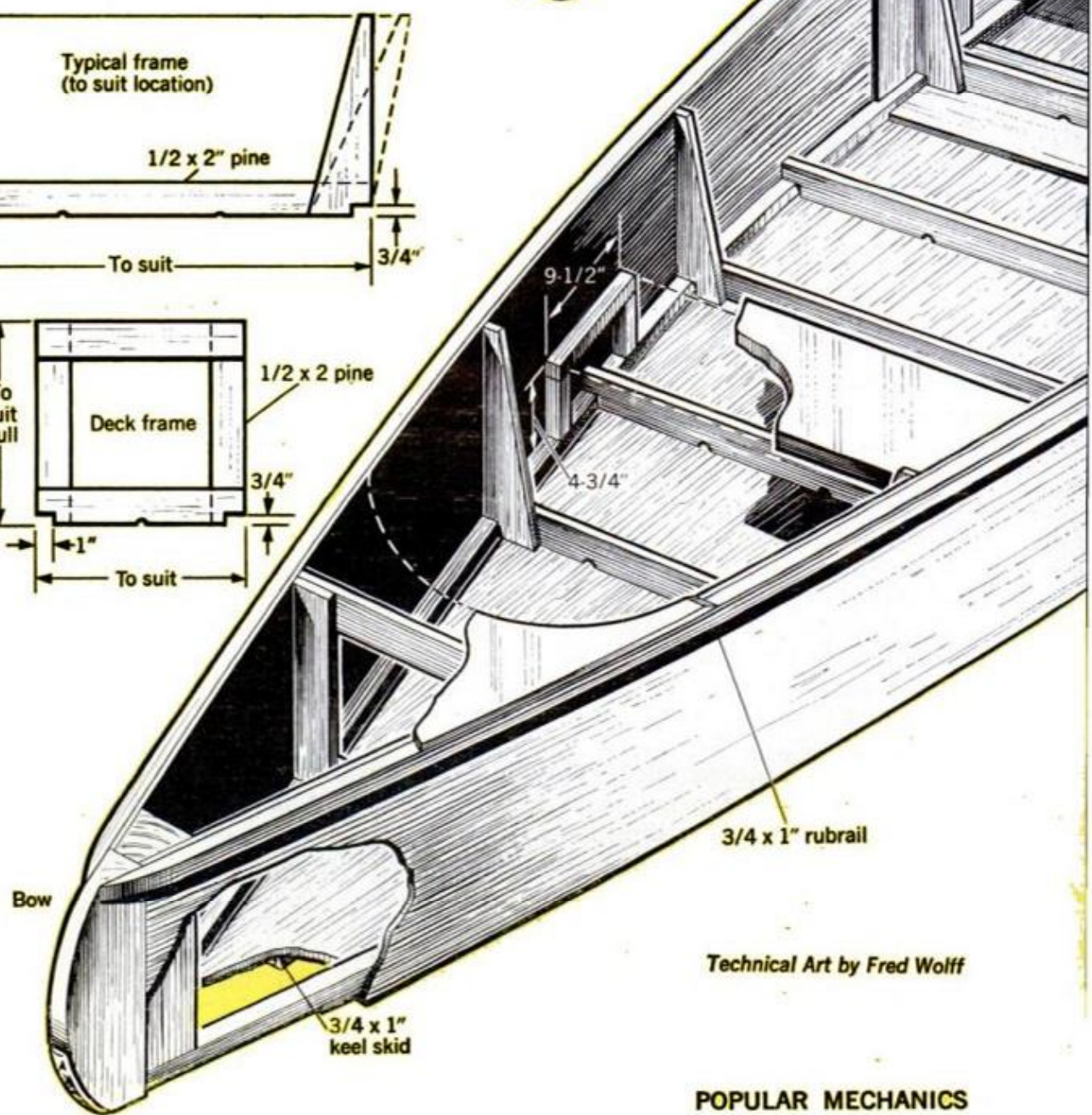
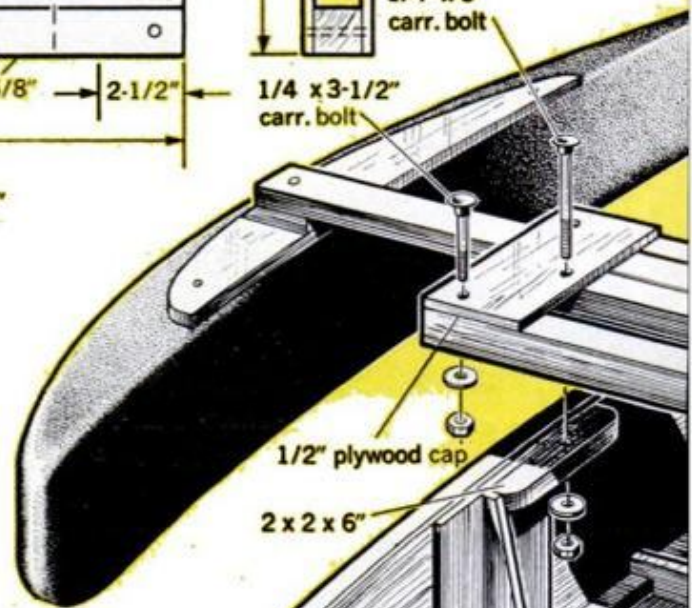
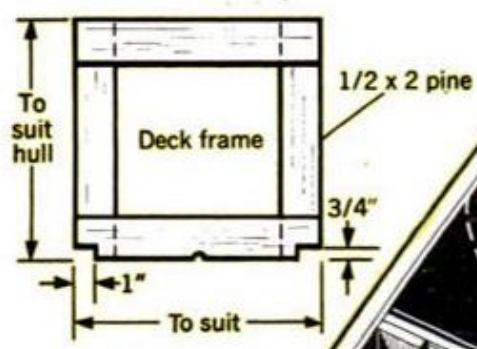
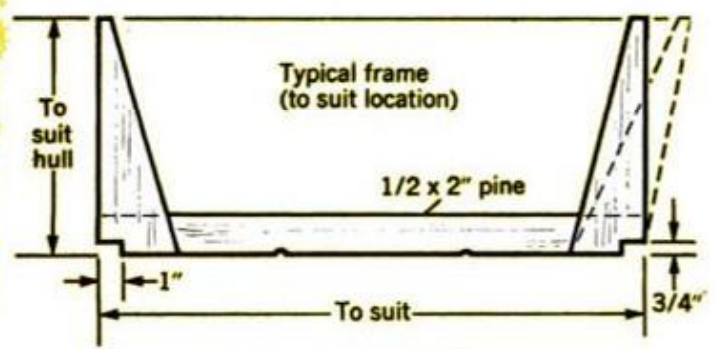
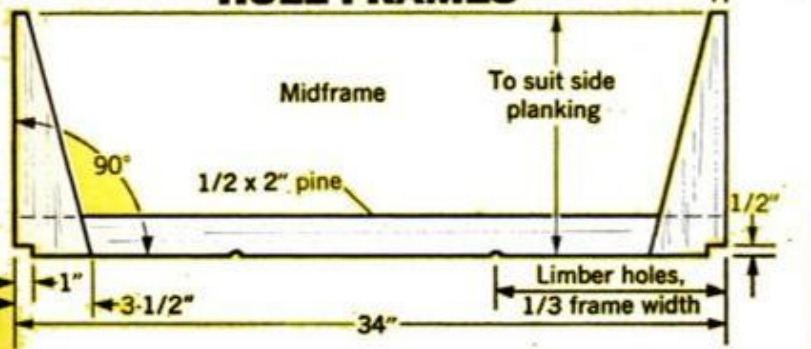

Technical Art by Fred Wolff

Pontoon Canoe

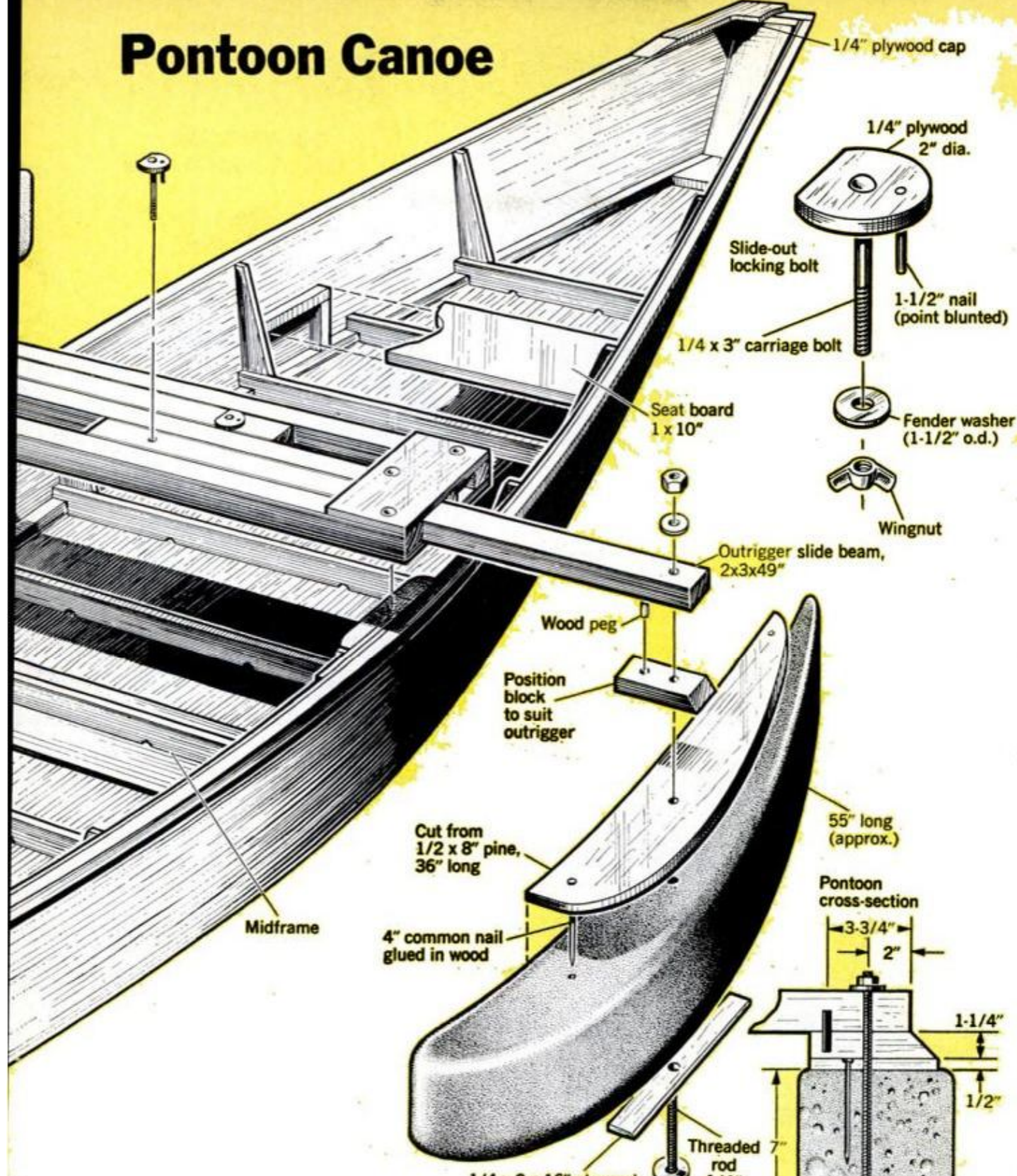

FRAME LOCATIONS

All frames 2' apart o.c. measured from midframe to bow and stern

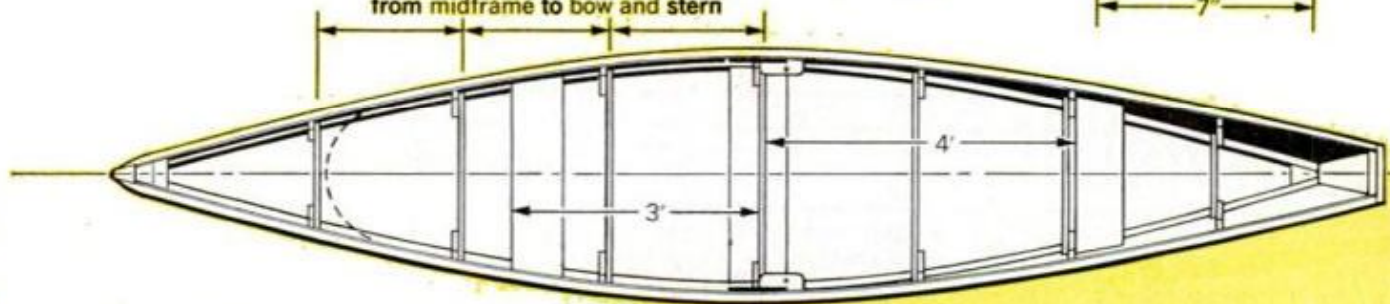

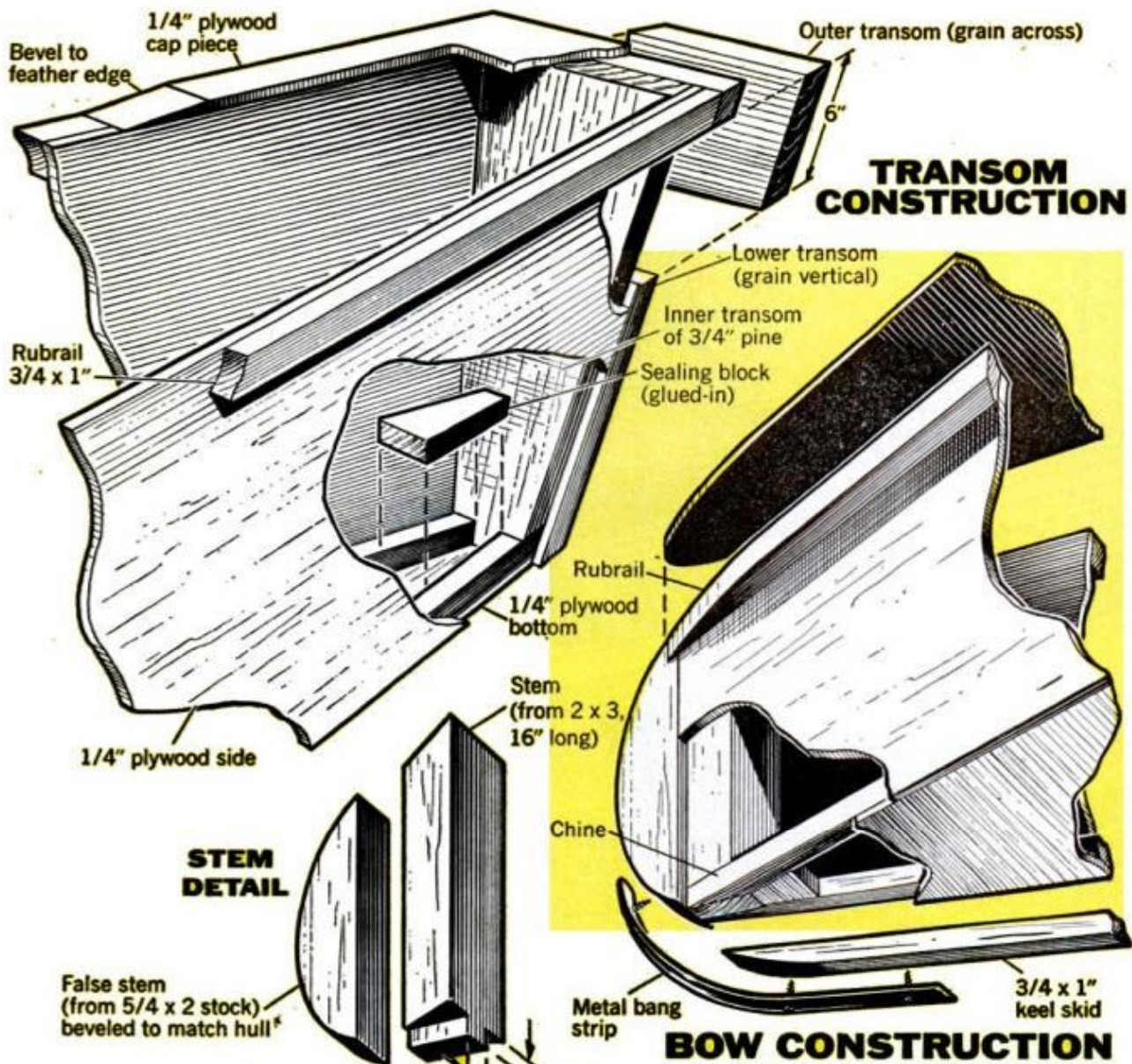

HOW TO FAIR BOTTOM AND SIDES

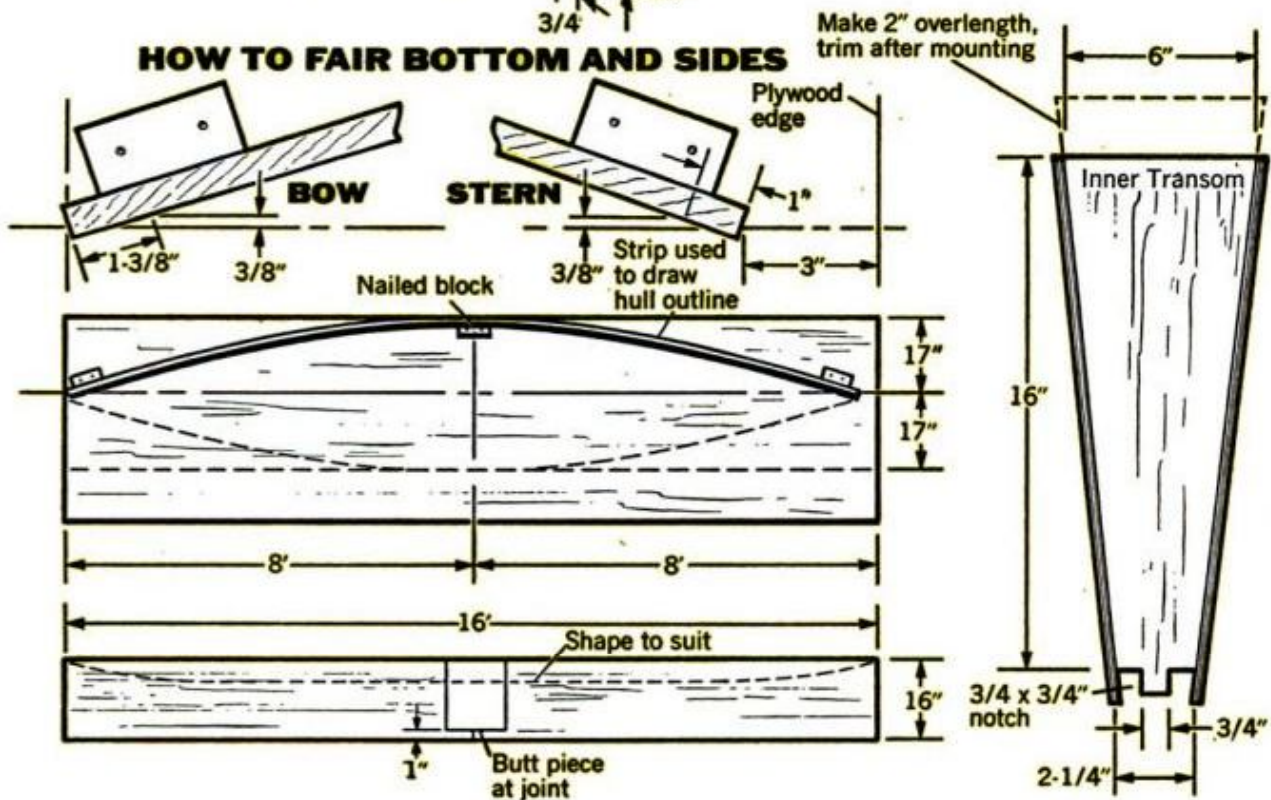

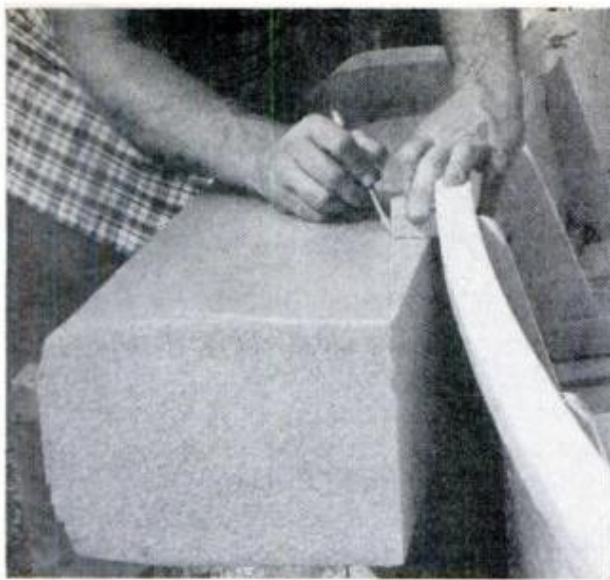

TO MAKE SPONSON, rest foam block beside hull, use a block of wood and pencil to scribe the curve

FINAL STEP in building the canoe is installation of seats (right). Paint craft in colors of your choice



along the chine edges of the bottom, and at any other points where it might interfere with subsequent fitting.

Assemble stem, mid-frame, transom and side planking on the bottom temporarily for marking all gluing areas (for coating later). Then disassemble. Remount the stem and transom with glue and a single 1½-in. finishing nail driven up through the bottom into each. Remount the mid-frame with glue and brads toenailed through it into the bottom. Then attach the sides, one at a time, with glue and brads. (These brads are left in.) The side planking should be flush with the bottom at the midpoint. It will protrude slightly below the bottom toward the ends, to be trimmed later. In bradding, work outward from midpoint toward the ends.

When both sides are attached, clamp on one rubrail. Pencil-mark the plywood along the rubrail's upper surface. Then take the rubrail off and sabre-saw along the line to remove the section above it. Use this section as a template to mark the other side for cutting. After cutting the second side, glue and brad both rubrails in place, using clamps at ends if needed.

The rest of the frames should now be fitted on the job, cut to size and assembled and mounted with glue and brads. Seats, foredeck, sealer blocks and all other parts are also fitted and glued in place. To avoid loosening freshly glued joints, the assembly is left to glue-harden overnight. When dry, turn the canoe over, glue on the

keel-skid and trim the bottom edges of the side planking. The rest is merely a matter of sanding and finishing. Plywood leftovers are used for the floor.

To make the sponson-pontoons, cut a Styrofoam billet (7x20x108 in.) to half length, then saw down the centerline. This provides two 7x10x54-in. blocks which are then shaped and fitted to the contour. (Many boatyards will sell half a billet.) The centerline cut is made with a coarse rip saw, curved cuts with a keyhole saw. Final shaping is with a rasp. To protect the completed pontoons from waterborne gas and oil (which can damage Styrofoam) give them two coats of a water-mix-type exterior house paint. (Never use oil paint directly on Styrofoam; it breaks down the foam.) After drying, this can be followed with a quick-drying enamel. To finish the main hull, I used two coats of Save-Cote.

The sponson slide-out unit is made of fir guides on a ½-in., sheathing-grade plywood base. To assure free sliding, set all parts, including beams, in place with cardboard shims between them when drilling the bolt holes before gluing. Use thin wood shims between the end cap pieces and the 2x2s (but not across the space between them) when gluing. The clearance thus allowed provides easy action after the finish is applied. When retracted, the sponsons should fit snugly under the rubrail. If too low, trim down the block on the pontoon. If too high, glue a wood shim on the block. ★★★

Four Projects You Can

Modern Lamp Base

CONSISTING of a center block of scrap wood faced on two sides with pieces of teak and covered in the middle with a strip of simulated vinyl leather, this smart lamp base is not only good looking but exceptionally simple to make.

The center block extends to form a recessed base that is later covered with a strip of gold metallized tape. The bottom edges of the teak sides are mitered 45° to accept mitered fill-in strips of the same wood and same thickness.

Make a central hole through the block for a 3-in. length of 1/2-in. threaded brass tube and a length of lamp cord. The V-cut in the end of the tube lets you drive it in tightly.

Finish the teak parts first, then cement the vinyl in place with contact cement. The vinyl should actually be applied before you drive the brass tube in place. Drill a hole in from the side for the lamp cord and add felt to the bottom to prevent marring polished surfaces.—Kenneth Wells

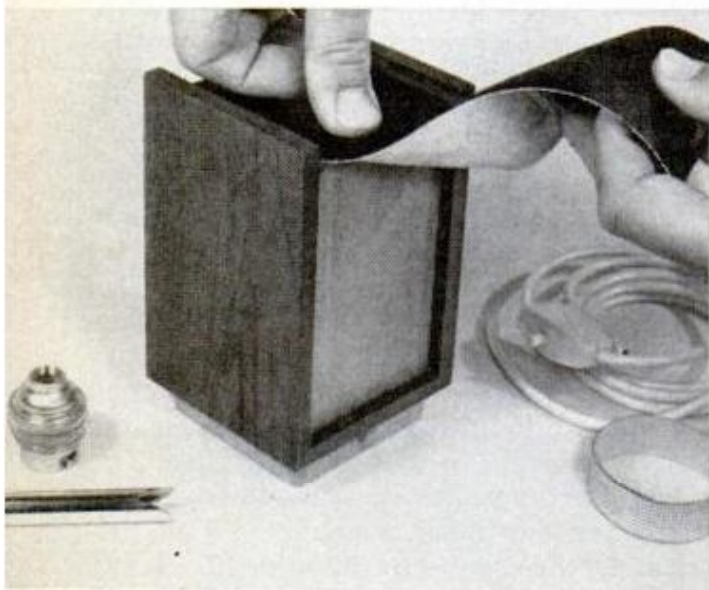
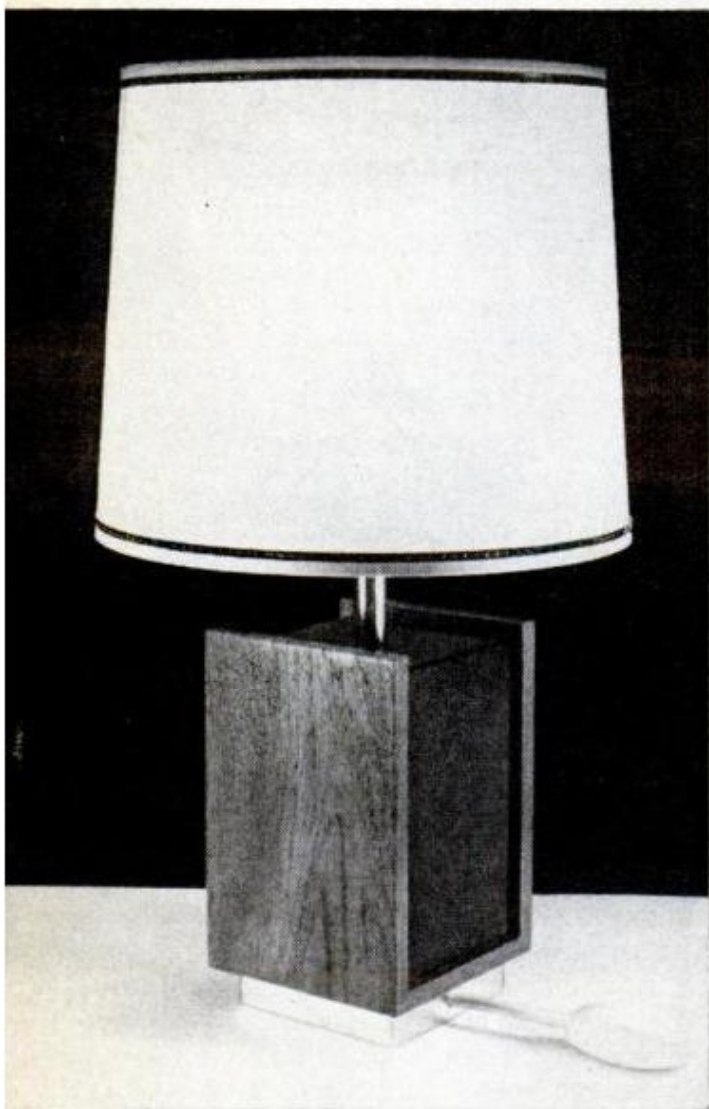

AFTER COATING both center block and vinyl with a pressure-sensitive adhesive and allowing it to set for 10 minutes apply vinyl between the teak sides

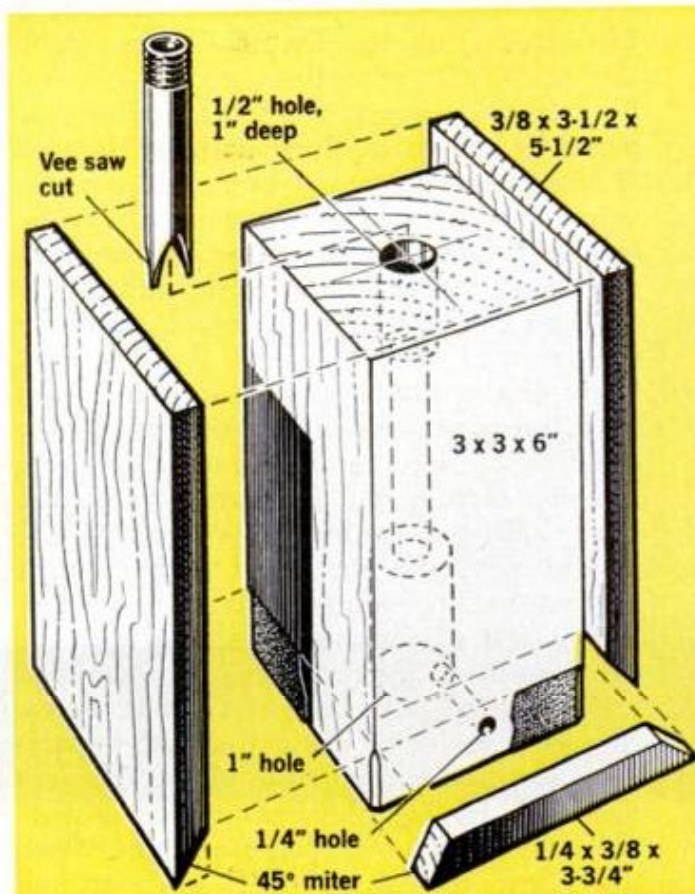

Finish in a Weekend

Bootjack Bookrack

USED BY COWHANDS to help remove their boots, the lowly bootjack with slight modifications makes a unique conversation piece when used as a bookrack.

By adding an endpiece and reducing it in size, the bootjack detailed below will hold a half-dozen books.

It's about as simple as can be, requiring only three parts. The V-notched piece is dadoed top and bottom for the $\frac{3}{4}$ -in. endpiece and foot. If you make it of wal-

nut, finishing is made easier when it's done before final assembly. This way you'll do a better job of filling the open grain with paste filler, and you'll not risk "sealing" the wood at the joints with glue so it won't take stain evenly.—Harold Jackson



SLANTING BASE makes the books lean and stand upright against endpiece.

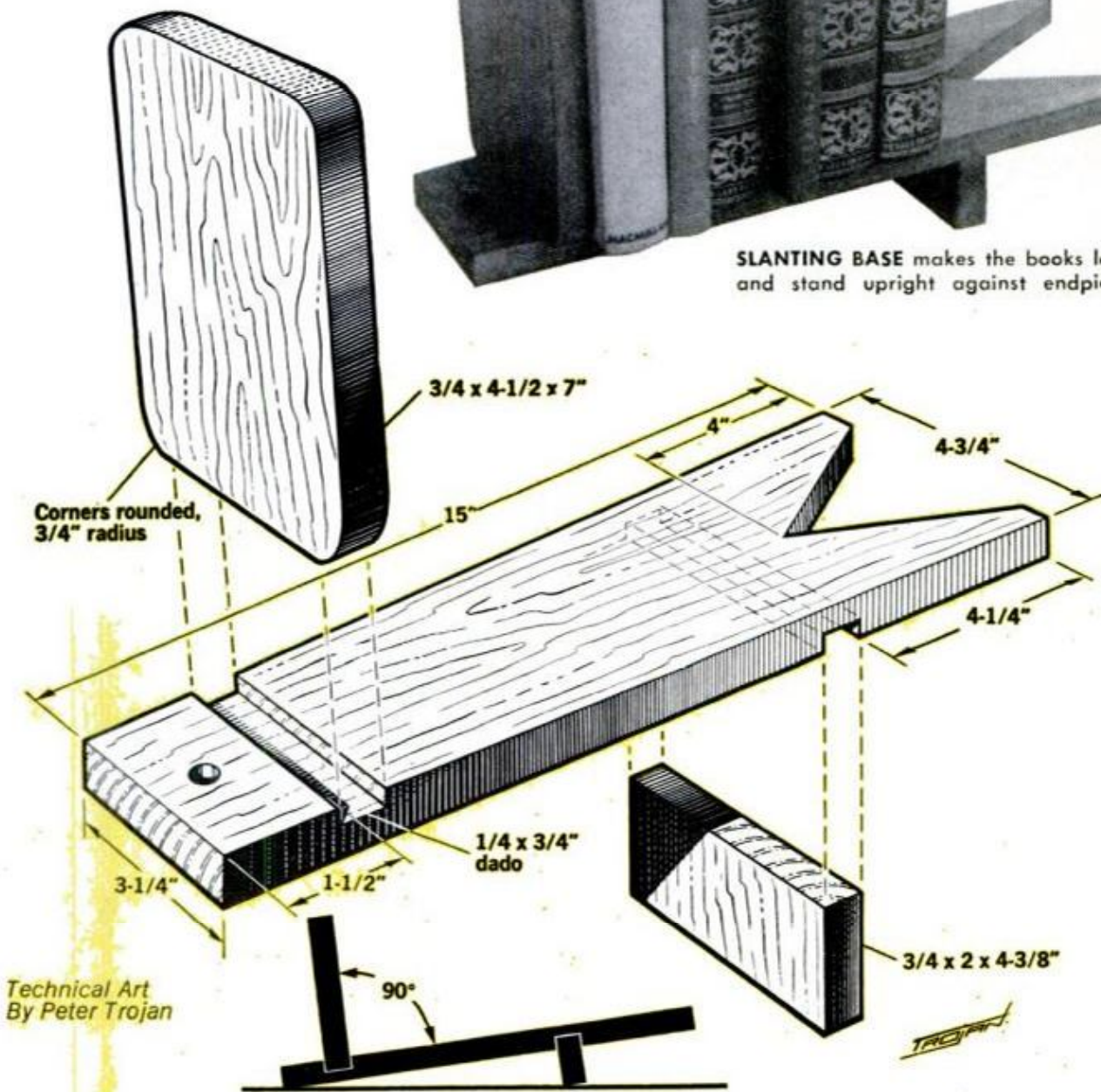

Armrest Tote Box

FAR HANDIER to the driver than the car's out-of-the-way glove compartment, this front-seat storage box serves also as a comfortable armrest when placed between the driver and passenger. Its double compartment offers roomy storage for countless items which the average glove compartment won't begin to hold. Best of all, they're all within easy reach.

The box hooks to the seat by a wire bail that tucks under the cushion, and its separate forward compartment keeps cigarettes, toll coins and the like handy.

It's made of 1/8-in. plywood or other thin material, glued together and reinforced on the inside with triangular corner cleats. The bottom is supported by a 3/4-in.-wide frame, and strips of thin plastic cemented to the top of the box hold the lids in place.—Hi Sibley

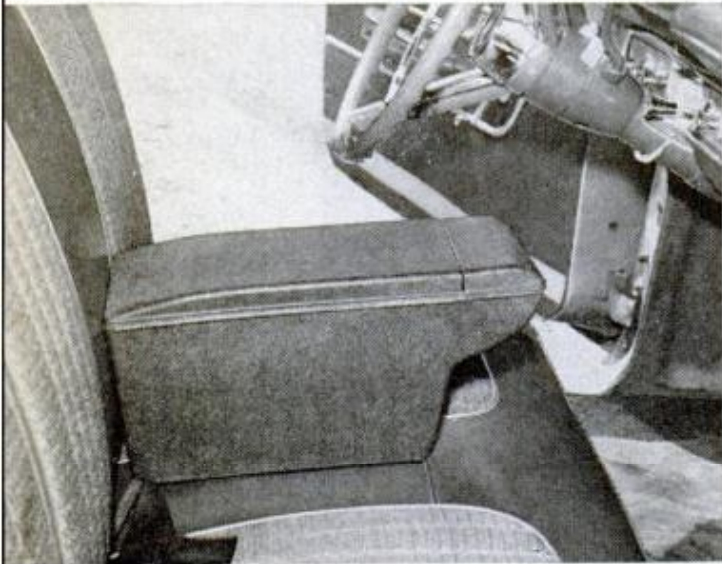

MATCHING VINYL COVERING makes box look like part of car. Hook under cushion holds the box in place

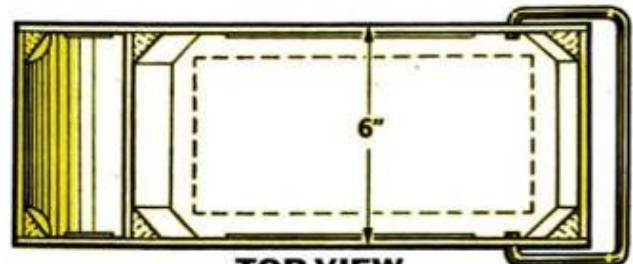

**TOP VIEW
WITHOUT COVERS**

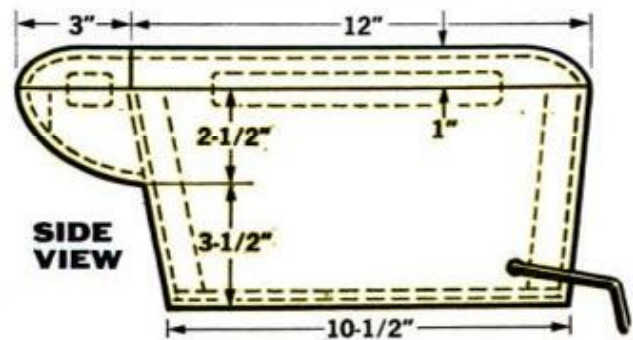

SIDE VIEW

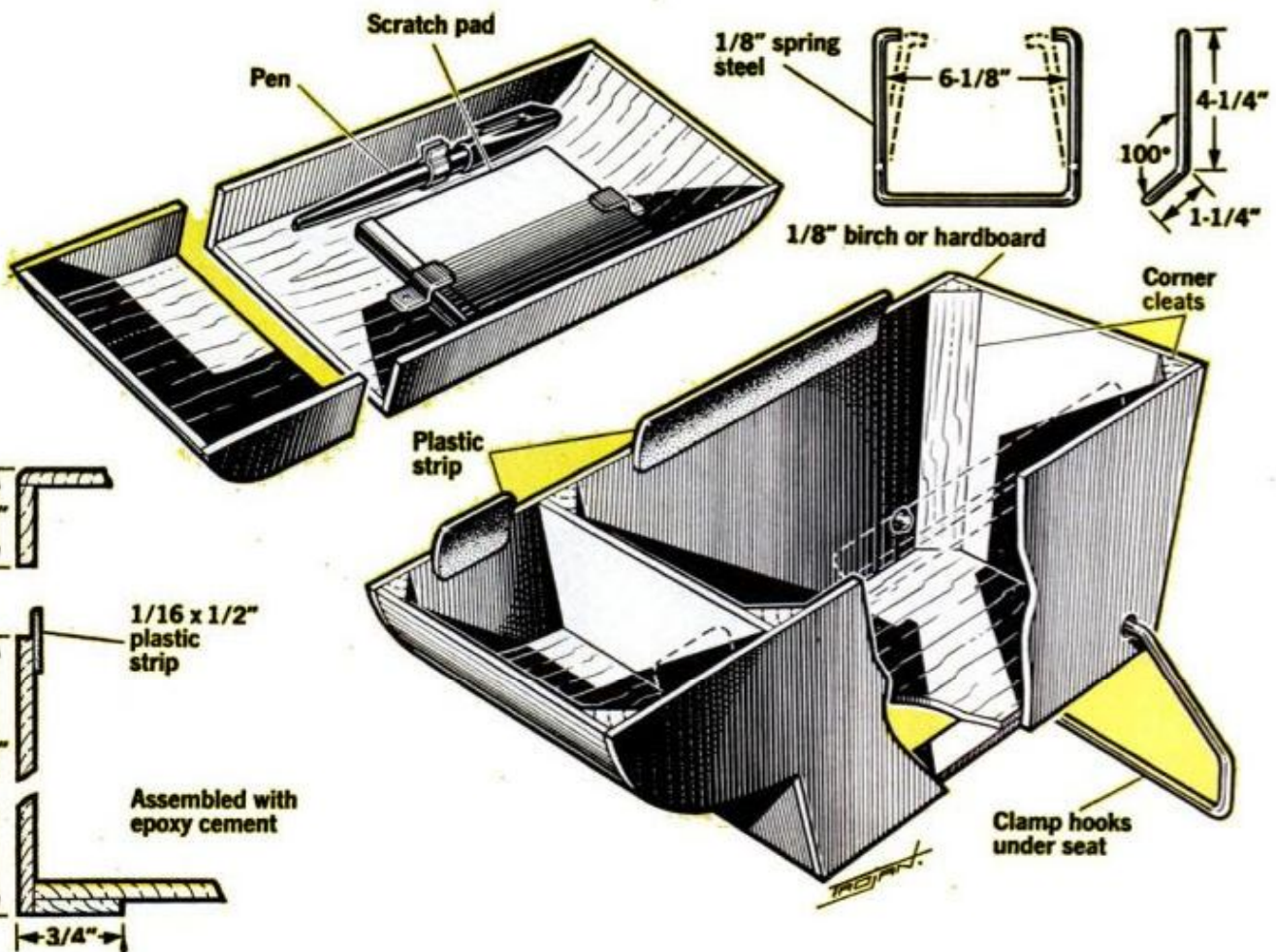

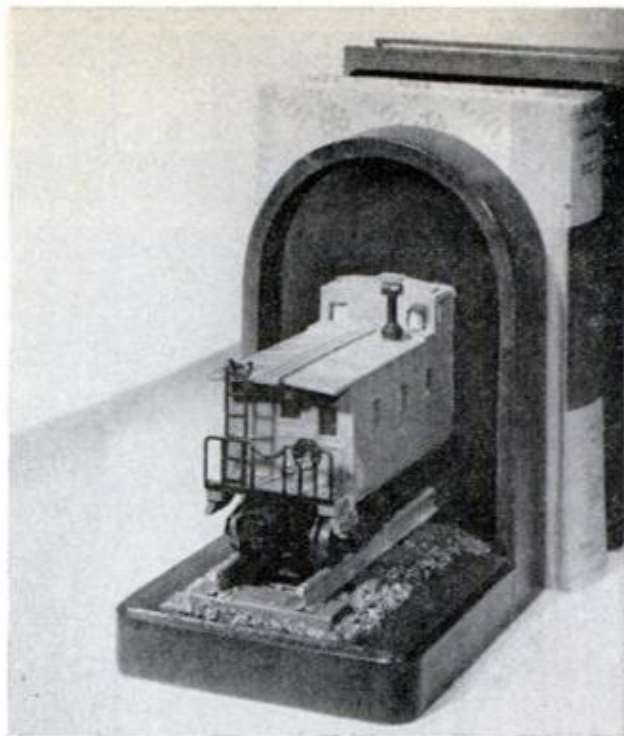

Train-Tunnel Bookends

THESE NOVELTY BOOKENDS, which represent tunnel portals, make it look like a fast freight is passing right through your books. The project makes good use of the locomotive and the caboose of an old O-ga. train set.

Both bookends are made alike insofar as the wood parts are concerned. Cut and sand the inside of the front arch first, then glue it to the tunnel block and cut and

sand the outside shape of both at one time. A disc sander is best for this. The base is attached to the tunnel block with dowels and glue. Give the inside of the tunnel two coats of flat black paint; paint the outside whatever color you wish.

Now remove the metal ties from a length of O-ga. straight track and saw the rails in half. Wooden ties replace the metal ones and are glued to the base as shown and painted black. The rails are fastened

(Please turn to page 208)

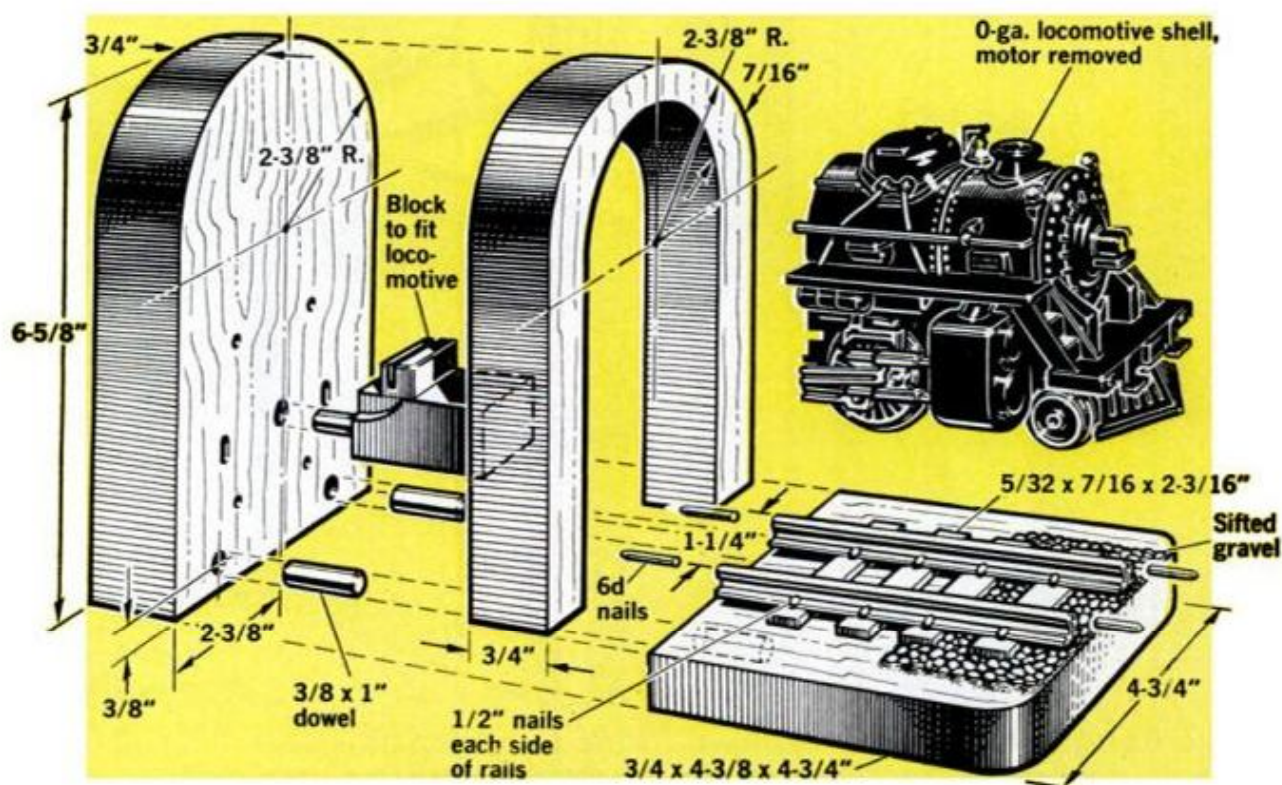



SOLVING

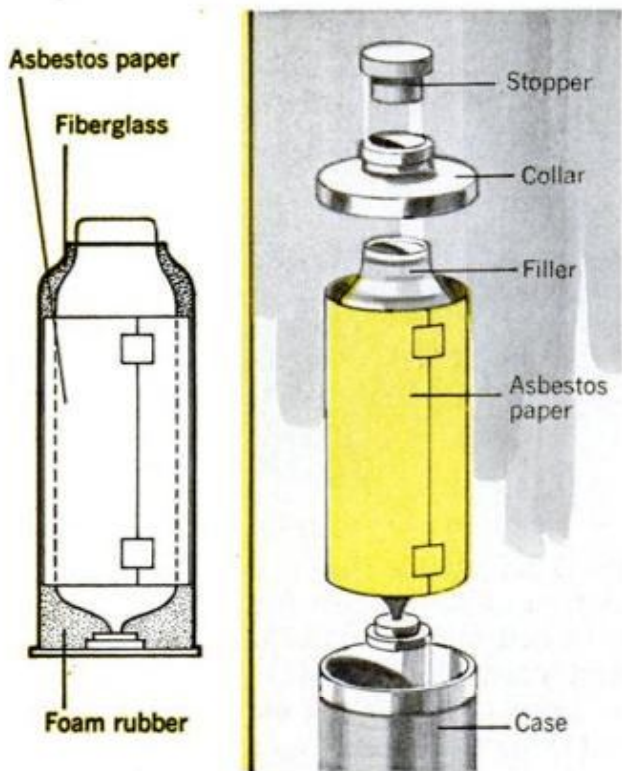

CONTENTS OF VACUUM BOTTLE will stay hot or cold longer if you remove the filler, place foam rubber in the bottom, wrap filler with asbestos paper and pack fiberglass around the neck of filler.—*Jan Van Eerde*

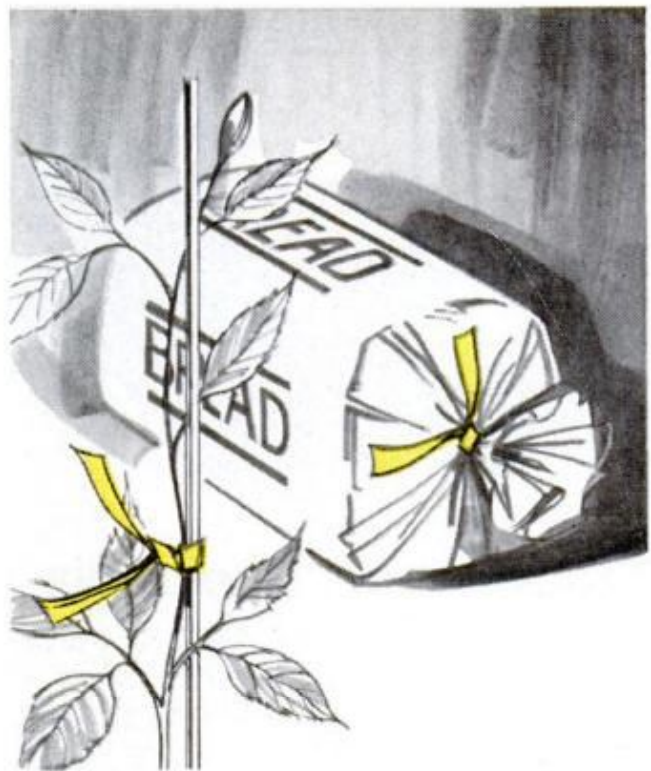

IF YOU START SAVING the wire ties you get with bread wrappers, you'll have enough when spring comes for tying tomato and other tender plants to stakes. The wires work fine and won't rust.—*John Krill*

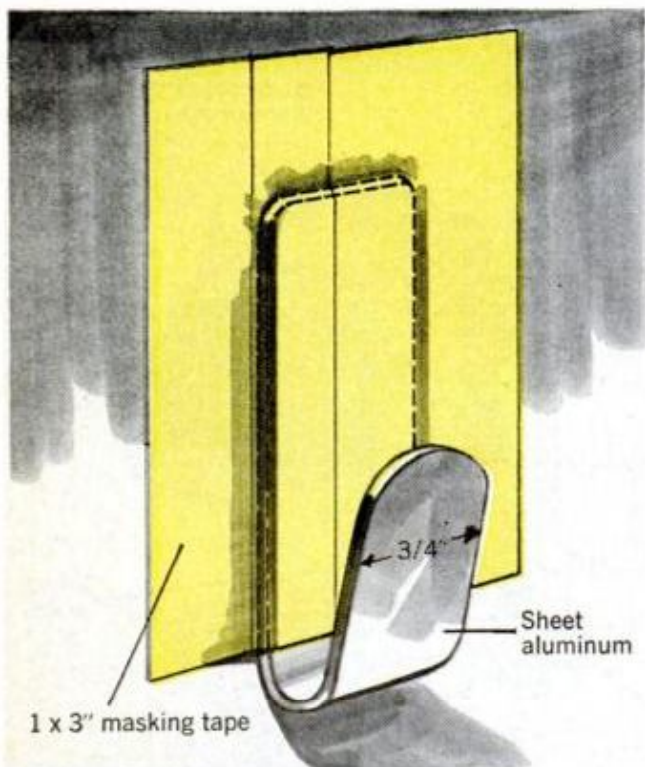

TO HANG LIGHTWEIGHT OBJECTS try this: Make a sharp bend in thin aluminum strip to form hook, cover with strips of masking tape and press firmly to the wall. Hook will hold five pounds or more.—*Wilbur Wardell*

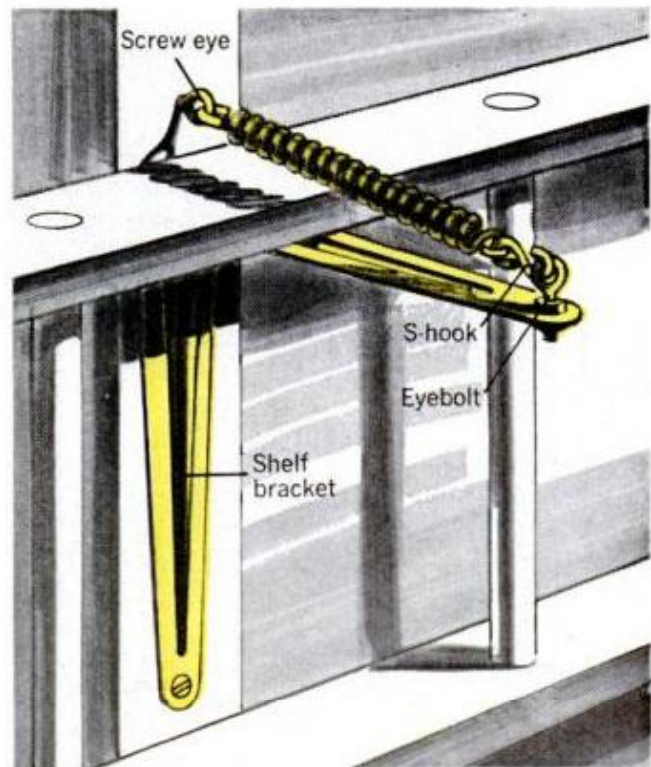

TWO SHELF BRACKETS attached to studs make a fine ladder rack. Screw them several studs apart and add tie-downs to brackets. The ties are screen-door springs fitted with S-hooks to engage screw eyes.—*Victor Lamoy*

HOME PROBLEMS

Illustrations by Adolph Brotman, Worman Associates

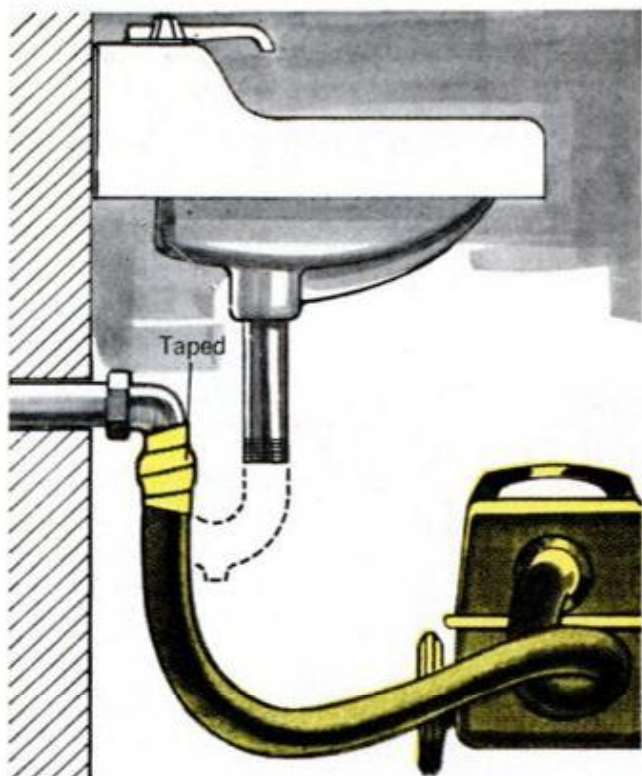

WHEN A DRAIN CLOGS, use your vacuum cleaner to blow out the obstruction. Remove the trap, tape the cleaner hose to the pipe so it's airtight and then turn the cleaner on "blow." Works great.—S. N. Stresnic

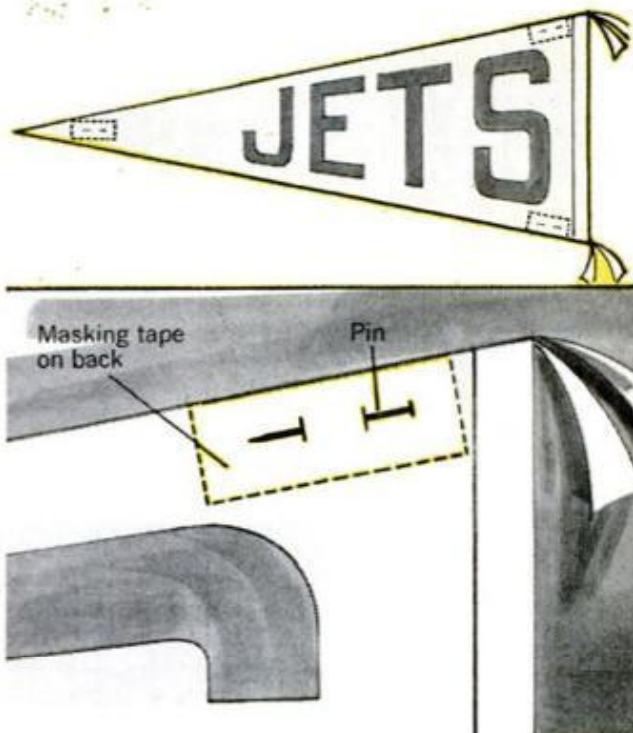

YOU CAN AVOID HOLES in the wall when hanging pennants if you pin tabs of masking tape to the backs of the pennants at corners and press tape against the wall. Pulls off without a trace.—Victor Lamoy



SEED WON'T WASH AWAY in "greenhouses" made from pint plastic freezer containers with clear tops. Cut out bottoms, serrate edge. Keep cover ajar for air, remove when second leaves appear.—Nellin Ives

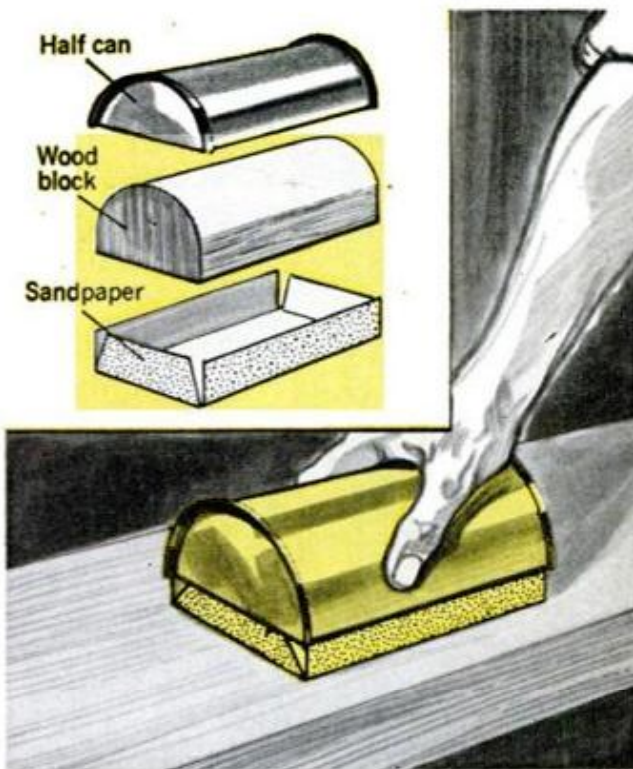

HOLDING SANDPAPER on a sanding block is made easy with a tin can cut in half lengthwise. Round the top of the block, then use the can as a cover to grip upturned end of paper covering block.—Peter Legon

You Can Drive

By R. G. CHRISTOPHERSEN

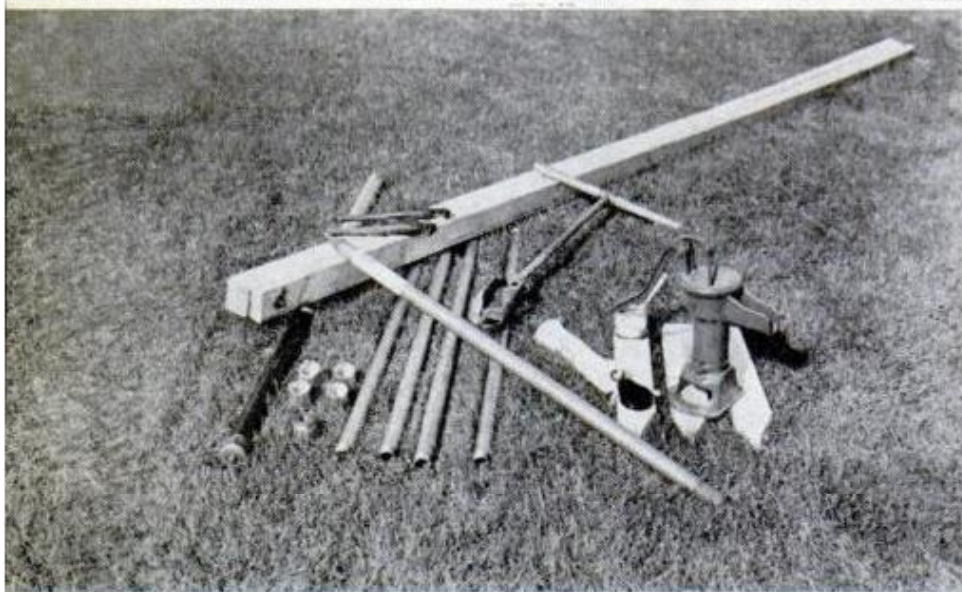

TO DRIVE A WELL you need quality equipment shown above. You'll speed up the job by first boring hole with a post-hole digger (above right). A sledgehammer can be used for driving, but a tripod and pulley arrangement (shown at top) saves arms and provides superior driving with less chance of damaging the pipe

Your Own Well

If the water-bearing sand formations in your area make it possible to obtain water at depths down to 40 feet, you can drive, rather than drill, a well.

MANY PEOPLE who own rural and country homes, lake cottages and even suburban homes install their own primary or secondary water-supply systems. If the soil formations permit, *driving* a well is a relatively easy, and possibly, one-day chore. But to avoid frustration or disappointment, it is wise to check with your state geological survey office before starting. If you submit a legal description (survey) of your property, it will advise you if the conditions in your area are suitable for a well.

Where to drive a well. It is important to locate a well away from any source of contamination such as marshy areas, cisterns, septic tanks and the like. And the well should be situated on higher ground than any of these areas. If a sewer line is present, stay at least 50 ft. away. Also, check with your utility company to make certain that you do not start your well on top of underground service lines. Before beginning construction, check your local building department. In many communities, this work requires a building permit.

It is wise to use the best possible equipment. You will need a pump, a wellpoint (1¼-in. diameter recommended), lengths of galvanized steel riser pipe, couplings, a drive cap, and pipe-thread compound. Tools include an auger or a post-hole digger, a driving device and pipe wrenches.

A hand-operated pitcher pump is sufficient for driven wells when the water lift does not exceed about 22 ft. at sea level. At 5000 feet above sea level, the limit of water lift is about 20 ft. Pitcher pumps depend upon a partial vacuum to operate; it is essential that all joints be airtight. Pipe compound helps achieve this.

If the water lift in your area is greater than the limits mentioned, a power-driven centrifugal pump and 2-in.-dia. equipment must be used. Normally, 40 ft. is about the limit to which a 2-in. well can be driven with hand tools. A 2-in. well is not only more difficult to drive than a 1¼-in. well but, also requires that a 1¼-in., drop-pipe (with turned couplings) be permanently installed inside.

Of three basic wellpoint types, one has

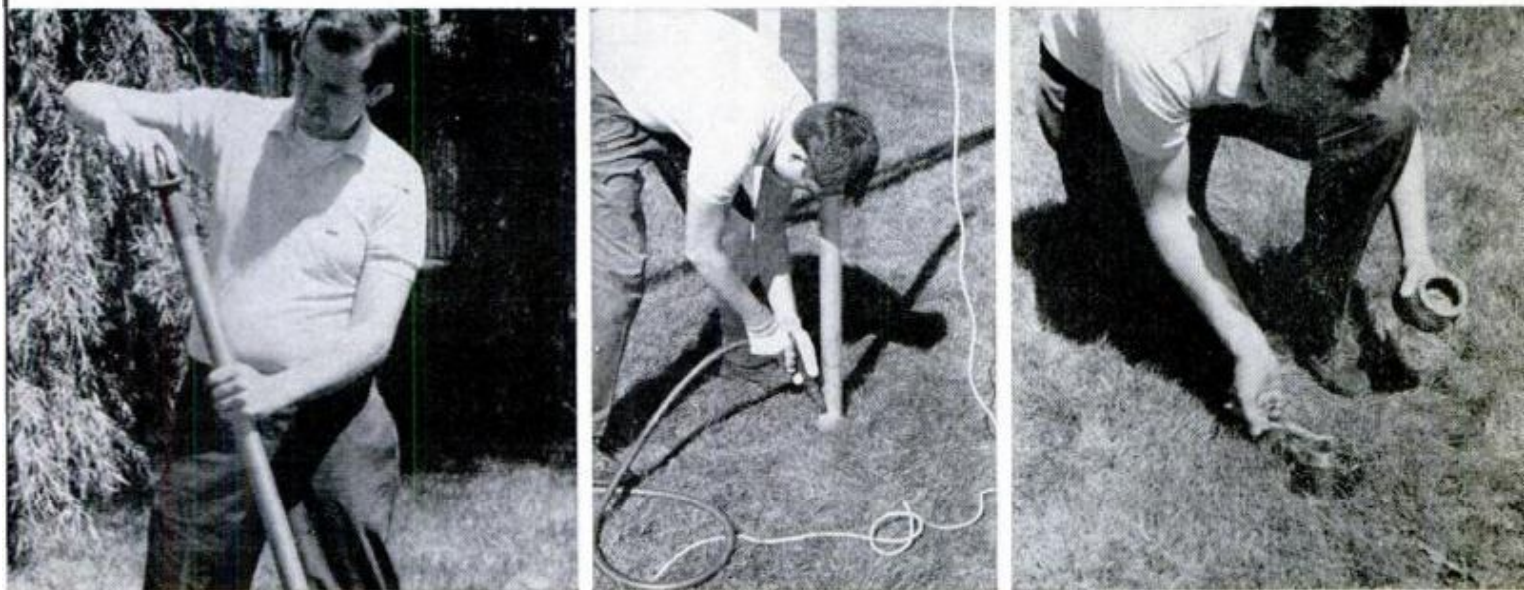

WELLPOINT is prepared for driving by threading on the drive cap (left). Driving is easier if you add water to the hole as you go (center). When the point is fully driven, remove cap and apply pipe compound to the threads (right) then, add the next length of pipe and continue the driving operation

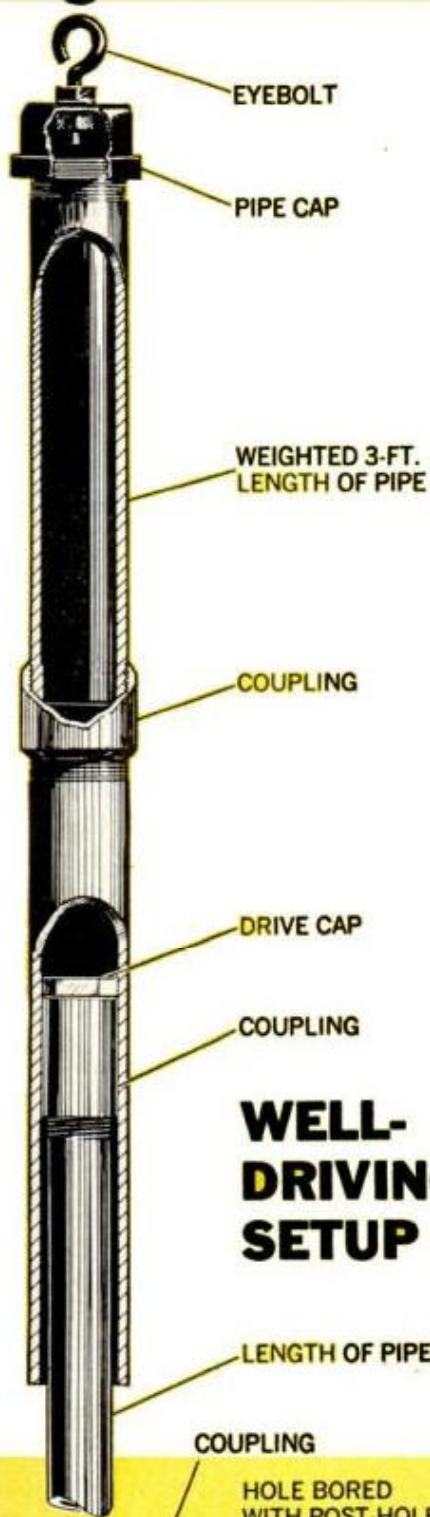

EYEBOLT

PIPE CAP

WEIGHTED 3-FT.
LENGTH OF PIPE

COUPLING

DRIVE CAP

COUPLING

WELL-DRIVING SETUP

LENGTH OF PIPE

COUPLING

HOLE BORED
WITH POST-HOLE
DIGGER

WELLPOINT



WITH TRIPOD ERECTED, new section of pipe is added. Notice that two wrenches are used to prevent the bottom section from turning. For smoother driving, coat each of the sections liberally with soap

three sets of holes: round holes or slots in the pipe, a metal screen over the pipe and a jacket with holes over the screen. The second has screen inserts behind holes in the pipe. I chose the third type: a nonclogging point of continuous V-shaped slot design. In addition to being nonclogging, its maker (U.O.P. Johnson Div., 315 N. Pierce St., St. Paul, Minn. 55104) claims it provides four times more open area than other points. The design is available under the Red Head brand name through hardware dealers or by order from Montgomery Ward.

Since it is of double galvanized steel, you will not have to worry about galvanic corrosion when it is used with galvanized steel pipe.

Which wellpoint-size opening to use is determined by the sand in which it will operate. Screen-type wellpoints use 60-gauze for coarse sand, 80-gauze for medium and 100-gauze for fine sand. With a nonclog, V-slot wellpoint, use No. 10 slot for all conditions except where the sand is so fine it is practically quicksand; in that event use a No. 6 slot.

Pipe sections five to six ft. long are generally used in driven wells. Make certain you use galvanized pipe and couplings with good clean threads free of defects. Couplings should be of the reamed and drifted (R & D) variety.

These couplings will provide tight joints since they have more threads than conventional couplings. The additional threads help prevent the couplings from becoming loose during driving. They also have a recessed design feature which aids in preventing corrosion of the male pipe threads. Hand driving is easiest when



TO DRIVE PIPE, simply raise the weighted section and let it fall (left). Periodically, stop and use a weighted line to test for water level. When the desired water level has been reached, clean (purge) the pipe by surging with stick and rags, or with water pressure from hose lowered to the wellpoint tip

the equipment you use pictured on page 188. The drive shown in the sketch is easiest to construct. Basically, it consists of a length of capped pipe with an inside diameter just large enough to slip over the capped riser pipe. The driver is partially filled with enough lead (lead wool can be used) so that it can be handled by one or two men.

Driving can be done with a heavy maul or sledge or with a tripod as shown. Since it is difficult to deliver square, solid blows with the maul, this is not recommended. Glancing blows may break or bend the pipe or strip the threads. Whichever method of driving you decide to use, remember that the riser pipe must be kept perfectly vertical.

The first step is to dig a hole in the ground. The hole can be made with a post-hole digger or hand auger. Here, again, the hole should be vertical and should be dug as deeply as possible to cut down on driving distance.

Assemble the wellpoint, using R & D couplings and pipe-joint compound, to one or more lengths of riser pipe, depending upon the depth of the hole. Fasten a malleable-iron drive cap to the top of the riser pipe. Make certain that all joints are as tight as possible. To avoid breakage of the pipe or splitting of the couplings it is advisable to use pipe wrenches no longer than 24 in.

COOL, FRESH WATER is the fruit of your labor. Before drinking, water should be laboratory tested

Insert the assembly into the hole and begin driving. Check frequently to insure that the pipe stays plumb and that the threaded joints remain tight during driving by giving the riser pipe a half turn with a wrench. Always turn to the right,

(Please turn to page 228)



New tools you should know about

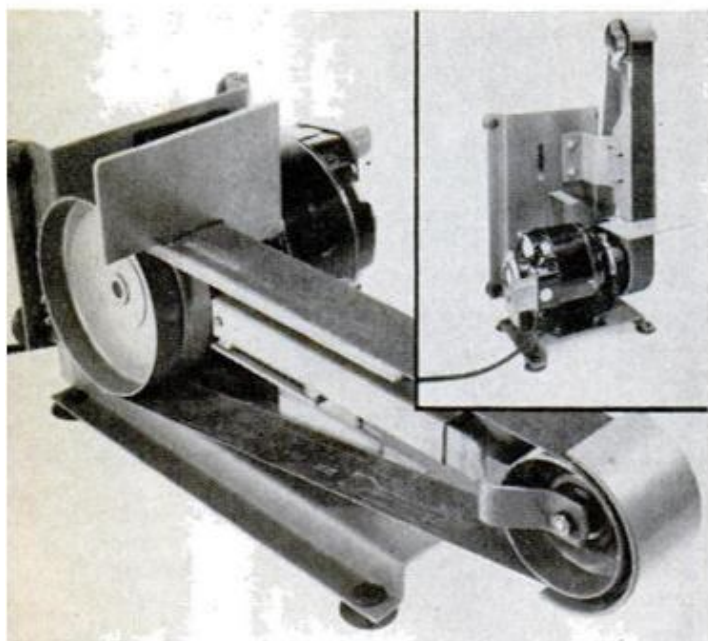

PORTABLE BELT SANDER can be used horizontally or vertically (inset) to grind, polish and deburr materials from wood to diamonds by using the correct belt and grit. Intended for a 1/2-hp, 1725-rpm motor, Model 369 uses 2x48-in. belts that are quick and easy to change (one comes with machine). Portable unit has adjustable worktable to make sanding chores easier. \$50 less motor. Arco Manufacturing Co., Box 817, 1701 13th Ave. N., Grand Forks, N.D., 58201 makes it.

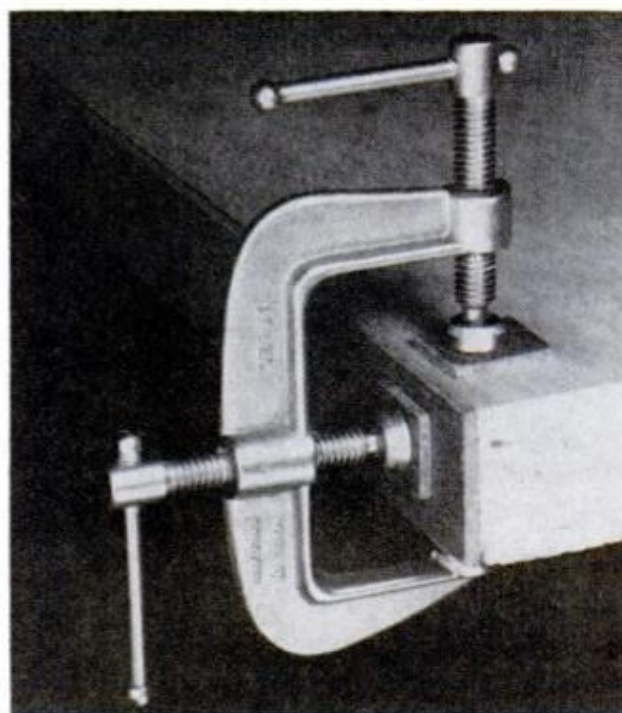

PRECISION-BUILT TOOL of unbreakable fine steel is designed to provide a third hand on tricky clamping jobs. Standard C portion holds one piece, while the secondary screw holds a second piece to the first. Throat opens from 1 1/4 to 2 3/8 in.; depth of throat is 1 1/4 in. Priced at \$4 each, or two for \$6.50. Available from E. S. Bowen, 40 Yonge St. N., Richmond Hill, Ont., Canada.

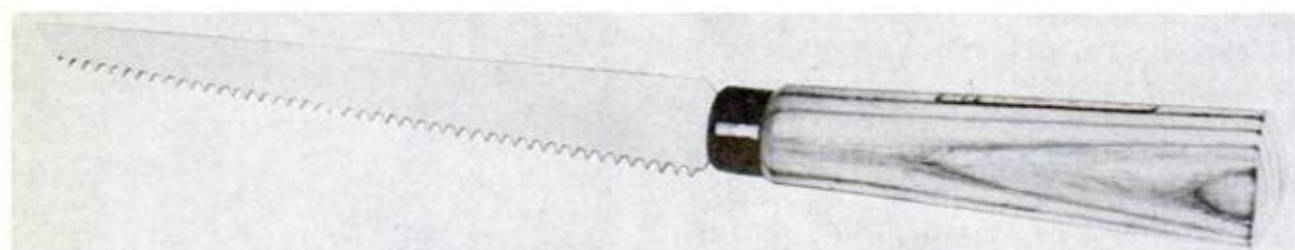

LIGHTWEIGHT UTILITY SAW can be used to cut plasterboard, hardboard, plywood, wood, frozen food and more. Featuring a high-quality tempered-steel blade with teeth filed 8 points per inch, the 11 1/2-in.-long saw has a tapered, conical-shaped handle for user comfort. It's sold through hardware stores and housewares, camping and hobby centers in department stores. True Temper Corp., 1623 Euclid Ave., Cleveland, Ohio 44115. Price is \$1.49.

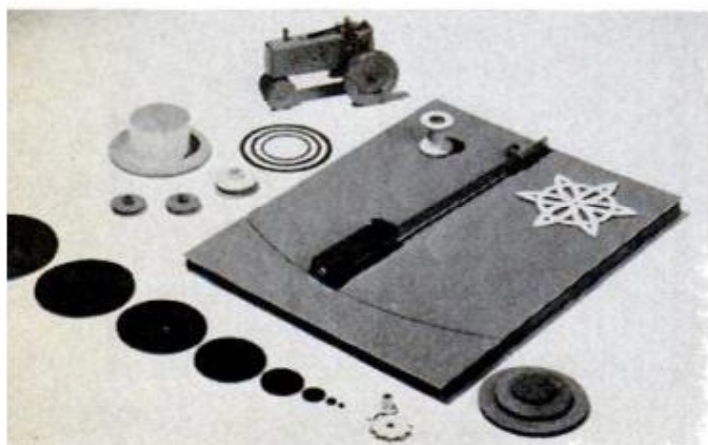

CIRCLE CUTTER is designed to cut perfect circles from 1/8 to 24 in. in diameter from cardboard, bristol or corrugated board, vinyl, acetate, gasket material and other soft materials 1/16 in. or thicker, depending on the material. The complete kit features a basic plastic and steel cutter, extension bar and clamp, cardboard protector, cutting board, plus 10 extra blades. By mail order only, Accu-Orb Circle Cutter sells for \$7.95. Technological Devices, Inc., 39 Echo Hill Drive, Stamford, Conn. 06905.

HINTS FROM READERS

Easy way to grind springs

Compression springs will work properly and seat better if both ends are ground square. Since grinding by hand is difficult, make a holder from a short length of tubing in which the spring fits snugly and will not turn, and plug the other end as in sketch A. For small springs, drill a rod to a depth that lets the spring project $\frac{1}{8}$ in. as in sketch B.—*Daniel Bousha*

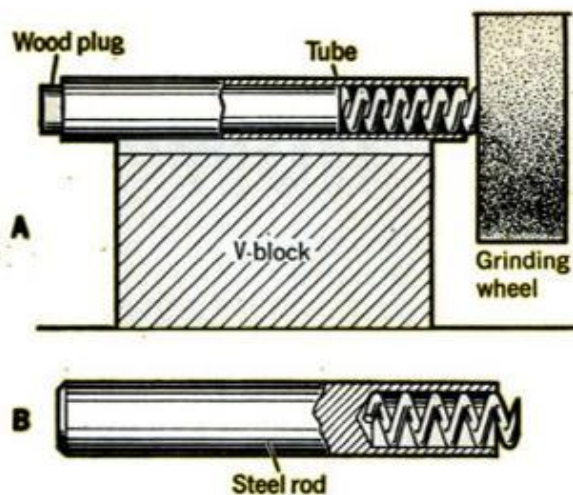

Garage-door spring adjustment

Here's a fast way to adjust overhead-garage-door tension. Prop the door open and attach upper end of the spring to the counterbalance arm. Hook lower end of the spring into last link of the adjustment chain and close door. Insert 12 8d nails in stretched spring and reopen door. Move adjusting hook down as far as it will go and reclose door.—*E. D. Merwin*



Easier battery-clamp removal

The nut that holds the lead clamp on the battery terminal is usually difficult to remove because there's little room for the wrench. However, if you file the threads out of an oversize nut so that it slides on the bolt as a spacer without meshing, it will serve as a filler to give you enough room to use a box wrench on the nut.

—*Walter Fehlberg*

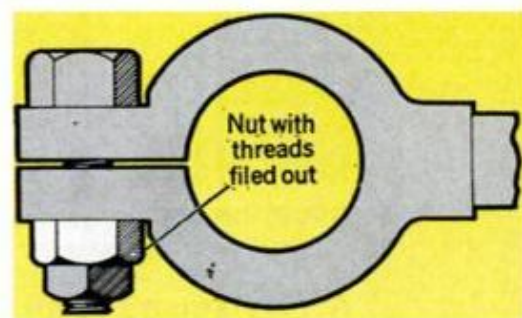

Marking angles by dipping

Laying out cutoff angles on odd-shaped workpieces is sometimes difficult and laborious. To do it I pour a small amount of contrasting oil paint into an open container of water. When the piece is eased along the set edge of a protractor into the container, the oil film on the water leaves a perfect cutting line around the piece.

—*William Slamer*

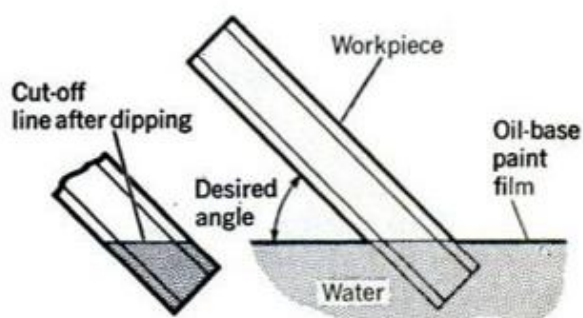

Tap removes worn bearings

Fast way to remove worn press-fitted bearings and bushings from closed-end housings is to drop a ball bearing into the hole, then tap into the hole with a tap slightly larger than the hole diameter. When the tap reaches the ball, it will force the bushing out enough to be removed with other tools. For bronze bearing, use rough-thread tap.—*Peter Legon*

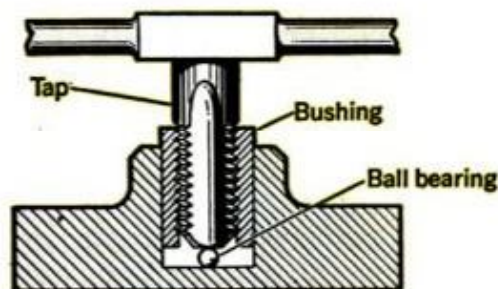

How to Put the Right

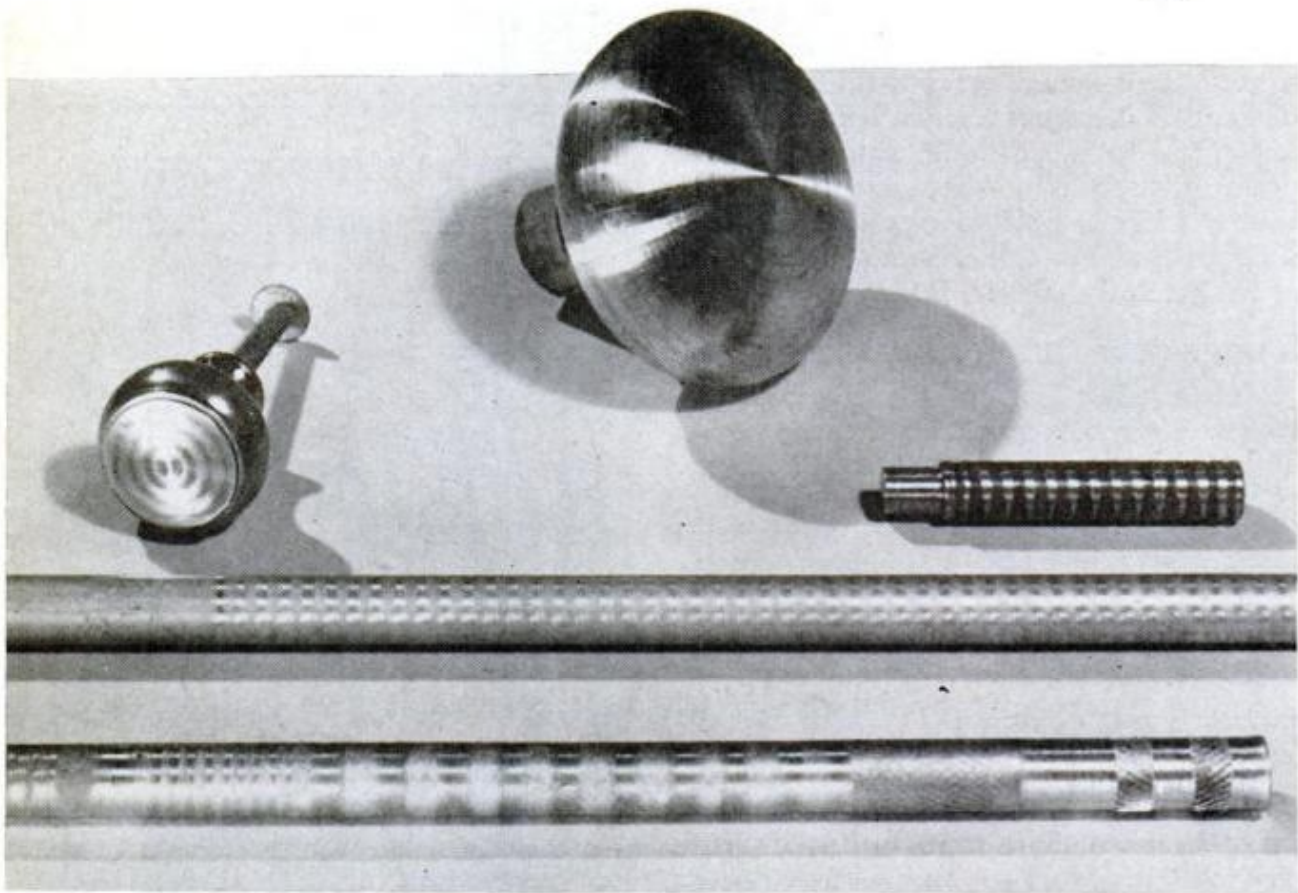

TYPICAL LATHE-PRODUCED FINISHES. Aluminum tubes were polished with abrasive rubber; their decorative bands were made with a knurler. Knobs were done with abrasive-rubber pencil or bit and abrasive cloth

A craftsman's skill and patience are often judged by the appearance of his finished job. Here are a number of ways for you to apply that final touch

By WALTER E. BURTON

A COMPLETED SHOP PROJECT is generally rated by the appearance of its finish—the treatment applied to the surface to bring out its beauty and, perhaps, enhance its functional value. This can be particularly true when doing home shop lathe work on a model, a special tool or an instrument part.

There are so many ways of finishing turned metal that it's just about impossible to present them all in one article. But this abundance can be stimulating—it provides a lot of room for experimenting; you can enjoy the adventure of working out and trying other stunts on your own.

As a general rule, the type of finish to apply depends on the use to which the

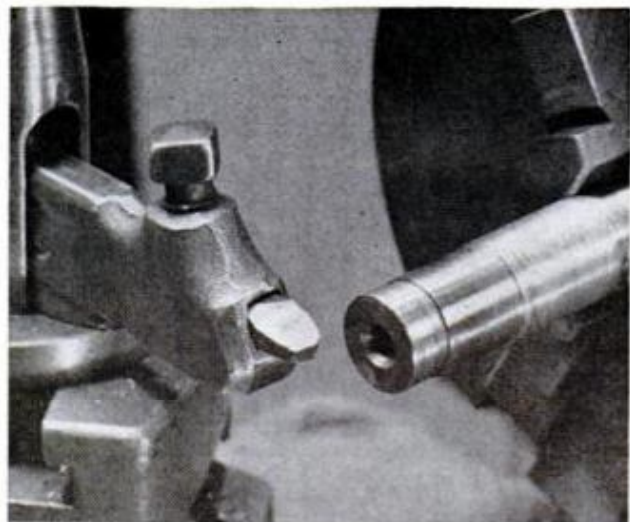

SHARP TURNING TOOL used with a light touch produces smoothness. Lathe bit should have rounded tip

POPULAR MECHANICS

Finish on Lathe Projects

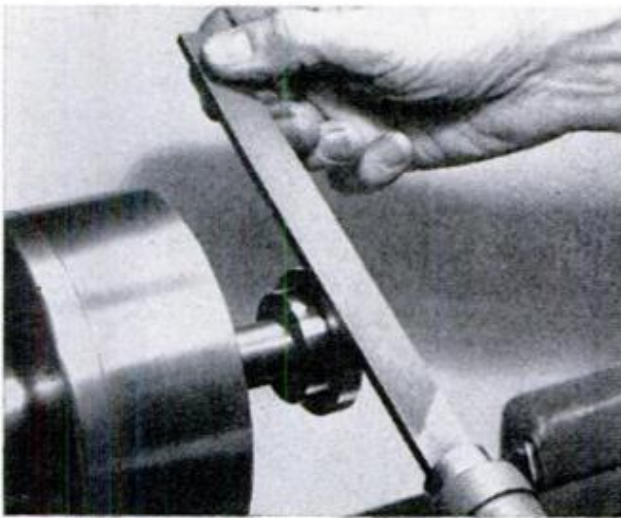

FLAT FILE with its teeth cut at sharper angle than conventional file removes marks left by turning tool

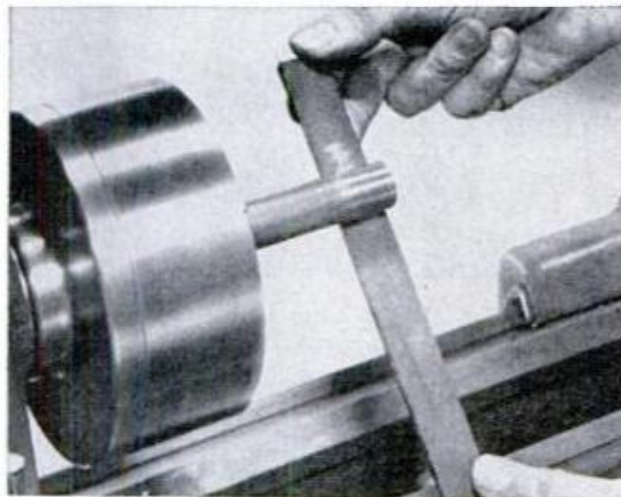

ABRASIVE CLOTH mounted on stick can be used for smoothing. Like file, abrasive should be kept moving



RIGID PLASTIC-FOAM BLOCK, rubbed over a cake of buffing compound, provides an adequate sheen, too

turned article is to be put. Roughly, some procedures can be grouped, as follows:

● *Turned finish.* For many purposes, as in making a punch for rough work, the finish left by the turning tool is good enough. A rounded tip is likely to produce a smoother finish-cut than a sharp, pointed tip. For the final, finishing pass, set the tool for a shallow cut and feed it very slowly along the work. Sulphurized oil or other lubricant may help. You'll find that nature of the metal, as well as tool shape and sharpness, has a lot to do with the appearance of the turned surface.

Finish can be improved by using an oil-stone (such as an Arkansas stone) to hone the cutting edge keen and smooth. *Tip:* If, when you attempt a very light cut, chatter develops and mars the turned surface, a switch to a lower spindle speed (even through back gears) may be a cure.

● *Filed finish.* When a turned surface isn't quite smooth enough, a bit of filing may be all that is needed. Although conventional files can be used on a lathe, steeper-toothed lathe files designed specifically for smoothing rotating work are better. Flat lathe files usually have untoothed edges. The work and file should be free of oil and other material, and the teeth kept clean by frequent brushing with a stiff wire brush. Bits of metal accumulating on and between file teeth can produce some unsightly grooves in the area being smoothed. Some mechanics rub a file with chalk to discourage chip pile-up. (When using a lathe file, take care to prevent fingers, sleeves and other parts of clothing from being snagged by the chuck, dog, or workpiece and always grip the file as if you are left-handed.)

● *Abrasive paper and cloth.* Coated abrasive materials include cloth and paper treated with aluminum oxide, silicon carbide, emery, crocus, or other abrasives such as grains or powders in various degrees of fineness. Grit size indicates the number of holes per inch in a sieve through which the grit will pass and may be expressed by that number, a fraction such as 4/0 or by an adjective such as

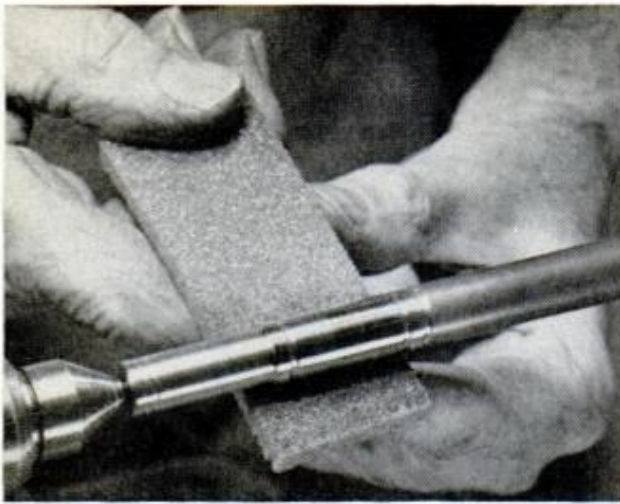

ABRASIVE-CHARGED FOAM PAD is used to polish a brass rod after you smooth it with an abrasive cloth



TIGHT GROOVES ARE POLISHED with flat stick charged with abrasive grit mixed with a light oil

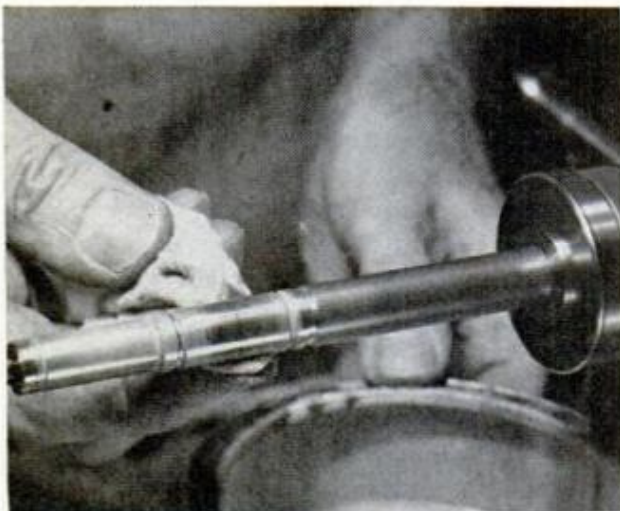

IMPORTED BUFFING POLISH, though intended for aluminum, works well on brass when applied with cloth

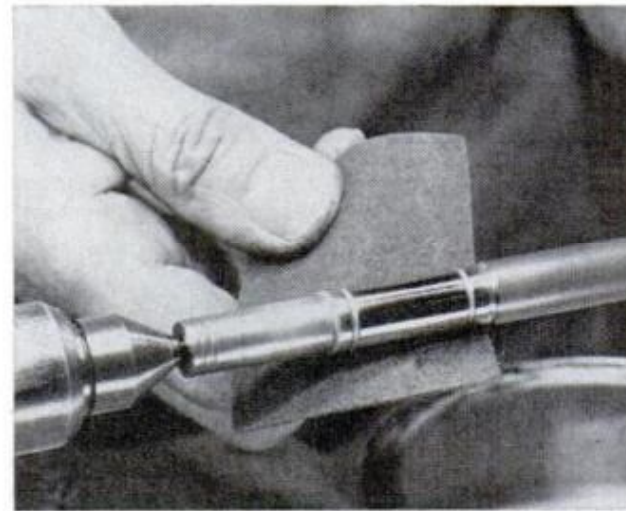

TO DEVELOP A LUSTER after polishing, use a piece of felt from old hat to remove any dried compound

“fine.” You can use loose abrasive grit; there will be more on this later.

You often see emery cloth or paper recommended for polishing steel and other materials. (Emery, a natural variety of corundum, contains aluminum oxide and other minerals.) Probably some recommenders had in mind man-made aluminum oxide (such as Aloxite), or even silicon carbide (such as Carborundum) which is suitable for polishing hard, brittle materials. (Aluminum oxide seems preferable for tough steels and the like.)

One polishing procedure is to glue or staple a strip of the abrasive-coated material to a flat wooden stick, and use it like a file—dry or sulphurized, or with machine oil as with an oilstone.

Whether abrasive cloth, paper or loose grit or powder is used to smooth turned work, the accepted sequence is to start with a certain size grit (for example, me-

dium No. 150, or 4/0) and proceed by steps to finer and finer sizes. The first grit polishes out tool or file marks; subsequent grits remove scratches caused by the preceding, coarser grit. The second grit might be fine, No 180 or 5/0, followed by extra-fine, No. 220 or 6/0; and then finer polishing could be done with buffing compounds or commercial polishers. In the end, there may still be polishing scratches—but so fine they can't be seen without magnification.

The precise grit sizes to use can be found by trial. Usually, in home-shop work, a sufficiently smooth surface can be developed in two or three polishing steps.

A worthwhile economy in the shop is to never throw away a piece of abrasive cloth that still holds together. The longer it's used, the finer it cuts; eventually it may produce a shine equal to that from the finest new material.

Instead of a stick to support the abra-

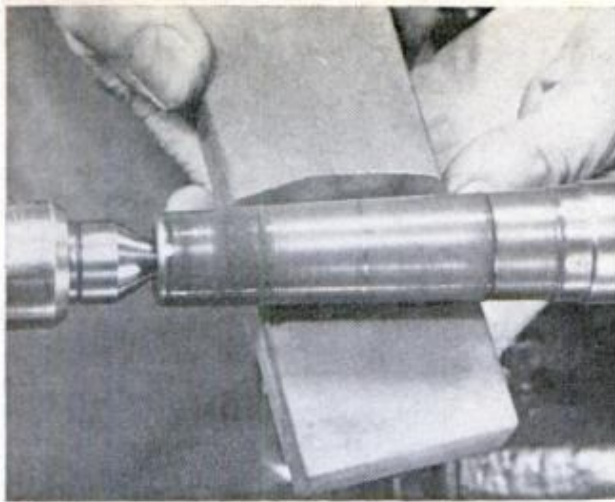

TAPER IS TURNED, using a flat oilstone lubricated with light oil. Move oilstone in back-and-forth motion

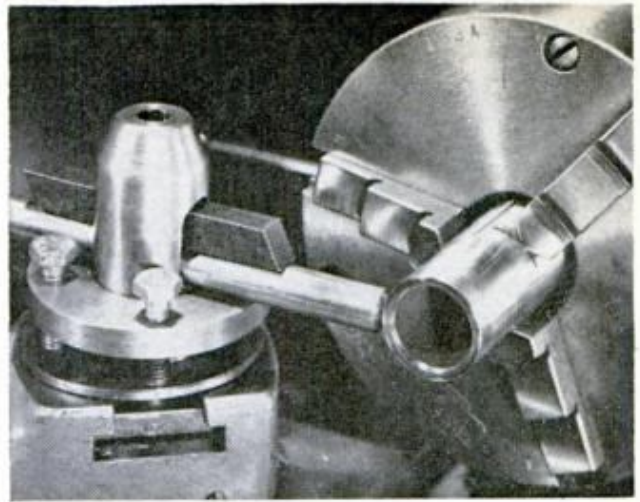

SMOOTH FINISH is given oiled brass tubing with diamond-tip grinding-wheel dresser used as burnisher

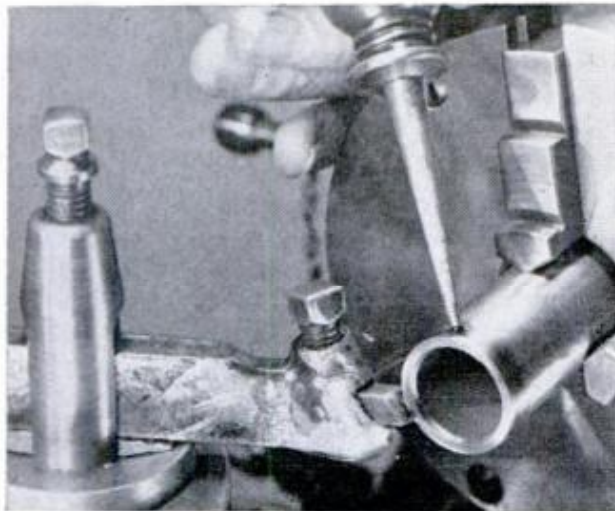

HIGH-SPEED LATHE BIT can be used as a burnishing tool. Be sure that the work is kept well oiled

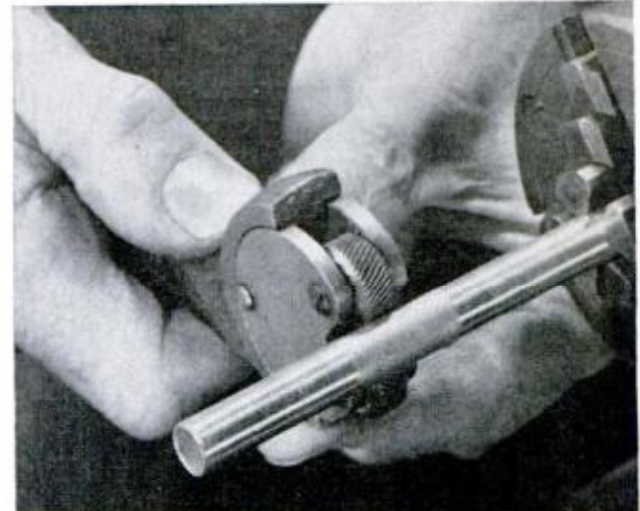

HAND-HELD KNURLING TOOL gives fine, crosshatched texture when held in lathe against spinning tubing

sive cloth or paper, you can shape various blocks, pads of felt, plastic foam, leather and the like to polish rounded shapes, including grooves.

● *Buffing, honing, and burnishing.* Buffing removes flaws left by previous polishing. Buffing compounds usually consist of finely divided material mixed with a binder (dry powder in oil or other fluid). In normal lathe work, you probably would be more likely to buff brass, copper, aluminum or silver than steel.

A buffing compound designed for "cutting" is intended to be used first, followed by final buffing with a "coloring" preparation. Tripoli is a typical cutting material in buffing, while rouge (producing a burnishing rather than a cutting action) is used to bring out the final luster.

The buffing compound can be used on work spinning in a lathe by spreading it on a block or pad serving as the tool. The

pad may be of leather, felt or plastic foam.

Of course, a piece can be polished on a conventional buffing wheel after removal from the lathe. Such a wheel, made of cloth or felt and charged with compound, might be mounted on a toolpost grinder and used to buff revolving work. Finally, buff with an uncharged wheel.

In oilstone lathe honing, an abrasive stone is held against the revolving work, primarily to grind down any metal points that might be projecting. Machine oil or special oilstone oil is the lubricant. The stone generally is moved back and forth parallel to the work axis, in circles or in figure-8s. "Superfinishing," a process attributed to David A. Wallace of the Chrysler Corp., is a form of honing with moving stones. Lathe headstock spindles operating in solid bearings are among parts on which superfinishing may be used.

Since a honed surface generally has a

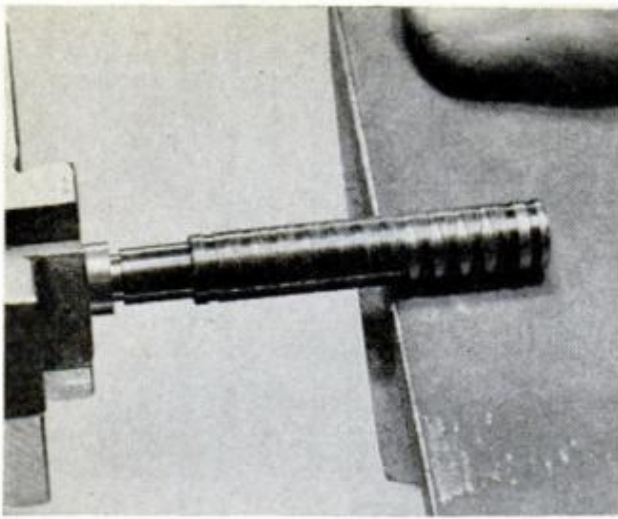

DESIGN IS BIT-CUT in blued-steel handle, and then polished with an abrasive cloth for two-tone effect

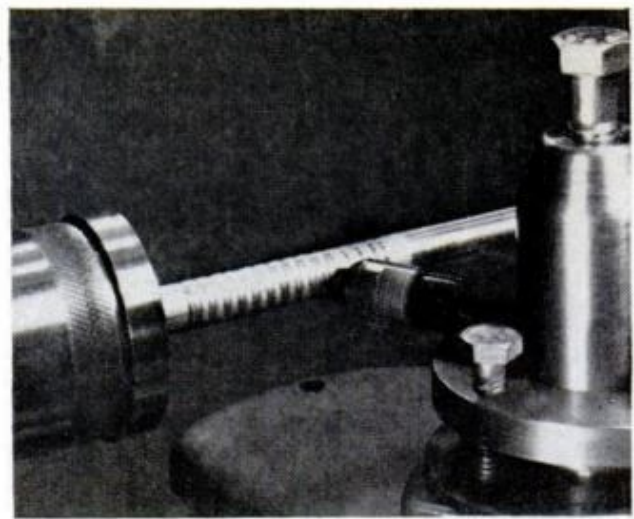

DOUBLE-SPIRAL DESIGN was turned in aluminum by abrasive-rubber pencil mounted as a "lathe tool"

duller finish than a polished one, it can form a basis for subsequent polishing.

Lapping is an operation performed (often by hand rather than power) with abrasive grains plus oil or other fluid, to achieve close fitting of parts, bring gauges to precise size, even out surfaces and so on. Thus, you might lap a taper shank into a taper hole. Some lapping compounds are designed to break down readily to make their action self-limiting, and thus prevent "overlapping."

Lathe burnishing is simply a rubbing operation with a hard, highly polished tool pressed against the revolving, lubricated surface. Its desirability is best found by trial, for sometimes a similar smoothness can be produced readily by other methods. A sort of burnishing can be achieved with a diamond-point grinding-wheel dresser by adjusting it for light rubbing contact, employing fine feed and keeping the work

well-oiled. But, some diamonds may prove too rough for a satisfactory result.

Sometimes the use of a commercial metal-polishing compound as a final finishing operation will develop on brass, aluminum, and the usual metals, a shine comparable to that achieved by wheel-buffing. Apply the polish to the spinning work with a small cloth or felt, manipulate the pad in contact for a while, then clean and polish with another cloth or felt. Always use a small cloth and check for roughness on the work that might snag it.

● *Texturing and "inlay" patterns.* Texturing consists of producing on the surface of turned work a pattern of lines or grooves that blend into a pleasing appearance. One way is to hand-hold a knurling tool lightly against the revolving work—preferably after polishing. Keep knurling pressure at a minimum, and frequently

(Please turn to page 208)

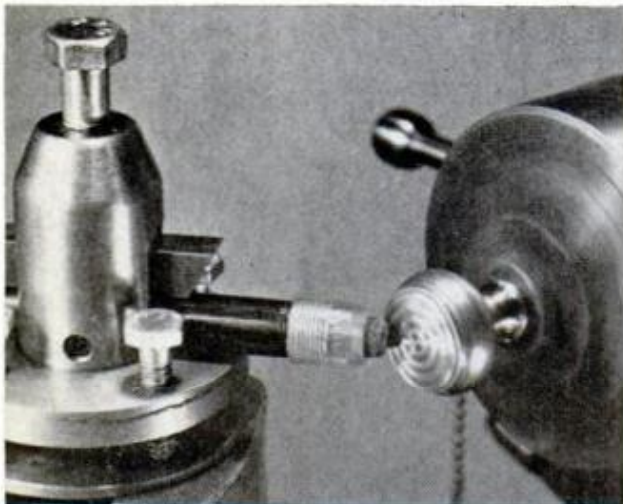

DECORATIVE CONCENTRIC RINGS are also produced by rubber. Space rings with aid of cross-feed scale

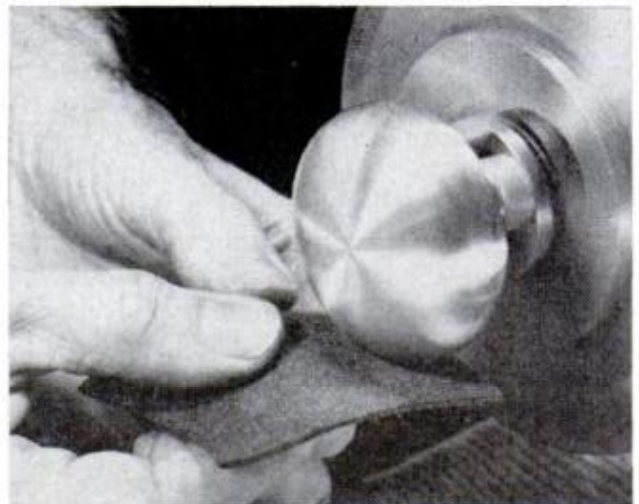

COUNTLESS CONCENTRIC SCRATCHES made with abrasive-charged cloth give starlike light reflection

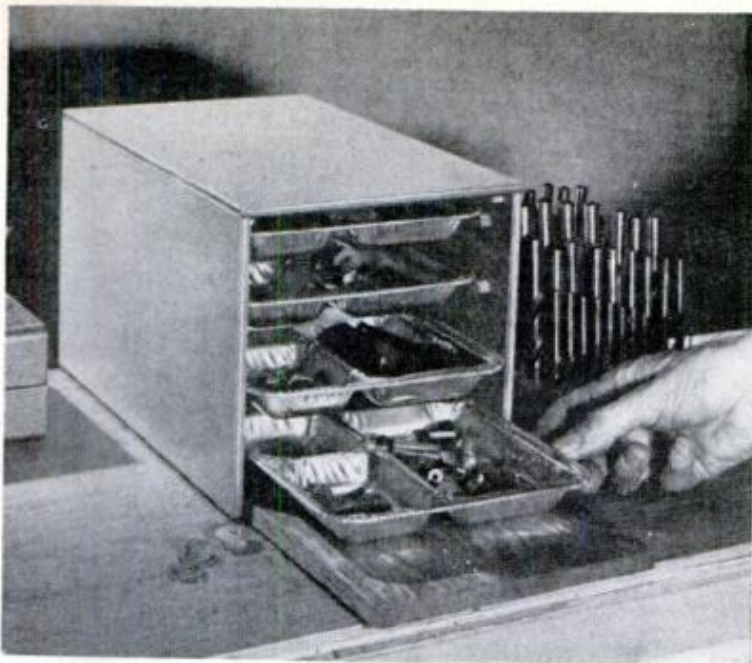

PARTS-CABINET DRAWERS are aluminum trays left over from four TV dinners. Compartments are adequate for small items

Small-Parts Cabinets From TV Dinner Trays

By **WALTER E. BURTON**

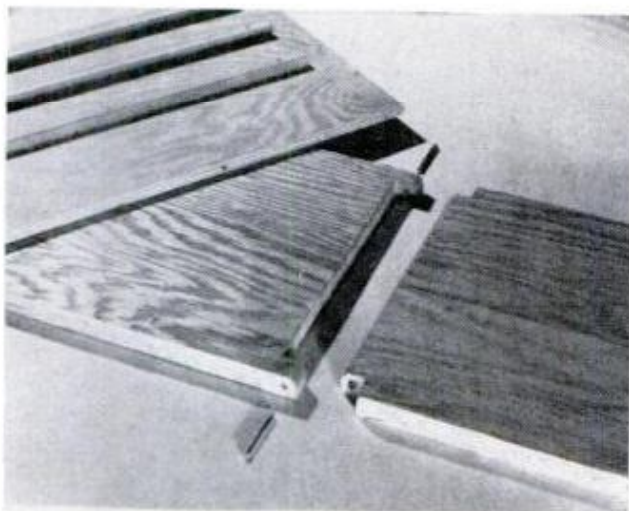

PIVOT PINS, about 1¼ in. long, serve as hinges. Door is hinged first, then the sides are attached

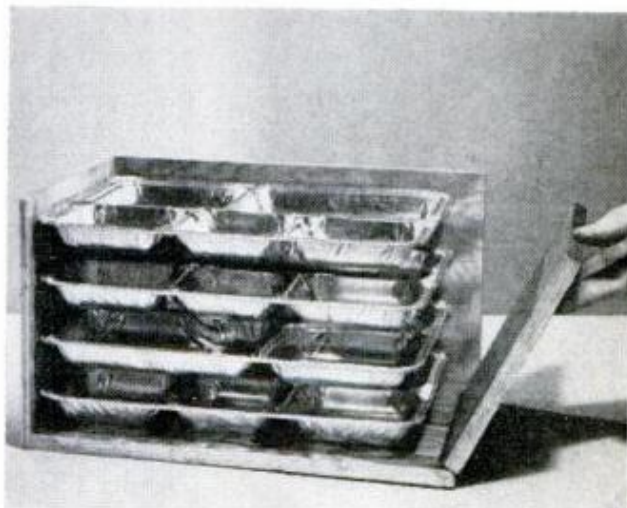

CUTAWAY INSIDE VIEW. Note that door swings down flat, provides surface for bottom tray to slide on

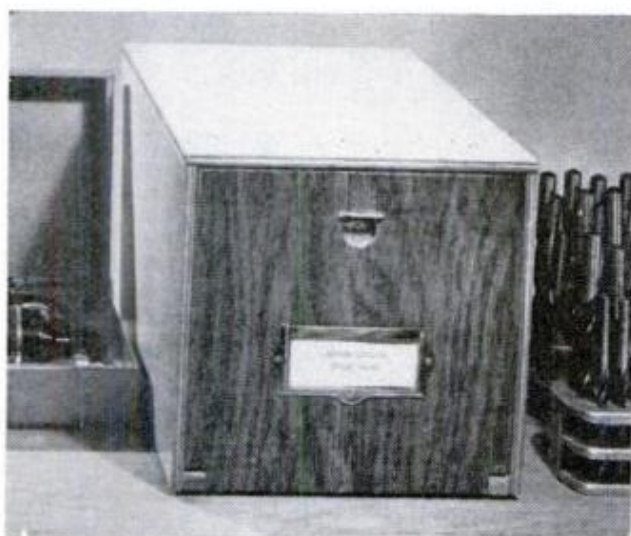

CABINET rests on four feet ¾ in. thick and 1 in. square to give clearance for door bottom edge

USED AS DRAWERS in a parts cabinet, TV-dinner trays can be put to work to store anything small enough to go into their compartments. The "full-course" dinner trays are best because they are of sturdier construction than the small, individual serving sizes.

The four-drawer unit shown is built of ¼-in. plywood except for the door and bottom. The latter are of ½-in. oak, which just happened to be kicking around my shop. The lowest tray rests on the cabinet bottom, while those above slide in and out on ⅝-in. wood strips nailed and glued to the side panels. These strips are spaced so that there is clearance above each tray in case any of the contents project a bit upward. ★★★

HINTS FROM READERS

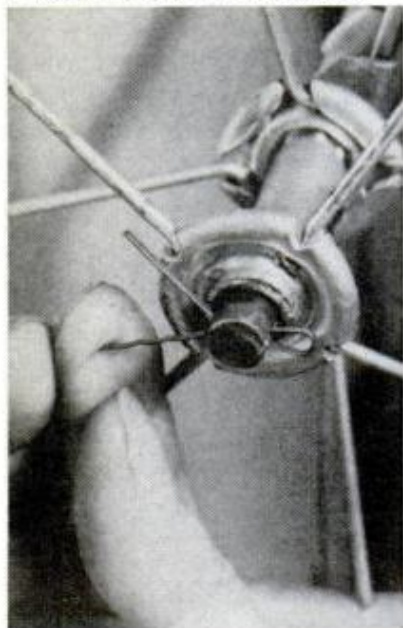

Emergency cotter pin

If caught short, you can substitute a bobby pin for a cotter pin on a baby-carriage, stroller or other small-size wheel. If the axle pinhole is of large diameter, use several bobby pins for a force-fit. The fasteners, of course, should be replaced with the proper size pin as soon as possible.—*William Swallow*



Improved caulking gun

If you have ever had a caulking gun break down during a Sunday caulking session, you know the frustration of having to leave the job unfinished. To continue working, use a sliding wood clamp as a gun. Maintain pressure as the pusher plate moves forward, by feeding in wood blocks.—*Michael Burn*

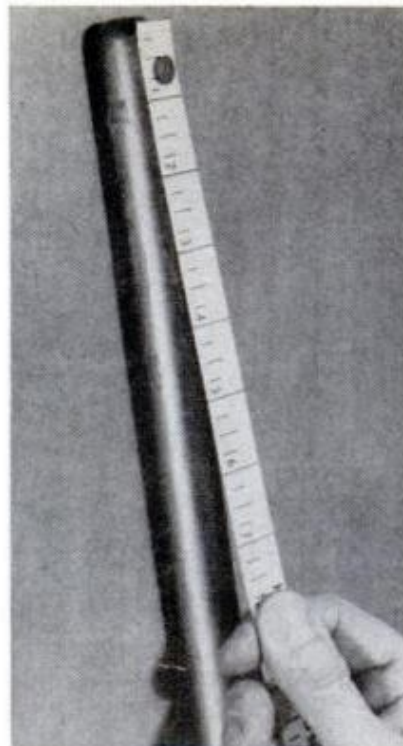

Homemade 'yardstick'

Lacking a wood yardstick when I measured a room for wallpaper recently, I thumbtacked a cloth tape measure to a broom handle as shown. The result was that I was spared having to move a ladder around to get vertical dimensions, and I didn't need a helper to hold the other end of the tape.—*William Swallow*

NEXT MONTH IN SHOP AND CRAFTS

TOO PRETTY TO CALL A SHED. Its western styling will make it an asset in any backyard because it doesn't look like a storage shed. It's roomy enough to serve as a playhouse when the youngsters are small and, when they outgrow it, Dad will have a convenient garden and yard-tool storage house. You'll find it in the May *PM*.

IMPROVE YOUR LATHE WORK WITH INDICATORS. A test indicator can do a lot to improve your accuracy on a metal lathe and, chances are if you use one, you will save time in the long run. Learn how to use it in next month's issue of *PM*.

THE FORGOTTEN HAND TOOLS: CABINETMAKERS' SCRAPERS. Before sandpaper, the scraper was one of the cabinetmakers' more valuable tools. Used primarily to smooth off blade-marks left by planing, the tool has now fallen into near oblivion. Pick up the May issue of *PM* and add this woodworking technique to your skills.

WHAT YOU SHOULD KNOW ABOUT IN-SINK GARBAGE DISPOSERS BEFORE YOU BUY. Few can argue with their purpose and healthful advantages. But, before you lay your money on the line, read this in-depth report on disposers, how they operate and which type is most likely to fill your requirements. It's in *PM* next month.

PLUS: a special four-page roundup of the latest in garden and yard tools.

Measurably
long...

immeasurably
cool



COME ALL THE WAY UP TO KOOL FILTER LONGS

© 1970, BROWN & WILLIAMSON TOBACCO CO. INC.

GE'S ELECTRIC TRACTOR

(Continued from page 123)

cles so big you can't cut a corner of the lawn without a lot of jockeying."

The short wheelbase was possible because of evenly distributed weight. A conventional tractor (with front-mounted engine and front-mounted mower) would be nose-heavy with a 39-inch wheelbase.

"The Electrak has almost the same pounds per square inch on front and rear wheels," said Laumeister. "The average tractor has 2 to 1 on front and rear—because of the engine—and the greater weight is on the front where you don't want it."

The Electrak weighs 865 pounds; battery weight accounts for 350 pounds. Four six-volt batteries are in a closed compartment under the driver's seat. Two more and the motor are under the hood.

"It's that weight distribution that lets you climb the hill without wheel-spin,"

Battery weight an advantage ... most tractors need additional weight for traction.

said Laumeister. "In an electric car, the weight of the batteries handicaps performance. In a tractor, battery weight is an advantage because most tractors need additional weight for traction. By putting battery weight in the right place we use it to get a tremendous amount of drawbar pull. Secondly, a gas engine develops its maximum power only at high rpm. The electric motor develops its rated horsepower at high rpm, but as you slow it down it develops up to 10 times its rated torque."

The motor in each Electrak model is capable of putting out up to about 20 hp on peak loads. The motors differ only in the amount of time that each will sustain the peak load. The reasoning behind this: People will buy 14-hp tractors to have extra power when they need it. In most applications they use much less. E-20 is the "Commercial" model designed for professional groundskeepers. The E-15 outpulls standard 12-hp engines; the E-12 outpulls 10-hp engines.

GE is reluctant to discuss the motor other than to say it bears no resemblance to the type used in electric cars and is a "very heavy industrial-grade motor."

"It is unique," says Laumeister. "There's nothing like it in any other vehicle at present. The motor and the control system are electrically integrated and matched."

GE also makes the batteries, guardedly referred to as "a new wet-cell type."

How many hours of use can you expect from the batteries?

"That depends on the job," said Laumeister. "One day we cut an alfalfa field about 1½ feet high. We had the mower at a low setting, which is a ridiculous application. Our power lasted two hours; we cut two acres. Normally the charge will last 2½ to six hours. It may last three or four hours if you're doing average mowing; five or six if you're towing a cart."

Does this leave you stalled in the field, far from an outlet for the charger?

"You won't 'run out of gas' because toward the end of the charge the voltage drops off; you feel the tractor or the mower blade slowing. Even if you run the Electrak to a standstill, just let it sit for five minutes and the batteries recover sufficiently to take you home. When the fuel gauge shows 'Empty,' you still have enough to return to a power source."

Will you run out before you finish?

"If you have over 3½ acres," said Laumeister. "Let's say you go out at 8:00 o'clock in the morning and cut 3½ acres (that's a lot of mowing) by 10:00 o'clock. You can recharge and go out at 4:00 o'clock and do as much again, because most of the charge is replaced in the first four or five hours. Batteries charge very fast and then taper. You have to put the taper in because it equalizes the cells, but the actual power is restored in four or five hours. Our built-in charger is designed for that. After a complete discharge, it takes about 10 to 12 hours for a 100 percent charge. However, in the first three hours you restore almost half the charge; in the first six hours you replace three-quarters of the charge."

How long will the batteries last and what will it cost to replace them?

"With normal care, we expect them to last 8 to 10 years. They carry a five-year warranty. Replacement cost should be between \$16 and \$32 per battery, depending on type purchased. But since recharging costs only pennies, you might say that included with the Electrak is an 8 to 10-year fuel supply."

Another plus for the Electrak: It doesn't have to look far for a "gas pump." The home electric outlet licks a common problem for mower pilots—running out of gas on Sunday when local stations are closed.

It remains to be seen whether an electric tractor will appeal to men who like the sound of an engine when they pour on the power. GE is aware of this; Laumeister seems happy about a slight natural gear noise that comes from the transaxle when the tractor is under load. ★★ ★

The new Sears fiber glass boat. It takes the rock and roll out of fishing.



Here's real fishing comfort—a swivel seat that screws into the boat's seat.

Ice chest, rod storage grooves, anchor rope guide, carrying handles—they're all molded right into the boat.

There's not a seam or rivet to leak. The boat's molded into one solid piece of fiber glass.

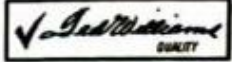
This check mark and  signature certify that Ted Williams, Chairman of the Sears Sports Advisory Staff, personally tested and approved "The Jonfisher."

A flat-bottom boat's great for still fishing. Stable. Comfortable. But on the move, it's something else. It rocks, rolls.

Ted Williams and Sears wanted a boat that wouldn't.

With a marine engineer's help, they got it. He designed a shallow-draft boat with a bottom flat as a raft's. Almost as steady, too. Next he added a modified V bow that makes this boat ride smooth even in choppy water.

Then Sears had the boat

molded into one solid piece of fiber glass. And with all the things a fisherman needs built in.

See this great new boat, "The Jonfisher," at a Sears Sports Center. Or in a Sears, Roebuck and Co. Catalog.

Sears 
SPORTS CENTER

where the new ideas are

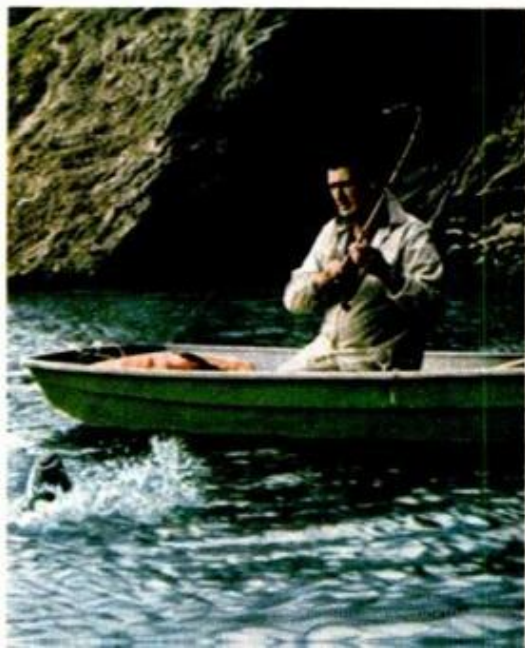

35 reassuring words from your Volkswagen dealer.

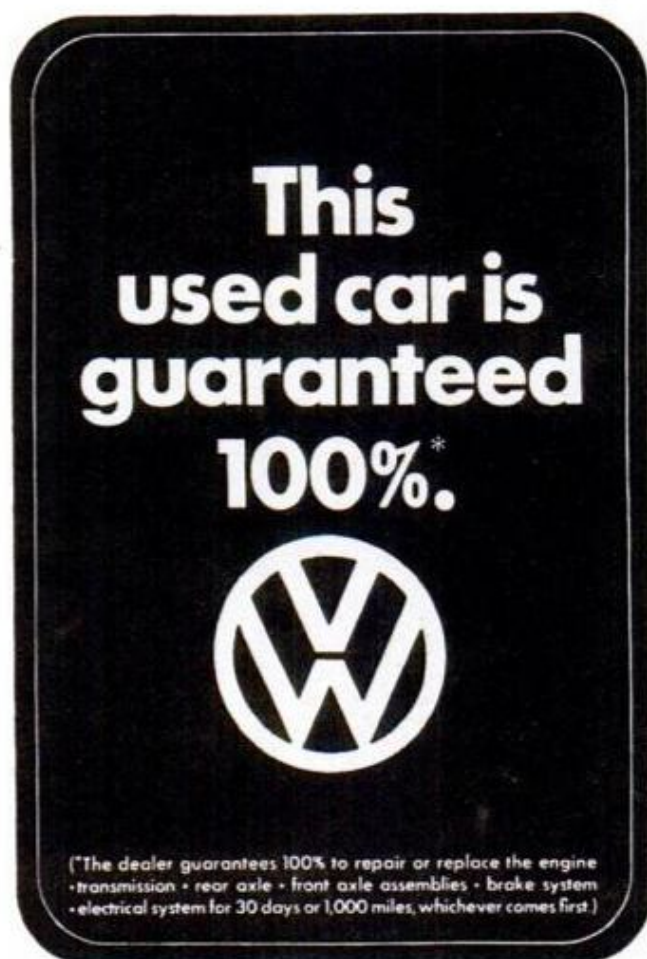

*This sign appears only in cars selected by your VW dealer.

© VOLKSWAGEN OF AMERICA, INC.

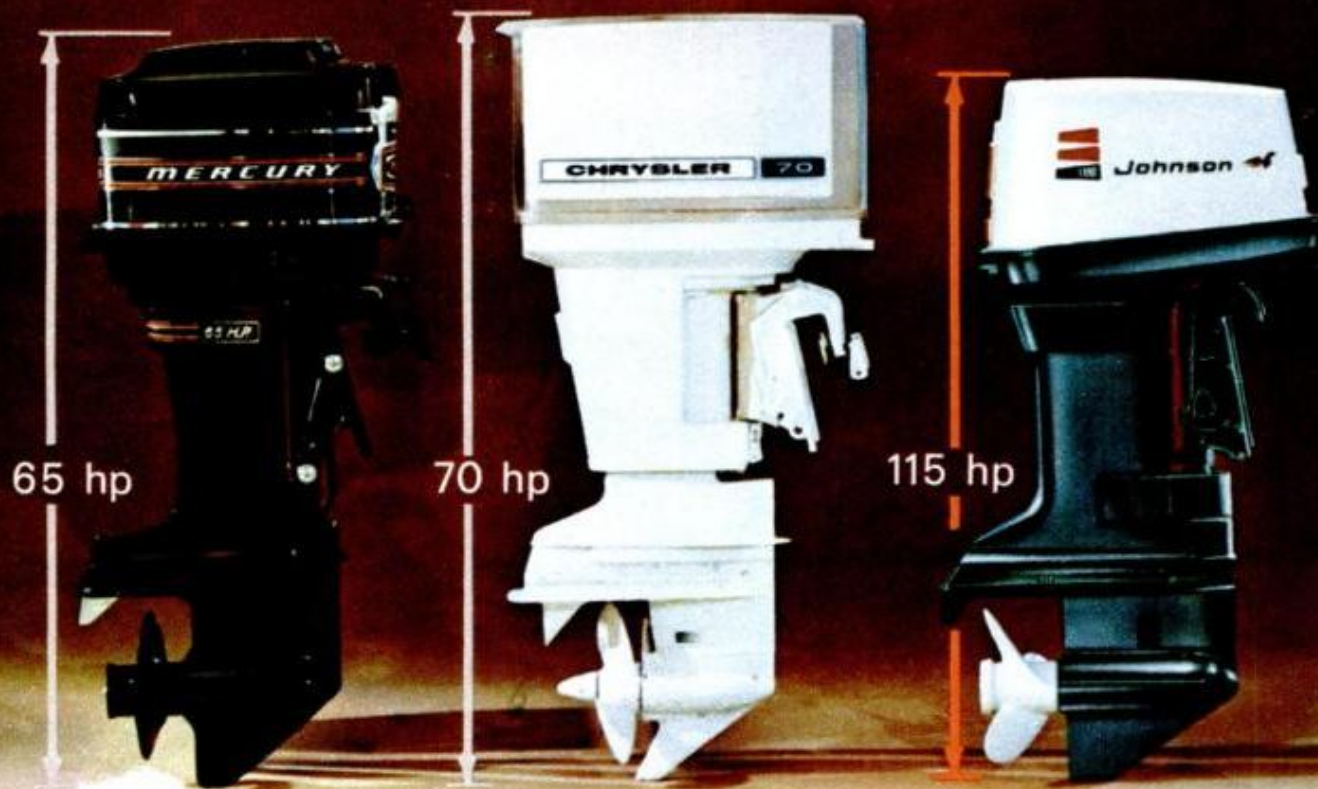

that's about the size of it

Standing still, these three outboards are approximately the same size. In action, there's no comparison. Under the low-down lid on the right, Johnson has tucked a powerful V-4 engine that churns out 115 horses with quiet, calm dependability. In addition to the efficient excitement of the V-design, this Sea-Horse also features Power/Pulse solid state ignition, new lightweight pistons with super-slim (no flutter) rings and a pair of fast-feeding two barrel carbs. Down where power becomes performance, you choose from six standard prop configurations with three more high performance bronze options. And to put

you in command of power and performance, Johnson's exclusive Hydro-Electric power shift is combined with the throttle in a new single lever remote control. You can buy other outboard motors with horsepower comparable to our new Sea-Horse 115. But you'll have to settle for something noisier, quite a bit taller, with fewer innovations and without Johnson dependability. It will be a big motor. And it could be a big mistake.

For 24 months after purchase, Johnson Motors will replace or repair without cost to the original purchaser any part of its manufacture which, upon inspection, proves to have failed in normal pleasure use due to faulty material or workmanship.

FIRST IN DEPENDABILITY
 **Johnson**
is the way to go!
 Div. Outboard Marine Corporation

Visit your Johnson dealer or write for a free catalog. Johnson Motors, Waukegan, Illinois 60085, Dept. PM-74.

YOURS ABSOLUTELY FREE

This big, practical book of plans, projects, "how-to" ideas from the all-new, profusely illustrated **POPULAR MECHANICS DO-IT-YOURSELF ENCYCLOPEDIA**

Let these shopwork experts show you techniques, procedures and short-cuts you need for really satisfying results!



BARBECUES



PLUMBING



SAILBOATS



AUTO REPAIRS

As a do-it-yourselfer, you take genuine pride in what you build, improve and repair with your own hands. Now—with the help of this remarkable FREE BOOK, you'll be able to sharpen your skills...do jobs better, faster, easier—and save a pocketful of cash at the same time.

The moment you open your FREE volume, you'll start reorganizing your workshop...get going on a whole new range of exciting projects for family, house, garden, car, boat, vacation.

Need more room in your home? See how easy it is to turn an unfinished attic or basement into the most striking room in the house. Practical, step-by-step plans help you do a perfect job and pocket savings of \$300 to \$1,500.

Want professional tips on sanding? Discover how to bring out the best finish in woods and metals with both hand and power sanding. 19 hands-at-work photos show clearly how to handle open-grained woods, pad sanders, flexible rubber sanders, disc sanders... answer every question.

Build an auxiliary table to enlarge your band saw. Your 12- or 14-inch band saw will cut anything you can get under the blade guide. The problem is to support and guide a large workpiece while it is being cut. Here's a 3 x 4 foot plywood table that gives any small band saw big-machine capacity and flexibility. Plans help you do it inexpensively.

Learn arc welding basics quickly. No need to shy away from arc welding. Practical tips help you lay a good weld in 6 hours easy practice.

Children love the Free-Flight Parashot Plane. Build this model for your children and you'll get a big hand at any flying competition. It may look like a flying dinner plate, but this way-out model is a rugged performer.

Brazing fixture for band saw blades. You can save half on blade costs if you buy bulk 100-foot rolls and make

your own. But you have to know these steps to silver-solder the joints.

These are just six of more than 6,000 exciting projects, plans and ideas you'll find in the new POPULAR MECHANICS DO-IT-YOURSELF ENCYCLOPEDIA...practical pointers to improve your skills in carpentry, metalwork, plumbing, masonry, electrical work, painting and decorating. Best of all, every volume in the set is a practical manual. Experts lead you step-by-step through every project you select. Without question, here is the most helpful, reliable, "how-to-do-it" guide you've ever seen—and Volume 1—a \$3.49 value—is yours ENTIRELY FREE.

You risk nothing on this free book offer!

Mail attached certificate at right, and we'll rush you the first of the 16 volumes of POPULAR MECHANICS DO-IT-YOURSELF ENCYCLOPEDIA as an outright gift. The book is yours to keep. You are not obligated to buy any other book in the set. We are giving you the first volume so you may see for yourself, at our expense, how easily you can do a better job on repairs, improvements, new projects—and save hundreds of dollars as well.

We believe that if you browse through the first volume—select a plan or project—use it at your workbench—try some of its money-saving short cuts—you will be anxious to receive the others. Therefore, we make this unusual offer. You may, if you wish, purchase the remaining volumes, at the low subscriber's price of only \$3.49 per volume.

Each new volume will come to you for 14 days' free examination entirely on approval. If you do not wish to keep it, return it and owe nothing. You may buy one, two, the whole set, or none at all.

Detach and mail the coupon at the right today to be sure of getting your free copy.

POPULAR MECHANICS do-it-yourself ENCYCLOPEDIA

16 outstanding volumes
3,136 how-to-do-it pages
Over 10,000 "show-me-how" illustrations
Instant Index to more than 6,000 ideas
Stain and scuff resistant, washable bindings
Big, easy-to-leaf-through pages
8 1/4" x 11" in size

You get more than 6,000 projects, plans and ideas for better living, greater savings, including...

93 tested projects on home maintenance, repairs, services to save you up to 75% on labor costs, materials.

538 "show-how" photos, drawings, diagrams on auto care and repair.

561 pages, over 1,000 illustrations on additions, remodeling, alterations.

107 money-saving tips on

power tools. Select the best tool for your needs.

68 detailed projects on electronics, radio, TV, hi-fi, tape recorders, stereo. Repair, maintain, install your own equipment.

76 illustrated projects and plans for sail and power boats, docks, moorings, water safety, navigation.

FREE GIFT CERTIFICATE

Popular Mechanics Book Division, Dept. 0014
250 West 55th St., New York, N.Y. 10019

Please send, **entirely free**, Volume 1 of the new, illustrated POPULAR MECHANICS DO-IT-YOURSELF ENCYCLOPEDIA. I'm not obliged to buy anything—now or later—but am entitled to receive additional volumes (including future Yearbooks), on approval as published each month. After examining each volume free for 14 days, I either return it and owe nothing—or keep it and remit low subscriber price of \$3.49 a volume, plus shipping. I reserve the right to cancel any time—without obligation. Whatever I decide, Volume 1 is mine to keep free!

Name _____
(Please Print)

Address _____

City _____

State _____ Zip _____

Signature _____

This offer available in Canada at a slightly higher price. Canadian residents please mail the coupon to New York address. Shipment of books and all services will be handled within Canada.



You'll see better ideas clear through Ford's Econoline

Small wonder it outsells all other vans



Twin-I-Beam ride. The independent front suspension made famous by Ford pickups: Twin-I-Beam. Two I-beam axles for strength... big coil springs for easy ride. Twin-I-Beam gives you greater stability, less wind wander, and a better ride. Only Ford has it.

"Walk-thru" to rear. Because the engine is forward out of the way, the driver can step from his seat into the load area and exit through side or rear doors. The loadspace is not only bigger than in older vans, it's easier to reach. See all the better ideas in the best selling van at your Ford dealer's.

Outside service center. Just raise the hood, and all these service points are at hand: oil, water, battery, windshield-washer water, wiper motor, brake master cylinder, voltage regulator. Ford's better idea vans make everything you do easier to do.

Greater payload than ever before. Now Ford vans can take on loads that vans never before were designed to take. Choose from three Econoline series and two body lengths. Power choices include two economical Sixes and a top-performance 302-cu. in. V-8.

FORD ECONOLINE VANS



RIGHT FINISH ON LATHE WORK

(Continued from page 198)

lift knurls from the surface and replace them, so they do not tend to follow a repeat path (as would occur in conventional knurling).

For metal tool handles and levers to be grasped, an interesting, nonskid effect can be produced by first knurling or cross-threading the surface, blueing the piece if it is steel or applying colored lacquer if it is another metal, then filing and polishing it to remove color from the high spots while leaving it in depressions. Steel can be blued chemically or by heating until the desired oxide color develops. (See *Lathe Inlaying*, page 170, July '65 PM.)

● *Pattern polishing.* Selective polishing with an abrasive rubber eraser (or with Brightboy stick) can produce interesting effects. The surface to be decorated should not be highly polished, but preferably a dull finish such as that developing on aluminum over a period of time.

Spiral patterns on cylindrical work can be produced by mounting the abrasive pencil like a regular lathe tool and using a coarse-thread setting, such as 4 t.p.i. (threads per inch), to control tool movement. Tracing right and left-hand overlapping "threads" produces a lattice effect. A series of bright bands or rings can be made with abrasive hand-held or in the toolpost.

By mounting the abrasive pencil as you would a conventional bit for a facing operation, you can produce concentric circles, spirals, or lattice designs on the flat surfaces or knobs, push plates and other items.

Those striking, circular-diffraction-grating-like effects you sometimes see on the front of transistor radios can be achieved on doorknobs, push plates and the like by mounting the item on a lathe faceplate or in a chuck and holding against it, as it spins, a fine-grit abrasive paper or cloth or a felt pad charged with fine abrasive powder.

● *Loose abrasive grits.* Almost any abrasive, if finely divided, can be used for polishing lathe work. It's fun to try different materials—such as aluminum oxide or silicon carbide grains and powders, pumice, Damascus ruby powder, rottenstone, valve-grinding compound, various abrasives used by rockhounds—and even household cleaning materials such as Bon Ami. Generally you can mix the abrasive with oil and use it to charge a pad or stick held against the spinning work. It's a good idea, when using any abrasive that could fall on the lathe, to cover the carriage and bed.

● *Grinding.* A toolpost grinder can produce a smooth finish on both hardened and unhardened metal. While grinding is often used primarily to bring the work to a definite dimension, or work metal too hard to cut with tool bits, the proper abrasive wheel can produce a very smooth finish. Recommendations for wheel choice can be obtained from suppliers of grinding materials and equipment.

There exists a considerable array of materials for producing smoothness and brightness, or achieving novel effects. In many cases, the best way to find out what is most suited for the job is to do some experimenting—to polish or treat some scrap pieces before tackling the main one.

Sources for various polishing and buffing supplies include William Dixon, Inc., Box 99, Newark, N.J. 07101; also various abrasive manufacturers such as Norton Co., 50 New Bond St., Worcester, Mass. 01606 and the dealers who handle their products. ★★ ★

FOUR WEEKEND PROJECTS

(Continued from page 185)

to the ties with ½-in. flathead nails, one being placed on one side of the rail and one on the other. Round the points of a couple 6d nails with a file, cut into ¾-in. pins and press them in the ends of the sawed-off rails. Finally, sift and sprinkle some fine gravel in a coating of wet shellac painted around the ties to simulate roadbed.

I used a Lionel No. 1101 metal-shell locomotive, but any train, even one with a plastic shell, will do. First remove the motor and scribe a line around the shell 4⅛ in. from the pilot. Then saw off with a hacksaw and file the end square. Fit a wooden block in the cavity and cement it in place. Also glue the small block that holds the shaft of the wheels.

To pinpoint the dowel hole in the cavity block, insert a dowel transfer plug in the hole and place the locomotive on the track. Then press the point of the transfer plug into the tunnel block and drill for a ⅜-in. dowel. Cut the side rods and the wire handrails so they extend ¼ in. beyond the cut end of the locomotive, drill tiny holes for them in the tunnel block and then with everything aligned, press in place.

The caboose is mounted similarly. It should be cut through at a point in the center of the observation roof.

If you wish, you can spray locomotive and all with several coats of clear acrylic. The last step is to glue felt to the bases and trim with scissors.—S. O. Dodge

FEEL

THE STRENGTH

While everyone else is pounding you with performance, Glasspar nudges. Because performance should be gentle, not shocking.

Like the 16' Cutlas. Lavishly roomy, luxuriously styled. Her subtle beauty belongs in the open water.

Under the rugged tri-hull design is Life/Guard Construction* That's what makes Glasspar a safer, quieter, smoother riding fiberglass runabout.

Before you buy a boat, take a look at a Glasspar. She's tough but beautiful.

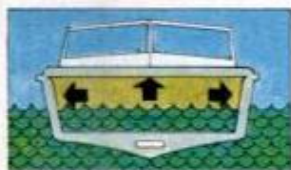

Safer — Life/Guard Construction features a unique foam collar in Glasspar's hull, combined with a "bige tunnel" to make Glasspar virtually noncompressible.



Quieter — Life/Guard Construction reduces engine and water noise. Tests performed in a Glasspar indicate that she is quieter than other fiberglass runabouts.



Stronger — Life/Guard combines layers of fiberglass, foam and additional layers of fiberglass. It makes Glasspar safer, stronger, quieter than conventional hulls.



Glasspar
BLUE WATER BOATS

A Division of Larson Industries, Inc.
Plants in Little Falls, Minn. / Nashville, Tenn.

*Patent Applied for

It's Here! The handiest
"tool" you'll ever own!

- 12 handy hang-up boards!
- 56 charts—scores of illustrations!
- Wipe-clean-plastic laminated to last for years!
- Authoritative answers to 1001 shop questions!

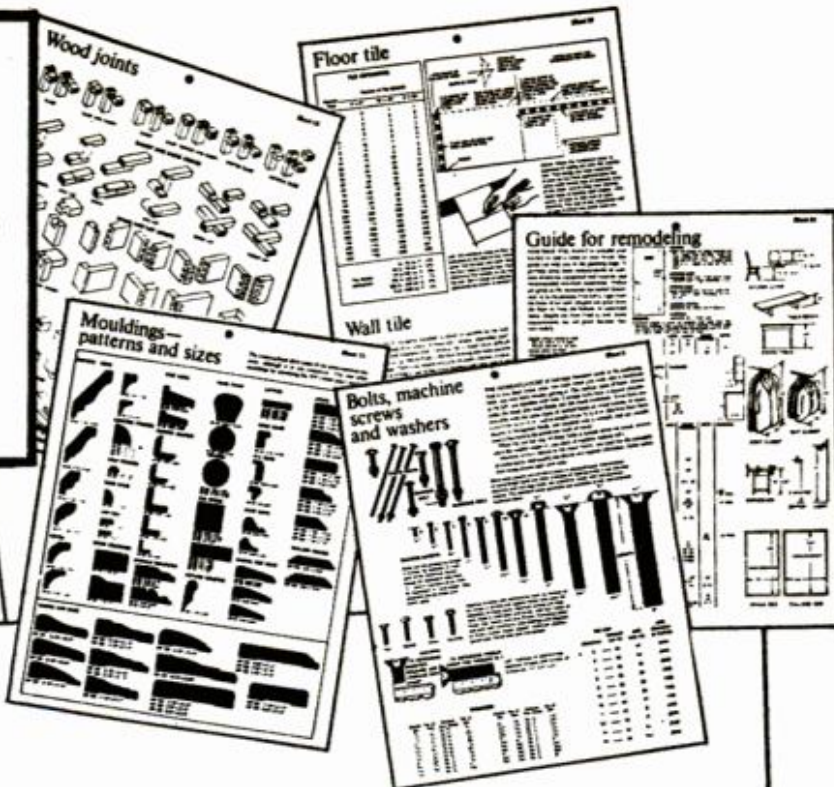

NEW!

**POPULAR
MECHANICS**

MASTER SHOP GUIDE

Save hundreds of dollars! Save hours of time!

Everything you need to know about: what nails, screws, bolts, wall-fasteners, drills, abrasives to use and why. How to order and use lumber, hardwoods, moldings, plywood, hardboard, gypsum, adhesives, plumbing, electrical work, floor and wall tile, glass. Plus the facts on remodeling measurements, gutters and downspouts, concrete work, lawn and garden chemicals! Plus—all on one "take-right-to-the-job" board—a ruler, centimeter rule, protractor, 45-degree triangle, and a compass for accurate circles up to 19½" diameter.

You'll reach for the MASTER SHOP GUIDE for every job you tackle!

What nail should you use for underlayment? What's the diameter of a No. 12 screw? What types and sizes of sheet-metal screws are available? How many pounds will a ¼-in. toggle bolt hold? How can you save money ordering lumber? What size quarter-rounds are available? How do you bleach close-grained hardwoods? What glue is best for cementing metal to wood?

All the answers on repairs, too! Illustrations of most-used plumbing and electrical fittings. How to fix dripping faucets, how to lay out a room for floor or wall tile, how to cut and apply plastic laminates, how to replace a pane of glass. Remodeling? All the basic dimensions you'll need to plan the job. Leaking gutters? Best way to patch them. What chemical controls which weeds and diseases? Best mixing ratio for concrete work? Just look it up.

One sheet even shows how to solve those puzzling math problems you often encounter in shop work.

By the editors of *Popular Mechanics*—order yours now—you'll use it the rest of your life!

MAIL COUPON TODAY!

\$3.95 complete set of 12
8½" x 11" boards!

PARTIAL LIST OF CONTENTS

Nail and screw sizes and uses	Bolts, machine screws, washers	Plumbing guidance
Useful mathematics	Wallpaper	Lumber sizes
Masonry	Wall fasteners	Mouldings—patterns and sizes
Lawn and garden chemicals	Plastic laminates	Properties of common woods
Stair construction	Glass	Glues and adhesives
Gutters and downspouts	Floor and wall tile	Wood joints
Guide for remodeling	Drill sizes	Plywood grades and uses
	Electrical work	Wood finishes
	Abrasives	

Popular Mechanics, Dept. SG
224 West 57th St., N.Y., N.Y. 10019

Rush me ___ sets of MASTER SHOP GUIDE.

I enclose check or money order for \$3.95 for each set ordered.

Name _____

Address _____

City _____ State _____ Zip _____

Come Saturday, this sporty new **Gladiator** becomes a backwoodsman.



This new 4-wheel drive 'Jeep' Gladiator is as smooth-riding as your family car. V-8. Power steering. Automatic transmission. All the options. And with its sleek lines, plush new interior and classy new grille, it's as stylish as your family car. Weekends, hook up your camper, even big cab-over rigs, and cut loose. You've got a big 132" wheelbase to carry the load. In confidence. See the new 'Jeep' Gladiator, a 2-Car Car. Just one in the world's first, finest and only complete 4-wheel drive family.

'Jeep'
4 WHEEL DRIVE
**The 2-Car
Car.** 





7:22. Good morning.

Your eggs are getting cold.

If it says 7:22, believe it. Because it's a **Waltham**. With a Swiss movement. The **Auto-Cal Courier**. Thoroughly male. Designed to get you through the day on time. Even if you're off to a late start right now.

Notice the calendar? Now you know what day it is. That's a significant start, Sleepyhead.

Consider: self-winding. Luminous hands. Luminous hour dots. Wow, that moon is bright! Sweep second. And a heavy, no-nonsense expansion band.

It won't wreck your budget, either. You can pick it up tonight, after work.

Don't gulp.

WALTHAM®
an international product of Waltham of Chicago

CHICAGO • NEW YORK • LOS ANGELES • GENEVA

Waltham watches are available in Canada, too.

Waltham clocks: everywhere!

If you have a
half-acre to mow...
you are a

Big tractor man!

(A Case-man, that is!)



You know from experience that caring for a lawn, tilling a garden, handling hauling chores and blasting a drive clear of snow are jobs for tractors—not people. REAL TRACTORS—engineered and built with the dependable hydraulic drive, job-matched attachments, performance, convenience and safety features *proved* in the BIG Case Agricultural and Construction Equipment.

Test drive a *real tractor*—7, 10, 12 or 14 hp—at your Case Dealer today! J I Case Outdoor Power Equipment Division, 131 So. 1st Street, Winneconne, Wisconsin 54986. A major component of  Tenneco Inc.

7 thru 14 HP Tractors

**“Built
like the
BIG ONES!”**

See Your Case Dealer or Write for FREE Full-Color Catalogs TODAY!

FREE

Popular Mechanics Catalog Plans, Publications, Projects

Want to build a boat, garage, sidewalk classic, plane or a clock, kayak, fireplace, kite, patio, coffee table aquarium, kitchen cabinet, organ, swimming pool, telescope, children's play furniture, camping trailer, science project, electronic project?

Send for the NEW Popular Mechanics illustrated catalog! 32 pages crammed full of fascinating and useful projects you can build yourself!

For more than 67 years, Popular Mechanics has been the world's leading authority on how-to information. In this brand new catalog you'll find the very best of Popular Mechanics plans and publications. In step-by-step text, photos and drawings, these plans show you how to build something for everyone in the family.



Above are shown a runabout boat you can build for less than \$75; a four-place plane you can construct yourself; a patio-garage and the famous sidewalk classic for youngsters that rolls along at 5 m.p.h.

For information on scores of other exciting projects, order the new catalog today! Send only 25c to cover postage and handling.

Enclose 25c in coin, no stamps please, to cover postage and handling.

Mail to: **Popular Mechanics Service Bureau Dept. B**
224 West 57 Street
New York, New York 10019

Please Print:

Name _____

Address _____

City _____ State _____

Zip _____

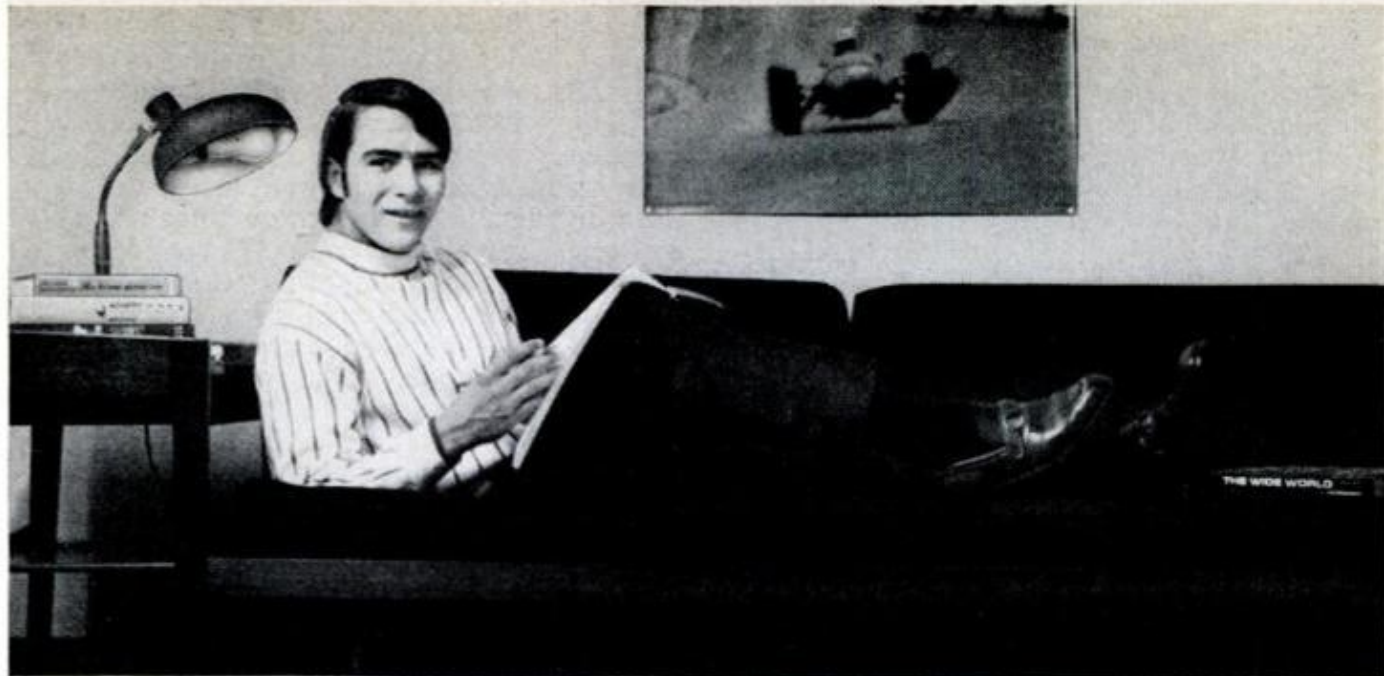

“I hated high school when I was a kid...and dropped out.

But I'm really enjoying finishing high school at home the Wayne way”

“The day I dropped out of high school, I would have bet my life that nothing could ever get me to crack a textbook again. I'd had it 'up to here' with being packed in stifling classrooms with dozens of other kids... trying to concentrate in the face of so many pressures.

“Even after I'd been out of school awhile, I felt pretty much the same. I was beginning to find out how tough it can be to get anywhere without a diploma. But I still couldn't bring myself to go back and get one.

“Then one day I ran across an ad for the Wayne School. It explained that there was now an *adult* way for me to finish high school. Right at home in my spare time, and at my own pace. And without giving up my job.

“So I enrolled with Wayne, and now I'm learning the Wayne School way. I get credit for subjects I've already completed...even have a choice of helpful vocational subjects too.

“I do my reading in the relaxed atmosphere of my own home. And I turn in my completed assignments by mail.

“Wayne's sympathetic instructors take a personal interest in my progress. They send me friendly notes of suggestion and encouragement when they mail back my graded assignments. And Wayne's

specially prepared lessons make even difficult subjects much easier to take. So I'm really enjoying finishing high school at home the Wayne way.

“Not only that, but it's already starting to pay off. When my boss heard I was studying with Wayne he was so impressed he gave me a \$10 a week raise. And he said I'd be paid even more after I get my diploma.”

This composite story describes the feelings of hundreds of men and women who are achieving success with the help of Wayne School. If you're over 17, not now in school, and would like to write yourself into a similar success story, mail the bound-in postpaid reply card for free information booklet. If card is missing, use coupon below.

Send for free facts

Wayne School

Dept. 28-501, 417 S. Dearborn
Chicago, Illinois 60605

Please send me your free illustrated booklet “*How to finish High School at home*” containing full information about your courses and teaching methods, and about opportunities for high school graduates.

Print Name _____ Age _____

Address _____

City _____

State _____ Zip No. _____

**Wayne School
wants to help you finish
high school at home**

foot, rear brake; right hand, front brake and throttle; left foot, gearshift; left hand, clutch. Directional indicator switch, headlight high-beam switch and choke give your thumbs something to do. Applying quickly becomes habit. And the toe shift—usually all the way down for first gear, up to neutral, up again for second, third and so on—is not at all as clumsy as it may sound.

However, I did find that on a motorcycle coordinating speed to the turning radius for a curve takes some practice—especially a variable turning radius. From bicycling, I was aware of the “invisible man” concept: Always assume that motorists and pedestrians don’t see you. Be prepared to take whatever action is necessary to protect yourself *and* them if indeed they don’t see you—as is so often the case. To be seen, I sometimes ride with my headlight on. Such

**Always assume that
motorists and pedestrians
don't see you.**

a safety precaution may become law, in fact.

If I hadn’t passed the riding test the first time, I wouldn’t bring up the subject. But I did and I will. After a few days’ wait, I got the good news to come down and have my license stamped “MC.” So, last summer while the Long Island Rail Road taxed commuters’ tempers, and with auto traffic as bad as ever, I took to the roads with a “vroom!” Well, more exactly, with a “ningningningning”—the sound made by smaller two-stroke bikes. They’re called ring-dings by four-stroke fans, for whom the throaty roar of a four-banger is an integral part of motorcycling.

Seventy miles per gallon from my 100-cc two-stroke meant a round-trip cost of one gallon of gas. My 35-mile trip from Long Island to Manhattan takes no longer than the railroad. It takes considerably less time if you streak along illegally between lanes of traffic even when cars are moving at or near the speed limit. In my book, doing that’s an abuse of the freedom a motorcycle gives you. The most safety-minded rider might do it occasionally, but only when traffic is at or almost at a standstill. Then you weave through slowly, very slowly.

I’ve sat in my lane in snarls and questioned riders who came up between lanes and slowed down to chat. I’m sure most of

The attitude of the wise guys was, “How are they going to catch you in all this traffic?” Most however, considered it unrealistic—impossible—for a rider not to use his machine to advantage, and figured that as long as he was careful and courteous to auto drivers he would not endanger himself or be stopped by police. A big danger in this situation, though, is incurring the resentment of automobile drivers stuck in traffic. Once I watched a driver in creeping traffic weave back and forth to block a motorcyclist from passing between lanes. The rider—I spoke to him later—was a mild-mannered older chap in a business suit who was not particularly upset by the motorist’s bullying tactics. The motorcyclist knew riding between lanes—however carefully—is illegal in New York. He felt the law should be amended for certain traffic situations.

To me, one of the most satisfying parts of the commuting trip is pulling into a marked space in a special motorcycle parking area and ambling the two blocks to PM’s offices. No trains, no subways, no buses, no aggravation and the Queensborough Bridge is free to all traffic. There’s talk about levying a toll on this bridge to help keep traffic from clogging Manhattan. If this should come to pass, motorcycles should be exempt. They’re not a substitute for rapid-transit systems, but a motorcycle doesn’t clog the streets like a Cadillac.

Heading back over the bridge one evening, I realized how important it is to have a checklist before you take off. I was riding on the bridge’s steel grating, fighting a broadside wind blowing up the East River. With a taxi on my tail, my engine started to quit. Luckily I realized I hadn’t opened the fuel-tank shutoff. I haven’t forgotten it since!

The only thing missing in that situation was a little rain. I find suiting up for rain just a matter of donning an inexpensive, lightweight, rubberized-nylon storm suit plus thin rubber stretch boots, all of which take but a small corner in a briefcase that rides my luggage rack. A helmet with face shield keeps the rest of you dry. I’ve ridden 35 miles in a downpour and stayed dry. In cold weather, a good snowmobile suit and a pair of gauntlet mittens will lengthen the riding season by months.

The thin, rubberized nylon of the storm suit is extremely wind-resistant. That’s the secret. In cool weather it’s warmer than a half-dozen sweaters. Traditional leather is still the tried and true riding gear cutting the wind. And, of course, it’s spill. Conventional shoes and socks are

(Please turn to page 218)

Big Profits in UPHOLSTERY

Get Your Share... FAST!

EARN BIG MONEY 3 NEW EASY WAYS

1. Be your own boss, make up to 85% profit.
2. Start earning right away at home in spare-time—keep furniture you make, or sell for hundreds of dollars.
3. Today's home and office upholstery, re-upholstery, slipcover boom make it easy to take your pick of big-pay jobs.

LEARN FAST—EARN FAST

You get expert instructions, plus all tools, new wooden frames, materials, fabrics, business tips, wholesale privileges, decorating magic **AT NO EXTRA CHARGE.** FREE Book, sample lesson pages show you how—no obligation—no salesman. Write TODAY.

UPHOLSTERY TRADES SCHOOL

Division of Singer Communications Corporation
Dept. 5110-040 Little Falls, New Jersey 07424
(N. J. State Approved. Accredited Member National Home Study Council. Vet Approved.)

MAIL COUPON TODAY

Upholstery Trades School, Dept 5110-040
Division of Singer Communications Corporation
Little Falls, New Jersey 07424

ESTABLISHED
1939

Please send me FREE book, "Your New Way to a Successful Career," and FREE sample lesson pages. No obligation—no salesman will call.

Name.....

Address.....

City..... State..... Zip.....

FREE
Deluxe Illustrated
Book and Sample
Lesson Pages



Tools, Equip.,
Frames, Mate-
rials, Fabrics,
Supplies yours
with course.

AFTER ONE HOUR'S WORK

*Your Typewriter
is now like new!
I'll send a bill
for the \$25.*



This Can Be YOU Sooner Than You Think!

BECOME A TYPEWRITER MAINTENANCE EXPERT

Quickly—Easily—At Home without risk!

Earn \$50 for 2 hours in your spare time, get a big pay position with a future or, start your own business.

There is a critical shortage of technicians to keep America's 30 million typewriters in repair. Now, regardless of age, education, or present job, you can enter this big-paying field by training in the Office Equipment Industry's *only* Approved Home Study Course.

Learn fast, and earn money while learning. Diagrams, photos, clear lessons, professional tools, plus benchwork assignments on actual typewriter that we give you, make learning easy.

Send name today for **FREE BOOKLET** telling of your opportunities in this profitable vocation. Full information, no obligation. No salesman will call. (VA Approved.)

Royal Typewriter
for practice
given you



**PLUS ALL YOUR
PROFESSIONAL
TOOLS FREE!**



MAIL COUPON FOR FREE BOOKLET

Typewriter Repair School, Dept. 3110-040
Little Falls, N. J. 07424

Please rush Booklet entirely FREE. No obligation. No salesman is to call.

Name.....

Address.....

City..... State..... Zip.....



"I Earn Two Incomes Now"

Says **JOHN BENNIE, Pittsburgh, Pennsylvania**

"Thanks to your wonderful training, I have been able to earn \$20 to \$25 extra each and every week doing little locksmith jobs at home and after work at my regular job. This is the best trade a man can take up."

Be a LOCKSMITH

Train at **HOME**—Earn While You Learn. Add 50% - 100% to **YOUR INCOME** with easy spare time earnings. Cash in on the nation-wide shortage—trained locksmiths in great demand! Quickly step into a big pay opportunity job or start a high-profit shop of your own.

Earn Extra Money RIGHT AWAY! All Master Locksmiths Special Tools, Equipment and Supplies Furnished **FREE** for use with course.

Age, education, minor physical handicaps don't matter in this growing trade. You can quickly qualify as a skilled locksmith. It's like a fascinating hobby. Study at home as little as one hour a week. Gain practical experience through complete well-illustrated lessons. Do real jobs on car locks, house locks, padlocks and safe locks, under the guidance of experts. **FREE Illustrated Book, write now.**

LOCKSMITHING INSTITUTE,
(Div. of Singer Communications Corp.)

Dept. 1110-040 • Little Falls, New Jersey 07424

306
pieces of professional equipment
FREE
for use with course.

Professional Equipment includes
**LOCKS—PICKS—PARTS—KEYS
SPECIAL TOOLS & SUPPLIES**
all **FREE** for use with course.

**MAIL
COUPON
for FREE
ILLUSTRATED
BOOK**

For a future as your own boss or in a high-pay job, write now for **FREE Illustrated Book.** Only school of its kind. Licensed by State of New Jersey. Approved for Veterans.

Accredited, Nat'l Home Study Council.

MAIL COUPON NOW

**LOCKSMITHING INSTITUTE, Dept. 1110-040
Little Falls, New Jersey 07424**

Please send **FREE Illustrated Book**—"Your Big Opportunities in Locksmithing," complete Equipment folder and sample lesson pages—**FREE** of all obligation—(no salesman will call).

Name.....

Address.....

City..... State..... Zip.....



LEARN TAX PREPARATION NOW WITH H&R BLOCK

GET READY TO EARN UP TO
\$700
PER MONTH

Learn tax preparation in your spare time at home with H & R Block, America's largest tax service. Get ready now to make up to \$700 a month next tax season as a tax preparer. Join the ranks of successful H & R Block graduates who occupy a respected position in the tax preparation field. No previous training or education required. Ideal for retired people and/or men and women seeking full or part time income. Job opportunities available for qualified graduates. Low tuition cost includes all supplies you need for this complete home study course. Write for free information. No salesman will call.

H&R BLOCK Inc.

301-40

TAX TRAINING INSTITUTE

4410 Main Street Kansas City, Mo. 64111

Yes, please send me without obligation full details on your home study course for income tax preparation.

Name _____

Address _____

City _____ State _____ Zip _____

FIRST YEAR ON A MOTORCYCLE

(Continued from page 216)

the best thing to be wearing if you spill. Conventional shoes and socks are fine. I only don a pair of dress boots when the temperature drops below 50°.

After putting 5000 troublefree miles on the Suzuki, I put a "for sale" sign on it. It sold fast to a family from the next town. By now the boys—Mike and Jamie Simon—have it stripped of lights and fenders and, along with their dad, are having fun scrambling the machine.

My first year of motorcycling began as an experiment, but I haven't been grounded by the sale of the Suzuki: I'm breaking in a second bike—a Honda 175K3 Super Sport. I'm hooked.

I plan to own bigger bikes, but for now the 175-cc Honda is fine. At 261 pounds, it's still under the 300-pound limit—meaning liability insurance costs half the automobile rate. Over that weight, or over 250-cc in some cases, the rates are the same as for a car. I spend \$52 a year to insure it. At that price I'll take a bike as a second car any day.

The four-stroke Honda, despite its 175-cc engine, heavier weight and better cruising speed and comfort, is as economical to operate as the two-stroke 100. Fuel economy is one advantage of four-strokes, but they do require a little more routine maintenance—valve-tappet adjustments and engine-oil changes, for example. It's too soon to tell if I will ultimately side with the two or four-stroke buffs—or straddle the fence. I'd like a stable of bikes including a couple of each!

More than one motorcycle is the only answer to the question: "How big a bike?" The 175 is perfect for commuting, but for rocketing up the freeways or throughways a couple of hundred miles—perhaps with a passenger—forget it. That means at least a 500-cc machine. If you're small you can get away with something smaller, but comfort starts at 500.

Recently I've gone out of my way to ride other machines. I recently borrowed a Yamaha 250—an extremely fast bike. A ride on a Triumph 250 was equally exhilarating, if a bit more nerve-racking because of the reverse foot controls on English bikes: Rear brake on the left, gear-box on the right. Nothing wrong with this when your reflexes are programmed for it, but my vote is for standardizing right-foot, right-hand for brakes. It is unlikely I will ever own the world's biggest production bike, a 1200-cc four-cylinder, 80-hp, \$4000 Mammoth, but I know I'll always

(Please turn to page 220)

Fox Mini Bike

DO IT
YOURSELF
OR FULLY
ASSEMBLED

from
\$99⁵⁰



SEND \$1 FOR BIG CATALOG Shows new line of the world's finest MINI-BIKES (street and trail models), plus Go Kart ®, parts, accessories and plans. Amazingly low prices! There's a Fox MINI-BIKE for everyone from age 10 to adults.

EXTRA BONUS Catalog shows radios, watches, walki-talkies, cameras, musical instruments, tools, appliances and many other items you can buy at practically wholesale prices. Free \$1 coupon.

FOX CORP., Box 797PM, Janesville, Wis. 53545

It only tastes expensive



Popular price

Also available in New large-size container.

BUILD A LOW COST PONTOON BOAT WITH THIS KIT...



FREE CATALOG

It's fun, it's easy too! You can build a rugged pontoon boat that will provide years of fun for your family at an amazingly low cost.

WRITE: PERMA-D MARINE PRODUCTS DIV.
DEPT. 46, CENTRAL MACHINE CORP.
P.O. Box 4243, Minneapolis, Minn. 55418

Make Rubber Stamps for BIG PAY

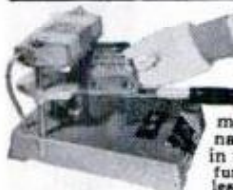

Need more money? Earn \$60-\$76 a week, spare time, at home making rubber stamps for offices, factories, individuals. Hundreds of uses. Hundreds of prospects—everywhere. Right in your own community. Turn out special stamps for names, addresses, notices, prices, etc., in minutes with table-top machine. We furnish everything and help finance you, at less than bank rates. Write for free facts. No salesman will call.

Rubber Stamp Div., 1512 Jarvis, Dept. R-2-D, Chicago 60626

HOW TO GET RICH

Secret Mail Order business brings cash by mail. Pyramid profits. No investment. Start at home in spare time. Write for full details and Free Book.

MAIL ORDER ASSOCIATES, INC.

Dept. 2, Montvale, New Jersey 07645

WRIST ROCKET

AMERICA'S Pat. HARDEST U.S. HITTING SLING

Range 225 yd.—232 fps

Matched spare rubbers and pouch assembly, \$1.00.

Write **WRIST ROCKET**® \$3.00 Post Pd.
2654 44th Ave. No C.O.D.'s
Columbus, Nebr. 68601



locksmithing and key making

PRACTICAL UP-TO-DATE COURSE — ONLY \$7.95

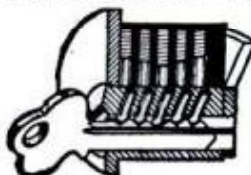

Teaches you how to pick locks, de-code, make master keys, repair, install, service, etc. New self-instruction lessons for every handyman, homeowner, carpenter, mechanic, service station operator, fix-it shop, hardware dealer, gunsmith. 53 easy illustrated lessons. Full price only \$7.95 postpaid. Satisfaction or refund guaranteed. Mail order today!

NELSON-HALL CO., Dept. DP-2
325 W. Jackson Blvd., Chicago 60606

APRIL 1970



Repair any watch

... SWISS OR AMERICAN

Unique, modern Sweazy System starts you making repairs right away. Develops skill step by step at home in spare time. Diploma awarded. Free sample lesson. No obligation.

CHICAGO SCHOOL OF WATCHMAKING
Dept. 140, Fox River Grove, Ill. 60021

BIG PROFITS FOR YOU!!

In your own spare-time PRINTING BUSINESS



Since 1872 thousands from high school to retirement ages have made important extra money with Kelsey hand presses, supplies, paper and how-to-do-it printing and business management help. Have your own printing business and your present job too. Send 25c (credited against your first order) for big catalog and details. **ACT NOW!!** **KELSEY PRESSES, Dept. 70D, Meriden, Conn. 06450**

HEARING AIDS

Huge savings on tiny, all-in-the-ear, behind the ear, eyeglass and body models. New space age models are so tiny and well concealed your closest friends may never even notice. **FREE HOME TRIAL.** No down payment. Low as \$10 monthly. Money back guarantee. Order direct and save. Write today for free catalog and confidential booklet. **PRESTIGE, Dept. D-34, Box 10947, Houston, Tex. 77018.**



ROTARY FILES

U.S. Surplus High Speed Milling Files going fast. New, in G.I. Packs. Hardened steel, for filing, milling, routing, drilling—any work in light metal or wood. Use in 1/4 in. drill, etc. Range in size from 1/4 to 1 inch wide. Get these most useful tools now.

16 tool set—government cost \$109.....\$ 9.00 to you!
36 tool set—government cost \$265.....\$15.00 to you!
100% GUARANTEED. WE PAY POSTAGE. A LIFETIME BUY!!

THE SURPLUS CENTER
LANCASTER, TEXAS 75146

**When Answering Advertisements
Always Use Zip Code**

219

**SAVE \$200 or MORE —
INSTALL YOUR
OWN AUTO AIR
CONDITIONER**



Supreme Unit

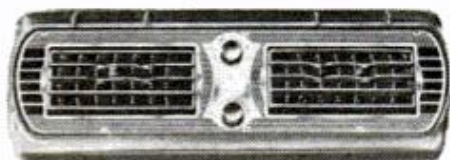

Super Unit

Enjoy summer driving this year by installing a Comfy-Kit auto air conditioner in your car. Comfy-Kit gives you all the cooling power you can use, and by installing it yourself you can save up to \$200. That's like being paid up to \$50 an hour for your time . . . while you have the satisfaction of doing it yourself.

Comfy-Kit's sleek design adds to your car's interior. Its efficient cooling . . . and money-saving price . . . make Comfy-Kit auto air conditioning a basic summer benefit.

Comfy-Kit will loan you the tools you need for installation, furnish you an easy-to-follow instruction book and give you a 12-month/12,000 mile warranty on your unit.

Send in your coupon today and get the jump on summer. Thousands of satisfied users are enjoying cool driving in sweltering heat. You can save money and drive cool, too with Comfy-Kit.

COMFY-KIT®

P.O. Box 8585, Dept. PM-4
Dallas, Texas 75216

- Enclosed is \$133.00 for Standard Unit*
- Enclosed is \$148.00 for Super Unit*
- Enclosed is \$165.00 for Supreme Unit*
- Enclosed is \$30 deposit on a Standard Super Supreme Unit. I will pay the balance, plus C.O.D. charges when delivered.
- Enclosed is \$8.00 deposit for a set of four tools, which will be returned to me when I return the tools.
- I would like to see the instruction book before I order. I enclose \$1.00 for the instruction book only. I understand this will apply on any future Comfy-Kit order.

Name _____
 Address _____
 City _____ State _____ Zip _____
 My car is a _____ (year) _____ (model) _____
 Engine displacement _____ Horsepower _____
 Power Steering _____ Yes _____ No _____
 Floor shift _____ Steering column shift _____
 Smog pump _____ Yes _____ No _____
 Please ship via _____
 *plus state tax where applicable

FIRST YEAR ON A MOTORCYCLE

(Continued from page 218)

be looking around for my next machine.

A few parting words of wisdom about motorcycling: The dangers are real—a cyclist is extremely vulnerable. Some riders I know have given up street-riding altogether and concentrated on trails. The joy of riding is reason enough to own a motorcycle—justify it if you will with a practical reason. Don't get carried away with the power and freedom and—in the pecking order of trucks, cars and motorcycles—you'll have nothing to give up but your right of way. ★★★

HOTTEST JOB IN THE WORLD

(Continued from page 92)

three choices: They and the astronauts can ride a slide wire 2000 feet down to ground level to a concrete bunker where other members of the rescue team wait for them; they can take the high-speed elevators down to the launch-pad base, and continue to where the shielded personnel carriers are waiting; or, as a final alternative, they can make a dash for the "doom room"—a shelter directly beneath the Saturn V, designed to let the astronauts and rescuers ride out in safety an explosion of the 3200-ton rocket.

Getting into the doom room is a nonsense procedure. At the bottom of the elevator is a Teflon-lined tube large enough to take a man in a pressure suit. Astronauts and rescuers dive or jump into the tube and drop onto a heavily padded crash base. From there they run several feet into the doom room. They seal the door, strap themselves into padded chairs, and ride out the blast atop huge coil springs.

The Astronaut Rescue Team is made up of 11 men from the TWA-Wackenhut (contractors to the space agency) fire-control force, plus three medical technicians from the Department of Defense. The chief training officer is Roy Terry; directing the team with him is his "right-hand man," Al Wozniak. The two men have been part of the team from the start. Wozniak is also the leader of Team 1.

Terry and Wozniak ride their men with an almost ruthless demand for perfection—and the men give it to them. M. Sgt. Jim Tanner is a medical technician in tank No. 3. Tanner served as a medic in Vietnam. He feels that at T minus 10 seconds in the countdown, when they're "buttoned up and waiting for liftoff," the tension and strain are just about as rough as in combat.

David Fullam is a tank driver; Randle

Marlow serves as anchorman in the White Room; Albert Praetorius is tank No. 2 driver; Adolph Garza Jr. has the White Room job of pulling out the second astronaut from the Apollo; Roderick A. Hobbs is the first man to enter the Apollo command module to release the connections from the spacecraft to the astronauts; G.E. Bidault is the lead man in the White Room who opens the hatch and then pulls out the first astronaut.

Senior M. Sgt. Joseph L. Nobles is a medical technician with tank No. 1; his primary Air Force duty has been as the NCO in charge of an Air Force hospital operating room suite—a far cry from hell at Pad 39A. Senior M. Sgt. William R. Churchill is a medical technician in tank No. 2.

The final three men are Charles H. Short, James P. McCallum Jr. and George H. Hoggard. Short is part of the White Room rescue force; he and Bidault have the job of rushing the first astronaut from the White Room and on his way to safety. McCallum drives the No. 3 tank, and Hoggard, in tank No. 2, is the team's trouble shooter.

For many weeks before a moon mission, the Astronaut Rescue Team follows full-time training schedules. The men practice eight hours a day, pushing themselves until ready to drop. It's grueling, brutal work. Some people might even consider it vicious physical punishment. The team members don't look at it that way, even when their training becomes downright frightening.

Wearing their silver suits and hoods, gas masks and special boots, they practice under conditions that duplicate the real thing—alongside a deep pit where rocket fuels create a small package of blazing, roaring hell. The fumes from the fire are *lethal*—and temperatures reach 3000° F.

No sooner do they finish this rescue session when, at double-time, they move to another area where huge oil fires roar into the air. Their job? To go into the fires and put them out.

Roy Terry says, "We haven't been able to toss anything at this team that the boys couldn't handle."

Before the team came into being, the fastest the astronauts could evacuate their Apollo spacecraft was in two minutes from the moment the emergency alarm sounded. But two minutes, said safety scientists, wasn't good enough.

So the Astronaut Rescue Team was formed. The team evacuates the astronauts from their spaceship in less than 54 seconds.

The men with the hottest job in the world really know how to move. ★★

GOVT. SURPLUS AND OTHER BARGAINS SAVE UP TO 90%



ROTARY GEAR PUMP Positive displacement. Rated 25 GPM @ 650 PSI @ 3600 RPM. Inlet & outlet ports 1 1/2" - 12 thread. 12 tooth, 5/8" male drive shaft. 6" H x 5" W. Govt. overhauled cond. Pumps fuel, hydraulic oil, etc. Shpg. wt. 12 lbs. GOVT. COST \$245. Now **\$15.50** (Stk. #1889)



HEAVY DUTY GEAR MOTOR All ball bearing construction. Rated approx. 3.5 HP @ 24 V.D.C. Turns 400 RPM, no load, on 12 V.D.C. & 800 RPM on 24 V.D.C. Contains instant start-stop magnetic clutch. Reversible. Has 12 tooth, 5/8" shaft. 18 1/2" L x 7" dia. GOVT. COST \$454. Shpg. Wt. 35 lbs. **\$29.50** Stk. #2465



ELECTRIC UTILITY PUMP Output up to 360 gal. per hr. @ 18 PSI. Exc. for water, fuel, insecticides, etc. Aluminum construction. Runs on 12 or 24 V.D.C. Explosion-proof motor. Inlet & outlet ports are 1/2" pipe. Draws 5.2 amps. 9 3/4" H x 6" W. Approx. GOVT COST \$150. Shpg. wt. 8 lbs. **\$14.50** (Stk. #2486A).



SILVER ANNIVERSARY EDITION

Send 25c for amazing catalog with 1000's of bargains in hydraulics; electrical, marine, automotive items, etc. 90 day guarantee. Order from ad. All prices FOB Culver City. 50% deposit for COD. Cal. res. add 5% sales tax. Include zip. Satisfying world-wide customers since 1945.

AIRBORNE SALES CO. Dept. PM470
8501 Stellar Dr., Box 2727 • Culver City, Calif. 90230

MAN-SIZE TRACTOR

MORE POWER FOR BIG JOBS.

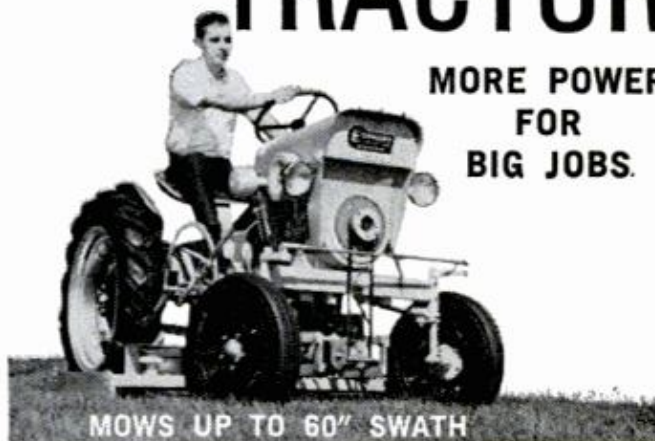

MOWS UP TO 60" SWATH

No week-end toy — this garden tractor has *real work power!* 14 hp, plus extra size, weight, and traction gives you added pull-power. No fluid-drive loss... geared drive leaves more horsepower for bigger attachments. You can mow 2 to 3 acres per hour; clear 16" snow in one pass; plow, roto-till, move dirt. So well built, you actually get over \$100 more value. Send for catalog, prices, name of dealer.

Name _____ c-17
Address _____
City _____
State/Zip _____

ECONOMY TRACTOR

1005 K-4 Anoka Avenue, Waukesha, Wis. 53186

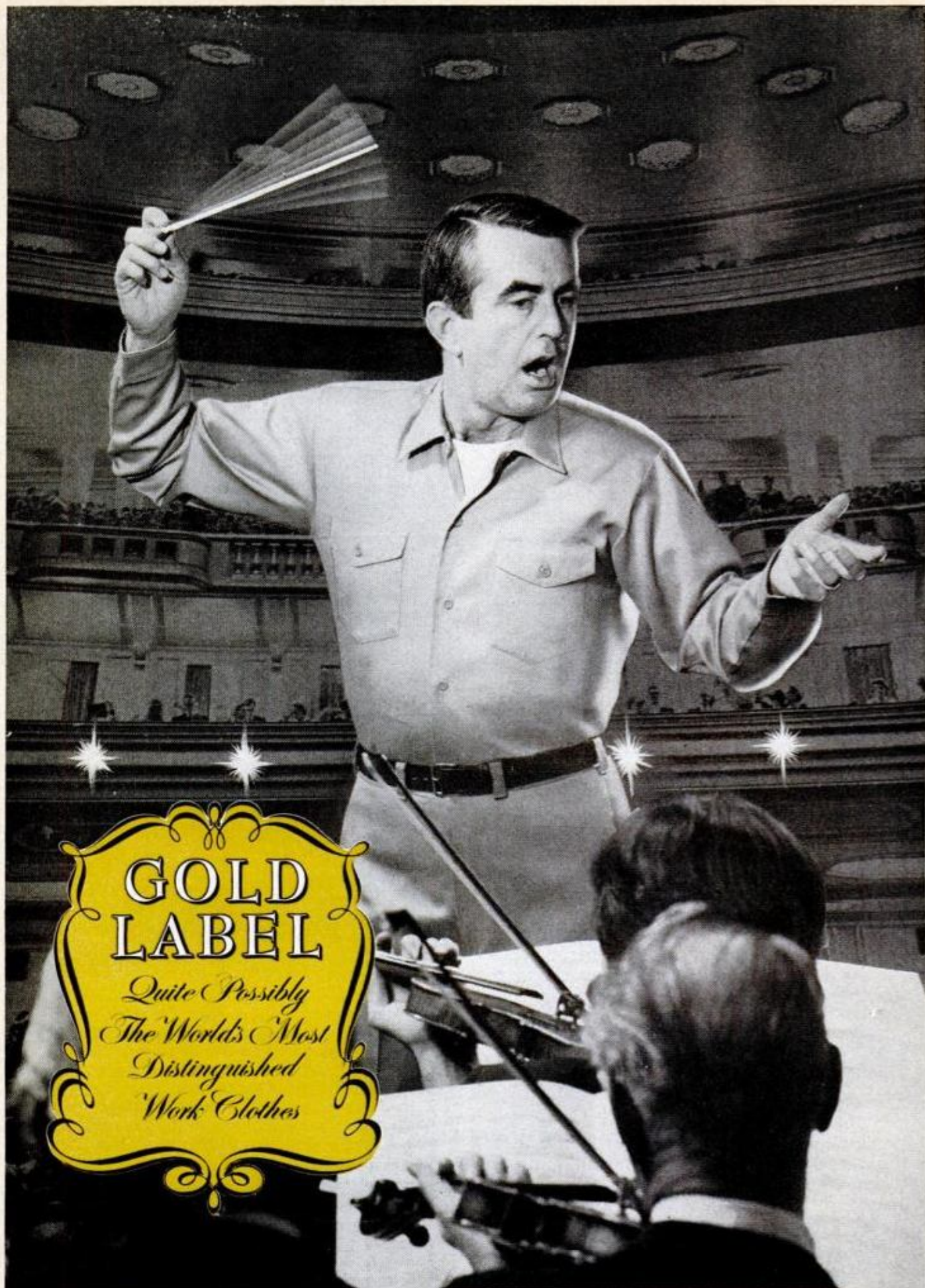

GOLD LABEL

*Quite Possibly
The World's Most
Distinguished
Work Clothes*

EHCO PRESS'D • Never need ironing • Fashioned by CANT BUST 'EM®
For the name of your nearest dealer, write Box 2468, South San Francisco, California 94080

FREE Popular Mechanics Catalog of Plans Publications Projects

A must for every man who builds and creates projects for the whole family to enjoy

For more than 67 years, Popular Mechanics has been the world's leading authority on how-to information. The NEW 32-page catalog includes the best of the famous Popular Mechanics plans and publications. Step-by-step text, photos and drawings show you how to build projects ranging from children's play furniture to a seven-room house and four-seater airplane, clocks, aquarium coffee table, swimming pools, kayaks, fireplaces, backyard railroad, boats, telescopes, patio-garages and camping trailers. Special electronic and science projects are included and many more building projects.

GET YOUR COPY TODAY!

Send only 25¢ to cover postage & handling.

Enclose 25¢ in coin, no stamps please, to cover postage and handling.

Mail to: **Popular Mechanics Service Bureau,**
224 W. 57th St.,
New York, New York 10019. 11

Please print:

Name _____

Address _____

City _____ State _____

Zip _____

APRIL 1970



Learn To Be A LOCKSMITH

**PROFESSIONAL
KEY MACHINE
YOURS TO KEEP!**

Big demand for skilled Locksmiths! Earn big money spare time in your own home. Be your own boss: earn steady, year 'round income with no layoffs. BELSAW INSTITUTE training, approved by master locksmiths, teaches you to make keys, open and repair locks on homes, cars and buildings. Easy, illustrated lessons complete with ALL tools and supplies, including the \$125 Key Machine which is yours to keep. Shows you how to get jobs, how to charge, how to earn while you learn and how to build a lifetime, cash-profit business.

Read These Reports from Belsaw Graduates:

Oscar Larson, Long Beach, Calif.: "I have all the locksmith work I can handle in spare time. I give hearty thanks for your wonderful training."

Herbert Bernard, Point Pleasant, N. J.: "I recommend your course highly. Locksmithing gives me real enjoyment and extra money."

J. Marko, Ferndale, Mich.: "With me locksmithing is full time. I sincerely thank you for giving me this chance to better myself."

J. W. Cookman, Lakeland, Fla.: "I've been in full time locksmithing for three months. Thanks for your fine cooperation."

Accredited Member National Home Study Council. Approved for Veterans. Mail coupon today... no salesman will call.

BELSAW INSTITUTE

100A Field Bldg., Kansas City, Mo. 64111

Send FREE book, "Keys To Your Future!"

**FREE
BOOK**

Name _____

Address _____

City _____ State _____ Zip _____



ALL FAMOUS
BRANDS!

**FARM
TRUCK
AUTO**

AT LESS
THAN
WHOLESALE

SAVINGS NEVER LESS THAN 50% up to 70% OFF REG. PRICE!

HEADQUARTERS for ALL SPORT CAR TIRE SIZES
FREE - SEND FOR YOUR FREE CATALOG - FREE!

RELIABLE TIRE DIST., 1111 Chestnut St., Camden, N. J.

NEW DYNAMIC MARK 88
80 AMP INDUSTRIAL TRANSFORMER ARC WELDER

IDEAL GIFT — EDUCATIONAL, ENJOYABLE, PROFITABLE

**WELD, BRAZE,
CUT, SOLDER, HEAT
STEEL, BRASS, ALUMINUM,
AND MOST OTHER METALS.**

Build and repair anything of metal. Save time & money with this **BRAND NEW, PROFESSIONAL ARC WELDER!** Rugged metal cabinet, baked Hammerloid finish. Ideal for home, shop, farm and industrial use. **POWERFUL** glass insulated transformer welds most metals up to 1/2" thickness with multi-pass weld, with 1/8" rods. 4 heat settings 20 to 80 amps. Operates on 110 Volt AC line fused for 30 amps. Complete with fibre glass helmet, electrode holder, ground clamp and cables, solder, assorted rods and simplified welding manual. **DOUBLE PROTECTION GUARANTEE.** 10 day money back trial plus full 5-yr. warranty. If inoperative return prepaid, we will repair or replace without charge & reship collect.

ORDER TODAY. Complete ready to weld. Only \$59.50 F.O.B. SEND ONLY \$6.00. Pay balance plus C.O.D. & delivery charges or write for easy "PAY AS YOU WELD" Low Down Payment Plan. Welder details FREE.



DYNAMIC WELDER CO.

1808 S. FEDERAL ST.
Dept. D2-D
CHICAGO, ILL. 60616

223

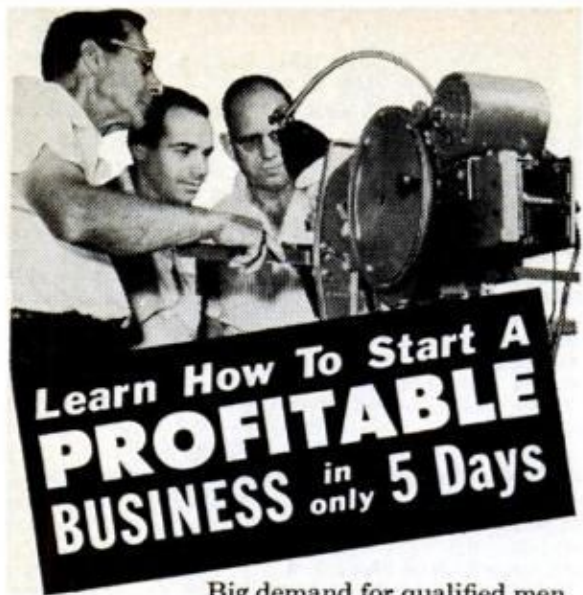

Learn How To Start A PROFITABLE BUSINESS in only 5 Days

Big demand for qualified men and women. Operate business in spare time to start. Customers are neighbors and big industry.

Foley's New School Shows How

Be a saw and tool maintenance expert. Professional instructors show you how. Automatic equipment. Proven teaching methods for faster, easier learning. New class opens soon. Enroll now. Write for Free Folder. No salesman will call. We Finance You!

Foley FOLEY SAW AND TOOL MAINTENANCE SCHOOL
 Dept. PMDB, 3300 N.E. 5th Street, Minneapolis, Minn. 55418

MECHANICS OF MEDICINE

(Continued from page 113)

the second for inside. The underside of the caliper has a 5-inch ruler with raised markings. The combination square uses the same dot system and the torque wrench is exactly like yours but with deeper markings.

A clinical thermometer made in Switzerland with a stainless steel case and stem, has a dial at one end—not unlike a meat thermometer, but smaller and far more accurate. The thermometer is inserted and left in place for four minutes. A button on the dial is then depressed—this connects the pointer on the dial, holding the reading which can be read from the raised buttons on the face.

Marker Buoy Legs

"We're taking the wood out of wooden legs," says Anthony Staros, pioneering director of New York City's Veteran's Administration Prosthetics Center. His center's new technique can produce a leg for below-the-knee amputees in two hours. Normally, this requires two days.

A thermoplastic material is heated and pulled directly over the leg stump, molding the socket directly and quickly. A new type of easily-adjustable alignment coupling is attached to this socket. One metal plate is attached to the socket and—held by a toggle system—is another plate which can be adjusted in every plane by means of a four-legged spider between. The legs are threaded, each holding a tapered wedgelike plate; tightening one while loosening another cocks the top plate so that relationship of the stump to the artificial leg (the "prosthesis") can be changed in any plane.

Utilizing this nut-and-bolt system, it takes only a few minutes to correct any error in the original alignment. It's also a simple matter to make a new socket and then attach it to the coupling.

From this coupling, aluminum tubing (the "pylon")—about 1 1/8 inch inside diameter and 1/8-inch thick walls—goes down to the foot. The usual hole through two B. F. Goodrich vinyl-foam marker buoys—normally used in the fishing industry—need only be enlarged. Common tools shape the leg and a urethane coating seals the material.

The pylon itself is split just enough to slip it over a boss on the undersurface of the coupling, then tightened with a simple hose clamp. At the foot end, the pylon ends in a large serrated bearing surface to which any standard foot is held by a bolt coming up through its bottom. ★★



Free!

Get this 16-page Window Planning Guide to help you make the right window decisions for your new home or remodeling project.

Send today for informative, full-color folder packed with helpful hints and facts plus a description of the Andersen Window line.

Mail to: Andersen Corp. Bayport, Minnesota 55003

Please send me your free booklet "How to get good windows." PM-40

I plan to build.

I plan to remodel a _____

Name _____

Address _____

City _____ State _____ Zip _____

Andersen Windows Window beauty is Andersen. Andersen Corp. Bayport, Minnesota 55003

BIG

YACHT-SMART
Sail Rig
DACRON
from
\$112



SPRING SAVINGS NOW

FOLBOT

TRAVEL CRAFT
fits in every
home or car

FOR YOUR SPORT AND FAMILY FUN
and
RECORD FISHING

GENUINE Folbot RECREATION for just ONE small investment, WITHOUT the continuous burdens of complicated 'big rig' operation. You GO CAREFREE anytime with COMPACT Folbot . . . rocky streams, lakes, marsh, surf & open sea. Superior non-sinkable designs provide SAFEST low gravity center, balanced low & high seating, substantial construction, protective decks & EXCLUSIVE swivel-back COMFORT. ALL within your reach. In handy Folbot YOU GLIDE smoother, faster & NOISELESS with paddles, oars, or sails and ride softly w. 1 to 10 HP. motors. Many styles & sizes from 1 to 4 seaters. FOLDING or rigid PORTABLE come in PREFAB KIT, or expertly FACTORY BUILT

Just a few Dollars start
YOU right away. From

ONLY \$19 NOW
for BASIC KIT

16 feet long

'CAYAT'
car top
YACHT.

and
RECORD FISHING



NEW
Fabulous
16 foot
\$115

Factory BUILT
FREE
ACTION CATALOG

STARTLING
FACTS & FIGURES
Mail coupon or address

to: FOLBOT CORP.
Dept. PM470, Charleston, S. C. 29405

Name _____
Address _____
City _____ State _____

An unsurpassed method of laying pipe under walks and driveways has been developed thru research by contractor-technicians . . . Called PLANT-A-PIPE, it operates by normal house water pressure thru an ordinary garden hose.

ALL YOU NEED IS A GARDEN HOSE AND...

PLANT-A-PIPE Nozzle and Hose Adapter attached to opposite ends of any length of pipe to be laid. When the water is turned on, high pressure jets of water are thrown from five, non-clogging openings in the Nozzle. Placed in a small trench, a gentle back and forth motion under the walk or driveway bores the Nozzle (and pipe) thru the soil quickly and easily.

PLANT-A-PIPE (patent pending) has been proved in use by thousands of customers. It eliminates the need for machinery and lasts a lifetime.

Exclusive PLANT-A-PIPE is available for three pipe sizes: 1/2", 3/4" and 1".

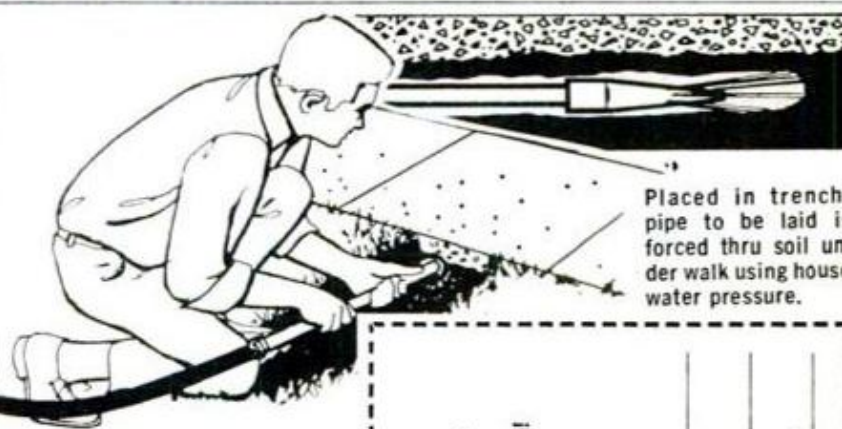

Placed in trench, pipe to be laid is forced thru soil under walk using house water pressure.

INTRO- DUCTORY OFFER

Order all three sizes of PLANT-A-PIPE (Nozzles plus Adapters) and save \$10 . . . you'll use 'em ALL! Send check or money order and we'll pay the postage. FULL MONEY-BACK GUARANTEE (within 10 days) if you're not satisfied.

BRITE-LITE ENTERPRISES, INC.

R.R. 2, P.O. Box 55, Springfield, Ill. 62707

Send me a PLANT-A-PIPE in the size I've checked:

1" 3/4" 1/2"

Check for \$19.95 enclosed, you pay the postage!

Send C.O.D.

SEND ME ALL THREE PLANT-A-PIPES.

Check for \$50 enclosed, you pay the postage!

Send C.O.D.

NAME

ADDRESS

CITY

STATE

ZIP

MEN—TRAIN NOW

FOR A BIG PAY JOB AS A CLAIMS ADJUSTER

Insurance Adjusters and Investigators are badly needed due to the tremendous increase in claims from auto accidents, fires, burglaries, riots, storms and industrial accidents. Over \$50 million paid out each day. Top money can be earned in this exciting, action-packed field. Car usually furnished; expenses usually paid; no selling; meet important and interesting people. Keep present job and train at home in spare time followed by practical training at our facilities. Nationwide placement assistance. For FREE information fill out and mail coupon today!



Accredited Member N.H.S.C.

**VA APPROVED FOR
VETERANS AND INSERVICE
PERSONNEL UNDER NEW G.I. BILL**

INSURANCE ADJUSTERS SCHOOLS DEPT. PM
1901 N.W. 7 Street, Miami, Fla. 33125

Please Print

Name _____

Address _____

City _____ State _____ Zip _____

Age _____ Phone _____

Nothing by any
other name is even
half the same as

spackle®



Unique — the painter's smoothing compound — first choice of the pro's — there's just one Spackle®. Works easiest, adheres to anything, dries fast, sands beautifully. Get it — and nothing but it — in the orange and blue can at paint and hardware stores.

the **muralo®** company inc.

New York/Bayonne/Chicago/Los Angeles

TO YOUR OWN DOCTOR'S PRESCRIPTION



EYEGLASSES
BY MAIL AT
GREAT SAVINGS!

Mail orders filled by **\$10⁹⁵**
licensed optician from

(Including single vision lenses, frame and case).

Doctor's prescription will be filled by a skilled, approved and licensed optician or your own prescription duplicated. Lenses are ground and manufactured to U.S. optical standards. Choose from complete catalog of men's, women's and children's glasses. Bifocals, trifocals, sunglasses or SAFETY HARDENED LENSES at low additional cost. We guarantee accuracy, perfect fit.

SEND FOR YOUR FREE CATALOG TODAY

PRISM OPTICAL INC.

Dept. P4, 136 Liberty St., New York, N. Y. 10006

CARE OF TAPE RECORDERS

(Continued from page 163)

classical, a reel of show tunes and so on. You can also intermix your own recorded remarks with prerecorded music, such as for making a movie sound track.

For editing tape, you need a splicing aid. The two basic types are the splicing block and the splicing machine. The block is simplest and costs only a few dollars. The machine splicer, a little more expensive, requires less skill and is faster.

The accompanying photos show how each type of splicer works. In either case, the tape is sliced diagonally instead of straight across. This allows the joint to pass over the heads progressively, instead of abruptly, and lessens the chance of sudden annoying noises. The joint is held together by special splicing tape. Ordinary cellophane tape won't do because it shrinks and gets tacky with age. Splicing tape is made to match recording tape's elastic characteristics, is ultrathin and adheres permanently.

In addition to editing, you'll need a splicer for repairing broken tapes and adding blank strips of leading and trailing tape at the ends of a reel. Leaders and trailers make tape handling easier and protect the ends, which otherwise tend to break off a bit at a time as the tape is played. Another use for such strips is to splice in "pauses" between recorded passages—short lengths of blank tape that help to keep your musical selections from running together. One blank tape made by 3M Co. (Scotch Brand) has timing marks one second apart at a tape speed of 3¾ or 7½ inches a second. By counting the marks, you can insert pauses timed precisely to any number of seconds you want.

As part of your program for regular tape care, run seldom-played tapes through your machine once in awhile to exercise them. You can do this at a fast wind if you don't care to take time to listen. Unless tapes are run occasionally, they may take a "set" and become brittle. Worse, some print-through may occur. This is when the recorded material on one tape layer makes a slight "print" or magnetic impression on the next layer. As a result, you may hear an annoying pre-echo of loud passages before they're due.

Recording supplies and accessories are available individually and in handy kits. Some best-known names are the Robins line, Robins Industries Corp., 15-58 127th St., Flushing, N.Y.; the Ultima line, Ehrenreich Photo-Optical Industries, Inc., 623 Stewart Ave., Garden City, N.Y.; and the Editall line, Elpa Marketing Industries, Inc., New Hyde Park, N.Y. ★★★

ADD MOTION TO YOUR SLIDES

(Continued from page 167)

other possibility is to set up a rotating color wheel in front of the spinning polarizer wheel. The color wheel won't add any motion, but will change color dramatically as patterns flash on the screen.

Ordinary clear, crinkled cellophane, combined with polarizing film, will also produce an array of changing colors. Crumple up a piece in your hand, then spread it out and sandwich it together with a piece of polarizing filter in a slide mount. The wrinkled cellophane creates a prism-like rainbow of colors as the polarizing wheel spins.

Most polarizing materials come with a self-sticking adhesive backing. You just cut out the size piece you need, peel off the protective backing paper and paste the film onto your slide. If you don't want to attach the film permanently to a slide, you can paste it onto a piece of clear cellulose acetate first. This makes it easier to change effects if you want to experiment a bit.

In most cases, it's recommended that the polarizing material be placed on the back side of the slide—the side facing the projector lamp—although it will usually work in front as well. If you like, you can make your own rotating polarizer wheel by cementing polarizing material onto a disc of clear plastic, but commercial wheels, complete with a small motor and stand, are available at moderate cost. Always keep the wheel turning while the projector lamp is on to prevent heat from damaging the polarizing film.

Polarizing materials are available in convenient kits, some of which are shown in the accompanying photos. Three major suppliers are Edmund Scientific Co., Barrington, N.J. 08007; Polarized Animations, 5153 Butler St., Pittsburgh, Pa. 15201; and Technamation, Inc., 30 Sagamore Hill Dr., Port Washington, N.Y. 11050. Color filters, called gels, can be obtained from Edmund Scientific or at photo shops and stores specializing in theatrical lighting supplies. Slide mounts are included in some kits or can be purchased at photographic dealers.

One particularly useful kit, sold by Polarized Animations, includes blank title slides and a selection of typical title words that can be inserted, along with polarizing film, linear motion strips, colored gels, slide mounts and an instruction manual. This Series 100 assortment sells for \$7.95. Catalogs listing individual items as well as kits are available from most suppliers and are helpful in ordering specific materials. ★ ★ ★

Amazing! New! ASTROTIME®

The Watch With Orbiting
Spacecrafts That Tell Time
With Countdown
Accuracy

COMMAND CAPSULE
tells the minute

EARTH
tells the hour

LUNAR MODULE
tells the second

ALL THREE
mysteriously
maneuver
around
the moon

R. Gsell & Co.,
New York, N.Y.

It's easy to tell ASTROTIME



17-Jewel Swiss movement—Swiss Timed and Tested for Precision

Be first to own this SPACE-AGE conversation piece! Lunar Module takes off, docks and lands on Moon every 60 seconds. Command Capsule orbits Moon once every hour. Earth orbits Moon once every 12 hours... it's all done with no visible hands! Moon-gold color case, blue suede band.

An ALDENS **\$25**
Exclusive!

ONE YEAR GUARANTEE

Aldens guarantees the 17-jewel Swiss watch movement for 1 full year. If for any reason the watch movement should fail it will be repaired at no charge.

GAMBLE ALDENS

81 Years of Serving Millions of Americans

MONEY BACK IF NOT SATISFIED

ALDENS—Box 5362, Chicago, Ill. 60680

Please rush _____ ASTROTIME watch(es)

No. 313 MC 1889W @ 25.00 each.

Enclosed \$ _____ Check Money order

NAME _____

ADDRESS _____

CITY _____

STATE _____ ZIP _____

2007



For Sparetime or
Full-Time Income
There's Good

MONEY IN SHARPENING

Here's a proven, practical way to earn sparetime cash while you develop a money-making business of your own. Investment is small. There's no overhead, no stock to carry, no selling involved.

FOLEY SAW FILER—Do a perfect job every time automatically with the Foley Saw Filer—and use the Modern Lawn Mower Sharpener to earn extra cash precision-grinding all mower blades. There's no experience needed—you can begin to make money right away in your basement or garage.

\$3 to \$6 An Hour Sparetime

Get started now and watch your business grow! Thousands are earning cash this easy way—many build a complete sharpening service with year around profits. You can, too, with the easy-to-follow Foley Plan—write us today!

Foley Manufacturing Co.
Minneapolis, Minnesota



FREE BOOK

Shows you how! Valuable book shows how to start and make profits fast. Mail coupon today. No obligation, no salesman will call.

FOLEY MFG. CO.
443-0 Foley Bldg., Mpls. Minn. 55418

- Saw Filer Information
- Mower Sharpener Information
- Money-Making Booklet

NAME _____

ADDRESS _____

CITY _____ STATE _____

HOLD IT!

the glue that never lets go!

write for FREE
glue and caulk
selector guides

WILHOLD GLUES, INC.

8707 Millergrove Dr., Santa Fe Springs, Cal. 90670



compact double duty tool sets unsurpassed for precise work

*Made for the skilled mechanic
and craftsman who appreciate
professional quality*

Five different sets with variety of 6 to 10 midjet drivers for delicate work with hex head screws and nuts; slotted, Phillips, hex socket, and Scrulox screws.

Each contains unique, slip-on, torque amplifier handle for added reach and driving power. Lets you do more jobs with fewer tools. Slim, trim, vest-pocket size case.

Nationwide availability through local distributors-dealers. Write for **FREE HAND TOOL CATALOG.**

XCELITE, INC., 162 Bank St., Orchard Park, N.Y.



DRIVE YOUR OWN WELL

(Continued from page 191)

but do not twist the pipe severely. Use the wrench just enough to take up any slack. When the driving tool will no longer strike the cap, add another length of riser pipe.

Pour water into the well, and alongside the drive pipe, at regular intervals. It makes driving easier, and tells when you have reached a water-bearing sand formation. When the wellpoint reaches water-bearing sand, you will notice an increase in the rate of descent of the drive pipe. It can be as much as 6 in. with each blow. When you think the point is in water-bearing sand, pour water into the pipe. If it stays in the point you guessed right. If it drains out, it's back to the driver. If the point is in clay, or other nonwater-bearing material, the water will either remain in the pipe or the drop in water level will be extremely slight.

Another method used to check for water is to lower a weighted line into the pipe. When you've hit water, the wet portion of line lets you know how deep the water stands in the well; the dry portion is a measure of depth from top of well to water level.

In some instances a greater length of the wellpoint can be brought into contact with water-bearing sand by raising or lowering the assembly about 1 or 2 ft.

When the wellpoint is at desired depth, it must be cleaned of sand and muddy water. Cleaning also helps to properly position loose material around the outside of the point which in turn brings the well up to maximum yield ability. Use either method shown (top of page 191) and then remove the fine sand from the well with a pump. Probably the better purging method is to jet water into the well with a garden hose inserted to the bottom of the well. The dirty water and sand will wash up and out around the hose. Repeat this flushing procedure until no more sand is obtained by pumping.

Before final installation of the pump, remove all sand particles from its interior, paying particular attention to the valves and plunger. Before drinking any water, contact your state health department to see if it will test the water for you. If not, use a commercial laboratory. They are listed in the Yellow Pages under "Laboratories, Analytical" or "Laboratories, Testing." ★★★

COMING NEXT MONTH

Camping '70: Special tear-out section
Electrolung: 1000-foot scuba dives now?
Indy Preview: Good show for Can-Am kings?

AN \$800 REEL?

(Continued from page 131)

when I had 'em alongside," one comedian joked. Four days later this same fellow sat stunned with burned thumbs and bruised pride after foolishly trying to stop the run of a small blue marlin that inhaled his bait and snapped the 50-pound test line like cotton thread.

On June 1, 1898 Dr. C. F. Holder caught a 183-pound tuna off San Francisco, a feat that fired the imagination of saltwater fishermen everywhere. However, the reel used was without a mechanical brake, and since busted knuckles and blistered thumbs are not conducive to happy angling, New Yorker William Boshen and the Englishman Mitchell-Henry began developing a mechanically braked trolling reel. Their work was independent of one another and so were their triumphs: On Sept. 12, 1913, Mitchell-Henry took a 520-pound bluefin tuna off Nova Scotia; that same year off Catalina Island in the Pacific Boshen became the first man to catch a broadbill swordfish on rod and reel. Dawn became sunrise for big-game angling.

Trolling reels range in size from compact 1/0s up to giant 18/0 models. The origin of this 1/0 - 18/0 scale is a mystery. One myth has it that the first digit refers to the hundreds of yards of 9-thread (approximately 27-pound test) line each reel can spool. Another story says that the first digit is the thread number best suited for that size reel. But since each thread represents only 3 pounds breaking strength, it seems unlikely that many offshore anglers would be willing to use 3 and 6-pound test line on reels the substantial size of the 1/0 and 2/0. And it's anybody's guess what the "0" stands for! Some insist it means *ocean*; others claim *zero*. Again, these explanations do more to cloud than clear the mystery, further compounded when you consider that the spool capacity of one company's 4/0 reel may be less or exceed that of another manufacturer's for the same diameter line!

But puzzlement notwithstanding, even today, saltwater reels reflect the watchmaker's skill first brought to fishing by George Snyder. For example, Fin-Nor's 12/0 spools, end plates and spacers are all hand tooled. An automated machine could stamp out a spool in minutes; the Fin-Nor process takes three hours. The assembly of all finished parts is frequently done by a single craftsman, and his precision is the closest thing to 21-jewel movement you'll find outside a horologist's workshop. Is the reel worth \$795? That depends on whether you'd like to buy equipment your great grandchildren can use. ★★★

BELSAW PLANER • MOLDER • SAW

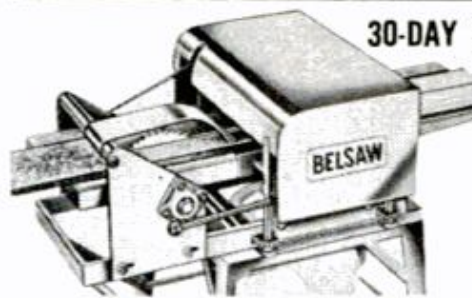

30-DAY FREE Trial!

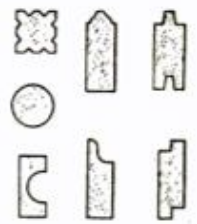

Now you can use this ONE power-feed shop to turn rough lumber into moldings, trim, flooring, furniture... ALL popular patterns. RIP... PLANE... MOLD—separately or all at once with a single motor. Free 30-Day Trial. Low Cost—only \$35 down. Send Postcard Today—No Salesman Will Call. BELSAW POWER TOOLS, 900A Field Bldg., Kansas City, Mo. 64111



BLAST CARBON

from every engine with
Fuel Mix Tune-Up Concentrate
New! from **GUMOUT**

HIGHBALL DOWN THE PIKE



TRIX

Tremendous pulling power. Greater variety in rolling stock and road names. Send for color catalog, 50¢ in coins (handling-postage.)

With world-famous 1:160 scale N-gauge **MINITRIX** series. Precision locomotives, bright headlights. 6 and 8 wheel drive, gear driven.

TRIX-TRAINS P.O. BOX 597 FARMINGDALE, N.Y. 11735

REAL ESTATE

BE A BROKER

PAYS BIG! SEND FOR BIG FREE CATALOG NOW! Graduates report making substantial incomes. Operate your own business quickly. Men, Women, all ages, learn easily. Course covers Sales, Appraising, Loans, Mortgages, & related subjects. **STUDY AT HOME** or in classrooms in leading cities. **Diploma Awarded. Write Today for FREE Book!** Accredited Member National Home Study Council. (Est. 1936) G. I. Approved.

FREE BOOK TELLS HOW

WEAVER SCHOOL OF REAL ESTATE
3521-P Broadway Kansas City, Mo. 64111

LOOSENS RUSTED NUTS, BOLTS, PARTS



LIQUID WRENCH

AT HARDWARE & AUTO STORES

HEAVY DUTY BALL-BEARING PUMP

IRRIGATE-DRAIN-SPRAY-CIRCULATE. All-metal, rust-proof, Type XB. Stainless shaft. Use 1/4 HP or larger. 1 HP 1,200 GPH 60' high or 3,000 GPH 25' well. 5,200 GPH max. 1 1/4" in; 1" out. Belt or direct drive \$12.95
Type P won't rust or clog. Bronze-bearing. Hundreds of thousands in use. Up to 2,400 GPH. 1" inlet. 3/4" outlet. Free coupling. \$8.95
P'pd. cash with order **MONEY BACK GUARANTEE**
LABAWCO. Box 40, Belle Mead, N. J. 08502



BE YOUR OWN BOAT TESTER

(Continued from page 159)

more suction under the stern and crazy things begin to happen—the boat becomes cranky to steer, planking under the stern can be ripped off by the suction; there are even cases of boats becoming so unmanageable they have rolled right over in reaction to the awful suction forces!

The top speed of a displacement hull depends on its waterline length, for that in turn controls the distance possible between the crests of the two waves just mentioned. It can be figured from a formula and works out to about four or five knots for a 20-foot waterline length such as on a powered lifeboat, and up to about 40 to 50 knots for the 1000-foot waterline lengths of big aircraft carriers.

To make boats in the small pleasure class go faster than four or five knots, the stern is cut off square so it will "let go" of that big second wave without creating suction, and the bottom is flattened out to

Practically all powered pleasure boats today have planing hulls.

provide a lifting surface. It is then possible for the boat to shrug off stern suction and lift onto the surface of the water so it can skim along swiftly. This is called "planing" and except for such craft as pontoon boats and dinghies, practically all powered pleasure boats today have *planing hulls*.

A planing hull can have a dead flat bottom, a mildly veed bottom, a deep-vee bottom, a round bottom, or any combination of these basic shapes such as the involved ones seen in cathedral hulls. A completely flat bottom can be shown to produce the most lift for the least expenditure of power, because every drop of water rushing under it pushes straight up on it. But such a bottom banks poorly, skids on turns and can pound like an aquaplane—ever ridden an aquaplane over choppy water?

So some degree of vee is wanted to encourage banking into turns, in addition to its beneficial effect on dynamic stability. Designers refer to the amount of vee as the "deadrise." Where the bottom meets the sides, the joint can be sharp (as on a sheet plywood boat) or somewhat rounded (as on a lapstrake boat). Designers refer to the first as a "hard chine" hull and to the latter as a "round bilge" hull. The round-bilge hull got its start in the days

when small wooden boats had steam-bent ribs, the roundness being due to the bent ribs. This shape is still used in fiberglass and in aluminum boats made by the stretch-forming process. Regardless of the shape in that area, *most* of the bottom is flat enough to provide a surface on which water can press up and provide the lift needed to plane. The deep-vee hull can be compared to an airplane whose wings have abnormally great dihedral; naturally, some lift is lost. Characteristically, deep-vee hulls need plenty of power to get up on plane.

The thing to do when testing a boat is to observe how water shoots free of the sides of the hull. Most of the water is being pushed down by the speeding hull, but some of it "spills out from under the edges." While a lot depends on the speed being made good and the load aboard, as a general rule water will shoot clearly out from under the sides of a hard-chine boat without touching the sides, but it will tend to roll out from under and flow up along the sides of a round-bilge hull. Logically, all the water passing under the hull of a hard-chine boat contributes to lift and none of it to unnecessary drag, because it does not touch the sides. The water rushing past the sides of a round-bilge hull creates skin friction while adding little to the lift.

The deep-vee hull characteristically "plows a groove" in the water, which flows up and out with considerable spray due to its being broken up by the lift strips on the hull bottom. You get a good ride but it consumes power.

Comparing these three hulls, you'll see that although a collection of boats may have the same overall length and width, they can still have a different amount of flat lifting area on their bottoms. Their "effective bottom loading" can thus vary, and so will their planing qualities. Compare the width of the flat part of the round-bilged boat's bottom at the stern with the width of the hard-chine boat. In rounding off the chines to make a round-bilge boat, some of the bottom area is taken away. This does not mean that round-bilge boats are necessarily inferior to boats with hulls having other shapes; I am merely calling attention to the differences that do exist which an experienced boat tester knows about and takes into account.

You're now a step closer to being such a boat tester. Next month, in Part 3, we will put the finishing touches on our survey of essential things to see when examining or handling a new boat, and add a detailed discussion of steering and riding characteristics. ★★★

INVENTORS

**INVENTIONS—NEW PRODUCTS—IDEAS
DEVELOPED & PREPARED**

For Commercial Appeal & Sales

DESIGN—MARKETING—PATENT RESEARCH—DRAWINGS

DIRECTOR: *United States Patent Office former Patent Examiner
Member: United States Council Int'l Chamber Commerce
Second Decade of Reliable Service to*

INVENTORS—MANUFACTURERS—ATTORNEYS

— — — — — FREE CONSULTATION — — — — —

THE RAYMOND LEE ORGANIZATION

230-Z Park Ave., New York 10017 (212-MU 6-8500)

SEND FREE "INVENTION RECORD," Form &
"PRODUCT MARKETING" BROCHURE

Name _____

Address _____

City _____ State _____ Zip _____

WANT MONEY?

Trading in common stocks may be your key to money. Learn to be a profitable trader at home in your spare time. Illustrated booklet tells you how to get started, pitfalls to avoid, money-making secrets. Send 50¢ coin, stamps, or check to



BARRETT Institute
P.O. Box 1020, Hemet, Ca. 92343

"LISTEN IN" TO POLICE-FIRE RADIO CALLS IN YOUR CAR!

WORKS with ANY CAR—Portable or HOME RADIO! Just PLUGS in—No wiring—3 minute hookup! Switch instantly from regular to ALL POLICE-FIRE-EMERGENCY-COMMERCIAL-TAXICAB-STATE-CITY-GOV'T 2 way Radio calls in YOUR AREA. DUAL—HI-LOW BANDS—36/50-150/175 MHZ. OVER a MILLION Radio Cars/stations. USE Everywhere—anytime—always works!



SEND ONLY \$2.00 (cash, Ck, M.O.) and pay postman \$9.99 plus COB pstg or send \$11.99 for ppd Del in USA. COMPLETE, ready to use with instructions. One Year service Warranty—10 DAY MONEY BACK TRIAL (if retnd). AMAZING OFFER good only by mail—WESTERN RADIO Dept. BPM-4 KEARNEY, NEBR. 68847



**EARN
HIGH
WAGES**
as a **HEAVY
EQUIPMENT
OPERATOR**

Train your way to high pay in the booming construction industry! Learn the skills you need to qualify, by actual field training on machines like the ones used by the industry. Huge training grounds in North Carolina, a million dollars worth of school-owned diesel-engined machines, experienced instructors, full 220-hour and 440-hour courses. National, the original school of heavy equipment operation, is a recognized leader. Member American Road Builders Assn., Services and Supply Division. Associate Member A.G.C. Full-time Job Advisory and Counseling Director on staff. VA approved. For men ages 17 to 56. Train Now-Pay Later plan... other payment plans also available. Write TODAY for FREE catalog and FREE copy of school newspaper reporting news of National School graduates. Accredited member NATTS.

**NATIONAL SCHOOL
OF HEAVY EQUIPMENT OPERATION, Dept. D-38**
P. O. Box 8529, Moores Chapel Road, Charlotte, N. C. 28201
Please send me FREE illustrated school catalog and complete information. I understand there's no obligation.

Name _____ Age _____
Address _____ Phone _____
City _____ State _____ Zip Code _____

The Swingline
Tacker Gun does
everything the \$12.95
gun will do...



for only \$8.95

Use the Model 800 Heavy-Duty Tacker Gun™ to install ceiling tile... repair screens... lay carpet... insulate... weather-strip... upholster... you-name-it! Takes 5 staple sizes, from 1/4" to 3/16" — plus special Loktile® staples for ceiling tile installation. Easy to load — easy to operate.



Model 800

Write for free booklet, TIPS ON TACKING Dept. P-4

Also available:
Model 101 Tacker Gun. Only \$5.95.
Takes 2 Staple Sizes 3/16" and 1/8"

Swingline

Consumer Products Division, 32-00 Skillman Ave., Long Island City, N.Y. 11101.



How to get good water.

You can get sparkling clean, spring-like water by the thousands of gallons for just \$29.95...

That's exactly what we offer with two types of Aqua-Pure home water filters. One removes dirt, rust, other solid matter. The other removes chlorine, sulphur, other bad tastes and odors.

Aqua-Pure water filters are now in use in over a million homes. They work. Year after year. They're sold by leading hardware, plumbing and farm supply dealers nationwide. They're the sure cure for almost every "bad water" problem.

For a free copy of AMF Cuno's informative booklet, "How To Get Good Water" write: Consumer Products Dept. PM-1, AMF Cuno Division, American Machine & Foundry Company, Meriden, Conn. 06450.



Aqua-Pure®
WATER FILTERS

AMF
CUNO

MY SPARE TIME HOBBY MAKES ME \$500 an hour CASH PROFIT

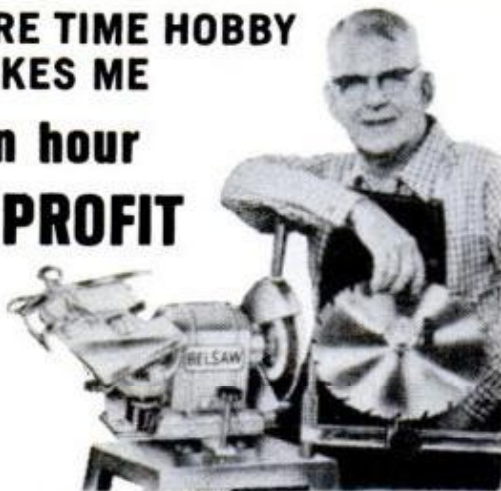

START YOUR OWN SPARE TIME BUSINESS
You can turn your spare time into Big Cash Profits with your own **COMPLETE SHARPENING SHOP**... Grind saws, knives, scissors, skates, lawn mower blades... all cutting edges. Your Own Cash Business with no inventory... right at home... no experience needed. **FREE BOOK** tells how you can start your own spare time business while you are still working at your regular job. Low Cost—time payments.



Just Mail Coupon—No Salesman Will Call

FREE BOOK

BELSAW SHARP-ALL CO., 710A Field Bldg., Kansas City, Mo. 64111
Send Free Book, "LIFETIME SECURITY." No obligation.

Name _____
Address _____
City _____ State _____ Zip _____

EARN \$20.00/HOUR



Assemble the **MINI-DOZER & MINI-BEEP** for resale at big profit. Unique easy-to-assemble kits. Full-line of attachments. "Build-it-yourself" Plans—either machine \$5.00, both \$7.50; 16-page Catalog—50¢ each, both 75¢.
C. F. STRUCK CORP., Dept. PM-40, Cedarburg, Wis. 53012

NEW Improved Accurate Scope-Shot

SCOPE-SHOT COMPLETE WITH 50 DISINTEGRATING PELLETS
They crack like a rifle when they hit—leave mark—puff of smoke! **\$2.50 P.P.**

Big Bag of **250 EXTRA PELLETS**
\$1.00 P.P.

World's Finest Precision **SLINGSHOT**
Scope-type sight!

Pure gum rubber slings. Beautifully polished cast aluminum stock. Pistol grip. So powerful it kills small game. Fits pocket perfectly! Guaranteed. **FREE** shooting manual.

EXTRA RUBBER SLINGS, 3 pairs \$1.00 p.p. Leather Pouch & Sling assembly only 50¢ p.p. Order NOW from:

GENERAL SPORTS
4184-MD Apple Street Cincinnati, Ohio 45223

train for Drafting Career in one year

Graduates of our accelerated four-quarter Drafting and Design Program employed by leading companies. Trained in everything from basic technical drawing to technical illustration and writing, they have entered into responsible positions in important industries. Tri-State also offers four-year degree programs in five fields of engineering... four areas of business administration... two-year programs of computer and machine design technology... of arts and science. Accredited. Approved for veterans. Moderate total costs. Enter June, Sept., Jan., March. Write Director of Admissions for Catalog, indicating the career you prefer. Unusual placement record!



TRI-STATE COLLEGE
440 College Avenue, Angola, Indiana 46703



LEARN MEAT CUTTING

Train quickly in 8 short weeks at Toledo for a bright future with security in vital meat business. Big pay, full-time jobs—**HAVE A PROFITABLE MARKET OF YOUR OWN!** Time payment plan available. Diploma given. Job help. Thousands of successful graduates. **OUR 47th YEAR!** Send now for big new illustrated **FREE** catalog. No obligation. **G.I. Approved**
NATIONAL SCHOOL OF MEAT CUTTING
Dept. 50-F, Toledo, Ohio 43604

40 AMERICAN MADE HIGH SPEED DRILL BITS WORTH AS MUCH AS \$20

Yours for only \$3.49

These are 1/8" to 1/4" high-speed drills—professional quality. The same drills used by big industry... metal fabricators, machine shops and professional carpenters. Your money back if not completely satisfied.

40 High Speed Drills only \$3.49
Save! 2 Sets (80 Drills) only \$6.49
13 pc. High Speed Set only \$1.49

add 35¢ postage & handling

CONSUMER'S BARGAIN CORP. Dept. PM-1
225 Westchester Avenue, Port Chester, N.Y. 10573
(N.Y. City & State residents add sales tax)

A POWER PACKED PERFORMER



- with Non-Breakable Fiber-Glass handle guaranteed not to break, bend or collapse in normal use.
- and PermaBond—keeps handle tight for added safety and service.

FA57

NAIL HAMMER

\$7.29

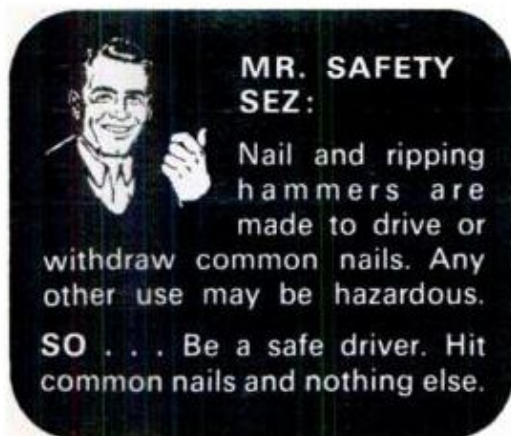

MR. SAFETY SEZ:

Nail and ripping hammers are made to drive or withdraw common nails. Any other use may be hazardous.

SO . . . Be a safe driver. Hit common nails and nothing else.

PLUMB

FAYETTE R. PLUMB, INC. • PHILADELPHIA, PA. 19137

PUBLICATIONS **WORTH WRITING FOR**

BY CATHERINE BILSKI

PLANNING A CAMPING TRIP this year? Then you'll be interested in a book entitled *Camping Maps U.S.A.* It includes reference maps of all states, information on pets, speed laws, cookery, first aid and much more. Send \$3.95 to Lawrence Irving, 1 Johnson Rd., Norwalk, Conn.

IT'S AMAZING what you can do with lights, and a multicolored looseleaf booklet, entitled *Unique Lighting Handbook*, will help you create or transform any

room in your home. It gives you instant mastery of black lighting, wet shows, lumia, kaleidoscopes and many more. The electric how-to-do-it section really spells it out to the last switch and wire. Copies are available for \$3 from Edmund Scientific Co., 380 Edscorp Building, Barrington, N.J. 08007.

GET THE ANSWERS to your questions relating to home comfort in the 16-page booklet *Comfort Plus*. In addition to a quick rundown of the various kinds of heating systems, the booklet furnishes homeowners and buyers with the standards of quality necessary to achieve indoor comfort. For a copy of the booklet, send 25 cents (to cover handling and postage) to Comfort Plus, Better Heating-Cooling Council, 393 Seventh Ave., New York, N.Y. 10001.

You Can Build This Four-Place BD-4



Featured in the May, 1969, issue of Popular Mechanics, the BD-4 is another of those famous Jim Bede designs. Lots of thought went into making it a smooth performer (186 mph with a 150-hp engine) and a fully detailed project for the home craftsman. For a complete set of plans, send your check or money order for \$30 along with the coupon below to:

Bureau of Information (Dept. KM), POPULAR MECHANICS, 224 West 57th St., New York, N.Y. 10019.

Please send a set of BD-4 plans to:

Name _____

Street _____

City _____ State _____ Zip _____

POCKET RADIO & TRANSMITTER



Surplus Bargain. Regular AM receiver. Broadcasts over AM. Use as walkie-talkie, intercom, detecaphone, radio. Complete with speaker, mike.

\$3.95 each. 2 for \$7.50

JOHNSON SMITH CO.,
Dept. 104, Detroit, Mich. 48224

TREASURE

Find buried gold, silver, coins, treasures.

5 Powerful models.

Write for free catalog



RELCO DEPT. D-3
BOX 10839, HOUSTON, TEX. 77018 **\$19.95 UP**

Make Big Profits In Your Own MAIL ORDER BUSINESS

U.S. Dept. of Comm. says you can "earn several hundred dollars every month". Mail for FREE details. No salesman will call.

Name _____

Address _____

City _____ State _____ Zip _____

MAIL TO: GIFT GUIDE
1137 1/2 CRENSHAW BLVD.
LOS ANGELES, CA 90019
DEPT. 198

\$12.95 BLACK DIAL TELEPHONES

Complete

add \$2.00 for color



Factory rebuilt Western Electric in white, beige, ivory, pink, green or blue. If 4 prong plug is required add \$2.00. Fully guaranteed.

Designs may vary.

Write for free list. All shipments F.O.B.

SURPLUS SAVING CENTER

DEPT. PM70, WAYMART, PENNA. 18472

Two or four-wheel drive
JEEP or SCOUT
owners

REPOWER with a 6 or V-8. H.D. ADAPTORS for using Car, Compact and some Truck engines. "State year & model. Jeep or Scout." Want fast action? Give us **FULL INFORMATION.** Send \$25.00 Dep. and we will ship correct kit, bal. COD. Send full amount for prepaid shipment. Wire, phone or write today. Details **FREE**

HOOSIER MACHINE PRODUCTS CO.

312 S. E. 6th St., Phone 276-3442, Pendleton, Oregon 97801

BASEMENT TOILET FLUSHES UP



TO OVERHEAD SEWER OR SEPTIC TANK. NO DIGGING UP FLOORS. INSTALLS EASY. Write McPHERSON, INC., BOX 15133, TAMPA, FLORIDA 33614



"If you can give me just 10 hours per week of your spare time, I'll show you how to add as much as \$300.00 to your present income."

DOES an extra \$300.00 per week sound "just too good to be true"? If you're willing to invest about 10 hours per week in your own future. I assure you that profits like this are very definitely within reach. Let me give you some real-life examples.

A Florida housewife, with no selling experience whatsoever, spent "maybe 5 minutes" talking to the Purchasing Agent of her local newspaper and left him a sample of a revolutionary new product. The result: a \$785 sale—including a \$215 commission for the housewife! The manager of a Connecticut bank, helped only by his teenage daughter, spends a few hours evenings and weekends mailing out samples of this same product. The orders that pour in a few days later net them an average of over \$275 a week. And a California businessman reports that the sales volume of his 14-year-old company has quadrupled since he started handling this product.

The product that makes success stories like these possible is called COPYFAX. This unique, patented "break-through" is rapidly replacing old-fashioned carbon paper—and carbon paper is a big, big, multi-million-dollar business

COPYFAX resembles carbon paper only in that it does the same job as carbon paper—although it does that job more effectively. Carbon paper is a flimsy grade of tissue paper coated with a mixture of grease and carbon particles. COPYFAX contains neither carbon nor paper.

COPYFAX is made from incredibly tough DuPont Mylar®, with a microscopic "honeycomb" surface impregnated with liquid ink similar to that used by printers.

COPYFAX won't curl, crease, or wrinkle like carbon paper. It won't smear or smudge. Try to tear a sheet of COPYFAX. You can't; it actually has one-third the structural strength of steel. A sheet of carbon paper is ready for the wastebasket after 5 to 10 uses. A sheet of COPYFAX is still giving sharp, crisp copies after 100 . . . 150 . . . even 200 uses. In terms of cost, COPYFAX outperforms carbon paper by at least 500%.

COPYFAX is available exclusively through distributors appointed by American Unifax. As shown by the house-

wife, the banker, and the businessman mentioned above, our distributors come from all walks of life. No special experience or big cash investment is required to become a COPYFAX Distributor. By acting now, YOU can cash in on this unusual opportunity to turn spare-time hours into dollars.

Within a few miles of your home, there are thousands of offices, industries, banks, stores, doctors, lawyers, schools, churches. They all use carbon paper—and they all hate it!

Show them COPYFAX . . . challenge them to try to tear it or smudge it . . . invite them to type with it. You'll make sales so fast it'll take your breath away! Not just small sales, either—even relatively small business offices are accustomed to ordering hundreds of dollars worth of carbon paper at a time. And these initial sales are just the beginning. As an American Unifax Distributor, your repeat-order business is automatic, fully protected, and fantastically profitable. Once a customer has tried COPYFAX, they'll never again be satisfied with carbon paper. It's as simple as that.

If you're of average intelligence, if you're ambitious, and if you'll give me just 10 hours per week of your time, I'll show you how to make more money than you ever dreamed possible. To get started, just fill out the coupon and drop it in the mail. There's no obligation and no one will call on you, so mail the coupon today, before some other wide-awake person in your area beats you to it!

AMERICAN UNIFAX, INC. Dept. P-47
 95 Madison Ave., New York, N. Y. 10016

YES! I want to get in on the ground floor with COPYFAX! Rush the order checked below:

RUSH FREE SAMPLE AND MONEY-MAKING DETAILS.

\$3.50 enclosed. Rush sample demonstrator pack of COPYFAX (worth \$4.50 retail) and all details.

\$15.00 enclosed. Rush limited introductory Wholesale Offer of 5 packs of COPYFAX (worth \$22.50 retail) and all details.

\$47.00 enclosed. Rush special complete sales kit: 15 packs of COPYFAX (worth \$68.85 retail), plus free samplers, brochures, business cards and invoices (worth over \$5.00).

NAME

ADDRESS

CITY STATE ZIP



95 MADISON AVE.
NEW YORK, N.Y. 10016

WHY LOSE! \$5 WIN

GET UP TO \$2 STAKE

A RACE DAY WITH \$2 STAKE



I WAS DEPRESSED—I'd lost again. This guy joked that with \$20 stakes he'd made \$1516 profit, also \$874 and \$1082 other days. Then I found out he wasn't joking, he had PENCLIFF world's top race computer.

Can YOU add up to \$1.87?

Of COURSE you can. The instrument was specially designed on the basis that after you have fed race information into it, figures in **Dollars and Cents** appear on the dials, and these are simply *added up* to make the ratings for each horse. The horse with the **HIGHEST** rating is calculated by PENCLIFF as being the best.

Get FACTS about PENCLIFF

We supply **FACTS**—complete *proof* that PENCLIFF is all that we claim. We supply **thousands** of Latest Checkable Big Win Results.

What EXACTLY IS PENCLIFF?

The instrument has 6 predictors and 1 Master Director Dial. You feed into the predictors: age of horse, position it finished in its *last 6* races, weight in current race, and comparison of weight to that carried in *last race*. Then the figures which appear on the dials are added up to make ratings.

MONEY REFUND GUARANTEE

When you receive PENCLIFF You **TEST** it, and if unsatisfactory you may return for a full **REFUND**. What fairer offer CAN we make?

PERCENT OF PENCLIFF WINS

Ron Hitchings first of all ran through the I.B.M. the results of 97,263 races to find out the best percent of **WINS** possible with PENCLIFF. He then conceived the idea of feeding them in from an entirely different angle, to find out what combinations of form, weight, etc., gave most **PROFIT**. Although under this basis the percent was lower—28%, the **PROFIT** was more than 50% **higher** than the 'most winners' basis and in fact the latter would have to be over 70% to be as good. The wins shown below in the panel are those at principal tracks only, but PENCLIFF operates equally successfully at **ALL** tracks.

DAILY WINS

LIKE THESE WAITING TO BE WON
ALL WON WITH ONLY \$2 STAKES

HIA	WON	\$187	} More recent wins Higher even than our heading		
HIA	WON	\$173			
HOL	WON	\$151		MON	WON \$107
HOL	WON	\$141		TRO	WON \$103
DMR	WON	\$134		PIM	WON \$102
BAY	WON	\$121		TRO	WON \$88
HOL	WON	\$118		HOL	WON \$87
BAY	WON	\$113		MON	WON \$87
HIA	WON	\$112		AQU	WON \$83
HIA	WON	\$108		SAR	WON \$81

SEND THIS COUPON NOW →

INVENTED BY RON HITCHINGS

EXPERT Handicapper with over 25 years of racing 'Know How'. Has been actively engaged in horse race computer research for many years. His facility at race reading has always proved a major asset, as it is in this art of being able to read into a race the hidden meaning behind the performances of the entrants—both winners and losers, that any logical basis of prognostication may be founded.

12 OTHER RACE EXPERTS

ALSO gave Ron Hitchings invaluable assistance towards the PENCLIFF invention.

OVER 4,000 BIG WINS

DON'T take our word for what we claim for PENCLIFF! We supply **OVER 4,000** latest *checkable* Big Win Results. Big Payoffs to \$2 stakes incl. \$89, \$106, \$169, etc. Big Track wins incl. \$151, \$173, \$187, etc., all won on the DAY with \$2 stakes on all selections in the 9 races.

A GIANT I.B.M. COMPUTER

Is one of the main reasons why PENCLIFF is so **successful**. *Thousands* of races were fed into the I.B.M. individually examining all the entrants. Whereas 50 mathematicians working a 35 hour week would have taken over 3 years, this magnificent instrument had it all worked out in a total of 97 and one-half hours! The instrument was first placed on sale by us in April 1965. Since then the consistent wonderful results continue to delight not only US but **THOUSANDS** of satisfied operators.

INVENTED BY 'ACCIDENT' BY RON HITCHINGS

We were trapped in the engine room of my yacht, the Titania. The hatch had jammed, and although straining and sweating and hammering, fit to burst our lungs, we just couldn't shift it. It occurred to me that if we had a radio in the engine room we could have called for help. Then I remembered that there were 12 other parts of the ship where we might have been trapped, whereas from only one, the chart room where the radio was, could we have called for assistance. Later in thinking about a new race computer and that previously I had always used only **one** dial on it, I remembered the incident on the yacht and thought, 12 places to radio from—12 times the chance of safety, now how about a race computer with **12 dials**, maybe **12 times as good**. Experimenting on those lines I eventually found that the ideal number was 6 with 1 Master Director Dial.

R.H.P. Co., P.O. BOX 5715 PWE7, CARMEL, CALIF. 93921.

R.H.P. CO. P.O. BOX 5715 PWE7, Carmel, Calif. 93921

Rush me full details of PENCLIFF Race Computer

Name _____

Address _____

City _____ State _____ Zip _____

We'll do a lot to please you. We even supply over 4,000 LATEST CHECKABLE PENCLIFF Big Win Results!

TREASURE & COIN DETECTOR

MONEY BACK GUARANTEE

New electronic detector penetrates deep into earth to locate gold, silver, coins, minerals. More penetrating power than ever before. Sensitive enough to locate a single coin or small nugget. Works through earth, wood, vegetation, water, rock, etc. Not a "probe" type but a fully electronic detector that is guaranteed to have at least twice the detection ability of any detector in this price range or return in 10 days for refund. Uses inexpensive 9V battery. Fully transistorized. Weighs only 2 pounds. Loudspeaker signals when object is detected. Has plug-in earphone for treasure hunting in privacy. **NOTHING ELSE TO BUY!**



29⁹⁵
POST PAID

Comes complete, ready for operation. Shipping container has compartments for detector and all accessories, serves as a carrying case. Send only \$29.95 check, cash or M.O. for postpaid shipment or \$2.00 and pay \$27.95 plus small C.O.D. when delivered. Viking Detectors, Dept. V-2, Box 10880, Houston, Texas 77018

Do Your FALSE TEETH Keep Coming Loose?

Don't keep worrying whether your false teeth are going to come loose at the wrong time. For more security and more comfort, just sprinkle famous FASTEETH on your plates. FASTEETH Denture Adhesive Powder holds false teeth firmer longer. Makes eating easier, more natural. FASTEETH is alkaline—won't sour under dentures. No gooey, gummy, pasty taste. Dentures that fit are essential to health. See your dentist regularly. Get easy-to-use FASTEETH today at all drug counters.

I-N-V-E-N-T-O-R-S WE NEED INVENTIONS

Sell your invention for cash—need money for Patent?—Are technical problems holding you back? Universal Inventions has helped inventors all over the world—just like yourself—why not you? Inventions provide the magic spring-board to sudden riches. REMEMBER, we either sell your invention or pay you a cash bonus. Write for details. **UNIVERSAL INVENTIONS, Dept. 13, Marion, Ohio**

ELECTRIC ARC WELDER \$11.99



NATIONALLY ADVERTISED \$18.95 VALUE!—NOW 40% DISCOUNT! WELDS—BRAZES—SOLDERS—CUTS—ALL METALS! Plugs into ANY 110 volt socket. **MAKE—REPAIR 1001 items for CAR—HOME—BUSINESS.** Lifetime **BURNOUT GUARANTEE** 10 day money back trial (if retnd). **HEAVY DUTY** Design—Uses \$85.00 welder work. No experience needed—**FREE WELDING LESSONS!** (cash, ck, M.O.) and pay postman \$9.99 **SEND ONLY \$2.00** COD postage or send \$11.99 plus \$1.00 postage for paid del. in U.S.A. **COMPLETE READY TO USE—** includes **BIG** pack steel, Brazing, Solder, Carbon "touch" rods. **ELECTROFLAME ARC TORCH! OFFER LIMITED—ORDER TODAY!** MIDWAY WELDER Dept. EPM-4 Kearney, Nebr. 68847

back trial (if retnd). **HEAVY DUTY** Design—Uses \$85.00 welder work. No experience needed—**FREE WELDING LESSONS!** (cash, ck, M.O.) and pay postman \$9.99 **SEND ONLY \$2.00** COD postage or send \$11.99 plus \$1.00 postage for paid del. in U.S.A. **COMPLETE READY TO USE—** includes **BIG** pack steel, Brazing, Solder, Carbon "touch" rods. **ELECTROFLAME ARC TORCH! OFFER LIMITED—ORDER TODAY!** MIDWAY WELDER Dept. EPM-4 Kearney, Nebr. 68847

2 for 1 WAREHOUSE CLEARANCE SALE



TWO \$1.98 FOR \$3.96 VALUE **10 Year Guarantee** **TWO FOR THE PRICE OF ONE** Razor sharp blade opens with flick of finger and automatically locks in place. **PUSH-BUTTON** release. Tough, razor steel blade honed and polished to mirror-like finish. Balanced for target throwing. Blade **GUARANTEED 10 YEARS.** If blade breaks we replace free. **30-day MONEY BACK GUARANTEE.** A favorite with sportsmen. Priced for quick sale of 200,000 knives. Makes excellent gift for any man or boy. Two for \$1.98 plus 50¢ shipping. Send cash, ck, or M.O. to **VIKING KNIVES, Dept. K-3, Box 10880, Houston, Tex. 77018.**



Chances are that pickup cover ahead of you is a Winnebago.

One out of every four on the road is.

Winnebago dealers sell more pickup covers than any other company in the world. Here's why they're so popular.

Selection: Winnebago has 90 versatile models to fit most any pickup.

Comfort: Fully foam insulated and lined with prefinished plywood.

Strength: Exclusive Winnebago Thermo-Panel® construction combines insulation with strength and light weight.

Safety: Safety glass windows all around that comply with all federal regulations.

Price: From less than \$200 to \$700.

Service: Over 140 assembler-dealers from coast to coast and Canada.

Chances are this is the kind of pickup cover you're looking for.

WINNEBAGO

Designed from the inside out

Send for a free catalog and the name of your nearest dealer!

Winnebago Industries, Inc. PM4
Thermo-Panel Div. Box 152
Forest City, Iowa 50436

NAME _____

ADDRESS _____

CITY _____

STATE _____ ZIP _____

FANTASTIC VALUES WITH THIS COUPON

AMERICAN MACHINE & TOOL CO., Dept. P M 4 L, Royersford, Pa. 19468

Please send me the units checked. Payment in full enclosed \$.....
or \$3 deposit each item enclosed, balance C.O.D. I MUST BE FULLY
SATISFIED OR WILL RETURN UNIT WITHIN 10 DAYS FOR FULL REFUND.
No questions asked.

- 8" Power Saw at \$14.95
 Standard Rip Fence at \$3.50
 Long Rip Fence at \$4.50
 Precision Ball Bearing Spindle at \$5.00
 Jointer Planer at \$19.95
 Drill Press at \$34.95
- Belt Sander at \$14.95
 Disc sander attach. at \$7.95
 Mitre Gauge for sander at \$1.95
 Lathe at \$14.95
 Face Plate at \$2.50
 Turning Chisels at \$4.95

G.E. Motor \$18.00 (with other item) \$24.85 (purchased separately)

NAME

ADDRESS

CITY STATE ZIP

SAVE AS MUCH
AS...
80% WITH
QUALITY 
POWER TOOLS

DIRECT FACTORY OFFER AND REVOLUTIONARY PATENTS decrease costs, increase efficiency. Full scale power tools of heavy duty 100% cast iron and steel. Streamlined design reduces weight, cuts material and production costs. Special patents provide added efficiency, accuracy, savings. Parts made, assembled, tested, packed right in our own factories shipped direct... save store profits.

ENDORSED BY AMERICA'S TOP MAGAZINES... Here is what the editors say:

"A good bit of sound—imaginative—engineering." Popular Science; "(saw) boasts many features of bigger brothers." Popular Mechanics; "Amazingly versatile." Workbench; "Highly substantial construction, sturdy enough for production line use."

UNCONDITIONAL 10-DAY MONEY BACK GUARANTEE
You must be fully satisfied. If not, return in 10 days, freight collect. Money promptly refunded in full.

Industrial Woodworking. And Workbench awarded these tools their coveted "Work Tested" Seal.

OVER A MILLION USERS confirm their precision, versatility and rugged performance.

***10-YEAR FULL SERVICE GUARANTEE**... Any part or parts of any AMCO power tool (except motor) which may become inoperative for any reason within ten years after the purchase date will be repaired or replaced by the factory without cost to the purchaser. Your only cost: for postage.



8" TILT ARBOR POWER SAW

DOES WORK OF \$75 BENCH SAW as is. Converts easily to equal any \$300 floor model cabinet units! Crosscuts, rips, mitres, cuts compound angles, dadoes, makes coves and mouldings.

\$14.95 f.o.b. factory. Wt. 25 lbs. Includes completely assembled cast iron and steel 8" saw with ground cast iron table... less blade. **RIP FENCE**, if desired, for easier work alignment, \$3.50 add'l.

PRECISION BALL BEARING SPINDLE for Commercial Service, \$5.00 add'l.

SAW BLADE TILTS... TABLE STAYS LEVEL

Locks securely at any angle up to 50°, raises, lowers 0°-2¼". Patented tilt mechanism, accurate etched scale. Patented motor mount takes std. ¼ h.p. or larger motor, keeps belt tight, assures perfect alignment at

any angle, transmits full power. Takes std. blade, saw insert removes to take dadoe heads, cutters, etc. (not incl.). Accurate mitre gauge assembly. Ground spindle. Enclosed steel base. "Compo" bearings. Access. Std. size (for bench saw) \$3.50; larger fence (for cabinet base, as ill'd.) \$4.50.

FREE CABINET BASE PLANS Use as portable bench saw as received (inset photo) or transform easily and inexpensively into floor model (as shown) guar. to do work of floor models costing \$300. **FREE plans**... all you'll need are a sheet of ¾" plywood and 3-4 hours. Use your AMCO saw for cutting. Plans provide 27" x 24" work surface, 33" height, tool storage compartment.

10-YEAR FULL SERVICE GUARANTEE*

6" SWING 3-FOOT LATHE



Optional faceplate for turning bowls, trays, lamp bases, rosettes, etc. \$2.50. **\$14.95** f.o.b. factory Wt. 14 lbs.

Set of 3 high speed turning chisels, \$4.95 add'l.

DOES THE WORK OF \$40 UNITS... with same precision and speed. Turns wood, plastic. Sturdy cast iron with tubular steel bed. Ball thrust cup center, spur center, T-rest assembly, lever action tail stock, 2-speed pulley. Fits any motor.

10-YEAR FULL SERVICE GUARANTEE*

PRECISION 4" x 36" BELT SANDER

f.o.b. factory. Wt. 15 lbs.

\$14.95 + Disc Sander attachment incl. disc bracket, ground cast table (tilts 0-45°): \$7.95 add'l.

DOES WORK OF \$50 SANDERS... The world's most talented belt sander. Heavy cast sander incl. 4" x 36" sanding belt, V-pulley drive, multi-purpose drive spindle. Changes from horizontal to vertical sanding in secs. Uses ½ hp or larger motor.

10-YEAR FULL SERVICE GUARANTEE*



Mitre gauge: \$1.95 add'l.

FULL 22" LONG, 4 1/8" JOINTER-PLANER

\$19.95

f.o.b. factory. Wt.: 19 lbs. Complete as shown.



100% precision ground cast iron and steel.

DOES THE WORK OF \$60 UNITS... Professional power planing at a hand tool price. Make faster, more accurate joints, rabbets, bevells for windows, doors, drawers, square tapered legs—Adjustable precision ground cast iron tables. Patent-pending design holds knife to table clearances at any depth. Rabbett depth ¾". Fence adjustable 0°-50°. Hardened, ground hi-speed steel knives. Dual cutter guards. Balanced cutter head.

10-YEAR FULL SERVICE GUARANTEE*

32" RADIAL DRILL PRESS

All cast iron and steel
f.o.b. factory
Wt. 30 lbs.
½" cap.
\$34.95

Jacob's chuck incl.

DOES WORK OF \$90 UNITS... and much more. Industrial quality precision unit with all standard features, many extras. Head raises, lowers. Depth of throat up to 16". Pre-set to any angle for on-or-off table drilling, even horizontal drilling. **10-YEAR FULL SERVICE GUARANTEE.***

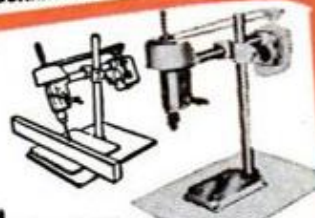

BRAND NEW MOTOR

DEVELOPING FULL 1 HP... **\$18.80**

F.O.B. FACTORY / FOR ANY OF ABOVE MACHINES. WT. 17 LBS. PURCHASED SEPARATELY, \$24.85

get the inside story on mercruiser matchmaking

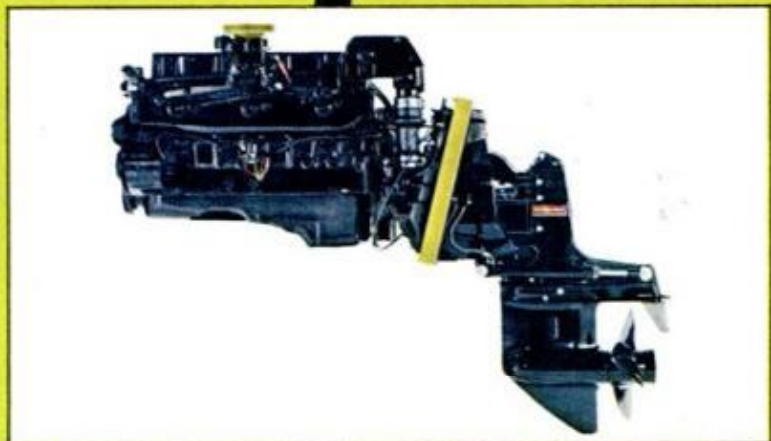
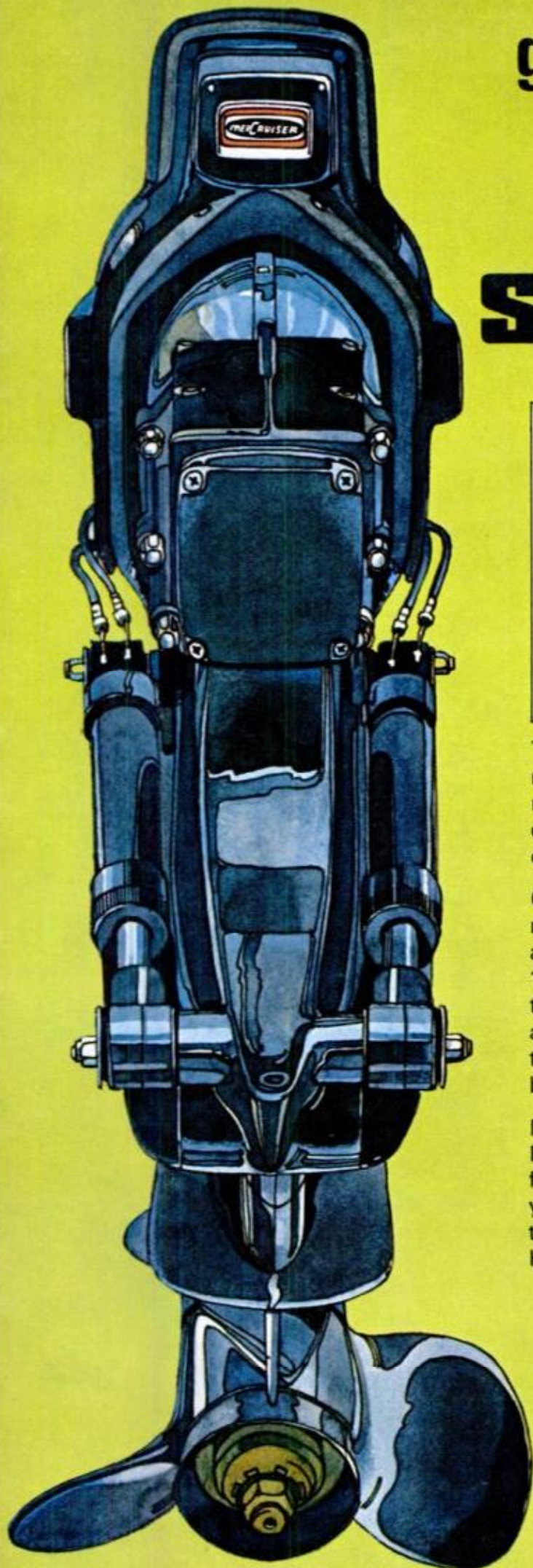

This sleek mechanism is a MerCruiser stern drive. The result of a perfect marriage between computer technology and experienced marine craftsmanship. Engine, drive, prop, even the controls—are designed for each other by Kiekhaefer Mercury engineers.

Only MerCruiser offers drive systems balanced and matched to engines by computers for maximum power and performance. Nine power units—90, 120, 140, 160, 165, 215, 270, 325 and 390 hp. Four drive units. And there's a Quicksilver prop designed for every conceivable speed and load. MerCruiser's got a combination that's just right for just about any size boat, any type boating application.

MerCruiser is a complete marine propulsion system. Everything from prop to tach designed and matched for precision handling, maximum performance. Before you buy a new boat or repower the one you've got, get the **INSIDE STORY** on MerCruiser from your dealer. He can find the perfect match for you.

MERCRUISER
STERN DRIVES



Kiekhaefer Mercury, Fond du Lac, Wisconsin; Canada, Ltd.; Australia Pty. Ltd.

Материал, защищенный авторским правом

100's
20 CIGARETTES

PALL MALL

FAMOUS CIGARETTES



FILTER TIPPED

U.S. Government
figures
show
PALL MALL GOLD 100's

**lower in
'tar'
than the
best-selling
filter king**

...longer yet milder



"Tar"
PALL MALL GOLD 100's 19mg.
Best-selling filter king 21mg.