

**BONUS**  
Tear-Out Booklet

**HOW TO BUY AND USE LUMBER**

# POPULAR MECHANICS

FEB 1970  
50 CENTS

**Build This 3-Way  
CAMPER-BOAT-  
CARTOP  
CARRIER**

Page 158

**Junior, Herb  
and Lee Roy—Can  
They Win  
Again at  
Daytona?**

**11 Pages of  
All-Time-Great  
PM Projects**



**Mini-Bikes: Just for Kids? Page 117**

**Across Canada in a Motor Home Page 122**

**Easier-to-Fix Cars • Pushbutton Fishing Gear**



**MILLER MAKES IT RIGHT!** Hearty,  
robust,  
deep-down good!  
So make your move to Miller . . .  
The Champagne of Beers.

# Norelco can shave you closer than a blade, and count how many times it does it.

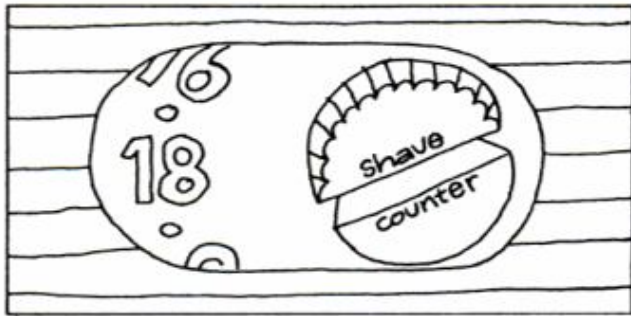

1,2,3,4,5,6,7,8,9,10,11,12,13,14,15,16,17,18 shaves.  
On a single charge.

The Norelco Rechargeable Tripleheader Shaver was made to do two things:

To shave you as close or closer than a stainless steel razor blade.

And to give you up to twice as many shaves per charge as any other rechargeable shaver.

Here's how it works.

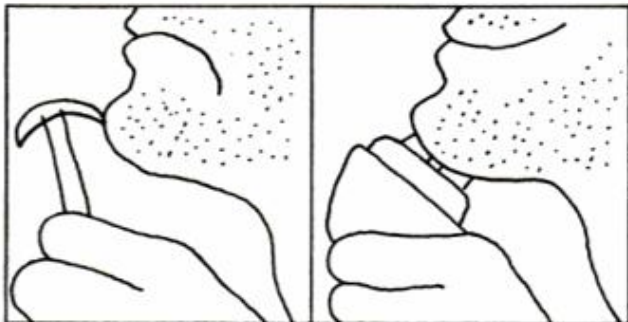

The Rechargeable Tripleheader has 18 self-sharpening rotary blades, inside of 3 Microgroove™ shaving heads.

The heads actually *float*, to follow the curves of your face.

They go in where your face curves in, and out where your face curves out.

And because the blades are *rotary*, they shave your beard in every direction at once. (If you don't think that means anything, feel your face. Feel how your beard grows in different directions on different parts of your face?)

The Norelco Tripleheader also has a pop-up trimmer, so you can see exactly what

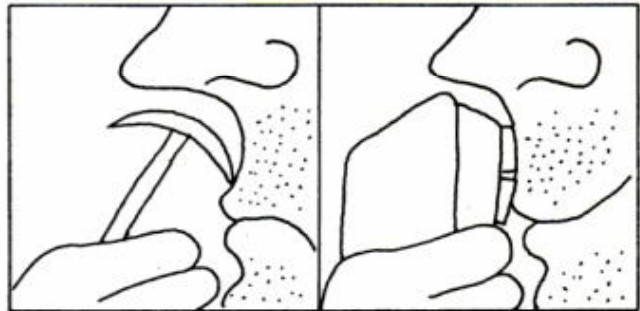

you're trimming.

It has a Charge Indicator that lights up when it's charging.

It has a Shave Counter to count your shaves.

And it gives you nearly twice as many shaves per charge as any other rechargeable.

So if you're shaving with a blade, feel around your chin and neck and upper lip.

If it feels like you could use a closer shave, get yourself a Norelco Rechargeable.

And shave your whole face for a change.



This One



647L-ELA-638Y

**Norelco**®

you can't get any closer

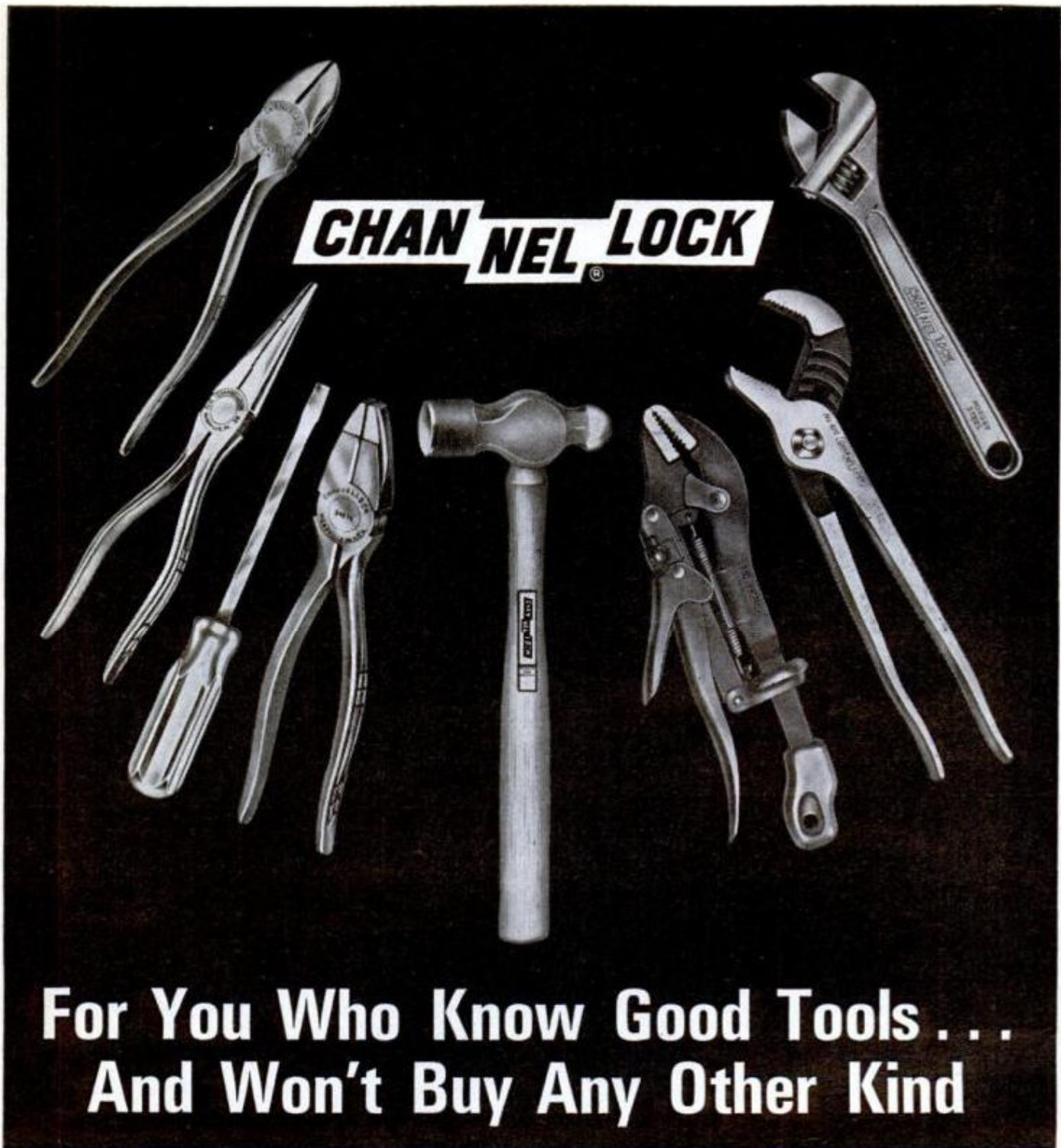

## For You Who Know Good Tools . . . And Won't Buy Any Other Kind

If you're one of those discriminating hand tool users who know and demand only the best, chances are you're already a Channellock customer. You know the beauty of full-polished, drop-forged steel, the smooth working precision-made working parts, the fine, hand honed cutting edges that distinguish hand

tools by Channellock. What you may not know is the wide choice of Channellock quality tools available to you. You can treat yourself to an arm-chair visit with the entire Channellock family in our color catalog. Let us send you a copy, no charge.

TOOLS BY  
**CHANNEL LOCK**  
MEADVILLE, PA.

**If the Honda Trail 90 had a  
10-speed transmission it would be  
almost as good as the  
Kawasaki Trail Boss except  
it still wouldn't have:**

- 11.5 horsepower
- Double loop tube frame
- Superlube automatic oil injection
- 12,000 mile or 12 month warranty
- or that 10-speed transmission



Kawasaki Motors Corporation, 1062 McGaw Avenue, Santa Ana, Calif. 92705  
Kawasaki Motors Corporation, 3 Production Way, Avenel, New Jersey 07001



Материал защищенный авторскими правами

# POPULAR MECHANICS®

INTERNATIONAL EDITIONS: AUSTRALIA, BRAZIL, CARIBBEAN, DENMARK, FRANCE, MEXICO, SOUTHERN HEMISPHERE, SWEDEN

## AUTOMOBILES AND DRIVING

- 14 Detroit Listening Post
- 40 Drivin' With Dan
- 82 Automobile Clinic
- 83 Easy-to-Fix Cars
- 86 Lee Roy's Secret Weapon
- 96 PM Road Test: AMC's New Hornet
- 102 To the Summit by ATV
- 117 A Family Guide to Mini-Bikes
- 122 Across Canada in a Motor Home
- 126 PM Owners Report: Datsun
- 134 Talk About Trucks
- 138 How to Keep Your Automatic Choke Working
- 154 Build This Three-Way Travelpod

## BOATING, OUTDOOR RECREATION

- 10 What's New Outdoors
- 22 On-the-Go Camping
- 100 Pushbutton Fishing
- 102 To the Summit by ATV
- 113 The Perfect Bass Boat
- 117 A Family Guide to Mini-Bikes
- 122 Across Canada in a Motor Home
- 142 So You Want a Quiet Outboard?
- 158 Build This Three-Way Travelpod
- 188 Inner-Tube Dog Boots

## SCIENCE AND INVENTIONS

- 20 Science Worldwide
- 90 The Big Lab That Tackles the Tough Ones
- 106 They Handle the Hot Stuff
- 110 Just Patented: PM's Pick of the New Inventions

## JOBS AND CAREERS

- 25 What You Should Know Before You Buy a Franchise

Cover Photo by Monty Mont de Oca at Cypress Gardens, Fla.  
*Build This Three-Way Camper-Boat-Cartop Carrier*

## HOME AND YARD

- 78 Homeowners' Clinic
- 154 Now: Prebuilt Saunas That Go Together in an Hour
- 164 Solving Home Problems
- 178 Install a Circuit for a 230-V. Arc Welder
- 182 Breathe Easier With a Home Air Cleaner
- 186 Exciting Home Products
- 190 A Lot of Railroad in a Little Space (Part 2)

## SHOP AND CRAFTS

- 163 Motors in Tandem Produce Higher Horsepower
- 166 All-Time Greats No. 3:
  - 166 Cocktail Snack Server
  - 170 Planter-Coffee Table
  - 172 Chairside Sewing Cabinet
  - 175 Flip-Over Ladder-Chair
- 177 Hints From Readers
- 178 Install a Circuit for a 230-V. Arc Welder
- 184 Handy Homemade Shop Tools
- 189 Hints From Readers
- 194 Hints From Readers

## ELECTRONICS, RADIO AND TV

- 130 Pick and Play Your Own TV Shows
- 148 New in Electronics
- 150 Build Your Own Indoor-Outdoor Electronic Thermometer
- 153 Electronic Hints

## PHOTOGRAPHY

- 144 Crop Those Shots for Better Pictures
- 149 Photo Hints

## REGULAR FEATURES

- 6 Letters

## NEXT MONTH IN POPULAR MECHANICS

**America's Supersecret Quiet Plane:** the Army's treetop reconnaissance glider.

**Build PM's Back-Yard Cookout Gazebo:** a handsome entertainment center for \$500.

**The 1970 Boats:** How to build a pontoon fun raft, choose a marina, size up a boat before you buy it—plus Mossberg's new camper.

**What Valiant Owners Say About the Duster.** Another exclusive PM Owners Report.

**ROBERT P. CROSSLEY**  
Editor

**JAMES M. LISTON**      **JOHN A. LINKLETTER**  
Executive Editor      Managing Editor

**WAYNE C. LECKEY**      **SHELDON M. GALLAGER**  
Home and Shop      Assistant Executive  
Editor      Editor

**THOMAS G. DAUER**  
Art Director

Published by The Hearst Corporation  
**RICHARD E. BERLIN, PRESIDENT**

**RICHARD E. DEEMS**  
President, Magazines Division

**JOSEPH F. KERN**  
Publisher

**WILLIAM KILPATRICK** \_\_\_\_\_ Automotive  
**JOHN F. PEARSON** \_\_\_\_\_ Science  
**GEORGE W. REIGER** \_\_\_\_\_ Boating and Outdoors  
**SHELDON GALLAGER** \_\_\_\_\_ Electronics and Photography  
**BILL HARTFORD** \_\_\_\_\_ Technical Automotive  
**HARRY WICKS** \_\_\_\_\_ Home Workshop  
**GARRY WINTER** \_\_\_\_\_ Copy and Production  
**RICHARD H. FUNK** \_\_\_\_\_ Associate Copy and Production  
**JOHN ADKINS** \_\_\_\_\_ Assistant Copy and Production  
**ALVIN KIETZ** \_\_\_\_\_ Assistant Art Director  
**DON EVANS** \_\_\_\_\_ Assistant Art Director  
**FRED A. LEERS** \_\_\_\_\_ Assistant Art Director  
**GEORGE W. BLOW** \_\_\_\_\_ Technical Art Director  
**CLIFFORD B. HICKS** \_\_\_\_\_ Special Projects  
**SOPHIE GRONOWICZ** \_\_\_\_\_ Director, Bureau of Information  
**EVERETT JOHNSON** \_\_\_\_\_ Cabinetmaker

ADDRESS ALL EDITORIAL COMMUNICATIONS TO: 224 West 57th St., New York, N.Y. 10019. For additional sources of information on the articles and products in this issue, write to Bureau of Information, Popular Mechanics, for free "Where-to-Find-It" list.

**DANIEL J. COLEMAN**  
Director of Advertising

ADVERTISING OFFICES: New York: 224 West 57th St., 765-6850; Chicago: 520 N. Michigan Ave., 527-2400; Detroit: General Motors Bldg., TRinity 5-8711; Cleveland: 20310 Chagrin Blvd., Shaker Heights, 283-7788; Los Angeles: 601 North Vermont Ave., 666-6263.

SUBSCRIPTION SERVICE: Mail all subscription orders, changes of address, correspondence concerning subscriptions, and Postmaster notices of undeliverable copies to Popular Mechanics, Box 646, New York, N.Y. 10019. Please enclose your latest address label for quickest service when writing about your subscription.

POPULAR MECHANICS IS PUBLISHED MONTHLY by The Hearst Corporation, 57th St. at 8th Ave., New York, N.Y. 10019, U.S.A. Richard E. Berlin, President; George Hearst, V-Pres.; Richard E. Deems, President of Magazines; John R. Miller, Executive V-Pres. of Magazines; Raymond J. Petersen, Senior V-Pres. of Magazines; William S. Campbell, V-Pres. of Magazines; Albert A. Rachol, V-Pres. and Director of Circulation; Joseph F. Kern, V-Pres. for Popular Mechanics; Frank Massi, Executive V-Pres. and Treasurer; Harvey L. Lipton, Secy. Single copy in the United States and Canada, 50 cents. Subscription prices: United States and Possessions, \$5.00 for one year; \$9.00 for two years; \$12.00 for three years. Canada, add \$0.75 for each year. Pan American Postal Union countries, add \$1.00 for each year. All other countries, add \$2.00 for each year. When changing address, give old address as well as the new, with postal-zone number, if any, and allow six weeks for change to become effective. Second-class postage paid at New York, N.Y., and at additional mailing offices. Authorized as second-class mail by the Post Office Department, Ottawa, and for payment of postage in cash. Registered as second-class matter at the Post Office at Mexico D.F., Mexico, June 20, 1950. © 1970 by The Hearst Corporation. All rights reserved. Printed in U.S.A.

FEBRUARY 1970

86 Proof Early Times Distillery Co., Louisville, Ky. ©1968



# fill'er up

Make yourself the greatest home bartender in town. Just send \$3.50 to Early Times Glass Offer\*— P. O. Box 1080, Louisville, Kentucky 40201. We'll send you a set of 6 Giant 15 oz. Early Times Jiggers. Or send \$3.00, for a set of 8 Early Times 10½ oz. Highball Glasses. They're beautiful, so get both sets while they last. Do it now.

\*offer valid only where legal—limited time only

**THE TRUE OLD-STYLE KENTUCKY BOURBON**

# LETTERS

TO THE EDITOR

## Make Orbis an outlaw?

The author of the article about Orbis (*Smile! You Just Got a Ticket*, page 73, Dec. PM) seems to think there is no way to put it out of business except with the crude and highly illegal method of ramming it with a car.

I can think of several ways just as effective, and probably not nearly as illegal. How about a whiff of spray paint or a handful of mud on its lens?

As for the individual protecting himself from getting a ticket, why not mount a mirror just above the front license plate? If adjusted right, it ought to reflect the flash of red light back into the lens.

Something ought to be done to outlaw the device. If it's set to flash every car that is even the tiniest fraction over the limit, it would, in effect, require driving well below the limit; nobody can drive exactly at a certain speed constantly. To do so would require that he watch the speedometer constantly, rather than the road. That would make him a more dangerous driver than a speeder.

SWISHER, IOWA                      ROBERT D. SMITH

Orbis represents an electronic computer way to collect taxes (you can call it fines) from plain citizens, and it will no doubt be the cornerstone of many a new speed trap. One *real* way to cut down on traffic accidents would be to make a scientific study of insurance files. They will reveal that higher than normal percentages of accidents take place in certain locations, regardless of speed. These are particular road conditions or traffic patterns which are dangerous. These would take money to correct, but lives would be saved.

MIAMI, FLA.                      HAROLD PALLATZ

## Weird gadgets!

Are those gadgets for stopping a car (*New Barriers That Cushion the Crunch in Crashes*, page 91, Nov. PM) really practical except for performing stunts? Don't nearly all fatal accidents involve the abrupt deceleration of head-on collision with another car or with a pole, tree, bridge and so on?

Obviously, except to gadgeteers, the solution is the insulation of the passenger from the vehicle's interior. Ever hear of a driver being killed by hitting a tree? No, he hit the interior of his own car.

In the same class of nonsense are the

water bumpers. Effective up to 2.8 mph, according to GM.

And air bags that inflate with a bang, leaving you dazed? They deflate in one-half second so you're unprotected in the impact following a sideswipe or ricochet.

For the love of humanity, let's be practical. These weird gadgets you tout aren't.

The answer? Package engineering. Occupant restraint, passive if possible. No one has yet improved on Barney Oldfield's seat belt preferably with shoulder harness.

BURLINGTON, VT.                      FRED BLACKSTONE

## Joint project

We've received many compliments on both the design and workmanship of the *Cradle-Bassinet* (page 138, March '68 PM). This was a joint project. I purchased



the rock maple rough-cut 1½ inches thick. Brother Louis Lachauc of the Marist Seminary here finished all the wood, and my dad, Joseph Bober Sr., did all the assembly, pegging and finishing. It's a marvelous piece of work.

FRAMINGHAM, MASS.                      ROBERT E. BOBER

## And hardly bloodthirsty

Vampires do not suck blood (*Science Worldwide*, page 20, Nov. PM). They scoop skin off the victim and lap up the blood. I would think that such a reliable magazine as PM would always print the right facts. What kind of editors do you have, anyway?

COLORADO SPRINGS, COLO.                      JAMES GOODWIN

*Old ones who still believe in Dracula.*

## Right speed, wrong plane

In Ralph Emerson's *Fastest Prop in the World* (page 94, Dec. PM), the statement that Fritz Wendel flew an Me 109R in 1939

*(Please turn to page 8)*



# "Look who's smiling now!"

"The department head's job had just been left vacant. When the boys in the office learned I was gunning for it, they gave me their widest grins. One thing they didn't know: I had made up my mind sometime back to take LaSalle training that would qualify me for a better job. My study paid off so fast it surprised even me—I was picked for that shiny promotion over everyone's head. Who wouldn't be smiling with a neat new \$1,500 increase!"

LaSalle's files are filled with letters with this kind of story from LaSalle graduates who have rapidly climbed the ladder of success. You, too, can qualify for the career opportunity of your choice through LaSalle home study—without interfering with your present work—and by devoting only a little of your spare time.

LaSalle has been an acknowledged leader in home education for over sixty years. It has enrolled more than 1,500,000 ambitious men and women in its many types of training courses. LaSalle's distinguished faculty includes some of the country's foremost practicing specialists and instructors. That's why your training is in good, experienced hands... why your LaSalle diploma will be respected by employers.

Mailing the LaSalle coupon below may be the first step in getting a better job, higher pay, and all of the good things that go with success. Simply check the program in which you are most interested, and we will send you a valuable free booklet describing the opportunities in that field. Mail the coupon to LaSalle, 417 S. Dearborn Street, Chicago, Illinois 60605.



## LA SALLE EXTENSION UNIVERSITY

A Correspondence Institution • 417 S. Dearborn Street, Dept. 50-121, Chicago, Illinois 60605

Please send me, without cost or obligation, FREE booklet and full information on the field I have checked below:

<p><b>ACCOUNTING</b></p> <input type="checkbox"/> Complete Accounting <input type="checkbox"/> Income Tax <input type="checkbox"/> Accounting Fundamentals <input type="checkbox"/> CPA Training <input type="checkbox"/> Modern Bookkeeping <p><b>BUSINESS MANAGEMENT</b></p> <input type="checkbox"/> Complete Business Management <input type="checkbox"/> Credit and Collections <input type="checkbox"/> Office Management <input type="checkbox"/> Personnel Management <input type="checkbox"/> Sales Management <p><b>REAL ESTATE</b></p> <input type="checkbox"/> Complete Real Estate <input type="checkbox"/> Real Estate Brokerage <input type="checkbox"/> Real Estate Management <p><i>Interested in a career not listed? Write here: _____</i></p>	<p><b>COMPUTER PROGRAMMING</b></p> <input type="checkbox"/> Complete Training <p><b>LAW COURSES</b></p> <input type="checkbox"/> Bachelor of Laws Degree <input type="checkbox"/> Business Law <input type="checkbox"/> Insurance Law <input type="checkbox"/> Claim Adjusting Law <input type="checkbox"/> Law for Police Officers <p><b>STENOTYPE</b></p> <input type="checkbox"/> Machine Shorthand <p><b>TECHNICAL COURSES</b></p> <input type="checkbox"/> Air Conditioning, Refrigeration, Heating <input type="checkbox"/> Diesel <p><b>TRAFFIC &amp; TRANSPORTATION</b></p> <input type="checkbox"/> Complete Traffic Mgt. Truck, Air, Rail, Sea	<p><b>DRAFTING</b></p> <input type="checkbox"/> Complete Drafting <p><b>INTERIOR DECORATION</b></p> <input type="checkbox"/> Professional Training <p><b>ART TRAINING</b></p> <input type="checkbox"/> Commercial Art <input type="checkbox"/> Oil, Water Color Painting <input type="checkbox"/> Complete Training <p><b>Mr.</b>  <b>Mrs.</b>.....  <b>Miss</b>.....</p> <p><b>Address</b>.....</p> <p><b>City &amp; State</b>.....</p>	<p><b>HIGH SCHOOL</b></p> <input type="checkbox"/> High School Diploma <p><b>LANGUAGE INSTRUCTION</b></p> <input type="checkbox"/> French <input type="checkbox"/> Spanish <p><b>HOTEL/MOTEL MANAGEMENT</b></p> <input type="checkbox"/> Executive Training	<p><b>CAREERS FOR WOMEN</b></p> <input type="checkbox"/> Accounting <input type="checkbox"/> Bookkeeping <input type="checkbox"/> Commercial Art <input type="checkbox"/> Computer Programming <input type="checkbox"/> Dental Assistant <input type="checkbox"/> Hotel/Motel Mgmt. <input type="checkbox"/> Interior Decorator <input type="checkbox"/> Real Estate <input type="checkbox"/> Secretarial <input type="checkbox"/> Stenotype <p>.....Age....</p> <p>.....Apt.No....</p> <p>.....ZipNo....</p>
---	---	--	--	--

If your wife says she  
doesn't go for the  
great autumn day  
aroma of Field  
& Stream...

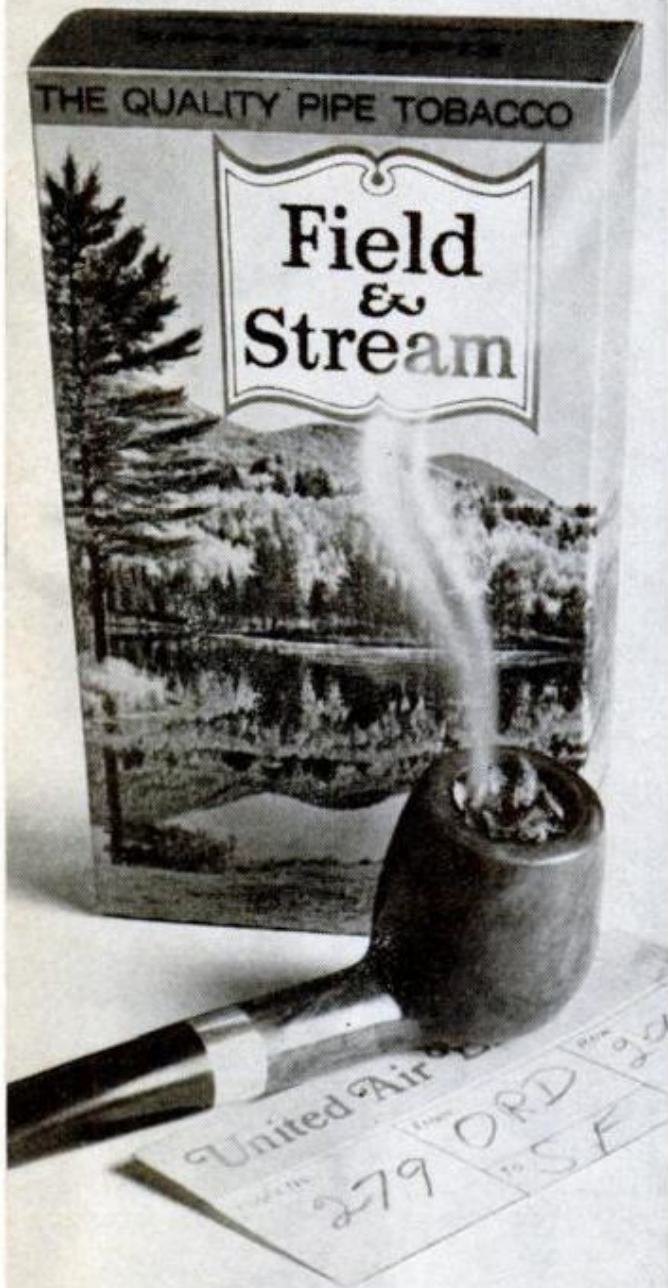

send her  
home to  
Mother.

A quality product of Philip Morris U.S.A.

## LETTERS

(Continued from page 6)

to set a world speed record of 469.22 mph is not quite right.

In April 1939 Wendel flew an Me 209VI at that speed. The Germans changed the name for propaganda purposes, and the plane was entered in the record books as the Me 109R. The truth was not known until after the war, but the record was not corrected.

OMAHA, NEBR.

STANLEY R. JAKES

### 'Remarkably effective'

I just read your editorial on my *Esquire* piece (*Everybody's Happy But Esquire*, page 48, Nov. PM), and of course I'm squealing with annoyance that you caught and exposed my historical and scientific mistakes. Nice going.

But, really, didn't you realize that I was 1) only half serious, and 2) remarkably effective? According to Henry Cooper's piece in the *New Yorker* back in August, Armstrong read the *Esquire* piece and thought by making an issue of what he would say it put him on the spot. Accordingly, he agonized over his words and came up with something quite nice.

NEW YORK

WILLIAM H. HONAN

*And you are 3) of good humor and 4) a good sport. Guess if you did challenge Armstrong, it was all worthwhile.*

I, too, thought Neil Armstrong acquitted himself well as an originator of historic phrases. I'm sure most of us could not have done as well . . . but, then, those of us who knew Neil had no cause for concern.

MARSHALL SPACE  
FLIGHT CENTER, ALA.

WERNHER VON BRAUN  
DIRECTOR

### Rereading the oil can

*How to Read an Oil Can* (page 134, Nov. PM) is dated in one respect. The current recommendation of the American Petroleum Institute is: Change oil every three months or 3000 miles, whichever comes first (but never exceed the carmaker's warranty).

AMERICAN PETROLEUM INST.  
NEW YORK

B. W. CECIL  
ASS'T DIRECTOR

### Words don't fit fittings

Two captions were transposed in *New Building Products* (page 174, Dec. PM). The fittings shown on page 175 are made of stainless steel by Truly Tubular Fitting Corp., and those on page 177 are plastic sewer fittings by Olin Evanite Plastics. ★★

**START YOUR NEW CAREER NOW! WITHOUT OVERHEAD! ANY PLACE! ANY AGE!**

# UPHOLSTERING JUST ONE

**you don't even have to quit your present job!!!**

**CHAIR can pay you as much as your present weekly paycheck!**

Start learning now. At home, or in the garage, in your spare time — no outside classes to attend. If you can tie a knot and drive a tack, you can learn this business, quickly, easily. You start learning the basics right away through the proven MUI Home Training Plan. And before you're barely into it, you can start doing the simple upholstering jobs that are all around you waiting to be done. Chairs, cushions, seats, footstools. Even before MUI students finish their training, people start bringing upholstering jobs to them, and remember—the world is full of furniture that needs fixing and re-upholstering and more is wearing out all the time!



**"What started as a hobby, now pays me \$10 an hour"**

Yes, many MUI graduates make better than \$10 an hour turning old wornout furniture into bright new decorator pieces! **Stack it up against what you're doing now!** Are you making \$150 a week? \$200? \$250? Do you put in long hours of dull work, with small raises? Is that the way you want to spend the rest of your life? Just imagine, you can make \$150, \$200, \$250 upholstering just one chair or sofa these days! And if you're the kind of person who likes to work and earn, you can sometimes finish a job like this in a day. That's pay, ... and it beats what most college graduates make!

**AS YOU LEARN, YOU JUST SLIP INTO THE IMMENSE FLOW OF UPHOLSTERY WORK!** Think of all there is! . . . Sofas, lounging chairs finished in beautiful fabrics, which MUI tells you how to get at the right price — even leather and all the new vinyls. And then you have built-ins and breakfast nooks, boats, trailers and all the millions of automobiles in America. Yes, you learn all this and more! When we finish teaching you, (in your own home in your spare time) and when you get our California state approved diploma, you know this business . . . as a real professional! You will then have one of the most fantastic moneymaking skills in America built into your head and hands! No one can ever take this skill away from you . . . and no one can ever fire you, because **you're the boss** of a business that you can take with you . . . You can make big money from then on . . . any time, **anyplace** you want to put out your shingle!

When you read the papers you see there's a strike here, a lockout there. Detroit lays off 150,000 men. A plant is shut down and moved out of state. A new automated machine eliminates 5,000 jobs. They talk about dislocated workers and try to do something about it. What pays the bills if you get caught up in one of these situations? When you know upholstering, life gets very simple and lots of fun. It's simple because where there are people, there are upholstering jobs and lots of them. It's fun because life is fun when the bills are paid and there's money in the bank, even enough to buy those things you've always wanted for yourself.

**YOU GET SIX BIG FURNITURE KITS FREE**



**YOU GET THIS AUTHORIZED DIPLOMA WHEN YOU GRADUATE**



MUI IS APPROVED BY THE CALIFORNIA SUPERINTENDENT OF PUBLIC INSTRUCTION AND IS AUTHORIZED TO ISSUE A DIPLOMA IN UPHOLSTERY.

MODERN UPHOLSTERY INSTITUTE  
Box 899-CRH Orange, Calif. 92669

## WORK THE HOURS YOU LIKE TO WORK!!

If you favor a regular 35 hours a week, upholstery lets you do it and make a really fine living. On the other hand, if you're really ambitious and want to work 60 or 70 hours a week, you are starting to talk about some big, big money! The important thing is that the choice is yours, not somebody else's! (Not like when you're working for someone else.) Many students of retirement age just do a few pieces now and then just to keep things nice and comfortable.

**TO GET STARTED, JUST GET THE COUPON IN THE MAIL . . . TODAY!**

It costs you nothing to get the information and there's no obligation. No salesman is going to call you. This much and this much only, every successful MUI graduate must do for himself — send the coupon today!

**YOU'LL GET A BIG ILLUSTRATED 32 PAGE BOOK ON UPHOLSTERY** and the upholstery business, and an actual free sample lesson showing how the fabulously successful MUI system is taught. For your sake and the sake of your future, do it now. Cut out the coupon, fill it out, put it in an envelope and mail it now. Air mail reaches MUI about two days sooner!

**ALL THE SPECIAL "TOOLS OF THE TRADE" ARE YOURS . . . FREE**

**THIS FREE UPHOLSTERY BOOK may be the most important information you ever read.**

**MAIL COUPON NOW!**

MODERN UPHOLSTERY INSTITUTE, Box 899-CRH Orange, Calif. 92669

Please send the FREE UPHOLSTERY CAREER BOOK, the FREE SAMPLE LESSON. I understand I am under no obligation whatever and am just sending for the free facts on job and career opportunities in Upholstering and the MUI home training program. I understand that no salesman will call.



Name \_\_\_\_\_ Age \_\_\_\_\_  
Address \_\_\_\_\_  
City \_\_\_\_\_ State \_\_\_\_\_ Zip \_\_\_\_\_

**APPROVED FOR VETERANS**

# WHAT'S NEW OUTDOORS

BY GEORGE REIGER

**WATER-RESISTANT MATCHES** newly developed by Diamond International (photo at right) should have a special attraction for all active outdoorsmen. I've tested them and found their resistance to be darn near "proof." I left a pack in the bottom of my fishing boat last fall and found the matches eager, willing and able to light *hours* after they had been in and out of shifting bilge water. Made of strike-anywhere wood splints, they are treated with a special coating to resist moisture and humidity without interfering with ignition or burning qualities. In formal tests, they are said to have lighted after eight hours of complete immersion. For more information, write Diamond Match Div., 733 Third Ave., New York, N.Y.



**SUPERSOFT IRON SHOT** may solve the problem of enormous waterfowl losses due to lead poisoning. Dabbling ducks ingest spent shot picked up from marsh and feeding-ground bottoms and as a result more than a million of them die each year!

Lead is the ideal element for ammunition. Only gold, silver and a few other precious metals match its ballistic qualities. Gold, however, is just too expensive to fire at ducks! Are we then destroying the future of waterfowling by firing thousands of lead-loaded rounds annually over choice marsh lands which in time become death traps for feeding ducks?

The Sporting Arms and Ammunition Manufacturers' Institute is even more concerned with this question than the av-

erage duck hunter. Four years ago, it commissioned the Illinois Institute of Technology to work with the staff and facilities at the Patuxent Wildlife Center in Laurel, Md., in the search for a suitable substitute for lead shotgun pellets. After considerable research, their efforts have centered on iron shot.

Many shortcomings had to be overcome, most significant, perhaps, the fact that hard iron shot will erode or "scar" gun barrels and deform chokes. A supersoft iron in wire form that was finally evolved has no such adverse effects. Results of tests in which both live and simulated birds were used indicate that shotshells containing one ounce of No. 4 soft iron shot have the same ballistics and identical killing effectiveness as those containing the conventional lead loads at in-range shots not exceeding 50 yards.

There remains the problem of finding a practical mass-production method. Until now, supersoft iron shot has been practically hand-made. Once mass-production is achieved, it is fervently hoped that waterfowling will do their share to preserve their favorite sport through purchase and use of this new generation of bird shot.



**FOGPROOF GLASSES** for skiers and snowmobilers can be prepared by coating glasses with a new material called Hydron. Developed by the Woodstream Corp. of Lititz, Pa., the product apparently absorbs lens moisture, yet it's water-clear and is chemically bonded to the lenses for durability. For further information, write to Woodstream's subsidiary in Aspen, Colo.: Trappe of Aspen Inc. ★★★



03648



03415



03292



03605



13359



03477



03500



10523



10278



03266



# RCA STEREO 8 TAPE CLUB

## Fabulous Savings!

## Spectacular Get-Acquainted Offer!



10280



03258



10084



03580



# Take Any 5 STEREO 8 TAPE CARTRIDGES

# for only \$6.95

Worth up to \$49.75 at regular Club prices!  
You merely agree to buy as few as six more cartridges within a year from hundreds to be offered.

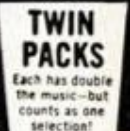

03558



03478



03480

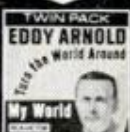

03558

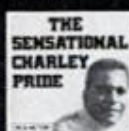

12141



03346



03412



00267



03419



03313

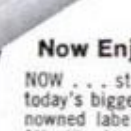

Now . . . start a library of today's greatest Stereo 8 hits by today's biggest stars . . . at top savings! Choose from such renowned labels as RCA, Warner Bros.-7 Arts, Reprise, London, Atlantic, Atco, Mercury—in every music category. Just look at these exclusive membership benefits:

- Start savings RIGHT NOW! Choose FIVE tapes for only \$6.95 (worth up to \$49.75 based on suggested manufacturers' list prices . . . optional with dealers). After trial membership, receive one tape of equivalent value FREE for every two you buy at regular Club price (usually \$6.95)—a 33 1/3% average saving!
- All tapes guaranteed. The Club's own Warranty unconditionally guarantees you perfect tapes for one year after purchase, regardless of label.
- Enjoy a charge account! We'll open a "pay later" account in your name; pay after you receive tapes and are enjoying them.
- Keep posted! Monthly SOUND TRACK brings news of almost 200 Stereo 8 releases, featuring a Selection of the Month. If you want this tape, do nothing—it will be shipped automatically. If you want other tapes, or no tapes, indicate your choice on the coupon provided, and return it by the date specified.
- Send no money! Just choose 5 of the 50 top-label hits shown here; we'll bill you \$6.95 plus small shipping-service charge later. You can cancel membership after accepting six more tapes . . . or keep enjoying savings of one-third for years to come with no obligation to buy.



10319



03498



03534



00046

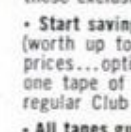

03313



03508



03578



03408



10235



03652



02318



03652

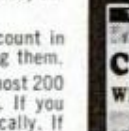

03316



00369



00202



10113

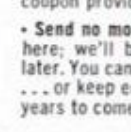

00953

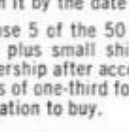

03572



03461



03572



03655



03316

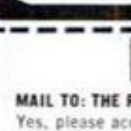

10113

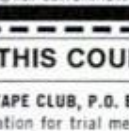

11349

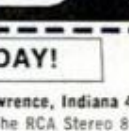

00363



03461



10882



00363

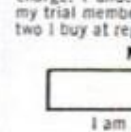

11349

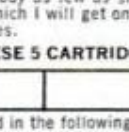

00363

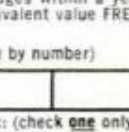

03395



03528



03395



03671



00752

### MAIL THIS COUPON TODAY!

MAIL TO: THE RCA STEREO 8 TAPE CLUB, P.O. Box 26888, Lawrence, Indiana 46226  
Yes, please accept my application for trial membership in The RCA Stereo 8 Tape Club, and send me the 5 cartridges I have selected for only \$6.95 plus small shipping-service charge. I understand I need buy as few as six more cartridges within a year to fulfill my trial membership, after which I will get one tape of equivalent value FREE for every two I buy at regular Club prices.

MAIL ME THESE 5 CARTRIDGES (indicate by number)

\_\_\_\_\_

I am most interested in the following type of music: (check one only)  
 Popular (Instrumental/Vocal Moods)  
 Country & Western  Today's Sound (Rock/Soul/Folk)

Mr. \_\_\_\_\_  
Mrs. \_\_\_\_\_  
Miss \_\_\_\_\_ (Please Print)  
Address \_\_\_\_\_  
City & State \_\_\_\_\_ Zip \_\_\_\_\_  
One Membership Per Family.  
APO/FPO addresses write for special offer.

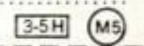

# This Seal means exactly what it says



It's a replacement or money-back guarantee.

It means that Good Housekeeping will replace to the consumer, or refund the full purchase price of any product accepted for advertising in Good Housekeeping, if that product or its performance should prove defective.

How do advertisers get the right to use the Seal? They have to *earn* the right. How? By submitting representative samples of their product to the Good Housekeeping Institute. If we satisfy ourselves that it is a *good* product and that the advertising claims offered to us are truthful, two things can then happen.

1. The product may be advertised in Good Housekeeping and will be covered by the Consumers' Guaranty, *whether the advertiser chooses to use the Seal or not.*

2. The product may then also display the Seal on its package and wherever it is advertised, subject to the issuance and conditions of a Seal licensing contract.

This simple, honest, and dedicated process has always had one basic purpose: to provide our readers with the most dependable and believable

editorial matter and advertising a magazine can possibly carry between two covers.

All this is not without cost to Good Housekeeping.

It requires a budget of approximately one million dollars a year just to maintain the Good Housekeeping Institute with its many laboratories and workshops, its scientific equipment and staff of 100 people. It also means that over the years Good Housekeeping (however reluctantly) has had to decline millions of dollars worth of advertising that could not meet the above-described requirements. But that's what makes us Good Housekeeping.

And remember, in back of it all is a *money-back guarantee*—something all consumers can readily understand and believe—

As the more than 13 million consumers who read and believe in Good Housekeeping can attest—

—as millions more who respect and respond to the Guaranty Seal wholeheartedly agree—

—as you can clearly see for yourself by *just reading the Seal.*

# If you're earning less than \$1,000 per week, we think that you're selling yourself short.

**T**HE very fact that you're reading this says something important about you: either you are now in business for yourself, or you plan to be in the near future. If so, here's something for you to consider. As a self-employed individual, your earning power should be in the neighborhood of \$1,000 per week, or about \$50,000 per year.

We didn't just pull this figure out of the air. It's based on our years of working with people who work for themselves. What's more, common-sense arithmetic bears us out.

Not too many years ago, a man was on his way to Success if he was earning \$10,000 per year by the time he was 30. But times have changed, and that \$10,000 figure has lost most of its glitter. Today, many kids straight out of school command starting salaries of \$12,000 to \$15,000. By the time they're 30, those same young men are being paid \$25,000 to \$35,000 per year—working for somebody else. Which brings us to our conclusion: if you can make, say, \$25,000 working for somebody else, you can make \$50,000 working for yourself. Because you'll work harder, and you'll work longer hours, and because you won't have to split your earnings with bosses.

If this kind of arithmetic makes sense to you, and if self-employment is indeed your near-future goal, American Unifax would very much like to hear from you, because our success is based upon attracting the interest and support of persons like you.

We're in the office products field. When we entered this field, we did so with two important principles fixed firmly in our mind.

The first of these principles was that we would offer for sale only those products which were demonstrably superior to any other products available from other companies, regardless of brand or price.

Our second principle was that we would make these products available to the

business community through Direct Distributors—men who had the drive and determination to earn \$50,000 or more per year.

We have never wavered from these two guiding principles, even though the kind of product we seek is rare, and the kind of man we seek is rarer still. As a result, we have enjoyed a steady, healthy growth, both in our merchandise line and in the team of Distributors which carries that line to the public.

It started with COPYFAX, our Space Age replacement for old-fashioned carbon paper. COPYFAX represents a totally new concept in multiple copying. Instead of the conventional combination of flimsy tissue and a carbon-grease-wax mixture, COPYFAX employs an incredibly strong film of DuPont MYLAR® only .001" thick, which, by means of a patented process, is treated with a liquid ink similar to that used by printers. One piece of ordinary carbon paper is good for about five rather smudgy copies before it's ready for the wastebasket. One sheet of COPYFAX gives as many as 200 crisp, clear, print-like copies—at about one-fifth the cost of carbon-paper copies.

Carbon paper is a \$203 million industry in America. Steadily and surely, COPYFAX is taking over the lion's share of that industry.

COPYFAX is just one of our products. We've introduced the American Unifax Typing Ribbon, which is based on the same patented process that makes COPYFAX possible. And American Unifax Correction Paper, a unique solvent-ink paper that makes correcting typing errors almost unbelievably easy. More new products are on the way.

In selecting our Distributors, we exercise the same care as in selecting our products. It seems to us that our kind of company—dynamic, flexible, and doing a very high sales volume—is better off with one man who demands \$1,000 per week than with five men who'll be

happy with \$200, or with ten who'll settle for \$100.

This is not to say that the bulk of our Distributors come from the ranks of the supersalesmen. Quite the contrary. One, for example, is a bank manager who makes over \$300 a week in his spare time, selling COPYFAX through the mail. Another is a printer who, with our help, has recruited over 100 sub-distributors who sell for him. A third, a housewife, had "never sold a thing in her life"—but who landed a \$785 order in less than five minutes.

Another thing about our company which might interest you—we don't charge franchise fees. We believe that your effort, interest, and loyalty are more valuable to us than any fee we could reasonably ask from you. Therefore we don't ask for any fee at all.

These are some of our principles and attitudes. We intend to stick by them, because they work. In two short years, American Unifax has grown into a company of major importance in the office products field. And we're growing faster all the time.

We'd like you to grow along with us. We won't guarantee that you'll make \$1,000 per week, but we promise you this: we'll give you all the tools you need to earn that much money. And if you're the kind of man we hope you are, you'll know how to use them.

**AMERICAN UNIFAX, INC. Dept. P27  
95 Madison Avenue  
New York, New York 10016**

The American Unifax way of doing business makes sense to me—give me the tools to start making \$1,000 per week.

- Rush complete information, FREE and without obligation.
- I enclose \$9.00. Rush me 1 pack COPYFAX, 1 Typing Ribbon, and 1 pack Correction Paper (retail value \$12.40), plus complete information.
- I enclose \$49.00. Rush me a special starter kit with profit potential of \$300 or more, and a balanced assortment of American Unifax products, plus complete information.

If you wish, specify make and model of typewriter.

NAME .....

ADDRESS .....

CITY..... STATE..... ZIP.....

**american**  
**unifax**

**AMERICAN UNIFAX**

Dept. P-27, 95 Madison Ave., New York, New York 10016

# DETROIT LISTENING POST

BY BILL KILPATRICK

**CONTROVERSY** between insurance companies and automakers re higher premiums for hot performance models is really starting to boil (see *DLP*, page 24, Jan. *PM*). One major insurer has already boosted muscle-car premiums, others are in line to do so on theory such cars are involved in higher percentage of accidents than so-called "average" cars (kids?), that fixing 'em costs more because damage is more extensive (higher speeds?). Auto men view the insurance industry's attitude darkly, threaten to offer coverage of their own for hot models. Guess here is that the auto industry—already up to here in red tape (the warranty snafu, for example)—is whistling in the dark, will threaten, bleat loudly, then back down and settle for some form of compromise, maybe a little less hp for an only slightly higher muscle-car premium.

**CHEVROLET'S FORTHCOMING XP-887** will be powered by an OHC water-cooled Four, much of it made of aluminum, a development that has the competition intrigued, to say the least. Aluminum blocks, heads are old hat, but Chevy's new Four is said to feature the exotic metal in heretofore unknown (unlikely, at least) applications. Result is said to be a great saving in overall weight, meaning the comparatively modest Four might make the XP something of a performer, a factor that could be a big thing in the mini-car sales race.

**CHRYSLER'S MINI-CAR**, due for introduction in the spring of '71, has been shelved for the time being. Corporate profits are down and the brass has put brakes on development of the car—dubbed the "25"—along with other research projects, presumably including the well-advanced turbine engine program. When the "resume" button will be pushed depends on the balance sheet.

**PONTIAC'S NEW FIREBIRD**, due for public introduction this month, will be another expression of the industry's overall effort to ease problems of serviceability, particularly in a car's electrical system, the most common form of car malfunction. The new Firebird's instrument panel, for example, has an easily-removable (via two quarter-turn release fasteners) lower panel through which all bulbs, flashers and the speedometer cable are accessible. Pontiac claims all lighting and warning bulbs in the instrument cluster can be replaced in 60 seconds.

**CONFUSION REIGNS** regarding industrialist Bill Lear's steam-car plans, quite grandiose a year ago, now seemingly on-again, off-again. When we reported Lear's originally-announced plans—a steam-powered Indy-type race car, a fleet of steam buses, a steam passenger car, and so on—as being "postponed indefinitely" (*DLP*, page 36, Sept. '69 *PM*), he wrote saying we were all wet (see *Letters*, page 6, Dec. '69 *PM*). Since, Lear has been quoted—and widely—as telling a meeting of the Detroit section of the Society of Automotive Engineers that, "No matter what you do, you'll never come up with a steam car that's good for the public." He told the SAE he had decided any plan to build a steam passenger car would be "utterly ridiculous." Perhaps the right hand knoweth not. . . .

**GM'S ANTITHEFT LOCKING SYSTEM**—a setup that locks the steering column, ignition switch and transmission—seems to be doing the job. The auto giant reported recently that National Automobile Theft Bureau figures for the first six months of last year show a 23 percent reduction in thefts of GM cars. If the system, introduced on the '69 GM models, has a "flaw," it's human, the corporation reported. In Chicago, for example, police studies show that 40 percent of the '69 GM cars stolen were stolen

*(Please turn to page 16)*



# Make sure the guy who tunes your car hits all the keys.

There's more to a tune up than meets the ear. It's not just a matter of points and plugs and timing.

There are other sour notes. Like a dirty, clogged-up air filter. Or a gummy, waterlogged fuel filter. Or a little gadget called the PCV valve you maybe didn't even know you had.

These clinkers can throw your engine out of tune—maybe stop it cold. So have 'em checked.

If they need replacing, replace 'em. Replace 'em with Fram. And when you drive out we'll have you humming a different tune.



**Fram Automotive Division, Providence, Rhode Island 02916**

# EARN BIG MONEY IN AIR CONDITIONING REFRIGERATION & HEATING

25 KITS SENT TO BUILD THIS  
COMPLETE REFRIGERATION SYSTEM



**APPROVED FOR GI TRAINING**  
If you served since January 31, 1955 or are  
in service, check GI line in coupon

A better job, top pay and steady work are easily within your reach. Learn to repair and install air conditioning systems, refrigerators and freezers. Air conditioning is one of America's fastest-growing industries. Millions of autos and homes are being air-conditioned. The need for trained men is immediate and great.

**Make Home Your Training Center**—Learn by practicing. CTI sends 25 kits of tools and parts to build a complete refrigeration system—which you later convert into a refrigerator or freezer. The course is easy!

**Earn Money As You Train**—Since the CTI course includes training with real equipment, many students earn money repairing units soon after enrolling. On completing training they go into top pay jobs. Many get started in their own business.

**Mail Coupon Today for FREE book.** No obligation. Prove to yourself that the air conditioning, refrigeration and heating field is best for you—the easiest training to master and loaded with top pay opportunities.

**Commercial Trades Institute, Chicago, Ill. 60626**

**COMMERCIAL TRADES INSTITUTE**  
1400 Greenleaf Avenue  
Chicago, Illinois 60626 Dept. PM-270



Send book, Be a Success in Air Conditioning,  
Refrigeration & Heating. No obligation.

Name \_\_\_\_\_ Age \_\_\_\_\_

Address \_\_\_\_\_ Zip \_\_\_\_\_

City \_\_\_\_\_ County \_\_\_\_\_ State \_\_\_\_\_

Check for facts on GI Bill

Accredited Member National Home Study Council

## DETROIT LISTENING POST

(Continued from page 14)

because they were not locked and ignition keys not removed.

**A DELICATE SNIFFER** that can take a whiff of your car's exhaust and diagnose real or potential ills has been developed by Honeywell, Inc., scientists, working with Ford's Service Research Center. To check an engine, a hose is connected to the exhaust pipe while the engine is idling. The emission passes to a small combustion chamber where a hot-wire filament burns a small portion of it. Ultraviolet radiation emitted from the filament is counted by a sensor and displayed on two meters, one indicating volume of carbon monoxide gas, the other the level of hydrocarbons. A skilled technician can read the meters, determine what needs adjustment, and how much, what elements in a combustion system are nearing the end of the line.

**LOOK FOR ADDITIVES** (chemistry anyway) to take over more and more of the car's "keep it running" chores. Specialized automotive chemicals have come a long way since the old so-called "mouse milks," now are highly sophisticated combinations designed to do specific jobs. Case in point is the new antileak antifreeze put out by Du Pont, capable of sealing off all but the most severe leaks or hose ruptures. Another boon is Cromwell's X3 PCV cleaner and conditioner, a "really works" brew designed to keep antipollution systems at peak efficiency. The big oil companies, noting the quick growth of additive outfits, are said to be working feverishly to come up with a single, all-purpose concoction, the aim of which will be to handle all forms of internal combustion engine contamination.

**IF YOUR SON** says he wants to be an auto mechanic, refer him to a recently published book entitled *A Job With a Future in Automotive Mechanics*, written by J. Robert Connor and published by Grosset & Dunlap. Connor's view of the trade is complete, explaining in no-nonsense terms the goods and bads of what in the past has been a much-maligned activity. The book will help a young man determine what area of automotive mechanics is best for him, how to get started, what he can expect in the way of earnings and future. Connor also covers such in-trade considerations as whether it's best to work for a large dealership or a small service station. Connor told us that in the course of his research he was surprised to learn how many mechanics are making \$10,000 and over. ★★★

# Take command of your future...now!

## Choose the job you want from 266 ICS Courses

Dozens of new careers are open to you with ICS training. Oldest, largest correspondence institution. 8,000,000 students since 1890. Learn facts, theories, practical applications. Instructors guide

you, answer your questions. Texts, written by authorities, are yours to keep. Famed ICS diploma to graduates. Convenient payment plan. Send our coupon for three FREE booklets.

### ACCOUNTING

Accounting (U.S.A.)  
Accounting (Canadian)  
Accounting for Business Programmers  
Accounting for Man'g'm't Decisions  
Auditing  
Business Law (U.S.A.)  
Canadian Business Courses  
Cost Accounting  
CPA Review (U.S.A.)  
General Accounting  
Income Tax (U.S.A.)  
Industrial Accounting  
Junior Accounting  
Office Accounting  
Practical Accounting  
Public Accounting  
Small Business Accounting (U.S.A.)  
Starting and Managing a Small Bookkeeping Service (U.S.A.)

### ARCHITECTURE AND BUILDING

Architectural Drawing and Designing  
Architecture  
Building Contractor  
Building Estimator  
Building Inspector  
Building Maintenance  
Carpenter-Building  
Carpentry and Millwork  
Fundamentals of Urban Planning  
House Planning and Interior Design  
Mason  
Painting Contractor  
Reading Arch. Blueprints  
Review in Architectural Design and Practice  
Review of Mechanical Systems in Buildings

### ART

Amateur Artist  
Commercial Art  
Commercial Cartooning  
Illustrating with Options:  
—Magazine  
—Advertising Layout and Illustration  
Interior Decorating  
Oil Painting for Pleasure  
Show Card and Sign Prod.  
Show Card Writing  
Sign Painting & Designing  
Sketching and Painting

### AUTOMOTIVE

Automatic Trans. Spec.

Automobile Air Conditioning Specialist  
Automobile Body Rebuilding & Refinishing  
Automobile Engine Tune-Up  
Automobile Mechanic  
Automobile Technician  
Diesel-Gas Motor Vehicle Engines

### BUSINESS

Advertising  
Business Administration  
Business Practice (Cond.)  
Canadian Business Course  
Condensed Marketing  
Direct Mail and Mail Order Advertising  
Industrial Psychology  
Inventory Control  
Magazine & Newspaper Advertising  
Managing a Retail Business  
Managing a Small Store  
Marketing Management  
Marketing Research  
Modern Exec. Management  
Office Automation  
Office Management  
Production Management  
Purchasing Agent  
Retail & Local Advertising  
Retail Bus. Management  
Retail Merchandising  
Retail Selling  
Systems and Procedures Analysis

### BUSINESS: SALES

Creative Salesmanship  
Real Estate Salesmanship  
Salesmanship  
Sales Management

### BUSINESS: SUPERVISION

Basic Supervision  
Industrial Foremanship  
Industrial Supervision  
Management, Salesmanship and Sales  
Modern Woman as a Supervisor  
Personality Development  
Personnel-Labor Relations (U.S.A.)  
Supervision

### CHEMICAL

Analytical Chemistry  
Chemical Engineering  
Chemical Laboratory Techn.  
Chemical Process Equip. Design & Operation

Chemical Process Operator  
Elements of Nuclear Energy  
General Chemistry  
Instrumental Laboratory Analysis

### CIVIL ENGINEERING

Civil Engineering  
Construction Eng'r'g Tech.  
Highway Engineering Tech.  
Principles of Surveying  
Reading Highway Bl'pr'ts  
Reading Structural Blueprints  
Sanitary Engineering Tech.  
Sewage Plant Operator  
Structural Eng'r'g Tech.  
Surveying and Mapping  
Water Works Operator

### COLLEGE COURSES

American History  
Calculus  
Economics

### COMPUTERS

COBOL Programming  
Fortran Programming for Engineers  
Programming for Digital Computers  
Programming the IBM 1401 Computer  
Programming the IBM System/360 Computer, Introduction

### DRAFTING

Aircraft Drafting  
Architectural Drafting  
Design Drafting  
Drafting Technology  
Electrical Drafting  
Electrical Eng'r'g Drafting  
Electronic Drafting  
Introductory Mech. Draft.  
Mechanical Drafting  
Pressure-Vessel and Tank Print Reading  
Sheet Metal Layout for Air Conditioning  
Structural Drafting

### ELECTRICAL

Electrical Engineering  
—Electronics Option  
—Power Option  
Electrical Appliance Ser.  
Electrical Appliance Ser. with Equipment Training  
Electrical Contractor  
Electrical Engineering Tech.  
Electrical Home Maint.  
Electrical Home Maint. with Equipment Training

### APPROVED FOR VETERANS

Accredited member, National Home Study Council.  
Convenient payment plan.  
Special rates to members U.S. Armed Forces

Electrical Instrument Tech.  
Electric Motor Repairman  
Industrial Electrical Tech.  
Power-Line Design and Construction  
Power Plant Operator —Hydro Option  
—Steam Option  
Practical Electrician  
Practical Electrician with Equipment Training  
Practical Lineman  
Reading Elec. Blueprints

### ENGINEERING (Refresher Courses for Graduate Engineers)

Chemical Civil Electrical  
Industrial Mechanical  
Sanitary Structural

### ENGLISH AND WRITING

Better Business Writing  
English for Spanish (U.S.A.)  
Free Lance Writing for Fun and Profit  
Introductory Tech. Writing  
Modern Letter Writing  
Practical English  
Short Story Writing

### HIGH SCHOOL

High School Business  
High School (Canadian)  
High School General  
High School Mathematics  
High School Secretarial  
High School Vocational  
High School College Preparatory—Arts  
High School College Prep—Engineering and Science  
Preparatory Course for High School Equivalency Test

### MACHINE SHOP PRACTICE

Grinder Operator  
Industrial Metallurgy  
Lathe Operator

Machine Shop Inspection  
Machine Shop Practice  
Metallurgical Eng'r'g Tech.  
Multicraft Maintenance Mechanic  
Practical Millwrighting  
Reading Shop Prints  
Rigging  
Tool & Die Making  
Tool Engineering Tech.  
Welding Engineering Tech.  
Welding Process

### MATHEMATICS

Advanced Mathematics  
Math and Mechanics for Engineering Technicians  
Math and Physics for Engineering Technicians

### MECHANICAL

Mechanical Engineering  
Aircraft and Power Plant Mechanic  
Hydraulic and Pneumatic Power  
Industrial Engineering  
Industrial Eng'r'g Tech.  
Industrial Instrumentation  
Machine Design  
Quality Control  
Safety Engineering Tech.  
Tool Design  
Vibration Analysis and Control

### PETROLEUM

Natural Gas Production and Transmission  
Oil Well Technology  
Petroleum Production  
Petroleum Production Engineering Technology  
Petroleum Refinery Oper.

### PLASTICS

Design of Plastic Products  
Plastics Technician

### PLUMBING, HEATING AND AIR CONDITIONING

Air Conditioning  
Air Conditioning Maint.  
Domestic Heating with Gas and Oil Heating  
Heating & Air Conditioning with Drawing  
Industrial Air Conditioning  
Pipe Fitting  
Plumbing  
Plumbing and Heating  
Plumbing & Heating Est.  
Practical Plumbing  
Refrigeration and Air Conditioning Servicing

### PULP AND PAPER

Paper Machine Operator  
Paper Making Pulp Making  
Pulp & Paper Eng'r'g Tech.

### SECRETARIAL

Clerk-Typist  
Commercial Secretary, Engineering Sec'y, Legal Sec'y, Medical Secretary, Professional Shorthand  
Stenographic Typewriting

### STEAM AND DIESEL POWER

Boiler Inspector  
Industrial Building Eng'r  
Power Plant Engineering  
Stationary Diesel Engines  
Stationary Fireman  
Stationary Steam Eng'r'g

### TEXTILES

Carding  
Carding and Spinning  
Dyeing and Finishing  
Loom Fixing  
Spinning  
Textile Mill Supervision  
Textile Technology  
Warping and Weaving

### TRAFFIC

Motor Traffic Management  
Traffic Management

### TV-RADIO-ELECTRONICS

Color Television Principles and Servicing  
Electronics Instrumentation and Servo Fundamentals  
Electronics Technician  
First Class Radio Telephone License

### Fundamentals of Electronic Computers

General Electronics  
General Electronics with Equipment Training  
Hi-Fi Stereo and Sound System Servicing  
Industrial Electronics Tech.  
Numerical Control Electronics & Maint.  
Practical Telephony  
Principles of Semiconductor Radio & TV Servicing with Equipment Training  
Second Class Radio Telephone License  
Sound Systems Specialist  
Telephony, Electronics, and Radio Communications

**ICS**<sup>®</sup>  
International  
Correspondence  
Schools  
Division of Intext

ICS, Scranton, Pa. 18515  
Canadian residents use this address for service from ICS Canadian, Ltd.  
In Hawaii: P.O. Box 418, Honolulu.

TAKE YOUR FIRST STEP... MAIL THIS COUPON TODAY—ICS, SCRANTON, PA. 18515. N1848A

I'm interested in a program of independent study. Send me, without cost, your booklet on the principles of success, sample text demonstrating famous ICS method, and your catalog for \_\_\_\_\_ (Print name of course. See list.)

Miss \_\_\_\_\_  
Mrs. \_\_\_\_\_  
Mr. \_\_\_\_\_ Age \_\_\_\_\_

Address \_\_\_\_\_

City \_\_\_\_\_ State \_\_\_\_\_ Zip Code \_\_\_\_\_

Occupation \_\_\_\_\_ Employed by \_\_\_\_\_ Working Hours \_\_\_\_\_ A.M. to \_\_\_\_\_ P.M.

**A supersensitive "fish" for locating sunken ships** has been developed by scientists at the U.S. Naval Oceanographic Office. Called *Teleprobe*, the device uses side-scan sonar to locate a target. Then it photographs it, using strobe lights, still cameras and TV. The sonar is so precise it can pinpoint a 4-foot-diameter object at a distance of 1200 feet. All of *Teleprobe's* instruments are mounted on an 18-foot-long sledlike frame that is towed by a surface ship. Designed to perform effectively at depths to 20,000 feet, *Teleprobe* could have speeded up the locating of the *Thresher* and *Scorpion*, nuclear subs that sank with great loss of life.

**No income-tax deductions to be allowed for children?** That provocative idea comes from Stanford University biologist Paul Ehrlich who also suggests that "luxury taxes should be placed on diapers, baby bottles and baby foods. It must be made clear to our population that it is socially irresponsible to have large families." Instruction in birth-control methods should be mandatory in all public schools, according to Prof. Ehrlich, and federal research funds should be applied to birth control rather than death control. "It is absurd to be preoccupied with the medical quality of life until and unless the problem of the quantity of life is solved."

**Icebergs—not seawater desalting plants**—might be the most economical source of fresh water for arid coastal regions. That's the theory of U.S. Geological Survey scientists who say that the flat slabs from Antarctica would be easier to tow than the ice "mountains" common to the Arctic. A slab about 140 yards thick and 2700 yards square would contain the equivalent of more than 200 billion gallons of water. It would cost about \$1 million to tow such a berg from Antarctica to northwest Australia, making the water far cheaper than that of a typical desalting plant. The scientists say that Antarctica's ice cap, which holds about 80 percent of the world's fresh water, could supply water for dry regions in South America and Africa as well as Australia.

**A greeting card that sounds off** has been invented by two Indianapolis men, according to an Ohio State University engineering publication. It is made up of two panels. The bottom panel contains a recorded message in the form of a sound strip that runs lengthwise. The upper panel holds a pickup needle and a tiny speaker. To hear the message, the recipient pulls the top panel, running the needle against the sound strip.

**Exceptionally smooth railroad travel** could be achieved by building into cars "reflexes" that would be able to sense out-of-line motions and react to keep the car steady. A study by Westinghouse researchers shows the method to be sound. Basic components would include sensing elements, hydraulic actuators and a hydraulic pump. Conventional suspension systems depend on springlike devices to simply soften bounces or swaying motions. The proposed "active" suspension system would actually eliminate such motions by lifting the wheels as they go over bumps, by pushing them down into depressions or by pushing or pulling the car back into line as it starts to roll or sway.

**An atom-powered traffic sign, easily visible at night from 500 feet**, is being tested in Phoenix. It works in a fashion similar to that of a TV tube. Electrons from a radioactive form of krypton gas hit a phosphor-coated surface, causing it to glow. The fuel, which keeps the sign illuminated night and day will reportedly last 10 years. The sign poses no safety hazard, say state officials, should it be shattered in an accident. The krypton is in a chemically inert form, and there is very little of it. If released, the gas would dissipate in the atmosphere almost immediately. Big advantage of the device is that it requires no electrical lines or replacement parts. ★ ★ ★

KEEP PACE WITH SPACE AGE! SEE MOON SHOTS—LANDINGS, SPACE FLIGHTS, CLOSE-UP!

# AMAZING SCIENCE BUYS

for FUN, STUDY or PROFIT



## WOODEN SOLID PUZZLES



Here's a fascinating assortment of 12 different puzzles to provide hours of pleasure and stimulate ability to think and reason. Animals and geometric forms. Take them apart and reassemble them. Lots of fun for the whole family—young and old. Will test skill, patience and ability to solve problems. Orders yours now.

Stock No. 70,205H .....\$5.00 Ppd.

## SCIENCE FAIR HEADQUARTERS

Grind your own mirror for powerful telescopes. Kits contain fine annealed pyrex mirror blank, tool, abrasives, diagonal mirror, and eyepiece lenses. Instruments you build range in value from \$75 to hundreds of dollars.

4 1/4" DIAMETER—3/4" Thick  
Stock No. 70,003H .....\$ 9.75 Ppd.

6" DIAMETER—1" Thick  
Stock No. 70,004H .....\$13.95 Ppd.

8" DIAMETER—1 1/4" Thick  
Stock No. 70,005H .....\$21.00 Ppd.

10" DIAMETER—1 3/4" Thick  
Stock No. 70,006H .....\$34.25 FOB

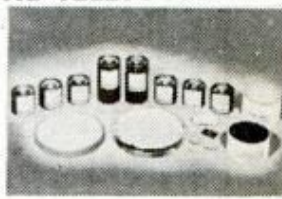

## AMERICAN MADE OPAQUE PROJECTOR



Projects illustrations up to 3" x 3 1/2" —enlarges them to 35" x 30" if screen is 6 1/2 ft. from projector, larger picture if screen is farther away. No film or negatives needed. Projects charts, diagrams, color or black-and-white. Operates on 115 volts A.C. current . . . 6 ft. extension cord and plug included. Size 12" x 8" x 4 1/2" wide. Weight 1 lb. 2 ozs. Plastic case.

Stock No. 70,199H .....\$8.75 Ppd.

## SUPER 6" SPACE CONQUEROR

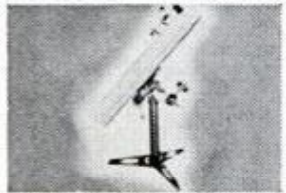

Share the wonders of space exploration. Capable of revealing faint stars of nearly 13th magnitude, split double stars separated by less than 1 sec. of arc. Features aluminized & overcoated 6" f/8 ground and polished pyrex parabolic mirror accurate to 1/4 wave, 48 F.L. 6X achromatic finder scope, 4 eye-pieces—48X Kellner, 1/2" 96X & 1/4" 192X Ramsdens, Barlow to double or triple power—rack & pinion focusing mount, 47 3/4" aluminum tube. Electric clock drive w/manual slow-motion control. Setting circles. Heavy-duty equatorial

mount. Pedestal base. Compares to \$295-\$350 models.  
Stock No. 85,086H .....\$239.50 FOB  
Stock No. 85,105H 4 1/4" ASTRONOMICAL TELESCOPE \$ 94.50 FOB  
Stock No. 85,050H 3" ASTRONOMICAL TELESCOPE \$ 29.95 Ppd.

## NEW BINOCULAR-TO-CAMERA HOLDER

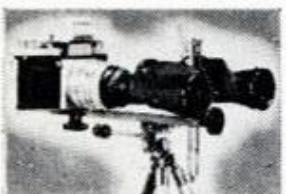

Fits any camera for exciting telephoto pictures. 35-mm camera with 7 x 50 binocular brings distant object 7 times nearer. Ideal for long-range photos of wild life, ships, people, planes, etc. Attaches easily. Use any binocular or monocular—and camera—still or movie, color or black & white. Gray crinkle and bright chrome finish. 10" long. Full directions.

Stock No. 70,223H .....\$12.50 Ppd.

## PLASTIC MODEL V8 ENGINE



Hours of fun! Get thrill of building your own easily assembled engine from over 350 parts. Then push starter and watch it run. Crankshaft revolves, pistons move, valves open and close in sequence with spark plugs. Does everything but burn oil. 1/4 scale, molded in 4 colors. Same motor used in many auto-mechanic courses. Excellent, easy-to-understand "tech manual."

No. 70,448H .....\$12.95 Ppd.

## WAR SURPLUS ELECTRIC GENERATOR



Brand new Signal Corps Electric Generator. Generates up to 90 volts by turning crank. Use in high impedance relays. Charge ground & bring up night crawlers for bait or study. 2 Alnico Magnets alone now worth more than original gov't cost of \$15. Wt. 2 lbs.

Stock No. 50,225H .....\$ 6.95 Ppd.  
MOUNTED WITH LIGHT, TO DEMONSTRATE ELECTRICITY.  
Stock No. 50,365H .....\$11.95 Ppd.

## AMERICAN MADE 7x50 BINOCULARS

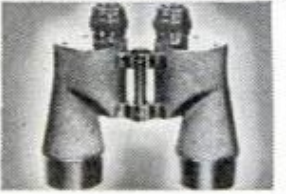

Big savings! Brand new! Crystal-clear viewing—7 power. Every optical element is coated. An excellent night glass—the size recommended for satellite viewing. Individual eye focus. Exit pupil 7 mm. Approx. field at 1,000 yds. is 376 ft. Carrying Case included. American 7x50's normally cost \$274.50. Terrific bargain.

Stock No. 1544H .....\$99.50 Ppd.  
AMERICAN-MADE 6x30's  
Stock No. 963H .....\$65.00 Ppd.

## ASTRONOMICAL TELESCOPE KITS

## VISUAL EFFECTS PROJECTOR SET

Dazzling, avant-garde visual effects. Fantastic variety. Incredibly beautiful. Special package offer contains all necessary apparatus. Create floating, exploding, fiery bursts of color like "Symphony of Spheres", "Chromatic Starbursts", "Crystal Starburst". Features 35mm 500 W fan cooled projector—produces big image at short distance. Accepts two 9" diam. wheels (Dry Kaleidoscope & Hexidoscope), 2 cylindrical accessories (6" Colored Cloud & 5" Hexidoscope w/six internal mirrored walls). Perfect for entertaining, parties, photography. Complete instructions.

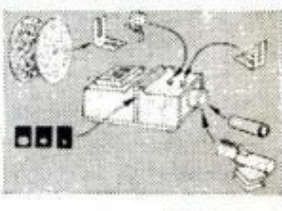

Stock No. 71,212H .....\$79.50 Ppd.

## "FISH" WITH A MAGNET

Go treasure hunting on the bottom! Fascinating fun & sometimes profitable! Tie a line to our 5-lb. Magnet—drop it overboard in bay, river, lake or ocean. Troll it along bottom—your "treasure" haul can be outboard motors, anchors, other metal valuables. 5-lb. Magnet is war surplus—Alnico V Type—Gov't cost \$50. Lifts over 150 lbs. on land—greater weights under water.



Stock No. 70,571H .....\$14.00 Ppd.  
Stock No. 70,570H .....3 1/2 lbs. (lifts 40 lbs.) \$ 8.75 Ppd.  
Stock No. 70,572H .....7 1/2 lbs. (lifts 175 lbs.) \$18.75 Ppd.  
Stock No. 85,152H .....15 3/4 lbs. (lifts 350 lbs.) \$33.60 FOB

## PSYCHEDELIC LIGHTING HANDBOOK

100 information packed pages! Fully explains the latest in psychedelic lighting equipment, techniques, developments. Covers all facets of psychedelic light-show production . . . including strobes, black lights, projectors, crystals, organic slides, mirrors, color organs, polarized color, light boxes, MusicVision, etc. Shows how to "psychedelize" parties, musical groups, shows . . . or how to set up "electric trips" for your own private gatherings. 8 1/2" x 11" looseleaf paper punched for 3 ring binder . . . add new developments as they happen.



Stock No. 9100H .....\$3.00 Ppd.

## GIANT WEATHER BALLOONS

"Balls of fun" for kids, traffic stoppers for stores, terrific for amateur meteorologists. Create a neighborhood sensation. Great backyard fun. Exciting beach attraction. Amateur meteorologists use to measure cloud heights, wind speed and temp. Made of heavy duty neoprene. Inflate with vacuum cleaner or auto air hose; or locally available helium for high rise.



Stock No. 60,568H .....( 8 Ft. diameter) .....\$2.00 Ppd.  
Stock No. 60,632H .....(16 Ft. diameter) .....\$7.00 Ppd.

## MINIATURE WATER PUMP

Wonderful for experiments, miniature waterfalls, fountains, etc. Tiny (2 5/8" x 1 3/4") electric motor and pump ideal for hobbyists, labs, schools. Pumps continuous flow of water at rate of one pint per minute at a 12" head. Wit' two "D" batteries in series, will pump up to 24" high. Runs 48 hours on battery. Works in 2 directions. Self-priming.



Stock No. 50,345H .....\$2.25 Ppd.

## MAIL COUPON FOR GIANT FREE CATALOG

148 PAGES! MORE THAN 4,000 UNUSUAL BARGAINS.

Completely new Catalog! Packed with huge selection of telescopes, microscopes, binoculars, magnets, magnifiers, prisms, photo components, parts, kits, accessories—many hard-to-get surplus bargains, 100's of charts, illustrations. For hobbyists, experimenters, schools, industry.

EDMUND SCIENTIFIC CO.  
300 Edscorp Building, Barrington, N. J. 08007  
Please rush Free Giant 1970 Catalog "H!"

Name .....

Address .....

City..... State..... Zip.....



ORDER BY STOCK NUMBER • SEND CHECK OR MONEY ORDER • MONEY-BACK GUARANTEE

# EDMUND SCIENTIFIC CO. 300 EDSCORP BUILDING

BARRINGTON, NEW JERSEY 08007

ON-THE-GO

# CAMPING

BY WADE MITCHELL

**CHEVROLETS MID-1970 VANS WILL BE MOST POWERFUL.** Early reports indicate that the new Chevy vans will have long wheelbase and a gross weight about 600 pounds heavier than Ford's 1969 E-300 series. The vans will also provide an outside front-service panel for oil, water and battery. Biggest lure is expected to be the 350-cu.-in. V8, most powerful engine yet offered in the field. Engine will be pushed farther ahead.

**WILL NATIONAL PARK SYSTEM GO ON RESERVATION BASIS?** Some recreation specialists predict that within three to five years, the pressure from millions of new campers may force a campsite reservation system onto harried park administrators. Or a lottery system may be devised whereby campsites in choice locations will be drawn by chance for such over-used and abused parks as Yosemite, Yellowstone and Grand Canyon. NPS would like to end long lines of vehicles waiting at the gates each morning.

**TENT-TRAILERS SET NATIONAL RECORDS.** Starcraft produced over 21,000 folding trailers last year, making it the "General Motors" of its field. Apache pushed hard with about 15,000 units. With over a score of folding-trailer manufacturers now in business and the Coleman Co. entry into this market, the tent-trailer may one day rival or exceed in number all other forms of recreational vehicle.

**CAMPGROUND SIGNS NEEDED ON U.S. HIGHWAYS.** Many travel experts lament the fact that while most other essential services are noted along major highways (such as *Food—Garage—Lodging*) there is no nationwide policy covering *Campground* signs. We believe such signs should be placed at all off-ramps leading to local facilities, whether they be public or privately operated, in order to end the late-night confusion facing millions of vacationers trying to find an overnight site. The U.S. Department of the Interior is just beginning to erect such signs. Iowa gets the treatment first, and we hope the program will spread cross-country.

**ADD A FABRIC ROOM TO YOUR CAMPER!** A new 6 by 7-foot room extension is now available on Wonder-Land Campers and, presumably, will be available for others. A drop-down design, it utilizes a sliding door for access into rear of main coach body. Owner says it sets up in eight minutes and is weathertight with screens and flaps for better control. (Wonder-Land Camper Co., 18500 Plymouth Rd., Detroit, Mich. 48228).

**SOME OF THE BEST PLACES IN NORTH AMERICA** to pitch a tent or pull up a trailer are listed in a booklet published by the Canadian Government Travel Bureau. The 52 pages of *Canada Campgrounds* give an easy-to-read, province-by-province run-down of tenting, trailer and picnic sites along the 5000-mile Trans-Canada Highway which extends from Victoria, B.C., to St. John's, Nfld. The colorful booklet uses easily-recognizable symbols to denote facilities available at each site. Readers can tell at a glance if the site is supervised, and if it has electrical and sewage outlets for trailers, fireplaces, campfires, picnic tables, drinking water, firewood, ice, supplies, and water for swimming, fishing and boating. Copies of *Canada Campgrounds* are available free from Canadian Government Travel Bureau offices throughout the United States.

**BUILT-IN VACUUM DUCT IS NEW OPTION FOR 1970 TRAILERS!** Streamline Trailer Co., (South El Monte, Calif.) recently released news of its new snap-in vacuum cleaner duct for trailer coaches. User can plug into the system anywhere in coach and use vacuum with handy short pickup hose. The special dust canister can be emptied outside, independent of the vacuum head itself. With a tentative price of "about \$200," the snap-in vacuum cleaner is the latest option in modern housing. ★★ ★

**8mm  
MOVIE  
CAMERA**

Electric powered—no winding! Detachable pistol grip. Loads in seconds. Adjustable lens. Black and white or color.

**\$5.50**



**INTERPHONE SET**



Closed circuit telephones for home or office. Signal bell in both units. Just pick up and talk.

**\$2.40** for two



**DIAMONDS**

One ct. weight, four diamonds for \$90, guaranteed, including postage and insurance from 50 year old Belgian firm. Many shapes and sizes available.

One ct. wt. **\$90**



**ELECTRIC RAZOR**



Product of Swiss Craftsmanship. Shaped to shave heaviest beard. Maker guarantees for one full year. With cord, head guard and brush. **\$1.70**

**DUTCH  
MOTOR-  
CYCLE**

**\$113.00**



Double tubular racing frame. Complete with buddy seat, chrome panels, lock, claxon, tools, speedometer. Deluxe Sprintmaster model for sporty appeal.

**FIELD  
GLASSES**

7x35 G.C.F.



Clear and powerful. Beautifully balanced. Lightweight. Protective lens covers. Center focusing. **\$2.10**

**JADE RING**



Genuine Jade Solitaire hand set in delicate mounting. Men's styles also available. **79¢**

Yes, only 79 cents.

More examples of thousands of import bargains you can get to make fantastic profits up to 200% and more.

- FISHING ROD . . . . .50
- FM HI-FI RADIO . . . . .8.80
- RIFLE SCOPE . . . . .1.85
- MOVIE TITLE KIT . . . . .1.00
- BEADED HANDBAG . . . . .1.01
- FLASHLIGHT . . . . .1.10
- TRANSISTOR RADIO . . . . .1.70
- CARDIGAN SWEATER . . . . .2.00
- SPINNING REEL . . . . .96
- STOP WATCH . . . . .1.12
- WRIST RADIO . . . . .2.90
- MODEL BOAT KIT . . . . .65
- WATER PISTOL . . . . .65

Prices subject to availability, price fluctuation.

**THE MELLINGER CO., Dept. D2252**  
1554 S. Sepulveda  
Los Angeles, Calif. 90025

**Buy Below  
Wholesale**

**Start your own BIG PROFIT  
Home Import Business...**

Import bargains by the thousands give you profit opportunities beyond your wildest dreams. Men—women start now in your own Home Import Business, full or part time. Cash in now without previous experience or capital investment. You can make your first import order 10 minutes after you get my proven drop ship plan. These bargains and thousands more go quick to stores, mail order operators, premium users, friends, others.

**DISCOVER SECRETS OF IMPORT  
The Profits are All Yours!**

Plan reveals everything to start you importing immediately. Giving you free membership in International Traders—famous world wide organization that puts you in direct contact with suppliers abroad. It's easy to buy below wholesale when we show you how. Rush coupon today for my FREE BOOK, "How to Import and Export"—get details about thousands of amazing buys. Airmail reaches me overnight.



B. L. MELLINGER, JR.  
Famous world trader...  
President of The Mellinger Co.

**Send No Money!**

Do Not Order From Us. I show you how to get these bargains and hundreds of others. Prices shown are direct from suppliers abroad.

Put coupon  
in mail today!

**MAIL THIS COUPON TODAY**  
Get details on 8 FREE Imports

**30-POWER  
TELESCOPE  
& TRIPOD**

Sturdy Metal Construction



3 section Telescope lets you see farther. Extends for razor-sharp focus.

**\$1.94**

**MINK  
COAT**

**\$285**



Latest style.

Full length Mink coat from Scandinavia.

**CALENDAR  
WATCH**



Swiss movement. Beautiful styling. Tells time and date. Sweep second hand, gift case, stainless steel back, water resistant, antimagnetic. METAL EXPANSION BAND 11¢.

**\$2.33**

**REAL SAPPHIRE  
RING**

Hand set Sapphire Stone in Sterling Silver mounting. Smart design. Ladies styles also available.



**3.50**

**HUMAN  
HAIR WIG**

Exciting new craze! Glamour high fashion wigs. Popular hair colors. Skillfully made. Luxuriously soft; fine textured.



**\$4.60**

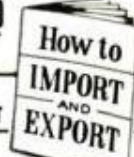

FREE BOOK TELLS HOW TO MAKE MONEY IN IMPORT

The Mellinger Co., Dept. D2252  
1554 S. Sepulveda, Los Angeles, Calif. 90025

Send Free Book showing how I can start a business of my own and make big profits. Show me how I can get bargains like these, how to buy below wholesale. (If under 21, state age.)

Name \_\_\_\_\_ Age \_\_\_\_\_  
Address \_\_\_\_\_  
City \_\_\_\_\_  
State \_\_\_\_\_ Zip Code \_\_\_\_\_

Save 3 days . . . Give Zip No. for fastest reply.

# The One Hour "Martinizing"<sup>®</sup> Dry Cleaning package is today's number one franchise opportunity

We have a thriving organization of over 3,000 independently operated stores — the World's Most Popular Dry Cleaners. New "Martinizing" stores open every week.

"Martinizing" means opportunity . . . obviously.

If you're looking for a business of your own, you're wise to compare various franchises. For example, what fees do you have to pay? Most franchisors take a percentage

of profits — the more you make, the higher their take. A "Martinizing" franchise, however, requires absolutely no percentage — just a modest annual fee. So the more money you *make*, the more you *keep*.

"Martinizing" has other advantages too. Use the checklist to compare it with as many other franchises as you like. You'll see why a One Hour "Martinizing" dry cleaning store is Opportunity Number One.

## CHECKLIST TO SUCCESS

	<b>"MARTINIZING"</b>	<b>OTHER</b>
Minimum cash requirement .....	\$12,000	_____
Total cost .....	\$25,000 plus (depending capacity and location)	_____
Assistance from franchisor in financing balance? .....	Yes (subject to credit check)	_____
Standard minimum franchise fee as opposed to percentage of sales or profits .....	Yes	_____
Nationally recognized name? .....	Yes	_____
Previous experience necessary? .....	No	_____
Training and supervision provided? .....	Yes	_____
Operator required to purchase supplies from franchisor? ...	No	_____
Type of business operation .....	Cash & carry	_____
Stock inventory necessary? .....	No	_____
Delivery service needed? .....	No	_____
Year 'round advertising support at no extra charge? .....	Yes	_____
Year 'round in-store promotion at no extra charge? .....	Yes	_____
Experience putting people in business? .....	20 years	_____

Does a One Hour "Martinizing" Dry Cleaning store appeal to you? Get the full story of this exceptional business opportunity by filling out and mailing the coupon below. No obligation of course.

®Certification Mark, Reg. U.S. Pat. and Canadian Trade Marks Off.

**Martin Sales, 2005 Ross Ave., Dept. PM-20  
Cincinnati, Ohio 45212**

**Please send your Key To Success brochure with  
full details on the "Martinizing" franchise.**

Name \_\_\_\_\_

Street \_\_\_\_\_

City \_\_\_\_\_ State \_\_\_\_\_ Zip \_\_\_\_\_

Phone \_\_\_\_\_

Occupation \_\_\_\_\_



# What You Need to Know Before You Buy a Franchise

Here are the questions you should ask before you sign a contract, and the answers given by Dr. Charles L. Vaughn, director of the Boston College Center for the Study of Franchise Distribution, in an interview with PM editors

**If I'm considering a franchise, should I seek a company with a well-known or well-advertised name?**

Yes. If you go with a company that is not well-known, you don't get the benefit of a nationally advertised name.

Many companies start with a product or a process or a service and build on it to create a brand name through advertising and satisfied customers. In the last few years, some companies have tried the op-

posite approach. They take a name and then build a service.

**Let's take the fried-chicken business. Col. Sanders wasn't a name to begin with. He became one because his chicken was good and was well-promoted. But what about Minnie Pearl or Eddie Arnold or some other celebrity who never fried any chicken, but is a name? Which am I better off with?**

If you buy a franchise from an organization based on a personality in entertainment or sports, you could be getting into a business that's not really set to go. Such a franchise is only as good as the franchisor's management.

**You would say, then, that if you're going to go into the restaurant business it would be safer to be in with experienced restaurant people?**

Right.

**Rather than with somebody who says, "I'll get a celebrity, and we'll start some restaurants?"**

Right. Again, you have to weigh the possible returns against the risks. Generally you take a bigger risk with a new organization, even though it has a big name to work with. If you have speculative money that you can put out, and the potential return is high, then it could be that you're getting a *better* deal with a new group with a big name than with an old, established group where you wouldn't

*(Please turn to page 26)*



*Charles L. Vaughn, Ph.D., is executive director of the Boston College Center for the Study of Franchise Distribution. He initiated the conference for top management on franchising held annually at Boston College since 1965. Editor of Franchising Today 1969 (Farnsworth Publishing Co., New York), Dr. Vaughn has written numerous articles on franchising and has lectured all over the nation on the subject. He has also been engaged full-time as a consultant in consumer- and systems-research firms.*

# BECOME A TRAINED DRAFTSMAN



**LEARN AT  
HOME IN  
SPARE TIME**

Now you can turn spare time into education and qualify for an interesting job as a draftsman by training right in your own home. United Technical Institute, division of Career Academy, has a proven program of teaching you all the skills you need to prepare for a job with an architect, electronics firm, space-age manufacturer, or other exciting spots. You'll receive your own kit of drafting materials and books . . . all you need to do your work right in your own home. And the instructors from UTI will work with you personally by mail. You work at your own speed in your spare time. Ask for details right now about the UTI Home Study Drafting Program . . . or about resident training at UTI Centers located in major cities.

## United Technical Institute

division of Career Academy

740 N. 2nd Street • Milwaukee, Wis. 53203  
Dept. N19200



Please rush me your free booklet with all the details of how I can train for an exciting job as a Draftsman.

Name \_\_\_\_\_ Age \_\_\_\_\_

Address \_\_\_\_\_ Phone \_\_\_\_\_

City/State/Zip \_\_\_\_\_

I am interested in  Home Study  Resident Training

## BEFORE YOU BUY A FRANCHISE

*(Continued from page 25)*

be taking as much risk, but where the potential return might be less.

**Does it cost more to get into an established operation than a brand-new one nobody ever heard of?**

It generally would cost more, and your expected return would not be as great.

**Your volume might be bigger?**

Yes, your volume might be bigger, but your net might be smaller. If you go in with a new, untried group, you're taking a greater risk, because they haven't established a track record. Therefore, your *expected* return—not promised return—should be greater because of the greater risks you're taking. If you recognize that, fine.

**What are some of the risks?**

Well, there's a risk that you won't make money. That's the basic risk. In fact, you may lose it all. Why might it net nothing? Well, maybe the name doesn't appeal. It may not be appropriate for the products or services you are trying to sell. Or you may not get enough good advice and counsel from the franchisor. He may advertise that you don't have to be a cook or restaurant man. "We'll give you all that," he says. But it's possible he can't give you that or that he won't.

**How can you check a franchisor's claims of what he will do for you?**

It's difficult. If it's a well-established operation, and you can interview other franchisees, it's relatively simple. If it is public you can go through his prospectus. If it's a well-established, well-known company, you can talk to local banks and maybe take a trip of a couple hundred miles and see what banks and other franchisees have to say. With a new outfit, it's hard to estimate the risk involved. It's probably high.

**There are agencies that help you find franchisors. Is it wise to approach an agency?**

*(Please turn to page 28)*

# 3 WAYS to a profitable business of your own

— and only —

## VON SCHRADER HAS ALL 3

Von Schrader is the oldest and largest company making Detergers of this type. For over 30 years our FREE ENTERPRISE PLAN has been fashioned with your future in mind. Start with the Deterger that most appeals to you. We have thousands of Associates who have built successful businesses with just one Deterger. Naturally, bigger and more profitable businesses can be built when you are able to offer two or all three cleaning services.

For example, let's say you start with the

### VON SCHRADER WALL DETERGER

(LOWEST PRICE OF ALL THREE)

1 • Associate G. H. Jones made \$1200.00 on one job. Associate R. G. Fullmer says contracts this year will gross about \$18,000.00. And no wonder...this machine washes walls 6 times faster than by hand...with no mess...no drop cloths needed. Washing is so easy...no tiresome scrubbing...special glider wipes walls clean with little effort. You can start part-time and by working week-ends add hundreds of dollars to your income while still employed.

Then you can double your profit by adding the

### VON SCHRADER UPHOLSTERY DETERGER

2 • Associate Charles Lemmin averaged \$100.00 a day during his first year. Associate Peter Young took in \$960.00 last week. You clean upholstered furniture on customers' premises—homes, hotels, motels, etc....even auto upholstery. No hauling...operate from your home. Watch business grow as customers tell their friends.

And, finally, you can more than triple your profits by adding the

### VON SCHRADER RUG DETERGER

because each service helps to sell the other two

3 • Associate C. E. Nevin reports he averaged \$1000.00 a month for 12 months. An Associate father-son team grossed \$33,000.00 their first year. Von Schrader's FREE ENTERPRISE PLAN is not a lease arrangement. You sign no contract. You own the equipment. You pay no fees, dues or royalties to anyone. Every dollar you take in is yours to keep.

Full Operating Instructions come with each Deterger... you need no special skill or training. And our Business Manual tells everything you need to know about getting business, suggested sales letters, tips on keeping books and tax records, suggested ads and radio announcements, etc. Our assistance is always at your service. Training and consulting with experts is also available...and without charge.

**Don't Delay...it costs nothing to get the details. Return the coupon TODAY for informative FREE booklet. Be sure to check the Deterger you are most interested in starting with.**

## VON SCHRADER MFG. CO.

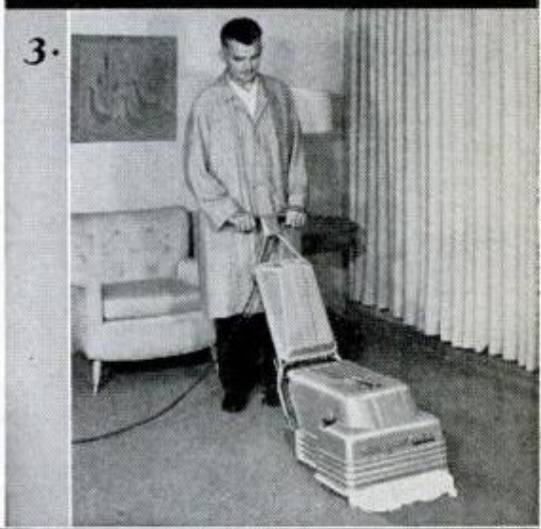

**SEND FOR THE FACTS TODAY**

**VON SCHRADER MFG. CO.**  
1027 Place, Racine, Wis. 53403

Please rush information about your \_\_\_\_\_ DETERGER(S)

(Write in name of detergent(s))  
and how I can start my own profitable business.

Name \_\_\_\_\_  
Address \_\_\_\_\_  
City \_\_\_\_\_ State \_\_\_\_\_ Zip \_\_\_\_\_

## Be Your Own Boss!

No experience necessary.

Offer the big bargain  
in auto service.

Earn \$100 to \$500 a week,  
part or full time in your  
own service business.

Any car waxed and  
polished with genuine

# SIMONIZ®

PASTE WAX

ONLY \$5<sup>95</sup>

REMARKABLE NEW PATENTED MACHINE  
ASSURES BRILLIANT JOB IN 30 MINUTES OR  
LESS... PROVIDES \$5.70 GROSS ON  
EVERY CAR SERVICED.

#### ENGINEERING BREAKTHROUGH

Patented Hand-Action Polishing Machine scientifically duplicates the polishing motion of the human hand, only several hundred times faster. It's Portable — (16 lbs.) — enables any one to paste wax a car in 30 minutes or less! So simple, a 12-year old child can operate it with fantastic results! No experience necessary.

#### START IN YOUR SPARE TIME

Many National Wax Dealers will keep their present jobs and start in their spare time (evenings, weekends) until they see how much more money they are making with a National Wax Dealership. BE YOUR OWN BOSS—you can do it, like so many others.

#### NO OVERHEAD

You can work from your own home. The HA Polisher will operate on any standard current. Materials and supplies cost you less than 30¢ per car. Almost all you take in is CLEAR PROFIT!

#### \$5.95 FOR A GENUINE SIMONIZ®

This miracle polisher enables you to clean, wax and polish a car to a brilliant luster, using the most respected paste wax in the industry — SIMONIZ® — in 30 minutes or less. You charge the low low price of — \$5.95 — while others charge anywhere from \$15 to \$25. You can gross up to \$500 a week — as much as \$20,000 to \$25,000 a year!

#### CUSTOMERS ARE EVERYWHERE

Customers will break down your door when they learn of the fabulous offer of a \$5.95 Simoniz® job. Fleet operators, used and new car dealers, rental agencies, will flock to you. You will never run out of customers.

For further information, write to:

### National Car Wax Systems

Dept. P M 1, 59-24 Maurice Avenue, Maspeth, N.Y. 11378

## BEFORE YOU BUY A FRANCHISE

(Continued from page 26)

No. That's the last thing I would do. They are not your agent—they are the agent of the franchisor. He is the one who pays the money. It is the commission on that sale that keeps the agency going.

Should I buy an ice-cream parlor or should I go into the rug-shampooing business?

That I can't answer. You have to invest so much cash and so much work—personal effort—in an ice-cream stand. The same is true in the rug-cleaning business. Which business do you want to be in?

Let us say that I've been a mechanic all my life. Should I take on a barbecue-beef franchise or would I be better advised to go into relining brakes?

Sometimes the franchisor wants the fellow who *doesn't* have a lot of experience so he won't have a lot of bad habits. But today the tendency is to try to get people with a little business experience.

Why have some businesses turned to franchising instead of becoming chains? Why do they become a franchisor instead of opening a store and hiring a manager?

A chain of men's clothing stores found recently that one of its company-operated stores was losing money. It put a franchisee in, and he made money hand-over-fist. The franchisee had a more realistic approach to inventory. He wasn't ordering just to be filling his shelves. He ordered stock that would sell. It was his own money. He exercised a lot tighter control.

I'm a 45-year-old magazine editor. If I should decide to take the plunge and buy a franchise, would I be a favorable risk?

At 45? Sure. But it depends a little upon the particular field. Many people who are 55 or 60 think they can "retire" into the motel field. That's the last place in the world they ought to go to retire.

Are franchises in general good retirement opportunities?

(Please turn to page 30)

# MAKE \$100 \$200 OR MORE

## per week... part time with a **FOOSBALL** Sportsystem Franchise



America's newest sport can make you a spare time fortune! Hundreds of men are now making thousands of dollars each with the FOOSBALL Competitive Sportsystem Program. . .you can too.

Here's how you start. . .

Show people how to play FOOSBALL, the action packed, new table-soccer game that's perfect for pool halls, bowling alleys, taverns, legion halls, snack shops, campus spots, union halls. . .the list of locations is endless. All you have to do is visit the locations during the fun hours. After one demonstration game, everyone wants to play. Competition builds. . .from then on, you simply collect your money from the cash box and split it with the location owner.

**FOOSBALL works full time. You work part time!** FOOSBALL works for you every day. Your money rolls in even when you're off for a few days or on vacation. No service calls! FOOSBALL is maintenance FREE. It's completely mechanical. . .no electric connection or circuits. . .no trouble shooting. And, it's legal everywhere.

American Youth Marketing Corp.  
alms building, cincinnati, ohio, 45206

interested parties may call Mr. Green collect (513) 281-7171.

Just look at the **FOOSBALL® FORTUNE**

\$200 in 10 days from 1 unit

C. H., Alabama. . ."I have taken in as high as \$200 in just ten days from one unit, and we have had units pay for themselves in less than one month. There are no maintenance problems and virtually no overhead."



No Selling! No experience needed!  
We help you every step. . .

Our FREE, illustrated and thoroughly proven manual, sound movies, banners and advertising materials, will guide you step-by-step to fabulous success with FOOSBALL. We show you how to get locations. . .how to install. . .how to promote. . .how to make one location lead to another and another.

We help you obtain financing through your local bank, and you can begin your FOOSBALL program for as little as \$650. In addition,

you will receive our FREE monthly Dealer NEWSLETTER to give you all the latest news on FOOSBALL, and we advertise in magazines like LIFE, ESQUIRE, SPORT, and on radio and TV to help even more.

**ACT NOW. . .DON'T DELAY. . .**

Fill out our coupon and mail it today. Others will be writing in from your local area, and inquiries are processed based on date of postmark. Remember, only one dealer can be appointed from your area. There's no obligation. . .only opportunity. . .the biggest you've ever had. Send in this coupon NOW!

© PIC. 1970

**FOOSBALL® COMPETITIVE SPORTSYSTEM™**

ADVERTISED IN

**LIFE**

div. American Youth Marketing Corp.  
dept PM-3-70  
alms building  
cincinnati, ohio 45206



No one will visit you. Please include phone number so we can call.  
Yes, I'm interested in a  part-time  full-time program. Send me all the facts on my FOOSBALL FORTUNE... FAST.

my occupation now is \_\_\_\_\_

name \_\_\_\_\_

phone \_\_\_\_\_ area code \_\_\_\_\_

address \_\_\_\_\_

(please use street number and zip code)

city \_\_\_\_\_ state \_\_\_\_\_ zip \_\_\_\_\_

# INVEST 6¢ in your family's future!

Send for your FREE copy of "Your Future as a GBS Area Director" today. Just mail the coupon, and discover the remarkable new career possibilities through an exclusive franchise to provide much needed services to small businesses. If qualified, as a GBS Area Director, you will have unlimited income potential . . . own a business with no labor problems, no perishable inventories, no high overhead. \$7,500 investment required. Send for FREE book today . . . the return on your 6¢ stamp investment could be astronomical!



**Mr. C. E. Gaw, Exec. Vice Pres.**  
General Business Services, Inc.  
7401 Wisconsin Ave. N.W.  
Washington, D.C. 20014

B-49

Rush me a FREE copy of "Your Future as a GBS Area Director."

Name \_\_\_\_\_  
Address \_\_\_\_\_  
City \_\_\_\_\_ State \_\_\_\_\_  
Zip \_\_\_\_\_ Phone \_\_\_\_\_

## SATURDAY MORNING INCOME PLAN!



Earn \$5 to \$20 extra in spare weekend or evening hours, accepting orders from friends and neighbors for our nationally famous shoes. Just show our beautiful full color catalog of over 275 exciting styles, many exclusive comfort features! No experience needed to make extra money, earn prizes, bonuses—even FREE SHOES for life! Rush name & address for FREE Starting Outfit today.

**MASON SHOE, Dept. H-739, Chippewa Falls, Wis. 54729**

## BEFORE YOU BUY A FRANCHISE

(Continued from page 28)

A franchise seems like a logical retirement business, but I'd shy away from it.

**If I should fail, what is the obligation of the franchisor to help prevent the total loss of my investment?**

He'll usually buy it back if you're losing money, but you may not get much out of it. Let's say you put \$30,000 into a franchise, and you're not doing very well. The first thing the franchisor is supposed to do, according to the agreement, is to give you management and marketing counsel and try to help you. Some will put a man right in there to run it for you or to help you run it for a few weeks or months. The older companies have more of a capability there.

**What are the give-away signs on a fast-buck outfit? What do you look out for?**

Somebody who's so new you can't get any information on him from the Better Business Bureau, or who doesn't have any franchises in existence, who doesn't have any company-owned stores and who makes exaggerated claims—that you're going to get rich overnight. I don't know one legitimate franchisor who promises riches overnight. If a franchisor says that you'll definitely make \$45,000 net or \$25,000 net, you can begin to wonder, because nobody can predict precisely what your revenue will be or what you will receive in net profits.

**Will most franchisors allow you to have an attorney go over your contract?**

Sure! The good ones recommend it and some even insist on it. If a franchisor says, "Oh, you don't need an attorney," I'd hesitate about putting out \$10,000.

Getting back to that age thing: Age doesn't seem to be a big factor in the franchise business. Kentucky Fried Chicken was started on Col. Sanders' social-security checks. On the other hand, some of the McDonald hamburger franchisees and the managers are in their 20's and making money hand-over-fist.

**How do I know whether a business is**

(Please turn to page 32)





**EARN  
HIGH  
WAGES**  
as a **HEAVY  
EQUIPMENT  
OPERATOR**

Train your way to high pay in the booming construction industry! Learn the skills you need to qualify, by actual field training on machines like the ones used by the industry. Huge training grounds in North Carolina, a million dollars worth of school-owned diesel-engined machines, experienced instructors, full 220-hour and 440-hour courses. National, the original school of heavy equipment operation, is a recognized leader. Member American Road Builders Assn., Services and Supply Division. Associate Member A.G.C. Full-time Job Advisory and Counseling Director on staff. VA approved. For men ages 17 to 56. Train Now-Pay Later plan . . . other payment plans also available. Write TODAY for FREE catalog and FREE copy of school newspaper reporting news of National School graduates. Accredited member NATTS.

**NATIONAL SCHOOL  
OF HEAVY EQUIPMENT OPERATION, Dept. D-36**  
P. O. Box 8529, Moores Chapel Road, Charlotte, N. C. 28201

Please send me FREE illustrated school catalog and complete information. I understand there's no obligation.

Name \_\_\_\_\_ Age \_\_\_\_\_

Address \_\_\_\_\_ Phone \_\_\_\_\_

City \_\_\_\_\_ State \_\_\_\_\_ Zip Code \_\_\_\_\_

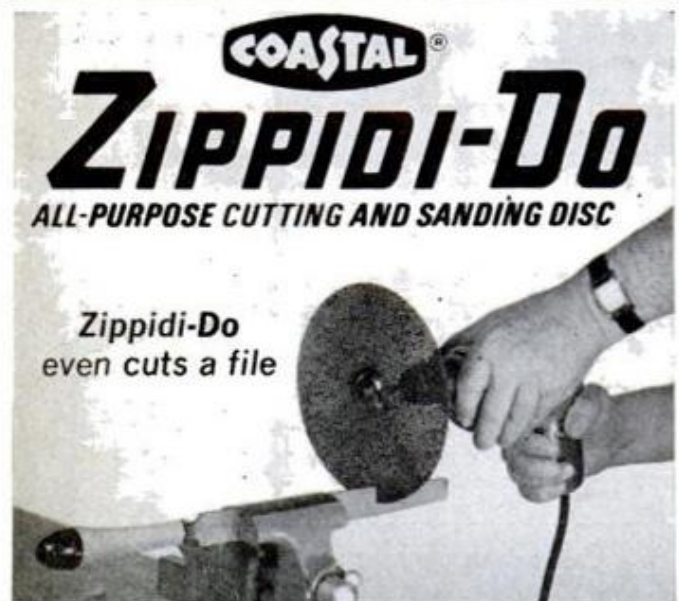

**The most versatile power  
tool accessory...ever!**

You can cut through ceramic tile, fiberglass, brick, slate, stone, all metals . . . even a hard file in minutes with the Zippidi-Do cutting and sanding disc. Silicon carbide grains embedded in nylon mesh give it amazing cutting ability. And the Zippidi-Do makes a great sanding and shaping disc for use on old paint, rust, wood, tile, all metals. The Zippidi-Do can be used with any electric drill or flexible shaft. It wears and wears and never clogs.

Complete kit contains Zippidi-Do disc, molded backing disc, arbor and flanges . . . now at many hardware stores and depts. Coastal Abrasive and Tool Co., Inc., Trumbull, Conn. 06611.

**BEFORE YOU BUY A FRANCHISE**

*(Continued from page 30)*

over-franchised? The chicken business is a good example. I mean how much fried chicken can people eat?

The saturation concept is pretty weak. When McDonald's started its hamburger business, who would have thought you could build up a string of over 1000 establishments selling hamburgers. Everybody can make a hamburger; everybody's selling hamburgers. Yet this "new" chain is highly successful. In other words, people didn't have all the hamburgers where they wanted them and at the price they wanted to pay. It's difficult to estimate the market, but much of the talk about saturation is unjustified.

Franchisors have information that helps them select new locations. Take Holiday Inns. They can tell from their records how many reservations were requested for a town 50 miles down the line from where they have a Holiday Inn, 200 miles down the line, and so on. So when they put up a Holiday Inn they can estimate accurately how many reservations they are going to get.

**What is considered a fair royalty?**

Around five percent. That's gone up a little bit lately. It varies from zero to say seven or eight percent.

**Prime sites for fast-food operations are getting scarcer, aren't they?**

Yes, they're hard to find. But I've noticed one thing. When one fellow opens a Kentucky Fried Chicken, let's say, there are soon six or eight franchised eating places all on the same little stretch of highway.

**Does this help or hurt?**

It probably helps, up to a point. But if you could break away and go someplace where you could get a cheaper site, maybe you would do just as well. Sometimes businesses cluster together, seeking what we might call an "umbrella effect," or mutual attraction of customers.

**If it's true that a franchisee must have**

*(Please turn to page 34)*



# If a car doesn't have to be an extension of your manhood.

Either you have it or you don't. No amount of bulging chrome, 5 or 6 on the floor, or overhead cams has ever turned a milksop into Attila the Hun.

The Renault 10 is for men who don't need a crutch. It is, simply and stubbornly, an intelligent well-made automobile.

It delivers a very efficient 35 miles a gallon. Does 0 to 60 in 18.6 seconds, and has a top speed of 85

mph. Enough for anybody who isn't trying to prove something. It's also got disc brakes on all four wheels to protect you from guys who are.

Besides, it even out-handles and out-corners a lot of fancy-price fantasy wagons.

Our price is a mere \$1725\*

But for another 50 bucks you can get bucket seats that fold down into a bed.



\*For nearest dealer see the Yellow Pages or write Renault Inc., 100 Sylvan Ave., Englewood Cliffs, New Jersey 07632.

**RENAULT** 

Материал, защищенный авторским правом

## BEFORE YOU BUY A FRANCHISE

*(Continued from page 32)*

some initiative and know-how in such complicated areas as marketing and merchandising, how's a young fellow coming back from Vietnam or a high school graduate with no experience going to succeed? The know-how has to come from the parent company, doesn't it?

Yes, right. The advantage of a franchise is that it makes you an instant manager. If you went to work for a chain, you couldn't be a manager until you had worked for it for 5, or maybe 10, years. Franchisors have so simplified the operation that almost anybody can succeed. That's why when you're talking about really fancy restaurants, or a complex department store, you're getting out of the field of franchising. You can't be an instant manager there. There's too much to it. Fifteen items on the menu, plus lobster: Just cutting the meat takes a guy who really knows his stuff. Say there's a little piece the average person would throw away. If you discard so much of it for every portion—365 days a year—your

profit's shot to beans. You can't franchise that type of restaurant. The real successes are the highly simplified operations. The more complex the operation, the more hazard there is.

Are there factors that a franchisee might not be aware of that make him a poor manager? Are there things he can do by himself to be better than he is—things the parent company might not catch or help him with?

Well, reliability and dependability: Those are two biggest factors. Opening up on time, being there, keeping the place clean and so on. The parent company will check up on your reliability and dependability. Marketing and public relations are things the average new manager may not be good at. If you get a chance to cater doughnuts and coffee for the Ladies' Aid Society, do it. You may not make any money on that particular occasion, but it builds acceptance for your place and its name.

**Does the franchisor set prices or do I?**

*(Please turn to page 36)*

## TURN YOUR TALENTS INTO A PROFITABLE BUSINESS... With a United Rent-All Franchise



How would you like to turn your hobby into a profitable, exciting, fun-career...be the headquarters in your community for all kinds of modern power tools, gardening tools, camping gear, exercise equipment, even party supplies, and convalescent supplies?

**You would...then read on!** Does doing what you like to do best in a booming growth industry appeal to you? Would you like to become the owner of a magnificent, completely fixturized, fully stocked rental store?

Okay...that's just for starters! As a UNITED RENT-ALL Franchisee you would also enjoy exceptional tax advantages, be the boss of a fun-recreation and hobby business—renting what your community needs. As a UNITED RENT-ALL store owner—you'll have it!

As a UNITED RENT-ALL Franchisee you would be completely trained (at our expense) in Los Angeles. You would be furnished with an IBM accounting system; backed with national advertising; given continuous parent company support! Our experts select the proper site, and we sign the master lease.

NOW...if you have \$16,000 (down) to invest—want to turn your talents into a profitable business...PHONE Collect, Barry Messer, National Director of Franchise Sales (213) 836-4900 OR WRITE: UNITED RENT-ALL INC.

10131 National Boulevard  
Los Angeles, California 90054  
Department PM-270



An International Industries Company, NYSE

# DOUBLE YOUR INCOME! MAKING ENGRAVED PLASTIC SIGNS ON A SCOTT ENGRAVER

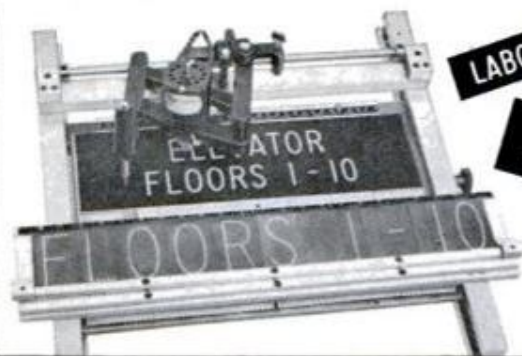

LABORATORY

269

Make professional engraved signs in minutes. Scott engraved signs have a markup of up to 500%. Work 2 hours a day and earn up to \$150 a week extra. Complete with accessories—everything you need to start—from \$130. Write for free catalog. Dept. PM 1169.

**SCOTT MACHINE DEVELOPMENT CORP.**  
215 PROSPECT AVE.  
P. O. BOX 217 • WALTON, NEW YORK 13856

## WOOD EVERYTHING FOR THE WOODSHOP TOOLS-SUPPLIES



World's Largest Selection of Finest Domestic and Imported Hardwoods, Veneers, Hardware—

**at MONEY SAVING PRICES**

Over 2000 items! Your money saving hardwood and woodshop buying guide. We've added new Clock kits, wood picture kits, musical instrument kits, many more. Complete selection of hard-to-find hardware, lamp and upholstery supplies, etc. Big savings on name brand power tools. Send name, address and 35¢ for handling and postage to:

**CRAFTSMAN WOOD SERVICE CO.**  
DEPT. A-20  
2729 S. Mary St., Chicago, Illinois 60608

**New Catalog!**  
Write Today!...

## INVENTORS

**INVENTIONS—NEW PRODUCTS—IDEAS DEVELOPED & PREPARED**  
*For Commercial Appeal & Sales*

**DESIGN—MARKETING—PATENT RESEARCH—DRAWINGS**

**DIRECTOR:** *United States Patent Office former Patent Examiner  
United States Dept. of Army former Patent Adviser  
Member: United States Council Int'l Chamber Commerce  
Second Decade of Reliable Service to*

**INVENTORS—MANUFACTURERS—ATTORNEYS**  
**FREE CONSULTATION**

**THE RAYMOND LEE ORGANIZATION**  
230-Z Park Ave., New York 10017 (212-MU 6-8500)

**SEND FREE "INVENTION RECORD" Form & "IMPORTANT PATENT INFORMATION"**

Name \_\_\_\_\_

Address \_\_\_\_\_

City \_\_\_\_\_ State \_\_\_\_\_ Zip \_\_\_\_\_



## The Halls had a ball WITH AN OLD FASHIONED Western Auto SIDEWALK SALE

A recent sidewalk sale proved to be both fun and profitable for Mr. & Mrs. C. E. Hall, owners of the Western Auto Franchise in Santa Paula, California. The Halls are one of over 4,000 successful Western Auto Dealers.

**ENJOY PRESTIGE IN YOUR TOWN**  
Like the Halls, you can get more out of life—enjoy new friendships and the luxuries you always wanted for your family. As your reputation for service and quality grows so will your stature in your community.

**OWN A WESTERN AUTO STORE**  
Be your own boss in a business that offers a full line of products everybody buys. Electrical merchandise and major appliances; Camping and Sporting Goods; Home and Garden needs—over 17,000 items, many of which you can sell from the big Western Auto Catalog without carrying a top heavy inventory.

**NO FRANCHISE FEE—NO MONTHLY ROYALTY!**  
Unlike other franchises you pay no franchise fee—training is free. We help you select store location; supply fixtures and store layout; advise on inventory, book-keeping and credit plans. No monthly royalty—all the profits are yours to keep. We back you up constantly with personal guidance, advertising and promotional help.

**WE FINANCE HALF THE COST**  
The total investment for opening your Western Auto Store is between \$20,000 and \$30,000, but for qualified men we finance much of it. This amount covers opening inventory, fixtures, grand opening and also includes a cash reserve for an operating fund. You can grow rapidly with the help of top merchandising men. Send for complete information without obligation. It's free.

**C. R. Hobbs, V. P., Western Auto Supply Co.**  
Room 52, 2107 Grand Avenue  
Kansas City, Missouri 64108

Please mail all the facts free showing how you can help me succeed in a business of my own.

Name \_\_\_\_\_

Address \_\_\_\_\_

City & State \_\_\_\_\_ Zip \_\_\_\_\_

My Phone No. is \_\_\_\_\_

MEN! WOMEN!  
COUPLES!

FREE  
CAREER KIT  
Mail Coupon  
Today!

Imagine

spending your "working hours" associating with happy, fascinating people in a "vacation atmosphere" and getting well paid for it, too! Think of free rent, resort living, great food, unlimited recreational activities and plenty of time to enjoy them. Add to this an exciting, secure future in one of the world's fastest-growing "glamour" fields.

PREPARE NOW  
At Home For A  
**MOTEL  
HOTEL**  
Career...where  
your life can be  
like a year 'round  
"vacation with pay!"

WHATEVER YOUR AGE...  
YOU CAN QUALIFY NOW!

Mature men & women (or couples), looking toward retirement to good income, fresh air, fun—20 years ahead of time: Be "Resident Manager" in your own area or vacation resort. Or, work toward owning your own motel.



Young men & women, looking for great career in booming field with big future: 1000s find positions now with expanding motels & hotels in cities, towns, resorts in America & overseas.

**BIG DEMAND FOR TRAINED  
PEOPLE...We Show You How!**

1000s great career opportunities with leading "chains" & top local motels in cities, towns, resorts in America and overseas vacation paradises "go begging" daily due to lack of trained people to fill them. Easy home-study plan trains you quickly to step into one of these wonderful big paying positions. Your training is up-to-date, thorough... nothing is left to chance. During training you "run your own motel"... using forms & procedures you'll encounter later in your Motel-Hotel Career. Our exclusive "Quick-Learn" Method has helped 1000s reach success through home study. Why not you?

**Rush Coupon for FREE  
"MOTEL-HOTEL CAREER KIT"**

... including 20-page book, "Your Future in Motel Management, Hospitality Career Selector Chart and revealing report "Owning Your Own Motel." Everything sent FREE & POSTPAID without obligation. No salesman will call.

ALL 3 FREE  
"MOTEL-HOTEL  
CAREER KIT"

**NORTH AMERICAN SCHOOL OF MOTEL-HOTEL MANAGEMENT**  
4500 Campus Drive, Dept. 4172, Newport, Calif. 92660

**RUSH** big "Motel-Hotel Career Kit" — ALL FREE! I understand this puts me under no obligation, now or ever, and that no salesman will call.

Name \_\_\_\_\_ Age \_\_\_\_\_

Address \_\_\_\_\_

City \_\_\_\_\_ State \_\_\_\_\_ Zip \_\_\_\_\_

Accredited  
Member,  
National Home  
Study Council

New, ALL-Terrain  
**Trail Bronc**  
Write For  
Free Literature



Features rigid frame of 1", welded tubular steel; powerful 5 h.p. Briggs & Stratton engine; hi-traction tires 18x850x8 rear and 15x600x6 front; automatic 2-speed Comet transmission and clutch; #40 motorcycle drive chain; full mud guards front and back. Ski, lights, and tote box optional.

A real "go anywhere" trail bike. Kit only \$199.95.

**HEALD, INC.**

Dept. 10A, P.O. Box 638, Benton Harbor, Mich. 49022

## BEFORE YOU BUY A FRANCHISE

(Continued from page 34)

By law, the franchisor can't fix prices. All he can do is suggest prices, except in his company-owned stores. The franchisee can do whatever he wants to about prices.

**If I'm successful, can I open more outlets?**

Yes. There are millionaire-franchisees who started with one unit and accumulated maybe a half dozen. But that leads to one of the big problems today: motivating the franchisee. Take the fellow who started with one franchise and was making maybe \$8000 a year. Then he began to make \$25,000 a year on that one alone. So he opened up some more. On half a dozen, he's making over \$100,000 a year. What incentive does he have to generate more business for each shop? From the company's point, it may be better to have single franchisees working hard. It may come to the point where it's better for the central company to have its own manager.

**If the parent company puts in its own manager, we're right back to a chain operation, aren't we?**

Right. There's a delicate balance between company-owned and franchised units. Sometimes franchises become worth so much that no one but the parent company can buy it.

**Is there a trend back to the \$8000-\$10,000 franchise? When it gets beyond that, Mom and Pop can't afford it.**

Yes, but that doesn't mean that Mom and Pop are the solution to this particular problem. What franchisors are looking for is some way to motivate the fellow who has a lot of ability and experience, some way to motivate him to even greater success. ★★★

## COMING NEXT MONTH

**Phono Pickups:** How to choose a good one.  
**Your Brake System:** A complete checkout.  
**Four-Foot Workshop:** Fine for apartments.  
**Dodge Corey Cruiser:** PM editor tests it.  
**Borderless Prints:** Easy ways to make 'em.  
**Plymouth Valiant's Duster:** Owners Report.

# PUBLICATIONS **WORTH** **WRITING FOR**

BY CATHERINE BILSKI

**MAKING A SAIL** for your boat needn't be a complicated task, thanks to a new booklet written by sailmaker Ted Bowen. The booklet, *How to Make Main and Jib Sails*, describes and illustrates, in simple and easy-to-follow terms, just how to make your sails. It is available for \$3 from E. S. Bowen, 41 Yonge Street North, Richmond Hill, Ont., Canada.

**BE PREPARED FOR EMERGENCIES** with this tiny survival manual. It's small enough to fit in your wallet and loaded with modern survival methods that tell you what you can do to survive on land, at sea and in the air. It's free; just mail your name and address to Walle Hawk, Box 1024, Burlington, Vt. 05401.

**LEARN THE CRAFT** of jewelry metal-

crafting at home with this 94-page illustrated book entitled *Handbook of Jewelry Metalcrafting*. It contains sections on what materials, tools and supplies are needed, handy reference tables and lots more. Priced at \$4.95 from Craft Training Institute, 7438 S.E. 40th St., Mercer Island, Wash. 98040.

**IF YOU'RE HOUSE HUNTING** you'll want to know the basic tips on house buying that are offered in a new 24-page *House Hunter's Guide*. It was prepared to help house-hunting families get more for their money, and the handy fill-in charts that are included will help you compare the value of one home against another. Copies are available for 50 cents from the American Wood Council, Suite 1625, 5454 Wisconsin Ave., Chevy Chase, Md. 20015.

## NEW... Ninth Edition of the

### Small Engines Service Manual

Complete repair information on over 1,000 models of foreign and domestic small engines that power lawn mowers, tillers, go-karts, etc. ... 328 pages of factory "Know-How!"

9th Edition  
4 95

### Motorcycle Service Manual

Volume 1 208 pages devoted to over 75 models of 18 manufacturers. Includes nearly every 2-stroke "popper" thru 1967 and many '68 cycles.

2nd Edition  
4 95

Both Volumes \$8.50

### Motorcycle Service Manual

Volume 2 A total of 16 manufacturers represented. Complete instructions on everything ... from brake adjustment to engine tear-down and reassembly. 232 big pages.

2nd Edition  
4 95

### Snowmobile Service Manual

Covers almost every machine built through 1968 and many '69 models! ... Engine section includes Hirth, JLO, Kohler, MAG, Sachs, Chrysler, OMC, Rotax, Lloyd, Yamaha and Wankel.

2nd Edition  
4 95

Money Back Guarantee. Send check or money order and we pay postage.

### Universally Accepted SMALL ENGINES SERVICE MANUAL

### Outboard Motor Service Manual

Volume 1 Covers outboard motors built from 1955 to 30 HP 1967! Every repair procedure from power head to prop. Over 35 different makes included. 239 pages.

4th Edition  
4 95

Both Volumes \$8.50

### Outboard Motor Service Manual

Volume 2 Contains all pertinent service data on motors from 30 to 110 H.P. Same thorough model and year coverage as in Volume one. 208 pages.

4th Edition  
4 95

### Small Tractor Service Manual

Universal service manual for popular "compact" garden/utility tractors. Covers models ranging from 6 to 12 1/2 HP.

2nd Edition  
4 95

Complete! Comprehensive! Each book concisely written. Heavily illustrated. Each contains hundreds of diagrams, exploded view drawings, photographs. Lets you see exactly how work should be performed. Used and acclaimed by professional mechanics, do-it-yourselfers, classroom instructors. The most accurate and easy to understand universal repair manuals available anywhere.

TECHNICAL PUBLICATIONS DIV., Dept. PM-270  
1014 Wyandotte, Kansas City, Mo. 64105

## OWN YOUR OWN LAFAYETTE RADIO ELECTRONICS ASSOCIATE STORE!

OVER 240 NOW OPERATING

"One of America's Fastest Growing Consumer Electronic Companies — A prestige line to Market."

ALL YOU NEED IS:

1. Basic Knowledge of Retailing, Television or Electronics
2. Financial Investment of \$20,000 to \$50,000

To learn how easy it is to have your own Lafayette Radio Electronics Store, fill in and mail the coupon below for full information FREE, There is no obligation.

Lafayette Radio Electronics Corporation  
Att: Associate Store Dept. RL  
111 Jericho Turnpike, Syosset, L.I., N.Y. 11791

Name.....  
Address.....  
City..... State.....  
Zip.....



# TUNE UP ELECTRONICALLY ANY CAR EVER MADE!

- ✓ COMPACT or LIMOUSINE
- ✓ DOMESTIC or FOREIGN
- ✓ 4, 6 or 8 CYLINDER
- ✓ 6 VOLT or 12 VOLT
- ✓ POSITIVE or NEGATIVE GROUND

With New Improved Model BT-162

## DWELL TACHOMETER

**ASSURE** - EASY STARTS, OPTIMUM PERFORMANCE and MAXIMUM GAS ECONOMY with MODEL BT-162

MADE ORIGINALLY FOR THE PROFESSIONAL AUTOMOTIVE TECHNICIAN, MODEL BT-162 WILL PAY FOR ITSELF MANY TIMES OVER FOR THE AUTOMOTIVE HOBBYIST AND EXPERIMENTER.

*The Model BT-162 will perform the services specified below in addition to many other tasks too numerous to mention:*

- ✓ Assure precise adjustment of points that are slightly worn or pitted.
- ✓ Indicate the most effective point setting **without removing the distributor cap.**
- ✓ Read the average dwell of dual breaker points as well as individual dwell of each individual set of points.
- ✓ Indicate the correct settings for **external adjustment type** distributors.
- ✓ Car manufacturers' dwell angle recommendations are included in the manual provided with the Model BT-162 for all cars including the external adjustment type distributors specified above.
- ✓ It is no longer necessary to file points to smoothness when using the Model BT-162. The instrument will automatically make allowance for any existing "pitting" or "wear."
- ✓ To adjust for mathematically correct carburetor adjustment and thus insure maximum gas economy and quiet engine running, simply use the Tachometer section of the Model BT-162. Read the exact RPM while the engine is in neutral position. Then adjust the carburetor in conformity with the car manufacturer's recommendations as specified in the manual provided with the Model BT-162.
- ✓ To locate a "miss" you need only disconnect or "short" the spark plugs one at a time with the Model BT-162 switched to the Tachometer position. You will be able to instantly identify which particular plug (or frequently its wire lead) is responsible for the malfunction.
- ✓ Cars with automatic transmissions function efficiently only if the fluid pressures are correctly maintained and since manufacturer's instructions always refer to RPM the Model BT-162 (or an equivalent tachometer) is required to properly service automatic transmissions. Incidentally, the 5,000 RPM maximum range of the Model BT-162 is adequate for all car engines without any exceptions.

Comes complete, ready to use. Operating manual includes manufacturer's dwell angle recommendations for all cars. The manual is yours to keep even if you decide to return the instrument.

**\$29<sup>95</sup>**

## SEND NO MONEY WITH ORDER PAY POSTMAN NOTHING ON DELIVERY

Pay Cash or in EASY MONTHLY PAYMENTS AFTER 15 Day Trial!

Try it for 15 days before you buy. If completely satisfied remit \$29.95 plus postage and handling charge. (If you prefer you may **PAY MONTHLY ON OUR EASY PAYMENT PLAN.**) If not completely satisfied, return to us, no explanation necessary.

ACCURATE INSTRUMENT CO., INC. Dept. 727  
2435 White Plains Road, Bronx, N. Y. 10467

Please rush me one Model BT-162. If satisfactory I agree to pay at the terms specified at left. If not satisfactory, I may return for cancellation of account.

Name \_\_\_\_\_

Address \_\_\_\_\_

City \_\_\_\_\_ State \_\_\_\_\_ Zip \_\_\_\_\_

**Save Money!** Check here and enclose \$29.95 with coupon and we will pay all shipping and handling charges. You still retain privilege of returning after 15 day trial for full refund.

## THIS IS A TRUE STORY\*

All details in our file #3789. Only the name of the Universal graduate has been changed to respect his desire for privacy . . . Ed.

# HOW TED VERNON AVERAGES \$20,000 WORKING 6 MONTHS A YEAR

**NO COLLEGE!  
NO EXPERIENCE!  
NO SELLING!**

When Ted Vernon\* walked to a mailbox that day, the things he wanted seemed far beyond his reach. Like lots more money, freedom from his dead-end job, independence and security, a new future.

Chances looked dim. Ted had no college. His only experience was his old job. And he was already past 40.

Yet, when Ted Vernon mailed his envelope, everything he dreamed of became possible. All he did was mail a coupon like the one below.

### Free book put Ted on road to big income

The coupon brought Ted the same fascinating Free Book you can have in just a few days. It tells about opportunities all around you in the booming Accident Investigation field.

It was all new to Ted. He'd hardly even heard of Accident Investigation. Yet he felt he had found his perfect opportunity.

And he had! His first full year he made \$14,768.72. Since then he's averaged \$20,000 working about six months a year. The rest of the time he just relaxes and takes it easy.

### He learned secrets of success in 30 minutes

Ted skimmed through Universal's Free Book in 30 minutes. He learned three big points that changed his life.

- Accident Investigation is a \$19 billion dollar industry safe from layoff, recessions and automation.
- More and more men are urgently needed to investigate and settle some 22 million accidents each year.
- Universal's training-by-mail has been the path to success for thousands of men in this high-pay field, mostly men with no college and no experience.

It was the opportunity of a lifetime. Ted enrolled for Universal's correspondence training at the mere cost of cigarette money.

It was easy. Ted simply studied his brief, interesting lessons at home in his spare time. He kept right on with his old job until he could start making money quickly in Accident Investigation.

Ted Vernon's income is unusually high and not typical of the industry. He's a busy specialist in storm loss adjusting. But it does show the big potential in this great field even for men with no college and no experience.



### READ WHAT RECENT STUDENTS SAY:

- "My income averages \$1,200 to \$2,000 a month."  
—Ed Crouch of California.
- "Thanks to you, I was contacted by 17 top companies."  
—Donald Doris of Illinois.
- "A raise every three months for the next two years, plus new car and expense account."  
—Oscar Singletary of Georgia.

### Send for your free opportunity book today

Mail coupon below to get your copy of the Free Book that started Ted Vernon to new big-money success. Read about the exciting full time or part time opportunities, about other successful Universal students, about Universal's Free Placement Service, and how to start your own full or part time business.

But act quickly. Take the first step to the big money field. Mail your coupon today.

### MAIL NOW FOR YOUR BIG, FREE BOOK

Universal Schools, Dept. PM-2  
6801 Hillcrest, Dallas, Texas 75205

Please rush my Free Book on earnings and opportunities in Accident Investigation. No obligation. No salesman will call.



Name \_\_\_\_\_ Age \_\_\_\_\_

Address \_\_\_\_\_

City \_\_\_\_\_ State \_\_\_\_\_ Zip Code \_\_\_\_\_



APPROVED FOR VETERANS' TRAINING

Accredited Member National Home Study Council

# Drivin' with Dan

When is the best time to buy a new car? What class of Formula racing cars is the fastest? Why don't dragsters run pure oxygen in their engines? Dan Gurney answers these and other automotive questions

**Q.** *Isn't the best time to buy a new car about six months after new models come out since improvements have been made by then as a result of customer complaints?—Peter Yeljenick, Union City, N.J.*

**A.** I have often had the same thought, but, with the knowledge that I have, I would say that it is rarely true. The new early-year versions are good, just as good as later ones. The key word is rarely. In other words, you're right a little, sometimes. When so-called "running" changes are made to a model in production you benefit. Otherwise, the earlier ones may be better because tools are not worn as much.

**Q.** *I am interested in Formula racing cars. What class is the fastest of them all?—Cliff Michaelson, Spotswood, N.J.*

**A.** Formula A, or Formula 5000, as it's known overseas, probably has more potential, although Formula 1 is undoubtedly a more highly developed type of racing right now, and at the moment would be the fastest. The

"A" cars have the advantage of still utilizing wings (banned in F1) and their 5-liter (305-cu.-in.) displacement gives them the biggest, most powerful engines. Also, the "A" weight minimum of 1250 pounds with water and oil allows for a car very close to Formula 1 weight in the same form.

**Q.** *Why don't dragsters, or any cars for that matter, run pure oxygen in their engines? I would think that horsepower and efficiency would be greatly increased.—Harold Andresen, Duluth, Minn.*

**A.** Yes, it would increase horsepower, but I'm not certain what you mean about efficiency. I suppose that it would be difficult to work out the necessary metering of the oxygen in sufficient quantities, and also to control the extra heat or instability caused by such a fuel mixture. The cost would probably be the toughest thing to handle. The technology would be all new and costly to work out.

**Q.** *What is a supercharger and how does it operate? Can it be used for street? If I installed one*

**FINISHING FOURTH** in the McLaren M6B-Chevy at last year's Times Grand Prix at Riverside International Raceway, Dan placed 11th in points and cash for 1969 Canadian-American Challenge Cup series of road races

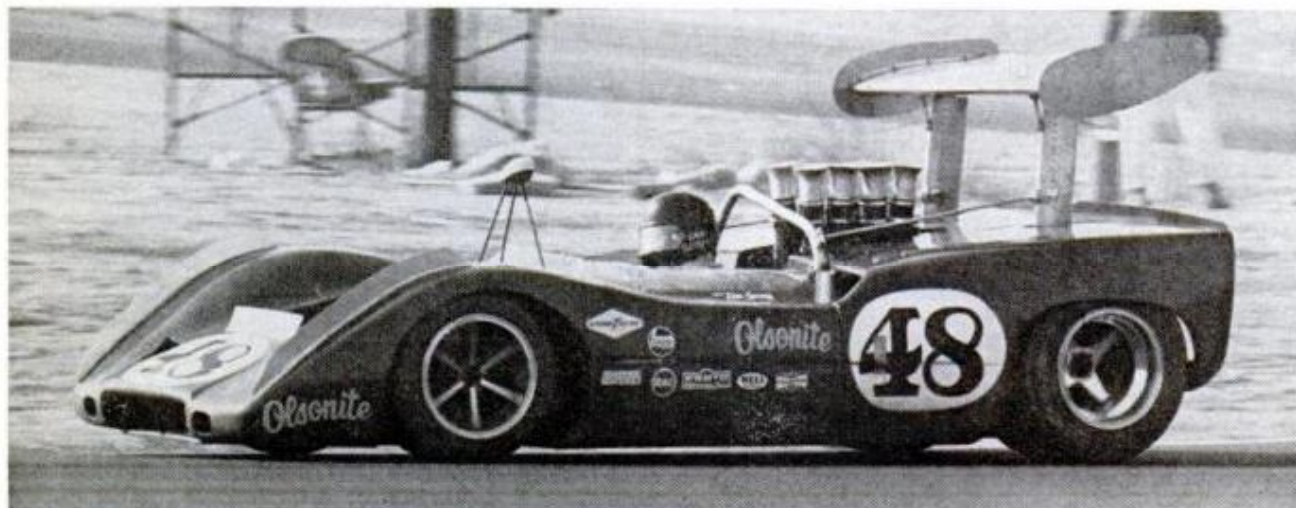





AN **AC** ACTION ADVENTURE

# AVALANCHE BUSTER



When you patrol a quarter of a million acres of rugged mountain forest on a snowmobile, blasting potential avalanches, your life can depend

on your engine.

That's why avalanche buster Walt Werner uses AC Snowmobile Spark Plugs. He knows AC's hot tip resists fouling—gives him faster

cold weather starts.

You may never drive a snowmobile at 20 below... but the same hot tip that's built into AC Snowmobile Spark Plugs is built into the AC Fire-Ring Spark Plugs that go into your car.

They fire hotter, burn cleaner—give you faster starts.

Next tune-up, insist on reliable AC Fire-Ring Spark Plugs. They're original equipment on all GM cars.



MARK OF EXCELLENCE

AC SPARK PLUG DIVISION of GENERAL MOTORS

AC BUILDS MORE PARTS FOR MORE CARS THAN ANYONE ELSE IN THE WORLD—AC FIRE-RING SPARK PLUGS • AC OIL FILTERS • AC AIR FILTERS • AC GASOLINE FILTERS • AC PVC VALVES • AC RADIATOR CAPS • AC GAS CAPS • AC CRANKCASE BREATHER CAPS • AC FUEL PUMPS

# Best seller

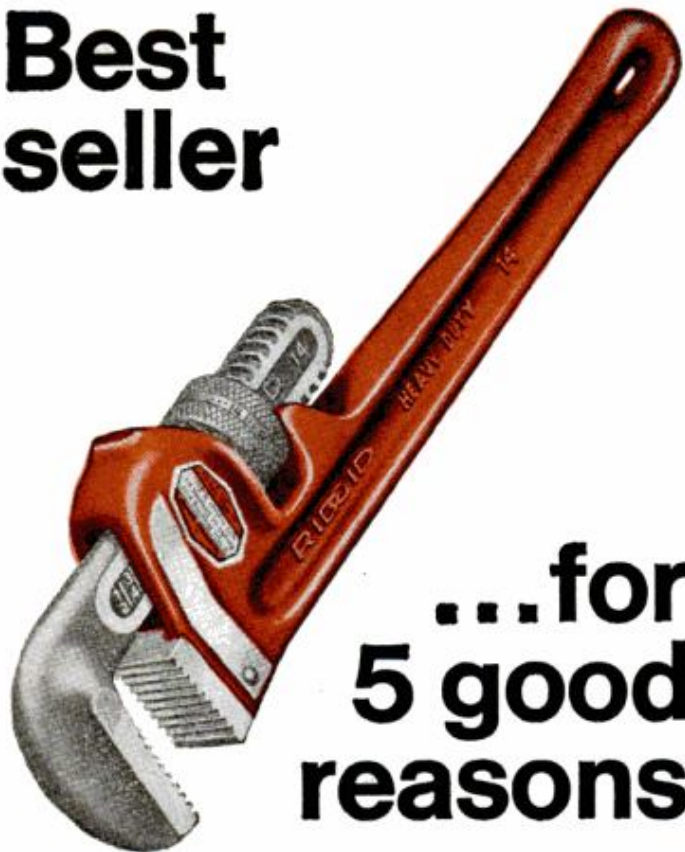

## ...for 5 good reasons

The world's most popular pipe wrench. Known for the brutal punishment it takes and the long service it delivers. Here's why.

1. Every wrench is work tested before shipment.
2. Unconditional RIDGID guarantee: "If this housing ever breaks or distorts we will replace it free."
3. Full range of 10 sizes: 6" through 60".
4. One hand operation: Easy spin, non-stick adjusting nut sets quickly to pipe size with accurate scale. Full-floating hook jaw with patented spring suspension then assures instant grip . . . easy release.
5. Built-in massive strength: Jaws are made of special alloy steel; teeth are specially heat treated. Extra tough, comfort-grip, I-beam handle has enlarged end with handy hang-up hole.

See the complete line of RIDGID pipe and special duty wrenches at your quality Hardware Store. He carries the famous RIDGID line of Pre-Tested Work Saver Tools and parts from The Ridge Tool Company, Elyria, Ohio 44035, U.S.A.

# RIDGID®

 Ridge Tool Subsidiary  
Emerson Electric Co.

## DRIVIN' WITH DAN

*(Continued from page 40)*

on my 283 Chevy, what would be my power increase?—Fred Craig, Ballwin, Mo.

**A.** A supercharger packs air into the inlet port of an engine under pressure so that more goes in when the valve opens. It can be used on the street. It usually increases power, hurts mileage and reliability, and increases maintenance requirements.

**Q.** What is the highest horsepower ever produced from a Formula 1 engine? How many cylinders did the engine have?—Hugh McCrackin, Derwood, Md.

**A.** Something over 600 hp out of approximately 360 cu. in. in a prewar German Mercedes Benz eight-cylinder, supercharged car. Another interesting one was a supercharged British BRM 16-cylinder engine that made over 575 hp in 1957.

**Q.** What final drive ratio is used in NASCAR racers to get to such speeds as 180-200 mph? How fast would the engine be turning at these speeds?—Brian Fohse, Spalding, Saskatchewan.

**A.** Between 2.90 and 3.10 to 1 and usually at 7200 to 7500 rpm.

**Q.** What are the consequences of removing all the smog-control contraptions (pump type) from a 1968 Cortina? Would it harm the engine if the whole kit were removed and the holes plugged?—A. A. Rassier, Minot, N.D.

**A.** I doubt if this would harm it. But don't sue me if it does. How's the smog up there in N.D.? You might want to change jets in the carb to enrich the mixture a little bit. The competition department of Ford of England could give you much better advice: Write Ford Motor Co. Ltd., Brentwood, Essex, England.

**Q.** Recently I had to turn back from a trip across the desert because my car's cooling system wouldn't take it. Do certain kinds of cars have difficulty with their cooling systems in deserts and mountains?—Donald Pickering, Saugus, Calif.

**A.** The basics are: It is easier to boil water at high altitude; it's harder to cool water with hot air than with cold air; cars with

*(Please turn to page 45)*

## DRIVIN' WITH DAN

*(Continued from page 42)*

airconditioning require more cooling capacity when it is switched on; some cars can cope with heat and altitude better than others. Crossing at night is usually easier on man and machine.

**Q.** *I'm taking a course in auto shop at school which requires having a car to work on. I was thinking about a small-block Chevy. Do you feel this is a good engine to work on and learn from?*  
—David Christenson, Aromas, Calif.

**A.** Yes, it is excellent. There is a vast array of special equipment, and information about this engine is available.

**Q.** *I read recently that you and A. J. Foyt held the record average speed at Le Mans. Why don't you race there any more?*—Jim Brown, Leawood, Kans.

**A.** I decided one win was sufficient so I'm racing elsewhere now. It took about eight or nine tries. I'll ask A. J. next time I see him. By the way, we still hold the record average speed there.

**Q.** *Where can I get information on the technique of small sports-car racing and racing rules?*—P.V.A., Peachland, B.C.

**A.** Write to the Sports Car Club of America at P.O. Box 791, Westport, Conn. 06880.

**Q.** *I was surprised to read of your switch from Ford to Plymouth. I think it was a stupid mistake. Does this mean you will not run stock-block Fords on the USAC trail or turn out heads for small-block Fords?*—Jeff Glazier, Allentown, Pa.

**A.** Our effort with the Plymouth 'Cuda will be in Trans-Am racing only at the moment. I plan to run a Plymouth Super Bird in the 1970 Motor Trend 500. We are continuing with our Ford-based 320 Gurney Eagle Indy stock-block engine. The Plymouth stock-block engine also looks excellent. We at AAR love racing, Jeff; we'll see if it's a mistake. We love competition and there will be plenty! ★ ★ ★

*If you have questions on racing, high-performance and everyday driving techniques, send them to "Drivin' with Dan," c/o Popular Mechanics, 224 West 57th St., New York, N.Y. 10019. Questions cannot be answered by individual letters. Questions on maintenance and repair should be addressed to the Auto Clinic (see page 82).*

# IT WORKS!



Just ask  
**Tom  
McCahill**



... "Cromwell X3 Oil Stabilizer... is guaranteed to stop your car's smoking and oil burning... or you get your money back!"

"It's not a mechanic in a can, but it does the job... I've tested Cromwell X3 Oil Stabilizer and it works!"

Cromwell X3 Oil Stabilizer's unique formula is compounded to stop excessive engine wear, oil burning and compression loss.

It forms an oil seal in the compression chamber preventing blow-by and compression loss; an oil barrier on piston and cylinder walls preventing oil burning and smoking.

Cromwell X3 Oil Stabilizer is permanent in the oil and is not a detergent. Like all Cromwell X3 Products, Oil Stabilizer is sold only at service stations and is 100% guaranteed.

**EXCLUSIVE DISTRIBUTORSHIP-FRANCHISES  
IN SELECTED AREAS ARE AVAILABLE.  
WRITE OUR FRANCHISE DIRECTOR.**



**CROMWELL OIL COMPANY**  
1737 Cordova Street • Los Angeles, California 90007

# Special Invitation to Inventors

If you have an invention or an idea for an invention, whether patented or unpatented, that you wish to sell outright or on a royalty basis, the booklet we offer free in the coupon below may be very valuable in saving you both time and money.

We are specialists in representing inventors and submitting their inventions and ideas to manufacturers. We work continuously with scores of manufacturers seeking new products, and we have connections from coast to coast and in foreign countries. We are well informed which manufacturers may be especially interested in your particular kind of invention. Hundreds of these manufacturers have written us descriptions of the types of inventions they want.

Our service is designed to do all the many things the average inventor does not have the time or facilities for doing, or who lacks knowledge of the proper markets. When you appoint us to represent you, we prepare sales material that points up your invention, its advantages, its construction, its market potential and profit possibilities.

For presenting your invention to selected manufacturers we charge a modest fee (which is refunded if we handle the sale of the invention for you) and the customary commission. We are a Nationally known concern, with an impeccable reputation for ethics and integrity. We believe ours is the finest service offered inventors.

We are not patent attorneys. However, if you have need for a patent attorney and do not know one, write us and we'll tell you how to obtain the names of all U. S. Patent Attorneys in your area, and you can make your own choice.

To encourage inventors, whether their inventions are patented or unpatented we have prepared a booklet entitled "How to Go About Selling Your Invention." This booklet contains such information as current royalty rates being paid by manufacturers, discusses various types of inventions and the markets for them, and tells the most effective methods you can use in presenting your invention for sale, whether you employ us or do it yourself.

You can obtain a copy of this booklet merely by mailing the coupon below. It will be sent to you with our compliments, free, without any obligation whatever. If you wish to write us for comments about your invention, please do so. We make no charge for consultation. But please do NOT send blueprints or models. Just describe your invention briefly, its nature and purpose.

**REFERENCES:** Your own bank attorney, or Chamber of Commerce.

**K. O. Kessler, President**  
**KESSLER SALES CORPORATION**  
**FREMONT, OHIO 43420**

Accredited as a Corporation  
Under the Laws of Ohio

## ---MAIL THIS COUPON FOR FREE BOOKLET---

**Mr. K. O. Kessler, President**

**Kessler Sales Corporation, Dept. D-52, Fremont, Ohio 43420**

Please mail me a copy of your FREE Booklet, "How to Go About Selling Your Invention," which reveals many points about selling inventions and explains your service. It is understood that there is no charge for this booklet now or at any other time and I am not obligated in any way.

MY NAME.....

STREET ADDRESS.....

CITY.....STATE.....ZIP.....

# Special introductory offer brings you \$400.00-A-MONTH EXTRA CASH INCOME whenever you go to the hospital

**Only 25¢ enrolls your entire family for the first month**

National Home Life Assurance Company invites you to enjoy \$400.00-A-MONTH tax-free cash whenever you are hospitalized, for just 25¢ for the first month's coverage. This coverage is for your entire family! Then, if you wish, continue at National Home's regular low rates!

**The added protection you NEED.**

All National Health Plan benefits are paid directly to you, in addition to whatever you may receive from your insurance with any other company — including Blue Cross, Blue Shield — even Medicare! Spend the money any way you choose. You get your \$400.00 A MONTH — TAX FREE — from your first day in the hospital, and as long as you are confined there, even for 24 months if necessary. And, when you and your insured spouse are hospitalized at the same time for accidental injury, National Health Plan pays out an EXTRAORDINARY DOUBLE-CASH BENEFIT. You receive not \$400.00, but \$800.00 a month. Your spouse receives not \$400.00, but \$800.00 a month. That's \$1,600.00 in all, in cash payments to you every month while you both remain in the hospital . . . even for 24 months!

**We can never cancel your Policy!**

National Health Plan guarantees never to cancel your protection. Only you can cancel — the Company cannot — no matter how many claims you have . . . or, how old you become . . . or for any other reason whatsoever. A GUARANTEED-RENEWABLE-FOR-LIFE clause has been printed right on the front of your Policy, and we're bound by it.

OVER 65? NOW COLLECT UP TO \$9,240.00 CASH IN ADDITION TO MEDICARE BENEFITS . . .

Here's the important addition to Medicare! National Health Plan pays you \$280.00 A MONTH for the first three months in addition to Medicare, and a full \$400.00 monthly while hospitalized thereafter . . . up to \$9,240.00 maximum!

And that's not all. Suppose you have a growing family — this special National Health Plan . . .

**Medical Costs Skyrocketing!**

(Source: U.S. Dept. of Health, Education & Welfare)

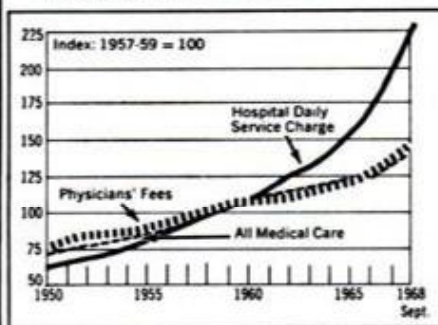

Govt. figures reveal your present health protection . . . may no longer protect you against today's rising medical costs! Don't leave your loved ones defenseless! Act at once to add up to \$9,600.00 to your health protection for only 25¢ for entire family.

**Pays you \$400.00-A-MONTH cash Maternity Benefits!**

When you and your spouse are insured for the entire pregnancy and have added Coverage for Children and Maternity Benefits, you collect for hospitalization due to pregnancy, childbirth, plus miscarriage and other complications.

**All these added cash benefits.**

**Added cash benefit:** Up to \$2,000 cash for accidental loss of limbs or eyesight.

**Added cash benefit:** Choose Coverage for Children (with or without Maternity Benefits) and they will be covered, too! Up to \$5,760.00 at the rate of \$240.00 A MONTH for each confinement in the hospital.

**Why you must act before the deadline date.**

National Health Plan can now provide you and your entire family with tax-free Extra Cash Protection for just 25¢ the first month only because we enroll a large number of people direct by mail. Of course, if we don't receive your Enrollment Form the same time as all the others we cannot pass on to you the savings that come from processing many policies at one time. That's why the deadline date must be, and is — strictly enforced.

**Money-Back Guarantee.**

You don't risk a penny. Because even after you mail your Enrollment Form . . . even after you examine the Policy in your own home . . . you can still return the Policy within 15 days of the date you receive it, and your quarter will be refunded!

However, after you've seen the Policy for yourself, we believe you will want to continue this \$400.00-A-MONTH extra cash protection at these low rates.

Age at Enrollment	Monthly Renewal Premium Per Adult
16-44	only \$3.30
45-49	only \$3.75
50-54	only \$4.25
55-59	only \$4.75
60-69	only \$5.70
70-74	only \$6.60
75 and over	only \$8.50

Naturally, at these low rates, we can issue you only one policy of this type.

**Only \$1.90 more covers all your dependent, unmarried children . . .**

from the age of month through 18 years. And then, if you wish, just add 95¢ more to that, and you're covered for Maternity Benefits, too! Newborn children are covered automatically at the age of one month — at no additional cost!

NOTE: The regular monthly premium shown here (for age at time of enrollment) is the same low premium you will continue to pay; it will not automatically increase as you pass from one age bracket to the next! Once you're enrolled in this National Health Plan, your rate can never be changed because of how much or how often you collect from us — or because of advanced age — but only if there is a general rate adjustment, up or down, on all policies of this type in your entire state!

**Act NOW—"Later" May Be TOO Late!**

TIME IS PRECIOUS! Act quickly. (No salesman will call.) Get your Enrollment Form into the mail today — once you suffer an accident or sickness, it's TOO LATE to buy protection at any cost. So act now — before anything happens.

**ENROLLMENT FORM MUST BE MAILED BEFORE MIDNIGHT  
SAT. FEB. 21 OR IT CANNOT BE ACCEPTED.**

**Now add up to \$9,600.00 EXTRA CASH  
to your health protection.  
Only 25¢  
covers your entire family the first month!**

## **THESE 11 QUESTIONS AND ANSWERS**

tell you how National Health Plan's \$9,600.00 EXTRA CASH HOSPITAL COVERAGE gives you the protection you need. Costs only 25¢ for the first month! Nothing else to pay now—then you may continue at our regular low rates.

- 1. How much will my Policy pay me when I go to the hospital?** \$400.00 per month—starting the first day—to the full maximum of \$9,600.00 cash. The same applies to other Covered Members of your family. If you're 65 or over, you collect up to \$9,240.00 cash benefits *on top of any Medicare benefits*. (\$280.00 a month for the first three months and \$400.00 monthly while continuously hospitalized afterwards, for an additional 21 months.) You can count on National Health Plan for extra cash—when you need it most!
- 2. When do I collect \$2,000.00 extra cash for accidents?** You collect \$1,000.00 extra cash for complete accidental loss of one hand or one foot or sight of one eye, and \$2,000.00 extra cash for loss of both hands or both feet or sight of both eyes—even if such loss occurs 3 months after time of the accident.
- 3. What if I am hospitalized by the same illness again?** You still collect to the full \$9,600.00 maximum.
- 4. Do you pay me cash for my children, too? And... for any children I have in the future?** Yes! You collect up to \$5,760.00—at the rate of \$240.00 a month with Coverage for Children added to basic Plan — *each time* any dependent, unmarried child (age 1 month through 18 years old) is hospitalized for sickness or injury. Newborn children are covered *automatically* when they're a month old.
- 5. How much do you pay me for pregnancy?** You collect \$400.00 a month for pregnancy, childbirth or miscarriage that results in a hospital stay when you have Coverage for Children and Maternity Benefits. (Both parents must be enrolled in this Plan during entire pregnancy.)
- 6. Am I allowed to stop paying premiums during a long stay in the hospital?** Yes you are! We pay all premiums that come due after you—the person to whom the basic Policy is issued—are in the hospital just 8 weeks or more!
- 7. What doesn't my Policy cover?** Your Policy covers everything except conditions caused by: war or act of war; mental disease or disorder; pregnancy, except as provided under the Maternity Benefit provision; and any sickness or injury you had before the Effective Date of your Policy. (Even this last "exclusion" is done away with after you've been a policyowner for just 2 years.)
- 8. Does this Plan pay in any hospital?** You are covered for care in the hospital of your choice except, of course, a U.S. Government hospital or a nursing or convalescent facility.
- 9. Will you cancel my Policy if I make too many claims? Or because of age?** No! National Health Plan guarantees never to cancel your Policy for any reason whatsoever!
- 10. What are the requirements to enroll in this Guaranteed Renewable Plan?** You must not have been refused or had cancelled any health, hospital or life insurance due to reasons of health; and, to qualify during this Enrollment Period, you must enroll before midnight of the date shown in the Enrollment Form.
- 11. How do I enroll?** Fill out the brief Enrollment Form and mail it with just 25¢ to: National Home Life Assurance Company, Valley Forge, Pennsylvania.

**Only 25¢ enrolls your entire  
family for the first month**

**ACT NOW! YOU MUST MAIL THE ENROLLMENT FORM ON ATTACHED CARD  
BEFORE MIDNIGHT FEB. 21 OR IT CANNOT BE ACCEPTED.**

# LIMITED ENROLLMENT PERIOD ENDS SOON

## MONEY-BACK GUARANTEE

We will send your National Home Policy by mail. Examine it carefully in the privacy of your own home. Show it, if you wish, to your own insurance agent, doctor, lawyer or other trusted adviser. If you decide, for any reason, that you don't want to continue as a member of this Plan, return the Policy within 15 days, and we will promptly refund your money. Meanwhile, you will be fully protected while making your decision!

*T. Robert Wilcox*

President  
National Home Life Assurance Company



**NATIONAL  
HEALTH  
PLAN**

a service of National Liberty Corporation

**National Home Life Assurance Company**

*The Honorable William W. Scranton, Chairman of the Board*

**Adm. Office: Valley Forge, Pa.**

This plan is underwritten by National Home Life Assurance Company, an old line legal reserve company of St. Louis, Missouri. National Home is licensed by your state and carries full legal reserves for the protection of all policyowners.

### HERE'S ALL YOU DO TO RECEIVE YOUR POLICY:

1. Complete this brief Enrollment Form.
2. Cut out along dotted line.
3. Enclose form in envelope with 25¢ and mail to: National Health Plan, Valley Forge, Pa. 19481

Official Enrollment Form for the Hospitalization Indemnity Plan 0-0354-0-01

**NATIONAL HOME LIFE ASSURANCE COMPANY**

An Old Line Legal Reserve Company of St. Louis, Missouri

**ADMINISTRATIVE OFFICE: VALLEY FORGE, PENNSYLVANIA**

**NAME** MR. \_\_\_\_\_ MRS. \_\_\_\_\_ MISS \_\_\_\_\_  
(Please Print) First Middle Initial Last

**ADDRESS** \_\_\_\_\_

**CITY** \_\_\_\_\_ **STATE** \_\_\_\_\_ **ZIP** \_\_\_\_\_  
Street or RD #

**DATE OF BIRTH** \_\_\_\_\_ **AGE** \_\_\_\_\_ **Sex** Male  Female   
Month Day Year

**OCCUPATION** \_\_\_\_\_

List all dependents to be covered under this Plan: (DO NOT include name that appears above. Use separate sheet if necessary.)

NAME (Please Print)	RELATIONSHIP	SEX	DATE OF BIRTH			AGE
			MONTH	DAY	YEAR	
1						
2						
3						

Check here if you want Coverage for your Children.

Check here if you want Coverage for your Children and Maternity Benefits.

To the best of my knowledge and belief neither I nor any person listed above has been refused or had cancelled any health, hospital or life insurance coverage due to reasons of health. I hereby apply for the Hospitalization Indemnity Plan. I understand that I, and any person listed above will be covered under this Policy for a recurrence of any injury or sickness I (we) had before the Effective Date of this Policy after two years from Effective Date, but not before; and that this Policy shall not be in force until the Effective Date shown in the Policy Schedule. I am enclosing the first month's premium for coverage for myself and all other Family Members listed above.

**Signature X** \_\_\_\_\_ **Date** \_\_\_\_\_

NHA-01

VH-995

**MAIL THIS ENROLLMENT FORM BEFORE MIDNIGHT, SAT., FEB. 21, 1970**

NH-02-369

0354

Материал защищенный авторским правом

# BIG

**YACHT-SMART**  
Sail Rig  
DACRON  
from  
**\$112**



# WINTER SAVINGS NOW

## FOLBOT

**TRAVEL CRAFT**  
fits in every  
home or car

**FOR YOUR SPORT AND FAMILY FUN**

and  
**RECORD FISHING**

GENUINE Folbot RECREATION for just ONE small investment, WITHOUT the continuous burdens of complicated 'big rig' operation. You GO CAREFREE anytime with COMPACT Folbot . . . rocky streams, lakes, marsh, surf & open sea. Superior non-sinkable designs provide SAFEST low gravity center, balanced low & high seating, substantial construction, protective decks & EXCLUSIVE swivel-back COMFORT. ALL within your reach. In handy Folbot YOU GLIDE smoother, faster & NOISELESS with paddles, oars, or sails and ride softly w. 1 to 10 HP. motors. Many styles & sizes from 1 to 4 seaters, FOLDING or rigid PORTABLE come in PREFAB KIT, or expertly FACTORY BUILT

Just a few Dollars start  
YOU right away. From

**ONLY \$19 NOW**

for BASIC KIT

16 feet long

'CAYAT'  
car top  
YACHT.

**NEW**  
Fabulous  
16 foot  
**\$ 115**

Factory BUILT

**FREE**  
ACTION CATALOG

**STARTLING**  
**FACTS & FIGURES**  
Mail coupon or address

to: FOLBOT CORP.  
Dept. PM270, Charleston, S. C. 29405

Name \_\_\_\_\_

Address \_\_\_\_\_

City \_\_\_\_\_ State \_\_\_\_\_

## 20 Pet Seahorses \$2.75

FREE Kit with Seashells, Coral, Food and instructions. Keep these fascinating pets in a jar or fishbowl. See the father Seahorse give birth to live ponies. **SPECIAL OFFER:** Order two mated pairs and receive ONE PREGNANT MALE, will give birth to 15 cute babies (total 20 seahorses) for only \$2.75. One mated pair only \$1.98 LIVE DELIVERY GUARANTEED.



**AQUALAND PET CENTER**  
P.O. Box 130, Dept. PM-4  
Shenandoah Sta., Miami, Fla. 33145



**IF YOU CAN SING, WHISTLE, OR HUM A TUNE . . .**

you can play the Musical Saw. No notes to read, no musical knowledge required. Since 1921 we have furnished the entire world this unusual, sweet-toned instrument. If you are 10 or 70, you play or no pay. Musical Saw, soft hammer, bow, resin and lessons mailed on 5 days' trial. Write today for details and free copy of "Sawing News of the World," picturing successful saw musicians. **MUSSEHL & WESTPHAL**, 107 Fort St., Fort Atkinson, Wisconsin. 53538.

## BUILD YOUR OWN CAMPER

### SAVE UP TO 50%



**VIKING CAMPER SUPPLY, INC.**  
99-BP Glenwood Ave.,  
Minneapolis, Minn. 55403  
Please send \_\_\_\_\_ for  
which I enclose \$\_\_\_\_\_  
NAME \_\_\_\_\_  
ADDRESS \_\_\_\_\_  
CITY \_\_\_\_\_  
STATE \_\_\_\_\_ ZIP \_\_\_\_\_

Complete, easy to follow plans, instructions, materials list.

Camper Plans . . . . . \$3.95  
Travel Trailer . . . . . \$3.95  
Pickup Cover . . . . . \$2.00  
**CONVERSION PLANS:**  
Econoline Type Van . . . \$2.95  
Passenger Bus or  
Delivery Van . . . . . \$2.95  
Satisfaction Guaranteed

**EQUIPMENT CATALOG \$1.00**

Refundable on First Order.  
Send Dime for Details.  
Save 50% on Camper Kit.  
All items from catalog to  
build \$1,795. Camper, 8',  
10', 10'6" or Chassis Unit.



## BIG NEED FOR SYSTEMS MEN

... LEARN AT HOME IN SPARE TIME



Every company, large & small, needs a Systems Man. As a Systems Man, you'll work with management . . . help them make vital decisions . . . make a prestige salary . . . and enjoy your work, too! You'll supervise **CHARTING, PROCEDURE PLANNING, FORMS DESIGN, OFFICE LAYOUT, COMPUTER PROGRAMMING, DATA PROCESSING**, etc. Big demand — see high salary positions in "help wanted" sections of your newspaper. You need no previous experience or special training . . . easy home-study plan guides you toward success, prestige, good salary in exciting, respected field. High school education required. Send for Free Booklet, "OPPORTUNITIES IN SYSTEMS."  
**North American Institute of Systems & Procedures**  
4401 BIRCH ST., DEPT. 4172, NEWPORT, CALIF. 92660





# Go to sea. In the Army.

Or fly the sky. Or highball a train.  
Or handle a dozer.

The Army teaches special skills of all kinds. High school graduates who enlist now can choose from hundreds of job training courses.

Along with seamen to man our ships and flyers to pilot our choppers, we need marine and aviation mechanics. Electronics experts. Surgical assistants. Scuba and deep-sea divers. Technicians skilled in malaria control, combat weapons operators, and many more.

If you qualify, we'll guarantee your course selection before you sign up. You'll learn a rewarding career skill.

There's something for every interest. First come, first served.

Use coupon or write:  
Army Opportunities, Dept. 200A,  
Hampton, Va. 23369.

Your future, your decision . . .  
choose ARMY.

Army Opportunities  
Dept. 200  
Hampton, Va. 23369

Date \_\_\_\_\_

Please send me more information on job and training opportunities.

Name \_\_\_\_\_ Age \_\_\_\_\_

Address \_\_\_\_\_

City \_\_\_\_\_ County \_\_\_\_\_

State \_\_\_\_\_ Zip \_\_\_\_\_

Phone \_\_\_\_\_ Education \_\_\_\_\_

2 PM 2-70



**SAVE  
AS MUCH AS  
66%  
WITH THIS  
COUPON**

**FABULOUS DIRECT-FACTORY LATHE OFFER!**

AMERICAN MACHINE & TOOL CO., Dept. PM2L, Royersford, Pa. 19468

Please send me the unit(s) checked, plus the FREE 16 Page booklet, "The ABC's Of Lathe Turning". Payment in full enclosed \$ or \$3 deposit each item enclosed, balance C.O.D. I MUST BE FULLY SATISFIED OR WILL RETURN WITHIN 10 DAYS FOR FULL REFUND No questions asked. And the lathe booklet remains mine to keep

6" Swing Lathes @ \$14.95       12" Swing Lathes @ \$29.95  
 Faceplates @ \$2.50       Sets of turning chisels @ \$4.95  
 GE Motors:  @ \$18.80 (with lathe)       @ \$24.85 (purchased separately)

Name \_\_\_\_\_  
 Address \_\_\_\_\_  
 City \_\_\_\_\_ State \_\_\_\_\_ Zip \_\_\_\_\_

**SAVE  
AS MUCH AS  
66%  
WITH THIS  
COUPON**

**World's greatest fun tool—Makes woodworking a delight**

**\$14<sup>95</sup>** f.o.b. factory **6" SWING 3-FT. WOOD LATHE**

Shipping wt.: 15 lbs.  
 Faceplate (optional) for turning bowls, lamp bases, etc. \$2.50  
 Set of 3 high speed turning chisels: \$4.95 add'l



The wood turning lathe was the first of all power tools. And it is still the most fun, the easiest for an amateur to master. Also converts easily for use as a disc sander, drum sander, horizontal drill press, a jig to hold work to be reeded or fluted.

**MAKE THESE AND 100'S OF OTHER FUN ITEMS**



**MOST VERSATILE!    EASIEST TO LEARN!    EASIEST TO USE!**

**INDUSTRIAL SIZE 12" SWING 4-FT. WOOD LATHE**



**\$29<sup>95</sup>** f.o.b. factory

Comparable in speed, precision and durability to units selling for \$75.00 and more. Full 36" between centers. For wood and plastics. Special tubular steel bed rails with dual point suspension increase accuracy, ease of operation, virtually eliminate vibration. Precision ball thrust cup center. Large graduated T-rest. Screw action tail stock. 3-Speed pulley for different work diameters. SAME DUAL GUARANTY APPLIES

Shipping Wt.: 30 lbs.  
 Faceplate (optional) for turning bowls, lamp bases, etc. \$2.50  
 Set of 3 high speed turning chisels: \$4.95 additional

- ALL CAST IRON AND STEEL PRECISION CONSTRUCTION
- DOES WORK OF MACHINES SELLING FOR 3 TIMES THE PRICE
- TURNS WOOD AND PLASTICS TO 23" LONG
- MADE BY AMERICA'S LARGEST DIRECT SALES POWER TOOL FACTORY
- ENDORSED BY EDITORS OF THE NATION'S TOP MAGAZINES

Professionals, industrial users, home hobbyists . . . over one million satisfied owners . . . attest to the precision, versatility and rugged performance of AMCO power tools. Praise heaped on them by America's top shop and crafts editors. **Popular Science**: "A good bit of sound, imaginative engineering." **Popular Mechanics**: "Amazingly versatile." **Workbench**: ". . . particularly delighted with the lathe . . . did everything we demanded of it." Sturdy cast iron and steel construction with tubular steel bed. Complete with ball thrust cup center, T-rest assembly, lever action tail stock, 2-speed pulley. Takes any standard motor ¼ hp or larger.

**UNCONDITIONAL 10-DAY GUARANTEE**

You must be fully satisfied. If not, return in ten days, shipping charges collect for prompt, full refund.

**10-YEAR FULL SERVICE GUARANTEE**

Any parts which may become inoperative for any reason within ten years after purchase date will be replaced or repaired without charge. Your only cost: for postage.



**FREE 16 PAGE BOOKLET "ABC'S OF LATHE TURNING"**

Fully illustrated step by step instructions in articles by the nation's leading hobby writers. Shows how easily and quickly you can reap the benefits of this most rewarding of hobbies. Included FREE with your purchase.

**BRAND NEW MOTOR DEVELOPING FULL 1 HP... \$18<sup>80</sup> F.O.B. FACTORY / FOR ANY OF ABOVE MACHINES. WT. 17 LBS. PURCHASED SEPARATELY, \$24.85**

# FREE! World's Largest Electronic Kit Catalog

New 1970 Edition... Over 300 Kits For Every Interest, Save Up To 50%

• **Deluxe Color TV** ... The sets you've heard and read about that give better performance yet cost no more; six models: 295, 227, & 180 sq. in. rectangular; with or without AFT; all with exclusive built-in self-servicing aids for best pictures always; custom, wall or cabinet installation; optional wireless remote controls. Also new Heathkit antennas, towers, and deluxe 12" B & W portable TV.

• **Stereo/Hi-Fi Components** ... Transistor stereo receivers (including the world famous Heathkit AR-15), amplifiers, tuners, speakers, turntables, cartridges, furniture.

• **Transistor Organs** ... Deluxe 19-voice "Paramount" and low cost 10-voice Thomas models in kit form with instant-play Color-Glo" keys — save up to \$500. Also Percussion and Rhythm accessories.

• **Music Instrument Amplifiers** ... 20, 25 & 120 watt amplifiers for lead and bass instruments; distortion boosters, headphone amps, plus mikes and stands.

• **Home Equipment** ... Intercoms, table radios, garage door openers, portable radios and phonographs, home protection systems.

• **Shortwave Radios** ... Multi-band shortwave receivers, solid-state and tube-type, portable and AC operated.

• **Amateur Radio Equipment** ... World's most complete line of SSB transceivers, transmitters, receivers, and accessories.

• **Citizen's Band Radio** ... 5-watt fixed and mobile transceivers, kit or assembled.

• **Test and Lab Instruments** ... A complete line of meters, generators and testers for shop, school, industrial and hobby use.

• **Scientific Instruments** ... Including Berkeley Physics Lab, Malmstadt-Enke instrumentation for spectroscopy, analog/digital equipment, pH meters, recorders.

• **Home Study Courses** ... Basic kit-courses in electronics, radio, and transistor theory. Application kit-courses on how to use meters, generators, and oscilloscopes.

• **Photographic Aids** ... Darkroom computers for B & W and Color printing; electronic timer; color developing trays.

• **Radio Control Electronics** ... For modelers, NEW Heathkit R/C gear including transmitters and receivers (choice of 3 bands) servos, tachometer.

• **Trail Bikes** ... For off-street use, the Heathkit Trail & Snow Bike; outstanding performance at low cost.

• **Marine Electronics** ... For safety and pleasure; radio-telephones, direction finders, depth sounders, weather monitors, and accessories.

• **Automotive Electronics** ... For hobbyist and professional, new Heathkit 3-in-1 Tune-up Meter, Ignition Analyzer Scope, Tachometer, accessories.



Learn how you can build sophisticated electronics at 50% savings ... no special skills needed, famous Heathkit instructions show you how, free technical consultation available ... enjoy the fun and satisfaction of building the best ...

**MAIL  
COUPON  
NOW!**

**HEATHKIT**

a Schlumberger subsidiary

**HEATH COMPANY, Dept. 17-2**

Benton Harbor, Michigan 49022

Please send FREE Heathkit Catalog

Name \_\_\_\_\_  
(please print)

Address \_\_\_\_\_

City \_\_\_\_\_ State \_\_\_\_\_ Zip \_\_\_\_\_

CL-366

# The bargain hunter

## AMERICA'S ORIGINAL LOW-COST ARC WELDER AND ELECTRIC TORCH

10 DAY  
TRIAL

LIFETIME  
GUARANTEE

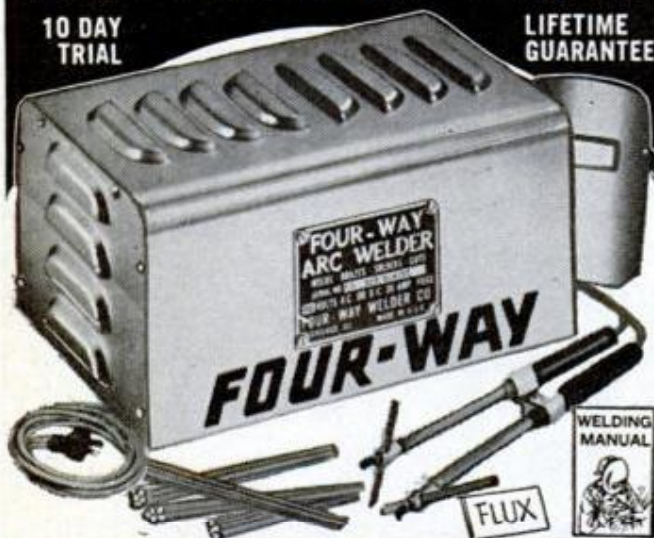

### MAIL THIS ORDER COUPON NOW!

Four-Way Welder Co., Dept. R2-B  
1810 S. Federal St., Chicago 60616  
Please send welder and 2 FREE gifts as indicated below.  
 Wrench Kit.  Wire Tool.  Welding Rod Pack.  
 Enclosed \$18.95. Ship  Enclosed \$2.00. I will pay \$16.95  
postpaid in U.S.A.  plus C.O.D. and delivery charges.

NAME \_\_\_\_\_

ADDRESS \_\_\_\_\_

CITY \_\_\_\_\_

STATE \_\_\_\_\_

ZIP \_\_\_\_\_

## New Improved HEAVY DUTY FOUR-WAY

Only \$18.95 Prepaid Complete Ready To Use  
\$22.95 VALUE WITH 2 EXTRA FREE GIFTS  
WELD, BRAZE, SOLDER, CUT

Every home, shop, and hobbyist needs this quality metal working machine. Use up to 1/8" welding rods and 1/4" carbons. Follow simple instructions to make or repair 1001 items including furniture, toys, auto bodies, fenders, trailers, boats, farm and garden tools and equipment. Operates on 110 V. 30A. for pennies—Adjustable Twin Carbon Arc Torch easily REGULATES HEAT FOR EACH JOB. Eliminates changing cables—replaces gas torches—no tanks or refills to buy—produces to 11,000° heat. YOU CAN PAY MORE BUT YOU CAN'T GET A BETTER LOW COST WELDER. Over 500,000 in use. Manufacturers of welders for over 30 years. LIFETIME GUARANTEE. Simply return prepaid. We will repair and reship FREE of charge. YOU GET: heavy duty welder in rugged metal cabinet, ground clamp, cables, combination torch and rod holder, welding manual and helmet, including \$2.00 pack "TOUCH WELD" rods for instant and automatic arc, brazing rods, 1/4" carbons, solder, flux. Complete ready to use. Nothing else to buy.

**FREE**

CHOICE OF 2 BONUS GIFTS  
WITH ORDER—\$4.00 VALUE

ORDER TODAY ON MONEY BACK TRIAL. If not completely satisfied, return in 10 days and we will refund purchase price.

- 1. 10-piece wrench, plier and screw driver kit in case.
- 2. Wire forming tool. Forms wire to weld valuable items.
- 3. Big pack welding & brazing rods, carbons, flux & solder.

SEND ONLY \$2.00 and pay \$16.95 plus C.O.D. and delivery charges. Or send only \$18.95 for postpaid shipment in Continental U.S.A.

### FOUR-WAY WELDER CO.

1810 S. Federal St., Dept. R2-B,

Chicago, 60616



### HOW MANY HANDY DANDYS CAN YOU USE?

Handy Dandys are plastic caps that hook onto pegboard and hold quarter-twist glass jars, such as used for baby food. Suggestions for getting FREE JARS in every package. Nothing better for storing supplies, parts and small tools. Keeps workshop neat. Sample pack 10 for \$1 \*\* 36 for \$3.50 \*\* 72 for \$6 \*\* 144 for \$11.50. Caps only. No jars. Postpaid U.S.A. No C.O.D.'s. WICKLIFFE INDUSTRIES, Box 286-PM-2, Wickliffe, Ohio 44092



Thousands of  
exciting tool  
values!

### SILVO (BRAND NAME) TOOL CATALOG

Thousands of Exciting Tool Values! Stanley, Millers Falls, Skill, Thor, Wen, Dieston, Wiss, Wellsaw, Dremel, Speedy Sprayers, Plumb, Huot, Kennedy, Channellock, Porter-Cable, Rockwell, Heliol, Vise-Grip, Crescent, Ridgid, Pony Clamps, Unimat, Foredom and many other Nationally Advertised brands of Tools & Supplies. We ship Coast to Coast at prices Hard to Beat. Send 25¢ for our big 132-page tool catalog, today. Silvo Hardware Co., PM-2, 107 Walnut St., Philadelphia, Pa. 19106.



### FREE!!! POWERFUL MUSCLES FAST!

Fantastic New Discoveries in the science of bodybuilding. Now, in the privacy of your bedroom, our method will add inches of powerful muscles to arms, chest, shoulders & legs. Learn secrets on trimming the waist with ultra-modern methods—fast! Results Guaranteed! Send for free brochure. Universal Bodybuilding, Box 485-M1, Dearborn, Mich. 48121.

**WHAM-O \$150**

HITS LIKE A RIFLE —  
KILLS RABBITS, SQUIRRELS  
Powerful, silent, accurate.  
For hunting, target,  
routing pests.  
Sportsman's  
choice sold  
world  
over!



### HUNTING SLINGSHOT

40 heavy extra steel balls 20'  
Heavy duty 7" ash stock,  
40 heavy steel balls, extra rubber,  
adapter for shooting arrows.  
GUARANTEED. Professional model of  
Nat'l Slingshot Assn. At Dealers, or write

WHAM-O MFG. CO., P.O. Box X-15 San Gabriel, Calif. 91778

## INSTALL ALARM SYSTEMS

... BIG PROFIT HOME BUSINESS

**MAKE BIG MONEY—BE YOUR OWN BOSS**

New plan opens big burglar fire alarm business to small home operators. Full or spare time without previous experience or big investment. Make big profits. No salesman will call. Write. NASCO, 11071 Massachusetts Avenue Dept. D2252, Los Angeles, Calif. 90025



### RIFLE WALL RACKS

For displaying valuable rifles — over-under and double barrel shotguns. Plastic — will not rust or corrode metal parts. Lock 2 or more sets together for multiple rack.

At your favorite sporting goods counter or order direct — enclosing correct amount for each set plus 25¢ additional to cover cost of handling.

**PYRO \$2.00 (Set of 2)**

PLASTIC CORP., PYRO PARK, UNION, N. J. 07088



# How About Joining in the Fun!



Playing the accordion does it every time! Maybe you have an accordion and would like to trade it on one of the fabulous "New Sound" electronic models. Beginner or professional . . . we can save you big money and put a fine accordion in your hands! Save 50% or even more! We are America's largest direct-importer-to-you dealer in accordions. We buy for

much less and we sell for much less. AND we back up every accordion with a positive money back guarantee and liberal 5 day home trial. We'll gladly send our newest color catalogs and low discount prices telling about newest models just arrived from Italy's most famous craftsmen. Mail the coupon . . . no obligation!

**I GUARANTEE TO**  
*Save You 1/2*  
**OFF RETAIL PRICES OF ANY COMPARABLE**  
**"NEW SOUND" ELECTRONIC OR STANDARD**  
**ACCORDION!**



**DAVE BIASCO**  
*President,*  
*Import Director*  
**Accordion**  
**Corporation**  
**of America**

**TRY BEFORE YOU BUY!**  
**5 DAY HOME TRIAL**  
**FREE Bonus Gifts -**  
 E-Z LESSONS • MUSIC PORTFOLIO  
 • MUSIC STAND • DELUXE CASE  
 YEAR'S SUPPLY OF MUSIC and other  
 valuable awards!  
**TRADES ACCEPTED...**  
 We'll accept anything of value in trade  
 ... cameras, encyclopedias, radios,  
 musical instruments. Tell us what you  
 have . . . get bigger than ever trade-in  
 allowance!

**EASY TERMS - LOW DOWN PAYMENT**  
 In all America you have your largest accordion selection at A.C.A.! Choose from over 40 "New Sound" accordion models. Accordions for the student . . . the advanced hobby player . . . and the skilled professional artist. Make your selection from the finest makes and greatest names . . . created for you by the Italian masters. *Yet you save at least half of what you'd expect to pay.* If you are interested in an Electronic Accordion amplifier, we offer you amazing savings. Why pay more when you can get so much more for your money buying *direct!* You buy just as the dealers do . . . and you can save yourself as much as several hundred dollars on advanced models. We make it easy to enjoy your new accordion. Convenient terms with a low down payment. **NO RISK PLAN . . . 5 day home trial** before you decide! Lifetime performance guarantee. Satisfaction guaranteed or your money refunded. Trade-ins welcomed.

**POPULAR "BUTTON" ACCORDIONS**  
 Full line now available at low discount prices. Check coupon.

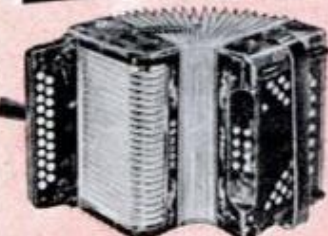

**ACCORDION AMPLIFIERS**  
 and reverb units. Custom designed for accordions. Finest makes at low money saving prices. Check coupon for details.



**FREE Color Catalogs, Selection Guide, Discount Prices, Color Swatches**

Let us prove how much you save . . . how much more you get for your music dollar! We'll send you complete details, color pictures, lowest discount prices . . . plus big savings on amplifiers and accessories. No obligation. Just mail the coupon.

**FREE COLOR CATALOGS - DISCOUNT PRICES**  
**Accordion Corp. of America Dept. R-20**  
**5535 W. Belmont Ave., Chicago, Illinois 60641**  
 Send FREE Color Catalogs and Discount Prices. Also include special information I have checked:  
 Accordion Amplifiers     Button Accordions

NAME \_\_\_\_\_  
 ADDRESS \_\_\_\_\_  
 CITY \_\_\_\_\_ STATE \_\_\_\_\_ ZIP \_\_\_\_\_  
**ZIP NUMBER SAVES THREE DAYS**

**Rush coupon at right to:**  
**Accordion Corp. of America, Dept. R-20**  
**5535 W. Belmont Ave., Chicago, Illinois 60641**

# The bargain hunter

**PRECISION TOOL HANDLE  
FOR INJECTOR TYPE  
RAZOR BLADES**



**\$1.89**  
P.P.

**RAZOSHARP**

Pat. Pend.

**IDEAL POCKET KNIFE—EXCELLENT OFFICE AND HOUSEHOLD UTILITY TOOL**—Only holder to use standard injector type razor blades. Only holder allowing for varying blade length exposure. Only holder allowing blade to be completely sheathed and protected. Only razor blade holder to give precision tool feel.

**ALWAYS RAZOR SHARP**—When blade dulls—pop in new blade. Re-use injector type razor blades. **SHAVE and SAVE.** Inexpensive injector type razor blades always available. To expose new sharp edge—reverse blade or clip dull edge. Excellent for cutting clippings, cardboard, trimming. Ideal for opening packages, cartons, boxes. Use for carving, whittling, sharpening, erasing, etc. Shape blade to suit use—snip edge, grind or break with pliers. Nothing to break or wear out.

**RAZOSHARP 421 Stockholm Street,  
Brooklyn, New York 11237**

## FIND BURIED TREASURE

**\$28.95**  
post paid

60 DAY  
UNCONDITIONAL  
MONEY BACK  
GUARANTEE

**ALL TRANSISTORIZED  
DEALER INQUIRES INVITED**

All models find buried coins, gold, silver, war relics and signal thru earphone with loud "beep". Features silicon planar transistors, PC boards, two separated colpitts oscillators for maximum stability, thumbwheel tuner allowing one hand operation, 5" search head for most useful range. All complete in "Unilate" black attache case with slide action locks, keys, grey foam interior cushions instrument. Included are sensitive earphone, battery, fascinating 196-page book "Lost Treasures and How to Find Them", and instructions.

MAIL THIS COUPON TODAY!

- MAVERICK KIT** only \$28.95 complete do it yourself instrument that we guarantee to work when completed.
- CONTINENTAL** only \$32.95 completely assembled and ready to use
- IMPERIAL** only \$38.95 an advanced model that includes a powerful built in speaker that automatically is disconnected when earphone is in use, completely assembled.

TO ORDER: send cash, check or money order. In N.J. Treasure House Dept. PAGO Trenton, N.J. 07763  
7% Sales Tax. \$3.00 deposit for C.O.D.

## IMPORTED LOCK BLADE STILETTO

ONLY \$2.75 Ea.

9" Overall Length

5" When Closed

- Opens instantly
- Sharp and Tough
- Stainless Steel Blade

Flips open instantly and locks automatically to prevent accidental closing. Razor sharp tough stainless steel blade for reliable use and hard, long service. Money back in 5 days if not satisfied. Send \$2.75 plus 25¢ to cover postage and handling.

**WESTBURY SALES CO.**  
P.O. BOX 415 WESTBURY, N.Y. 11591  
DEPT. L-2-PM



**NOW! Letter like a pro! It's as easy as number painting**

### RUB-ON PATTERNS END TRACING

A dip in two solutions enables anyone to transfer prepared "Rub-on" outlines of letters directly to all surfaces.

"Quick as a wink." No tracing. No carbon paper. The line then guides your hand to a professional job. Just • fill in with brush or felt tip pen • carve, inlay, engrave • burn in, cut out, rout • apply glue and glitter for night reflection.



**Make your own unique name plates for fun, profit, gifts.**

Make number plaques, name plates for home, estate, ranch, boat, mailbox. Banners, signs, etc. on wood, cloth, stone, paper, ceramics, metal, walls.

### INTRODUCTORY KIT \$3 postpaid.

Contains 2 inch, 4 inch alphabets, numbers, design suggestions.

U. S. Patent 3446683

Available only from **DEAN DESIGNS**  
P.O. Box 2858, San Francisco, Ca. 94126



**Bartlett Flying Saucer** ultra-light hovercraft powered by ordinary lawn mower engine—easy to build—fun to fly—complete plans, kit brochure, photos and supply sources \$4.00. All orders returned via airmail. Write:

**HERB BARTLETT**

Box 3234-M, Scottsdale, Arizona 85257

## WESTERN HAIG

.12 CALIBER  
SPECIAL FACTORY  
OFFER!

**\$300**  
post-paid



### USES POWDER CHARGE

This small bore gun shoots .12 cal. steel bullets fired by small 4.4 mg. powder charge. Not a CO<sub>2</sub> gun. You'll like the handsome lines, grip, and balance. Western in style, but patented ball and cap action allows this low price. 9 3/4" steel barrel cased in knurled styrene stock, overall 13 1/2". Develop pistol form, accuracy at a fraction of cost of large cal. pistols. Comes with 50 steel bullets. Satisfaction guaranteed. Send \$3.00 to:

**HAIG MFG. CO., P.O. Box J-26 Alhambra, Calif. 91802**

**WHEN  
ANSWERING ADS  
GIVE YOUR  
ZIP CODE**

## Apply yourself.



Send just 50¢ for 1/2-pint sample. A rich, hand-rubbed finish is easy to achieve with Pen-Chrome Clear Satin wood finish. Brushes on evenly and smoothly to accent the natural wood grain. Dries quickly. Use on stained or raw wood. Offer limited to 1 can per customer.

Send 50¢ to: **The O'Brien Corp., Dept. PM-2, South Bend, Ind. 46621.**

**THIS IS IT!**



Popular Mechanics said in July, 1969 (p. 166):

**"Handiest Tool You Can Have in Your Shop"**

It sands, grinds, polishes, sharpens. It's portable. Take it on the job. Use with any 1/4 hp motor. Model 165. Factory direct special.

**\$19.95** less motor

**ARCO MFG. CO.**

P.O. Box 817, Grand Forks, N. Dak. 58201

100 STYLES FOR

**WIDE FEET**

and **HIGH INSTEPS**

EE to EEEEE Only

Sizes 5 to 13

Men only. Casual, dress, work shoes that really fit. Top quality, popular prices. Money-back guarantee.



Not sold in stores

Write Today for **FREE CATALOG**  
**HITCHCOCK SHOES, INC.**  
Hingham 28-A, Mass. 02043



6-in-1 Sharpener

### How To Give Yourself A REAL RAISE

You can now enjoy more money for better living, retirement, security,—by being your own boss. Turn Your Spare Or Full Time Into Cash.

As Much As \$6.00 per Hr.

HOLLOW GRIND knives, scissors, planer blades, clippers, tools, skates, rotary mowers, everything. TREYCO 6-in-1 sharpening machines do ALL for the price of one machine. Thousands making money throughout the world since 1946. Start NOW, everybody needs sharpening,—housewives, hobbyists, beauty shops, restaurants, markets, contractors, farmers, tool renters, etc. How-to-Do-It manual furnished. ACT Now, Write for FREE Catalog and low Factory-To-You prices. No salesmen.

**TREYCO PRODUCTS, INC.**  
332-A Niagara St., N. Tonawanda, N.Y. 14120

### LESS THAN 15¢ PER OIL FILTER CHANGE WITH AMAZING

# STILKO



### ETERNAL OIL CLEANER

Full-flow oil filtering system uses the best-known filtering material available anywhere—toilet tissue—already proven in thousands of automobiles. Recommended for all types of cars and trucks. Keeps oil cleaner sludge-free and carbon-free. No costly installation or maintenance—simply spins on in place of regular throw-away filter! Each filter change costs less than 15¢ and oil lasts longer (some users report never changing oil). Fully guaranteed. Send check or MO for \$24.95. Or send \$5.00 and pay balance COD. Include Make, Model & Year of car, engine type and no. of cylinders.

DEALER INQUIRIES INVITED  
**STILKO ETERNAL OIL CLEANER**  
7445 Convoy Court  
San Diego, Calif. 92111



BC1500SH

# BIG BIKE POWER MINI

Outdigs the big ones! This hot mini with a 5-speed 100 cc Hodaka engine accelerates from 0 to 50 faster than most heavyweights that cost \$1000 more! Even more big bike features have been added for '69. 8 models, starting at \$69.95. Send 25¢ for brochure, \$1 (refundable) for packet on entire line. Dept. PM119 1775 S. First St., San Jose, California 95112.

**BONANZA**



### FREE MUSCLE COURSE!

Want a new Jet-Charged body? In 15 minutes I'll prove you can slap on 4" of muscles to your chest—3" to each arm—give you life-guard shoulders, trim your waist to athletic size—give you speedy athletic legs. I don't care if you're short or tall (skinny or fat) young or not so young, expect a muscle building miracle when you send for my free course. Send only 25¢ to cover postage and handling to Joe Weider, Dept. 38-20D2, 531 32nd St., Union City, N.J.

### NOW! GET 5 REAL OLD LINCOLN CENTS --for only 10¢



Only 10¢ brings you 5 old Lincoln pennies issued before 1927. (One set to a customer.) This offer made to introduce our "Coins on Approval" service. You may return without purchase and can stop service at any time. Also big free illustrated catalog. Send 10¢, name, address and zip code to: Littleton Stamp & Coin Co., Inc., Dept ML-7, Littleton, N. H. 03561.

### BULL FIGHTER Lock Blade STILETTO KNIFE

5 1/4" Overall Length 3" Blade ONLY \$125

- Tough and Sharp
- Opens Instantly
- Stainless Steel
- Folding Finger Guard
- Blade Locks



Flips open instantly and locks automatically to prevent accidental closing. Razor sharp tough stainless steel blade for reliable use and hard, long service. Money back in 5 days if not satisfied. Send \$1.25 plus 25¢ to cover postage & handling. Please state age. WESTBURY SALES CO., DEPT. B.M.5M P. O. BOX 415, WESTBURY, N. Y.

## "They laughed when I sat down at the piano ...but when I started to play!"

This famous ad headline was first published in 1922 by the then little-known U.S. School of Music. The ad offered readers details about a remarkable way to learn music by mail. Thousands responded—and discovered the method really worked! Now you can make the same discovery yourself. Learn piano, guitar, accordion, etc., at home in spare time, without a teacher—and for only about \$1 a lesson. For full details send for free booklet. Mail this ad with your name, address and zip to U.S. School of Music, Studio 302, Port Washington, N.Y. 11050. ©1970 U.S. School of Music

Give your zip code when answering ads

### SAVE! INSTALL IT YOURSELF



Remote control Garage Door Opener ONLY \$99.50

Easy to install. Garage door opener with solid state transmitter and receiver. Built by Crane, manufacturers of quality door operators for over half a century. Guaranteed for one year. Save by buying direct and installing yourself (selling nationally for \$165.00 installed). F.O.B. Factory. Send check or money order. Deposit of \$10.00 required on COD orders. Ill. residents add 5% sales tax. Additional transmitters \$18.00 ea. F & A SALES 9810 W. Lawrence Ave. Schiller Park, Ill. 60176

MOMENTOS of the infamous 3rd REICH Cast NAZI Eagle—Wall Plaque 7"x20" Wide. Bronze finish. While they last \$5.00 postpaid.



Our fully illustrated collector's CATALOG of ... Helmets, Hats, Medals, Pins, Badges, Books, Photos, Posters, Manuals, Stamps, Flags, Decals, Arm Bands & other hard-to-find items. CAT-ALOG free with order or Air Mailed to you for \$1.00. W.W. 2-M Ltd., Box 2063, St. Louis, Mo. 63158



**HENLEY'S 20th Century Book of 10,000 Recipes, Formulas & Processes** here is a wealth of practical, accurate and clear information and instruction that can save you thousands, or make you a fortune! Housewives, manufacturers, farmers, handymen, home experimenters, electricians, chemists, people in every walk of life, refer to Henley's daily. In this gold-mine of a book, you too will find formulas and recipes for almost everything used in the home, farm, workshop or industry. Discover the trade secrets of thousands of commercial products—learn new money-saving and exciting ways of doing things. As indispensable as a dictionary. Satisfaction guaranteed. 900 pages hard cover—cloth binding. Only \$5.95 postpaid. EMBASSY SALES, Dept. PM-9 Box 67, East Elmhurst, N.Y. 11369

## HOW TO MAKE MONEY IN MAIL ORDER

FREE REPORT shows man, woman how to get into big profit home mail order business fast. Part time or full time. Millionaire reveals own personal success plan. No experience or product investment. Write (state age). Mallico, 1554 Sepulveda, Dept. D2252, Los Angeles, CA 90025.

# CLASSIFIED ADVERTISEMENTS

Rate: \$1.85 per word payable in advance each insertion. Capitalized words—75¢ per word additional. Minimum insertion ten words. To be inserted under the proper classification, copy must be in our office by the 15th of the second month preceding date of issue. The next available issue to place an advertisement in America's No. 1 Classified Section is April. The closing date is February 15th. Send remittance and order to C. A. Martin, Popular Mechanics, 224 West 57th Street, New York, New York 10019. Please make remittance payable to Popular Mechanics.

POPULAR MECHANICS

## WE MOVED

Our New Classified Address is:

Popular Mechanics  
Classified Adv. Dept.,  
224 West 57th Street  
New York, N. Y. 10019

### AUTOMOBILES

**CONTACT DETROIT** when you have something to say about your car. Send for list of addresses, and contact car manufacturers. List 35¢. Dorin, 711 Starkweather Avenue, Plymouth, Michigan 48170.

### MIDGET CARS

**YOUR Ad** in Popular Mechanics will be seen by more than 5,000,000 active buyers for your products and services. It costs only \$1.85 per word. And, if you wish to run all or part of your ad in capital letters—you can do so for as little as 75¢ per word additional. Act now! Place your Classified ad in Popular Mechanics today.

### AUTO SUPPLIES AND EQUIPMENT

**AMAZING FIND:** Increase your vehicle gas mileage UP to 55%. For information and instructions send Auto or Truck Make, Engine Type, self-addressed stamped envelope and \$3.00 to Miles FitzGerald, 615 St. James Pl., Wichita, Kansas 67206.

**VOLKSWAGEN** and Dune Buggy Accessories. Catalog 50¢. Gem Products, Box 845P, Carol Stream, Ill. 60187.

**PARTS:** Army jeep and truck parts. Spare Parts & Equipment Co., P.O. Box 751, Lexington, Ky. 40502.

**CROSLEY.** Foreign, American, Parts. Discounts Accessory Catalog 616 Burnside, Inwood, New York 11696.

**AUTO Parts** for old and new Cars. All makes. Catalogue \$1.10. Antique Auto, Milwaukee, Wisconsin 53204.

**STOP CAR THIEVES: DO IT YOURSELF** plan discloses six inexpensive, highly effective, common-sense ways to stop theft and pilfering. Complete plan \$3.00 Check or M.O. Verdi-systems, P.O. Box 186, Belle, Missouri 65013.

**BE Your own Ignition expert.** Free details. Q-arc, Box 47876, Los Angeles, Calif. 90047.

**GIANT Car cover (13½'x24')** For Inclement weather is weatherproof, waterproof, and resists tears or cracks. \$5.50 ppd. Harvard House, 1691 Davidson, Bronx, New York 10453.

**REVITALIZE**—Save your transmission. \$2.50 postpaid. Guaranteed. Profitable for salesmen. Weldtite, 120 N. Fourth St., North Wales, Pa. 19454.

**VX-6 PREVENTS Battery Killing Sulphation.** Increases Capacity. Guaranteed! \$2.98. Herford, 2729-G Midvale Ave., Los Angeles, Calif. 90064.

**NEW Alternators** \$27.95 GM, Ford, Chrysler products 90 day guarantee. Add \$2.00 tax, postage. Vehicle Supply, Box 23146, Dallas, Texas 75203.

**HANDY For Glove Compartment**—Computes Driving Time, Average Speed, Fuel Consumption, Distance Between Gas Stops, Plus Other Functions. \$1.00. Crest House, 3224 Peachtree Road, Atlanta, Ga. 30305.

**BUILD Car Burglar Alarms.** Plans \$1.00. 808 North 2nd, Central City, Kentucky 42330.

**JEOP Owners**—V8 conversions. Read Jeep Owners' ad, page 210.

**AUTOMOBILE HEADLIGHT ALARM.** Reminds you to turn off lights when ignition switch is turned off. Alarm sounds if lights are left on. Clips on under dash so anyone can install in minutes. No tools required. Two year guarantee. \$14.50 postpaid. PG Electronics, Box 4981, El Paso, Texas 79914.

**BE A SPEEDOMETER EXPERT.** Use professional system on old and new cars. Send \$3.95. Correia, 246 Marylou Avenue, Yonkers, New York 10703.

**BIGGEST \$\$\$\$\$ Saver** in Automotive History!! Motaloy Ring-Valve Job \$6.50 postpaid. Lasts 100,000 miles! (New engines too) 18 years proven results! Motaloy, Grantham, Penna. 17027.

### SNOWMOBILES

**SUPERCHARGER;** Pep up your Snowmobile Engine with the Cyclone. Free brochure. Power Systems, Minneapolis, Minnesota 55412.

**SNOWMOBILE KITS** \$25. Plans and photos \$1.00. Information 10¢. Compco, Box 1267, Redwood City, California 94064.

### AUTO TRAILERS

**BUILD Your Pickup Camper.** Precut Kits. Blueprints, Supplies, Literature 25¢. Comstock Trailers, Dept. 664, Parsons, Kansas 67357.

**PICKUP Camper, Trailer or Pickup—Cover . . . Build yourself. Save!** Complete plans \$3.95 each Cover plans \$2.00. Conversion Plans—econoline type van \$2.95; passenger bus or delivery van \$2.95. Satisfaction Guaranteed. Equipment catalog \$1.00 (refundable). Details 10¢. Viking Camper Supply, 99-F Glenwood, Minneapolis, Minn. 55403

**CAMPING Trailer,** sleeps 6. 15 photos, complete plans \$3.50. Canvas top and kits available. Circulars 15¢. Stratford Trailers, Stony Creek, Conn. 06405.

**VANS . . . Why freeze? Winterize!** Be 50% warmer! New booklet, "Insulating and Covering Van Interiors" contains complete instructions, drawings. \$2.00. Craft, Box 513, Arroyo Grande, Calif. 93024.

### MOTORCYCLES, BICYCLES, MOTORSCOOTERS AND SUPPLIES

**BUILD "Popular Mechanics" MINIBIKE** featured June 1967 issue. Detail plans, photographs \$2.50 refundable. Kits, parts, engines; factory discount prices. Catalog 25¢. Gilliom Mfg.; PMC; St. Charles, Missouri 63301.

**EVERY PART for Kart or Mini-bike.** Bargain prices. Giant catalog \$1.00. Brown's Motorsports, 19 Central St., Worcester, Mass. 01608.

**SNOW VEHICLE & KART Hop up accessory CATALOG.** Speed and performance equipment—manifolds, engine mounts, exhaust systems. Send 25¢. G.E.M. PRODUCTS, Box 845, Carol Stream, Ill. 60187.

**MINI-BIKES, Wheels, Chain Saws.** Catalog 25¢. Loren Products, Danville, Illinois 61832.

**ILLUSTRATED Catalog 25¢.** Parts, Accessories. Custom Stock, most makes, models. Cycle Supply, Box 192M Fairbury, Ill. 61739.

**BUILD Motorbike From Bicycle!** Plans \$2: Go-Cart Plans \$2: Snowmobile Plans \$3: Go-Byk Industries, Rothsay, Minn. 56579.

**MOTORCYCLE TURN SIGNALS** Accessories. Catalog 25¢. Houston, PM Lockport, Illinois 60441.



## SPACE, ROCKETS AND ASTRONAUTS

**ROCKETS!!** Real flying models—2500 feet altitude with powerful motors. Terrific Science Projects. Tubes—Cones—Parachutes—Launchers—Igniters. Gigantic catalog—rocket data—diagrams—25¢. Fast Delivery. Centuri Rockets, Box 1988, Phoenix, Arizona 55001.

**ROCKETS:** Real flying models—flights up to 2500 ft. New illustrated catalog 25¢; Singles and multistage kit, cones, engines, launchers, trackers, rocket aerial cameras, technical information. Fast service. Estes Industries, Penrose 7, Colorado 81240.

**OUR FIRST 19 IN SPACE.** This limited edition lithograph has been created as a tribute to America's Gallant Astronauts. 12 X 18 inch chart ready for framing. Only 75 cents. Popular Mechanics, Dept. GWP, 224 West 57 Street, New York, New York 10019.

**FLYING SAUCER** kit. Fly indoors outdoors. Rubber launched. \$1.00 P.P. Saucer-Roonie, 1103 Madison, St. Charles, Mo. 63301.

**FREE Rocket** sent with catalog. 50¢ Scientific. 8886 Melvin, Livonia, Michigan 48154.



## AVIATION

**BE A Government licensed aviation mechanic.** Practical training. Free information. Aero Mechanics School, Municipal Airport, Kansas City, Missouri 64116.

**AIRBOAT, Propellers, Engines, Plans, Kits, Supplies.** Complete Airboats Outboard Airdrives. Catalog \$1.00. Banks-Maxwell, Box 3301E, Ft. Worth, Texas 76105.

**HELICOPTER, One-Man, Portable Kits, Plans, Information 10¢.** Photos and three-view drawings \$1.00 Compcop, Box 1267, Redwood City, California 94064.

**AVIATION Surplus Big Catalogue 50¢ (Refundable).** Box 1TFPM, Spring Grove, Penna. 17362.

**BARTLETT FLYING SAUCER.** Amazing machine hovers 200 lb. man over land/water. Powered by ordinary lawn mower engine. Easy to build. Fun to fly. Complete plans. Kit brochure and photo review \$4.00. Airmail return. Write: Herb Bartlett, Box 3234-C, Scottsdale, Arizona 85257.

**HI-INTENSITY STROBE.** Aircraft Beacon. Complete kit \$89.50. Plans and pictures \$4.50 refundable. Ewes, 1286 St. Paul, Rochester, N.Y. 14621.

**BUILD THIS 4-PLACE PLANE FOR \$3500.** Called the BD-4. Send \$30.00 to: POPULAR MECHANICS, 224 West 57 Street, New York, New York 10019.



## BOATS AND TRAILERS

**NEW 1969 McCulloch And Other outboards 4 H.P. \$114 . . . 9 electric \$288 . . . 18 \$338 . . . 25 \$388 . . . 40 electric \$558 . . . 55 electric \$768 . . . all sizes. Literature 50¢, Electra Marine 1427 Broadway, Brooklyn, N. Y. 11221.**

**CANOE! Kayaks! Factory-direct quality kits, from \$25.00.** Many different models. Canvas hulls. Strongest construction materials. Free literature. Sportsraft, Box 8393-PM, Columbus, Ohio 43201.

**BOAT PLANS, FRAME KITS, BOAT KITS.** World's largest catalog—Over 200 top design for the amateur builders. New catalog includes Cruisers, Runabouts, Deep vee's, Catamarans, Trimarans, Houseboats, Sailboats from small sail fish to 34 ft. motor sailers, large selection of inboard and outboard Hydroplanes. Send \$1.00 for large new plan & kit catalog or \$2.00 for catalog plus Boat Builder's Guide. Clark Craft Boat Company, 16-P Aqua Lane, Tonawanda, New York 14150.

**BUILD Your own boat from our large-scale blueprints.** Books of plans give how-to-build help. Hundreds of professional designs—motor, sail or auxiliary—for amateur builders. Free catalog. MoTOR Boat-ing, 959 Eighth Ave., Dept. PM-RS, New York, N.Y. 10019.

**FIBERGLASS Cloth and resin.** World's finest cloth and non-run resin, at direct mill prices Flotation foam. Complete line of plastics, silicon bronze and brass screws, save 60%. No sales tax. Boat Plans. Catalog 25¢. Freight prepaid. Stiles Boat Supply, Box 11P, Linden Ave., Mantua Hts., N.J. 08051.

**PLANS, FULL-SIZE PATTERNS, FRAME KITS** with step-by-step instructions specially for amateurs. Send \$1.00 for new 96 page catalog of over 80 designs: 8' to 36' Sail, Jets, Inboards, Outboards, Cruisers, Houseboats, Hot Boats, Catamarans, Hydros "plus" boat trailers. New "How To Build Boat Trailers" book \$4.00 ppd. Glen Designs, 9152 Rosecrans, Bellflower, Calif. 90706.

**FIBERGLASS CANOES.** Four Exciting Models. Easily Assembled Kits. \$39.95 up. Factory Direct. Free Literature. Riverside Canoes, Box 5595-B, Riverside, California 92507.

**BOAT maintenance information, LIFE-CALK, "GIT"-ROT, LIFE-GLAS, Finishes & Cleaners.** Send for "How to do-where to do" literature. FREE. Boatlife, 5-45 49th Av., L.I.C., N.Y. 11101.

**PLANS, Kits:** canoes, kayaks, sailing rigs, accessories. Free Catalogue. Quick-silver, 115 McGavock Pike, Nashville, Tennessee 37214.

**BOAT Kits.** Molded Fiberglass. Save money—assemble yourself. Factory molded sections bond into one-piece craft. 20 models—14' to 32'. Cruisers, Runabouts, Houseboats, Sailboats. Big line accessories, motors, trailers. Easy terms. Free 80 page catalog. Luger, Dept. BC-70, 1300 East Cliff Road, Burnsville, Minnesota 55378.

**AMATEUR Boat Building Magazine.** Plans, Discounts, books, instructions. 3183 Merrill, Royal Oak, Michigan 48072.

**SAIL BOAT KITS.** Molded fiberglass and wood for Snipe, Lightning, Penguin, and many others. Free catalogue on sail boats, canoes, ice boats, and fiberglass and sail making supplies. Taft Marine Corp. 636 3/4 39th Avenue, Minneapolis, Minnesota 55421.

**KAYAK Kits,** inexpensive professional models. Exclusive Nylon hull, aluminum trim. One day assembly. S-T Kayaks, Stony Creek, Conn. 06405.

**BE MARINE Dealers for fun and money.** contact Walters Marine Supply, 2620 Deepwood Drive, Wilmington, Delaware 19803. We also discount travel trailer accessories.

## MARINE EQUIPMENT AND SERVICES

**CONVERT Auto engines to marine.** 68 Page Catalog. 50¢. Lehman Manufacturing Company, 800 Elizabeth Avenue, Linden 4, New Jersey 07036.

**NEW, Used, rebuilt marine motors.** Marine conversions, fittings Free catalog. Stokes Marine Supply, Dept. 24, Coldwater, Michigan 49036.

**FREE Catalog—Gary inboard, inboard-outboard marine engines—gasoline, diesel.** Graymarine Corporation, Coldwater, Michigan 49036 or Berkeley, California 94710.

**BIG Discounts—Conversion Kits—Marine Engines—Manifolds—Transmissions—Outdrives—Free Brochure.** Star Marine, Berkeley, California 94710.

## ATHLETIC AND BODY BUILDING COURSES

**"GIANT Arms."** Dr. Young's, D.C. revolutionary discovery. \$2. Satisfaction or refund. Gaucho, Box 9309-S7, Chicago 60690.

**POWERFUL Muscles fast!** Free brochure! Universal Bodybuilding, Box 4327-C, Dearborn, Michigan 48126.

## SPORTING GOODS AND EQUIPMENT

**FREE . . . Wholesale Catalog, Arrow Shafts, Broadheads, Fletchings Fisharrow Parts, Tools, Bows, Finnyports.** (22G), Toledo, Ohio 43614.

**FREE 1970 Catalog, Guaranteed Lowest Prices!** Rods Reels, Lures, Accessories—Thousands of Items. Cabela's Inc., Dept. S, Sidney, Nebraska 69162.

**HUNTERS Compact SURVIVAL KIT,** includes purification tablets, \$1.25, Box 156, Stratford, Conn. 06497.

**AMAZING! Reusable dehumidifier.** Eliminates mildew, mustiness, dampness and rust from campers, trailers, guns and fishing tackle. \$1.00. Acro-Products, M2, 4043 NE z8, Portland, Oregon 97212.



## FISHING, TACKLE, LURES

**AUTOMATIC Rod Tender—holds all sizes.** Rods or poles, on bank, dock, boat or ice. Sets hook sharply when fish bites. Simple adjustment for large or small fish. Plated steel—patented—list price \$8.95. Buy direct wholesale \$4.95 F.O.B. Delta River Corp., P.O. Box 385, Shawnee Mission, Kansas 66200.

**SEND for FREE Wholesale Catalog.** The most complete and fully illustrated catalog of reels, rods, beads, spinners, jigs, bodies and parts, sinker molds, feathers, tools, hooks, rod blanks, rod parts, swivels, wire, etc. FINNYSPOITS, ME Sports Bldg., Toledo, Ohio 43614.

**Molds—For casting your own fishing sinkers.** Free illustrated booklet. Reading Instrument Co., Box P78, Reading, Pa. 19603.

**MOLDS For fisherman's sinkers, jigs, squids, casting and spinning lures.** Free catalog. Sweets Molds, Tonawanda 1, New York 14150.

**CRAPPIE Jigs \$1.00 per dozen.** Buy 5 dozen get dozen free. P.P.D. C.O.D. add 50¢. Assassinator Lures, Box A, Oak Grove, Missouri 64075.

## EARTHWORMS, LIVE BAIT

**BLACK Widow Spider Ranchers wanted!!** Tremendous profits! Complete program \$1 (refundable). NBWC, Box 260-PM6A, Brigham City, Utah 84302.

**EARN Money raising fishworms for us!** Exciting details free! Oakhaven—56, Cedar Hill, Texas 75104.

**HYBRID Redworms—3,000—\$5.75.** 5,000—\$8.00, 10,000—\$14.00. Bedruns 20,000—\$18. postpaid with raising instructions. Brazos Bait Farms, R-9, Waco, Tex. 76705.

**SUCCESS for you! Raise red wigglers, crickets, mealworms, 6 inch garden wigglers, 12 inch African worms.** We teach you to raise and sell. Make money fast! Free literature. Carter Redworms, Plains, Georgia 31780.

**GROW FISHWORMS.** Outstanding NewBreed produces great profits! Free literature. Fain's Hatchery-31, Edison, Ga. 31746.

## FROGS, FISH, REPTILES

**YOUNG Frogs and Giant Breeders.** Stock your lakes and ponds. Nu-Tex Frog Farm, Box 4029, Corpus Christi, Texas.



## HUNTING, GUNS, DECOYS

**PROFITS FROM CLASSIFIED ADVERTISING!** Booklet shows you how to start your own business with Classified Advertising. Only \$1.00 (Refundable with first order.) C. A. Martin, Popular Mechanics, Dept. PM, 224 West 57 Street, New York, N.Y. 10019.



## POULTRY & GAME BIRDS

QUAILS, Incubators, cages, supplies catalog. Marsh, 14216 Brookhurst, Garden Grove, Calif. 92640.

BABY Chicks, Ducklings, Goslings, Turkeys, Guineas. Free Catalogue, Hockmans, Box 7187K, San Diego, Calif. 92107.

## RABBITS—FUR BEARING ANIMALS

RAISE Rabbits successfully by knowing facts. 48 page illustrated book describing 25 breeds. Housing, breeding, feeding, markets, marketing etc. 25 cents. American Rabbit Association, 36 Arba Building, Pittsburgh, Penn. 15217.

MAKE Big Money raising chinchillas, rabbits, guinea pigs for us. Catalog—25¢. Keeney Brothers, New Freedom, Pa. 17349.

RAISE Rabbits for us on \$500 month plans. Free details. White's Rabbitry, Mt. Vernon, Ohio 43050.

\$500—\$800 MONTHLY Raise small Laboratory-breeding stock for us. We supply equipment, breeders, and instructions. Illinois Research Farms, Dept. MPB-1, Barrington, Illinois 60010.

AMAZING PROFITS! \$10,000 Yearly Raising Rabbits for Wool and Breeding. Details 25¢ coin. American Angora, Malta 12, Montana 59538.

## PETS—BIRDS, CATS, HAMSTERS, ETC.

HAWKS, Reptiles, raccoons, skunks, squirrels. Catalogue 25¢. Trails End Zoo, St. Stephens, S.C. 29479.

LIVE SEAHORSES, Marine Specimens, aquarium supplies. Illustrated catalog 20¢. Marine, Box 248-310 Dania, Florida 33004.

LIVE Traps, all sizes, mouse to dog. Collapsible or rigid. Carrying Cages. Free literature. National Live Traps, Tomahawk, Wisconsin 54487.

BUY Direct. Save! Monkeys, Ocelots, Birds, Reptiles, Wildlife—Dog Books. List 10¢. Exotic Animal Importers, Inc., Box 3069-25 Hialeah, Florida 33013.

SEAHORSES, Animals, Aquariums and Pet Supplies. Catalog 10¢. Aqualand, Box 130, M2, Miami, Fla. 33145.

## HORSES, LIVESTOCK

"HOW To Train Horses"—Everyone who likes horses or ponies should have this book; Free. Write Beery School, 1102, Pleasant Hill, Ohio 45359.

VETERINARY Guide to Farmers. The only book of its kind. Send \$6.95 to POPULAR MECHANICS, Dept. VG, 224 West 57 Street, New York, N.Y. 10019.

## CAMPING EQUIPMENT AND TENTS

FREE Catalog! Camping, Boating, Sailing Supplies; Gadgets, Hardware and Gifts. Laacke and Joys, 1439 N. Water St., Milwaukee, Wisconsin 53202.

CAMPER plans and full sized patterns. The most detailed available with written and pictorial instructions. Various models and accessory kits offered. Send for literature—Glen L, 9152—PM2—Rosecrans, Bellflower, California 90706.

SPORTSMEN, CAMPERS! NEW INSTANT CAMPFIRE sticks. Use everywhere. Fast, safe, economical. Big supply only \$2.00. Guaranteed. Winfields, Box 590 P, Burbank, California 91503.

## CAMPING

SAVINGS Plus dividends! Campers-fishermen-outdoorsmen cooperative. Free 68-page catalog. Recreational Equipment, Inc., 1525-P 11th, Seattle, Washington 98122.

## TRAVEL AND RESORTS

WILDERNESS Canoe Trips—Outpost Cabins. Write Bill Rom, Ely, Minnesota 55731.

## ELECTRICAL SUPPLIES

METERS—Surplus, new, used, panel and portable. Send for list. Hanchett, Box 5577, Riverside, Calif. 92507.

LO-VOLT Circuit Tester. Handiest ever! Free catalog: Mathco, 4256-1 Minmor, Cincinnati 45217.

LAMP Parts. Catalog, prices, wiring instructions. 50¢. Refunded first order. Gyro, 5218P N.W. 35 Ave., Miami 42, Fla. 33142.

LAMP and fixture parts, home decor craft catalog. Hundreds of newest items for home, hobby, profit, 60 illustrated pages. Savings! Send 20¢. Dani-Robin, Dept. F, 1231 Arch, Philadelphia, Penna. 19107.

LAMP Parts for building, repairing converting. Catalog 40 cents. Refunded first order. Brown Lamp Co., Box 12511, Creve Coeur, Mo. 63141.

## BATTERIES, GENERATORS

BATTERY Reconditioning Kit, includes molds, material, instructions. Battery Shop, Route 1-188D, Blythe, Calif. 92225.

EASY To Learn!! Hydraulic Jack Repairing. Complete Guide \$3.00. Write now. Bayerco, L938 Betty Avenue, Neenah, Wis. 54956.

## ENGINES, MOTORS, MAGNETS

WINDING Data, 275 motors. \$1.20. Data Company, 512 Kensington, Kansas City, Mo. 64124.

LIVE Steam powered backyard railroads! All sizes. Complete "bolt-together kits," and rough castings. Excellent drawings. 100 page catalog \$1.00. Little Engines, Lomita, Calif. 90717.

PROJECT PLANS! Motors! Generators! Batteries! Electroplaters! Motequip, Box 7266, Kansas City, Missouri 64113.

OPERATE Three phase motors from single phase. Plans \$2.00. Donald Howell, Barnesville, Ohio 43713.

STEAM Engine Kits, Automotive, Marine. Catalog-Handbook, \$1.00. Reliable Industries, New Baltimore, Michigan 48047.

## MACHINERY, TOOLS AND SUPPLIES

SMALL Foundry furnaces, Supplies. Free literature. Pyramid Products, 3736 South 7th Avenue, Phoenix, Arizona 85041.

MICROMETERS — Indicators — Rods — Lathes — Accessories. Campbell, 1424 Barclay, Springfield, Ohio 45505.

FREE Catalog—Micrometers, Dial Calipers, Indicators, Lathe—Raymond Leung, Rm136, 664, King's Road, Hong Kong.

BIG 170 Page Tool And Hardware Catalog \$1.00. Refunded. Elwick, Dept. 119, 230 Woods Lane, Somerdale, New Jersey 08083.

METRIC (Foreign) Nuts, Bolts, Wrenches etc. Catalogue \$1.00. Refundable first order. VETERAN, 3 Howard Street, New York 10013.

EXPANDED Metal. 16 gauge. Cut to size \$1.25 square foot. \$5.00 Minimum order. A-Z, Box 55, Midland, Michigan 48640.

"FREE Catalog. Imported Micrometers and Precision Measuring Tools. Savings up to 50%. Ralmike's, Springfield, N.J. 07081.

## WELDING, SOLDERING, PLATING

WELDERS—110/220, 150 Amperes, \$53.50. Morris, 1070 Inner, Schenectady, New York 12303.

CHROME Plating equipment, supplies. All other finishes. Home workshop and production sizes. Send \$2.00 (refundable) for formulas, operating data, equipment guide and catalog. HBS Equipment Division L50, 3543 East 16th, Los Angeles, Calif. 90023.

BUILD arc welder with car batteries. Has 5 heat settings. Use regular welding cable and electrode holder. Operates on 110 volt line. Dept. PM, Instructions \$2.00. Bob Hutson, 4807 Hillcrest Drive, Waco, Texas 76708.

## GOVERNMENT SURPLUS

SURPLUS BARGAINS! Government, Industrial, War Surplus at savings to 80%! FREE CATALOG! Write today giving zip code. Surplus Store, PMA, Sioux Falls, S.D. 57102.

1969 SURPLUS Army, Navy store illustrated catalog. Send 25¢ (refundable with first \$5.00 order). Ruvel, 3037 North Clark, Dept. 9-J, Chicago, Illinois 60614.

GOV'T Surplus. How and where to buy in your area. Send \$1.00. Surplus information, Headquarters Building, P.M., Washington, D.C. 20036.

JEeps Typically From \$53.90 . . . Trucks From \$78.40 . . . Airplanes, Typewriters, Boats, Clothing, Camping, Sporting, Photographic, Electronics Equipment, Wide Variety, Condition, 100,000 Bid Bargains Direct From Government Nationwide. Complete Sales Directory and Surplus Catalog \$1.00 (Deductible First \$10.00 Order). Surplus Service, Box 820-A, Holland, Michigan 49423.

FREE Jeep buying information when you send 50¢ for 1970 Gov't. Surplus Bargain Catalogue. Surplus, Box 1PMTF, Spring Grove, Penna. 17362.

JEOP and Gov't. Surplus Buying Manual (Jeeps Pictured) 50¢. Surplus Bargain Catalogue 50¢. Both \$1. Surplus Bargains, Box 789PM, York, Penna. 17405.

JEeps From—\$52.50; Typewriters from—\$4.15; Cars from—\$31.50. Walkie-talkies, motorcycles, airplanes, boats, Typical "As Is" bid bargains from Uncle Sam. Tremendous variety. Exciting free list. Write: Enterprises, Box 402X55, Jamaica, New York 11430.

GOVERNMENT Lands . . . Low as \$1.00 Acre. Millions Acres! For Exclusive Copyrighted Report . . . plus "Land Opportunity Digest" listing lands available throughout U.S., send \$1.00. Satisfaction Guaranteed! Land Disposal, Box 9091-RN, Washington, D.C. 20003.

## HOBBIES AND COLLECTIONS

SHOULDER PATCHES—Official U.S. Army and Air Corps. Special patches made to order. 10 assorted patches, price list and catalog, \$2.50. Catalog only, 25¢. SPRINGER'S, Box 577, El Paso, Texas 79944.

COLLECT Regimental Crests! 3 samples and 32 page Military catalogue. Send 50¢ postage and handling. Insignias, Box 71-M, Rockaway, N.Y. 11694.

50 GORGEOUS Jungle butterflies \$2.50. Collectors Wonderland, Box 1170, New York 10008.



## STAMP COLLECTING

SURPRISE COLLECTION! Exotic mint British Colonials, absolutely free with approvals. VIKING, Great Neck 8, N.Y.

UNUSUAL Set 10¢, with approvals. Gorliz, Box 1915PM, Naples, Florida 33940.

FAR East Assortment—Stamps from Viet Nam, Japan, Korea, Formosa and others only 10¢ with world-wide approvals. Clark Stamps, Dept. 57V, Muskegon, Mich. 49444.

200 WORLD WIDE \$1.00 with fine approvals. Deffee, Box 1701, Santa Cruz, California 95060.

(Continued on next page)

## STAMP COLLECTING

(Continued from preceding page)

FREE 400 Genuine postage stamps! Worth \$10.00 at catalogue prices. Africa, Europe, Asia, British Emp.—a fascinating valuable mixture from foreign convents, banks, etc. Who knows what you will find. Also free valuable booklet. Adults only. Approvals enclosed. Frasek Co., PM-2, White Plains, N.Y. 10601.

FREE Illustrated lists. Great Britain and worldwide sets. StarLux, 1695-PM Fulton, Bronx, New York 10457.

HIGHEST PRICES PAID for Collections or U.S. Mint stamps. Send self addressed and stamped envelope. Stamp Exchange, 1232 Neil Ave., PMJ, Columbus, Ohio 43201.

ISRAEL 10 Pictorials 10c. Approvals. Gouge, Box 88, Elizabethton, Tennessee 37643.

I PAY \$250 EACH for 1924 1c green Franklin stamps rotary perforated eleven (\$2.500 unused). Send 25c for illustrated folders showing amazing prices for old stamps, coins, collections. Vincent, 85PM, Bronx, New York 10458.

SENSATIONAL Clearance. Forty Different Packets \$1.00. No approvals. Norge, Ho-Ho-Kus, New Jersey 07423.

25 DIFFERENT IRAQ 10c with approvals. Shannons Stamps, Box 165, Sparta, Michigan 49345.

70,000 VARIETIES. 1c and up. Premiums. Discounts. Penny Stamps, Orange, California 92669.

25 DIFFERENT U.S. Airmails 25c. 45 Different \$1.00. Free pricelist. Eberling, 105 Franklin Avenue, Staten Island, New York 10301.

500 DIFFERENT Worldwide \$1.00! Ross, 320 Rockland Road, Wayne, Penna. 19087.

DEFECTIVE Old U.S. Approvals. Karl Swartz, Box 373, Venice, Fla. 33595.

PAKISTAN 25 Different 10c approvals. Lansdowne Stamp Co., Box 257, Lansdowne, Pa. 19050.

PENNY! Approvals! Regardless catalogue! Kloster, 4164 52nd St., San Diego 5, Calif. 92105.

500 DIFFERENT Stamps, \$1.00. Smith, 508-A Brooks, College Station, Texas 77840.

50 YEARS Old, fifteen different United States, over fifty years old—10c with approvals. Jaxon, Box 145-P, Brooklyn, New York 11230.

FREE Surprise collection sent with approvals. Gould, 1784 Union, San Francisco 94123.

FREE!! Two Beautiful Multi-Colored Complete Mint Sets. Approvals. Hamilton, 1246 Pratt, Chicago OE-2, Illinois 60626.

FREE 50 Worldwide. Approvals. University Stamps, P.O. Box 1471, Lake Worth, Florida 33460.

GIANT Stamp Collection including: Astronauts. Satellites. Moonrocks. Boy Scout issue. Complete U.N. Set, recent Olympic and Sport issues from many countries, etc., Plus Big Stamp Dictionary and approvals. Everything 10c! Stampex, Box 47-RM, White Plains, N.Y.

ABSOLUTELY FREE 25 different United States Commemoratives when requesting United States Approvals. K & B, Box 70, Brooklyn, N.Y. 11223.

FREE! Big Bargain Catalog—New Edition listing thousands of bargains including U.S. & B.N.A. stamps, packets, albums, accessories and supplies. Also, fine stamps from our approval service which you may return without purchases and cancel service at any time. Jamestown Stamp, Dept. E20PM, Jamestown, N.Y. 14701.

WOW! 110 All Different Germany 10c. Commemoratives. Airmails. High Values. Big catalog, bargain lists. Also, fine stamps from our approval service, which you may return without purchases and cancel service at any time. Jamestown Stamp, Dept. A20PM, Jamestown, N.Y. 14701.

U.S. Mint specials! Flag set, complete \$1.00. 1c, 2c, 3c famous Americans (21 different) \$1.00. Free list. Brooks, 2601 Avenue "U," Brooklyn, N.Y. 11229.

100 OLD United States between 1861 and 1935, \$1.00. Roush Stamps, 51 Chestnut, Mansfield, Ohio 44903.

FREE Stamp Wallet with approvals. Wide choice collections by Countries. Clark, Box 428, Northbrook, Illinois 60062.

50 DIFFERENT United States Commemoratives only 10c. Approvals Included. Shelron, Box 547 C, North Miami, Florida 33161.

1500 FOREIGN \$1.00; 5000 \$3.00; 9000 \$5.00; 5000 USA, Contains airm. dues. 19th Century, presidentials, revenues, high values, etc. \$3.00, 300 pre-1939 USA commemoratives \$2.00. 200 pre-1926 USA \$1.00; 700 \$3.00; 3000 \$12.00. No approvals. Meyers, 5321 Fleming, Richmond, Calif.

"GORGEOUS" Sets Free. Request Approvals. Martell, Box 421, Westerly, Rhode Island 02891.

UNITED STATES commemorative collection containing 33 different—10c. Approvals. White, 516-A Avenue L, Brooklyn 30, New York.

50 DIFFERENT U.S. Commemoratives, 10c. Approvals. Cambridge, Box 2311, Heath, Ohio 43055.

FREE: Triangles, Scout, 25 others. Approvals. Cambridge, Box 2311, Heath, Ohio 43055.

MILLIONS Foreign Stamps! 2c each! Send for gigantic approvals! ABC, Box 6000-MB, San Francisco, California 94101

ONE Pound value Geo. VI Bermuda, plus 100 worldwide 10c. approvals. Stevens, Box 105A, Homecrest Sta., Brooklyn, N.Y. 11229.

PENNY Stamps! 1000 Mounted in book at 1c each. Trust Stamp Company, P.O.B. 132-P, Jamaica, N.Y. 11435.

"SPACE" Pictorials, others, 110 Different—10c! Approvals. Shaw, Drawer E-64, Montevallo, Alabama 35115.

FREE!! 25 US Commemoratives, 2" diameter Magnifier. Postage—10c. Approvals. Mixdrak, 5630 West Wilson, Chicago 60630.

PICTORIAL BONANZA! 10c Brings gorgeous collection. Includes sports, space, paintings, animals. Also, other stamps to examine. Buy any or none, return balance. Romar Stamps, Box 8642, Kansas City, Missouri 64114.

UNITED STATES. Fascinating approvals, and lists that are replete with bargains and specialties. Remarkably different. Adult beginner or advanced, you'll be amazed. Engle, Box 8P, Lowell, Mich. 49331.

FOURTEEN different Confederate states facsimiles 10c. Seven different 3c commemorative plate blocks \$1.00! Approvals. Gordon Davison, Henniker, New Hampshire 03242.

20 ATTRACTIVE Worldwide Sets \$1.00 with approvals. Klondike, Harrisburg, Ill. 62946.

500 MIXED Canada 25c, Approvals. Continental, 174 Lakeshore, Oakville, Ontario, Canada.

FREE mint set. Approvals accompany. Stamps, Box 22092, Memphis, Tenn. 38122.

RYUKYU Turtles complete set 15c approvals. Herman Mills, 237 Ashworth Avenue, Toronto 4, Ontario, Canada.

CANADA outdoor recreation set, 40c value only 15c approvals. Rheauem, 6591 11th Ave., Montreal 408, Canada.

FREE duplicate exchange. Details 10c. approvals. Belden, Box 4175C, Dearborn, Michigan 48126.

20 GIANT Paintings 25c with approvals! Roger Williams Stamp Co., Box 1281-P, Pawtucket, R.I. 02862.

U.S. Bargain, 50 different 10c, with beautiful worldwide, approvals. Stamp Center, Kennebunk, Maine 04043.

14,000 DIFFERENT! AMAZING new plan builds your collection systematically, country by country. Only 50c weekly. Ware, Monroe, Conn. 06468.

255 DIFFERENT Worldwide: 15c. Approvals. Tibbets, 8675 Meadow, Downey, Calif. 90242.

CANADA Sports complete. 10c. Canada approvals. Valley Stamps, Little Valley, New York 14755.

RUSSIAN Space collection 10c. Russian Approvals. Snedco, Box 68-P, Waldwick, N.J. 07463.

QUALITY AND LOW PRICE. EXCELLENT For advanced or beginner. Mounted approvals 2c up, all countries in Scott's Order. Preview Stamps, P.O. Box 9809M, San Diego, California 92109.

EXCHANGE Send 100-200 Different stamps with 25c. Receive different. Patterson, Lancaster, New York 14086.

"INVERTED ERROR" Dag Hammarskjold. 6c with approvals. Belmont Stamps, Washington, D.C. 20015.

CANADIAN CENTENNIAL \$1.00 plus 30 others, approvals. 15c. Lewis, 360 Fundy Drive, Saint John B, New Brunswick.

ABSOLUTELY Free—100 Different Worldwide. Approvals Iannuzzi, Box 76241-PM Los Angeles 90005.

400 FINE Mixed U.S. 15c. Wright, Box 753-M, Hagerstown, Maryland 21740.

500 DIFFERENT Stamps 25c. Adults Only. Approvals. Stamps, Box 4155M, Tulsa, Oklahoma 74104.

FREE: World's largest catalog of country packets and collections. Lowest prices. Morgan Stamp Co., Dunkirk, N.Y. 14048.

THREE Stunning Sets 10c Approvals. Fee, Box 493Q, Gibsonton, Florida 33534.

FREE Mint triangle set, approvals Moublow, 1834-C Bassett, Anaheim, Calif. 92805.

STAMPS Free! New issues—New Countries—Triangles—Rockets—Olympics—Scouts—Birds—Flowers—Animals—Also old Canadian and U. S. Stamps. Plus complete illustrated Canadian Stamp Catalog. Send 10c for mailing. Gray Stamp Co., Dept. A, Toronto, Canada.

ONE CENT a Stamp. Write for a jumbo book of Foreign stamps at 1c each, mounted in Scott order. P. P. Bullot, 6815 Bay Parkway, Bklyn., N.Y. 11204.

90 DIFFERENT Canada Including Dollar Centennial 10c with Approvals. Maritime, Box 662, Saint John, N.B.

1500 WORLDWIDE \$1.00 off paper no approvals. Regency Stamps, Box 8854, Pittsburgh, Pa. 15221.

TEN Different Nudes: 20c. Approvals. Stamp Farm, 2M15, Oxford, Wis. 53952.

LIQUIDATING Tremendous Accumulation. Collections, Lots, Miscellaneous Lists Free. Alatalo, Maynard, Mass. 01754.

SPAIN 50 different 5c. Approvals. Hijop, Box 505, Norristown, Pa. 19404.

THREE Colorful Topical Sets: Paintings, Space, Sports, only 10c! Approvals. Guzman, 2138 Crotona, New York, N.Y. 10457.

10 KOREA Pictorials 25c. Approvals? Penniston, (302) 6000 Stevenson, Alexandria, Va. 22304.

307 DIFFERENT triangles, sports, topicals, etc. Worth near \$8.00. Only 25c. Bargain approvals. Jayto Stamps, Box 177-M, East Syracuse, New York 13057.

BRITISH EMPIRE! 50 Beauties 10c. Approvals Accompany. Edwin B. Dean, Box 46PM, Beltsville, Maryland 20705.

(Continued on next page)

## STAMP COLLECTING

(Continued from preceding page)

**WOW! \$25.00 VALUE!** 1000 Different Worldwide \$1.50 with PROFIT SHARING APPROVALS. Universal, Box 6-A, Kenosha, Wisconsin 53141.

"USA APOLLO Moonlanding." Grenada's latest Gigantic Bicolored Commemoratives—Free! Approvals plus 101 Bonus Sets. William Deems, 226x Race, Ravenswood, West Virginia 26164.

**RUSSIA High-Value Collection.** 32 different Russia—some over 50 years old! Commemoratives, Czarist Issues, Airmails, Catalog price \$2.50. Special Get Acquainted Offer—all for only 10¢! H. E. Harris, Dept. GG 49, Boston, Mass. 02117.

"ASTRONAUTS—Space stamps. 25 all different 25¢. Approvals. George Bell, 1115 Barnes, Milton, Florida 32570."

**DESIRABLE SETS—3 different 10¢ with quality approvals!** Cole, Box 223A, Buffalo, N.Y. 14221.

**225 STAMPS for only 10¢!** Airmails. Pictorials: stamps from strange countries cataloging up to 25¢ each! Plus unusual stamps to examine. Buy any or none return balance, cancel service anytime. Mystic Stamp Co., Camden 80, New York 13316.

U.S. Approvals Low prices. Eagle, 2221 Romine Ave., Pittsburgh, Pa. 15226.

"WHOLESALE" U.S.—Foreign Pricelist and catalog Free! Everything Guaranteed. Schneider, Box 1240, Grand Rapids, Michigan 49501.

**50 DIFFERENT Old U.S. Revenue stamps 50¢.** Winchester Stamps, Box 1592, Mansfield, Ohio 44907.

**ASIA—100 Different, including pictorials, 10¢.** Approvals. Tarheel Philatelics, Siler City, North Carolina 27344.

**VIETNAM 25 Different 10¢ approval.** Sam Chazen, Box 95, Ozone Park, N.Y. 11417.

**WORLDWIDE Collection .10** to introduce lowest prices and discount credit plan. W. Lamkin, Farmington, Maine 04938.

## COINS, TOKENS, CURRENCY

**25 UNCIRCULATED coins 25 different countries \$1.00.** Worldwide Coins, Box 265-P, Garden City, N.Y. 11530.

**UNITED STATES Coins Cheap!** Retail Catalog, 25¢. Buying (prices paid) Catalog, 50¢. Currency Valuation Catalog, \$1.50. Max's, Box 11055-BB, Minneapolis, Minnesota 55411.

**40 GENUINE Coins from 40 countries.** Mostly uncirculated. Beautiful, \$2.00. Hindley, Box 708, Aurora, Illinois 60507.

**BUY Coins cheap! List 10¢ (Refundable).** Economy Sales, Mansfield, Mass. 02048.

**SCARCE JEFFERSON Nickels.** All V.G. 100% Satisfaction Guaranteed, 1942-D, 1949-S, 1950—50¢ each, 1943-D—1951-S—1955 75¢, 1939-S \$1.00, 1938-D \$1.50, 1938-S \$2.95, 1939-D \$4.95, 1950-D \$13.95. Dates not listed 19¢. Free coins with order. Premiere Coins—Box 7776, Spokane, Washington 99208.

**LINCOLN'S: 10 Different Before 1930,** only 25¢. Stevens, Box 546F, North Miami, Florida 33161.

**BARREL of Pennies found on ranch!** All before 1956 (mostly "S")—includes Indianheads! 50 mixed \$1.75. Huge Wholesale Listings 25¢. HARRIS, 2373P Pruneridge, Santa Clara, California 95050.

**COMPLETE U.S. Coin List: Cents to Silver Dollars 10¢ with 69S Nickel 25¢.** Schultheis, Box 151 M, New Hyde Park, New York 11040.

**PRICE list.** Send 25¢. Village Coin Shop, Dept. P, Plaistow, N.H. 03865.

**BRILLIANT Proof Sets—1957 \$6.97, 1961, 1962, 1963, each \$4.97.** List Other Bargains 25¢. Bebee's Incorp., Omaha, Nebraska 68111.

**SILVER Dollars, Three Different Uncirculated, \$10.00 or 4 Different Used \$10.00.** Illustrated Catalogue 50¢. Schultz, Salt Lake City, Utah 84110.

**FREE Price list.** D. Hoffman, PM2, Box 98, Clarence, New York 14031.

**LINCOLN Cents complete, "S" Mints 1939-S-1970S \$1.50.** Edel's, Carlyle, Illinois 62231.

**100 INDIAN and Lincoln cents, 1920's and older \$5.00.** Wesley Road, West Union 4, Iowa 52175.

**49S LINCOLN Cent and Price list 10¢.** Rich, Box 34133, San Francisco, California 94134.

**BARGAINS! Discounts! Bonus Gifts! Lists 15¢.** Fairway, 121-P, Rye, New York 10580.

**AMAZING Lincoln MOON PENNY!** Pictures Lem Module, both Astronauts, Earth in distance, etc. Only 10¢. Offer made to introduce "Coins on Approval" Service. You may return without purchases and stop service at any time. Littleton Stamp & Coin Company, Inc. Dept. A1, Littleton, New Hampshire 03561.

**COLLECT COINS for Profit** how to start where to sell lists of valuable coins check your change send \$1.00. S. L. Johnson, PM-1, 80-15 260th St., Floral-Park, New York 11004.

**BARRELFUL 100,000 Lincolns.** 100 different 1909-up \$5.00. 25 different Canadian cents \$1.75. 3 1970pds Lincolns 25¢. Earl Sprague, Kingston Drive, Muskego, Wisconsin 53150.

**INDIANHEAD Cents 7 Different \$1.98.** Coins, Box 35041, Minneapolis, Minnesota 55435.

**ROOSEVELT Dime Specials.** All Very Good Or Better, 1949S-80c, 1955-\$1.50, 1955D-65c, 1955S-40c. All Other Dates Are 25¢ Each. Complete Set Of 55 Different With Album For \$14.50. Satisfaction Guaranteed. Bryson Inc., 612A White, Toledo, Ohio 43605.

**40-PAGE Illustrated United States and Canadian coin list 10¢.** Stoney, 260 Washington, Boston, Mass. 02108.

"S" LINCOLNS, 1941S Through 1969S, \$1.25. Morehead, 208B Houston, Thousand Oaks, Calif. 91360.

## ANTIQUES, RELICS, INDIAN GOODS & CURIOS

**TONS Of antique gun parts and supplies.** All reproduction muzzle loading guns. Send \$1.00 for enlarged illustrated catalog No. 119. Dixie Gun Works, Union City 12, Tennessee.

**LIST Indian relics.** 10 Arrowheads \$3.00. Hyde's, Box 2304, Santa Fe, New Mexico 87501.

**10 PERFECT Arrowheads \$4.00.** George Smith, 9825 Conway Drive, Indianapolis, Indiana 46236.

**INDIAN relic list.** Birdpoints \$7.50, doz. Folsom, \$5.00 each. C. Secrist, Muscatine, Iowa 52761.

**ANTIQUE Price Guide, 224 pages, illustrated, \$2.00 + 25¢ postage.** Or write for free list of books on Antiques. Beck, Griffon Rd., Hometown, Ind. 46748.

**10 BEAUTIFUL Arrowheads \$2.00.** Guajardo's, 8713 Shaver, El Paso, Texas 79925.

**WESTERN ANTIQUE MART: Collector's Monthly newspaper.** \$4.00 year, \$1.00 three Months, sample 35¢. Box 2171M, Eugene, Oregon 97402.

## MODELS—SHIPS, TRAINS, PLANES, ETC.

**SHIP And yacht model fittings: Pine construction hull kits: blueprints.** Send 50¢ for illustrated catalog. A. J. Fisher, Inc., 1002 Etowah Avenue, Royal Oak, Michigan 48067.

**SHIP Model kits and fittings: clippers, frigates, etc.** Catalog paint-tool list, 1969 catalog 50¢. Models Shipways, Box 65, Bogota, N.J. 07603.

**SHIP Models catalog 25¢.** Scientific, Inc., 100 Monroe, Newark, N.J. 07105.

**ROCKETS: Real flying models—flights up to 2500 ft.** New illustrated catalog 25¢. Single and multistage kits, cones, engines, launchers, trackers, rocket aerial cameras, technical information. Fast service. Estes Industries, Dept. 2, Penrose, Colorado 81240.

**SHIP Models, Kits, fittings, plans, books, tools, engines, motors.** Big illustrated catalog 50¢. Mass. residents add 3% tax. James Bliss & Co., Dept. SM, Route 128, Dedham, Mass. 02026.

**RADIO CONTROL model power boats.** Kits, engines, propellers, flywheels, universals, etc. Stamped, self-addressed envelope for illustrated literature. Octura Models, 8148 Milwaukee, Niles, Illinois 60648.

**MODEL Airplanes—Big 220 Page Catalog 50¢.** Sig Company, Montezuma, Iowa 50171.

**LIVE Steam Engine Kits.** Fascinating Hobby For Model Mechanics. Boilers, Fittings, Accessories. Pictured Catalog \$1.00. H.P.K. Models, Centuck 34, Yonkers U, New York 10710.

## GAMES, TOYS, PUZZLES, NOVELTIES

"ROULETTE DICE" . . . dice that have a range of 36 numbers. Only \$1.00, write D.E. Products & CO. Box 488, Worcester, Mass. 01601.

**CARIBBEAN Checker games \$2.00, color \$3.00.** C. Ljohn, 5118 Dorchester, Chicago, Ill. 60615.

**FREE Catalog.** D&J Novelties, 5044 Castlewood Drive, San Jose, Calif. 95129.

## MAGIC TRICKS, JOKES, VENTRILOQUISM

**HOUDINI'S Greatest Magic Tricks!!** You can do them! Giant Illustrated Catalog and Free Secret Trick, 25¢ House of 1000 Mysteries, Dept. PM70C, Ft. Lauderdale, Florida 33308.

**500 TRICKS.** Douglas famous Magic Catalog, only 10¢. Better Magic for pocket, club, stage. Fastest mail service. Douglas Magicland, Dept. 11, Dallas, Texas 75221.

**BE A Magician!** Two booklets explaining sixty-eight tricks plus large professional catalog. \$1.00. Magic Inc., 5082 Lincoln, Chicago, Illinois 60625.

**COMPLETELY Illustrated catalog, 84 pages, 25¢.** Manhattan Magic, Box 334-M, N.Y.C. 10011.

**WORLD'S Finest professional magic tricks.** Joker's Novelties. Giant illustrated catalog 10¢. Top Hat, Evanston, Illinois.

**MAGIC Catalog.** World's finest 3000 tricks. (340) pages \$2.50. Beginners, amateurs, professionals. Kanter's, A-200 South 13th St., Philadelphia, Pa. 19107.

**FREE! World's Leading Catalog 2000 Novelties, Jokes, Tricks, Scientific Gadgets, Hobbies.** Johnson-Smith, D-191, Detroit, Michigan 48224.

**FABULOUS MAGICS new 1970 catalogue 25¢.** Our specialty orders shipped same day no substitutes. Fabulous Magic, 3319 East Charleston, Las Vegas, Nevada 89104.

**HOUDINI'S Original Magic Shop.** Established 1856. Send 25 cents for illustrated Catalog containing 5000 Tricks. Mindreading, Puzzles, Hypnotism and Jokes. Flosshornmann, 304 West 34th St., N.Y. 10001.

**VENTRILOQUISM! Information free!** Dummy catalog 25¢. State age. Maher, Studio B, Box 9037, Denver, Colorado 80209.

**MAGIC MAGAZINE—Monthly since 1936.** 44 pages. All phases. 3 month trial \$1.00. Genii, P.O. Box 36068, Los Angeles, Calif. 90036.

**FREE Trick, Magic Magazine and Catalog 25¢.** Magic & Fun, Box 9-PM, New York, N.Y. 10022.

## BOOKS, CATALOGS, NEWSPAPER

FREE List of Low Cost Popular Books. Success, Wealth, Happiness, Personality, Personal Problems. PERCAPITA, UNLTD. 152 West 42nd Street, Suite 536-A New York, N.Y. 10036.

PAPERBACK Catalogue, 15,000 titles, \$1.00. Free Listings Publishers' Overstocks, Hardbounds, L.P.s, Savings to 84%. New York Book, 4 P West 43rd Street, N.Y.C.

FREE BOOK. Prophet Elijah Coming Before Christ. Megiddo Mission, Dept. 63, 481 Thurston Road, Rochester, N.Y. 14619.

1,000,000 BOOKS! Bargains! Free Catalogs! Bookanza, 6990 Aberdeen, Upper Darby, Pennsylvania 19082.

NATIONAL Geographic Magazines, 1888-1967, any issue. Buxbaum, Box 465-PM, Wilmington, Delaware 19899.

FREE! New List "How To" Books. Elston House, 35 Stonycliff, Centerville, Mass. 02632.

FREE! . . . FREE LIST! 73 low cost books on self-development. Amazing easy subjects to improve health, wealth, every day knowledge. Kenrey Books, 30 Ellwood St., New York, N.Y. 10040.

SELF-DEVELOPMENT. Autosuggestion books. Free Catalog. Collinse, Box 67 Appalachia, Virginia 24216.

BACK Issues, Thousands, List 50¢. Kelley, 65 California, Hempstead, N.Y. 11550.

ARCHAEOLOGY and Bible prophecy disclose, dangerous era ahead. Apostasy delineated. A real eye opener. Multiple horizons unveiled. "The Two Babylons," 330 pages, 61 illustrations. \$3.95 plus 50¢ mailing. Book Nook, Carls Viking House, Box 173, Minneapolis, Minnesota 55440.

BOOK Sale. Free List. Hillsdale Gifts, Box 144, Hillsdale, New Jersey 07642.

SEND 50¢ for Giant New Color Navy Arms Catalog Reference Book featuring America's largest selection of Muzzle Loading Replica Firearms & Accessories, which can be purchased by mail. Complete instruction on how to handle a Muzzle Loader and kits to build your own. Address: Navy Arms Company, 689 Bergen Blvd., Ridgefield, New Jersey 07657.

FREE Popular Mechanics NEW illustrated 32 page catalog of plans, publications and projects. Crammed full of fascinating ideas. Plans for boats, patio furniture, camping trailers, swimming pools. Projects for the home and shop. Special sections covering electronics and science. For information on hundreds of other exciting projects send for your catalog today. Enclose only 25¢ to cover postage & handling to: POPULAR MECHANICS, Dept. HE, 224 West 57th Street, New York, New York 10019.

## PLAYS, STORIES, MANUSCRIPTS

WANT Your book published? Learn how we publish advertise, promote, distribute. Many successes. Free booklet PM. Vantage, 120 West 31, New York City.

MANUSCRIPTS WANTED! Cash in on booming markets. Free information. R. French, P.O. Box 68, Middlesex, New Jersey 08846.

## BUSINESS OPPORTUNITIES

HOW And Where To Get Capital. Get \$500 to \$2,000,000 anywhere. Free trial offer. Counselor-17, Kerrville, Texas 78028.

SECRETS! Mail Order Success. Internationally famous expert reveals how to make home business fortunes. Beginners: Get free copy "Make Money By Mail." Discloses free advertising, profitable products. Mailco, 1554 Sepulveda, Dept. D-2702, Los Angeles 90025.

MAILORDER strategies that make men rich, revealed in dynamic new Guide. Free literature. Enterprises, 12860 Mayfield Rd., Box 107-L, Chardon, Ohio 44024.

MAKE Extra Money—Show friends, neighbors All Occasion Assortments, Easter, Stationery, Wrappings, Gifts, Toys, Jewelry. Experience unnecessary. Salable Samples on Approval. Free color catalog. Bonus Plan. Write Hedenkamp, 361 Broadway, Dept. PM-110, New York 10013.

HOW to Start and Operate a Successful Small Business. Write for free information and brochure. Merit House, 1810 Cabrillo, Oxnard, California 93030.

MONEYMAKING Plans! Over 600 Profit Proven Enterprises. Full, Sparetime. Write Wallace, Box 288-PM, Gladstone, Oregon 97207.

START Your Own Importing Business. Details Free. Merrihew, Department G1, 219 Lytton Road, Coraopolis, Pennsylvania 15108.

INSTALL Burglar alarms without previous experience or costly equipment. Big profit. Free details. Nasco, 11071 Massachusetts, Dept. D2702, Los Angeles 90025.

SELL Gifts And Household Items—Make extra money. Toys, Jewelry, Stationery, Wrappings, All Occasion, Easter Card Assortments. Salable Samples on approval. Free color catalog, Bonus Plan. Write Hedenkamp, 361 Broadway, Dept. PM-104, New York 10013.

MAKE Durable building plastic easily. Waterproof, fireproof, economical. Bays Laboratory, Cedaredge, Colo. 81413.

NAMES, Address of 100 Kyoto Japan Exporters, Importers, Manufacturers, only \$2.00. Meade Seaman, 1702 Followthru, Dept. Pal, Tampa, Florida 33612.

USED Ornamental Concrete Products Molds for Sale or Trade. Lawn Ornaments, Joliet, Montana 59041.

NEW plan! Pays up to \$25.00 an hour! Little as 4 hours weekly. Place Luxko self-service displays in stores. No cost to merchants. No experience needed. Free details. Lux Company Incorporated, Dept. 1300, Elkhart, Indiana 46514.

LIQUID Molding rubber also liquid plastics. Free information. Chaney's, 5415-A San Jose Blvd., Jacksonville, Fla. 32207.

OPERATE Restaurant. Free booklet reveals profitable plan. Write Restaurant Business School, Dept. EC-20 1920 Sunnyside, Chicago, Illinois 60640.

MY Invention Made Over \$1,000,000. Still making a fortune. My book "Secrets of Inventing" discloses it and other similar simple product ideas waiting to be invented. Proof \$1.95. Charles S. Prince, 509 5th Avenue, N.Y. 10017.

IMPORT-Export opportunity, profitable world-wide mailorder business from home, without capital; or travel abroad. We ship proven plan for no risk examination. Experience unnecessary. Free details. Mellinger, Dept. D2702, Los Angeles 90025.

BOOK Sent "999 Little-Known, Successful Businesses" on request. SBI-7, Kerrville, Texas 78028.

PIANO Tuning Learned Quickly at Home. Tremendous field! Musical Knowledge unnecessary. GI approved. Information Free. Empire School, Box 327, Miami, Florida 33145.

GROUND Floor opportunity in an Engraving business of your own—spare time or full time. One piece of raw material costing \$3.75 will produce products worth \$180.00! Free particulars! Write Warner, Room CE-2-E, 1512 Jarvis, Chicago, Ill. 60626.

MAKE Gorgeous original candles for all holidays and special occasions. Learn expert Candle decorating, candlemaking, use of professional molds. Free details on home instruction method. Candle Institute, Dept. YF, 1600 Cabrillo, Torrance, Calif. 90501.

FREE Book "990 Successful, Little-Known Businesses." Work Home! Plymouth—T-472, Brooklyn, New York 11218.

BIG Profits await you in Mailorder. Free Opportunities Catalog. Paul's, Box 5273-A, Phoenix, Arizona 85010.

BE YOUR OWN BOSS. Our instructional manuals show you how. Thousands of business opportunities. Free catalog. Informative Publications, Box 187, Painted Post, New York 14870.

MAILORDER Book publisher wants dealers. Wonderful "drop-ship" proposition. Sample imprint circulars free. Neil H. Tasker, Shamokin, Pennsylvania 17872.

I GROSSED OVER ONE MILLION DOLLARS year selling by mail. So can you, at home! Send \$2 for success book #PM. Wayne Johnson, 880 SW 60th Avenue, Ft. Lauderdale, Florida 33314.

BUILD Custom Cases at home for profit. Get orders by mail. We supply materials, instruction—everything. Free home business details. Custom Case Supply Co., 6961 CPB, Hayvenhurst Avenue, Van Nuys, California 91406.

TAKE Catalog orders. We drop-ship 1001 best selling specialty products. Guaranteed lowest below wholesale prices. Fantastic spare-full time home business. Free book shows you how. SMC 6963 SPB, Hayvenhurst Avenue, Van Nuys, California 91406.

MAILORDER Selling; what, where how. Details: Doorbar-PM, 3364 North West 35th Street, Fort Lauderdale, Florida 33309.

HUGE Profits! Mail order importing. Free information. ITIS, PM-2, Box 454, Hollywood, Calif. 90028.

\$400.00 MONTHLY Raising giant fishworms. Soilless method. Charlie Morgan, Bushnell, Florida 33513.

EARN Money raising fishworms for us! Write: Oakhaven-38, Cedar Hill, Texas 75104.

400,000 BARGAINS Below wholesale! Many free. Liquidations . . . closeouts . . . job lots . . . single samples. Free details. Bargainhunters Opportunities, Box 730A Holland, Michigan 49423.

ESTABLISH Profitable Catalog Mailorder Business! Vikari's, Box 1312-PMB, Salt Lake City, Utah 84110.

STOP Throwing Away Those Boxtops! They're worth money, some 25¢ each! Write: Boxtops—80, Cedar Hill, Texas 75104.

ADVERTISING BUSINESS—YOU own it. \$350 First Week or Money Back. Electric Neon Action Ad Clock, 229 W. Illinois, Chicago 60610.

JOIN "MONEY GETTER'S GUILD". Receive hundreds money-making, Business Building Propositions. Year's membership only 25¢. Write: Fourstars, Box 839, Long Beach, New York 11561.

I MADE \$40,000.00 Year by Mailorder! Helped others make money! Start with \$10.00—Free proof! Torrey, Box 318-Y, Ypsilanti, Michigan 48197.

MAIL Baby Catalogs imprinted with your address to New Mothers for Big Profits! Details 25¢. Volz-PM, Ypsilanti, Michigan 48197.

READ Progressive Mailtrade, the magazine that tells how to make money by mail. Quarter brings sample and special offer. Mailtrade, P.O. Box 357, Sheboygan, Wis. 53082.

VENDING Machine big catalog. Rake, 523 A Spring Garden, Philadelphia, Pa. 19123.

CLIP Newspaper items, \$1.60-\$5.00 each. Details free. Walter, Box 1360-PA Erie, Pa. 16512.

WANT To make big money at home? \$10.00 profit in an hour possible with invisible mending. Make tears, holes disappear from clothing, fabrics. Steady year-round demand from cleaners, laundries, homes. Details free. Fabricon, 1585 Howard, Chicago 60626.

(Continued on next page)

## BUSINESS OPPORTUNITIES

(Continued from preceding page)

**SELL Lifetime, Metal, Social Security Plates. Big Profits!** Sample and Sales Kit Free. Russell, Box 286-PM, Pulaski, Tennessee 38478.

**SPARE Time Cash—Sell Advertising Book Matches—every business a prospect—no investment—no experience needed to build steady repeat business. Daily Cash commission in advance. Write today—We'll send your sure-fire selling kit by return mail. Dept. MX270, Superior Match Co., 7530 S. Greenwood, Chicago, Illinois 60619.**

**COPUBLISH "Mail Sale Advertiser,"** leading mailorder paper. Copy and details 25¢. U.S.A. only. Vanroy Shirk, Lebanon, Pa. 17042.

**\$200.00 DAILY** in your mailbox! Your opportunity to do what mailorder experts do. Free details. Associates, Box 136-A, Holland, Michigan 49423.

**BIG Money-making new greaseless donuts in kitchen. Everything furnished. Sell stores. Free recipes. Montgomery Ray, Waseca, Minnesota 56093.**

**\$75.00 THOUSAND. Home Addressing!** Longhand, Typewriter. Information, send stamped self-addressed envelope. Brewster, Box 1348-TF, Clearwater, Florida 33517.

**FREE Selling Outfit, Office Supplies. Furniture & Equipment. Oseco, 15-PM North Jefferson. Chicago 60606.**

**UNLOCK Your Future. Become professional Locksmith by spare time home-study. Make up to \$6 per hour. All tools, equipment incl. Facts free. Send name. Locksmithing Inst., Dept. 1310-020, Little Fall, New Jersey 07424.**

**DRAFTSMEN! Operate own DRAFTING SERVICE!** Full, Part Time; Experience unnecessary; Details: Roberts Drafting, 1741 Circle Road, Baltimore, Maryland 21204.

**JEWELRYCRAFT—It's easy! Big profits!** Catalog, 25¢, Modern Craft, 12790 US 19; Clearwater, Florida 33516.

**MAIL Baby Catalogs, Imprint, to new Mothers. Big Profits!** Details \$1.00. Krefski, 609 Lee, Plymouth, Pa. 18651.

**RAISE Rabbits for us on \$500 month plan. Free details. White's Rabbitry, Mt. Vernon, Ohio 43050.**

**PERFECT husband-wife business. Learn Upholstery at home. Make \$10 in an hour. Buy-repair-sell for even bigger profits. Kits, tools included. Free Booklet. Upholstery Institute, Dept. 5310-020, Little Falls, New Jersey 07424.**

**MAKE, Sell magnetic car signs. Write PM-1834 Edgeland, Louisville, Ky. 40204.**

**PLASTERCRAFT Molds, liquid rubber, plasters, flock, candle supplies. Catalog and manual free. Blue Rapids Supply, Blue Rapids, Kansas 66411.**

**MAIL ORDER. No Inventory Needed. Free Catalog. Your Name imprinted. 127-FD Mailing Methods, Lafayette Hill, Pennsylvania 19444.**

**EARN \$60.00 DAILY** manufacturing Concrete Fence Posts. Practically no investment. Free information. Send stamp. American, Excelsior Springs, Mo. 64024.

**VACUUM Plastic Molding & Liquid Plastic Casting—At Home!** Make Hundreds of full 3-D plastic products. Big profit in spare time. Facts. Nationwide Plastics, Dept. LH, 4140 Eagle Rock Blvd., L.A., Calif. 90065.

**56 ACTIVE Franchise opportunities available all over USA. Brochure details 56 franchise chances for you to have your own business tied with successful national companies. Send name, address to P. Stewart, 1085 Walnut, Des Plaines, Illinois 60016.**

**TREMENDOUS \$1,000.00 Profit From 1,000 Mailings! Free Proof! George-PM, Box 2188, Cypress, California 90630.**

**MAILORDER Records help get increased business!** Complete 32 Page Record Book shows your inquiries, orders, advertising, expense, etc. Only \$1.00. C. A. Martin, Popular Mechanics, Dept. PM, 224 West 57 Street, New York, N.Y. 10019.

**\$500—\$800 MONTHLY** Raise small Laboratory-breeding stock for us. We supply equipment, breeders, and instructions. Illinois Research Farms, Dept. MPD-1, Barrington, Illinois 60010.

**MAILORDER—Profitable products; drop-shipped. No merchandise investment. Everything supplied—catalogs, ads, mailing lists. Gif-Guide, 1137 1/2 Crenshaw, Dept. 185, Los Angeles 90019.**

**MAILORDER "Pro" reveals secrets for starting profitable home business. Free brochure. Tory, Dept. 884PM, Bayonne, N.J. 07002.**

**BOOKKEEPERS Earn \$500.00 week. Operate Bookkeeping Tax Service. Details free. Universal, Box 664-M, Springfield, Missouri 65801.**

**MAIL ORDER Sell books. Fascinating, profitable, details. Jobre, Box 27, Great Neck, N.Y. 11023.**

**REPAIR WATCHES for profit. Learn at home. Free sample lesson. Chicago School, YBB, Fox River, Grove, Illinois 60021.**

**WORLD'S Largest supply. Merchandise 25% to 40% under wholesale. Bankrupts. Closeouts 10¢ on dollar. Imports. Hongkong clothes. Automobile discounts. Free details. International Buyers, Box 16386-MM Portland, Oregon 97233.**

**HOLLYWOOD CEMENTCRAFT: Offers Highly Profitable Home Business. Experience Unnecessary. Unlimited Unique Pottery Designs Easily Made Without Moulds. Bird-baths, Fountains, Wishing-Well, Waterfalls, etc. Chemical Coloring Formulas, Marble-glazing. FREE Illustrated Brochure. CONCRETE FACTS, 602 Athens Street, Altadena, California 91001.**

**\$60.00 DAY. Manufacturing concrete Posts, Blocks, Mold Equipment Catalog \$1.00 refundable. Carlyne, Route One, Box 106T, Rapid City, South Dakota 57701.**

**AMAZING PROFITS! Sell by mail quality self-improvement books. Drop-shipped by reliable publisher. GRAPHIC, 1033-PM S.W. 53rd, Oklahoma City, Oklahoma 73109.**

**SIMPLE, EASY way to enter mail order. Earn \$12,000 year up. Stamp for details. Emptage, 1033-PM S. W. 53rd, Oklahoma City, Oklahoma 73109.**

**SELL Books by mail. 400% profit. Royal, Box 450-X Cleveland, Ohio 44127.**

**OUR "Never Undersold" guarantee enables you to offer Toys, Novelties, Watches, Clocks, Binoculars, Hats, Premium, Plush etc. At unbelievable profits. Specialty Wholesale Products Co., 11136 Chandler Blvd., Dept. PM-2, N. Hollywood, Calif. 91601.**

**FREE "Franchise Profit Letter" tells how unique NR Service is helping thousands seeking profitable businesses. Write today. National Franchise Reports, W-528, 333 North Michigan, Chicago 60601.**

**RECEIVE Lots of mail with money-making offers! Your name on giant, nationwide mailing lists, 20¢. Sullins, Box 2062-M, Forsyth, Georgia 31029.**

**YOUR OWN BUSINESS Part-Full Time \$2-500 Week. Become Professional Driving Instructor. Free Details, Howard David, 1818 Evarts St., Phila., Pa. 19152.**

**QUICK Income with Mail Order Collection Agency. \$1000 monthly and more. We show you how. Continental, Box 2023-A, Des Moines, Iowa 50310.**

**MAKE Money from old tires. Operators clearing \$800, weekly. Equipment costs \$1500. Get facts, S & S Patents, Inc., 3752 N. Damen, Chicago 60618.**

**MAKE \$46 from square foot plywood: jigsaw or bandsaw necessary. Free details. Woodard, Bridgewater, Mass. 02324.**

**BIG profit in mail order. Hilltop, Dept. 24, Clive, Iowa 50053.**

**MAKE Big Money Growing Ginseng. \$3,000-\$30,000 annually. We buy your crop. Send \$2 for seed sample and information. Glass' Ginseng Exchange, Box 336 Rochdale Station, Jamaica, N.Y. 11434.**

**SELL Greeting Cards—Make extra money. All Occasion Assortments, Easter, Stationery, Wrappings, Gifts, Toys, Jewelry. Experience unnecessary. Salable Samples on Approval. Free color catalog. Bonus Plan. Write Hedenkamp, 361 Broadway, Dept. PM-107, New York 10013.**

**\$9/1000 MAILORDER Catalogs! Prepare your own catalog, easily, including hundreds popular "Drop Ship" products! Guaranteed 100% Do-It-Yourself! Free Catalog—Proof! Obie, 5711-MKB—14th, Brooklyn, New York 11219.**

**GROW FISHWORMS. Outstanding New Breed produces great profits! Free literature. Fain's Hatchery-26, Edison, Ga. 31746.**

**609 UNUSUAL Businesses. Unlike anything you have ever read before! Work at home. Free details. Carita, Dept. PM, 8 Hillcrest Road, Norwood, Massachusetts 02062.**

**"100 MAIL Order Success Secrets." Details—25¢. Munroe, Box 3152-EE, Winter Haven, Fla. 33880.**

**BUSINESS OPPORTUNITIES—Sell Name brand Records 45 RPM 10¢ in 100 lots 33 RPM albums Retail to \$4.75. Only \$1.00 in 100 lots. Send check, Money order. Ragan International, 1450 West 72nd Street, Hialeah, Florida 33014.**

**HOMEWORK, mailing circulars! Free details! Cam Co., Dept. 155-XO Verona, N.J. 07044.**

**MIMEOGRAPH Machine 8 1/2 x 11. \$11.00. Guaranteed. Homecraft, 2350 W47 Denver, Colorado 80211.**

**START Your PROFITABLE, LOW Investment Mailorder Business the EASY way. Details free. Falk, 91-P Myles, Levittown, New York 11756.**

**BECOME Tax consultant. Our students earn \$1,000-\$3,000 every tax season preparing returns evenings. State approved. National Tax School, Monsey 2PB, New York 10952.**

**FREE Catalogs. Repair air conditioning refrigeration. Tools, supplies, full instructions. Doolin, 2016 Canton, Dallas, Texas 75201.**

**\$2.00 PER Dozen Cash Profits. Assemble New Art Foam Products. All Supplies Furnished. Showcase, Box 55392D, Indianapolis, Indiana 46205.**

**CALIFORNIA MANUFACTURER NEEDS man to assemble our product and be local agent, experience unnecessary. May start while presently employed. Five-figure income for responsible applicant. S.K.R.M. Manufacturers, 2347 West 238 Street, Torrance, California 90501.**

**\$300.00 WEEKLY Profit Possible using our proven mailorder plan. Excellent part time business for either men, women. Details free. Write: Williams, Box 44646A, Los Angeles 90044.**

**VENDING Machines. No selling. Routes earn amazing profits. Big catalogue Free. Parkway Corporation, 715PBM Ensor Street, Baltimore, Maryland 21202.**

**MAKE \$1000 PER MONTH—Vacuum Forming 3-D and Magnetic Signs, Packaging. Mold Thousands of items. Build Professional 25 x 36 Machine Yourself. Send 24.95 for complete Plans. Kits Available. Refundable. Slack's Enterprises, Box 458, Melbourne, Florida 32901.**

**HOME WORK—PART TIME Male or fem., age no limit. Can earn \$2 or more per hour. Nothing to buy, nothing to sell; we supply all. Send stamped, addressed envelope World Sales, Box 8102, Glendale, Cal. 91214.**

**AN Analysis of the MAIL ORDER MONEY GAME will save you money and assist you. Guaranteed. \$1 Complete. Myriad, Box 18102, Cleveland 44118.**

**IMPORT BUSINESS. Details \$1.00. Swiss Import, Box 191, Verona, New Jersey 07044.**

(Continued on next page)

## BUSINESS OPPORTUNITIES

(Continued from preceding page)

**SECRETS!!!** Hundreds Proven Money-Making Opportunities!! Write Today! International; Box 1138-AB; Monroe, Louisiana 71201.

**\$70.00 WEEKLY**—home, spare time. Simplified mail bookkeeping. Immediate income easy. Auditax, 34741A, Los Angeles 90034.

**"MONEYMAKING Secrets Revealed"!** Unique Newsletter. Moneymaker Reports, 1405 Locust, EB-0502, Philadelphia, Pennsylvania 19102.

**ESTABLISH** profitable CONCERT MANAGEMENT. Your community. Details free. CONCERTS, 905-A Fox Bldg., Detroit, Mich. 48201.

**1/2 PRICE!** Cameras! Wigs! 1001 more. Buy direct or start Mail Order Business. Directory of 200 foreign firms. \$2.00 Catalina, Box 10077, San Diego, Calif. 92110.

**"DETERGENT** for motor oil. Need distributors, retailers for DuPont's cyclohexanone, 12-95¢ bottles for \$4.00. Pure Detergent, Box 1081, Buffalo, N. Y. 14240."

**TIN-Cans, Sawdust, Newspapers, Glass, Rags, Rubber, 324 Uses, Instructions \$3.00.** Satisfaction guaranteed. Charles Company, 42-GWP, Norwood, Ohio 45212.

**PIANO** Tuning instructions with tools, only \$19.95. Details free. Stamm Industries, Dept. PM-2, Oregon, Ill. 61061.

**MAILORDER** books and directories. Free information. E-C Supply, Box 149, N. Olmsted, Ohio 44070.

**BURGLAR** Alarms. 200% Profits. Easy! Free Particulars, Alarms, Uleta, Florida 33164.

**"BUILDERS** Trace Secrets" Become Rich!! Builder, Box 99, Uleta, Florida 33164.

**EARN \$10,000** Yearly Raising Chinchillas. Instructions, Price List \$1.00. High's Chinchillas, Peosta, Iowa 52068.

**WANT** Mail order profits? Avoid costly mistakes! Get low cost professional help. Free literature. Ryan, Box 148A, Oakland, California 94604.

**ADDRESSERS** And mailers needed. Send stamp for information. Lindbloom, 3636 West Peterson, Chicago 60645.

**1000% PROFIT** Bronzing Shoes. Free Literature—N.B.C. Box 11069-PM Kansas City 64119.

**FANTASTIC** Opportunity—Your Own Gift Catalog Business! No merchandise investment! Free Sample Catalog! Mail Marketing Services, Benton, Illinois 62812.

**CLIP** short newspaper paragraphs. Up to \$10 each. Details free. Foster, 272-M2, Brooklyn 11235.

**ROAD TO INDEPENDENCE!** Take The First Step Today. Start Your OWN Business. Free Details. SCOTT, PM270, 3 Journal Square, Jersey City, N.J. 07306.

**ADOPT AN IMPORT.** Increase your firm's sales potential. Or start new business or part-time venture. Our newsletter lists hundreds of new foreign products offered direct by foreign manufacturers. Details Free. International Interdex, Box 636, Newark, N.J. 07101.

**WHOLESALE**—Buy 40% to 50% off retail—same prices retailers pay! Thousands of name brands: watches, cameras, jewelry, radios, phonographs, tape recorders, etc. Buy for yourself or resell at fat profit. Big Wholesale Catalog, Confidential Wholesale Price List. Free details. Consumers' Buying Guild, Dept. PM, 250 Fulton, Hempstead, N.Y. 11550.

## MONEYMAKING OPPORTUNITIES

**SELF-MADE MILLIONAIRE** tells his secret. Immediate results guaranteed. \$1.00. Box 232, Woodstock, N.Y. 12498.

**\$5.00 A FOOT** Possible for green or dead wood. List of buyers \$2.00. Awant, 314 Ashland, San Antonio, Texas 78218.

**TEAR OUT THIS AD,** mail with name, address for big box of home needs and cosmetics. **FREE** to reliable men and women. Tell and show friends, make good money spare time taking their orders. Write today. BLAIR, Dept. 31JB, Lynchburg, Va. 24505.

**SHARP \$\$\$\$** opportunity! One low-cost machine sharpens serrated knives, scissors, pinking shears. Earn \$6-\$9 hourly in spare time. Professional results without experience. Free details. Beaver Grinder 320 Nielsen Building, Eugene, Oregon 97402.

**CAMERA** Owners, earn easy money for photographs. Send \$1.00 for information booklet. Satisfaction Guaranteed. Burns, 5509B West Rosedale, Ft. Worth, Texas 76107.

**INFORMATION** On opportunities in importing-exporting, photographing models. Write: PM-1 Distributors, Box 83, Verdun, Quebec.

**SKETCH** Photos—Home Goldmine! Details. Gem, 365F Longhill, Shelton, Conn. 06484.

**SMALL PRESS OWNERS!** Kelsey, others. 3x5, 5x8, etc. Proven mailorder plans. Details, samples, \$1.00. Seiders, 591 Washington, Amherst, Ohio 44001.

**MONEY—SPARETIME OPPORTUNITY PANELISTS AT HOME WANTED BY NEW YORK RESEARCHER.** Leading research firm seeking people to furnish honest opinions by mail from home. Pays cash for all opinions rendered. Clients' products supplied at no cost. For information write: Research 669 Mineola, N.Y. 11501. Dept. PM-24.

**EXCELLENT PROFITS! LIFETIME** Engraved Social Security Cards. Free Sample. MGR STUDIOS, 4445 Berke, Fort Worth, Texas 76115.

**OVER \$16.50** an hour. Spare time at home! Rubber Stamp industry needs small manufacturers. We furnish all equipment and know-how! Particulars free! Write: Roberts, 1512 Jarvis, Room CR-2-E, Chicago, Ill. 60626.

**SELL** Sensational Car Thief Signal. Write Northwest Electric, Ave. 627, Mitchell, S. Dak. 57301.

**BLACK** Widow Spider Ranchers wanted!! Tremendous profits! Complete program \$1 (refundable). NBWC, Box 260-PM6, Brigham City, Utah 84302.

**"FLESH** Eating Moon Plants!!!" Raise Astronomical Profits!!! 3 living plants, tremendous guaranteed program!! \$1.25 (returnable). Biowitics, P.O. 260 BPM1, Brigham City, Utah 84302.

**BIG** Money dealership. 7 new mailorder offers. Everything dropshipped. Free details. Marnel, Box 485-C, Framingham, Massachusetts 01701.

**MAKE** \$5,000 yearly, sparettime, raising mink, chinchilla, nutria, etc. Free booklet reveals proven plan. Write: Furs, Dept. R, Bewdley, Ont., Canada.

**CIGARETTES** 12¢ a pack. Improved roller makes 20 filtertip, plain, king or regular for 12¢. Facts free. Moberly, Box 953, Owensboro, Kentucky 42301.

**EARN** \$240.00 a month at home, spare time, doing only two \$5.00 invisible mending jobs a day. Big money paid for service that makes cuts, tears disappear from fabrics. Steady demand. Details free. Fabricon, 1532 Howard, Chicago 60626.

**MAKE** Statuettes, novelties, imitation marble. Sell to stores or start gift shop. Free details. Marbleizing, 41 Waverton, St. Louis, Mo. 63124.

**HOW** To Make money writing short paragraphs. Information free. Barrett, Dept. C-27-A1, 6216 N. Clark, Chicago 60626.

**FREE** Copy of world's leading contest magazine! Write Prizewinner, Box 11569, St. Petersburg, Fla. 33733.

**FREE.** 206 Easy Ways to make money taking orders for exciting new products—spare time. Send name, age for 5 months free subscription. Opportunity Magazine, 1460 Hancock Center, Dept. 17-BM, Chicago 60611.

**HOMEWORK.** Mailing circulars. Free details! Cam Company, Dept. 155-KP, Verona, N.J. 07044.

**SCIENTIFIC** Messages: Big Earnings uncrowded profession. Learn spare time at home. Diploma awarded. Free catalog. Write Anderson School, Dept. B-1C, Princeton, Illinois 61356.

**CLIP** Newspaper items. \$1.00-\$5.00 each. Details free. Walter, Box 1360-P, Erie, Pa. 16512.

**MAKE:** \$12.00 Profit each dozen assembling Belts. Details Free. (Stamp appreciated.) Redikut's-40, Richland Center, Wis.

**HOW** TO GET RICH!! Free "Money-making Brochure"! Success International, Box 2447-C, Livonia, Mich. 48151.

**ART** Talent? Be your own boss. Earn \$200 weekly freelancing. Free Brochure. Famous American Studios, P6, Spring Park, Minnesota 55384.

**\$200.00** FROM Sheet 1/4" plywood (scrap). Details 25¢. Novelties, 610 So. 24th, Elwood, Indiana 46036.

**LEARN** To Fix Typewriters. Desperate shortage trained men. Hundreds needed. Make up to \$25 in one hour. Learn at home in spare time. Industry Approved course. Facts free. Send name. Typewriter Repair School, Dept. 3310-020, Little Falls, New Jersey 07424.

**HOMEWORKERS!** 200 companies—48 page Directory. FREE details. Quest-12, Box 6029, San Jose, California 95150.

**MAKE** more money—Take orders for Book Matches. Prospects everywhere—every day is payday—no experience needed—no investment. We'll send you power house selling kit with new complete catalog so you can make quick sales and big cash commissions. Superior Match. Dept. MA270, 7528 S. Greenwood, Chicago 60619.

**FREE** Book "MoneyMoneyMoney—How to Make it in Mail Order." Plymouth-T47, Brooklyn, N.Y. 11218.

**SELL** What You Write. Instantly! Beginners Market List tells where, how, and what to write. Send stamped, self-addressed envelope, free proof. Economy, Box 1348-G, Clearwater, Florida 33517.

**PLASTERCRAFT** HANDBOOK Illustrated, instructions statuary pouring, finishing, selling and mold making. Also where to obtain all materials. Only \$3.00 postpaid. Guaranteed. Wolfe, Box 561GB, Melbourne Beach, Florida 32951.

**\$500—\$800** MONTHLY Raise small Laboratory-breeding stock for us. We supply equipment, breeders, and instructions. Illinois Research Farms, Dept. MP-1, Barrington, Illinois 60010.

**HOW** To Prepare Mailorder 'Drop Ship' Catalog, easily . . . inexpensively! Obie, 5711-MLB-14th, Brooklyn, New York 11219.

**\$52.00** WEEKLY! Sparettime! Addressing. Details—10¢. Tory Co., Dept. 206PM, Bayonne, N.J. 07002.

**MECHANICALLY** inclined? Learn profitable WATCH REPAIRING. Free sample lesson. Watchmaking, YBA, Fox River Grove, Illinois 60021.

**SPARE** Time cash. Sell Famous Hanover Shoes. Actual samples and sales kit Free. No experience needed. No age limit. Lowest prices for high quality makes selling easy. Every man a prospect. Big daily commissions. For full details. Write Hanover Shoe, 531 Carlisle, Hanover, Penna. 17331.

**FREE** Details. "990 Successful, Little-Known Businesses." Conn. Box 1274-A, Fort Wayne, Indiana 46801.

**MAKE** Money writing short articles at home. Details FREE. Lockett; Dept. 170; 4153 Lancaster, Philadelphia, Pa. 19104.

(Continued on next page)

## MONEYMAKING OPPORTUNITIES

(Continued from preceding page)

**HOW TO GET RICH!** Amazing plan revealed! \$2.00 Refundable. Seco, Box 144, Walkerton, Indiana 46574.

**HOME Business Opportunity Pac 50¢.** Details Free. UMC, Hartford, South Dakota 57033.

**LEARN** The secrets of repairing junk batteries "Fabulous Profits" at home. Batterymen, Route 1-188 D, Blythe, Calif. 92225.

**WRITE** for Television. Will establish. Boiticus, 22841 Calabash, Woodland Hills, Calif. 91364.

**\$2.40 HOURLY** Making simple wood novelties. Free details! Gene's, 55 Boxwood, Falmouth, Mass. 02540.

**HOMEWORK Pays!** 75 Companies Begging for Sparetime Workers . . . Complete Instructions. List, \$1.00. Opportunities, Box 11071-PB, Indianapolis, Indiana 46201.

**WIN \$1,000,000?** Others Have in little-known Government Oil Lottery! Odds Better than Sweepstakes! Exclusive New Report gives complete details. Send \$1.00. International Publications, Box 29193-AB, Indianapolis, Indiana 46229.

**FREE!** List of low cost Popular Books. Success, Happiness, Personality, Wealth, Personal problems. **KINGSBORO GIFTS**, 3439C, Kingsboro Road N.E., Atlanta, Georgia 30326.

**BUILD UNIQUE AUTO LIFTS** in your home for under \$5.00. Instructions \$1.00 Indy Tek, 1233 E. Troy, Indianapolis, Ind. 46203.

**"WOULD \$50,000.00 a year interest you?"** With all replies send \$1.00 to C. P. A. P.O. Box 221, Great Falls, Montana 59401.

**START Your Own Mailorder Business.** No inventory—everything drop shipped to your customers under your label. Details Free. American Enterprises, Dept. 97 PM, Chauvin, Louisiana 70344.

**PROFIT** from coin collecting! Booklet tells how to start, where to sell. Lists of valuable coins. Send \$1.00. Gift Corner, 18 Marlon Drive, Wayne, N.J. 07470.

**MAKE Big Money.** Write short paragraphs. Details absolutely free. Imperial, 501 Wayoata, Winnipeg 25, Manitoba, Canada.

**INTERESTED** in Mailorder and Money? Advancement, Box 24, La Grange, Illinois 60525.

**SELL Lifetime Social Security plates.** Free sample, Lady P. McGuire, Rt. #6, Anderson, S.C. 29621.

**FREE Circular-Manuscript:** raising Capital. Gene Chiasson, 507 West 8th Street, Dept. PM, Thibodaux, Louisiana 70301.

**VENDING Machines.** No selling. Routes earn amazing profits. Big catalogue Free. Parkway Corporation, 715PMM Ensor Street Baltimore, Maryland 21202.

**HOME Profits!** Sell books by mail. Small capital, no inventory. Rudinger, 224PM Post, San Antonio, Texas 78215.

**START A profitable subscription business** in spare time! We need men and women (young and old) as representatives for all leading national magazines. Liberal commissions on all subscriptions. Supplies free. No experience needed. Send this ad with your name and address to Popular Mechanics, Room 2-0, 250 W. 55th St., New York, N.Y. 10010.

**SELL YOUR Home-manufactured products** for profit. New manual tells how. Free details. Flexipress-PM2, 10918 South Western, Chicago, Ill. 60643.

**"CLIP Newspaper Items for Cash.** Details Davan, Box 269DX, Holden, Massachusetts 01520."

**WANTED:** Men, Women to re-write ideas, suggestions for newspapers, magazines. We show you how. National Writers, Box 2190-A, Des Moines, Iowa 50310.

**MAKE MONEY** operating high profit, low investment home business. MONOGRAPH, Box 661, Cucamonga, California 91730.

**HIGH Profits—Strong demand.** Sell U.S. stamps by mail. Cross, 1212 Lynch St. Louis, Mo. 63118.

**EARN Good Money Using Your Pen!** How . . . What . . . Where . . . \$1.00. Best Seller Gifts, 485-A Fifth Avenue, New York, N.Y. 10017.

**HIGHER INCOME, Security and Power.** 256 page Book "Thinking Big" reveals secrets that make men Rich! Send \$2.00. Shoppers Friend, 1107 Lehman, Houston, Texas 77018.

**NEW Sign Making Discovery.** Learn in day. Talent Experience Unessential. Paint signs in minutes. \$1.50 investment. Free Details. Simplex Signs, P.O. Box 3059, Hamilton, Ohio 45013.

**\$350 MONTH Addressing!** Details, mail self-addressed envelope and 25¢. Happy, Box 1161-CC, Battle Creek, Michigan 49016.

**RICHES WITHOUT GIMMICKS.** This self-advancement strategy with action—techniques can work for you. Details free. Arbor House, 220 Sherman Street, Watertown, New York 13601.

**FREE FRANCHISE JOURNAL** magazine with over 100 franchise opportunities in every issue. Franchise Journal, Dept. G, Box 1790, Newport Beach, Calif. 92663.

**"SWEEPSTAKES Can Be Reapstakes"** \$1.00. Benro Enterprises, Box 6656-PM, Philadelphia, Pa. 19149.

**"MONEY Making Guide"** using everyday procedures \$3.00. Guaranteed. L. W. Carr, P.O. Box 822, Bronx, New York 10459.

## PROFITABLE OCCUPATIONS

**FREE Book "990 Successful, Little-Known Businesses."** Work Home! Plymouth 47-T, Brooklyn, New York 11218.

**EARN \$240.00 A month** at home, spare time, doing only two \$5.00 invisible mending jobs a day. Big money paid for service that makes cuts, tears disappear from fabrics. Steady demand. Details free. Fabricon, 1586 Howard, Chicago 60026.

**HOW To Make Money writing short Paragraphs.** Information Free. Barrett, Dept. C-27-A2, 6216 N. Clark, Chicago 60626.

**CHROME Plating Instructions,** equipment and supplies. Platers' Supply, P.O. Box 565, Lugo Station, Los Angeles, Calif. 90023.

**FT. SMITH Auction School.** Ft. Smith, Ark. Residents & Home study. Veteran approved.

**BAKE New greaseless doughnuts** in kitchen. Sell stores. Free recipes. Michael Ray, Waseca, Minnesota 56093.

**BECOME A mortgage broker,** earn \$10,000 to \$50,000 a year. Details free. United, Box 6284A, Marietta, Georgia 30060.

**\$500—\$800 MONTHLY** Raise small Laboratory-breeding stock for us. We supply equipment, breeders, and instructions. Illinois Research Farms, Dept. MPA-1, Barrington, Illinois 60010.

**CULTURED MARBLE** vanity tops with lavatory bowls cast into one unit. Manufacture in your basement or garage. Big profits. Marco, P.O. Box 2733, Augusta, Georgia 30904.

**HOW To Make Money Writing Short Paragraphs.** Information Free. Treasures, 6210-B, Hampton, Norfolk, Virginia 23508.

**SHARPEN Scissors, Pinkers.** Inexpensive equipment, tools, supplies. Blackhawk's, Sheldahl, Iowa 50243.

**START A magazine subscription business.** Earn generous commissions on Popular Mechanics, Good Housekeeping and all others. Best commissions, bonus, all material sent free. No experience needed. Write Popular Mechanics, Room 2-P, 250 West 55th St., New York, N.Y. 10019.

**FREE Information! Homeworkers' Opportunity!** Hathaway, 1522-PBM Beechwood Circle, Cuyahoga Falls, Ohio 44221.

**MORTGAGE Brokerage, Lucrative!** Huge Commissions. Free Particulars. Chase, Uleta, Florida 33164.

## SALESMEN—DISTRIBUTORS

**HOUSEHOLD Products Route.** Earn \$25.00 or more daily. Larger repeat orders. Man, woman. Full, part time. McNess, Freeport 2620, Illinois 61032.

**GET New shirt outfit free!** \$90 weekly on 5 average orders a day. Famous quality made-to-measure dress and sport shirts at \$4.95 up, sell to all men. No experience needed. Full or part time. Write: Packard Shirt Co., Dept. 316, Terre Haute, Indiana 47808.

**LONG needed invention.** Man contact service stations. Full or part time. Huge profits. Write Cyclo Mfg., 3816 Dahlia, Dept. 115, Denver, Colorado.

**MAKE extra \$25 to \$75 spare time!** Take orders for double air cushion Bronson Shoes. Men's, women's line for dress, work, play. Highest commissions. Shoes for yourself. Outfit Free. Bronson, Dept. 202, Minneapolis, Minnesota 55408.

**BIG earnings selling Hertel Bibles.** New 3-dimension cover, finest reference edition sells fast. Demonstrator furnished. Big commission. International Book, Dept. PM, Box 118, Wichita, Kansas 67201.

**47 MONEY-making Specialties.** Latest conveniences for home, car. Send no money. Just your name. Kristee 136, Akron, Ohio 44308.

**SELL America's biggest value wedding line!** Big 40% profit showing wedding invitations and over 50 exciting accessory items. Sideline for printing, Christmas card salesmen. Send \$1.00 for album, refundable on first order. Elmcraft, 7201 S. Cicero, Dept. EW-168, Chicago, Illinois 60629.

**SELL Advertising Ball Pens, Calendars, Ad-Specialties—Build Own Repeat Business—Free Kit—Fleming, Dept. A, 6535 Cottage Grove, Chicago 60637.**

**SELL yourself,** sell neighbors mobile home awnings, carports, tool sheds, skirting. Groff, Box 15417, Tampa, Florida 33614.

**EARN Big Commission Full or Part Time.** Show America's largest line Low Priced Business Printing and Advertising Specialties Plus calendars in season. No experience. No investment. No collections or deliveries. On-the-spot commissions. Big Free Sales Kit samples hundred items used daily by businessmen. Merchandise bonuses for you. Build profitable repeat business. Start now. National Press, Dept. 01D, North Chicago, Ill. 60064.

**DO You wish to use or sell a plant food** that is field proven, shows the greatest results at lowest cost? Something different in sales and use. Big monthly income or get your fertilizer FREE. Campbell's Gro-Green, 414 Dewey, Rochelle, Illinois.

**FREE. 206 Easy Ways to make money** taking orders for exciting new products—spare time. Send name, age for 5 months free subscription. Opportunity Magazine, 1460 Hancock Center, Dept. 17-BS, Chicago 60611.

**EARN big money calling on business-professional men.** Send us their delinquent accounts for collection. General Finance, Dept. PM-11 Columbia Bank Bldg., Kansas City, Mo. 64106.

**100% PROFIT—Sweet Georgia Brown** Cosmetics sell fast. Write for Sample Case offer. Valmor, Dept. H, 2411 Prairie, Chicago 60616.

**FREE Selling Outfit Office Supplies.** Furniture & Equipment. Osco, 15-PM North Jefferson, Chicago 60606.

**HOW To Prepare Mailorder 'Drop Ship' Catalog,** easily . . . inexpensively! Obie, 5711-MMB-14th, Brooklyn, New York 11219.

(Continued on next page)



## SALESMEN—DISTRIBUTORS

(Continued from preceding page)

SELL High Profit service station items. Free list. Inka, 2401 Crocker, Houston, Texas 77006.

SALESMEN DISTRIBUTORS Show men how to save up to \$200.00 yearly on haircuts with new mfg. product \$3.00. Send \$18.00 SAMPLE dozen United Company, 1231 Lafayette Street, Cape Coral, Florida 33904.

\$1200.00 + MONTH Distributing New Household Repeat Product. Details. Flash, 3816 Butler Street, Pittsburgh, Penna. 15201.

PERSONAL Protective Devices Now In Big Demand due to increased crime rate. Proven. Sell easy to Drive-ins, Stores, Nurses, Night Workers, Motorists. Sales experience unnecessary. Get profit details now. Hagen Supply, Dept. CLA20, St. Paul, Minn. 55107.

\$2.00 PAINTINGS! Enormous Profits Possible Selling—Artist's Original Canvas Oil Landscapes. Realistic. Professional Quality 4"X6" Samples \$2.00 each. Low Wholesale prices. Other sizes. Harris, Box 1567, Portland, Oregon 97207.

## AGENTS WANTED

MAKE Extra Money—Show friends, neighbors All Occasion Assortments, Easter, Stationery, Wrappings, Gifts, Toys, Jewelry. Experience unnecessary. Salable Samples on Approval. Free color catalog. Bonus Plan. Write Hedenkamp, 361 Broadway, Dept. PM-111, New York 10013.

WANT TO MAKE UP TO \$100 A WEEK spare time, and get free shoes for life, too? No investment. Rush card for free details. Mason Shoes, K-768, Chippewa Falls, Wisconsin 54729.

EVERY Man a prospect. Refundable sales kit offer showing line belt buckles, tie clasps, money clips, cuff links, lapels, identification badges, individualized with customer's name and emblems. Cap badges for trucking, bus, taxi, police, firemen, also postal, letter carriers and heavy construction emblems. Choice 3000 emblems. Hook-Fast, Box 1088PM, Providence, R.I. 02901.

PRINTING, Advertising Salesmen—Excellent moneymaking sideline selling Decalcomania Name Plates, small quantities. Advertising Specialties, sign letters. Free Samples, Raico XL, Boston, Mass. 02119.

LIFETIME Income. Business Loan Representative Write: Financial, 28 E. Jackson, Suite 1204-X3, Chicago 60604.

FREE. 206 Easy Ways to make money taking orders for exciting new products—spare time. Send name, age for 5 months free subscription. Opportunity Magazine, 1460 Hancock Center, Dept. 17-BA, Chicago 60611.

PROFITABLE! FULL OR PART TIME. Represent largest manufacturer of removable magnetic signs for cars and trucks. Trimetric, 2654 Saddle, Oxnard, California 93030.

TEXAS OIL COMPANY. PREFER GOOD MEN OVER 40. Tremendous earning potential. Call on building owners and managers. Leading products. We train. Air mail M. A. Dickerson, Pres., Southwestern Petroleum Corp., Dept. L, Fort Worth, Texas.

SELL Gifts And Household Items—Make extra money. Toys, Jewelry, Stationery, Wrappings, All Occasion, Easter Card Assortments. Salable Samples on approval. Free color catalog. Bonus Plan. Write Hedenkamp, 361 Broadway, Dept. PM-105, New York 10013.

WILL you test new items in your home? Surprisingly big pay. Latest conveniences for home, car. Send no money. Just your name. Kristee, 163, Akron, Ohio 44308.

YOUR own business—Used Suits \$1.50; Overcoats 65¢; Mackinaws 35¢; Shoes 12½¢; Ladies' Coats 30¢; Dresses 15¢. Enormous profits. Catalog free. Superior Jobbing, 2111-AA Roosevelt Road, Chicago, Illinois 60608.

SELL Greeting Cards—Make extra money. All Occasion Assortments, Easter, Stationery, Wrappings, Gifts, Toys, Jewelry. Experience unnecessary. Salable Samples on Approval. Free color catalog. Bonus Plan. Write Hedenkamp, 361 Broadway, Dept. PM-108, New York 10013.

## EMPLOYMENT INFORMATION

AUSTRALIA 1970 Directory! Biggest! 65,000 Jobs in Construction, Mechanics, Sales, More! Guaranteed, \$1.00. Austrajobs, Box 5157-G, Fort Wayne, Indiana 46805.

AUSTRALIA WANTS YOU! Government Assisted Passage. 50,000 Jobs. Latest Government Information and Forms \$1.00. Special Reports on Employment, Business, Taxes, Housing, Education, Ranching, Farming, Teaching, Maps, Etc. AUSTCO, Box 3623-E, Long Beach, California 90803.

HIGH Paying overseas jobs. Construction, other projects. Bonuses. Travel Expenses. Extras. International Information, 124, Cortez, Florida 33522.

ALASKA. High pay jobs, many with room and board furnished. Send \$3.00 for brochure. H-W ENTERPRISES, Box 4-406 Anchorage, Alaska 99503.

FOREIGN And USA job opportunities available now. Construction, all trades. Earnings to \$3,000.00 monthly. Paid overtime, travel bonuses. Write, Universal Employment, Woodbridge, Conn. 06525

"HOW To Get Overseas Jobs"—World-wide—Lists Hiring Organizations—143 pages—\$3.98—Refundable. Staydryp—Whitestone, New York.

CONSTRUCTION WORKERS—Hundreds of big jobs now underway in the USA and Overseas—Send \$2.00 for World-Wide Guide—Satisfaction Guaranteed. Construction Job-Guide, P.O. Box 09195, Chicago, Illinois 60609.

ALASKA! Due to the interest in the oil industry and construction projects in Alaska, our Research Department has made public their annual report; showing how to obtain employment, cost of living, wages paid, etc. For a copy, send \$3.00 to B & J Surveys, Box 265, Lost Hills, California 93249.

"AUSTRALIAN OPPORTUNITIES HANDBOOK" . . . latest information about Government Paid Transportation, Employment, Land, Farming . . . plus Employers List and Forms. Send \$1.00. International Services, Box 12-A2, Greenfield, Indiana 46140.

FLORIDA Opportunities Booklet! Sunshine State employment, living facts. \$2.00. Tomar, 4512N Jamaica, Tampa, Florida 33614.

WORLD-WIDE . . . U.S.A. jobs now!!! \$600.00 to \$3,000.00 monthly. Travel allowance, paid overtime. Write: Global Employment, Box 706-C2, Orinda, California 94563.

AUSTRALIA!! AUSTRALIA!! (1969) Handbook and forms describing Government assisted transportation, high living standard, climate, entry requirements, employment opportunities. Jobs Galore!! Send \$1.00. Other Reports on Employment, Ranching, Housing, Taxes, etc. Associated Box 17-B20, Lafayette, California 94549.

TREMENDOUS Opportunities U.S.A. overseas, choose jobs-locations, transportation. Free details. Occupations, International Airport, Box 100-C1, Jamaica, N.Y. 11430.

MEN over sixteen needed to work on ships. Average pay \$800 monthly plus sixty days paid vacation. Send \$1.00 Ships Help, Box 20434, Long Beach, California 90801.

## HELP WANTED

OVERSEAS Jobs—Europe, South America, Australia, Far East, etc. 2000 openings all trades. Construction, Office, Engineering Sales, etc. \$700 to \$3,000 month. Expenses paid. Free Information. Write Overseas Jobs, International Airport, Box 536-M, Miami, Florida 33148.

OVERSEAS Jobs—Australia, Europe, South America, Far East, Etc. Openings in all trades and professions. \$400 to \$2,500 monthly, free information write: Foreign Employment Mart, Box 2235 A.M.F. Miami, Florida 33159.

## REAL ESTATE & FARMS

ADVERTISE In Gulf Beach Journal covering all Tampa Bay's fabulous west coast beach areas. 15¢ per word min. 20 words. Meade Seaman, 1702 Followthru, Tampa, Florida 33612.

THE Only "No-Risk Land Purchase Plan" in America—10 year money-back guarantee on any Vacation, Retirement or Investment homesite in Boiling Spring Lakes—the multi-million dollar, 14,000-acre development on the Carolina Coast. All facilities, electricity, roads, motel, golf course, country club, already in. Private ocean beach, 50 fresh water lakes, ¼-acre homesites as low as \$700.00 cash price; \$8.00 down, \$7.70 monthly for 120 months, including interest at an annual percentage rate of 6%. Write for free literature. Dept. 1-W, Boiling Spring Lakes, North Carolina 28461. (Not offered to residents of California, Florida, New York.)

CANADIAN HUNTING/FISHING PROPERTIES, from \$7.00 an acre. Choice properties available across Canada. Acquired through estate liquidations. Low monthly payments. Ideal hunting, fishing, cottages, farming, timber, minerals, investment. Write for free catalogue. Canadian Estate Land, Department 65A, 194 Wilson Ave., Suite 101, Toronto 12, Canada.

CANADIAN Lands, seized and sold for taxes. Our 53rd annual series of lists, describe many choice properties, situated from coast to coast, acquired by us through Tax Sale. Priced as low as six dollars per acre, guaranteed perfect title, small monthly payments, no mortgage. Beautifully situated hunting and fishing camps, where there is real sport; summer cottage sites, heavily wooded acreages. Now is the time to invest in Canada's minerals, forests and farms. Write to-day for free booklet with full explanation. Tax Sale Service, Room 301-D, 85 Bloor St., East, Toronto 5, Canada.

LESS Than 1 mile to Disney property. Lake living, ¼ acre. Private ramp, beach, 11 mi. to Orlando. \$24 mo., \$50 down. BLOCH BROS., 1 North Rosalind, Orlando 26, Florida. AD65LS169-L.

CANADIAN Vacation lands: Full price \$385.00. 40 acres. \$10 month. Suitable cottage sites, hunting, fishing, investment. Free information. Land Corporation, 3768-C Bathurst, Downsview, Ontario, Canada.

\$1 ACRE—Canadian Border—hundreds campsites, islands, farmlands, directly from tax authorities. (Non-profit). Lists, photographs mailed. Register. Room 10, 110 Church Street, Toronto 1, Canada.

CENTRAL Ontario—Choice 640 acre Sportsmen's paradises still available—\$20.00 plus \$6.50 taxes yearly. Maps, pictures. \$2.00 (Refundable). Information Bureau, Norval 4, Ontario, Canada.

GOVERNMENT LANDS . . . Low as \$1.00 acre. Millions acres. For exclusive copyrighted report . . . plus "Land Opportunity Digest" listing land available throughout U.S., send \$1.00. Satisfaction guaranteed. Land Disposal, Box 9091-PB, Washington, D.C. 20003.

BUY CANADA \$10—10 ACRES. Thousands of Tax Sale properties direct from government authorities. Atlantic to Pacific. Good roads. Near border. Sensational investment gains. Lake frontage. Cottages. Hunting. Fishing. Unique researched lists. Maps, Photos. "BUREAU," 16 Quinby Court, Thistletown, Ontario Canada.

ARIZONA. Great investment opportunity. North of Lake Havasu City! Level 2½ acres \$895, low terms. Mrs. Anne Young, Glenarm Land Co., 2233 North 7th St., Phoenix. 85006.

(Continued on next page)

## REAL ESTATE & FARMS

(Continued from preceding page)

**FLORIDA CAMPSITES**—Deep in the heart of the great Ocala National Forest—Good fishing, hunting, Warranty Deed. Free maps and photos. (Unavailable in states requiring separate registration) (AD 66 LS 149) Howard Vernor, Deland, Florida 32720.

**NEW CANADIAN regulations:** Border crossing, hunting, fishing, visitors, tourists, accommodation. Free information. Official, Box 560-F Westmount, Montreal 215.

**CANADIAN AND U.S. LAND . . .** 640 acre sportsmen's utopias in heart of Ontario for 50¢ per week! Millions of government surplus acres throughout U.S.A. and Canada. Every province, every state. Low, low prices. Complete details and maps \$2.00 (Returnable). Land Sales, Maple, Ontario, Canada.

**LAND! EASY TERMS LESS THAN BANK RATES.** NORTHWEST TIMBERED ACREAGES as low as \$950 Total Price, 5-10-20-40-acres. For people who love the land—A tract of Recreation Land to have for your very own! In Northern Idaho and North-eastern Washington, and Western Montana. In the heart of lakes and big game country. All covered with growing timber. Access and Title insurance with each tract. This is select land with natural beauty, recreational and investment values. Plan for the future and retirement recreation. We have tracts of many types and sizes from which you can choose, including beautiful Northwest Waterfront property. Your inspection is welcomed. Write us for free list, maps and complete information. Write to: Dept. PC, Reforestation, Inc., P.O. Box 8146, Spokane, Wash. 99203.

**GOVERNMENT Land**—450,000,000 acres, U.S.A.—ALASKA, \$1.25 acre, up. Buy; Homestead; Vacation, Cabin, Ranch Sites. Copyrighted guide, guaranteed!! Rush \$1.00 today. Surplus Land Bureau, Box 808M, Las Vegas, Nevada 89101.

**CANADIAN GOVERNMENT land . . .** Low as \$1.00 Acre! Non-Profit! Homesteading, Vacationing, or Investment. Exclusive New Handbook includes complete information. Send \$1.00. International Lands, Box 29193-AN, Indianapolis, Indiana 46229.

**HOW to obtain homestead land from the province of British Columbia.** Information booklet \$2.00. Sourdough Slim, Horsefly, B.C., Canada.

**FREE! Real Estate Catalog!** Farms, Ranches, Business, Recreational and Investment Property. 18 States, Pictures Galore. Note State Desired. BANNER Adv., Box 3333, 19-A, Springfield, Mo. 65804. "Real Estate Our Specialty."

**FREE CATALOG NEW SPRING issue!** Late real estate bargains in: Farms, Ranches, Business, and Retirement! Write today. **SAFE BUY REAL ESTATE**, P.O. Box 589-PM, Little Rock, Ark. 72203.

**450,000,000 ACRES Valuable Government Land Now Available Low as \$1.00 Per Acre.** Buy, Lease or Homestead Free. For Latest Report Send \$1.00. American Land Disposal, Box 725-A, Holland, Michigan 49423.

**FREE . . . NEW 216-page SPRING 1970 real estate catalog.** All types property coast to coast! **UNITED FARM AGENCY**, 612-PM West 47th St., Kansas City, Mo. 64112.

**FREE GOVERNMENT LAND.** Also Lease or Purchase Throughout U.S.A. and Canada. Millions of acres Available. Agricultural, Vacation, Developmental. 1970 Listing and Report \$1.00. Homesteads, Box 1433, Swan Lake, Montana 59911.

**NEW 1970 JOURNAL! FREE copy!** Arkansas property listings! Statewide Realty Co., 507-AE Pyramid Bldg., Little Rock, Ark. 72201.

**AUSTRALIAN LAND** Send two dollars and your name and address to Young, P.O. Box 2225 Kokomo, Indiana 46901 to receive a genuine warranty deed for two square inches of Ballarat, Victoria.

## FARM & GARDEN EQUIPMENT

**MAILORDER Records** help get increased business! Complete 32 Page Record Book shows your inquiries orders, advertising, expense, etc. Only \$1.00. C. A. Martin, Popular Mechanics, Dept. PM, 224 West 57 Street, New York, N.Y. 10019.



## FLOWERS, PLANTS & NURSERY SUPPLIES

**RAYNER'S Free 1970 Strawberry Book.** Grow bigger, tastier berries for table, freezing, market. Book describes 29 virus-free varieties including Guardian, new this year. Illustrates best for your area. Gives instructions for planting in simple terms. All plants certified, guaranteed. Lists blueberries, raspberries, grapes, fruit trees, etc. Write today for free copy. **RAYNEK BROS., INC.**, Dept. 65, Salisbury, Md. 21801.

**600 ASSORTED sweet onion plants** with free planting guide, \$3.60 postpaid. Tonco, "home of the sweet onion," Farmersville, Texas 75031.

**LEARN Landscaping and the growing of plants.** Start a profitable business part or full time. Free information without obligation. Lifetime Career Schools, Dept. A-750, 2251 Barry Avenue, Los Angeles, California 90064.

**GREENHOUSES—Build yours!** Fiberglass Kits. Greenhouseman, Box 5276-MB, Riverside, California 92507.

## CONSTRUCTION PLANS

**HOBBYISTS, EXPERIMENTERS,** amateur scientists, students . . . Construction Plans—All complete including drawings, schematics, parts list with prices and sources . . . Laser—Build your own coherent-light optical laser. Operates in the visible light range, pulsed mode—\$6.00 . . . Radar—Build your own ultrasonic doppler radar. Detect motion of people, automobiles, even falling rain drops. Transistorized, uses standard small 9-volt battery—\$4.00 . . . Long Range "Sound Telescope"—This amazing device can enable you to hear conversations, birds, other sounds hundreds of feet away. Very directional. Transistorized, uses 9-volt battery—\$3.00 . . . Or send 25¢ coin (no stamps) for complete catalogue . . . Wide range of other plans, including psychedelic lights, color organs, robot man, etc. . . . 38 different plans . . . Technical Writers Group, Box 5994, State College Station, Raleigh, N.C. 27607.

## HOME CRAFTSMEN

**101 PATTERNS** of smart Gifts, Novelties, Shelves, Action Windmills, plus "Make Money Jig Sawing," \$1.00. Mastercraft, 25M, 7041 Olcott, Chicago 60631.

**MAKE your own fine picture frames** with our beautiful moldings and amazing Clamless Assembly Method. Terrific savings! We show how. Free proof, particulars. Japs, 126-PM Seventh North, Hopkins, Minnesota 55343.

**CABINETMAKING MADE EASY** and "How to Make Formica Counter Tops," two excellent guides let you build kitchen cabinets and counter tops like professionals. Extraordinary guides bring master craftsmen's shortcut methods. Satisfaction guaranteed. Write: Japs, 126-P Seventh North, Hopkins, Minn. 55343.

**WOODWORKING Catalog and Manual 25¢ Plus free "101 Project Ideas."** World's most beautiful veneers, lumber, plywood! Wood finishing, upholstery supplies, Cane Lamp parts. Furniture hardware. Animal whittling blocks, 2,000 workshop products. Constantine, 2051-B Eastchester Road, Bronx 10461.

**SKIL-CRAFTS new 200 page catalog** with world's largest, finest selections of hobby-craft, leather-craft, artist supplies. Send 50¢ (refunded plus free gift with first \$5 minimum catalog order). Skil-Crafts, Box 105-P, Joplin, Mo. 64801.

**WALNUT And Cherry tapered legs, lumber, gunstock blanks, picture frame moulding.** Midland Lumber Company, Box 262, Savannah, Missouri 64485.

**FULL SIZE FURNITURE PLANS.** Traditional, Early American, Danish Modern. Catalog 50¢. Furniture Designs, Dept. P-20, 1425 Sherman, Evanston, Illinois 60201.

**PLANS, Bird houses.** Send 15¢ for brochure and free feeder plan. Yeager, 1665 Linden, Homewood, Ill. 60430.

**PLANS, Professional drafting table, 7 ft., 8 drawer machinist chest, \$2.50 each.** Plans catalog 30¢. Dandyplans, Box 14915, Phoenix, Arizona 85031.

**FREE Heating all the time for whole house.** Won't cost you one penny after you install powerful, new unit. Send \$5.00 for plans & details. S & S Mfg., 555 Sumas Street, Victoria, B.C., Canada.

**BLUEPRINTS.** Lathe Milling Attachment, details Dan Potter, Box 73, Cedar Rapids, Iowa 52406.

**POPULAR MECHANICS MASTER SHOP GUIDE.** Greatest product offered to a man with a workshop. All information printed on heavy boards, punched and ready to hang above his workbench. Covers wall fasteners, nails, screws, bolts, twist drills, plywood grades, hardboard, drywall, plumbing supplies, electrical supplies. Plus information on scores of other subjects. Send \$3.95 to: **POPULAR MECHANICS**, 224 West 57th Street, New York, New York 10019.

## DO-IT-YOURSELF

**DO-IT-YOURSELF simplified Central Air Conditioning.** Approximately \$400 for homes with forced air furnaces. Write for step-by-step brochure. McGraw-Edison Company, 705A N. Clark St., Albion, Michigan 49224.

**WATER! How to Drill your own Well and Save 75%.** Free. DeepRock Company, 2003 Poplar, Opelika, Alabama 36801.

**REFRIGERATOR Door gaskets—Electric Range and Washer Parts.** Send Make and model for cost. Box 5465, Hamden, Conn. 06518.

**BURGLAR-Fire Alarm Supplies and information.** Free Catalog. Protecto Alarm Sales, Box 357, Birch Run, Michigan 48145.

**EXERCISE At home on build-it-yourself physical fitness equipment,** including bicycle exerciser, rowing machine, belt massager, and abdominal board. Send \$3.00 for blueprints B1208 and instructions. Popular Mechanics Service Bureau, 224 West 57th St., New York, New York 10019.

**AIR Compressors made from Mower Engines.** Write: Showalter, Box 409, Abilene, Kansas 67410.

**HIGH Flying Delta Wing Kite.** Easy to make. Outperforms other kites. Plans \$1. L.M., 85 Country Lane, West Seneca, N.Y. 14224.

**FLOURESCENT Tubes rejuvenated at no cost.** Instructions \$1.00. Rejuvenators, 172 Bolton St., Portland, Me. 04102.

**SAUNA Bath.** You can build your own Sauna for less than \$20.00. \$2.50 for plans. S and S Mfg., 555 Sumas Street, Victoria, B.C., Canada.

**BUILD A HOUSEBOAT FOR LESS THAN \$1000.** For plans write to **POPULAR MECHANICS**, Dept. RJ 224 West 57 Street, New York, N.Y. 10019.

## ARTS AND CRAFTS

**MAKE Figurines, plaques, lawn ornaments.** Molds, plastercraft kits, liquid rubber. Sample and catalogue 10¢. Woolley Company, Box 29-B, Peoria, Illinois 61601.

**200 FIBERGLASS Molds for casting ornamental concrete.** Catalog 25¢. Plycrete Molds, Elk Rapids, Mich. 49629.

## BINOCULARS, TELESCOPES, MICROSCOPES, MAGNIFIERS

**BINOCULAR Sale!** Free color catalog 100 models \$9.95-\$25.00. Write, United, 9043 So. Western, BCAT-1408, Chicago 60620.

**SCIENCE Bargains!** Lenses, telescopes, binoculars, microscopes, kits, parts, war surplus. Send \$1.50 for beginner's 10-lens kit with instruction booklet. Order Stock 2-CH. Request free 148 page Catalog CH. Edmund Scientific Co., 300 Edscorp Bldg., Barrington, New Jersey 08007.

**BINOCULAR Specialists.** Repairs And Sales. Free Catalog. Tele-Optics, 5514 Lawrence, Chicago, Ill. 60630.

**TELESCOPES (Reflectors)** complete kits, other accessories, request free literature. Criterion Manufacturing, Dept. PM-4, Hartford, Conn. 06101.

**BINOCULARS** Direct from manufacturer. Finest quality, tremendous savings! Request catalog. Koyu, 3860 Crenshaw Blvd., Los Angeles, Calif. 90008.



## CAMERAS AND EQUIPMENT

**48 PAGE ILLUSTRATED CATALOG** with the low Central Discount price. Send 50¢, get 75¢ CREDIT on order of \$7.50 or more. **CENTRAL CAMERA CO.**, Photographic Headquarters for the Amateur and Professional **SINCE 1899**. Central Camera, Dept. 1AJ, 230 S. Wabash Ave., Chicago, Ill. 60604.

**WORLD'S Largest Buying Guide—800 Illustrations—50¢—Deductible With Your Order—Olden Camera—1265 Broadway, New York, N.Y. 10001.**

"**PROFITS In Aerial Photography**" for beginners \$2.50. Details. "My Twenty Best Photos" \$1.50. Roberts, 125 University, East Hartford, Connecticut 06108.

## PHOTO SUPPLIES

**ANSCOCHROME—DYNACHROME—FILM—** save by mail—free price lists. Hillis Products, Dept. M Box 1182, Kokomo, Indiana 46901.

**NEW Film Catalog.** Write Chai Photo Supply Co., 14-03 Berdan Avenue, Fair Lawn, New Jersey 07410.

## PHOTO FINISHING

**SPECIAL WITH THIS AD—Kodacolor** developed 12 prints \$2.25. Black & White developed 2 prints each Jumbo size—12 exposure 70¢. **LENS PHOTOS**, Dept. J-4, Janesville, Wis. 53545.

**CAMERA FANS!** Expert photofinishing by one of Country's largest labs at lowest prices. Fast service and free "Foto-Fan" Stamps you quickly redeem for valuable Photo Supplies. 8MM Kodachrome \$1.29; 8 Exp. Kodacolor \$1.79; 35MM Kodachrome. 20 Slides \$1.39; 8 Exp. Black White 69¢. Satisfaction guaranteed. Send exposed film or request free mailers, complete Price List and Gift Catalog. Direct Mail Photo, Box 8352-PM, Pittsburgh, Pa. 15218.

**TRIAL OFFER.** Twelve prints from roll 60¢. Eight enlarged color prints from Kodacolor roll \$1.39; twelve \$1.79; twenty \$2.69. Young Photo Service, 45C, Schenectady, N.Y. 12301.

**OLD PHOTOS COPIED RESTORED.** High Quality, Special Photo Services. Send Photos, free estimates. Originals Returned unharmed—(enclose 95¢ Special Handling)—(Color-B&W-Enlarging unlimited.) Giant Photos—Camden, Alabama 36726.

## COLOR SLIDES

**PROFITS FROM CLASSIFIED ADVERTISING!** Booklet shows you how to start your own business with Classified Advertising. Only \$1.00 (Refundable with first order.) PM, 224 West 57 Street, New York, N.Y. 10019.

## MOTION PICTURES AND SOUND EQUIPMENT

**SUPER-8 Titles, Featurettes.** Unusual, outstanding. Vega, Box 14172, Las Vegas, Nevada 89114.

**FREE!** 64-page catalog. 8-16mm film, supplies, processing equipment. Superior, 448 N. Weils, Chicago 60610.

**16MM. FILM Lists:** 12¢: Gordon—28-53 Steinway Street, Astoria, L.I. N.Y. 11103.

**UNUSUAL Movie supplies.** Free circular. Esor, 47th Holly, Kansas City, Missouri 64112.

**16MM SOUND Features, Shorts.** New, used for Sale. Free Catalog. National Cinema, 333 W. 57th St.—N.Y.C., N.Y. 10019.

## RADIO, TELEVISION AND HAM EQUIPMENT

**EXCITING LISTENING!** Police-Fire-VHF Calls on Broadcast Radio! Free catalog! Salch Company, Woodsboro 23, Texas 78393.

**TUBES—Lowest world prices.** Foreign—American. Obsolete, current, receiving, special purpose, transmitting tubes. Send for tube and parts catalog. United Radio Company, 56-PM Market St., Newark, N.J. 07105.

**33¢ RADIO & TV tubes.** Free list. Cornell, 4213-17 University, San Diego, California 92105.

**BEGINNERS, Experimenters Kits, Parts** Catalog. Lectronix, Box 42, Madison Heights, Michigan 48071.

**GOVERNMENT Surplus receivers, transmitters, snooperscopes, parts.** Catalog. 25¢. Meshna, Nahant, Mass. 01908.

**HOME Radio-Television Course.** Free literature. Progressive Edu., Department 722B, Hewlett, New York 11557.

**ATTENTION: 9 1/2" X 6 1/2" X 3 1/2" Radio** Has Police Band, Marine Band, VHF, FM, AM, 18 Transistors. Operates on Batteries or AC Build in adapter. Only \$69.95. California Residents add 5% sales tax. Nifty Gifities, 1980 N. Third Street, Concord, California 94520.

## HIFI, TAPES, RECORDS AND ELECTRONICS

**FREE—FREE—FREE—FREE—FREE—FREE**—FREE. Send in for your FREE one year subscription to Olson Electronics' fantastic value packed catalog—unheard of low, low prices on brand name speakers, changers, tubes, tools, stereo amplifiers, tuners, CB and other values. Credit plan available. If you have a friend interested in electronics, send his name and address for a FREE subscription also. Olson Electronics, 567 S. Forge St., Akron, Ohio 44308.

**FREE!** Illustrated Catalog. Oldies—Goodies! 45 rpm, 1800 Titles! Carroll's, 209 Armand, Ville Platte, Louisiana 70586.

**TAPE Recorders, hi-fi components.** Sleep learning equipment, tapes. Unusual values. Free catalog. Dressner, 1523C Jericho Tpke., New Hyde Park, N.Y. 11040.

**FREE Catalogues, 2000 hard to find** unusual records. Rose's Records, 300 Chelsea, Louisville, Ky. 40207.

**RECORDS!** Discounts on all LP's. Free details. Citadel Record Club, Synphonette Sq., Dept. 2, Larchmont, N.Y. 10538.

**STEREO TAPES!** 33% discount! Unavailable elsewhere. Cartridges, cassettes, reels. Latest hits . . . Oldies . . . Professionally recorded. 25¢—catalogs, free offer. Star Recordings—PM, Box 1055, El Paso, Texas 79946.



## MUSIC AND MUSICAL INSTRUMENTS

**EXCELSIOR Accordions and Amplifiers.** Save 50%. Buy Direct. Factory Distributor. Terms. Trades. Free Catalog. Excelsior, 3147 North Luna, Chicago 60641.

**ACCORDIONS and Amplifiers!** Save to 50%. Famous makes. Easiest terms. Trades accepted. Free home trial. Free discount catalog. Accordion Corporation, 5535-R West Belmont, Chicago 60641.

**VIOLIN and Guitar makers—send for** latest Free Catalogue of woods & accessories. International Violin, PMO, 414 East Baltimore St., Baltimore, Md. 21202.

**ACCORDION Manufacturing, 6846-P** North Avenue, Chicago, Illinois 60635. Concertinas, Hohners, Chromatics, Guitars, Drums. New, Used. Tuning, Repairing. Wholesale Catalogs Free.

**POEMS** Wanted for new songs and records by America's largest song studio. Send poems. Free examination. Five Star Music, 6M Beacon, Boston, Mass. 02108.

**GUITAR, Banjo Making books Plans,** woods, necks, tools. List 25¢. Satinwood, 510 East 11th Street, New York, N.Y. 10009.

**ELECTRIFY Player Pianos, Pump Organs** quickly, inexpensively with Lee Silent Suction Units. Write Lee Music, 525 Venezia Avenue, Venice, California 90291.

**GUITAR MAKING Books, Imported** Woods, Supplies, Accessories. Catalog 25¢. Guitar Center, Box 15444, Tulsa, Okla. 74115.

**PLAYER Piano Rebuilding—get details** from: Vestal Press, Vestal 11, N.Y. 13850.

**GUITARS, MANDOLINS, BANJOS.** Complete stock of Gibson Martin guitars. Free 100 page catalog, parts and accessories. Big Savings. New York discount prices. Send 50¢ postage handling. Eddie Bell Guitar, Dept. PM, 201 West 49, New York 10019.

**PROFESSIONAL 674 Watt Amplifiers,** Guitars. Free Wholesale Catalog. Carvin PM70, Escondido, Calif. 92025.

**POEMS, Songs** wanted for new song hits and recordings by America's most popular studio. Tin Pan Alley, Dept. PM, Lake Grove, New York 11755.

**SONGWRITERS!** London Company now in USA needs poems for new songs. All types wanted. Details free. Musical Services, 715/P, West Knoll, Hollywood, California 90069.

**LEARN Musical instrument of your choice**—easy! New home study tape course. Write for free brochure. Carver School, 7 West 1st, Dept. H, Hinsdale, Illinois 60521.

**POEMS, Songs, wanted for new songs** and immediate recordings. Contracts, royalties. Weiss Music Company, 1472-PM Broadway, New York, New York 10036.

**POEMS Wanted For Songs.** Nashville Music Productions, Box 9001-P, Nashville, Tennessee 37204.

**HANDMADE Dobro type guitar—world's** best acoustical. Professional handmade classical, flamenco. Greatest Spanish constructors. The Guitar, 4668 Hollywood Blvd., Hollywood 90027.

**30% DISCOUNT Any Name Brand** musical instruments. Write for low price. Freeport Music, 127 W. Sunrise Highway, Freeport, New York 11520.

**DRUMS, Electric guitars, amps, organs.** Free catalog M: A.L.A.S. Import Company, 31 East 18th Street, NYC. 10003.

**ACCORDION Top brands.** Buy direct. Tremendous discounts. Trade accepted. Free brochure PM. Accordion-O-Rama, 874 Broadway, N.Y.C. 10003.

**WE Pay All Recording Costs on accepted** material! Need new Song Material for immediate recording! Grand Recording, 1354-PM Hancock St., Quincy, Mass. 02169.

**GUITAR Instruction Book \$1.25.** Jack L. Lamb, Rt. #4, Box 3018, Lakeland, Florida 33803.

**WHOLESALE Musical Instruments Cata-**log. Allied, 406 East 189, Bronx, N.Y. 10458.

(Continued on next page)

## MUSIC AND MUSICAL INSTRUMENTS

(Continued from preceding page)

POEMS Set to music. Songs recorded. Send poems, songs. Crown Music, 49-C West 32, New York 10001.

30% TO 50% DISCOUNT. Any Guitars, Amps, Drums. You name brand, model. Fast. Warehouse P7, Box 9352, Fort Worth, Texas 76107.

LEARN 5-String Banjo. Play Bluegrass the first week. \$4.95 Postpaid. Satisfaction guaranteed. Blaylock, Box 25-M, Marietta, Georgia 30060.

SONGPOEM WRITERS BARGAIN! Information: Co-Operative Publishers, 2005 St. Anne, Santa Ana, Calif. 92704.

## RECREATION MANAGEMENT TRAINING

MOTEL MANAGERS Wanted by leading chains, resorts, motels-hotels everywhere! Men, women, couples enjoy free rent, plenty of free time. Easy home-study plan. Free! "Motel Career Kit." No salesman will call. North American School of Motel-Hotel Management-AZW, Newport, California 92660.

## PLAYGROUND MANAGEMENT TRAINING

PLAYGROUND-PARK, Recreation, Sports, Craft instructors needed now! Beginners—Get Paid for Having Fun!!! We show you how! U.S. Government says "750,000 new Recreation jobs by 1980." Easy home-study plan. Free! "Recreation Career Kit." North American School of Recreation-AZW, Newport, California 92660.

## CONSERVATION TRAINING

GAME WARDEN, Government Hunter, Forestry, Park & Wildlife Service announce job openings regularly. Prepare at home for outdoor work, good pay, security. Complete information Free! Write North American School of Conservation-MPW, Newport California 92660.

## TRAVEL TRAINING

TRAVEL AGENTS Make \$\$\$\$\$. Exciting Booming Careers! Easy Home-Study Plan. Free! "Travel Career Kit" Write—North American School of Travel-AZW, Newport, California 92660.

## DRAFTING TRAINING

DRAFTING: Learn at Home. U.S. Government reports "42% more Draftsmen needed next 10 years." Send for Free "Drafting Career Kit." No salesman will call. G.I. Bill approved. North American School of Drafting-AZW, Newport, California 92660.

## SURVEYING TRAINING

LEARN SURVEYING—join high pay Team . . . help plan highways, bridges, dams, subdivisions, etc. U.S. Government predicts big need for beginners. Easy home-study plan. Free! "Surveying Career Kit." North American School of Surveying-AZW, Newport, California 92660.

## EDUCATION AND INSTRUCTION

FINGERPRINTING—Investigation. Exciting, secure career. Learn at home. Free book. State age. Institute of Applied Science, 1920 Sunnyside, Dept. 162, Chicago, Illinois 60640.

GRAPHOANALYSIS—Learn scientific handwriting analysis for profit, pleasure. Free sample lesson, catalog, reveals plan. Write: Igas Inc., 325 Jackson, Dept. 2AP-2, Chicago 60606.

AUTOSUGGESTION. Sleep-learning headquarters! Tapes, records, books. Gigantic catalog free. Research Association, Box 24PM, Olympia, Washington.

ENGINEERING and Art degrees earned through home study. Electronics, Mechanical, Liberal Arts. When writing specify course desired. Pacific International College of Arts & Sciences, primarily a correspondence school. Resident classes also available. 5507 Santa Monica Blvd., Hollywood, California 90038A.

USED CORRESPONDENCE Courses and Books sold and rented. Money back guarantee. Catalog free. (Courses bought.) Lee Mountain, Pisgah, Alabama 35765.

GAME Warden, Government Hunter, Forestry, Park & Wildlife Service announce job openings regularly. Prepare at home for outdoor work, good pay, security. Complete information Free! Write North American School of Conservation—AZW Newport, California 92660.

COMPLETE YOUR HIGH SCHOOL at home in spare time. Texts furnished. No classes. Diploma. Approved for Veteran Training. Founded 1897. Free Brochure. American School, Dept. X245, Drexel at 58th, Chicago, Illinois 60637.

EARN College degree at home. Many subjects. Ohio Christian College. 1156 Striebel Road, Columbus, Ohio 43227.

LEARN Auctioneering. Term soon. Free catalog. Reich Auction College, Box 850, Mason City, Iowa 50401.

PIANO Tuning quickly learned with home study course. Diploma granted. American Tuning School, Gilroy, Calif. 95020.

BOOKKEEPERS. Operate your own "Dollar-A-Week" system. Ellis, Box 200, Cedar Grove, North Carolina.

OWN Collection agency. "Little Gold Mine!" Franklin Credit, Roanoke, Virginia 24004.

EARN \$125 A week and up. Learn a trade with a future. Learn auto diesel mechanics in our shops. You learn with tools on real equipment. Earn while you learn. Many of our graduates earn \$125 a week and up. Write for free bulletin: Dept. 256, Auto Diesel College, Nashville, Tennessee 37219.

MISSOURI Auction School, GI Approved. Free Catalog! 424-03 Nichols Road, Kansas City, Mo. 64112.

FCC First Class License in six weeks—Nations highest success rate—Approved for Veteran's Training. Schools in Dallas, Atlanta, Chicago, New Orleans, Minneapolis and Houston. Write Elkins Institute, 2603D Inwood Road, Dallas, Texas 75235.

USED Courses! Books! List 10¢. Smith's. 124 Marlborough, Salem, Mass. 01970.

HIGHLY EFFECTIVE home study courses in Electronics Engineering Technology and Electronics Engineering Mathematics. Earn your Degree. Write for Free Descriptive Literature. Cook's Institute of Electronics Engineering, (Dept. 10), P.O. Box 10634, Jackson, Miss. 39209. (Established 1945).

SUPERIOR Auction School. Nation's top Auctioneers own and instruct. Box 1281, Decatur, Ill. 62523.

AUCTIONEERING Resident or Home Study Course Free Catalog. Nashville Auction School, 2004 West End, Nashville, Tennessee 37203.

DETECTIVE Course. Free information. Universal Detectives, Box 8180-F, Universal City, California 91608.

HIGH SCHOOL diploma at home. Licensed teachers. Send age, highest grade completed for free details. No salesman will call. Southern States Academy, Westbury Square Professional Bldg., Dept. 16, Houston, Texas 77035.

PIANO Tuning pays. Big money in spare time. Learn at home. No musical knowledge necessary. Phonograph, records, tools and instructions furnished. Electronic tuning also taught. Free catalog. Capital Tuning School, 3160 S.W. 16th Court, Ft. Lauderdale, Fla. 33312.

LEARN To prepare income tax returns. It's easy and profitable. Act today! Write American Tax Training Institute, Dept. PM, Box 4845, Chicago, Ill 60680.

PROFITABLE Camera service training at home. National Camera, Dept. PM, Englewood, Colo. 80110.

LEARN Bookkeeping: Excellent pay; Full, spare time. Simplified Technique for home study. Inexpensive. Free Details. Business Research, Box 745E, Wilmington, Delaware 19899.

PENMANSHIP Corrector. Improve Poor penmanship quickly. Details free. Ozment, Box 2344-34, St. Louis, Mo. 63114.

EXTENSION And Post-Graduate Awards in Philosophy, Arts, Sciences, Botanic Medicine, Homeopathy, Radionics and others. 30 subjects. Curricular free (air-mail \$1.00 refundable). Registrar, Sussex College of Technology, Highfield, Danehill, Sussex, England.

REAL ESTATE—Get your license now as 150,000 Anthony Graduates have! Easy home-study plan. Send for Free Report, "Your Future in Real Estate." Anthony Schools-AZW, 1112 West Olympic, Los Angeles 90015.

PENMANSHIP Improver: Improve penmanship quickly, easily. Write: Tevis, Chillicothe, Mo. 64601.

PHOTO RETOUCHING. Interesting, profitable career at home; full or part-time. Easily learned. Hamilton Studios, Dept. PR-39, Claymont, Del. 19703.

WATCH REPAIRING. Learn to repair American and Swiss watches in spare time at home. Diploma awarded. Free sample lesson. No obligation. Chicago School, Dept. YB, Fox River Grove, Illinois 60021.

FREE Bible course! Degree! Request information! 708 Bragg, Monroe, North Carolina 28110.

SHEET-Metal Bend Allowance and Bend Deduction Tables for Ferrous and Non-Ferrous Metals, with instructions. \$3.95 Postpaid. Desco Products, Box 395-PM, San Dimas, California 91773.

PIANO Technology—Electronic organ servicing. Learned easily at home. G.I. Approved. Free booklet. Niles Bryant School, Dept. P, 3631 Stockton, Sacramento, California 95820.

LEARN Handwriting analysis. International, Dept. 700, 11749 Eldridge, Lake View Terrace, Calif. 91342.

BE a Real Estate Broker. Write Moran, Box 602 Highway 9s, Ben Lomond, California 95005.

KENNEDY'S Educational Recording. 12", 33 $\frac{1}{3}$ , Stereophonics, \$3.95. R. Vallett Sales, 443 Pasadena, Youngstown, Ohio 44507.

LIFETIME ORDINATIONS. Send Stamp for information. Church, 2207 Cardinal, Rolling Meadows, Ill. 60008.

LEARN ACCIDENT INVESTIGATION. Train at home to earn \$750 to \$1,000 monthly. Car furnished. Expenses paid. No selling. No college needed. Full or spare time. Men urgently needed. Free placement service. Write for FREE information. No obligation. Universal Schools, CPM-2, 6801 Hillcrest, Dallas, Texas 75205.

HIGH SCHOOL DIPLOMA FAST! Free information. Educational Service, Box 514, Dept. PM, Jackson Heights, N.Y. 11372.

HIGH SCHOOL diploma at home. Licensed teachers. Send age, highest grade completed for free details. No salesman will call. Southern States Academy, 5300 W. Belfort, Dept. 16-B, Houston, Texas 77035.

"CLEAR \$50.00 Daily Year-round. Course, Certification Test, Manual. \$4.95. Free Brochure, Chicago School of Termite Inspection, 735 Junior Terrace, Chicago, Illinois 60613."

(Continued on next page)

## EDUCATION AND INSTRUCTION

(Continued from preceding page)

**LEARN Bartending.** Bartenders Correspondence School, P.O. Box 6253, Tucson, Ariz. 85716.

**IF TRIG SCARES YOU! IF YOU'RE FLUNKING TRIG! BUT YOU CAN MULTIPLY 1.23456 X 2 YOU CAN LEARN TRIGONOMETRY IN ONE ENJOYABLE EVENING.** \$6.98 FOR NEWLY COPYRIGHTED TRIG OVERNIGHT COURSE, NATIONAL SPEED COURSES, P.O. BOX G D, WILLIAMSBURG, VIRGINIA 23185.

**COLLEGE Degree at home.** Free catalog. Youngberg, 364-99th Avenue SE, Calgary, Alberta.

**DRAFTING (Electronic, Mechanical, Architectural).** Home Courses \$50.00. Send \$5.00 first lesson. Prior, Inc., 23-09 169 Street, Whitestone, New York 11357.

**LEARN Asleep or awake!** Records, tapes, equipment! Free catalog! Drawer PM-400, Ruidoso, New Mexico 88345.

**POLICEMAN Correspondence Course and Diploma.** — \$10.00 — Free Information. Southern Police Academy, Box #306, Fairfield, Alabama 35064.

**COMBINE Bible Records.** Have complete Evangelization Instructions. Box 233, Newport News, Virginia 23607.

**GET A British Degree.** Divinity, Philosophy, Radionics. 35 Courses. Prospectus free. Brantridge Forest School, Highfield, Dane Hill, Sussex, England.

### FOR INVENTORS

**INVENTORS—If you have an invention for sale, patented or unpatented, write for free brochure outlining manufacturers requirements, royalty rates.** Kessler Corporation, C-52-F1, Fremont, Ohio 43420.

**PATENT Searches complete and thorough.** Related copies Air Mailed with maximum speed \$6.00. Free "Protection Forms" and "Patent Information." Write American Patent Search Company, Dept. 27, 711 14th St., N.W. Washington, D.C. 20008.

**PATENT Application Financing.** Free patent search plan. Global Patent Division, 2420 77th, Oakland, Calif. 94605.

**U.S. Patent Office Searches,** 234 Broadway, Room 3615, New York. Free invention certificates.

**PATENT And invention development** by licensed professional patent engineer and U.S. Patent Office former examiner, and engineering specialists. Your inventions and ideas engineered for patent protection and commercial value. Inventions developed by us negotiated for cash or royalties with our nationwide contacts. Send for free protection "Invention Certificates" and further interesting, valuable patent information. George Spector, Licensed Professional Patent Engineer, Woolworth Building, New York.

**INVENTORS.** Send \$2 for Invention Protection, Patent Procedures and Save \$\$ Invention Guideline, Box 293, Jacksonville, N.C. 28540.

**PROFESSIONAL society for inventors.** Details, application form upon request. "Inventors." Membership Department, Box 247, Webster, N.Y. 14580.

**HOW TO INVENT.** What to invent. Booklet \$1.00. Century Press, Box 1343, Portland, Oregon.

**MANUFACTURERS NEED New Products!** FREE Literature explains "How to Submit Your Invention." Congress Invention Company, 911-C Warner Building, Washington, D.C. 20004.

**PATENT Searches, including copies of related U.S. patents.** Inventors attorneys, manufacturers use our "worldwide" airmail service! "Invention Record" form and "Information Every Inventor Needs." Sent free: Hayward Company, 1029P Vermont, Washington 5, D.C.

**FREE PAMPHLET: "Tips on Safeguarding Your Invention."** Write: United States Inventors Service Company, 501P Thirteenth Street N.W., Washington, D.C. 20004.

**INVENTORS: Your ideas and inventions (patented: unpatented) expertly searched, developed for commercial appeal and cash/royalty sales to manufacturers by professional Invention Developer with excellent record of experience.** B.S. Industrial Engineering; United States Patent Office former Patent Examiner, United States Government former Patent Advisor, Second decade reliable service! Member: United States Chamber Commerce. Free "Invention Record" and "Recommended Protection Procedure." Airmailed! Write: Raymond Lee, Invention Developer 230P Park Ave., New York City 10017.

**IMMEDIATE Cash,** for patent applications. Free patent searches. Write for details. Universal Patents, 184-D, Marion, Ohio.

### INVENTIONS WANTED

**INVENTIONS Needed immediately for manufacturers.** For additional information write Kessler Corporation, C-52-IW, Fremont, Ohio 43420.

**INVENTIONS Wanted.** Patented: unpatented. Tremendous manufacturers lists. Global Marketing Service, 2420G 77th, Oakland, California 94605.

**INVENTORS! Sell your invention for cash or royalties!** Our client manufacturers eagerly seek new items. Patented. Unpatented. Financial assistance if needed. 25 years proven performance. For free information, write Dept. 15, Gilbert Adams, Invention Broker, 80 Wall St., New York, N.Y. 10005.

**INVENTORS! We will develop, sell your idea or invention patented or unpatented.** Our national manufacturer-clients are urgently seeking new items for highest outright cash sale or royalties. Financial assistance available. 10 years proven performance. For free information write Dept. 47, Wall Street Invention Brokerage, 79 Wall Street, New York, N.Y. 10005.

**INVENTORS! Don't sell your invention, patented or unpatented, until you receive our offer.** Eagle Development Company, Dept. H, 79 Wall Street, New York 5, N.Y.

**INVENTORS! Protect your ideas!** Free "Recommended Procedures." Washington Inventors Service, 422F, Washington Building, District of Columbia 5.

**FREE "Directory of 500 Corporations Seeking new Products."** For information regarding development, sale, licensing of your patented/unpatented invention. Write: Raymond Lee Organization, 230-N Park Avenue, New York City 10017.

**WE Either sell your invention or pay cash bonus.** Write for details. Universal Inventions, 298-E, Marion, Ohio.

### PATENTS FOR SALE

**MAILORDER Records help get increased business!** Complete 32 Page Record Book shows your inquiries orders, advertising, expense, etc. Only \$1.00. C. A. Martin, Popular Mechanics, Dept. PM, 224 West 57 Street, New York, N.Y. 10019.

### MANUFACTURING

**INVENTORS Ideas developed.** Research. Models. Manufacturing. Sales. Free brochure. William Parker, 32 Westminster, Worcester, Mass. 01605.

### BUY IT WHOLESALE

**BARGAINS! Buy wholesale and below.** Name brands. Appliances, furniture, sports equipment, televisions, cameras, watches, jewelry thousands more. Huge discounts to \$1,000.00 on new automobiles. All makes. Free details. Write today: Worldwide Bargainhunters, Box 730-A, Holland, Michigan 49423.

**HEARING Aids, Batteries, Wholesale.** Catalog 25c. Fiston, Box 1444, New Preston, Conn. 06777.

**GIANT Illustrated Tool—hardware—automotive catalog.** \$1.00, refundable. Lithco, Box 51, Canoga Park, Calif. 91305

**FACTORY Prices: portable TV's only \$57.75.** Snowthrowers, cameras, stereos, sporting goods and more. All at rock-bottom factory prices. Giant color catalog and confidential factory cost book, \$10.00. Croymen Enterprises, Box 65A, Brooklyn, New York 11214.

**800,000 BARGAINS!** Tremendous Discounts Available! Wholesalers 1265-MR Broadway, New York, N.Y. 10001.

**BEAUTIFUL "FLOWER" CLOCKS** with six interchangeable colors. \$15.00 clocks, \$9.95; \$11.00 clocks, \$6.95, or BUILD YOUR OWN CLOCK! Cordless movements, \$5.95; Electric, \$3.95. Color Catalog, 25c, Morse Products, Box 38930-C, Hollywood, California 90028.

**WORLD'S Largest wholesale dropship sources.** U.S., foreign. Factory suppliers dropship direct to you or customers. Now! have your own catalog for pennies. Free details. International Buyers, Box 16386-M, Portland, Oregon 97233.

### EXPORT-IMPORT

**JAPAN: 1200 Products Directory.** Illustrated Manufacturers' names, addresses. \$3.00. Send cash. Yamagata Office, 814 Togin Bldg., Marunouchi, Tokyo.

**REVISED Foreign Suppliers Directory** \$4.95. World Shoppers, P.O. Box 151-W, Oklahoma City, Oklahoma 73123.

### FOR THE HOME

**DE-SKUNK Car, Cleaners, Silver, Copper, Brass.** Household ingredients—\$1.00. Recipes, Box 5343, Sandia Base, New Mexico 87115.

**HOTCHKISS FIRE ESCAPE LADDERS.** For Homes, Apartments, Farms. Be Safe From Fires. Free Details. Red Oak Sales, Maple Street, Somersville, Conn. 06072.

### OF INTEREST TO WOMEN

**MAKE Extra Money—Show friends, neighbors All Occasion Assortments, Easter, Stationery, Wrappings, Gifts, Toys, Jewelry.** Experience unnecessary. Salable Samples on Approval. Free color catalog, Bonus Plan. Write Hedenkamp, 361 Broadway, Dept. PM-109, New York 10013.

**\$50.00 TO \$100.00 week possible** in hundreds of sparetime opportunities. Write Opportunities Unlimited, Box 55417-P1, Indianapolis, Ind. 46205.

**WOMEN! Make big money at home.** \$10.00 profit in an hour possible with invisible mending. Make holes, tears disappear from clothing fabrics. Steady year-round demand from cleaners, laundries, homes. Details free. Fabricon, 1533 Howard, Chicago 60626.

**HOW To make money writing short paragraphs.** Information free. Barrett, Dept. C-27-A3, 6216 N. Clark, Chicago 60626.

**DRIVE New car, wear new clothes, buy color TV.** Get daily cash income. Put spare hours to work. Write for 5 months free subscription Opportunity Magazine, see hundreds easy ways to make money. Opportunity, 1460 Hancock Center, Dept. 17-BO, Chicago 60611.

**\$75.00 THOUSAND.** Home addressing! Longhand, typewriter. Information, send stamped self-addressed envelope. Brewster, Box 1348-YL, Clearwater, Florida 33517.

**\$500 MONTHLY POSSIBLE—Clipping news at home.** No experience. Free information—send stamp. American, Excelsior Springs, Mo. 64024.

(Continued on next page)

## OF INTEREST TO WOMEN

(Continued from preceding page)

\$25.00 HUNDRED Addressing, Possible! Year 'round. Complete instructions 25¢ for registration, postage, Cove, Box 1348-B, Clearwater, Florida 33517.

\$100 WEEKLY Possible addressing mailing circulars. Send self address stamped envelope. Details Free! Ayers Opportunities, Box 1591PM, Denton, Texas 76201.

EARN Up to \$2.00 Hour Lacing Baby Boots!! Cowboy, Warsaw 9, Indiana 46580.

\$100 WEEKLY Possible—Home Typing Immediate earnings! Employers list, complete instructions. Details 25 cents. Typing, Box 593, PM-2, Bettendorf, Iowa 52722.

WANTED! Addressers — Commission Mailers. Stamp required. Ooton Distributors, 4120-P Duke Drive, Portsmouth, Virginia 23705.

EARN Money Painting Novelties at home. N. Roland, 10-V Lakeview, Hammon, N.J. 08037.

CLIP Newspaper Items. \$1.00-\$5.00 Each. Free Facts, Treasures, 6210-M. Hampton, Norfolk, Virginia 23508.

FREE information! Personalized Stationery, Labels, Envelopes, Longwood, 4720 Fort Johnson, New York 12070.

SELL Greeting Cards—Make extra money. All Occasion Assortments, Easter, Stationery, Wrappings, Gifts, Toys, Jewelry. Experience unnecessary. Salable Samples on Approval. Free color catalog, Bonus Plan. Write Hedenkamp, 361 Broadway, Dept. PM-106, New York 10013.

CHURCHES, School Groups, Civic Clubs, Scouts! \$50.00 cash is yours everytime 10 members each sell 10 canisters of Nationally Advertised Candy at \$1.00 a can using our "50-50" Funds Raising Plan. Fun, Fast, Easy. Send no money. 30 days to pay. Write Verne Collier, Dept. PM-3, 900 North 19th, Birmingham, Alabama 35203.

HOMEWORKERS! Make money mailing postcards. Particulars 10¢. Wesley, Western Springs, Illinois 60558.

SELL Gifts And Household Items—Make extra money. Toys, Jewelry, Stationery, Wrappings, All Occasion, Easter Card Assortments. Salable Samples on approval. Free color catalog, Bonus Plan. Write Hedenkamp, 361 Broadway, Dept. PM-103, New York 10013.

EARN \$100.00 Modeling Garments local areas. Plan \$1.00. Packer, Box 1742, Hollywood Station, Los Angeles, California 90028.

## GIFT SHOPPING

FREE Catalog, Gifts, novelties, books. Harry Haines, R1, Box 151, Mill Hill, Pennsylvania 17751.

WATCH fobs and belt buckles featuring Caterpillar products. Collector's item; 1970 date imprinted on back of fobs. For more information and prices, write Today's Merchandising, 1909 E. Cornell, Peoria, Illinois 61614, Dept. PM2.

## WATCHES, OLD GOLD, JEWELRY

HIGHEST CASH For Gold, Jewelry, Gold Teeth, Rings, Diamonds, Watches, Silver, Platinum. Mail Articles Today. Free gift with information. Chicago Gold & Precious Metals, 6 E. Monroe, Dept. 658, Chicago 60603.

WATCH And clock repairing books. Free catalog. North American, Box 77-AP, Fox River Grove, Illinois 60021.

WANTED—gold, silver, platinum (any form), mercury. Information free. Wilmo's, 1067 Bridge Street, Grand Rapids, Michigan 49504.

CASH Immediately for old gold, jewelry, gold teeth, watches, diamonds, silverware, spectacles, platinum, mercury. Free information, Rose Industries, 29-A East Madison, Chicago 60602.

JEWELRY and HANDICRAFT—Catalogue #10 M 25¢ (refunded with first order) EVE'S GIFTS, Box 132 Tallman, New York 10982.

## WEARING APPAREL

PROFITS FROM CLASSIFIED ADVERTISING! Booklet shows you how to start your own business with Classified Advertising. Only \$1.00 (Refundable with first order.) C. A. Martin, Popular Mechanics, Dept. PM, 224 West 57 Street, New York, N.Y. 10019.

## HEARING AIDS

HEARING AIDS—Batteries Wholesale! Brochure—Hearing Center, Box 211, St. Petersburg, Florida.

HEARING Aids below wholesale. Regular, eyeglass, completely hidden models. Smallest, most powerful. Free home trial. No Salesman will call. Free details. Write Prestige-C6, Box 10880, Houston, Texas 77018.



## SCIENCE AND CHEMISTRY

"ELECTRONIC EXPERIMENTS WITH PLANTS: Sensitive response detector gives dramatic audio pitch as living plant reacts to smoke, injury, touch. Uses famous Backster Effect described in Electronics World, Oct. '69. Ideal for making new discoveries in bioelectric communications phenomena. Plans with FREE scientific references—\$5.00. Instrumentation kits from \$69.95. Information—50¢ (no stamps). E-P Laboratory, Dept. PM, Box 277, Rialto, Calif. 92376."

CHEMICALS, Apparatus, Biological Supplies, Microscopes, etc. Catalog 35¢. Sheard Science, Dept. PM, Columbus, Wisconsin 53925.

FREE Periodic classification of elements and conversion tables with catalog 35¢. Chemicals, apparatus, biology. Mid-States Scientific, 7053 N. Clark, Chicago, Ill. 60626.

CHEMICALS And apparatus for industrial, analytical, and private laboratories. Catalog 50¢, Dept. M-50, Biological Supply Co., 1176 Mt. Hope Ave., Rochester, N.Y. 14620.

ILLUSTRATED Catalog: Chemistry mineralogy, biology 25¢. Tracey Laboratories, Evanston, Illinois 60204.

LASER PISTOL—\$1.00. How to build. PHASER PISTOL—\$1.00. (Add 25¢ postage.) New catalogue—25¢. Roy Davis Laboratories, Dept. PM, 118 West Adams St., Jacksonville, Florida 32202.

SEARCHING For economically priced Laboratory Supplies? Gifts with catalogue—25¢. Hagenow Laboratories; Manitowoc, Wisconsin 54220.

SEARCHING For Economically priced Chemicals And Apparatus? Gifts With Catalogue 35¢. Starr Scientific, Manitowoc, Wisconsin 54220.

LABORATORY Supplies At Discount Prices. Catalog—35¢. Deluxe Scientific, Manitowoc, Wisconsin 54220.

AMAZING New Book of Science Experiments, formulas and Catalogue of Laboratory Supplies. Only 50¢. National Scientific Co., 9 S. Park Avenue, Lombard, Illinois 60148.

## FORMULAS, PLANS, ETC.

FOR Proof of what you can do in specialty manufacturing get our literature. It's free! Miller, Chemist, 1517-P, Tampa, Florida 33601.

ANY Formula \$3.00. Catalog—Treatise 10¢. Belfort, 192 N. Clark, Chicago 60601.

## PLASTICS

CASTOLITE pours like water and hardens like glass at room temperature. Embed natural flowers, coins, special collections Also new molding and casting resins for reproducing originals. Manual 25¢. CASTOLITE, 70/101B, Woodstock, Ill. 60098.

PLASTIC Embedders, jewelry workers. We have everything. Findings, moulds. New Catalog 25¢. David Co.; 861 Broad St., Dept. M, Providence, R.I. 02907.

PLASTIC Craft Kits—Supplies. New, Enlarged Catalog 50¢. (Refundable). Specialty Products, Dept. 7, 731 Brooks Road, Muskegon, Michigan 49442.

## TREASURE FINDERS

TREASURE LOCATORS MOST COMPLETE LINE. FREE INFORMATION. TESOROS, APARTADO 7-948, MEXICO 7, MEXICO.

POWERFUL Metrotech locator detect gold, silver, coins, relics. Moneyback guarantee, terms. Free information. Underground Explorations, Dept. A, Box 793, Menlo Park, California 94025.

FREE 128 Page detector catalog. General Electronic Detection Co., Box 67, Bellflower, California 90706.

FREE TREASURE GUIDE! Fact-filled collectors edition; send 50¢ for postage. Also request free literature on ultrasensitive, professional Fisher Detectors. FISHER RESEARCH, Dept. PM-2, Palo Alto, California 94303.

ULTRA-SENSITIVE AND POWERFUL METAL DETECTORS—join the many who are finding buried coins, minerals, relics and artifacts. Don't buy till you see our FREE catalog of new models. Write Jetco—Box 132, PM, Huntsville, Texas 77340.

NEW: Non-residents: Canadian Oil leases. \$4.00 acre. Free Information. Northern, Box 560-F, Westmount, Montreal 215.

TREASUREPROBES. Patented transistorized detector signals "dig" by earphone "beeping." 5" search head, PC boards, two colpitt oscillators improve stability. Kit \$13.95, assembled \$18.88, with speaker \$24.88. 60 day guarantee. Send for Free bibliography, "Treasure Maps and Books of U.S." Treasurehouse, PA20, Tennesse, N.J. 07763.

TREASURE Hunters! Prospectors! Relco's new instruments detect buried gold, silver, coins, minerals, historical relics. Transistorized. Weighs 3 pounds. \$19.95 up. Free catalog. Relco-A40, Box 10839, Houston, Texas 77018.

FIND Buried treasure with new revolutionary analytical metal detector. Features push button tuning, automatic tuning, loudspeaker, negligible ground pickup greatest range. Free catalog. Gardiner Electronics, Dept. 9, 4729 N. 7th Ave., Phoenix, Ariz. 85013.

"TREASURE BOOKLET. Excellent information on treasure hunting and metal detectors. Send 25¢. BOOKLET, Box 243, San Gabriel, California 91778.

GOLDAK Treasure Locators—New for '70! A hobby you'll enjoy for fun and profit. Find coins, gold, silver. Goldak, Dept. PMC, 1101A Airway, Glendale, California 91201.

"SEARCH Metal Detectors, solid state, sensitive. Free literature. Search Electronics, Box 8396, St. Petersburg, Florida 33738."

## PRECIOUS STONES AND MINERALS

MOONROCK—Tektite from Thailand. 1 inch \$1.00. Larger \$2.00, \$3.00, \$5.00. Plummer's, 4720 Point Loma Ave., San Diego, Calif. 92107.

EARTH Science Rockhound Magazine. Subscription \$2.50. Sample 35¢. Box-550-PM, Downers Grove, Ill. 60515.

100 COLORFUL, Polished gemstones \$1.00. Tumblecraft, 5401 James North, Minneapolis, Minnesota 55431.

(Continued on next page)

## PRECIOUS STONES AND MINERALS

(Continued from preceding page)

GET Free catalog no serious rockhound, gem cutter, jewelry maker, hobbyist or craftsman can be without. Full of bargains, exclusive items, low prices from largest suppliers and authorities in the field. Free new catalog just off the press, yours for the asking. Write Grieger's, Dept. C-12, 1633 E. Walnut, Pasadena, California 91106.

SEMI-Precious uncut gems. Ten different for \$1.00. Request list #35. Prospectors Shop, 201 San Francisco, Sante Fe, New Mexico 87501.

12 POLISH-Gem-Stones-Of-The-World, Names-And-Locations. — Educational — \$1.00. Empire Gem's, Trinidad, Calif. 95570.

LARGE POLISHED GEMSTONES. 15 different \$1.00. Colorful crystal specimens, 3 different \$1.00. Lists with order. Sering, 1705 E. Michigan, Indianapolis, Indiana.

500 BEAUTIFUL POLISHED GEMSTONES \$1.50. Floodstones, P.O. 1673 Fremont, California 94538.

GOLD 10 Small Nuggets Panned from Oregon Streams \$1.00. Robert Brandt, Sweet Home, Oregon 97386.

## CARTOONING, COMMERCIAL ARTS, SHOWCARD & SIGN PAINTING

COMPACT 23 lesson Cartoon Course and Cartoonist's Magazine. \$2.00. Hartman, Box 30367, Lincoln, Nebraska 68510.

LEARN sign painting at home. Free talent test. Ben Kerns, Box 812-PM, Greenville, S.C. 29601.

SIGN Painting. Fascinating System—Straley, 410 So. Western, Springfield, Ohio 45506.

ART Talent? Make money right away. Course may not be necessary. Free brochure. Famous American Studios, P5, Spring Park, Minn. 55384.

LEARN CARTOONING at home. Free book, "Key To A Cartoon Career." Write: Cartooning, Box 0-3176, Colorado Springs, Colo. 80907.

SIGN Painting Matthews' big new 18 lesson course \$5.00 postpaid. Circulars free. Sign Book Co., 470 Oak Street, St. Louis, Mo. 63119.

"HOW TO MAKE MONEY WITH SIMPLE CARTOONS"—Everyone who likes to draw should have this book: FREE. Write Cartoonists' Exchange, 92 Pleasant Hill, Ohio 45359.

SIGN Painting—Free Catalogue. Instructions. Equipment. Kaufmann Signs, Centertown, Missouri 65023.

SIGN Painting Secrets, Tricks, illustrated booklet \$2.95. Letter pattern catalog free! Paulow, 1935-M Stardust, Waukesha, Wisconsin 53186.

"LETTERING Tricks" (Deluxe Edition Airmailed \$1.25) Harris, Box 1567-XM, Portland, Oregon 97207.

LEARN Profitable tattooing. Illustrated information and instruction \$3.00. Zels, 2220-P Delcy Dr., Rockford, Illinois 61107.

## ADVERTISING AGENCIES, ADV. SERVICE, MAILING LISTS

ADVERTISING Ratebook leading newspapers, magazines, 25c. Chicago Advertising Agency, 28-E Jackson, Chicago 60604.

MAILING Lists most all kinds 1000 \$5.00. Free folder Your circulars mailed \$4.00 1000. Dixie Mailers, King, N.C. 27021.

## TYPEWRITERS, DUPLICATORS, OFFICE EQUIPMENT

FREE Plan. Start printing, lettershop. Offset Presses. Mimeograph Copy machines. DixieGraph, King, N. Car. 27021.

CLOSEOUT—Typewriters, Adders, cash registers, P.A. systems, trumpets, guns, recorders. Gestetners, Gestafax's, Box 94173, Oklahoma City, Okla. 73109.

## RUBBER STAMPS AND OFFICE SUPPLIES

FREE 40 Page catalog. Rubber stamps, office supplies. Youngers Stamp Shop, Princeton, Iowa 52768.

ADDRESS Stamp 85c. Signature \$2.80. Carol's, McLoud, Okla. 74851.

RUBBER Stamps. Any Copy, 4 lines \$1.00. Phillips, Box 164A, Staten Island, New York 10314.

FREE Illustrated rubber stamp booklet. Beckley's, 119 DeLong Avenue, Syracuse, New York 13208.

ENGRAVED Brass, Plastic Nameplates, Permanent Dies for making Stamps, \$1.00. Literature. Morris, Box 331, Lake Charles, Louisiana 70601.

POCKET Stamp Self-Inking \$1.00 3 Lines. Martin House 2052 East 24th Street, Brooklyn, N.Y. 11229.

ADDRESS Stamp with Handle. Four lines \$1.25. House Tom Henry, Bensenville, Illinois 60106.

ADDRESS Stamp with handle \$1.25. Brookfield Stamps, Box 121, Brookfield, Wis. 53005.

## PRINTING PRESSES, RUBBER STAMP OUTFITS

SIMPLE-X RUBBER STAMP PRESSES, hydraulic operated, electrically heated. Sizes 5"x8", 8"x12", 10"x15". Starting outfits. Orders for presses, supplies shipped day received. Free catalog low supply prices. Custom Manufacturers, 406-P East Elm, Springfield, Mo. 65801.

PRINTING Presses, type, supplies. Lists. 5c. Turnbaugh Service, Mechanicsburg, Pennsylvania 17055.

TYPE Catalog No. 12, 120 pages. Send One Dollar. Deductible First Order. Acme Type, 732 Federal, Chicago, Illinois 60605.

SAME Day shipment on rubber stamp supplies. Revised wholesale price list No. 6 free. Star Stamp Supply, 732 Federal, Chicago, Ill. 60605.

RUBBER Stamp outfits, supplies. Kiewiet, 2025 Barney Road, Kalamazoo, Michigan 49007.

MAKE your own self-molding rubber stamps and printing cuts. Plexirubber, Argyle 1, Wisconsin.

ADDRESS Stamp. \$1.00. Wendell's, Box 2284, Dept. 3, Everett, Wash. 98201.

DEEP Face Hard Type for better rubber stamps and printing. Complete Line, stamp presses and supplies. Buy direct. Barco Type Manufacturing, 237 Evergreen, Bensenville, Illinois 60106.

RUBBER Stamp Manufacturers Supplies. Presses, starting outfits. Best Prices, Service, Catalog. Jackson Supply, Box 443-A Franklin Park, Ill. 60131.

MIMEOGRAPH Machine 8½"x11", \$11.00 Guaranteed. Homecraft, 2350 W47, Denver, Colorado 80211.

## PRINTING AND SUPPLIES

1,000 QUALITY Business cards up to seven lines, raised letter printing \$4.75. Robert Gersh, Stetson Street, Hyannis, Massachusetts 02601.

AMAZING business printing values. Quotations. Print Shop. Box 576, Greenville, R.I. 02828.

QUALITY Printing, discount prices, free catalog. Gables—405A Clifton—Glenshaw, Pa. 15116.

FREE Literature. Address Labels, Business Cards, Printing, Rubber Stamps: Jordan's, 552 West O'Connor, Lima, Ohio 45801.

8 HOUR PRINTING—Free Booklet "Secrets of Cutting Printing Cost" Nationwide Printing, Atlanta, Ill. 61723.

1000 LABELS, 4 Lines \$1.00. Pocket Stamp, \$1.00, Catalog 25c. Refunded. Seal, Box 505P Elgin, Ill. 60120.

1000 BUSINESS Cards, \$4.95 Postpaid!!! "Raised Lettering". . . . Samples . . . . Noble PM2, 505 Briggs, Bellmore, New York 11710.

FREE GIANT Discount Printing Catalog. Gables, 405A Clifton, Glenshaw, Penna. 15116.

## MULTIGRAPH, MIMEOGRAPH

PROFITS FROM CLASSIFIED ADVERTISING! Booklet shows you how to start your own business with Classified Advertising. Only \$1.00 (Refundable with first order.) C. A. Martin, Popular Mechanics, Dept. PM, 224 West 57 Street, New York, N.Y. 10019.

## GUMMED LABELS

1,000 GUMMED Address labels \$1.00. Walt's, Box 966A, South Bend, Indiana 46624.

1,000 GUMMED address labels 50c. Fabrico, PB-1, 1512 N.E. 29th Street, Ocala, Florida 32670.

1000 GOLD Striped Address Labels \$1.00. Meade Seaman, 1702 Followthru, Tampa, Florida 33612.

## REMAILING SERVICE

CANADA Remails, 50c each. Confidential. Dependable, Box 61, Whitehorse, Yukon Territory.

LAS VEGAS, NEVADA Remails, stamped letters, cards, 25c each. Phil Lafran, 425 N. 16th Street 89101.

MOTOR CITY Remails Special Services Available. M.C.R.S., Drawer 890, Dearborn, Michigan 48121.

LANNON is your new address. Box 211, Lannon, Wisconsin 53046.

"RECEIVING-Forwarding \$4.00 monthly. Wright House, Box 2112-M, Asheville, N.C. 28802."

MIAMI Remails 25c. Monthly rates. Marie, Box 1266, Coral Gables, Fla. 33134.

RECEIVING—Forwarding. \$4 Monthly. Hedgpeh, 406-M South Second, Alhambra, Calif. 91802.

CONFIDENTIAL New York City mail address \$3.00 month. Remails 25c. Details Free. Birnhan, 152 W. 42. New York City 10036.

NEW YORK City: United Nations 25c. Additional Services. Snow-M, 458 Vermont, Brooklyn 11207.

SECRET. Receiving-forwarding. Discreet and confidential. Remail 25c single. Mail Forwarding Service, 8050 S. Main, Houston, Texas 77025.

KENTUCKY Remails 25c. \$3.00 Monthly rates. Smile, Box 203, LaGrange, Ky. 40031.

MARYLAND Remails—25c. Prompt. Dependable. MarMar, Box 2114, Wheaton, Maryland 20902.

SACRAMENTO Remails 25c Singles. \$3.00 monthly. Box 19123, Sacramento, Calif. 95819.

DETROIT! 1/25c. Dependable. Confidential. Receiving—Forwarding. FB-Lemke's, 3476 Balfour, Michigan 48224.

(Continued on next page)

## REMAILING SERVICE

(Continued from preceding page)

**MARVELOUS** Old Mexico. Registered remails \$1.00 each. Colorful Postcards 4 for \$1.00. Receiving Forwarding \$3.00 Monthly. Confidential. Femor, PM, Apartado 5-131 México 5, D.F.

**SAVE N.Y.C.** Remails 20¢. \$2.00 monthly. Paul's, Box 1307, New Rochelle, N.Y. 10802.

**BEAUTIFUL** Lake Huron Resort. Remails 25¢. Monthly \$3.00, post cards. John, 6746 Lakeshore, Lexington, Michigan 48450.

**BOSTON, Plymouth**—Remails 25¢ each. \$3.00 monthly. Dependable, confidential. Sirron, Box Nine, Weymouth, Mass. 02188.

**DYNAMIC DALLAS**—Remailing Service. 25¢ singles. Frank and Son, Box 34443, Dallas, Texas 75234.

**VALENTINE** Remail **LOVELAND**, the Sweetheart Town 25¢; also Denver. Beautiful postcards 6/\$1.00. Mile-Hi, Box 11265, Denver, Colorado 80211.

**LESLIE** Singles—25¢.—Monthly \$3.00. Unlimited. Caleb Barden, Kirby St., Leslie, Mich. (49251.)

**FORT WAYNE** Remails. Receiving. Re-mailing. Confidential. 25¢ Single; \$3.00 Monthly. Adams, Box 500, Auburn, Indiana 46706.

## REPAIRS AND SERVICING

**REPAIR TV TUNERS: FREE TRICKS.** Bocek, Box 832, Redding, California 96001.

## SPECIAL SERVICES

**COMMUNICATE** with the Universal Plan. Improve your Life. New O-Cult Device allows you to do this in moments. Simple operation. "The First Step Dial." \$1.00. MoonRiver-B, 99 Charles St., Boston, Massachusetts 02114.

**AUTHORITATIVE** Information On Anything! \$2.00 (deductible). Metzler Research, Box 2206PN, Long Island City, New York 11102.

**INFORMATION** On anything. Ferguson Research Specialists, 83-45 Vietor Ave., Elmhurst, N.Y. 11373.

**ALASKA?** for background information on a new job or business. New house, new future. \$2.00 ALASKA-UN, Ltd. Box 10-028, Klatt Station, Anchorage, Alaska 99502.

## TOBACCO

**FREE** Twist Samples Smoking—Chewing 10¢. Jolley Farms, Dresden, Tenn. 38225.

## PERSONAL

**BORROW** Up to \$1,000 By Mail. Money on your signature for any purpose. Write: American Loan Plan, Dept. AA-0135, City National Bank Bldg., Omaha, Nebraska 68102.

**SECRET LOANS BY MAIL.** Borrow \$100 to \$1500 for any good reason in absolute privacy. No interviews, no endorsers, no co-signers. Fast service. Write Dial Finance Co., Dept. B-214, 410 Kilpatrick Bldg., Omaha, Nebraska 68102.

**SECRET** Law Wipes Out All Debts. Immediate relief. Clear credit. Free details. Capital-7, Kerrville, Texas 78028.

**SUBCONSCIOUS** Conditioning remakes personality while you sleep. Free details. Sleep-Learning, Box 24N, Olympia, Washington 98551.

**MICRO MINIATURE LISTENING DEVICES** Construct eight simple devices yourself (49¢-\$20),—or buy pre-assembled units from catalog accompanying detailed instructions. Instructions \$1.00. SIMTRONICS, P.O. Box 113, Downey, California 90241.

**BEAUTIFUL** Girls. Free Information "International Introductions," Apartado 950, Guadalajara, Mexico.

**TATTOO** Removing. Do-It-Yourself Kit \$14.00. Information Free: Atlanta Co., 907 Lakecrest, Fairport Beach, Ontario.

**INVESTIGATORS.** Latest electronic Aids. Free Literature. Clifton, 11500-P NW 7th Ave., Miami, Florida 33168.

**RUPTURED.** Relief and comfort. No understraps, elastic or steel. Write Hand-Lock Products, Preston 4, Ont., Canada.

**BIBLE** Questions answered. Stamped envelope. Bylon, 17167 Bentler, Detroit, Michigan 48219.

**HYPNOTISM SECRETS.** Lowest prices. Free information. Merlin Enterprises, P.O. Box 613, Los Gatos, Calif. 95030.

**MAKE NEW FRIENDS** Worldwide. Meet Marriage minded Girls through our illustrated Catalog. 1200 Ladies' Fotos and Descriptions \$2.00. I. C. B., Box 12, Sta. O Toronto, 375, Ont. Canada.

**MAKE YOUR WILL.** Get 4 Will Forms and attorney's informative book. \$1.00. Legal Forms Company, Department 124, 1830 Guardian Building, Detroit, Michigan 48226.

**"LONELY? 200** Names, Addresses, Descriptions, either sex. \$1.00. Free Membership. Mention Popular Mechanics, receive 50 extra names. California Club, Box 314, Long Beach, California 90801"

**GET OUT OF DEBT** in 90 minutes, legally without borrowing or bankruptcy. facts so explosive, credit syndicate tried suppressing, free details. Anderson, 5818E Hamilton, Cincinnati, Ohio 45224.

**HOW** to have confidence, make good first impressions. Send \$2.00 for book to: Family Gift Center, 1240 B2 Boulevard, Athens, Georgia 30601.

**BORROW** up to \$1500 by mail on convenient terms! State licensed. Postal Finance, Dept. 17-A, 200 Keeline Building, Omaha, Nebraska 68102.

**ARE YOU REALLY SINCERE** about wanting to find a marriage partner? **SOCIAL INTRODUCTION SERVICE**, P.O. Box 1547, Eugene, Oregon 97401.

**SMOKING?** This booklet may save your life—Medical and psychological method to stop smoking. Booklet #WB106 \$2.00. Mills Mail Mart, Dept. PM270 130 Herbert Avenue, Elmont, New York 11003.

**CANCER!** You May be Next! Stop Smoking! New Book reveals medical and psychological method. Money Back Guarantee. Only \$1.00. Merritt House, 126 Bergen Terrace, Cresskill, N.J. 07626.

**DO NOT** have your next dental checkup until you read the sensational **MOLARIS** report. Save up to \$10,000.00 and more in dental bills for an investment of only \$5.00 with guaranteed results. **MOLARIS**, 2821 East Atlantic Blvd., Pompano Beach, Florida 33062.

## WANTED—MISCELLANEOUS

**MERCURY.** Gold, Silver, Platinum: Ores assayed. Wholesale Terminal, Norwood, Mass. 02062.

## MISCELLANEOUS

**UP** To \$151 Daily Track Wins With Scientific Computer. \$2 Stakes. Proof Supplied. Free Details: RH-P10A, 5715, Carmel Calif. 93921.

**KNIVES**—101 imported. Novelty knives—catalogue (50¢). Friedmar Imports, Box (533-PM), Montebello, Calif. 90640.

**DUPLICATE** Birdcalls! Entertaining, educational. Mail \$1.00 bill for two Handreck "Birdcallers"; sent airmail. Millions sold in Europe. Guaranteed. Handreck, Box 720B, 43 Essen, Western Germany.

**SLOT & Pinball** machines. Replicas. Catalog 35¢. Coffco, P.O. 522, Lake Zurich, Illinois 60047.

**WANT** Greatest Cash Crop working for you? Write Ginseng, Asheville 53, N.C.

**YOUR** Name sent to 1000 importers, publishers, mailers, wholesalers, etc. on our mailing list. Year \$1.00. Dixie Mailers, King, N. Car. 27021.

**WINEMAKERS**—Free catalog and recipes. Kraus, Box 451-L, Nevada, Missouri 64772.

**CIGARETTES** 12¢ a pack. Improved roller makes 20 filtertip, plain, king or regular for 12¢. Facts Free. Moberly, Box 954, Owensboro, Kentucky 42301.

**BIRTH** Certificates, Marriage Certificates, Diplomas! 2 blank forms \$1.00. Sample 10¢. Standard Forms, Box 482-M, Washington, D.C. 20044.

**WINEMAKING** . . . Grape, Elderberry, Dandelion, Frozen Juices, etc. Brewmasters' secrets revealed! Powerful Methods! Instructions, Recipes, and Supplies Catalog. \$1.00. Continental, Box 11071 PB, Indianapolis, Indiana 46201.

**BOOKS** On antiques and their prices. Free circular!! P. Warman Publishers, Uniontown, Penna. 15401.

**WINEMAKERS.** Free illustrated catalog of yeasts, equipment. SempLex, Box 12276, Minneapolis, Minn. 55412.

**HEARING** Aid batteries wholesale. Free list. Habs, Box 51, York, Penna. 17405.

**UNUSUAL RACING PROFITS** From Simplified Handicapping Methods. Gil Howard, Box 507 PM, Carroll, Iowa 51401.

**YOUR** Address placed with hundreds of distributors, wholesalers, publishers, importers. Year \$1.00. California Listing, Box 1114H, Saugus, California 91350.

**IDENTIFICATION CARDS**—Send stamped self-addressed envelope for free samples & details to: E.C.S.M., P.O. Box 12117, Las Vegas, Nevada 89112.

**AMAZING!** Instant Salads. Brochure Free. Novak, 18720 Hatteras, Tarzana, California 91356.

**ORNAMENTAL** Iron designs. Book of 1600 beautiful, practical designs for railings, columns, etc. Free literature. Cunningham, 3881 South 3200 West, Salt Lake City, Utah 84119.

**MOON** Photographs. Free information. Clayton's, 1415 Jefferson Heights, Pittsburgh, Pennsylvania 15235.

**DO** You have coins or stamps? New Service gets you top market. 6¢ stamp for particulars. Dryz, P.O. Box 9209, Treasure Island, Florida 33740.

**1001 FREE ITEMS.** List 50¢. Shopper's Fair, 1025C Bristow, Belleville, Illinois 62221.

**LIKE** Country Music? Rush 25¢ for all star song-picture book. (\$1.00 Value) Country Scene, Dept. 10, Sadieville, Kentucky 40370.

**WINEMAKING**—Hundreds of Exotic Wine Recipes—Also Brandies, Ciders, Gins, Whiskies "etc." Recipes—with Complete Directions for all Fruits, Vegetables Supply Source and Bartender's Guide—all for \$2.00. FISHER'S, 2735-D Mission, San Francisco, Calif. 94110.

**RHEUMATISM.** Ischiat, Cold, Backache? You want to get rid of that quickly, send \$3.00 for details. Z. S., P.O. Box 213, Sidney, B.C., Canada.

**BIRTH** Certificate, Driver's License, H.S. & College Diploma—Blank Forms, fill them in yourself. \$2.00 each; All four—\$5.00!!! Glennco, Box 834-PM Warren, Mich. 48090.

**LONG** Lasting Vinyl Bumper Stickers. Sticker. \$1.00. Box 901, West Sacramento, California 95691.



# LEARN THE PROFESSIONAL METHOD OF APPLIANCE REPAIR

*For extra income, a job skill in demand, a business of your own — or to save money on your own appliance repairs.*

## SEND FOR FREE CATALOG

Appliance Division, National Radio Institute  
Washington, D.C. 20016

600-020

Send me your illustrated free book that tells about opportunities in Servicing Electrical Appliances, and gives details of NRI's simplified training plan. I understand there is no obligation, no salesman will call.

Name \_\_\_\_\_ Age \_\_\_\_\_

Address \_\_\_\_\_

City \_\_\_\_\_ State \_\_\_\_\_ Zip \_\_\_\_\_ Code \_\_\_\_\_

Check here for facts on New GI Bill.

Accredited Member National Home Study Council



MAIL COUPON ABOVE  
FOR THIS  
**FREE**  
**NRI**  
**CATALOG**

AVAILABLE UNDER NEW GI BILL

If you served since January 31, 1955, or are in service now, check GI line in coupon above.

## A new, short, easy course trains you at home

Now you can prepare quickly to do professional appliance servicing at home in your spare time.

You are ready to start servicing appliances after only a few lessons. The entire course can be finished in a matter of months.

This is the fastest way to a new job or skill or extra income or a business of your own. Wherever you live or want to live, you'll find a demand for top-notch appliance servicemen.

There are probably thousands of broken appliances right in your neighborhood. These can mean cash profits for you starting soon. Use your spare time

to make \$5 to \$7 an hour fixing appliances for friends and neighbors.

Low-cost training plans cover —

- Small and large home appliances
- Farm and commercial equipment
- Portable electric tools
- Small gasoline engines

— there is even special training to prepare you for air conditioning and refrigeration.

Special NRI appliance testing equipment is included in your course at no extra cost. Mail coupon for your FREE NRI Catalog. No salesman will call.



NATIONAL RADIO INSTITUTE • APPLIANCE DIVISION  
Washington, D. C. 20016

# HOMEOWNERS' CLINIC

BY W. CLYDE LAMMEY

## Case for lightning rods

*My house was struck by lightning last summer and although there was limited damage, I was badly scared. Is there any truth in the saying, "Lightning never strikes twice in the same place"? I've thought of installing rods but do they offer any protection?—T.L., Mo.*

According to well-established records it is not true that lightning never strikes twice in the same place. Tall buildings attract repeated strikes; homes and other buildings, on farms and in urban communities, have been struck more than once.

Lightning rods, properly installed, do protect against damage by lightning. Venerable old trees in parks, structures of historical interest, church steeples, country homes, barns and outbuildings and many industrial installations have been protected by lightning rods for years. Tall buildings of structural-steel construction are lightning rods in themselves and need no additional protection as a rule. You will likely find competent installers listed in the Yellow Pages of your local telephone directory or in those of nearby cities.

## Cedar shakes over old roof

*My asphalt-shingle roof is nearing the end of its normal life and I want to install a cedar-shake roofing. The deck, of boards laid edge-to-edge, seems to be in good condition. Do I need to take off the old shingles or can I lay the shakes over them? Should I replace the felt under-covering? If so, with what?—N.O., Ohio.*

I would remove the old shingles—everything right down to the decking—then go over the decking to make sure no boards are loose or cupped. The latter should be replaced and the former nailed securely. Any deck boards that seem deteriorated, rotted, full of knots or otherwise defective due to aging should also be replaced. It's important to provide a solid nailing surface for shakes.

While you can use an ordinary felt under-covering, or liner, this may tend to prevent the underside of shakes from drying. I would, rather, install the "breather-type" liner usually recommended for use under shakes. This should be available

through your local building materials dealer, and laid according to the manufacturer's recommendations. If you do the job yourself, be especially careful to avoid splits or hammer dents and make sure you use the right nails.

## Rotary or reel mower?

*Finally I'm going to discard my hand lawn mower and buy a new power mower next spring. I don't like the awful racket made by a rotary mower, but I'm told it's the one to buy—more efficient, cheaper in cost and in upkeep. What do you say?—G.K., N.Y.*

Perhaps a dozen rotary mowers are sold for every reel type. Somewhat lower initial cost is a likely factor in the wide disparity of sales. The rotary is efficient when cutting fine and coarse-bladed lawn grasses and it'll buzz through quite tall grasses and weeds without stalling; that is, if the blade is razor sharp.

You don't mention a choice between the rotary self-propelled and push types so I'm assuming you refer to the latter. If I were discarding a hand mower I would want to discard the "push" also.

On the other hand, the reel-type mower can be set to make the very low cut required on some varieties of lawn grasses, usually works better on slopes and terraces and operates efficiently at a much lower blade speed. When properly sharpened and correctly operated, it does an unbeatable job on a smooth lawn. Most reels are self-propelled and easily maneuvered around shrubbery, near fences and along quite steep slopes. Blades and bed knife must be sharpened by someone with special equipment. If blades are damaged by a stone, repair may be more costly.

The reel type is generally less efficient than the rotary on a rough lawn and, though operational hazards are present with both types, is generally considered less hazardous.

## Waiting game

*Why do I have so much trouble taking off old finishes with a remover? I put the stuff on, but can't get the old finish off. After several applications, I still have to do a lot of scraping.—I.L., Ore.*

Perhaps you don't wait long enough for the remover to "work," or you may be using a liquid remover on a vertical surface, where a paste-type should be used. Give it time—10, 15, 20 minutes or even more—to cut through the old finish. You'll find the washoff-type less messy. ★★★

This on-off anti-reverse lever activates drag action instantly—or lets the line run free.

# Ted Williams didn't think a great spin-casting reel had to cost a bundle.

## Sears proved it.

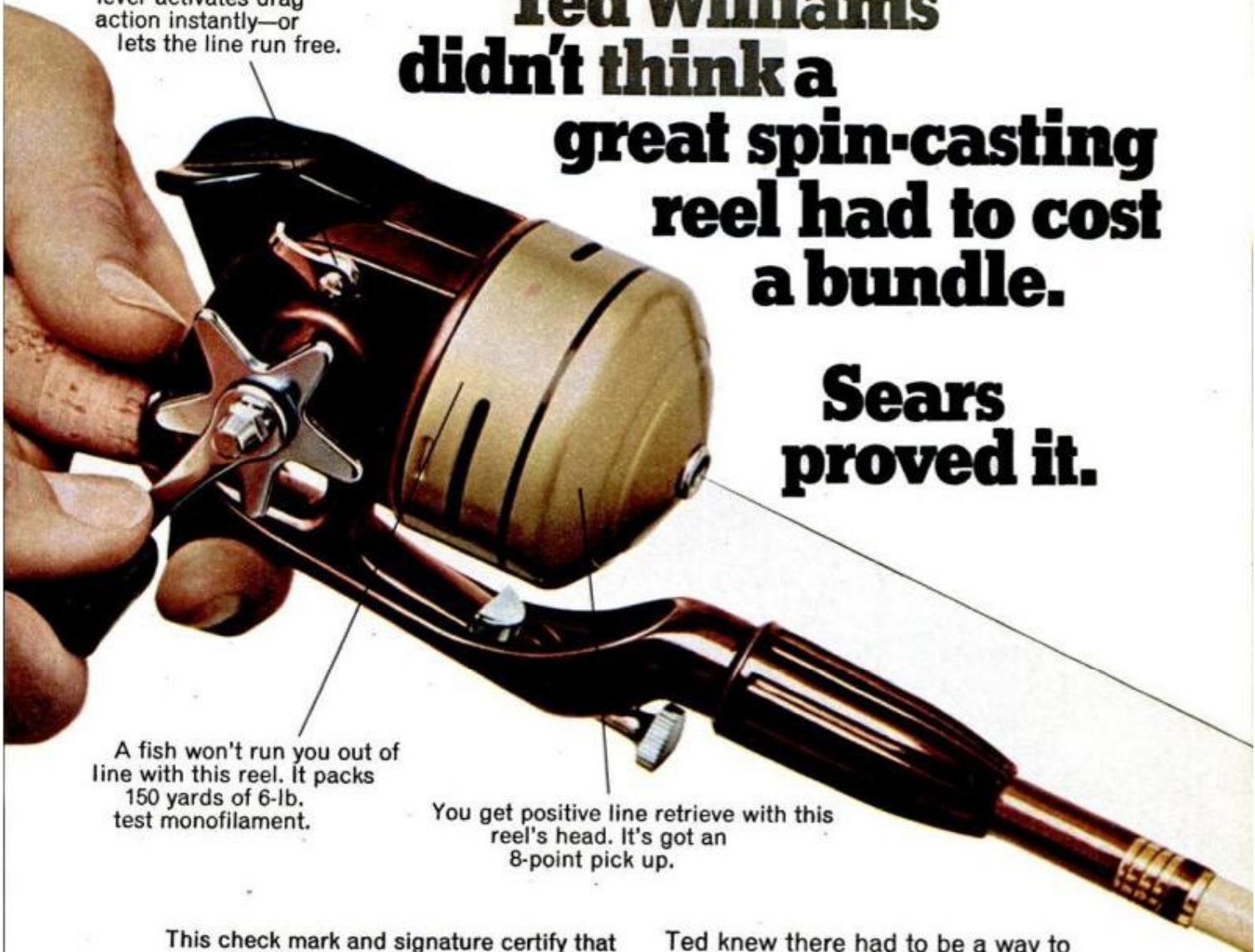

A fish won't run you out of line with this reel. It packs 150 yards of 6-lb. test monofilament.

You get positive line retrieve with this reel's head. It's got an 8-point pick up.

This check mark and signature certify that Ted Williams, Chairman of the Sears Sports Advisory Staff, personally tested and approved this Model 240 reel and Model II rod.



Ted knew there had to be a way to make a great reel—without making it expensive. With his help, that's what Sears did with this one.

It's loaded. With features you'd expect only on more expensive reels. Like the big star drag that gives you the proper line tension for any fish. Precision, diamond-cut 4 to 1 gears that pack plenty of fish-fighting power.

Ted and Sears put a lot of other great things on this reel—including a price tag of under \$12.

Tomorrow, see this Ted Williams Model 240 reel and other great spin-casting reels at the Sears Sports Center in a Sears, Roebuck and Co. store. Or the Catalog.



**Sears**   
**SPORTS CENTER**  
where the new ideas are

# If you're pulling any of these, you may be killing your car.

That's why INTERNATIONAL® built the TRAVELALL®. It's the one wagon built to tow up to five tons.

Customers come in to our dealerships with perfectly fine sedans and station wagons twisted out of line. Transmissions worn out. Engines burned out. Rear ends shot to pieces.

They've come to the right place. They've just come a little too late.

Travelall is built on a truck style frame. And built strong. Special engines. Special drive trains. Special cooling systems that won't overheat when you're pulling something big up a mountain.

Travelall is the only wagon that can be equipped to handle anything up to a five-ton travel trailer or a thirty-foot cabin cruiser.

But don't think of it as a truck, just because it's built like one. Inside, it's as soft and luxurious as anything on the road. And with power steering, power brakes and automatic transmission, wives can drive it with the same ease as they drive standard station wagons.

It's roomier inside, too. Fully 25% roomier than even the largest conven-

tional wagon. Because you need comfort when you're driving all those miles to your special spot. Getting to the fun should be fun, too.

When you do want to pull a trailer or a big boat, you probably need a Travelall. Maybe you ought to drive on into your International dealer's and find out more.

Send today for valuable towing information. Free towing guide from Travelall.

Write to: International Harvester Company  
P.O. Box 7333, Dept. PM-2  
Chicago, Illinois 60680

Or: Ask your nearest International Truck Dealer.

Name \_\_\_\_\_

Address \_\_\_\_\_

City \_\_\_\_\_ State \_\_\_\_\_ Zip \_\_\_\_\_

## Travelall by International

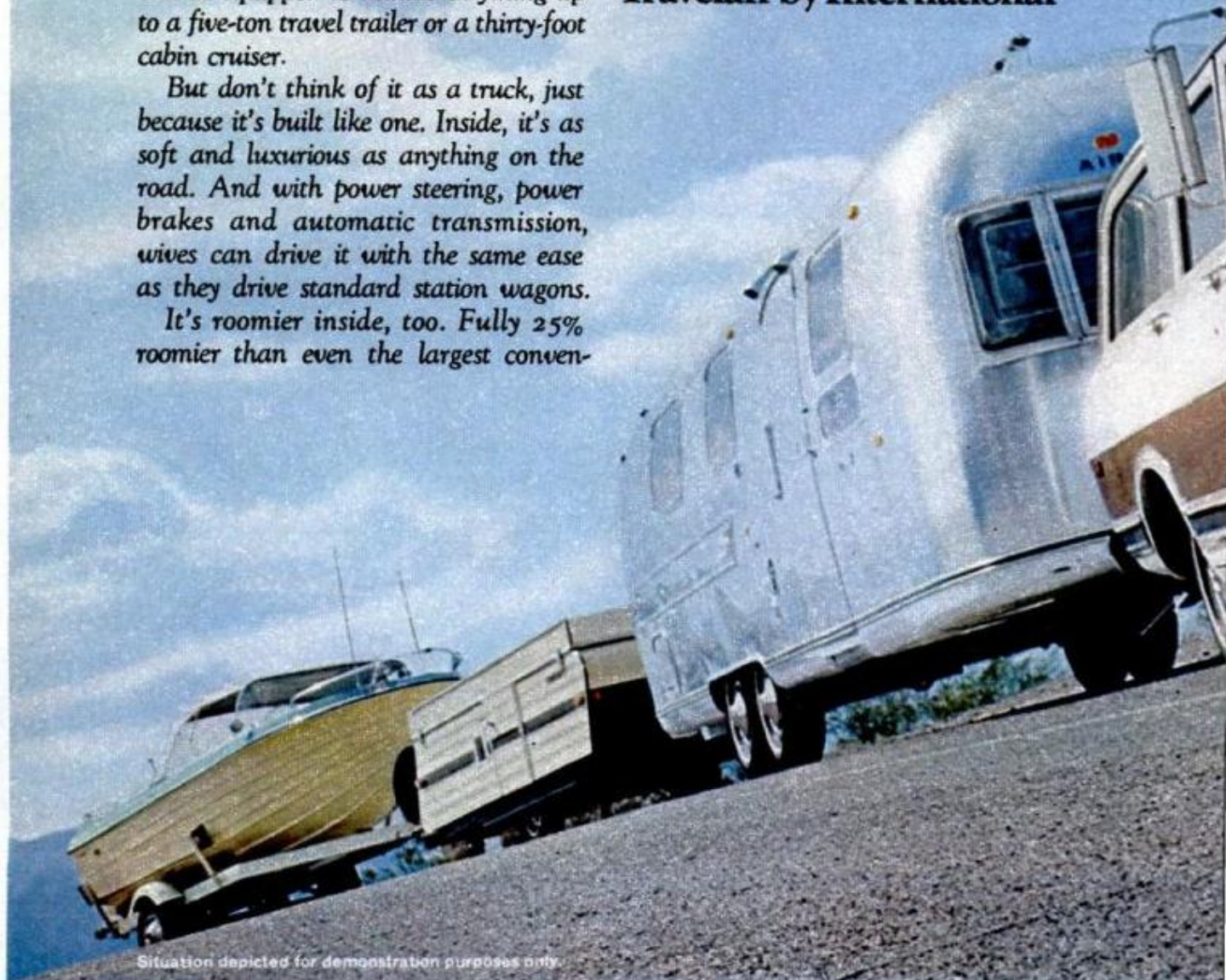

Situation depicted for demonstration purposes only.



Automatic and standard shifts



Engines to 392 cubic inches



124 cu. ft. interior



4-wheel drive available



**INTERNATIONAL HARVESTER COMPANY**  
CHICAGO, ILLINOIS 60611

# SOLUTIONS FOR MECHANICAL HEADACHES

# AUTOMOBILE CLINIC

BY MORT SCHULTZ

## Back in the saddle

*The rear springs of our 1966 Chevrolet Impala station wagon have squeaked and squawked since the car was new. Replacement springs haven't helped at all, and the Chevy garage is at a loss. Any suggestions?—George Parks, Greensburg, Ind.*

Rear-spring squeak is usually the result of interference between the spring and the upper seat or the spring and the lower retaining-bolt saddle. Interference at the upper seat can be corrected by using a rear-spring insulator (part No. 9775680). Be sure the insulator fits correctly—it might be necessary to trim the insulator to get the upper seat and upper end of the spring to fit properly.

Should interference be located at the lower retaining-bolt saddle, reposition the spring and retorquer the attaching bolt to 30 ft.-lb.

## Spark knock mystery

*Replacing the distributor breaker points, timing the ignition and changing from regular to premium gas have not stopped the spark knock in my 1968 Plymouth with 318-cu.-in. engine. The knock is particularly loud under load, as when I speed up to pass another car. The dealer says that all 318s do this, and I have to live with it. Do you agree?—Michael McDaniel, Erie, Mich.*

You might have to if your dealer has readjusted ignition timing to the standard now called for by the manufacturer. That 318-cu.-in. engine is designed to run on regular fuel, so I'd switch back to that. Now, make sure that the basic timing is in accordance with revised specs made in the service manual, which is wrong. This engine should be timed to  $2\frac{1}{2}^\circ$  after top center if the car has an automatic transmission— $5^\circ$  after top center with a stick. If there's no improvement, you can safely retard the spark up to  $3^\circ$  in trying to clear the knock.

## A lot of static

*I get loud static from my radio when I operate the electric windows on the right front, intermittent noise when the driver*

*side window is operated, and no noise at all with the rear windows. The car is a 1967 Buick Wildcat with electric antenna. Is there anything I can do?—Nat Schleger Levittown, N.Y.*

There are things you can try, but I won't promise that you'll eliminate all static when operating the right side window. That's the one nearest the antenna. When the window's motor is operated (each window operates on a separate motor), some pickup by the antenna must be expected. Anyway, to minimize the static, make sure the connection at the antenna lead-in is clean and tight. Although your antenna might not be so equipped, there should be a ground wire from the antenna sleeve to the car body. Make sure this ground connection is absolutely clean and tight. Remove any paint at the ground connection to bare metal. Finally, remember that too much static could also result if brushes in the window motor are worn.

## For a Peugeot manual . . .

*Where can I get a shop manual for a 1969 Peugeot 404 sedan?—J. H. Fielding, Orange, Conn.*

If the parts department of a Peugeot dealer can't help you, write to the Peugeot-Renault distributor in the United States. That's Dolphin Magna Motors, Inc., Parts Department, 76-02 Northern Blvd., Jackson Heights, N.Y.

## Rough rider

*I've been experiencing a violent vibration with my 1967 Chrysler Newport at speeds in excess of 65 mph. When the car hits an irregularity or bump in a highway, the result is a terrible up-and-down movement. My dealer says it's nothing, so I took the car to a local garage which assured me that shocks, ball joints, wheel alignment, wheel balance and the idler arm are in good order. What do I do now? Daniel F. Kelly, Old Bethpage, N.Y.*

First, make sure that wheel balancing is done correctly. Wheels must be balanced dynamically as well as statically. I'll bet you'll find that wheel balance is off when you balance by spinning the  
(Please turn to page 82B)

# Crank up your spirits.



The Starcraft Stardust.

Just turn the crank and you've  
got the most elegant digs  
this side of a mountain stream.

Nobody else cranks you up like  
we do. Another Great  
Escape Machine From Starcraft.

  
The  
**STARCRAFT**  
*Wide World of Recreation*

WRITE STARCRAFT COMPANY, DEPT. 0PM-2, GOSHEN, INDIANA 46526, FOR A FREE CATALOG.

## AUTOMOBILE CLINIC

(Continued from page 82)

wheels. If not, there are about 10 sets of bushings in that front end holding such things as struts and torsion bar. The problem is probably weak or worn bushings that have to be uncovered. Also keep in mind that tires which are out of round will cause vibration.

### Collected condensation

*My 1969 Ford pickup is equipped with a toolbox on the right side of the bed. It sweats terribly, so that any metal I keep in the box gets rusty. The Ford dealer doesn't have the answer. Any solution?—J. E. Shook, Woodburn, Ore.*

I guess FoMoCo hasn't received word of this trouble from the field, because it hasn't issued a service bulletin. Yet, the solution is simple. Just drill a small hole in each corner to vent the box.

### Check the obvious

*I have a 1960 DeSoto with a 361-cu.-in. engine in beautiful shape, except that it refuses to start when the engine is at operating temperature. I've had the starter rebuilt, new battery installed, a complete motor overhaul (including a carbon and valve job) and, of course, endless ignition tune-ups. Everything's been done according to the manual. The car's cost me too much to get rid of it. Please help.—John Cetani, River Edge, N.J.*

Could it be, John, that you've overlooked the obvious in your search? Hard starting when the engine's hot is usually caused by an oversupply of fuel because of various conditions such as nonoperable automatic choke, float level set too high, leaky float, worn or dirty needle-valve seat, sticky float and percolation. If you've gone this far, take a step back and check the fuel system.

### Depressing clutch

*The clutch pedal of my 1965 Chevrolet Impala with four-speed transmission is hard to push in. The dealer says it's normal. What can be done?—Fred Burkhardt Jr., Robstown, Tex.*

I assume you have a heavy-duty clutch and it's working properly. If so, your dealer told you the truth. It requires

greater effort to operate than a conventional clutch because of the high pressure-plate force. Effort can be kept to a minimum by cleaning and lubricating the clutch-fork fulcrum ball, clutch cordon, shaft supporting studs and the clutch-pedal shaft. If it's really tough, there's a chance that the clutch-bearing retainer is scored. If so, replace the retainer and the release bearing.

### A gusher

*My 1963 Oldsmobile 98 is leaking a tremendous amount of oil from the rear of the pan. We've dropped the pan and replaced the gasket. This helped for 100 miles; then the leak started again. Why are these gaskets shrinking?—George J. Bass, Westport, Ind.*

Gaskets don't shrink. I'll bet that the upper seal on the rear main bearing is shot. The reason the condition seems to be alleviated with a new gasket is that the leak is slowed down by the new gasket and a lot of gasket sealer.

## Service Tips

● **Ford-built 1969 cars** with the 351-cu.-in. engine may experience cranking problems when a hot engine is restarted. If starter and battery repairs, including lubrication of the starter's drive housing bearing, fail to cure the condition, battery-to-relay, relay-to-starter, and battery-to-ground cables should be replaced with the following cables, respectively: C2RZ-14300-H, C2RZ-14431-E, and C2RZ-14300-C.

● **Cadillac** advises that before taking drastic action to correct a low brake pedal the car be driven backward and forward several times with the brakes applied at the end of each directional movement. If the car has seen only forward driving over a prolonged period, which prevents the automatic self-adjusting mechanism from doing its job, a low pedal will result.

● **All 1969 Chrysler products** with the 383 or 440-cu.-in. engine and a Holley carburetor may have a hard hot-starting and rough-idle condition that normal adjustments haven't fixed. The cause is probably a warped secondary-metering block in the carburetor. The company has issued a secondary-metering-block modification kit (part No. 3514459) and service bulletin 69-14-4 that tells your mechanic what to do. ★★

---

**GOT A PROBLEM WITH YOUR CAR?** Ask Mort about it. Send your question to Auto Clinic, Popular Mechanics, 224 West 57th St., New York, N.Y. 10019. Letters cannot be answered individually, but problems of general interest will be published in the column.

---



# Outsells all other vans combined

...because Ford's better ideas make all other vans obsolete!



## 23% more floor space.

Ford moved the engine forward—to give you 23% more unobstructed floor area than any other van can offer. Clear load length measures over 8½ ft. in the Econoline Van ... over 10 ft. in the Supervan.



## Twin-I-Beam ride.

The independent front suspension made famous by Ford pickups: Twin-I-Beam. Two I-beam axles for strength ... big coil springs for easy ride. Wide-track design adds new highway stability, even on windy days.



## Payloads to 3600 lbs.

Choose from three Econoline series. Payloads to 3600 pounds. As much as 1325 pounds more than in other vans. Power choices include top-performing 302-cu. in. V-8.



## Outside service center.

Just raise the hood and all these service points are at hand—oil, water, battery, windshield washer water, wiper motor, brake master cylinder, voltage regulator. Ford's better van ideas make everything you do easier to do.



## "Walk-thru" to rear.

Because the engine is forward out of the way, the driver can step from his seat into the load area. The loadspace is not only bigger, it's easier to reach. Check all the better ideas in the best selling van—at your Ford dealer's.



# FORD ECONOLINE VANS



# Thunderbolt ignition. Fastest start in boating.



## Now all Mercs have it.

Thunderbolt is Mercury's exclusive ignition system that zaps up to 40,000 volts to the spark plugs in microseconds.

With Thunderbolt, Mercury continues to have the hottest spark, the fastest start, the smoothest run in the industry.

For 1970, every Mercury in the line, from 135 hp down to 4 hp, has Thunder-

bolt ignition. *Breakerless* Thunderbolt (no points at all) from the 135 hp through the 40 hp. Mercs from 20 hp through 4 hp have new *Maker-Point* Thunderbolt: the plug is fired by the points making contact.

There's more: Perma-Gap spark plugs. A new, super-tough metal alloy for the center electrode resists spark erosion. You may never need to change spark plugs, because under normal conditions, Perma-Gap spark plugs can last the life of the engine.

Thunderbolt ignition and Perma-Gap spark plugs prevent preignition and fouling problems formerly caused by lead deposits. This means you can now take advantage of regular gasoline (in the 50:1 gas-oil mix) for every 1970 Mercury.

Your Mercury Dealer has the fastest start in boating for you—in ten new models.

**MERCURY**  
OUTBOARDS

COMPLETE RANGE OF POWER: 4, 7½, 9.8, 20, 40, 50, 65, 80, 115, 135 HP.  
For Nearest Mercury Dealer, see the Yellow Pages under "Outboard Motors."  
Kiekhaefer Mercury/Fond du Lac, Wisconsin/Canada, Ltd./Australia Pty. Ltd.





Coming  
Down the Pike:

# Easy-to-Fix Cars

**Bit by bit, cars are being simplified to make service easier, less expensive**

By ROBERT LUND

**D**ETROIT IS TRYING to take some of the sting out of owning and operating an automobile. Repair bills and service charges on cars of the '70s won't wallop your wallet as hard as they did on cars of the '60s. Automakers are finally trying to simplify repairs, improve accessibility, and reduce overall service.

"Vehicle serviceability is going to be one of the most competitive areas of our business in the years ahead," says Harold C. MacDonald, in charge of product development for Ford. MacDonald's prediction is shared by his counterparts throughout the industry.

MacDonald had a hand in development of the new service-it-yourself Maverick, a car that—along with

American Motors' new Hornet (see page 96)—is a lap ahead of the competition on easy-service features. That's because both cars were engineered with the Saturday mechanic in mind. But other carmakers are moving to close the gap. Take a look at some of the easy-service innovations on rival '70 model cars:

Several of GM's standard-size cars have pop-out dash panels. Instrument bulbs can be replaced by removing a snap-off bezel and four screws. A mechanic used to have to remove part or all of the instrument cluster to install a 25-cent bulb. GM is expected to extend the pop-out panel to other car lines over the next few years.

All '70 model Ford products have ex-

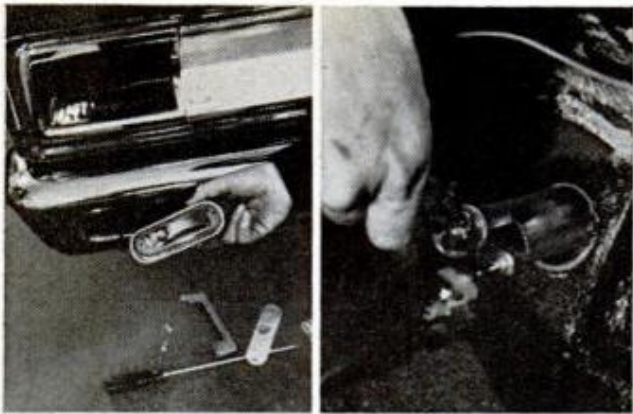

**REPLACING** taillight bulb on AMC Rambler required unit disassembly (left). On new Hornet, it snaps in

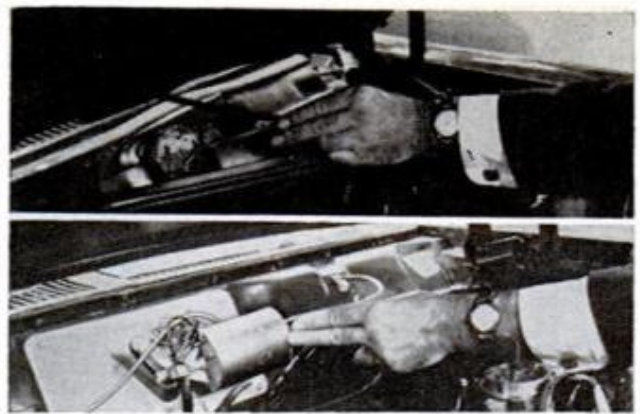

**WINDSHIELD WIPER MOTOR**, behind cross bar on the Rambler, is in open, easy-to-get-at spot in Hornet

ternally adjustable headlamps. The job can be done with a screwdriver without removing the decorative hardware surrounding the headlight.

American Motors has a list of 19 easy-service features on its '70 cars, some new, some carryovers from '69. They range from an easy method of adjusting parking-brake linkage to a central, one-panel location for all fuses. In the case of Hornet, the list of easy-do innovations runs to 22 items, including sparkplug changing, ignition timing, adjusting wheel bearings, setting the carburetor choke—all jobs that usually require an experienced mechanic. (AMC rates at least a nod for having pioneered the whole idea a decade ago when it promoted self-service on the 1960 Rambler American.)

Chrysler's approach is somewhat different from that of the other companies. Its focus is on building more life

into critical components to reduce the frequency of service. A case in point is the electronic voltage regulator on the firm's '70 cars. The unit has no movable parts, lengthening the life of battery and lights. For one of its axles—the 8.25—Chrysler has devised a cover plate for the differential. The plate can be removed to inspect bearings, ring and pinion gears without dropping the differential or removing the axle. This is a real time-saver. However, under pressure from other automakers, Chrysler's program could change direction, with more emphasis being put on how-to advice for the motorist who wants to handle his own service.

If these concessions to do-your-own-thing don't strike you as anything to get excited about, consider a few ideas Detroit has up its sleeve for cars of the immediate future:

- A built-in unit that will let you make



**INSTRUMENT PANELS** on new Hornet (left) and Maverick are easily removed, providing quick access for check-out of wiring, instrument repair, bulb replacement. Note foolproof printed circuit on Maverick

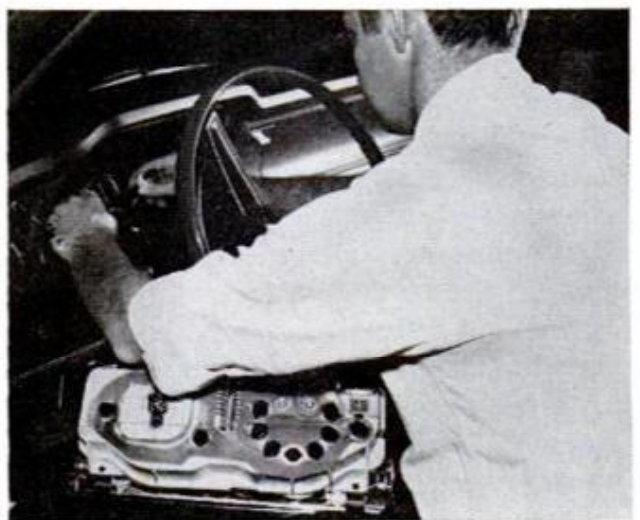

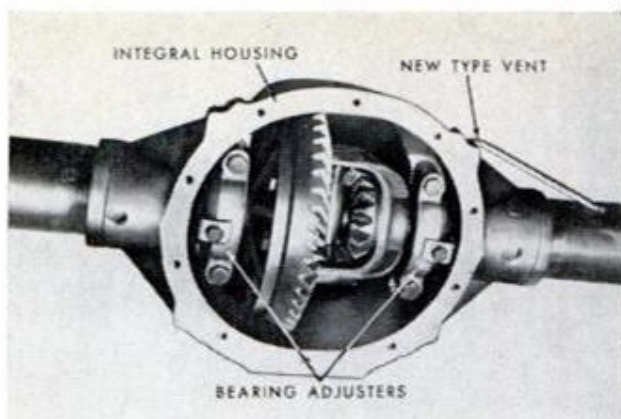

**EASILY REMOVABLE** plate on pinion housing of many new Dodges makes possible quick inspection, repair



**SNAP-IN, SNAP-OUT** components, featured on many new cars, represent trend in future car engineering

a precise adjustment of headlights without stepping out of the car.

- More self-contained, plug-in, pull-out units—radios, tape players, heaters and other add-on accessories—which you can repair yourself or drop off for a mechanic to work on without surrendering use of your car.

- Printed circuits that can be installed only one way, so there's no chance of making a mistake.

- A new family of warning lights that will tell you when a part needs service—ahead of time, before trouble develops.

Detroit engineering departments are intentionally vague on how soon these improvements will show up and how far and fast they expect to move in simplifying service. In some areas, the goal is to knock 20 percent off the time it takes to repair or replace a part. Opti-

*(Please turn to page 196)*

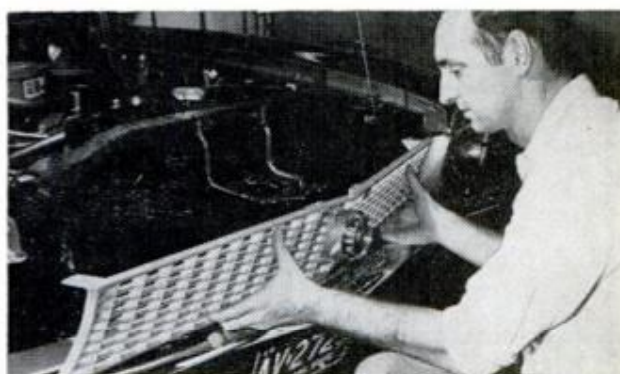

**PLASTIC GRILLE** of Maverick is attached with only five screws, can be replaced in a matter of minutes



**RADIO** of Maverick can be removed via four screws in fraction of time required for most installations

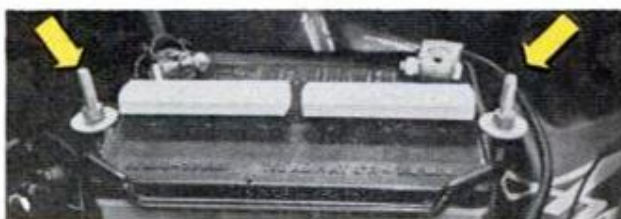

**BATTERY** OF AMC Rambler is held in place by means of two bolts. Same job is done by one on the Hornet

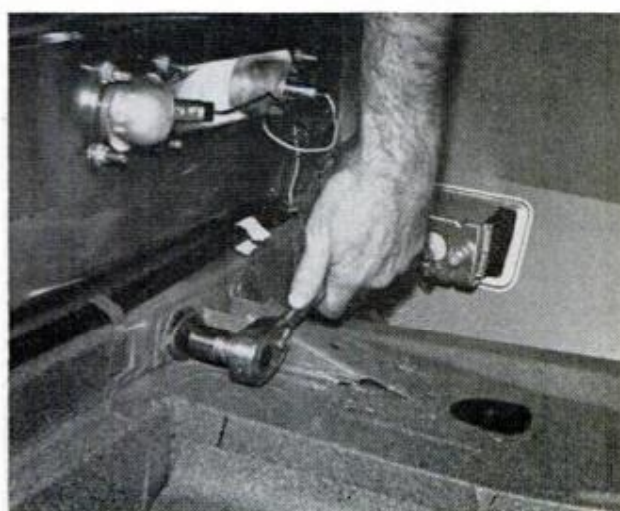

**REAR BUMPER** of Maverick can be removed easily via four bolts located at corners of car's trunk floor

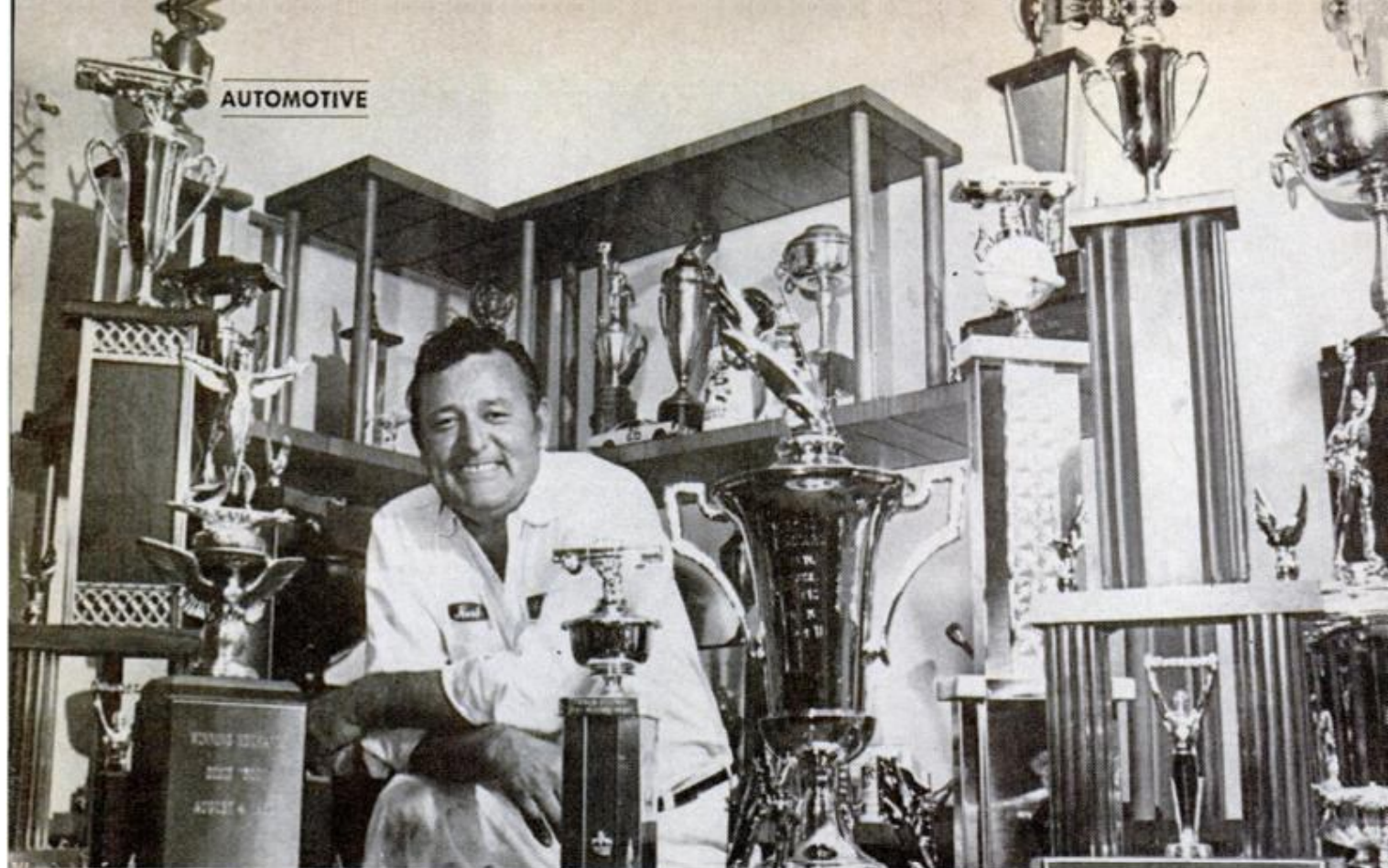

TO THE VICTOR go the trophies, and Herb Nab has earned a lot of them in his long career as one of the top mechanics in stock-car racing. One he'd like to add is another symbolic of winning the Daytona 500

# Lee Roy's Secret Weapon

When Daytona's green flag drops, Herb Nab may just be the best setup man on pit row

By **BILL KILPATRICK**, Auto Editor / Photos by Don Hunter

**T**HE TUNE Herb Nab whistles through his teeth as he works is nothing you ever heard. It's an aimless, pleasant phrase that these days might be titled "Daytona On My Mind."

This is the month of the Big One—the annual Daytona 500, the richest, most prestigious stock-car race in the world. And Nab is a race-car crew chief who finds himself in the position of the high-climbing monkey—the higher up he goes, the more vulnerable he is.

Nab sets up cars driven by Lee Roy Yarbrough and masterminded by former stock-car star Junior Johnson, a three-way combination that last season

set records at which every other man on the NASCAR circuit will be shooting.

The formidable threesome started their phenomenal year by winning the 1969 Daytona 500 at a record speed of 157.950 mph. They followed with wins at Darlington, Charlotte, Daytona again, Atlanta, a repeat at Darlington, and Rockingham for a total of seven superspeedway victories in a single season, more than any team had won in NASCAR history. As this is written (mid-November), the team has taken home \$187,135, another record. Last fall Ford Motor Co. named Yarbrough "Man of the Year."

But now, of course, all that is his-

tory. On the 22nd of this month the entire racing world will be watching to see if Nab, Johnson and Yarbrough can keep the ball rolling.

"There's no doubt about it," Nab says with the weariness of a winner who must give his all every time out, "the guy that wins at Daytona is the guy to beat for the rest of the year.

"Riverside is important, and all that, but winning out there doesn't give a team the psychological 'leg up' that Daytona does. Like last year, no foolin', when we won down there we just *knew* we were in for a helluva good year. Lee Roy felt good, Junior had a big grin, and I was on Cloud Nine. Man, you couldn't have beat us with a club."

Car owner Johnson, the team's master planner, says the Daytona race not only gives the winning team a great boost in spirit, but it also serves as a sort of final proving ground.

"What with all the practice and the race itself," Johnson says, "we get to know the car real well. We find out—all of us, Herb, Lee Roy, me—what the car'll do and what it won't do. You might think that if you win down there one year, why, you just go back and set up the same way. But it doesn't work. Every year is a whole new ball game."

Asked about the famous bump coming out of Daytona's Turn Four, Nab says it's enough to give a chassis man nightmares.

"Oh, it's a beaut, I guarantee. When a car comes off it, all sorts of things happen. For one thing, the car damn near bottoms out, meaning the suspension has to be stiff enough to take it, yet not so stiff the car's a stone. For another, the wheels toe *out* when the car lands, something that doesn't happen anywhere else on the track. So you have to set up to take that jolt, but still be just right for the rest of the track. Each year, you know, we seem to pick up a few more rpm, a little more speed, maybe we're working with a little bit different tires, and so on, meaning that each year we have to

FEBRUARY 1970



**NAB PERSONALLY** handles the right front tire on Lee Roy Yarbrough's car during a pit stop. "They all have to be right," he says, "but 'specially that one'"

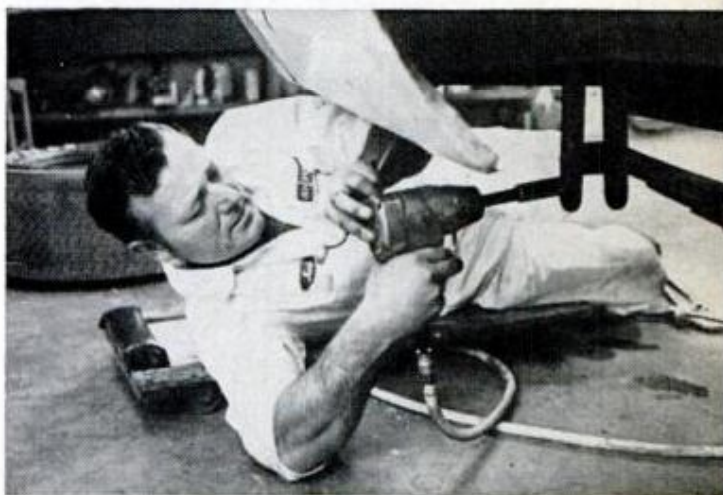

**SETTING UP** suspensions is Nab's specialty. Each race requires a different setup, regardless of how often a crew has run various tracks on the circuit



**FORMER DRIVING GREAT** Junior Johnson, winner of the Daytona 500 in 1960, owns and masterminds cars on which Nab works. He calls Nab "One of the best"



**OUT FRONT** (where he finished seven superspeedway events last year) is Lee Roy Yarbrough at the 1969 American 500 at Rockingham, a race he won. Nab says, "Seeing your man out front makes the work worth it"

start with pretty much a clean sheet of paper.

"Now if we figure it out about right, maybe even win, well, we got pretty good evidence we can set up for just about anything."

Johnson, who himself won the Daytona 500 in 1960, adds that the race is every factory team's maximum effort if

only because a victory simplifies administrative problems for the rest of the season.

"Win Daytona," he says, "and you'd be surprised how many people you can get to answer the phone."

Smiling slightly, Nab adds: "No, we didn't have much trouble getting parts this past year."

The 1969 season saw a big change in the way at least one part of Ford's stock-car racing program was handled. In the past, all engines provided the various Ford teams on the NASCAR circuit came from a common pool at Holman-Moody, the Charlotte-based "factory branch" that builds the basic Ford and Mercury racers and engines.

"Of course they got their own team," Johnson says, "and they want David (Pearson) to win just like we want Lee Roy to win or the Wood Brothers want Cale (Yarborough) to win. So naturally, the engines that seemed to pull a little better on the dyno, or seemed to run a little better, they went into Holman-Moody cars. We raised a

*(Please turn to page 212)*



**AT THE READY** is Nab, here flashing instructions to Lee Roy Yarbrough during last year's Daytona 500



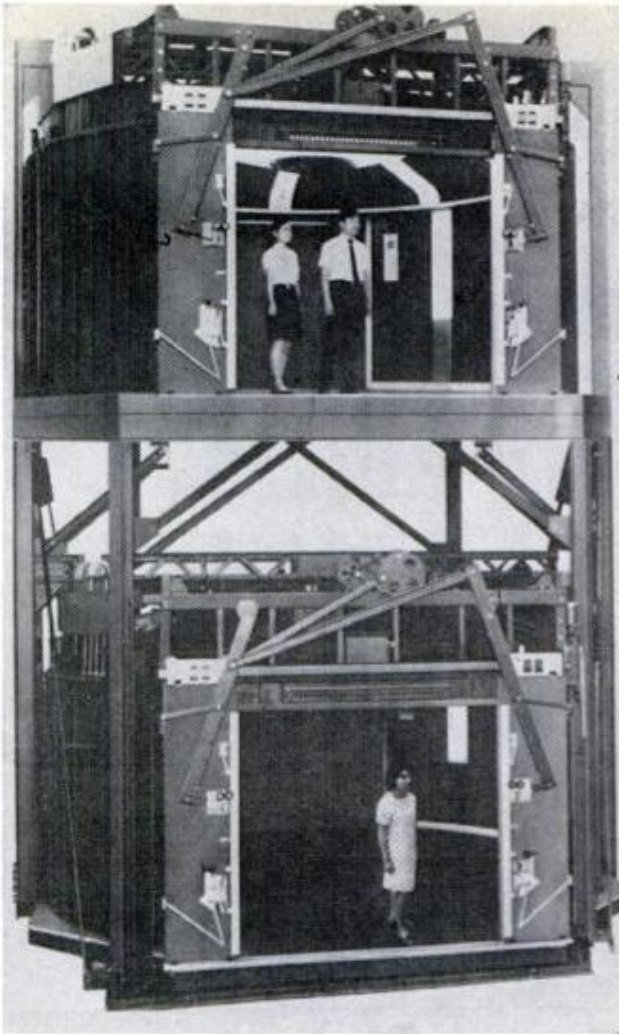

### Double-decker for Expo 70

Largest elevator in the world, this double-decker will be able to carry 260 passengers at a time in the Hitachi Pavilion at Expo 70 in Osaka. The elevator, which operates on an oil-pressure system, was built by Hitachi for its "Air Travel Simulation" exhibit.



### Honest Abe in fiberglass

A heroically proportioned statue of Abraham Lincoln, made of fiberglass and steel, stands in the new Lincoln Memorial Park near Charleston, Ill. The statue, 62 feet in height and 16,000 pounds in weight, is the work of Bob Eglett of Minneapolis. Some idea of its scale can be gained from the relative size of the lady standing at the base.



### It all started with a matchbox

To amuse his son, handyman Leslie Abrahams of Shawford, England, built a small house of "bricks" that he made by casting cement in matchboxes. Now, some 75,000 matchboxes and 11 years later, an entire village made of those little cement bricks covers Abrahams' vegetable garden and most of his yard. Visitors keep adding to his matchbox supply.



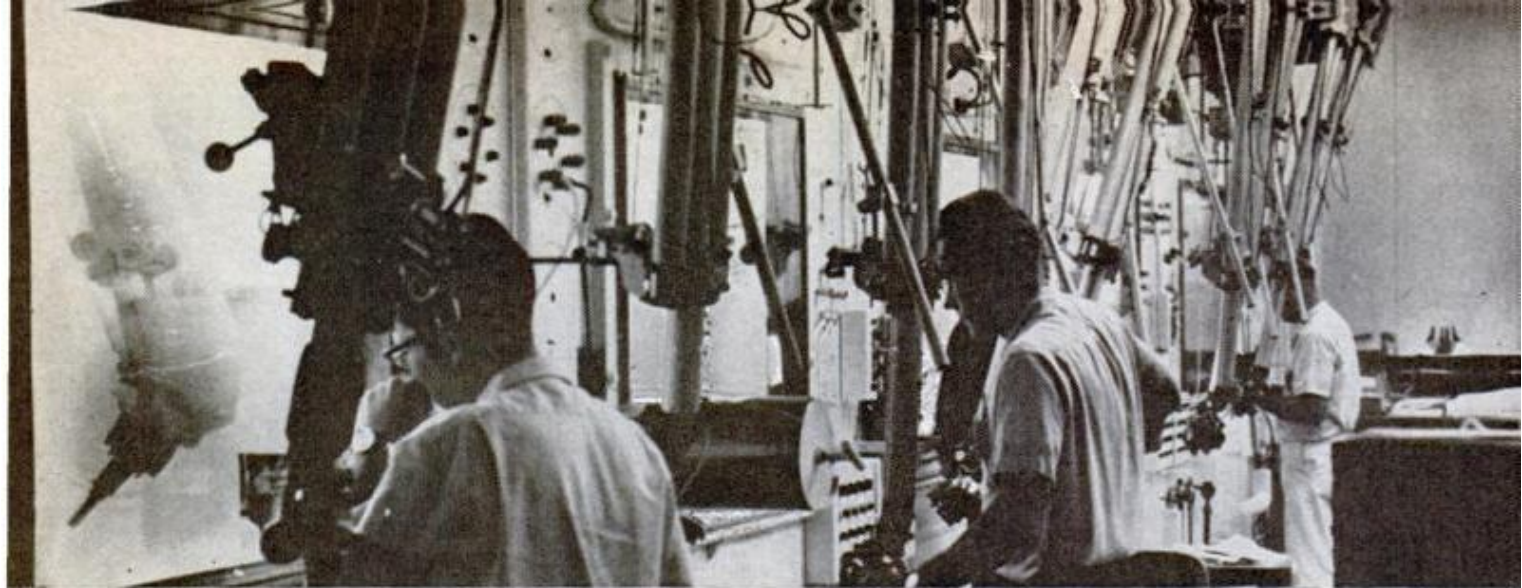

**SHIELDED CHEMISTRY LABORATORY** at Battelle-Northwest is used for analyzing radioactive materials. Operators are very skilled with the manipulators, can pour liquids from one small vessel into another

# THE BIG LAB THAT TACKLES



**SIMPLIFIED PUMP** was developed for use and manufacture in underdeveloped lands



**ARTIFICIAL HEART STUDIES** and other experiments involve use of miniature pigs of strain developed at Hanford lab



**SPINNING PROCESS** is used at Geneva laboratory in making nonmeat protein food



**MAGNIFIED PHOTOMOSAIC** of cross section of a half-inch-diameter fuel element is studied for possible improvement

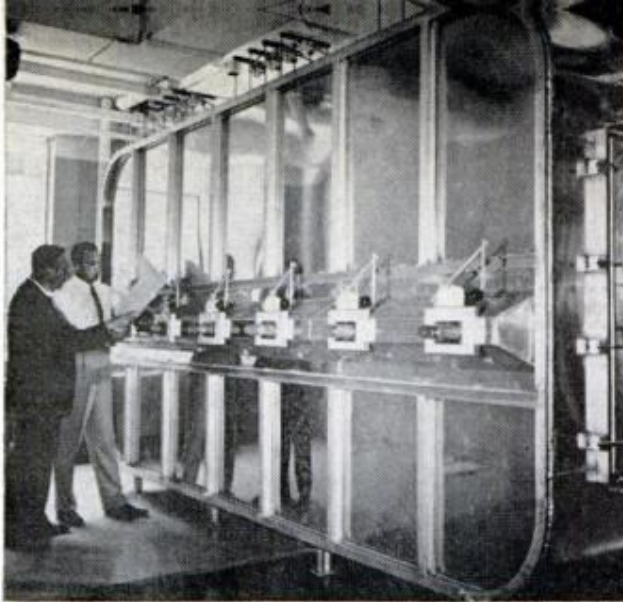

**COLUMBUS SMOG CHAMBER** has ports in one wall to permit test subjects to expose eyes to pollutants

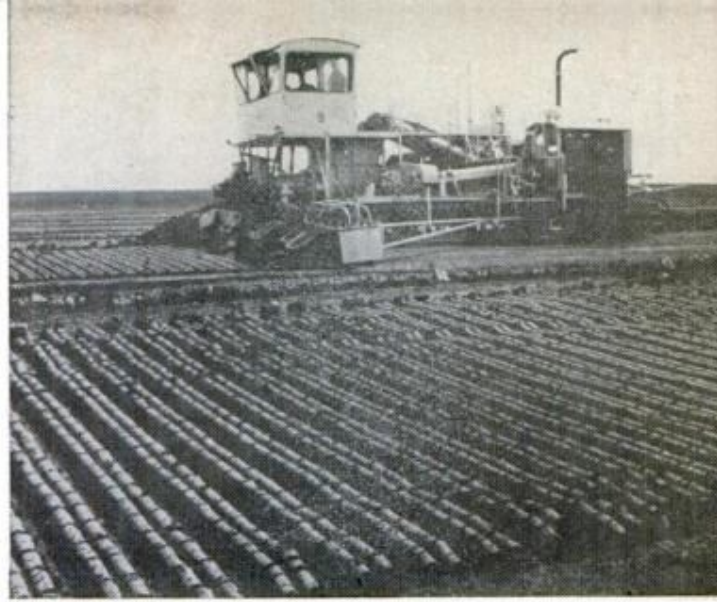

**BIG NEW MACHINE** for cutting peat sod in Ireland was developed with the help of Battelle engineers

# THE TOUGH ONES

By **JOHN F. PEARSON**  
Science Editor

**Fish farming, better artificial hearts, a gel "blanket" for the sea floor—they are but a few of the fantastic array of studies now pursued by the Battelle Memorial Institute**

**C**ONSIDER THIS GRAB BAG of research problems:

- The U.S. Agency for International Development seeks a design for a simplified water pump that would be easy for underdeveloped countries to make.
- The Navy wants to find a way of preventing ocean-floor silt from being stirred up and clouding water during bottom salvage operations.
- The National Heart Institute seeks a way to treat plastics so that they are compatible with human tissue and don't cause blood clotting when used in devices like artificial hearts.
- A group of European and North American companies want a projection for the next decade of trends in sea and air cargo operations across the North Atlantic.

It's a big stretch from water pumps to transatlantic cargo forecasts, but that doesn't faze the Battelle Memorial Institute. These are but a few of the hundreds of studies in progress at vari-

ous Battelle laboratories, and applied research is only one of BMI's areas of concentration. It is also committed to the generation of new knowledge, to the support of advanced scientific education and to programs for moving new methods and inventions from the laboratory to the marketplace.

If you've never heard of BMI, you're not alone. Though it has existed since 1925 and has made impressive technical and scientific contributions—perfecting the Xerox process, for one—BMI doesn't go in for horn-tooting.

Battelle is considered to be the largest organization in the world doing research under contract. Its headquarters is in Columbus, Ohio, but it has other applied research complexes in Richland, Wash., Geneva, Switzerland, and Frankfurt, West Germany, and a center in Seattle, a "think tank" created expressly for basic research and scholarly pursuits. In addition, it maintains smaller facilities or offices at about a



**RADIOIODINE IN THYROID** of miniature goat is monitored by staff members at Battelle-Northwest lab

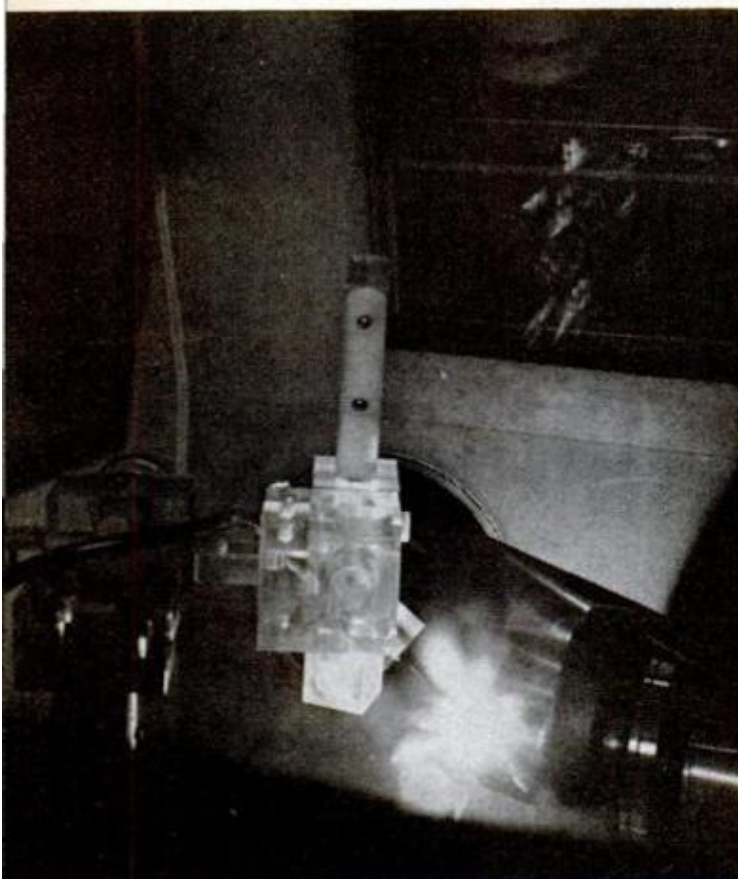

**TUNGSTEN-ARC WELDS** are used to seal ends of plutonium fuel rod. Helium provides inert atmosphere

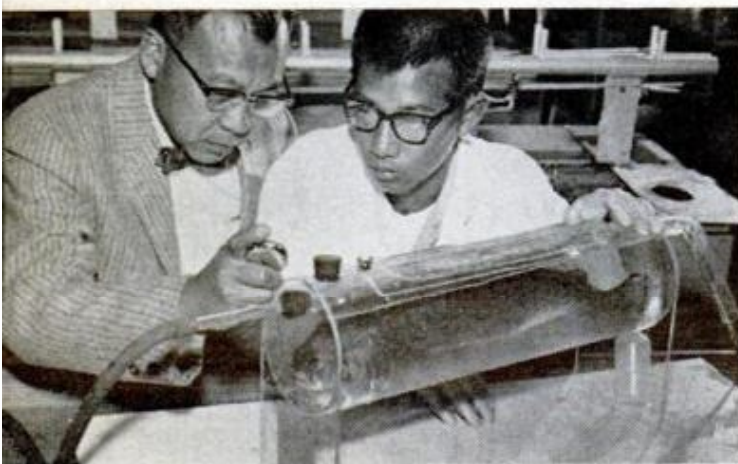

**RADIOACTIVITY IN FISH** is checked by Northwest researchers. Marine biology program is extensive

dozen other American and foreign locations.

I recently visited the Columbus headquarters and the big facility in the state of Washington called Battelle-Northwest. I met and talked with some of the 7000 administrators, scientists, engineers and supporting personnel that are the backbone of this widespread organization. And I saw building after building crammed with scientific gear: lasers, electron microscopes, banks of computers and huge machines such as a 2750-ton press used in making atomic reactor fuel elements.

It was at the Columbus lab that I talked with Robert D. Fannon who bubbles with enthusiasm when he explains how the simplified pump will benefit countries like India and Pakistan, where ponds and rivers are sources of disease because they're used for waste disposal, bathing and drinking.

"The object is to encourage the drinking of groundwater, which is pure water," explains Fannon. "But for a pump to be useful it must be simple. No nuts and bolts—they're hard for poorly trained machinists to make, and they're too easy to steal. Our design has relatively few parts and is held together with cotter pins.

"Another problem is that the machinists can't make smooth bores in the pump cylinders. We got around that by using ordinary cast-iron pipe and coating it with a nickel's worth of epoxy. That bit of plastic makes the cylinder as nice and smooth as brass."

Dr. Richard D. Falb, chief of biochemistry at Columbus, is investigating materials that may be used in an artificial heart. He and his colleagues currently are trying to find ways of treating plastics like Dacron and Teflon to make them compatible with the human organism.

"The basic problem is that these plastics do damage to the blood and cause it to clot," Dr. Falb told me. "The body, in turn, attacks foreign substances and breaks them down.

One of the more promising methods

Dr. Falb is exploring is the chemical bonding of heparin to plastics. Heparin is the blood's own anticlotting agent. The permanency of such bonds is now under study. Dr. Falb's group is also involved in a fascinating study for NASA: how to convert the carbon dioxide in a spaceship's atmosphere into edible carbohydrates. Such a system would be useful for long flights.

The Battelle scientists are taking a different tack than most other investigators looking at the problem. Instead of thinking in terms of living plants, they are isolating the enzymes in plants that accomplish the conversion.

"We've taken three of the key enzymes that operate in the cycle and shown that we can get the sequential steps to occur," says Dr. Falb. "We still have a way to go but I think the principle is sound." He envisages a cylindrical device in the spaceship containing enzymes in solution. Carbon dioxide goes into solution at the top and carbohydrates come out at the bottom.

The Naval Ship Systems Command asked BMI to try to develop a system for stabilizing ocean-floor silt during salvage. When agitated, silt clouds the water and cuts the vision of divers and submersibles almost to zero—a problem that added to the difficulty of recovering the H-bomb lost off the coast of Spain three years ago (*How We Found the Missing H-Bomb*, page 72, Aug. '66 PM).

BMI chemists and engineers have developed a system in which two solutions are squirted from a single, three-foot-wide nozzle. The solutions don't disperse in seawater; they react to form a tough, rubbery gel that settles like a skin over the silt. In tank tests the gel has proven stable and strong, capable of supporting tools.

"Support strength is one of the Navy's requirements," a young chemical engineer told me. "When you drop a wrench or a hammer in silt, it just disappears."

Though the bulk of BMI's investigations are focused on current problems,

FEBRUARY 1970



ECOLOGISTS follow migratory paths of salmon and steelhead in Columbia River. Fish carry sonic tags



HEATED, titanium alloy "remembers" original coiled shape, as shown through time-lapse photography



UNDERWATER TOOL can drill through quarter-inch steel in 20 seconds. It was developed for the Navy



**ARCTIC FALLOUT**, Battelle study shows, results in a high level of radioactivity for Alaskan Eskimos

many of its experts are taking cool looks at the future. One such hard look (made for the air-pollution unit of the Department of Health, Education and Welfare) predicts that the Rankine cycle (steam) engine is the auto power-plant of the future because it creates much less air pollution than the standard internal combustion engine. Battelle's forecast recently prompted HEW to start research on steam powerplants for cars.

And when a group of 27 European and North American railroads, airlines, ship lines and port operators wanted to know what transatlantic cargo trends for the next decade would be, they also came to Battelle. This study, started just a few months ago by staffers at both Columbus and Frankfurt, will consider many factors: jumbo cargo planes, fast containerized ships and palletization systems.

There are so many investigations in the works at the Columbus laboratories that it's impossible to describe more than a few. In addition, many are in the "top secret" category, not discussed with anyone but the sponsor. Under contract research, all findings belong to the firm or government group that pays the bill.

But here are several other interesting studies that aren't hush-hush:

- Research focused on the development of an electronic system capable of automatically sorting mail with an accuracy approaching 99 percent.
- Development of a computer technique for predicting smoke movement



**BATTELLE HEADQUARTERS** in Columbus, now staffed by 3000, did pioneering work in metals technology

in tall buildings, so that potential dangers due to smoke flow can be eliminated during the design phase. Tall buildings tend to act like huge smokestacks. In a recent New York City fire, for example, smoke and fumes traveled up from a basement blaze and killed two firemen on the 22nd floor.

● Operation of a fish farm at Daytona Beach by scientists from Columbus and from another BMI facility in Massachusetts. Their goal: to determine if food fish (in this case, pompano) can be raised under controlled conditions to produce fleshier strains.

BMI dates back to 1925 when it was established in the will of businessman Gordon Battelle, who believed there was a need for a not-for-profit foundation that could provide applied research for industry. He also wanted to perpetuate the family name; hence, the Battelle Memorial Institute.

"There are people who think we make grave vaults, caskets and monuments," a smiling David C. Minton Jr., director of the Columbus laboratories, told me.

One man who knew better was Chester Carlson, inventor of a copying process that enjoys some success today. He came to Battelle with his invention in the mid-forties after failing to interest several manufacturers. BMI's eventual financial interest in the invention, which it turned into a marketable product, led to the ownership of a large block of stock in the firm that was to become the Xerox Corp. Mon-

*(Please turn to page 221)*



### No question about it

It's a clock shop. And the hands in the front window of Carl Jansen's shop in Elspeet, Holland, actually tell time.



### Aid from amusement park

Thalidomide-handicapped children in England are being given modified amusement-park "bump cars" to move about easily.



### Watchmaker's hourglass

It took watchmaker Svend Andersen five months to reconstruct this clock inside a bottle. The bottle's mouth measures 18 mm.

FEBRUARY 1970



### Headed for Japan

Skillful maneuvering was required to get this "20-story" Douglas fir out of British Columbia and on its way to Osaka for Expo 70.



PM ROAD TEST

# AMC's New Hornet

It has a lot of good things in a not-too-small package

By BILL KILPATRICK, Auto Editor/Photos by Jeannie Weaver

**A**MERICAN MOTORS these days seems to be doing everything about right.

- It offers buyers an interesting line of competent cars backed by an imaginative ad campaign.
- It's seeing a little black ink, a refreshing change we can assume contributes in part to board chairman Roy Chapin's radiant good health.
- It signed the red-hot racing team of driver Mark Donohue and strategist Roger Penske to campaign a Javelin in this year's Trans-Am series.
- It announced plans to introduce a new model every six months, a move bound to attract a little attention.
- It makes the Hornet.

There's probably a lot more good stuff rattling up and down the halls of AMC's Detroit headquarters, but the above is more than enough to convince

even skeptics that things ain't what they used to be. Take the Hornet.

Unlike the Rambler, it's not an *economy* car (although the minimum model—a 199-CID Six widely advertised at \$1994—can be gloriously close with a buck, should that be what you want). It's just small, yet small without being puny. It's comparatively inexpensive (in low-line versions, anyway) without being cheap. All in all, it looks, "feels," and drives like a car that started out as a total concept—compromises and all—and wound up as just about what everyone had in mind. This last is a rare thing in Detroit; most cars start out as one thing, are quite different by the time they get to dealer showrooms. But not the Hornet. Even its goofs seem to have been lovingly retained.

The goofs are minor, probably more





**HORNET** offers pleasing, contemporary lines based on "long hood, short rear deck" theme. Car received first curious, then admiring looks wherever I went

matters of personal preference than anything else. For one thing, I don't care for the dash layout. Form follows function so severely it has a gerrymandered look about it, as if its elements have been added on rather than thought out as integral parts of a whole. A bit of my gripe may be attributed to *PM's* test car being airconditioned, necessitating outlets where—to my eye, anyway—outlets just shouldn't be.

Another thing I don't like are the armrests. (They *are* armrests, aren't they, fellas?) They're ridiculous; with the driver's seat even halfway back, one's elbow gropes for expected support, doesn't get it by several inches. I like the seat as far back on the track as it will go, and my left elbow just hung there awkwardly, looking for a place to light. But maybe they're not armrests, just door pulls.

One more gripe: The guy in charge of fitting carpeting to the floors of AMC cars ought to be ashamed of himself. Not just the Hornet, but all AMC cars. Lumpy and ill-fitting, they lie there like a tired 48 stout on a 34 short. For all I know, a good carpeting fit may be a major production problem, but I can promise AMC a certain



**TRUNK SPACE** is surprisingly good for a car of the Hornet's size, more than enough for weekend packing



**EASE OF PARKING** is Hornet plus. Car, particularly with power steering, is highly maneuverable, agile



**ARMREST** just isn't with seat all the way back on track. Even at mid-track, elbow misses the rest by inches, tends to grope awkwardly for usual support

amount of its gung-ho effort to build good, salable cars is negated by this particular oversight.

Now for the good stuff.

Let's hit again the point about the Hornet being a small car without being puny, and inexpensive without being cheap. Again, it's *not* an economy car. Available as either a two or four-door sedan, you can load it to the gunnels for scoot, handling, "comfort and convenience." This means you can wallow in all the gadgetry you care to; just is, the overall package is smaller.

PM's test car featured an automatic transmission, power brakes and power steering, airconditioning, vinyl top, elegant upholstery, rim-blow steering wheel and a snappy 304-CID V8 engine. Also, it was equipped with a heavy-duty suspension, about which more later.

When one first slides behind the wheel of the Hornet, the most noticeable thing (to my mind, anyway) is its

feeling of *compactness*, as if it was part of you rather than the other way around. Controls are within easy reach and the response to them is quick and direct . . . none of the will-it or won't-it lag so prevalent in many large cars. This feeling of fast response may be indigenous to the V8, yet I recall a similar opinion when I first drove a Hornet—a Six—at a press preview early last summer.

The next thing one notices, particularly out on an open highway (and again, perhaps because of the V8), is that traffic isn't passing you by. In fact, the tail ends of trucks and other highway monsters tend to come up in very short order. I found myself backing off quite often and glancing in the rear-view mirror to determine if I had offended the forces of law and order.

But make no mistake; the ride, however swift, is not rocking-chair smooth. This could have been the heavy-duty suspension, which—when coupled to a short wheelbase (108 in.)—may be more of a good thing than is called for (at least as such suspensions are executed in Motor City, U.S.A.). Our test car was far from subtle about making me aware of each little bump, hole and highway seam. On the other hand,



**DASH PANEL** is functional to a fault, to me having a slightly cluttered look. Legroom is outstanding



**HORNET** proved comfortably stable in tight cornering situations. Body lean was minimal, steering accurate tight cornering didn't find me almost over on my side and far off the intended line. Oh, it understeers (they all do), but cornering control isn't an adventure, even though the variable-ratio power steering tends to speed up as you turn, meaning it's easy to get in over your head if you don't pay strict attention. The wide, low-profile C78 x 14 Goodyears with which our test car was equipped to a certain extent help compensate for driver errors.

Brakes—drums fore and aft—are good, but nothing spectacular. The Hornet features AMC's anti-brake-dive setup, but still the nose tends to dip quite low in a panic situation. When I rammed on the brakes, I found the rear wheels first to lock up. Even so, I stopped in a reasonably straight line each time, with minimum fade.

Off-the-dime acceleration is respectable, period. At "green," the Hornet moves right out with everyone else, snapping no necks, but not leaving you back in the ruck, either. Again, this could have been the V8. If all goes as rumored, by the time this appears AMC will have announced a 360-CID V8 option, meaning you'll stand every good chance of being a contender at traffic-light drag meets.

The Hornet earns high marks for

front-seat comfort, at least when it comes to the optional split-bench arrangement. I felt good support down the so-called "small" of my back, and my legs had plenty of room to move about, something I find a must for sustained driving. In back, as it figures, things are a bit cramped. Youngsters, fine. Adults, let's hurry and get there 'cause my legs are killin' me back here.

Visibility is good to front and sides, a bit restricted out the rear corners, a fault of far too many cars today. I'm one of these look-before-I-leap guys and looking out the rear corner of the Hornet (or anything else, by and large) is little more than a neck exercise.

Trunk room is surprising, considering

*(Please turn to page 220)*

#### **HORNET DIMENSIONS AND CAPACITIES**

Wheelbase	108 in.
Track, F/R	57.2 in./56.6 in.
Length overall	179.3 in.
Width overall	71.1 in.
Height	52.6 in.
Weight distribution, F/R	59/41%
Fuel capacity	20 gal.
Oil capacity	5 qts.
Water capacity	14 qts.
Curb weight (PM test car)	3200 lbs.
Wheel size	14x5 in.

# Pushbutton Fishing

'Snap, crackle, pop'  
are the sounds made by the newest  
equipment for fresh-water  
fishermen

By GEORGE REIGER, Boating and Outdoors Editor

WHILE FLY FISHING is still a long way from being an armchair sport, a pushbutton net from France and Kodiak's fly-rod with pushbutton remote control for automatic fly reels make life easier for a hard-casting, many-mile-a-day wading angler.

The appeal of the Kodiak rod is in its common sense. Instead of fussing with the rewind lever of your automatic fly reel, you merely activate a switch on the cork grip where your thumb normally rests to effortlessly retrieve all loose line. There's little that can go

wrong with the system—no whirling gears nor loosening screws. The switch is connected by means of a metal strip inside the grip directly to the rewind lever of your reel. Kodiak makes adapters for most contemporary automatic reels, and is about to market a rod and reel combination priced under \$50.

For PM's field test, I used a Shakespeare Tru-Art (Model EC) with a full spool of Cortland 444 Rocket Taper floating line. My quarry was largemouth bass; my lures, small popping plugs. But except for one 10-incher, my

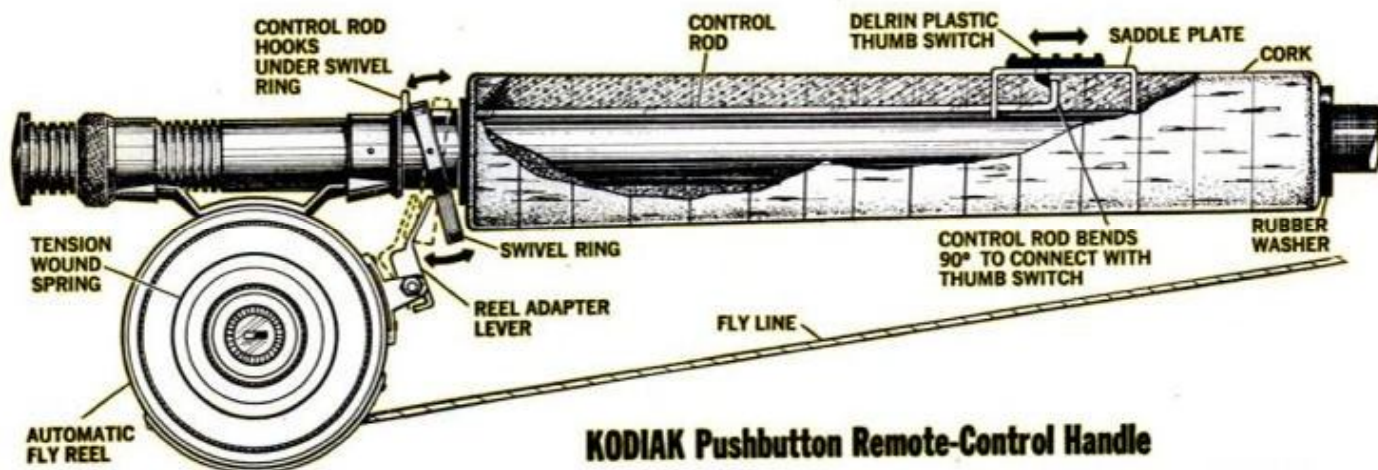

**KODIAK Pushbutton Remote-Control Handle**

POPULAR MECHANICS

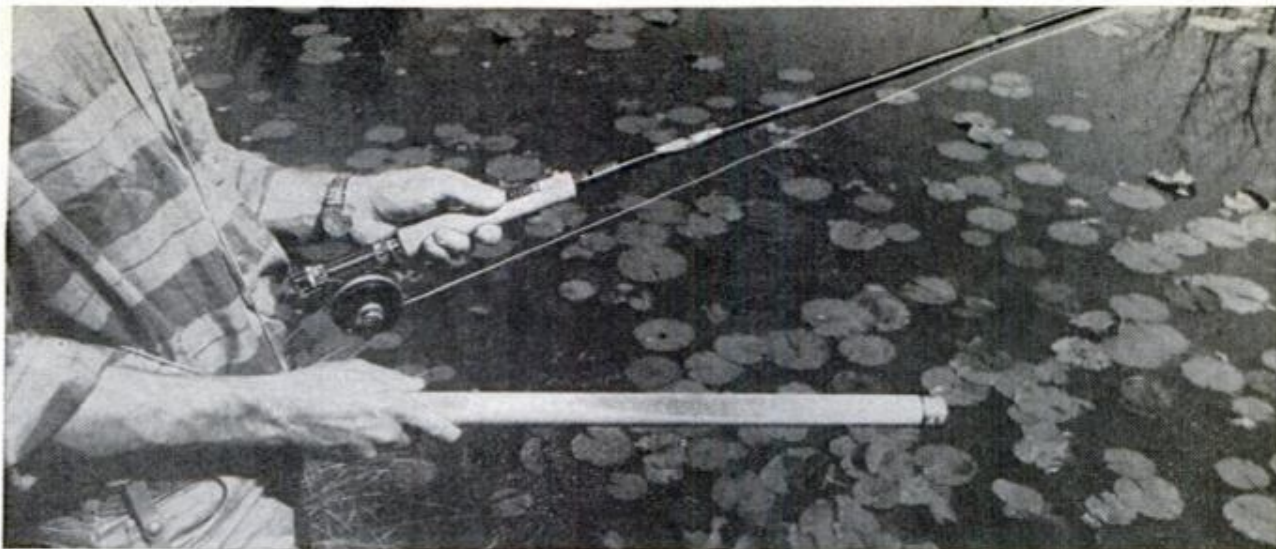

A COMBINATION to take the awkwardness out of landing fish. Net is 26 inches long, loaded; 5 feet extended

catch was made up of sunnies, all of whom gave a fair account of themselves on the bass-weight 8½-foot rod.

During the afternoon's fishing I found only one difficulty in using this latest idea in facile fishing. While concentrating on a cast or excited by the rise of a fish, I sometimes triggered the thumb switch by mistake. But since my line hand still controlled the flow of line onto the reel, and since the errors may have been due to my own inexperience in handling the new product, I assume the problem is eliminated with practice.

I first discovered the "Stainless-Otomatic" net at a fishing lodge in Normandy, France. Curiously handling the strange fiberglass tube, I triggered its powerful spring by mistake and nearly impaled a lady angler strolling by! Fortunately, the net we imported for the *PM* test came with a safety clip. Even so, since the net snaps out with a jolt,

it's probably best to point the container tube to one side of any fish you hope to land. Otherwise, you could end up with a severed line.

Disturbingly flimsy when extended and with a tendency to lock up after a single dip in freezing weather (grayling fishermen take note), this over-the-shoulder item does have one advantage over other nets—it never gets caught in branches or weeds while you move around a stream or along banks. In addition, a fisherman can use the stubby shaft as an emergency wading stick. Boat fishermen may find it especially handy as there is no exposed mesh to catch hooks or rod tips when it is loaded.

For more information about the net which costs roughly \$15, write Wyers Freres & Brehier, 30, Quai du Louvre, Paris 1, France; about Kodiak's new line of flyrods, Box 467, Ironwood, Mich. 49938. ★★★

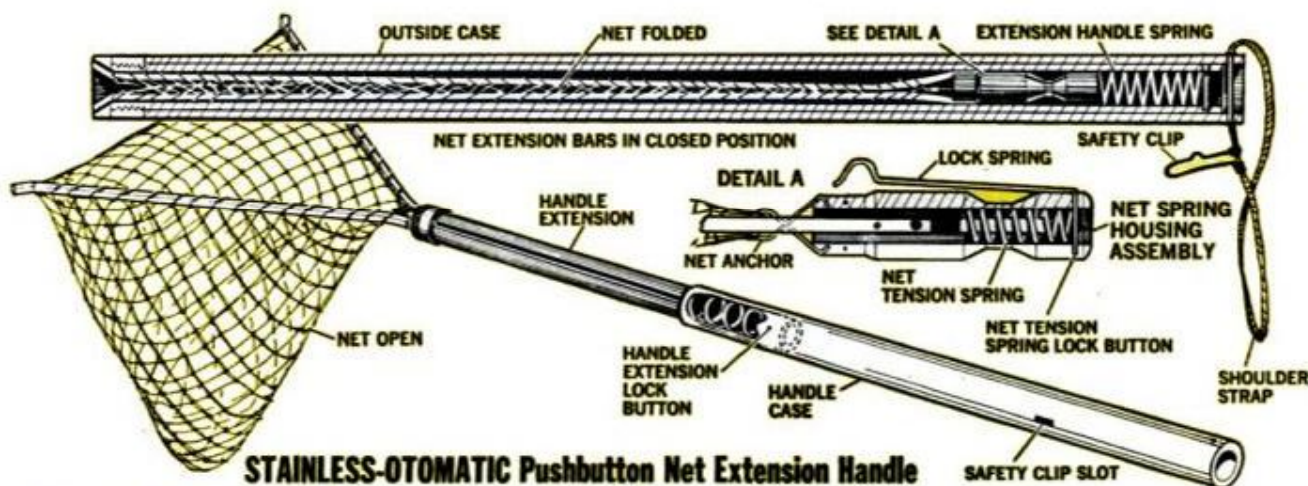

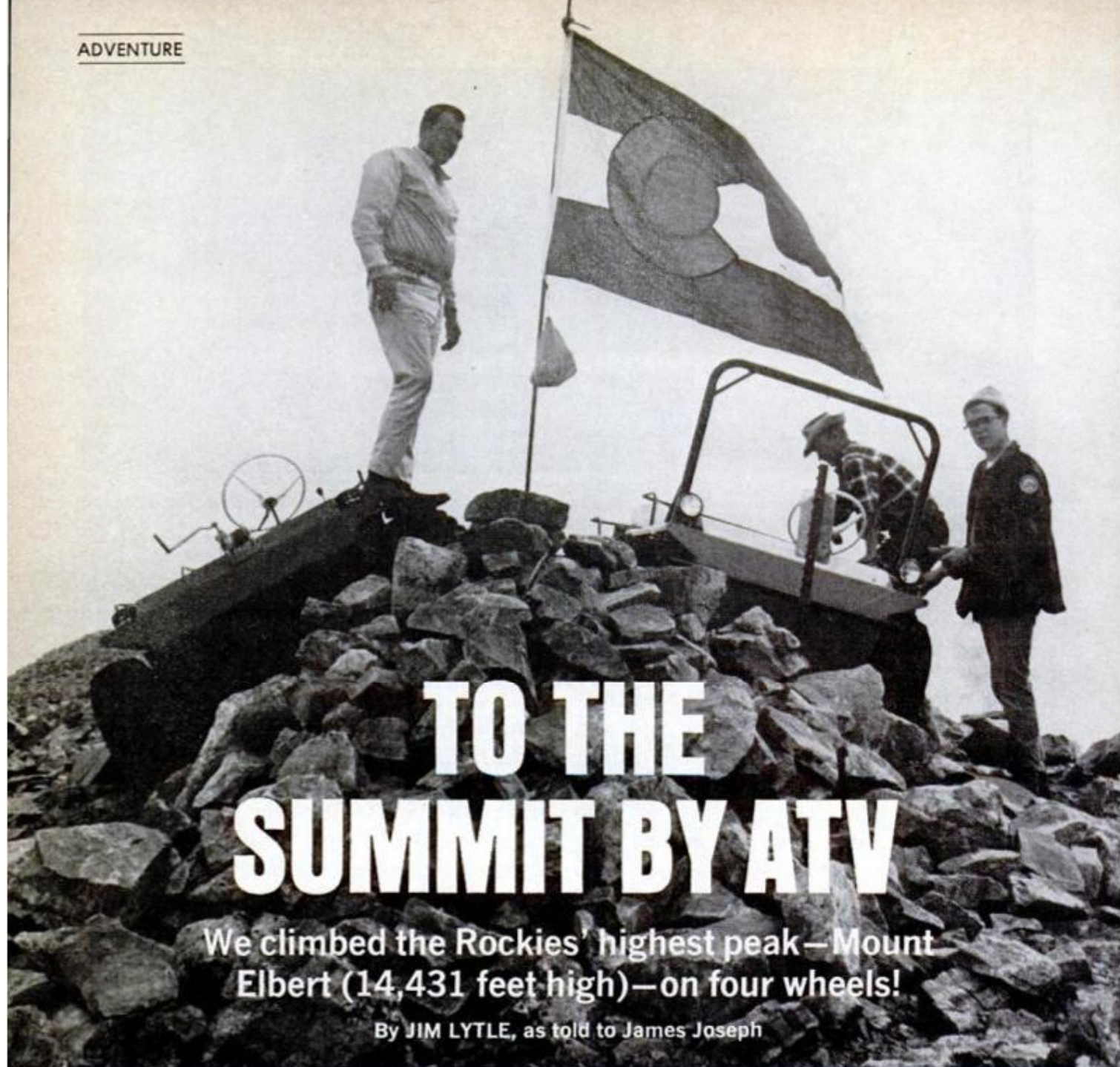

# TO THE SUMMIT BY ATV

We climbed the Rockies' highest peak—Mount Elbert (14,431 feet high)—on four wheels!

By JIM LYTLE, as told to James Joseph



**AT THE SUMMIT,** Coot expedition poses on highest point in Colorado and the Rocky Mountains, second highest in the lower 48 states (only California's Mount Whitney, at 14,495 feet, is loftier). The expedition leader, Jim Lytle, stands atop four-wheel-drive Coot to inspect Colorado state flag he has just erected on summit. At right is four-wheel-steer ATV which, with Lytle at the wheel, was first to reach the top at 9:35 a.m., Aug. 3, 1969. Rock pile cairn, which is typical of those placed on the world's highest mountain peaks, is work of previous climbers of Mount Elbert

**LYTLE BREAKS OUT** of the timber at 12,000 feet (left) and pauses for a backward glance

POPULAR MECHANICS

**O**NLY A VERTICAL HALF-MILE below Mount Elbert's summit—Colorado's tallest peak and second highest in the U.S. outside of Alaska—things were all uphill and down. And so steep in both directions that a restless turn in our sleeping bags would have triggered a kind of human avalanche—hurtling the seven of us downslope with no stopping until we hit timber.

We were camped on a rocky, nearly 30° slope on the northeastern flank of the highest of 14 peaks which comprise the awesome Sawatch Range—the nation's "rooftop"—90 miles southwest of Denver. Upslope a few yards we'd parked and chocked the three tough little four-wheel-drive Coot ATVs ("all-terrain vehicles") as windbreaks. They had gotten us this far and would, we were betting, take us clear to Elbert's summit when we made the final assault at daybreak.

But our luck seemed to be running out. Gathering mist threatened rain which might make the mountain slick as glass. And one of our three ATVs, involved in a runaway accident just before dusk, was crippled.

That was only part of the challenge. While we wouldn't be first to Mount Elbert's summit on four wheels, we were doing it the hard way, via the trackless northeast approach. Scrambling up top from the northeast would prove that our ATVs, billed as "go-anywhere vehicles," were just that.

We had two even more serious purposes. One was to test the first of a new breed of ATV: Coot's 4-by-4, which is both *four-wheel drive* and *four-wheel steer*. All four wheels are powered—and steerable. The linkage is mechanical. Turning the front wheels in one di-

rection turns the rears in the opposite. Where the rear wheels of most ATVs merely "follow" in negotiating obstacles or hairpin trail-turns, the 4 by 4's steerable rears "snake" through and around the tight spots. Four-wheel steered, the ATV can turn completely around in its own 7½-foot length, and I was driving the very first of the new vehicles—Coot's model 444-SS—to come off the production line.

Our third objective was to show that ATVs don't—as some critics have charged—tear up the high country's fragile terrain. Wide-tired and as under-inflated as most ATVs ride—our vehicle carried Coot's standard, nearly 9-inch-wide 8.85x15s, inflated to 8 pounds per square inch up front, 6 in the rear—the average ATV's "footfall" is light as any elf's. And significantly lighter than the tread of either man or horse. Low gearing prevents tires from spinning, and with something like 440 square inches of tread on the ground, our ATVs weighed a maximum of 2000 pounds, including four passengers and gear. The vehicle tiptoed upslope exerting less than 5 pounds pressure per square inch distributed equally because of the vehicle's articulating features. A horse and rider, by comparison, ex-

**WHERE FOUR-WHEEL STEER** made a difference. Standard four-wheel-drive ATV hangs up between trees while Lytle (background) zigzags uphill



ert close to 24 p.s.i., a man—about 7 p.s.i.

We had shoved off on Saturday morning, Aug. 2, 1969, from San Isabel National Forest's Halfmoon Campground (elevation: 9800 feet), huddling Mount Elbert's northeastern approach. I led in the four-wheel steer. Beside me rode the expedition's guide, young Bill Peterson, from nearby Leadville, who'd previously made the summit on foot. Behind tracked Sam Umberger, Coot dealer from Riverton, Wyo. Sam had brought along a standard four-wheel-drive Coot. Riding with him were Dick Kruse, 26, sports photographer from Denver's KBTV and *Denver Post* photog Ed Sielsky. Driving tail position—also in a standard four-wheel-drive—were mechanic Dave Kittinger and Derrick Dodge, a crack snowmobile-team driver, both from Ski-Doo West, Inc., Coot's Rocky Mountain distributor.

Before pushing off, we'd roughed out a route and mapped our assault. Moving upslope, cross-country and ever southwestward, we'd climb to 12,000 feet. That would put us just above timberline. Once we'd shaken timber and with the slope steepening (our contour maps showed the north ascent to be more than 60° in places), we'd bed down as best we could for the night. Next morning, early, we'd make our try for the summit.

That first hour, working southwest by compass but with Elbert's bald summit fleetingly in view, we picked our way to 10,500 feet through dense stands of pine and Engelmann spruce.

"Power's holding," Sam told me by walkie-talkie.

Power, which would grow ever more critical the higher we went, was another of the things the climb would test: Whether factory-standard ATVs, as our own, could get up top a nearly three-mile-high summit under their own power.

An engine loses about three percent of its power for every 1000-foot increase in elevation. We were running



**DENSE GROWTH** briefly stops one ATV. Though two of the vehicles had winches, they were seldom used

with Coot's standard 12-hp, air-cooled, single-cylinder Tecumseh gasoline engine. Atop Elbert's 14,431-foot summit, the power loss would be more than 42 percent—reducing the engine's output to a mere seven hp.

Anticipating this, we'd fitted two of the vehicles (my four-wheel steer and Dave Kittinger's standard four-wheel drive) with Coot's optional 12-tooth drive sprocket. Switching sprockets increased the gear reduction by better than 25 percent—and power by the same amount to 16 hp effectively. So atop Elbert we'd have nine hp anyway. Other than fueling my four-wheel steer with cooler-burning 90-octane aviation gas, this was the only change we made. Sam hadn't bothered to make any changes at all. Yet here he was, nearing 11,000 feet, and feeling no power pinch.

By now we were running into boobytraps of timber and terrain so precipitous we often had to side-hill a hundred yards laterally to gain a few feet vertically.

"At the rate we're going," Dave shouted from his four-wheel drive, "we'll be a month of Sundays getting up top."

"The 'Sunday'," I replied, "had bet-





ON SUNDAY'S FINAL ASSAULT ON SUMMIT, ATVs picked way up slope, skirting strange snow-and-glacier-dug bowl at right. The bowl, nearly a quarter of a mile in diameter, had small, stagnant lake at bottom

ter be tomorrow." Each vehicle carried only an extra five gallons of gas. We didn't have many hours to squander during this climb.

Trouble was, the trees grew so thick that our Coots, 5½ feet wide at their tires, often couldn't squeeze through. We spent the better part of an hour backing and hawing. That's where my four-wheel steer proved itself. Often, with hardly more than a whisper to spare, I'd kick the rear wheels of my Coot around a tree that had hung-up the others.

The ever-steepening grades were something else again. Slip down a mountainside like that, and you might be an hour scrambling back up. Our Coots—with their independently "articulated" fronts and rears—managed to keep their tires planted and their cool better than some of their drivers. At times things were pretty scary. Not that we were in any real danger. We could have always bailed out. That was the reason we didn't wear seat belts or shoulder harnesses. But losing a vehicle to Elbert wasn't in our plans. Over the trickiest fallofts, we'd sometimes "walk" our ATVs: Walk alongside with one hand on the steering wheel, the

other working the throttle extension designed for just such hard-going terrain.

A little past 11,000 feet—and nearly the whole way to timberline, at 12,000 feet—we ran into tree trouble of another kind: A crazy quilt of deadfalls. Some of the logs ran to over two feet in diameter. Some deadfalls we simply rode over. Others, too high for riding, we teetered over. The trick was to power the front tires atop the log, then push off with the Coot's powered rears. For a breathless moment, the ATV seemed to teeter, taking the brunt of the punishment on its tough, nearly ¼-inch-thick steel underbelly. Then it'd nose over, literally sliding over the log until its front wheels caught hold and pulled the rears over.

Suddenly, nearing 12,000 feet, we were out of timber and into the clear. As it was too late to try for the summit before dusk, we decided to camp where we were. Yet there wasn't a flat spot or windbreak anywhere—just an endless upgrade, spotted with boulders as big as our ATVs, and naked to the winds and thunderstorms which breed near Elbert's summit. The only thing in our

*(Please turn to page 216)*

# They Handle the Hot Stuff

Radioactive materials occasionally get loose in hospital operating rooms, fall off trucks, or are lost in shipment. When the situation is too hot to handle, they call the men from REAT

By NORMAN CARLISLE

Photos: Bill Aller



**I**T WAS A BITTER winter night, but Francis X. Gavigan was out in the back yard of his suburban Chicago home, wielding a garden hose. He had promised the kids he'd put a new glaze on the ice of their improvised skating rink but until his wife stuck her head out the door and yelled, "Phone call. . . emergency," he hadn't been able to think of any good excuse for getting out of it.

As he put down the receiver he wondered, however, if the cold job in the back yard might not be preferable to the one he was about to take on.

Gavigan is not a fireman, though he knows a lot about fighting fires. He is a member of a unique organization, the Radiological Emergency Assistance Teams.

The task of the men of REAT (they number something over 100) is to speed to the scene of any emergency situation involving radioactive materials. A corresponding organization—NET (Nuclear Emergency Teams) works on mishaps that befall nuclear weapons.

These emergency forces are needed because the use of radioactive materials is now rather commonplace. Scientific labs use all kinds of "hot" materials for research purposes. Thousands of hospitals use radioisotopes for therapy and diagnosis. Industry puts them to work at hundreds of tracing, measuring and testing tasks. Over 300 powerplants use nuclear materials. And nuclear explosives are now being employed to tap earth's riches.

On 24-hour alert, REAT operates out of eight main bases—Atomic Energy Commission Labs in New York, Chicago, Albuquerque, San Francisco, Oak Ridge, Idaho Falls, Richland, Wash., and Savannah River, S.C.—where they work as engineers and researchers. NET outfits are attached to various mili-



**PHYSICIST AT MANHATTAN HEADQUARTERS** of REAT readies equipment for mobile unit. On table are alpha and beta scintillation counters. Shelves hold radioactive detection gear ready for emergencies



**REAT COMMUNICATIONS CENTER** coordinates emergency team, tells mobile, via two-way radio hookup, equipment to be loaded, activates mobile communication channel, alerts Defense Department's team

tary bases located around the country.

The Chicago emergency was at Lutheran General Hospital, where, a short time before Gavigan and three other REAT men arrived, hospital officials had put in a worried call to the AEC. Two technicians had been working in the therapy room, where patients received radiation treatment. Somehow a tiny cylinder of cobalt 60 had slipped from its case and dropped to the floor. The technicians ran from the room and slammed the door. Through the observation window they looked back with horror at a room that would now be extremely dangerous to anyone who entered it.

The first thing the REAT experts did was to determine if any radiation had gotten outside the room. Their sensitive radiation counters—variations of the well-known Geiger counter—showed that some had. They roped off the hot areas. The technicians were already being checked out; neither had received a dangerous dose.

The problem narrowed down to getting the capsule out of the room. A man, no matter how heavily shielded by protective coveralls, couldn't just run in and grab it, or even pick it up with a standard six-foot tongs. He'd get too great a dosage before he got the capsule safely into a lead container. Also, in his

haste, he could drop the thing, or it could roll into an inaccessible corner.

Gavigan had to do some fast talking to hospital authorities, reassuring them that no harm at all was being done by the capsule lying there, but that plenty could ensue if they were to bungle the job of getting it out.

The following afternoon, a strange device rolled down the hospital corridors as personnel looked on in amazement. It was a PAR (for Program And Remote Control) a caterpillar-treaded, cable-controlled device that handles radioactive materials in the Argonne National Laboratory. Operating the controls from outside the room, one of the REAT men carefully closed its manipulative "hand" over the capsule, then slowly eased it into the lead box atop the PAR. After making sure there was no radioactivity in the room, or anywhere around it, the REAT engineers marked another case closed.

#### **There's always human carelessness**

Half a million shipments of potentially dangerous materials are moved annually by truck, rail and air. Though the hot stuff is always packed carefully in lead-lined containers and plainly marked "Radioactive Materials," a certain number of accidents are bound to happen. Trains can be derailed, trucks



**INSIDE EMERGENCY VAN** is lead-shielded gamma "well" (large cylinder) into which samples are placed for analysis. Multichannel analyzer (left) gives a printout of analysis. Oscilloscope (resembling TV screen) shows spectrum, helps identify radio nuclei. Electronic gear (right) is radio communications equipment

can have wrecks, planes can crash. And then there's always human carelessness.

The AEC's lab in Idaho Falls, Idaho, had ordered some ampules of gaseous iodine from a company in New York State. When the containers reached the National Reactor Testing Station, 50 miles west of Idaho Falls, it was discovered that they had leaked; they hadn't been sealed properly by the shipper. Had they spread a trail of contamination along the entire 2500-mile route? Here was a job for REAT.

A team led by John Horan of Idaho Falls checked out the driver of the station wagon that had conveyed the iodine from Idaho Falls to the test station, the pilot and crew of the plane that had brought the shipment up from Salt Lake City, and the personnel work-

ing in the air freight station there. All okay so far.

The New York team checked out handlers at Newark Airport, where the iodine had been loaded aboard the plane, and personnel at the manufacturing plant in upstate New York, from which the vials had been taken to the airport in a station wagon. In all, the two teams examined three planes, four trucks or cars and 80 people. Of them, 50 showed some signs of having received dosages of radiation, fortunately none in harmful amounts.

One of REAT's toughest jobs is locating all the hot spots that may have been created. The leaking iodine didn't involve many. Much more complex was a case that didn't cover such a wide geographic area. A shipment made between two points 600 miles apart was

10 days in transit. During that time it moved through four different terminals, leaking all the way. The REAT engineers had to take readings on the trucks that had hauled it and on every possible place it might have sat in all four terminals. They moved their counters in a grid pattern to make sure no spot was missed. It took two men two days at each terminal before they could be sure they had found every area of contamination. Meanwhile another team was tracking down and taking readings on the four trucks that had been involved.

After they've discovered the hot spots they have to get the radioactivity out. On surfaces where the radioactive substance has soaked in, they come up against some tough problems, such as the one encountered in a warehouse, where radioactive liquid had poured onto the concrete floor. They tried washing the concrete with acid but finally had to bring in grinders that cut deeply into the floor.

A fear that haunts REAT men is the possibility of public panic. There is always the danger that their efforts to track down and get rid of radioactivity will create hysteria in people already frightened by real and imagined dangers of radioactivity. In the '50s before the REAT groups were established, there was a chemical explosion in a laboratory in New York City's borough of Queens. One person was killed as a result of the explosion, which involved radioactive materials used in the plant. Wild rumors quickly spread. Hundreds of people were concerned about whether they had been exposed to radiation, and newspapers carried scare-head stories that increased the general panic. Actually, no one, including workers in the plant, suffered any dangerous exposure.

"If we'd had a team at that time," says Arnold Weintraub, of the New York team, "public concern would have been minimized."

Team members are always prepared

*(Please turn to page 208)*



**REAT MOBILE UNIT** being loaded with lockers containing gear specified for a radiological emergency

**ALPHA BETA SCINTILLATION COUNTER** in mobile unit has power supply mounted above; radioactive samples are on table and electronic "heads" give count

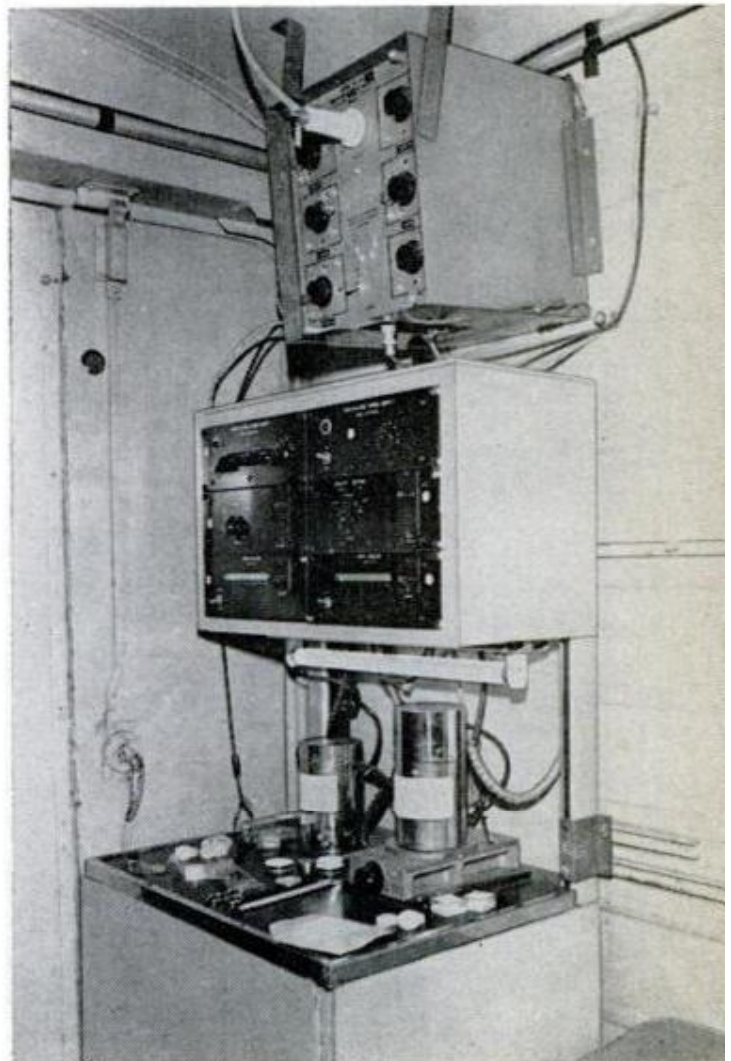

# Just patented

PM'S PICK OF THE NEW INVENTIONS

Prepared in cooperation with Roger S. Shashoua, Director, International Inventors Assn., Inc.

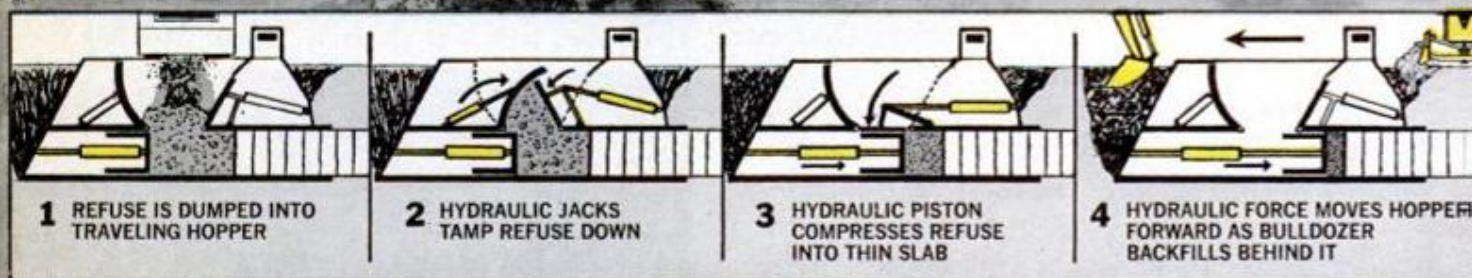
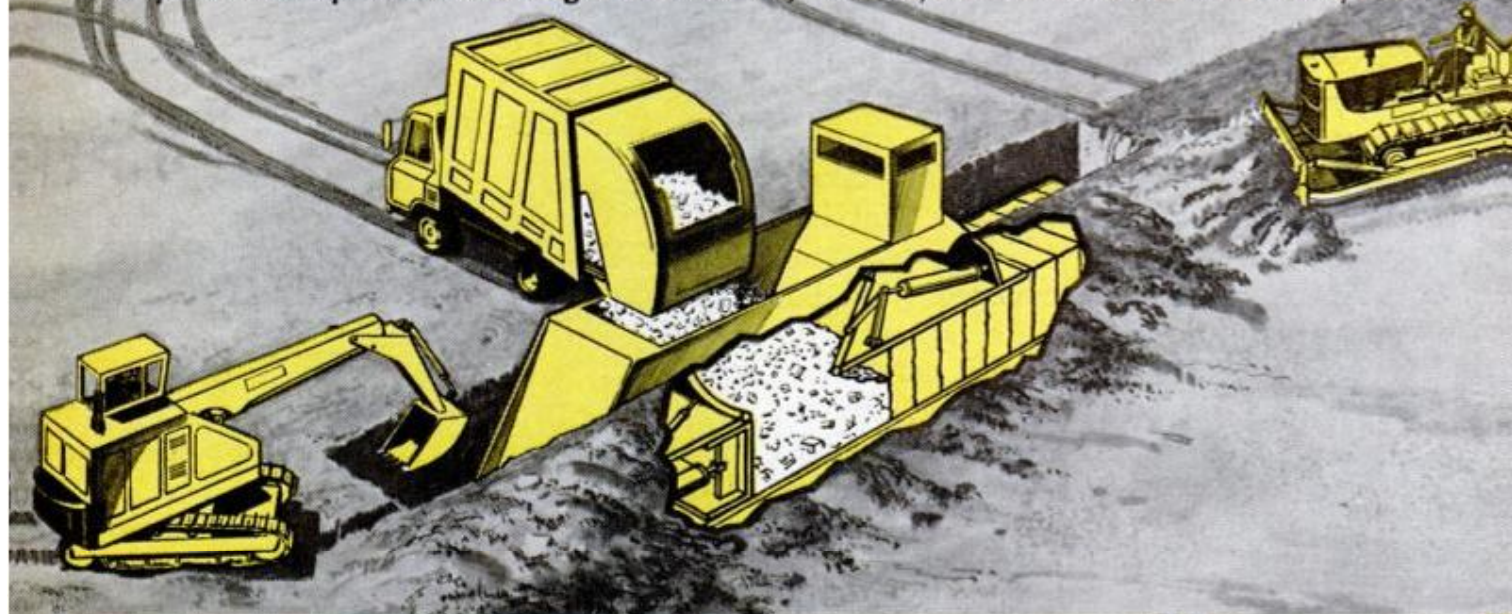

1 REFUSE IS DUMPED INTO TRAVELING HOPPER

2 HYDRAULIC JACKS TAMP REFUSE DOWN

3 HYDRAULIC PISTON COMPRESSES REFUSE INTO THIN SLAB

4 HYDRAULIC FORCE MOVES HOPPER FORWARD AS BULLDOZER BACKFILLS BEHIND IT

**1. REFUSE-BURYING MACHINE** above travels slowly through the ground, depositing trash and garbage safely under the soil. Designed as an answer to the growing problem of garbage disposal, the ingenious device not only gets rid of the refuse, but makes use of it as fill material in land-development projects as well. Garbage is dumped into a hopper-like opening in the machine and doors close down over it,

sealing it in. A hydraulic ram then compresses the refuse into a thin, compact slab, at the same time pushing the machine forward for the next load. As the machine moves ahead, the compressed slabs are forced out through the back where they're completely covered with dirt by a following bulldozer. A trench digger moves ahead of the refuse machine, clearing a path for it in the ground as it inches along

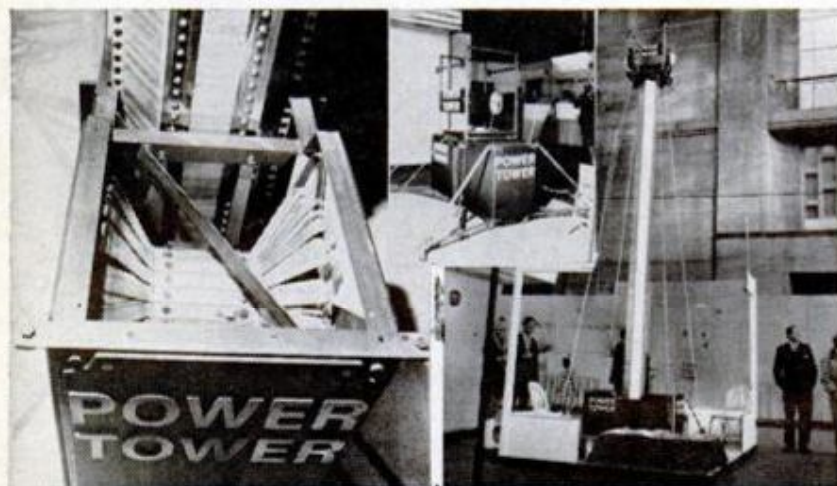

**2. INSTANT TOWER** at left extends to any desired height like a steel tape measure unrolling from its reel. Two flexible metal strips are wound onto motor-driven hubs at the base. As the strips are unreeled, they come together and fingers at the edges interlock like a zipper to form a rigid boom that can be raised to 50 feet or more. Reeling in the strips retracts the tower. Designed for power-line maintenance, as well as firefighting and similar jobs, the Power Tower can be extended faster and stored in less space than the conventional type of "cherry-pickers" now being used

Inventors of the items shown on these pages are as follows: 1. Tyman H. Fikse, 1459 Loraine St., Enumclaw, Wash. (No. 3,446,026); 2. John Lyons, 72 Eamont Court, St.

Johns Wood, London, England; 3. W. T. Sommer, 601 Orleans St., Detroit; 4. Avrom Greenberg, Granby, Conn., William H. Brown, Jr., Suffield, Conn., Clifford B. Packard,

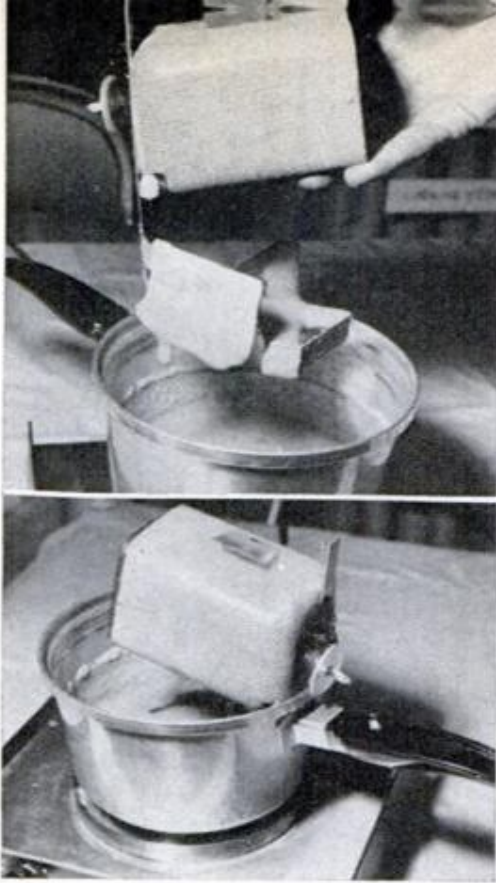

**3. MECHANICAL SPOON** above keeps stirring the contents of a pan, freeing the cook to do other kitchen chores. The clever self-propelled device rides around the rim of the pan on a flanged wheel, turning in circles. This rotates a blade in the center to stir the food. Three ordinary flashlight batteries power a small electric motor to drive the wheel. The stirring arm of the device can be either shortened or lengthened in order to fit pots of different sizes

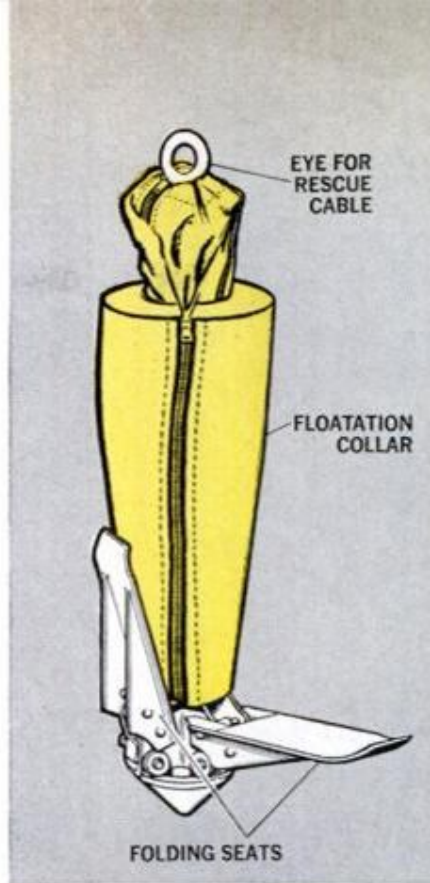

**4. RESCUING AIRMEN DOWNED AT SEA** would be easier with this floating seat. Hinged panels fold out to support up to three men around a central column of flotation material. When a rescue helicopter arrives, it just hooks onto a ring and hoists the men safely aboard without their having to hold onto ropes or get into slings. The devices could be dropped by the rescue helicopter or by crewmen in the disabled plane before ditching. There's provision for strapping an injured flyer into the seat so he can't accidentally fall out. Various types of survival gear, such as food and flares, can be stowed inside a zippered cover around the flotation material



**5. PORTABLE CONVEYOR** below lets you carry your own transportation with you. The battery-powered platform, just big enough to stand on, whisks you over sidewalks and other smooth surfaces at speeds up to several miles an hour. When not in use, it can be collapsed and carried like a suitcase. The

conveyor rides on rubber belts driven by an electric motor. Squeezing a lever in the handle adjusts a rheostat to control the platform's speed. You steer by pushing or pulling on the handle to "hitch" the platform around in one direction or the other. The telescoping handle folds flat to make carrying easy

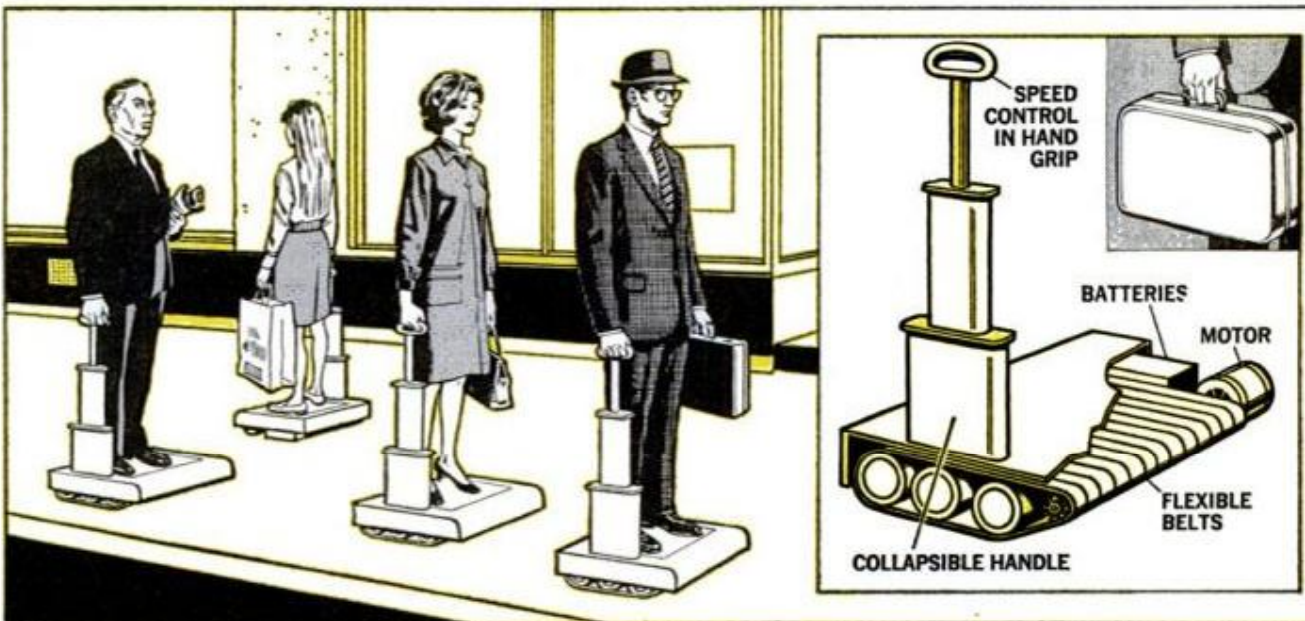

South Glastonbury, Conn. and George L. Hackenberger Jr., Suffield, Conn. (No. 3,444,569); 5. Constantin Alimanestiano, 200 S. Michigan Ave., Chicago, Ill. (No. 3,446,304). Read-

ers wishing to bring new inventions to the attention of Roger Shashoua can reach him at the International Inventors Assn., Inc., 608 Fifth Ave., New York, N.Y. 10019.

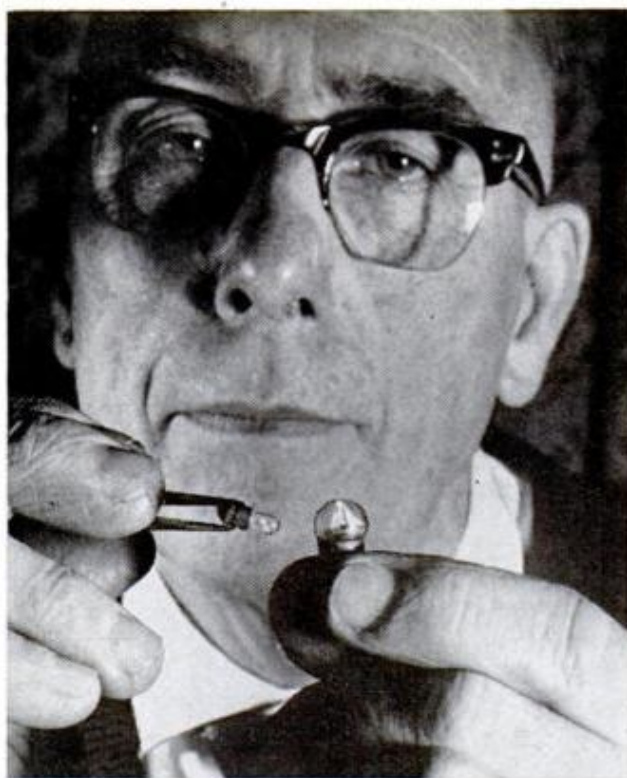
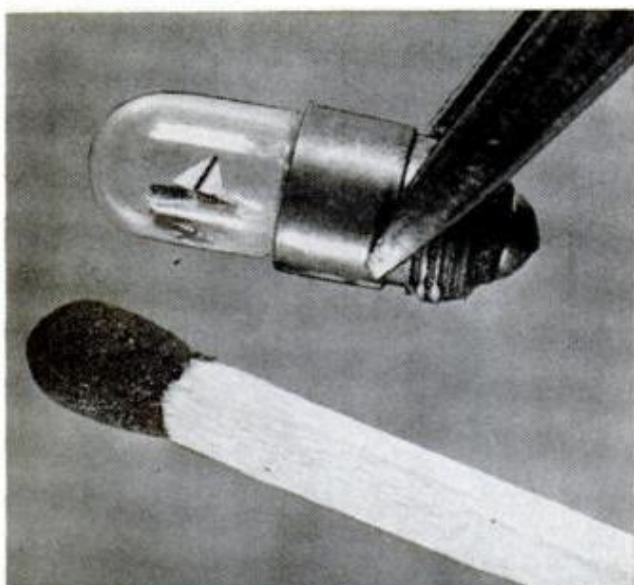

### Mini-mini-boats

Albert Stannard, London bus driver, spent three weeks building the tiny sailboat inside a computer bulb (upper left-hand photo). The boat, which he believes is the smallest of the built-in-glass boats in the world, measures just 1/16th inch from bow to stern. The hull is made of vinyl, the mast of wire and the sails of rice paper. The flashlight-bulb model (above) was easy; it took just four hours. The wood-hulled, three-masted galleon (left) is in a 40-watt bulb. Stannard does all building with forceps inside the bulbs.

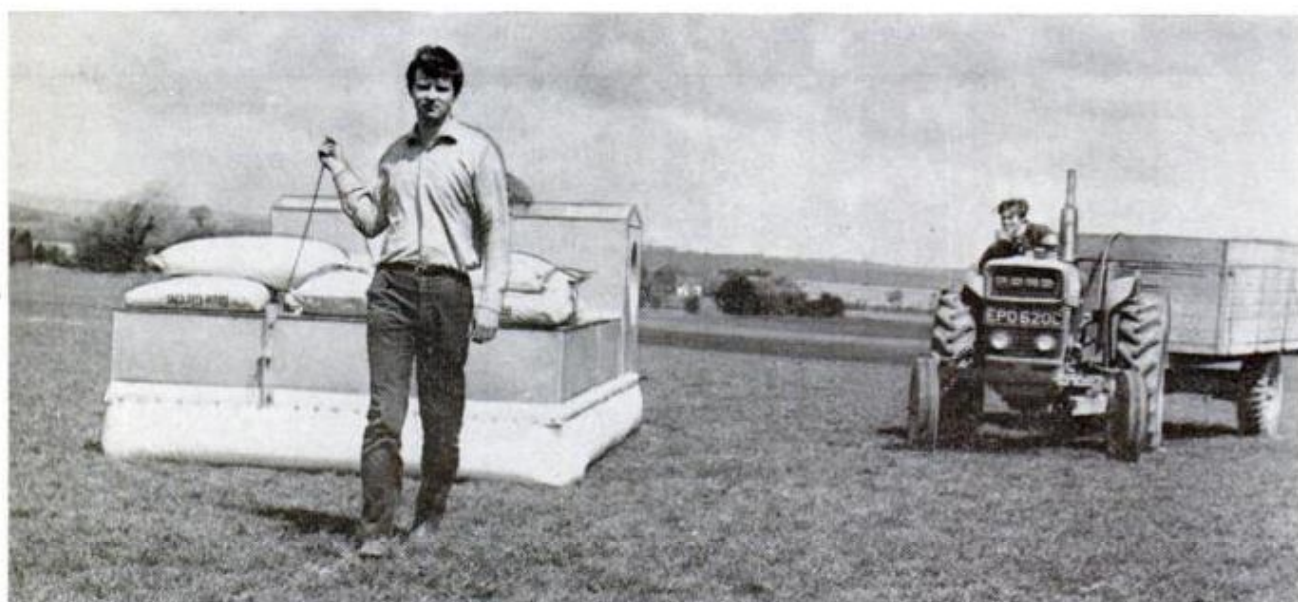

### Air-cushion trailer for hauling over marshy terrain

Loads of up to 1½ tons can be carried over marshy ground by the Hovertrailer, an air-cushion vehicle developed by Paul Jennings of England. Jennings is shown demonstrating the ease of pulling the Hovertrailer while a conventional tractor and trailer follow.



# THE PERFECT BASS BOAT

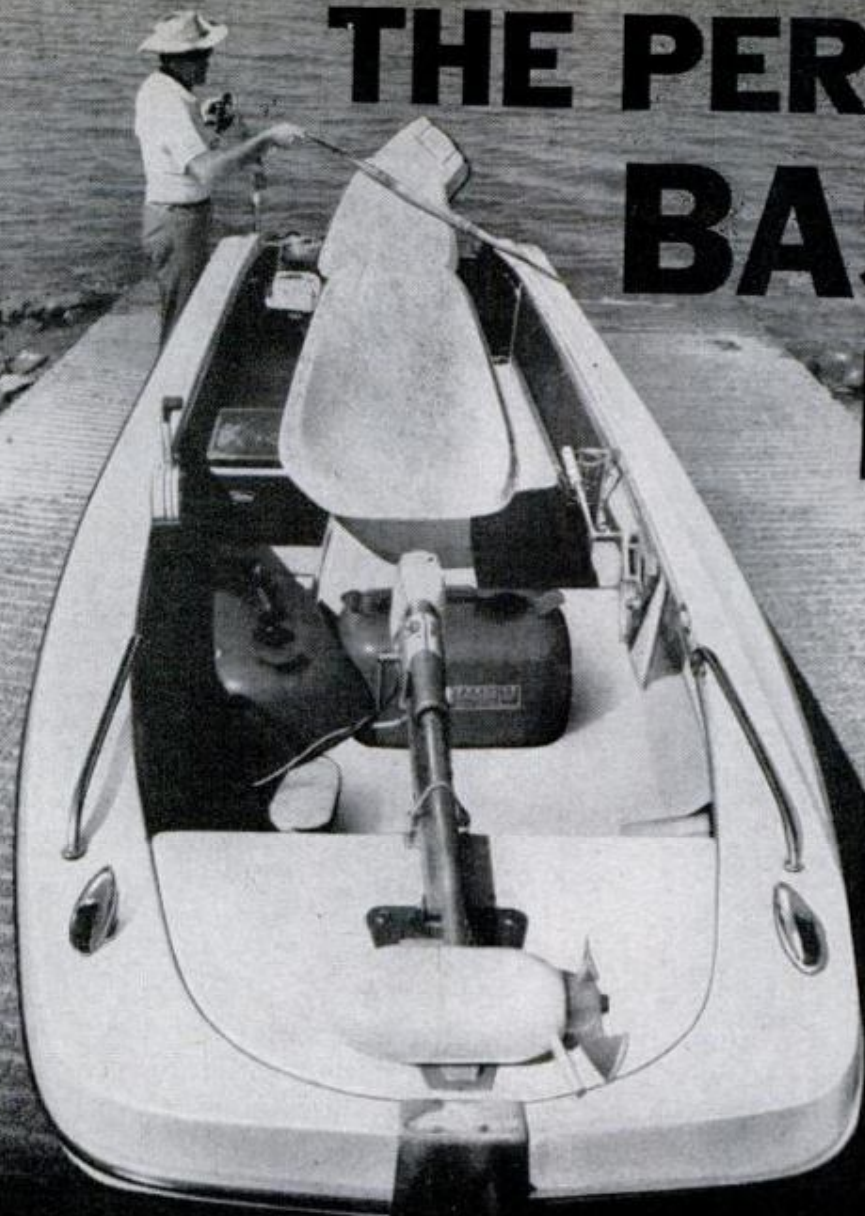

**Thoroughbred with a mongrel past—part pirogue, part jon boat—“skeeter boats” are offering new designs in comfort and efficiency that are bound to sweep the country**

By **GEORGE REIGER**, Boating and Outdoors Editor

**Y**ANKEE BEWARE! The South is rising again! Boat companies from Olive Branch, Miss., to White Bluff, Tenn., are taking the wraps off sleek craft intended to conquer the North and West. Texas has joined in the assault with secret weapons: Skeeter and Kingfisher. Border state Missouri has already succumbed to the new designs with at least two companies working for the cause. Even mighty Chrysler has sent spies south and come up with a counter-measure they call the Dart.

Intrigued by the uprising, *PM* infiltrated Arkansas, where we met with angling expert Grits Gresham for a rundown on what the hullabaloo was all about. Grits grinned at our fears and said, “Heck, this item’s no threat to you folks up north—not unless you like fishing. Then you might end up spending so much time on the water that you won’t have a family or job when you come ashore!”

Five years ago, Grits warned the fishing fraternity of this boating phenomenon in his *Complete Book of Bass Fishing* (Harper & Row, New York). He devoted an entire chapter to describing the advantages of his favorite bass craft made by the



**THERE'S MORE THAN AMPLE CASTING ROOM.** Hugh Miller sits on folding chair between Grits and author while the three work the shoreline without crowding

Delhi Manufacturing Co. in Delhi, La. It's nearly 15 feet long, 54 inches wide and weighs just 280 pounds, including flotation foamed between the double bottom. The craft is called the Terry Bass Boat (Model 1599) and has a trihedral or inverted "W" bow. Many skeeter designs are flat bottomed, but Grits thinks the trihedral shape has an advantage when air is scooped in on a fast ride to help smooth out the bumps.

And this boat is fast! Equipped with a 55-hp Johnson, it does better than 40 mph with two aboard. Such power is not recommended for the novice; a sudden turn could easily upset the boat.

But hull design alone doesn't give this boat the edge over conventional runabouts for sheltered-water angling. It's mostly a combination of factors that center about the driver's seat. All controls and accessories are located forward. Steering wheel and dashboard control panel have been scrapped in favor of the stick steering system first developed by Jim Dockery of Shreveport, La. Though present Delhi models use a Morse control stick shift, Grits abides by the Jim Stick: "I've used it so long now, the darned thing is practically an extension of my arm."

Grits caught so many fish during our stay at Dardanelle that I rather imagined his fishing rod, and not the Jim Stick, was the extension of his arm!

After launching at the Russellville Marina, we picked up parks official

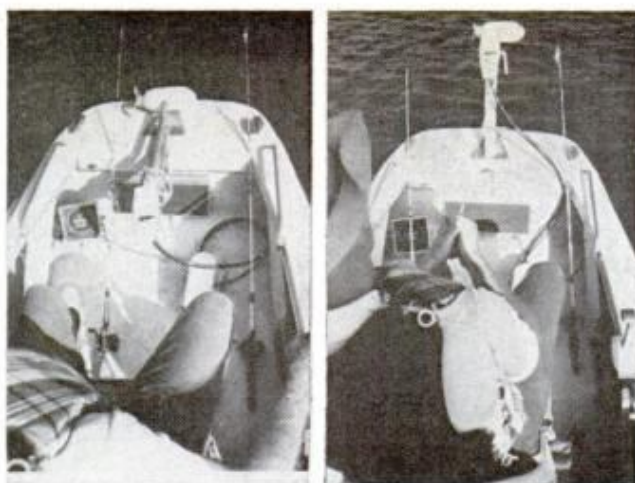

**GRITS EASES OFF** the throttle and drops electric outboard over bow as he approaches good fishing spot. Note Lowrance Fish Locator in front of left foot

Hugh Miller and began a systematic exploration of fishing spots he knew along the north shore of the lake. Dardanelle Lake is an impoundage of the Arkansas River created by a dam located five miles southwest of Russellville. Eventually this lake will form a link in a chain of navigable channels in the Arkansas from Catoosa, Okla. (15 miles east of Tulsa), to the Mississippi.

Reservoirs generally see their best fishing during their first 10 years of existence. The Dardanelle powerhouse was completed in June 1966, and the best fishing is just getting underway.

An angling scenario with Grits goes something like this: After shutting off the Johnson and lifting its prop clear of snags with a power-tilt mechanism located beneath the starter, Grits lowers his foot-operated, remote-control electric Motor Guide over the bow. Then after checking the Lowrance (300-SL) Depth Sounder & Fish Locator to see how deep we're fishing and whether there are any big ones below us, and after putting his cold drink in a spillproof swiveled holder, Grits begins to cast. And as soon as he casts, he seems to have fish!

When we got restless sitting in our 360° pivot chairs, we stood on a completely flat deck with confidence in the boat's stability. Even when Grits, Hugh and I all leaned to one side, the boat merely tilted a bit.

I stress the levelness because, in ad-



**BOAT SHOWS PERFECT STABILITY** (above left) when Grits stands to cast for white bass on the Arkansas. Above right: Grits lands a lunker; then later at the Russellville Marina, weighs in a pair of big ones. Below: Grits cuts the running time between hot spots with a 55-hp Johnson. Note vest-type life preserver.



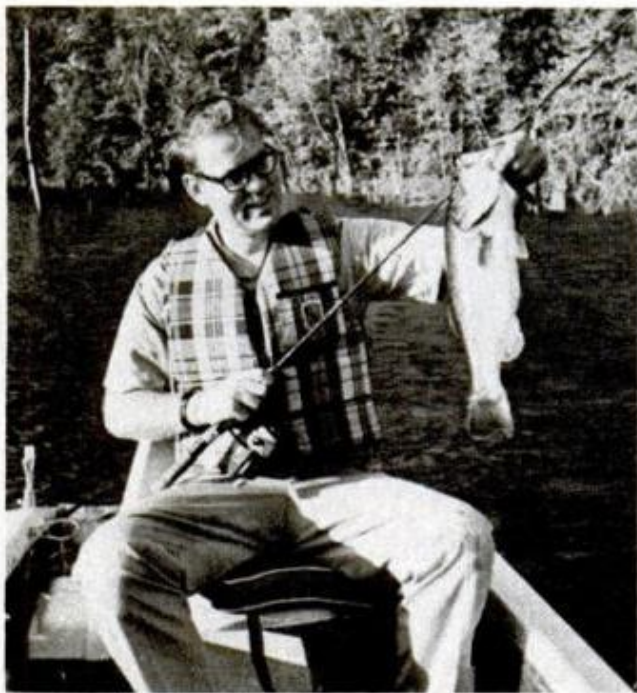

**FISHING SUCCESS** isn't confined to the driver's seat, as proved by this four-pounder landed by the author



**DURACRAFT'S ALUMINUM** bass boats have high freeboard and a sturdy bow platform to support caster



**OUACHITA'S CONVINCER** provides spotlight, bow-mounted winch anchor, trolling-rod holder options

dition to less fatigue for standing legs, a horizontal platform means that gear won't roll around or tangle in one spot. Since the boat comes equipped with under-the gunwales storage space for rods and tackle, there's really no reason to have much of anything loose.

The sensation of control is exhilarating! The waterscape sweeps by at terrific speed, but since you occupy the forward seat with nothing to obstruct your view, you have perfect visibility. Snags you might never see from the stern or over the top of a windshield are readily observed and easily slalomed by.

Appeal of the Terry Boat is in its stability, speed, excellent visibility and bow control. The family tree of bass boats is so intertwined that it's impossible to separate them into categories. If you're interested in getting one, first, decide on your requirements. For example, as a big-water fisherman you should be willing to sacrifice speed for greater freeboard. Then write for information from representative companies, some of which are listed below.

In addition to the Ranger made in Flippin, Ark., that state has Duracraft at Monticello, 71655; General Marine Industries, Inc., at Arkadelphia, 71923; Monark Boats at Monticello, 71655; and Ouachita Marine in Arkadelphia, 71923.

Tidecraft is produced in Minden, La.; Arrow Glass at 1371 Farmville, Memphis, Tenn. 38122; Ebbtide at Jones Creek Rd., White Bluff, Tenn. 37187; and PolarKraft, Box 236, in Olive Branch, Miss. 38654. Information about Chrysler's Dart can be obtained from Box 2641, Detroit, Mich. 48231, and two companies in Missouri are Beaver Boat Co., Inc., Box 740, Cape Girardeau 63701; and Richland Manufacturing Co., in Richland 65556.

While not all these firms make boats styled exactly like Grits' Terry, their designs incorporate most features of his "perfect boat." And if you can't beat this Southern way of fishing, why not join 'em? Grits insists it's only a matter of time anyway. ★★★

A black and white photograph of a man riding a mini-bike through a wooded area. The man is wearing a heavy jacket and is looking towards the camera with a slight smile. The background is filled with bare trees and brush, suggesting a late autumn or winter setting. The mini-bike is a small, motorized two-wheeler with a front fender and a rear seat.

# A Family Guide to Mini-Bikes

Any boy, girl, mom or dad can scramble through the thicket of mini-bike models for the perfect all-season, go-anywhere, two-wheel ticket to ride!

By **BILL HARTFORD**,  
Technical Auto Editor

**L**EAP THE GENERATION GAP!" is a phrase that's bound to show up as part of a smart manufacturer's mini-bike advertisement. "... One for father, one for son... Instant rapport!" The six-to-sixty slogan couldn't be more appropriate to these generation-jumping machines: The first racing class of the Southern California Mini-Bike and Kart Assn., for example, is for six- to eight-year-olds! Competitive hill climbs and dusty scrambles comprise the popular mini-bike events. Dads and grandpas aren't racing the motorized two-wheelers, but they're ending the old huffing and puffing, and putt-putting into the good backwoods fishing areas.

The fun, unique appeal and versatility of these machines has sold over a million to kids of all ages during the mini-bike boom of the '60s. And it won't take a whole decade to see a second million on the roads and trails, and unfortunately, because

*(Text continues on page 120)*

## MINI-BIKES

**MOTORCYCLE ENGINE** powers Honda's 108-pound Mini-Trail. The 50-cc, single-cylinder powerplant is of four-stroke, overhead-camshaft design a la Honda. An automatic clutch is used with a three-speed transmission. Left toe selects the gears. Both front and rear internal-expanding brakes are actuated with the levers on the handlebars which fold for transport. Vent lock on the gas cap and folding foot pegs also facilitate taking it along. The 39-inch-wheelbased machine has kick starter, telescope front fork.

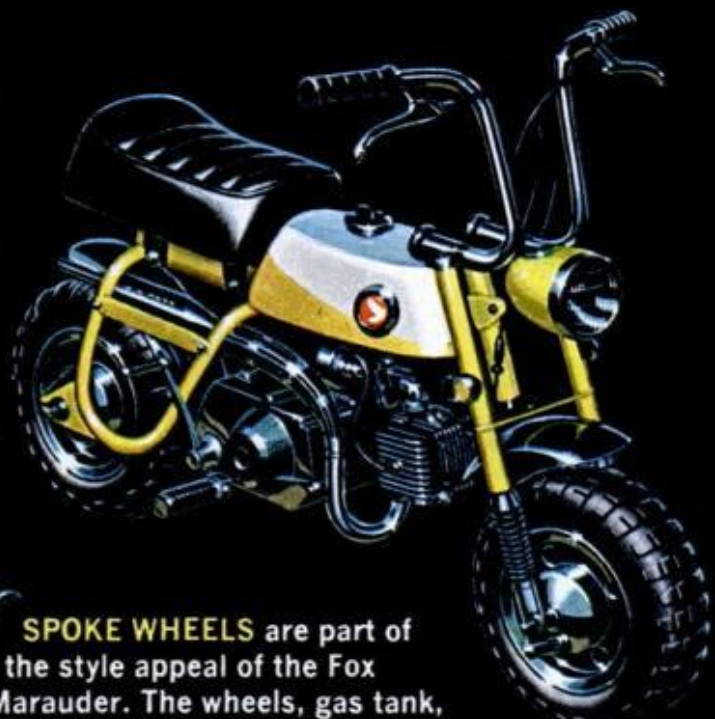

**SPOKE WHEELS** are part of the style appeal of the Fox Marauder. The wheels, gas tank, upswept exhaust and contoured fenders are all plated to satisfy the chrome craze among mini-bike enthusiasts. Two types of large diameter, 2.50 x 10-inch tires for street and trail provide a stable ride, and disc brakes front and rear quick, stable stopping. Engine is a four-hp, four-cycle Lauson with two-speed automatic transmission.



**ELECTRIC MINI-BIKE** is powered by a 2½-hp electric motor and standard 12-volt automotive battery. Fiberglass panels are removable to reveal the 140-amp.-hour battery which gives the Cal-Jet Electra-cycle a 60 to 100-mile cruising range. Standard sprockets allow 40 mph top speed; optional sprockets gear machine for higher top speed or lower speed with higher torque. The two-speed bike features front and rear internal-expanding brakes, front coil springs, rear shocks, dual seat for rider and passenger.





**SNOW SKI** snaps onto the front fork of Heathkit's Boonie-Bike for all-weather versatility. The 18 x 8.50 knobby on the rear wheel drives the trail bike through the snow or mud.

Output of the five-hp Briggs & Stratton four-cycle engine is geared to the rear wheel at 7.5:1 and 15:1 ratios through a centrifugal clutch and frame-mounted selector.

Horn, lights and battery are accessories for the 116-pound bike.

### MINI MINI-BIKE

is a scant 37 inches long and 21 inches high. The Scat-Kitty is powered by a 2½-hp Tecumseh four-cycle engine with built-in 12-volt alternator. Frame and fenders are of unique, one-piece cast aluminum design. The single-speed bike from Projects Unlimited has detachable handlebars for stowing. Among accessories are a deck mount for boats and campers, and a detachable sidecar!



**"CHOPPER"** is motorcycle lingo for a bike with a chopped or lowered frame and raked front fork. Bonanza's mini-bike chopper—appropriately dubbed the Minichopper—is an eye-catching machine complete with banana seat, chrome sissy bar, mag-type wheels and pegs way out front. A four-horse, four banger with centrifugal clutch drives the bike through a 6:1 overall gear ratio. The 80-pound machine has a wheelbase of 42 inches. Internal-expanding, dual-shoe drum brake acts on the rear wheel. Front shocks and spring-mounted seat cushion the ride.

of the lack of riding areas, furtively buzzing up, down, around and through public parks, closed school yards and supermarket parking lots.

Maybe there already are two million mini-bikes in action. There's no way to know. Entrepreneurs who can weld together a frame—from guys in backyard garages to industrial giants in the motorcycle manufacturing business—are welding for all get-out. And they're selling them all. The mini-bike kid-cult consumes them like Good & Plenties. They're the hottest toys going. Adults who just want a toy can rationalize the sheer fun of ownership by using their mini-bike in any one of countless "practical" applications, or for honest recreational pursuits. So the machines sell and sell—to all ages of investors-in-fun—with still no recession in sight.

**The basic machine.** The average price paid for a mini-bike has been steadily increasing. The slightly under \$100 to \$150 price range is still the kickoff point, but the demand is for ever more sophisticated, stylized, chrome-plated and powerful machines. The archetypal mini-bike—a simple frame with small, unsuspended wheels and low-horsepow-

er, four-cycle "lawnmower" engine and friction brake, if any—seems destined for the Smithsonian. At best these are "first" bikes—sometimes built from kits by teen and even preteen kids just trying their wings. They provide a great education in basic mechanics and motorized two-wheeler handling, and the rough ride is hardly noticed by enthusiastic youngsters.

Even if you're a dad and you want to find out what mini-bikes are all about, try one of these basic models. When you start some serious family mini-biking, that first bike in your stable will never go unused: The hand-me-down minibike is the most exciting hand-me-down the youngest member of the family will ever receive. Even with its small wheels, usually five-inch, that will bog down in trail ruts, and its unworthiness for street use, the smallest machines in the mini-bike family have their place.

**The engines.** Most manufacturers or distributors of mini-bikes offer a line or lines of machines that are basically the same except for engine size. The air-cooled, single-cylinder, four-cycle gasoline engine is still the prime mover

**MINI-BIKES OR ATVs?** Two departures from conventional mini-bike or mini-trail designs are the three-wheel Scoot or Ski and the flotation-tired El Burro. Pivoting rear tandem, double-drive wheels give the Scoot or Ski fantastic traction, speed of 35 mph; eight-inch wide rear track and front ski are fitted for snow. El Burro's low-air-pressure tires make it almost unstoppable. Top speed with its 5-hp engine is 20 mph





## SOME SOURCES AND MODELS

Alexander-Reynolds Corp., Hackensack, N.J. 07601.  
 American Aluminum & Steel Products, Inc., 814 N. San Fernando Rd., Los Angeles, Calif. 90065.  
 American Honda Motor Co., 100 W. Alondra Blvd., Gardena, Calif. 90247.  
 Aragon Distributing Co., Inc., 323 Maple Ave., Monrovia, Calif. 91016.  
 Bird Engineering, Inc., Box 427, Omaha, Neb. 68101.  
 Bonanza Industries, Inc. Scout Div., 1775 S. First St., San Jose, Calif. 95112.

Bonham Corp., Box 858, Provo, Utah 84601.  
 California Jet Marine, Inc. (CAL-JET), 1900 Avenue of the Stars, Los Angeles, Calif. 90067.  
 Central Cycle Supply, 51025 U.S. 31 North, South Bend, Ind. 46637.  
 Cosmopolitan Motors, Hatboro, Pa. 19040.

Engine Specialties, Inc., Croydon, Pa. 16220.  
 Floyd Clymer Motorcycle Div., 222 N. Virgil Ave., Los Angeles, Calif. 90004.  
 Fox Corp., Box 747, Janesville, Wis. 53545.

General Appliance Mfg. Co., Box 429 Downtown Station, Omaha, Neb. 68101.

G.E.M. Sales International, Inc., 3505 Long Beach Blvd., Long Beach, Calif. 90807.

Gilliom Mfg. Corp., St. Charles, Mo. 63301.

Harrison Research, Inc., 50591 Ryan Rd., Utica, Mich. 48087.

Heald Inc., Box 638, Benton Harbor, Mich. 49022.

Heath Co., Benton Harbor, Mich. 49022.

HPE, Inc., 225 Acacia St., Colton, Calif. 92324.

KAL Mfg. Corp., 18121 S. Broadway, Gardena, Calif. 90247.

King O'Lawn, Inc., 10127 Adella Ave., South Gate, Calif. 90280.

K&P Mfg., 330 S. Irwindale, Azusa, Calif. 91702.

Lomart Engine Products, 980 Alabama Ave., Bklyn., N.Y. 11207.

Manco Products, Inc., 3337 Freeman St., Fort Wayne, Ind. 46804.

B. F. Meyers & Co., Fountain Valley, Calif. 91405.

Michrina Enterprises, Inc., 11859 Levan Rd., Livonia, Mich. 48150.

Nova Products of Calif., 16800 S. Broadway, Gardena, Calif. 90247.

Powell Brothers, 5903 E. Firestone Blvd., South Gate, Calif. 90280.

Projects Unlimited, Inc., 1926 E. Siebenthaler Ave., Dayton, Ohio 45414.

Rokon, Inc., 160 Emerald St., Keene, N.H. 03431.

Rupp Mfg., Inc. Box 1095, Mansfield, Ohio 44903.

Ruttman Co., 24732 Ford Rd., Dearborn Hts., Mich. 48127.

Spreads-All Co., West Hwy. 330, Marshalltown, Iowa 50158.

Sport Craft Engineering, Box 47, Lombard, Ill. 60148.

SportStyl, Inc., RD4, Lewistown, Pa. 17044.

Starlight Tool & Mfg. Co., Inc., 3300 W. 7th St., Joplin, Mo. 64801.

Steens, Inc., 1635 W. Valley Blvd., Alhambra, Calif. 91803.

Stellar Industries, Plainview, N.Y., Joplin, Mo., and Opa-Locka, Fla.

Valiant Mfg. Corp., 4000 Toulouse, New Orleans, La. 70119.

2 to 5-hp models  
 Maverick I, II, III

Mini-Trail,  
 Trail 70  
 El Burro

Wren, Lark,  
 Duck, kits  
 Minichopper,  
 BC-1000,  
 1100, 1200,  
 1300, 1400T,  
 others  
 Mini-Gote,  
 Tote-Gotes  
 Electracycle  
 Electrocon

Charger Jr.,  
 Charger 1,2,3  
 Benelli Buzzer,  
 Hornet,  
 Dynamo  
 Broncco  
 models to 5 hp  
 Indian  
 Ponybike  
 Marauder,  
 Campus,  
 Spoiler, others  
 Trail Horse  
 GTO 1400,  
 1500, others  
 Go Devil,  
 others

Plans and  
 parts  
 Wildcat,  
 Bobcat  
 Model VT-1 kit

Boonie-Bike

Cat 400X,  
 300X, 250X  
 Bandit I, II,  
 TT  
 KB-2, KB-3,  
 Aggie Bike  
 Flea, others

Cheeftah

Little Gen  
 models to 5 hp  
 Lynx Cub, Lynx  
 53, 63, 65  
 "Lil" Indians  
 (2 1/4 to 5 hp)  
 King Cobra,  
 Ruff-Rider,  
 others  
 Challenger

Scat-Kitty

Trail-Breaker

Roadster,  
 others  
 Judge, GT140,  
 GT150, GT240,  
 GT50  
 Scoot Or Ski

Trailmaster  
 models 2-5 hp  
 Kat, Bob Kat,  
 others, kits  
 Models up to  
 3 1/2 hp  
 Taco 22, 44,  
 99, 100, kits  
 Quasi Stellar,  
 Model A, D  
 Simplex

for mini-bikes. Engines with horsepower ratings from two to five are available. Major engine suppliers and manufacturers are Briggs & Stratton, Lawson and Tecumseh.

Increasing in popularity as mini-bike powerplants are two-stroke motorcycle engines. Among the two-strokes are Hodakas and Garellis which power some Bonanza and Broncco bikes. Benelli mini-bikes, of course, use the two-stroke engines long-produced by the famed Italian motorcycle manufacturer. Part of the thrill of motorcycle-engined mini-bikes is using the integral gearbox which has anywhere from three to five gears to shift for full utilization of engine power. Honda mini-bikes—the Mini Trail illustrated on the color spread and a larger, more powerful Trail 70 model—also use motorcycle engines but they are four-stroke, overhead-cam units like those used in Honda motorcycles. Displacements of current motorcycle engines are from 50 to 100 cc with power up to 10 hp—no machines for inexperienced kids.

Most motorcycle engines are shifted using a hand clutch although some use automatic clutches of various designs. Universally used with four-stroke, "lawnmower-engine," variable-gear-ratio mini-bikes is the centrifugal clutch. Attached to the engine shaft, it engages with increased engine rpm and disengages when you throttle down to shift. All mini-bikes are chain-driven by the rear wheel.

**The popular minis.** A step up from the very basic minis are machines using these motorcycle engines or higher-horsepower four-strokes, and incorporating desirable design features. In this popular price range—starting slightly under \$200 and running up to \$300—are a host of mini-bikes and mini-trails of differing appeal. All of the machines on the preceding color spread, except the Electracycle, are in this category. All have at least a rear brake, and front and/or rear suspension (except the Scat-Kitty) and have

(Please turn to page 223)



**PRINCE EDWARD ISLAND**, a beautiful little province off the coast, was easternmost point of our trip. Above: we watched lobster fishermen work on their boat on north shore of the island. Traveling west, we visited historic Quebec City and strolled along the boardwalk in front of Chateau Frontenac (below, left). Farther west, Scott and John (below) prepared their own hamburgers at Agawa Bay, Ont., provincial campsite



# Across Canada In a Motor Home

It's a big country—and it takes a lot of driving to see even half of it. We found the quick-setup, quick-departure features of our luxurious camper ideal for the long trip.

By JOHN LINKLETTER, Managing Editor

Photos by the Author

**E**VEN ON A MAP, the great mass of land north of the U.S. border looks vast. It's no mapmaker's illusion. Canada is the second largest country in the world.

Stretching for 5000 miles from coast to coast across the country is the famed Trans-Canada Highway, the longest national highway on earth.

Last July, when we set off westward from Summerside, P.E.I., we were on an island off the east coast—yet we were almost 1000 miles west of the beginning of the Trans-Canada Highway at St. John's, Nfld. And when we turned south to the United States from Winnipeg, Man., we were still a long way from the west coast even though we had traveled a respectable 2222 miles getting to Winnipeg from Summerside.

It isn't that miles and speed and other statistics have anything to do with a proper vacation; it's just that when one wishes to lay claim to "crossing Canada"—or a portion thereof—one soon learns that he must reckon with great distances.

For this kind of long-distance traveling (the odometer rolled up 5356



**COLORFUL WINNIPEG**, capital of Manitoba, was western end of trip. Below: map of 5300-mile round trip from Old Greenwich, Conn., near New York

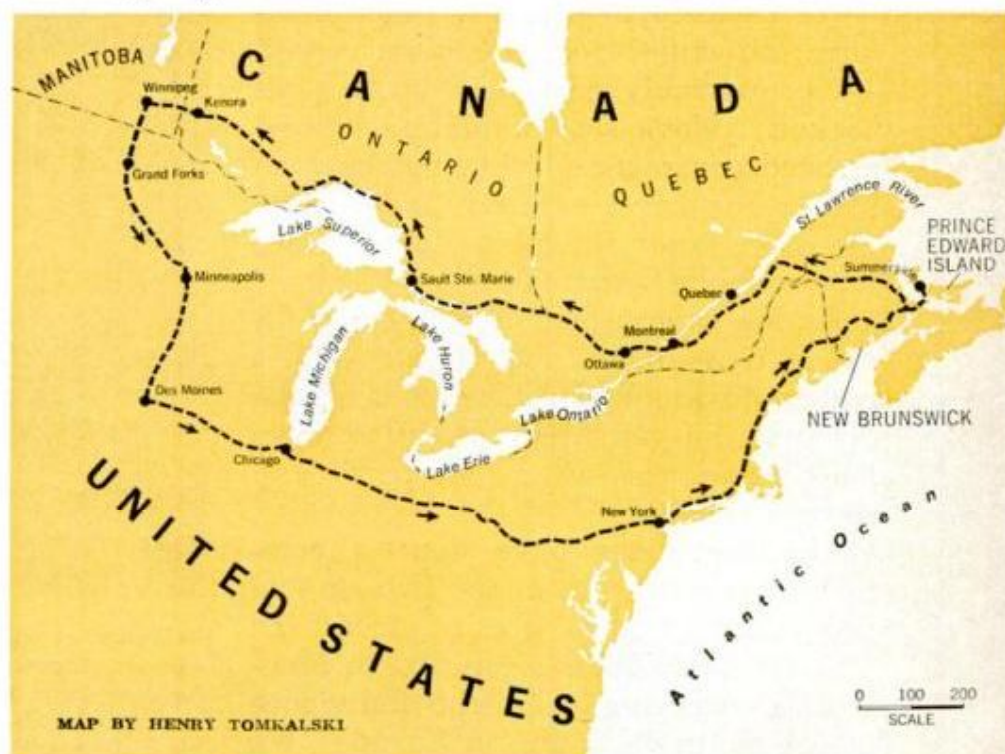



**TWO COMPARTMENTS** on side of Glastron have 17 cu. ft. of storage and ample width for folding chairs

miles round trip from Old Greenwich, Conn.), I can't imagine a better vehicle than a motor home—particularly when you have a wife, three kids and a dog, all of whom must be comfortably transported, bedded and fed in order to have the vacation achieve any degree of success.

We drove a Glastron motor home (that's correct: Glastron, the boat-builder, is now making a recreation vehicle that is as handsome as the Nautaline houseboat we took on our *Houseboat Vacation* (page 100, Nov. '68 PM), and we borrowed one of the first off the production line).

We traveled in this luxurious, insulated, airconditioned, fiberglass cocoon—I comfortably ensconced in a high-backed "pilot's seat" handling power-assisted controls and viewing the road from a bus driver's vantage point while the other family members lolled about in our mobile "apartment."

As for camping—if it can really be called that amidst such luxury—all I had to do was find a level spot on the grounds and spend less than 10 minutes hooking up the water, electrical and sewer systems.

The Canadians have done a commendable job for campers. Private and provincial grounds abound from the Maritime Provinces westward to Montreal. I was reminded of the abundance of campsites we found in Europe (*We*

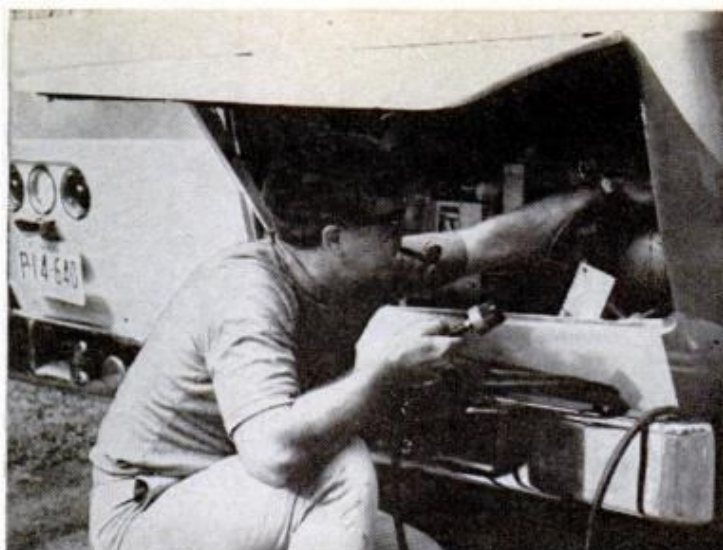

**GENERATOR** supplies 110-v. system. At campground, simply unplug from generator, plug into camp line

*Camped Our Way Through Europe*, page 128, Jan. '68 PM). Beyond Montreal they were spaced out, but those we stayed in were excellent provincial parks. All were well marked with road signs. (On our return trip through the United States, only in Iowa did we see a comparable frequency of road signs for campsites.)

Camping and sightseeing in Canada are not necessarily, as I may have led you to believe, a succession of long



**INTERIOR** of Glastron motor home is as slick as its exterior. Above: ol' Dad swivels driver's seat around for easy chair. At right, my wife with Gayle, John and Chumley. Gayle's on sofa that folds out as double bunk; another bunk folds out of wall behind her



**WE WEREN'T THE ONLY ONES** camping in eastern Canada. Here our Glastron waits in line to board ferry to Prince Edward Island. The wait wasn't long—four boats make continual crossings all day long

drives over vast plains with short rests in between.

In the charming little province of Prince Edward Island—variously called the “Garden of the Gulf” (it is pretty); “Spud Island” (potatoes are a major crop), and “Birthplace of the Confederation” (Canada started on its way to confederation in Charlottetown in 1864)—we spent three days camping, touring, digging for clams, swimming and enjoying beautiful, sunny days.

Our campsite there was in a farmyard next to the century-and-a-half-old farmhouse in which my father lived as a boy and where my elderly uncle and aunt still reside. Their farm, near Summerside, borders on the south shore of the island and also on a provincial campground that is immaculately clean, well equipped and offers salt-water swimming on a beach with such a shallow slope that even a toddler could wade in without causing much

concern. To be objective about the campground (it's difficult because, after all, it's on Linkletter Beach), I must report that the site is a bit flat and virtually treeless.

Another campground on the north shore at P.E.I. National Park borders on the red sandstone bluffs that overlook Cavendish Beach. It's well forested, and the swimming is superb. The water is as clear as that in a swimming pool, and there's a lively surf. I would agree with the tourist-office people who describe it as one of the finest beaches in North America.

Touring the island was, as in past years (this was my fourth trip there), a pleasant

*(Please turn to page 206)*



# PM OWNERS REPORT DATSUN

A Nationwide Survey Based on  
2,247,000 Owner-Driven Miles

By **BILL HARTFORD**  
Technical Auto Editor

Photos by Irv Dolin



1970 SEDANS have manual choke on right side of steering wheel, ventless side windows. Interior is smartly done except for crinkled carpet on tunnel

# An Economy With a

**N**ISSAN MOTOR CO. is the Japanese manufacturer that makes the Datsun line of automobiles. Last year two Nissan R382s swept the Japan Grand Prix for Group 7 cars. Drivers Kurosawa and Sunako drove the lead car 447 miles at an average speed of 121.241 mph around the Fuji International Speedway. Their 6-liter, 520-hp machine ran beautifully for almost four tense hours on the 3.7-mile circuit.

The R382 bears practically no resemblance to any of the Datsuns—two and four-door sedans, two softtop sports cars, station wagons and pickup trucks—imported to the United States and included in *PM's* survey. (The exciting new 240Z, a personal, two-passenger fastback was introduced too late to be included.)

While it's true that the resemblance stops with the number of wheels, the

## Summary of 1969 Datsun Owners Reports\*

Total miles driven ..... 2,247,780

Average miles per gallon  
(1595cc engine):

Local driving ..... 23.8  
Long trips ..... 27.6

Specific likes:

Economy ..... 61.6%  
Handling ..... 49.5  
Comfort ..... 21.2  
Style ..... 18.2  
Performance ..... 18.2  
Power ..... 15.1  
Ride ..... 10.8  
Price ..... 8.8  
Size ..... 8.1

Specific dislikes:

Rattles ..... 12.2%  
Service ..... 10.5  
Quality ..... 9.1  
Brakes ..... 7.0  
Heater ..... 5.6  
Clutch ..... 5.6  
Vent system ..... 4.5  
Workmanship ..... 4.2  
Cold start ..... 4.2

What changes would you like?

Seat style ..... 11.8%  
Better tires ..... 9.6

Quality of materials ..... 8.5  
Interior styling ..... 7.4  
Vent windows ..... 6.6  
Dash layout ..... 5.5

Body style:

4-door sedan ..... 27.1%  
2-door sedan ..... 21.9  
Wagon ..... 28.1  
2000 sports car ..... 17.4  
1600 sports car ..... 5.2  
Pick-up truck ..... 0.3

Transmission:

4-speed manual ..... 91.6%  
Automatic ..... 8.4

Had any mechanical trouble?

No ..... 71.7%  
Yes ..... 28.3

What kind of trouble?

Carburetor ..... 12.9%  
Oil leak ..... 10.6  
Clutch ..... 7.1  
Starter switch ..... 7.1  
Choke ..... 7.1  
Electrical ..... 7.1

Dealer repair satisfactory?

Yes ..... 75.0%  
No ..... 25.0

Why the Datsun?

Economy ..... 56.2%  
Style ..... 15.9  
Size ..... 13.6  
Price ..... 13.0  
Performance ..... 9.4  
Handling ..... 8.8

Is the Datsun your only car?

No ..... 58.4%  
Yes ..... 41.6

Other cars owned:

Chevrolet ..... 22.1%  
Ford ..... 14.4  
Pontiac ..... 10.5  
Dodge ..... 9.4  
Oldsmobile ..... 8.3  
Datsun ..... 6.6  
Volkswagen ..... 6.1  
Buick ..... 5.5

What options/accessories?

Radio ..... 71.0%  
Airconditioning ..... 12.5  
Cigaret lighter ..... 6.1  
Whitewall tires ..... 4.3  
Luggage carrier ..... 4.3

Age distribution of owners:

15-29 ..... 39.5%  
30-49 ..... 40.1  
50 plus ..... 20.4

\*Where applicable, percentages may not equal 100 percent due to rounding and/or insufficient sample.

# Car for Enthusiasts, Few Little Annoyances

enthusiastic reaction to both race car and passenger cars is very similar. Datsun owners in the United States—even though they are motivated by economy of purchase price and operation—are impressed by what they consider the advanced design of their car: overhead-camshaft engine, independent front and rear suspension in the sedans and sports models, and front disc brakes. These “race car” features, combined with items like whitewalls and wheel covers that are included in the list price, give them a sense of owning something special that is, as many say, “fun to drive”—even if they’ve never heard of a Nissan R382.

The economy of ownership that owners praise so strongly is mostly for miles-per-gallon figures of 23.8 and 27.6 for local driving and trips, respectively. This exceeds Datsun’s claim of 25 mpg

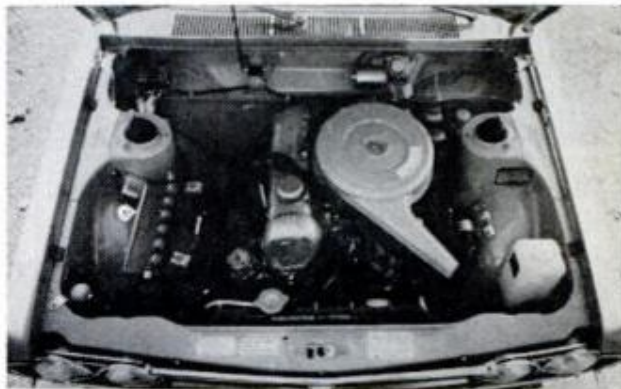

**1.6-LITER OHC ENGINE** is equivalent to a little less than 100 cu. in. Easy to maintain, say owners





**STYLE IS DESCRIBED** by owners with adjectives like "crisp, neat, perky," with no owners dissenting. Handling is well-liked (second to economy); over 90 percent have four-speed box. Fun to drive, say many



**FUN FOR KIDS** but a few adults find the rear seat skimpy. Most, however, feel it compares favorably with U.S. fastbacks and some other imports. Nice feature for rear passenger's access in the two-door sedan is mechanism that automatically slides entire front bucket forward when backrest is moved

overall. Even though owners might only grin and bear the expense of premium fuel, they feel that the payoff is performance: The small, four-cylinder 1595-cc engine puts out a full 96 hp at 5600 rpm. It's normally aspirated using a single two-barrel carburetor. "Better gas mileage from Datsun's 96 hp than from '66 VW's 50 hp," beams a Kentucky barber.

Very few owners, therefore, have any complaints about the pickup and super-highway performance of the roughly 2100-pound sedans—about 2200 pounds with the optional automatic transmission. (The 17.4 percent owning the 150-hp model 2000 sports car with its 1982-cc ohc four and twin carbs report they are getting 23.0 mpg around town and 27.8 mpg traveling.)

A North Carolina computer salesman's call for a "super sedan" model certainly isn't a complaint. He's an ecstatic owner of a two-door sedan who thinks it would be interesting to have an even more "high-performance engine and drive train in the existing sedan body." His only complaint about the car is one that is also shared by many other owners, "that the turn-signal blinker is too quiet!" and therefore is unconsciously left on.

What a few owners do not find economical about owning a Datsun is the cost of service. A USAF medic complains about "\$34 for a 9000-mile maintenance, \$24 of which is for labor." He now does his own for \$4. Most service

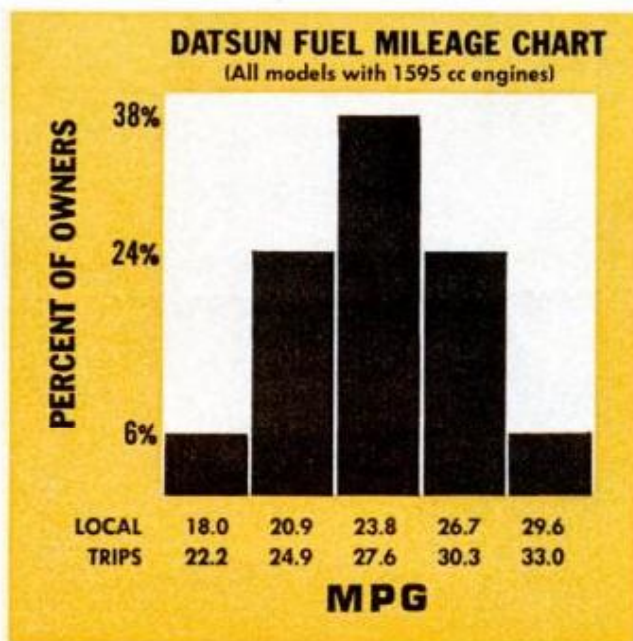





**FAST-MOVING FIRE AND RESCUE TRUCK** accelerates to 100 kph (62.5 mph) in 55 seconds. 1000-hp Daimler-Benz V10 diesel drives all eight wheels. Carrying 18,000 liters of water, plus 2000 liters of foam, Faun-Werke's "Flugfeld-Tanklöschfahrzeug" is designed to smother fires at jumbo jetports like Frankfurt and Orly

# TRUCKS!

By ROBERT P. CROSSLEY, Editor

**These sophisticated European jobs do about everything but drive themselves!**

**T**HEY CALL IT the Internationale Automobil-Ausstellung. They hold it every two years in Frankfurt. It's like no automobile show you ever saw. More like a state fair in Illinois, it overflows 20 buildings; only one is devoted to passenger cars. Three contain trucks and buses, including double-deckers; two, pickups, vans and campers.

The trucks were so exciting we never got back for a second look at the Mercedes, Renaults and Lotus Europas. What kept us wandering among the trucks were advanced engineering features, many not available on American trucks or only as special options: Rear axles that steer, cab-controlled air-suspension, horizontal engines, ingenious unloading systems. Someone said, "Be sure to see 'the world's biggest dump truck.'" We never figured out which one he was talking about.



**THE 60-TON BIG BROTHER** of this huge 45-ton Berliet dump truck was purchased by the Russian government, which plans to operate it in Siberia. Many parts of the truck had to be made of special synthetics that were designed to withstand temperatures as low as minus 70° F. The giant vehicle was knocked down, packed into several containers and then flown from Lyon, France, in two Antonov cargo planes

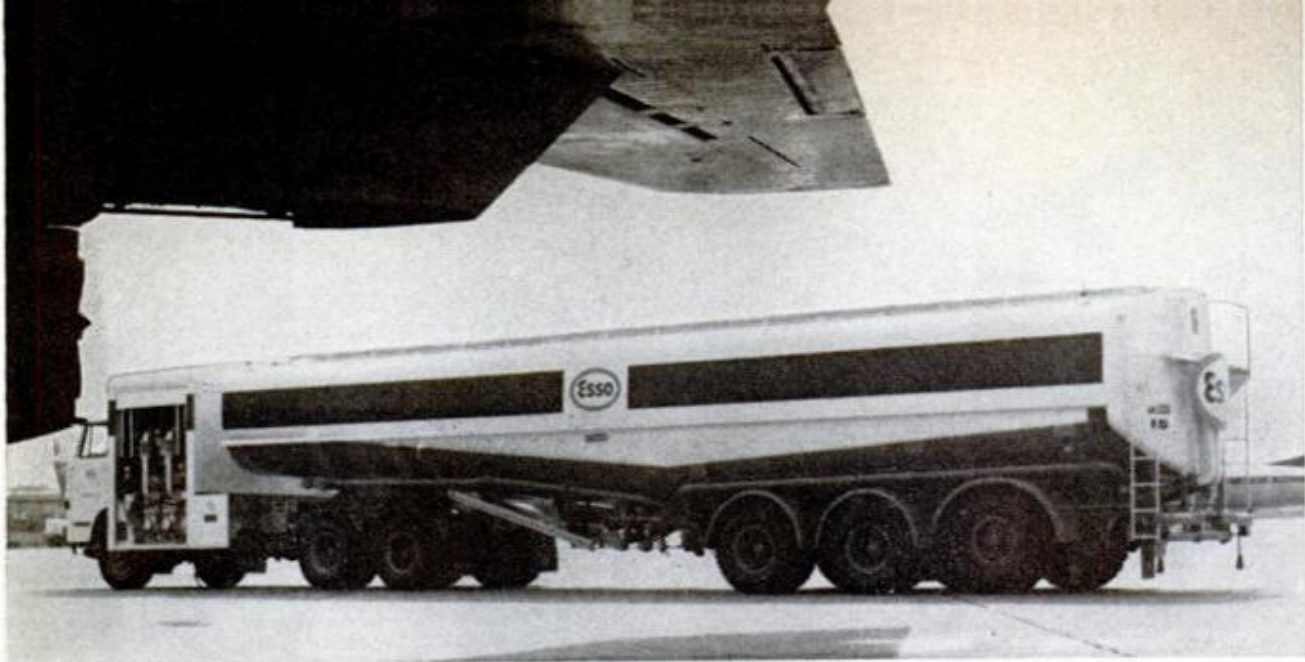

**TANKER FOR JUMBO JETS.** Struver Flugfeldtankfahrzeug will refuel Boeing 747s later this year at Amsterdam Airport. Tanker holds 75,000 liters of jet fuel, can pump 4000 liters a minute. Despite their great size, it will take two of the Flugfeldtankfahrzeugs to refuel one of the 747s. Front axle of the trailer steers

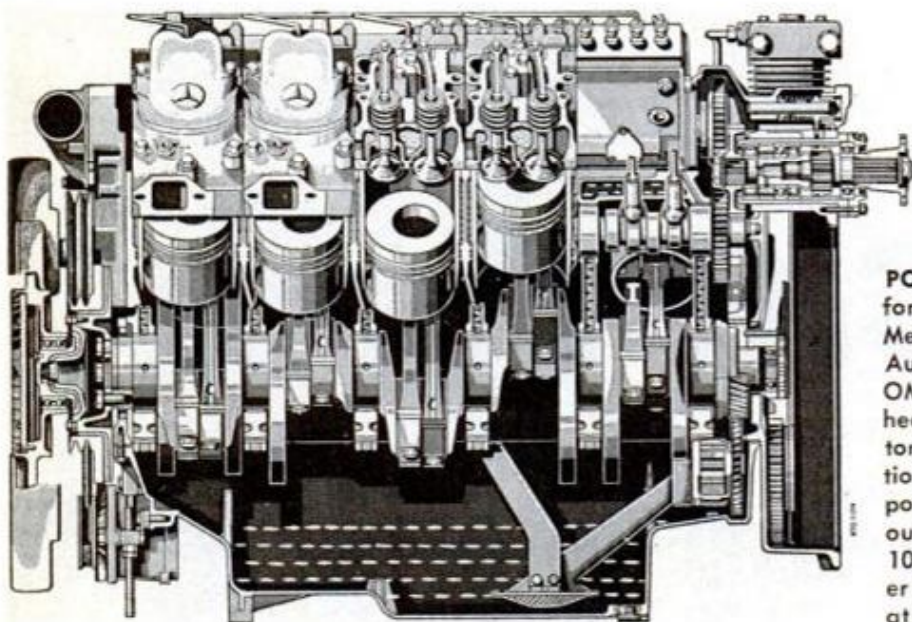

**POWERFUL NEW V10** diesel engine for trucks made surprise debut in Mercedes-Benz exhibit at Frankfurt Auto Show. Direct-injection 970-cc OM 403 engine is available in heavy trucks and semi-trailer tractors. It is also offered as an installation engine. Notable for its low power-to-weight ratio, the V10 puts out up to 350 hp (SAE). Of this, 100 hp is available through a power takeoff that can provide power at the front end of the crankshaft



**ELEVATING LOADER**, shown here on big beer trailer, moves up and down electrically at push of a button, full length of the trailer bed on a suspended track. When you're through using the loader, you park and tote it in the "kneehole" located underneath the floor of the trailer. Loader was exhibited by Rationorm



**FRONT-WHEEL-DRIVE** gives Fiat 238 trucks and vans great capacity, low loading height (16 inches). Engine-transmission unit mounted transversely ahead of cab puts load on front wheels to give maximum traction, even when van is empty. Four-cylinder engine has 1438 cc, all four wheels independent suspension

**DRIVER CAN JACK UP TANK** of Schaubstahl-Werk chemical tanker, drive chassis home for another load

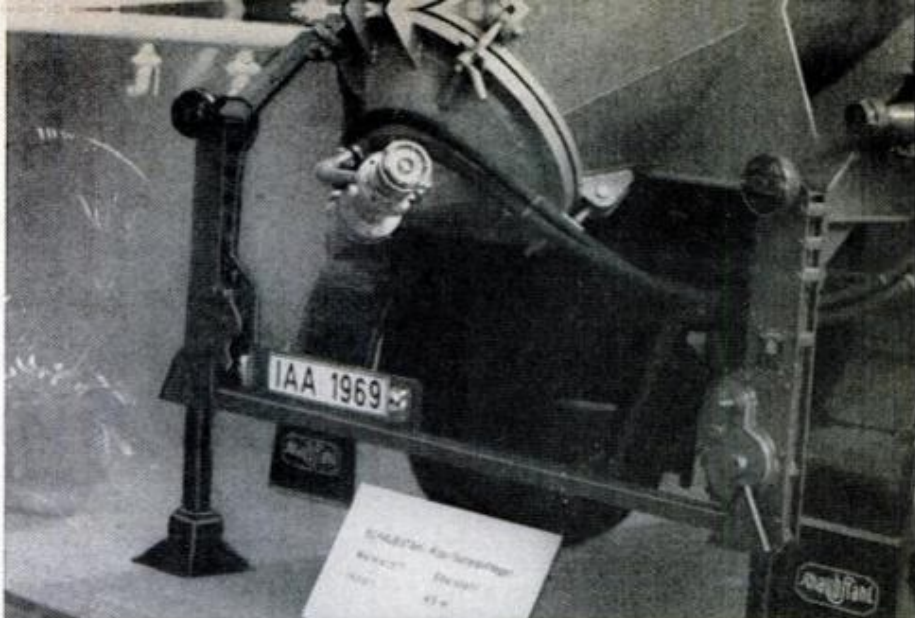

**REAR-ENGINED FOUR-WHEEL DRIVE**

Haflinger 700 AP is truck and recreation vehicle. Opposed two-cylinder, air-cooled engine puts out 30 hp (SAE). Light weight (1400 lbs. min.) permits climbing grades up to 65°. Short wheelbase (59 or 71 inches), combined with high clearance, enables it to climb embankments and over tree trunks, yet center of gravity is so low 700 AP can cut across 50° slope. Optional power takeoff operates winches, generators and pumps. All wheels have independent suspension. Differential lock on both axles. A real Alpine goat by Steyr-Daimler-Puch of Austria



**BUSSING'S** under-the-frame, back-of-front-wheels diesel takes engine out of driver's lap, makes cab a cab, not an engine compartment. Company claims easier servicing and that low center of gravity improves cornering and braking. Entirely under frame, engine can't interfere with superstructure design. U 12 D six-cylinder direct-injection diesel puts out 260 hp (SAE). The wet cylinder liners are replaceable

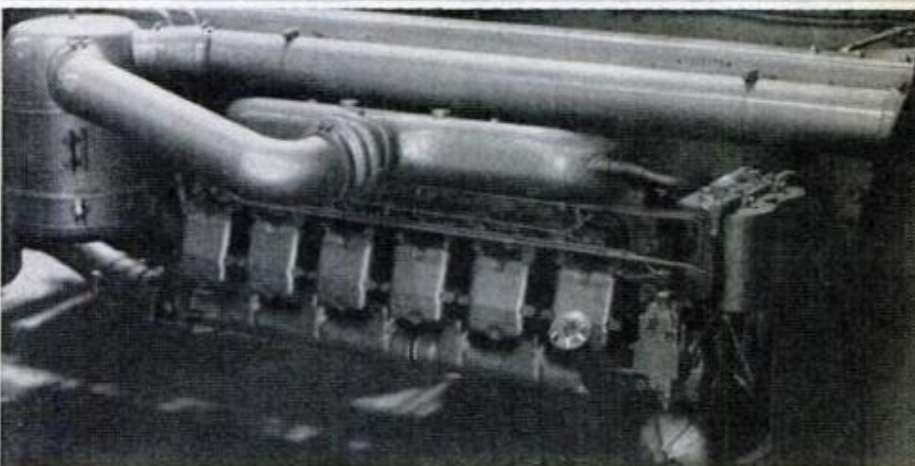

**MOST SPECTACULAR SIGHT** at show was Viberti's fully raised giant dumping semi. Trailer unit is 8.39 meters long overall, weighs 8480 kilograms empty, holds 20 cubic meters and can carry 23,200 kilos fully loaded on its four 12:00x20 18-ply tires. Lifting is accomplished by one single-ram hydraulic cylinder mounted in a semihorizontal position between frame members. The pressure oil pump and other controls are mounted on tractor unit



# How to Keep Your AUTOMATIC

By MORT SCHULTZ

**A**N AUTOMATIC CHOKE that's out of whack not only increases fuel consumption and causes hard starting—especially in cold weather—it makes an engine idle rough, misfire at high speed, backfire, lose power.

Choke mechanisms differ from carburetor to carburetor. However, they all work much the same. When you start a cold engine, a plate automatically closes over the carburetor throat to restrict air intake and provide a rich fuel mix for easy starting.

Once the engine starts, a piston or vacuum mechanism immediately exerts pressure on the choke plate to let it open slightly. This keeps the engine from loading up and stalling on fuel that's now too rich.

All automatic chokes also have a mechanism (fast-idle cam) to permit a fast idle while the engine is cold. This lets the engine reach operating temperature quickly and prevents stalling.

A choke unloader that relieves flooding brought about by overzealous cranking is also a part of the system.

This is activated when you floor the accelerator pedal and hold it. A cam trips a linkage that causes the choke plate to open, thus relieving an over-rich mixture.

To tell if your choke is functioning as it should, watch how it acts on a cold day with the engine cold. Press the accelerator pedal to the floor and release it. The choke plate should close.

Start the engine. The plate should im-

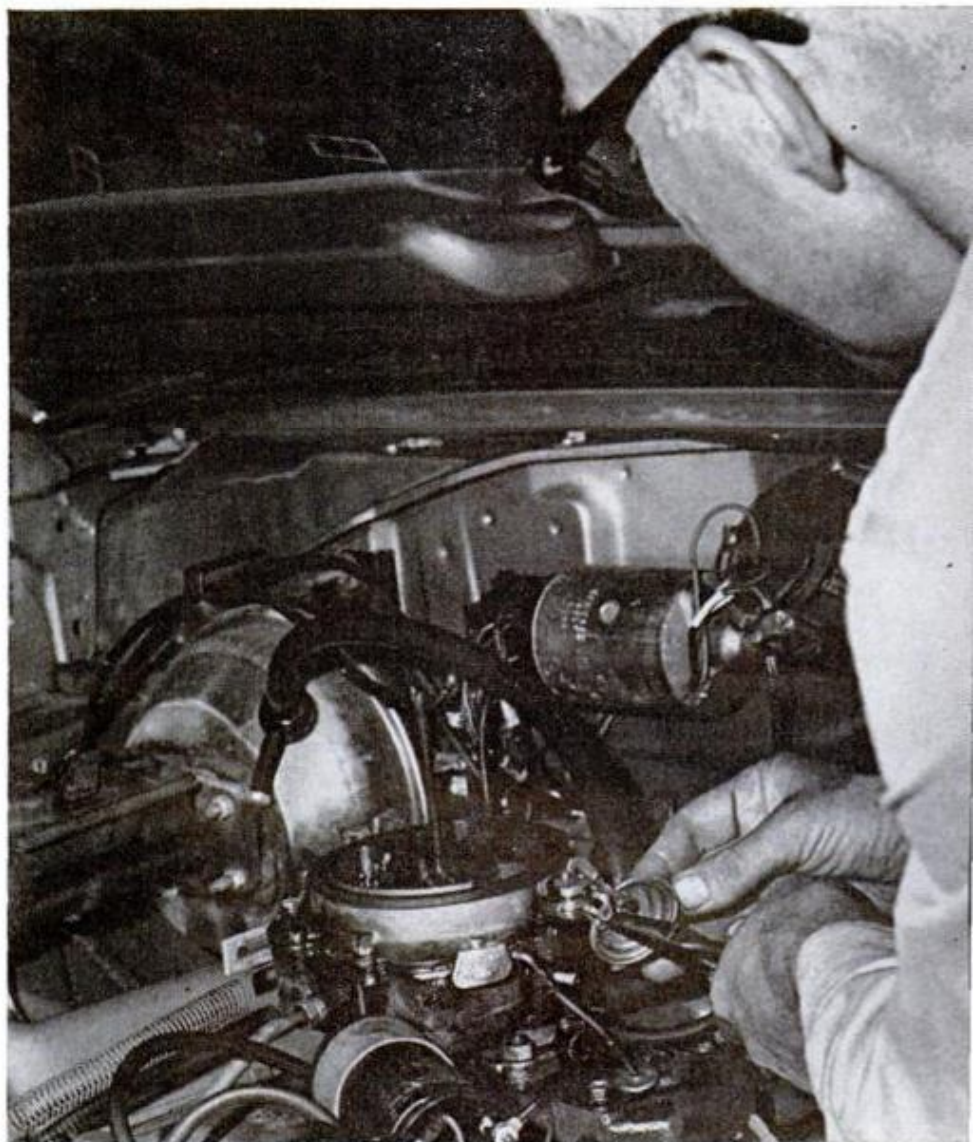

SOME AUTOMATIC CHOKES use a vacuum-operated piston to override thermostatic coil tension when starting. Adjust by bending

mediately open slightly, continue to open gradually as the engine gets warmer, and be fully opened as the engine approaches operating temperature.

To tell if the fast idle is working, listen. When first started, the engine should idle fast. Tap the gas pedal. Idle should drop off. As the engine gets warmer, it should drop back further.

Repairing an automatic choke is routine

A thermostatic device connected to a butterfly valve in your carburetor is all it is—regardless of make of car or year. Here are all the details on various types, how to find them and fix them

# CHOKE WORKING



once you identify the type of mechanism on your carburetor. Unfortunately, you can't tell what you have just by knowing the make and type. For example, since 1963 the Rochester two-barrel carb has used four different choke systems. It is a mainstay for many model Buicks, Chevrolets, Jeeps, Oldsmobiles and Pontiacs.

One type is a heat-sensitive coil mounted in a housing on the air horn or throttle body and connected to the choke plate by a short linkage. Heat is concentrated on the coil through a tube that extends from the exhaust manifold. This type of

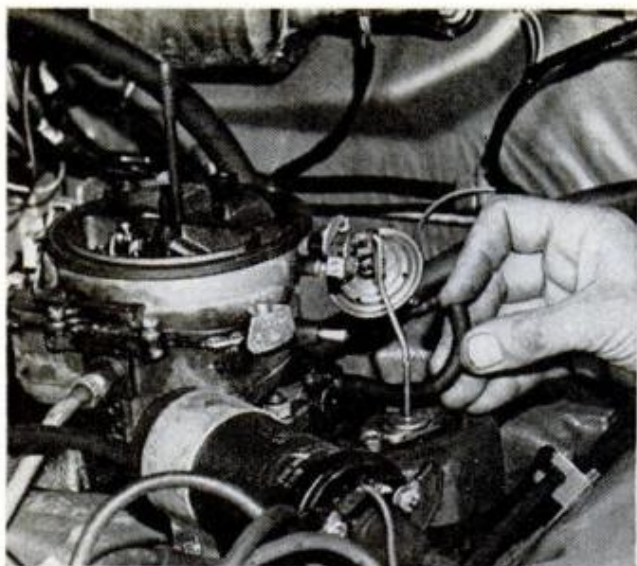

**CHOKE VACUUM DIAPHRAGM** is tested by starting engine and feeling for vacuum at disconnected line

coil is controlled by heat from the cooling system rather than from the exhaust manifold. Hot coolant circulates directly from the engine to a chamber in the choke cover.

Another choke widely used, especially on Chrysler engines, is the well-type. It's contained primarily on Holley and Carter carburetors. Actually, the well-type choke is similar to the Rochester mechanism mounted in the exhaust manifold. Both, for example, use a vacuum diaphragm to open the choke plate when a cold engine is first started. However, in the well-type the coil is mounted in a well at the exhaust crossover passage on the intake manifold. Most well-type choke coils are adjustable—the Rochester mechanism isn't.

Before you can set a choke properly, you must find out what kind you're dealing with and what adjustments have to be made to what specifications. Different types of chokes require some adjustments that are similar, but others that aren't.

Where or how do you find this information? You can usually tell what kind of choke mechanism you have by examining it. If it's carburetor mounted, you'll see a choke stove on the air horn or throttle body. If it's the well-type or exhaust manifold choke, a long rod will extend from the choke plate linkage to a cover on the engine.

If you're not sure what kind of mechanism is on your carburetor, note the carb's manufacturer and model number. This information is on a tag attached to the carburetor or is stamped into the casting.



**IF VACUUM IS GOOD** check diaphragm by depressing stem, then covering vacuum opening (see text)

If you don't have a service manual for your car, go to the library and consult *Motor's Auto Repair Manual* to learn what adjustments have to be made for the make and model number of your carb.

There is a question concerning the choke thermostatic coil setting of carburetor-mounted and well-type chokes that can be adjusted to provide a richer or leaner fuel mixture. Should you follow the manufacturer's specification?

This specification is a compromise. The choke setting required in the southern part of the country during the winter is certainly different from that required in the northern part during the winter. The specification given is for average air temperature and volatility of fuel. It's a good spot from which to start, but ideally the thermostatic coil should be set to meet the air temperature and winter grade of fuel prevalent in your area.

Whether you're adjusting a carburetor-mounted or well-type choke, set the coil a mark or two to the lean side of the specification and then move toward the rich side, if necessary, until you find the best setting. Keep in mind, however, that if you can adjust the choke more than two marks from the specified setting, either rich or lean, the thermostatic coil is probably bent or has lost tension and needs replacing.

To adjust a carburetor-mounted choke, loosen the choke-cover retaining screws and rotate the cover. Usually, moving the cover clockwise reduces choking action (lean), while counterclockwise movement increases it (rich).

Adjusting well-type chokes is done by



**CHOKE VALVE** sticking because of buildup of deposits is troublemaker. Clean as routine maintenance

loosening the mounting-post locknut and turning the post until the correct mark falls into position with the index. After this, place the coil back into the well and hook the choke rod to the choke plate. Make sure the coil doesn't come in contact with the sides of the well. Lift the cover disc, and open and close the choke valve manually to see if the connector rod clears the sides of the hole in the cover without binding. If the rod binds, you'll have to replace the whole unit.

Whether your choke is a well-type that can be adjusted or an exhaust-manifold thermostatic coil that can't be adjusted, the vacuum diaphragm unit should be tested and, if necessary, adjusted or replaced.

To determine whether the vacuum unit is in good shape, disconnect the vacuum

**HEAT TUBE** from manifold into choke housing enters at location that varies. Check tube if the choke fails

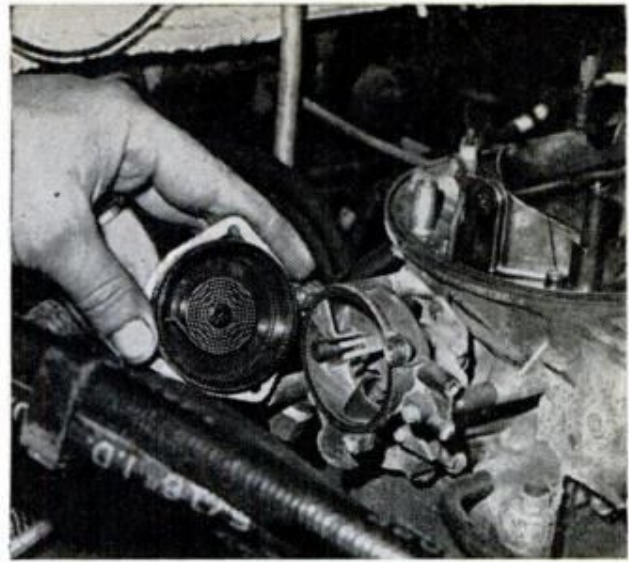
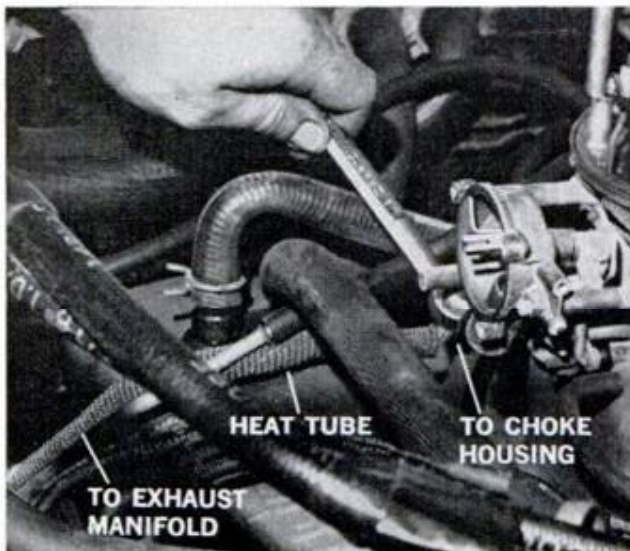

**CARBURETOR-MOUNTED CHOKE** should be opened and inspected. Dirt, gum indicate damaged heat tube

line and check it for splits and holes. Depress the stem of the diaphragm and place your finger over the vacuum opening. Release the stem. If the stem moves more than  $\frac{1}{16}$  of an inch in 10 seconds, the diaphragm is leaking, so replace the vacuum unit.

To set the diaphragm, close the choke valve and hold the vacuum break against its stop. Measure the distance between the edge of the choke valve and the wall of the air horn. This must be to specification. If not, adjust it by bending the vacuum break link or the choke rod. Your service manual or *Motor's* will tell you what to bend where and give specifications.

One of the best favors you can do for your choke system is to keep it clean. Dirt-clogged choke mechanisms are slug-

*(Please turn to page 222)*

**CLOGGED AIR FILTER** can have the same effect as a faulty choke. Clean and/or replace it regularly



# SO YOU WANT A *QUIET* OUTBOARD?



**DEPENDABLE AND LIGHTWEIGHT**, Motor Guide's Bass Tracker model is so silent you have to check your wake to make sure you're moving. Price is \$99.95

Electric outboards have been around for half a century. Now new developments in handling and power are making them popular with the entire small-boat fraternity.

By **GEORGE REIGER**  
Boating and Outdoors Editor

**U**SED AS AN AUXILIARY or as their main power source on sheltered waters, electric outboards have become nearly as essential to serious boating anglers as life vests and an anchor. Since these featherweights pose no threat of noise, fumes or film pollution, some enlightened city water commissions permit urban boaters to use electrics on reservoirs where gas engines are forbidden.

Of the two basic designs in electric outboards, the below-water types are quieter and their new housing styles and shaft seals have greatly reduced the possibility of leaks. Electra Pal even advertises its Barracuda and Marlin models with aluminum castings and four-barrier water seal systems as suitable for use in corrosive saltwater environments.

Advocates of electrics with motors above water don't regard the necessity of transmission gears (except in the few models using a flexible-cable driveshaft) as a drawback. Instead they claim greater speeds and fewer snags for their straight-line propeller designs. They say the hum of above-water electric motors is still quieter than most household fans and claim that less vibration and noise are transmitted to the fish.

Whether motor vibration frightens the fish or not, you'll probably find that you

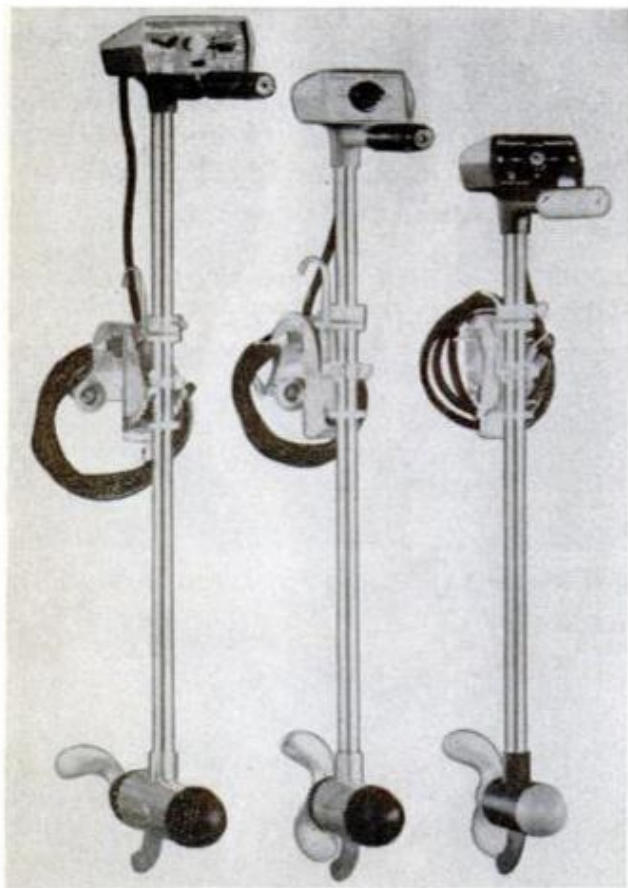

**PANEL NIGHT LIGHT** for night fishing is on Super 606 model of Shakespeare's stylish lineup at left. Weighing but 11 lbs., model has 8.8-lb. static thrust at 2035 rpm in highest of three speeds. Price, \$125



catch more fish maneuvering and trolling with a foot-operated, remote-control electric than you do in the same circumstances when using a manually operated engine of either above or below-water-motor design. Modern remote controls make propulsion as easy as rolling your foot around a metal plate—all you do to run forward and make left or right turns.

Electra Pal, Lazi-Trol, Motor Guide and Sears Roebuck all make remote-control models that free an angler's hands for fishing. Minn-Kota has even created a unit that not only fits all its motors but can be adapted to work with most other brands.

Perhaps, the easiest way for you to gain an overall view of what's available in electrics is to write for information and prices from this representative list:

Electra Pal Div., Osborn Engineering Corp., 1400 E. Lafayette St., Bloomington, Ill. 61701.

Lazi-Trol, Byrd Industries Inc, Ripley, Tenn. 38063.

Minn-Kota Manufacturing Co., Inc., Moorhead, Minn. 56560.

My-Te Electric, City Engineering Co., Inc., 3547 Massachusetts Ave., Indianapolis, Ind. 46218.

Motor Guide Div., Hershede Hall Clock Co., Starkville, Miss. 39759.

Pflueger Electric Fishing Motors, Pflueger Corp., 110 North Union St., Akron, Ohio 44309.

Silvertrol, Silver Creek Precision Corp., 282 Central Ave., Silvercreek, N.Y. 14136.

Wondertroll Div., Shakespeare Co., Kalamazoo, Mich. 49001.

Tempo-Troll, Tempo Products Co., 6200 Cochran Rd., Cleveland, Ohio 44139.

Three mail-order firms also offer electrics: Herter's, Waseca, Minn. 56093; L. L. Bean, Freeport, Me. 04032; and Sears Roebuck, Chicago, Ill. 60607.

For the past two years I have made fishing trips to Maine. Last June there were high winds on the lake, and I spent far too much time with a paddle in my hand trying to keep the canoe in good casting position. This year I'm taking a foot-operated electric motor. I may be sacrificing some of the romance of canoeing—but I bet I'll catch a heck of a lot of more fish! ★★

**TWELVE-POSITION TILT BRACKET** and 31½-in. aluminum shaft are features of Electra Pal's 26-lb. Barracuda 84A. With 12-v., 60-amp.-hour battery, motor can run two days before recharge is needed. \$199.50

FEBRUARY 1970

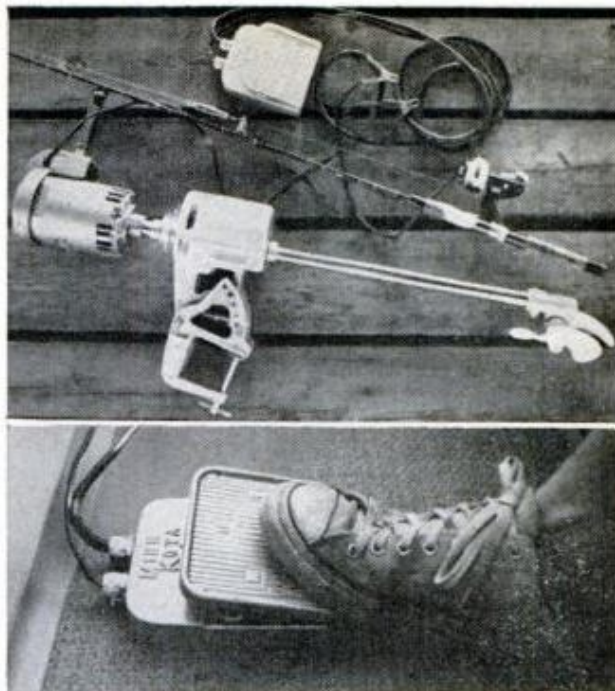

**REMOTE FOOT CONTROL** is on Minn-Kota's HGR; reversing switch is available. Maker claims model has more power than many other units, despite 50 per cent less amperage draw. Runs on 6, 12, 18 or 24 v. \$208.95

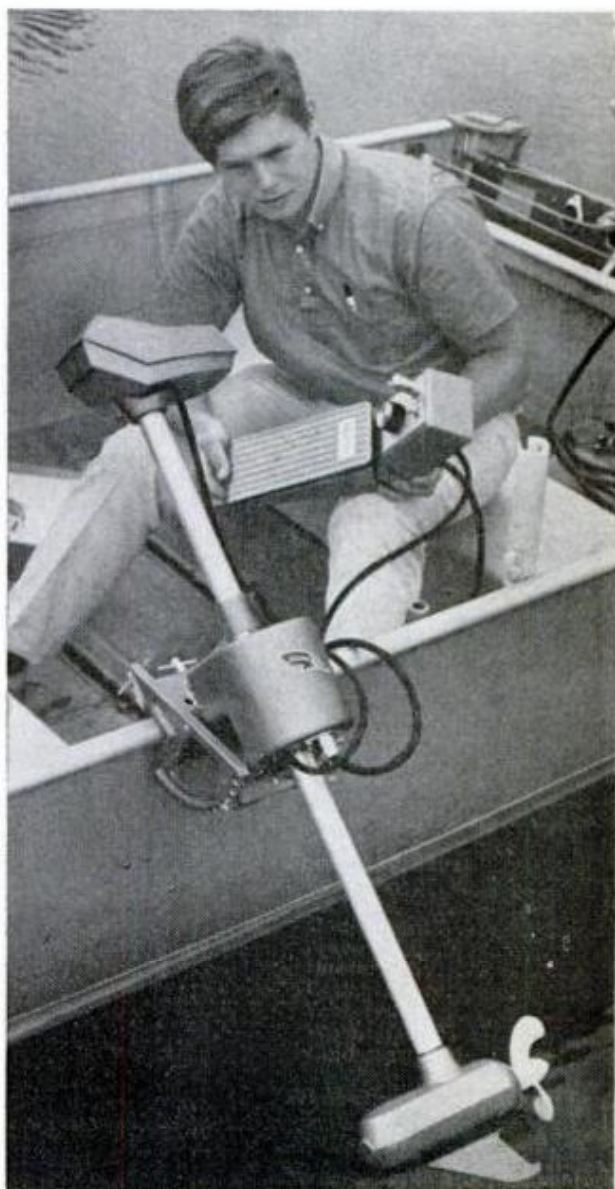

# Crop Those Shots

**Good composition is the key to making dramatic, pleasing blowups. Here are helpful tips on cutting out the bad spots to let the good ones show**

By PHIL GERACI



**O**NE OF THE HARDEST THINGS a photographer has to do is throw away part of his hard-spent effort. Yet that's exactly what must be done to make a good picture. In most cases, you have to discard, or crop out, some of the scene in order to make the remaining portion more dramatic, less distracting, pleasanter to look at.

When you're taking a picture, you're usually concentrating on getting the shot, not necessarily on what the finished picture will look like. Sometimes you're hurried and have to grab what you can. Sometimes you can't get as close as you'd like and you have to

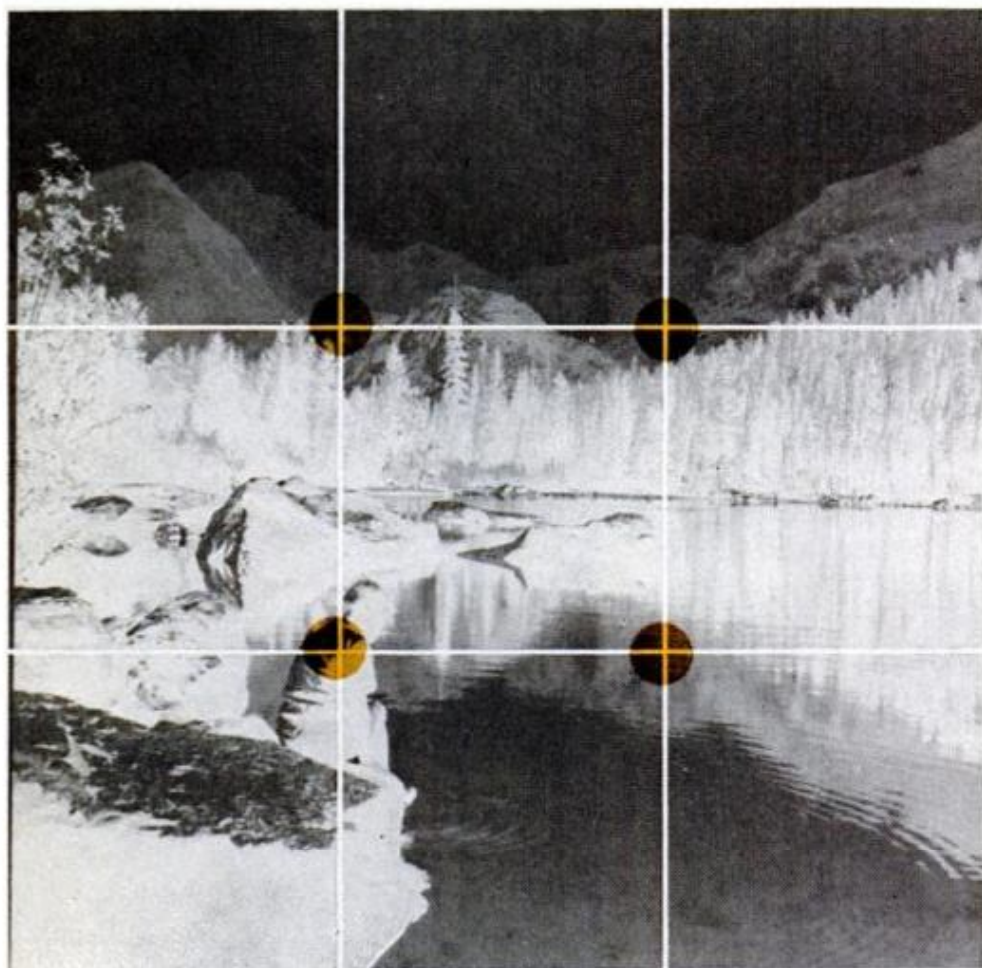

**SKY AREA** usually occupies upper third of photo in outdoor scenes for good balance, as here. Where sky is main element in the picture, it can take top two thirds

**GROUND AREA** generally fills lower two thirds of photo with foreground in bottom third. Note here that main center of interest—the boy sitting on the rock—is located off-center at the lower left where two dividing lines intersect

**RULE OF THIRDS** is a quick guide to good photo composition. Divide picture into thirds both ways. Points where lines cross are good spots for main focus of attention. Offcenter composition is more interesting than a centered subject

# for Better Pictures

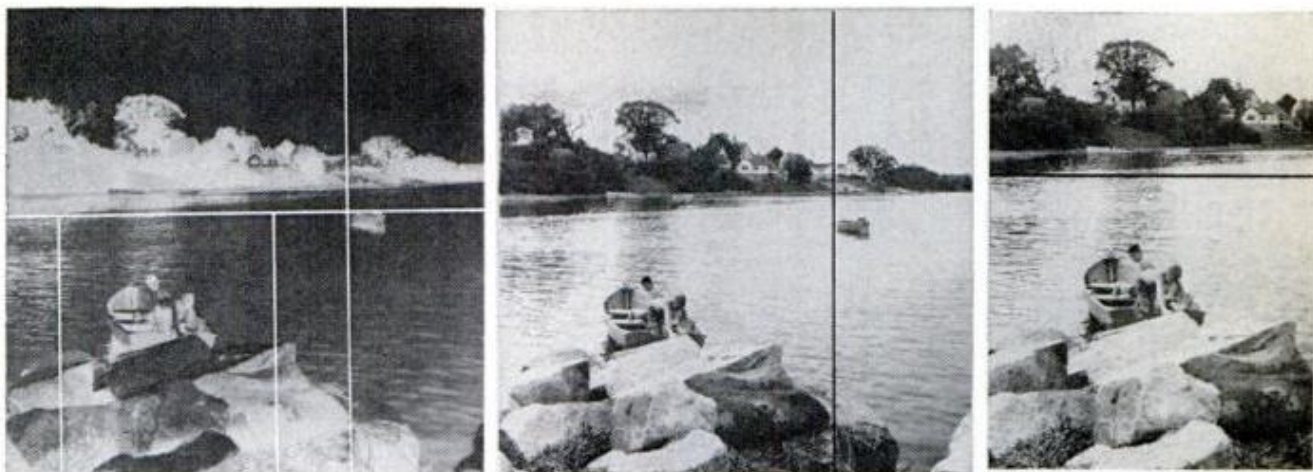

**THREE STEPS** to a better picture: Boating scene above is weakened by large expanse of water on the right side, making for a dull picture. First step is to crop this off, turning photo into a vertical. But now shoreline in background tends to split the picture into two separate elements, distracting attention from main subject. Next step is to lop off upper half to get rid of shoreline. This is all right, but picture still has useless areas at sides. Final step is to trim off the edges of photo, creating a tight vertical

shoot from a distance, taking in too much area.

Your film itself limits you to a fixed picture shape, which may not be the best for the shape of your subject. The familiar  $2\frac{1}{4} \times 2\frac{1}{4}$  square format, for instance, almost always requires cropping simply because most subjects aren't naturally square. They're tall and thin, requiring a vertical format, or they're short and wide, lending themselves better to a horizontal format. Most other commonly used films produce horizontals when the camera is held in the normal fashion. This means that much of the time you're shooting pictures that are too wide for your subjects, cluttering the sides with useless, uninteresting area.

The simpler and cleaner a photograph is, the more powerful its impact and the quicker it gets its meaning across to a viewer. By cropping, you can remove unnecessary portions and concentrate attention on the main center of interest. You can turn a weak horizontal into a strong vertical or vice versa. You can zero in on a single face in a crowd and produce an eye-catching close-up.

Cropping is easiest if you do your own printing, but you don't have to have a darkroom to get the pictures you want. Custom photo processors will crop your

First step ▲

▲ Second step



▲ Third step



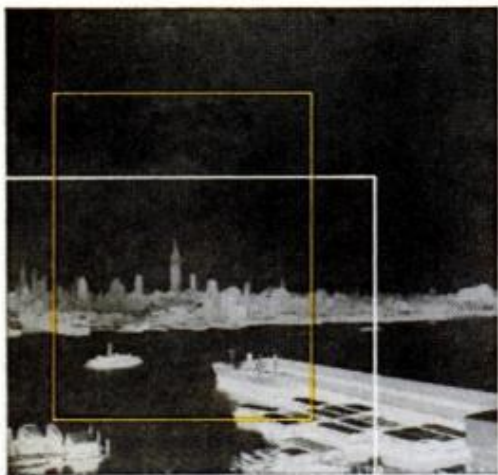

**TWO WAYS TO CROP** the same picture for different effects are shown here and on the opposite page. In the river scene above, emphasis is on docks in foreground, and city skyline is a secondary interest in background. With most of the foreground cropped out at left, skyline becomes the main center of interest

prints to your specifications, sometimes at a slight extra charge, sometimes for no more than what it would cost to have the full negative printed. Most photo stores offer custom processing or can refer you to a processor that will handle orders by mail.

If you think you're going to want special cropping, ask for contact prints when your film is first developed. These are inexpensive prints in strip form, the same size as your negatives. From these, you can pick the shots you want enlarged and decide how they're to be cropped. Mark each contact print with a grease pencil to indicate the area you want blown up.

Often, there's more than one way to crop

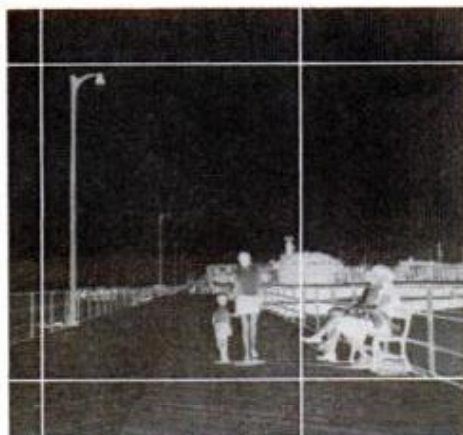

**HOW CROPPING CAN STRENGTHEN** a photo's impact is shown here. People on bench at right, above distract the eye from main center of interest. Cropping them out focuses attention on boardwalk stretching into distance. Note that mother and child are offcenter but nicely balanced by tall pole on the opposite side

POPULAR MECHANICS

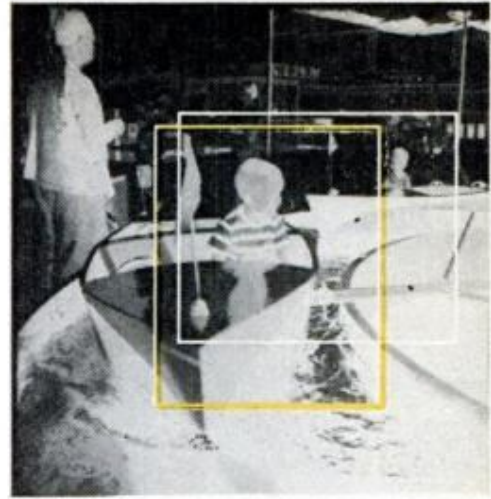

**THESE TWO PICTURES** are both good but different. Horizontal cropping above shows two boys, makes a more storytelling scene. Vertical cropping at right sacrifices second boy for appealing close-up of one. Both eliminate objectionable elements in the original picture—bystander at left and cluttered background

a picture effectively. The two shots above and at right of the two youngsters on an amusement-park ride are a good example. One way, you get a vertical showing one boy close up; the other way, a horizontal including both boys and more detail. Both are good, but they're completely different pictures. This shows how cropping can give you a choice of effects from a single negative, depending on what you want to emphasize.

The first step in cropping is to decide what you want in the picture. This usually determines its basic shape—vertical or horizontal. Next, plan where the main subject

*(Please turn to page 224)*

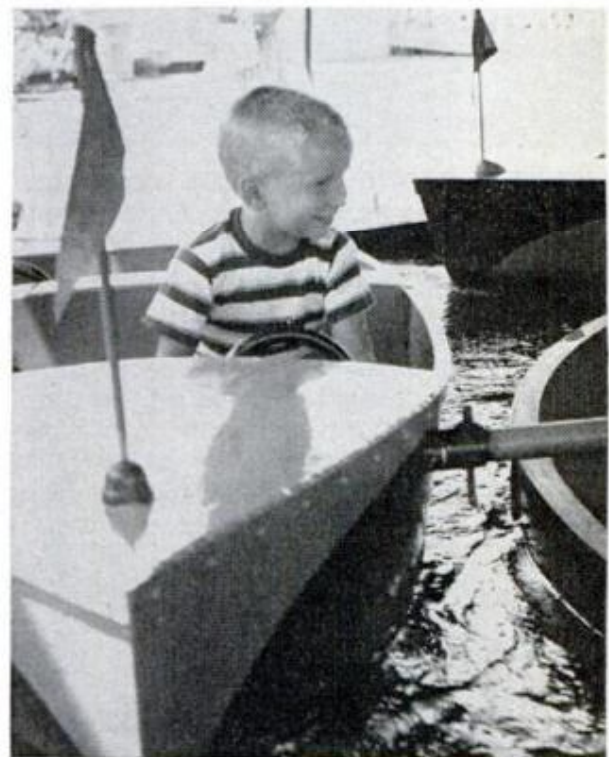

**SHAPE OF SUBJECT** should determine whether picture is best as a vertical or horizontal. Tall statue at the right is a natural vertical. Cropped horizontally above, it looks smaller and the excessive background area is distracting

# NEW IN ELECTRONICS

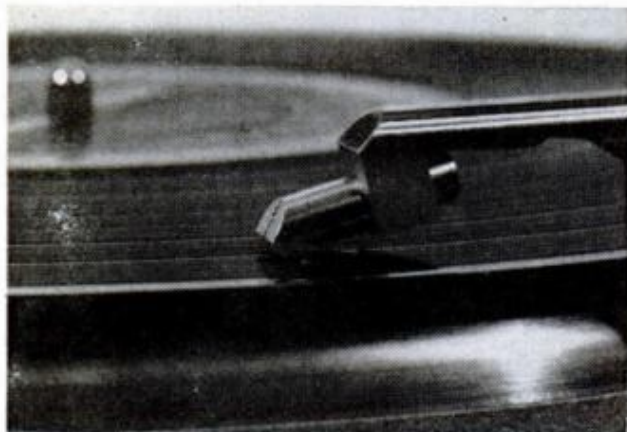

**LIGHTEST PHONO CARTRIDGE** ever made is this new design by Matsushita Electric, maker of Panasonic hi-fi equipment. Two tiny bits of film coated with germanium semiconductor, one for each stereo channel, are moved by the stylus, generating electric signals corresponding to the depressions in the record groove. The cartridge, expected to be on the market soon, is so small it weighs only  $\frac{3}{4}$  of a gram in all and has a moving mass of just  $\frac{1}{10,000}$ th of a gram. This is said to provide perfect tracking with minimum record wear.



**TONE ARM FLOATS** gently down onto the record in new Garrard automatic turntables. A viscous damping arrangement built into the arm eliminates having to operate a separate cueing set-down lever. In either manual or automatic operation, the stylus settles smoothly onto the record by itself, preventing scratches and groove-jumping. Prices range from \$89.50 to \$129.50, less base and cartridge. Garrard Div., British Industries Co., Westbury, N. Y.



**HIDDEN INSIDE** this rear-view car mirror is a tiny, transistorized radio antenna, eliminating the need for tall masts that are often damaged by overhead obstructions or stolen. Signals are received by a small loop and then amplified for greater strength. This amplification is said to reduce interference and provide better reception than with conventional car antennas. Idea comes from the West German firm of Hans Kolbe & Co. near Stuttgart.



**YOU CAN PLAY THIS SPEAKER** in the box it comes in. The heavy cardboard carton has a slotted front-panel grill and is designed to serve as a temporary enclosure until you're ready to mount the speaker in a permanent housing. The arrangement is handy for rigging up portable hi-fi speakers or adding extra car speakers. Four sizes from 5 to 12 in. in diameter are priced at \$4.95 to \$8.95. Radio Shack, 730 Commonwealth Ave., Boston.

# PHOTO HINTS



**TWO-WAY TILTING BRACKET** for a light stand holds both an electronic flash and a mushroom bulb for modeling. Sheet metal is bent to form a pie-shaped box about an inch thick. This pivots on a fork bent from a steel angle. The electronic flash is mounted on top with a  $\frac{1}{4}$ -20 bolt. The modeling light is fastened to the side with a strap. You can lock the bracket at any angle by means of a bolt that rides in a curved slot.—Gerald Schumann



**YOU CAN KEEP CAMERAS WARM** in cold weather with this trick. Place a self-heating hand warmer on top of the camera and cover it with a plastic bag, as shown above. The bag holds in the heat well enough to keep cameras operating smoothly even in subzero temperatures. Hand warmers are available at sports shops.—Rohn Eng

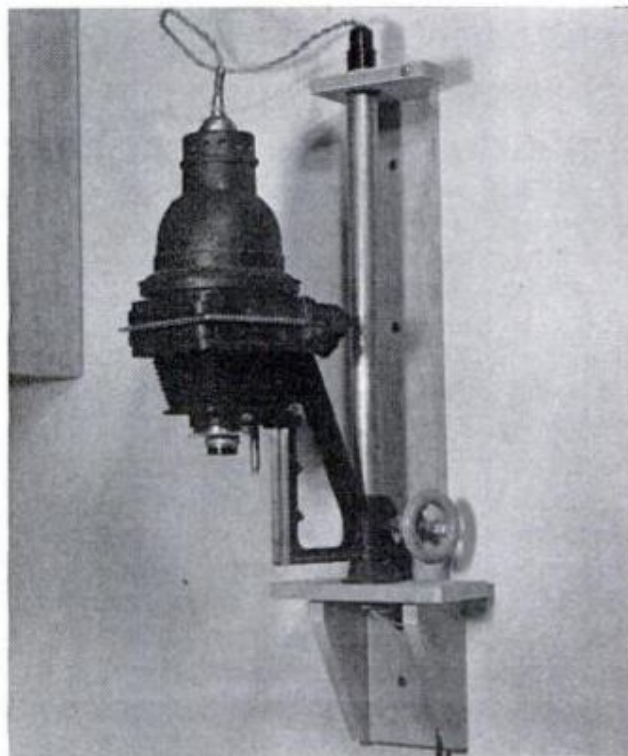

**ENLARGER VIBRATION** can be eliminated with this easily constructed wall mount that anchors the column firmly to the house. The mount can be made from scraps of plywood or solid hardwood stock. The enlarger base is screwed to the small shelf near the bottom. Top of column is held in a clamp made by drilling a block, sawing it in two and then screwing the halves together.—Arthur L. Ramos



**SMALL DARKROOM SAFELIGHT** can be made from a brown plastic pill bottle. Use a small-base 115-volt bulb of the type sold for night lights. You can mount it in two ways. Cut a hole in the plastic cap and thread the bulb through this into a standard-base adapter screwed into a brass lamp socket (at bottom, above). Or use a small-base socket and wire it directly to a plug (top).—Joseph Braunstein

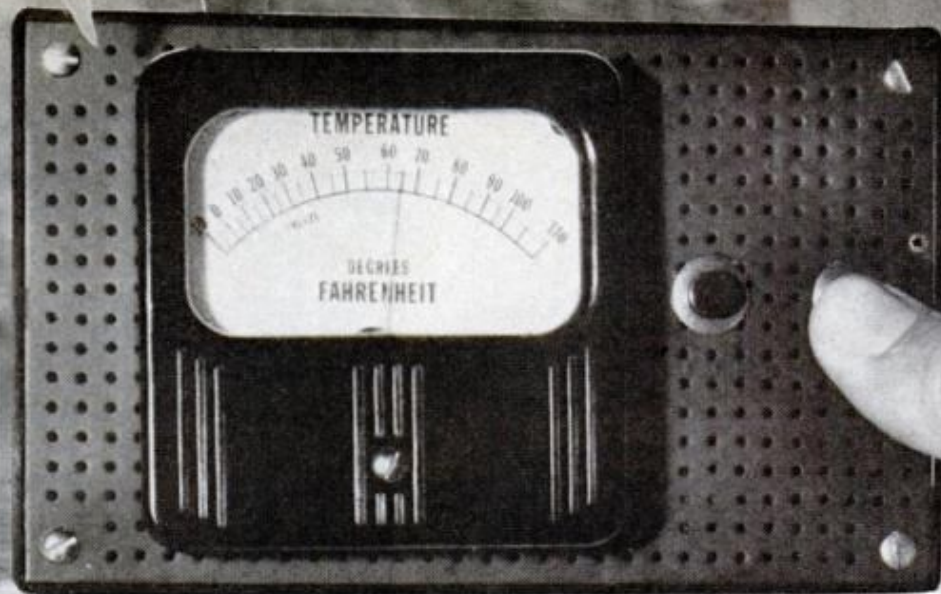

# Build Your Own Indoor-Outdoor ELECTRONIC THERMOMETER

Press a button and you can read the temperature in any location inside or out. Tiny heat-sensing thermistor probes give you instant checks on what's doing with the weather

By RUDOLF F. GRAF and GEORGE J. WHALEN

ANY ORDINARY mercury or alcohol thermometer will measure temperature, but it has one big disadvantage—you have to be where it is to read it. With this handy battery-powered electronic thermometer, you can tell what the temperature is outdoors or in other remote locations just by pressing a button and watching a needle on a dial.

As shown here, the thermometer incorporates two temperature-sensing elements, one in the case itself for measuring indoor temperature and one on a long cable for mounting outside or in a distant part of the house. Any number of additional sensors can be hooked up to give readings in other areas.

The temperature-sensing elements are tiny thermistors—special semiconductors that change their resistance according to changes in temperature. Measuring their resistance tells you what the temperature is. In this case, a highly accurate resis-

tance-measuring circuit known as a Wheatstone bridge is used. The bridge has two “arms.” One consists of resistors R1 and R2, the other of resistor R5 and thermistor T1.

Connected between these two arms is a sensitive microammeter, M1. This meter is wired in series with current-limiting resistor R3 and calibrating resistor R4. R1 is selected so that it will equal the resistance of the thermistor at minus 10°F. R5 is chosen to limit the current flow through the thermistor to prevent it from heating up and thus impairing the accuracy of its sensing.

Meter M1 measures the current differential between the two arms. Since all the resistances in the bridge are fixed except that of the thermistor, the current differential is an accurate indication of the thermistor's change in resistance and thus the change in temperature. At minus 10°F., the two arms of the bridge are bal-



# ELECTRONIC THERMOMETER

Range:  $-10^{\circ}\text{F}$  to  $+110^{\circ}\text{F}$

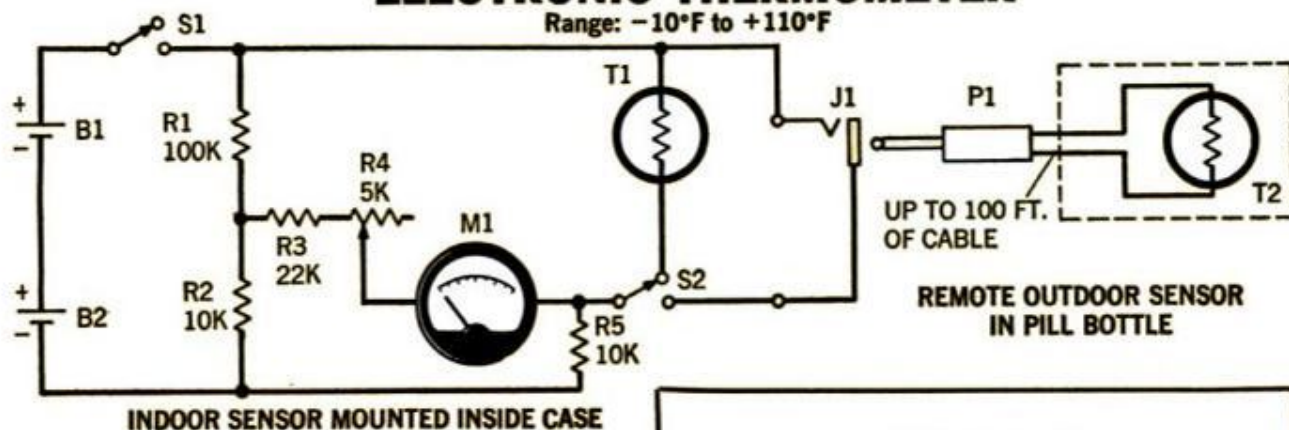

INDOOR SENSOR MOUNTED INSIDE CASE

## PARTS LIST

- M1—0-50 microammeter (Lafayette 99T5042)
- R1—100K,  $\frac{1}{2}$ -watt resistor
- R2—10K,  $\frac{1}{2}$ -watt resistor
- R3—22K,  $\frac{1}{2}$ -watt resistor
- R4—5K potentiometer (Mallory type MTC53L1; Lafayette 33T1647)
- R5—10K,  $\frac{1}{2}$ -watt resistor
- S1—S.p.s.t. pushbutton switch (Switchcraft type 903)
- S2—S.p.d.t. pushbutton switch (Switchcraft type 913)
- T1, T2—glass probe thermistors (Fenwal Electronics type GB41P2; Allied 60C8630)
- J1—open-circuit jack (Switchcraft 41 Jax)
- P1—plug (Switchcraft 750)
- B1, B2—1.5-volt, C-size alkaline cells (Mallory MN-1400)
- Misc.—plastic case, pill bottle, perforated phenolic board, small bolts and solder lugs, two-conductor connecting wire.

anced in resistance and there is no current differential between them. As the temperature rises, the change in the thermistor's resistance causes the arms to become unbalanced, and the meter needle records the amount, indicating the temperature.

With a new scale pasted over the original meter dial, the needle will read temperature directly in degrees. A scale calibrated in degrees is shown actual size on the following page. This can be cut out and cemented over the existing dial to give the thermometer a neat, professional look. The scale is designed as an exact fit for the Lafayette meter specified in the parts list.

In applying the scale, handle the meter carefully. Lay it face down on a soft surface and remove the four screws in back that hold on the face. Then turn it over and remove the two tiny screws that hold the dial plate in place. Slide the plate out, taking care not to damage the delicate needle, then attach the new scale and screw the plate back in place.

The parts fit in a Bakelite box measuring  $6 \times 3\frac{3}{4} \times 2$  inches. A piece of perforated phenolic board is used as the front panel so its holes will permit air to circulate around the temperature-sensing thermistor. A smaller piece of perforated board is mounted on back of the meter to serve as a circuit board.

The remote sensor is merely a second thermistor, T2, in a small plastic pill bottle. A closed container is deliberately chosen here so the thermistor will respond slowly to outdoor temperatures and not be affected by sudden breezes. Mount the sensor in a shaded location so it measures air temperature, not direct heat from the sun. A miniature plug and jack are used to connect it to the thermometer

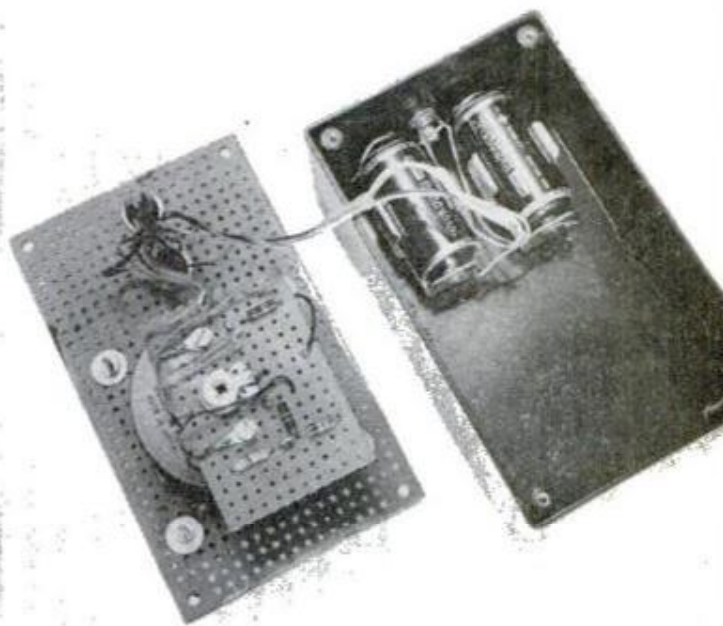

INSIDE VIEW (above) shows battery compartment and tiny circuit board mounted on the back of the meter. Batteries are the C-size alkaline type—more stable and longer-lasting than ordinary dry cells

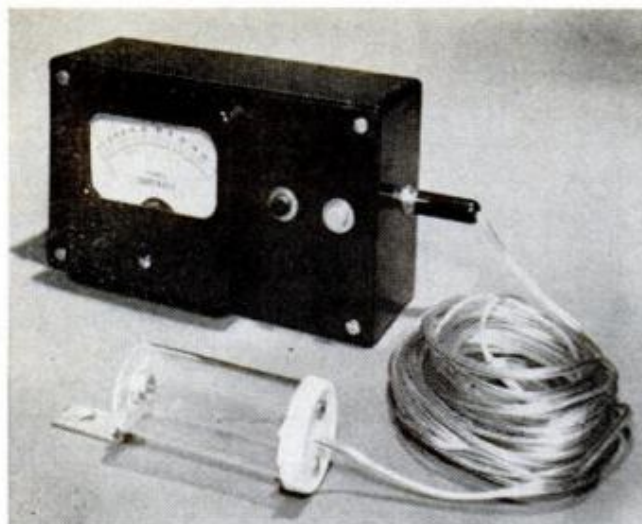

**REMOTE SENSOR** plugs into side of thermometer. It consists of a tiny thermistor inside a plastic pill bottle. Small bolts through the plastic cap hold solder lugs to which the thermistor leads and



connecting cable are soldered, as shown at right. Up to 100 feet of cable can be safely used, but it must be good-quality, low-resistance wire, such as lamp cord. Don't use a high-resistance bell wire

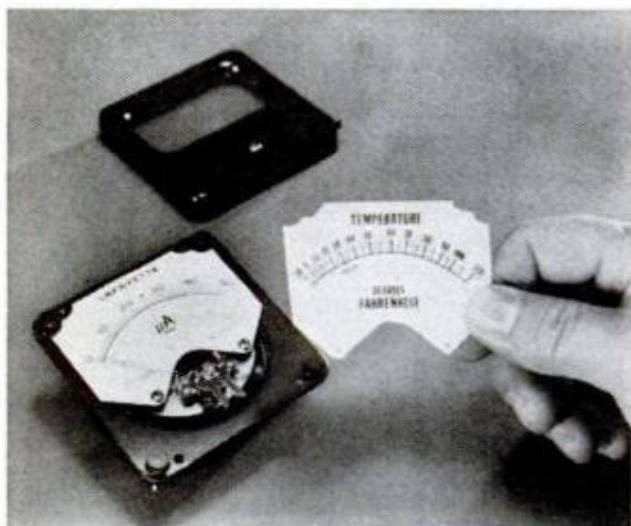

**NEW SCALE** is cut out and pasted over meter dial so needle shows temperature directly in degrees. Scale is shown full size below. Cut just inside the dotted lines and cement it to the metal face. Remove the dial from the meter before attaching the scale to avoid damaging the delicate needle

so it can easily be removed and other sensors plugged in.

Two small pushbutton switches, S1 and S2, control the thermometer. One turns on the power when you want to take an indoor reading. The other cuts out the thermistor inside the case and switches in the remote sensor. You must press both buttons to get an outdoor reading. Note that the second pushbutton, S2, must be of the double-throw type so that in its off position it closes the circuit to the inside thermistor.

If you want more than one remote sensor, you can add others in one of two ways. You can either plug one at a time into the jack on the side of the case or, for a neater arrangement, you can substitute a multiposition rotary switch for pushbutton switch S2. With a rotary switch, you can dial whatever sensor you want and press the first pushbutton to get a reading. If you decide on this arrangement, remember to wire one switch position so it closes the circuit to the internal thermistor for indoor readings.

To calibrate the thermometer, remove the pill bottle from around the remote sensor and dangle the thermistor in a bowl of cracked ice and water. Leave it in at least a minute, being careful not to get the thermistor leads wet. Press both buttons and adjust R4, the potentiometer, until the meter reads exactly 32°F., the temperature of the ice water. Once it has been set to this reading, the thermometer will accurately record all other temperatures up to 110°F. ★★★

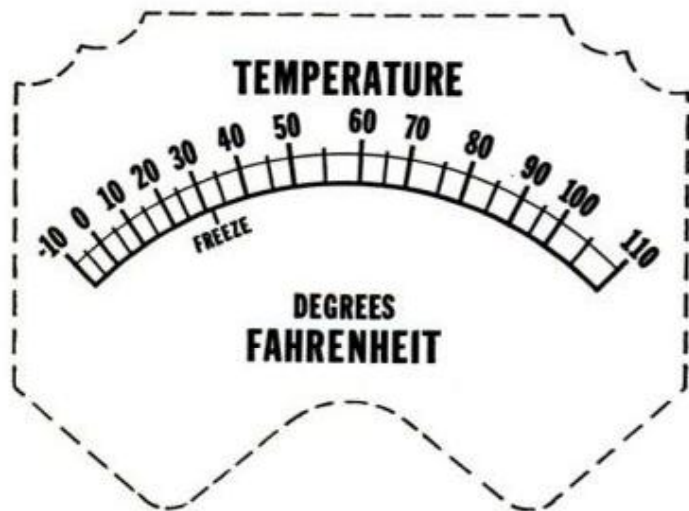

**PRINTED SCALE**, calibrated in degrees, is easy to attach, gives the thermometer a neat appearance

# ELECTRONIC HINTS

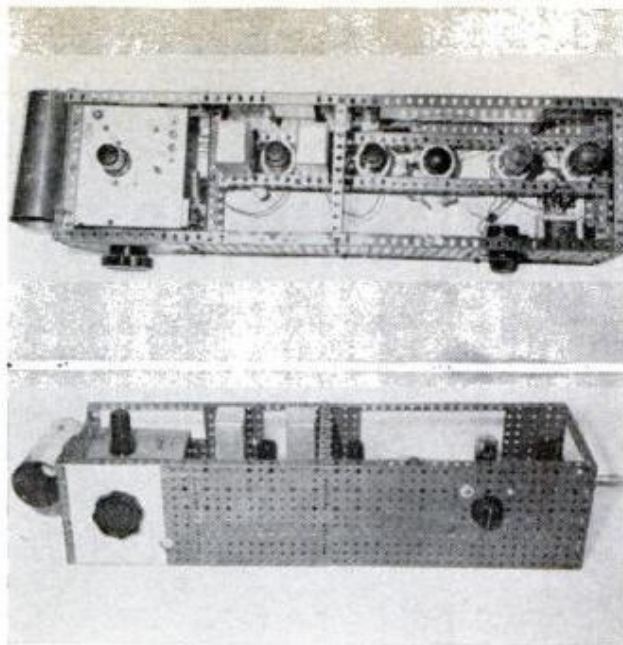

**OLD ERECTOR-SET PARTS** are useful for "breadboarding" experimental electronic circuits. The spaced holes enable you to assemble the pieces in any size and shape to suit your particular components. The slotted "girders" are especially helpful in mounting tube sockets and similar parts in rows. When you finish one project, you can take it apart and reuse the pieces on another.—C. E. Cohn

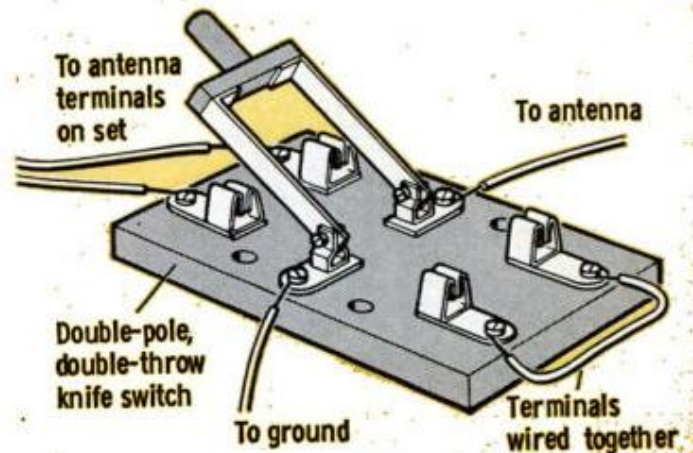

**PROTECT A RADIO** from lightning damage with this simple antenna-cutout switch. Wire a d.p.d.t. knife switch as shown above. With the toggle thrown one way, the antenna and ground leads are connected to the radio for normal use. When the set is not in use or a storm threatens, throw the toggle the other way to disconnect antenna from the set and connect it directly to ground.—Skip Singer

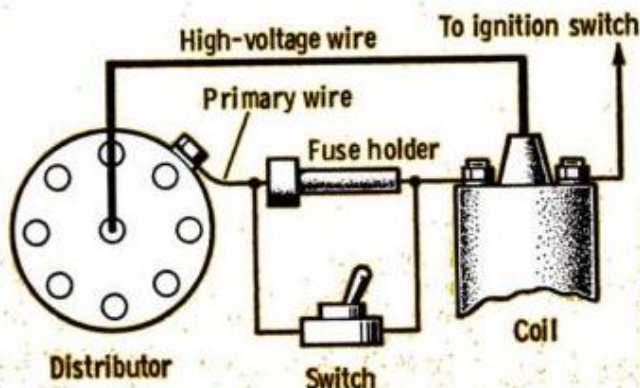

**THIS ANTITHEFT DEVICE** for cars is downright cruel. It lets a thief start your engine by crossing the ignition wires, but then shuts it off before he can get more than a few feet. Since the engine starts normally, he isn't likely to suspect that the car is bugged. He simply assumes you have a bum power plant and abandons the assault. First connect a fuse holder between the coil and distributor, as shown above. Then bypass the fuse holder with a toggle switch hidden under the dashboard. Use 18-gauge or heavier wire. With the switch closed, the fuse is out of the circuit and the engine runs normally. As you leave the car, you just flip the switch open, cutting in the fuse. A fuse of the right size will let the engine run for about 10 seconds before blowing. For a big V8 engine, a 1¼-amp. slow-blow works perfectly. Smaller engines will require lighter fusing.—B. F. Samuels



**EARPHONES WITH BUILT-IN RADIOS** are becoming a popular novelty, but they're expensive. You can make your own by taping a tiny pocket radio to the headband on an ordinary set of earphones. Most such radios have a jack for plugging in a miniature earphone. Use a matching plug for connecting the leads from the big earphones. A headset radio is handy when you want to listen in private and have your hands free.—Joseph Braunstein



**BOOTH-SIZE SAUNA** lets tired businessman unwind in "solitary" for \$695

# Now: Prebuilt Saunas That Go Together In an Hour

Shipped in a package and ready to assemble with nothing but a wrench, they come complete with heater, controls, even carpet

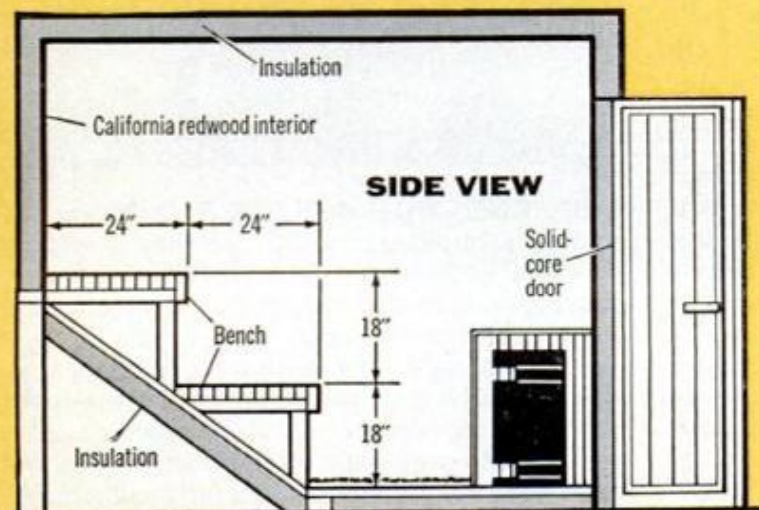
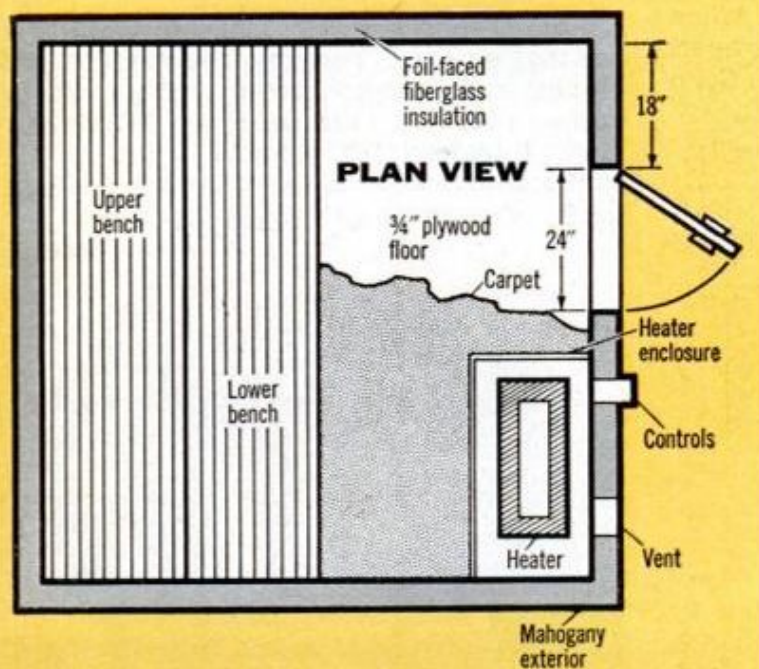

**I**T USED TO BE that a sauna went with the house, like the bathtub. But not any more. When you sell your home, the sauna can now be packed up and moved with the rest of the furniture.

The Viking Sauna Co. of San Jose, Calif., has introduced free-standing, self-contained rooms which let you do just that. Walls of prebuilt redwood panels lock together effortlessly and come apart just as easily. In less than an hour you can set up or dismantle a sauna that has all the quality and features of a custom-built room.

You can order one the size of a phone booth or one big enough for the whole family. Whatever the size, the precut kit includes walls, ceiling, benches and floor of California redwood, heating unit and electrical controls, sauna rocks and carpet. There is no plumbing to install, and the whole thing goes together with a special wrench that's furnished.

Prices range from \$695 for a 3x3-ft. solo room to \$2795 for a family-size one that measures 6x12 ft. You actually have a choice of five different sizes; 3x3, 4x6, 6x6, 6x9 and 6x12 ft. All have head-room of approximately 6 ft., 8 in. Except for the solo model having

## SAUNA BATH—FAMILY STYLE

GREATEST WAY YET to unwind and relax after a hard day at work or play is in the desert-dry air of a sauna. There's little sensation of heat and no discomfort as in a steam bath





**YOUR PREBUILT SAUNA** comes like this, knocked down in cartons, complete, ready to assemble in hour



**WALL SECTIONS**, redwood on inside, mahogany outside, come insulated and designed to hook together



**OPEN-SLAT BENCHES** of kiln-dried redwood come ready-built, never become uncomfortably hot to touch

a heating unit which can be plugged into a 110-v. outlet, the electric heaters of the larger units all require 240-v. wiring to operate.

A sauna can be put almost anywhere; a basement corner is perfect, especially if you have a basement shower. The ideal place for a sauna, of course, is in the bathroom, and while you may not have room for one now, a sauna is certainly something to consider if you are thinking of remodeling your bathroom. They go hand in hand.

You are not limited to an indoor sauna; you can get one that's designed for pool-side use. Built like a little house, it comes complete with exterior siding, battens, subfloor and structural roof components. Its proximity to the pool makes it especially convenient when it comes to cooling off. A quick dip in a pool is an exhilarating part of sauna bathing.

Viking also offers a way in which you can economically convert an unused clothes closet into a sauna. The firm makes a self-contained door that houses the whole works—heater, light, timer and controls, plus window. It's of standard closet-door width, 24 in., and comes ready to plug in. You simply line the closet with redwood, install a subfloor and carpet, add a suitable bench and hinge the door.



**UNIQUE LOCKING DEVICE** hooks and clamps multi-panel walls tightly together with a twist of wrench



**SAME LOCKING METHOD** is used to clamp ceiling panels in place. Panels are treated against warping

There's a heater to suit whatever size sauna you build, the smallest measures 14 in. wide, 13 in. deep and 24 in. high, the largest 23x13x24 in. They are virtually noiseless, operating on a "jet air-stream" principle to circulate the air, and all heaters afford complete protection against overheating through the use of a UL-required, high limit cut-out.

There are a number of luxuries you can add to your sauna. One is a hygrometer which shows how quickly the relative humidity drops as the sauna temperature soars. Another is a wooden ladle and bucket which are used to sprinkle water on the sauna rocks for those who enjoy the "steam shock." There's even an audio transducer that attaches to the sauna exterior, producing a stereo sound effect inside. ★★★



**FINALLY, ELECTRIC HEATER** is placed in corner and fenced-in by picket enclosure. Heater runs noiselessly

**WHAT DO YOU DO** when you step inside a sauna? Nothing. You just sit or stretch out and the 175° desert-dry air goes to work on you. It melts away business tensions and cleanses the body more thoroughly than ordinary soap-and-water bathing. There is no better therapeutic way to relax and refresh

#### HOW TO ENJOY A SAUNA

1. Heat sauna room to a temperature of 175°F. for about 30 minutes.
2. Shower with soap and water.
3. Enter sauna for 8 to 10 minutes.
4. Take a short, cool shower.
5. Re-enter sauna for 8 to 10 minutes.
6. Take a long, cool shower.
7. Relax from 15 to 20 minutes before dressing.

*Note: You should not smoke, exercise or wear clothing in a sauna.*

CAMPING PROJECT

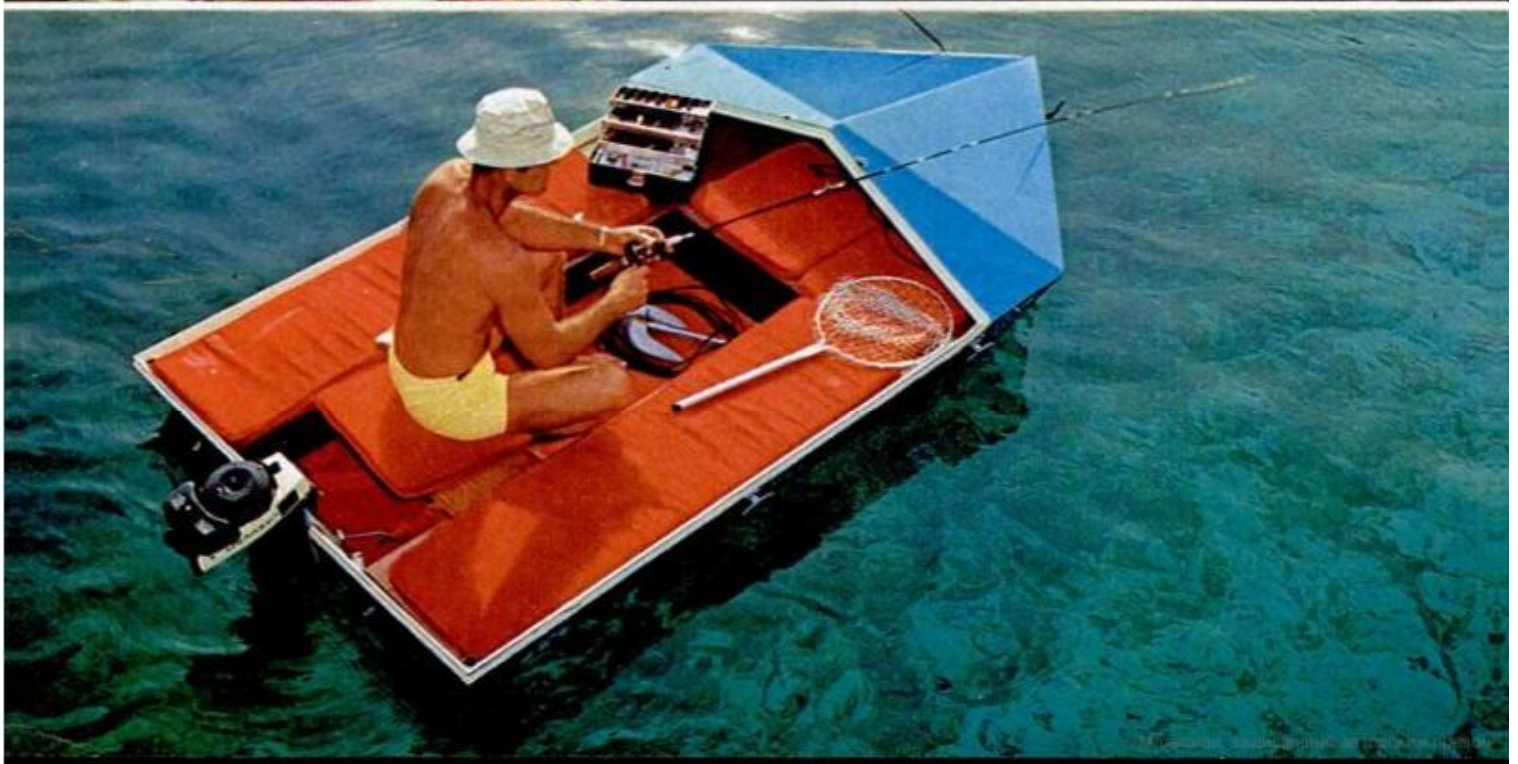



# Build This Three-Way Travelpod

It's a boat, it's a camper, it's an equipment carrier all in one. And it closes up like a capsule for high-speed highway travel.

By CHARLES R. GRETZ



**I**F THE CAMPING BUG hasn't had his stinger in you yet, watch out! Here's just the rig that could give you the fever. It's the perfect answer to family camping in a car. After an 8500-mile trip, I should know.

What's so great about it? Imagine being able to take off with a king-size, cartop luggage carrier that packs a whopping 36 cubic feet of waterproof tote space.

Imagine having an overnight overhead sleeper when you arrive that's as easy to set up as an umbrella!

Imagine being able to take along your own boat for a day of trolling a quiet stream!

All this is possible with this all-in-one Travelpod which I designed, built and tested with 300 lbs. of camping gear.

It turned out to be the most versatile and most functional camper on the road. What's more, we had the whole car to ourselves since

everything can be stowed topside.

The Pod is designed to mount on

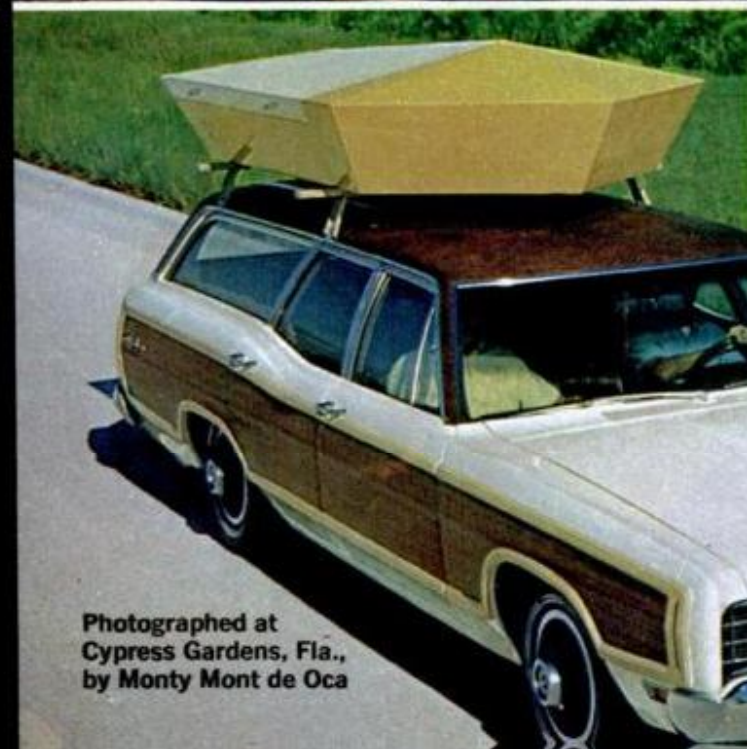

Photographed at  
Cypress Gardens, Fla.,  
by Monty Mont de Oca

# TRAVELPOD - CARTOP CAMPER

Technical Art by Fred Wolff

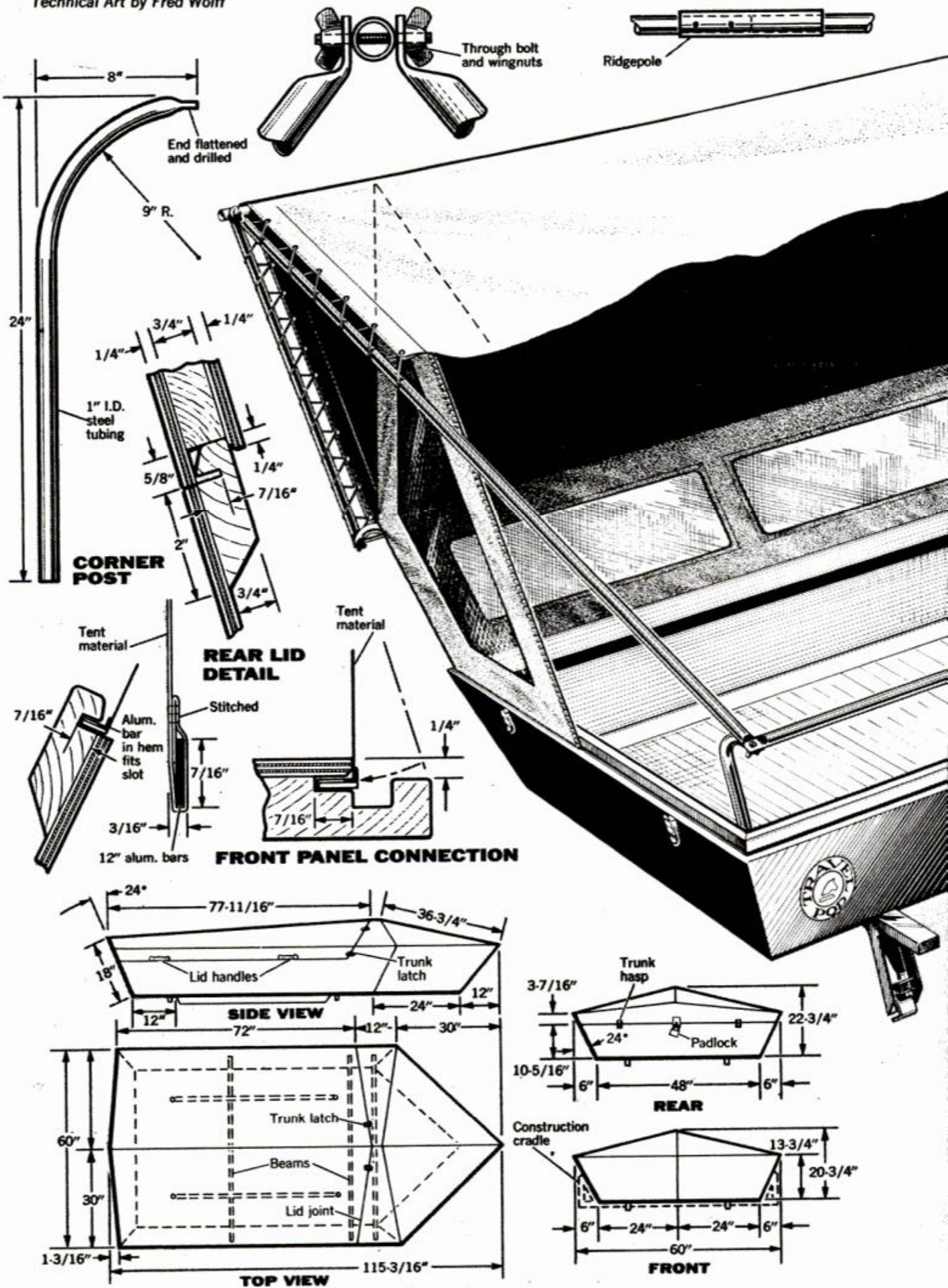

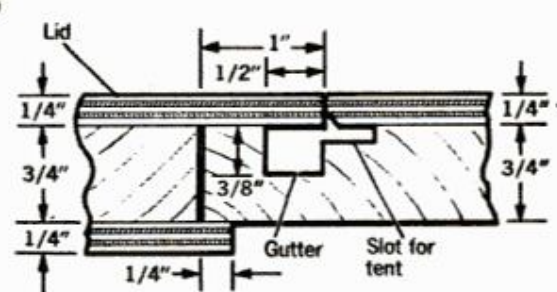
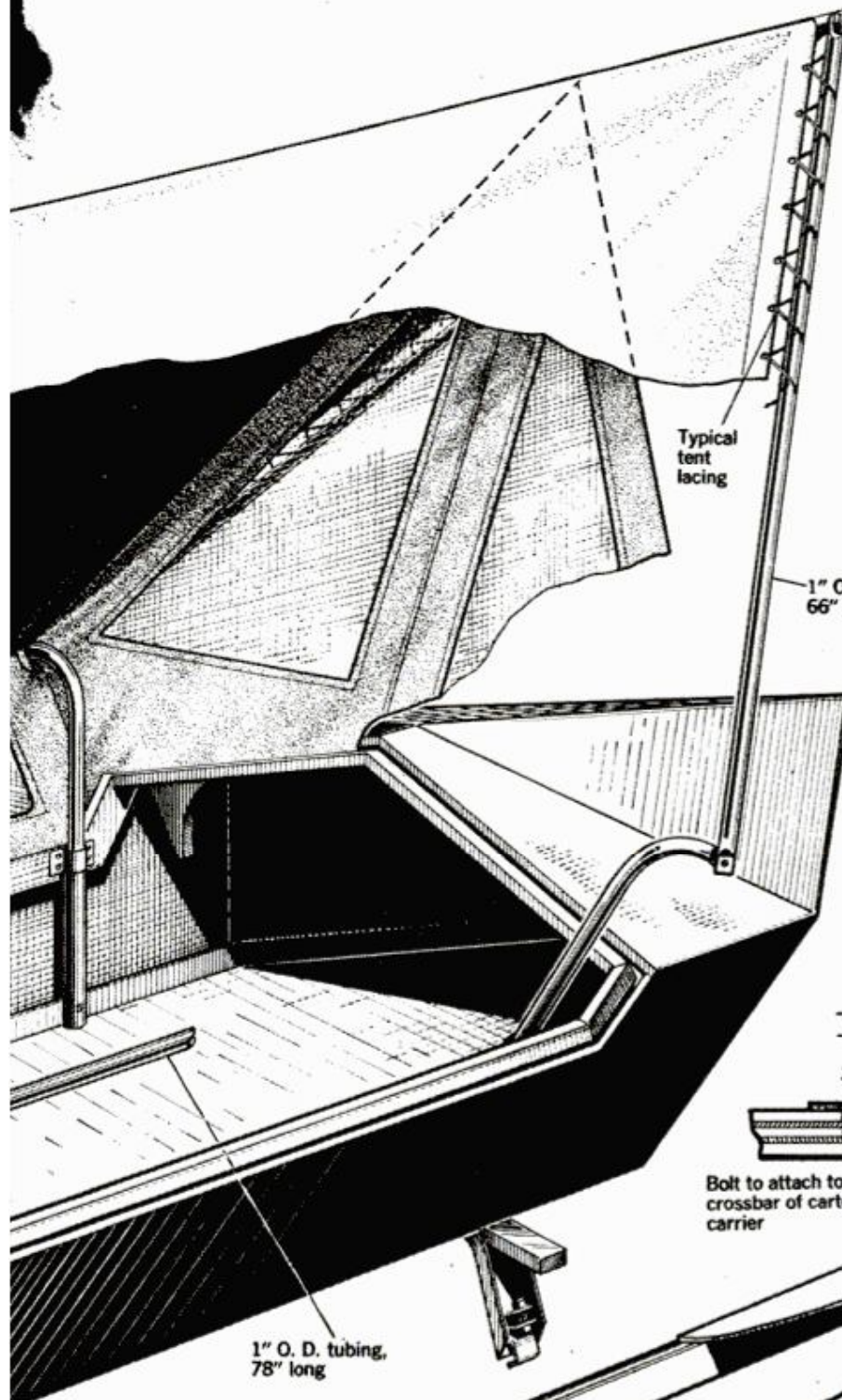

**TOP FRONT LID DETAIL**

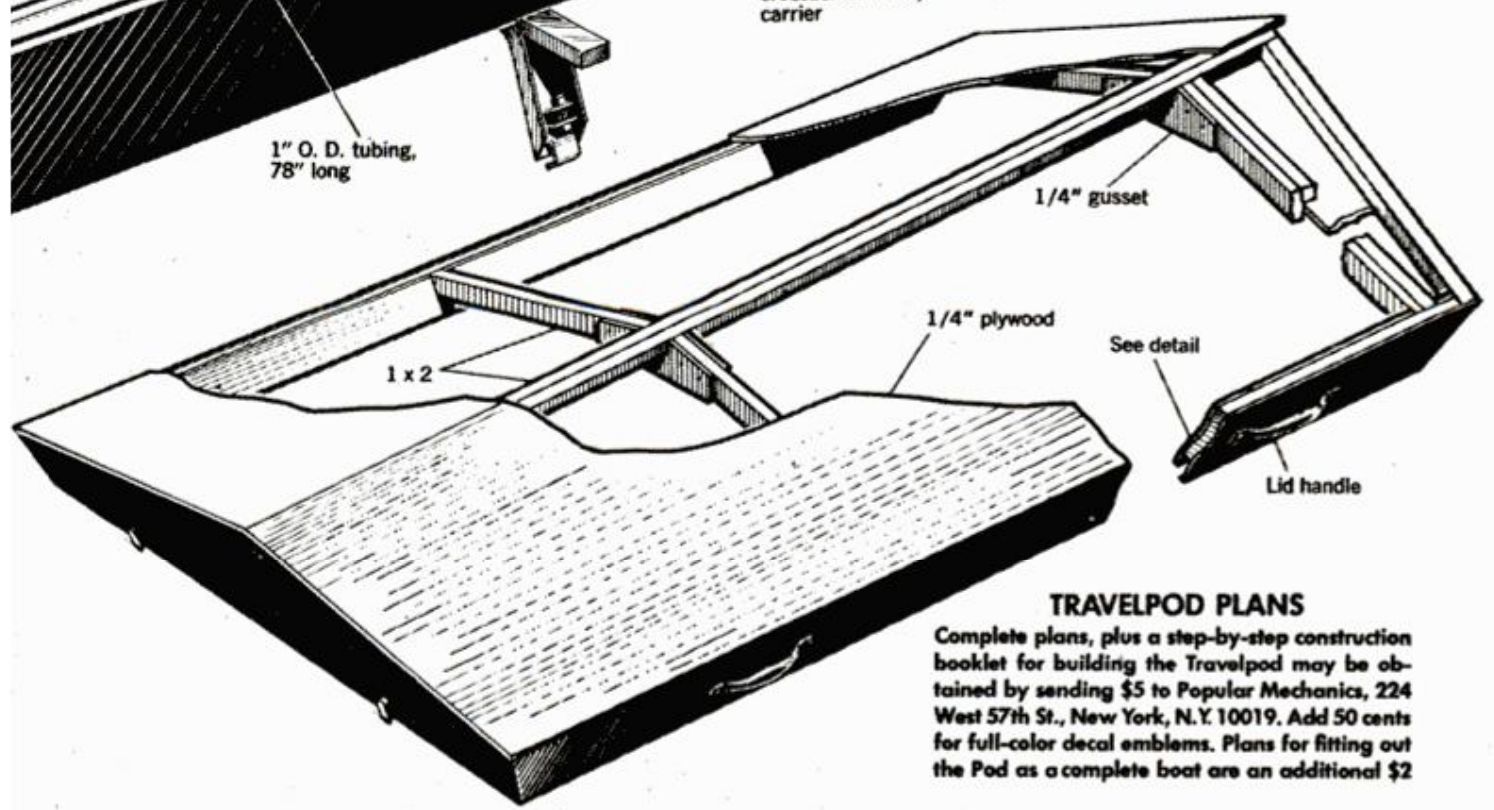
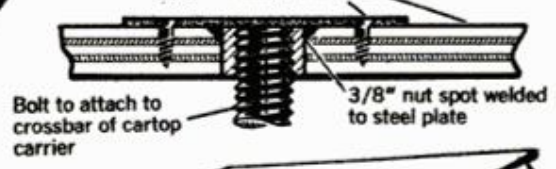
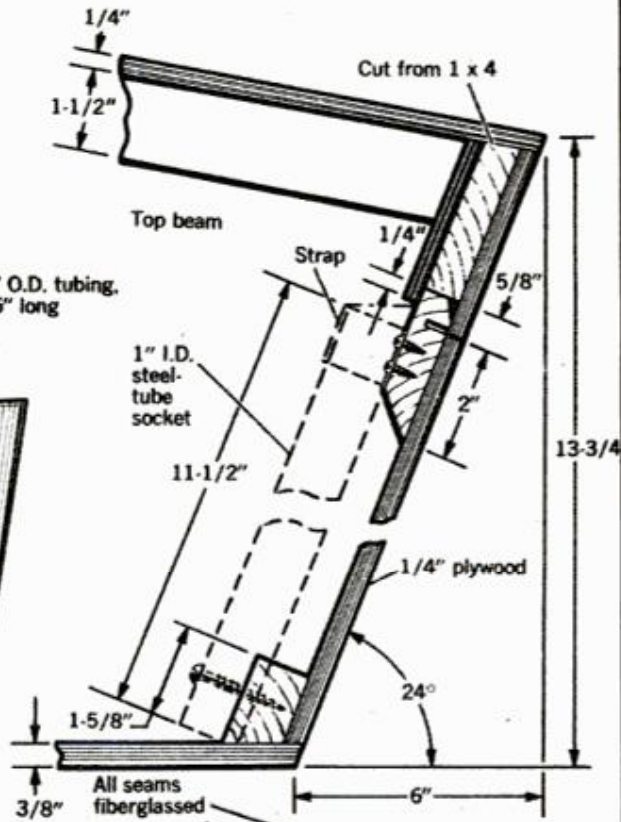

**TRAVELPOD PLANS**

Complete plans, plus a step-by-step construction booklet for building the Travelpod may be obtained by sending \$5 to Popular Mechanics, 224 West 57th St., New York, N.Y. 10019. Add 50 cents for full-color decal emblems. Plans for fitting out the Pod as a complete boat are an additional \$2

# Travelpod



regular steel luggage bars which rest on the wagontop and clip to the rain gutters. Access to the sleeper is by an aluminum boat ladder which stores on the underside of the sliding lid. To open the Pod on the road you simply slide back its lid; it has handles to lift it off. Contents are safe from rain by virtue of a tongue-and-groove waterproof track and are secured from theft by foot-locker-type trunk latches and a padlock.

One person can set up the Pod in minutes for sleeping. It's draftproof and you'll have no fear that the kids will fall out. Nylon-net windows ventilate the tent and, by design, the overhang of the roof provides adequate sun and rain protection. The tent rolls in a bundle only 8 in. in diameter by 6 ft. long and weighs 15 lbs. The broad, flat bottom allows the Pod to be a stable, minimum draft boat. A small electric [\(Please turn to page 220\)](#)

# Motors in Tandem Produce Higher Horsepower

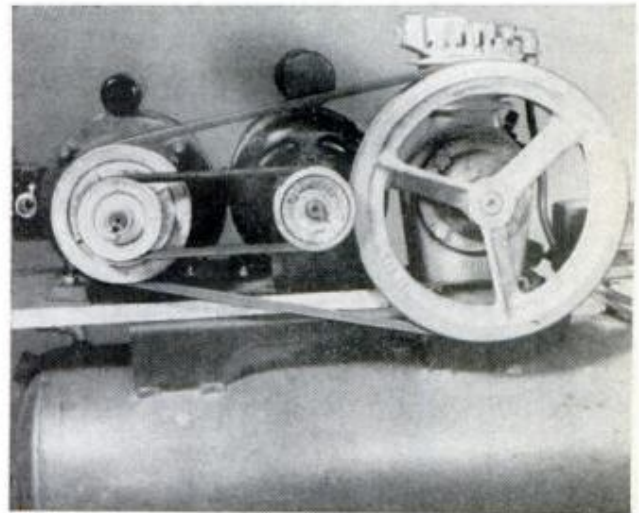
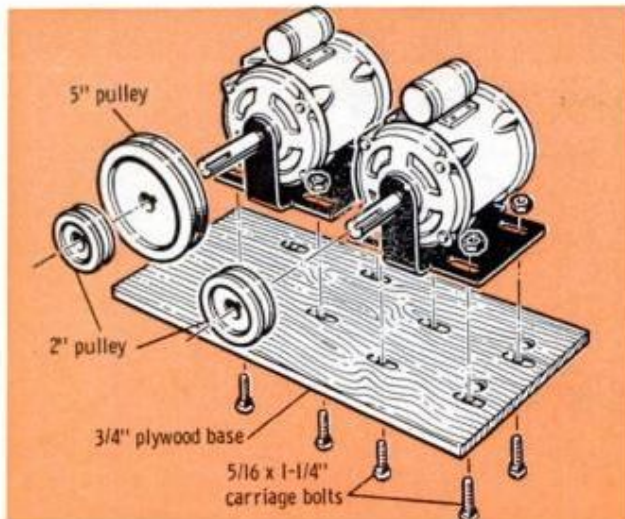

After struggling for years with an air compressor that shared a motor with my table saw, I decided that two motors I had in the shop could be paired to serve as a power supply for the compressor alone. Applications will vary depending on the equipment being driven, but there are two rules of thumb. First, the pulleys used to couple the motors must be of the same size, and second, a sub-base is required so

that the motors can be moved as a unit when you are adjusting output tension. Check the nameplate on changing rotation, or see a local appliance repairman for expert assistance. The  $\frac{1}{3}$  and  $\frac{1}{4}$ -hp motors shown above are ganged so they can be moved independently on the sub-base to adjust belt tension, and the sub-base moved to adjust the belt to the air-compressor pulley.—*Frank L. Greenwald*

## Nail clipper is shop nipper

Here's an inexpensive tool that can be added to your shop inventory for use as a bench-vise accessory. Available in drug and dime stores, these nail clippers are usually priced at less than 50 cents. For use in a bench vise, it is first necessary to remove the lever and locking arrangement (if your clipper has one). The tool can then be used for nipping corners from cardboard, fiber and leather, or for shaving "whiskers" clean on cut edges of softboards.—*Walter E. Burton*

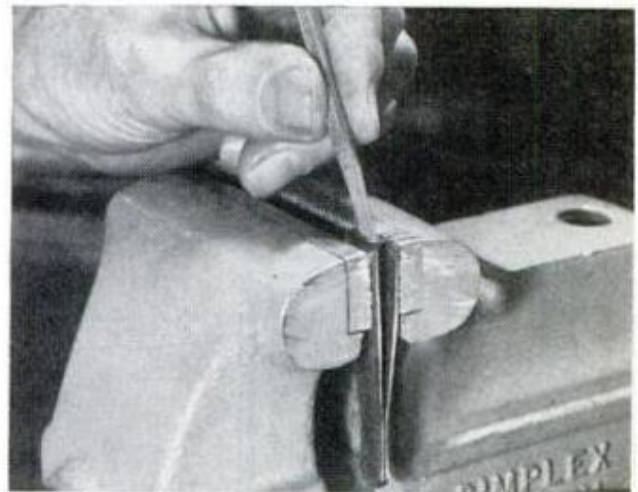

## Doctoring damaged glass

When a piece of art glass, such as a paperweight, becomes chipped, it can be fixed if the broken-off piece is located and epoxy-glued in place. Lacking the piece, you can camouflage the damage by using a fine-grit abrasive stick (of aluminum oxide or silicone carbide) as a file to remove any sharp edges. Then smooth the abraded surface with a very fine-grit stone and finish polishing with a wood stick charged with jeweler's rouge.

—*Walter E. Burton*





# SOLVING

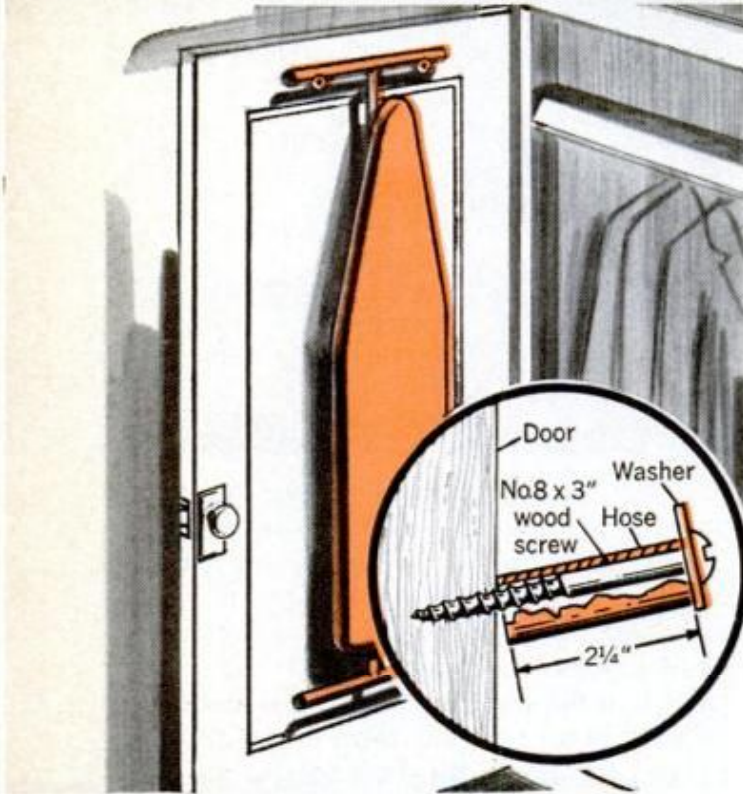

**CONVENIENT IRONING-BOARD STORAGE** can be created by using screws, washers and lengths of garden hose. Make certain screws used take a healthy bite into wood, and project amply to hold leg.—Lee Adams

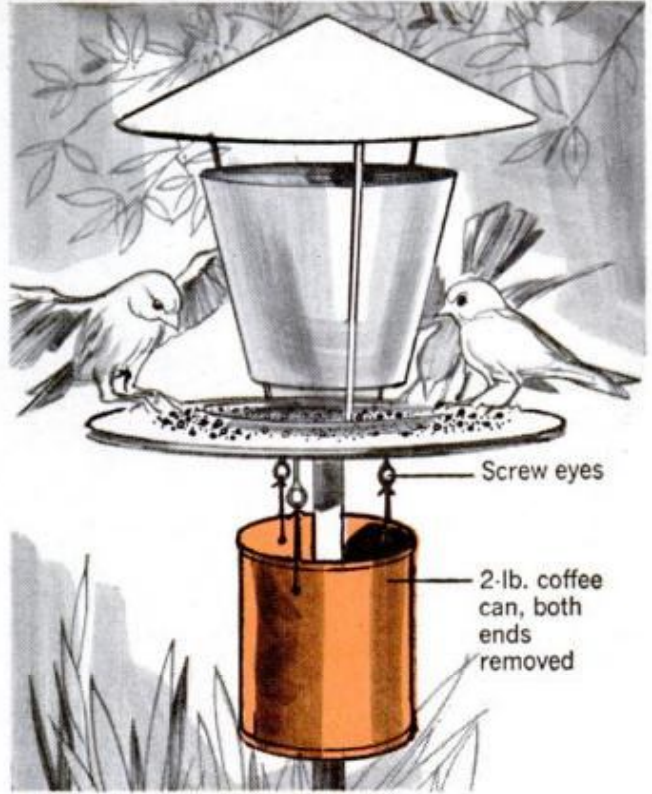

**SUSPEND A COFFEE CAN** from three wires attached to bird feeder bottom and you can keep unwanted poachers from eating birdseed. It swings if touched, thus causing squirrels to lose their grip.—Carl H. Stute



**WHEN DRIVING LONG GARDEN STAKES**, why not try standing in your wheelbarrow? The added height will simplify your chore—just make sure that the legs and wheel of the barrow are steady, not rocky.—John Krill

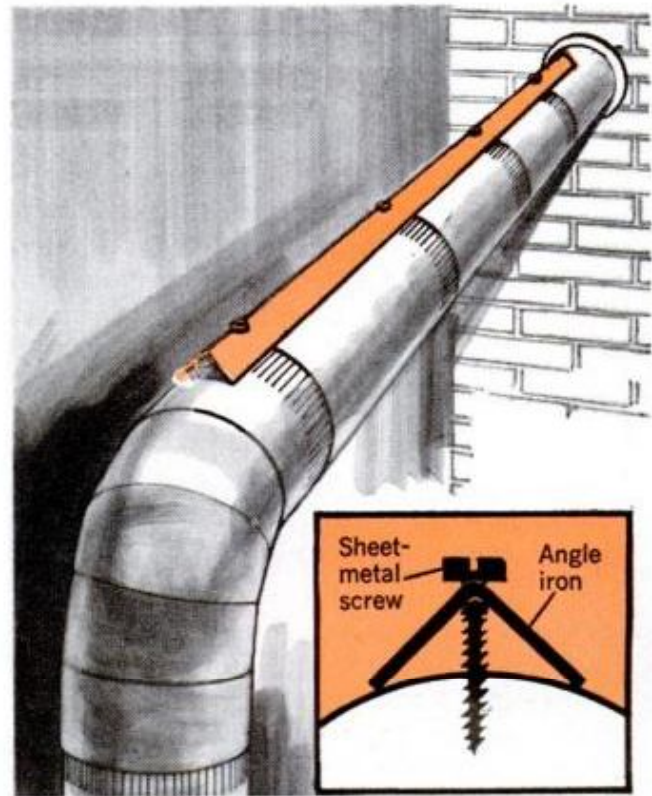

**KEEP FURNACE PIPE FROM SAGGING** on long horizontal runs by fastening a length of 1-in. angle iron along the top. Drill angle and pipe, and secure them at each joint, using sheet-metal screws.—Andrew Vena

# HOME PROBLEMS

Illustrations by Adolph Brotman, Worman Associates

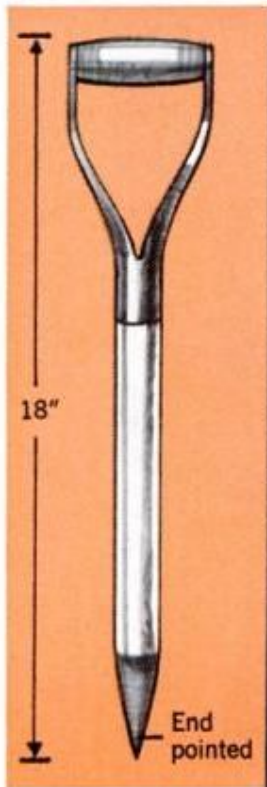

**BROKEN SHOVEL HANDLE** can be put back to work as a dibble for transplanting young seedlings. Just cut the handle to a length of about 18 in. and point the end for easy insertion in the ground.—*Albert T. Pippi*

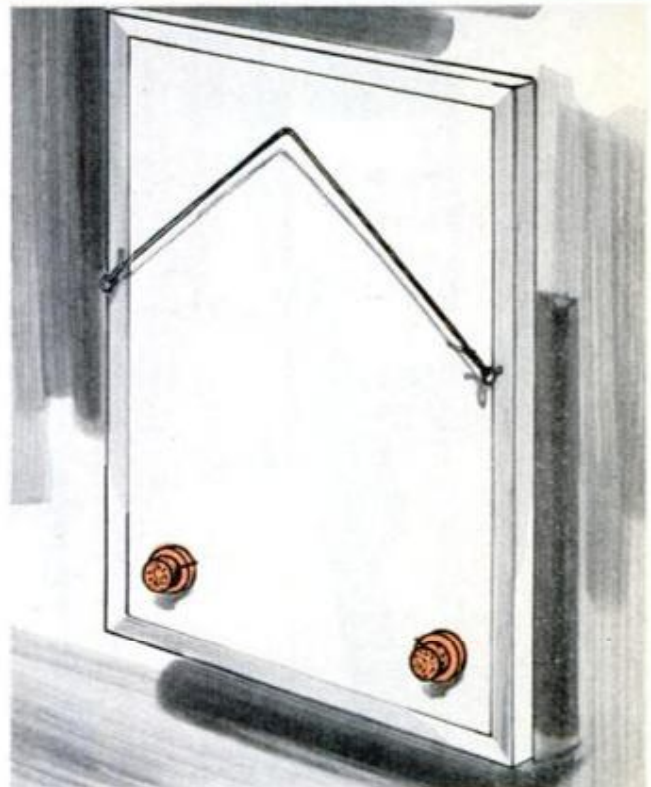

**STOP PICTURES FROM SWINGING ASKEW** every time a door is slammed or a draft hits them. Simply glue two bottle corks to the lower back as shown. The friction they produce will eliminate the problem.—*Hi Sibley*

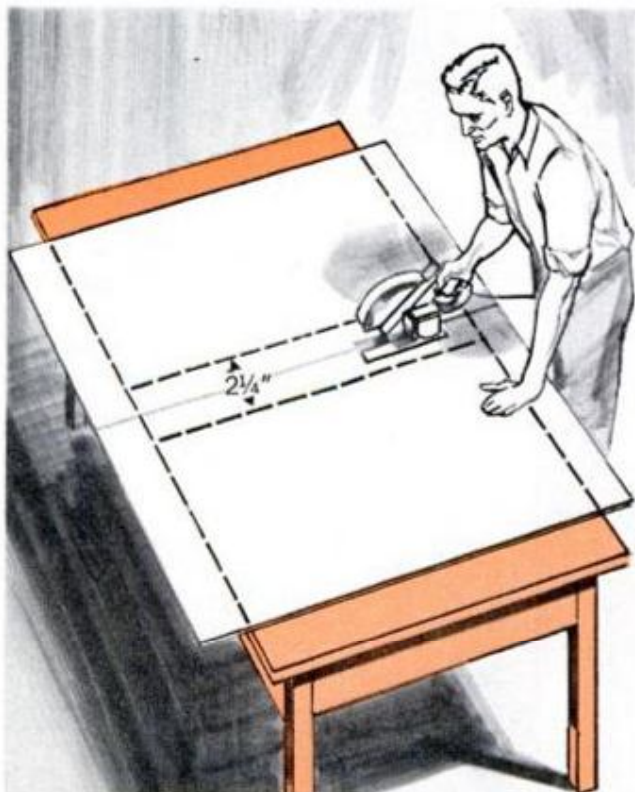

**OLD KITCHEN TABLE** with a removable leaf at center can be used for a portable saw table. To make a cut, remove the leaf, set the blade height to just clear the workpiece and make cut over gap.—*Robert J. Lodi*

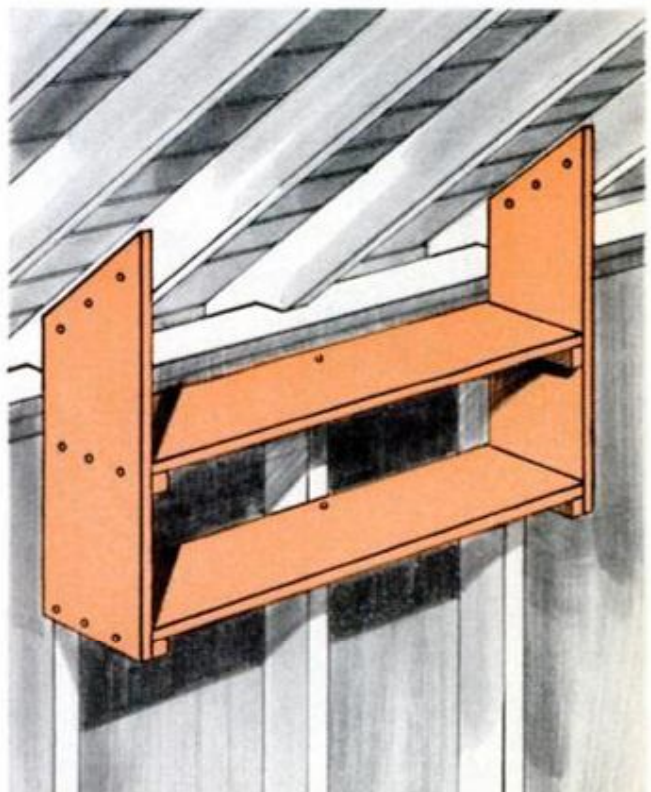

**UTILIZE WALL SPACE** above long-handled tools in the garage by hanging shelves from the rafters. For stability against lateral movement, toe additional nails through the shelves into the studs.—*Harvey H. Haynes*



**STURDY SERVER** gives two generous-size surfaces for holding snacks and libations when open. Closed (photo opposite page), the spacesaving table folds flat for convenient out-of-sight storage in closet



# ALL-TIME GREATS No. 3

## Four Popular Woodworking Projects

Great projects never die, but sometimes we forget just how popular they were. Here are four which made a hit with PM readers years ago and are equally great today

By WAYNE C. LECKEY, Home and Shop Editor

Technical Art by Peter Trojan  
Photos by Robert Borst

### Cocktail Snack Server

WHEN HOME PARTIES reach the point of help yourself, this handsome hors d'oeuvre server will soon become the life of the party. Placed in the center of things and loaded with tempting cheese dips, chips and the makings of a drink or two, this self-service server will receive a standing ovation in more ways than one.

You'll find it equally as useful at bridge, or wherever snacks are served. Best of all, the server folds flat for storing. It made a hit with readers as soon as it first appeared in our June 1937 issue and we received many letters and photos from those who built it.

To make one like it, start with the legs. These are twin assemblies which are cut in pairs, following the pattern given on page 169. All four legs are bored for  $\frac{3}{4}$ -in.-dowel rungs, but keep in mind that the blind holes must be bored in facing surfaces. One pair of legs is drilled for four roundhead brass screws which serve as pivot-pins for the trays, and here you'll wisely drill the holes through both legs at the same time to insure identical spacing. If you own a router, run a bead cut along the curved edges of the legs; it will relieve their plainness and give that store-bought look.

One pair of legs is joined at the top with a crossrail which is shaped like the legs and then glued and screwed to the pair of legs previously drilled for the pivot screws. Two flathead screws are used at each end of the crossrail to fasten it.

Each tray consists of a hardwood-faced plywood center which is faced around the



**BETWEEN PARTIES**, if you don't want it standing around, you can fold the server flat and stow it away. Trays lap and nest between the hinged legs

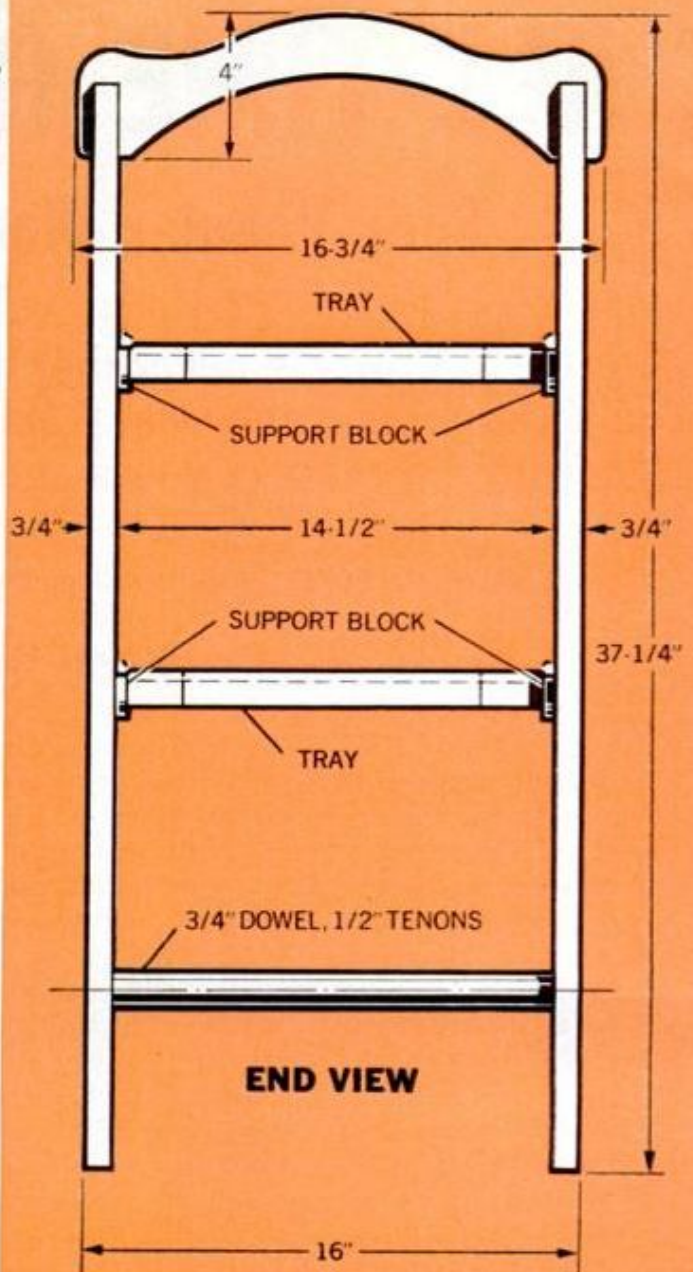
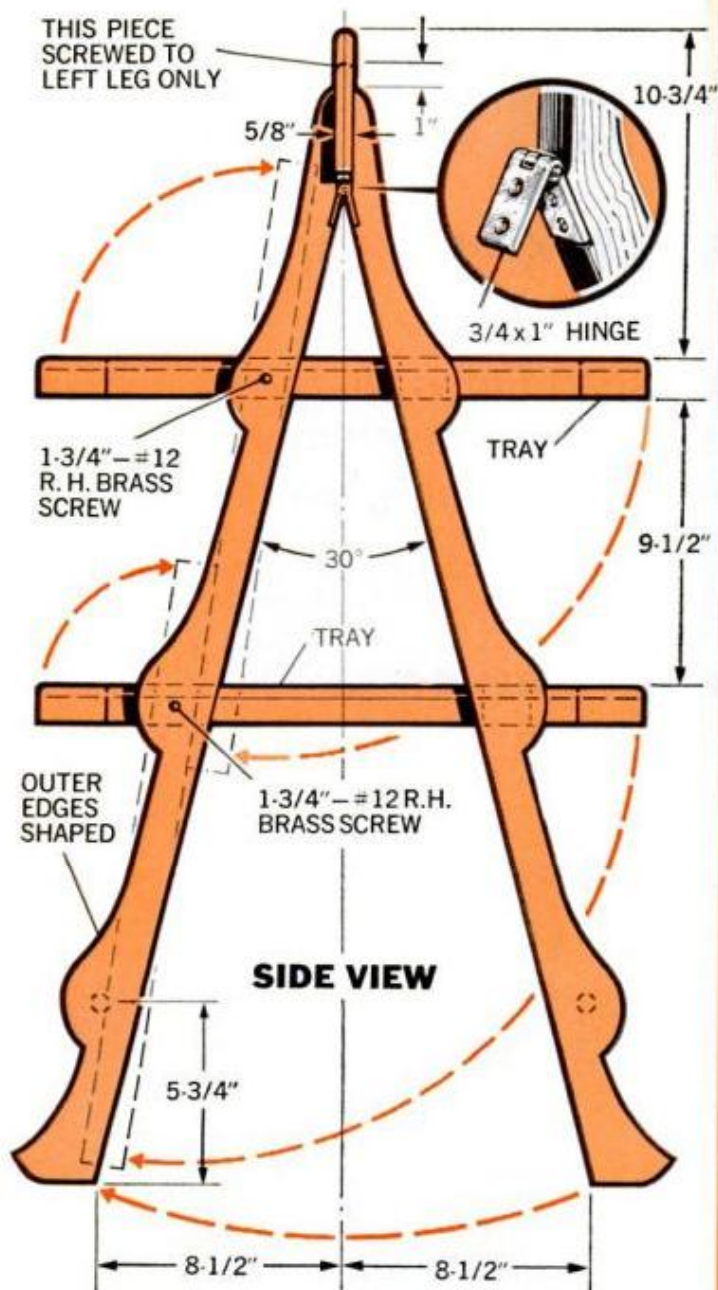

edge with a  $\frac{1}{4} \times \frac{3}{4}$ -in. molding, neatly mitered at the corners, then glued and nailed. Stop pins, made of nails with the heads cut off, are driven into the trays to rest in support blocks glued to the second pair of legs. The pins must not project so far that they rub and mar the legs. Wooden washers keep the trays from rubbing as they pivot for folding.

Pick small brass hinges to hinge the legs at the top. The hinge pins must be first driven out (if you can't get loose-pin hinges) so that the hinge leaves can be screwed in place. The pins are then replaced and your stand is completed.

Finishing the stand depends on the kind of wood you used. If it's walnut, you'll need to fill the open grain of the wood with a paste filler, then stain as desired. Two coats of rubbed-effect varnish will make a mighty handsome piece.

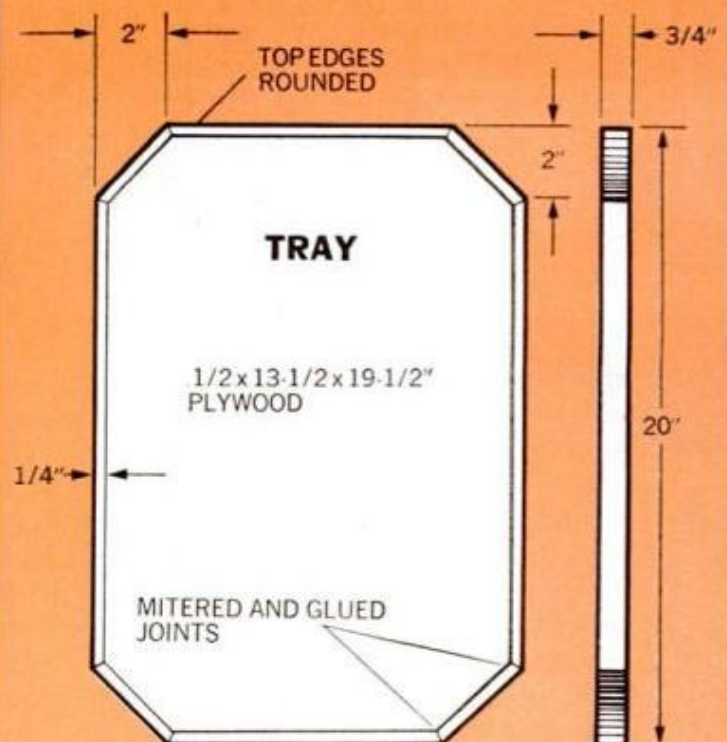

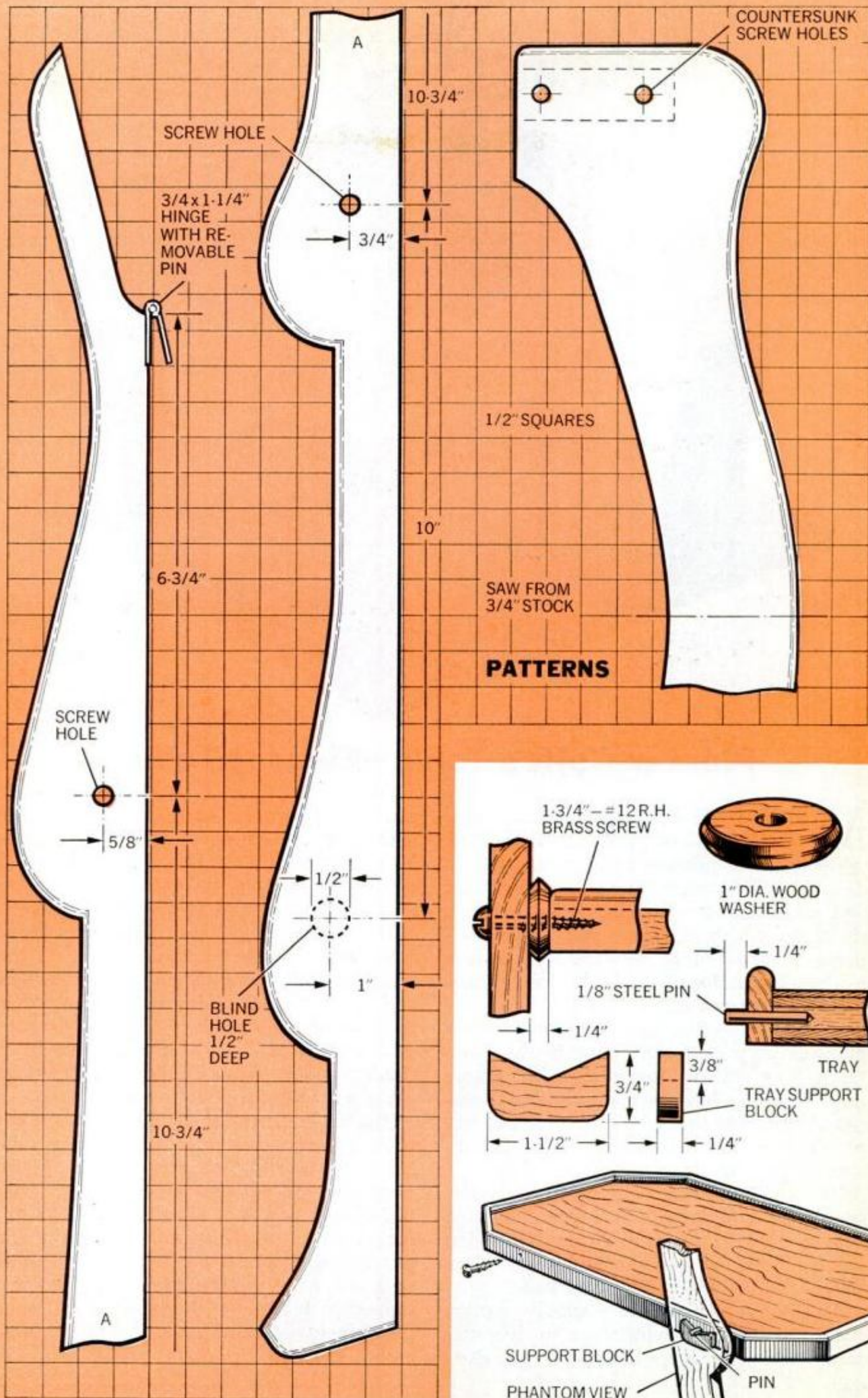



## Planter-Coffee Table—Elegant Today

**M**ARBLE and wood-grain decals, new to *PM* readers back in 1951, helped to make this handsome coffee table the hit it was in the January issue. The fact that you could cover common wood with a simulated finish of rare wood was something in itself. Many readers were quick to show us photos of the tables they made.

Its good looks make this table as elegant looking today and even more serviceable since one can now add the same "skin-deep" beauty to a plain wood frame with durable, long-wearing plastic laminate. Available in wood-grain and marble patterns, the plastic covering is easy to apply and provides an instant finish.

Our cabinetmaker, Everett Johnson, used J-M's Melamite to cover the table shown above. He used a tan Georgian marble finish on the top and brown Imperial walnut on the legs and base.

The top and base are simply square pieces of plywood which are made extra thick at the edges with wood strips. Both

panels are covered completely with laminate, first the edges, then the top. However, wait until after the legs are attached before laminating the top. The hole for the metal planter is sabre-sawed last.

The four curved legs are bandsawed from 4x4 blocks after you first cut off the ends at a 60° angle. Then they're sanded and covered with laminate; first the edges, then the curved surfaces. Easiest way to attach the legs is with screws down from the top and up from the bottom. They are set in 6 in. from the table-base edge.

Plastic laminate is glued to the work with contact cement. After cutting the laminate roughly to size (about 1/8-in. oversize) the cement is brushed on both the plastic and the wood and left to dry for 30 minutes. When it's just dry to the touch (use brown paper to test), the laminate is carefully centered on the work and tapped with a mallet. Remember that once the cemented surfaces touch, the laminate can't be moved.

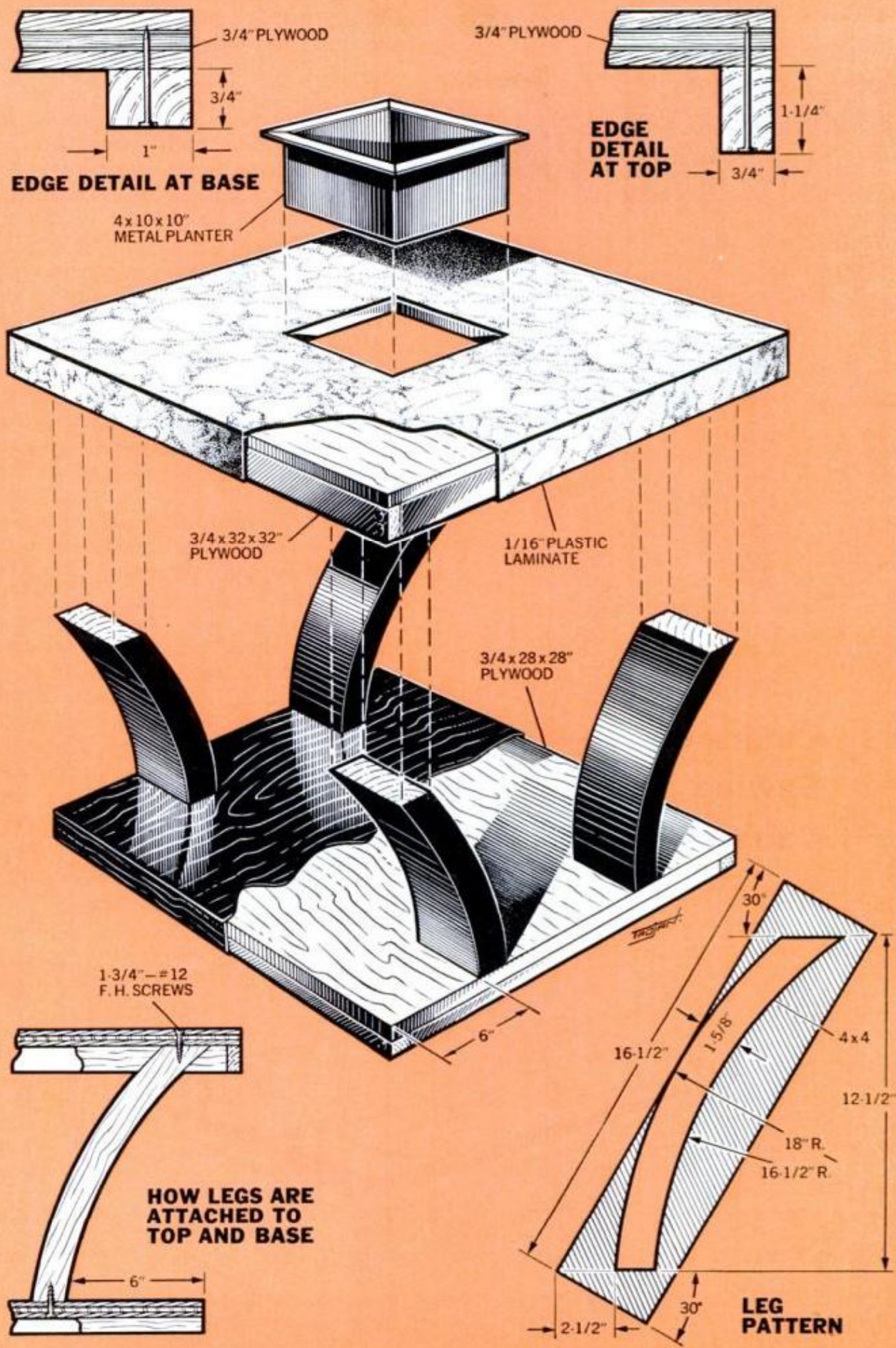



## Chairside Sewing Cabinet

**H**ERE'S A PROJECT readers really liked. This chairside sewing-cabinet design is patterned after one published in February 1954 which won more reader praise than any other furniture project.

In this 1970 version, construction has been simplified by switching to ready-made legs that you can buy in many different shapes and merely screw in place. If your wife likes to sew, she'll love the convenience of this chairside companion.

While it will necessitate gluing up boards, you'll have a more handsome piece if you build it of solid stock—walnut, birch or cherry. Not only will you be able to shape the top and bottom edges as indicated, but you'll have no problem in finishing all edges. However, if you skip the shaping of the edges of the top and bottom members and leave them square, you can use hardwood-faced plywood and cover the exposed wood-plyies with glue-on flexible wood tape.

Start with the two inner side members. These are alike but are made right and left-hand when you're running the dados on the inside for the two  $\frac{3}{16}$ -in. drawer shelves. Notice that the  $\frac{1}{4}$ -in.-deep dados are stopped  $1\frac{1}{4}$  in. from the front edges and then finished up by hand with a narrow chisel. If they're made with a router, you won't have to chisel them. Cut the upper dado 3 in. down from the top.

The back is the same height as the sides and is simply a plain, square-edge member. Before it can be nailed and glued to the sides, the two drawer shelves must be in place. Notice that the back member projects  $1\frac{1}{2}$  in. past the sides.

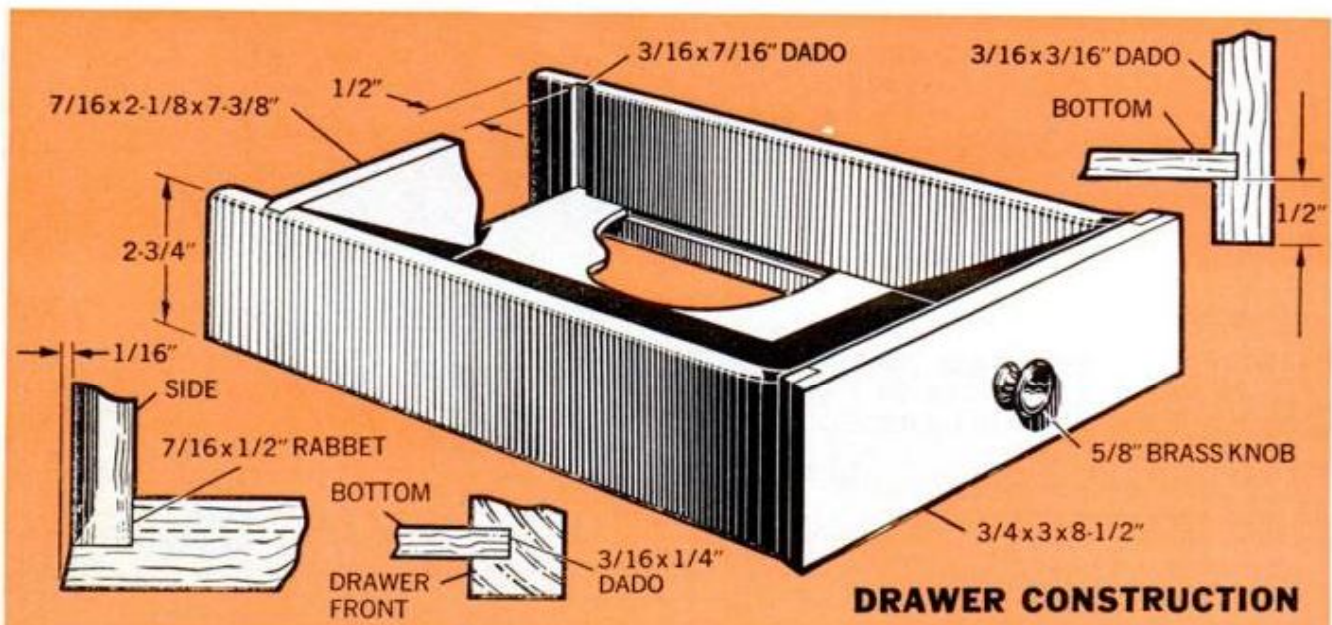

After gluing up stock to a width of 15½ in. cut the top and bottom members 16 in. long. They're shaped only along three sides, not the back. You'll notice that spring-loaded bullet catches are used to "lock" the swing-out spool doors, and you'll be smart if you bore the ¼-in. holes for them before you add the top and bottom members. The latter are kept flush with the back when you glue them.

Both side doors are alike but, again,

they must be made right- and left-hand. The narrow fronts are joined to the sides with a miter-and-spline corner joint, after which three shelves, bored for rows of ⅛-in. dowels, are added. The upper shelf is located 1¾ in. down from the top and the lower one is positioned ⅛ in. up from the bottom. Each door is hinged to the back (see detail). Hinge them for 1/16-in. clearance top and bottom.

The detail on the opposite page shows

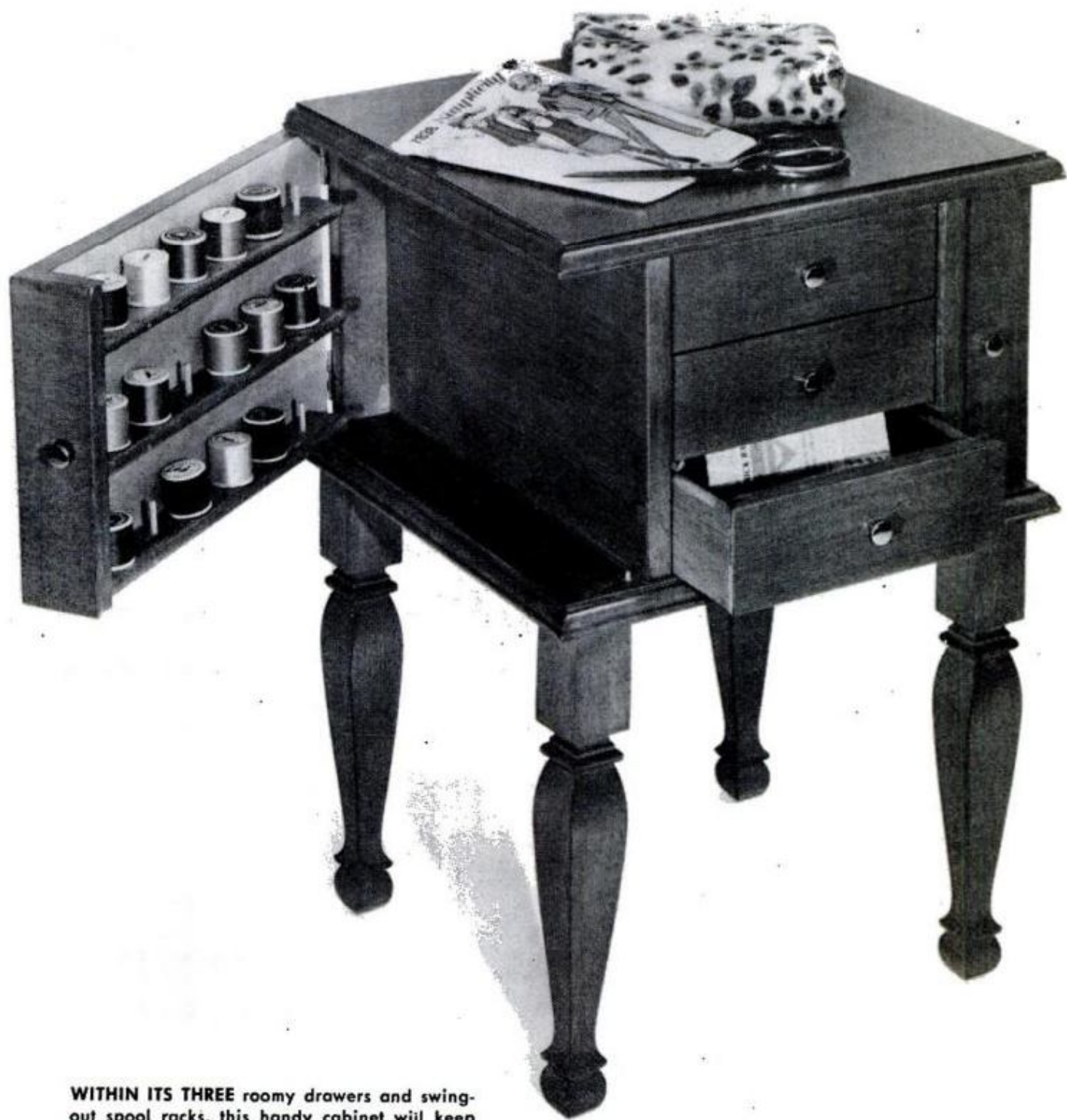

**WITHIN ITS THREE** roomy drawers and swing-out spool racks, this handy cabinet will keep sewing essentials all in one convenient place

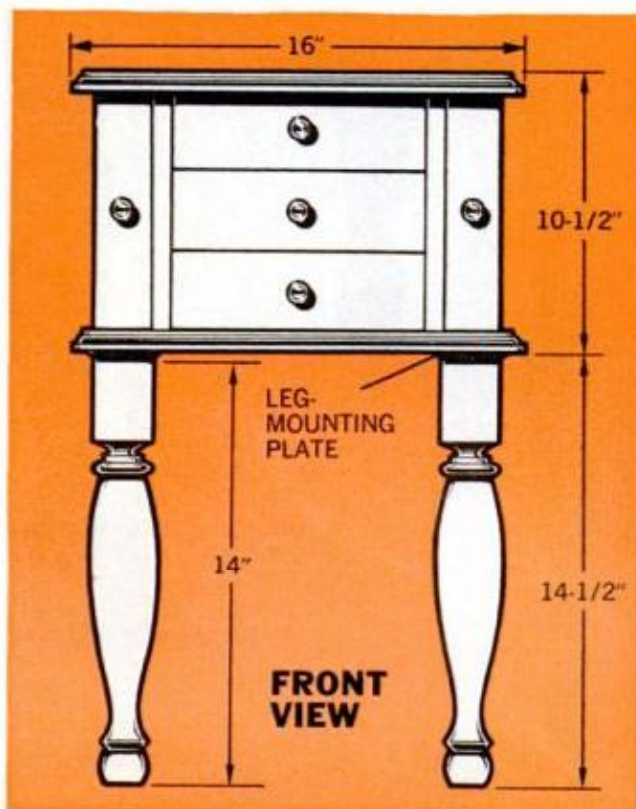
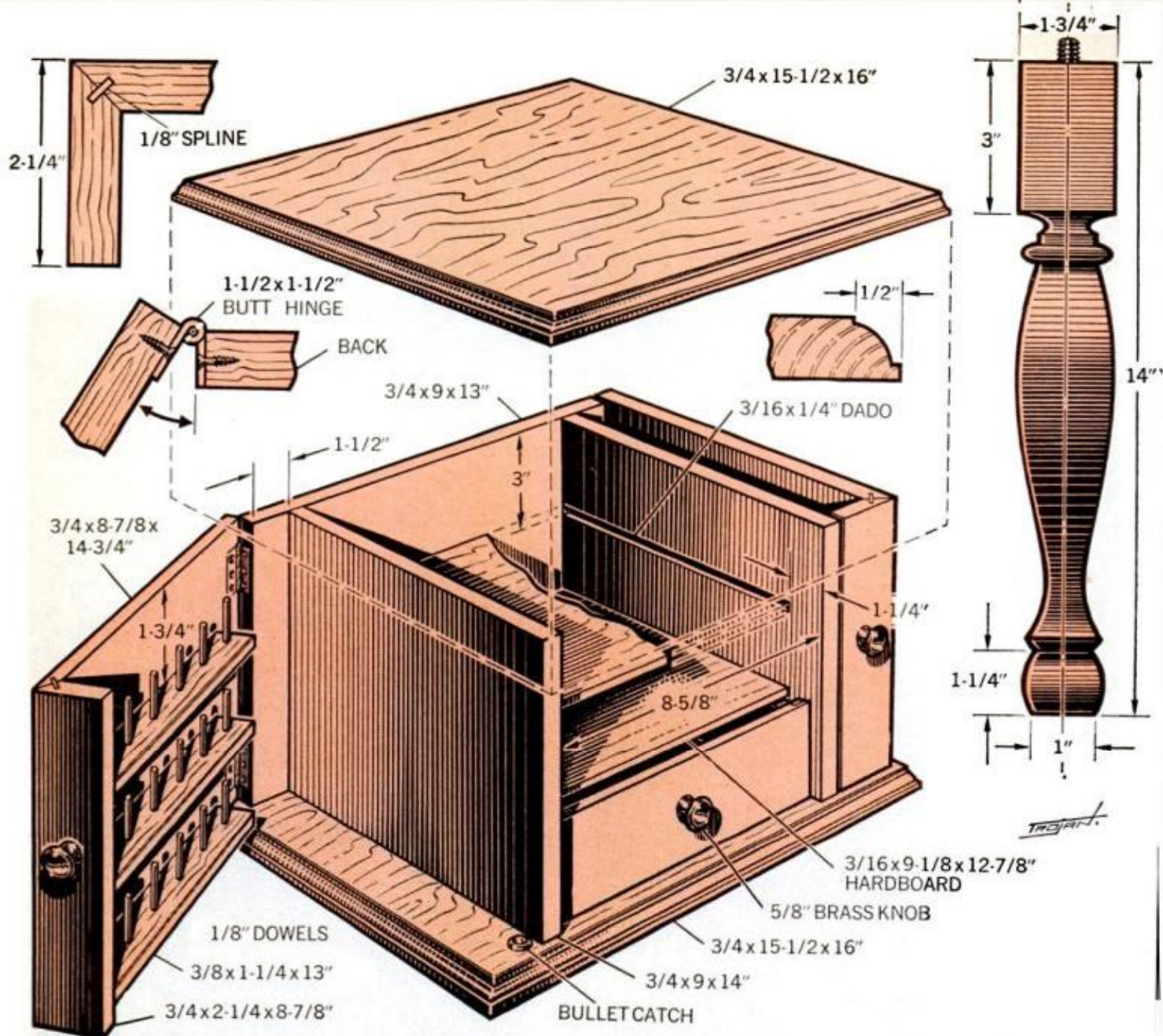

how each drawer is made. You should actually fit them to their openings, leaving enough clearance all around for free sliding. The fronts are  $\frac{3}{4}$ -in. stock; sides and backs are  $\frac{3}{8}$  in. The fronts are also  $\frac{1}{8}$  in. higher than the sides to lap and conceal the drawer shelves. Notice that rabbeted ends of the drawer fronts have a slight inward bevel. This assures ample side clearance for the drawer itself without a sloppy fitting front. Notice, too, that the drawers set back in  $\frac{1}{4}$  in. A thumbtack at each front corner of the lower opening will keep the bottom drawer from rubbing on the cabinet and marring its finish.

If you own a router or shaper, you can give the drawers a factory-made look by rounding the top edges of the side members. You would do this, of course, before the drawers are assembled and stop the cutter at a point where the side enters the rabbet. Your cabinet is completed when you add small brass knobs.





## Flip-Over Ladder-Chair

**I**T'S A CHAIR, it's a ladder, it's unique. To top it off, it's extra handy to have sitting around. That's what a lot of readers thought of this novel chair design when first published in the February 1952 issue.

When the average chair is too low or too high to enable you to reach a cupboard shelf, attach a curtain rod or change a light bulb, this double-duty version simply flips over to become a sturdy 3-ft. stepladder.

To make one like it, start with the four leg assemblies. These are made in pairs and, in the case of the back legs, the two assemblies must be made right and left-hand when you bore the holes for the slats. Dowels are used throughout to join the legs to their rails and



the slats to the legs. When you bore holes for the slats, make certain you don't go deeper than  $\frac{1}{2}$  in.

Except for the two halves of the seat, which are added last, each half of the chair is assembled as a separate unit. The steps are notched to fit around the legs, and in the case of the back assembly, the step, plus the four slats, must all be glued and clamped at one time.

The two seat-halves meet at a bevel and are cut to overhang the legs as indicated. After the seat members are aligned and screwed in place, the two sections are hinged together with narrow  $\frac{3}{4} \times 1\frac{1}{2}$ -in. steel butts. These are set flush in shallow gains hand-chiseled in the surface. Finally, when the chair is painted or varnished, as the case may be, rubber stair treads are cut to fit and tacked to the steps for added safety. Flat brass, S-hooks made to lock over roundheaded screws, are added to hold the two chair sections together when the ladder-chair serves as a chair. \*\*\*

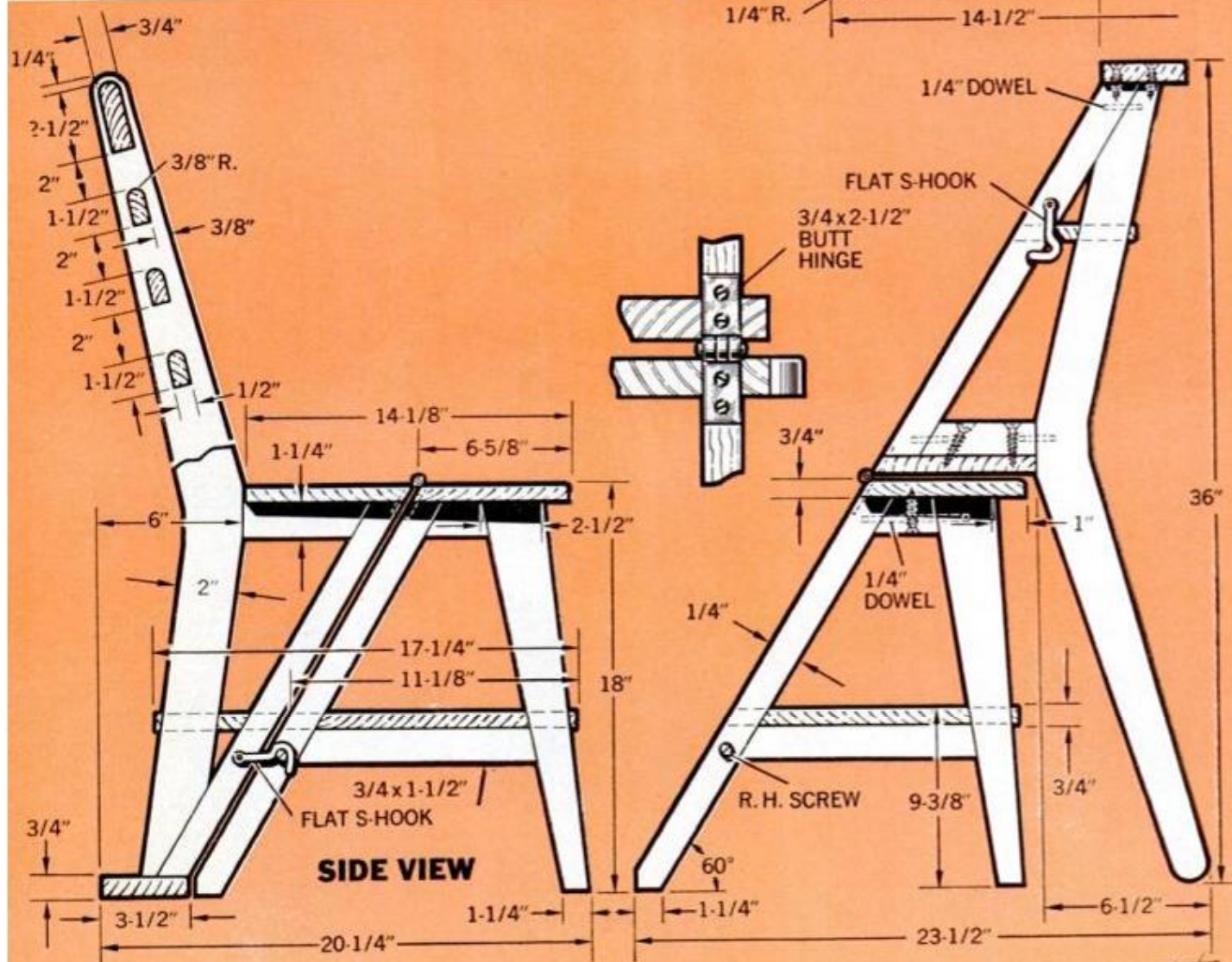
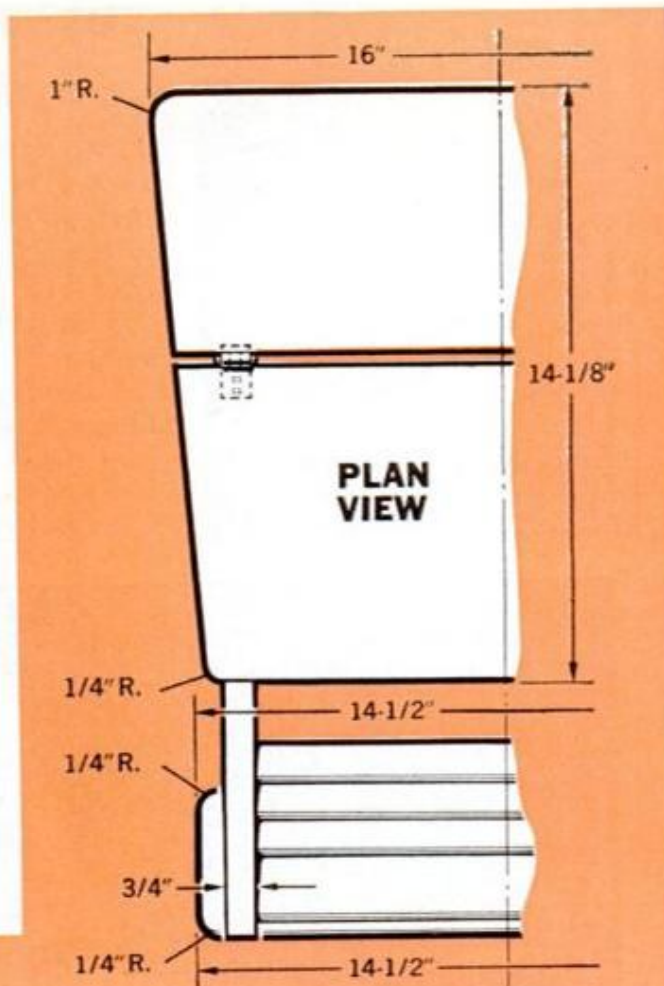

# HINTS FROM READERS

## Washers guard toggle switch

A critical toggle switch, such as one for a fire alarm, should have a guard that will prevent its accidental activation. Two washers, one smaller than the other, can be brazed together to serve such a function. Place the "base" over the switch, and cement it in place with epoxy resin.

—William S. Gallagher

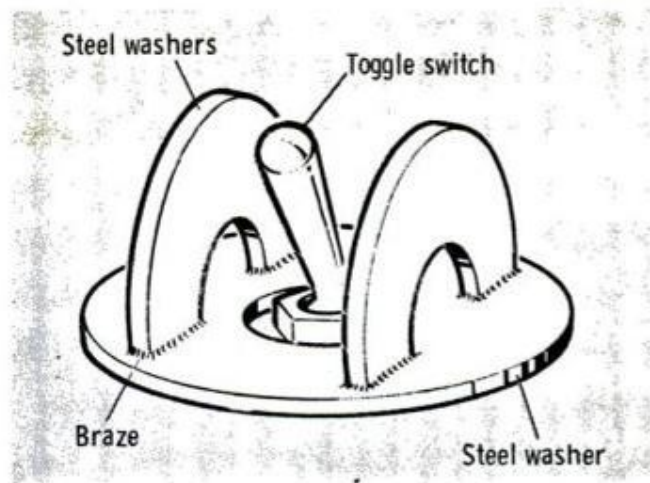

## Roll out the saw table

Wanting a movable table for my table saw, I customized two legs of a laundry table as shown at right. When I'm sawing, the table is perfectly still; to move the unit I simply lift the table at the side between the two nonrolling legs. To insure no movement while you saw, be sure there is no weight on the casters when the table is on all fours.—William Slamer

## Fast way to quiet squeaky floors

A squeaky first floor can be hushed by driving wedges between floor joists and flooring, but this is impractical on the second level because of the ceiling below. To stop such squeaks, clip the heads off underlayment nails and drive them between boards where the noise occurs. The noise will stop and the headless nails are practically invisible.—Julie Neibert

## Low-cost welding vise

Here's a handy bench welding "vise" you can make in less than an hour for a couple of bucks or so. Simply cut two pieces of 1x1-in. angle iron to length as shown and fit with a 6-in. C-clamp. After inverting the irons, locate the clamp to insure best contact for welding, spot-weld the setup and you're in business.

—Leonard Workman

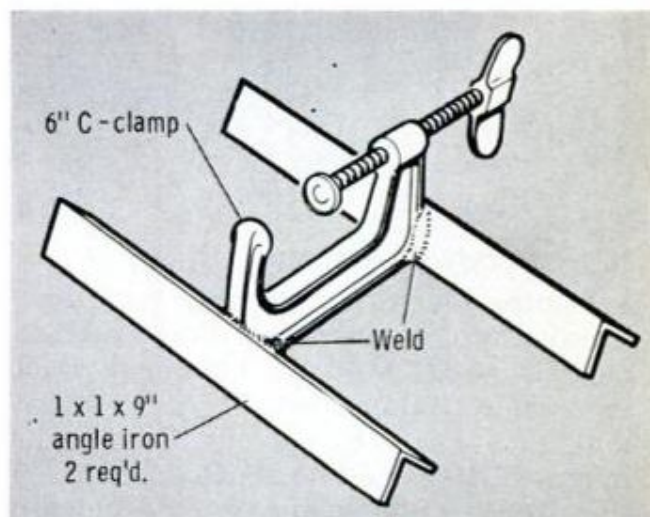
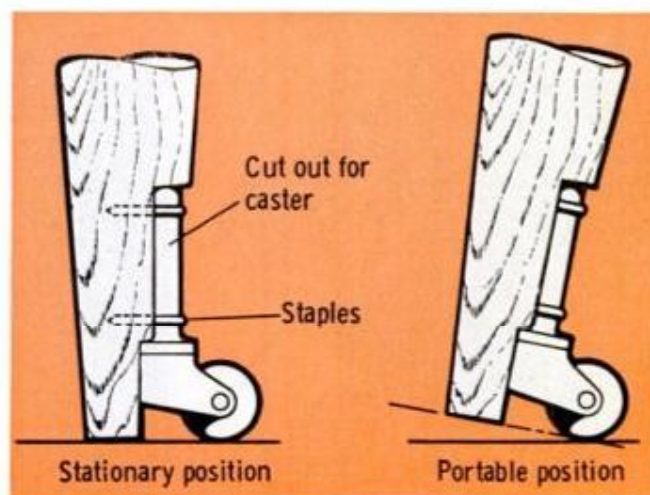

## Custom-made wood molding

On a recent project I needed some very small cove moldings which I found were impossible to buy. So, I made my own as shown at right by: 1. squaring a piece of stock; 2. routing the edges with a 7/32-in., veining bit; 3. making two saw cuts in the edge, and 4. slicing off the two lengths of molding (and scrap center) on the table saw. The result was exactly what I needed.—Eugene Florida

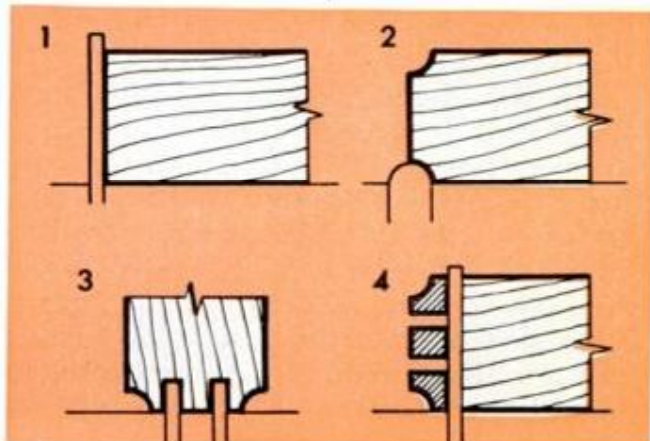

Before you buy an arc welder, make sure that your shop has adequate power. If not, here's how to . . .

# Install a Circuit For a 230-v. Arc Welder

By JOHN BURROUGHS

*Technical Art  
By John Lind*



**N**OT TOO MANY YEARS AGO transformer type a.c. welders had three drawbacks. For one, they didn't perform as well as d.c. welding equipment. Each time the a.c. alternated, 120 times a second, the arc tended to go out. Then manufacturers developed flux-coated electrodes that would stabilize an a.c. arc—and this made comparatively inexpensive transformers work about as well as higher-cost d.c. welders.

Another drawback was that when molten metal from the welding electrode sprayed across the arc, decreasing the arc's electrical resistance, older welding transformers drew amperage from the line in irregular surges, and this tended to disrupt power-company distribution systems. Improved transformer design solved this problem. The windings of modern "limited input" transformers provide enough reaction to limit fluctuation.

The third disadvantage was that you needed a high-capacity separate 230-v. circuit to plug an a.c. welder into. You still do. But today 230-v. circuits are common in every home. The circuit needed for a limited-input shop welder is the same as the 50-amp. circuit required for a modern electric range or clothes dryer.

Putting in a suitable circuit takes care of this last disadvantage—and you can then begin enjoying the biggest bargain in a shop tool you'll ever find. I'm convinced that no other shop machine expands your capabilities like an arc welder. You can buy a welder for around \$100 that will last a lifetime (maintaining its resale value), and it will save you its cost many times over.

Don't let lack of welding know-how hold you back. You'll learn to weld by welding. A complete novice can catch the knack of making satisfactory welds in



**WELDER MANUFACTURERS** advise using a three-wire cable enclosed in grounded conduit. Circuit wired with three No. 8 copper conductors has the capacity for a 180-amp. welder. Use  $\frac{3}{4}$ -in.-dia. conduit

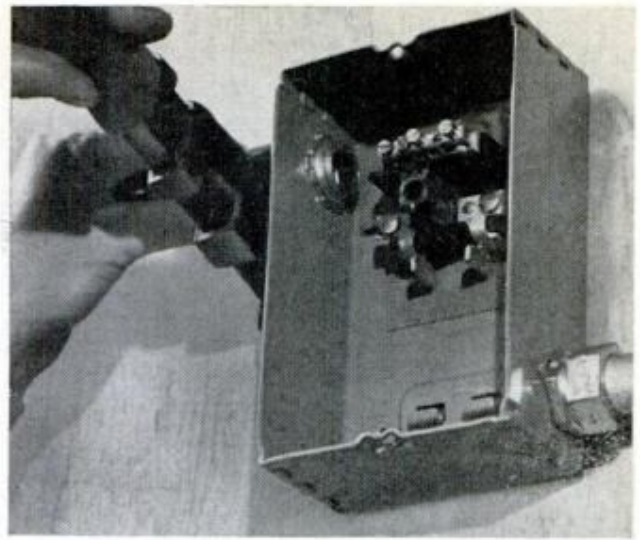

**AUXILIARY BREAKER PANEL** should be installed in shop near the machine that will use it. Except in some rural areas, permits are required for wiring the installation and work is checked by inspector

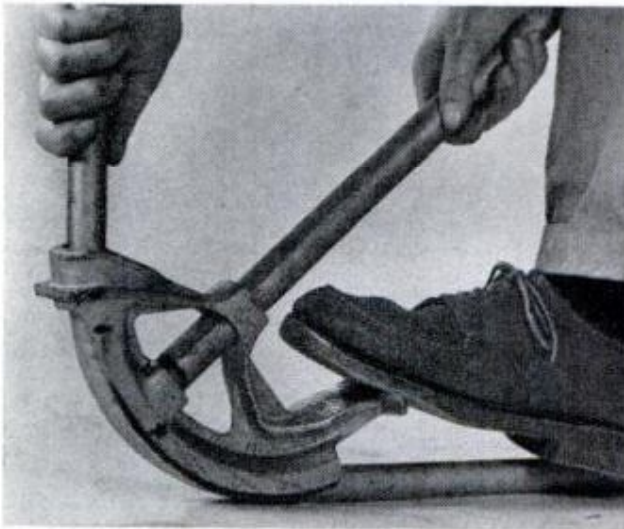

**CONDUIT BENDER** makes quick work of making 90° bends. Since the electrical code allows four 90° bends per conduit run (box to box), you'll be able to make installation without using junction boxes

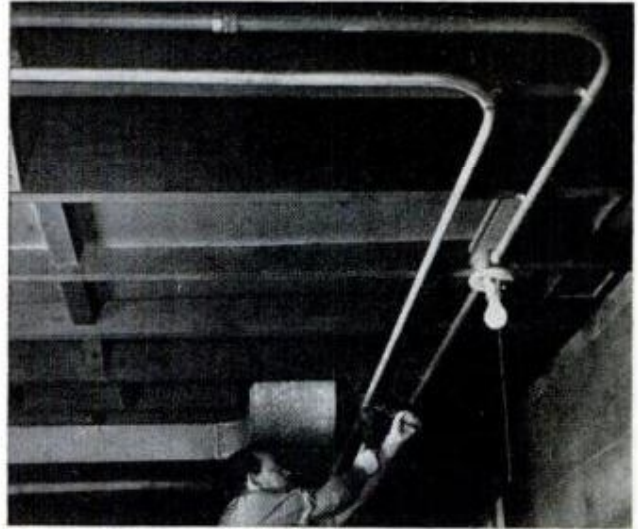

**JOB LOOKS NEATER** if new conduit is run parallel to an existing circuit. Remember to ream burrs from all cut ends when installing conduit. For rigidity, pipe straps are spaced no more than 5 ft. apart

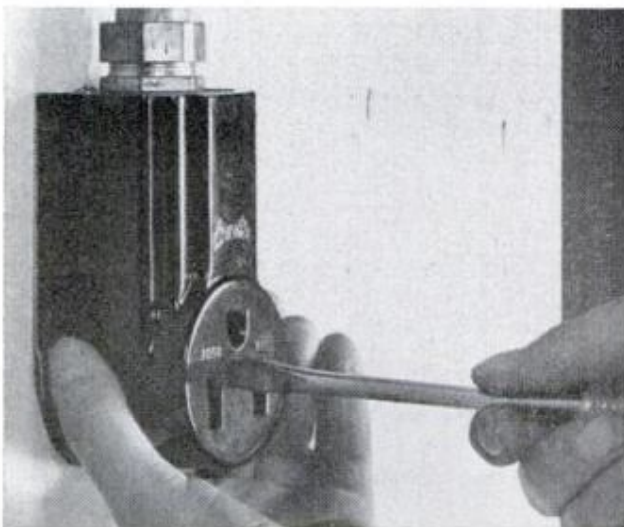

**230-V. RECEPTACLE** is installed with ground terminal at top to permit welder's input cable to hang down. Final step in the work is to check for electrical continuity by using a test lamp at the receptacle

mild steel with an hour's practice. The instruction booklet supplied with the equipment will give you enough information to get you started.

If you take an experimental crack at welding with a rented machine, an instruction booklet should come with the rental. If not, you can get a booklet on arc welding from Sears for 50 cents.

When planning a permanently-installed circuit for a welder, choose a fire-safe work area. Since the arc will throw sparks, an area used regularly for welding should have fire-rated walls, ceiling and floor. And, because welding galvanized steel produces fumes, the area should also be well ventilated.

Check with your power company before beginning the wiring job. Some localities

have antiquated distribution lines so the utility company imposes restrictions on the use of welders. Be sure you explain that you plan to perform light, home-shop welding with a limited-input, 20 percent-duty-cycle machine; not heavy-type work with industrial equipment.

Also check with your fire department. Although fire codes require permits for arc-welding equipment, in most localities fire authorities apply this requirement only to welders used commercially.

All wiring must be installed in conformance with the National Electric Code and all installations should be UL-inspected and approved.

Provided you use common sense, you needn't hesitate to put in the circuit for an arc welder yourself. Unless you're thoroughly familiar with your home's service-entrance panel, however, don't attempt to hook the new circuit to the line. Play it safe: Run the wiring yourself, which will save you most of the labor cost, and then call in a qualified electrician to connect the circuit to the line at the service panel. He can do it in minutes.

Since the 230-v. circuit is very simple, you'll have no difficulty complying with the code. The wiring should be enclosed in grounded thinwall conduit, which makes the installation fail-safe. The code requires that the circuit shall have (1) a disconnect means, (2) overcurrent protection, and (3) conductors large enough to carry the load.

Installing either a fused switch (with a cartridge fuse for each hot leg of the circuit) or a 230-v. circuit breaker at the

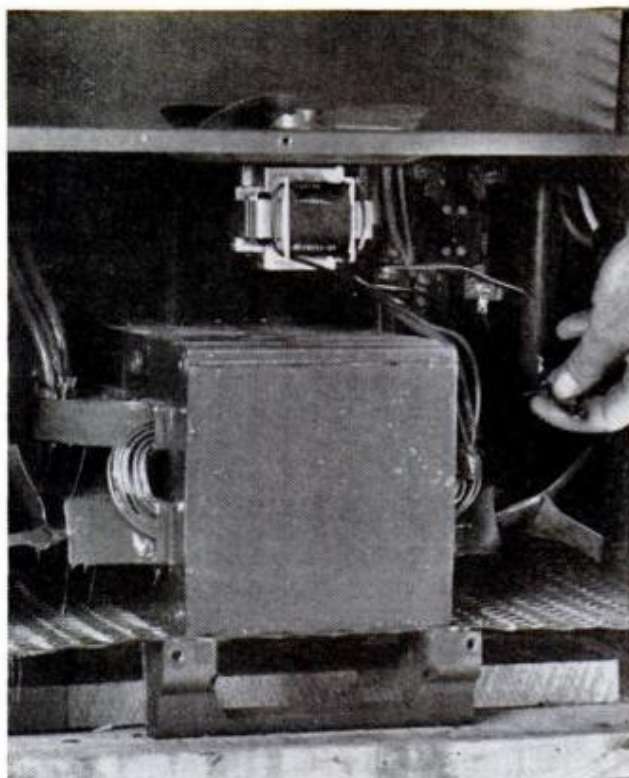

service entrance panel will satisfy the first two requirements.

Both the size of the circuit's three conductors and the diameter of the conduit needed to enclose them will depend on the welder's rating. Two arc-welder sizes, 180-amp.-output and 225-amp.-output models, are commonly used in home shops. A welder that delivers higher amperage can "burn" larger-diameter electrodes and deposit weld-metal more rapidly. But since most shop welding—pipe, angle and light-plate—is done in the 60-to-130 amp. range, a 180-amp. transformer is adequate for all but the heaviest work.

Most 180-amp. welders have 20 percent-

### Typical Power Circuit for Arc Welder

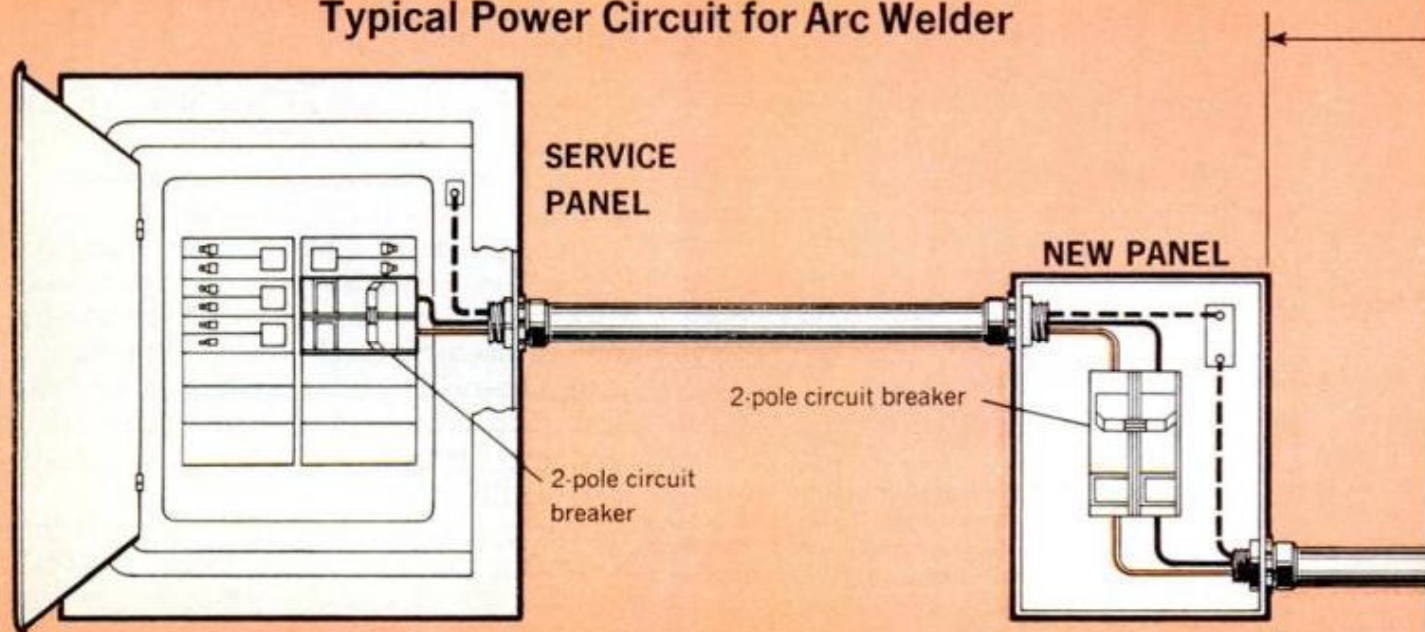



**MOST TRANSFORMERS** in 230-v. welders have 280-v. primary tap that can be disconnected to operate on low line voltage (photo, far left). Arc welding (left) should be done in fire-safe, well-ventilated area. Shop preferably should have concrete floor and walls, and sheet-metal ceiling. Fire-brick makes an adequate work surface. If you would like to experiment before buying your own welder, you can rent a machine for about \$5 a day and plug it into your dryer receptacle. Most rental firms will also supply heavy-duty, three-wire 230-v. extension cables with No. 10 conductors. You can then use the welder at 20-percent duty-cycle with settings up to about 140 amps. without fear that it will trip the 50-amp. breaker in the circuit

duty-cycle *input* ratings of 37 amps., low enough to permit their use on rural power lines. Most 225-amp. machines have 20 percent-duty-cycle input rating of about 50 amps.

For a 180-amp. machine install a circuit wired with three No. 8 copper conductors in  $\frac{3}{4}$ -in.-dia. conduit. For a 225-amp. machine use three No. 6 conductors in 1-in.-dia. conduit.

The conductors used must be continuous (without splices), and must be color-coded—the hot legs red and black and the neutral wire white. You can pull three separate wires into the conduit, or, as some welder manufacturers recommend,

simply shove in three-wire plastic-sheathed cable. The fuses or two-pole breaker protecting the circuit must be in the two hot (red and black) legs. Be sure the white neutral runs uninterrupted.

While a 50-amp. circuit normally must have a 50-amp. circuit breaker or fuses, the section of the code devoted to arc welders allows use of larger breakers or fuses in welding circuits to avoid unnecessary tripping by momentary current surges. Use a breaker or fuses with a high enough rating that they will stay closed when the arc is struck but low enough that they will open when the welding electrode "freezes" to the work. ★★

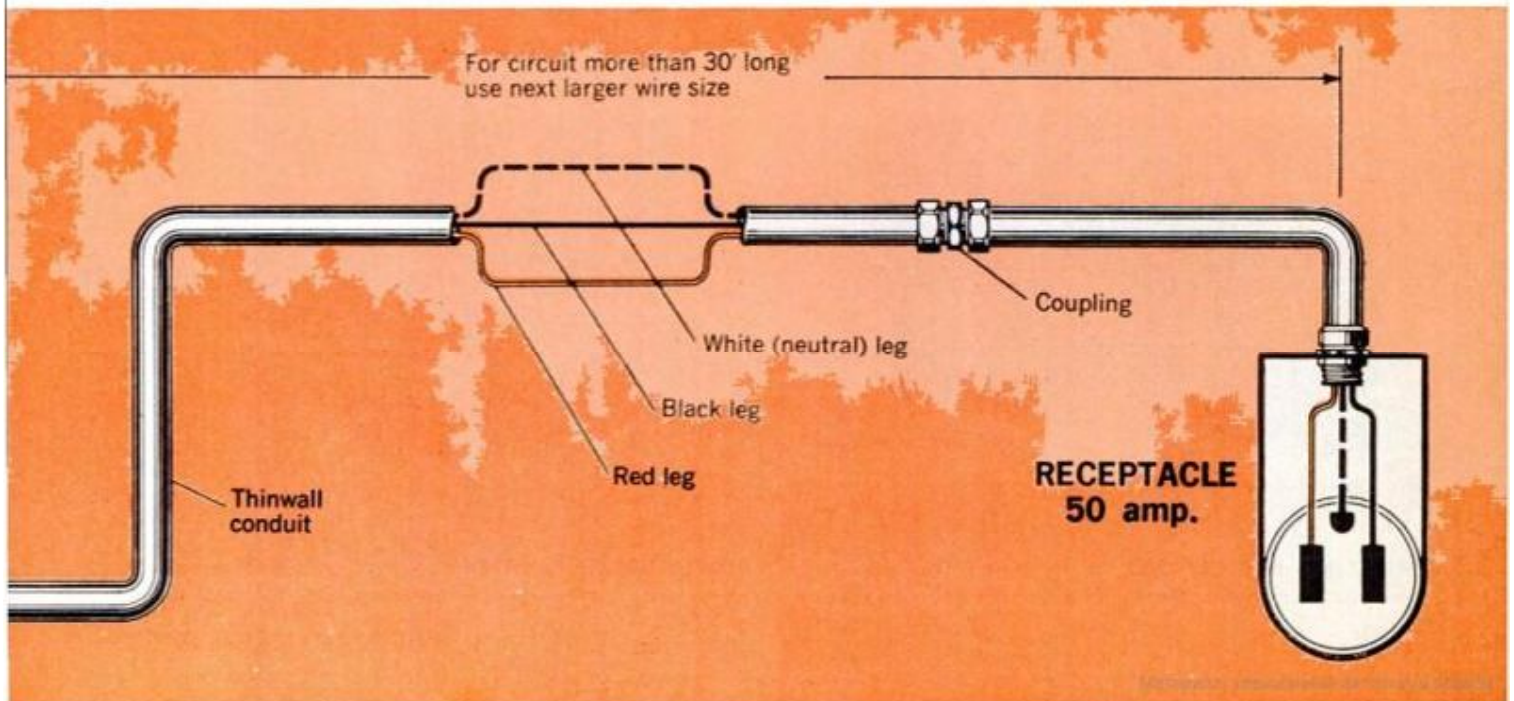

# Breathe Easier With a Home

**Air pollution is a problem that is constantly increasing. But now, activated charcoal is being put to work to create a more healthful climate inside the home**

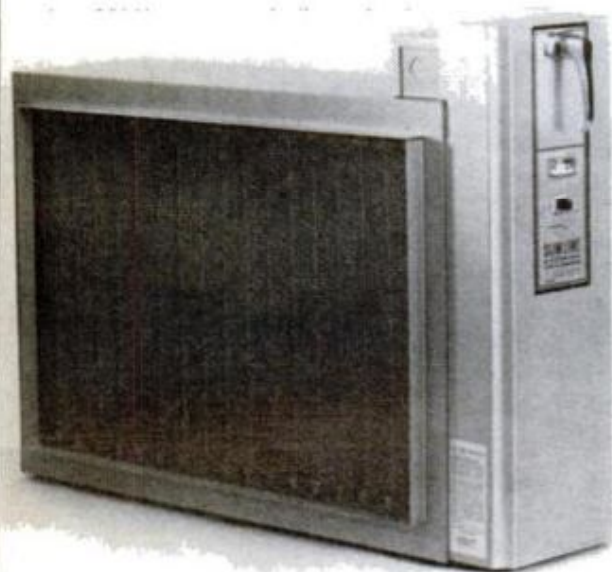

**DOUBLE-CELL ELECTRONIC CLEANER** by Honeywell is claimed to increase air cleaning by 75 percent

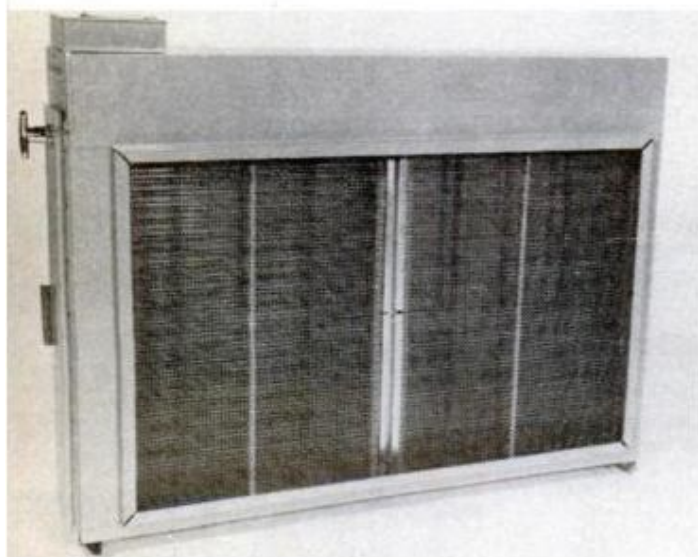

**SLIM-LINE AIR CLEANER** is designed for use with central heating system. Emerson Electric makes it

**CLEANUP OF THE AIR** outdoors is too big a job for an individual. But, you can now do something about the air inside your home with air-cleaning appliances. Known variously as home air filters, cleaners or purifiers, these devices don't create completely "pure air" but they do serve to bring about a more healthful household climate.

As the name suggests, an air filter sets up a screen to trap dirt particles and other impurities as air passes through. Hundreds of models are on the market, but most fall into three basic categories: the electronic appliance which usually requires professional installation as a part of the household heating system; portable room units; and mechanical filters which can be attached to heating ducts in the home by the user.

Typical electronic air cleaners, which are installed in the return-air section of a furnace duct system, are the Slim Line unit manufactured by Electro-Air, a division of Emerson Electric Co., and the Double-Cell Electronic Air Cleaner in Honeywell's Residential Div.

Units like these are capable of removing up to 90 percent of all soot, smoke, pollen, spores, bacteria dust and dirt from the air passing through them. Their installation in a home helps to keep the furnace combustion chamber and the airconditioner cooling coils clean, which allows the furnace and conditioner to operate at peak performance.



**POWER-DRIVEN ASHTRAY** with charcoal filter eliminates, odors. Paar Manufacturing, Des Moines, Iowa

POPULAR MECHANICS



# Air Cleaner

To help filter toxic or corrosive gases, vapors and household odors from the air, many electronic furnace filters utilize an activated charcoal filter. Activated charcoal has long been known for its capability of adsorbing impurities in the air. Used to filter the smoke in certain brands of cigarets, activated charcoal is so porous that a single pound of the substance offers the equivalent of 140 acres of surface to trap impurities.

For a less expensive method of cleaning the air in homes not equipped with central heating, the portable air purifiers now on the market give a highly effective means of single-room air cleaning. They can be especially helpful in the homes of allergy sufferers where the air in a single room has to be kept as clean as possible.

★★★

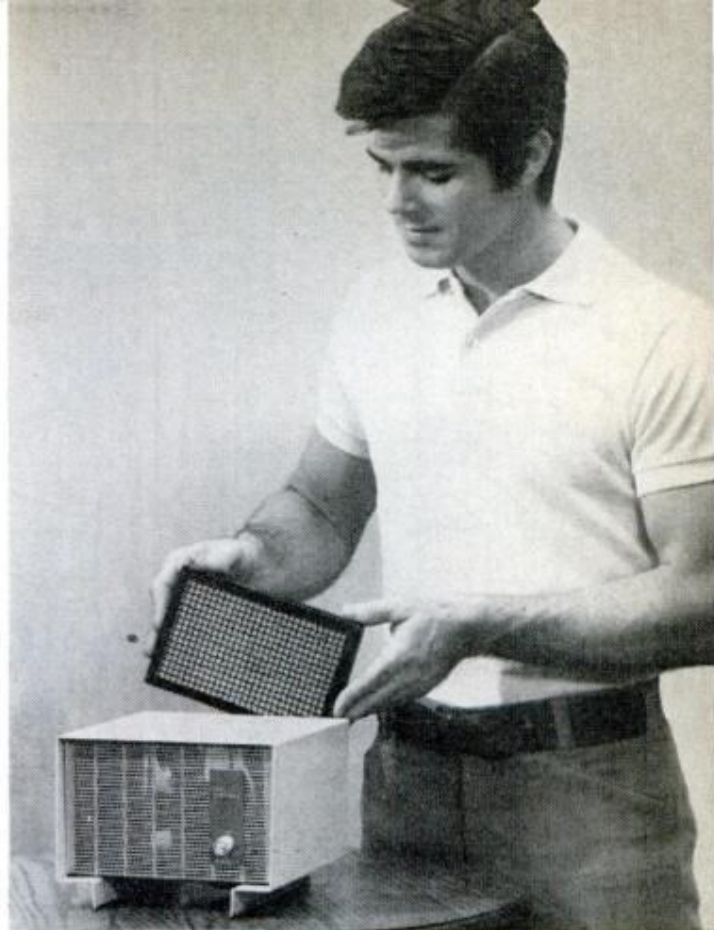

**LIGHTWEIGHT PORTABLE** plugs into any outlet, utilizes charcoal. Emerson Electric, McKees Rocks, Pa.

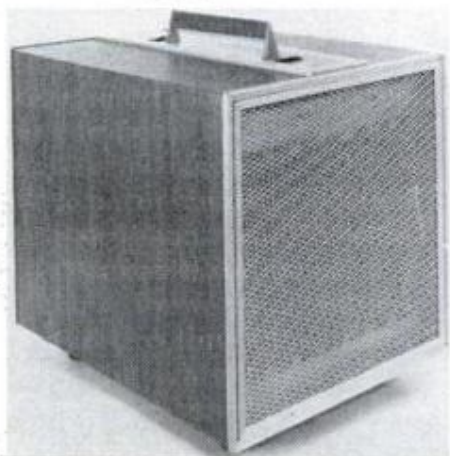
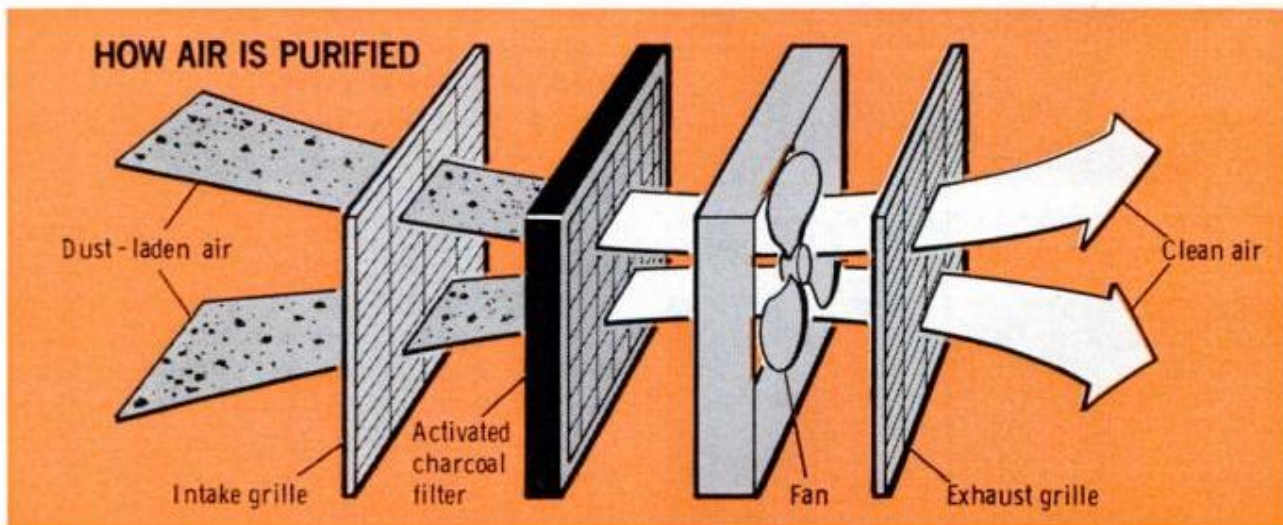

**SELF-CONTAINED UNIT** which will remove up to 95 percent of dust in 20x20-ft. room. Emerson Electric  
FEBRUARY 1970



**PORTABLE UNIT** boasts patented collector plate. It's made by Radex, 2076 Elston Ave., Chicago, Ill. 60614

# Handy Homemade

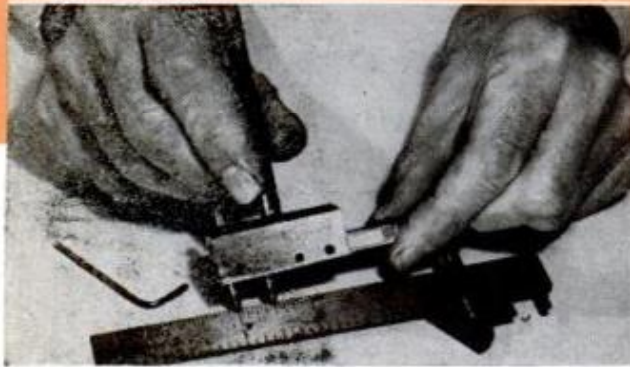
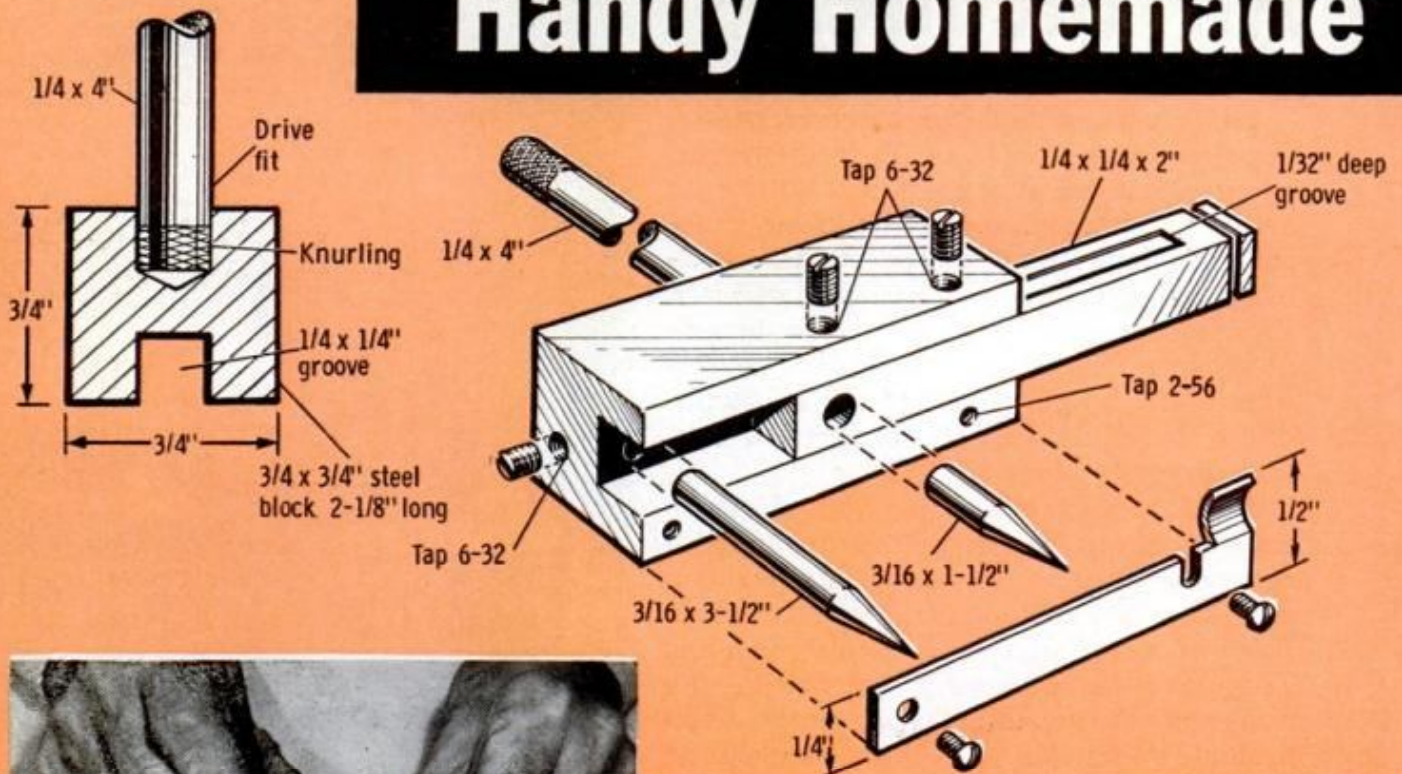

**SET POINT SPACING** with the aid of a steel scale. Once set, jobs can be laid out in production fashion

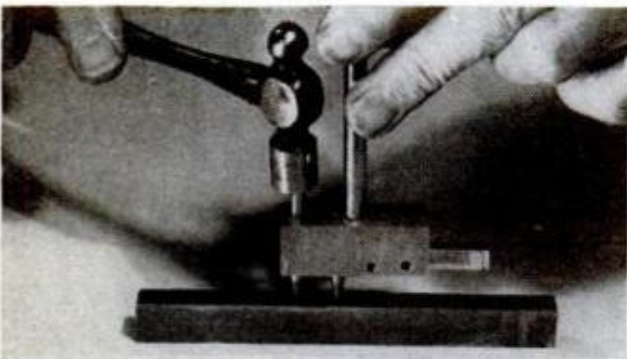

**FOR PRECISE POSITIONING**, adjustable point is placed in starter hole, fixed point is then rapped

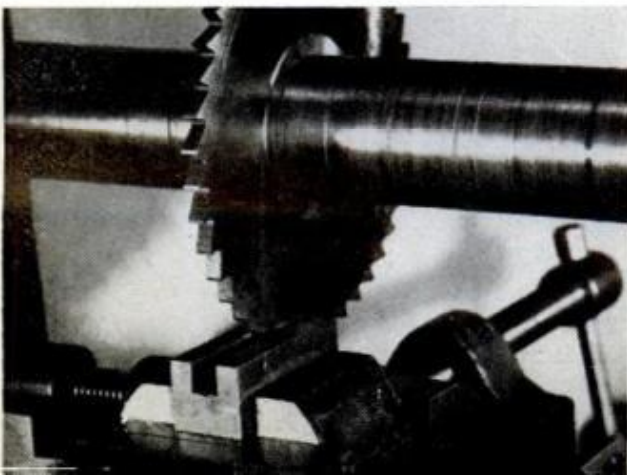

By **WALTER E. BURTON**

## SPACING PUNCH

This spacing punch simplifies the positioning of layout marks for drilling holes or performing other operations. It consists of a body fitted with a fixed punch point and an adjustable point in a sliding bar. In normal use, the adjustable point is placed on the reference mark (this can be a punch mark), and the upper end of the fixed point is tapped with a hammer.

The punch shown, dimensioned as in the drawing, has a normal range of  $\frac{1}{4}$  to  $1\frac{3}{8}$  in. By reversing the slide, the range can be increased to 3 in.

To use the punch in the maximum spacing range, the slide is reversed to position the point outside the body groove. To do this, it is first necessary to loosen the spring strip and swing it out of the way. Screws holding the strip need not be removed if one screw extends through a notch, as shown in the drawing.

The handle is simply a length of round rod driven with a force fit into the top hole in the body. The slide is held snug where it's wanted by the spring-strip while two 6-32 setscrews, which press against its side, can be tightened.

**SLOT IS MILLED** in body block for adjustable slide

# Shop Tools

## HOLE-SAW EDGE ROUNDER

If your toolbox lacks an edge-rounding tool when you want to remove sharp corners from wood, you can make an efficient one from a hole saw. In the side of the saw, file a rounded notch just deep enough to intersect the inner surface. Usually (unless you have inserted a plug to act as a support) this surface will spring inward without breaking. Remove the springy metal film with a knife, then carefully continue to file until the opening is the size desired for the edge radius. Hone the inner surface with a rounded oil stone to remove burrs and form a keen edge.

**IF METAL IS DIFFICULT TO FILE** (top right), use abrasive wheel to cut notch. To shave square edge of a board round, use edge of the notch to "plane"

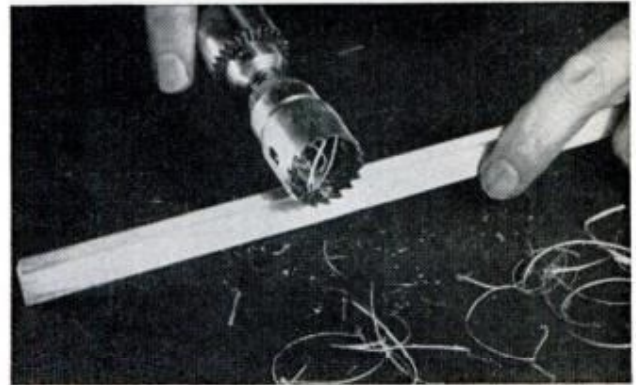
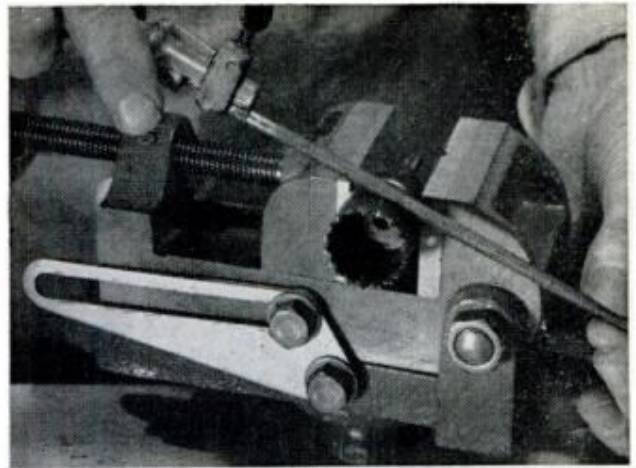

## CHIP CONTROL FOR LATHE BIT PREVENTS BUILDUP

On a recent aluminum-turning job I did, the chips came off in long ribbons which wrapped around the chuck and work, making it necessary to stop the spindle every minute or so to clear the chips. To end this nuisance I installed a "chip crimper" on the toolholder. The crimper is a strip of stiff sheet metal C-clamped to the toolholder so that it presses against the bit on the side away from the cutting edge and extends  $\frac{1}{16}$  in. above the sloping top surface of the bit. The chip, sliding down this slope, strikes the projection and is crimped or broken. Chips thus accumulate in compact bunches which don't entangle the work. The lug projecting under the bit prevents upward movement of the chipper and eliminates the tendency of it to move out of the path of the chip. To do the trick the chipper need not extend to the tip of the bit. ★★

**CHIP CRIMPER** is shaped to fit around end of toolholder, C-clamps hold the crimper in place on toolholder

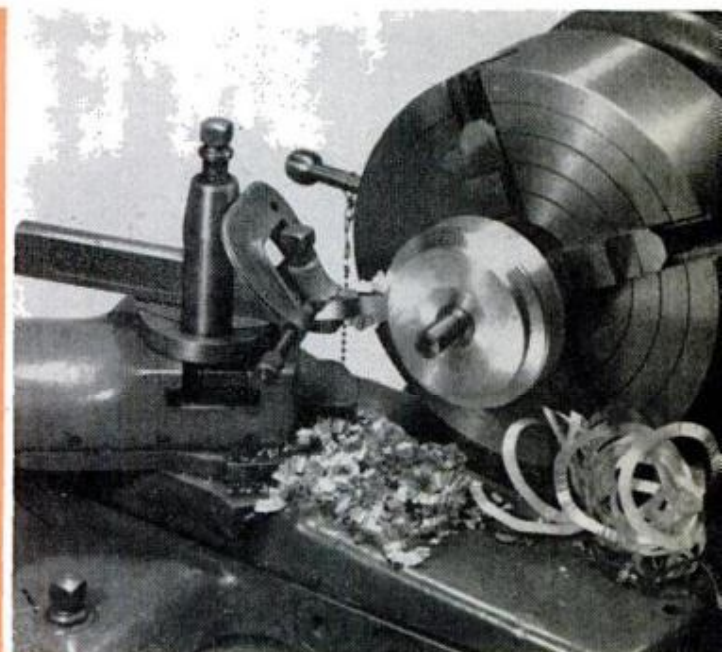
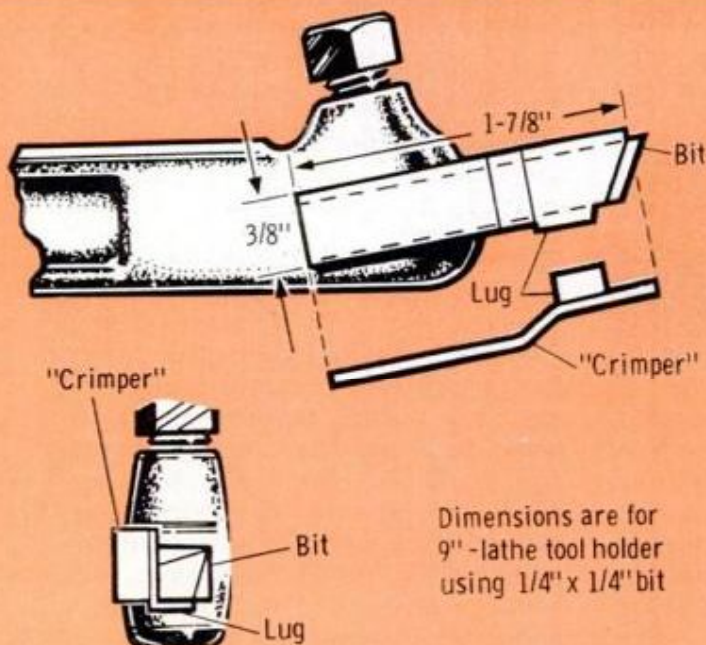

# EXCITING NEW PRODUCTS

By CATHERINE BILSKI



**CHESS EXPERTS** and beginners will enjoy this challenging, fun-filled game. Called Double-Chess, it can be played by two, three or four players. The set includes four "armies" (64 chessmen), a 24x24-in. game field hand-screened in red and white, plus complete instructions on how to play the game. It retails for \$14.95, or \$19.95 for a deluxe set, both postpaid from Normandy House, 4701 Normandy Drive, Fort Worth, Tex. 76103.



**HANDY WAY TO MIX EPOXY**, as well as to dispense it, is with the "Mix-Tube," which consists of two tubes hitched together. You squeeze the contents of the small tube into the large tube and mix by rolling the latter tube between palms. Retailing for \$1.80, it is made by Devcon Corp., Danvers, Mass. 01923.



**APPLY STRAPPING TAPE THE EASY WAY** with the Strap-It 4T Tape Dispenser. It applies as much as required, cuts the tape and leaves a tab in position for applying the next strip. Ideal for wrapping, palletizing, unitizing, holding and reinforcing applications, it's available at stationery stores and office supply houses at a retail price of \$11.95. Manufactured by the Permacel Div. of Johnson & Johnson, New Brunswick, N.J. 08903.

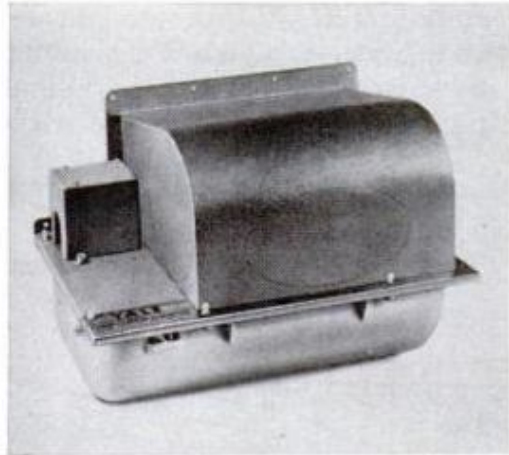

**FURNACE HUMIDIFIER** for your home is offered by Eaton, Yale & Towne, Inc., 100 Erieview Plaza, Cleveland, Ohio 44114. Humidifier has a centrifugal pump that automatically flushes the unit every six hours to clean the reservoir of residue. Warm air from plenum is forced over and around 23 moist 8-in. bronze discs, which slowly rotate in a reservoir of water. Unit comes with saddle valve and hardware, costs about \$200 installed.



**CHAIRS TO MATCH RUGS?** Yield House, North Conway, N.H., is offering wrought-iron chair frames that are graceful, sturdy and inexpensive. The finished chairs are easy to make; just use leftover carpeting or remnant pieces. "Carpet Chairs" are sold for \$19.95 and come complete with a special cement and full instructions for assembly.

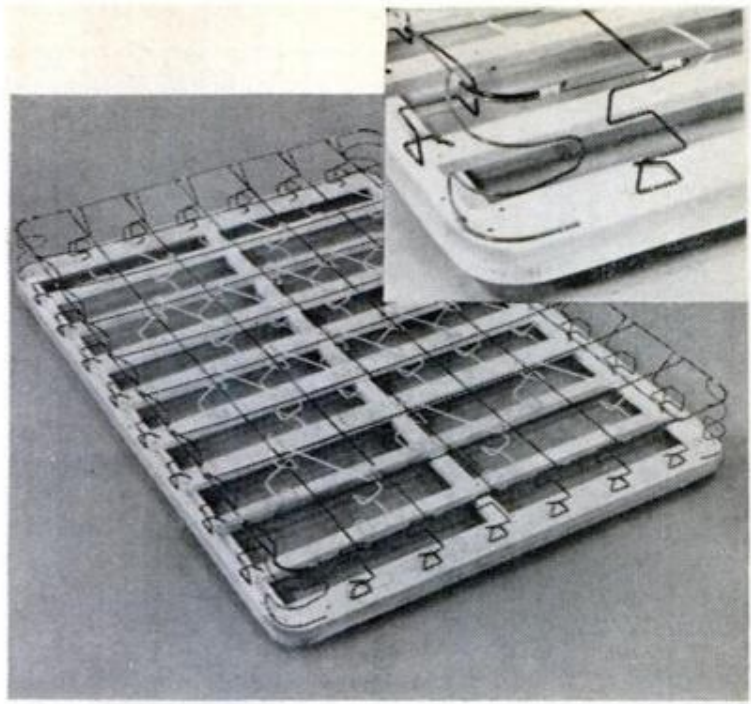

**FOR GREATER SLEEPING COMFORT,** Sealy, Inc., has developed a mattress foundation without coil springs. Called Posture-Grid, it has torsion bar suspension and is constructed with geometrically-formed spring wire to give firm support to every inch of the structure. It's designed to cradle the mattress to reduce shifting and thus keep gaps from forming between the mattress and the foundation. Prices range from \$89.95 and up. Manufactured by Sealy, Inc., 75 East Wacker Drive, Chicago, Ill. 60601.

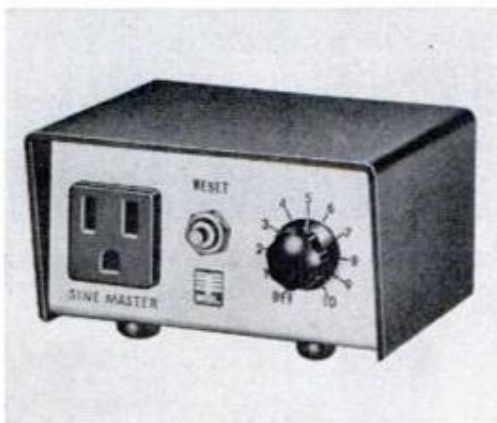

**USEFUL ADDITION** to every home workshop is the new electronic Sine Master 100. This solid-state unit lets you control the speed of virtually any home tool or household appliance. Simple to operate, you just plug it in an outlet, (it has an a.c. current controller) and dial whatever speed you want. This control is enclosed in a handsome, all-metal housing and is available in a choice of five-amp. (priced at \$12.95) or ten-amp. (priced at \$16.95) models. It's manufactured by Howard Industries, 2420 18th St., Racine, Wis. 53403.

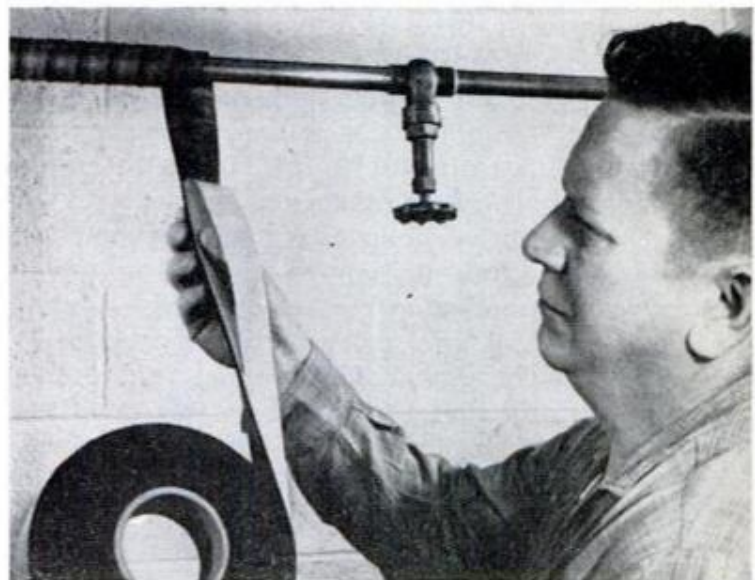

**PROTECT YOUR WATER PIPES** against condensation with Amaflex All-Purpose Tape. It's easy to apply—you just pull off the release backing and wrap the self-sticking tape in a spiral pattern around the pipe. Made of flexible foamed plastic, it can also be used in a number of other ways, such as insulating doors, sealing narrow openings, cushioning handgrips on tools, to mention a few. A 12-foot roll of this versatile material ( $\frac{1}{8}$  inch thick and 2 inches wide) retails for \$1.98. Manufactured by Armstrong Cork Co., Lancaster, Pa. 17604.



## INNER-TUBE DOG BOOTS

**Inexpensive, lightweight dog boots take only five minutes to make, but last a season**

By **TED PYLE**

I'VE KNOWN HUNTERS who expect their gun dogs to perform brilliantly without proper foot protection in upland bird cover so thick with grass burrs and other thorns that they crunch underfoot like popcorn. Your gun dog will do a better job if you take a few minutes to fit him with proper boots. For about 10 cents per dog foot you can make boots from a damaged or worn inner tube available free from most shops that sell or service motorcycles. Inner-tube rubber is flexible enough to allow your dog free movement and traction.

By digging through a pile of tubes in the shop, you can usually find some still in fair condition. Don't take one spattered with patches; it's probably too old. Test for flexibility and strength by pinching a fold of the tube between thumb and index finger. If breaks or cracks appear, it's too old.

Save time in the field by first getting your dog accustomed to wearing tube boots. Put a set on and let him romp in the yard. If he starts to pussy-foot around or tries to chew the boots off, attract his attention. Pet him, have him fetch, or take him for a walk. In a few minutes he'll believe he was born in dog boots.

Inner-tube boots are lightweight and compact to carry. Folded flat and wrapped with a rubber band, a set of four is less bulky to tote in your hunting-jacket pocket than the stale sandwich the Mrs. packed for lunch. ★★★



**DEPENDING ON DOG**, cut 6 to 8-in. tube length, allowing for sufficient toe room



**WRAP "STOCKING"** of refrigerator tape around dog's leg just above his dew claw



**ATTACH BOOTS** with inch-wide waterproof tape which won't work loose when it's wet



**COMFORTABLE**, durable pair of dog boots has sufficient room for circulation of air

POPULAR MECHANICS

# HINTS FROM READERS

## Oil dispenser traps chips

When a brush is used to dip cutting oil from a common tin can, you can't avoid getting metal chips in the oil when applying it repeatedly to the work. I solved the problem with the double-deck container shown—two cans soldered together. The upper section catches the chips as you wipe them from the brush. Since the bottom is dished, the oil runs back clean into the lower section.—*Paul Mengel*

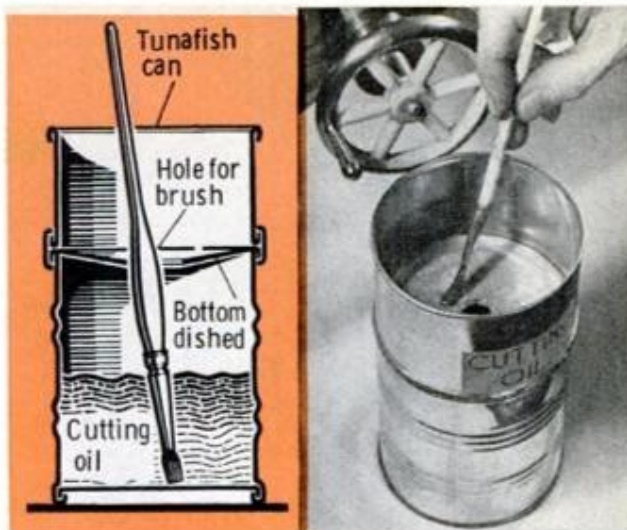

## V-block from pipe coupling

A handy V-block to hold rods, pipe and tubing can be made quickly from a large pipe fitting: File one end of the coupling to insure a smooth, even base. Notch the other end as shown so that a rod laid across the notches will parallel the coupling bottom. The  $1\frac{1}{2} \times 1\frac{1}{4}$ -in. reducer (right) has notches about  $\frac{1}{2}$  in. deep and  $1\frac{3}{16}$  in. wide at the top.—*Walter Burton*

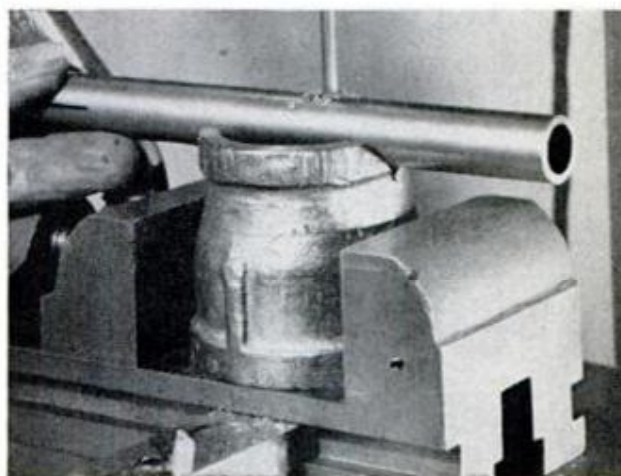

## Make a solderless connection

If you are ever short of solder when making electrical connections to brass screws, you can still continue working. This is especially true when the screw is in a solid base of a low-voltage mechanism. Simply lay the bared wire in the screw-head slot and peen screwhead toward center. This closes the slot and crimps the wire in place.—*Frank Shore*

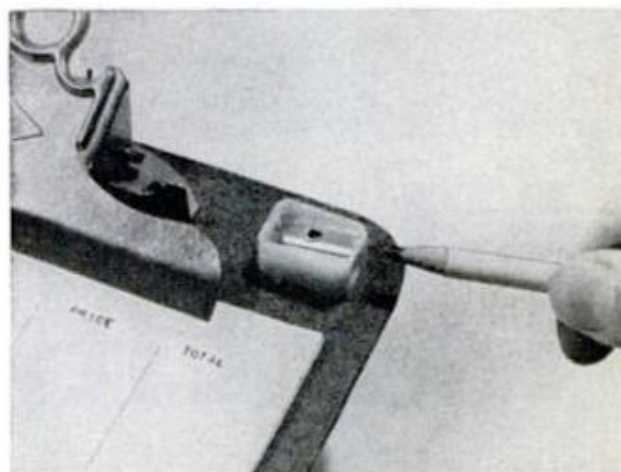

## Portable pencil sharpener

Anyone who has reason to use a clipboard usually does so because he is away from the comforts of an office. For field work, I've fastened an ordinary dime-store pencil sharpener at the top of my clipboard. Now, when the point is blunt, there's no hunting for a pocketknife to sharpen it.—*William Swallow*

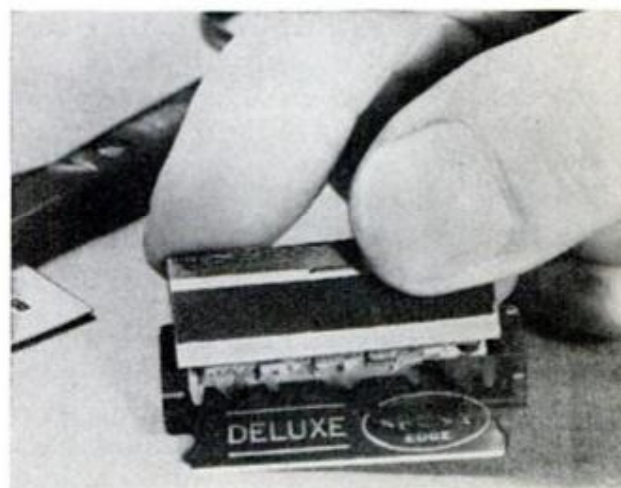

## Matchbook safeguards against cuts

Next time you need a razor blade for cutting or scraping, and the only one you can find is double-edged, try this trick. Cut off the end of a matchbook cover and place it over one edge of the blade as shown. You'll have a cutting blade as safe to use as its single-edge brother—especially if you wrap a piece of masking tape around it.—*William Swallow*

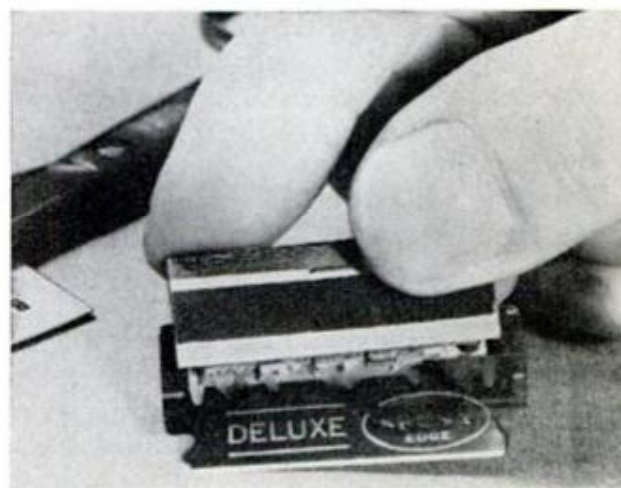

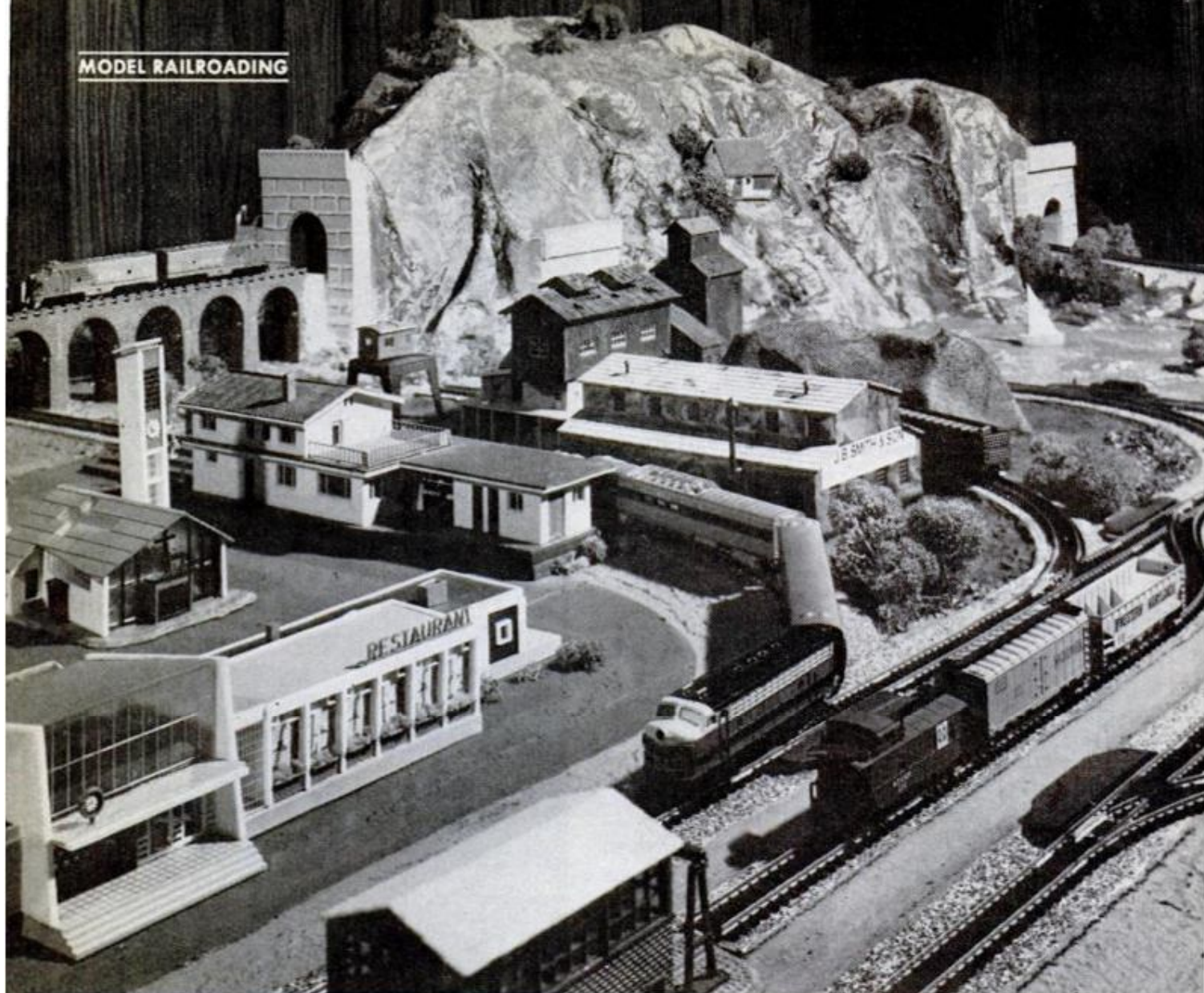

# A Lot of Railroad In a Little Space

**PART 2** By WAYNE C. LECKEY, Home and Shop Editor

Photos by Robert Borst

**W**ITH YOUR TRAIN BOARD completed as described last month, you are ready to start building your system. It can be laid out in a dozen different ways, from a simple oval to an elaborate setup, depending on the size you made it and the amount you want to spend. The system I built strikes a happy medium. Scalewise, it represents a system over a mile long. Moneywise, it represents a cash outlay of about \$150. That is what I spent for two N-ga. trains (freight and passenger), track, switches, power pack and building and bridge kits. Plywood, glue, wallpaper paste

and texture paint ran another \$10 or so.

You can design your own track layout. Follow one of many you'll find in books at your hobby store or follow mine. Straight track comes in sections 1½, 2, 2½, 3, 4½ and 12 in. long. Curved track comes in three sizes (6°, 24° and 30°) in both 7½ and 9-in.-radii, which gives broad flexibility in constructing all types of curves. My layout is single-track with seven switches, three left-hand and four right-hand. However, with the curved track mentioned, your layout can have double track if you wish: I used 41 sections





**TUNNEL PORTALS** are neatly made by first boring holes with a 1½-in. multi-spur bit, then sawing in to meet the holes and, finally, gluing blocks back in. "Stone" tops are a series of saw kerfs. Cleats on back provide a place to glue paper which is used to form the mountains. All tunnel entrances are made the same size, 1½ x 2¼ in. Piers of varying heights support elevated roadbed between portals. Like portals, they are glued to train board. Can be cut from ¾-in. scrap

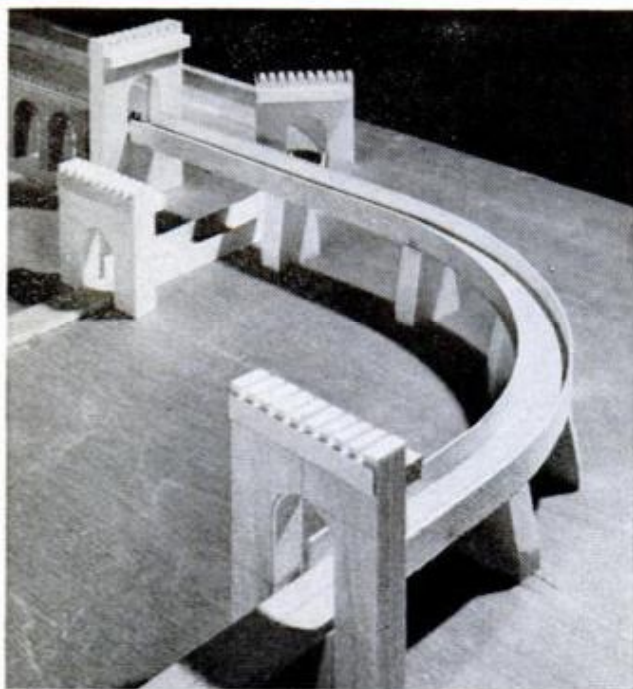
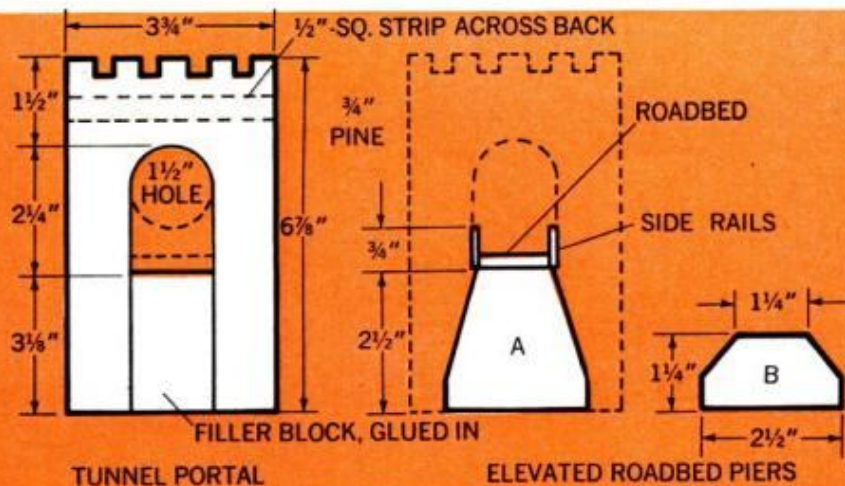

**HERE'S HOW** elevated section of roadbed is supported inside mountains with piers placed between portals

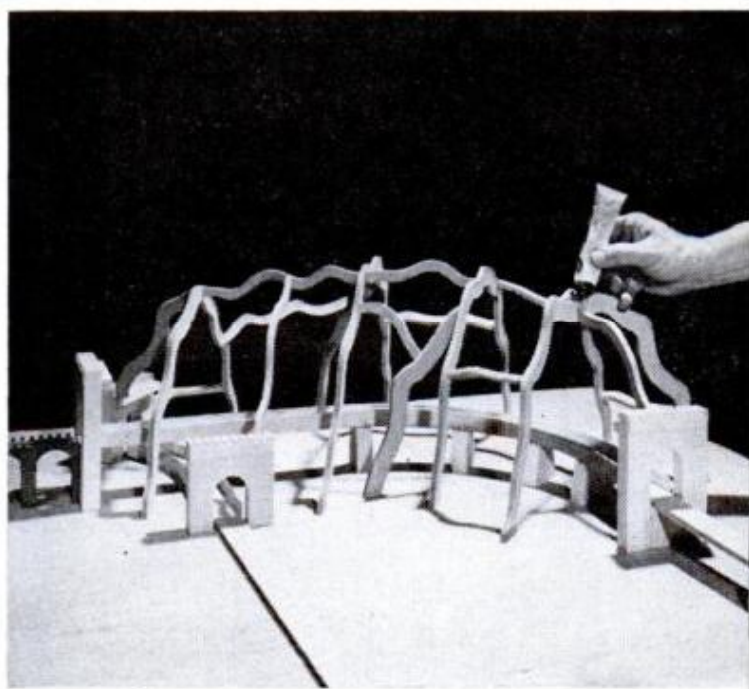

**SUPPORTING CAGE** of wooden arches is erected over mountain roadbed, bridged with butt-glued strips



**WOOD CAGE IS COVERED** with strips of shopping bags dipped in wallpaper paste and draped over top



**THICK TEXTURE PAINT** applied to paper shell stiffens it, adds terrain detail. Mountain is finally colored

of 30° (9-in. radius) curved track, 12 sections of 6° curved track, 17 sections of 4 1/8-in. straight track and 19 sections of 12-in. (actually 12 5/16-in.) straight track.

I made my roadbed of 1/4-in. plywood and laid out the complete roadbed on one full sheet by first drawing the centerlines of all the tracks. That's what you see in the diagram on page 191. Then I drew lines parallel to the centerlines to mark a roadbed 1 1/4 in. wide. Finally, I sawed out the whole roadbed in one piece with a sabre saw and wound up with a pretzel-like cutout.

Where the roadbed runs elevated inside mountains, the cutout is severed at points where the roadbed passes beneath at right angles to grade level. This is done at the three points marked "underpass" on the track diagram. You can now glue the whole roadbed cutout to the train board except portions of the roadbed that are to be elevated. These sections are left unglued. Where the roadbed is cut through, the missing sections are filled in with extra blocks.

Except for being of different heights, all tunnel portals are made alike from scraps of 3/4-in. pine. The two mountains require two 6-in. portals, two 5 1/2 in. and four 3 3/4 in. In addition you'll need a number of piers of varying height to support the roadbed between the portals. Pier A is glued to the back of the 6-in. portal, pier B to the back of the 5 1/2-in. one. Others are spaced 4 or 5 in. between. Both the portals and the piers are glued directly to the train board. Guard rails are finally glued to sides of the roadbed.

Mountains are fun to make. The first step is to build a wooden cage over the roadbeds. Here you jigsaw a number of arches of irregular shape and varying size, the largest being about 10 in. high and 14 in. wide, from 1/4-in. plywood. Cut them individually about 1/2 in. wide, making no two alike. Glue the arches here and there to the train board and brace them with anything handy until the glue dries. Stand the tall ones in the middle, the low ones on each side. Now bridge the arches with more wavy-cut strips, glued here and there, until you have a firm supporting framework. Your track, of course, should be tacked to the roadbed before you start.

The grocery bags you get at the supermarket are used to cover the wood cage.

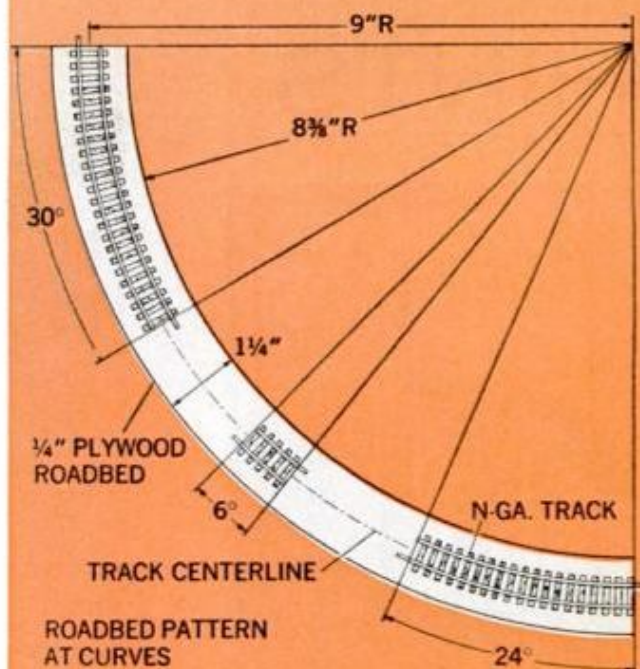

**TRACK SECTIONS** are standardized, come in six sizes; three shown here are of 9-in. radius and three of 7 1/2-in. radius. Permit double tracks at curves

Tear up about a dozen bags in 3-in.-wide strips and crumple them in balls to produce wrinkles in the paper.

The paper balls are dipped in wallpaper paste, two or three at a time. Crunch and squeeze them repeatedly while in the paste until they are completely saturated. Open up the strips and start draping the gooey lengths vertically over the wood cage, beginning at the bottom. Stick about 1/2 in. of the strip to the surface of the train board.

As you go, begin building up layers by placing more strips on top of the others. Use your fingers to smooth out the strips as they are applied. You'll find that the torn edges of the paper feather out perfectly in creating hills and valleys, cliffs and other mountainous terrain. Where a spot may look too flat you can use a stick on the inside to poke a bulge in the wet paper. After 10 minutes you can reach in and remove the stick and the bulge will stay. Stick the paper to the cleats on the backs of tunnel portals, also to edges.

The paper shell is now covered with a thick coat of texture paint, dabbed on with the swirl of a brush. When the paint is dry, you color your mountains with flat-drying (not glossy) green and charcoal paint. This is done with a "dry" brush so you retain some of the white undercoat. Apply the green first, then when dry, the charcoal, brushing the surface only here

*(Please turn to page 226)*

# HINTS

FROM READERS

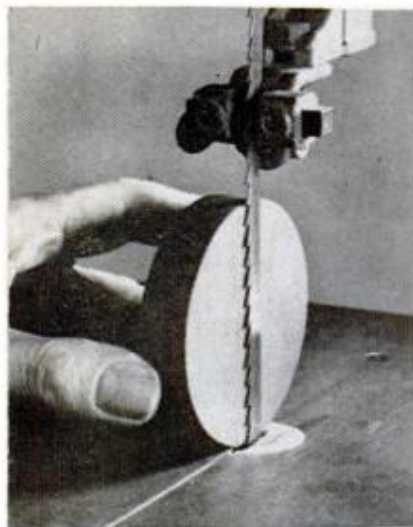

## Honing bandsaw blade

A bandsaw blade that constantly tracks to one side makes it difficult to follow the line when cutting intricate work. To correct this, you can hone the teeth on the errant side while the machine is running. Hold a fine stone with a light touch against blade, following standard safety practice to protect fingers. When blade tracks properly, readjust guides as per maker's instructions.—*Wilfred Beaver*



## Small-parts storage

Spotting ice-cube trays on sale in a supermarket, I picked up four to make this convenient shop organizer for small parts. Using scrap lying about the shop, my total investment was a miserly 40 cents. The cabinet shown has a  $\frac{3}{4}$ -in. pine base; sides, top and drawer-runners are of plywood scrap. Use glue and brads to assemble, then paint. The cabinet has 64 compartments for all small shop items.—*Edward H. Gold*



## Cap for oil-can spout

While reaching for my old-fashioned oil squirt-can, I inadvertently jabbed my palm on the tip. To avoid a recurrence, I tried corks and Styrofoam as caps but found these soft substances tended to plug up the spout. Then I hit on the idea of using a solderless-type wire connector. It was easy to find one that fit snugly. The threaded insert grips the spout and the connector stays put.—*Charles H. Hardy*

## NEXT MONTH IN SHOP AND CRAFTS

**HOW TO WORK WITH PLASTIC LAMINATES.** Though plastic laminates are generally acknowledged to be attractive and practically maintenance-free, they also have the undeserved reputation of being difficult to work with. This story gives all you need to know about cutting, bonding and trimming laminates to give your projects the craftsmanship look they deserve. To learn how, pick up a copy of the March PM.

**BUILD PM'S COOKOUT GAZEBO.** It's a freestanding beauty that we built in the hills of Connecticut. Featuring a cedar-shingle roof and a he-man-size barbecue cooking center, the gazebo lets you enjoy outdoor cooking, rain or shine. Complete plans for building it are in PM next month.

**NEW TOOLS FOR ORNAMENTAL SCROLLWORK.** They're imported from Great Britain and will have you turning out scrolls for railings, fences and the like in no more time than it takes to read the article. Learn how in PM next month.

**WEEKEND PROJECTS.** We've rounded up a passel of woodworking projects to keep your workshop humming productively over those late-winter weekends. Included in this 16-page special are instructions for making three footstools, a desk, chair, laundry table, lamp, knife tray and coffee table. For an "album" of woodworking fun, see the March PM.

Disturbed by dull taste?

20 CLASS A CIGARETTES

**KOOL**

*Filter Kings*

MILD MENTHOL CIGARETTES

Come up to  
**KOOL**  
It's refreshing

© 1970 B&W T Co. WILSON & GORHAM TOBACCO CORP.

## EASY-TO-FIX CARS

*(Continued from page 85)*

mistically, this might be accomplished by the time the '71 cars come out. On other components, the target is an improvement of five percent a year. An improvement at even the low end of the range could translate into impressive savings on a major teardown such as a transmission overhaul.

"We have different objectives for different parts," states Robert B. Alexander, chief engineer for Ford's product development group, "so it's difficult to pinpoint an overall figure.

"I'd put it this way: On a stripped car—I mean without airconditioning or mechanical complications—we've cut service time about five percent a year over the past five years. I think we'll equal or exceed that over the next five.

"But don't lock me in on the prediction," Alexander cautions, "because as cars grow more complicated, service problems multiply. In making that forecast, I'm

---

### **Detroit is . . . uncomplicating the steps necessary to get at the wearing parts of cars**

---

talking a stripped car today against a stripped car five years from now."

"Don't look for miracles," a GM man adds. "I think you'll see some pretty astounding developments viewed retrospectively, looking back say seven or eight years from now, where we stand today against where we expect to be then. But it will be an inch-by-inch proposition.

"Suppose we reduce service time on a three-hour job by a tenth of an hour this year, another tenth next year, another tenth the third year and so on. Over a period of eight or nine years we might conceivably lop an hour off the total time, so it becomes a two-hour job instead of three. That's not a dramatic gain on a year-by-year basis, but apply the same rate of improvement to other parts of the car and it's a real accomplishment. So if a car requires, say, 12 hours of service a year now, it might be possible to get the figure down to six hours by 1977."

If the best is yet to come, what do the changes car producers have made thus far mean to the man interested in cutting his repair bills now? The answer is another question: How do you rate as a mechanic?

The jobs the factories suggest do-it-yourselfers tackle are not difficult—changing plugs, replacing points, fuel filters, bulbs, adjusting engine timing, idle

speed and headlights and inspecting and packing front-wheel bearings. These suggestions come from the Maverick owner's manual, which has a 24-page section of self-service tips. (To the chagrin of some dealers, incidentally.) The jobs listed can be done by anyone who has tinkered with cars and has a fair assortment of tools.

"Even your fenders are bolt-on affairs," says a Maverick ad in an obvious tit-for-tat at Volkswagen, which has had bolt-on fenders since Car One. Going Ford one better, American Motors has bolt-on front fenders on all of its '70 cars. Bolt-on parts represent a break for the car owner if only because they don't have to be torched or hacked off. The less time it takes a mechanic to repair or replace a part, the lower the labor charge on the repair bill.

Lower labor charges are what car manufacturers are really talking about when they speak of simplifying service. Prices of service parts and materials are not being reduced. What Detroit is doing is uncomplicating the steps necessary to get at the wearing parts of cars—the items most likely to give trouble—so the mechanic can get at them in less time than before.

While the labor portion of repair bills should go down as a result of such efforts at service simplification, the total bill could remain the same, even go up a little over the next few model years. The trend in automobiles for 25 years has been to more equipment, more options, more luxury accessories, more safety devices, more everything. This adds up to more service. So the gains Detroit makes in reducing labor costs could be cancelled out as car buyers add on the extras.

Why Detroit's sudden interest in saving the long-paying motorist repair money?

Detroit denies its interest in cutting the cost of service is a recent development. "We've been working in this direction as long as I can remember," declares an engineer whose experience spans 28 years with Packard, Chrysler and GM. But while the industry may deny its interest is recent, the fact is that it's only within the past several months car companies have opened up on the subject publicly. Service used to be to automobiles what the common cold is to medicine—something to be endured.

"Service and repairs are negatives," a veteran public relations man explains. "Can you blame us for not talking about them? We're trying to sell a \$3000 to \$4000 product. It's an exciting transaction for most people. Sure, the car's going to get dirty, use oil, and the sheet metal will probably get dinged up. But the customer knows that. We just don't talk about it."

There's a long list of reasons for De-

*(Please turn to page 200)*

In the midst of all this excitement, there's one large bore. It's the carburetor with a fast feed design augmented by stainless steel reed valves.

This Sea-Horse 25-hp wins a lot of praise where dependability and operating economy rank high. Whether you're looking for sea food or sea fun, this is the motor to have in a pinch.

Start here with easy pulling manual starting. Accessory electric starting kit available.

Grab it here and by the handle in front. Now lift. 25 horses at only 3¼ lbs. per horse! You can easily carry it from car to boat. And once on the water, you can leave the lifting to those 25 lightweight horses.



If smooth, quiet, float-boating is your game, more power to you with this Sea-Horse 25. Slim, flutter-free piston rings and a counter-weighted crankshaft take all the shout and shimmy out of pontoon power. You'll never lose your cool or spill your cola with this old smoothie on board.

This outboard is a moderately-priced introduction to the fun of water skiing. It can go all out, all day with someone hanging on behind. Tomorrow, it'll be ready to go again, if you are.

Like all Johnson outboards from 115-hp to 1½-hp, the Sea-Horse 25 carries this exclusive 2-year warranty: For 24 months after purchase, Johnson Motors will replace or repair without cost to the original purchaser any part of its manufacture which, upon inspection, proves to have failed in normal pleasure use due to faulty material or workmanship.



Fishermen are lured by the 25's combination of quick delivery, tireless trolling and a high performance prop that runs surprisingly weed-free. It's the greatest thing to happen to fishing since the self-opening beer can.

Snorkelers will fog their face masks over the way this Johnson jets them to the scene. Once underwater, a peek at the lower unit tells why. It's hydro-dynamically designed to minimize turbulence and drag forces.

FIRST IN DEPENDABILITY  
**Johnson** Div. Outboard Marine Corporation  
*is the way to go!* Visit your Johnson dealer. Or write for a free catalog. Johnson Motors, Waukegan, Ill. 60085, Dept. PM-72.

**WHO  
BUILT  
THE  
WORLD'S  
LARGEST  
BREWERY?**

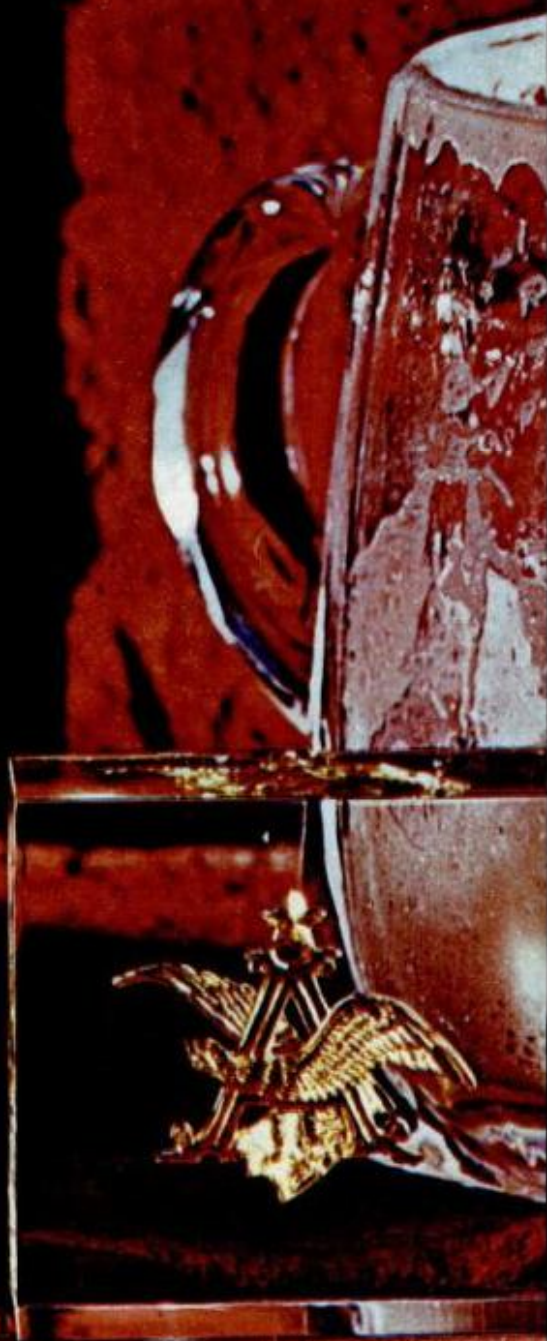





**You did.  
(and we thank you!)**

## EASY-TO-FIX CARS

*(Continued from page 196)*

troit's dramatic turnaround. For one thing, the industry is concerned about the declining "fun factor" of owning a car. High insurance premiums, license fees, the parking problem, mandatory inspection laws, congested highways, accident statistics and frightening headlines telling of car fatalities, the cost of borrowing money to finance an automobile, the cost of repairs, not to mention higher price tags on the basic wheels—all of these factors conspire against the pleasure of owning an automobile. Detroit believes anything it can do to ease the burden will make operating an automobile more of a pleasure.

Another objective is to take the heat off Detroit. The insurance industry accuses automakers of designing cars that are cumbersome and costly to repair, a charge backed up by many mechanics.

The chorus of complaints on this count reached such a crescendo last spring that

---

### **One Detroit estimate pegs the shortage of mechanics at . . . 750,000 by 1975**

---

Congress held hearings on the subject. Spending on car repairs, according to Michigan Sen. Phillip A. Hart, is running at a rate of \$26 billion a year, only \$3 billion under the amount spent on new cars. Hart also estimates that the repair bill is accelerating at a rate of \$1 billion a year!

There are more Congressional hearings to come. In the first go-around, Detroit wasn't in a position to do much but take the pie full in the face. But in the next phase of the investigation, carmakers will come armed with attache cases bulging with evidence they are concerned about and doing something to reduce repair bills.

(Off the Congressional hot seat, automakers angrily refute the charge they are unconcerned about the price the public pays for service. "We have a selfish interest in keeping repair bills as low as possible," the service manager of a Big Three division snaps. "Under the new car warranty, we foot the repair bill for the first year, so it's to our advantage to reduce the cost of service.")

But there's an even more urgent reason—more compelling than any of those cited above—behind Detroit's drive to simplify car repairs. Car manufacturers won't say so for direct attribution, but they admit privately there are not enough mechanics and service capacity to care for the num-

ber of automobiles in use. In 1950, there was one mechanic for every 73 vehicles (cars and trucks). The ratio today is one mechanic for every 131 vehicles. A Chrysler vice president, Byron J. Nichols, sees the gap growing to one technician per 140 vehicles by 1975. An ideal ratio, most authorities agree, would be one man for every 80 to 85 vehicles.

One Detroit estimate pegs the shortage of mechanics at 500,000 and predicts the figure will grow to 750,000 by 1975. This assumes a recruiting rate of no fewer than 40,000 new mechanics a year and no significant drop in the present work force.

The demand for automobile service, in the words of Henry Ford II, is "an explosive problem with a short fuse already lit. The roots of the problem," says Ford, "are familiar. More vehicles being driven more miles, the growing variety and complexity of models, and the rising expectations of car and truck owners."

GM president Edward N. Cole makes the same point in more conservative language. "The magnitude of this assignment (providing service) is increasing," Cole admits, "because of a rise of more than 40 percent (in car population), the higher level of expectations by car owners, and the critical shortage of competent automobile mechanics."

The auto industry, service industry, oil companies, trade schools and other groups have undertaken crash programs to recruit more mechanics. But the lines in front of dealer service departments and repair shops grow longer and form earlier in the morning. Where Detroit used to campaign in its advertising against gas station mechanics, downgrading them as inferior "grease monkeys" to the "factory-trained" technicians employed by dealers, many industry executives now make a point of throwing in a kind word for non-dealer mechanics in discussing service.

Detroit doesn't hold much hope of restoring a balance between the number of cars on the road and the number of mechanics to work on them. But it sees a sliver of light at the end of the tunnel in the idea of simplifying repairs so (1) car owners can handle more of the minor jobs on their own and, (2) a smaller force of mechanics will be able to turn out a greater volume of work.

What are the prospects for a car you can service entirely on your own?

"I can't see it," says Ford's Bob Alexander. "We're making improvements all the time. We can lengthen the life of parts and reduce service requirements. But you can carry that concept only so far. I don't think any mechanic has to worry about losing his job." ★★★



We build a Chevy Mover for extraordinary use. (The ordinary, we leave for ordinary pickups.)

So it'll do a better day's work than the best of them. And come on stronger when the good times start to roll.

Because of extra power from the biggest 6 or V8 engines provided in any popular make. And a suspension so smooth and tough it's known as the Bump Exterminator.

This one's something else. You can order

it with all the interior niceties of a car and car-like power assists to spirit you through week-end jaunts or suburban chores.

Come to think of it, a Chevy Mover not only has more going for it than the ordinary truck. It also has more than the ordinary car. Maybe that's why it's living in those one-car garages.



**Putting you first, keeps us first.**

**A lot of Chevy pickups live in one-car garages.**



# SEE FOR YOURSELF How to Fix Almost Any Part of Any Car!

**QUICKLY, EASILY and RIGHT on the very first try**

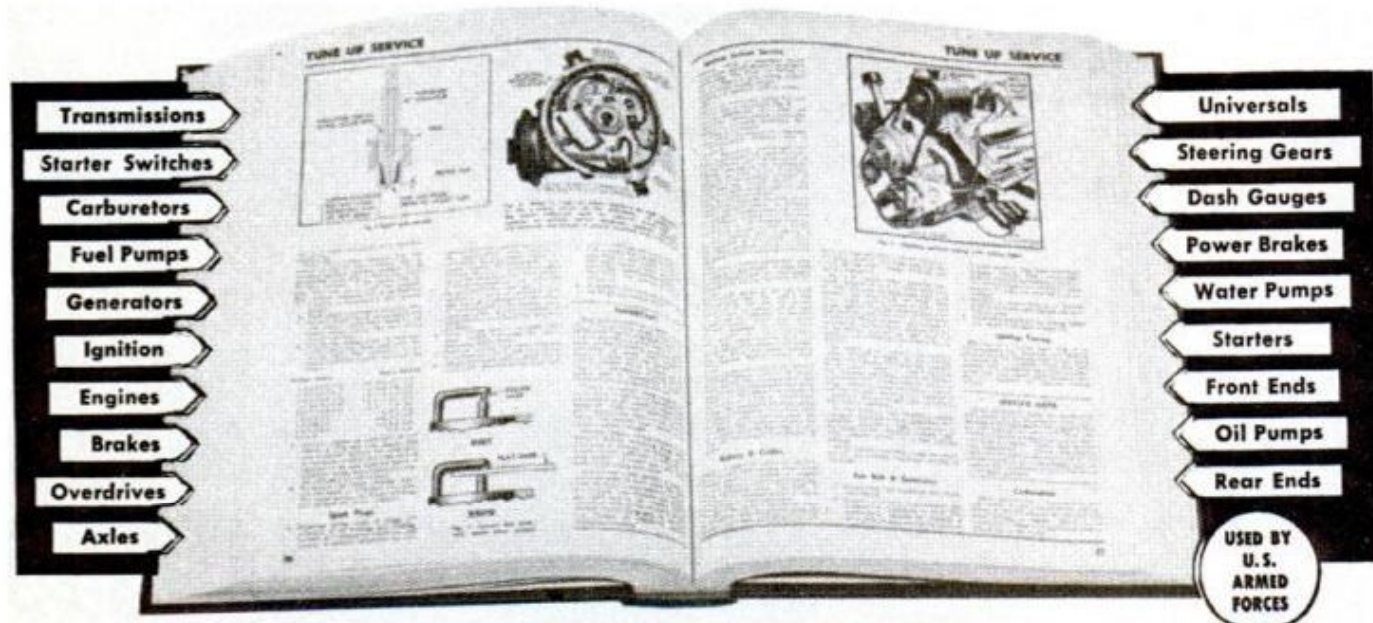

Transmissions

Starter Switches

Carburetors

Fuel Pumps

Generators

Ignition

Engines

Brakes

Overdrives

Axles

Universals

Steering Gears

Dash Gauges

Power Brakes

Water Pumps

Starters

Front Ends

Oil Pumps

Rear Ends

USED BY  
U.S.  
ARMED  
FORCES

## THIS GIANT PICTURE BOOK SHOWS YOU STEP-BY-STEP HOW TO REPAIR PRACTICALLY EVERY CAR BUILT FROM 1964 THRU 1970

Whether You're a Beginner or an Expert Mechanic—This Manual Can Help You "Breeze Through" the Toughest Auto Repair Job

OVER 5,000,000 COPIES SOLD!

**D**ON'T waste time, money, energy by trying to guess how to fix a car! Do what the experts do. Whether it's a simple carburetor adjustment or a complete overhaul—simply look up the job in the index of MOTOR's New **AUTO REPAIR MANUAL**. Turn to page covering job. Follow clear, illustrated, step-by-step instructions. See for yourself how easy it is!

No guesswork! MOTOR's Manual takes nothing for granted. Tells you where to start. What tools to use. Then it leads you easily and quickly through the entire operation!

**Over 3,000 Pictures! So Complete, So Simple, You CAN'T Go Wrong!**

**BRAND NEW!** Covers all major makes, 1964 thru 1970, including all new compacts, over 1,000 pages, 3,000 "This-Is-How" pictures, 365 "Quick-Check" charts, 55,000 essential specifications. Over 225,000 service and repair facts. Instructions and pictures are so crystal-clear you just can't go wrong!

**Same FREE 10-DAY Offer on AUTO ENGINES & ELECTRICAL SYSTEMS**



1,300 big pictures. Clear how-to text on principles, design, maintenance of all parts of engines & entire electrical system. For **FREE** trial, check coupon.

### Meat of 300 Official Shop Manuals

Engineers from every automobile plant in America worked out these time-saving procedures for their own motor car line. Now this wealth of "Know-How" from 300 Official Shop Manuals has been "boiled down" into crystal-clear terms in one handy indexed book! No wonder Manual is used by so many schools!

**SEND NO MONEY  
Try Book for 10 Days FREE**

Just mail coupon. We'll send you this 1970 Edition to use **FREE** for 10 days. Test book in your own garage or shop. It's **GUARANTEED** to pay for itself in 10 days. If it doesn't, return it, and owe nothing. Rush coupon now. **MOTOR Book Dept., 250 W. 55th St., New York, N. Y. 10019.** (SCHOOLS, BOOKSTORES: Write for discounts.)

**CLEAR UP 'MYSTERIES'.** "I always rely on Motor when I do a repair I am not familiar with."  
—E. Jones, Minnesota (Shop Owner)



**GREAT HELP FOR STUDENT.** "Motor pulled me out of some rough spots in high school, and now in the Armed Forces motor pool."  
—W. Bekemer, Missouri (Apprentice)



MAIL COUPON FOR  
**FREE**  
**10-DAY TRIAL**  
OF MOTOR'S AUTO REPAIR MANUAL

No obligation. No risk.  
If not delighted, return  
book and owe nothing.

**MAIL COUPON NOW FOR 10-DAY FREE TRIAL**

**MOTOR BOOK DEPT., Desk 0012  
250 W. 55th St., New York, N. Y. 10019**

Rush to me at once (check box opposite book you want):

**MOTOR's New AUTO REPAIR MANUAL.** If O.K., I will remit \$2 in 10 days, \$3 monthly for 2 months and a final payment of \$1.95 (plus delivery charge and sales tax if any) one month after that. Otherwise I will return the book postpaid in 10 days.

Print Name..... Age.....

Address.....

City & State..... Zip Code.....

Also send me for 10-day Free Trial **MOTOR's AUTO ENGINES & ELECTRICAL SYSTEMS.** If O.K., I will remit \$8.95 delivery charge and sales tax, if any, in 10 days. Otherwise I will return book postpaid in 10 days.

Check box and save shipping charge by enclosing **WITH** coupon payment of \$9.95 for **AUTO MANUAL** (or \$8.95 for **AUTO ENGINES**) plus sales tax, if any. Same 10-day return-for-refund privilege.

# You get more for your money from NRI

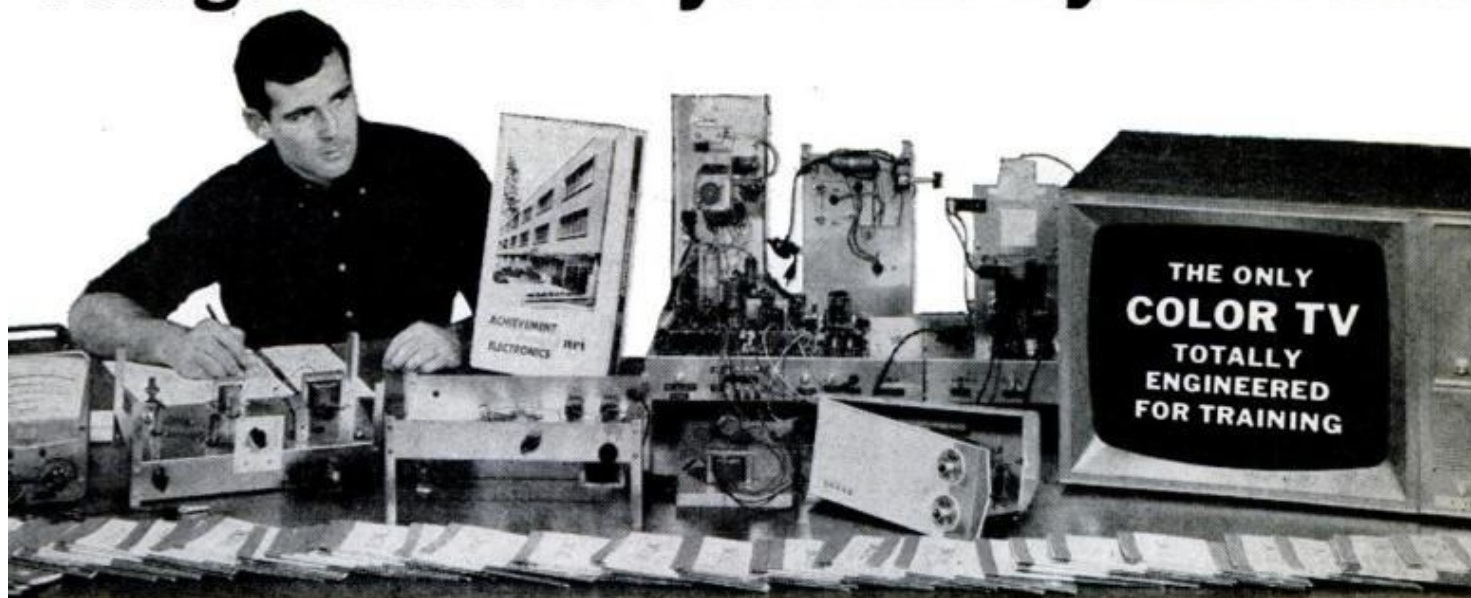

**BUILD • TEST • EXPLORE** All this is yours — from Achievement Kit, to solid state Radio, to training-engineered Color TV set—when you enroll for NRI's TV-Radio Servicing course. Other courses equally complete. Unique training methods, "bite-size" texts, many personal services have made NRI the leader in its field for over 50 years.

## NRI Programmed Equipment Gives You Priceless Confidence, Makes Learning TV-Radio, Electronics Fast and Fascinating

NRI pioneered the idea of supplying home-study students with custom designed training kits to give practical on-the-job experience as you learn. Today, NRI's "3-Dimensional" training can't be equalled. You get more value — from the exclusive Achievement Kit sent the day you enroll, to "bite-size" texts and custom training equipment. Learning TV-Radio, Electronics or Communications at home is easy, exciting, the NRI simplified, dramatized way.

### BE A SKILLED TECHNICIAN IN AMERICA'S FASTEST GROWING INDUSTRY

Regardless of your educational background, you can learn the Electronics field of your choice the practical NRI way. The NRI color catalog, sent to you free and without obligation, tells you how you can qualify quickly to be a part of the fast growing Electronic Age; about engineering jobs in business, industry, broadcasting, government, now offered to men without college degrees. It will open your eyes to the great number of success opportunities available right now in the high-pay world of TV-Radio Servicing, Broadcasting-Communications and Industrial-Military Electronics. With NRI technical training, you can take your choice of a wide variety of career

openings or have a business of your own. And if you choose one of five NRI courses that include FCC License preparation, you must earn your FCC License or NRI refunds your tuition!

### MAKE \$5 TO \$7 AN HOUR EXTRA IN SPARE TIME STARTING SOON

Tens of thousands of NRI graduates are proof it is practical to train at home in your spare time. Keep your present job while preparing for a better one, and earn \$5 to \$7 an hour extra in spare time while you train, fixing sets for friends and neighbors. NRI shows you how. Equipment you build and keep becomes useful in your work.

### STEP UP TO BETTER PAY, A BRIGHTER FUTURE

NRI can help you, but the decision to act must come from you. Decide now to move ahead . . . mail the postage-free card today for your FREE NRI color catalog. No obligation. No salesman will call. NATIONAL RADIO INSTITUTE, Electronics Division, Washington, D.C. 20016.

#### APPROVED UNDER GI BILL

If you served since January 31, 1955, or are in service, check GI line on postage-free card or in coupon.

### CASH IN ON THE BOOM IN COLOR TELEVISION



The NRI TV-Radio Servicing course includes your choice of black and white or color TV training equipment. Color TV needs thousands of trained men to keep pace with millions of sets being sold every year. NRI prepares you quickly. Cash in on the boom.

Mail insert card for your **FREE NRI color CATALOG**

No salesman will call



## ACROSS CANADA

(Continued from page 125)

succession of delightful little scenes: the lobstermen's wharves; the brick-red soil of the island contrasting with the green of the crops; the neat fields trimmed with deep-toned evergreens (I'm always reminded of pictures of British countryside).

Having driven the Trans-Canada Highway part way across New Brunswick to get to Prince Edward Island a few days earlier, we chose an alternate route to the St. Lawrence River above Quebec City.

It took us along Highway 109 through a game refuge located between Renous and Plaster Rock. The scenery was exactly what the province promises: thick forests crowding the road and sweeping views of gently sloped mountains. That road, though, was something else: an unre-

---

### **A long, potentially exhausting trip—but a real vacation because of the vehicle.**

---

lenting gravel washboard, occupied by us and huge, log-bearing trucks. Our motor home got its most thorough shakedown, and we happily discovered that the body is so tight no dust got inside.

This was the worst road of the trip, but I must emphasize that it was not part of the Trans-Canada Highway.

As we traveled westward toward Winnipeg, we stayed in both provincial and private campgrounds. Prices averaged \$3.

At Quebec City we camped in a private site on the northwest edge of the city, then drove downtown the next morning early enough to avoid traffic and get a good parking spot. We left the motor home near the tourist center a few blocks from Chateau Frontenac. Our walking tour of the city started from the tourist office. . . on to the boardwalk in front of the Chateau . . . up the slope to the Citadel where we watched the French-Canadian Royal 22nd Regiment perform its colorful changing of the guard ceremony. . . then down into the lower city among fine old buildings that date back to the 1600s.

The next big city to the west, Montreal, is still unmistakably the site of Expo 67. Virtually all of Expo's exciting buildings still stand on the islands in the St. Lawrence, and "Man and His World" is still a fascinating exposition. The city itself is a lively mixture of culture, history and night life. We left our camper in a private site along the river and traveled by cab, bus and rail.

Our visit to Montreal points up one of the negative characteristics of a single-unit camping vehicle. If you want to leave your campsite, you either get another vehicle or take your entire camp with you—even if it's only to go a mile to a store for a loaf of bread. (Okay, okay, I *should* walk.) Our Glastron was easy to drive, and I had no particular problems even in heavy traffic, but I found that—with other transportation available—I was reluctant to take it into a city like Montreal and go through the drill of parking it.

Farther west is Ottawa, Canada's capital, where gothic Parliament buildings reassert the British heritage that a tourist may have forgotten in French Canada.

Beyond Ottawa, Ontario seems to stretch on forever. The highway leads through forests and scrubland, past tree-lined lakes, beside streams filled with sawmill-bound logs and along the edge of Lake Superior. The lake route was the most surprising part of the trip for me. It's mountainous and spectacular—especially in Lake Superior Provincial Park—where I expected relatively flat terrain. I was surprised again after we entered Manitoba and approached Winnipeg—this time by the absolute flatness of land that I had expected to find flat, but not *that* flat.

Winnipeg, too, is different from what I expected. Right now, it's probably the way I generally think of it: buried in snow. But in summer, it's a handsome, colorful city.

From Winnipeg, we headed south and returned through the United States.

In all, it was a long and potentially exhausting trip—but a real vacation because of the kind of vehicle we used. To its list of pluses, I should add the 318-cu.-in. Dodge engine that moved us as fast as we ever wanted to go (Mileage: 8.9 mpg.)

Even in luxury, though, one must complain. I'll start with the bunks. They're generally a bit tight to be called "double," and the mattresses (seat cushions in daytime) tend to slide around and leave me on plywood. There's just one door located about halfway back on the right side, and the driver must scramble back to it every time he wants out. And the back windows do not open, a situation that leaves sleepers the choice of running the airconditioner or sleeping in dead air.

But, having camped in everything from a jungle hammock to this Glastron, I'd judge a motor home the best way to go when you want to do a lot of traveling. Like maybe the other half of Canada which I still want to see. ★★

Next month, auto editor Bill Kilpatrick will describe his vacation in a smaller motor home, the Corey Cruiser.

Need More Money? Want to Be Your Own Boss?

# START SAW SHARPENING BUSINESS

Of Your Own - in Your Sparetime



Turn your spare hours in the evening or weekends into extra dollars, this proven practical way—start your own money-making sharpening business—No selling or canvassing—No experience required. You can do it automatically with the Foley Saw Filer or Lawn Mower Sharpener.

## Beginners Earn \$3 to \$6 an Hour

People, just like yourself, all over the United States are making extra cash—\$20 to \$30 a week—right now in their spare time. "My sparetime saw filing business has made me \$952 these first ten months," says R. T. Chapman. Many start part-time, find it so profitable that they build year-round service business. You can, too, simply by following easy Foley plan.

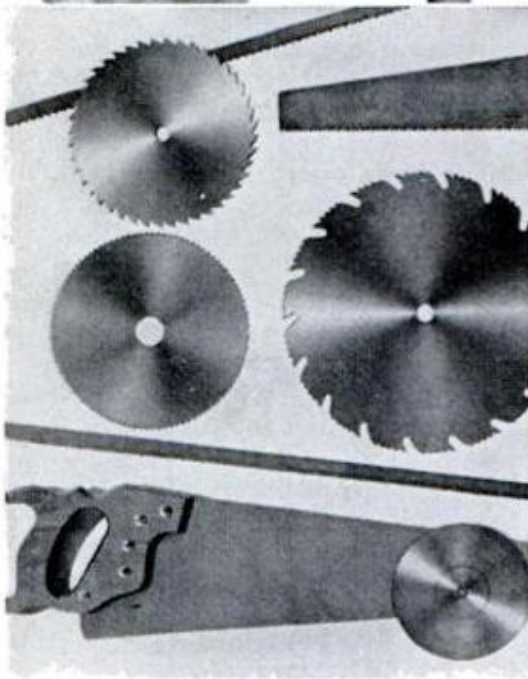

## Town of 150 Supports Profitable Business

Here's the story from Dick and Jo Ann Koester after being in business less than a year. "We have acquired another Foley Saw Filer and for the past two months we have been in full-time operation. As we live in a small town of 150 population in farm area we use our truck to pick up saws in five nearby towns. With a family to support and plans for building to our house we had to pick up a business fast and already sharpen an average of 15-20 saws a day. Business for the future looks even better as good machine filing is our best advertising."

## CASH for Sharpening Mowers

Every neighbor with a lawn needs his lawn mower sharpened at least once a year. No experience is needed to start—anyone can operate and turn out professional jobs. All operations are handled quickly, easily and accurately.



## Sharpen These Professionally with amazing Foley Saw Filer

You can sharpen combination (rip and crosscut) circular saws, band saws, hand saws, crosscut circular saws—and do a perfect job every time without experience or special training. The precision Foley Filer does it for you automatically! A complete repair shop in one machine! Set up in basement or garage, work your own hours in your own way and earn big sparetime profits.



## FREE

**BOOKLET TELLS HOW!** Free Book "Money Making Facts" shows just how you can start at home in spare time. Small investment—time payments if desired. Get this booklet—study it! Send coupon today. No salesman will call on you.

Foley Manufacturing Co., 216-O Foley Bldg.  
Minneapolis, Minnesota 55418

Send Free Booklet on  Saw Sharpening Business  Lawn Mower Sharpening

Name \_\_\_\_\_

Address \_\_\_\_\_

City \_\_\_\_\_ State \_\_\_\_\_ Zipcode \_\_\_\_\_

## THEY HANDLE THE HOT STUFF

*(Continued from page 109)*

to take over the big job of reassuring the public.

"We never attempt to conceal anything" Weintraub goes on. "We give people the straight facts, whatever they are. Far from trying to avoid the press, we call in reporters and TV men, especially if the situation is a continuing one, calling for efforts on our part that might alarm people."

A situation that dramatically illustrates what he's talking about occurred at the University of Alabama. The REAT members from Savannah River responded to the call that came in from worried university officials. A container of polonium 210 used in a physics lab had been damaged. When the leak was discovered nobody knew exactly when it had started. A lot of students and teachers had been in and out of the lab during the day and had gone home and into the other buildings.

From the degree of contamination their

---

### **All teams are . . . rehearsing what they'll do if they have to deal with the Big One . . .**

---

instruments showed in the lab, the REAT men were sure that the radioactivity had been spread on clothing and shoes. All "carriers," their cars, and the buildings they had entered would have to be checked. University officials were upset by the possibilities of creating public hysteria as this process went forward. Would an effort be made to conceal it?

"It'll create problems if we try to keep it secret," was REAT's advice.

The result was that the search for radioactivity was made in the full glare of TV and newspaper coverage, with briefings from REAT men. The search eventually extended to 15 cars, 40 rooms in 10 campus buildings, and 10 homes. No appreciable radioactivity was found. Nor was there any undue concern on the part of the well-informed citizens of Tuscaloosa.

Some of the most troubling public reactions have been in response to incidents that didn't involve radioactive material at all. They're hoaxes, false alarms. Typical was the call that came in from an Oregon beach community. A crowd of Fourth of July revelers was panicked by a barrel which had floated ashore. Stenciled on it in ominous red letters was "Radioactive—AEC."

When the team that flew out from Richland, Wash., arrived, a check with their instruments showed nothing. Still, to make everybody happy, they solemnly carted the barrel away, and flew it back to the labs in Richland. It turned out to contain only oil and water.

Many REAT cases involve a search for a lost radioactive item that couldn't do any widespread harm, but which might possibly injure a person who happened to pick it up and carry it around. A recent one was the affair of the missing needles. The Chicago REAT got a call from a railroad official. Somewhere between California and New York some tiny radioactive needles, used in radiation treatment, had fallen out of a crate. The boxcar they had been hauled East in had already been reloaded and sent to another destination but it had been shunted to a siding in Elkhart, Ind., as soon as the loss was reported.

The Chicago men drove to Elkhart where, sure enough, their instruments revealed that the boxcar was hot. It took almost a day to have the car unloaded. When it stood empty, the REAT men found the source of the radioactivity fast enough—one needle nestled between the floor's metal tracks. Just one. The search would have to be widened.

One at a time more needles were found. At the trucking terminal in San Diego, where the shipment had originated; in Los Angeles, in a truck; in San Jose, where the truck had picked up another shipment; in New York, in a station wagon that had carried the crate to a Queens chemical plant; on the plant's parking lot; and alongside a loading platform on a Manhattan street.

The REAT men are unhappy about the fact that they never found four of the missing needles. They conclude that they were swept away with trash or washed down storm drains. The tiny objects are not the sort of thing anybody would pick up, even if he saw one. Actually, no great harm would have been done had they not found any of them, but it's a matter of pride that REAT men don't give up trying until they know there's zero chance of success.

All teams are constantly rehearsing what they'll do if they have to deal with the Big One—a major disaster involving radiological materials. There is an ominous list of possibilities—fire, flood, hurricane, tornado, earthquake, plane crash, train wreck. So far they've dealt with an avalanche and a fire.

The avalanche occurred in Idaho when a snow and rock slide roared down on a

*(Please turn to page 210)*



# YOUR SPARE TIME + TABLETOP MACHINE

# = EXTRA INCOME!

From Amsterdam, New York, to Zenia, California, people are converting spare time to dollars in the fabulous Plastic Laminating field . . . *right from their own homes!* No canvassing or selling. We not only supply the equipment you need for the work but show you exactly how to cash in on the BIG, daily profits in two big-demand fields.



WHAT OTHERS SAY...

## A Fortune in Plastic Sealing

This is the area in which you can really make money. Your material costs are only ten percent of your selling price! And, there are millions of people wanting to protect valuable cards, photographs, documents and papers against wear, soil, damage. Through the MAGIC MAIL Plan you get this business through the mails . . . open envelopes . . . take out money and orders . . . just let your mailman be your banker! Details of the plan will amaze you; and all you need to do is mail the coupon to receive the complete details . . . *absolutely FREE*. We will even furnish financing help.

The opportunities in Plastic Laminating are so tremendous that space here does not permit even skimming the surface. To get any idea of the scope of these markets, *and your place in this sensational business*, you must read the full details . . . see for yourself how easy it is to do the work . . . find out how YOU can fit yourself into this BIG-PROFIT picture.

## Huge Profits in ART CREATIONS

Laminations lend themselves beautifully to original and unusual art forms that sell for twenty or more times the cost of materials. Gift and boutique shops are a ready market for your entire output because of the one-of-a-kind appeal. Here is your opportunity to put your own creative, artistic talents to work for you . . . and, it costs you nothing to find out how you can gain complete, personal independence in a big-money business of your own. All informations, fully illustrated with pictures, is FREE. No salesman will call.

### Make Thousands of Beautiful Art Creations

LAMP BASES • CLOCK CASES • LETTER HOLDERS • PICTURE FRAMES  
CIGARETTE BOXES • NAME PLATES • CHARMS • COASTERS • CHECKERS  
CANDLESTICKS • NOVELTY BUTTONS • FISH LURES • KEEPSAKES OF ALL KINDS



"I only wanted a few extra dollars a week to get my hair done. Now I could get my hair done twice a day, every day, and still have money left over! Thanks to Warner's Model 100 Laminating Press."

Mrs. J. C., NY

"We were married and had three children when we decided to go to college. After seeing their paste-board I.D. cards, I contacted the administration and arranged to perm-anize all I.D. cards. With an enrollment of 700 or more students each year, you can see that this came in mighty handy for my family. My thanks to all of you at Warner's."

C. F. M., MO

"We bought one of your Laminating presses six months ago, and have built up a good business . . . both wholesale and retail. Please send us another complete Laminating Shop."

D. F. B., TX

And S. D. M. says—"My income from plastic sealing and laminating now exceeds thirty thousand dollars a year, and my supply orders to your firm over the past few years will bear me out. I'm happy I added your Model 400 to my shop."

## MAGIC MAIL PLAN...

"With the MAGIC MAIL PLAN I get better than 100% returns. I follow your program exactly . . . laminating in advance. This way I get 90% of the money asked, plus additional work. I always end up with more than 100% returned."

E. M., OH

## YOU CAN SAY!

Never before has an opportunity with such scope been offered the small home business operator . . . offered at a time when that extra income is of prime importance. Read what others have to say and be assured that you'll be able to say it, too.

Warner Electric Co., Inc., Dept. L-2-B  
1512 Jarvis Ave., Chicago, Ill. 60626

**TO LEARN WHY PLASTICS  
are the WAVE of the FUTURE  
. . . MAIL THIS COUPON TODAY!**

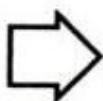

When all it takes is a postage stamp to find out about a spare-time, home-operated business that is easy . . . fun . . . and profitable, what are you waiting for? Get the FREE facts . . . read all about it in the quiet of your own home . . . find out how you can test the market potential in your own locality without investing one penny! All information about this fascinating business is absolutely free and no salesman will call.

WARNER ELECTRIC CO., Inc., Dept. L-2-B  
1512 Jarvis Avenue, Chicago, Illinois 60626

Yes, I am interested in converting my spare time into extra income. Please send me complete information, FREE, and tell me about your new Lower-Than-Bank-Rate Credit Plan and how I can get orders and money by the MAGIC MAIL Plan. I understand no salesman will call.

NAME \_\_\_\_\_

ADDRESS \_\_\_\_\_

CITY \_\_\_\_\_ STATE \_\_\_\_\_ ZIP \_\_\_\_\_

Two or four-wheel drive  
**JEEP OR SCOUT OWNERS**

**REPOWER** with a 6 or V-8. H.D. ADAPTORS for using Car, Compact and some Truck engines. "State, year & model, Jeep or Scout." Want fast action? Give us **FULL INFORMATION**. Send \$25.00 Dep. and we will ship correct kit, bal. COD. Send full amount for prepaid shipment. Wire, phone or write today. Details **FREE**

**HOOSIER MACHINE PRODUCTS CO.**

312 S. E. 6th St., Phone 276-3442, Pendleton, Oregon 97801

**MAKE MONEY!**

**REPAIR HYDRAULIC JACKS**



Earn while you learn at home. Millions of jacks in gas and auto service stations, trucking firms, body shops, riggers, factories and farms need servicing... most of which you can learn to repair. We show you HOW. Start spare time in your basement or garage. Big opportunity for mechanics. **ACT NOW!**

Write for Folder P.M.-2 and Free Bonus Offer

**Hydraulic Jack Repair Manual Co., Inc.**

P.O. BOX 3 • STATEN ISLAND, N.Y. 10314

**LIFETIME "SPIN-ON" OIL CLEANER**



Cleans motor oil 100 times cleaner than any other "spin-on" filter. Never drain oil again. Never buy another spin-on filter. Change 15 cent element every 3000 miles, available everywhere. Doubles engine life. Oil is 100% clean 100% of the time. Guaranteed 5 years. \$25.95 post paid. Write for the facts. Save \$8.00 every 3000 miles.

**VIRDEN PERMA-BILT**

Box 7066 PM, Amarillo, Texas 79109

**LOOSENS RUSTED NUTS, BOLTS, PARTS**



**LIQUID WRENCH**

AT HARDWARE & AUTO STORES

**ROTARY FILES**



U.S. Surplus High Speed Milling Files going fast. New, in G.I. Packs. Hardened steel, for filing, milling, routing, drilling—any work in light metal or wood. Use in 1/4 in. drill, etc. Range in size from 1/4 to 1 inch wide. Get these most useful tools now.

16 tool set—government cost \$109..... \$ 9.00 to you!  
36 tool set—government cost \$265..... \$15.00 to you!  
100% GUARANTEED. WE PAY POSTAGE. A LIFETIME BUY!!

**THE SURPLUS CENTER**

LANCASTER, TEXAS 75146

**locksmithing and key making**

**PRACTICAL UP-TO-DATE COURSE—ONLY \$7.95**

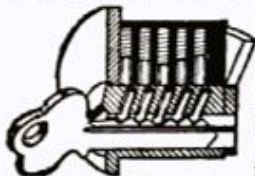

Teaches you how to pick locks, de-code, make master keys, repair, install, service, etc. New self-instruction lessons for every handyman, homeowner, carpenter, mechanic, service station operator, fix-it shop, hardware dealer, gunsmith, 53 easy illustrated lessons. Full price only \$7.95 post-paid. Satisfaction or refund guaranteed. Mail order today!

**NELSON-HALL CO., Dept. BP-2**  
325 W. Jackson Blvd., Chicago 60606

**LAW FREE BOOK** **THE LAW TRAINED MAN**

Write today for a **FREE** copy of illustrated law book, "THE LAW-TRAINED MAN," which shows how to earn the professional Bachelor of Laws (L.L.B.) degree through home study of the famous Blackstone Law Course. All necessary books and lessons provided. Moderate cost; convenient monthly terms. Write for **FREE** law training book today.

**Blackstone School of Law, 307 N. Michigan Ave.**  
Founded 1890 Dept. 52, Chicago, Illinois 60601

**OUTDOORSMEN**  
wanted for 500,000  
exciting new jobs!



**FREE** Career Kit shows how to qualify at home in spare time for big-pay jobs now open as Forest Ranger, Park Officer, Fish-Wildlife Mgr., Game Warden. Lifetime security. Many other benefits. H.S. diploma not required. Approved under GI Bill. Write Conservation, 2000 P St., N.W., Washington, D.C. 20036, Dept. 2102N.

**THEY HANDLE THE HOT STUFF**

(Continued from page 208)

train which was hauling treated uranium from one AEC plant to another. The team from Idaho Falls got there by plane, quickly started the task of locating the particular cars that contained the hot stuff. That done, they directed the process of getting it loaded aboard other cars and on its way again.

The fire rates as the greatest disaster in the history of the atomic age. One Sunday in May, 1969, plutonium used in making nuclear warheads burst into flames at the Rocky Flats, Colo., plant near Denver. Regular firefighters stationed at the plant on working days were off duty, and the fire department which responded to the alarm turned in by a watchman used water on the fire, causing it to spread. Before the flames were extinguished, the cost ran to \$50,000,000. Actually, the Albuquerque and Idaho Falls teams, though they stood by, were not needed to cope with this emergency. There were no explosions. No radioactivity was spread, and regular plant personnel was able to take over the task of supervising removal of radioactive debris to Idaho, where it was buried in an atomic "graveyard" used for the purpose.

A disaster that REAT is ready to cope with is an accident involving an aircraft carrying nuclear weapons. Actually, it's not likely to happen—and if it did, the experts are reassuring. No atom bomb is going to be set off by flames, impact, or anything short of the designed mechanism, which has proved itself to be thoroughly fail-safe.

In such an emergency, though they know how to handle it, the men of REAT would toss the ball to the parallel organization, NET, the nuclear emergency teams maintained by the Department of Defense. So far, NET's emergency calls have been few.

Most famous NET job was the one that resulted from the Palomares incident. In January, 1966, a KC-135 tanker and a B-52G collided during a refueling operation at 30,500 feet near the southeast coast of Spain. The bombs aboard fell onto land at Palomares and into the sea nearby. Within hours of the event, NET teams from Albuquerque and other bases were on their way to Spain. The earth contaminated by the bombs that fell on land was analyzed and all that was radioactive was removed. Eventually, with the submarines, underwater cameras, and many sophisticated detection devices, the bomb which had fallen into the water was located and retrieved.

★ ★ ★

# Introducing Victor's newest, lowest-priced outfit!

For welding, cutting, heating, brazing, soldering, straightening, paint burning, hard-facing.. the budget-priced **VICTOR PERFORMER!**

A shop-in-a-box . . . Deluxe Performer includes: welding torch and 2 chrome-plated nozzles for welding up to  $\frac{5}{64}$ "; new cutting attachment and chrome-plated tip (six others to choose from for cutting up to 3"); new balanced (compensated) Micro-regulators to give you constant delivery pressure and flow; 10',  $\frac{3}{16}$ " Dualine hose, safety goggles, spark lighter and 32-page Welding-Cutting Guide.



AT YOUR AUTHORIZED VICTOR DISTRIBUTOR — NOW YOUR SINGLE SOURCE FOR ALL THREE

**VICTOR**

**COMPLETE OUTFITS**

JOURNEYMAN • Heavy duty  
SUPER-RANGE • Medium duty  
PERFORMER • Light duty

# Buy NAVAL JELLY®

and let the rust of the world go by



Ask for NAVAL JELLY Rust Dissolver wherever you shop.



World's Finest Fix-It Products  
Woodhill Chemical Sales Corp., Cleveland, Ohio 44128

## ALL NEW WINDICATOR

- RUGGED • ACCURATE
- DEPENDABLE

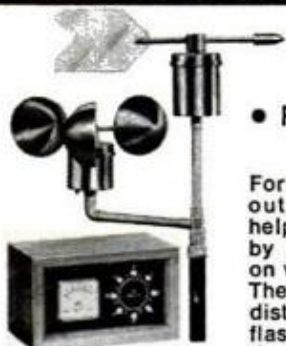

Send check or money order for prepaid shipment \$125.00 for 115 volt household current model. (add \$15.00 for battery equipped model)

For Anyone who works or plays outdoors... the WINDICATOR helps anticipate weather changes by giving instantaneous readings on wind direction and wind speed. The walnut finished console has distinctive wind speed meter and flashing direction indicator. Outdoor components are of weather-proof aluminum. Top quality .. top performance.

WEATHER PRODUCTS CO.  
COLOMA, MICHIGAN 49038

## HANDBOOK OF Knots and Splices

By CHARLES E. GIBSON

Now tie knots for every purpose—useful, ornamental, fun-to-make! Book gives complete "1-2-3" sketches and instructions for every hitch, splice, bend, sling, lashing or whipping you'll ever need for boating, camping, climbing, fishing, hunting... for patio awnings, swings, hammocks, rope fences, "welcome" mats... ornamental lamps, vases, bell ropes, key chains, buggy whips, cat-o-nine tails, rope handcuffs, play quilts, etc. They're all here... over 100 kinds of knots and ropework! From the simple square knot to such fancy numbers as the Manrope, Stopper, Shroud, Crown, Turk's Head, and Pineapple knots. Also covers plaiting, braiding, much more! "Highly recommended."—Library Journal. Profusely illustrated. ORDER NOW! 10-day Money-Back Guarantee. Send only \$4.95 plus 25 cents postage and handling, to EMERSON BOOKS, Inc., Dept. 458-S, 251 West 19 St., New York, N. Y. 10011.



## LEE ROY'S SECRET WEAPON

(Continued from page 88)

little hell about that, and it was decided that every team would have assigned to it one Holman-Moody engine man who would build engines for that team and that team only. We picked Bob Alman. Guess we picked about right, wouldn't you say?"

Nab says there are definite differences in engines, even though in theory they are all the same.

"It's little things—clearances, camshafts, a hair ground off here, a little something added there," says Nab. "We think Alman's the best there is when it comes to figuring out the right combination."

Nab, despite his incredible record as a winning crew chief, admits engines aren't his specialty. But he's expert at his game—chassis—attested to by his holding the NASCAR record for being the winning crew chief on superspeedways. Winners for whom Nab has served as "top wrench" include such stock car racing greats as Curtis Turner, Joe Weatherly, Fireball Roberts and Fred Lorenzen.

Nab entered racing in 1952 when he helped build a car for the Mexican Road Race. By the mid-'50s, he was in the Holman-Moody shop in Charlotte, his job the building of cars for Ford's stable of stars. In 1961 he joined forces with Fred Lorenzen, the results being several trophies in Nab's Wilkesboro, N.C. living room inscribed to "Herb Nab, from your driver, Fred Lorenzen."

Not only has Nab been crew chief for scores of winners, he has won several individual mechanics awards for excellence.

"But you know, all that stuff—the races and the awards and the competitions and so on—all that's yesterday's news," Nab says soberly. "It's the next race that counts. That's why Daytona is so important. You know everybody's out there with the best they've got and... well, you just want to beat 'em, that's all."

Nab says wind currents are always a big thing at Daytona and he's just as curious as everyone else to see how the new aerodynamically designed cars work out.

Winning at the Big D last year, Nab says, was his biggest thrill to date in racing, that it provided the momentum and confidence the team needed to carry them through their great year right up to the point where they're eager to try to bring off unprecedented back-to-back Daytona 500 victories.

"Yeah, I want to get back into that victory lane again this year. I'll never forget what it felt like last year. But then, I'll never forget the ten years it took me to get there, either." ★★★

# THIS CAN BE YOUR "BIG BREAK"

if you're a man who's ever said...

**"I'm sick  
and tired  
of my Job!"**



Read here about the exciting, high-pay careers waiting in one of today's hottest growth fields—and how preparing for these great jobs can be easier than you might ever have imagined.

IT'S A SHAME to go on struggling along in the same old rut—while others around you move up to better jobs, better homes, better cars. Especially when it's now so easy for you to do something about it.

Just mail the card bound in here and we'll send you, FREE, two books that have started thousands of men on the road to rewarding new careers. Careers they can be proud of. Careers where the work is exciting. And careers where they can earn the kind of money that many men only dream of.

Thousands of career opportunities like this exist right now in America's hottest growth industry—Electronics. It's an industry where you can take your pick of literally scores of different "glamor jobs"—in broadcasting, automation, the aerospace program, and many other areas. And it's an industry where, once you have some experience under your belt, you can earn up to \$5, \$6, \$7 an hour...\$200, \$225, \$250 a week...\$10,000, \$11,000, \$12,000 a year.

You don't need college training to break in. Our free books will show you how you can prepare right at home in your spare time. And they'll show you, too, how we can help you land the "dream job" of your choice.

Mail the postpaid reply card or coupon below today for two FREE books.

**CIE** Cleveland Institute of Electronics  
1776 East 17th Street, Cleveland, Ohio 44114

Cleveland Institute of Electronics  
1776 East 17th Street, Cleveland, Ohio 44114

Please send me 2 FREE books describing opportunities in Electronics and how to prepare for them.

Name \_\_\_\_\_  
(Please Print)

Address \_\_\_\_\_

City \_\_\_\_\_ State \_\_\_\_\_

Zip \_\_\_\_\_ Age \_\_\_\_\_

Veterans & Servicemen: check here for G.I. Bill information

Accredited Member National Home Study Council

PM-34

## TO THE SUMMIT BY ATV

*(Continued from page 105)*

favor was the temperature, balmy and in the 60s and 70s.

Before sundown we fanned out in an exploration foray toward the summit. We discovered a lingering glacier, its crystal clear melt-off a source of the mighty Arkansas River whose headwaters rise a few miles northeast of Mount Elbert. Just before dark, Dave Kittinger and Derrick Dodge, heading downslope with their ATV to our camping place, slipped the gears momentarily into neutral. The moment's error almost cost them their lives. As their vehicle hurtled down the 45° grade toward the timberline, a mile below, Derrick bailed out. Dave, staying with it, grabbed frantically for the brake, saw it was useless and buried himself in the seat cushion. The Coot slammed into a boulder,

---

**. . . throttle wide open, I bulled the four-wheel steer on a beeline climb for the top.**

---

bounced six feet, flipped over once and landed upright, dropping Dave out. But the damage had been done. The crash stripped a U-joint, putting one wheel out of action. The crippled Coot, now reduced to a three-wheel (instead of four-wheel) drive, limped back to camp. For Dave and Derrick, and their ATV, the try for the summit was over.

*Sunday, Aug. 3:* The final assault. The Rockies' highest peak lay dead ahead—and half a mile straight up. But to reach it, we'd need to climb at least two miles, maybe three. Surprisingly, a rain that had hit our camp about midnight had all but evaporated. If it had slicked the slope, our Coots didn't notice.

Sam, with Bill Peterson, our guide, led in Sam's four-wheel drive. The two photographers and I, in the four-wheel steer, tracked close behind. Dave and Derrick headed back downgrade for Halfmoon campground with their crippled vehicle.

For a slow-going hour we worked upgrade. We skirted the bowl, zigged toward the southeast to avoid a particularly steep place, then zagged around toward the southwest—on compass course for the summit. The weather still held warm—in the mid-60s—and hardly a breeze stirred.

8:30 a.m. We topped a ridge and there it was—not Elbert's summit (which was now away to the northwest), but the foot trail. Our maps had indicated that the trail petered out a mile or so short of the top.

"Can't quite figure it," Sam said, "but when somebody hands me a trail, I'm not about to say anything but 'thank you'."

Actually, it wasn't much of a trail. In places it was too narrow for our ATVs. And as we worked closer toward the summit—which still wasn't visible—the path grew perilously steep. That's when Sam decided to work south around the summit where things looked easier.

"With this four-wheel steer," I told him confidently, "I'm heading straight up. And I bet I beat you up top."

He grinned and I headed upslope.

9:35 a.m. With the throttle wide open, I bulled the four-wheel steer on a beeline climb for the top. Suddenly—so suddenly it came as a surprise—we were up.

Beside me, Dick Kruse quipped: "This must be the place."

It was the summit, for sure. Beyond our perch, which was scarcely 15 feet wide in places, everything else was strictly down. And along our perch's north side, it was straight down—an almost sheer drop of more than 2000 feet.

Two minutes later Sam hove in sight, gunning fast for our summit. Getting up wasn't Sam's problem. Finding a parking place was. There we were, with one of the world's highest peaks all to ourselves—and right away we were caught in a traffic jam.

Atop Elbert's highest spot was a massive rock cairn. It'd been thrown up—a tradition with climbers—by those who, over the years, had preceded us. Nearby was a U.S. Coast and Geodetic Survey "witness post." Its weathered sign cautioned that close by was the official U.S. government survey marker, marking Mount Elbert's 14,431-foot summit. We found the peak's official "register" housed in a length of capped, waterproof pipe. Each of us logged in—signing his name, the date and the exact time we'd reached the top.

I had one final mission: Raise Colorado's state flag above the summit. I tied the flag, using pullstrings from the parka I'd brought along, to a makeshift flagstaff planted atop the cairn.

Carefully, then, and mindful of the precariousness of our perch, we stood back to take in the scenery. No artist could have painted a mountainscape more awesome. To the north reared Mount Massive, its 14,418-foot summit nearly as high as Elbert's. Far below, to the northeast, was Leadville—looking like a toy town. Seemingly within reach—but really nearly a mile below—shimmered Twin Lakes Reservoir.

We had done what we had set out to do: Climb continental America's second highest peak—by ATV. ★★★

**It's Here!** The handiest "tool" you'll ever own!

- 12 handy hang-up boards!
- 56 charts—scores of illustrations!
- Wipe-clean-plastic laminated to last for years!
- Authoritative answers to 1001 shop questions!

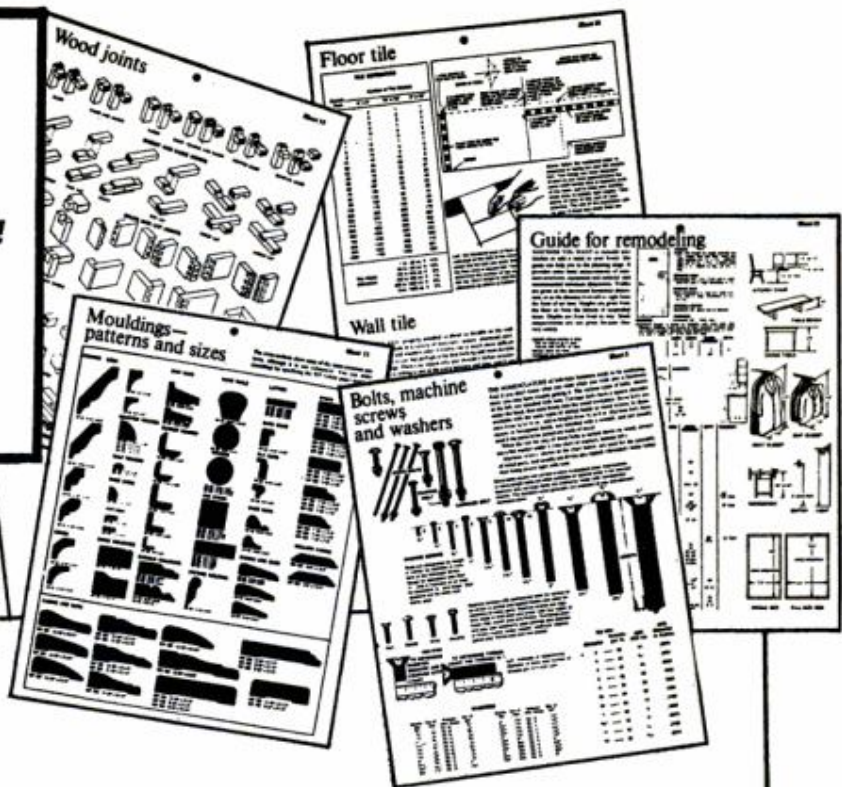

**NEW!**

**POPULAR MECHANICS**

# MASTER SHOP GUIDE

**Save hundreds of dollars! Save hours of time!**

Everything you need to know about: what nails, screws, bolts, wall-fasteners, drills, abrasives to use and why. How to order and use lumber, hardwoods, moldings, plywood, hardboard, gypsum, adhesives, plumbing, electrical work, floor and wall tile, glass. Plus the facts on remodeling measurements, gutters and downspouts, concrete work, lawn and garden chemicals! Plus—all on one "take-right-to-the-job" board—a ruler, centimeter rule, protractor, 45-degree triangle, and a compass for accurate circles up to 19½" diameter.

You'll reach for the MASTER SHOP GUIDE for every job you tackle!

What nail should you use for underlayment? What's the diameter of a No. 12 screw? What types and sizes of sheet-metal screws are available? How many pounds will a ¼-in. toggle bolt hold? How can you save money ordering lumber? What size quarter-rounds are available? How do you bleach close-grained hardwoods? What glue is best for cementing metal to wood?

All the answers on repairs, too! Illustrations of most-used plumbing and electrical fittings. How to fix dripping faucets, how to lay out a room for floor or wall tile, how to cut and apply plastic laminates, how to replace a pane of glass. Remodeling? All the basic dimensions you'll need to plan the job. Leaking gutters? Best way to patch them. What chemical controls which weeds and diseases? Best mixing ratio for concrete work? Just look it up.

One sheet even shows how to solve those puzzling math problems you often encounter in shop work.

By the editors of *Popular Mechanics*—order yours now—you'll use it the rest of your life!

**\$3.95** complete set of 12 8½" x 11" boards!

**PARTIAL LIST OF CONTENTS**

Nail and screw sizes and uses	Bolts, machine screws, washers	Plumbing guidance
Useful mathematics	Wallpaper	Lumber sizes
Masonry	Wall fasteners	Mouldings—patterns and sizes
Lawn and garden chemicals	Plastic laminates	Properties of common woods
Stair construction	Glass	Glues and adhesives
Gutters and downspouts	Floor and wall tile	Wood joints
Guide for remodeling	Drill sizes	Plywood grades and uses
	Electrical work	Wood finishes
	Abrasives	

**Popular Mechanics, Dept. SG**  
 224 West 57th St., N.Y., N.Y. 10019  
 Rush me \_\_\_ sets of MASTER SHOP GUIDE.  
 I enclose check or money order for \$3.95 for each set ordered.

Name \_\_\_\_\_  
 Address \_\_\_\_\_  
 City \_\_\_\_\_ State \_\_\_\_\_ Zip \_\_\_\_\_

**MAIL COUPON TODAY!**

# BUILD REFINISH RESTORE

## ...anything of wood

LET Constantine's picture-packed Catalog-Manual help you build new furniture — help you restore and refinish beat-up cabinets, chairs, chests, tables. Find instantly whatever you need. Newest materials plus plans, instructions. Largest selection of beautiful woods. Specialty tools. Products not found in stores or by mail elsewhere. *Unsurpassed values.* Send for vast, illus. catalog NOW!

**2,000**  
CRAFTSMAN PRODUCTS  
Woods—Veneers—Inlays  
Newest Workshop Tools  
Wood Finishes—Moldings  
Carving Woods & Patterns  
Cane Kits—Lamp Parts  
Hard-to-find Hardware

Tear out ad. Mail with 25¢ for vast new CATALOG Plus New "101 Project Ideas"

**CONSTANTINE**  
2050 Eastchester Rd., Bronx N.Y. 10461 Dept. B-5

MAIL AD

## 2 for 1 WAREHOUSE CLEARANCE SALE

© 1969 Viking

TWO \$1.98 \$3.96 VALUE **10 Year Guarantee**  
FOR TWO FOR THE PRICE OF ONE

Razor sharp blade opens with flick of finger and automatically locks in place. PUSH-BUTTON release. Tough, razor steel blade honed and polished to mirror-like finish. Balanced for target throwing. Blade GUARANTEED 10 YEARS. If blade breaks we replace free. 30-day MONEY BACK GUARANTEE. A favorite with sportsmen. Priced for quick sale of 200,000 knives. Makes excellent gift for any man or boy. Two for \$1.98 plus 50¢ shipping. Send cash, ck. or M.O. to VIKING KNIVES, Dept. K-3, Box 10880, Houston, Tex. 77018.

## NEW Improved Accurate Scope-Shot

SCOPE-SHOT COMPLETE WITH 50 DISINTEGRATING PELLETS

World's Finest Precision SLINGSHOT Scope-type sight!

They crack like a rifle when they hit—leave mark—ouff of smoke!

Price without pellets \$2.00 P.P.

Big Bag of 250 EXTRA Pellets \$1.00 P.P.

Pure gum rubber slings. Beautifully polished cast aluminum stock. Pistol grip. So powerful it kills small game. Fits pocket perfectly! Guaranteed. FREE shooting manual.

EXTRA RUBBER SLINGS, 3 pairs \$1.00 p.p. Leather Pouch & Sling assembly only 50¢ p.p. Order NOW from:

**GENERAL SPORTS**  
4184-MB Apple Street Cincinnati, Ohio 45223

## WRIST ROCKET

AMERICA'S Pat. HARDEST U.S. HITTING SLING

Range 225 yd. - 232 fps

Matched spare rubbers and pouch assembly, \$1.00.

Write WRIST ROCKET® \$3.00 Post Pd. 2654 44th Ave. Columbus, Nebr. 68601 PM No C.O.D.'s

## BASEMENT TOILET FLUSHES UP

TO OVERHEAD SEWER OR SEPTIC TANK. NO DIGGING UP FLOORS. INSTALLS EASY. Write McPHERSON, INC., BOX 15133, TAMPA, FLORIDA 33614

## REAL ESTATE BE A BROKER

PAYS BIG! SEND FOR BIG FREE CATALOG NOW! Graduates report making substantial incomes. Operate your own business quickly. Men, Women, all ages, learn easily. Course covers Sales, Appraising, Loans, Mortgages, & related subjects. STUDY AT HOME or in classrooms in leading cities. Diploma Awarded. Write Today for FREE Book! Accredited Member National Home Study Council. (Est. 1936) G. I. Approved.

**WEAVER SCHOOL OF REAL ESTATE**  
3521-P Broadway Kansas City, Mo. 64111

FREE BOOK TELLS HOW

## Print Your Own

Cards, Stationery, Advertising, Circulars, labels, photo and movie titles, church work, tags, greeting, sympathy, prayer cards, etc. Save money. Pays for itself in a short time.

**Own a Printing Business**

Good Profit. Raised printing like engraving too. Have home shop. We supply everything. Direct from factory, only. Easily followed rules. Write now for free details. **KELSEY PRESSES E-37 Meriden, Conn. 06450**

## BLAST FURNACE 2400 F

Since 1935  
Hobbyists • Schools • Inventors, etc. Make your own castings of any metal from cast iron, down to lead and zinc. Available in 6 sizes, 1 1/2 to 50 lbs. Complete units from \$50.40 to \$162. Send 25¢ for circular—refundable.

**KANSAS CITY SPECIALTIES CO.**  
Dept. P-2 P.O. Box 193 Middleton, Wisc. 53562

## Hard-to-Find TOOLS

### NEW 1970 CATALOG

Unique collection of versatile hand tools and small power tools rarely found in stores or other catalogs. Scores of new, fascinating items to make projects easier, more fun. All are top quality with money back guarantee. Used extensively by woodworkers, machinists, craftsmen. Send 25¢

**BROOKSTONE CO.**  
2024 Brookstone Building, Peterborough, N.H. 03458.

## train for Drafting Career in one year

Graduates of our accelerated four-quarter Drafting and Design Program employed by leading companies. Trained in everything from basic technical drawing to technical illustration and writing, they have entree into responsible positions in important industries. Tri-State also offers four-year degree programs in five fields of engineering... four areas of business administration... two-year programs of computer and machine design technology... of arts and science. Accredited. Approved for veterans. Modest costs. Enter March, June, Sept., Jan. Write Director of Admissions for Catalog, indicating the career you prefer. Unusual placement record!

**TRI-STATE COLLEGE**  
420 College Avenue, Angola, Indiana 46703

## LEARN MEAT CUTTING

Train quickly in 8 short weeks at Toledo for a bright future with security in vital meat business. Big pay full-time jobs — HAVE A PROFITABLE MARKET OF YOUR OWN! Time payment plan available. Diploma given. Job help. Thousands of successful graduates. OUR 47th YEAR! Send now for big new illustrated FREE catalog. No obligation. G.I. Approved.

**NATIONAL SCHOOL OF MEAT CUTTING**  
Dept. 50-D, Toledo, Ohio 43604

## MONEYMAKING MACHINES! GET UP TO \$15 WIN A RACE DAY \$2

"HE SAID HE'D had wins at tracks on the day of \$874, \$1082, and \$1516. I thought he must be a millionaire. Then I found out he wasn't. He'd simply had \$20 on all predictions of PENCLIFF world's top race computer." SENSATIONAL —space age—scientific, yet so easy to operate, wonderful Pencliff on sale since 1965, has a master director and 6 predictors. You simply FEED IN previous form, weights, etc. FABULOUS results U.S.A., Canada, U.K., etc. We supply FACTS — over 4,000 latest U.S.A. CHECKABLE big win PENCLIFF predictions. BIG \$2 payoffs incl. \$66, \$70, \$82, \$90, \$96, \$104, etc., and BIG track wins — \$2 stakes on all predictions in all races incl. \$113, \$118, \$121, \$134, \$141, \$151, etc. CLEAR PROFIT ON THE DAY. Money refund guarantee. Learn how an accident on the inventor's yacht, his 25 years racing experience, aid of 12 other experts, and a giant I.B.M. computer, all led to the invention of amazing PENCLIFF, R.H.P. Co., Box 5715-PME5, Carmel, Calif. 93921. Tear out this ad NOW and mail with name, address, and zip.



**HEAVY DUTY WELDER**  
**10-DAY FREE TRIAL**  
**Lifetime Guarantee**  
**Brand New 1895**  
**1969 Model POST PAID**  
**Fits ordinary 110V outlet**  
**Not one • but 3 welding heats**



Weld, braze, solder or cut most anything made of metal. No experience necessary. Follow simple instructions to make repairs on cars, trailers, farm and lawn equipment, bicycles, appliances, etc. Make campers, boats, furniture, hundreds of valuable items. **NOTHING ELSE TO BUY!** Comes complete with full face shield, \$2.00 pack of welding and brazing rods, heavy duty power cables, special electric torch attachment, ground clamp, flux, easy-to-follow illustrated instructions, rod holder, etc. Uses standard 1/8" rods and 1/4" carbons to weld iron, steel, brass, bronze, aluminum, other metals. New improved HEAVY DUTY circuit gives more welding power. Gives 4 times the heat needed to melt toughest iron. Plugs into ordinary 110V outlet. **3 WELDING HEATS** . . . Not just one as with other low cost models. Use "high" for tough jobs, "medium" or "regular" for lighter work. This important feature saves you money and time. Makes it possible for even beginners to start welding professionally the very first day. Pays for itself quickly. 10 day MONEY BACK GUARANTEE. You must be satisfied or return for refund.

FREE automatic arc striker. Now weld with push-button ease.  
**SEND ONLY \$2.00.** Pay postman \$16.95 plus postage when delivered, or send \$18.95 cash, c.k., M.O., for fast postpaid shipment.  
**WEL-DEX MFG. CO., Dept. W-10, Box 10776, Houston, Texas 77018**

**BUILD YOUR OWN POWER TOOLS**

**METAL PARTS KITS AT LOW FACTORY DISCOUNT PRICES FOR: \$50 OR MORE**

- 10-IN. TILT/ARBOR SAW
- COMB. DRILL PRESS-LATHE
- 12-IN. BAND SAW
- 18-IN. BAND SAW
- 6-IN. BELT SANDER
- SPINDLE SHAPER

**PLANS \$1.00 EACH FULL SIZE PATTERNS DEDUCTIBLE**

Kits from \$16.99 to \$43.99. Satisfaction guaranteed. Built and sold for 23 years. 50,000 units in use. Send \$1.00 for Plans, or 25¢ for Catalog!

**GILLIOM MFG. CO. Dept. PMT-2 St. Charles, Mo. 63301**



**TREASURE**  
 Find buried gold, silver, coins, treasures.  
 5 Powerful models.  
 Write for free catalog

**RELCO DEPT. D-3 \$19.95 UP**  
 BOX 10839, HOUSTON, TEX. 77018



At Last a New Amazingly Simple  
**GAS TURBINE JET ENGINE**

Build from easy to follow plans. Length 15", Dia. 8 1/2", Wt. 15 lbs. Fuel: Gasoline or Kero.

"Screamin Demon" develops 20 H.P. Ideal project for serious-minded hobbyists, students; scientific and industrial arts classes. Make on 9" metal cutting lathe with milling attachment. For use on small racing boats, midget cars, etc. Full size assembly drawings with critical dimensions, bill of materials and photos. Price \$5.00. No C.O.D.

**SAVOY SCIENTIFIC, BOX 1398, SANTA MONICA, CALIF. 90406**



**"\$33,000 LAST YEAR"**  
**OPERATING AUTO RADIATOR SHOP**

— Mercier Bros., Lowell, Mass. Make big money repairing radiators — servicing cooling systems. Inland's Proven Program includes: training, equipment, "How-to-Operate" Manual, advertising aids and "Pay-As-You-Profit" purchase plan. **START YOUR OWN SHOP OR ADD TO PRESENT BUSINESS.** Market Growing — More vehicles on road each year. Small modern cooling systems and air conditioning are adding extra stress on radiators—demanding frequent service. Cash in now!

**FREE!** INLAND MFG. CO., Dept. PM-2  
 1108 Jackson Street, Omaha, Nebr. 68102

Send free 42-page booklet and money-making plan.  
 Print Name \_\_\_\_\_  
 Address \_\_\_\_\_  
 City \_\_\_\_\_ State \_\_\_\_\_

42-page booklet "Make Money Repairing Radiators" shows equip., prices, owner letters—complete program.

**GOVT. SURPLUS AND OTHER BARGAINS SAVE UP TO 90%**

**HEAVY DUTY GEAR MOTOR** All ball bearing construction. Rated approx. 3.5 HP @ 24 V.D.C. Turns 400 RPM, no load, on 12 V.D.C. & 800 RPM on 24 V.D.C. Contains instant start-stop magnetic clutch. Reversible. Has 12 tooth, 5/8" shaft. 18 1/2" L x 7" dia. GOVT. COST \$454. Shpg. Wt. 35 lbs. \$29.50 Stk. #2465



**MOTORIZED TRANSFER PUMP** High volume. Delivers up to 700 GPH @ 35 PSI. 1 1/2" pipe ports. Exc. for pumping water & oil base insecticides, transferring diesel fuels, gas, kerosene & solvents. 1/4 HP motor will operate 24 or 12V DC. Tested prior to shipment. Shpg. wt. 17 lbs. Approx GOVT COST \$135. NOW \$24.50 (Stk. #1243).



**ELECTRIC UTILITY PUMP** Output up to 360 gal. per hr. @ 18 Psi. Exc. for water, fuel, insecticides, etc. Aluminum construction. Runs on 12 or 24 V.D.C. Explosion-proof motor. Inlet & outlet ports are 1/2" pipe. Draws 5.2 amps. 9 3/4" H x 6" W. Approx. GOVT COST \$150. Shpg. wt. 8 lbs. \$14.50 (Stk. #2486A).



**SILVER ANNIVERSARY EDITION**

Send 25¢ for amazing catalog with 1000's of bargains in hydraulics; electrical, marine, automotive items, etc. 90 day guarantee. Order from ad. All prices FOB Culver City. 50% deposit for C.O.D. Cal. res. add 5% sales tax. Include zip. Satisfying world-wide customers since 1945.



**AIRBORNE SALES CO. Dept. PM270**  
 8501 Stellar Dr., Box 2727 • Culver City, Calif. 90230

**MORE POWER FOR BIG JOBS**

man-size **ECONOMY TRACTOR**

Mow 2-3 acres/hour, plow acreage fast. Big 14 hp engine, all-gear drive for more work-power. No belt or fluid-drive loss. Over 20 implements, 48" dozer, 32" tiller, 48" snow-blower. Write: **ECONOMY TRACTOR** 1005 K-2 Anoka Avenue Waukesha, Wis. 53186



**Bean's Free Spring Catalog**

Ready February 15

Fully illustrated 108 pages of campingspecialties, fishing tackle, clothing and footwear for men and women. Featuring practical outdoor items, many of our own manufacture.

Send Free Catalog

Name.....  
 Address.....  
 Zip.....

**L. L. Bean, Inc.**  
 625 Main St., Freeport, Maine 04032  
 Fishing, Camping and Hunting Specialties



**LAND!**  
EASY TERMS  
LESS THAN BANK  
RATES!

**Northwest Timbered  
ACREAGES as low as  
\$950 Total Price**  
5 - 10 - 20 - 40 - ACRES

For people who love the land—A tract  
of Recreation Land for YOUR Own!

In Northern Idaho, Northeastern Wash-  
ington, and Western Montana. In the heart  
of lakes and big game country. All covered  
with growing timber. Access, Title insurance  
with each tract. This is select land with  
natural beauty, recreational and investment  
values. We have tracts of many types and  
sizes from which to choose, including beau-  
tiful Northwest Waterfront property. Your  
inspection welcomed. Write us for free list,  
maps and complete information. Write to:  
Dept. P.

**R**  
REFORESTATION  
Inc.

P.O. Box 8146, Spokane, Wash. 99203

## I-N-V-E-N-T-O-R-S WE NEED INVENTIONS

Sell your invention for cash—need money for Patent?—Are technical problems holding you back? Universal Inventions has helped inventors all over the world—just like yourself—why not you? Inventions provide the magic spring-board to sudden riches. REMEMBER, we either sell your invention or pay you a cash bonus. Write for details.  
**UNIVERSAL INVENTIONS, Dept. 13, Marion, Ohio**

**FREE!**  
Learn how you  
can buy used  
engines \$15 up,  
new engines \$30  
with FREE con-  
fidential list and  
coupons when you  
order your plans

- **BUILD THIS MINI-BIKE!**  
Plans reveal step by step details!
- **BUILD A RACING KART!**  
Build frame for less than \$10!

RUSH \$2 for plans (indicate type) or  
send 25c for circular describing plans  
PLANS, Box 517, Omaha, Nebr. 68101

## AMC'S NEW HORNET

(Continued from page 99)

the overall size of the car. Enough for two weeks in the mountains or at the sea-shore, no; a weekend, yes.

Workmanship on our test Hornet was about on a par with the rest of Detroit's production—good to fair to dreadful. There were gaps where there shouldn't have been, poor fits that should have been like a kid glove. There was a good bit of interior plastic, a material I appreciate is a wonder of our times, but one whose inventor I'd like to poke in the nose. It's so . . . so . . . well, chintzy, and that says it.

Exterior styling on the Hornet is very smooth, very clean. It has a pleasing basic shape—no add-on trim, no seemingly tortured angles. Again, it looks like a car born of a single piece, not an assemblage of committee ideas. I can attest to several admiring glances; perhaps because the Hornet is still relatively new on the road, perhaps because it's simply a good-looking car. I hope with all my heart AMC stylists resist the temptation to festoon the car with the tacky, tasteless geegaws Detroit seems to have by the binful. I appreciate that cars have to appeal to kids, but the Woodstock nonsense was no epitome of good taste.

Summing up, I don't care for the Hornet's dash layout, its armrests, the fit of its carpet. I think the weight distribution could have been a little more equal (but here again this could have been because of the V8 and airconditioning); while not nose-heavy, the car leans that way ever-so. I like everything else about the car, not the least of which is its serviceability. I think the Hornet is honest goods, honestly sold; e.g., AMC doesn't claim buying the car will cure acne, restore flagging virility, make math a breeze. That it happens to be an exciting idea well done is just so much extra. ★★★

## THREE-WAY TRAVELPOD

(Continued from page 162)

trolling motor is ideal to propel it and will run all day on a fully charged car battery. There's plenty of shade under the nose cone for an ice cooler, even a mini-TV set.

You can build a Travelpod of your own for about \$125 for materials. A complete set of plans includes the cutting patterns for the tent and details tubular framework. For the most part, the Pod and its lid are made of 1/4-in. marine plywood. Members which form the tongue-and-groove tracks are of solid stock. ★★★

## THE BIG LAB

(Continued from page 94)

ey from that venture proved significant in BMI's later development.

The European laboratories were established in the fifties, and in 1965 Battelle took over the operation of the Atomic Energy Commission's big Hanford laboratory in the state of Washington. Thus, Battelle-Northwest was established.

Hanford was a key site in the Manhattan Project of World War II. It was there that the world's first reactors were built to produce plutonium for nuclear weapons.

The site was ideal. Located in the eastern part of Washington, it was a sparsely settled area of sun, sand and sagebrush, close to the mighty Columbia River, whose waters could cool the reactors.

You don't inspect the various facilities of Battelle-Northwest on foot. You go by car and pack a lunch. The original installation is scattered over an area equal to nearly half the size of Rhode Island.

Battelle-Northwest, now an organization of over 2700 scientists and support personnel, continues the Hanford pioneering in nuclear energy. But the emphasis today is on peaceful uses of this power.

Recently, Battelle-Northwest was assigned responsibility for the construction of an AEC test facility said to be the most advanced complex of its type ever conceived. It will be the prime testing complex for the United States' fast breeder reactor program. Breeder reactors produce more fissionable materials than they consume in creating a chain reaction.

Like the Columbus lab, however, Battelle-Northwest is capable of handling studies in many fields. Its researchers, for example, test the astronauts' body wastes after all Apollo flights. They study radioactive phenomena in a tunnel 360 feet below the top of the Grand Coulee Dam, and diseases that kill salmon and steelhead in the Columbia River. They recently devised a monitor that uses sound waves to detect flaws in welds during the welding process, and they developed a new type of cereal food, called Batina, designed to help alleviate world food problems.

But what lies in the future for Battelle? I put that question to Sherwood L. Fawcett, president of BMI. "There's much that needs to be done in environmental studies," he replied. "One of the things we're thinking about is the role that a laboratory can play in the development of a region. Regions have individual problems—those of the Great Lakes are different from those of Appalachia. An organization like ours can take an independent look at those problems." ★★★

## NEW 80 AMP DYNAMIC MARK 88 INDUSTRIAL TRANSFORMER ARC WELDER

IDEAL GIFT — EDUCATIONAL, ENJOYABLE, PROFITABLE

WELD, BRAZE,  
CUT, SOLDER, HEAT  
STEEL, BRASS, ALUMINUM,  
AND MOST OTHER METALS.

Build and repair anything of metal. Save time & money with this BRAND NEW, PROFESSIONAL ARC WELDER!

Rugged metal cabinet, baked Hammerloid finish. Ideal for home, shop, farm and industrial use. POWERFUL glass insulated transformer welds most metals up to 1/2" thickness with multi-pass weld, with 3/8" rods. 4 heat settings 20 to 80 amps. Operates on 110 Volt AC line fused for 30 amps. Complete with fibre glass helmet, electrode holder, ground clamp and cables, solder, assorted rods and simplified welding manual. DOUBLE PROTECTION GUARANTEE. 10 day money back trial plus full 5-yr. warranty. If inoperative return prepaid, we will repair or replace without charge & reship collect.

ORDER TODAY. Complete ready to weld. Only \$59.50 F.O.B. SEND ONLY \$6.00. Pay balance plus C.O.D. & delivery charges or write for easy "PAY AS YOU WELD" Low Down Payment Plan. Welder details FREE.



DYNAMIC WELDER CO.

1808 S. FEDERAL ST.  
Dept. D2-B  
CHICAGO, ILL. 60616

NOT TO BE CONFUSED WITH IMITATION \$5.95  
PLASTIC MODELS SELLING FOR LESS!!

Not Sold  
to Calif.  
or N.Y.  
res.

22 Cal. Blank Cart. 8 Shot Revolver  
No Permit Required  
Imported from ITALY



"BLACK VENETTA"

Latest model, not a toy. Gun is of solid steel construction. Lightweight and perfectly balanced. Fires 8 rounds in 2 seconds! Double or single action. Precision crafted. 5 1/2 inches long. Ideal for stage, sporting events, boating, protection. Revolver \$5.95, deluxe leather holster \$2.25. Send cash, check or M.O. and save C.O.D. charges. \$1.00 deposit with C.O.D. orders.

BIG THREE ENT., INC. 1109 Sixth Ave., Dept. PM270, N.Y., N.Y. 10036

# the wood fixer

filler-surfacer

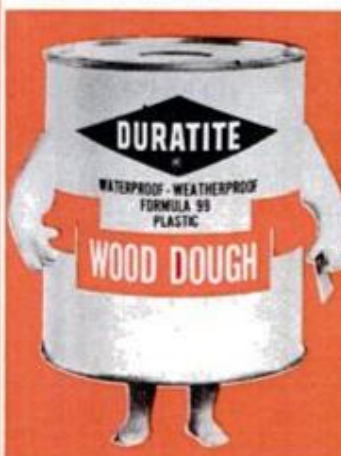

DURATITE® plastic Wood Dough by DAP. The superior one-time wood filler. Virtually shrink-proof. Easy to handle. Dries hard as wood—sands smooth. Takes stains. Comes in natural and 8 wood colors.

DAP®

DAP Inc., Dayton, Ohio 45401/Subsidiary of Plough, Inc.

Also available in Canada

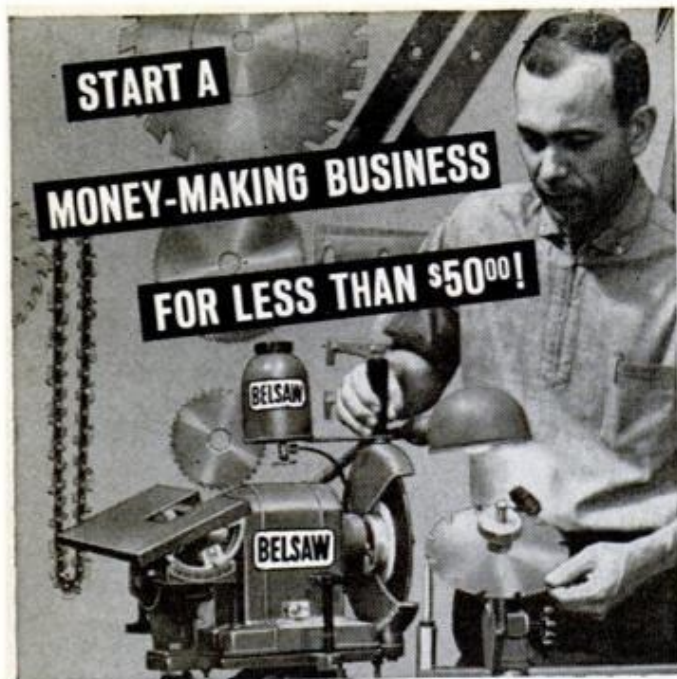

## No Selling, No Inventory... All Cash Profits and YOU Set The Hours!

You can have your own lifetime business right at home... work in spare time... and make up to \$200 a month CASH! My FREE PLAN gives you all the facts: How to start, how to grow. You don't need previous experience. You don't have to sell. I'll even finance you. People bring you the work and pay cash. Over 90¢ of every dollar you collect is clear cash profit. And you work when you want to. Let me prove you can't find a more certain, lower cost, higher paying business of your own.

## Does The Belsaw Pay? YOU BET!

### W. R., Maryland

"My BELSAW is working fine and business is increasing by 20 to 30 customers a month. I've added one employee and am looking for a night man to handle rush jobs."

### C. S., Minnesota

"The sharpening business has helped me buy two homes and three motor cars. The nice thing about the Sharp-All is that you get some cash every day."

## RUSH COUPON TODAY!

Just Mail Coupon — No Salesman Will Call

**BELSAW SHARP-ALL CO.**

Stan Field, President  
710F Field Bldg., Kansas City, Mo. 64111

Name \_\_\_\_\_

Address \_\_\_\_\_

City \_\_\_\_\_ State \_\_\_\_\_ Zip \_\_\_\_\_

**FREE  
BOOK**

## AUTOMATIC CHOKES

(Continued from page 141)

gish or bind, causing excessive fuel consumption, poor performance during warm-up and hard starting.

Every so often, give the choke-plate pivots and choke rods and linkage a shot of choke cleaner. This inexpensive spray-can product can be purchased in auto supply outlets. Some hardware stores also sell it.

Never oil any part of the choke system. It will cause a rapid accumulation of dirt that will bind the mechanism.

If you run into a problem with a carburetor-mounted choke, one of the first things to do is remove the cover and look inside the housing. If it's dirty, gummed or rusty, the heat tube that extends from the manifold to the choke housing is punctured. Clean choke parts thoroughly in kerosene and replace the tube. Well-type and exhaust manifold chokes have no such problem.

The automatic choke is often blamed for a problem caused by the carburetor air-cleaner filter. When the filter becomes too badly clogged with dirt, it acts like a choke that's stuck in the closed position. The engine will be fed a rich fuel mixture. Make sure it's clean. ★★★

## DATSUN OWNERS REPORT

(Continued from page 129)

to degree of rake (too much, too little, not adjustable) to amount of back and forth travel, buckets too small and the smell of the vinyl. The vinyl upholstery is actually the culprit responsible for a constant complaint: haze on the inside of the glass. "Hazing, fogging and oily film" will just have to get the elbow-grease and ammonia-cleaner treatment. No shoulder harness holding bracket is another lack.

A Louisiana graduate student finds that "parts seem to loosen up, i.e. nuts and screws, giving rise to vibrations at certain speeds, and squeaks." Annoying but correctable is the consensus of most owners who complained of rattles.

A Colorado claims adjuster who now owns his second four-door sedan had a "rattling" experience with his first: "Good metal and construction," he says, adding: "I flipped a 1969 Datsun same style as I have now. A car side-swiped me and I rolled two and a half times at 60 mph. Doors and top stood up and I wasn't even scratched."

Care to try that again for the fans at the Japan Grand Prix this year? ★★★

## FAMILY GUIDE TO MINI-BIKES

(Continued from page 121)

features such as spark-arrestor mufflers mandatory for trail use, tires or tire options for trail use, horn-light options for night use or street licensing, and various degrees of collapsibility for transporting. The Heath bike is one of the few bikes available with a go-in-snow ski option.

**Specialty machines.** Some mini machines have evolved into what can be called two-wheel adverse-terrain-vehicles (ATVs). Aragon's \$400 El Burro and Rokon's Trail-Breaker, for example, look like monster minis with their tubeless, high-flotation tires. With 1.5 p.s.i. air pressure and large footprints, the tires will take the machines practically anywhere. Spreads-All's Scoot or Ski with its double-drive rear wheels is a \$435 machine, which tops out at \$580 with optional gearbox, track, ski, lights, alternator and other equipment necessary for licensing in most states. Cal-Jet's electric mini-bike provides quiet, sophisticated, adult transportation for \$450.

**Coming down the pike.** How far can the design of the conventional mini-bike go without becoming either a full-blown motorcycle or a motor scooter? Maybe a small-wheeled machine that Benelli is about to introduce gives a clue: Would you believe 185 cc, all chrome, a scant 120 pounds and \$450? It's called the Volcano. Keep it away from the kids. ★★★

**TWO-STROKE MOTORCYCLE ENGINE** in the Ace 100 mini-bike from Bonanza is a 100-cc, 5-speed Hodaka. Portability and size of the model BC1500SH gives it its advantage over a full-size motorcycle. Here, AMA motorcycle champ Bart Markel pops a wheelie



**IT'S HOLLOW GROUND** to bore cleaner, faster at any angle

Now step-up the boring range of your small electric drill or drill press to 1 1/2" with Irwin Speedbor "88" wood bits. 1/4" shank chucks perfectly. No wobble. No run-out. Sharp cutting edges on exclusive hollow ground point start holes faster, let spade type cutters bore up to 5 times faster. You get clean, accurate holes in any wood at any cutting angle.

Each Irwin Speedbor "88" forged from single bar of finest tool steel. Each machine-sharpened and heat tempered full length for long life. 17 sizes, 1/4" to 1 1/2", and sets. See your Irwin hardware or building supply dealer soon.

\$ .85 each	\$ .95 each	\$ 1.50 each
1/4" to 3/8"	3/8" to 1"	1 1/8" to 1 1/2"

**IRWIN SPEEDBOR "88" WOOD BITS**

at Wilmington, Ohio, Since 1885

## SAVE \$\$\$\$\$\$\$\$\$\$\$\$\$\$\$\$ DO YOUR OWN PRECISION BRICKWORK

**NEW** Patented tool makes precision brickwork possible by even unskilled worker; bricks are positioned automatically by tool's platform. No spirit level is required; bricks are laid faster and more accurately. Tools adapt easily to various brick sizes and job requirements.

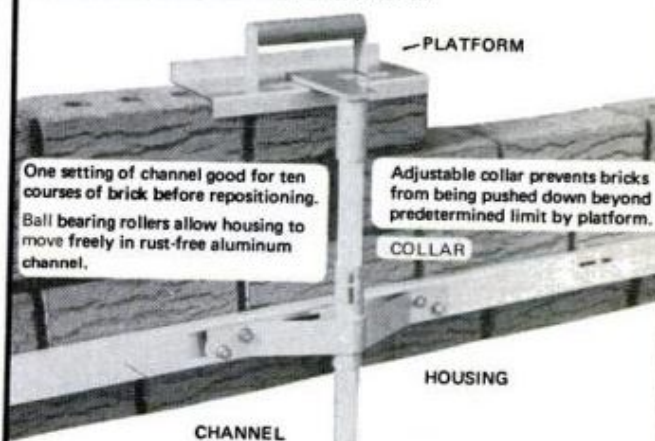

One setting of channel good for ten courses of brick before repositioning. Ball bearing rollers allow housing to move freely in rust-free aluminum channel.

Adjustable collar prevents bricks from being pushed down beyond predetermined limit by platform.

**NO SHIPPING CHARGE** on orders mailed before 3/1/70

**WRITE FOR FREE CATALOG**

**DEALER INQUIRIES INVITED**

**B-1 MODEL** for small home improvement projects. **\$20**

**B-2 MODEL** for brick veneer work. **\$45**

**B-3 MODEL** (shown above) for brick veneer or solid brick walls. **\$49**

**ZETCO CORP.**

Dept. M-1

POST OFFICE BOX 1660, BROOKLYN, NEW YORK 11202

# Be a computer pro!

## Get computer home-training tested on a real computer!

Yes, with RCA Institutes home training, selected programs you prepare are actually tested and run on real computers. There are no limits to the challenges and rewards of computer programming. Aerospace, Industry, Science! The RCA Institutes home-study course teaches you at your own speed to program the latest 3rd generation computers including IBM/360 and RCA Spectra 70. Mail the coupon today.

RCA INSTITUTES INC.  
Computer Home Training Dept. 699-002-9  
320 West 31 St.  
New York, N. Y. 10001

Please send me FREE career catalog and information on your Home Training Computer Programming course.

Name \_\_\_\_\_

Address \_\_\_\_\_

City \_\_\_\_\_

State \_\_\_\_\_ ZIP \_\_\_\_\_

# RCA

## LICKITY WACO LOG SPLITTER

**Splits Big Profits from toughest woods—Ends Splitting Drudgery with 18 ton hydraulic power!**

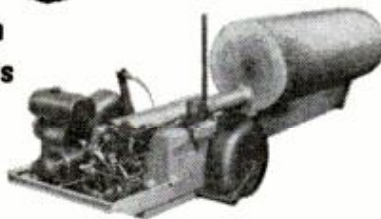

7 H.P. trailer unit squats under power to load logs without dead lift. Has 2 speeds, auto-shift, auto-stroke. 26" ram travel splits logs up to 34", any diameter — with extended frame and adjustable wedge splits up to 60". **NEW LOW COST** Economy model for farmers and small wood lots. Also ask about the 60L Series for logs up to 8½ ft. long—Details free.

**Piqua Engineering Inc., Dept. P, Box 605, Piqua, Ohio**

## CROP THOSE SHOTS

*(Continued from page 147)*

or center of interest will go. Contrary to what you might expect, it should not go in the center of the picture. There are exceptions, of course, but in most cases the center of interest is best placed off to the side and above or below the middle. Dead center, it tends to destroy any feeling of action and the picture becomes static.

The classic "Rule of Thirds" is a handy guide to proper placement of the main subject. Divide the picture into thirds, both vertically and horizontally. The four points where the dividing lines intersect are good locations for the dominant element. Where the center of interest is in the foreground, it usually falls at one of the two lower points. Where it appears in the background, such as a distant mountain peak, it would logically be located at one of the two upper points.

Wherever you place the focal point, the action or direction of motion should be coming into the picture, not going off the edge. Action moving toward the center of the photo looks like it's happening now, or just about to happen, and there's a feeling of anticipation and excitement. Action that trails off toward the edge of the picture looks like it's already taken place and the viewer feels let down—as if he's come along a couple of seconds too late for the main event.

Action doesn't necessarily have to be actual motion, either. Shots of a speed-blurred racing car or a diver caught in midair are great, but there's also a lot of implied action in a chess game or a still life. The curve of a tree branch, a long, sweeping road or river, objects with sharp, angular lines, a crouching animal—all these suggest motion even though they aren't moving. Imaginative cropping can heighten this feeling of movement and make a picture more exciting.

While cropping can improve a picture after it's been taken, the best time to eliminate serious flaws is before you snap the shutter. Composing a picture well in the viewfinder can save a lot of cropping later and can also get rid of problems that cropping can't solve, such as a poor background immediately behind the main subject.

Try to pose your subjects against uncluttered backgrounds. Get as close as you can. The more you move in, the less extraneous area you include in the picture and the more you focus attention on the subject. The rules for locating your center of interest apply equally well in the viewfinder as on the printing easel. The better the picture you get on film, the easier it will be to come up with good prints. ★★

**It only  
tastes  
expensive**



## MOLDS

for making  
Ornamental Concrete  
Items...



Book about Aluminum  
Molds with prices and  
production trade secrets  
direct from world's larg-  
est mold manufacturer.

SEND  
\$2.00

CONCRETE MACHINERY COMPANY, INC.

P. O. BOX 99 • HICKORY 2, N. C. 28601

## HEARING AIDS

**2/3 OFF DEALER  
PRICES**

LARGEST SELECTION of tiny, all-in-the-ear, behind the ear, eyeglass and pocket models. FREE HOME TRIAL. No obligation. Money back guarantee. No down payment. Easy terms. No salesmen or dealers. Order direct, save 65%. Write for free catalog. PRESTIGE, Dept. D-34 Box 10947, Houston, Tex. 77018.



**YOU CAN OWN A 56' x 12' MOBILE HOME, KING SIZE LOT and UTILITIES—ALL FOR ONLY \$6995 FULL PRICE**

Easy Terms Available

AD0741(C)



60' x 12' & 64' x 12' Models Also Available

Located In The Heart Of The Citrus And Lake Section Of Florida, On Four Lane U.S. #441-27.

Why pay rent when you can immediately move into a brand new two bedroom Mobile Home beautifully furnished on a 75 ft. x 125 ft. lot, all in readiness for immediate occupancy to enjoy leisure Florida living at its best. The original offering of 480 units was completely sold out. New addition now ready. Investigate before it's too late! For free booklet "Mobile Home Living in Florida", photos and information write:

ORANGE BLOSSOM HILLS, Dept. 32  
2148 N.E. 164th Street, Miami, Florida 33162

FEBRUARY 1970

## ESCOOT or SKI

For all Seasons — Unique and New

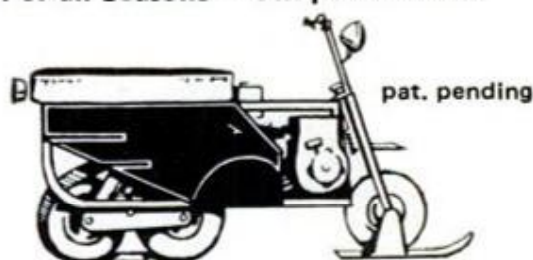

Easily Attached Track and Ski, Pivoting Tandem, 2 Speed Gear, Powerful, Automatic Torque Converter will carry two men 35 m.p.h.

Some Distributor & Dealerships Still Available  
SPREADS-ALL INC. Marshalltown, Iowa 50158

# Check the Kind of Body You Want

Charles  
Atlas

... and I'll Show You How  
EASILY You Can Have It!



Just tell me, in coupon below, the kind of body you want and I'll give it to you SO FAST your friends will be amazed. "Dynamic-Tension," my easy, 15-minute-a-day method, will make your chest and shoulders bulge... arms and legs surge with power... you: whole body feel "alive!"

**FREE BOOK** Learn how I became "World's Most Perfectly Developed Man"—Mail coupon! CHARLES ATLAS, Dept. 8B, 115 East 23rd Street, New York City, N. Y. 10010

CHARLES ATLAS, Dept. 8B  
115 East 23rd St., New York, N. Y. 10010

Dear Charles Atlas: Here's the Kind of Body I want:

(Check as many as you like)

- Broader Chest, Shoulders  
More weight—Solid—  
in the Right Places
- Powerful Arms, Legs, Grip  
Slimmer Waist, Hips  
Better Sleep, More Energy

Send me absolutely FREE a copy of your famous book showing how "Dynamic-Tension" can make me a new man—32 pages, crammed with photographs, answers to vital questions, and valuable advice. No obligation.

PRINT NAME..... AGE.....

ADDRESS.....

CITY..... ZIP.....

STATE..... CODE.....

In England: Atlas, 21 Poland St., London, W. 1

## Briggs & Stratton — Clinton New Gas Engine Sale

Never before and perhaps never again—this offer of brand new genuine Clinton and Briggs & Stratton engines including 1 yr. factory warranty at less than cost. Perfect power for go-carts, scooters, tractors, mowers, generators, pumps, sprayers, etc. We bailed out 3 big factories who needed cash and the savings are yours while quantities last. Act fast.



Clinton 2 1/2 hp. Md. 500—Re-coil starter Std. 5/8 shaft w. keyway—ready to go. Reg. price \$59.50 Special (item 1002)

**\$39.95**

2 for ..... \$78.95  
6 for ..... \$229.50



Briggs & Stratton 2 3/4 hp. Md. 81106 ratchet start, 3/4 shaft. Sturdy 4 cycle engine. Reg. price \$69.50 Spec Item = 1518

**\$39.50**

2 for ..... \$78.95  
6 for ..... \$229.50

**\$69.95**

**5 3/4 hp.**

**Briggs & Stratton**



Same engine with 12 v. elec. start and battery charging. (item = 1571) **\$99.50**

Briggs & Stratton 5 3/4 hp. Md. 143302. Re-coil start. Std. 1" shaft w. keyway, and adjustable governor—a rugged big engine ready to tackle any job. Regular price.. \$92.60

Special (item 1059) ... **\$74.50**  
2 for **\$145.00** 6 for **\$375.00**

**2 3/4 h.p. Clinton—39.95**

Model 400, rugged 4 cycle model. Alum. Block, castiron cylinder Rope start—5/8" std. shaft.

Item 1107 ..... **39.95**  
2 for ..... **78.95**

**3 1/2 h.p. Clinton—44.50**

A big engine with big power. Model 404, 4 cycle, rope start, 3/4" std. shaft, industrial ball bearing engine.

Item 404 ..... **44.50**  
2 for ..... **87.50**

Remember these engines are absolutely perfect and standard and under factory warranty. Money back guarantee. Order now while stocks are complete. Factories—we buy new engines.



### STANDARD DIAL PHONES WITH BELL

Bell System late model dial phones same as used by all telephone companies. Ideal as extensions on any system. Easy to connect. Several may be connected on one line. Easily modified for private inter-com system. Cost \$40.00 new—guaranteed excellent condition.

ITEM 855 NC. Wt. 8 lbs. .... **\$8.95**

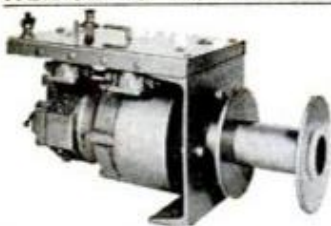

### TRUCK OR BOAT WINCH 2000

A powerful, compact winch which installs easily even in limited space. Works with any 12, 24 or 32 volt system. Reverses under power—positive brake holds load. Drip proof cover. Remote control if desired. Drum holds 100 ft. of 1/4" cable. Speed 30 ft. per minute. A terrific winch at an economy price.

Item 1263 ..... **\$69.50**  
Wt. 55# .....

## RECHARGE ALL BATTERIES

**Only Everlite**

- Charges 6 batteries
- Charges 3 times faster
- Charges all batteries

Including hearing aid, flashlight, lantern, radio, in fact any battery up to 12V. Save Money and have the convenience of fresh batteries always. Simple and 100% Safe. Plugs into any 115V. outlet. Guar. for one year. Send \$6.95 plus \$.65 for shipping .....

**695**



Model 75

Send 10c for 100 page Catalog FREE with order. Prices f.o.b. factory—Send check or MO

**MASTER MECHANIC MFG. CO., Dept. A-20, Burlington, Wis.**  
Southern Customers write Dept. A-20, Box 65, Sarasota, Florida

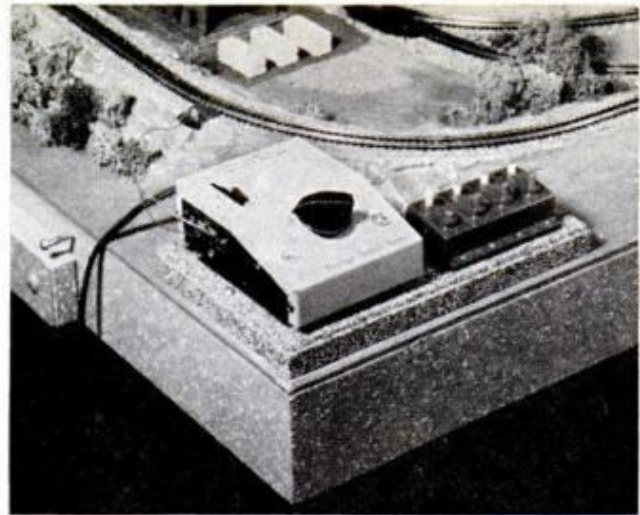

**THE POWER PACK** provides speed control, forward and reverse, a circuit breaker and the terminals for 16 v.d.c. (for trains) and 18 v.a.c. (for switches)

## A LOT OF RAILROAD

(Continued from page 193)

and there. When bits of lichen are added for trees and underbrush, the overall effect is most realistic.

Embankments leading from grade-level roadbed to tunnel portals are formed like the mountains, only here the crumpled paste-soaked paper is simply stuck to the edges of the inclined roadbed and sloped down to the train board. Texture paint is applied as before.

Before I fastened the track in place I painted the roadbed with a speckled black-and-white paint called Plextone which made it look like a bed of gravel. Normally the paint is sprayed but you can apply it with a brush.

I used tiny dressmaker's sequin pins to anchor the track and found them just the right size to pass through the minute holes in the track ties. The pins are so small you'll have to hold them with tweezers or small pliers to drive them.

To add ground cover along the tracks I used drywall joint compound. If you mix it to a somewhat soupy consistency, brush it on and then roll it with a 3-in. paint roller, it will look just like rough terrain when painted flat green.

I used joint compound also to slope the sides of the square-edge roadbed, and to form rivers and lakes. In the latter case, I created white caps by applying the compound with a swirling motion of the brush. Then, when dry, I painted it flat blue with a dry brush and purposely let some of the white compound show through.

When it came to adding trees and underbrush, some I planted right in the wet compound. On the mountains I attached them with glue. Here you can plant them anywhere you want, but stick them on



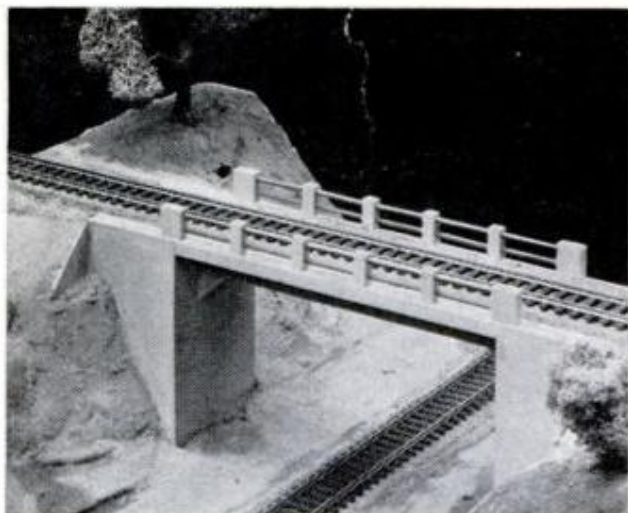

**PLASTIC STRUCTURAL SHAPES** let hobbyist build own scale-model bridges and overpasses. Write Plastruc Inc., 1621 N. Indiana St., Los Angeles, Calif.

well so they won't fall off when you swing up the train board.

The elevated roadbed between the two mountains can be handled in different ways. It can be supported by a single embankment formed by piers and paper. Or you can discard the roadbed as I did and replace it with several sections of plastic viaduct. The viaduct I used is made by Atlas and comes in a kit which you assemble with airplane cement. When I had several joined together as a unit, I cut it down to make it even with the tunnel roadbed, then glued it in place. The track at that point passes through one of the arches of the viaduct.

You have a choice of manual and remote-controlled switches. If you follow my track layout, there are places where you must use remote-controlled switches since they are beyond reach. These are switches that are located along the rear of the train board. Aurora Plastics Corp. offers individual pushbutton controls for such remote switches which can be ganged together in a row at the power pack. All wiring from the button controls to the switches is made below the train board. A good location for the power pack is at the left front corner of your layout. Attach it permanently to your train board so it can swing up with the rest of your railroad.

You'll find dozens of building kits at your hobby store for creating towns, farms, factories and rail yards. They are N-ga. scale to match the trains and require cementing together. All buildings are glued securely in place so they won't fall off. In fact, your rolling stock is all you should have to remove when you swing your railroad against the wall. When your layout is completed, you can hinge it to the bookshelf and finally add the screweyes to hook the trainboard to the wall. ★★★

## LEARN TO BE A SKILLED LOCKSMITH



Change combination of pin tumbler cylinder—**EARN \$1.50 in 15 MIN.**

Owner loses key; pick car trunk—**EARN \$5.50 in 10 or 20 MIN.**

**TYPICAL JOBS EARN YOU \$271 PART TIME (in only 53 hours!)**



Install new knob door lock—**EARN \$15.00 in 30 MIN.**



After-hour emergency opening—**EARN \$2.50 to \$5.50 in 20 MIN.**

**Hundreds have succeeded like these Belsaw Graduates:**

**R. W. Davis, St. Louis, Mo.:** "I am doing a wonderful business thanks to your course in locksmithing. Last Saturday I took in \$110.00."

**Pierson Crook, Los Angeles, Calif.:** "I am making \$200 a month extra income with the Belsaw Locksmith Course. I would recommend your course to anyone."

Big demand for skilled Locksmiths! Earn big money spare time in your own home. Be your own boss. No layoffs. Steady year 'round income. Age and schooling are no handicap.

**BELSAW INSTITUTE** training...approved by master locksmiths...helps you start faster with easy picture lessons guided by your own mail instructor.

Get thorough job training on all types of locks. We supply tools, equipment and business help: how to start, how to charge, how to get jobs, how to earn while you learn and build a lifetime cash-profit business. Accredited Member National Home Study Council. Approved by State Board of Education. Approved for Veterans.



**This \$125 key machine is yours to keep!**

**MAIL COUPON—NO SALESMAN WILL CALL**

**BELSAW INSTITUTE, 100F Field Bldg. Kansas City, Mo. 64111**

Send **FREE** book, "Keys To Your Future!"

**FREE BOOK**

Name \_\_\_\_\_

Address \_\_\_\_\_

City \_\_\_\_\_ State \_\_\_\_\_ Zip \_\_\_\_\_

Get more  
for your \$\$



with **ATLAS 12" lathes**

Quick change gear box with 54 threads and feeds. 16 spindle speeds—V-belt drive. Power cross feed—power longitudinal feed. Timken tapered roller bearings. 12 1/4" swing—big capacity. And more—from only \$565 f.o.b. factory.

Write for free catalog.  
**ATLAS PRESS CO.**

2-24 N. Pitcher St. • Kalamazoo, Mich. 49001  
537

Do This If  
**FALSE TEETH**  
Feel Loose, Insecure

Don't be so afraid that your false teeth will come loose or drop just at the wrong time. For more security and more comfort, just sprinkle famous **FASTEETH** Denture Adhesive Powder on your plates. **FASTEETH** holds dentures firmer longer. Makes eating easier. **FASTEETH** is alkaline—won't sour under dentures. No gummy, gooey, pasty taste. Dentures that fit are essential to health. See your dentist regularly. Get **FASTEETH** at all drug counters.

Learn Profitable Profession  
in few months at Home



**MEN AND WOMEN, 18 TO 60**

\$4.00 to \$5.00 for 1-hour treatment is the established charge for a skilled operator. Easy to learn and do. Diploma awarded. Open your own office or earn good income from Doctors, Hospitals, Clubs and other health or recreational centers. Wonderful part-time profession. Low monthly payments. Write today for free Anatomy Charts and catalog. No obligation.

**ANDERSON SCHOOL OF SCIENTIFIC MASSAGE**  
Dept. B-1, Princeton, Illinois



**110-120 VOLT A.C. LIGHT PLANTS—60 CYCLES**

Fanbelt driven from pickup or small gas engine. Operates saws, drills, pumps, freezers, T.V. X1000 Watts—Needs No Battery. Now \$70.00. 1500 Watts—8 and 12 volt vehicles. Now \$60.00. 3000 Watts—12 volt vehicles only. Now \$99.50. Guaranteed. Check or Money Order.

**VIRDEN PERMA-BILT, Box 7066 P.M., Amarillo, Texas 79109**

**BE A LANDSCAPE CONTRACTOR**

**LEARN MODERN LANDSCAPING** for exciting hobby or profit. Thousands of spare or full time money making opportunities. Start a profitable business—we show you how. Study and earn your certificate at home. Write today for Free Book. **LIFETIME CAREER SCHOOLS** Dept. A-790 2251 Barry Ave. Los Angeles, Calif. 90064

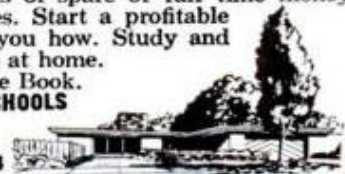

The Easy  
Way to  
Build



**BEAUTIFUL CLOCKS**

Send 25¢ for 48-page catalog of easy patterns, fine clock movements, dials and hardwood kits.

**CRAFT PRODUCTS**  
ELMHURST (1) ILL. 60126

TO YOUR OWN DOCTOR'S PRESCRIPTION  
**EYEGLASSES**  
BY MAIL AT  
GREAT SAVINGS!



Mail orders filled by **\$10<sup>95</sup>**  
licensed optician from

(Including single vision lenses, frame and case).

Doctor's prescription will be filled by a skilled, approved and licensed optician or your own prescription duplicated. Lenses are ground and manufactured to U.S. optical standards. Choose from complete catalog of men's, women's and children's glasses. Bifocals, trifocals, sunglasses or SAFETY HARDENED LENSES at low additional cost. We guarantee accuracy, perfect fit.

SEND FOR YOUR FREE CATALOG TODAY  
**PRISM OPTICAL INC.**

Dept. P2, 136 Liberty St., New York, N. Y. 10006

**HOLD IT!**  
the glue that never lets go!

write for FREE  
glue and caulk  
selector guides



**WILHOLD GLUES, INC.**

8707 Miller Grove Dr., Santa Fe Springs, Cal. 90670



**HEAVY DUTY BALL-BEARING PUMP**

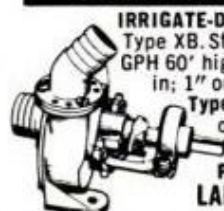

**IRRIGATE-DRAIN-SPRAY-CIRCULATE.** All-metal, rust-proof, Type XB. Stainless shaft. Use 1/4 HP or larger, 1 HP 1,200 GPH 60" high or 3,000 GPH 25' well. 5,200 GPH max. 1 1/4" in; 1" out. Belt or direct drive ..... \$12.95  
Type P won't rust or clog. Bronze-bearing. Hundreds of thousands in use. Up to 2,400 GPH. 1" inlet, 3/4" outlet. Free coupling..... \$8.95

P'pd. cash with order **MONEY BACK GUARANTEE**  
**LABAWCO, Box 40, Belle Mead, N. J. 08502**

GET INTO **ELECTRONICS**

V.T.I. training leads to success as technicians, field engineers, specialists in communications, guided missiles, computers, radar, automation. Basic & advanced courses. Electronic Engineering Technology and Electronic Technology curricula both available. Assoc. degree in 29 mos. B.S. obtainable. G.I. approved. Start Sept., Feb. Dorms, campus. High School Graduate or equivalent. Catalog.

**VALPARAISO TECHNICAL INSTITUTE**

DEPARTMENT D, VALPARAISO, INDIANA 46383



# Announcing the Popular Mechanics DO-IT-YOURSELF YEARBOOK 1970

• 14 Big "How-To" Classifications, 63 Section Topics •  
Over 500 "Show-How" Photos and Illustrations • Printed  
2-Colors Throughout • Washable, Permanent Hardbound  
Cover, 196 Big 8½" x 11" Pages • Quick Reference Index

**Just off the press—Popular Mechanics New Yearbook gives you the newest do-it-yourself advances that save time, work and money for the home handyman and hobbyist!**

Here at last—a new and ideal way to keep up with the how-to field! The most up-to-date guidebook and workshop companion available: **POPULAR MECHANICS DO-IT-YOURSELF YEARBOOK—1970!**

Whether you're a beginner or an experienced handyman, a hobbyist or sportsman, here are illustrated, easy-to-follow, step-by-step instructions on new projects and news of new products sure to increase enjoyment and save money for you and your family this year and every year.

You'll be able to do things that weren't even possible a year ago. Tape your own TV show. Build a whole aquarium in a coffee table. Make a stereo balance meter. Install an inexpensive automatic lawn sprinkling system. Put together your own brush buggy for a few hundred dollars. Put in an alarm system built from a kit. Construct a no-hands telephone amplifier. Select the right gun for the game you seek. Create a child's sidewalk car that looks like a Grand-Prix racer.

You'll be brought up-to-date on the year's best new products: building materials, tools, electronic devices, fishing gadgets, boats, recreation vehicles, the pace-setting 1970 cars, photography equipment. Whatever job you tackle, you'll know about the newest materials and tools to make-it or fix-it better.

**Examine 14 Days On Approval  
Available Now**

**Only Through Popular Mechanics**

As a Popular Mechanics reader, you can have your copy of the Do-It-Yourself Yearbook—1970 sent to your home by return mail for 14-days no-risk examination. It is not available in stores or from any other source. For hundreds of the best time and money-saving ideas of the year, detach and mail the coupon now. *This is a limited edition. So please order promptly before supply is exhausted.*

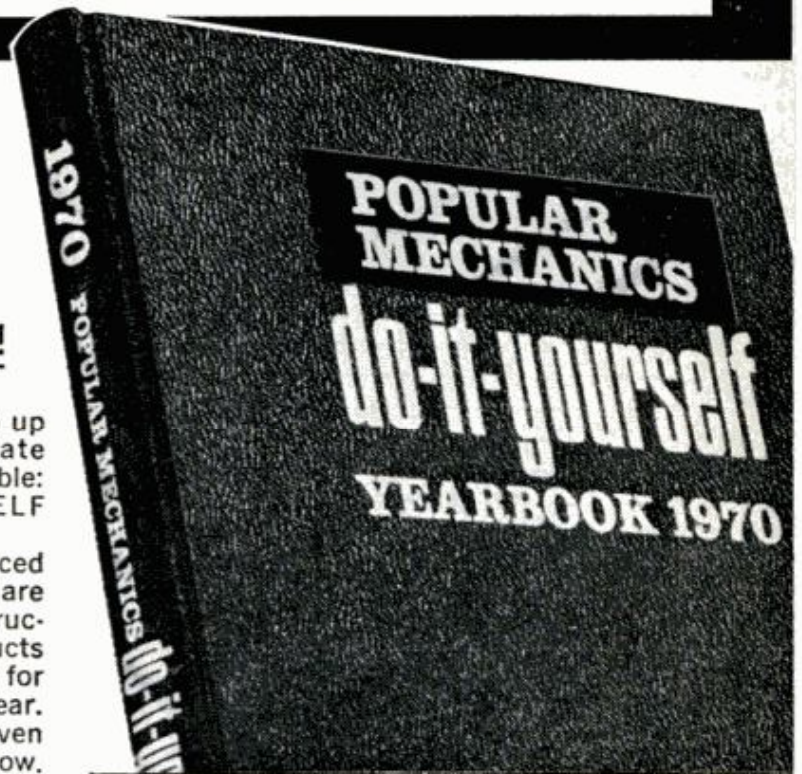

Here's just a small sampling of the hundreds of new ideas, short-cuts, inventions and projects . . .

Parade of '70 Cars & Recreation Vehicles	Build a Coffee-Table Aquarium
A Great New Duplicating Machine	What Gun for What Game
Multispeed Power Tools	Put Titles on Your Photo Slides
Those Fantastic New Films	All-Purpose Alarm from a Kit
The New Wonder Paints	Build a Child's "Grand Prix" Racer
Nifty New Automatic Turntables	One-Man Boat Loader for Your Car
Instant Grab—New Glue Guns	

## Mail for On Approval Examination

**Popular Mechanics Book Division, Dept. 0012  
250 West 55th Street, New York, N.Y. 10019**

Please rush me my copy of POPULAR MECHANICS DO-IT-YOURSELF YEARBOOK—1970. I enclose a check or money order for \$4.95. You will pay all postage and handling. I must be completely satisfied or I may return the Yearbook within 14 days for full refund.

Print Name \_\_\_\_\_

Address \_\_\_\_\_

City \_\_\_\_\_

State \_\_\_\_\_ Zip \_\_\_\_\_

This offer available in Canada at a slightly higher price. Canadian residents mail coupon to New York address. Shipment of books and all services will be handled within Canada.

## SAVE \$200 ON AUTO AIR CONDITIONING

Now save even more on NEW, LOWER PRICES on Comfy-Kit—world's leading install-it-yourself auto air conditioner. Standard Unit is now just \$133—Super is still just \$148—and Supreme still only \$165.

Easily installed with simple tools (we'll loan you the tools if desired). Comfy-Kit has been proven to exceed the performance of air conditioning units costing hundreds of dollars more.

Join the thousands of satisfied Comfy-Kit owners. Mail coupon today, and get the jump on summer.

**COMFY-KIT**

P.O. Box 8585, Dept. PM 2  
Dallas, Texas 75216

- Enclosed is \$133 for Standard Unit.  
 Enclosed is \$148\* for Super Unit.  
 Enclosed is \$165\* for Supreme Unit.  
 Enclosed is \$30 deposit on a Super /Standard   
 Supreme Unit. I will pay the balance, plus C.O.D. charges when delivered.  
 Enclosed is \$8.00 deposit for a set of four tools, which will be returned to me when I return the tools.  
 I would like to see the instruction book before I order. I enclose \$1.00 for the instruction book only. I understand this will apply on any future Comfy-Kit order.

Name \_\_\_\_\_

Address \_\_\_\_\_

City \_\_\_\_\_ State \_\_\_\_\_ Zip \_\_\_\_\_

My car is a \_\_\_\_\_ (year) \_\_\_\_\_ (model)

Engine displacement \_\_\_\_\_ Horsepower \_\_\_\_\_

Power Steering \_\_\_\_\_ yes \_\_\_\_\_ no

Floor shift \_\_\_\_\_ Steering column shift \_\_\_\_\_

Smog pump \_\_\_\_\_ yes \_\_\_\_\_ no

\*plus state tax where applicable

## DON'T QUIT SMOKING

*before giving my pipe  
a 30 Day Trial*

New principle that contradicts every idea you've ever had about pipe smoking. I guarantee it to smoke cool and mild hour after hour, day after day, without rest, without bite, bitterness or sludge. To prove it, I'll let you try a new Carey Pipe. Send your name and address today for my free complete trial offer. Write:

E. A. CAREY, 1920 Sunnyside Ave., Dept. 252-B, Chicago 40

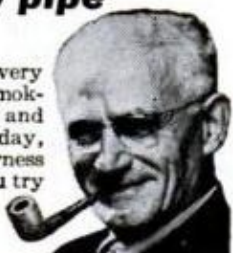

## Don't change your address without notifying us!

To insure uninterrupted service on your **Popular Mechanics** subscription, please notify us at least six weeks before you move.

1. Attach your address label from a recent issue in the space provided below... (If label not available, be sure to give us your old address, including Zip Code)

2. Print your name and new address below (be sure to include your Zip Code).

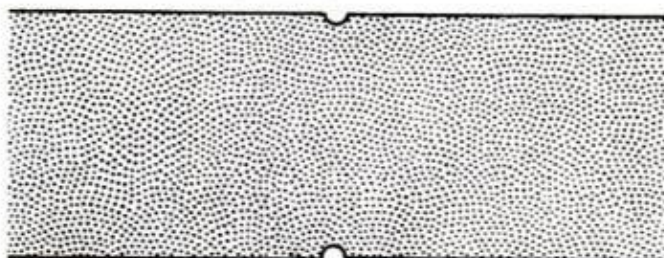

3. Mail entire notice to: **Subscription Service Dept.  
Box No. 646  
New York, N. Y. 10019**

Name \_\_\_\_\_

*Please Print*

New Address \_\_\_\_\_

City \_\_\_\_\_

State \_\_\_\_\_ Zip Code \_\_\_\_\_

**AMERICA'S NO. 1  
CLASSIFIED SECTION  
CAN BE FOUND  
ON PAGE 60  
IN THIS ISSUE**



# How to get good water.

You can get sparkling clean, spring-like water by the thousands of gallons for just \$29.95.

That's exactly what we offer with two types of Aqua-Pure home water filters. One removes dirt, rust, other solid matter. The other removes chlorine, sulphur, other bad tastes and odors.

Aqua-Pure water filters are now in use in over a million homes. They work. Year after year. They're sold by leading hardware, plumbing and farm supply dealers nationwide. They're the sure cure for almost every "bad water" problem.

For a free copy of AMF Cuno's informative booklet, "How To Get Good Water" write: Consumer Products Dept. PM-1, AMF Cuno Division, American Machine & Foundry Company, Meriden, Conn. 06450.



**Aqua-Pure**<sup>®</sup>  
WATER FILTERS

**AMF**  
CUNO



# Toughest oil in the block

Any engine worth its power is tough on oil. Change to the 100% Pure Pennsylvania that's extra-refined to take the rough stuff.

Buy your oil the way you bought your car. Carefully. Wolf's Head Oil Refining Co., Oil City, Pa. 16301

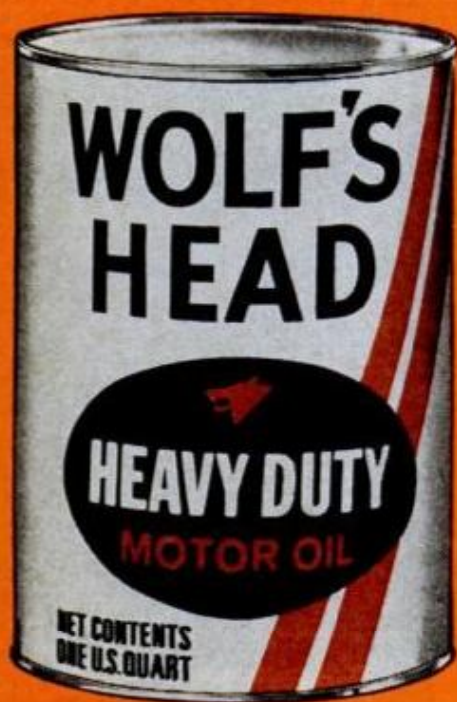

the uncommon motor oil  
Exceeds car makers'  
warranty requirements.

## Fox Mini Bike

DO IT  
YOURSELF  
OR FULLY  
ASSEMBLED

from  
**\$99<sup>50</sup>**



**SEND \$1 FOR BIG CATALOG** Shows new line of the world's finest MINI-BIKES (street and trail models), plus Go Kart <sup>®</sup>, parts, accessories and plans. Amazingly low prices! There's a Fox MINI-BIKE for everyone from age 10 to adults.

**EXTRA BONUS** Catalog shows radios, watches, walki-talkies, cameras, musical instruments, tools, appliances and many other items you can buy at practically wholesale prices. Free \$1 coupon.

**FOX CORP.**, Box 797PM, Janesville, Wis. 53545



## PLANER · MOLDER · SAW!

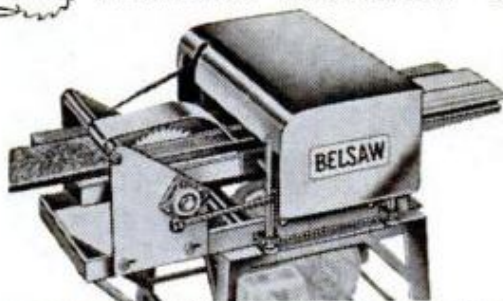

Now you can use this **ONE power-feed** shop to turn rough lumber into moldings, trim, flooring, furniture... **ALL** popular patterns. **RIP**... **PLANE**... **MOLD**... separately or all at once with a one HP motor. Use 3 to 5 HP for high speed output. Low Cost... You can own this power tool for only **\$30.00** down.

Send Postcard Today... No Salesman Will Call  
**BELSAW POWER TOOLS**, 900F Field Bldg., Kansas City, Mo. 64111



"G.I. BILL APPROVED"

## Excitement! Security! Good Pay! CRIME DETECTION

**LEARN AT HOME IN SPARE TIME—START NOW!**  
Crime everywhere is on the rise! Learn now, in your own home, the profitable profession that enables you to track down criminals and bring them to justice! Hundreds of Identification Bureaus employ I. A. S. graduates... trained in finger printing, police photography, handwriting identification, firearms and investigation. Our 44th year! **FREE** "Blue Book of Crime"... packed with crime facts and the full story of famous I. A. S. training. State exact age. No salesman will call. Rush Coupon!  
*A Correspondence School Founded in 1916.*

**FREE**  
Blue Book  
of Crime  
MAIL  
COUPON

**INSTITUTE OF APPLIED SCIENCE, Dept. 1352**  
1920 Sunnyside Avenue, Chicago, Ill. 60640  
Rush Blue Book of Crime... **FREE!**

NAME ..... Age.....  
ADDRESS .....  
TOWN..... STATE..... ZIP CODE.....

POPULAR MECHANICS



## "I Earn Two Incomes Now"

Says **JOHN BENNIE, Pittsburgh, Pennsylvania**

"Thanks to your wonderful training, I have been able to earn \$20 to \$25 extra each and every week doing little locksmith jobs at home and after work at my regular job. This is the best trade a man can take up."

# Be a LOCKSMITH

Train at HOME—Earn While You Learn. Add 50%—100% to YOUR INCOME with easy spare time earnings. Cash in on the nation-wide shortage—trained locksmiths in great demand! Quickly step into a big pay opportunity job or start a high-profit shop of your own.

**Earn Extra Money RIGHT AWAY!** All Master Locksmiths Special Tools, Equipment and Supplies Furnished FREE for use with course.

Age, education, minor physical handicaps don't matter in this growing trade. You can quickly qualify as a skilled locksmith. It's like a fascinating hobby. Study at home as little as one hour a week. Gain practical experience through complete well-illustrated lessons. Do real jobs on car locks, house locks, padlocks and safe locks, under the guidance of experts. FREE Illustrated Book, write now.

**LOCKSMITHING INSTITUTE,**  
(Div. of Singer Communications Corp.)  
Dept. 1110-020 • Little Falls, New Jersey 07424

**306** pieces of professional equipment  
**FREE** for use with course.

Professional Equipment includes  
**LOCKS—PICKS—PARTS—KEYS**  
**SPECIAL TOOLS & SUPPLIES**  
all FREE for use with course.

MAIL COUPON for FREE ILLUSTRATED BOOK

For a future as your own boss or in a high-pay job, write now for FREE Illustrated Book. Only school of its kind. Licensed by State of New Jersey. Approved for Veterans.

Accredited, Nat'l Home Study Council.

MAIL COUPON NOW

**LOCKSMITHING INSTITUTE, Dept. 1110-020**  
Little Falls, New Jersey 07424

Please send FREE Illustrated Book—"Your Big Opportunities in Locksmithing," complete Equipment folder and sample lesson pages—FREE of all obligation—(no salesman will call).

Name \_\_\_\_\_  
Address \_\_\_\_\_  
City \_\_\_\_\_ State \_\_\_\_\_ Zip \_\_\_\_\_



**AFTER ONE HOUR'S WORK**

Your Typewriter is now like new!  
I'll send a bill for the \$25.

This Can Be YOU Sooner Than You Think!

## BECOME A TYPEWRITER MAINTENANCE EXPERT

Quickly—Easily—At Home without risk!

Earn \$50 for 2 hours in your spare time, get a big pay position with a future or, start your own business.

There is a critical shortage of technicians to keep America's 30 million typewriters in repair. Now, regardless of age, education, or present job, you can enter this big-paying field by training in the Office Equipment Industry's only Approved Home Study Course.

Learn fast, and earn money while learning. Diagrams, photos, clear lessons, professional tools, plus benchmark assignments on actual typewriter that we give you, make learning easy.

Send name today for FREE BOOKLET telling of your opportunities in this profitable vocation. Full information, no obligation. No salesman will call. (VA Approved.)

Royal Typewriter for practice given you

PLUS ALL YOUR PROFESSIONAL TOOLS FREE!

MAIL COUPON FOR FREE BOOKLET

Typewriter Repair School, Dept. 3110-020  
Little Falls, N. J. 07424

Please rush Booklet entirely FREE. No obligation. No salesman is to call.

Name \_\_\_\_\_  
Address \_\_\_\_\_  
City \_\_\_\_\_ State \_\_\_\_\_ Zip \_\_\_\_\_

## Big Profits in UPHOLSTERY

Get Your Share... FAST!

EARN BIG MONEY **3** NEW EASY WAYS

FREE Deluxe Illustrated Book and Sample Lesson Pages

1. Be your own boss, make up to 85% profit.
2. Start earning right away at home in spare-time—keep furniture you make, or sell for hundreds of dollars.
3. Today's home and office upholstery, re-upholstery, slipcover boom make it easy to take your pick of big-pay jobs.

LEARN FAST—EARN FAST

You get expert instructions, plus all tools, new wooden frames, materials, fabrics, business tips, wholesale privileges, decorating magic AT NO EXTRA CHARGE. FREE Book, sample lesson pages show you how—no obligation—no salesman. Write TODAY.

**UPHOLSTERY TRADES SCHOOL**  
Division of Singer Communications Corporation  
Dept. 5110-020 Little Falls, New Jersey 07424  
(N. J. State Approved. Accredited Member National Home Study Council. Vet Approved.)



Tools, Equip., Frames, Materials, Fabrics. Supplies yours with course.

MAIL COUPON TODAY

**Upholstery Trades School, Dept 5110-020**  
Division of Singer Communications Corporation  
Little Falls, New Jersey 07424

ESTABLISHED 1939

Please send me FREE book, "Your New Way to a Successful Career," and FREE sample lesson pages. No obligation—no salesman will call.

Name \_\_\_\_\_  
Address \_\_\_\_\_  
City \_\_\_\_\_ State \_\_\_\_\_ Zip \_\_\_\_\_

**Bargain From London** **113 DIFFERENT British Colonies 24¢**  
Including Churchill "Gold" Stamps



Valuable "export parcel" includes gold-inscribed Churchill commemoratives from far-away Mauritius, Antigua, Tristan, etc.—all in fine mint condition. You also get brilliant set of flower stamps from Pahang, Perak, Selangor; other exciting issues. Total—113 different British Colonies—regularly \$1.75—but yours at export price only 24¢ to introduce bargain overseas approvals.

**Famous Stamp FREE if you act now!**  
Great Britain 1864 Queen Victoria  
OVER 100 YEARS OLD  
Send 24¢ in unused U.S. Stamps (no coins). Ask for Lot ZN-6

**BROADWAY APPROVALS, LTD.** 50 Denmark Hill  
London S. E. 5, England

## \$\$ TREASURE \$\$



New revolutionary analytical transistorized metal detector will distinguish a gold bar from a tin can. No more unnecessary digging for tin cans, nails, bottle caps, etc. Also features push button tuning, automatic tuning, loud-speaker. Negligible ground pickup. Greatest detection range, etc. Many models — free catalog.

### GARDINER ELECTRONICS CO.

Dept. 8, 4729 No. 7th Ave., Phoenix, Ariz. 85013



### Learn how to become a GAME WARDEN

GOV'T HUNTER, FORESTER, WILDLIFE MANAGER

Exciting job openings now for qualified men who love outdoor work. Protect forests and wildlife—arrest violators! Good pay, security, prestige and authority for respected career Conservation Officers. Easy home-study plan! Send for FREE Fact BOOK, aptitude QUIZ, SUBSCRIPTION to Conservation magazine. State age.

**NORTH AMERICAN SCHOOL OF CONSERVATION**  
Campus Drive, Dept. 4172, Newport, Calif. 92660

**SOLD!** **LEARN REAL ESTATE AT HOME**

... Get your license now, just as over 150,000 Anthony graduates have done! Send for FREE REPORT, "Your Future in Real Estate."

NAME \_\_\_\_\_ AGE \_\_\_\_\_  
ADDRESS \_\_\_\_\_  
CITY \_\_\_\_\_ STATE \_\_\_\_\_ ZIP \_\_\_\_\_

ANTHONY SCHOOLS, 1112 W. Olympic Blvd., Dept. 4172, Los Angeles, Calif. 90015

**HIGHBALL DOWN THE PIKE**

**TRIX** With world-famous 1:160 scale N-gauge **MINITRIX** series. Precision locomotives, bright headlights. 6 and 8 wheel drive, gear driven.

Tremendous pulling power. Greater variety in rolling stock and road names. Send for color catalog, 50¢ in coins (handling-postage.)

TRIX-TRAINS P.O. BOX 597 FARMINGDALE, N. Y. 11735

### SAVE FOREVER YOUR

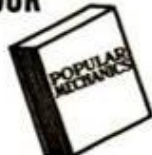

### IN FLEXIBLE VINYL INSTANT CASES

Send full address, title of Magazine & 85¢ for 1 case /for 12 issues/ or \$2.25 for 3 cases.

To: D. Hudac, P.O. Box 50249  
Cicero, Illinois 60650

## Career in ELECTRONICS?

Career training at home the new easy way with RCA Institutes. Lab work with first lesson. Easy payment plans. Send for free 64-page book.

RCA Institutes, Dept. 699-002-0  
320 W. 31 St., N.Y., N.Y. 10001



## WINE MAKING

...the fun hobby you can drink

Kit \$4.98

Free Catalog & Recipes

JIM DANDY WINE SUPPLIES  
Box 30230-M, Cincinnati, Ohio

## "LISTEN IN" TO POLICE-FIRE RADIO CALLS IN YOUR CAR!

Works with regular CAR RADIO and ANTENNA! NO special wiring or installation. Mounts UNDER DASH in 5 minutes in ANY CAR OR TRUCK. Panel switches INSTANTLY from REGULAR to POLICE-FIRE-EMERGENCY radio CALLS—Receives ALL stations in your AREA within range Works with ALL HOME RADIOS TOO!

**SEND ONLY \$2.00** (Cash, Ck. M.O.) and pay postman \$9.95 plus COD post or send \$11.99 for ppd Del in USA. COMPLETE ready to clip in your CAR with all parts and instructions. One year parts and service Warranty—10 day money back trial (if retnd). **AMAZING OFFER** good only by mail and from: **WESTERN RADIO** Dept. BPM-2 Kearney, Nebr. 68847



### BUILD YOUR OWN MODEL ENGINE

Got a lathe? You can do it! From high quality castings & drawings you can machine beautiful high performance engines. A wide selection is available including 9 gas & 3 steam engine designs. Single cylinders, twins, four's, & a V-8 with HP ranges from .25 to 3 HP. Air cooled and water cooled in both 4 cycle & 2 cycle designs. Send \$1.25 for catalog.

Lancer Engineering, P.O. Box 544, Pekin, Illinois 61554

### \$12.95 BLACK DIAL TELEPHONES

Complete add \$2.00 for color  
Factory rebuilt Western Electric in white, beige, ivory, pink, green or blue. If 4 prong plug is required add \$2.00. Fully guaranteed.



Designs may vary.  
Write for free list. All shipments F.O.B.

**SURPLUS SAVING CENTER**  
DEPT. PM70, WAYMART, PENNA. 18472

### BUILD A LOW COST PONTOON BOAT WITH THIS KIT...



### FREE CATALOG

It's fun, it's easy too! You can build a rugged pontoon boat that will provide years of fun for your family at an amazingly low cost.

WRITE: PERMA-D MARINE PRODUCTS DIV.  
DEPT. 46, CENTRAL MACHINE CORP.  
P.O. Box 4243, Minneapolis, Minn. 55418

## be a TAX CONSULTANT

Income unlimited in ever growing profession. Our students are earning lucrative fees in dignified full or part time home-office business preparing income tax returns during busy tax season. Many operate profitable Business Tax Service with steady monthly fees of \$10-\$50. No bookkeeping experience necessary. We train you at home and help you start. Licensed by N.Y. Education Dep't. No agent will call. Write for free literature. Accredited Member NITSC. Approved For Veterans. **NATIONAL TAX TRAINING SCHOOL, Monsey, 20PB, N. Y. 10952**



Get more  
**GETUPANDGO**  
from every engine with  
**GUMOUT**



**FIX** your appliances,  
car,  
house,

**SAVE**

on home improvements,  
air conditioning,  
power tools and more

WITH THIS

**FREE \$3.49**  
VALUE  
**GIFT VOLUME**

Just look back over the past few years and figure how much you have spent on repairs for your home, your car, your appliances. Wouldn't you like to keep these high-priced repair fees for yourself? Well, now you can.

As a reader of *Popular Mechanics* the chances are that you already have a considerable degree of skill with tools. Nevertheless, you may have hesitated to tackle more complicated repairs, improvements or hobby projects.

Now, however, this FREE Book—packed with the combined skill and know-how of 257 *Popular Mechanics* expert editors, consultants and designers—can put a professional edge on your do-it-yourself skills.

### The most difficult jobs will soon become easy

Before you know it, you'll be able to fix car engine troubles... transform unfinished attic space into an extra bedroom... catch more fish using homemade lures... learn "tricks-of-the-trade" in handling power tools... save hundreds of dollars when buying and servicing appliances.

These are just a few of more than 6,000 exciting "how-to" ideas, plans, and valuable projects you'll find in *POPULAR MECHANICS DO-IT-YOURSELF ENCYCLOPEDIA*. You'll learn how to get more professional-looking results than ever before in your carpentry, metalwork, plumbing, masonry, electrical wiring, electronics, hi-fi, stereo, car repair, painting, decorating... PLUS exciting new ways to help you get more fun out of your hobbies, sports, vacations. Experts lead you step-by-step through every project you select. Without question, here is the most helpful, reliable, "how-to-do-it" guide you've ever seen—and Volume 1—a \$3.49 value—is yours ENTIRELY FREE!

### You risk nothing on this FREE Book offer!

As soon as your gift book comes, browse through it—try some of the exciting ideas—use some of the money-saving tips. We're sure you'll get so much valuable help from this book, you'll want to see the other volumes as they are published. You can see future volumes without risk—on a 14-day FREE TRIAL basis. But this first volume is yours as an outright gift—whether you buy one, two, five, the whole set, or none at all. But please hurry. Our supply of gift volumes is definitely limited. To be sure of getting your copy FREE, mail the coupon today.

### Here is a brief glimpse of all your FREE Volume brings you:

- Fix 8 common car engine problems and save garage fees
- Save money air conditioning your entire home
- Cure a wet basement and save \$200 to \$2,000 under what professionals charge
- Burglarproof your home with special power alarm
- Professional tips for expert sanding
- Learn arc welding basics in 6 hours of easy practice
- How to save on band saw blade costs by making your own
- Build a gas-fired barbecue for more back-yard fun

PLUS much, much more

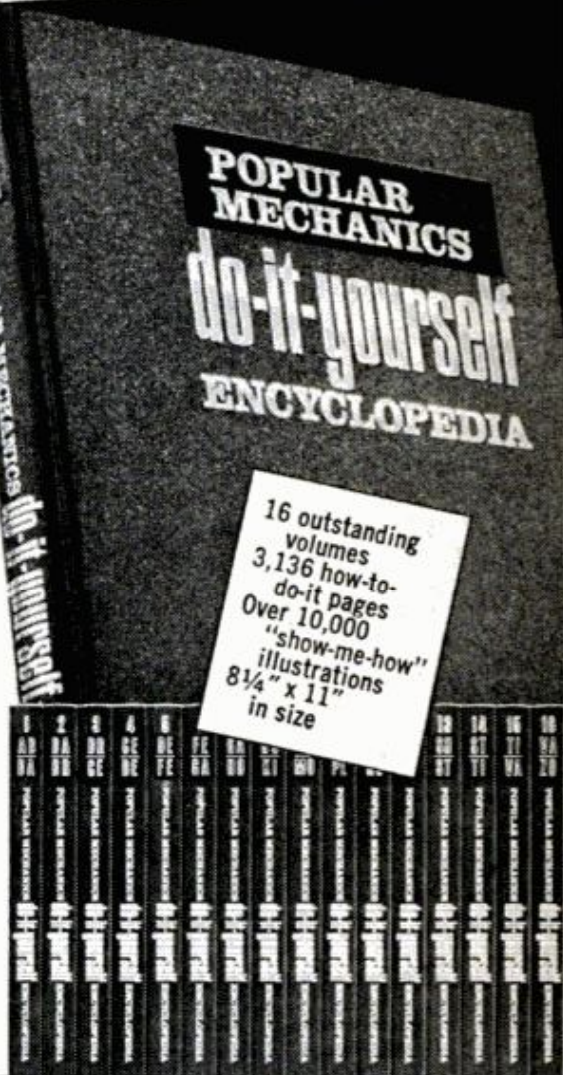

### MAIL COUPON TODAY!

Popular Mechanics Book Division, Dept. 0012  
250 West 55th St., New York, N.Y. 10019

Please send, entirely free, Volume 1 of the new, illustrated *POPULAR MECHANICS DO-IT-YOURSELF ENCYCLOPEDIA*. I'm not obliged to buy anything—now or later—but am entitled to receive additional volumes (including future Yearbooks), on approval as published each month. After examining each volume free for 14 days, I either return it and owe nothing—or keep it and remit low subscriber price of \$3.49 a volume, plus shipping. I reserve right to cancel any time—without obligation. Whatever I decide, Volume 1 is mine to keep free!

Name \_\_\_\_\_  
(Please Print)

Address \_\_\_\_\_

City \_\_\_\_\_

State \_\_\_\_\_ Zip \_\_\_\_\_

Signature \_\_\_\_\_

This offer available in Canada at a slightly higher price. Canadian residents mail coupon to New York address. Shipment of books and all services will be handled within Canada.

# RADIAL ARM SAW KIT—for under \$100...

Buy direct from factory, assemble yourself. Incl. 1/2 h.p. G.E. motor, easy to follow instructions, all parts, nuts and bolts. Guar. for life pat. pend. radial arm track; twice the usual bearings for extra rigidity, greater precision. Rips 24", crosscuts 12"; belt brake. \$99. complete, freight col. Kit less motor (any standard 1/3 h.p. or larger will do) \$ 84.85. With opt'l G.E. motor developing 1 h.p. \$108.65. Money back guaranteed by one of world's largest manufacturers of bench power tools.



## MAIL COUPON FOR ILLUSTRATED BROCHURE

American Machine & Tool Co.  
Dept. PM2R, Royersford, Pennsylvania 19468  
Please send me without obligation your free illustrated brochure containing full information on the PermaTrak radial arm saw kit. Also send free reprints of feature articles by editors of Popular Mechanics, Workbench and Family Handyman. NO SALESMAN IS TO CALL.

NAME \_\_\_\_\_

ADDRESS \_\_\_\_\_

CITY \_\_\_\_\_ STATE \_\_\_\_\_ ZIP \_\_\_\_\_

# DART<sup>®</sup> ELECTRONICS ANNOUNCES THE ALL NEW GOLDSEYE<sup>®</sup> SERIES

COPYRIGHT 1969 DART ELECTRONICS U. S. PAT. PEND.

## NEW PROFESSIONAL METAL LOCATOR OUTPERFORMS OTHER MODELS

**GUARANTEED** • Easily detects buried coins, relics, gold, silver, copper and all other metals. Works through dirt, sand, rock, wood, water, etc. New solid state circuit assures maximum performance.



Fully Transistorized 1970 MODEL

MODEL XL

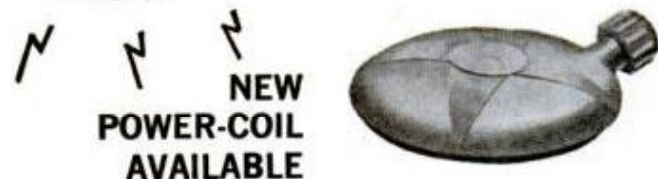

NEW POWER-COIL AVAILABLE

Order one now or add it on later. Why buy a detector without this valuable feature?

The all new Dart power-coil will effectively double the penetration depth of the XL and XXL Goldseye Models on larger objects that are buried deeper.

POWER-COIL, ONLY \$1295 POSTPAID

## BUILD YOUR OWN ALCORT Sailfish<sup>®</sup>



(Standard Model) Only \$224 F.O.B. Waterbury, Conn.

Kits are also available for popular Super Sailfish and Sunfish models. Sails and all fittings included.

FOR DETAILS WRITE:

AMF ALCORT, PM270 P.O. BOX 1345, WATERBURY, CONN. 06720

## HOME WORKSHOP ARC WELDER!



**NATIONALLY ADVERTISED \$18.95 VALUE—NOW 40% DISCOUNT! WELDS—BRAZES—SOLDERS—CUTS—ALL METALS!** Plugs into ANY 110 volt socket. MAKE—REPAIR 1001 items for CAR—HOME—BUSINESS. Lifetime BURNOUT GUARANTEE 10 day money

back trial (if retrnd). HEAVY DUTY Design—Does \$85.00 welder work. No experience needed—FREE WELDING LESSONS! (cash, ck, M.O.) and pay postman \$9.99 SEND ONLY \$2.00 COD postage or send \$11.99 plus \$1.00 postage for paid del. in U.S.A. COMPLETE READY TO USE Includes BIG pack steel, Brazing, Solder, Carbon "touch" rods. ELECTROFLAME ARC TORCH! OFFER LIMITED—Order TODAY! MIDWAY WELDER Dept. EPM-2 Kearney, Nebr. 68847



## DEFENDER OF WOMEN!

Instantly Stops Attacker

Assailants run screaming when sprayed in face with DEFENDER. When you're in danger, simply press top. Temporarily leaves attackers helpless. Dyes skin identifying

attacker for police. Effective up to 15 ft. Lip-Stick size—hides easily in palm of hand. Women buy on sight. Amazing profit! SAMPLES for TRIAL Sample offer sent to all who send name at once. Postcard will do. SEND NO MONEY, Just your name. KRISTEE CO., Dept. 679, Akron, Ohio 44308

ONLY \$2995 POSTPAID

Comes complete, ready to use. New powerful circuit for maximum sensitivity. Has both loudspeaker and earphone, uses inexpensive 9 volt battery. Lightweight: Only 2 pounds.



VIEW-METER MODEL ONLY \$3995 POSTPAID

VIEW-METER MODEL XXL New View-Meter model detects objects on the fringe of detectable depths, means more sensitivity.

## ORDER NOW FOR IMMEDIATE SHIPMENT!

TO: DART ELECTRONICS P. O. BOX 361 PM HUNTSVILLE, TEXAS 77340  
ENCLOSED THE SUM OF \$ \_\_\_\_\_ FOR THE ITEMS CHECKED BELOW.  
 CASH  CHECK  MONEY ORDER  
 DART MODEL XL ..... \$29.95  
 DART MODEL XXL, WITH VIEW-METER... \$39.95  
 POWER-COIL ..... \$12.95

NAME \_\_\_\_\_

ADDRESS \_\_\_\_\_

CITY \_\_\_\_\_ STATE \_\_\_\_\_ ZIP \_\_\_\_\_

POPULAR MECHANICS

# Now Annoying Squeaky Hinges Can Be Sprayed Quiet.

One sw-o-o-sh is all it takes to get rid of the nerve-wracking squeak of a stubborn hinge when you apply new 3-IN-ONE Oil Spray. Lubricates. Cleans. Polishes. Prevents rust and tarnish. Get 3-IN-ONE can or new aerosol spray at all hardware stores.



**3-IN-ONE®**  
HOUSEHOLD OIL

## ENROLL—EARN YOUR DEGREE

of Bachelor of Bible Philosophy (B.Ph.B.), Master of Bible Philosophy (M.Ph.B.), Graduate of Bible Philosophy (G.Ph.B.), Doctor of Metaphysics (Ms.D.), or Doctor of Divinity (D.D.). Chartered by State, Correspondence Courses only. Please write for FREE BOOKLET.

**AMERICAN BIBLE INSTITUTE**  
Dept. PM, Post Office Box 8748, Kansas City, Missouri 64114

## MEN-TRAIN NOW FOR A BIG PAY JOB AS A CLAIMS ADJUSTER

Former U.S. Army mechanic and service station attendant EDWARD D. PAIGE is now employed as staff adjuster by Free State Adjusters, in Virginia. "Your I.A.S. Home Study Course, in my opinion, is the best that can be obtained. Also, the Resident Training I received, gave me a good working knowledge and understanding of the claim adjusting business."



You can earn top money in this fast moving, action packed field. Insurance Investigators are urgently needed to settle claims worth billions of dollars annually. The tremendous increase of auto accidents alone have doubled the need of qualified adjusters. INSURANCE ADJUSTERS SCHOOLS lets you train at home in your spare time, followed by Resident Training at school owned facilities at MIAMI BEACH, FLA. or LAS VEGAS, NEVADA. Nationwide employment assistance. Don't Delay! Write for FREE information today!

Accredited Member N.H.S.C.

APPROVED FOR VETERANS UNDER NEW GI BILL

INSURANCE ADJUSTERS SCHOOLS DEPT. PM  
1901 N.W. 7 Street, Miami, Fla. 33125

Please Print

Name \_\_\_\_\_

Address \_\_\_\_\_

City \_\_\_\_\_ State \_\_\_\_\_ Zip \_\_\_\_\_

Age \_\_\_\_\_ Phone \_\_\_\_\_

# NEW RUBBER STAMP BUSINESS PAYS BEGINNERS UP TO \$16.50 AN HR.

**START AT HOME  
IN SPARE TIME**  
with Table Top Machine!

We Help Finance You  
... at less than bank rates!

The multi-million dollar Rubber Stamp business—once controlled by a few big companies—is now being taken over by small operators—one in each community throughout the United States. Men and Women who have this inexpensive machine can turn out huge quantities of Rubber Stamps with special wording that buyers once were forced to buy from big cities. Material costing only 27c makes a stamp that sells for \$2.75. The machine that does the work is simple and easy to operate and it turns out as many as six Rubber Stamps at a time, each with different wording such as names, addresses, notices, stock numbers, prices and other "copy" needed by offices, factories and individuals. Working full capacity, it can earn as much as \$33.00 an hour for the operator! Now you can get into the big-pay business yourself, with your own home as headquarters. You don't need experience. We supply everything, including complete instructions and eight ways to get business coming in fast. We even help finance your start. Start making up to \$16.50 an hour from the very beginning. Cash in on the profitable Rubber Stamp business in your community, right away. We'll mail full particulars FREE and no salesman will call. Be first in your locality. Rush coupon today or send your name on postcard to:

**RUBBER STAMP DIV., R-2-B**  
1512 JARVIS AVENUE • CHICAGO, ILL. 60626



**RUBBER STAMP DIV.**  
1512 Jarvis Ave., R-2-B  
Chicago, Illinois 60626

**FREE!**

Please rush full particulars about your financing plan and the little machine that can get me started in the profitable Rubber Stamp business at home in spare time. Everything you send me is FREE and no salesman will call.

NAME \_\_\_\_\_

ADDRESS \_\_\_\_\_

CITY \_\_\_\_\_ STATE \_\_\_\_\_ Zip Code \_\_\_\_\_

# AMT 40<sup>TH</sup> YEAR DIRECT FACTORY BLOCKBUSTER

# SAVE UP TO 70%

ON THIS DELUXE FULLY GUARANTEED

## 8" TILT ARBOR POWER SAW

NOW ONLY \$39<sup>95</sup> THE "MUST" TOOL FOR EVERY WOODWORKER

COMPLETE AS SHOWN  
F.O.B. FACTORY Shipping Wt. 30 lbs.

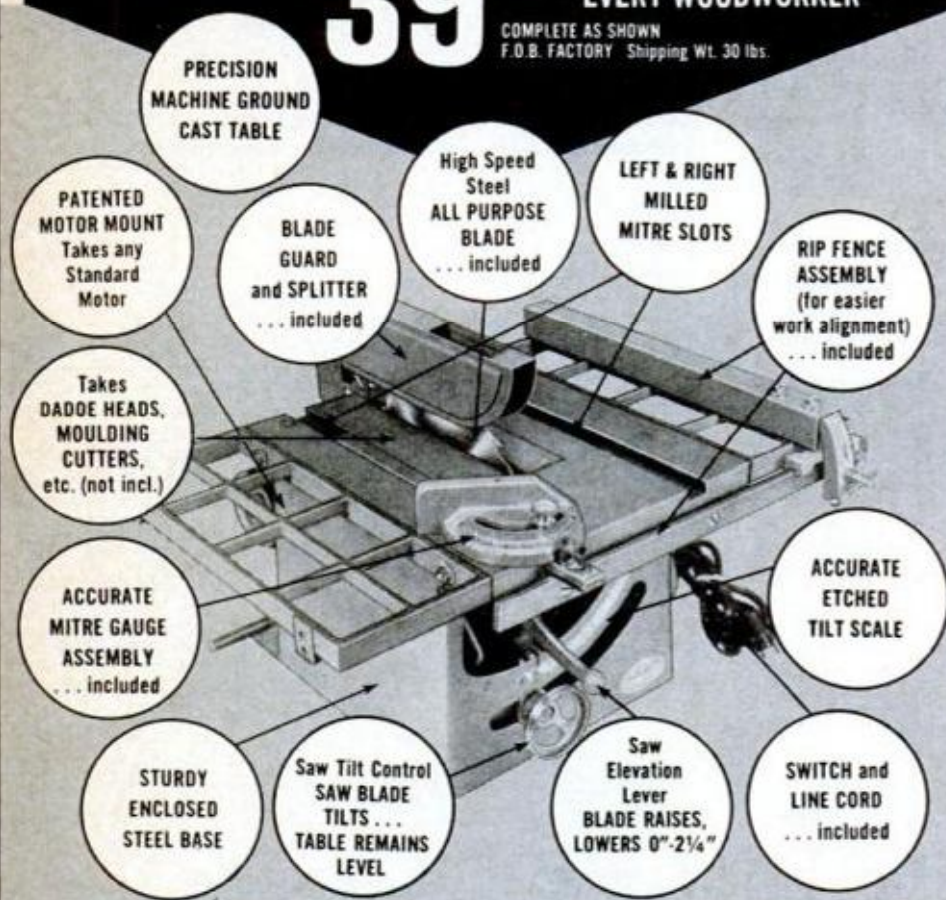

Compare this professional quality 10-year guaranteed workhorse with any similar unit at any price. You'll know how well AMT has earned its reputation as the miracle worker of the power tool industry. Compare the extra convenience and accuracy of its special tilt arbor construction and its patented tilt mechanism. Compare its large precision ground cast iron table. Compare its accuracy, versatility and ease of operation. Compare the fantastic difference in cost with any similar unit on the market. Consider all the added top quality engineering and design features. Here's dramatic proof that this is, indeed, so far as we can determine, the most sensational power tool buy in history!

### 1.4 MILLION USERS KNOW AMT'S VALUES

Factory-to-you sales and revolutionary patents decrease costs. The elimination of costly chrome trim and other non-functional doodads add to your savings. And the just completed addition to our Royersford plant doubles our manufacturing space, provides added economies. All this has made possible a full function power tool that performs in every way as well as and, in some ways, very much better than bench saws selling for considerably more than three times the price.

The patented motor mount takes any standard 1/4 hp motor or larger; its special design keeps belt tight, assures perfect alignment at any angle, transmits full power.

- **Popular Science** says: "no woodworker's fantasy . . . it's for real . . . Sound, imaginative engineering . . . Saw deal a nifty."
- **Workbench Magazine** awarded us their coveted "Workshop Tested" seal.
- **Saw in use 23 years.** "I still use the 8" saw I bought from your company 23 years ago." A. Bordogna, Trafford, Pa.
- **Praised by veteran pattern maker.** ". . . Never saw a machine take the use this saw has without failure." Lawrence King, Springfield, Mass.

- CROSSCUTS • RIPS • MITRES • CUTS COMPOUND ANGLES
- DADOES • MAKES COVES, MOULDINGS

## GUARANTEE

### 10-DAY MONEY BACK GUARANTEE

Put it through its paces. Give it any valid test you can think of for accuracy, speed and ruggedness. Compare its performance with any similar machine at any price. Not satisfied? Return it—freight collect—for a prompt, no-questions-asked refund.

### 10-YEAR FULL SERVICE GUARANTEE

Any part or parts (except motor and blade) which may become inoperative for any reason within ten years after purchase date will be repaired or replaced by the factory without cost to the purchaser except for postage.

### AMERICAN MACHINE & TOOL CO.,

Dept. PM20, 4th & Spring Sts., Royersford, Pa. 19468

Please send me the units checked. Payment in full enclosed \$\_\_\_\_\_ or \$6. deposit enclosed, balance C.O.D.  I MUST BE FULLY SATISFIED OR WILL RETURN WITHIN 10 DAYS FOR FULL REFUND. No questions asked.

Fully equipped 8" Deluxe Bench Saw \$39.95

GE Motor:  Ordered separately \$24.85  Ordered with saw \$18.80

NAME \_\_\_\_\_

ADDRESS \_\_\_\_\_

CITY \_\_\_\_\_

STATE \_\_\_\_\_

ZIP \_\_\_\_\_

MAIL  
QUICK  
ACTION  
COUPON  
TODAY

**BRAND-NEW GE MOTOR** DEVELOPING FULL 1 HP \$18.80 F.o.b. factory / if purchased with saw. Purchased separately, \$24.85 Wt. 17 lbs.

# Caution: The Spoiler<sup>®</sup> is habit-forming.

Not a pill. Not a powder. It's a razor blade. The Gillette Spoiler.

A blade that brings relief to the man with the sensitive skin who feels the slightest tug of blade on whisker, right down to the roots.

Baked on to the edge of this blade is the miracle plastic coating

you've been hearing so much about.

Invented by Gillette, this coated edge reduces the pull to a fraction of what it would be without the coating.

You'll notice the difference especially when you shave those extra sensitive spots, such as under your nose, under your mouth, around the edge of

the chin and on the neck.

Caution: This blade is habit-forming. (The men of America have become so dependent on it, they buy more Gillette Spoilers than all competitive double-edge blades combined.)

Yes—the Spoiler edge is also available for injector blade users.



Evinrude motors are designed to

# catch more fish



we give luck a little help

Most outboard builders think fishing motors are the same as other motors. At Evinrude, we know better. A fishing motor is part of your *fishing tackle*. So naturally, we give more attention to the things that fishermen need. Things like a sensitive speed control that makes it easy to find, and return to, the *one best trolling speed*. And a carburetor that holds that speed, hour after hour.

Things like quiet that comes from *isolating* noise and fish-spooking vibration, instead of quiet that comes from covering it up.

We go further in providing *underwater propeller protection*, in designing for *true weedless operation*, and in protecting against salt water corrosion.

Because fishermen aren't all alike, we build *different kinds* of fishing motors for different kinds of fishing — instead

of building the same standard motor for everybody, in different sizes.

Being fishermen ourselves, we try to build every fishing motor as though our next fishing trip depended on it.

So naturally, we do everything we can to give luck a little extra help.

Evinrude fishing motors are made in 1½, 4, 6, 9½, 18, and 25 hp sizes. Conventional, low-silhouette, and weedless models. Free catalog: Write Evinrude Motors, 4190 N. 27th St., Milwaukee, Wis. 53218.

power for the performance generation **EVINRUDE** **fish in**  
Div. of Outboard Marine Corporation **OUTBOARD**