

How to Go After a Better Job

POPULAR MECHANICS

OCT. 1968
50 CENTS

What's
New in
Outboards
and
Snowmobiles

In Color! '69 Cars

Aboard the World's Last Battleship
Build Your Own Flight Simulator

First Report: TROOPER TV
Instant Replay for Tailgaters;
A Videotape for the Judge

Test Report:
New 7-Pound
Chain Saw

HOW TO:

Lay Concrete Block • Buy and Install
Prefinished Siding • Choose and Use Screws • Take
Portrait Photos • Safety-Check Your Car (Saturday Mechanic)
Solder With a Gun • Make Your Own Dowels • Call Ducks and Other Game

WEEKEND PROJECTS: Remodeling Ideas

Automobile Clinic • Dan Gurney Answers Your Questions on Racing and Driving

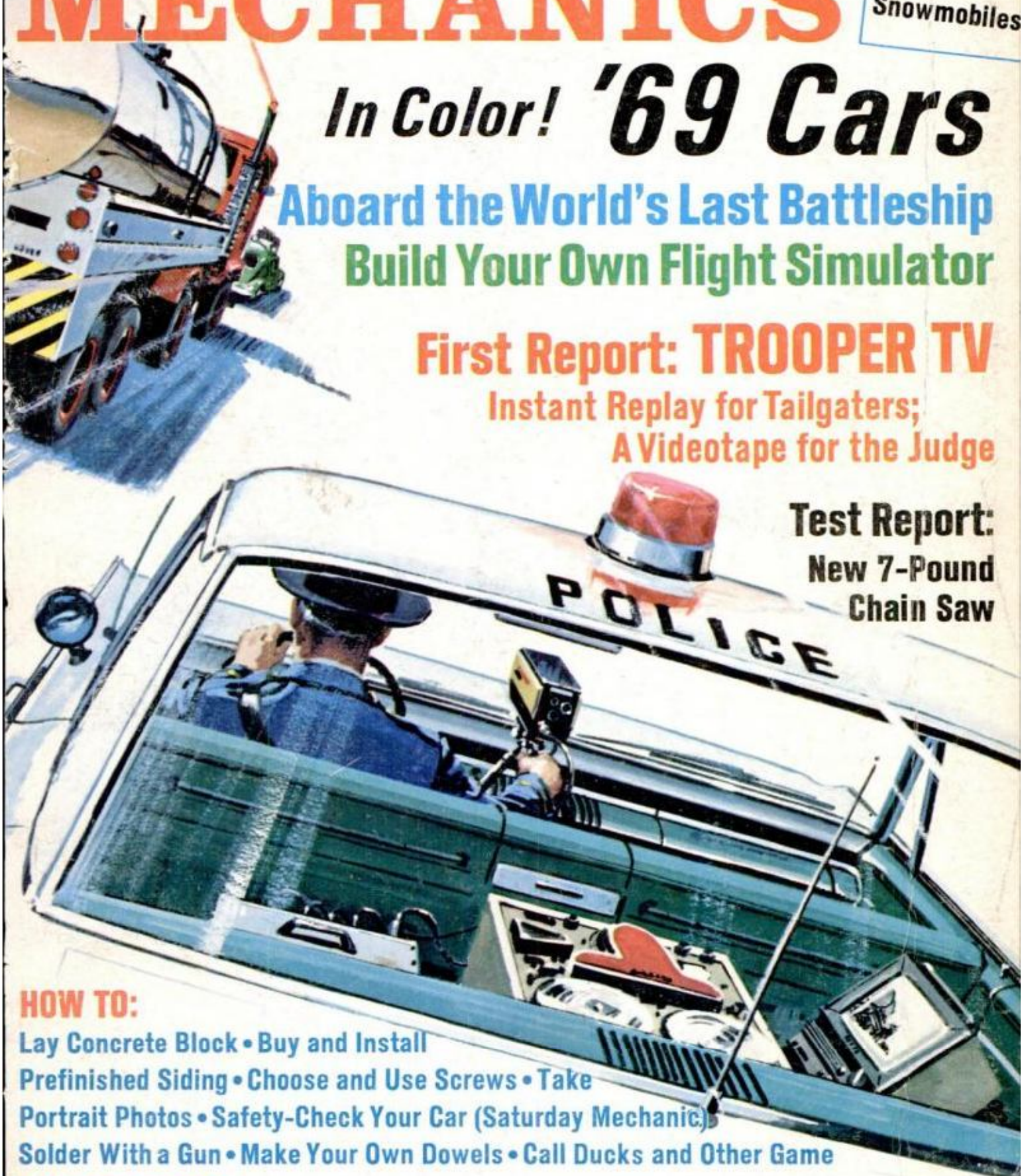

Oneida...the boot that took Antarctic punishment in stride



Glacier-hopping on perilous Heard Island, this explorer wears Oneida for warmth, safety, comfort.

You probably won't ever sail a small vessel through sub-antarctic waters to a treacherous, weather-blasted island and climb to the summit of a storm-swept volcano.

But it's nice to know Red Ball Oneidas can take that kind of punishment!

That's why Oneida, the fully insulated boot that conquered cold, repelled water, resisted wear, required no maintenance and gave solid comfort to members of an Antarctic expedition—is the best boot for you.

Buy a pair and do your own exploring!

 **Red Ball Oneida**

Look for the Red Ball by Ball-Band, Mishawaka, Indiana



It's your face.

If you think the only way to get a good, close shave is with a razor blade, we've got some news for you.

In an independent laboratory, some very independent men shaved one side of their faces with a leading stainless steel blade and shaved the other side of their faces with a new Norelco Tripleheader Speedshaver®.

The results showed the Tripleheader shaved as close or closer than the blade in 2 out of 3 shaves.

Instead of one straight shaving edge like a blade, the Tripleheader has rotary

blades inside of new, thin, Microgroove™ heads that 'float.'

So the Tripleheader follows your face, to shave you closer.

It has a pop-up sideburn trimmer. A handy, coiled cord.

It comes in either a Rechargeable or a Cord model.

And it won't pull or nick or cut.

Because it shaves your beard.

Not your face.

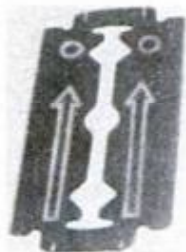

This One



FRZH-34N-54GS

©1968 North American Philips Company, Inc., 100 East 42nd Street, New York, N. Y. 10017



**40,000
mile
tread wear
guarantee
Virtual
elimination
of punctures
and blowouts
Up to 10%
gas economy**



It's all wrapped up in this.

Guarantee given by MICHELIN TIRE CORPORATION covers repair, credit or refund at its option. Credit or refund based on consumer's original purchase price and proportion of mileage run. (See us for details).

**Maximum
all-weather
traction
Easier
steering
Quicker
stopping
Smoother
high-speed
driving**

* Bibendum the tire man. Michelin's trademark of quality since 1891.

68-1742

**MICHELIN
'X'RADIAL®**

CONSULT THE YELLOW PAGES FOR YOUR NEAREST MICHELIN DEALER

The next time some guy tells you a used car is "just like new" ask for the guarantee.



When all the smooth talk is done, a guarantee is about the only thing this kind of guy is guaranteed not to give you.

Which might explain why so many people find it rough going with a used car they got from a smooth-talking salesman.

VW used car dealers aren't smooth talkers. In fact, they aren't talkers at all. Their guarantee says it all.

A Volkswagen dealer will repair or replace any of the major working parts of his guaranteed used cars, for 30 days or 1000 miles,

whichever comes first, free.

The engine, transmission, rear axle, front axle assemblies, brake system, electrical system are all covered.

He can cover them because he fixes what needs fixing beforehand. When he inspects his trade-ins.

If they don't pass inspection, of course, they don't get the guarantee.

But if they do, anything he has to say about them he says in writing.

It's all the conversation you need.



POPULAR MECHANICS®

INTERNATIONAL EDITIONS: AUSTRALIA, BRAZIL, CARIBBEAN, DENMARK, FRANCE, MEXICO, SOUTHERN HEMISPHERE, SWEDEN

AUTOMOBILES AND DRIVING

- 10 Detroit Listening Post
- 40 Drivin' With Dan
- 84 Automobile Clinic
- 85 Watch It! You're on Trooper TV
- 96 The '69 Cars
- 99 Family Cars: Size Up, Market Down
- 103 Intermediates: Where Buyer Action Is
- 107 Personal Cars: High Style Combined With Speed 'n' Sport
- 113 Luxury Cars: Just Bring Lots of Money
- 116 Compacts: Good Size, Good Sense
- 148 Saturday Mechanic: Make This 13-Point Check for a Safe Car
- 159 Cartop Carrier Gives Bikes a Free Ride

HOME AND YARD

- 146 New 7-Pound Chain Saw—A Rip-Roaring Performer
- 156 At Last: a Self-Cleaning Furnace Humidifier
- 160 Down-to-Earth Facts About Prefinished Sidings
- 164 Exciting New Products
- 166 How to Lay Concrete Blocks Like an Amateur
- 176 Home Remodeling Ideas
- 180 Solving Home Problems
- 209 Homeowners' Clinic

AEROSPACE, AVIATION, MILITARY

- 78 Aviation Jetstream
- 88 A Battlewagon Returns From Mothballs
- 173 Build It Yourself, Then Learn to Fly This \$200 Flight Simulator

BOATING, OUTDOOR RECREATION

- 82 What's New Outdoors
- 92 '69 Outboards: Potent Power in Pint-Size Packages
- 124 Call of the Wild—Man-Made
- 130 '69: A Surprise Year in Snowmobiles

ELECTRONICS, RADIO AND TV

- 127 New Paper Battery
- 138 How They're Killing the Dead Heat
- 182 New in Electronics

SHOP AND CRAFTS

- 142 How to Choose and Use Screws
- 165 Colonial String Box
- 166 How to Lay Concrete Blocks Like an Amateur
- 172 Hints From Readers
- 173 Build It Yourself, Then Learn to Fly This \$200 Flight Simulator
- 184 Self-Ejecting Dowel Maker
- 186 Easy on the Draw—Soldering Guns Are Hotter Than Ever
- 189 New Tools You Should Know About
- 190 Maximat 7: The Tool to Stretch Your Machining Skills
- 194 Torch Attachments for Perfect Cuts
- 196 Hints From Readers

SCIENCE AND INVENTIONS

- 16 Science Worldwide
- 118 Whale Farming in a Coral Corral
- 128 Just Patented: PM Picks the New Inventions
- 134 The New Patent Law: Blessing or Blunder?

PHOTOGRAPHY

- 46F Picture This
- 145 Photo Hints
- 152 What's So Hard About Shooting a Portrait?

REGULAR FEATURES

- 6 Letters

JOBS AND CAREERS

- 21 How to Be the Man They Want

Cover Illustration by Ed Valigursky

NEXT MONTH IN POPULAR MECHANICS

- How to Bargain With a Car Dealer.** Save money on the next car you buy.
- Seeing the Real America in a Houseboat.** An editor's family takes a 2-week cruise.
- Automobile Proving Grounds:** What do they really prove?
- 'I Lost My License.'** A driver learns that life's an ordeal without wheels.

ROBERT P. CROSSLEY

Editor

JAMES M. LISTON
Executive Editor

JOHN A. LINKLETTER
Managing Editor

WAYNE C. LECKEY
Home and Shop
Editor

SHELDON M. GALLAGER
Assistant Executive
Editor

THOMAS G. DAUER
Art Director

Published by The Hearst Corporation
RICHARD E. BERLIN, PRESIDENT

RICHARD E. DEEMS
President, Magazines Division

JOSEPH F. KERN
Publisher

CLIFFORD B. HICKS _____ Midwest Editor
WILLIAM KILPATRICK _____ Automotive
KEVIN V. BROWN _____ Aviation
DANIEL C. FALES _____ Boating and Outdoors
BILL HARTFORD _____ Electronics and Associate Automotive
LEONARD E. SABAL _____ Home Workshop
ARTHUR MIKESELL _____ Associate Home and Shop
GARRY WINTER _____ Copy and Production
RICHARD H. FUNK _____ Associate Copy and Production
KATHY GARAVUSO _____ Assistant Copy and Production
ALVIN KIETZ _____ Assistant Art Director
NILS NELSON _____ Assistant Art Director
DON EVANS _____ Assistant Art Director
GEORGE W. BLOW _____ Technical Art Director
SOPHIE GRONOWICZ _____ Director, Bureau of Information
EVERETT JOHNSON _____ Cabinetmaker

ADDRESS ALL EDITORIAL COMMUNICATIONS TO: 575 Lexington Ave., New York, N.Y. 10022. For additional sources of information on the articles and products in this issue, write to Bureau of Information, Popular Mechanics, for free "Where-to-Find-It" list.

DANIEL J. COLEMAN
Director of Advertising

ADVERTISING OFFICES: New York: 575 Lexington Ave., Murray Hill 8-8500; Chicago: 520 N. Michigan Ave., 527-2400; Detroit: General Motors Bldg., TRinity 5-8711; Cleveland: Hanna Bldg., 1422 Euclid Ave., PRospect 1-0150; Los Angeles: 601 North Vermont Ave., 666-6263; San Francisco: 1101 Hearst Bldg., YUkon 2-0823.

SUBSCRIPTION SERVICE: Mail all subscription orders, changes of address, correspondence concerning subscriptions, and Postmaster notices of undeliverable copies to Popular Mechanics, Box 646, New York, N.Y. 10019. Please enclose your latest address label for quickest service when writing about your subscription.

POPULAR MECHANICS IS PUBLISHED MONTHLY by The Hearst Corporation, 57th St. at 8th Ave., New York, N.Y. 10019, U.S.A. Richard E. Berlin, President; George Hearst, V-Pres.; Richard E. Deems, President of Magazines; John H. Miller, Executive V-Pres. of Magazines; Raymond J. Petersen, Senior V-Pres. of Magazines; William S. Campbell, V-Pres. of Magazines; Albert A. Rachoi, V-Pres. and Director of Circulation; Joseph F. Kern, V-Pres. for Popular Mechanics; Frank Massi, Treasurer; Harvey L. Lipton, Secy. Single copy in the United States and Canada, 50 cents. Subscription prices: United States and Possessions, \$4.00 for one year; \$7.00 for two years; \$10.00 for three years. Canada, add \$0.50 for each year. Pan American Postal Union countries, add \$1.00 for each year. All other countries, add \$2.00 for each year. When changing address, give old address as well as the new, with postal-zone number, if any, and allow six weeks for change to become effective. Second-class postage paid at New York, N.Y., and at additional mailing offices. Authorized as second-class mail by the Post Office Department, Ottawa, and for payment of postage in cash. Registered as second-class matter at the Post Office at Mexico D.F., Mexico, June 20, 1950. © 1968 by The Hearst Corporation. All rights reserved. Printed in U.S.A.

86 Proof Early Times Distillery Co., Louisville, Ky. ©1968



portable bar

Make yourself the greatest home bartender in town. Just send \$3.50 to Early Times Glass Offer*—P. O. Box 1080, Louisville, Kentucky 40201. We'll send you a set of 6 Giant 15 oz. Early Times Jiggers. Or send \$3.00, for a set of 8 Early Times 10½ oz. Highball Glasses. They're beautiful, so get both sets while they last. Do it now.

*offer valid only where legal

THE TRUE OLD-STYLE KENTUCKY BOURBON

LETTERS

TO THE EDITOR

Speaking of goofs . . .

Your *Dear Mr. Automaker* (page 76, Aug. *PM*) is terrific. From my observations over the years, I doubt that any of the manufacturers' power structure will read it—I suspect they are illiterate as well as insensible.

PONTIAC, MICH. D. H. HOARD

I enjoyed your holier-than-thou letter to the automotive companies. I wonder if any of those who actually are the poor workmen or who inspect poor workmanship or who hire inspectors and workmen ever say, "Hey, he means me!" I doubt it. They're too busy grousing about the poor workmanship on television sets and furniture. By the way, your August cover was not on straight.

GAINESVILLE, FLA. R. L. HADLEY

Ha! You missed that misspelled word, didn't you?

Easier Puzzle

The puzzle in *This Block Puzzle Is a Real Puzzler* (page 126, Aug. *PM*) can be made without the hand-cut, chiseled-out section of the No. 4 piece by changing pieces 1, 2 and 4—and leaving 3, 5 and 6 the same. I am enclosing the design (drawing below). It's not original; I think

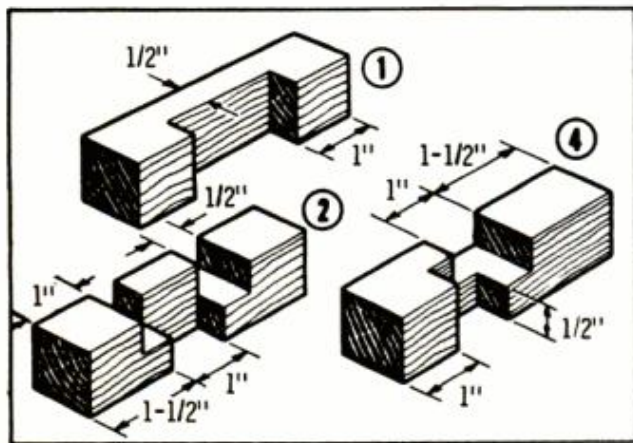

it was published in *American Boy* in about 1906.

Back in those days, I had a scroll saw and made these puzzles by the dozen in half-inch stock instead of one-inch and sold them for five cents!

BERNARDSVILLE, N.J. JESSE F. WENTZ

When I was 10 years old, I cut a similar

puzzle from a piece of basswood with my father's pocketknife. I still have it—and I'm over 82.

KNOXVILLE, TENN.

F. W. DAVIDSON

It took me about two hours to cut, chisel and sand the pieces out of two-by-two pieces of stock.

WEST GOSHEN, CONN.

MARIO BRUNO

On guard

I have just read the excellent article, *How to Defend Yourself Against Dangerous Drivers* (page 59, July *PM*). I'm writing to request permission to have it published in our next Safety Newsletter for distribution to automobile drivers of this squadron.

2135th COMMUNICATIONS
SQUADRON
DEPT. OF THE AIR FORCE

F. D. TAPPIN,
LT. COL., USAF
COMMANDER

Permission granted.

Your article was informative and helpful. However, the author's suggestion that "one way to handle a foolhardy passer is to run up your own speed" is, I think, foolhardy in itself. If you have someone trying to pass you and he's driving 90 or 100 mph at night, once you speed up, the race is on—and the only thing that can happen is disaster.

LAS VEGAS, NEV.

JAMES C. BENNETT

The speed-up is suggested only as an emergency measure to keep the speeder behind you when you know there's a third car coming in the opposite lane. Once there's no danger of the passer hitting an oncoming car, let him go by.

Building-block sprinkling

Congratulations on your fine article, *You Can Afford Automatic Lawn Sprinkling* (page 152, July *PM*). It is indeed encouraging to finally see an article appear which not only points out the practicality of automatic lawn sprinkling, but also explains the value of the building-block approach whereby the homeowner can do a good job in easy stages instead of a bad job all at once.

IRRIGATION TECHNICAL
SERVICES
BERKELEY, CALIF.

A. C. SANSFIELD
DIRECTOR

ADDRESS LETTERS to Letters to the Editor, Popular Mechanics, 575 Lexington Ave., New York, N.Y. 10022. Please keep them short as possible, and be sure to include your name and address.

This
valuable
draftsman's
equipment
is given
to you...



Drafting is the open
door to success in
any industry

- The draftsman is the link between engineering and production. No project, big or small, gets "off the ground" before it comes from the draftsman's board.
- Look at the columns and columns of "Help Wanted—Draftsman" ads that appear in a single issue of a city newspaper. They are evidence of the heavy demand that exists for draftsmen in every technical field today.
- No previous drawing skills are required to become a draftsman. The draftsman's tools can be quickly mastered by anyone.
- During more than sixty years, LaSalle has enrolled over 1,500,000 students for success training in business and industry. A LaSalle diploma is respected by employers.
- You owe it to yourself to find out now what LaSalle Drafting training can do for you. Mail the coupon today.



when you train with LaSalle
for a big-pay job as a technical

DRAFTSMAN

Learn at home in spare time. No previous skills required!

EVERYTHING you need to get started in the lucrative drafting profession—instruction and full equipment—is supplied to you by LaSalle. All you are expected to supply is an interest in technical subjects and the ambition to qualify for a bigger future.

Draftsmen are in heavy demand in America's booming industries. They are needed in aeronautics, in architectural work, in electrical, mechanical, and structural fields.

Not a single new production improvement, not a single building or mechanical project, gets under way without the skilled help of the modern draftsman.

Why don't you get started in this busy field and prepare to earn big pay? LaSalle trains you by mail; expert instructors start you at the beginning and give your work personal attention until your course is completed. The cost of instruction is remarkably low.

Free

Booklet gives facts on opportunities in drafting and describes LaSalle training. Mail coupon to LaSalle, 417 S. Dearborn, Chicago, Ill. 60605.

LA SALLE EXTENSION UNIVERSITY

A Correspondence Institution

417 S. Dearborn, Dept. 82-126, Chicago, Illinois 60605



Please send Free booklet, "Opportunities in Drafting," and full information on training at home.

Print Name..... Age.....

Address..... Apt. No.....

City.....

State..... Zip No.....

923

CHAPTER TWO: THE RENAULT 16 SEDAN-WAGON

Our story opened with the Renault 10. And that chapter is being written every day. At last count, there were over 35,000 Renault 10's on the road.

And so the stage is nicely set for our latest installment: The Renault 16 Sedan-Wagon.

The Sedan-Wagon. Besides being a new chapter for us, the Sedan-Wagon represents a new chapter in the industry.

Until now, even if you only needed a station wagon occasionally, you had to drive one around all the time. With the Renault 16, you drive around a sedan. And when you need a station wagon, it turns into a station wagon.

The front-wheel drive. Quite logical. The engine up front to get maximum hauling area in the rear. The drive wheels also up front to get maximum traction from the engine's weight.

The engine. Pressure cast aluminum block. 5 main bearings. And a sealed liquid cooling system that virtually eliminates the bother of having to

add anti-freeze. It can milk 28 miles out of a gallon of gas, and still manages a top speed of 93 mph. It is so well put together that you could roll up 30,000 continuous miles at 85, as we did, back and forth and back and forth between Rome and Milan.

The seats. They're every bit as comfortable as those in the

Renault 10. And the seats in the Renault 10 have been stacked up against the seats in the Rolls-Royce.

The road manners. The suspension is soft, without being mushy. Each wheel moves up and down independently, controlled by long torsion bars.

The price. The Sedan-Wagon sells for \$2,445.* The price of most sedan-sedans.



RENAULT 

FOR INFORMATION SEE YOUR DEALER OR
WRITE RENAULT INC., 100 SYLVAN AVENUE,
ENGLEWOOD CLIFFS, N. J. 07632, BOX 37.

*P. O. E. EAST COAST.

TOM McCAHILL SAYS:

"The appliance repair field is so uncrowded it's almost lonely!"

Someone once said that if you build a better mousetrap, the world will beat a path to your door. In the home appliance business, a lot of enterprising companies have gotten rich peddling a list of handy electrical gadgets for the home longer than Wilt Chamberlain's arm. The trouble is, the dozen or more appliances in the average American home can go on the fritz, and men with the proper training to do repairs are as scarce as knee-length skirts on teen-agers.

Good Appliance Repairmen are a rare breed these days. Those with a little ambition are booked so solidly you can wait days to get somebody to fix a balky refrigerator or cantankerous toaster. Sometimes, you have to settle for a bum job from a guy who had no business calling himself an Appliance Repairman in the first place.

This brings me to my point. If you want to make money in a field that's begging for trained technicians, there's a fine, low-cost home-study plan available that teaches you how to handle every type of Appliance repair in detail—including refrigeration, air conditioners, and even small gas engines. The course was prepared by the instructors at National Radio Institute. This is the oldest and largest home-study school in the Electronics/Electrical fields with more than fifty years' experience training men like yourself for new careers or spare-time or full-time businesses of their own.

A few years ago, NRI recognized the increasing demand for trained Appliance Repairmen. They set about preparing well-illustrated, easy-to-understand lessons that teach you how to repair home, commercial and farm Appliances. NRI even added a professional Appliance Tester that's included in their low tuition. With the Tester and a few basic tools you probably already have,

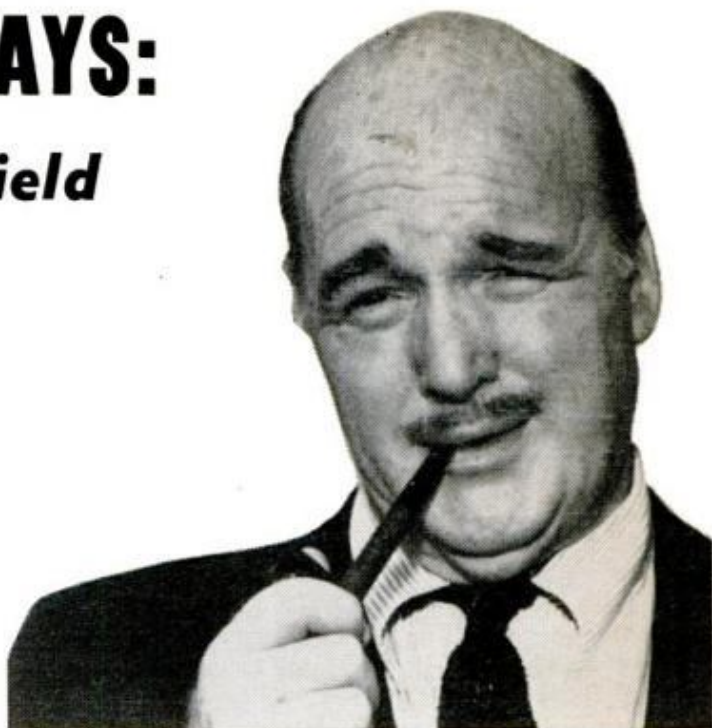

you're equipped to service most Electrical Appliances. If you aren't making as much as \$4 to \$6 an hour in spare time fixing Appliances for friends and neighbors within a few months after enrolling, my name isn't McCahill.

The reason I'm no doubting Thomas, is because the staff at NRI is composed of experienced instructors who guide you through the course with more personal attention than you'd get in many classrooms. With the kind of help they give a student and the kind of course they have, you can be the man in demand in this field—even if you've never tried to rewire a plug, or got fed up with school at the 9th grade.

The best advice I can give you is to clip the coupon below and send for the NRI Appliance Training Catalog. It's free, and there's no obligation. NRI doesn't employ salesmen, so nobody will be knocking at your door. All it will cost you is a postage stamp. Take it from Uncle Tom, the Appliance Repair field needs good men. Now.

TOM McCAHILL

APPLIANCE DIVISION, NATIONAL RADIO INSTITUTE
3939 Wisconsin Avenue, Washington, D.C. 20016

APPROVED UNDER NEW GI BILL.
If you served since January 31, 1955, or
are in service, check GI line below.

600-108

OK—I want to see for myself. Send me the free book on Professional Appliance Servicing. No salesman will call.

Name..... Age.....

Address.....

City..... State..... Zip Code.....

Accredited Member National Home Study Council.

Check for facts on new GI Bill.

DETROIT

LISTENING POST

BY BOB IRVIN

THE 1970 MODEL YEAR will be one of minor styling changes for the full-size cars which are all new for 1969. Rear-end styling changes are planned for the Chrysler and Imperial cars. Front-end changes are on tap for the Plymouths and Dodges. Word is that General Motors' standard cars as well as those from Ford will have revised grilles along with some changes in fenders and hoods. Look for complete restyling of some of the personal cars, including the Thunderbird, Toronado and Riviera.

USED-CAR SAFETY STANDARDS are ready to be issued. They are expected to cover such things as brakes, tires and steering. The National Highway Safety Bureau has been working on the standards for more than a year. Compliance will be another matter since only 31 of the 50 states have mandatory motor vehicle inspection and there are 100 million cars on the road.

SEE-THROUGH STOPLIGHTS almost made it to production on the 1969 Thunderbird. Ford had considered offering them as optional equipment until it found that they would violate some state lighting codes. The stoplights would have been mounted in the rear window and could have been seen by following cars several cars back, thus helping to prevent chain-reaction collisions on crowded urban freeways. State lighting codes are also slowing industry plans to eliminate the present system of superimposing tail and stoplights in favor of a safer system using separate lights.

USE OF SHOULDER BELTS is proving to be even less popular with American drivers than use of the lap type. One study indicates less than five percent of motorists with 1968 model cars are using them. Lap belt usage is 30-35 percent. Things may improve in 1970 when some cars introduce integrated systems in which the belts retract into the seats when not in use, and are mounted on inertia reels which allow people to move about while wearing the belts.

THE THREE-POINTED STAR HOOD EMBLEM is going to remain on the Mercedes cars sold in the United States despite a government move to outlaw all such ornaments. Mercedes has come up with a design to make the emblem disappear into the hood if it's struck. It'll be used if the U.S. government insists. Ornaments have been dropped from American-built cars in recent years following complaints they can injure pedestrians.

AN EXPERIMENTAL HYBRID BUS has been developed by Mercedes. It uses a diesel engine to recharge 3000 pounds of lead-acid batteries which provide the electricity to power the vehicle. The diesel runs at a constant speed to reduce air pollution.

ELECTRONIC FUEL INJECTION will be on the next family of Mercedes engines. The company presently uses a mechanical system but in a few years it's expected to employ a computer-controlled system like that introduced on some 1968 Volkswagens.

AN END TO TAILGATING. Ford's testing two devices to take the driving away from the driver and eliminate rear-end pileups on freeways. Both use cars equipped with computers and an invisible electronic beam which is projected from the front of one vehicle to the rear of another.

The basic system, called "Automatic Highway Control," uses the radar-type beam and computer to control a car's accelerator and brake settings to maintain a safe following distance. The driver still has to steer, but even the steering is done automatically under the second system, called "Minigap." This links cars together electronically in

(Please turn to page 14)

Make a \$10,000.00 pipe dream come true!

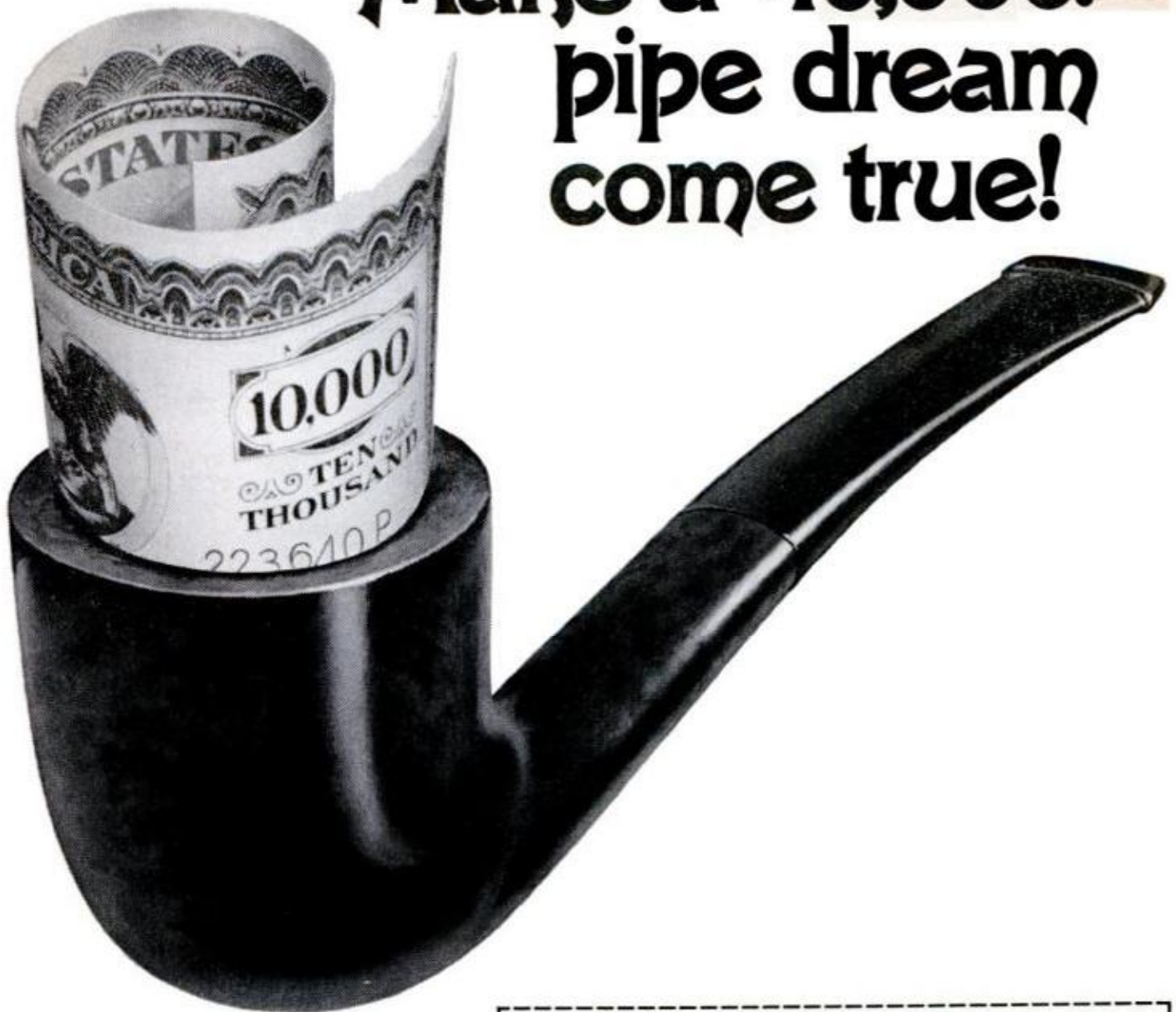

Winner takes all in Philip Morris' Pipe Tobacco Sweepstakes!

RULES:

- A. Print your name and address on the entry blank and mail it to: Philip Morris, P.O. Box 4141, New York, New York 10017, together with the end panel from a pack of Revelation, Bond Street, or Field & Stream; or the name of one of these pipe tobaccos hand-printed in plain block letters on the entry blank.
- B. Each entry must be mailed separately. Entries must be post-marked by December 24, 1968, and received by December 31, 1968.
- C. No purchase is required to enter the \$10,000 Sweepstakes.
- D. The winner will receive \$10,000 in cash. Winning entry will be drawn by an independent judging organization.
- E. Sweepstakes open to all residents (21 years and over) of the U.S., except employees (and their families) of Philip Morris Inc., its advertising agencies, and the judging organization.
- F. Residents of Missouri enclose no proof of purchase or substitute therefor.
- G. Void where prohibited or regulated by law.

OCTOBER 1968

JUST SEND END PANEL FROM ONE OF THESE PACKS



Revelation: The all tobacco pipe tobacco—for the experienced pipe-smoker.



Bond Street: The lazy pipe tobacco—takes its own good time about burning.

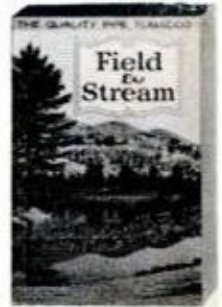

Field & Stream: The flavor and aroma of a great autumn day in the woods.

To: Philip Morris, P.O. Box 4141, New York, New York 10017:

Please enter me in your \$10,000 Sweepstakes. I enclose one pack end panel or the name of one of these fine tobaccos hand-printed in plain block letters:

NAME _____

ADDRESS _____

CITY _____ STATE _____ ZIP

NO PURCHASE REQUIRED

(Necessary)



GET A

Get the Workhorse tire by

Don't let worn tires get you down.

Get the tough job tire built for pickup trucks and delivery vans.

Get a rugged nylon cord carcass.

Get up to 14% thicker tread than most tires used in pickup and delivery work.

In addition, get as much

HORSE!

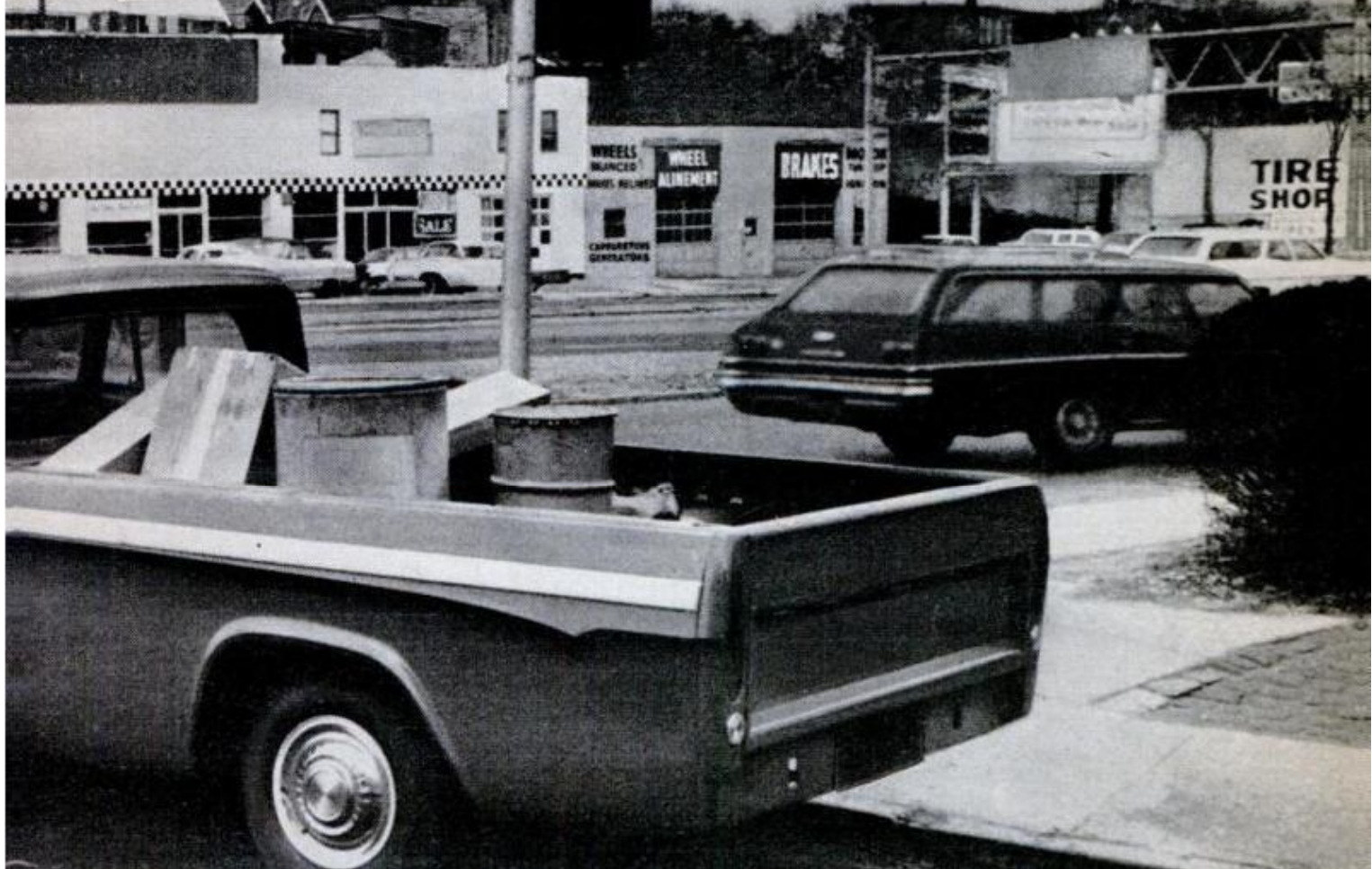

Goodyear.

as 25% more mileage with
Goodyear's super-tough
Tufsyn rubber.

So get going. Get a horse.
The Workhorse tire, for
as low as \$16.50.*

GOOD YEAR

Tufsyn, Workhorse, Traction Sure-Grip—
T.M.'s The Goodyear Tire & Rubber Company, Akron, Ohio

WORK  HORSE

Available in two tread designs.
Rib-type for over the road use. Traction
Sure-Grip tire for on and off the road use.



*(Size 6.00 X 16, 6 PR. Rib-type, black sidewall. Plus \$2.38 federal excise tax and recappable tire. Prices in effect at all Goodyear Stores. See your Goodyear Dealer for his competitive prices.)

UNIQUE, USEFUL TOOLS



straight or curved. \$3.50 ppd.

JEWELERS' METAL SHEARS.
Extra-hard blades for accurate, fine cutting of steel, other metals, plastics, leather, wire, etc. Finest professional quality. 7" long. Specify Both, \$6.50 ppd.

WATCHMAKERS' BENCH BLOCK.
Hardened steel. Finely ground top. 15 thru holes for driving out rivets, pins, broken screws, enlarging holes, dimpling, heading, etc. 4 bending slots. Hex shape for use as anvil. About 1 7/8" across points, 1 1/16" thick. \$4.35 ppd.



MINIATURE TURNING CHISELS
of fine tool steel, correctly hardened, tempered to cut steel, other metals, wood, plastics, other materials. Extremely useful—use in any kind of lathe freehand on tool rest. Blades 1/8" diam. or square. 2" long—each tool about 5" long. Set of 10 handy turning chisels \$10.95 ppd.

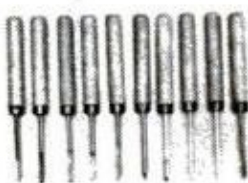

CARBIDE HACKSAW BLADE—
Super-hard round blade cuts virtually all those hard materials regular blades won't—in any direction, straight or curved. Easily cuts Inconel, hardened steel, titanium, glass, Refrasil, Metalmine, firebrick, marble, carbon phenolics, tile, etc. Blade reverses for double life. 12" blade fits any standard hacksaw frame. \$2.20 ea. ppd. (6 or more, \$1.80 ea.)



CLEVER POSITIONER—positions objects at just-right angle. 6 ball joints for complete flexibility. Leaves hands free for tough glueing, soldering, etc. Nickel plated. Crossbar 5 1/4" long. Painted, heavy base. \$5.50 ppd. Replacement clamps 10¢ each.

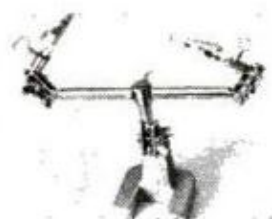

GENUINE DIAMOND GLASS CUTTER—Now you can easily cut any glass or mirror up to 1/4" thick. Requires little skill. Head swivels or locks rigid. Outlasts dozens of ordinary cutters. \$4.90 ppd. (2 for \$9.30).

We ship same day. **MONEY-BACK GUARANTEE**
FULLY ILLUSTRATED CATALOG 25¢. (Free with order)

THE brookstone co. 10824-A River Road
Worthington, Mass. 01098

Please rush items illustrated above

A B C D E F 25¢ CATALOG

ENCLOSE FIND _____ Cash, Check, M.O.

Name _____

Address _____

City _____

State _____ Zip _____

THE brookstone co. 10824-A River Road
Worthington, Mass. 01098

DETROIT LISTENING POST

(Continued from page 10)

convoys. A special lead vehicle directs the train of cars. Each car operates under its own power but it's all automatic. A key feature of each system is that it can use existing highways and the specially equipped cars can be mixed with vehicles not having the devices.

ANTISKID BRAKING still hasn't found full favor with officials of General Motors and Mercedes. Both say there are still some problems to be solved even though Ford introduced a two-wheel skid-control system on some 1969 cars and claims it's fail-safe. But competitors say it takes longer to stop on ice and gravel roads.

GROUP AUTO INSURANCE, long discussed as a means of reducing rates, is now a reality. The Farm Bureau Insurance Corp. granted such a policy to 300 members of the Michigan Credit Union League. The workers pay \$60 per year, the League \$52, or about \$20 less than before. It's expected the results will be watched closely by other companies before they decide on similar plans.

DISTRESS SIGN BALLOONS are being used on New York expressways. State officials have asked motorists to buy balloons and display them outside the car if they get into trouble. A red balloon signifies a medical emergency, blue is for mechanical help, while green is for police help.

PRIVATE INVESTIGATORS: About 3500 accidents have been investigated by General Motors researchers in the past year. It's the only program of its kind in the industry. Most of the leg work is done by investigators for Motors Insurance Corp., a GM subsidiary, who send reports they process to safety people here. The material is fed into a computer for analysis. The approach is unique because up to now such research has been primarily in the hands of government and university researchers. Other companies have considered the idea but presumably budgetary problems stood in the way.

NEW JERSEY LAW to protect motorists against arbitrary cancellation of their car insurance went into effect recently. The law will prevent indiscriminate cancellations by insurance companies for unspecified reasons. Under the law, policies can only be terminated when the insured fails to pay the premium or he has his driver's license suspended or revoked. ★★



TUNE UP ELECTRONICALLY ANY CAR EVER MADE!

- ✓ COMPACT or LIMOUSINE
- ✓ DOMESTIC or FOREIGN
- ✓ 4, 6 or 8 CYLINDER
- ✓ 6 VOLT or 12 VOLT
- ✓ POSITIVE or NEGATIVE GROUND

With New Improved Model BT-162

DWELL TACHOMETER

ASSURE - EASY STARTS, OPTIMUM PERFORMANCE and
MAXIMUM GAS ECONOMY with MODEL BT-162

MADE ORIGINALLY FOR THE PROFESSIONAL AUTOMOTIVE TECHNICIAN, MODEL BT-162 WILL PAY FOR ITSELF MANY TIMES OVER FOR THE AUTOMOTIVE HOBBYIST AND EXPERIMENTER.

The Model BT-162 will perform the services specified below in addition to many other tasks too numerous to mention:

- ✓ Assure precise adjustment of points that are slightly worn or pitted.
- ✓ Indicate the most effective point setting **without removing the distributor cap.**
- ✓ Read the average dwell of dual breaker points as well as individual dwell of each individual set of points.
- ✓ Indicate the correct settings for **external adjustment type distributors.**
- ✓ Car manufacturers' dwell angle recommendations are included in the manual provided with the Model BT-162 for all cars including the external adjustment type distributors specified above.
- ✓ It is no longer necessary to file points to smoothness when using the Model BT-162. The instrument will automatically make allowance for any existing "pitting" or "wear."
- ✓ To adjust for mathematically correct carburetor adjustment and thus insure maximum gas economy and quiet engine running, simply use the Tachometer section of the Model BT-162. Read the exact RPM while the engine is in neutral position. Then adjust the carburetor in conformity with the car manufacturer's recommendations as specified in the manual provided with the Model BT-162.
- ✓ To locate a "miss" you need only disconnect or "short" the spark plugs one at a time with the Model BT-162 switched to the Tachometer position. You will be able to instantly identify which particular plug (or frequently its wire lead) is responsible for the malfunction.
- ✓ Cars with automatic transmissions function efficiently only if the fluid pressures are correctly maintained and since manufacturer's instructions always refer to RPM the Model BT-162 (or an equivalent tachometer) is required to properly service automatic transmissions. Incidentally, the 5,000 RPM maximum range of the Model BT-162 is adequate for all car engines without any exceptions.

Comes complete, ready to use. Operating manual includes manufacturer's dwell angle recommendations for all cars. The manual is yours to keep even if you decide to return the instrument.

\$29⁹⁵

SEND NO MONEY WITH ORDER
PAY POSTMAN NOTHING ON DELIVERY

Try it for 10 days before you buy. If completely satisfied then send \$5.00 and pay the balance at the rate of \$5.00 per month until the total price of \$29.95 (plus P.P., handling and budget charge) is paid. If not completely satisfied, return to us, no explanation necessary.

ACCURATE INSTRUMENT CO., INC.
Dept. 596, 2435 White Plains Road, Bronx, N. Y. 10467

Please rush me one Model BT-162. If satisfactory I agree to pay \$5.00 within 10 days and balance at rate of \$5.00 per month until total price of \$29.95 (plus P.P., handling and budget charge) is paid. If not satisfactory, I may return for cancellation of account.

Name _____

Address _____

City _____ Zone _____ State _____

Save Money! Check here and enclose \$29.95 with this coupon and we will pay all shipping charges. You still retain the privilege of returning after 10 day trial for full refund.

Some people get sick from Chinese food. They suffer from headaches, dizziness, numbness and burning sensations—symptoms called the Chinese Restaurant Syndrome, or CRS. Researchers at New York's Albert Einstein College of Medicine and at New York University recently isolated the probable cause—monosodium glutamate, a salt used for flavoring in Chinese cookery. People who get CRS apparently are allergic to monosodium glutamate or some contaminant in it, say researchers.

As constant as a clock that is off only one second in 30 million years—that's the rate of accuracy Caltech scientists ascribe to those "clocks in the sky" called pulsars, mysterious objects that send out bursts of radio energy according to a rhythmic pattern. The Caltech researchers used an atomic clock of great precision in making their determinations. Scientists can offer no explanation for pulsars, though they tend to rule out the possibility that the signals are from sources under intelligent control. The signals are concentrated at frequencies that are unsuited to space communication.

A breakthrough in surveying methods has been achieved with the laser, that versatile scientific tool that had no known use when invented. According to the Department of Commerce's Environmental Science Services Administration, lasers used with a geodimeter (a surveying instrument that utilizes the known speed of light to measure linear distances) have enabled survey teams to cover larger pieces of terrain than before and to increase their accuracy. (Geodimeters were previously equipped with mercury lights.) Laser beams are bounced from portable towers to reflectors on other towers some 12 to 20 miles away to get measurements.

Nearsightedness, farsightedness and astigmatism can now be accurately diagnosed through the use of a computer that records brainwaves. The method was developed by two researchers at the Naval Electronics Laboratory Center, San Diego, who explain that there is a change in electrical energy, in the range of two to three-millionths of a volt, created by the brain when the subject being tested sees an object sharply or in a blurred manner. The brainwave recordings show these electrical differences, thus providing a chart of a subject's visual problems. Big advantage of the method is that it is not dependent on a subject's use of judgment and verbal responses, as are present eye-testing procedures, making it ideal for the testing of babies.

An antidote for nerve gas can be self-injected by a soldier during combat if he is equipped with a new type of hypodermic syringe developed by a Swedish pharmaceutical company. The syringe is said to be armed with a spring and a trigger mechanism. When the soldier presses the syringe against his body, the spring forces the needle through the uniform and into his muscle. An ampule, punctured in the process, provides the antidote.

A "Central Premonitions Registry" has been established in New York. Its purpose: to collect and evaluate premonitions involving state, national and international events. The agency is modeled after another bureau established in London over a year ago. In its first year of operation, the English agency collected 469 premonitions, 18 of which proved accurate. Two people, responsible for 12 of the 18 validated premonitions, are now under intensive study.

If you're left-handed, it's not because you inherited this hand preference from your parents, according to geneticist Robert L. Collins of the Jackson Laboratory at Bar Harbor, Me. His studies of paw preference among genetically identical mice indicate that environment, not heredity, is responsible. Dr. Collins suspects that among humans hand preference is determined by something—just what, he can't say—that happens in a child's environment before or after birth.

★ ★ ★

SEE YOUR MUSIC IN DAZZLING ACTION WITH



MusicVision

**Dramatic Breakthrough
In Audio-Visual Enjoyment**

Adds a spectacular new dimension to the world of music and entertainment. Now you can actually see your favorite musical selection translated into fantastic patterns of beautiful color—each individual note creating

*Patent Pending.

its own unique, twisting, radiating shape . . . each shape dancing and prancing, whirling and swirling in perfect time with the music. Science, art and electronics combined with dramatic results. Attaches in seconds to your radio, tape recorder, hi-fi or stereo with two alligator clips. Can be used on small screens, large walls, stages and whole auditoriums. Loads of fun! Wonderful for parties! Practical, too! Unlimited special effects for bands, dances, clubs, sales meetings, trade shows—put zip into classroom or private music instruction and appreciation. Available in Cabinet Model, Tube Unit, 8" and 12" sets or build your own MusicVision* with our low-cost Do-It-Yourself Kit—all you'll need is a light source. If you don't have one, the versatile Edmund 35mm 500 Watt Projector is a terrific bargain. Order by stock numbers listed below. Money-back guarantee. Complete information in new catalog available September 10. If you want additional details now, send 25¢ in coin for fully illustrated, 16-page Booklet No. 9096H "Introduction to MusicVision.*"

Walnut Veneered Cabinet Model
Stock No. 85,181H \$99.50 F.O.B.
8" Do-It-Yourself Kit
Stock No. 71,009H \$22.50 Ppd.

8" Set (Motiondizer, color wheel, apertures)
Stock No. 71,030H \$45.00 Ppd.
12" Set (same as above w/larger Motiondizer)
Stock No. 71,032H \$57.50 Ppd.
500 Watt 35mm Projector (for above sets)—
Stock No. 71,057 \$24.50 Ppd.

500 Watt 35mm Projector (for above sets)

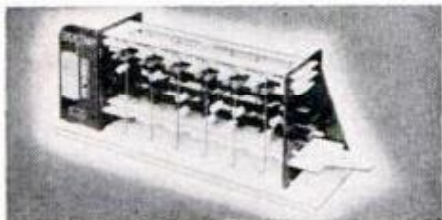

MODEL DIGITAL COMPUTER

Solve problems, teach logic, play games with miniature version of giant electronic brains! Adds, subtracts, multiplies, shifts, complements, carries, memorizes, counts, compares, sequences. Colored plastic parts easily assembled. 12" x 3 1/2" x 4 3/4". Incl. step-by-step assembly diagrams, 32-page instruction book covering operation, computer language (binary system) programming, problems and 15 experiments.

Stock No. 70,683H \$5.98 Ppd.
BIG NEW DIGICOMP III!
Stock No. 70,946H \$16.00 Ppd.

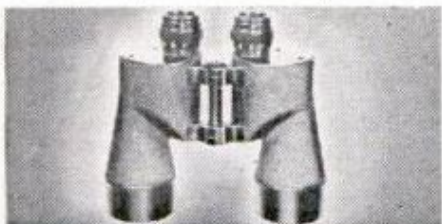

AMER. MADE 7 x 50 BINOCULARS

Big savings! Brand new! Crystal-clear viewing—7 power. Every optical element is coated. An excellent night glass—the size recommended for satellite viewing. Individual eye focus. Exit pupil 7 mm. Approx. field at 1,000 yds. is 376 ft. Carrying Case included. American 7x50's normally cost \$274.50.

Stock No. 1544H \$74.80 Ppd.
Stock No. 963H (6x30) \$40.00 Ppd.

AMER. MADE OPAQUE PROJECTOR



**KEEP PACE WITH
THE SPACE AGE!**

**AMAZING
BARGAINS**

for Fun • Study • Profit
from
EDMUND SCIENTIFIC CO.
300 Edscorp Building
Barrington, N. J. 08007



WOODEN SOLID PUZZLES

Here's a fascinating assortment of 12 different puzzles to provide hours of pleasure and stimulate ability to think and reason. Animals and geometric forms. Take them apart and reassemble them. Lots of fun for the whole family—young and old. Will test skill, patience and ability to solve problems. Order yours now.

Stock No. 70,205H \$4.00 Ppd.

Projects illustrations up to 3" x 3 1/2" —enlarges them to 35" x 30" if screen is 6 1/2 ft. from projector, larger pictures if screen is further away. No film or negatives needed. Projects charts, diagrams, color or black-and-white. Operates on 115 volts A.C. current; 6 ft. extension cord and plug included. Operates on 60 watt bulb, not included. Size 12" x 8" x 4 1/2" wide. Weight 1 lb. 2 ozs. Plastic case.
Stock No. 70,199H \$7.95 Ppd.



LOW-COST OVERHEAD PROJECTOR

Don't pay \$150 here's your opportunity to get a 5"x5" model ideal for school, home and small audience use. Comes without light source—use your own 35mm projector (or buy ours). Ideal for transparencies, lantern slides, negatives, drawings, unusual lighting effects. 3 1/2 lbs. 9 1/4" x 6 1/2" x 5 7/8". Top-and-bottom mirrors, F/3.5, 16mm F.L. lens, double Fresnel condenser. Easy friction-focusing, Keystone adjustment. Easily portable.
Stock No. 71,011H \$29.50 Ppd.
VERSATILE 500 Watt 35mm PROJECTOR
Stock No. 71,057H \$24.50 Ppd.



"FISH" WITH A MAGNET

Tie a line to our 5-lb. Magnet—drop it overboard in bay, river, lake or ocean. Your "treasure" haul can be outboard motors, anchors, fishing tackle, metal valuables. War surplus—Alnico V Type—Gov't cost \$50. Lifts over 150 lbs. on land—much greater weights under water.
Stock No. 70,570H . . . 3 1/2 lb. . . \$8.75 Ppd.
Stock No. 70,571H . . . 5-lb. . . \$12.50 Ppd.



GIANT WEATHER BALLOONS

"Balls of fun" for kids, traffic stoppers for stores, terrific for amateur meteorologists. Create a neighborhood sensation. Great backyard fun. Exciting beach attraction. Amateur meteorologists use to measure cloud heights, wind speed and temp. Heavy duty neoprene. Inflate with vacuum cleaner or auto air hose; or locally available helium for high rise.
Stock No. 60,568H 8' \$2.00 Ppd.
Stock No. 60,632H 16' \$7.00 Ppd.

MONEY-BACK GUARANTEE

Order by Stock No.—Send Check or M.O.

GIANT FREE CATALOG

148 Pages! More than 4,000



UNUSUAL BARGAINS

Completely new Catalog. Packed with huge selection of telescopes, microscopes, binoculars, magnets, magnifiers, prisms, photo components, parts, kits, accessories—many hard-to-get surplus bargains. 100's of charts, illustrations. For hobbyists, experimenters, schools, industry. Mail coupon for FREE Catalog "H".

EDMUND SCIENTIFIC CO., 300 Edscorp Building, Barrington, N. J. 08007.

NAME _____
ADDRESS _____
CITY _____
STATE _____ ZIP _____

"My Wife and I started our own Anti-poverty program with this beat-up davenport—  **picked up for \$5—sold for \$300! Now that MUI taught us the secret, we'll never be poor or dependent again!"**

Better than \$10 an hour for our time!

"I hate to think how many years I put in, slaving away at a dull, dead-end job. My wife and family were doing without the good things in life, while right at hand were opportunities for making money I never dreamed about. Now that we know upholstery, we know that every second-hand furniture store or thrift store—where they practically give away old, beat-up furniture—is a gold mine for us!"

Bought it for \$5. Sold it for \$300!



UPHOLSTERY IS ON THE MOVE WITH AMERICA!

JOIN THE GROUP—AND PROSPER! Just open your eyes and look around you! Never in all American history has there been a boom to equal this one. New freeways, new buildings, new real estate developments, new homes, hotels, motels, restaurants, bars. Can you imagine how much **UPHOLSTERED FURNITURE** is required for all this? And can you imagine how much of it will be *worn out and need reupholstering!* America is on the move with campers, trailers, mobile homes, boats—and even these constantly need upholstery and re-upholstery! Autos—26 million of them on the road, millions in need of new re-upholstered seats, headliners, door panels! All this spells opportunity, security, independence, good hard cash in your pocket if you have the know-how to take advantage of this greatest of all booms. Don't let it pass you by!



BUSINESS OF YOUR OWN! TOP PAY, AUTOMATION-PROOF JOB OPPORTUNITIES!
M.U.I. Step-by-step training qualifies you for jobs, or your own business, or both!
Husband-wife teams ideal!

One of the great features about upholstery is that it takes so little capital to start. Many begin in their garage, doing small jobs for friends and neighbors. Then the word gets around and your own private "boom" begins. Many have far more work than they can handle in a few short months. To get started easily, the husband often stays on his job while the wife learns the easy MUI way. Or if you don't want your own business, check the Sunday classified ads. Industry is **CRYING** for skilled upholsterers right now. Top wages are offered. And the jobs are **AUTOMATION-PROOF!** Computers will never learn upholstery—but **YOU** can—quickly, easily, the practical, step-by-step, tried and proven MUI way!

THIS FREE UPHOLSTERY CAREER BOOK & SAMPLE LESSON MAY BE THE MOST IMPORTANT LITERATURE YOU'LL EVER READ.

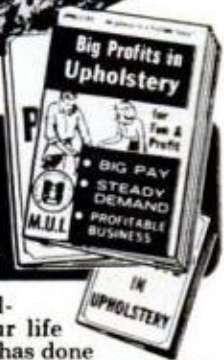

This free, illustrated 32-page upholstery career book may change your life in ways you can't even imagine! It has done so for others, thousands! It has taken low-pay men and women, all ages, regardless of education or experience, and has brought them up out of their workaday ruts and exposed them to the ways of prosperity, pleasure, independence, security, through **UPHOLSTERY**, the great boom business that is eager to share its **BILLIONS** with **YOU!** Send for **FREE BOOK & SAMPLE LESSON** today!

UPHOLSTERY NEEDS YOU—YOU NEED UPHOLSTERY! AT LEAST SEND FOR THE FREE FACTS—YOU CAN'T LOSE—YOU MUST GAIN!

A simple act—just clipping and mailing the coupon in this ad—brings you the MUI 32-page illustrated career book, the free sample lesson and all free information about **UPHOLSTERY**, the automation-proof industry that has more to offer ambitious men and women today than ever before in history. Clip the coupon and mail it now! Start your own anti-poverty program!



BUILD A ROOMFUL OF FURNITURE WITH MUI'S 6 BIG KITS. KEEP IT—SELL IT.—PROFIT BY IT.

YOU LEARN AT HOME, IN SPARE TIME... YOU GET SIX TOP-QUALITY FURNITURE KITS AND FREE HAND TOOLS FOR PRACTICAL "LEARNING-BY-DOING" TRAINING.

MODERN UPHOLSTERY INSTITUTE, Box 899-Orange, Calif. 92669

MODERN UPHOLSTERY INSTITUTE, Box 899-BAH Orange, Calif. 92669

Please send the **FREE UPHOLSTERY CAREER BOOK**, the **FREE SAMPLE LESSON**. I understand I am under no obligation whatever and am just sending for the free facts on job and career opportunities in Upholstery and the MUI home training program.

Name _____ Age _____
 Address _____
 City _____ State _____ Zip _____

APPROVED FOR VETERANS

IF YOU CAN'T BE A COLLEGE GRAD—AT LEAST EARN LIKE ONE. Get this diploma—your passport to prosperity. We can't all go to college—but now, thanks to the progressive MUI training program, you can earn as much—**AND MORE**—than many college graduates. MUI is authorized by the California Superintendent of Public Instruction to issue a **DIPLOMA** in upholstery.



AIRMAIL COUPON TODAY

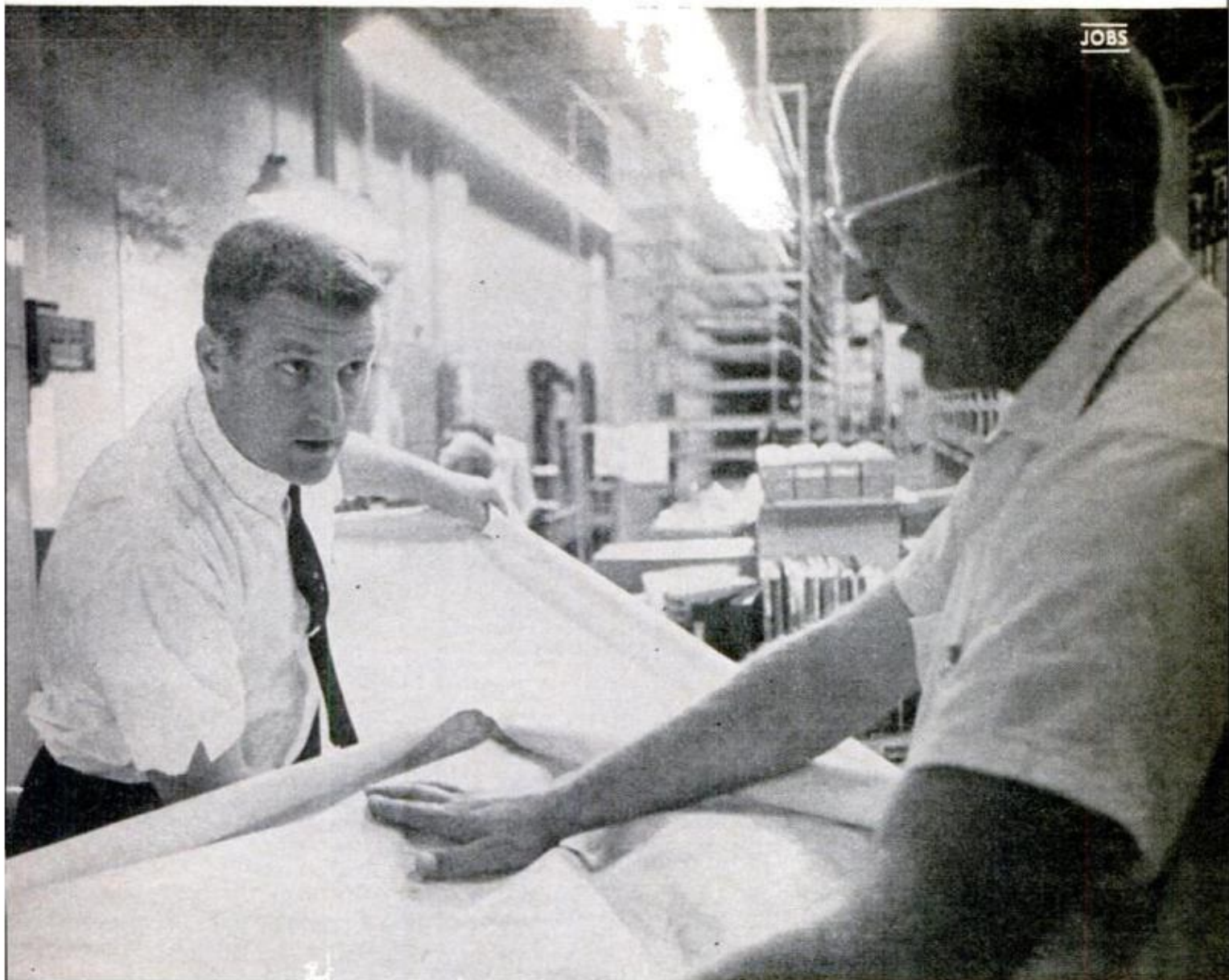

INDUSTRY IS FULL of exciting, well-paying jobs for engineers and technicians of all levels of education

How to Be The Man They're Looking For

Industry urgently needs skilled engineers and technicians. Many companies will even help to train you free. Here's how to cash in on the opportunities by making sure you have what they want

By JAMES R. BERRY

INCREDULOUS, Ullman Rosenfield stared across the desk at me and almost shouted:

"You must be kidding!"

Rosenfield is vice-president of Ideal Corp., a maker of auto parts in New York. I had just thrown him with what I thought was a reasonable question: "Is it true that

industry is really desperate for engineers and technical graduates from colleges, junior colleges, technical schools and high schools?"

Rosenfield calmed down. "The demand for technical help is tremendous. We often have to take expensive short cuts or not meet deadlines because we don't



SITTING AT A GIANT CONSOLE, telephone troubleshooter Bob Dietl monitors calls and makes on-the-spot diagnoses of difficulties in phone lines and switches. To help deskmen like Dietl, American Telephone & Telegraph sponsors on-the-job training courses in electronic circuits. Deskmen typically earn \$150 a week

have enough qualified men. And it's the same all over."

I got the same answer everywhere I went.

"We could hire 10,000 new technicians right now," states Warren Rhodes, educational consultant for General Electric.

"The situation is critical. We hire 4000 engineers a year, but we need 25 percent more than that," adds Tracy Brooks, personnel manager at General Dynamics Corp.

"There just aren't enough high school grads, even when we're willing to train them," says Lenz Meylan, general employment manager for American Telephone and Telegraph.

And the situation is growing worse. Between 1900 and 1950, the demand for technical help doubled once. Now it doubles every *five* years. Just in the next three to five years, industry will soak up half a million additional technicians and still scramble for more.

It all adds up to a healthy flock of technical jobs. Given basic training, your getting one isn't a problem. But you—like thousands of other tech grads—may be heading for a job slot that won't satisfy your ambitions, fulfill your need for challenge, or pay what you had hoped. If you find yourself in such a situation, chances are it will be your own fault. Turning native ability into a career—a lifetime

satisfaction of applying skills to the jobs *you* select—takes more than professional competence. It means perfecting a pyramid of characteristics that employers value highest and reward the most.

This pyramid's foundation is formal schooling. Once, high school grads got the dregs of technical jobs. But with today's shortage of help, they're sought after by scores of firms willing to train them as everything from pipefitters to computer repairmen. But the more time you spend in school, the wider the selection of choice jobs becomes. A diploma from a two-year technical school or junior college automatically qualifies you for responsible and challenging positions that are closed to graduates of high school alone. If it isn't possible to go to school full time, there are also home-study courses available in almost every technical field.

"We're trying to raise the quality of our work force and we just don't hire high school graduates," says Douglas Stevenson, recruiting officer at Ford Motor Co. "We're scratching for two-year technical school grads all the time. A technical school diploma jumps a guy from nonconsideration into a good recruiting position."

It also jumps starting salary. Typically a high school trainee makes around \$1.50 an hour to start. Two years in a technical school jumps this starting salary to \$2 an hour. "And if the guy is any good, he'll



APPRENTICE TRAINING PROGRAMS at Ford mean better jobs for thousands of employees every year. Lynwood Whyte (left above) joined as a sand shoveler in Dearborn, is now a journeyman pipefitter. Roy Clarke (right) started out as an assembler, has worked up to skilled welder after two years of training

jump to \$3 an hour or more darned fast," says Tracy Brooks.

As for college engineering grads, they're fought over like free beers in an Army barracks. According to the College Placement Council, a private survey organization, engineering recruitment is at a record level with salaries ranging from \$783 a month for a freshly graduated chemical engineer to \$760 a month for mechanical engineers.

Whatever educational level you start with, getting a job is a perfect way to raise it. Practically every firm hiring technical help offers free job-related courses at its plants, or it may encourage employees to get further technical schooling outside by refunding part of their tuition. "These tuition refund programs aren't altruism," states Ed Stafford, a manager at the nationwide employment agency of Dunhill, Inc. "Qualified help is so scarce that firms pay for further education in self defense."

Training is important. But almost equally prized by employers are verbal skills.

Sure, students should learn to speak and write clearly and accurately in school. But often they don't. According to New Jersey business consultant Peter Drucker, the ability of engineers and other employees to make people understand their work is frequently as important as the work itself. In a pamphlet outlining technical job



UNION CARBIDE TECHNICIAN Bill Runkle experiments with superfrigid liquid helium. Only 30, he attended General Motors Institutes for three years, has been involved in many exciting research jobs

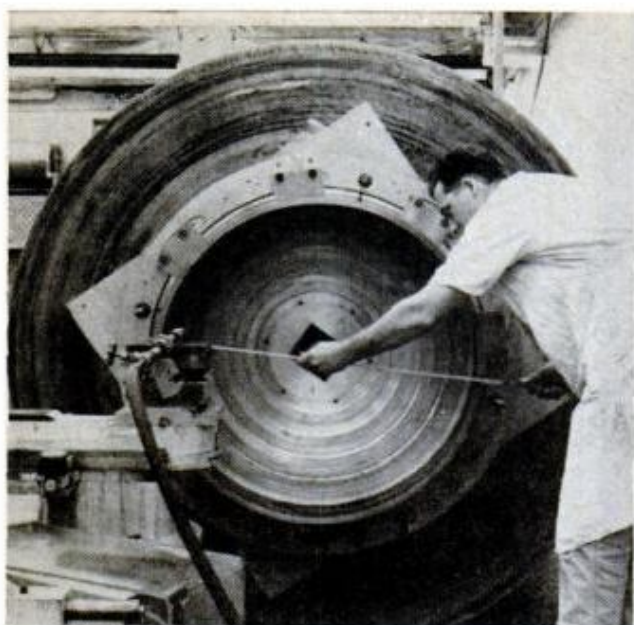

SUCCESS IN A BIG WAY has come to Vernon P. Tutterow, a North American Rockwell employee who joined company in 1953 as an apprentice. After a two-month training course, he was made a lathe operator. By 1959 he had achieved classification of senior turret lathe operator. Now he's a machinist working on construction of giant industrial lathes

opportunities, GE states: "No matter what your career, a command of the English language is the most important skill you can acquire. We put the need to study English first, over science or mathematics."

Acquiring verbal skills—while in school or afterward—quickly improves promotion possibilities. At New York's Ideal Corp., a 40-year-old press operator, and a high school drop-out, showed so much native ability that the firm asked him to go to school. "He finished his high school equivalency at our expense, then went on to a management trainee course where he learned, among other things, how to communicate effectively," explains Ideal executive Rosenfield. Just a few months after finishing his courses, the man was promoted to foreman, with a dozen or so people working under him. "Without being able to explain job specs to men under him, or report his problems to executives, he couldn't have gotten that job," adds Rosenfield.

Another important characteristic that helps further a career—and one steadily becoming more appreciated by employers—is perspective. Once, employers looked only for technical skills and dismissed an employee's other interests as irrelevant. No longer. "More and more, engineers and technicians are asked to provide technological solutions to social problems," states GE's Warren Rhodes. "Courses like civics, geography, sociology, economics, and especially history establish a framework in which to place the technology learned."

Far-ranging personal interests—from hobbies to community activities—create perspective, too. "The man who makes the greatest contribution to his company is the mature person, and you cannot have maturity without an interest outside of the job," writes Peter Drucker in a national business magazine.

Often, an elementary but difficult step in launching a career is deciding what skills to perfect. A concrete decision is important. "Guys walk in here and actually say they'll take any job around," says AT&T's Lenz Meylan. "They haven't the foggiest notion of what they want to do."

In one case, Douglas Stevenson of Ford had a campus interview with a mechanical engineer in the top 10th of his class. The student, though brilliant, had only a vague idea of the kind of work he was interested in. "I washed him out," states Stevenson. "He didn't know anything about Ford and, worse, he didn't even know the area of work that interested him. We want to see guys who can at least indicate a specific job area, say design work as opposed to research and development."

If deciding what skills you possess and should develop is a problem, Dr. Harry Levinson, formerly of the Industrial Health Div. of Kansas' Menninger Foundation, offers these two tips:

First, seek out vocational guidance. "Such guidance can keep a man from wasting time in an area that really doesn't suit him," states Levinson.

Second, find a successful man in the
(Please turn to page 26)

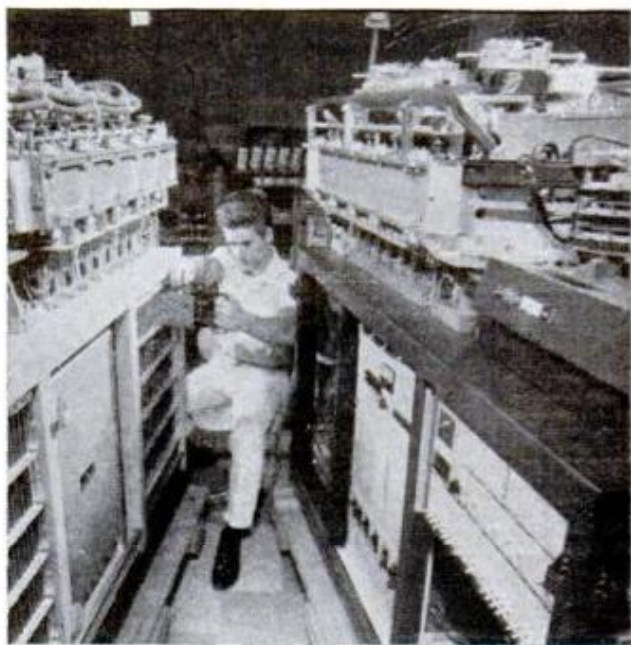

KEEPING TABS ON A COMPUTER is typical of many challenging jobs open to trained technicians. Here, Harry Plunkett checks out complicated memory bank on RCA computer manufactured at Van Nuys, Calif.



We want you.

We want you to make more money.

If you are dissatisfied with your career to date, we want you to work for The Travelers.

What will you get out of it?

An opportunity to help other people with financial planning. An opportunity to help yourself—to run a business as your own without risking your own money.

Training and licensing in insurance and complete personal financial planning. Unlimited earning potential.

If you are interested in a career as a financial planner, we want you to contact your nearest Travelers office, or write James R. Bryant, Jr., The Travelers Companies, One Tower Square, Dept. B4., Hartford, Connecticut 06115.

We want you to want us.

The Travelers Companies



MAN THEY'RE LOOKING FOR

(Continued from page 24)

field you think you're interested in. Ask him about the satisfaction he's found in his work and any drawbacks he's encountered. If his ideals and career match what you want, chances are he can help you to achieve similar success and avoid problems you can't anticipate.

It's not hard to find out what skills or aptitudes you possess. Many organizations give aptitude tests, including some YMCAs, college and high school vocational offices, and federal and state employment agencies. Your school guidance counselor might know where you can take such tests. You can also write to the American Personnel and Guidance Assn., 1607 New Hampshire Ave., NW., Washington, D.C., for a list of organizations in your area that sponsor aptitude testing.

Once you've picked out or studied a skill, landing a job that best suits you starts at a firm's recruitment desk.

Attitude vital to your job

Surprisingly, training isn't always the quality firms value most. "We're mainly interested in a candidate's attitude. It's the key factor," says Warren Rhodes of GE. "A man with less training than we want, yet who is willing to take courses and convince us that he's going to make a lot of effort, is a lot better off than the guy with good training and a poor attitude."

Besides attitudes, recruiters look for career hunters, not just job seekers. "If a fellow asks questions that show he's measuring a job by slight pay differences, he's not looking for a career. He's out for some place to hang his hat," states Ed Stafford of Dunhill, Inc. "And interviewers spot the difference immediately. Men, especially younger men, should choose a job by measuring how much experience and training it will give them."

An important step in making sure a company's offer suits you is getting some background information about the firm. "It's incredible how little time men spend on exploring a company where they'll be working a good part of their coming years," says Dudley Darling, vice-president of Ward Howell Associates, a managerial recruitment agency. "Doing a little homework about the firm pays big dividends and indicates what life with a given company will be like."

"Interviewers can tell when someone has done background research about a firm by the questions asked," says Donald Liebers, a personnel manager at AT&T. "This kind of digging shows that a man is

interested in being satisfied with his work, something that interests us just as much."

For high school grads, getting an interview is simply a matter of applying for a job at the personnel office of a firm. College and technical school grads often meet recruiters on campus. Otherwise, they should forward a resume with a covering letter to the personnel officer of the firm they would like to work for. Many firms that become interested in a candidate need help so badly they'll pay all expenses to and from the nearest personnel office.

"A resume needn't be over one page long and should include the applicant's vital data, such as schooling, previous jobs, and accomplishments," explains Tracy Brooks of General Dynamics. "But the resume should be accompanied by a freshly typed letter telling why the person wants to work for the firm. This letter should be short. Three or four paragraphs is all you're going to get a personnel manager to read these days.

"What we look for in interviews and resumes is a record of accomplishment. What a man has done is a pretty good indicator of what he will do. So a guy should tell us what he's proud of, what he's accomplished. This includes extracurricular activities and personal interests as well as academic record."

During the 30 minutes typically allotted to an interview, a candidate should stick to pertinent facts. "Some guys come in and talk about grossly irrelevant things and just waste time. Others are so meek you have to draw information out of them," says Lenz Meylan of AT&T. "Remember this, too. We want to give guys jobs, so don't offer an interviewer a reason to reject you for such things as sloppy dress or indifference."

Use the right reference

References are a help in clinching the job you're shooting for. But use references who are most pertinent to the job in view. Asking a gym teacher to vouch for you when you're hoping for a position as an electronics technician won't aid you as much as the support of an electronics or mathematics instructor. And make sure you've asked if you can use a person's name as a reference.

A final tip: The U.S. Department of Labor publishes a book that describes in detail the current outlook for thousands of job titles, from auto mechanic to physicist. The book, entitled *Occupational Outlook Handbook, Bulletin No. 1550*, sells for \$4.25 and can be obtained by writing to the Superintendent of Documents, U.S. Government Printing Office, Washington, D.C. 20402. ★★★

Could you make it in electronics?

Why not...

Because you're not a genius? So What? All you need is a good mind and the desire to learn. We can help you learn what you need to know to get the kind of job you want. And we can help you land the job, too. We've done it before. *Thousands* of times.

Because you can't quit your job? Keep it. If you can't come to our resident schools, we'll come to you, by mail. Take the courses you need, at home. In our schools or at home, you'll get an excellent, practical education in electronics.

Because you think it's too tough? Too slow? Too expensive? Because you're afraid maybe we can't help you get a good job? Fill in the coupon, and *make us prove it!*

DE VRY INSTITUTE OF TECHNOLOGY
4141 BELMONT AVE., CHICAGO, ILL. 60641

 **BELL & HOWELL SCHOOLS**

DE VRY INSTITUTE OF TECHNOLOGY Dept. PM-10Y
4141 BELMONT AVE., CHICAGO, ILL. 60641

BELL & HOWELL SCHOOLS

Please send me your two free booklets, "Pocket Guide to Real Earnings," and "Electronics in Space Travel;" also include information about preparing for careers in Electronics. I am interested in the following opportunity fields (check one or more):

- | | |
|--|---|
| <input type="checkbox"/> Space & Missile Electronics | <input type="checkbox"/> Communications |
| <input type="checkbox"/> Television and Radio | <input type="checkbox"/> Computers |
| <input type="checkbox"/> Microwaves | <input type="checkbox"/> Broadcasting |
| <input type="checkbox"/> Radar | <input type="checkbox"/> Industrial Electronics |
| <input type="checkbox"/> Automation Electronics | <input type="checkbox"/> Electronic Control |

Name _____ Age _____

Address _____ Apt. _____

City _____

State _____ Zip Code _____

Veterans: Check here. If you were discharged after Jan. 31, 1955, the "G.I. Bill" may cover the entire cost of your tuition.

106

ACCREDITED MEMBER, NATIONAL HOME STUDY COUNCIL



I'd like to give this to my fellow men... while I am still able to help!

I was young once, as you may be—today I am older. Not too old to enjoy the fruits of my work, but older in the sense of being wiser. And once I was poor, desperately poor. Today almost any man can stretch his income to make ends meet. Today, there are few who hunger for bread and shelter. But in my youth I knew the pinch of poverty; the emptiness of hunger; the cold stare of the creditor who would not take excuses for money. Today, all that is past. And behind my city house, my

summer home, my Cadillacs, my winter-long vacations and my sense of independence—behind all the wealth of cash and deep inner satisfaction that I enjoy—there is one simple secret. It is this secret that I would like to impart to you. If you are satisfied with a humdrum life of service to another master, turn this page now—read no more. If you are interested in a fuller life, free from bosses, free from worries, free from fears, read further. This message may be meant for you.

By Victor B. Mason

I am printing my message in a magazine. It may come to the attention of thousands of eyes. But of all those thousands, only a few will have the vision to understand. Many may read; but of a thousand only you may have the intuition, the sensitivity, to understand that what I am writing may be intended for you—may be the tide that shapes your destiny, which, taken at the crest, carries you to levels of independence beyond the dreams of avarice.

Don't misunderstand me. There is no mysticism in this. I am not speaking of occult things, of innumerable laws of nature that will sweep you to success without effort on your part. That sort of talk is *rubbish!* And anyone who tries to tell you that you can *think* your way to riches without effort is a false friend. I am too much of a realist for that. And I hope you are.

I hope you are the kind of man—if you have read this far—who knows that anything worthwhile has to be *earned!* I hope you have learned that there is no reward without effort. If you have learned this, then you may be ready to take the next step in the development of your karma—you may be ready to learn and use the secret I have to impart.

I Have All The Money I Need

In my own life I have gone beyond the need of money. I have it. I have gone beyond the need of gain. I have two businesses that pay me an income well above any amount I have need for. And, in addition, I have the satisfaction—the deep satisfaction—of knowing that I have put more than three hundred other men in businesses of their own. Since I have no need for money, the greatest satisfaction I get from life is sharing my secret of personal independence with others—seeing them achieve the same heights of happiness that have come into my own life.

Please don't misunderstand this statement. I am not a philanthropist. I believe that charity is something that no proud man will accept. I have never seen a man who was worth his salt who would accept something for nothing. I have never met a highly successful man whom the world respected who did not sacrifice something to

gain his position. And, unless you are willing to make at least half the effort, I'm not interested in giving you a "leg up" to the achievement of your goal. Frankly, I'm going to charge you something for the secret I give you. Not a lot—but enough to make me believe that you are a little above the fellows who merely "wish" for success and are not willing to sacrifice something to get it.

A Fascinating and Peculiar Business

I have a business that is peculiar—one of my businesses. The unusual thing about it is that it is needed in every little community throughout this country. But it is a business that will never be invaded by the "big fellows." It has to be handled on a local basis. No giant octopus can ever gobble up the whole thing. No big combine is ever going to destroy it. It is essentially a "one man" business that can be operated without outside help. It is a business that is good summer and winter. It is a business that is growing each year. And, it is a business that can be started on an investment so small that it is within the reach of anyone who has a television set. But it has nothing to do with television.

This business has another peculiarity. It can be started at home in spare time. No risk to present job. No risk to present income. And no need to let anyone else know you are "on your own." It can be run as a spare time business for extra money. Or, as it grows to the point where it is paying more than your present salary, it can be expanded into a full time business—overnight. It can give you a sense of personal independence that will free you forever from the fear of lay-off, loss of job, depressions, or economic reverses.

Are You Mechanically Inclined?

While the operation of this business is partly automatic, it won't run itself. If you are to use it as a stepping stone to independence, you must be able to work with your hands, use such tools as hammer and screw driver, and enjoy getting into a pair of blue jeans and rolling up your sleeves. But two hours a day of manual work will keep your "factory" running 24 hours turning out a product that has a steady and

ready sale in every community. A half dollar spent for raw materials can bring you six dollars in cash—six times a day.

In this message I'm not going to try to tell you the entire story. There is not enough space on this page. And, I am not going to ask you to spend a penny now to learn the secret. I'll send you all the information, free. If you are interested in becoming independent, in becoming your own boss, in knowing the sweet fruits of success as I know them, send me your name. That's all. Just your name. I won't ask you for a penny. I'll send you all the information about one of the most fascinating businesses you can imagine. With these facts, you will make your own investigation. You will check up on conditions in your neighborhood. You will weigh and analyze the whole proposition. Then, and then only, if you decide to take the next step, I'll allow you to invest \$15.00. And even then, if you decide that your fifteen dollars has been badly invested I'll return it to you. Don't hesitate to send your name. I have no salesmen. I will merely write you a long letter and send you complete facts about the business I have found to be so successful. After that, you make the decisions.

Does Happiness Hang on Your Decision?

Don't put this off. It may be a coincidence that you are reading these words right now. Or, it may be a matter that is more deeply connected with your destiny than either of us can say. There is only one thing certain: If you have read this far you are interested in the kind of independence I enjoy. And if that is true, then you must take the next step. No coupon on this advertisement. If you don't think enough of your future happiness and prosperity to write your name on a postcard and mail it to me, forget the whole thing. But if you think there is a destiny that shapes men's lives, send your name now. What I send you may convince you of the truth of this proverb. And what I send you will not cost a penny, now or at any other time.

VICTOR B. MASON

1512 Jarvis Ave., Suite M-2-LO
CHICAGO, ILLINOIS 60626

POPULAR MECHANICS

HOLIDAY SHOPPING GUIDE

AMERICA'S ORIGINAL LOW-COST
ARC WELDER
AND ELECTRIC TORCH

10 DAY TRIAL

LIFETIME GUARANTEE



New Improved HEAVY DUTY
FOUR-WAY

Only \$18.95 Prepaid Complete Ready To Use
WELD, BRAZE, SOLDER, CUT
All Metals Including Aluminum

Every home, shop, and hobbyist needs this quality metal working machine. Anyone can use. No experience needed. Use up to 1/8" welding rods and 1/4" carbons to make or repair 1001 items including furniture, garden tools, toys, auto bodies, fenders, trailers, boats, farm equipment. Operates on 110 V. line for pennies—replaces gas torches—no tanks or refills to buy—produces to 11,000° heat. Twin Carbon Arc Torch easily controls heat for each job YOU CAN PAY MORE BUT YOU CAN'T GET A BETTER LOW COST WELDER. Over 500,000 in use. Manufacturers of welders for over 30 years. LIFETIME UNCONDITIONAL GUARANTEE. Simply return. We will repair or replace and ship FREE of charge. YOU GET: heavy duty welder in rugged metal cabinet, ground clamp, cables, combination torch and rod holder, welding manual and helmet, plus Free \$2 pack "TOUCH WELD" rods for instant and automatic arc, brazing rods, 1/4" carbons, solder and flux.

ORDER TODAY ON 10-DAY UNCONDITIONAL MONEY BACK TRIAL.

MAIL THIS ORDER COUPON NOW!

Four-Way Welder Co., Dept. R2-K
1810 S. Federal St., Chicago, 60616
Please send welder as indicated below and include FREE gift of
 Wrench Kit or, Wire Tool or, Welding Rod Pack.
 Enclosed \$18.95. Ship postpaid in U.S.A. Enclosed \$2.00. I will pay \$16.95 plus C.O.D. charges on delivery.

NAME _____

ADDRESS _____

CITY _____ STATE _____ ZIP _____

FREE EXTRA BONUS GIFT with your order. Choice of:

1. 10-piece wrench, plier and screw driver kit in case, or,
2. Wire forming tool. Forms wire to weld valuable items, or
3. Big pack welding & brazing rods, carbons, flux & solder.

SEND ONLY \$2.00 and pay \$16.95 plus C.O.D. charges on delivery, or send only \$18.95 for postpaid shipment in U.S.A. Specify gift.

FOUR-WAY WELDER CO.

1810 S. Federal St., Dept. R2-K, Chicago, 60616

MEN! 100 STYLES FOR

W-I-D-E
F-E-E-T

and HIGH INSTEPS
EE to EEEEE Only
Sizes 5 to 13

Men only. Casual, dress, work shoes that really fit. Top quality, popular prices. Money-back guarantee.



Not sold in stores

Write Today for FREE CATALOG
HITCHCOCK SHOES, INC.
Hingham 28-H, Mass. 02043



GIVE YOURSELF A BIG
PAY BOOST FOR 1969!

Spare time, full time Accident Investigators badly needed in every state. Exciting prestige profession pays to \$8 an hour spare time. No selling. Only average education required. Easy home training program requires only 15 minutes reading a day. FREE employment help given. Let us show how you can quickly become an expert Accident Investigator. No salesman will call. To get FREE FACTS mail this ad with your name, address, zip to LIBERTY SCHOOL, Dept. 710, 162 E. Cook, Libertyville, Illinois 60048. (G.I. Approved)



AIR LIFT AUTO LEVELERS

These tough, inflatable butyl cylinders raise the rear of your vacation-loaded car to safe, normal riding level. Air Lift Auto Levelers literally lift excess weight from overworked springs... also minimize sway on turns and absorb impact of bumps. Simple to install—no parts to remove from car. Ideal for camping, a "must" for trailering. Low as \$33.95 per set—tell us model of car. Free literature.

AIR LIFT COMPANY
Dept. PM, 2710 Snow Road, Lansing, Mich.

as low as
\$1.20 ea.

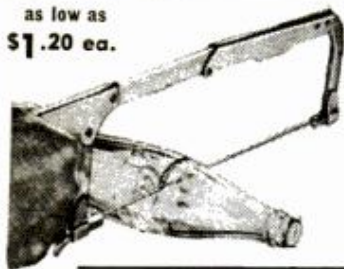

CUT ANY MATERIAL with Super-Hack

Tungsten carbide blade cuts glass, tool steel, (even a file) . . . bricks, ceramic, plastic, transite . . . all the things you never could cut before. Sold 100 for \$1.20 ea., or 1 for \$2.79, 3 for \$6.20, 6 for \$2 ea. (total \$12). All prices postage paid.

FREE OFFER

All items on this page are offered on money-back guarantee by MEREDITH SEPARATOR CO., Dept. PM-10, 310 West 9th St., Kansas City, Mo. 64105. See coupon below. Anyone who asks for our HOSPITALITY Magazine will receive a FREE subscription. Next issue will be of especial interest to Popular Mechanics Readers.

Johns Manville Asbestos-Lined STEEL FIREMAN'S SAFE

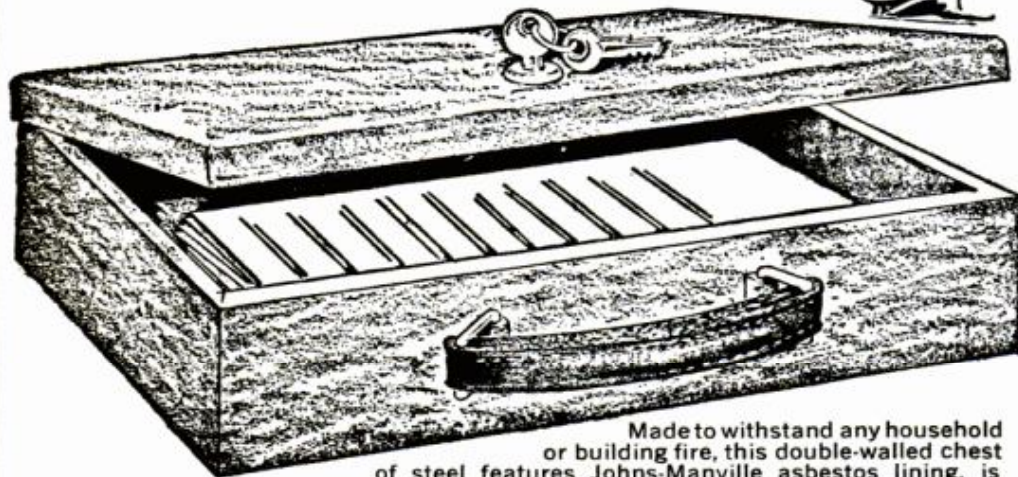

Made to withstand any household or building fire, this double-walled chest of steel features Johns-Manville asbestos lining, is about 14" long by 9" wide and just under 4" high. A heavy barrel lock with two keys protects contents from theft. The lid has a full length piano hinge like industry seldom makes anymore. You get five valuable paper folios . . . for insurance, cash reserves, social security records . . . children's health certificates . . . personal family records . . . priceless photographs . . . stocks and bonds. Baked enamel outer finish makes chest attractive and luggage-style handle makes it easy to carry this 8½-lb. UNDERWRITER'S Safe \$15.95 (We pay all shipping costs.) Double capacity Box (same rectangular dimensions but twice as deep) and worth much more \$22—ppd.

COLONIAL SWORD CANES

\$14.95

ppd.

. . . as British as gin and tonic . . . as oriental as the mandarin dragon which twines about the cane from handle to tip . . . intricately carved in exotic wood. From the handle peers the face of an inscrutable Confucius. No colonial gentlemen would have walked the streets of Singapore or Mandalay without his sword cane. The old craftsmen of Tapest are about all gone. Sword canes like these are collectors' items already. In another while you may not be able to get them at all. A great buy at \$14.95 postpaid while they last.



WATCH RUST DISAPPEAR NAVAL JELLY

is an extremely active new cleaner that removes rust by chemical combination . . . sticks to verticals and overheads. Brush it on, hose it off.

Use on pipes, fences, tools, tanks, all machinery. Eliminates sandblasting, scraping, etc. Easy and quick.

- 40# @ .65/lb. \$26 4# @ 2.00/lb. \$8.00
 10# @ 1.50/lb. \$15 #4 ppd.—other units FOB KC

Naval Formula X-300 Closeout Prices of this half-strength blue material write for details.

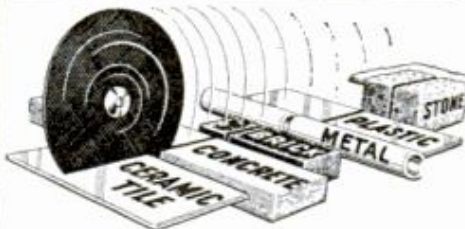
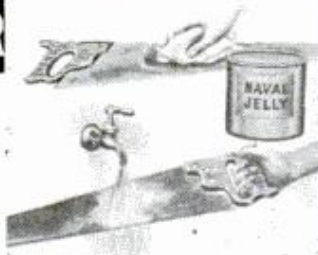

NAVAL ROUND SAW is a 7" silicon carbide disc that lets you do what Super-Hack does (except glass) . . . cut nearly anything. Ruse on drill or flexible shaft, sand with it too (has 5" rubber disc for back-up), and comes complete with all flanges and nuts. Made in England. \$5 each, 3 for \$4.50, ea. (total \$13.50) all postpaid.

MEREDITH SEPARATOR CO., Dept. PM-10
310 West 9th St., Kansas City, Mo. 64105

Ship as follows (specify quantity):

- Super Hacks Fire Chests Reg. Larger
 Naval Jelly Round Saws Naval 5 Plastic
 Sword Canes Free Hospitality Mag. Subscription

Name _____

Address _____

City _____ State _____ Zip _____

© 1968 Meredith, K.C., Mo.

LIQUID PLASTIC



protects like a shield of unbreakable glass.

Polyurethane that applies like paint forms a skin so tough it won't crack, chip or peel. Cuts painting costs . . . covers and

WATERPROOF IN 30 MINUTES

Adheres to practically anything, stops leaks. Ideal for concrete, aluminum, wood, masonry, canvas, any metal. Clear—any major color. Just specify. \$5.95 per qt., \$18.50 per gal. We pay all shipping costs. Order NAVAL 5.



**STEEL SOUP BONE
Has 8 Swiveling
Socket Wrench HEADS**

8-Ender is a full sized offset 8 head socket wrench. The heads swivel, making available the right socketsize when needed. Ideal for tractors, autos, tillers, pumps, etc.

Does work of full sets of socket, open end or box end wrenches.

Drop forged, chrome vanadium steel, in regular sizes from 7/16 thru 7/8" . . . also in metric model from 9mm thru 24mm. Be sure to specify which model you wish. \$6.95 each postpaid. 2 for \$5.95 each.

**MEREDITH, Dept. PM-10,
310 West 9th St., Kansas City, Mo. 64105**



**"Old Millstream" GRIND
Portable Wheat Mill YOUR OWN
FLOUR**

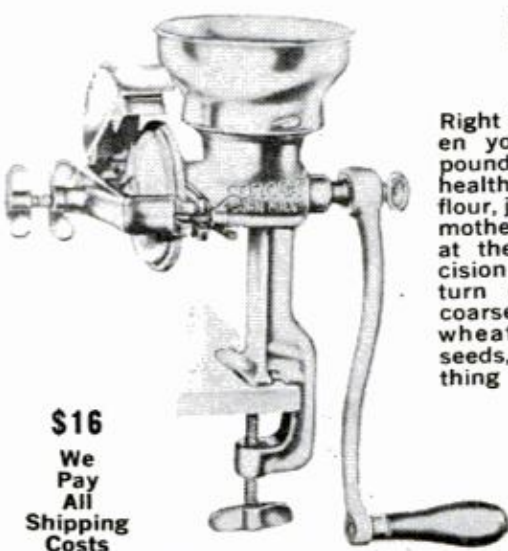

Right in your own kitchen you can grind one pound per minute of healthful, flavorful fresh flour, just like your grandmother used to buy down at the "Old Mill." Precision cast-iron grinders turn easily, adjust for coarse or fine. Use for wheat, corn, sesame seeds, nuts, coffee, anything you wish. Retain the food values nature put into the grain. "Old Millstream" Portable Mills are brightly plated, weigh about 11 pounds.

**\$16
We
Pay
All
Shipping
Costs**

MEREDITH, Dept. PM-10, 310 West 9th St., Kansas City, Mo. 64105

**SMOKERS
TOOTHPOWDER
removes tobacco film**

This activated British toothpowder is a strong power against the most stubborn and ugly tobacco stains, while gently refreshing your mouth. Remarkable formula, used by Winston Churchill, \$2.50 a tin and worth 3 times the price.

MEREDITH, Dept. PM-10, 310 West 9th St., Kansas City, Mo. 64105

**\$70 AIR-GUN
only \$29.95**

Complete with chisel this 3 lb. Air-Gun rips into metal, chips concrete, drives pins, etc. Delivers 5500 2" strokes a minute. Operates on 3 to 5 hp compressor. Made especially for govt. and manufacturer made too many. At only \$29.95 ppd. while they last, a \$70 value. 3 extra accessories for exhaust pipe cutting, riveting, etc. \$9 ppd.



Meredith Separator Co. Dept. PM-10, 310 W. 9th St. KANSAS CITY, MO. 64105

\$50 REWARD

for Any Type Spider, Bug, Insect that Bugmaster Units Fail to Kill!

No spraying or stains. No messy powder. UL approved.

Fully Automatic, Just Plug in. Completely and permanently rid your apartment, home, office, factory, restaurant, bakery, of disease carrying, filthy, disgusting bugs. Bugmaster quickly kills



ROACHES, all crawling and flying insects. Gets them anywhere. The Professional indoor bug killer.

- Model H—\$9.95 plus 75¢ p&h
- Xtra Crystals for H—75¢ per box
- Model G—\$15.95 plus \$1 p&h
- Xtra Crystals for G—\$1.50 per box
- Model H— 6,000 cubic feet
- Model G—12,000 cubic feet
- Pkg. Chlorophyll Odor Kill Crystals 75¢

**COLORFUL
Ceramic
PUB JUGS
of British Bars**



Distillers give to bars for the dispensing of water. They are regularly stolen. Each in different shape, bright colors, trademark of distiller, all about 5 1/2 inches high, beautiful and sturdy. The White Horse jug is white on pale blue, looks like Wedgewood.

\$7 each, set of 6 at \$5 each (total \$30) postpaid. Specify brand and we'll try to fill your spec. We have Cutty Sark, J&B, Chivas Regal, Dewars, Black & White, Johnny Walker, White Horse, Wild Turkey, Bombay and Gilbeys.

**MEREDITH SEPARATOR CO.,
Dept. PM-10, 310 West 9th St., Kansas City, Mo. 64105**

Ship as follows: Wheat Mills
 Steel Soupbones 1 2 Air Guns AG Xtras
 Smokers Toothpowder Bugmasters as checked above
 Pub Jugs 1 6 Free Hospitality Magazine Subscription
 Name _____ Address _____
 City _____ State _____ Zip _____

© 1968 Meredith, K.C., Mo.

HENLEY'S
20th Century Book of 10,000 Recipes, Formulas & Processes

Here is a wealth of practical, accurate and clear information and instruction that can save you thousands, or make you a fortune! Housewives, manufacturers, farmers, handymen, home experimenters, electricians, chemists, people in every walk of life, refer to Henley's daily. In this gold-mine of a book, you too will find formulas and recipes for almost everything used in the home, farm, workshop or industry. Discover the trade secrets of thousands of commercial products—learn new money-savings and exciting way of doing things. As indispensable as a dictionary. Satisfaction guaranteed. 900 pages hard cover-cloth binding. Only 4.95 plus 35c post.

EMBASSY SALES, Dept. PM-2
 Box 67, East Elmhurst, N.Y. 11369



AUSSIE BUSH HAT
 Only \$6.45 ppd.

Famous Australian Hunter and Soldier Hat—in 100% wool felt. Dashing leopard hat band trim, full inside sweat band. Kangaroo brown. Sizes 6 3/4 to 7 3/8. Satisfaction guaranteed. Order yours today!

OUTDOOR WORLD
 Div. of Western Brands PM-10
 PHONE 303-586-3361 ESTES PARK, COLO. 80517

Fantastic NEW Swiss Measuring Tools



Dial Caliper 5 1/2" RANGE MODEL 70D
 Measures inside, outside, depth & step readings. Dial graduated in .001" unbreakable, rust proof, patented construction of Borg-Warner Cyclocac®. Verniers 1/16" - 1/10 mm, illustrated instructions included.

ONLY 7.95 + 25c POSTAGE 3 for \$23.00
 SEND 25c FOR CATALOG 12 for \$85.00 postpaid



Caliper MODEL 50P
 2 vernier scales .001" - 1/10 mm on each caliper. Depth and step, inside & outside measuring ability - parallax-free, unbreakable Cyclocac® precision construction.

ONLY 2.50 + 25c POSTAGE 3 for \$7.50
 SEND 25c FOR CATALOG 12 for \$25.00 postpaid

A.O.K. TOOL CORPORATION
 82-27 SUTTER AVE., OZONE PARK, N.Y. 11417



SOLID STATE "CAPACITOR DISCHARGE" IGNITION SYSTEM IMPROVES THE PERFORMANCE OF AUTOMOBILES, MOTORCYCLES AND OUTBOARD MOTORS. SAVES ON GAS, POINTS & PLUGS. FEATURE article in Nov. 1966 Popular Electronics. Available for 6 or 12 volts, negative ground. FREE LITERATURE. Wired, Tested & Guaranteed. \$35.50 ppd. SYDMUR 1268 E. 12th St., Brooklyn, N.Y. 11230. SYDMUR . . . 1268 E. 12th St. Brooklyn, New York 11230

UTILITY 4 in 1 PLIERS



A welcome addition to any tool chest. This most often used of all tools has been designed to contain a four inch adjustable wrench, 6 inch slip joint wire cutters, pliers and a screw driver. Made in the U.S.A. for the U.S. Ski Troops of forged steel and beautifully chrome plated. This highly finished pocket tool is a must for the fisherman, boating enthusiast, motorist or outdoorsman. A fine household utility tool. Satisfaction guaranteed. \$4.95 plus 30c post. 2 for \$9.45 postpaid.

EMBASSY SALES, Dept. PM-2
 Box 67, East Elmhurst, N.Y. 11369

Just Published

How 88,648 Heavy Smokers Stopped Smoking

NEW YORK--The Anti-Tobacco Center of America has just published a booklet which explains how 88,648 heavy smokers (of whom many are physicians) have stopped smoking without straining their will power. This booklet is available free of charge to smokers. All you need do, to obtain it, is to send your name and address to The Anti-Tobacco Center of America, Dept. 670-B, 276 Park Avenue South, New York City 10010.

This offer is open while the supply of these booklets lasts.

THE SCHMID CROSSBOW



Ever shot a really good crossbow? Try a Schmid! Shoots like a rifle, silent as a longbow—with the finest trigger mechanism in any crossbow! Walnut stock, recurved bow, famous Schmid stirrup for easy cocking. Fish, hunt or target shoot. Send for free literature now!

SCHMID & COMPANY, DEPT. P-10
 P.O. BOX 24851
 LOS ANGELES, CALIFORNIA 90024

THE SUPER HOT ONE

RACE-CYCLE GUTS in a MINI-BIKE

OUT-DIGS THE BIG ONES!

Optional gear changes give you a Super Trail Bike—as powerful, but 100 lbs. lighter than others. Superbly easy to handle.

SEND 25c FOR BROCHURE OR \$1.00 FOR PACKET ON ENTIRE LINE



BONANZA INDUSTRIES
 DEPT. PMB 1775 SO. FIRST ST., SAN JOSE, CALIF. 95112

HOW DOES IT WORK?
 Have you asked yourself—or been asked by a child—how does it work? How is color television transmitted? How does a speedometer work? What happens in supersonic speed? Now, at last, you can find the answers to about everything that might puzzle you—from A to Z. This fascinating book is not limited to familiar things that surround us but gives clear and easy to understand illustrated explanations of complex industrial processes as well! Each page of drawings is faced by a page of explanatory text. Complete index for easy reference, but you'll find yourself leafing through its pages, discovering the answers to questions you have always asked yourself. "The Way Things Work" will delight and inform the layman and satisfy the expert. A very welcome gift for that inquisitive mind, and must for any home library. 1,071 two-color drawing with detailed explanations. Cloth bound, hard cover; nearly 600 pages. \$8.95 ppd. Satisfaction guaranteed or money back.

EMBASSY SALES, Dept. PM-2
 Box 67, East Elmhurst, N.Y. 11369

\$8.95 ppd.

ENJOY YOUR OWN BUSINESS
 Start earning at once—No special experience required

A SHOP IN ITSELF
AUTOMATIC FOOLPROOF



SMITH-NIELSEN EQUIPMENT CO. STAND-ALL Model 7
 Sharpens & Retoots Hand Saws 2 metal through 1 1/2 point. **SHARPENERS—HAND SAWS—HACK SAWS—WOOD AND METAL CUTTING SAWS** with straight back and identical tooth profile. **CROWNS**—adjusts to any standard crown. **HOOKS**—5° to 21° **BEVELS**—0° to 30° Mfg. of Saw Grinders—Distributor of Complete Saw Shop Equip. Box 2505 Terminal Annex, Spokane, Washington 99220 FA 8-6680.

FIX CLOCKS, WATCHES

FOR FUN & PROFIT! Fascinating new Handbook by master craftsman H. Harris gives you the knowledge skilled watchmakers learn.

OVER 200 ILLUSTRATIONS show how to install hands, dials, crystals, mainsprings, stems . . . rehouse old movements in modern cases . . . clean timepieces, etc.

INSTRUCTIONS COVER every popular watch and clock, chimes, grandfather's, cuckoo, everyday alarm and electric clocks. Handbook tells you where to buy parts . . . where to send "overflow" work for repairs at wholesale prices as business expands!

Friends gladly pay \$5 to \$50 for restoring cherished timepieces. Try the **HANDBOOK OF WATCH AND CLOCK REPAIRS** seven days! Rush only \$1.95, on money-back guarantee. **EMERSON BOOKS, Inc., Dept. 814-R, 251 West 19 St., New York, N. Y. 10011.**

WATCH BAND CALENDARS

See the date instantly on your wrist! These handy metal calendars fasten to the band of your wristwatch. Set of 12 contains a new calendar for each month; starts with month order is received. Fits metal or leather bands. Comes in gold or chrome color to match watch. Makes any watch a calendar watch. Gift-boxed. Send \$1.50 for each set or \$7.50 for 6 sets to **YOSHIDA CO., Box 26878-D10 Los Angeles, Calif. 90026**



Earn Up to \$6 Hourly



Thousands of people like yourself are making cash like this, \$20 to \$30 a week—right now in spare-time. Many have built a year-round full-time business by following the sure, easy Foley plan.

No Experience Needed

Sharpen circular, hand and bank saws and do a perfect job every time without training. The precision automatic Foley Saw Filer does it for you. A complete sharpening shop.



Get **FREE BOOKLET**
10-29-8 Foley Bldg.
Minneapolis, Minn. 55418

NEL-KING MAGNA-FI

makes close work, fine print look big!

FOR CRAFTSMEN,
HOBBYISTS,
TECHNICIANS,
HOMEMAKERS...

People of all ages! You see clearer, work faster and more accurately with less tension, less strain, less fatigue. MAGNA-FI is a precision optical instrument with finest ground and polished prismatic lenses. Can be worn with or without glasses... even bifocals. Adjusts comfortably to any head size. Leaves hands free to work. Only \$7.95 postpaid with removable 2½ diopter lens. An extra, more powerful 3 diopter interchangeable lens available at \$2.98 additional. **Exclusive Feature:** Hinged lens swings up out of the way when not in use. **GUARANTEED:** Money back if returned postpaid in 30 days. Nel-King Products Dept. P108 • 811 Wyandotte • Kansas City, Mo.



BIG EARNINGS AS A



FREE Use Of
Professional Tools
And Full-Sized
Typewriter
With Course



TYPEWRITER SERVICEMAN

Big demand! Earn \$50 a week while learning. High pay job. Your own business. Only industry apvd. HOME STUDY course. Low cost. Tools, etc., included. **FREE INFORMATION.** Typewriter Repair School. Little Falls, N.J. 07424.

TYPEWRITER REPAIR SCHOOL
(Div. Technical Home Study Schools)
Dept. 3110-108, Little Falls, N.J. 07424
Send **FREE BOOKLET** without obligation.

Name.....
Address.....
City.....State.....Zip.....

RARE
1955S
NEW
1968S



Included in collection 30 diff. Uncirculated (new) Lincoln Cents: 1954 to 1968 plain-D-S complete (Regularly \$5.95)—**SPECIAL ONLY \$2.95** (Limit 2 sets). 35 tough "S" cents mixed (used) only \$1.00. 30 Uncirculated coins—30 countries. Bargain—\$1.00. Buy all 3 packets we'll toss in an old Indianhead Cent! Include 20¢ Insurance. Silver Dollars \$2.45 ea. Huge bargain coin lists with year sets, silver dollars, accessories, etc., included with order, otherwise 25¢.

**BONANZA, Box 4491P,
San Jose, Calif. 95126**



ONLY
1.98
AUTOMATIC
100 SHOT
PELLET STINGER

Holds and Fires 100 Pellets Automatically as Fast as You Can Pull the Trigger. Harmless, but Stings to Keep Most Assailants Off Guard. Keep Animal Pests Away. Made of High-Impact Styrene. Send \$1.98 Cash, Check or Money Order. 50 Pellets Included. Not Sold in N.Y.C. or if Under 16 Years (State Age). Extra Ammunition (100 Pellets \$1.00) (250 for \$2.00) (1000 for \$5.00) Money Back Guarantee.

**NATIONAL SURPLUS, Dept. 9-PM
Box 826, Niagara Falls, N.Y. 14302**



FREE MUSCLE COURSE!

Want a new Jet-Charged body? In 15 minutes I'll prove you can slap on 4" of muscles to your chest—3" to each arm—give you life-guard shoulders, trim your waist to athletic size—give you speedy athletic legs. I don't care if you're short or tall (skinny or fat) young or not so young, expect a muscle building miracle when you send for my free course. Send only 25¢ to cover postage and handling to Joe Weider, Dept. 38-108D, 531 32nd St., Union City, N.J.

WIN CASH

by solving puzzles!

Now you can have all the fun of doing puzzles as you compete for big cash prizes. Puzzle contests of all kinds offer you from \$100.00 to \$3,000.00. And you can win more than once. Send 25¢ for full-size 12-page contest newspaper plus all information you need to win our cash.

PUZZLE LOVERS CLUB

Box 2B, Prince Street Station
New York City, New York 10012



Flying models of the space age

AEROSPACE ACTION AND PERFORMANCE

Rockets

Join the fun and challenge of the space age. Build working models of America's mighty missiles, or build and test your own designs.

OVER 35 EXCITING KITS

**STARTER KIT
SPECIAL OFFER**
Includes Alpha rocket, 2 engines, instructions, design manual.
No. DSK-20.....only \$2.00
DSK-65 - with Electro-Launch and batteries.....\$4.50

Flights up to 2500 ft.

96 page color catalog (free with order) ...25¢

ESTES INDUSTRIES

Dept. 15, Penrose, Colo. 81240

PROTECT YOURSELF! from the hazards of HOME & GARDEN... with PROFESSIONALLY-PROVEN SAFETY PRODUCTS.

GOGGLE: protects against — hazardous flying objects, no matter how small or sharp!



Priced at:
goggles — \$4.75
respirator — \$3.75

BOTH FOR \$8.00

RESPIRATOR: protects against — non-toxic sprays; dust; all allergic-sensitivity.



(add \$.50 for pp & tax)

check or M.O. to:
COML. CLASS. PROD.
2 Barclay St., N. Y. 10007

For more information on articles in this issue... Write Service Bureau Popular Mechanics, 575 Lexington, New York, New York 10022



"I Earn Two Incomes Now"

Says **JOHN BENNIE, Pittsburgh, Pennsylvania**

"Thanks to your wonderful training, I have been able to earn \$20 to \$25 extra each and every week doing little locksmith jobs at home and after work at my regular job. This is the best trade a man can take up."

Be a LOCKSMITH

Train at **HOME**—Earn While You Learn. Add 50%-100% to **YOUR INCOME** with easy spare time earnings. Cash in on the nation-wide shortage—trained locksmiths in great demand! Quickly step into a big pay opportunity job or start a high-profit shop of your own.

Earn Extra Money RIGHT AWAY! All Master Locksmiths Special Tools, Equipment and Supplies Furnished **FREE** for use with course.

Age, education, minor physical handicaps don't matter in this growing trade. You can quickly qualify as a skilled locksmith. It's like a fascinating hobby. Study at home as little as one hour a week. Gain practical experience through complete well-illustrated lessons. Do real jobs on car locks, house locks, padlocks and safe locks, under the guidance of experts. **FREE** Illustrated Book, write now.

LOCKSMITHING INSTITUTE,

(Div. Tech. Home Study Schools)

Dept. 1110-108 • Little Falls, New Jersey 07424

306
pieces of professional equipment
FREE
for use with course.

Professional Equipment includes
**LOCKS—PICKS—PARTS—KEYS
SPECIAL TOOLS & SUPPLIES**
all **FREE** for use with course.

**MAIL
COUPON
for FREE
ILLUSTRATED
BOOK**

For a future as your own boss or in a high-pay job, write now for **FREE** Illustrated Book. Only school of its kind. Licensed by State of New Jersey. Approved for Veterans.

Accredited, Nat'l Home Study Council.

MAIL COUPON NOW-----
**LOCKSMITHING INSTITUTE, Dept. 1110-108
Little Falls, New Jersey 07424**

Please send **FREE** Illustrated Book—"Your Big Opportunities in Locksmithing," complete Equipment folder and sample lesson pages—**FREE** of all obligation—(no salesman will call).

Name _____
Address _____
City _____ State _____ Zip _____



NEW TREASURE FINDER!

**TWO YEAR GUARANTEE—7 TRANSISTORS
MORE POWER
MORE DEPTH**

The Amazing new **JETCO "GOLDSTAR" TREASURE DETECTOR** outperforms the probing type instrument. New type **SEARCHLOOP** gives the **GOLDSTAR** over **3 feet of depth power**. The **GOLDSTAR** finds buried coins, relics, gold, silver, ore, etc. Detects all metals thru dirt, rock, wood, sand and water. Complete with battery. Nothing else to buy. Send check, cash or money order save postage. \$5.00 deposit for C.O.D. Immediate shipment.

Comes complete ready to operate.

\$29.95
PPD.

In Texas add 6% sales tax.



JETCO ELECTRONICS, Inc.
P.O. Box 132-PM
Huntsville, Texas 77340

HANDY? YOU BET!



Only
\$295
P.P.

Hung magnetically on **MAGNABAR**, metal tools are always safe and orderly. **MAGNABAR** mounts anywhere. Hardwood natural finish. 1" by 12" long. Other lengths available.

MARK X styled in white, preferred for kitchen. Handsome. Lasts a housewife. Gift boxed.

Only
\$395
P.P.

Complete line folder on request. Money back guarantee. Send check or M.O. to Dept. B.

PHELON MAGNAGRIP COMPANY, INC.
East Longmeadow, Mass. 01028

REDUCIBLE

RUPTURE

AGONY Removed
(or trial **COSTS YOU NOTHING**)



WHEN you slip into a low-cost, contour-designed **Brooks Patented Air Cushion Appliance!** Your reducible rupture will be held in securely yet gently—or the trial costs you nothing! This invention has made millions of sufferers happy. You can enjoy heavenly comfort night and day at work and play—or the Appliance costs you **NOTHING**. Isn't this worth a no-risk trial by you? If interested, write for free facts now. **BROOKS CO., BOX 346-G, MARSHALL, MICH. 49068**

EARN A STEADY INCOME SHARPEN CIRCULAR SAWS

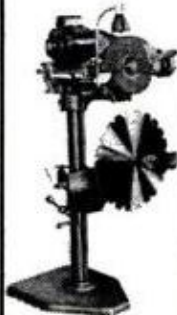

Professional circular saw sharpener sharpens saws 5" to 60", rip, cross-cut, combination, dado. Easy to operate—accurate—fast—safe. Bevels 45°, joints, gums. You can profit from this machine.

Thousands of Circular saws need sharpening every month.

Write for details

BURR MANUFACTURING CO.
8933 W. VENICE BLVD.
LOS ANGELES, CALIF. 90034

NEW — POWERFUL — LONG RANGE RADAR DETECTOR



STILL
ONLY
\$39.95

Safe drivers are alerted far in advance of radar zones thru new long-range antenna design — transistorized — no wires — comes complete — clip on visor and use. Send check, or charge to Diners Club, American Express or C.O.D.

RADATRON, INC. Dept. 2424-37
P.O. Box 177 • N. Tonawanda, N.Y. 14121

METAL PIERCING THROWING KNIFE



Easy to throw, use for hunting, self-defense, target practice. Hits with a hard smack. Razor-sharp cutlery steel—10" long, double edge. Leather-wrapped handle. Free instructions. \$1.00 (2 for \$1.85) (3 for \$2.75) Money back guarantee.

HELLER CO., Dept. 9-PM2
Box 826, Niagara Falls, N.Y. 14302



DieHard

SOLID STATE 81000

The DieHard rules the dashboard jungle

Size for size, it's America's most powerful car battery—by 35%

That tangle goes to the radio, heater, defroster, wipers. Some 20-odd light bulbs, a horn and an electric clock. And then you hang on an air conditioner and a stereo tape player!

Kind of makes you wonder. Will your battery have enough power left to start your car tomorrow morning?

If your battery isn't big enough, every start drains out a little more power than an overloaded alternator can put back in. Especially if you're making a lot of short trips.

Then pretty soon you need a push. Or a trip to the shop for a battery recharge. What you really need is a bigger battery.

The DieHard. America's most powerful car battery of its size.

Actually, the DieHard is the

same size as your old battery on the outside. It's bigger on the inside—where it counts. There's more room for power—in the shape of bigger plates and more acid. We gained this extra room by making the battery walls thinner. With polypropylene, a new see-through white plastic that doesn't have to be thick to be strong.

We were able to pack in enough extra power so that the DieHard gives you 35% more usable starting power than the best battery anyone else makes. And when you come right down to it, that's the name of the game. Starting power. And that's where the DieHard shines.

You can find it shining in more than 2500 places, all Sears, Roebuck and Co. stores. You can Charge It, of course, on your Sears Revolving Charge.

Why wait another day to trade in your old battery? Especially

when you'll probably be trading in your car long before the DieHard outlives its guarantee.

The Sears 5-year guarantee:

"Free replacement within 90 days of purchase, if battery proves defective. After 90 days we replace the battery, if defective, and charge you only for the period of ownership, based on the regular price less trade-in at the time of return, prorated over number of months of guarantee."

The DieHard. Sold only at Sears, \$29.95 with trade-in. In Canada, at Simpsons-Sears at slightly higher prices.

Sears

ALLSTATE

You can't do better than Sears.

DieHard batteries now fit 81% of the 12-volt cars on the road. Sears carries a complete line of other fine batteries as well, in a wide range of prices.

Drivin' with Dan

Can professional race drivers carry life insurance? What's the big difference between a turbocharged and turbine engine? Can a gal get started in racing? Dan Gurney answers these and other provocative questions



DAN DONS his driving helmet just before start of the 1968 Indy 500. His Eagle, with stock block Ford power, finished second. Note the exclamation point!

Q. Are Formula 1 race drivers a very close-knit group? How close were you to Jim Clark?—Robert Swenson, Detroit, Mich.

A. I think we are as close as any other group of professional competitors. Respect for a competitor's ability can often be very strong without a feeling of friendship. Jim had my utmost respect. I always enjoyed talking with him and racing against him. I'm an American, he was a Scot. Our paths seldom crossed outside of racing, so I'd say we were close only at the races. I miss him very much both as a friend and competitor.

Q. Do professional race drivers carry life insurance, and if so, what does it cost annually?—Alan Enstrom, Kokomo, Ind.

A. Yes. The cost depends on the type of racing a driver is doing—or rather, the extent of his exposure on the racing circuit. It's from \$5 up to \$20 per year per \$1000 for term insurance, and from \$25 up to \$40 per \$1000 for whole life. Insurance for race drivers is available from about 50 out of the 1800 companies in the U.S. Most racing organizations (such as NASCAR, USAC, SCCA) provide a \$10,000 policy with a driver's racing license.

Q. Would you give the kids of the United States your view on drinking and driving?—Jim Brown, Englewood, Tenn.

A. Good driving requires concentration. A person's senses make him aware of potentially dangerous situations and enable him to exercise good judgment in operating a vehicle. One drink impairs this balance perceptibly, requiring a reduction in speed and further planning ahead to maintain a good safety level. Excessive drinking followed by driving is like playing Russian roulette—with your own head, and the heads of other, innocent people as well.

Q. Do you have any suggestions or hints for getting started in racing that could help a female would-be driver? I know that it's a man's world, but we girls like the thrills and excitement of competition racing just as much as you guys.—Mrs. Darla Moodispaugh, St. Charles, Mo.

A. How about a disguise? Seriously, SCCA sports car racing has many active female drivers. Some are very good.

Q. How is it decided who gets a chance to qualify for the pole on the first day of Indy 500 trials, (Please turn to page 42)

"KONVERSATION KLIPS"

YCDBSOYA

TGIF

DBLITY

OBILSWCSTII

These handsome metal tie clips are ideal conversation openers and are certain to get a laugh. The initials represent: 911—You can't do business sitting on your assets; 930—Thank God it's Friday; 940—Our business is like sex, we are constantly striving to improve it; 920—Dress British, look Italian—think Yiddish. Speedy rhodium- or gold-plated. \$1.50 each, post-paid, check, cash, or money order.

JALCO, Dept. PMO, P.O. Box 2519, Palos Verdes Peninsula, Calif. 90274

VACUTEX



UGLY BLACKHEADS OUT IN SECONDS
Keep your complexion free of blackheads—look attractive instantly. This scientific-ally designed vacuum pump gently "lifts" out ugly blackheads safely without pinching or squeezing. Try Vacutex for 10 days—if not completely delighted return it for refund. Beware of imitations. Send \$1.25. We pay postage.

REGENCY CO. Dept. 9-PM2
Box 826, Niagara Falls, N.Y. 14302

NEW 1968-69 BIRDWATCHER'S CATALOG

from NEW HAMPSHIRE

24 page Catalog features over 100 items that will enter to your (and friends) Wild Bird Hobby. Largest GIFT selection available in this Specialty Field: FEEDERS, ALL TYPES • HUMMING BIRD FEEDERS • BIRD HOUSES • BIRD BATHS • FIELD GUIDE BOOKS • BIRD SONG RECORDS, LP • BIRD NOTES (COLOR) • BIRD TILES (COLOR) • PATIO TORCHES • ANIMAL TRAPS • PURPLE MARTIN HOUSES • SQUIRREL GUARDS, ETC.

Duncraft: Dunn Bldg., Dept. MC, Penacook, N.H. 03301
Please send Birdwatcher's Gift Catalog by return mail. Enclosed find 25c (coins or stamps) for handling.

Name _____
Address _____
Zip _____

WATCH "MIRACLE" Of Birth. Only \$3.98

EXCITING—
EDUCATIONAL
EYE to Chick before
your eyes

(Ducks, pheasant, quail, etc.)
(Postage 27c/Fla. Res. add 20c Tax)

**MAGIC MIXER—
LOOK NO HANDS**
Amaze Your Guests
Mixes drinks
automatically.

Practical—Useful
Newest Gift Sensation
Only \$9.95
(Postage 30c—Fla. Res.
add 50c Tax)

**FREE "BONUS GIFTS"
CATALOGUE**
PARIS ORIGINALS, Inc.
(Suite 492),
23938 Oakland Park,
Florida 33307



Fires
70 Rounds
New Luger
Automatic
Free Ammo

\$1.95



Amazing full-size model of high-powered Luger automatic pistol holds and fires 70 rounds automatically from over-size chamber at incredible firing speed. Peak accuracy firing power to distances of 20 feet or more. No recoil. Safe. Non-lethal. Walnut color stock is contoured to fit the hand. Smooth, jam-proof action guaranteed. Not sold in NYC, or if under 16, (State age with order) Send \$1.98 cash, check or money order plus 27c shipping charges. We include free silver pellets. (200 rounds \$1) (400 rounds \$2) (1000 rounds \$5) **WORLD CO., DEPT. 10PM, 1 Park Avenue, New York 10016.**



LAST COMPLETE SILVER SET \$2.95 + 25c p.p.

Brilliant uncirculated 1964 Phila. or Denver mint with scarce J.F.K. Silver 1/2 dollars \$2.95 + .25 p.p. Free 50c gift case. Both mints 10 coins \$5.50 + .25 p.p. Free luxurious \$1 Velvet lined, gold embossed presentation case (as illust.). Save, 10 sets \$49.50—twenty sets \$95. Fifty sets \$225. Collectors rare 80 yr. old uncirculated silver dollars \$4. each in gift case + .25 p.p. Five asst'd dates in luxurious velvet lined presentation case \$19 + .50 p.p. 5 sets (25 coins) \$90 + 1.00 p.p. Roll of 20 silver dollars \$70. Five rolls (100) coins \$340. Ten rolls \$660. Add .50 per roll p.p. Money back guarantee. A valuable gift or investment rapidly growing in value. Write for free catalog. Member Retail Coin Dealers Assn., Amer. Numismatics Ass'n. Est. 1941. Novel Numismatics, 31 - 2nd Ave. Dept. H.G-51, New York, N.Y. 10003.



**Metal Piercing
Throwing Knife 99¢**

Great for hunting game, Weighted, balanced for sure throwing accuracy. Hits with a hard smack. **FAST, EASY TO THROW.** Use for self defense, hunting, thrills, targets. Razor sharp cutlery steel. 10" long—Double edge. Wrapped leather handle. **99¢** (2 for **\$1.85**) (3 for **\$2.75**). Knife-throwing instructions **FREE.** Order Now.

**WORLD CO., Dept. 10PM
1 Park Ave., N.Y., N.Y. 10016**

AMERICA'S LOWEST PRICED JET ENGINE



Hell cat takes off all by itself or powers model autos, plane, boat, train, etc. Strong constant thrust for exciting experiments. Operates on ram jet principle. Fast starting. No Moving Parts. Operates on solid fuel. Only \$1.49 ea. & 50¢ for fuel.

**WORLD CO., Dept. 10PM
1 Park Ave., New York 10016**



IMPORTED LOCK-BLADE KNIFE

OPENS WITH FLICK OF FINGER, and locks with a click into position. Blade can't shut when in use. **PUSH BUTTON** release. Handy pocket size, yet rugged. Fine quality, polished stainless steel razor-sharp blade. **PIERCES METAL.** Narrow tapered stiletto blade with thick rigid backbone for heavy duty trouble-free use. Fine outdoor knife for sportsmen and emergencies. Comfortable handle. Safety guards. **DELUXE NON-LOCK LARGE SIZE 7" BEAUTY** Only **\$3.98.**

\$1.88

Free Postage

**WORLD CO., Dept. 10PM
1 Park Ave., N.Y., N.Y. 10016**



Precision tool

LEATHER STITCHER Stitches like a machine

No experience needed. Sew, repair leather, canvas convertible tops, upholstery. Just push in, pull out. Fast, easy. Automatically you have a lock stitch just like an industrial sewing machine. **FREE 30 FT. HEAVY CORD AND SPECIAL NEEDLES.** You also receive utility wrench, extra waxed thread and needles that fit right into handle. Easy to follow directions. Send **\$1.98** plus 25c pp and hdlg.

**WORLD CO., Dept. 10PM
1 Park Ave., New York 10016**

Searching?

Should you wait years to meet your match?? Take the opportunity to establish new friendships **NOW!** The computer has smashed the social time barrier . . .

Request free
questionnaire
\$10.00 fee
payable
when you
return
questionnaire.



**COM/PAIR SYSTEMS, Inc., PM-4
194 Nassau St., Princeton, N.J. 08540**

Name _____

Address _____

City _____ State _____

© Copyright 1966 COM/PAIR Systems Inc.

Stihl O41 AV

World's
only Chain Saw
with built-in
Shock Absorbers
that eliminate

Vibration

As shown by the figures — Shock absorbers strategically positioned at 3 suspension points absorb and reduce engine and chain vibration. Give you the smoothest working chain saw ever — practically eliminate muscle fatigue! This advanced 5 1/2 horsepower lightweight makes even big cutting jobs seem shorter, easier. You'll have to try it to believe it — at your local Stihl Dealer of course!

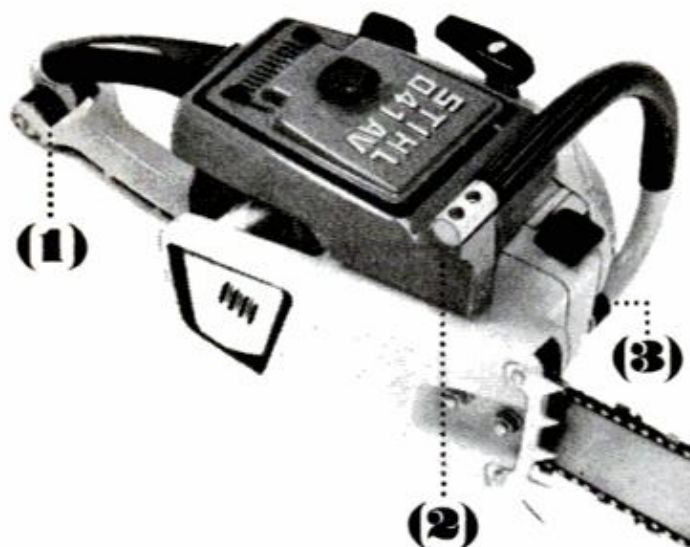

STIHL American, Inc.

194 Greenwood Ave., Midland Park, N.J.
Telephone 201-445-0890
7364 Lee Industrial Blvd., Mableton
(Atlanta) Georgia
2468 Teagarden Street, San Leandro, California

DRIVIN' WITH DAN

(Continued from page 40)

and what if more drivers are ready to go than time permits, or weather interferes?—Don Aukamp, New Castle, Del.

A. This year we drew capsules out of a covered box. Each capsule had a number inside it up to 60. On the first day, if everyone was ready, then some would not get a chance. Rain could ruin it, as it did on the second day this year when only one car qualified.

Q. In watching a cross-country motorcycle race on TV, I noticed that European riders seemed to be doing very well—they won every race! I don't think their bikes are better than ours. What do you think they have on their side?—Randy Bovell, Chattanooga, Tenn.

A. They have more experience in a tougher league. Motorcycle racing in Europe is professional and international. It even crosses back and forth over the Iron Curtain.

Q. To design cars (not racing or drag-race cars), what kind of courses would one have to take, and how could one get a good job with a company like Ford?—M. Harding, Quebec, Canada

A. I would write Ford or GM or Chrysler or American Motors and ask them. Engineering courses cover a lot of ground—mechanical drawing, higher mathematics, stress metalurgy, electricity, plastics, liquid and gas flows. You'd better ask them.

Q. What put the turbines out of the Indy 500? How many seconds were you behind Bobby Unser? What speed did you average during the race?—Lary Polhamua, Piqua, Ohio

A. I believe that partial seizure of the fuel pump due to overheating during slow running (the fuel flow cools the pump) caused fuel-pump driveshafts to shear. Graham Hill's turbine went out with suspension failure. I was about 53 seconds behind and averaged 152.18 mph approximately.

Q. My parents don't want me to become a race driver. Did yours?—Jim Samuel, Cherry Hill, N.J.

A. No, they didn't. I didn't start in earnest until I was about 24 years old. By then I had
(Please turn to page 44)

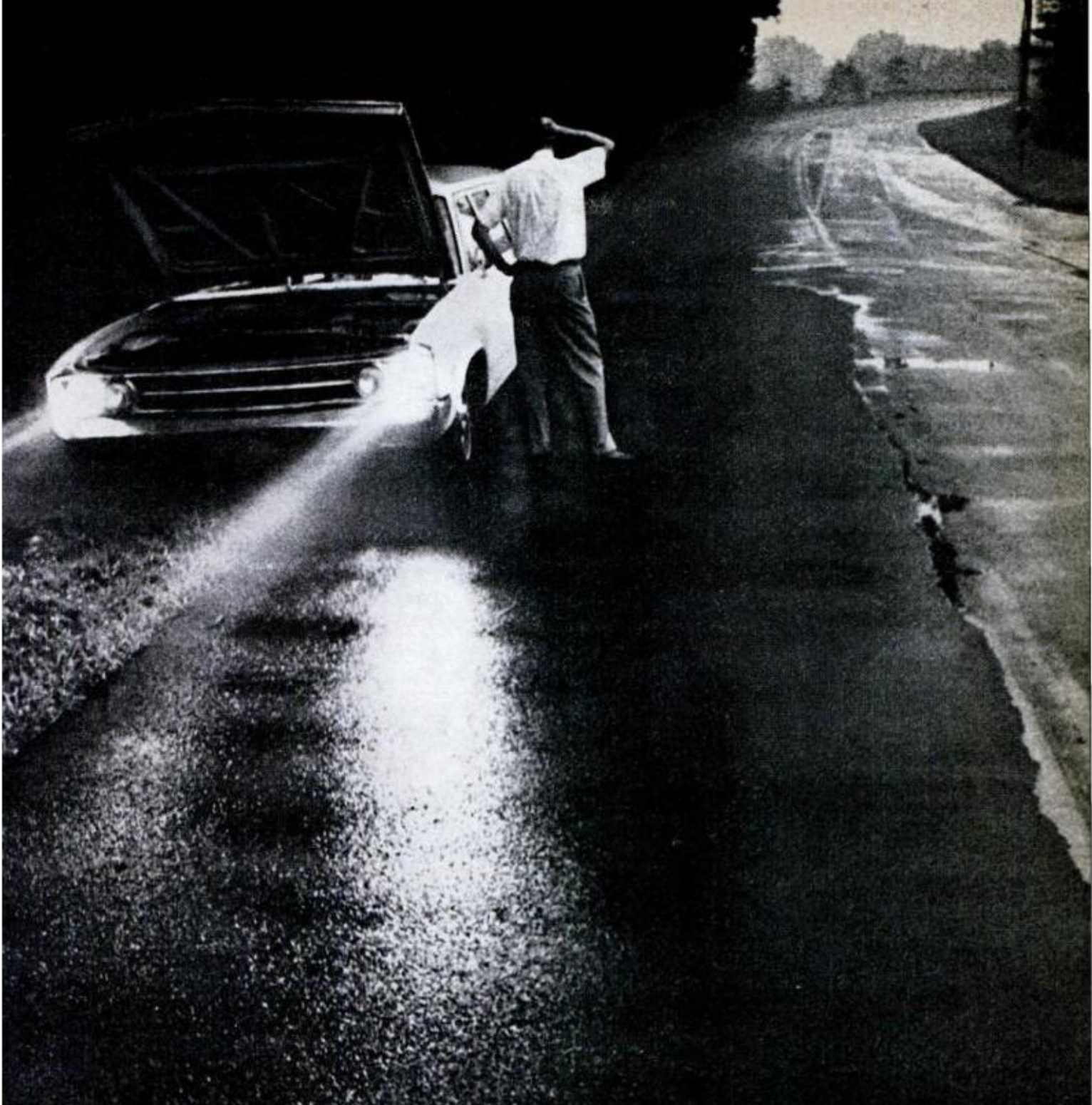

Stop a \$100 valve job before it starts.

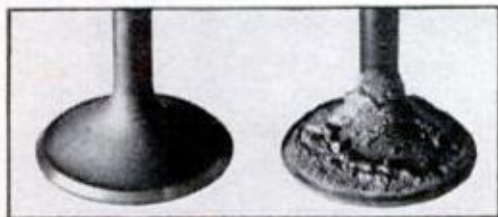

Look at these engine valves. One is relatively free of deposits. The other is heavily encrusted with carbonaceous ash deposits. You certainly don't want this happening to your valves. And there is a way you can help prevent it. Just drive in to your nearest Texaco station. And start filling up with new Texaco Sky Chief gasoline. New Sky Chief minimizes deposit formation on new valves and arrests further deposit build-up on old valves. Better than any other leading gasoline you can buy.

This also means good things in terms of compression pressure, idling, acceleration, and mileage. Over the long haul, it can drive down the cost of driving. Save you money. And help prevent a \$100 valve job. We want to drive down everybody's cost of driving. That's why we made new Texaco Sky Chief gasoline. You see, we're first . . . and we think that's a big responsibility.

New Texaco Sky Chief can drive down the cost of driving and save you money.



Материал, защищенный авторскими правами

Something
so loaded with
talent



should be
given a chance
to shine.

Classic not only shines, but protects your car's finish like no other. Because it's loaded with carnauba wax, the hardest, most expensive wax known. Classic rubs on and dusts off effortlessly. The ingredients do the work, not you. Does a whole car — a big one — in less than an hour. Waxes right in the sun without streaking. And the protection lasts longer than any other wax. 1 lb. 2 oz. tin is \$5, good for *at least* 6 full wax jobs. Try it. If you don't think it's worth it, return the rest and you'll get your money back.

CLASSIC PRODUCTS, LTD. PM-10
2616 N. Tamarind Ave., West Palm Beach, Fla. 33407

Enclosed is \$_____ in check or money order.
Please rush _____ cans of Classic Car Wax at \$5.00 each.

Name _____

Address _____

City _____

State _____

Zip _____

DRIVIN' WITH DAN

(Continued from page 42)

been exposed to quite a bit of education, and I wasn't quite so harebrained or fearless as I was when I was younger. I recommend this approach.

Q. *What is the difference between a turbocharger on a Meyer-Drake, and a turbine engine? What does "liter" mean in racing?—Jerry Chamberlin, Brookville, Pa.*

A. A turbocharger on a Meyer-Drake refers to an exhaust-driven centrifugal supercharger that forces air and fuel into a reciprocating four-cylinder piston engine. A turbine engine is not a reciprocating engine; it's a "jet" engine of the type used most successfully in aircraft. A liter is a volume measure. It's a little more than a quart, equal to 1000 cubic centimeters, or 61 cubic inches.

Q. *Where and when is the Grand Prix of the U.S. held? Where does one write for tickets?—N. Porter, Vineland, N.J.*

A. Watkins Glen, New York, Oct. 6. Try writing to Watkins Glen Grand Prix, P.O. Box 187, Watkins Glen, New York (14891). To get a good fill-in on the race read "The Wildest Show on the Road" in last month's *PM*.

Q. *What is your opinion on Jet Fire Fuel Igniter Plugs, and the G.T. Energy Chamber gas saver?—Anthony Kotchi, Oak Creek, Wis.*

A. I have no first-hand knowledge of either, but I am skeptical of their merit when applied to modern, well-tuned auto engines.

Q. *A classmate and I have been having an argument. He says that a '68 Firebird will wipe out a '68 Corvette Stingray. I strongly disagree. Who's right?—Stephen Boutilier, Rangeley, Me.*

A. I think you ought to go to the nearest drag strip and settle it. I'd pick the Corvette offhand, other things being equal, but I'm sure there are many Firebirds around that can "wipe out" many Corvettes. ★★★

If you have questions on racing, high-performance and everyday driving techniques, send them to "Drivin' with Dan," c/o Popular Mechanics, 575 Lexington Ave., New York, N.Y. 10022. Questions cannot be answered by individual letters. Questions on maintenance and repair should be addressed to the Auto Clinic (see page 84).

Read here about the exciting, high-pay careers waiting in one of today's hottest growth fields—and how preparing for these great jobs can be easier than you might ever have imagined.

IT'S A SHAME to go on struggling along in the same old rut—while others around you move up to better jobs, better homes, better cars. Especially when it's now so easy for you to do something about it.

Just mail the coupon to the right and we'll send you, FREE, two books that have started thousands of men on the road to rewarding new careers. Careers they can be proud of. Careers where the work is exciting. And careers where they can earn the kind of money that many men only dream of.

Thousands of career opportunities like this exist right now in America's hottest growth industry—Electronics. It's an industry where you can take your pick of literally scores of different "glamor jobs"—in broadcasting, automation, the aerospace program, and many other areas. And it's an industry where, once you have some experience under your belt, you can earn up to \$5, \$6, \$7 an hour...\$200, \$225, \$250 a week...\$10,000, \$11,000, \$12,000 a year.

CIE

Cleveland Institute of Electronics
1776 E.17th St., Cleveland, Ohio 44114

Please send me 2 FREE books describing opportunities in Electronics and how to prepare for them.

Name _____
(Please Print)

Address _____

City _____ State _____

Zip _____ Age _____

Veterans & Servicemen: check here for G.I. Bill information

Accredited Member National Home Study Council

PM-18

You don't need college training to break in. Our free books will show you how you can prepare right at home in your spare time. And they'll show you, too, how we can help you land the "dream job" of your choice.

Mail the postpaid reply card or coupon above today for two FREE books.

THIS CAN BE YOUR "BIG BREAK"

if you're a man who's ever said...

"I'm sick and tired of my Job!"



The bargain hunter



CHEESE GIFTS ASSORTMENTS

The most distinctive assortments of domestic and imported cheeses. Arrangements to fit every budget. Plus supreme jellies, preserves, fruit cakes, imported candies, smoked Salami, Turkey Roll and whole Turkey. Satisfaction guaranteed. Catalog free. Continental Cheese Farms Corp., Dept. 7, 5450 Monroe Street, Toledo, Ohio 43623.

OVERTIME PAY You Can Depend On

Why be at the mercy of overtime cut-backs? Turn your own spare time into regular overtime pay. Get sharp and start your sharpening shop. Housewives, hobbyists, barbers, beauty and pet shops, sportsmen, markets, restaurants, contractors, rental shops, farmers—everybody is your cash customer. **TREYCO 6-in-1 Machine** hollow-grinds knives, saws, tools, scissors, pinky shears, clippers, garden tools, rotary mowers, everything! Make as much as \$6 an hour. Learn how **TREYCO** gives you **6 MACHINES IN 1** for low price of one. Quality guaranteed. Thousands of users since 1946. Write for big **FREE CATALOG** and **LOW Factory-To-You Prices**.



TREYCO Products, Inc.
381 Niagara St.
N. Tonawanda,
N.Y. 14120



WSA COLLECTION

STUDY

ART

In Spare Time

LIKE TO DRAW OR SKETCH?

Take fascinating lessons at home in drawing, painting, advertising art, fashion, cartooning, TV art.

Distinguished faculty. Draw and paint in just a few weeks. **FREE Booklet**. No obligation. **WASHINGTON SCHOOL OF ART**, Studio 10-021, PORT WASHINGTON, N. Y. 11050.

Est. 1914. Accredited Member NHSC



McGREGOR

GOES
KING-SIZE!

FOR TALL OR BIG MEN ONLY

McGregor Jackets, Slacks, Sweaters . . . all extra long. Dress, Sport Shirts with bodies 4" longer, sleeves to 38". Also 70 SMART SHOE STYLES in Sizes 10 AAA to 16 EEE. Hush Puppies, Boots, Dress, Sport, Casual shoes. Mail only. 100% Guaranteed. Send for **FREE 48 Page CATALOG**. **KING SIZE, Inc.** 5428 Forest St., Brockton, Mass.



Thousands of exciting tool values!

SILVO (BRAND NAME) TOOL CATALOG

Thousands of Exciting Tool Values! Stanley, Millers Falls, Skil, Thor, Wen, Disston, Wiss, Wellsaw, Dremel, Speedy Sprayers, Plumb, Huot, Kennedy, Channellock, Porter-Cable, Rockwell, Helios, Vise-Grip, Crescent, Ridgid, Pony Clamps, Unimat, Foredom and many other Nationally Advertised brands of Tools & Supplies. We ship Coast to Coast at prices Hard to Beat. Send 25c for our big 148-page tool catalog today. **Silvo Hardware Co.**, PM-10, 107 Walnut St., Philadelphia, Pa. 19106.

NEW Heathkit® Solid-State Tachometer



Professional performer — that's the new Heathkit MI-18 tach. Unique inductive pickup allows use with any spark-type engine & any ignition system; 2 cycle 1-6 cyl. engines & 4 cycle, 2-8 cyl. engines. All electronics mount inside the tach itself. 0-6000 & 0-9000 RPM ranges . . . 250° edge-lighted dial . . . temperature compensated for ±4% accuracy from 0° - 120° . . . adjustable red line pointer . . . runs on 10.5 - 17.5 VDC power . . . stainless steel hardware, splash-proof black & chrome case & scratch-proof glass face. The MI-18-1 kit mounts in dash — only \$29.95. The MI-18-2 kit comes with mounting hardware & case — only \$32.95. **Order from Heath Company, Dept. 17-10, Benton Harbor, Michigan 49022.**

BULL FIGHTER
Lock Blade
STILETTO KNIFE

5 1/2" Overall Length
3" Blade

ONLY \$1.25

- Tough and Sharp
- Opens Instantly
- Stainless Steel
- Folding Finger Guard
- Blade Locks

Flips open instantly and locks automatically to prevent accidental closing. Razor sharp tough stainless steel blade for reliable use and hard, long service. Money back in 5 days if not satisfied. Send \$1.25 plus 25c to cover postage & handling. Please state age.

WESTBURY SALES CO., DEPT. BF
P. O. BOX 415, WESTBURY, N. Y.

DISPOSABLE PLASTIC LEAF BAGS
30 BAGS for
\$2.98 plus 50c postage

Save time & work on that annual Fall headache — leaf disposal. Big roomy bags hold 2 full bushels each. Rake leaves into bags, twist shut with included wire ties, throw bags away. Saves extra raking, burning, wind scattering. Perfect for trash too.

50 Bags, \$4.45 plus 50c postage
100 Bags, \$8.50 plus 50c postage

DELUXE SIZE 12 for \$2 plus 50c postage
holds 7 bushels or 55 gallons

BARCLAY Dept. 59-L, 170-30 Jamaica Ave., Jamaica, N.Y. 11432

MAKE DELICIOUS GERMAN BEER AT HOME — Legally
— For only 6c A BOTTLE

Imagine the money you'd save in one year! With my easy-to-follow book I'll unconditionally guarantee that you can make 4-5 cases of fantastically delicious German, Canadian or American style Beer in only 30 minutes or your money back. This amazing new process (actually borrowed from an old German one!) uses only standard kitchen equipment. Make it light or dark, "weak" or "powerful". Federal law allows you to make beer at home for consumption by your friends and family—it cannot be sold. A whole case costs you less than 90c because there's no tax or dealer profit. Remember, I'll guarantee your beer will **TASTE BETTER** than commercial brands yet cost no more than 6c a bottle or your money back. Only \$3.98 to **Bierhaus Book, P.O. Box 5157, 1800 Hazlewood Dr., Ft. Wayne, Ind. 46805**

FREE CHINESE KNIFE COIN PLUS 50 DECALS WITH SENSATIONAL **BIG GIFT BOOK**

FREE **SEND \$2 TO**

FREE **CATALOGS INC**
BOX 835A JANESVILLE, WIS. 53545

Hundreds of unusual exciting items! Automotive, build-your-own, models, pro football, sporting goods, skin diving, surfing, imports, war relics, decals, patches, pennants, posters, signs, pictures, clothing, and more!

Mention Popular Mechanics when writing to advertisers

SECRET AGENT BALLPOINT PENKNIFE



OPENS INSTANTLY INTO A
7 1/2" POCKET KNIFE

- RAZOR SHARP STAINLESS STEEL BLADE
- LIGHT WEIGHT, YET STURDY
- INTERNATIONALLY ACCLAIMED



ONLY
\$2.75

It looks like an expensive ball point pen, but with a simple flip of the top, the Hidor Metal housing becomes a handle to a sleek stainless steel blade sharpened to razor edge. This unique pocket knife has rarely been offered before. Send \$2.75 plus 25c to cover postage and packing. Five-day money back guarantee.

WESTBURY SALES CO., Dept. XM-53
P.O. BOX 415, WESTBURY, NEW YORK

"\$33,000 LAST YEAR"

OPERATING AUTO
RADIATOR SHOP

—Mercier Bros., Lowell, Mass.



NEW 1-PIECE SHOP
Tests • Cleans • Repairs

START SHOP OR ADD TO BUSINESS. Market growing. More cars each year. Packaged radiator shop incl.: equipment, training, 98-page manual, initial supplies. Proven merchandising attracts business. Pay-as-you-profit plan. Write.

INLAND MFG. CO., Dept. PM-10
1108 Jackson St., Omaha, Neb. 68102

Investigate Before
You INVEST



A radiator service business can be a profitable one! If you are thinking of a business of your own or adding a department write Barbee for details. No investment of \$1500 to \$3000 will pay greater dividends. Two weeks free schooling masters fundamentals. Small down payment starts you. Our easy pay plan lets you pay from profits.

Free Catalog on request.



The BARBEE Co.,
P. O. Box 323PM,
Louisville, Ky.

OCTOBER 1968



FREE!!! POWERFUL MUSCLES FAST!

Fantastic New Discoveries in the science of bodybuilding. Now, in the privacy of your bedroom, our method will add inches of powerful muscles to arms, chest, shoulders & legs. Learn secrets on trimming the waist with ultra-modern methods—fast! Results Guaranteed! Send for free brochure, Universal Bodybuilding, Box 5327, M8, Northeastern, Dearborn, Mich. 48126.



22 CAL.
PELLET
FIRING

"STINGER AUTOMATIC"

50 22 CAL. PELLETS FREE
Looks and Feels Like Real
Pocket Automatic—
Loads 15 Shots

Fires 22 cal. pellets just as fast as you can pull the trigger. Great for fast action combat-type target practice. 50 reusable 22 cal. pellets free. Free supply of targets. Money back if not satisfied. Just send \$1.00 plus 25¢ for postage and handling to: Honor House, Dept. 96RA46, Lynbrook, N. Y. 11563



MAKE YOUR CAR

THEFT-PROOF

With New Amazing

STEAL 'N STALL



Installs quick—car starts but stalls & stops shortly—thief cannot start again—only you know the secret—hides under seat, dash, etc.—works on any battery-ignition car (6-12 volt)—fully guaranteed—eliminates car-theft damage.

ONLY **\$4.95** P.P.D. anywhere continental U.S.

Order now! Check or money order to: Steal 'N Stall, Ocean-Aire, Inc., P.O. Box 52833, Baton Rouge, La. 70805.

WHEN
ANSWERING ADS
GIVE YOUR
ZIP CODE



HANDY DANDYS STORE SUPPLIES
FOR NEAT AND CLEAN WORKSHOPS

Sturdy, plastic caps snap into 1/4" pegboard and hold quarter twist baby food glass jars. Perfect for storing all kinds of small parts and things. Keep your workshop neat. 10 for \$1; 26 for \$3; 72 for \$5; 500 for \$32.50. Handy Dandys only. No jars. Shipping paid anywhere USA. Send payment with order—no C.O.D.

WICKLIFFE INDUSTRIES, INC., P.O. Box 286,
Dept. PM-10, Wickliffe, Ohio 44092.

FIND BURIED TREASURE!

10-DAY MONEY BACK GUARANTEE

TREASURE
PROBE
\$18.88 P.P.D. ALL TRANSISTORIZED

3 ft. portable detector finds buried metal objects. Signals location with loud audible sound. Detects gold, silver, metallic ore and nuggets of all kinds. Find lost coins, jewelry, Indian artifacts, civil war souvenirs. Treasureprobe guaranteed to equal detectors selling to \$150 or your money back. Absolutely complete, sensitive earphone, 9v battery, nothing else to buy. TO ORDER: Send check, cash or money order, \$5.00 deposit for COD in N.J. add 57¢ tax.

TREASUREPROBE Dept. PAK, P.O.
Box 228 Toms River, N.J. 08753

SECRETS of Teaching
Yourself MUSIC

revealed in your own home
this money-saving way



YES! Teach yourself Piano, Guitar, Accordion, Violin, ANY instrument—even if you don't know a single note now! No special "talent," no previous training needed. Famous low-cost U.S. School of Music Course, with step-by-step pictured lessons, makes it simple as A-B-C.

Everything is in print and pictures. First you are told what to do. Then a picture shows you how. It's as easy as cutting a soft cake. You start by playing actual pieces. Sooner than you may imagine you'll amaze friends by playing your favorite music—popular, classical, jazz, country music, dance tunes, etc. Over 1,250,000 students all over the world.

Stop Cheating Yourself of These Joys

Popularity. New friends. Gay parties. Musical career. Extra money. Banish worries, frustrations. Satisfy self-expression, creative urge. Gain self-confidence.



Write today for our new illustrated FREE booklet, U.S. SCHOOL OF MUSIC, Studio 3010, Port Washington, N.Y. 11050. (Est. 1898. Approved by N.Y. State Education Dept.)

Print Name
Address
City
State Zip Code

46C

CHINA DOLLAR only 10¢



Uncirculated nickel silver dollar minted in 1960 to Commemorate 50th anniversary of the Republic of China (Formosa) . . . only one to a customer . . . a beautiful coin and ONLY 10¢. **SUPPLY LIMITED! SEND TODAY.** Also get free big catalog illustrating coins and supplies, plus selections of coins from our approval service returnable without obligation. Send name, address & zip number and 10¢ for your China Dollar to: **LITTLETON COIN CO., Dept. KC-25, Littleton, New Hampshire 03561**

SUB-ZERO THERMAL BOOTS

Here is a replica of the G.I. Mickey Mouse boot that will let you enjoy years of cozy warm foot comfort no matter what the temperature—right down to 70 below zero. Just what you have been waiting for for hunting, ice fishing, outdoor work. And they are built rugged—to last and last while cuddling your feet in bedroom slipper comfort and fireplace warmth.

Guaranteed Warmth Down to 70 Below

only \$13.95



SATISFACTION GUARANTEED

Just check the table and see if these are not "just what the doctor ordered." Order today. You must be pleased—they must be "the best you've ever had" or just return them after 10 days trial for a full purchase price refund. Fair enough. And they cost only \$13.95 plus 55¢ for postage and handling. Give us your regular shoe size and we guarantee fit. For COD send \$2 good will deposit and pay balance plus postage and handling to postman when your boots arrive.



HONORHOUSE DEPT. BTLN BROOK, N.Y. 11563

"Cold Temperature" Test By A Leading Independent Laboratory

. . . Based on actual wear test and worn with a wool sock, with a thermocouple attached to the big toe and ankle:

Bath Temperature °F	Minutes	Temperature
0	60	80°F
-50	30	79°F
-50	30	79°F
-70	30	78°F

Stamp Your Name PERMANENTLY

\$3.95 ppd.

EVERSTAMP

DIE TOOL

Hardened tool steel. Lasts a lifetime. Comparable to a \$10 die tool, still available at this special price. Stamps almost anything you own with a single blow. Made only by the Henry A. Evers Co., Inc., makers of quality marking devices since 1898.

HENRY A. EVERS CO., INC.

Dept. PM, 72 Oxford St., Prov., R. I. 02905

Enclosed is payment for die tool:

- Reg. size 1/16". 15 letters max. @ \$3.95 ppd.
- Large size 3/32". 10 letters max. @ \$5.25 ppd.

NAME.....

Please Print

STREET.....

CITY..... STATE..... ZIP.....

PLAY GUITAR IN 7 DAYS OR MONEY BACK



ED SALE'S 66 page system worth \$3.00 teaches you to play a beautiful song the first day and many more songs by ear or note in seven days! Contains 52 photos, 87 finger placing charts, 110 popular and western songs; a \$1.00 Chord Finder of all the chords used in popular music; and a \$3.00 Guitarist Book of Knowledge.

TOTAL VALUE \$7.00 \$2.98 —ALL FOR ONLY

SEND NO MONEY! Pay postman \$2.98 plus C.O.D. postage. Or send \$3.00 with order and I pay postage. (Sorry, no C.O.D. outside Continental U.S.A.—please remit with order). **Unconditional Money-Back Guarantee.** ED SALE, Studio 153-N, Avon by the Sea, N.J.

AUTOMATIC 66-SHOT PELLET STINGER

FREE Wild animals and AMMO assailants instantly repelled

The pellet is harmless but STINGS. Holds and fires 66 pellets automatically as fast as you can



\$1.98

pull the trigger to knock most stubborn assailants off guard. Portable. Fits easily into pocket or purse. Made of high impact styrene for long life, trouble-free use. Fully guaranteed. Keeps animal pests off your property. More humane to animals than kicking or hitting. Send \$1 cash, check or money order plus 27¢ to cover handling and we include 50 stinging pellets. Not sold in N.Y.C. or if under 16 (state age with order).

World Co., Dept. 10PM, 1 Park Ave., New York 10016. (100 pellets \$1) (250 pellets \$2) (1000 pellets \$5)

AMERICA'S NO. 1 CLASSIFIED SECTION CAN BE FOUND ON PAGE 51 IN THIS ISSUE



The Easy Way to Build



BEAUTIFUL CLOCKS

Send 25¢ for 48-page catalog of easy patterns, fine clock movements, dials and hardwood kits.

CRAFT PRODUCTS

ELMHURST (1) ILL. 60126

locksmithing and key making

PRACTICAL UP-TO-DATE COURSE — ONLY \$6.95



Teaches you how to pick locks, de-code, make master keys, repair, install, service, etc. New self-instruction lessons for every handyman, homeowner, carpenter, mechanic, service station operator, fix-it shop, hardware dealer, gunsmith. 53 easy illustrated lessons. Full price only \$6.95, postpaid. Satisfaction or refund guaranteed. Mail order today!

NELSON-HALL CO., Dept. K5-2
325 W. Jackson Blvd., Chicago 60606

WRIST ROCKET

AMERICA'S Pat. HARDEST U.S. HITTING SLING

Range 225 yd.—232 fps

Matched spare rubbers and pouch assembly, \$1.00.

Write WRIST ROCKET® \$3.00 Post Pd. 2654 44th Ave. Columbus, Nebr. 68601 PM No C.O.D.'s



BIG FALL SAVINGS NOW

FOLBOT

fits in every home or car

FACTORY BUILT
\$165

CHOICE of CHAMPIONS

belongs to You

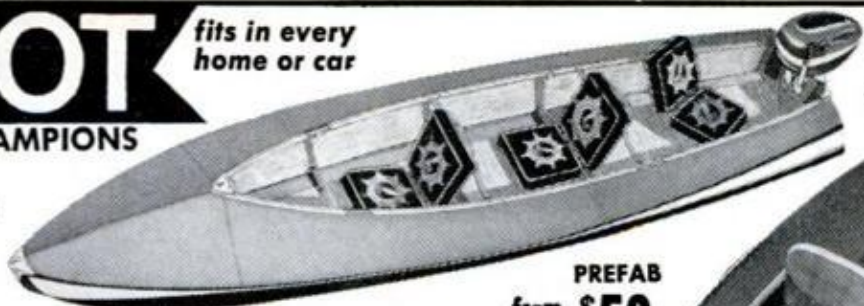

PREFAB
from \$53

Most inexpensive too

GENUINE Folbot RECREATION for just ONE small investment, WITHOUT the continuous burdens of complicated 'big rig' operation. You GO CAREFREE anytime with COMPACT Folbot . . . rocky streams, lakes, marsh, surf & open sea. Superior non-sinkable designs provide SAFEST low gravity center, balanced low & high seating, substantial construction, protective decks & EXCLUSIVE swivel-back COMFORT. ALL within your reach. In handy Folbot YOU GLIDE smoother, faster & NOISELESS with paddles, bars, or sails and ride softly w. 1 to 10 HP. motors. Many styles & sizes from 1 to 4 seaters, FOLDING or rigid PORTABLE come in PREFAB KIT, or expertly FACTORY BUILT

NOW at SPECIAL SAVINGS
YACHT-SMART large DACRON Sail Rig \$104

NEW Fabulous 16 foot \$119

Factory BUILT Folding from \$169 Factory finished

FREE ACTION CATALOG

Mail coupon or address

to FOLBOT CORP. Dept. PM-1068
Charleston, S. C. 29405

Name _____

Address _____

City _____ State _____

for YOUR SPORT & FAMILY FUN

Guard Your Family and Property with New HEATHKIT® Home Protection System



Receiver/Alarm kit GD-77 plugs into AC outlet, no other wires needed. \$39.95

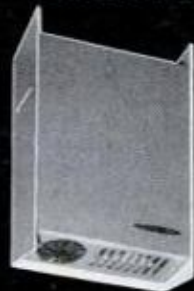

Smoke & Heat Detector kit GD-87 plugs into AC outlet, no other wires needed; signals Receiver of emergencies.

\$49.95



Universal Unit kit GD-97 plugs into AC outlet; attach switches for intrusion or any hazard; signals Receiver

\$34.95

Protection Unlimited . . . Customize To Your Needs



Intrusion



Smoke & Heat



Freezing



Changing Temp.



Flooding

POWER FAILURE

- Exclusive new "load" signaling method
- Easy to install, uses AC power line for connecting medium
- Inexpensive operation
- Fail-Safe
- No false alarms
- Use as many units as you wish
- You may add external alarm to Receiver, extra heat sensors to Smoke & Heat Detector, and any type of switch or sensor to Universal Unit, as you wish, to guard against any hazard
- Numerous accessory sensors available from Heath
- Solid-State
- Easy to build, complete each unit in 3 hours

FREE CATALOG

Shows these and over 300 other easy to build kits that save up to 50%. . . Color TV, Electronic Organs, Stereo, Marine, CB, Ham Radio, Test, Photography, Educational, for home & hobby. No skills or experience needed. Send for your free copy today.

HEATH COMPANY, Dept. 17-10
Benton Harbor, Michigan 49022



Enclosed is \$ _____ plus shpg. chgs.

Please send models _____

Please send FREE Heathkit catalog

Please send FREE Home Protection Brochure

Name _____

Address _____

City _____ State _____ Zip _____

Prices & specifications subject to change without notice.

CL-329

This great **RIDGID**

Tube Cutter gives you 3 tools for the price of 1.

It's the RIDGID No. 15 tube cutter, and it's one of the handiest tools ever invented!

One. It's the smoothest little tube cutter available for all $\frac{3}{16}$ " through $1\frac{1}{8}$ " copper, brass and aluminum tube, also thin-wall conduit.

Two. Our tool is also a reamer. The blade folds into the frame where it's out of the way but always handy.

Three. The No. 15 is also a gas cylinder wrench. The key is cut right into the blade... it can't get lost.

So get 3 tools for the price of 1. Get a RIDGID No.15 Tube Cutter at your Dealer's. He carries a complete stock of Work Saver Tools from The Ridge Tool Company, Elyria, Ohio 44035.

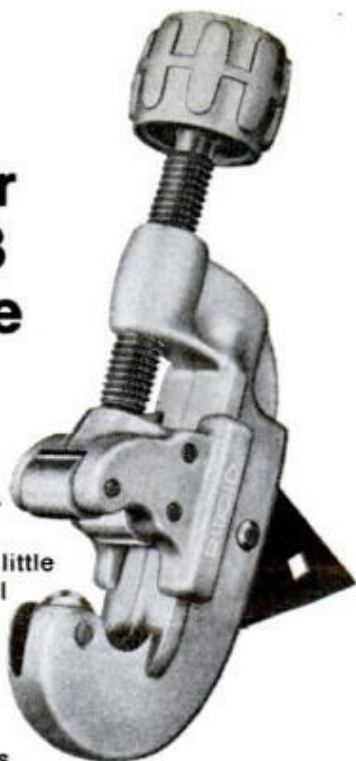

RIDGID

MY SPARE TIME HOBBY MAKES ME \$500 an hour CASH PROFIT

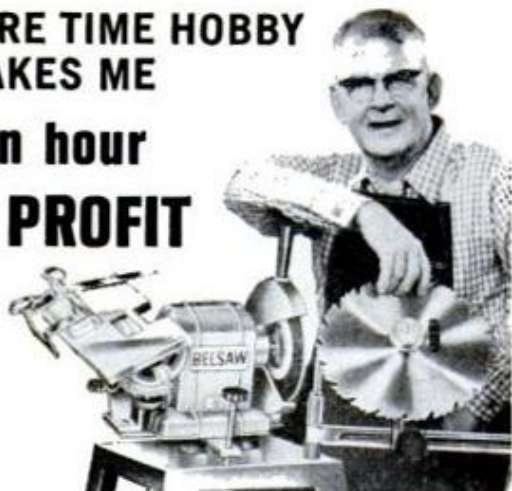

START YOUR OWN SPARE TIME BUSINESS
You can turn your spare time into Big Cash Profits with your own **COMPLETE SHARPENING SHOP**... Grind saws, knives, scissors, skates, lawn mower blades... all cutting edges. Your Own Cash Business with no inventory... right at home... no experience needed.

FREE BOOK tells how you can start your own spare time business while you are still working at your regular job. Low Cost—time payments only \$15.00 a month. **Send coupon today.**

No Salesman Will Call.

BELSAW SHARP-ALL CO., 719T Field Bldg., Kansas City, Mo. 64111
Send Free Book, "LIFETIME SECURITY." No obligation.

Name _____

Address _____

City _____ State _____ Zip _____

PICTURE THIS

By SHELDON M. GALLAGER



FIVE NEW INSTAMATIC CAMERAS from Kodak are designed to cover the needs of most snapshooters. Included in the group is the lowest-priced model ever to incorporate an electric-eye diaphragm, the Instamatic 134 shown above. The electric eye automatically adjusts the lens opening to varying light conditions. The camera has a shutter speed of $1/50$ th of a second and sells for about \$28. A similar model without the electric eye, the Instamatic 124, sells for under \$20. Two other new models offer a handy spring-motor drive that advances the film each time you press the shutter release. One winding of the spring knob, shown on top of the camera below, handles a full roll of film and lets you fire off shots at the rate of one a second. The motorized models are the Instamatic 414 with electric-eye diaphragm and close-up lens for about \$50 and the Instamatic 174 without the extra features for under \$30. There's also the Instamatic 314, similar to the 414 but without the spring drive for under \$40. All models take flash cubes and drop-in Instamatic film cartridges. On electric-eye models, a red warning light shows in the viewfinder when you need to use flash. (Please turn to page 46H)



How Harold Dail Made \$7,975.00 In 59 Days!

By Tom Harding

The true story of Harold Dail could happen only in the fantastic world of Accident Investigation.

Where else could a man with no experience and only average education go out and pick up a check for nearly \$5,000 for 5 days work?

Where else could this same man later go out and earn at the rate of \$135.00 a day for 59 straight days?

Is Harold Dail some kind of a money-making genius? Not at all. He's just an average man who had the good sense to take some training in a field that's bursting with opportunity.

It all began when Dail was working as a night clerk in a hotel in Barstow, Cal. It was a dull, low-pay job. There obviously wasn't much of a future. But Dail wasn't about to give up.

The Big Break

He enrolled with Universal Schools of Dallas for correspondence training in Accident Investigation. He started reading lessons-by-mail in his spare time.

Then came the big break. A large furniture store burned in Long Beach. Dail quickly reviewed one of his Universal lessons then hurried out to see the owner of the store. He offered to represent the owner in obtaining an insurance settlement.

In just 5 days, working entirely from directions in his Universal lessons, Dail obtained a settlement for \$90,000. His fee—\$4,474.00!

Almost without knowing it, Harold Dail had become what is known as a Public Adjuster. The Public Adjuster works as an independent operator. He helps people settle insurance claims. It is only one of the many money-making careers open today in the booming field of Accident Investigation.

A New Career Opens

But this was only the beginning for Harold Dail. His new career opened up like the door to a bank vault.

When a large area of Los Angeles was swept by fire, Dail went to work in earnest. His Universal training turned into a jackpot. He helped 21 businessmen handle their insurance claims and made \$7,975.00 in 59 days. That's an average pay of \$135.00 a day!

Today Harold Dail has made so much money in Accident Investigation that he spends his summers on his ranch

Amazing Things Can Happen To You In This Big-Money Industry



near Kingman, Arizona. He's also building a sub-division in Barstow—the same city where he was once merely a night clerk in a local hotel.

"If it hadn't been for my income from Public Adjusting I wouldn't be financially able to carry on this project," Dail writes. "If it hadn't been for the training of Universal Schools I wouldn't have been in the 'know' about Accident Investigation in the first place. I owe a lot to Universal Schools."

You Can Train, Too

The story of Harold Dail is unusual. His income is far above average for the field. But it shows what a man can do in Accident Investigation when he is trained to take advantage of the opportunities around him.

Now you can take exactly the same training Harold Dail had. You can do it easily in your own home, in your spare time, and at low cost.

You need no experience, no college education. There's no equipment to buy. No classes to attend. Keep right on with your present job until ready to switch.

And when you are ready, Universal gives you free, nation-wide job placement service. Universal has trained and placed more men in Accident Investigation

Approved for Veterans' Training

careers than any other organization.

Men Urgently Needed

The need for more trained men in all areas of Accident Investigation is absolutely critical today. This huge, growing \$19 billion industry must investigate and settle some 22 million accidents and losses a year! And the job gets bigger every month as the accident rate goes up and up.

There simply are not enough trained men in the country to handle this enormous workload. That's why hundreds of companies have standing requests with Universal for names and addresses of all our graduates.

Free Book of Facts

We can't begin to tell the whole story of this huge, exciting business here. But we do tell you all about it in an exciting, free book which you can have for the asking. There's no obligation. No salesman will call.

Learn about the 3 major careers open now in Accident Investigation. Read how clerks, truck drivers, laborers, factory hands have moved up to professional pay and standing with the help of Universal. (We give you names, addresses, earnings.)

Discover your opportunities now. Send for free book of facts today. Mail the coupon or write Universal Schools, 6801 Hillcrest, Dallas, Texas 75205.

MAIL NOW FOR FREE BOOK OF FACTS



UNIVERSAL SCHOOLS, INC.

6801 Hillcrest, Dept. PM-69, Dallas, Texas 75205

Without obligation, please send me the free book on my opportunities in Accident Investigation. I understand that no salesman will call on me.

Name _____ Age _____

Street _____

City & State _____ Zip Code _____

103

We'll Help
You Start A

BUSINESS of YOUR OWN No Money Down



Here's an unusual opportunity to start a business of your own without investing any money to get started... that's because we know that any person who wants to succeed in a profitable saw sharpening operation can make money. Thousands are already doing it but every neighborhood can use this service. No need to quit your present job—Start in sparetime and build it into a money-making full-time business of your own.

No Experience! No Selling

The easy-to-operate Foley Saw Filer is automatic—it does the job for you. You can be doing business the day after you receive your machine. And with a saw filing business customers will come to you. No door to door selling! You are supplying a much needed service. If you'd like more information about this unique business opportunity, return coupon (no salesman will call) and we'll send you our fact-filled

MONEY-MAKING BOOKLET FREE!



Foley Manufacturing Co.
1043-8 Foley Bldg., Minneapolis, Minn. 55418
Send for FREE book on Money-Making facts about the sharpening business.

NAME _____
ADDRESS _____
CITY _____ STATE _____ ZIP CODE _____

BE YOUR OWN BOSS!

A SPACE AS SMALL AS 10" X 13" CAN MAKE YOU INDEPENDENT

in the high profit (low investment) rubber stamp field. Increase your income; full or part time basis. Deal direct with manufacturer offering lowest prices on professional SIMPLE-X presses & supplies, plus valuable aid. For FREE full facts write

CUSTOM MFRS.

406PM E. Elm, Springfield, Mo. 65801



MAGIC MAIL PLAN

that comes with this Little Machine
CAN MAKE YOU \$1200 AN HOUR

The machine is turning out a job that will bring operator \$2.58, by mail. Material cost, only 11c



Write today for free facts about the newest and most fascinating of all new home operated businesses. For the first time, a simplified machine brings the fabulous profits of Plastic Sealing and Plastic Laminating within reach of the small operator. Anyone can learn to operate it with a few minutes practice. Then—with our MAGIC MAIL PLAN—we get mail orders pouring in daily with cash in every envelope.

No Canvassing or Selling

Fill orders at home in spare time to start. Then expand to full time business. We even supply circulars to bring back cash and orders. Rush name for all the facts you need to start. A postcard will do. No charge.

WARNER ELECTRIC CO., Dept L-2-L0
1512 Jarvis, Chicago, Ill. 60626

PICTURE THIS

(Continued from page 46F)

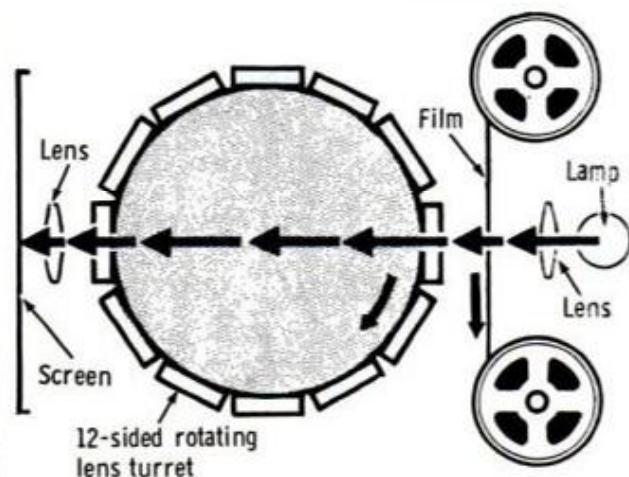
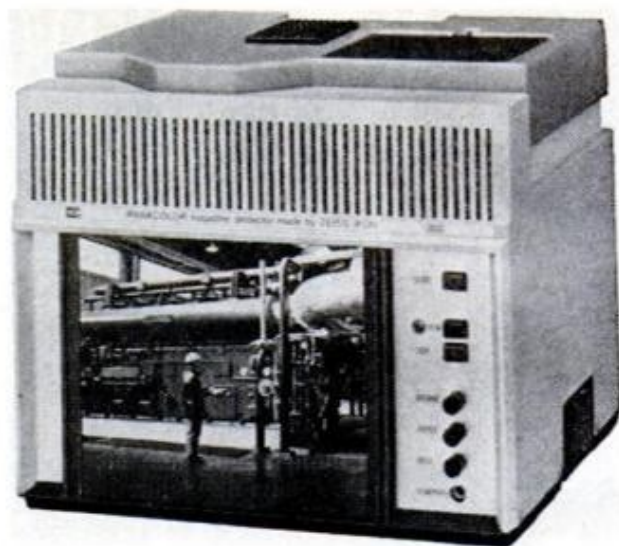

YOU GET TWO HOURS OF VIEWING from one reel of film on this novel sound movie projector. It uses 70-mm film—eight times wider than conventional 8-mm film—with 12 rows of pictures side by side. The pictures show up on a built-in rear-projection screen. Instead of the usual sprockets and pull-down claw to provide intermittent motion, the film runs continuously through a capstan drive—like tape in a tape recorder. A rotating lens turret transmits a frame at a time, creating the effect of intermittent motion without the wear that sprockets cause. \$595 from Panacolor, Inc., 100 E. 42nd S., New York City

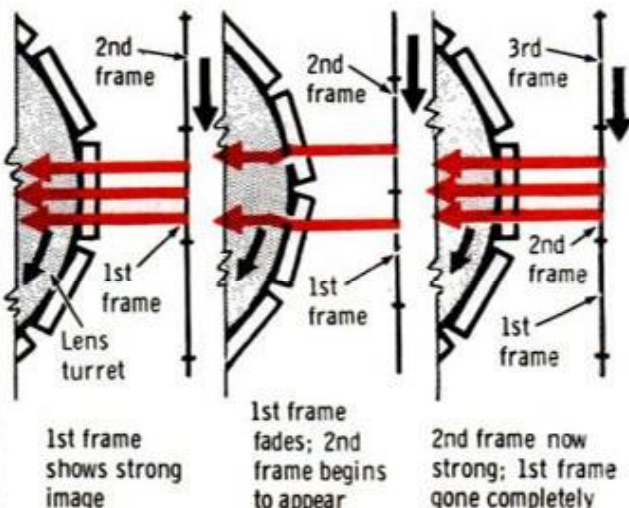

CLASSIFIED ADVERTISEMENTS

Rate: \$1.85 per word payable in advance each insertion. Capitalized words—75¢ per word additional. Minimum insertion ten words. To be inserted under the proper classification, copy must be in our office by the 15th of the second month preceding date of issue. The next available issue to place an advertisement in America's No. 1 Classified Section is December. The closing date is October 15th. Send remittance and order to C. A. Martin, Popular Mechanics, 575 Lexington Avenue, New York, New York 10022. Please make remittance payable to Popular Mechanics.

CHRISTMAS GIFT SHOPPING

FREE Gift catalog, Dept. P, Topp Enterprises, 175 Fifth Ave., New York, N.Y. 10010.

CHRISTMAS Gifts—Free Catalog. Chevo, Box 2053, N. Babylon, N.Y. 11703.

AMAZING Broker Game. Uses actual stock market strategy. Entire family can play; learn how market works. \$5.95. Descriptive catalog free. Shasta Enterprises, McCloud, California 96057.

CHRISTMAS SHOPPING made easy. Free catalog. Nolan Enterprises, 10280 Vicksburg, Cupertino, Calif. 95014.

AUTOMOBILES, MIDGET CARS

YOUR Ad in this space will be read by more than 1,662,961 active mail order buyers. Join the march to greater profits, place your products and services in front of them today with a small low cost classified ad. For further details, write: C. A. Martin, Dept. 1R, Popular Mechanics, 575 Lexington Avenue, New York, New York 10022.

AUTO SUPPLIES AND EQUIPMENT

CROSLEY And foreign car parts. Box 7, Elmont, N.Y.

GAS-OIL HOG??? . . . Smoking?? . . . No Pep?? . . . Hard Starting?? (Save \$150-\$250) with Motaloy Ring-Valve Job While driving (\$6.50 postpaid) Advertised here every month for years! Continues saving money on repairs, gas, oil for 100,000 miles! Absolutely true! (new engines too) Nothing compares! . . . Money-back guarantee. You can't lose! Motaloy, Grantham, Penna. 17027.

EASY add-on IGLIT checks ignition. Q-arc, Box 47876 Los Angeles, Calif. 90047.

ANTIQUE Car pistons, gaskets, gears, valves, etc. Catalogue \$1.10. Antiques Auto, Milwaukee, Wisconsin 53204.

WARNING Flasher, emergency four directional under dash mounting \$3.98. Gift catalog. E. Remlinger, 116 Hardenburg Lane, East Brunswick, N. J. 08816.

JEEP Owners—V8 conversions. Read Jeep Owners ad, page 221.

POWER Steering Aid. Wheel Position Indicator. Detailed Plans \$1.00. Instrument Control, P.O. Drw. 188, Lakewood, Calif. 90714.

DRIVE Your car without sparkplugs, save \$100.00 yearly. Free literature. Blanchette's Enterprises, Voluntown, Connecticut. 06384.

KNOW Your Car Expenses! Record Blanks, one dollar for six month supply. Write: P.O. Box 132, Scarboro, Ontario, Canada.

NEW Method cuts oil consumption. No additives. No extra costs. \$1 from MOT-R-FAX, Box 2101, Sacramento, California 95810.

AMAZING NEW PARK-GUIDE Device! Park on a dime. Simplifies parking in garage. Prevents accidents. Guaranteed. Complete \$1.00. Exclusive with William Spencer Company, 3201 MacVicar Court, Topeka, Kansas 66611.

PERMANENT Spark Plugs?—Yes!!! Lectra Fuel Igniters replace ordinary spark plugs—permanently! 50,000 mile guarantee. Write for free literature and low prices. ARESS, Dresher, Pennsylvania 19025.

SNOWMOBILES

SNOWMOBILES—Factory Direct Prices. Save 20%. 6 latest 1969 models, 10-24 HP. Free Inspection Money Back Guarantee. Easy terms. Free catalog. Luger, Dept. SB-68, 9200 Bloomington Freeway, Minneapolis, Minnesota 55431.

AUTO TRAILERS

CAMPER Plans. Compact buses, Vans—Volkswagens, Econoliner, Dodges. Build yourself—Save! Details—Dot Campers, Box 2115M, Culver City, California 90230.

BUILD Your Pickup Camper. Precut Kits. Blueprints. Supplies. Literature 10¢. Comstock Trailers, Dept. 664, Parsons, Kansas 67357.

PICKUP Camper, Trailer or Pickup-Cover . . . Build yourself. Save! Complete plans \$3.95 each. Cover plans \$2.00. Econoline Bus or Van, Bus Conversion drawings, \$2.95 each. Satisfaction Guaranteed. Equipment catalog \$1.00 (refundable). Details 10¢. Viking Camper Supply, 94-F Glenwood, Minneapolis, Minn. 55403.

MOTORCYCLES, BICYCLES, MOTORSCOOTERS AND SUPPLIES

RECONDITIONED Motorcycle motors. Indian, Mustang, Royal Enfield, Suzuki. Parts, Accessories. Indian Motorcycle Sales, Kansas City, Missouri 64127.

HONDA 50-90-160 Speed Equipment. Cams—Big-Bore-Stroker. Columbia Engineering, 2105 E. 37 St., Los Angeles, Calif. 90058.

BUILD Motorbike from Bicycle! Plans—\$2.00; Go-cart plans—\$2.00; Snowmobile plans—\$5.00; Go-byk Industries, Rothsay, Minn. 56579.

SNOW VEHICLE & KART CATALOG. Hop up accessories—speed and performance equipment—manifolds, engine mounts, exhaust systems. Send 25¢. G.E.M. PRODUCTS, 494 E. St. Charles Rd., Carol Stream, Ill. 60187.

HARLEY-Davidsons—Used bargains. New, used parts, accessories, all models. Bulletin 35¢. Knuth's (Factory Dealer), 1753 Muskego, Milwaukee, Wis. 53204.

BUILD "Popular Mechanics" MINI-BIKE featured June 1967 issue. Detail plans, photographs \$2.50 refundable. Kits, parts, engines; factory discount prices. Catalog 25¢. Gilliom Mfg.; PMC; St. Charles, Missouri 63301.

MINI-Bikes, Kits, plans, parts (including Fox, Rupp, etc.). Factory prices. Discounts to 60%. 1969 illustrated catalog 50¢ (double refund). MERCURY PM1083751 West 63rd, Chicago 60629.

AVIATION

BE A Government licensed aviation mechanic. Practical training. Free information. Aero Mechanics School, Municipal Airport, Kansas City, Missouri 64116.

FREE Catalog. 1000 Aviation Space Books. Aero Publishers, 329 Aviation, Fallbrook, Calif. 92028.

HELICOPTER One-man. Portable Kits Plans, Information 25¢. Photos and three-view drawings \$1.00. Compco, Box 1267, Redwood City, California 94064.

HOMEBUILT. Real enclosed helicopter, 24 pages ideas, information, \$2.50. Build "executive" helicopter, drawings, specifications, \$2.00. Helicopter Development, Box PM147, Washington, New Jersey 07882.

LEARN AVIATION AT HOME. Navigation, aerodynamics, communications, weather taught in your home. Unique method. Free information. United Aero-Sciences Institute, Dept. C, P.O. Box 4106, Torrance, California 90503.

PROPELLERS. Plans, Supplies for Airboats-Snowplanes, Corvair, Volkswagen conversion. 125 Lycoming Engines. Gyrocopter, Hovercraft propellers. Catalog \$1.00. Banks-Maxwell, Box 3301E, Ft. Worth, Texas 76105.

POLISH All metal, especially aluminum! Quart \$4.50, gallon \$13.50. Postpaid. Paulhardt, 249H Market, Warren, R. I. 02885.

LEARN AVIATION AT HOME. Navigation, aerodynamics, communications, weather taught in your home. Unique method. Free information. United Aero-Sciences Institute, Dept. C, P.O. Box 4106, Torrance, California 90503.

AIRBOAT Plans \$3.00; Gyrocopter Plans \$5.00; Hovercraft Plans \$5.00. Propellers, hubs, 6-blade fans, McCulloch engines, air-drives. 1969 Catalog \$1.25. Esco-m, Bradenton, Florida 33505.

BARTLETT FLYING SAUCER. Amazing machine hovers 200 lb. man over land/water, powered by ordinary lawn mower engine. Easy to build. Fun to fly. Complete Plans, Kit Brochure and Photo Review \$3.00. Write: Herb Bartlett, Box 3234-C, Scottsdale, Arizona 85257.

AIRCRAFT Listings. Thousands everywhere. \$4 year. **AERO SHOPPER**, Henrietta, Texas 76365.



BOATS

CANOES! Kayaks! Factory-direct quality kits, from \$20.00. Many different models. Canvas hulls. Strongest construction materials. Free literature. Sportsraft, Box 8393-PM, Columbus, Ohio 43201.

AMATEUR Boat Building Society, 111-B Woodcrest Ave., White Plains, N.Y. 10604; Plans, kits, discounts, books, technical help, local building clubs, instruction, monthly magazine. Free information.

BOAT Kits. Save money—assemble yourself. Factory molded fiberglass or pre-assembled plywood. 12' to 32' Cruisers, Runabouts, Houseboats, Sail Boats. Big line accessories, motors, trailers. Easy terms. Free catalog. Luger, Dept. BC-68, 9200 Interstate 35 W South, Minneapolis, Minnesota 55431.

BOAT PLANS, FRAME KITS, BOAT KITS. World's largest catalog—Over 200 top design for the amateur builders. New catalog includes Cruisers, Runabouts, Deep vee's, Catamarans, Trimarans, Houseboats, Sailboats from small sail fish to 34 ft. motor sailers, large selection of inboard and outboard Hydroplanes. Send \$1.00 for large new plan & kit catalog or \$2.00 for catalog plus Boat Builder's Guide. Clark Craft Boat Company, 16-P Aqua Lane, Tonawanda, New York 14150.

KAYAKS—One-man \$19.50; two-man \$24.50; Sailboat \$44.00. Exciting Sitka Kayak Kits known world wide for speed and safety. Assemble in one afternoon. Free pictorial literature. Box 582-P, Willoughby, Ohio 44094.

FULL Size, cut-to-shape boat patterns, blueprints. Send 60¢ for big new illustrated "Build a Boat" catalog includes fishing boats, garvies, cruisers, catamarans, houseboats—7½ to 38'. "How to Build a Boat" booklet, \$2.50. Cleveland Boat Blueprint Co., Box 18250, Cleveland, Ohio.

PLANS, Full Size Patterns, Frame Kits with step-by-step instructions specially for amateurs. New "Glen L" Boats 8' to 36' Sail, Jets, Inboards, Outboards, Cruisers, Houseboats, Hot Boats, Catamarans, Hydros "plus" boat trailers and a camper. Send 50¢ for complete catalog. New "How To Build Boat Trailers" Book \$3.00 ppd. Glen Designs, 9152 Rosecrans, Bellflower, Calif. 90706.

BUILD Your own boat from our large-scale blueprints. Books of plans give how-to-build help. Hundreds of professional designs—motor, sail or auxiliary—for amateur builders. Free catalog. MoToR Boating, 959 Eight Ave., Dept. PM-RS, New York, N.Y. 10019.

NEW 1968 McCulloch and other outboards. 4 H.P. \$108.00. . . . 7½ \$224.00. . . . 9 Electric Start \$288.00. . . . 18 \$316.00. . . . 40 Electric \$514.00. . . . 65 Electric \$698.00. . . . All sizes. Literature 50¢. Electra Marine 1427 Broadway, Brooklyn, N. Y. 11221.

SAILBOAT Kits. \$395.00 and up. Nordex, Box 7, Zenda, Wis. 53195.

FIBERGLASS Canoes. Four exciting models. Easily assembled Kits. \$39.95 up. (Factory Direct) Free Literature. Riverside Canoes, Box 5595B, Riverside, Calif. 92587.

OUTBOARD Motors built from lawn-mower engines. \$2.00 for detailed plans. Box 3723, Anaheim, California 92802.

PROFESSIONAL Marine engines from Star Marine kits. Engines—Gears—Pops—Everything necessary for your boat propulsion. Write for free brochure. Star Marine Engine Works, Berkeley, California 94710.

MARINE EQUIPMENT AND SERVICES

CONVERT Auto engines to marine. 68 Page Catalog. 50¢. Lehman Manufacturing Company, 800 Elizabeth Avenue, Linden 4, New Jersey 07036.

NEW, Used, rebuilt marine motors. Marine conversions, fittings. Free catalog. Stokes Marine Supply, Dept. 24, Coldwater, Michigan 49036.

FIBERGLASS Canoes. Four exciting models. Easily assembled Kits. \$39.95 up. (Factory Direct) Free Literature. Riverside Canoes, Box 5595B, Riverside, Calif. 92587.

INBOARD-OUTBOARD engines— complete "Nothing else to buy" installation kits for re-powering all makes outboard or inboard powered boats. 80, 85, 110, 120, 155, 200, 265 300 H.P.—Chrysler Volvo, Interceptor, Universal, Ranger at factory-to-you prices. Install yourself, complete instructions. 10% down, 3 years to pay FREE catalog. Luger, 9200 Interstate 35W South, Dept. BI-68, Minneapolis, Minnesota 55431.

YOUR Ad in Popular Mechanics will be seen by more than 5,000,000 active buyers for your products and services. It costs only \$1.85 per word. And, if you wish to run all or part of your ad in capital letters—you can do so for as little as 75¢ per word additional. Act now! Place your classified ad in Popular Mechanics today.

ATHLETIC AND BODY BUILDING COURSES

"GIANT Arms." Dr. Young's, D.C. revolutionary discovery. \$2. Satisfaction or refund. Gaucho, Box 9309-ST, Chicago 60690.

POWERFUL Muscles fast! Free brochure! Universal Bodybuilding, Box 4327-C, Northeastern, Dearborn, Michigan 48126.

KARATE—Complete instructions. Illustrated, only \$1.25 Bales Co., 650 Metcalf, P.M. Escondido, Calif. 92025.

YOUR Ad in Popular Mechanics will be seen by more than 5,000,000 active buyers for your products and services. It costs only \$1.85 per word. And, if you wish to run all or part of your ad in capital letters—you can do so for as little as 75¢ per word additional. Act now! Place your classified ad in Popular Mechanics today.

SPORTING GOODS AND EQUIPMENT

FREE 1968 Catalogue! Guaranteed lowest prices. Fishing Tackle, Archery, Hunting and Camping Equipment. Thousands of items. Cabelas' Inc., Dept. S, Chappell, Nebraska 69129.

FREE . . . Wholesale catalog. Arrow shafts, broadheads, fletchings, fisharrow parts, tools, bows. Finnsports (22G), Toledo, Ohio 43614.

HUNDREDS Of Army-Navy surplus items, camping, hunting, fishing equipment, gun accessories, etc. Write for free catalog. P&S Sales, Box 155, Tulsa, Oklahoma.

1969 GIANT catalog for Shooters, Hunters, Collectors; 48 illustrated pages, thousands of guns, plus ammunition, accessories, collectors items, 25¢. MARTIN B. RETTING, INC., 11029 WASHINGTON BLVD., CULVER CITY, Calif.



FISHING, TACKLE, LURES

MOLDS For fisherman's sinkers, jigs, squids, casting and spinning lures. Free catalog. Sweets Molds, Tonawanda 1, New York 14150.

MOLDS—For casting your own fishing sinkers. Free illustrated booklet. Reading Instrument Co., Box P78, Reading, Pa. 19603.

FISH Traps, collapsible. Pond-lake types. Animal, bird traps. Free catalog and trapping secrets. Sensitronix, 2225-F27 Lou Ellen, Houston, Texas 77018.

OVER 5,000 HARD-TO-FIND FISHING SPECIALTIES and kits galore. Send for free 170 page catalog. Netcraft Co., Dept. PM, Toledo, Ohio 43613.

FREE . . . Wholesale catalog. Beads, Spinners, Lure parts, Sinkers molds, Jigs, Reels. Finnsports (ME), Toledo, Ohio 43614.

LIVE-CATCH Animal traps. A size for every purpose. Also fish, sparrow, turtle, and other traps. World's largest selection. Free catalog. Sensitronix, 2225-MC36 Lou Ellen, Houston, Texas 77018.

USE Your power tools to manufacture and sell patented fishing lure. Sample lure and details \$1.00. Sherman Bryant Lures, Lewisport, Ky. 42351.

EARTHWORMS, LIVE BAIT

BIG Money growing fishworms, giant African Crawlers, crickets. Free Literature. Pain's Hatchery-31, Edison, Georgia 31846.

EARN Money raising fishworms for us! Exciting details free! Oakhaven—56, Cedar Hill, Texas 75104.

BIG Profits raising worms. Instructions 25¢. Three Oaks, Dresden, Tennessee 38225.

FROGS, FISH, REPTILES

MAILORDER Records help get Increased Business! Complete 32 Page Record Book shows your inquiries, orders, advertising, expense, etc. Only \$1.00. C. A. Martin, Popular Mechanics, Dept. PM, 575 Lexington Ave., New York 10022.

YOUR Ad in Popular Mechanics will be seen by more than 5,000,000 active buyers for your products and services. It costs only \$1.85 per word. And, if you wish to run all or part of your ad in capital letters—you can do so for as little as 75¢ per word additional. Act now! Place your classified ad in Popular Mechanics today.



HUNTING, GUNS, DECOYS

FREE Gun & Ammo Bargain Lists. Century Arms, St. Albans, Vermont.

NEW LYMAN RELOADING HAND BOOK The "bible" gives 7,060 tested loads. Rifle, shotgun and handgun. For beginner or expert. Send \$3.50 to: Lyman Gun Sight Corporation, Dept. CMP8-10 Middle Field, Conn. 06455.



DOGS AND KENNELS

YOUR Ad in Popular Mechanics will be seen by more than 5,000,000 active buyers for your products and services. It costs only \$1.85 per word. And, if you wish to run all or part of your ad in capital letters—you can do so for as little as 75¢ per word additional. Act now! Place your classified ad in Popular Mechanics today.



GAME BIRDS

FREE Big quail color catalog. Marsh, 14216 Brookhurst, Garden Grove, Calif. 92640.

HAWKS—FALCONS

MAILORDER Records help get Increased Business! Complete 32 Page Record Book shows your inquiries, orders, advertising, expense, etc. Only \$1.00. C. A. Martin, Popular Mechanics, Dept. PM, 575 Lexington Ave., New York 10022.

RABBITS—FUR BEARING ANIMALS

EARN \$10,000 Yearly raising angora rabbit wool, and breeding stock for us. Information 25¢ coin. American Angora Company, Malta 12, Montana 59538.

RAISE Rabbits for us on \$500 month plan. Free details. White's Rabbitry, Mt. Vernon, Ohio 43050.

RAISE Rabbits successfully by knowing facts. 48 page illustrated book describing 25 breeds. Housing, breeding, feeding, markets, marketing etc. 25 cents. American Rabbit Association, 36 Arba Building, Pittsburgh, Penn. 15217.

MAKE Big Money raising chinchillas, rabbits, guinea pigs for us. Catalog—25¢. Keeney Brothers, New Freedom, Pa. 17349.

TAXIDERMY

TAXIDERMY Success Training sure, easy way into Taxidermy. Complete training. No skimming. All steps illustrated. Request information and free samples. Box 5815E, Bossier City, Louisiana 71010.

PETS—BIRDS, CATS, HAMSTERS, ETC.

LIVE Traps, all sizes, mouse to dog. Collapsible or rigid. Carrying Cages. Free literature. National Live Traps, Tomahawk, Wisconsin 54487.

LIVE SEAHORSES, marine specimens, aquarium supplies. Illustrated catalog 15¢. Marine, Box 248-210, Dania, Florida 33004.

BUY Direct—Save: Monkeys, Ocelots, Birds, Reptiles. List 10¢. Exotic Animal Importers Inc., Box 632-7, South Miami, Florida 33143.

HAWKS, Reptiles, raccoons, skunks, squirrels. Catalogue 25¢. Trails End Zoo, St. Stephens, S.C. 29479.

HORSES & LIVESTOCK

"HOW To Train Horses"—Everyone who likes horses or ponies should have this book; Free. Write Beery School, 11010-C Pleasant Hill, Ohio 45359.

CAMPING EQUIPMENT AND TENTS

SAVINGS Plus dividends! Campers-fishermen-outdoorsmen cooperative. Free 68-page catalog. Recreational Equipment, Inc., 1525-P 11th, Seattle, Washington 98122.

YOUR Ad in Popular Mechanics will be seen by more than 5,000,000 active buyers for your products and services. It costs only \$1.85 per word. And, if you wish to run all or part of your ad in capital letters—you can do so for as little as 75¢ per word additional. Act now! Place your classified ad in Popular Mechanics today.

EMBLEMS, BRASSARDS, PATCHES

MAILORDER Records help get Increased Business! Complete 32 Page Record Book shows your inquiries, orders, advertising, expense, etc. Only \$1.00. C. A. Martin, Popular Mechanics, Dept. PM, 575 Lexington Ave., New York 10022.

TRAVEL & RESORTS

YOUR Ad in Popular Mechanics will be seen by more than 5,000,000 active buyers for your products and services. It costs only \$1.85 per word. And, if you wish to run all or part of your ad in capital letters—you can do so for as little as 75¢ per word additional. Act now! Place your classified ad in Popular Mechanics today.

ELECTRICAL SUPPLIES

METERS—Surplus, new, used, panel and portable. Send for list. Hanchett, Box 5577, Riverside, Calif. 92507.

LAMP Parts. Catalog, prices, wiring instructions, 50¢. Refunded first order. Gyro, 5218P N.W. 35 Ave., Miami 42, Fla. 33133.

LAMP parts for building, repairing, converting. Catalog 40 cents. Refunded with first order. Brown Lamp Co., Box 11305, Clayton, Mo. 63105.

BATTERIES, GENERATORS

BATTERY Reconditioning kit, includes molds, material, instructions. Battery Shop, Palm Desert, California 92260.

ENGINES, MOTORS, DYNAMOS

LIVE Steam powered backyard railroads! All sizes. Complete "bolt-together-kits," and rough castings. Excellent drawings. 100 page catalog \$1.00. Little Engines, Lomita, Calif. 90717.

TOTAL Power, steam equipment, Catalog, 50¢. Reliable Industries, New Baltimore, Mich. 48047.

WINDING Data, 275 motors, \$1.20. Data Company, 512 Kensington, Kansas City, Mo. 64124.

REWINDING Specifications, 300 motors, \$1. Modequip, Box 10025, Kansas City, Mo. 64111.

MACHINERY, TOOLS AND SUPPLIES

MICROMETERS, Indicators, Chucks, Rods. Direct Supply, 1424 Barclay, Springfield, Ohio 45505.

SAW Sharpening equipment available on trial. Free details. Zapart, 586-P Manhattan Ave., Brooklyn, N.Y. 11222.

GERSTNER Tool chests new SECONDS. Free catalog. Gerstner & Sons, Dayton, Ohio 45407.

UNEXCELLED WOODCARVING tools, supplies. Catalog, 25¢. Woodcarving Shop, 3112 W. 28th, Minneapolis, Minn. 55416.

BUILD Inexpensive milling machine, Castings supplied, Blueprints \$1.00. Microm, Box 2313, Santa Ana, California 92707.

ROUTER Bits, 1/4" Shank, hi-speed, used; excellent condition, \$2.50 Dozen Postpaid. Lillian's, Box 17165, Chicago, Illinois 60617.

WELDING, SOLDERING, PLATING

WELDERS—Welds Fenders, Bulldozers, \$49.50. Morris, 1070 Inner, Schenectady, New York 12303.

CHROME Plating equipment, supplies. All other finishes. Home workshop and production sizes. Send \$1.00 (refundable) for formulas, operating data, equipment guide and catalog. HBS Equipment Division 1.50, 3543 East 16th, Los Angeles, Calif. 90023.

GOVERNMENT SURPLUS

GOV'T. Surplus. How and where to buy in your area. Send \$1.00. Surplus Information, Headquarters Building, P.M., Washington, D.C. 20036.

JEEPS From—\$52.50; Typewriters from—\$4.15; Cars from—\$31.50. Walkie-talkies, motorcycles, airplanes, boats. Typical "As Is" bid bargains from Uncle Sam. Tremendous variety. Exciting free list. Write: Enterprises, Box 402X39, Jamaica, New York 11430.

1968 SURPLUS Army, Navy store illustrated catalog. Send 25¢ (refundable with first \$5.00 order). Ruvel, 707 Junior Terrace, Dept. 9-J, Chicago, Ill. 60613.

JEEPS Typically From \$53.90 Trucks From \$78.40 . . . Airplanes, Type-writers, Boats, Clothing, Camping, Sporting, Photographic, Electronics Equipment, Used, 100,000 Bid Bargains Direct From Government Nationwide. Surplus Catalog. Directory and Sales Bulletins Application \$1.00 (Deductible First \$10.00 Order). Surplus Service, Box 820-A, Holland, Michigan 49423.

FREE JEEP Buying Information when you send us 50¢ for NEW Gov't Surplus Bargain Catalogue (Refundable). Surplus Trader, Box P1, Spring Grove, Penna. 17362.

GOVERNMENT Surplus Bargains Now! Latest factual information on how, where to buy near You \$1.00. Surplus Opportunities, Box 1032FG, Fairborn, Ohio 45324.

SURPLUS BARGAINS—War, Government, Industrial surplus at savings to 80%! Clothes, boots, cots, tents—bargains for farm, home, outdoors. SEND FOR FREE CATALOG—must give zip code. Surplus Store Dept. U-10, Sioux Falls, S.D. 57102.

HOBBIES AND COLLECTIONS

FREE German Regulation Medal; Send 50¢ Postage, handling, get catalog; Iron Cross with ribbon \$1.50. International, Box 303-M, Jamaica, N.Y. 11431.

50 GORGEOUS Jungle butterflies \$2.00. Collectors Wonderland, Box 1170, New York, 10008.

U.S. ARMY SHOULDER PATCHES. Great for collectors. Official patches, all major Army and Air Corps Units, 10 asst'd patches, price list and catalog, \$2.00. Catalog of unusual gift items, 25¢. SPRINGER'S-PM, P.O. Box 577, El Paso, Texas 79944.

BUILD Race Horse Game 30 x 20" Color photograph drawings instructions A.C. 110 \$3.00 Box 8991 Dundalk, Md., 21222.

SEVEN Beautiful Colombian postcards—One Dollar—Castrillion, AA-1700, Medellin, Colombia.

FREE German Regulation Medal; Send 50¢ postage, handling, get catalog. Iron Cross with ribbon \$1.50. S. S. Collar Device 50¢. International, Box 303-M, Jamaica, N.Y. 11431.



STAMP COLLECTING

PENNY! Approvals! Regardless catalogue! Kicster, 4164 52nd St., San Diego 5, Calif. 92105.

500 DIFFERENT Stamps, \$1.00. Smith, 508-A Brooks, College Station, Texas 77840.

PENNY Stamps! 1000 Mounted in book at 1¢ each. Trust Stamp Company, P.O.B. 132-P, Jamaica, N.Y. 11435.

100 OLD United States between 1861 and 1935, \$1.00. Roush Stamps, 51 Chestnut, Mansfield, Ohio 44903.

50 DIFFERENT Old U.S. Revenue stamps 50¢. Winchester Stamps, Box 1592, Mansfield, Ohio 44907.

FREE Surprise collection sent with approvals. Gould, 1784 Union, San Francisco 94123.

U.S. Mint specials! Flag set, complete \$1.00. 1¢, 2¢, 3¢ famous Americans (21 different) \$1.00. Free list. Brooks, 2601 Avenue "U," Brooklyn, N.Y. 11229.

FREE! Triangles, Scout, 25 others. Approvals. Cambridge, Box 411, Cambridge, Ohio 43725.

FREE! Big Bargain Catalog—New Edition listing thousands of bargains including U.S. & B.N.A. stamps, packets, albums, accessories and supplies. Also, fine stamps from our approval service which you may return without purchases and cancel service at any time. Jamestown Stamp, Dept. E108PM, Jamestown, N.Y. 14701.

FREE! 30 Different U.S. Commems. with approvals. Shelton, Box 547C, North Miami, Fla. 33161.

U.S. Bargain, 50 different 10¢. with beautiful worldwide approvals. Stamp Center, Kennebunk, Maine 04043.

RUSSIAN Space set 10¢. Russian approvals. Snedco, Box 68-P, Waldwick, N.J.

40,000 DIFFERENT! Amazing new plan builds your collection systematically, country by country. As low as 50¢ weekly. Ware, Monroe, Conn. 06468.

COLLECTION, 222 different: 10¢. Approvals. Stamp Farm, 7S31, Oxford, Wis. 53952.

OLD U.S. seconds, Bargains, Karl Swartz, Box 313, Flat Rock, N.C. 28731.

2,000,000 STAMPS, 150 Countries, 2¢ Each. Belden, Box 175, Dearborn, Michigan.

RUSSIA High-Value Collection, 32 different Russia—some over 50 years old! Commemoratives, Czarist Issues, Airmails. Catalog price \$2.99. Special Get-Acquainted Offer—all for only 10¢! H. E. Harris, Dept. GG-5, Boston, Mass. 02117.

LARGE COLORFUL SETS, 3 different only 10¢! Approvals, Cole, Box 223-A, Buffalo, N.Y. 14221.

ONE Pound value Geo. VI Bermuda, plus 100 worldwide 10¢ approvals. Stevens, Box 105A, Homecrest Sta., Brooklyn, N.Y. 11229.

U.S. Approvals Low prices, Eagle, 2221 Romine Ave., Pittsburgh, Pa. 15226.

WOW! 110 all different Germany 10¢ Commemoratives, Airmails, High Values, Big catalog, bargain lists also, fine stamps from our approval service, which you may return without purchases and cancel service at any time. Jamestown Stamp, Dept. A108PM, Jamestown, N.Y. 14701.

MILLIONS Foreign Stamps! 2¢ each! Send for gigantic approvals! ABC, Box 6000-MB, San Francisco, California 94101.

UNITED STATES STAMPS? If you collect them, you'll want our approvals. Beginning or advanced adults only, please. Engle, Box 8P, Lowell, Michigan 49331.

FREE 50 Worldwide Approvals, University Stamps, P.O. Box 1471, Lake Worth, Florida 33460.

FREE!! Two Complete Mint Sets, Approvals, Hamilton, 7150 Cyril, Chicago OE-10, Illinois 60649.

INTRODUCING Our better United States approvals we offer 15 United States stamps including Columbian, Bi-Centennials, famous American, airs, others; only 10¢. Ocean Stamps, Box 64-PM, Brooklyn, New York 11229.

UNITED States commemorative collection containing 33 different—10¢. Approvals, White, 516-A Avenue L, Brooklyn 30, New York.

50 YEARS Old, fifteen different United States, over fifty years old—10¢ with approvals. Jaxon, Box 145-P, Brooklyn, New York 11230.

GIANT Stamp Collection including: Astronauts, Satellites, Moonrockets, Boy Scout issue, Complete U.N. Set, recent Olympic and Sport issues from many countries, etc., Plus Big Stamp Dictionary and approvals. Everything, 10¢! Stampex, Box 47-RM, White Plains, N.Y.

"ATTRACTIVE" Set free! Request Approvals, Gorliz, Box 1915PM, Naples, Florida 33940.

EXPLOSIVE Near East always in the news. We are offering a nice collection of stamps from Israel, Egypt, Jordan, Syria, Iraq, etc. for only 10¢ to approval applicants. Clark Stamps, Dept. 57C, Muskegon, Mich. 49444.

ABSOLUTELY Free 25 different United States Commemoratives when requesting United States Approvals, K & B, Box 70, Brooklyn, N.Y. 11223.

QUALITY And price. Mounted approvals 2¢ up. Preview Stamps, P.O.B. 9809M, San Diego, Calif. 92109.

HISTORIC First Day covers that will make your collection sing with excitement and interest. Free details from K. M. WALSH, Box 308, Dept. PM-10, Tuckahoe, N.Y. 10707.

NEW Issues—Free weekly illustrated list. Brooks, 2601N Avenue "U," Brooklyn, N.Y. 11229.

SPAIN 50 Different 5¢ Approvals. Hijop, Box 505, Norristown, Pa. 19404.

GRAB Bag 25¢; Super Grab Bag \$1.00. Satisfaction guaranteed. No approvals. Metzger, 8 CragKnob, St. Louis, Mo. 63122.

PAINTINGS Three sets 10¢ with approvals. Berchtold Stamps, Troy, Ohio 45373.

WORLD'S Only Three Dimensional Stamp, many others, 10¢. Approvals, Erickson, 736 Cottage, St. Paul, Minnesota 55106.

TRIANGLES Galore! Three beautiful sets of triangles plus 105 different including colorful Asiatic pictorials. Send only 10¢ today. Also, collection building set—and—single approvals. Shaw Stamp Company, Dept. 140, Drawer E, Montevallo, Alabama 35115.

1500 FOREIGN \$1.00; 5000 \$3.00. 5000 USA commemoratives, revenues, airs, presidentials, 19th Century, high values \$3.00. 300 pre-1939 USA commemoratives \$2.00. 200 pre-1923 USA \$1.00; 700 \$3.00; 3000 \$12.00 1000 foreign pre-1940 \$3.00; 5000 \$12.00. No approvals. Meyers, 5321 Fleming, Richmond, Calif.

FREE Mint set, Approvals Accompany. Stamps, Box 22092, Memphis, Tenn. 38122.

WORLDWIDE Mixture, 250 unpicked stamps 10¢. Premiums, bonus coupons, approvals included. White, Box 26265-AJ, Indianapolis, Indiana 46226.

701 U.S.A. (Plenty Commemoratives)—25¢. Request approvals. Horace Gatewood, Winston-Salem, N.C. 27102.

1045 DIFFERENT—\$1.50. Foreign approvals. KayKaye, Box 452, Harrisburg, Ill. 62946.

100 WORLDWIDE 10¢ with low cost approvals. Skytop, Box 1022-PM, Binghamton, N.Y. 13902.

LUMINESCENT Tagged U.S. stamps bought sold exchanged. Glen, Glen Arm, Maryland 21057.

STAMPS Free! New issues, new countries, triangles, rockets, Olympics, Scouts, birds, flowers, animals. Also old Canadian and U.S. Stamps. Plus complete illustrated Canadian stamp catalog. Send 10¢ for mailing. Gray Stamp Co., Toronto, Canada.

FREE Stamp Wallet with approvals. Wide choice collections by countries. Clark, Box 28-P, Wilmette, Ill. 60091.

PENNY Approvals, Premiums with purchases. Large selections. Penny Stamps, Orange, California 92669.

500 DIFFERENT Worldwide 35¢ approvals. Regency Stamps, Box 8854, Pittsburgh, Pa. 15221.

"WHOLESALE" Pricelist and catalog free! Everything guaranteed. Schneider Company, Holland, Michigan 49423.

WHILE They last! \$5.00 Hamilton fine used 30¢ with approvals to advanced collectors. Borgen, Box 502A, Paso Robles, Calif. 93446.

15 U.S. Commemoratives 10¢ with U.S. of interest approvals; Salsman, P.O. Drawer 109, Fairfield, Calif. 94533.

TWO Cent Approvals, The Best Scotty Stamp Co., Box 155, Staten Island, New York 10301.

307—ALL—Different triangles, sports, topical, etc. Worth near \$8.00. Only 25 cents. Bargain Approvals, Jayto Stamps, East Syracuse, New York 13057.

VIETNAM 25 Different 10¢ approval. Sam Chazen, Box 95, Ozone Park, N.Y. 11417.

225 STAMPS for only 10¢! Airmails, Pictorials; stamps from strange countries cataloging up to 25¢ each! Plus unusual stamps to examine. Buy any or none, return balance, cancel service anytime. Mystic Stamp Co., Camden 80, New York 13316.

FREE British Colonies collection. Request discount approvals. Wijim, Hooksett, N.H. 03106.

MEXICAN Olympics, Rwandas Gigantic Colorful Sports, Indian Monuments Commemoratives—Free! Approvals plus 101 Bonus Sets, William Deems, 226B, Ravenswood, West Virginia 26164.

THIRTEEN "Fantastic" Foreign Sets All Different Countries 10¢ Approvals. Myakka, Box 287-G, Miami, Florida 33165.

NEED Extra Income? Send For Opportunity Mail, 25¢. Smyre's, Newark, New Jersey, 07101.

EXCHANGE Circuit wants new members 10¢ brings details. Bohns, 72 Ave Breton, Laval Des Rapides, Q. Canada.

PICK Your choice from our old approvals at flat one-fifth of catalogue prices. Popstamps, Valrico, Florida 33594.

LITERATURE And generous assortment 30 cts. Large bargain lot \$1. High value packet \$2. Persile, 436 N.Y. Ave., Brooklyn, N.Y. 11225.

"INVERTED Error" Dag Hammarskjold, 6¢ with approvals. Belmont Stamps, Washington, D. C. 20015.

COINS, TOKENS, CURRENCY

SCARCE Date Jefferson nickels. All V.G. Satisfaction Guaranteed. 1942D—1949S—1950—50¢ each. 1943D—1951S—1955—75¢ each. 1938S—\$1.25. 1938D—\$1.65. 1938S—\$3.25. 1939D—\$5.00. 1950D—\$14.50. Dates not listed 20¢ each. Bryson Inc., 612A White, Toledo, Ohio 43605.

1924S LINCOLN plus Catalog 50¢ Discounts, fastest service. Martin's, 36-PM, Tucson, Arizona 85701.

UNCIRCULATED 1921 Morgan, 1923 Peace Dollars, \$3.50 ea. Illustrated Catalogue 50¢. Shultz, Salt Lake City, Utah 84110.

20 UNCIRCULATED Foreign Coins \$1.00. Coins, Box 8541, Minneapolis, Minnesota 55435.

FREE! 1960D Small Date Circ. Lincoln, with Price List. Stevens, Box 546F, North Miami, Florida 33161.

GOLD Coins of the world, Beautiful. Low prices. Plus thousands of United States Coins. Free Price List. Please send long, airmail, envelope, self-addressed, stamped. Silver Center, Box 22171-M, San Francisco, California 94122.

FREE Coin supplies, bargain coin list, 25¢ (Refundable). Economy Sales, Mansfield, Mass. 02048.

SILVER Dollar Album. 100 square coin envelopes. Giant Illustrated Catalog. Everything \$1.00. RARCOA, 31-A Clark, Chicago 60602.

AUTHENTIC Ancient coin reproductions. Sample coin and catalog, \$1.00. Ancient Coins, Box 1121M, Monrovia, California 91016.

40 PAGE Illustrated United States and Canadian coin list 10¢. Stoney, 260 Washington, Boston 8, Mass.

COINS Cheap. Catalog 10¢. Buying Catalog 25¢. Winters, Box 7055BN, Minneapolis, Minnesota 55411.

CHINA Dollar (nickel silver) for 50th year of Free China only 10¢ with big catalog and approvals. Littleton Coin Co., Littleton KC1, N.H. 03561.

OFFICIAL New United States Coin Guide. Authentic Information for Your Success in Coins. Illustrated. 160 Pages. Only \$1.00. John A. Wonsley Company, Dept. D, 15024 Joy Road, Detroit, Michigan 48228.

100 INDIAN, Lincoln Cents, 1920's and older \$5.00. Wesley Rood, West Union, Iowa 52175.

MAKE Money collecting coins! How to enter this fascinating field! Where to buy and sell! Booklet \$1.00. Hammond Products, 244-139th Street, Hammond, Indiana 46327.

BARGAINS—Fifteen different Indian Cents \$4.95, 1909VDB Cent Uncirculated \$3.95. Bargain Lists 25¢. Bebee's, Incorp., Omaha, Nebraska 68111.

LINCOLNS, all different, 24 "S" 's, 1955-S, 10 Uncirculated, \$1.70, 30, 1909-1940, \$1.55. ANCIENT Roman Coin \$2.95. Kennedy's Box 726A, Saratoga, California 95070.

MEXICAN \$1.00 coins, send \$1.00 for two coins. Aztec Coins, Box 2, Patton, California 92369.

BARGAINS Galore: Beginner-Advanced, (16) page United States Coin Catalog 10¢. Schultheis 214M, Devonshire, New Hyde Park, N.Y. 11040.

MERCURY DIMES, 20 different, \$3.95. "S" ROOSEVELTS, 10 different (1945S-1955S complete), \$2.95. Uncirculated 1955S Cent, 2 for \$1.00. 1943PDS STEEL Cents, 2 sets \$1.00. SERENDIPITY, Box 820P, Cupertino, California 95014.

YEAR SETS. Make excellent gifts. Will increase in value. Mounted in sturdy, attractive holders. Contains Cent, Nickel, Dime, Quarter, 50¢. Year of your choice. Circulated (good or better) to 1950; Uncirculated (new) from 1951. \$18.95: 1955, \$11.95: 1951, \$9.95: 1913, 1914, 1956, \$6.95: 1915, 1952, \$5.95: 1900 to 1912, 1927, 1928, 1929, 1953, 1954, 1957, 1958, \$4.95: 1959 to 1963, \$3.95: 1934 to 1950, 1964 (last year silver, has Kennedy 50¢), \$2.95: 1965 to 1968 (new alloy). Large Bargain Lists with Silver Dollars, other Year Sets, Accessories, included with order, otherwise 25¢. ROBERT HARRIS, 4535P Stevenscreek, Santa Clara, California 95050.

ANTIQUES, RELICS, INDIAN GOODS AND CURIOS

LIST Indian relics, 10 Arrowheads \$3.00. Hyde's, Box 2304, Santa Fe, New Mexico 87501.

TONS Of antique gun parts and supplies. All reproduction muzzle loading guns. Send \$1.00 for enlarged illustrated catalog No. 117-A. Dixie Gun Works, Union City 12, Tennessee.

KNOW How much to pay for antiques—380 Page illustrated handbook lists current prices on 3200 items, \$6.95. Supply limited. S. Lazaro Enterprises—178, 502 So. Clementine, Oceanside, Cal. 92054.

ONE Dozen perfect arrowheads \$4.00. George Smith, 9825 Conway Drive, Indianapolis, Indiana 46236.

ANTIQU DEALER'S HANDBOOK. List prices of over 30,000 items, 380 pages covering more than 250 categories. Send \$6.95 to: Nortex Novelties, 1605 Random Rd., Carrollton, Texas 75006.

MODELS—SHIPS, TRAINS, PLANES, ETC.

SHIP Model kits and fittings: clippers, frigates, etc. Catalog paint-tool list, book list. 40¢. Model Shipways, Box 65, Bogota, N.J. 07603.

SHIP Models, Kits, fittings, plans, books, tools, engines, motors. Big illustrated catalog 50¢. Mass. residents add 3% tax. James Bliss & Co., Dept. SM, Route 128, Dedham, Mass. 02026.

ROCKETS! Flying models, engines. Beginning through advanced. Catalog 25¢. Rocket Development Corporation, Route 3-M, Seymour, Indiana 47274.

SHIP Models catalog 25¢. Scientific, Inc., 100 Monroe, Newark, N.J. 07105.

ROCKETS: Real flying models—flights up to 2500 ft. New illustrated catalog 25¢. Single and multistage kits, cones, engines, launchers, trackers, rocket aerial cameras, technical information. Fast service. Estes Industries, Penrose 2, Colorado 81240.

SHIP And yacht model fittings: Pine construction hull kits: blueprints. Send 50¢ for illustrated catalog. A. J. Fisher, Inc., 1002 Etowah Avenue, Royal Oak, Michigan 48067.

SCALE Building materials, 1/4" & 1/8" scale. Windows, doors, siding, roofing, lumber and structural shapes. Send 50¢ for catalog. Small Sales Co., P.O. Box 177, Shawnee Mission, Kansas 66201.

MODEL Builders Tools, Machines. Free Brochures. Microm, Box 2313, Santa Ana, California 92707.

STUART Steam engines, castings, catalog 75¢. Carolus Models, 1131 Wilson Avenue, Salt Lake City, Utah 84105.

LIVE Steam engine kits. Fascinating hobby for model mechanics. Boilers, fittings, accessories. Pictured catalog \$1.00. H.P.K. Models, Centuck 34, Yonkers J, New York 10710.

HOBBY Catalogs—Purchase Price Refundable Military Miniatures \$1.00. Ships \$1.00 Airplanes \$1.00. Trains \$2.00 Crafts 35¢. Collectors Cars 35¢. Toys 50¢. Polk's Hobby Dept. Store, 314P.M. 5th Ave., N.Y.C., N.Y. 10001.

GAMES, TOYS, NOVELTIES

HORSESHOE—World's best turf game! Free literature. Funanza, Box 2513, San Bernardino, Calif. 92406.

EXTRA Income at home in Spare Time! Booklet shows you how to start your own business with Classified Advertising. Only \$1.00. C. A. Martin, Popular Mechanics Dept. PM, 575 Lexington Ave., New York 10022.

LIKE Beautiful Kites? Excellent Christmas gifts. Illustrated booklet. KYTE TALES, 25¢. Purchase refund. Kyte House, Box 145C, Richardson, Texas, 75080.

SOLITARE!! 150 ways to play. Booklet shows how. Includes styrofoam board to hold cards, \$2.98 Valley Gift House, Dept. 841, White River Jct., Vermont, 05001.

TOMMY TURTLE. Helps Baby learn to help himself, guaranteed. Send \$2.95. Castillo, Box 38698, Hollywood, Calif. 90038.

MAGIC TRICKS, PUZZLES JOKER NOVELTIES

MAGIC Catalog. World's finest, 3000 tricks, (340) pages \$2.50. Beginners, amateurs, professionals. Kanter's, A-200 South 13th St., Philadelphia, Pa. 19107.

AMATEUR and PROFESSIONAL MAGICIANS all new magic tricks and gags catalog 25¢. Our specialty same day service. Fabulous Trick and Magic, 3319 E. Charleston, Las Vegas, Nevada 89104.

MAGIC MAGAZINE—Monthly since 1936. 44 pages. All phases. 3 month trial \$1.00. Genii, P.O. Box 36068, Los Angeles, CA 90036.

COMPLETELY Illustrated catalog, 84 pages, 25¢. Manhattan Magic, Box 334-M, N.Y.C. 10011.

WORLD'S Finest professional magic tricks. Joker's Novelties, Giant illustrated catalog 10¢. Top Hat, Evanston, Illinois.

LATEST World Famous Giant Surprise Catalog!! 1000 Professional tricks, magic, jokers!! 164 Page deluxe edition!! Only 25¢. House of 1000 Mysteries, Dept. PM8C, Ft. Lauderdale, Florida 33308.

42 PAGE Illustrated joke—novelty catalog 25¢. Joke, Box 7212E, Chicago 60680.

FREE! World's Leading Catalog 2000 Novelties, Jokes, Tricks, Scientific Gadgets, Hobbies. Johnson-Smith, D-341, Detroit, Michigan 48224.

VENTRILOQUISM! Information free! Dummy catalog, 50¢. State age. Maher, Studio 1, Box 8356, Kensington Station, Detroit, Michigan 48224.

HOUDINI'S Original Magic Shop. Established 1856. Send 25 cents for Illustrated Catalog containing 5000 Tricks, Mindreading, Puzzles, Hypnotism and Jokes. Flosshornmann, 304 West 34th St., N.Y. 10001.

BE A Magician! Two booklets explaining sixty-eight tricks plus large professional catalog, \$1.00. Magic, Inc., 5082 Lincoln, Chicago, Illinois 60625.

NEW 1969 Catalog, 500 Tricks, now ready! Visit our store, or send 10¢ for Catalog showing latest magic for pocket, parlor, stage. Fastest mail service for 54 years. Douglas Magicland, Dept. 11, Dallas, Texas 75221.

FREE Jokers catalogue. Magic tricks book 35¢. Big, Box 694, Cleveland, Ohio 44107.

BOOKS, PERIODICALS, NEWSPAPERS

NATIONAL Geographic Magazines, 1888-1967, any issue. Buxbaum, Box 465-PM, Wilmington, Delaware 19899.

PROPHET Elijah coming before Christ. Wonderful book free. E. Megiddo Mission, 481 Thurston Rd., Rochester, New York 14619.

FREE Catalog. Self-help books. Write Wilshire, 8721 Sunset, Los Angeles 90069.

FREE List of low cost popular booklets. Success, happiness, personality, wealth, personal problems. Wilmar Enterprises, 56 Porterfield Place, Freeport, New York 11520.

FREE Book catalog. Adult reading. Catalog, 2217 Lackland, St. Louis, Missouri 63114.

WANTED: Encyclopedias Worldbooks, Britannicas 1967 to 1969. Write: Bargain Store, 709 Pratt, Huntsville, Ala.

BOOKS! New and Used. List 10¢. Lakeland Books, Thornville, Ohio 43076.

KNOW YOUR GOVERNMENT—complete GUIDE TO CONGRESS. Listing of all congressmen, Committees, How Laws Are Made, U.S. Constitution, How to Write Your Congressman, much more. \$1. Liberty Lobby, Box 1622-P, Washington, D.C. 20013.

SAVE 80%! Adult, moneymaking, books. Free Catalog. Crossland, 11126 Corbett, Detroit, Michigan 48213.

CONCERNED About today's tragedies? "Good News For You" will answer questions. "Good News" Box 141, West Carrollton, Ohio 45449. Free.

STARTLING Book shows how to attain secret of Achievement. Details free. M. & M. Sales Co. 1628-A West 19th Terr., Lawrence, Kansas 66044.

MIND over Platter, Magic of Thinking Big \$2.00 each. Free catalog. DeBords, Box 1153, Berkley, Michigan 48072.

HOW To gain self-confidence and get more living out of life. Psycho-Cybernetics reveals positive ways to control hidden power within you. Send \$2.00 for this self-help inspirational book. Avondale House, 17511 Avondale Road, Woodinville, Washington 98072. Washington residents add 9¢ tax.

THE BATTERY MAN monthly magazine—Starting, Lighting, Ignition and Generating Systems. \$3.50 yearly. 100 Larchwood Drive, Largo, Florida 33540.

2 DIFFERENT Paperback Books! Now \$1.00! Interesting. B-723c, Metuchen, New Jersey 08840.

PLAYS, STORIES, MANUSCRIPTS

WANT Your book published? Learn how we publish, advertise, promote, distribute. Many successes. Free booklet PM, Vantage, 120 West 31, New York City.

YOUR Ad in Popular Mechanics will be seen by more than 5,000,000 active buyers for your products and services. It costs only \$1.85 per word. And, if you wish to run all or part of your ad in capital letters—you can do so for as little as 75¢ per word additional. Act now! Place your classified ad in Popular Mechanics today.

BUSINESS OPPORTUNITIES

ADDRESSERS And mailers needed. Send stamp for information. Lindbloom, 1508 West Erie, Chicago 60622.

HUGE Profits! Mail order importing. Free information. ITIS-PM-8, Box 454, Hollywood, Calif. 90028.

\$15.00 HOURLY PROFIT—OWN Business with one serviceman. Quickly learned. Easy to do. Operate from home. Few hundred dollars builds your own nationally advertised business while continuing present job. Investigate immediately. . . . before your territory is taken. Free booklet explains everything. Send Today. Then decide. Duraclean, C8-160, Duraclean Building, Deerfield, Illinois.

IMPORT Export opportunity, profitable world-wide, mail-order business from home, without capital, or travel abroad. We ship proven plan, for no risk examination. Experience unnecessary. Free details. Mellinger, Dept. B70A, Los Angeles 90025.

BOOKKEEPERS Earn \$1000.00 month. Operate simplified Bookkeeping tax service. Universal, Box 664-M, Springfield, Missouri.

WANT To make big money at home? \$10.00 profit in an hour possible with invisible mending. Make tears, holes disappear from clothing, fabrics. Steady year-round demand from cleaners, laundries, homes. Details free. Fabricon, 1585 Howard, Chicago 60626.

I MADE \$40,000.00 Year by Mailorder! Helped others make money! Start with \$10.00—Free proof! Torrey, Box 318-Y, Ypsilanti, Michigan 48197.

CONCRETE FACTS: Highly profitable home business. Experience unnecessary. Unlimited unique pottery designs easily made without moulds. Birdbaths, fountains, wishing-wells, benches, etc. Chemical coloring formulas, marbled glazing. FREE illustrated brochure. Hollywood Cementcraft, 602 Athens Street, Altadena, California 91001.

MAKE Money from old tires. Operators clearing \$600 weekly. Equipment costs \$1000. Get facts. S&S Patents, Inc., 3911 N. Damon, Chicago 60618.

DRAFTSMEN! Operate own DRAFTING SERVICE! Full, Part Time; Experience unnecessary. Details: Roberts Drafting, 1741 Circle Road, Baltimore, Maryland 21204.

MAKE \$46 from square foot plywood; jigsaw or bandsaw necessary. Free details. Woodar, Bridgewater, Mass. 02324.

SELL Books by mail. 400% profit. Royal, Box 450-X, Cleveland, Ohio 44127.

\$1000.00 MONTHLY Collecting Delinquent accounts by mail. Continental, Box 2023-A, Des Moines, Iowa 50310.

MAKE \$32 from 49¢ piece vinyl. PM-1834 Edgeland, Louisville, Ky. 40204.

\$60.00 DAY. Manufacturing concrete posts, blocks, etc. Carlayne, 1803 Fremont, Rapid City, South Dakota 57701.

WORLD'S Largest supply. Merchandise 25% to 40% under wholesale. Bankrupts, closeouts 10¢ on dollar. Imports. Hong-kong clothes. Automobile discounts. Free details. International Buyers, Box 4633-MM, Colorado Springs, Colo. 80909.

PROFITABLE Catalog Mailorder Business! Vikari's, 335PM-J, First Avenue, Salt Lake City, Utah 84103.

VENDING Machines. No selling. Operate a route of coin machines and earn amazing profits. 32-page catalogue free. Parkway Machine Corporation, 715 PMB Ensor Street, Baltimore, Maryland 21202.

RAISE Rabbits for us on \$500 month plan. Free details. White's Rabbitry, Mt. Vernon, Ohio 43050.

MAIL Baby Catalogs imprinted with your address to New Mothers for Big Profits! Details 25¢. Volz-PM, Ypsilanti, Michigan 48197.

UP To \$5.00 each for newspaper clippings! Free details. Phillip, Box 368-S, Southfield, Michigan 48075.

MAILORDER Business. Experience unnecessary. Harry Andrews, 160 Bleeker, New York, N.Y. 10012.

SECRETS! Mail Order Success. Internationally famous expert reveals how to make home business fortunes. Beginners: Get free copy "Make Money By Mail". Discloses free advertising, profitable products. Mallico, 1554 Sepuveda, Dept. B70A Los Angeles 90025.

EXCLUSIVE Distributor Franchise. make big money selling quality automotive products. Many prime territories available. Write for free catalog and details. Cleanbright, Dept. 610-2202 Folin St., Bronx, New York 10457.

INSTALL Burglar alarms without previous experience or costly equipment. Big profit. Free details. Nasco, 11071 Massachusetts, Dept. B270A, Los Angeles 90025.

NEW Plan! Pays up to \$25.00 an hour! Little as 4 hours weekly. Place Thriftee self-service displays in stores. No cost to merchants. No experience needed. Free details. Lux Company Incorporated, Dept. 1001, Elkhart, Indiana 46514.

MEDICARE-Social Security. Earn top fees assisting clients obtain maximum benefits. National Tax School, Monsey, 302WB, New York 10052.

OPERATE Restaurant. Free booklet reveals profitable plan. Write Restaurant Business School, Dept. EC108, 1920 Sunny-side, Chicago, Illinois 60640.

OPERATE Home mailorder business! Send stamp. Vosacek Printing, Box 1217-A Garden Grove, Ca. 92640.

CASH For newspaper clippings. Free details. Foren Associates, 176 Federal, Boston, Mass. 02110.

FREE Catalogs. Repair air conditioning refrigeration. Tools, supplies, full instructions. Doolin, 2016 Canton, Dallas, Texas 75201.

FREE "Franchise Profit Letter" tells how unique NFR service is helping thousands seeking profitable businesses. Write today. National Franchise Reports, W-528, 333 North Michigan, Chicago 60601.

VENDING Machine big catalog. Rake, 523 A Spring Garden, Philadelphia, Pa. 19123.

56 ACTIVE Franchise opportunities available all over USA. Brochure details 56 franchise chances for you to have your own business tied with successful national companies. Send name, address to P. Stewart, 1085 Walnut, Des Plaines, Illinois 60016.

\$400.00 MONTHLY Raising giant fishworms. Soilless method. Charlie Morgan, Bushnell, Florida 33513.

EARN Money raising fishworms for us! Write: Oakhaven-38, Cedar Hill, Texas 75104.

400,000 BARGAINS Below wholesale! Many free. Liquidations . . . closeouts . . . job lots . . . single samples. Free details. Bargainhunters Opportunities, Box 730A, Holland, Michigan 49423.

\$200.00 DAILY In your mailbox! Your opportunity to do what mailorder experts do. Free details. Associates, Box 136-A, Holland, Michigan 49423.

BIG Profits in mail order. Details free. Knowledge, 30A West Washington, Chicago, Illinois 60602.

SPARE Time Cash—Sell Advertising Book Matches—every business a prospect—no investment—no experience needed to build steady repeat business. Daily Cash commission in advance. Write today—We'll send your sure-fire selling kit by return mail. Dept. MX1068. Send 10¢ Match Co., 7530 S. Greenwood, Chicago, Illinois 60619.

CLIP Newspaper items. \$1.60-\$5.00 each. Details free. Walter, Box 1360-PA, Erie, Pa. 16512.

MAILORDER—Profitable products, drop-shipped. No merchandise investment. Everything supplied—catalogs, ads, mailing lists. Gif-Guide, 3408½ Motor, Dept. 97, Los Angeles 90034.

FREE Book "990 Successful, Little-Known Businesses." Work home! Plymouth-272J, Brooklyn, N.Y. 11218.

TRUCK CAMPER FRANCHISE National Advertised Brand Retail \$795. Big Profits Requires \$3000. Inventory Investment Write: Tour-A-Home, P. O. Box 467, Dept. C Port Huron, Michigan 48060.

TREMENDOUS Opportunities in growing mail order field. Earn and learn at home. Details 25¢. Bennet Enterprises, Box 98-PM, Richmond, Indiana, 47374.

PLASTERCRAFT Molds, liquid rubber, plasters, flocks, candle supplies. Catalog and manual free. Blue Rapids Supply, Blue Rapids, Kansas 66411.

BIG Money—making new greaseless donuts in kitchen. Everything furnished. Sell stores. Free receipts. Montgomery Ray, Waseca, Minn. 56093.

SELL Lifetime, Metal, Social Security Plates. Big Profits! Sample and Sales Kit Free. Russell, Box 286-PM, Pulaski, Tennessee 38478.

430% PROFIT Selling Books By Mail! Free Details. D&B, Box 338-A, Holland, Michigan 49423.

BIG Profits—Operating your own plastic laminating business with low cost equipment and supplies, money making methods included. Money back guarantee. Jiffy—Box 23485P, Los Angeles, Calif. 90023.

COPUBLISH "Mail Sale Advertiser," leading mailorder paper. Copy and details 25¢: U.S.A. only. Vanroy Shirk, Lebanon, Pa. 17042.

MAILORDER Records help get Increased Business! Complete 32 page Record Book shows your inquiries, orders, advertising expense, etc. Only \$1.00. Martin, Popular Mechanics, Dept. R-108, 575 Lexington, New York 10022.

\$70.00 WEEKLY—home, spare time. Simplified mail bookkeeping. Immediate income easy. Auditax, 34741A, Los Angeles 90034.

PROFIT With Popular Mechanics' subscription plan. No investment, no experience needed. Earnings begin immediately when you obtain subscription for Popular Mechanics, Good Housekeeping and others. High commissions, bonus. No experience needed. Deal directly with the publisher. Write Popular Mechanics, Room 6B, 250 West 55th St., New York 19, N.Y.

BIG MONEY MAKER! Custom Furniture Upholstery plus Auto Trim, Slip Covers, Drapes. Tremendous spare-full time earnings. Men, women, all ages. No experience required. We furnish everything: Easy Home Instruction, Tools, Supplies to build roomful of beautiful furniture . . . yours to keep-sell! Approved for Veterans. Send for Big FREE Illustrated Book. Modern Upholstery Institute, Box 899-BDB, Orange, California 92669.

PROFIT With Popular Mechanics' subscription plan. No investment, no experience needed. Earnings begin immediately when you obtain subscription for Popular Mechanics, Good Housekeeping and others. High commissions, bonus. No experience needed. Deal directly with the publisher. Write Popular Mechanics, Room 9B, 250 West 55th St., New York 19, N.Y.

QUIT JOB! Work home. Free confidential information with book "990 Little-Known Businesses." Willfind, Box 11432L, Phoenix, Arizona 85017.

SURE-FIRE, Guaranteed Retail Collection System Free Details, Box 9762, Austin, Texas 78757.

AMAZING Automatic Fishhook. Free details. Sample \$1.00 Refundable. Aron, Post-box 61-PM, Mastic Beach, New York 11951.

HOME Electronics course only \$26.95. Free literature. Edu-Kits, Department 702B, Hewlett, New York 11557.

"MAILORDER . . . No Investment in products!" Free Catalog! Methods, 1839-FD, Lafayette Hill, Pennsylvania 19444.

PREPARE Tax returns—Housewife Jo Ann Netzey made \$5,500 last season. Train at home. VA Approved. National Tax School, Monsey, 2WB, N.Y. 10952.

PIANO Tuning learned quickly at home. Tremendous field! Musical knowledge unnecessary. GI approved. Free information. Empire School, Miami, Florida 33145.

MAKE MONEY spare time at home! Mail order—no inventory. Details: Unique Products, Box 1186, Dept. 8B-10, Arlington, Texas, 76010.

MAKE Gorgeous original candles for all holidays and special occasions. Learn expert Candle decorating, candlemaking, use of professional molds. Free details on home instruction method. Candle Institute, Dept. RJ, 1600 Cabrillo, Torrance, Calif. 90501.

MAKE 2 to 3 times your cost wholesaling 1001 products. Gifts, Mail Order Specialties, Toys, Novelties, Carded Merchandise . . . Guaranteed lowest below wholesale prices. Free home business details SMC 7630 SPJ, Gloria Ave., Van Nuys, Calif. 91406.

AUTOMATIC FIRE EXTINGUISHER \$19.95 Retail, Your cost \$8.50. Sample \$10.00 Postpaid. **AUTOMATIC FIRE ALARM** \$5.98 Retail, Your cost \$2.00. Sample Postpaid \$2.50. Satisfaction Guaranteed. P. M. Warren Company, 6922 East Congress, Detroit, Mich. 48207.

MAKE Money! "Terrific new booklet tells you how." Rush 50¢. Unique, 8C10, 12219 Cheshire, Norwalk, Calif. 90650.

100 SOURCES NOVELTIES. \$1.25 Mampa Publications, 2050 Hutchinson, Suite 200, Chicago 60618.

SAILBOAT Rental business. Unusual program. Write: Nordex, Box 7, Zenda, Wis. 53195.

\$2983.75 PROFIT First month. W. Beier did it with new "Instant" Photo Album. Sells itself. Pages are self-adhesive. Sample, details Free. Keating, 3524PM10 Brighton, Pittsburgh, Pennsylvania 15212.

\$100.00 MONTHLY Profit. Your own part time local collection bureau. Free information. Associated Collection Bureau, Box 143 No Station, White Plains, N.Y. 10603.

BIG Profits Wholesale gifts items novelties toys carded merchandise in full or spare time. Goldman, Dept. A98, 931 N. Ditman Ave., Los Angeles, Calif. 90063.

FREE! Beginners mailorder success letter. Sullins, Box 18810M, Forsyth, Georgia 31029.

INSTALL Burglar Alarm Systems. Big profit home business. Beginners start spare time, without mechanical experience or costly equipment. Free starter plan. Nasco, Dept. B270A 11071 Massachusetts, Los Angeles 90025.

SELL Your photos. Report tells How. Where. Color Slide Markets, \$1.00. Durham, 406 South Second, Alhambra, Calif. 91802.

BECOME PROFESSIONAL DRIVING INSTRUCTOR. Big demand. Earn \$10.00 hour. \$300 week. Part time. Full time. Business for yourself. Free details. Write Howard David, 1818 Everts St. Phila., Pa. 19152.

MAKE BIG MONEY GROWING GINSENG! \$3,000-\$30,000 annually. We buy your crop. \$2.00 brings seed sample and information Glass' Ginseng Exchange Box 1969, Springfield, Mass. 01101.

CALIFORNIA MANUFACTURER NEEDS man to assemble our product and be local agent, experience unnecessary. May start while presently employed. Five figure income for responsible applicant. Write, S.K.R.M. Manufacturers, 2540 Olive Ave., Long Beach, California 90806.

DROP-SHIPING 1,000,000 Items! Camille, 202-PX Brownell Street, New Bedford, Mass. 02740.

I RAISED \$250,000. Helped others get capital. Free details. Counselor-17, Harlingen, Texas.

IMPORT SERVICE! Tremendous profits now! No product searching. Parrish, 5600 Hamilton St., Hyattsville, Md. 20781.

\$10,000 per year in your own Second-hand Business. Empire, 13292p Euclid, Garden Grove, California 92640.

NEW CATALOG! 92 ways to earn Money. Details 25¢. Planned Products, Box 2645, P-7, St. Louis, Mo. 63116.

HOW TO PREPARE YOUR OWN MAIL-ORDER CATALOG for pennies. . . . Including All Popular Merchandise! Free Catalog-Proof! Obie, 5711-MO-14th, Brooklyn, New York 11219.

DATA-CRAFT Agency. \$10,000 Year Plan. Provide services to stores, banks, doctors, others. Under \$65 puts you in excellent husband-wife home business. Free details. Datacraft-71A, Harlingen, Texas.

TRIPLE Your income! Invest Japan's & Europe's bargain catalogs 7,500 pages, \$30.00. Samples, \$2.00. Millionaire-M10, 57 West 76th, New York City 10023.

PICTURE-FRAME Mouldings closeout! From 2¢ Ft. Send Stamped envelope for list. Artcrafts, Mooers, New York 12958.

BOOKKEEPERS. Operate profitable bookkeeping service. R. I. Systems, 1645 Warwick Avenue, Warwick, R. I. 02889.

ONE-MAN or part-time business (or hope to be)? We help with monthly publication, books, meetings, tax, law information, office equipment discounts. Send \$1 for details. (Applies toward \$12 annual dues.) Individual Businessmen's Institute, 111-B Woodcrest, White Plains, N.Y. 10604.

LIQUID Molding rubber also liquid plastic. Free information. Chauey's, 5415-A San Jose Blvd., Jacksonville, Fla. 32207.

MAKE Money Operating home Mailorder Business. No Inventory. Write Purple Enterprises, Box 16291AY, Jacksonville, Fla. 32216.

HOW To write letters that sell. Compact Manual by expert. Literature 25¢ refundable. Helinger, Court Street, Syracuse, New York 13206.

QUIT JOB! Work home! Free confidential information with book "990 Little Known Businesses." Willfind, Box 11432L, Phoenix, Arizona 85016.

MAILORDER Book publisher wants dealers. Wonderful "drop-ship" proposition. Sample imprint circulars free. Neil H. Tasker, Shamokin, Pennsylvania 17872.

MONEYMAKING OPPORTUNITIES

BECOME Notary Public! Free particulars. Stationers Exchange, 405-PM Richardt, Evansville, Indiana 47711.

\$200.00 FROM Sheet 1/4" plywood (scrap). Details 25¢. Novelties, 610 So. 24th, Elwood, Indiana 46036.

EARN \$240.00 a month at home, spare time, doing only two \$5.00 invisible mending jobs a day. Big money paid for service that makes cuts, tears disappear from fabrics. Steady demand. Details free. Fabricon, 1532 Howard, Chicago 60626.

HOUSEHOLD And food products route. \$25.00 or more daily profit. Larger repeat orders. Man, woman. Full, part time. McNess, Freeport 26, Illinois 61032.

WATCH REPAIRING. Swiss and American watches. Develop skill step by step in spare time at home. Diploma awarded. Free sample lesson. Chicago School, Dept. YKA, Fox River Grove, Ill. 60021.

RAISE Rabbits and fishworms on \$500 month plan. Free details. White's Rabbitry, Mt. Vernon, Ohio 43050.

MAKE Statuettes, novelties, imitation marble. Sell to stores or start gift shop. Free details. Marbleizing, 41 Waverton, St. Louis, Mo. 63124.

VENDING Machines. No selling. Operate a route of coin machines and earn amazing profits. 32-page catalogue, free. Parkway Machine Corporation, 715 PMM Ensor Street, Baltimore, Maryland 21202.

MANUFACTURER Offers quality line of automotive chemicals. High profits. Repeat sales. Choice territories open. Write for catalogue and details. Cleanbright Dept. 210-2202 Folin St., Bronx, New York 10457.

FREE, 206 Easy ways to make money taking orders for exciting new products—spare time. Send name, age, for 5 months free subscription. Opportunity Magazine, 850 N. Dearborn, Dept. 17-JM, Chicago 60610.

HOW To Make money writing short paragraphs. Information free. Barrett, Dept. C-27-H1, 6216 N. Clark, Chicago 60626.

MAKE Amazing profits winning contests. Fool proof method. Free Details. Cook, 2132 Hamlin Road, Hamlin, New York 14464.

\$140.00 DAY'S Homework! Haines, 86 Great Hill Rd., Seymour, Conn. 06483.

\$500—\$800 MONTHLY. Raise small laboratory-breeding stock for us. We supply equipment, breeders, instructions. Illinois Research Farms, Dept. MP-10, 2711 Justen, McHenry, Illinois 60050.

SELL Advertising book matches. Write us today; we put you in business by return mail, handling complete line ad book matches in demand by every business right in your town! No investment; everything furnished free! Top commissions daily! Superior Match, Dept. MA1068, 7530 S. Greenwood, Chicago, Ill. 60619.

MAKE \$12.00 Profit each dozen assembling Belts. Details: Send Stamp. Redikut's, Loganville 40, Wisconsin.

HOMEWORK. Mailing circulars, salary! Free details! Cam Company, Dept. 155-KP, Verona, N.J. 07044.

WANT To win a contest? Write Prize-winner, Box 11569, St. Petersburg, Fla. 33733.

HOMEWORKERS! 200 companies—48 page Directory. FREE details. Quest Enterprises, Box 6029, Dept. 110, San Jose, California 95150.

OWN A franchised business! Learn who to contact. Over 750 franchising firms in 1968 Franchise List. Send \$1.00 today to National Franchise Reports, WP-528, 333 North Michigan, Chicago 60601.

CLIP Newspaper items, \$1.00-\$5.00 each. Details free. Walter, Box 1360-F, Erie, Pa. 16512.

FOLIO Listing \$5,000.00 Spare-time Opportunities. Homeworkers, 18643 Ventura, Tarzana, Calif. 91356.

MAKE MONEY AT HOME. 'Inside' reports reveal 5 unusual small businesses you can start on a "shoestring", run from your home. No door to door selling. Reports give facts, figures, case histories, how to start. Money back guarantee! All 5 Confidential Reports, Only \$2.98 ppd. Rudolf Herford, Dept. B, 2729 Midvale Ave., Los Angeles, Calif. 90064.

MAKE \$5,000 yearly, sparetime, raising mink, chinchilla, nutria, etc. Free booklet reveals proven plan. Write: Furs, Dept. R, Bewdley, Ont. Canada.

LEARN The secrets of repairing junk batteries. "Fabulous Profits" at home. Batteryman, Palm Desert, California 92260.

EXTRA Income at home in Spare Time! Booklet shows you how to start your own business with Classified Advertising. Only \$1.00. Martin, Popular Mechanics, Dept. P-108; 575 Lexington, New York 10022.

MAKE Big Easy Profits making costume jewelry at home, spare time! Quick, easy to make; easier to sell! Details Free! DonBar, 2934 Fullerton, Dept. K-208, Chicago, Ill. 60647.

MAKE Money Operating Home Mail-order Business. No Inventory. Write Purple Enterprises, Box 16291AY1, Jacksonville, Fla. 32216.

MAILORDER IMPORTS. Report reveals foreign Drop-Ship sources. World Trader's Digest ideal mailorder items. \$1.00 Patti's Enterprises, 7909 Alverstone Ave., #6, Dept. M13, Los Angeles, Calif. 90045.

TEAR OUT THIS AD AND MAIL WITH NAME, address for big box of home needs and cosmetics for Free Trial, to test in your home. Tell your friends, make money. Rush name, Blair, Dept. 31GT, Lynchburg, Va. 24505.

\$15.00 HOURLY Profit—Own Business with one serviceman. Quickly learned. Easy to do. Operate from home. Few hundred dollars builds your own nationally advertised business while continuing present job. Investigate immediately . . . before your territory is taken. Free booklet explains everything. Send Today. Then decide. Duraclean, C8-160B, Duraclean Building, Deerfield, Illinois.

WITHOUT Knowing it you may be passing up your GUARANTEED chance of undreamed of wealth. Find out today. Send \$1 to VPI, 3665 Oregon Trail, Decatur, Ga. 30032.

FAST Profits. Low capital. Stock market plan. Free facts. Galligan, Box 3375, Ventura, Calif. 93003.

MAKE Money with foreign imports. Write: Valley House, Harrisonburg 5, Virginia 22801.

PROFIT From coins! How to start, where to sell. How to become franchised dealer. Send \$1.00. McHale, Dept. PM 108, 15 Wales Pl., Mt. Vernon, N.Y. 10552.

FREE Catalog! Selected home money-making opportunities. United Sales Company, 117 Missouri, Ferdinand, Ind. 47532.

CLUBS. Churches, societies. Earn \$500.00 and 24 fine card tables. No risk, nothing to pay. The Gerden Johnson Plan, Box 955 M, Deerfield Beach, Florida 33441.

SHARP \$\$\$ Opportunity! One low-cost machine. Sharpens—Serrates knives, Scissors, pinking shears. Earn \$6-\$9 hourly in spare time. Professional results without experience. Free Details. Beaver Grinder, 3108C Nielson Bldg., Eugene, Oregon 97402.

MAKE Money writing short paragraphs. Information. Waagner Company, 22 Harold Place, Clifton, New Jersey 07013.

WANTED! Addressers - Commission Mailers. Stamp required. Oortm Distributors, 122-P Duke Drive, Portsmouth, Virginia. 23703.

SELL Facts at big fees; operate Home Research Services; free details; write now. Rudinger, 224PM Post, San Antonio, Texas 78215.

50 MONEY-Making opportunities. Only \$1.00. Huge profits. D. Le Blanc, 10265 Glendye, Richmond, Virginia 23235.

FREE Catalog! Homework opportunities. Camille, 202-PH Brownell Street, New Bedford, Mass. 02740.

1000% PROFIT BRONZING baby shoes literature Nichols, Box 11069, Kansas City, Mo. 64119.

BOOMING NATIONWIDE! Start mail delivery system from your neighborhood U.S. Post Office. Information, \$1.00. Speedy Mail System Corp. P.O. Box 4543A Miami Beach, Florida 33141.

STOCK Market—Get "Wise Investing" 50 moneymaking ideas. Send \$1.00. Schrader, 800 Colonial, Forty Fort, Penna. 18704.

PROVEN PLAN Sell books by mail. Free Details. K & I, 349 Summerhill, Fayetteville, North Carolina 28303.

MONEY—SPARETIME OPPORTUNITY PANELISTS AT HOME WANTED BY NEW YORK RESEARCHER. Leading research firm seeking people to furnish honest opinions by mail from home. Pays cash for all opinions rendered. Clients' products supplied at no cost. For information write: Research 669 Mineola, N.Y. 11501. Dept. PM-24.

PAINT Signs! Easy! Speedy! Accurate! With letter patterns. Paul, w. 1935 Stardust, Waukesha, Wisconsin 53186.

SPARE Time cash. Sell Famous Hanover Shoes. Actual samples and sales kit Free. No experience needed. No age limit. Lowest prices for high quality makes selling easy. Every man a prospect. Big daily commissions. For full details, write Hanover Shoe, 387 Carlisle, Hanover, Penna.

PROFITABLE OCCUPATIONS

BECOME A mortgage broker, earn \$10,000 to \$50,000 a year. Details free. United, Box 6284A, Marietta, Georgia 30060.

RAISE Rabbits for us on \$500 month plan. Free details. White's Rabbitry, Mt. Vernon, Ohio 43050.

YOUR Own Sign shop. Signs 410-S So. Western, Springfield, Ohio 45506.

EARN \$240.00 A month at home, spare time, doing only two \$5.00 invisible mending jobs a day. Big money paid for service that makes cuts, tears disappear from fabrics. Steady demand. Details free. Fabricon, 1586 Howard, Chicago 60026.

SCIENTIFIC MESSAGE: BIG EARNINGS uncrowded profession. Learn spare time at home. Diploma awarded. Free catalog. Write: Anderson School, Dept. M-1-C, Princeton, Illinois 61356.

HOW To Make Money Writing Short Paragraphs. Information Free. Barrett, Dept. C-27-H2, 6216 N. Clark, Chicago 60626.

CHROME Plating. Instructions, equipment and supplies. Platers' Supply, P.O. Box 565, Lugo Station, Los Angeles, Calif. 90023.

FREE Book "990 Successful, Little-Known Businesses." Work home! Plymouth-27J, Brooklyn, N.Y. 11218.

BAKE New greaseless doughnuts in kitchen. Sell stores. Free recipes. Michael Ray, Waseca, Minn. 56093.

MEN—Women! Start money-making Plastic Laminating business at home in spare time. Material that costs 11¢ brings back \$2.58. No canvassing or selling but mail orders bring in \$20 a day. Write for full particulars free. Rush name on postcard to: Warner, Room CL-2-LO, 1512 Jarvis, Chgo., Ill. 60626.

SHARPEN Scissors, Pinkers. Inexpensive equipment, tools, supplies. Blackhawk's, Sheldahl, Iowa 50243.

FT. SMITH Auction School. Ft. Smith, Ark. Residents & Home study. Veteran approved.

NEW Modular system makes you successful adman overnight. Free details. Box 87-P108, Hollywood, Florida 33022.

SALESMEN—DISTRIBUTORS

MAKE Extra \$25 to \$75 spare time! Take orders for double air cushion Bronson Shoes. Amazing comfort. Terrific men's, women's line for dress, work, play. Highest commissions. Shoes for yourself. Big outfit free. Write Bronson, Dept. 670, Minneapolis, Minnesota 55408.

FREE, 206 Easy Ways to make money taking orders for exciting new products—spare time. Send name, age for 5 months free subscription. Opportunity Magazine, 850 N. Dearborn, Dept. 17-JS, Chicago 60610.

GET New shirt outfit free! \$90 weekly on 5 average orders a day. Famous quality made-to-measure dress and sport shirts at \$4.95 up, sell to all men. No experience needed. Full or part time. Write: Packard Shirt Co., Dept. 921, Terre Haute, Indiana 47808.

MAKE Extra Money! Introduce new Miracle Cantreze Nylons. Amazing low price. Guaranteed never to run. We show you how. Big outfit, sample stocking free. Spare time cash year-round. It's easy. Write American Hosiery Mills, Dept. A18A, Box 753, Cincinnati, Ohio 45202.

FREE Selling outfit. Office supplies, furniture & equipment. Osoco, 15-PM North Jefferson, Chicago, Ill. 60606.

SELL Advertising book matches. Write us today, we put you in business by return mail; handling complete line ad book matches in demand by every business right in your town! No investment; everything furnished free! Top commissions daily. Superior Match Dept. M1068, 7530 S. Greenwood, Chicago, Illinois 60619.

EARN Terrific commissions listing delinquent accounts. General Finance Company, 304-A Pickwick Building, Kansas City, Mo. 64106.

NEW Car Thief Signal. Lightning Seller. Samples for trial. Northwest Electric, Ave. 488, Mitchell, S. Dak. 57031.

100% PROFIT—Sweet Georgia Brown Cosmetics sell fast. Write for Sample Case offer, Valmor, Dept. H, 2411 Prairie, Chicago 60616.

SENSATIONAL "Defender of Women!"
Stops attackers instantly! Effective to 15 feet. Lipstick size. Samples for trial. Rush name. Kristee, 157, Akron, Ohio 44308.

PERSONAL Protective Devices Now in Big demand due to increased crime rate. Proven. Sell easy to Drive-ins, Stores, Nurses, Night Workers, Motorists. Sales experience unnecessary. Get profit details now. Hagen Supply, Dept. CLA10, St. Paul, Minn. 55107.

BIG Earning selling Hertel Bibles. New 3-dimension cover, finest reference edition sells fast. Demonstrator furnished. Big commissions. International Book, Dept. PM, Box 118, Wichita, Kansas 67201.

AGENTS WANTED

FREE. 206 Easy Ways to make money taking orders for exciting new products—spare time. Send name age, for 5 months free subscription. Opportunity Magazine, 850 Dearborn, Dept. 17-JA, Chicago 60610.

WORLD'S Greatest Motivation Program Offers you unlimited earnings as Agent or Franchise Distributor. Choice areas available. Appeals to people in all walks of life. Address, Alpha Distributing Company, P.O. Box 816-M, Chicago, Illinois 60690.

EVERY Man a prospect. Refundable sales kit offer showing line belt buckles, tie clasps, money clips, cuff links, lapels, identification badges, individualized with customer's name and emblems. Cap badges for trucking, bus, taxi, police, firemen, also postal, letter carriers and heavy construction emblems. Choice 3000 emblems. Hook-Fast, Box 1088PM, Providence, R.I. 02901.

MAKE \$50.00 Daily selling air-operated vacuum cleaners to service stations. Free details. Inka Industries, 2401 Crocker, Houston, Texas 77006.

PRINTING. Advertising Salesmen—Excellent moneymaking sideline selling Decalcomania Name Plates, small quantities. Advertising Specialties, sign letters. Free Samples. Ralco XL, Boston, Mass. 02119.

YOUR Own business—Used suits \$1.50; overcoats 65¢; mackinaws 35¢; shoes 12½¢; ladies coats 30¢; dresses 15¢. Enormous profits. Catalog free. Nathan Portnoy Associates, 2109-AA Roosevelt Road, Chicago Ill. 60608.

CHRISTMAS CARDS—Business and Personal. Customer's name imprinted. Earn unusually high commissions from this medium- and high-priced line. No investment. No inventory. Free Sample Album. Process Corp. (our 47th year), 3436 S. 54th Ave., Chicago, Ill. 60650.

LIFETIME Income. Business Loan Representative Write: Financial 28 E. Jackson, Suite 1204-X3, Chicago 60604.

WANT TO MAKE UP TO \$100 A WEEK spare time, and get free Shces for life. too? No investment. Rush card for free details. Mason Shces, K-605, Chippewa Falls, Wisconsin 54729.

ESTABLISH Your own business. Low prices on used clothing, shoes, household goods. Unlimited profits. Free catalog. Northwestern Distributors, 2129 No. Western Avenue, Chicago, Illinois 60647.

NONCOMPETITIVE Sideline. People contacting businesses. Free samples. Press-tiks, 534 Danube, Atlanta, Ga. 30305.

BE The Popular Mechanics representative in your neighborhood and earn big profits in your spare time. Write Popular Mechanics, Room 10A, 250 West 55th St., New York 19, N.Y.

EMPLOYMENT INFORMATION

AUSTRALIA Wants You! Government assisted passage. Unlimited opportunities. Latest Government Information and Forms \$1.00 Ausco, Box 3623-E, Long Beach, California 90803.

HIGH Paying overseas jobs. Construction, other projects. Bonuses, Travel Expenses, Extras. International Information, 124, Cortez, Florida 33522.

OVERSEAS JOBS—Engineers, Construction, Refinery Operation, Medical, Clerical, Worldwide Integrated List—Where, How Apply. \$4.00 to **OVERSEAS ADVISORY SERVICE.** Apartado Aereo 2897, Barranquilla, Colombia.

TREMENDOUS Opportunities U.S.A. overseas, choose jobs-locations, transportation. Free details, Occupations, International Airport, Box 100-C11, Jamaica, N.Y. 11430.

FOREIGN And USA job opportunities available now. Construction, all trades. Earnings to \$2,000.00 Monthly. Paid overtime, travel bonuses. Write: Universal Employment, Dept. C-1, Woodbridge, Connecticut 06525.

JOBS GALORE AUSTRALIA!! Government assisted transportation! Information packet and forms \$1.00. Associated, Box 17B10, Lafayette, California.

HELP WANTED

OVERSEAS Jobs—Australia, Europe, South America, Far East, etc. Openings in all trades and Professions. \$400 to \$2,500 monthly. Free Information write National Employment Service (Foreign Division), Box 2235 P.M.F., Miami, Florida 33159.

OVERSEAS Jobs—Europe, South America, Australia, Far East, etc. 2000 openings all trades. Construction, Office, Engineering Sales, etc. \$400 to \$2,500 month. Expenses paid. Free Information. Write Overseas Jobs, International Airport, Box 536-M, Miami, Florida 33148.

FOREIGN EMPLOYMENT INFORMATION. Construction, other high paying overseas jobs. Bonuses, travel expenses, extras. Write: Manager, Foreign Service Bureau, Bradenton Beach, Florida 33510.

YOUR Ad in Popular Mechanics will be seen by more than 5,000,000 active buyers for your products and services. It costs only \$1.85 per word. And, if you wish to run all or part of your ad in capital letters—you can do so for as little as 75¢ per word additional. Act now! Place your classified ad in Popular Mechanics today.

REAL ESTATE—FARMS

CANADIAN Vacation lands: Full price \$385.00. 40 acres, \$10 month. Suitable cottage sites, hunting, fishing, investment. Free information. Land Corporation, 3768-C Bathurst, Downsview, Ontario, Canada.

\$1 ACRE—Canadian Border—hundreds campsites, islands, farmlands, directly from tax authorities. (Non-profit). Lists, photographs mailed. Register, Room 10, 110 Church Street, Toronto 1, Canada.

CENTRAL Ontario—Choice 640 acre Sportsmen's paradises still available—\$20.00 plus \$6.50 taxes yearly. Maps, pictures. \$2.00 (Refundable). Information Bureau, Norval 4, Ontario, Canada.

FREE! Real Estate Catalog! Fall Edition! Farms, Ranches, Business, Recreational and Investment Property. BANNER Adv., P.O. Box 3333 GS, 19A, Springfield, Mo. 65804. "Real Estate Our Specialty"

CANADIAN Lands, seized and sold for taxes. Our 51st annual series of lists, describe many choice properties, situated from coast to coast, acquired by us through Tax Sale. Priced as low as five dollars per acre, guaranteed perfect title, small monthly payments, no mortgage. Beautifully situated hunting and fishing camps, where there is real sport; summer cottage sites, heavily wooded acreages. Now is the time to invest in Canada's minerals, forests and farms. Write today for free booklet with full explanation. Tax Sale Service, Room 301D, 85 Bloor St., East, Toronto 5, Canada.

40 TIMBERED Acres \$1650.00 Total Price. Wash.—Idaho—Mont. \$50.00 Down —\$25.00 month, in Northern Idaho, Northwestern Washington, and Western Montana. In the heart of lakes and big game country. All covered with growing timber. Access, title insurance with each tract. This is select land with natural beauty, recreational and investment values. We have tracts of many types and sizes from which to choose, including Waterfront property on Pend Oreille, Priest, Kettle and the St. Joe Rivers and in Pend Oreille Lake area. Your inspection welcomed. Write us for free list, maps and complete information. Write to: Dept. PJ, Reforestation, Inc., P.O. Box 8146, Spokane, Wash. 99203.

GOVERNMENT Lands One Cent An Acre. For exclusive report send \$1.00 to: National Lands, Box 241-E, Massapequa, N. Y. 11758.

GOVERNMENT LANDS . . . Low, as \$1.00 acre. Millions acres. For exclusive copyrighted report . . . plus "Land Opportunity Digest" listing lands available throughout U.S., send \$1.00. Satisfaction guaranteed Land Disposal, Box 9091-PJ, Washington, D.C. 20003.

FLORIDA CAMPSITES—Deep in the heart of the great Ocala National Forest—where few individuals have the privilege of owning land. Isolated yet accessible, with electricity. Good fishing, hunting, Warrant Deed. Pitch tent, park trailer, build lodge. Free maps and photos. Howard Vernor, DeLand, Florida, 32720. AD66LS149

FREE CATALOG! Big 196 page FALL- HOLIDAYS edition! Thousands of properties described, pictured—Land, Farms, Homes, Businesses—Recreation, Retirement. Selected Best throughout the U.S.! 68 Years' service, over 500 Offices, 39 states Coast to Coast. Mailed FREE from the World's Largest! SROUT REALTY, 60-RX E. 42nd St., N.Y., N.Y.; 7-RX S. Dearborn, Chicago, Ill.; 521-RX E. Green, Pasadena, Cal.

THE Only "No-Risk Land Purchase Plan" in America—10 year money-back guarantee on any Vacation, Retirement or Investment homesite in Boiling Spring Lakes—the multi-million dollar, 14,000-acre development on the Carolina Coast. All facilities, electricity, roads, motel, golf course, country club, already in. Private ocean beach, 50 fresh water lakes, ½-acre homesites as low as \$645.00; \$7.00 down, \$7.10 month. Write for free literature. (Not offered to residents of California, Florida, New York) Boiling Spring Lakes, Southport 1-B, North Carolina 28461.

LESS Than 1 mile to Disney property. Lake living, ¼ acre. Private ramp, beach; 11 mi. to Orlando. \$24 mo., \$50 down. BLOCH BROS., 1 North Rosalind, Orlando 26, Florida. AD65LS169-L

FREE . . . Big FALL-WINTER CATA- LOG Describes and pictures over 2,000 farms, ranches, town and country homes, businesses in 32 states coast to coast! Specify type property and location preferred. Zip code, please. UNITED FARM AGENCY, 612-PM West 47th St., Kansas City, Mo. 64112.

FREE REAL ESTATE CATALOG! New Fall-Winter edition; exciting bargains, actual property photos. Write for YOUR copy to-day! SAFE-BUY REAL ESTATE, P.O. Box 589-PM, Little Rock, Ark. 72203.

FARM AND GARDEN EQUIPMENT

EXTRA Income at home in Spare Time! Profit Booklet shows you how to start your own business with Classified Advertising. Only \$1.00. C. A. Martin, Popular Mechanics Dept. PM, 575 Lexington Ave., New York 10022.

FLOWERS, PLANTS and NURSERY SUPPLIES

WANT Greatest cash crop working for you? Write Ginseng, Asheville 53, N.C.



DRINKING WATER-PURIFIERS

MAILORDER Records help get Increased Business! Complete 32 Page Record Book shows your inquiries, orders, advertising expense, etc. Only \$1.00. C. A. Martin, Popular Mechanics, Dept. PM, 575 Lexington Ave., New York 10022.

HOME CRAFTSMEN

CABINETMAKING MADE EASY and "How to Make Formica Counter Tops," two excellent guides let you build kitchen cabinets and counter tops like professionals. Extraordinary guides bring master craftsmen's shortcut methods. Satisfaction guaranteed. Write: Japs, 126-P Seventh North, Hopkins, Minn. 55343.

SKIL-CRAFTS New 200-page '67-'68 Catalog. Largest selection of Leathercraft, Artist, Hobby and Craft Supplies from one source. Send 50¢ (refunded with first \$5 minimum catalog order). Skil-Crafts, Box 105-P, Joplin, Missouri 64801.

WOODWORKING Catalog and Manual 25¢. Plus free "101 Project Ideas." World's most beautiful veneers, lumber, plywood! Wood finishing, upholstery supplies. Cane, Lamp parts. Furniture hardware. Animal whittling blocks. 2,000 workshop products. Constantine, 2051-P, Eastchester Road, Bronx 10461.

101 PATTERNS Of smart Gifts, Novelties, Shelves, Action Windmills plus "Make Money Jig Sawing", \$1.00. Mastercraft, 105M, 7041 Olcott, Chicago 60631.

PLANS Bird Houses, Feeders. Send 10¢ for Brochure. Yeager, 1665 Linden, Homewood, Ill. 60430.

FOUNDRYETTE 2400 P. 1½ to 48 lb. capacity. Circular 10¢. Kansas City Specialties, Box 193, Middleton, Wis. 53562.

FREE! World's largest leathercraft catalog. Hundreds of Make-it Ideas. Tandy Leather Co., Dept. J-85, Fort Worth, Texas.

FREE Popular Mechanics 16 page illustrated catalog of publications, plans and projects. Booklet covers an extremely wide variety of do-it-yourself data on home remodeling, shop tools and machines, car repair, hobbies, crafts, boating, games, lawn and garden and hundreds of others. For your free copy write to Service Bureau, Dept. PE, Popular Mechanics, 575 Lexington Ave., New York, N.Y. 10022.

PLANS For pool table with extra two-face top for table tennis and model railroad. Blueprints B1209 and building instructions \$3.50. Popular Mechanics Service Bureau, 575-M Lexington Ave., New York, N.Y. 10022.

EXOTIC And domestic hardwoods catalog, 10¢. Wood Product Specialties, 30 Bartholomew Ave., Hartford, Conn. 06106 Dept. R-5.

FURNITURE Finishing and refinishing is fun. Copyrighted simplified method insures professional results. Instructions \$1.00. Satisfaction Guaranteed. Zanetto, P. O. Box 492, Jewett City, Connecticut 06351.

FASCINATING Stained glass hobby Details free. Whittemore Durgin, Box 206SY, Hanover, Mass. 02339.

WALNUT And Cherry tapered legs, lumber, gunstock blanks, picture frame moulding. Midland Lumber Company, Box 262, Savannah, Missouri 64485.

PICTURE-FRAME Mouldings closeout: From 2¢ Ft. Send Stamped envelope for list. Artcraft, Mooers, New York 12958.

UPHOLSTERY

MAILORDER Records help get Increased Business! Complete 32 Page Record Book shows your inquiries, orders, advertising expense, etc. Only \$1.00. C. A. Martin, Popular Mechanics, Dept. PM, 575 Lexington Ave., New York 10022.

DO-IT-YOURSELF

BURGLAR-FIRE ALARM Supplies and information. For homes and businesses. Send \$1.00 (refundable) for catalog to: Protecto Alarm Sales, Box 357-A, Birch Run, Mich. 48415.

WATER!! Drill Your Own Well for 2¢ per foot! New Invention! Free information. Deep Rock Drilling Company, Opelika, Alabama 36801.

REPAIR Manuals, automatic washers, dryers, dishwashers, 20 different manuals. \$2.75 each Ppd. Send make and model number. Major Appliances, 13106 Caine Ave., Cleveland, Ohio 44105.

MAKE GRANDFATHERS Hilarious toys. Instructions 25¢. Hill, Box 351 Point Arena, Calif. 95468.

EXERCISE At home on build-it-yourself physical fitness equipment, including bicycle exerciser, rowing machine, belt massager, and abdominal board. Send \$2.50 for blueprints B1208 and instructions. Popular Mechanics Service Bureau, 575-K Lexington Ave., New York, N.Y. 10022.

BOOKBINDING Kit—write for FREE gold stamped material samples and brochure. BH Bookbindery, Box 22291, Dallas, Texas 75222.

AVOID Expensive television repairs, homeowners repair guide, \$3.50. Maine Electronics, Box 5673, Tucson, Arizona 85703.

REFRIGERATOR Door gaskets—ELECTRIC RANGE parts. Send make and model for cost. Box 5465, Hamden, Conn. 06518.

RECHARGE OLD BATTERIES: Save up to \$3.00 on every 20¢ flashlight battery. Recharge old batteries and get 15 times the normal use. Recharge 9-volt radio batteries, AA, C, D, Nickel Cadmium, Carbon, Zinc and Mercury batteries. Ideal for toys, flashlights, photo flashes, tape recorders and radios. Recharge costs less than 1¢. Plugs into 110 AC outlet. Only \$5.95. Bryant's Mail Order House, 116 Water Street, Evansville, Wisconsin 53536.

ALUMINUM AWNING WINDOWS AND PATIO DOORS. Free Catalog. Jalco, 623 Sunrise Highway, West Babylon, New York 11704.

FLUORESCENT Tubes rejuvenated at no cost. Instructions \$1.00. Rejuvenators, 172 Bolton St., Portland, Me. 04102.

ARTS AND CRAFTS

MAKE Figurines, plaques, lawn ornaments. Molds, plastercraft kits, liquid rubber. Sample and catalogue 10¢. Woolley Company, Box 29-B, Peoria, Illinois 61601.

THOUSANDS OF UNKNOWN AND AMATEUR ARTISTS' PAINTINGS ARE NEEDED FOR CASH. Especially landscapes and portraits. Where to sell paintings. Send \$1.00. Art Sales, Sta. A, 812, Searcy, Ark. 72143.

FREE Catalog—over 10,000 handicraft items. Supreme Handicrafts, Box 395-PM, Sioux Falls, S. Dak. 57101.

DRIFTWOOD Good sample \$1.00. Decorative Tree Cones good assortment \$1.00 Postpaid. CHURCHCO. Alpine, Wyo. 83127.

STAINED Glass for beginners. Whittemore, Box L2065, Hanover, Mass. 02339.

YOUR Ad in Popular Mechanics will be seen by more than 5,000,000 active buyers for your products and services. It costs only \$1.85 per word. And, if you wish to run all or part of your ad in capital letters—you can do so for as little as 75¢ per word additional. Act now! Place your classified ad in Popular Mechanics today.

BINOCULARS, TELESCOPES, MICROSCOPES, MAGNIFIERS

WORLD Famous "Dynascope" Telescope. Build your own reflector telescope, mirrors, eyepieces, tripods, accessories. Request free brochures. Criterion Manufacturing, Dept. PP24, Hartford, Connecticut 06101.

SCIENCE Bargains! Lenses, telescopes, binoculars, microscopes, kits, parts, war surplus. Send \$1.50 for beginner's 10-lens kit with instruction booklet. Order Stock 2-CH. Request free 148 page Catalog CH. Edmund Scientific Co., Barrington, New Jersey 08007.

MANON Binoculars. Buy direct from importer. Best quality and prices. Write: Manon, Dept. M, Box 1386, Huntington Beach, California 92647.

BINOCULARS Direct from manufacturer. Finest quality, tremendous savings! Request catalog. Koyu, 3860 Crenshaw Blvd., Los Angeles, Calif. 90008.



CAMERAS AND EQUIPMENT

POLAROID Camera Owners Make Extra Copies Instantly. Free Brochure. Rhedan Electronics, Box 42P, Bridgeport, Connecticut 06601.

WORLD'S Largest Buying Guide—800 Illustrations—50¢—Deductible With Your Order—Olden Camera—1265 Broadway, New York, N.Y. 10001.

NIKON Specialists—Cameras, Binoculars, Projectors. Free Discount Catalog. Norman's, 56 W. Michigan, Battle Creek, Mich. 49014.

MAKE Money with your camera: Join Camera Arts Exchange: Free report. Box 101-M Hollywood, California 90028.

PHOTO SUPPLIES

MAILORDER Records help get Increased Business! Complete 32 Page Record Book shows your inquiries, orders, advertising expense, etc. Only \$1.00. C. A. Martin, Popular Mechanics, Dept. PM, 575 Lexington Ave., New York 10022.

PHOTO FINISHING

A FREE Kodak roll returned with each black and white or Kodacolor developed and printed, fast service, lowest prices, guaranteed quality send for free mailers. Economy Photo Service, Dept. P.M., Box 1111, Albany, N.Y. 12201.

8X10 COLOR Enlargements 80¢ each—Special Trial offer from 120 color negatives, professionals only send business card with order. Professional, Box 1873, New Haven, Connecticut.

PHOTOGRAPHY For Pleasure or profit. Learn at home. Practical basic training. Long established school. Free booklet. American School of Photography, 835 Diversey Parkway, Dept. 674-010, Chicago, Illinois 60614.

KODACOLOR—With this advertisement only—8-12 exposure, \$1.19. Astro Photo Service, Box 166M, Waterloo, New York 13165.

CAMERA Fans! Expert photofinishing and fresh Kodak film returned: 8MM Kodachrome \$3.45; 8 exp. Kodacolor \$3.40; 35MM Kodachrome, 20 slides, \$3.15; 8 exp. black & white 99¢. We give you free photo stamps to redeem for gifts. Satisfaction guaranteed. Send exposed film or request mailers and complete price list. Direct Mail Photo, Box 8352-PM, Pittsburgh, Pa. 15218.

SPECIAL WITH THIS AD—Kodacolor developed 12 prints \$2.25. Black & White developed 2 prints each Jumbo size—12 exposure 70¢. LENS PHOTOS, Dept. J-4, Janesville, Wis. 53545.

PHOTOGRAPHY For Pleasure or profit. Learn at home. Practical basic training. Long established school. Free booklet. American School of Photography, 835 Diversey Parkway, Dept. 674-010, Chicago, Illinois 60614.

COLOR SLIDES

EXTRA Income at home in Spare Time! Booklet shows you how to start your own business with Classified Advertising. Only \$1.00. C. A. Martin, Popular Mechanics Dept. PM, 575 Lexington Ave., New York 10022.

MOTION PICTURES AND SOUND EQUIPMENT

UNUSUAL Movie supplies. Free circular. Esor, 47th Holly, Kansas City, Missouri 64112.

8mm **MOVIES**—2" x 2" Color Slides—Biggest selection anywhere! Hollywood classics, great comedians, railroads, automobiles, trolleys, wars, travel, wild life, circuses, many others! 16mm. films also. Big catalog free! Blackhawk Films, 70 Eastin-Phelan Bldg., Davenport, Iowa 52808.

16MM sound-projectors, films, new, used for sale. Free catalog. National Cinema, 333 W. 57 Street, New York City, N.Y. 10019.

5,000 8-16MM **MOVIE** Films. Free catalogues. International, Greenvale, L.I., N.Y.

FREE 64-PAGE CATALOG. All your movie needs. 8MM-Super 8—16mm. B&W and color film. Cameras, supplies, accessories. Home processing equipment. Sound stripping. Superior, 448 N. Wells, Chicago 60610.

RADIO, TELEVISION AND HAM EQUIPMENT

33¢ **RADIO & TV** tubes. Free list. Cornell, 4213-17 University, San Diego, California 92105.

POLICE-FIRE etc. on Broadcast radio! Brochure. Tunerter, Woodsboro PM20, Texas 78393.

BRAND New tubes. World's lowest prices on radio, TV-industrial, special purpose tubes. Write for free parts catalog. United Radio, Newark, N.J.

HOME Electronics Course only \$26.95. Free literature. Edu-Kits, Department 701B, Hewlett, New York 11557.

GOVERNMENT Surplus receivers, transmitters, snooper scopes, parts. Catalog. 25¢. Meshna, Nahant, Mass. 09108.

POLICE-FIRE radio directories. Catalog 10¢. Communications, Box 56-PM, Com-mack, N.Y. 11725.

HIFI, RECORDS AND ELECTRONICS

FREE Catalogues, 2000 hard to find unusual records. Rose's, 300 Chelsea, Louisville, Ky. 40207.

STEREO TAPE CLUB. Average cost \$3.78 (4 track), \$4.20 (8 track). Cartridges, cassettes, reels. No minimum purchases. Free brochure—catalog. STAR RECORDINGS—PM, Box 1055, El Paso, Texas 79946.

TAPE Recorders, hi-fi components. Sleep learning equipment, tapes. Unusual values. Free catalog. Dressner, 1523C Jericho Tpke., New Hyde Park, N.Y. 11040.

RECORDS! Discounts on all LP's. Free details. Citadel Record Club, Symphonette Sq., Dept. 2, Larchmont, N.Y. 10538.

FREE-Free-Free-Free-Free-Free-Free. Send in for your free one year subscription to Olson Electronics' fantastic value packed catalog—unheard of low, low prices on brand name speakers, changers, tubes, tools, stereo amplifiers, tuners, CB and other values. Credit plan available. If you have a friend interested in electronics, send his name and address for a Free subscription also. Olson Electronics, 968 S. Forge St., Akron, Ohio 44308.

HOME Electronics course only \$26.95. Free literature. Edu-Kits, Department 700B, Hewlett, New York 11557.

NEW RECORDS DIRECT FROM ENGLAND. Every Continental artist. Classical. Popular. Rare singles, albums. Shipped by boat 4 weeks; air 4 days. Send 25¢ (Airmail 50¢) for comprehensive Catalog listing 4000 titles. Record Centre, Heanor, Dept. M-50, Derbyshire, England.



MUSIC AND MUSICAL INSTRUMENTS

PLAYER Piano Rebuilding—get details from: Vestal Press, Vestal 11, N.Y. 13850.

GUITAR, Banjo Making books Plans, woods, necks, tools. List 20¢. Satinwood, 510 East 11th Street, New York, N.Y. 10009.

ELECTRIFY Player pianos, pump organs quickly, inexpensively with Lee Silent Suction Units. Write Lee Music, Box 595P, Tujunga, California 91042.

ACCORDIONS 5 switches \$159.95. Any size. Melody Music, 4909 West 95th St., Oaklawn, Ill. 60453.

ACCORDION Top brands. Buy direct. Tremendous discounts. Trade accepted. Free brochure PM. Accordion-O-Rama, 874 Broadway, N.Y.C. 10003.

DRUMS, Electric guitars, amps, organs. Free catalog M: A.L.A.S. Import Company, 31 East 18th Street, NYC. 10003.

POEMS Wanted for new songs and records by America's largest song studio. Send poems. Free examination. Five Star Music, 6M Beacon, Boston, Mass. 02108.

30% DISCOUNT On any Name Brand musical instruments. Write for our low price. Freeport Music, Dept. A, 127 W. Sunrise Highway, Freeport, N.Y. 11520.

GUITARS, MANDOLINS, BANJOS complete stock of Gibson Martin fender free!! New 66 page catalogue parts and accessories, big savings New York discount prices send 50¢ postage, handling, Eddie Bell Guitar, 201 W49, New York 10019.

SWISS Musical Movements. Mechanical-Electrical. Spielman, 131 West 42nd, New York 10036.

ACCORDIONS, Guitars, Band Instruments! Save to 50%. Famous makes. Easiest terms. Trades accepted. Free home trial. Free discount catalog. Mention instrument. International Music Mart, 5535-R Belmont, Chicago 60641.

GUITARS, Accessories—Guitar maker's books, materials, supplies. Free catalog. Guitar Center, Box 15444, Tulsa, Oklahoma 74115.

ACCORDION Manufacturing, 6846-P North Avenue, Chicago, Illinois 60635. Concertinas, Hohners, Chromatics, Guitars, Drums, New, Used, Tuning, Repairing. Wholesale Catalogs Free.

POEMS, Songs wanted for new song hits and recordings by America's most popular studio. Tin Pan Alley, 1650-PM Broadway, New York 10019.

EXCELSIOR Accordions and Amplifiers. Save 50%. Buy Direct. Factory Distributor. Terms, Trades. Free Catalog. Excelsior 3147 North Luna, Chicago 60641.

WE Pay all recording costs on accepted material! Need new song material for immediate recording! Free examination! Grand Recording, 835-PM Dorchester Ave., Dorchester, Mass. 02125.

LEARN Musical instrument of your choice—easy! New home study tape course. Write for free brochure. Carver School, 10036 South Western, Dept. A, Chicago 60643.

SONGWRITERS Services. Free catalog. Baron Promotions, Box 464, Kenner, La. 70062.

GUITAR Amplifier. Practice in private. Make your own earphone amplifier. Extremely simple and inexpensive. Easy, complete plans. \$1.00 to: Amplifiers, Box 4110, Evansville, Indiana 47711.

ELECTRIC Guitars, amplifiers, wholesale. Free catalog. Carvin, PMM, Valley Center, Calif. 92082.

SONGPOEMS Wanted. Send poems for offer. Nashville Music Institute, Box 532-PM, Nashville, Tennessee.

SONGPOEMS Wanted! Write with active professional songwriters. Share royalties. Songwriters Contact, 1619-D Broadway, New York 10019.

EDUCATION AND INSTRUCTION

DETECTIVE Course. Free information. Criminology Institute, Box 201, Geronimo, Oklahoma 73543.

FREE Bible course. Exciting! CCM, 708 South Bragg, Monroe, N.C. 28110.

EARN College degree at home. All subjects. Ohio Christian College, 1156 Striebel Road, Columbus, Ohio 43227.

FCC First Class License in six weeks—nation's highest success rate—approved for Veterans Training. Write Elkins Institute, 2603D Inwood Road, Dallas, Texas 75235.

LEARN Auctioneering. Term soon. Free catalog. Reisch Auction College, Box 850, Mason City, Iowa 50401.

LEARN Civil and criminal investigation at home. Earn steady, good pay. State age. Institute Applied Science, 1920 Sunnyside, Dept. 16A, Chicago, Illinois 60640.

WATCH REPAIRING. Learn to repair American and Swiss watches in spare time at home. Diploma awarded. Free sample lesson. No obligation. Chicago School, Dept. YK, Fox River Grove, Illinois 60021.

SECOND Chance for high school drop-outs. Get diploma at home in spare time. Full credit for previous schooling. No classes. Given Free: Booklet on finishing high school at home. Government advice for drop-outs, aptitude test. Write: Academy for Home Study, 425 S. Dearborn, Dept. 82-935, Chicago, Illinois 60605.

LEARN Asleep or awake! Records, tapes, equipment! Free catalog! Drawer, PM-400, Ruidoso, New Mexico 88345.

EARN College Degree through experience. Send dollar for program. All subjects. Illinois Christian College, 537-PM South Dearborn, Chicago, Illinois 60605.

AUTOSUGGESTION, Sleep-learning headquarters! Tapes, records, books. Gigantic catalog free. Research Association, Box 24-PM, Olympia, Washington.

SWEDISH Massage. Foot technique. Post graduate. Home study. Residential. Diploma. Dr. Swanson's Illinois Licensed School, 3809-PL Alta Vista, Chicago 60613.

PENMANSHIP Improver: Improve quickly! Complete information free. Tevis, Chillicothe, Mo. 64601.

\$1,000,000 MEMORY. Yours Overnight. Free Details. Box 444PE, Maywood, CA 90270.

BIG MONEY—BARBERING. For career folder and list of recommended schools, send 10¢ to Barbering Careers, Dept. PM, 3839 White Plains Road, Bronx, N.Y. 10467.

FORGE Ahead With World's Greatest Motivation Program. Scientific, amazing, effortless. Includes following subjects: (1) "Financial Abundance", (2) "Self Confidence", (3) "Health and Happiness", (4) "Business Progress", (5) "Marital Harmony", plus 20 more incomparable recorded-printed courses. Free descriptive brochure. Alpha Distributing Company, P.O. Box 816-M, Chicago, Illinois 60690.

GET A British degree. Divinity, Philosophy, Radionics, 35 courses. Prospectus free. Brantridge Forest School, "Lodge" Brantridge Forest, Balcombe, Sussex, England.

USED Courses! Books! List 10¢. Smith's, 124 Marlborough, Salem, Mass. 01970.

EARN Your degree in electronics engineering. Highly effective home study courses in electronics engineering technology and electronics engineering mathematics. Free literature. Cook's Institute of Electronics Engineering, P. O. Box 36185, Houston, Texas 77036 (Established 1945).

DETECTIVE Training—for free information write to: 1917M, North Kenneth Ave., Chicago, Illinois 60639.

PIANO Tuning quickly learned with home study course. Diploma granted. American Tuning School, Gilroy, Calif. 95020.

PIANO Tuning pays. Big money in spare time. Learn at home. No musical knowledge necessary. Phonograph, records, tools and instructions furnished. Electronic tuning also taught. Free catalog. Capital Tuning School, 3160 S.W. 16th Court, Ft. Lauderdale, Fla.

DETECTIVE Course. Free information. Universal Detectives, Box 8180-F, Universal City, California 91608.

MISSOURI Auction School. GI Approved. Free catalog! 1330-03 Linwood, Kansas City, Mo. 64109.

SWEDISH Massage and physical culture pays big profits. Learn at home. Diploma. Free catalog. National Institute, Dept. E-107, 307 North Michigan, Chicago 1.

BE A Real Estate Broker. Big earnings. Free catalog. Weaver School of Real Estate, 3519-P Broadway, Kansas City, Missouri 64111.

AUCTIONEERING Free Catalog Resident or Home Study Course. Nashville Auction School, 2004 West End, Nashville, Tenn. 37203. Veteran approved.

Game Warden, Government Hunter, Forestry, Park and Wildlife Services announce job openings regularly. Prepare at home for outdoor work, good pay, security. Complete information Free! Write North American School of Conservation-AZ, Newport, California 92660.

WHY WASTE MONEY? Learn from Professors. University correspondence credit from 50 top United States colleges. No entrance examinations. 650 course brochure \$3.00. High school brochure \$2.00. Scientific Research, Box 2147 Napa, California 94558.

BOOKKEEPERS. Operate your own "Dollar-A-Week" system. Ellis, Box 200, Cedar Grove, North Carolina.

USED CORRESPONDENCE courses and books sold and rented. Money back guarantee. Catalog free. (Courses bought.) Lee Mountain, Pisgah, Alabama 35765.

COMPLETE YOUR HIGH SCHOOL at home in spare time with 71-year-old school. Texts furnished. No classes. Diploma. Information booklet free. American School Dept. X745, Drexel at 58th, Chicago, Illinois 60637.

DRAFTING—Home Courses \$25.00. Send \$2.00 First Lesson. Prior, Inc. 23-09 169th Street, Whitestone, New York 11357.

COMPUTER PROGRAMMING—The big opportunity career. New recognized correspondence course. No maths needed. FREE brochure. Canadian Institute of Science & Technology, 263M, Adelaide St. W., Toronto.

BECOME A bartender professional in short time, earn up to \$200 weekly. Write for free Home Study Course Brochure and Questions and Answers Folder. Dino's School of Bartending, 4587 E. Lake Meade, Suite 21, Las Vegas, Nevada 89110.

HOME Electronics Course only \$26.95. Free Literature. Edu-Kits, Department 703B, Hewlett, New York 11557.

BOOKKEEPING For Small Businesses. Short, low-cost course. Houghton Simonds, Salisbury, Conn. 06068.

AUCTIONEERING. New Concept. Two Step Program. Central States Auction School, Inc., 10934 Hickman Mills Drive, Kansas City, Missouri 64137.

AMAZING AUTOSUGGESTION record-keeping releases fantastic mental power! Free offer expires soon. Write: Forum, Studio AD10, 333 North Michigan, Chicago 60601.

LEARN SPEEDOMETER repair. Make good money. Instrument School, Box 1361-M, Muskogee, OK. 74401.

PENMANSHIP Corrector. Improve poor penmanship quickly. Details free. Ozment, Box 665-34, St. Louis, Mo. 63188.

SMALL ENGINE SPECIALISTS make big money. Lincoln Tech will qualify you to diagnose, adjust, repair or rebuild all outboard motors and small engines by shop method home study. Big pay jobs open, or start your own profitable business. Write for folder and application. Lincoln Technical Institute, Dept. PMC, 472 Market St., Newark, N.J. 07105.

TREMENDOUS Profits operating local or mail order Collection Agency. Continental, Box 2023-AA, Des Moines, Iowa 50310.

DETECTIVE Course—Florida's finest. Free information, 1034 Liberty St., Jacksonville, Florida 32206.

MINISTERIAL Extension courses. Send for entrance examination. Approved for veteran's. Soms, 887 West Spruce, Ravenna, Ohio 44266.

LEARN To Sing Beautifully! Free Particulars. Publisher, Box 118-P, Brooklyn 11203.

NONE-DEGREE ENGINEER: Become professional draftsman. Home study. Free career booklet. National Drafting Institute, 1820 Sanderson Ave., Scranton, Pa. 18509.

DETECTIVE Course. Free information. Criminology Institute, Box 201, Geronimo, Oklahoma 73543.

OVERCOME INFAMY PROBLEMS \$20. Pervis, 6421 40th Street, Tampa, Fla. 33610.

VISUAL Aids, 10-piece sectioned skulls, genuine human plastic models, skeletons etc. Ostan Company, P. O. Box 287, Northport, N. Y. 11768.

DETECTIVE Course. Free information. Criminology Institute, Box 201, Geronimo, Oklahoma 73543.

FOR INVENTORS

PATENT Searches complete and thorough. Related copies Air Mailed with maximum speed \$6.00. Free "Protection Forms" and "Patent Information." Write American Patent Search Company, Dept. 27, 711 14th St., N.W. Washington, D.C. 20005.

PATENT Application Financing. Free patent search plan. Global Patent Division, 2420 77th, Oakland, Calif. 94605.

PATENT And invention development by licensed professional patent engineer and U.S. Patent Office former examiner, and engineering specialists. Your inventions and ideas engineered for patent protection and commercial value. Inventions developed by us negotiated for cash or royalties with our nationwide contacts. Send for free protection "Invention Certificates" and further interesting, valuable patent information. George Spector, Licensed Professional Patent Engineer, Woolworth Building, New York.

U.S. Patent Office Searches, 234 Broadway, Room 3615, New York. Free invention certificates.

PATENT SEARCH SERVICE \$15.00! For Lawyers, Companies, Inventors. "Confidential report" including copies of related United States patents rushed "Certified Airmail" Free! "Patent Search Information." Write: Congress Patent Search Company, 911-C Warner Building, Washington, D.C. 20004.

QUALITY Patent Searches \$15.00! Preferred by Professional Inventors, Lawyers, Manufacturers. "Confidential Report" including related United States patent copies "Airmailed Certified." FREE Information! United States Inventors Service Company, 501-P Thirteenth Street, N.W. Washington, D.C. 20005.

IMMEDIATE Cash, for patent applications. Free patent searches. Write for details. Universal Patents, 184-D, Marion, Ohio.

PATENT Searches, including copies of related U.S. patents, \$15.00. Inventors attorneys, manufacturers use our "worldwide" airmail service! "Invention Record" form and "Information Every Inventor Needs" sent free! Hayward Company, 1029P Vermont, Washington 5, D.C.

INVENTORS Service Bureau—licensed professional patent consultants and development engineers, inquiries invited, 6635 Delmar—St. Louis, Missouri 63130.

INVENTIONS Needed immediately for manufacturers. For additional information write Kessler Corporation, C-510-FI, Fremont, Ohio.

TEST YOUR NEW PRODUCT'S retail sales potential. Free details, D-Nor Sales, 437 Dawn, Danville, Illinois 61832.

MANY Million dollar corporations have authorized us to locate new products. FREE "Directory of 500 Corporations Seeking New Products". For information regarding development, sale, licensing of your patented/unpatented invention. Write: Raymond Lee Organization, 230-N Park Avenue, New York City 10017.

INVENTIONS WANTED

INVENTIONS Wanted. Patented: unpatented. Tremendous manufacturers lists. Global Marketing Service, 2420G 77th, Oakland, California 94605.

INVENTORS! Outright cash sale or royalties for your inventions. Patented, Unpatented. Active demand from our client manufacturers. Financial assistance available. Write Dept. 36, United States Invention Brokerage, 78 Wall Street, New York, N.Y. 10005.

MANUFACTURERS NEED NEW ITEMS! B. F. Goodrich, Black & Decker, South Bend Tackle and other million dollar corporations have authorized us to locate new products. For details regarding development, sale, licensing of your patented/unpatented invention, write: Raymond Lee Organization, 230-N Park Avenue, New York City 10017.

INVENTORS! Don't sell your invention, patented or unpatented, until you receive our offer. Eagle Development Company, Dept. H, 79 Wall Street, New York 5, N.Y.

INVENTORS! Sell your invention for cash or royalties! Our client manufacturers eagerly seek new items. Patented, Unpatented. Financial assistance if needed. 25 Years proven performance. For free information, write Dept. 15, Gilbert Adams, Invention Broker, 80 Wall St., New York, N.Y. 10005.

INVENTORS! We will develop, sell your idea or invention patented or unpatented. Our national manufacturer-clients are urgently seeking new items for highest outright cash sale or royalties. Financial assistance available, 10 years proven performance. For free information write Dept. 47, Wall Street Invention Brokerage, 79 Wall Street, New York, N.Y. 10005.

WE Either sell your invention or pay cash bonus. Write for details. Universal Inventions, 298-E, Marion, Ohio.

INVENTORS: Protect your ideas! Free "Recommended Procedure." Washington Inventors Service, 422F, Washington Building, District of Columbia 5.

INVENTORS—If you have an invention for sale, patented or unpatented, wire for free brochure outlining manufacturer's requirements, Royalty rates, Kessler Corporation, C-510-IW, Fremont, Ohio.

THOUGHTS Inc., sold their patents. May we help you? 3625 W. North, Milwaukee, Wisconsin 53208.

PATENTS FOR SALE

TELL The more than 1,662,921 avid readers of Popular Mechanics about your products and services. It costs very little to place your classified message in front of these proven mail order buyers. For further details, write: C. A. Martin, Dept. 82R, Popular Mechanics, 575 Lexington Avenue, New York, New York 10022.

EXTRA Income at home in Spare Time! Booklet shows you how to start your own business with Classified Advertising. Only \$1.00. C. A. Martin, Popular Mechanics Dept. PM, 575 Lexington Ave., New York 10022.

MANUFACTURING

MODELS — small lot manufacturing. Metals, plastics, etc. Milburn, Burlington, Kentucky 41005.

INVENTORS Ideas developed. Research. Models. Manufacturing. Sales. Free brochure. William Parker, 32 Westminster, Worcester, Mass. 01605.

PARTS Manufactured or repaired 1 or 1000 pieces metal plastic rubber. Send for instructions. Line Tool, 21225 Van Dike, Warren, Michigan 48091.

BUY IT WHOLESALE

500,000 **BARGAINS BELOW WHOLESALE**. New, name brand merchandise. Buy at 10¢ on the dollar. Closeouts, surplus, bankrupts, liquidations, imports. Free details. International Buyers, Box 4633-M, Colorado Springs, Colo. 80909.

BARGAINS! Buy wholesale and below. Name brands. Appliances, furniture, sports equipment, televisions, cameras, watches, jewelry, thousands more. Huge discounts to \$1,000.00 on new automobiles. All makes. Free details. Write today: Worldwide Bargainhunters, Box 730-A, Holland, Michigan 49423.

"MAKE—Save Money: Buy Wholesale." Yourself, sell others. Dynamic facts. Send your name: Hymel, 2223A West Park Avenue, Houma Louisiana 70360.

ELECTRIC Guitars, amplifiers, wholesale. Free catalog. Carvin PMW, Valley Center, Calif. 92082.

ALUMINUM AWNING WINDOWS AND PATIO DOORS. Free Catalog. Jalco, 623 Sunrise Highway, West Babylon, New York 11704.

EXPORT-IMPORT

JAPAN: 1200 Products Directory. Illustrated. Manufacturers' names, addresses: \$3.00. Mail-Order Catalog. Novelties, \$1.00. Send Cash. Yamagata Office, 814 Togin Bldg., Marunouchi, Tokyo.

POMANDERS From England a lasting gift every woman will admire for illustrated price list enclose stamped self-addressed envelope to: Lawrence Co., Box 206, Hollywood, Calif. 90028.

FOR THE HOME

FOAM Furniture and boat cushions, direct from factory. 50% discount, free catalog. Perma-Foam, Inc., 605-C South 21st Street, Irvington, New Jersey 07111.

MAILORDER Records help get Increased Profit Business! Complete 32 Page Record Book shows your inquiries, orders, advertising, expense, etc. Only \$1.00. C. A. Martin, Popular Mechanics, Dept. PM, 575 Lexington Ave, New York 10022.

OUTDOOR Aroma the year around. Packets of Oregon sage, 35 cents. Ruby Baker, 430 W. Broadway, Eugene, Oregon 97401.

QUALITY Hardwood chairs, bar stools and benches. Free Catalog. World Products Co. R-1, Indian Trail, N.C. 28079.

ALUMINUM AWNING WINDOWS AND PATIO DOORS. Free Catalog. Jalco, 623 Sunrise Highway, West Babylon, New York 11704.

FOR PARENTS

EXTRA Income at home in Spare Time! Profit Booklet shows you how to start your own business with Classified Advertising. Only \$1.00. C. A. Martin, Popular Mechanics, Dept. PM, 575 Lexington Ave., New York 10022.

OF INTEREST TO WOMEN

WOMEN! Make big money at home. \$10.00 profit in an hour possible with invisible mending. Make holes, tears disappear from clothing, fabrics. Steady year-round demand from cleaners, laundries, homes. Details free. Fabricon, 1533 Howard, Chicago 60626.

TYPING Pays! Unbelievable \$30.00 thousand addressing envelopes from lists. Typewriter, longhand. Immediate earnings. Instructions \$1.00. Florida Service, P.O. Box 1017C, Hialeah, Fla. 33011.

HOME Typing. Earn up to \$100.00 weekly. Instructions, employers' list, \$1.00. Satisfaction or refund. Summithouse, Box 1762PM, New York 10017.

RAISE Rabbits for us on \$500 month plan. Free details. White's Rabbitry, Mt. Vernon, Ohio 43050.

DRIVE New car, wear new clothes, buy color TV. Get daily cash income. Put spare hours to work. Write for 5 months free subscription Opportunity Magazine: see hundreds easy ways to make money. Opportunity, Dept. 17JO, 850 N. Dearborn, Chicago 60610.

HOW To make money writing short paragraphs. Information free. Barrett, Dept. C-27-H3, 6216 N. Clark, Chicago 60626.

MAKE Extra Money! Introduce new Miracle Cantreze Nylons. Amazing low price. Guaranteed never to run. We show you how. Big outfit, sample stocking free. Spare time cash year-round. It's easy. Write American Hosiery Mills, Dept. AA18A, Box 753, Cincinnati, Ohio 45202.

EARN Up to \$2.00 hour lacing baby moks. Cuties, Warsaw 9, Indiana 46580.

HOUSEWIVES. Teachers, students, office workers. If you need extra cash each week but household or other duties prevent you from taking a part-time job, learn how you can earn by accepting orders to Popular Mechanics. Good Housekeeping and all other magazines. No experience needed. Write Popular Mechanics, Room 9-W, 250 West 55th St., New York 19, New York.

MAKE Money, spare time. Sensational manual reveals 25 fascinating, tested methods. Only \$2.00. Satisfaction guaranteed. True Values, 753 East 4th South, Salt Lake City, Utah 84102.

\$150.00 **WEEKLY** Typing, possible! Plans \$1.00. (Guaranteed) Camille, 202-PM, Brownell Street, New Bedford, Massachusetts 02740.

GIFT SHOPPING

ASTONISHING Offer! Full Color Catalog, 200 Gifts. Name brand watches, lifetime guarantee. Tremendous savings! Send \$1.00 Tryon Products Company, Dept. B, P.O. Box 2535, New Bern, North Carolina 28560.

SPORTSMEN, Homemakers, golfers, children. Free gift catalog. Brent Shinall, 1601 Westwood, Springdale, Arkansas 72764.

IDEA Packed 4-color, 132 page catalog. Send \$1.00 Country Manor, 5100 Edina Industrial Blvd., Minneapolis, Minnesota 55435.

UNUSUAL Christmas items distinctive gift catalogue free. Stanbridge House, 4228P Stanbridge, Long Beach, Calif. 90808.

FREE COLOR CATALOG, over 200 distinctive items, free bonus gifts, satisfaction guaranteed. C. E. Enterprises, 1305-A, Redondo, Killeen, Texas 76541.

COLORFUL Gift catalog free. Glen Bowles, Dept. PM-1, Winston, Oregon 97496.

GREATEST Drawing aid since the T-square. Draw circles, arcs, squares, quadrants, crosshatching, vertical and parallel lines easier. Guaranteed time saver. Free information, HFF Specialties, 158-A2 Glenridge Road, Scotia, New York 12302.

FREE Gift catalog—Personalized Delft baby plates \$4.75. Hundreds of items. DeBords 3115 Cumberland, Berkley, Michigan 48072.

BROCHURE Of unusual and new gift ideas free. MARSCH SERVICE, Box 112-P Hecla, So. Dak. 57446.

SHOP By mail gifts galore. Free catalog. Penry's, 11423-D Orchardview, Penton, Mich. 48430.

FREE! Catalog of unusual items. Many uses. Excellent as gifts. Immediate service. Satisfaction guaranteed. Act Now! AMZ Merchandising, Bldg. 198, 76 W. 22, Bayonne, New Jersey 07002.

WATCHES, OLD GOLD, JEWELRY

WATCH And clock repairing books. Free catalog. North American, Box 77-AX, Fox River Grove, Illinois 60021.

USED Pocket watches — as is — 5 for \$25.00. Joseph Bros., 5 South Wabash, Chicago 60603.

USED Wrist, pocket watches—\$3.00 up. Free list. Southern Watches, 5-PM South Wabash, Chicago 60603.

CASH Immediately for old gold, jewelry, gold teeth, watches, diamonds, silverware, spectacles, platinum, mercury. Free information. Rose Industries, 29-A East Madison, Chicago 2.

WANTED—Gold, silver, platinum (any form), mercury. Information free. Willmot's, 1067 Bridge St., Grand Rapids, Mich. 49504.

HIGHEST CASH for Gold, Jewelry, Gold Teeth, Rings, Diamonds, Watches, Silver, Platinum. Mail Articles Today. Free gift with information. Chicago Gold & Precious Metals, 6 E. Monroe, Dept. 958, Chicago 60603.

WATCH 17 Jewel gold plated German made. Men's, Ladies'. Wonderful Gift. \$12.00 Guaranteed. Crocker, Box 333, Laguna Beach, California 92652.

GART'S Book, "Pyrotechnics" \$8.50. Catalog 25¢, with samples 50¢. Bilton, Box 399, Hasbrouck Heights, N.J. 07604.

WEARING APPAREL

MEN—Buy your Outerwear Coats and Jackets **WHOLESALE** directly from manufacturer. Write now for free illustrated booklet showing styles for Fall 1968. Sharob Corp. Carbondale, Penna. 18407.

YOUR Ad in Popular Mechanics will be seen by more than 5,000,000 active buyers for your products and services. It costs only \$1.85 per word. And, if you wish to run all or part of your ad in capital letters—you can do so for as little as 75¢ per word additional. Act now! Place your classified ad in Popular Mechanics today.



SCIENCE AND CHEMISTRY

CHEMICALS Apparatus, Microscopes, Mineralogy Sets, Telescopes. Catalog 35¢. Sheard Science Supplies, Inc. Columbus, Wisconsin 53925.

CHEMICALS And apparatus for industrial, analytical, and private laboratories. Catalog 50¢. Dept. M-50, Biological Supply Co., 1176 Mt. Hope Ave., Rochester, N.Y. 14620.

ROCKETS!! Real flying models—2500 feet altitude with powerful motors. Terrific Science Projects. Tubes—Cones—Parachutes—Launchers—Igniters. Gigantic catalog—rocket data—diagrams—25¢. Fast Delivery. Centuri Rockets, Box 1988, Phoenix, Arizona.

UNDERWATER Fuse 3/32" Diameter. 25 Feet \$1.00—125 feet \$4.00. Postpaid. Free Catalog. Zeller, Box 646, Hudson, Mich. 49247.

ROCKETS: Real flying models—flights up to 2500 ft. New illustrated catalog 25¢. Single and multistage kit, cones, engines, launchers, trackers, rocket aerial cameras, technical information. Fast service. Estes Industries, Penrose 7, Colorado 81240.

PYROTECHNIC Casings, stars, devices of all types. Send 50¢ for samples. Ecco, Box 189, Northvale, New Jersey 07647.

UNDERWATER Fuse 63 feet \$1.00. Professional green fuse 45 feet \$1.00. Christie, Box 85, Bergenfield, New Jersey 07621.

PYROTECHNIC Instruction manual. Make Stars, Gerbs, Smokes, Many more. Only \$1.50. Solowel, Box 123, Dumont, N.J. 07628.

PYROTECHNIC Casings. Low, low prices. Underwater fuse 70 feet \$1.00. Professional green fuse 50 feet \$1.00. Weingart's book, "Pyrotechnics" \$8.50. Catalog 25¢, with sample 50¢. Bilton Box 399, Hasbrouck Heights, N.J. 07604.

AMAZING Amature rocket. Heights to 15,000 feet. Instructions and diagrams only \$1.00. Solowel, Box 123, Dumont, N.J. 07628.

FLYING Saucers (New—Sun Powered—No Motors). How to Build Easily for less than \$5 using Styrofoam and Plastic Bags. Many Sizes—Designs. Complete Descriptions—Plans—Drawings. \$2 Guaranteed. Spacetronics, Box 31043-PM San Francisco, California 94131.

PYROTECHNIC Chemicals, casings, supplies. List 10¢. Pyrochem, Box 189, Berlin, New Jersey 08009.

PROFESSIONAL model rocket ignition fuse, burns underwater, 75 feet, \$1.00. Edcolabs, Box 99, Berlin, New Jersey 08009.

PYROTECHNIC Instruction manual. Reveals formulas, preparations, uses. Only \$2.00. Free with order, \$1.95 bonus Kit. Edco, Box 99, Berlin, New Jersey 08009.

NEW Formula Catalog. 15¢. Bylina, P.O. Box 09131, Chicago, Illinois 60609.

SEARCHING For economically priced Laboratory Supplies? Gifts with catalogue—25¢. Hagenow Laboratories; Manitowoc, Wisconsin 54220.

FREE Gift and discount lists with Laboratory Supplies. Catalogue—35¢. Deluxe Scientific, Manitowoc, Wisconsin 54220.

SEARCHING For economically priced chemicals and apparatus? Gifts with catalogue, 25¢. Starr Scientific, Manitowoc, Wisconsin 54220.

FUSE SAMPLE and Pyrotechnical Chemical catalog—25¢. Box 121, Sierra Madre, Calif. 91024. Absolutely LOWEST Prices.

ROCKETRY and Pyrotechnics catalog. 20¢. Franks Scientific Co., P.O. Box 156, Martelle, Iowa 52305.

LASER Pistol how to build \$1.00. PHASER PISTOL you have seen it on TV, now build your own, safe, loads of fun, \$1.00 Laser Rifle, Electronic Laser, Helium-Neon Laser, \$4.95 Each. Complete Catalogue of "PRIZE-WINNING" Science Projects 35¢. Roy Davis Laboratories, Dept. PM Drawer 17067, Jacksonville, Fla. 32216.

CATALOG Of exclusive products! 20¢. PMT, 50 Atlantic, Metuchen, New Jersey 08840.

SELENITE Crystals 60—\$10! Samples—1 for 50¢, 4 for \$1. Rockhound-c, 50 Atlantic, Metuchen, New Jersey 08840.

GROW Gigantic Crystals! Manual—\$2.00. PMT, 50 Atlantic, Metuchen, New Jersey 08840.

ILLUSTRATED Catalog: Chemistry, mineralogy, biology 25¢. Tracey Laboratories, Evanston, Illinois 60204.

FORMULAS, PLANS, ETC.

FOR Proof of what you can do in specialty manufacturing get our literature. It's free! Miller, Chemist, 1517-P, Tampa, Florida 33601.

ANY Formula \$3.00. Catalog—Treatise 10¢. Belfort, 192 N. Clark, Chicago 60601.

ENCYCLOPEDIA Of formulas, processes. Details free. Cassill, Box 1535, Eugene, Oregon 97401.

PLASTICS

PLASTIC Embedders, jewelry workers. We have everything. Findings, moulds. New catalog 25¢. David Co., 861 Broad St., Dept. M, Providence, R.I. 02907.

CASTOLITE Liquid Plastic pours like water and hardens like glass without heat. Clear, colors. Embed real flowers, butterflies, photos, coins. Also new molding formulas for perfect reproductions. Illustrated booklet shows how. Send 25¢—Dept. 68-101L, Castolite, Woodstock, Ill. 60098.

TREASURE FINDERS

TREASURE Booklet. Excellent information on treasure hunting and metal detectors. Send 25¢. Booklet, P.O. Box 243, San Gabriel, California 91778.

FREE 128 Page detector catalog. General Electronic Detection Co., Box 67, Bellflower, California 90706.

POWERFUL Metrotech locators detect gold, silver, coins, relics. Moneyback guarantee, terms. Free information. Underground Explorations, Dept. A, Box 793, Menlo Park, California 94025.

FIND Buried treasure with new revolutionary analytical metal detector. Features push button tuning, automatic tuning, loudspeaker, negligible ground pickup, greatest range. Free catalog. Gardiner Electronics, Dept. 9, 4729 N. 7th Ave., Phoenix, Ariz. 85013.

URECON Metal finder. 8" head, transistorized, \$37.50 delivered. Urpa, 6304 Beechwood, Sarasota, Fla. 33581.

TREASURE Hunters! Prospectors! Relco's new instruments detect buried gold, silver, coins, minerals, historical relics. Transistorized. Weighs 3 pounds. \$19.95 up. Free catalog. Relco-A40, Box 10839, Houston, Texas 77018.

NEW Sensitive Treasure Metal Detectors. New low prices. Professional models from \$29.95 to \$129.50. Write for free catalog today. Jetco Electronics, Box 132-PM, Huntsville, Texas 77340.

TREASURE. Gold, silver, relics. New 1938 detectors now available. Free information. Rayscope, Box 715, North Hollywood, California 91603.

LOCATE—Underground streams Water, Tile Lines, Sewer Pipes Etc. Make Locator 5 minutes. Few cents Hardware. Full Instructions \$1.00. FAR, Box 141, Watertown, Wisconsin 53094.

METAL DETECTOR, can't afford one \$2.00 for complete plans, diagrams, to construct a sensitive metal detector Phaeton Corp. 291 W. Boylston St., West Boylston, Mass. 01583.

TREASURE Hunters—You'll find more authentic leads in True Treasure magazine than anywhere else in world. \$2.75 six issues, \$5 twelve. Box 217-P, Conroe, Texas 77301.

"METAL Locators—Accessories. Write: Detectors, Inc., Box 101-D, Springfield, Va. 22150."

FISHER "METALERT" award-winning Model 70. Brand new treasure and metal detector for exciting results! Unsurpassed sensitivity. Use anywhere, even beaches and streams. For Free literature write: Fisher Research, Dept. PM-10 Palo Alto, California 94303.

PRECIOUS STONES AND MINERALS

EARTH Science Rockhound Magazine. Subscription \$2.50. Sample 35¢. Box-550-PM, Downers Grove, Ill. 60515.

100 COLORFUL, Polished gemstones, \$1.00. Tumblecraft, 5401 James North, Minneapolis, Minnesota 55431.

GET Free catalog no serious rockhound, gem cutter, jewelry maker, hobbyist or craftsman can be without. Full of bargains, exclusive items, low prices from largest suppliers and authorities in the field. Free new catalog just off the press, yours for the asking. Write Grieger's, Dept. C-12, 1633 E. Walnut, Pasadena, California 91106.

400 POLISHED GEMSTONES \$2.75. Beautiful crystals, 6 different \$2.00. Lists with order. Sering, 1705 E. Michigan, Indianapolis, Indiana 46201.

SEMI-Precious uncut gems. Ten different for \$1.00. Request list 30. Prospectors Shop, 201 San Francisco, Santa Fe, New Mexico 87501.

CARTOONING, COMMERCIAL ART, SHOWCARD & SIGN PAINTING, TATTOOING

SIGN Painting. Fascinating System—Straley, 410 So. Western, Springfield, Ohio 45506.

COMPACT 23 lesson Cartoon Course and Cartoonist's Magazine, \$2.00. Hartman, Box 30367, Lincoln, Nebraska 68510.

LEARN Profitable tattooing. Illustrated information and instructions \$3.00. Zeis, 2220-P Delcy Dr., Rockford, Illinois 61107.

CARTOONING AND COMMERCIAL ART. Easy home-study drawing course. Art background not necessary. Excellent creative money making opportunities part or full time. We show you how. Low monthly tuition. Free booklet. Continental Schools, Dept. 8A29, 1330 W. Olympic Blvd., Los Angeles, Calif. 90015.

"HOW TO MAKE MONEY WITH SIMPLE CARTOONS"—Everyone who likes to draw should have this book: Free. Write Cartoonists' Exchange, 910 Pleasant Hill, Ohio 45359.

LEARN Sign painting at home. Free talent test. Ben Kerns, Box 812-PM, Greenville, S.C. 29601.

SIGN Painting—Instructions, brushes, equipment. Free catalog. Kaufmann Supply, Centertown, Missouri 65023.

LEARN Diploma Lettering. Big earnings. Lesson \$2. Scriptcraft Studios, 350 West Pine, Long Beach, New York 11561.

DRAW For profit. Learn cartooning professionally. Free booklet. National School of Cartooning, Studio-H, Box 8958, Cleveland, Ohio 44136.

ADVERTISING AGENCIES, ADV. SERVICE, MAILING LISTS

MAILING Lists most all kinds 1000 \$5.00. Free folder. Your circulars mailed \$4.00 1000. Dixie Mailers, King, N.C. 27021.

ADVERTISING Ratebook leading newspapers, magazines, 25¢. Chicago Advertising Agency, 28-E Jackson, Chicago 60604.

TYPEWRITERS, DUPLICATORS, OFFICE EQUIPMENT

FREE Plan. Start printing, lettershop. Offset Presses, Mimeograph Copy machines. DixieGraph, King, N. Car. 27021.

RUBBER STAMPS AND OFFICE SUPPLIES

FREE 40 Page catalog. Rubber stamps, office supplies. Youngers Stamp Shop, Princeton, Iowa 52768.

ADDRESS Stamp \$1.50 Signature \$2.80 Catalog. Carol's McLoyd, Okla. 74851.

FREE Catalog. Rubber stamps 4 Lines \$1.25. Bilmar, 11117 Ewing, Minneapolis, Minnesota 55431.

3 LINE Address stamp, \$2.50. Indexed walnut mounts. Robert Hancox, 18 Sherwood Drive, Latham, N.Y. 12110.

OVER \$16.50 an hour Spare Time at home! Rubber Stamp industry needs small manufacturers. We furnish all equipment and know-how! Particulars Free! Write: Roberts, 1512 Jarvis, Room CR-2-LO, Chicago, 60626.

PRINTING, MULTIGRAPHING, MIMEOGRAPHING, GUMMED LABELS

BOOKLET Specialist, on Hi Speed Web. Free Price List 20M 16pg 8 1/2 x 11 2 color booklets at 2¢ each. Copen Press, 337P Butler St., Brooklyn, N.Y. 11217.

OFFSET PRINTING—8 HOUR SERVICE 25 to 5,000 copies. Free booklet "Secrets of Cutting Printing Cost." Nationwide Printing, Atlanta, Illinois 61723.

AMAZING Business printing values. Quotations. Print Shop, Box 576, Greenville, R.I. 02828.

250 8 1/2 X 11 LETTERHEADS, \$3.50; 250 Envelopes, \$3.50. Davis, 7609 Spruce, Baltimore, Maryland 21222.

PERSONALIZED MEMO PADS 200 sheets 5x8 bond with your name \$1.00. Make impressive gifts. Colorcraft, 541 Lake, Saint James, N.Y. 11780.

MIMEO OWNERS: turn your mimeograph into a printing press with electronic stencils. FREE instructions, samples, introductory offer. Seaview-P, 212-26 48th Avenue, Bayside, N.Y. 11364.

1,000 GUMMED Address labels \$1.00. Walt's, Box 966A, South Bend, Indiana 46624.

CARTOON SCRATCH PADS—5 pads \$2.00. Northfield Press, Beechcroft Rd., Hydes, Maryland 21082.

1000 BUSINESS Cards. "Raised Lettering." \$4.50 Postpaid!!! . . . Samples Noble PM10, 505 Briggs, Bellmore, New York 11710.

DISTINCTIVE "Embossed" Letterheads. Amazing Bargains. Postpaid. Universal, 226-MJ Myrtle, Scotch Plains, N.J. 07076.

PRINTING? Speed—Quality—Economy. Samples. JLP, Box 817, Fort Lauderdale, Florida 33302.

FREE Literature: Address Labels, Business Cards, Printing, Rubber Stamps. Jordan's, 552 West O'Connor, Lima, Ohio 45801.

TOP QUALITY OFFSET. 8 1/2 x 11. 20 lbs. bond. \$6.75 postpaid. Special handling. Biscayne, Box 346, Wall Street, New York, New York 10005. Write for catalog.

PRINTING & RUBBER STAMP OUTFITS—SUPPLIES

MAKE Your own self-molding rubber stamps and printing cuts. Plexirubber, Argyle (-1-), Wisconsin.

TYPE Catalog No. 11, 96 Pages. Send One Dollar. Deductible First Order. Acme Type, 732 Federal, Chicago, Illinois 60605.

SAME Day shipment on rubber stamp supplies. Revised wholesale price list No. 5 free. Star Stamp Supply, 732 Federal, Chicago, Ill. 60605.

DO Your own printing. Save money. Simple rules. We supply everything. Print for others; good profit. Raised printing like engraving too. Have home shop. Details free. Kelsey Presses, V-11, Meriden, Connecticut 06450.

RUBBER Stamp outfits, supplies. Kiewit, 2025 Barney Road, Kalamazoo, Mich. 49007.

PRINTING Presses, type, supplies, Lists, 5¢. Turnbaugh Service, Mechanicsburg, Pennsylvania 17055.

NEW 1968-69 Printers Supply Catalog 264 page 9" x 12" book. Hundreds of new items. Rubber stamp presses and supplies, hot stamping equipment, hand and power printing presses, proof presses, paper cutters, folding machines, composing room equipment, offset equipment, drawing equipment, thousands of items. The most complete Graphic Arts book published. All items illustrated. Postpaid. \$5.00 American Printing Equipment & Supply Co., "Dept. PM" 42-25 Ninth St., Long Island City, N.Y. 11101.

DEEP Face Hard Type for better Rubber Stamps and printing. Complete line of stamp presses and supplies. Buy direct. Barco Type Manufacturing, 237-A Evergreen, Bensenville, Illinois 60106.

POCKET Stamp printer, your name, address 89¢. B. Ormiston, Stockport, Ohio 43787.

REMAILING SERVICE

SECRET Receiving and remailing. Discreet and confidential. Remail 25¢ single. 8050 S. Main, Houston, Texas 77025.

LOS ANGELES, Hollywood, 25¢ single, \$3.00 monthly postcards. Confidential, 10437 Lanark, Sun Valley 91352.

RECEIVING-Forwarding, \$3 Monthly. Hedgpeh, 406-M South Second, Alhambra, Calif. 91802.

SO. AMERICA Registered re-airmails \$1.00. Confidential. Genaro, Box 360, Guayaquil, Ecuador.

MIAMI Remails 25¢. Monthly rates. Marle, Box 1266, Coral Gables, Florida 33134.

KANSAS CITY, Kansas, Missouri. Confidential Remails 25¢. Receiving, Forwarding. Information Free. Midway Enterprises Inc., 3115-F South 45th Street, Kansas City, Kansas 66106.

CONVENTION City Remails 25¢. Colorful Postcards. Schoen, Box 1963-P, Chicago, Illinois 60690.

TEXAS Remails, 25¢ Singles, \$3.00 monthly. Box 9762, Austin, Texas 78757.

ENTERSULL, Your secret address. Prompt. Reliable. Box 18810M, Forsyth, Ga. 31029.

ATLANTA Remails 25¢. Monthly rates \$3.00. Daytona, Box 8087, Atlanta, Georgia 30306.

REMAIL WITH ASSURANCE. \$3.00 monthly—singles 25¢. Confidential Remails, Box 114, Placentia, California 92670.

LAS VEGAS Remails 25¢, \$3.00 monthly, Confidential, free details. Bmec, Box 1186, Las Vegas, Nevada 89101.

HONOLULU HAWAII Fast Remails 25¢; \$3.00 Monthly. Bernard, Box 9667, Honolulu, Hawaii 96820.

MILWAUKEE Remails, 20¢ each. Monthly, yearly rates. Rausch, 797 N. Marshall, Milwaukee, Wis. 53202.

CHICAGO—Remailings, 25¢, Confidential. Modern Services, Box 27056-P, Chicago, Illinois 60627.

LOS Angeles 20¢, \$2.00 monthly. Hess (8A10), 11112 Osage, Inglewood, California 90304.

BOSTON—Singles 25¢ REQUEST SPECIAL FORWARDING RATES Dad-PM Box 651, Waltham, Massachusetts 02154.

CANADA Remails 35¢. Confidential Service, P.O. Box 132, Scarborough, Ontario.

CHICAGO Instant remailing \$3. Monthly. Karales, 5116 So. Bishop, Chicago, Illinois 60609 (PM-10).

MIAMI Remails 25¢. Monthly \$3.00. 430 Alcazar Ave, Coral Gables, Florida 33134.

FLORIDA Remails 25¢, Monthly Rates. Ciria, Box 11032, St. Petersburg, Florida 33713.

REPAIRS AND SERVICING

EXTRA Income at home in Spare Time! Booklet shows you how to start your own business with Classified Advertising. Only \$1.00. C. A. Martin, Popular Mechanics Dept. PM, 575 Lexington Ave., New York 10022.

SPECIAL SERVICES

INFORMATION On anything. Ferguson Research Specialists, 83-45 Victor Ave., Elmhurst, N.Y. 11373.

RESEARCH By a professional. Jeltema, Box 554, Inglewood, California 90307.

AUTHORITATIVE INFORMATION On Anything. \$2.00 deductible. Metzler Research, P. O. Box 2206Y, Long Island City, New York 11102.

NEW Car buyers you can figure dealer cost and properly value your trade in. Simple, complete instructions \$3.00. Macs, Box 162 PM, Topeka, Kansas 66603.

EMPLOYMENT Opportunities including names and address. Dollars and cents information on cost of living. \$3.00 for large packet. Box J, Torrance, California 90507.

HOW To retire without money! Now! Any Age! Free Details, Brooks, 320-Q West 34th, N.Y.C. 10001.

TOBACCO

PROFIT With Popular Mechanics' subscription plan. No investment, no experience needed. Earnings begin immediately when you obtain subscription for Popular Mechanics, Good Housekeeping and others. High commissions, bonus. No experience needed. Deal directly with the publisher. Write Popular Mechanics, Room 3B, 250 West 55th St., New York 19, N.Y.

SELECT From one of the largest stocks of imported pipe tobaccos, pipes, smoker's accessories. Free brochure. Briar Haven, Box 125P, St. Ann, Mo. 63074.

RAZORS

MAILORDER Records help get Increased Business! Complete 31 Page Record Book shows your inquiries, orders, advertising, expense, etc. Only \$1.00. C. A. Martin, Popular Mechanics, Dept. PM, 575 Lexington Ave., New York 10022.

NEW SHAVING IDEA. I average 40 shaves per blade. No Sharpening. Full Information \$1.00. W. H. Sherick, 1354 Bernard Ave., Willow Grove, Pa. 19090.

WANTED—MISCELLANEOUS

MERCURY. Gold, Silver, Platinum: Ores assayed. Wholesale Terminal, Norwood, Mass. 02062.

PERSONAL

BORROW \$1,205 Airmail! Repay \$47 for 36 months. State licensed. Postal Finance, Dept. 17-T, 200 Keeline Building, Omaha, Nebraska 68102.

WILL Forms (2) Instructions by lawyer covering 50 states \$1.00. Ward, Ward & Ward, Box 185, Fairfield, Alabama 35064.

SUBCONSCIOUS Conditioning remakes personality while you sleep. Free details. Sleep-Learning, Box 24N, Olympia, Washington 98551.

STOP Smoking! New Book presents Medical and Psychological Step-By-Step Method. Money Back Guarantee. Send \$2.00. Lincoln, 2237 1/2 N. Bissell, Chicago, Ill. 60614.

SELF-HYPNOSIS. Home Study Course. Authoritative, easy, practical. Details free. Southern Institute of Hypnology, Dept. M, 644 N.W. 95 St., Miami, Fla. 33150.

WIN MONEY EVERY MONTH working contests and puzzles. Free details. NO MINORS. International Contest Club, Box 10153, Dept. PM-4, Kansas City, Missouri 64111.

RUPTURED. Relief and comfort. No understraps, elastic or steel. Write Hand-Lock Products, Preston 4, Ont., Canada.

RAISE Money, consolidate bills. Free amazing details. Write Interstate, 28 E. Jackson, Suite 1204-PM, Chicago 4.

FREE Catalog low priced, high performance subminiature listen-in devices straight from manufacturer. Dealers welcome. Audiotronix-P, 156 Fifth Avenue, New York, N.Y. 10010.

PAY Bills! Have cash left over. \$39.39 repays \$1000 in 36 months. Write for details. World Finance Company, Dept. OW-010B, 620 Symes Bldg., Denver, Colorado 80202.

WHY Worry about work? Read Secret of Achievement. Details free. Nichols, 2161-C Sunnyland Boulevard, Springfield, Ohio 45506.

ELIMINATE Worry, Fear. \$1.00 R. Wood, 255-9th Ave., San Francisco, Calif. 94118.

NOTORIOUS Pctato whisky. Northumberland rum made legally without distilling plus Elizabethan strong ale and many other potent brews. Reprint of ancient recipes, but using simple modern kitchen methods. Send \$2 to: Olde London Brewhouse, 423 Riverside, Oakville 1, Ontario, Canada.

RETIRE WITHOUT MONEY Age not important. Details Free. Chester Products, 741 North Chester Street, Baltimore, Maryland 21205.

PERPETUAL Motion Journal 4 \$2. Information free. 1616 Compton PM10, St. Louis 63104.

BORROW \$100 to \$1000 by Mail. Quick. Easy. Private. No Co-Signers. Repay in 36 small monthly payments. For the amount you want write today to Dial Finance Co., 410 Kilpatrick Bldg., Dept. K-214, Omaha, Nebraska 68102.

HOW To Have Confidence and Power with Other People. Make them say "Yes". Get what you want. Good first impressions. 164 Page Book reveals ways. Send \$2.00. Heritage House, Dept. PM-1081, 28 Sheffield, Longmeadow, Mass. 01106.

YOU Can amaze people by appearing to have gained the powers of extrasensory perception, overnight. Guaranteed to work. Send \$2.00 to: R. L. Jones, P.O. Box 9771, El Paso, Texas 79988.

LOWEST Priced subminiature electronic surveillance equipment. Omega. Box 4021M, Fayetteville, N.C. 28306.

I CAN Wipe Out Your Debts. No Red-Tape. Free details. Counselor-7, Harlingen, Texas.

LIFETIME IN PERSPECTIVE—Handy reference card recalls changes of the past 80 years. Includes inventions, discoveries, wars, presidents, historical 1st's, and world events—all arranged to show which changes occurred during a person's lifetime. Only \$1.00. Lifetime, Box 156, Bon-sall, Calif. 92003.

LONELINESS, POOR HEALTH, FEAR, make life dreary. Find love, joy, peace. Free information. Eternal Lite, 33 New Tripoli, Pa. 18066.

HIGHER INCOME, security and power. 256 page book "thinking big" reveals secrets that make men rich! Send \$2.00. Cyrus Morgan, 4511 Don Ricardo, Los Angeles, California 90008.

HOW To retire without money Now! Any age. Free details. Brooks, 320-M West 34th, New York City 10001.

LAW ENFORCEMENT agents and legal investigators only. Free literature, latest electronic aids. Request must be on your official letterhead. F Clifton, 11500-P NW 7th Ave., Miami, Florida 33168.

"MAKE FRIENDS" send your description and a stamp for bulletin "INTRODUCTIONS" P.O. Box 2471, Detroit, Mich. 48231.

BIBLE Questions answered. Stamped envelope. Bylon, 17167 Bentler, Detroit, Michigan 48219.

FANCY ORNAMENTAL POULTRY

MAILORDER Records help get Increased Business! Complete 32 Page Record Book shows your inquiries, orders, advertising, expense, etc. Only \$1.00. C. A. Martin, Popular Mechanics, Dept. PM, 575 Lexington Ave., New York 10022.

MISCELLANEOUS

ORNAMENTAL Iron designs. Book of 1600 beautiful, practical designs for railings, columns, etc. Free literature. Cunningham, 3881 South 3200 West Salt Lake City, Utah 84119.

SILENCERS For pistols and rifles. Complete details for construction and operation. \$1.00. Gunsmith, Box 185, Fairfield, Alabama 35064.

YOUR Name sent to 1000 importers, publishers, mailers, wholesalers, etc. on our mailing list. Year \$1.00. Dixie Mailers, King, N. Car. 27021.

HEARING Aid batteries wholesale. Free list. Habs, Box 51, York, Penna. 17405.

WINEMAKERS—Free catalog and recipes. Kraus, Box 451-L, Nevada, Missouri 64772.

QUART Oregon Hops with 101 recipes—Homebrewing, Winemaking, Hoppreads. Catalogue, \$1. Nichols Hops, 1190 North, Albany, Oregon 97321.

BIRTH Certificates, Marriage Certificates, Diplomas! 2 blank forms \$1.00. Sample 10¢. Standard Forms, Box 482-M, Washington, D.C. 20044.

KILL Mosquitoes, Insects, electrically. Free information. US Insect Control, Box P374, Royal Oak, Michigan 48068.

BOOKS On antiques and their prices. Free circular! P. Warman Publishers, Uniontown, Penna. 15401.

SHEEPSKIN—Genuine, washable, natural and colors for rugs, car sets, etc. Inquire—Sheepskin Decor, 1404 Bath Road, Bristol, Penna. 19007.

CIGARETTES 12¢ a pack. Improved roller makes 20 filtertip, plain, king or regular for 12¢. Facts Free. Moberly, Box 954, Owensboro, Kentucky 42301.

WINEMAKERS. Free illustrated catalog of yeasts, equipment. Semplex, Box 7208, Minneapolis, Minn. 55412.

LIST Your name with Importers, Manufacturers, Mailers, etc. One year, \$1.00. Includes sample product. Cal-Mail, Box 1264 Annex, Canga Park, California 91304.

WINEMAKERS! New Illustrated Supplies Catalog. Free! Write Today! Winemakers Box 11211PJ, Indianapolis, Indiana 46201.

WINEMAKING . . . Grape, Elderberry, Dandelion, Frozen Juices, etc. Brewmasters' secrets revealed! Powerful methods! Instructions, recipes and supplies catalog. \$1.00. Continental, Box 11071-PJ, Indianapolis, Indiana 46201.

FLYING Saucer photos. Catalog 35¢. UFO International, P.O. Box 552, Detroit, Mich. 48232.

SICK Of being sick? Sick of being a loser? Send 25¢. Rev. Suber, Box 7872, Phila., Pa. 19101.

AUTHENTIC Reproduction of 1840 \$1000.00 American Bill. \$1.00 Five Star. Dept. 10M, 2238 East 15th Street, Brooklyn, New York 11229.

BEERS, Wines, Peach Brandy—Strongest Formulas, \$2.25. (complete brew supplies hydrometers catalog included)—Research Enterprises, 29-SN35 Samoset.

RECEIVE Mails, magazines, samples, catalogues. Get listed. 30¢. Norman Rorick, Pleasant Plain, Ohio 45162.

BEDWETTING Stopped Scientifically! Doctors Approved Method. Instructions \$2. Szypszak, 104 Husa, Linden, N. J. 07036.

1001 FREE THINGS—just writing different places!! List 50¢. Complete writing kit \$1.00. Sunshine House, Dept. P501, Flushing, New York 11352.

EXCLUSIVE Original illustrations not prints space scenes and others. Information. \$1. 615 N. Rossmore, 104, Los Angeles, California 90004.

EINSTEIN'S Space theory simplified. \$1.00. Chris. 4493 Felton, San Diego, Calif. 92116.

RECEIVE Volume mail, 10¢. Kirkman, 1 Ann Street, Woodbridge, Virginia 22191.

AMAZING Books, jewelry-sweaters-watches. Lynn's, Box 1573 Waco, Texas 76703.

CHEAP Heat Burn used oil. Garage, work shop, etc. Plans—\$2.95 Wm. E. Thomas—Belle Fourche, S. Dak. 57717.

MAKE Five Gallons of Real Canadian Beer. Send \$1.00 to: Easy, Box 1181, Vernon, B.C. Canada. No Cheques.

MEN! Confidential Directory containing 69 Dealers. Unique, Unusual items. \$1. Royal, Box 599, Dept. P.M. Grand Central Station, N.Y.C. 10017.

LET US tell you how to turn the reading habits of your friends into profit for you. \$10.00, \$25.00 or \$50.00 can easily and quickly be made under our Popular Mechanics subscription plan. No experience needed. Write Popular Mechanics, Room 10-M, 250 West 55th St., New York 19, N.Y.

We put fiber glass in FGA® shingles for the same reason it's in crash helmets:

Lightweight Protection

J-M's lightweight FGA® shingles give your roof special protection from weather, plus long roof life and lasting good looks. Because fiber glass in shingles (as in helmets) resists cracking, curling, rotting and warping.

The combination of fiber glass and asbestos in FGA shingles also gives you extra fire protection. They've been awarded the Underwriters' Laboratories Class A fire rating—the highest given. And our Seal-O-Matic® feature makes them exceptionally wind resistant. They've actually withstood hurricanes.

If your roof needs replacing, do it with FGA shingles. They come in 14 wife-pleasing color blends. See them at your J-M dealer's.



Johns-Manville

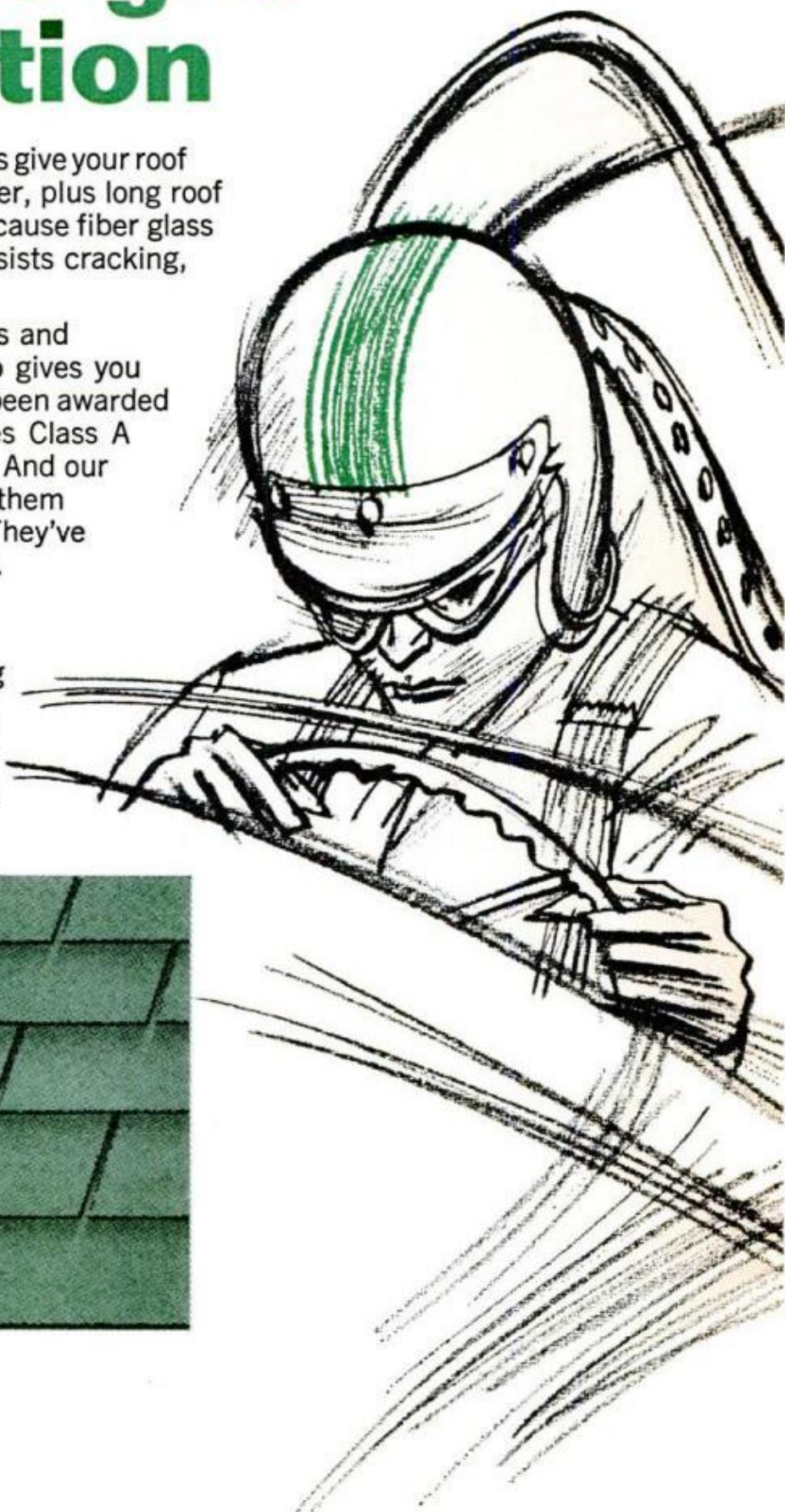
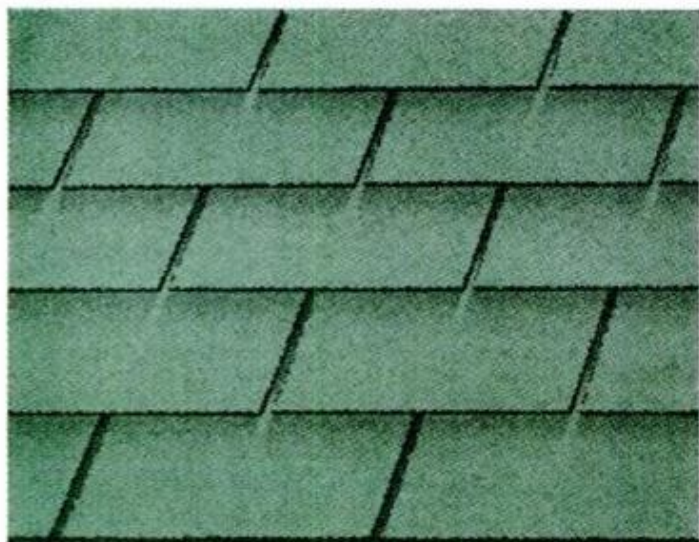



Back-yard trimaran

Peter Wilde of England is a determined boat builder. After starting a 43-foot trimaran in his back yard, he sold the house to raise money for completing the boat. He and his wife plan to sail it to New Zealand.

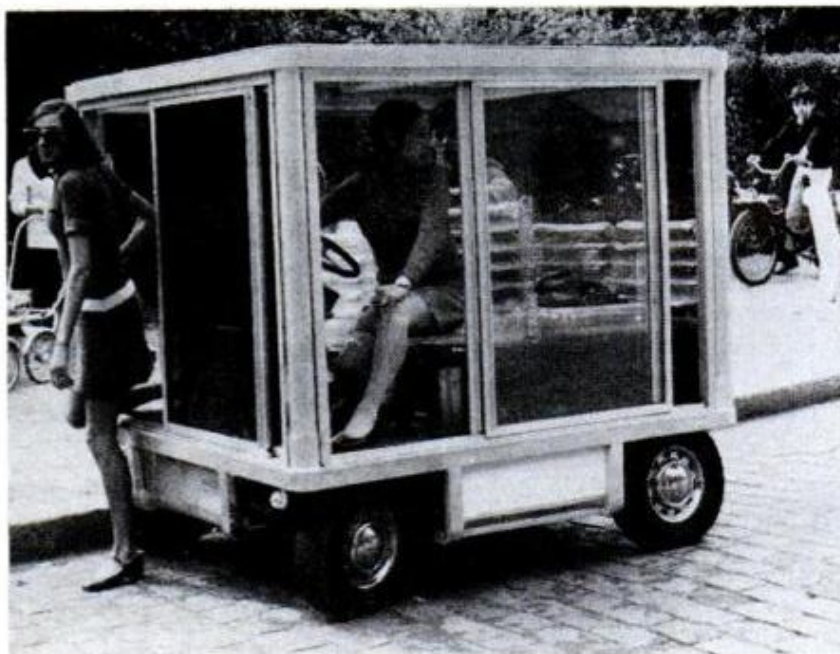

Glass cube on wheels is presented as ideal commuter car

With its roof and four walls made of glass, the British Cubicar offers a driver just about as good visibility as a bicycle for maneuvering in city traffic. And its size—it's a mere six feet, four inches long—lets it get into parking spaces (head-on) where no other car will fit. But the driver and passengers will have to get used to the idea of looking like goldfish in a bowl every time they take to the streets. The new car, conceived by French designer Quasar Khanh, is manufactured by Universal Power Drives, Ltd. It has an 1100-cc BMC engine with automatic transmission that drives the vehicle at a top speed of 55 mph; it gets about 24 miles per gallon of gas. Five adults can be comfortably seated, and they can exit from any of five sliding glass doors, including one at the front (photo, right). List price is \$2160.

The modern Army goes to school, and there's a place in class for you.

In fact, high school graduates have more than 300 job training courses to choose from.

And if you qualify for the Army's enlistment program, we guarantee your course selection *before* you step forward and raise your hand.

There's still another plus. The training is great. A leading American university credits the Armed Forces with one of the most advanced and comprehensive educational programs in the world.

Job training in the Army could be the opportunity you need to acquire a vital and rewarding skill. At the same time, you fulfill your military obligation.

We can give you more than 300 good reasons for joining the Army.

But all you need to choose is one.

Your future, your decision...choose **ARMY**.

Army Opportunities
Dept. 200
Hampton, Va. 23369

PM-10-68

Please send me your free 40-page booklet. I understand there's no obligation attached to this request.

Name _____ Age _____

Address _____

City _____ County _____

State _____ Zip _____

Phone _____ Education _____

Enroll in the Army.



AMAZING \$1 ART OFFER! — NEW!

4 Glorious Paintings Reproduced in Spectacular Full Color For Your Home

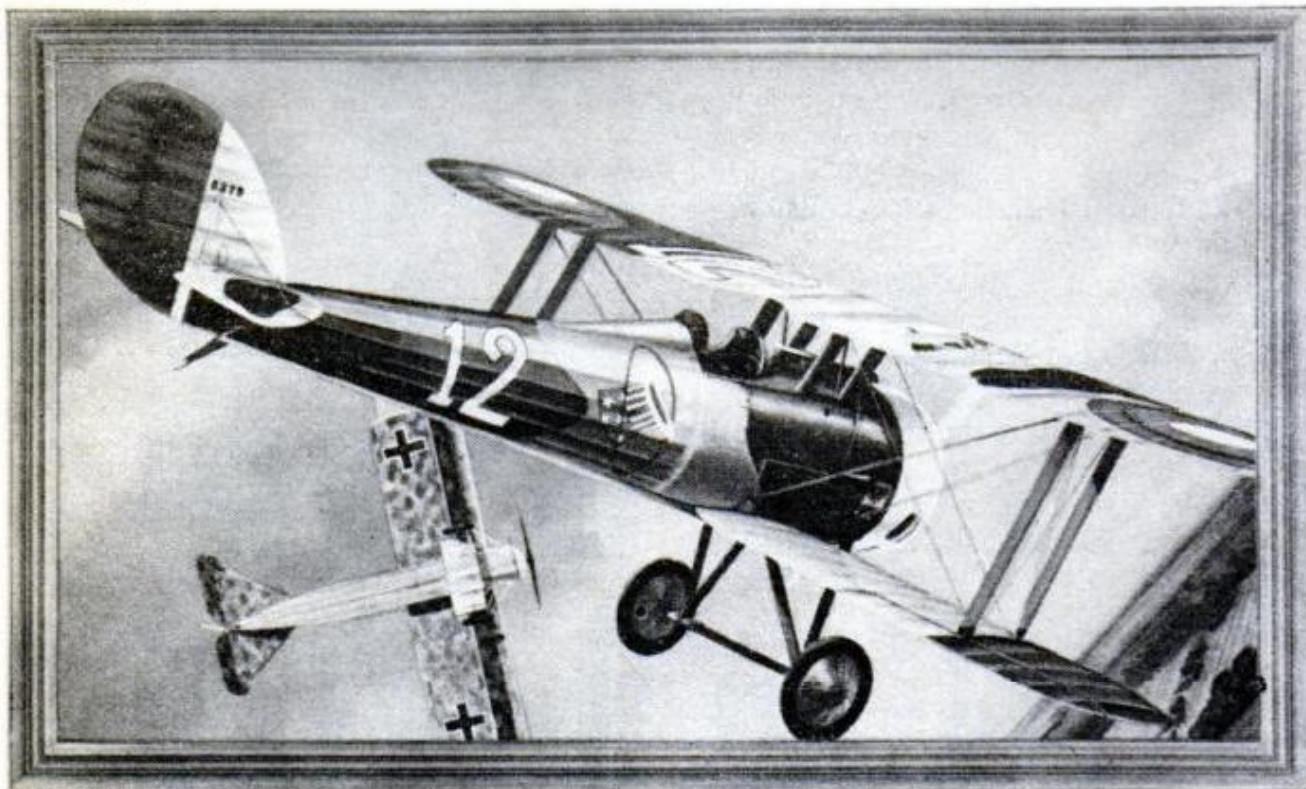

© R.T.V. Sales, Inc. 1968

Capt. E. V. Rickenbacker's NIEUPOINT 28



Major Hawker's DE HAVILLAND D.H. 2



Lt. Seligman's CURTISS GOSHAWK F11C-2



Frank Hawks' HEDDON JENNY

Add Adventure to Your Home With These Classic Aeroplane Art Prints! All 4 Large Prints Only \$1

These superb art prints are exciting conversation starters. You can imagine the glories of these amazing men of pioneer flight. The art prints of those magnificent men in their classic but often clattery flying machines will roar you into many flights of fancy. They're pure adventure. The daring heroics will come alive when these prints decorate your home, office or club.

You can almost hear the roar of excitement in these magnificent reproductions of the spectacular full color paintings. You cannot truly appreciate the beauty of the large and glorious prints from the small black and white miniatures above. The art prints are richly and meticulously detailed. We have shown one painting larger (all 4 are the same size) to indicate the intricate detailing and excitement of this set.

OFFER WILL NOT BE REPEATED THIS SEASON

Supply is limited. We urge you to order your full color reproductions now while the supply lasts. We will send you all four reproductions for the amazing low price of \$1 plus 25¢ postage. Each fine print is 11" x 14". You will be delighted with the glorious color and excitement these 4 classic aeroplane prints will add to your home, office or club. This is your only chance to order. Be sure to fill out coupon and mail at once. This offer will not be repeated this season in Popular Mechanics.

MADISON HOUSE, Dept. 548
239 Great Neck Rd., Great Neck, N. Y. 11021

Please send me the 4 Classic Aeroplane prints (frames not included) for just \$1 plus 25¢ for postage on full money-back guarantee if I am not delighted.

Enclosed is \$ _____ (Please Print)

Name _____

Address _____

City _____ State _____ Zip _____

SAVE! SPECIAL OFFER: Order three sets of 4 prints each for only \$2.50. (You save \$1.25). Extra sets make great gifts.



\$12.95

Uses 6
staple sizes

SHOOT A STAPLE WHEREVER YOU'D DRIVE A NAIL!

ARROW® ALL PURPOSE HEAVY DUTY **T-50**

STAPLE GUN

FASTER! BETTER! CHEAPER!
for 1001 home fix-it fastening jobs.

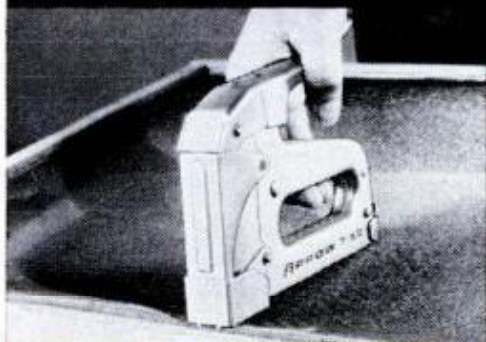

1/4" STAPLE

for tacking window screening, shelf papers, closet linings, window shades, draperies, etc.



5/16" STAPLE

for tacking light upholstery, leatherettes, cornices, quilting for closets, wall decorations, etc.



3/8" STAPLE

for fastening light insulation, roofing papers, electrical wires, weatherstripping, wire mesh, etc.

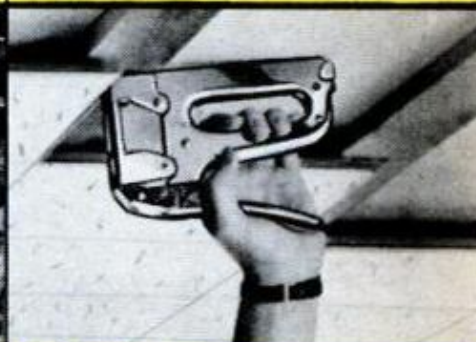

1/2" STAPLE

for tacking underlayments for carpets, porch screening, felt stripping, canvas, fiberglass, etc.



9/16" STAPLE

for tacking metal lathing, cornerite, wire fencing, roof coverings, insulation board, etc.



CEILTILE

staple - especially made for safe, secure installation of ceiling tile.

LIMITED TIME "FALL SPECIAL"

Get T-50 Screening and Wiring Attachments worth \$2.00 FREE!, with purchase of T-50 Staple Gun.

At hardware, building material, variety and other retail outlets everywhere.

ARROW FASTENER COMPANY, INC., 271 Mayhill Street, Saddle Brook, N. J. 07663

\$14.95 VALUE

for only

\$12.95



POWERFUL WIRELESS TRANSMITTER



... the size of a package of cigarettes
ONLY \$12.95

Completely Assembled
Incl. 2 Microphones & Battery

Here's a compact marvel of transistorized electronics that does just about everything... yet is tiny enough to fit in a pack of cigarettes. Called the WIRELESS BROADCASTER, this battery operated transmitter picks up sound through its sensitive microphone and transmits (without wires) thru any nearby AM radio. Unlimited applications:

- Broadcasting
- Guitar amplification
- Baby minding
- Remote Recording
- Sickroom Signal
- Auto to Home

This Really Modern Wonder Package includes two microphones (1 Xtal for broadcasting, 1 contact type for musical instrument amplifying) plus a 9-volt battery. Fully guar.

SUPER SLEUTH



This fantastic new private listening device has many applications, some of which we're sure you'll think of yourself.

- Help hard-of-hearing
- Hear TV Sound privately
- Amplify phone conversation
- Hear almost inaudible sounds
- 1001 Other Amplification Uses

Where do you want to listen in? The SUPER SLEUTH Audio Snooper is powered by a single penlight cell (1.54). 3-transistor circuit. Complete with output earpiece. Money back guarantee. Free catalog.

BUY EITHER UNIT FOR \$12.95
OR 2 FOR \$23.95.

IMPERIAL ELECTRONICS,
DEPT. PM-10

114 E. 32 St., New York, N.Y. 10016

UNITS ARE COMPLETELY ASSEMBLED. NOTHING ELSE TO BUY!

HEAVY DUTY WELDER



Does work of \$85.00 welder yet costs only **1895**
POST PAID
Fits ordinary 110V outlet
Not one • but 3 welding heats

Weld, braze, solder or cut most anything made of metal. No experience necessary. Follow simple instructions. Uses standard 1/8" rods to weld iron, steel, brass, bronze, aluminum, other metals. Repair cars, farm implements, appliances, toys. Make campers, trailers boats. Pays for itself quickly. Comes complete with mask, \$2.00 pack of rods, flux, etc. NOTHING ELSE TO BUY.

3 WELDING HEATS... Not just one as with other low cost models. "High" for tough jobs, "Medium" or "Regular" for lighter work. 3 heat feature saves you money. New HEAVY DUTY circuit gives more welding potential than ever before. Approved for homes, garages, factories, shops. Has power boost circuit for industrial uses. Raises heat to 4 TIMES that needed to melt toughest iron. No other welder has all three fine features.

FREE! Automatic arc striker now makes welding easy, even for beginners. Just plug welder into ordinary 110V outlet, touch automatic arc striker and start welding. You can't buy this important new Wel-Dex invention but it's yours free if you order from this ad.

10 day MONEY BACK TRIAL. Guaranteed against burnout.

SEND \$2.00 and pay \$16.95 plus small C.O.D. when delivered or \$18.95 for postpaid shipment. Phone (713) 682-5811 for C.O.D.

WEL-DEX MFG. CO., Dept. W-10, Box 10776, Houston, Texas 77018

DON'T QUIT SMOKING

before giving my pipe
a 30 Day Trial

New principle that contradicts every idea you've ever had about pipe smoking. I guarantee it to smoke cool and mild hour after hour, day after day, without rest, without bite, bitterness or sludge. To prove it, I'll let you try a new Carey Pipe. Send your name and address today for my free complete trial offer. Write:

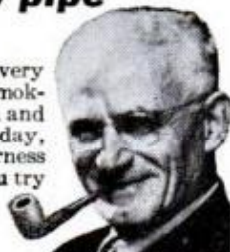

E. A. CAREY, 1920 Sunnyside Ave., Dept. 252-L, Chicago 40

How to make money in MAIL ORDER

Free Copy! "How to Make Money in Mail Order" shows men, women, families how to start full or spare time big profit home mail order business. See how you get best products to sell by mail. Discover how your pocket profits in advance. Newest mail order techniques revealed. Start without experience or product investment. No salesman will call. Write for Free Copy, MAILCO, 1554 S. Sepulveda, Dept. B225A, Los Angeles, Ca. 90025.

LAFAYETTE RADIO ELECTRONICS

FREE!



1969 Catalog 690

Over 500 Pages

BETTER THAN EVER

Stereo Hi-Fi • Citizens Band • Ham Gear • Tape Recorders • Test Equipment • TV and Radio Tubes and Parts • Cameras • Auto Accessories • Musical Instruments • Tools • Books

LAFAYETTE Radio ELECTRONICS

Dept. 15108 P.O. Box 10

Syosset, L.I., N.Y. 11791

Send me the FREE 1969 catalog 690.

15108

Name

Address

City

State Zip

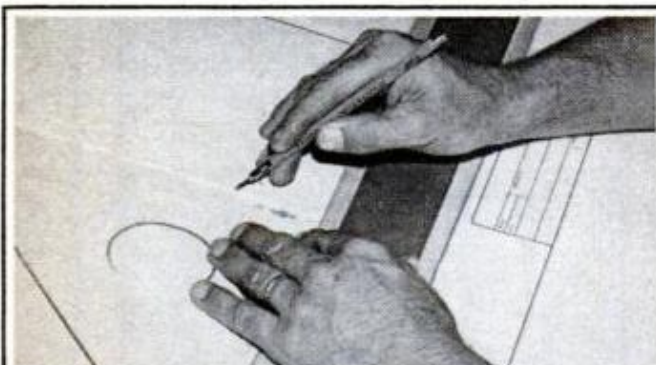

There's Money in Drafting!

Make the drawing board your springboard to success with a career in DRAFTING.

Opportunities, job openings, big salaries and rapid advancement... are unlimited in drafting.

We offer you expert training. Your choice of Home Study or Resident Training. Day or Evening programs available at our training centers.

FREE Placement Service for graduates, part-time jobs for students. Get the facts, no obligation.

FREE BOOKLET — MAIL TODAY!

Rush FREE booklet on Drafting Training

Name _____

Address _____ Zip _____

Phone _____ Age _____

Interest: Day Eve Home Study (check one)

the first place to look for self-help

ITT Educational Services, Inc.
5610 Crawfordsville Road, Suite 6C
Indianapolis, Indiana 46224

ITT

3 WAYS

TO A PROFITABLE BUSINESS of your own with small investment

**YOU CAN START WITH ONE DETERGER...
ANY TWO...OR ALL THREE
FULL OR PART TIME!**



■ Von Schrader offers you these three tried and proven money-making businesses. You can start with one Deterger and, by working week-ends, add hundreds of dollars to your monthly income while still employed.

■ Or, you can start your business with any two, or all three Detergers, and build rapidly to a point where helpers and even additional Detergers are necessary. All three Detergers are reasonably priced...and many Associates make more than the price they paid in the first few weeks and from the supplies that came with their original order.

■ You need no shop because all work is done in customers' homes or on their premises. And you have no overhead because you work out of your own home.

■ Full operating instructions come with the Detergers and you need no special skill or training. You can grow as fast as you want to with the assurance that Von Schrader will help you every step of the way. Our Business Manual tells everything you need know, including how to go about getting business, suggested sales letters, tips on keeping books and tax records, suggested ads and radio announcements, etc. Von Schrader assistance is always at your service. Training and consulting with experts is also available... and without charge.

■ Von Schrader is the oldest and largest company manufacturing machines of this type and we are keenly interested in the success of each of our Associates. Our FREE ENTERPRISE PLAN has been developed and fashioned with your future in mind. Your business always belongs to you...no one can ever take it away. You pay no dues or fees or royalties to anyone. All the money you take in belongs to you...you are truly your own boss in your own business.

VON SCHRADER MFG. CO.

READ BELOW what a few of our many Associates have to say about the success of Von Schrader's FREE ENTERPRISE PLAN. Then return the coupon or write today. It costs nothing to get the details. Be sure to check the Deterger you are most interested in starting with.

E. L. McLAINE • New York • Wall—"I'm over 60 years old. In my spare time I make \$125 to \$175 per week."

F. LOTMAN • Canada • Wall—"Our machines have grossed us over \$50,000 for the past 12 months."

R. MORTON • Michigan • Wall—"This last month just working Saturdays and occasional evenings I cleared around \$600."

G. WINTER • Wyoming • Upholstery—"Last year I did \$10,000. This is a one-man operation. Many weeks are now \$250-\$300."

E. ACTON • Oregon • Upholstery—"I don't work very hard at this but in one day my boy and I made \$170."

S. RALLINGS • California • Upholstery—"I'm averaging about \$200 a week...one month went up to \$1000."

T. NORTHRUP • New Jersey • Rug—" \$2000 in two weeks...several weeks over \$1000."

J. THORNTON • Illinois • Rug—" \$90 and \$100 a day is common with your wonderful detergent."

C. LEONARD • Ohio • Rug—"My largest week so far brought me \$1568."

SEND FOR THE FACTS TODAY

VON SCHRADER MFG. CO.
9N10 "A" Place, Racine, Wis. 53403
Please rush information about your

_____ DETERGER(S)
(Write in name of detergent(s))
and how I can start my own profitable business.

Name _____

Address _____

City _____ State _____ Zip _____

RADIAL ARM SAW KIT—for under \$100...



Buy direct from factory, assemble yourself. Incl. 1/2 h.p. G.E. motor, easy to follow instructions, all parts, nuts and bolts. Guar. for life pat. pend. radial arm track; twice the usual bearings for extra rigidity, greater precision. Rips 24", crosscuts 12"; belt brake. \$99. complete, freight col. Kit less motor (any standard 1/2 h.p. or larger will do) \$ 84.85. With opt'l G.E. motor developing 1 h.p. \$108.65. Money back guaranteed by one of world's largest manufacturers of bench power tools.

MAIL COUPON FOR ILLUSTRATED BROCHURE

American Machine & Tool Co.

Dept. PMOR, Royersford, Pennsylvania 19468

Please send me without obligation your free illustrated brochure containing full information on the PermaTrak radial arm saw kit. Also send free reprints of feature articles by editors of Popular Mechanics, Workbench and Family Handyman. NO SALESMAN IS TO CALL.

NAME _____

ADDRESS _____

CITY _____

STATE _____

ZIP _____

REMINGTON ROD SAW...THE TOOTHLESS WONDER.



Our new Rod Saw has no teeth. Instead, it has thousands of permanently bonded tungsten carbide cutting edges.

The rod itself fits any standard 10" hack saw frame. But the similarity ends there. Because the Rod Saw cuts through things a regular hack saw blade won't even scratch.

It cuts through spring steel, hardened bolts, welds and cast iron with ease. And because of the tool design, the cutting edges go all the way around the rod. So it not only cuts straight, but also cuts in any direction on brick, glass, flagstone, ceramics, fiberglass, laminates and other hard-to-cut materials. (And does it faster, because it cuts on both forward and backward strokes).

Originally developed for industry, now priced for home use, the Remington Rod Saw is now available at most hardware stores.

You should not have any trouble recognizing it. Just look for the saw without any teeth.

Remington® DUPONT

AS A MEMBER OF THE CARTRIDGE TAPE CLUB

Here's what you get

- 1/3 off on ALL cartridge tapes—4-track, 8-track, cassette
- Special members' prices on home and auto stereo tape players
- Bi-monthly magazine with complete listings, features, news and pictures
- Free gifts and special offers



For just \$5, you can become a lifetime member of the only club of its kind... the club that lets you choose from over 6,000 tapes... every label, every artist, everything that's available... at 1/3 savings. No minimum purchases required, you buy only what you want when you want. Write for full details, or join today and receive a special FREE gift.

CARTRIDGE TAPE CLUB OF AMERICA Dept 10L
1509 South Michigan • Chicago, Illinois 60605



PLANER · MOLDER · SAW!

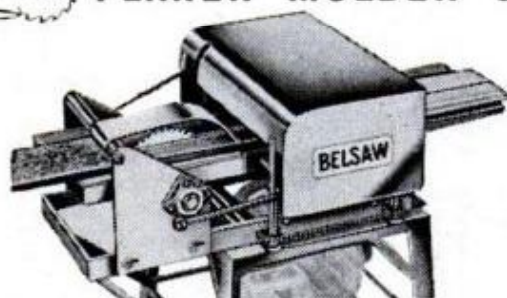

Now you can use this ONE power-feed shop to turn rough lumber into moldings, trim, flooring, furniture... ALL popular patterns. RIP... PLANE... MOLD... separately or all at once with a one HP motor. Use 3 to 5 HP for high speed output. Low Cost... You can own this power tool for only \$30.00 down.

Send postcard today for complete facts.

Send Postcard Today... No Salesman Will Call

BELSAW POWER TOOLS, 909-T Field Bldg., Kansas City, Mo. 64111

You can make money in

WATCH REPAIR



Learn at home the low cost Sweazey Way

Watch repairing pays up to \$6 an hour, part time watch makers report on survey. Unique and modern Sweazey home study System starts you making repairs right away on Swiss and American watches. Professionally prepared training. No previous experience needed. Special tools provided for practice. Diploma Awarded. Free sample lesson and opportunity book give all facts. Write today. No obligation.

CHICAGO SCHOOL OF WATCHMAKING
1108 Fox River Grove, Illinois 60021

FREE BOOK and SAMPLE LESSON

CHICAGO SCHOOL OF WATCHMAKING
Dept. 1108, Fox River Grove, Illinois 60021
Please rush FREE BOOK and Sample Home Study Lesson.

Name _____ Age _____

Address _____

City _____ State _____ Zip _____

POPULAR MECHANICS

Материал, защищенный авторским правом

FREE! World's Largest Electronic Kit Catalog

● **Deluxe Color TV . . .** the sets you've read about that give better performance yet cost no more; three models: 295, 227 & 180 sq. in. rectangular; exclusive built-in self-servicing aids. Custom, wall, or cabinet installation. New optional wireless remote controls, and new Heathkit antenna line.

● **Transistor Organs . . .** deluxe 19-voice and low cost 10-voice Thomas models in kit form — save up to \$500. Also VOX "Jaguar" combo organ at \$200 savings.

● **Electric Guitar Amplifiers and accessories...** amps, "fuzz" booster, microphones and speakers.

● **Portable and Table Radios and Phonographs . . .** AM, FM, short-wave radios . . . mono or stereo phonographs.

● **Stereo/Hi-Fi Components . . .** stereo receivers (including the famous Heathkit AR-15), amplifiers, tuners, speakers, turntables.

● **Amateur Radio Gear . . .** world's most popular line . . . SSB transceivers, transmitters, receivers, accessories.

● **Citizen's Band Radio . . .** fixed and mobile transceivers, walkie-talkies.

● **Test and Lab Instruments . . .** a complete line for home & hobby, shop, educational and industrial use. Newly designed and styled.

● **Scientific and Educational . . .** Berkeley Physics Lab, Malmstadt-Enke instrumentation including Analog/Digital equipment, kits for home & classroom study.

● **Marine Electronics . . .** radio-phones, RDF, depth sounder, fuel vapor detector.

● **Photographic Aids . . .** Heath/Mitchell Fotoval[®] and Colorval[®] darkroom computers for perfect B&W and color printing; electronic photo timer.

**New . . . Over 300 Kits
For Every Interest . . .
Save Up To 50%**



MAIL COUPON NOW!

- **Biggest Selection . . . Over 300 Kits**
- **Up to 50% Savings**
- **Easiest To Build**
- **World Famous Easy-To-Understand Construction Manuals**
- **Highest Quality Components**
- **Best Performance**
- **Unique Creative Satisfaction**
- **Pride Of Achievement**
- **Free Technical Consultation**
- **Easy Credit Terms**

HEATH COMPANY, Dept. 17-10

Benton Harbor, Michigan 49022



Please send FREE Heathkit Catalog

Name _____
(please print)

Address _____

City _____ State _____ Zip _____

CL-339

BY KEVIN V. BROWN
AVIATION
JETSTREAM

RUNWAY GROOVING—cutting shallow grooves crossways in runways to prevent hydroplaning and to improve braking and stopping distances on wet surfaces—seems to be working out.

After a year-long evaluation at three different airports, pilot reports showed that stopping distances were reduced as much as 1000 feet, and the airport operators themselves reported that no noticeable increase in deterioration of the runways took place.

Other experiments underway to make runways safer in all weather include use of commercial fertilizer to remove or prevent ice formation during snow or freezing rain and tests for runway friction to predict braking before the plane lands.

SEEN ANY lost flying boats?

The Boeing Co., just for nostalgic reasons, is trying to locate the whereabouts of any of its old Model 314 Clippers. These huge aircraft plied both the Atlantic and Pacific Oceans during the late '30s and

'40s. Some were sighted as late as 1950.

Boeing built 12 of them, mostly for Pan American Airways, and some are known to have crashed (singer Jane Froman survived one of the crashes near Portugal) or to have been scrapped for parts, but the others just disappeared, and no one knows where.

If you've seen any, contact Boeing.

AND SPEAKING OF FLYING BOATS, they may not be all that dead.

The Navy is thinking seriously of converting the venerable C-130 Hercules into a seaplane. Lockheed, the builder, has been awarded a feasibility contract to put the Hercules on water.

The Hercules is considered by some to be the logical successor to the old DC-3, being all things to all men.

THE GUN-LAW CONTROVERSY has seeped over into aviation.

Scheduled airlines have announced new regulations requiring shippers of firearms to mark each piece or package prominently with the word "firearms," and to notify proper law-enforcement officials. The notification will list the contents of the shipment, the receiver's name and address, the date of shipment and the method of shipment. ★★★

Our oil was good enough for everybody. Except us.

People thought Dino Supreme was about the best oil you could buy.

But it still wasn't good enough. For us!

So we set up some new standards. Even above those of the car makers. And developed a new 10W-40 oil.

Then we tested this newly formulated oil against four top multi-graded motor oils.

We came out ahead. In protection against wear.



Against rust. And ahead in resistance to sludge formation as well.

It proved we were good enough. For ourselves.

And better than good enough for your car.

In fact, if your car had a mind of its own, it wouldn't run without us.

 **Sinclair**
SINCLAIR REFINING COMPANY

Up, up and away on your playful, powerful '69 Polaris



So maybe you don't need to leap streams...or fly across gullies. But it's nice to know you can on a Polaris. That's because only Polaris has Powertrain. Powertrain puts the fun into snowmobiling. Power with a purpose.

It starts with the new Polaris Star, the finest snowmobile engine ever built. It flows smoothly and efficiently through the famous Polaris Torque-O-Matic drive. It ends with the Polaris power tracks that propel you over powder or hardpack with sure-footed dependability.

The Polaris Powertrain is the heart of true snowmobile performance. Without it, a snowmobile is something less than what it could be. With it, your Polaris becomes the most spirited over-the-snow funmobile ever built. Powerful reasons for you to test drive a '69 Polaris.

*Step up... Step out...
on a playful,
powerful Polaris!*



**POLARIS
INDUSTRIES, INC.**

Department 6905
Roseau, Minnesota 56751

1969 Buick



No wonder Buick owners

GS 400.

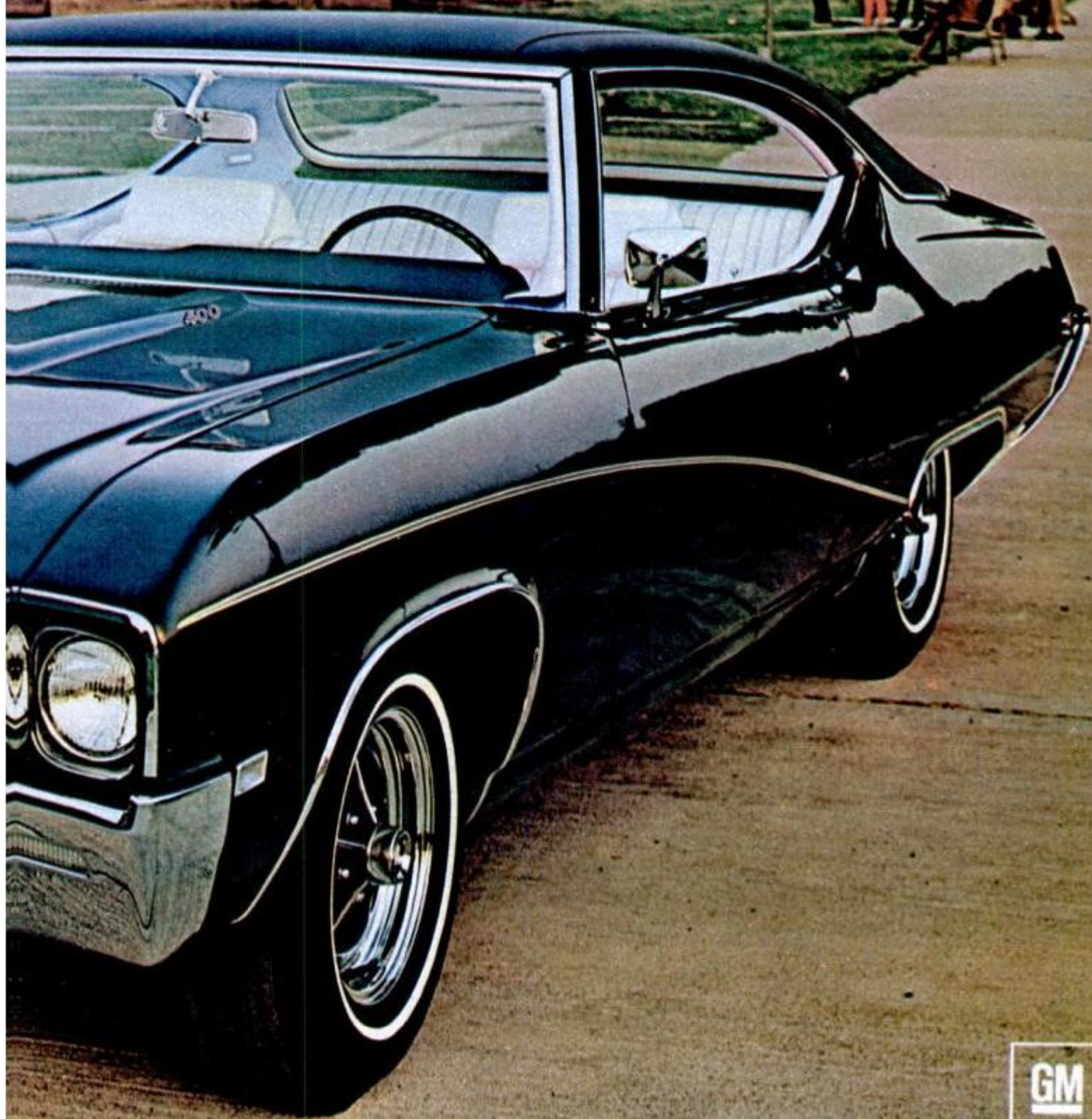

keep selling Buicks for us.
Wouldn't you really rather have a Buick?

**A handful of
compact power
30,000 rpm!**



NEW!
DREMEL MOTO-TOOL
with constant-torque
permanent-magnet motor

Now all Dremel Moto-Tools belt out twice the torque of previous models! They're virtually stall-proof, even when you're really bearing down. Compact — lightweight — and now super-powered for grinding, drilling, polishing, carving, deburring, and sanding. Shock-proof Lexan housing. See your dealer for a demonstration.

- No. 260 super-compact \$22.95
- No. 270 with bronze bearings . . . \$29.95
- No. 280 ball bearing construction . \$39.95

New Moto-Tool Kits
Complete with Moto-Tool
and 34 accessories

- No. 261 \$32.95
- No. 271 \$39.95
- No. 281 \$49.95



DREMEL MFG. CO., Dept. 118-J, Racine, Wis. 53401

New 160-page "Dremel Handbook of Hobbies, Crafts, and Projects", only \$1.45.

- Please send book. I enclose \$1.45.
- Send free power tool literature.



Name.....
Address.....
City..... State..... Zip.....

WHAT'S NEW
OUTDOORS
BY DAN FALES

HERE'S YOUR CHANCE to tell the Coast Guard your gripes about, and suggestions for, modernizing the navigational aid system. The CG is studying the present system and wants comments from the maritime community, including small pleasure-craft skippers like you who use both inland and coastal waters. It's considering the "system" of navigational aids in general. The specific question asked is: "If the existing navigation system is inadequate, what is needed, and where to make it (the system) more effective for mariners' needs?"

My suggestion is to increase the lumen rating of flashing white channel markers. All too often, I've approached an unfamiliar harbor or channel at night and been unable to locate a critical flashing marker because of highway or town lights in the background. It's probably not a problem for those looking down from the bridge of a big ship. But I look straight away from my "bridge" which is only two feet off the water. Should you have suggestions, write the National Navigational Planning Staff, U.S. Coast Guard, 1300 E St. N.W., Washington, D.C. 20591.

FOR A BUCK you can get a Bear. It's not as crazy as it sounds. Famed archer Fred Bear has made a recording called *Fred Bear's Secrets of Hunting*. It's a collection of fascinating hunting yarns and solid tips — not only on bowhunting, but on outdoorsmanship in general. This LP record is selling for \$1 at sporting-goods stores.

BEWARE OF WORMS THAT BITE is the advice of Winchester-Western's conservation department. As the story goes, a game warden in Lubbock, Tex., was checking fishermen on a local river. He met a small boy with a fine string of channel catfish, and asked what he was baiting with.

"I'm ketching 'em on these good ol' biting worms that I found under a rock," said the boy, displaying several five-inch baby rattlesnakes.

Rattles are born alive and fully equipped. Their fangs and poison sacs may be tiny—but a rattler of any size is still a rattler. The biting worms had nipped the boy's hand several times, and it was swollen. The warden rushed the boy to a hospital where he was treated and soon released. He kept his catfish, but got rid of that good ol' bait. ★★

Here! New '69 CHEVROLET PICKUPS!



Half-ton Fleetside CST Pickup with shell body

Now there are even more reasons why Chevrolet is more truck.

For '69, Chevrolet goes to new lengths in modern pickup design. We mean Chevy Fleetsides with boxes as long as 8½ feet. Get one for the biggest of camper bodies — or cargoes. You'll get more style in any '69 Chevy pickup model. Including a bold new profile and new aluminum grille. In the cab, new bench or avail-

able bucket seats and thick insulation make it more comfortable. There's more power, too; order the new 350-cu.-in V8 or one of five other V8's and 6's. We have a whole catalog full of reasons why a Chevy pickup is more truck. You'll see when you see the new '69's at your dealer's. . . . Chevrolet Division of General Motors, Detroit, Mich.



More trucks are Chevrolets
because Chevrolet is more truck!

SOLUTIONS FOR MECHANICAL HEADACHES

AUTOMOBILE CLINIC

BY MORT SCHULTZ

Carbon cleaning

Are additives worthwhile in getting rid of carbon deposits once they have formed in cylinders?—Robert E. Beaudoin, Brookfield, Ill.

Let's put it this way. It's a heck of a lot less expensive to try a few cans of an additive made by a reputable manufacturer than to rip the engine apart for a carbon job. There's another thing to try before engine work. Fill the gas tank with a premium-grade fuel and get the car on a superhighway. Open it up for a long period. I had a car that developed a ping I eventually attributed to carbon, and I tried the high-octane-fuel, high-speed method. It got rid of the carbon and ping.

Wonder why I wander

I own a 1967 Chevy II that wanders when the car's cold. Miraculously, after I drive several miles, the problem clears up by itself. I've had front-wheel bearings checked, the brakes don't grab, and the front end's not out of line. What's the cause of this mystery?—Miss Virginia Halloran, Earlton, N.Y.

You probably don't have a mechanical problem. How long's it been since you've checked your tire pressure? Conceivably, your front tires could be underinflated. This will cause wander. As you drive the car, tires get warmer, and the air pressure increases. This could account for the wander with tires cold and lack of wander with tires hot.

Chattering lifters

The valve lifters of my 1963 Oldsmobile Super 88 with 390-cu.-in. engine begin to clatter after I drive about five miles and keep it up more or less on a constant pitch. So far, I've replaced the lifters twice, tried different brands and viscosities of oil, had the valves ground, and overhauled the carburetor. I've just about had it unless you can come up with a solution.—Donald W. Trusty, Akron, Colo.

The answer is probably in Oldsmobile's service bulletin No. 62-W-32 dated 7/15/63.

Olds says the problem could be caused by oil level being too high or too low. Make sure you check oil with the engine cold or a good 10 minutes after you're turned it off. Also, make sure the dipstick is seated fully. It should be 10-7/8 inches long. Check for external oil leaks if you get a low reading. Secondly, you could have air in the oil causing aeration and foaming from a leak at the oil screen. Finally, worn valve-train parts (such as guides and seals) could lead to low oil level by letting oil leak into combustion chambers.

A hot tip

I have a 1967 Ford Galaxie 500 with 390 engine. I'm fouling plugs every 2000 miles. The Ford dealer has checked everything and finds nothing wrong. What can be the matter?—T.E. McLain, Stanhope, N.J.

Your Ford dealer hasn't checked everything. He ought to look at the service instructions sent to him by the company. He'd find that the plugs recommended for this engine have been changed. You should be using Autolite 42s, which are hotter plugs than the 82s that were called for originally.

Wrong number

I would like to call your attention to an error in a part number in the May Auto Clinic. The article speaks of repairing low brake-pedal height in the 1965 Mercury. You listed the number for a spacer as C5A2-2849-B. An order from a dealer to a parts depot would be marked "no item listed for this part number." The correct number is C5AZ-2849-B.—A.G. Torrance, Milledgeville, Ga.

P.S.: I enjoy reading Auto Clinic.

You're so right.

P.S.: Thanks for your P.S.

Points a poppin'

I have a 1960 Rambler Classic I use for a second car. It runs well, but I'm burning points every 200 to 400 miles. I have a new coil, ignition resistor, rotor and cap. All parts are those specified for the car. What (Please turn to page 84B)



Pontiac announces the great break away: '69 Grand Prix.

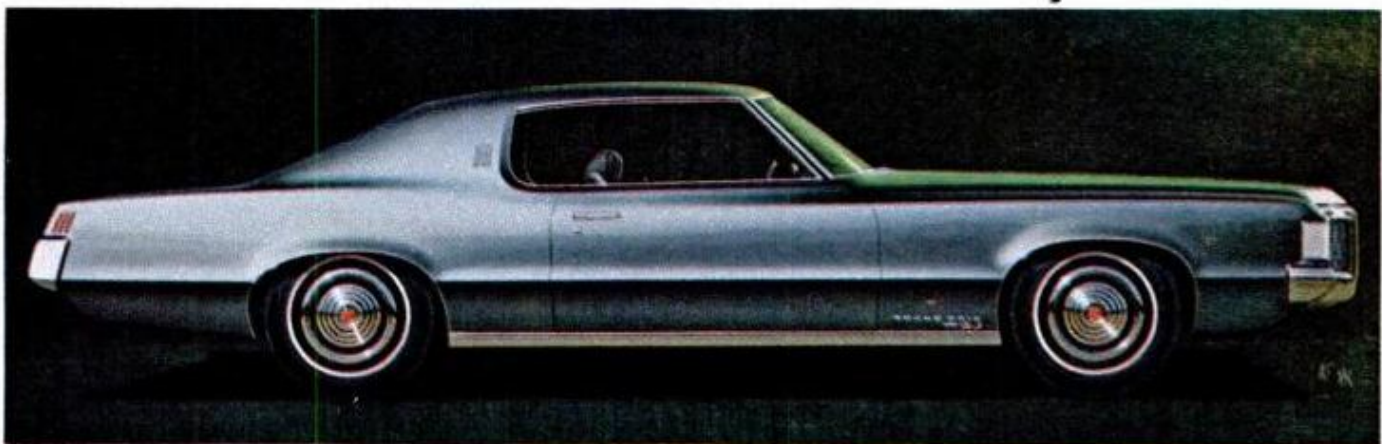

Pontiac Motor Division

Meet our newest and most exciting invention. That's the swank Grand Prix parked on this page. A car so completely new, you couldn't get a radio antenna on it if you wanted one. (It's hidden in the windshield.) And under that six feet of hood, a list of equally impressive power plants: 350-horsepower standard. Or you can order up to a 390-horsepower V-8 and your choice of 3- or 4-

speed manual, or our super-slick, 3-speed Turbo Hydra-Matic—and tell your friends you're driving our Model SJ. With Grand Prix, you'll also discover a real handler with super-wide G78 tires. And an interior that looks ready for interplanetary travel. Pontiac Grand Prix—the break away car of the year. Get in line at your Pontiac dealer as soon as you can.



AUTOMOBILE CLINIC

(Continued from page 84)

else should I suspect?—Neil Noland, Baton Rouge, La.

Excessive amperage is usually the reason for burning points so quickly. First thing to check is to make sure the coil and ignition resistor are the correct ones for your engine. You don't mention what engine is in the car, so you'll have to refer to the specs for these parts in the manual or at your dealer's. If they are okay, install an ammeter in series with the coil. With the ignition on, the meter should read 3.75 amps. for a six-cylinder engine, or 3.0 amps. for a V8. If amperage is excessive, look for a defective ignition switch or poor distributor ground.

How much of an adjustment?

My 1965 Plymouth Fury with automatic transmission often doesn't shift until speed reaches 30 to 35 mph. The car has only 33,000 miles on it. A Plymouth serviceman says I need a transmission tune-up. Am I about to be taken?—H.L. Hinkson, Youngstown, Ohio.

If your serviceman defines "transmission tune-up" as I do, then I don't think you're going to be taken. In fact, when something like this crops up it's tough to pinpoint the exact reason, so it is best to do a "tune-up." By tune-up I mean changing transmission fluid, adjusting bands, shift selector and throttle linkage. In my area, the job costs about \$25 to \$30.

A vintage whine

I have a 1967 Chevrolet with 327 engine. It has a whine in the rear end that occurs only on deceleration. The dealer has replaced pinion ring and gears, and the driveshaft. No help. What do you think it is?—Keith R. Argo, Ottumwa, Iowa.

Most likely the carrier bearing in the rear end. It could also be improper driveshaft alignment, but I'll bet on the carrier bearing.

Rear-end riddle

I read that the differentials of 1968 Chev-

rolets are filled with lubricant to a point above plug level. My question: If I had to add grease, how the devil would I get it above plug level without having it pour out the filler hole?—W. Simmons, Brooklyn, N.Y.

The instructions you refer to were sent to Chevy shops to avoid concern in new-car preparation for delivery when it was found that differentials had been filled above the filler hole at the factory. The instructions do not apply once a car is delivered. In other words, should the differential in your 1968 Chevy need grease, fill it to the filler plug. Can't see how you can do otherwise.

Service Tips

● Oldsmobile warns that nothing but the recommended solution of ethylene-glycol and water is to be used in its products—not even plain water. And this means all year long and in warm climates, like Florida and Southern California. Plain water, the company says, doesn't provide water-pump lubrication, and won't inhibit rust and corrosion. Owners who insist on using plain water as an engine coolant, the company states, should be advised that failure to use the recommended coolant "may jeopardize their car warranty."

● 1968 Chrysler Corp. cars—Dodges, Plymouths and Chryslers—with 340, 383 or 440 cu.-in. engines and Carter AVS four-barrel carburetors have a problem. The plastic bushings in the air valve of the carburetor may fail from high underhood temperature, leading to a rough-running engine because of altered air-fuel ratio.

The trouble has been corrected in production by use of aluminum bushings. Chrysler Corp. dealer shops have been advised to make replacements of plastic with aluminum bushings when the trouble is noted. Authority is Service Bulletin 68-14-9 (4/3/68) for Chryslers and Plymouths, and Service Bulletin D68-14-8 (4/17/68) for Dodges.

● 1968 Mercury Montego tailpipes shouldn't be replaced just because they're flattened out just aft of the rear hanger bracket. This section of pipe is supposed to be shaped precisely that way in order to allow sufficient clearance at the frame side rails and the rear springs under full jounce and rebound conditions. ★ ★ ★

GOT A PROBLEM WITH YOUR CAR? Ask Mort about it. Send your question to Auto Clinic, Popular Mechanics, 575 Lexington Ave., New York, N.Y. 10022. Letters cannot be answered individually, but problems of general interest will be published in the column.

Spark plug advertisers go to great lengths to use race drivers.

Jim Hall went out of his way to use us.

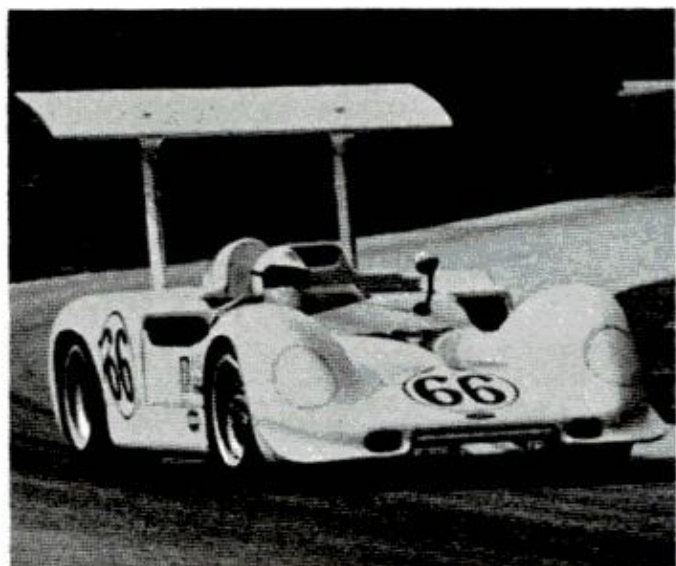

This may surprise you.

Spark plug and automotive advertisers induce race drivers to use their products.

This is the reason you find a lot of advertising after a big race that claims several different products were responsible for a single victory.

In a way, Robert Bosch started the whole thing. In 1908, he put his newfangled

spark plugs in a Mercedes and it won the French Grand Prix. Bosch was happy. Mercedes was happy. And they let it go at that.

We haven't changed our philosophy much in 60 years. We still don't make it a project of seeking out race drivers just for the use of their names. This is why Bosch was pleased when Jim Hall, after testing many spark plugs, came to us.

So now he uses Robert Bosch plugs in the famous Chevy-powered Chaparral cars which he builds and drives. Cars that have won in competition from Nürburgring to Sebring to Riverside to Watkins Glen. And he uses them in his wife's Chevrolet—the same plugs that will give you perfect performance in your car, no matter what the make.

Next tune up, insist on Robert Bosch spark plugs. You'll get the same sparkling performance Jim Hall gets.

As for race endorsement ads, this is it. We have to get back to work.

ROBERT BOSCH CORPORATION

New York • Chicago • San Francisco • 2800 South 25th Avenue, Broadview, Illinois



People on the GO...know
Miller makes it right!

Miller Home packs are on the move... as more and more people taste and enjoy the hearty, robust flavor of Miller High Life. Taste test it yourself with a handy 6-pack of Champagne-gold cans or no-return bottles. Always right!

The Champagne of Bottle Beer



Watch It!

**Popular
Mechanics**

You're on Trooper TV



Bad-guy drivers, who put a tailgating, lane-switching show on the road find themselves performing on TV and starring in a replay for the judge

By E. D. FALES JR.

Photos by Ben Ross

A TAILGATING TRUCK DRIVER, bulldozing everyone who got in his way, forced a startled driver into a guard rail near Stamford, Conn., recently. The trucker went on his merry way, free as a bird. Nobody could prove anything.

On a New York State highway not long ago a bus was tailgating a VW at 60 mph. The bus was so close its shadow actually covered the little car. The guy driving the VW was scared silly and hailed a cop. But again nobody could prove anything. If the cop *had* nailed

him, the bus driver would simply tell the judge, "I was just waiting for a chance to pass."

Earlier this year in Chicago, a tailgater on the Eisenhower Expressway drove three feet behind one car for more than two miles. The driver of the followed car, rattled by the tailgater, sideswiped another car. Of course the tailgater drove on in blissful unconcern. And again, nothing could be proved.

But now tailgating—along with speeding, hogging the road, going too slow, driving erratically and so on—



VIDEO CAMERA CATCHES TRUCK tailgating station wagon at high speed, records it for driver and judge

can be proved. Thanks to a new weapon being tried by Connecticut State Police, nutballs may find the highway less hospitable. The weapon is videotape, and in court it provides damning evidence.

Several states are using videotape in traffic work, but its main use so far has been to record interrogation *after* an arrest, or after an accident. Connecticut is the first state to try it on actual traffic conditions.

To see the new system in action, I rode with State Police Sgt. Nelson Hurlburt in one of Connecticut's two unmarked video cars.

When Sgt. Hurlburt came by in the patrol car to pick me up, I noticed a small TV camera mounted atop the instrument panel. On the back seat was a videotape recorder and, beside it, a standard, small TV screen. On the front seat was an on-off pushbutton control cable. Around his neck, Sgt. Hurlburt was wearing a small studio-type microphone. The entire 12-volt system, which costs less than \$2000, was on and running. Sgt. Hurlburt said he usually lets the system run full-time.

"One of these tapes will run 30 minutes," he said, "and if I don't pick anything up, I just rewind it and run it through again."

I climbed in and we started out looking for trouble. The day was dark and drizzly, and I wondered whether the overcast would affect picture quality.

"Not too much," he said. "TV amplifies light. It's a lot better for our purposes than movies."

He told me he sets the camera lens opening three times a day—at dawn, at 10:00 a.m., and at dusk. Between times it adjusts automatically.

"If we go through a tunnel," he said, "the lens opens wider. In fact, if a highway is lighted, we can tape at night, too."

Even works in the dark

Even on unlighted roads TV will show taillight movements or record passing lights so that speed and recklessness can be determined later.

It was getting on toward noon when we spotted our first "case"—a speeding tailgater on the Connecticut Turnpike. He was going faster than anyone else, bullying cars right and left. Inconspicuously, two lanes over, we were getting the whole performance down on tape.

The guy would rush up behind a car and crowd its bumper, literally *intimidating* the other driver 'til he pulled over and let him by. And all this—the crowding, the switching back and forth



DRIVERS WHO BULLY MOTORISTS and get away with it better think twice in future; now there's evidence

across three lanes—at turnpike speeds.

“This guy doesn't play fair,” Hurlburt said, all the while steering with his left hand while with his right he operated the camera's small pistol grip control, swiveling the camera back and forth on its tripod mounting. The camera is always aimed at the violator, sees everything he does. And our subject was busy bullying everything in sight,

including a couple of trucks. I heard Hurlburt calling off speeds into the mike—64, 68, 76 and so on. It all went on the tape.

Suddenly there was a scream of tires. A horn blared. Trouble.

Bullyboy, blocked by one driver who refused to be intimidated, scooted by on the wrong side, running a small

(Please turn to page 201)

SURPRISED DRIVER WATCHES REPLAY of his own car bullying other cars for three miles before his arrest



A Battlewagon Returns From Mothballs

Idle since Korea, the USS *New Jersey* has been brought out of retirement. Reason: Her ability to blast targets 20 miles inland will spare pilots the risky job of dodging flak and missiles.

By **BOB ZIMMERMAN**

Photos by U.S. Navy and the San Diego Union



SOME WOULD SAY she belongs in a museum, along with the dodos and dinosaurs. She weighs in at 58,000 tons. Her coat of armor is 18 inches thick. Her gargantuan main turrets fire bullets as tall as a man from gun barrels 65 feet long. A seagoing behemoth—in the missile age.

I spent seven days in the Pacific aboard the recently reactivated USS *New Jersey*, and after talking with her enthusiastic crewmen and watching them breathe new, thunderous life into her long-silent guns, I came away convinced: There's at least one more war

left in that old monarch of the fleet, the battleship.

The U.S. Navy has spent \$21 million to take the 25-year-old *New Jersey* out of mothballs and prepare her for her third war. A new breed of battleship sailor has been trained to man her. The assignment: Shore bombardment and gunfire support for troops fighting a dug-in enemy along the coast of Vietnam.

The arithmetic behind this move is simple. Nine 16-inch guns make the *New Jersey* a massive, mobile artillery piece that can lob shells weighing a ton

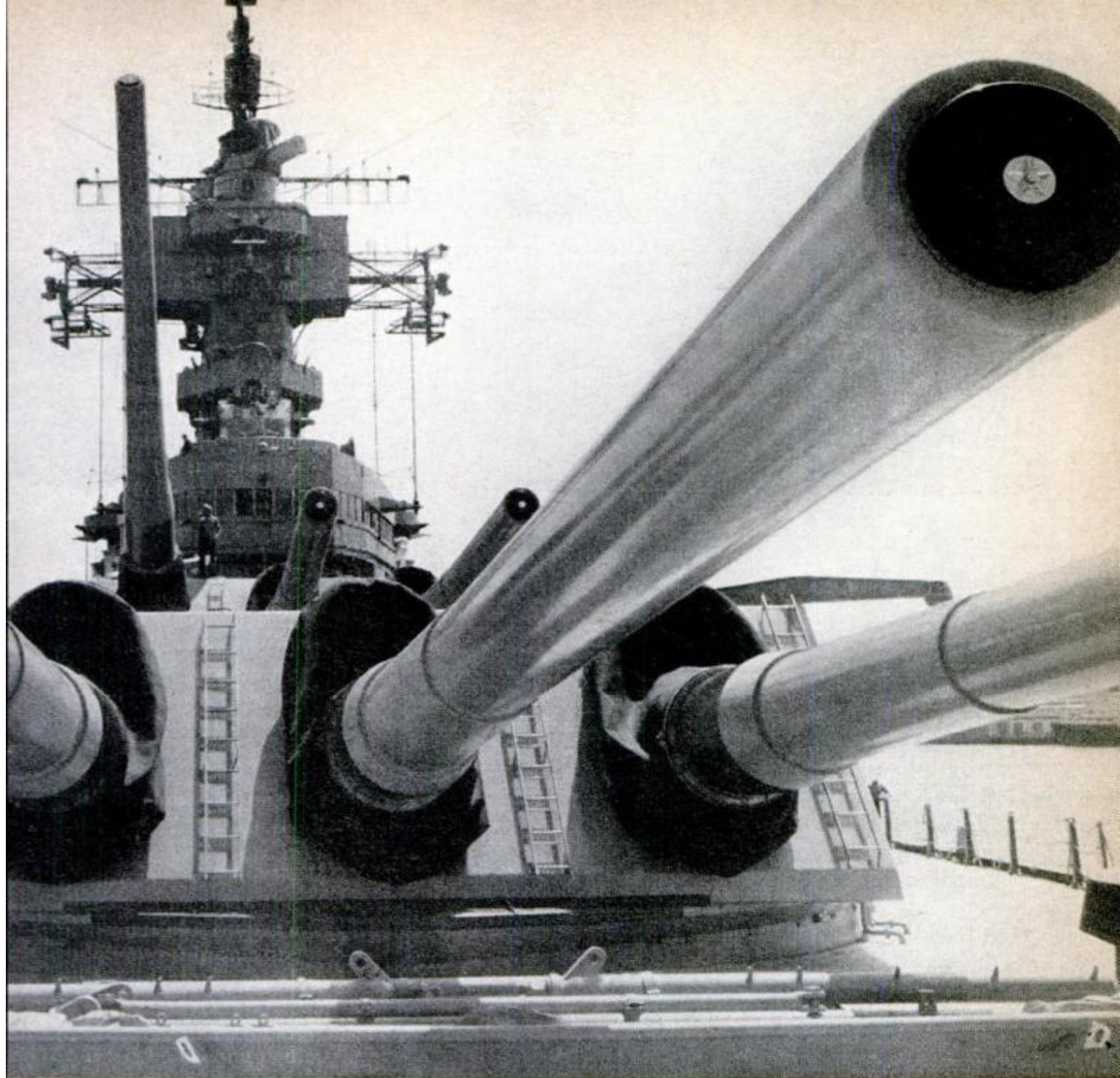

or more at targets 20 miles inland. That's half again as far as the range of a cruiser's 8-inch guns, up to now the biggest on the line off Vietnam.

A battleship projectile, eight times heavier than the cruiser's, can penetrate more than 30 feet of reinforced concrete, or with an air burst can rain shrapnel on enemy troops in an area 200 yards wide. Broadships can sow fantastic devastation with accuracy measured in feet—in any kind of weather.

Match this capability against the only other way of hitting many heavily

defended targets—sending precious jet aircraft and even more precious pilots through a hail of flak and missiles to drop the equivalent tonnage of bombs. You get the kind of “cost effectiveness” equation they like to see in the Pentagon. That's what brought the *New Jersey* back from 11 years of retirement.

Capt. J. Edward Snyder, who began his naval career as signal officer aboard the old battleship *Pennsylvania* during World War II, is now the skipper of the *New Jersey* and a firm believer in battleship firepower.

He scoffs at the idea that the big

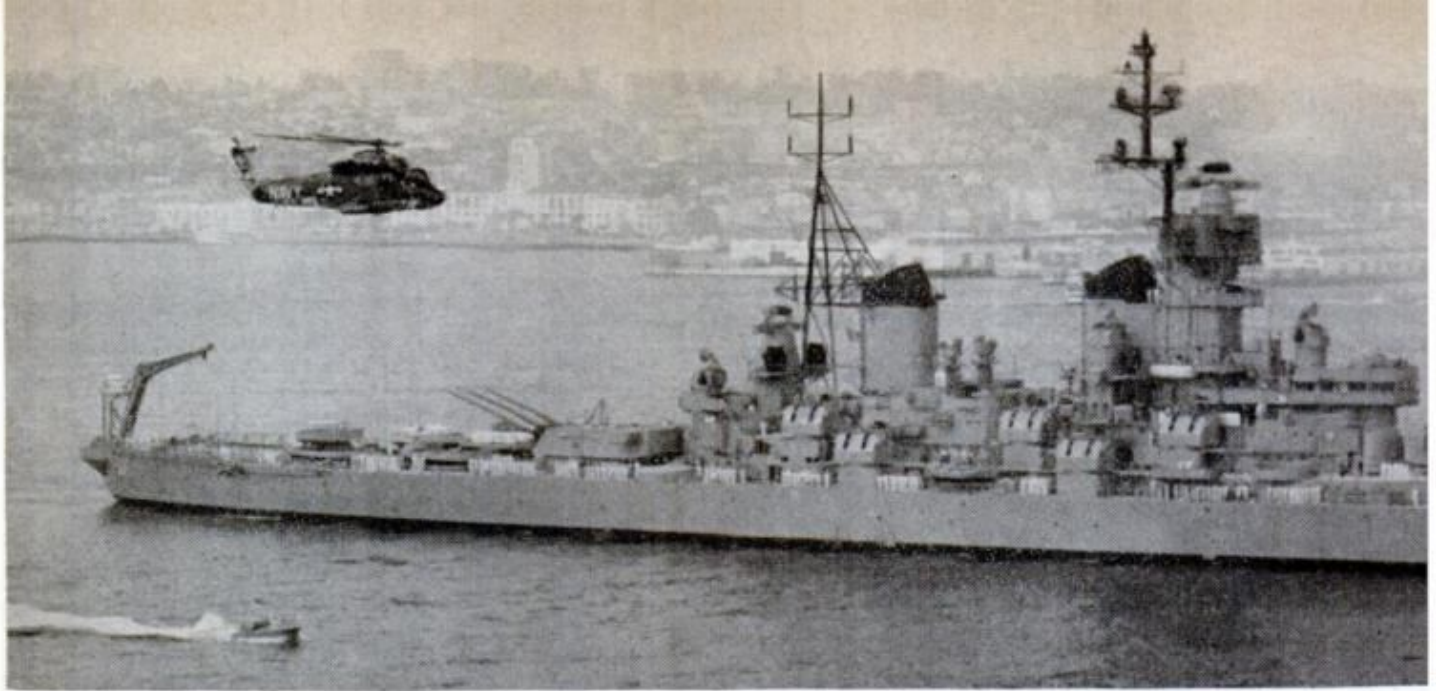

battlewagon is a sitting duck. "This breed of duck is one we could use more of," he says. His argument is the ship itself—no creaky veteran in spite of its age. "See for yourself," he tells the skeptics.

Come aboard the only battleship in active service in the world.

You could squeeze almost three football fields in the length of the *New Jersey*—888 feet from the high tip of her bow down the dramatic sweep of her main deck to her blunt stern. Amidships she fills out to a maximum beam of 108 feet—just the width of the Panama Canal.

You're walking on a teakwood deck, bleached almost white and scored from

countless rubdowns with "holystone." Young sailors who do the job now weren't even born when the *New Jersey* first steamed into combat in 1944.

Don't let the teakwood fool you. The *New Jersey's* suit of armor begins one deck below, a shield so formidable that hatches leading to the heart of the ship have to be raised and lowered mechanically. The same steel shell extends down her flanks. "We're designed to take 10 torpedo hits simultaneously on both sides and stay afloat," says Capt. Snyder.

Down you go, ladder after ladder, through crew's quarters that were air-conditioned for the *New Jersey's* return to the fleet. Finally you're on "Broadway"—an old name that still sticks to a central passageway extending one-third the length of the ship and linking the boiler and engine rooms.

Here's where the *New Jersey* gets its go-power: eight boilers feeding steam to four engines that can send up to 212,000 hp into shafts turning four propellers, for 33-knot top speed.

But you're perspiring in the clamorous engineering spaces. The airconditioning doesn't extend down here, and the boiler crews will tell you they get used to 130° at their stations in hot weather.

HUGE SHELLS for 16-inch guns are as tall as a man and weigh 2700 pounds each. It takes six 100-pound powder bags to fire one of these projectiles to its maximum range of 23 miles

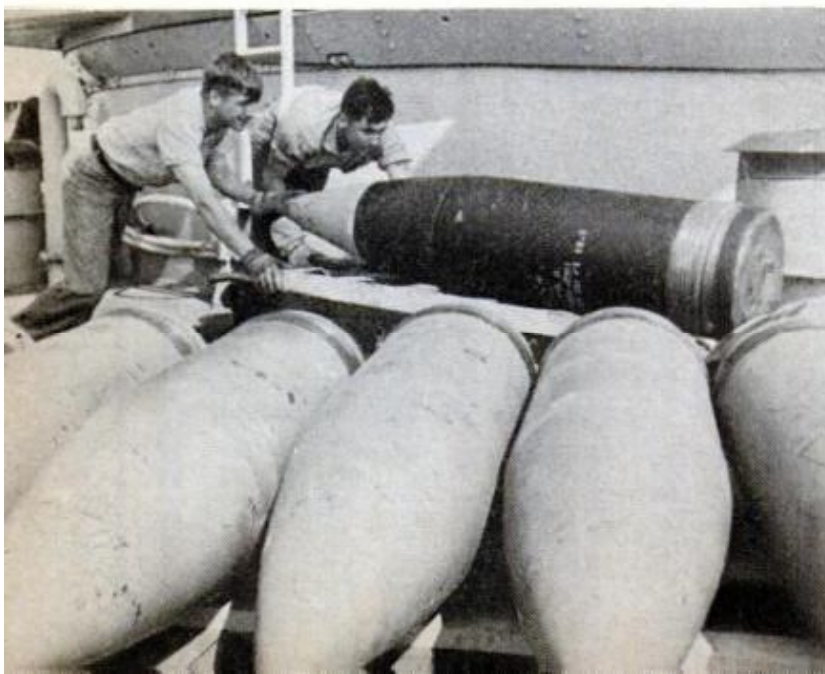



REACTIVATED SHIP *New Jersey* sails majestically past San Diego skyline, en route to Vietnam. Her 16-in. guns, bristling in silhouette, will be used to pound Vietcong entrenchments up to 20 miles inland. Old warrior, now 25 years old, was put in mothballs shortly after Korea, but looks none the worse for wear after long layup

So it's back up the ladders into the brisk breeze on the 03 level—the flag bridge. Now pause for some history. There's the same high swivel armchair where Adm. William F. (Bull) Halsey sat during some of the great battles of the Pacific war, when the *New Jersey* was his flagship. Just below is the "Halsey Suite," now empty.

The flag bridge . . . the Halsey suite . . . they're deserted now. This part of the *New Jersey* was not reactivated. And looking out over the decks you see other evidence that this battleship is something less than what it was built to be. The 40-mm antiaircraft guns that knocked kamikazes out of the sky off Okinawa—they're gone. Empty gun tubs remain, like so many kiddie-sized swimming pools.

But from up high you can see that the 40-mm cannon were popguns compared with what remains. There are two 16-inch turrets forward and one aft. Each turret with its three deadly snouts and the mechanism that feeds it weighs as much as a typical destroyer!

Its roots extend five decks below, to a powder magazine where sailors heave 100-pound, silk-wrapped bags of powder onto a "dumbwaiter" that lifts them to the gun breech. One level above, men use rope and a capstan to maneuver projectiles—they're called "bullets" here—into the cradle of a powerful hoist.

Climb into the turret and you'll know how a Lilliputian felt inspecting Gulliver's blunderbuss. The slim-nosed bullet (the biggest weighs 2700 pounds) is tipped from the hoist into a cradle and a hydraulic ram shoves it into the barrel. Then six bags of powder are shoved in behind and the breech slams shut.

Radar and electronic equipment in a plotting room elsewhere on the ship feed instructions to a chief gunner in a saddlelike seat. He turns hand-wheels to control the direction of the turret and the elevation of the barrel, and at the command of fire, squeezes a pistol-grip trigger to send more than a

(Please turn to page 206)

QUARTERS of Adm. William F. (Bull) Halsey, former fleet commander who used *New Jersey* as his flagship during World War II, are empty out of respect. Five-star flag on wall is kept with other memorabilia



'69 OUTBOARDS

Potent Power

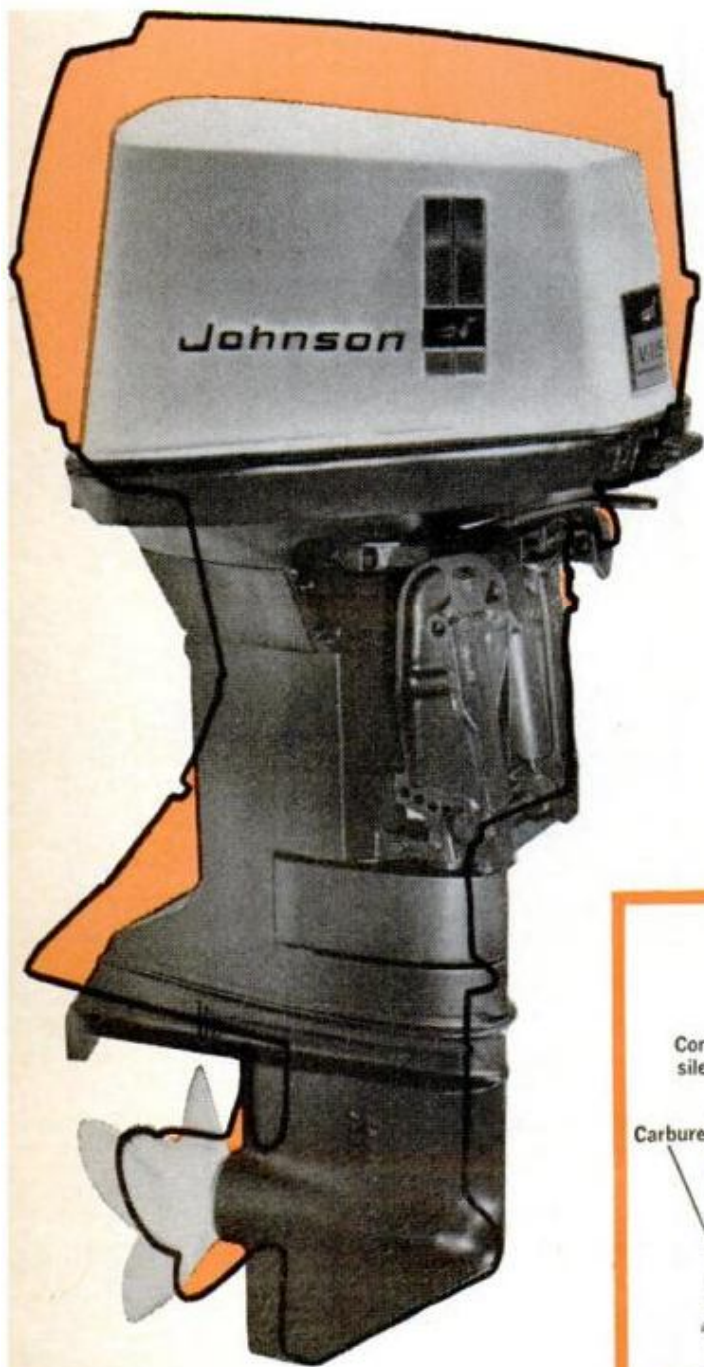

Smaller motors with bigger zing, better-for-the-job horsepower ratings, piston changes, metered oil—all combine to give you a wide choice in outboards this season

By DAN FALES, Boating Editor

ESPECIALLY in lower horsepower, outboard motors this season will have more power in smaller units. Chrysler, for example, is upping its 4.4 to 5 hp, while cutting motor weight from 49 to 48 pounds.

There are also smaller packages in the superhorsepower classes. Johnson and Evinrude are introducing 115-hp motors that are 20 percent smaller than last years' 100-hp models.

The new Evinrude 25-hp has much

COLORED AREA shows larger size of last year's 100-hp Johnson motor in a comparison with this year's more compact 115-hp model. Cutaway photo at the right shows how units are compacted around the powerhead of 115-hp motor made by Outboard Marine Corp. for Johnson and Evinrude. Attaching components directly to the head permits a smaller overall size of motor. In place of old system which provided space for powerhead movement during speedup and slow-down, OMC had to save that space and let entire motor move against bushings on transom bolts

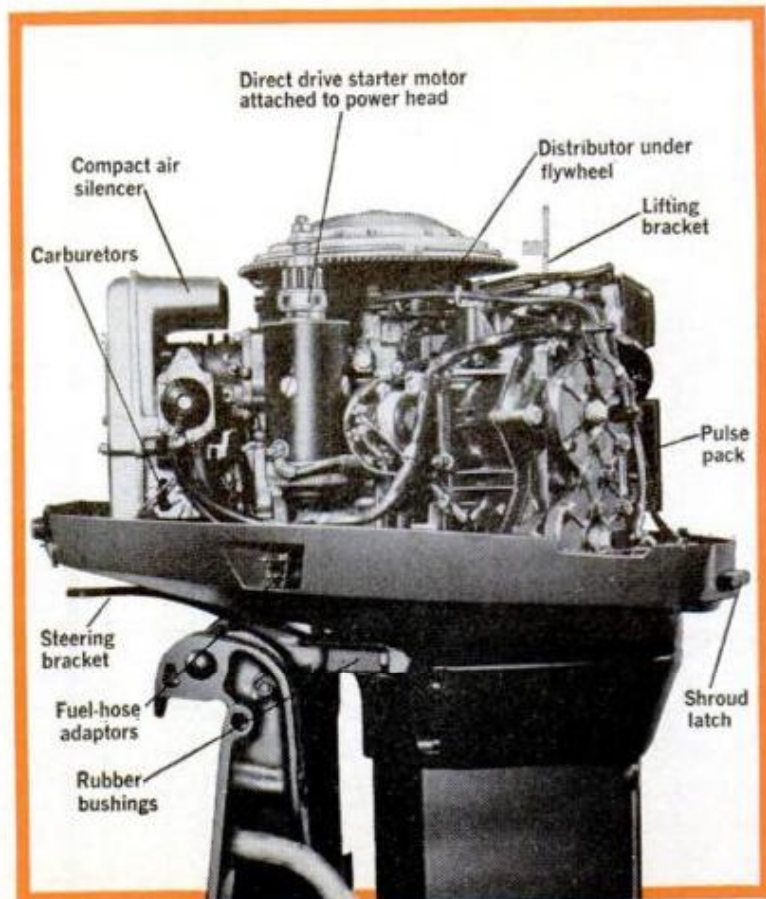

in Pint-Size Packages

more zip than the 18-hp model, but is only 2 pounds heavier—81 pounds.

Mercury is size conscious, too, introducing a brand-new piston-cylinder design called Direct Flow. This design is incorporated in Mercury's new 80-hp motor—the most compact 80 it has ever made.

New also is Yamaha's 15-hp outboard equipped with metered oil—no need to mix gas and oil in this two-cycle motor.

Fisher-Pierce, maker of the popular Homelite 55-hp four-cycle motor, is dropping the Homelite name. From now on the 55 will be known as the Bearcat.

Seagull is boosting the power on many of its popular models and calling the line Silver Century. Brand new from Seagull is the 6½-hp Silver Century with clutch drive. Suggested price: \$265.

McCulloch isn't making any changes this year—deciding to go with the same model it had last year.

Montgomery Ward is adding a new 45-hp, while Sears is adding electric start to the 7.5 model.

Johnson's Sea Horse line has 26 models this season in 11 horsepower classes. New are the 4-hp



EVINRUDE is adding the spiffy new 25-hp model called Sportster. This 81-pound package has enough power to handle many of your big-power needs for fishing or zipping around lakes just for the fun of it



Mercury's Direct Flow

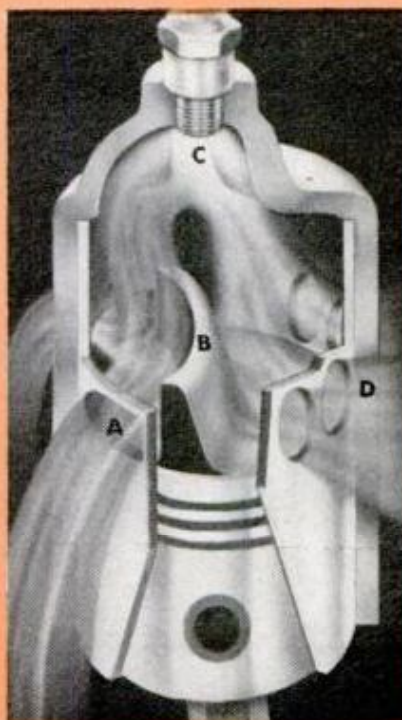

During operation of Mercury's new 80-hp model a fresh fuel-air charge travels through a transfer passage in engine block and enters cylinders through the intake ports (A). The split-air charge meets and is deflected upward by new piston head (B). Converging streams travel a precise course to top of chamber (C) and then down sloping side of deflector, effectively scavenging spent grease from previous stroke out through four exhaust ports (D).

and 25-hp. Though the 115-hp and the 85-hp are not new for Johnson, they now come in new packages smaller than last year's 100-hp—which has been discontinued. The 115-hp has an upper unit shorter by $2\frac{3}{8}$ inches, lower by $2\frac{1}{2}$ and lighter by 20 pounds. than the 100. This space is saved by a new design. Now items like the starter motor and distributor are attached directly to the power head. (Note caption on page 92.)

Last year's 115-hp was a GT model used strictly for racing. Johnson's changed that, making the new V-115 a family-use motor that's fully guaranteed.

Sister to the V-115 is the 85-hp. The V-85 is the same motor as the V-115 with less displacement. While the V-115 has 96.1 cubic inches, the V-85 has 92.6 cubic inches. The price is different, too—\$1450 for the V-115; \$1300 for the V-85 (f.o.b. Waukegan, Ill.). Both motors have larger displacement than last year's models.

While beefing up the high-powered models, Johnson has dropped the 65-hp,

improved on the popular loop-charged 55-hp, the 40-hp and the 33-hp.

Brand new to the line is the Sea-Horse 25. This 25-hp model with 22-cubic-inch engine weighs 81 pounds. It's made for fishermen who want power to push a large skiff across lakes. The 25, with weedless prop, has a suggested price of \$510.

The Sea-Horse 20 has a weedless prop this year, too.

Johnson has restyled the 6-hp model, dropped the 5-hp and 3-hp models, and added the 4-hp. This new motor is also for fishermen.

Johnson has also improved the very popular $1\frac{1}{2}$ -hp trolling motor.

Mercury is introducing what it calls "a revolutionary means of charging the cylinders." This system is exclusive in a brand-new 80-hp outboard. This addition to the Mercury series has a four-in-line powerhead which develops 80 hp with only 66.6-cubic-inch displacement. This makes for a very compact 80-hp motor.

Mercury's new Direct Flow scavenging system takes the

(Please turn to page 212)



TWO NEW OUTBOARDS developed this year by Chrysler: a low-profile 7-hp model (right) and a three-cylinder 70-hp motor (below), the latter shown on one of Chrysler's new boats to be introduced for the '69 season. The 70 is a smaller horsepower version of the three-cylinder 85-hp Chrysler motor

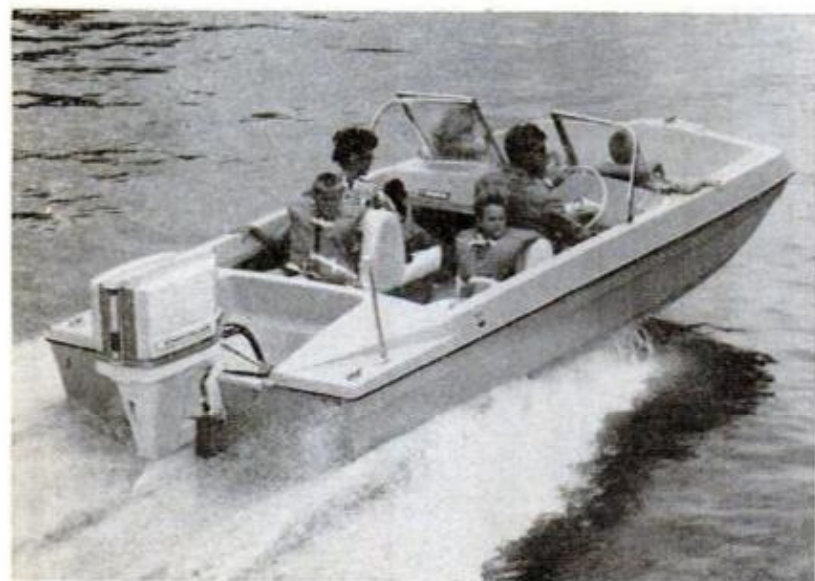

SEAGULL is introducing its new Silver Century line, topped by this $6\frac{1}{2}$ -hp model with clutch drive. Silver Century motors will have 25 percent more power than the regular Century models



POPULAR MECHANICS

ALL THE OUTBOARDS FOR 1969

Hp	Cylinders	Weight	Bore & Stroke	Displacement	Starting
CHRYSLER					
105	4	248 lbs.	3.312" x 2.800"	96.55 cu. in.	electric
85	3	221 lbs.	3.312" x 2.800"	72.39 cu. in.	electric
70	3	221 lbs.	3.312" x 2.800"	72.39 cu. in.	electric
55	2	140 lbs.	3.187" x 2.800"	44.7 cu. in.	electric
45	2	127 lbs.	3.125" x 2.750"	42.18 cu. in.	manual*
35	2	127 lbs.	3.000" x 2.540"	35.9 cu. in.	manual*
20	2	79 lbs.	2.437" x 2.140"	19.96 cu. in.	manual*
9.9	2	56 lbs.	2.187" x 1.750"	13.15 cu. in.	manual**
7	2	49 lbs.	2.000" x 1.625"	10.2 cu. in.	manual
5	2	47 lbs.	1.875" x 1.625"	8.99 cu. in.	manual
3.5	1	29 lbs.	2.062" x 1.562"	5.18 cu. in.	manual
* Electric model available			** Autoelectric model available		
EVINRUDE					
115	4	245 lbs.	3.438" x 2.588"	96.1 cu. in.	electric
85	4	245 lbs.	3.375" x 2.588"	92.6 cu. in.	electric
55	3	197 lbs.	3" x 2-11/32"	49.7 cu. in.	electric
40	2	156 lbs.	3-3/16" x 2-3/4"	43.9 cu. in.	electric*
33	2	140 lbs.	3-1/16" x 2-3/4"	40.5 cu. in.	electric*
25	2	81 lbs.	2 1/2" x 2 1/4"	22.0 cu. in.	manual**
18	2	80 lbs.	2 1/2" x 2 1/4"	22.0 cu. in.	manual**
9 1/2	2	60 lbs.	2-5/16" x 1-13/16"	15.2 cu. in.	manual
6	2	51 lbs.	1-15/16" x 1 1/2"	8.84 cu. in.	manual
4	2	35 lbs.	1-9/16" x 1 3/8"	5.28 cu. in.	manual
1 1/2	1	20 lbs.	1-9/16" x 1 3/8"	2.64 cu. in.	manual
* Also available with manual starting			** Also available with electric starting		
FISHER-PIERCE					
55*	4	239 lbs.	2.75" x 2.50"	59.4 cu. in.	electric
* Four-cycle engine, the only such outboard available in the United States today					
JOHNSON					
115	4	245 lbs.	3.438" x 2.588"	96.1 cu. in.	electric
85	4	245 lbs.	3.375" x 2.588"	92.6 cu. in.	electric
55	3	197 lbs.	3" x 2-11/32"	49.7 cu. in.	electric
40	2	156 lbs.	3-3/16" x 2-3/4"	43.9 cu. in.	electric*
33	2	140 lbs.	3-1/16" x 2-3/4"	40.5 cu. in.	electric*
25	2	81 lbs.	2 1/2" x 2 1/4"	22.0 cu. in.	manual**
20	2	80 lbs.	2 1/2" x 2 1/4"	22.0 cu. in.	manual**
9 1/2	2	60 lbs.	2-5/16" x 1-13/16"	15.2 cu. in.	manual
6	2	51 lbs.	1-15/16" x 1 1/2"	8.84 cu. in.	manual
4	2	35 lbs.	1-9/16" x 1 3/8"	5.28 cu. in.	manual
1 1/2	1	20 lbs.	1-9/16" x 1 3/8"	2.64 cu. in.	manual
* Manual starting also available			** Electric starting also available		
MCCULLOCH					
75	3	196 lbs.	3 1/8" x 2-3/4"	63.3 cu. in.	electric
45	2	145 lbs.	3 1/8" x 2-3/4"	42.2 cu. in.	electric
9	2	48 lbs.	1-15/16" x 1-45/64"	10 cu. in.	manual*
7 1/2	2	39 lbs.	1-15/16" x 1-45/64"	10 cu. in.	manual*
4	1	37 lbs.	2 1/8" x 1 1/2"	5.3 cu. in.	manual
* Electric model also available					
MERCURY					
125	6	—	2 7/8" x 2-9/16"	99.812 cu. in.	electric
100	6	—	2 7/8" x 2-3/10"	89.587 cu. in.	electric
80	4	—	2 7/8" x 2-9/16"	66.6 cu. in.	electric
65	4	—	2-15/16" x 2-3/10"	62.35 cu. in.	electric*
50	4	—	2-9/16" x 2 1/4"	43.837 cu. in.	electric**
35	2	—	3" x 2-3/10"	32.516 cu. in.	manual**
20	2	—	2-9/16" x 2 1/8"	21.918 cu. in.	manual**
9.8	2	—	2" x 1-3/4"	11.000 cu. in.	manual
7.5	2	—	2" x 1-3/4"	11.000 cu. in.	manual
4	1	—	2" x 1-3/4"	5.5 cu. in.	manual
* Manual-starting model also available			** Electric starting also available		
MONTGOMERY WARD					
80	4	242 lbs.	3 1/8" x 2-3/4"	84.36 cu. in.	electric
55	2	153 lbs.	3-3/16" x 2-8/10"	44.7 cu. in.	electric
45	2	145 lbs.	3 1/8" x 2-3/4"	42.18 cu. in.	electric
35	2	145 lbs.	3" x 2.54"	35.9 cu. in.	electric
20	2	73 lbs.	2.44" x 2.14"	19.9 cu. in.	manual
9.2	2	56 lbs.	2 1/8" x 1-11/16"	11.97 cu. in.	manual
6	2	55 lbs.	2" x 1-11/16"	10.6 cu. in.	manual
3 1/2	1	29 lbs.	2-1/16" x 1-9/16"	5.18 cu. in.	manual
SEAGULL					
6 1/2*	1	37 lbs.	2.244" x 1.575"	6.1 cu. in.	manual
5*	1	37 lbs.	2.244" x 1.575"	6.1 cu. in.	manual
4**	1	34 lbs.	2.244" x 1.575"	6.1 cu. in.	manual
3**	1	28 lbs.	1.772" x 1.575"	3.8 cu. in.	manual
2**	1	26 lbs.	1.772" x 1.575"	3.8 cu. in.	manual
* Clutch			** Available in Silver Century model which is 25% more powerful		
SEARS					
75	3	196 lbs.	3 1/8" x 2-3/4"	63.27 cu. in.	electric
45	2	145 lbs.	3 1/8" x 2-3/4"	42.18 cu. in.	electric
28	2	102 lbs.	2-51/64" x 2-7/16"	29.97 cu. in.	electric
14	2	82 lbs.	2 1/4" x 2-1/8"	16.4 cu. in.	manual
9	2	49 lbs.	1-15/16" x 1-45/64"	10 cu. in.	manual*
7.5	2	42 lbs.	1-15/16" x 1-45/64"	10 cu. in.	manual*
4	1	37 lbs.	2.125" x 1.5"	5.3 cu. in.	manual
* Electric model also available					
YAMAHA					
15*	2	—	—	—	manual
7.5*	2	59 lbs.	2.13" x 2.13"	7.5 cu. in.	manual
5*	2	49 lbs.	1.97" x 1.85"	5.6 cu. in.	manual
3.5*	2	35 lbs.	1.77" x 1.57"	3.84 cu. in.	manual
* Metered oil					

THE '69 CARS

By **BILL KILPATRICK**, Auto Editor

Photography by Jeannie Weaver

GADGETS AND GIMMICKS, some for real, some for fun—but all aimed at pushing sales—are the big Detroit news for '69.

Pontiac's Grand Prix (described in the *Personal Cars* section) is the industry's only really new car. There are some safety modifications and innovations and some minor engineering "improvements." But the trump cards automakers will play to woo you into the showrooms add up to variations on performance (spelled S-P-E-E-D), appearance, comfort and convenience.

Perhaps even better than he realized, Ford Div. headman John B. Naughton, summarized his fellow manufacturers' 1969 offerings when, speaking of Ford's, he said, "We've got a basketful of goodies second to none in the industry."

Being heavily hawked are such things as wider rear-view mirrors, wipers that clear more windshield area, belted, wide-tread tires, hood scoops, trim stripes, hotter engines, a sliding roof panel (Now *there's* a novel idea), relocated door-lock buttons, and on and on. Some make sense, some nonsense.

One that makes sense is the "guard rail" General Motors features on its bigger cars. It looks like a section of typical steel highway guard rail mounted inside door panels, to protect occupants in broadside collisions.

Another that makes sense is called Super-Lite, a low-beam supplement developed by Sylvania and available as an option on the Dodge Polara and Monaco. Consisting of a single high-intensity lamp mounted in the grille, Super-Lite casts a narrow beam of light to the right, illuminating the infamous gloom between high and low beams. It's nonglaring.

Ford is featuring what it calls an "S" frame, the front side members of which curve outwards to help soak up impact forces. This makes sense, too. So does the optional antiskid device Ford is introducing this year on the Lincoln Mark III and the Thunderbird.

As of Jan. 1, Big Brother demands front-seat headrests on all new cars. Manufacturers started off the model year with them in certain cars. The ones I've seen so far are hard, bulky and can restrict vision somewhat. I think there just *has* to be a better solution to the entire problem, but I'm personally delighted Detroit is finally admitting its shiny beauties *can* be improved from the view of safety.

GM is offering ignition locks mounted on steering columns. In the "Off" position, keys removed, the column is locked and the car can't be steered. It's an old idea that may make car theft a bit more difficult.

Dodge this year is offering as an option a seat that can be mechanically adjusted for height. Hooray! At last! Only every manufacturer should have it (soon will, hopefully) and it shouldn't be an option, but as basic to car seats as fore and aft adjustment.

Chrysler and Ford station wagons offer what may prove a useful idea. Via a sort of "spoiler" at the back of the roof, air is deflected down over the rear window, the thought being the wrinkle will keep the window clean.

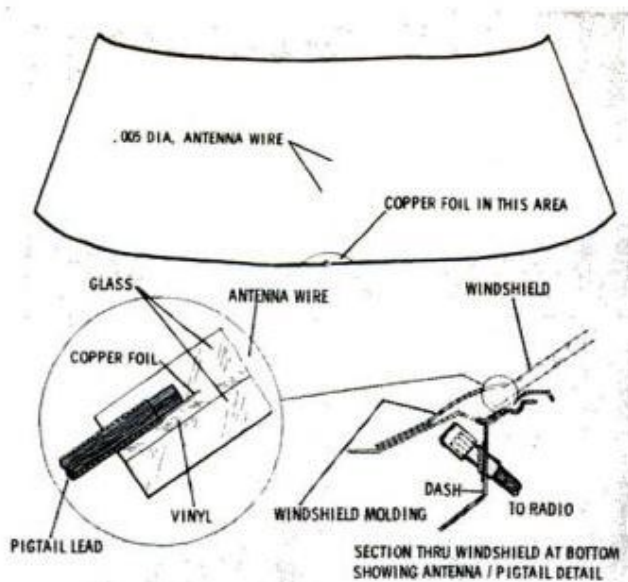

PONTIAC'S NEW GRAND PRIX has radio antenna concealed in windshield. Wire is .005-in. diameter

The relocated door-lock buttons mentioned earlier are situated about midway on the upper sill, meaning you won't have to spring a shoulder or get a crick in your neck twisting around to lock the door from inside. It seems obvious and long overdue, but we'll take anything we can get.

What we *are* going to get whether we like it or not are higher prices. Altruism is not the name of Detroit's game, and that "basketful of goodies" referred to by Ford's Naughton is going to cost money—*yours*. As this is being written (early August), automakers have been reluctant to discuss just how much they plan to tag onto car prices. Industry observer estimates (an editorial euphemism meaning my own estimate) are bandying about figures from \$35 to \$125. Anyhow, know your new car is going to cost you more.

In general, what you'll get for what you'll pay is about what you got last year, the year before, and presumably will get next year—that is, a basically sound overall concept that may or may not be worth its price, that may or may not—depending upon initial workmanship, dealer service, economy, and so on—be a delight to own and operate. The '69 cars *are* nice, *are* good, *are* in theory better than they have ever been. Individual dogs, however, can give the entire pack a bad name. Nothing can

assuage the outrage of a man who has had a sad experience with a new car.

Detroit knows it, too. Witness the second thoughts regarding warranties. Automakers, believers in their own stars, are appalled at the mounting pile of warranty claims. The warranty idea has proved more trouble and expense than it's worth. The subject is up in the air, so when and if you go to buy a new car, realize there have been some warranty changes made.

Another thing you should realize is that the auto business is changing by the minute, more so now than ever. In many respects, the manufacturers have created a marketing monster even *they* are finding difficult to control.

Perhaps the best example of this took place last summer at a press preview of '69 cars. A prominent industry marketing executive was speaking.

"This beautiful new car," he was saying, pride in his voice as he pointed

DODGE'S NEW SUPER-LITE, mounted halfway up left side of grille, is option on Polara, Monaco, beams light to right side of road, illuminates critical area between low and high beams, does not glare in eyes of oncoming driver. The idea works very well



HIGH



LOW + SUPER-LITE



LOW

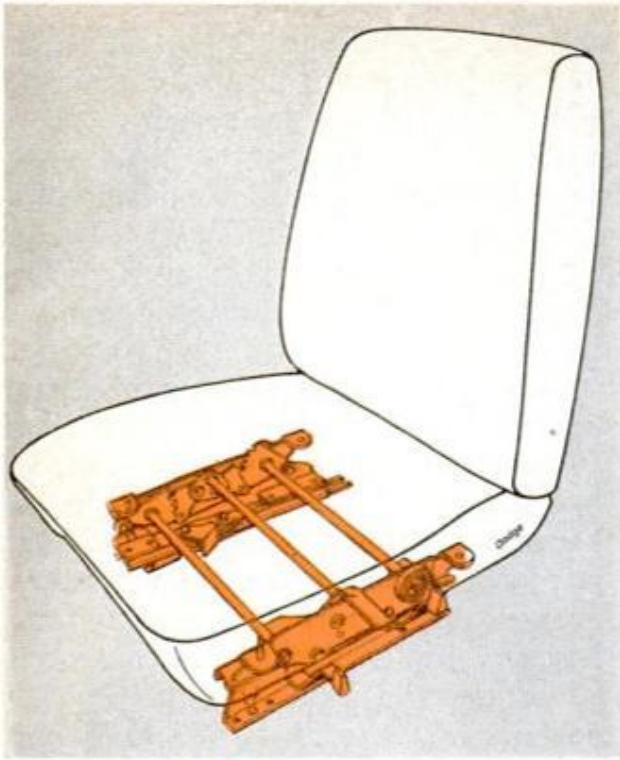

DODGE manually operated seat adjusts height, too. Front lever is horizontal adjustment, rear vertical

at a spotlighted and sparkling example of Detroit's consumer-awareness, "is aimed squarely at the upper premium segment of the medium-priced field."

I nearly fell off my chair. What kind of mumbo-jumbo was *this*? Is there a *middle* or *lower* premium segment of the medium priced field?

Yep. The speaker knew exactly what he meant. So did every other auto man in the room. He had summed up a car market that has become so "fractionalized"—to quote a Ford executive—it's becoming ever more difficult to pigeonhole industry production in

PONTIAC GRAND PRIX options include a wired rear window that provides quick defogging, ice removal



clearly defined marketing categories. Thus automakers, faced with a self-created maze of options within models within series within lines within makes, have had to resort to a "fractionalized" lingo just to keep track of things.

But what about you, the poor buyer? Must you master the tongue in order to make an intelligent buying choice? You can't, for example, just go in and order, say, a Chevy, period; you have to choose between 35 models within seven distinct product lines. Is it any wonder you don't know exactly *what* to buy? As a result, you buy *something* and tell yourself you like it and have done well, but it's touch and go there for awhile, isn't it? Yet industry executives claim *you* are the culprit.

'Tain't so. Their good eye on the money machine, they've created this mutual monster by covering all conceivable market bases so thoroughly they're hard-pressed to find a niche into which they can introduce anything really new. Your attention, therefore, must be attracted by a plethora of gadgets and gimmicks. And as mentioned, '69 looks like a vintage year.

Is this bad? Not really, I suppose. Just thoughtless. Each year automakers crank out still another version of a worn-out theme postpones the day we—you, me, the industry—must grow up regarding automobiles and face the tremendous social and economic problems we've let them become. ★★★

COCKPIT of new Grand Prix resembles just that—a cockpit—typifies industry's new dash panel designs

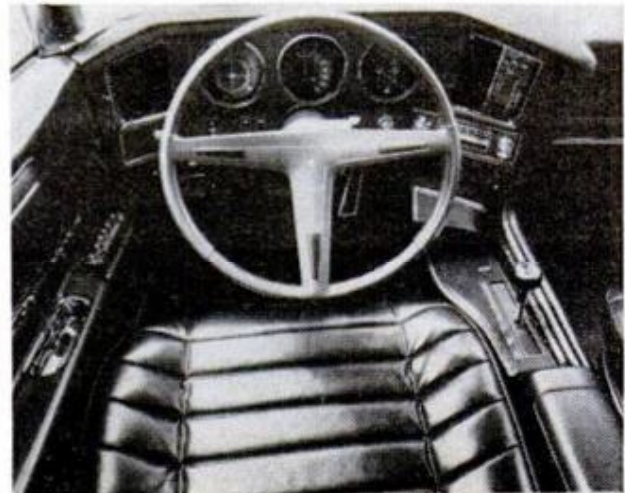



BUICK LESABRE, billed as standard-size value leader, has a new grille, side-body accent line of two elements

Family Cars: '69

Size up, market down

THE
'69
CARS

ONE OF THESE DAYS we may witness the end-of-the-line for the traditional, full-size family car.

Current manufacturer marketing philosophies and buyer preferences are fragmenting the market, giving greater and certainly louder emphasis to intermediates, the personal/specialty field, and all-out luxury cars. As a result, sales of what used to be "the only game in town" are falling off.

Is this a good thing? Well, to a man who lives and works in, say, traffic-clogged New York City, perhaps yes; to a man who appreciates a few more inches of, say, rear-seat legroom, but can't (or won't) pop for a luxury job, perhaps no. In any event—death watch or no—carmakers are enthusiastically (albeit more quietly) pumping new styling

and engineering life into their heretofore most profitable, thus most venerable idea—a car designed for the entire family. On tap for '69: **AMERICAN MOTORS:** Styling changes fore and aft mark the new Ambassador. There's new front-end sheet

metal, a new grille and bumper, new taillights, a new deck lid, new rear quarter-panel caps. I think the car is better looking than it has been in recent years. Wheelbase and overall length are up four inches, front and rear tracks widened two inches. You can get a plain Ambassador four-door, a four-door or two-door hardtop and station wagon in either the DPL or the SST. Airconditioning is again standard.

Check this one out. It's worth a look.

PONTIAC CATALINA, here in Ventura option, highlights split bumper look





MERCURY MARAUDER X-100 is new this year, features tunneled back-light in a styling mix of semi-fast-back, hardtop themes. Entire rear deck is in matte black, giving car unique look, may be hard to clean

THE '69 CARS

BUICK: That Li'l Ol' Phrasemaker is back in business, this time at Buick. He assures me the styling on the '69 Wildcat will "excite the most jaded individual." No chance. While I'm far from jaded, neither the Wildcat nor the lower-priced LeSabre caused jumps for joy. They're both nice cars, both

look very much like they did last year. Grilles have been changed, and that single, flowing sideline along the body broken up into two elements. Interior trims have been juggled around, as has ornamentation. Buick says suspensions have been improved to provide "the best directional stability ever experience in an automobile." The Phrasemaker apparently has never driven, say, a

BMW, and he can't always find the letter "d" on the keyboard. Wonder where he'll be working next year? **CHEVROLET:** Consistently leading the sales race, Chevy's back in the pack when it comes to new styling for 1969. Changes on the Caprice, Impala, Bel Air and Biscayne are few and far from obvious. Grilles have been slightly altered, there's a new front bumper, and

DODGE POLARA has new grille, new exterior lines, new taillight styling. Available only on Polara and Monaco this year is Super-Lite, an auxiliary system that illuminates area between high, low beam lights



PLYMOUTH FURY is longer overall, wider, has a one-inch longer wheelbase, a new grille, more interior room





FORD XL, with LTD, is at top of Ford's full-size line, features luxury options, minor styling changes



CHEVROLET CAPRICE heads full-size line of 11 models including Impala, Bel Air, Biscayne. Overall length is up 1 in. throughout line. Car still has 119-in. wheelbase. Styling changes are minor, with concealed headlights, special grille available only on Caprice. Included in Impala series is a hot SS 427 powered by 390-hp, 427-cu.-in. V8

AMC AMBASSADOR this year is all-new, features new grille, fenders, hood, rear-end styling. Additional features include 122-in. wheelbase, up 4 in. over '68, and 4-in. boost in overall length to 206 in. Car is available in seven models, three series—Ambassador, DPL, SST. Wagons are available as DPL and SST



CHRYSLER NEWPORT is up 5 in. overall to 224 in. for '69, as is entire full-size line. Grilles have been slightly modified, dimensions of interiors, exteriors increased. Hidden headlights on 300 feature a manually operated fail-safe setup for emergencies. On Newport, 383-cu.-in. V8 is standard, a big 440 standard on the 300 and New Yorker

FAMILY CARS—HOW THEY COMPARE

Car	Wheel-base (in.)	Track (f/r, in.)	Overall Length (in.)	Overall Width (in.)	Engines in Model(s) Series* (Displacement, cu. in.—V8 except as noted—carburetion)
American Motors (Ambassador)	122.0	60.0/60.0	206.5	77.2	232-6-2bbl., 290-2bbl., 343-2&4bbl., 390-4bbl.
Buick (Wildcat, LeSabre)	123.2	63.44/63.00 (Wildcat) 63.0/63.0 (Le Sabre)	218.5	79.5	350-2&4bbl., 430-4bbl.
Chevrolet (Biscayne, Bel Air, Impala, SS427, Caprice)	119.0	62.5/62.4	215.9	79.8	250-6-1bbl., 327-2bbl., 350-4bbl., 396-2bbl., 427-4bbl.
Chrysler (Newport, Custom, 300, New Yorker)	123.5	62.1/60.7	224.7	79.0 79.1 (4dr.)	383-2&4bbl., 440-4bbl.
Dodge (Polara, Monaco)	122.0	62.1/60.7	220.8	79.3	318-2bbl., 383-2&4bbl., 440-4bbl.
Ford (Custom, 500, LTD, XL, Galaxie 500)	121.0	63.0/64.0	214.0	79.4 79.8 (4dr.)	240-6-1bbl., 302-2bbl., 390-2bbl., 429-2&4bbl.
Mercury (Monterey, Custom) (Marquis, Brougham)	121.0 124.0	63.0/64.0 63.0/64.0	218.0 224.3	79.8 79.8	390-2bbl. (reg. or prem. fuel), 429-2&4bbl.
Oldsmobile (Delta 88, Custom, Royale)	124.0	62.5/63.0	218.6	79.9	350-2bbl., 455-2&4bbl.
Pontiac (Catalina, Ventura) (Executive, Bonneville, Brougham)	122.0 125.0	64.0/64.0 64.0/64.0	217.5 223.5 (Executive) 224.0 (Bonneville, Brougham)	79.8 79.8	400-2bbl. (reg. or prem. fuel), 428-4bbl.
Plymouth (Fury I, II, III, Sport, VIP)	120.0	62.1/60.7	214.5	79.6	225-6-1bbl., 318-2bbl., 383-2&4bbl., 440-4bbl.

*Not all engines available in all models

rectangular taillights have been incorporated in the rear bumper. There's a new instrument panel and a new two-spoke steering wheel, plus 13 new exterior colors. A lot of things—according to Chevy—have been “improved,” or made “wider, smoother, quieter, richer,” and so on, all of which is probably true. What the cars are, however, are Chevrolets. And that ain't bad.

CHRYSLER: Overall length of the Newport, Newport Custom, 300 and New Yorker is up five inches over last year to 224.7. Wheelbase remains 124 inches. Dimensions inside are up, too, the result being a roomier, more comfortable car all-'round. There are new grilles, new looped, “wraparound” bumpers in front, new concealed windshield wipers, and a new taillight arrangement. Standard power on the Newport and Custom is a 383-

cu.-in. V8, with Chrysler's 440 as the option. The 440 is standard on the 300 and the New Yorker with a higher performance option of the same engine available to muscle enthusiasts.

I think Chrysler's coming on.

DODGE: The Polara and the top-of-the-line Monaco have been completely re-

styled for '69, but the changes are subtle and general as opposed to startling and specific. The car offers a lower, rounded, more aerodynamic appearance emphasized inside by new interior layouts featuring “cockpit” dash panels. Throughout the line there's a strong hint of Charger, i.e.,

(Please turn to page 216)

OLDSMOBILE DELTA “88” retains a by-now-traditional Olds grille theme





MERCURY CYCLONE CJ features minimum trim, blacked-out grille, hood scoops, is all "go" with 428 engine

Intermediates:

THE
'69
CARS

Where buyer action is

CRYSTAL BALL genius isn't needed to figure out at least three big reasons why intermediates are the fastest-growing segment of the auto business.

One, they're big enough for family use, yet small enough to provide a "personal"-car feeling. Two, they're priced right. Three, the wide range of available power and other options make them the most flexible cars on the market.

Intermediates are locked in a neck-and-neck sales race with standard, family-size cars, each type grabbing off approximately 25 percent of the market. Auto men, cautious to a fault at times, confidently expect intermediates to pull ahead in the coming year. A few, speaking privately, predict that within five years, inter-

mediates will represent between 40 and 50 percent of the market. It could happen.

Here's what manufacturers are entering in the 1969 sales battle:

AMERICAN MOTORS: Changes on the new Rebel and its companion SST are minor. There's a new grille, new wraparound taillight assembly, new deck lid, new instrument panel, and new trim and ornamentation changes. Front and rear tracks have been upped from 59 to 60 inches, but all other dimensions—both inside and out—have been carried over. The 550 and 770 model designations have been dropped, as have all AMC convertibles. You can get the Rebel in a four-door sedan, a two-door hardtop and a station wagon. Same with the SST. The 232-cu.-in. Six is the

standard engine, a 290 V8 and 343 V8 optional. The manual transmission is a column-mounted three-speed. The automatic is called Shift-Command.

BUICK: Offered here are the Special Deluxe, GS 350, Skylark, Skylark Custom, GS 400 and Sport Wagon. In the two-door coupes and convertibles, the wheelbase is 112 inches, carried over from last year. In the four-door sedans, hardtops and Special Deluxe wagons, the wheelbase is 116 inches, also carried over. In the Sport Wagon, it's 121 inches.

Styling changes include new grilles and trim and ornamentation changes, plus revamped interiors. The GS series features a distinct grille, also functional hood air scoops that stuff cool air directly into the carburetor. A 250-cu.-in. Six is standard on the Special Deluxe and Skylark, a 350 V8 on the Special Deluxe wagon, Skylark Custom and GS 350, and a 400 V8 on the GS 400 and Sport Wagon 400.

CHEVROLET: Two series here—the Malibu and 300

INTERMEDIATE



OLDS 4-4-2 for '69 gets an appearance change via altered hood, grille, bold lettering, hood paint stripes

AMC REBEL has dropped 550, 770 series designations this year, will offer three models—two-door hard-top, four-door sedan, station wagon—in Rebel and Rebel SST series. Front and rear track have been increased almost 2 in. for what AMC says is a smoother, quieter ride



PLYMOUTH BELVEDERE series includes Belvedere, Sports Satellite, GTX, Road Runner, the RR also as convertible



THE
'69
CARS

INTERMEDIATES—HOW THEY COMPARE

Car	Wheel-base (in.)	Track (f/r, in.)	Overall Length (in.)	Overall Width (in.)	Engines in Model(s) Series* (Displacement, cu. in.—V8 except as noted—carburetion)
American Motors (Rebel)	114.0	60.0/60.0	197.0	77.2	232-6-1&2bbl., 290-2bbl., 343-2&4bbl.
Buick (Special Deluxe, GS350, Skylark, GS400)	112 (2dr.) 116 (4dr.)	59.0/59.0 (2&4dr.GS350) 59.4/59.0 (GS400)	200.7 (2dr.) 204.7 (4dr.) 202.0 (GS Models)	75.6	250-6-1bbl., 350-2&4bbl., 400-4bbl.
Chevrolet (Chevelle, Concours, SS396, Malibu, 300 Deluxe)	112 (coupe & convert.) 116 (sedan)	59.0/59.0	196.9 (coupe & convert.) 200.9 (sedan)	76.0	230-6-1bbl., 250-6-1bbl., 307-2bbl., 350-4bbl., 396-4bbl.
Dodge (Coronet Deluxe, 440, 500, Super Bee)	117	59.5/58.5	206.6	76.7	225-6-1bbl., 318-2bbl., 383-2&4bbl., 426(2)4bbl., 440-4bbl.
Ford (Fairlane, 500, Cobra, Torino, Torino GT)	116.0	58.8/58.5	201.1	74.6 (2dr.) 74.8 (4dr.)	250-6-1bbl., 302-2bbl., 351-2&4bbl., 390-4bbl., 427-4bbl., 428-4bbl. and 4bbl. with Ram Air
Mercury (Comet, Montego, MX, Brougham, Cyclone, CJ)	116.0	58.8/58.5	206.2 (2dr. & 4dr.) 203.2 (fastback)	76.0	250-6-1bbl., 302-2bbl., 351-2&4bbl., 390-4bbl., 427-4bbl., 428-4bbl.
Oldsmobile (F-85, 4-4-2) (Cutlass, Supreme)	112.0 116.0	59.0/59.0 59.0/59.0	201.9 205.9	76.2 76.8	250-6-1bbl., 350-2&4bbl., 400-4bbl.
Plymouth (Belvedere, Satellite) (Road Runner, Sport Satellite, GTX)	116	59.5/58.5 59.5/59.2	202.7	76.4	225-6-1bbl., 318-2bbl., 383-2&4bbl., 426-(2)4bbl., 440-4bbl.
Pontiac (Tempest, Custom, LeMans)	116.0 112.0 (coupe & convert.)	61.0/60.0	205.5 201.5 (coupe & convert.)	75.8	250-0HC6-1&4bbl., 350-2&4bbl.
(GTO)	112.0	61.0/60.0	201.5	75.8	400-2&4bbl.

*Not all engines available in all models

Deluxe. In Malibu, you can get a sport coupe, a sport sedan, a four-door sedan and a convertible; in the 300 Deluxe, a coupe, sport coupe and four-door sedan. Available only on the Mali-

bu sport sedan is a dressy Concours option consisting of special trim and appointments. On the Malibu sport coupe and convertible, and on the 300 Deluxe coupe and sport coupe, you can

order an SS 396 option consisting of special trim and ornamentation, a black-accented grille, a twin-domed hood, and a 396-cu.-in. V8 of either 325 or 350 hp.

With the exception of a new grille and restyled bumpers and taillights, exterior appearance changes are few and minor. Inside, there's new trim, a new instrument cluster, a new two-spoke steering wheel.

DODGE: Exterior changes are minor, the main ones being a new grille and taillight treatment. Dodge's intermediates—called Coronets—are offered as a Deluxe, a

(Please turn to page 218)

PONTIAC GTO carries over its energy-absorbing rubberized front bumper





PONTIAC FIREBIRD features a new grille, front bumper extensions made of energy-absorbing polymeric plastic

Personal Cars:

High style combined with speed 'n' sport

THE
'69
CARS

AUTOMOTIVE PUNDIT David E. Davis Jr. once said something to the effect that when a man buys a car, he makes a public statement about himself.

Perhaps with the exception of out-and-out sports or specialty cars, nowhere is Mr. Davis more on the money than in the category of so-called "personal" cars—cars in which utility is played down, mild self-aggrandizement played up. Cars of this type are highly visible ornaments that tell it like their owners earnestly hope it is—that by own-

ing and driving such a car it's obvious they're the tuned-in people of our times.

Delusion or not, the type is a howling success, its sales in both stripped-down and all-out luxury versions accounting for about 25 percent of the market.

In previous years we've confined the personal car category to the sporty compacts—Mustang, Camaro, et al. But if you pay attention to the ads, you'll note that the Buick Riviera, say, is heralded in essentially the same terms as, say, AMC's

Javelin. Both are sold with the implied promise that plunking your money down for a car of this type will immediately unlock the gates of paradise and social equality and acceptance.

Thus a teen-ager behind the wheel of a hot Mustang is heedless of failing grades and acne, and an aging sport tooling his Toronado or Thunderbird up to the country club veranda is every bit the man he always was. Beautiful.

On tap for the new model year . . .

AMERICAN MOTORS: Two cars here—Javelin and AMX, the former a four-seater, the latter, two.

Javelin was all-new last year and is carried over pretty much as is for '69. There's new ornamentation, new trim, a new grab handle on the dash above the glove compartment. There's also a new floor-mounted



BUICK RIVIERA features slightly altered grille, new hood ornament, modifications of side marker lamps and backup lamps. Choice on inside trim is widest in Riviera history. For '69, car retains its appeal to both high style and a luxury feel, accounted for in part by completely restyled interiors. Buick claims to have given car "more drama." What?

PLYMOUTH BARRACUDA is available in three body styles—a hardtop, a fastback and a convertible. There are slight changes front and rear, new taillight styling, new accent striping. New for '69 is the 'Cuda, a stripped-down performance model featuring standard 275-hp engine



AMC JAVELIN retains last year's styling features, adds new emblem, ornamentation changes. Also new is floor-mounted three-speed on both the standard 232 Six and 290 V8. Other V8 engines for Javelin include 225, 280 and 315-hp. Car is hot performer in high-hp versions

DODGE CHARGER is little changed for '69, offers slight grille restyling, new taillight treatment, interiors



OLDS TORONADO is up almost 4 in. in overall length this year, features a restyled rear end. Optional is an electrically heated backlight defogging system. Relocated is the driver's ashtray, and there's a new rotary latch on the glove-box door. Interiors have been revised. Olds claims ride has been improved at no sacrifice of car's unique handling



FORD MUSTANG for '69 features two new models—a fastback called Mach 1, and a hardtop called Grande. New styling includes grille, taillamps, ornamentation. Interior dimensions have increased. Also new, high-performance 428 engine

CHEVROLET CAMARO features all-new grille, bumper, parking lights, is slightly over 1 in. longer, wider overall. SS shown here has 300-hp V8 as standard engine, with a 325 as optional. Four-wheel discs are available on all models, as is new rubberized-plastic resilient bumper



AMC AMX preserves the status quo this year, being virtually unchanged, remains an absolute delight to drive

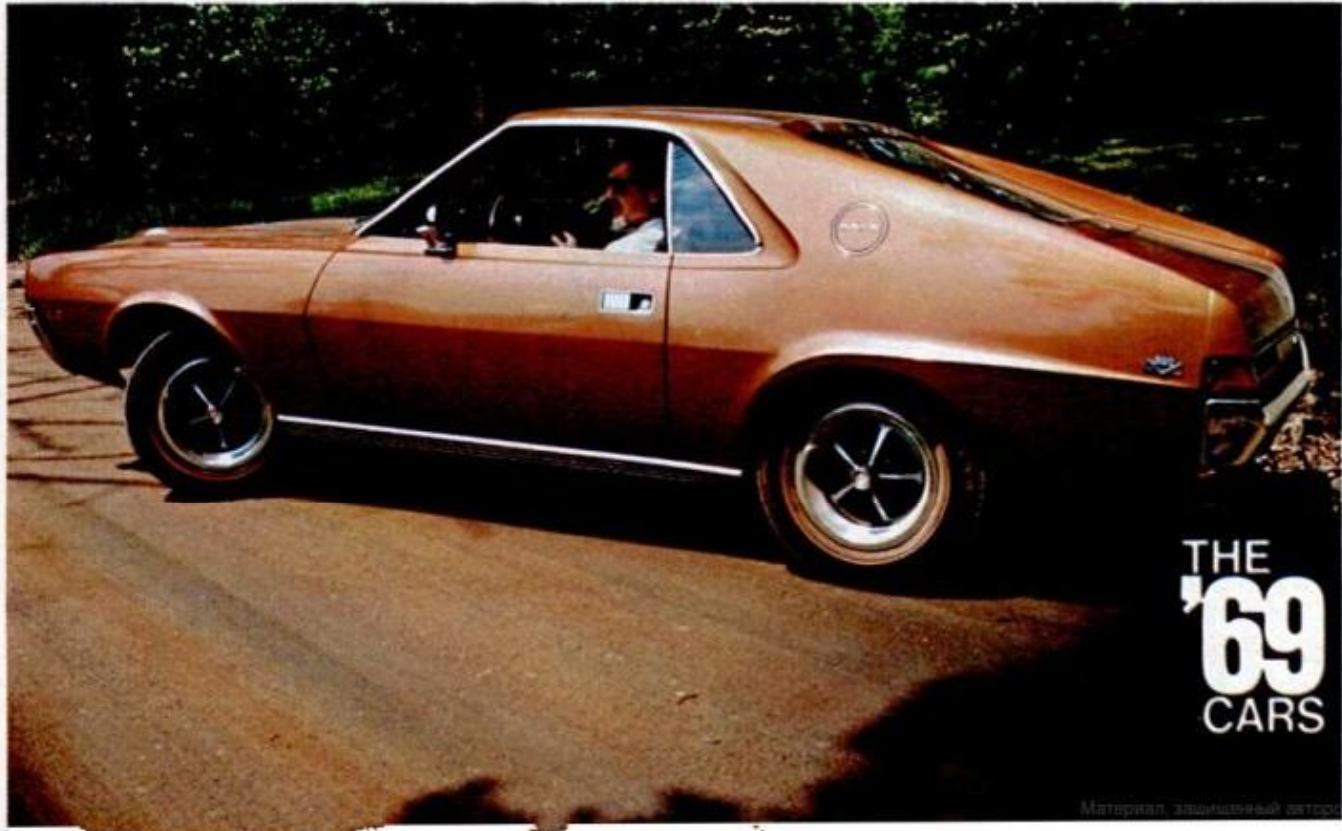

THE '69 CARS

THE '69 CARS

three-speed synchromesh transmission that replaces 1968's column-mounted three-speed. It's standard overall.

Engines range from a 232-cu.-in. Six to a 390 V8. In addition to the transmission mentioned above, you can get four-on-the-floor or an automatic.

The car is available only as a two-door sports coupe in either the plain Javelin or dolled-up SST versions. Either way it's a supple, tidy package.

Even less has been done to the AMX. About all there is outside is an increase from two to five of color choices for the over-the-top racing stripe. Inside you'll find a 140-mph speedometer (a little optimistic, I'd say) and a new 8-8000-rpm tach, both of which are standard. There's new trim and new carpeting.

The standard AMX engine is a 290-cu.-in. V8, with a 343 and 390 V8 available as options, all of which can be ordered with either a four-on-the-floor manual or an automatic. The one available body style is a two-door hardtop coupe.

BUICK: The Riviera is the entry here, and an enduring one it is, too, having been on the market since 1963. Over the years it hasn't changed too much, the theory presumably being that there's no need to mess with a good thing. I'd have to agree; it's a striking-looking car.

This year Buick claims to have given the car more "drama" (whatever that means) via a new grille and hood-top ornament. Could be. In any event, there are new side-marker lamps up

front, new back-up lamps incorporated in the rear bumper.

Inside you'll find new trim in a wide choice of materials and colors. You'll also find a new console featuring a side-mounted transmission shift lever that stays below the top of the console during operation.

Important but out of sight is a new electric fuel pump located in the gas tank. It feeds the carburetor under pressure, helps cut down on engine stalling and acceleration lag.

There's one engine—a 430-cu.-in. 4-bbl. V8—and one transmission—a three-speed automatic.

CHEVROLET: Again we have two cars—Corvette and Camaro.

Camaro, although up almost two inches in overall length and width, hasn't been fussed with too much. There's a new grille, some new sheet metal, new bumpers and parking lights, a new instrument panel and steering wheel, new rear panel and taillight styling. Otherwise things look about the same. You can still get all kinds of trim options—bumblebee stripes, fender stripes, and so on. A special grille featuring hidden headlights is available in the Rally Sport option. An option I really like is four-wheel power disc brakes, available on all Camaros. Hear! Hear!

The car comes as either a two-door sports coupe or a convertible. Bucket seats are standard.

Engines include a 230-cu.-in. Six, a 250 Six, a 327 V8, two 350 V8s (one of 255 hp, one 300), and a 396 V8. The 300-hp 350 and the 396 are available only in the SS Camaro. Transmissions

include two three-speed and one four-speed manuals and three automatics.

The Camaro's a lovely little car, but finding your way through the labyrinth of model variations, engines, transmissions and options requires study.

The Corvette comes as either a coupe or convertible, the latter with either a folding rag top or removable hardtop (you can even get both if you want 'em). The car was strikingly new last year and looks about the same this year. There's a new black grille, some new taillight and back-up light styling, new interior trim, new built-in headlight washers, some fractional changes in length, width, track. But that's about it.

Engines start with a 300-hp 350-cu.-in. V8, end with a 435-hp 427. This last one is out of sight, as you'll be the moment you tromp on it. In between are a 350 of 350 hp, and two 427s of 390 and 400 hp. Transmission choices include a manual three-speed, a manual four-speed and an automatic.

In all, a boss car.

DODGE: Okay, I admit the Charger is an intermediate, but the Dodge Boys are pushing it like a Walter Mitty Special, and that's why it's here and not there.

The car was new and handsome last year and it's just as handsome this year, changes being strictly minor. There's the usual "new" grille and some new taillight treatment. Interiors have been revamped, including an optional "Special Edition" decor package featuring wood grain dash panel inserts, leather bucket seats, a wood grain steering wheel and special exterior ornamentation.

PERSONAL CARS—HOW THEY COMPARE

Car	Wheel-base (in.)	Track (f/r, in.)	Overall Length (in.)	Overall Width (in.)	Engines in Model(s) Series* Displacement, cu. in.—V8 except as noted—carburetion)
American Motors (AMX) (Javelin)	97.0	58.4/57.0	177.2	71.6	290-4bbl., 343-4bbl., 390-4bbl.
Buick (Riviera)	109.0	57.9/57.0	189.2	71.9	232-6-1bbl., 290-2&4bbl., 343-4bbl., 390-4bbl.
Chevrolet (Camaro)	119.0	63.44/63.00	215.3	79.2	430-4bbl.
(Corvette)	108.0	59.6/59.5	186.0	74.0	230-6-1bbl., 250-6-1bbl., 327-2bbl., 350-4bbl., 396-4bbl.
Ford (Mustang)	98.0	58.7/59.4	182.5	69.0	350-4bbl., 427-(1)4bbl., or (3)2bbl.
	108.0	58.5/58.5	187.4	71.3	200-6-1bbl., 250-6-1bbl., 302-2bbl., 351-2&4bbl., 390-4bbl., 428-4bbl. & 4bbl. with Ram Air
				(Hdtop, Convert.)	
				71.8	
				(2+2)	
(Thunderbird)	115	62/62	206.9	77.3	429-4bbl.
	(2dr.)		(2dr.)		
	117		209.4		
	(4dr.)		(4dr.)		
Mercury (Cougar)	111.1	58.5/58.5	193.8	74.2	351-2&4bbl., 390-4bbl., 428-4bbl. & 4bbl. with Ram Air
Oldsmobile (Toronado)	119.0	63.5/63.0	214.8	78.8	455-4bbl.
Plymouth (Barracuda)	108.0	57.7/55.6	192.8	69.6	225-6-1bbl., 318-2bbl., 340-4bbl., 383-4bbl.
Pontiac (Firebird)	108	60/60	191.1	73.9	250-0HC6-1&4bbl., 350-2&4bbl., 400-4bbl.
(Grand Prix)	118	62/60	210.2	75.7	400-2&4bbl., 428-4bbl.

*Not all engines available in all models

The car is available as a Charger, period, or in a beefed-up R/T version. The only body style is a two-door sports hardtop.

Engine choices range from the standard 230-hp, 318-cu.-in. V8 to two optional 383 V8s—one 290 hp, the other 330—on the plain Charger. On the R/T, the 375-hp 440 Magnum is standard, the 425-hp 426 Hemi optional. Transmissions include a manual three-speed, a manual four-speed and an automatic.

When this restyled Charger was introduced last year, Dodge figured to sell about 35,000. Instead, well over 80,000 were sold. It's easy to see why—it's a stopper.

FORD: Again two cars, this time Mustang and Thunderbird. The T-bird first.

Styling changes are slight. There's a recognizably new grille, new bumper, tail and back-up light treatment. Also, there have been some

minor ornamentation changes.

The big T-bird news involves much improved handling and braking. I've never been a devotee of the car, largely because I thought both inadequate for its power and weight. But this new one may convert me. While no Mustang on a handling course, it doesn't wander all over the lot as it once did. And it stops. Huzzah!

The usual plethora of plush options prevails, of course, including a new, electric-powered sliding sun roof, a new "Headlight On" light and warning buzzer, and a new electrically heated rear window for fast snow and ice removal and defogging.

Models available include a two-door hardtop and a two or four-door landau. The standard engine on the T-bird is a 429-cu.-in. V8. It's the only one you can get. The only available

transmission is an automatic.

There are two new Mustangs, one aimed at performance, the other at luxury. An all-out muscle car is the new Mach I 2+2 fastback. The luxury entry is called the Grande Hardtop.

Although still on a 108-in. wheelbase, all Mustangs are almost four inches longer overall. Overall height has been lowered, too. The result, while still very much Mustang, is a somewhat more sleek appearance. There's a revised grille and revamped taillights and ornamentation. Inside is more room and a new instrument panel.

Mustangs come in five models—two hardtops (including the Grande), two fastbacks (including the Mach I), and a convertible. Both fastbacks are dubbed 2+2.

Mach I is an impressive
(Please turn to page 220)

PERSONAL



FORD THUNDERBIRD features optional all-metal, electrically powered sun roof, electrically heated backlight. Grille has been changed; handling, braking much improved. Car is somewhat lower in two-door hardtop and landau. Another option is warning light-buzzer telling driver headlights are still on

CHEVROLET CORVETTE is offered in two models—coupe and convertible, latter being available with either folding top or removable hardtop at no extra cost. Changes for '69 are minor, include restyled interiors, slight trim variations. A 350-cu.-in. V8 is standard this year. You can get a 435-hp, 427-cu.-in. mill; if you do, hold onto your hat



MERCURY COUGAR adds a convertible this year, has upped overall length nearly 4 in., overall width almost 3 in. Car is also lower, affords increased luggage, fuel capacity. Front-end styling treatment is new as is side body sculpturing. Car's available in standard or XR-7 types. Windows are ventless

PONTIAC GRAND PRIX, the auto industry's only all-new car this year, is built on General Motors' new "G" body



IT'S A TEMPTATION to be glib about luxury cars. More often than not, one would guess, they are bought as status symbols, and as such—in these egalitarian times of ours—are prime targets for whatever envious barbs the have-nots choose to hurl.

But to niggle over these opulent behemoths is to deny them due respect for what they are as opposed to what they represent. What they represent is money, displayed right out there for all to see. What they are are big, powerful, plush, comfortable automobiles. And it is as such, I think, they should be viewed.

Keeping this in mind, it would be tough to find fault with Detroit's luxury offerings for 1969. They remain all they've traditionally professed to be, affording those who buy them most of whatever it is owning and driving such a car has to offer.

Other than the new Imperial by Chrysler, there are no extensive styling changes. Radical innovations in this class of cars are—in general—rare, the idea being that at these prices this year's status shouldn't become next year's stigma. Grilles have been altered a bit here and there, interiors made even more luxurious, mechanical refinements incorporated, and the list of available options seems to proliferate like crabgrass. But real revolution in the luxury-car field is as unthinkable as it presumably would be in the Houses of Parliament.

BUICK: Side body line curve in the Electra 225 has been reduced somewhat, giving the car a longer look. Interiors have been restyled and there's an all-new dash panel featuring what Buick



OLDS "98" this year plainly indicates a strong Cadillac styling influence

Luxury Cars: '69

THE CARS

Just bring lots of money



CHRYSLER IMPERIAL, handsomely restyled, should be highly competitive

LINCOLN CONTINENTAL MARK III remains virtually unchanged—all luxury





BUICK ELECTRA 225 appears longer and lower thanks to less curve in uninterrupted side body crease line

THE '69 CARS

calls "upper level ventilation," regrouped instruments and controls, and a larger glove compartment. In the Limited, top of the Electra line, the front-seat armrest has been offset left to allocate 40 percent of the seating space to the driver, 60 percent to the passenger(s). The setup works, being extremely comfortable and reducing lateral driver movement at critical control times. Both sections of the seat are adjustable and power options are available. The new seat is standard on the Limited, an option on the Electra Custom.

Power for all Electras is carried over from last year—a 430-cu.-in. V8 with a single four-barrel carburetor. The only transmission available is GM's new three-speed automatic called the Turbo-Hydramatic 400.

CADILLAC: Again this year I didn't get to drive any of the new Cadillacs; my schedule never seems to jibe with theirs (which may be telling me something about myself I'd just as soon not know). Also, we didn't get to photograph any of them, the prototypes not being ready in time to make *PM's* deadline.

The car is available in three series—Calais, DeVille and Fleetwood, the latter including the front-drive Eldorado. You can get a coupe or hardtop sedan in the Calais, a coupe, convertible, sedan and hardtop in the DeVille, and, in addition to the Eldorado, a Sixty Special, Brougham, Seventy-five sedan and Seventy-five limousine in the Fleetwood. Power up and down the line is the 472-cu.-in. V8 introduced last year, and the aforementioned GM Turbo-Hydramatic 400 automatic transmission is standard on all cars.

Hood length is up over two inches and grilles have been restyled. In back are new vertical taillamps incorporating stop, turn signal, emergency flasher and back-up lights. Rear bumpers have been restyled, as have dash panels. Front-wheel disc brakes are standard, as are power windows and head restraints.

You get a lot to like in "The Standard of the World"—quality, enduring style and value, plus the personal satisfaction of knowing you've "arrived."

CHRYSLER: They've finally restyled the Imperial, doing away entirely with what I've always felt was

the "trying too hard" look of the past few years. The new Imperial is sleek, tasteful, eye-catching. Fore and aft, it has been completely redone. Overall length is up five inches, while the 127-inch wheelbase has been carried over. The result is a long, low, graceful-looking car that for the first time in years is competitive in style with Cadillac and Lincoln. The car is available as a Crown four-door sedan, a LeBaron two-door and four-door hardtop. Headlights are concealed. So are windshield wipers. There's a new dash panel featuring ultraviolet floodlighting of instruments. Power remains the 440-cu.-in. V8 and the transmission is automatic.

If, as a cherished Detroit maxim goes, styling sells cars, Imperial should have a good year. In any event, the car's appeal within an admittedly narrow market should be much broader.

LINCOLN: Two cars here—the Mark III and the "plain" Continental. The Mark III was introduced earlier this year and is carried over as is, meaning a plush two-door coupe that strives to combine the concept of a personal car with all-out luxury. Whether or not the idea is a success is in the

LUXURY CARS—HOW THEY COMPARE

Car	Wheel-base (in.)	Track (f/r, in.)	Overall Length (in.)	Overall Width (in.)	V8 Engines in Model(s) Series (Displacement, cu. in.—carburetion)
Buick (Electra 225)	126.2	63.44/63.00	224.9	79.5	430-4bbl.
Cadillac (Eldorado)	120.0	63.5/63.0	221.0	79.9	472-4bbl.
(Calais, DeVille)	129.5	63.0/63.0	225.0	79.9	
(Brougham, Sixty Spec.)	133.0		228.5	79.9	
(Seventy-five)	149.8		245.5	79.9	
Chrysler (Imperial)	127.0	62.4/61.1	229.7	79.2	440-4bbl.
Lincoln (Mark III)	117.2	62.0/62.0	216.1	79.4	460-4bbl.
(Continental)	126.0	62.1/61.0	224.2	79.7	
Oldsmobile ("98")	127.0	62.5/63.0	224.4	80.0	455-4bbl.

eye of the beholder. The "plain" (blasphemy!) Continental features a new grille that really sets the car off from its immediate predecessors. It's still distinctly Continental, however. Overall length is up three inches in both the four-door sedan and the two-door coupe. Power is a big 460-cu.-in. V8 of 365 hp, the same engine that debuted in the Mark III. Transmissions are automatic throughout.

Ford knows I'm not nuts about the Mark III, but I think the regular Continental is handsome.

OLDSMOBILE: Long known as a "baby Cadillac," the '69 Olds "98" does nothing to discourage the impression. To the contrary—with the exception of a by-now-almost-traditional Olds grille—the car looks more like a Cadillac than ever, complete with an Eldorado-ish, sharply creased hood. The front

part of the rear fender has been peaked and accented, which—combined with a slightly longer overall length and wheelbase—gives the car a long, low look. Interiors are posh and tasty, as is the case with all Olds cars. Power is a carried-over 455-cu.-in. V8, the transmission automatic. You can get three four-door sedans, a hardtop sedan, a coupe and convertible.

—Bill Kilpatrick

LINCOLN CONTINENTAL features newly styled grille that's different, at same time resembles recent models





PLYMOUTH VALIANT, offered in 100, Signet series, features new grille

Compacts:

Good size, good sense

THE
'69
CARS



CHEVROLET NOVA SS with optional 300-hp V8 is potent performance car

DODGE SWINGER is a new stark Dart offered as a low-priced muscle car



YOU'LL NEED a sharp eye and lots of car know-how to detect changes in the '69 compacts. There aren't many, and what changes have been made are elusive.

Still, in my book, anyway, compacts as offered by U.S. manufacturers add up to good buys. I think they make sense as to size, economy of operation and dollar-for-dollar value.

True, compacts in general—unless they bear an exotic-sounding foreign name (and in fact *are* imports)—don't do much for the ego. And true, they tend to drop dead on the resale or trade-in market. But these "drawbacks" are more a matter of human folly than an adverse reflection on the cars themselves.

When you come right down to it, all you're getting for more money when you buy a larger car is more of what compacts offer as a minimum; i.e., they, too, start, stop, cruise at 85 mph, carry in reasonable comfort a driver and one or more passengers, plus a fair amount of attendant luggage. All they really lack, I gather, is prestige.

Note we've said nothing about compacts as being fun to drive. They can be. In their warmer versions, such as AMC's Rogue or Dodge's new Dart Swinger, they can approach performance levels to gratify all but the most jaded enthusiasts.

So why don't more people buy 'em? Beats me. But then I thought *A Hard Day's Night* was bad Keystone Cops.

Anyway, here's how the new compacts stack up:

CORVAIR: Chevy's minimal offering is rapidly taking on the attributes of a hardy

perennial. Despite troubles in court, a concerted attack led by Ralph Nader (God's last angry man?), and a ho-hum attitude on the part of car buyers, the Corvaire blooms every fall, looking pretty much as it always does—neat and tidy.

There's nothing new outside. Interior trim has been changed slightly. The Monza is offered as a sport coupe or a convertible, the 500 as a sport coupe only. A single 164-cu.-in. engine is offered in three versions—95, 110, and 140 hp. Transmissions can be either three-speed, four-speed, or Powerglide automatic.

DART: As mentioned above, new this year is something called "The Swinger," a low-priced muscle car aimed at the kid market. The car is available only as a two-door hardtop and only in a bright, day-glo-ish red. The "Swinger 340," powered by a 340-cu.-in. engine and equipped with four-on-the-floor, dual exhausts, wide tires, and stiff suspension, is what the kids would call "tough." For those of voting age and more, there's the plain Dart, a new Dart Cus-



CHEVROLET CORVAIRE, offered as Monza and 500, is a holdover from '68



FORD FALCON, little changed from last year, retains purposeful look

tom (replacing the 270 series), the GT, and the GTS (for Sport), each of which does its own thing very well. What does its own thing very, *very* well is a GTS that for the first time can be equipped with Mopar's 383 Magnum engine.

Don't look for two-door sedans. There aren't any. You'll notice a slightly al-

tered grille, a different headlamp setup, and a few interior trim changes. But that's about it.

FALCON: As near as I can make out by poring over the promotional literature, and from what I saw and experienced driving the car early this past summer, Falcon's biggest news this year has to do with differently

(Please turn to page 222)

AMC RAMBLER is offered as base Rambler, Rambler 440, Rambler Rogue. The name "American" has been dropped



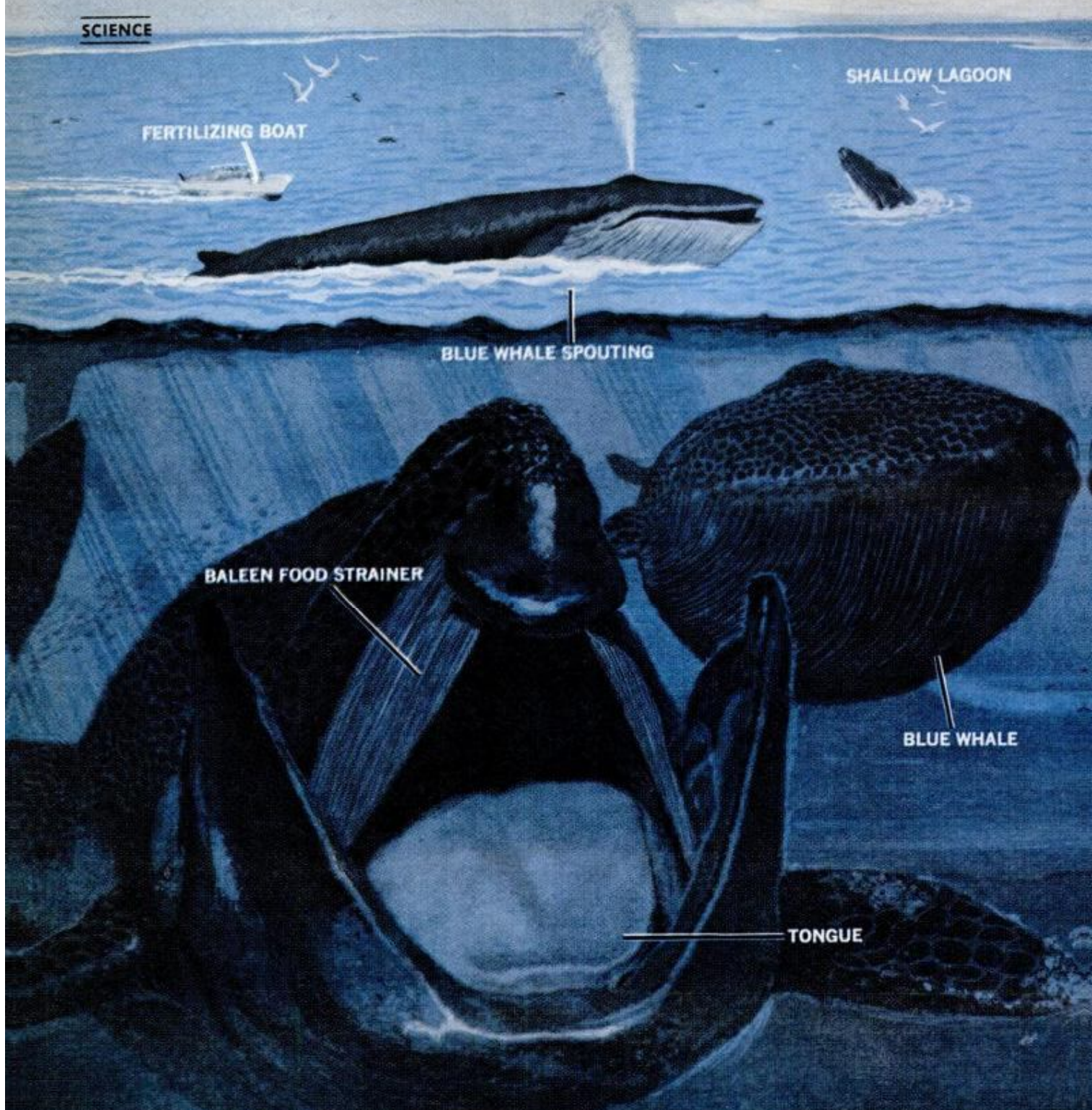

WHALE FARMING IN A CORAL CORRAL

Man has domesticated other animals. Why not the largest one of all?

By KEVIN V. BROWN

Illustrations by Miller Pope

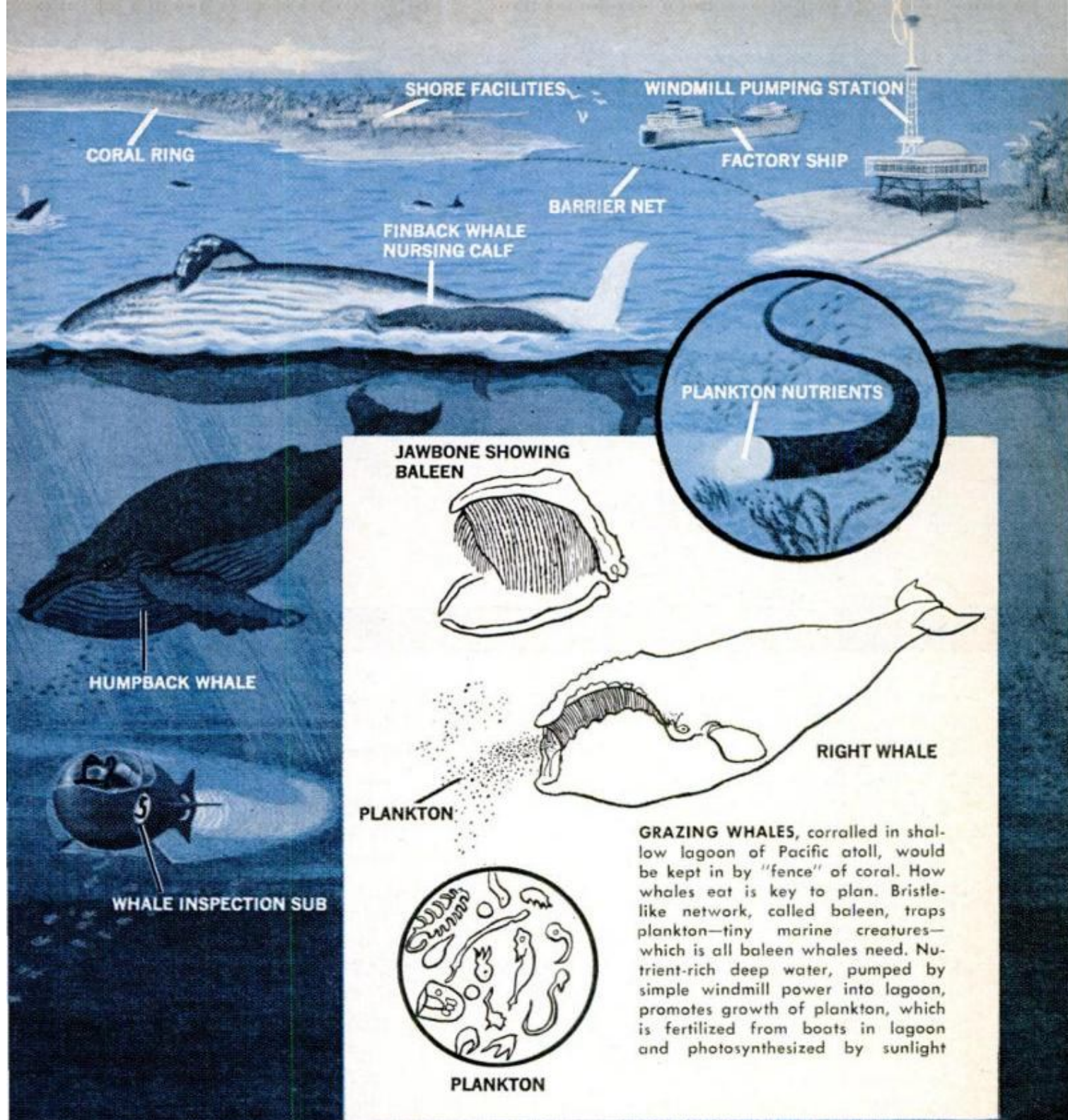

GRAZING WHALES, corralled in shallow lagoon of Pacific atoll, would be kept in by "fence" of coral. How whales eat is key to plan. Bristle-like network, called baleen, traps plankton—tiny marine creatures—which is all baleen whales need. Nutrient-rich deep water, pumped by simple windmill power into lagoon, promotes growth of plankton, which is fertilized from boats in lagoon and photosynthesized by sunlight

HOW DO YOU LIKE your whale steak—rare or well done? You may have a chance to find out. If so, your choice cut may someday come from a whale "farm" far out in the Pacific Ocean where the mighty mammals could be bred and fattened up for eating in much the same way that cattlemen raise beef on the hoof.

While whale meat may not become a standby on American dinner tables, it may well be an answer to the world's rapidly worsening food shortage. With many underdeveloped and overcrowded regions already facing near-famine conditions, a fresh, new source of food is urgently needed. Whales may be that source.

A plan to establish whale farms in the Pacific, using circular coral atolls as natural pens or corrals, is exciting serious interest. Fenced in by rings of coral, the whales would breed and graze contentedly, growing plump for later slaughter. The proposal was made recently by Professor Gifford B. Pinchot, a biologist for the

THE WHALE is the largest creature ever to live on Earth; larger than elephants, even prehistoric dinosaurs. Food potential from such an animal might help solve world's critical food shortage

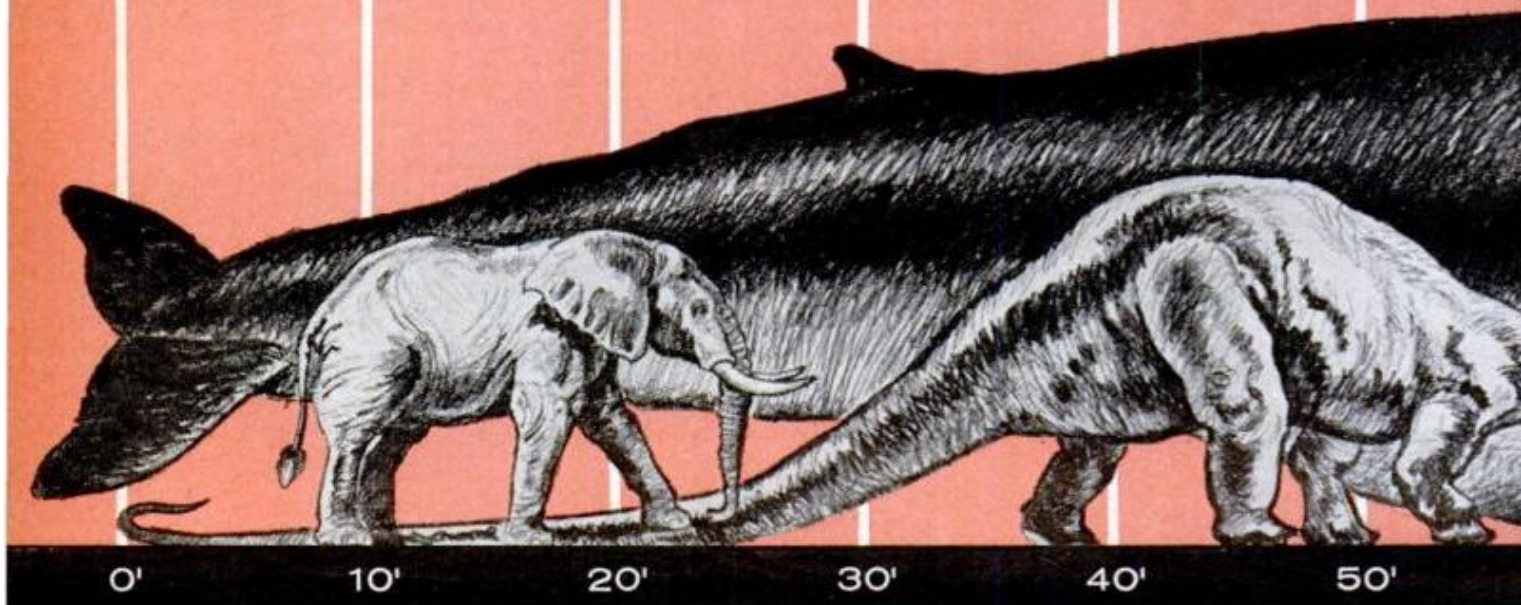

Johns Hopkins University, Baltimore, Md. Into Prof. Pinchot's plan dovetail many of the world's great challenges: expanding populations, diminishing food supplies and, especially, the immense, untapped resources of the sea.

"We still hunt, rather than farm the ocean," he argues.

In its simplest terms, his plan goes like this. It has its roots in the fact that all life depends on using energy from the sun in photosynthesis to convert inorganic nutrients into organic foodstuffs, a process carried out by plants on land and in the ocean.

"All the rest of us," he says, "those who are not capable of photosynthesis, live either directly or indirectly on these plant products."

And, Prof. Pinchot goes on, oceans cover almost three-quarters of the surface of the earth, so they receive roughly three times as much sunlight and are potentially three times more capable of food production.

So "farming" the ocean would involve seeding, fertilizing and harvesting it just as we do the land.

Enter the whales. Prof. Pinchot chose whales for the obvious reason—they're

the biggest mammals that ever lived—but for other reasons that conservationists and sociologists would applaud. They've been hunted almost to extinction and could use some help from man to survive. Also they are a great source of animal protein.

Not only is the world's food supply dwindling in relation to its expanding population, but even in areas where food is available, there's a shortage of animal protein, and some sources blame half the deaths of children between one and five in underdeveloped areas on the lack of animal protein.

But how do you domesticate a whale in the same way as a Hereford steer? Prof. Pinchot's plan is to use tropical lagoons in the center of coral islands. These islands are actually the tops of extinct underwater volcanoes, so the area within the ring or lagoon is relatively shallow, and the openings could be closed off by underwater fences. A coral corral.

Whales, like any other animals, have only two basic needs: food and the propagation of the species. If they're content, they'll take care of the propagation themselves, and food will be

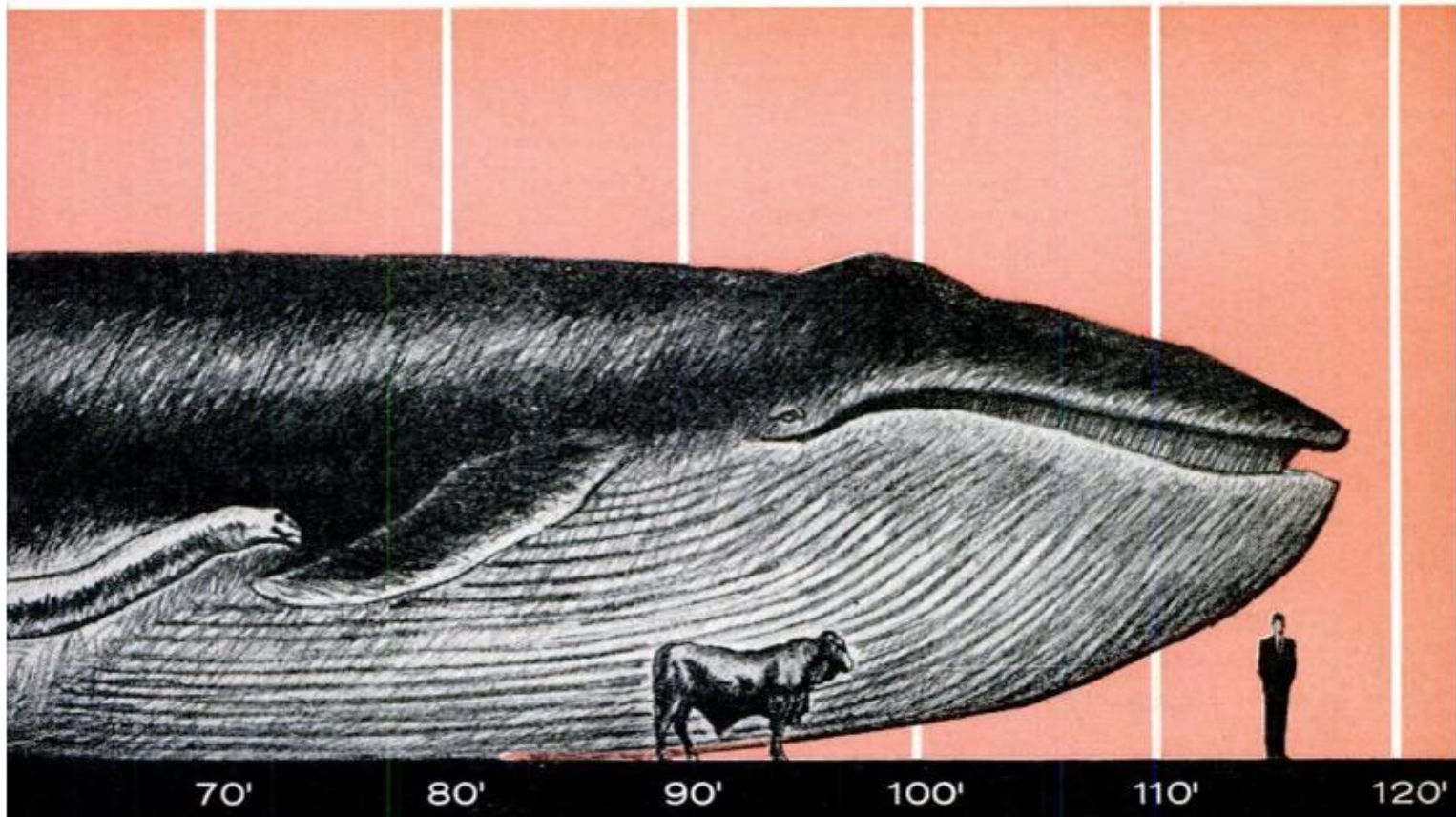

the only problem. Just as the farmer brings feed to his livestock to fatten it, the whale farmer would have to do the same. And we're back to photosynthesis.

Most whales, notably the blue, humpback and sei species, live almost entirely on infinitesimal plants and creatures called plankton. Killer and sperm whales are carnivorous, so they could not be raised under these conditions.

Tropical waters are rich in inorganic nutrients, but not at the surface. Pinchot would draw nutrients from deep outside the coral reef, perhaps with windmills, and pour them into the coral corrals where they would be fertilized by man, photosynthesized by

nature and consumed by contented whales.

Whales used to be hunted for their oil with their meat as a lightly regarded by-product. Now, however, with other, less expensive sources for oil, whales are looked to more for their meat.

Capturing the whales initially would not be a major problem, although the logistics would be whale-sized. They could be drugged and towed to the corrals. Hopefully, after that nature would take its course and the whale population would increase in size without any help from man. At slaughter time, these chores could be carried out on shore facilities on the corral ring or, as they are done now, on whaling ships. ★★★

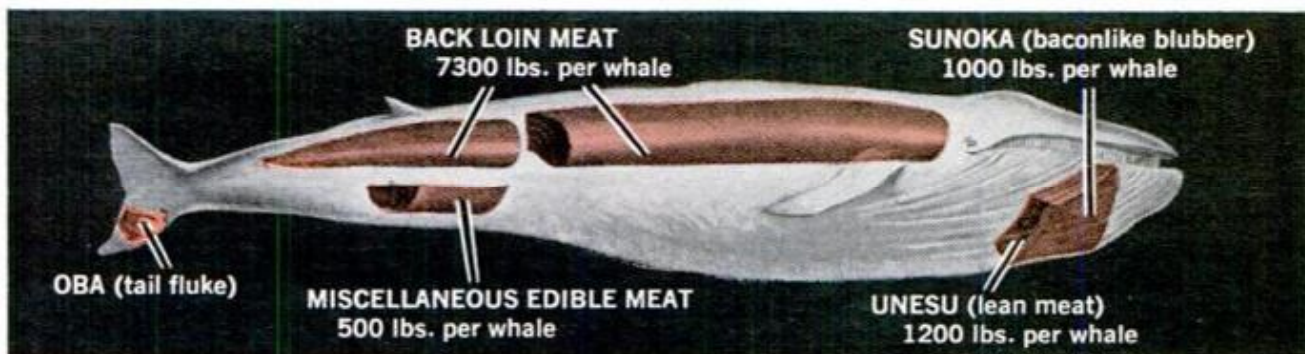

EDIBLE MEAT from just one blue whale would total five tons, equivalent of more than 20 good-size steers
 OCTOBER 1968



Sound of (gurgle) music

It's said that you get a gin fizz by playing a chord on the "Piano cocktail." The instrument will appear in the film, *L'Ecume des Jours*.



Old-timer

Oldest human remains found in the Western Hemisphere is this skull, about 13,000 years old, in southeastern Washington state.



These pyramids will turn into peanut butter

Though they look like Egyptian monuments, these pyramids are simply stacks of peanuts that are awaiting shipment to world markets out of Kaduna, Northern Nigeria.



Mile-long radiotelescope

Three bowl antennas, each 60 feet in diameter, ride on rails that extend the length of the mile-long "array" of the Mullard Radio Observatory in England.



For cool-weather sunbathers

There's a lot to be said for sunbathing in early spring or late autumn—just ask this young lady's neighbors. She's in a new fiberglass-framed plastic tent made in France.

Traffic beater

This is one way to beat traffic congestion, claims a London commuter. The only road hazard, he adds, is ducks. The Power-Ski is also a good means of recreation on the water, points out the manufacturer, Bond Minicar Works of England. The skier stands with one foot on each of the two 10-foot-long fiberglass floats and steers via the upright tubular frame that tilts the skis in the direction of the turn. The controls are also mounted on the frame. The Power-Ski uses an outboard motor of up to 18 hp.

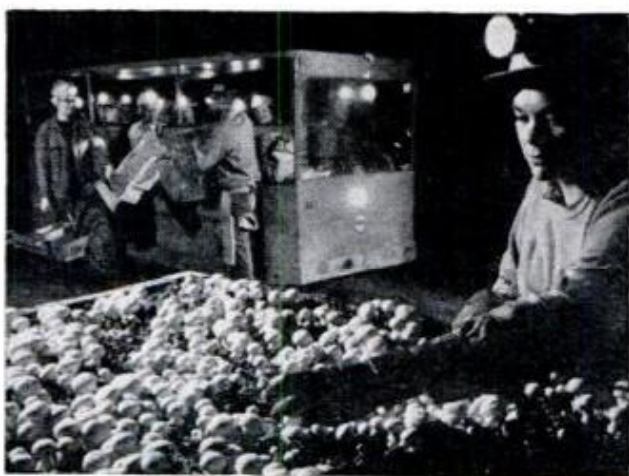

Maids mine mushrooms

An attractive "mushroom maid" harvests succulent saprophytes in an abandoned limestone mine that's now the Butler County (Pa.) Mushroom Farm. The farm, world's largest, yields mushrooms year-round.



20-second physical

It takes just 20 seconds for Philco-Ford's "MediScreen" to monitor and chart each of these children's heart rate, electrocardiogram, heart sounds, pulse volume and rate of breathing. Patients simply sit in the chair.



Electronic teacher delivers chosen lesson within seconds

Up to 25 students can use Ampex's random-access audio information retrieval system at Oak Park-River Forest High School in Illinois. A student selects one of 224 15-minute programs, which, within 30 seconds, is transferred to his unit from a master tape and begins to play. Even if all other students have selected the same program, maximum wait is 59 seconds.





Call of the Wild—Man-Made

An expert hunter tells you why game calls work and why you should use them

By ROGER LATHAM

CALLING WILD ANIMALS is by no means unique to the modern-day hunter—even though he has the advantage of some mighty sophisticated equipment.

Centuries ago, the American Indian and the Eskimo learned that they could imitate the voice or sounds of various kinds of wild game and bring them within bow and arrow or harpoon range. To them, it was a matter of survival. You either called successfully or you didn't eat!

But today, modern, efficient instruments are made to call just about anything. You can even get portable record players for attracting predators. These cost \$75 to \$125 with records.

Among upland game there are callers for wild turkeys, bobwhite quail, mourning doves, pheasants (in a sense), Hungarian partridges and squirrels.

The duck callers include quackers (black and mallards) and whistlers (pintails, wood ducks and widgeon). Goose callers are made for Canadas, blues, snows and whitefronts (specklebellies). Bird callers are reed instruments made from walnut, cherry wood or plastic. Some are more exotic models made from zebra wood or mahogany. For the sound, you must blow from your diaphragm, not just from your mouth. These calls cost \$1.50 to \$20.

The fife devices bugle in bull elk and entice buck deer. These are made from

bamboo, rubber or plastic. Bears may even come to some predator calls. The moose is still called with the voice, using a birchbark horn as an amplifier.

The range for predator calling is great. These reed calls, which imitate the squalling of a terrified cottontail or jackrabbit, will bring foxes, coyotes, big cats and many other animals on the run. Even cows and mother rabbits will respond!

Then there are distinct callers for crows and magpies, owls and hawks—again reed calls costing \$1.50 to \$4. Audubon Society members even use a little squeaker to bring songbirds within close range.

But why do these creations of wood, metal, rubber and plastic work? Several principles seem to be involved.

Some work because the animals involved have strong flocking instincts. Scattered wild turkeys, bobwhite quail, ducks or geese want to find more of their kind and will respond to imitations of their voices. They're lonesome.

Many kinds of game can be called during the mating season. Some species thus deluded are the moose, wild turkey, dove and horned owl.

Still others seem to answer a challenge when they think another male is invading their rightful territory. Bull moose, bull elk and deer all get fighting mad when someone is able to imitate the throaty cough, bugling or low grunting of these big game animals. In parts of the West, buck deer are brought to

the hunter by rattling two antlers together. The wild tom turkey may come to a gobble on a box caller with fire in his eyes, when it's springtime in the mountains.

Predators which come to a rabbit squeal or mouse squeak are looking for food. But they are just as likely to be fooled by the imitation squeal of their own young. This response is obviously a protective instinct.

Then there's curiosity. Deer will answer a predator call, as will many other kinds of wild game which certainly have no intention of eating a rabbit! Domestic cattle and horses behave the same, often come on a dead run. Maybe they want to be where the action is.

And finally, there's the reverse-action effect! Hunters in the know often use a hawk caller to hunt pheasants. Pheasants notoriously run before a bird dog and may never stop to permit a point and a shot. However, a blast on a hawk caller and the pheasant will usually "freeze" in its tracks and stay put. He's scared to death to move for fear the hawk he hears will swoop down upon him. So, the dog points, the hunter moves in and there's a bird in the bag.

Learning to call game successfully is more than a matter of becoming adept on the mechanical device itself, although this is mighty important. It takes hours of practice to be able to get just the right note or tonal quality. The smart hunter practices while listening to the animal itself or to a good instructional



WATERFOWL CALLERS. Wide assortment of reed types that are used for varieties of geese and duck
OCTOBER 1968



TURKEY CALLERS. These include slate callers (left), box callers (center) diaphragm callers and a yelper
125



BIG GAME CALLERS. Birchbark horn to amplify moose calls; rubber band deer callers; a bamboo flute for elk

record. You can get these records for \$2 to \$5. Better still is a tape recorder. With a small cassette type, you can record game in the off-season, practice, and be ready for opening day.

But knowing something about the habits of the wild game is just as important. The hunter has to know where to find his quarry and where to place himself for best results. For some animals which aren't color blind, like

the wild turkey, you may find it necessary to wear camouflage clothing. Turkeys, ducks, geese, coyotes and elk don't miss much and all operate under the theory that "every stump is a man."

The nimrod is warned against the reckless use of callers, too. Well hidden hunters yelping like a turkey have been filled with fine shot. Brush shooters have been known to take a "blind" shot at another hunter rattling antlers or bugling for elk. The best rule for the hunter is to leave his back open to view and to screen himself in front only where he can see anyone approaching.

But actually, calling game is safe enough and it's most certainly one of the most rewarding ways to take game or to get good pictures.

There's a double delight in success. First, the hunter must have mastered the calling technique, and his art gives him as much satisfaction as that of an accomplished musician. Then, too, there is a far greater anticipation as the game approaches, often answering as it comes. Anyone who has listened to an old turkey gobbler talking as he gets closer, or heard the angry grunting of a bull-moose crashing through the alders, or thrilled to the roar of an answering jaguar, knows full well how the adrenalin flows.

One thing sure, there's no dearth of

(Please turn to page 212)



PREDATOR CALLERS. Crow call (upper left) owl call (center), other four for rabbit, fox, coyote, bobcat



SQUEAK AND SQUEAL CALLS. Squirrel caller (lower left), songbird squeaker, dove caller (upper right)

New Paper Battery

Just Dunk It and It's Charged

THE MAN dunking a small, thin object in a glass of water is activating a battery for a cordless shaver. It's the world's first paper battery, a dramatic development in portable power by North American Philips, marketer of Norelco products. No bigger than a business card, it consists of paper layers impregnated with salt and potassium persulphate. When moistened, the salt acts as electrolyte. Electricity flows from a zinc or magnesium plate to the potassium persulphate.

Still experimental, the battery will run a shaver for five minutes—enough for a

quick shave. Envisioned for the future are all sorts of cordless devices powered by disposable batteries you could carry in your wallet. One possibility: an emergency booster for a dead car battery. ★ ★ ★

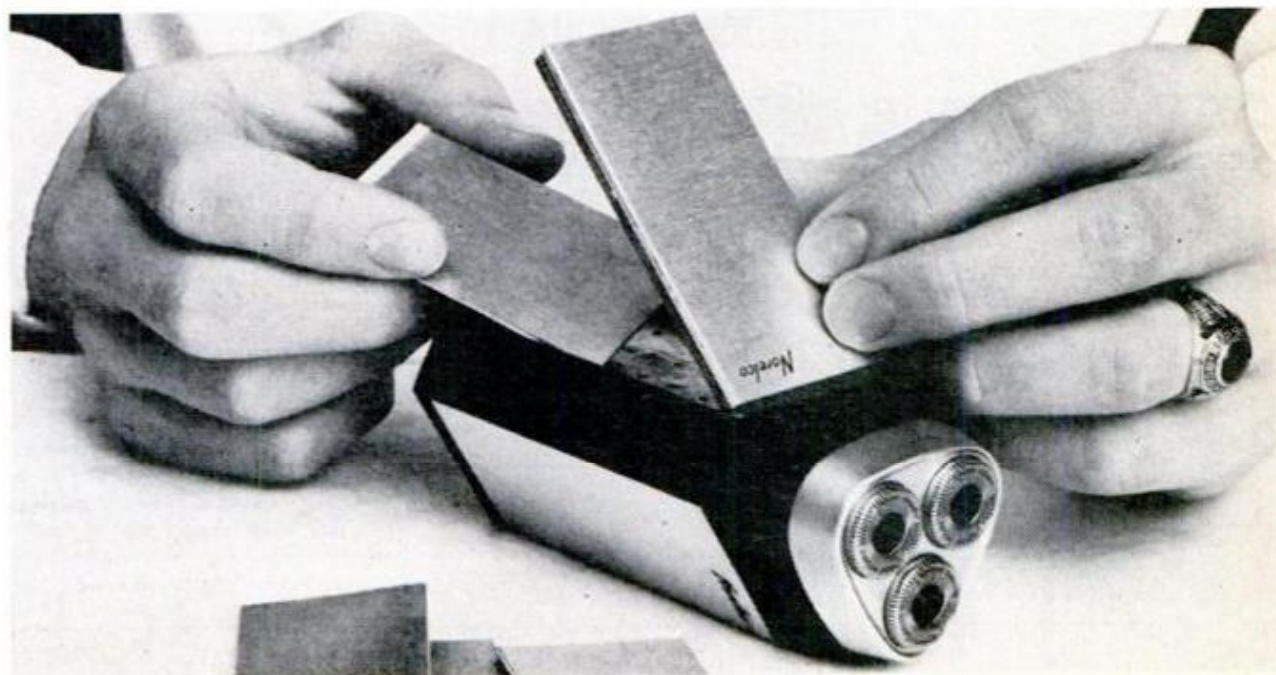
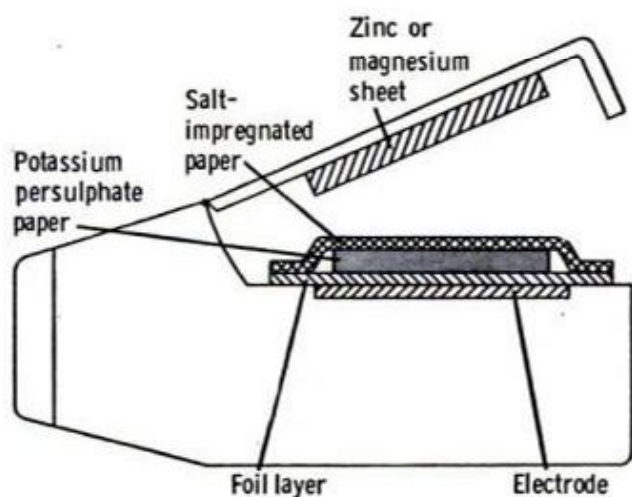

Just patented

PM'S PICK OF THE NEW INVENTIONS

Prepared in cooperation with Roger S. Shashoua Director, International Inventors Association, Inc.

CLOSED FOR TRAVEL



OPEN FOR LOADING

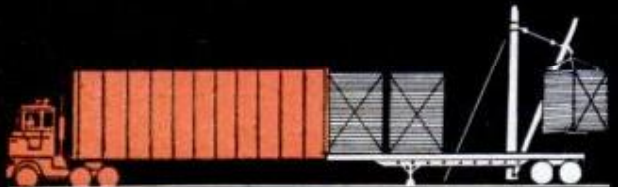

1. **FASTER LOADING** is the object of this clever telescoping tractor trailer. To pick up cargo, the tractor uncouples and moves forward, pulling the trailer body with it. This leaves the trailer bed open and unobstructed for quick loading from an overhead crane. When the trailer is full, the tractor pushes the body back into place and the truck is ready to go. The body slides on rails along the trailer's sides

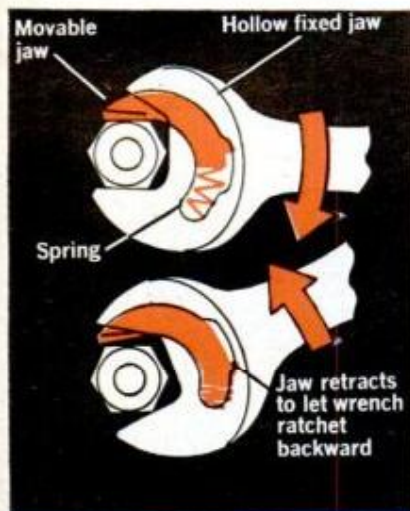

2. **EVER WISH YOU HAD** an open-end wrench that would also ratchet when working in cramped quarters? Well, the design at left does just that. All you have to do is slip it on a nut once and swing the handle rapidly back and forth. As the wrench is turned forward, a spring-loaded jaw hooks snugly against the nut to tighten or loosen it. On the back stroke, the jaw retracts into a curved channel, allowing the head to slip past the corners on the nut. The jaw then springs out, takes a new grip on the nut, and the wrench is turned forward again. There's a conventional box head on other end

Inventors of the items shown on these pages are as follows: 1. George Stewart and Ernie Laprairie, North Vancouver, B. C., Canada; 2. Briles Mfg. Co., El Segundo, Calif.; 3. David Tait, Peacehaven, Sussex, England; 4. Alvin E. Walker,



3. WORKING LIKE A SEESAW, this simple back-yard lift for a car lets you tilt up either end for making repairs easily underneath. It consists of two triangular ramps with adjustable spacers to fit different wheel widths. You just drive onto the ramps until the car's weight is centered, then you can tip the rig in either direction at the touch of a hand. Rolling the car slightly past the center point insures that it won't tip back the other way while you're under it. For added safety, it can also be blocked up

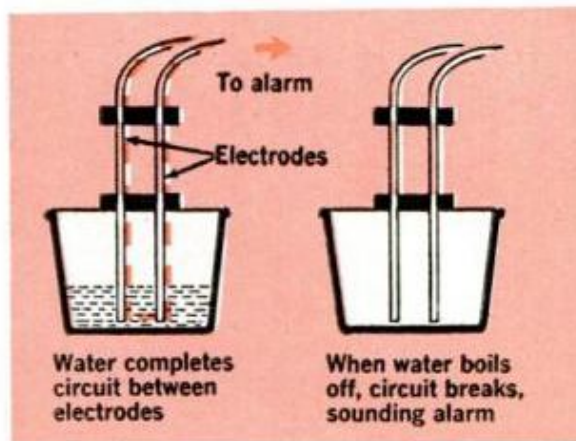
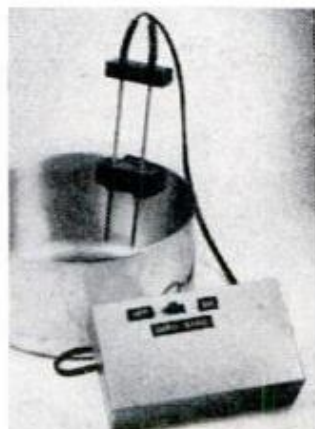

4. FOOD CAN'T BURN in the pan shown at left. Two electrodes are attached to the side and stick down into the cooking water. As long as the water remains high enough to cover the electrodes, current flows between them, holding a relay open. If the water level drops below the electrodes, it breaks the circuit and the current stops flowing. This closes the relay, shutting off the burner or sounding an alarm

5. THIS WALL-HUNG TRASH BIN lets your wife get rid of garbage and refuse from inside the house and have it collected from the outside without her going outdoors. In its upright position, the pivoted bin connects with a small chute in the kitchen wall through which rubbish is discharged. To empty the bin, it's simply swung down against counterbalancing springs, making it easy to handle. The bin automatically interlocks with the lid and chute to form airtight seals against odor and moisture. It would also be out of the reach of animals and couldn't be tipped over like conventional trash cans

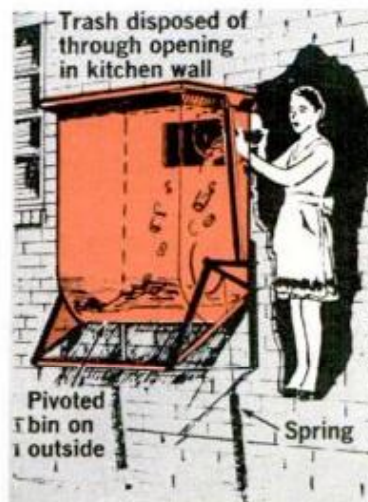

Phoenix, Ariz.; 5. L. E. Smithers, Silver Spring, Md. Anyone interested in bringing new inventions to the attention of Mr. Shashoua at the International Inventors Association, Inc. can reach him at 554 Fifth Ave., New York, N. Y.



69

A SURPRISE

YEAR IN

Snowmobiles

Superpower, sexy design, startling stability are all part of the new snowmobile you'll see this fall

By **DAN FALES**, Boating and Outdoor Editor

YOU'RE IN FOR SURPRISES this year—be you first-time snowmobile buyer or one who's trading up.

You'll find eye-catching machines, rugged back-trail rigs, speedsters that are light on your pocketbook.

You'll find, as I did during a snowmobile preview, new trends, new makers, new models in established brands.

The first surprise will come through your eardrums. This year the industry is adopting guidelines on noise. I find most machines are quieter running.

But mufflers mean a loss of a few horsepower. Thus the second trend—high-horsepower engines. Where the average motor last year was 15 hp or 16 hp, you'll find 18 hp to 22 hp this year.

The third trend you'll notice is sleek design and the addition of gadgets. This year, snowmobiles have gas gauges, fuel-tank filters that bar ice crystals from the carburetor, beefed-up thumb throttles, sturdy handle grips, cigaret lighters, tachometers, speedometers, pushbutton primers.

But this isn't all. You'll find that except for a few cases, there's been a general elimination of reverse.

"It adds weight," says one maker. "Besides, if you're so fouled up that you can't drag the machine out or turn it around, reverse won't help."

Some buyers didn't want reverse last year. But they did want electric start. So all companies are offering it as an option. On some big models, it's standard.

And don't forget to look at the big powerful models. They're running as high as 660 cc and 744 cc. That's power. That's money, too. If you're not planning to run off with all the trophies in the unlimited class races—just look and yearn—don't touch. They're real hot.

Though there are many changes in snowmobiles this year, price increases are few. Most companies are suggesting prices that are very competitive.

This is true of the new machines being introduced by Mercury, Yamaha and Massey-Ferguson.



SKI-DOO has a new bullet-shaped design this year. Being added to Ski-Doo's line are Nordic and T'NT

Mercury is hitting the market this year with a sleek new model fully equipped with a 399-cc, 25-hp motor. The engine is a two-cylinder in-line type activated by Mercury's Thunderbolt capacitance-discharge ignition. The 17-inch-wide track is made of rubber with reinforcing steel cable. The drive chain runs in an oil bath. Steering skis

3 BRAND-NEW ENTRIES



MERCURY (left) is just entering snowmobile market this season, offering the new 250 series. All models, designed by Kiekhaefer engineers, have 25-hp motors, run on 17-inch, steel-reinforced tracks for stability

YAMAHA (lower left) is introducing an SL-351 line using motors which turn up 23 hp at 6000 rpm. The engines have metered-oil systems which eliminate mixing oil and gas. The SL-351 runs on 15-inch tracks

SKI-WHIZ (below) is the new machine being made by Massey-Ferguson. With a track width of 15½ inches, this snowmobile comes with 17.5-hp or 22-hp engine. Shroud covers engine which is mounted backwards

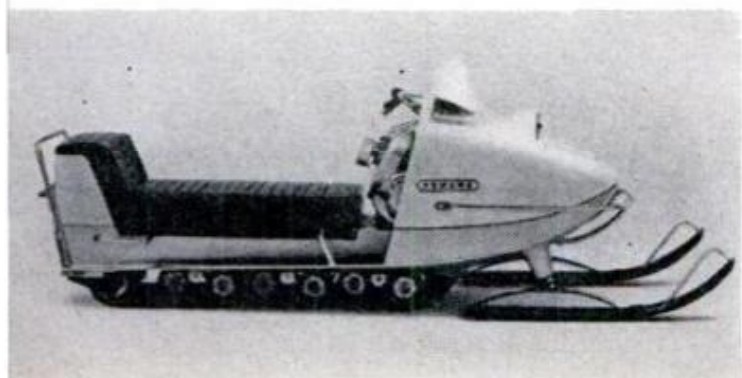



POLARIS Mustang is a family-size machine. The track has been widened to 20 inches for more stability. Mustang is available with any of six engine sizes

cant on turns. There are three Mercury models—250 (manual start), 250E (electric start), 250ER (electric start with reverse).

Yamaha is the first on the market to use metered oil (oil and gas separate) in a snowmobile engine. Entering one model this year called the SL-351, Yamaha is using a 350-cc, 23-hp motorcycle engine with a looped scavenged system (flathead piston, five-port fuel-exhaust configuration).

The motor is driven through an automatic clutch transmission with V-belt and with secondary chain drive in an oil bath. The 15-inch-wide track is rubber with reinforcing steel. Equipped with an automatic rewind manual start, the Yamaha's suggested retail price is \$975. The machine weighs 320 pounds.

Massey-Ferguson, the tractor maker, is entering the snowmobile market this year with two models—the 297-cc JLO 17.5-hp and the 372-cc, 22-hp JLO. Called Ski Whiz, the machines have a unique feature—the engine is mounted backwards, to help weight distribution and engine efficiency, and permit complete engine enclosure under the hood.

A torque converter and roller chain drive the 15½-in. polyurethane track. The 29-cc model weighs 350 pounds; the 372-cc unit is 370 pounds. Ski Whiz has adjustable ski springs and rear idler sprockets so machine height can be varied depending on weight of operator. Suggested prices are \$949 for 297 cc and \$1059 for 372 cc.

You'll be seeing another new machine, too. The Bolens Co., in the snowmobile business for several years, is introducing a brand-new conventional-looking model called Sprint. It still makes the two-section Diablo Rouge.

Powered by a 297-cc, 17-hp engine, Sprint has a track width of 15 inches. In two models—the manual-start weighs 325 pounds and sells for \$895, and electric-start, 355 pounds and \$995.

Changes in snowmobiles are not just limited to new entries. The so-called old-line makers have new ideas, too.

Ski-Doo is modifying the general shape of many of its machines. The new "bullet look" is adding sleek aerodynamic design. Ski-Doo is also introducing two new models this year—the Nordic and the T'NT. Bombardier, maker of Ski-Doo, is keeping the low-priced Olympic series (12-hp, 15-inch track still sells for \$695) and the twin 15-inch track (30-inch) Alpine series in the \$1200 area.

The Nordic brings a new track size to Ski-Doo's line: 18 inches. In both manual and electric-start, it's powered by a 371-cc, 24-hp Rotax engine. Manual weighs 360 pounds, the electric, 400. Suggested prices are \$1045 and \$1165.

Ski-Doo's big guns this year are in the T'NT class. Here you can get a speedster with a 399-cc (30-hp) engine

SNO-JET is offering four new engine sizes and eight models priced from \$750 to \$1299. Engines range from 15 to 35 hp. Sno-Jet is now part of Glastron





BOTH EVINRUDE AND JOHNSON are offering snowmobiles with 25-hp engines priced from \$985 to \$1255. Each company is also introducing new lines which offer 19.5 and 23.5 hp models. Evinrude's new line is called Bob Cat—Johnson's is called Challenger



on a 15-inch track. The whole thing weighs 314 pounds and sells for \$1045. But the real tiger is the T'NT 640—a monster with a 640-cc (40 hp) motor weighing 385 pounds, running on an 18-inch track, and selling for \$1395.

Polaris takes the prize this year for choice. There's available everything from the brand new Charger models up through the big rugged Voyagers. You can get small 275-cc Sachs engines, medium and high-horsepower Hirths, JLOs, Kohlers and Polaris's own engine. And you can get Wankel engines as well. In all, there're 29 models.

Polaris's new Charger is what they call the "sports car" of the snowmobile set. It's a snappy light machine with 15½-in. track weighing about 298

pounds—depending on motor size. You have a choice of motors from 275-cc Sachs to the 634-cc Hirth.

The widest variety in models is found in the 330-pound, 15½-inch track Colt series, offered with choice of 12 motors, or twin Polaris engines which up the cubic-centimeter rating to 744. The Colt has electric-start options.

The Mustang series has a new 20-inch track width. This 365-pound machine has options for electric starting and for a forward-neutral-reverse shift.

Polaris's big Voyager, a tough 477-pounder with 30-inch-wide track, has a 372-cc JLO or 634-cc Hirth engine.

Another Polaris surprise is Playmate, an 80-inch mini-snowmobile with a

(Please turn to page 224)

AMF'S SKI-DADDLERS are available in six models this fall. They range from the Wide Track 22 at right in photo to the "essentials only" Sno-Scout at left

ARCTIC CAT is specializing in its Panther series. Eight different models range in size from 246 to 600-cc machines. All models have AC's special suspension



That New Patent Law: Blessing or Blunder?

By **NORMAN CARLISLE**
Co-Author, *The Successful
Inventor's Guide*



INDEPENDENT INVENTOR would be no match for big "invention factories"

Aimed at reforming our antiquated patent system, the proposed bill may actually work a hardship on small, independent inventors. Here's what the law will mean

LEGISLATORS in Washington are about to tackle America's 175-year-old patent system. The system is admittedly outmoded and full of faults. But the question many inventors are asking is whether the proposed remedy, a new Patent Reform Act, will kill the patient in the process of attempting to cure his ills.

It's a good question. The reform law, embodied in House Bill 5924 and Senate Bill 1042, was presented to Congress recently with great fanfare. In offering it, President Johnson stated: "The Patent Reform Act contains a series of far-reaching and fundamental proposals. They will benefit businessmen, scientists and inventors."

The trouble is, they will *not* benefit the small, independent inventor—the fellow who sweats out an idea in his

basement workshop or at a kitchen table, perhaps working for years on a single, lifelong dream. This type of inventor has been completely forgotten by the framers of the new patent law. As a leading patent attorney put it, "They propose to reform the independent right out of existence."

Let's take a specific example. An independent inventor, Edwin Foster of Austin, Tex., recently patented and sold an invention to a leading appliance manufacturer. It's an arrangement of springs that automatically lifts an iron off the ironing board when a housewife lets go of it. It was a triumph of ingenuity, hard work and long effort. In fact, Foster worked on it on and off for more than 25 years!

Foster was able to take his time about developing his invention, secure

in the knowledge that U.S. patent law would protect him. He was able to make experimental models and have them tested by consumers. He was able to delay seeking a patent until he was sure that he had perfected his invention and that the conditions were right for marketing it.

Foster's case is typical of the thousands of inventions that are developed every year by hard-working independents. The new bill would rob the independent inventor of many rights Foster exercised in making his invention—the right to experiment long enough to perfect it, the right to let consumers test it, and the right to delay seeking a patent until the market appears ready.

Can we afford to ignore the welfare of the independent inventor? We can't. Even in this age of teamwork invention, we owe an astonishingly large part of our technological progress to the independent. The contributions of such creative individuals include the vacuum tube, Xerography, DDT, the zipper, the automatic transmission, the gyro compass, FM radio, the helicopter, power steering, airconditioning and many others in a wide variety of fields.

Despite such great contributions by the independent inventor, the new bill is full of booby traps for him. Let's



GETTING USERS to test your invention would nullify your claim to a patent under the proposed law

look at the most dangerous provisions.

A sweeping change in the new proposal calls for the patent to be awarded to the first to apply for it. Under present law, the patent is awarded to the "true" inventor, the one who thinks of the invention first and who works diligently to develop his concept into a workable invention.

What's so bad about giving a patent to

(Please turn to page 226)



RACE TO BE FIRST would cause inventors to rush to the Patent Office with half-baked ideas, say experts
OCTOBER 1968



Only a few left of the 'Few' that flew

It took three years to collect the airplanes for the filming of *The Battle of Britain* 28 years after the great World War II encounter. Among the craft are 24 Spitfires and Hurricanes (left) and a Stuka dive bomber (right). At upper right are two Battle of Britain pilots, E. Lacey (left) and R. Stanford-Tuck (right) with H. Manhaddie, who collected the planes.



Stairway art exhibit

Dennis Huntley, a British woodcarver, makes art objects of his banisters, creating a permanent display that takes up little space.



Gently sloping bank

Sloping sides give Chicago's First National Bank Building a distinctive look. The 60-story structure will be completed in 1969.



Lamborghini 'family' car

Sleekly styled and featuring a huge rear window that raises for access to the baggage compartment (right), the Lamborghini-Espada Bertone is described as the "family version" of the sports car. It has four bucket seats.

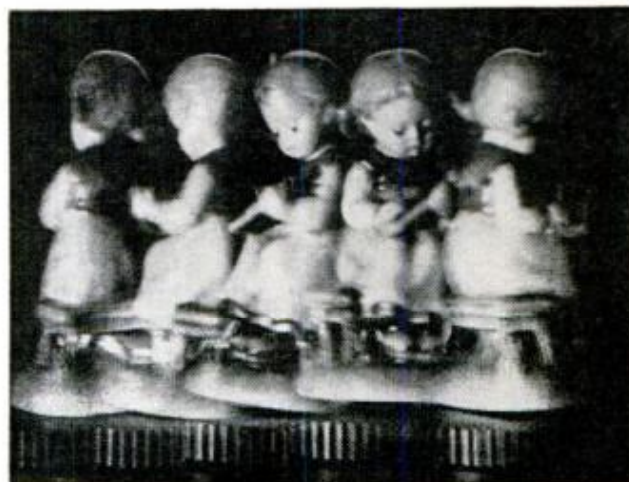
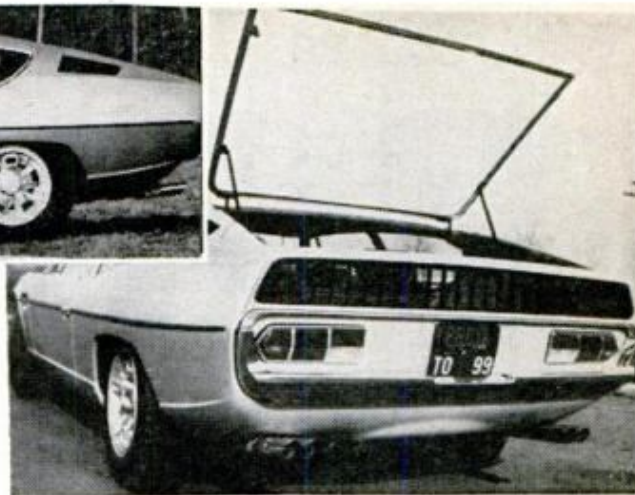

Full-circle holograms

A new kind of hologram made at Bell Telephone Lab allows a viewer to see a three-dimensional image rotate through a full circle when he moves his head from side to side in front of the flat hologram. Multiple-exposure (above) is from five different positions.

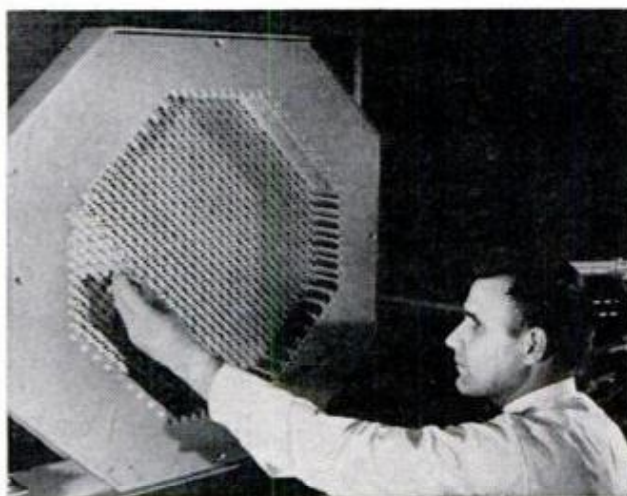

Rotator eliminator

A new phased array radar system eliminates the need for a rotating antenna. Each of 604 modules contains a transmitter and receiver; electronic scanning of the modules provides the sweeping vision.



Deep-diving Beaver IV

On display here is a full-scale mock-up of the *Beaver IV*, a new deep submersible being constructed by North American Rockwell. In the foreground are pilots Joe Thompson (left) and Ed Cargill, who'll test-dive it.



WHAT LOOKS LIKE a single photo of five sprinters is actually a picture made on moving film of each runner the instant he crossed the finish line. Note how two men at right—Harry Jerome of Canada and Willie Turner of the United States—appear to have tied. But when lines are drawn from runners' chests to time scale below, winner is shown to be Jerome (in middle lane) by $2/1000$ ths of a second. Picture was made by Photosprint camera at the '67 Pan American games in Canada

How They're Killing The Dead Heat

By JAMES R. BERRY

During the '68 Olympics, new second-splitting timing gear will be used to eliminate ties.

THE TWO LEAD RUNNERS, legs pumping like pistons, thundered down the track side by side. The men—Canada's Harry Jerome and the United States' Willie Turner—had each run the 100-meter dash in a record 10 seconds in earlier races. Now, at the 1967 Pan American games, the two were finally getting a chance to prove who was faster.

The crowd's roar mounted to a frenzy as the runners flashed across the finish line. Then a hush fell over the Winnipeg Stadium. Jerome and Turner had chested the finish tape at exactly the same instant—at least it appeared that way to the naked eye.

But not to the mechanical umpires presiding over the meet. In less than two minutes, officials announced that Jerome was the winner—by a scant 2/1000ths of a second.

No human eye or conventional camera could be trusted to judge a race as close as this. In times past, such a finish would have had to have been declared a tie—a dead heat.

In the 1932 Olympics, contestants were timed to 1/10th of a second. By 1948, the second had been split into 100ths. Today, superaccurate robot

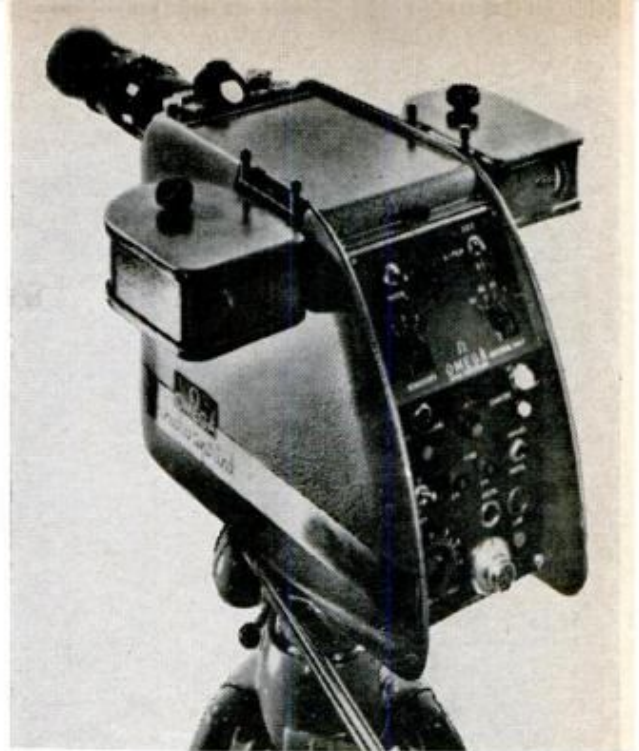

NO BIGGER THAN A TV CAMERA, Omega's Photosprint timer not only photographs the contestants—it even processes the film at the same time. As the film moves from the left-hand reel past the lens, it is automatically developed and is ready for viewing by the time it winds onto take-up reel on the right

referees are chopping seconds into 1000ths, virtually eliminating the possibility of the old-time dead heat.

These timers, which will be watching competitors at the Olympics in Mexico City this month, have been developed none too soon. High-powered training is steadily edging athletes toward

HOW THE PHOTOSPRINT TIMER WORKS is shown in the diagrams below. The camera consists of a lens, a narrow vertical slit that serves as a diaphragm, and a strip of 35-mm film on motor-driven reels. The diaphragm slit is lined up precisely with the finish line. The film moves across behind the slit in the same direction as the runners, and its

speed is adjusted to match their speed. As the runners pass the slit, their images are recorded on the moving film in exactly the same relative positions, revealing which man crossed the finish line first. A time scale along the bottom of the film shows each runner's time in thousandths of a second so there's no dispute over who the winner is

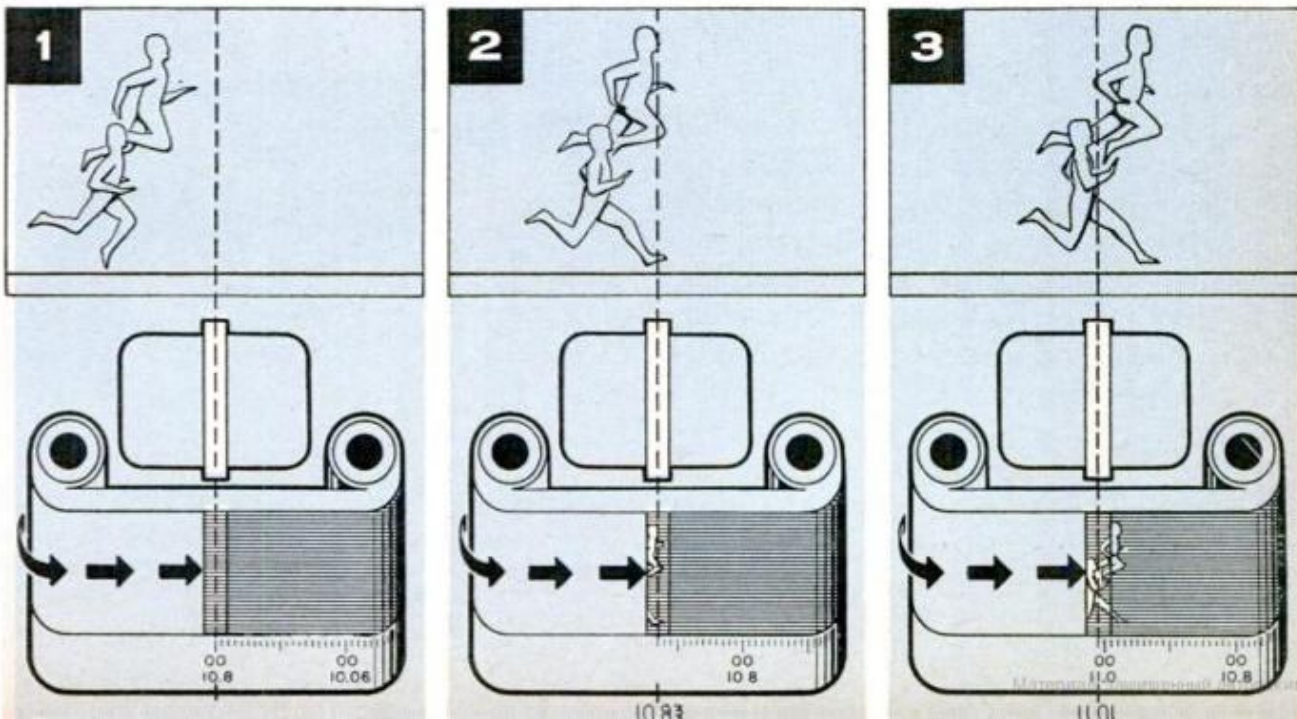

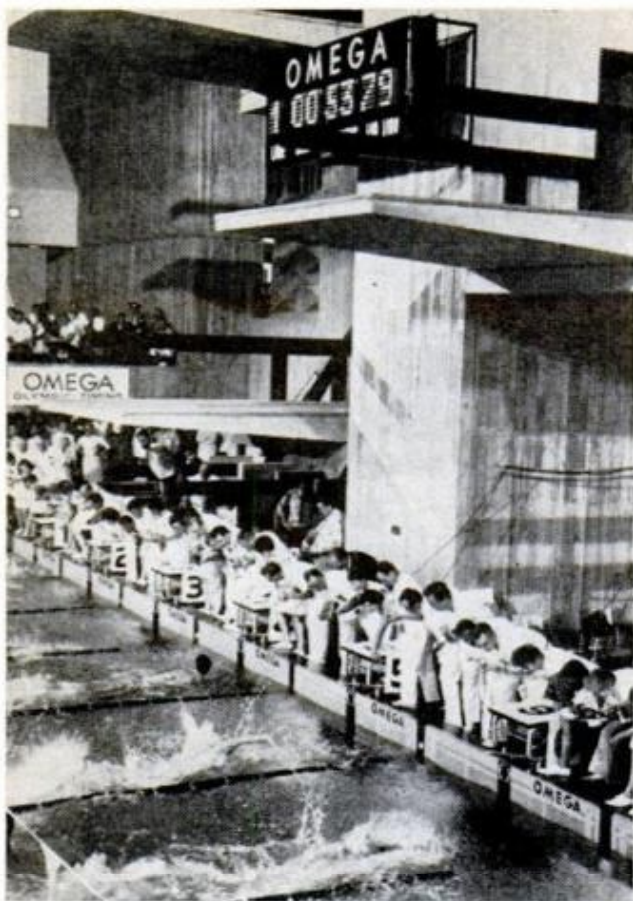

SENSITIVE TOUCH PLATES in this Olympic pool are triggered by swimmers as each reaches the end of his lane, actuating a timer. Times in thousandths of a second then show on overhead display board

the limits of human performance. Consequently, contestants tend to reach the finish line in closely bunched packs. In a 500-meter race, for instance, runners speeding 30 mph or better often breast the tape within $3/10$ ths of a second of one another.

One of the prime robot referees picking winners and recording their time at the 1968 Olympics will be a camera that shows the moment every contestant crosses the finish line on a single photograph.

Called Photosprint, this device—about the size of a small TV camera—replaces the conventional blinking shutter of typical motion-picture cameras with a half-inch-high slit about the thickness of this paper. As athletes approach the finish tape, a reel of 35-mm film starts to slide in back of the slit at almost precisely the same speed as the moving contestants. The men crossing the finish line are focused through the slit onto the moving film. Since the film and

the runners are moving at the same speed and in the same direction, the photograph results in a sharply focused, uninterrupted picture of the finish.

But that's not all. The time elapsed for the race is projected onto the base of the film, which is automatically developed as it passes into the pickup reel. Within a minute or so after a race, officials have an enlarged, positive photograph of the exact instant each runner passed over the finish line. Such a photo reveals the time (read off the film's base)—not the distance—between runners at the race's end. *This* time is recorded on Olympic records.

Another Olympic arbiter is a device called Swim-O-Matic. Because of the splashing water and the fact that contestants are partially underwater, judging swimming meets was particularly difficult. Formerly, three judges were assigned to each swimmer and the times on their stopwatches averaged out: a grossly inadequate method by today's Olympic standards.

Recently Dr. Charles Sickert of the Omega Watch Co., official timers of the Olympic games, demonstrated just how imprecise human referees are. He handed stopwatches to three sports fans. Then he jerked his hand off his desk to signal the start of a "race," held it aloft a few moments, then ended the simulated race by slamming it down. The



NEW STARTING GUN has microphone on muzzle to relay sound to a loudspeaker in each contestant's lane. Each hears signal at same instant, eliminating delay caused by sound's slow travel through air

three fans clocked the race at 15.8, 15.2 and 14.9 seconds—a spread of 9/10ths of a second, which is an eon in Olympic competitions.

Swim-O-Matic scraps this problem by submerging a touch plate 32 inches below the water line at the end of each swimmer's lane. The plates are hinged so that a slight movement presses them against waterproof switches that are connected to an electronic stopwatch. The touch plates are perforated so that while the pressure of a swimmer's finger will close the switch, the force of waves flowing through the holes won't.

The electronic stopwatch linked to the touch plates automatically prints out a swimmer's lane number, the order of his arrival and his swimming time in 1000ths of a second. Hopefully, Swim-O-Matic, which will be used for the first time at the Mexico City Olympics, will end the controversy that has formerly accompanied many meets.

Still another way Omega plans to make Olympic records more accurate is to feed athletes a starting signal at the same instant. Sports events usually count on a gunshot to signal a race's beginning. But sound travels about 650 miles an hour. Therefore, a contestant a few feet from the starting gun will hear the signal 1/100th of a second or so before an athlete 30 yards away. Once, this wouldn't have mattered. Today, it's considered a huge disadvantage.

To end the discrepancy, Omega now attaches a small microphone to its starting guns. The sound, recorded by the mike, is fed to amplifiers and from there broadcast over loudspeakers at the head of each contestant's lane. All contenders now hear the starting signal electronically before the noise passes through the air to the nearest athlete.

Will the highly trained athletes make measurements to 1/1000th of a second obsolete? Omega Watch Co., at least, isn't taking any chances. Already the Swiss firm is working on yet more precise sports timing devices. Reportedly these robot referees will list Olympic records to 10,000ths of a second! ★★

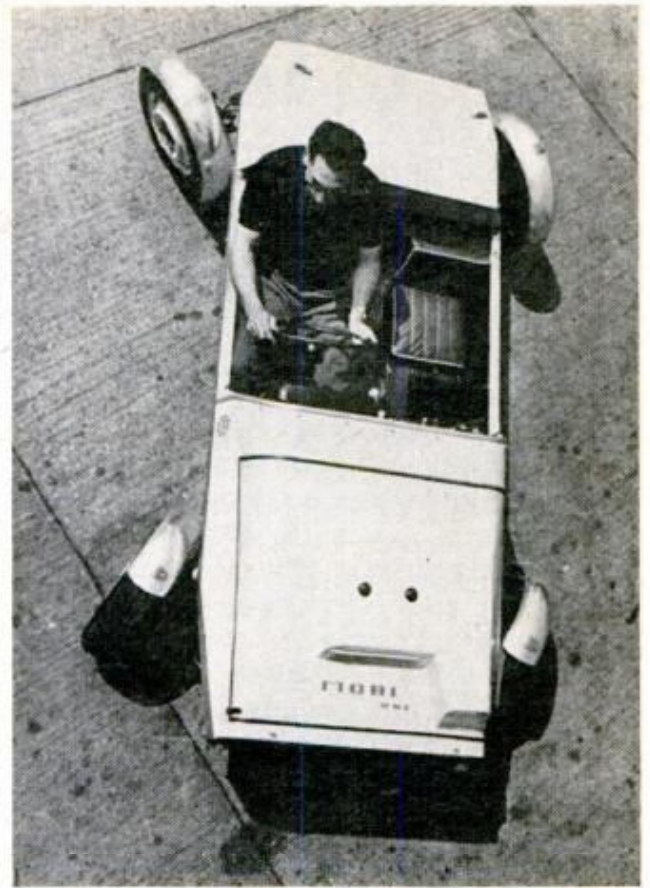

He does a good turn

When Morris Bishop turns the steering wheel of his home-built car, all four wheels respond—enabling the nine-foot "Mobi One" to turn within a nine-foot space. The vehicle has three rack and pinion steering systems, two at front and one at back; a shaft connects them. Top speed is 120 mph.



Army gets new ACVs

Two of the Army's first three assault air-cushion vehicles are shown after delivery by Bell Aerosystems. The 70-mph ACVs carry two 50-cal. and two 7.62-mm machine guns plus a 40-mm grenade launcher. The Navy has used ACVs in Vietnam since early 1966 (see [Tiger Sharks](#), page 131, Nov. '67 PM).

How to Choose and Use Screws

Screws are among the most efficient fastening devices in your workshop . . . if you know how to use them

By STEVEN J. HOWARD

AS A HOMEOWNER and workshop enthusiast, you're concerned with only two general types of screws—the ordinary wood screw and the sheet-metal screw.

Wood screws are used to fasten pieces of wood to each other or to anchor objects to a wood surface. They probably form the bulk of your screw inventory.

Sheet-metal screws (also called tapping screws or self-threading screws) are used for fastening pieces of metal together or for attaching objects to metal. They have sharp threads that can cut their own grooves into the metal.

The easiest way to distinguish wood screws from sheet-metal screws is to look at the threads. Sheet-metal screws are threaded all the way from point to head. Wood screws, on the other hand, have threads running only two thirds of the way up from the point. A smooth shank extends the rest of the way to the head.

The special characteristics of screws, as opposed to other methods of fastening, make them ideal for the following jobs:

- *When the pull of the load is directed along the length of the fastening device and you need maximum holding power.* This would cover jobs such as hanging a door.
- *When there's a chance that you may have to take the work apart some day.* It's much easier to back out a screw than to pull a nail. You also run less risk of damaging the work.
- *When there's a chance you'll mar the piece of work while installing the fastener.* You'll be safer driving a screw into fine finish work than hammering a nail into it. The hammer is more likely to slip.
- *When you plan to leave the fastener exposed.* Screws are somewhat more decorative than nails.

If your job doesn't fall into one of these categories, use nails instead of screws. They're not only cheaper, but require a lot less time and effort to install.

Once you've decided to use screws, you have to consider four things: the type of

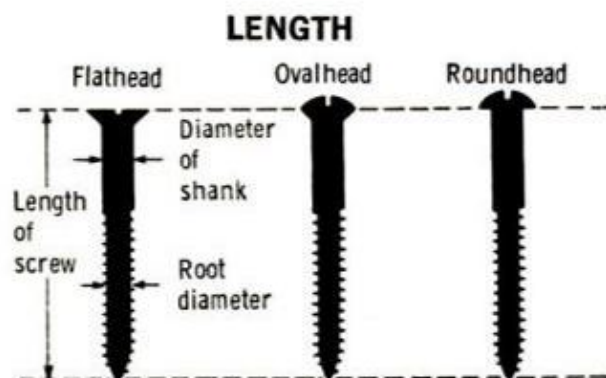
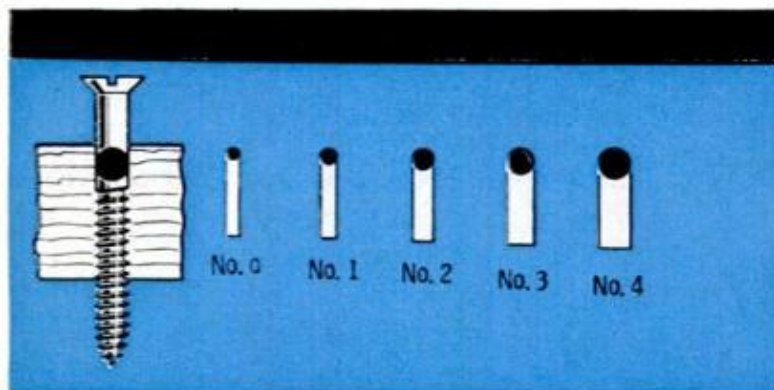

HEAD



FLATHEAD screws don't protrude above the surface. They can either be driven flush or slightly countersunk and concealed with wood putty or small wood plugs



ROUNDHEAD screws protrude more than other types but offer good slot depth. They're designed for universal application and can be used in practically any project



OVALHEAD screws share characteristics of round and flat heads. The bottom of head is countersunk into surface, while rounded top increases depth of the slot



TRUSS-HEAD screws have a wide low-profile configuration often described as an "oven head." They are ideal for covering large-diameter holes in sheet metal



PAN-HEAD screws resemble truss heads—low with a large diameter—but have thicker outer edges to allow maximum driving power. Dotted line shows contour of the head when cut with Phillips slot

POPULAR MECHANICS

head, the metal the screw is made of, the length and the diameter.

The type of head includes both the shape which is explained in the table, and the "style." The term style refers to the notch in the head, either a straight slot or Phillips (a cross). Wood and sheet-metal screws come in either style.

The main advantage of a Phillips head

is that it permits application of maximum driving pressure. A Phillips screwdriver makes a close fit in the cross-shaped slot, so that pressure is applied on four sides instead of only two, as with a straight-slotted head. Also, there is less chance of the screwdriver slipping out of the screw head and marring the work.

As for the type of metal used, steel and

KNOW YOUR SCREWS

DIAMETER

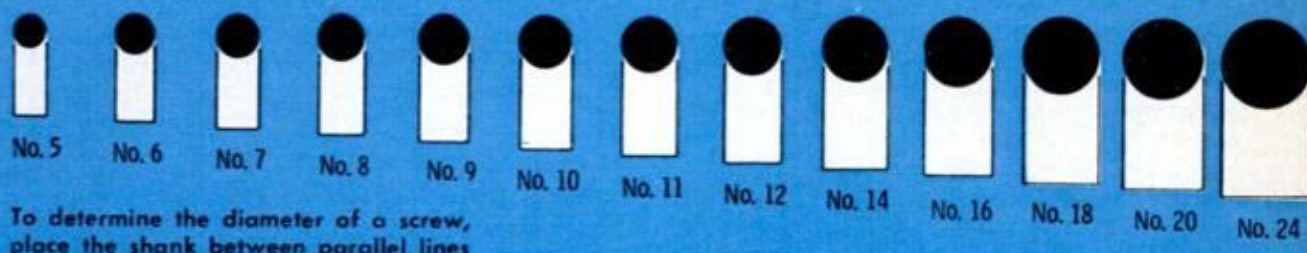

USEFUL TIPS ABOUT USING SCREWS

- When drilling lead holes in softwoods, such as pine or spruce, make them only half as deep as the threaded portion of the screw. If you're working with hardwoods—oak, maple or birch, for instance—drill the lead hole as deep as the screw.

- Choosing the right screwdriver is extremely important, as shown in the drawing below. The blade should be as near the length of the slot as possible. It should also be thick enough to fill the slot completely, yet thin enough to reach to the bottom. A worn blade, such as the one on the left, is not only difficult to use but likely to damage the slot. So is a too-thin blade (right). Middle view shows proper fit.

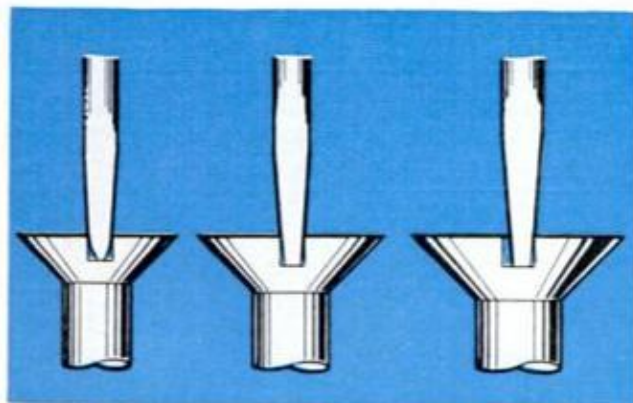

- While applying soap to the threads will make a screw easier to drive, this isn't good practice. The soap eventually turns to a form of glue and cements the screw in the hole. It also causes corrosion. You're better off using paraffin or graphite. They work just as well and involve less risk.

- A screw that's frozen in place can often be freed by heating it with a soldering iron.

- When you back out a screw, the hole that remains is slightly larger than that cut by the threads originally. Before you replace the screw, fill the hole with wood putty or use a plastic plug to provide a firm grip. Or use a larger screw.

- There are two ways of removing a screw that has broken off in the hole. If you know its size, you can drill dead center into the screw with a drill that's of the same size. This will clear the hole, but it's somewhat risky because you have to drill absolutely straight in order not to mess up core threads. If you don't know the size of the screw, and thus can't pick the right drill to remove it this way, try using a drill that's smaller than the diameter of the broken screw. Just drill a small hole in the end of the broken screw and use a regular screw extractor, or tap a square-end nail into it, and use the nail like an Allen wrench to back out the stub.

SAFE LOAD PER INCH OF THREADS

WOOD	SCREW NUMBER				
	4	8	12	16	20
In Oak	80 lbs.	100 lbs.	130 lbs.	150 lbs.	170 lbs.
In Yellow Pine	70 lbs.	90 lbs.	120 lbs.	140 lbs.	150 lbs.
In White Pine	50 lbs.	70 lbs.	90 lbs.	100 lbs.	120 lbs.

NOTE: Keep in mind that the threads of a wood screw represent two thirds of the length of the screw. Also, setting a screw into end grain reduces the holding power by 40 percent. For example, a No. 20 screw set with threads 1 in. into the cross grain of white pine will hold 120 lbs. Set into the end grain, however, it will hold only 72 lbs. If threads penetrate only 1/2 in. into end grain, the holding power drops to 36 lbs.

SHEET-METAL SCREWS

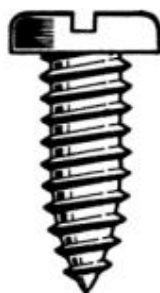

TYPE A sheet-metal screws have coarse threads and are used for joining pieces of sheet metal of gauges from .015 to .050 in. They are available in diameters ranging from Nos. 4 through 14 and in lengths from ¼ to 2 in. You can buy them with either style head, slotted or Phillips.

TYPE B sheet-metal screws can be used for the same applications as Type A screws, but they are recommended for the more rugged jobs involving joining sheet metal with gauges of from .050 to .200 in. They are available in the same diameters and lengths as Type A in both Phillips and slotted.



TYPE C screws differ from the first two types in that they have standard threads rather than coarse. Type C tapping screws are used for sheet-metal joining when the gauges range from .030 to .100 in. They are available in diameters ranging from ⅜ in. to 1¼ in.

TYPE F sheet-metal screws are used primarily for joining metals ranging in thickness from .050 in. all the way up to ½ in. They are sold in diameters from No. 2 to ¼ in. and in lengths from ⅛ in. to ¾ in. Like the three above types, you can get Type F screws with either Phillips or slotted heads.



TYPE U screws actually seem more like nails than screws. Their heads are not slotted because they're installed with a hammer rather than with a screwdriver. Type U screws are used with heavier-gauge metals—.050 in. to ½ in.—and are made in lengths from ⅛ in. through ¾ in. One common use is attaching metal nameplates to sheet metal.

TYPE 21 sheet-metal screws are commonly used for fastening other materials to metal—fabrics, cardboard and leather, for instance. Like the type U screws, they have plain heads and are installed with a hammer. This type of screw is available in three lengths: ⅓, ⅜ and ½ in.



brass are the most common. Generally, brass screws are used for lightweight work, steel for heavy work. If there is a possibility of corrosion, use screws of aluminum or those protected by some kind of plating—galvanized steel, zinc chromate or plated cadmium.

Selecting the right length simply means picking the longest possible screw that won't pass entirely through the wood. The more screw body in the wood, the greater the holding power.

Although you can get screws as long as 6 in. on special order, commonly available sizes range from ¼ in. to 4 in. Below 1 in. the length increases by ⅛-in. increments; from 1 in. to 3 in. length goes up in ¼-in. steps; and above 3 in. this increases to ½ in. intervals.

Screw diameter is expressed in arbitrary numbers which represent relative differences in thickness rather than actual measurement. Wood screws are made in diameters of No. 0 (.060 in.) to No. 24 (.372 in.). However, your hardware store probably carries sizes from No. 2 (.086 in.) to No. 18 (.294 in.).

You have to know the screw's diameter in order to select the right drill size for making the lead hole. While this will depend on the hardness of the wood, it's generally equal to or slightly less than the screw's root diameter. For maximum holding power, use the smallest drill diameter that won't cause cracking or difficulty in driving. ★★

DRILLING LEAD HOLES

SCREW SIZE (No. and Diameter)	DRILL SIZE (No. and Diameter)	
	HARDWOODS	SOFTWOODS
0 (.060")	70 (1/32")	71 (1/32")
1 (.073")	66 (1/32")	65 (1/32")
2 (.086")	56 (3/64")	58 (3/64")
3 (.099")	54 (1/16")	55 (3/64")
4 (.112")	52 (1/16")	53 (1/16")
5 (.125")	49 (5/64")	52 (1/16")
6 (.138")	47 (5/64")	51 (1/16")
7 (.151")	44 (3/32")	48 (5/64")
8 (.164")	40 (3/32")	45 (5/64")
9 (.177")	37 (7/64")	43 (3/32")
10 (.190")	33 (7/64")	38 (7/64")
12 (.216")	30 (1/8")	32 (7/64")
14 (.242")	25 (9/64")	29 (9/64")
16 (.268")	18 (5/32")	26 (9/64")
18 (.294")	13 (3/16")	19 (11/64")
20 (.320")	4 (13/64")	15 (3/16")
24 (.372")	1 (7/32")	

NOTE: Lead holes aren't usually required for Nos. 0 and 1 screws. For sizes smaller than No. 6, lead holes can be eliminated in softwoods, except near the edges and ends of boards.

PHOTO HINTS



DISCARDED PLASTIC PILLBOXES make neat cases for filters. For padding, line the bottom with thin plastic foam. The square, shallow boxes stack snugly together and take up little room in a camera bag. Bind them together with a rubber band to keep them from scattering in the bag. The boxes are used for several different kinds of medication and are readily available at all drugstores.—Arthur L. Ramos

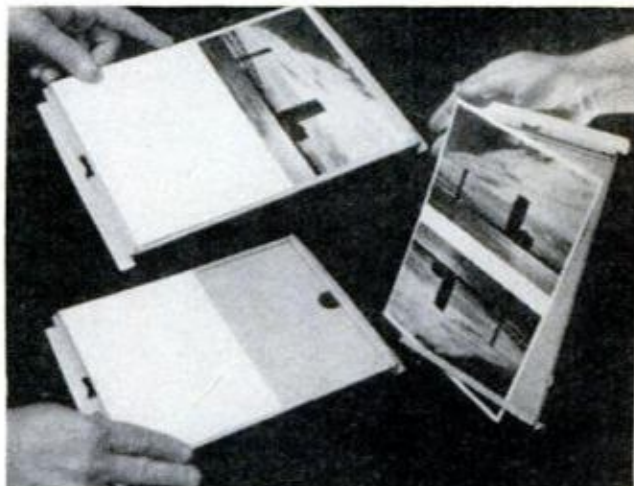

IF YOU HAVE A NUMBER of duplicate 5x7 prints to make, you can turn them out faster using an 8x10 easel this way. Cut a cardboard mask to cover slightly more than half of the easel as shown. Expose half a sheet of 8x10 paper with the mask covering the other half. Then, without moving the easel, carefully turn the paper around and expose the other half, giving you two 5x7 prints—Bob Corley

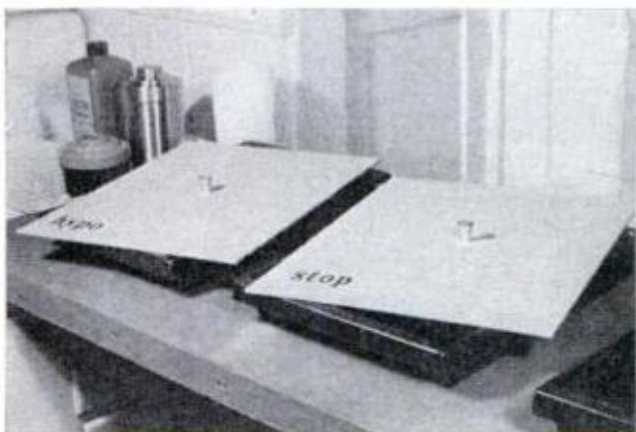

PHOTO-PROCESSING CHEMICALS quickly pick up dust and dirt if allowed to stand in open trays. If you leave your trays filled for more than a few hours, it's a good idea to cover them with homemade lids. Cut the lids from thin hardboard or plywood, making them slightly larger than the trays all around. Seal the covers against moisture with a coat of shellac or varnish. Ordinary wood or metal cabinet knobs make excellent handles for the lids, as shown above. Even when empty, the trays will stay cleaner if you keep them fully covered.—Arthur L. Ramos

NEED AN EXTRA FLASH for an extension setup? You can make one up from common items, as shown in the photo at right. Use a small aluminum pieplate for the reflector—it makes a fine fill light. Fasten the plate to a spring light bulb clip of the type used on lampshades. The reflector can then be clipped right on the flashbulb and swiveled to any angle. For a flashbulb holder, you can use a standard spring-clamp floodlight socket. Large-base flashbulbs can be screwed directly into such a socket, or you can use an adapter for smaller bulbs. The extension outlet on most flashguns will take a regular two-prong lamp-cord plug.—Ken Patterson



New 7-Pound Chain Saw— A Rip-Roaring Performer

By LEONARD E. SABAL
Workshop Editor

Photos by the Author



POWER-MAC 6

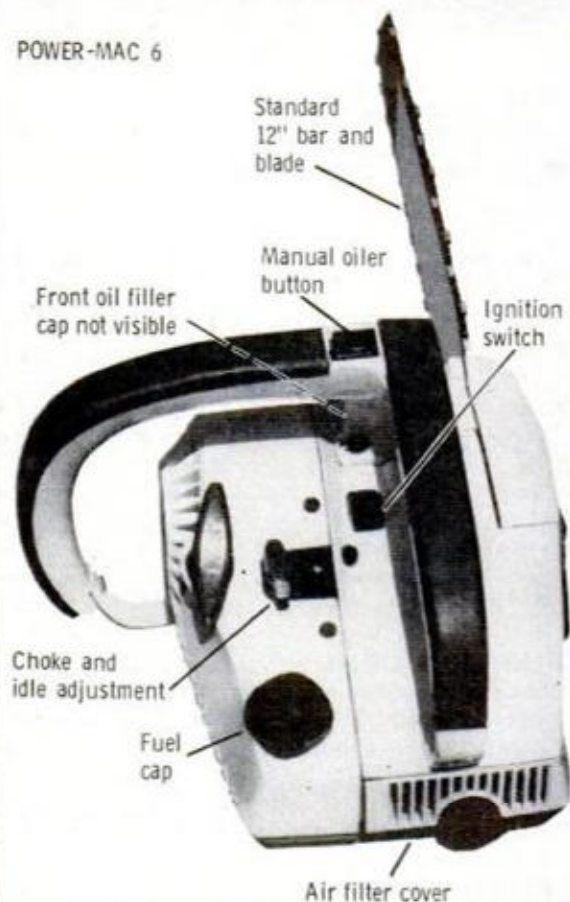

HANDY TO HEFT and easy to start, McCulloch's mini-saw has well-located controls, adjustments

"IT LOOKS LIKE A TOY!" was my first reaction—but after a weekend with McCulloch's new ultralight chain saw, I had to admit that while it *was* fun to use, it proved remarkably surprising in the performance department.

Six and 8-in. diameter logs were no match for the mighty mite. In fact, in a test running a little less than a minute, I sliced better than a dozen three-finger chunks from a 5-in.-dia. tree branch. While this test in itself doesn't set any records, it would take a modern Paul Bunyan to match this *one-handed* test with a conventional-size chain saw.

And *that*, as any 10-year-old will tell you, is where it's all at. The Power-Mac 6 is light enough to be controllably wielded with only one hand, yet it's powerful enough for all but professional lumber-jacks.

Its tiny 1.96-cu.-in., two-cycle, single-cylinder engine belts out almost 2 hp, and will run for a half-hour or so on a single tank ($\frac{1}{2}$ pt.) of 40-to-1 gas-to-oil mixture. Length of the bar is a standard 12 in., although if desired, an optional 16-in. bar can be factory-fitted for about \$6 over the basic price. Use of the 16-in. bar increases total weight from $7\frac{1}{4}$ to $7\frac{1}{2}$ lbs., but unless you live in a heavily wooded area, the 16-in. bar and blade is an unnecessary frill.

The body of the saw is made from a magnesium alloy, which makes possible the low $6\frac{1}{2}$ -lb. weight of the power unit. The black tip at the end of the bar is an alloy inlay to reduce friction and possible burning of the bar due to insufficient oiling. This is the only fault I could find with

the Power-Mac 6—automatic oiling would make continuous one-handed operation possible without running the risk of overheating the bar and blade.

All controls and adjustment points are conveniently located, although I wished the handles were covered with soft rubber, bottom as well as top. Ribbed or contoured handles would also reduce the chance of accidental slippage.

Priced at \$169.95 complete with 12-in. bar and tension adjustment tool, the little saw will require only one test run to convince you that it's anything but a toy. ★★★

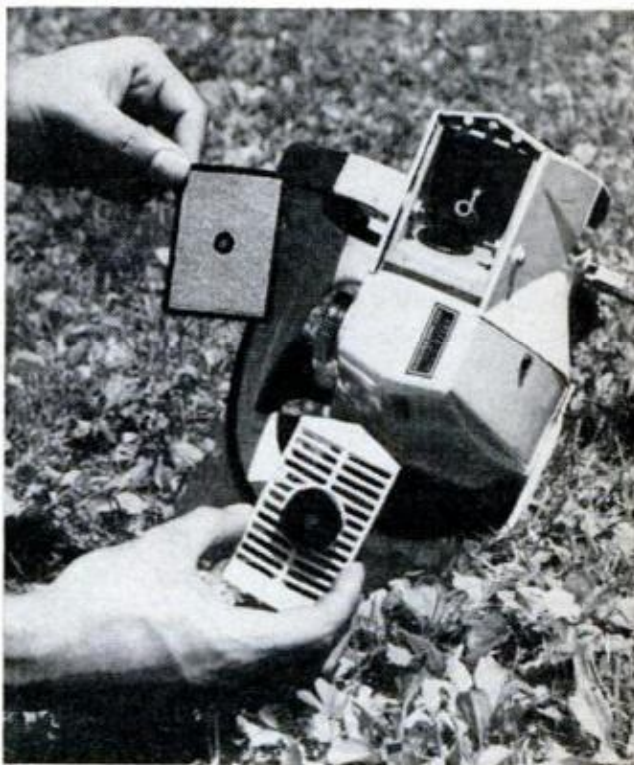

AIR FILTER MEMBRANE should be cleaned daily, is readily accessible by turning knob, removing cover

DWARFED BY ANTIQUATED MONSTER, Power-Mac 6 comes with 12-in. bar and chain; 16-in. bar is optional

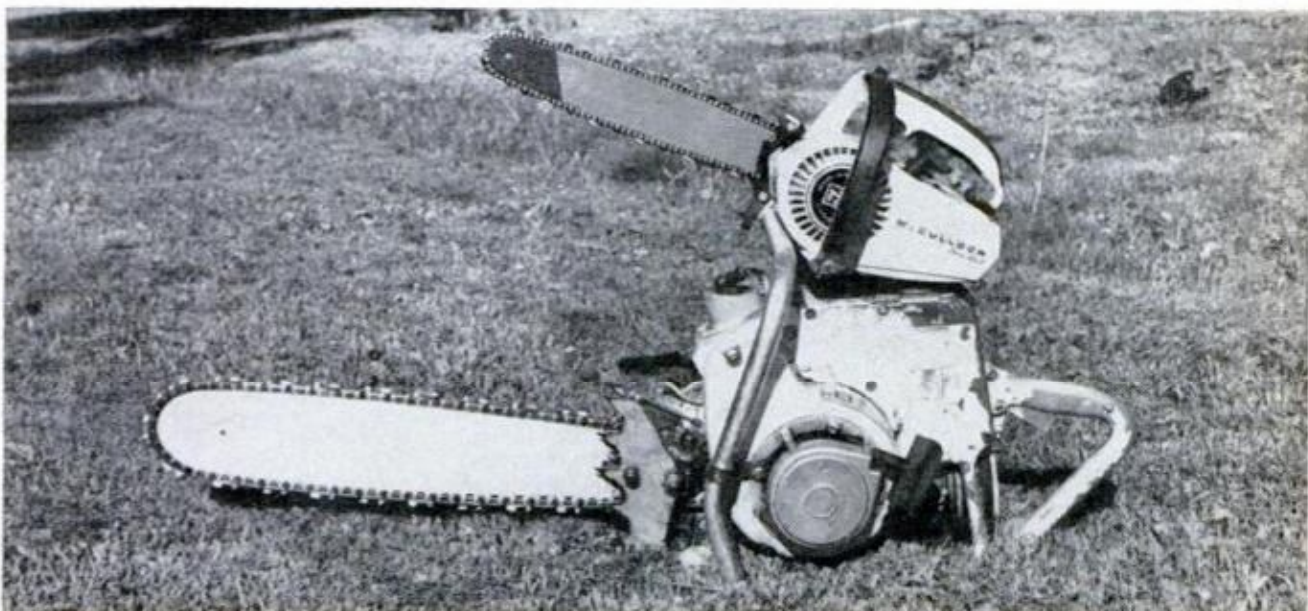

13-Point Check

You're gambling with your life if you leave the driveway without knowing if your car will let you see, steer, stop and communicate with other drivers on the road

By MORT SCHULTZ

A SAFE CAR is one that gives you every chance to avoid an accident. Specifically, it's one that lets you see, stop, steer and communicate properly.

The equipment necessary for visibility includes windshield washers, glass, mirrors, windshield wipers, defrosters and lights.

Just a glance at windshield, rear window and side panes is all that's necessary to check for cracked, discolored or cloudy glass. Replace any that hampers your vision. Also, keep glass clean and watch where you place decals.

You can check your wipers simply by wetting the windshield and operating them

for a few cycles. If the motor doesn't work, the cause is most likely the switch, although wiper motors do gum up or burn out and need cleaning or replacing.

If your wipers leave the windshield streaked, the rubber blades are deteriorated and should be replaced.

If your car has windshield washers, activate them while the wipers are operating. If they aren't spritzing, you're out of water, have a clogged reservoir strainer or jets, or connecting tubing has slipped off somewhere in the system.

If your heater is working, the only reasons for inadequate defroster action are an obstructed duct or torn or disconnected

1

WINDSHIELD WIPERS get their hardest workout in winter snow. Check motor, arms and linkages. Replace rubber if it's streaking windshield

2

WINDSHIELDS and all other glass should be inspected for cracks and other faults that would obscure your vision or otherwise be unsafe

3

REAR-VIEW MIRRORS and side-view mirrors, too, should be examined for faults in the glass. Also check the swivel mountings for tightness

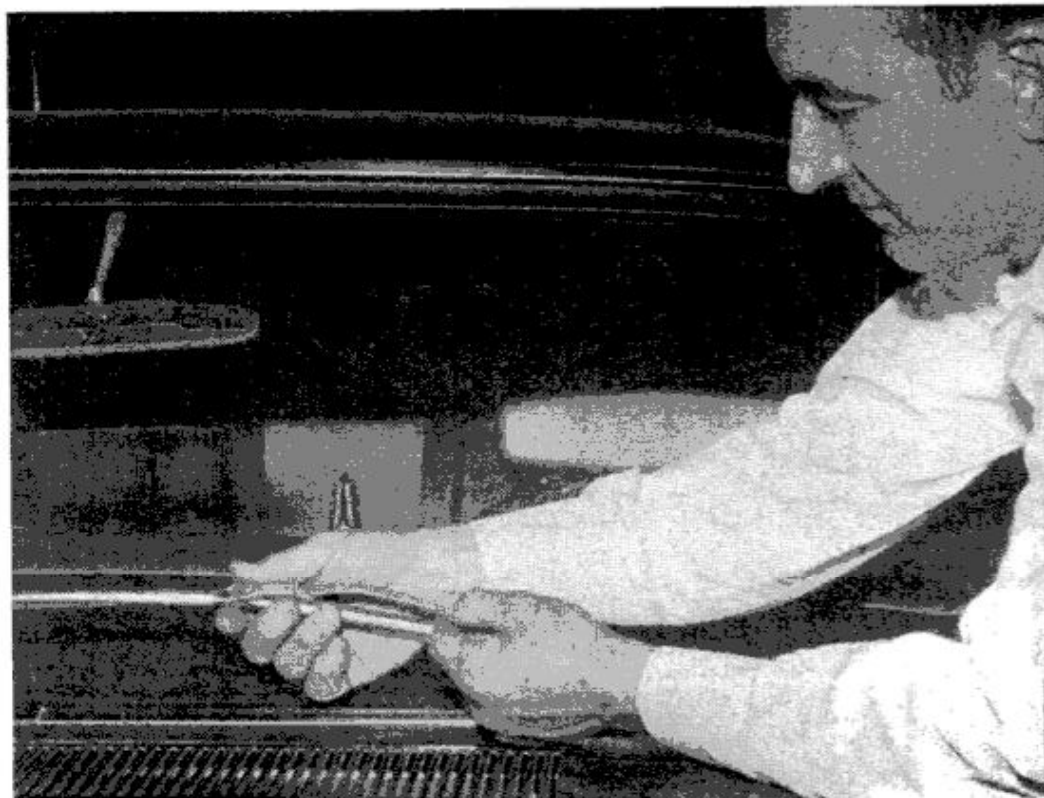

Luck . . . Make This for a Safe Car

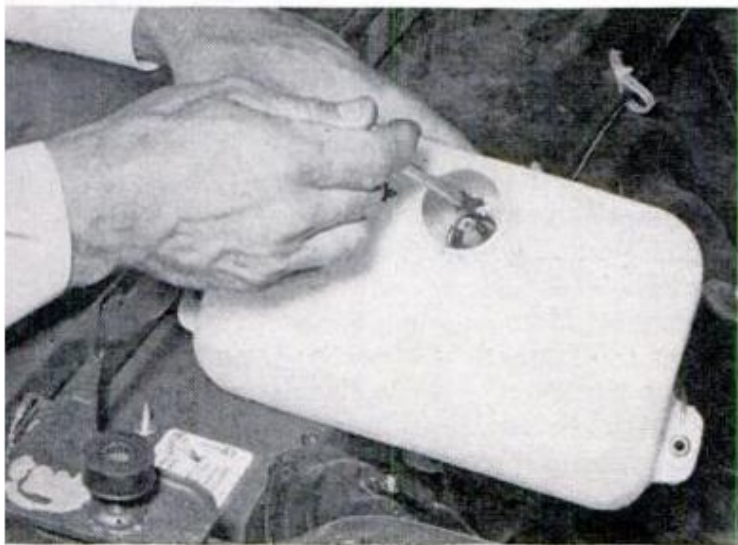
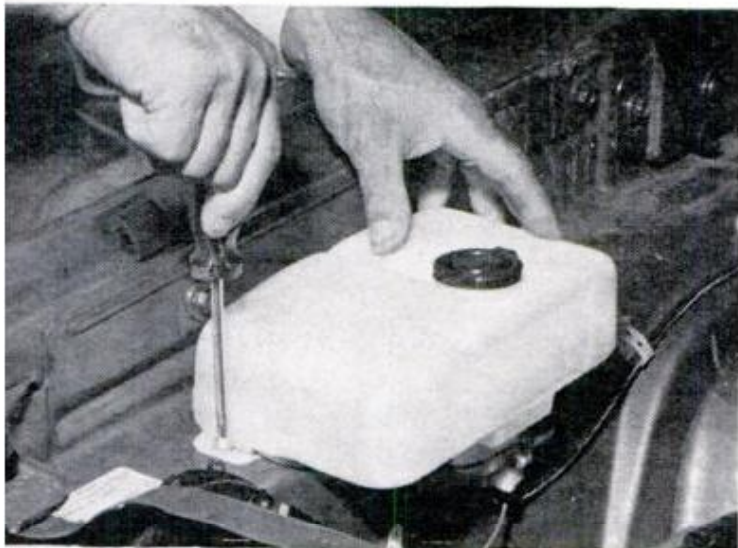

4

WINDSHIELD WASHER reservoirs are easy to remove for cleaning. Disconnect wires to the centrifugal pump and check that tubing is tight and can't be forced off by fluid pressure. Clean strainer with a brush

5

DEFROSTERS can be lifesavers . . . as long as they're working. Don't assume they're working just because your heater is. Defroster hoses often become disconnected and are susceptible to splits and tears

hose. Check them and replace if necessary.

Rear and side-view mirrors should be checked for cracks and discoloration. While you're at it make sure to check swivel mountings that hold the mirror firmly in place. If they're loose and can't be tightened, get a new mirror.

The many lights on your car are used for both seeing and communicating with other drivers. Up front, check your parking lights, headlight high and low beams, and turn-signal lights. In the rear, check license-plate light, taillights, stoplights, turn-signal lights, and backup lights.

A burned-out bulb or sealed-beam headlight unit is easy enough to replace. Simply remove the lens or retaining ring of the sealed-beam unit, remove the unit and replace with a new one of the same number.

If a group of bulbs fail to work, the problem is most likely a bad switch. For example, if both headlights fail to light when you pull out the switch, it's not likely that both bulbs have burned out. The trouble is probably a bad headlight switch.

Details on how to remove switches vary from car to car. It can be a tough job, so check a service manual for your car. Generally, the procedure is to remove the battery ground cable (do this when replacing



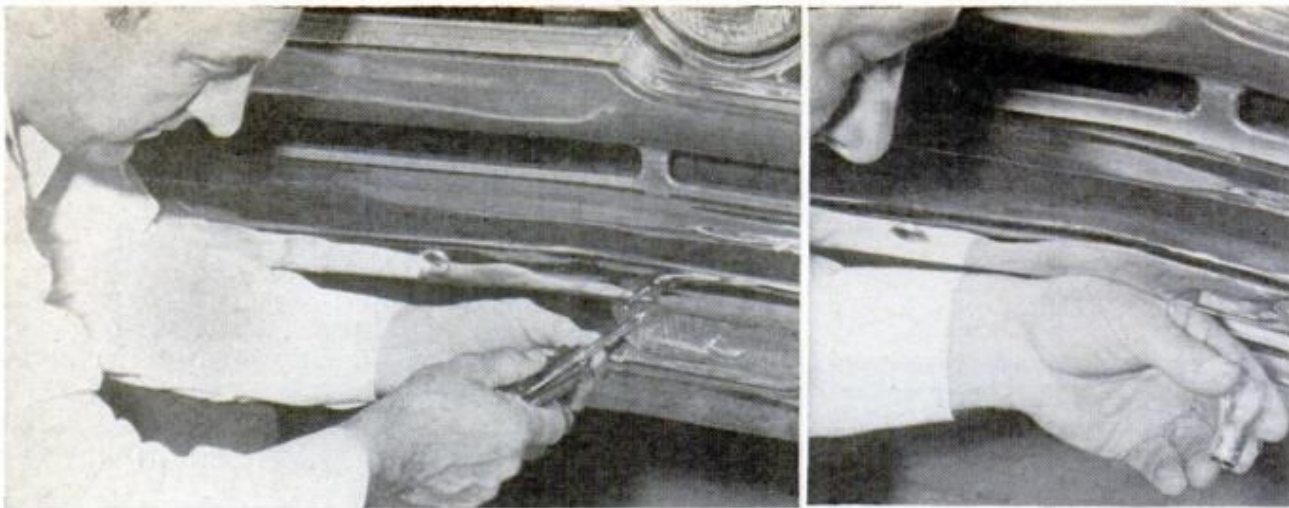

6 **CAR LIGHTS** always fail unexpectedly and the cause is most often a burned-out bulb. It can be reached by removing the lens and frame or, in many cases, directly from the rear without removing the frame. Make sure you replace with same number bulb. A good idea is to keep spares in your car

7 **DIRECTIONAL-SIGNAL FLASHER** is most often mounted under the dash or on the firewall in your engine compartment. A bad one is easily replaced with another unit of the same number. Mark wires if you don't have plug connector

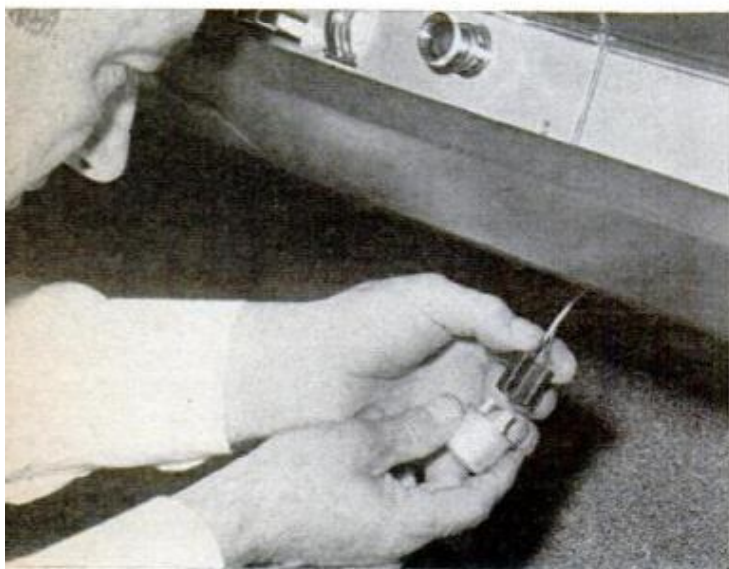

any switch), and pull the switch to full ON position. Loosen the retainer and pull the knob shaft out of its hole.

Reach behind the dash and pull the switch down. Disconnect the leads, reconnect them on a new switch and replace it.

If your headlight dimmer switch seems faulty—if it doesn't cause lights to go from high to low beam, or vice versa—throw back the floor mat and unscrew the dimmer switch from the floor. Pull the switch from connector leads and hook up a new switch.

There's one other aspect about headlights you've got to consider from a safety standpoint—vertical and horizontal adjustment. Home-grown methods of alignment are “guessy” at best, so invest a dollar or two every year to have the job done with professional equipment.

If your directional-signal light bulbs

8 **AUTO HORN** that's not working needs immediate troubleshooting. A troublelight across leads removed from horn proper (left) will light when the horn ring is pressed if the horn is bad. If good, move to relay (right) and check it with same technique. Finally, check wiring and horn-ring switch

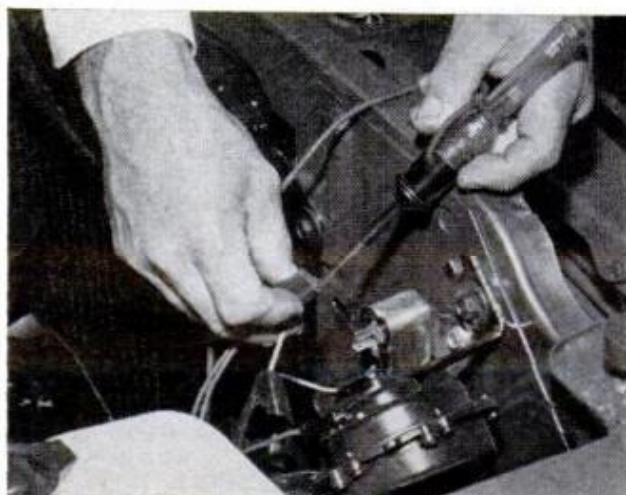
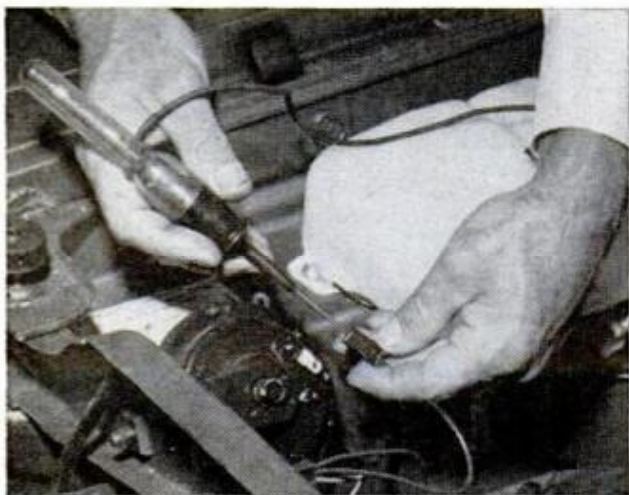

9 **TIRE TREAD** should be checked for depth. Trade in tires with less than a 16th of an inch on the gauge. Also inspect for even tread wear and damage. Sidewalls should get equal attention; look for cuts, breaks, bruises. Check air pressure, too

10 **BRAKES** can telegraph trouble through brake pedal and steering wheel. A low or spongy pedal, excessive pressure needed to apply brakes, pulling to one side are all symptoms to watch for. Visual checks of lining keep you alert to rate of wear

11 **STEERING LINKAGE** should be checked for positive response, damping, lubrication, and alignment. Power-steering components should also be checked for proper functioning. Front suspension alignment is integral to steering setup and should also be true

12 **EXHAUST SYSTEM** components can rust through without your knowing it. Lightly probe rusted muffler and tailpipe areas; paper-thin metal will crumble, and the part can be replaced before small but dangerous leak of exhaust gases develops unnoticed

check out okay, the problem is most likely a burned-out flasher. On most cars, the flasher is mounted on the back of the instrument panel. To replace it involves dropping the flasher, unhooking it and connecting a new one.

If directional signals fail to function after bulbs and flasher have been checked, the trouble has to be the turn signal switch. If it's inside the steering column, it's usually hard to get at. If you've got a steering-wheel puller you can do it. Otherwise leave it to a mechanic.

The chief means of communicating with other drivers and pedestrians is with your horn. It's used sparingly, but when it's needed, it had better be working. A horn (or horns) that isn't working usually has either a dirty horn-switch contact plate, a bad horn, a bad horn relay, or broken or poorly grounded wiring.

You troubleshoot a horn circuit like you'd troubleshoot any other circuit. First you need a test light, which you can buy in an auto parts store. Disconnect the wire at the horn and connect one lead of your test light to the terminal. The other lead goes to ground. Press the horn button. If the test light lights, you know the horn isn't blowing because it's bad. Replace it. If the test light fails to light, the trouble is

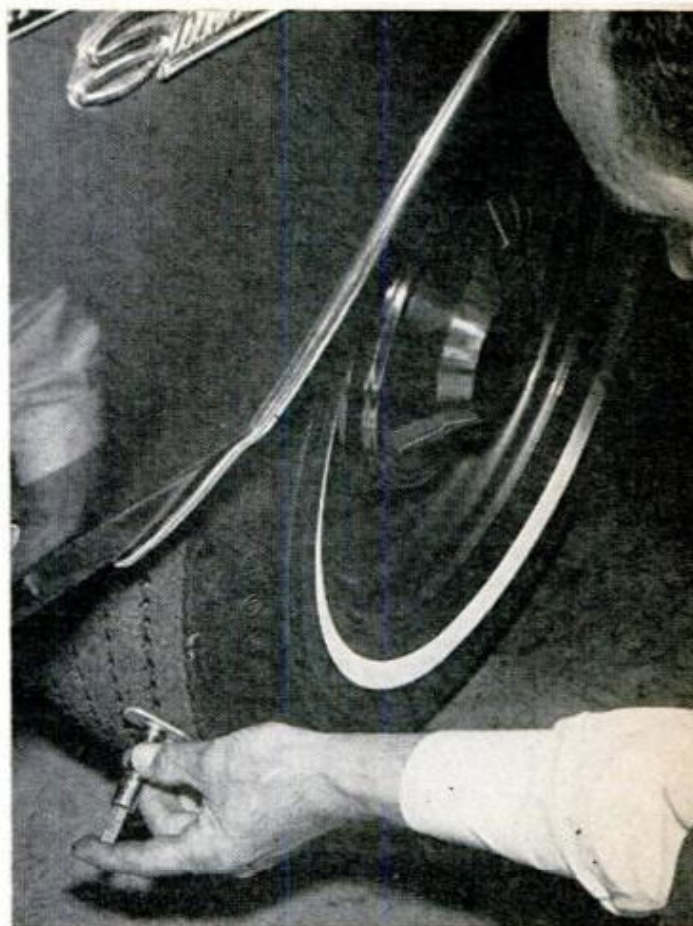

further back in the circuit, so you've got to trace it back, using the same technique at the relay and wire connections.

If the problem's a bad relay, replace it. If bad wiring seems to be the problem, make sure connections are tight and clean before you start replacing it.

If all these things check out, the trouble's probably a dirty horn switch contact plate. It's inside the steering column, and

(Please turn to page 229)

13 **SEAT BELTS** and shoulder harnesses don't help you see, steer, stop your car, or communicate with other drivers, but they do stop you from flying around in the event of an accident. Check the buckles, webbing and anchor bolts... just for good luck!

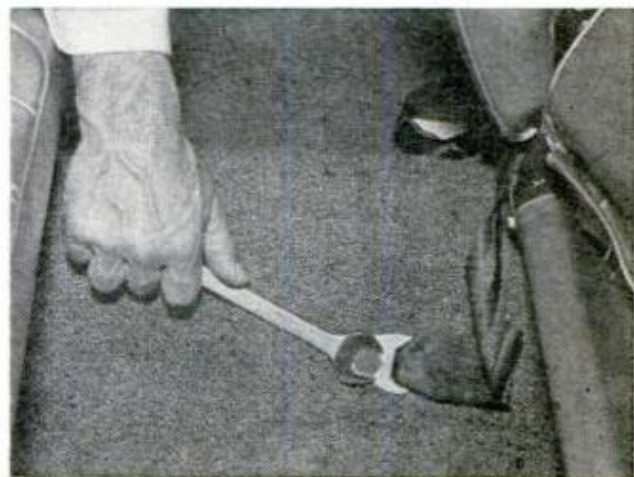

What's So Hard About

It's all in knowing where to put your lights. This step-by-step pictorial guide gives you easy setups for a variety of dramatic effects

By SHELDON M. GALLAGER

Photos by Robert D. Borst

IF YOU THINK that portrait photography is for professionals only, take a few minutes to study the pictures and diagrams on these pages. They show that portrait lighting is not only basically simple—it's also a lot of fun to try because there are so many interesting and unusual effects you can get.

Shooting a portrait does require some know-how, but it doesn't take a studio full of fancy equipment. You can create just about any lighting setup you want with four ordinary mushroom-type photo-floods available at photo shops. Light

stands are helpful, but you don't need to assemble a whole bunch at once. The back of a chair, a broomstick taped to a table leg, a standing lamp borrowed from the living room—such makeshift aids will hold your lights quite adequately.

There are four basic light positions. Your lights don't always have to be in exactly these positions, but they give you a starting point from which to try other variations. The main or "key" light is usually placed to one side of the camera so it lights the subject from an angle. This cross light casts shadows that give depth



1

HOW YOU BUILD UP BASIC



2

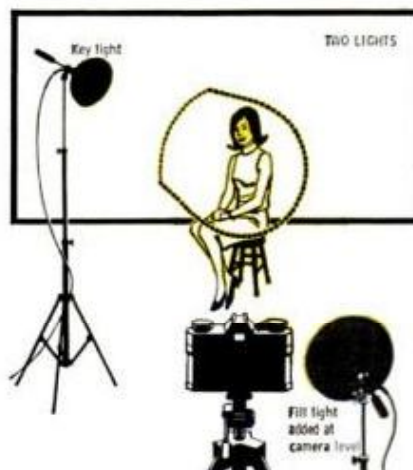

SEQUENCE OF PHOTOS here and on opposite page shows what happens as you add one light at a time in a four-light setup. Using a plain rubber ball helps to illustrate effect that each light produces. Key light (1) provides main illumination. Placed off to the side, it creates strong shadows, giving shape

Shooting a Portrait?

and shape to the subject's facial features.

A "fill" light at or near the camera illuminates the side of the face that's away from the key light and softens the shadows so they don't become too harsh. A third flood is used to light up the background so the subject stands out clearly. A fourth flood, called a "hair" light, is placed so it shines down on the subject's head from the rear, adding a brilliant glow to the hair.

While there are four different light positions, you don't have to use all four to make a good picture. Many eye-catching portraits are made with only two or three lights. Once you learn the basic arrangement, you can experiment—that's when the fun starts. Try different combinations of lights and see what happens. You'll

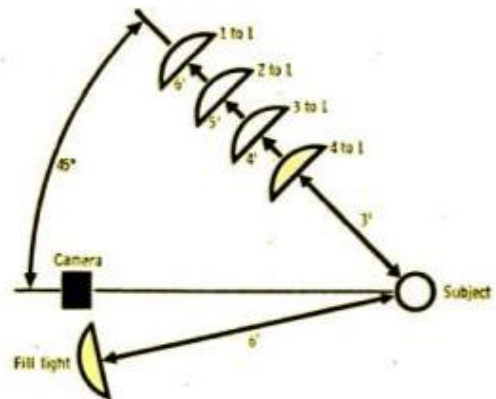

HOW FAR AWAY you put the key light in relation to the fill light determines your "lighting ratio." When both are at the same distance, their ratio is 1 to 1 and they illuminate the subject more or less equally. As the key light is moved closer, its ratio increases. It becomes stronger and the fill light gets weaker. The higher the ratio, the deeper the shadows and the more contrasty the effect

FOUR-POINT LIGHTING

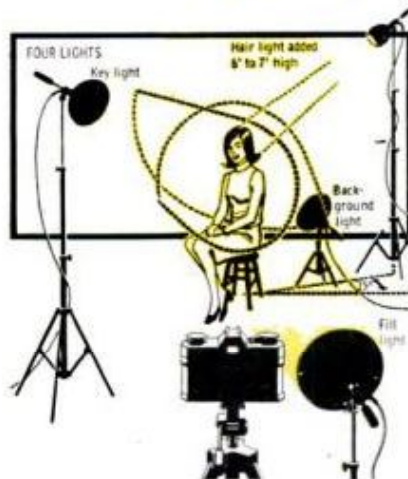
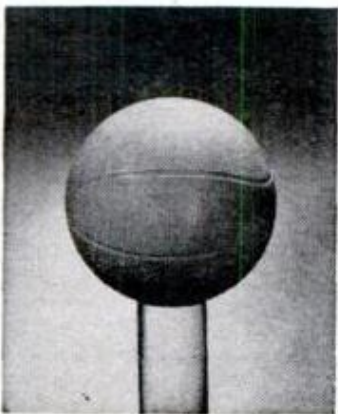
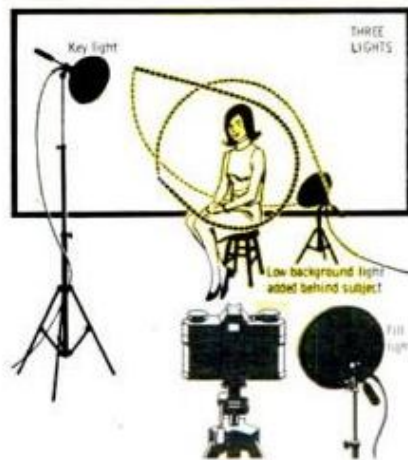
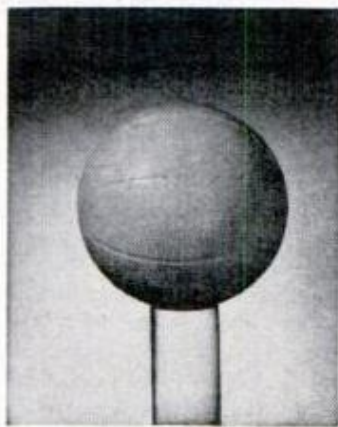

to facial features. Adding fill light (2) softens shadows and evens out lighting. Background light (3) outlines subject's head, separating it from background. Final light (4) puts attractive shine on hair

find, for instance, that killing the fill light heightens the contrast on the face. Omitting the background flood makes everything go dark except the subject's face, creating a moody effect.

Using various combinations of the four lights, you can actually make 15 different setups—four with only one light in each, six with two lights, four with three lights, and one with all four lights. Not all will produce pleasing or useful results, but

they'll let you see the wide variety of effects that are possible.

Proper location of the key light is important. The familiar "45/45" rule—angled 45° from the camera and tilted down 45° to the subject—is a handy guide, but don't stick to it rigidly. Study what the light does in different positions. Moving it farther from the camera sharpens the shadows it casts. Up to a point, this looks dramatic, but eventually it becomes gro-

WHAT YOU CAN DO WITH ONE OR TWO LIGHTS

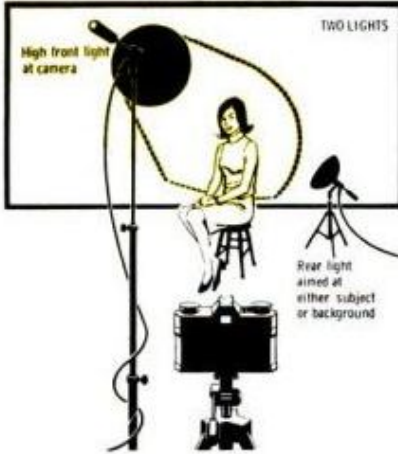

IT DOESN'T TAKE a lot of lights to make a picture. The results may not be technically perfect, but they're often unusual and eye-catching. The photo at left above was made with a single high front flood. Adding a second flood to illuminate the background provides good separation between the subject and background, but doesn't make a particularly interesting picture. Now note what happens when you turn the rear flood around so it backlights the subject instead. The brilliant edge lighting on the hair creates a dramatic effect, yet you've used only two lights

NEED AN EXTRA LIGHT? The two photos below show how a white cardboard reflector can serve the same purpose as a light. Here, it acts as a front fill, and the key light is swung around almost broadside to the subject to provide a dramatic cross light. The photos show the effect without the cardboard on the left and with it added on the right. Note how it casts just enough light to open up the dark side of the face and keep it from going completely black. Even if you have plenty of lights, a reflector is often a better choice where you need only a small amount of fill

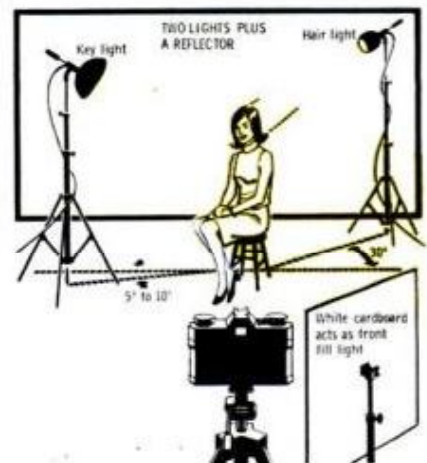

tesque. If your subject has a prominent nose that casts a long shadow, keep your key light low to make the shadow as short and inconspicuous as possible. On the other hand, raising the key light will help to de-emphasize an excessively long chin by throwing the lower part into shadow.

The relationship of the key light to the fill light is another important factor. Since you want the key light to do most of the work, you usually place it closer to the

subject than the fill. The difference between the two distances is expressed as a ratio. The closer you move the key light to the subject, the stronger it becomes in relation to the fill light and the higher the ratio. Its shadows become deeper and more pronounced as the effect of the fill light gets weaker. High-ratio lighting produces striking results, but is better suited to rugged masculine features. A

(Please turn to page 230)

THREE WAYS TO CREATE SPECIAL EFFECTS

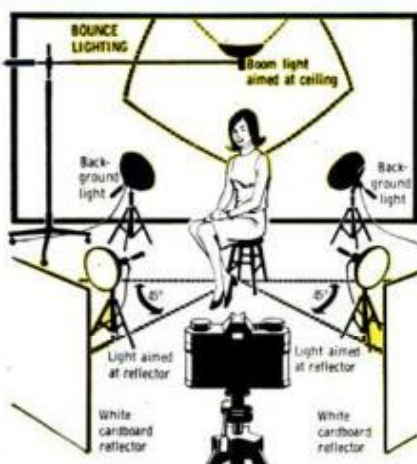

BOUNCE LIGHTING creates a soft, pleasing effect without shadows. While not as dramatic as direct lighting, it's often more flattering, especially on subjects with prominent features that cast deep shadow lines. Here, the illumination is entirely by reflected light. Front lighting is provided by two photofloods aimed away from the subject at white cardboard reflectors. Two more floods light up the background. A fifth light is aimed straight up so it reflects downward, casting a highlight (if ceiling isn't white, tack up a white bedsheet to give good reflection)

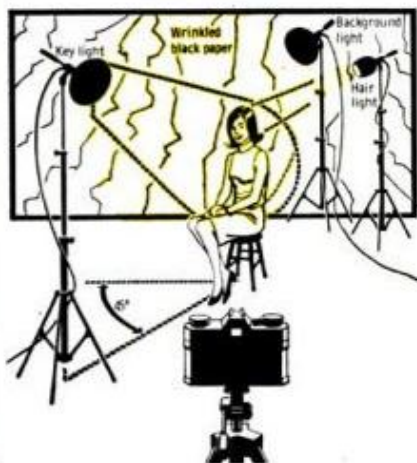

A FEW SIMPLE PHOTO PROPS can completely change a subject's appearance and personality, as shown at left. The background is an old piece of black paper deliberately crinkled to produce a coarse-textured pattern of light and dark tones. A peaked cap and high-necked sweater give the subject the tough, sexy look of an apache dancer—just the opposite of the sweet little girl mood in the upper picture. Note there is no fill light to soften shadows cast by the key light. This heightens the dramatic effect. Hair and background lights complete the setup



RANDOM SHADOW PATTERNS often add an unusual touch to an otherwise routine picture. You'll find many objects around the home that can be used to create interesting shadow effects. You'd never guess that the mottled background at left was produced by an ordinary kitchen stool turned upside down. One light is placed so it shines through the stool, casting shadows of its legs on white background paper. Locating the light low and off to the side, as shown at right, lets you throw shadows behind the subject without the stool itself getting in the way. Moving the light closer or farther away varies the shape and intensity of the pattern. Also in the setup are a key light (behind camera), a hair light overhead and a fill light at left



At Last: a Self-Cleaning

The new Lennox computer-controlled unit sets moisture level with solid-state precision and flushes away mineral deposits automatically

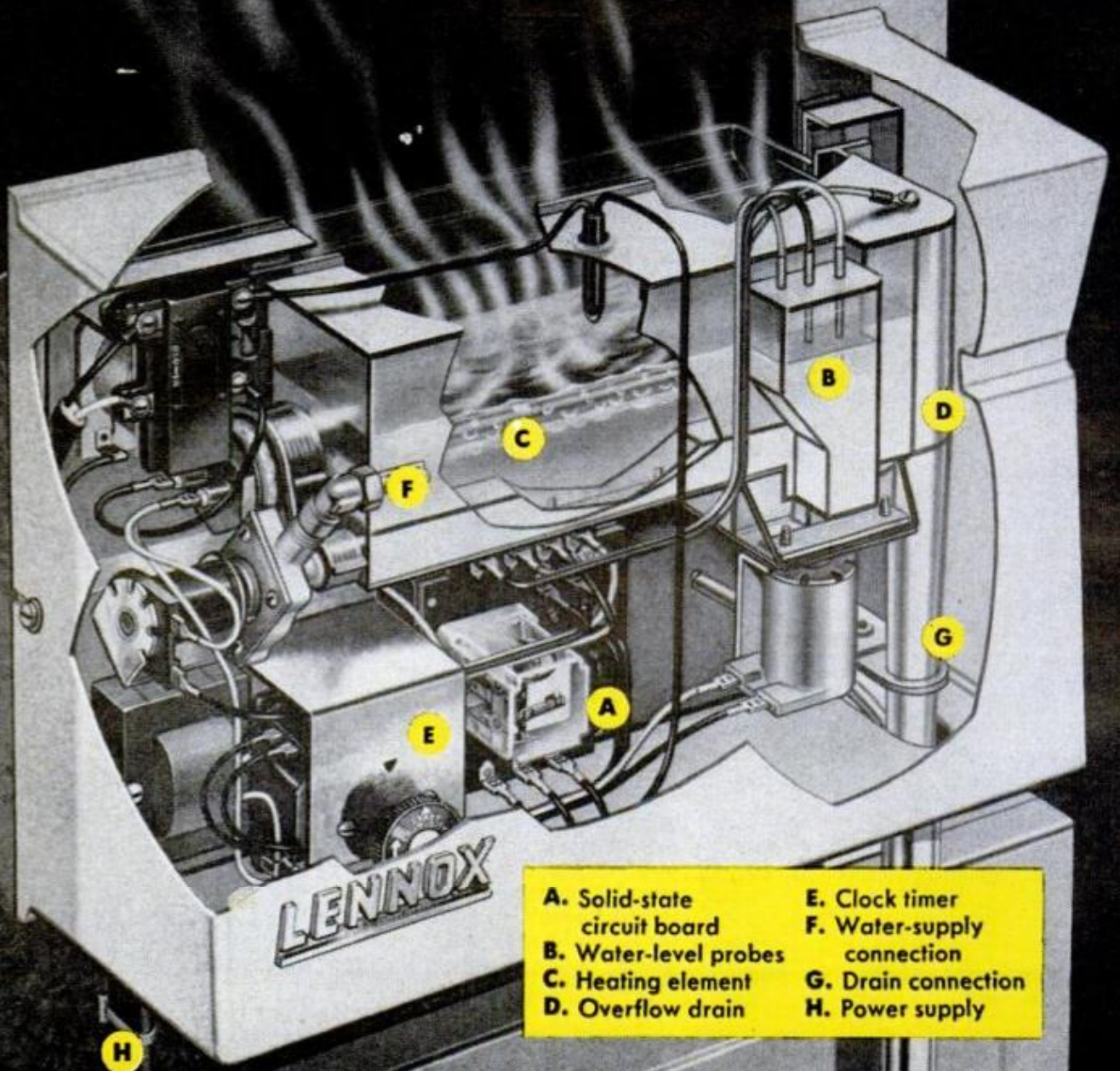

- | | |
|------------------------------|----------------------------|
| A. Solid-state circuit board | E. Clock timer |
| B. Water-level probes | F. Water-supply connection |
| C. Heating element | G. Drain connection |
| D. Overflow drain | H. Power supply |

Furnace Humidifier

WATER IS THE CAUSE of most humidifier problems. When it evaporates, it leaves behind mineral solids which tend to cake on float assemblies and clog drains. At best, this causes a drop in efficiency. At worst, it can mean a messy overflow and costly damage.

The new Lennox WE-9 electronically controlled humidifier represents a major breakthrough in the battle against mineral residues. It's an automatic self-cleaning unit which can operate almost indefinitely without service on any kind of water. Furthermore, its special design features permit a number of new installation possibilities in all types of warm-air systems.

Because the WE-9 generates steam electrically, it doesn't require heat from a furnace in order to operate. Thus, the unit can be installed in the supply or return air duct. It can be used with a heat pump or with electric heating. You can even put one on a central airconditioning system.

Control circuitry of the WE-9 regulates three operating cycles—filling, flushing and humidification.

The fill cycle is controlled by three water-level probes connected to a solid-state electronic circuit. As water evaporates and drops below the low-level probe, a signal goes to the circuit board which automatically opens the fill valve and shuts off the heating element. Water enters through a water distribution channel with six inlet jets positioned to scrub the bottom and sides of the reservoir. When water reaches the high-level probe, the fill valve closes.

Clock timer runs flush cycle

The flush cycle operates from a clock timer wired in parallel with the fill valve. You can adjust the timer to flush the reservoir after anywhere from two to ten hours of humidifier operation, depending on how hard the water is in your locality. At the preset time, the clock opens the drain valve to empty the reservoir and start the flush cycle.

The reservoir in the WE-9 is made of

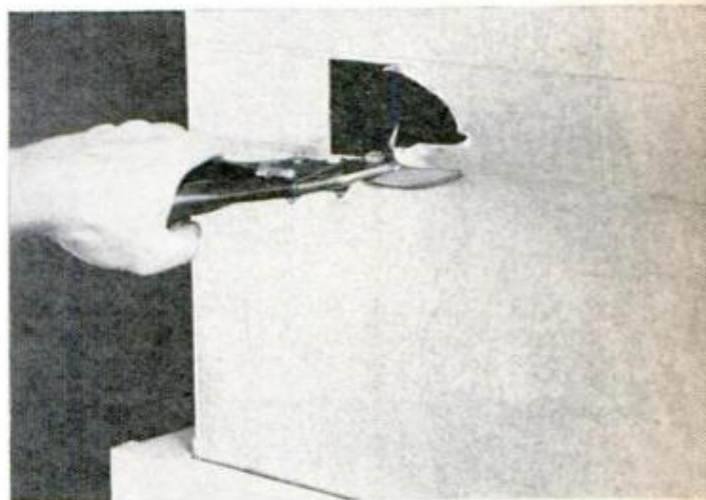

OPENING REQUIRED by the WE-9 measures $2\frac{1}{4}$ x 11 in. Unit can be mounted on plenum or on air ducts

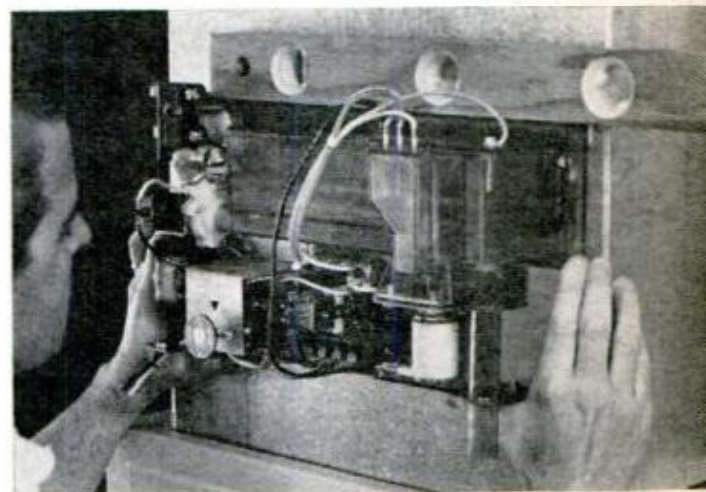

MOUNTING HOLES are located by positioning unit in opening and leveling it with a carpenter's level

WATERTIGHT SEAL between humidifier and plenum chamber is ensured by caulking all mounting openings

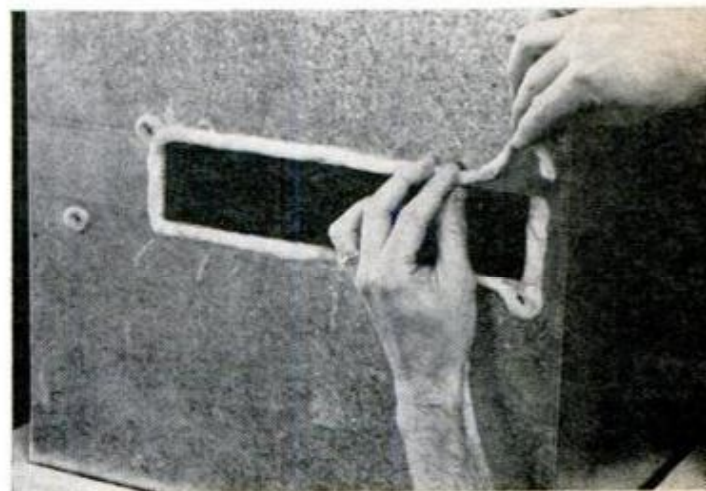

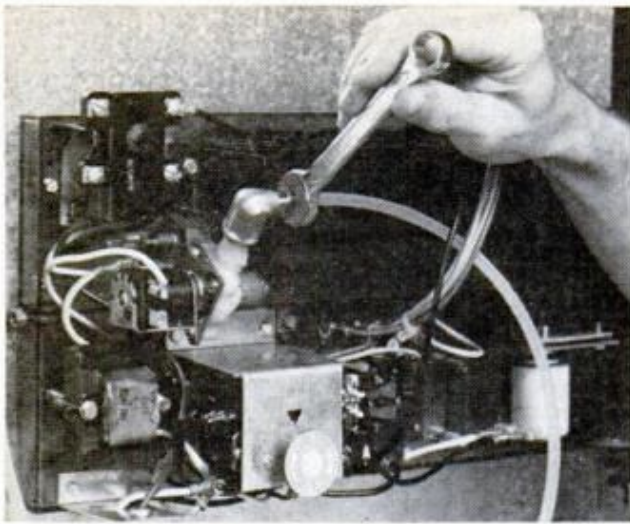

PLASTIC WATER LINE runs from nearest water supply to the inlet side of the unit. Fittings are provided

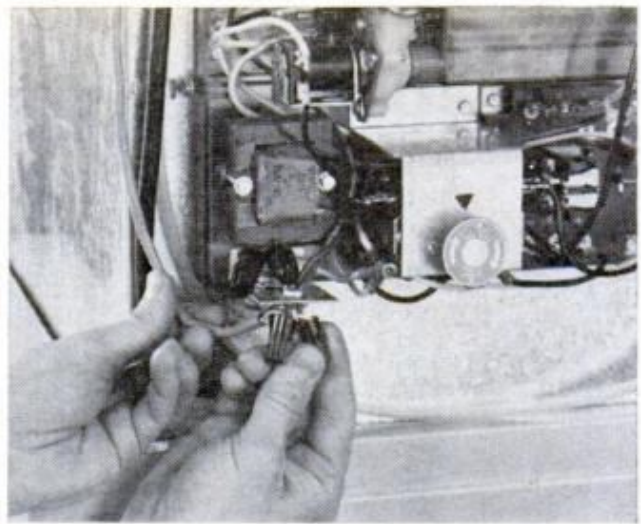

POWER CONNECTIONS, all standard 110-v., are made by following detailed instructions included with unit

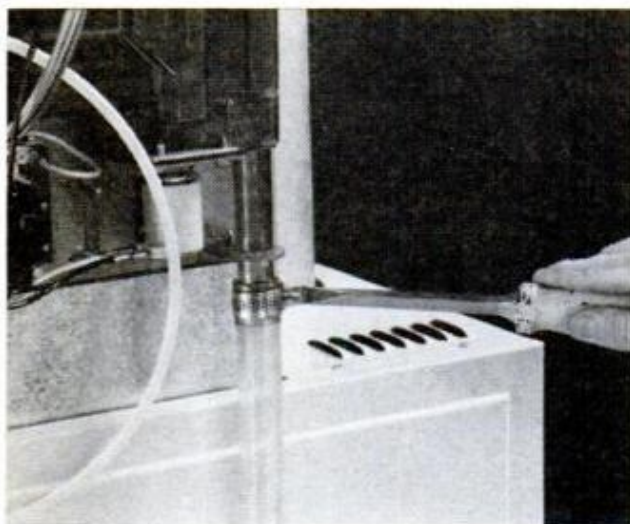

DRAIN LINE is simply pushed up over the drain extension on humidifier and secured with a hose clamp

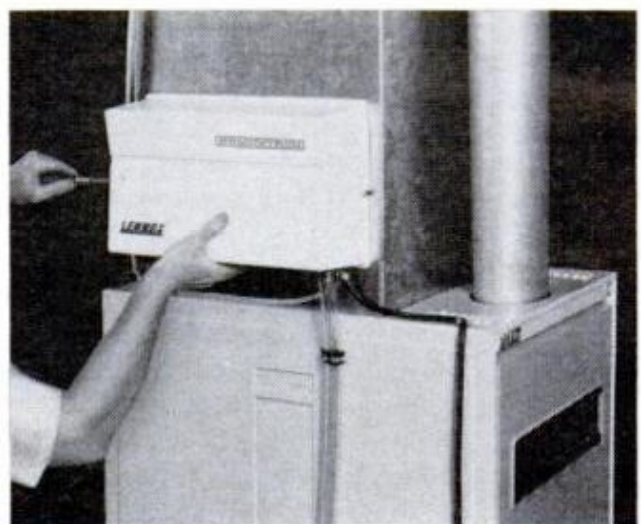

AFTER TESTING the entire operation of the unit, the plastic cover is installed to complete the job

a transparent heat-resistant plastic which has a hard nonporous finish that resists scale buildup. Jets of water scrub this surface as the water level drops, breaking away any deposits of solids that have formed so they can then be flushed down the drain.

Flushing sequence is as follows: 1. Drain valve snaps shut for 10 seconds, breaking up any residue caught in drain hole and permitting partial filling of reservoir; 2. Drain opens for two-minute flush; 3. Drain closes for 10-second fill; 4. Drain opens for final 10-second flush; 5. Drain closes and reservoir is refilled.

The humidification cycle is triggered by a humidistat which causes the control relay to close and send current to the heating element. The unit will continue to produce steam until the humidistat signals that the air contains sufficient moisture.

For safety, the WE-9 features double protection against overflowing. If the fill valve should fail to close, potential overflow is channeled out the overflow drain. If this drain should become plugged, a special overflow safety probe sends a signal overriding the fill control and shutting the fill valve.

Fuse guards against overheating

To prevent overheating, a hermetically sealed fuse will open if the temperature just above the heating element reaches 235°F. However, the only possible cause for this would be failure in the solid-state control circuit or mechanical failure of the control relay. Either one is highly unlikely.

The WE-9 weighs just seven pounds and has an evaporation capacity of 8.6 gal. per day. It's available only through authorized Lennox dealers. ★★★

Cartop Carrier Gives Bikes a Free Ride

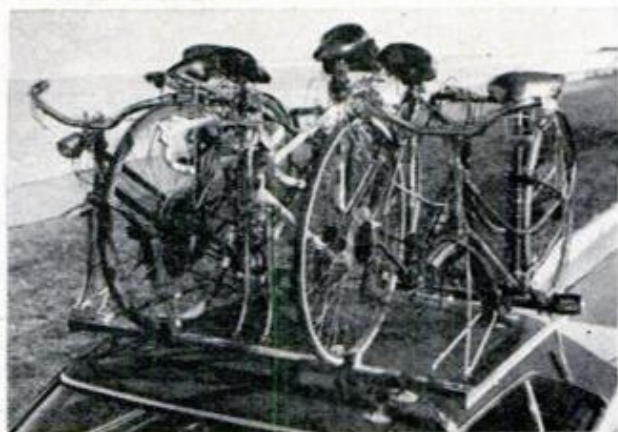

PEDALING ALONG to admire scenic spots is great sport and exercise, but getting to such spots on a bike is not so easy in congested areas for the bike-riding family.

The safe way is to head for the country with the bikes perched on the roof of the car. Then when heavy traffic is left far behind, you can switch from car to bike and be off on your merry way.

The cartop carrier shown here will transport as many as five bikes, all in an upright position; you simply take off their front wheels and stow them in the trunk. Each bike is anchored securely to the crossrails by tightening the front fork to a pair of L-shape bolts and then wedging the rear wheel between tapered blocks as detailed at the right.

A detailed plan for building this rack can be obtained free of charge by writing to Bicycle Institute of America, Inc., 122 E. 42nd St., New York, N. Y. 10017.

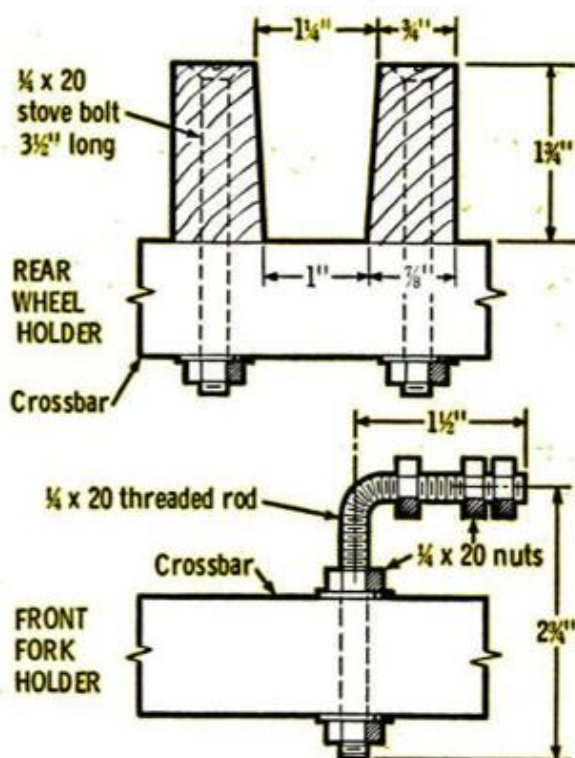

Offset Brackets Support Basketball Backboard on Hip Roof

MOUNTING a basketball backboard on a garage is fairly simple when it has a gable roof, but not when it has a hip roof and wide overhang. Not wanting to go through the shingles in attaching the necessary braces, I decided to support the backboard from the underside of the overhang. I made three offset brackets of angle iron, cutting the pieces long enough to clear the gutter, drilled them for bolts and had them welded together. To attach the brackets, I used 12-in. bolts to pass through both fascia board and door header and screws into the soffit.

—Frank A. Bartonek

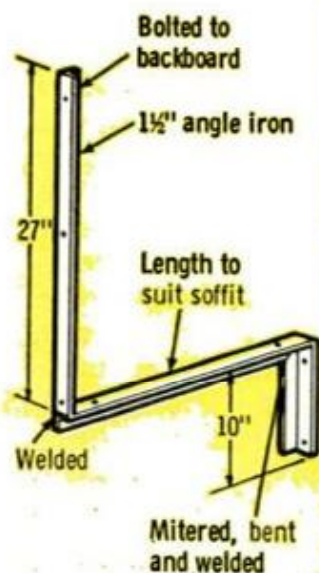

Down-to-Earth Facts About PREFINISHED SIDINGS

PVC, aluminum, hardboard, plastic-coated wood—these ready-to-go sidings solve paint problems for good

BY STEVEN J. HOWARD

IF YOU'VE BEEN READING the ads for prefinished sidings, you're probably familiar with all the miraculous claims being made for these wonder building materials. Thus, let's forget about miracles for a moment and begin with a bit of nitty-gritty which isn't mentioned in most ads: *How much does it cost?*

Good-quality prefinished siding usually sells for around 40 cents per square foot, give or take a few pennies. To put this in more easily understandable terms, it will cost you about \$1200 to re-side a home having 3000 sq. ft. of area. Another way to think of it is to divide the walls of your house into 10-ft. squares and put a \$40 price tag on each one. So much for the actual cost.

A second down-to-earth question: *How does this compare with the cost of painting?* On a strict materials-cost basis, that \$1200 would buy enough paint to give your 3000-sq.-ft. house a two-coat paint job every five years for the next half century. Obviously, this is an unrealistic basis for comparison, since it doesn't take into account the total amount of labor involved, much less such things as durability, maintenance or appearance. Once you begin to consider these factors, you're back to the miracle-material claims being made for prefinished sidings, and most of them are solidly based in the nature of the materials involved.

There are five basic types of prefinished sidings being sold today. The newest is poly-





OCTOBER 1968

Alcoa Photo

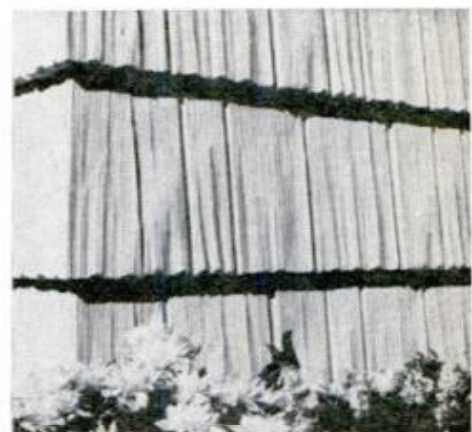

ALUMINUM SIDING comes in wide variety of styles in addition to the conventional smooth-finish clapboard. Shown above are (top to bottom) rough-sawn vertical, rustic shingle (which can also be used for roofing), rough-sawn clapboard in popular 8-in. width and double 5-in. clapboard

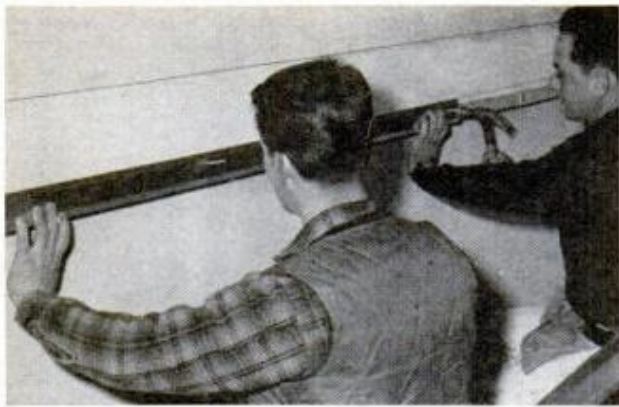

ALUMINUM SIDING installation begins with nailing a starter strip along the bottom. Use aluminum nails



LAYER OF FOIL under the siding protects against condensation. Vertical laths bridge old lapped siding



INSTALL TRIM PIECES around doors and windows and in corners before you begin nailing siding

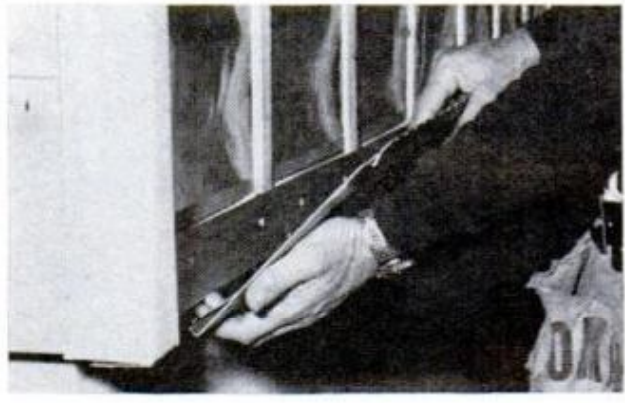

FIRST SIDING PANEL is locked over the lip of the starter strip, which automatically aligns the siding



SIDING IS NAILED to the lath. It's important that you leave 1/32-in. gap between nailhead and crown



JOINTS IN SIDING should always be reinforced with backer. This makes entire panel more rigid

vinyl chloride (PVC), a solid vinyl siding. The other four are more familiar materials—aluminum, wood, plywood and hardboard—featuring a baked-on or laminated plastic finish.

PVC won't blister, peel, flake, warp, dent, corrode or scratch. It can be cleaned with soap and water. It scoffs at fungi, termites and vermin. Unlike aluminum, you don't have to ground this type of siding, because PVC doesn't conduct electricity. Neither does it support fire.

The only trouble with PVC is that you

probably won't be able to buy it for do-it-yourself installation. As of this writing, it's sold only to contractors.

One PVC manufacturer told me, "We disagree with the concept which aims at encouraging installation of vinyl siding by do-it-yourselfers." The industry claim is that this siding can only be installed properly by "dealer-trained, experienced applicators." This is pure nonsense.

PVC can be handled with relative ease by any man who can swing a hammer properly, measure a straight line and fol-

PREFINISHED SIDINGS: HOW THEY COMPARE

	PVC	ALUMINUM	WOOD, PLYWOOD, HARDBOARD
Styles and sizes	Limited to clapboard and vertical styles only with traditional smooth finish. Sizes include double 4" horizontal, 6" horizontal, double 6" horizontal, 8" horizontal, double 5" vertical, 8" vertical.	Great choice including rustic shingle; wood textures in 8" clapboard, double 5", and board and batten; sculptured (8" face); stucco embossed clapboard; traditional clapboard in all sizes.	Greatest variety in lap, paneled, textured and grooved boards. Included are board-and-batten, channel groove, traditional clapboard, shingle, saw kerf and plain.
Cost	Most expensive of all—\$1 to \$1.25 per sq. ft. installed (difficult to quote uninstalled price, which depends on how you barter with man selling it).	Ranges from 40¢ to 50¢ per sq. ft. for plastic coated and as low as 30-35¢ per sq. ft. for enamel coated.	Least expensive of all. Even with plastic coating, price is about 35¢ per sq. ft. However, plywood siding that has an aluminum sheet finished in baked enamel is more expensive, running to about 60¢ a sq. ft.
Performance characteristics	Most sturdy of all. Resists practically every form of normal damage. Guaranteed by most manufacturers for 20 years. Will in time weather, but resists weathering better than other types.	Plastic-coated is very sturdy. Resists every form of normal damage except denting, chemicals and fire. Weathering resistance is as good as PVC. Less expensive aluminum without plastic coating more prone to damage. Guarantees in 10-20-year range.	Plastic-coated products generally guaranteed for 10 years against weathering, cracking, blistering, and peeling. Aluminum-covered plywood generally carries a 15 year guarantee.
Installation factors	Can be done by competent do-it-yourselfer. No more difficult to install than aluminum.	Can be done by competent do-it-yourselfer.	Can be done by competent do-it-yourselfer.
Accessories	Anything you need, including window/door channels, window/door caps, window/door trim, corner posts, gutters and downspouts, shutters, roof edgings.	All accessories available in aluminum, including shutters, gutters and downspouts, corner posts, window/door trim, louvers, soffits.	

low the simple installation instructions which are packed with the material. It's installed in the same way as aluminum siding, which is available to anyone.

The manufacturers' main objection to do-it-yourself installation is that "special" nailing must be done to compensate for the "great" tendency of the material to expand and contract when subjected to variations in temperature. However, PVC installation instructions are the same as

aluminum siding instructions on this point.

The instructions packed with PVC carry this warning: "Important—avoid driving nails too tightly." You are cautioned to allow a 1/32-in. gap between nailhead and siding crown. This same instruction appears in the *Aluminum Siding Application Manual* prepared by the Aluminum Assn., 420 Lexington Ave., New York, N.Y. 10017. (If you're planning to install

(Please turn to page 231)

EXCITING NEW PRODUCTS

By CAROL SCHULTZ

HIGH SECURITY ENTRY CONTROL SYSTEM limits the use of a door to holders of an invisibly coded plastic card instead of keys. Insertion of this coded card into the sensor unit completes a low-voltage circuit which activates the release and allows the door to be opened. Duplication of card is almost impossible. Literature and price information on the system, called "Dentco," are available from Detex Corp., 53 Park Pl., New York.



PLASTIC TAPE is ideal for sealing ductwork seams, wrapping tool handles, sealing doors and windows, patching hoses, tents and dozens of other jobs around the home. "Duc-tape" (shown at right) provides an airtight, waterproof seal because it has a plastic coating on a heavy adhesive base. A 30-foot roll of 2-inch tape sells for \$1.29. Arno Adhesive Tapes, Inc., Michigan City, Ind.

A BATTERY AND CHARGER SYSTEM is a practical alternate to the constant buying of batteries for use in flashlights and radios. General Electric's nickel-cadmium batteries are rechargeable again and again, and used instead of a standard battery. Battery charger costs \$9.95; battery twin-packs in three sizes sell for about \$3.95. Made by General Electric, Gainesville, Fla.



GARDEN EDGER with its convenient hand-grips and footplate was designed to give a clean, good-looking edge without tiresome bending or squatting. It's ideal for lawns, walks and driveways. "E-Z Edger" features a seven-inch cutting blade of 12-gauge steel, which may be sharpened as often as necessary with a file or emery wheel. Costs \$7.95. Made by Kemp Mfg. Co., 838 Kemp Bldg., Erie, Pa.



Colonial String Box

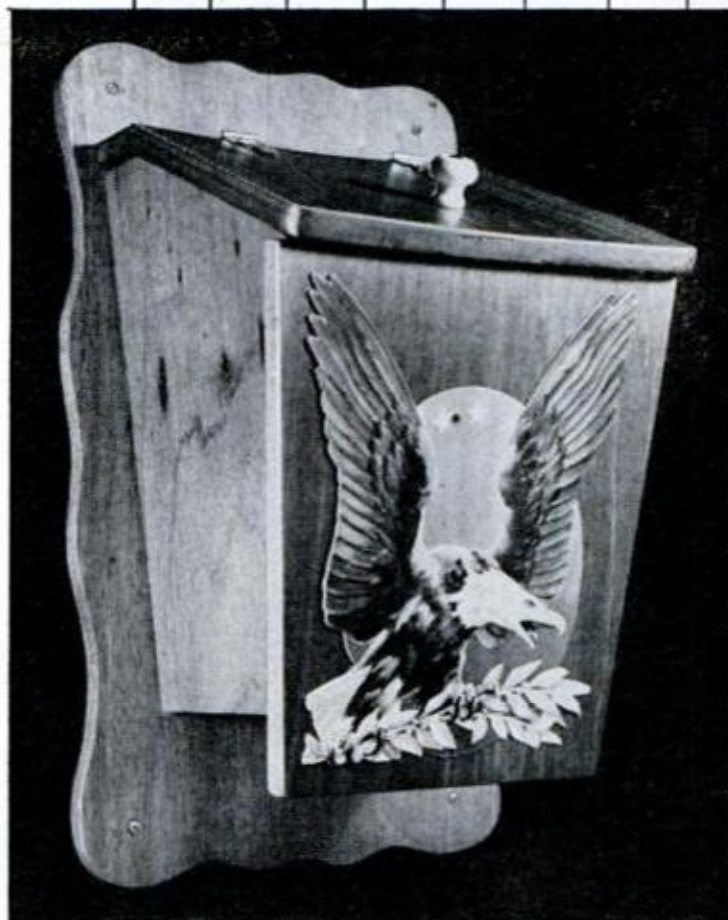
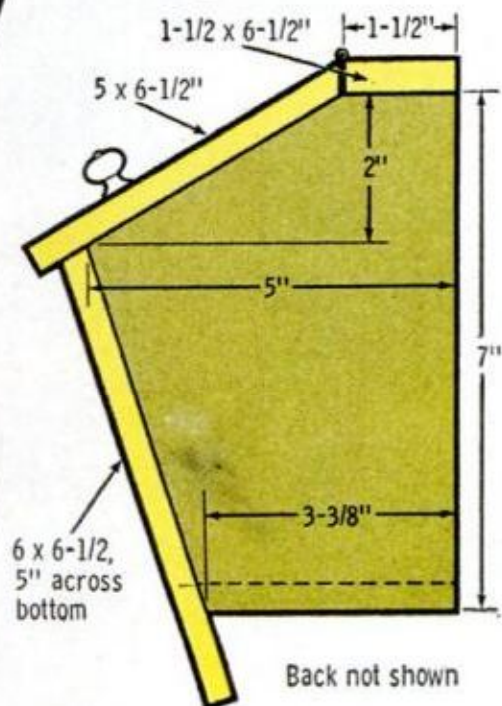

IT'S CALLED A STRING BOX mainly because in days gone by, colonists found string hard to buy. Thus, every scrap was usually saved in boxes handily hung on kitchen walls.

This modern version of the colonists' string box is just as handy for storing cord, tape and string for gift-wrapping and mailing packages. It's made of $\frac{3}{8}$ -in. solid cherry or soft pine and has scalloped edges for that Early American look. The cutting pattern on this page will make it easy to cut the scalloped rear panel.

—Don Shiner

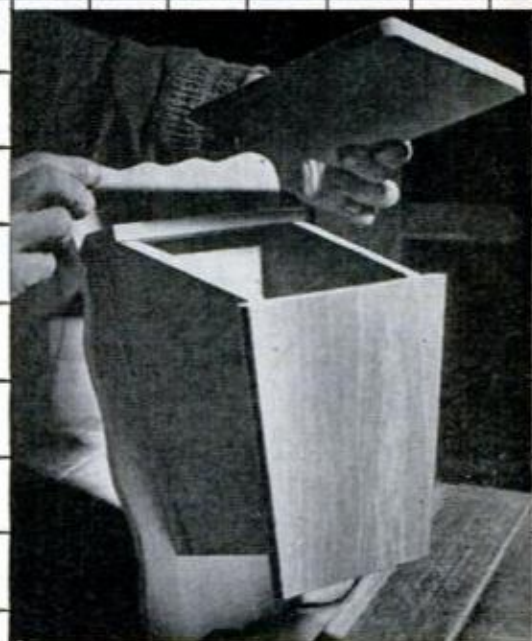

HINGED TOP overlaps the front panel. The American eagle cutout is of cardboard

1/2" squares



EASIEST REINFORCEMENT to install is steel block mesh set in mortar. Ends of mesh strips are overlapped

How to Lay Concrete Blocks

The best jobs are often those of an interested beginner who cares enough to pay close attention to all details

YOU'RE NOT A MASON, so why try to lay blocks like one? Especially when you can get better results by taking advantage of your amateur status.

A professional mason spends years mastering the skills of his trade. Once he has acquired the necessary experience, he can lay blocks quickly with a machine-like efficiency that seems almost effortless. On the first job, though, the professional method is actually much more difficult than a straightforward amateur approach.

The following nonprofessional method of laying concrete blocks is designed for an unskilled man working alone. True, it may take longer, but it will enable you to build a concrete block wall that's as strong and good looking as one built by a pro. All you need is the desire to do a good job and a few specialized tools.

The first tool to buy is a mason's trowel. This is used to pick up and place mortar. The blade is about 10 in. long and 5 in. across.

Mason's trowels come in two shapes—Boston and Philadelphia. For block laying, you'll probably prefer the Philadelphia, because its straighter edges are better for picking up straight beads of mortar.

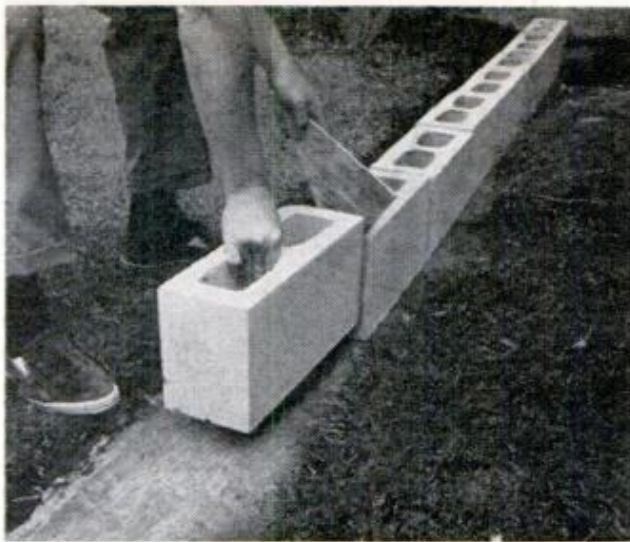

DRY LAYOUT of blocks on the footing is a good precaution. Use scraps of $\frac{3}{8}$ -in. plywood as spacers



SMALL CONCRETE MIXER makes it possible to mix fresh batch of mortar while you are using up first

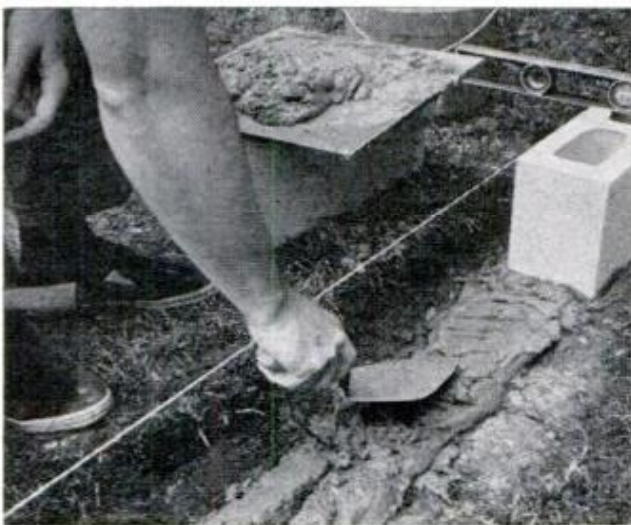

BOTTOM COURSE is laid on full mortar bed which has been furrowed with trowel point. Note guide line



CORNER BLOCKS are laid to interlock. These govern position of all other blocks, so level them both ways

Like an Amateur

By **RICHARD DAY**

Technical Art by Glen Fleischmann

Incidentally, professionals use the wooden trowel handle for tapping blocks into position. When amateurs try this, they usually end up spattering mortar all over the place. Better to resist the temptation to "do it like a pro" and position the blocks by tapping lightly with a hammer.

The hammer you use will depend on the job. A regular mason's hammer has a square head at one end and a chisel edge on the other. It's used for cutting the blocks to size, making holes or chipping the edges to special shapes. If your project doesn't include any of this type of work, you can get along very well without a special hammer.

You can't get along without an accurate level, for the whole success of the project depends upon how carefully it is leveled. As in the case of the hammer, however, it doesn't have to be a mason's level. A true mason's level is 4 ft. long, with the extra length more for use as a straightedge than a plumb or level. As an amateur, you can get along fine with a good 2-ft. carpenter's level.

You'll also need a jointing tool in order to produce smooth, tight mortar joints. For rounded joints, the tool to use is a $\frac{5}{8}$ -in. round bar or pipe that's curved at the ends to prevent gouging. For V-joints, use a $\frac{1}{2}$ -in.-sq. bar with curved ends. The ends can be used for tooling short vertical

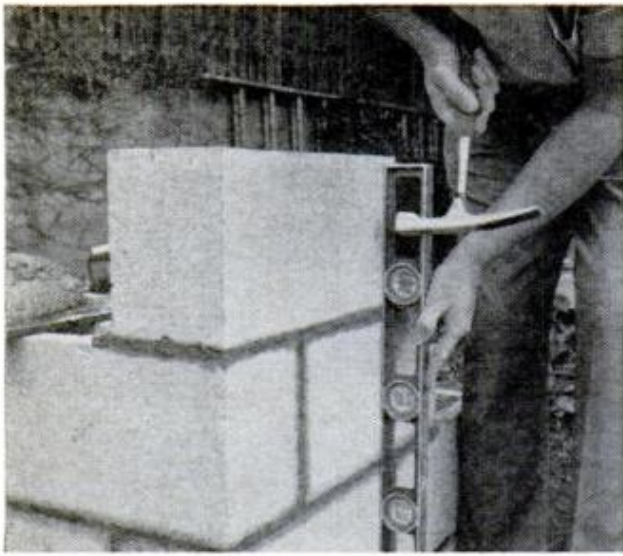

LONG FACE of each corner block must be lined up and plumb with blocks below. Tap lightly into place

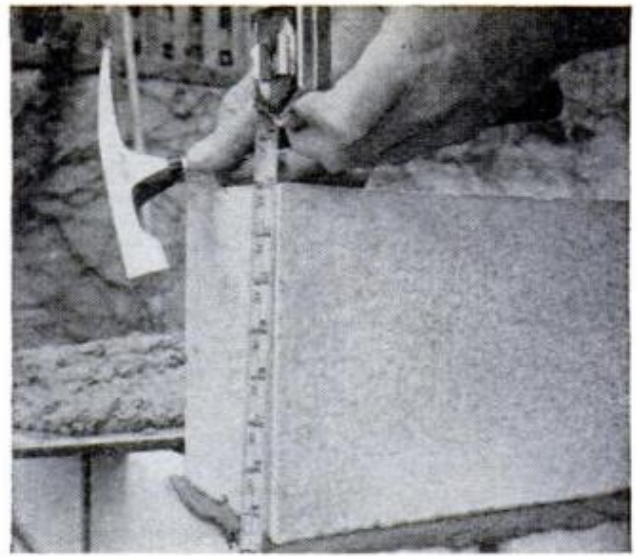

CHECK HEIGHT by measuring from the footing to top of corner. If block has settled, remove and re-lay

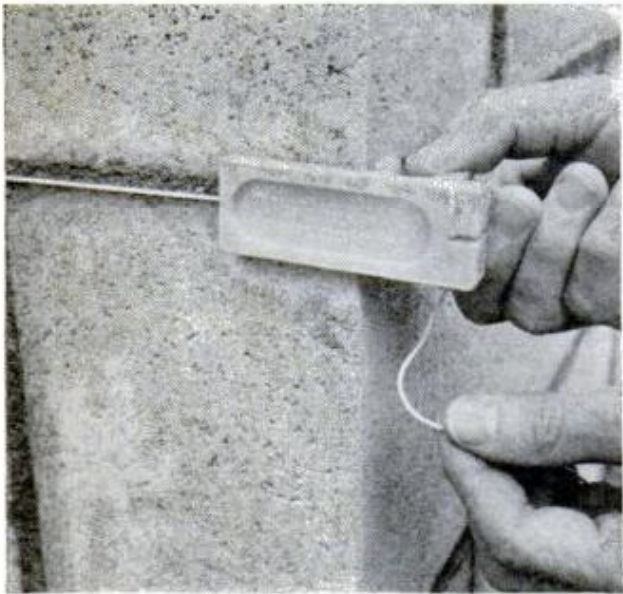

LINE BLOCK holds line flush with top of corner. Move to next course when blocks will stand pull

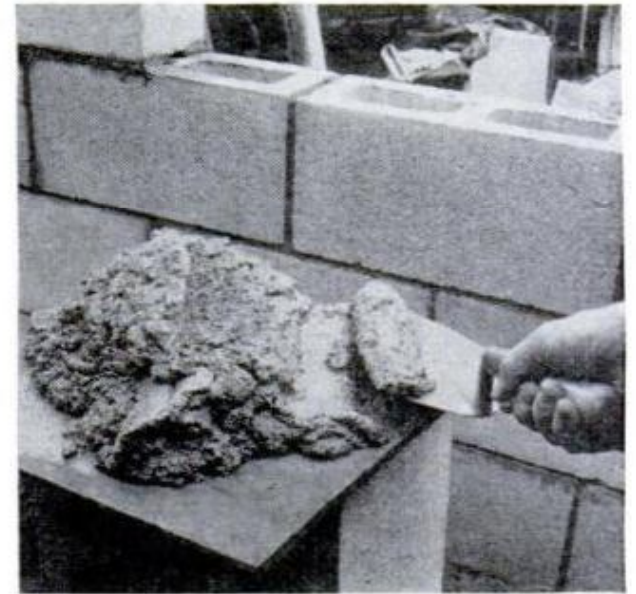

GOOD MORTAR BOARD is an 18-in. square piece of plywood. Support on a pair of upended block legs



RIBBONS OF MORTAR on ends of each intermediate block fill vertical joints. For best bond, slap them on

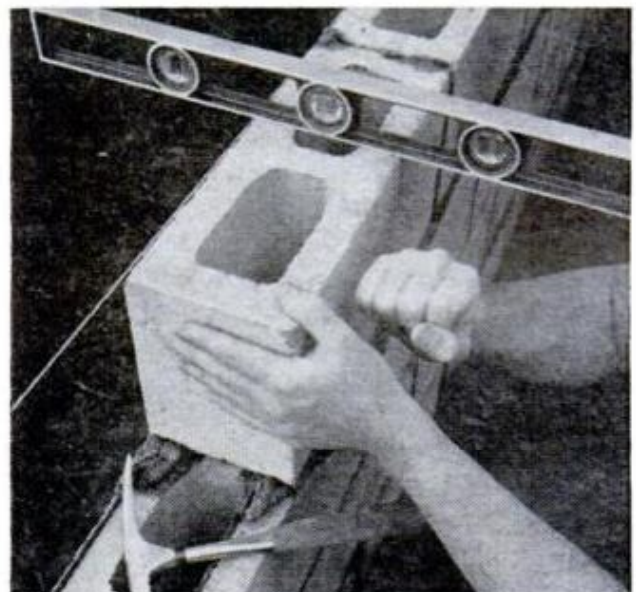

INTERMEDIATE BLOCKS should be laid to align with the guide line and leveled across to square them

joints. A good jointing tool should be at least 22 in. long to span irregularities. The main reason for tooling mortar joints incidentally, is to compact them and make them more weather-resistant. Just as important, though, is the fact that this finishes off the joints and produces a better looking wall.

Other useful items are a nylon mason's line (the amateur can use a strong fish-line) and a pair of line blocks. The blocks hook over the ends of the wall to anchor the line, keeping it properly positioned and taut. The cost is peanuts.

A small concrete mixer is also highly desirable, since it produces better, more workable mortar than you can get by mixing with a hoe or shovel. The 5-gal.-bucket type is ideal. If you can't rent one, they sell for about \$40.

So much for the equipment. Now you're ready to plan the job. The most important thing here is to use modular dimensions, if possible. This will avoid hours of tedious cutting and fitting. Concrete blocks are made to fit 8-in. modules, so if you design the wall to fit them, using full and half blocks, you'll do yourself a favor. Draw a rough-dimensioned sketch to be sure you've got everything straight and you're ready to install the footing.

A good footing is twice as wide as the wall. It should be cast on unexcavated earth, not on backfill. The bottom of the footing must be below the frost line in your area and at least 12 in. deep.

Build your footing of quality concrete

CONTROL JOINT is needed in walls more than 20 ft. long. Grout transfers lateral load. Joint is raked, caulked

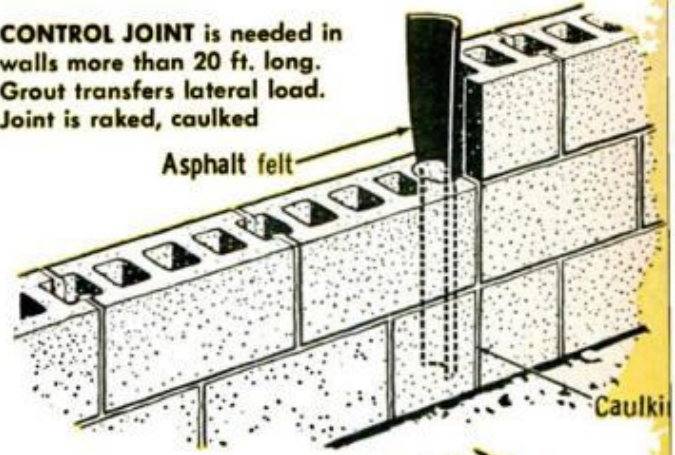

NONLOADBEARING Walls are tied with strip of 1/4-in. hardware cloth in mortar across joint in every other course

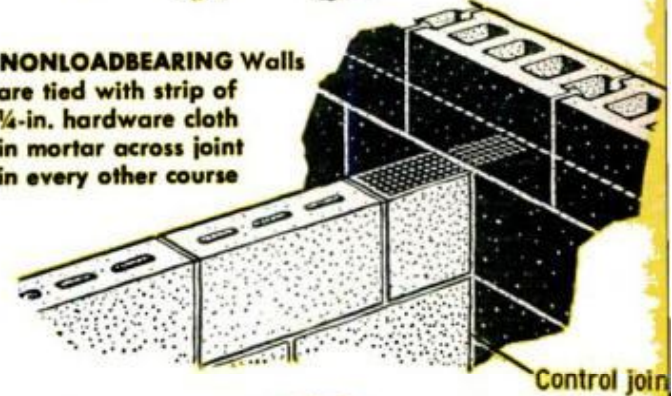

LOADBEARING walls are tied with a bar grouted in every sixth course

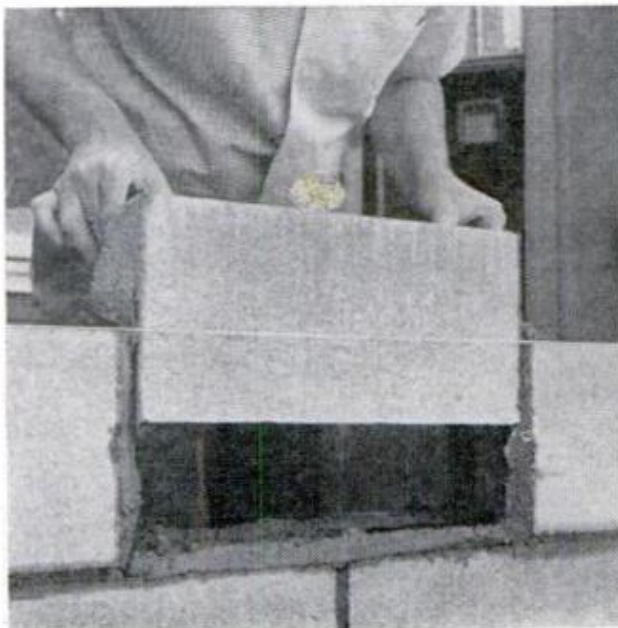
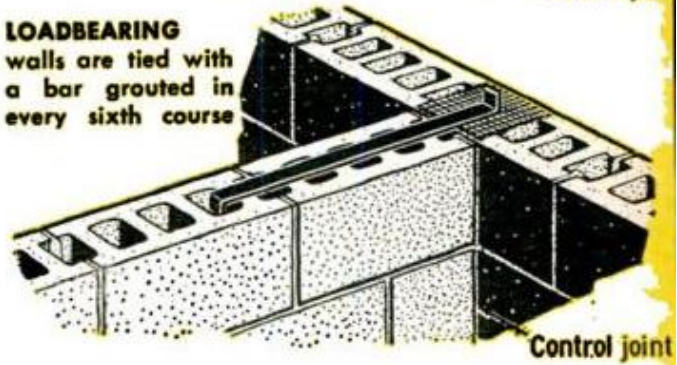

TO LAY LAST BLOCK in each course, butter the ends with mortar and lower it carefully down into the slot

OCTOBER 1968

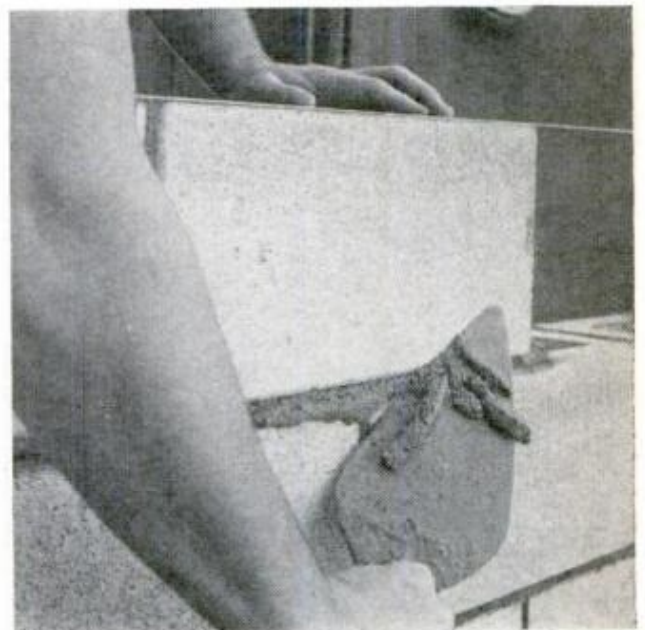

SLICE OFF MORTAR along joints of newly laid blocks without smearing. It may be remixed and used again

169



TO KEEP MORTAR FRESH, slice through it occasionally with the trowel and add more water if necessary

containing six bags of portland cement per cubic yard and not more than six gallons of water per bag of cement. Ready-mix can be ordered to these specs. If the job is small, use packaged concrete mix. Don't overwater. Place it stiff.

Strike off the footing level and to the proper grade. Care taken here will pay off later. Floating it once will make the surface as smooth as you need it. Cover with



TOOL JOINTS when mortar is thumbprint-hard by working the jointing tool back and forth along joint

wet soil or sand and let the footing cure for six days. Then clean off all of the sand or soil and you're all set to start laying block.

The strength of your wall will depend largely on the strength of the mortar. Also important is the "bond" of the mortar—how tightly it holds to the blocks once it has set. Your best bet is to buy a packaged

(Please turn to page 210)



ANCHOR BOLTS or other fixtures can be installed in the wall by grouting. Just place a piece of mesh across the core beneath to prevent grout from dropping to the bottom of the wall, then fill the core with concrete or mortar and set the bolt in this. To avoid the possibility of the bolt working loose, it should either have a large head or be bent to a right angle. Use 1/2-in. bolts for most such applications



TO REINFORCE WALL laterally, use strips of steel block mesh, below left. For vertical reinforcement, cast reinforcing bars with bent ends into footing and grout cores around bars, center and lower right

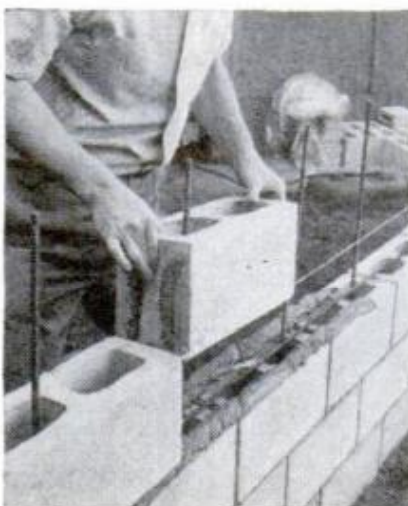

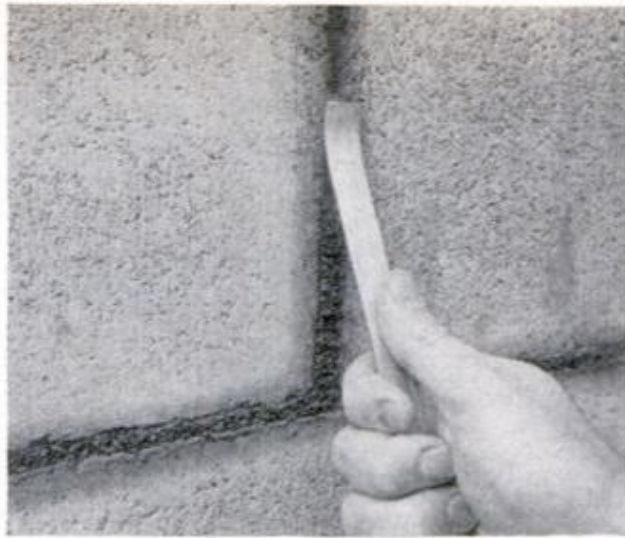

TOOL VERTICAL JOINTS with end of jointing tool. Remove burrs by rubbing across joint with wire brush



MORTAR DEPOSITS on face of wall can be rubbed away with a piece of broken block after hardening

A THUMBNAIL GUIDE TO CONCRETE BLOCKS

The workhorse of concrete blocks is the standard 8x8x16-in. block, commonly known as an 8-in. block because it makes a wall 8 in. wide. You can also buy 6-in. block, which is primarily for nonloadbearing walls, and 4-in. block for even slimmer nonloadbearing walls. For big jobs, like foundations and heavy retaining walls, there are 10 and 12-in. blocks.

Block measurements always describe the area a block will take up when laid in the wall. Actually, the block measures $\frac{1}{8}$ in. less on a side to allow for a $\frac{1}{8}$ in. mortar joint. To estimate the number of blocks required for a job, figure the wall area in square feet, subtract the area of openings and multiply by 1-1/9. For example, a 90-sq.-ft. wall would require 100 blocks. Half blocks used at ends and corners are counted as halves, not whole units.

Most blocks have two or three cores. The two-core type, which offers somewhat better insulating qualities, is popular in the West. Both are available in standard and lightweight types, the latter containing cinders, shale or slag for aggregates. A standard block weighs from 40 to 50 lbs., a lightweight only 25 to 30 lbs. *Never use lightweight blocks for load-bearing walls.*

Many blockmakers are doing away with special corner blocks, and are making all their structural blocks with square ends.

Among the glamour types are: split block (made by breaking an oversize block into two pieces so the resulting faces resemble rough stonemasonry); slump block (like adobe brick in appearance); grille or screen block (for garden walls) and sculptured block (to create a three-dimensional effect). Like all blocks, they can be painted with latex or portland-cement paint. Some makers even sell blocks ready-colored with mortar to match.

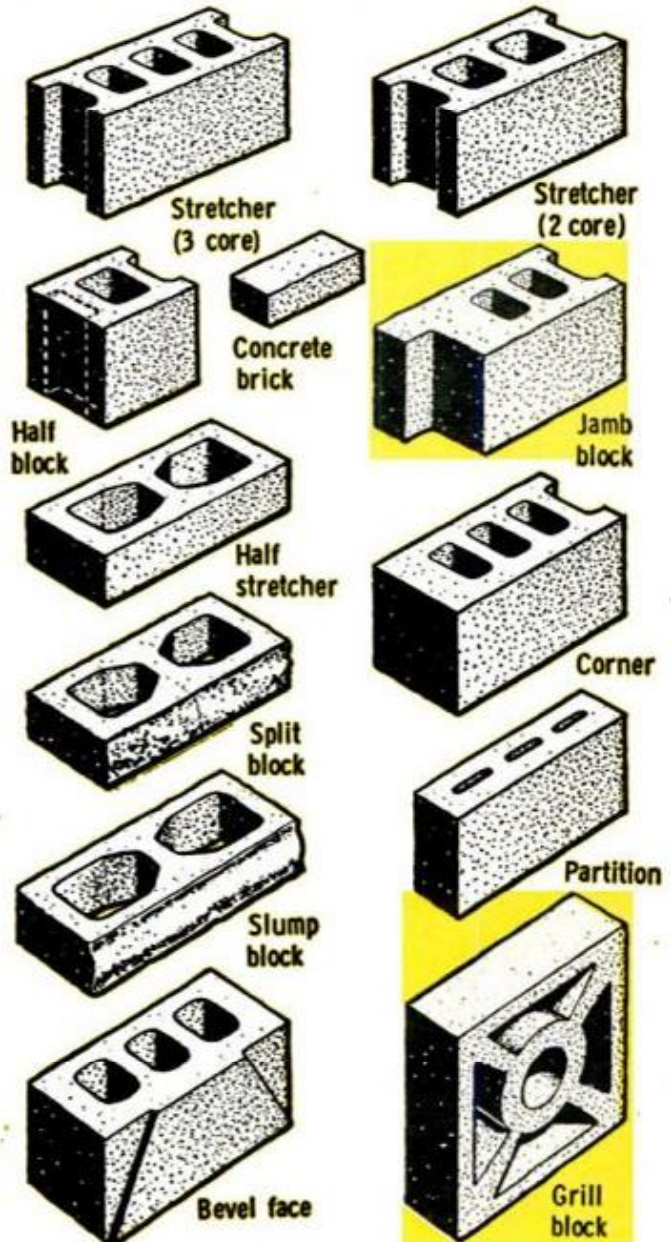

HINTS FROM READERS

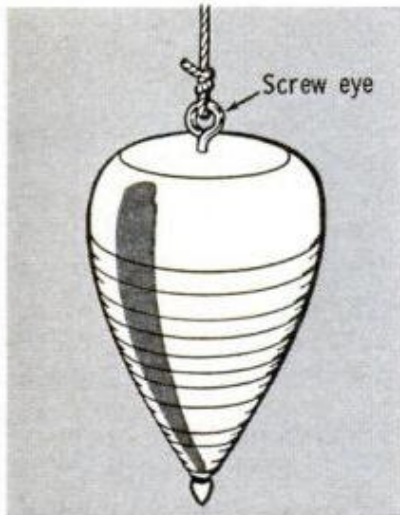

Quickie plumb bob

A toy top can be turned into an effective plumb bob by drilling a small hole in the center and driving a screw eye into it. Tie a string to the eye and your "plumb top" is ready for use. A couple of nuts placed over the cord will add weight.

King-size clamp

When you need a large hose clamp and one isn't available, try hooking two smaller clamps together as shown below. Don't forget that you'll have two screws to tighten instead of one.

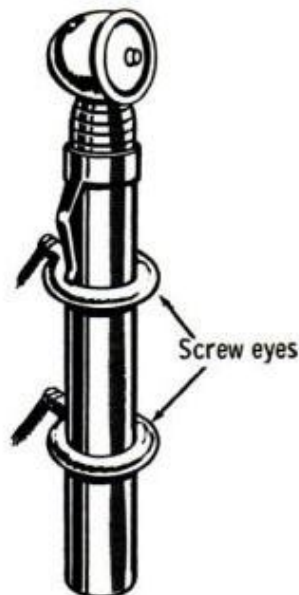
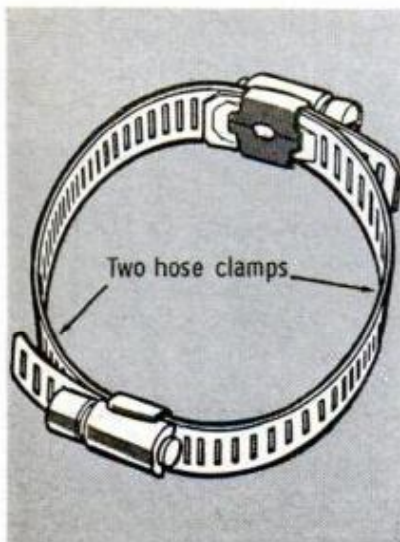

Tire gauge rack

You won't have to hunt for the pressure gauge to check cold tire pressures at home if you make a simple rack to hold it. Just drive a couple of large-diameter screw eyes into a garage stud. The spring clip will keep it from falling through.

Small parts tongs

It's easy to cut a finger when rummaging in a box of small hardware. To avoid this, make up a pair of tongs from a steel strip of the type used to reinforce packing cases. Taper ends, smooth edges.

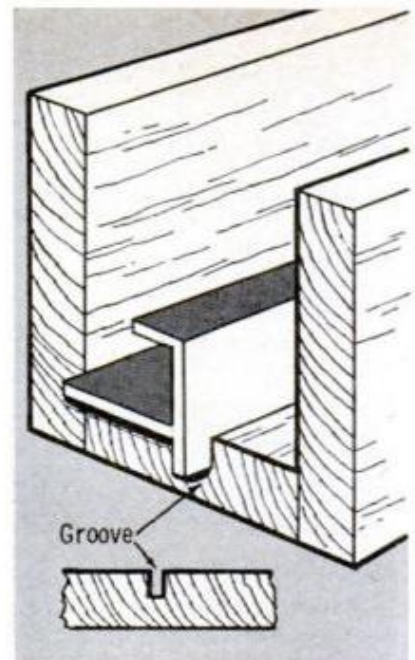

Molding miterbox

Some metal moldings have no flat side so you can't seat them properly in the miter box to cut an exact miter. It will pay you to make a special box with a kerf down the middle, or add a second bottom to an existing box to hold the molding flat.

Tape storage pocket

A shallow plastic dish cut in half and mounted on the shop wall provides an ideal storage pocket for your steel measuring tape. Drill holes in the rim and secure it to the wall with three screws.

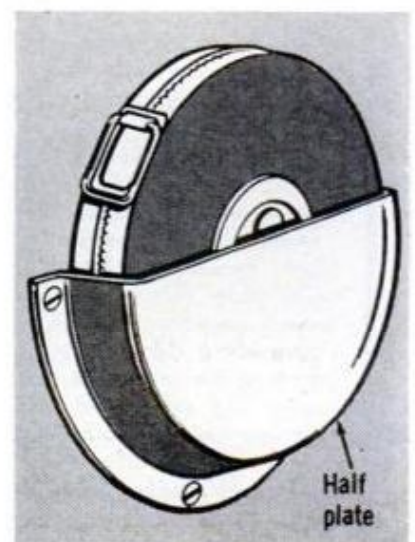

Build It Yourself, Then Learn to Fly in This \$200 Flight Simulator

It's an ingenious and realistic simulator that you can build at home using salvaged instruments—and a paint compressor

By LEONARD E. SABAL, Workshop Editor

IF THE WILD BLUE YONDER is your cup of tea, building and “flying” this flight simulator will fill many spare hours.

The heart of the simulator is an old paint compressor that feeds a full panel of instruments modified to operate on air pressure. A complete array of air speed, altimeter, rate of climb, turn-and-bank, directional gyro and artificial horizon indicators is included, as are navigational instruments, stall warning, radio, marker beacon and turbulence features.

“Seat-of-the-pants” flying is provided by a four-section seat that inflates and de-

flates according to rate of climb, descent or bank—while a small tracking device at the rear of the simulator plots your progress over a map and leaves an ink line to show the route of the flight.

As shown in the drawing on the following two pages, surgical tubing is used to connect the instruments and indicators, while ordinary aquarium-type air valves are used for calibrating the instruments. The only electrical wiring required is low voltage d.c. for the stall warning system, directional needle and glide path indicator. For more details, turn to next page. ★★

TRACKING DEVICE IN REAR OF SIMULATOR allows instructor to watch progress of the person at controls

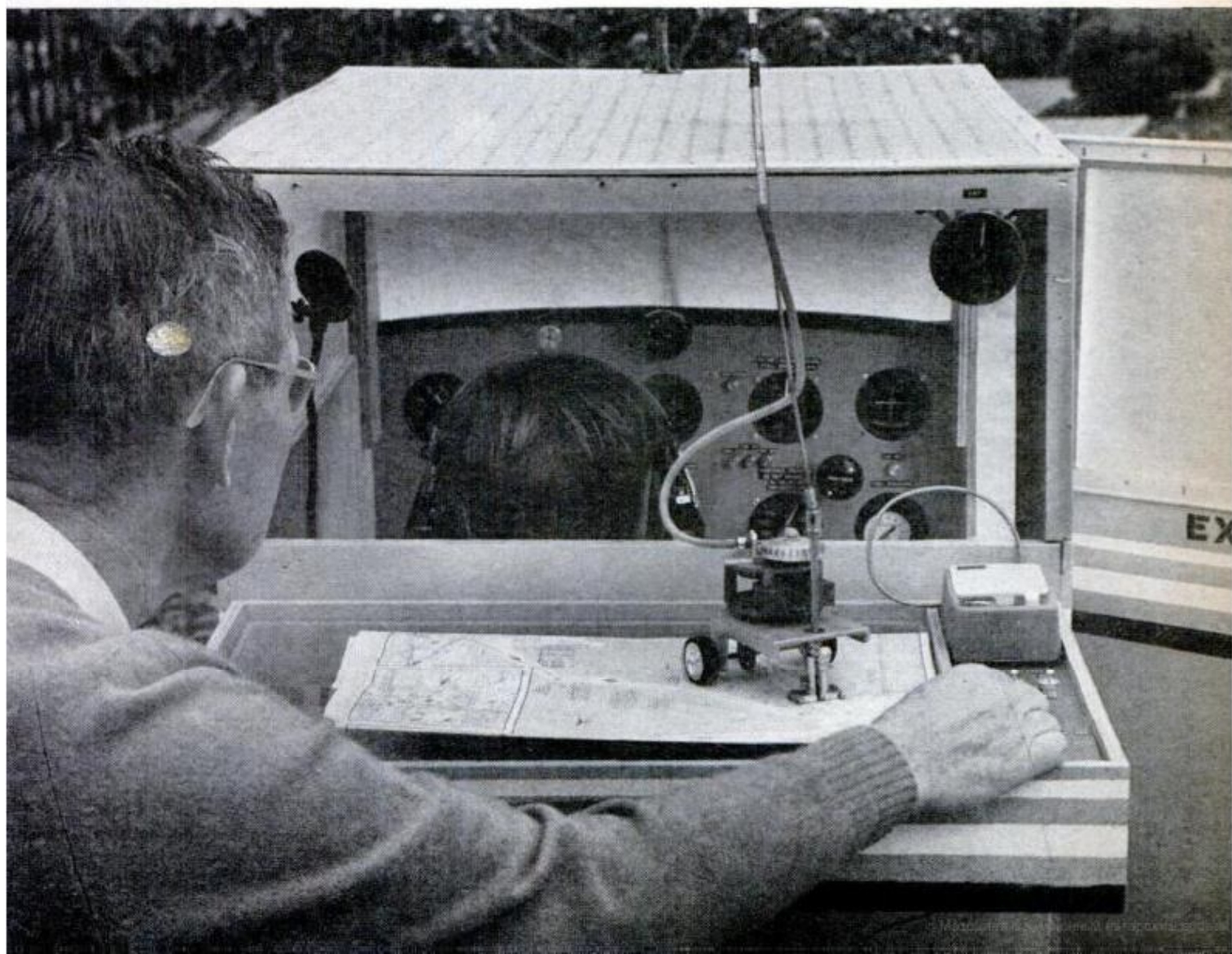

BLOCK DIAGRAM OF FLIGHT SIMULATOR

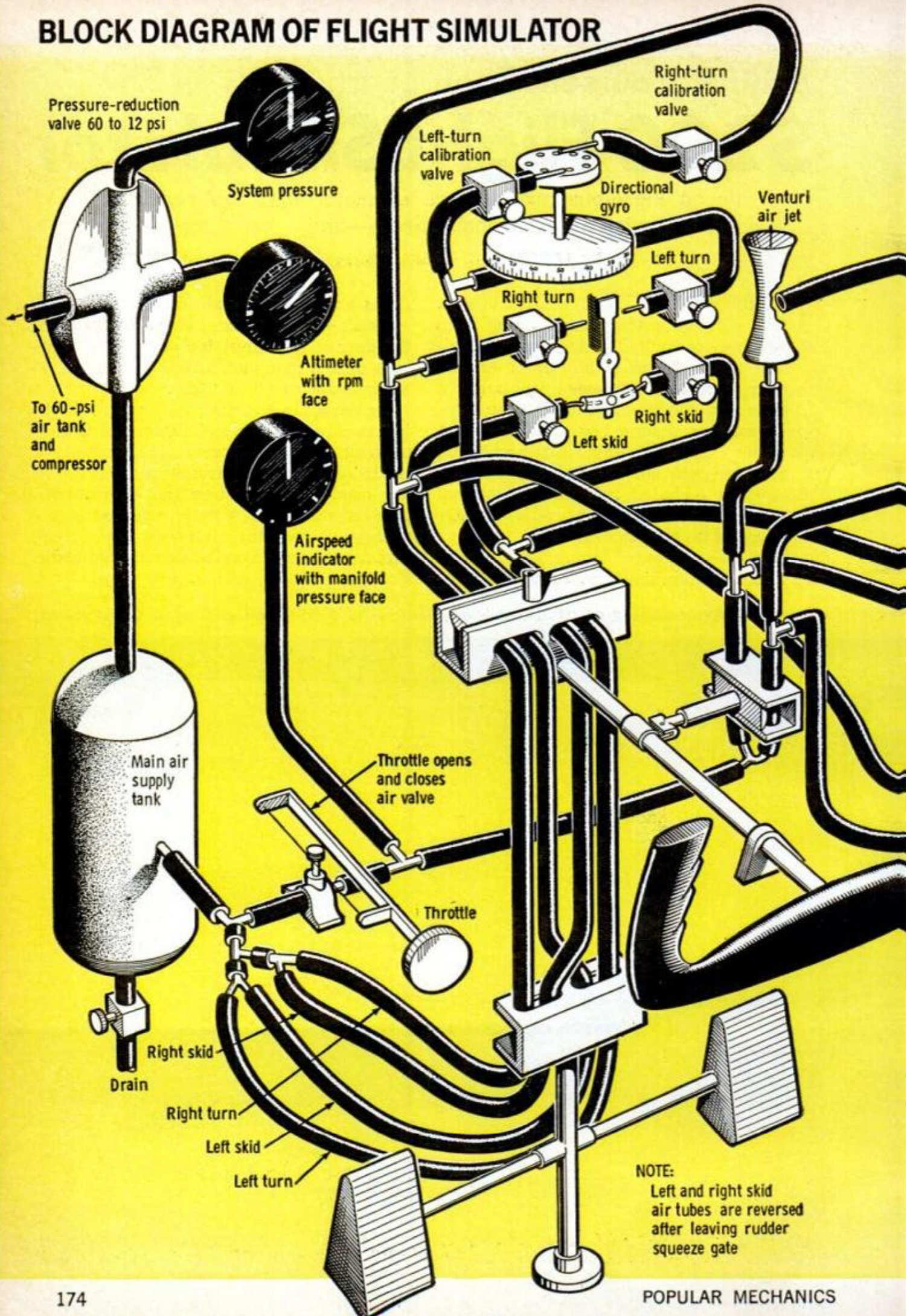

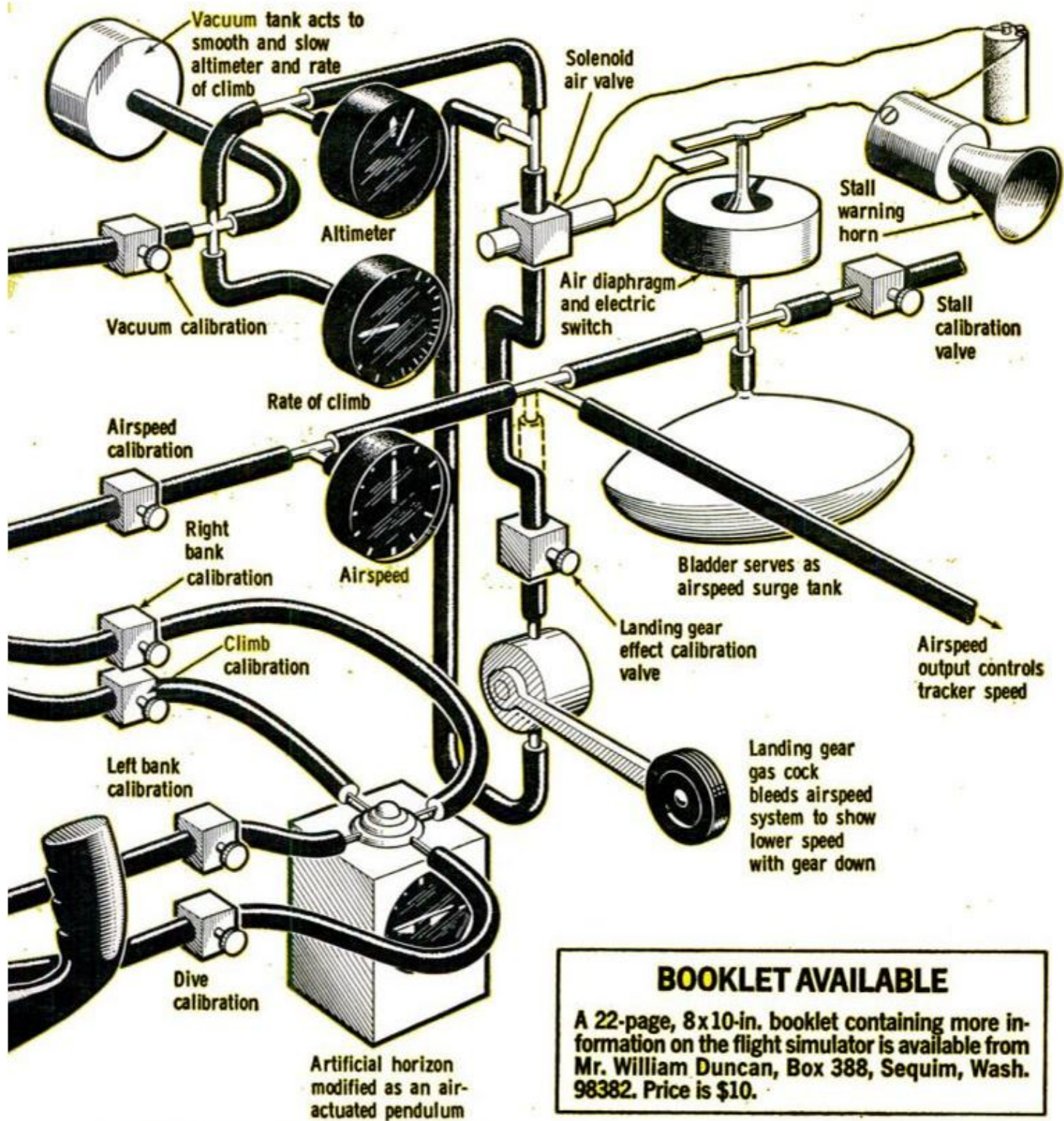

REAR VIEW OF INSTRUMENT PANEL reveals how components can be fitted in front section of simulator

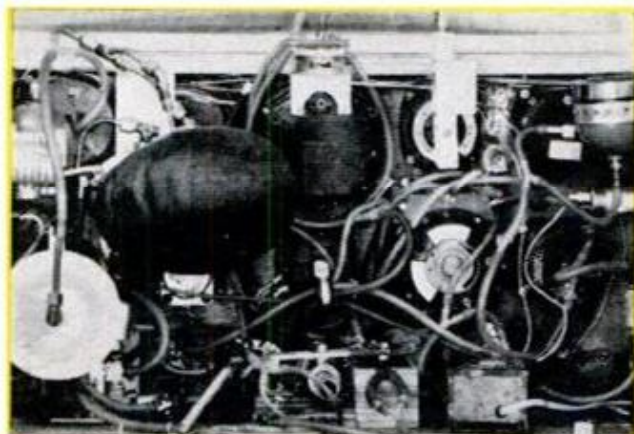

OPERATOR'S VIEW OF PANEL shows complete collection of flight indicators and navigation instruments



HOME REMODELING IDEAS

Horse Idea, But Clever

Want to be different? Put a horse in your basement—the wooden kind, that is—and you'll have a surefire conversation piece as well as a wonderful toy for young buckaroos. It's perfect for adding a gay carnival note to a recreation room. Simply impale it on a sturdy floor-to-ceiling, lally-type column. Where would you go to fetch such a fine prancing steed? Keep an eye on antique barns in country towns.



ARMSTRONG CORK CO. PHOTOS

For Peace and Quiet

If your bedroom is your only haven when Suzie or Johnny invites the "gang" over for a Saturday-night watusi, you won't feel so marooned with a get-away-from-it-all spot like this. Likewise, when the adults take over downstairs for an evening of bridge, it will serve the kids as a comfortable out-of-the-way place to read, watch TV or do homework.

It's a great idea for putting a spare bedroom to good use, the main feature being a divider wall which earns its keep and then some. A his-and-hers affair, it's split down the center to provide a dressing table and mirror on one side and a kneehole desk and shelves on the other. The big full-length mirror lets everyone look his best. It starts out as a T-shape wall with a 10-in. soffit. Desk and vanity are built-in against a dividing wall.

TWO-FACED DIVIDER makes most of space with desk and shelves on one side, vanity and mirror on other

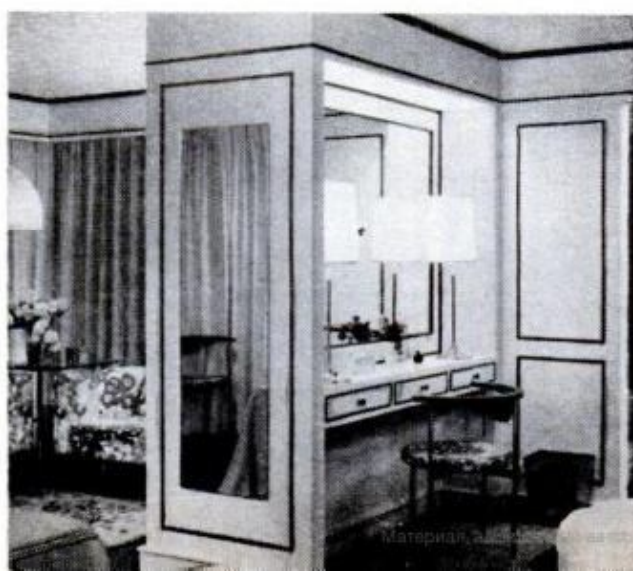

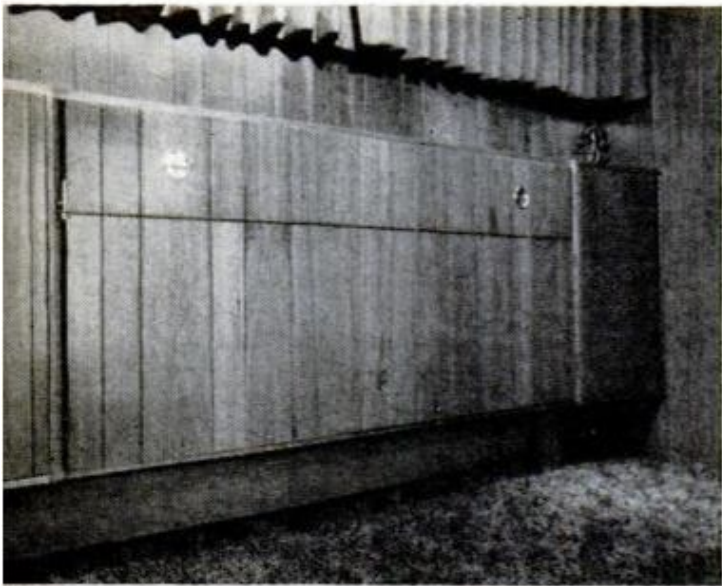

OUT OF SIGHT but not out of mind, there's an extra bed waiting for that unexpected overnight guest

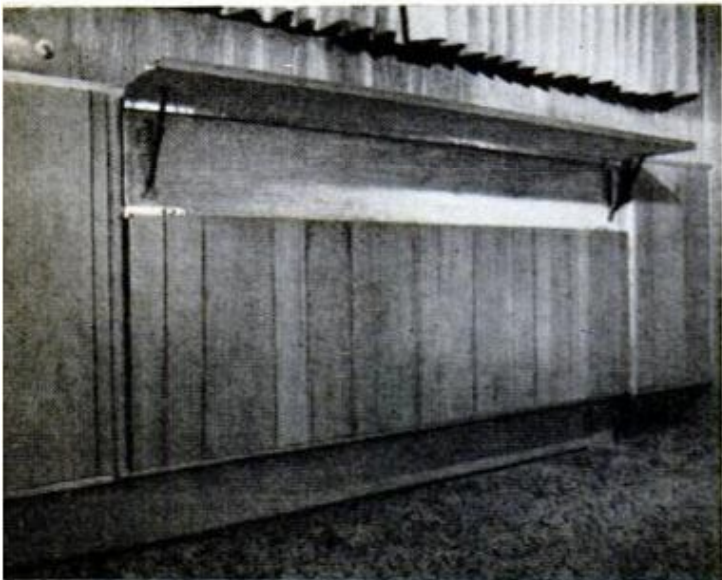

SWING-UP PANEL, actually the bed's leg, is opened first and locked at 90° angle by table-leaf brackets

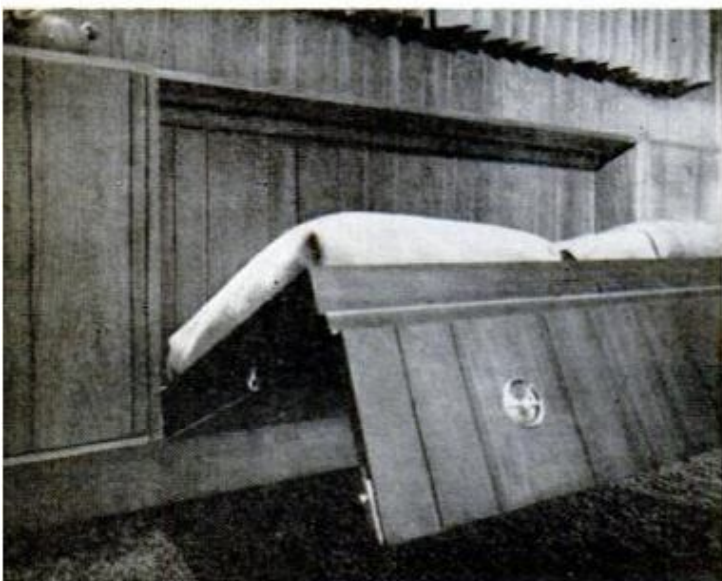

BED SWINGS DOWN from cabinet by unlocking flush bolts at sides. Seat belts hold mattress, bedding

Standby Bed in a Wall

How are you fixed for an extra bed? Could you put up an unexpected guest for the night? This bed stands by out of sight for just such emergency use. It swings down like a Murphy bed and up again.

As you see in the photos at the left, the bed pivots flush in a shallow cabinet that's only 12 in. deep and which extends wall to wall. Flanking bedding-and-storage cabinets at each end of the bed add to its overall convenience. The resulting ledge across the top provides a welcome shelf area for books, bric-a-brac and pictures.

The tray-like bed frame holds a standard 6-in.-thick foam-rubber mattress. This, along with a double sheet, bedspread, blanket and pillow, is strapped in place with regular car-seat belts to fold intact.

The original unit was installed in a small dressing room off a master bedroom

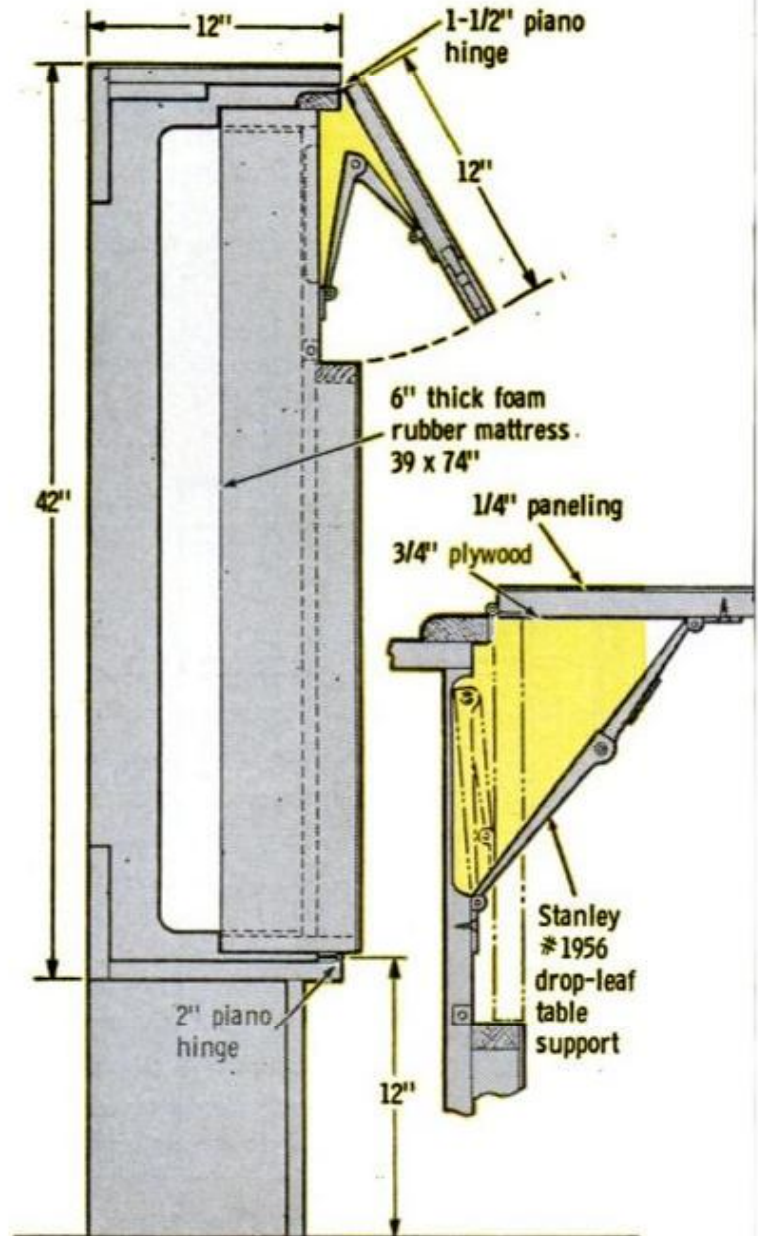

paneled with prefinished plywood. The paneling shows through the open back when the bed is down and provides a finished look. Matching paneling was used on cabinet doors and underside of the bed.

Basically, the unit consists of three cabinets, all more or less built in place and supported by a single shelf board 12 in. off the floor. Top and bottom cleats, screwed securely to wall studs, hold units firmly.

In the drawing on page 178, note how the bed's hinged "leg" folds flush in a recess extending across the top. Clearance for the spring-loaded drop-leaf table supports which hold the leg at 90°, is provided by routing wells in the bottom bed board. King-size piano hinges are used to hinge the leg as well as the bed. Sliding flush bolts lock the bed shut. Room for the two bolts at the ends of the leg is provided by making the latter an inch or so shorter than the bed.—Bill Baker



BED CABINET PROPER is anchored to wall and studs first by driving screws through top and bottom cleats

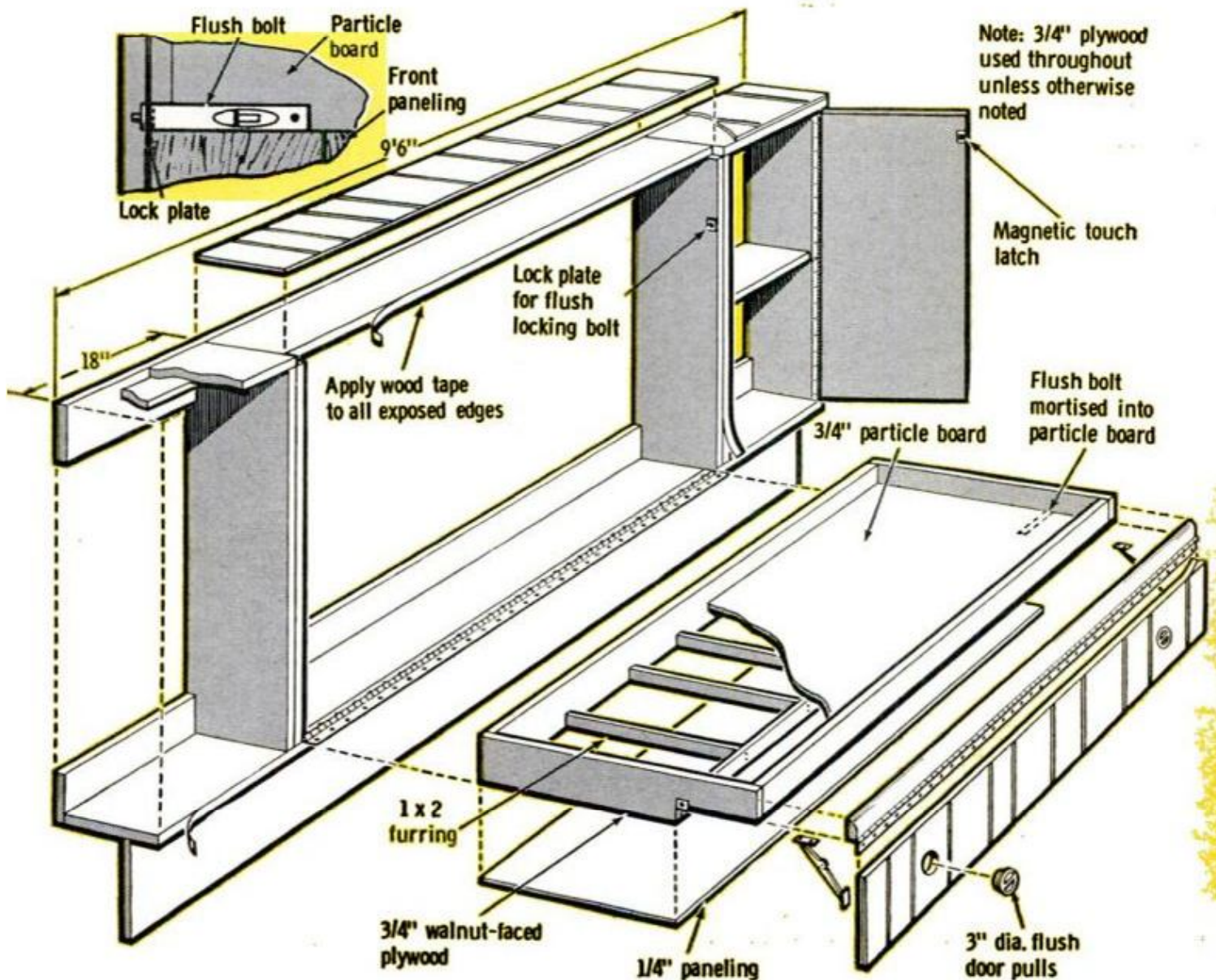

Solving Home Problems



EXTENSION TUBE on your caulking gun simplifies the job of caulking hard-to-reach spots. Use a 10-in. length of plastic tubing, cutting one end to 45° and pushing the other end over the nozzle of the gun

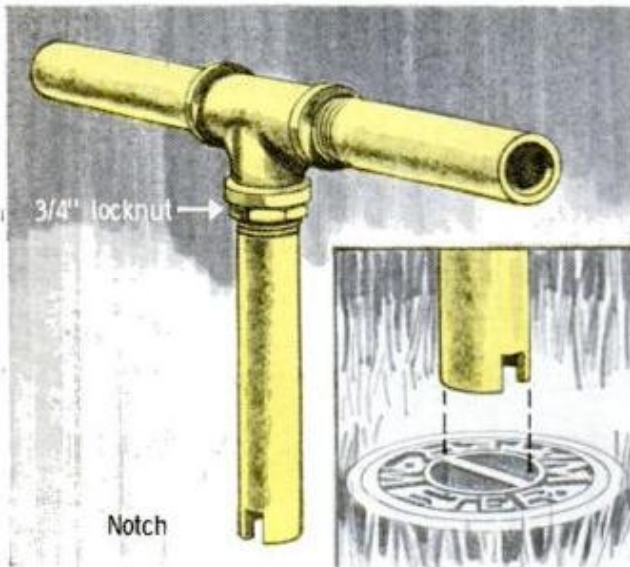

SPECIAL WRENCH to fit the recessed stop cock at your water meter can easily be made from three lengths of 3/4-in. pipe and a 3/4-in. tee. Notch bottom pipe and use a locknut to secure it in the pipe tee

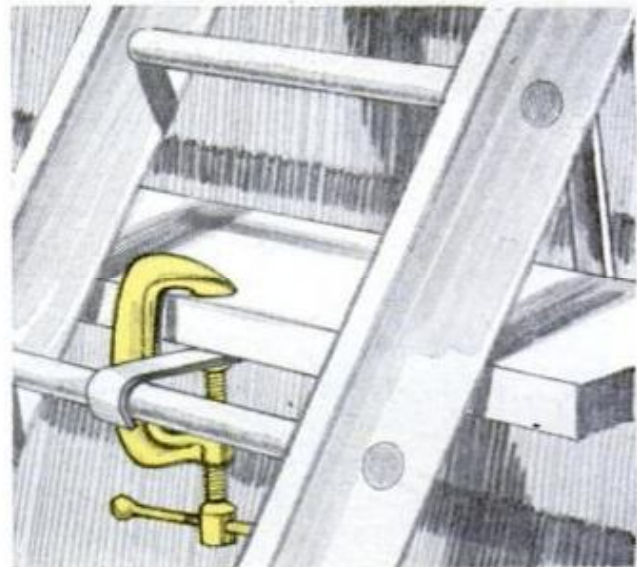

TO PREVENT ACCIDENTS when working from a scaffold plank on ladder brackets, secure the plank at each end with a C-clamp. This will prevent the plank from shifting and possibly slipping off the bracket

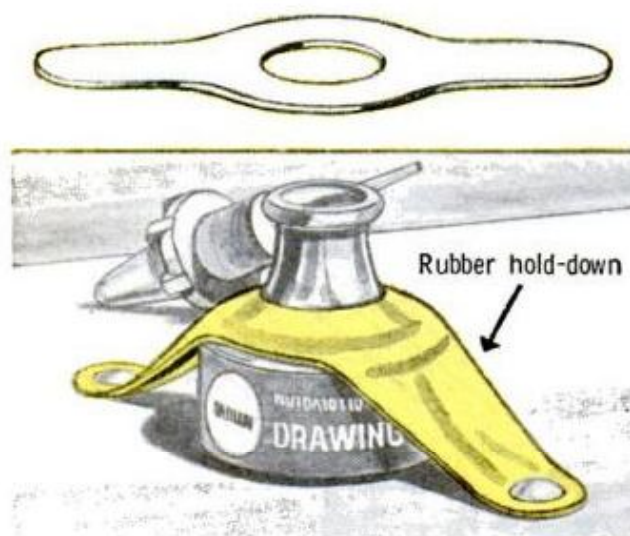

SAFETY BELT for a draftsman's ink bottle anchors it firmly to the drawing board, making it impossible to tip over. Made from a strip of rubber salvaged from an old inner tube, it's secured with thumbtacks



SIMPLE WAY TO avoid the frustration involved in trying to lace up a child's shoes once the ends have become frayed is to use a bobby pin to pull ends of the laces through the eyelets. Try it next time

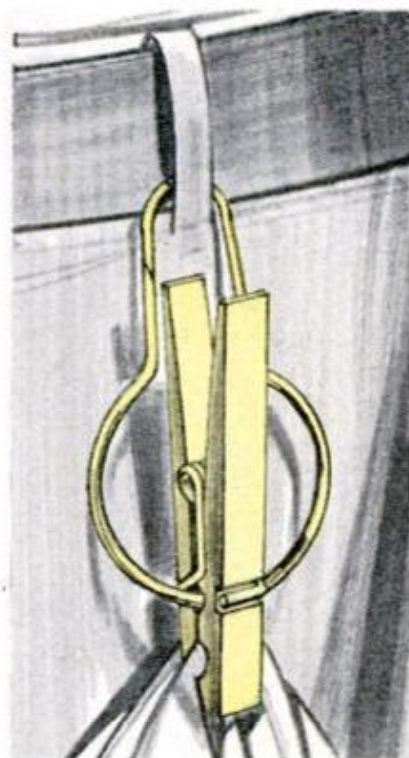

BELT CLIP to hold a wiping cloth when you're washing windows is made by slipping the wide loop of a shower-curtain ring through the spring of a wood clothespin



ALCOHOL LAMP can be made from an empty Magic Marker. Just clean the bottle, then pull out the felt strip and replace it with a wick (use string or shoelace)

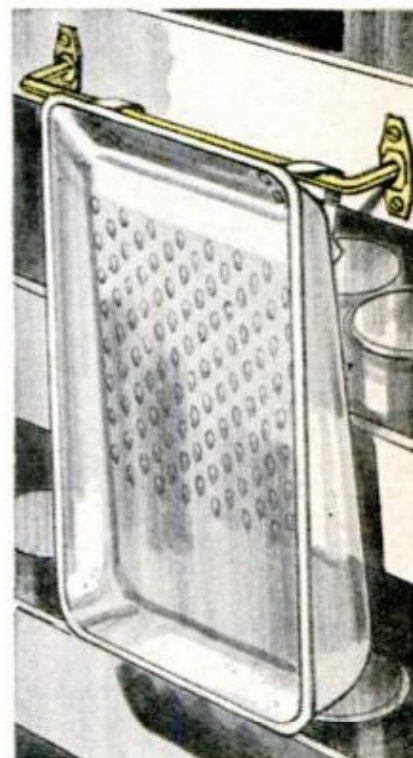

STORAGE RACK to hold a paint-roller tray is just a cheap towel rack mounted high out of the way on a shelf edge or wall. Use tray clips to hang it on the rack



WHEN REGLUING CHAIRS, you can do a fast and neat job of removing old glue with a split sanding jig. Clamp two blocks together and drill a hole $1/16$ in. larger than spindles, then line jig with sandpaper

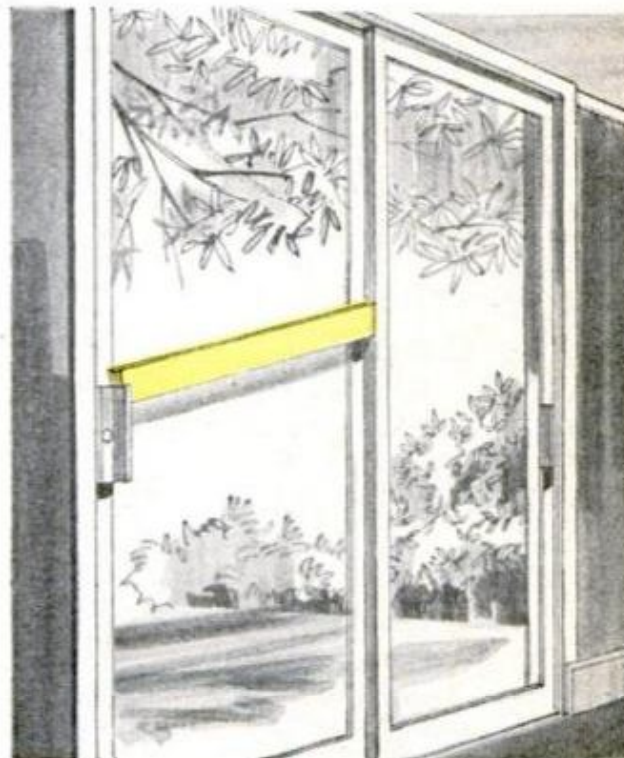

LOCKING BAR for sliding glass doors is notched at one end to rest on door handle. The other end is wedged against second door. It may be primitive, but this is one lock that can't possibly be jimmied

NEW IN ELECTRONICS

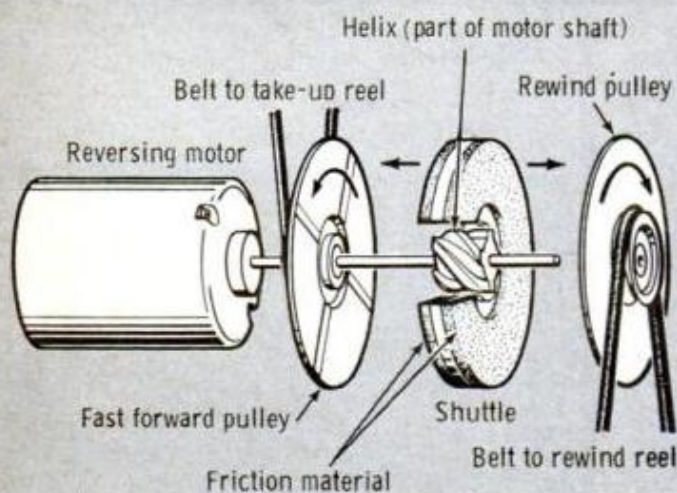

TAPE TRANSPORT COMPONENTS are spaced out on shaft to visualize action. Pulleys are free on shaft; only the helical gear is secured to motor shaft which turns counterclockwise (viewed from shaft end) in the "play," "record" and "fast forward" mode, and clockwise in "rewind." When the helix turns ccw in its matching internal gear in the shuttle, the shuttle is forced against the fast forward pulley driving take-up reel. Cw rotation forces shuttle against rewind pulley to drive rewind reel. In "stop" clutch disengages and brakes unwinding reel.

TAPE RECORDER features open-front tape loading, simple but ingenious clutching system and low wow and flutter. "Stop" control automatically retracts tape guides, pads and pinch roller for easy threading. Clutch, detailed above, is operated by reversing d.c. motor; capstan by its own primary motor. Wollensak 6300, \$230 including separate speakers, will be available in January along with integral-speaker and deck models



HEADSET STEREO RADIO is an anticipated entertainment product from Panasonic. The FM stereo receiver is built into the headset and battery powered to give the wearer complete mobility. Designed around integrated circuits, the receiver has tuning, balance, tone, mono/stereo and on-off controls. Model RF-60, introduced at the annual Consumer Electronics Show, operates from three AA-size batteries. Available early in 1969, it should be priced at less than \$100



VIDEO TAPE RECORDER records pictures and sound on standard one-quarter-inch magnetic tape. The combination machine records 4-track stereo sound and video using the helical-scan technique with a tape speed of 11.25 inches per second. A half-hour of TV sound and picture can be recorded off the air with a standard 7-inch reel of tape. The Roberts 1000 recorder is under \$1000 with the TV monitor set and camera extra

RECORD CHANGER of low profile design is ready to plug into your stereo rig. The compact BSR McDonald "Minichanger" includes stereo cartridge, base and dust cover. Either a 430 mv ceramic or 2-volt crystal stereo cartridge with sapphire styli can be selected with the Minichanger module. Unit is priced at \$40

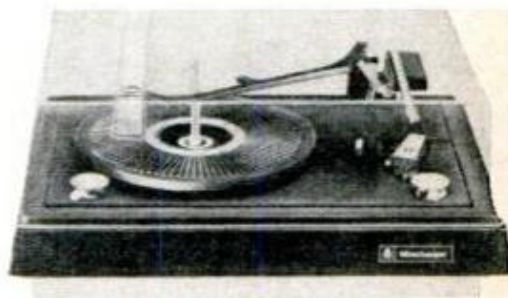

COLOR PORTABLES in larger, increasingly popular 14-inch screen size expand GE's original 10-inch Porta Color series. The WM237GWD shown here is a 38-pound set with handle and tinted sun screen. The deluxe model, it incorporates a sleep-switch and timer, earphone and woodgrain finish. A slide-rule dial can be preset for VHF channels. Price of model is \$315



CB TRANSCEIVER is aptly named "The Baton." Cylindrical design for easy handling houses 8-transistor circuit with a 100-mw. output. The single channel is crystal controlled and has a battery strength indicator for the six penlights. Toshiba unit is 1½ pounds, 9½ inches high, 2½ inches diameter. \$60

PORTABLE RADIO looks like a buoy and floats like one. The RCA design is the latest in many unique ways of packaging transistor sets. The AM "Floater" keeps its top third above water; the controls are on the top and sound is dispersed from periphery slots. Model RZG-28 is designed for fresh-water pools and lakes. \$20

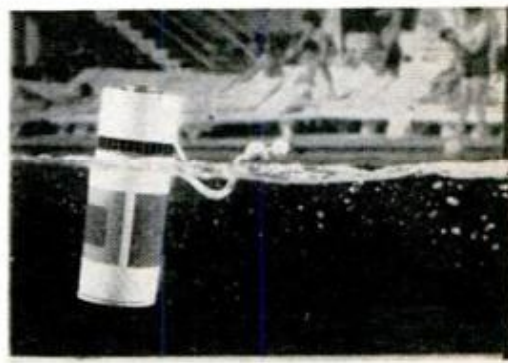

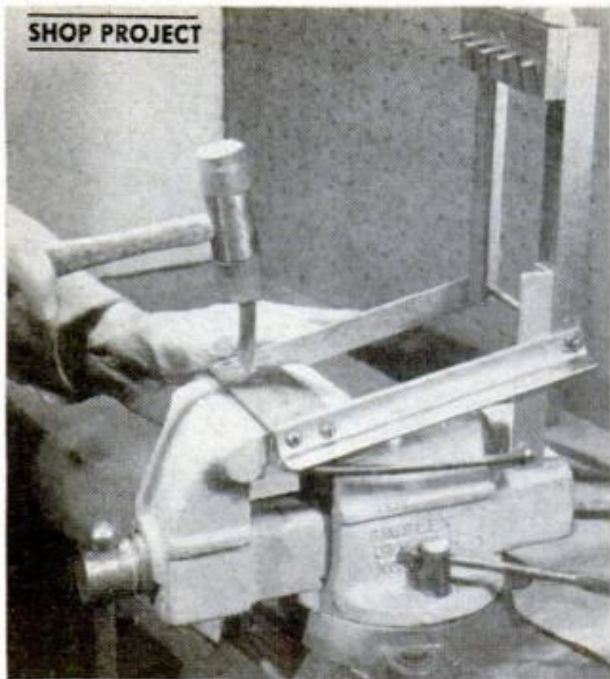

PLASTIC HAMMER is used to drive blank through largest hole. Punch head is held back by coil spring



FOR SMALLER DOWELS, blank is then driven through a succession of smaller holes until it is desired size

You can produce your own dowels with this **SELF-EJECTING DOWEL MAKER**

By **WALTER E. BURTON**

Technical Art by Don Evans

A DOWEL PLATE can be a very handy piece of shop equipment, especially if you do much furniture work. With it, you can turn out odd dowel sizes for repairing antiques, make supertough dowels from different hardwoods and, if the lumberyard happens to be out of the size you need, even make your own stock-size dowels.

In case you've never used one, a dowel

plate is just a thick steel plate with a series of graduated holes drilled in it. Square blanks slightly oversize for the holes are hammered through them to produce dowels or dowel pins.

The standard dowel plate has one big drawback. Once the upper end of the blank has been driven flush with the plate, you often have to use a drive punch to push it the rest of the way through. This dowel maker solves the problem with a swing-down "punch head."

To extract a finished dowel, you simply bring the head down until one of its punches hits the dowel end. Two or three short swings are usually enough to tap the dowel out the bottom.

Plates A and B should be clamped together before you do any drilling in order to assure proper alignment of the holes. Drill the knockout holes for the punches first. These serve as guides for drilling the punch holes in A and the dowel-forming holes in B. The dowel holes can be any size you require. The punches should be small enough to enter and leave the dowel holes without binding. You may

(Please turn to page 228)

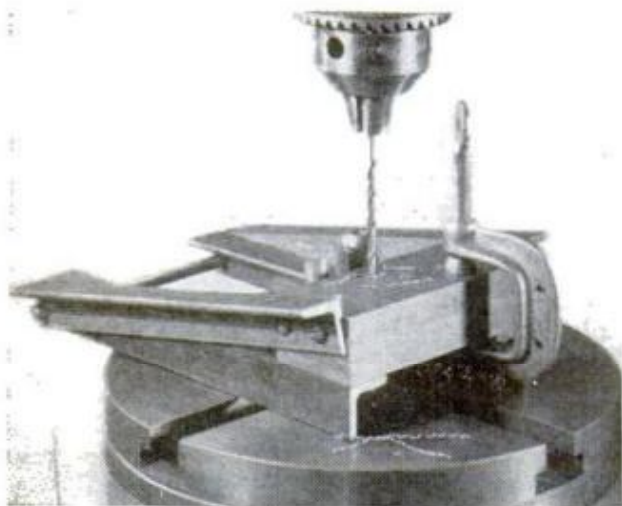

CLAMP PLATES TOGETHER to drill the pilot holes. In the top plate, these will double as knockout holes

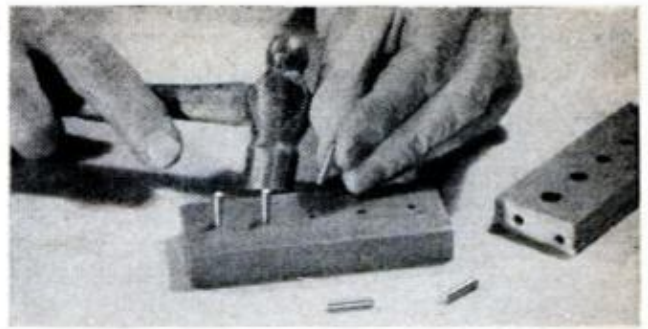
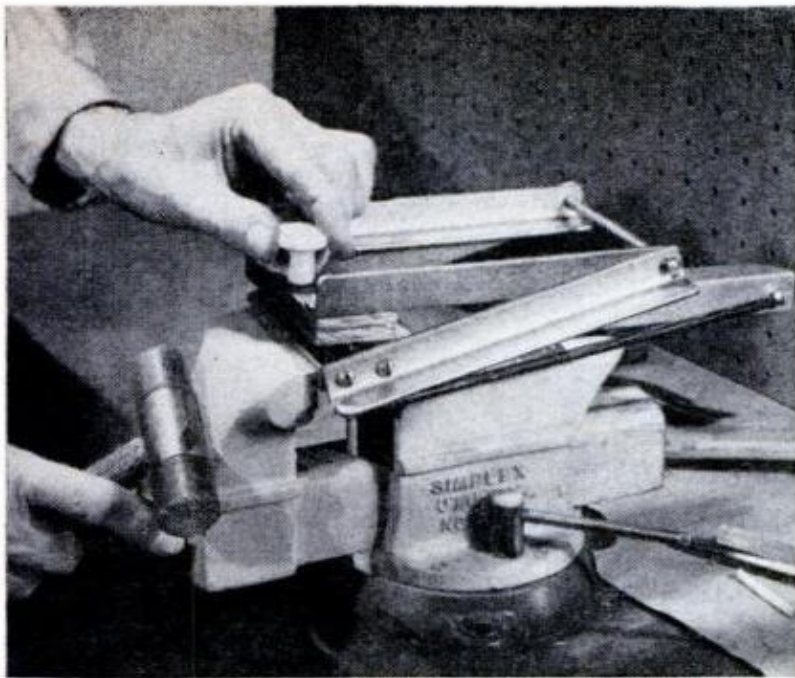

SMALL PUNCHES in the punch head fit tightly in the top plate. Knockout holes allow easy replacement

FINISHED DOWEL is ejected from the hole by gently tapping it with the punch head two or three times

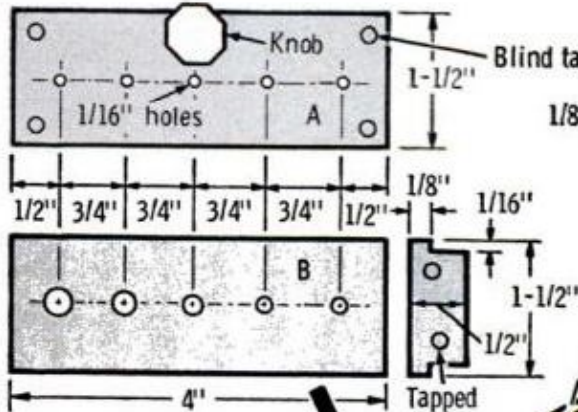

5/16, 9/32, 1/4, 7/32, 3/16"
holes drilled
through plate B

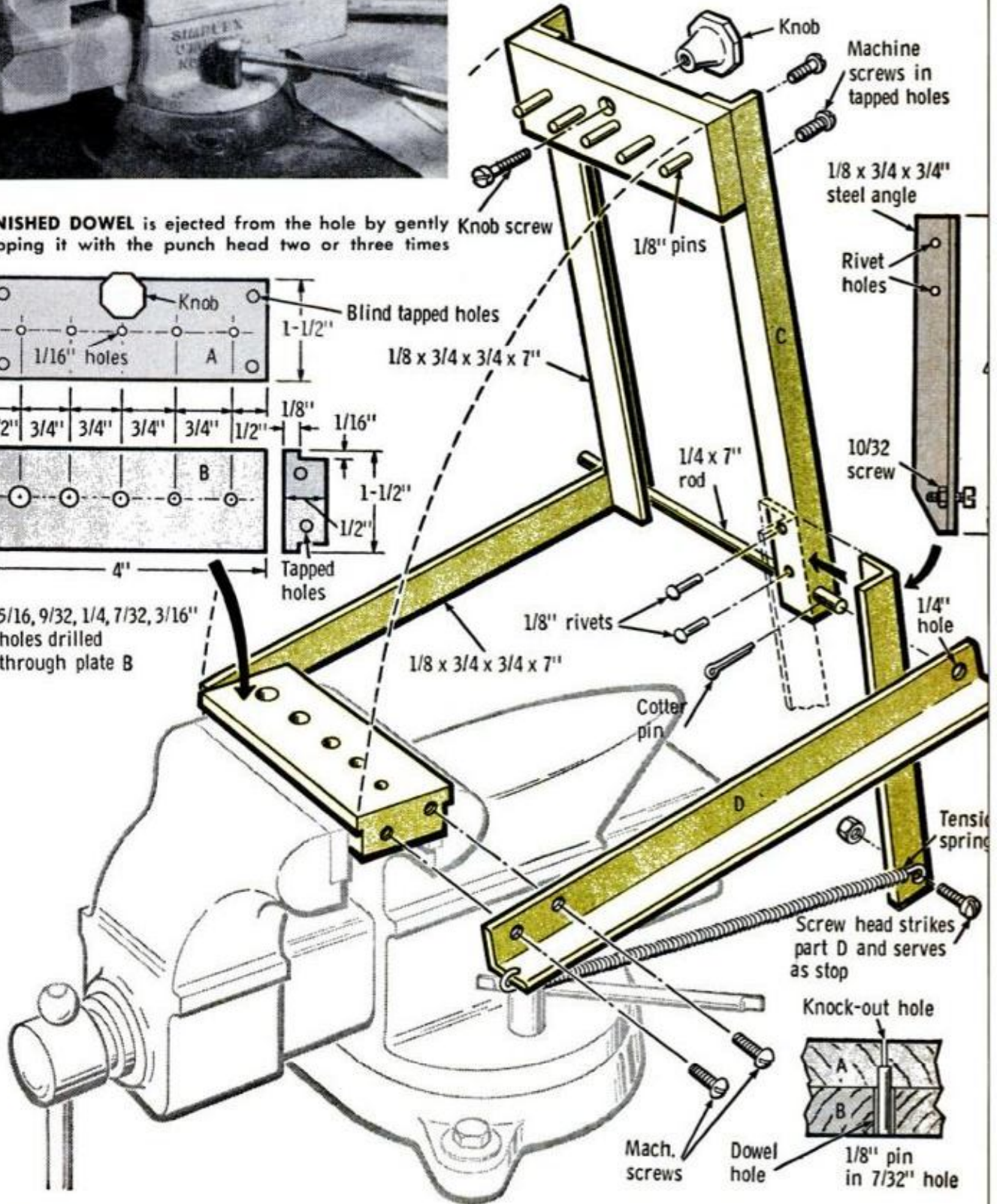



Weller
Model
8200



Wen
Model
450

Easy on the Draw— Soldering Guns Are Hotter than Ever

By JOHN BURROUGHS

A BIG sheet-metal soldering job requires a large soldering iron or a torch. Delicate printed-circuit soldering, on the other hand, takes a temperature-controlled soldering pencil. But for nearly all ordinary soldering jobs between these extremes, nothing beats a soldering gun. These general-purpose guns are so fast-heating and so easy to handle they've made medium-size barrel-type irons all but obsolete.

While the leading makes of guns may look alike they aren't built alike. There are actually only two types: those heated by induction or by resistance elements.

An induction-type gun is built around a step-down transformer that induces low voltage, but very high amperage in the

gun's hairpin-like loop tip. This heavy current flow heats the tip to soldering temperature in a few seconds.

Weller Electric's popular induction-type gun, the medium-duty Model 8200, has a two-position trigger switch for convenient heat control, the first position producing 100 watts and the full-on position 140 watts. A heavier-duty Weller gun, Model D550, is rated at 240/325 watts.

Sears Craftsman guns are also dual-heat induction units. The heavier-duty Model 200 is rated at 150/200 watts; the Model 100 at 100/130 watts. Both have on-off trigger switches and high-low heat selector knobs on the backs of the casings. The slim loop tips, made of steel for rigidity, are gold-flashed to prevent corrosion.



Craftsman
Model
200



Skil
Model
340

LEADING MAKES OF SOLDERING GUNS fall into two categories; induction type and heated-element type. The Weller and Craftsman models (above, left) are induction types offering dual-heat controls and interchangeable tips, while the Wen and Skil models (above, right) have changeable heating-element tips

Transformers in both models have low-temperature windings.

Element-heated guns are built much like conventional nichrome-element soldering irons—but with refinements. Wen's Model 450, for example, uses interchangeable tips in three sizes—for light, medium and heavy jobs. Each tip has a built-in nickel and copper-wire heating element. Encased in ceramic-like insulation to exclude air and prevent burn-out, these space-age elements tend to be self-regulating. As they heat, their resistance increases and they draw less current; as they cool in use, resistance decreases and they draw more current. For this reason the tips are rated according to their heat range. The large tip covers the 100/200-watt range, the medium tip the 50/100-watt range, and the small tip the 25/50-watt range. A similar light-duty gun, designated the Model 220, uses either of the two smaller tips.

Trigger feed a new feature

Skil's new Model 340 auto-feed gun is also an element-heated tool. Its special feature is a trigger-operated pawl mechanism that feeds $\frac{1}{16}$ -in.-dia. wire solder from a spool magazine through a small tube to a continuously-heated tip. This



SOLDER-FEED FEATURE of Skil's new gun allows you to dispense solder and hold the gun with one hand

OCTOBER 1968

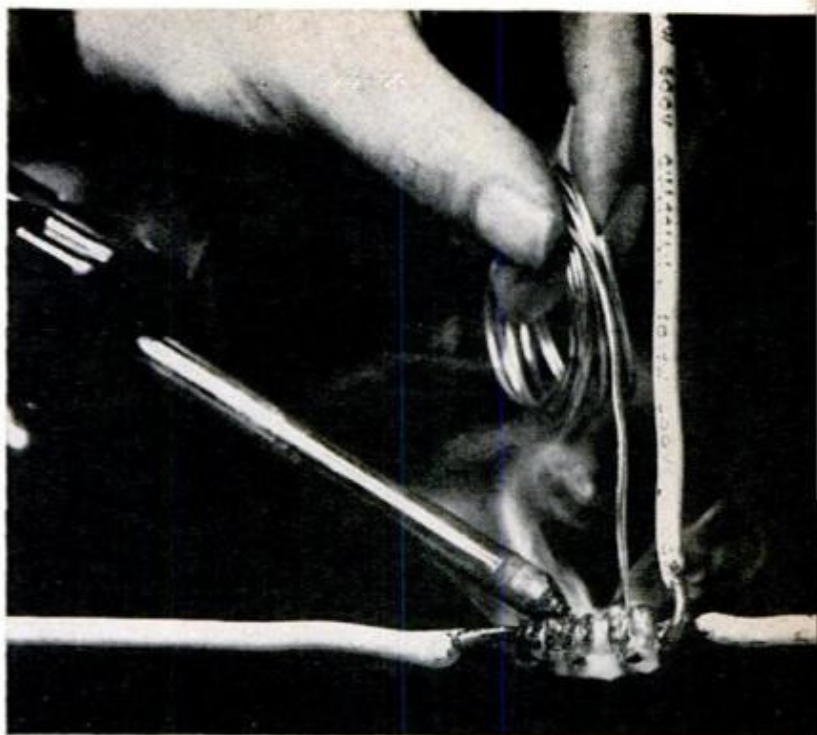

THE MOST IMPORTANT POINT TO REMEMBER when soldering is to heat work until solder melts. Never heat solder directly



TIPS SHOULD ALWAYS BE TIGHT to assure good conductivity. Occasionally clean the clamp bushings

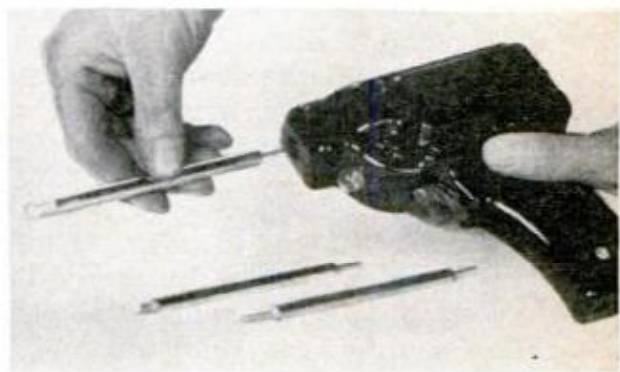

THE SINGLE-POST DESIGN of element-heated guns makes it easy to solder most hard-to-reach connections

187



UNUSUAL REPAIR JOBS such as welding plastic, cutting floor tiles and heat-sealing plastic bags are also possible by fitting special-duty tips or slip-on tip attachments. When working with plastic, however, use the lowest heat possible to do job without melting work



GUNS ARE SUITABLE for many light-duty sweat-soldering jobs, but their small tips can't transfer heat fast enough for heavy sheet metal work. In that case, use a barrel-type iron with a high heat rating (300-400° F.) after tinning the point for good heat transfer

permits you to solder with one hand as you hold the work with the other, which makes the gun particularly suitable for appliance repair work. This 115-v. element is rated at 45 watts.

As a rule, induction-type guns heat faster than element-heated guns, and replacement tips cost less, but element-heated guns maintain a somewhat steadier heat. However, either type of gun is suitable for most of the home-workshop soldering jobs you'll encounter.

Rules to follow

The very fact that soldering guns are so easy to use often leads to unsatisfactory jobs. When you're working hurriedly, it's easy to disregard the fundamental soldering rule—*heat the work, not the solder*.

Other soldering rules also should be followed. For a sound bond, parts to be soldered first must be cleaned free of oxida-

tion. Use resin flux for soldering copper or brass; zinc chloride flux whenever you're soldering iron or steel.

When using zinc chloride, remember to wash off residue since the acid salts will corrode the work in time. Separate flux is nearly always preferable to flux-core solder for any job larger than an electrical connection.

Keeping your gun's tip clean and well-tinned speeds heat transfer to the work. When heating large work, melt extra solder on the tip—it will serve as a good heat-transfer medium.

Always remember that soft solder should be used as a filler or sealant rather than as an adhesive. Be sure that joints are mechanically secure before solder-sealing them. When making electrical connections, bend the wire-ends through and around the terminals before heating the work and applying the solder. ★★★

New Tools You Should Know About



Industrial tilting-arbor saw

A new 10-in. light-industrial saw having a $3\frac{1}{4}$ -in. depth-of-cut capacity with full 45° arbor tilt has been introduced by Shopmaster. The worktable, with web extensions, measures 20x33 in., and features the new Easy-Vu blade-angle indicator. The built-in floor stand is equipped with wheels for easy moving. The TA10 sells for \$199.95 without motor or \$229.95 with a $\frac{3}{4}$ -hp motor from Shopco, Inc., 6600 S. County Rd. 18, Eden Prairie, Minn. 55434.

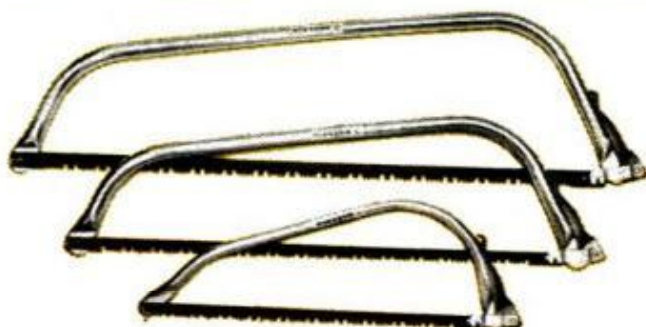

Bow saws with Teflon-coated blades

The new Disston bow saws feature blades coated with Teflon-S, a special abrasion-resistant formula developed by DuPont which not only reduces friction but rustproofs as well. Prices range from \$3.99 (21 in.) to \$5.99 (36 in.). They're from H. K. Porter Co., Inc., Porter Building, Pittsburgh, Pa.

Portable electric pipe threader with automatic shutoff

Weighing only 22 lbs., a new portable pipe threader automatically cuts thread to preset length, then disengages the die and shuts itself off. It can handle any size pipe from $\frac{1}{8}$ -in. to $\frac{3}{4}$ -in. and will thread galvanized pipe, regular and heavy black pipe, and even rigid conduit (thus eliminating the need for threadless connectors). After a pipe is inserted through a built-in vise, the machine automatically oils the threading die and pipe while it is cutting. The new machine carries a price tag of \$545.95 and is being marketed by the Ram Tool Corp., 2110 W. Walnut St., Chicago, Ill.

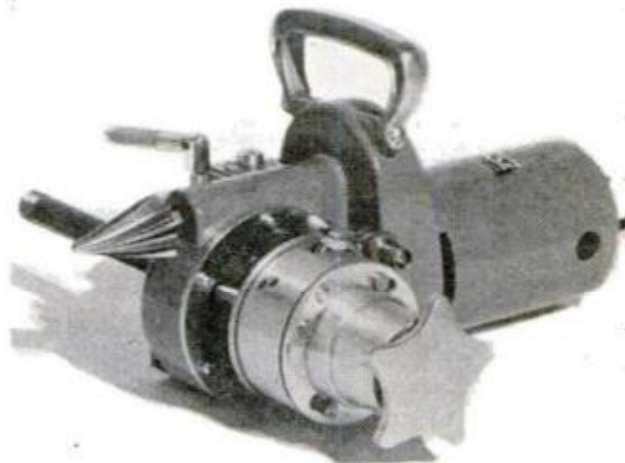
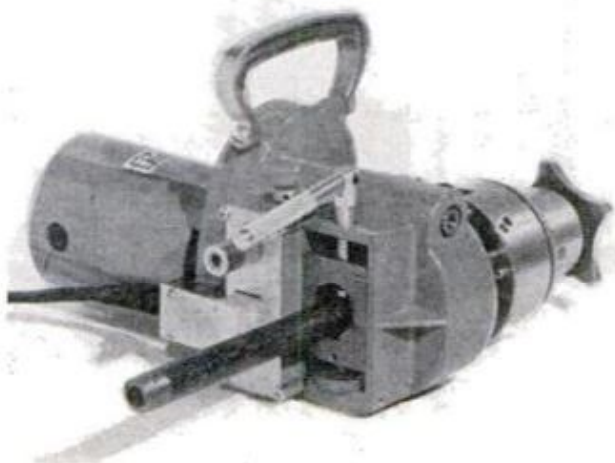

MAXIMAT 7

The tool to stretch your machining skills



By JOHN BURROUGHS

IT'S MADE IN AUSTRIA and looks typically European, with blockish styling, solid metal handwheels, critical surfaces ground to a near-mirror finish, and an overall scaled-down appearance—as if it were a half-size version of a larger industrial machine.

Actually the Maximat 7 is a combination and scaled-down version of *three* industrial tools—lathe, drill press and vertical mill. The vertical motor-spindle head is set on a 2 $\frac{3}{4}$ -in.-dia. column mounted behind the lathe's bedway casting and serves for both drilling and milling.

Since this vertical drilling-milling head can be swung back out of the way, it doesn't interfere with normal use of the lathe. When the head is swung forward over the ways, the lathe carriage (with the toolrest's compound slide unbolted) doubles as a precision worktable for work to be drilled or milled.

The lathe itself has several unfamiliar features. Unlike U.S.-built bench lathes, which have awkward countershaft drives, the 7-in.-swing Maximat uses a built-in two-speed (1725/3450 rpm) motor.

The motor belt-drives a back-gear shaft that has sliding gears shifted by levers. The levers give four geared speeds, which, multiplied by the motor's two speeds, provide eight spindle speeds in all. Both back

gears and spindle are enclosed in a transmission-like ribbed headstock casting and run in SAE 10 oil. Synthetic and steel gears are used in combination for quiet operation. The spindle has preloaded tapered roller bearings.

The lathe's leadscrew has no quick-change gearbox. A compound drive gear

MAXIMATS ARE SHIPPED from New York in two crates. One contains lathe; other drilling-milling unit



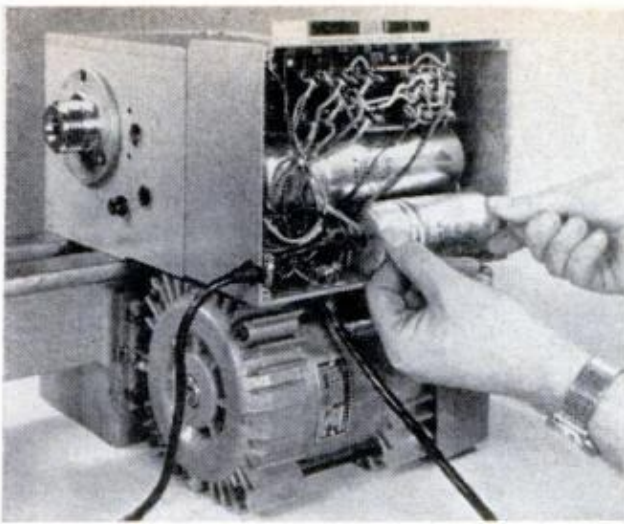

SHORT CORD FROM VERTICAL HEAD runs to lathe's switchbox. Both of the motors have starting capacitors

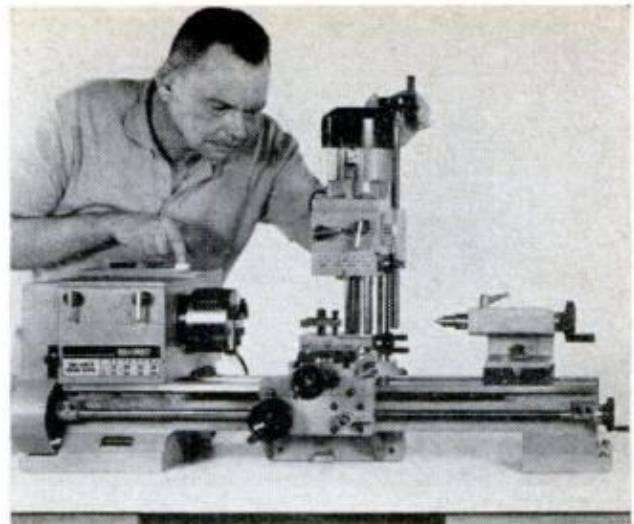

LATHE SPINDLE AND VERTICAL HEAD can be operated simultaneously. Power feeds can be used for milling

in the headstock gear train, however, has a push-pull shift mechanism providing two longitudinal carriage feeds, one "coarse" (.005 in. per spindle revolution) for roughing cuts, and the other "fine" (.002 in. per revolution) for finish turning. Since these rates are suitable for most lathe work, the gears are changed only when cutting screw-threads.

Pushbutton switches in the headstock's built-in switchbox control the lathe's two-speed reversible 1/2-hp motor and the vertical head's single-speed 1/4-hp motor. The stop button stops both motors.

Lubrication points in the carriage and tailstock have grease nipples and are lubricated with a grease gun supplied with the tool. All handwheels have friction-setting micrometer collars calibrated in thousandths of an inch.

TWO-SPEED MOTOR drives enclosed back gears (cover is removed in photo) to produce eight spindle speeds

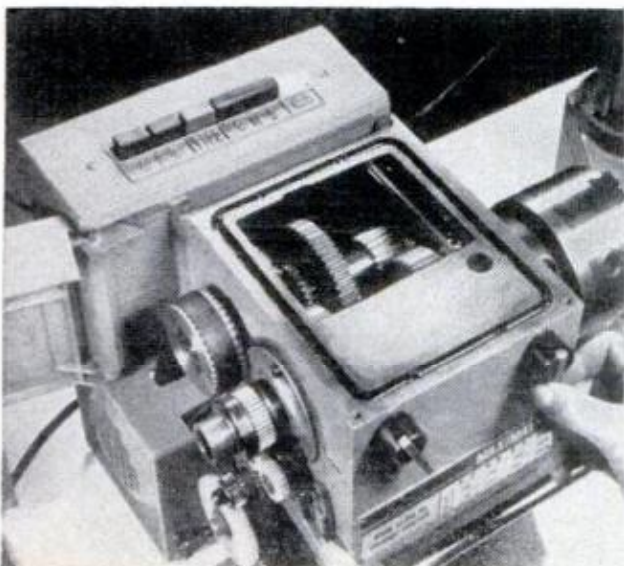

The Maximat's vertical head is a self-contained unit, with motor, gear drive and ball-bearing spindle. Shift levers provide four spindle speeds from 420 to 1740 rpm. The spindle is spring-loaded, much like a drill-press quill, and travels 1 3/16 in. Its No. 2 Morse taper bore permits the use of an arbor chuck or collets to hold drills.

When the head is used for milling, the spindle's rack-and-pinion is locked, and the head's precision feed screw is used for accurate depth-of-cut control. The head slides the full length of the column. The carriage worktable can be engaged at any of 16 power feeds, or work can be handed to the milling cutter with the lead-screw's calibrated handwheel.

Since the head rotates 360° in two planes, it's possible to mill at compound angles. Either end mills or arbor-type

SPINDLE GEAR TRAIN has a push-pull mechanism for two power feeds. Change gears are for thread-cutting

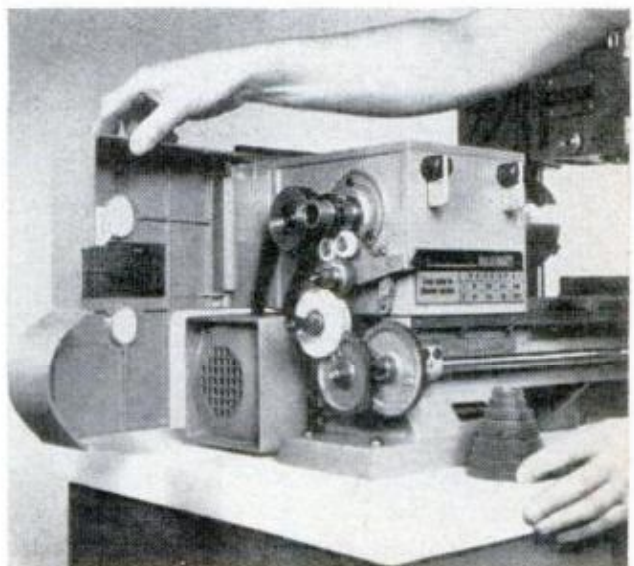

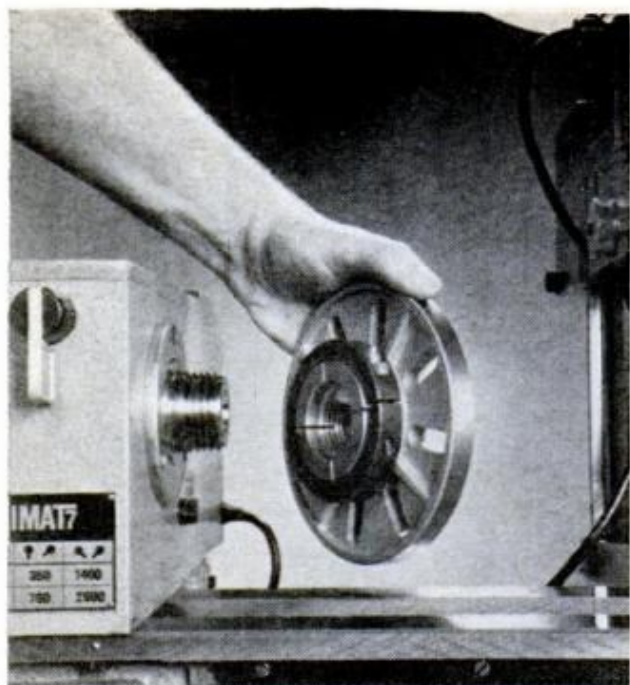

FACEPLATES and chuck-mounting plates have lock rings to keep them from spinning off as spindle stops

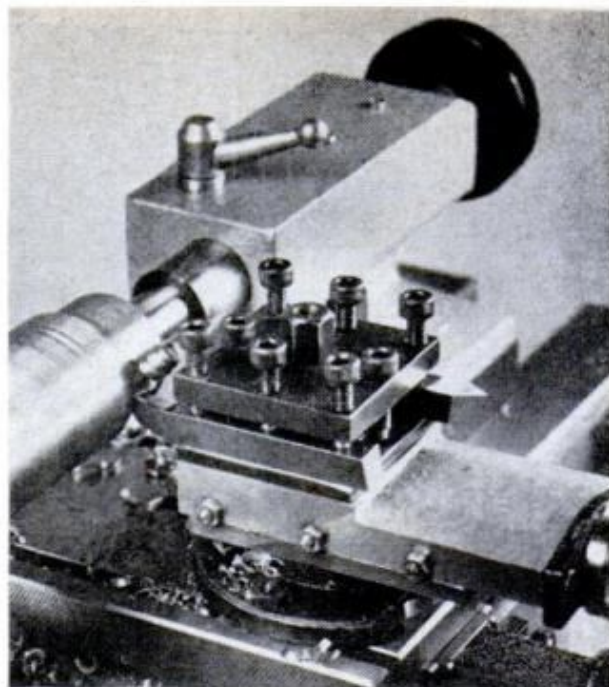

TURRET-BLOCK TOOLHOLDER, available as accessory, holds up to four lathe bits, replaces standard clamp

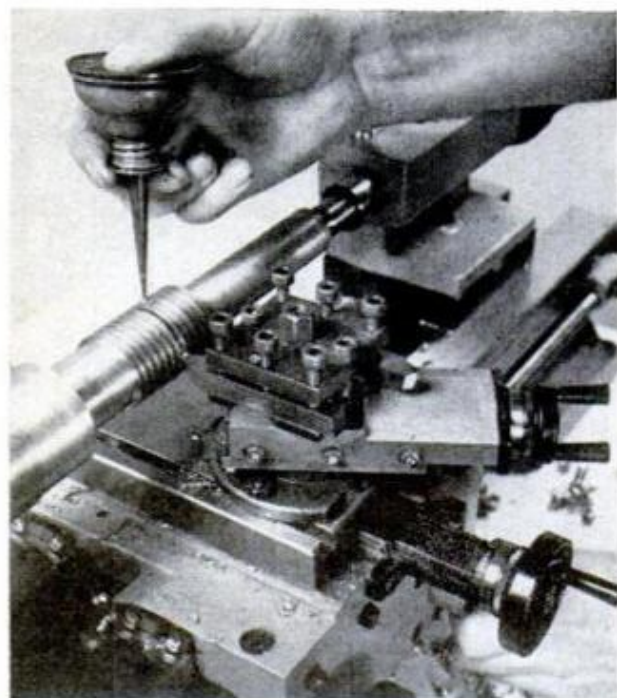

SCREW THREADS from 8 to 80-pitch—standard, Acme, square, right and left-hand—can be cut on Maximat

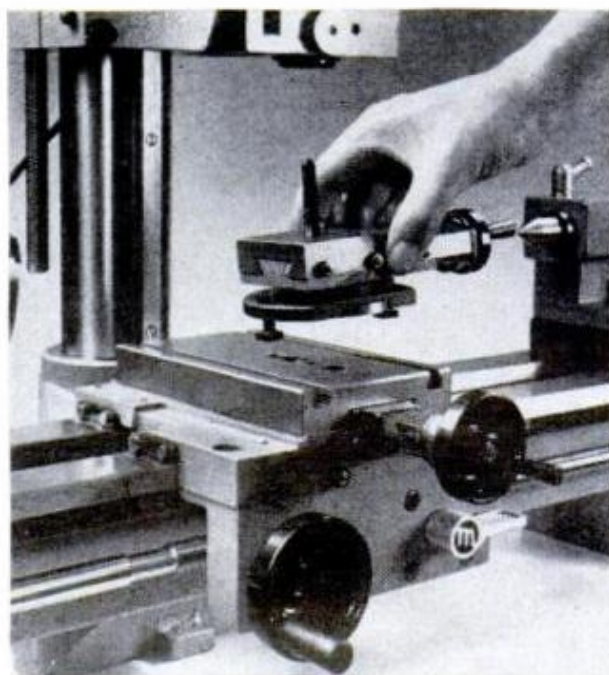

COMPOUND SLIDE bolts to T-slots in cross slide, which alone serves as milling and drilling worktable

cutters (with the head turned horizontally) can do many metalworking jobs.

When operated at 1740 rpm, the head can also be used for surface grinding, preferably with cup wheels. Work to be drilled, milled or ground can be bolted to the carriage table's T-slots, or it can be held in a machine vise or on an index head accessory.

There are a few precautions to take when using the Maximat, because the tool is built to standards surpassing ASA re-

quirements for toolroom lathes. To preserve its precision, the machine must be carefully set up—shimmed level, that is, on a solid, bolted-down bench. The vertical column should be squared accurately to the worktable with a dial indicator.

While the lathe has plenty of power to lug $\frac{1}{8}$ -in.-deep roughing cuts, it can be damaged by overloading. Cutting bits, mounted horizontally rather than in angled toolholders, need suitable back rake ground into the bit. It's important to avoid

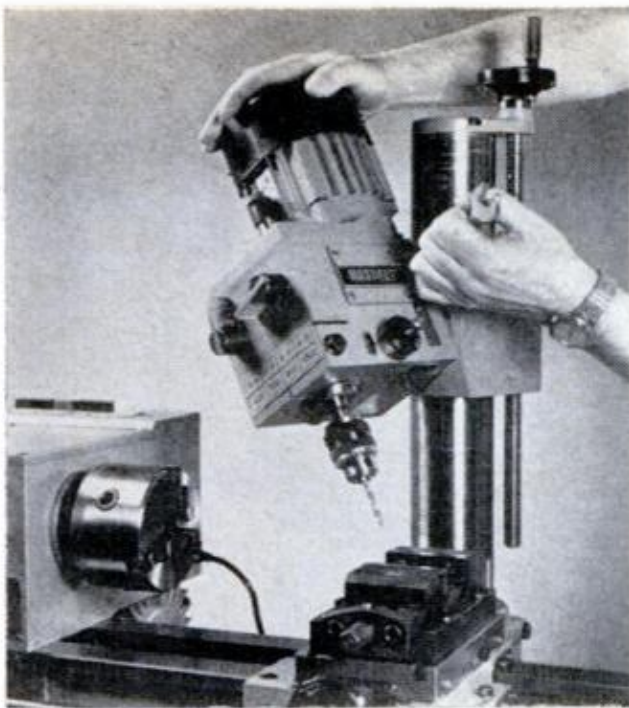

MOTOR-SPINDLE UNIT rotates 360° on mount. For compound angles, entire column rotates 360° in base

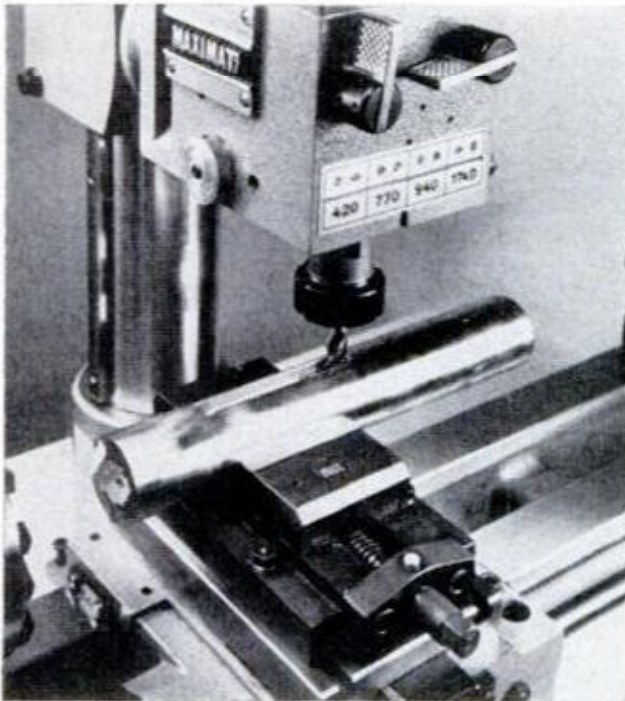

FOR MILLING OPERATIONS, spring-loaded spindle is locked in position, feed screw controls depth of cut

banging the spindles when removing chucks or other accessories. Screw-ejection is provided to press tools from the vertical head's spindle taper.

Base price of the Maximat with a 3-ft. bed (18 in. between centers), including vertical column and drilling-milling head, is \$595. Chucks, collets, machine vise and other accessories—a full line, beautifully made—are extra. For more information write American Edelstaal, Inc., 350 Broadway, New York 10013. ★★★

OCTOBER 1968

Two New Saw Blades For Your Workshop

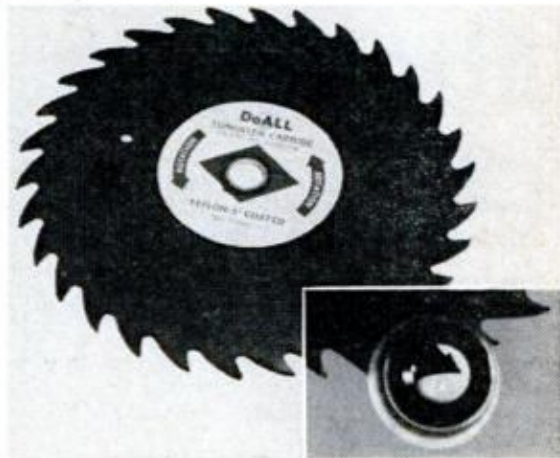

CARBIDE-TIPPED BLADES with Teflon coatings are the latest in workhorses for the workshop. The advantages of either of these characteristics are obvious: Teflon reduces friction between blade and work, and also resists the buildup of sap, pitch and other impurities on the blade. Tungsten carbide, on the other hand, is one of the hardest man-made materials and will retain its sharpness for long periods.

The DoAll blade shown above is manufactured using a patented process to weld the carbide tips to the blade. Standard blades have 6, 6½, 7¼ and 8-in. dia., with prices ranging from about \$18 to \$24.

The Disston blade (below) from H. K. Porter is available in sizes from 8 to 20-in., with prices from about \$20 for an 8-in. dia., 8-tooth blade to almost \$150 for a 20-in., 100-tooth blade.

For more information and specification sheets, write to DoAll, 254 N. Laurel Ave., Des Plaines, Ill. or H. K. Porter Co., Inc., Hardware and Industrial Products Div., Porter Building, Pittsburgh, Pa. ★★★

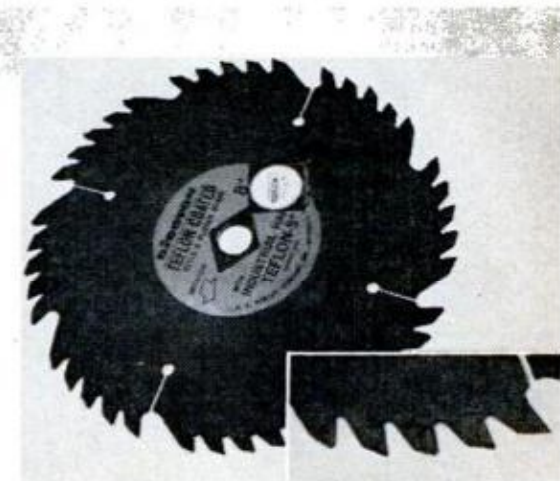

193

Torch Attachments Guarantee Perfect Cuts

By KENNETH B. LITTLEFIELD

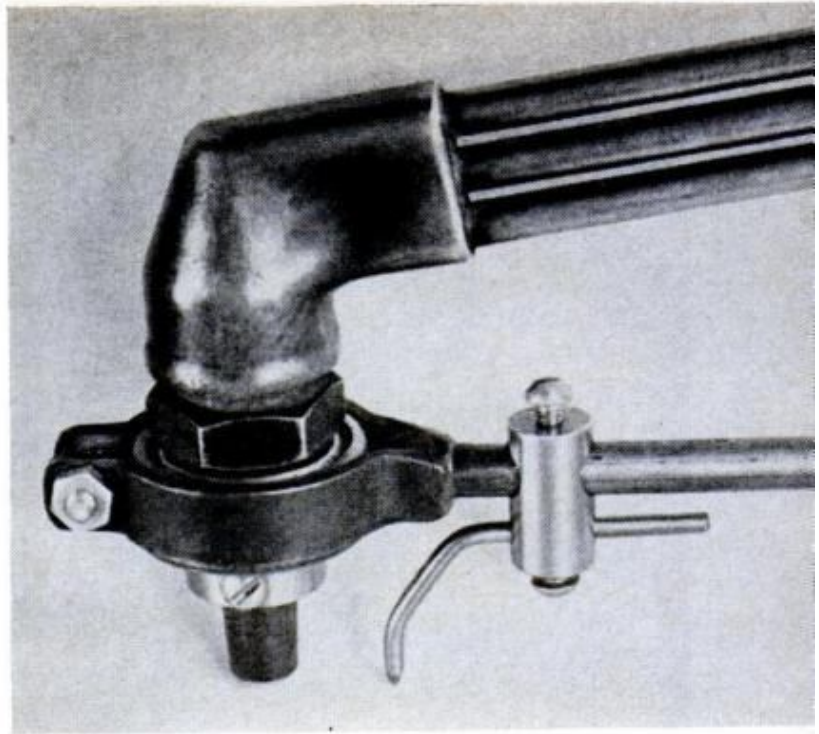

THE OXYACETYLENE TORCH is probably the handiest and fastest working tool when it comes to cutting steel. But unfortunately, considerable skill and practice are needed—both of which the infrequent do-it-yourself user seldom acquires.

Consistently good results with a cutting torch *can* be assured, however, simply by using the torch attachments shown. The cutting of circles, straight lines, bevels and other unusual shapes simply becomes

a matter of setting up a guide, then fitting and adjusting the proper attachment for the job.

Since the tip is held at a fixed distance from the work, the preheat action of the torch is highly efficient and reduces the chances of excessive melting.

To obtain the best results with these attachments, however, some deviation from standard practice is necessary. First lay out the work with scribed lines. Then measure the distance from the jet to the

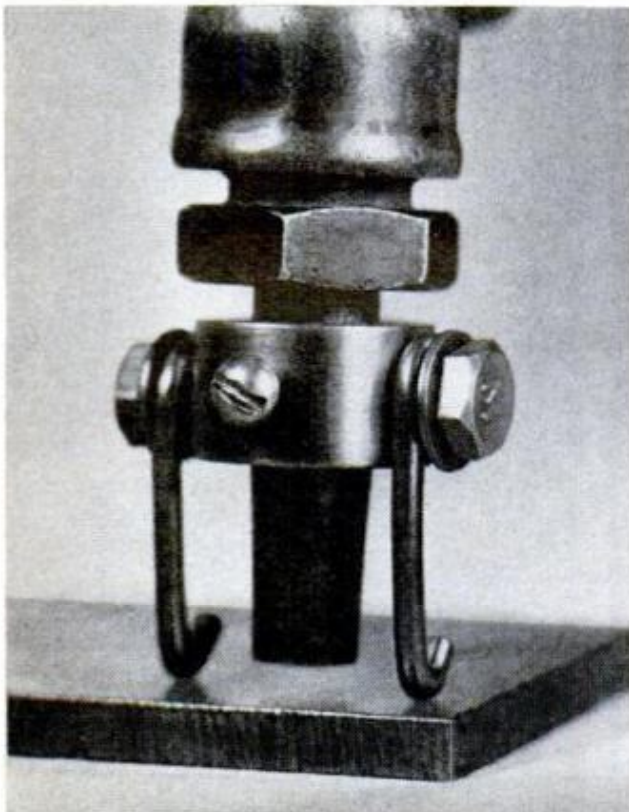

STRAIGHT CUTS AND MODERATE CURVES are easy to cut with this attachment. The two legs assure exact 90° cuts, while the height is easily adjusted to suit length of preheat flames and width of the cut

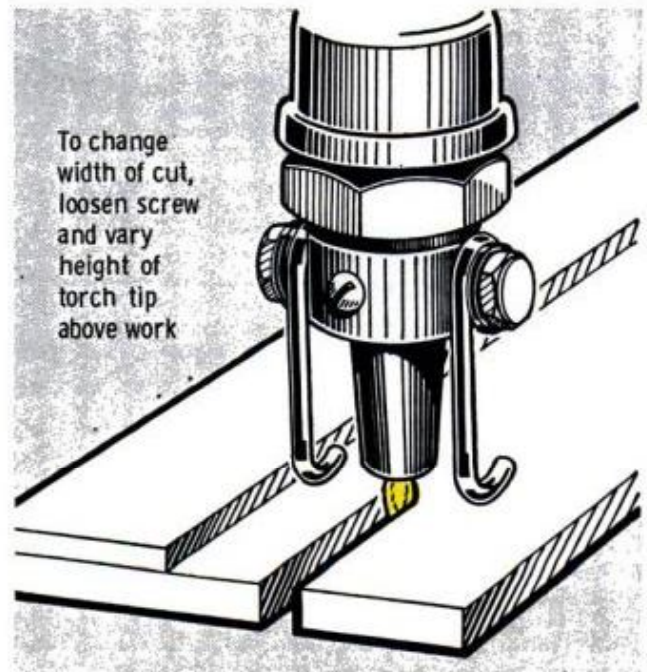

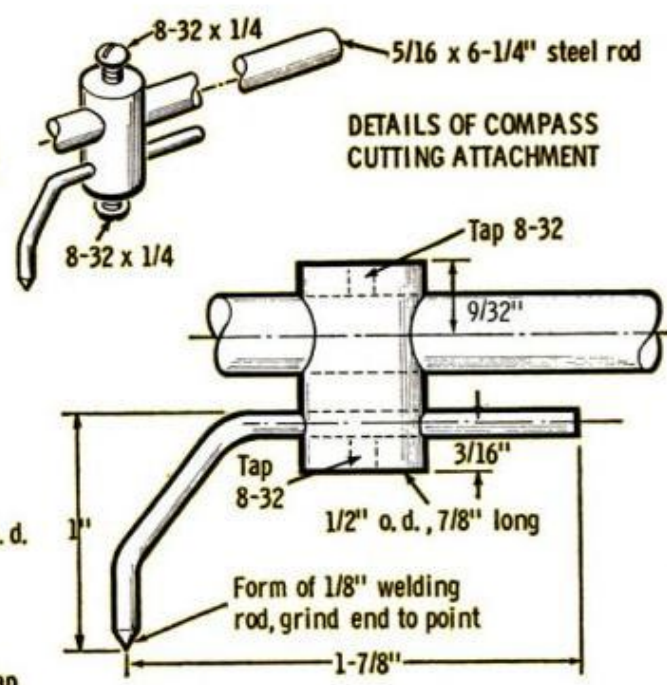
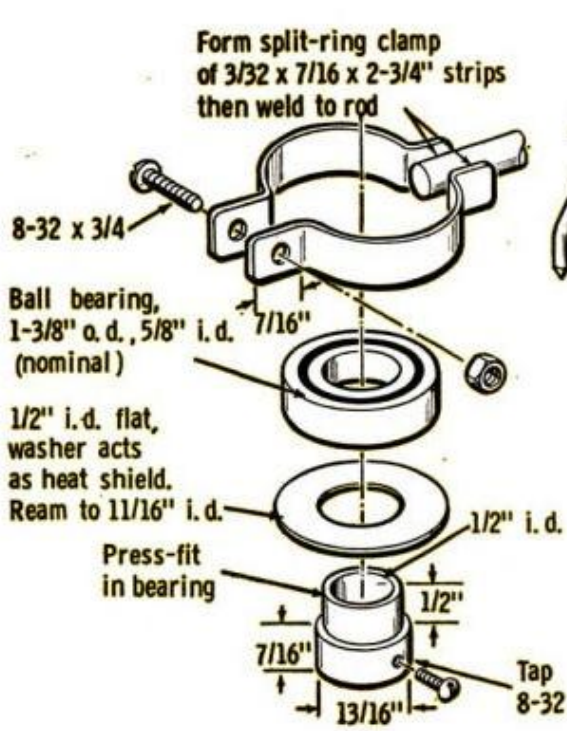

guide leg and set up a guiding straight-edge the same distance away from the scribed lines. Thus, as you start moving the burning torch evenly along the guiding edge, a clean, uniform cut will appear on the scribed line.

For an inside cut, a small hole (at least 1/8-in.) should be drilled in the work as a starting and ending point—while cutting circles with the compass attachment requires a centerpunched hole and a similar 1/8-in. hole to start the cut. ★★★

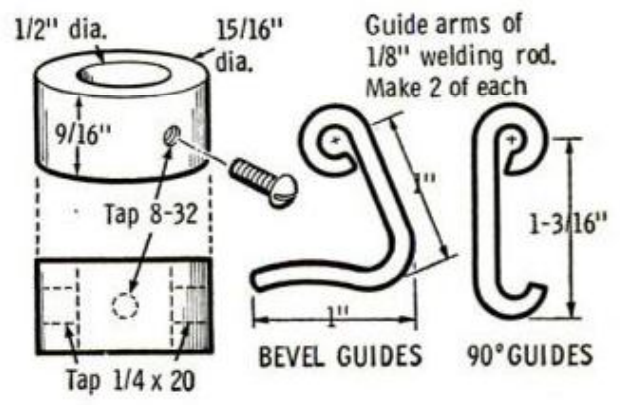

WHEN MAKING BEVELED CUTS, first make a trial cut in a piece of scrap to determine the exact distance from the straightedge to the cutting jet. Then clamp or weight the straightedge to work to be cut

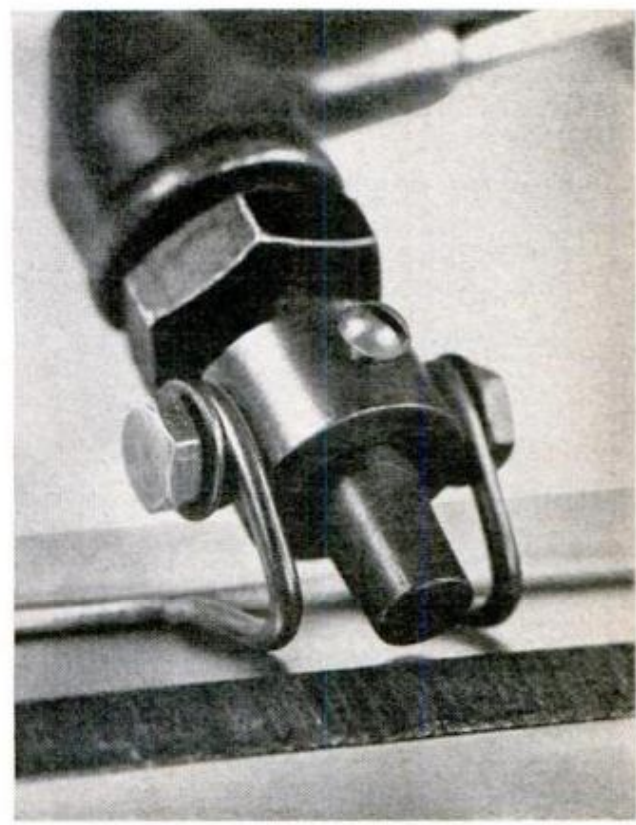
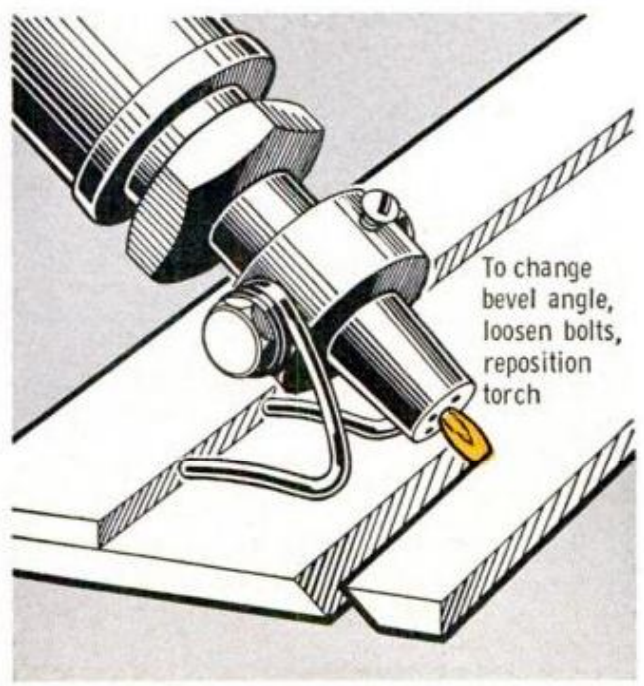

HINTS FROM READERS

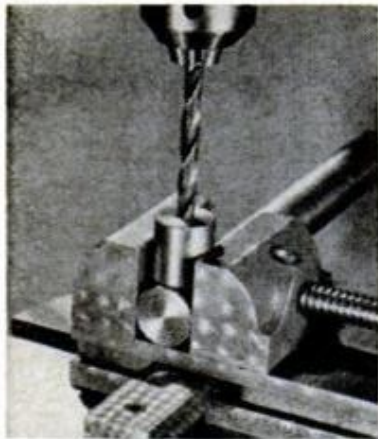

A sleeve does it

When the hole through a rod or pipe must be dead accurate, there's a simple trick to follow. First make a sleeve from a scrap of the same diameter rod by chucking it in the lathe and center-drilling it with the drill bit to be used. Then with both the sleeve and the work clamped in a drill vise as shown, and the same bit chucked in the drill press, lower the bit through the hole in the sleeve. The resulting hole will be right on center.

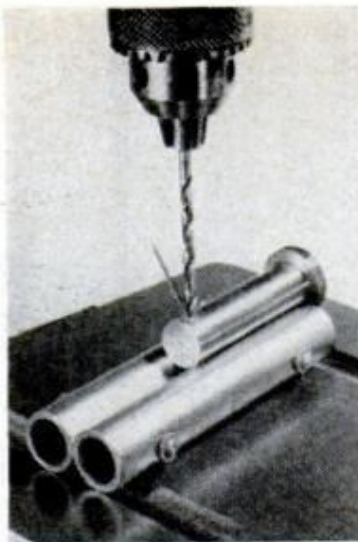

Quickie V-block

There are several ways to make a V-block for supporting round work for drilling it transversely, but none is as simple, perhaps, as bolting together two lengths of pipe of the same diameter. To cross-drill the pipe accurately you can make use of the sleeve idea as explained at the left. The trick here is to drill all four holes so they align and permit the bolts to pass through. Drill first four holes at same time; insert bolt to align.

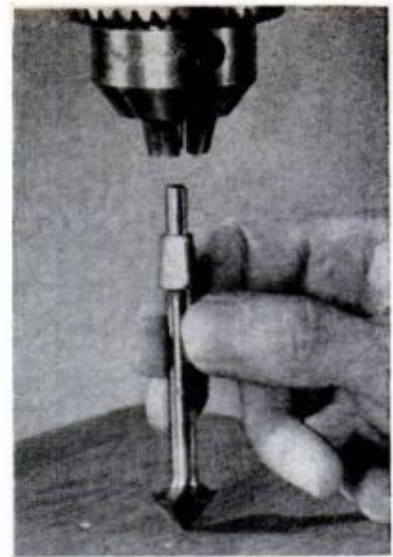

Countersink trick

Rather than cut the square head from a rose-head countersink which means it then can only be used in the drill chuck, play it smart and form a round shank at the end. This way it can be used in both the chuck as well as the brace. The most accurate way to round the end is to mount the countersink in a four-jaw lathe chuck and turn it. However, it's possible to do a fairly accurate job by grinding the end and rotating the tool.

NEXT MONTH IN SHOP AND CRAFTS

HOW TO BUILD A BRUSH BUGGY. Made for rough and rugged terrain, this little brother to the dune buggy is made from standard Volkswagen driveline components and will outperform many four-wheel-drive vehicles. Next month's story details construction and shows some action photographs that must be seen to be believed.

WEEKEND PROJECTS MAKE GREAT CHRISTMAS GIFTS. A single weekend in the workshop can produce a collection of seven handsome gifts you'll be proud to present to friends, children—even yourself. Drawings and construction details make them all easy to fabricate.

BUILD THIS SLEIGH FOR YOUR SNOWMOBILE. Taking the rest of the family along on winter outings will be simple when you hitch this sleigh to your snowmobile. A five-passenger seat down the middle lets riders sit saddle fashion to center the weight over the runners. Complete plans are included.

BUILD A STEREO/BOOKCASE WALL. It's an extremely handsome unit that houses a built-in sound system, a bar, dozens of feet of bookshelves and also cabinets to hold the family's games and puzzles. Presented in color and with complete construction drawings, the unit will make any empty wall in your home really come to life.

How much can one motor oil be expected to do?



This new
one
does it!

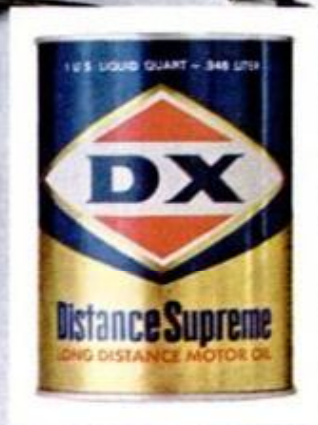

SUNRAY DX OIL COMPANY
*Known by the
customers we keep*

ORDER THESE PM PAINTINGS!

Four outstanding PM illustrations printed in full color on heavy paper suitable for framing.

RACING CARS

The finest painting ever made of racing cars. 32 types in 8 major classes—Championship, Stock, Sports, Formula, GT, Drag, etc. Includes summary of specifications. A great argument settler.

Size: 35 x 23 inches.

\$1.50 each postpaid

SATURN V

The world's biggest rocket.

Size: 19 x 25 inches.

\$1.25 postpaid

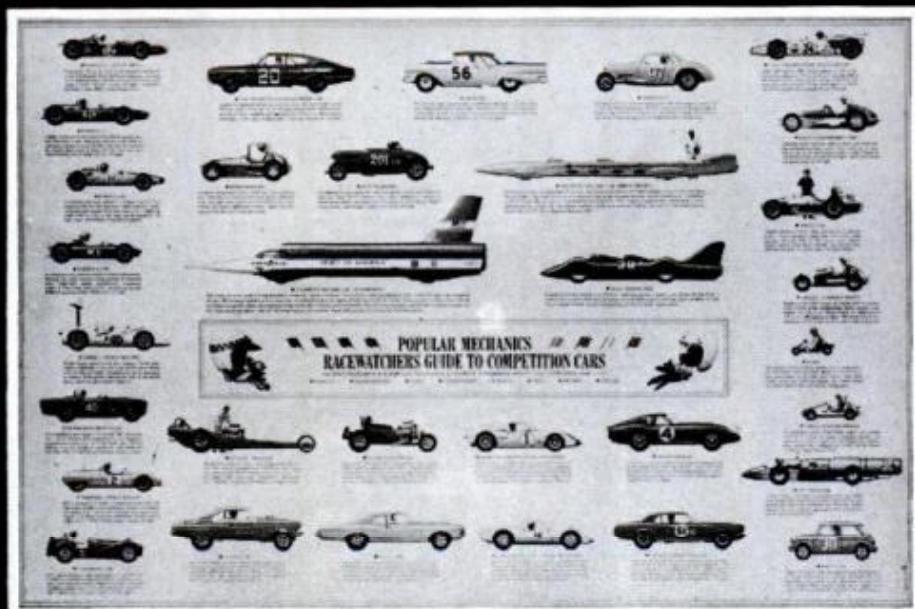

THE SATURN V
LARGEST ROCKET IN THE WORLD
POPULAR MECHANICS
BY GUY WATSON, 1970, 25 INCHES SQUARE



U.S. PLANES IN VIETNAM
POPULAR MECHANICS



U.S. HELICOPTERS IN VIETNAM
POPULAR MECHANICS

VIETNAM COMBAT PAINTINGS

U. S. Planes in Vietnam and U. S. Helicopters in Vietnam. All latest models shown in blazing action.

Each 18 x 24
Both for \$1.95

Use the coupon below to order your paintings.

Pictures, Popular Mechanics, 575 Lexington Ave., New York, N. Y. 10022

Please mail PM paintings as indicated below:

Racing Cars _____ Copies @ \$1.50 ea.

Saturn V _____ Copies @ \$1.25 ea.

Planes and Helicopters _____ Copies @ \$1.95 set

Enclosed find _____

Name _____

Street _____

City _____ State _____ Zip Code _____

Hang on!

Don't make a move
until you've seen
the revolutionary new
Merc 800
and a dozen other
brand-new ideas from
MERCURY/MERCUISER
for 1969!

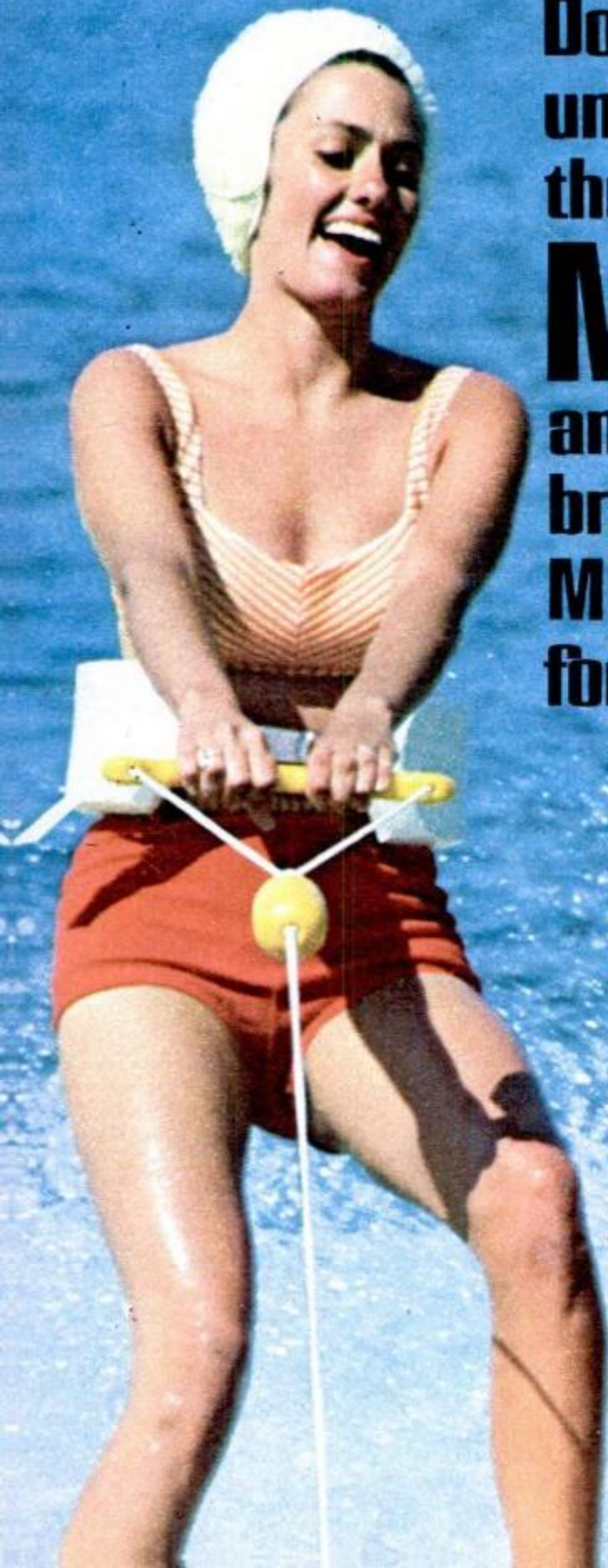

MERCURY/MERCUISER



BRAND NEW 80-hp Merc 800



with a powerhead smaller than a competitor's 55 hp—equals it in fuel economy, yet surpasses competitors' 85 hps in top speed and acceleration! New Merc 800 has revolutionary Direct Flow charging—first new two-cycle charging system design in 40 years! Unlike conventional "loop-scavenging" and cross-flow systems long in use, this exclusive Kiekhaefer development directs the fuel-air charge on a precise course within the cylinder. With Direct Flow, unique transfer passage, port and piston design pinpoints the path of the incoming charge for precisely controlled scavenging under all operating conditions from idle to full throttle. You get this far-in-front engineering and reliability only from Mercury. The exciting new four-in-line Merc 800 is a *Thunderbolt*-fired charger that creates new standards of performance, economy and compactness in the high-horsepower class!

NEW MERC 1250—World's Most Powerful Outboard. This is the champ—the one that picks up all the silver from Nassau to the Salton Sea. Yet she's tame enough for family cruisers, runabouts. *Thunderbolt* ignition, new race-proved components, new fuel economy plus new anti-corrosion treatment add up to the most powerful, dependable champion ever built.

NEW 200-HP MERCUISER Stern Drive with slimline 6-cylinder design (ideal for twin installations) gets 10% more speed and up to 40% better fuel economy at top speeds than its top competitor in the 200-hp class! Power Shift and exclusive Power Trim (trims your boat at all speeds regardless of load or water conditions) come standard.

'69... new models, new features, exciting new performance from the world's top line of marine power!

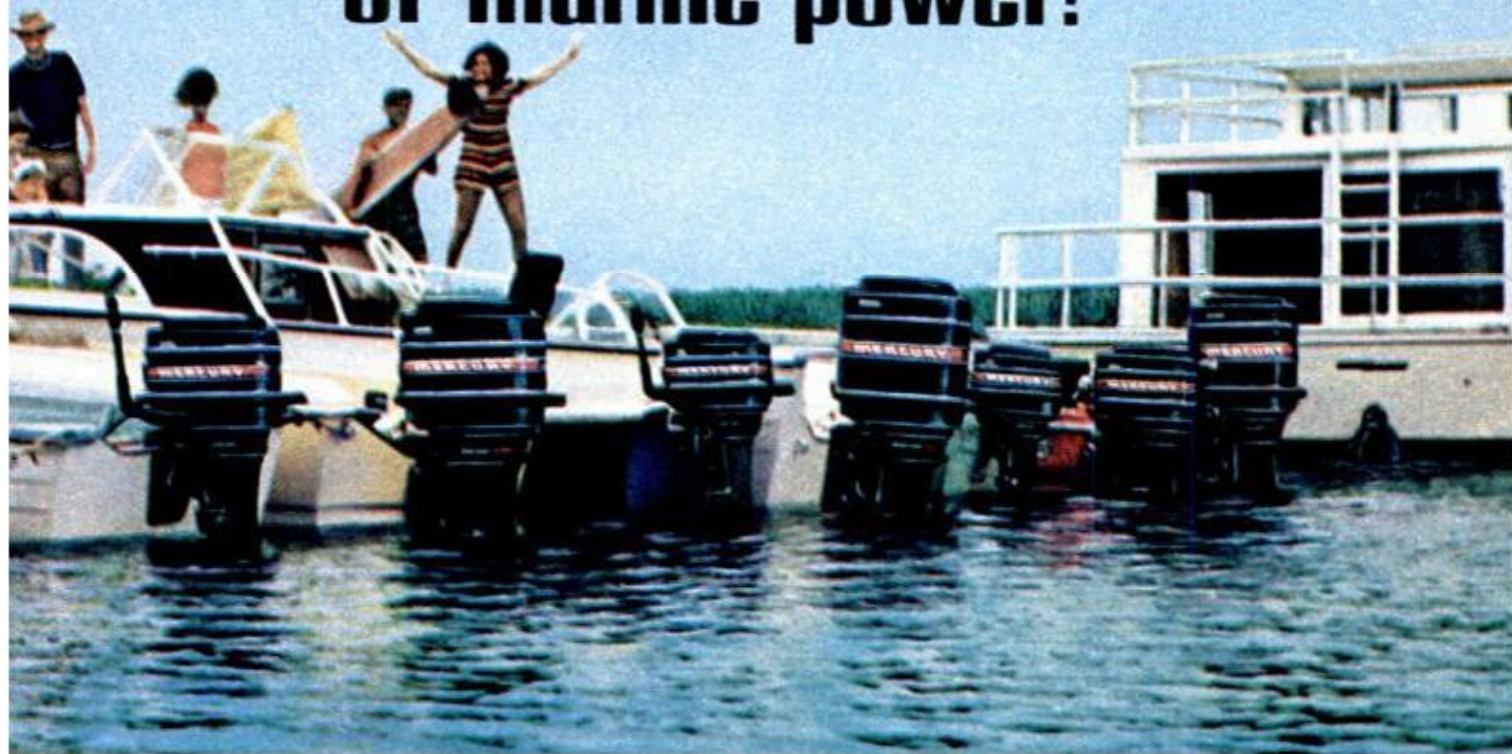

TERRIFIC NEW 7½-HP MERCURY.

Get set for a surprise when you give 'er the gas. Terrific low-end torque comes from a big 10.9 cubic-inch powerhead. Small-bore, short-stroke design is a miser on gas. New fuel pump and water pump let you go where the fish are. One more surprise: you wouldn't dream that a feature-packed 7½ like this could be so light. There's also a new 4-hp Merc fisherman that outruns, outpulls competitive 5 hps without breathing hard.

NEW MERCUISER INBOARDS are the most advanced ever built—from the company that knows how. Designed with automotive quiet, easy maintenance in mind. *Thunderbolt* ignition without breakers, *Quadra-Jet*

carburetion and big constant-lubricating 8-quart oil pan are standard equipment. *MerCruiser stern drives and inboards are serviced by over 2,000 dealers throughout U.S. and Canada.*

PLUS: Thunderbolt ignition without breaker points—standard on every Mercury outboard from 50 hp up, on 250- and 325-hp *MerCruiser* stern drives and on all *MerCruiser* V8 inboards... *MerCruiser III* drive delivers runabout performance on big houseboats and cruisers when teamed with *MerCruiser* V8s. Swings 20" prop. Only *MerCruiser* offers you a choice of 7 stern drive engines and 4 drives... *MerCruiser Power Trim* keeps you riding high and dry in white water, stretches out gas mileage, increases

speed—at the touch of a dash button. Nobody else has anything like it!

MERCURY '69: Engineered to fight corrosion like never before. We took the sting out of saltwater (polluted water, too). All new Mercs are built of a special new aluminum alloy, "XK." We engineered out many corrosion points. Then we added a new paint process that keeps the finish looking showroom fresh years longer. Corrosion resistance, *Thunderbolt* ignition without breakers... fixed-jet carburetors that never need resetting... rugged one-piece lower unit and drive-shaft housings that keep water out, lubrication in—it all adds up to the most dependable, most trouble-free outboards ever built—Mercury for 1969!

The toughest test program in the industry makes Mercury '69 the world's most dependable outboard.

You don't have to be a mechanic to run a Merc. And a big reason you don't is Mercury's unique test program. Four test sites—2 in Florida and 2 in Wisconsin—provide extreme conditions for year-round day-and-night testing. Another important part of our test program is racing. Because we believe

that only under the severe, unpredictable conditions of competition does an engine or a component meet its moment of truth. What we learn testing—and in competition—we put into every Mercury and MerCruiser. We're the experts—so you don't have to be!



In endurance testing the engine continues running through refueling and changing of drivers. In a test like this, Mercury set the world's endurance record: 50,000 miles nonstop in 68½ days at an average speed of 30.3 MPH.



A marathon champion powered by 2 MerCruiser 325-hp stern drives. Mercury and MerCruiser consistently dominate competition. In 30 years, MerCs and MerCruisers have won more races, set more speed and endurance records, than all other outboards and stern drives combined.

Mercury Outboards: 4, 7½, 9.8, 20, 35, 50, 65, 80, 100, 125 hp.

MerCruiser Stern Drives: 120, 140, 160, 200, 225, 250, 325 hp.

MerCruiser Inboard Engines: 200, 225, 250, 325, 390 hp.

MerCruiser Special Option Engines and Stern Drives: 2 liter 130 hp. 120 cubic inch, 3 liter 155 hp. 181 cu. in., 320 hp. 327 cu. in., 425 hp. 427 cu. in. and Bahamas 500 series 482 cu. in.* 475 and 500 hp.

*Up to 500 cu. in. depending on permissible overbore.

The Payoff is Performance!

MERCURY  **MERCRUISER**
FIRST IN MARINE PROPULSION

Kiekhaefer Mercury, Fond du Lac, Wis. Division of Brunswick Corp. Kiekhaefer Mercury of Canada, Ltd. Kiekhaefer Mercury of Australia Pty. Ltd.

YOU'RE ON TROOPER TV

(Continued from page 87)

truck off the road in the process. Hurlburt hit the siren and seconds later a very surprised violator was walking back toward a flashing red light.

"What did I do?" he demanded angrily.

Hurlburt, a lean, good-humored man, smiled gently. "Want to see yourself on TV? Step into my studio."

The guy peered through the window. Hurlburt rewound the tape and started playing it.

"Now look," he said, pointing to the screen. It's said that when a man is dying his whole life flashes by. True or not, the guy looked as if he was dying as the TV screen showed him his last seven miles of driving. The tape even recorded the sound of the siren when Hurlburt stopped him. In fact, he even got to see how he looked as he walked back to our car.

"What's all this for?" he asked.

"I just thought you'd like to see yourself on TV before the judge does," Hurlburt said.

"Okay, Trooper," the guy said. "You win. I must be nuts to drive like that."

Hurlburt agreed, wrote out a ticket, and we went back on the prowl.

Hurlburt was climbing a long, narrow two-lane country road when the camera caught our next "case." Approaching the top of the grade, a car came at Hurlburt like a jet strafing a highway. The guy obviously had it floored. What's more, he was on *Hurlburt's side of the road!* On the viewing screen, the road and surrounding countryside flashed by in a dizzying blur. Hurlburt, braking to evade him, went into a long spin. A former race driver, he caught it, rode it into the ditch. When he came out, he'd done a full 180. And this was all on tape!

"He's gotta be drunk," Hurlburt grunted grimly. He shot up out of the ditch and went after the car. Into the mike around his neck Hurlburt said, "Southbound in pursuit . . . white convertible . . . ran me off the road . . . clock one mile . . . clock two . . . doing 84 . . . 94 . . . I'm stopping him."

It had been a wild ride.

The guy stumbled out of his car and staggered back.

"I'm cold sober," he said thickly, his eyes blank. "I do something?"

"Like run me off the road," Hurlburt said.

"Unh-unh. Not me."

"Want to see what you did?"

Goggle-eyed, the drunk stared at the screen, saw himself come over the hill on

(Please turn to page 204)



The Smart Set.

That describes Kodak's top super 8 movie twosome—the new KODAK INSTAMATIC® M9 Movie Camera and the KODAK INSTAMATIC M95 Movie Projector.

The instant-load M9 movie camera gives you greater movie-making versatility. Battery drive—no winding ever. A wide zoom range—5 to 1. More shooting speeds—four, ranging from 12 to 32 frames per second. Precise through-the-lens viewing, zone focusing, and automatic exposure control. Sports finder, too. And handsome wood-grain vinyl styling.

The M95 movie projector gives you greater movie-showing versatility. It has seven projection speeds—three forward speeds . . . three reverse speeds . . . and a still "speed" when you want to freeze on a single frame. Shows both super 8 movies and 8mm. Has 400-foot reel capacity.

See this smart pair at your Kodak dealer's.

The camera, less than \$230. The self-cased projector, from less than \$200.

Prices subject to change without notice.

Kodak

KNOCK KNOCK

Loose piston pin? Or is it a loose rod bearing?
MOTOR's Manual pinpoints which it is—and helps you fix it fast.

You can't afford guessing games when an auto engine tries to tell you something. That's why MOTOR's Auto Repair Manual tells you exactly what a knock, clatter, ping, or backfire may mean, and then shows you how to fix it fast.

Time-saving tips on sounding out trouble are just one small reason why over 5 million students, beginners, and trained mechanics rely on MOTOR's Auto Repair Manual.

The 1968 edition of this hefty, 1,196-page Manual lets you find and fix almost any car problem quickly and right. It covers Dodge, Chevy, Valiant, Mercury, Imperial, Cadillac, Pontiac, Ford, Buick, Corvette—over 2,300 models of every American car built from 1962 to 1968 (including all the hot '68's like Javelin, Montego, and Torino) plus Volkswagen. Gives tune-up specs for 30 foreign makes. Even has tune-up and front-end alignment data for 1941-1961 cars.

MOTOR's helps make repairs on all these cars practically foolproof. First, a big trouble-shooter section, plus detailed trouble-shooting information throughout, helps you nail down any of 4,200 car problems. Then, nearly 300,000 specs, charts, and "this-is-how" pictures show you exactly where to start work. Which tools to use. What to do on any job, from a simple carb adjustment to a full-scale overhaul.

And all this information is the last word. It comes from the car makers themselves. MOTOR's editors distill hundreds of factory manuals and service bulletins to make sure no repair question goes unanswered.

Just mail the coupon. We'll send you a copy of MOTOR's 1968 Auto Repair Manual to look over and use, free, for 10 days. If you're satisfied, you merely pay \$9.95 plus a few cents shipping. Otherwise, return the book and owe nothing.

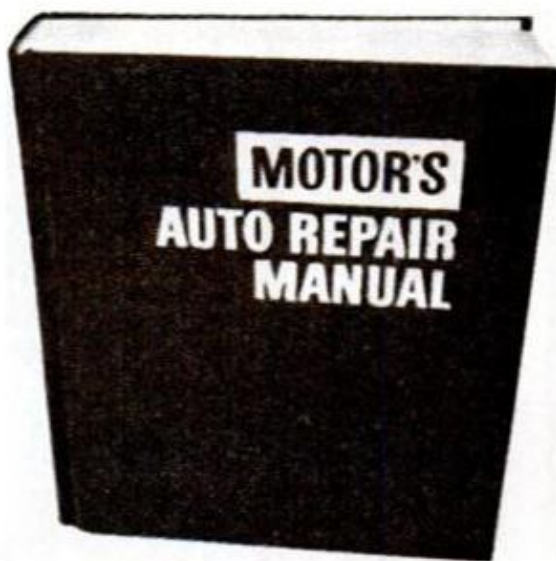

MOTOR Book Dept., Desk 810
250 West 55th St., New York, N. Y. 10019

Please send the book(s) checked below for a free 10-day trial. If I decide to keep the book(s), I'll remit payment as indicated.

MOTOR's Auto Repair Manual. \$9.95, for which I will remit \$2.00 in ten days, \$3.00 monthly for two months, and a final payment of \$1.95 (plus delivery charges and sales tax, if any).

MOTOR's Auto Engines & Electrical Systems. Ideal basic book for students and beginners. Shows exactly how and why engines and electrical systems work. Over 600 pages, 1,300 pictures. \$8.95, for which I will remit \$3.00 in ten days, \$2.00 monthly for two months, and a final payment of \$1.95 (plus delivery charges and sales tax, if any).



Print Name _____ Age _____

Address _____

City _____ State _____ Zip _____

Save money. Check here if you include payment in full for book(s) (\$9.95 for Auto Manual; \$8.95 for Auto Engines). We then pay delivery. Return for refund if not satisfied. Add state, city sales tax, if any.



**Your Aunt Martha borrows it to go antique hunting.
Is she a truck driver?**

No. But then, there's nothing trucky about the new INTERNATIONAL® pickup. Its reputation as the strongest and sturdiest hasn't changed. That will never go out of style.

In fact, style is what the new INTERNATIONAL is all about. It's driving in style. In comfort. So when Aunt Martha takes it for a

spin, or your family takes it on vacation, you have to agree that this pickup is far from a truck.

Now there's an easy swing in the way it handles. Brakes and clutch respond quickly and gently. You can have power brakes, brand new integral power steering, and automatic transmission too. And you can enjoy

unusual comforts in the cab: air conditioning, bucket seats, soft carpeting and stereo.

The new INTERNATIONAL is still a real workhorse. But now it's much more. It's changing people's minds about pickups.

Just ask Aunt Martha.

I. INTERNATIONAL HARVESTER COMPANY
Chicago, Illinois 60611

**The New International Pickup.
Don't call it a truck.**

3 tools that stop leaks permanently.



Now you can waterproof, repair, seal and insulate virtually anything—with these three Silicone rubber sealers from Dow Corning!

Pick the one you need for your job. These are tough sealers, like those developed by Dow Corning to help keep Gemini spacecraft in orbit. All are silicone rubber, so they're guaranteed for ten years against shrinking or cracking.

Whatever the job, there's a Dow Corning® silicone rubber sealer that will get it done. Pick up some today at your hardware, paint supply or specialty store.

Use aluminum Dow Corning® metal sealant for sealing casement and storm windows; gutters, ducts and downspouts; air conditioners and exhaust fan casings; etc.

Use Dow Corning® clear sealer for sealing basement wall cracks; window frames; awnings, tarpaulins, tents; rubber garments; etc.

Use black Dow Corning® glass caulk for sealing headlight gaskets; gas tanks; flashing and roof vents; electrical insulation; models; car tops, windshields.

DOW CORNING

DOW CORNING

YOU'RE ON TROOPER TV

(Continued from page 201)

the wrong side of the road, saw the world spin as Hurlburt evaded him, saw himself chased, saw himself weaving so bad a front wheel wobbled almost out of control, saw himself stopped.

"Gee," the driver said quietly, "I must be stoned."

"Yeah," Hurlburt said, making the official arrest.

For men of Hurlburt's skill and experience, arresting a killer-drunk is almost routine. But it's never easy to convince a judge and jury that this "upstanding, sober citizen here in court with us today" (complete with neat haircut, a freshly pressed suit) could be a potential killer. That's where TV comes in.

"This guy will deny everything tomorrow," Hurlburt pointed out. "He's still so stiff he'll even forget the TV. But wait'll his lawyer sees it."

Later, throughout that day and the next, we nailed the driver of a stolen truck, a second driver whose diesel rig was blowing clouds of thick smoke, another tail-gater, a truck that cut us off, a couple of speeders. In each case the offense and subsequent apprehension was recorded on videotape. In one case—that of the stolen truck—the driver was taken to the nearest police station where the video unit was removed from the car, plugged into a wall socket, and a record made of the suspect being duly advised of his rights. In court, all this presents a powerful argument on the law's behalf.

But use in court of such taped proof of bad and/or illegal driving is only beginning. To date, only two or three courts have admitted videotape as evidence. Yet court acceptance of the tape isn't always necessary.

"Just the fact the tape is there has a tremendous effect on bad drivers," Hurlburt pointed out. He told about a time he chased a speeder only to lose him in traffic. But not before the guy had a chance to see the TV camera and guess that a record was being made of his asinine driving.

"Later, when I got back to my station," Hurlburt said, "the guy came in and gave himself up. He said he figured he couldn't beat a camera. And he couldn't have. I had it all . . . his license number, the year and make of his car, the speed he was traveling, *everything* . . . all on tape.

"What did I do? Well, I was so surprised that the guy gave himself up, I let him off with a warning. I know damn well that's one guy who'll think twice before trying to outrun a cop again." ★★★



When Ford spent \$150,000 creating this experimental car, you can be sure they didn't scrimp on the oil filter.

They used an Autolite filter. Like you buy. About \$4.

This is the experimental Ford Mach II. It took two long years to design and build. It cost over \$150,000.

It is a one-of-a-kind, two-passenger sports car, designed for street and competition use.

The beautiful hand-built Fiberglas body, which stands only 47 inches high, has the kind of aerodynamic lines that predict the look of tomorrow.

The unusual midship-mounted engine gives the car

near-perfect balance—for the kind of performance and handling you'd expect from a foreign racing machine.

And the oil filter? The kind you might not expect. A standard Autolite filter. Exactly the same kind *you* buy.

Why a standard \$4 Autolite oil filter in a \$150,000 experimental car? Because there is no better oil filter. Not at *any* price.

So put this filter in your car. Whatever kind you drive.

Autolite . . . filters, spark plugs, batteries, shock absorbers and complete ignition systems.

Autolite 



Материал подготовлен авторским правод

So easy...even your wife can install this new hardwood floor!

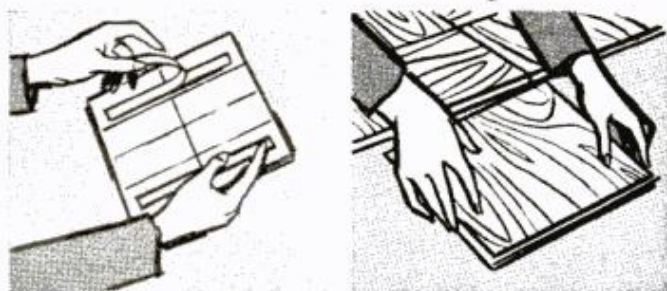

Just peel off film backing and press tile in position

- Lay over old asphalt tile or wood floor, concrete or plywood subfloor
- Self-Stik tape holds floor tile in place permanently—no nailing or messy adhesives required
- Beautiful genuine hardwood (Oak or Pecan) in stylish parquet pattern
- Easy-care Urethane Prefinish (best ever developed) resists wear and stains
- Laminated hardwood is good for a lifetime of hard wear

New, easy beautiful Bruce Self-Stik Hardwood Floor Tiles

See your lumber or building supply dealer



Mail for free literature

E. L. Bruce Co.
1746 Thomas St., Memphis, Tenn. 38101
Send complete data on Bruce Self-Stik Hardwood Tile and other Bruce Floors to:

Name _____

Address _____

A BATTLEWAGON RETURNS

(Continued from page 91)

ton of steel and explosives on its way in a peal of thunder!

The *New Jersey's* 16-inch turret crews—no less than 97 men in each turret—can fire their mammoth shells at a rate of once every 40 seconds, in single shots, multi-gun salvos or broadsides of all nine.

The 16-inchers are the *New Jersey's* offensive power. You'll see a forest of smaller gun barrels huddled around the superstructure—five turrets on each side mounting twin 5-inchers. They're the same kind of gunmounts seen on most destroyers.

"These five-inch mounts give us the equivalent of two and a half destroyers, port and starboard," says Capt. Snyder. These rapid-fire guns can blow a torpedo boat out of the water, or they can shut out the sun with a dense curtain of flak.

Snyder believes the 5-inchers can even protect the *New Jersey* against a missile attack. What if a Russian-made Styx missile like the one that sank an Israeli destroyer in 1966 should come at them?

"We'd shoot it down," says Snyder flatly. "If we didn't hit the missile, the missile would hit the flak."

Maybe. But high in the *New Jersey's* forest of masts and antennas is a big gray oblong box. If you climb that high, signs saying "Security Area" will warn you away. Officially this rig is called "electronic counter-measures." Ask a *New Jersey* officer what that means and you get a blank look. But it's no secret that enemy guidance and homing devices on missiles can be jammed or confused.

At their combat stations are sailors too young to remember when the *New Jersey* was in its heyday. But they're learning fast, thanks to seasoned officers and petty officers who cut their teeth on battleships in World War II and Korea.

As a "gun platform" the *New Jersey* is back at war with a crew of just over 1500—half of the complement she was designed for. Removal of the anti-aircraft batteries accounts for much of the reduction.

"We're confident we can do the job they're giving us," says Capt. Snyder. "But we don't know all the answers. Only time will tell whether the battleship really has a future in this limited role."

Come what may in Vietnam, the Navy expects to keep the *New Jersey* in commission for at least three years, and three other American battleships, all we have left—the *Iowa*, *Missouri* and *Wisconsin*—are still available in the mothball fleet. The museums will have to wait. ★★★

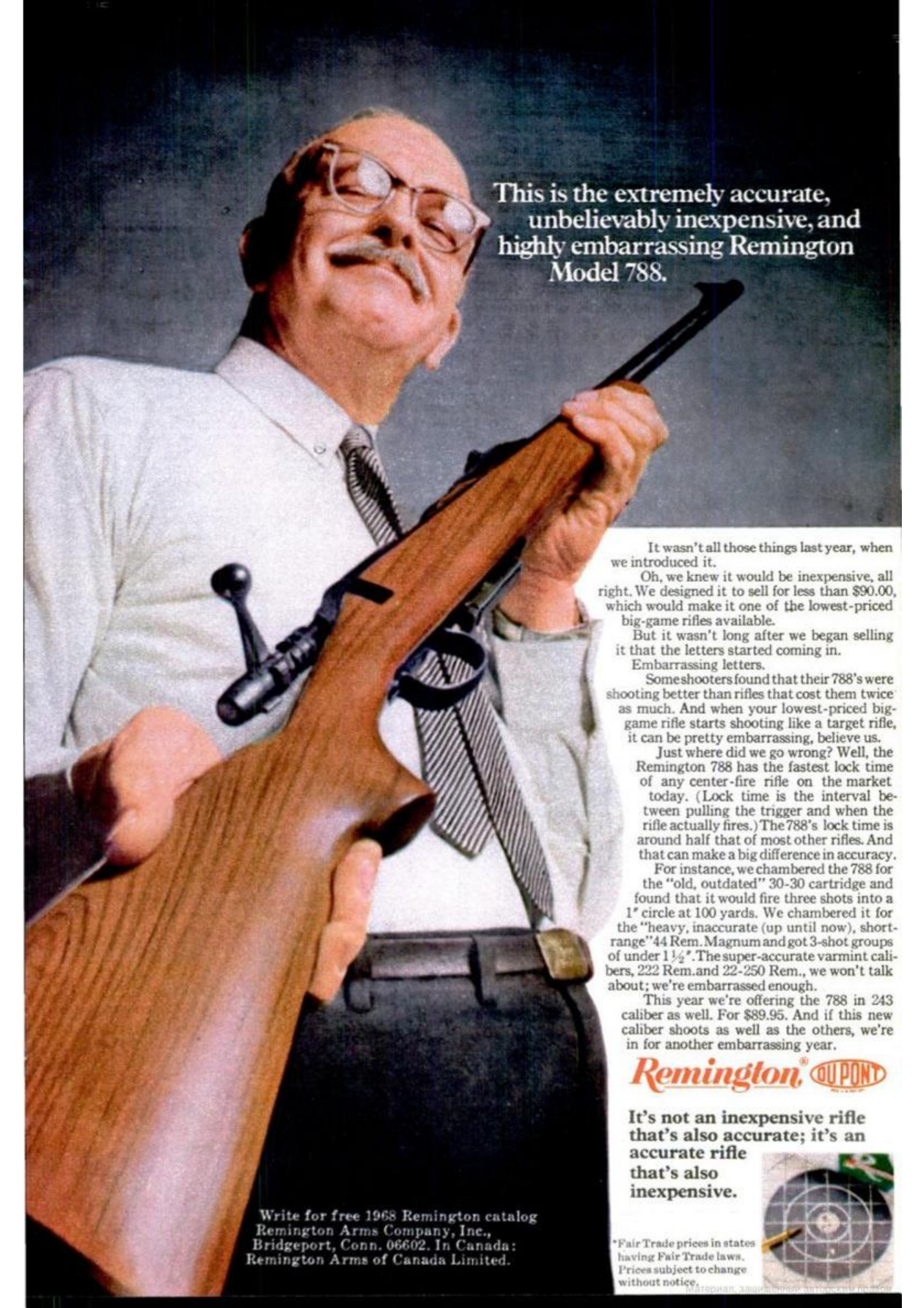
A man with glasses and a mustache, wearing a white dress shirt and a striped tie, is holding a Remington Model 788 rifle. He is looking upwards and to the right with a slight smile. The rifle is a wooden-stocked, bolt-action rifle. The background is a dark, textured wall.

**This is the extremely accurate,
unbelievably inexpensive, and
highly embarrassing Remington
Model 788.**

It wasn't all those things last year, when we introduced it.

Oh, we knew it would be inexpensive, all right. We designed it to sell for less than \$90.00, which would make it one of the lowest-priced big-game rifles available.

But it wasn't long after we began selling it that the letters started coming in. Embarrassing letters.

Someshooters found that their 788's were shooting better than rifles that cost them twice as much. And when your lowest-priced big-game rifle starts shooting like a target rifle, it can be pretty embarrassing, believe us.

Just where did we go wrong? Well, the Remington 788 has the fastest lock time of any center-fire rifle on the market today. (Lock time is the interval between pulling the trigger and when the rifle actually fires.) The 788's lock time is around half that of most other rifles. And that can make a big difference in accuracy.

For instance, we chambered the 788 for the "old, outdated" 30-30 cartridge and found that it would fire three shots into a 1" circle at 100 yards. We chambered it for the "heavy, inaccurate (up until now), short-range" 44 Rem. Magnum and got 3-shot groups of under 1 1/2". The super-accurate varmint calibers, 222 Rem. and 22-250 Rem., we won't talk about; we're embarrassed enough.

This year we're offering the 788 in 243 caliber as well. For \$89.95. And if this new caliber shoots as well as the others, we're in for another embarrassing year.

Remington® 

**It's not an inexpensive rifle
that's also accurate; it's an
accurate rifle
that's also
inexpensive.**



Write for free 1968 Remington catalog
Remington Arms Company, Inc.,
Bridgeport, Conn. 06602. In Canada:
Remington Arms of Canada Limited.

*Fair Trade prices in states
having Fair Trade laws.
Prices subject to change
without notice.

Fox Mini Bike

DO IT YOURSELF
OR FULLY ASSEMBLED

FROM
\$79⁵⁰



12 MODELS
3 TO 5 HP

SEND \$1 FOR BIG CATALOG

Shows new 1968 line of the world's finest **MINI-BIKES** (most are licensable for street use), plus parts, accessories and plans. Big selection! Amazingly low prices! There's a Fox **MINI-BIKE** for everyone — from age 10 and adults.

EXTRA BONUS — Catalog shows radios, watches, walki-talkies, cameras, models, tools, pool tables and many other items you can buy at practically wholesale prices.

FOX CORP., Box 797 PM Janesville, Wis. 53545

Mention **POPULAR MECHANICS**
when writing to advertisers.

From *PM's How-to-Do-It Library*:

6 Easy-to-Build FUN BOATS

- **SAUCY SHINGLE**—Make this fast and rugged 3-point hydro from \$30 worth of materials.
- **POWER OR PEDAL WATER BIKE**—Putt-putt or puff-puff at drop of your paddle wheels.
- **RIBLESS 14-FT. CANOE**—It's fast, light and stable, just perfect for camping trips.
- **WATERBUG**—The midget hand-cranked paddle wheeler that's perfect for your small fry.
- **FEATHERWEIGHT KAYAK**—You carve it out of an 8-ft. block of foam, it's unsinkable.
- **PLATFORM BOAT**—Plans for pontoons and a deck; base for any kind of floating fun.

Construction details for all six of these fun boats are in *PM's* 32-page Booklet H102. For your copy send 50¢ to

Popular Mechanics Bureau of Information,
575 Lexington Ave., New York, N.Y. 10022



3 1/2" x 9 1/4"

Let's Do **LEATHERCRAFT!** HERE'S A GENUINE LEATHER BILLFOLD KIT AS A STARTER

WORTH \$5.00 AFTER YOU
ASSEMBLE AND LACE!

ONLY **50¢** with
coupon
below

ONLY 50¢ IF YOU ACT NOW!

Tandy
LEATHER COMPANY

1001 Foch, Dept. DU, Fort Worth, Texas, 76107

Yes, send me your embossed billfold kit and 112-page catalog. I'm sending 50¢ as full payment. (Limit one per family.)

NAME _____

ADDRESS _____

CITY _____ STATE _____ ZIP _____

ONLY 50¢ IF YOU ACT NOW!

Get all the features of expensive billfolds... hidden money pocket, four-unit card case and two side pockets. Handsome design already embossed. Kit complete. Easy 'n fun to assemble and lace. You'll also receive a 112-page Leathercraft catalog and easy-to-follow instructional manual. **Order yours today!**

the thirst slaker

Falstaff—brewed clear
to drink fresh.
The one that
wets down a thirst
with cold,
foaming flavor.

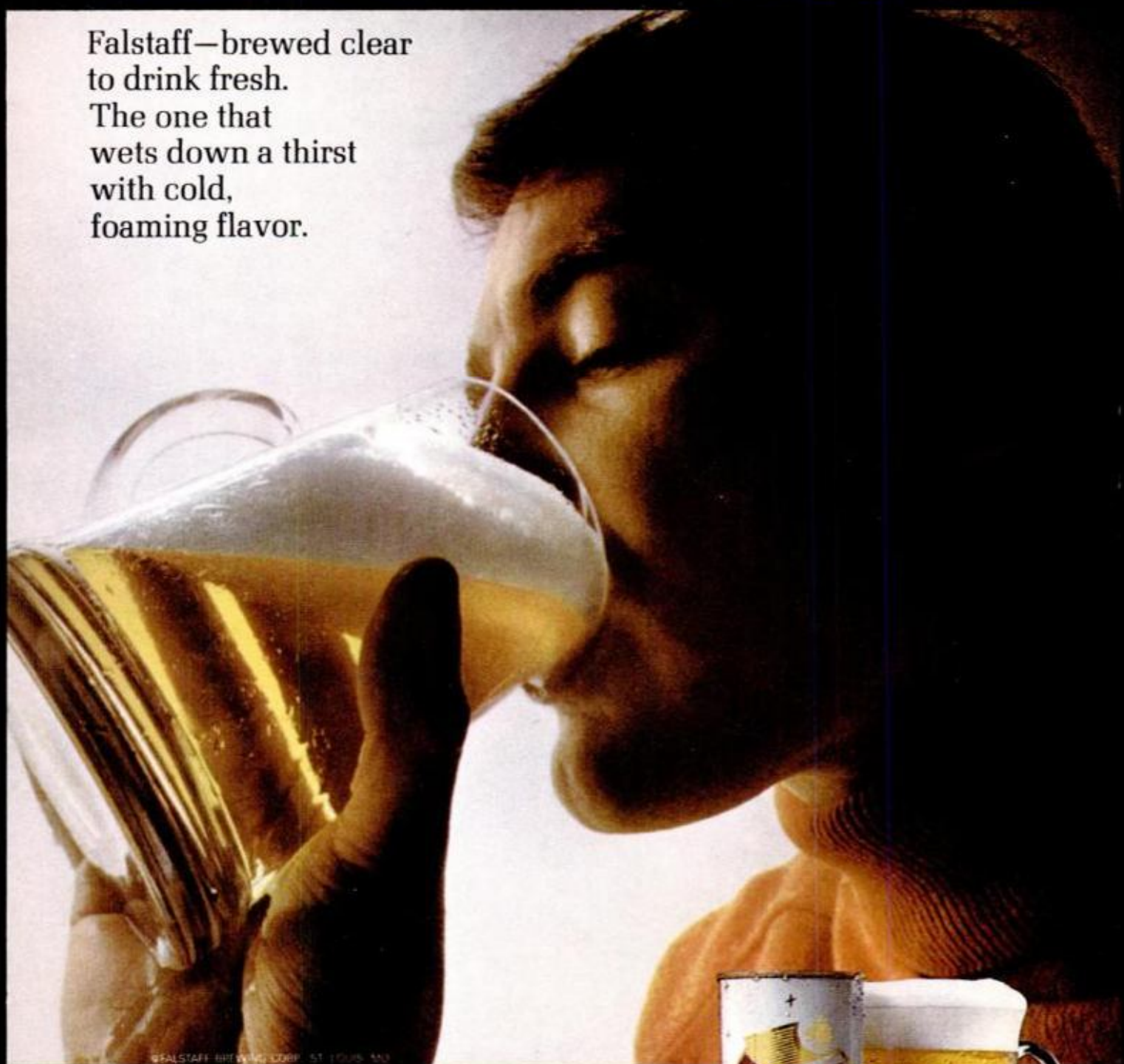

©FALSTAFF BREWING CORP. ST. LOUIS, MO

Falstaff®



from the land of the Ferrari—



THE 1969

ITAL

Jet

TRACK SURPRISE

“THE
COCKY
ONE”

Italian automotive engineering supremacy adds another jewel to its crown.

It's the Ital Jet motorbike. It has won four major awards.

Race it if you wish. You'll bow to few—if any—on the track.

But buy—or rent—an Ital Jet for mechanical perfection. For enduring fine performance. For incredible dependability.

And above all...for value.

There are 12 models in '69. From low-cost 50cc's to comparatively low-cost 350cc's. From \$190 to \$749. Each is a mechanical gem. Each is a wonderful buy.

See your local Ital Jet dealer. Do it soon.

FRANCHISES AVAILABLE

Add up *all these features* you'll see why an
(THE COCKY ONE)

ITAL

Jet

FRANCHISE

should be *your business*
if you want to spend *your time* making money
if you want to convert *your working time* into

CONTINUING PROFITS!!!

write or phone
marketing associates
international corp.

P.O. Box 1067, Buena Vista Station
Miami, Florida 33137
(collect)
(305)
373-6373



DYER PRODUCTS COMPANY

Ital-Jet Motorbike National Distributor

HOMEOWNERS' CLINIC

BY W. CLYDE LAMMEY

Salvaging old bench

I've bought an old, beat-up cabinet-maker's bench for my home workshop. I can repair the legs and rails but the top stumps me. It's good maple, 2½ in. thick but it's been hacked at the edge, chopped into and drilled through in several places along the length. Any suggestions?—P.G., Mich.

Bought new, such a bench would cost you a pretty penny today, so perhaps it's well worth the salvage. At best the top is going to look rather patchy but with good repairs, it should be serviceable for years to come. If the holes are of standard diameters they can be eliminated by driving in dowels that have been dipped in glue, then cutting them off flush at top and bottom.

Neat fitting inserts in those areas that have been "hacked" and "chopped" can challenge your skill as a craftsman but, with care and a razor-sharp chisel, you should be able to bring it off. Use a scribe to mark areas where waste is to be removed, scribing the lines rather deeply so the chips will lift along the scribed lines. Then cut straight down along the lines with the chisel and chip out the waste by making a series of repeat cuts equally spaced in the waste. Square up the bottom and sides of the notch at the edge, then cut inserts from maple for a snug, true fit. Spread glue on these and clamp them in place until the glue has hardened. Then sand or scrape (with a cabinetmaker's scraper) to a smooth surface. Finish with paste wax.

Balky bookcase door

I have a sectional bookcase of the type seen in offices some years ago. One door lacks the fixture, or guide. I can find no name of the maker on the case. Is there some way to fix this door so it will open easily and without jamming?—O.N., Md.

It should be possible to duplicate the guide, assuming that the other sections of the case have the door guides, one of which you could use as a pattern. Usually these are of ¾ x ¼-in. flat steel, and typically, two pieces of a given length are riveted together at the approximate center.

One piece is usually drilled near the end to take a small staple which is driven into the back of the compartment, permitting this piece to pivot. The opposite end of this member is bent to a long radius and passed through a screw eye turned into the back face of the top rail of the door. The second member has both ends bent to a long radius. These bent ends also pass through screw eyes, one turned into the back of the compartment, the other into the back of the top rail of the door. The location of the members in relation to the door, the location of the screw eyes and the staple, and the radius of the bends all must be determined from one of the original guides. The bends should be easy to make in a vise if you are careful not to kink the material.

Paper over insulating planks

I have one room with walls of V-groove insulating planking. The planks are of uniform width with a wood trim at the ceiling and a narrow baseboard. Can I wallpaper over these planks without preparation?—N.R., S.D.

Yes and no. The wallpaper would likely show the grooves and it might pick up the texture of the planks. You might get by using thick paper with a fairly strong overall pattern, but I'm doubtful the result would be entirely satisfactory. In any case you would have to fill the grooves flush with a spackling compound or, perhaps better, the special putty used in plasterboard joints. Even so this would be rather tedious and tricky in a room of any appreciable size. It seems to me it would be better and more satisfactory in the long run to remove the planks and finish the walls with plasterboard—you probably could remove the planks and have the plasterboard on in less time than it would take to fill all the grooves in the planks neatly. Of course, you would have to sand the plasterboard putty joints lightly and size the board before applying the wallpaper but such steps can be finished in a short time.

Sansevieria propagation

How does one propagate new plants from an old sansevieria?—G.C., Va.

You can do it two ways: first, by dividing the old plant, with each division making a new plant. Repot each division in new sandy loam. Second, you can cut old leaves and insert them about half their length in new soil, which is kept moist but never wet. Select the best leaves for this purpose.

★★★

Now! put on a new roof with a paint brush



How? Use it to brush on the colorful magic of Sipes Luma-Tint Paint. One coat of this new paint will insulate, decorate and waterproof your roof.

Sipes Luma-Tint contains pigments of Alcoa Aluminum and comes in many colors. It will add up to 10 years to the life of your roof.

Before you buy a new roof, ask your Sipes Paint dealer about Luma-Tint Paint. Or send the coupon below.

James B. Sipe & Company, Inc.

P.O. Box 8010

Pittsburgh, Penna. 15216

Please send me more information on Sipes Luma-Tint Paint

Name _____

Address _____

City _____ State _____ Zip _____

SIPES LUMA-TINT
colored aluminum paint

HOW TO LAY CONCRETE BLOCKS

(Continued from page 170)

mortar mix (Sakrete, for instance) and simply add water to it.

Mortar should be mixed as wet as you can get it and still have it workable. Workable mortar is buttery, yet sticky. It clings to the trowel, even holds to vertical end-joint surfaces.

A good way to judge if your mortar is the right consistency for block-laying is to see that the blocks hold to the right height while you're laying them. If they sink, add more mix to dry out the mortar. If they have to be pounded down, add more water to the mortar and re-mix. It's important to measure everything, though, so you will be sure of getting the proper mix next time.

If you have to mix the mortar by hand, spread the dry materials on a flat concrete surface or in a mortar box and add about three quarters of the water. Mix these with a hoe until the mortar is uniformly damp, then add the remaining water a little at a time while you continue mixing. Let the batch stand for five minutes. Before use, remix the mortar thoroughly without adding water. Mortar not used within 2½ hours should be discarded. Within that time you can mix in more water with the trowel to retemper the mortar.

Long walls need control joints

The procedure to follow when laying the blocks is detailed in the accompanying photos. However, one thing that can't be overstressed is the importance of control joints in any block wall more than 20 ft. long. As shown in the drawing on page 169, a control joint is a continuous vertical joint from top to bottom which lets the wall change dimension slightly without cracking.

You can use either special control-joint blocks or regular blocks with provision for transferring lateral loads across the joint, as shown in the drawing. Lay up the joint with mortar. Then, before the mortar gets too hard, rake it out to a depth of ¾ in. and fill the joint with an elastic caulking. Be sure to follow the caulking manufacturer's recommendations about priming the surface.

One final precaution: Whatever your project happens to be, make sure you check local building codes before you begin construction. Walls under 4 ft. are usually exempt, but check anyway, just to be on the safe side. Besides, your building officials are familiar with local conditions, and they often can help you get off to a good start.

★★★



more
SOCK
less shock

with the
PLUMB®
FA57

A "Proven Performer"

Swings easy and hits hard.
Dura-Cushion Grip absorbs shock.
And Plumb Fiber-Glass Handles are
guaranteed not to break, bend or
collapse in normal use.

They have been for over 13 years!

Advertised
Price
\$6.49

FAYETTE R. PLUMB, INC.

• PHILADELPHIA, PA. 19137

New process to form ammonia

An ordinary electric current is capable of yielding the electrons necessary to fix nitrogen from the atmosphere to form ammonia, two scientists working at Stanford University have found.

Nitrogen fertilizer is now synthesized, at the rate of about 12 million tons a year, by chemically reacting gaseous nitrogen in the presence of iron, molybdenum or other catalysts at very high temperatures and pressures.

A method that works at room temperatures and pressures with a titanium catalyst was developed by Drs. Eugene E. van Tamelen and Bjorn Akermark.

With cheap electric power available in many countries, the laboratory-proved concept that nitrogen in the air can be converted to ammonia under ambient conditions is very attractive.

Self-destroying beer bottle

A beer bottle that disintegrates when thrown away has been made by Rigello Pak AB, Stockholm. Made of rigid polyvinyl chloride, Saran and a paper sleeve lined with thin aluminum foil and plastic glue, the container is decomposed by sunlight and acids in the soil.

Fewer meteoroids near moon

The density of meteoroids near the moon is about half that near the Earth, according to lunar orbiter data. Over the last 17 months, five satellites have collected information on the rate of penetration of thin beryllium-copper sheets by meteoroids. The rate of penetration near the moon is half that near Earth, report Drs. C. A. Gurtler and Gary W. Grew of Langley Research Center in Hampton, Va.

'69 OUTBOARDS

(Continued from page 94)

best features of the cross-scavenging (bump piston head) system and the loop-scavenging (flat piston head) system. (Scavenging is the process of replacing burnt gases after a firing stroke with a fresh charge in the cylinders.) Mercury engineers say the new Direct Flow system will give more miles per gallon and claim the 80-hp Merc 800 will outrun, and out-accelerate 85-hp motors with the fuel economy of 55-hp outboards.

Throughout Mercury's entire line of 26 models in 10 power classes, a new aluminum alloy called "XK" is being used. This and new anticorrosion finishes improve corrosion resistance.

Mercury is also adding a 7½-hp outboard. While dropping the 6-hp, Mercury has increased the horsepower rating of last year's 3.9 to 4 this season.

Still in the Merc line are the 125-hp Merc 1250, 100-hp Merc 500, 35-hp Merc 350, 20-hp Merc 200 and 9.8-hp Merc 110.

Other highlights on Mercury outboards are Shallow-Water Slant on the Merc 110, Merc 75 and Merc 40 models; elimination of fuel bleed from the crankcase on all models from the Merc 500 up; non-fouling water pumps with large spring-loaded valves on all models.

Chrysler has big news this season with its introduction of four new horsepower ratings, topped by the three-cylinder, 85 hp engine. It's the only three-cylinder outboard on the market in this horsepower rating.

Also new at Chrysler are the 70-hp, 7-hp and 5-hp motors. It has dropped last year's 75-hp model to make room for the new 70 and 85-hp models—both are three-cylinder with 72.39 cu.-in. displacement.

Chrysler is also adding its capacitor-discharge ignition system, called Magnapower, to the 55-hp models. This is already on the top-of-the-line 105-hp, and the 85-hp and 70-hp models.

In the compact, low-profile class, Chrysler is adding 7-hp and 5-hp models. These are upgrades from last year's 4.4-hp and 6.6-hp outboards used by fishermen.

Chrysler is making improvements on the rest of the line—35-hp, 20-hp, 9.9-hp and 3.5 hp. All in all, there are 39 outboard models in 11 horsepower classes.

Evinrude is making a big splash with a line of outboards from 115-hp down to the popular 1½-hp. New to the line is a 25-hp Sportster, which sportsmen can use for many big-power applications.

Evinrude's Lightwin and Yachtwin models, rated at 3 hp last year, have been com-

pletely redesigned to increase their rating to 4 hp.

At the high end of the line is the Starflite 115-S. This V4 engine has a new fuel-induction system and a new exhaust deflector which increase engine efficiency. The midsection features a sound-sealing layer of water between the inner and outer exhaust housings. Drag has been cut by the design of a one piece die-cast gear case. This big baby has electro-hydraulic drive that locks automatically in forward drive should there be a malfunction in the shift mechanism.

The Starlite 85 is virtually a twin to the 115, except for lower horsepower. Both these engines are physically smaller than Evinrude's 100-hp of last year.

Evinrude's 55-hp Triumph, introduced last year, has new-type piston rings this year to reduce friction and for higher power. New rings are also featured in the 18 hp Fastwin. To eliminate electrical failures that may be caused by corrosion, the electric-start 33-hp and 40-hp models are equipped with a new sealed electrical connector.

The 1½-hp Mate is available only in 15-inch shaft length, while the 115-S and 85 have only a 20-inch shaft length. All other models come with either a 15 or 20-inch shaft.

Evinrude has dropped the 5-hp and 3-hp models in favor of the new 4-hp.

Yamaha's new 15-hp will be the top-of-the-line for now. This motor will be added to the existing Yamaha models already in distribution (*Outboards from Yamaha?*, page 122, July '68 PM). These are the 7.5-hp, 5-hp and the 3.5 hp. Both the 7.5 hp and the 5-hp will be equipped with metered oil systems. ★★★

CALL OF THE WILD

(Continued from page 126)

callers on the market. The price may vary from as little as \$1 or \$1.50 for a rubber diaphragm turkey caller to \$15 for a deluxe, imported wood, goose or duck caller.

One basic thing you should remember is that not all callers are good. Some are better at frightening game away than attracting it. If possible, try them out before you buy. And try them outside; using them inside a shop doesn't give you the true sound. Standard models by nationally known manufacturers are likely to be fair to good, but there are definitely outstanding makes in every category. You find out which these are only by trial and error, or by asking a local expert to try the call and give you his opinion. ★★★

FIX your appliances,
car,
house,

SAVE

on home improvements,
air conditioning,
power tools and more

WITH THIS

FREE \$3.49
VALUE
GIFT VOLUME

Just look back over the past few years and figure how much you have spent on repairs for your home, your car, your appliances. Wouldn't you like to keep these high-priced repair fees for yourself? Well, now you can.

As a reader of *Popular Mechanics* the chances are that you already have a considerable degree of skill with tools. Nevertheless, you may have hesitated to tackle more complicated repairs, improvements or hobby projects.

Now, however, this FREE Book—packed with the combined skill and know-how of 257 *Popular Mechanics* expert editors, consultants and designers—can put a professional edge on your do-it-yourself skills.

The most difficult jobs will soon become easy

Before you know it, you'll be able to fix car engine troubles... transform unfinished attic space into an extra bedroom... catch more fish using homemade lures... learn "tricks-of-the-trade" in handling power tools... save hundreds of dollars when buying and servicing appliances.

These are just a few of more than 6,000 exciting "how-to" ideas, plans, and valuable projects you'll find in *POPULAR MECHANICS DO-IT-YOURSELF ENCYCLOPEDIA*. You'll learn how to get more professional-looking results than ever before in your carpentry, metalwork, plumbing, masonry, electrical wiring, electronics, hi-fi, stereo, car repair, painting, decorating... PLUS exciting new ways to help you get more fun out of your hobbies, sports, vacations. Experts lead you step-by-step through every project you select. Without question, here is the most helpful, reliable, "how-to-do-it" guide you've ever seen—and Volume 1—a \$3.49 value—is yours ENTIRELY FREE!

You risk nothing on this FREE Book offer!

As soon as your gift book comes, browse through it—try some of the exciting ideas—use some of the money-saving tips. We're sure you'll get so much valuable help from this book, you'll want to see the other volumes as they are published. You can see future volumes without risk—on a 14-day FREE TRIAL basis. But this first volume is yours as an outright gift—whether you buy one, two, five, the whole set, or none at all. But please hurry. Our supply of gift volumes is definitely limited. To be sure of getting your copy FREE, mail the coupon today.

Here is a brief glimpse of all your FREE Volume brings you:

- Fix 8 common car engine problems and save garage fees
- Save money air conditioning your entire home
- Cure a wet basement and save \$200 to \$2,000 under what professionals charge
- Burglarproof your home with special power alarm
- Professional tips for expert sanding
- Learn arc welding basics in 6 hours of easy practice
- How to save on band saw blade costs by making your own
- Build a gas-fired barbecue for more back-yard fun

PLUS much, much more

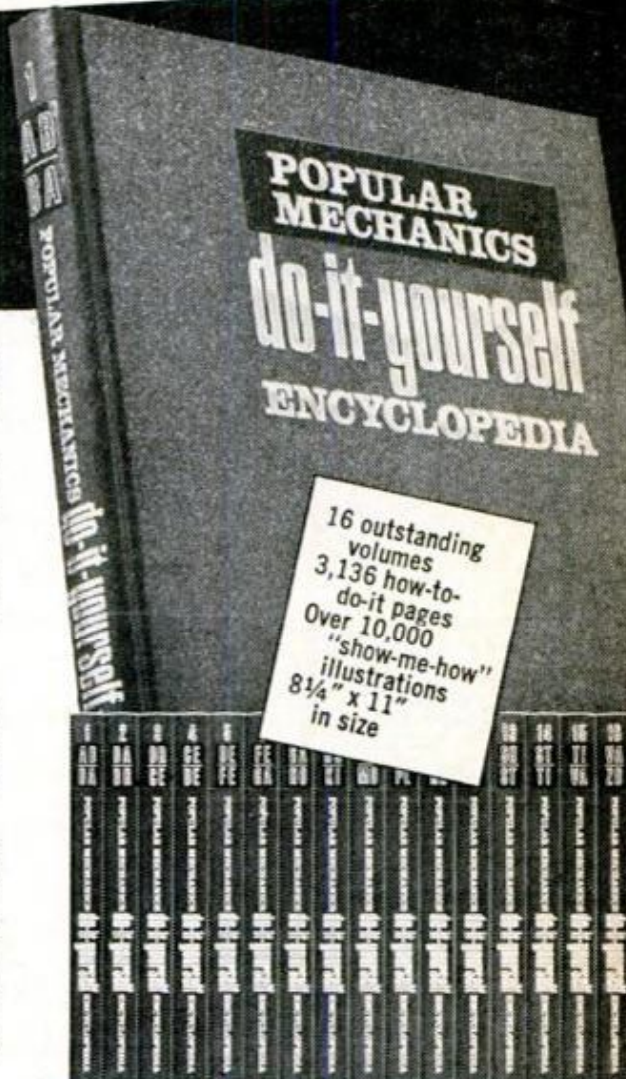

MAIL COUPON TODAY!

Popular Mechanics Book Division, Dept. B610
250 West 55th Street, New York, N.Y. 10019

Please send me, ENTIRELY FREE of any charge, my complimentary copy of Volume One of the all-new, illustrated *POPULAR MECHANICS DO-IT-YOURSELF ENCYCLOPEDIA*. I am not obligated to buy anything—now or later.

I understand I will be entitled to receive additional volumes for my FREE EXAMINATION as they are published each month. After examining each volume FREE for 14 days, I will either return it and owe nothing—or keep it and remit low subscriber price of only \$3.49 a volume, plus a few cents for shipping.

I reserve the right to cancel any time I wish—even immediately after receiving my FREE Volume 1—without obligation. Whatever I decide, Volume 1 is mine to keep FREE.

Name _____
(Please Print)

Address _____

City _____

State _____ Zip

Signature _____

free

The U.S. PROFIT PROGRAM...
A TESTED PROGRAM FOR A PROFITABLE
Business of Your Own!
"Mail-Order Distributorship"



*Book Size — 8½" x 11"
100 Pages — 24 Chapters

MAKE MONEY BY MAIL

TAKE THIS MONEY-MAKING 100 PAGE BOOK, FILLED WITH 24 COMPLETELY ILLUSTRATED CHAPTERS AND HUNDREDS OF MERCHANDISING IDEAS, FACTS AND PHOTOS—IT'S YOURS ABSOLUTELY FREE.

Nothing like this has ever been published...until NOW. This Book tells and shows everything you need to know about building up a profitable Mail-Order Business Of Your Own—In Spare Time or Full Time!

Why do we give you this fascinating book FREE?—Because it's our way of introducing you to the newest and most successful of all small businesses...An unusual business where mail orders pour in daily with cash in every envelope.

Here's your chance to get all the facts and CASH IN on the Booming Billion Dollar Leisure Home Market. No Selling—No Canvassing—No Equipment to buy—No Fees of any kind... **YOU DO NOT SELL HOMES!**

All we need is your name and address—if you act promptly while the supply lasts, we will send you this valuable Money-Making Book...at absolutely NO COST! Write to:

U.S. RUSTIC CEDAR HOMES, INC.—Book Dept.
3440 WILSHIRE BOULEVARD, LOS ANGELES, CALIF. 90005

**NEW MONEY MAKING BOOK NOW READY TO MAIL
TELL US WHERE TO SEND YOUR FREE COPY!
SEND NO MONEY—NO OBLIGATION—NO SALESMAN WILL CALL**

The original "Wedge-Type" screwdriver

QUICK-WEDGE®
SCREWHOLDING SCREWDRIVER

Just ONE
Screwdriver
does all the job!

**HOLDS
STARTS
DRIVES AND
SETS** THE SCREW
to normal tightness!
Only QUICK-WEDGE
does the whole job —
GET A SET TODAY!

At Your Dealers or Write

KEDMAN COMPANY

P. O. Box 267 Salt Lake City, Utah 84110

© 1968 by Kedman Co.

\$20,000 In 6 Months

Joe Miller, Duncan, Okla., averages \$20,000 working 6 months a year as a storm loss adjuster. No college or experience to start. He learned how in spare time at home for 33 cents a day. Income far above average. Check your opportunities in this amazing field. Send for FREE BOOK of facts. No obligation. V.A. Approved. Write Universal Schools, 6801 Hillcrest, Dallas, Texas 75205 Dept. PM-69

**MAKE
MONEY!
REPAIR
HYDRAULIC
JACKS**



Earn while you learn at home. Millions of jacks in gas and auto service stations, trucking firms, body shops, riggers, factories and farms need servicing... most of which you can learn to repair. We show you HOW. Start spare time in your basement or garage. Big opportunity for mechanics. ACT NOW!
Write for Folder P10 and Free Bonus Offer

Hydraulic Jack Repair Manual Co., Inc.
P.O. BOX 3 • STATEN ISLAND, N.Y. 10314



**BIG BOSS
WELDER**

110V 29⁹⁵
Post Paid

The big, FULL SIZE arc welder for home, shop, industry. Powerful but portable. Carry it with one hand. Handsome, rugged, dependable. Heavy duty FULL POWER circuit for welding most anything made of metal. Plugs into any 110V outlet. EASY TO USE! No experience necessary. Just follow simple DIRECTIONS. MULTIPLE HEAT SELECTION. Uses standard ¼" rods. 5 year guarantee. NOTHING ELSE TO BUY! Comes complete with helmet, rods, flux, all attachments. Send only \$3.00 and pay \$29.95 plus small C.O.D. when delivered or send \$29.95 and we ship postpaid. BIG BOSS WELDER, Dept. BWS Box 10947, Houston, Texas 77018.

**VYTRON
INTRODUCES**

THE FOTOLUX SPECIAL



CAMERA 68—The better insta-cartridge-loading job; Sports 2.8 Nordinar lens, 4 shutter-speeds, iris steps down F/22; zone focusing, easy-set controls, lever-wind, fully synchronized flash-cube automatic, battery compartment, accessory shoe w. center contact (hot shoe) for electronic flash Starlux-16, price for camera 68 . . . \$25.95 ppd. Battery Mallory PX-23 . . . \$.85. Genuine leather case . . . \$5.50. (Not shown.)
STARLUX-16—The smallest yet full power electronic flash; Guide No. Kodachr. II: 40; Built In: Recharger, exposure computer, ready light, open-flash button, nickel-cadmium battery for continuous use & recharge; comes with AC-cord, PC-adaptor, lined leatherette case. Price, complete unit . . . \$35.95 ppd. **SLIDEVIEWER**—The collapsible handy viewer for all 2x2 slides. "Miniscope" . . . \$.98.

Get all 5 items as described above, for only \$59.00.

Problems, anyone? (photographic-wise), here is our free advice & question-answering service, given by a longtime pro, to each of our customers. Yours for the asking.

**VYTRON SPECIAL BONUS
(W. EVERY PURCHASE)**

Just include self-addressed stamped envelope.

Want to do your own developing? Get our famous developing tank. Stack of 2 reels; all film sizes, easy-load feeder; fast fill/drain price f. complete unit . . . \$6.95. Want to do your own slide mounting? Get our sensational slide binding machine, genuine breakthrough for the do-it-yourself of color films; with it you transport, illuminate, view (enlarged), edit, cut, mount—all in one operation; never touch the film; double cutting action lets you mount only those you choose; diaperfecter, complete with lamp, optics, blades, AC-cord . . . \$22.95 ppd. Slide mounts, for above, xtrathin, plastic, re-usable, easy-write-on area, fit all 2x2 projectors, price, w/o glasses \$4.50 p. 100 ea. price, with glasses \$8.00 p. 100 ea. More cameras, flash models, mini-binoculars, and other fine products, info upon request, everything from West Germany. Check or M.O.; \$5.00 deposit f. C.O.D., f. items under \$10.00 add postage.



VYTRON CO.

P.O. Box 832
Amityville, N.Y. 11701
Phone: (516) 691-0624

Tear Out & Mail. No Letter Needed!

Free New Catalog 2000 Novelties

Send for world famous catalog of novelties, live animals, scientific supplies, hobbies, funmakers, planes & boats, looms, magic tricks, joke articles, unusual seeds, gadget timesavers, cameras, optical goods, projectors, movies, lucky jewelry, religious novelties, disguises, musical instruments, stamps, coins, puzzles, fortune tellers, radios, auto & bike accessories, telescopes, magnifiers, compasses, banks, smokers' gadgets, artists supplies, printing sets, engines, motors, shockers, knives, billfolds, fireworks, guns, rifles, sports, books, games, plants, etc. Send postcard or this ad. No letter needed!

CHECK HERE YES—I want FREE Catalog. My Name & Address Attached or on Envelope

Johnson Smith Co., Dept. 353, Detroit, Mich. 48224

2,000 Wood CATALOG & MANUAL

Hard-to-find PRODUCTS for easier...better woodworking!
 Discover! Enjoy! Benefit from newest products and ideas in Constantine's big picture-packed Manual. Wood headquarters since 1812. Largest selection of world's most beautiful cabinet lumber, veneers, plywood, inlays, moldings. Woods in natural color. Tool bargains. Furn. hdwe. Finishing & upholstery supplies. Fabulous glue that needs no clamps! Instructions. Everything. Unsurpassed values. Send 25¢ now for your copy. TEAR OUT AD.



ALBERT CONSTANTINE AND SON, INC.
2050 Eastchester Rd., Bronx N.Y. 10461 Dept. P-5
Enclosed 25¢ for new Constantine Catalog-Manual.



NAME.....
ADDRESS.....

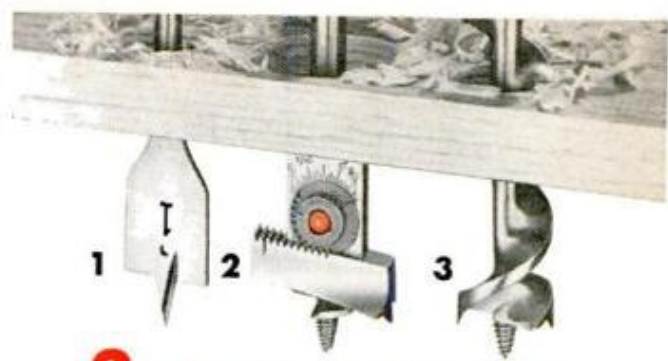

3 easy ways to bore holes faster

- 1. Irwin Speedbor "88"** for all electric drills. Bores faster in any wood at any angle. Sizes 1/4" to 3/16", \$.85 each. 5/8" to 1", \$.95 each. 1 1/8" to 1 1/2", \$1.50 each.
 - 2. Irwin No. 22 Micro-Dial** expansive bit. Fits all hand braces. Just dial your size. Bores 35 standard holes, 7/8" to 3". Only \$5.00. No. 21 small size bores 19 standard holes, 5/8" to 1 3/4". Only \$4.50.
 - 3. Irwin 62T Solid Center** hand brace type. Only 16 turns to bore 1" holes through 1" wood. Double-cutter boring action. Sizes 1/4" to 1 1/2". As low as \$1.45 each.
- EVERY IRWIN BIT** made of high analysis tool steel, heat tempered, machine-sharpened and highly polished, too. Buy from your independent hardware, building supply or lumber dealer.

Strait-Line Chalk Line Reel Box
only \$1.35 for 50 ft. size
New and improved Irwin self-chalking design. Durable aluminum alloy box. Practically damage-proof. Fits pocket or hand. 50 ft. and 100 ft. sizes.



IRWIN every bit as good as the name
at Wilmington, Ohio, since 1885



EARN HIGH WAGES as a HEAVY EQUIPMENT OPERATOR

Train your way to high pay in the booming construction industry! Learn the skills you need to qualify, by actual field training on machines like the ones used by the industry. Huge training grounds in North Carolina, a million dollars worth of school-owned diesel-engined machines, experienced instructors, full 220-hour and 440-hour courses. National, the original school of heavy equipment operation, is a recognized leader. Member American Road Builders Assn., Services and Supply Division. Associate Member A.G.C. Full-time Job Advisory and Counseling Director on staff. VA approved. For men ages 17 to 56. Train Now-Pay Later plan . . . other payment plans also available. Write TODAY for FREE catalog and FREE copy of school newspaper reporting news of National School graduates. Accredited member NATTS.

NATIONAL SCHOOL OF HEAVY EQUIPMENT OPERATION, Dept. D-20
P. O. Box 1686, Moores Chapel Road, Charlotte, N. C. 28201

Please send me FREE illustrated school catalog and complete information. I understand there's no obligation.

Name..... Age.....
Address..... Phone.....
City..... State..... Zip Code.....

'69 FAMILY CARS

(Continued from page 102)

side glass is rounded toward the extreme, and sills tuck under sharply. Standard power on the Polara is a 318-cu.-in. V8, on the Monaco a 383. A new "air spoiler" has been integrated into the roof of the station wagons, the idea being to deflect air down and over the rear window to help keep it clean.

FORD: You can buy a full-size Ford as a Custom, a Custom 500, a Galaxie 500, an XL, and an LTD, the main differences being—from the Custom up to the LTD—progressively more luxurious appointments and trim and hotter performance options. The entire line has been restyled, adding two inches to the wheelbase, a fraction to overall length, and one inch to front track, two in back. Grilles have been changed, and there's a new "cockpit" instrument panel featuring what Ford calls a "control center." Windshields have been slanted back 5°. The new Galaxie 500 fast-back features a tunneled backlight (a rear window when I was a boy). In Ford's convertibles, a new top-folding mechanism makes possible a wider rear seat by doing away with side linkage. Headlights on the XL and LTD are hidden.

A nice, cleanly styled, well-done lineup. **MERCURY:** Going all-out in the full-size field for '69, Mercury is offering a maze of models and options. At the top of the line are the Marquis and Marquis Brougham, both of which look like small Lincoln Continentals. Length overall is up four inches over last year's Marquis, wheelbase up one. Standard two-bbl. power is Ford's new 429-cu.-in. V8. Next in line is the new Marauder and its spin-off Marauder X-100. The concept is luxury plus performance. Front-end styling is again a takeoff on the Continental. In back it's a tunneled semifastback featuring hardtop overtones and a special matte finish over the entire rear deck.

This last thing you're going to either hate or think great. The 429 two-bbl. engine is standard on the Marauder, a four-bbl. 429 on the X-100. At the low end of the line are the Monterey and Monterey Custom. The Montclair and Park Lane have been dropped. Again the Lincoln styling hand is in evidence, but the car has an appearance continuity with previous Mercurys. The grille is new and the car is longer and wider. Standard power is a 390-cu.-in. V8.

The Mercury marque is 30 years old this year and these '69s add up to an appropriate and stylish celebration.

OLDSMOBILE: All cars in the "88" family are Deltas—a Delta, a Delta Custom, and

a Delta Royale (auto purists will probably object to this pirated allusion to the late Ettore Bugatti's elegant creation). And, as with the bigger "98s," styling is distinctly Cadillac-ish, the main difference being, of course, size, plus a grille only slightly revised from last year. Wheelbase is up an inch, as is overall length. You can get a hardtop coupe, a Holiday or Town sedan, and a convertible in the Delta, the same but no convertible in the Custom, and only a hardtop coupe in the Royale. The engine lineup has been carried over and transmissions are either three-speed manual or automatic.

The cars have a nice attention-to-detail look characteristic of the entire Olds line.

PLYMOUTH: A new grille, new headlight arrangement (horizontal rather than vertical), new bumpers front and back, new sheet metal, and new rear end styling mark the new full-size Plymouths. Available as Fury I, II, III, Sport Fury, VIP, Suburban, Custom Suburban, and Sport Suburban, the model lineup totals 17. Overall length is up almost two inches, as is overall width. Wheelbase is up one inch to 120. Interior dimensions have been increased. Windshield wipers are recessed. If you order airconditioning, you get ventless windows. Otherwise, vents. Hooray! Engine availability ranges from a 225-cu.-in. Six to a high-performance 440 V8. Transmissions are a manual three-speed and an automatic.

I said earlier Chrysler was coming on. The Plymouths support the contention.

PONTIAC: Sixteen models are offered here in three series—Catalina, Executive, Bonneville. There's a Ventura version of the Catalina, a Brougham of the Bonneville. All have been restyled, albeit not radically, all are on slightly longer wheelbases, all are fractionally wider. With the exception of the Executive, which remains as is, all are longer overall. Front track has been increased one inch to 64. Rear track remains at 64. The Bonneville has been given a different grille to set them apart from other full-size Pontiacs. In the three series you can get a two-door hardtop, a four-door sedan or hardtop, and two- or three-seat wagons (no two-seater in the Bonneville). Convertibles are available as either Catalinas or Bonneville, but you can't get the Ventura trim option on the Catalina convertible. Standard power on the Bonneville is a 428-cu.-in. V8, a 400 V8 on the others. However, the 428 is an option on the Catalina and Executive. Transmissions include a manual three-speed, a manual four-speed, and a Turbo Hydra-Matic automatic.

I think you'll like these cars. Pontiac did its customary nice job.—Bill Kilpatrick

Mercury. Takes you out of winter hibernation.

Explode into a winter you never knew existed. Enjoy the rich, clean, exhilarating winter-conditioned air. Here's the new Mercury snow vehicle. It's for leveling hills. Blitzing through drifts. Discovering new trails. Another leader from Mercury engineering.

See your Mercury outboard dealer for a test ride. You'll never spend another winter holed up at home.

It's the best thing that's happened to winter since spring.

'69 Mercury. The winter fun vehicle.



Mercury.

Built better inside to run better outside.

Sports styling.

Chassis is sturdy lightweight reinforced aluminum. All parts are specially treated to resist rust and corrosion. The split fiberglass cowl lays low to the ground to give Mercury a long, lean, racer look.

Thunderbolt ignition.

Thunderbolt ignition for the first time ever on a 2-cylinder engine. Can deliver up to 40,000 volts for quick starts in any temperature. Spark plugs last for seasons with Thunderbolt . . . the ultimate in ignition. Only Mercury has it.

Mercury-built engine.

This 25-hp alternate-firing twin runs smoothly and quietly. Small-bore, short-stroke, in-line design minimizes engine wear. Fuel-air mixture stays constant with fixed-jet carburetion. Never needs resetting. Parts are as close as your Mercury snow vehicle dealer.



Hill-leveling traction.

An exclusive steel cable reinforced rubber track bends easily from front to back but not crossways. This allows the track to hold its course and its life. And it gives you better flotation.

Easy handling.

A precise balance between skis and track makes Mercury extra responsive. Skis tilt to make turning easier. Mercury's extra strength steering system withstood thousands of miles of rugged Kiekhaefer testing for utmost reliability.

'69 Mercury.
The winter fun vehicle.

Now at your Mercury dealer...from the world leader in outboards.



FIRST IN MARINE PROPULSION

R-2 Kiekhaefer Mercury, Fond du Lac, Wis. Division of Brunswick Corp. Kiekhaefer Mercury of Canada, Ltd. Kiekhaefer Mercury of Australia Pty. Ltd.

Материал, защищенный авторскими правами

For Sparetime or Full Time
Income, There's Good

MONEY IN SHARPENING

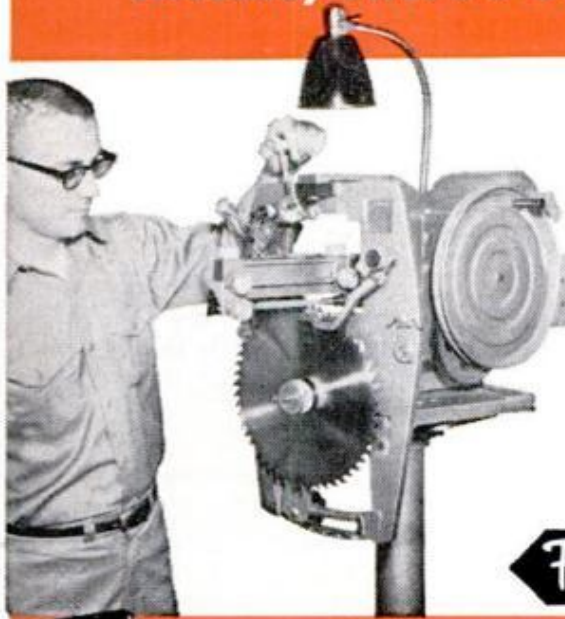

Here's a proven practical way to earn extra dollars in spare time—to develop a money-making repair business of your own. Investment is small. There's no overhead, no stock of goods to carry. No experience needed, no canvassing. You do it with the famous Foley Saw Filer that automatically sharpens all kinds of saws—and the Modern Lawn Mower Sharpener that precision sharpens all types of mowers.

EARN \$3 TO \$6 AN HOUR SPARETIME

Hundreds of people like yourself are making cash like this—\$20 to \$30 a week—right now in spare time. "My spare time saw filing business has made me \$952 these first ten months"—says R. T. Chapman. Many have built a complete sharpening service with such year-around profits. You can too, simply by following the sure, easy Foley Plan.



Foley

MANUFACTURING CO.
MINNEAPOLIS, MINN.



MONEY MAKING FACTS BOOKLET FREE!!!

This valuable book shows you how to start, how to get business from home owners, factories, carpenters, etc., and how to make profits fast. Mail coupon today. No salesman will call.

FOLEY MFG. CO. 1016-8 Foley Bldg., Minneapolis, Minn. 55418
 Saw Filer information. Lawn Mower Sharpener information. Money Making Facts booklet.

NAME _____
 ADDRESS _____
 CITY _____ STATE _____

NEW RUBBER STAMP BUSINESS PAYS BEGINNERS UP TO \$16.50 AN HR.

**START AT HOME
IN SPARE TIME**
with Table Top Machine!

We Help Finance You
... at less than bank rates!

The multi-million dollar Rubber Stamp business—once controlled by a few big companies—is now being taken over by small operators—one in each community throughout the United States. Men and Women who have this inexpensive machine can turn out huge quantities of Rubber Stamps with special wording that buyers once were forced to buy from big cities. Material costing only 27c makes a stamp that sells for \$2.75. The machine that does the work is simple and easy to operate and it turns out as many as six Rubber Stamps at a time, each with different wording such as names, addresses, notices, stock numbers, prices and other "copy" needed by offices, factories and individuals. Working full capacity, it can earn as much as \$33.00 an hour for the operator! Now you can get into the big-pay business yourself, with your own home as headquarters. You don't need experience. We supply everything, including complete instructions and eight ways to get business coming in fast. We even help finance your start. Start making up to \$16.50 an hour from the very beginning. Cash in on the profitable Rubber Stamp business in your community, right away. We'll mail full particulars FREE and no salesman will call. Be first in your locality. Rush coupon today or send your name on postcard to:

RUBBER STAMP DIV., Dept. R-2-LO
1512 JARVIS AVENUE • CHICAGO, ILL. 60626



RUBBER STAMP DIV.
1512 Jarvis Ave., Dept. R-2-LO
Chicago, Illinois 60626

FREE!

Please rush full particulars about your financing plan and the little machine that can get me started in the profitable Rubber Stamp business at home in spare time. Everything you send me is FREE and no salesman will call.

NAME _____
 ADDRESS _____
 CITY _____ STATE _____ Zip Code _____

'69 INTERMEDIATES

(Continued from page 106)

Super Bee, 440, 500 and R/T. The Deluxe comes as a two-door coupe, four-door sedan, two-seat wagon; the Super Bee as a coupe and new two-door hardtop; the 440 as a two-door coupe and hardtop, a four-door sedan, and two and three-seat wagons; the 500 as a two-door hardtop, a four-door sedan, a convertible, and two and three-seat wagons; the R/T as a two-door hardtop convertible. Engines, not all of which are available in all models, range from a modest 170-cu.-in. Six up to the howling 440-Magnum and 426-Hemi, both V8s. The latter engines, being strictly performance-oriented, call for beefed-up suspensions and heavy duty brakes.

FORD: Two new model designations here—a Cobra hardtop and a Cobra fastback, both performance cars. Other models include the Fairlane, the Fairlane 500, the Torino and Torino GT. Four-door sedans are available as Fairlanes, 500s, Torinos. You can get a two-door hardtop as a Fairlane, a 500, a Cobra, a Torino and GT. Fastbacks are offered as Fairlane 500s, Cobras, Torino GTs. The only convertibles in the series are the Fairlane 500 and Torino GT. Four-door wagons are available as Fairlanes, 500s, and something called Torino Squire.

Overall styling changes are slight. The ever-present new grille prevails, with minor variations between Fairlane, Cobra and Torino. There are distinctive trim and ornamentation differences, too, the most obvious being a reptilian horror (I think, anyway) nailed to the Cobra front fenders just aft of the wheel opening. Standard engine on everything up to the GT convertibles and hardtops is a new 250-cu.-in. Six. This is also the standard engine on the wagons. Standard on the GT convertibles and hardtops is a new 351-cu.-in. V8. Transmissions include three and four-speed manuals and an automatic.

MERCURY: Available in this series are a Comet, a Montego, a Montego MX, an MX Brougham, a Cyclone, a Cyclone CJ (for Cobra Jet, no less), and a Montego MX station wagon. You can get a four-door sedan in any of the Montegos, a two-door hardtop in the Montegos and the Comet, a fastback in the Cyclone and Cyclone CJ, a convertible and a wagon in the Montego MX. Styling changes throughout the line are minor, the most obvious being reworked grilles. The Cyclone CJ has a "no nonsense," muscle car look that plainly transmits its message—go, and plenty of it. Armed with a 428-cu.-in. 4-bbl. V8, the CJ is as subtle as a baseball bat. Ford's

new 250 Six, plus the new 2 and 4-bbl. 351 V8, are also included in the engine lineup. In transmissions, there's a manual three-speed, a manual four-speed, an automatic called Select-Shift.

OLDSMOBILE: Starting with the F-85, Olds intermediates include the Cutlass, Cutlass Supreme and the all-out performance-oriented 4-4-2. You can get a two-door sports coupe as an F-85, a 4-4-2, or a Cutlass, the latter available only in the dolled-up "S" package. Four-door sedans are offered as an F-85, a Cutlass and a Cutlass Supreme. Two-door hardtops are available as a Cutlass (the "S" package again), a Cutlass Supreme, a 4-4-2. Four-door hardtops come as a Cutlass and Cutlass Supreme. There's a Cutlass "S" convertible and a 4-4-2 convertible. Two-seat wagons are available as a Cutlass and a Vista Cruiser, which also offers a three-seater. The two-door sports coupes are built on a 112-in. wheelbase, the others (with the exception of the wagons) on 116, carried over from last year, as are all other dimensions.

Standard engines include a 250-cu.-in. Six for the F-85 and Cutlass, and, for the same cars, a 350 2-bbl. V8. Standard on the Cutlass Supreme is a 4-bbl. version of the same 350 engine. A 4-bbl., 400-cu.-in. V8 is standard on the 4-4-2, making it a real go-buggy. Styling changes are slight, mostly ornamentation and trim.

PONTIAC: Fifteen models in four series here—Tempest, Custom S, LeMans, GTO. In the Tempest, you can get a two-door coupe and a four-door sedan; in the Custom S, the same models plus a two and four-door hardtop, a convertible and a wagon; in the LeMans, everything except a four-door sedan (the wagon is called a Safari); in the GTO, only a two-door hardtop and a convertible. Not much styling news. Grilles have been slightly modified, there's a new taillight arrangement and instrument panels are new. Although the 112-inch (GTO) and 116-inch wheelbases are carried over, the entire line is fractionally longer and wider overall. Front track has been upped one inch to 61. Rear track remains at 60 inches.

Standard engine for everything except the GTO is a 250-cu.-in. OHC Six, with a 350 V8 as the option. Further options include 2 or 4-bbl. carburetion. Standard on the GTO is a 400-cu.-in. 4-bbl. V8. There are two Ram Air options available on this one, the latter of which—called Ram Air IV—approaches the unreal. Transmissions include a three-speed manual and a two or three-speed automatic.

PLYMOUTH: In this series are Belvedere, Road Runner, Satellite, Sports Satellite

(Please turn to page 220)



LIQUID WRENCH

The super-penetrating rust solvent that loosens rusted nuts, bolts, screws, parts . . . in seconds! Powerful, yet safe on all metals...use it on your watch or farm tractor.

Radiator Specialty Co.
Charlotte, N. C. 28201



In Squirt or Spray Cans

ALL FAMOUS BRANDS! **FARM TRUCK AUTO** **AT LESS THAN WHOLESALE**

TIRES! SAVINGS NEVER LESS THAN 50% up to 70% OFF REG. PRICE!

HEADQUARTERS for ALL SPORT CAR TIRE SIZES
FREE - SEND FOR YOUR FREE CATALOG - FREE!

RELIABLE TIRE DIST., 1111 Chestnut St., Camden, N. J.

BILL PROBLEMS?
WE CAN HELP YOU - TODAY
NOBODY REFUSED UP TO \$18,000.00
Bad Credit No Problem - Not a Loan Co.
Send Your Name and Address
For FREE Application To Nearest Office

INTERNATIONAL ACCEPTANCE, dept. M-8
★ 5133 N. Central Ave., Phoenix, Ariz. 85012 ★
★ 711 - 14th St. N.W. Washington, D.C. 20005 ★
★ 507 Carondelet St., New Orleans, La. 70130 ★

make your own Gems 39.50 F.O.B.

The Gem Maker comes complete with all necessary equipment, including a super-charged diamond blade for sawing, and all the wheels for grinding, shaping and polishing; also complete instructions. The complete equipment as shown, less motor and belt for only \$39.50, f.o.b. Burlington, Wisconsin. Write today for information and literature.

B&I MANUFACTURING CO.
Dept. P, Burlington, Wis. 53105

CARS & PARTS

OLD CAR BUFFS

Subscribe to a monthly magazine published for those interested in the preservation, restoration and enjoyment of the cars of yesteryear. Parts, literature, antique, vintage, classic cars for sale and wanted. \$3.00 year. Single copies 25c.

CARS & PARTS MAGAZINE
Box 299H, Sesser, Illinois 62884

Money Back Guarantee HEAVY DUTY-ARC WELDER Life Time Guarantee

New Advanced 1968 Model 110 Volt Arc Welder. You cannot buy a better welder anywhere at this low price. NO EXPERIENCE NEEDED. With our easy-to-understand welding book, anyone can braze, solder and weld any metal, even aluminum, NOTHING ELSE TO BUY. Comes complete with rod holder, helmet, ground clamp, twin carbon torch which generates over 11,000 degrees heat to braze, solder, cut, melt and bend all metals. Also included FREE \$2.00 supply of 1/16" and 1/8" welding rods, 1/4" carbons and flux. LIFE TIME GUARANTEE. Never a repair charge for parts or labor. 10 DAY MONEY BACK GUARANTEE. SEND ONLY \$2.00 and when delivered pay postman \$10.95 plus postage. or send full price \$18.95 and we pay postage.



SEND ONLY \$2.00

Order Direct from factory: NATIONAL ELECTRIC, Dept. PM-10, Box 48-544 Miami, Fla. 33148

MEN: Wall panel jobs are a snap with DAP Panel and Drywall Adhesive. No nailing! Waterproof. Fastens to any clean surface.

THINK ABOUT IT



DAP®



DAP Inc., Dayton, Ohio 45401 / SUBSIDIARY OF Pabco, Inc.

Mention POPULAR MECHANICS when writing to advertisers.

For **TOOLMAKERS** who use the **FINEST**

GERSTNER TOOL CHESTS
Dept. C-8, 20 Cincinnati Street
Dayton, Ohio 45407

Free Catalog!

WARNING

U.S. Surplus High Speed Milling Files going fast. New, in G.I. Packs. Hardened steel, for filing, milling, routing, drilling—any work in metal or wood. Use in 1/4 in. drill, etc. Big tools, from 1/4 to 1 1/2 in. wide. Get these most useful tools now.

22 tool set—government cost \$109. \$ 9.00 to you!
46 tool set—government cost \$265. \$15.00 to you!
100% GUARANTEED. WE PAY POSTAGE. A LIFETIME BUY!!

THE SURPLUS CENTER
LANCASTER, TEXAS 75146

'69 PERSONAL CARS

(Continued from page 111)

car of the type; i.e., a performance car. Powered by Ford's 351-cu.-in. engine, it gets out and marches. Powered by the optional 428 Cobra Jet "Ram Air," it can impart the feeling one is on a low level strafing mission. It has all the "go" styling touches, too—stripes, hood lock pins, hood scoop, spoiler, racy steering wheel.

The Grande features a special insulation package, a soft-riding rear suspension and special interior and exterior trim.

Mustang engines include the standard 200-cu.-in. Six, an optional 250 Six, and optional 302, 351, 390 and 428 V8s. Transmissions include a three-speed, a four-speed and an automatic.

MERCURY: Cougar is all-new this year and for the first time is offering a convertible. There's new sheet metal, a new grille, new head and taillight treatment, a new instrument panel and a new size. Although last year's 111-in. wheelbase is retained, the '69 Cougar is almost four inches longer, almost three inches wider. Inside dimensions are up, too.

You can get either a standard Cougar or an XR-7, both in either a two-door hardtop or the new convertible. In both you have a wide choice of trim, ornamentation and performance, comfort and convenience options.

Standard engine is Ford's 351-cu.-in. 2-bbl. V8. You can get the same engine with a 4-bbl. carburetor, or a 4-bbl. 390 and either of the two 428 4-bbl. V8s, the hottest of which comes with a Ram Air option. In transmissions, there's a three or four-speed manual and an automatic.

OLDSMOBILE: The new Toronado is almost four inches longer overall, over two inches wider. The rear-end appearance has been altered substantially, eliminating that "chopped off" look. Elsewhere you'll find new interiors, a revamped dash, some minor gadget tinkering and an electrically heated rear window for quick defogging and deicing.

The car is available only as a two-door hardtop coupe. Its front drive is pushed by a standard automatic transmission and a carried-over 455-cu.-in. 4-bbl. V8.

PONTIAC: Two cars here—the Firebird and the all-new Grand Prix.

The Firebird features a revamped grille, resilient front bumper extensions, a new instrument panel, new side marker lamps and a revised rear end. Overall length is up two inches, width an inch. Standard engine is the 250-cu.-in. OHC Six. Options include a Sprint version of the OHC Six, a 350 V8 with either a 2-bbl. or 4-bbl. carburetor, and two ver-

sions of a 400 V8, one being a Ram Air package. Transmissions include manual three and four-speed and an automatic.

The Grand Prix is the industry's only all-new car and it's more a triumph of marketing than design and engineering. The car—built on what GM calls its "G" body—gives Pontiac an impressive entry in the personal cum luxury field. It's built on a 118-in. wheelbase, is slightly over 210 inches long, 75.7 inches wide, 52 inches high, and features some impressive—albeit not radical—styling touches and gadgetry. I didn't get to spend much time with the car, so more later.

Available only as a two-door hardtop, the Grand Prix's standard engine is a 350 hp, 400-cu.-in. V8. You can also get a 265-hp version of the same engine and two versions of a 428 V8, one 370 hp, one 390. Transmissions are a three-speed manual and an automatic.

PLYMOUTH: The Barracuda is again available as a fastback, hardtop or convertible. Styling changes are slight. There's new ornamentation, new "go" options, a new, low-priced muscle entry called the 'Cuda. A 225-cu.-in. Six is standard, with 318, 340 and 383 V8s optional. A manual three or four-speed, an automatic are transmissions. The Barracuda, nicely done, deserves more attention than it seems to get.—Bill Kilpatrick

'69 INTERMEDIATES

(Continued from page 218)

and the GTX. In the low-line Belvedere you can get a two-door coupe, a four-door sedan, a station wagon. In the Road Runner, there's a two-door coupe and hardtop and a new convertible. The Satellite offers a two-door coupe, a four-door sedan, a convertible, and two and three-seat wagons. The same models apply in the Sports Satellite, except for wagons. GTX comes as a two-door hardtop or convertible.

Styling changes consist of what Plymouth terms "refinements," meaning few and far between. Grilles have been altered and rear ends given a different treatment. Dimensions inside and out remain pretty much the same. The comfort/convenience, performance and dress-up option list is impressive. The standard Six on the Belvedere and Satellite is a 225, with a 318-cu.-in. engine the standard V8, including the Sport Satellite. Optional V8 for Belvedere, Satellite and Sport Satellite is the 383 in 2 and 4-bbl. versions. Road Runner comes with the 383 4-bbl. GTX with the 440. Optional on both is the 426-Hemi. There's a manual three or four-speed, an automatic three-speed.

—Bill Kilpatrick

Don't Neglect Slipping FALSE TEETH

Do false teeth drop, slip or wobble when you talk, eat, laugh or sneeze? Don't be annoyed and embarrassed. Just sprinkle a little **FASTEETH** on your plates. This alkaline powder holds false teeth more firmly. Gives confident feeling of security and added comfort. No gummy, gooey, pasty taste. Dentures that fit are essential to health. See your dentist regularly. Get **FASTEETH** at all drug counters.

LIVE-CATCH ALL-PURPOSE TRAPS



Write for
FREE
CATALOG

Low as \$4.95

Trap without injury squirrels, chipmunks, rabbits, mink, fox, raccoons, stray animals, pests, etc. Sizes for every need. Also traps for fish, sparrows, pigeons, crabs, turtles, quail, etc. Save 40% on low factory prices. Send no money. Free catalog and trapping secrets.
TRAP FACTORY, Dept. M14 Box 10880, Houston, Texas 77018

TO BE A TOP GUN, WEAR ONE!

Try on the **TOP GUN**, a remarkable new dimension in hunting garments. See for yourself how **AMERICAN FIELD** has built in more of the style, comfort, and convenience features you've always wanted in your hunting clothes.

TOP GUN, made only by AMERICAN FIELD HETRICK MFG. CO., Statesville, N. C. 28677

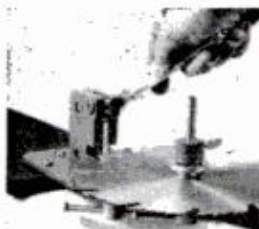

Big Money-Maker for Handymen!
HOLST Self-Aligning TOOTH SETTER
QUICKLY ADJUSTABLE for ANY DEGREE of SET **\$2250**

Fast, consistently accurate tooth for tooth. Ends guess-work of older methods. Life-time tempered steel dies and universal locking cone. Handles 4" to 20" blades. Steel plate construction. Moneyback guarantee. Pat. Pend.

Holst Saw Service, 24066 Neece St., Torrance, Calif. 90505

NOT TO BE CONFUSED WITH IMITATION **\$5.95**
PLASTIC MODELS SELLING FOR LESS!!

Not Sold to Calif. or N.Y. res.

22 Cal. Blank Cart. 8 Shot Revolver
No Permit Required
Imported from ITALY

"BLACK VENDETTA"



Latest model, not a toy. Gun is of solid steel construction. Lightweight and perfectly balanced. Fires 8 rounds in 2 seconds! Double or single action. Precision crafted, 5 1/2 inches long. Ideal for stage, sporting events, boating, protection. Revolver \$5.95, deluxe leather holster \$2.25. Send cash, check or M.O. and save C.O.D. charges. \$1.00 deposit with C.O.D. orders.
BIGTHREENT., INC. 1109 Sixth Ave., Dept. PM-108, N.Y., N.Y. 10036

FREE!

Learn how you can buy used engines \$15 up, new engines \$30 with FREE confidential list and coupons when you order your plans

• **BUILD THIS MINI-BIKE!**
Plans reveal step by step details!
• **BUILD A RACING KART!**
Complete frame for less than \$10!



RUSH \$2 for plans (indicate type) or send 25¢ for circular describing plans PLANS, Box 517, Omaha, Nebr. 68101

MOLDS

for making
Ornamental Concrete
Items...



Book about Aluminum Molds with prices and production trade secrets direct from world's largest concrete mold manufacturer.

SEND
\$2.00

CONCRETE MACHINERY COMPANY,

INC.

P. O. BOX 99 • HICKORY 2, N. C. 28601

WHICH TYPE ROTARY TILLER Have YOU Been Using?



TORTURE!



JOY!

If the tiller you've been using has its revolving blades in **FRONT** (See 'Torture!' at left), you won't ever be happy with it again once you try the **TROY-BILT®** which has its revolving blades in the **REAR** — and is **SO EASY** to use you guide it with just **ONE HAND!** (See 'JOY!' at left). You do **NOT** have to walk behind it, leaving footprints! It does **NOT** shake you half to death! It leaves **NO** wheel-marks! The **TROY-BILT®** is now in its 8th great year. **SO**, if you want tilling to be a **JOY** instead of **TORTURE** from now on, please send a postcard now for the whole story of this wonderfully better design in tillers! Ask for complete details, including prices and name of nearest dealer where you can see, buy or rent.

TROY-BILT® TROJAN HORSE ROTO TILLERS
Dept. 1960, 29 102nd St., Troy, N.Y. 12182

Two or four-wheel drive
JEEP or SCOUT
owners

REPOWER with a 6 or V-8. H.D. ADAPTORS for using Car, Compact and some Truck engines. Conversion Kits \$45.35 to \$56.90. Want fast action? Give us **FULL INFORMATION**. Send \$15.00 Dep. and we will ship correct kit, bal. COD. Send full amount for prepaid shipment. Wire, phone or write today. Details **FREE**

HOOSIER MACHINE PRODUCTS CO.

312 S. E. 6th St., Phone 276-3442, Pendleton, Oregon 97801

Build Your CAMPER

SAVE UP TO 50%

Complete, easy to follow Camper or Trailer Plans. **\$3.95**
Instructions, Material List. ea.
SATISFACTION GUARANTEED
Pickup Cover Plans \$2.00
Econoline Van or Bus Conversion Plans—indicate choice ea. \$2.95



EQUIPMENT CATALOG \$1.95

Refundable on first order.
SEND DIME FOR DETAILS
SAVE 50% ON CAMPER KIT
All items from our catalog to build a \$1,795 camper. 8', 10', 10'6" or Chassis Unit.

VIKING

VIKING CAMPER SUPPLY, INC.
94-BP Glenwood Ave.,
Minneapolis, Minn. 55403
Please send _____ for which I enclose \$_____
NAME _____
ADDRESS _____
CITY _____
STATE _____ ZIP _____

'69 COMPACTS

(Continued from page 117)

styled wheel covers. Yet this is not to carp at Ford; the Falcon remains as honest as an old shoe and in my opinion delivers what it promises—good, reliable, reasonably comfortable, rather stylish, low-cost transportation.

Anticipating federal regulations that become effective Jan. 1, 1969, standard on all Falcons from the word go this year are fixed front-seat headrests. Adjustable headrests are optional. There's a new steering wheel, some new side trim, new side marker lights, and a new 2-bbl. version of the 302-cu.-in. V8. Transmissions include a three-speed manual and an automatic.

The present Ford idea for the Falcon isn't bad. Maybe next year's will be even better.

NOVA: Chevrolet has dropped the "Chevy II" designation this year, choosing to go along with the name it last year applied only to certain models of the car. It's still a Chevy II, however, and just as trim and handsome as always. Very little has been changed. Some exterior trim has been what Chevy calls "refined," but that's about all there is outside. Inside you'll note a few differences. There's a new instrument cluster, a newly designed steering wheel, a wide rear-view mirror, some trim changes, relocated door-lock buttons, front-seat head restraints and—as with all GM cars—the anti-theft steering column ignition system. As a standard Nova, the car is available as a two-door coupe or a four-door sedan. In the hotter SS version you can only get the coupe. Depending upon what you want to pay, you can order the Nova powered by one of three standard engines—153-cu.-in. Four, 230 Six, 307 V8. Optional engines include a 250 Six and a 350 V8. In the SS the standard engine is the 350, but hp has been upped from 255 to 300. And this little kid can step, believe

me. Transmissions include a manual three or four-speed and an automatic.

As you've surely figured out, I like this car, particularly the SS.

RAMBLER: Last year's "American" tag for this series has been dropped and the entire line redesignated Rambler. The name change is one of the very few changes AMC has made in the car, the company's philosophy here being to hold annual styling changes to a minimum and the price down. There's some new exterior trim, new interior trim, and that's it. The best way to tell a '69 is by a new triangle tricolor hood ornament.

The car is available as a basic Rambler in a two-door and four-door sedan, a Rambler 440 in a four-door sedan and a station wagon, a Rambler Rogue in a two-door hardtop. Standard engine on the Rambler and the 440 is a 199-cu.-in. Six, with a 232 Six as an option. As a further option on the 440, you can get a 290 V8. The 232 Six is standard on the Rogue, the 290 in two versions the options. A manual three-speed and an automatic are the transmissions, with a manual four-speed optional on the Rogue only.

VALIANT: Last year we reported a Plymouth engineer as terming the Valiant "the world's smallest limousine." We thought him right then and—had he said it this year—he'd be right again. The car hasn't been changed much. There's a revamped grille, a modified rear-window design and new taillight treatment. Interior trim has been redone, too. A new option this year is a fold-down arm rest.

You can get either a Valiant 100 or a dressier Signet in a two-door or four-door sedan. Again depending upon what you want and can afford, standard engines are either a 170-cu.-in. Six or a 273 V8. Optional engines include a 225 Six and a 318 V8. Transmissions include manual three and four-speeds and an automatic. You can only get the four-speed with a V8, however.—*Bill Kilpatrick*

COMPACTS—HOW THEY COMPARE

Car	Wheel- base (in.)	Track (f/r, in.)	Overall Length (in.)	Overall Width (in.)	Engines in Model(s) Series* (Displacement, cu. in.—V8 except as noted—carburetion)
American Motors (Rambler, 440, Rogue)	106.0	56.0/55.0	181.0	70.8	199-6-1bbl., 232-6-1bbl., 290-2&4bbl.
Chevrolet (Nova, SS)	111.0	59.0/58.9	189.4	72.4	153-4-1bbl., 230-6-1bbl., 250-6-1bbl., 307-2bbl., 350-4bbl.
Dodge (Dart, Custom, Swinger, GT, GTS)	111.0	57.4/55.6	195.4	69.6	170-6-1bbl., 225-6-1bbl., 273-2bbl., 318-2bbl., 340-4bbl., 383-4bbl.
Ford (Falcon, Futura)	111.0	58.8/58.5	184.3	73.2	170-6-1bbl., 200-6-1bbl., 302-2bbl.
Plymouth (Valiant, Signet)	108.0	57.7/55.6	188.4	69.6	170-6-1bbl., 225-6-1bbl., 273-2bbl., 318-2bbl.

*Not all engines available in all models

TAX SALE—\$1 ACRE

Properties now being sold for municipal tax arrears. Hundreds of cottages, farms, hunt-camps, timberlands, homes from coast to coast along Canadian Border. Purchase direct from Tax authorities—NON PROFIT! For lists, pictures, regulations, write: Register, Room 15, 110 Church Street, Toronto, Canada.

ENROLL—EARN YOUR DEGREE

of Bachelor of Bible Philosophy (B.Ph.B.), Master of Bible Philosophy (M.Ph.B.), Graduate of Bible Philosophy (G.Ph.B.), Doctor of Metaphysics (Ms.D.), or Doctor of Divinity (D.D.). Chartered by State, Correspondence Courses only. Please write for FREE BOOKLET.

AMERICAN BIBLE INSTITUTE

Dept. PM, Post Office Box 8748, Kansas City, Missouri 64114

EVERYONE'S A SKILLED NAVIGATOR AT HULL DIRECTIONAL DRIVING



ROUTE-GUIDE
Charts your course!
CAR COMPASS
Keeps you on course!

At your dealer's or write.
THE QUALITY COMPASS...IT WORKS!



HULL MFG. CO. • Box 246-D-10 • Warren, Ohio 44482



Solves Repair Problems

Durham's fills cracks and holes in plaster, wood and tile. Won't shrink or fall out. Economical, easy to use. Big 4-lb. can, only 1.60 at lumber, paint, and hardware dealers, or shipped direct postpaid in U. S. for \$2.00. Money-back guarantee. Order now. Donald Durham Co., Box 804-T, Des Moines, Iowa.

CERTIFIED AIRCRAFT BIRCH PLYWOOD

FOB per 48X18" sheet, 1 to 3 sheets \$2.50 extra, 20% dealers discount 100 sheets. Cut in half or quarter for parcel post with faster delivery. Also industrial and cabinet birch plywood, all thicknesses, sheets and cut to any size and shape.

1/32"	\$5.90	1/8"	\$10.50
1/16"	6.90	3/16"	14.50
3/32"	8.90	1/4"	17.50

Violette Plywood Corp., Box 141-A Lunenburg, Mass.



Print Your Own

Cards, Stationery, Advertising, Circulars, labels, photo and movie titles, church work, tags, greeting, sympathy, prayer cards, etc. Save money. Pays for itself in a short time.

Own a Printing Business

Good Profit. Raised printing like engraving too. Have home shop. We supply everything. Direct from factory, only. Easily followed rules. Write now for free details. **KELSEY PRESSES E-37 Meriden, Conn. 06450**

75 POWER TELESCOPE 25X-45X-75X \$498

NEW 3 in one telescopes, 3 variable 25X, 45X-75X magnification. Brass bound, 25 power for ultra bright images 45 & 75 power for long range. Guaranteed to bring distant stars, moons, objects, sports 75 times closer.

Most powerful scope anywhere at this amazing-low price. 5 sections. Opens 36" closes 1 ft.; contains 4 ground & polished lenses. Can also be used as powerful microscope. American made. Mass production enables us to offer telescope complete including case \$4.98 post paid. Money back guarantee.

CRITERION CO., Dept. PBM-48, 331 Church St., Hartford, Conn. 06101

BUILD THESE BEAUTIFUL CLOCKS

Now at big savings! Send just \$1 for plans & instructions to build choice of: (A) Grandfather (B) Steeple (C) Grandmother, plus information-packed catalog of movements, dials, parts & kits to build these & 16 other fine clocks. All 3 plans \$2.50. Catalog alone—25¢.

MASON & SULLIVAN CO.
Dept. PM, Osterville, Mass. 02655

Travel the SHORT way

avoid wrong turns — save time, money and frustration with



... at leading stores everywhere!

AIRWAY COMPASS, Mexico, Indiana 46958

REAL ESTATE BE A BROKER

PAYS BIG! SEND FOR FREE, BIG, ILLUSTRATED CATALOG NOW! Graduates report making substantial incomes. Start and run your own business quickly. Men, Women, all ages, learn easily. Course covers Sales, Property Management, Appraising, Loans, Mortgages, & related subjects. **STUDY AT HOME** or in classrooms in leading cities. **DIPLOMA AWARDED. Write TODAY for FREE Booklet!** Accredited Member National Home Study Council. (Established 1936)

FREE BOOK TELLS HOW

WEAVER SCHOOL OF REAL ESTATE
3521-P Broadway Kansas City, Mo. 64111

HEAVY DUTY BALL-BEARING PUMP



IRRIGATE • DRAIN • SPRAY • CIRCULATE • Famous all-metal, rust-proof XB pump with stainless shaft. Use 1/4 HP or larger. 1 HP for up to 5,200 GPH 60" high or 3,000 GPH from 25' well. 1 1/4" inlet. 1" outlet. For belt or direct drives. Only \$12.95
Famous Type P won't rust or clog. Bronze bearing. Hundreds of thousands in use. Up to 2,400 GPH. 1" inlet. 3/4" outlet. Only \$8.95
Postpaid cash with order. Money Back Guarantee.
LABAWCO, Box 2, Belle Mead, N. J. 08502

MAN-SIZE DOES TOUGH JOBS OTHERS CAN'T!



Clears 16" snow. Mows 2 to 3 acres/hour. Handles bigger garden implements. More power with 12 hp, all-gear-drive, extra size and traction. Your best buy! Free catalog.

ECONOMY TRACTOR

1005 K-10 Anoka Avenue

Waukesha, Wisconsin



Excitement! Security! Good Pay! CRIME DETECTION

LEARN AT HOME IN SPARE TIME—START NOW! Crime everywhere is on the rise! Learn now, in your own home, the profitable profession that enables you to track down criminals and bring them to justice! Hundreds of Identification Bureaus employ I. A. S. graduates... trained in fingerprinting, police photography, handwriting identification, firearms and investigation. Our 44th year! FREE "Blue Book of Crime"... packed with crime facts and the full story of famous I. A. S. training. State exact age. No salesman will call. Rush Coupon!
A Correspondence School Founded in 1918.

FREE Blue Book of Crime MAIL COUPON

INSTITUTE OF APPLIED SCIENCE, Dept. 135A
1920 Sunnyside Avenue, Chicago, Ill. 60640

Rush Blue Book of Crime... FREE!

NAME Age
ADDRESS
TOWN STATE ZIP CODE

SNOWMOBILES '69

(Continued from page 133)

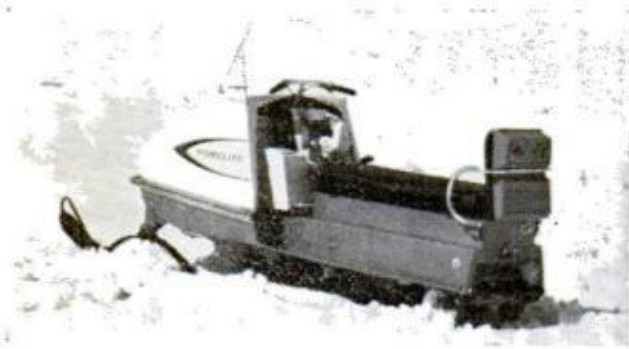

HOMELITE has three new machines: the mini-model with 10 hp, and two regular models with 18 and 20 hp

track aimed at the youngsters. With a 10-hp Polaris engine, it weighs 212 pounds and costs approximately \$595.

Big news at Johnson this year is the introduction of three 25-hp models of Skee-Horse. The first is a Light Trac model with a 15-inch track. The second is a manual-start, 20-inch track, and the third is an electric start with a 20-inch track. Both 20-inch models have reverse as standard.

Johnson is also introducing the Challenger line. These light machines come with 19.5-hp and 23-hp JLO engines.

Three other models in the Skee-Horse line are equipped with 16-hp engines. You can get these models in electric start with reverse, and with 20 or 15-inch tracks.

Evinrude has come up with a surprise—by adding something new to its regular line. Besides the three models equipped with 25-hp engines, and the three 16-hp models, Evinrude has the Bob Cat series in addition to its Skeeter line. This new Bob Cat is a lightweight machine which uses either 19.5-hp or 23-hp JLO engine. The Bob Cats will run on 15½-inch tracks, have Salisbury clutch transmissions and sell for \$910 and \$1075.

AMF's Ski-Daddlers have two new running mates—the 600-cc Super Twin and the 20-hp Lloyd 386-cc Wide Track 18. The popular Sno-Scout model has more power with either the 12½-hp JLO or 15½-hp JLO. Though most Ski-Daddlers are 30½ inches wide, the Wide Track 18 is 33½ inches running on a 15-inch track. The Super Scout Mark III also has more power this year—22½ hp.

A big service surprise from Trail-A-Sled, maker of Scorpions: Starting this fall, you can take your new machine back to the dealer for a free check after 10 hours' operation. The company pays for this service.

Scorpions come in three models—the Mark II with 15-inch track weighing 290 pounds; the Mark III with 18-inch track



SPRINT, new Bolens machine, has regular snowmobile design. This 17-hp model weighs 355 pounds

weighing 340; the new Mark IV with 23-inch track weighing 415. Engine options run from the 297-cc Sachs to the 634-cc Hirth. New clutch bearings eliminate creeping and freeze-up.

Arctic Cat this year is concentrating on its Panther series. These light, fast machines are available with engines from 246 cc to 600 cc. Arctic Cat also has a 300-cc Wankel engine model, and a 12-hp, four-cycle model. Weights of machines in the entire eight-machine line vary only from 290 pounds to 345 pounds. Panthers run on 17-inch tracks, are 30 inches wide. Most can be adapted to electric start.

Another surprise this year is the purchase of Sno-Jet by the Glastron Corp.—builder of Glastron boats and Nauta-Line houseboats. Sno-Jet is offering four new engine sizes and eight new models priced from \$750 to \$1295.

Running on a 16-inch track and weighing about 270 pounds, Sno-Jets have Hirth engines that develop 15, 17½, 19, 23 and 35 hp. Some have electric start available.

Yukon King is adding the Super Grizzly. This machine is powered by an 18-hp JLO and runs on a 15-inch track.

Boatel is adding a 20-inch track model to its line of Ski-Birds, which come with engines running from 300 to 634 cc.

Rupps' Sno-Sport line has five models with engines that develop 12 to 20 hp. Models weigh from 280 to 330 pounds.

Fox Trac's series features machines with engines from 227 cc to 450 cc. Six models have 15-inch tracks; four, 20-inch.

Alouette Div. of Featherweight Corp. of Canada will have six major models with Sachs engines from 277 cc to 368 cc. Weight runs from 294 pounds to 389 pounds. Five models have 15-inch tracks, while the sixth has an 18-inch track.

Homelite is entering three new machines: 10-hp Ranger, 18-hp Forester, 20-hp Explorer. Tracks run 12, 15 and 18 inches. ★★★

SNOWMOBILES / SAVE 20%

Buy DIRECT at FACTORY PRICES—Save dealer profit. Have fun this winter! 6 Models from 12-24 HP in 15" and 18" track width. '69 styling, performance. Welded steel chassis, fiberglass body. 10% down, E-Z terms. Free, inspection money back guarantee. Free delivery, Free color catalog. Write: LUGER INDUSTRIES, DEPT. 8S-108 9200 Bloomington Freeway Minneapolis, Minnesota 55431



E-Z TERMS

LEARN TO BE A SKILLED LOCKSMITH

Professional Key Machine yours to keep!

Be your own boss. Earn steady, year-around income in your spare time at home. BELSAW INSTITUTE lessons show you how to make keys, open and repair locks on homes, cars, business buildings. Accredited Member NHSC. Approved for Veterans. All tools and supplies furnished including the \$125 Key Machine. Write for FREE BOOK. No salesman will call.

BELSAW INSTITUTE / 109T Field Bldg.
Kansas City, Mo. 64111

WORTH \$50 Powermaster hunting CROSSBOW

Special \$35
POST PAID

KILLS DEER, BEAR, Etc.
RABBITS, SQUIRRELS,
ALL SMALL GAME
COLLECTOR'S
ITEM

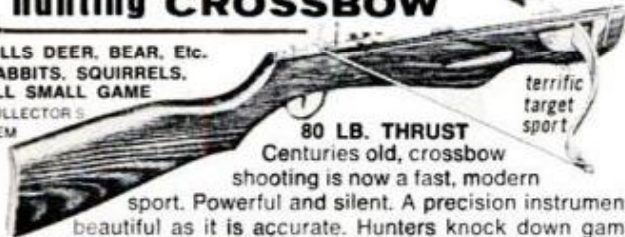

terrific target sport

80 LB. THRUST
Centuries old, crossbow shooting is now a fast, modern

sport. Powerful and silent. A precision instrument, beautiful as it is accurate. Hunters knock down game at 200 ft. Two-way sights—open and peep—windage and elevation. Anyone can target-shoot right in their own backyard. Harpoon fish with free line attachment. 34" hardwood stock. 33" bow. Handsome den display. Possession is legal in all states... Money back if not completely satisfied. Target arrows 80¢ each. Hunting and fishing arrows \$1.25. Send to: S & R RESEARCH, Box 20-J, San Gabriel, California 91778



LABORATORY TESTED!
U.S. PATENT 3,159,140

TRAINS ANY DOG INSTANTLY!

* PUPPIES, DOGS OF ALL AGES. NEVER FAILS!

TEACHES

- Come—at all times!
- Sit
- Heel
- Guard
- Drop, etc.
- House soiling
- Chewing
- Jumping-up
- Barking, etc.

STOPS

(even in your absence)

40,000 satisfied users. Hundreds of unsolicited testimonials. 4 times with Art Linkletter. CBS-TV News. Johnny Carson, Mike Douglas, To Tell The Truth, Joe Pyne: "It really works." Recommended by leading veterinarians, breeders. Hi-FiDo, "Pavlov's Bell" is a small scientifically developed chain-tuning fork, bell-like device. Just shake or toss, controls dog near or far, permanently by a unique sound-association. Kind, not electric.

Includes FREE 353-pg. reference manual. Illustrated. Indexed Guaranteed. Write, wire or phone for information. Fascinating!

CANINE BEHAVIOR INSTITUTE
11927 Montana Avenue
Dept. PM 108 Los Angeles, California 90049

HI-100

ACCORDIONS and AMPLIFIERS



BIG SAVINGS up to 1/2 or more on famous make accordions. Over 40 models. Standard and new electronic models. Buy direct at low discount prices. Get five-day home trial. Small down payment, easy terms. Free gifts. Trade in allowance. Money back guarantee. Rush coupon for color catalogs, discount price list. Accordion Corp. of America, Dept. R-108, 5535 W. Belmont Ave., Chicago, Illinois 60641

COUPON BRINGS FREE COLOR CATALOG & DISCOUNT PRICES

ACCORDION CORP. of AMERICA—Dept. R-108
5535 W. Belmont Ave., Chicago, Illinois 60641

Send FREE Color catalogs and discount prices. Include special information checked:

Amplifiers Button Type Accordions

Name _____
Address _____
City _____ State _____ Zip _____

SECOND CHANCE FOR HIGH SCHOOL DROP-OUTS

A high school diploma means a lot today — in prestige and IN CASH! It can be your key to:

- A better job, higher pay
- Greater social opportunities
- More security — for you, your family

U.S. government figures show the average high school graduate earns \$75,000 more during his lifetime than the drop-out who didn't finish high school.



← All 3 FREE

Clip coupon below for Academy's booklet on how to finish high school at home, Government booklet with advice for drop-outs and a self-scoring test of your general knowledge. Mail today.

ACADEMY FOR HOME STUDY

425 S. Dearborn, Dept. 82-929, Chicago, Ill. 60605

Rush FREE booklet on finishing high school at home, also free Government booklet and self-scoring test. No obligation.

Print Name _____ Age _____

Address _____
City & State _____

County _____ Zip No. _____

THAT NEW PATENT LAW

(Continued from page 135)

the first applicant? Nothing for the well-heeled corporation, plenty for the independent. For the latter, it would involve a huge increase in paper work, legal expense, and Patent Office fees, with the added risk of losing a deserved patent in the end.

Robert W. Fulwider, chairman of the Patent Section of the American Bar Assn., predicts that "it would create a stampede to the Patent Office to file hastily prepared applications."

'True' inventor protected now

Compare this to the present method. After you get an idea for an invention, you immediately start keeping records and having them properly witnessed. You have a search made to see if there are comparable inventions. If your search encourages you, you continue your development work. When, in good time, you're satisfied that your invention is ready for practical application, you seek a patent. Up to that time, you have incurred no legal expenses other than for the patent search, and you have paid no fees to the Patent Office. Yet all the time you've been protected by the law, which considers you the "true" inventor.

Now look how things would work out under the new bill. You'd feel compelled to make your application as soon as possible. You'd either file it on the basis of inadequate research, which would require making many amended applications later, or you'd have to rush your development work faster than you could probably afford to.

Either way you're in trouble. Filing a series of amended applications involves much higher legal fees. One attorney told me that this and other provisions of the new bill would require him to raise his fees as much as 100 percent.

Pay now, cry later

If you hurry your work in the hope of not having to file a lot of amended applications, you'll be hit with all the expenses of development, plus the legal fees, plus the filing fees, at a time when you probably can least afford to put in all the time and money required.

None of this presents any problem to corporations with plenty of money and large engineering and legal staffs. Big "invention factories" can afford to make numerous amended applications if needed.

Even at that, it might not be so bad for the independent if he could be sure of coming out of it all with a patent on a

profitable invention. But what if you run into unexpected difficulties and your invention flops? Under the present law, you just let it die a natural death. All you're out of pocket is the cost of materials used in development and the fee for the patent search. But under the new bill your rude awakening would come *after* you'd shelled out the money for the legal costs, application fees and all the rest.

Another clause in the new bill takes away an inventor's right to test out an invention. It declares that you cannot get a patent if you let anybody use your invention before you have applied for a patent! The bill puts it this way: "A person shall not be entitled to a patent if . . . prior to the filing date of the application, the subject matter sought to be patented . . . was made available to the public by means of disclosure in tangible form."

Tests can make the difference

The present law says you have a whole year to consumer-test your invention. Such tests can make the difference between a successful invention and a failure. Loss of the right to carry out these tests hurts only the independent, not the big-lab inventor. The big companies have plenty of test facilities—lab researchers, consumer surveys and market information sources—that enable them to size up an invention before they apply for a patent.

Another drastic change proposed in the new bill calls for publication of patent applications. Under the present law, patent applications are never published—they're kept secret in the files of the Patent Office. Publishing a patent application before a patent has been granted to him will hurt the independent inventor in several ways.

One is that he'll be robbed of a second chance. Let me show you how this works. After you've made your application, circumstances arise that cause you to change your mind. Maybe you find there's no one interested in buying your invention at the moment. Maybe the invention is ahead of its time, or maybe it needs more development.

In any case, you may wisely decide to call it quits for the time being. If so, all you have to do is temporarily abandon your efforts to get a patent. The matter contained in the application will be sealed and kept secret. Then, later, when you decide that the situation is right for the success of your invention, you can go ahead and file a new application.

Under the new bill it wouldn't work that way at all. If you withdrew your application, you'd lose all chance of getting a

patent. The contents of your application would be published within 24 months of the time you filed. The bill states that if an invention description has been published any place, it can't be patented. So if you come back and try to file a new application on your invention, the Patent Office would say, in effect, "Sorry. Details of this invention have already been published." Your own work would thus be used against you!

How come such a disastrous law could be considered? Like many controversial proposals, its basic intent is good. The first-come-first-served provision is aimed at getting inventions developed and into use faster by making it unprofitable for an inventor to "sit" on an idea for years. It's also designed to put an end to long and costly legal squabbles over who invented what when. The first to file an application would get the patent, and that would be that. Another reason for the law is to bring U. S. patent practices into line with those of foreign countries. Major differences in requirements have made it hard for the U. S. to negotiate patent treaties with other nations.

All of these aims are fine in theory, but they must be judged in terms of other needs as well. Fortunately for the independent inventor, the Patent Reform Act has not sailed through Congress as its advocates thought it would. Since its introduction, it has been challenged by the American Bar Assn., the American Patent Law Assn., and numerous inventors, engineers and scientists.

A better bill

A new bill, offered as an alternative to the Administration's reform law, has been drawn up by members of the American Bar Assn. It eliminates the most harmful provisions of the Administration version. This bill (S.2597) was introduced in the Senate by Sen. Everett M. Dirksen.

The two proposals are expected to come up for consideration some time next year. According to Patent Commissioner Edward J. Brenner, possible compromises are already being weighed. One such modification might be to grant a patent to the first filer, *provided* no one else comes along and proves prior rights within a specified time.

If you wish to support the cause of the independent inventor, you can help by expressing your opinion personally. Write to your senators and representatives indicating that you favor the Bar Association bill over the Administration-sponsored reform bill. It's just good common sense to fight for a law that will help, not hurt, the independent inventor. ★★ ★



Crosman pistols. Good enough to go to school.

Crosman 38's are used throughout the country in police training.

And there are three simple reasons for that. Looks, feel and performance.

The Crosman Combat "38"

is a CO₂ Pellgun Revolver. It offers single and double action and revolving cylinder which holds six .22 caliber Crosman Super Pells. Cost of the "38" is about \$34.50.

Mark I Target Pistol.

Shoots .22 cal. pellets. Efficient single-shot action for accuracy. New easy loading. Also available is Mark II. It is designed to shoot .177 cal. pellets and BBs. Either sells for about \$26.95.

Model Sa6. Single Action, 6-shot-Revolver.

Authentically-styled western

gun holds six .22 cal. Crosman Super Pells in a revolving cylinder. CO₂-powered. About \$21.95.

Model 600, 10-shot Semi-Automatic.

This CO₂ Pellgun Pistol fires 10 .22 caliber Super Pells in less than three seconds. One of our finest target pistols. Retail for about \$34.50.

See all of these pistols at your Crosman dealer's today. PM-108

The Fun Guns from
Crosman
Crosman Arms Co., Inc., Fairport, N. Y.
Crosman Arms (Canada) Ltd., Dunnville, Ont.

WALLY FRANK PIPE QUIZ
WIN A FREE DEMONSTRATOR PIPE

We want real pipe smokers to Test Smoke this revolutionary idea in pipe smoking before we spend big money in advertising. So, if you pass the Pipe Quiz shown below, we will send you a demonstrator pipe, Absolutely Free, to test smoke. This new pipe will smoke sweeter and drier than any pipe you've had before. And because of the special coconut-shell activated charcoal lining in the Imported Briar Bowl, unpleasant tongue bite is gone forever. Your very first puff will be dry, clean and sludge-free because the special shank construction utilizes the 3 C's of scientific smoke control . . . Combustion, Condensation and Capillary action.

Here's all you have to do. Answer all 5 questions below by indicating True or False. Then fill in your name, address and zip code and mail to Wally Frank Ltd. If you pass the Pipe Quiz, we will send you the demonstrator pipe ABSOLUTELY FREE. Test smoke it, then answer and return the simple questionnaire enclosed with the pipe. One pipe to a family. (in U.S.A. only).

Wally Frank Ltd. PIPE QUIZ DEPT. Q116
 132 CHURCH STREET, NEW YORK, N. Y. 10007
 ANSWER ALL QUESTIONS BELOW

	TRUE	FALSE
1. Briar is a Mediterranean root.	<input type="checkbox"/>	<input type="checkbox"/>
2. Meerschaum is mined in Germany	<input type="checkbox"/>	<input type="checkbox"/>
3. Latakia is imported from Syria.	<input type="checkbox"/>	<input type="checkbox"/>
4. Perique is an imported tobacco.	<input type="checkbox"/>	<input type="checkbox"/>
5. Calabashes come from Africa.	<input type="checkbox"/>	<input type="checkbox"/>

PRINT NAME, ADDRESS AND ZIP CODE BELOW

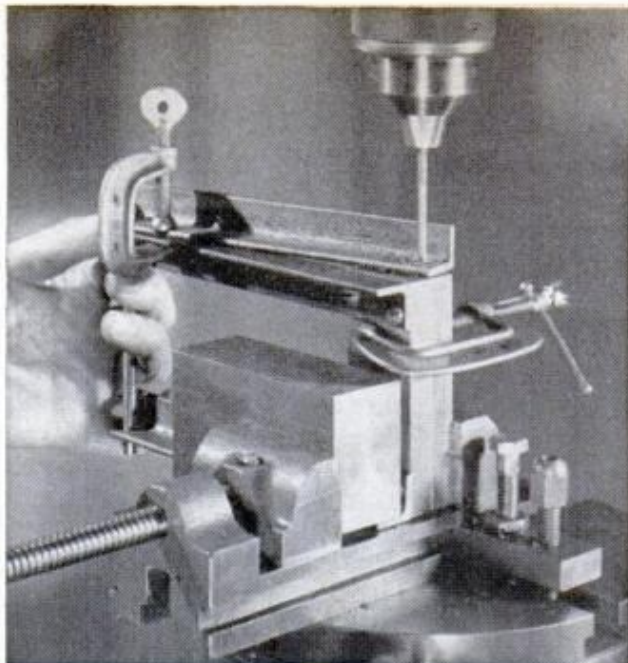

ANGLE-IRON ARMS are clamped to the blocks before being drilled for bolts. This assures right alignment

SELF-EJECTING DOWEL MAKER

(Continued from page 184)

have to bend them slightly and perhaps file a little clearance on the ones that are close to dowel size.

Make the punch holes enough smaller than the punches to permit tight drive fits. The knockout holes will enable you to remove the punches easily in case you should ever have to replace them. You might prefer to make the punches slightly shorter than the thickness of the dowel plate so that the dowels will not be pushed completely clear of the holes. This way, you can pull them clear with your fingers instead of having to retrieve them when they drop free.

Incidentally, don't forget that the dowel maker must be clamped in a vise in order to use it. Thus, the plate should be long enough to project beyond the edges of the jaws.

The dowel maker detailed on page 185 was designed for making rather short dowels and intended to be mounted in a medium-size bench vise. For longer dowels, use a vise having more clearance under the jaws or mount the unit permanently on a stand assembled from lengths of angle irons.

The dowel plate shown was rabbeted along its lower edges to form shoulders that rest on top of the vise jaws and prevent the plate from settling under repeated hammer blows. As an alternative to this, you might install a few pins near the upper edges of the plate, setting them in blind holes so that they project $\frac{1}{8}$ in. or so.

★★★

NOW! DO ALL MACHINE OPERATIONS ON ONE TOOL.

Wonderful for hobbyists. Work with metal, wood and plastics. UNIMAT is lathe, vertical miller, drill press, tool grinder and polisher—all in one compact unit. Change from one machine to another in seconds. No machine shop experience necessary. With precision UNIMAT anyone can turn out perfect parts by following simple instructions. Make all kinds of hobby, experimental or repair parts. Motorized UNIMAT is portable and ready to use. Also available in Canada. Write for free color folder, or send \$1 for "Miniature Machining Techniques" handbook.

UNIMAT

COSTS ONLY \$139⁵⁰

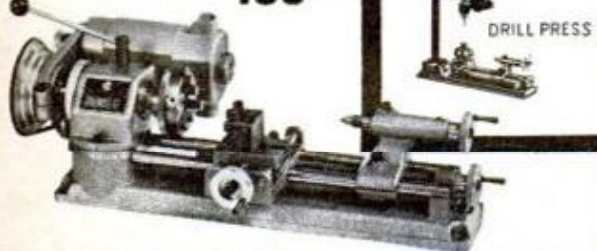

AMERICAN EDELSTAAL, INC.
 Dept. BJ8, 350 BROADWAY, N.Y., N.Y. 10013

CHECK FOR A SAFE CAR

(Continued from page 151)

the steering wheel has to be removed to get at it. As mentioned before, it's a rough job usually requiring a steering wheel puller.

When testing brakes, look for:

- Low or excessive pedal travel (to test a power brake, have the engine running). If the pedal gets within an inch of the floor or if it takes more than an inch of travel before braking action starts, you've got a problem in the brake system.
- Pulling to one side when braking.
- Insufficient braking power.

Each of these problems has a multitude of possible causes. Check for low fluid level, leaky wheel cylinders, worn linings, damaged brake drums, bad master cylinder and so on until the trouble is found.

Steering is an extension of the suspension system. In order for your car to steer properly, the tire pressure and wheel alignment must be within specification and ball joints have to be in good shape. There's also a matter of good steering system parts, such as idler arm and gear box.

If your car has power steering, the drive belt has to be in good shape, fluid level up to the line, and linkage tight.

As for tires—and this includes snow tires at this time of year—look for cuts, breaks and bruises in the sidewall and tread; excessive or uneven tread wear; and make sure that pressure is as specified.

While you're down on the ground checking tires, take a look at your exhaust system. (It could have been discussed under equipment that let's you see since carbon monoxide leaking into the passenger compartment will quickly make you drowsy and impair your vision.) Start the engine and look under the car for wisps of gray-white smoke, and probe areas that look almost rusted through. Rusted mufflers have been known to blow out simply by added exhaust pressure when shifting to passing gear.

One last, miscellaneous part not used for seeing, stopping, steering or communicating should conclude your checklist: seat belts. Many used for several years may be approaching the end of their life.

Examine belt-buckle operation first. See that they all fasten easily, and give them a quick, firm pull to make sure they hold.

Inspect the entire length of each belt for broken or frayed fiber strands. This is the first sign of belt failure. A belt in such condition should be replaced.

Finally, give each belt a hard pull as you examine belt anchors. If an anchor bolt is loose, tighten it up. The life you save may be your own! ★ ★ ★

GOVT. SURPLUS AND OTHER BARGAINS SAVE UP TO 90%



ELECTRIC UTILITY PUMP

Output up to 360 gal. per hr. @ 18 PSI. Exc. for water, fuel, insecticides, etc. Aluminum construction. Runs on 12 or 24 V.D.C. Explosion-proof motor.

Inlet & Outlet ports are 1/2" pipe. Draws 5.2 amps. 9 3/4" H x 6" W. Approx. GOVT COST \$150. Shpg. wt. 8 lbs. NEW \$14.50 (Stk. #2468)

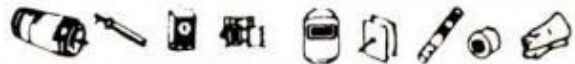

DC JET GENERATOR ARC WELDING KIT

Mfg. by G.E. 400 AMP DC continuous duty @ 3700 RPM @ 43 V.D.C. Capable of up to 600 AMP intermittent. Kit contains Gen., Volt. Reg., Electrode Holder, Welder's Helmet, Toggle switch, 1/8" welding Rods & Welder's Gloves & 2 Rheostats. All units guaranteed pre-tested. Shpg. Wt. 110 lbs. Approx. GOVT COST \$700. Complete Kit \$64.50 (Stk. #75) Incl. wiring diagram.



MOTORIZED REDUCTION GEAR

110 to 1 reduction. 1/2 HP @ 62 RPM under load @ 24 V.D.C. Reversible. Also runs well on 12 V.D.C. at reduced rating.

Exc. as heavy door opener, sidewalk cart motor, winch or capstan. 5/8" shaft, 12" L x 4" W x 4 3/4" H. GOVT COST \$249. Gov't overhauled cond. Shpg. wt. 12 lbs. \$17.50 (Stk. #2311)



NEW! BIG! 1968 CATALOG

Send 25c for amazing catalog with 1000's of bargains in hydraulics; electrical, marine, automotive items, etc. Order from this ad. All prices FOB Culver City, 50% deposit required for all COD sales. Cal. res. add 5% sales tax. Must include your zip code number. Satisfying mail order customers thru-out the world for 23 years.

AIRBORNE SALES CO. Dept. PM1068

8501 Stellar Dr., Box 2727 • Culver City, Calif. 90230



Learn Profitable Profession in few months at Home

MEN AND WOMEN, 18 TO 60

\$4.00 to \$5.00 for 1-hour treatment is the established charge for a skilled operator. Easy to learn and do. Diploma awarded. Open your own office or earn good income from Doctors, Hospitals, Clubs and other health or recreational centers. Wonderful part-time profession. Low monthly payments. Write today for free Anatomy Charts and catalog. No obligation.

ANDERSON SCHOOL OF SCIENTIFIC MASSAGE
Dept. M-1, Princeton, Illinois

TRAIL-BIKE FACTORY DIRECT!

159⁹⁵
as shown
\$10 Dn.
\$10 Mo.*

DUCK™ BIRD

BUY DIRECT
SAVE HALF



Also available in welded kit form for only \$149.95



- 3 1/2 hp engine
- Spark arresting muffler
- Automatic clutch
- Twin shock suspension
- Goodyear pneumatic tires
- Weight: 80 lbs.

RUSH YOUR ORDER!

This rugged trailbike is designed to take you where the going gets tough! A powerful 3 1/2 hp forced air cooled engine provides plenty of hill climbing power. Carries up to 250 lbs! Send 25c for complete information.

Send only \$10!

TIME PAYMENT

With Bird engineering's Time Payment plan, you can pay-as-you-ride. Just send \$10 down with completed coupon on the right.

*Plus interest (rate varies with local state).

RUSH information PM-10
(I enclose 25c)
HURRY and RUSH trailbike (I enclose \$10)
(I enclose 50% Dn. Bal. COD)

Name _____
Street _____
City _____ State _____ Zip _____

BIRD engineering
Box 427 DTS
Omaha, Neb. 68101

COASTAL®
ZIPPIDI-DO
 ALL-PURPOSE CUTTING AND SANDING DISC

Zippidi-Do
 even cuts a file



The most versatile power tool accessory... ever!

You can cut through ceramic tile, fiberglass, brick, slate, stone, all metals... even a hard file in minutes with the Zippidi-Do cutting and sanding disc. Silicon carbide grains embedded in nylon mesh give it amazing cutting ability. And the Zippidi-Do makes a great sanding and shaping disc for use on old paint, rust, wood, tile, all metals. The Zippidi-Do can be used with any electric drill or flexible shaft. It wears and wears and never clogs.

Complete kit contains Zippidi-Do disc, molded backing disc, arbor and flanges... only \$4.00 at hardware stores and depts. Coastal Abrasive and Tool Co., Inc., Trumbull, Conn. 06611.



Transistor Radio with Battery \$1.70

Calendar Watch \$2.44

Derringer Pistol \$5.99

HOME-IMPORT
 BUSINESS-Make Big Profits

New Drop Ship Plan offers you first day profits! Deal direct with overseas sources at prices shown. Dazzling bargains with no investment. Full or spare time. Write for FREE BOOK today to...

MELLINGER, Dept. #225A, 1554 S. Sepulveda, Los Angeles, Calif. 90025

storage wall plans



Get more storage space with plywood built-ins. 1. Wall unit with adjustable shelves. 2. Room divider with drawers, cabinets. 3. Wall unit with shelves, closet. For three plans send 10c to American Plywood Assn., Dept. PM, Tacoma, Washington 98401.

SHOOTING A PORTRAIT

(Continued from page 155)

flatter, lower-ratio lighting is kinder to elderly people, women and children.

Watch your background, too. One of the most common mistakes in portrait photography is to place the subject too close to the background—often right smack up against it. This causes the subject to cast ugly multiple shadows all over the background. Also, your lights will wash out the background, especially if you're deliberately trying to keep it dark. Light falling on a black background will actually make it look light gray or almost white in the picture.

Keep your subject well in front of the background—as much as five to six feet. If you want the background to go dark, don't put a light on it. In general, a dark background looks more dramatic, especially against a light-haired subject. However, dark-haired subjects generally photograph better against a light background.

Keep the background plain and uncluttered. A bare wall will often do, or you can hang up a sheet or blanket. At six feet, small wrinkles usually won't show. For a convertible backdrop, paint a sheet of thin plywood or hardboard white on one side and black on the other. Then a quick flip of the board will give you a choice of a light or dark background depending on the type of subject you're shooting at the moment.

Exposure stays the same

It's best to establish your exposure with a light meter, although you'll be surprised to find that it will change very little no matter how many lights you use or how you move them around. The accompanying photos were all shot on Super Pan-chro Press film with an ASA rating of 250. Basic exposure throughout was 1/10th of a second at f/16. On a slightly slower fine-grain portrait film, such as Kodak's Plus-X at ASA 125, this would be equivalent to 1/10th of a second at f/11 or 1/25th of a second at f/8.

For additional information, there are several simplified guides to portrait photography that you'll find helpful. One, entitled *A Word About Portrait Lighting*, is available from Smith-Victor Corp., Griffith, Ind. 46319. Another, entitled *Portrait Photography from the Light Side*, is available from Sylvania Lighting Products, 730 Third Ave., New York, N. Y. 10017. In addition, a Kodak booklet, *Snapshots By Photoflood*, (Customer's Service Pamphlet No. AC-5), can be obtained free at some Kodak dealers. ★★

PREFINISHED SIDINGS

(Continued from page 163)

aluminum siding, a request to the association for this manual might prove fruitful. Although an association spokesman told me the manual is presently distributed to professional applicators only, he said that this policy may change. The manual sells for 15 cents and is an excellent guide.)

I called a number of contractors in my area and found that the going rate for a PVC installation ranges from \$1 to \$1.25 a square foot. However, I did find one contractor who was willing to sell the siding itself for 50 cents. "I'm in business to make a profit," he said, "and I'd just as soon make it selling you the stuff." If PVC strikes your fancy, you may be able to make a similar deal. On the other hand, you might prefer one of the other pre-finished sidings.

Plastic-coated aluminum, for instance, doesn't need painting for a minimum of 15 years. It's guaranteed not to rust, split, peel or chip for 20 years. As shown in the photos on page 161, aluminum siding is available in a number of other designs in addition to the traditional clapboard. Depending upon gauge, the price runs from 40 to 50 cents a square foot. Of course, you can buy less expensive grades. Enamel-coated aluminum siding, for example, costs between 30 and 35 cents a square foot, but it isn't as durable and doesn't carry the same broad guarantee as the plastic-coated material.

Wood, plywood and hardboard sidings might all be lumped together, in that they are applied more-or-less like conventional uncoated siding. Check the table on page 163 for what's available in each type.

All prefinished sidings are offered in a number of colors. With PVC and aluminum, at least, you can also buy any accessory necessary to finish the job—corner posts, gutters, downspouts and various trim pieces.

As for guarantees, check not only what's mentioned but what isn't mentioned. For example, aluminum isn't guaranteed against lightning, fire, hailstorm or chemicals; PVC seems to be guaranteed against almost everything but scratching; and wood isn't guaranteed against termites or vermin. Most guarantees are on a pro rata basis—that is, replacement of damaged panels will probably cost you a certain amount of money, depending upon how long the material has been in place.

One final point. The term "square" applied to siding means 100 sq. ft., so don't be shocked if you're quoted a price of \$40 a square. It's the same as 40 cents a square foot. ★★

FREE!

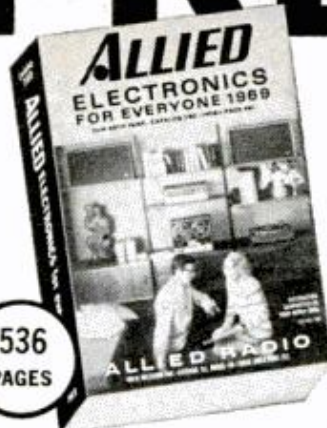

**536
PAGES**

Shop by mail and save at Allied, world's largest electronics headquarters. Hundreds of money-saving values. **NO MONEY DOWN.** Up to 2 years to pay!

MAIL COUPON BELOW

**1969
ALLIED
CATALOG**

SAVE ON:

- Electronic & Hobby Kits
- Stereo Hi-Fi
- Tape Recorders, Tape
- CB 2-Way Radios
- Walkie-Talkies
- FM-AM & AM Radios
- Shortwave Receivers
- Portable TV
- Phonographs
- Amateur Gear
- Intercoms & PA
- Automotive Electronics
- Test Instruments
- TV Antennas & Tubes
- Power Tools, Hardware
- Tubes, Transistors
- Parts, Batteries, Books

ALLIED RADIO, Dept. 075
P.O. Box 4398, Chicago, Ill. 60680 (Please Print)

NAME _____
First Middle Last

ADDRESS _____

CITY _____

STATE _____ ZIP _____

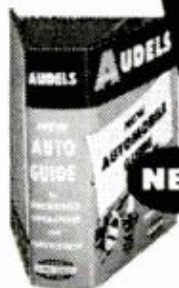

**AUDEL SKILL-BUILDING
GUIDES**

NEW AUTO GUIDE!

FIX ANY CAR FAST! Step-by-step handy Repair Guide shows you how to troubleshoot and repair every part and system in any make or model car. Features

unique symptoms-and-causes charts. Covers absolutely everything from axles to valves, including engine tune-up. Hundreds of illustrations. 736 pages. To order, check No. 1 below. **Only.....\$6.95**

USE THIS HANDY ORDER FORM

<input type="checkbox"/>	No. 1	AUTO GUIDE. 736 pages	\$ 6.95
<input type="checkbox"/>	No. 8	Carpenters & Builders Guide. 4 Vols. 1616 pages	16.95
<input type="checkbox"/>	No. 15A	New Electric Library. 10 Vols. 6016 pages	25.00
<input type="checkbox"/>	No. 2	Home Appliance Service Guide. 608 pages	6.95
<input type="checkbox"/>	No. 14A	Home Refrigeration & Air Conditioning. 575 pages	6.95
<input type="checkbox"/>	No. 26	Masons & Builders Guide. 4 Vols. 1478 pages	10.50
<input type="checkbox"/>	No. 6	Plumbers & Steamfitters Guide. 3 Vols. 960 pages	9.95
<input type="checkbox"/>	No. 12N	Machinists & Toolmakers Guide. 3 Vols. 1312 pages	13.50
<input type="checkbox"/>	No. 10	Welders Guide. 624 pages	4.95
<input type="checkbox"/>	No. 4	Handy Book of Practical Electricity. 1088 pages	5.95

FREE 10-DAY TRIAL • SEND NO MONEY

THEODORE AUDEL & CO. Since 1879
4300 W. 62nd St., Indianapolis, Ind. 46206

P-108

Please mail me for 10 days **FREE EXAMINATION** the books checked above. I agree to mail \$3 in 10 days for each book or set ordered, and to mail \$3 a month for each book or set until I've paid the purchase price, plus shipping costs. If I'm not completely satisfied with my Audel Guides I may return them.

**ORDER
TODAY!**

Name _____

Address _____

City _____ State _____ Zip _____

SAVE SHIPPING COSTS. Check here if you enclose complete payment (plus sales tax, if any) with order. We pay postage. Same return privilege.

BENJAMIN INTRODUCES A FABULOUS NEW AIR RIFLE

... that takes up where
the Ol' Reliable Super
Single Shot leaves off.

You Can **DEPEND** on **BENJAMIN**

Push-Pull Safety on top
of Stock behind Breech.

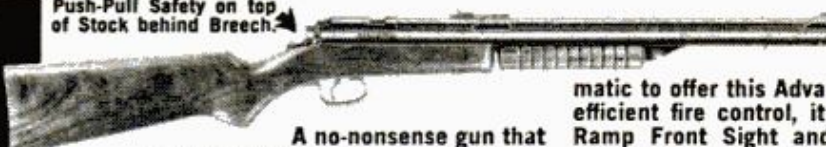

\$34.95

MODEL 340 CAL. .08
MODEL 342 CAL. .22
PELLET—MODEL 347
CAL. .177 PELLET.

A no-nonsense gun that means business every time you fire, this New Benjamin combines all the superb Quality and Performance features of its famous Predecessor with extra improvements for your shooting pleasure. Foremost, is a Thumb Operated Top Safety. The only pneu-

matic to offer this Advanced feature for more efficient fire control, it also includes a new Ramp Front Sight and adjustable Stepped Leaf Rear Sight to bring out the full Accuracy potential of the New Model. Shoot target, small game. This Benjamin stands alone for its Power — Convenience — Safety — Reliability. At your Benjamin Dealer's.

Use Benjamin H-C Pellets—Sized & Lubricated.

BENJAMIN AIR RIFLE COMPANY, 896 Marion St., St. Louis, Mo. 63104 **FREE CATALOG! Write**

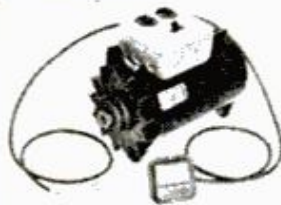

110-112 VOLT A.C. LIGHT PLANTS—60 CYCLES

Fanbelt driven from pickup or small gas engine. Operates saws, drills, pumps, freezers, T.V. X1000 Watts—Needs No Battery. Reg. \$99.50. Now \$62.50. 1500 Watts—6 or 12 volt vehicles. Reg. \$89.50. Now \$52.50. 3000 Watts—12 volt vehicles only. Reg. \$179.50. No. \$99.50. *Guaranteed.* Check or Money Order.

VIRDEN PERMA-BILT, Box 7066 P.M., Amarillo, Texas 79109

WANT MORE MONEY? GET INTO PHOTOGRAPHY

Coast-to-coast, high-paying jobs in photography are waiting for people with the "know-how" to fill them. You can quickly, easily qualify at home with the world-famous NYI Learn-by-Doing Method. Write today for free catalog. Also resident training in New York. Our 58th Year.

NEW YORK INSTITUTE OF PHOTOGRAPHY
Dept. 49-10, 10 West 33 St., New York, N.Y. 10001

LAW FREE BOOK THE LAW TRAINED MAN

Write today for a FREE copy of illustrated law book, "THE LAW TRAINED MAN," which shows how to earn the professional Bachelor of Laws (LL.B.) degree through home study of the famous Blackstone Law Course. All necessary books and lessons provided. Moderate cost; convenient monthly terms. Write for FREE law training book today.

Blackstone School of Law, 307 N. Michigan Ave.
Founded 1890 Dept. 57, Chicago, Illinois 60601



Learn how to become a GAME WARDEN

GOV'T HUNTER. FORESTER. WILDLIFE MANAGER

Exciting job openings now for qualified men who love outdoor work. Protect forests and wildlife—arrest violators! Good pay, security, prestige and authority for respected career Conservation Officers. Easy home-study plan! Send for FREE Fact BOOK, aptitude QUIZ, SUBSCRIPTION to Conservation magazine. State age.

NORTH AMERICAN SCHOOL OF CONSERVATION
Campus Drive, Dept. 4170, Newport, Calif. 92660



SEND FOR THIS FREE!

Make money. Know how to break and train horses and ponies. Send name and zip-code for this free booklet with special offer of a course in Animal Breeding. If you are interested in Gaiting and Riding the saddle horse check () Do it today! Write to **BEERY School of HORSEMANSHIP** 11010-D, Pleasant Hill, Ohio 45359

WE CAN SAVE YOU MONEY when you buy a Used Car

Don't buy now and cry later. Know exactly what you are getting before you spend a penny. Here's how: it takes just minutes to read our sensational booklet. It is so concise and simple, it explains clearly every aspect of what to look for when buying a used car. **COPYRIGHTED BY AUTOMOTIVE AUTHORITY.** Don't be fooled. This booklet will make you an authority so that you'll know exactly what to look for and what to pay. Your Dollar for this little gem may save you hundreds. Don't delay. (no COD's) Send \$1 to

AUTO-MATE Inc.

195-04 Sagamore Ave.,
Hollis, N. Y. 11423



EARN EXTRA MONEY!

Make **BIG** spare time profits with our "Glamour Girl" plastic coated playing cards, featuring 52 beautiful calendar models in full color all different, all magnificently posed. Regulation size, finest quality cards. Add fun and zest to every card game. Show to friends, neighbors, fellow-workers, in stores, offices, factories. Watch men grab this deck of American beauties out of your hand for only \$1.00 a deck. Your low cost: 1 doz. decks \$6.90; 3 doz. \$19.80; 12 doz. \$68.40. (Sample deck \$1.00.) All orders postpaid. Free catalog of over 100 other fast sellers included with all orders. Order today! **Lakeside Import Co.;** Dept. PC-108; 6800 N. Campbell; Chicago, Ill. 60645.



LEARN MEAT CUTTING

Train quickly in 8 short weeks at Toledo for a bright future with security in vital meat business. Big pay, full-time jobs — **HAVE A PROFITABLE MARKET OF YOUR OWN!** Time payment plan available. Diploma given. Job help. Thousands of successful graduates. **OUR 46th YEAR!** Send now for big new illustrated FREE catalog. No obligation. **G.I. Approved**
NATIONAL SCHOOL OF MEAT CUTTING
Dept. 50-M Toledo, Ohio 43604

MECHANICAL PENCIL CALCULATOR.



Math-Wiz mech. pencil calculator gives answers automatically to addition, subtraction, multiplication, division and square root problems. 6 1/2" x 1/2" gold anodized sturdy aluminum casing. Practical and useful gift. \$2.95 ppd. (No C.O.D.) **Jack Weiser, dept. 1, 1417 S. Fairfax Ave., Los Angeles, Calif. 90019**

Career in ELECTRONICS?

Career training at home the new easy way with RCA Institutes. Lab work with first lesson. Pay as you go. Send for free 64-page book.

RCA Institutes, Inc. Dept. PM-08
320 W. 31 St., N.Y., N.Y. 10001



OWN a Business

If employed, start part time. Alert dealers can gross \$9 hourly profit plus \$6 on EACH service-man. Clean, revive, mothproof, flameproof rugs & upholstery. No shop needed. Nationally advertised world-wide service. We train and assist you. Easy to learn. Quickly established. One job daily brings a good income. Easy terms. Send today for FREE booklet. No obligation.

DURACLEAN CO., 8-160 Duraclean Bldg., Deerfield, Ill.

PROFIT IN YOUR SPARE TIME SMALL ENGINE REPAIR PAYS BIG!



Outboard • Powermower • Chain Saw • Tractor
MAKE EXTRA MONEY — or fix your own engines and **SAVE!** Illustrated, easy-to-learn Home Study Course qualifies you as expert. Approved for Veterans. Write today!

LINCOLN TECHNICAL INSTITUTE
SUITE 10-E, 427 MARKET ST., NEWARK 5, N.J.



There must
be something better about
the world's fastest-selling
chain saws.

Homelite XLs are the world's most popular, and for good reasons. Homelite engineering makes the difference. This Homelite XL-101 is a streamlined, low-profile chain saw with performance to match its looks. Cuts through a 12-inch log in 8 seconds, yet weighs only 10½ pounds*.

You'll be proud to own it. You can't find a more dependable, easier-handling chain saw for cutting your own firewood. Perfect for removing storm-damaged tree limbs, too. Take a test cut with the XL-101 now, at your Homelite Dealer. He's listed in the Yellow Pages. Other Homelite chain saws are priced as low as \$129.95.

*less bar and chain

HOMELITE

10210 RIVERDALE AVE., PORT CHESTER, N.Y.

Atextron
DIVISION



8-74

OCTOBER 1968

233

Материал, защищенный авторскими правами

Panther®

Always First with the Features that Count!

ARCTIC CAT EXCLUSIVE Torsion Spring Suspension System (pat. pend.)

No "Bogie Wheels" to Wear Out, Burn Out or Pop Out... Adjusts for Light or Heavy Loads...
Trouble-free and Service-free 80% LESS MOVING PARTS

Only Panther has this revolutionary new chassis support system. "Torsion Spring Suspension" was originated by Arctic Cat, and is now in exclusive use on over 20,000 Panthers. 80% LESS MOVING PARTS makes it virtually trouble-free and service-free. No "bogie wheels" to wear out, burn out or pop out. No more "bottoming" on rough terrain. Simple driver's seat adjustment for light or heavy loads. Try the industry's most advanced suspension system with a test ride today. It's yours at no extra cost!



The "Give and Take" of Arctic's Torsion Spring Suspension



Front end of track absorbs obstacle shocks
Track "rides the top" to span ridges and bumps
Floating action cushions sudden rear end drops

ARCTIC Cat
SNOWMOBILES



For FREE Color Brochure and Name of Local Dealer—Write or Phone your Nearest Arctic Cat Distributor:

WESTERN

ALASKA/Ace Fuel & Petroleum Co. (907) 277-4113
2425 East 5th Ave., Anchorage 99501

CALIFORNIA/California Arctic Distributors (916) 258-6196
P.O. Box 451, Chester 96020

COLORADO-NEW MEXICO/Valentine Distr. Co. (303) 366-3240
10929 E. Colfax, Aurora 80010

IDAHO-MONT.-WYO.-UTAH/Robison's Parts and Service
(208) 522-6757, 690 No. Yellowstone Hwy., Idaho Falls 83402

OREGON-WASHINGTON/Kunze-Case Co. (503) 884-9855
2977 Washburn Way, Klamath Falls, Ore. 97601

WEST CENTRAL

MINNESOTA-southern/D and V Enterprises (612) 774-1214
1160 Frost Ave., St. Paul 55109

NORTH DAKOTA & SOUTH DAKOTA Farm Implement Wholesalers
(701) 235-0577, 3121 1st Ave. No., P.O. Box 129, Fargo 58102

EAST CENTRAL

MICHIGAN, L. Pen.-IND.-ILL./Traverse Bay Marine (616) 947-8243
3055 Cass Rd., Traverse City, Mich. 49684

MICHIGAN, E. of Hwy. 77/U.P. Arctic Distr. (906) 121
Box 187, Trout Lake, Mich. 49793

WISCONSIN-MICH.,/U. Pen., W. of Hwy. 77 Arctic Distributors
(414) 725-6823 Route 2, Larson Rd., Neenah, Wisc. 54956

EASTERN

NEW ENGLAND STATES & Provinces of Quebec, Brunswick, Nova Scotia, P.E. Isl., Newfld./Rodco Inc. 93 (802) 728-3342,
Box 40, Randolph, Vt. 05060

NEW YORK/O. G. Schwarz Co. (716) 482-9282
430 Atlantic Ave., Rochester 14609

PENNSYLVANIA/Penn-Arctic Distributors (717) 769-8620
Box 59, Star Rt., Lock Haven 17745

IN CANADA

ALBERTA/Alberta Engineering Ltd. (403) 352-6061
P.O. Box 1628, Wetaskiwin

BRITISH COLUMBIA/Western Snowmobiles Ltd. (604) 684-5151
1820 W. Georgia St., Vancouver

MANITOBA/Robinson-Alamo Distr. Ltd. 774-1971
1425 Erin St., Winnipeg 3

ONTARIO/Mylie's Place (607) 488-5616
R.R. 1, Sleeman

SASKATCHEWAN/Dumarr Equip. Ltd. (306) 569-9651
140 E. 4th Ave., Regina

Manufactured by ARCTIC ENTERPRISES, INC., Thief River Falls, Minn. 56701 • (218) 681-1147

Master Mechanic Everlite Battery Charger

DON'T BUY BATTERIES SAVE \$ - RECHARGE THEM

Over and over up to 15 times or more

- By far the best
- Charges 6 batteries at once
- Charges 3 times faster
- Charges all types of batteries.

Only Everlite charges tiny hearing aid batteries as well as big lantern batteries.

Only Everlite charges flashlight, toys, radio, telephone, hearing aid, cameras—yes, even mercury cells. Save money and have the convenience of fresh batteries. Simple, safe, foolproof and unbelievably efficient. Plugs into any 115 volt outlet. Free battery tester included. Guaranteed for one year.

2 MODELS—The Everlite #75 for all Dry Cell Batteries up to 12 volts.Send

\$6.95

plus 5.65 for shipping.

\$8.95

plus 5.75 for shipping.

The Everlite #76 for all Dry Cell Batteries plus a special charge for Car Batteries to assure fast starts on cold mornings.Send



"Copy any Contour Instantly"



NEW IMPROVED Contour Copy

Copies exact outline
of any object!

Save dollars—save material. Can pay for itself on one job. The perfect tool for fitting in against door casings, bath fixtures, moldings, pipes, sinks, masonry, etc. A real boon to pattern makers, sheet metal mechanics, tool makers, body men, linoleum and floor tile men, etc. EASY TO USE—Just push the gauge leaves against any contour and lock. A perfect template every time. Works against any surface or material.



TEMPLATES

DOOR CASINGS



Made of hardened aluminum alloy.

Size 1#—4¼" x 4¼"

\$6.90

plus 5.65 for shipping.

Will retain its accuracy forever.

Size #2—7½" x 4¼"

\$9.90

plus 5.75 for shipping.

EVERLITE® World's THRIFFIEST Light Plants



THE CHAMPION \$144.50

The Champion—1200 watts 115 volts AC for only \$139.95. Unbelievable but true—Brand new production methods now make possible world's finest design in a service free alternator light plant at this unprecedented price. Plant puts out a steady 1200 watts of 115 volt AC power to run power tools, oil burners, pumps, TV, or anything that requires up to 1200 watts. Powered by a rugged 3 HP, 4 cycle, easy start gas engine with 1 year factory warranty. Complete with carry handle and shock mounts. Why fool with short life 2 cycle plants when you can buy this rugged top quality machine at our factory price.

Item #1265 **\$144.50**
Wt. 65 lbs.

2¾ h.p. Clinton—34.95

Model 400, rugged 4 cycle model. Alum. Block, castiron cylinder. Rope start—¾" std. shaft. Item 1107 **34.95**
2 For **69.95**

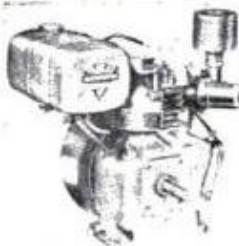

3½ h.p. Clinton—39.95

A big engine with big power. Model 404, 4 cycle, rope start, ¾" std. shaft, industrial ball bearing engine. Item 404 **39.95**
2 for **77.50**

Remember these engines are absolutely perfect and standard a under factory warranty. Money back guarantee. Order now while stocks are complete. Factories—we buy new engines.

STANDARD DIAL PHONES WITH BELL

Bell System late model dial phones same as used by all telephone companies. Ideal as extensions on any system. Easy to connect. Several may be connected on one line. Easily modified for private inter-com system. Cost \$40.00 new—guaranteed excellent condition.



ITEM 855 NC. Wt. 8 lbs. **\$7.45**

All Prices FOB Factory—10 Day Money-Back Guarantee

Briggs & Stratton — Clinton New Gas Engine Sale



Clinton 2½ hp. Md. 500—Re-coil starter. Std. 5/8" shaft w. keyway—ready to go. Reg. price \$59.50
Special (item 1002)

\$34.95

2 for **\$64.50**
6 for ... **\$190.00**



Briggs & Stratton 2½ hp. Md. 81106 ratchet start, ¾" shaft. Sturdy 4 cycle engine. Reg. price \$69.50
Spec Item #1518

\$34.50

2 for **\$67.50**
6 for **\$199.50**

\$69.95

5¾ hp.

Briggs

&

Stratton



Same engine with 12 v. elec. start and battery charging.

(Item #1571) **\$94.50**

Remember these engines are absolutely perfect and standard and under factory warranty. Money back guarantee. Order now while stocks are complete. Factories—we buy new engines.

TRUCK OR BOAT WINCH 2000



A powerful, compact winch which installs easily even in limited space. Works with any 12, 24 or 32 volt system. Reverses under power—positive brake holds load. Drip proof cover. Remote control if desired. Drum holds 100 ft. of ¼" cable. Speed 30 ft. per minute. A terrific winch at an economy price. Item 1263
Wt. 55# **\$69.50**

MASTER MECHANIC MFG. CO.

Dept. A-108

Box A, Burlington, Wis.

Box 65, Sarasota, Fla.

Send orders to nearest office.



London bank installs money machine for quick loans

A London bank has installed an "instant-money" machine that delivers a packet of 10 one-pound notes to a customer any time of day or night. The customer inserts a small plastic card into the machine (left) and then taps out a personal code number on the keyboard. The machine then keeps the card (to be returned by mail) and delivers the money (right).



Barrel of fun

Kids can run and tumble to their hearts' content inside the rotating Barrel of Fun. Made of molded fiberglass planks, the barrel turns in either direction. It's a product of Miracle Equipment Co., Grinnell, Iowa.

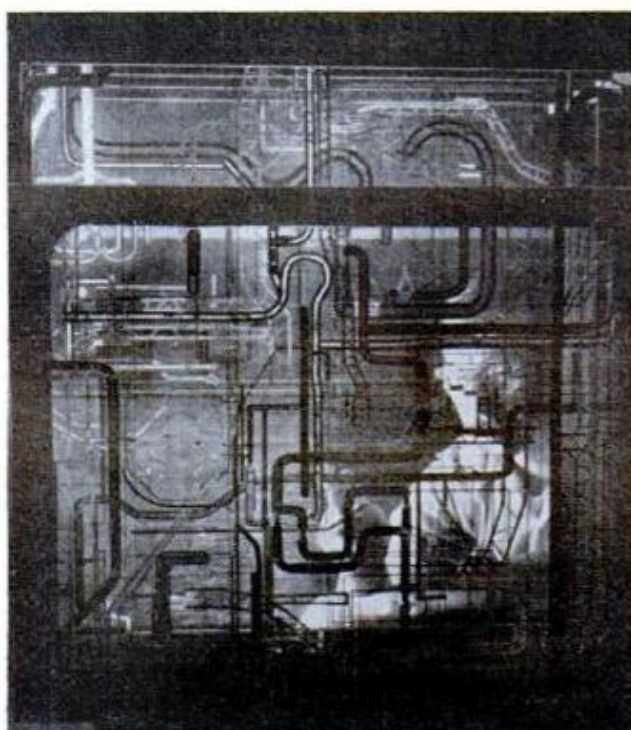

Shipbuilder's visualizer

Lockheed Shipbuilding Co. engineers visualize design problems in a ship's machinery space by "constructing" pipe and duct systems with colored tape on clear plastic sheets set up at one-foot intervals.

BASEMENT TOILET FLUSHES UP



TO OVERHEAD SEWER OR SEPTIC TANK. NO DIGGING UP FLOORS. INSTALLS EASY. Write McPHERSON, INC., BOX 15133, TAMPA, FLORIDA 33614

\$5.50
less bell

DIAL TELEPHONES

With bell \$8.45. If plug is required add \$2.00. Factory reconditioned, Guaranteed. Many other phones available, write for free list.

All shipments FOB Waymart, Pa.

SURPLUS SAVING CENTER

Dept. PM-8 Waymart, Penna. 18472



AMAZ-ING! \$130 PROFIT A RACE DAY WITH \$50

Get this valuable and amazing book. Clearly reveals secrets of 10 world's greatest race professional investors. 25 yrs. actual results included showing 7 in 10 plays won and \$130 average race day profit with \$50. Wins at all tracks, horses, harness, dog. Here's proof of it's amazing success—eighth year of publication. HITCHINGS, Box 8715, PMA Carmel, Calif. 93921. Tear out this ad now and mail with name and address with zip code for bonanza offer.

Now! Heat a Six-Room Home with Electric Hot Water Heat for \$14.90 a Month*

*Based on 9-month heating season. Statistics available on request.



International Electric Hot Water Heat eliminates the muss and dust of oil, gas and coal heat. Now, for the first time, homes, apartments and commercial applications can be heated with economical hot water heat at far lower cost than you ever thought possible. There's thermostatic control in every room. Installation is a fraction of the cost of hot water heating systems. No pipes, no tanks, no boilers, no chimney needed. Call PRespect 1-2410, St. Louis, or write for full details immediately!

International Electric Heating Division PM 1068
3800 Park Ave., St. Louis, Mo. 63110

For _____ Home _____ Apt. _____ School _____ Commercial

Please send your brochure explaining your hot-water electric baseboard heater.

Enclosed is a rough sketch showing the dimensions of the rooms in my home, and location of outside windows and doors. Please send free factory-engineered heating layout.

NAME _____ ADDRESS _____
CITY _____ STATE _____

The Devil has quite a temper!



We're proud of the temper in Red Devil's high carbon steel blades . . . just one of the quality features in our full line of putty knives, wall scrapers, wood scrapers and other home patch-up tools. Buy the best! Buy Red Devil!

Red Devil inc

UNION, N. J., U.S.A.



15737-B

GREER TECHNICAL INSTITUTE, INC.

OFFERS TRADES THAT PAY



Become Successful as Thousands of Others!

- DIESEL TRUCK DRIVER*
- WELDING: GAS, ARC, HELIARC*
- AUTOMOTIVE SPECIALISTS*
- BODY AND FENDER
- MACHINIST—TOOL AND DIE
- DIESEL SPECIALIST*
- REFRIGERATION - AIR CONDITIONING*
- HEAVY EQUIPMENT OPERATOR OR MECHANIC*
- 2 YEAR AUTOMOTIVE & DIESEL TECHNOLOGY



Founded 1908

*Courses also Available in Home Pre Training VETERAN APPROVED

2233 SO. MICHIGAN AVENUE
CHICAGO, ILLINOIS 60616

GREER TECHNICAL INSTITUTE, INC.
2233 SO. MICHIGAN AVENUE
CHICAGO, ILLINOIS 60616

- PRE TRAINING
 RESIDENTIAL
 VETERAN

Gentlemen: Please send more information about above trades.

COURSE _____ AGE _____

NAME _____

ADDRESS _____

CITY _____ STATE _____ PO 68M

SAVE ON WOOD

Imported & Domestic



CABINET HARDWARE - VENEERS - TOOLS
EVERYTHING for the Wood Shop

New 1969 Catalog Ready!

OVER 1500 ITEMS at MONEY SAVING PRICES! Finest domestic and imported hardwoods... all dimensions. Hardwood veneers. Power tools at discount prices. Hardware, lamp parts, upholstery supplies, mosaic tile. Hard to find inlays, bandings, etc. Get new catalog... send name, address and enclose 35¢ to pay postage, handling.

CRAFTSMAN WOOD SERVICE CO. Dept. A-108
2729 S. MARY ST., CHICAGO, ILL. 60608

NEW WESTERN HAIG
.12 CALIBER
SPECIAL FACTORY
OFFER!



\$300
post-paid

USES POWDER CHARGE

This small bore gun shoots .12 cal. (steel) bullets fired by small 4.4 mg. powder charge. Not a CO₂ gun! You'll like the handsome lines, grip, and balance. Western in style, but patented ball and cap action allows this low price. 9 3/4" steel barrel cased in knurled styrene stock, overall 13 1/2". Develop pistol form, accuracy at a fraction of cost of large caliber pistols. Comes with 50 lead bullets. Satisfaction guaranteed. Send \$3 to: Haig Mfg. Co., P.O. Box 24-B, Alhambra, Calif. 91802

GOLD!...TREASURE!



YOURS FOR THE FINDING —
and it's easy to find with a RELCO detector
Detect buried gold, silver, nuggets, coins, mineral deposits, historical relics.

Relco detectors are favorites with treasure hunters, prospectors and coin collectors throughout the world. Here's why:

- Now you can determine the approximate size and depth of an object being detected without complicated switches or dials.
- Distinguish between gold bearing magnetite, certain minerals and metals such as silver, iron, copper, etc.
- New all-transistor circuitry has increased sensitivity for more penetrating power.
- Lightweight, rugged, easy to carry.
- Permanently tuned molded exploring heads.
 - Excellent for use on beach, in caves, ghost towns, mountains, etc.
 - Broader detection field. Finds treasures other detectors miss.
 - Full two year guarantee.

Only \$19.95 to \$129.50

Write for FREE CATALOG
and treasure hunting tips

RELCO
Dept. A-11
Box 10563,
Houston, Texas
77018

SAW SHARPENING IS EASY

Super Filer No. 11 joints and sharpens circular saws 6" to 10" with all teeth correct in height, depth, pitch, bevel. When file hits steel roller, teeth are finished. **\$10.95** Saw runs true with no side pull. Includes 8" file. PPD.



"TRU-CIRCLE"
saw set automatically sets teeth at 10° **\$2.95** or more. PPD.

MONEY BACK GUARANTEE
A.D. McBURNEY, 1610 Victory Blvd., Glendale, Calif. 91201, A-107

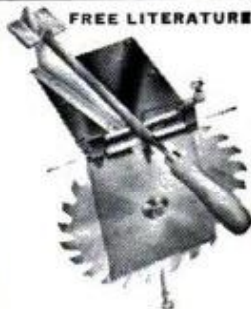

FREE LITERATURE

NEWS BRIEFS



Shock cart

The "shock cart," a mobile unit developed by Honeywell, contains electronic equipment that gathers information vital to the treatment of patients suffering from shock.

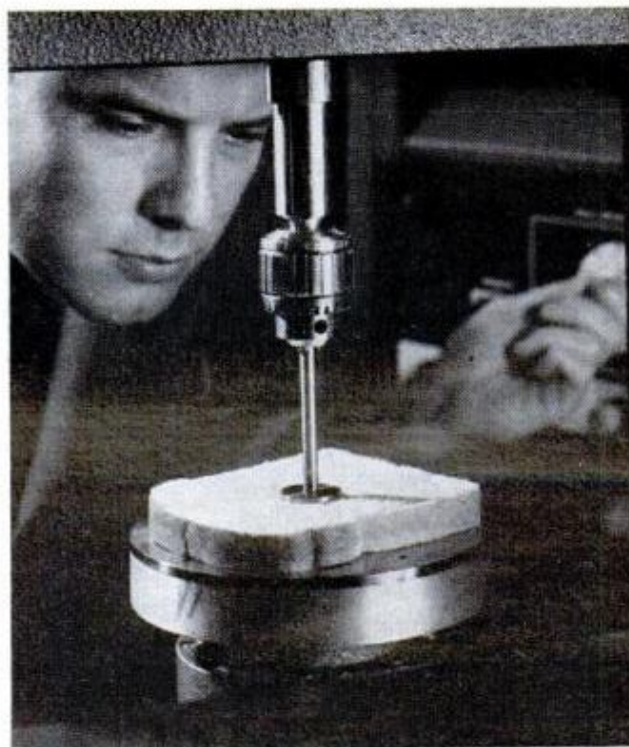

How fresh is fresh?

What constitutes freshness in a slice of bread? That's a question Instron Corp. scientists are helping answer for the food industry with this electronic force-measuring system.

Your car is too young to smoke.



There's bound to be a secret puff now and then, but steady smoking from a young car?

Sometimes worn parts cause it. But it often starts with deposits in your engine. Stop-and-go driving can form them, or the oil itself.

Quaker State Motor Oil is free of tars, asphalts and other

impurities to begin with, a natural advantage of 100% Pure Pennsylvania Grade Crude Oil.

Then it's fortified to provide sure protection under any driving conditions.

Your car can kick the smoking habit.

But you've got to take the first step:



Quaker State your car to keep it running young.

5000° OXYGEN WELDING TORCH \$34.95 New portable SOLIDOX welding torch goes anywhere. Only 4 lbs. Burns amazing solid oxygen pellets & propane. Flame exceeds 5000°F. Braze weld, silver solder, melt 1/4" steel. Complete kit: torch, pellets, propane, glasses, braze rods, lighter, etc. Ideal for shops, hobby, metal repair. Professional results. Low-cost SOLIDOX is simple and safe. Money-back guarantee. Only \$34.95 ppd.

Cleanweld Products, PM-10, Box 1061, South Gate, Calif. 90280

BUY GOV'T SURPLUS SAVE TO 85%

<p>FISH/WORM SHOCKER</p> <p>\$7.95 FOB</p> <p>Cost Gov't Over \$11.99</p> <p>• (ITEM #670) -- Harvest worms without digging, clear private ponds of coarse fish. Hand cranked unit puts out 110-VAC. Creates powerful electrical field in ground or water. Ideal for experiments, shocking fun of parties, etc. SAFE, 2 1/2" x 3" x 4". Shpg. wt. 3 lbs.</p>	<p>BATTERY GEAR MOTOR</p> <p>Cost Gov't Over \$175.99</p> <p>\$25.95 FOB</p> <p>• (ITEM #571-A) -- Powerful, ball bearing unit. Use with worm gear winches, build hoists, electric cars, etc. Operates on 6 to 12 volts DC. 20 to 1 gear ratio, fully reversible. 130-270 RPM. 6-12 VDC. Shaft 5/8" d. x 1.1 2" l. 6" diam x 15". Shpg. wt. 30 lbs.</p>	<p>WALL TYPE TELEPHONE</p> <p>Orig. Cost Over \$27.50</p> <p>\$7.95 FOB</p> <p>• (ITEM #715-W) -- Genuine Automatic Electric dial telephones. Ideal for use as extension phones, for use on private systems, etc. Work on any commercial telephone system. Reconditioned, tested, guaranteed. Excellent condition, work like new. Shipping weight 9 lbs.</p>
--	---	--

Send 25c (Cash or Stamps) For BIG BARGAIN CATALOG

1000's Of Bargains; Surplus, Excess Inventory, Brand Name Equipment! Hydraulics • Power Plants Winches • Gear Motors • Surveying Instruments • Pumps • Welders Compressors • Telephones • Binoculars • Electronics • Many Others

"SATISFACTION OR MONEY BACK GUARANTEE"

SURPLUS CENTER PM-108 Lincoln, Nebraska Zip Code 68501

FANTASTIC VALUES WITH THIS COUPON

AMERICAN MACHINE & TOOL CO., Dept. P M08, Royersford, Pa. 19468
Please send me the units checked. Payment in full enclosed \$.....
or \$3 deposit each item enclosed, balance C.O.D. I MUST BE FULLY
SATISFIED OR WILL RETURN UNIT WITHIN 10 DAYS FOR FULL REFUND.
No questions asked. Jointer-Planer at \$19.95
 8" Power Saw at \$14.95 Lathe at \$9.85
 Standard Rip Fence #354 at \$3.50 Set of 3 High Speed
Turning Chisels at \$4.95
 Long Rip Fence #354C at \$4.50 Drill Press at \$29.95
 Belt Sander at \$14.95 Disc Sander at \$7.95
 Mitre gage for Sander at \$1.95

GE Motor } \$18.80 (purchased with other item)
 \$24.85 (if purchased separately)

NAME.....
ADDRESS.....
CITY..... ZONE/ZIP..... STATE.....

**SAVE AS MUCH
AS...
80% WITH
QUALITY  POWER TOOLS**

DIRECT FACTORY OFFER AND REVOLUTIONARY PATENTS decrease costs, increase efficiency. Full scale power tools of heavy duty 100% cast iron and steel. Streamlined design reduces weight, cuts material and production costs. Special patents provide added efficiency, accuracy, savings. Parts made, assembled, tested, packed right in our own factories shipped direct... save store profits.

ENDORSED BY AMERICA'S TOP MAGAZINES... Here is what the editors say:

"A good bit of sound—imaginative—engineering." Popular Science; "(saw) boasts many features of bigger brothers." Popular Mechanics; "Amazingly versatile." Workbench; "Highly substantial construction, sturdy enough for production line use."

Industrial Woodworking. And Workbench awarded these tools their coveted "Work Tested" Seal.

OVER A MILLION USERS confirm their precision, versatility and rugged performance.

***10-YEAR FULL SERVICE GUARANTEE...** Any part or parts of any AMCO power tool (except motor) which may become inoperative for any reason within ten years after the purchase date will be repaired or replaced by the factory without cost to the purchaser. Your only cost: for postage.

**UNCONDITIONAL
10-DAY MONEY
BACK
GUARANTEE**

You must be fully satisfied. If not, return in 10 days, freight collect. Money promptly refunded in full.



8" TILT ARBOR POWER SAW

DOES WORK OF \$75 BENCH SAW as is. Converts easily to equal any \$300 floor model cabinet units! Crosscuts, rips, mitres, cuts compound angles, dadoes, makes coves and mouldings.

\$14.95 f.o.b. factory. Wt. 25 lbs. Includes completely assembled cast iron and steel 8" saw with ground cast iron table... less blade. **RIP FENCE**, if desired, for easier work alignment, \$3.50 add'l.

SAW BLADE TILTS... TABLE STAYS LEVEL

Locks securely at any angle up to 50°, raises, lowers 0"-2 1/4". Patented tilt mechanism, accurate etched scale. Patented motor mount takes std. 1/4 h.p. or larger motor, keeps belt tight, assures perfect alignment at any angle, transmits full power. Takes std. blade, saw insert removes to take dadoe heads, cutters, etc. (not incl.). Accurate mitre sories available at factory prices. Enclosed steel base. "Compo" bearings. Accur. Std. size (for bench saw) \$3.50; larger fence (for cabinet base, as ill'd.) \$4.50.

FREE CABINET BASE PLANS Use as portable bench saw as received (inset photo) work of floor models costing \$300. **FREE plans...** all you'll need are a sheet of 3/4" plywood and 3-4 hours. Use your AMCO saw for cutting. Plans provide 27" x 24" work surface, 33" height, tool storage compartment.

10-YEAR FULL SERVICE GUARANTEE*

6" SWING 3-FOOT LATHE



Optional faceplate for turning bowls, trays, lamp bases, rosettes, etc. \$2.50. **\$985** f.o.b. factory Wt. 14 lbs.

Set of 3 high speed turning chisels, \$4.95 add'l.

DOES THE WORK OF \$40 UNITS... with same precision and speed. Turns wood, plastic. Sturdy cast iron with tubular steel bed. Ball thrust cup center, spur center, T-rest assembly, lever action tail stock, 2-speed pulley. Fits any motor.

10-YEAR FULL SERVICE GUARANTEE*

PRECISION 4" x 36" BELT SANDER

f.o.b. factory. Wt. 15 lbs.



Mitre gage: \$1.95 add'l.

\$1495 †Disc Sander attachment incl. disc bracket, ground cast table (tilts 0-45°): \$7.95 add'l.

DOES WORK OF \$50 SANDERS... The world's most talented belt sander. Heavy cast sander incl. 4" x 36" sanding belt, V-pulley drive, multi-purpose drive spindle. Changes from horizontal to vertical sanding in secs. Uses 1/2 hp or larger motor.

10-YEAR FULL SERVICE GUARANTEE*

FULL 22" LONG, 4 1/8" JOINTER-PLANER

\$1995



f.o.b. factory. Wt.: 19 lbs. Complete as shown.

100% precision ground cast iron and steel.

DOES THE WORK OF \$60 UNITS... Professional power planing at a hand tool price. Make faster, more accurate joints, rabbetts, bevells for windows, doors, drawers, square tapered legs—Adjustable precision ground cast iron tables. Patent-pending design holds knife to table clearances at any depth. Rabbett depth 3/8". Fence adjustable 0°-50°. Hardened, ground hi-speed steel knives. Dual cutter guards. Balanced cutter head.

10-YEAR FULL SERVICE GUARANTEE*

32" RADIAL DRILL PRESS

All cast iron and steel
f.o.b. factory **\$2995**
Wt. 30 lbs.
1/2" cap.
Jacob's chuck incl.

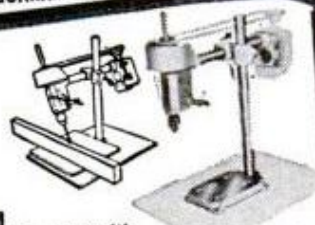

DOES WORK OF \$90 UNITS... and much more. Industrial quality precision unit with all standard features, many extras. Head raises, lowers. Depth of throat up to 16". Pre-set to any angle for on-or-off table drilling, even horizontal drilling. **10-YEAR FULL SERVICE GUARANTEE.***

BRAND NEW  MOTOR DEVELOPING FULL 1 HP... **\$18.80** F.O.B. FACTORY / FOR ANY OF ABOVE MACHINES. WT. 17 LBS. PURCHASED SEPARATELY, \$24.85

Amazing 200th Anniversary Celebration Limited Time Offer on Fine Bindings

SAVE 30%

on this luxurious new edition of

ENCYCLOPAEDIA BRITANNICA

You get all 24 volumes now...direct from the publisher...pay later on easy Book a Month Payment Plan

Yes, in honor of our 200th Anniversary Celebration, Britannica is now offering generous discounts on its fine, richly gilded leather bindings—for example, you can save 30% on this luxurious edition of Encyclopaedia Britannica, bound in durable, hand-tooled calfskin. This latest edition—the greatest treasury of knowledge ever published—is being offered on a remarkable direct-from-the-publisher plan.

Amazing Savings Opportunity. You may wonder how we're able to make this truly amazing discount offer on our fine bindings. First, we hope for great demand on these luxurious, fine bindings, and would expect to materially reduce our costs. And, because we would like every youngster to have the advantages of this great encyclopaedia—to help with homework—we pass these savings on to you. All 24 volumes will be placed in your home NOW . . . you pay *later* on convenient budget terms. It's *as easy as buying a book a month*.

Thousands of Subjects and Illustrations For Homework and Household Help. In the new Britannica, you'll find special articles on household budgets, interior decorating, medicine and health, home remodeling, and child care. For students, the new Britannica is indispensable—more readable, interesting and easy to use. It develops the active, alert minds that bring success in school and later life. The latest edition offers more than 22,000 magnificent illustrations. It is the work of 10,200 of the world's great authorities—the largest, most complete reference published in America.

Also, may we send you our special new 200th Anniversary Preview Booklet which pictures and describes the latest edition? For your free copy and complete information about this dramatic discount offer on our fine bindings—**available only during this year**—simply mail the attached postage-paid card now.

The finest edition in 200 years—bound in durable, hand-tooled calfskin.



FREE!

Mail attached card now for
Special New Preview Booklet
and complete details on this remarkable offer.

If card is detached, write to Encyclopaedia Britannica, Dept. 965-X, 425 N. Michigan Ave., Chicago, Ill. 60611.

Watch the National Geographic Special, "America's Wonderlands," brought to you by Encyclopaedia Britannica, in color on CBS-TV, 7:30 p.m. (E.D.T.) Wed., Oct. 23.

If you could put Tareyton's charcoal filter on your cigarette, you'd have a better cigarette.



But not as good as a Tareyton.

"That's why
us Tareyton smokers
would rather fight
than switch!"



Activated
charcoal filter.



100's or king size.
© The American Tobacco Company