

How to Handle the Deadly Hazards of Night Driving

POPULAR MECHANICS

SEPT. 1968
50 CENTS

What V
Owners
Think
of the
New Beetle

Exclusive!

**Top Ideas From the
World's Greatest
Inventors Show**

**40 Pages of Ideas
To Make Your
House More
Livable**

Modernizing Old Doors

How to Build a Closet

\$15 Tricks That Look
Like a Million

Floor Underlayment

Remodeling With Shelves

House-Painting With
A Roller

Shop in a
Bench

**SEALAB III
Home,
Sweet
Home at
600 Feet!**

Grand Prix of the U.S.

Dan Gurney's Column

SATURDAY MECHANIC: Installing Real Gauges • Auto Clinic



The jig's up.



On all other jig/sabre saws.
Millers Falls deals in Shock-Proof
safety. Our jig/sabre saw has each live
part encased in a thick wall of insulation.
No grounding necessary.

No three prong plug nuisance.

No adaptor needed.

Exclusive angle blade design for faster cutting.

A shoe that tilts 45° in either direction.

And reverses for tight, flush cuts.

Automatic blowing action: better chip clearance.

Husky motor, balanced lightweight design.

With the strongest guarantee in the trade.

And only the low price could shock you.

\$23.88 retail.

So the jig's up on all other jig/sabre saws. See your Millers Falls dealer.

Millers Falls Greenfield, Mass.

The safest name in tools.



The Round Tire is **Ply-ier**



It gives you at least 3,000 extra miles

"Ply-ier?" That's right. We mean Atlas Plycron* —The Round Tire—has the strength of four full plies as part of its rugged overall construction. That's just one of the reasons why this quality tire can roll at least 3,000 miles further than tires that come on most new cars. Once again, grueling road tests against complete sets of tires for new 1968 cars proved it.

Another strength. It's "tread-ier." The muscu-

lar Atlas Plycron tread is made of tough, long-lasting rubber compounds. This tread has a unique design that puts more of its surface on the road. So it grips harder! Gives you better stopping, surer control.

And you'll look long to find a safer tire! We test the Atlas Plycron for safety 54 different ways. Get Atlas Plycron tires and start thousands of miles ahead!

This One

ATLAS

Tires • Batteries • Accessories



RCZT-RCL-8N8J

Sold at over 50,000 leading service stations

*TRADE-MARKS "ATLAS" "PLYCRON" REG. U.S. PAT. OFF. © 1968 ATLAS SUPPLY CO.



Lee makes it tough for the working man.

Tough polyester
and cotton in the
fabric takes
toughest wear,
looks great.

Tough to beat
for fit—
tailored sizes
to fit any shape.

Tough main
seams that won't
shrink or pucker.

Tough on wrinkles—
smooth, permanent-
press good looks.
No ironing.

Lee-Prest Chetopa Twills

Lee Chetopa Twills are guaranteed—if you think a pair isn't doing the job, we'll give you a new pair free.

H. D. Lee Company, Inc., Dept. A, P. O. Box 440, Shawnee Mission, Kansas 66201. World's Largest Manufacturer of Union-Made Work Clothes. Also available in Canada.

Since you're going to pay a little more for one of our used cars, you ought to know why.

© VOLKSWAGEN OF AMERICA, INC.

It costs money to put a used car into shape.

Especially the way a Volkswagen dealer does it.

With the Volkswagen 16-point Safety and Performance Inspection.

He checks out things like cylinder compression and ignition timing, brake fluid and battery terminals and even how the headlights are aimed.

And when he's through he's still not through. Because then he checks out what he's checked out with a road test.

Anything he finds along the way that needs fixing gets fixed or the

car doesn't pass.

And when it finally passes, it gets the VW dealer's 100% guarantee that if anything goes wrong with the engine, transmission, rear axle, front axle assemblies, brake system, electrical system, within 30 days or 1000 miles, whichever comes first, he'll repair or replace it free.

So all the major working parts—the parts you worry about most when you buy a used car—are covered.

All of which is why you pay a little more for one of our used cars.

But there's one consolation. You worry a little less.

**This
used car is
guaranteed
100%.**



*The dealer guarantees 100% to repair or replace the engine, transmission, rear axle, front axle assemblies, brake system, electrical system for 30 days or 1000 miles, whichever comes first.

POPULAR MECHANICS®

INTERNATIONAL EDITIONS: AUSTRALIA, BRAZIL, CARIBBEAN, DENMARK, FRANCE, MEXICO, SOUTHERN HEMISPHERE, SWEDEN

AUTOMOBILES AND DRIVING

- [32 Detroit Listening Post](#)
- [44 Drivin' With Dan](#)
- [58 Automobile Clinic](#)
- [65 Night Driving: How to Handle Its Deadly Hazards](#)
- [76 Hard 'Charging' Through Old Mexico](#)
- [80 The Wildest Show on the Road!](#)
- [108 PM Owners Report: Volkswagen](#)
- [118 Saturday Mechanic: How to Install Gauges That Really Tell You Something](#)

HOME AND YARD

- [60C Homeowners' Clinic](#)
- [88 Have House, Will Travel](#)
- [122 How to Build an Extra Closet](#)
- [126 \\$15 Home Ideas That Look Like a Million](#)
- [132 Now You Can Panel an Outmoded Door](#)
- [134 New Building Products](#)
- [136 How to Be 'Shelf' Sufficient](#)
- [140 Build This Shop in a Bench](#)
- [148 Paint Your House With a Roller](#)
- [152 Solving Home Problems](#)
- [154 How to Install Underlayment](#)
- [157 Automatic Paint Tray](#)
- [164 Build PM's Maneuverable Mini-Mover](#)

SCIENCE AND INVENTIONS

- [20 Science Worldwide](#)
- [61 Hurricane! When Nature Lays On the Lash](#)
- [95 A Longer, Deeper, Daring Quest for the Secrets of Living in the Sea](#)
- [100 Greatest Gadget Show on Earth](#)

AEROSPACE, AVIATION, MILITARY

- [70 From a Dead Stop to 40 Knots in 75 Seconds](#)

SHOP AND CRAFTS

- [122 How to Build an Extra Closet](#)
- [126 \\$15 Home Ideas That Look Like a Million](#)
- [132 Now You Can Panel an Outmoded Door](#)
- [134 New Building Products](#)
- [136 How to Be 'Shelf' Sufficient](#)
- [140 Build This Shop in a Bench](#)
- [145 Hints From Readers](#)
- [154 How to Install Underlayment](#)
- [157 Automatic Paint Tray Mounts on any Ladder](#)
- [158 Hints From Readers](#)
- [159 Crosscut Guide for Your Portable Power Saw](#)
- [160 How to Put a Keen Edge on Irons and Chisels](#)
- [163 How Would You Do It?](#)
- [164 Build PM's Maneuverable Mini-Mover](#)
- [168 Hints From Readers](#)
- [169 New Tools You Should Know About](#)
- [170 Versatile Package Combines Lathe and Milling Machine](#)
- [172 Hints From Readers](#)

ELECTRONICS, RADIO AND TV

- [84 Nifty, New Automatic Turntables](#)
- [146 Let Your Lights Turn On Automatically With Outdoor Photo Controls](#)

BOATING, OUTDOOR RECREATION

- [92 What Gun for What Game?](#)
- [112 A Fisherman's Dream Boat](#)

PHOTOGRAPHY

- [151 Photo Hints](#)

REGULAR FEATURES

- [6 Letters](#)

Cover Illustration by Ed Valigursky

NEXT MONTH IN POPULAR MECHANICS

The 1969 Cars: What's really new about them? How do they compare? Twenty-six pages—eight in full color—of exclusive *PM* photos and first-hand reporting.

First Report: Trooper TV. Instant replay for tailgaters; videotape for the judge!

New Outboards and Snowmobiles. Two complete roundups of exciting '69 models.

How to Go After a Better Job. Break out of that rut and create a bright, new future!

ROBERT P. CROSSLEY

Editor

JAMES M. LISTON

Executive Editor

JOHN A. LINKLETTER

Managing Editor

WAYNE C. LECKEY

Home and Shop
Editor

SHELDON M. GALLAGER

Assistant Executive
Editor

THOMAS G. DAUER

Art Director

Published by The Hearst Corporation

RICHARD E. BERLIN, PRESIDENT

RICHARD E. DEEMS

President, Magazines Division

JOSEPH F. KERN

Publisher

CLIFFORD B. HICKS _____ Midwest Editor

WILLIAM KILPATRICK _____ Automotive

KEVIN V. BROWN _____ Aviation

DANIEL C. FALES _____ Boating and Outdoors

BILL HARTFORD _____ Electronics and Associate Automotive

LEONARD E. SABAL _____ Home Workshop

ARTHUR MIKESSELL _____ Associate Home and Shop

GARRY WINTER _____ Copy and Production

RICHARD H. FUNK _____ Associate Copy and Production

KATHY GARAVUSO _____ Assistant Copy and Production

ALVIN KIETZ _____ Assistant Art Director

NILS NELSON _____ Assistant Art Director

DON EVANS _____ Assistant Art Director

GEORGE W. BLOW _____ Technical Art Director

SOPHIE GRONOWICZ _____ Director, Bureau of Information

EVERETT JOHNSON _____ Cabinetmaker

ADDRESS ALL EDITORIAL COMMUNICATIONS TO: 575 Lexington Ave., New York, N.Y. 10022. For additional sources of information on the articles and products in this issue, write to Bureau of Information, Popular Mechanics, for free "Where-to-Find-It" list.

DANIEL J. COLEMAN

Director of Advertising

ADVERTISING OFFICES: New York: 575 Lexington Ave., Murray Hill 8-8500; Chicago: 520 N. Michigan Ave., 527-2400; Detroit: General Motors Bldg., TRinity 5-8711; Cleveland: Hanna Bldg., 1422 Euclid Ave., Prospect 1-0456; Los Angeles: 601 North Vermont Ave., 666-6263; San Francisco: 1101 Hearst Bldg., YUkon 2-0823.

SUBSCRIPTION SERVICE: Mail all subscription orders, changes of address, correspondence concerning subscriptions, and Postmaster notices of undeliverable copies to Popular Mechanics, Box 646, New York, N.Y. 10019. Please enclose your latest address label for quickest service when writing about your subscription.

POPULAR MECHANICS IS PUBLISHED MONTHLY by The Hearst Corporation, 57th St. at 8th Ave., New York, N.Y. 10019, U.S.A. Richard E. Berlin, President; George Hearst, V-Pres.; Richard E. Deems, President of Magazines; John R. Miller, Executive V-Pres. of Magazines; Raymond J. Petersen, Senior V-Pres. of Magazines; William S. Campbell, V-Pres. of Magazines; Albert A. Raehol, V-Pres. and Director of Circulation; Joseph F. Kern, V-Pres. for Popular Mechanics; Frank Massi, Treasurer; Harvey L. Lipton, Secy. Single copy in the United States and Canada, 50 cents. Subscription prices: United States and Possessions, \$4.00 for one year; \$7.00 for two years; \$10.00 for three years. Canada, add \$0.50 for each year. Pan American Postal Union countries, add \$1.00 for each year. All other countries, add \$2.00 for each year. When changing address, give old address as well as the new, with postal-zone number, if any, and allow six weeks for change to become effective. Second-class postage paid at New York, N.Y., and at additional mailing offices. Authorized as second-class mail by the Post Office Department, Ottawa, and for payment of postage in cash. Registered as second-class matter at the Post Office at Mexico D.F., Mexico, June 20, 1950. © 1968 by The Hearst Corporation. All rights reserved. Printed in U.S.A.

SEPTEMBER 1968

86 Proof Early Times Distillery Co., Louisville, Ky. ©1968



let's make it

Make yourself the greatest home bartender in town. Just send \$3.50 to Early Times Glass Offer*— P. O. Box 1080, Louisville, Kentucky 40201. We'll send you a set of 6 Giant 15 oz. Early Times Jiggers. Or send \$3.00, for a set of 8 Early Times 10½ oz. Highball Glasses. They're beautiful, so get both sets while they last. Do it now.

*offer valid only where legal

THE TRUE OLD-STYLE KENTUCKY BOURBON

**It's true. The aroma
of Field & Stream
will remind you
of a great
autumn day
in the woods.**



**But don't
cancel
your vacation.**

A product of Philip Morris Inc.

LETTERS TO THE EDITOR

Skin problems

On page 119 of your May issue, you show a picture of the Tulsa "golden driller" and state that it "is constructed of fiberglass placed over a wire framework."

This is not the case. The exterior skin is made of Vonco, which is a special catalytic cement which we manufacture and on which we have patents pending.

Our company spent many hours working on this project and we've used this statue in our national advertising. Now our customers are questioning whether we've misrepresented our product in saying that the statue's skin is of Vonco.

MD CORPORATION
SPRINGFIELD, MO.

HARVEY J. DAVIS
PRESIDENT

The only misrepresenting was in the information supplied us by our news source. Obviously, it was wrong. Tell those doubting customers that you were right all along.

No deep-diver

I have reviewed the plans for the Markham semi-dry type submarine (*One-Man Sports Submarine*, page 90, June PM).

Mr. Markham includes on the first sheet most of the precautionary warnings that I consider desirable. There is only one additional precaution which I think should be included: namely, that the submarine should not be operated in waters exceeding 100 feet in depth. This should preclude a situation in which the submarine could sink to an irretrievable depth should buoyancy control be lost.

NAVAL SUBMARINE BASE, NEW LONDON GROTON, CONN.

GERALD J. DUFFNER
CAPT., MC, U.S. NAVY

Good word for Detroit

I very much enjoy your magazine. But I completely disagree with articles like Alex Markovich's *In the Driver's Seat of the Saab Sonett II* (page 22, July PM). How come everybody makes those little imported cars sound like such great sports cars? What about American cars like the Pontiac GTO? I think our American cars deserve much more praise than they get.

MASSAPEQUA, N.Y.

GEORGE WATTOFF

It'd be pretty difficult for Alex to say that the Sonett II isn't a nifty little machine when it really is. Besides, we do

(Please turn to page 8)

"Look who's smiling now!"

"The department head's job had just been left vacant. When the boys in the office learned I was gunning for it, they gave me their widest grins. One thing they didn't know: I had made up my mind sometime back to take LaSalle training that would prepare me for a better job. My study paid off so fast it surprised even me—I was picked for that shiny promotion over everyone's head. Who wouldn't be smiling with a neat new \$1,500 increase!"

LA SALLE'S files are filled with letters from graduates who have rapidly climbed the ladder of success. You, too, can qualify for the job opportunity of your choice through LaSalle home study—without interfering with your present work—and by devoting only a little of your spare time.

LaSalle has been leader in home education for more than half a century and has enrolled more than 1,000,000 ambitious men and women. Its faculty includes some of the country's foremost practicing specialists and instructors. Your training is in good, experienced hands.

Mailing the LaSalle coupon below may be the first step in getting a better job, higher pay, and all of the good things that go with success. Simply check the program in which you are most interested, and we will send you a valuable free booklet describing the opportunities in that field. Mail to LaSalle, 417 Dearborn, Chicago, Illinois 60605.



LA SALLE EXTENSION UNIVERSITY

A Correspondence Institution • 417 South Dearborn, Dept. 81-134, Chicago, Illinois 60605

Please send me, without cost or obligation, FREE booklet and full information on the field I have checked below:

ACCOUNTING

- Complete Accounting
- Income Tax
- Accounting Fundamentals
- CPA Training
- Modern Bookkeeping

BUSINESS MANAGEMENT

- Complete Business Management
- Credit and Collections
- Office Management
- Personnel Management
- Sales Management

REAL ESTATE

- Complete Real Estate
- Real Estate Brokerage
- Real Estate Management

Interested in a career not listed? Write here: _____

COMPUTER PROGRAMMING

- Complete Training

LAW COURSES

- Bachelor of Laws Degree
- Business Law
- Insurance Law
- Claim Adjusting Law
- Law for Police Officers

STENOTYPE

- Machine Shorthand

TECHNICAL COURSES

- Air Conditioning, Refrigeration, Heating
- Diesel

TRAFFIC & TRANSPORTATION

- Complete Traffic Mgt. Truck, Air, Rail, Sea

DRAFTING

- Complete Drafting

INTERIOR DECORATION

- Professional Training

ART TRAINING

- Commercial Art
- Oil, Water Color Painting
- Complete Training

HIGH SCHOOL

- High School Diploma

LANGUAGE INSTRUCTION

- French
- Spanish

MUSIC INSTRUCTION

- Piano
- Guitar
- Other: _____

CAREERS FOR WOMEN

- Accounting
- Bookkeeping
- Commercial Art
- Computer Programming
- Dental Assistant
- Interior Decorator
- Real Estate
- Secretarial
- Stenotype

Name Age Apt. No.
Please print carefully

Address County

City & State Zip No.

Occupation Working Hours ... A.M. ... P.M.

hunters: Learn Fred Bear's "Secrets of hunting" for a buck!

Right now, your Bear dealer has a special limited edition long-playing record album featuring Fred Bear and Curt Gowdy. This \$3.95 value is filled with inside tips on stalking and bagging game, and is yours for just \$1.00.



For the first time, Fred Bear, bowhunting superstar, tells his "Secrets of Hunting"—secrets gathered from 50 years of hunting with bow and gun all over the world. Everything from a Michigan whitetail to an African lion, including a polar bear and bull elephant, are included among Fred's game trophies.

You can get this special album *only at your Bear dealer's* for just a dollar. You're in for an hour of listening enjoyment—hunting secrets and tales of the trail—as Fred reminisces with Curt Gowdy, popular television sportscaster.

See your Bear dealer soon. Check out the new '68 hunting line and get your copy of Fred Bear's "Secrets of Hunting." It's bound to be the best dollar you've spent this year.



 **BEAR ARCHERY**

DIVISION  VICTOR COMPTOMETER CORPORATION
RURAL ROUTE ONE, GRAYLING, MICHIGAN 49738 • AREA CODE 517-348-6011

LETTERS

(Continued from page 6)

say some nice things about American cars. For example, take a look at Len Sabal's comments on Dodge Charger (page 76).

Where credit is due

In your excellent article, *Our Wingless Airplane That Flies in Space* (page 64, July PM), you state that the lifting-body program goes back several years . . . that it began with the M-2. Nothing could be so wrong.

It is a historical fact that the lifting-body concept was originated by Vincent J. Burnelli in the early 1920s, and the present use of the idea by NASA reflects simple variations of the Burnelli designs.

MERRICK, L.I., N.Y. TED GEFFNER, P.E.

Disagrees with Dan

I much disagree with Jim Vincent and Dan Gurney when they agree that they don't like the idea of turbines racing anywhere (*Drivin' With Dan*, page 10, June PM). Theirs is a very narrow point of view.

I say let the turbines and any other types of engines be allowed in racing. Maybe this will lead to an earlier development of an automobile that costs less to drive and maintain, pollutes the air less and doesn't have to be scrapped before it is five years old.

If they want noise at the races, it shouldn't be too difficult to rig some kind of noisemaker which doesn't interfere with efficiency or pollute the air.

LINDSTROM, MINN. A. MINNICHOFFER

Track power

You called the 4000-hp Kestral (page 86, June PM) the most powerful single-engined locomotive in the world.

Beginning in 1941, the American Locomotive Co. built a fleet of 25 class 4000 steam locomotives for the Union Pacific Railroad. These 4-8-8-4 locomotives produced 7000 boiler horsepower and 6000 drawbar horsepower.

GREENVILLE, MISS. HAROLD HOLIMAN

Some of the railroad buffs here still fondly remember 'em—but none of those locomotives is operating anymore.

Informed boater

PM is one of the best books that I have. The *Outboard Clinic* has some of the most informative reading I've seen.

BROOKLYN, N.Y. JAMES PENDLETON

FANTASTIC VALUES WITH THIS COUPON

AMERICAN MACHINE & TOOL CO., Dept. M98, Royersford, Pa. 19468
Please send me the units checked. Payment in full enclosed \$.....
or \$3 deposit each item enclosed, balance C.O.D. I MUST BE FULLY
SATISFIED OR WILL RETURN UNIT WITHIN 10 DAYS FOR FULL REFUND.
No questions asked.

| | |
|--|---|
| <input type="checkbox"/> 8" Power Saw at \$14.95 | <input type="checkbox"/> Jointer-Planer at \$19.95 |
| <input type="checkbox"/> Standard Rip Fence #354 at \$3.50 | <input type="checkbox"/> Lathe at \$9.85 |
| <input type="checkbox"/> Long Rip Fence #354C at \$4.50 | <input type="checkbox"/> Set of 3 High Speed Turning Chisels at \$4.95 |
| <input type="checkbox"/> Belt Sander at \$14.95 | <input type="checkbox"/> Drill Press at \$29.95 |
| <input type="checkbox"/> Mitre gage for Sander at \$1.95 | <input type="checkbox"/> Disc Sander at \$7.95 |

GE Motor } \$18.80 (purchased with other item)
 \$24.85 (if purchased separately)

NAME

ADDRESS

CITY ZONE/ZIP STATE

SAVE AS MUCH AS...
80% WITH
QUALITY 
POWER TOOLS

DIRECT FACTORY OFFER AND REVOLUTIONARY PATENTS decrease costs, increase efficiency. Full scale power tools of heavy duty 100% cast iron and steel. Streamlined design reduces weight, cuts material and production costs. Special patents provide added efficiency, accuracy, savings. Parts made, assembled, tested, packed right in our own factories shipped direct... save store profits.

ENDORSED BY AMERICA'S TOP MAGAZINES... Here is what the editors say:
"A good bit of sound—imaginative—engineering." Popular Science; "(saw) boasts many features of bigger brothers." Popular Mechanics; "Amazingly versatile." Workbench; "Highly substantial construction, sturdy enough for production line use." Industrial Woodworking. And Workbench awarded these tools their coveted "Work Tested" Seal.

OVER A MILLION USERS confirm their precision, versatility and rugged performance.

***10-YEAR FULL SERVICE GUARANTEE**... Any part or parts of any AMCO power tool (except motor) which may become inoperative for any reason within ten years after the purchase date will be repaired or replaced by the factory without cost to the purchaser. Your only cost: for postage.

UNCONDITIONAL MONEY BACK GUARANTEE
You must be fully satisfied. If not, return in 10 days, freight collect. Money promptly refunded in full.



8" TILT ARBOR POWER SAW

DOES WORK OF \$75 BENCH SAW as is. Converts easily to equal any \$300 floor model cabinet units! Crosscuts, rips, mitres, cuts compound angles, dadoses, makes coves and mouldings.

\$14.95 f.o.b. factory. Wt. 25 lbs. Includes completely assembled cast iron and steel 8" saw with ground cast iron table... less blade. RIP FENCE, if desired, for easier work alignment, \$3.50 add'l.

SAW BLADE TILTS... TABLE STAYS LEVEL
• Locks securely at any angle up to 50°, raises, lowers 0"-2 3/4". Patented tilt mechanism, accurate etched scale. Patented motor mount takes std. 1/4 h.p. or larger motor, keeps belt tight, assures perfect alignment at any angle, transmits full power. Takes std. blade, saw insert removes to take dadoe heads, cutters, etc. (not incl.). Accurate mitre gauge assembly. Ground spindle. Enclosed steel base. "Compo" bearings. Access. Std. size (for bench saw) \$3.50; larger fence (for cabinet base, as ill'd.) \$4.50.

FREE CABINET BASE PLANS Use as portable bench saw as received (inset photo) or transform easily and inexpensively into floor model (as shown) guar. to do work of floor models costing \$300. FREE plans... all you'll need are a sheet of 3/4" plywood and 3-4 hours. Use your AMCO saw for cutting. Plans provide 27" x 24" work surface, 33" height, tool storage compartment.

10-YEAR FULL SERVICE GUARANTEE*

6" SWING 3-FOOT LATHE



Optional faceplate for turning bowls, trays, lamp bases, rosettes, etc. \$2.50. Set of 3 high speed turning chisels, \$4.95 add'l.

DOES THE WORK OF \$40 UNITS... with same precision and speed. Turns wood, plastic. Sturdy cast iron with tubular steel bed. Ball thrust cup center, spur center, T-rest assembly, lever action tail stock, 2-speed pulley. Fits any motor.

10-YEAR FULL SERVICE GUARANTEE*

\$9.85 f.o.b. factory Wt. 14 lbs.

PRECISION 4" x 36" BELT SANDER



f.o.b. factory. Wt. 15 lbs. **\$14.95** †Disc Sander attachment incl. disc bracket, ground cast table (tilts 0-45°): \$7.95 add'l.

DOES WORK OF \$50 SANDERS... The world's most talented belt sander. Heavy cast sander incl. 4" x 36" sanding belt, V-pulley drive, multi-purpose drive spindle. Changes from horizontal to vertical sanding in secs. Uses 1/2 hp or larger motor.

10-YEAR FULL SERVICE GUARANTEE*

FULL 22" LONG, 4 1/8" JOINTER-PLANER



\$19.95 f.o.b. factory. Wt.: 19 lbs. Complete as shown.

100% precision ground cast iron and steel.

DOES THE WORK OF \$60 UNITS... Professional power planing at a hand tool price. Make faster, more accurate joints, rabbetts, bevels for windows, doors, drawers, square tapered legs—Adjustable precision ground cast iron tables. Patent-pending design holds knife to table clearances at any depth. Rabbett depth 3/8". Fence adjustable 0°-50°. Hardened, ground hi-speed steel knives. Dual cutter guards. Balanced cutter head.

10-YEAR FULL SERVICE GUARANTEE*

32" RADIAL DRILL PRESS

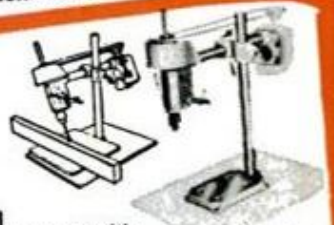

All cast iron and steel f.o.b. factory **\$29.95** Wt. 30 lbs. 1/2" cap. Jacob's chuck incl.

DOES WORK OF \$90 UNITS... and much more. Industrial quality precision unit with all standard features, many extras. Head raises, lowers. Depth of throat up to 16". Pre-set to any angle for on-or-off table drilling, even horizontal drilling. 10-YEAR FULL SERVICE GUARANTEE.*

BRAND NEW  MOTOR DEVELOPING FULL 1 HP... **\$18.80** F.O.B. FACTORY / FOR ANY OF ABOVE MACHINES. WT. 17 LBS. PURCHASED SEPARATELY, \$24.85

as low as
\$1.20 ea.

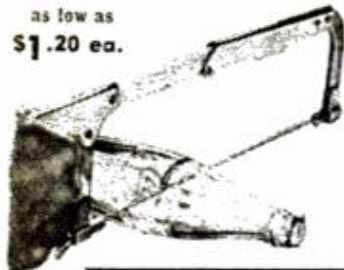

CUT ANY MATERIAL with Super-Hack

Tungsten carbide blade cuts glass, tool steel, (even a file) . . . bricks, ceramic, plastic, transite . . . all the things you never could cut before. Sold 100 for \$1.20 ea., or 1 for \$2.79, 3 for \$6.20, 6 for \$2 ea. (total \$12). All prices postage paid.

FREE OFFER

All items on this page are offered on money-back guarantee by MEREDITH SEPARATOR CO., Dept. PM-9, 310 West 9th St., Kansas City, Mo. 64105. See coupon below. Anyone who asks for our HOSPITALITY Magazine will receive a FREE subscription. Next issue will be of especial interest to Popular Mechanics Readers.

John's-Manville Asbestos-Lined STEEL FIREMAN'S SAFE

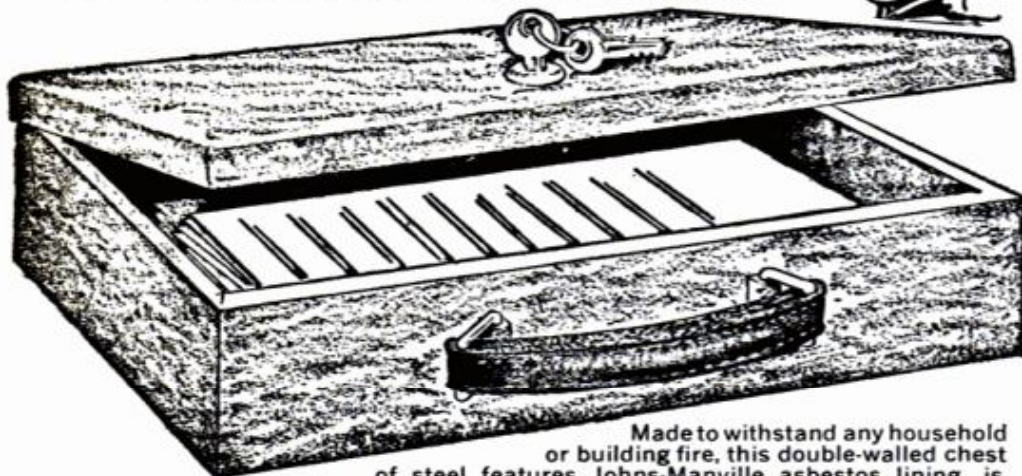

Made to withstand any household or building fire, this double-walled chest of steel features Johns-Manville asbestos lining, is about 14" long by 9" wide and just under 4" high. A heavy barrel lock with two keys protects contents from theft. The lid has a full length piano hinge like industry seldom makes anymore. You get five valuable paper folios . . . for insurance, cash reserves, social security records . . . children's health certificates . . . personal family records . . . priceless photographs . . . stocks and bonds. Baked enamel outer finish makes chest attractive and luggage-style handle makes it easy to carry this 8½-lb. UNDERWRITER'S Safe \$15.95 (We pay all shipping costs.) Double capacity Box (same rectangular dimensions but twice as deep) and worth much more \$22—ppd.

COLONIAL SWORD CANES \$14.95

ppd.

. . . as British as gin and tonic . . . as oriental as the mandarin dragon which twines about the cane from handle to tip . . . intricately carved in exotic wood. From the handle peers the face of an inscrutable Confucius. No colonial gentlemen would have walked the streets of Singapore or Mandalay without his sword cane. The old craftsmen of Tapei are about all gone. Sword canes like these are collectors' items already. In another while you may not be able to get them at all. A great buy at \$14.95 postpaid while they last.



WATCH RUST DISAPPEAR NAVAL JELLY

is an extremely active new cleaner that removes rust by chemical combination . . . sticks to verticals and overheads. Brush it on, hose it off.

Use on pipes, fences, tools, tanks, all machinery. Eliminates sandblasting, scraping, etc. Easy and quick.

- 40# @ .65/lb. \$26 4# @ 2.00/lb. \$8.00
 10# @ 1.50/lb. \$15 #4 ppd.—other units FOB KC

Naval Formula X-300 Closeout Prices of this half-strength blue material write for details.

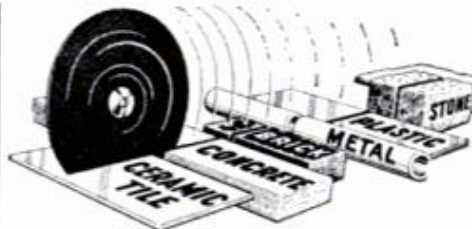

NAVAL ROUND SAW is a 7" silicon carbide disc that lets you do what Super-Hack does (except glass) . . . cut nearly anything. Ruse on drill or flexible shaft, sand with it too (has 5" rubber disc for back-up), and comes complete with all flanges and nuts. Made in England. \$5 each, 3 for \$4.50, ea. (total \$13.50) all postpaid.

MEREDITH SEPARATOR CO., Dept. PM-9,
310 West 9th St., Kansas City, Mo. 64105

Ship as follows (specify quantity):

- Super Hacks Fire Chests Reg. Larger
 Naval Jelly Round Saws Naval 5 Plastic
 Sword Canes Free Hospitality Mag. Subscription

Name _____

Address _____

City _____ State _____ Zip _____

© 1968 Meredith, K.C., Mo.

LIQUID PLASTIC



protects like a shield of unbreakable glass.

Polyurethane that applies like paint forms a skin so tough it won't crack, chip or peel. Cuts painting costs . . . covers and

WATERPROOF IN 30 MINUTES

Adheres to practically anything, stops leaks. Ideal for concrete, aluminum, wood, masonry, canvas, any metal. Clear—any major color. Just specify. \$5.95 per qt., \$18.50 per gal. We pay all shipping costs. Order NAVAL 5.

How to get rich

How can you get rich some day? Make a hit record . . . a killing on the stock market . . . or invent a gadget like the hula hoop?

For most of us, these are just dreams. But have you ever stopped to think that there is a way to get rich—possibly only one sure way? Most fortunes, as you know, are made by people who own their own business.

Perhaps you've thought of starting a small business of your own . . . a franchised drive-in, or maybe a service business. Trouble is, you need \$10,000 to \$15,000 to get started and even then it's a gamble—with slim chances of ever making really big money.

But there is *one* business which could make you rich—almost overnight! And the beauty of it is, you can start on a shoestring during your spare time, even while holding your regular job.

Cash by Mail

The business is Mail Order—and it's fabulous! Come up with a 'hot' new item . . . and WHAM!

It strikes like a bolt of lightning! Suddenly, you are deluged with cash orders from all over the country . . . MORE MONEY than you could ever make in a lifetime!

Like the Vermont dealer who ran one ad in Sports Afield Magazine. His ad pulled 22,000 orders—over A HALF MILLION DOLLARS IN CASH!

There is no other business where you can make a fortune so quickly!

● A beginner from Newark, N.J. ran his first small ad in House Beautiful—offering an auto clothes rack. Business Week reported that his ad brought in \$5,000 in orders. By the end of his first year in Mail Order, he had grossed over \$100,000!

● Another beginner—a lawyer from the midwest, sold an idea by mail to fishermen. Specialty Salesman Magazine reveals, "he made \$70,000 the first three months!"

Proof

It's a fascinating business! Running ads in newspapers and magazines . . . mailing gift catalogs . . . getting cash orders in your daily mail—steady as clockwork.

There is no other business where you can start on a shoestring and pyramid your profits—without investing in merchandise! One husband and wife mail order team took in \$40,000 selling one item. They obtained FREE ads in national magazines . . . didn't invest a cent in merchandise, and even got the supplier to ship all orders for them!

These exceptional cases are absolute proof that you can get rich in your own Mail Order business. Very rich. Even a U.S. Gov. Report stated: "A number of

one-man Mail Order enterprises make up to \$50,000!"

Pick up any magazine. Notice how the same mail order ads are repeated . . . month after month? That's concrete proof! You know those ads wouldn't be repeated over and over again—unless they were bringing in big cash profits to their owners.

The Secret

The secret of getting rich in Mail Order lies in *financial leverage*. It's a little-known, almost secret method—using other people's capital to make money for you!

You can get thousands of dollars worth of advertising in big national magazines—without investing your own money! And you don't have to write a single ad. Tested and proven ads are prepared for you by experts. Reinvest the profits from your first successful ad—to get more, larger ads, and the profits begin to snowball! It's like building a chain of stores . . . each new store puts more money in your pocket.

You mail out beautiful catalogs which offer hundreds of dollars worth of fine, quality gifts—yet you don't invest one

Repeat orders alone, just from mailing catalogs, could bring you a steady income for the rest of your life!

Yes, Mail Order is the fastest-growing, most profitable business in America! And now, with more people moving to the suburbs . . . the population explosion . . . and the expanding teenage market . . . we are on the verge of the BIGGEST BOOM in Mail Order history!

Now, with the help and backing of Mail Order Associates, Inc., of Montvale, N.J., you can follow the same proven steps to Mail Order success—using the 'secret' of financial leverage!

Start Now

We supply you with beautiful gift catalogs throughout the year. All products are dropshipped for you, with up to 100% mark-up! You get free samples of top-selling mail order items, plus monthly trade reports on 'hot' new products . . . tested, successful ads are sent to you monthly. You get advertising directories, postal laws, complete courses, expert guidance—EVERYTHING you need to practically guarantee YOUR SUCCESS. Why? Because *our* business depends upon your success. It's mutually profitable!

A recent feature article in Income Opportunities Magazine stated, "Mail Order Associates Inc., offers the most comprehensive Mail Order program ever offered to beginners." They go on to say, "This could be the opportunity you've been looking for. A chance to get in on the ground floor in a little-known business which we believe is on the verge of a new boom."

Free

We are now accepting a limited number of charter members in our new Mail Order Program. No previous experience is required but you must be over 21.

If you are sincerely interested in starting a profitable business of your own . . . if you can see the tremendous advantages which Mail Order offers . . . then ACT NOW!

Mail the coupon today, or simply send your name and address on a postcard. No salesman will call. We will send you a free book—gift catalog, reprints of feature articles, plus complete facts about our program. Write to:

Mail Order Associates, Inc., Dept. 97
Montvale, New Jersey 07645



The thrill of receiving money in your mail is one you'll never tire of!

cent of your own money in merchandise! Your catalogs are printed with your name and address, so all orders come to you. Everything is "drop-shipped" for you, and there's up to 100% mark-up! You pocket the cash profits immediately—even before the orders are shipped to your customers!

Rush Coupon for
FREE BOOK!

plus reprints of
Mail Order
articles

Mail Order Associates, Inc., Dept. 97
Montvale, New Jersey 07645

Please rush complete details on your Mail Order Program. I understand everything is free and there is absolutely no obligation. I am over 21.

Name

Address

City State Zip

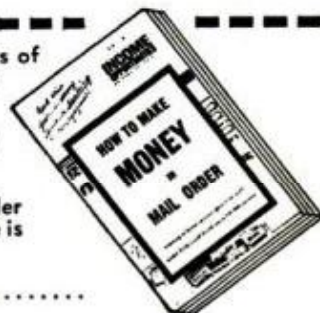

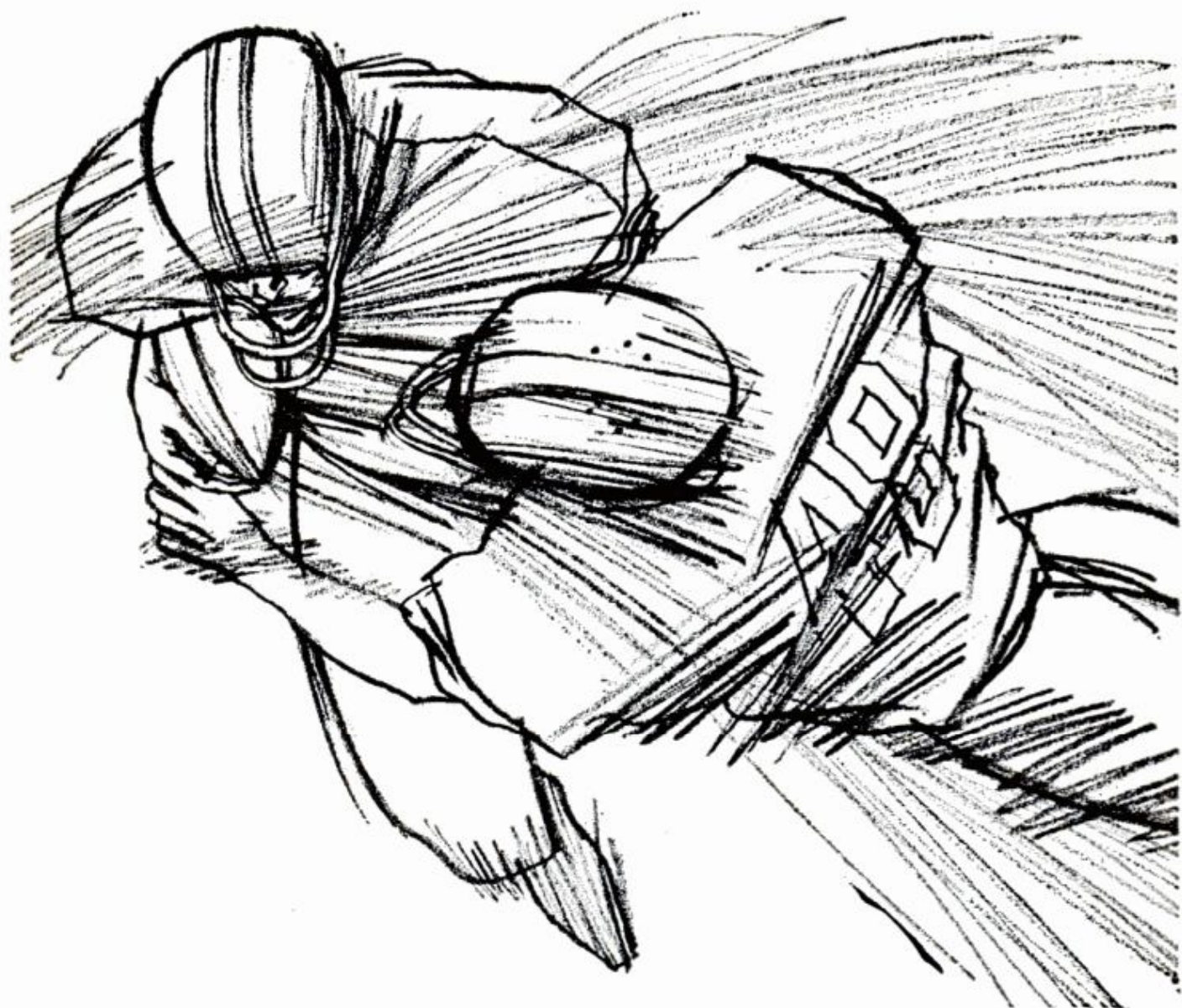

**We put fiber glass in FGA® shingles
for the same reason it's in helmets:
*lightweight protection.***

J-M's lightweight FGA® shingles give your roof special protection from weather, plus long roof life and low maintenance. Because fiber glass in shingles (as in helmets) resists cracking, curling, rotting and warping.

The combination of fiber glass and asbestos in FGA shingles also gives you extra fire protection. They've been awarded the Underwriters' Laboratories Class A fire rating—the highest given. And our Seal-O-Matic® feature makes them exceptionally wind resistant. They've actually withstood hurricanes.

If your roof needs replacing, do it with FGA shingles. They come in 14 wife-pleasing color blends. See them at your J-M dealer's.



Johns-Manville

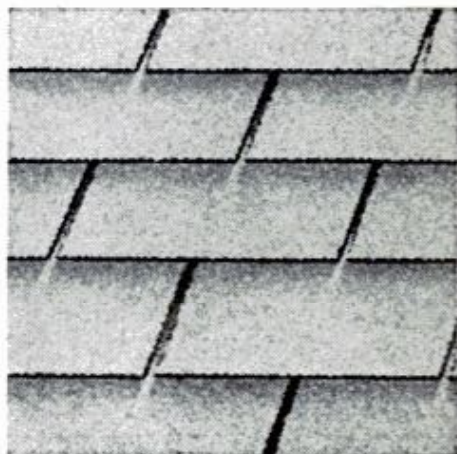

Get the great view of the whole wide, wild world of living science

See it whole—the beautiful and the brutal, the crowded jungles and the quiet woods, the natural worlds of beast, bird and insect and the mysterious worlds of man's first beginning. One book club brings it to you at its richest and most exciting, its most real—the Natural Science Book Club.

Each month, our editors select only the most interesting and most important books in the

natural sciences for you to choose from. These are offered at our low member prices—savings up to 40% (sometimes more). Comprehensive, detailed reviews are sent to you in advance, so that you choose only the books you want to own. For every four books you select, you earn your choice of a valuable free bonus book. It's the easiest, most inexpensive way you've ever known to build a superb library covering the whole great range of the natural sciences!

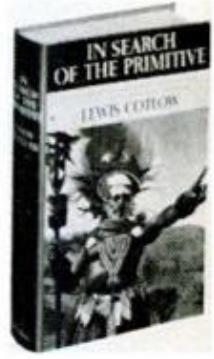
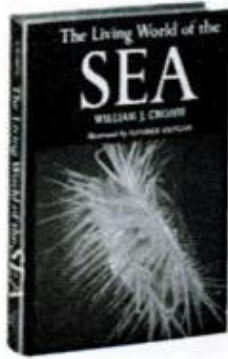
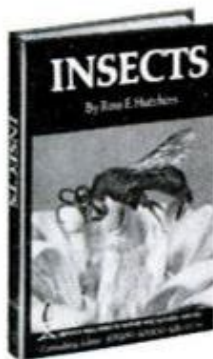

Choose any 3 books
—values to \$37⁷⁵—for only **99¢** with your first selection (at low member prices) in a short experimental membership in

The Natural Science Book Club

All these to choose from (retail prices in light face, member prices in bold face).

59610. THE MAMMALS. *Desmond Morris.* Treasure trove of information on the fascinating world of mammals. Descriptions of over 300 species with photographs. \$12.95/**\$6.50**

55530. INSECTS. *Ross E. Hutchins.* Superbly written account of what is perhaps the most weird, beautiful and complex community of animals in existence. 135 photos. \$6.95/**\$5.75**

34100. THE APES. *Vernon Reynolds.* Profusely illustrated, delightful-to-read treatment of the latest scientific findings on man's nearest relatives—the gorilla, chimpanzee, etc. \$10.00/**\$7.50**

58710. LIVING WORLD OF THE SEA. *William J. Cromie.* Amazing story of sea creatures—from organisms neither plant nor animal to the giant squid with arms as long as a 3-story building. \$6.95/**\$5.75**

55830. INTELLIGENT LIFE IN THE UNIVERSE. I. *S. Shklovskii and Carl Sagan.* Two world famous astronomers consider whether intelligent beings occupy worlds outside our own. \$9.95/**\$7.50**

78100. SEX LIFE OF THE ANIMALS. *Herbert Wendt.* Remarkable account of the often incredible processes of animal reproduction—from the amoeba to the elephant. Over 100 photos. \$7.95/**\$5.95**

85010. MARTIN GARDNER'S NEW MATHEMATICAL DIVERSIONS FROM SCIENTIFIC AMERICAN / 536 PUZZLES AND CURIOUS PROBLEMS. Rich collection of mathematical games and puzzles—with solutions. *Two books count as one choice.* \$13.90/**\$9.95**

41770. DEATH OF THE SWEET WATERS / BREATH OF LIFE. *Donald E. Carr.* Brilliant discussion of water and air pollution, and what steps must be taken to avert a national disaster. \$10.90/**\$7.50**
Two books count as one choice.

55540. IN SEARCH OF THE PRIMITIVE. *Lewis Collow.* Explorer's absorbing account of his incredible, often perilous life with the last of the world's exotic peoples. \$8.95/**\$6.95**

62100. MEN AND DINOSAURS: The Search in Field and Laboratory. *Edwin H. Colbert.* Profusely illustrated, with many previously unpublished photographs—the fascinating saga of man's search for, and reconstruction of, the giants of all time. A suspenseful, exciting, true detective story of science. \$8.95/**\$6.95**

Trial Membership Application

Natural Science Book Club
Front and Brown Streets, Riverside, N. J. 08075

Please enroll me as a Trial Member and send the 4 books whose numbers I have filled in below. Bill me just 99¢ for the first three, member's price for the fourth book, plus shipping. If not delighted, I will return them within 10 days and my membership will be cancelled.

As a Trial Member, I need accept as few as 3 more Selections during the next 12 months, always at reduced Member's Prices plus shipping, and I may cancel Membership any time thereafter. Each month I will receive a Newsletter describing the forthcoming Selection, along with a convenient form for requesting Alternate Selections or no book at all. I understand I may choose a free Bonus Book for every 4 Selections purchased. (Introductory Offer counts as the first Selection.)

(write in numbers)

NAME.....

ADDRESS.....

CITY.....STATE.....ZIP.....

Please be sure to indicate correct zip code. 4-731

**POWERFUL
"WRAP AROUND"
BITE**



NEW!

CHAN NEL LOCK

CURVED JAW

TONGUE & GROOVE PLIERS

Curved jaws that wrap around and really grab hold of round work such as pipe. Smooth, machined, undercut mating parts that can't slip the tighter *YOU* grip, the tighter *THEY* grip). Long, slender handles that give you tremendous leverage. Slim design that noses into hard-to-reach spots. In short, all the "muscle" of a pipe wrench PLUS the fast, easy handling

of a plier . . . **YOURS** with CHANNELLOCK Curved Jaw Tongue and Groove Pliers.

Available in two sizes:

No. 422, 9½ inch, 1½" jaw capacity

No. 442, 12 inch, 2¼" jaw capacity

CAUTION: Make sure you're getting the ORIGINAL, GENUINE CHANNELLOCK . . . look for the trade mark on the handle.

TOOLS BY
CHAN NEL LOCK
MEADVILLE, PA.



TUNE UP ELECTRONICALLY ANY CAR EVER MADE!

- ✓ COMPACT or LIMOUSINE
- ✓ DOMESTIC or FOREIGN
- ✓ 4, 6 or 8 CYLINDER
- ✓ 6 VOLT or 12 VOLT
- ✓ POSITIVE or NEGATIVE GROUND

With New Improved Model BT-162

DWELL TACHOMETER

ASSURE - EASY STARTS, OPTIMUM PERFORMANCE and
MAXIMUM GAS ECONOMY with MODEL BT-162

MADE ORIGINALLY FOR THE PROFESSIONAL AUTOMOTIVE TECHNICIAN, MODEL BT-162 WILL PAY FOR ITSELF MANY TIMES OVER FOR THE AUTOMOTIVE HOBBYIST AND EXPERIMENTER.

The Model BT-162 will perform the services specified below in addition to many other tasks too numerous to mention:

- ✓ Assure precise adjustment of points that are slightly worn or pitted.
- ✓ Indicate the most effective point setting **without removing the distributor cap.**
- ✓ Read the average dwell of dual breaker points as well as individual dwell of each individual set of points.
- ✓ Indicate the correct settings for **external adjustment type distributors.**
- ✓ Car manufacturers' dwell angle recommendations are included in the manual provided with the Model BT-162 for all cars including the external adjustment type distributors specified above.
- ✓ It is no longer necessary to file points to smoothness when using the Model BT-162. The instrument will automatically make allowance for any existing "pitting" or "wear."
- ✓ To adjust for mathematically correct carburetor adjustment and thus insure maximum gas economy and quiet engine running, simply use the Tachometer section of the Model BT-162. Read the exact RPM while the engine is in neutral position. Then adjust the carburetor in conformity with the car manufacturer's recommendations as specified in the manual provided with the Model BT-162.
- ✓ To locate a "miss" you need only disconnect or "short" the spark plugs one at a time with the Model BT-162 switched to the Tachometer position. You will be able to instantly identify which particular plug (or frequently its wire lead) is responsible for the malfunction.
- ✓ Cars with automatic transmissions function efficiently only if the fluid pressures are correctly maintained and since manufacturer's instructions always refer to RPM the Model BT-162 (or an equivalent tachometer) is required to properly service automatic transmissions. Incidentally, the 5,000 RPM maximum range of the Model BT-162 is adequate for all car engines without any exceptions.

The Model BT-162 comes complete, ready to use. Tune-up and operating procedure manual included with your Model BT-162 describes in detail how to make all tests. Also includes manufacturer's dwell angle recommendations for all cars. American and foreign. Packed with information from cover to cover. The manual is yours to keep even if you decide to return the instrument.

\$29⁹⁵

SEND NO MONEY WITH ORDER PAY POSTMAN NOTHING ON DELIVERY

Try it for 10 days before you buy. If completely satisfied then send \$5.00 and pay the balance at the rate of \$5.00 per month until the total price of \$29.95 (plus P.P., handling and budget charge) is paid. If not completely satisfied, return to us, no explanation necessary.

ACCURATE INSTRUMENT CO., INC.
Dept. 589, 2435 White Plains Road, Bronx, N. Y. 10467

Please rush me one Model BT-162. If satisfactory I agree to pay \$5.00 within 10 days and balance at rate of \$5.00 per month until total price of \$29.95 (plus P.P., handling and budget charge) is paid. If not satisfactory, I may return for cancellation of account.

Name _____

Address _____

City _____ Zone _____ State _____

Save Money! Check here and enclose \$29.95 with this coupon and we will pay all shipping charges. You still retain the privilege of returning after 10 day trial for full refund.

1. Training Means Money These Days

In today's job market, men with specialized training get the good jobs—and good pay. Trained men get the promotions and pay raises that count. In virtually every field, TRAINING spells the difference between staying where you are—and moving ahead.

Look over the list of fields below. In each, I. C. S. has been training men and women for years. Giving them up-to-date knowledge that will let them advance in their present job... or break into an entirely new field. I. C. S. can do the same for you—starting RIGHT NOW.

2. Jobs in Architecture, Building

ARCHITECTS—Qualify for advanced positions in architectural, engineering offices. I. C. S. courses begin with basics. Knowledge to help prepare for A.I.A. exams. Math. Drawing. Design. B'ld'ng, M'ch'n'r'l trades. Write "Architecture" on coupon for FREE booklets.

ARCH. DRAWING—One-course stepping-stone to architecture. Emphasis on drawing practice. No previous experience necessary. Apply now.

CARPENTRY—Largest demand area in building trades. \$4.07 average hourly wage. Over 20,000 openings yearly. Training needed. Send coupon NOW.

PLUMBING-HEATING—Earn \$4.30 hourly—average for plumbing-heating specialists. I. C. S. course has proven track record. Starts with basics. Mail coupon for FREE Success Kit.

3. Art Talent Sought

COMMERCIAL ARTISTS—Experienced artists earn \$150 and more weekly. But training is essential. Course starts with fundamentals. Job-related. Personalized instruction. Break into field full- or part-time. Write "Commercial Art" on coupon.

INTERIOR DECORATING—Non-technical course for homemaker, home furnishings salesperson. Study carpets, furniture, walls, windows, decor, color, taste. Mail coupon now.

SIGN PAINTING—Course prepares you to break into field. Covers all aspects: layout, design, painting, gilding, screen process. Send coupon for 3 FREE booklets.

SKETCHING & PAINTING—Like to draw? Feel you have talent? Get training. For spare-time enjoyment, or use in present line of work. Course starts with basics, covers popular art mediums.

4. Automotive Specialists

AUTO ELECT. TECHNICIAN—More electrical equip. on cars—more need for elect. specialists. I. C. S. course covers the circuits, headlamp to taillights. Simply written, illustrated texts. Send coupon for 3 FREE booklets.

MECHANIC (GEN'L)—700,000 employed. 20,000 openings yearly, and employment on the upswing. Famous I. C. S. course taken by thousands in field. Coupon brings Success Kit.

TRANSMISSION SPEC'L'ST—If you now know cars, why not become a specialist? Course covers transmission troubles, testing, repairing, overhauling. Auto., standard.

5. Businessmen Make \$\$\$\$\$

ACCOUNTANTS—20,000 openings a year in this high-pay field. I. C. S. courses cover the basics plus 10 vital accounting specialties. Get information. Send coupon right NOW.

ADMINISTRATION—The key to business success. Famous I. C. S. course covers 3 vital areas: management, production, marketing. Write "Business Administration" on coupon.

EXEC. TRAINING—A company's as good as its top people. Learn to train men, to spot "comers." Mail the coupon.

MARKETING MEN—Advance to management? You'll need marketing knowledge. Course covers management practices, principles, with emphasis on marketing. Get started now.

PROGRAMMERS for digital computers. Space-age specialty. Earn up to \$15,000 yearly. Specialized—training vital. This course gives it.

PURCHASING—Advance to purchasing agent? Break into field? Take this course. Demand for PA's rising. Experienced men earn average salaries of \$8-\$15,000. Send for Success Kit.

SALESMANSHIP—I. C. S. is famous for this course. Covers basics of selling that stay same, no matter the field. 1,000,000 new salesmen needed 1965-75. Get started NOW. Write "Salesmanship" on coupon.

YOU CAN GET A BETTER JOB

by spare-time study with I. C. S.

SMALL BUSINESS MGT.—Run your own business. Course tells how. Covers purchasing, merchandising, sales, taxes, accounting, etc.—all you need to know.

TRAFFIC MGT.—Employment forecasts show upward trend for trained traffic people. Course covers entire traffic picture. Prepares you to enter or advance in field. Send coupon today.

6. Chemistry

CHEM. ENGINEERS—Youngest engineering field, expanding with industrial development. Course prepares you for registration exams. Also for breaking into chemical design, development or production departments. Send coupon for Success Kit. It tells whole story.

GEN'L CHEM.—A good course in gen'l chemistry? What easier way than at home, in spare time. Also covers basic math, physics.

NUCLEAR ENERGY—Course for engineers, technicians, maintenance men who want to enter nuclear field. Covers basic math, physics & chemistry leading to study of radioactivity and nuclear energy.

PLASTICS—Qualify as plastics technician. Take this course. Texts easy to read, written by experts. Mail the coupon for 3 FREE booklets.

PULP, PAPER SPECIALISTS—Courses cover engineering to paper machine operator. Demand field, exp'ct'd to increase 75% in next 25 years. Write for information.

7. How to Become a Civil Engineer

CIVIL ENGINEER—Famous course recognized by many states, prepares you to take exams. All aspects of civil engineering. Thousands of graduates. Write now for 3 FREE booklets.

HIGHWAY ENGINEER—Advance in field. Course complete, covers theory, practice. Recognized by many states. Send coupon now.

STRUCTURAL BLUEPRINTS—How to read them. A key to advancement for ironworkers, patternmakers, builders of concrete structures. Mail coupon now.

SANITARY ENG'N'RING—Men trained in this field in constant demand. Course covers water treatment-supply, sewerage, eradicating menaces to health. Apply now.

SURVEYING, MAPPING—Course for man who wants to enter civil engineering field, but undecided about branch. Texts illustrated, simply written. Personalized instruction. Mail coupon.

8. Draftsmen in Demand

DRAFTSMEN—Over 4000 openings yearly. Senior draftsmen earn average \$550/month. Break into field? I. C. S. training in specialized area can help you. Don't delay. Choose field, then clip coupon.

ARCHITECTURAL drafting course covers arch. drawing, house planning, freehand & ornamental drawing, shades & shadows.

ELECTRICAL—Arithmetic, electricity basics, projection drawing, machine sketching, electrical drafting, other subjects.

ELECTRONIC—Math, mechanical drawing, formulas, electricity, electronic & printed circuit drafting, others.

MECHANICAL DRAFTING—Arithmetic, algebra, geometry & trig, projection drawing, mechanical drawing, machine sketching, others.

9. Electronics, Electricity

APPLIANCE SERVICING—More appliances mean more demand for servicemen. I. C. S. gives you know-how worth money from start. Clip coupon for Success Kit.

ELECTRICAL ENGINEERS—Demand field. Jobs in gov't, industry. I. C. S. training helps worker in field advance to junior, sr. eng'n'ring positions. Also helpful in preparing for registration exam. Starts with basics, if you have limited knowledge. Send coupon for 3 FREE booklets.

ELECTRIC MOTOR REPAIRMAN—Course starts with basics, covers AC, DC motors—perfect for would-be maintenance men, or those who seek advancement to supervisor.

INSTRUMENT TECHNICIAN—Specialists in electrical measuring & control equip. will be scarce in late '60's. Take advantage! Course gives training, starting with gen'l principles. Send for Success Kit right away.

PRACTICAL ELECTRICIANS earn an average of \$4.37 per hour. Get the know-how! Course covers building wiring, elect. equip'm't. Helps prepare for licensing, journeyman exams.

INDUSTRIAL ELECTRONICS—Technical-level course—thorough grounding in electronics. Take first step to cracking this rapidly expanding field. Mail the coupon.

ELECTRONICS TECHNICIANS—With 5 yrs. exp., they average \$6500—many earn more!

Be a specialist in this booming field! Course prepares you. Theory—you learn it. Plus practical application. Mail coupon now.

10. Engineering—a Profession

Take your first step to becoming a registered, professional engineer, with the help of famous I. C. S. courses. There are two routes to eng'n'ng: college and 4 yrs' exp. in field; or high school and 8 yrs.' exp. Then, state registration exam. I. C. S. courses help you obtain work where you can gain necessary field experience; give you knowledge you need to pass exams. Instruction available in Civil, Chemical, Electrical, Mechanical Engineering. Texts authored by authorities, are illustrated and simply written for quick comprehension. Study now, in spare time, for future success or retirement career in engineering. Write "Professional Engineer" on coupon. Do it now.

11. Success, Pleasure Through Better English Writing

BUSINESS WRITING—Command the written word—a key to business success! Course covers composition, copywriting, editing, typography, report writing. Send coupon for FREE Success Kit.

FREE-LANCE WRITING—A career for anyone with talent for writing. Course treats techniques, forms and—how to sell articles. Step-by-step instruction. Send coupon.

SHORT STORY WRITING—An avocation that can lead to spare-time profit. Course covers English grammar, elements of a good story. Emphasis on actual writing. Get started now.

PRACTICAL ENGLISH—A bedrock study of basic English. To improve your speech, writing. As refresher in the basics. People judge you by your language. Send coupon today.

12. More Formal Education

FINISH HIGH SCHOOL—It's never too late. And H.S. completion means much greater earning power and job security. I. C. S. High School programs let you complete your schooling at home, in spare time, at your own pace. Variety of courses offered: Business, Secretarial, Vocational, General. Complete only work you need for I. C. S. High School diploma. Start doing it now—by filling out coupon and mailing it!

COLLEGE PREPARATORY high school course also available. Take credits you need for I. C. S. H. S. diploma that prepares you for college entrance exams. It's never too late to start—if you have the desire. How about now?

LEARN LANGUAGES—Special, low-cost courses. Instruction by records, text, the world-famous Berlitz way. Specify language you're interested in: French, Italian, German or Spanish.

13. \$\$\$\$ in Mechanics, Shopwork

AIR CONDITIONING EXPERT—Experienced men make \$125 a week, average, and demand is rising. If you have basic mechanical knowledge, take this course. Instruction in maintenance, too. Write "Air Conditioning" on coupon.

INDUSTRIAL ENGINEERING—Advance to higher position in operation/management of industrial plant: this course gives the knowledge you'll need. Also first step to becoming registered eng'n'r. Send coupon.

INSTRUMENTATION—Several thousand new jobs a year in this demand field. A basic course. Write for Success Kit.

MACHINE DESIGN—A technical field itself, this knowledge is vital to draftsmen, and a big plus for production men, shop workers.

MACHINE SHOP PRACTICE—A basic course, giving overall knowledge of shop oper't'ns. Emphasis on practical facts. Personalized instruction. A must for the man who wants to advance. First step? Mail coupon.

MECHANICAL ENGINEERING—Within your grasp a high-pay field where at least 2600 new jobs open yearly. Write for Success Kit.

SHOP PRINTS—And how to read them. An authoritative, factual study. Vital to men who want to advance in shop work. Mail coupon now.

REFRIGERATION SPECIALISTS—Enter this booming field and learn the hard way? There's no need. Training spurs advancement—it's never been truer! Fill out coupon for complete information.

TEXTILE TECHNICIAN—The job outlook is good—for trained men. Course designed to help you break into field—or advance to management. Write "Textile" on coupon.

TOOLMAKING—The average toolmaker earns \$26 daily. For good reason: he knows a specialized skill. I. C. S. course equips machinists to crack this specialty, where over 4000 jobs open up annually.

SAFETY ENGINEERING—A comparatively new field, and men with formal training are scarce. Be one. Take I. C. S. course. Covers math, plant design, equipment placement, psychology, safety principles, practices. Apply now. Clip coupon.

WELDING—6000 openings yearly for welders, and pay in line with demand. I. C. S. offers several courses, from the basics to specialized areas. Write "Welding" on coupon for 3 FREE books.

14. Secretarial Help Wanted

WHERE THE MONEY IS—It's in specialized secretarial work. Few secretaries know specialized terminology, procedures. Those who do are in demand, command good pay.

LEGAL SECRETARY—Course covers instruction in typing, English, Gregg method sh'rt'h'nd, business law, insurance, office practice, public relations, legal shorthand. Equips you to work in law office. Apply immediately—the coupon's hot.

MEDICAL SECRETARY—Basic secretarial skills covered in detail. Plus: instruction units on duties of a medical secretary, medical terminology, related subjects. Send coupon NOW for information.

STENO-TYPIST—Want to be a secretary? Break into steno-typist work first. Send coupon for facts on I. C. S. training in typing, stenography, business practice—all you'll need to know.

15. Steam, Diesel Power. You're Needed

BOILER INSPECTOR—Course equips you to break into field, inspecting boilers. Subjects include basic science, steam, boiler fundamentals, steam-boiler design, pumps & compressors.

POWER PLANT ENG'N'R'NG—Want to advance to watch or chief engineer? You'll need knowledge this course contains. Mail coupon right away.

16. Wanted—Trained Supervisors

FOREMAN—You can be one—training speeds the way. Course gives you the broad view of production. Send coupon.

PERSONNEL-LABOR RELAT'NS—Enjoy working with people? I. C. S. course can help you crack personnel field—or advance, if you're already in it. Labor relations also covered. Send coupon for FREE Success Kit.

17. Earn Money in Radio-TV

SERVICEMAN—Trained radio-TV servicemen average \$100-\$150 a week. I. C. S. course covers fundamentals of field step by step. Basic electricity, electronics; AM, FM radio; B & W, color TV. Mail coupon NOW.

RADIOTELEPHONE LICENSES—1st and 2nd class. Courses give thorough grounding in communications fundamentals, preparing you for FCC examinations. Get complete details. Mail coupon for Success Kit.

The Training You Need—from I. C. S.

Get the training you need for the job you want. Get it through I. C. S.—International Correspondence Schools. America's oldest home study institution. 7,500,000 students. Over 6000 training agreements with business and industry. More than 200 courses . . . thousands of individual instruction units, written by experts, then illustrated and edited to "build the teacher into the text." Personalized guidance from your I. C. S. instructor. Convenient payment plan.

Each of the I. C. S. courses on this page has been designed for one reason only: TO HELP YOU BREAK INTO . . . OR MOVE AHEAD FASTER . . . IN THE FIELD YOU CHOOSE.

Take the first step right now. Find out about I. C. S. by filling in the coupon and mailing it. You'll receive three valuable booklets—the famous I. C. S. "Success Kit"—completely without obligation.

Your actions this minute could mark a major turning point in your life. Start filling out the coupon RIGHT NOW.

CLIP COUPON HERE—TAKE YOUR FIRST BIG STEP TO REAL SUCCESS!

I. C. S., Scranton, Penna. 18515 Accredited Member, National Home Study Council

INTERNATIONAL CORRESPONDENCE SCHOOLS I C S

Dept. B2266H, Scranton, Penna. 18515

(In Hawaii: P.O. Box 418, Honolulu. Canadian residents mail to Scranton, Penna. Further service handled through I.C.S. Canadian Ltd.)
Without cost or obligation, rush me "HOW TO SUCCEED," the opportunity booklet about the field I have indicated below, and a sample I.C.S. lesson.

Field of interest _____

Name _____
(Indicate Mr., Miss, Mrs.)

Address _____

City _____ State _____ Zip Code _____

Occupation _____ Employed by _____

Working Hours _____ A.M. to _____ P.M.

Low rates to members of U. S. Armed Forces.

Approved for Veterans under new G. I. Bill. Special I. C. S. booklets for women.

Science Worldwide BY JOHN F. PEARSON

Houses can now be extruded—spun out in one continuous unit—on site. No forms or framing are needed. The construction technique employs a new epoxy resin material fed into a boom-mounted mold that forms, as it continually moves, floors, walls and roof. Curing takes only 10 seconds. The result: a house with four-inch thick walls that require no finishing inside or out. The method was developed by Midwest Applied Science Corp. of West Lafayette, Ind., and Amicon Corp. of Lexington, Mass. The companies claim that a building of 1000 sq. ft. can be erected in six hours by a crew of two.

Knee joints severely disabled by arthritis are now being replaced with hinges made of a cobalt-chrome alloy that is stronger than steel and relatively inert in the human body. Dr. Frank C. Wilson, a University of North Carolina orthopedist, reports replacing 16 knee joints. The metal hinges have enabled several to give up the use of wheel chairs or crutches.

Birds driven away from London years ago by polluted air are now returning. Increasing numbers of insect-eating birds—the first to leave when poisoned air kills bug populations—have been reported. House martins, which haven't nested in England's capital in 80 years, are back. Scientists credit the change to recent smog-control laws.

The radius of Venus has been determined as 6053.7 kilometers (about 3760 miles) by radar measurements made by Jet Propulsion Laboratory's Goldstone facility in the California desert. The accuracy of this finding was corroborated by Lincoln Laboratory's Millstone Hill radio telescope in Massachusetts. Lincoln puts the radius at 6050 kilometers, plus or minus 5 kilometers.

Steam—not oil—is what several big oil companies are drilling for in sites in California and Nevada. The goal is to tap vast "boilers" located from 600 to 8000 feet underground. The geothermal steam they contain can be piped off and used to generate electrical power, as is already being done in northern California and several foreign countries. Geologists say that the natural boilers are fed by subterranean streams and that the water is turned into steam by heat radiated from molten rock.

A satellite as tall as a two-story house and weighing about 1600 pounds is now being built for the Defense Department. Plans are to make it the basis for a worldwide communications system that will enable individual soldiers to contact distant command centers anywhere any time on a moment's notice. The satellite will be able to handle 10,000 two-way conversations simultaneously. It is expected to be in orbit late this year or early next.

How does stress of one's job affect a person's heart? Members of launch crews at Cape Kennedy are helping to find the answer to that question by wearing portable electrocardiograph machines while they work. Heart activity is monitored by three sensors on the chest. Signals are relayed to an eight-hour tape recorder worn at the waist.

Instructions for building a ground station that can receive local cloud-cover pictures anywhere in the world from U. S. weather satellites have been published by NASA. Detailed how-to directions, drawings, wiring diagrams and parts lists are contained in a 66-page booklet. It's said that a reliable receiving station can be built from surplus parts for less than \$500. The booklet is for sale as NASA SP-5079 from the Clearinghouse for Federal Scientific and Technical Information, Springfield, Va. 22151. Cost: 50 cents.

Ten miles of 48-inch pipe are being laid on the floor of the Persian Gulf by a Texas-based international construction firm. Said to be the world's biggest buried submarine pipeline, it will carry crude oil from the rich Kuwait fields to tankers offshore. The pipe will be capable of loading big tankers at a rate of 15,000 tons per hour. ★★★

SEE YOUR MUSIC IN DAZZLING ACTION WITH



*Patent Pending

MusicVision

Dramatic Breakthrough
In Audio-Visual Enjoyment

Adds a spectacular new dimension to the world of music and entertainment. Now you can actually see your favorite musical selection translated into fantastic patterns of beautiful color—each individual note creating whirlring and swirling in perfect time with the music. Science, art and electronics combined with dramatic results. Attaches in seconds to your radio, tape recorder, hi-fi or stereo with two alligator clips. Can be used on small screens, large walls, stages and whole auditoriums. Loads of fun! Wonderful for parties! Practical, too! Unlimited special effects for bands, dances, clubs, sales meetings, trade shows—put zip into classroom or private music instruction and appreciation. Available in Cabinet Model, Tube Unit, 8" and 12" sets or build your own MusicVision* with our low-cost Do-It-Yourself Kit—all you'll need is a light source. If you don't have one, the versatile Edmund 35mm 500 Watt Projector is a terrific bargain. Order by stock numbers listed below. Money-back guarantee. Complete information in new catalog available September 10. If you want additional details now, send 25¢ in coin for fully illustrated, 16-page Booklet No. 9096H "Introduction to MusicVision."

Walnut Veneered Cabinet Model
Stock No. 85,181H\$99.50 F.O.B.
8" Do-It-Yourself Kit
Stock No. 71,009H\$22.50 Ppd.

500 Watt 35mm Projector (for above sets)—Stock No. 71,057\$24.50 Ppd.
*Patent Pending.

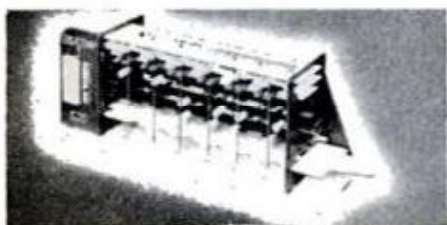

MODEL DIGITAL COMPUTER

Solve problems, teach logic, play games with miniature version of giant electronic brains! Adds, subtracts, multiplies, shifts, complements, carries, memorizes, counts, compares, sequences. Colored plastic parts easily assembled. 12" x 3 1/2" x 4 3/4". Incl. step-by-step assembly diagrams, 32-page instruction book covering operation, computer language (binary system) programming, problems and 15 experiments.
Stock No. 70,583H\$5.98 Ppd.
BIG NEW DIGICOMP II!
Stock No. 70,946H\$16.00 Ppd.

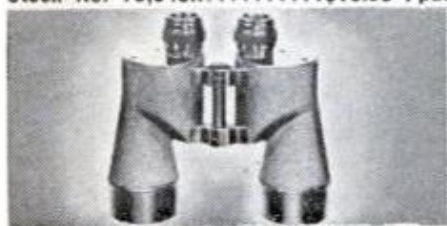

AMER. MADE 7 x 50 BINOCULARS

Big savings! Brand new! Crystal-clear viewing—7 power. Every optical element is coated. An excellent night glass—the size recommended for satellite viewing. Individual eye focus. Exit pupil 7 mm. Approx. field at 1,000 yds. is 376 ft. Carrying Case included. American 7x50's normally cost \$274.50.
Stock No. 1544H\$74.80 Ppd.
Stock No. 963H (6x30)\$40.00 Ppd.

AMER. MADE OPAQUE PROJECTOR



KEEP PACE WITH
THE SPACE AGE!

AMAZING BARGAINS

for Fun • Study • Profit
from
EDMUND SCIENTIFIC CO.
300 Edscorp Building
Barrington, N. J. 08007

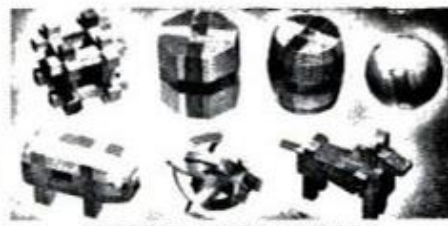

WOODEN SOLID PUZZLES

Here's a fascinating assortment of 12 different puzzles to provide hours of pleasure and stimulate ability to think and reason. Animals and geometric forms. Take them apart and reassemble them. Lots of fun for the whole family—young and old. Will test skill, patience and ability to solve problems. Order yours now.
Stock No. 70,205H\$4.00 Ppd.

Projects illustrations up to 3" x 3 1/2" —enlarges them to 35" x 30" if screen is 6 1/2 ft. from projector, larger pictures if screen is further away. No film or negatives needed. Projects charts, diagrams, color or black-and-white. Operates on 115 volts A.C. current; 6 ft. extension cord and plug included. Operates on 60 watt bulb, not included. Size 12" x 8" x 4 1/2" wide. Weight 1 lb. 2 ozs. Plastic case.
Stock No. 70,199H\$7.95 Ppd.



"FISH" WITH A MAGNET

Now go treasure hunting on the bottom! Tie a line to our 5-lb. Magnet—drop it overboard in bay, river, lake or ocean. Your "treasure" haul can be outboard motors, anchors, fishing tackle, metal valuables. War surplus—Alnico V Type—Gov't cost \$50. Lifts over 150 lbs. on land—much greater weights under water.
Stock No. 70,571H...5-lb. ...\$12.50 Ppd.
Stock No. 70,570H...3 1/2 lb. ...\$8.75 Ppd.



3" ASTRONOMICAL TELESCOPE

See the stars, moon, phases of Venus, planets close up. 60 to 180 power. Aluminized and overcoated 3" diameter f/10 primary mirror, ventilated cell. Equatorial mount with locks on both axes. Equipped with 60X eyepiece and mounted Barlow lens, 3X finder telescope, hardwood tripod. Included FREE: "STAR CHART"; 272-page "HANDBOOK OF HEAVENS"; "HOW TO USE YOUR TELESCOPE" book.
Stock No. 85,050H.....\$29.95 Ppd.
Stock No. 85,105H...4 1/4" ...\$84.50 f.o.b.

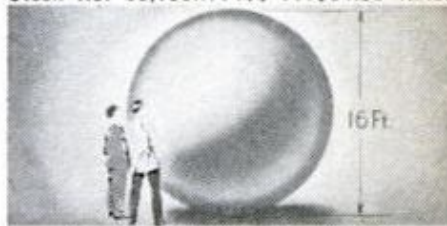

GIANT WEATHER BALLOONS

"Balls of fun" for kids, traffic stoppers for stores, terrific for amateur meteorologists. Create a neighborhood sensation. Great backyard fun. Exciting beach attraction. Amateur meteorologists use to measure cloud heights, wind speed and temp. Heavy duty neoprene. Inflate with vacuum cleaner or auto air hose; or locally available helium for high rise.
Stock No. 60,568H....8'\$2.00 Ppd.
Stock No. 60,632H....16'\$7.00 Ppd.

MONEY-BACK GUARANTEE

Order by Stock No.—Send Check or M.O.

GIANT FREE CATALOG

148 Pages! More than 4,000 UNUSUAL BARGAINS

Completely new Catalog. Packed with huge selection of telescopes, microscopes, binoculars, magnifiers, prisms, photo components, parts, kits, accessories—many hard-to-get surplus bargains. 100's of charts, illustrations. For hobbyists, experimenters, schools, industry. Mail coupon for FREE Catalog "H".

EDMUND SCIENTIFIC CO., 300 Edscorp Building, Barrington, N. J. 08007.

NAME _____
ADDRESS _____
CITY _____
STATE _____ ZIP _____



I'd like to give this to my fellow men... while I am still able to help!

I was young once, as you may be—today I am older. Not too old to enjoy the fruits of my work, but older in the sense of being wiser. And once I was poor, desperately poor. Today almost any man can stretch his income to make ends meet. Today, there are few who hunger for bread and shelter. But in my youth I knew the pinch of poverty; the emptiness of hunger; the cold stare of the creditor who would not take excuses for money. Today, all that is past. And behind my city house, my

summer home, my Cadillacs, my winter-long vacations and my sense of independence—behind all the wealth of cash and deep inner satisfaction that I enjoy—there is one simple secret. It is this secret that I would like to impart to you. If you are satisfied with a humdrum life of service to another master, turn this page now—read no more. If you are interested in a fuller life, free from bosses, free from worries, free from fears, read further. This message may be meant for you.

By Victor B. Mason

I am printing my message in a magazine. It may come to the attention of thousands of eyes. But of all those thousands, only a few will have the vision to understand. Many may read; but of a thousand only you may have the intuition, the sensitivity, to understand that what I am writing may be intended for you—may be the tide that shapes your destiny, which, taken at the crest, carries you to levels of independence beyond the dreams of avarice.

Don't misunderstand me. There is no mysticism in this. I am not speaking of occult things, of innumerable laws of nature that will sweep you to success without effort on your part. That sort of talk is *rubbish!* And anyone who tries to tell you that you can *think* your way to riches without effort is a false friend. I am too much of a realist for that. And I hope you are.

I hope you are the kind of man—if you have read this far—who knows that anything worthwhile has to be *earned!* I hope you have learned that there is no reward without effort. If you have learned this, then you may be ready to take the next step in the development of your karma—you may be ready to learn and use the secret I have to impart.

I Have All The Money I Need

In my own life I have gone beyond the need of money. I have it. I have gone beyond the need of gain. I have two businesses that pay me an income well above any amount I have need for. And, in addition, I have the satisfaction—the deep satisfaction—of knowing that I have put more than three hundred other men in businesses of their own. Since I have no need for money, the greatest satisfaction I get from life is sharing my secret of personal independence with others—seeing them achieve the same heights of happiness that have come into my own life.

Please don't misunderstand this statement. I am not a philanthropist. I believe that charity is something that no proud man will accept. I have never seen a man who was worth his salt who would accept something for nothing. I have never met a highly successful man whom the world respected who did not sacrifice something to

gain his position. And, unless you are willing to make at least half the effort, I'm not interested in giving you a "leg up" to the achievement of your goal. Frankly, I'm going to charge you something for the secret I give you. Not a lot—but enough to make me believe that you are a little above the fellows who merely "wish" for success and are not willing to sacrifice something to get it.

A Fascinating and Peculiar Business

I have a business that is peculiar—one of my businesses. The unusual thing about it is that it is needed in every little community throughout this country. But it is a business that will never be invaded by the "big fellows." It has to be handled on a local basis. No giant octopus can ever gobble up the whole thing. No big combine is ever going to destroy it. It is essentially a "one man" business that can be operated without outside help. It is a business that is good summer and winter. It is a business that is growing each year. And, it is a business that can be started on an investment so small that it is within the reach of anyone who has a television set. But it has nothing to do with television.

This business has another peculiarity. It can be started at home in spare time. No risk to present job. No risk to present income. And no need to let anyone else know you are "on your own." It can be run as a spare time business for extra money. Or, as it grows to the point where it is paying more than your present salary, it can be expanded into a full time business—overnight. It can give you a sense of personal independence that will free you forever from the fear of lay-off, loss of job, depressions, or economic reverses.

Are You Mechanically Inclined?

While the operation of this business is partly automatic, it won't run itself. If you are to use it as a stepping stone to independence, you must be able to work with your hands, use such tools as hammer and screw driver, and enjoy getting into a pair of blue jeans and rolling up your sleeves. But two hours a day of manual work will keep your "factory" running 24 hours turning out a product that has a steady and

ready sale in every community. A half dollar spent for raw materials can bring you six dollars in cash—six times a day.

In this message I'm not going to try to tell you the entire story. There is not enough space on this page. And, I am not going to ask you to spend a penny now to learn the secret. I'll send you all the information, free. If you are interested in becoming independent, in becoming your own boss, in knowing the sweet fruits of success as I know them, send me your name. That's all. Just your name. I won't ask you for a penny. I'll send you all the information about one of the most fascinating businesses you can imagine. With these facts, you will make your own investigation. You will check up on conditions in your neighborhood. You will weigh and analyze the whole proposition. Then, and then only, if you decide to take the next step, I'll allow you to invest \$15.00. And even then, if you decide that your fifteen dollars has been badly invested I'll return it to you. Don't hesitate to send your name. I have no salesmen. I will merely write you a long letter and send you complete facts about the business I have found to be so successful. After that, you make the decisions.

Does Happiness Hang on Your Decision?

Don't put this off. It may be a coincidence that you are reading these words right now. Or, it may be a matter that is more deeply connected with your destiny than either of us can say. There is only one thing certain: If you have read this far you are interested in the kind of independence I enjoy. And if that is true, then you must take the next step. No coupon on this advertisement. If you don't think enough of your future happiness and prosperity to write your name on a postcard and mail it to me, forget the whole thing. But if you think there is a destiny that shapes men's lives, send your name now. What I send you may convince you of the truth of this proverb. And what I send you will not cost a penny, now or at any other time.

VICTOR B. MASON
1512 Jarvis Ave., Suite M-2-KO
CHICAGO, ILLINOIS 60626

"WILL YOU SMOKE MY NEW KIND OF PIPE ..."

30 Days at My Risk?"

New principle that contradicts every idea you've ever had about pipe smoking. I guarantee it to smoke cool and mild hour after hour, day after day, without rest, without bite, bitterness or sludge.

To prove it, I'll let you try a new Carey Pipe. Send your name and address today for my FREE complete trial offer. Write to: E. A. CAREY, 1920 Sunnyside Ave., Dept 252-K, Chicago 40.

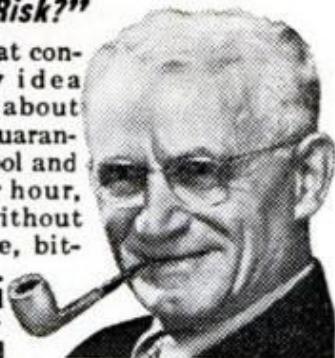

NEW CAR FURNISHED

This is only one of the benefits enjoyed by many Accident Investigators. Learn why this is called "the ideal job;" how men earn to \$1,000 a month in this exciting, secure profession. Men without experience or college have easily trained and qualified. No selling. Send now for FREE BOOK of facts. No Obligation. Write Universal Schools, Dept. PM-68, 6801 Hillcrest, Dallas, Texas 75205.

WHAT'S HE DOING!

Making a Concrete Flower Pot! ... and SO CAN YOU!

Make and sell your own Ornamental Concrete items. Rush \$2.00 for book about Aluminum Molds with prices and production trade secrets direct from world's largest mold manufacturer. Over 350 designs to select from.



Send \$2.00 CONCRETE MACHINERY COMPANY

Today To ➤ P. O. BOX 99 • HICKORY 2, N. C. 28601

MONEY TROUBLES? NOBODY REFUSED UP TO \$20,000.00

Bad Credit is No Problem - Not a Loan Co.

STRICTLY CONFIDENTIAL - A PLAN FOR EVERYONE

WE CAN HELP YOU - TODAY

Send your name and address for FREE application

ATLANTIC ASSOCIATES, Dept. R10

3312 No. Central Avenue, Phoenix, Ariz. 85012
146 Westminster Street, Providence, R. I. 02903

PLEASE PRINT CLEARLY

NAME _____

ADDRESS _____

CITY _____

STATE _____

SUPER SCOPE



Super scope? Yes... because a Weaver K Model offers you the quickest, surest, most dependable way to improve your shooting accuracy.

Compare K Models with any other scopes. Check K Models' magnesium fluoride-coated lenses, strong steel tube, micrometer click adjustments, and exclusive triple weatherproofing.

See the super scope at your dealer ... in eight models, from 1.5-power to 12-power. Choose from five reticle styles. Prices start at \$29.50.

WEAVER  **SCOPES**

**WRITE FOR FREE CATALOG:
W. R. WEAVER COMPANY
DEPT. 91 / EL PASO, TEXAS 79915**

©1968 W. R. Weaver Co.

On the road

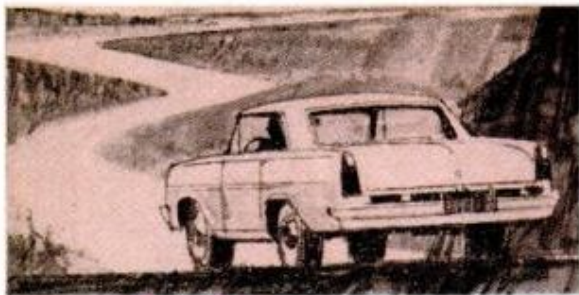

On the water



In your back yard



GUMOUT Cleans carburetors

Every carburetor gets dirty and gummed-up. GUMOUT is the easy way to clean carburetors fast.

Just add GUMOUT to the gas tank. Cures ROUGH IDLING, STALLING, POWER LOSS and HARD STARTING. You'll quickly notice the big difference.

Enjoy a really smooth running engine. Buy GUMOUT at leading Auto Supply Stores, Service Stations—wherever fine auto products are sold.



GUMOUT DIVISION
Pennsylvania Refining Co., Cleveland, Ohio 44104

HEAVY DUTY WELDER

Does work of \$85.00 welder yet costs only **1895** POST PAID

Fits ordinary 110V outlet
Not one • but 3 welding heats

Weld, braze, solder or cut most anything made of metal. No experience necessary. Follow simple instructions. Uses standard 1/8" rods to weld iron, steel, brass, bronze, aluminum, other metals. Repair cars, farm implements, appliances, toys. Make campers, trailers boats. Pays for itself quickly. Comes complete with mask, \$2.00 pack of rods, flux, etc. **NOTHING ELSE TO BUY.**

3 WELDING HEATS . . . Not just one as with other low cost models. "High" for tough jobs, "Medium" or "Regular" for lighter work. 3 heat feature saves you money. New HEAVY DUTY circuit gives more welding potential than ever before. Approved for homes, garages, factories, shops. Has power boost circuit for industrial uses. Raises heat to 4 TIMES that needed to melt toughest iron. No other welder has all three fine features.

FREE! Automatic arc striker now makes welding easy, even for beginners. Just plug welder into ordinary 110V outlet, touch automatic arc striker and start welding. You can't buy this important new Wel-Dex invention but it's yours free if you order from this ad.

10 day MONEY BACK TRIAL. Guaranteed against burnout. SEND \$2.00 and pay \$16.95 plus small C.O.D. when delivered or \$18.95 for postpaid shipment. Phone (713) 682-5811 for C.O.D.

WEL-DEX MFG. CO., Dept. W-10, Box 10776, Houston, Texas 77018

CROSSBOW

Outfit
\$29.95



USE 30 DAYS
AT OUR RISK!

CROSSBOW SHOOTING—the exciting modern sport. Kill game, do backyard target shooting, even crossbow fishing! Powerful 80 lb. thrust shoots arrows "like bullets". Easy pull. Aims like a rifle, has adjustable open and peep sights.

POWERFUL—SILENT—ACCURATE
Handsome, polished hardwood stock. Steel trigger. Aluminum bow. Automatic safety lock. Simple instructions. Ready to use. Crossbow plus leather quiver, 1 hunting, 2 target arrows and fishing harpoon. Only \$29.95. Add \$1.75 for shipping. COD's require \$3 deposit. **SHOOT 30 DAYS IF NOT SATISFIED RETURN FOR A FULL REFUND!**

ORDER TODAY!
Midwest Crossbow Co., Dept. XB-9508 Established 1936
9043 S. Western Ave., Chicago, Ill. 60620

Learn Profitable Profession in few months at Home

MEN AND WOMEN, 18 TO 60

\$4.00 to \$6.00 for 1-hour treatment is the established charge for a skilled operator. Easy to learn and do. Diploma awarded. Open your own office or earn good income from Doctors, Hospitals, Clubs and other health or recreational centers. Wonderful part-time profession. Low monthly payments. Write today for free Anatomy Charts and catalog. No obligation.

ANDERSON SCHOOL OF SCIENTIFIC MASSAGE
Dept. L-1, Princeton, Illinois

Print Your Own

Cards, Stationery, Advertising, Circulars, labels, photo and movie titles, church work, tags, greeting, sympathy, prayer cards, etc. Save money. Pays for itself in a short time.

Own a Printing Business

Good Profit. Raised printing like engraving too. Have home shop. We supply everything. Direct from factory, only. Easily followed rules. Write now for free details. **KELSEY PRESSES E-37 Meriden, Conn. 06450**

KELSEY PRESSES

TAX SALE—\$1 ACRE

Properties now being sold for municipal tax arrears. Hundreds of cottages, farms, hunt-camps, timberlands, homes from coast to coast along Canadian Border. Purchase direct from Tax authorities—NON PROFIT! For lists, pictures, regulations, write: Register, Room 14, 110 Church Street, Toronto, Canada.

Career in ELECTRONICS?

Career training at home the new easy way with RCA Institutes. Lab work with first lesson. Pay as you go. Send for free 64-page book.

RCA Institutes, Inc. Dept. PM-98
320 W. 31 St., N.Y., N.Y. 10001

RCA

TOM McCAHILL SAYS:

"A Smart Guy Can Really Clean Up in the Appliance Repair Field"

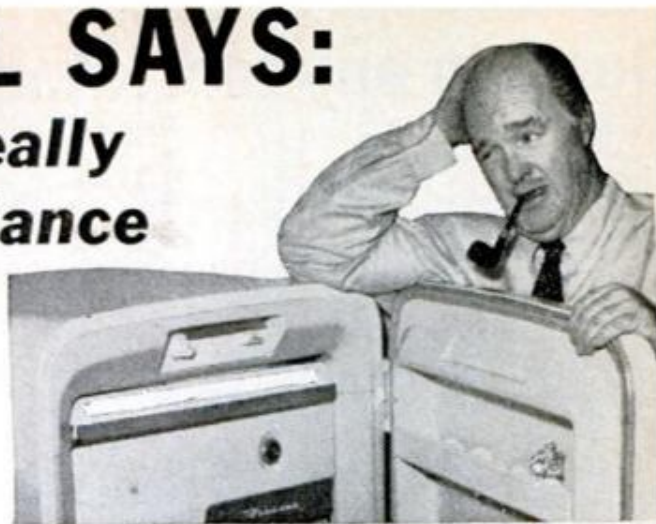

Those electrical gadgets you have around your house are great on convenience, but if you're like a lot of do-it-tomorrow Johnnies, you don't know where to turn when one breaks down. So you call one of the busy Appliance Servicemen in your town, then drink instant until that fancy automatic coffee pot is perking again.

People have so many electrical appliances, it's no wonder Appliance Repairmen are busy as a bear in a bee nest. Count yours. The average home has at least a dozen, maybe more. There are better than 800 million appliances in the U.S.A. right now. No wonder the man who knows how to service appliances properly is pocketing \$4 to \$6 an hour, for as many hours as he cares to work!

If you're interested in making money (and who isn't), here is a job field crying for good men. And it's no sweat at all to get the training you need. Thousands have trained with National Radio Institute's Appliance Division. NRI has a great, low-cost home-study program covering every type of Appliance repair in detail. You study at home, in your spare time, learning through actual practice how to fix home, commercial and farm appliances. And not just the little stuff, either. Besides cantankerous coffee pots and toasters, you can learn how to repair air conditioners, refrigeration equipment, even small gasoline engines—and that's where the big bucks are, in the major appliances you'll fix.

NRI is one of the biggest and best schools in the home-study field. They have this Appliance Servicing course worked out to the most nit-picking detail. Yet, you'll be amazed at how little it costs. You even get a 25-buck professional Appliance Tester without extra cost. With your Tester and a few basic tools you probably have in your house, you'll be doing repair work long before you finish the course. And you can work anywhere—

in a corner of your basement, in the garage, even on the kitchen table.

NRI has been in home-study education since 1914. Experienced, well-trained instructors on the staff of 150 in Washington, D. C., give you all the personal attention a man could ask. You don't even need a high school diploma. Take it from Uncle Tom . . . this can be one of the easiest and most rewarding businesses you'll find today, either full-time or in spare hours. As a matter of fact, knowing how to service Electrical Appliances can pay off even if you don't want to strike out on your own. That coffee pot on the fritz probably needed ten minutes of a repairman's time to be perking again like the mudpots in Yellowstone Park. You can do it yourself with the training NRI gives you. And if you're thinking about Social Security years, this is a great way to pick up some money and keep yourself busy at the same time.

There's nothing to lose except a postage stamp and the energy it takes to walk to the mailbox. What you'll get for your efforts is the newest NRI Appliance Servicing catalog. Nobody is going to ring your doorbell to pressure you into signing an enrollment blank. NRI doesn't employ salesmen.

Do yourself a favor and mail the coupon now—before you turn this page.

Tom McCahill

NATIONAL RADIO INSTITUTE, APPLIANCE DIVISION
3939 Wisconsin Avenue, Washington, D. C. 20016

APPROVED UNDER NEW GI BILL
If you served since January 31, 1955
or are in service, check GI line below.

600-098

OK—I want to see for myself. Send me the free book on Professional Appliance Servicing. No salesman will call.

Name Age.....

Address

City State Zip Code

Accredited Member National Home Study Council.

Check for facts on new GI Bill.

Basic in any tool kit...



Swingline® 800

HEAVY-DUTY TACKER GUN

Hundreds of uses indoors and out:

- Ceiling tiles
- Upholstering
- Shelf trimming
- Valances
- Window shades
- Fencing
- Insulating
- You-name-it!

A real precision heavy-duty gun! Easy action handle... exclusive "Power Dot" for greater staple penetration... handle lock... built-in staple extractor... takes 5 staple sizes plus special Loktile® staples for ceiling tile installation.

at all hardware, department, stationery stores. **\$8.95**

800-X Chrome Heavy-Duty Tacker Gun \$9.50

101 High Compression Tacker Gun. Takes 2 staple sizes. \$5.95



New! Swingline Riveting Pliers. **\$3.95**

Ask your dealer! From

Swingline® INC.

32-00 SKILLMAN AVENUE, LONG ISLAND CITY, NEW YORK 11101

enjoy a real wood-burning fireplace without expensive masonry



So Easy To Install You Can Do It Yourself



For 1, 2, or 3 STORY HOUSES

Save time, labor and money. No masonry or footings needed. Use ordinary tools. Complete Package, base to chimney top. Choice of contemporary or simulated brick chimney top — single or double.

Any room location. It's as easy to locate in an old or new house as a sofa. Finished with any mantel materials or trims. Corner or front styles. Choice of size. Listed by U/L. Built-in clearances permit butting against wood studs, floors, or walls. Thousands in use — nationwide.

Majestic® thulman® FACTORY-BUILT WOOD-BURNING FIREPLACES

Write Today for Details — also other Majestic Fireplaces

The Majestic Co., Inc., 704 Erie St., Huntington, Ind. 46750



POLICE RIOT & FIRE CALLS



Hear dramatic events while they happen! Know where action is! Police. Fire. Aircraft. Control Tower. Accidents, riots, hold-ups, emergencies, police chase, bank robberies, stolen cars, etc.

2-Band AM & Police Portable Radio

Illustrated. Regular AM plus police calls (147-175 MC). Also audio of many TV & FM stations. Dynamic speaker. Telescoping antenna for super-results. Plug-in earphone. Operates in car, anywhere. 10 transistors. Useful companion. With 9-v. batt. 8½ x 5 x 3". Complete Postpaid \$19.95.

New Police & Aircraft Tuners Only \$5.95

Tuner-Converter works with standard radio. No connections. Nothing to build. Solid state circuit. Uses 9-v. battery (35¢). Indispensable at this price. (Any 2, \$10.75. 3 for \$14.95)

POLICE-FIRE TUNER. Low band (30-50) Only \$5.95

AIRCRAFT TUNER (118-128) Hear pilots, tower. Only \$5.95

WORLD-WIDE Short Wave TUNER. (25, 31, 41 meters: 7-12)

News, music, amateurs, propaganda. Only \$5.95

JOHNSON SMITH CO., Dept. 264, Detroit, Mich. 48224

Money Back Guarantee. Serving you since 1914. FREE — World Famous Catalog of 2000 Science, Hobby, Novelty Items & Gadgets.

Tear Out & Mail. No Letter Needed!

Free New Catalog 2000 Novelties

Send for world famous catalog of novelties, live animals, scientific supplies, hobbies, funmakers, planes & boats, looms, magic tricks, joke articles, unusual seeds, gadget timesavers, cameras, optical goods, projectors, movies, lucky jewelry, religious novelties, disguises, musical instruments, stamps, coins, puzzles, fortune tellers, radios, auto & bike accessories, telescopes, magnifiers, compasses, banks, smokers' gadgets, artists supplies, printing sets, engines, motors, shockers, knives, billfolds, fireworks, guns, rifles, sports, books, games, plants, etc. Send postcard or this ad. No letter needed!

CHECK HERE YES—I want FREE Catalog. My Name & Address Attached or on Envelope

Johnson Smith Co., Dept. 350, Detroit, Mich. 48224

Mail This Card Today

LAFAYETTE 1969 CATALOG 690 our 48th Year

FREE!

BETTER THAN EVER

Your Complete Buying Guide to
Everything in Electronics



OVER
500
PAGES!

Featuring Everything in Electronics for
• HOME • INDUSTRY • LABORATORY
from the "World's Hi-Fi & Electronics Center"

Use LAFAYETTE'S Easy-Pay
Budget Plan NO MONEY DOWN . . .
Up to 24 Months to Pay

Satisfaction guaranteed
or Money Refunded

Mail This Card Today for Your Friend

STORE LOCATIONS

| | | |
|--|-----------------------------------|---------------------------------------|
| NEW YORK | NEW JERSEY | MASSACHUSETTS |
| Brooklyn Jamaica Lynbrook | Manhattan Scarsdale Syosset | Newark Paramus Plainfield |
| PENNSYLVANIA | CONNECTICUT | WASHINGTON, D.C. (Area) |
| King of Prussia Monroeville Philadelphia Pittsburgh | Hamden W. Hartford | Falls Church, Va. Mt. Rainier, Md. |

Mail the Coupon Today for Your
FREE 1969 Lafayette Catalog 690

LAFAYETTE Radio ELECTRONICS

Dept. 16098 P.O. Box 10
Syosset, L.I., N.Y. 11791

Please send the FREE 1969 LAFAYETTE Catalog 690

Name

Address

City State Zip

(Please Give Your Zip Code No.)



Mail This
Card Today
For Your

FREE!

1969 Lafayette Catalog 690

Dept. 15098

Name

Address

City

State

Zip

(Please Give Your Zip Code No.)

Name

Dept. 15098

Address

City

State

Zip

(Please Give Your Zip Code No.)

FREE!



Mail The Card
Today for Your

FREE!

1969 Lafayette Catalog 690

MAIL THIS CARD TODAY FOR FREE!

FREE!

1969 LAFAYETTE CATALOG 690



Over 500 Pages

Shop At the "World's Hi-Fi & Electronics Center" For Widest Selection, Low Prices

- Stereo Hi-Fi • Citizens Band • Ham Gear • Tape Recorders • Test Equipment • TV and Radio
- Phonographs, Accessories • Intercoms and PA
- Closed Circuit TV • Tubes and Parts • Cameras
- Auto Accessories • Musical Instruments • Tools • Books

Featuring Everything in Electronics for • HOME • INDUSTRY • LABORATORY from the "World's Hi-Fi & Electronics Center"

REVOLUTIONARY NEW



Electronic Miracle of the Space Age



Award winning LR-1500T
IC solid state Receiver



New! Revolutionary "IC"
2-Way Radios
"IC" (Integrated Circuit)



New!
Dyna Com
Series
Super
Walkie-Talkies



New! Musical
Instruments and
Accessories

Do A Friend A Favor . . .

Have a friend interested in hi-fi or electronics? Send us his name and address and we will send him his own personal copy of the 1969 Lafayette Catalog 690.

FREE! MAIL THE CARD TODAY!

LAFAYETTE RADIO ELECTRONICS

P.O. BOX 10
SYOSSET, L.I., N.Y. 11791

PLACE
STAMP
HERE

LAFAYETTE RADIO ELECTRONICS

P.O. BOX 10
SYOSSET, L.I., N.Y. 11791

PLACE
STAMP
HERE

HE'S AVERAGING \$20,000 WORKING 6 MONTHS A YEAR

★ No College ★ No Experience ★ No Selling

Joe Miller of Duncan, Oklahoma, stepped out of a dead-end, low-pay job and made \$14,768.72 his first year in Accident Investigation. Now he's averaging \$20,000 working 6 months a year!

Joe didn't know the first thing about Accident Investigation. He had no college. Yet, he started his fast move to big money with one, simple act: He sent away for a free book from Universal Schools—the same book you can have just by mailing the coupon below.

Joe learned that Accident Investigation is part of the world's biggest business. That more trained men are urgently needed now—everywhere—to investigate and pay out claims for millions of accidents and losses.

Free Book Tells The Whole, Exciting Story

But, most important, Joe Miller learned how to train for this fantastic business just by reading lessons-by-mail in his own home in spare time. Universal Schools of Dallas has trained and placed more men in the booming Accident Investigation field than any other organization.

Today Joe Miller is a specialist investigating storm damage. His unusual income is far above typical earnings.

But get the whole story. Send now for your copy of the free book that put Joe Miller on the road to big money. Learn how you can start, too. No obligation. No salesman will call. Just mail the coupon or write to Universal Schools, 6801 Hillcrest, Dallas, Texas 75205.



This is Joe Miller. He's averaging \$20,000 a year now because he sent for Universal's Free Book of facts on Accident Investigation. Get your copy now. Mail the coupon today. Universal is approved for Veterans' Training.



UNIVERSAL SCHOOLS, DEPT. PM-9
6801 Hillcrest, Dallas, Texas 75205

Please rush FREE BOOK on opportunities in Accident Investigation. I will have no obligation and no salesman will call on me.

Name _____
Address _____
City _____ State _____ Zip _____

MY WIFE AND I FOUND A GOLD MINE IN OLD DISCARDED FURNITURE

WE PICKED UP THIS OLD CHAIR AT A LOCAL THRIFT STORE! FIXED IT UP LIKE NEW!

BOUGHT IT FOR \$5.00 SOLD IT FOR \$150.00
BETTER THAN \$10.00 PER HR. FOR OUR TIME!

IMAGINE!

A "gold mine" right in our own back yard! We never thought about it until M.U.I. showed us how to take old, beat up furniture, picked up in Salvation Army stores and thrift stores (they practically give it away!) and fix it up, re-upholster it, and sell it for fantastic profits. Up to \$10 an hour for our time PLUS 100% profit on the fabric too!

UPHOLSTERY IS BOOMING WITH A BOOMING AMERICA! JOIN THE "IN" GROUP AND PROSPER!

Never in all American history has there been a boom to equal the current one. New homes, hotels, motels, restaurants, lounges, all need UPHOLSTERED FURNITURE! And within a few years it will all need reupholstering! America is restless, on the move with campers, trailers, boats, all needing upholstery and re-upholstering year after year! Autos — 26 million of them — in constant need of re-upholstered seats, headliners, door panels!

If you have the know-how to take advantage of this great boom, you're "in"! Don't let it pass you by!



BUSINESS OF YOUR OWN?

TOP-PAY JOB OPPORTUNITIES! M.U.I. STEP-BY-STEP UPHOLSTERY TRAINING QUALIFIES YOU FOR BOTH!

HUSBAND-WIFE TEAMS IDEAL!

Start your own home upholstery business on a "shoe-string"! Many begin in their garage, doing small jobs for friends and neighbors. Soon the word gets around and you may have more work than you can handle in a few short months. Often, the husband stays on his job temporarily, while the wife learns the easy MUI way! If you don't want your own business, TOP WAGES ARE OFFERED UPHOLSTERS BY INDUSTRY, with hundreds of automation-proof jobs going unfilled! Computers will never learn upholstery — but YOU can easily, the MUI way!

BUILD A ROOMFULL OF FURNITURE

WITH MUI'S 6 BIG KITS. KEEP IT — SELL IT! PROFIT BY IT!

SEND FOR UPHOLSTERY CAREER BOOK & SAMPLE LESSON NOW!

FREE

UPHOLSTERY NEEDS YOU!

YOU NEED UPHOLSTERY!

AT LEAST SEND FOR THE **FREE FACTS** YOU CAN'T LOSE — YOU MUST GAIN!

A simple act — just clipping and mailing the coupon in this ad — brings you all the free information about UPHOLSTERY, the fascinating, automation-proof industry that offers ambitious men and women lifetime career insurance — better, far better than any form of Social Security! With MUI training you may earn as much — or more — than many college graduates! MUI is authorized by the California Superintendent of Public Instruction to issue a DIPLOMA in upholstery.

APPROVED FOR VETERANS

MODERN UPHOLSTERY INSTITUTE Box 899 BAG Orange, Calif. 92669

Please send FREE Upholstery Career Book & Sample Lesson, I am under no obligation. I am just sending for the free facts on job and career opportunities in Upholstery, and details of the MUI home training program.

Name _____ Age _____
Address _____
City _____
State _____ Zip _____

AIRMAIL COUPON TODAY!

Upholstery, America's Great Boom business, is eager to share its BILLIONS with YOU! Send for this free, illustrated 32-page upholstery career book. It may change your life in ways you can't even imagine, as it has for countless others! Send for FREE BOOK & SAMPLE LESSON today!

FREE TOOLS TOO!



MODERN UPHOLSTERY INSTITUTE Box 899 BAG Orange, Calif. 92669



NOW ONE BETTER

the uncommon motor oil
100% Pure Pennsylvania + ZDP
for the hottest cars going, or coming
Exceeds all car makers' latest specifications

New racing decal.
Send 10¢ and self-addressed,
stamped envelope.



Wolf's Head Oil Refining Co.,
Dept. PM, Oil City, Pa. 16301



Look Ma, no bristles.

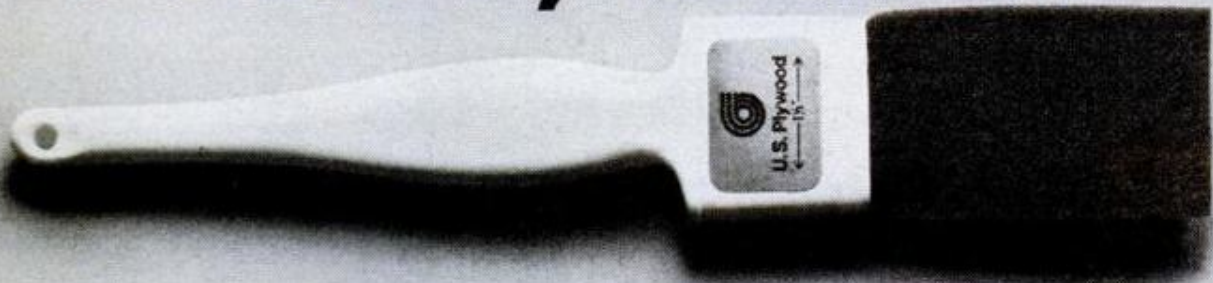

Snap-a-Brush™ has no bristles, because bristles are what's wrong with paintbrushes. They shed, curl, flip and spatter. And they're murder to clean.

So Snap-a-Brush has a "blade" of plastic foam instead. Holds

more paint. Flows it on smoother. No shedding. No bristle marks.

No cleaning either: it's disposable. You just snap out the blade, snap in a refill. You can clean it if you want, but why bother? Refills are as cheap as 2 for 79¢.

Snap-a-Brush

U.S. Plywood
A Division of U.S. Plywood-Champion Papers Inc.



**40,000
mile
tread wear
guarantee
Virtual
elimination
of punctures
and blowouts
Up to 10%
gas economy**



It's all wrapped up in this.

Guarantee given by MICHELIN TIRE CORPORATION covers repair, credit or refund at its option. Credit or refund based on consumer's original purchase price and proportion of mileage run. (See us for details).

**Maximum
all-weather
traction
Easier
steering
Quicker
stopping
Smoother
high-speed
driving**

* Bibendum the tire man. Michelin's trademark of quality since 1891.

68-1742

**MICHELIN
'X'RADIAL®**

CONSULT THE YELLOW PAGES FOR YOUR NEAREST MICHELIN DEALER

LISTENING POST

BY BOB IRVIN

1970 FORD INTERMEDIATES—the Fairlane-Torino and Cyclone-Montego models—are getting an extra \$30 to 40-million facelifting. “We’re going to throw the book at them,” said one Ford man of the competition. The intermediates, all-new in 1968, will get only minor changes in 1969. A new Lincoln-Continental is expected to be ready in 1970. Next big change for the full-size Ford-Mercury and the sporty Mustang-Cougar models is due in 1971. All-new this fall, they will get only minor appearance alterations in 1970.

SEPARATE TAIL AND STOPLIGHTS for all new cars are being considered by the auto industry. “I see this coming in the future,” says Tom Kilgour, a top Chrysler engineer and chairman of a special auto-industry lighting committee. At present, the stop and brake lights are superimposed. Kilgour believes making them separate would provide more safety. He also thinks there’s a need for variable-intensity stoplights—brighter in the daytime than at night. But he notes this poses a lot of problems, citing, for example, the fact that on a foggy night the lights should be daytime-bright. It’s a good bet the proposal to separate tail and stoplights has a better chance of being adopted than the idea of having variable-intensity lights or the even farther-out suggestions for tricolor taillights—green, yellow and red.

NEW GM SIGNS should start appearing in numbers next year at General Motors dealerships. They will be based on the “GM Mark of Excellence” plaques that have been on all the company’s cars the past two years. The new corporate identity program—which follows similar moves at Ford and Chrysler—will cost more than \$200 million. The other two companies are pleased with the results of their programs.

TELEVISION INVESTIGATION AT AUTO ACCIDENTS is an interesting possibility. Cornell’s experimenting with the idea—transmitting pictures from a portable camera at the accident scene to a panel of experts seated before TV monitors. This would enable skilled investigators to be “on the scene” of every major accident. Two-way radio would also be used. The study’s being made under a government contract.

COMPUTERS IN CARS have a real future. First there was the Volkswagen computer-controlled fuel injection in 1968. In 1969, Ford will have computer-controlled antiskid systems on the Thunderbird and Continental Mark III. That’s just a start. An official of Kelsey-Hayes, which developed the skid-control system, believes a computer eventually can control about 100 different operations in a car—from adjusting power seats to shifting gears in an automatic transmission.

NEW ELECTRIC CAR, most interesting to come down the road yet, is a hybrid developed by General Motors. Called “Stir-Lec I,” the car is driven by an electric motor with energy from 14 conventional 12-volt lead-acid batteries. The unique feature is that the batteries are recharged while the car is moving by means of a Stirling heat engine. The Stirling engine was invented 150 years ago, but it’s being used in the hybrid car—actually a modified 1968 Opel Kadett—because it’s virtually emission-free. This is due to an external combustion chamber which provides almost complete burning of the kerosene fuel. The resulting heat expands hydrogen gas in the sealed engine cylinder. The gas pushes down a piston which drives a generator to recharge the batteries. This arrangement overcomes the limited range of battery-powered electrics, which take hours to recharge when the batteries run down. But GM’s hybrid, under optimum conditions, has unlimited cruising range at 30 mph, providing you stop every

(Please turn to page 34)



How to keep valves like this... from getting like this.

First we'd better tell you how they get this way. Stop-and-go driving, as well as turnpike driving, cause carbonaceous ash deposits to lodge on, and build up on, valves.

These deposits can flake off and lodge on valve seats and prevent proper sealing. This eventually can destroy valve functioning and result in a major repair job.

That drives up the cost of driving... can cost you money.

Texaco has a new Sky Chief gasoline that can drive down the cost of driving. It can save you money. How?

New Sky Chief minimizes

deposit formation on new valves and arrests further deposit build-up on old valves. Better than any other leading gasoline.

You don't have to be an engineer to realize

what this can mean in terms of compression, idling, acceleration, mileage—and repairs.

All car owners are interested in saving money. And over the long haul, new Sky Chief can save plenty.

Driving down the cost of driving is one reason Texaco sells more gasoline than anybody else.

We're first... and we think that's a big responsibility.



New Texaco Sky Chief can drive down the cost of driving.



Материал, защищенный авторским правом

(Continued from page 32)

150 to 200 miles to replenish the kerosene fuel for the Stirling engine. At the car's top speed of 55 mph, the range is cut to 30-40 miles because the batteries are using more power than the 8-hp Stirling engine can replace. GM Vice-Pres. Lawrence R. Hafstad says the car "has more promise than any other electric that we have had a chance to look at so far."

"Calvair" was the name of General Motors' first Stirling-powered car, a modified Corvair. While never shown to the public or press, it's been learned the car used thermal batteries instead of an external combustion chamber to provide heat for the 30-hp engine which actually drove the car. The "heat batteries" were 50,000 aluminum-oxide pellets, with charging by bottled natural gas. GM people called it "our zero smog car."

PREDICTIONS OF THINGS TO COME:

Automatic highways will be common by the 1990s, with many vehicles electrically propelled. This from Dr. William Seifert, assistant engineering dean at MIT. On the other hand, Transportation Secretary Alan S. Boyd says the electric car "is a pretty long way down the road" and doesn't see any possibility of the internal-combustion engine being replaced in the foreseeable future. Dr. Jack Goldman, one of Ford's top scientists, says battery power can't make it in cars unless it's combined with a second power source. Goldman says any electric car produced "in our lifetime will have to be a hybrid."

EXPERIMENTAL HYBRID ELECTRIC

car is being built by Toyota, the Japanese firm. It will use a small gasoline engine and electric storage batteries. Meanwhile, Chrysler's rumored to be talking with a Japanese firm about work on a rotary piston engine.

HIGHWAY PATROLMEN

may be too eager in pursuing people, according to the Physicians for Automotive Safety. The doctors' group says three out of four hot pursuits are for minor offenses, yet one out of five ends in death, five out of 10 in serious injuries and seven of 10 in an accident.

FORD'S INTENTION

is to continue its aftermarket parts operation regardless of what happens in an antitrust suit brought by the government because it purchased Autolite several years ago. A federal judge in Detroit recently ruled the purchase violated antitrust laws. ★★★



If you think soldering is difficult...



this *Weller* kit will change your mind

Soldering is simple, sure and fast with a Weller dual heat gun. It heats up to 40% faster than other soldering tools. Its exclusive two-position triggers lets you switch instantly to high or low heat. The gun has long reach, lets you get into tight places. Its built-in spotlight lets you see what you're doing. The kit includes all your soldering needs in a rugged plastic case.

Dual heat soldering gun kit. 100/140 watt gun, 3 soldering tips, tip wrench, soldering aid, solder. Model 8200PK. **\$9⁹⁵** list

Heavy-duty dual heat soldering gun kit. 240/325 watt gun; tips for soldering, cutting, smoothing; tip changing wrench and solder. Model D550PK. **\$13⁹⁵** list

Available in Canada

WELLER ELECTRIC CORP., Easton, Pa.

World Leader in Soldering Tools



"I Earn Two Incomes Now"

Says **JOHN BENNIE, Pittsburgh, Pennsylvania**

"Thanks to your wonderful training, I have been able to earn \$20 to \$25 extra each and every week doing little locksmith jobs at home and after work at my regular job. This is the best trade a man can take up."

Be a LOCKSMITH

Train at HOME—Earn While You Learn. Add 50%-100% to YOUR INCOME with easy spare time earnings. Cash in on the nation-wide shortage—trained locksmiths in great demand! Quickly step into a big pay opportunity job or start a high-profit shop of your own.

Earn Extra Money RIGHT AWAY! All Master Locksmiths Special Tools, Equipment and Supplies Furnished FREE for use with course.

Age, education, minor physical handicaps don't matter in this growing trade. You can quickly qualify as a skilled locksmith. It's like a fascinating hobby. Study at home as little as one hour a week. Gain practical experience through complete well-illustrated lessons. Do real jobs on car locks, house locks, padlocks and safe locks, under the guidance of experts. FREE Illustrated Book, write now.

LOCKSMITHING INSTITUTE,

(Div. Tech. Home Study Schools)

Dept. 1110-098 • Little Falls, New Jersey 07424

306
pieces of professional equipment
FREE
for use with course.

Professional Equipment includes
LOCKS—PICKS—PARTS—KEYS
SPECIAL TOOLS & SUPPLIES
all FREE for use with course.

MAIL COUPON for FREE ILLUSTRATED BOOK

For a future as your own boss or in a high-pay job, write now for FREE Illustrated Book.

Only school of its kind. Licensed by State of New Jersey. Approved for Veterans.

MAIL COUPON NOW

LOCKSMITHING INSTITUTE, Dept. 1110-098 Little Falls, New Jersey 07424

Please send FREE Illustrated Book—"Your Big Opportunities in Locksmithing." complete Equipment folder and sample lesson pages—FREE of all obligation—(no salesman will call).

Name _____

Address _____

City _____ State _____ Zip _____

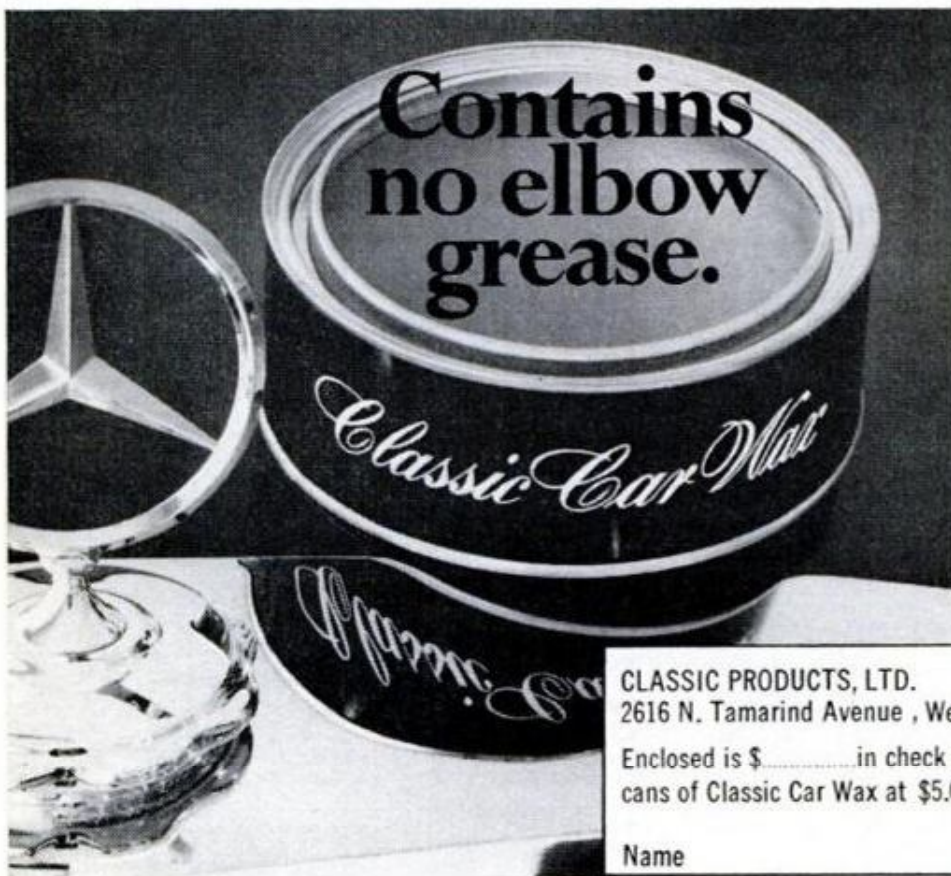

Doesn't need any. The ingredients do the work, not you. Classic rubs on and dusts off effortlessly. Wax a whole car—a big one—in less than an hour. You get a shiny, hard protective coat that lasts longer than any other. Classic contains plenty of carnauba, the hardest wax known. Plus other ingredients that revitalize and protect your paint finish. Wax right in the sun without streaking. Our 1 lb. 2 oz. tin gives you at least six full wax jobs. Only \$5. Try it. If you don't think it's worth it, return the rest and you'll get your money back!

CLASSIC PRODUCTS, LTD. PM-9
2616 N. Tamarind Avenue, West Palm Beach, Florida 33407

Enclosed is \$..... in check or money order. Please rush..... cans of Classic Car Wax at \$5.00 each.

Name _____

Address _____

City _____ State _____ Zip _____

NOW AVAILABLE IN CANADA
Sales Representatives Wanted Nationwide

New MOLLY® drive fastener for dry walls.

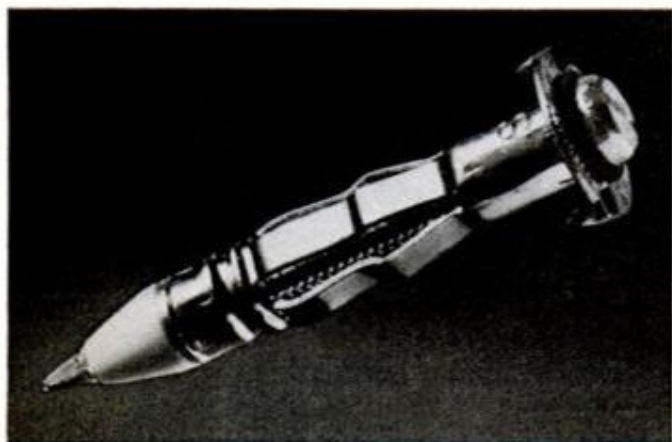

No more drilling

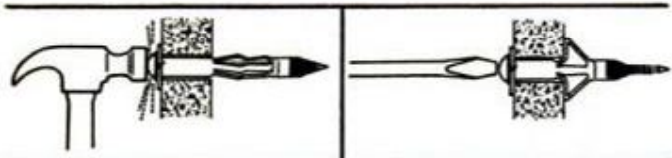

Just tap and turn

Now it's easy to fasten things to hollow dry walls. Just use new MOLLY Drive Fasteners. They eliminate drilling. Only a hammer and screwdriver are needed to install them. And their holding power is tremendous. Use MOLLY Drive Fasteners to secure all kinds of fixtures, pictures to dry walls. Four on card. **49¢**
list

THERMOGRIP® Electric Glue Gun

Bonds almost any material in 60 seconds. No clamping. Comes with hot-melt glue and sealer sticks. **\$7.95**
list



"POP"® RIVETOOL KIT

Sets all blind rivets through $\frac{3}{16}$ " diameter from one side of the work. "POP"® RIVET assortment included. **\$5.95**
list

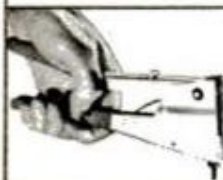

Available wherever hardware is sold



CONSUMER PRODUCTS CENTER
United Shoe Machinery Corporation
221 OLEY STREET, READING, PA. 19601

Bean's Catalog

Just off the press



Hunters, Campers and Fishermen will find many practical items in our fully illustrated Fall Catalog. Shows hunting footwear, clothing and other specialties of interest to both men and women. Many items are of our own manufacture.

L. L. Bean, Inc.

366 Main St., Freeport, Maine 04032
Hunting, Fishing and Camping Specialties

Hard-to-Find TOOLS

CATALOG of exceptionally useful tools rarely found in stores or other catalogs. Industrial-professional quality only. Used by wood and metal workers, repairmen, welders, machinists, clock, watch and instrument makers, jewelers and model makers. Brookstone tools solve problems—make work easier, more fun. Send 25¢.

BROOKSTONE CO.

9824 River Road
Worthington, Mass. 01098

BUILD REFINISH RESTORE ... anything of wood

LET Constantine's picture-packed Catalog-Manual help you build new furniture—help you restore and refinish beat-up cabinets, chairs, chests, tables. Find instantly whatever you need. Newest materials plus plans, instructions. Largest selection of beautiful woods. Specialty tools. Products not found in stores or by mail elsewhere. *Unsurpassed values.* Send for vast, illus. catalog NOW!



2,000



Tear out ad. Mail with 25¢
for vast new CATALOG
Plus New "101 Project Ideas"

CONSTANTINE

2050 Eastchester Rd., Bronx N.Y. 10461 Dept. M-5

CRAFTSMAN PRODUCTS
Woods—Veneers—Inlays
Newest Workshop Tools
Wood Finishes—Moldings
Carving Woods & Patterns
Cane Kits—Lamp Parts
Hard-to-find Hardware



ACCORIONS and AMPLIFIERS

BIG SAVINGS up to $\frac{1}{2}$ or more on famous make accordions. Over 40 models. Standard and new electronic models. Buy direct at low discount prices. Get five-day home trial. Small down payment, easy terms. Free gifts. Trade in allowance. Money back guarantee. Rush coupon for color catalogs, discount price list. Accordion Corp. of America, Dept. R-98, 5535 W. Belmont Ave., Chicago, Illinois 60641

**COUPON
BRINGS
FREE
COLOR
CATALOG &
DISCOUNT
PRICES**

ACCORDION CORP. of AMERICA—Dept. R-98
5535 W. Belmont Ave., Chicago, Illinois 60641
Send FREE Color catalogs and discount prices. Include special information checked:

Amplifiers Button Type Accordions

Name _____

Address _____

City _____ State _____ Zip _____

The answer to sticky problems.

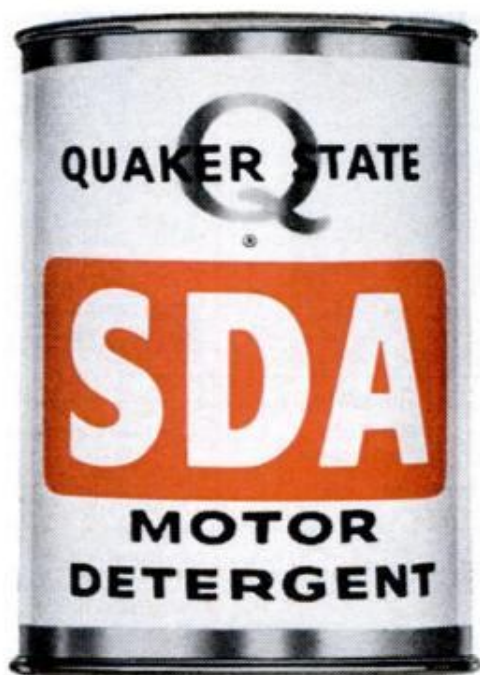

You've heard that annoying clatter of sticky valve lifters. It means trouble now, and maybe bigger trouble down the road.

Quaker State SDA takes sticky problems like these in stride. Frees up sluggish valves, lifters and piston rings. Cleans out the offending varnish and sludge deposits. And restores the engine power a car should deliver.

If you do a lot of stop-and-go driving, SDA is the answer here, too. It prevents the rust and corrosion that can build up in this kind of driving.

All this sounds like quite a major overhaul. It isn't. In just two minutes SDA goes to work to tune up your engine.

Quaker State your car to keep it running young.



5000° OXYGEN WELDING TORCH
\$34.95 New portable SOLIDOX welding torch goes anywhere. Only 4 lbs. Burns amazing solid oxygen pellets & propane. Flame exceeds 5000°F. Braze weld, silver solder, melt 1/4" steel. Complete kit: torch, pellets, propane, glasses, braze rods, lighter, etc. Ideal for shops, hobby, metal repair. Professional results. Low-cost SOLIDOX pellets available by mail. SOLIDOX is simple and safe. Money-back guarantee. Only \$34.95 ppd.

Cleanweld Products, PM-9, Box 1061, South Gate, Calif. 90280

SAVE ON WOOD

Imported & Domestic

For 28 Years... Serving the Wood Hobbyist, Home Craftsmen, School, Shop and Industry

CABINET HARDWARE - VENEERS - TOOLS
EVERYTHING for the Wood Shop

New 1969 Catalog Ready!

OVER 1500 ITEMS at MONEY SAVING PRICES! Finest domestic and imported hardwoods . . . all dimensions. Hardwood veneers. Power tools at discount prices. Hardware, lamp parts, upholstery supplies, mosaic tile. Hard to find inlays, bandings, etc. Get new catalog . . . send name, address and enclose 35¢ to pay postage, handling.

CRAFTSMAN WOOD SERVICE CO. Dept. A-98
 2729 S. MARY ST., CHICAGO, ILL. 60608

The Devil has quite a temper!



15737-B

We're proud of the temper in Red Devil's high carbon steel blades . . . just one of the quality features in our full line of putty knives, wall scrapers, wood scrapers and other home patch-up tools. Buy the best! Buy Red Devil!

Red Devil inc

UNION, N. J., U.S.A.

APPROVED VETERANS

These 3 BIG DRAFTING KITS GIVEN TO YOU!

... when you train at home with NASD for a

HIGH PAY JOB IN DRAFTING!

Take your pick of 1000s big salary jobs open to Draftsmen. U.S. Labor Dept. reports "42% more Draftsmen needed in next 10 years—not enough applicants to fill jobs available now." Easy home-study plan has helped 100s beginners toward \$\$\$\$\$, security, prestige as Draftsmen—many with only grade school training. Others report good earnings drafting part time while still learning. Why not you?

RUSH COUPON FOR FREE KIT!

Mail coupon for FREE "DRAFTING CAREER KIT," Sample Lesson, Drafting Aptitude Test including new 5-Way Drafting Instrument & 20-Page Book, "Your Future in Drafting"—ALL FREE. No salesman will call. G.I. approved. Write today.

NORTH AMERICAN SCHOOL OF DRAFTING, Dept. 4179
4500 Campus Drive, Newport, California 92660

Rush "Drafting Career Kit," including Book, Sample Lesson, Aptitude Test & Drafting Instrument—All Free!

NAME _____ AGE _____
ADDRESS _____
CITY _____ STATE _____ ZIP _____

If you want to
STOP SMOKING

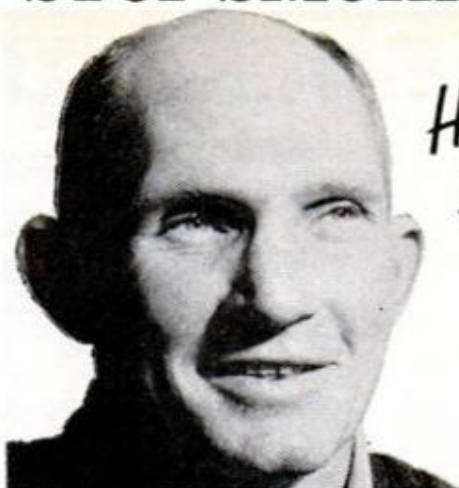

Here's How!

by Y. A. Tittle

Y. A. Tittle is a former great NFL quarterback, now a successful insurance executive and back-field coach for the San Francisco Forty-Niners.

After my doctor advised me to quit smoking I made many starts—with no success. Just as I needed help from my teammates on the football field, I found that desire, alone, wasn't enough to stop smoking. Then Bantron was recommended to me by a friend. Bantron did the job! I stopped smoking completely in 5 days and I'm proud to say I haven't smoked in well over a year.

I've learned that clinical evidence has established that Bantron is more than 80% effective in helping chronic chain smokers give up smoking completely. Extensive research work at a great American University has shown that 4 out of 5 patients who had a desire to stop smoking were able to do so within one week with the help of Bantron. Even those who didn't stop completely cut down drastically.

And the Bantron way is so easy and pleasant! Bantron does not affect your taste, is not habit forming. It acts as a substitute for the nicotine in your system, and curbs your desire for tobacco.

Try Bantron. You will be amazed at the results you get. It's so safe when taken as directed that you can get it at all drug stores without a prescription. Also available in Canada.

Bantron
BRAND
Smoking Deterrent Tablets

DEFENDER OF WOMEN!

Instantly Stops Attacker

Assailants run screaming when sprayed in face with DEFENDER. When you're in danger, simply press top. Temporarily leaves attackers helpless. Dyes skin identifying ing attacker for police. Effective up to 15 ft. Lip-Stick size—hides easily in palm of hand. Women buy on sight. Amazing profit!

SAMPLES for TRIAL Sample offer sent to all who send name at once. Postcard will do. SEND NO MONEY. Just your name.

KRISTEE CO. Dept. 671, Akron, Ohio 44308

CERTIFIED AIRCRAFT BIRCH PLYWOOD

| | | |
|---|--------------|--------------|
| FOB per 48x48" sheet, 1 to 3 sheets \$2.50 extra, 20% dealers discount 100 sheets. Cut in half or quarter for parcel post with faster delivery. Also industrial and cabinet birch plywood, all thicknesses, sheets and cut to any size and shape. | 1/32" \$5.90 | 1/8" \$10.50 |
| | 1/16" 6.90 | 3/16" 14.50 |
| | 3/32" 8.90 | 1/4" 17.50 |

Violette Plywood Corp., Box 141-A Lunenburg, Mass.

WHY SPACKLE®?



IT'S THE BEST THERE IS

for smoothing walls prior to painting. Adheres to any surface. Holes, cracks, crevices disappear. Rough surfaces vanish. Guarantees a smooth finish coat. Use in powder or vinyl paste form. Make sure it says SPACKLE® on the box.

Made only by

The muralo Company/Bayonne, New Jersey

HANDBOOK OF Knots and Splices

By CHARLES E. GIBSON

Now tie knots for every purpose—useful, ornamental, fun-to-make! Book gives complete "1-2-3" sketches and instructions for every hitch, splice, bend, sling, lashing or whipping you'll ever need for boating, camping, climbing, fishing, hunting . . . for patio awnings, swings, hammocks, rope fences, "welcome" mats; . . . ornamental lamps, vases, bell ropes, key chains, buggy whips, cat-o-nine tails, rope handcuffs, play quilts, etc. They're all here . . . over 100 kinds of knots and ropework! From the simple square knot to such fancy numbers as the Manrope, Stopper, Shroud, Crown, Turk's Head, and Pineapple knots. Also covers plaiting, braiding, much more! "Highly recommended."—Library Journal. Profusely illustrated. ORDER NOW! 10-day Money-Back Guarantee. Send only \$3.95 to EMERSON BOOKS Inc., Dept. 781-R, 251 West 19 St., New York, N. Y. 10011.



RADIAL ARM SAW KIT—for under \$100...

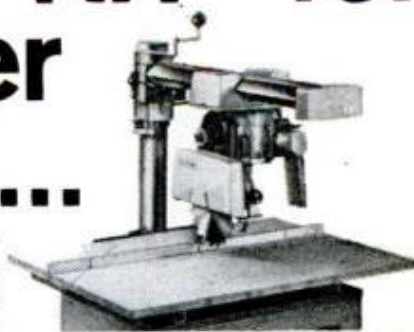

Buy direct from factory, assemble yourself. Incl. 1/2 h.p. G.E. motor, easy to follow instructions, all parts,

nuts and bolts. Guar. for life pat. pend. radial arm track; twice the usual bearings for extra rigidity, greater precision. Rips 24", crosscuts 12"; belt brake. \$99. complete, freight col. Kit less motor (any standard 1/2 h.p. or larger will do) \$ 84.85. With opt'l G.E. motor developing 1 h.p. \$108.65. Money back guaranteed by one of world's largest manufacturers of bench power tools.

MAIL COUPON FOR ILLUSTRATED BROCHURE

American Machine & Tool Co.

Dept. PM9R, Royersford, Pennsylvania 19468

Please send me without obligation your free illustrated brochure containing full information on the PermaTrak radial arm saw kit. Also send free reprints of feature articles by editors of Popular Mechanics, Workbench and Family Handyman. NO SALESMAN IS TO CALL.

NAME _____

ADDRESS _____

CITY _____

STATE _____

ZIP _____

CASH BONANZA IN ENGRAVED SIGNS!

Double your income making engraved plastic signs on a Scott SM-100A engraver. Quality precision instrument, complete with accessories. Models from \$130. Earn 500%-markup profits! Sign market fat as the yellow pages. Free catalog.

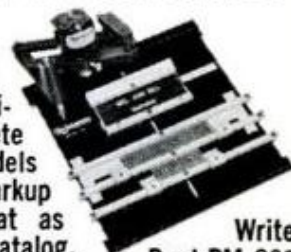

Write Dept. PM-968.

SCOTT MACHINE DEVELOPMENT CORP.

215 Prospect Avenue

P. O. Box 217 • Walton, New York 13856

Magic Mail Plan—Make up to \$12 an Hour!



THIS MAN . . .
... is taking out of the machine a Plastic Sealing Job—ordered by mail—only 11c in material cost brings back \$2.59 in cash by mail. Capacity of machine: \$40.00 profit per hour of operation.

Get **ORDERS** and **CASH** from your mailman—do work in **SPARE TIME** at home—or expand into **FULL TIME** business.

Send coupon for Free facts about the newest and most fascinating of all home operated businesses. For the first time a simplified machine brings the fabulous profits of **Plastic Sealing** and **Plastic Laminating** within the reach of the small operator. Anyone can learn to operate the machine with a few minutes practice—then with our **Magic Mail Plan** can get mail orders pouring in daily with cash in every envelope. **No canvassing—no selling.** We even

Get into PLASTIC LAMINATING at home

WE'LL HELP FINANCE YOU AT LESS THAN BANK RATES. supply the circulars you mail to bring back cash and orders, financing help, too. Rush name. We'll send you **FREE** and postpaid, pictures, prices, details, finance plan, all the facts you need. Mail coupon or send name on postcard. No charge. **WARNER ELECTRIC, 1512 Jarvis, Dept. L-2-KO, Chgo., Ill. 60626**

Make Thousands of Beautiful Art Creations

COSTUME JEWELRY • CIGARETTE BOXES TRAYS • CANDLESTICKS • COASTERS LAMP BASES • BOOK ENDS...ALL IN SPARKLING COLORED PLASTIC



WARNER ELECTRIC CO., 1512 Jarvis Av.

Dept. L-2-KO, Chicago, Ill. 60626

At no cost to me, please rush full details and financing plan, postage prepaid. No obligation.

Name _____

Address _____

City _____ State _____ Zip Code _____

Big jobs to do? Use your electric drill and power-boosting

Versamatic

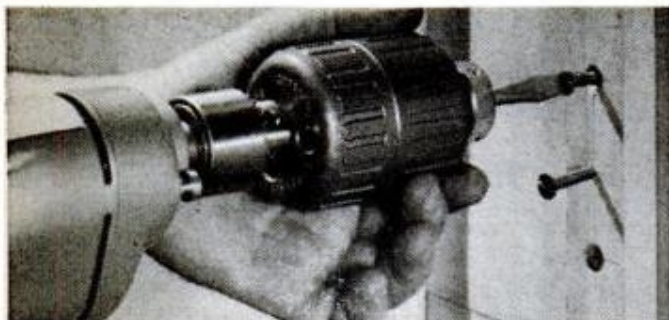

- Screw Driving
- Screw Removal
- Driving Nuts
- Removing nuts
- Heavy-duty drilling
- Tapping

RIDGID
Supreme

Power Tool
Equipment

Lots of big screws to drive or remove? Nuts to put on? Or take off? Need to drill in concrete or hard steel? Use power. Attach a reversible Versamatic to your portable drill for seven-fold power increase and 7 to 1 speed reduction. Versamatic more than doubles power drill usefulness. Send for free folder — "How to double the value of your power drill."

The Ridge Tool Company, Dept. D, Elyria, Ohio 44035

More Comfort Wearing FALSE TEETH

Here is a pleasant way to overcome loose plate discomfort. FASTEETH — an improved powder sprinkled on upper and lower plates — holds dentures firmer so they feel more comfortable. No gummy, goeey, pasty taste or feeling. FASTEETH is alkaline. Doesn't sour. Helps check "dental plate odor". Dentures that fit are essential to health. See your dentist regularly. Get FASTEETH at all drug counters.

WHICH TYPE ROTARY TILLER Have YOU Been Using?



TORTURE!



JOY!

If the tiller you've been using has its revolving blades in **FRONT** (See 'Torture!' at left), you won't ever be happy with it again once you try the **TROY-BILT®** which has its revolving blades in the **REAR** — and is **SO EASY** to use you guide it with just **ONE HAND!** (See 'JOY!' at left). You do **NOT** have to walk behind it, leaving footprints! It does **NOT** shake you half to death! It leaves **NO** wheel-marks! The **TROY-BILT®** is now in its 8th great year. **SO**, if you want tilling to be a **JOY** instead of **TORTURE** from now on, please send a postcard now for the whole story of this wonderfully better design in tillers! Ask for complete details, including prices and name of nearest dealer where you can see, buy or rent.

TROY-BILT® TROJAN HORSE ROTO TILLERS
Dept. 1919, 29 102nd St., Troy, N.Y. 12182

LAW FREE BOOK THE LAW TRAINED MAN

Write today for a **FREE** copy of illustrated law book, "THE LAW TRAINED MAN," which shows how to earn the professional Bachelor of Laws (LL.B.) degree through home study of the famous Blackstone Law Course. All necessary books and lessons provided. Moderate cost; convenient monthly terms. Write for **FREE** law training book today.

Blackstone School of Law, 307 N. Michigan Ave.
Founded 1890 Dept. 56, Chicago, Illinois 60601

**Guaranteed
10 Years!**

\$1.98



The knife for hunting, fishing and all around use.

Mirror polished, imported stainless steel blade honed to a razor's edge. Rugged. Opens with flick of finger. Locks into position. Blade will not close when in use. Press button in handle to close. Safety finger guard. Sure-grip handle. Balanced for target throwing. **IF BROKEN WITHIN 10 YEARS WE WILL REPLACE AT NO CHARGE!** Use 30 days. Money back if not pleased. Only \$1.98 plus \$.27 postage and handling.

ORDER NOW! Midwest Knife Co., 9043 S. Western Ave., Dept. RC-8808, Chicago, Ill. 60620. Established 1936.

DOT

SPEEDY RIVETS

"JUST SWAT with Hammer"



- Works like a charm . . . holds firm!
- Look for **NEW** red and yellow Skin-Pack Cards!
- Look for **Colorful NEW** Display Carton, too!
- Available in two sizes; nickel, gilt, black and brown colors!
- Sold at hardware stores.

**COLUMBIA
FASTENER**

SUBSIDIARY OF UNITED-CARR
3229 S. Ashland Av., Chicago, Ill. 60608

Every home should have Speedy Rivets . . . "The Fix-it Man's Best Friend"!

REAL ESTATE BE A BROKER

PAYS BIG! SEND FOR FREE, BIG, ILLUSTRATED CATALOG NOW! Graduates report making substantial incomes. Start and run your own business quickly. Men, Women, all ages, learn easily. Course covers Sales, Property Management, Appraising, Loans, Mortgages, & related subjects. **STUDY AT HOME** or in class-rooms in leading cities. **DIPLOMA AWARDED. Write TODAY for FREE Booklet!** Accredited Member National Home Study Council. (Established 1936)

**FREE
BOOK
TELLS
HOW**

WEAVER SCHOOL OF REAL ESTATE
3521-P Broadway Kansas City, Mo. 64111



Excitement! Security! Good Pay! CRIME DETECTION

LEARN AT HOME IN SPARE TIME—START NOW!

Crime everywhere is on the rise! Learn now, in your own home, the profitable profession that enables you to track down criminals and bring them to justice! Hundreds of Identification Bureaus employ I. A. S. graduates . . . trained in fingerprinting, police photography, handwriting identification, firearms and investigation. Our 44th year! **FREE "Blue Book of Crime"** . . . packed with crime facts and the full story of famous I. A. S. training. State exact age. No salesman will call. Rush Coupon!
A Correspondence School Founded in 1916.

**FREE
Blue Book
of Crime**
**MAIL
COUPON**

INSTITUTE OF APPLIED SCIENCE, Dept. 1359
1920 Sunnyside Avenue, Chicago, Ill. 60640
Rush Blue Book of Crime . . . **FREE!**

NAME Age
ADDRESS
TOWN STATE ZIP CODE

NEW FINCO® COLOR SPECTRUM™ antennas are "signal customized" for better color reception...

"the ANTENNA that captures the RAINBOW"

FINCO has developed the Color Spectrum Series of antennas— "Signal Customized" — to exactly fit the requirements of any given area. There is a model scientifically designed and engineered for your area.

Check this chart for the FINCO "Signal Customized" Antenna best suited for your area.

| STRENGTH OF UHF SIGNAL AT RECEIVING ANTENNA LOCATION | Strength of VHF Signal at Receiving Antenna Location | | | | |
|--|--|----------------------|------------------------------------|-----------------------|--------------------------------------|
| | NO VHF | VHF SIGNAL STRONG | VHF SIGNAL MODERATE | VHF SIGNAL WEAK | VHF SIGNAL VERY WEAK |
| NO UHF → | | CS-V3 \$11.50 | CS-V5 CS-V7 \$18.50 \$25.95 | CS-V10 \$37.95 | CS-V15 CS-V18 \$50.95 \$59.50 |
| UHF SIGNAL STRONG → | CS-U1 \$10.50 | CS-A1 \$19.95 | CS-B1 \$31.50 | CS-C1 \$45.95 | CS-C1 \$45.95 |
| UHF SIGNAL WEAK → | CS-U2 \$15.95 | CS-A2 \$23.95 | CS-B2 \$41.95 | CS-C2 \$54.50 | CS-D3 \$73.50 |
| UHF SIGNAL VERY WEAK → | CS-U3 \$22.95 | CS-A3 \$32.50 | CS-B3 \$52.50 | CS-C3 \$62.95 | CS-D3 \$73.50 |

All Prices Subject to Change.

NOTE: In addition to the regular 300 ohm models (above), each model is available in a 75 ohm coaxial cable downlead where this type of installation is preferable. These models, designated "XCS", each come complete with a compact behind-the-set 75 ohm to 300 ohm balun-splitter to match the antenna system to the proper set terminals.



THE FINNEY COMPANY
34 West Interstate Street
Dept. PM • Bedford, Ohio 44146

Send for free brochure

Name _____

Address _____

City _____ State _____ Zip _____

Not everyone does as well,
but C. E. Nevin, who started a
business of his own, reports...

for 12 months
I've averaged
\$1000⁰⁰
per
month



—most of it Clear Profit for Me!

• Mr. Nevin expressed his grateful thanks for the opportunity to have a fine business of his own. Many men have discovered how to be independent, to be freed of bosses and layoffs—to build their own future on a steady, dependable foundation. G. Mundt made more than \$400 one week. A father-son combination grossed \$33,000 first year. H. Lemon says, "I netted \$133 in one 8-hour day."

How much you make depends largely on you. You need no special skill, no large investment. Start part-time if you wish. We will help you get started and work with you for your success. Training and consulting with experts is available at no additional cost.

No shop necessary • Our **ELECTRIC RUG WASHER** cleans rugs and carpets like new right on the floor...removes dirt and grime and helps to show their natural color and beauty. So efficient and safe for carpets, it is used by largest hotels and railroads.

Don't delay. Mail coupon today for complete information including how to start making big profits in **YOUR OWN** business. **BIG** opportunity.

Ours is Not A Lease Arrangement • You are free to operate independently. You sign no contract. You own the detergent and are your own boss...every dollar you take in is yours. You pay no fees, or dues, or royalties, and enough supplies come with it to return far more than your investment. Many earn the cost of the detergent in a week or two. It costs nothing to get details...write **TODAY**.

Mail coupon today for interesting

FREE BOOK

VON SCHRADER MFG. CO.
9910 "R" PL., Racine, Wisconsin 53403

Send at once (no obligation) your **FREE** booklet containing information about your **ELECTRIC RUG WASHER** and how I can start my own permanent, profitable business.

Name _____

Address _____

City _____ State _____ Zip _____

VON SCHRADER MFG. CO.



WE'LL SEND YOU
A MONEY-MAKING
"SHOE STORE BUSINESS"

FREE

Rush postcard today for
free sales outfit



Run your own profitable shoe store at home. Sell to friends, neighbors, folks where you work. Earn \$217.00 EXTRA monthly on just 2 easy orders a day. You feature 230 styles of quality shoes for men and women. Famous Air Cushion Mason Shoes that sell themselves. Sizes 4-15. Widths AAAA to EEEE. Many comfort features—stock of over 250,000 pair to draw from. Also horsehide jackets. Represent fast-growing million dollar shoe firm in spare or full time and big profits are yours. Everybody is a customer. You don't need to invest a cent in this wonderful sales opportunity. We'll rush you **FREE** a complete starting outfit that contains everything you need to begin making money. Just send us a postcard today!

MASON SHOE, Dept. H-190, Chippewa Falls, Wisc.

BASEMENT TOILET FLUSHES TOILET UP



TO OVERHEAD SEWER OR SEPTIC TANK.
NO DIGGING UP FLOORS. INSTALLS EASY. Write
McPHERSON, INC., BOX 15133, TAMPA, FLORIDA 33614

EXTRAORDINARY OFFER!

To Help You Start **YOUR OWN BUSINESS**



No Money Down

Start in sparetime; build a money-making full-time business in your garage or basement. We'll start you in business with **No Money Down**. Your earnings easily cover the low monthly payments. Sharpening saws is an important service in any neighborhood or small town—You can earn \$3 to \$6 an hour sharpening hand, band or circular saws.

No Experience! No Selling

The easy-to-operate **Foley Saw Filer** is automatic—it does the job for you. You can be doing business the day after you receive your machine. And with a saw filing business customers will come to you. No door to door selling! You are supplying a service they need. If you'd like more information about this unique business opportunity, return coupon (no salesman will call) and we'll send you our fact-filled

MONEY-MAKING BOOKLET FREE!

Foley Manufacturing Co.
916-8 Foley Bldg., Minneapolis, Minn. 55418
Send for **FREE** book on Money-Making facts about the sharpening business.

NAME _____

ADDRESS _____

CITY _____ STATE _____ ZIP CODE _____



**LEARN MORE—
EARN MORE!**

AUDEL SKILL-BUILDING PRACTICAL GUIDES

AUTO ENGINE TUNE-UP

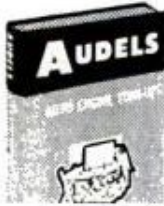

Complete tune-up procedures for all types of auto engines. Full adjustment data for carburetors, ignition, valves, etc. For the car owner who wants to do his own tune-up, as well as for the student or experienced mechanic. Fully illustrated. 416 pages. \$4.95
Circle No. 58 in Coupon

NEW



AUTO GUIDE

ALL-NEW

biggest Auto Guide value! **\$6.95**

FIX ANY CAR FAST!

STEP-BY-STEP REPAIR GUIDE COVERS EVERYTHING: Troubleshooting—unique symptoms-and-causes charts • Spark Plugs • Batteries • Tune-up • Distributors • Ignition Testing • Starters & Generators • Lighting • Tire Servicing • Brakes • Power Brakes • Front Suspension • Steering Systems • Wheel Alignment • Chassis, Springs & Shocks • Fuel Pumps • Carburetors • Cooling Systems • Lubricating Systems • Pistons & Rings • Crankshafts and Connecting Rods • Camshafts • Valves • Clutches • Automatic & Manual Transmissions • Drive Shafts • Universal Joints • Rear Axle Assemblies—ABSOLUTELY EVERYTHING YOU SHOULD KNOW TO FIX: ANY CAR! Hundreds of illus. 736 pages. \$6.95
Circle No. 1 in Coupon

Home Appliance Service Guide

How to fix refrigerators, washers, ranges, toasters, and all other electric & gas appliances. Fully illus. 608 pages. \$6.95
Circle No. 2 in Coupon

Home Refrigeration & Air Conditioning

Servicing, operation and repair of all systems and machines, freezers, lockers, water coolers, etc. Illus. 576 pages. \$6.95
Circle No. 14 in Coupon

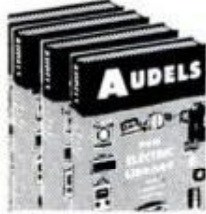

new Electric Library

10 volume electrical encyc. Answers questions on thousands of electrical problems. 9000 ill. 5558 pgs. Set \$25.00
Circle No. 15 in Coupon

Practical Electricity

Complete handbook; practical, simplified ready reference on all electrical subjects. 1300 illus. 1088 pages. \$5.95
Circle No. 4 in Coupon

TV-Radio Library

Two vols. on TV & radio circuits & how to install and repair all radio and TV including color. Illus. 960 pages. Set \$9.50
Circle No. 3 in Coupon

Mathematics for Mechanics

A complete guide to the mastery of practical math. Simplified method makes learning fast and easy. Ill. 704 pgs. \$4.95
Circle No. 11 in Coupon

Sheet Metal Pattern Layouts

Modern guide to all phases of sheet metal work, including pattern development. 350 layouts. Illus. 1152 p. \$7.50
Circle No. 29 in Coupon

COMMERCIAL REFRIGERATION

Practical guide and ready reference for students and workers. Covers all phases of installation, operation, maintenance and repair of commercial systems and machines. Complete coverage of electrical and mechanical work. Includes many useful tables and data. Fully illustrated. 544 pages. \$5.95
Circle No. 14B in Coupon

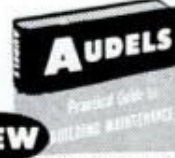
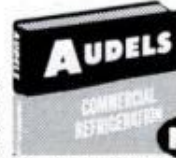

BUILDING MAINTENANCE

A guide for maintenance & custodial workers & building managers. Covers everything: Painting & Decorating • Plumbing • Concrete & Masonry • Carpentry • Roofing Maint. • Glazing & Calking • Elec. Maint. • Heating • Air Conditioning • Insect and Rodent Control, etc. Comprehensive; fully illustrated. 488 pages. \$4.95
Circle No. 99 in Coupon

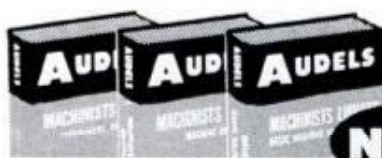

MACHINISTS LIBRARY

Three volumes of ready reference on all the latest shop practices for machinists and toolmakers. Vol. 1—Practical Fundamentals of Basic Machine Shop Operations. Vol. 2—Setup and Operation of all the widely used, important shop machines. Vol. 3—Toolmakers Handybook with down-to-earth data on layouts, specifications, jigs and fixtures, gear forming, cams, etc. Illus. 1310 pages. 3-Vol. Set \$13.50
Circle No. 12N in Coupon

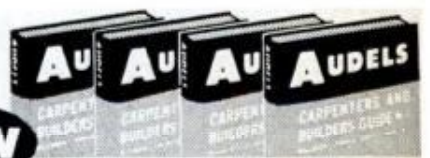

CARPENTERS & BUILDERS GUIDES

Four all-inclusive volumes provide latest inside trade information on modern construction. Vol. 1—Tools, Steel Square, Joinery. Vol. 2—Builders Math, Drawings, Specs. Vol. 3—Layouts, Foundations, Framing. Vol. 4—Millwork, Power Tools, Windows, Doors, Roofing, Flooring. Most practical guide available. Thousands of diagrams, charts, graphs and photos. 4-Vol. Set \$16.95
Circle No. 8 in Coupon

Truck and Tractor Guide

A guide for mechanics, drivers and maintenance men. Gas & Diesel repair, service and operation. Illus. 1366 pages. \$5.95
Circle No. 5 in Coupon

Masons and Builders Guides

Four practical vols. for bricklayers, stone masons, cement workers, plasterers. 2000 illus. 1488 pages. Set \$10.50
Circle No. 26 in Coupon

Blueprint Reading

For mechanics and construction men. Step-by-step explanation of how to read all types of blueprints. Ill. 416 pgs. \$4.95
Circle No. 25 in Coupon

Electric Motor Guide

Covers hookups, control, maintenance and troubleshooting of all types of motors. Complete; 617 illus. 1062 pages. \$5.95
Circle No. 27 in Coupon

Millwrights & Mechanics Guide

Practical information on plant installation; operation and maintenance data for foremen & workers. Illus. 1236 pgs. \$6.95
Circle No. 42 in Coupon

Diesel Engine Manual

Complete practical guide to modern Diesel engines. Explains principles & how to maintain & oper. Illus. 544 p. \$6.00
Circle No. 9 in Coupon

Plumbers & Steam-fitters Guides

3 vols. of ready reference for plumbers, steam fitters, gas fitters, sheet metal workers. 540 ill. 960 pages. Set \$9.95
Circle No. 6 in Coupon

Welders Guide

Practical guide to theory, operation. Maintenance of all types of electric, oxy-acetylene & Thermit welding. Ill. 626 p. \$4.95
Circle No. 10 in Coupon

Foreign Auto Repair Manual

Up-to-date service data for all popular imports: English, French, German, Italian, Swedish. Illus. 592 pages. \$5.00
Circle No. 53 in Coupon

Outboard Motor & Boating Guide

Practical details on all phases of outboard motor repair, maintenance and operation. Up-to-date. Illus. 446 pages. \$4.00
Circle No. 49 in Coupon

10-DAY FREE EXAMINATION

SEND NO MONEY—Pay the postman nothing! We are glad to send you any of the Audel Guides for absolutely FREE examination in your own home. We take all the risks and leave all the decisions up to YOU. There is no obligation! If you decide to keep the books of your choice you may pay for them under our astounding easy-pay plan of only \$3 a month.

HERE IS ALL YOU DO—IT'S EASY TO ORDER: In the No-Risk Mail Order Coupon at the right just draw a circle around the number of Audel Guides you want us to send you for FREE EXAMINATION. We will send them to you at once to help you build a brighter future by increasing your SKILL. If you are not COMPLETELY satisfied, return the books, and that will end the matter! NO STRINGS OR CATCHES TO THIS OFFER.



THEODORE AUDEL & CO.
division of HOWARD W. SAMS & CO., INC.
Indianapolis • New York

MAIL THIS NO-RISK COUPON TODAY!

THEODORE AUDEL & CO.—Self Improvement Publishers Since 1879—
4300 W. 62nd Street, Indianapolis, Indiana 46206

Please mail me for 10 days' FREE EXAMINATION the books I have circled at right. I agree to mail \$3 in 10 days on each book or set ordered, and to further mail \$3 a month on each book or set ordered until I have paid the purchase price, plus shipping costs. If I am not completely satisfied with my Audel Guides I may return them.

Name _____
PLEASE PRINT
Address _____
City _____ State _____ Zip _____

Employed By _____

SAVE SHIPPING COSTS! Check here if you enclose complete payment with order (plus sales tax, if any). We pay postage charges. You have same return privilege.

I have bought Audel books before

| | | | | |
|-------------------------|-----|-----|-----|-----|
| 1 New Auto Guide | 2 | 3 | 4 | 5 |
| | 6 | 8 | 9 | 10 |
| | 11 | 12N | 14A | 14B |
| | 15A | 25 | 26 | 27 |
| | 29 | 42 | 49 | 53 |
| | 58 | 99 | | |

Drivin' with Dan

What's the tire pressure on a racing car? When do you plan to retire from driving? What's the best vantage point for watching road races? Dan Gurney answers these and other provocative questions



ALL BUSINESS is Dan these days as his AAR shops crank up to fill orders for new Eagles following car's great success in this year's Indy 500-mile classic

Q. Since Indy, I have seen reference to your engine as both Gurney-Weslake and Gurney-Eagle. Are these different engines or one and the same?—Nate Goldberg, Miami, Fla.

A. One and the same. But to be perfectly correct, the reference should be Gurney-Eagle Stock-Block Ford. We changed the name shortly before Indy this year when our company took over the manufacture of the cylinder heads we utilize on our Ford racing engine at Indy and in sports-car competition. These heads were originally manufactured by the Weslake Co. of England. We have also rechristened our Grand Prix powerplant to Gurney-Eagle V12.

Q. With Camaro blitzing Mustang in Trans-Am racing, why don't you enter a car with your cylinder heads? As I understand, Trans-Am racing utilizes 302 engines, the same as you use in your Eagles.—Paul McDuffy, Menlo Park, Calif.

A. We are considering an AAR entry in the Trans-Am series in 1969. At the moment, the Ford 302 engine as we use it in our Indy car would not be eligible because Trans-Am rules require production-type cylinder heads. However, since these heads are now in production, we hope to have a chance of running them in the near future in this very interesting type of racing.

Q. I have been arguing with a friend about tire pressure. He says some racing cars use just as low a pressure as the street car (about 25 lb.), but I have always heard that very high pressure is used.—Conrad Githens, Steamboat Rock, Iowa

A. The pressure in general is probably lower than you think, but there are many variables including chassis setup and the type of racing you are doing. Stock-car tires may carry 50 lbs. or more for a given race. Drag racers may run as little as 4-lb. pressure;

it depends on what you are trying to achieve. Quite often, tire pressure is in the 30 to 35-lb. range.

Q. I occasionally read where you or your father used to be an opera singer. Is there any truth to this?—Clifford T. Hallingsworth, White Plains, N.Y.

A. As a singer, I might make a race-car driver. You probably are referring to my dad, John Gurney, who put in nine seasons as a bass baritone with the Metropolitan Opera Co. in New York.

Q. I had seen only oval track races until this year when I took in my first road race. Frankly, I found it much harder to watch and wondered if you had some suggestions.—Rod Renner, Travelers Rest, S.C.

A. Although most of the well-established road circuits have grandstand sections available, you should be prepared to move around a bit to get the most out of your next road race. I would suggest you get a program or listing of the cars and then try to acquaint yourself with the circuit. Look for a couple of the more interesting corners and see if there is a long straightaway that is accessible. Hilltops afford the broadest range of view, but the real opportunity that a road course presents is the great number of vantage points available for fans who wish to study every technique from braking and down-shifting to high-speed cornering.

Q. Is it true that Stirling Moss, the retired British World Champion, will soon be driving again in competition?—Joe Edwards, Dallas, Tex.

A. Moss, now 39, recently announced he would enter a European rally, emphasizing that it was not a race and he had no plans to return to racing per se. Although he is credited with 194 victories including rallies, and a brilliant career that ended in 1962 with a very bad crash at Goodwood, he never won the World Championship.

Q. I am familiar with the abbreviations "CC," "MM," "RPM," etc., but recently in an English paper, I saw two that stopped me—"IFS" and "RAC." What do they stand for?—Mike Tarkington, Lansing, Mich.

A. "IFS" probably refers to Independent Front Suspension and "RAC" is the Royal Automobile Club. The one you have to watch

out for is "IRS" which can mean independent rear suspension or Internal Revenue Service.

Q. I had a guy tell me there was once a car named "Arab." Is that true?—Ralph Clotne, San Francisco.

A. That one threw me, too, Ralph. Would you believe the "Arab" was introduced in Britain in 1927, a "super-sport, two-seater with a two-litre, four-cylinder engine" and "a top speed of 90 mph." That's what the book says, anyway.

Q. While spending a couple of months in Italy, I was disappointed to learn they no longer run the Mille Miglia race. When and why was it stopped?—T. L. Overbrook, Hutchinson, Kans.

A. The Mille Miglia, a 1000-mile race across the roads of Italy, was canceled because of the danger caused by the uncontrollable crowds who were being injured in increasing numbers. Taruffi led a 1-2-3 Ferrari sweep of the '57 race which concluded the legendary event after about 30 years of running.

Q. How old are you and when do you plan to retire? (I hope never.)—Roger Shroder, East Lansing, Mich.

A. Well, now, Roger, I am 37 as of April and to be perfectly truthful I have no specific retirement plans, although I certainly don't plan to race indefinitely. I would like to win the World Championship and the Indy 500, but I also find great satisfaction in building Eagle cars and operating a racing research development company like All-American Racers.

Q. Who won Le Mans this June? I haven't been able to find a word about it in the papers or magazines.—Margaret McDonnell, Elizabeth, N.J.

A. The French students. Because of the spring rioting in France, it was decided to postpone this year's 24-hour race from June until September. ★ ★ ★

If you have questions on racing, high-performance and everyday driving techniques, send them to "Drivin' with Dan," c/o Popular Mechanics, 575 Lexington Ave., New York, N.Y. 10022. Questions cannot be answered by individual letters. Questions on maintenance and repair should be addressed to the Auto Clinic (see page 58).

"Six ounces of metal is the difference between a new car and the junkyard"

Charles F. Kettering

Read how Casite's "Canned Car Insurance" can save you costly repairs and actually improve the performance of your car.

When G.M. pioneer, Kettering made his famous statement concerning moving metal-to-metal contact in an engine, he underscored for motorists of all time the importance of good engine lubrication . . . and the maintenance of the lubricants themselves. The following report shows you the exact "how and when" of additive usage by one of the industry's full-line additive producers. Keep it as a reference on how you should—and shouldn't—use these low-cost engine savers.

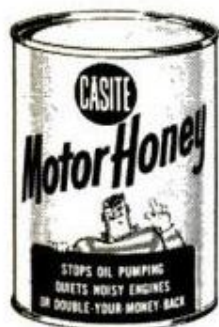

First aid for a worn engine—Casite Motor Honey. Add to oil.

If your car is starting to smoke, sound noisy, or has lost its power, add Casite Motor Honey to the oil. The cure is fast. You can actually hear your engine quiet down. Exhaust smoking stops, usually within 10 miles of driving. You can feel the restored pep

and power. Motor Honey coats metal parts with a super-tough oil film that won't run off. Not even under extreme heat or pressure. It improves lubrication. It cushions moving parts. It seals compression—restores power and increases your oil pressure. Motor Honey is a Viscosity Index Improver. It contains concentrated polymers—the stuff that made modern multi-viscosity oils possible. They thicken the host oil when hot, keep it normal when cold. Motor Honey blends with all oils including heavy duty, high detergent oils. One can every 2,000 miles or oftener keeps your car running better.

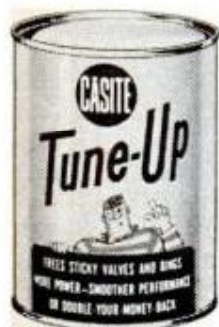

Tune your car while you drive—with Casite Tune-Up. Three ways to use—in the oil — in the gas tank — or through the carburetor air intake. Casite Tune-Up is a solvent cleaner. It dissolves varnish and gum. Poured slowly into the carburetor intake of a running engine,

Tune-Up frees sticky valves and rings, cleans

spark plugs and combustion areas—fast! In the gas tank, it does the same work, but more slowly—plus cleans carburetor jets. In the crankcase, Tune-Up dissolves sludge, gum and goo—cleans oil rings and frees sticky valves. Restores engine pep and power and reduces wear. Your car starts easier—even in coldest weather. Tune-Up is also ideal for breaking-in new or rebuilt engines, and is compatible with all oils including the newest LD and HD oils.



How can you improve oil? Add Casite 3-C.

3-C reduces engine friction! And improves oil. Any oil—including premium oils. The new premium oils are excellent lubricants. Their premium price is related to their additive content—the detergents, dispersants and viscosity improvers. Remember, though, oil additives, even in premium oils, expend themselves in use. 3-C is an additive concentrate. It replenishes the additives in your oil, keeps it at full working strength between oil changes. Fact is, when you add 3-C to regular grade oil you've got an oil that outperforms premium oils! 3-C cushions all moving parts, reduces friction, keeps your engine clean, quiet and smooth running. Eliminates valve lifter noise. Start using 3-C the day you drive home a brand new car. And use it regularly if you're shooting for 100,000 easy miles with a sweet running engine that keeps on delivering all the power put there by the maker.

Remember, though, oil additives, even in premium oils, expend themselves in use. 3-C is an additive concentrate. It replenishes the additives in your oil, keeps it at full working strength between oil changes. Fact is, when you add 3-C to regular grade oil you've got an oil that outperforms premium oils! 3-C cushions all moving parts, reduces friction, keeps your engine clean, quiet and smooth running. Eliminates valve lifter noise. Start using 3-C the day you drive home a brand new car. And use it regularly if you're shooting for 100,000 easy miles with a sweet running engine that keeps on delivering all the power put there by the maker.



Before your transmission jerks—or the seal shrinks—add Casite Smooth-Seal. The old irony about not giving the patient any medicine until it's too late is just as true with your car as it is with people. In your car — new or old — time and heat change the chemical composition of the fluid in the auto-

matic transmission. Time and heat also harden and shrink the transmission seal which can result in leaks. Smooth-Seal softens and expands hardened, shrunken seals to stop transmission leaks. It keeps good seals soft and pliable to prevent leaks. In addition, Smooth-Seal also cleans the surfaces of delicate internal parts. It restabilizes your transmission fluid because it also contains anti-foam agents and corrosion inhibitors. The result is smooth transmission action—no jerks—no jars. Smooth-Seal blends with all brands of transmission fluids. Add Smooth-Seal every 15,000 miles to prevent trouble and the first time gear shifting becomes erratic, or you notice an "oil" spot under your car. Saves money in transmission repair bills.



When you suspect a cooling system leak — add Casite Leak-Stop. Leak-Stop plugs up big holes in radiators. Also, hairline cracks in the engine block. It contains exclusive mermithite that seeks out ruptures in radiator, engine blocks, heater and gaskets. It clings to rough edges of ruptures, builds

up to form a tight seal. Yet it slides easily through tiny tubes—will not harden, cake, rot or clog. Leak-Stop lubricates your water pump, neutralizes acid and inhibits rust. Mixes instantly with all anti-freeze solutions and is harmless to hoses, metal or paint.



Prevent cooling system rust and acid build-up with Casite Stop-Rust. Stop-Rust in your radiator keeps your cooling system in top condition. It neutralizes acids—prevents rust—lubricates your water pump to prevent

squeals. Add one can of Stop-Rust with every change of coolant, and at least once a year to prevent acid build-up. Stop-Rust is completely harmless to hoses, metal and paint, and is compatible with all anti-freezes.



THE GUARANTEE WITH GUTS

Buy any of the six Casite products advertised on these pages with confidence. It must do the job—to your satisfaction. Or you get double your money back. This powerful guarantee is printed on the label of every Casite product. Remember, you alone are the judge! And you must be satisfied.

Watch **CAR and TRACK**—
TV's only all-automotive show
with *Bud Lindemann*



CAR and TRACK, the weekly, color TV series, answers the car-lover's prayer. See the thrilling action of important stock, sportscar and formula races. Watch host Bud Lindemann wring secrets from the current crop of passenger cars. (If the brakes fade, or if the engine won't top out quite as high as the manufacturer says—or "if" anything, you'll hear about it.) Car and Track is all about cars. It's colorful. Informative. See your local TV listings for time and channel.

Send for your **FREE Casite "TOUGH GUY" decal**

Simply write the words "Send Me a Tough Guy" and your name, address, city, state and zip code on a plain piece of paper. Address your request to Hastings Manufacturing Company, Hastings, Michigan 49058.

SAVE 25¢

Get acquainted with any one of the six Casite additives today—and save! This coupon entitles you to 25c off list price on the purchase of any Casite product from any Casite retailer. Offer Expires June 30, 1969. Dealer's Note: Hastings Manufacturing Company will redeem this coupon for 25c plus 10c handling fee providing dealer can show proof of purchase of items sold, if requested. Send coupon to Hastings Manufacturing Co., Hastings, Mich. 49058 before December 31, 1969.

CASITE DIVISION, HASTINGS MANUFACTURING COMPANY, HASTINGS, MICHIGAN 49058

for prestige, high pay, advancement



Learn TECHNICAL WRITING!

All industries need trained Tech Writers now. Behind every product from a car to a shotgun is a Tech Writer telling you how to use it. Technical Writing is one of the highest paying careers NOT requiring college. The demand for trained writers is growing with thousands needed in all areas.

ATWS WILL TRAIN YOU AT LOW COST. Fascinating, easy-to-follow home instruction includes everything you need to become a top-notch highly paid Tech Writer. Send today for free book and sample lesson. No salesman will call. **APPROVED FOR VETERANS.**

AMERICAN TECHNICAL WRITING SCHOOLS, Dept. PM-28
5512 Hollywood Blvd., Hollywood, Calif. 90028



Transistor Radio with Battery \$1.70

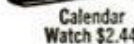

Calendar Watch \$2.44



Derringer Pistol \$5.99

HOME-IMPORT BUSINESS-Make Big Profits

New Drop Ship Plan offers you first day profits! Deal direct with overseas sources at prices shown. Dazzling bargains with no investment. Full or spare time. Write for **FREE BOOK** today to...

MELLINGER, Dept. #2258, 1554 S. Sepulveda, Los Angeles, Calif. 90025

FREE!

WORLD'S LARGEST ELECTRONIC KIT CATALOG!



The latest edition . . . with more kits and more color. Includes over 300 kits for unique creative fun at 50% savings. You can build your own color TV, stereo system, electronic organ, home protection system, portable and shortwave radios, ham and CB equipment, marine electronics and many more. No special skills or knowledge needed. Millions of others have done it already — you can too! Mail the coupon today and see how easy it is.



Heath Company, Dept. 17-9 CL-337
Benton Harbor, Michigan 49022

Please send **FREE** 1969 Heathkit Catalog.

Name _____

Address _____

City _____ State _____ Zip _____

REMINGTON ROD SAW...THE TOOTHLESS WONDER.



Our new Rod Saw has no teeth. Instead, it has thousands of permanently bonded tungsten carbide cutting edges.

The rod itself fits any standard 10" hack saw frame. But the similarity ends there. Because the Rod Saw cuts through things a regular hack saw blade won't even scratch.

It cuts through spring steel, hardened bolts, welds and cast iron with ease. And because of the tool design, the cutting edges go all the way around the rod. So it not only cuts straight, but also cuts in any direction on brick, glass, flagstone, ceramics, fiberglass, laminates and other hard-to-cut materials. (And does it faster, because it cuts on both forward and backward strokes).

Originally developed for industry, now priced for home use, the Remington Rod Saw is now available at most hardware stores.

You should not have any trouble recognizing it. Just look for the saw without any teeth.

Remington 

are you in-gen-ius?

. . . do you have a bent for the unusual? Do you like to dream, to test and tinker? Chances are you have a touch of genius. . . Here's a bright new magazine, devoted to the exploration of man's ability to invent and to create. Started as an exchange of letters among professional designers, it has now become a unique bimonthly source, capturing in word & image the personal approach of inspired artists and inventors or others with unusual skills. It presents the step-by-step unfolding of creative strategies and a rich variety of methods to trigger the imagination. If you look for fresh insights into your own resources, as amateur or pro . . . take advantage of this special offer; fill in and mail the coupon today!

YES, enter my subscription now at the introductory rate of \$7 (regular \$10) per year. I may cancel any time and receive a prompt pro-rata refund. (Foreign postage \$1 extra)

NAME

ADDRESS

ZIP

Make check or money-order payable to:

Genius

INTERNATIONAL®

151 HILLSPOINT RD., WESTPORT, CONNECTICUT, USA 06880



The Transport Wide Oval truck tire — extra wide, high-strength tire for all wheel positions.

Wide Oval truck tires take your camper in where the road runs out.

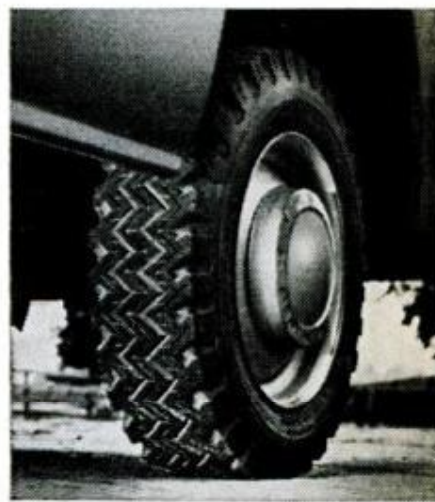

The Town & Country Wide Oval truck tire — new drive-wheel tire for all-season traction.

The rugged outdoors. Where you need a tight-fisted, knuckle-grabbing tire to get you in where the going gets rough.

The Transport Wide Oval truck tire. Original equipment tire for new pickup campers. Wide tread holds the road. Gives more flotation. Reduces sway.

The Town & Country Wide Oval truck tire. New. With aggressive traction tread that takes hold. In mud or mire. Or skidderish gravel. A drive-wheel tire that's optional on new pickup campers.

Wide Oval truck tires give you the advantage. For a safer, softer ride. Less rolling resistance. More miles per gallon.

Choose the Wide Oval tire that's best for your pickup camper. At any Firestone Safe Tire Center. And specify Firestone tires on your new pickup camper or truck.

Transport Wide ○ Oval, Town & Country Wide ○ Oval—
Firestone TM's, Transport®, Town & Country®

Firestone

THE SAFE TIRE

The bargain hunter

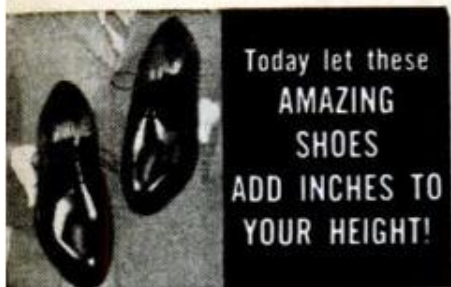

Today let these
**AMAZING
SHOES**
ADD INCHES TO
YOUR HEIGHT!

Nothing like a pair of "ELEVATORS" to help you get up in the world! In seconds, these miraculous height-increasing shoes make you almost 2 inches taller! And no one will suspect that you're wearing them because "ELEVATORS" look just as smart and feel just as comfortable as any other fine shoes.

Write for **FREE
CATALOG** today.

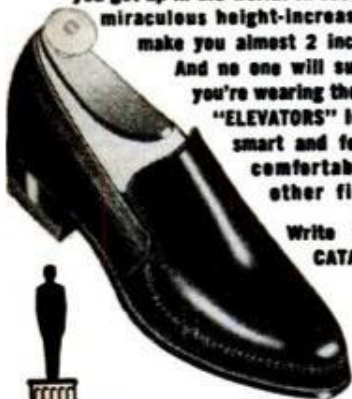

ELEVATORS® HEIGHT-INCREASING SHOES

Brockton Footwear, Inc.
Dept. 1109J, Brockton, Mass. 02403
Please send free catalog

Name _____
Street _____
City _____ State _____

CLIP AND MAIL COUPON NOW



HANDY DANDYS STORE SUPPLIES FOR NEAT AND CLEAN WORKSHOPS

Sturdy, plastic caps snap into 1/4" pegboard and hold quarter twist baby food glass jars. Perfect for storing all kinds of small parts and things. Keep your workshop neat. 10 for \$1; 36 for \$3; 72 for \$5; 500 for \$12.50. Handy Dandys only. No jars. Shipping paid anywhere USA. Add payment with order—no C.O.D.
**WICKLIFFE INDUSTRIES, INC., P.O. Box 286,
Dept. PM9, Wickliffe, Ohio 44092.**



AIR LIFT AUTO LEVELERS

These tough, inflatable butyl cylinders raise the rear of your vacation-loaded car to safe, normal riding level. Air Lift Auto Levelers literally lift excess weight from overloaded springs... also minimize sway on turns and absorb impact of bumps. Simple to install—no parts to remove from car. Ideal for camping, a "must" for trailering. Low as \$33.95 per set—tell us model of car. Free literature.

AIR LIFT COMPANY

Dept. PM, 2710 Snow Road, Lansing, Mich.

EVERYBODY NEEDS IT! AUTO CLEANER VAC

\$6.97
ADD 75c
POSTAGE



**WORKS OFF
CIGARETTE LIGHTER**
Powerful suction picks up toughest kind of dirt, even cleans workbench, garage, etc. Extra narrow-nozzle attachment, 12 volt, wonderful gift.

MONEY BACK GUARANTEE!

NATIONAL M.O., Dept. PM-8

1821 Broad St., Utica, N.Y. 13501
Check or money order. No C.O.D.



.....boat plans
full size patterns
frame kits.....

catalog
50¢

BOAT PLANS—PATTERNS—FRAME KITS

Send 50¢ for Glen L's new catalog offering a complete selection of build-it-yourself designs with step-by-step instructions. Inboards & outboards, jets, 16' to 36' cruisers, 8' to 21' sailboats, houseboats, hot boats, boat trailers and camper trailer. Books: Inboard Motor Installations In Small Boats \$6.00 ppd.; Boat Building With Plywood \$7.50 ppd.; How To Build Boat Trailers \$5.00 ppd. Glen L, 9152T Rosecrans, Bellflower, Calif. 90706.

Stamp Your Name PERMANENTLY

\$3.95
ppd.

EVERSTAMP

DIE TOOL

Hardened tool steel. Lasts a lifetime. Comparable to a \$10 die tool, still available at this special price. Stamps almost anything you own with a single blow. Made only by the Henry A. Evers Co., Inc., makers of quality marking devices since 1898.



HENRY A. EVERS CO., INC.

Dept. PM, 72 Oxford St., Prov., R. I. 02905

Enclosed is payment for die tool:

- Reg. size 1/16". 15 letters max.
@ \$3.95 ppd.
 Large size 3/32". 10 letters max.
@ \$5.25 ppd.

NAME _____ Please Print

STREET _____

CITY _____ STATE _____ ZIP _____

TALL or BIG MEN ONLY

McGREGOR
goes
KING-SIZE

New McGregor Jackets,
No-Iron Shirts, Sweaters,
Arrow Shirts, Slacks
for Tall or Big Men!
ALSO 80 Shoe Styles
Sizes, 10-16 AAA-EEE.
Send for **FREE** Catalog.



KING-SIZE, INC., 5068 Forest St., Brockton, Mass.



Thousands of
exciting tool
values!

SILVO (BRAND NAME) TOOL CATALOG

Thousands of Exciting Tool Values! Stanley, Millers Falls, Skil, Thor, Wen, Disston, Wiss, Wellsaw, Dremel, Speedy Sprayers, Plumb, Huot, Kennedy, Channellock, Porter-Cable, Rockwell, Helios, Vice-Grip, Crescent, Ridgid, Pony Clamps, Unimat, Foredom and many other Nationally Advertised brands of Tools & Supplies. We ship Coast to Coast at prices Hard to Beat. Send 25¢ for our big 148-page tool catalog today. Silvo Hardware Co., PM-9, 107 Walnut St., Philadelphia, Pa. 19106.



HANDY! DANDY! PORTABLE STEREO TAPE CONSOLE WITH ARM-REST TOP

Slot for toll cards, hidden coin compartment, holds any travel items, letters for personalizing with initials—check or money order, no C.O.D.

\$4.95
ADD 75c
POSTAGE

NATIONAL M.O., DEPT. PM-9

1821 BROAD ST., UTICA, N.Y. 13501

FIND BURIED TREASURE!

10-DAY MONEY BACK GUARANTEE

TREASURE PROBE

\$18.88 p.p.d. ALL TRANSISTORIZED



3 ft. portable detector finds buried metal objects. Signals location with loud audible sound. Detects gold, silver, metallic ore and nuggets of all kinds. Find lost coins, jewelry, Indian artifacts, civil war souvenirs. Treasureprobe guaranteed to equal detectors selling to \$150 or your money back. Absolutely complete, sensitive earphone, 9v battery, nothing else to buy. TO ORDER: Send check, cash or money order, \$5.00 deposit for COD in N.J. add 57¢ tax.

TREASUREPROBE Dept. PAJ, P.O. Box 228 Toms River, N.J. 08753



FREE!!! POWERFUL MUSCLES FAST!

Fantastic New Discoveries in the science of bodybuilding. Now, in the privacy of your bedroom, our method will add inches of powerful muscles to arms, chest, shoulders & legs. Learn secrets on trimming the waist with ultra-modern methods—fast! Results Guaranteed! Send for free brochure. Universal Bodybuilding, Box 5327, M-7, Northeastern, Dearborn, Mich. 48126.



FREE FEL-PRO GASKET MANUAL

... for top performance in all gasket applications

Learn about the latest gasket materials and trouble-free gasket installation techniques from Fel-Pro... for 50 years a leader in gasketing improvements. Improve engine...transmission...and rear end performance with these helpful tips. 36 fact-filled pages.

Write: **FEL-PRO, INC.**
7452 N. McCormick Blvd. Dept. PM-9
Skokie, Illinois 60076

HOW TO MAKE MONEY SHARPENING

Cash in on today's demand for sharpening service. Education, age, minor handicaps make no difference. TREYCO 6-in-1 Sharpeners turn out professional hollow-ground work right from the start. Housewives, hobbyists, barber, beauty and pet shops, supermarkets, contractors, farmers, everybody needs sharpening.

MAKE AS MUCH AS \$6.00 AN HOUR

Sharpen knives, scissors, pinking shears, saws, tools clippers, planer blades, rotary mowers, etc. Start full or part time with low Factory-To-You Price. Thousands of successful users. Established 1946. Quality guaranteed. Write for illustrated catalog. No salesman. No obligation.



TREYCO 381 Niagara St. N. Tonawanda, N.Y. 14120
Products, Inc.

2 Art Lessons FREE



ENJOY glamorous high-pay career or profitable hobby! Study at home in spare time.

Drawing, Painting, Advertising Art, Fashion Illustration, TV Art, etc. Remarkably low cost. Send name, address, zip and age for free booklet. **WASHINGTON SCHOOL OF ART, Studio 09-022, Port Washington, N. Y. 11050.** (Est. 1914) Accredited Member NHSC.

HIGH INTENSITY LIFETIME BAR MAGNET

Guaranteed to Lift 50 Lbs.



FREE!!! SUPER-POWERED, PERMANENT! Small (3" x 3/4" x 1") but strong; holds up to 50 lbs. of iron or steel securely. Countless uses; tied to pole, grabs hard-to-reach cans on upper shelves; in shop serves as guide for cutting wood or metal, as a clamp; finds scattered nails and pins. Ideal toy for children, too. Send check or M.O.; no C.O.D.'s. Money-Back Guarantee.

\$1.98 plus 25c postage

BARCLAY, Dept. 59-K
170-30 Jamaica Ave. Jamaica, N.Y. 11432

IMPORTED STILETTO POCKET KNIFE



ONLY \$1.75

9" Overall Length
5" When Closed

- Opens instantly
- Sharp and Tough
- Stainless Steel Blade

Opens instantly — folding finger guard snaps into position automatically. Razor sharp tough stainless steel blade holds its edge for years of long hard service. A knife you will be proud to own. Guaranteed. Money back in five days if not satisfied. Send \$1.75 plus 25c to cover postage and handling. NOT SOLD TO MINORS. Please state age.

WESTBURY SALES CO., DEPT. S185
P. O. BOX 415, WESTBURY, N. Y.

Mention POPULAR MECHANICS when writing to advertisers.

SAILBOAT KITS

Save \$ \$ \$ building your own Penguin, Snipe, Windmill, Blue Jay, O K Dinghy, or Lightning sailboat. Send for free color catalog of kits and accessories.



TAFT MARINE WOODCRAFT
Dept. PM-9-8, 636 39th Avenue N.E. Minneapolis, Minnesota 55421

43 WONDERS OF THE WORLD!



To Introduce You to America's Favorite Hobby and World's Largest Stamp Firm:

Nature on the rampage — ruins of ancient empires — stone-age man — bizarre creatures... astounding wonders of the world you live in! Discover rare art treasures, miracles of science, incredible objects and events. Prehistoric monsters to space-age triumphs — dramatically pictured on 43 genuine postage stamps from all over the world. This fantastic collection (catalog price over \$1.00) — for only 10¢! Plus attractive stamp selections to examine free. Buy any or none — cancel service anytime. EXTRA: Special Bargain Lists.

RUSH name, address, zip and 10¢ — TODAY
H.E.HARRIS, Dept. W-80, Boston, Mass. 02117

SECRETS of Teaching Yourself MUSIC

revealed in your own home this money-saving way



YES! Teach yourself Piano, Harp, ANY instrument—even if you don't know a single note now! No special "talent," no previous training needed. Famous low-cost U.S. School of Music Course, with step-by-step pictured lessons, makes it simple as A-B-C.

Everything is in print and pictures. First you are told what to do. Then a picture shows you how. It's as easy as cutting a soft cake. You start by playing actual pieces. Sooner than you may imagine you'll amaze friends by playing your favorite music—popular, classical, jazz, country music, dance tunes, etc. Over 1,250,000 students all over the world.

Stop Cheating Yourself of These Joys

Popularity. New friends. Gay parties. Musical career. Extra money. Banish worries, frustrations. Satisfy self-expression, creative urge. Gain self-confidence.

Write today for our new illustrated FREE booklet. **U.S. SCHOOL OF MUSIC, Studio 309, Port Washington, N.Y. 11050.** (Est. 1898. Approved by N.Y. State Education Dept.)

Print Name.....
Address.....
City.....
State..... Zip Code.....



Amazing New Paint Applicator Covers 468 Sq. Inches in 3 Seconds

- **Faster Than Brush, Far Less Messier Than a Roller**
- **Paints Walls, Furniture, Roofs, Bookcases, Any Job With "Professional" Looking Finishes For First Time Beginners**
- **Saves Many Dollars On Each Room—Up To \$500 On Average 7-Room House**

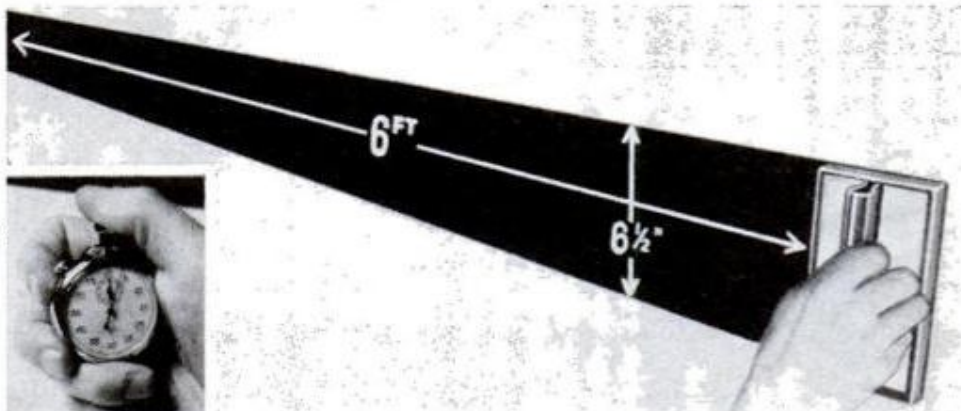

In Actual Tests Painted Twice As Fast As Conventional Brushes, Saved 1/4 Cost Of Paint and Cost 1/3 The Price of Conventional Brushes It Competed Against.

FROM ROCHESTER, NEW YORK COMES NEWS of a revolutionary new indoor-outdoor applicator that does painting jobs easier, better and in half the time!

There's no more hard work brushing back and forth with an old-fashioned paint brush. No more splatter and bubble finish with a roller. Now there's a revolutionary new paint applicator that spreads paint so fast, so smoothly and so easily it makes everything else out of date.

Called Immie, this amazing new lightweight applicator is already being used by professional painting contractors and thousands of home painters. You "dip" it about one third as many times. It stores up vast quantities of paint spreads it so smoothly, so evenly, so expertly it makes paint spread way farther. Doesn't hold back paint in bristles as a regular brush does. Releases ALL of it. But most amazing is the incredible speed it makes possible. It spreads a strip 6 1/2 inches wide and 6 feet long in just 3 seconds.

Immie is fantastic on any surface including rough shingles and curved mouldings! Covers completely like lightning. And with Immie there's virtually no dripping, no spatter, no mess!

**ONLY 99¢ EACH
IN OFFER BELOW**

All that amazing new IMMIE in the offer below costs is 99¢ apiece. Yet just one of the IMMIE applicators included outperformed

and outpainted a nationally known brush costing \$13.95. But because of revolutionary design, through this magazine's coupon below you will receive **SIX** different IMMIE applicators for almost every type of painting job you'll ever have for just 99¢ each.

First, a giant coverage applicator, 6 1/2 inches wide, with over 700,000 tiny fibers to "wipe" paint on and whip through house, roof, floor even shingle painting in as little as half the usual time.

Capillary action of up to 700,000 tiny fibers from the soft underbelly of the **Angora Goat** "wipe" paint on... reach into microscopic indentations, pock-marked concrete, deep grooved shingles, contour to curved surfaces, wrap around radiators and fence posts!



Second, a pure angora 4 1/2-inch applicator with almost 400,000 tiny fibers that glide through indoor wall and ceiling painting. Third, a 3 1/2-inch applicator with almost 250,000 tiny, soft angora fibers to give "professional" finishes to stairs, furniture, coffee tables and this is just part of this amazing applicator bargain.

Next, included is a revolutionary window sash painter with 50,000 tiny fibers. This sash painter has a patented metal "Paint Guard" to prevent smear on adjoining surfaces... edges an entire room in minutes. Finally, with 30,000 tiny angora fibers, Long handle with foam cushion and painting fibers on side lets you touch up spots rollers and brushes can't reach.

USED BY N. Y. CITY HOUSING AUTHORITY, GIANT FIRMS, PUBLIC SCHOOLS, GOV'T CONTRACTORS.

Already 2,000,000 In Use by Home Owners Saving Time, Paint, Money.

AMAZING TRIAL OFFER

No longer do you have to be a slave to dirty, messy home painting. Say Goodbye to unnecessary wrist fatigue, splash and spatter, hours of tiresome extra work, sky high professional prices. Try amazing IMMIE without risking a

penny. All you do is mail the no-risk amazing trial coupon below. In a few days your IMMIES will be delivered to your door. Use them for a full month without risk.

See how beautifully constructed they are how easy to use... how smooth the finish.

See for yourself how IMMIE paints window sashes in seconds, a picnic table in the time you have a cigarette, paints deep grooved shingles, pock-marked concrete with amazing ease... paints, varnishes, shellacs, stains, virtually any surface, any job... does 1001 painting jobs for you and NEVER SEEMS TO TIRE YOU OUT.

Use IMMIE on lawn furniture, boat finishes, furniture, panelled doors, coffee tables. Let your children paint practically without getting the paint on themselves. Put IMMIE to every test. If you don't agree IMMIE will save you endless painting time, effort, and money, you have used it at no cost. It won't cost you a penny.

MAIL NO-RISK COUPON TODAY

MADISON HOUSE, Dept. PM-9
239 Great Neck Rd., Great Neck, N.Y. 11021

Send me the IMMIE "Basic Home Owner's Set" of 6 IMMIE brushes pictured below. If I am not thrilled with the way they paint—if they don't do everything claimed for them—then I may return them used and dirty and you will refund my \$5.98 in full.

IMMIE BASIC HOME OWNER'S SET



SEND PREPAID. I enclose \$5.98 in full payment to save postage.

Enclosed \$1. deposit. Send C.O.D. I will pay postman \$4.98 balance and all postal charges.

NAME _____

ADDRESS _____

CITY _____

STATE _____ ZIP _____

**NO DRIP! NO MESS!
NO SPATTER!**

Chair, Ceiling, Whatever

**PAINTS ROUGH AND
IRREGULAR SURFACES**

**Perfect
Deep-Grooved
Shingles**

SLASH PAINTING TIME

2/3 on door

3/4 on chair

1/2 on window

OVER 100,000 MEN CAN TELL YOU:

“NTS HOME-TRAINING REALLY WORKS!”

AND PUTS YOU WHERE THE BIG MONEY IS!



If you think you can't learn a new technical skill with NTS Home-Training, you're wrong. Over 100,000 men have done it in the past half-century since the school was established.

And so can you.

NTS Project Method makes learning fast, easy and exciting. Takes only a few hours a week. Hours any man can fit into his life.

So, stop wasting time. Pick from these big money-making fields. We'll send you all you need to know to get started towards a new, better job. It's a sure thing!

ELECTRONICS DIVISION (New 25" Color TV Kits)

Train with the biggest, most exciting package of electronics kits ever offered! Beautiful new 25" Color TV kits included in color TV courses. No kit deposits — no extra cost. All-new Communications and Industrial Electronics Kits & Courses — put you two steps ahead of tomorrow. Check coupon for choice of Project Method Courses and New Free Color Catalog.

MECHANICS DIVISION (New Test Equipment)

NTS makes you a skilled Mechanic — Diagnostic Technician in a hurry! You get professional engine analysis test instruments at no extra cost! Special Engine Diagnostic and High Performance lessons included — everything you need to be a pro. Four fields from which to choose. Service your own car — earn while you learn. Check the coupon for new catalog.

AIR-CONDITIONING, REFRIGERATION DIV. (New Kits)

A wide-open field. NTS opens it up for you — fast and easy! Trains you to handle the big jobs. Start your own business with either of the two courses in this division. We give you the tools, tester, and instruments you need at no extra cost. No kit deposits! Check the coupon below and get rolling!

HOME APPLIANCES DIV. (New Circuit-Trainer)

Dig deep into the Major Home Appliance repair field for the big money! NEW, EXCLUSIVE! THE NTS CIRCUIT-TRAINER! Shows you the ins and outs of major appliance circuitry. Makes training a snap. Puts you in line for a piece of the billion-dollar appliance repair field. New Kits! New Catalog. Check coupon for earn-while-you-learn courses.

HIGH SCHOOL AT HOME

National offers accredited High School programs. Take only subjects you need. Study at your own pace. Everything included at one low tuition. Check special High School box in coupon for full information and FREE catalog.

CLASSROOM TRAINING AT LOS ANGELES.

You can take classroom training at Los Angeles in Sunny Southern California. NTS occupies a city block with over a million dollars in training facilities.

NATIONAL TECHNICAL SCHOOLS

WORLD-WIDE TRAINING SINCE 1962

4000 So. Figueroa St.
Los Angeles, Calif. 90037

No obligation.
No salesman will call.

SEND POSTCARD
FOR FREE BOOK AND
SAMPLE LESSON

TEAR OUT AND MAIL THIS CARD TODAY. CHECK ONE ONLY.

ELECTRONICS DIVISION

- MASTER COURSE IN COLOR TV SERVICING
- COLOR TV SERVICING
- MASTER COURSE IN TV & RADIO SERVICING
- PRACTICAL TV & RADIO SERVICING
- MASTER COURSE IN ELECTRONIC COMMUNICATIONS
- FCC LICENSE COURSE
- MASTER COURSE IN ELECTRONICS TECHNOLOGY
- INDUSTRIAL AND AUTOMATION ELECTRONICS
- COMPUTER ELECTRONICS
- BASIC ELECTRONICS

HOME APPLIANCES DIVISION

- HOME APPLIANCES MASTER TECHNICIAN'S COURSE
- HOME APPLIANCES SERVICING
- HANDYMAN APPLIANCE REPAIR

AUTO-MECHANICS DIVISION

- MASTER COURSE IN AUTO & TRUCK MECHANICS
- AUTOMOTIVE MECHANICS
- TRUCK & HEAVY DUTY MECHANICS
- ENGINE TUNE-UP & ELECTRICITY

AIR CONDITIONING-REFRIGERATION DIVISION

- AIR CONDITIONING, REFRIGERATION & ELECTRICAL APPLIANCES MASTER COURSE
- AIR CONDITIONING-REFRIGERATION SERVICING COURSE

HIGH SCHOOL DEPARTMENT

- HIGH SCHOOL AT HOME Dept. _____



NAME _____ AGE _____

ADDRESS _____

CITY _____ STATE _____

Please fill in Zip Code for fast service _____

Check if interested in veteran training under the new GI Bill.

Check if interested ONLY in classroom training at Los Angeles.

GET OFF THE DIME. HERE'S 4 WAYS TO BOOST YOUR INCOME!



ELECTRONICS DIVISION

New color catalog

NTS Project-Method home training makes it easy for you to make your mark in Electronics. To get the big-paying job you want. Learn more, faster, with exciting kit equipment included at no extra cost. There's no better time than right now to do it! Send the coupon!



MECHANICS DIVISION

NTS gives you professional engine analyzing equipment. And top mechanics' know-how in diagnosis... speed... performance. Industry needs over 200,000 trained mechanics right now. And you can be one of them. Mail the coupon for our new catalog today!



AIR CONDITIONING, REFRIGERATION DIV.

We give you the tools, tester, instruments. Show you how to service giant industrial cooling systems and commercial refrigeration installations. There's a big job waiting for you here. All it takes to get it is the skill we give you. Don't wait any longer.



HOME APPLIANCES DIVISION

Learn to service major home appliances. Get the new, exclusive NTS CIRCUIT-TRAINER! It helps train you faster for the big jobs. Learn troubleshooting, open your own business, be your own boss. So get off the dime. Mail the coupon. We'll send you all the facts in our new catalog.



FILL OUT AND MAIL CARD TODAY

GET FULL COURSE DETAILS AND LEARN ABOUT THESE NTS EXTRAS:

1. BONUS CLASSROOM TRAINING
2. JOB PLACEMENT CONSULTATION
3. BUSINESS CONSULTATION

NO OBLIGATION. NO SALESMAN WILL CALL.

APPROVED FOR VETERANS



Accredited Member
National Home Study Council



Accredited Member
National Association of Trade and Technical Schools

FIRST CLASS
Permit No. 3087
Los Angeles, Calif.

VIA AIR MAIL

BUSINESS REPLY MAIL

No Postage Stamp Necessary if Mailed in the United States

POSTAGE WILL BE PAID BY

NATIONAL TECHNICAL SCHOOLS

4000 South Figueroa Street

Los Angeles, California 90037

CLASSIFIED ADVERTISEMENTS

Rate: \$1.85 per word payable in advance each insertion. Capitalized words—75¢ per word additional. Minimum insertion ten words. To be inserted under the proper classification, copy must be in our office by the 15th of the second month preceding date of issue. The next available issue to place an advertisement in America's No. 1 Classified Section is November. The closing date is September 15th. Send remittance and order to C. A. Martin, Popular Mechanics, 575 Lexington Avenue, New York, New York 10022. Please make remittance payable to Popular Mechanics.

AUTOMOBILES, MIDGET CARS

YOUR Ad in this space will be read by more than 1,662,961 active mail order buyers. Join the march to greater profits, place your products and services in front of them today with a small low cost classified ad. For further details, write: C. A. Martin, Dept. 1R, Popular Mechanics, 575 Lexington Avenue, New York, New York 10022.

SAVE Up to \$1300.00 buying new automobile. \$1.00 booklet explains how. Egil Publishing, Box 2023, Sunnyvale, California 94087.

AUTO SUPPLIES AND EQUIPMENT

ANTIQUE Car pistons, gaskets, gears, valves, etc. Catalogue \$1.10. Antiques Auto, Milwaukee, Wisconsin 53204.

CROSLY And foreign car parts. Box 7, Elmont, N.Y.

GAS-OIL HOG???. Smoking???. No Pep???. Hard Starting???. (Save \$150-\$250) with Motaloy Ring-Valve Job While driving (\$6.50 postpaid) Advertised here every month for years! Continues saving money on repairs, gas, oil for 100,000 miles! Absolutely true! (new engines too) Nothing compares! . . . Money-back guarantee. You can't lose! Motaloy, Grantham, Penna. 17027.

EASY add-on IGLIT checks ignition. Q-arc, Box 47876 Los Angeles, Calif. 90047.

WARNING Flasher, emergency four directional under dash mounting \$3.98. Gift catalog, E. Remlinger, 116 Hardenburg Lane, East Brunswick, N. J. 08816.

HYDRAULIC Jack repair kits, parts and supplies. Catalog 50¢ (in coin). Hydraulic Jack Packing & Tool Co., Inc., General, P.O. Box 3, Staten Island, N.Y. 10314.

FREE Information on building or buying Capacitor Discharge Ignition Systems under \$25.00. SYDMUR, Dept. 25 Midwood, Brooklyn, N.Y. 11230.

JEEP Owners—V8 conversions. Read Jeep Owners ad, page 205.

SNOWMOBILES

SNOWMOBILES—Factory Direct Prices. Save 30%. Five latest 1969 models, 5—18 HP. Easy Terms. Driving trial. Money back guarantee. Free catalog. Luger, Dept. SB-68, 9200 Bloomington Freeway, Minneapolis, Minnesota 55431.

AUTO TRAILERS

CAMPER Plans. Compact buses, Vans—Volkswagens, Econoline, Dodges. Build yourself—Save! Details—Dot Campers, Box 2115M, Culver City, California 90230.

BUILD Your Pickup Camper. Precut Kits. Blueprints, Supplies, Literature 10¢. Comstock Trailers, Dept. 664, Parsons, Kansas 67357.

PICKUP Camper, Trailer or Pickup-Cover . . . Build yourself. Save! Complete plans \$3.95 each. Cover plans \$2.00. Econoline Bus or Van, Bus Conversion drawings, \$2.95 each. Satisfaction Guaranteed. Equipment catalog \$1.00 (refundable). Details 10¢. Viking Camper Supply, 94-F Glenwood, Minneapolis, Minn. 55403.

MOTORCYCLES, BICYCLES, MOTORSCOOTERS AND SUPPLIES

RECONDITIONED Motorcycle motors. Indian, Mustang, Royal Enfield, Suzuki. Parts, Accessories. Indian Motorcycle Sales, Kansas City, Missouri 64127.

BUILD "Popular Mechanics" MINI-BIKE featured June 1967 issue. Detail plans, photographs \$2.50 refundable. Kits, parts, engines; factory discount prices. Gilliom Mfg.; PMC; St. Charles, Missouri 63301.

SNOW VEHICLE & KART CATALOG. Hop up accessories—speed and performance equipment—manifolds, engine mounts, exhaust systems. Send 25¢. G.E.M. PRODUCTS, 494 E. St. Charles Rd., Carol Stream, Ill. 60187.

HARLEY-Davidsons—Used bargains. New, used parts, accessories, all models. Bulletin 35¢. Knuth's (Factory Dealer). 1753 Muskego, Milwaukee, Wis. 53204.

HONDA 50-90-160 Speed Equipment. Cams—Big-Bore-Stroker. Columbia Engineering, 2105 E. 37 St., Los Angeles, Calif. 90058.

NEW Cycle and mini-bike carriers, \$17.95 ppd. Mini-bike plans \$1.00. Brochures 10¢. J & W Steel Products, P.O. 766, Adelphi, Md. 20783.

BUILD Motorbike from Bicycle! Plans —\$2.00; Go-cart plans—\$2.00; Snowmobile plans—\$5.00; Go-byk Industries, Rothsay, Minn. 56579.

BUILD Your own minibike! No welding required. Plans \$1.50. Westate Enterprises, Dept. PM-9, Box 9216, San Jose, California 95117.

MINI-Bike 3 speed pedal or motor drive, frame unpainted \$14.00. Info and fotos \$1.00. 2202 Tulare, Burbank, Calif. 91504.

MOTORIZED Bicycle, plans \$3.00. N. Pion. 5635 Monte Vista, Los Angeles, Calif. 90042.

MINI-BIKES, Minicars, Sno-carts, Fun Karts and parts. Catalog 25¢. Stephenco, Bridgman, Mich. 49106.

AVIATION

BE A Government licensed aviation mechanic. Practical training. Free information. Aero Mechanics School, Municipal Airport, Kansas City, Missouri 64116.

PROPELLERS, Plans, Supplies for Airboats—Snowplanes, Corvair, Volkswagen conversion. 125 Lycoming Engines, Gyrocopter, Hovercraft propellers. Catalog \$1.00. Banks-Maxwell, Box 3301E, Ft. Worth, Texas 76105.

HELICOPTER One-man. Portable Kits Plans, Information 25¢. Photos and three-view drawings \$1.00. Compco, Box 1267, Redwood City, California 94064.

HOMEBUILT. Real enclosed helicopter. 24 pages ideas, information, \$2.50. Build "executive" helicopter, drawings, specifications, \$2.00. Helicopter Development, Box PM147, Washington, New Jersey 07882.

FREE Catalog. 1000 Aviation Space Books. Aero Publishers, 329 Aviation, Fallbrook, Calif. 92028.

LEARN AVIATION AT HOME. Navigation, aerodynamics, communications, weather taught in your home. Unique method. Free information. United Aero-Sciences Institute, Dept. C, P.O. Box 4106, Torrance, California 90503.

AERO-CAR. Amazing Hovercraft built easily with ordinary tools. Lawnmower engine power. Carries one man plus. Hovers, flies forward, backward, sideways over land/snow/water. Complete construction plans and brochure, \$4.25. Aero-Projects, Box 5118, Clinton, N.J. 08809.

ADVERTISE Airplanes, accessories, parts, everywhere. 6 months \$1. Aero Shopper, Henrietta, Texas 76365.

AIRBOAT, Snowplane, Gyrocopter, Hovercraft propellers. Complete airboats, Kits, Plans, Mounts, Engines, Supplies. Corvair, Volkswagen Conversions. Outboard airdrives. Catalog \$1.00. Banks-Maxwell, Box 3301E, Ft. Worth, Texas 76105.

AIRCRAFT Communications on Broadcast radio! Brochure. Tunavter, Woodboro PM19, Texas 78393.

AIRBOAT PLANS \$3.00; Gyrocopter Plans \$5.00; Hovercraft Plans \$5.00. Propellers, hubs, 6-blade fans, McCulloch engines, airdrives. 1969 Supply Catalog \$1.25. ESCO-M, Brandenton, Florida 33505.



BOATS

FIBERGLASS Cloth and resin. World's finest cloth and non-run resin, at direct mill prices. Flotation foam. Complete line of plastics, silicon bronze and brass screws, save 60% No Sales tax. Boat Plans, Catalog 25¢. Freight prepaid. Stiles Boat Supply, Box 11P, Linden Ave., Mantua Hts., N.J. 08051.

KAYAKS—One-man \$19.50; two-man \$24.50; Sailboat \$44.00. Exciting Sitka Kayak Kits known world wide for speed and safety. Assemble in one afternoon. Free pictorial literature. Box 582-P, Willoughby, Ohio 44094.

FULL Size, cut-to-shape boat patterns, blueprints. Send 60¢ for big new illustrated "Build a Boat" catalog includes fishing boats, garies, cruisers, catamarans, houseboats—7½ to 38'. "How to Build a Boat" booklet, \$2.50. Cleveland Boat Blueprint Co., Box 18250, Cleveland, Ohio.

FREE Catalogue—plans for canoes, kayaks, accessories. Clark, 115 McGavock Pike, Nashville, Tenn. 37214.

PLANS, Full Size Patterns, Frame Kits with step-by-step instructions specially for amateurs. New "Glen L." Boats 8' to 36' Sail, Jets, Inboards, Outboards, Cruisers, Houseboats, Hot Boats, Catamarans, Hydros "plus" boat trailers and a camper. Send 50¢ for complete catalog. New "How To Build Boat Trailers" Book \$3.00 ppd. Glen Designs, 9152 Rosecrans, Bellflower, Calif. 90706.

CANOES! Kayaks! Factory-direct quality kits, from \$20.00. Many different models. Canvas hulls. Strongest construction materials. Free literature. Sportsraft, Box 8393-PM, Columbus, Ohio 43201.

BUILD Your own boat from our large-scale blueprints. Books of plans give how-to-build help. Hundreds of professional designs—motor, sail or auxiliary—for amateur builders. Free catalog. MoToR Boat-ing, 959 Eighth Ave., Dept. RS, New York, N.Y. 10019.

PLANS, Kits, hulls. 24-page 20th Anniversary catalog. All class racing boats, Flatbottom to Drag Hydros. Midget to 7 Litre, 50¢. Champion Boats, Box 9215A, Long Beach, Calif. 90810.

AMATEUR Boat Building Society, 111-B Woodcrest Ave., White Plains, N.Y. 10604; Plans, kits, discounts, books, technical help, local building clubs, instruction, monthly magazine. Free information.

FREE NEWSPAPER: 1968 Boat Buyer's Price Guide, POB 10744, Tampa, Florida 33609.

SAILMAKING Step by step purely practical \$3.00. Also finished sails. SAUGER, 120 Manville, Scarborough, Ontario.

NEW 1968 McCulloch and other outboards. 4 H.P. \$108.00. . . . 7½ \$224.00. . . . 9 Electric Start \$288.00. . . . 18 \$316.00. . . . 40 Electric \$514.00. . . . 65 Electric \$698.00. . . . All sizes. Literature 50¢. Electra Marine 1427 Broadway, Brooklyn, N. Y. 11221.

BOAT Kits. Save money—assemble yourself. Factory molded fiberglass or pre-assembled plywood. 12' to 32' Cruisers, Runabouts, Houseboats, Sail Boats. Big line accessories, motors, trailers. Easy terms. Free catalog. Luger, Dept. BC-68, 9200 Interstate 35 W South, Minneapolis, Minnesota 55431.

BOAT PLANS, FRAME KITS, BOAT KITS. World's largest catalog—Over 200 top design for the amateur builders. New catalog includes Cruisers, Runabouts, Deep vee's, Catamarans, Trimarans, Houseboats, Sailboats from small sail fish to 34 ft. motor sailers, large selection of inboard and outboard Hydroplanes. Send \$1.00 for large new plan & kit catalog or \$2.00 for catalog plus Boat Builder's Guide. Clark Craft Boat Company, 16-P Aqua Lane, Tonawanda, New York 14150.

FIBERGLASS Cloth, matt, polyester and epoxy resins. Lowest prices. Seifert's, Box 1206-M, Green Bay, Wis. 54305.

NAUTICAL Accessories—Gifts. Brochure, 25¢. Leonard, Box 284-M, Dedham, Massachusetts 02026.

BOAT Plans, including deep V, some kits. Catalogs: Powerboat 50¢. Sailboat 40¢. Marinecraft, Box 161-M, Brighton, Mass. 02135.

MARINE EQUIPMENT AND SERVICES

NEW. Used, rebuilt marine motors. Marine conversions, fittings. Free catalog. Stokes Marine Supply, Dept. 24, Coldwater, Michigan 49036.

CONVERT Auto engines to marine. 68 Page Catalog. 50¢. Lehman Manufacturing Company, 800 Elizabeth Avenue, Linden 4, New Jersey 07036.

FREE Pontoon Boat Catalog, Dock Brackets, Float Brackets, Mooring Bars, Dock Ladders. Perma-D Marine Products Dept. 36, 2308 Central Ave., Mpls., Minn. 55418.

ATHLETIC AND BODY BUILDING COURSES

"GIANT Arms." Dr. Young's, D.C. revolutionary discovery. \$2. Satisfaction or refund. Gaucho, Box 9309-S7, Chicago 60690.

POWERFUL Muscles fast! Free brochure! Universal Bodybuilding, Box 4327-C, Northeastern, Dearborn, Michigan 48126.

EXERCISE IN CLAY! Anatomically perfect. Stop kidding yourself with weights, isometrics, gadgets. Human body has only 31 major movements, learn these. Free brochure of FACTS. Classics Of Muscular Exercise, 210 Fifth Avenue, New York, N. Y. 10010.

FEAR No bully! Master authentic Chinese Kungfu Unbeatable Techniques! Defeat Within seconds any Attacker including Giant Judo-Karate experts. Free details by air. Write Asia's Greatest Master, Leongfu (MI/34) 119, Aderson Road, Ipoh, Malaysia.

SPORTING GOODS AND EQUIPMENT

FREE 1968 Catalogue! Guaranteed lowest prices. Fishing Tackle, Archery, Hunting and Camping Equipment. Thousands of items. Cabelas' Inc., Dept. S, Chappell, Nebraska 69129.

FREE . . . Wholesale catalog. Arrow shafts, broadheads, fletchings, fisharrow parts, tools, bows. FinnySports (22G), Toledo, Ohio 43614.

HUNDREDS Of Army-Navy surplus items, camping, hunting, fishing equipment, gun accessories, etc. Write for free catalog. P&S Sales, Box 155, Tulsa, Oklahoma.

BIG Money raising crickets and 12 inch African fishworms. Free literature. Carter Ranch, Plains, Georgia 31780.



FISHING, TACKLE, LURES

MOLDS—For casting your own fishing sinkers. Free illustrated booklet. Reading Instrument Co., Box P78, Reading, Pa. 19603.

FISH Traps, collapsible. Pond-lake types. Animal, bird traps. Free catalog and trapping secrets. Sensitronix, 2225-P27 Lou Ellen, Houston, Texas 77018.

MOLDS For fisherman's sinkers, jigs, squids, casting and spinning lures. Free catalog. Sweets Molds, Tonawanda 1, New York 14150.

FREE . . . Wholesale catalog. Beads, Spinners, Lure parts, Sinker molds, Jigs, Reels. FinnySports (ME), Toledo, Ohio 43614.

OVER 5,000 HARD-TO-FIND FISHING SPECIALTIES and kits galore. Send for free 170 page catalog. Netcraft Co., Dept. PM, Toledo, Ohio 43613.

LIVE-CATCH Animal traps. A size for every purpose. Also fish, sparrow, turtle, and other traps. World's largest selection. Free catalog. Sensitronix, 2225-MC36 Lou Ellen, Houston, Texas 77018.

EARTHWORMS, LIVE BAIT

BIG Money growing fishworms, giant African Crawlers, crickets. Free Literature. Fain's Hatchery-31, Edison, Georgia 31846.

EARN Money raising fishworms for us! Exciting details free! Oakhaven—56. Cedar Hill, Texas 75104.

BIG Profits raising worms. Instructions 25¢. Three Oaks, Dresden, Tennessee 38225.

SUCCESS For You! Raise Carter's Pure-bred hybrid red wiggler fishworms, crickets, and 12 inch African worms. Write for Free Literature and our Success Story in Life Magazine. Carter Red-worms, Plains, Georgia 31780.

FROGS, FISH, REPTILES

MAILORDER Records help get Increased Business! Complete 32 Page Record Book shows your inquiries, orders, advertising, expense, etc. Only \$1.00. C. A. Martin, Popular Mechanics, Dept. PM, 575 Lexington Ave., New York 10022.



HUNTING, GUNS, DECOYS

FREE Gun & Ammo Bargain Lists. Century Arms, St. Albans, Vermont.

200 ASSORTED Gun screws, pins, springs, etc. 6.75. Overland's Gun Supply, Independence, Iowa 50644.

NEW LYMAN RELOADING HAND BOOK The "bible," gives 7,060 tested loads. Rifle, shotgun and handgun. For beginner or expert. Send \$3.50 to: Lyman Gun Sight Corporation, Dept. CPM 8-9 Middle Field, Conn. 06455.



DOGS AND KENNELS

RECENT Surveys show many dogs have worms. These parasites can cause serious health problems. Free information. Send stamped self addressed envelope to Analysis, Box 1051, Warren, Michigan 48090.



GAME BIRDS

FREE Big quail color catalog. Marsh, 14216 Brookhurst, Garden Grove, Calif. 92640.

RAISE Pharaoh's Quail. Worlds fastest multiplying bird. Free information. Goering, RR1 Box 44, McPherson, Kansas. 67460.

HAWKS—FALCONS

MAILORDER Records help get Increased Business! Complete 32 Page Record Book shows your inquiries, orders, advertising, expense, etc. Only \$1.00. C. A. Martin, Popular Mechanics, Dept. PM, 575 Lexington Ave., New York 10022.

RABBITS—FUR BEARING ANIMALS

EARN \$10,000 Yearly raising angora rabbit wool, and breeding stock for us. Information 25¢ coin. American Angora Company, Malta 12, Montana 59538.

MAKE Money raising chinchillas, mink, rabbits, cavies for us. Free catalog. Keeney Brothers, New Freedom 2, Penna. 17349.

RAISE Rabbits successfully by knowing facts. 48 page illustrated book describing 25 breeds. Housing, breeding, feeding, markets, marketing etc. 25 cents. American Rabbit Association, 36 Arba Building, Pittsburgh, Penn. 15217.

RAISE Rabbits for us on \$500 month plan. Free details. White's Rabbitry, Mt. Vernon, Ohio 43050.

PETS—BIRDS, CATS, HAMSTERS, ETC.

HAWKS, Reptiles, raccoons, skunks, squirrels. Catalogue 25¢. Trails End Zoo, St. Stephens, S.C. 29479.

LIVE Traps, all sizes, mouse to dog. Collapsible or rigid. Carrying Cages. Free literature. National Live Traps, Tomahawk, Wisconsin 54487.

LIVE SEAHORSES, marine specimens, aquarium supplies. Illustrated catalog 15¢. Marine, Box 248-210, Dania, Florida 33004.

BUY Direct—Save! Monkeys, Ocelots, Birds, Reptiles. List 10¢. Exotic Animal Importers Inc., Box 632-7, South Miami, Florida 33143.

HORSES & LIVESTOCK

"HOW To Train Horses"—Everyone who likes horses or ponies should have this book! Free. Write Beery School, 1109, Pleasant Hill, Ohio 45359.

CAMPING EQUIPMENT AND TENTS

SAVINGS Plus dividends! Campers-fishermen-outdoorsmen cooperative. Free 68-page catalog. Recreational Equipment, Inc., 1525-P 11th, Seattle, Washington 98122.

EMBLEMS, BRASSARDS, PATCHES

MAILORDER Records help get Increased Business! Complete 32 Page Record Book shows your inquiries, orders, advertising, expense, etc. Only \$1.00. C. A. Martin, Popular Mechanics, Dept. PM, 575 Lexington Ave., New York 10022.

TRAVEL & RESORTS

EXPO 70, Hawaii, Japan! See them all on our Lay-a-way Plan. Grosh, O'Hare, Chicago, Illinois 60666. Interest Available.

OFFTRACK, Tiny island, luxury house, low rent, Lullely, Bequia, St. Vincent, West Indies.

ELECTRICAL SUPPLIES

METERS—Surplus, new, used, panel and portable. Send for list. Hanchett, Box 5577, Riverside, Calif. 92507.

LAMP Parts. Catalog, prices, wiring instructions. 50¢. Refunded first order. Gyro, 5218P N.W. 35 Ave., Miami 42, Fla. 33133.

\$100.00 12V, 100-200 AMPERE Selenium rectifier unit, \$25.00, prepaid. Other close-outs. Strickland, Box 11387, Columbus, Ohio 43211.

LAMP arts for building, repairing, converting. Catalog 40 cents. Refunded with first order. Brown Lamp Co., Box 11305, Clayton, Mo. 63105.

BATTERIES, GENERATORS

BATTERY Reconditioning kit, includes molds, material, instructions. Battery Shop, Palm Desert, California 92260.

COMPLETE Rebuilding Manual!!! Batteries \$3.00. Hydraulic Jacks \$3.00. C.O.D. Accepted. Write Today! Bayer Publications, 938FT Betty Avenue, Neenah, Wisconsin 54956.

ENGINES, MOTORS, DYNAMOS

WINDING Data, 275 motors, \$1.20. Data Company, 512 Kensington, Kansas City, Mo. 64124.

LIVE Steam powered backyard railroads! All sizes. Complete "bolt-together-kits," and rough castings. Excellent drawings. 100 page catalog \$1.00. Little Engines, Lomita, Calif. 90717.

TOTAL Power, steam equipment, Catalog, 50¢. Reliable Industries, New Baltimore, Mich. 48047.

MACHINERY, TOOLS AND SUPPLIES

MICROMETERS, Indicators, Chucks, Rods. Direct Supply, 1424 Barclay, Springfield, Ohio 45505.

PRECISION GEARS. Write for list. Berman, 198 Hawthorne Ave., Yonkers, New York 10705.

SAW Sharpening equipment available on trial. Free details. Zapart, 586-P Manhattan Ave., Brooklyn, N.Y. 11222.

CLEAN files cut: File cleaner \$1.00 post-paid, guaranteed. Nutmeggers add tax. Maltin Machine Products, Box 254, Lisbon, Conn. 06351.

GRANITE Surface plate special. Unilateral accuracy $\pm .00015"$. 6"X10"X2", \$9.95; 8"X12"X2", \$14.95; 12"X12"X2", \$21.75 Plus Postage. Precision Granite, 11550 Larch, Mpls., Minn. 55433.

WELDING, SOLDERING, PLATING

CHROME Plating equipment, supplies. All other finishes. Home workshop and production sizes. Send \$1.00 (refundable) for formulas, operating data, equipment guide and catalog. HBS Equipment Division L50, 3543 East 16th, Los Angeles, Calif. 90023.

ELECTROPLATING, Metalizing Book, Solution Formulas, \$2.50. Helm Publishing, 7366 Brookdale Court, Dublin, Calif. 94566.

WELDERS—Welds Fenders, Bulldozers. \$49.50. Morris, 1070 Inner, Schenectady, New York 12303.

GOVERNMENT SURPLUS

GOV'T. Surplus. How and where to buy in your area. Send \$1.00. Surplus Information. Headquarters Building, P.M., Washington, D.C. 20036.

JEEPS From—\$52.50: Typewriters from—\$4.15; Cars from—\$31.50. Walkie-talkies, motorcycles, airplanes, boats. Typical "As Is" bid bargains from Uncle Sam. Tremendous variety. Exciting free list. Write: Enterprises, Box 402X38, Jamaica, New York 11430.

1968 SURPLUS Army, Navy store illustrated catalog. Send 25¢ (refundable with first \$5.00 order). Ruvel, 707 Junior Terrace, Dept. 9-J, Chicago, Ill. 60613.

JEEPS Typically From \$53.90 Trucks From \$78.40 . . . Airplanes, Typewriters, Boats, Clothing, Camping, Sporting, Photographic, Electronics Equipment, Used, 100,000 Bid Bargains Direct From Government Nationwide. Surplus Catalog. Directory and Sales Bulletins Application \$1.00 (Deductible First \$10.00 Order). Surplus Service, Box 820-A, Holland, Michigan 49423.

FREE JEEP Buying Information when you send us 50¢ for NEW Gov't Surplus Bargain Catalogue (Refundable). Surplus Trader, Box P1, Spring Grove, Penna. 17362.

GOVERNMENT Surplus: complete directory and information, \$1.00. Pacific, 215 Spruce St. Needles, Calif. 92363.

GOVERNMENT Surplus Bargains Galore! Latest factual information on how, where to buy near You \$1.00. Surplus Opportunities, Box 1032FC, Fairborn, Ohio 45324.

HOBBIES AND COLLECTIONS

50 GORGEOUS Jungle butterflies \$2.00. Collectors Wonderland, Box 1170, New York, 10008.

FREE German Regulation Medal: Send 50¢ Postage, handling, get catalog; Iron Cross with ribbon \$1.50. International, Box 303-M, Jamaica, N.Y. 11431.

AQUARIUM Hobbyists: Send for free catalog of complete aquarium supplies. Free gift offer. Hobby Products, Dept. G-2, P.O. Box 62, Great Neck, N.Y. 11023.

FREE LISTING in national catalog of ANY hobby equipment you want to sell. Send full description and price to Hobbycraft Exchange, 7703 Clarendon Road, Indianapolis, Indiana 46260.

YOU May get Big Mail and Picture Post Cards from everywhere. Year's listing guaranteed. Don't hesitate. Mail \$1 today. Olding, Box 123, Windsor, Ontario, Canada.



STAMP COLLECTING

PENNY! Approvals! Regardless catalogue! Kloster, 4164 52nd St., San Diego 5, Calif. 92105.

500 DIFFERENT Stamps, \$1.00. Smith, 508-A Brooks, College Station, Texas 77840.

PENNY Stamps! 1000 Mounted in book at 1¢ each. Trust Stamp Company, P.O.B. 132-P, Jamaica, N.Y. 11435.

100 OLD United States between 1861 and 1935, \$1.00. Roush Stamps, 51 Chestnut, Mansfield, Ohio 44903.

50 DIFFERENT Old U.S. Revenue stamps 50¢. Winchester Stamps, Box 1592, Mansfield, Ohio 44907.

FREE Surprise collection sent with approvals. Gould, 1784 Union, San Francisco 94123.

FREE! Triangles, Scout, 25 others. Approvals. Cambridge, Box 411, Cambridge, Ohio 43725.

HISTORIC First Day covers that will make your collection sing with excitement and interest. Free details from K. M. WALSH, Box 308, Dept. PM-9, Tuckahoe, N.Y. 10707.

FREE! Big Bargain Catalog—New Edition listing thousands of bargains including U.S. & B.N.A. stamps, packets, albums, accessories and supplies. Also, fine stamps from our approval service which you may return without purchases and cancel service at any time. Jamestown Stamp, Dept. E 98PM, Jamestown, N.Y. 14701.

FREE! 30 Different U.S. Comems. with approvals. Shelton, Box 547C, North Miami, Fla. 33161.

U.S. Bargain, 50 different 10¢, with beautiful worldwide approvals. Stamp Center, Kennebunk, Maine 04043.

INTRODUCING Our better United States approvals we offer 15 United States stamps including Columbian, Bi-Centennials, famous American, airs, others; only 10¢. Ocean Stamps, Box 64-PM, Brooklyn, New York 11229.

UNITED States commemorative collection containing 33 different—10¢. Approvals. White, 516-A Avenue L, Brooklyn 30, New York.

RUSSIAN Space set 10¢. Russian approvals. Snedco, Box 68-P, Waldwick, N.J.

40,000 DIFFERENT! Amazing new plan builds your collection systematically, country by country. As low as 50¢ weekly. Ware, Monroe, Conn. 06468.

1500 FOREIGN \$1.00, 5000 \$3.00, 5000 USA commemoratives, revenues, airs, presidentials, 19th century, high values \$3.00, 50 USA revenues \$1.00. No approvals. Meyers, 5321 Fleming, Richmond, California.

50 YEARS Old, fifteen different United States, over fifty years old—10¢ with approvals. Jaxon, Box 145-P, Brooklyn, New York 11230.

U.S. Mint specials! Flag set, complete \$1.00, 1¢, 2¢, 3¢ famous Americans (21 different) \$1.00. Free list. Brooks, 2601 Avenue "U," Brooklyn, N.Y. 11229.

ONE Pound value Geo. VI Bermuda, plus 100 worldwide 10¢, approvals. Stevens, Box 105A, Homecrest Sta., Brooklyn, N.Y. 11229.

NEW Issues—Free weekly illustrated list. Brooks, 2601N Avenue "U," Brooklyn, N.Y. 11229.

GIANT Stamp Collection including: Astronauts, Satellites, Moonrocks, Boy Scout issue, Complete U.N. Set, recent Olympic and Sport issues from many countries, etc., Plus Big Stamp Dictionary and approvals. Everything, 10¢! Stampex, Box 47-RM, White Plains, N.Y.

COLLECTION. 222 different: 10¢. Approvals. Stamp Farm, 9M27, Oxford, Wis. 53952.

"ATTRACTIVE" Set free! Request Approvals. Gorliz, Box 1915PM, Naples, Florida 33940.

OLD U.S. seconds. Bargains. Karl Swartz, Box 313, Flat Rock, N.C. 28731.

2,000,000 STAMPS, 150 Countries, 2¢ Each. Belden, Box 175, Dearborn, Michigan.

BETTER Stamps for less money! Large sample assortment 30¢. Bargain lot: Packets, sets, rare stamps \$1. Giant Assortment \$5. High value packet \$3. Persile 436, N.Y. Ave., Brooklyn, N.Y. 11225.

225 STAMPS For only 10¢! This mammoth value includes airmails, pictorials, stamps from strange countries cataloging up to 25¢ each! Also approvals. Mystic Stamp Company, Camden 80, New York 13316.

RUSSIA High-Value Collection. 32 different Russia—some over 50 years old! Commemoratives, Czarist Issues, Airmails. Catalog price \$2.99. Special Get-Acquainted Offer—all for only 10¢! H. E. Harris, Dept. GG-5, Boston, Mass. 02117.

"INVERTED Error." Dag Hammerskjold 5¢ with Approvals. Belmont Stamps, Washington, D. C. 20015.

LARGE COLORFUL SETS, 3 different only 10¢! Approvals. Cole, Box 223-A, Buffalo, N.Y. 14221.

U.S. Approvals Low prices. Eagle, 2221 Romine Ave., Pittsburgh, Pa. 15226.

AMAZING OFFER! 200 United States stamps—including commemoratives, airmails, high denominations to \$1.00. Only 10¢ to approval applicants! Illustrated bargain lists free. Mystic Stamp Co., Dept. 80, Camden, New York 13316.

WOW! 110 all different Germany 10¢ Commemoratives, Airmails, High Values. Big catalog, bargain lists also, fine stamps from our approval service, which you may return without purchases and cancel service at any time. Jamestown Stamp, Dept. A 98PM, Jamestown, N.Y. 14701.

SENSATIONAL Free Offer. 20 Outer space stamps, selected approvals. Louis Morrison, 1027 Maryland, Cape May, N.J. 08204.

MILLIONS Foreign Stamps! 2¢ each! Send for gigantic approvals! ABC, Box 6000-MB, San Francisco, California 94101.

UNITED STATES STAMPS? If you collect them, you'll want our approvals. Beginning or advanced adults only, please. Engle, Box 8P, Lowell, Michigan 49331.

FREE Stamp Wallet with approvals. Wide choice collections by countries. Robert J. Clark, Box 28-P Wilmette, Ill. 60091.

EXPLOSIVE Near East always in the news. We are offering a nice collection of stamps from Israel, Egypt, Jordan, Syria, Iraq, etc. for only 10¢ to approval applicants. Clark Stamps, Dept. 57C, Muskegon, Mich. 49444.

BEAUTIFULL COLORFULL BULL-FIGHT SCENES POSTER OIL PAINT REPRODUCTIONS Ideal for decoration excellent paper and printing 23 by 48 inches three dollars each send to Benavides Box 27-105, Mexico 7, D.F., Give Address Clearly, ZIP CODE.

BEAUTIFUL Foreign sets on approval. Amiflip, 211 So. Garden, Clearwater, Florida 33516.

FREE-7 Giant stamps-Approvals-Moumbow, 12542-5G Keel, Garden Grove, California 92640.

FREE! 25 Egypt. 10¢ handling. Approvals. Bellet, Mapledale, Hazel Park, Michigan.

FREE Gift to approval applicants. Moore, Box 22092, Memphis, Tenn. 38122.

\$12.50 VALUE! 500 different worldwide \$1.00. Approvals. Ronnie's, 6117P South Kingston, Tulsa, Oklahoma 74135.

TURKEY 50 Different 5¢. Approvals. Hijop, Box 505, Norristown, Pa. 19404.

FREE 50 Worldwide. Approvals, University Stamps, P.O. Box 1471, Lake Worth, Florida 33460.

ONE Cent a stamp. Write for a jumbo book of foreign stamps at 1¢ each, mounted in Scott order. Bulloet Approvals, 6815 Bay Parkway, Bklyn., N.Y. 11204.

FREE!! Two Complete Mint Sets. Approvals. Hamilton, 7150 Cyril, Chicago OE-9, Illinois 60649.

RARE Stamp free. Also new packet Aden to Urundi with Kennedy, triangles, space, sports, ships, dogs, cats, reptiles plus others. All free. Send 10¢ for mailing, Empire Stamp Co., Toronto, Canada.

SEND 10¢ For Stamp Grab Bag. Over 100 unsorted old and new Asia, Africa, Europe, South Seas, etc. Approvals, illustrated catalog included. Littleton Stamp Co., Littleton GB1, N.H. 03561.

FREE!! 109 U.S.A. stamps. Request approvals. Horace Gatewood, Winston-Salem, N. C. 27102.

ABSOLUTELY Free 25 different United States Commemoratives when requesting United States Approvals. K & B, Box 70, Brooklyn, N.Y. 11223.

MEXICAN Olympics, Rwanda's Gigantic Colorful Sports, Indian Monuments Commemoratives—Free! Approvals plus 101 Bonus Sets. William Deems, 226 Race, Ravenswood, West Virginia 26164.

FREE German mint set. Request discount approvals. Wijn, Hooksett, N.H.

99 DIFFERENT Valuable "British Empire" 10¢! "Approvals". Myakka, Box 278-C, Miami, Florida 33165.

NEW Romania transportation set—19 values. Complete—10¢. Approvals. Continental Stamps, Barrie, Ontario, Canada.

SURPRISE COLLECTION! Exotic mint British Colonials, absolutely free with approvals VIKING, Great Neck 8, N.Y.

QUALITY And price. Mounted approvals 2¢ up. Preview Stamps, P.O.B. 9809M, San Diego, Calif. 92109.

COINS, TOKENS, CURRENCY

40 PAGE Illustrated United States and Canadian coin list 10¢. Stoney, 260 Washington, Boston 8, Mass.

FREE Coin supplies, bargain coin list, 25¢ (Refundable). Economy Sales, Mansfield, Mass. 02048.

SCARCE Date Jefferson nickels. All V.G. Satisfaction Guaranteed. 1942D—1949S—1950—50¢ each. 1943D—1951S—1955—75¢ each. 1939S—\$1.25. 1938D—\$1.65. 1938S—\$3.25. 1939D—\$5.00. 1950D—\$14.50. Dates not listed 20¢ each. Bryson Inc., 612A White, Toledo, Ohio 43605.

SILVER Dollar Album, 100 square coin envelopes. Giant Illustrated Catalog. Everything \$1.00. RARCOA, 31-A Clark, Chicago 60602.

BARGAINS—Latest coin price list, 10¢. Ron Farley, Metamora, Ill. 61548.

U.S. List plus 40S cent 10¢. Schultheis. (Devonshire) New Hyde Park, New York 11040.

BIG Price List U. S. Coins, Supplies free. Sundman, Littleton, N. H. 03561.

1924S LINCOLN plus Catalog 50¢ Discounts, fastest service. Martin's, 36-PM, Tucson, Arizona 85701.

BARGAINS—1931-S Cent VF \$24.95. 1950D Nickel Uncirculated \$12.95. 1969 Redbook \$2.00. Bargain Lists 15¢. Bebee's, Incorp., Omaha, Nebr. 68111.

UNCIRCULATED 1921 Morgan, 1923 Peace Dollars, \$3.50 ea. Illustrated Catalogue 50¢. Shultz, Salt Lake City, Utah 84110.

20 UNCIRCULATED Foreign Coins \$1.00. Coins, Box 8541, Minneapolis, Minnesota 55435.

AUTHENTIC Ancient coin reproductions. Sample coin and catalog, \$1.00. Ancient Coins, Box 1121M, Monrovia, California 91016.

\$1.00 SPECIALS: 50 "S" Cents, 3 California Gold Pieces, 7/\$2.00. Stamped envelope for list. Allen's, 5674 Beacon, Pittsburgh, Pa. 15217.

LINCOLNS: Rare Uncirculated 1955S—Exciting new 1968S. Both included with 50 mixed "S" cents, only \$2.00! Wholesale pricelists included. HARRIS, 4535P Stevenscreek, Santa Clara, California 95050.

COLLECTORS! RARE CANADA AND BRITISH COLUMBIA CENTENNIAL BRONZE MEDALLION. Beautiful mint condition. Plastic sealed. Limited issue. Value May Skyrocket. Don't miss this. Act now. Only \$1.00 Post Paid. W. Conley, Distributor, Suite 7, Mahon Bldg., 1110 Government St., Victoria, British Columbia, Canada.

FREE! 1960D Small Date Circ. Lincoln, with Price List. Stevens, Box 546F, North Miami, Florida 33161.

AMAZINGLY Brilliant, uncirculated 1968 Canada Dollar. \$2 U.S. Order today. Olding, Box 123, Windsor, Ontario, Canada.

GOLD Coins of the world. Beautiful. Low prices. Plus thousands of United States Coins. Free Price List. Please send long, airmail, envelope, self-addressed, stamped. Silver Center, Box 22171-M, San Francisco, California 94122.

60 FOREIGN Coins mixed, \$1.69. 100 mixed, \$2.69. Markleys, Baldwin, Maryland 21013.

TRUNKFUL 25,000 Indian-Lincoln cents from the 1920's & Older, mixed 'Grab-bag' style, 150-\$10; sample bag of 20-\$2. Mrs. F. Fischer, Box 743, Encino, Calif. 91316.

LINCOLN CENTS: 1943PDS, 1954, 1955S, 1960D small date, all \$1.00. 15 Different Brilliant Uncirculated (includes 1968S), only \$1.00. 30 Uncirculated coins—30 countries, Special \$1.00. Bonanza, box 4491P, San Jose, California 95126.

ANTIQUES, RELICS, INDIAN GOODS AND CURIOS

LIST Indian relics, 10 Arrowheads \$3.00. Hyde's, Box 2304, Santa Fe, New Mexico 87501.

TONS Of antique gun parts and supplies. All reproduction muzzle loading guns. Send \$1.00 for enlarged illustrated catalog No. 117-A. Dixie Gun Works, Union City 12, Tennessee.

HUNDREDS. Nautical items, wheels, cannons, Binnacles, Bells, Swords, models, etc. etc. Free illustrated catalog. Stoneage Antiques, 733 N.W. 27 Ave., Miami, Florida 33125.

SAVE Money on antiques. Dealer's handbook tells you how much to pay before you buy. Tells prices of over 30,000 items. Pays for itself by saving you money. Send \$6.95. Timm Enterprises, 901 Zinnia Lane, Palatine, Ill. 60067.

INDIAN Relics. Arrows, \$4.00 doz. Bird-points, \$7.50 doz. Folsom or Sandia \$5.00. List. C. Secrist, Muscatine, Iowa 52761.

MODELS—SHIPS, TRAINS PLANES, ETC.

SHIP Model kits and fittings: clippers, frigates, etc. Catalog paint-tool list, book list. 40¢. Model Shipways, Box 65, Bogota, N.J. 07603.

SHIP Models, Kits, fittings, plans, books, tools, engines, motors. Big illustrated catalog 50¢. Mass. residents add 3% tax. James Bliss & Co., Dept. SM, Route 128, Dedham, Mass. 02026.

SHIP Models catalog 25¢. Scientific, Inc., 100 Monroe, Newark, N.J. 07105.

SHIP And yacht model fittings; Pine construction hull kits; blueprints. Send 50¢ for illustrated catalog. A. J. Fisher, Inc., 1002 Etowah Avenue, Royal Oak, Michigan 48067.

ROCKETS: Real flying models—flights up to 2500 ft. New illustrated catalog 25¢. Single and multistage kits, cones, engines, launchers, trackers, rocket aerial cameras, technical information. Fast service. Estes Industries, Penrose 2, Colorado 81240.

SCALE Building materials, 1/4" & 1/8" scale. Windows, doors, siding, roofing, lumber and structural shapes. Send 50¢ for catalog. Small Sales Co., P.O. Box 177, Shawnee Mission, Kansas 66201.

PIRATE Ship 28" long, 40" high; solid wood construction; very easy to make; send \$2.00 for complete pattern. Oriental Pacific, Box 22, West Vancouver, B.C. Canada.

MODEL ROCKETRY magazine—sample 25¢. Box 110, MIT, P.O., Cambridge, Massachusetts.

LIVE Steam engine kits. Fascinating hobby for model mechanics. Boilers, fittings, accessories. Pictured catalog \$1.00. H.P.K. Models, Centuck 34, Yonkers H, New York 10710.

SAVINGS For model builders (up to 1/3 off)—airplanes, radio control, trains, cars, ships, plastics. Send 10¢ for Jumbo Bulletins. America's Hobby Center, 148B W. 22nd, New York 10011.

MODELMAKERS MINIATURE MACHINES free brochures, Microm, Box 2313, Santa Ana, California 92707.

ROCKETS! Flying models, engines. Beginning through advanced. Catalog 25¢. Rocket Development Corporation, Route 3-M, Seymour, Indiana 47274.

GAMES, TOYS, NOVELTIES

EXTRA Income at home in Spare Time! Booklet shows you how to start your own business with Classified Advertising. Only \$1.00. C. A. Martin, Popular Mechanics Dept. PM, 575 Lexington Ave., New York 10022.

HORSESHOE—World's best turf game! Free literature. Funanza, Box 2513, San Bernardino, Calif. 92406.

MAGIC TRICKS, PUZZLES JOKER NOVELTIES

ENTERTAIN With magic! For 53 years Douglas magic has mystified people all over the world. Send 10¢ today for Catalog #37, Douglas Magicland, Dept. 21, Dallas, Texas 75221.

MAGIC Catalog. World's finest. 3000 tricks. (340) pages \$2.50. Beginners, amateurs, professionals. Kanter's, A-200 South 13th St., Philadelphia, Pa. 19107.

COMPLETELY Illustrated catalog. 84 pages, 25¢. Manhattan Magic, Box 334-M, N.Y.C. 10011.

AMATEUR and PROFESSIONAL MAGICIANS all new magic tricks and gags catalog 25¢. Our specialty same day service. Fabulous Trick and Magic, 3319 E. Charleston, Las Vegas, Nevada 89104.

WORLD'S Finest professional magic tricks. Joker's Novelties. Giant illustrated catalog 10¢. Top Hat, Evanston, Illinois.

LATEST World Famous Giant Surprise Catalog!! 1000 Professional tricks, magic, jokers!! 164 Page deluxe edition!! Only 25¢. House of 1000 Mysteries, Dept. PM8C, Ft. Lauderdale, Florida 33308.

42 PAGE Illustrated joke—novelty catalog 25¢. Joke, Box 7212E, Chicago 60680.

FREE! World's Leading Catalog 2000 Novelties, Jokes, Tricks, Scientific Gadgets, Hobbies. Johnson-Smith, D-341, Detroit, Michigan 48224.

VENTRILOQUISM! Information free! Dummy catalog, 50¢. State age. Maher, Studio I, Box 8356, Kensington Station, Detroit, Michigan 48224.

MAGIC MAGAZINE—Monthly since 1936. 44 pages. All phases. 3 month trial \$1.00. Genil, P.O. Box 36068, Los Angeles, CA 90036.

BE A Magician! Two booklets explaining sixty-eight tricks plus large professional catalog. \$1.00. Magic, Inc., 5082 Lincoln, Chicago, Illinois 60625.

ENTERTAIN: 20 page Joke book. Original. \$1.00. Box S, Walters, Va. 23481.

HOUDINI'S Original Magic Shop. Established 1856. Send 25 cents for Illustrated Catalog containing 5000 Tricks, Mindreading, Puzzles, Hypnotism and Jokes. Flossie-Hornmann, 304 West 34th St., N.Y. 10001.

SQUIRTING—"Toilet", "The Out-house", many more. Free catalogue. Biggie, Box 694, Cleveland, Ohio 44107.

VENTRILOQUISM: Tape recorded lessons by America's best known teacher. Learn at home. Dialogue books, Dummies. Send for brochures. Paul Stadelman, Studio A, 7242 N. Claremont, Chicago, Ill. 60645.

BOOKS, PERIODICALS, NEWSPAPERS

NATIONAL Geographic Magazines, 1888-1967, any issue. Buxbaum, Box 465-PM, Wilmington, Delaware 19899.

PROPHET Elijah coming before Christ. Wonderful book free. E. Megiddo Mission, 481 Thurston Rd., Rochester, New York 14619.

FREE Catalog. Self-help books. Write Wilshire, 8721 Sunset, Los Angeles 90069.

PAPERBACK Books, used, good condition. 10 for \$2.00. R. Mills, 33A Hamburg Tpke., Riverdale, N.J. 07457.

FREE! Catalog with list of self-help Books. Munroe, 2221 Monrow, Racine, Wis. 53405.

BOOKS, BARGAINS. NEW. Thousands. Interesting. Free Catalogs. Larrymar Sales, Box 78 E, Bronx, N.Y. 10461.

HIGHER INCOME, security and power. 256 page book "Thinking Big" reveals inside facts and secrets of riches. Send \$2.00. D. W. Bahr, 5860-A Lilac Lane, Hales Corners, Wisconsin 53130.

FREE List of low cost popular booklets. Success, happiness, personality, wealth, personal problems. Wilmar Enterprises, 56 Porterfield Place, Freeport, New York 11520.

PLAYBOY Magazines buying and selling all dates. Jerald Daily, 2901 Oak, Evansville, Indiana 47714.

1,000,000 BOOKS! Bargains! Free Catalogs! Bookanza, 6990 Aberdeen, Upper Darby, Pennsylvania 19082.

PUBLISH Your book! Join our successful authors: All subjects invited. Send for free appraisal and detailed booklet. Carlton Press, Dept. PM1, 84 Fifth Avenue, New York 10011.

FUN Projects for dad and the kids. Deluxe binding \$3.50. EduTech, 4141 Highway 38, Franksville, Wisc. 53126.

PERPETUAL Motion Journal 4/\$2. Information free. 1616 Compton PM09, St. Louis 63104.

SECURITY Higher Income. 256 page book "Thinking Big" reveals secrets that make men rich. Send \$2.00. Maxanne's Gift House, 1520-A Walnut Grove, San Jose, Calif. 95126.

FREE Book catalog. Adult reading. Catalog, 2217 Lackland, St. Louis, Missouri 63114.

2 DIFFERENT Paperback Books—\$1. Interesting. Box 723 PM, Metuchen, New Jersey 08840.

FREE LIST! Low cost books. Hacienda House, PM98D, 900 North Howard, Glendale, Calif. 91207.

PLAYS, STORIES, MANUSCRIPTS

WANT Your book published? Learn how we publish, advertise, promote, distribute. Many successes. Free booklet PM. Vantage, 120 West 31, New York City.

BUSINESS OPPORTUNITIES

PIANO Tuning learned quickly at home. Tremendous field! Musical knowledge unnecessary. GI Approved. Information free. Empire School, Miami, Florida 33145.

BIG Profits—Operating your own plastic laminating business with low cost equipment and supplies, money making methods included. Money back guarantee. Jiffy—Box 23485P, Los Angeles, Calif. 90023.

ADDRESSERS And mailers needed. Send stamp for information. Lindbloom, 1508 West Erie, Chicago 60622.

HUGE Profits! Mail order importing. Free information. ITIS-PM-8. Box 454, Hollywood, Calif. 90028.

\$15.00 HOURLY PROFIT—OWN Business with one serviceman. Quickly learned. Easy to do. Operate from home. Few hundred dollars builds your own nationally advertised business while continuing present job. Investigate immediately. . . . before your territory is taken. Free booklet explains everything. Send Today. Then decide. Duraclean, C8-167, Duraclean Building, Deerfield, Illinois.

IMPORT Export opportunity, profitable world-wide, mail-order business from home, without capital, or travel abroad. We ship proven plan, for no risk examination. Experience unnecessary. Free details. Mellinger, Dept. B709, Los Angeles 90025.

BOOKKEEPERS Earn \$1000.00 month. Operate simplified Bookkeeping tax service. Universal, Box 664-M, Springfield, Missouri.

UNLOCK Your Future. Become professional Locksmith with spare time home-study. Make up to \$6 per hour. All tools, equipment incl. Facts free. Send name. Locksmithing Inst., Dept. 1310-098, Little Falls, New Jersey 07424.

WANT To make big money at home? \$10.00 profit in an hour possible with invisible mending. Make tears, holes disappear from clothing, fabrics. Steady year-round demand from cleaners, laundries, homes. Details free. Fabricon, 1585 Howard, Chicago 60626.

I MADE \$40,000.00 Year by Mailorder! Helped others make money! Start with \$10.00—Free proof! Torrey, Box 318-Y, Ypsilanti, Michigan 48197.

PERFECT Husband-wife business. Learn Upholstery at home. Make \$10 in an hour. Buy—repair—sell for even bigger profits. Kits, tools included. Free booklet. Upholstery Institute, Dept. 5310-098, Little Falls, New Jersey 07424.

FREE Catalogs. Repair air conditioning refrigeration. Tools, supplies, full instructions. Doolin, 2016 Canton, Dallas, Texas 75201.

FREE "Franchise Profit Letter" tells how unique NFR service is helping thousands seeking profitable businesses. Write today. National Franchise Reports, W-528, 333 North Michigan, Chicago 60601.

CONCRETE FACTS: Highly profitable home business. Experience unnecessary. Unlimited unique pottery designs easily made without moulds. Birdbaths, fountains, wishing-wells, benches, etc. Chemical coloring formulas, marbling. FREE illustrated brochure. Hollywood Cementcraft, 602 Athens Street, Altadena, California 91001.

MAKE Money from old tires. Operators clearing \$600 weekly. Equipment costs \$1000. Get facts. S&S Patents, Inc., 3911 N. Damon, Chicago 60618.

DRAFTSMEN! Operate own **DRAFTING SERVICE!** Full, Part Time; Experience unnecessary; Details: Roberts Drafting, 1741 Circle Road, Baltimore, Maryland 21204.

MAKE \$46 from square foot plywood: jigsaw or bandsaw necessary. Free details. Woodard, Bridgewater, Mass. 02324.

COPUBLISH "Mail Sale Advertiser," leading mailorder paper. Copy and details 25¢; U.S.A. only. Vanroy Shirk, Lebanon, Pa. 17042.

SELL Books by mail. 400% profit. Royal, Box 450-X, Cleveland, Ohio 44127.

VENDING Machine big catalog. Rake, 523 A Spring Garden, Philadelphia, Pa. 19123.

56 ACTIVE Franchise opportunities available all over USA. Brochure details 56 franchise chances for you to have your own business tied with successful national companies. Send name, address to P. Stewart, 1085 Walnut, Des Plaines, Illinois 60016.

FREE Book "Wholesaling For Profit" puts you in New Home Business. Direct Mail—Drop Ship Program brings you orders. S.M.C., 7630SPI Gloris Avenue, Van Nuys, California 91406.

\$400.00 MONTHLY Raising giant fishworms. Soilless method. Charlie Morgan, Bushnell, Florida 33513.

EARN Money raising fishworms for us! Write: Oakhaven-38, Cedar Hill, Texas 75104.

BUILD Custom cases at home for profit. Get orders by mail. We supply materials, instructions, everything. Free home business details. Customcase, 7630-CPI Gloria Avenue, Van Nuys, California 91406.

400,000 BARGAINS Below wholesale! Many free. Liquidations . . . closeouts . . . job lots . . . single samples. Free details. Bargainhunters Opportunities, Box 730A, Holland, Michigan 49423.

\$200.00 DAILY In your mailbox! Your opportunity to do what mailorder experts do. Free details. Associates, Box 136-A, Holland, Michigan 49423.

BIG Profits in mail order. Details free. Knowledge, 30A West Washington, Chicago, Illinois 60602.

MAILORDER Records help get Increased Business! Complete 32 page Record Book shows your inquiries, orders, advertising expense, etc. Only \$1.00. Martin, Popular Mechanics, Dept. R-98, 575 Lexington, New York 10022.

SPARE Time Cash—Sell Advertising Book Matches—every business a prospect—no investment—no experience needed to build steady repeat business. Daily Cash commission in advance. Write today—We'll send you sure-fire selling kit by return mail. Dept. MX968, Superior Match Co., 7530 S. Greenwood, Chicago, Illinois 60619.

\$1000.00 MONTHLY Collecting Delinquent accounts by mail. Continental, Box 2023-A, Des Moines, Iowa 50310.

MAKE \$32 from 49¢ piece vinyl. PM-1834 Edgeland, Louisville, Ky. 40204.

\$70.00 WEEKLY—home, spare time. Simplified mail bookkeeping. Immediate income easy. Auditax, 34741A, Los Angeles 90034.

CLIP Newspaper items. \$1.60-\$5.00 each. Details free. Walter, Box 1360-PA, Erie, Pa. 16512.

\$60.00 DAY. Manufacturing concrete posts, blocks, etc. Carlyne, 1803 Fremont, Rapid City, South Dakota 57701.

MAILORDER—Profitable products, drop-shipped. No merchandise investment. Everything supplied—catalogs, ads, mailing lists. Gif-Guide, 3408½ Motor, Dept. 96, Los Angeles 90034.

WORLD'S Largest supply. Merchandise 25% to 40% under wholesale. Bankrupts, closeouts 10¢ under dollar. Imports. Hong-kong clothes. Automobile discounts. Free details. International Buyers, Box 4633-MM, Colorado Springs, Colo. 80909.

PROFITABLE Catalog Mailorder Business! Vikari's, 335PM-I, First Avenue, Salt Lake City, Utah 84103.

FREE Book "990 Successful, Little-Known Businesses." Work home! Plymouth-272J, Brooklyn, N.Y. 11218.

VENDING Machines. No selling. Operate a route of coin machines and earn amazing profits. 32-page catalogue free. Parkway Machine Corporation, 715 PMB Ensor Street, Baltimore, Maryland 21202.

RAISE Rabbits for us on \$500 month plan. Free details. White's Rabbitry, Mt. Vernon, Ohio 43050.

MAIL Baby Catalogs imprinted with your address to New Mothers for Big Profits! Details 25¢. Volz-PM, Ypsilanti, Michigan 48197.

OWN Your own professional collection service. Be in business in 30 days. \$10,000 first year easily. Details 25¢ refunded. Daudfeldt-PM, Atalissa, Iowa 52720.

STEP By step mailorder business. Manuscript—4.95. Marsch Service, Box 112-C, Hecla, So. Dak. 57446.

UP To \$5.00 each for newspaper clippings! Free details. Philip, Box 368-S, Southfield, Michigan 48075.

MAILORDER Business. Experience unnecessary. Harry Andrews, 160 Bleeker, New York, N.Y. 10012.

SECRETS! Mail Order Success. Internationally famous expert reveals how to make home business fortunes. Beginners: Get free copy "Make Money By Mail". Discloses free advertising, profitable products. Mailco, 1554 Sepulveda, Dept. B709 Los Angeles 90025.

SELL Greeting Cards—Make extra money. Gifts, Toys, Jewelry, Stationery. 600 items. Experience unnecessary. Salable Samples on approval. Free—Catalog. Personalized Christmas Card Album. Gift Offer. Hedenkamp, 361 Broadway, Dept. PM-99, New York, 10013.

EXCLUSIVE Distributor Franchise. Make big money selling quality automotive products. Many prime territories available. Write for free catalog and details. Cleanbright, Dept. 608-2202 Folin St., Bronx, New York 10457.

SELL Gifts, Household Items—Make extra money. Toys, Jewelry, Stationery, Greeting Cards. Experience unnecessary. Salable Samples on approval. Free—catalog. Personalized Christmas Card Album. Gift offer. Hedenkamp, 361 Broadway, Dept. PM-98, New York, 10013.

MAILORDER BEGINNERS. Tired of wasting stamps, making unprofitable mailings? Details free! Mailorder Success, Box 188-M, Forsyth, Ga. (31029).

MAKE Extra Money—Show friends, neighbors—Gifts, Stationery, Toys, Jewelry, Greeting Cards. Experience unnecessary. Salable Samples on approval. Free—Catalog. Personalized Christmas Card Album. Gift Offer. Hedenkamp, 361 Broadway, Dept. PM-97, New York, 10013.

PROFIT With Popular Mechanics' subscription plan. No investment, no experience needed. Earnings begin immediately when you obtain subscription for Popular Mechanics, Good Housekeeping and others. High commissions, bonus. No experience needed. Deal directly with the publisher. Write Popular Mechanics, Room 6B, 250 West 55th St., New York 19, N.Y.

FASTEST Growing! Most completely trained and equipped! Unlimited growth in your own professional cleaning services business. Moderate investment. For full information, write world's leading system—ServiceMaster, Dept. 490, Downers Grove, Illinois 60515.

HOW To prepare your own mailorder catalog for pennies. . . . including All Popular Merchandise! Free Catalog—Proof! Obie, 5711-MS—14th, Brooklyn, New York 11219.

AMAZING Automatic fishhook, free details. Sample \$1.00 refundable. Aron, Post Box 61-PM, Mastic Beach, New York 11951.

DON'T WORK for others! Order money-making booklets today. "How To Make Money—On Government Surplus (MO-50S)—In Mail Order Imports (MO-52I)—Collecting Coins (MO-53C)—With Your Camera (MO-54P)." \$1.00 each. Homestead House Gifts, Dept. 119, 817 Chestnut Street, Grand Forks, North Dakota 58201.

TRUCK CAMPER FRANCHISE National Advertised Brand Retail \$795. Big Profits Requires \$3000. Inventory Investment Write: Tour-A-Home, P. O. Box 467, Dept. C Port Huron, Michigan 48060.

QUIT Job! Work Home! Free confidential information with book "990 Little-Known Businesses." Willfind, Box 11432K, Phoenix, Arizona 85017.

FREE Book: "609 Unusual, Successful Businesses!" Box 51-PZ, Des Plaines, Illinois 60017.

TREMENDOUS Opportunities in growing mail order field. Earn and learn at home. Details 25¢. Bennet Enterprises, Box 98-PM, Richmond, Indiana, 47374.

PLASTERCRAFT Molds, liquid rubber, plasters, floccs, candle supplies. Catalog and manual free. Blue Rapids Supply, Blue Rapids, Kansas 66411.

\$1000 MONTHLY \$2.00. Details free. Melotz, 2350 West 47-A, Denver, Co. 80211.

DIFFERENT! Outstanding profits from high quality mailorder businesses. Complete setup; not just instructions. Hermes Co., 152 West 42, New York City 10036.

BIG Money—making new greasable donuts in kitchen. Everything furnished. Sell stores. Free receipts. Montgomery Ray, Waseca, Minn. 56093.

MAILORDER Advertising, analysis, consultation, etc. Details. Earl, Box 626-PM, Dania, Florida 33004.

SELL Books the Torrey way! \$40,000 yearly possible. No inventory, low capital start. Write Bradshaw's, Burgin, Kentucky 40310.

HOME Electronics course only \$26.95. Free literature. Edu-Kits, Department 699B, Hewlett, New York 11557.

SELL Lifetime, Metal, Social Security Plates. Big Profits! Sample and Sales Kit Free. Russell, Box 286-PM, Pulaski, Tennessee 38478.

BIG Money raising fishworms and crickets. Free literature. Carter Farms, Plains, Georgia 31780.

INSTALL Burglar alarms without previous experience or costly equipment. Big profit. Free details. Nasco, 11071 Massachusetts, Dept. B2709, Los Angeles 90025.

NEW Plan! Pays up to \$25.00 an hour! Little as 4 hours weekly. Place Thriftee self-service displays in stores. No cost to merchants. No experience needed. Free details. Lux Company Incorporated, Dept. 1000, Elkhart, Indiana 46514.

FREE Report, "Forty Ways To Make Money At Home." Immediate earnings! Wyman, A-231, Congers, New York 10920.

MEDICARE—Social Security. Earn top fees assisting clients obtain maximum benefits. National Tax School, Monsey, 302VA, New York 10052.

"START Your Own Home Mail Order Business." New dealers wanted. No investment. FREE Details. Bay House, Pasadena, Md. 21122.

MAKE Money with foreign imports. Write. Valley House, Harrisonburg 3, Virginia 22801.

OPERATE Restaurant. Free booklet reveals profitable plan. Write Restaurant Business School, Dept. EC 98 1920 Sunny-side, Chicago, Illinois 60640.

BIG MONEY MAKER! Custom Furniture Upholstery plus Auto Trim, Slip Covers, Drapes, Tremendous spare-full time earnings. Men, women, all ages. No experience required. We furnish everything: Easy Home Instruction, Tools, Supplies to build roomful of beautiful furniture . . . yours to keep—sell! Approved for Veterans. Send for Big FREE Illustrated Book. Modern Upholstery Institute, Box 899-BAM, Orange, California 92669.

PREPARE Tax returns—Policeman Albert Myers made \$2000 his very first season. Train at home. VA Approved. National Tax School, Monsey, 2VA, N.Y. 10952.

HOW To start a Secondhand Business. Free information. Empire, 13292f Euclid, Garden Grove, California 92640.

CALIFORNIA MANUFACTURER NEEDS man to assemble our product and be local agent, experience unnecessary. May start while presently employed. Five figure income for responsible applicant. Write, S.K.R.M. Manufacturers, 2540 Olive Ave., Long Beach, California 90806.

"MAILORDER" No investment in products! Free Catalog! Methods, 1838-FD, Lafayette Hill, Pennsylvania 19444

MAKE Money Operating Home Mailorder Business. No Inventory. Write Purple Enterprises, Box 16291AX, Jacksonville, Fla. 32216.

OPERATE Home mailorder business! Send stamp. Vosacek Printing, Box 1217-A Garden Grove, Ca. 92640.

NOW! A list of 500 firms that can put you in business. Send \$1.00. Ross, 837 Glenway, Inglewood, California 90302.

CASH For newspaper clippings. Free details. Foren Associates, 176 Federal, Boston, Mass. 02110.

DATA-CRAFT Agency. A dignified spare-time business. Compile service reports for local firms. Start at home. Write: Data-craft-71A, Harlingen, Texas 78550.

I RAISED \$250,000 Business Capital. Helped others start. \$5. investment—free proof. Counselor-17, Harlingen, Texas.

\$200 WEEKLY in your own mailorder business. Free Details. Manor Sales, 4651 North Manor, Chicago, Illinois 60625.

MAILORDER Beginners. Start Correctly! Details, Phillips, Box 164, Staten Island, New York 10314.

MAILORDER Book publisher wants dealers. Wonderful "drop-ship" proposition. Sample imprint circulars free. Neil H. Tasker, Shamokin, Pennsylvania 17872.

430% PROFIT Selling Books By Mail! Free Details. D&B, Box 338-A, Holland, Michigan 49423.

TRIPLE Your Income!! Buy Japan's+ Europe's wholesale catalogs!! 7,500 pages, \$30.00. Samples, \$2.00. Millionaire-M9, 57 West 76th, New York City 10023.

PROFIT With Popular Mechanics' subscription plan. No investment, no experience needed. Earnings begin immediately when you obtain subscription for Popular Mechanics, Good Housekeeping and others. High commissions, bonus. No experience needed. Deal directly with the publisher. Write Popular Mechanics, Room 9B, 250 West 55th St., New York 19, N.Y.

MAILORDER . . . Profitable! Tested! No merchandise investment. 100% markup. Dynamics, 1430P Wells, Milwaukee, Wisconsin 53233.

FREE FRANCHISE JOURNAL MAGAZINE with over 100 business opportunities. Franchise Journal, 892-G West 16th St., Newport Beach, California 92660.

TAKE Orders for business printing. Earn money full or part time. No investment, experience, collections. Build repeat order business. Free kit. Allstate Press, 2006-PM North Pulaski, Chicago, Illinois 60639.

250,000 NEW Mothers Every Month! Bonanza for Bronzed Baby Shoes! \$50.00 a day profit. No investment, no inventory. Full or spare time. Exciting details Free. Sentimental, 1919 Memory Lane, Dept. 81, Columbus, Ohio 43209.

NEW-Business opportunities buyers guide. Tells where to find everything, including merchandise, suppliers, advertising sources. Alphabetically arranged. Over 70 headings/500 listings. \$2 ppd. Free brochure. INDEX, Box 146-C, Burlington, Indiana 46915.

MAKE MONEY AT HOME! Inside Reports 5 unusual small businesses run from your home on a shoestring. Money back guarantee. All 5 Confidential Reports, only \$2.98 ppd. FREE Catalog. Jesse Black & Co., Rt. #3, Box 15, 7th Avenue, Arab, Alabama.

MONEYMAKING OPPORTUNITIES

BECOME Notary Public! Free particulars. Stationers Exchange, 405-PM Rich- ardt, Evansville, Indiana 47711.

LEARN The secrets of repairing junk batteries. "Fabulous Profits" at home. Batteryman, Palm Desert, California 92260.

\$200.00 FROM Sheet 1/4" plywood (scrap). Details 25¢. Novelties, 610 So. 24th, Elwood, Indiana 46036.

EARN \$240.00 a month at home, spare time, doing only two \$5.00 invisible mending jobs a day. Big money paid for service that makes cuts, tears disappear from fabrics. Steady demand. Details free. Fabricon, 1532 Howard, Chicago 60626.

LEARN To Fix Typewriters. Desperate shortage trained men. Hundreds needed. Make up to \$25 in one hour. Learn at home in spare time. Industry approved course. Facts free. Send name. Typewriter Repair School, Dept. 3310-098, Little Falls, New Jersey 07424.

HOUSEHOLD And food products route. \$25.00 or more daily profit. Larger repeat orders. Man, woman. Full, part time. Mc-Ness, Freeport 26, Illinois 61032.

WATCH REPAIRING. Swiss and American watches. Develop skill step by step in spare time at home. Diploma awarded. Free sample lesson. Chicago School, Dept. YJA, Fox River Grove, Ill. 60021.

EXTRA Income at home in Spare Time! Booklet shows you how to start your own business with Classified Advertising. Only \$1.00. Martin, Popular Mechanics, Dept. P-98, 575 Lexington, New York 10022.

SELL Advertising book matches. Write us today; we put you in business by return mail, handling complete line ad book matches in demand by every business right in your town! No investment; everything furnished free! Top commissions daily! Superior Match, Dept. MA968, 7530 S. Greenwood, Chicago, Ill. 60619.

MAKE \$12.00 Profit each dozen assembling Belts. Details: Send Stamp. Red-kut's, Loganville 40, Wisconsin.

HOMEWORK. Mailing circulars, salary! Free details! Cam Company, Dept. 155-KP, Verona, N.J. 07044.

WANT To win a contest? Write Prize-winner, Box 11569, St. Petersburg, Fla. 33733.

HOMEWORKERS! 200 companies—42 page Directory. FREE details. Quest Enterprises, Box 6029, Dept. 19, San Jose, California 95150.

RAISE Rabbits and fishworms on \$500 month plan. Free details. White's Rabbitry, Mt. Vernon, Ohio 43050.

MAKE Statuettes, novelties, imitation marble. Sell to stores or start gift shop. Free details. Marbleizing, 41 Waverton, St. Louis, Mo. 63124.

OWN A franchised business! Learn who to contact. Over 750 franchising firms in 1968 Franchise List. Send \$1.00 today to National Franchise Reports, WP-528, 333 North Michigan, Chicago 60601.

CLIP Newspaper items. \$1.00-\$5.00 each. Details free. Walter, Box 1360-P, Erie, Pa. 16512.

BIG profits in becoming a supplier to Major Industry through electroplating small parts and metalizing non-metals. Write for free particulars: Mason, Room CM-2-HO, 1512 Jarvis, Chicago, Ill. 60626.

VENDING Machines. No selling. Operate a route of coin machines and earn amazing profits. 32-page catalogue, free. Parkway Machine Corporation, 715 PMM Ensor Street, Baltimore, Maryland 21202.

\$800.00 WEEKLY. My net profit, year. Magic Method Mail Selling. Free proof with samples, send stamped, addressed envelope. C. Brewster, Clearwater, Florida 33577.

FOLIO Listing \$5,000.00 Spare-time Opportunities. Homeworkers, 18643 Ventura, Tarzana, Calif. 91356.

GOOD Money in writing. Write short articles at home. Copyrighted report tells how and where. Directory included. Send \$1.00. Stautz, Dept. PM8, 601 East 53rd, Austin, Texas 78751.

MANUFACTURER Offers quality line of automotive chemicals. High profits. Repeat sales. Choice territories open. Write for catalogue and details. Cleanbright Dept. 208-2202 Folin St., Bronx, New York 10457.

FREE. 206 Easy ways to make money taking orders for exciting new products—spare time. Send name, age, for 5 months free subscription. Opportunity Magazine, 850 N. Dearborn, Dept. 17-HM, Chicago 60610.

SPARE Time cash. Sell Famous Hanover Shoes. Actual samples and sales kit Free. No experience needed. No age limit. Lowest prices for high quality makes selling easy. Every man a prospect. Big daily commissions. For full details, write Han-over Shoe, 419 Carlisle, Hanover, Penna.

MAKE MONEY AT HOME. 'Inside' reports reveal 5 unusual small businesses you can start on a "shoestring", run from your home. No door to door selling. Reports give facts, figures, case histories, how to start. Money back guarantee! All 5 Confidential Reports, Only \$2.98 ppd. Rudolf Herford, Dept. B, 2729 Midvale Ave., Los Angeles, Calif. 90064.

PANELISTS AT HOME WANTED BY NEW YORK RESEARCHER. Leading research firm seeking people to furnish honest opinions by mail from home. Pays cash for all opinions rendered. Clients' products supplied at no cost. For information write: Research 669 Mineola, N.Y. 11501 Dept. CE-24.

OPPORTUNITY Mail—25¢: Carman, 350-M, Groveport Rd., Columbus, Ohio 43207.

MAKE Extra Money—Show friends, neighbors—Gifts, Stationery, Toys, Jewelry, Greeting Cards. Experience unnecessary. Salable Samples on approval. Free-Catalog, Personalized Christmas Card Album, Gift Offer. Hedenkamp, 361 Broadway, Dept. PM-97, New York 10013.

HOW To Make money writing short paragraphs. Information free. Barrett, Dept. C-27-H1, 6216 N. Clark, Chicago 60626.

YOU Need only a mimeograph machine and ruler to become financially independent! Sensational details 25¢ Via Associates, Box 28072-MR, Washington, D. C. 20005.

MAKE Money collecting coins. Send \$1.00. A. Snyder Company, 609A Main, Bangor, Pa. 18013.

VX-6 SALE, \$1788 retail, \$500 cash; make 250% profit. 2135 Calabazas, Santa Clara, Calif. 95051.

WE Guarantee 50¢ for every newspaper clipping or photo sent to us. Details only \$1.00. Box 83, Knox City, Texas 79529.

MAKE Amazing profits winning contests. Fool proof method. Free Details. Cook, 2132 Hamlin Road, Hamlin, New York 14464.

\$100.00 WEEKLY and more spare time mailing our circulars. Everything furnished. Details, send stamped self addressed envelope immediately! Enterprises, Box 16143-PM, Phoenix, Arizona 85011.

FREE Folder: "\$50,000 Part Time!" MTD Service, Box 3778, San Ysidro, Calif. 92073.

FIVE Businesses you can start at home. Complete facts. Make money. Satisfaction guaranteed. All five \$2.98 postpaid. White's, PM-1, 830 Spruce, Rock Hill, S.C. 29730.

GOLD Mine in your hands! Thousands of camera owners are **SELLING** their pictures. Amazing booklet tells how. Send \$1.00. Gordon's Gifts, 70 Joseph Rd., Framingham, Massachusetts 01701.

MAKE Big Easy Profits making costume jewelry at home, spare time! Quick, easy to make; easier to sell! Details Free! DonBar, 2934 Fullerton, Dept. K-208, Chicago, Ill. 60647.

SILVER—STRIKE IT RICH! Earnings unlimited reclaiming pure bullion silver from photographic developing solutions. Be first in your area. Rush \$3.00 for step-by-step instructions. Associated Ag. Processors, 210-A Fifth Avenue, New York City 10010.

MAKE \$5,000 yearly, sparetime, raising mink, chinchilla, nutria, etc. Free booklet reveals proven plan. Write: Furs, Dept. R, Bewdley, Ont. Canada.

EXTRA Income? Sell lifetime, metal, social security plates. Big Profits! Free sample. Perry Wright, Box 3053, Paterson, N.J. 07509.

GREATER PROFITS in rack merchandising. Free details! The Thomas Company, Box 235-A, Greenwood, Indiana 46142.

FREE CATALOG of amazing gift, self-improvement, money making opportunities. Pilot's Chronograph, Scientific breakthrough stops smoking for good. Write short fillers. Livingood's 1542 Pickett Road, Lutherville, Maryland 21093.

YOUR Own mail order business. Complete dropship setup. Mail \$3.00. Aycock's, Box 107-PM, Douglas, Ga. 31533.

HOW To raise capital for your needs. Details free. Bernard's, 122-B Central Avenue, Faribault, Minnesota 55021.

BIG Money raising fishworms and crickets. Free literature. Carter Hatchery, Plains, Georgia 31780.

MAILORDER Imports. Report Reveals Foreign Drop-Ship Sources, World Trader's Digest, Ideal Mailorder Items, \$1.00. Rhodes, 3963 Altamont, Oakland, California 94605.

\$140.00 DAY'S Homework! Haines, 86 Great Hill Rd., Seymour, Conn. 06483.

CASH With your camera! Sell your photos. Report tells how, where. \$1.00. P&M Sales, 207 Palm, Hamlet, N.C. 28345.

MAKE Money with imports. Our directories show where to buy. \$3.00. May & McNeil, 1041-PM East Wardlow Road, Long Beach, California 90807.

HOW To get rich! Success secret of wealthy investors. Details \$3. BEZARD, 610 Patton, Jackson, Mississippi 39216.

WE PARLAYED \$488 INTO \$9746 last year in the stock market. To learn how, send \$1.00 for 4 pages of stock rules we used to forecast which stocks would go up. Then take off and go! Stock Rules, 5225 Northfield, PM-9 Bedford, Ohio 44146.

EARN \$5 to \$15 PER HOUR at HOME, part or full time. Guaranteed method suitable rural, town, city, adults, children. Your limited investment 100% convertible to cash. Complete instructions, \$1.00. Teach-Me Publications, Box 491-B, Wallingford, Conn. 06492.

AMAZING Detailed report how I pyramided \$112 to \$13,000 in the stock market. Plus 20 invaluable steps I followed for success. Send \$1 to Alan Roberts, 13338 Albers St., Van Nuys, Calif. 91401.

"MR. VENTUROUS", Here's an amazing chance to change your life. Top earnings, Early retirement. Write, Leisure Way, U.S.A., Box 9601, St. Louis, Mo. 63122.

IF YOU Want to make a quarter of a million, a half a million dollars, or more! Overnight! Then **YOU OWE IT TO YOURSELF** to see this **AMAZING METHOD** you can't even afford NOT to try! Send \$10 cash, check, or Mo. to: G. W. S. Associates, 611 Princess, Kingston, Canada.

MAKE Money Operating Home Mail-order Business. No Inventory. Write Purple Enterprises, Box 16291AXI, Jacksonville, Fla. 32216.

SWEEPSTAKES Contests. How To Win. Write for free particulars. General Contests, 1809-18 East Fifth, Duluth, Minn. 55812.

\$500—\$800 MONTHLY. Raise small laboratory-breeding stock for us. We supply equipment, breeders, instructions. Illinois Research Farms, Dept. MP-9, 2711 Justen, McHenry, Illinois 60050.

PROFITABLE OCCUPATIONS

BECOME A mortgage broker, earn \$10,000 to \$50,000 a year. Details free. United, Box 6284-C, Marietta, Georgia 30060.

CHROME Plating. Instructions, equipment and supplies. Platers' Supply, P.O. Box 565, Lugo Station, Los Angeles, Calif. 90023.

FT. Smith Auction School, Ft. Smith, Ark. 2 locations. Resident & home study. Veteran approved.

RAISE Rabbits for us on \$500 month plan. Free details. White's Rabbitry, Mt. Vernon, Ohio 43050.

YOUR Own Sign shop, Signs 410-S So. Western, Springfield, Ohio 45506.

FREE Book "990 Successful, Little-Known Businesses." Work home! Plymouth-27J, Brooklyn, N.Y. 11218.

EASY-To-Start rubber stamp business at home in spare time. Make up to \$16.50 an hour without experience. Facts free. Write to: Roberts, 1512 Jarvis, Room CR-2-HO, Chicago, Ill. 60626.

EARN \$240.00 A month at home, spare time, doing only two \$5.00 invisible mending jobs a day. Big money paid for service that makes cuts, tears disappear from fabrics. Steady demand. Details free. Fabricon, 1586 Howard, Chicago 60626.

SCIENTIFIC MASSAGE: BIG EARNINGS uncrowded profession. Learn spare time at home. Diploma awarded. Free catalog. Write: Anderson School, Dept. L-I-C, Princeton, Illinois 61356.

HOW To Make Money Writing Short Paragraphs. Information Free. Barrett, Dept. C-27-H2, 6216 N. Clark, Chicago 60626.

REFRIGERATION—Appliance course, Analyzer, \$29.95. Free literature. Ace Appliance, 1465 North Clifton, Springfield, Missouri 65802.

NEW Modular technique makes you successful advertising man overnight. Free details. Box 87-P9, Hollywood, Florida 33022.

BAKE New greaseless doughnuts in kitchen. Sell stores. Free recipes. Michael Ray, Waseca, Minn. 56093.

JANITORS—Cleaners—Custodians. Get a better job—Make more money. Become a maintenance supervisor. Homestudy details free: Maintenance Training, 907 Lakecrest, Fairport Beach, Ontario.

MAKE GIFT AND SOUVENIR ITEMS IN YOUR HOME FOR PROFIT. Send 50¢ for catalog which includes wholesale sources for hundreds of component parts and craft supplies. Merry Madison Handicrafts, Dept. PM9, 500 W. Florida St., Milwaukee, Wis. 53204.

BIG Money raising fishworms and crickets. Free literature. Carter Wormery, Plains, Georgia 31780.

SALESMEN—DISTRIBUTORS

FREE Selling outfit. Office supplies, furniture & equipment. Osoco, 15-PM North Jefferson, Chicago, Ill. 60606.

MAKE Extra \$25 to \$75 spare time! Take orders for double air cushion Bronson Shoes. Amazing comfort. Terrific men's, women's line for dress, work, play. Highest commissions. Shoes for yourself. Big outfit free. Write Bronson, Dept. 669, Minneapolis, Minnesota 55408.

SELL Advertising book matches. Write us today, we put you in business by return mail; handling complete line ad book matches in demand by every business right in your town! No investment; everything furnished free! Top commissions daily. Superior Match, Dept. M968, 7530 S. Greenwood, Chicago, Illinois 60619.

EARN Big Commission full or part time. Show America's largest line low priced Business Printing and Advertising Specialties. Plus calendars in season. No experience. No investment. No collections or deliveries. On-the-Spot commissions. Big Free Sales Kit samples hundreds items used daily by businessmen. Merchandise bonuses for you. Free gifts for customers. Build profitable repeat business. Start now. National Press, Dept. 806, North Chicago, Ill. 60064.

EARN Terrific commissions listing delinquent accounts. General Finance Company, 304-A Pickwick Building, Kansas City, Mo. 64106.

FREE Franchise: Everything you need for your own shoe business absolutely free. No experience. No investment. Immediate cash commissions. Earn 8 different ways with own franchise sales team. Make money with exclusive invention. America's fastest growing shoe company. Write: Ortho-Vent Shoe Co., 1189 Brand Road, Salem, Virginia 24153.

PERSONAL Protective Devices Now In Big Demand due to increased crime rate. Proven. Sell easy to Drive-ins, Stores, Nurses, Night Workers, Motorists. Sales experience unnecessary. Get profit details now. Hagen Supply, Dept. CLA9, St. Paul, Minn. 55107.

FREE, 206 Easy Ways to make money taking orders for exciting new products—spare time. Send name, age for 5 months free subscription. Opportunity Magazine, 850 N. Dearborn, Dept. 17-HS, Chicago 60610.

GET New shirt outfit free! \$90 weekly on 5 average orders a day. Famous quality made-to-measure dress and sport shirts at \$4.95 up, sell to all men. No experience needed. Full or part time. Write: Packard Shirt Co., Dept. 919, Terre Haute, Indiana 47808.

NEW Car Thief Signal, Lightning Seller. Samples for trial. Northwest Electric, Ave. 487, Mitchell, S. Dak. 57031.

GOOD MAN. Mature. Short trips around county. Part time. Excellent earnings. Write Cyclo Mfg., 3816 Dahlia, Dept. 158, Denver, Colo.

SELL ADVERTISING BALL POINT PENS—Advertising Specialties—Calendars. Free details, or sample kit \$1.00—(Refunded first order). Full or part time. Fleming, 6535-PM Cottage Grove, Chicago 60637.

MAKE Extra Money! Introduce new Miracle Cantreze Nylons. Amazing low price. Guaranteed never to run. We show you how. Big outfit, sample stocking free. Spare time cash year-round. It's easy. Write American Hosiery Mills, Dept. A189, Box 753, Cincinnati, Ohio 45202.

100% PROFIT—Sweet Georgia Brown Cosmetics sell fast. Write for Sample Case offer. Valmor, Dept. H, 2411 Prairie, Chicago 60616.

SELL Hertel Bibles—Part Time. Finest reference Bible available. Demonstrator and supplies furnished. Excellent commissions. Write International Book, Dept. PM, Box 118, Wichita, Kansas 67201.

AGENTS WANTED

EVERY Man a prospect. Refundable sales kit offer showing line belt buckles, tie clasps, money clips, cuff links, lapels, identification badges, individualized with customer's name and emblems. Cap badges for trucking, bus, taxi, police, firemen, also postal, letter carriers and heavy construction emblems. Choice 3000 emblems. Hook-Fast, Box 1088PM, Providence, R.I. 02901.

MAKE \$50.00 Daily selling air-operated vacuum cleaners to service stations. Free details. Inka Industries, 2401 Crocker, Houston, Texas 77006.

PRINTING, Advertising Salesmen—Excellent moneymaking sideline selling Decalcomania Name Plates, small quantities. Advertising Specialties, sign letters. Free Samples. Ralco XL, Boston, Mass. 02119.

YOUR Own business—Used suits \$1.50; overcoats 65¢; mackinaws 35¢; shoes 12½¢; ladies coats 30¢; dresses 15¢. Enormous profits. Catalog free. Nathan Portnoy Associates, 2109-AA Roosevelt Road, Chicago Ill. 60608.

CHRISTMAS CARDS—Business and Personal. Customer's name imprinted. Earn unusually high commissions from this medium- and high-priced line. No investment. No inventory. Free Sample Album. Process Corp. (our 47th year), 3436 S. 54th Ave., Chicago, Ill. 60650.

LIFETIME Income, Business Loan Representative Write: Financial 28 E. Jackson, Suite 1204-X3, Chicago 4.

BIG Money! Sell devices for personal protection! Write H&H Supply, Box 5073-C, St. Paul, Minnesota 55104. (Adults only).

SELL Gifts, Household Items—Make extra money. Gifts, Jewelry, Stationery, Greeting Cards. Experience unnecessary. Salable Samples on approval. Free—Catalog, Personalized Christmas Card Album, Gift Offer. Hedenkamp, 361 Broadway, Dept. PM-98, New York, 10013.

SELL Greeting Cards—Make extra money. Gifts, Toys, Jewelry, Stationery.. 600 items. Experience unnecessary. Salable Samples on approval. FREE—Catalog, Personalized Christmas Card Album, Gift Offer. Hedenkamp, 361 Broadway, Dept. PM-99, New York 10013.

FREE, 206 Easy Ways to make money taking orders for exciting new products—spare time. Send name age, for 5 months free subscription. Opportunity Magazine, 850 Dearborn, Dept. 17-HA, Chicago 60610.

MAKE Extra money—Show friends, neighbors—Gifts, Stationery, Toys, Jewelry, Greeting Cards. Experience unnecessary. Salable Samples on approval. Free—Catalog, Personalized Christmas Card Album, Gift Offer. Hedenkamp, 361 Broadway, Dept. PM-97, New York, 10013.

WILL You test new items in your home? Surprisingly big pay. Latest conveniences for home, car. Send no money. Just your name. Kristee, 129, Akron, Ohio 44308.

AMAZING Christmas card profits, \$50.00 to \$500.00 cash in spare time. Plus bonuses. 250 easy money-makers. Free Personalized Album. Experience unnecessary. Charming \$1.00 "Sachet of Flowers" Keepsake Lavender Free for promptness. Approval samples. Creative, 4401 Cermak, Dept. 509-B, Chicago 60623.

BUSINESS KIT FREE! Postcard puts you in business! Complete line 275 shoe styles, jackets! New Discoveries pay Big Commissions. No investment. Send for Free Kit. Mason, K-602, Chippewa Falls, Wisconsin 54729.

WORLD'S Greatest Motivation Program Offers you unlimited earnings as Agent or Franchise Distributor. Choice areas available. Appeals to people in all walks of life. Address, Alpha Distributing Company, P.O. Box 816-M, Chicago, Illinois 60690.

WILL You test new items in your home? Surprisingly big pay. Latest conveniences for home, car. Send no money. Just your name. Kristee, 128, Akron, Ohio 44308.

INCREASE Your income! Take orders for sensational advertising stickers. Free samples. Presstiks, 534-A Danube, Atlanta, Ga. 30305.

EMPLOYMENT INFORMATION

AUSTRALIA Wants You! Government assisted passage. Unlimited Opportunities. Latest Government Information and Forms \$1.00 Austco, Box 3623-E, Long Beach, California 90803.

FOREIGN And USA job opportunities available now. Construction, all trades. Earnings to \$2,000.00 Monthly. Paid overtime, travel bonuses. Write: Universal Employment, Dept. C-1, Woodbridge, Connecticut 06525.

HIGH Paying overseas jobs, Construction, other projects, Bonuses, Travel Expenses, Extras, International Information, 124, Cortez, Florida 33522.

OVERSEAS JOBS—Engineers, Construction, Refinery Operation, Medical, Clerical, Worldwide Integrated List—Where, How Apply. \$4.00 to OVERSEAS ADVISORY SERVICE, Apartado Aereo 2897, Barranquilla, Colombia.

TREMENDOUS Opportunities U.S.A. overseas, choose jobs—locations, transportation. Free details. Occupations, International Airport, Box 100-C10, Jamaica, N.Y. 11430.

JOBS GALORE AUSTRALIA!! Government assisted transportation! Information packet and forms \$1.00. Associated, Box 17 B9, Lafayette, California.

HELP WANTED

OVERSEAS Jobs—Australia, Europe, South America, Far East, etc. Openings in all trades and Professions. \$400 to \$2,500 monthly. Free Information write National Employment Service (Foreign Division), Box 2235 P.M.F., Miami, Florida 33159.

OVERSEAS Jobs—Europe, South America, Australia, Far East, etc. 2000 openings all trades. Construction, Office, Engineering Sales, etc. \$400 to \$2,500 month. Expenses paid. Free Information. Write Overseas Jobs, International Airport, Box 536-M, Miami, Florida 33148.

FOREIGN Employment information, Construction, other work projects, Good paying overseas jobs with extras, travel expenses. Write only: Foreign Service Bureau, Dept. PM, Bradenton Beach, Florida 33510.

REAL ESTATE—FARMS

CANADIAN Vacation lands: Full price \$385.00. 40 acres. \$10 month. Suitable cottage sites, hunting, fishing, investment. Free information. Land Corporation, 3768-C Bathurst, Downsview, Ontario, Canada.

\$1 ACRE—Canadian Border—hundreds campsites, islands, farmlands, directly from tax authorities. (Non-profit). Lists, photographs mailed. Register, Room 303, 110 Church Street, Toronto 1, Canada.

CENTRAL Ontario—Choice 640 acre Sportsmen's paradises still available—\$20.00 plus \$6.50 taxes yearly. Maps, pictures. \$2.00 (Refundable). Information Bureau, Norval 4, Ontario, Canada.

GOVERNMENT LANDS . . . Low, as \$1.00 acre. Millions acres. For exclusive copyrighted report . . . plus "Land Opportunity Digest" listing lands available throughout U.S., send \$1.00. Satisfaction guaranteed Land Disposal, Box 9091-PI, Washington, D.C. 20003.

CANADIAN Lands, seized and sold for taxes. Our 51st annual series of lists, describe many choice properties, situated from coast to coast, acquired by us through Tax Sale. Priced as low as five dollars per acre, guaranteed perfect title, small monthly payments, no mortgage. Beautifully situated hunting and fishing camps, where there is real sport; summer cottage sites, heavily wooded acreages. Now is the time to invest in Canada's minerals, forests and farms. Write today for free booklet with full explanation. Tax Sale Service, Room 301D, 85 Bloor St., East, Toronto 5, Canada.

FLORIDA CAMPSITES—Deep in the heart of the great Ocala National Forest—where few individuals have the privilege of owning land. Isolated yet accessible, with electricity. Good fishing, hunting. Warranted Deed. Pitch tent, park trailer, build lodge. Free maps and photos. Howard Verner, DeLand, Florida, 32720. AD66LS149

CANADA'S Finest lands, \$4.00 an acre and up. Acquired through estate liquidations. Suitable for hunting, fishing, camps, cottages, farming, timber, minerals, investment. Small monthly payments. Free descriptive booklet. Canadian Estate Land, 194 Wilson Ave., Suite 101, Toronto, 12, Canada.

CANADIAN Fishing and hunting lands with substantial water frontage at low prices. Heavily wooded. Well situated. Great investment potential. Free booklet. Northern Corporation, 194 Wilson Ave., Suite 101, Toronto 12, Canada.

40 TIMBERED Acres \$1650.00 Total Price. Wash.—Idaho—Mont. \$50.00 Down—\$25.00 month, in Northern Idaho, North-eastern Washington, and Western Montana. In the heart of lakes and big game country. All covered with growing timber. Access, title insurance with each tract. This is select land with natural beauty, recreational and investment values. We have tracts of many types and sizes from which to choose, including Waterfront property on Pend Oreille, Priest, Kettle and the St. Joe Rivers and in Pend Oreille Lake area. Your inspection welcomed. Write us for free list, maps and complete information. Write to: Dept. PI, Reforestation, Inc., P.O. Box 8146, Spokane, Wash. 99203.

IOWA Land—1 square ft. \$1.00. Void where illegal. Albert's, 601 West South, Jefferson, Iowa 50129.

FREE! Real Estate Catalog! Fall Edition! Farms, Ranches, Business, Recreational and Investment Property. BANNER Adv., P.O. Box 3333 GS, 19A, Springfield, Mo. 65804. "Real Estate Our Specialty"

FREE REAL ESTATE CATALOG loaded with outstanding bargains and actual property photos! Send for your copy today! SAFE-BUY REAL ESTATE, 712-PM West Third, Little Rock, Ark. 72203.

ALL NEW! FREE! Big 196 page FALL CATALOG! Thousands of properties described, pictured—Land, Farms, Homes, Businesses—Waterfront, Recreation, Retirement. Selected Best thruout the U.S. 68 Years' service, over 500 Offices, 39 states Coast to Coast. Mailed FREE from the World's Largest! STROUT REALTY, 80-RX E. 42nd St., N.Y., N.Y.; 7X S. Dearborn, Chicago, Ill.; 521-RX E. Green, Pasadena, Cal.

BUY Without risk for Retirement, Vacation, or investment—under America's only "No-Risk Purchase Plan"—in Carolina Coast multi-million dollar, 14,000-acre development. 10 year money-back guarantee. ½-acre homesites as low as \$495; \$5.00 down, \$5.44 monthly. Motel, hunting, fishing, golf, country club, right on property. Private ocean beach, 50 fresh water lakes. Write for free literature. (Not offered to residents of California, Florida, New York.) Boiling Spring Lakes, Southport 1-A, North Carolina 28461.

FREE. . . New FALL-WINTER CATALOG! Describes and pictures over 2,000 farms, ranches, town and country homes, businesses in 32 states coast to coast! Specify type property and location preferred. Zip code, please. UNITED FARM AGENCY, 612-PM West 47th St., Kansas City, Mo. 64112.

GOVERNMENT Lands One Cent An Acre. For exclusive report send \$1.00 to: National Lands, Box 241-E, Massapequa, N. Y. 11758.

MODERN RAMBLER with body shop and well established business 4 miles south of Duluth \$20,000. Write box 271, Carlton, Minn. 55718.

FARM AND GARDEN EQUIPMENT

EXTRA Income at home in Spare Time! Profit Booklet shows you how to start your own business with Classified Advertising. Only \$1.00. C. A. Martin, Popular Mechanics Dept., PM, 575 Lexington Ave., New York 10022.

SPRINKLER Systems. Easy assembled. Lawn, garden, orchard, etc. Buy wholesale. Free details. Waterchamp Box 3336 So. El Monte, California 91733.



FLOWERS, PLANTS and NURSERY SUPPLIES

WANT Greatest cash crop working for you? Write Ginseng, Asheville 53, N.C.

GROW A COAL CORAL PLANT Kit includes coal plus instructions. \$1.98. A.C. Oldt, 4250 South Drive, Allentown, Pa. 18103.



DRINKING WATER-PURIFIERS

MAILORDER Records help get Increased Business! Complete 32 Page Record Book shows your inquiries, orders, advertising, expense, etc. Only \$1.00. C. A. Martin, Popular Mechanics, Dept. PM, 575 Lexington Ave., New York 10022.

MAKE Bottled water from any water supply. Government developed process, pressure osmosis (R/O). We make simple home unit. Free details Waterchamp, Box 3336 So. El Monte, California 91733.

HOME CRAFTSMEN

CABINETMAKING MADE EASY and "How to Make Formica Counter Tops," two excellent guides let you build kitchen cabinets and counter tops like professionals. Extraordinary guides bring master craftsmen's shortcut methods. Satisfaction guaranteed. Write: Japs, 126-P Seventh North, Hopkins, Minn. 55343.

WALNUT And Cherry tapered legs, lumber, gunstock blanks, picture frame moulding. Midland Lumber Company, Box 262, Savannah, Missouri 64485.

FREE Popular Mechanics 16 page illustrated catalog of publications, plans and projects. Booklet covers an extremely wide variety of do-it-yourself data on home remodeling, shop tools and machines, car repair, hobbies, crafts, boating, games, lawn and garden and hundreds of others. For your free copy write to Service Bureau, Dept. PE, Popular Mechanics, 575 Lexington Ave., New York, N.Y. 10022.

PLANS For pool table with extra two-face top for table tennis and model railroad. Blueprints B1209 and building instructions \$3.50. Popular Mechanics Service Bureau, 575-M Lexington Ave., New York, N.Y. 10022.

SKIL-CRAFTS New 200-page '67-'68 Catalog. Largest selection of Leathercraft, Artist, Hobby and Craft Supplies from one source. Send 50¢ (refunded with first \$5 minimum catalog order). Skil-Crafts, Box 105-P, Joplin, Missouri 64801.

FOUNDRYETTE 2400 F. 1½ to 48 lb. capacity. Circular 10¢. Kansas City Specialties, Box 193, Middleton, Wis. 53562.

FREE! World's largest leathercraft catalog. Hundreds of Make-it Ideas. Tandy Leather Co., Dept. J-65, Fort Worth, Texas.

WOODWORKING Catalog and Manual 25¢. Plus free "101 Project Ideas." World's most beautiful veneers, lumber, plywood! Wood finishing, upholstery supplies, Cane, Lamp parts, Furniture hardware, Animal whittling blocks, 2,000 workshop products. Constantine, 2051-N, Eastchester Road, Bronx 10461.

101 PATTERNS Of smart Gifts, Novelties, Shelves, Action Windmills plus "Make Money Jig Sawing", \$1.00. Mastercraft, 95M, 7041 Olcott, Chicago 60631.

PLANS Bird Houses, Feeders. Send 10¢ for Brochure. Yeager, 1665 Linden, Homewood, Ill. 60430.

FAMILY Or party fun. Nine foot shuffleboard type game. Two evenings work. Plans, \$1.00. Williams, 824 Abbot Ave., San Gabriel, California 91776.

54J POPULAR MECHANICS

PLANS, Authentic Baby Barn Utility Buildings. Send 25¢ for brochure. Mini Structures, 204 Poplar, Westfield, Indiana 46074.

FIRE Conscious? Advanced design fire extinguishers—Kidde, Fantastic discounts! Postpaid. Free details. Richard Minnich, 11507 Lovejoy, Silver Spring, Maryland 20902.

UPHOLSTERY

MAILORDER Records help get Increased Business! Complete 32 Page Record Book shows your inquiries, orders, advertising, expense, etc. Only \$1.00. C. A. Martin, Popular Mechanics, Dept. PM, 575 Lexington Ave., New York 10022.

DO-IT-YOURSELF

EXERCISE At home on build-it-yourself physical fitness equipment, including bicycle exerciser, rowing machine, belt massager, and abdominal board. Send \$2.50 for blueprints B1208 and instructions. Popular Mechanics Service Bureau, 575-K Lexington Ave., New York, N.Y. 10022.

BURGLAR-FIRE ALARM Supplies and information. For homes and businesses. Send \$1.00 (refundable) for catalog to: Protecto Alarm Sales, Box 357-A, Birch Run, Mich. 48415.

WIRING SIMPLIFIED for home and farm. 127 pages illustrated instructions Postpaid \$1.00. Hood, 610 N. Bois d'arc, Tyler, Texas 75701.

WATER!! Drill Your Own Well for 2¢ per foot! New Invention! Free information. Deep Rock Drilling Company, Opelika, Alabama 36801.

EXERCISE At home on build-it-yourself physical fitness equipment, including bicycle exerciser, rowing machine, belt massager, and abdominal board. Send \$2.50 for blueprints B1208 and instructions. Popular Mechanics Service Bureau, 575-K Lexington Ave., New York, N.Y. 10022.

REFRIGERATOR Door gaskets—ELECTRIC RANGE parts. Send make and model for cost. Box 5465, Hamden, Conn. 06518.

REPAIR Manuals, automatic washers, dryers, dishwashers, 20 different manuals, \$2.75 each Ppd. Send make and model number. Major Appliances, 13106 Caine Ave., Cleveland, Ohio 44105.

MAKE GRANDFATHERS Hilarious toys. Instructions 25¢. Hill, Box 351 Point Arena, Calif. 95468.

AVOID Expensive television repairs, amateurs repair guide, \$3.50. Maine Electronics, Box 5673, Tucson, Arizona 85703.

WATER—Free! Drill your own well. Easy illustrated instructions. \$2.00. Butler, Box 67Y, East Longmeadow, Mass. 01028.

ARTS AND CRAFTS

MAKE Figurines, plaques, lawn ornaments. Molds, plastercraft kits, liquid rubber. Sample and catalogue 10¢. Wooley Company, Box 29-B, Peoria, Illinois 61601.

192 PAGE Handicraft Catalog. Free. All Crafts, Steece Bros., Box 177-PM, Sioux Falls, S. Dak. 57101.

WOOD VENEER Inlay Pictures. Easy new method to make beautiful inlays for profit or pleasure. Complete details—\$5.00. Collet, 620 Steiner, Pittsburgh, Pa. 15227.

BINOCULARS, TELESCOPES, MICROSCOPES, MAGNIFIERS

BINOCULARS Direct from manufacturer. Finest quality, tremendous savings! Request catalog. Koyu, 3850 Crenshaw Blvd., Los Angeles, Calif. 90008.

WORLD Famous "Dyname" Telescope. Build your own reflector telescope, mirrors, eyepieces, tripods, accessories. Request free brochures. Criterion Manufacturing, Dept. PP-23, Hartford, Connecticut 06101.

SCIENCE Bargains! Lenses, telescopes, binoculars, microscopes, kits, parts, war surplus. Send \$1.50 for beginner's 10-lens kit with instruction booklet. Order Stock 2-CH. Request free 148 page Catalog CH. Edmund Scientific Co., Barrington, New Jersey 08007.

BINOCULAR Sale! Free color catalog 100 models \$9.95-\$250.00. Write, United, 9043 So. Western, BCAT-8508, Chicago 60620.

MANON Binoculars. Buy direct from importer. Best quality and prices. Write: Manon, Dept. M, Box 1386, Huntington Beach, California 92647.



CAMERAS AND EQUIPMENT

POLAROID Camera Owners Make Extra Copies Instantly. Free Brochure. Rhedan Electronics, Box 42P, Bridgeport, Connecticut 06601.

WORLD'S Largest Buying Guide—800 Illustrations—50¢—Deductible With Your Order—Olden Camera—1265 Broadway, New York, N.Y. 10001.

PHOTO SUPPLIES

MAILORDER Records help get Increased Business! Complete 32 Page Record Book shows your inquiries, orders, advertising, expense, etc. Only \$1.00. C. A. Martin, Popular Mechanics, Dept. PM, 575 Lexington Ave., New York 10022.

BARGAIN Prices on film, cameras! Free price list. Michigan Photo Supply, 14321 Harper, Detroit, Michigan 48213.

PHOTO FINISHING

A FREE Kodak roll returned with each black and white or Kodacolor developed and printed, fast service, lowest prices, guaranteed quality send for free mailers. Economy Photo Service, Dept. P.M., Box 1111, Albany, N.Y. 12201.

CAMERA Fans! Expert photofinishing and fresh Kodak film returned: 8MM Kodachrome \$3.45; 8 exp. Kodacolor \$3.40; 35MM Kodachrome, 20 slides, \$3.15; 8 exp. black & white 99¢. We give you free photo stamps to redeem for gifts. Satisfaction guaranteed. Send exposed film or request mailers and complete price list. Direct Mail Photo, Box 8352-PM, Pittsburgh, Pa. 15218.

PHOTOGRAPHY For pleasure or profit. Learn at home. Practical basic training. Long established school. Free booklet. American School of Photography, 835 Diversey Parkway, Dept. 674-019, Chicago, Illinois 60614.

8X10 COLOR Enlargements 80¢ each—Special Trial offer from 120 color negatives, professionals only send business card with order. Professional, Box 1873, New Haven, Connecticut.

KODACOLOR—With this advertisement only—8-12 exposure, \$1.19. Astro Photo Service, Box 166M, Waterloo, New York 13165.

COLOR SLIDES

EXTRA Income at home in Spare Time! Booklet shows you how to start your own business with Classified Advertising. Only \$1.00. C. A. Martin, Popular Mechanics Dept. PM, 575 Lexington Ave., New York 10022.

35 MM Color slides, 10,671 Individually Sold, Described Encyclopedia-Catalog 10¢. Wolfe Worldwide, Dept. 14-98, Los Angeles, Calif. 90025.

VIETNAM IN BLAZING COLOR! Rare 35mm slides, 15 for \$5. Money orders, W. Vause, Dept. P, Box 31266, Diamond Hts. Station, San Francisco, Calif. 94131.

MOTION PICTURES AND SOUND EQUIPMENT

16MM sound-projectors, films, new, used for sale. Free catalog. National Cinema, 333 W. 57 Street, New York City, N.Y. 10019.

5,000 8-16MM MOVIE Films. Free catalogues. International, Greenvale, L.I., N.Y.

UNUSUAL Movie supplies. Free circular. Esor, 47th Holly, Kansas City, Missouri 64112.

FREE 64-PAGE CATALOG. All your movie needs. 8MM-Super 8-16mm. B&W and color film. Cameras, supplies, accessories. Home processing equipment. Sound stripping. Superior, 448 N. Wells, Chicago 60610.

8mm MOVIES—2" x " Color Slides—Biggest selection anywhere! Hollywood classics, great comedians, railroads, automobiles, trolleys, wars, travel, wild life, circuses, many others! 16mm. films also. Big catalog free! Blackhawk Films, 70 Eastin-Phelan Bldg., Davenport, Iowa 52808.

RADIO, TELEVISION AND HAM EQUIPMENT

BRAND New tubes. World's lowest prices on radio, TV-industrial, special purpose tubes. Write for free parts catalog. United Radio, Newark, N.J.

33¢ RADIO & TV tubes. Free list. Cornell, 4213-17 University, San Diego, California 92105.

POLICE—FIRE etc. on Broadcast radio! Brochure. Tunavertter, Woodsboro PM20, Texas 78393.

HOME Electronics course only \$26.95. Free literature. Edu-Kits, Department 698B, Hewlett, New York 11557.

HIFI, RECORDS AND ELECTRONICS

FREE Catalogues, 2000 hard to find unusual records. Rose's, 300 Chelsea, Louisville, Ky. 40207.

TAPE Recorders, hi-fi components. Sleep learning equipment, tapes. Unusual values. Free catalog. Dressner, 1523C Jericho Tpke., New Hyde Park, N.Y. 11040.

RECORDS! Discounts on all LP's. Free details. Citadel Record Club, Symphonette Sq., Dept. 2, Larchmont, N.Y. 10538.

NEW 45s! Forty Assorted, \$3.95 Post-paid, \$1.25 cloth included. JO-JA, 816-P North Western, Kokomo, Indiana 46901.

STEREO TAPE CLUB. Average cost \$3.78 (4 track), \$4.20 (8 track). Cartridges, cassettes, reels. No minimum purchases. Free brochure—catalog. STAR RECORDINGS—PM, Box 1055, El Paso, Texas 79946.

HOME Electronics course only \$26.95. Free literature. Edu-Kits, Department 697B, Hewlett, New York 11557.



MUSIC AND MUSICAL INSTRUMENTS

PLAYER Piano Rebuilding—get details from: Vestal Press, Vestal 11, N.Y. 13850.

GUITAR, Banjo Making books Plans, woods, necks, tools. List 20¢. Satinwood, 510 East 11th Street, New York, N.Y. 10009.

ELECTRIFY Player pianos, pump organs quickly, inexpensively with Lee Silent Suction Units. Write Lee Music, Box 595F, Tujunga, California 91042.

ACCORDIONS 5 switches \$159.95. Any size. Melody Music, 4909 West 95th St., Oaklawn, Ill. 60453.

ACCORDION Top brands. Buy direct. Tremendous discounts. Trade accepted. Free brochure PM. Accordion-O-Rama, 874 Broadway, N.Y.C. 10003.

ELECTRIC Guitars, amplifiers, wholesale. Free catalog. Carvin, PMM, Covina, Calif. 91722.

DRUMS, Electric guitars, amps, organs. Free catalog M: A.L.A.S. Import Company, 31 East 18th Street, NYC. 10003.

POEMS Wanted for new songs and records by America's largest song studio. Send poems. Free examination. Five Star Music, 6M Beacon, Boston, Mass. 02108.

30% DISCOUNT On any Name Brand musical instruments. Write for our low price. Freeport Music, Dept. A, 127 W. Sunrise Highway, Freeport, N.Y. 11520.

GUITARS, MANDOLINS, BANJOS complete stock of Gibson Martin fender free!! New 66 page catalogue parts and accessories, big savings New York discount prices send 50¢ postage, handling. Eddie Bell Guitar, 201 W49, New York 10019.

ACCORDION Manufacturing, 6846-P North Avenue, Chicago, Illinois 60635. Concertinas, Hohners, Chromatics, Guitars, Drums, New, Used, Tuning, Repairing, Wholesale Catalogs Free.

COUNTRY Record Albums free. Circular. Box A-, Arcadia, Calif. 91006.

SWISS Musical Movements, Mechanical-Electrical, Spielman, 131 West 42nd, New York 10036.

ELECTRIC Guitars. Modern cut-away designs. Complete plans—\$2.50. Collet, 620 Steiner Street, Pittsburgh, Pa. 15227.

MUSIC Catalogs, Guitar, Accordion, Piano, Mandolin. 25¢ each. Pagani, 289 Bleecker Street, New York 10014.

POEMS, Songs wanted for new song hits and recordings by America's most popular studio. Tin Pan Alley, 1650-P Broadway, New York 10019.

GUITARS, Amplifiers, Chord & Combo Organs, Drums. Wholesale! Free catalogs. Write: National Wholesale Musical Instrument Company, Box 52, Orrville, Ohio 44667.

ACCORDIONS, Guitars, Band Instruments! Save to 50%. Famous makes. Easiest terms. Trades accepted. Free home trial. Free discount catalog. Mention instrument. International Music Mart, 5535-R Belmont, Chicago 60641.

GUITARS. Accessories—Guitar maker's books, materials, supplies. Free catalog. Guitar Center, Box 15444, Tulsa, Oklahoma 74115.

MUSIC Lovers! Take your music anywhere with a portable two-track tape machine. For descriptive folder. Write: Ken-Krafts, Broadalbin, N.Y. 12025.

HARD-TO-GET Juke Box, Game, Vender parts, also service information, schematics. Complete lists 25¢ or write stating your needs. Music Sales, 2929 Main St., Santa Monica, Calif. 90405.

SONGS, Poems wanted! Accepted songs published, recorded at our expense! Talent, 17-PM, Longwood Road, Quincy, Mass. 02169.

EDUCATION AND INSTRUCTION

FREE Bible course. Exciting! CCM, 708 South Bragg, Monroe, N.C. 28110.

EARN College degree at home. All subjects. Ohio Christian College, 1156 Striebel Road, Columbus, Ohio 43227.

OWN Collection agency. "Little Gold Mine!" Franklin Credit, Roanoke, Virginia 24004.

FCC First Class License in six weeks—nation's highest success rate—approved for Veterans Training. Write Elkins Institute, 2603D Inwood Road, Dallas, Texas 75235.

LEARN Auctioneering. Term soon. Free catalog. Reich Auction College, Box 850, Mason City, Iowa 50401.

LEARN Civil and criminal investigation at home. Earn steady, good pay. State age. Institute Applied Science, 1920 Sunnyside, Dept. 168, Chicago, Illinois 60640.

B. SC. Engineering Management—Correspondence Course Prospectus \$1. Canadian Institute of Science & Technology, 263A Adelaide St. W., Toronto.

GET A British degree. Divinity, Philosophy, Radionics, 35 courses. Prospectus free. Brantridge Forest School, "Lodge" Brantridge Forest, Balcombe, Sussex, England.

WATCH REPAIRING. Learn to repair American and Swiss watches in spare time at home. Diploma awarded. Free sample lesson. No obligation. Chicago School, Dept. YJ, Fox River Grove, Illinois 60021.

USED Courses! Books! List 10¢. Smith's, 124 Marborough, Salem, Mass. 01970.

SECOND Chance for high school drop-outs. Get diploma at home in spare time. Full credit for previous schooling. No classes. Given Free: Booklet on finishing high school at home. Government advice for drop-outs, aptitude test. Write: Academy for Home Study, 425 S. Dearborn, Dept. 81-930, Chicago, Illinois 60605.

EARN Your degree in electronics engineering. Highly effective home study courses in electronics engineering technology and electronics engineering mathematics. Free literature. Cook's Institute Of Electronics Engineering, P. O. Box 36185, Houston, Texas 77036 (Established 1945).

BOOKKEEPERS. Operate your own "Dollar-A-Week" system. Ellis, Box 200, Cedar Grove, North Carolina.

USED CORRESPONDENCE courses and books sold and rented. Money back guarantee. Catalog free. (Courses bought.) Lee Mountain, Pisgah, Alabama 35765.

DETECTIVE Training—for free information write to: 1917M, North Kenneth Ave., Chicago, Illinois 60639.

EARN \$125 A week and up. Learn a trade with a future. Learn auto diesel mechanics in our shops. You learn with tools on real equipment. Earn while you learn. Many of our graduates earn \$125 a week and up. Write for free bulletin: Dept. 256, Auto Diesel College, Nashville, Tennessee 37219.

PIANO Tuning quickly learned with home study course. Diploma granted. American Tuning School, Gilroy, Calif. 95020.

LEARN TECHNICAL WRITING—at home. High paying prestige careers not requiring college. Growing demand, all industries for tech writers now. Low monthly tuition. Easy to understand. FREE career book, sample lesson. APPROVED FOR VETERANS. American Technical Writing Schools, Dept. PMC-98, 5512 Hollywood Blvd., Hollywood, Calif. 90028.

COMPLETE YOUR HIGH SCHOOL at home in spare time with 71-year-old school. Texts furnished. No classes. Diploma. Information booklet free. American School, Dept. X645, Drexel at 58th, Chicago, Illinois 60637.

PIANO Tuning pays. Big money in spare time. Learn at home. No musical knowledge necessary. Phonograph, records, tools and instructions furnished. Electronic tuning also taught. Free catalog. Capital Tuning School, 3160 S.W. 16th Court, Ft. Lauderdale, Fla.

PENMANSHIP Corrector. Improve poor penmanship quickly. Details free. Ozment, Box 665-34, St. Louis, Mo. 63188.

DETECTIVE Course. Free information. Universal Detectives, Box 8180-F, Universal City, California 91608.

MISSOURI Auction School. GI Approved. Free catalog! 1330-03 Linwood, Kansas City, Mo. 64109.

SWEDISH Massage and physical culture pays big profits. Learn at home. Diploma. Free catalog. National Institute, Dept. E-97, 307 North Michigan, Chicago 1.

LEARN Asleep or awake! Records, tapes, equipment! Free catalog! Drawer, PM-400, Ruidoso, New Mexico 88345.

BE A Real Estate Broker. Big earnings. Free catalog. Weaver School of Real Estate, 3519-P Broadway, Kansas City, Missouri 64111.

EARN College Degree through experience. Send dollar for program. All subjects. Illinois Christian College, 537-PM South Dearborn, Chicago, Illinois 60605.

MATHEMATICAL Topics for Tradesmen, Businessmen. Improve your ability. Write Lee's Service, 1224 Shakespeare Ave., Bronx, N.Y. 10452.

AUTOSUGGESTION. Sleep-learning headquarters! Tapes, records, books. Gigantic catalog free. Research Association, Box 24-PM, Olympia, Washington.

MINISTERIAL Extension courses. Send for entrance examination. Soms, 887 West Spruce, Ravenna, Ohio 44266.

SWEDISH Massage. Foot technique. Post graduate. Home study. Residential. Diploma. Dr. Swanson's Illinois Licensed School, 3809-PL Alta Vista, Chicago 60613.

PROFITABLE National Camera Repair School training at home! PM5, Englewood, Colorado.

PENMANSHIP Improver: Improve quickly! Complete information free. Tevis, Chillicothe, Mo. 64601.

\$1,000,000 MEMORY. Yours Overnight. Free Details. Box 44PE, Maywood, CA 90270.

BIG MONEY—BARBERING. For career folder and list of recommended schools, send 10¢ to Barbering Careers, Dept. PM, 3839 White Plains Road, Bronx, N.Y. 10467.

FREE Lessons: How God changes you. Home Bible Studies, Box 370PS, Elkhart, Indiana 46514.

AUCTIONEERING Free Catalog Resident or Home Study Course. Nashville Auction School, 2004 West End, Nashville, Tenn. 37203. Veteran approved.

BANK Bock balance? ELIMINATE ERRORS. Simple-Self explanatory General Math \$1.00. Griffith Distr., Box 31015, San Francisco, 94131.

HUMAN Skulls (genuine) skeletons, torso, plastic models,—to schools, universities, students doctors, Ostan Company, P. O. Box 287, Northport, N. Y. 11768.

Game Warden, Government Hunter, Forestry, Park and Wildlife Services announce job openings regularly. Prepare at home for outdoor work, good pay, security. Complete information Free! Write North American School of Conservation-AZ, Newport, California 92660.

WHY WASTE MONEY? Learn from Professors. University correspondence credit from 50 top United States colleges. No entrance examinations. 650 course brochure \$3.00. High school brochure \$2.00. Scientific Research, Box 2147 Napa, California 94558.

USED Courses, books, bought, sold. Catalog 10¢. Bayles, 78B Courtright, Wilkes-Barre, Pa. 18702.

FORGE Ahead With World's Greatest Motivation Program. Scientific, amazing, effortless. Includes following subjects: (1) "Financial Abundance", (2) "Self Confidence", (3) "Health and Happiness", (4) "Business Progress", (5) "Marital Harmony", plus 20 more incomparable recorded-printed courses. Free descriptive brochure. Alpha Distributing Company, P.O. Box 816-M, Chicago, Illinois 60690.

LEARN To Sing Beautifully! Free Particulars. Publisher, Box 118-P, Brooklyn 11203.

LEARN "New math" concepts with "On-Sets", 30 game kit \$4.00. EduTech 4141 Highway 38, Franksville, Wisconsin 53126.

STUDY Profitable field of Art Production at home. Drawing ability not necessary. Free information: Box 122, New Canaan, Connecticut 06840.

LEARN A TRADE—Armed Forces Training Courses—only \$10 each—Free information—Clark, 47-30 PMB 61st, Queens, N.Y. 11377.

MECHANICAL Designers' portfolio samples. Write: "Techref", Box 1001, Hilo, Hawaii 96720.

PIANO Technology—Electronic organ servicing, learned easily at home. G.I. Approved. Free booklet. Niles Bryant School, Dept. P, 3631 Stockton, Sacramento, California 95820.

SELF-Improvement records, free details. Thomas Slonaker, Thompson, Mo. 65285.

FOR INVENTORS

INVENTORS: Your ideas and inventions (patented; unpatented) expertly searched, developed for commercial appeal and cash/royalty sales to manufacturers by professional Invention Developer with excellent record of experience. B.S., Industrial Engineering; United States Patent Office former Patent Examiner, United States Government former Patent Advisor. Second decade reliable service! Member: United States Chamber Commerce. Free "Invention Record" and "Recommended Protection Procedure." Airmailed! Write: Raymond Lee, Invention Developer, 230-P Park Ave., New York City 10017.

PATENT Searches complete and thorough. Related copies Air Mailed with maximum speed \$6.00. Free "Protection Forms" and "Patent Information." Write American Patent Search Company, Dept. 27, 711 14th St., N.W. Washington, D.C. 20005.

PATENT Application Financing. Free patent search plan. Global Patent Division, 2420 77th, Oakland, Calif. 94605.

PATENT SEARCH SERVICE \$15.00! For Lawyers, Companies, Inventors. "Confidential report" including copies of related United States patents rushed "Certified Airmail" Free! "Patent Search Information." Write: Congress Patent Search Company, 911-C Warner Building, Washington, D.C. 20004.

PATENT And invention development by licensed professional patent engineer and U.S. Patent Office former examiner, and engineering specialists. Your inventions and ideas engineered for patent protection and commercial value. Inventions developed by us negotiated for cash or royalties with our nationwide contacts. Send for free protection "Invention Certificates" and further interesting, valuable patent information. George Spector, Licensed Professional Patent Engineer, Woolworth Building, New York.

QUALITY Patent Searches \$15.00! Preferred by Professional Inventors, Lawyers, Manufacturers. "Confidential Report" including related United States patent copies "Airmailed Certified." FREE Information! United States Inventors Service Company, 501-P Thirteenth Street, N.W. Washington, D.C. 20005.

U.S. Patent Office Searches, 234 Broadway, Room 3615, New York. Free invention certificates.

IMMEDIATE Cash, for patent applications. Free patent searches. Write for details. Universal Patents, 184-D, Marlon, Ohio.

PATENT Searches, including copies of related U.S. patents, \$15.00. Inventors attorneys, manufacturers use our "worldwide" airmail service! "Invention Record" form and "Information Every Inventor Needs" sent free! Hayward Company, 1029P Vermont, Washington 5, D.C.

INVENTORS—If you have an invention for sale, patented or unpatented, write for free brochure outlining manufacturer's requirements. Royalty rates. Kessler Corporation, C-54-FI, Fremont, Ohio.

PROTECT Your inventions, save money. 10 valuable pages of patent hints by professionals. \$3.00 Box 463, Radburn, New Jersey 07410.

INVENTIONS WANTED

INVENTORS! Outright cash sale or royalties for your inventions. Patented, unpatented. Active demand from our client manufacturers. Financial assistance available. Write Dept. 36, United States Invention Brokerage, 78 Wall Street, New York, N.Y. 10005.

MANUFACTURERS NEED NEW ITEMS! B. F. Goodrich, Black & Decker, South Bend Tackle and other million dollar corporations have authorized us to locate new products. For details regarding development, sale, licensing of your patented/unpatented invention, write: Raymond Lee Organization, 230-N Park Avenue, New York City 10017.

INVENTORS! Don't sell your invention, patented or unpatented, until you receive our offer. Eagle Development Company, Dept. H, 79 Wall Street, New York 5, N.Y.

INVENTIONS Wanted, Patented; unpatented. Tremendous manufacturers lists. Global Marketing Service, 2420G 77th, Oakland, California 94605.

INVENTORS! Sell your invention for cash or royalties! Our client manufacturers eagerly seek new items. Patented, unpatented. Financial assistance if needed. 25 Years proven performance. For free information, write Dept. 15, Gilbert Adams, Invention Broker, 80 Wall St., New York, N.Y. 10005.

INVENTORS! We will develop, sell your idea or invention patented or unpatented. Our national manufacturer-clients are urgently seeking new items for highest outright cash sale or royalties. Financial assistance available. 10 years proven performance. For free information write Dept. 47, Wall Street Invention Brokerage, 79 Wall Street, New York, N.Y. 10005.

WE Either sell your invention or pay cash bonus. Write for details. Universal Inventions, 298-E, Marlon, Ohio.

INVENTORS: Protect your ideas! Free "Recommended Procedure." Washington Inventors Service, 422F, Washington Building, District of Columbia 5.

INVENTIONS Needed immediately for manufacturers. For additional information write Kessler Corporation, C-54-IW, Fremont, Ohio.

PROFESSIONAL Analysis of ideas inventions \$10.00. Thought's Inc. 3625 West, North Milwaukee, Wisconsin 53208.

PATENTS FOR SALE

TELL The more than 1,662,921 avid readers of Popular Mechanics about your products and services. It costs very little to place your classified message in front of these proven mail order buyers. For further details, write: C. A. Martin, Dept. 82R, Popular Mechanics, 575 Lexington Avenue, New York, New York 10022.

EXTRA Income at home in Spare Time! Booklet shows you how to start your own business with Classified Advertising. Only \$1.00. C. A. Martin, Popular Mechanics Dept. PM, 575 Lexington Ave., New York 10022.

MANUFACTURING

INVENTORS Ideas developed, Research, Models, Manufacturing, Sales. Free brochure. William Parker, 32 Westminster, Worcester, Mass. 01605.

MODELS—small lot manufacturing. Metals, plastics, etc. Milburn, Burlington, Kentucky 41005.

BUY IT WHOLESALE

ELECTRIC Guitars, amplifiers, wholesale. Free catalog. Carvin PMW, Covina, Calif. 91722.

BARGAINS! Buy wholesale and below. Name brands. Appliances, furniture, sports equipment, televisions, cameras, watches, jewelry, thousands more. Huge discounts to \$1,000.00 on new automobiles. All makes. Free details. Write today: Worldwide Bargainhunters, Box 730-A, Holland, Michigan 49423.

500,000 BARGAINS BELOW WHOLESALE. New, name brand merchandise. Buy at 10¢ on the dollar. Closeouts, surplus, bankrupts, liquidations, imports. Free details. International Buyers, Box 4633-M, Colorado Springs, Colo. 80909.

MEXICO Imports, handbags, wallets. Free brochure. Lumbley, Dept. P. Box 5535, San Diego, Calif., 92105.

HEARING Aid Batteries at dealer's prices. Confidential price list free. Energetics Co., P.O. Box 41, Hartsdale, N.Y. 10530.

EXPORT-IMPORT

JAPAN: 1200 Products Directory. Illustrated. Manufacturers' names, addresses; \$3.00. Mail-Order Catalog. Novelties, \$1.00. Send Cash. Yamagata Office, 814 Togin Bldg., Marunouchi, Tokyo.

GOODS From Holland and West Germany at low prices. \$1.00 brings catalog. Refunded on first order. E. Ray, Dept. PM-1, Box 613, Santa Anna, Texas 76878.

Fortunes In direct listings over 100 to select from Europe, Asia, West Indies. Send 2.00 cash check or money order to Gulf Sales, Post Office Box 636, Pascagoula, Mississippi 39567.

FOR THE HOME

MAILORDER Records help get Increased Profit Business! Complete 32 Page Record Book shows your inquiries, orders, advertising, expense, etc. Only \$1.00. C. A. Martin, Popular Mechanics, Dept. PM, 575 Lexington Ave. New York 10022.

FOAM Furniture and boat cushions, direct from factory, 50% discount, free catalog. Perma-Foam, Inc., 605-C South 21st Street, Irvington, New Jersey 07111.

QUALITY Hardwood chairs, bar stools and benches. Free Catalog. World Products Co., R-1, Indian Trail, N.C. 28079.

FOR PARENTS

EXTRA Income at home in Spare Time! Profit Booklet shows you how to start your own business with Classified Advertising. Only \$1.00. C. A. Martin, Popular Mechanics, Dept. PM, 575 Lexington Ave., New York 10022.

OF INTEREST TO WOMEN

WOMEN! Make big money at home. \$10.00 profit in an hour possible with invisible mending. Make holes, tears disappear from clothing, fabrics. Steady year-round demand from cleaners, laundries, homes. Details free. Fabricon, 1533 Howard, Chicago 60626.

\$500 MONTHLY Possible—Clipping news at home. No experience needed. Free information. Send stamp. American, Box 11056, Kansas City, Kansas 66111.

TYPING Pays! Unbelievable \$30.00 thousand addressing envelopes from lists. Typewriter, longhand. Immediate earnings. Instructions \$1.00. Florida Service, P.O. Box 1017C, Hialeah, Fla. 33011.

EARN Up to \$2.00 hour lacing baby moks. Cuties, Warsaw 9, Indiana 46580.

HOME Typing. Earn up to \$100.00 weekly. Instructions, employers' list, \$1.00. Satisfaction or refund. Summithouse, Box 1762PM, New York 10017.

RAISE Rabbits for us on \$500 month plan. Free details. White's Rabbitry, Mt. Vernon, Ohio 43050.

DRIVE New car, wear new clothes, buy color TV. Get daily cash income. Put spare hours to work. Write for 5 months free subscription Opportunity Magazine; see hundreds easy ways to make money. Opportunity, Dept. 17-HO, 850 N. Dearborn, Chicago 60610.

MAKE Extra Money—Show friends, neighbors—Gifts, Stationery, Toys, Jewelry, Greeting Cards. Experience unnecessary. Salable Samples on approval. Free—Catalog, Personalized Christmas Card Album, Gift Offer. Hedenkamp, 361 Broadway, Dept. PM-97, New York, 10013.

HOW To make money writing short paragraphs. Information free. Barrett, Dept. C-27-H3, 6216 N. Clark, Chicago 60626.

MAKE Extra Money! Introduce new Miracle Cantreze Nylons. Amazing low price. Guaranteed never to run. We show you how. Big outfit, sample stocking free. Spare time cash year-round. It's easy. Write American Hosiery Mills, Dept. AA169, Box 753, Cincinnati, Ohio 45202.

HOME Addressers Wanted! Longhand, typewriter. Details, 20¢ and self-addressed stamped envelope. Aberdeen's, Dept. PM, Millbrook, Mass. 02349.

WOMEN: Big Money! Studio Girl Cosmetics needs women in all states including Hawaii, Alaska, Puerto Rico and American Samoa. Full or part time. No experience required. No territory restrictions. Take orders anywhere. Highest profits. 500 Good Housekeeping approved cosmetics. Everything furnished. Credit extended. No stock to carry. No franchise fees. No stock investment. For full information by mail, plus 3 free samples, write Harry Taylor, Chairman, Studio Girl Cosmetics, Dept. BC144, 11461 Hart Street, No. Hollywood, Calif. 91605. Also immediate big profit earnings for experienced city and state managers and former party plan operators.

HOUSEWIVES, Teachers, students, office workers. If you need extra cash each week but household or other duties prevent you from taking a part-time job, learn how you can earn by accepting orders to Popular Mechanics, Good Housekeeping and all other magazines. No experience needed. Write Popular Mechanics, Room 9-W, 250 West 55th St., New York 19, New York.

GIFT SHOPPING

FREE Catalog. Unusual Christmas Gifts for all! DeMUNN 16310 Jacobs Highway, Binghamton, New York 13901.

FREE Catalog! Gift merchandise at bargain prices. Kansas Enterprises, 8524 West 77th., Overland Park, Kans. 66204.

GREATEST Drawing aid since the T-square. Draw circles, arcs, squares, quadrants, crosshatching, vertical and parallel lines easier. Guaranteed time saver. Free information. HFF Specialties, 158-A2 Glenridge Road, Scotia, New York 12302.

FREE Family brochure—Write Tole House, Box 2521-M, Hollywood, Calif. 90028.

FREE Gift Catalog. Plus folio—Business Opportunities. International, Box 8063-D9, Jacksonville, Florida 32211.

GIFT Catalog free. T & R SALES, 3801 Giles, Chgo. 53 Ill.

WATCHES, OLD GOLD, JEWELRY

WATCH And clock repairing books. Free catalog. North American, Box 77-AW, Fox River Grove, Illinois 60021.

USED Pocket watches — as is — 5 for \$25.00. Joseph Bros., 5 South Wabash, Chicago 60603.

USED Wrist, pocket watches—\$3.00 up. Free list. Southern Watches, 5-PM South Wabash, Chicago 60603.

CASH Immediately for old gold, jewelry, gold teeth, watches, diamonds, silverware, spectacles, platinum, mercury. Free information. Rose Industries, 29-A East Madison, Chicago 2.

WANTED—Gold, silver, platinum (any form), mercury. Information free. Wilmot's, 1067 Bridge St., Grand Rapids, Mich. 49504.

WATCHMAKERS'—Jewelers' catalog, surprise, \$1.00. Watchmaking Course, Tools \$35.00. Bengal's, 17942 Ventura, Encino, California 91316.

HIGHEST CASH for Gold, Jewelry, Gold Teeth, Rings, Diamonds, Watches, Silver, Platinum, Mail Articles Today. Free gift with Information. Chicago Gold & Precious Metals, 6 E. Monroe, Dept. 858, Chicago 60603.

WEARING APPAREL

MEN—Buy your Outerwear Coats and Jackets WHOLESALÉ directly from manufacturer. Write now for free illustrated booklet showing styles for Fall 1968. Sha-rob Corp. Carbondale, Penna. 18407.



SCIENCE AND CHEMISTRY

CHEMICALS. Apparatus, Microscopes, Mineralogy Sets, Telescopes. Catalog 35¢. Sheard Science Supplies, Inc. Columbus, Wisconsin 53925.

CHEMICALS And apparatus for industrial, analytical, and private laboratories. Catalog 50¢. Dept. M-50, Biological Supply Co., 1176 Mt. Hope Ave., Rochester, N.Y. 14620.

ROCKETS. Single, multi-stage kits, parts amazing Accelerometer. Illustrated catalogue 25¢. Rocket Supply, Box 51B, Tappan, New York 10983.

ROCKETS: Real flying models—flights up to 2500 ft. New illustrated catalog 25¢. Single and multistage kit, cones, engines, launchers, trackers, rocket aerial cameras, technical information. Fast service. Estes Industries, Penrose 7, Colorado 81240.

ROCKETS!! Real flying models—2500 feet altitude with powerful motors. Terrific Science Projects. Tubes—Cones—Parachutes—Launchers—Igniters. Gigantic catalog—rocket data—diagrams—25¢. Fast Delivery. Centuri Rockets, Box 1988, Phoenix, Arizona.

UNDERWATER Fuse 3/32". Diameter, 25 Feet \$1.00—125 feet \$4.00. Postpaid. Free Catalog. Zeller, Box 646, Hudson, Mich. 49247.

MICRO-Grain Rocket Book 100 drawings 32 pages \$1.00. Humphreys, Box 7274, Long Beach, Cal. 90807.

ILLUSTRATED Catalog: Chemistry, mineralogy, biology 25¢. Tracey Laboratories, Evanston, Illinois 60204.

PYROTECHNIC Casings, stars, devices of all types. Send 50¢ for samples. Ecco, Box 189, Northvale, New Jersey 07647.

UNDERWATER Fuse 63 feet \$1.00. Professional green fuse 45 feet \$1.00. Christie, Box 85, Bergenfield, New Jersey 07621.

PYROTECHNIC Chemicals, casings, supplies. List 10¢. Pyrochem, Box 169, Berlin, New Jersey 08009.

PROFESSIONAL model rocket ignition fuse, burns underwater, 75 feet, \$1.00. Edcolabs, Box 99, Berlin, New Jersey 08009.

PYROTECHNIC Instruction manual. Make Stars, Gerbs, Smokes, Many more. Only \$1.50. Solowel, Box 123, Dumont, N.J. 07628.

PYROTECHNIC Casings. Low, low prices. Underwater fuse 70 feet \$1.00. Professional green fuse 50 feet \$1.00. Weingart's book, "Pyrotechnics" \$8.50. Catalog 25¢, with samples 50¢. Bilton Box 399, Hasbrouck Heights, N.J. 07604.

PYROTECHNIC Instruction manual. Reveals formulas, preparations, uses. Only \$2.00. Free with order, \$1.95 bonus Kit. Edco, Box 99, Berlin, New Jersey 08009.

AMAZING Amature rocket. Heights to 15,000 feet. Instructions and diagrams only \$1.00. Solowel, Box 123, Dumont, N.J. 07628.

FLYING Saucers (New—Sun Powered—No Motors). How to Build Easily for less than \$5 using Styrofoam and Plastic Bags. Many Sizes—Designs. Complete Descriptions—Plans—Drawings. \$2 Guaranteed. Spacetronics, Box 31043-PM San Francisco, California 94131.

100 ONE Minute Time Delay Fuses! \$1. 240-\$2. 700-\$5. PMS, 50 Atlantic, Metuchen, New Jersey 08840.

CONSTRUCTION Manual for skyrockets and fireworks \$1.95. Franks Scientific Co., P.O. Box 156, Martelle, Iowa 52305.

BIZARRE Information. Catalog, 15c. Bylina, 5115 S. Campbell, Chicago, Illinois 60632.

FREE Rocketry, pyrotechnics catalog. Franks Scientific Co., P.O. Box 156, Martelle, Iowa 52305.

PYROTECHNICAL chemicals, casings, tools, supplies, fuse, literature for responsible hobbyists. Lowest prices, fastest service anywhere! Catalogue plus samples, instructions, formulas—50¢. Pyrocenter, Box 9591, Arlington, Virginia 22209.

GROW Incredibly Large Crystals. Large, well printed instruction book—\$2. PMS, 50 Atlantic, Metuchen, New Jersey 08840.

LABORATORY Chemicals, supplies, etc., including lapidary supplies. The Chemical Formulary series Mineralogical and chemical dictionaries and other scientific books. Complete lists 25¢. Casco, Box 77, Riverdale, New Jersey 07457.

LASER PISTOL . . . \$1.00, how to build. New PHASER PISTOL project, you have seen it on TV now build your own, safe, loads of fun. \$1.00. Prize-Winning Science Projects. "HOW TO MAKE A WINNER" detailed directions, illustrations, etc.—\$1.00. NUCLEAR & RADIATION EXPERIMENTATION, projects with plants, animals, minerals and fallout—\$2.00. Catalogue 35¢. Roy Davis Laboratories, Dept. PM, Drawer 17067 Jacksonville, Fla. 32216.

CATALOG! Verr-ry Interesting Products! 20¢. PMS, 50 Atlantic, Metuchen, New Jersey 08840.

FORMULAS, PLANS, ETC.

ANY Formula \$3.00. Catalog—Treatise 10¢. Belfort, 192 N. Clark, Chicago 60601.

STOP SMOKING! New Book presents Medical and Psychological Step-By-Step Method. Money Back Guarantee. Send \$1.00. Roger's Mart, Dept. J5-06, 800 North Smith Road, Bloomington, Indiana 47401.

ENCYCLOPEDIA Of formulas, processes. Details free. Cassill, Box 1535, Eugene, Oregon 97401.

FOR Proof of what you can do in specialty manufacturing get our literature. It's free! Miller, Chemist, 1517-P, Tampa, Florida 33601.

PLASTICS

CASTOLITE Liquid Plastic pours like water and hardens like glass without heat. Clear, colors. Embed real flowers, butterflies, photos, coins. Also new molding formulas for perfect reproductions. Illustrated booklet shows how. Send 25¢—Dept. 68-101K, Castolite, Woodstock, Ill. 60098.

PLASTIC Embedders, jewelry workers. We have everything. Findings, moulds. New catalog 25¢. David Co., 861 Broad St., Dept. M, Providence, R.I. 02907.

TREASURE FINDERS

POWERFUL Metrotech locators detect gold, silver, coins, relics. Moneyback guarantee, terms. Free information. Underground Explorations, Dept. A, Box 793, Menlo Park, California 94025.

FIND Buried treasure with new revolutionary analytical metal detector. Features push button tuning, automatic tuning, loudspeaker, negligible ground pickup, greatest range. Free catalog. Gardiner Electronics, Dept. 9, 4729 N. 7th Ave., Phoenix, Ariz. 85013.

NEW Sensitive Treasure Metal Detectors. New low prices. Professional models from \$29.95 to \$129.50. Write for free catalog today. Jetco Electronics, Box 132-PM, Huntsville, Texas 77340.

URECON Metal finder. 8" head, transistorized, \$37.50 delivered. Urpa, 6304 Beechwood, Sarasota, Fla. 33581.

TREASURE Hunters! Coin collectors! New metal locator detects buried coins, gold, silver, etc. New design, rugged, sensitive. Transistorized, economical. Free detailed information. Detectors Inc., Box 101, Springfield, Virginia 22150.

TREASURE Booklet. Excellent information on treasure hunting and metal detectors. Send 25¢. Booklet, P.O. Box 243, San Gabriel, California 91778.

FREE 128 Page detector catalog. General Electronic Detection Co., Box 67, Bellflower, California 90706.

FISHER "GEMINI" M-Scope. All-new treasure and metal detector. Superb sensitivity, space age design. Write world's leading manufacturer for free DISCOVERY booklet and product information. Guaranteed. Terms. Fisher Research, Dept. PM-6, Palo Alto, California 94301.

TREASURE Hunters! Prospectors! Relco's new instruments detect buried gold, silver, coins, minerals, historical relics. Transistorized. Weighs 3 pounds. \$19.95 up. Free catalog. Relco-A40, Box 10839, Houston, Texas 77018.

PRECIOUS STONES AND MINERALS

EARTH Science Rockhound Magazine. Subscription \$2.50. Sample 35¢. Box-550-PM, Downers Grove, Ill. 60515.

100 COLORFUL. Polished gemstones, \$1.00. Tumblecraft, 5401 James North, Minneapolis, Minnesota 55431.

GET Free catalog no serious rockhound, gem cutter, jewelry maker, hobbyist or craftsman can be without. Full of bargains, exclusive items, low prices from largest suppliers and authorities in the field. Free new catalog just off the press, yours for the asking. Write Grieger's, Dept. C-12, 1633 E. Walnut, Pasadena, California 91106.

400 POLISHED GEMSTONES \$2.75. Beautiful crystals, 6 different \$2.00. Lists with order. Sering, 1705 E. Michigan, Indianapolis, Indiana 46201.

SEMI-Precious uncut gems. Ten different for \$1.00. Request list 30. Prospectors Shop, 201 San Francisco, Santa Fe, New Mexico 87501.

HAWAII'S Green and black sands. One vial of each, \$1.00. Lava, 2018 Kaumana Drive, Hilo, Hawaii 96720.

CARTOONING, COMMERCIAL ART, SHOWCARD & SIGN PAINTING, TATTOOING

SIGN Painting, Fascinating System—Straley, 410 So. Western, Springfield, Ohio 45506.

COMPACT 23 lesson Cartoon Course and Cartoonist's Magazine, \$2.00. Hartman, Box 30367, Lincoln, Nebraska 68510.

CARTOONING AND COMMERCIAL ART. Easy home-study drawing course. Art background not necessary. Excellent creative money making opportunities part or full time. We show you how. Low monthly tuition. Free booklet. Continental Schools, Dept. 8A-26, 1330 W. Olympic Blvd., Los Angeles, Calif. 90015.

"HOW TO MAKE MONEY WITH SIMPLE CARTOONS"—Everyone who likes to draw should have this book! Free. Write Cartoonists' Exchange, 99 Pleasant Hill, Ohio 45359.

LEARN Cartooning at home. Free book "Key To A Cartoon Career". Write Cartooning, Box 3176-B, Colorado Springs, Colorado 80907.

LEARN Profitable tattooing. Illustrated information and instructions \$3.00. Zeis, 2220-P Delcy Dr., Rockford, Illinois 61107.

ADVERTISING AGENCIES, ADV. SERVICE, MAILING LISTS

MAILING Lists most all kinds 1000 \$5.00. Free folder. Your circulars mailed \$4.00 1000. Dixie Mailers, King, N.C. 27021.

ADVERTISING Ratebook leading newspapers, magazines, 25¢. Chicago Advertising Agency, 28-E Jackson, Chicago 60604.

"SECRETS Of Successful Classified Advertising" \$1.00 postpaid. Classified, Inc., Dept. C-68, 100 East Ohio, Chicago 60611.

WRITERS Current needs, names, addresses: Agents; Book Publishers; Magazines; \$1.00 each; all, \$2.00. Edie Enterprises, P.O. Box 19061, Louisville, Kentucky 40219.

TYPEWRITERS, DUPLICATORS, OFFICE EQUIPMENT

FREE Plan. Start printing, lettershop. Offset Presses. Mimeograph Copy machines. DixieGraph, King, N. Car. 27021.

RUBBER STAMPS AND OFFICE SUPPLIES

FREE 40 Page catalog. Rubber stamps, office supplies. Youngers Stamp Shop, Princeton, Iowa 52768.

ADDRESS Stamp \$1.50 Signature \$2.80 Catalog. Carol's McLoyd, Okla. 74851.

FREE Catalog. Rubber stamps 4 Lines \$1.25. Bilmar, 11117 Ewing, Minneapolis, Minnesota 55431.

3 LINE Address stamp, \$2.50. Indexed walnut mounts. Robert Hancock, 18 Sherwood Drive, Latham, N.Y. 12110.

SIGNATURE Stamp—\$2.50. Address stamp—\$1.25. Illustrated Catalog: Frost, 17639—67CT, Tinley Park, Ill. 60477.

PRINTING, MULTIGRAPHING, MIMEOGRAPHING, GUMMED LABELS

BOOKLET Specialist, on Hi Speed Web. Free Price List 20M 16pg 8½x11 2 color booklets at 2¢ each. Copen Press, 337p Butler St., Brooklyn, N.Y. 11217.

FREE Printing catalog. Engraved letterheads, envelopes. Youngers Printing, Princeton, Iowa 52768.

OFFSET PRINTING—8 HOUR SERVICE 25 to 5,000 copies. Free booklet "Secrets of Cutting Printing Cost." Nationwide Printing, Atlanta, Illinois 61723.

FREE Literature: 1000 address labels \$1.00, 1000 business cards \$4.95. Printing, rubber stamps. Jordan's, 552 West O'Connor, Lima, Ohio 45801.

AMAZING Business printing values. Quotations, Print Shop, Box 576, Greenville, R.I. 02828.

1,000 GUMMED Address labels . . . \$1.00. 1,000 shipping labels . . . \$3.95. Walt's, Box 966A, South Bend, Indiana 46624.

PERSONALIZED MEMO PADS 200 sheets 5x8 bond with your name \$1.00. Make impressive gifts. Colorcraft, 541 Lake, Saint James, N.Y. 11780.

SAMPLES!!! 1000 Business Cards "Thermographed" \$4.50 Postpaid!!! Noble, 505 Brigg, Bellmore, New York 11710.

250 8½x11 LETTERHEADS, \$3.50; 250 Envelopes, \$3.50. Davis, 7609 Spruce, Baltimore, Maryland 21222.

BUSINESS CARDS, raised printing! \$3.50—1000. Franklin, 72 Columbia, Vine-land, N.J. 08360.

TOP QUALITY OFFSET, 8½x11, 20 lbs. bond, \$6.75 postpaid. Special handling. Biscayne, Box 346, Wall Street New York, New York 10005.

OFFSET Printing—8 hour service. No order too small or too large. Cut your business printing costs. We also print for churches, social groups, fraternal organizations. Free Booklet "Save on Printing Costs." Allstate Press, 2006-P North Pulaske, Chicago, Illinois 60639.

PRINTING & RUBBER STAMP OUTFITS—SUPPLIES

PRINTING Presses, type, supplies, Lists, 5¢. Turnbaugh Service, Mechanicsburg, Pennsylvania 17055.

MAKE Your own self-molding rubber stamps and printing cuts. Plexirubber, Ar-gyle (-1-), Wisconsin.

TYPE Catalog No. 11, 96 Pages. Send One Dollar, Deductible First Order. Acme Type, 732 Federal, Chicago, Illinois 60605.

SAME Day shipment on rubber stamp supplies. Revised wholesale price list No. 5 free. Star Stamp Supply, 732 Federal, Chicago, Ill. 60605.

DO Your own printing. Save money. Simple rules. We supply everything. Print for others; good profit. Raised printing like engraving too. Have home shop. Details free. Kelsey Presses, V-11, Meriden, Connecticut 06450.

RUBBER Stamp outfits, supplies. Kiewiet, 2025 Barney Road, Kalamazoo, Mich. 49007.

COMPLETE C&P \$225. Cases \$1. Cutter \$125. Lists, Cpps, 50 Broadway, N.Y.C. 10004.

REMAILING SERVICE

SECRET Receiving and remailing. Discreet and confidential. Remail 25¢ single. 8050 S. Main, Houston, Texas 77025.

LOS ANGELES, Hollywood, 25¢ single, \$3.00 monthly postcards. Confidential, 10437 Lanark, Sun Valley 91352.

REMAIL WITH ASSURANCE. \$3.00 monthly—singles 25¢. Confidential Remails, Box 114, Placentia, California 92670.

RECEIVING-Forwarding, \$3 Monthly. Hedgpath, 406-M South Second, Alhambra, Calif. 91802.

SO. AMERICA Registered re-airmails \$1.00. Confidential. Genaro, Box 360, Guayaquil, Ecuador.

MIAMI Remails 25¢. Monthly rates. Marie, Box 1266, Coral Gables, Florida 33134.

ATLANTA Remails 25¢. Monthly rates \$3.00. Daytona, Box 8087, Atlanta, Georgia 30306.

CHICAGO Remails 25¢ Confidential Modern Services, Box 27056-P, Chicago, Illinois 60627.

MID-AMERICA Remails. Singles 25¢. \$3 Monthly. Post cards available. Kansas City Area. HUBCO, Box 1425, Topeka, Kansas 66601.

FLORIDA, St. Petersburg, remails 50¢ each, 3—\$1.00. P.O. Box 587, St. Petersburg 33731.

KANSAS CITY, Kansas, Missouri. Confidential Remails 25¢. Receiving, Forwarding. Information Free. Midway Enterprises Inc., 3115-F South 45th Street, Kansas City, Kansas 66106.

CONVENTION City Remails 25¢. Colorful Postcards. Schoen, Box 1963-P, Chicago, Illinois 60690.

TEXAS Remails, 25¢ Singles, \$3.00 monthly. Box 9762, Austin, Texas 78757.

NEW ORLEANS Remails. Confidential receiving. \$3.00 monthly. Singles 25¢. United Enterprises, Box 51345, New Orleans, Louisiana 70150.

ENTERSULL. Your secret address. Prompt. Reliable. Box 188M, Forsyth, Ga. 31029.

FLORIDA REMAILS 50¢ each postpaid. Trustworthy monthly forwarding, receiving \$2.00 plus postage. Suncoast Remails, Box 587, St. Petersburg 33731.

SECRET Mail Receiving—Forwarding System. Discreet. Confidential \$8.00 mo. S2411MM SanJac. Houston 77002.

CHICAGO Instant remailing \$3 monthly. Karales, 5116 South Bishop, Chicago, Illinois 60609 (PM-9).

HOLLYWOOD Permanent address. Monthly 3.00, singles 25¢. Free information on additional services. Security, 2331 Baxter, Hollywood, Calif. 90039.

REPAIRS AND SERVICING

EXTRA Income at home in Spare Time! Booklet shows you how to start your own business with Classified Advertising. Only \$1.00. C. A. Martin, Popular Mechanics Dept. PM, 575 Lexington Ave., New York 10022.

SPECIAL SERVICES

INFORMATION On anything. Ferguson Research Specialists, 83-45 Victor Ave., Elmhurst, N.Y. 11373.

RACING SYSTEMS CHECKED. One Month—One Track \$10.00. ATAD, Box 211, Milwaukee, Wis. 53201.

RESEARCH By a professional. Jeltema. Box 554, Inglewood, California 90307.

MAKE Your own will! Copyrighted booklet, forms, \$1.00. Bennington, Box 541, Clarksville, Tenn., 37040.

TOBACCO

PROFIT With Popular Mechanics' subscription plan. No investment, no experience needed. Earnings begin immediately when you obtain subscription for Popular Mechanics, Good Housekeeping and others. High commissions, bonus. No experience needed. Deal directly with the publisher. Write Popular Mechanics, Room 3B, 250 West 55th St., New York 19, N.Y.

GENEROUS Samples Sweet Chewing-Smoking, 10 cents, Jolley Farms, Dresden, Tenn. 38225.

RAZORS

MAILORDER Records help get Increased Business! Complete 31 Page Record Book shows your inquiries, orders, advertising, expense, etc. Only \$1.00. C. A. Martin, Popular Mechanics, Dept. PM, 575 Lexington Ave., New York 10022.

WANTED—MISCELLANEOUS

MERCURY, Gold, Silver, Platinum: Ores assayed. Wholesale Terminal, Norwood, Mass. 02062.

PERSONAL

RUPTURED. Relief and comfort. No understraps, elastic or steel. Write Hand-Lock Products, Preston 4, Ont., Canada.

BORROW \$1,205 Airmail! Repay \$47 for 36 months. State licensed. Postal Finance, Dept. 17-N, 200 Keeline Building, Omaha, Nebraska 68102.

WILL Forms (2) Instructions by lawyer covering 50 states \$1.00. Ward, Ward & Ward, Box 185, Fairfield, Alabama 35064.

SUBCONSCIOUS Conditioning remakes personality while you sleep. Free details. Sleep-Learning, Box 24N, Olympia, Washington 98551.

RAISE Money, consolidate bills. Free amazing details. Write Interstate, 28 E. Jackson, Suite 1204-PM, Chicago 4.

SECURITY Equipment, lowest prices, free brochure. Deharte Electronics, P.O. Box 5232 Sarasota, Fla. 33579.

"MAKE FRIENDS" send your description and a stamp for bulletin "INTRODUCTIONS" P.O. Box 2471, Detroit, Mich. 48231.

FREE Catalog low priced, high performance subminiature listen-in devices straight from manufacturer. Dealers welcome. Audiotronix-P, 156 Fifth Avenue, New York, N.Y. 10010.

IMPROVE Your personality! Fascinating 110 page book reveals the technique of using your subconscious mind to make a new personality for yourself. Be one of the lively ones. Start to live! Read how in book WB113, \$1.00, Almar House, 1263 Topaz Avenue, San Jose, California, 95117.

LONELINESS, POOR HEALTH, FEAR, make life dreary. Find love, joy, peace. Free information. Eternal Lite, 33 New Tripoli, Pa. 18066.

IMPROVE Your life, personality, confidence, wealth. Free list of low cost books. Scher of California 9749C Odessa Avenue, Sepulveda, California 91343.

STOP Smoking! New Book presents Medical and Psychological Step-By-Step Method. Money Back Guarantee. Send \$2.00. Lincoln, 2237½ N. Bissell, Chicago, Ill. 60614.

FREE! Low cost book list success, happiness, wealth, confidence. Richard Yentema, 1016 Ellis Ave., Fairlawn, New Jersey 07410.

SELF-HYPNOSIS. Home Study Course. Authoritative, easy, practical. Details free. Southern Institute of Hypnology, Dept. M, 644 N.W. 95 St., Miami, Fla. 33150.

BORROW \$100 to \$1000 by Mail. Quick, Easy, Private. No Co-Signers. Repay in 36 small monthly payments. For the amount you want write today to Dial Finance Co., 410 Kilpatrick Bldg., Dept. J214, Omaha, Nebraska 68102.

PAY Bills! Have cash left over. \$39.65 repays \$1000 in 36 months. Write for details. American Loan Plan, Dept. MA-010B, City National Bldg., Omaha, Nebraska 68102.

SECURITY And privacy protection devices. Free details: Security Electronics-PM-15 East 43 Street, N.Y.C. 10017.

LAW Enforcement agents and legal investigators only. Free literature, latest electronic aids. Request must be on your official letterhead. F Clifton, 11500-P NW 7th Ave., Miami, Florida 33168.

BIBLE Questions answered. Stamped envelope. Byron, 17167 Bentler, Detroit, Michigan 48219.

LOSE WEIGHT. Get fabulous diet for losing weight. Eat plenty and still lose following directions. Send 50¢ to Special Diet Plan, Box 4199, Milwaukee, Wis. 53210.

"MIND Over Platter." Tried to lose weight and failed? Read how famous doctor successfully treated 2000 overweight people. Rush \$2.00. FREE list low cost books. Bowmans, 308 West Third, Dept. PM-98, Lordsburg, New Mexico 88045.

SLEEP! Without Pills! Simple Exercises. 64 Page Book. Only \$1.00. WB-120. Fitzpatrick's, 190 Birdseye Street, Bridgeport, Conn. 06604.

SECRETS Of longevity, 24 exotic, international recipes on Arisa Pilaf. \$1.00. Long-life, M2409P, San Jac., Houston 77002.

H-BOMB sign of His coming, end of age. Matt. 24:1-3, 4-22. Zech. 5:1-4. Many secrets, free. Era, Box 1221, Kingsport, Tenn.

RETIRE without money. Lead worry-free life. Details FREE. CHESTER-BROOKE, Dept.-A, Box 41226, Atlanta, Georgia 30331.

TATTOO Removing Do-it-Yourself-Kit \$14.00. Information free. Atlanta Co. 907 Lakecrest Fairport Beach/Ontario.

TWO Legal Will Forms \$1.00. Phillips, Box 164, Staten Island, New York 10314.

AMAZING Key to Better Memory. Details free. Inspiration, Box 1684-PM, Rochester, New York 14603.

FOR A better future take our tests. They help discover interests abilities personality. Easy professional low cost. Free Booklet. Career Testing Service, 27 Bicknell Road, Pinehurst, Mass. 01866.

HOW To Pay Debts On Borrowed Money. Bizarre cash-back plan. Free details. Counselor-7. Harlingen, Texas.

PANTSKINS—Skin tight black leather pants for men. Brochure 10¢. Pantskins, Box 75775-K, Los Angeles, California 90005.

WIN MONEY EVERY MONTH working contests and puzzles. Free details. . . . **NO MINORS.** International Contest Club, Box 10153, Dept. PM-3, Kansas City, Missouri 64111.

FANCY ORNAMENTAL POULTRY

MAILORDER Records help get Increased Business! Complete 32 Page Record Book shows your inquiries orders, advertising, expense, etc. Only \$1.00. C. A. Martin, Popular Mechanics, Dept. PM, 575 Lexington Ave., New York 10022.

MISCELLANEOUS

ORNAMENTAL Iron designs. Book of 1600 beautiful, practical designs for railings, columns, etc. Free literature. Cunningham, 3881 South 3200 West Salt Lake City, Utah 84119.

SILENCERS For pistols and rifles. Complete details for construction and operation, \$1.00. Gunsmith, Box 185, Fairfield, Alabama 35064.

YOUR Name sent to 1000 Importers, publishers, mailers, wholesalers, etc. on our mailing list. Year \$1.00, Dixie Mailers, King, N. Car. 27021.

HEARING Aid batteries wholesale. Free list. Habs, Box 51, York, Penna. 17405.

WINEMAKERS—Free catalog and recipes. Kraus, Box 451-L, Nevada, Missouri 64772.

QUART Oregon Hops with 101 recipes—Homebrewing, Winemaking, Hopbreads, Catalogue, \$1. Nichols Hops, 1190 North, Albany, Oregon 97321.

BIRTH Certificates, Marriage Certificates, Diplomas! 2 blank forms \$1.00. Sample 10¢. Standard Forms, Box 482-M, Washington, D.C. 20044.

CIGARETTES 12¢ a pack. Improved roller makes 20 filtertip, plain, king or regular for 12¢. Facts Free. Moberly, Box 954, Owensboro, Kentucky 42301.

WINEMAKERS! New Illustrated Supplies Catalog . . . Free! Write Today! Winemakers Box 11211-PI Indianapolis, Indiana 46201.

WINEMAKING . . . Grape, Elderberry, Dandelion, Frozen Juices, etc. Brewmasters' secrets revealed! Powerful methods! Instructions, recipes, and supplies catalog. \$1.00. Continental, Box 11071-PI, Indianapolis, Indiana 46201.

KILL Mosquitoes, Insects, electrically. Free information. US Insect Control, Box P374, Royal Oak, Michigan 48068.

WINEMAKERS. Free illustrated catalog of yeasts, equipment, Semplex, Box 7208, Minneapolis, Minn. 55412.

FLYING Saucer photos. Catalog 25¢. UFO International, P.O. Box 552, Detroit, Mich. 48232.

WINEMAKING Anywhere at home. Dust and gnat free. Step by step instructions with recipes \$1.00. The Finest, Box 10032, Sta. V, Cincinnati, Ohio 45210.

HEARING Aids below wholesale. Regular, eyeglass, completely hidden models. Smallest, most powerful. Free home trial. No salesman will call. Free details. Write Prestige-C6, Box 10880, Houston, Texas 77018.

CONVERT Your auto air conditioner to compressorless type. Plans \$2.00 Kit \$39.95. Refrigeration Research, P.O. Box 13321PM, Orlando, Florida 32809.

BREWS, Wines, Peach brandy—Strongest Formulas, \$2.25. (complete brew supplies hydrometers catalog included—Research Enterprises, 29-SN35 Samoset, Woburn, Mass. 01801.

BOOKS On antiques and their prices. Free circular! P. Warman Publishers, Uniontown, Penna. 15401.

HIGHER Income, Security, and Power. 256 page book "Thinking Big" reveals secrets that make men Rich. Book = WB 123 only \$2.00. L. R. Ferguson, 637 Flannery Street, Santa Clara, Calif. 95051.

SHEEPSKINS—Genuine, washable, natural and colors for rugs, car sets, etc. Inquire—Sheepskin Decor, 1404 Bath Road, Bristol, Penna. 19007.

ALCOHOLICS Can be cured! Send \$1.00 for instructions. D. Fuerst, Route 4, Box 285-A Tampa, Fla. 33615.

LIST Your name with Importers, Manufacturers, Mailers, etc. One year, \$1.00. Includes sample product. Cal-Mail, Box 1264 Annex, Canoga Park, California 91304.

MAGNETS. All types. Specials—20 disc magnets, or 2 stick magnets, or 10 small bar magnets, or 8 assorted magnets, \$1.00. Maryland Magnet Company, 5412-A Gist, Baltimore, Maryland 21215.

AMISH BEER FORMULA. Brew at home. \$1.00. Coe, 521 South 27th, South Bend, Indiana.

UNHAPPY, Nervous, alcoholic, fat, smoker. Want to do something about it? Send \$2.00 to: Box 31, Vernon, Conn. 06086.

UNUSUAL Books; Jewelry, watches. Write: Lynn's, Box 1573, Waco, Texas 76703.

NOTORIOUS Potato whisky, Northumberland rum made legally without distilling plus Elizabethan strong ale and many other potent brews. Reprint of ancient recipes, but using simple modern kitchen methods. Send \$2 to Olde London Brew-house, 423 Riverside, Oakville 1, Ontario, Canada.

WELLSAW® 400

... The ALL-AROUND Power Saw

Use it

- all-around the home
- all-around the workshop
- all-around the garden
- all-around the clock!

Tough, rugged WELLSAW 400 puts you in the expert class—no matter how tough the saw job you tackle. Handles comfortably as a hand saw, but is power-packed to lick the toughest jobs. Safest power hand saw of them all—even teenagers use it skillfully. Choice of models with 8" or 16" blades. Long-lasting blades are economical, throwaway type, quick and easy to change. Your equipment, hardware or tool dealer has a WELLSAW 400 or can get one for you. See him today.



Trim trees



Trim fence posts



Cut rafters



Cut plywood

Send coupon for "Sawing Magic of WELLSAW 400." 16 pages telling the story of WELLSAW 400 versatility.

WELLS MANUFACTURING CORPORATION
490 Service Road, Three Rivers, Michigan 49093

Name _____

Address _____

City _____ State _____

456

CASH IN ON THE BOOM IN COLOR TELEVISION

The NRI TV-Radio Servicing course includes your choice of black and white or color TV training equipment. Color TV needs thousands of trained men to keep pace with millions of sets being sold every year. NRI prepares you quickly. Cash in on the boom.

IF
CARD IS
MISSING
MAIL
THIS
COUPON

NATIONAL RADIO INSTITUTE
Washington, D.C. 20016

100-098



Name _____
Address _____ Age _____
City _____ State _____ Zip _____
 Check for facts on GI Bill

You get more for your money from NRI

NRI pioneered the idea of supplying home-study students with custom designed training kits to give practical on-the-job experience as you learn. Today, NRI's "3-Dimensional" training can't be equalled. You get more *value* — from the exclusive Achievement Kit sent the day you enroll, to "bite-size" texts and custom training equipment. Learning TV-Radio, Electronics or Communications at home is easy, exciting, the NRI simplified, dramatized way.

BE A SKILLED TECHNICIAN IN AMERICA'S FASTEST GROWING INDUSTRY

Regardless of your educational background, you can learn the Electronics field of your choice the practical NRI way. The NRI color catalog, sent to you *free* and without obligation, tells you how you can qualify quickly to be a part of the fast growing Electronic Age; about engineering jobs in business, industry, broadcasting, government, now offered to men without college degrees. It will open your eyes to the great number of success opportunities available right now in the high-pay world of TV-Radio Servicing, Broadcasting-Communications and Industrial-Military Electronics. With NRI technical training, you can take your choice of a wide variety of career

openings or have a business of your own. And if you choose one of five NRI courses that include FCC License preparation, *you must earn your FCC License or NRI refunds your tuition!*

MAKE \$4 TO \$6 AN HOUR EXTRA IN SPARE TIME STARTING SOON

Tens of thousands of NRI graduates are proof it is practical to train at home in your spare time. Keep your present job while preparing for a better one, and earn \$4 to \$6 an hour extra in spare time while you train, fixing sets for friends and neighbors. NRI shows you how. Equipment you build and keep becomes useful in your work.

STEP UP TO BETTER PAY, A BRIGHTER FUTURE

NRI can help you, but the decision to act must come from you. Decide *now* to move ahead . . . mail the postage-free card. If missing, use coupon above for FREE NRI color catalog. No salesman will call. NATIONAL RADIO INSTITUTE, Electronics Division, Washington, D.C. 20016.

APPROVED UNDER GI BILL

If you served since January 31, 1955, or are in service, check GI line on postage-free card or in coupon.

NRI Programmed Equipment Gives You Priceless Confidence, Makes Learning TV-Radio, Electronics Fast and Fascinating

BUILD • TEST • EXPLORE All this is yours — from Achievement Kit, to solid state Radio, to training-engineered Color TV set — when you enroll for NRI's TV-Radio Servicing course. Other courses equally complete. Unique training methods, "bite-size" texts, many personal services have made NRI the leader in its field for over 50 years.



SOLUTIONS FOR MECHANICAL HEADACHES

AUTOMOBILE CLINIC

BY MORT SCHULTZ

Overlooking the obvious?

My friend's 1967 Dodge station wagon loses rear-axle lubricant so badly over the course of 400 miles that the back end of the wagon is splattered with the stuff. He's taken it to the dealer service department, but has received no satisfaction. What are they overlooking?—Elmer Gifford, Waldport, Ore.

I don't know, but they sure don't have that much to overlook. There are only two things that can cause such a loss of lubricant: 1. A bad rear-axle pinion seal; 2. A plugged vent valve on the rear housing, which could cause enough pressure build-up to blow the pinion seal.

Seeing red

Have you had any complaints about the temperature light of the 1967 Buick Wildcat? It goes "red," but the engine isn't overheating. The sending unit in my car was replaced when the car had only 50 miles on it, again at 3000 miles and now at 7000 miles it's acting up. Is the sending unit defective?—William M. Dean, Wilmington, Del.

Yes, to both questions. I've had complaints from owners of 1967 and 1968 Oldsmobiles as well as of Buicks, and the trouble seems to be a batch of defective sending units that have made their way into the field. The only cure, I'm afraid, is to double check whenever you see that red light go on—just to make sure that the engine isn't overheating. Then, replace the bad sending unit. As long as you're still within the warranty period, there should be no charge for this service.

Hung up

I have a starting problem with my 1966 MG 1100 sport sedan. At temperatures below 40° I must turn the engine over six to eight times in the morning before it will start. I follow recommended starting procedures. After it does start, the engine runs and starts perfectly for the rest of the day. Next morning, though, same thing. The car's been tuned up and checked with electronic testing equipment. Everything is fine. So what gives?—E.E. Unger, Midland, Tex.

Better ask me what isn't giving. I think that the chokes of your dual SU carburetors are hanging back. If the manually operated linkage isn't set just right, the choke needles won't drop into the orifices all the way or won't work in synchronization. This leads to hard starting and is a condition the electronic testing equipment won't pick up. My advice is to have the choke linkage set properly between the carburetors.

Raise your right hand

Suddenly, for no reason, the heater core of my 1967 Chevrolet began leaking so badly where the tube attaches to the core that I had to replace the entire unit. I don't know what could have caused this. Neither does the dealer. It happened, by the way, after the heater hose was replaced, but the mechanic says he was careful.—Marshall Moore, Lancaster, Pa.

You can't be careful enough when working around the core. Too much force exerted on the seams when removing the hose will split them. That's why the proper way to remove heater hoses (both of them) must be followed. If the hoses don't come off the tubes easily after the clamps have been removed, they should be cut just before the tubes. The remaining part of the hoses left on the tubes should be split longitudinally—then removed.

No indication

As you know, my 1960 Plymouth station wagon has an oil-pressure "idiot" light. I don't think it's working, because the light never goes on—not even when I turn the ignition key on to start the motor. Is this the way it should operate?—Lonnie Mills, Yucaipa, Calif.

No. That light should shine when you turn on the ignition switch and should go out when the engine starts and oil pressure reaches 5 to 12 pounds. You have a problem in one of three places: in the bulb, the wiring or the oil light switch. To find out which is at fault, run a ground wire from the oil light switch, which is at the oil pump just behind the oil filter, to the ground. Then turn on the ignition. If the light goes on, the oil light switch is

(Please turn to page 60)

FIX your appliances,
car,
house,

SAVE

on home improvements,
air conditioning,
power tools and more

WITH THIS

FREE \$3.49 VALUE
GIFT VOLUME

Just look back over the past few years and figure how much you have spent on repairs for your home, your car, your appliances. Wouldn't you like to keep these high-priced repair fees for yourself? Well, now you can.

As a reader of *Popular Mechanics* the chances are that you already have a considerable degree of skill with tools. Nevertheless, you may have hesitated to tackle more complicated repairs, improvements or hobby projects.

Now, however, this FREE Book—packed with the combined skill and know-how of 257 *Popular Mechanics* expert editors, consultants and designers—can put a professional edge on your do-it-yourself skills.

The most difficult jobs will soon become easy

Before you know it, you'll be able to fix car engine troubles... transform unfinished attic space into an extra bedroom... catch more fish using homemade lures... learn "tricks-of-the-trade" in handling power tools... save hundreds of dollars when buying and servicing appliances.

These are just a few of more than 6,000 exciting "how-to" ideas, plans, and valuable projects you'll find in *POPULAR MECHANICS DO-IT-YOURSELF ENCYCLOPEDIA*. You'll learn how to get more professional-looking results than ever before in your carpentry, metalwork, plumbing, masonry, electrical wiring, electronics, hi-fi, stereo, car repair, painting, decorating... PLUS exciting new ways to help you get more fun out of your hobbies, sports, vacations. Experts lead you step-by-step through every project you select. Without question, here is the most helpful, reliable, "how-to-do-it" guide you've ever seen—and Volume 1—a \$3.49 value—is yours ENTIRELY FREE!

You risk nothing on this FREE Book offer!

As soon as your gift book comes, browse through it—try some of the exciting ideas—use some of the money-saving tips. We're sure you'll get so much valuable help from this book, you'll want to see the other volumes as they are published. You can see future volumes without risk—on a 14-day FREE TRIAL basis. But this first volume is yours as an outright gift—whether you buy one, two, five, the whole set, or none at all. But please hurry. Our supply of gift volumes is definitely limited. To be sure of getting your copy FREE, mail the coupon today.

Here is a brief glimpse of all your FREE Volume brings you:

- Fix 8 common car engine problems and save garage fees
- Save money air conditioning your entire home
- Cure a wet basement and save \$200 to \$2,000 under what professionals charge
- Burglarproof your home with special power alarm
- Professional tips for expert sanding
- Learn arc welding basics in 6 hours of easy practice
- How to save on band saw blade costs by making your own
- Build a gas-fired barbecue for more back-yard fun

PLUS much, much more

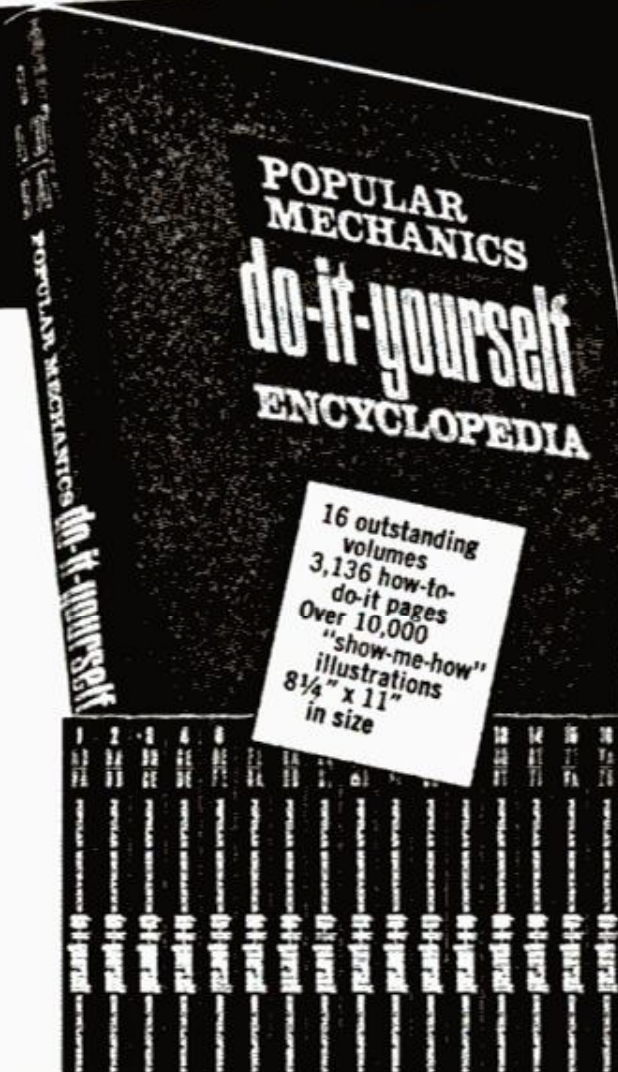

16 outstanding volumes
3,136 how-to-do-it pages
Over 10,000 "show-me-how" illustrations
8 1/4" x 11" in size

MAIL COUPON TODAY!

Popular Mechanics Book Division, Dept. 819
250 West 55th Street, New York, N.Y. 10019

Please send me, ENTIRELY FREE of any charge, my complimentary copy of Volume One of the all-new, illustrated *POPULAR MECHANICS DO-IT-YOURSELF ENCYCLOPEDIA*. I am not obligated to buy anything—now or later.

I understand I will be entitled to receive additional volumes for my FREE EXAMINATION as they are published each month. After examining each volume FREE for 14 days, I will either return it and owe nothing—or keep it and remit low subscriber price of only \$3.49 a volume, plus a few cents for shipping.

I reserve the right to cancel any time I wish—even immediately after receiving my FREE Volume 1—without obligation. Whatever I decide, Volume 1 is mine to keep FREE.

Name _____ (Please Print)

Address _____

City _____

State _____ Zip

Signature _____

AUTOMOBILE CLINIC

(Continued from page 58)

bad. If it doesn't, a defective bulb or wire is indicated.

Gas pains

My problem is a gasoline heater in a 1960 Corvair. When I turn it on, I get some heat, but then the thing starts backfiring. I shut it off for fear of a fire or having it blow up. Do you have a solution?—Joseph Nicotra, Ansonia, Conn.

Have a competent mechanic take the thing apart, clean it, check it for leaks, and overhaul it. This type of unit is much like an oil burner in a house. When the oil burner gets dirty or a part of it goes bad, it will "puff." Your Corvair gas burner does the same thing—that's the backfire you hear.

Grease job

It was right after I had my 1967 Buick greased that I noticed a drastic reduction in braking power. I took the car back to the dealer, and we found that the discs of my disc brake system were coated with grease. How did it get there?—Nathan Brilles, Minneapolis.

Well, I'd say that someone went a little giddy with a grease gun while lubing the front lower-control-arm ball joints, which lie pretty close to those discs. Next time, ask the man to be a little more careful and mask off the discs by inserting a clean piece of cardboard between them and the splash shield of each front wheel during ball-joint lubrication.

Psychedelic paint swirls

The paint on my 1967 Lincoln Continental is pretty faded, and I've tried hand buffing without success. Someone suggested an electric buffer, but I'm afraid it will leave swirls. What do you think?—Terry Ford, Ukiah, Calif.

An electric buffer in the hands of someone who doesn't know how to use it will leave "swirls." I put quotes around that word, because "swirls" are areas where paint gets burned by improper use of a buffing machine. The tendency on the part

of amateurs is to apply too much pressure. In addition, too many people use a 1/4-in. electric drill with a buffer attachment to polish their cars. Because it rotates at such a rapid rpm, this instrument is more likely to cause trouble. I'd suggest that if you can get a real buffer and wish to try it, go ahead. But watch that pressure. Better to use too little than too much. If you're not sure of yourself or don't have the proper equipment, leave buffing to a body shop. If "swirls" occur, they're responsible.

Service Tips

● **Owners of 1968 Dodge Coronets and Chargers with 426 Hemi engines** could be operating with the wrong oil dipstick. This car requires one quart more of oil than 1966 and 1967 models with 426 Hemis. But some early-production 1968 models were accidentally equipped with the 1967 oil dipstick which shows overfill when the '68 engine has a full oil supply—eight quarts.

● **1968 Ford or Mercury cars running at unusually high engine-idle speeds** may have a minor problem: The vacuum hose to the servo motor in the air cleaner might be improperly routed, holding the fast-idle cam in the "on" position. Have it checked by removing the air cleaner and inspecting for hose interference. Reroute the hose away from the cam mechanism, if necessary.

● **1968 Plymouth Valiant 170-cu.-in. engines (with automatic transmission)** may be stumbling and stalling. The problem lies with the metering wire of the step-up piston, which is inside of the carburetor. The wire helps to control the amount of mixture going to the cylinders. Some of these have been adjusted too short. So, if your Valiant is stumbling and stalling, especially during warm-up, ask your dealer to apply the cure as specified in service bulletin 68-14-6 (3/27/68).

● **1968 Chevilles built before Nov. 15, 1967,** should have drain holes in both front side members at the stabilizer shaft brackets. The frame has a dip in it at these points, which allows water to collect. This could lead to corrosion. Chevilles built after this date have drain holes drilled at the factory. If you don't have them, have your dealer drill them. If he hasn't heard of it, ask him to check page 5 of Chevrolet Service News No. 3 (3/68). ★ ★ ★

GOT A PROBLEM WITH YOUR CAR? Ask Mort about it. Send your question to Auto Clinic, Popular Mechanics, 575 Lexington Ave., New York, N.Y. 10022. Letters cannot be answered individually, but problems of general interest will be published in the column.

Until this house was painted with Dutch Boy Latex seven years ago, it needed re-painting almost every year.



We've been watching this house in Roxbury, Connecticut ever since it was painted with our Dutch Boy Latex House Paint in 1962.

It's now nearly seven years—and we're still waiting for our first blister.

(For twenty years before, the house blistered so badly it needed re-painting almost every year.)

Obviously, neither rain, nor sleet, nor snow—even years and years of the tough New England kind—can put a dent in the exclusive resins we put in our Dutch Boy Latex.

But then, everything about Dutch Boy Latex makes it the ideal house paint.

Colors don't fade, there's little or no chalking. And, both tools and hands clean up easily with soap and water.

Paint your house with Dutch Boy Latex House Paint—and watch what doesn't happen.

Dutch Boy Latex House Paint

DUTCH BOY PAINTS
National Lead
Paint Division



If there's quality on the inside... there's a Dutch boy on the outside.

It's Like Having Auto Factory Experts Right Beside You...

when you use this famous illustrated step-by-step guide that shows you



HOW TO FIX ALMOST ANY PART OF ANY CAR

Now—Whether You're a Beginner or Pro Mechanic—You Can "Breeze Through" Almost ANY Repair Job on Any Popular-Make Car—1962-1968!

MOTOR'S AUTO REPAIR MANUAL shows you in step-by-step words and pictures all the factory-approved repair procedures you'll ever need for fixing practically ANY part of ANY car listed here—1962-1968.

1,196 BIG PAGES — 3,200 PICTURES!

This NEW, REVISED, 1968 Edition covers everything you need to know to fix almost any car model from 1962 thru 1968. 1,196 giant pages. 3,200 pictures. 365 "Quick-Check" charts. 55,000 essential repair specifications. Over 225,000 service and repair facts.

PLUS Adjustment Tables, Tune-Up Charts, Tables of Measurements and Clearances, Overhauling and Replacement Facts, Carburetor Adjustment, etc. Special Trouble-Shooter Section and detailed trouble-shooting information thruout help pinpoint the cause of any of 4,200 car troubles in a jiffy.

Same Offer on MOTOR'S AUTO ENGINES & ELECTRICAL SYSTEMS

1,300 big pictures. Clear text explains how parts work; principles involved; design; construction; maintenance. Covers all parts of engines & entire electrical system. For FREE trial, check coupon.



No guess-work! Even a green beginner mechanic can do a good job with this giant manual before him. And if you're a top-notch mechanic, you'll profit from the time-saving and work-cutting procedures you'll find.

MOTOR'S MANUAL makes almost every operation on any car—from Volkswagen to Cadillac—as easy as A-B-C! Eliminates trial and error — saves you time, work and money.

OVER 5 MILLION COPIES SOLD

SEND NO MONEY Try Manual at OUR Risk — FREE

See for yourself why U.S. Armed Forces, Schools, and garages everywhere "swear" by MOTOR. Just mail the coupon. TRY Manual for 10 full days—FREE! If it doesn't pay for itself in those 10 days, just return it and pay nothing, owe nothing. Mail the coupon AT ONCE to MOTOR Book Dept., 250 West 55th Street, New York, N.Y. 10019 (SCHOOLS, BOOKSTORES: Write for Discounts.)

TRY BOOK FOR TEN DAYS FREE

FIX ALL THESE CARS

| | |
|-------------|-------------|
| Volkswagen | Oldsmobile |
| Mustang | Ford Bronco |
| Barracuda | Buick |
| Jeep | Special |
| Chevy II | Comet |
| Pontiac | Corvair |
| Thunderbird | American |
| Buick | Olds F-85 |
| Imperial | Falcon |
| Cadillac | Fairlane |
| Continental | Lancer |
| Dart | Tempest |
| Mercury | Corvette |
| Ford | Valliant |
| Chevelle | Cougar |
| Chevrolet | Toronado |
| Camaro | Riviera |
| Scout | Firebird |
| Chrysler | Eldorado |
| Plymouth | Marlin |
| Fury | Javelin |
| Rambler | Montego |
| Dodge | Torino |

MOTOR'S AUTO REPAIR MANUAL

TROUBLE-SHOOTER Section Helps Spot 4,200 Car Troubles
 Trouble-Shooter section & detailed trouble-shooting info thruout help pinpoint 4,200 causes of car trouble: transmissions, brakes, engines, electrical systems, much more!

MAIL COUPON NOW FOR 10-DAY FREE TRIAL

MOTOR BOOK DEPT., Desk 819
250 W. 55th St., New York, N. Y. 10019

Rush to me at once MOTOR's New AUTO REPAIR MANUAL. If O.K., I will remit \$2 in 10 days, \$3 monthly for 2 months and a final payment of \$1.95 (plus delivery charges and sales tax, if any) one month after that. Otherwise I will return the book postpaid in 10 days.

Print Name..... Age.....

Address.....

City & State.....

ZIP CODE ZONE NO.

| | | | | | |
|--|--|--|--|--|--|
| | | | | | |
|--|--|--|--|--|--|

Also send me for 10-day Free Trial MOTOR's AUTO ENGINES and ELECTRICAL SYSTEMS. If O.K., I will remit \$8.95, plus delivery charges and sales tax, if any, in 10 days. Otherwise I will return book postpaid in 10 days.

Check box and save shipping charge by enclosing WITH coupon in envelope entire payment of \$9.95 for AUTO REPAIR MANUAL (or \$8.95 for AUTO ENGINES and ELECTRICAL SYSTEMS) plus sales tax, if any. Same 10-day return-for-refund privilege applies.

QUESTIONS ANSWERED

HOMEOWNERS' CLINIC

BY W. CLYDE LAMMEY

Replacing curved rung

I have an heirloom highchair that's been in the family for generations. One lower rung is missing. The other three are curved about 3/4 in. so the missing one must have been bent to the same radius. How can I replace it?—R.R., Ark.

The original was probably made from hickory or white ash, the most bendable of native woods. You no doubt can locate a suitable piece of these woods locally. Select one that best matches the originals, and is sound and straight-grained. Cut it somewhat longer than required, round it to size with a drawshave or jackplane, sand smooth and place in a receptacle that will hold sufficient water to cover it. Weight the piece so it does not float. Then boil for at least two hours.

To make a bender, cut two pieces of 1x4, each about 6 in. longer than the part to be bent. Drill three holes in each piece to take 1-in. dowels; one hole near each end, about 1/2 in. above the center line. Center the third hole on the 1x4 about 1/2 in. below its center line, making the offset about 1 in. Insert 6-in. lengths of 1-in. dowel in the holes. Remove the rung from the water and immediately place it in the bender, feeding it over the first dowel, under the middle one and over the third, forcing the rung to take the bend. Leave it this way at least 36 hours, then remove it from the bender, cut it to length and install it in the original holes in the chair legs.

Pesky spray cans

I use spray cans quite frequently, but even though I invert the can and spray out the residue as directed, the next time I pick up the can the spray tip is apparently clogged and won't work. What does one do to make these things work?—B.E., Wis.

Look closely at the tip after spraying as directed; you'll often see a tiny bubble of the material covering the tip. This seeps back into the orifice and hardens. Thus the next time you try spraying you may get a fizz or two, a splatter of drops or, more likely, nothing. I've found that if I pull off the spray tip—after inverting and spraying out residue—and dunk it in lacquer thinner I have no further trouble. ★★★

Special Invitation to Inventors

If you have an invention (whether patented or unpatented) that you believe has commercial value, our Free Booklet entitled "How to Go About Selling Your Invention" may help you save time and money.

We are specialists in representing inventors and submitting their inventions to manufacturers. We work with scores of manufacturers who are seeking new products or new product ideas, and we therefore know which firms may be interested in your particular invention. Our service is designed to do all those things the average inventor lacks the knowledge or facilities for doing, or does not have time to do. We prepare your sales letters, folios, duplicate drawings, handle correspondence, select the firms.

We charge the standard commission (on sales) and a modest fee for the submitting service. This fee is refunded if a manufacturer buys your invention through our efforts. We are a nationally known concern with an impeccable reputation for ethics and integrity.

The Free Booklet we have prepared especially for inventors contains such information as current royalty rates being paid by manufacturers, discusses many types of inventions, the possible market for them, tells the effective methods of presenting your invention for sale, whether you employ us or do it yourself, and outlines how we may be able to help you.

You can obtain this booklet "How to Go About Selling Your Invention" by mailing the coupon below. And if you wish to write us for comments on your invention, please do so. We make no charge for consultation. But please do NOT send drawings or models. Just describe the purpose and nature of your invention. Mail the coupon to K. O. Kessler, Pres., Kessler Sales Corporation, Dept. D-59, Fremont, Ohio 43420.

You are welcome to ask your lawyer, local Bank, Chamber of Commerce to carefully check on our reputation for honesty and fair-dealing.

MAIL THIS COUPON

Mr. K. O. Kessler, President, Dept. D-59
Kessler Sales Corp., Fremont, Ohio 43420

Please mail me a copy of your Free Booklet "How to Go About Selling Your Invention." It is understood that this does not obligate me in any way to use your Service.

My Name

Street Address.....

City State..... Zip.....

*“When you're out
of Schlitz,*

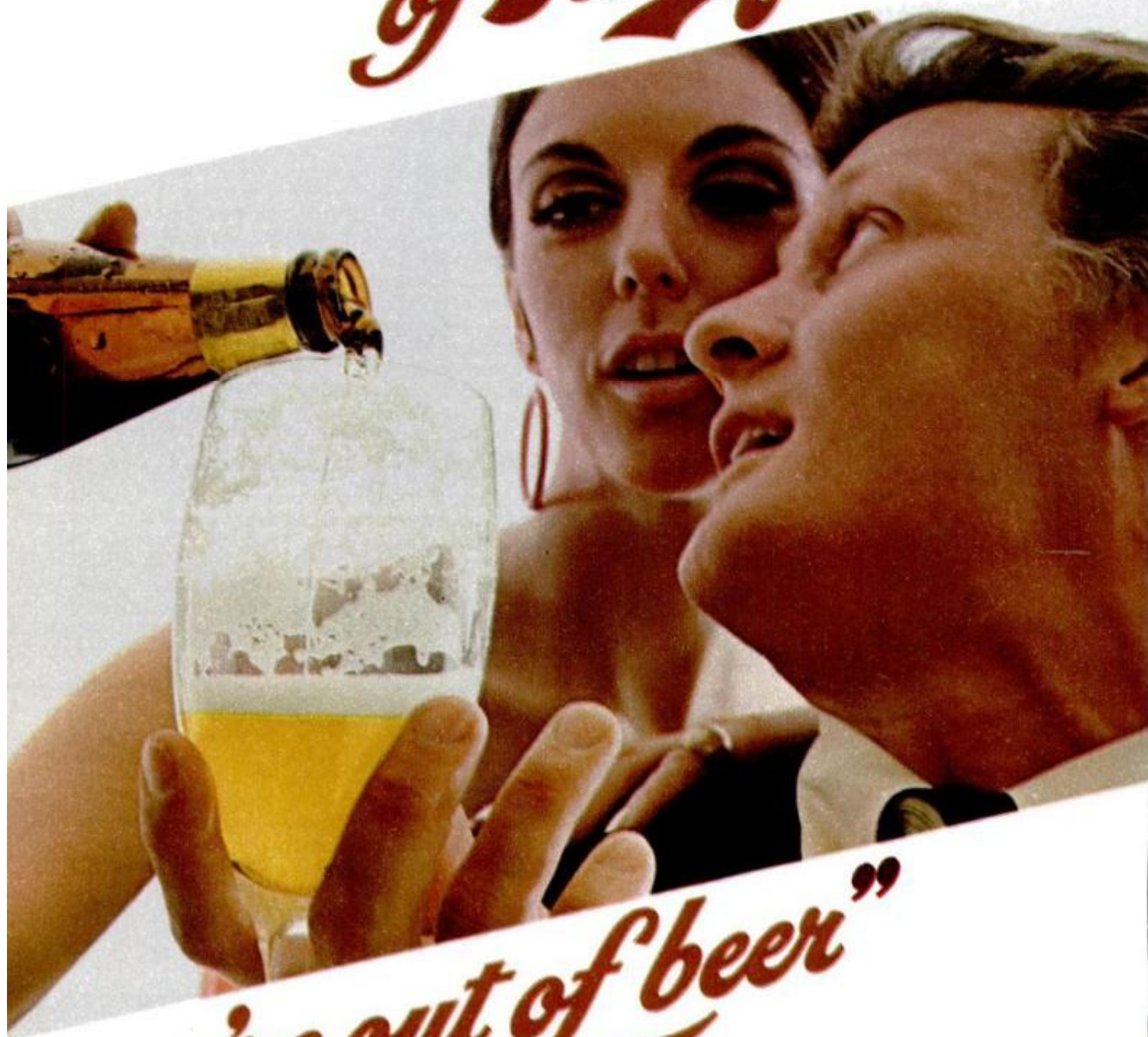

you're out of beer”

Quality never comes easy. Schlitz is most carefully brewed for smoothness, gusto, and aroma, without "beer bite." This is pure beer. This is Schlitz. The beer that made Milwaukee famous.

© 1988 An. Schlitz Brewing Co., Milwaukee and other great cities.



HURRICANE!

When Nature Lays On the Lash By JAMES M. BERRY

SHE BOILED IN FROM SEA the morning of Sept. 20, 1967, with the force of 20 atomic bombs a second. Within two days, Hurricane Beulah had devastated 40,000 square miles of Texas with 160-mph winds, 30 inches of rain and 97 tornadoes sparked by the maelstrom. Wind-driven floods crumpled steel and concrete levees, caused entire towns to be evacuated and made hundreds of square miles of citrus-growing land resemble ocean. Thousands of poisonous snakes, whose natural habitats were disturbed, terrified survivors. When she was through, Beulah had cost 11 lives and \$1 billion in property damage. Beulah was bad news, but so are the other six

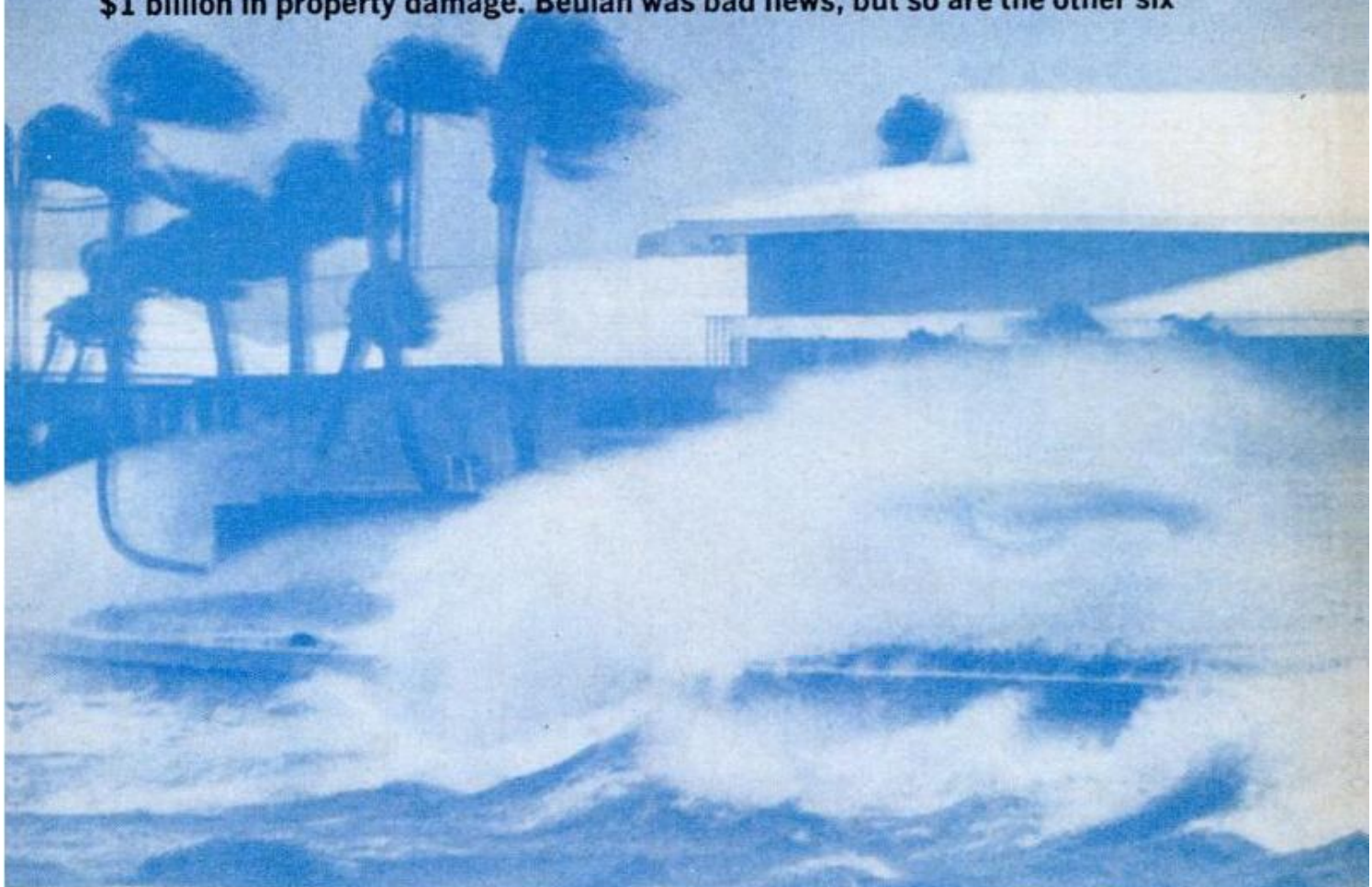

HURRICANE SPOTTER PLANE

TOP OF HURRICANE ABOUT 140,000 FT

HURRICANE

EYE

WARMEST AIR NEAR CENTER

10 TO 30 MI
RAIN BAND

WINDS WHIP UPWARDS AT 300 M. P.H.

HURRICANE
75 TO 200
50 MI RADIUS

WARM, WATER LADEN AIR
DRIFTS TOWARD CENTER
AT 10 TO 25 MI. PER HR.

FORWARD
MOVEMENT OF
HURRICANE ABOUT
20 MI. PER HR.

SEASWELLS

MIAMI

KEY WEST

SWIFT HIGH ALTITUDE WINDS

The Anatomy of a Hurricane

A typical hurricane bears down on the Florida coast at a relentless 20 mph. Warm, moisture-laden air from the Caribbean forms a gigantic counter-clockwise spiral. Heat from this rising vortex is carried away by high-altitude winds that create a chimney draft, evaporating wind-driven sea spray, increasing the hurricane's warm-air supply and boosting it to 40,000 feet. Devastating winds are racking Key West (left) and the sea surge is hammering Cape Kennedy and Daytona Beach (right). The eye will pass just north of Miami.

Illustration created especially for Popular Mechanics by Herb Matt, Sid Zigas and William Seifert

10 TO 30 MI.
RAIN BAND

JACKSONVILLE

DAYTONA

SEASWELLS, FIRST INDICATION
OF HURRICANE

WINDS
M.P.H.

GALE FORCE WINDS

400 MI. RADIUS

hurricanes that hit the United States in a typical June to November season. "Hurricanes," states the Department of Commerce, "cause more widespread damage than any other natural disaster." They also kill—an average of 75 people a year from Texas to Maine.

Better tracking and prediction have cut this toll of lives and property. But the real aim of meteorologists is more ambitious: to learn the anatomy of hurricanes so they can pull the eye-teeth of those heading for land. "Conditions that seem ripe for a hurricane often exist without one forming," says Dr. Cecil Gentry, the gentle, middle-aged director of Miami's National Hurricane Research Laboratory. "We're still missing some elements that go into hurricanes."

WEATHER TERMS

Cyclone: A low pressure storm area into which air spirals, usually forming clouds and precipitations. Cyclone centers are the low pressure areas on weather maps.

Anticyclone: A high-pressure area from which air spirals outwards.

Gale: Winds from 39 to 74 mph. The Weather Bureau divides a gale into several categories. Strong gale: winds from 47 to 54 mph; storm: winds from 55 to 63 mph; violent storm: winds from 64 to 74 mph.

Hurricane: A tropical cyclone with winds above 74 mph. The word hurricane probably comes from the name of a Mayan storm god called Hunraken.

Typhoon: A term for hurricane commonly used in the Pacific.

Willy-willie: Australian term for hurricane. The Philippine name is even more exotic—*baguio*.

VIEW INTO THE EYE of Hurricane Ida from a high-flying U-2 plane reveals the dead calm in center

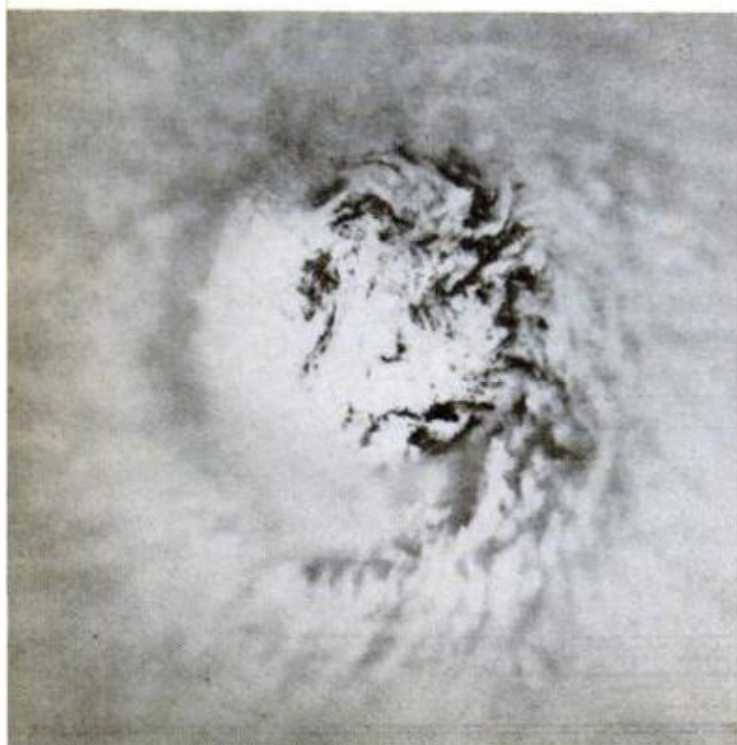

Details are lacking. But with the help of improved weather radar, satellite observations, airborne monitoring, and better global weather reporting, meteorologists have pieced together the best picture yet of a hurricane's conception and birth—the first steps in controlling its life.

Hurricanes that strike the United States begin in the Gulf of Mexico or Caribbean Sea as calm, low-pressure areas. Air from hundreds of miles away begins to drift into such an area; first sluggishly, then picking up to about 20 mph. During the trip, air soaks up heat and—most important—water vapor.

The air is also molded into a gigantic spiral by the Coriolis force—tendency of the earth's spin to cause fluids to rotate counterclockwise in the Northern hemisphere, clockwise in the Southern. As the soggy, warm air and the clouds it forms rush toward the spiral's center, it speeds up. At the vortex, the air winds skywards, expands, cools—then dumps its moisture as rain.

This rainfall is a hurricane's fuel supply. To become vapor, water absorbs heat, warming the spiraling cloud column and boosting its air upward as high as 40,000 feet. The quantity of heat released by the rain is so great that a hurricane's eye wall—rain clouds surrounding the calm, windfree center or

(Please turn to page 176)

EIGHT MAJOR STORMS of 1967 were tracked by satellite. Photo mosaic was made from computer tape



Night Driving: How to Handle Its Deadly Hazards

By E. D. FALES JR.



YOUR WORST ENEMY on the road after dark is the "wrong-way flyer," the fellow—usually stone drunk—who comes at you in your lane. Your best bet? Pull off the road to your right, thus avoiding a head-on

DRIVING AT NIGHT is three times as dangerous as driving in daylight. Weird things can happen.

I know personally how easy it is on a rainy night to steer for a silver birch tree on a curve. After many hours on the road a single silver birch can look like an extension of a white center line. I darned near followed that "center line" into the woods one wet, weary night when the road veered sharply to the right.

The wee small hours bring out all sorts of phantoms, too. For example, a Wyoming driver worried for years about hitting stray horses. One night his headlights showed a herd racing across the road, tails flying, manes tossing. Scared stiff, he went into a long, screaming skid. When he finally stopped he found not a horse in sight; not a hoofprint. His tired mind had conjured up a phantom herd.

Then there was the Texas trucker

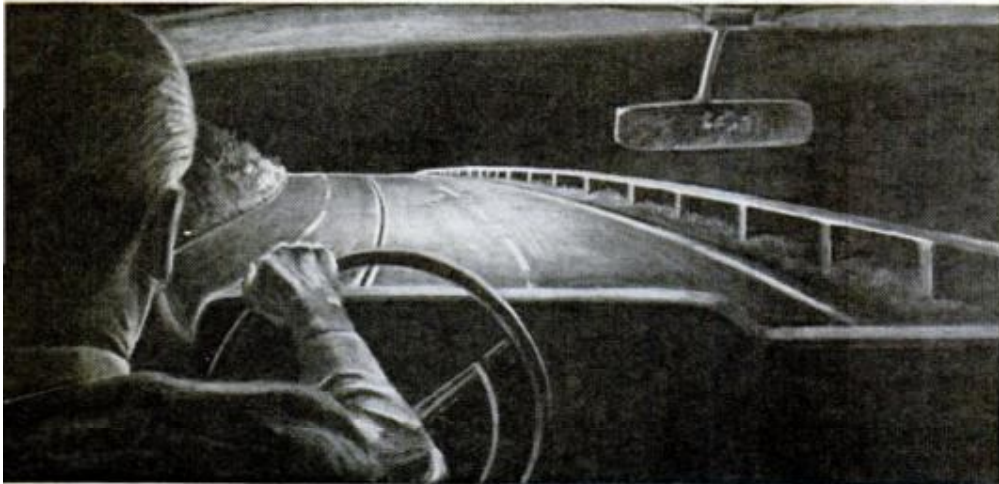
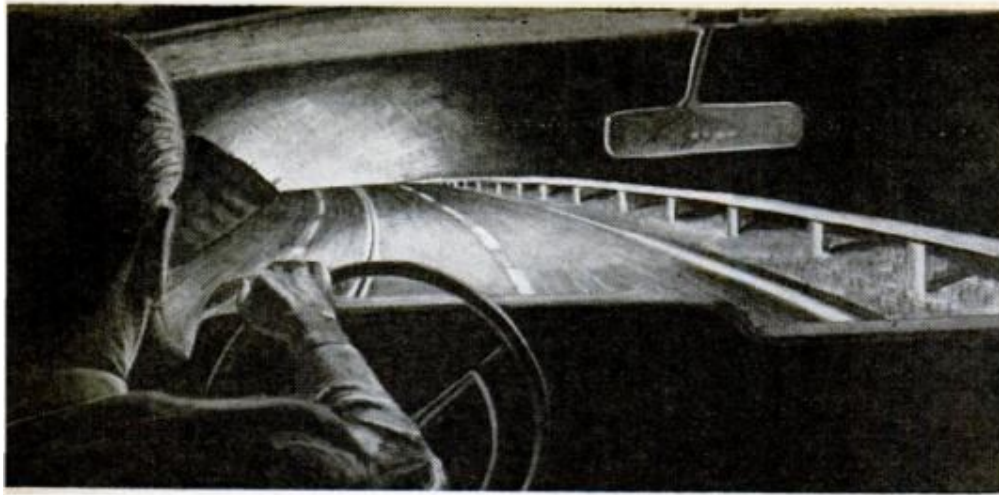

APPROACH CURVES on low beams to check for glow of oncoming car. Your high beams will blot out the warning you need

who jackknifed one gloomy midnight. His partner, in another truck, stopped, ran forward, found his friend alive. "I hit a calf," the trucker said. But when they searched, there was no calf; there never had been. Another tired driver's phantom.

These two eerie cases are from the files of Dr. Alfred E. Moseley, Boston psychologist, who investigates accidents for lawyers. How can you avoid these traps? First, says Dr. Moseley, by letting someone else drive when you are bothered,

tired or angry. Next, by never driving more than ten minutes after your eyes get droopy. Finally, by being a 100 percent teetotaler, particularly when tired or upset.

What warning signs should you look for? Three, says Moseley: "First: applying the brakes suddenly without good reason. Second: misinterpreting night shadows and seeing things that aren't there. Third: 'homing in on'—aiming for—the wrong lights or turns." If *any* of these happen you're heading for trouble and had better knock off for a while.

Other night problems. I can add these pointers of my own, based on years of on-the-road investigation:

- *Quit getting sore* when you think someone is deliberately shining his high beams in your eyes. Usually he isn't. More on this later.
- *Know your own worst enemy* on the night road, the fellow police call the "wrong-

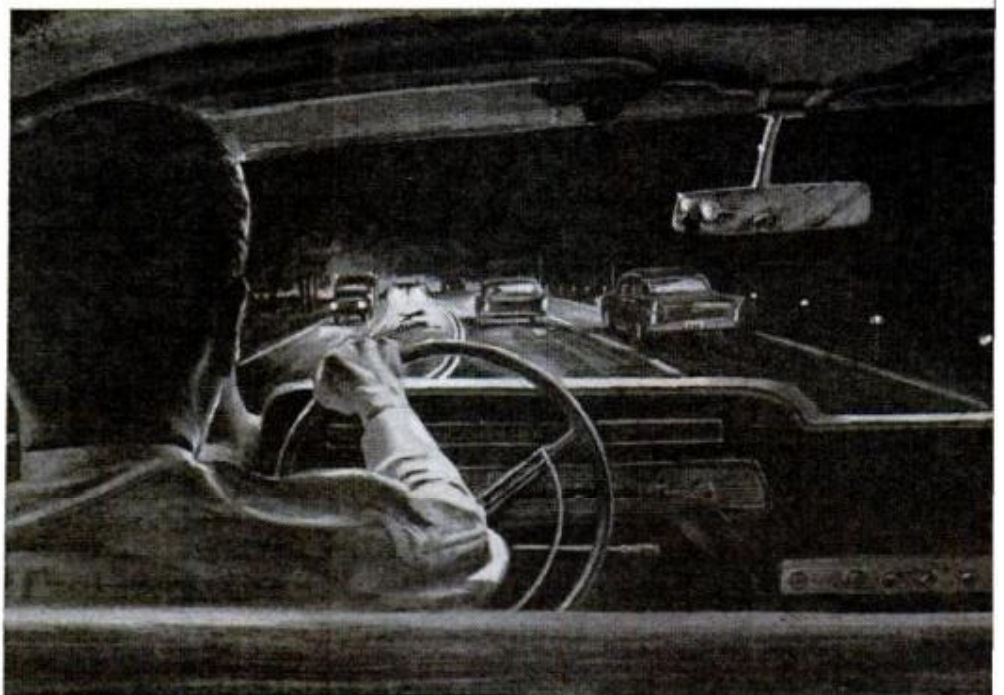

CLUES to night-driving vision include other drivers' lights, "reading" roadside reflectors, white lines, light reflections

way flyer." This is the mixed-up driver—usually stone drunk—who comes roaring toward you in your lane.

Warns the California Division of Highways: Look for him around bar-closing time. He's the fellow mainly responsible for those early-morning head-ons. California alone figures it had 33,000 "wrong way" incidents last year.

If you see a wrong-way flyer coming on a two-way road, your best bet may be to pull off the road—far off. If you can't, it may be best to stop at once. However, conditions vary. Twice I have met drunks coming fast on my side and I escaped only by steering left and passing them on my right. But this is highly dangerous. It makes *you* a wrong-way guy, and if the other fellow switches back to his lane a smart lawyer could make you appear to be at fault.

● *Use low beams on sharp curves.* Most drivers go into blind curves on high

beams, then get startled when someone comes around the curve without warning. It's a mistake to approach blind curves on high beam, since your brights blot out the advance warning glow of cars coming toward you.

● *But also use a warning "flick."* Going into a blind curve it pays to flick to brights once or twice, just for a second. This changes the intensity of light at the



DEER roam roads at night, especially toward dawn. A deer's eyes are highly reflective, often resemble reflection of beer can on the roadside

apex of the curve, helps the other fellow know you're coming.

● *Look for "deer lights."* One of the worst (but least-known) night dangers is deer. Deer roam most states and many motorists have hit, or at least had a close brush with them. I have hit one, even had one jump over the hood as I turned into a farm road. Keep a sharp watch, especially toward dawn (when deer come down to feed in roadside ditches) for deer eyes. A deer's eye is as reflective as a cat's: it looks like a pocket flashlight, or the shiny end of a beer can, hung in bushes or small trees. When you see it, brake fast. Remember, a deer won't turn like a cat and run back into the woods; he usually jumps into the road.

● *Suppose you have to overdrive your lights?* It's absurd but true that most of our wonderful new roads are designed so you can't use your high-beam lights. If you do, you throw an unbearable glare at other drivers. Experts say: "Use low beams on high-speed roads, but don't overdrive them." Taken seriously, this would slow night traffic on all super-roads to 40 mph or less—for many low

(Please turn to page 204)

IF HEADLIGHTS GO OUT SUDDENLY, flick on your directionals to help you spot the road stripe



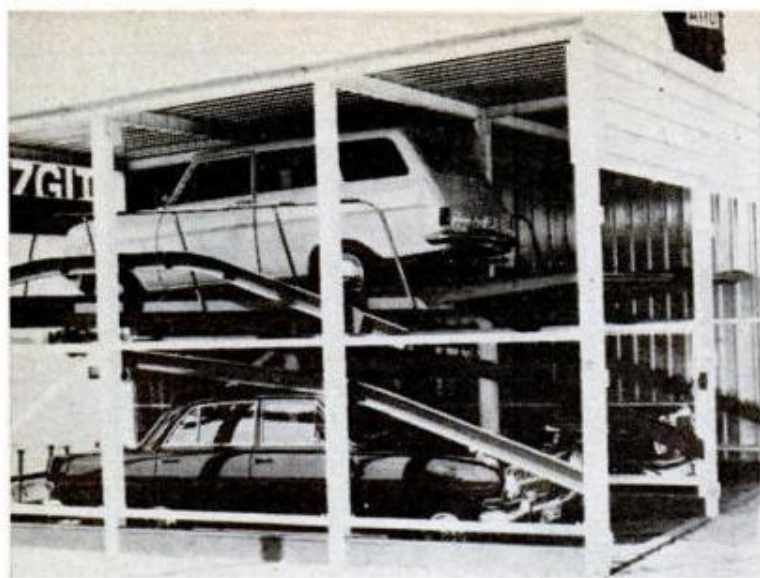

Two cars in one parking spot

For a two-car family with space to park only one car, a German firm has developed a garage that stacks the cars (as in the demonstration unit, above). To use the upper-deck car, the owner pushes a button, and the metal frame swings down (upper right) and out into the driveway so he can drive on or off. When frame is replaced, lower car becomes available (right).

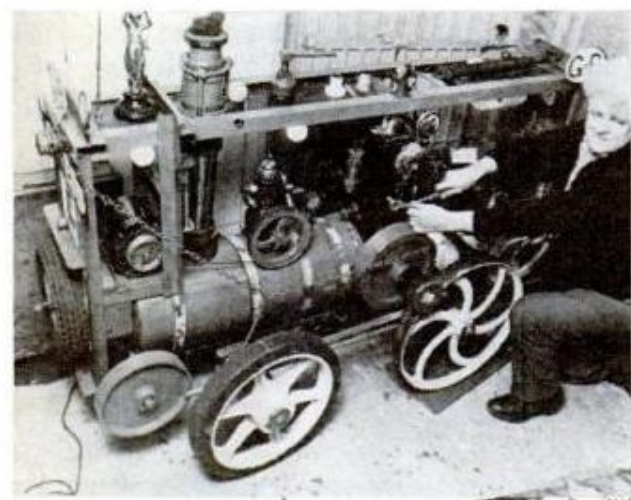

Bedroom engineer

Stan Kipling of Sunderland, England, had an unusual workshop while he built his bright red steam engine. It was his bedroom. The reason? He found it very restful to work on the project at night when he couldn't sleep.



Homemade orchard pruner

Zane Newton of George, Wash., combined some pieces of equipment already on his farm to make a pruning machine for use in his orchard. The gas-powered cutter on the end of the boom can be set vertically for hedging (above) or horizontally for trimming the tops of trees.



Marine assault boat

The Marine Corps is testing this "riverine assault boat" for possible combat use. The 16-foot fiberglass craft is powered by a 35-hp outboard. It can carry 1500 pounds of supplies or six combat-loaded troops. Various weapons, including the 106-mm recoilless rifle and 81-mm mortar, have been mounted on it and fired during tests.

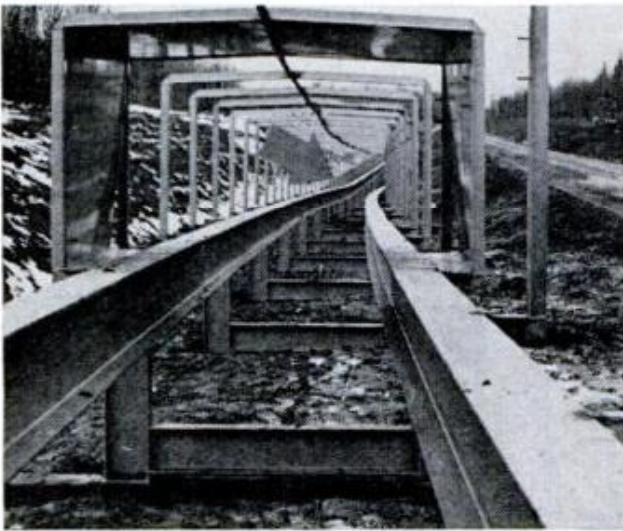
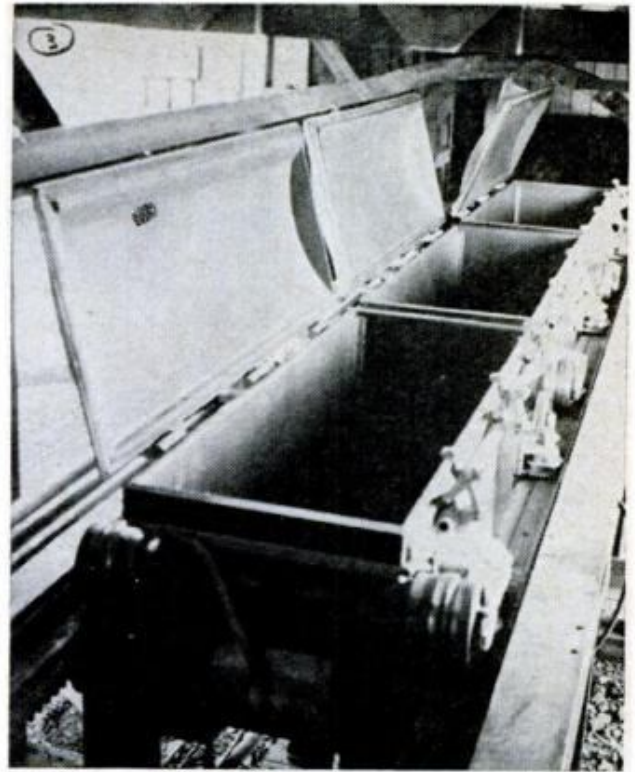
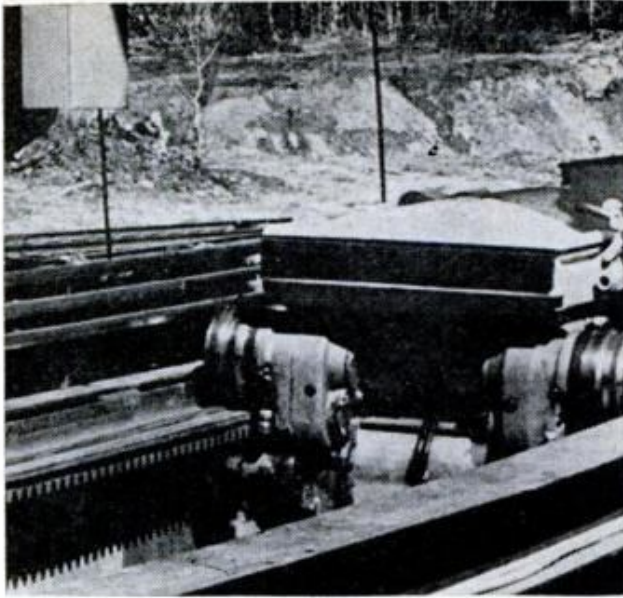

New ore-carrying system

An unusual system of transporting copper ore is scheduled to begin operating this year at White Pine copper mine in Michigan. The automatic system, the "Dashaveyor," features individually powered modules traveling over a 27,000-foot enclosed track on a dual I-rail. (Photos were taken before the track was enclosed.) The Dashaveyor system is also under study for transporting people at the Seattle-Tacoma International Airport.



Army works to keep its foot soldiers afloat

Getting across rivers, swamps and rice paddies is a major problem for infantrymen in an area such as the Mekong Delta. To help soldiers move more rapidly, the Army Limited War Laboratory has developed such aids as the foam-core bridge (left) and the eight-ounce, breath-inflatable flotation device shown at right. The bridge can be carried in sections and weighs only $2\frac{1}{2}$ pounds per linear foot. The "jacket" will carry a soldier plus 60 pounds of equipment.

From a Dead

By ROBERT ZIMMERMAN

Illustration by Fred Wolff



USS CROCKETT, one of Navy's fast new gunboats, cuts rakish swath during maneuvers. Cutaway (right) shows relationship of jet engine to diesels

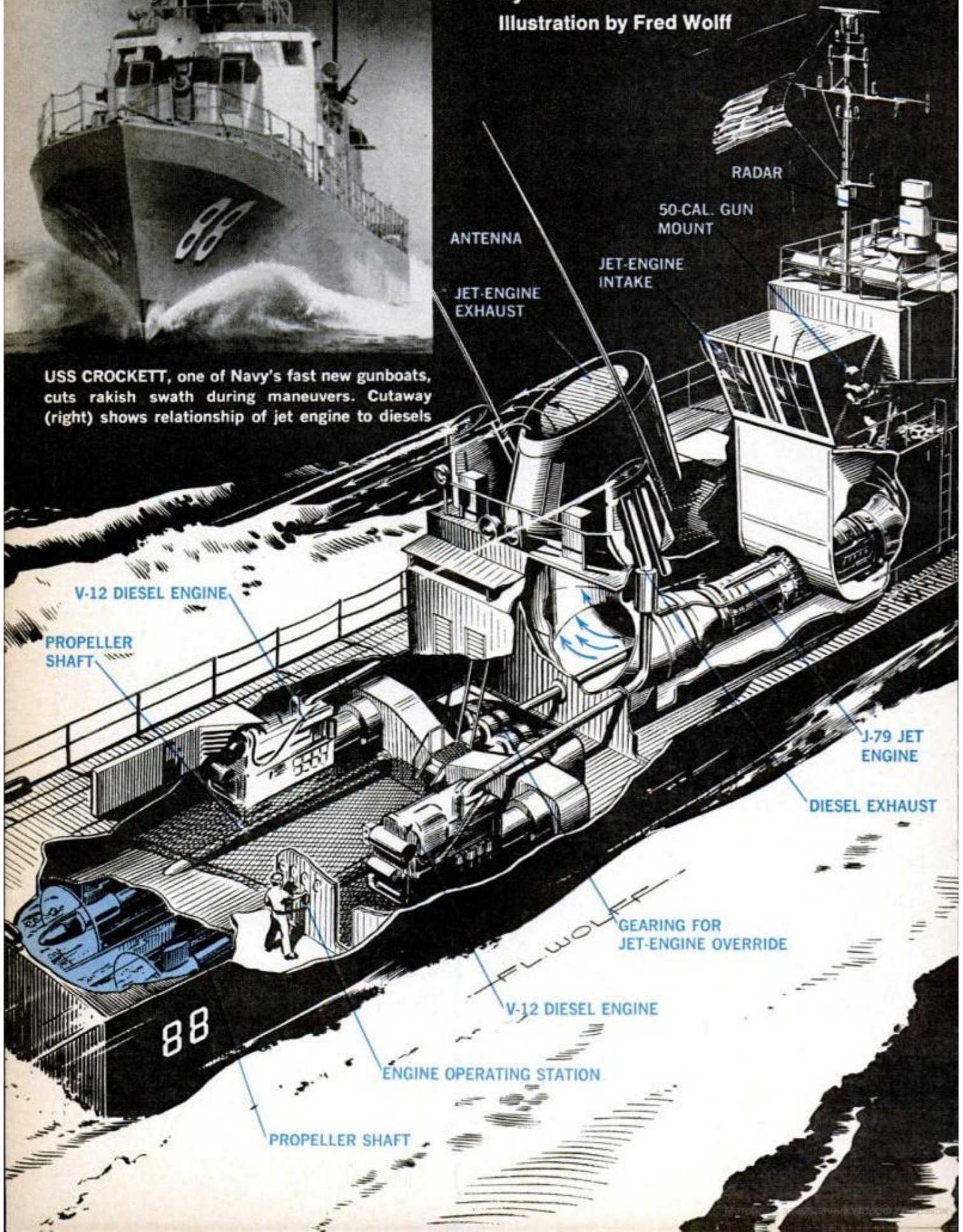

Stop to 40 Knots In 75 Seconds

PILOT HOUSE

3-IN. GUN TURRET

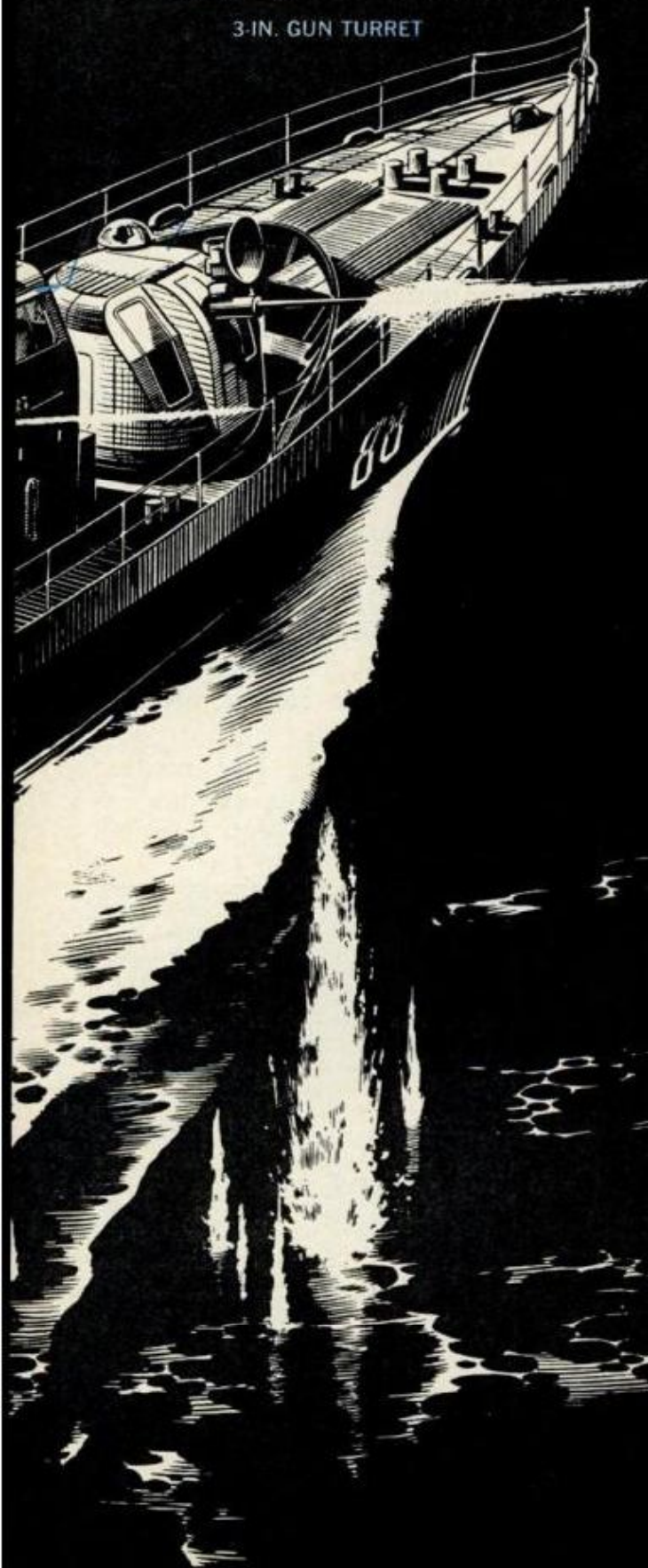

The Navy's new, hard-hitting patrol gunboat is a 165-foot aluminum-hulled speedster that can switch from diesel to jet power—and the crew needs seat belts.

THE NAVY GUNBOAT USS *Gallup* had been plowing through the swells at 15 knots, no strain for her two 725-hp diesel engines. Then the helmsman pushed forward on a throttle marked "Turbine," and the sailor standing next to me on the bridge said, "Hang on."

I hung on and I'm glad I did. A sudden burst of power pitched up the bow of the 165-foot aluminum-hulled *Gallup* and we were off and running. The needle on the speed indicator began moving like the sweep hand on a watch—20 knots . . . 30 . . . 35 . . . 40!

That high-pitched whine mounting in our ears was a J-79 turbojet engine, the same kind that powers an F-4 Phantom II fighter. Only this one was pouring 14,000 horsepower into the *Gallup's* twin screws.

Lt. Cmdr. Bill Spane, the skipper, took over the helm, a swivel stool in front of a 10-inch steering wheel. He put the *Gallup* through flank-speed maneuvers that had us rolling into our spray. It was easy to see why the designers had called for anchored seats at each duty station throughout this revolutionary new warship—and why they added seat belts for good measure.

Spane sent a man scurrying to the top deck to haul down the colors. "Usually

we only do that in a typhoon," he said, "but we're wearing out too many flags."

The *Gallup* is one of the first of a new class of Navy craft called PGs (for Patrol Gunboat). They're the largest all-aluminum ships ever built for the Navy and the first to use an aircraft jet engine.

The PG is the closest thing to a sports car in the fleet. It can accelerate from a dead stop to 40 knots in about 75 seconds. With its reversible-pitch propellers it can stop even more quickly—within two ships lengths!

Commander Spane invited me aboard for a training run out of San Diego be-



JET ENGINE geared in, PG boat races through practice missions with all hands at battle stations. At ship builder's (right), aluminum-alloy sheets are welded over what will be jet-engine room. More than 75 tons of the light metal are used in each ship, ranging from $\frac{1}{2}$ to $\frac{3}{4}$ inch thick. Made in Tacoma, they cruise down Pacific Coast to San Diego, before going to Vietnam assignment

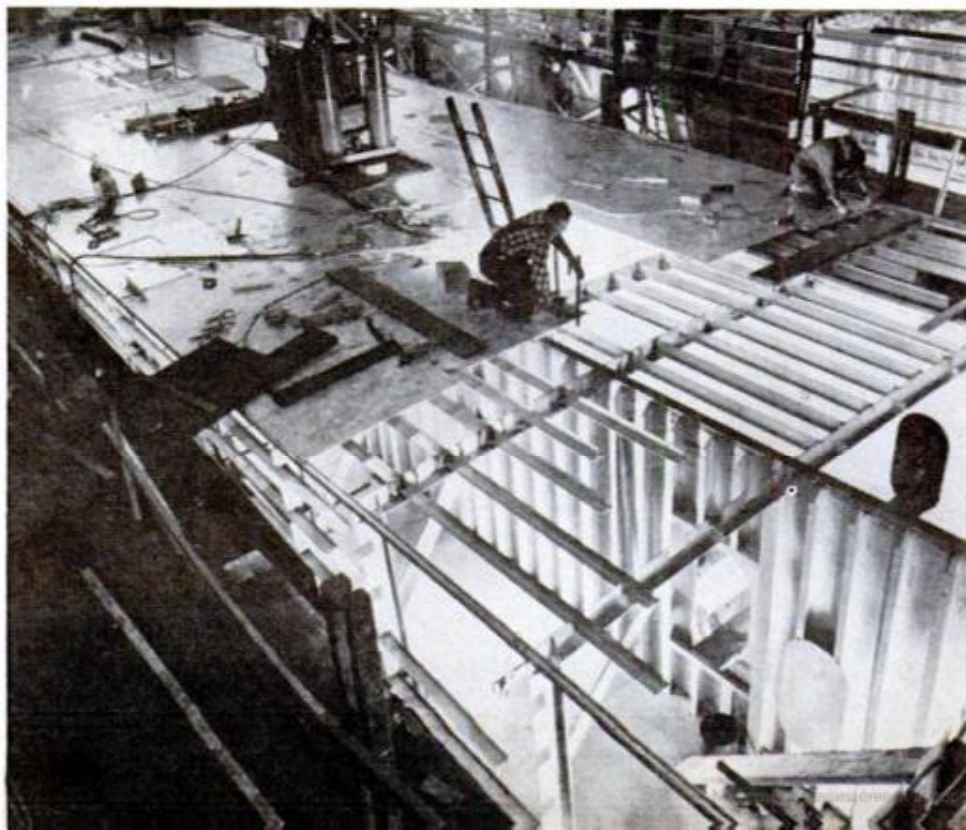

fore he took the *Gallup* to Vietnam. The new gunboats are getting their introduction to combat in the "Market Time" patrol, helping other Coast Guard and Navy patrol craft keep an eye on Vietnamese coastal traffic for contraband shipments.

The PGs are the first U.S. warships in 40 years to be commissioned as gunboats—a class that dropped out of ship lists after World War II. A far cry from their predecessors—the 1200-ton jobs that could muster 12 knots plying the Yangtze River or ducking in and out of Latin American revolutions a generation ago—they're not only smaller but much, much lighter.

With aluminum ribs and hull plating, aluminum decks and fiberglass superstructure, the new PGs weigh in at 250 tons. Their 9½-foot draft means they can move fast with their firepower on shallow coastal waterways and rivers.

The main armament of this jet-age gunboat is a rapid-fire 3-inch gun, radar-controlled, on the forward deck. A single-barrel 40-mm cannon covers the stern, and .50-cal. machine guns are mounted on either side of the second deck.

The Navy hopes the low routine maintenance requirements of this essentially rustproof ship will give the

PG's small crew—28 men—enough time to tend to the high maintenance requirements of the power plant: three engines, an intricate power train and network of controls.

The system of gears and clutches that permits the General Electric J-79 to apply its power to twin propeller shafts—simply by overriding the two Cummins V12 diesels that drive the same shafts in normal cruising—is an engineering marvel.

On the bridge, the man in the driver's seat has direct control of the engines through switches and levers on a console within reach of the wheel. There's no need to call orders to the engine room below. Once the turbojet is started, it's ready for high-speed maneuvers at the touch of the throttle. There's no loss of power when shifting from diesel to turbine, or back.

Putting a J-79 into a boat hull had its problems. What about salt spray being drawn into the jet inlet? Designers placed the inlet 18 feet above the water line—in the second deck, facing aft. Air drawn to the turbine has to make a 90° turn to travel to the engine room and, thanks to centrifugal force, drops of moisture don't quite make the turn and can be drawn by a suction fan through slots in the elbow.

Exhaust from the J-79 also makes a



ON PG BRIDGE, helmsman (right) holds relatively small wheel. Jet-engine throttle is in foreground

right-angle turn, traveling from the engine room through a duct to a fat funnel at the rear of the superstructure.

Construction of a PG doesn't start with a traditional keel-laying. Sections of the hull are fabricated upside down—around a center I-beam of aluminum—then flipped over and welded together, the I-beams forming the keel.

Handsome, clean and fast, the PGs offer a choice assignment for sailors, but they have to have a stomach for it—literally. Lightness and shallow draft

(Please turn to page 183)

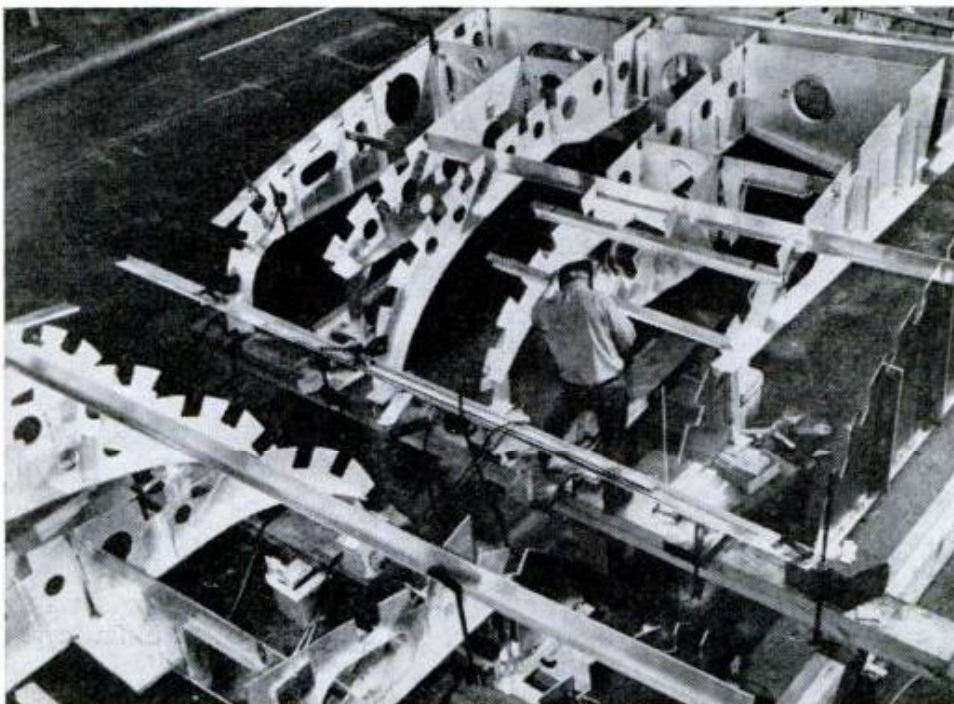

UPSIDE-DOWN construction of PG involves welding frames to center I-beam which becomes main keel. Six hull sections are made and flipped over, then all are welded together. The PG's three engines use same fuel, JP-5, simplifying refueling operations

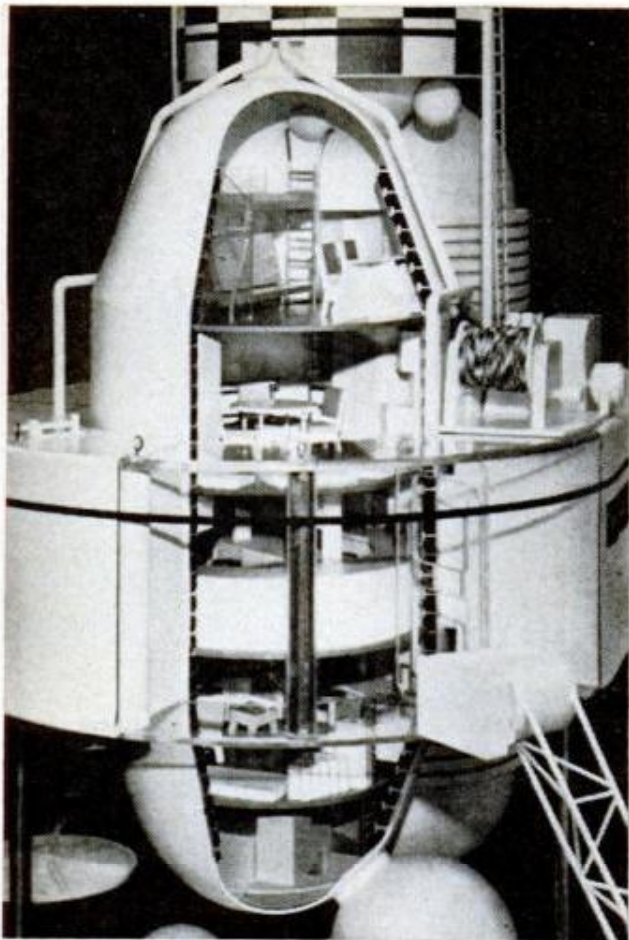

Ocean-bottom apartment

A five-man scientific team will be able to live 30 days at a depth of 6000 feet on the ocean floor in this underwater station being developed for the Navy by General Dynamics.

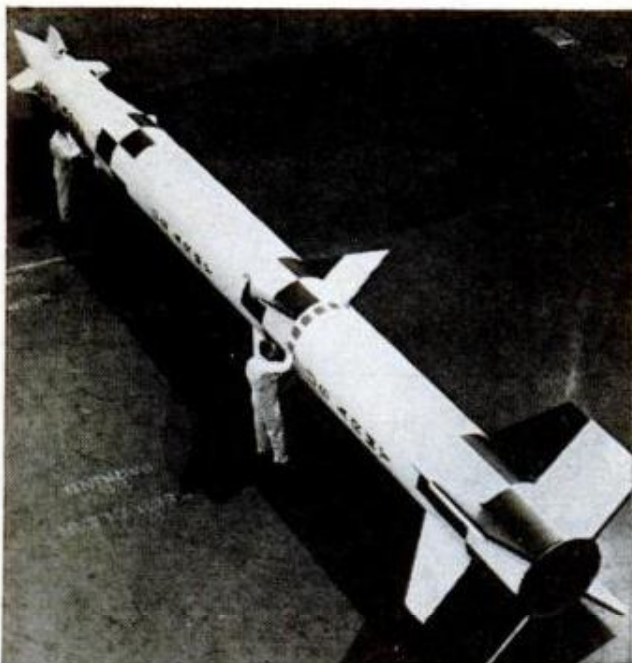

Missile interceptor

Technicians work on a mockup of the Army's Spartan antimissile, being developed as a long-range interceptor capable of hitting warheads outside the earth's atmosphere.



Light snack

Weighing a butterfly's breakfast is easy, claims Statham Instruments, Inc. All you need is firm's sensitive transducer and a butterfly. (Weight: 0.009 gram more after meal.)



Luggage pack for jets

A new baggage container, developed by Goodyear for the Boeing 747 jet airliner, permits 60 pieces of luggage to be loaded and unloaded as a unit rather than piece by piece.



Plastic plane

Europe's first plastic-fuselage plane is the four-seat LFU-205, built by Germany's Leichtflugtechnik-Union. The plastic is lekutherm. The plane's 200-hp engine will move it at a top speed of about 225 mph.



Research cat

An all-steel, catamaran-type vessel, the *Atlantic Twin*, is a new oceanographic-research boat built by Twin Hull Boat Co. The design, says the builder, offers maximum deck space, lower freeboard and great stability.

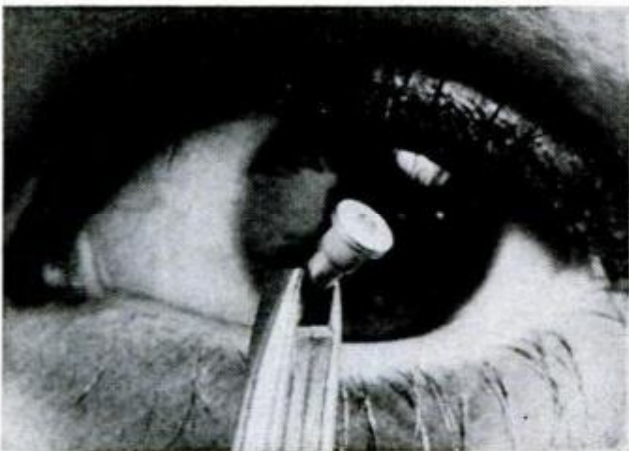

Improves laser systems

An electron flow, set off by light entering Texas Instruments' new laser detector, makes it 200 times more sensitive than previous detectors. Result: Improved laser instruments.

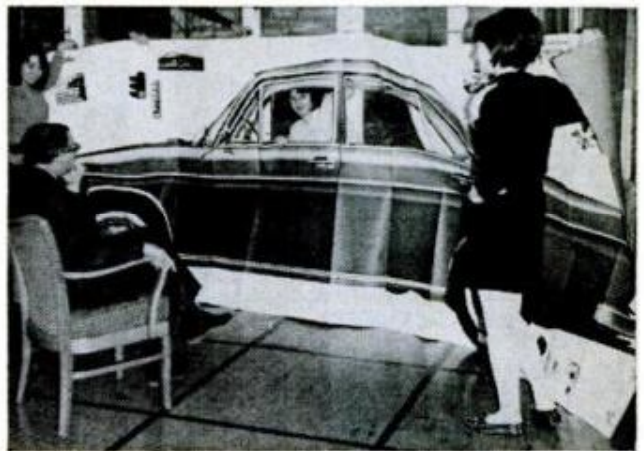

Nothing left to imagination

A German car maker, Audi, sends potential buyers a pamphlet that unfolds to reveal a full-size photo of the car with cut-out windows so they can see how they'll look in it.

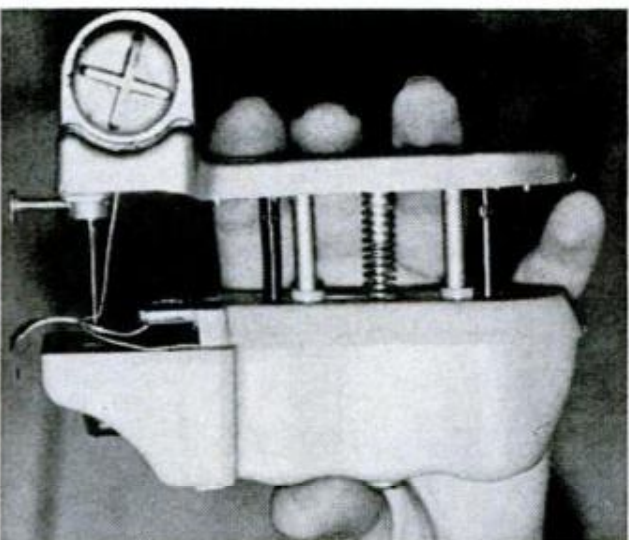

Tiniest sewing machine

Hand-operated (by squeezing), the Jiffy Stitch sews seams and replaces buttons. The fabric goes between metal shoe and platform.



Quick check on drivers

It takes just five minutes for GE's Intoxograph to measure alcohol in a suspect's system by analysis of his breath.



Hard 'Charging' Through Old Mexico

So you want to drive to the Olympics? Better think twice
—it's a demanding trip for both the car and driver

Photos by the Author

By LEONARD E. SABAL



PYRAMID OF THE MOON



AZTEC RUINS AROUND PYRAMID OF THE SUN



ACAPULCO ELEVATOR



THE TRIP nearly ended when it was five minutes old. It was then I discovered the R/T's right-rear blind spot by almost playing The Matting Game with a fast-moving Corvair.

It wasn't until 6355 miles later that I forgave the Dodge designers. Suddenly I realized their 375-hp brute had made up for this isolated incident by surviving a blistering pace through deserts, mountains and Mexico City's mile-high altitude. It had proven its supercar status by zapping all comers from Los Angeles to Acapulco to New York. It had demonstrated its endurance and stamina by taking on Mexico's demanding roads and obstacles without once faltering. And, it had shown the need for careful car preparation for the odd situations you will encounter in Mexico. Eighty-to-zero emergencies are common—ancient road-

crossing reapers and wandering cattle lie around every bend. Good acceleration is just as important, especially as Mexican drivers tend to take personal offense when passed—and speed up. Indeed, driving in Mexico is a nerve-racking experience.

D-Day minus one: Los Angeles. The “white-hat boys” have gone all out on this one—new Goodyear Polyglas tires, heavy-duty clutch, full tune-up job. It's no wonder, either, for with 8300 miles on the odometer (all put on by West Coast automotive writers with access to Riverside), she was probably running like a two-banger MG Midget.

Surprisingly, there's no tach. In fact, it's outright ridiculous to equip any car with a high-performance 440-cu.-in. Magnum, a four-speed manual transmission and a 3.54 rear, only to forget the tachometer.

She idles smooth but is hard to get off the line at lights, primarily due to the 28-lb. clutch. After stalling twice, though, I learn the secret—you *can't* drive this monster slow and smooth. You've got to push her a bit. (Happy to oblige.)

Heading out to Marineland of the Pacific for a short test spin, about seven out of every ten cars look us over carefully—and some three of the seven try to egg us into eighth-mile, light-to-light sprints. Thus, at the end of the day, gas consumption seems a little high, the short Dart stick is a long reach in first and third, and a tach is sorely missed.

D-Day: Los Angeles-Tucson. Departure preliminaries include checks of oil, water and tires, ownership papers

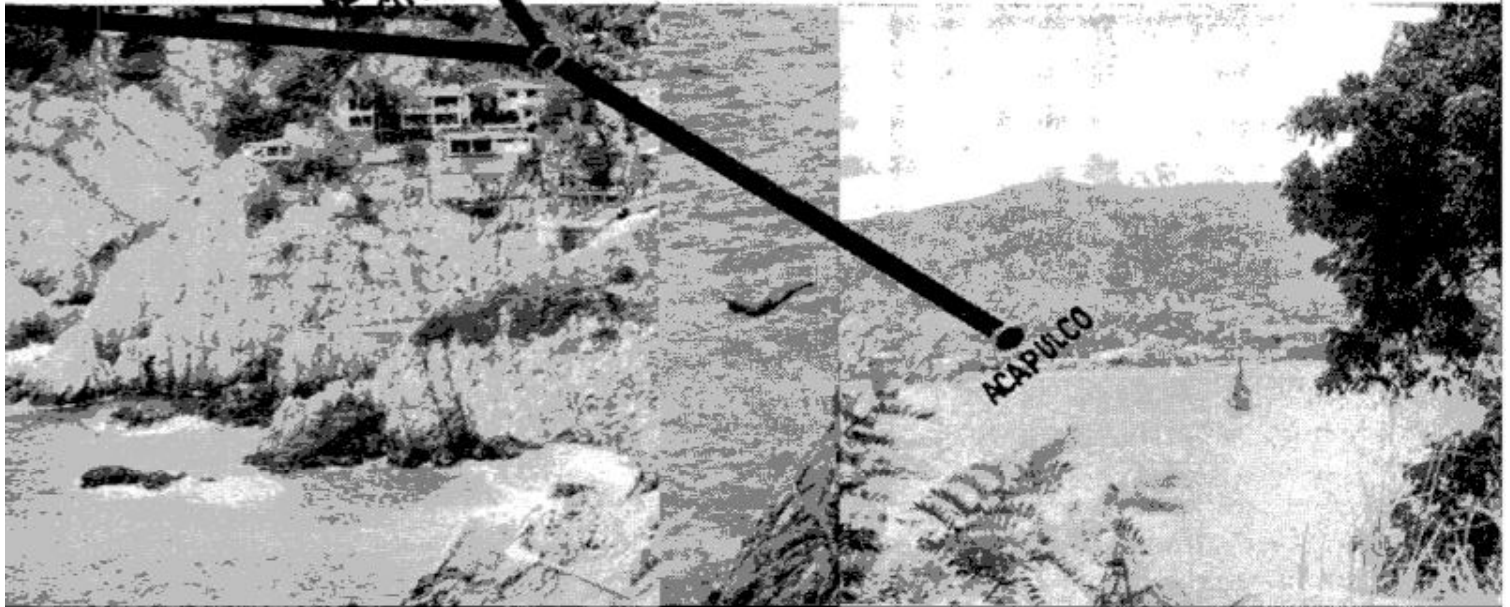
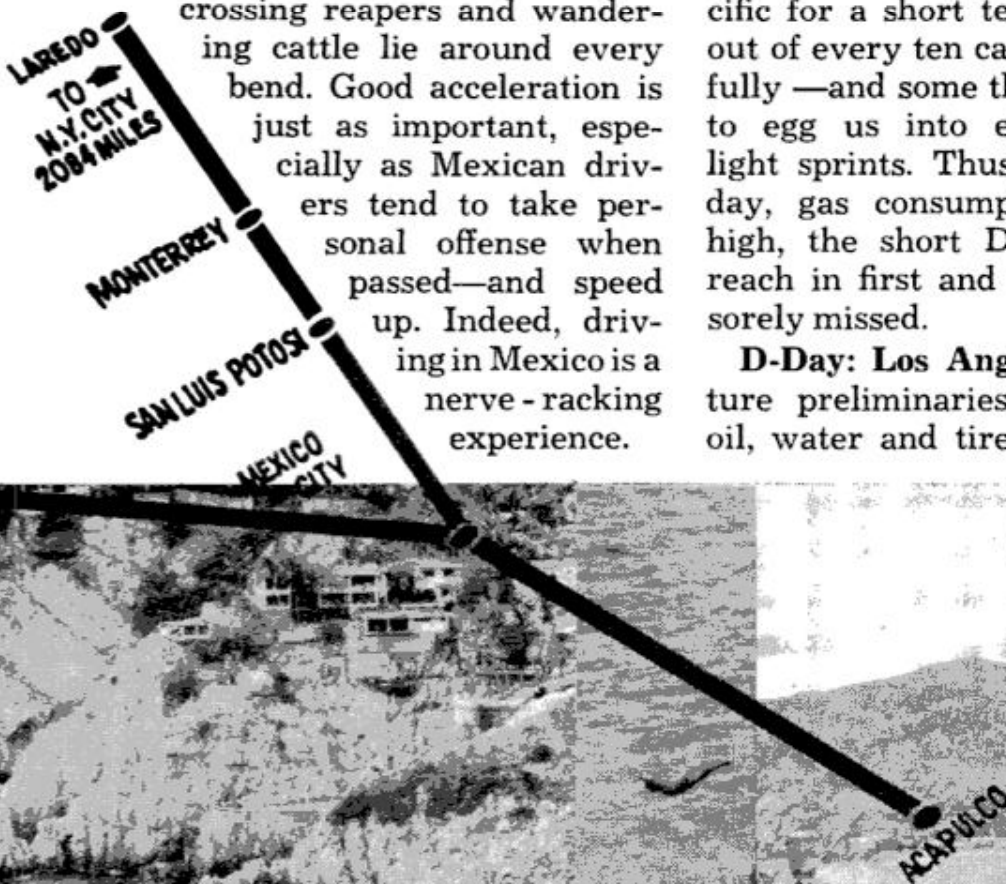

CLIFF-HUNG EL MIRADOR HOTEL

DIVER

OVERLOOKING ACAPULCO BAY



TESTS OF EXCELLENT BRAKES were frequent, included cattle, landslides and questionable road signs

(a must at the border), tourist cards (free at a Mexican Consul or tourism office), maps (also free), and an emergency kit consisting of a fan belt, spare radiator hoses and clamps, sparkplugs, first-aid gear, flares and a few hand tools. Then it's off, using Interstate 10, to California 86 along the Salton Sea, and finally Interstate 8 to Tucson. During the entire trip, try to leave by six each morning, so you'll have full afternoons to spend sightseeing, shopping, poolside or at the beach.

Day's tally: 533 miles, 7½ driving hours. Average: 71 mph, 11.3 mpg.

D-Day plus one: Tucson—Guaymas. Heading south on U.S. 89, you begin to sense the proximity of Mexico—and suddenly you find yourself surrounded by the burros, colors, wagons and smells of Nogales. The American officials at the border crossing wave you on without hesitation, as does the first wave of Mexican customs officials.

Keep your eye on the right for the *Emigración* office, for it has to stamp your tourist card. It's also here that you should buy Mexican auto insurance if you haven't arranged for it already. Typically, it cost us \$40 to insure the Charger for three weeks.

About four kilometers down the road, car registration and customs inspection are held under one long carport. Here, there's a small clique of Mexican "expeditors" that will take you in hand and hustle you through the registration procedure, and then

through the casual customs count of your suitcases. Our smiling guide was quite helpful and thus was rewarded with two dollars when he finally whispered, "Senor, I no work for government—you can teep me now." I was amazed, however, to watch the staunch customs inspector nudge my expediter, while clearing his throat in the process. The smiling little man shrugged his shoulders, looked at me and started to say something, but I beat him to it by handing over another two greenbacks. *Everybody* then began smiling, especially me, because they had overlooked my recent discovery—the license plates did not quite match the numbers in the letter of authorization from Chrysler.

Off we went once more, with cries of "*Mucho gracias, senor,*" "*Buena suerte*" and "*No importante.*" The latter was in response to my final query about registering the camera equipment we had brought along. The two Honeywell Spotmatics and the big 200-mm telephoto lens cost about \$700 and one of the *last* things I wanted to do was pay U.S. customs duty on cameras bought in New York. As it turned out, my smiling friends were right—it's not important to register such equipment, but it's wise nonetheless to bring along your sales receipts.

Off we sped, free spirits, into sun-drenched Mexico—only to meet, in rapid succession, two dogs, one burro, three squawking chickens and two lane-straddling buses. You learn fast in

Mexico—towns mean people and people mean burros and dogs and chickens and cattle and 5 to 15-mph speeds. An approaching column of black smoke, on the other hand, means a fuming bus is on its way—to meet its maker, you think, from the way that it's driven. Straight down the line they come—only they stick about three feet into *your* lane! Not just one or two are like this, either. They're *all* lane-straddlers, and they don't move over—ever!

This first day in Mexico you also learn quite a bit of Spanish. *Peligroso* for example, means danger; *punte angosto* means narrow bridge (a *very* narrow bridge); *no rebase* means do not pass, and *Pemex* means stop for gas. Pass up a Pemex station and you likely won't find another for 150 miles.

Never leave your car completely unattended in a station, and always make sure they use only Pemex 100 from the yellow pump. The other grades smell like a mixture of kerosene and raw petroleum and, judging from the exhaust of Mexican vehicles, the mixture smolders rather than ignites.

Even the 100 is often of questionable quality, mainly because some operators can't resist the temptation to fill a yellow pump with half 100 and half low-grade gas.

In a short time, the air turns cooler, and you know Guaymas lies ahead. Yet you're still surprised when you round that hilly curve and see the Gulf of California for a fleeting instant—it looks so small on the maps.



AFTER MORE THAN 6000 miles of hard driving, the two-ply Polyglas wide treads showed very little wear

The best beaches and accommodations are those just north of the town. If you find yourself going over a long narrow bridge, turn back and look again for the colony of beach hotels. These all cater to tourists, thus the food is reasonably good and at most, the water is bottled. If in doubt as to the ice or water, don't be afraid to ask. Guaymas is a nice place to visit, but not for three or four days in bed.

Day's tally: 347 miles, 5.1 driving hours. Average: 68 mph, 11.1 mpg.

D-Day plus three: Guaymas-Mazatlán. A half hour out of town, the roads open up and run arrow-straight for miles on end, with only slight curves and gradual slopes. This is where you can get into real trouble because the

(Please turn to page 202)

"HANDSOME," "BEST-LOOKING '68," "GUTSY" are among comments made by passers-by about Charger R/T



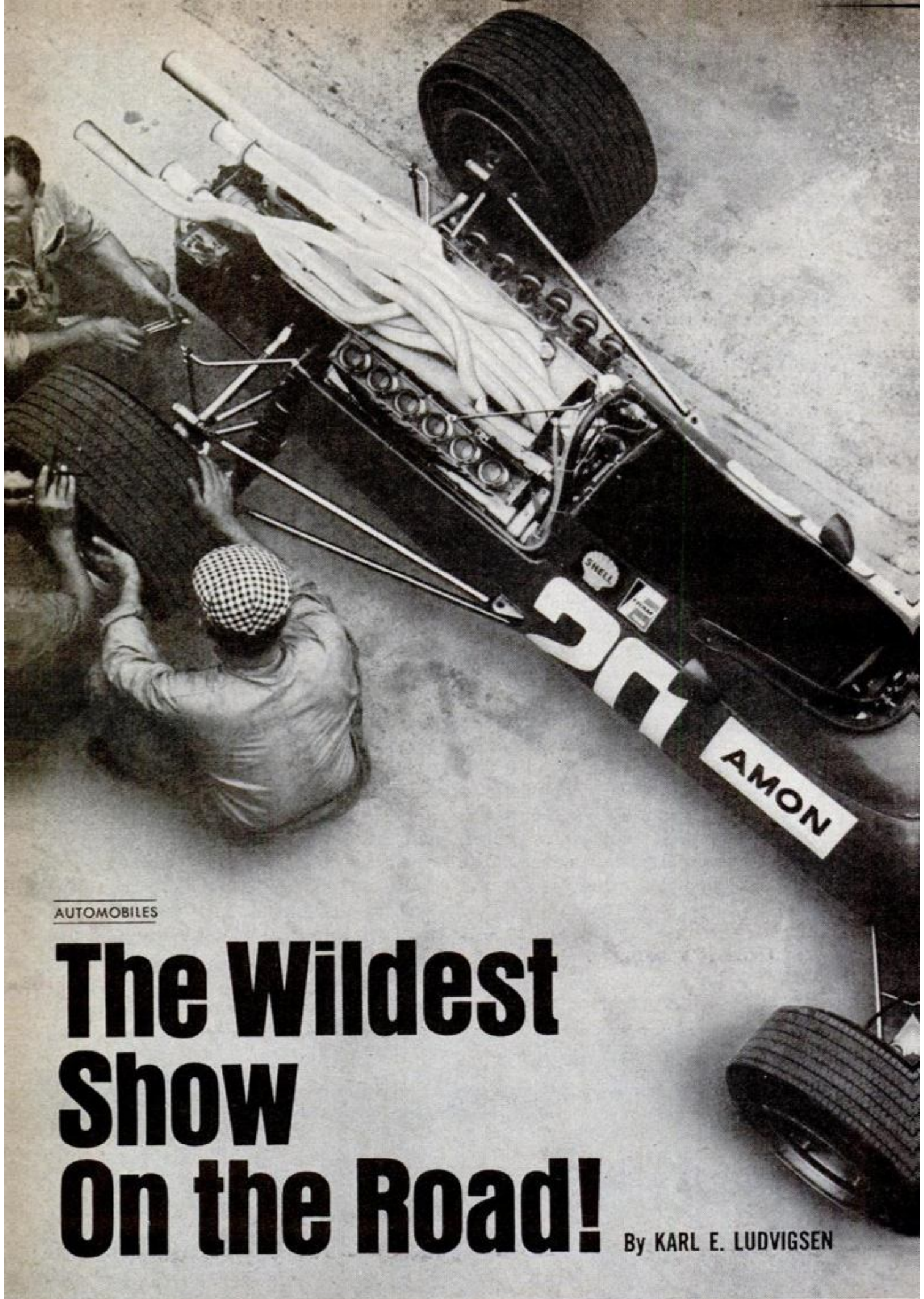

AUTOMOBILES

The Wildest Show On the Road!

By KARL E. LUDVIGSEN

It's not as rich as Indy or as fast as Daytona, but when the Grand Prix circus comes to Watkins Glen it's the Ringling Brothers of racing.



INDIANAPOLIS is longer and faster than any Grand Prix race—and richer than all of them put together. Fastest of all road-racing cars today are the spectacular Can-Am sports-racers, competing in a prize-packed North American championship. And nothing tops the speed and drama of the big stock cars on the banked tracks of the South, unless it's the powerful prototypes that run at Sebring and Le Mans.

With all this incredible equipment around, why do drivers and designers still develop with such devotion the classic Grand Prix car? Isn't it an outdated idea in this advanced age of turbine-powered, automatic-transmission racers? When asked about this, Bruce McLaren replied, with some amazement, "Why . . . because it's Grand Prix racing."

In saying little, McLaren said it all. G.P. racing is not a fleeting fad. It's the current expression of a tradition that dates from 1906. It's a tradition rich with heroic acts, racing drama, political power, industrial achievement and technical advance. Not until 1959, with the running of the first modern U.S. Grand Prix, did our country start to share in this exclusive apogee of the world's racing ambitions.

This glamorous tradition makes up the aptly-nicknamed Grand Prix "Circus"—setting up in town Thursday, practicing Friday and Saturday, and racing for gold and glory on Sunday. On Oct. 3 the "Circus" comes to Watkins Glen, N.Y., birthplace of modern road racing in America; on Oct. 6 the race will be held.

Grand Prix (French for "big prize") racing is unique in its total internationalism. Technically, any reputable organizer can stage a race for cars fitting the Grand Prix Formula 1; there are several nonchampionship races in England and Italy. But each nation is allowed to host only one race counting for championship points. Through the

OPEN WHEELS, simple cigar-like shape mark design of most Grand Prix cars. Note complex exhaust tubing

'50s, Indianapolis counted for points, but no longer. The first U.S. Grand Prix was at Sebring, the second at Riverside in 1960, and all since have been at Watkins Glen.

The Grand Prix calendar for '68 is the most crowded in history, with twelve championship events. In sequence, they're run in South Africa, Spain, Monaco, Belgium, Netherlands, France, Great Britain, Germany, Italy, Canada, United States and Mexico. No other form of racing comes close to such global acceptance.

The Grand Prix Championship is for drivers, not cars. This is significant. Because all the cars must conform to the strict Formula 1 design requirements, their performance abilities are similar, though far from identical. Today's G.P.

cars, with 400 or more hp, also demand the utmost in driving skill. Thus, Grand Prix racing may be the truest test—over 12 of the toughest tracks in the world—of all-round driving ability.

One of the great tragedies of recent racing history has made this year's championship a wide-open affair. Jim Clark of Scotland won the season's first race and looked like he'd win many more to earn his third championship. Recognized by his contemporaries as the most talented among them, he was later killed at a minor racing event in Germany.

If there's to be a successor to the great Clark, he'll be discovered this season. There are many candidates for the laurels. Another Scotsman, Jackie Stewart, has so far won a Grand Prix. A

Mexican, Pedro Rodriguez, has led one. Britain's Graham Hill, a former champion, won at Monaco, where another Briton, Dick Attwood, set the fastest lap. New Zealanders Chris Amon and Bruce McLaren have been in front, as have Frenchmen Jean-Pierre Beltoise and Johnny Servoz-Gavin.

Others who are always a threat for the lead are Jack Brabham (Australia), Jochen Rindt (Austria), John Surtees (Britain), Dan Gurney (United States) and the reigning world champion, Denny Hulme of New Zealand. So anything can happen at the Glen. The one regret is that there aren't more American drivers in today's Grand Prix "Circus." California's Phil Hill was a great world champion in 1961. Our own Ron Bucknum and Bob Bondurant gave it a good try, but are no longer G.P. competitors.

If it weren't for the tenacity and patriotism of Dan Gurney, Americans wouldn't have a car of their own to cheer for at the Glen. When the current Formula 1 was introduced in 1966, Gurney was ready with an organization to build the Grand Prix Eagle. It took a lot of guts. You have to respect the skill and courage of any man who says, "I think I can design and make a better car

(Please turn to page 186)

DETAIL, WORKMANSHIP stand out on B.R.M.'s rugged, dependable V12

POPULAR MECHANICS



BRUCE McLAREN of New Zealand drives cars of his own design and make, powered by the Ford-Cosworth 408-hp V8. Note the fiberglass cone

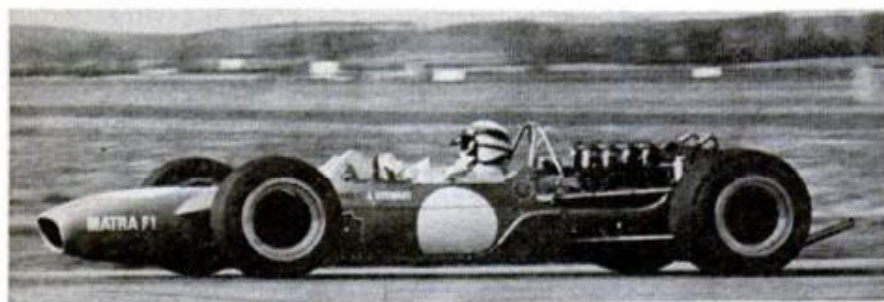

JACKIE STEWART, a fine driver and one of the most popular Grand Prix stars, drives a French-built Matra powered by a British Ford V8 engine

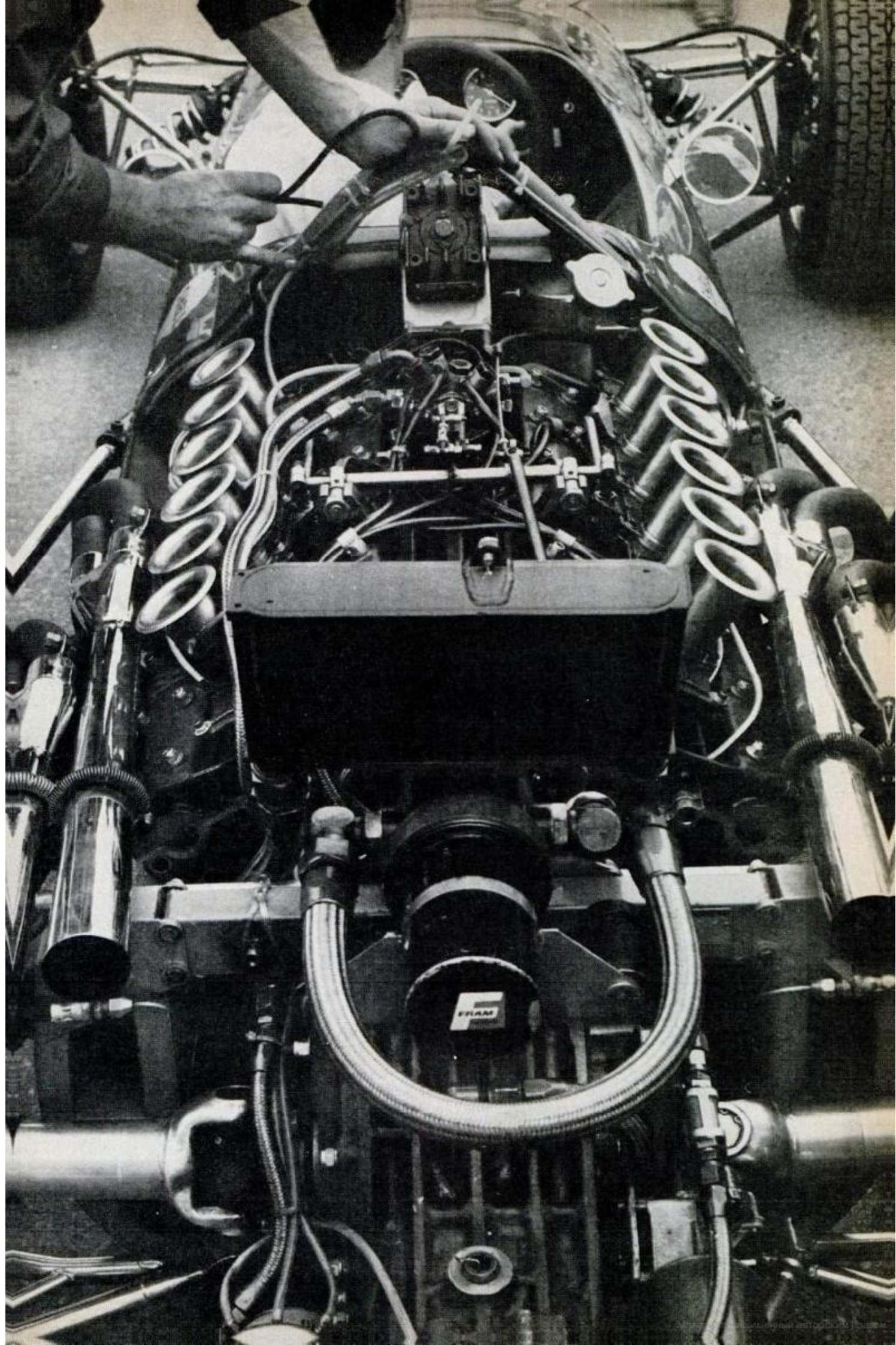



What you should know about those Nifty, New Automatic Turntables

These modern hybrids now give you the convenience of a record changer and the quality of a turntable in one slick piece of hardware. Here's what to look for

By LEN BUCKWALTER

Technical Art by Associated Technical Services, Ltd.

MIRACORD: \$150

HI-FI EXPERTS are finally agreeing on one point: The "automatic turntable" has made it. That's the exotic new name for something once sneeringly called a "record changer." After decades of clanking, low-fi performance, the changer is enjoying remarkable improvement. The reasons are easy to find.

The automatic turntable is a marriage between the old changer and the single-play turntable—without the deficiencies of either. Until recently, the single-play model was the professionals' choice. They liked the combination of simple construction and the manufacturer's fanatical care in designing every last detail of motor, turntable and drive system. So the meticulous music lover willingly paid the big penalty—tedious loading of each disc—to

obtain the very best audio available.

Although record changers would mangle discs and add gargles and growls to music, they couldn't be faulted on sheer convenience. A changer automatically plays through a stack of discs for an evening of music. But thanks to the current crop of automatics, it's now possible to have the best of both possible worlds.

A typical automatic turntable operates three ways. Load it with a pile of records and it cycles through the familiar drop-play sequence of a record changer. Then there's semi-automatic play. A record is loaded and played singly, but you don't have to touch the tone arm. The disc is handled automatically by the changer mechanism. Most automatics include an extra, short spindle that rotates along with



INGENIOUS MOTOR on this Garrard is one of many turntable refinements. Though basically an induc-

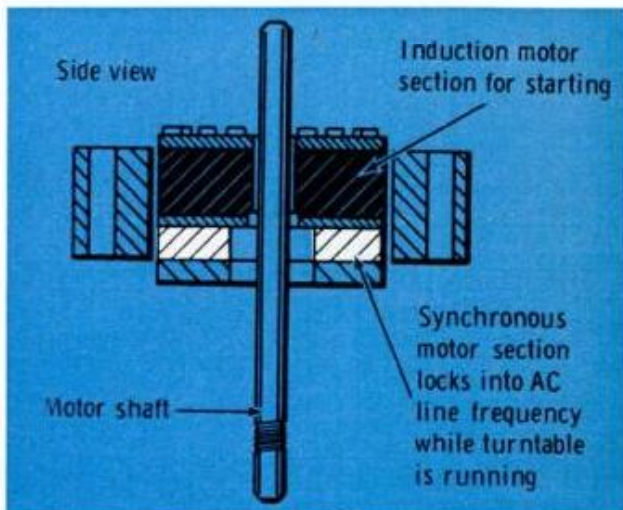

tion motor, it uses rotating magnetic field to lock on 60-cycle line frequency and keep speed constant



ANTI-SKATING CONTROL on the Dual 1019 puts arm under slight spring tension to offset tendency to

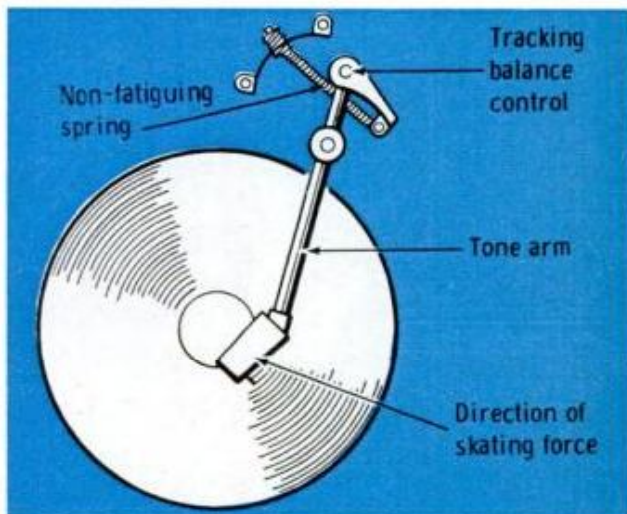

skid toward spindle. As spring stretches, clever geometry shifts leverage pivot to keep force even

the disc. (The long spindle for changer operation doesn't turn.) To the purist, the advantage is that the record hole won't wear and ultimately cause the disc to wobble.

Finally, the automatic turntable can be played in a completely manual fashion. You can pick up the tone arm and place it anywhere on the record without the changer mechanism fighting back.

To obtain the benefits of the new automatics you'll encounter a price range of about \$30 to \$150. The general dif-

ference between models is twofold. First, higher-priced automatics possess considerable technical refinement to lick the problems that plagued old record changers. Second, the automatics are laden with a new spectrum of special adjustments you can make in the home. No longer does the factory lock the mechanical adjustments into some fixed or buried position. Many are now plainly visible and easy to manipulate.

In the first area—technical refinement—the automatics can be judged on several counts. Manufacturers use a

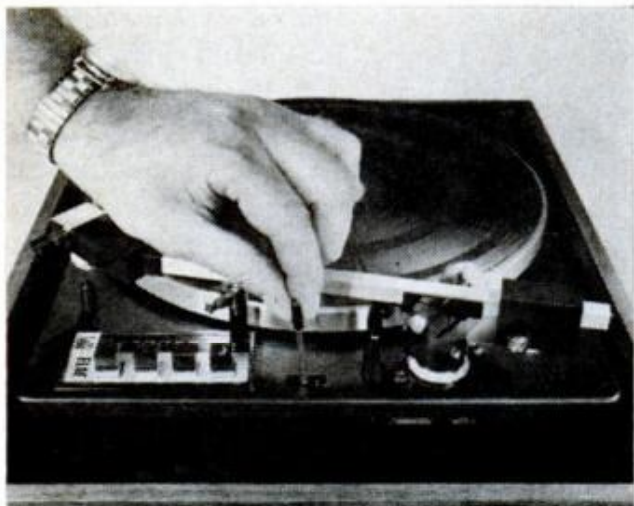

CUEING CONTROLS like the one on this Miracord save wear on your stylus and records. Moving the

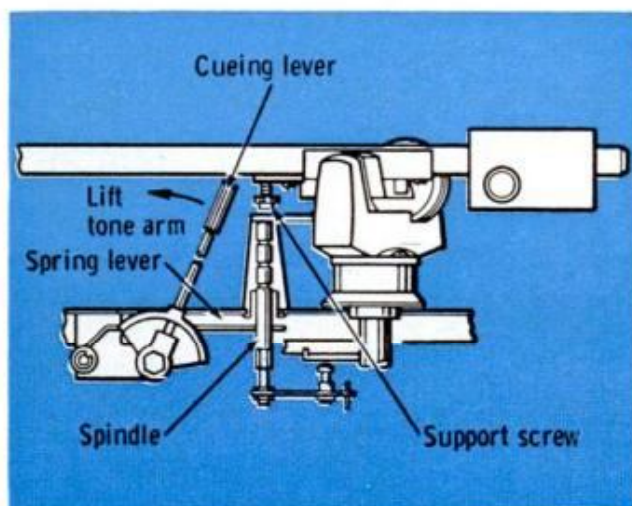

lever gently lifts the tone arm and lowers it onto the record without your touching the arm yourself

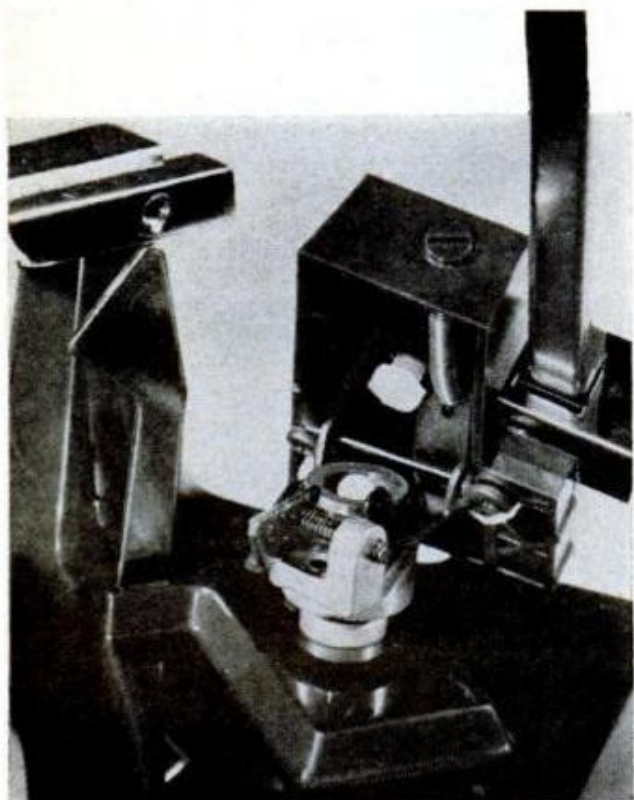

DELICATE ARM SETTINGS, such as on this Lafayette, are typical of modern automatics. Screws on

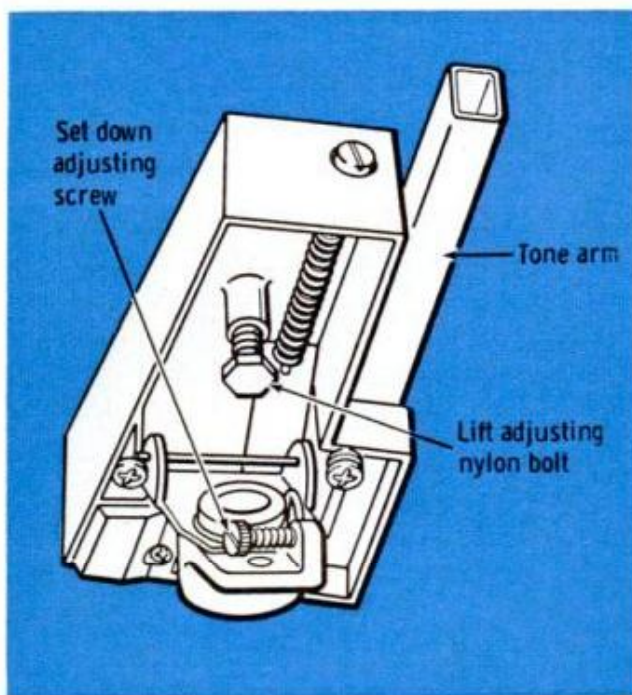

post let you adjust arm's height to clear stacked records and its precise set-down on record's edge

variety of engineering techniques, but they're all aimed at a common goal—to spin the disc at an accurate speed, change it gently, prevent mechanical noises from becoming part of the music and make the pickup cartridge track with great precision over the record grooves with little distortion.

That's quite a tall order. The successful automatic does it with extremely low levels of rumble, wow and flutter—three big sore points of old changers. You'll hear rumble as an unpleasant, low-pitched sound. It's transmitted

through the drive mechanism to the pickup cartridge and ultimately to the loudspeaker. If the rest of your hi-fi system is good in reproducing bass tones, turntable rumble must be low.

Wow and flutter also signal mechanical problems. An attentive ear will hear them when the record is sounding a solo instrument—the piano, for example. Wow usually produces a warbling tone for each revolution of the disc. Flutter is a rapid, continuously wavering quality. Virtually all current

(Please turn to page 188)

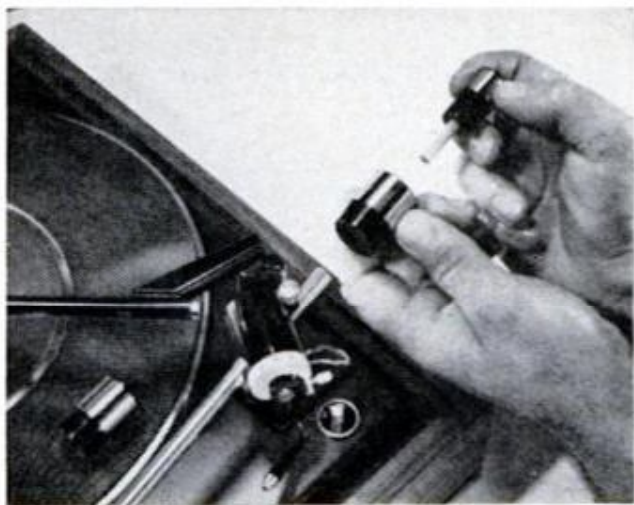

INTERCHANGEABLE WEIGHTS make it easy to adjust arm balance to any cartridge in this BSR McDonald

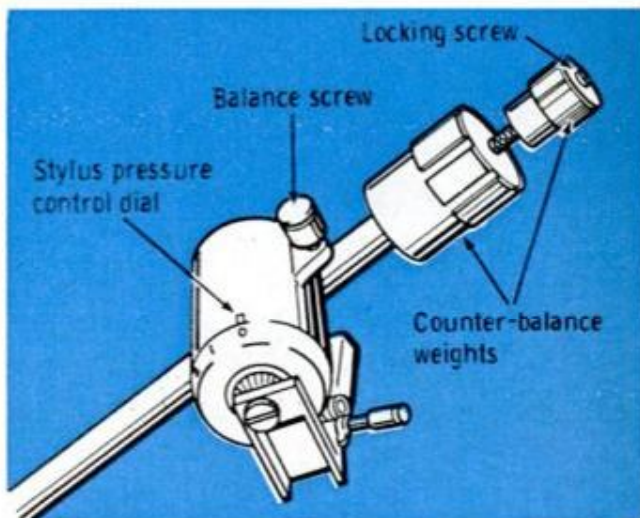

system. Metal cylinders can be used individually or telescoped to give various weight combinations



PRECISE PICKUP MOUNTING is aided by this plastic jig supplied with Perpetuum-Ebner models. Jig

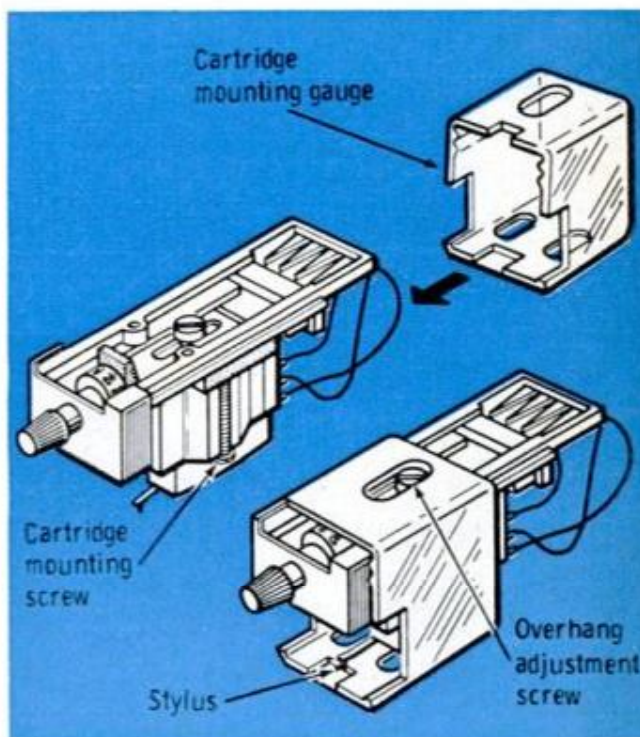

properly aligns cartridge on mounting plate, then it's removed and plate is slid into tone arm head

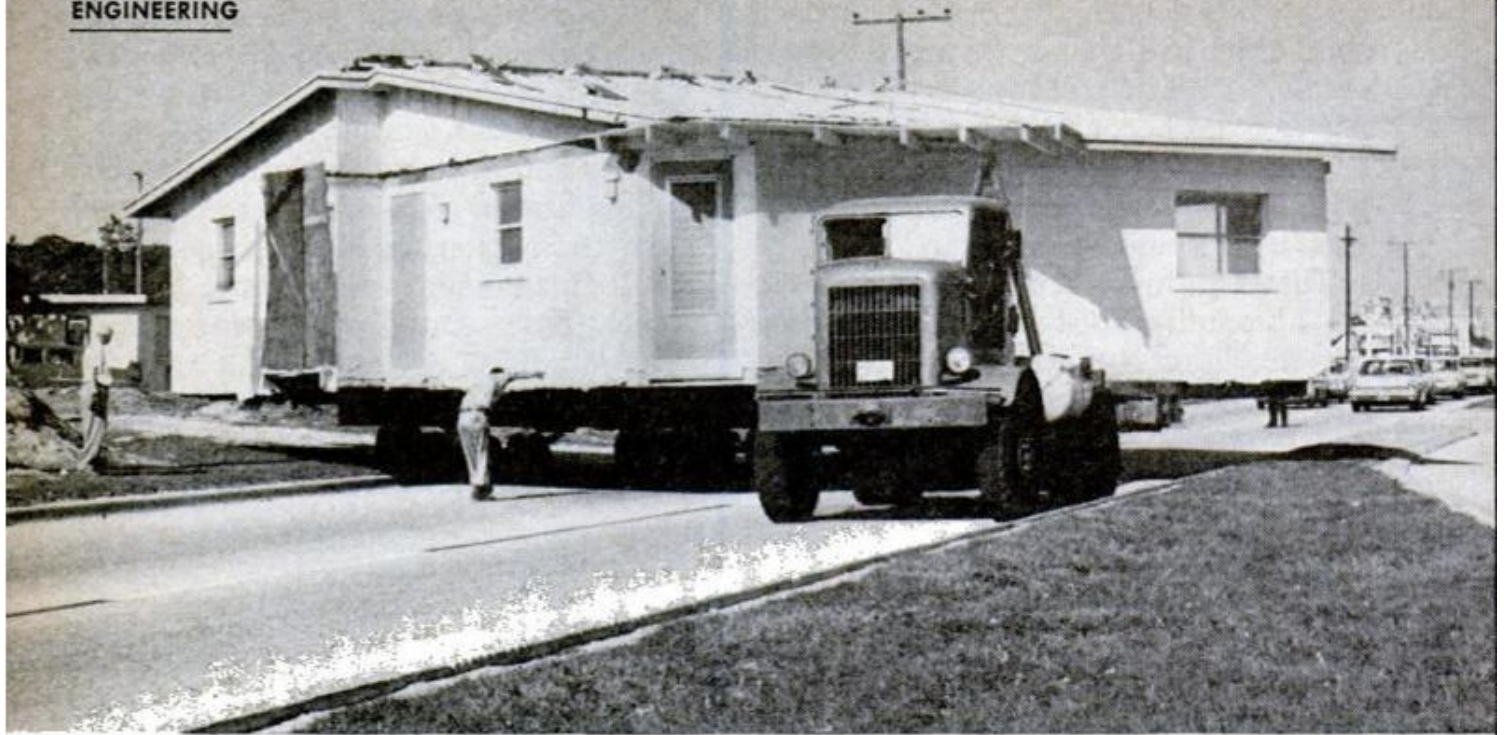

STOPPING TRAFFIC, 90 tons of house hit the road starting a ticklish, two-day journey to a new location

HAVE HOUSE, WILL TRAVEL

Your best buy in a new home may be from those engineering magicians—professional house movers—who will deliver one to your lot, ready to live in, for as little as half the normal cost

By KEN WARNER

A CREW OF SIX MEN can move a 1300-sq.-ft., 90-ton house with a week's work. They can move it 100 yards, or 40 miles, without any damage. These facts make buying a house

c.o.d. a good way to save much of the money, time and agony involved in the normal construction job. The time is shortened by months; the agony is less by several gallons of perspiration; and



WILL IT MAKE IT? Negotiating a seemingly impossible turn calls for tricky maneuvering. Tractor must be unhitched, as shown at right, and the house



inched gradually around by winches. Wheels on inside of turn are blocked stationary so that load pivots on them, swinging around on the outer wheels

the money is down to about 50 percent. That's right: A moved house will cost about half what a similar house would cost built in the same place.

As a reporter, I can vouch for this personally, for I own such a moved house myself. While my wife and I use it primarily as a vacation cottage in the country, it's no ramshackle old barn. It's a 24x56-ft. ranch house with an 8x16-ft. glassed-in porch on one end. It was originally built on a slab at a site that is now a department-store parking lot 10 miles away.

The house and a two-car frame garage were purchased, *in place on the new site*, for \$7200. The mover guaranteed the house would pass the pertinent county codes, furnished the foundation and septic tank, and also guaranteed that only hairline plaster cracks would appear as the house settled on the new foundation—a four-block-high crawl space with the slab supported on pillars inside.

About \$800 more went into grading and filling, a pump, decorating, and some interior alterations such as floor-to-ceiling bookshelves. Of the total, \$7500 was borrowed on a first mortgage arranged before the mover's contract was signed. The banker saw the house and the new site and agreed. Later, he said he figured a conservative \$13,500 on the value of the finished house in its new location.

Professional house movers put it this way: "We figure the customer gets



WITH ONLY INCHES TO SPARE, house skins through a railroad crossing as driver heeds helper's hand signals—like a pilot approaching a carrier deck

SEPTEMBER 1968

AUTHOR'S OWN HOME was moved from overgrown lot (top photo below) to new site 10 miles away (bottom photo). Note how appearance was actually improved by raising house from original slab to new crawl-space foundation. Moving job was relatively simple because house was long and narrow. Only problems were overhanging wires, being warded off by man on roof (center)





ON THE OPEN ROAD, house can breeze along at a respectable 15 to 18 mph. It must stick to secondary roads, though, avoiding heavily traveled routes

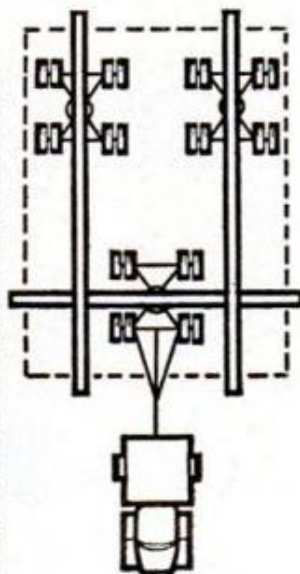

ON SOFT GROUND, crewman shores up wheels with metal mats used for jungle airstrips. Three-point wheel principle (diagram) makes load self-leveling



AT THE NEW SITE, house is jacked up so wheels can be removed from underneath. Temporary blocking will be built up around jacks to take main weight

by for about half," says the firm of William Adamowitz and Sons, Hillside, N.J. BMH, Inc., Columbus, Ohio reports: "With about half the cost of construction of a new house going for interior finish, it's easy to save money on a moved house. To move a good frame house about three miles will cost from \$2500 up, depending on the route." According to the Schwartz Construction Co., Bayport, Minn., "When we're lucky at bidding for houses displaced by highways, people can get some real bargains because up here we can move pretty cheaply. We move some good frame houses for as low as \$1200."

How do you find a house to move? The quickest way is to call house movers within 25 to 75 miles (depending on the terrain) of the chosen site. Find movers in the Yellow Pages of the phone books of surrounding towns available at your local phone company office. The first mover who has a house that might serve your needs is your teacher. Go see him.

Be prepared to be disappointed, and be prepared to talk about money, but don't lay all your cards on the table since you may wind up buying a house from this man and have to dicker. Learn all you can about the house-moving business locally and about any local problems and restrictions.

House movers are used to such calls. Most of the time, a mover has an "inventory" of houses due for moving and can show them right away.

It is also possible to find a house, make a direct deal with the owner, then have movers bid. Ordinarily, this means finding a house someone hasn't thought of moving yet, since the movers are the first to hear when a building is scheduled for moving. Obviously, a firm bid for the moving job is necessary before closing any deal.

Contractors' model homes and houses owned by state and county governments as a result of condemnation for new roads and other projects are other possibilities. The model house is more costly because it is a new house,

but the contractor generally just wants his cost out of it and it sells considerably under the same house built on your site.

For the ground rules on bidding for government-owned houses, call on your local road department. Often, you can get on a mailing list for the asking. Since movers bid low, a private individual buying a house just once can afford to go a little high and still come out ahead.

These are the main routes to finding a movable house. Dealing with a house mover is the simplest, but involves paying him a profit on the house. He earns this, of course, and, in return, can be induced to take on additional responsibilities during the dickering. Buying a house directly may get you the best price, but it also carries the liability that you, the owner, become the contractor thereafter. On the theory that amateurs can get hurt playing with professionals, dealing with the house mover is probably worth whatever extra profit he earns.

In choosing a house to move, apply the same criteria as in buying any used house. Wiring, plumbing and heating equipment should be carefully appraised since these systems have a high replacement cost and are often rigidly controlled by building codes.

If the house is in good condition, it will arrive in good condition. Indeed, it may be a better house once moved. Slab houses moved to crawl-space foundations generally are dryer thereafter; old houses gone slouchy are straightened up plumb; sometimes a house comes to life when reoriented relative to the sun and a new, more majestic view.

Structure and size are important. For moving, the all-frame house is best because it is lightest and strongest off its foundation. However, all types of masonry houses can be moved. States vary widely in their attitudes toward house-moving. Some, like Florida, enforce strict limits on load size; others, like Minnesota, allow the mover to haul

nearly any size load. Thus, a movable house in Florida must have one dimension of 30 feet or less at foundation level unless it can be moved in two pieces.

The structure of the house must be judged for strength. Often, what seem to be integral parts of the house are simply tacked on. Termites or dry rot



WITH HOUSE BLOCKED UP, wheels are pulled out. Foundation walls will then be built up to fill the gap and the house will be jacked gently onto them

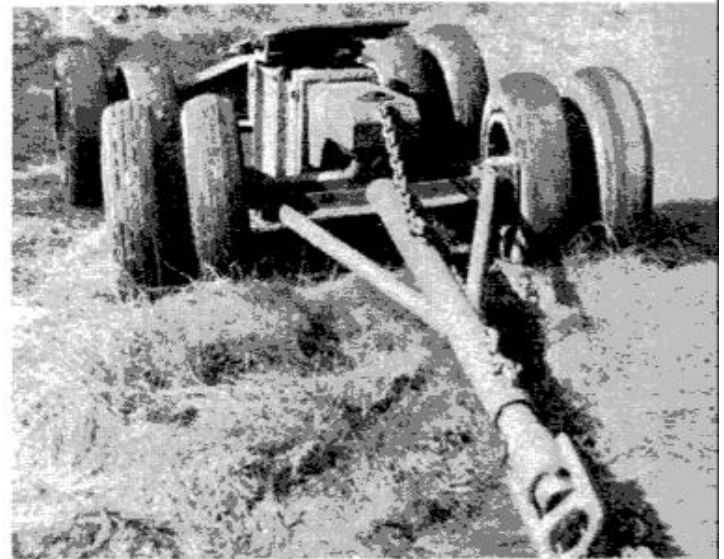

TRAVELING GEAR consists of eight wheels on two independently suspended axles. Axles can tilt and twist to follow the ground without disturbing load

in a frame mean it is weak—let an expert look at it.

The mover is concerned only with the bottoms of most of the houses he moves. If plumbing and heating pipes project below the floor joists in the wrong places, he will simply cut them

(Please turn to page 190)

WHAT GUN FOR WHAT GAME?

You need different kinds of rifles for different game on different terrain in different parts of the country. As hunting season approaches, here's a rundown on what you should know about long arms

By GEORGE NONTE JR.

IS THERE ANY SUCH THING as an "all-around rifle"? One that is equally efficient on all sorts of American game in all the hunting areas of North America? Not now, in my opinion, nor has there ever been, in spite of great-grandpappy's bragging about his favorite Sharps or Winchester that would "kill any animal as far away as I could see it."

Of course, you can get by (and many do) with a single rifle—but it will be too heavy or too long, too light or too short, too powerful or not potent enough as often as it will be right. The big .375 Magnum ideal for brown and grizzly bear is completely out of place on whitetail deer. Conversely, the flat-shooting .225 Winchester that does so well on varmints and light game is certainly no elk or moose gun. Then, too, the short, light, open-sighted carbine that does well in Pennsylvania timber or Florida swamp is next to useless in the High Sierras or open prairie.

Depending upon how varied your hunting interests might be—and we refer *only* to hunting guns, not specialized target equipment—two, or at most, three rifle-cartridge combinations will do the job well on almost any game in virtually any part of this country.

When talking rifles, you talk models, like the Remington Model 660. When talking cartridges, you refer to caliber

and in many cases developer—the .284 Winchester, the .300 Savage, the 7-mm Remington. This confusion started years ago when one riflemaker would design a special type cartridge to fit a model of his rifle. Hunters liked the new cartridge, so other gunmakers would design their own brand of rifle to take the popular cartridge. So now you have Browning making rifles that take the .284 Winchester cartridge; Winchester making rifles for the 7-mm Remington; Remington making rifles for the .300 Savage; and Savage making rifles that take Remington cartridges. And all makers now have rifles that take the extra-high-powered Magnum shells in many different calibers.

Where to start? Small game, such as squirrels and rabbits, are the most popular and are taken at short range, in timber or close cover. In addition, they are easily killed, and you don't want to blow them to pieces—after all, you hunt them to eat. For this kind of shooting, you just can't beat a good .22 rimfire rifle loaded with high-velocity long-rifle ammunition. Take your pick of gun types: bolt action; slide action; automatic, or lever action. All of them have plenty of accuracy for small game. If the bunnies are tougher than usual in your area, then switch to hollow-point bullets, and they won't get far. The .22 rimfire is also good for close-up varmints of



Model 70
Winchester .270

Model 49 Ithaca
.22 single shot

Model 660 Remington
.350 Magnum carbine

Model 99-C
Savage .243

Browning .30-06,
Mauser action

small-to-medium size. Woodchucks are about its upper limit for clean kills. Even then, head shots are necessary. The .22 fits in—well, anywhere.

Stepping up a notch, we come to varmint shooting, from prairie dogs and crows, nearby, to rock chucks out at a quarter mile or so. This type work calls for more range and a much flatter trajectory than the .22 RF. A high-velocity .22 centerfire is the ticket here, combined with a fairly heavy-

superduper round pushing bullets at 4000 feet per second (f.p.s.). The .222 Remington with its superbly accurate 50-grain bullet at 3100 f.p.s, or the .222 Remington Magnum at 3300 f.p.s. is all you'll ever need. And, they don't make much noise or cost as much as the hotter, faster .22 centerfires.

West of the Mississippi, ranges get longer—as much as 400 yards or more in the Plains States where prairie dogs and coyotes are the favored targets.

BULLET WEIGHTS (in grains)

| CALIBER | Rabbit, squirrel, other small game and small animal pests | Woodchuck, fox, coyote, and other varmints | Deer, antelope, mountain sheep, and other medium-sized animals | Moose, elk, Alaskan brown bear, caribou, and grizzly | Elephant, rhinoceros, and other thick-skinned game |
|-------------------|---|--|--|--|--|
| .22 Rimfire | 27, 29, 36, 37, 40, 45 | | | | |
| .222, .222 Magnum | 50, 55 | 50, 55 | | | |
| .22/250 | 40, 45, 50, 55 | 40, 45, 50, 55 | | | |
| .243 | | 80 | 100 | | |
| .270 | | 100 | 130, 150 | | |
| .284W | | 125 | 125, 150 | | |
| 7mmR Magnum | | 125 | 125, 150, 175 | 175 | |
| .30-06 | | 110, 125 | 125, 150, 180 | 220 | |
| .300 H&H Magnum | | | 150, 180 | 220 | |
| .300W Magnum | | | 150, 180 | 220 | |
| .308 | | 110, 125 | 125, 150, 180 | 200 | |
| .308 Norma Magnum | | | 180 | 180 | |
| .338 Magnum | | | | 200, 250, 300 | |
| .375 H&H Magnum | | | | 270, 300 | 300 |
| .458 Magnum | | | | | 500, 510 |

BROWNING ARMS CO. CHART

barreled rifle and a good, high-powered scope sight.

The rifle should be a bolt action with locking lugs up front—unless you're partial to the new Remington Model 788 which uses multiple lugs at the rear of the bolt. The M-788 has proved itself just as accurate as front-locking types.

Because of design features for convenience and handling speed, lever, pump and automatics simply don't have the accuracy required for precise long-range work. Don't pick a short, light carbine. Get the longest barrel offered, and take the heaviest weight you can handle. Remember that you'll shoot this gun mostly from rest, and you won't be carrying it a lot. The extra weight won't inconvenience you, and it will make hitting easier.

Choosing a cartridge for small game depends a great deal upon where you'll be shooting. East of the Mississippi River, shots tend to be at 250 yards or less. For this range, you don't need a

Here you need 3800 to 4000 f.p.s. with 55-grain or heavier .22 bullets. The new .224 Weatherby, .22-250 Remington and the venerable .220 Swift are at their best in this kind of shooting. The lesser .22s already mentioned simply don't have steam enough for truly long-range work.

The most popular big game in this country is the whitetail deer. This species is found in every state except Hawaii, and is hunted legally in all but two or three states. There are far more whitetail now than when the first Pilgrim set foot on Plymouth Rock. The other kinds of deer follow it in shooting and eating popularity.

The whitetail is a highly nervous, easily-killed animal. And he inhabits fairly open timber where short ranges are the rule. The average shot is at considerably less than 100 yards. This means you don't need a powerful, flat-shooting rifle. Tens of thousands of .30-30 Winchester and Marlin carbines

(Please turn to page 192)

A LONGER, DEEPER, DARING QUEST FOR THE SECRETS OF LIVING IN THE SEA

This Fall the Navy's **SEALAB III** project will send five teams of aquanauts 600 feet deep—for a total of 60 days—to find: How long can man live and work effectively in the depths of the ocean? □ By Hans Fantel

“LOWER AWAY!” When that command rings out off California's San Clemente Island this fall, it will mark the beginning of man's boldest foray into the last unknown region on this planet. Gushing and gurgling from filling ballast tanks, the Navy's Sealab III will drop from sight and slowly sink to the bottom of the Pacific Ocean. Like the earlier Sealab I and II, the new Sealab III is a kind of ocean-floor hotel and research laboratory. Its two-room interior is crammed with bunks,





Telephone

Oxygen makeup system

Emergency bell

Stowage

TV monitor

Deep Diver work sub

Benthic trunk for air hoses

Power hoist

TV camera

Viewing port

LABORATORY AREA

Figure-eight cable attachments

Aft hatch

Hoist

DIVERS' STATION

Workbench

Concrete deck

Concrete deck

Swimming equipment storage

Air Hoses

Entrance hatch

Luminous guide lines

Divers' navigational aid

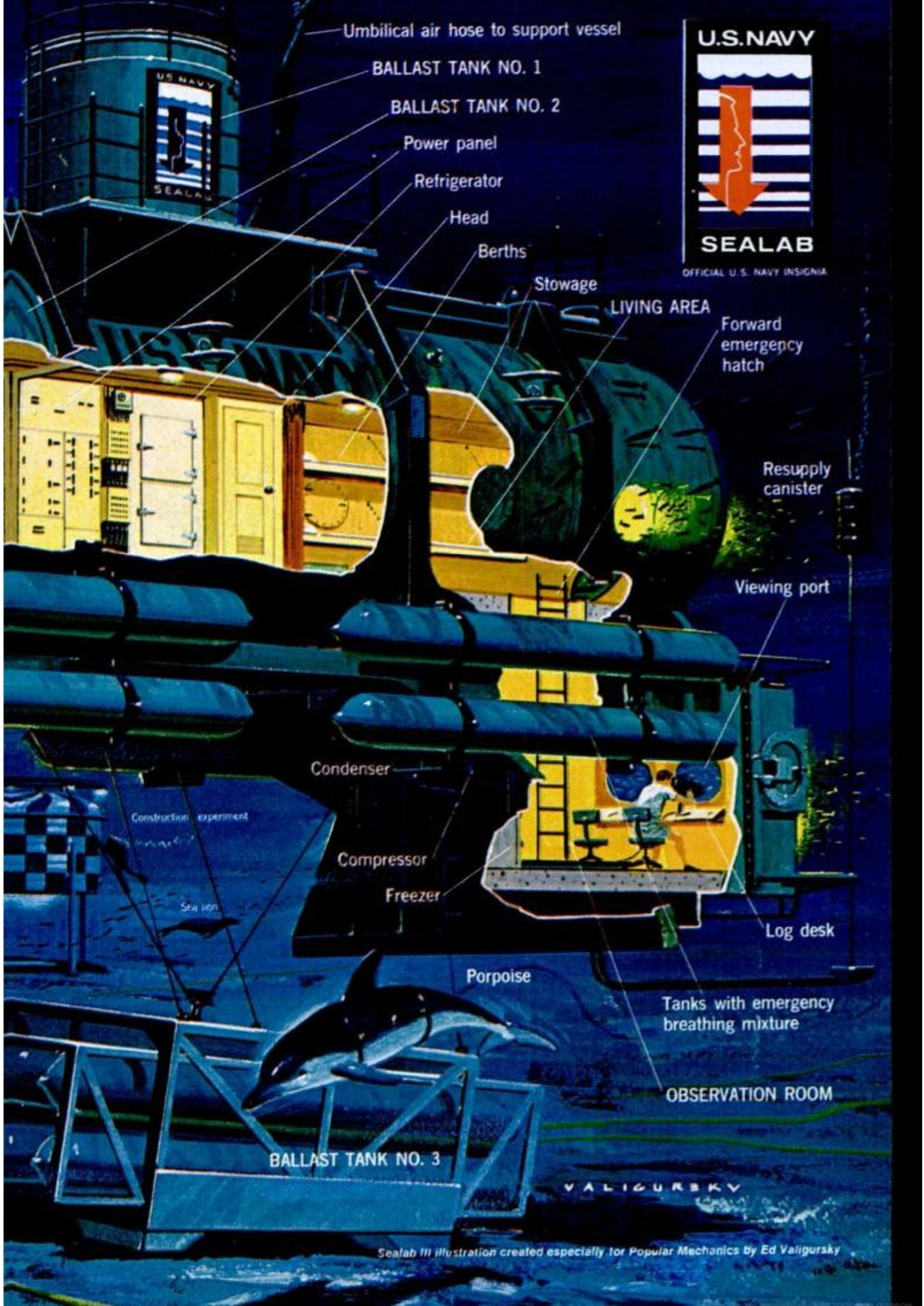

Umbilical air hose to support vessel

BALLAST TANK NO. 1

BALLAST TANK NO. 2

Power panel

Refrigerator

Head

Berths

Stowage

LIVING AREA

Forward emergency hatch

Resupply canister

Viewing port

Log desk

Tanks with emergency breathing mixture

OBSERVATION ROOM

Condenser

Compressor

Freezer

Porpoise

BALLAST TANK NO. 3

Construction experiment

Sea lion

VALIGURSKY

Sealab III illustration created especially for Popular Mechanics by Ed Valigursky



SEALAB AQUANAUTS AND MEDICAL OFFICERS pose after a previous successful dive. Shown from left to right are Capt. George Bond, who initiated the program in 1957, Torpedoman's Mate Billie Coffman, Cmdr. Scott Carpenter and Capt. Walter Mazzone

IN ARTIST'S CONCEPT, support ship *Elk River* feeds transfer capsule to 600-foot level of Sealab III

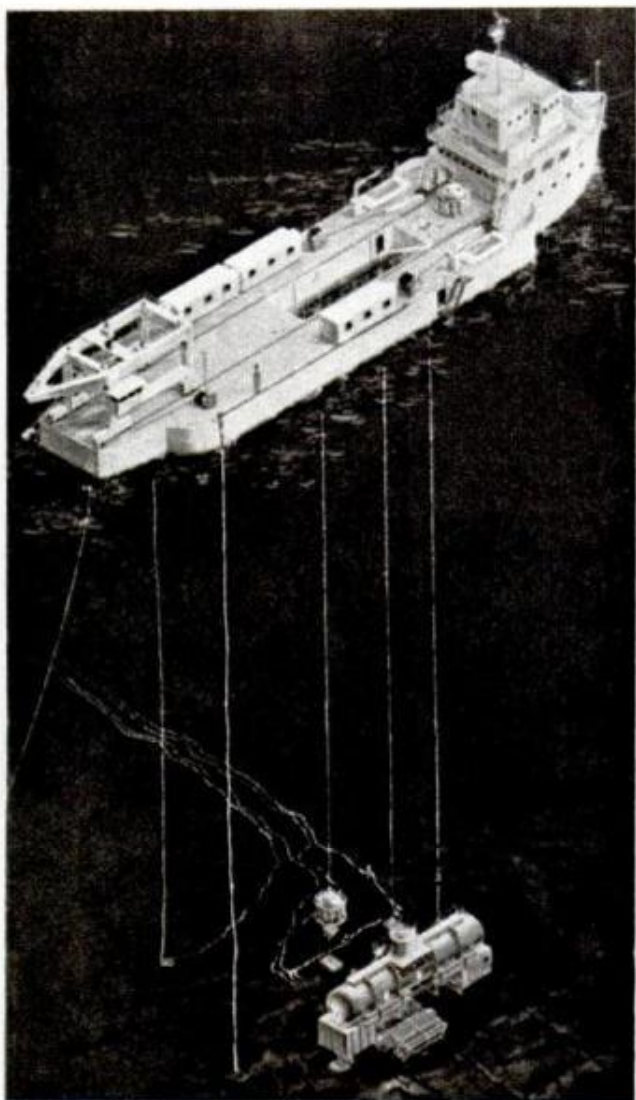

fresh-water showers, desks, chairs, books, hi-fi and nearly all the comforts of home, along with a mind-boggling array of special instruments. But, unlike the earlier Sealabs, this new "life capsule" will rest at a depth of 600 feet—three times deeper than its daring predecessors. "The longest 600 feet in the world," one crew member said.

"Diving craft go deeper," a heavily gold-braided officer explained, "but in a diving craft—as in submarines—men live at normal surface pressure. They can't go outside. Our aim, by contrast, is not just traveling in the sea. It's *living* in the sea, going in and out at will like you do at your own home, working outside, and staying down long enough to accomplish major projects."

At this moment, all equipment is ready:

- The Sealab habitat—a huge steel cylinder resembling an outsize tank car, studded with portholes, floodlights, hatches, pipes, valves, ballast and auxiliary breathing tanks, painted bright yellow for underwater visibility. Moored to the ocean floor, the habitat is the basic undersea abode. From here divers swim out on work missions, dangling on 600-ft. umbilicals, going down on the sloping sea floor to depths of 750 feet.

- Two PTCs (personnel transfer capsules)—free-hanging, pressurized ele-

SEALAB SITE is just off coast of Southern California

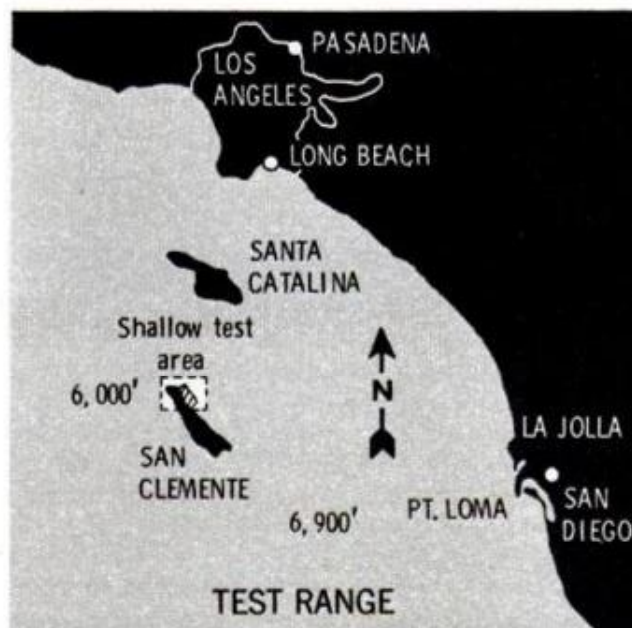

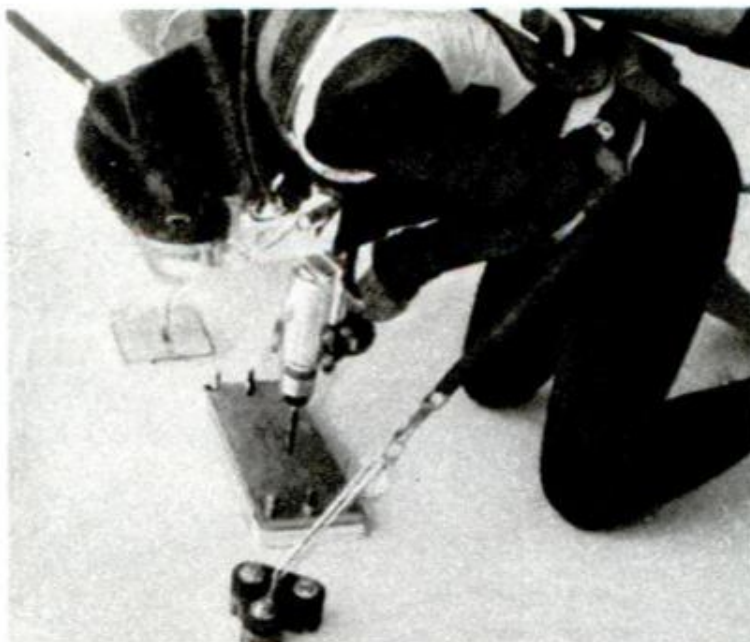
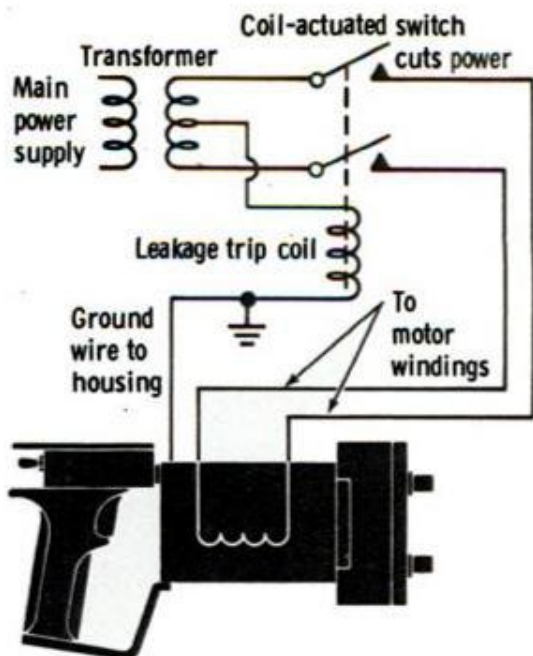

SHOCKPROOF POWER TOOL for underwater use has ingenious safety shutoff. Any short circuit immediately trips a relay (see diagram), cutting power within 30 milliseconds—long before diver can feel a tingle

vators to lower aquanauts to the habitat and to bring them back up. Each holds four men and is hoisted up and down by a crane on the surface support ship.

- Two DDCs (deck decompression chambers)—pressurized living quarters about the size of a VW bus, located on the surface ship. On arrival from below, the PTC “mates” with the decompression chamber so that the aquanauts can transfer into the DDC under pressure. Then they are gradually decompressed over a period of 150 hours. Faster decompression would make the nitrogen in their blood bubble at body

temperature, causing the often-fatal “bends.”

- A “dry pot”—a sealed transfer chamber to deliver food, mail, newspapers and supplies to the habitat.

- A surface support ship, the *Elk River*, carrying out command and monitor functions, serving as communications center and supply store for the entire undersea operation.

The enemy to be vanquished in this Navy mission is the sea itself. It is powerful and unforgiving. The first mistake is likely to be the last. “We can’t forget this for a moment during the whole 60-day project,” says Lt. Cmdr. C. W. Larson, a Sealab briefing officer.

At 600 feet down, the sea presses in on the human invaders at a shattering 275 p.s.i. Just staying alive is a chore in this environment. Every breath becomes a scientific challenge, for at such pressure, the body reacts very differently than at the surface.

Pure air becomes pure poison. Its nitrogen, pressed into the blood by the extra pressure, knocks a man’s mind off its moorings, rendering him a helpless victim of the “rapture of the deep.” That’s why most nitrogen is removed from the aquanauts’ breathing mixture and replaced by helium—a physiologically harmless gas. Oxygen, too, must

(Please turn to page 180)



AMERICANS ARE NOT ALONE IN THE DEEP! Russia’s Sadko-2 (above) spent 10 days at a depth of about 82 feet with two men in it, and the Soviets have reported preparing Sadko-3 for further experiments, as well as Bentos-300, a transportable vehicle capable of depths close to 1000 feet, housing 10 aquanauts for two weeks

Greatest



EXCITING SNOW SKIMMER PULLS YOU ON SKIS

SO WHO NEEDS hills to ski? This gas-powered sled scoots through the snow while you hang on behind like a water skier. It hits 15 to 20 mph with a 4-hp engine and can reach 50 mph with added power. Propelled by two chain-driven augers, the skimmer is designed for cross-country jaunts or for ski buffs who live in flat areas.

The clever part about the drive is that, while the chain always runs in the same direction, the augers turn in opposite directions to balance their side thrust. This is done by reversing the bevel drive gears, as at left. You steer by twisting the handlebar to the right or left, like pulling on the reins of a horse. A remote throttle controls speed. Inventor is Miklos Von Kemenczky of Greenbrook, N. J.

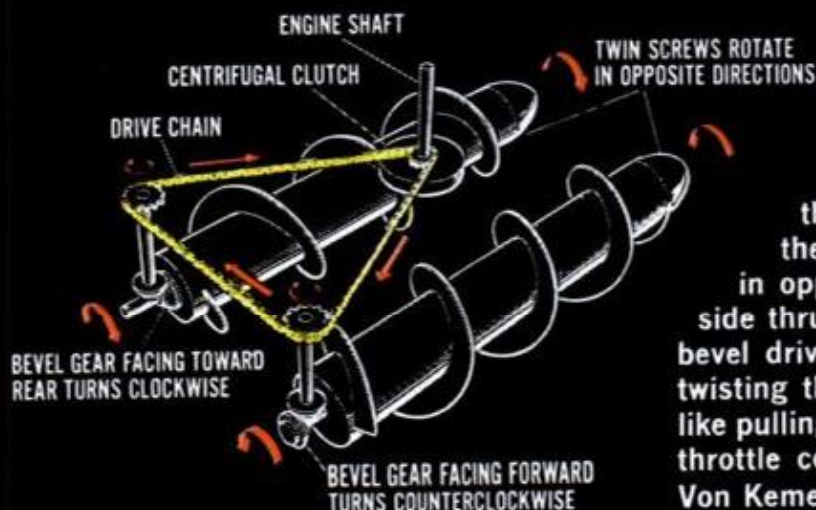

Gadget Show on Earth

This month more than 10,000 clever ideas, intriguing devices and far-out gimmicks will be unveiled at the big annual International Inventors and New Products Exposition at the New York Coliseum. Here and on the next six pages, by special arrangement with the show's producer, Patent Exhibits, Inc., is an advance look at some of the most exciting entries

By SHELDON M. GALLAGER

Art by Fred Wolff

TURN ON A DIME? ALMOST!

PARKING in tight places is no problem for the car below—its wheels turn 90°. In narrow streets, it can turn in its own length, pivoting on one rear wheel. What makes this possible is a special jointed tie-rod linkage. The rack, instead of being straight, is V-shaped. As it's moved sideways by the

pinion gear on the steering wheel, it also rides downward. This forces the tie-rod arms outward, making them progressively longer as the turn tightens. The lengthened rods thus allow the wheels to swing farther around (cars with conventional fixed-length tie rods lock up at about 45°). André Rey of Albi, France, devised the system.

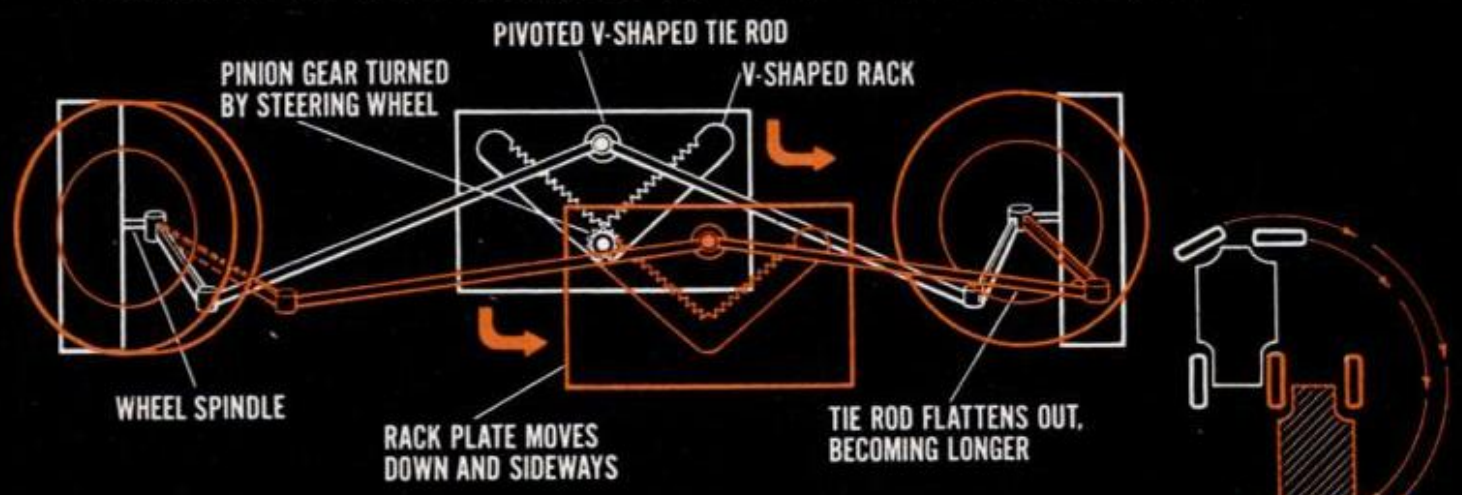

CONVENTIONAL STEERING ARRANGEMENT

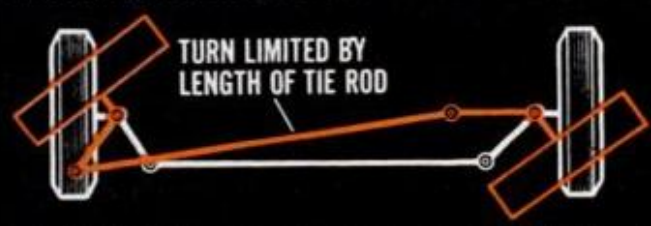

NEW 90° STEERING



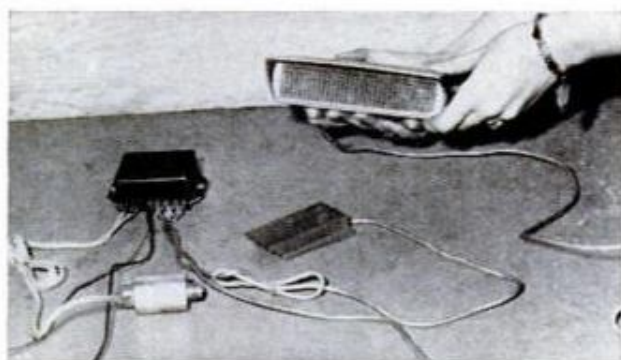
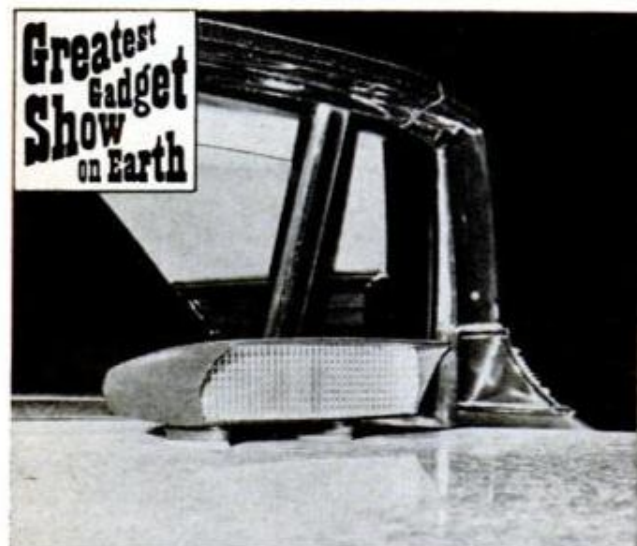
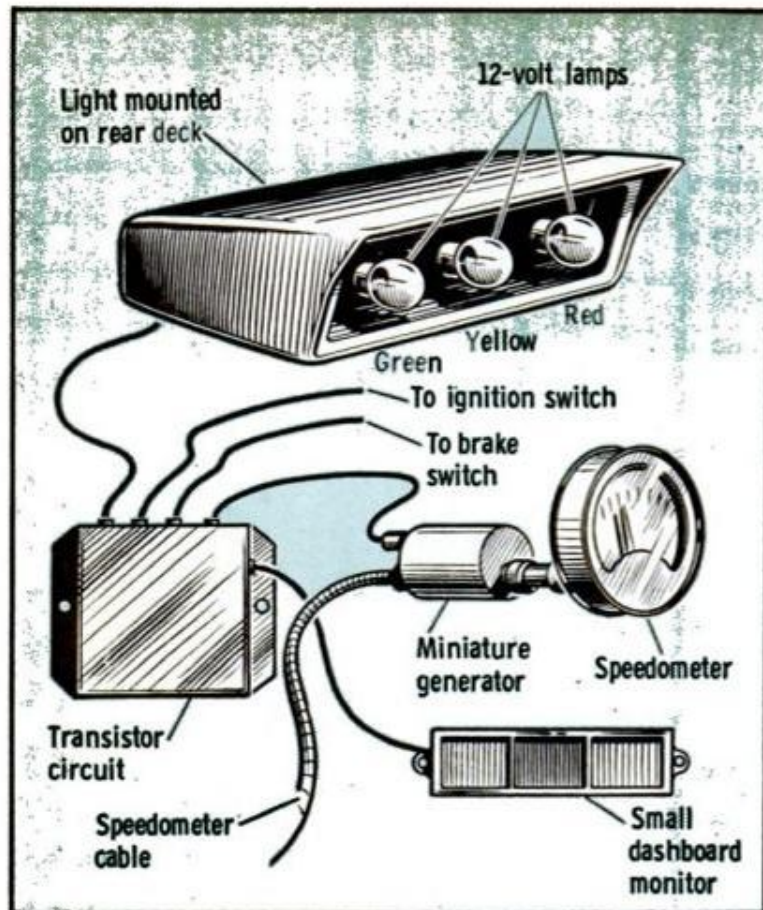

LIGHT WARNS OF SPEED CHANGES

CONVENTIONAL STOPLIGHTS tell you only that a car ahead is braking. This multi-colored accessory light flashes green if the car accelerates, yellow-green if its speed is steady and yellow only if it starts to slow down before actually braking—helpful in high-speed turnpike driving. Its heart is a clever speed sensor consisting of a tiny generator driven by the speedometer cable—the faster the cable turns, the more current it generates. Electronic circuits trip relays to turn the appropriate lights on or off. Pressing the brake adds red. Inventor is Norman H. Dankert of Michigan City, Ind.





TWO-WAY TOOTHBRUSH DOES A SPLIT

YOU CAN CHANGE the shape of this toothbrush at will. The head consists of two curved rows of bristles mounted on pivots. With the rows side by side, you have a small, hook-shaped brush for getting in hard-to-reach spots. The handle is made in two strips so that sliding one over the other provides a bell-crank action that swings the bristles outward. This gives you a wide curved brush for scrubbing teeth in front. Raul Eklund of Lincoln Park, Mich., invented the convertible toothbrush.



SELF-SERVICE GAS PUMP

YOU PUMP your own gas with the system devised by Wilfred Smeiman of Dana Point, Calif. You drop a credit card into a slot, dial a secret code number, and the amount of the sale is electronically recorded and charged to your account. The idea could also be used for supermarket checkouts, self-service department stores and the like.

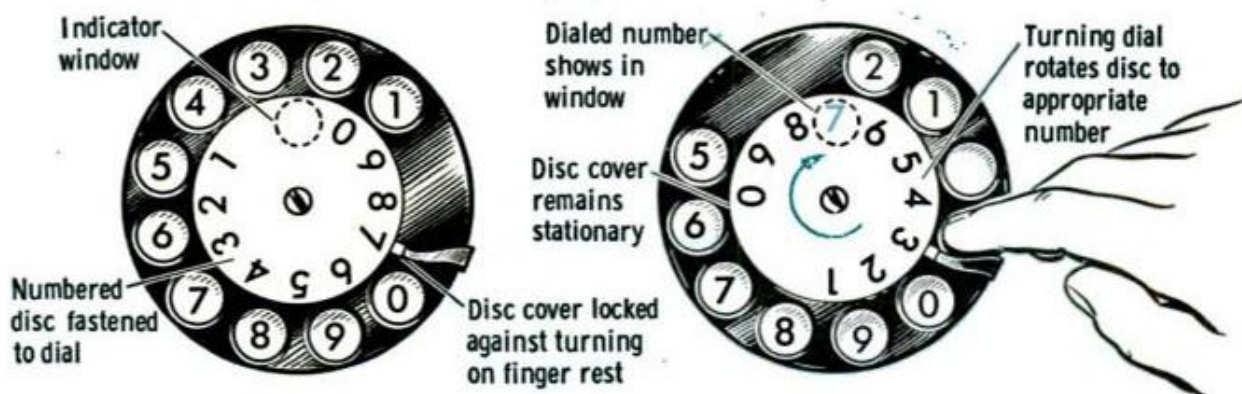

PHONE DIAL REMEMBERS FOR YOU

EVER GET halfway through dialing a long phone number and forget which digit you were on? This clever telephone attachment ends the guesswork. As you dial each digit, it shows up in a small window, helping you

to keep track of the number. A numbered disc turns with the dial. A cover plate with a window hole in it fits over the disc so that each dialed number shows up in the window as the dial is turned. Maurice Darimont of Jalhay, Belgium, designed the accessory to fit on any standard telephone.

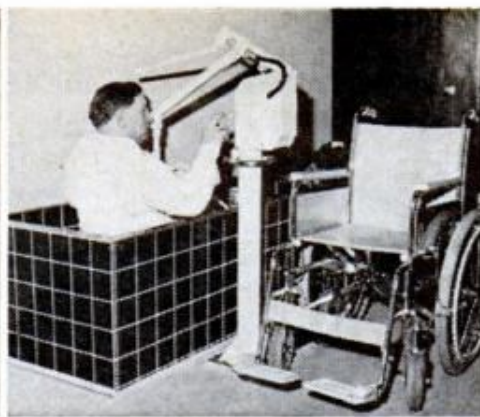

PUSHBUTTON WHEELCHAIR HOIST

YOU'D NEVER GUESS that a wheelchair invalid could get himself in and out of a bathtub without help. With this electric-hydraulic hoist, invented by G. W. van Gerven of

Valkenswaard, Netherlands, he can do just that. Padded arms mounted on top of a pedestal grasp an invalid around the knees and shoulders, lift him out of the chair, then swivel around in a half circle and lower him gently into the tub.



POP-UP MAIL FLAG

WHEN this flag flies up, you know the mailman has arrived. The counterweighted arm is held down by a tab under the door lip. When the mailman opens the door, the weight falls and the flag swings up. Aldo Margoni of Monongahela, Pa., invented it to supplement the regular mail-pickup flag, not used much today.



SLIP-IN SHOE RACKS

THESE quick-grip racks keep shoes flat and neat without the need for shoe trees. You just slip a shoe into the toe clamp and slide it forward in the track until the heel hooks under another clamp in back. Spring tension holds the shoes snugly and allows the racks to adjust to different sizes. Allsop Automatic, Inc., makes the racks for wall mounting or in a four-way swivel caddy.

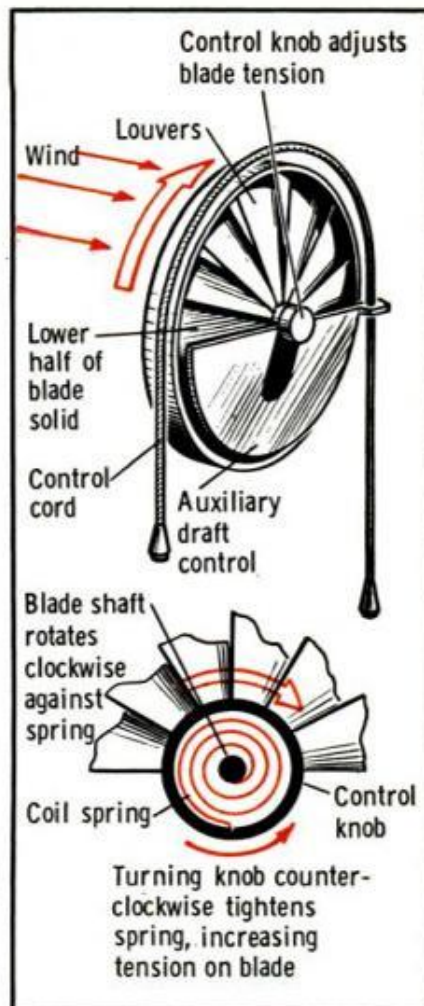
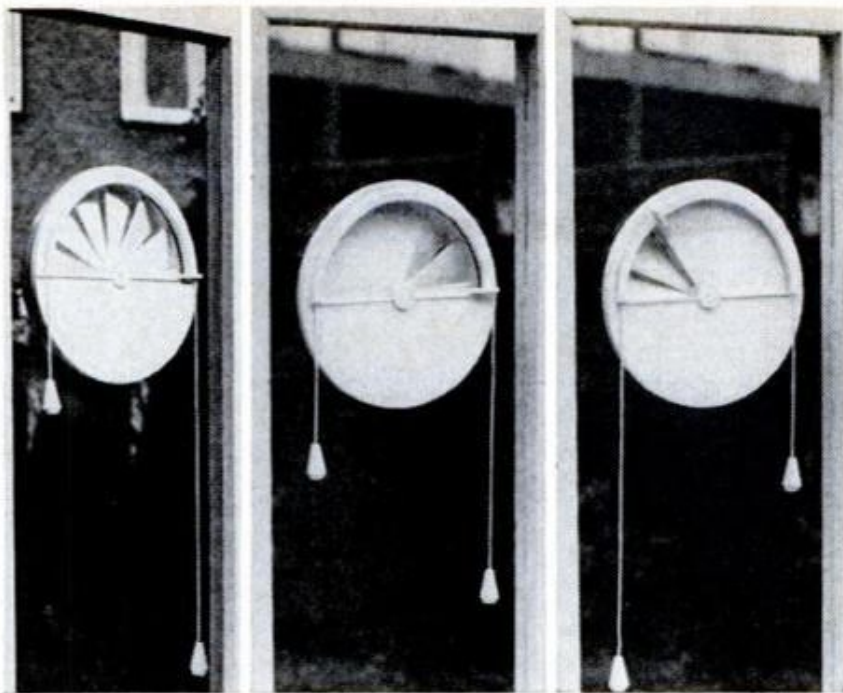

THE HARDER IT BLOWS, THE LESS YOU FEEL IT

THERE ARE NO SUDDEN DRAFTS with this ingenious self-closing vent. If it starts to blow, air pressure rotates the louvered disc, shutting the vent (center, above). As the wind slackens, a spring forces the louvers open again. Vent area can also be adjusted manually (right). Inventor is E. M. van de Pol of The Hague, Netherlands.

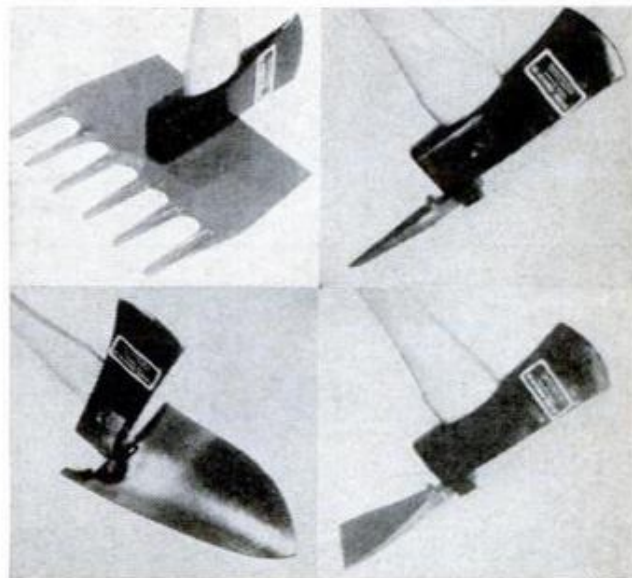
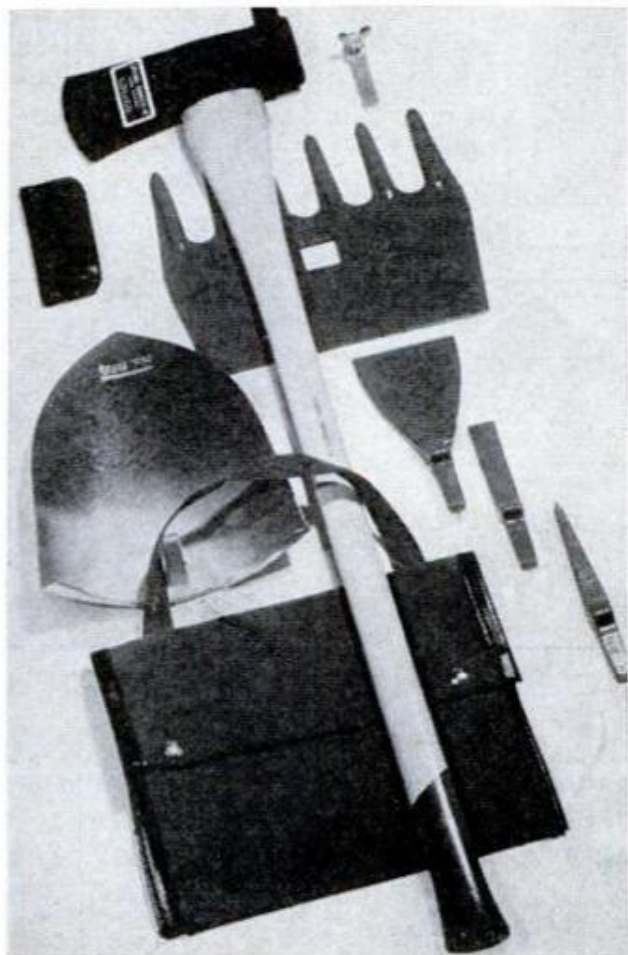

IT'S AN AX, IT'S A PICK, IT'S A . . .

IF YOU COULD TAKE only one tool into the wilderness with you, this many-headed ax would be a good choice. Interchangeable attachments slip into a socket in the ax head and quickly convert it to a pick, hoe, mattock, rake and shovel. Fred Shandel of Albion, Calif., made the tool for campers, sportsmen and military survival kits.

**Greatest
Gadget
Show
on Earth**

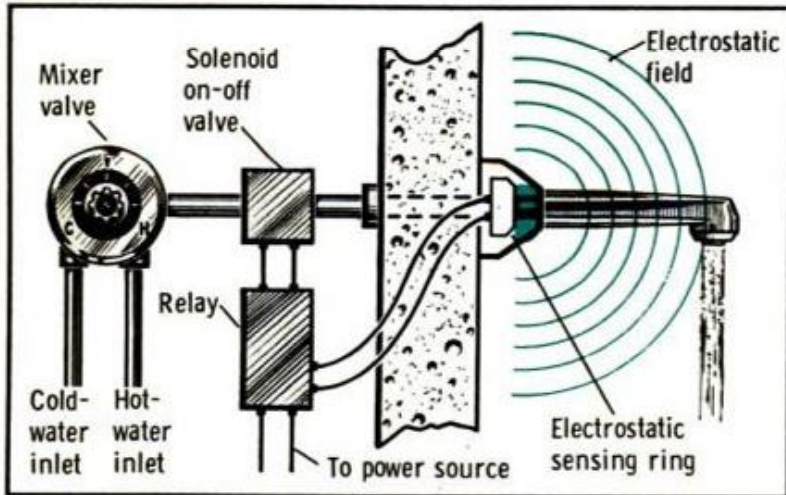

LOOK, MA, NO HANDLES!

YOU'RE SEEING RIGHT—this faucet has no valve handles. It turns on and off almost magically at the wave of a hand. The trick? Moving your hand near the spout disturbs an electrostatic field, triggering a solenoid valve that controls the water flow. The West German firm of Rokal GmbH developed the electronic faucet for hospitals and public rest rooms to save touching dirty handles.

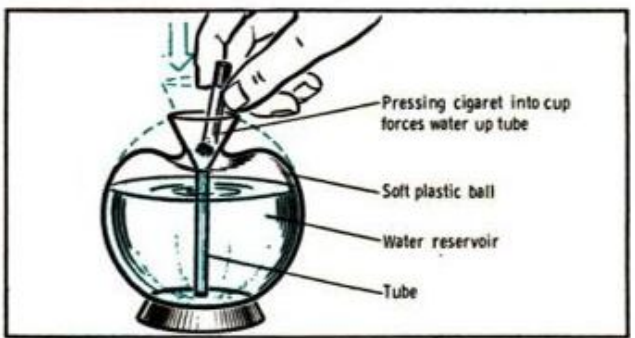
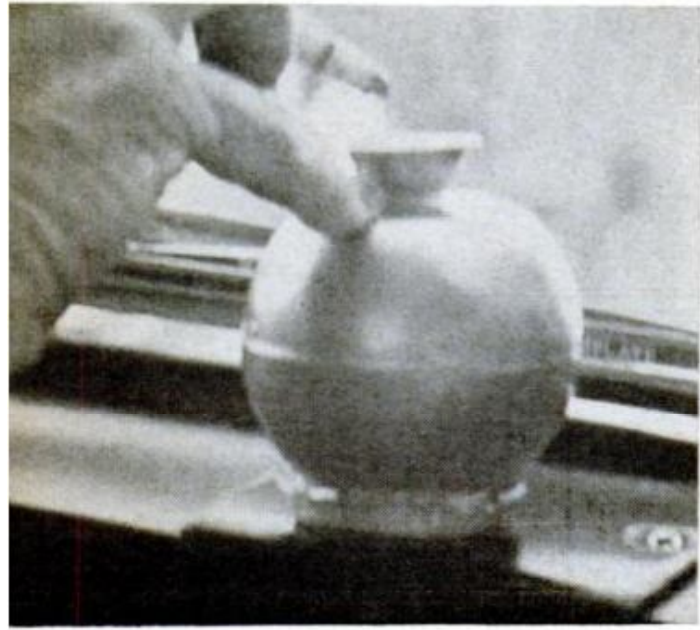

FIRE EXTINGUISHER FOR CIGARETS

THIS WATER-FILLED BALL can't spill, but press a lighted cigaret into it and the water rises in a tube to put out the stub. It was devised by Kai Ferrelli of Hollywood, Calif., to lessen the danger of fire, especially when smoking in cars.



STADIUM SHELTER IN A SUITCASE

WATCHING cold-weather sports would be more comfortable with this portable seat and insulated leg bag designed by Flor-

ence W. Du Priest of Waco, Tex. At the stadium, you just open out the seat, climb in, and you're warm and dry for the whole game. For easy carrying, the bag and seat fold to the size of a small suitcase.

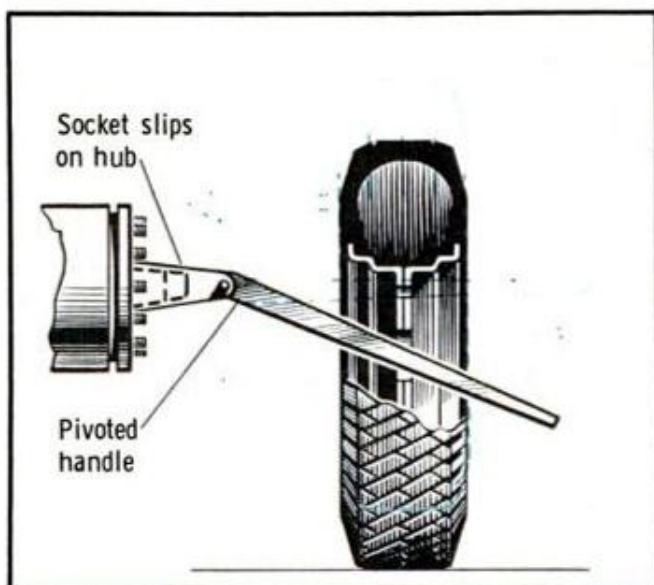

CHANGING A TIRE THE EASY WAY

HORSING A HEAVY WHEEL up on a jacked axle and getting the lug holes lined up is the hardest part of changing a tire, thinks Walter Dombeck of Ellwood City, Pa. To solve the problem, he came up with this handy lever. You slip it onto the axle, pull up on the handle, and lift the wheel neatly onto the hub. Then you line up the holes and slide the wheel onto the studs.

See these and other inventions at the Inventors Show, Sept. 12-15, at the New York Coliseum.

SEPTEMBER 1968

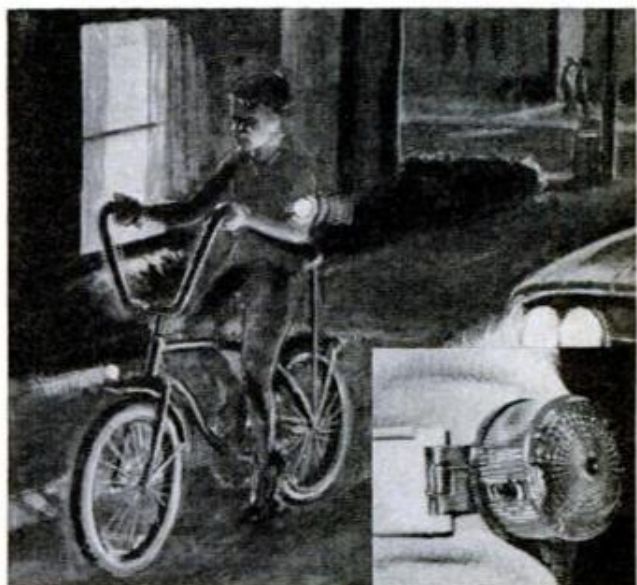

ARM FLASHER FOR BIKE RIDERS

IF YOU PUT warning lights on cars, why not on people? That's the idea behind this flashing armband lamp designed to protect bike riders and pedestrians on the road at night. The battery-powered yellow flasher slips around your arm and is held by padded spring clamps. The Egebo Co. of Dijon, France, markets the safety device and hopes to sell it in this country.

107



VOLKSWAGEN

A Nationwide Survey Based on
1,000,000 Owner-Driven Miles



Handling's Fun, Economy's Tops, But Hold Tight on a Windy Day!

By **BILL HARTFORD**, Associate Auto Editor

Photos by Irving Dolin

"I take my grandsons fishing in it and they all love it!" beams an Iowa grandma about her new, automatic stick-shifting "Beetle."

Fishing? But that's impossible! Even if lots of owners say the "Bug" is extraordinarily air and watertight, and other sources report VWs have gone into the drink and stayed afloat for quite awhile, you simply cannot praise its "seaworthiness." There's no such category in our Owners Report!

Owners who stuck to the questions—and who stick to the road!—tell us about their VWs in no uncertain terms. They have no use for the vagaries of style; it's eating up asphalt at a few cents per mile that counts. Not that they don't pose their VWs in the driveway like all proud, new car owners, but, as they tell us, they do it with the satisfaction that the style is constant—even classic—functional and, to quite a few, strangely appealing.

But when they leave their driveways,

FAMILIAR SHAPE is part of landscape. But owners are aware of such things as rakish new gas-filler flap!





REAR-SEAT PASSENGERS agree that it beats walking. Luggage well behind the seat is convenient, however

both first-time and old-time Beetle owners can tell you what puddle-jumping is all about: First and foremost, it's fun. "I like the fun of driving it; it does things other cars can't," says a Delaware serviceman. "It's fun, and with the automatic stickshift I have a very happy wife," gloats an Arizona student. "It sets you free!" yells a Tennessee civil servant. "I love the way it handles," beams a Louisiana secretary.

A Utah welfare case worker finds it "fun to drive," but adds, "you can't afford to be hit because of its 'squashability.'"

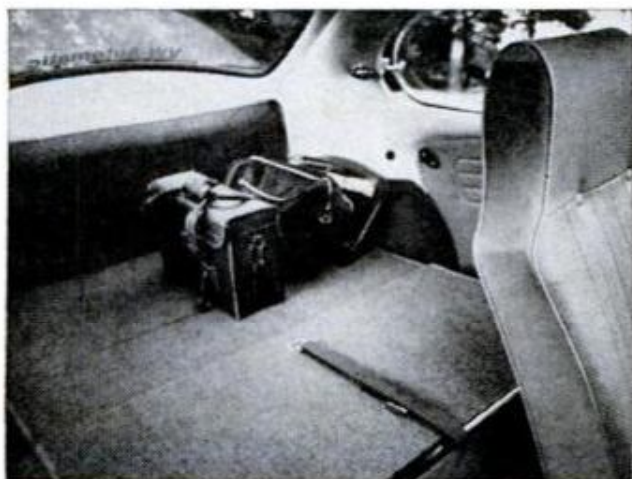

FOLD-DOWN ARRANGEMENT of back seat is standard. Owners like semistation-wagon configuration

(It may be a lightweight, says a New Mexico writer, but "I feel more secure in my VW on the highway than in my bigger and heavier country sedan.") "Nimble" is a Maryland illustrator's word for his Bug. And, it's "fun taking hills and curves," says a Kansas student.

It's not all fun, however. A charge of poor "roadability" is the biggest indictment owners level against the VW's driving characteristics. But, as they say themselves, a guilty verdict is only handed down on windy days. "Hard to handle in



HEAVY NEW BUMPERS get praise, but owners find sloping hood takes beating from stones and insects

the wind," says a Nebraska investment analyst. "It's sometimes a bit difficult to keep on the road in the strong Delaware wind," says a teacher. A Maryland chemist finds "drifting in high winds" annoying.

A Texas housewife, who has learned to ride with the gusts, sympathetically says, "Complaints? None really, except the wind sure gives that car a bad time." A West Virginia civil-servant applicant likes the fact that he can "keep the VW wound tight all day long," but finds that "at high speeds when the wind is blowing hard or a tractor-trailer passes you, the car sways a little." A South Carolina production supervisor doesn't put it that mildly, however: "I hate to drive it in wind or pass a big truck at high speed . . . real nerve-racking . . . nearly get blown off the road." But he, too, is a forgiving owner: "Other than that I love everything about it; once you've had a VW you never want to be without one."

A Georgia master barber, who also gets



FRONT-SEAT ADJUSTMENTS allow comfortable positioning for drivers under five feet to over six feet tall

a bit nervous at high speeds, says he picked the VW "because you can drive it faster and harder than most small cars." But he'd like to see the car "lower to the ground so it can take curves better." Like a Georgia production supervisor, who likes the VW's "sport car feel," he must be running some real fast qualifying heats down to the shop. A law student in Carolina who also likes sports cars, says he "couldn't afford a Porsche, so got the best car mechanically."

His request that VW offer an optional Porsche engine for the Beetle is only one of many various options and refinements owners suggested. A *decrease* in horsepower is what a Minnesota steelworker wants; a "passing gear" with the automatic stick, requests a Tennessee telephone operator; "power windows," says a New York marketing man; "instruments instead of idiot lights," says a Kentucky radio engineer; "tinted glass!" squints a Georgia accountant; "a 13-gallon fuel tank," says an Indiana switchman; "a speaker in the roof so everyone can hear the radio," requests an Indiana tool and

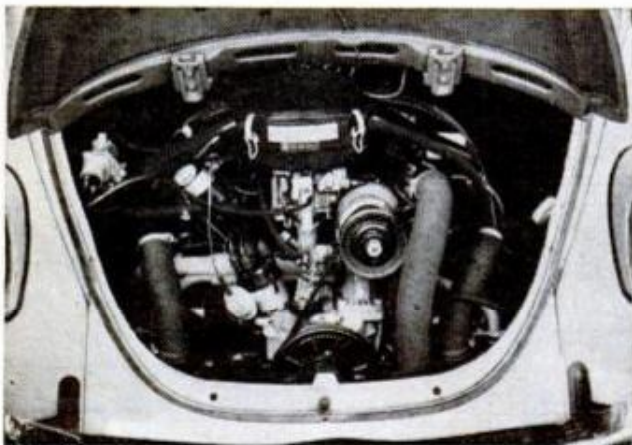

IT'S NOISY, only 53 hp, a poor source of heat in winter, but is extremely reliable and economical



BUILT-IN HEADRESTS annoy drivers, passengers; restrict visibility enough to be a hazard, say owners

die man; "front luggage compartment designed for my golf clubs," says Delaware supervisor. "A convertible that doesn't look like a doll carriage," is the dream of a New Hampshire mechanic; and a "simple, splined shaft instead of the puny round shaft and setscrew to mount the windshield wiper arms," is one plea of an airline pilot/flight engineer who would probably be welcome in VW's "improvements" department.

If it doesn't have everything for everybody, what it does have is great economy—the best thing about the car to four out of five owners. Mileage figures for the manual four-speed and automatic stick-shift are given in the accompanying chart.

But fuel economy is only part of the story to VW owners. An Oklahoma office worker tells the rest, while summing up the feeling of the typical owner: "Good



FRONT LUGGAGE COMPARTMENT is not easy to use, but owners like its capacity and efficient layout

fuel economy along with durability, minimum trouble and repair expense, and moderate depreciation combine to make the VW a real economy car." This owner backs up his conclusions with some rather impressive calculations. This is his sixth VW since 1960. He drove his first five a total of 209,474 miles, with the total cost of fuel oil, maintenance, taxes, insurance and depreciation being \$7,094.55. As he says, that's 3.3868 cents a mile. "My cost on Fords and Chevys was approaching nine cents a mile which I consider excessive." He averages 25.03 mpg overall, with his automatic stickshift, and with that, we'll let him have the last digit on VW economy. *Punkt!*

A couple of owners have a good word for the front seats VW introduced on the '68 models: "Front seats with built-in headrests add comfort to the ride," says an Indiana teacher; and "new, front, airplane seats are great," says a Georgia cab driver. A third owner, a Maryland store manager, praises the seats, too, but he has a suspicion, and correctly, that he's in the minority: "This sounds crazy but I liked the high seats at first glance."

From here on in the high-backs prove devastating to VW's renowned "annual

VOLKSWAGEN FUEL MILEAGE CHART

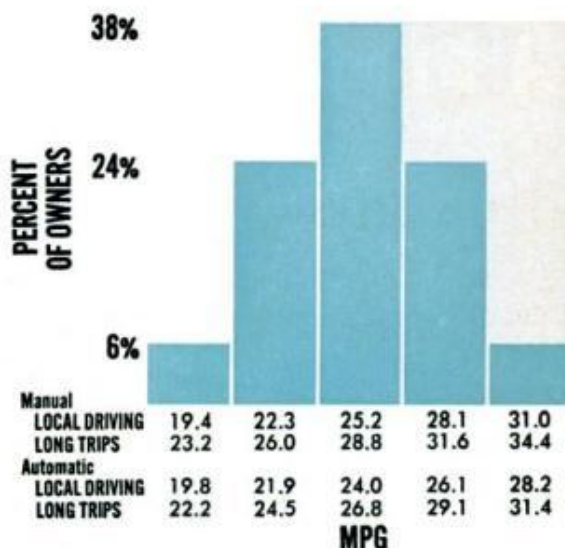

improvements" list. Federal safety standards notwithstanding, there must be a better way: "The high-back seats are hazardous for seeing the cars behind you," says an Alabama dental technician, who goes on to mention that he racked up \$321 worth of damage when he was hit while changing lanes. Next customer: "Change the seat backs; I hate them. The only reason I'm filling out this questionnaire is to

(Please turn to page 193)

Summary of 1968 Volkswagen Owners Reports*

Total miles driven 1,073,718

Average miles per gallon:
 4-speed manual transmission
 local driving 25.2
 long trips 28.8
 Automatic stick shift
 local driving 24.0
 long trips 26.8

Specific likes:
 Economy 82.4%
 Handling 68.8
 Durability 15.1
 Comfort 12.2
 Workmanship 8.3
 Size 7.8
 Trade-in value 6.3
 Style 5.8
 Power 5.9
 Roadability 5.4
 Construction 5.4
 Price 4.9

Specific dislikes:
 Roadability 19.5%
 Front seats 18.9
 Dealer service, availability and cost 12.4
 Rear-seat room 11.8
 Brakes 11.8
 Power 8.3
 Engine noise 6.5
 Slow, ineffective heater 6.5
 Vent system 5.9

What changes would you like?
 Eliminate high-back front seats (poor visibility to and from rear) 19.8%

More power (engine option) 11.7
 Heater (slow warm-up, inadequate at low speeds) 10.5
 More room in rear 9.3
 Vent system 8.0
 Brakes (eliminate screech) 6.2
 Wing-window knobs 4.3
 Trunk room 3.7

Transmission:
 Manual 4-speed 78.6%
 Automatic stick shift 21.4

Why the automatic stick?
 For wife/daughter 41.9%
 Don't like shifting in heavy traffic 41.9
 Just learned to drive 4.7
 Just like it 4.7

Had any mechanical trouble?
 No 62.9%
 Yes 37.1

What kind of trouble?
 Brakes 26.9%
 Electrical 16.7
 Carburetor 16.7
 Valve-cover gaskets 7.7
 Automatic transmission 6.4
 Automatic choke 6.4

Dealer repair satisfactory?
 Yes 64.3%
 No 31.4

Why the VW?
 Economy 29.3%
 Reputation 27.9
 Past experience 23.6

Durability/reliability 22.6
 Resale value 19.7
 Service availability 17.8
 Price 9.6
 Handling 9.6
 Construction 8.7
 Quality 7.7
 Performance 7.7
 Workmanship 7.2

Would you buy another VW?
 Yes 89.6%
 No 10.4

Is the VW your only car?
 No 61.7%
 Yes 38.3

Other cars owned:
 Chevrolet 27.1%
 Ford 17.8
 Volkswagen 14.0
 Pontiac 14.0
 Oldsmobile 9.3
 Rambler 7.0

What options/accessories?
 Radio 80.7%
 Whitewall tires 32.0
 Opening rear windows 26.0
 Leatherette interior 17.1
 Undercoat 12.7
 Bumper guards 11.0
 Sun roof 9.6
 Cigaret lighter 8.3
 Gravel guard 8.3

Age distribution of owners:
 15-29 50.5%
 30-49 40.0
 50 plus 9.5

*Where applicable percentages may not equal 100 percent due to rounding and/or insufficient sample.

A Fisherman's Dream Boat

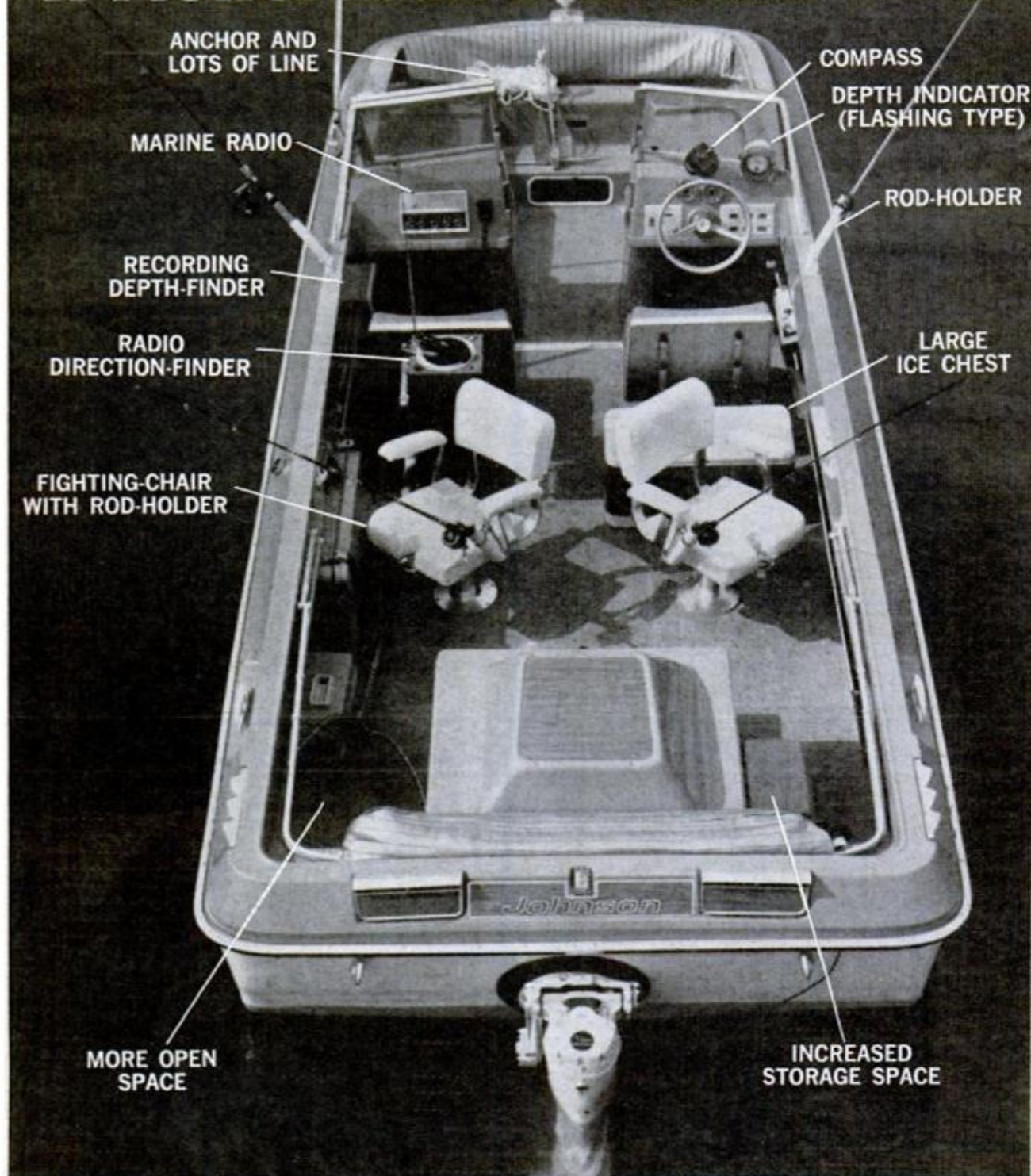

Here's how you can rig your boat to make it a great sport-fisherman

By PAT RICHARDS

YOU CANNOT BUY this boat as is. You'll have to equip it yourself.

But once you've added the electronic and fishing extras, you'll have a snappy sport-fisherman that'll handle almost any kind of fishing water—the swells off Mon-

tauk Point, the chop of the Gulf, the ripples of Lake Powell, the uncertain emotions of the Great Lakes. And this type of boat is trailerable to boot.

It was in the wake of a 40-mph line squall that blew up 15-foot waves in Lake

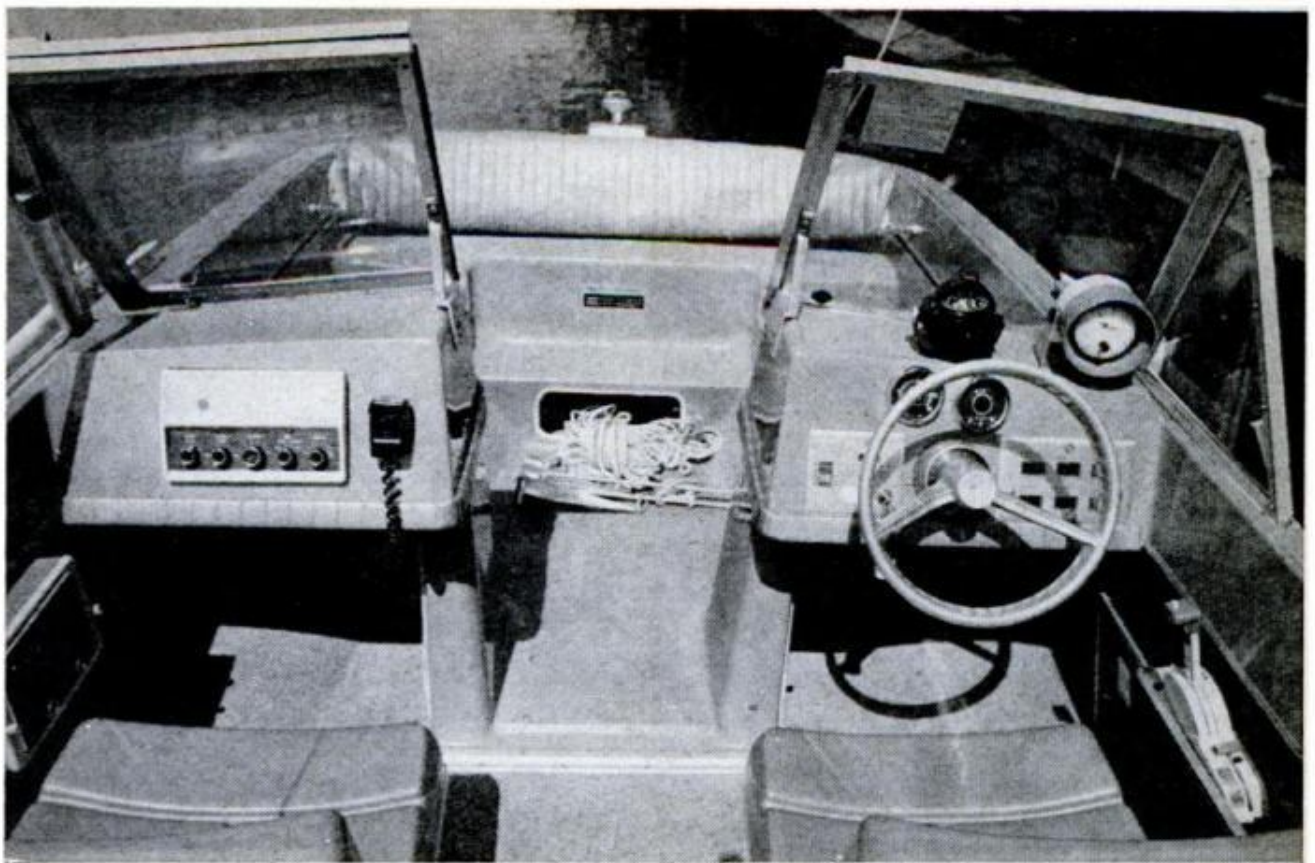

CLOSE-UP VIEW of installation of main electronic components. Note storage area forward for the anchor

Michigan that the idea for this boat was born. That was just a year ago this month. During that storm, more than 200 boats swamped or capsized. Miraculously, only seven persons drowned. Many fishermen were poorly equipped. They had no way of getting bearings once lost—they had no compasses, no charts. Others, without radio, never knew the storm was advancing.

Many were "inland" fishermen who didn't know that much about open waters. They had trailered their small boats to Lake Michigan, which can kick up in minutes to become one of the nastiest pieces of big water in North America. They were following the Coho salmon—many were too far offshore.

It was only last May that a tougher, unpredicted squall knocked down hundreds of boats along the Northeast coast.

Winds hit 60 mph, and the air crackled with rescue requests from Sunday boatmen. More than 100 calls for aid were recorded off Cape Ann, Mass. In Long Island Sound, distress frequency 2182 kc was jammed with rescue traffic.

Many of these boatmen knew what they were doing, and had the right gear. But others were not properly equipped when the storm hit, so had a rough time.

Following the Lake Michigan squall, engineers and boat designers at Johnson

Motors set out to build and equip a trailerable boat that could fish big waters safely, and which could get out of big trouble if necessary. They worked with electronics specialists from Ben-Mar, the marine division of Bendix Corp. Here's what the experts feel is necessary to transform any small fishing boat into the ultimate in a trailerable sport-fisherman. You can install any or all of the equipment depending on your needs and pocketbook. Prices listed are suggested retail.

The basic boat is the Johnson 191 Big

THE INTERIOR of the 19-foot Johnson 191 is designed to provide maximum room for fishermen



Fisherman—a 19-foot, gull-wing-hulled utility runabout with an 88-inch beam, 24-to-40-inch freeboard, and 81 square feet of open cockpit space, thanks to a walk-through dash and windshield and a convertible foredeck top that opens to leave the entire deck space clear.

The Dick Cole-designed "Sea Foil" hull, an improvement on his original cathedral types, rides like a 25-footer even at speed through a good chop. With its high freeboard and deep, flared entry, it rides quite dry, even in a blow. The convertible top snaps in place to form a foredeck, and the windshield closes watertight to turn incoming water as nicely as any one-piece design. An optional full convertible top (\$130) with snap-on side curtains will button the boat up into a rainproof shelter, but with the stern curtain left off, you can troll dry through any rainstorm.

This boat is powered by a 120-hp, OMC stern-drive. Though not a great deal of power for the hull, it will plane four fishermen and their gear at an easy 25 mph, yet when throttled back to 500 or 600 rpm, it trolls as quietly as a five-horse outboard.

To this stock Big Fisherman (\$4595 f.o.b. Waukegan, Ill), Johnson's engineers added accessories and safety equipment until they were convinced that their boat was as comfortable and safe as a saltwater sport-fisherman—yet could be trailered easily at expressway speeds, and be planed comfortably for runs to the fishing grounds.

Since most big-game fishing means trolling, they removed the rear-facing

REGULAR COPPER SCREENING is all that's used on the engine compartment lid to cut down on static

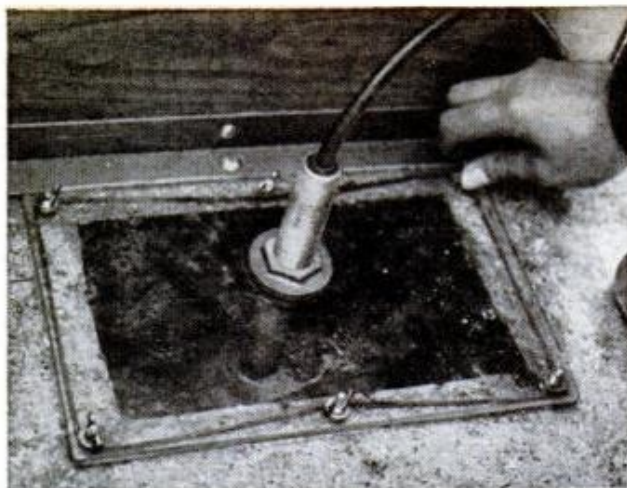

PLEXIGLAS COVERS the inboard well for the depth recorder transducer. The well is filled with water

runabout seats and replaced them with two Pompanette fighting chairs (\$136 each). You may need only one. The flange-based chairs are secured to the deck with ordinary Molly bolts, which expand into the closed-cell flotation material beneath the fiberglass deck just as they would in the insulation behind a wall in your home. With their built-in rod holders, the fighting chairs are perfectly comfortable on long trolling runs, yet shock-absorbing enough for running through a chop. For the two bow-facing seats, adjustable nylon rod holders were mounted on the gunwales, just behind the windshield edges.

The built-in water-ski rack down the inside of the starboard cockpit wall serves as an excellent rack for fishing rods, too. A shorter rack on the port side holds other tackle secure and leaves room for a 20-gallon fuel tank, plenty for a day's running and trolling with an extra margin for safety.

For finding fish, keeping track of depth and bottom type and for navigation as well, two depth finders were installed—one flashing-dial type (\$120, DI-9) for instant readings, and one recording type for its built-in memory tape (\$370, DR-19). Ordinarily, the transducers for depth indicators are either mounted in a hole cut through the hull, or hung over the side or the transom. Either way, they are difficult to install permanently, and create drag when the boat is run at speed.

So the engineers tried two new, drag-free, easy installations. The transducer selected for the flashing-dial indicator is a flat-bottomed attachment that screws onto the transom with its bottom parallel

(Please turn to page 196)



Seats on wheels

Twenty-four giant, rubber-tired sections can be wheeled into place to increase seating space in San Diego's new sports stadium.



Can't blow its top

Heavy steel cables anchored in the ground keep the roof of this Bavarian guest house from blowing away in high winds.



Music wherever it goes

Youthful San Francisco musicians perform through a \$30,000 vehicle created by Thomas Organ Co. The car has an organ, 14 speakers and 32 input jacks for guitars.

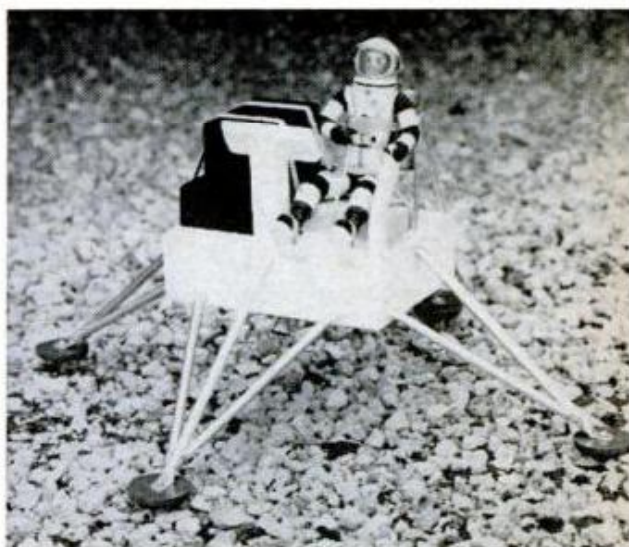

Moon runabout

Under study by TRW, Inc., is this model of a proposed "lunar flyer." It might someday be carried aboard Apollo lunar landing vehicles and used for exploration or rescue.

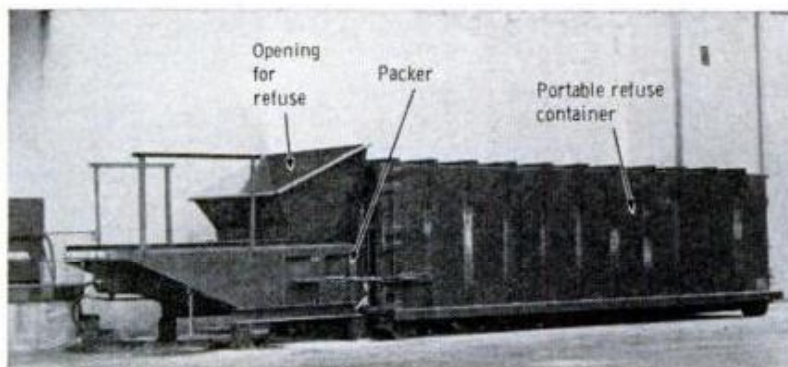

And there's no garbage man banging lids at 6:00 a.m.

Refuse disposal is quick and clean with the Swiftainer system. Trash, dumped into the packer, is compacted hydraulically in a portable container and carried off (right) for dumping.



No strings attached

No wire connections are needed to operate the new CBS Minicam Mark VI color television camera. It transmits picture information up to three miles via microwave to a base station. The portable unit weighs 18 pounds.

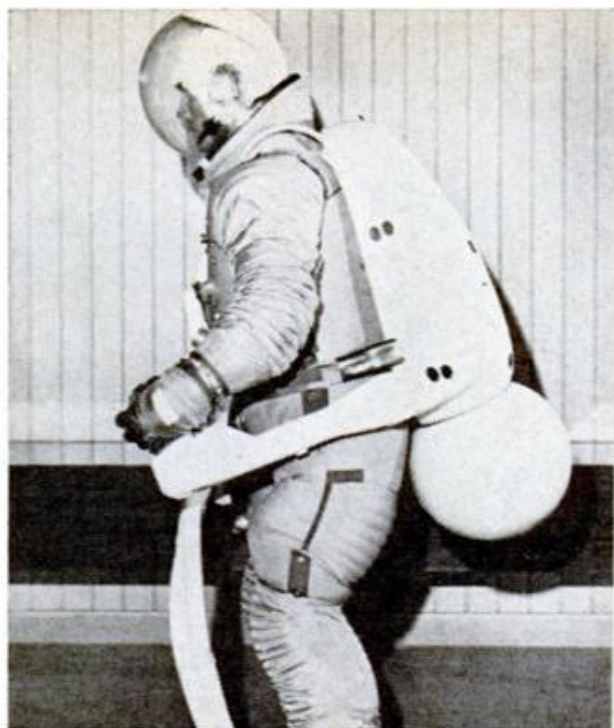

Space-station outboard

An oxygen jet-powered maneuvering unit is undergoing tests to determine its suitability for astronauts in space-station tests. The developer, North American Rockwell, has "flown" it on friction-free air bearings.



Hot spotter

A radio-controlled cart has been designed by German scientists to enter contaminated areas and map out the "hot spots" in the event of a nuclear accident.



Live TV from the moon

Apollo astronauts will use this seven-pound camera to send live television pictures back to Earth during the United States' first moon flight. It's a Westinghouse product.

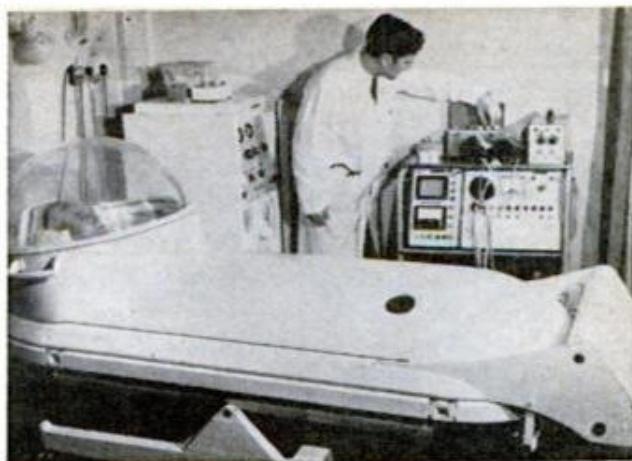
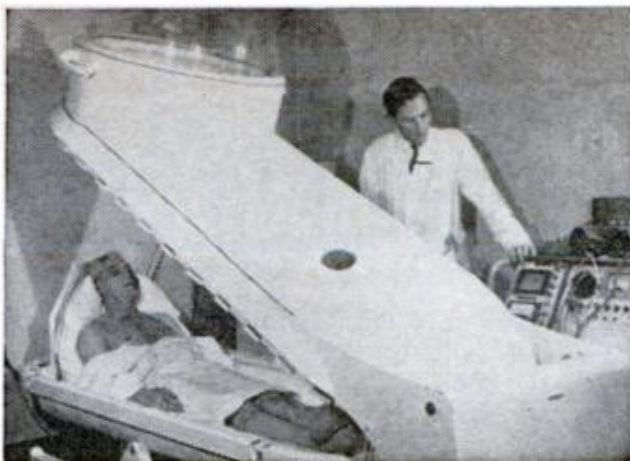

Hyperbaric oxygen bed saves heart patients in London

A single-patient bed system for administering hyperbaric oxygen treatment has been developed by the Medical Group of Vickers. With the chamber closed, the patient is in an atmosphere of pure oxygen at twice normal atmospheric pressure. Tests at Westminster Hospital, London, indicate heart-attack death rate can be halved with this treatment.

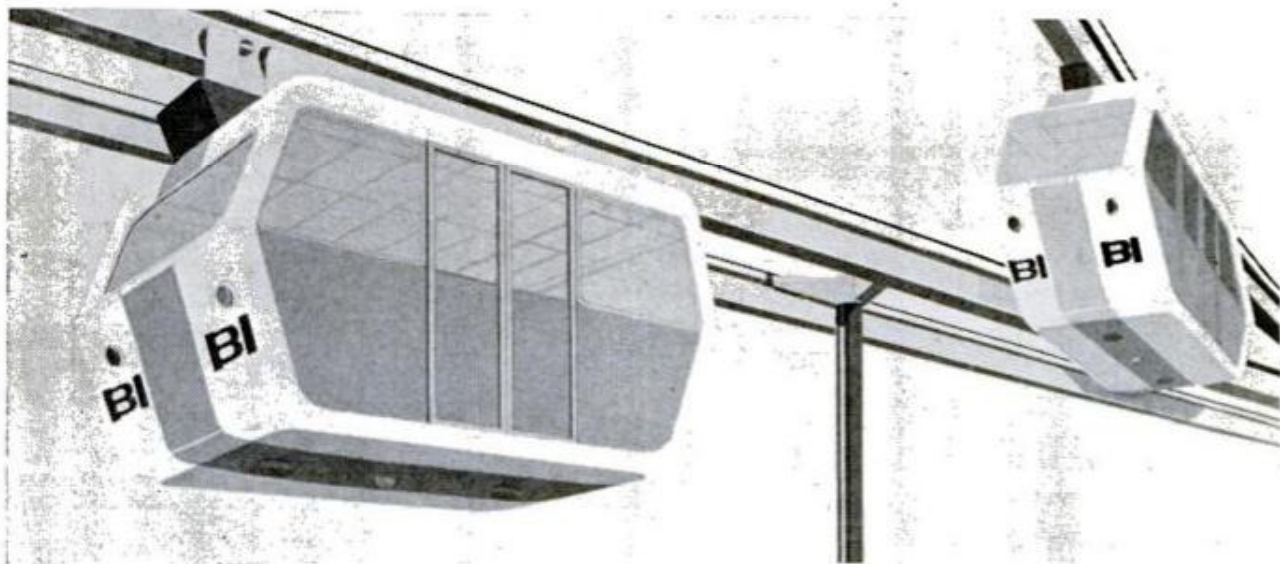

Air passengers will ride to terminal on a monorail

Monorail cars like those in the drawing will transport passengers and baggage between the Braniff terminal at Love Field, Dallas, and a remote parking lot. The three-quarter mile, overhead-rail system is expected to be completed by the end of this year.

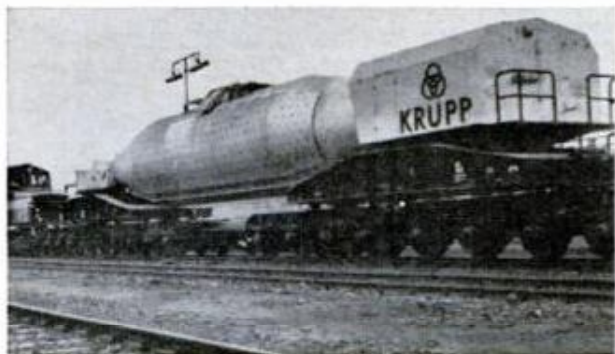

Hot cargo

Firebrick and asbestos line the interior of Krupp's new "torpedo cars" which are designed to carry molten steel from one plant to another. Each car carries 165 tons.

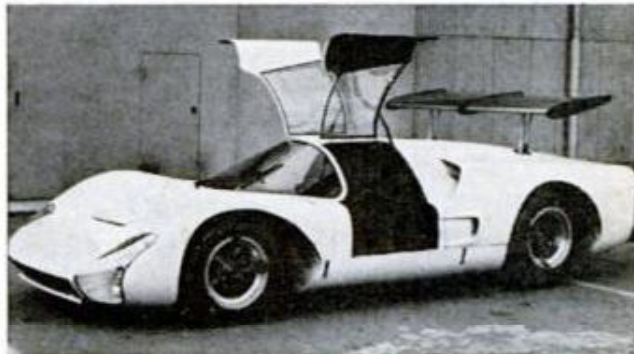

Nissan's new racer

A new racing car from Japan, the Nissan R381, has a 5.5-liter engine that turns out 450 hp, driving the machine at a top speed of 198 mph. The body shell is fiberglass.

Don't Rely on 'Idiot Lights'

HOW TO INSTALL GAUGES THAT REALLY TELL YOU SOMETHING

By MORT SCHULTZ

WHEN IT COMES to instrumentation, even the auto manufacturers can't agree. A few years ago, many switched from those good old-time gauges to lights to warn you of electrical system, oil pressure or cooling system trouble. Now, some have switched back to gauges again. Still other manufacturers provide only one gauge, usually water temperature, but stick with ammeter and oil pressure warning lights.

The "idiot" lights may be fine for some people, but anyone with a mechanical savvy who's interested in what goes on under his hood needs instrumentation.

The advocates of warning lights contend that a burned-out bulb, which is the chief danger, seldom occurs. But the other danger is that warning lights are calibrated to flash only when there's a com-

plete system failure or when a given function is working merely in degrees—you don't know if your engine is operating just inside the danger zone, where it's on the borderline of permanent and costly damage.

If you feel half-safe because your car is equipped with warning lights, go ahead and install your own instruments. When buying units, there are a few things to keep in mind. For instance, oil-pressure and water-temperature gauges function either mechanically or electrically.

Mechanical gauges employ pressure lines and cables, and are more difficult to install than those that are electrically operated—but the buffs like the challenge. For the family car though, I suggest the electric type. Just make sure that they are compatible with your car's electrical

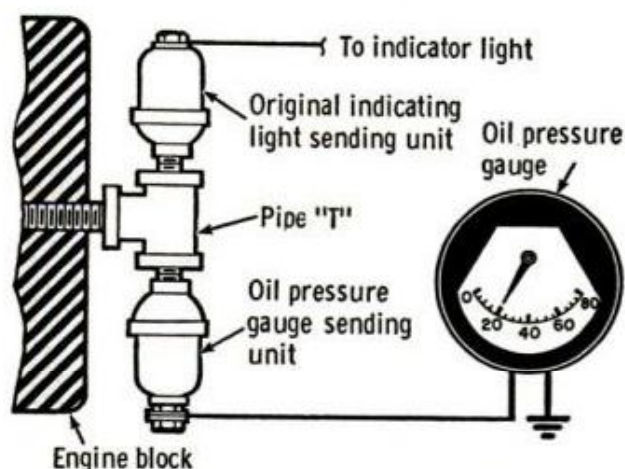

OIL-PRESSURE GAUGE can be installed and connected without eliminating dash warning light. A T-pipe in the block will mount both electrical sending units

WATER-TEMPERATURE sending unit on this Chevrolet block operates dashboard indicating lights. It must be removed and replaced with unit in photo at right





THREE-GAUGE CONSOLE from Rite Autotronics is designed for under-the-dash. It's the easiest type to install

system. Most of today's cars have 12-v. negative-grounded electrical systems, so you need gauges designed for them.

If your car is equipped with a generator, the ammeter gauge you purchase need be calibrated only for plus and minus 30 amps. However, most of today's cars are equipped with a 45 or 60-amp. alternator. In this case, be sure to get a gauge that registers plus and minus 60 amps.

Indicating range is not a particular factor with oil-pressure and temperature gauges. Most show the same markings. A 0-to-80-pound oil-pressure gauge graduation, for example, serves virtually all cars. But you should know the normal oil pressure for your engine as specified by

NEW SENDING UNIT for water-temperature gauge is screwed into the engine block using a thread lubricant and the wire is led through the firewall



SEPTEMBER 1968

the manufacturers, so the gauge reading means something to you.

The best coolant temperature for the best engine performance is one that's as hot as possible without boiling out the coolant—anywhere from 180° to 210°. All cars can use a temperature gauge that's calibrated to a maximum of 240°.

Gauges come in many shapes, sizes and prices. Airguide Instrument Co. of Chicago, for example, makes a unique three-in-one gauge which has all functions (oil, amps. and temperature) shown on one dial face. This instrument (Model 1606) is electrically operated and comes with sending units, adapters and everything else needed for installation. It lists for

COMPLETED INSTALLATION of water-temperature gauge and sending unit. Negative terminal is connected to ground. Third wire goes to ignition terminal

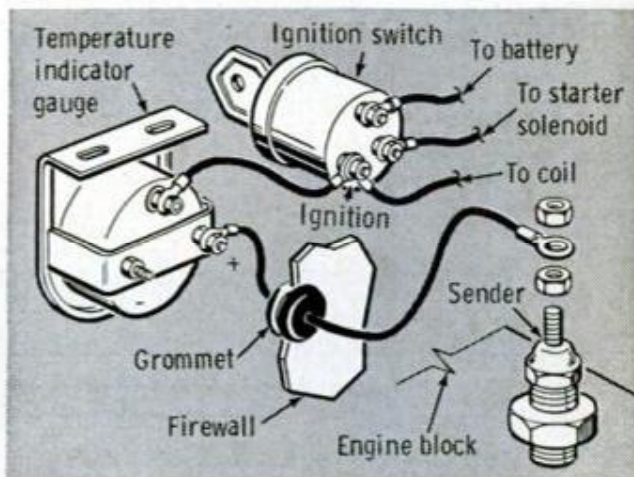

119

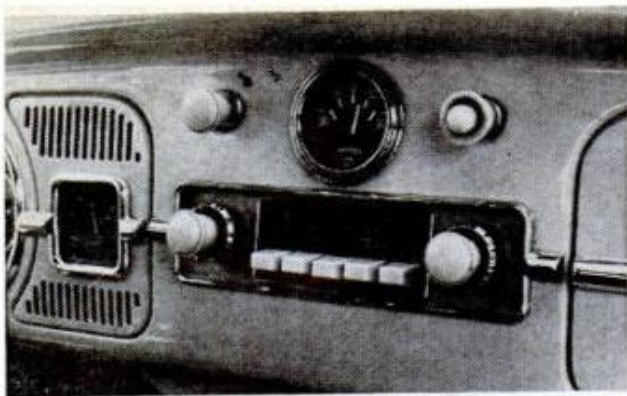

CUSTOM GAUGE INSTALLATIONS, as in this VW, are tough but rewarding. One lead from ammeter (below) goes to junction on light switch, other through roof to starter-solenoid lead in rear engine compartment

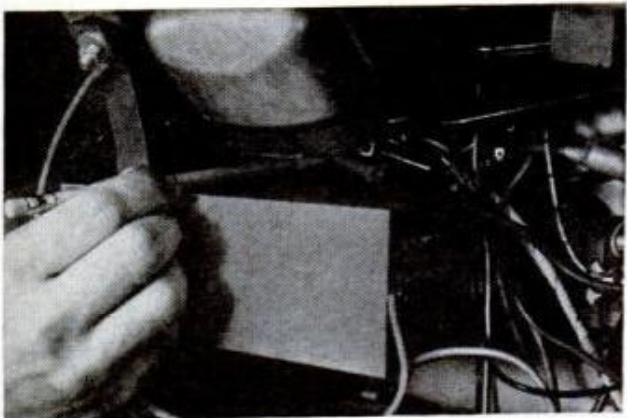

\$44.50, but can be bought for less. One automotive mail-order house, for example, sells the three-in-one unit for \$27.95. An automotive parts dealers in my area sells it for \$26.70.

You can buy good gauges for less. Rite Autotronics Corp. of Los Angeles makes a three-unit console (Model 957) with ammeter, water-temperature and oil-pressure gauges in line on a handsome panel. It lists for about \$30. A discount store in my area sells it for \$18.

As a further example, Stewart-Warner of Chicago makes two units or retrofitting cars—Model 366-MJ, which has three gauges in a console, and Model 366-MK, which has an ammeter and oil-pressure gauge in a console. The 366-MJ lists for \$28.95, and the 366-MK for \$15.05. If you shop around, you can buy either for about 30 percent less.

The ease or difficulty of custom installing gauges depends almost entirely on your make of car, style of engine and number of accessories. For instance, on a Chevy Six installation is quick and easy. On a big V8 with airconditioning, power brakes and power steering, it's more difficult to get at the temperature and oil-pressure sending units.

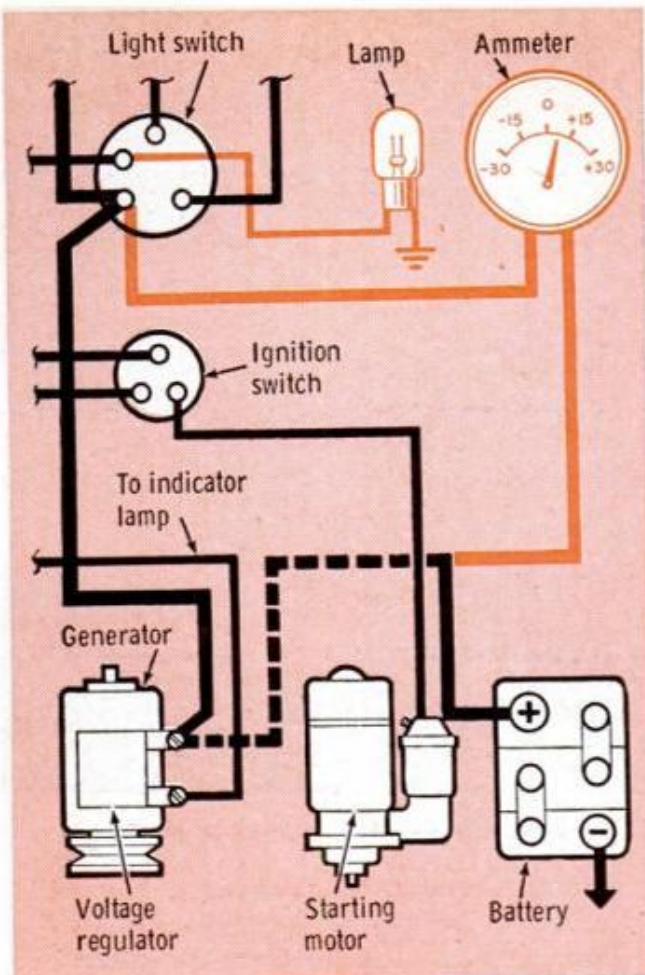

The gauge you buy should have complete installation instructions. If it doesn't, I wouldn't buy it. The instructions should thoroughly discuss the connections that must be made for the unit to work properly. No instructions can be given for placing the gauge or gauges on your dashboard, however. That's up to you. The Stewart-Warner ammeter on

SOLID-STATE TACHOMETER for top-of-dash or steering column mounting is new from Motorola Automotive Products, comes in 8000 and 10,000-rpm models

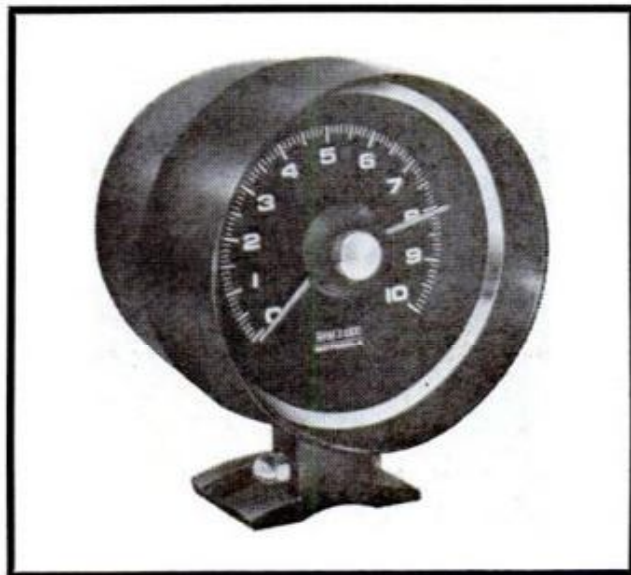

POPULAR MECHANICS

the Volkswagen dash on page 120, just fits in the small area available and makes a good custom installation. A multigauge console, like the Rite Autotronics three-unit model on page 119, is designed to fit under your dash. To install it, find a good spot, drill mounting holes and attach the console with the hardware supplied.

To facilitate the hookup of the gauges, you should have your car's service manual handy. Illustrations in the manual's "instrument" and/or "electrical" section will let you pinpoint sending units to be removed and circuits to be modified. The drawing on page 118 shows a new oil-pressure sending-unit installation.

The wiring setup for an electrically operated water-temperature gauge is shown on page 119. Again, you have to locate and remove the sending unit for the warning light now in your car. When installing the new sending unit in the block, first coat the threads with Permatex to insure a sure-proof seal.

As shown in the diagram, attach the wire to the sending unit, run it back through the firewall and hook it to the positive post of the temperature gauge, assuming a negative grounded system. The gauge's negative post is connected to a clean ground. Finally, another wire is run from the middle terminal to the ignition side of the ignition switch.

A typical ammeter installation is shown on page 120. The wiring diagram shows how the car's electrical circuit was modified. The dotted line represents the wire removed between voltage regulator and

positive battery terminal. As modified, it can be seen that battery charging and discharging current must flow through the ammeter. The lamp illuminates the meter when car lights are on at night.

There are two other gauges you might want to consider for your car: a tachometer and a vacuum gauge. A tach will indicate the revolutions per minute of your engine and enable you to determine whether your engine needs tuning, when to shift for maximum acceleration with a stick shift, when to downshift to keep your engine from lugging, and when the engine is operating at the best cruising speed. It's easy to install—generally, one wire goes to the distributor primary terminal and the other to ground.

I think the vacuum gauge is even more important to possess than the tach. It tells you how hard your engine is working and can warn you of such things as a restricted exhaust, leaking intake system, and improper ignition timing (see *Use a Vacuum Gauge*, page 114, June '68 PM).

A good vacuum gauge for installation inside your car runs about \$20. Again, hookup is a cinch. To pick up the vacuum, tubing is connected to the intake manifold (or the intake manifold side of a vacuum booster pump if your car's so equipped) by means of adapters. The tubing is brought back through the firewall and connected to the gauge.

Go ahead, try it. Whether you replace one or all of your idiot lights, you'll be way ahead on gauging the state of affairs under your hood. ★ ★ ★

THREE-IN-ONE GAUGE reads amperes, oil pressure and engine temperature on one dial face. Airguide Instrument unit mounts on dash or steering column



SEPTEMBER 1968



UNDER-THE-DASH CONSOLES combine various types of gauges. This Stewart-Warner unit includes a tach

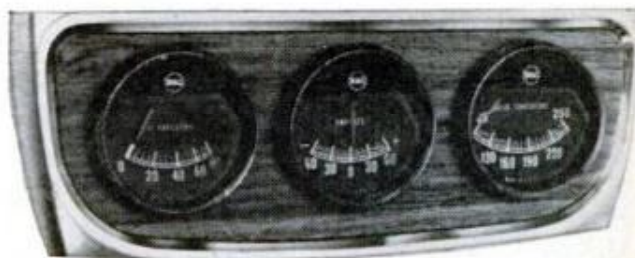

DELUXE CONSOLE with standard instrumentation is chrome with simulated teak. It's RAC's Model 989

121

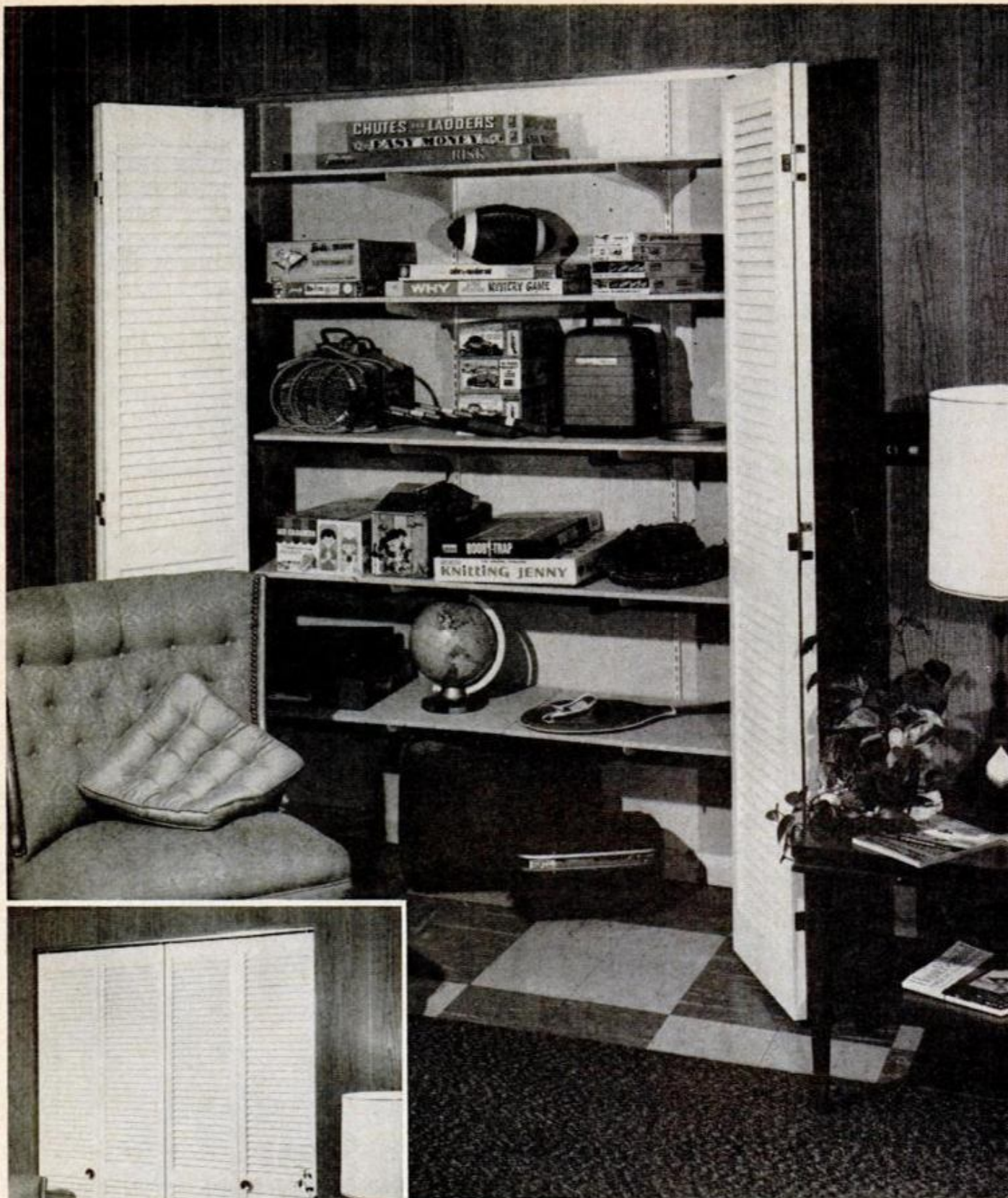

SHALLOW CLOSET such as this will hold a multitude of items. This one has taken over as a hobby closet to keep track of games, sports gear, movie equipment. However, these roomy shelves will be found handy for storing almost anything



LOUVERED BIFOLD DOORS give instant access to shallow closets and are most attractive. Pivoting on pins and sliding on overhead track, doors glide open with little effort. You can get them full louvered, as shown, or partially paneled

POPULAR MECHANICS

How to Build an Extra Closet

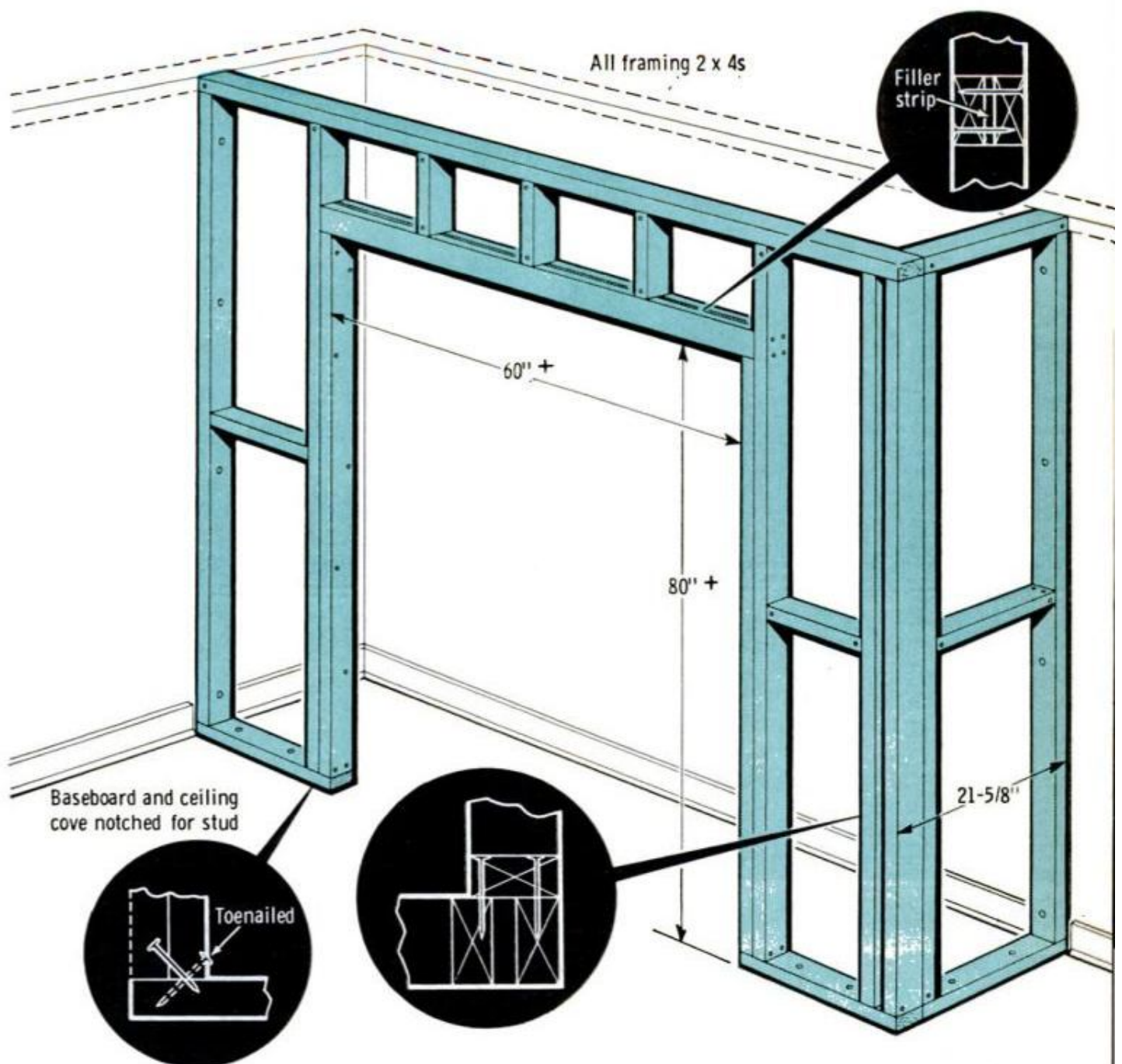

As little as 20 in. off the corner of a room will help relieve your storage problem in a weekend's time

By **WAYNE C. LECKEY**, Home and Shop Editor

Technical Art by Don Evans

FEW HOMEOWNERS CAN BOAST of having too many closets. More often it's a case of not having enough. The solution, of course, is to add another.

While the thought of building an extra closet could cause the less experienced home remodeler to turn and run, it's not

the major job it sounds. Actually, a good share of the task is rough work, particularly the framing. As to where to put it, most times there's a corner that will let you rob it of 20 in. or so without it being missed a bit. And as for it looking like a "sore thumb," you can see in the photos on



SLOTTED STANDARDS, 5 ft. long, are screwed to the studs in the back wall of the closet for solid support

page 122 that such a closet adds considerable eye appeal.

The length and depth you make the closet is up to you. I made it shallow so it would accept six 16-in. shelves, 8 ft. long. While the overall size can vary to suit your needs, the size given for the rough door opening should be maintained if you use standard-size 15-in. bifold doors. Here the actual width and height of the rough opening is determined beforehand by the way the opening is to be trimmed. For example, if $\frac{1}{4}$ -in. prefinished hardboard paneling is to be used, the rough opening is made $\frac{1}{2}$ in. greater than the finished width of 60 in., and $\frac{1}{4}$ in. greater than the finished height of 80 in. If, on the other hand, you plan to face the walls with plasterboard and trim the opening in the conventional manner with $\frac{3}{4}$ -in. jambs and casings, the rough opening would have to measure $61\frac{1}{2}$ in. wide and $80\frac{3}{4}$ in. high.

You can't go astray by following the drawing shown on page 123. Your very first step after plotting the closet's size on the floor, is to cut out 4-in. sections of the existing baseboard so the framing will butt tight where it joins the wall. When this is done, 2x4 plates are nailed to both the floor and ceiling, fastening the ceiling ones first so they can be used in locating the floor plates directly below. A plumb line dropped from the top plates will spot the

exact position of the floor plates quickly.

Whether you have anything to which to nail the ceiling plates depends on the direction the ceiling joists run. If they cross the top plate at right angles, you're in luck. If they don't, a few toggle bolts will do the trick. The same holds true in fastening the vertical framing members to the walls. Chances are they won't fall directly on a stud for nailing.

Once the top and bottom plates are in place, it's now a case of cutting the 2x4 studs to wedge between. The three-piece corner post is preassembled in the manner shown in the circular detail and then nailed in place as a unit. All studs are toenailed, and those framing the door opening are doubled up in the manner shown. Keep in mind that the studs should be placed 16 in. on centers.

I used prefinished hardboard paneling to cover the studs since I wanted to match the paneling which was already there. If you do likewise, the details at the top of the opposite page show how matching metal molding is used to add a neat trim to the hardboard around the door opening

TABS ON THE BRACKETS hook in slots of standards and a tap of a hammer or mallet locks them in place



HARDBOARD TREATMENT

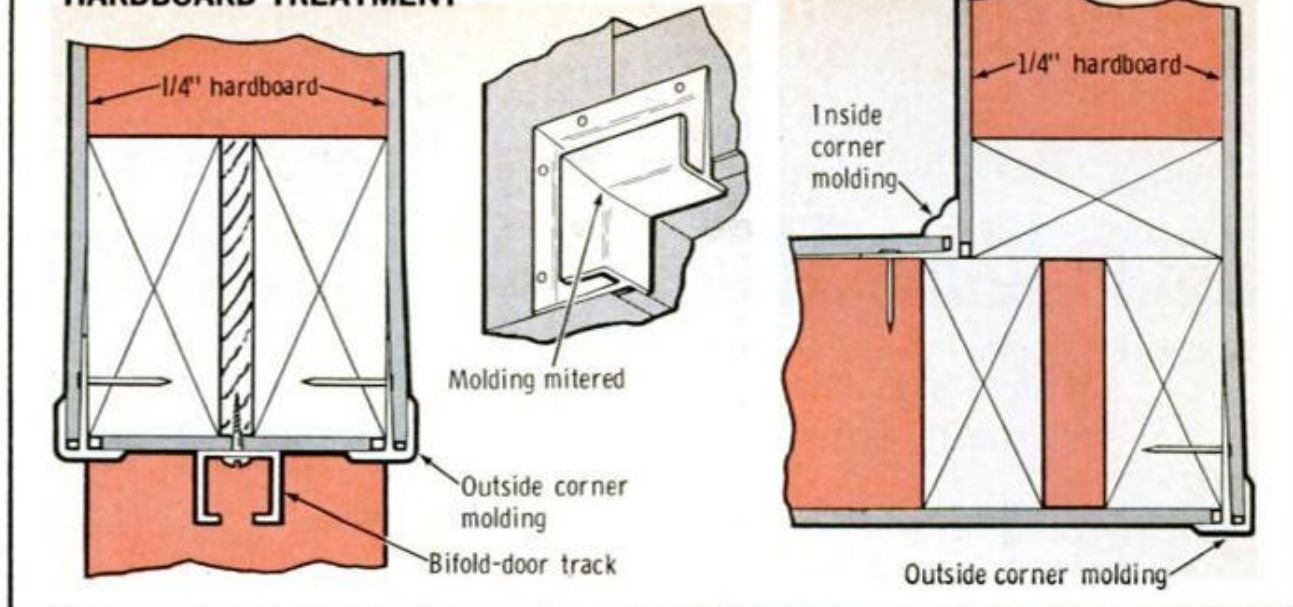

and to both inside and outside corners.

In using hardboard (and the same procedure is followed in using plywood paneling), you first line the door opening with strips of paneling ripped $3\frac{1}{2}$ in. wide. These are cemented with special mastic directly to the studs and headers. Next, outside corner molding is applied around the outer edges of the opening, front and back, by nailing through the flange part of the molding. Note that it's mitered at the corners and nailed every 4 in.

From here on you apply the paneling to the studs and cut it to fit into the grooves of the molding. When you reach the corner, the same molding is applied in the same manner, first hooking it over the paneling, then nailing through the flange and inserting the succeeding piece in the molding as you continue around the cor-

ner. Inside corners are trimmed similarly but with molding of a different shape.

If you plan to use plasterboard, study the drawings below. Procedure differs in that the door opening is lined with $\frac{3}{4}$ -in. jambs, ripped $4\frac{5}{8}$ in. wide, and centered so they project $\frac{1}{2}$ in. each side. The $\frac{1}{2}$ -in. plasterboard is cut to butt against the shoulders formed by the overhanging jambs, after which regular door casing is applied to cover the joint and add a finished trim. Regular plasterboard nails are used to fasten the $\frac{1}{2}$ -in. sheets, spacing them 8 in. apart.

Where the plasterboard laps at an outside corner, the corner is reinforced with a strip of regular metal plaster beading. The nails which hold it, plus those holding the plasterboard, are later covered with

(Please turn to page 198)

PLASTERBOARD TREATMENT

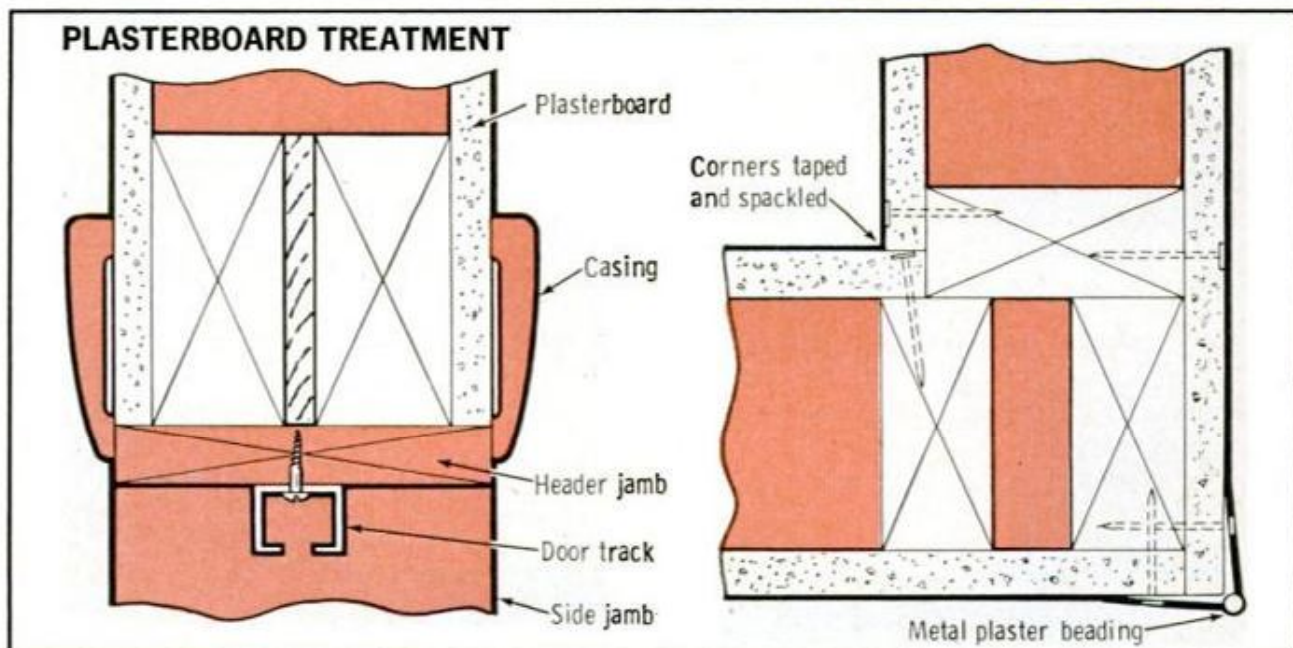

\$15

Home Ideas That Look Like a Million

Little things that you can add over a weekend will make your home more livable than ever

By WAYNE C. LECKEY, Home and Shop Editor

THE ADAGE, "Home is what you make it," certainly applies when it comes to making home improvements, especially when you make them yourself.

What's more, such improvements don't always have to be major projects. In fact, it's often the little things you add which make your home extra special.

Best of all, little improvements don't cost a fortune though they may add a "million." To prove it, not one of the eleven home improvements suggested on this and the following four pages will cost over \$15; some cost even less. While you may not borrow all eleven, just one will make your home a better place to live.

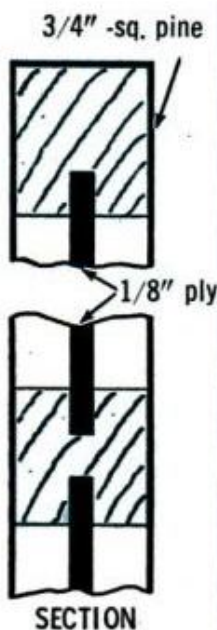

A Touch of Luxury

The graceful charm of a leaf-pattern grille can add a classic look to an austere foyer which features a plain glass panel. This one consists of five ready-cut wood scrolls grouped in a single mitered frame and held in the recessed window with four screws. The detail shows how the 3/4-in.-sq. frame members are grooved down the middle to fit over the edges of the scroll-cut panels and form a frame.

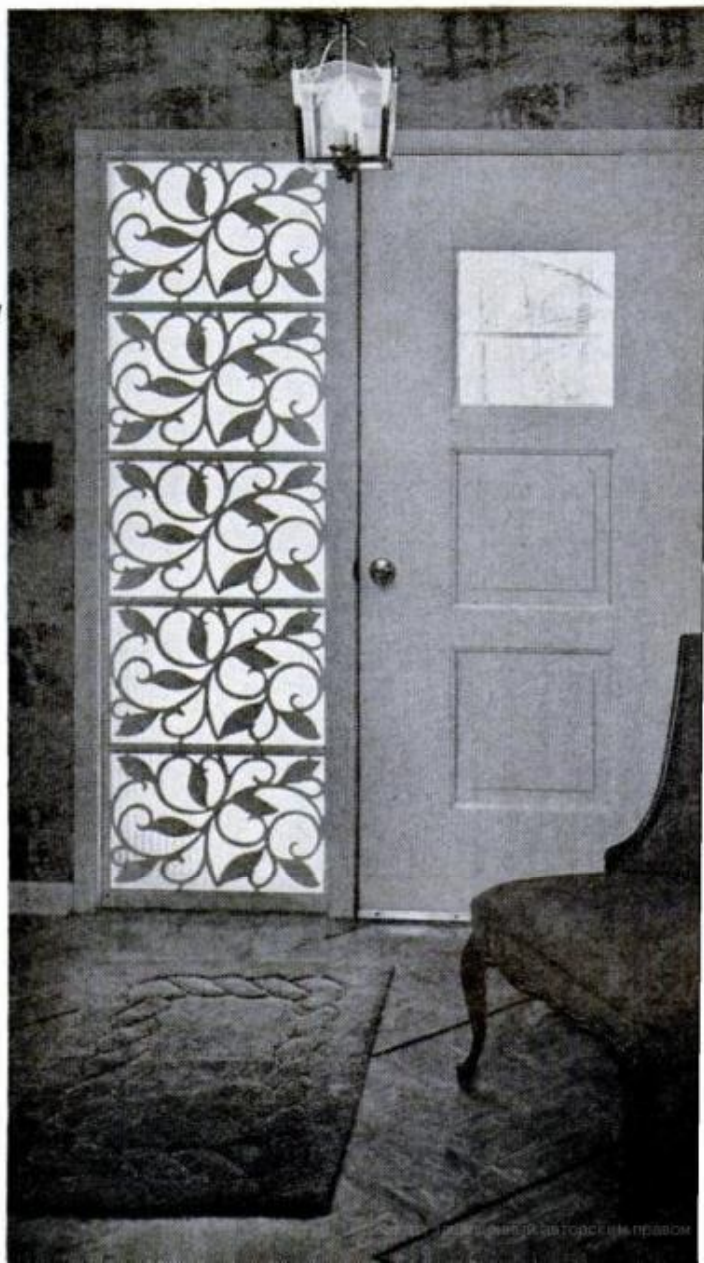



Countering With Light

Extra thin fluorescent counter lights, made to fit the recessed bottoms of your wall cabinets, not only will add dramatic lighting to your kitchen but will help you see what you're doing. Being only an inch thick, the fixtures are practically hidden from view. To install them, you slip off the plastic cover, drive a couple of screws up into the cabinet and replace the cover. Several lamps can be ganged together end to end over a long counter.

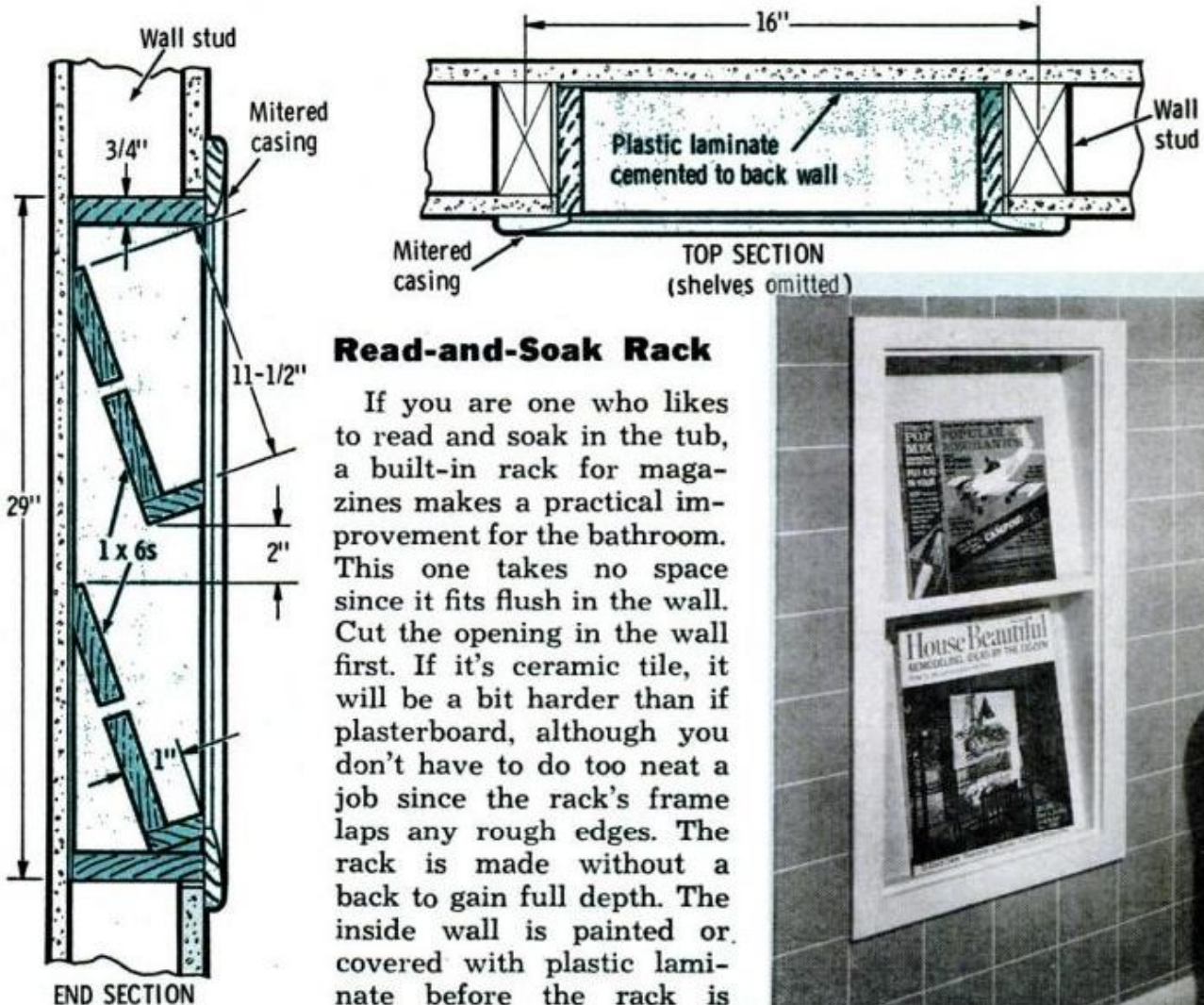

Read-and-Soak Rack

If you are one who likes to read and soak in the tub, a built-in rack for magazines makes a practical improvement for the bathroom. This one takes no space since it fits flush in the wall. Cut the opening in the wall first. If it's ceramic tile, it will be a bit harder than if plasterboard, although you don't have to do too neat a job since the rack's frame laps any rough edges. The rack is made without a back to gain full depth. The inside wall is painted or covered with plastic laminate before the rack is set in place.



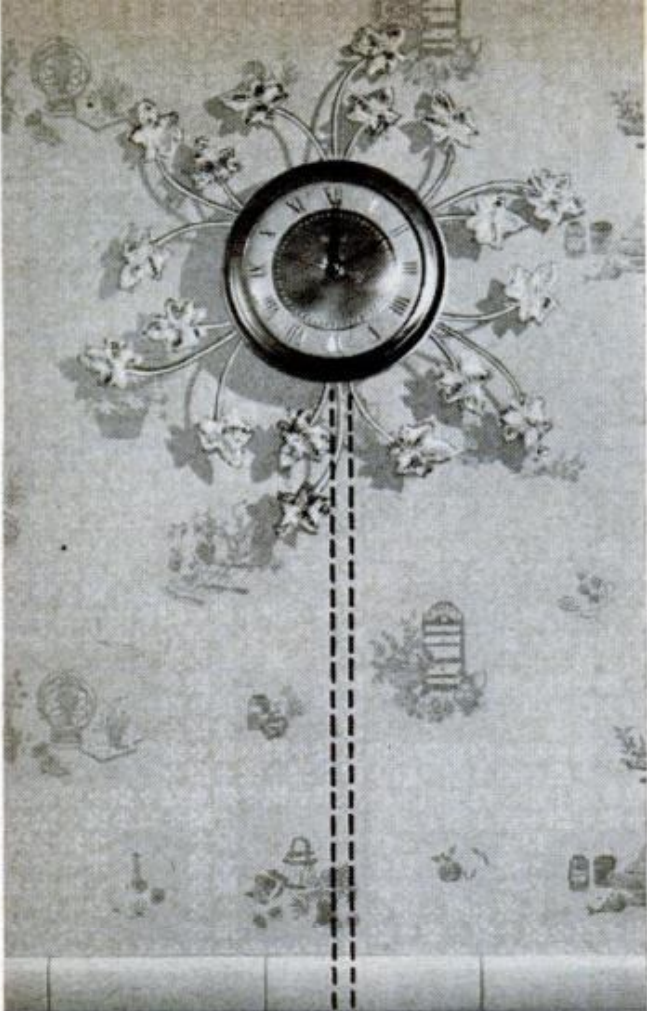

To Be or Not to Be—Seen

Simplest way to hang an electric wall clock is to drive a nail and let the cord hang down the outside of the wall. The neatest way is to install a regular recessed clock receptacle and conceal the wire inside the wall.

This becomes a simple job when you are able to locate the clock directly above a base receptacle since you then can tap into it for power. To make this timely improvement, buy a gem box and cut a hole for it in the wall. Then turn off the electricity and open up the base receptacle as shown. Pry open a knockout in the box and fish a long wire up through the hole until you can spot it through the opening at the top. Now hook the wire to the end of a prepared length of BX cable and pull it down through the hole in the base receptacle. Complete hookup by attaching the BX to the gem box and in turn to the clock receptacle, and finally tap into the wires in the base receptacle by twisting the white wire to the existing white wire and black wire to black wire. Tape the connections and you're in business.

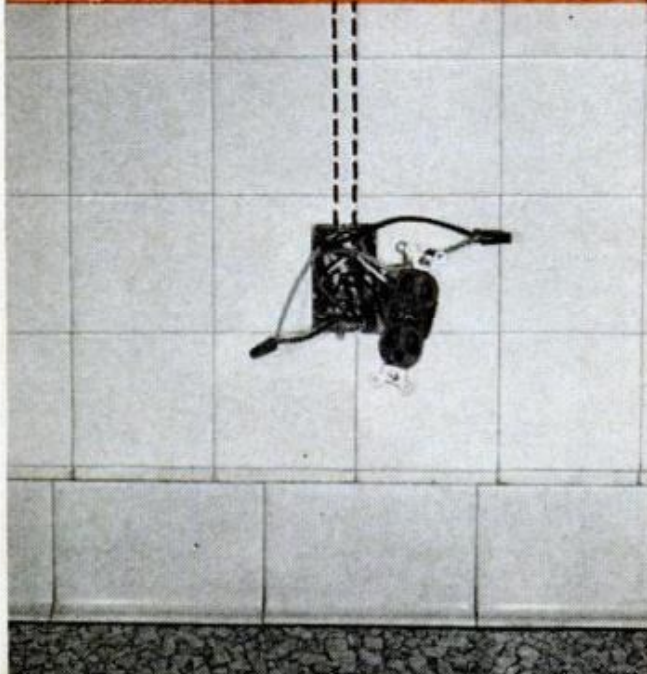
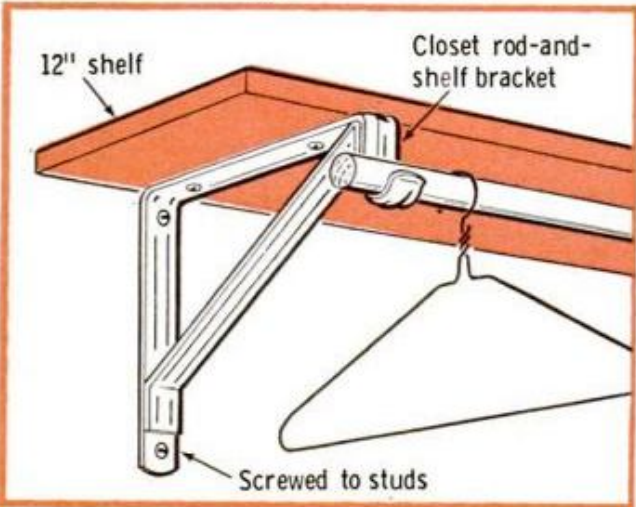
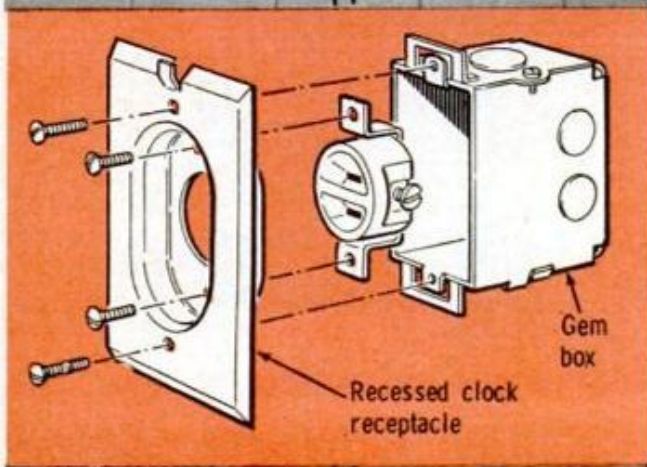

An Idea Not to Be Shelved

If you're looking for a simple way to add a shelf and hanger rod in a clothes closet, there's a clever metal bracket to be had which makes the job ridiculously simple. Instead of going to the trouble of resting the shelf on cleats at each end and installing recessed blocks to hold the rod, all you do is screw a pair of these brackets to the studs and the shelf to the brackets. A hook formed at the end of each bracket cradles the rod right up front. Where the shelf is fairly long, a third bracket installed in the center will eliminate sag in both the shelf and rod.

Pilot Won't Forget

Checking the garage door when you put the cat out is one way of being sure it is closed when you retire. But what if you don't have a cat?

This was our problem until I installed a pilot light in the kitchen. Now a glance tips us off since the pilot glows as long as the door is left open.

Rigging it required running BX from a new box in the kitchen to the box in the garage into which the electric operator was plugged. Then a plug on a wire from this box was plugged into a side-outlet socket screwed into the operator. Thus when the door is open and the light is on, the pilot is on. Granted, this improvement is most practical when the garage is attached and the operator is the type where its light burns as long as the door is open.

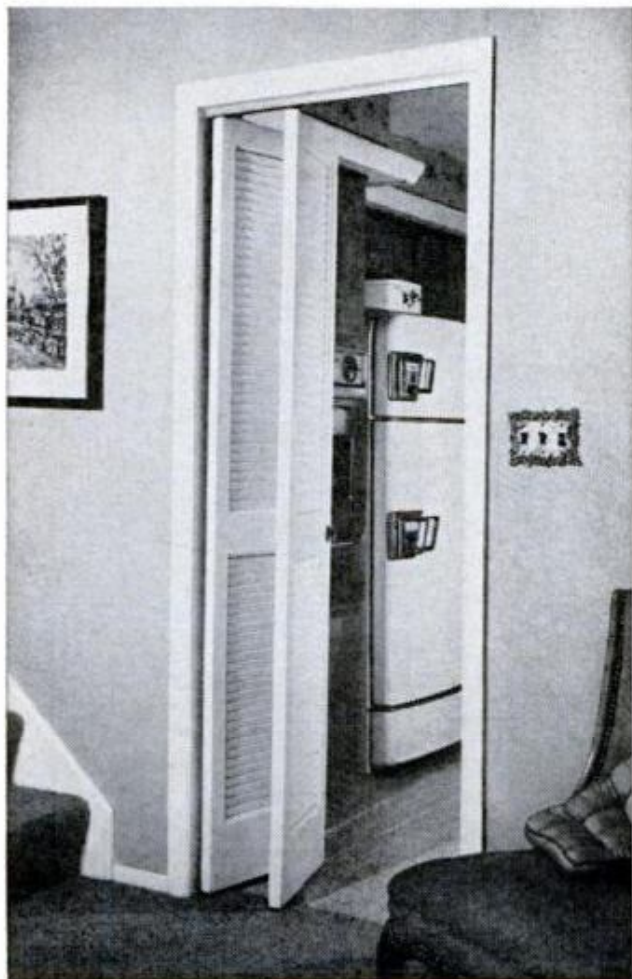
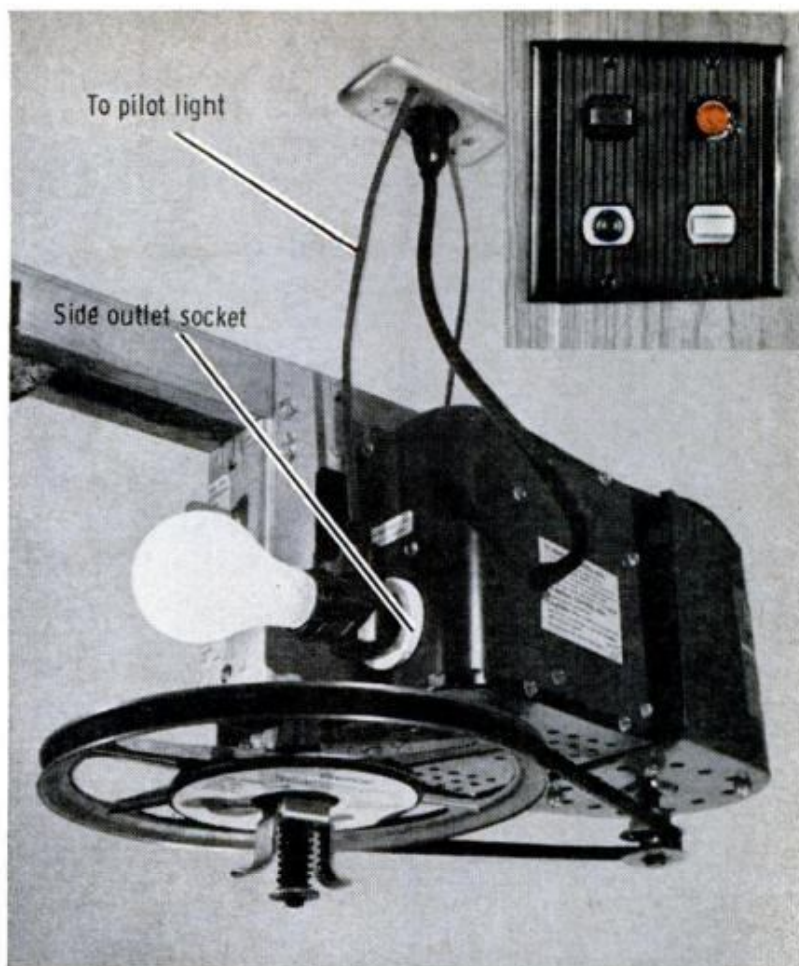

Wanted, Sight Unseen

If you have a situation where guests can look directly into the kitchen, louvered bifold doors politely block the view most attractively. What's more, they take less space than a regular door when standing open, and also permit free movement of air.

Such doors come in pairs, complete with hardware, to fit standard-width doorways. Some come already hinged, others have holes already drilled for top and bottom pivots.

To install bifold doors, first screw the channel track to the top of the door frame, placing it in the center. Next screw the L-shape bracket to the side of the door frame at the floor. Hinge the doors together if they aren't, and insert the three pivots in the holes provided.

To hang the doors, lift them so the two top pivots enter the track, then swing the doors in at the bottom to seat in the hole in the floor bracket. Vertical play in the doors is taken up with a thin, flat wrench (comes with the hardware) used to back out the floor pivot, that, in turn, raises the doors to hold them in the track at the top.

Now You See It, Now You Don't

Pardon the pun, but a bathroom scale can get underfoot when standing around waiting for that once-a-day weigh-in. However, you can make a scale disappear into the wall and yet be Johnny on the spot by attaching it to a swing-up door. First, pick a spot between two studs and cut a hole that's $\frac{1}{2}$ in. smaller on three sides than the door. Then hinge the door to the floor so it swings flat against the wall and laps the opening. Finally, the baseboard is cut back for a mitered casing which frames the door. A magnetic catch holds the door shut, and a finger hole lets you give a tug to open it. How you attach the scale to the plywood door depends upon the type of scale. Some have holes in the bottom which are adaptable, or a bottom which can be drilled for small bolts. Both door and casing can be painted to match the baseboard.



Knock, Knock, Who's There?

Callers won't be able to get one foot in the door when you're able to see them before they see you. You can provide this protection by installing a one-way viewer which lets you look out but they can't see in. Merely drill a $\frac{1}{2}$ -in. hole (head high) through the door, inserting one part of viewer from the inside and the other from the outside.

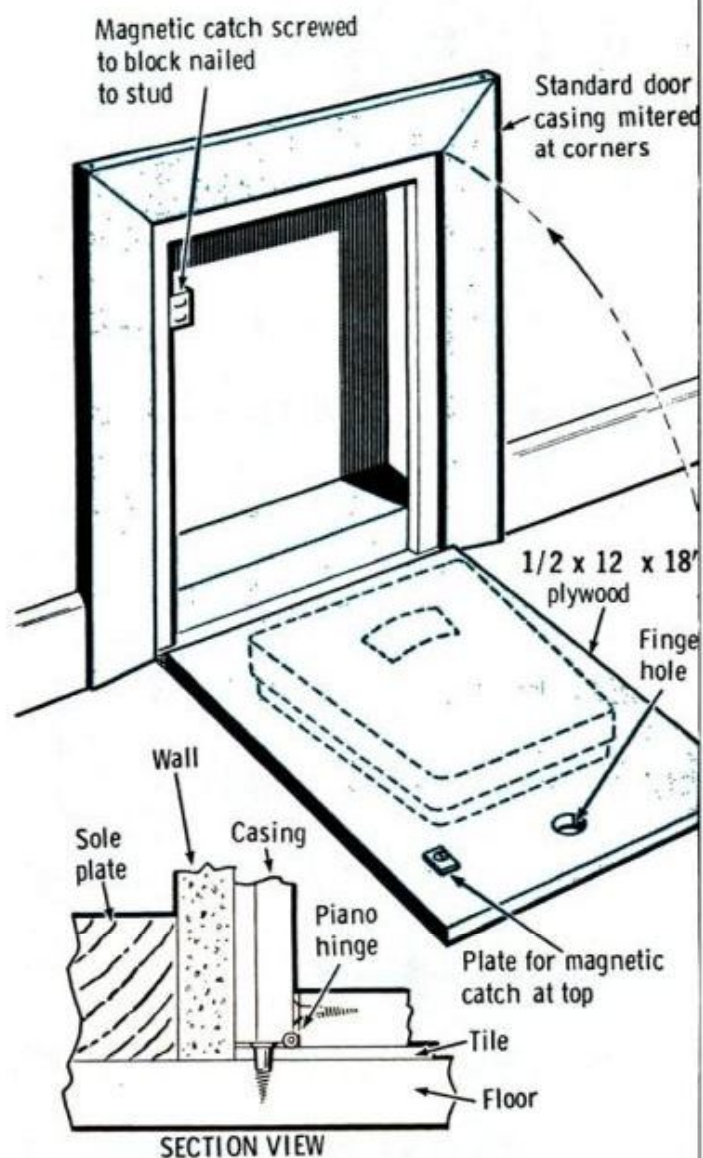
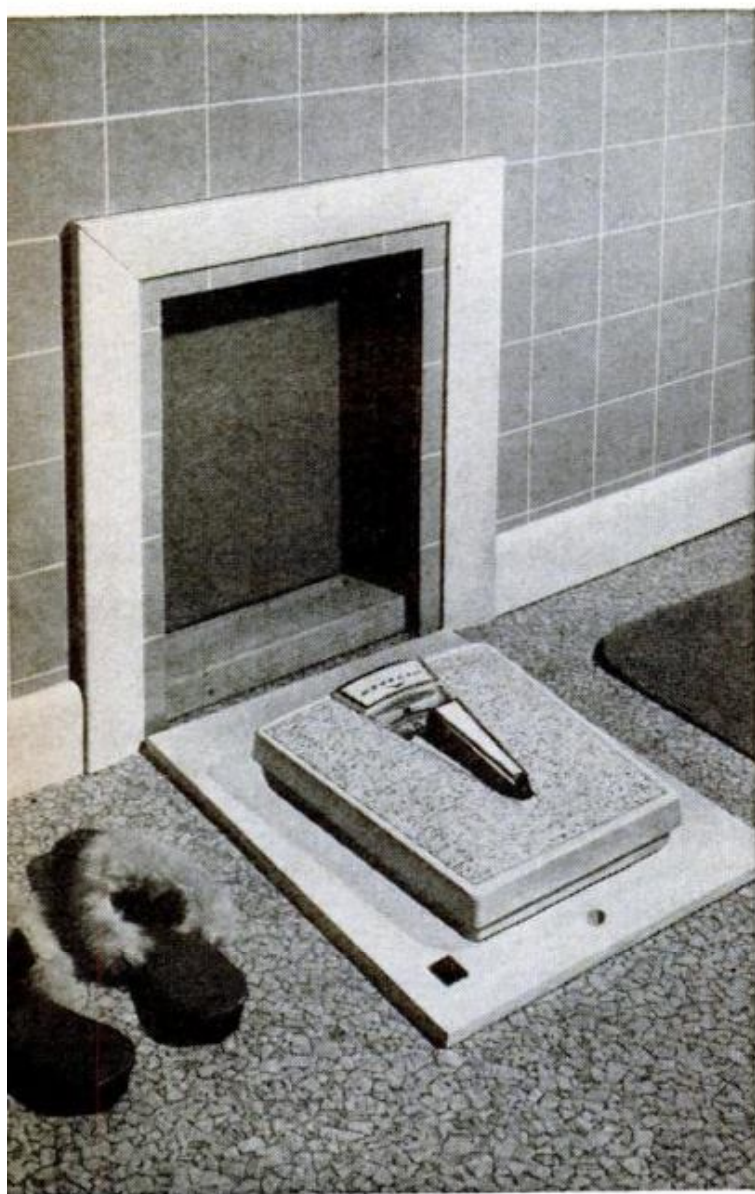

Let There Be 'Dim' Light

Like to be able to dim the light over your dining table to a soft candle glow? All you need do is replace the present on-off switch with a 500-w. SCR light dimmer control.

You can install one in minutes with just a screwdriver. First, turn off the electricity. Then take off the wall plate, back out the screws which hold the switch and remove the two wires. Now attach these same two wires to the terminals of the dimmer. It's as simple as that.

A turn of the dimmer's dial creates dozens of dramatic lighting effects—from full brightness to candlelight mood. You can buy dimmers that control both incandescent and fluorescent lamps.

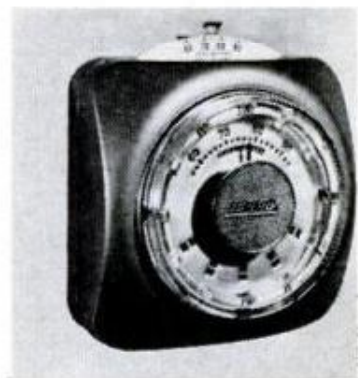
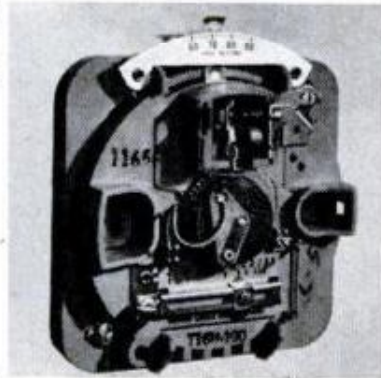
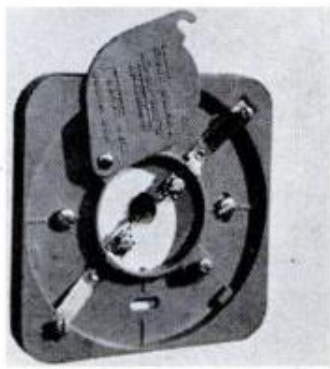
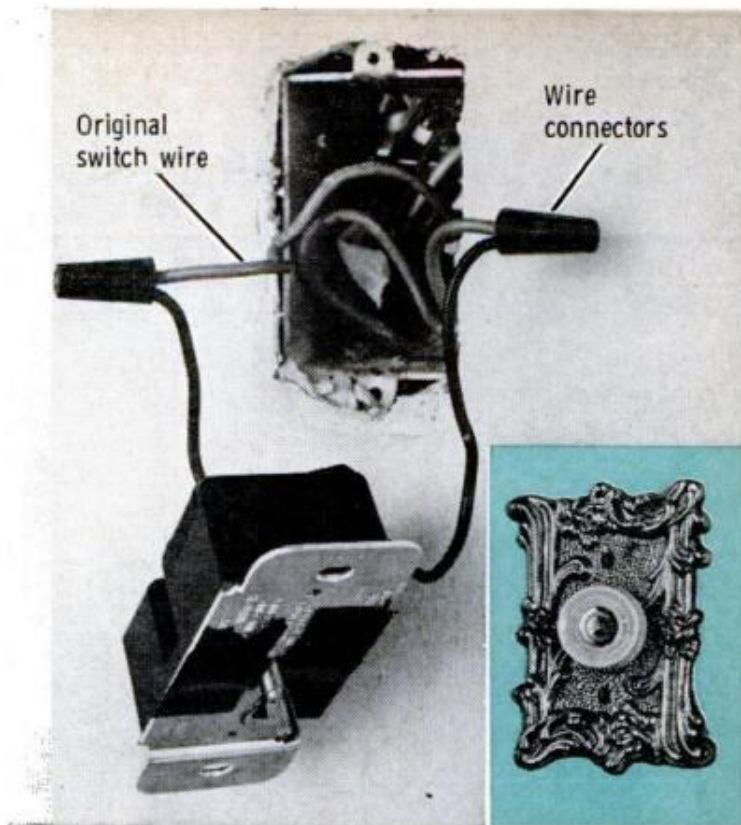

An End to Heat Over-Ride

Many thermostats (especially the older models) have but one setting on the heat anticipator and, if it should not be the right one for your heating system, it causes a considerable variance in room temperature.

Modern thermostats, like the three-piece one shown above, have adjustable heat anticipators that allow perfect tuning of your system. Normally, by the time the heat from the furnace reaches the thermostat at a sufficient temperature to turn it off, the residual heat in the distribution system continues to raise the room temperature and over-rides the thermostat. Your thermostat setting could be 73° and the over-ride could raise it easily to 77 or 78°.

The heat anticipator does just what its name implies—it anticipates the exact

moment when the temperature will reach a given degree (this could be 68° in some cases). At this moment the anticipator, which is a tiny, wire heater coil within the thermostat, is energized. The heat it generates is enough to satisfy the thermostat so that the burner shuts off while the heat still remaining in the system is sufficient to bring the room temperature to the desired point. These modern thermostats are fully adjustable and they can be easily applied to all warm-air heating systems.

There's no mystery to replacing your old thermostat with a modern one. You simply remove the cover, disconnect the two wires which poke through the wall and connect these same two wires to the terminals of the new thermostat. There's no need to worry about getting a shock—it's low-voltage wiring (24-v.) like your doorbell's and won't hurt you a bit. ★★

Now You Can Panel An Outmoded Door

AFTER YOU'VE FINISHED paneling a room, you're faced with the problem of what to do with the door—especially if it's one of the antiquated recessed-panel-type doors. Until now, you had the choice of repainting or replacing it, and you still wound up with a contrasting door that detracted from the good-looking paneled areas in the rest of the room.

Now, however, you can panel any old

door so that it actually matches the wall paneling. The trick is to use General Plywood's new Eagle-Mate panels which are only $\frac{1}{8}$ -in. thick. With a choice of most wood species patterns and five pastel colors, the panels are available in one easily-worked size, 32x80 in. Costing about \$7 each, they are applied with contact cement, then trimmed with a saw and plane, or with a router.

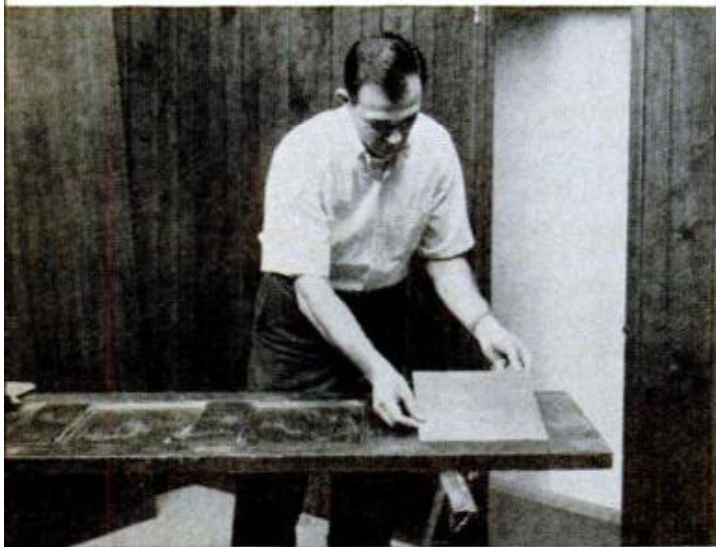

CUT PLYWOOD FILLER BLOCKS and cement or tack them in recessed areas of the outmoded panel door

CAREFULLY ALIGN THE EDGE of panel with the edge of door, then press on panel to remove air bubbles

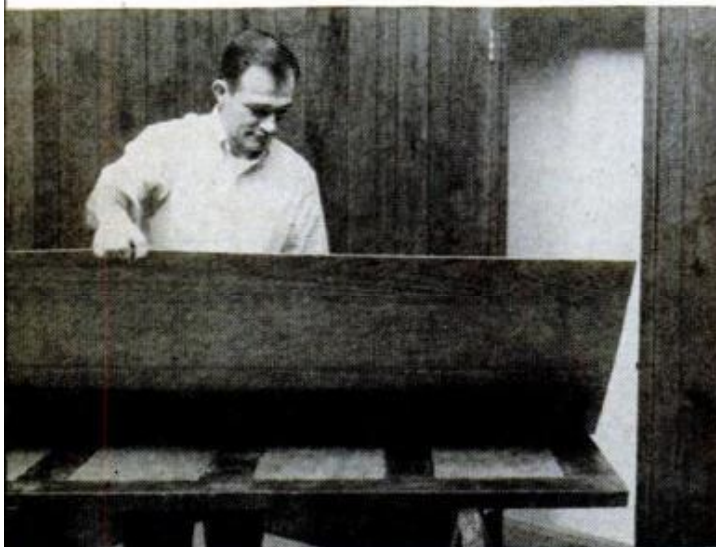

APPLY A LIBERAL COATING of contact cement to both the door and $\frac{1}{8}$ -in. panel and allow to dry

TRIMMING IS EASY if a router is available. If not, a small handsaw and careful planing do as well

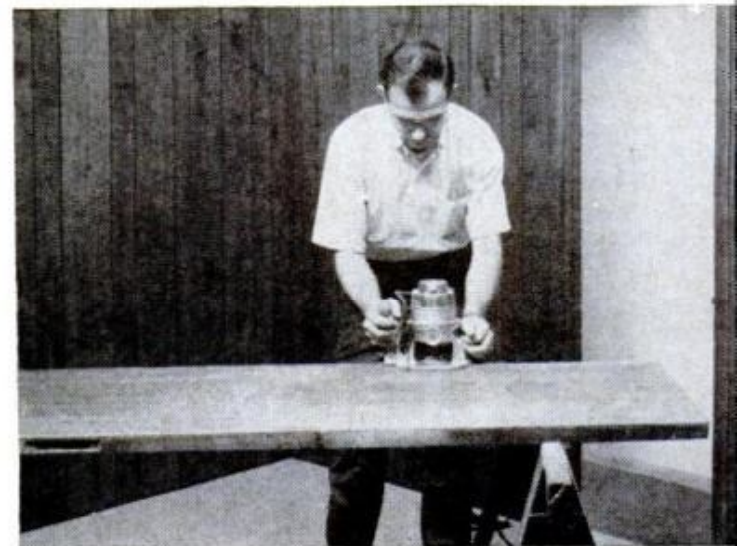

Most important, however, is that no relocation of hinges or of the door jambs is required. When standard 1/4-in.-thick panels are added to a door, both the hinges and jambs have to be relocated so the door will open and close properly.

Application is the same for both flush and old panel doors, except that recessed areas in panel doors must be filled before cement is applied. As shown in the sketch at right, plywood filler blocks can be nailed or glued in place. It's not necessary to bevel the blocks, however, especially if curved molding lines the recesses.

For dealers handling Eagle-Mate panels in your area, write General Plywood Corp., 417 S. 32nd St., Box 1403, Louisville, Ky. 40201. ★★★

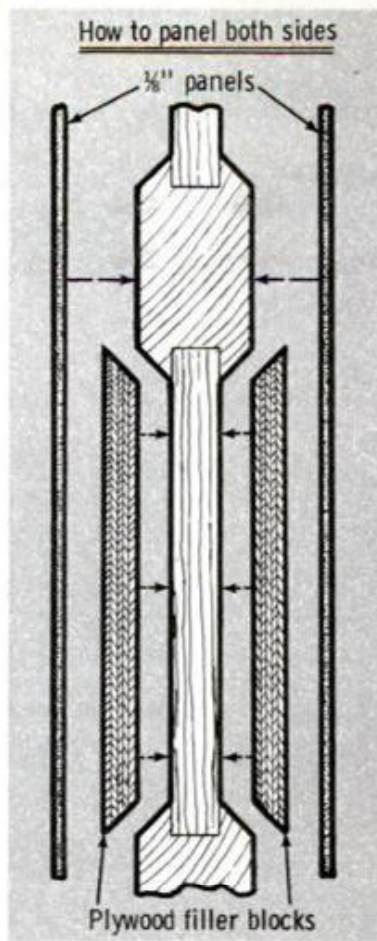

CHANGING scarred door (above) to modern door (below) takes an hour



New Building Products

EVERY YEAR, the building supply industry comes up with a new assortment of special-purpose products. While these don't make a very big splash in the general market, they can be the answer to a prayer if they're aimed at your particular problem.

Climate Command, for instance, is a combination heating and cooling system which can simultaneously heat one room and cool another. Each unit in the system incorporates a self-contained air-conditioning chassis and a hot-water heating coil in a slim sill-height cabinet. The cut-away at right shows the basic component layout. Up to eight such units can be connected to a single loop of pipe.

Unlike most self-contained cooling units, the Climate Command condenser is water-cooled, thus reducing noise level and eliminating the need for a through wall opening.

During the winter, hot water is circulated to provide heat in the normal way. In summer, unheated water is circulated to cool the condensers. During tricky between-season weather, warm water enables each unit either to heat or cool, according to individual thermostat settings. With 110° water, for example, a single unit can provide either 11,000 B.T.U. cooling or 6500 B.T.U. heating.

While designed primarily for office buildings

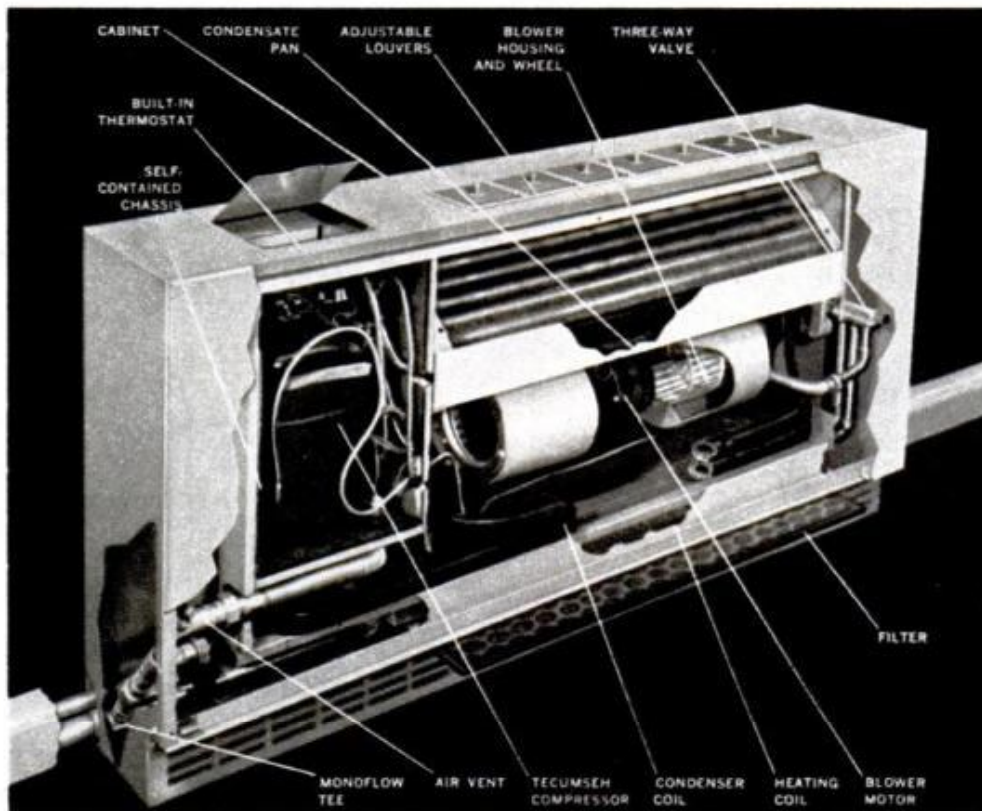

and high-rise apartments, this hydronic system might well solve your special problems. It's made by Slant/Fin Corp., 100 Forest Drive at East Hills, Greenvale, N.Y. 11548.

A development of more general interest is Armstrong's Tilemate light fixture (below). Made expressly for installation in a tile ceiling (it won't fit anywhere else), this moderately-priced 12 x 12-in. fixture matches the size of a standard tile and is installed in place of one of these tiles when you're putting up the new ceiling.

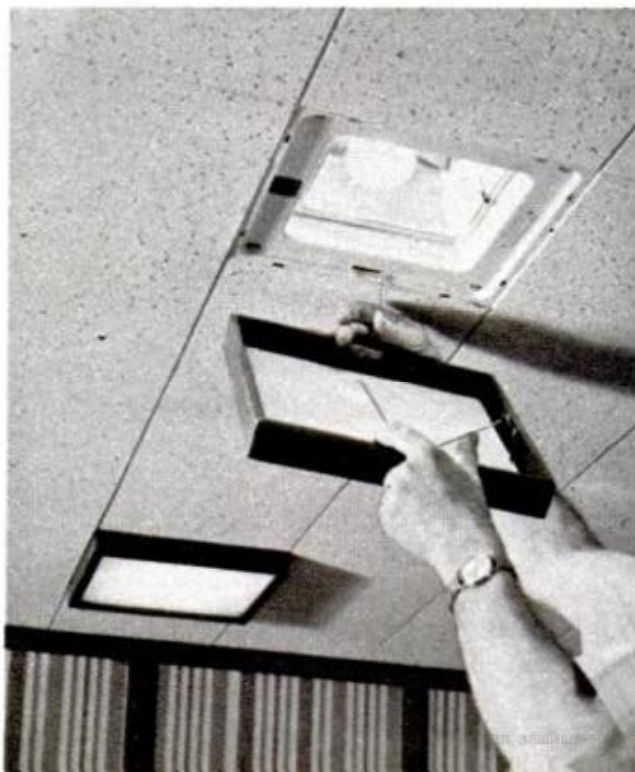

The secret of its simple installation is an adapter plate which fits into the tongue-and-groove tiles around it and serves as a base for the other parts. The exposed frame has a wood-grain finish. The fixture is priced at \$10.50. If you can't find a source in your area, write to Armstrong Cork Co., Lancaster, Pa., for the name of the nearest dealer.

More of an idea than a product, the glass block installation shown in the photo at right features a modular ventilator panel in the center which allows you to have both fresh air and light. These are being fabricated locally in many parts of the country, so you'll have to check the masonry contractors in your area for further information.

If you're looking for durability, check Leviton's new Centura line of pushbutton switches and grounding receptacles. (center right). The company backs each one with a 25-year guarantee. Available in a wide range of colors, they're made by Leviton Mfg. Co. Inc., 236 Greenpoint Ave., Brooklyn, N.Y.

Finally, you might be interested in a new concept in chimney flashing. A Wisconsin company is now marketing a preformed "all pitch" flashing kit (below), engineered to fit any chimney that protrudes through the slant slide of a roof. No soldering is required. Instead, all you have to do is caulk the interlocking seams. The whole flashing job can be accomplished in about 15 minutes.

These kits are available in sizes to fit all standard chimney-block dimensions. For price information and details, write to Miller Metal Products Co., 1310 Edgewood Drive, Appleton, Wis. 54911.

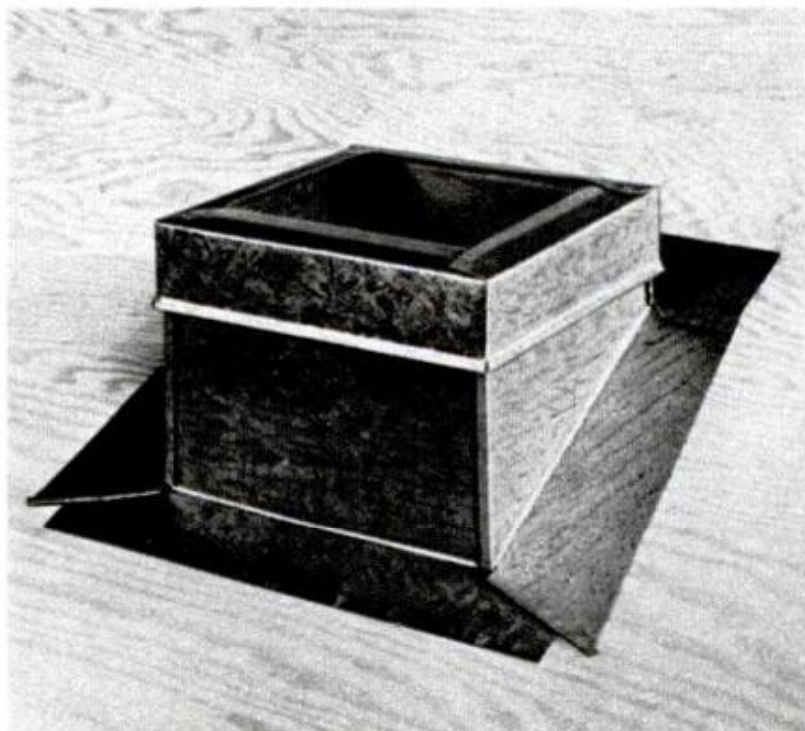
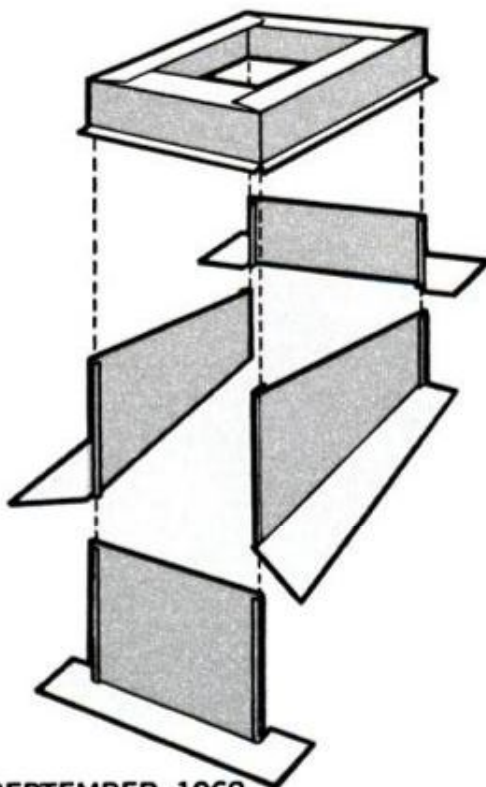
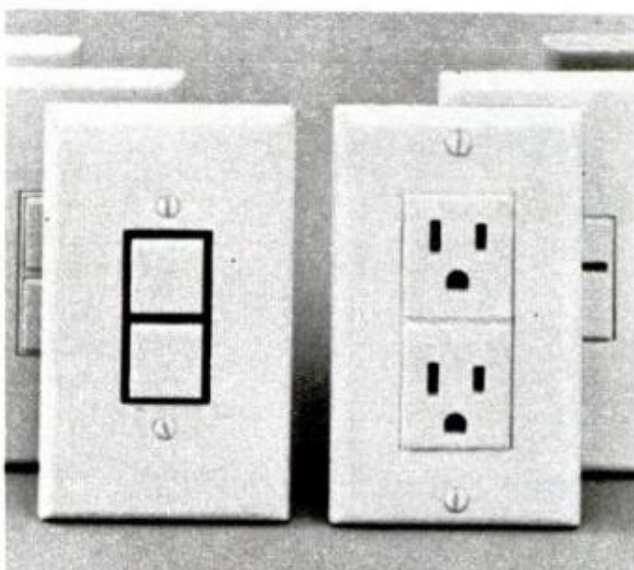

HOW TO BE 'Shelf' Sufficient

Standards and brackets provide simplest way to have too many shelves—if that's possible.



By WAYNE C. LECKEY

WHY HAVE WALLS just standing there when they could be holding shelves galore?

Slotted, wall-mounted standards and cantilevered shelf brackets, which hook into them, can transform such lazy walls into stunning workable "shelf-walls" in a matter of minutes.

That's how utterly simple it is to "build" your own custom-designed shelves for your favorite books, vases, art objects, trophies, hi-fi components—you name it.

Once the standards are screwed to the wall you can create dozens of dramatic shelf arrangements by merely inserting the brackets anywhere you want. When you tire of one arrangement, you can break it up and create a totally new effect by playing musical chairs with the brackets. And, such shelves are not limited to walls. Floor-to-ceiling poles are available for creating dramatic room dividers.

To top it off, the only tools you need are a ruler, drill, screwdriver and, for the room divider, a level.

While you can make your own wood shelves by cutting up flat boards or ripping them from $\frac{3}{4}$ -in. plywood, the job becomes a lot simpler when you buy them ready-made. Besides being nice and flat, they come completely finished, edges and

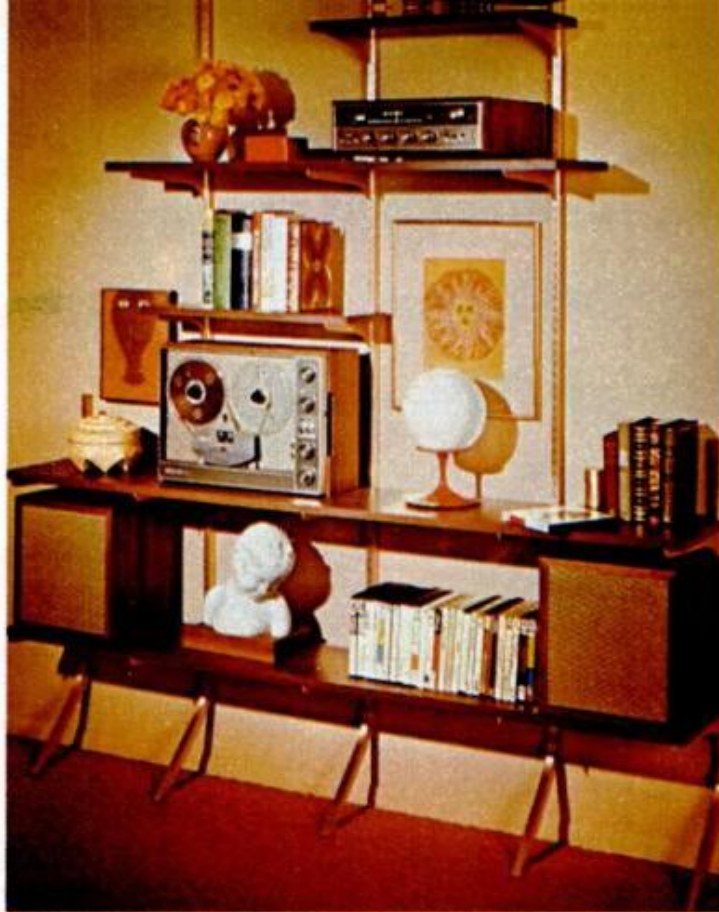

PORTA-POSTS rest on floor to support load, offer minimum defacing of wall, require but one screw

sides, with a choice of colors and wood grains. You can get them in 2, 3, 4 and 6-ft. lengths, and in 8, 10 and 12-in. widths.

Shelf standards (as well as the brackets) are available in finishes to blend with



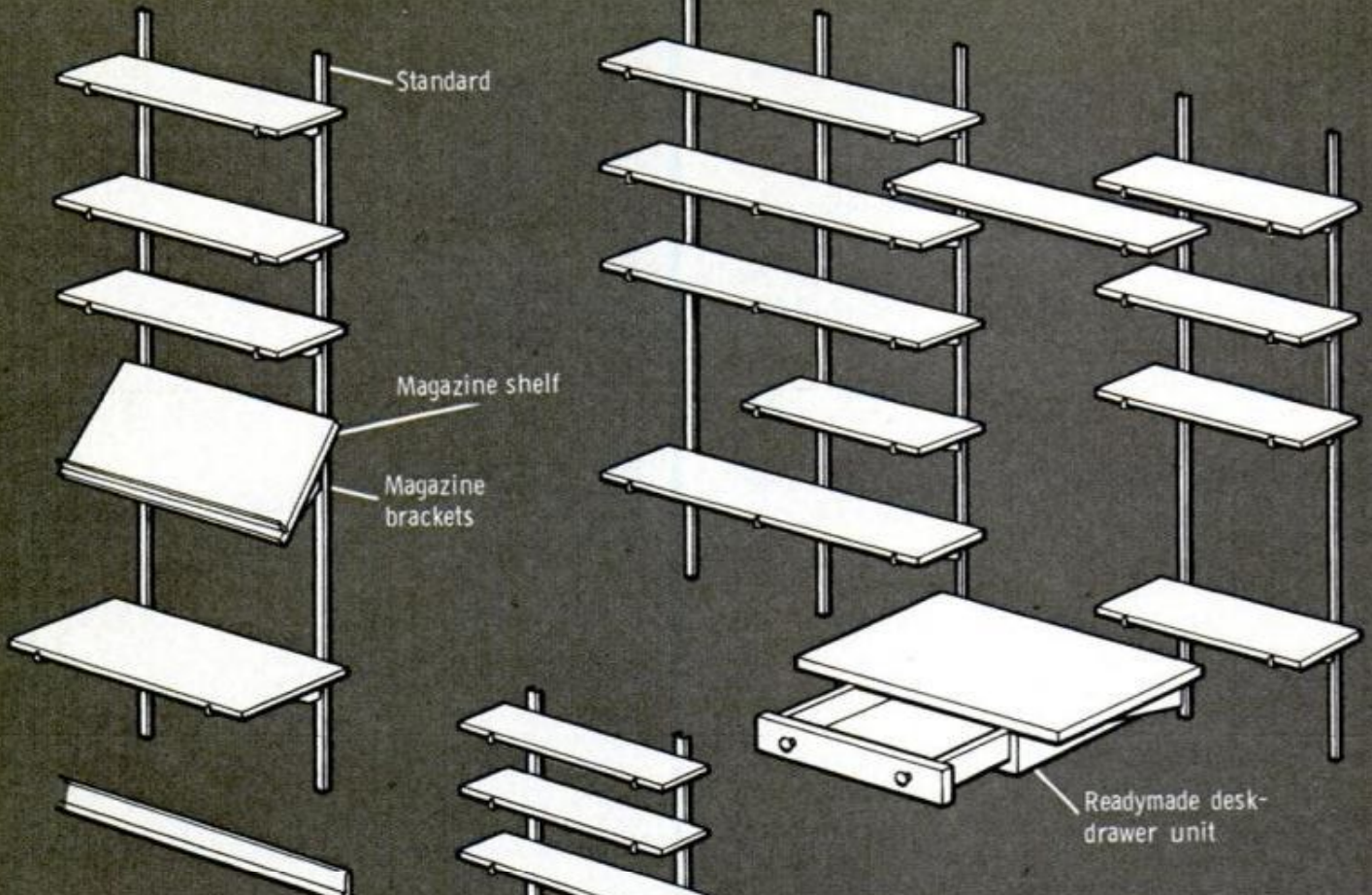

Standard

Magazine shelf

Magazine brackets

Readymade desk-drawer unit

The many design possibilities available will lead you to an endless variety of shelf arrangements — there is no limit. What's more, you can move the shelves and brackets around to your heart's content for totally new and dramatic wall effects.

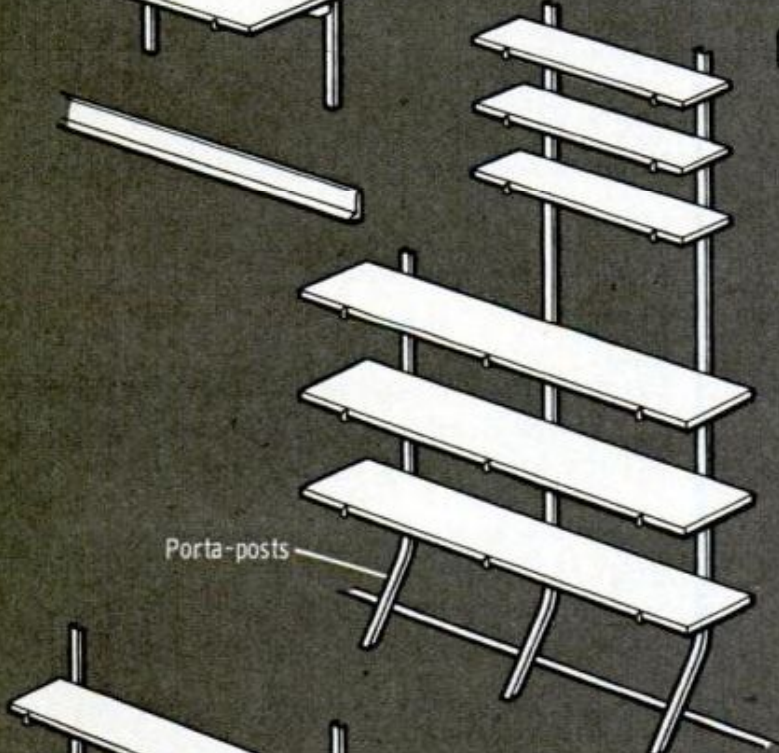

Porta-posts

Magazine shelf

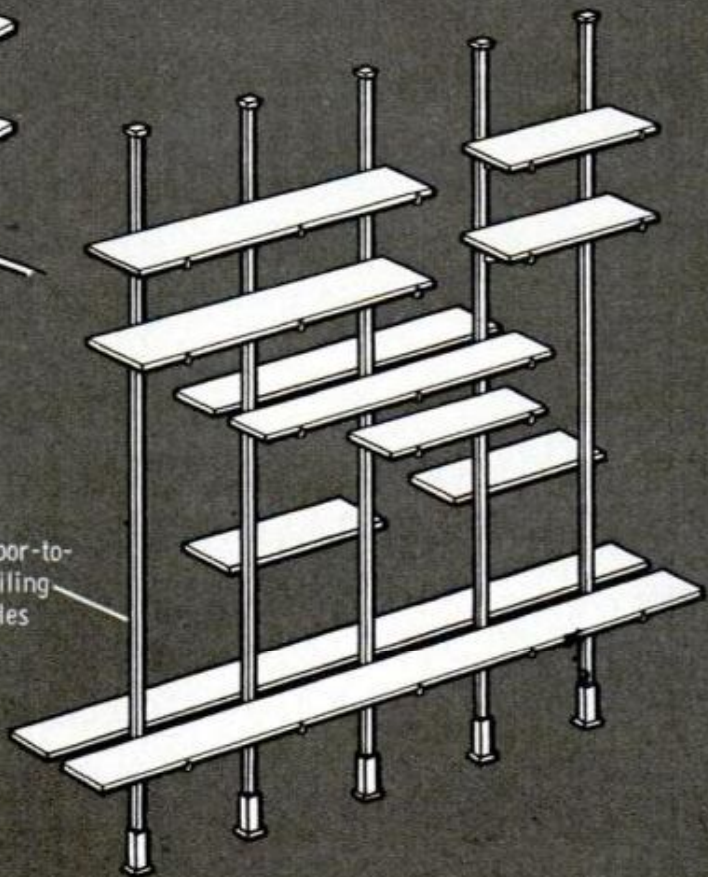

Floor-to-ceiling poles

any color scheme. They come in 1, 2, 3, 4, 5 and 6-ft. lengths, both in steel and aluminum, and anodized, brushed or plated. Finishes include antique copper, satin bronze, gold, charcoal, white, black and walnut.

In addition to plain channel-shape standards, you can get slotted ones called Porta-Posts which are particularly practical for apartments since one screw is all that's necessary to fasten each post. The posts are made by the Dorfile Mfg. Co. of Portland, Ore.

Bracket lengths match shelf widths and range from 6 to 16 in. You can get 14-in. ones which support magazine shelves at a 45° angle, and there's even a desk-shelf complete with drawer.

Sears offers a unique free-standing room divider of standards and brackets which requires no nails, screws or drilling, nor floor-to-ceiling poles.

Masonite features with their Royalcote Living Wall a clever shelf-and-bracket system which requires no standards. The brackets hook into the slotted paneling.

Spacing of the standards is dictated by the type of wall, shelf width and load. Where the shelves will display many books, a maximum spacing of 24 in. is recommended. For lighter loads, it can be up to 36 in. If the wall is paneled with solid tongue-and-groove boards, you have no spacing and load limits—screws provided will hold with complete safety. However, if the wall is paneled with 1/4-in. plywood or hardboard, the load per lineal foot of 8-in. shelf should not exceed 20



SLOTS IN THE GROOVES of special paneling take place of standards to support brackets and shelves

lbs., 15 lbs. for 10-in. shelves. In walls of plaster or plasterboard, screw anchors must be used for each screw.

In attaching the standards drive the top screw first and let the standard swing free. It will plumb itself, after which you can mark and drill the other holes. A hammer tap on the base of each bracket will wedge it securely in the slots. ★★★

PLASTIC CLIPS allow screwing heavy-duty brackets to shelves after tapping brackets in slots with mallet

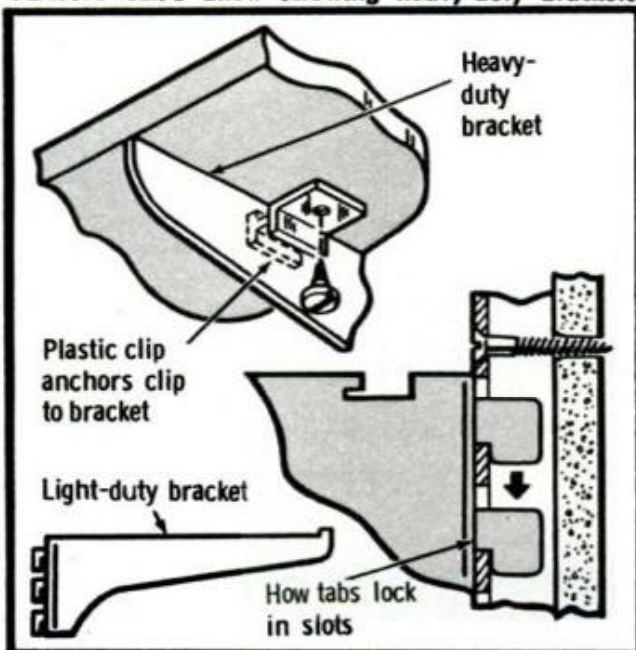

BUILD THIS SHOP IN A BENCH

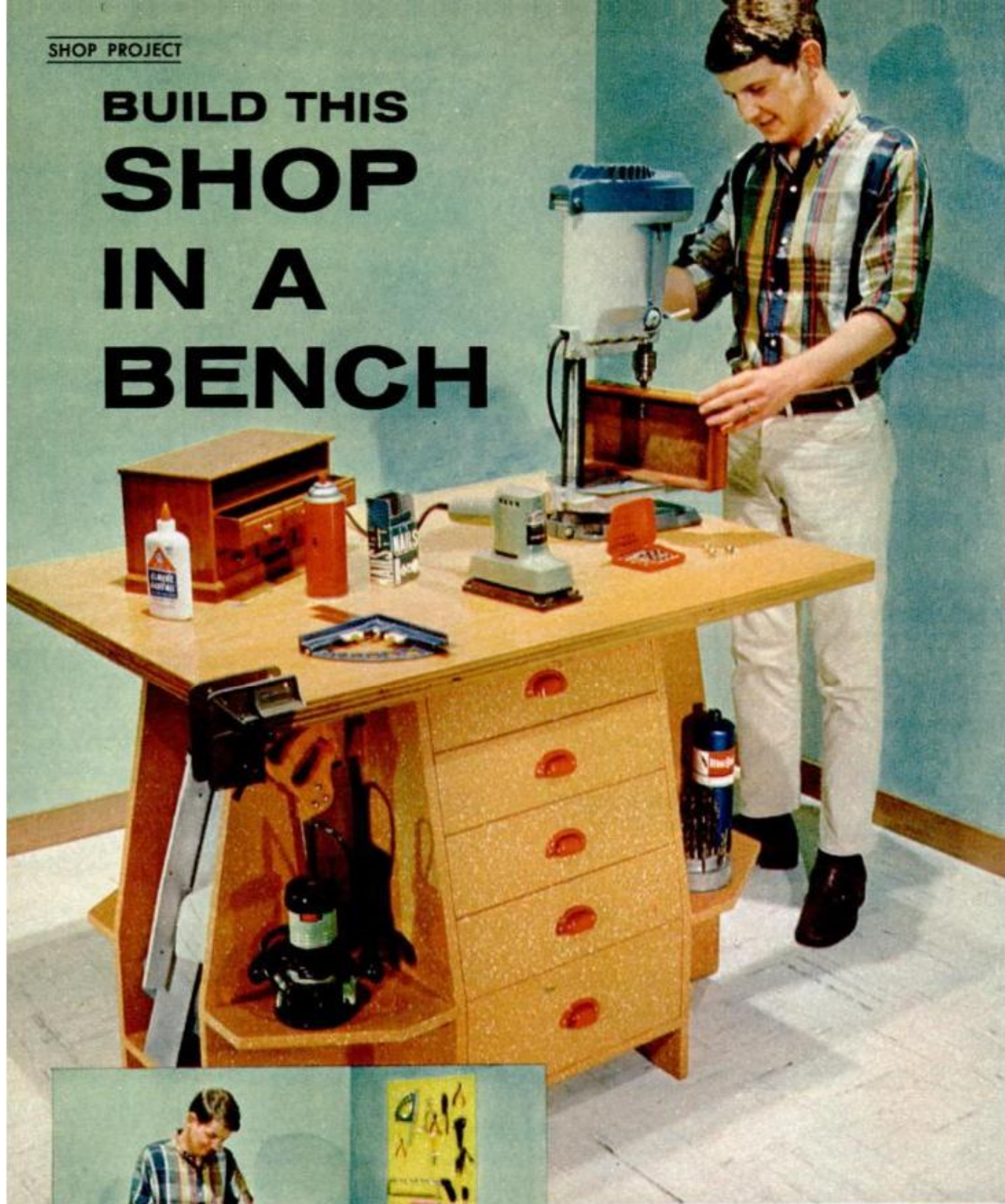

THE BENCH becomes a tool stand when you want to drill a hole. Lightweight drill press is lifted from its stall in base and set in anchor holes drilled in the benchtop. Jointer is parked at opposite end

Technical Art by Graphic Presentations Services

WITH POWER TOOLS parked in the base, workbench top offers big uncluttered work area which lets you spread out layout and assembly jobs. Note stall in the front of bench which holds circular saw

Serving as a combination tool stand and workbench, this space-saving work center becomes a workshop in itself

By WAYNE C. LECKEY, Home and Shop Editor

IF YOU HAVE a hankering to get started in the rewarding and relaxing hobby of making and fixing things but are stymied for a place to work, here's the perfect answer to the question of space.

We call it a shop-in-a-bench and that's just what it is—a self-contained island work center which can be equipped with both hand and power tools to let you have the time of your life in just 3x4 ft. of space.

Not only do you have a king-size workbench with a top that's accessible from all four sides, but a bench which serves as a power-tool stand at the drop of a hat.

A drill press, a 4-in. jointer and an 8-in. circular saw are conveniently parked in stalls in the base of the bench. Thus when you want to saw, plane or drill a board with the accuracy of a power tool, you simply reach down, grab the tool you want, plunk it in predrilled holes in the bench top, plug it in and away you go. It's not necessary to bolt the machines in place.

When you want to clear the deck and use the big 3x4-ft. top for layout and assembly work, you can do it in a jiffy by returning the tools to their respective stalls.

In addition to all this, the bench has five roomy drawers, plus four shelves, where you can store all the hand and portable electric tools you'll ever need, all within easy reach.

While these stalls are dimensioned to accommodate Rockwell's three Compactools, they can be made to suit other small-size, self-contained machines.

The quick-change, no-fastening feature of the machines is accomplished by fitting their bases with $\frac{3}{8}$ x 2-in. bolts which are left projecting. Registering holes drilled in the benchtop for the projecting bolts on each machine are all that's needed to anchor the machines. When through using them, you simply lift the machines out of

the holes and park them in their stalls.

Two sets of holes are provided for the circular saw which lets you position it to suit the shape of the room and the size of the work. For example, if the room is long and narrow and you want to rip a 10-ft. or longer board, the saw is set in the four holes which will let you rip the length of the room. Conversely, when you want to crosscut a long board, you set the saw in the four holes which let you crosscut the length of the room. This way you can make the most of cramped quarters and be



POSITIONING SAW on bench with relation to room's size lets you rip and crosscut long boards easily and without hindrance

less restricted in the size of the work you can handle.

In the case of the drill press and jointer you merely have to drill out the original holes in the machine bases to accept the $\frac{3}{8}$ -in. bolts. However, the circular saw requires bolting a $\frac{3}{4}$ x $9\frac{1}{2}$ x 12-in. plywood base to the saw's sheet-metal base. Four holes for the $\frac{3}{8}$ -in. bolts are first bored through the plywood and counter-bored $\frac{1}{4}$ -in. deep on the underside for

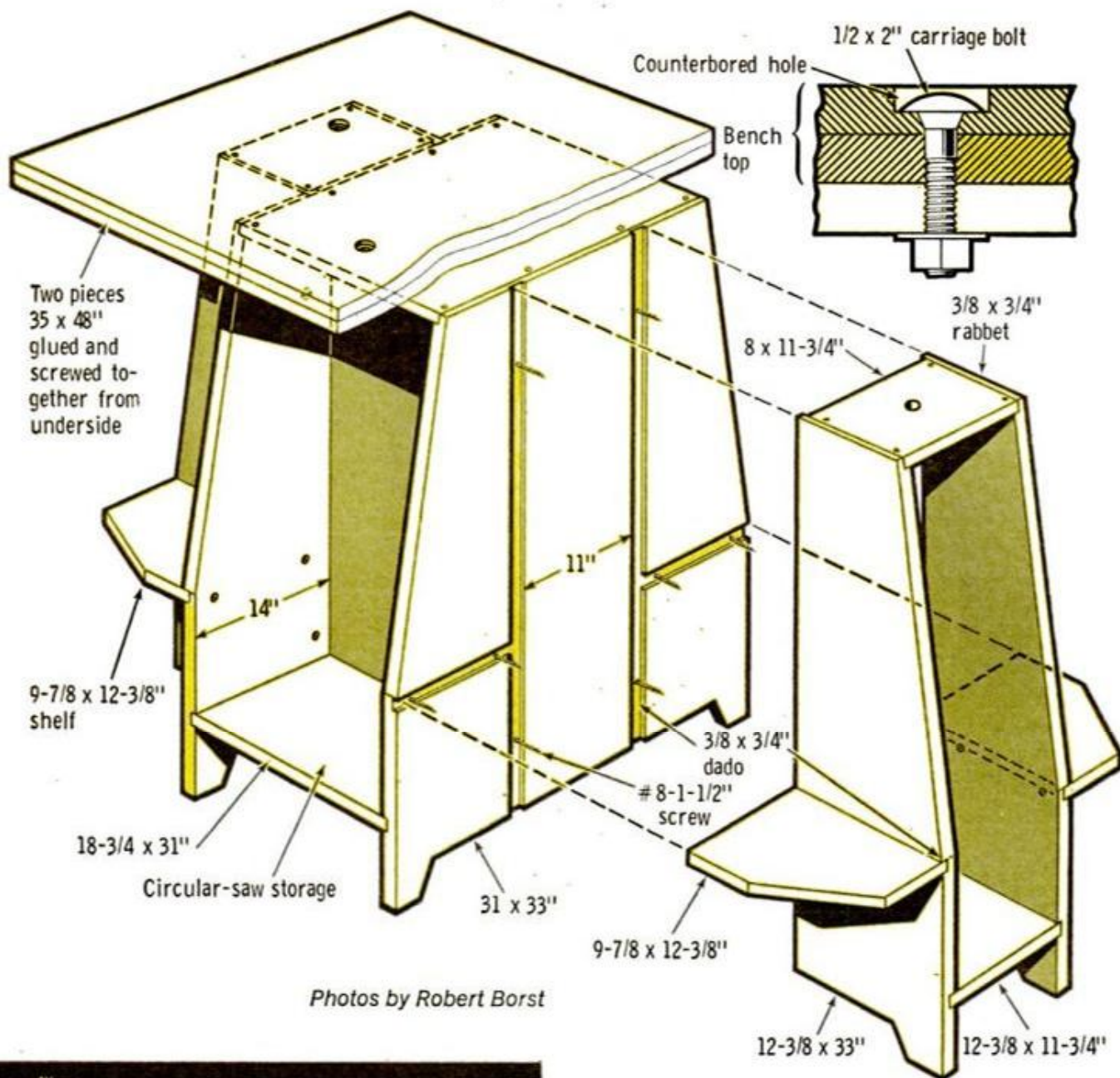

Photos by Robert Borst

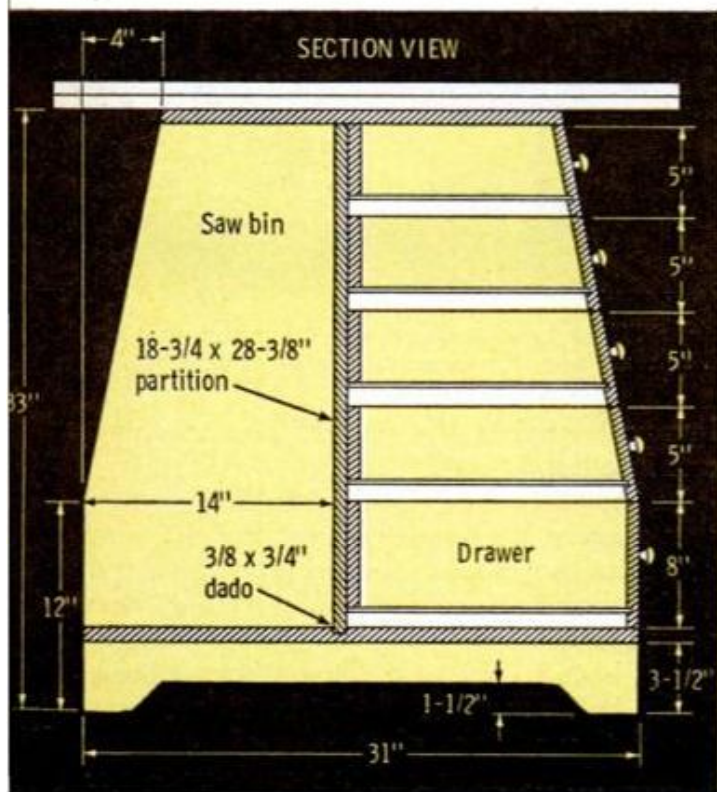

the nuts. Next, the holes in the saw's base are marked on the plywood, then drilled for $\frac{3}{16} \times \frac{3}{4}$ -in. stovebolts and also counterbored for their nuts. The stovebolts are used to attach the plywood base to the saw.

The bench, entirely of $\frac{3}{4}$ -in. fir plywood, is made in four sections; a main drawer section, a jointer stall, a drill-press stall and a double-thick top. The four sections are designed to bolt and screw together so the bench can be dismantled for easy transporting and for negotiating turns, doorways and stairs.

Start making the main drawer section first by laying out the two dadoed ends. These are made in pairs and the dados cut before the members are tapered. Dadoed joints make the sturdiest bench, but you can skip them and use plain butt

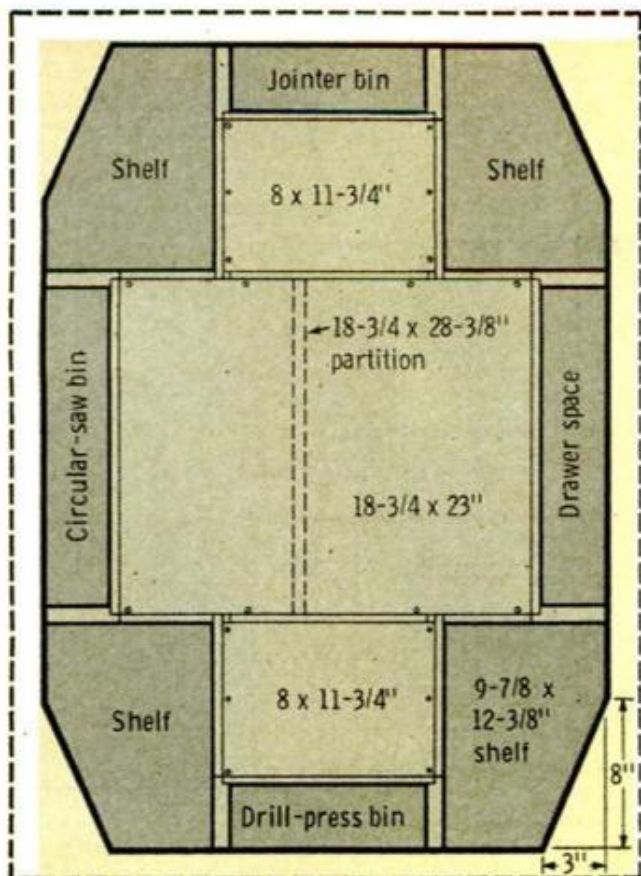

TOP VIEW

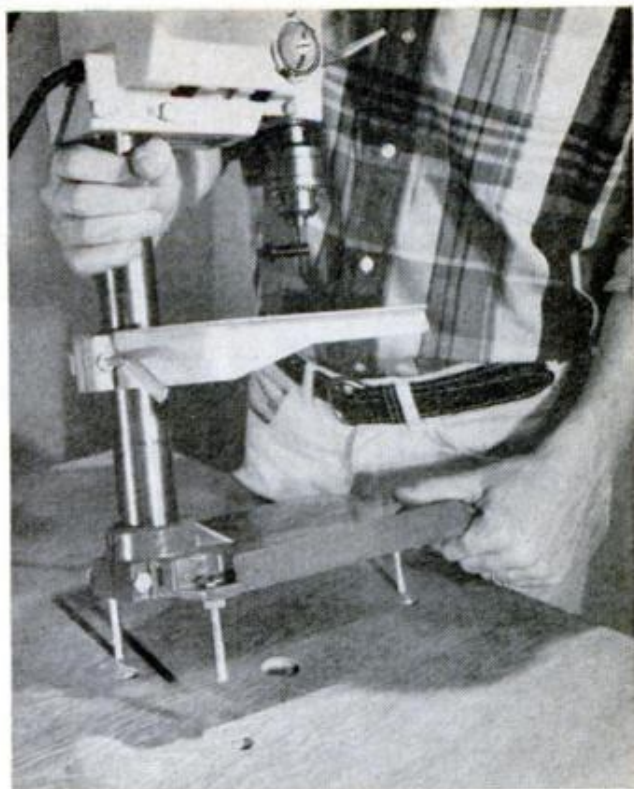

REGISTERING HOLES in benchtop receive projecting studs on each machine to anchor it while being used

joints. Likewise, the rabbeted joints across the top of the ends can be butt joints. The partition, in turn, fits a dado in the bottom member and dados in the side members, although these, too, can be mere butt joints. Nail and glue the five parts together, leaving the drawer runners until later.

The drill-press and jointer stalls are twins and identical in size. Should you not

join them to the main section in dados, you don't have to deduct the 1/4-in. depth of the grooves from the dimensions given, everything will still fit. In either case, 1 1/2-in. flathead wood screws are used to attach the stalls to the main section. Note that the stalls slant inward at the top to match the main section.

Short lengths of dowel glued in blind holes in the side of the stalls, as well as in the sides of the main section, provide pegs for hanging saw blades, the saw's rip fence and miter gauge, and countless hand tools, which will save drawer space.

The benchtop is made extra solid by gluing and screwing together two thicknesses of plywood. The screws are driven from the underside. The top is attached to the base with three husky 1/2 x 2-in. carriage bolts set flush in counterbored holes. A bolt is located over each of the three stalls. Either a clamp-on or edge-mounted vise can be added to the top.

Except for the bottom

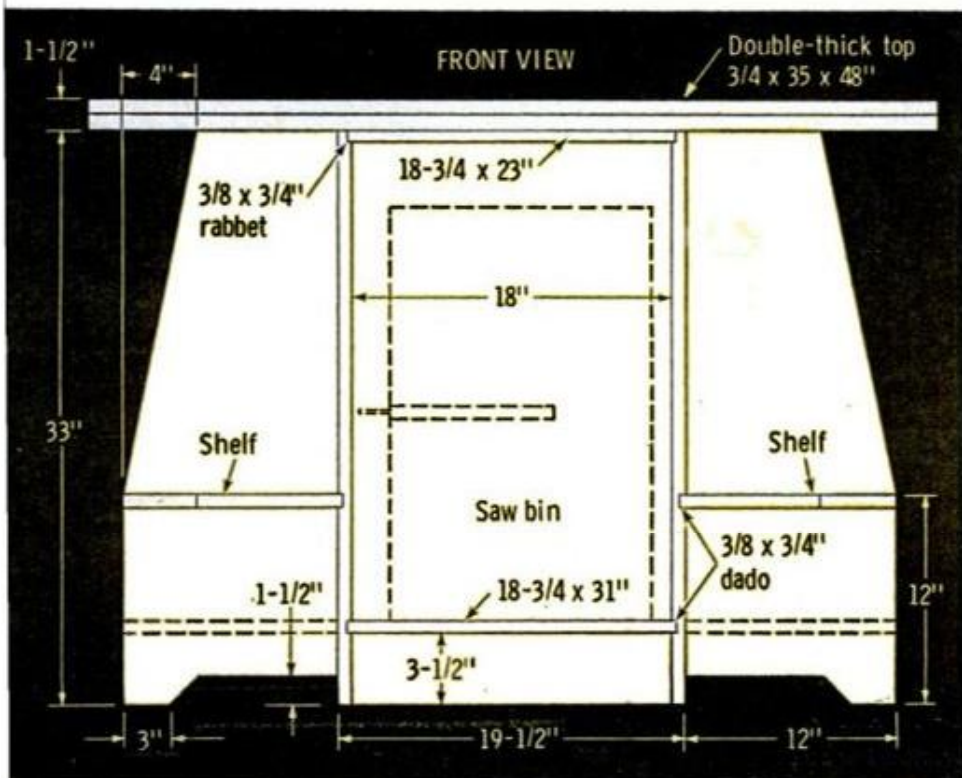

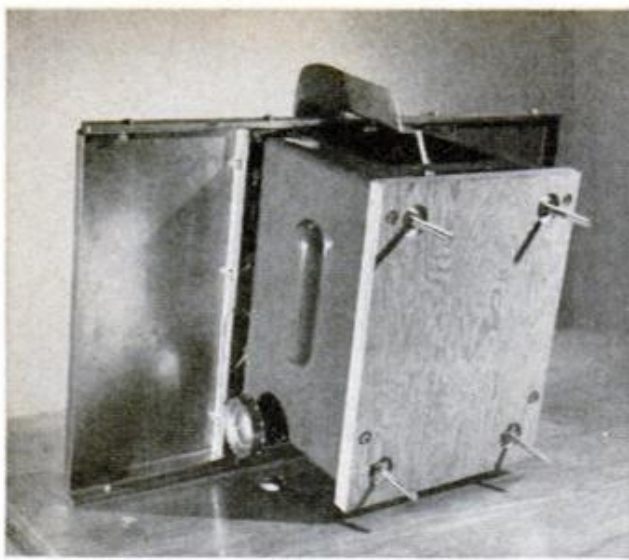

A PLYWOOD BASE is added to the saw's base to accommodate the four studs which fit holes in benchtop drawer, the drawer fronts are slanted to match the slant of the main section. Fronts, sides and backs are cut from $\frac{3}{4}$ -in. plywood, while the bottoms are $\frac{1}{4}$ -in. hardboard. The sides are dadoed for the backs and join the fronts in rabbets. Top and bottom edges of the slanting fronts are beveled so they are level, and the drawer-bottom grooves which are cut in the backs of the drawer fronts, are cut at the same angle. Similar grooves are cut in the drawer sides but these are made at right angles. Finally, $\frac{3}{8} \times \frac{3}{4}$ -in. grooves are run down the center of all drawer sides for the runners on which they slide.



FIVE ROOMY DRAWERS provide lots of storage for both hand and portable tools, sandpaper, nails, screws

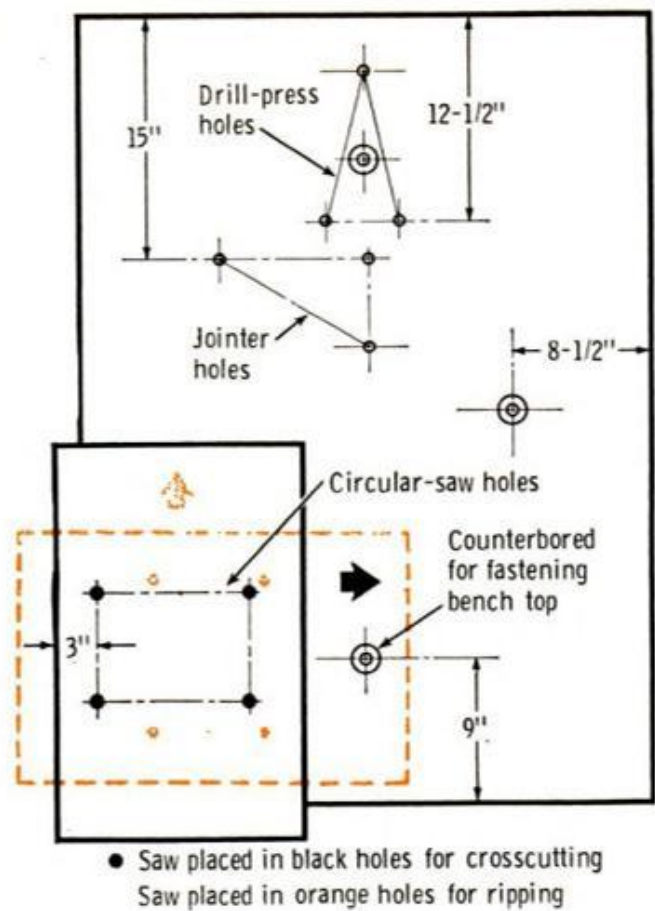

Now assemble the drawers with glue and nails and add knobs or pulls. Cardboard shims between the drawers will help position the runners so the drawers will have proper clearance. If they should rub or bind, a skimming cut through the saw will do the trick. Wax applied to the runners and grooves will make the drawers slide freely when loaded.

A 4-in. junction box screwed to the side of the bench and fitted with four cover-mounted outlets, plus a 10-ft. cord, will make it handy to plug-in your power tools right at the bench. ★★★

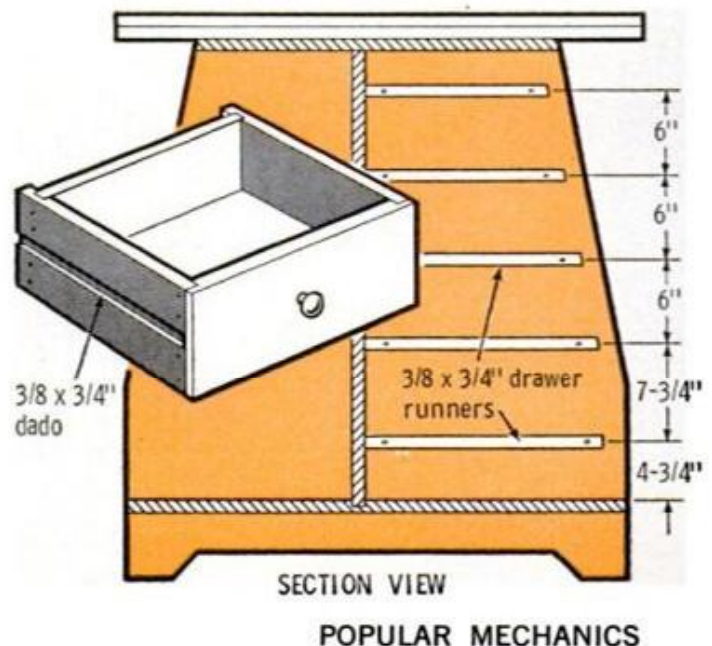

HINTS FROM READERS

Stop splitting when planing

To eliminate the danger of edges splitting when using a butt plane for end planing, clamp a block of wood of the same thickness to the end of the board being planed. Flush with the surface, it will act as an extension of the area being worked and can be planed down right along with the work. Splitting will occur in the edge of the block, not in the work.

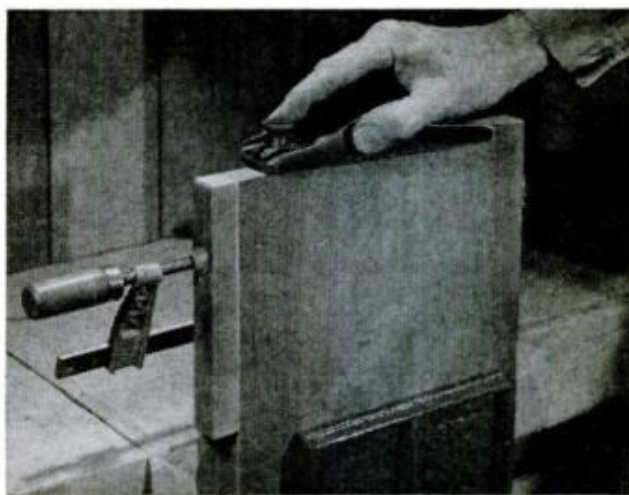

Use C-clamps as bar clamps

In an emergency, C-clamps can be used on a job which would normally require bar clamps if you make up wooden extensions to increase the capacity of the C-clamps. The L-shaped extensions can be cut from any scrap stock of sufficient length to achieve the desired span. Ideally, they should be of the same length, though this isn't absolutely necessary. Wood blocks screwed or nailed to the ends of the extensions should be small enough to fit between jaws of the clamp.

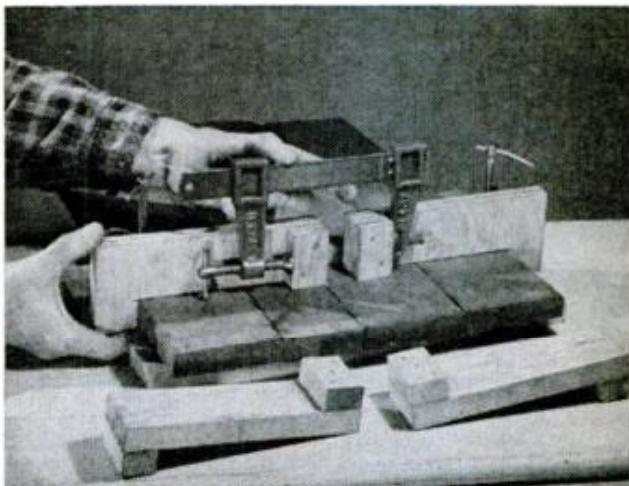

Easy way to slot tubing

To ensure accuracy when making lengthwise cuts in tubing or shafts, make up a simple hacksaw guide from a hardwood or metal block. Drill the block so that it will slip over the work and cut a slit for the saw blade halfway through the block running across the diameter of this hole. The guide rides the back of the blade and follows the cut. All you have to do is work the saw and keep the cutting action vertical. You'll be surprised how much easier this makes such jobs.

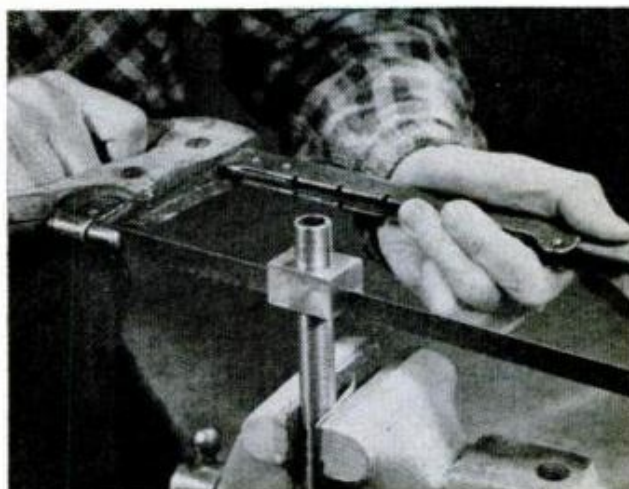

Smooth cuts with cold chisel

When using a cold chisel to cut sheet metal, clamp the work in a vise so that the cutting line is flush with the top of the vise jaws. Hold the chisel at a slight angle to the work so the cut will run from right to left (if you're right-handed) and keep the short bevel of the cutting edge flat against the top of the vise. By tapping the chisel lightly with a hammer you can produce a smooth shearing action which results in a clean and even cut in the sheet metal.



Let Your Lights Turn On Automatically with OUTDOOR PHOTO CONTROLS

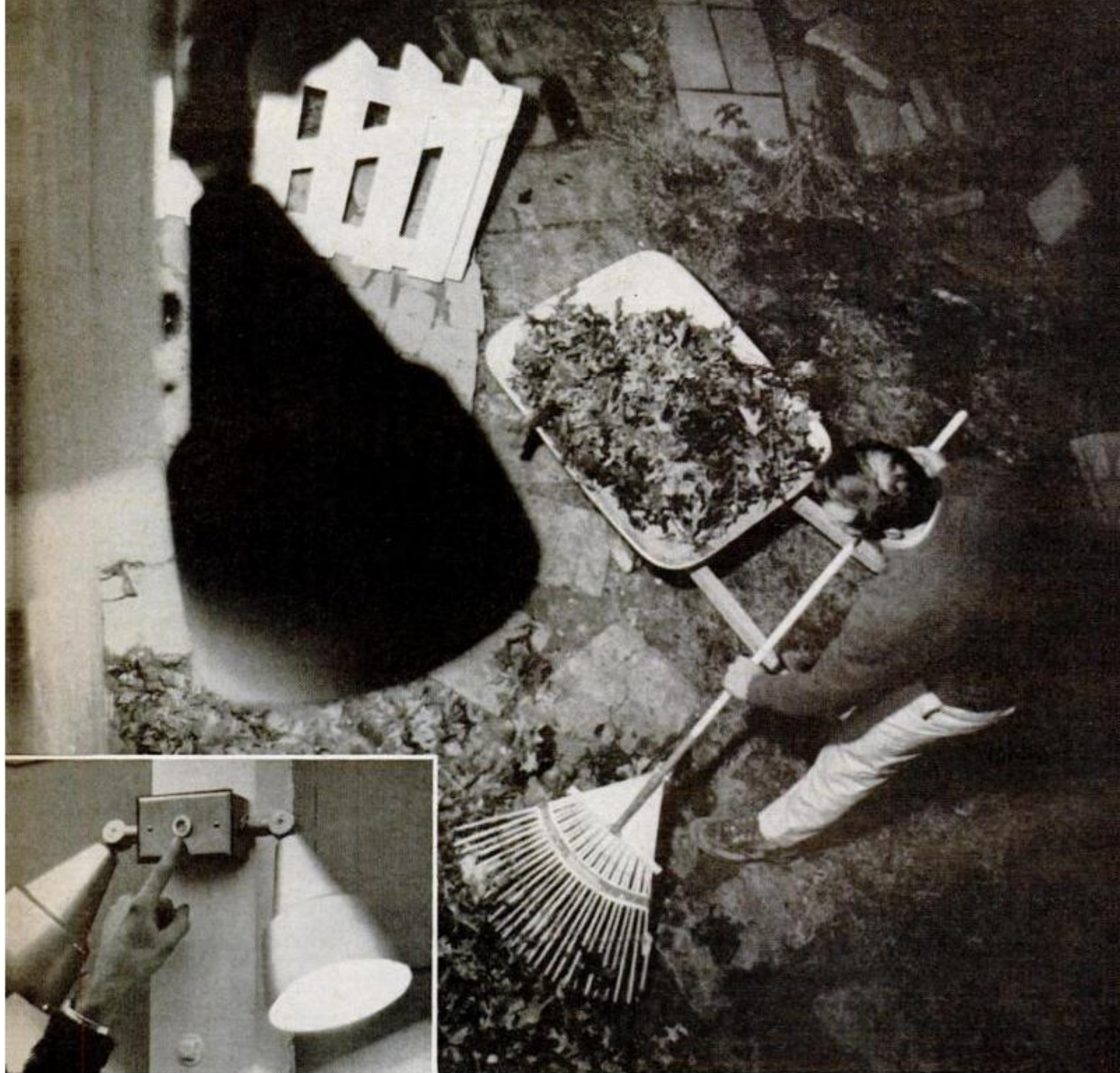

Yard lights that flash on by themselves let you finish those last few evening chores without interruption and end the apprehension of leaving your home in the dark when you're away

By BILL HARTFORD

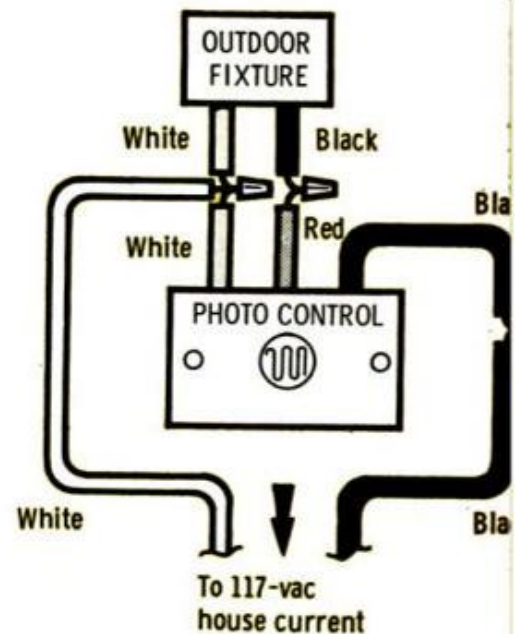

ANY OUTDOOR JUNCTION BOX will receive this stainless-steel plate with photo control from LGM Electronics. The Model W-300, rated at 300 watts incandescent, controls outdoor PAR lamps in two Bryant B-1100 fixtures. Wiring diagram at the right shows how the three leads from control are connected into the circuit

THERE'S NOTHING NEW about the phenomenon of light-sensitive photocells. Practical switching devices—the familiar electric eye, for example—use them and are familiar to us all. But what is exciting and different is the packaging of photocells in a variety of easy-to-install outdoor controls for yard lighting that are increasingly available at electrical supply stores, mail-order houses and even some department stores.

One such configuration is a photo control plate that replaces the cover plate of an outdoor junction box. The photocell triggers a switch in the control to turn your lights on at dusk and off at dawn. Wiring it into your outdoor lighting circuit is simple. Solderless connectors are the easiest way to tap the leads into the existing circuit.

Another type of photo control has the photocell mounted on a collar for a permanent lamp post installation. You can also get photo controls incorporated in swivels, in tubes and in variously shaped cases for meeting any conceivable installation requirement.

While the controls are easy to install, there are a few tips to follow so you won't be scratching your head over a blinking outdoor light or one that's on during the day and out at night. So that the light doesn't go on during the day, avoid installing the control in heavy daytime shadows. Similarly, don't have it pointing toward a streetlight or other light source that would keep it from turning on at night. Brief flashes from car headlights, incidentally, won't affect the controls since they have a built-in time-delay circuit.

Finally, make sure the photocell isn't exposed to light from the lamp it controls or the lamp will blink on and off. Use a shield between the cell and lamp if necessary. ★ ★ ★

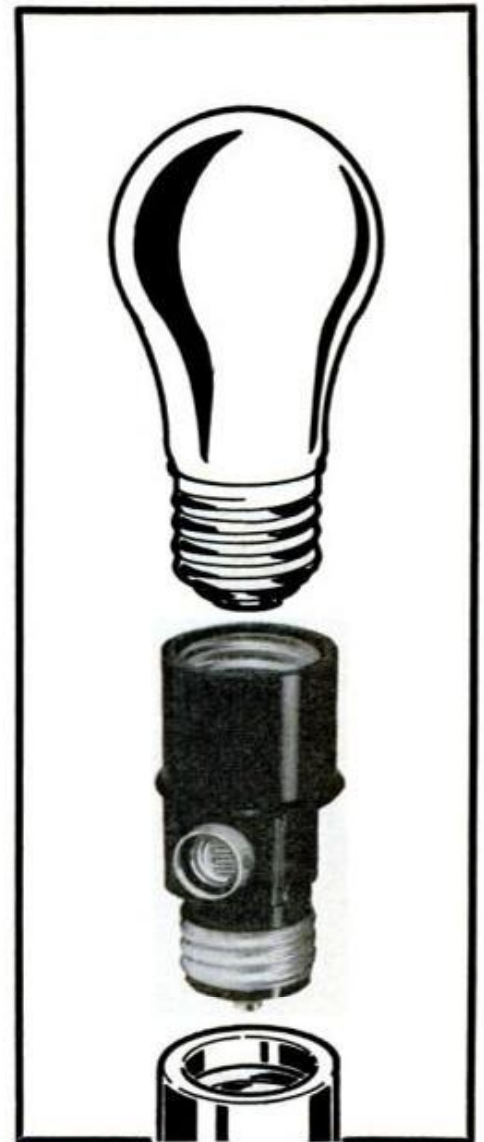

SIMPLEST TYPE of home photo controls screws into outdoor lamp sockets and turns on and off bulbs up to 150 w.

PAINT YOUR HOUSE



WITH A ROLLER

Now that water-base paints have moved outdoors you can use the same painting methods on the outside of the house as on living-room walls

THE ROLLER REVOLUTION in do-it-yourself painting is about to spread outdoors.

Actually, the only thing that has held it back this long was the lack of good exterior water-base paints. Now that these have been perfected, there's no reason why you can't tackle the job of painting your house with the same confidence you have when painting a bedroom. The only real difference is in the size of the job.

Preparation is the same as for painting your house with a brush, which in turn is basically the same as preparing to paint with a roller indoors. Surfaces should be reasonably clean—wash any particularly dirty spots—and free of loose paint. Check for areas which may have to be scraped, and do this a couple of days before you plan to paint.

Putty nail holes and cracks. Reset any nails that have worked out. Renail clapboards or shingles that have pulled away from the surface, using extra nails if necessary.

The day before you paint, stake back foundation plantings. Just drive a couple of stakes in the outer edge of the bed for

FOUNDATION PLANTINGS should be tied back if necessary and covered with a dropcloth or newspapers



SEPTEMBER 1968

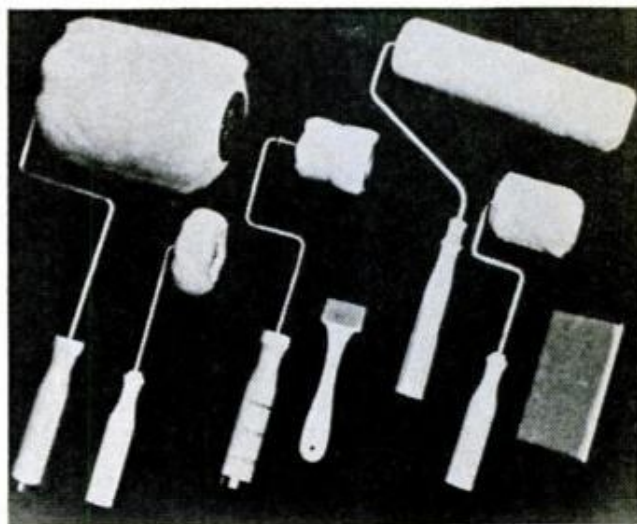

ROLLERS AND PAINTING PADS are special-purpose tools. For top results, don't skimp on your equipment

each bush and tie one end of a line to one stake, then pass the line around the bush so you can pull it away from the wall and tie it to the other stake. When painting, cover the bushes with a dropcloth or old newspapers for additional protection.

Buying the paint should present no special problems. Since you'll be using a roller, you'll have to stick with some brand of water-base paint, and here, as with many

NONSKID GRID helps you to load rollers. Hardware cloth is shown, but EZ Painter sells a sturdier unit



149



USE SASH FLATS for window mullions and trim. Other special-purpose pads and daubers will speed the job

other home-improvement materials, it generally boils down to a matter of getting what you pay for. Special sales may offer a chance to save a little on the total cost, but real bargains in paint are rare.

Before you head for the paint store, take a few measurements to get a rough idea of the area to be covered so you'll know how much paint to buy. Make a mental note of the different surfaces you'll be working on; this will determine the kinds of rollers you'll need and how many.

Nap length is one important consideration when selecting rollers. It may vary

MATCH ROLLER to the area to be covered. Small one coats a railing much faster than standard size would



150



SEGMENTED ROLLER on a flexible core wraps around downspouts so you can paint them in one easy pass

from $\frac{1}{4}$ in. (most common, and still best for most work) up to $1\frac{1}{4}$ in. (special-purpose length for extra-rough masonry, chain-link fences and other unusual jobs).

A short-nap roller will lay on the smoothest coat and is best for smooth surfaces. A long-nap roller is better for rough surfaces, because it can reach the bottoms of minor irregularities. For the best compromise between smoothness and coverage capability, always pick the shortest nap that will handle the job efficiently.

The type of fiber is also important. Always choose a synthetic. Natural fibers

(Please turn to page 195)

TO STORE ROLLER overnight, just wrap in foil or a polyethylene bag and place it in your refrigerator



POPULAR MECHANICS

PHOTO HINTS

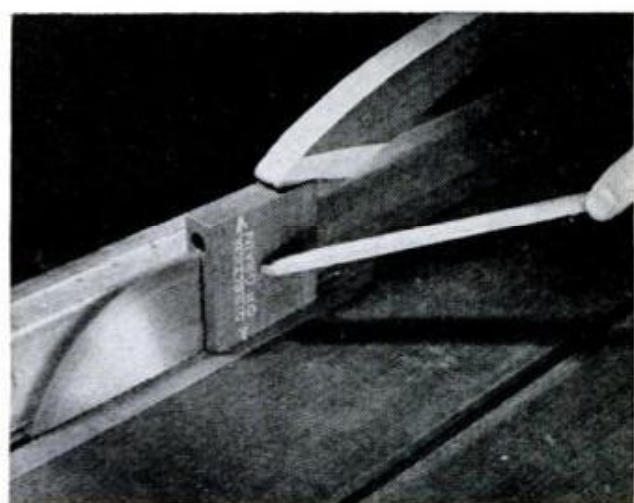
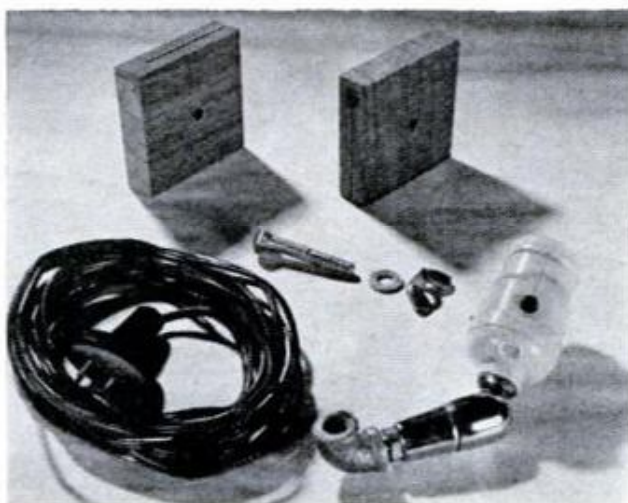
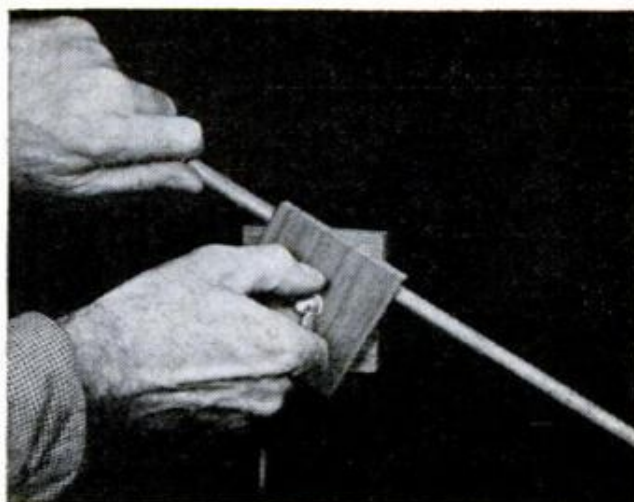

BUILD YOUR OWN BOOM LIGHT. Commercial boom lights are costly, but you can put this homemade version together for about \$3. The boom is made to fit on a regular light stand. For the main arm, you'll need a 4-ft. length of $\frac{1}{8}$ -in. galvanized pipe, threaded on one end. The power cord is hidden neatly inside the pipe so it's not in your way. For the lamp socket, it's best to use the plastic type so you can move it around easily without having to touch hot metal. To the socket, add a lamp swivel. These are available at hardware stores and lamp shops. Thread the swivel onto a 90° pipe elbow. The elbow, in turn, is screwed onto the threaded end of the boom pipe. The boom is mounted on a

light stand by means of a homemade swivel that enables you to slide the boom in and out and tilt it in any direction. This consists of two split blocks of wood held together by a bolt and wingnut (upper right). The boom slides in a hole in one block, and the other block slips over the top of the light stand. Tightening the wingnut squeezes the blocks and locks everything rigid. The blocks are 3 in. square and $\frac{3}{4}$ in. thick, preferably of hardwood. Drill the holes across the grain, then carefully cut the slits with the grain on a table saw (bottom photo at right above). The block that fits on the light stand should be drilled only part way through so it can't slide down.—F. L. Greenwald

IF YOU'RE ALWAYS RUNNING OUT OF FILM because it's inconvenient to carry along extra rolls, here's a solution. Make a handy belt pouch for your film supply from an ordinary plastic container of the type designed to hold a pack of cigarettes. Such containers usually have an extra compartment at the side for matches that makes them easy to alter for the purpose. Slots cut in this compartment allow you to run a belt through the container without interfering with the main space. Matching slots cut in the upper half of the container let the lid slip on and off over the belt. The pouch will hold two rolls of 620-size film or four 35-mm cartridges. Carrying one or more pouches around your waist will put the film where it's easy to reach and keep your hands free.—Arthur L. Ramos

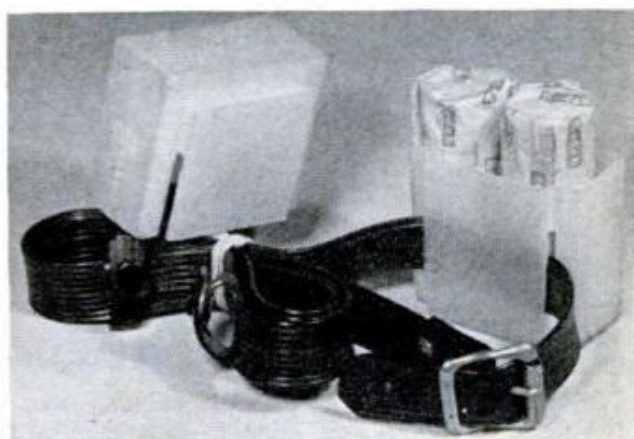

Solving home problems

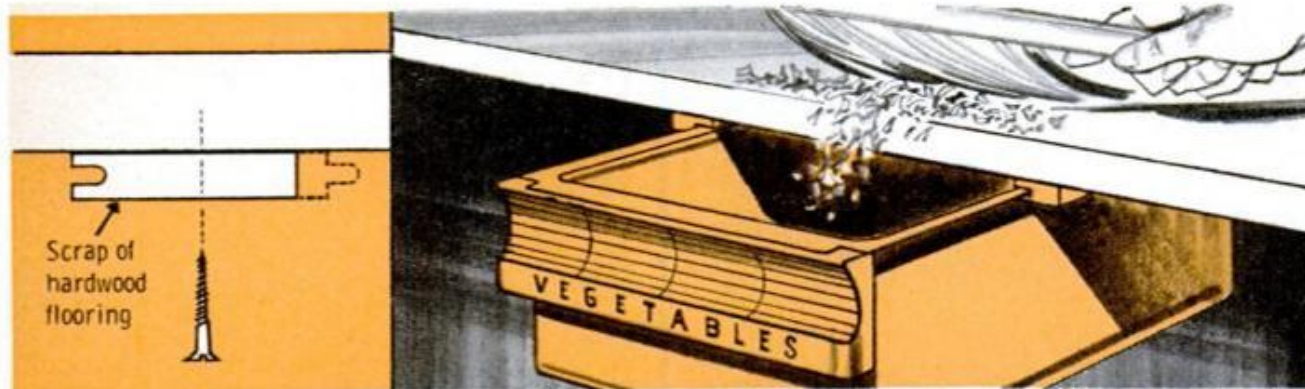

DEBRIS DRAWER on the underside of your workbench slides out to catch the mess when you're cleaning up. Use the vegetable bin from an old refrigerator, mounting it on tracks made of grooved hardwood flooring



TO MAKE ONE KEY stand out from the others on a loaded key ring, drill an offcenter hole in the top and slip the ring through this. It's great for a key used often or one you have to find in the dark



LIGHT-DUTY WALL HOOK to hold a couple of suits or dresses can be made by cutting off the upper part of a heavy coathanger and bending the cut ends to form mounting loops for screws. Bend hook out 90°

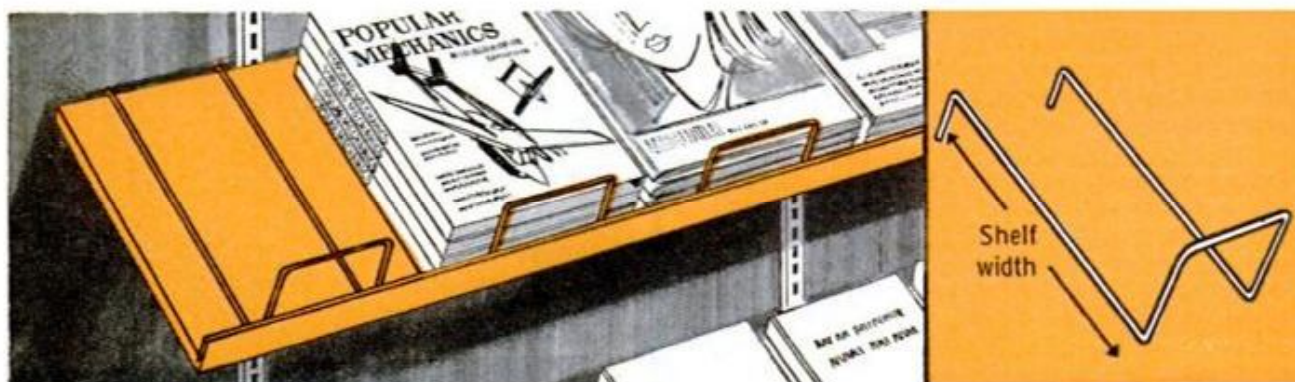

TO INCREASE CAPACITY of an inclined magazine shelf, make extension brackets of coathanger wire to fit the shelf. These will hold three or four times as many magazines as the normal retainer lip on the shelf

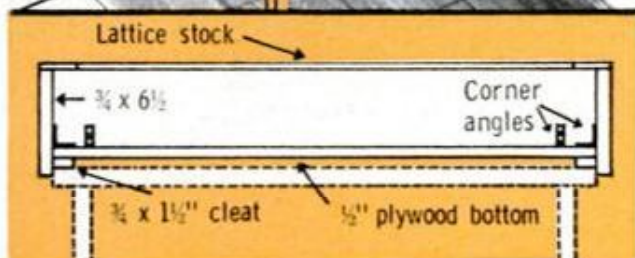

INDOOR SANDBOX is a real mom-saver for those rainy days. It's just a shallow tray with a plywood bottom and a narrow rim which (hopefully) keeps the sand inside. Mount the tray on a cut-down card table

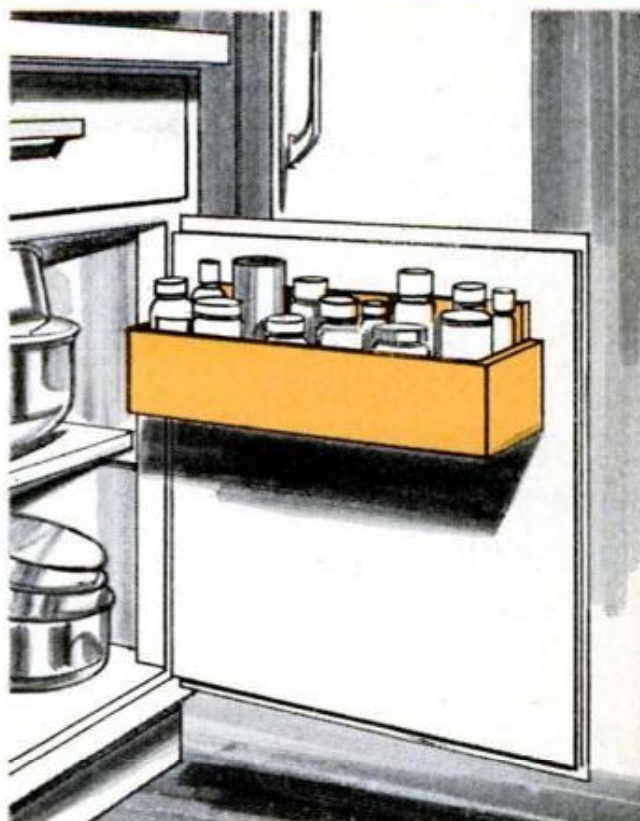

HIDDEN SPICE RACK hung on the inside of a cupboard door near the kitchen range will protect spice containers from heat, dust and cooking film. Make it from plywood and finish to match the cupboards

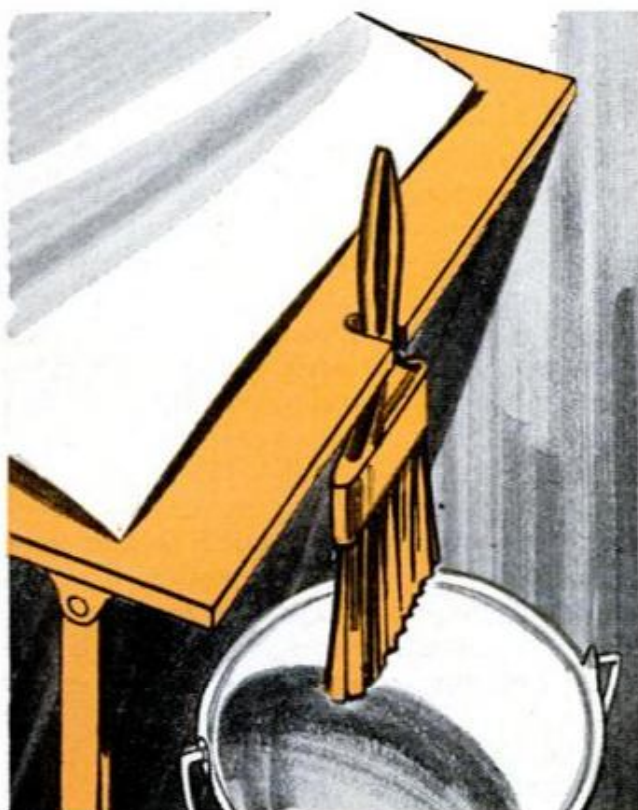

HANDY HOLDER for a paperhanger's paste brush can be made by sawing a square notch in the end of the table slightly narrower than the wide portion of the handle. The paste pail below will catch any drips



BATHTUB VANITY with its own mirror is also the fold-down door to a space-saving storage cabinet installed between the studs. Make the whole thing from exterior plywood and finish to match the bathroom tile

How to Install Underlayment

Any resilient floor covering requires a smooth, firm foundation. This quick course in underlayment covers the three materials you can use under tile or linoleum.

By ARTHUR MIKESSELL

Technical Art by Don Evans



THE BEST TIME to learn about underlayment is *before* you add that extra room, *before* you remodel the kitchen or *before* you convert the garage into a family room. Otherwise, you may discover too late just how important this special foundation is to a new tile or sheet floor, and that's the most expensive way to learn.

Today's resilient floor coverings are all relatively thin. Under the pressure of normal wear, they soon lose that fresh-from-the-carton flat surface and settle to conform to the contours of the surface on which they have been laid. If you have a good underlayment installation, you have nothing to worry about since the surface is perfectly flat.

On the other hand, if the surface is an improper underlayment installation or if you've omitted underlayment entirely, your new floor will soon begin to show high and low areas. High spots automatically receive more than normal wear and they don't take long to show it. Cracks may develop. The floor loses its like-new appearance long before it should and ultimately will have to be replaced much sooner than would otherwise have been necessary.

Underlayment not only provides the



MASONITE PHOTO

necessary smooth and firm foundation for your resilient floor, but also adds a certain degree of stiffness. While not a structural member, the sheet nature of the material has the effect of spreading the load over a larger area, a fact of particular importance if you're putting down resilient floor covering over an old wood floor.

There are other advantages to underlayment not directly related to the floor covering it supports. Insulation, for instance. That extra layer of material can make a big difference, especially if the floor happens to be located over a crawl space.

Underlayment also cuts down on noise transmission. That noisy game of table tennis in your basement rec room will seem much quieter to anyone in the room above if the sound has to penetrate through another layer of material. Like-

TYPES OF APPLICATION

OVER WOOD SUBFLOOR. When an underlayment is being installed directly above a damp basement or an unheated crawl space, apply a suitable vapor barrier between the subfloor and the underlayment material

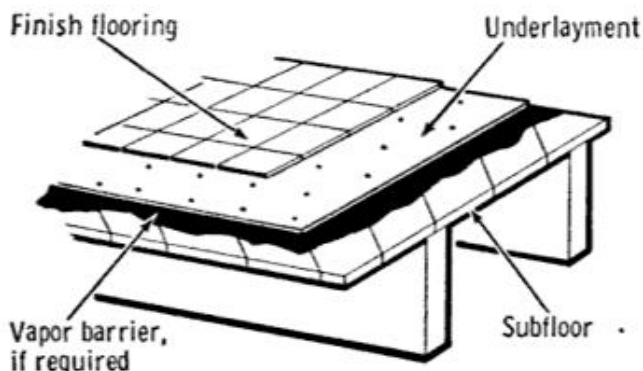

OVER OLD WOOD FLOOR. Remove the base shoe and check the existing floor for flatness and freedom from any protruding nails. The underlayment is stiff enough to bridge small irregularities, such as those that exist in a washboard floor, but any large gaps or low portions should be filled and all high spots should be cut down to furnish a solid base

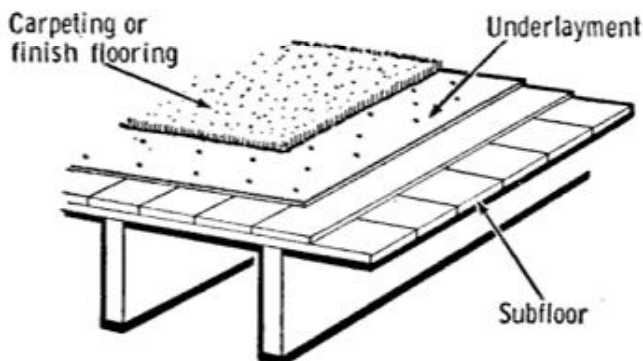

OVER OLD TILE FLOOR OR FILLER LAYER. When it's necessary to build up a new floor to the level of an adjacent floor, asphalt-impregnated insulation board of the required thickness may be used as a filler between the subfloor and the underlayment. Of course, this is assuming that you anticipate no more than normal traffic and average loads. If you expect heavy concentrated loads, you'll need a dense filler, such as additional layers of underlayment. Fasten the filler material to the subfloor, then use at least 1½-in. underlay nails when installing the underlayment. You may install an underlayment directly over an existing tile or linoleum floor, provided that you first remove any loose pieces. However, be sure that it's dry and free of protruding nails

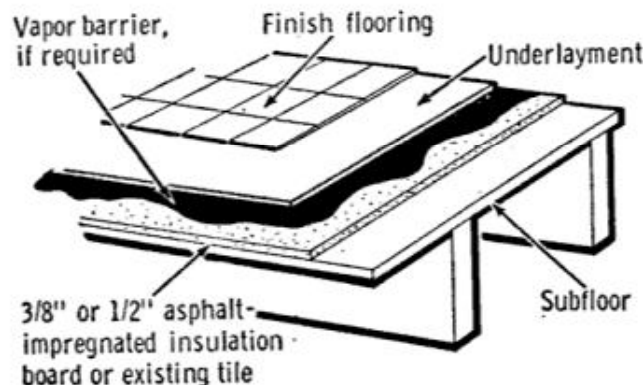

wise, an upstairs nursery having a resilient floor covering laid on underlayment will be better insulated from downstairs noise than if the underlayment were omitted.

Underlayment can be any of three different materials: plywood, hardboard or particleboard. All are specially manufactured for use as underlayment.

Plywood underlayment, for instance, has a "C" pluggier face ply which has been fully sanded for maximum smoothness. Under this is a "B" or "C" veneer designed to reinforce the face ply and resist puncturing. For reasons of economy, the remaining veneers and back are "D".

You can also buy plywood underlayment of the same construction bonded with exterior-type glue for use where unusual moisture might otherwise create a problem.

If you decide to use plywood, be sure to buy underlayment grade. Don't be tempted to go to the more economical "C-D Plugged." This is similar to underlayment, but that veneer beneath the face ply is "D" instead of "B" or "C." This means that knotholes measuring up to 2½ in. are permitted, so it's not as well suited to resist dents and concentrated loads.

Combination product

Incidentally, in new construction you can use a special 1⅜-in. plywood which combines subfloor and underlayment. This "2-4-1" grade not only saves time during installation but performs just as efficiently as separate subfloor and underlayment layers of plywood.

Hardboard underlayment is made by "felting" selected wood fibers, then consolidating them under heat and pressure. The resulting material is dense, grainless and moisture-resistant.

Masonite's hardboard underlayment features the normal smooth hardboard surface on one side, while the other is planed smooth to provide uniform thickness. Printed on each panel are installation instructions, nailing locations and edge alignment marks.

Georgia-Pacific's hardboard underlayment has a coarse-sanded surface to increase adhesive bonding properties.

As noted in the table, some floor-covering manufacturers specifically recommend bonding their products to either the smooth or rougher side of hardboard

FACTS ABOUT UNDERLAYMENT

DESCRIPTION

HARDBOARD

3x4' and 4x4' sheets 1/4" thick

PARTICLEBOARD

4x8' panels in thicknesses of 1/4, 3/8, 1/2, 5/8 and 3/4"

PLYWOOD

4x8' panels in thicknesses of 1/4, 3/8, 1/2, 5/8 and 3/4". Face ply, plugged C; back ply, D

PRELIMINARY WORK

HARDBOARD. Existing subfloor should be clean, dry, securely fastened and free of protruding nails. Where floor is irregular over large areas, low portions should be filled or high spots sanded to provide solid base. (Joint fillers are not recommended.) If atmosphere is abnormally damp due to wet concrete, wet plaster or other temporary conditions, wait until room has dried out before beginning installation. When humidity conditions are close to normal, unwrap panels and stand them on edge separately around the room for at least 24 hours to stabilize to existing conditions.

PARTICLEBOARD. Same precautions as for hardboard concerning atmospheric moisture, condition of subfloor and stabilizing period. For installation over unexcavated crawl space, make sure foundation is well-vented and install a vapor barrier directly over the ground. Never apply directly to concrete or below grade. Hot-air ducts and area over furnace must be well-insulated to prevent localized drying of floor components. Vapor barrier must be installed over subfloor if it's square-edged dimensional lumber. (This is recommended as "good practice" even when subfloor lumber is tongue-and-groove.)

PLYWOOD. Where floor may be subject to unusual moisture conditions, use exterior-grade panels. Choose 1/4" for installation over plywood subfloors or lumber subfloors in which the boards are 3 5/8" wide or narrower. With lumber subfloors made up of wider boards or those that are particularly uneven, go to 3/8" thickness.

FASTENING

HARDBOARD. Use 1 1/4" ring-grooved underlay nails or 4d cement-coated sinker nails. Begin nailing at the center of each panel and work out toward the edges. Nails should be spaced 6" o.c. throughout, but no closer than 3/8" to edge. Drive nailheads flush with surface. You can also use staples to fasten underlayment, but you'll need a "spotnailing" machine. Recommended are etched or galvanized divergent chisel-point or plastic-coated staples 7/8" long, such as those made by Spotnails, Inc. These should be spaced 6" o.c. throughout the body of the panel, but only 3" apart along the edges and no closer than 3/8" to edge.

PARTICLEBOARD. Nails or staples should be long enough to penetrate subfloor at least 3/4". Begin at center and work outward. Use 6d ring-grooved nails for 3/8"-5/8" thickness, spacing them 10" o.c. throughout body, 6" o.c. along edges and no closer than 1/2" to the edge. If stapling, use 1 1/8" galvanized divergent chisel-point staples for thicknesses to 3/8", 1 3/8" length for 1/2" thickness and 1 1/2" for 5/8". Staples should be spaced 6" o.c. throughout body, 3" o.c. around the edges and no closer than 1/2" to the edge. Staples should be countersunk.

PLYWOOD. If nailing, use 3d ring-shank nails for thicknesses to 1/2" and 4d nails for 5/8 or 3/4". Space them 8" o.c. throughout the body and 6" o.c. along the edges. Staples should be 16-ga. (18-ga. for 1/4") and long enough to penetrate at least 5/8" or completely through subfloor. Staple spacing is 6" o.c. in body and 3" o.c. along edges. Unless subfloor and joists are thoroughly seasoned material, countersink nailheads 1/16" just prior to laying the finished floor to avoid nail popping. Staples should be countersunk 1/32".

APPLICATION

HARDBOARD. Start in one corner, fastening each panel securely before laying adjoining panel. (Note: Some floor-covering manufacturers specifically recommend bonding their products to the smooth surface or the rough surface. Check this before installing first panel.) Stagger panel joints in one direction. If subfloor is lumber, plan layout so that continuous joints in underlayment are perpendicular to the direction of boards in the subfloor. Avoid placing underlayment joint directly over joint in subfloor. Allow 1/8" space between wall and underlayment. Fit panels loosely, leaving space about the thickness of a dime between adjoining edges. Before putting down finish floor, check all joints for rough edges caused by cutting and use sandpaper or a block plane to smooth any rough areas.

PLYWOOD. Stagger all joints with respect to subfloor joints. For maximum stiffness, place face grain of underlayment across supports and end joints over framing. Allow 1/32" space between panels. Fill any damaged or open areas (joints or splits wider than 1/16", for instance), but don't bother filling nail holes. Sand down any surface roughness around nails or along joints before installing finish floor.

INSTALLATION TIPS

EDGE SPACING

Hardboard: 1/8"
Particleboard: 3/8"
Plywood: 1/32"

PANEL SPACING

Hardboard: thickness of dime
Particleboard: none specified
Plywood: 1/32"

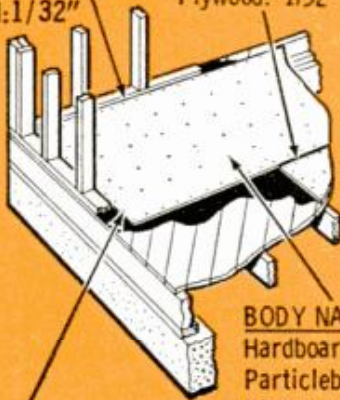

BODY NAIL SPACING

Hardboard: 6" o.c.
Particleboard: 10" o.c.
Plywood: 8" o.c.

EDGE NAILING

Hardboard: 6" o.c. ; 3/8" from edge.
Particleboard: 6" o.c. ; 1/2" from edge
Plywood: 6" o.c.

underlayment, so be sure to check this before you begin the installation.

Particleboard underlayment is made up of matted wood fibers which have been compressed to uniform density and bonded with special adhesives under heat. It's hard, durable, resilient and will resist sharp blows.

When installing underlayment, be sure to stagger the joints in bricklayer fashion. Also, be careful not to locate these joints so that they will coincide with joints in the subfloor. Ideally, the long axis of the underlayment should be at right angles to that of the subfloor.

Detailed instructions for installing each of the three types of underlayment may be obtained from your lumberyard or directly from the manufacturer. For a brief outline of these recommendations, check the table above. ★★★

AUTOMATIC PAINT TRAY MOUNTS ON ANY LADDER

WATER-BASE PAINTS designed for exterior use made it possible to use a roller when painting the outside of your house. They also led to development of an entirely new type of applicator—the foam-plastic “painting pad.”

Basically, this consists of a handle unit and a foam pad having fibers on the painting face. You simply load the pad with paint and wipe it on the surface.

You can replace the foam pad in most models for about the same cost as a paint-roller cover. Like rollers, many have handles threaded for extension poles.

Up to now, painting pads had one big drawback—you had to have a paint-roller tray to load the flat face of the pad. While this presented no problem at ground level or on a stepladder, it made pad painting from an extension ladder almost impossible.

EZ Painter's new Tip'n Dip paint tray, which sells for \$3.49, is an ingenious solution. The wire bracket can be hooked over the square edge of a stepladder step or hung from the round rung of an extension ladder. It also doubles as a carrying handle.

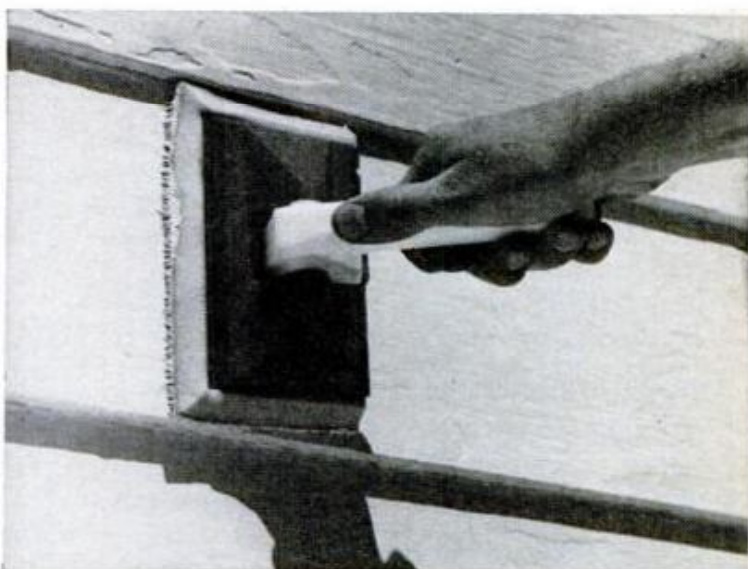
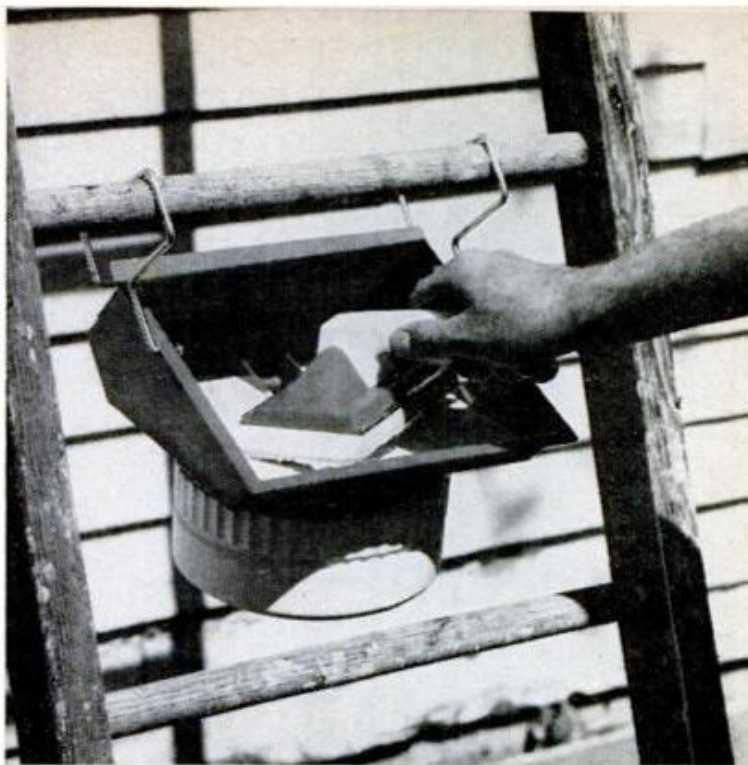

WIRE BRACKET allows tray to hang level (top photo). You can use it with either a painting pad, above, or a paint roller

1. FILL RESERVOIR



2. TIP TO FILL TRAY



3. LOAD PAD OR ROLLER



HINTS FROM READERS

Use guide to tap thin metal

A small wood block with clamping shoulders cut in either end will simplify the job of tapping holes in thin metal. Just drill same-size lead holes in the block and the metal, then align the hole in the block with the hole in the metal and cut threads all the way through. The block has the effect of thickening the metal and serves as a guide for the tap as it threads the hole in the metal.

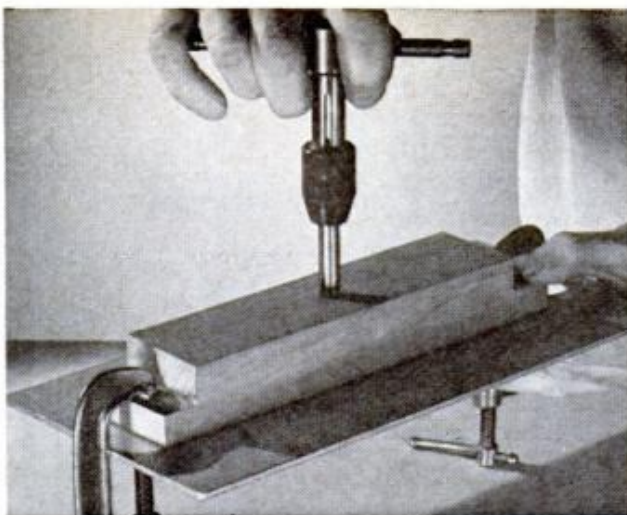

Mini-clamp for small jobs

Occasionally, you may run into clamping jobs too delicate for the clamps you have on hand. The best solution is to make up small clamps such as those shown at right. Each requires a pair of spools, two large washers and a long bolt with a wingnut. The washers go on the ends to provide bearing surfaces for the bolt head and nut. For most small jobs, tightening the wingnut with your fingers will produce sufficient pressure. If more is required, grip the bolt head with a wrench. It's a great idea for hobbyists.

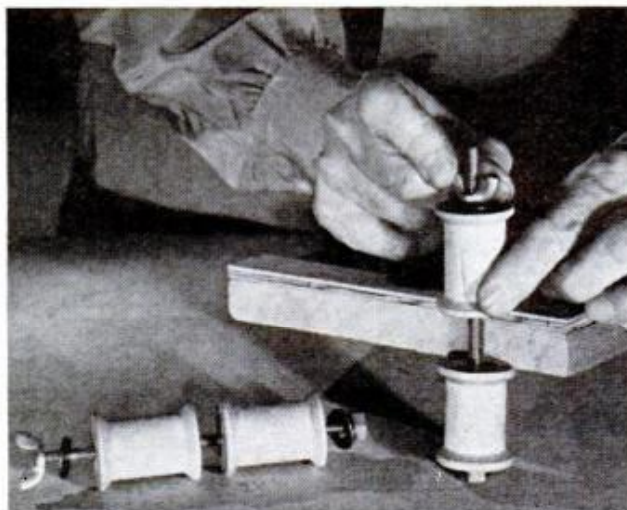

Handy solder dispenser

Any small straight-sided plastic bottle with a screw-on or snug-fit cap can be turned into an easy-to-use solder dispenser with a minimum of work. Drill a hole in the cap to feed the solder through. Next find a dowel or shaft having a diameter slightly smaller than that of the bottle and coil the solder around this. Leave one end long so it can be pulled up through the coil and out the top.

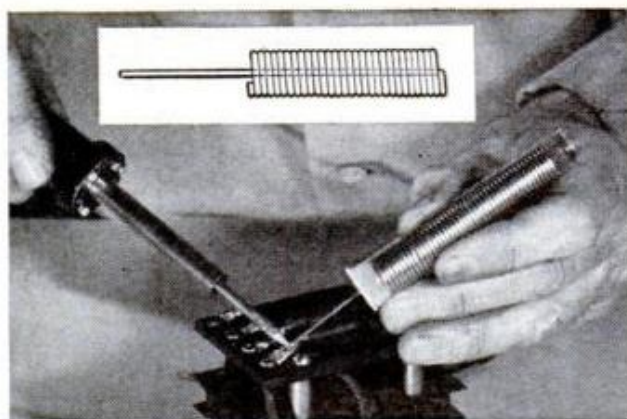

Improvised marking gauge

When you need a marking gauge you can easily improvise one with a wooden clothespin. Cut off one leg of the pin flush with the bottom of the notch to form a shoulder which will ride against the edge of the stock. Then drill marking holes at desired intervals, measuring from this shoulder. If you need greater capacity than that offered by a clothespin, the same basic idea can be used with any light square stock in your scrap box. Just cut a shoulder, then drill marking holes.



Crosscut Guide for Your Portable Power Saw

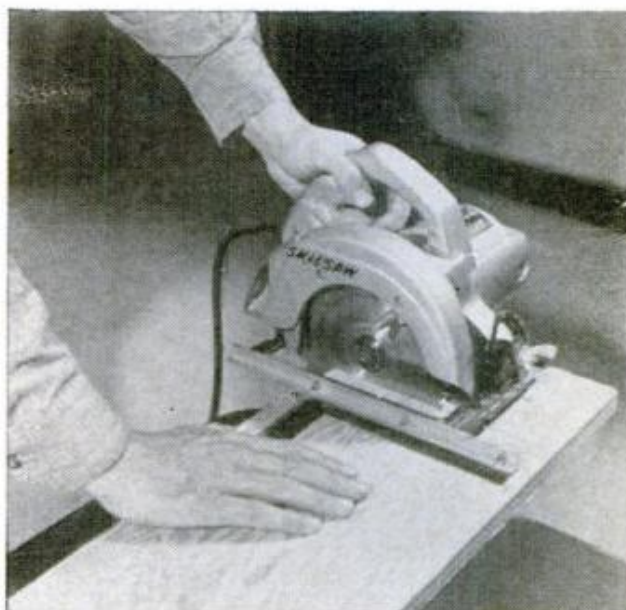
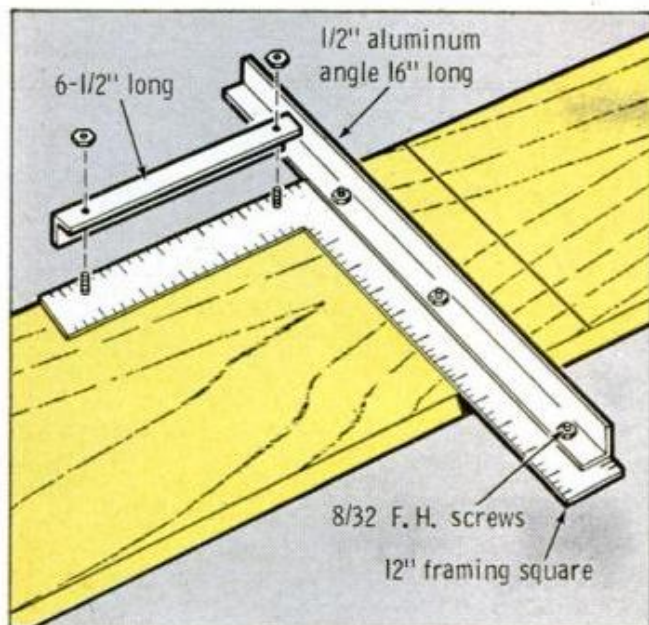

THIS SIMPLE SAW GUIDE is the handiest possible accessory when you run into a job requiring table-saw accuracy from your portable power saw. Made from a 12-in. framing square and two lengths of aluminum angle, it will handle stock up to 12 in. wide which is sufficient for most cutting jobs of this type. You can make it for about two dollars.

Mount the aluminum angle on the square with countersunk flathead screws so that it will lay flat on the stock. The shorter piece of angle fits against the edge of the stock and automatically aligns the square. The longer piece guides the saw.

Incidentally, the guide shown here is strictly for southpaws. If you're right-handed, change the angle mounting accordingly.—*Joseph L. Barry Jr.*

Syringe proves handy in shop

A battery-filling syringe can be a valuable addition to your shop. It's great for forcing solvent or oil into hard-to-reach spots, and it holds enough fluid to make frequent refilling unnecessary. Such a syringe is also handy for washing the parts of a firearm without completely dismantling it.—*Wayne M. Judy*

Improvised chuck-key holder allows key to turn freely

There are plenty of chuck-key holders on the market today, and most of them work quite efficiently. However, this easy-to-make holder not only ranks right up at the top in efficiency but costs practically nothing. It's made from a scrap strip of sheet metal roughly 3 in. long. Just drill a hole near one end slightly over-size for the key shaft and crimp the other end around the drill cord about a foot from where it enters the handle. Then drive the key handle out, slip the shaft through the hole and replace the key handle.—*William Waggoner*

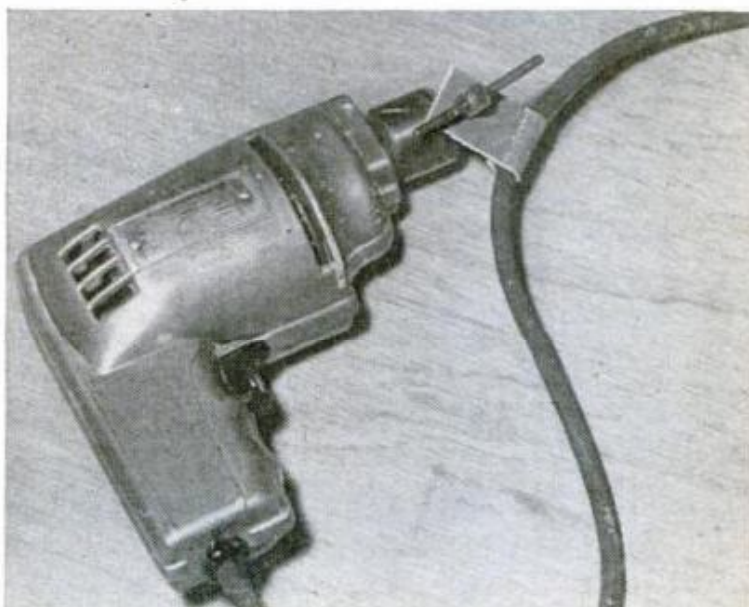

How to Put a Keen Edge on Irons and Chisels

Once you know how blades are sharpened originally, resharpening them becomes a simple 3-step procedure

DURING THE MANUFACTURE of a plane iron or chisel, a blade is heat-treated to make the steel hard enough to "take" a cutting edge and tough enough to "hold" it. After the blade is surface-ground, the business end is ground to a 25° to 30° bevel, yielding a wedgelike edge acute enough to cut wood fibers, yet beefy enough to resist nicking. The edge then is whetted true and honed smooth.

Thus, resharpening such a blade is really a metal-finishing job. If you repeat the manufacturer's three original finishing steps, you can resharpen *any* beveled cutting tool scalpel-sharp in minutes.

The first step is to true the blade's flat face; the second, to recut the edge-bevel; third, to hone both faces perfectly smooth.

You'll need two oilstones; a combination coarse-and-fine stone for whetting, and an Arkansas stone for honing.

Most combination stones are made of vitreous-bonded synthetic abrasive grit, such as silicon carbide or aluminum oxide. Silicon carbide stones are sharper and fast-cutting. Aluminum oxide stones cut slowly, plowing shallow scratches and leaving a smooth finish.

Arkansas stones are finely-textured



By JOHN BURROUGHS

natural white rocks actually quarried in the Ozarks. They're available in two quality grades, hard and soft. Hard Arkansas stones are expensive and slow-working, but hone superbly and wear forever. Soft Arkansas stones are cheaper and slightly faster-working, but are more porous and thus wear faster. (All stones should be saturated with non-gumming mineral oil before use.)

Ordinarily a bevel-edged blade won't require grinding. When the cutting edge is chipped or badly nicked, however, grind down the bevel on a 70-grit aluminum oxide wheel to remove the nicks. Take care when grinding not to heat the blade enough to draw its hardness.

Whetting the flat side of the blade, the initial step in resharpening, produces a perfectly true plane surface by removing minute rust pits and scratches *without* rounding the cutting edge. Place the blade flat on the fine-grit side of your combination stone and lightly work it over the stone without rocking. With plenty of oil, suction will help keep the blade flat. Continue whetting until the steel has a smooth, true finish edge to edge.

To whet the blade's edge bevel (the



TRUE THE FLAT FACE of the blade on the fine-grit side of combination stone. Oil is necessary

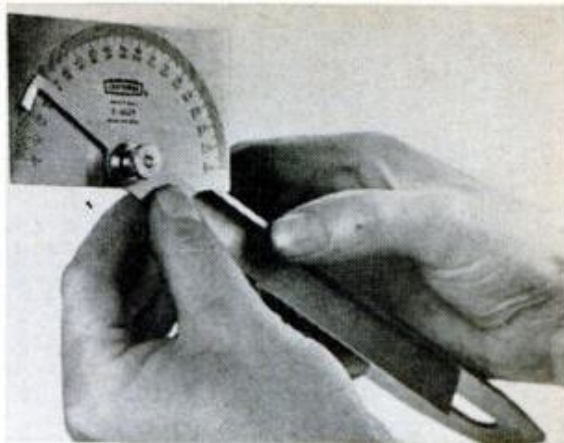

BEVEL ANGLES range from 25° for finish work to 30° for rough cutting. Always maintain original bevel

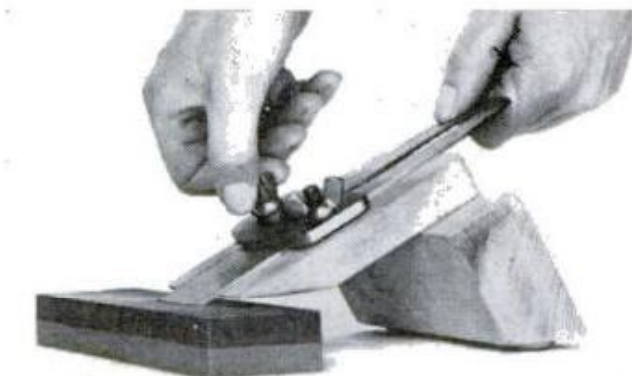

WHETTING BLADE PRECISELY is simple with aid of jig shown. Rig a wingnut clamp to hold the blade



SWIRL BLADE on coarse side of stone to true bevel and grind out nicks. Then finish-whet on fine side

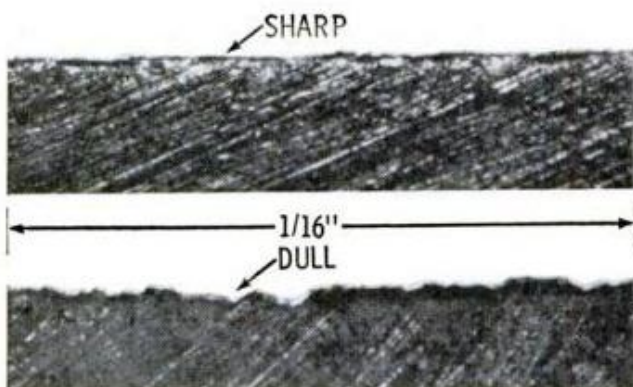

MICROPHOTOGRAPH of 1/16-in. portion of plane iron shows cutting edge before and after oilstoning

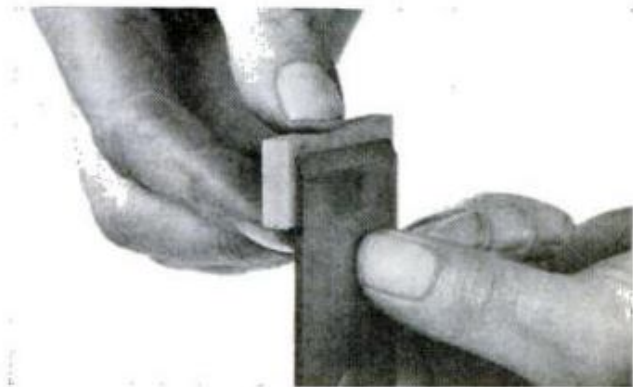

HONING BACK AND BEVEL with a pocket-size hard Arkansas stone leaves cutting edge scalpel-sharp



WITH A BENCH-SIZE STONE, keep the bevel flat on stone surface to avoid rounding the cutting edge

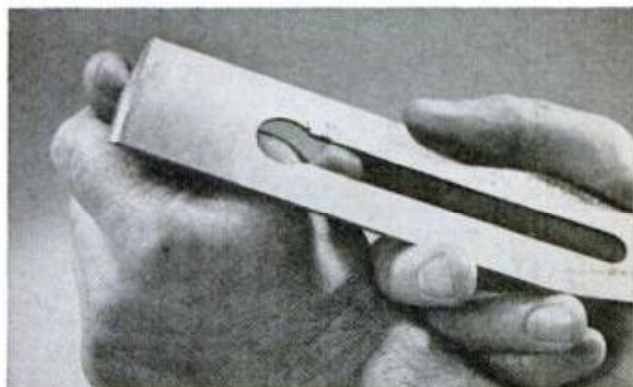

STANDARD TEST FOR SHARPNESS is to push blade lightly over thumbnail. Edge should bite, not slide

GRINDING ANGLES FOR WOODTURNING TOOLS

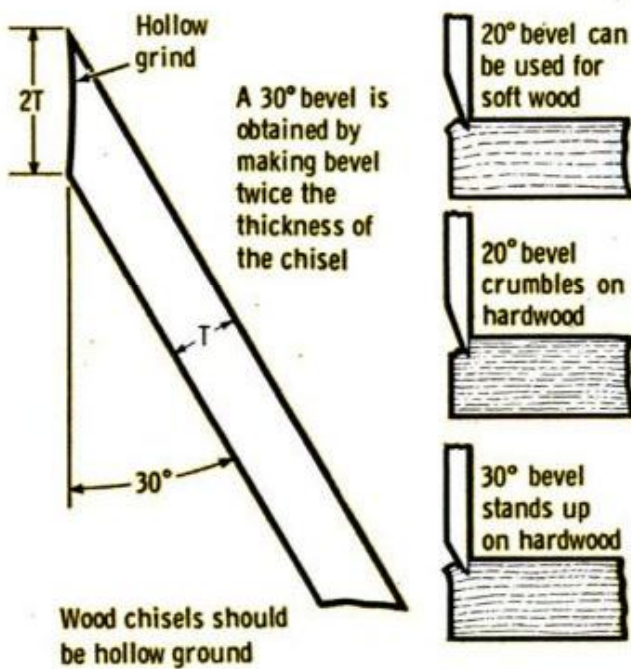
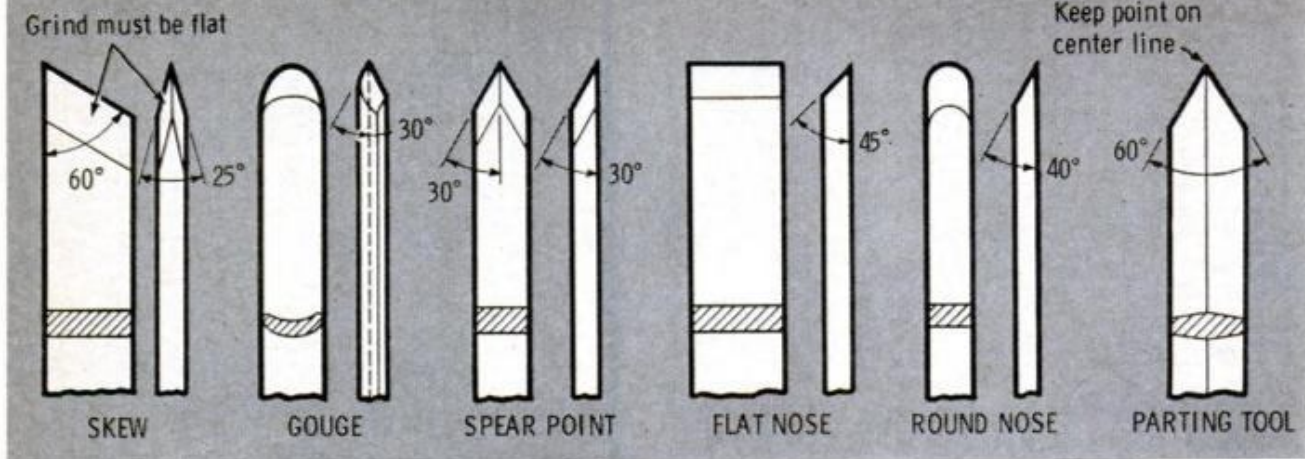

second step), switch to the stone's coarse-grit side. While it's possible to whet the bevel with the blade held freehand, you can do a better job if you clamp the blade in the sharpening jig shown in the photos and drawing. Secured in the jig, the blade can be swirled rapidly on the coarse side of the stone with firm pressure, which will quickly cut the bevel perfectly true. Then re-whet the bevel on the stone's fine-grit side. Finish this fine-whetting by using very light pressure—just the weight of the blade—to whet away any burr or wire edge on the cutting edge. Lubricate the stone liberally with mineral oil and at intervals wipe it clean with a rag to prevent the grit from loading with metal cuttings and swarf.

Blades of hand planes used for edge-joining are sharpened straight across, like chisels. Blades of jack planes used for surface planing have slightly rounded corners to minimize lap marks. To round a plane iron's corners, carefully stone ends of the edge-bevel freehand when you've finished jig-whetting.

Finish-honing the edge on an Arkansas stone, the last step, is really a polishing operation. Removing little metal, the Arkansas stone polishes out the minute scratches left by the synthetic stone's grit and thereby smooths microscopic ragged sections along the cutting edge. The edge honed to a mirror finish cuts more cleanly and stays sharp much longer.

To hone an edge with a pocket Arkansas stone, clamp the blade edge-up in a vise. Holding the stone flat, work it back and forth first along the edge-bevel and then across the flat face, honing both sides of cutting edge equally. If you use an Arkansas bench stone, keep the blade's flat face squarely on the stone. ★★★

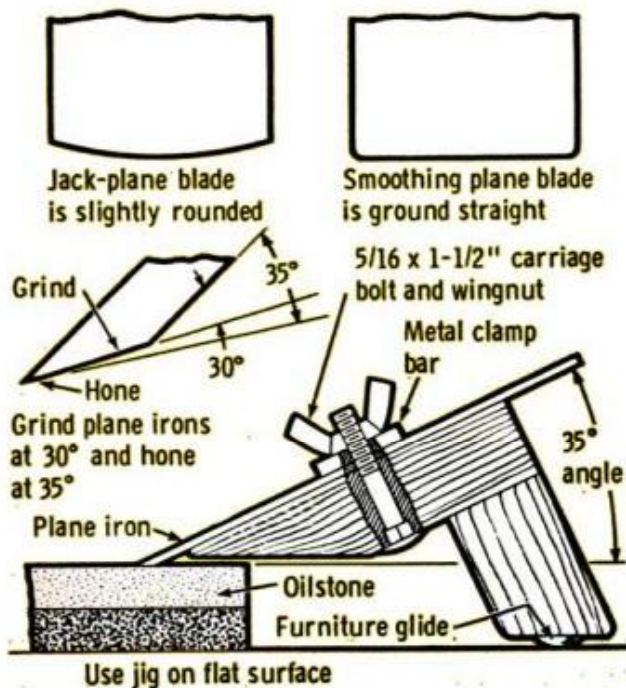

HOW WOULD YOU DO IT?

Gaining those extra inches

"The new jet they just delivered won't fit into the hangar, Mr. Keen," reported the company pilot. "The doorway has 17 ft. of clearance, but the tail of the plane is 17 ft. 4 in. high."

"Can we notch the opening and roll the plane in?" asked the vice-president.

"No, the lintel is a load-bearing steel girder," said the chief mechanic. "We'd have to cut it and weld in a new section."

"Not enough time with that hurricane due in eight hours," injected the pilot.

"Wait! Instead of cutting, let me try *adding* something to do the job!" exclaimed the chief mechanic. "Just give me another man to help."

Three hours later, the plane, completely intact, snugly stood in the hangar.

How was it done?

Tail 4" higher than hangar opening

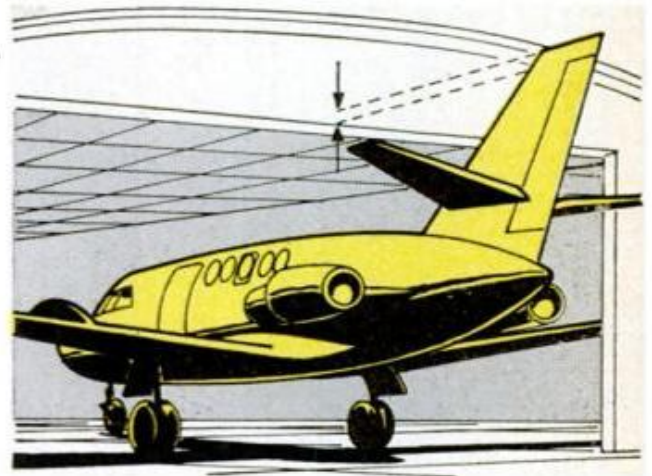

Thinking twice did it

"Got to string eight lengths of wire across this new quarter-mile stretch of fence," moaned Pete. "Since it's a straight run, though, I can tie one end to the first post, secure the reel to the Jeep and unreel the wire as I drive. But I'll never make the eight trips in time to see the rodeo."

Pete's crony took the wire and examined it. "It's light and flexible," said Steve. "I saw a big old hoist pulley just lying over by that gully. Why don't you use it and run the eight wires in four trips? That would get you to town in time."

Pete paused before answering. "I don't see how I could do it in four trips."

"Bet you the price of two tickets you can," retorted Steve.

Can you explain how?



A matter of rigging

Preparing to install his newly-overhauled auto engine, Ted dollyed it into the driveway between his and his neighbor's garage and then stretched a rope tight from roof to roof.

"That's 1000-lb.-test nylon line," he told Jim. "With my one-ton tackle hooked to the center of the line, that 650-lb. motor won't be any trouble to lift."

"The line's sure to break," warned Jim.

"You're kidding," scoffed Ted. "The line's practically doubled. It should stand up under a ton, not just 650 lbs."

He hauled on the tackle. The line sagged in a shallow V and broke. Ted, however, re-rigged the tackle and five minutes later, the engine was ready to be installed.

How did Ted do it?

(Answers can be found on page 197)

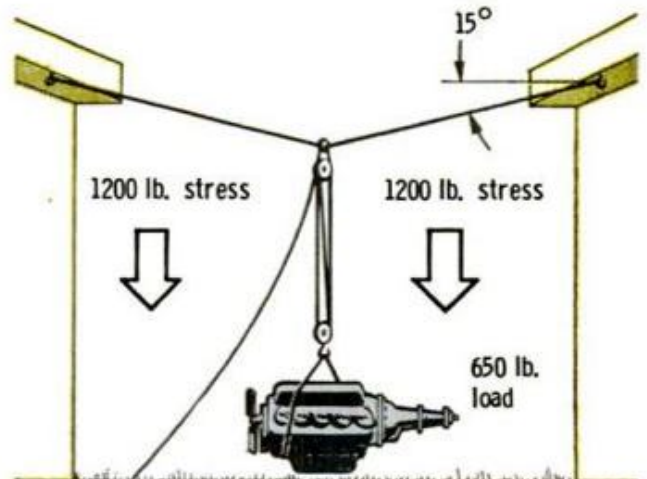

Build PM's Maneuverable Mini-Mover

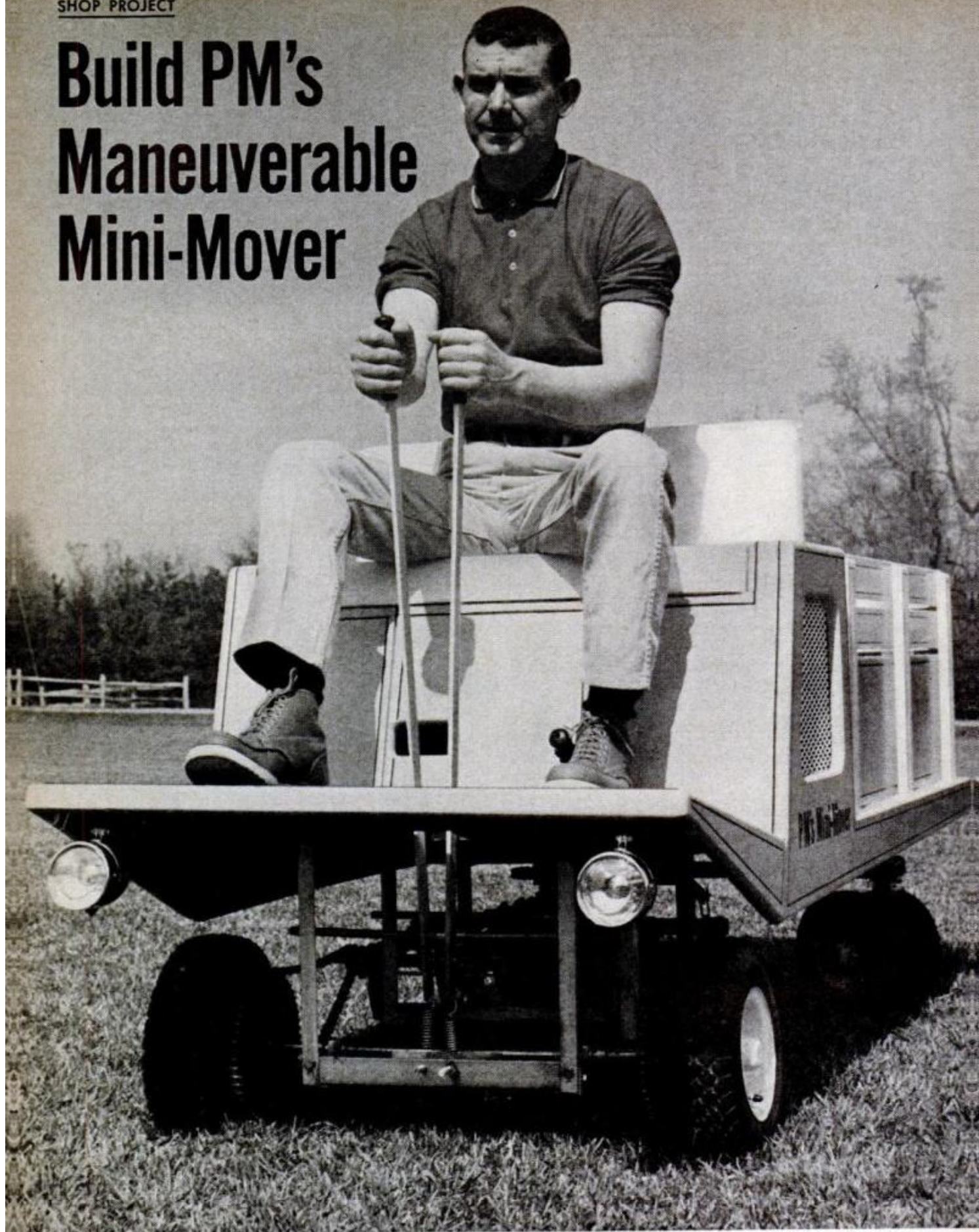

Photo by the author

It's a classy, sassy little utility vehicle you can make for under \$400

By LEONARD E. SABAL, Workshop Editor

Part 2: Body and Finishing

THE BODY of the Mini-Mover is constructed of exterior plywood, with the exception of the trim pieces, which are cut out of pine.

Cut all pieces to size, then assemble with glue and screws. It may be easier if you first align the sections with each other by using finishing nails.

Before assembling the front compartment panels, rabbet the inside edges to accept the sliding center panel. Use a table saw or a router if available. (You can also use the router to round off the edges of the side panel cutouts and deck trim).

In order to clear the heads of the chassis bolts, drill clearance holes on the underside of the cargo bed. Use a $\frac{3}{4}$ -in. spur bit, but make certain the point does not penetrate the top surface of the bed.

Placement of the metal grilles as indicated provides ample ventilation for the 4-hp engine. Outer sections of the grille are held in place by thin cleats with a rab-

beted edge. The inner sections fit into a dadoed frame of pine strips that borders the inner cutouts.

To keep the outer edges of the galvanized sheet lining from lifting, especially when the vehicle is used without the sideboards, a coating of contact cement must be used. Apply the cement to both the lining and the bed, allow it to dry, then fit the lining on the bed and pound it down with a hammer and block of scrap wood. Be sure, of course, that the bed is free of oil and dust before applying the cement.

The basic body can now be secured to the chassis with carriage bolts that also keep the galvanized sheet from lifting in the center. Make certain, however, that the cleats for the sideboard posts are attached to the underside of the bed before fitting the body to the frame.

The sideboards and seat are assembled next. Construction is straightforward, as detailed on page 167. Just be sure to

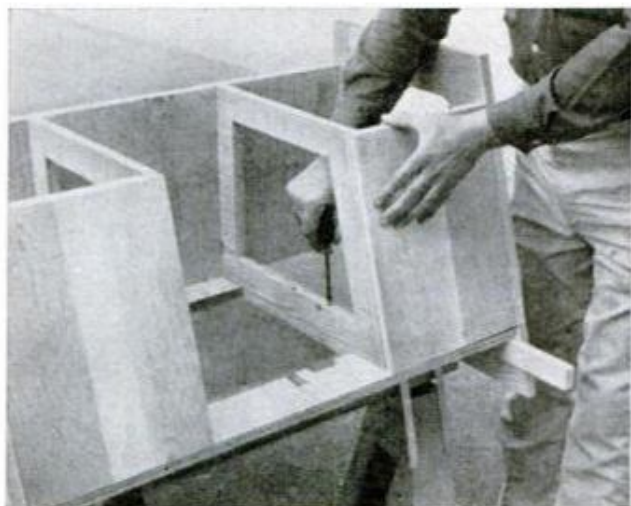

ALIGN PLYWOOD SECTIONS with finishing nails, then use glue and screws to assemble sturdy body

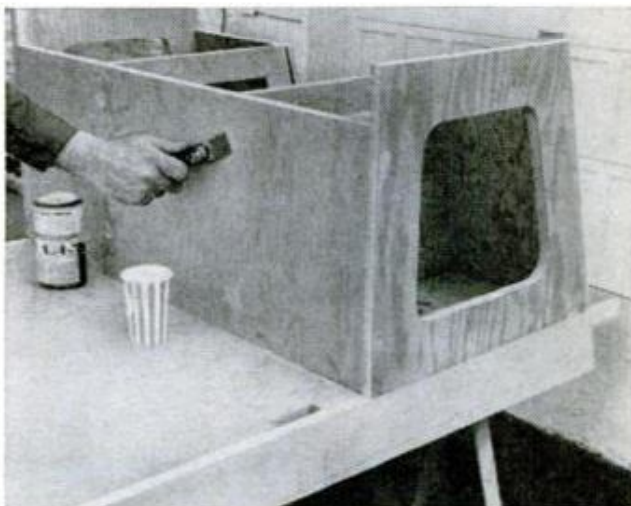

SINK ALL SCREWS and fill holes with wood putty. Allow putty to dry thoroughly before sanding smooth



POSITION SIDEBOARD POSTS accurately by the use of a block of wood as a vertical placement guide

SEPTEMBER 1968

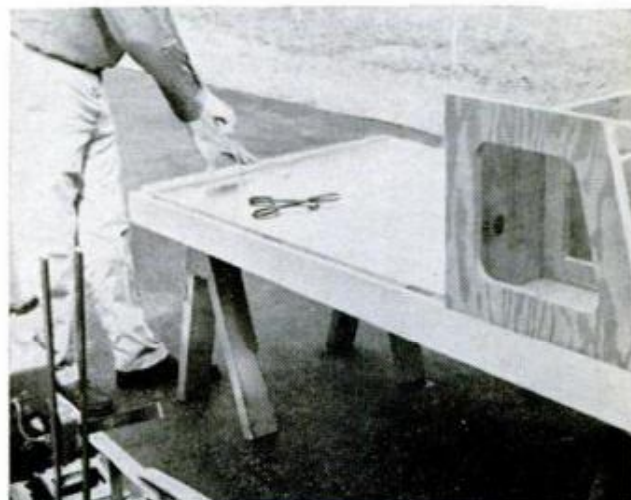

MEASURE AND CUT galvanized sheet for bed so it covers the cargo area just inside the post holes

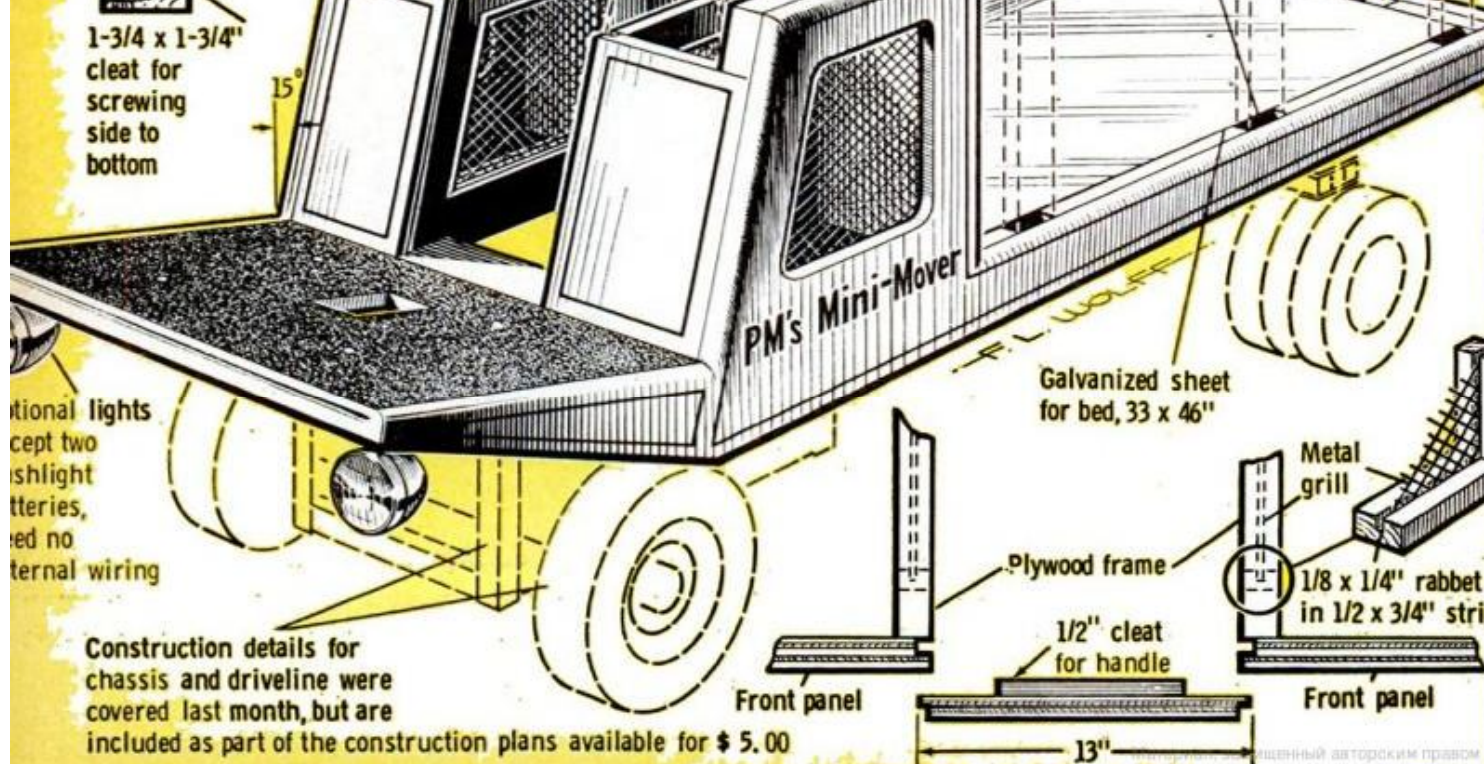
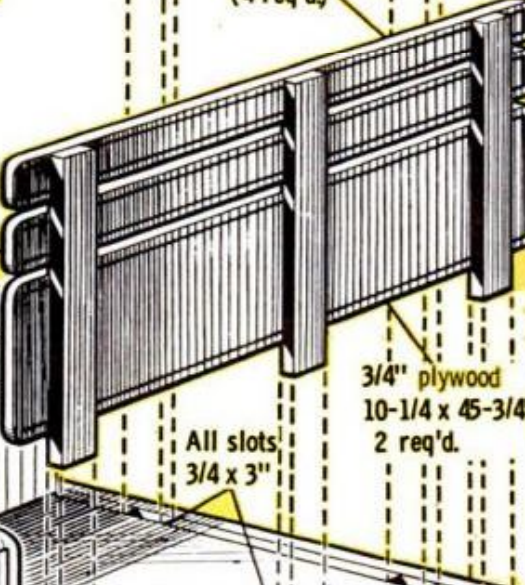
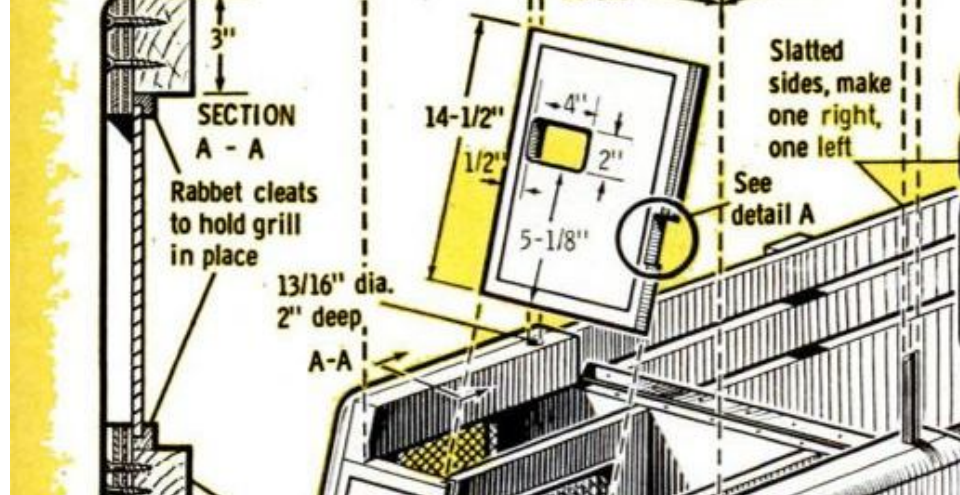
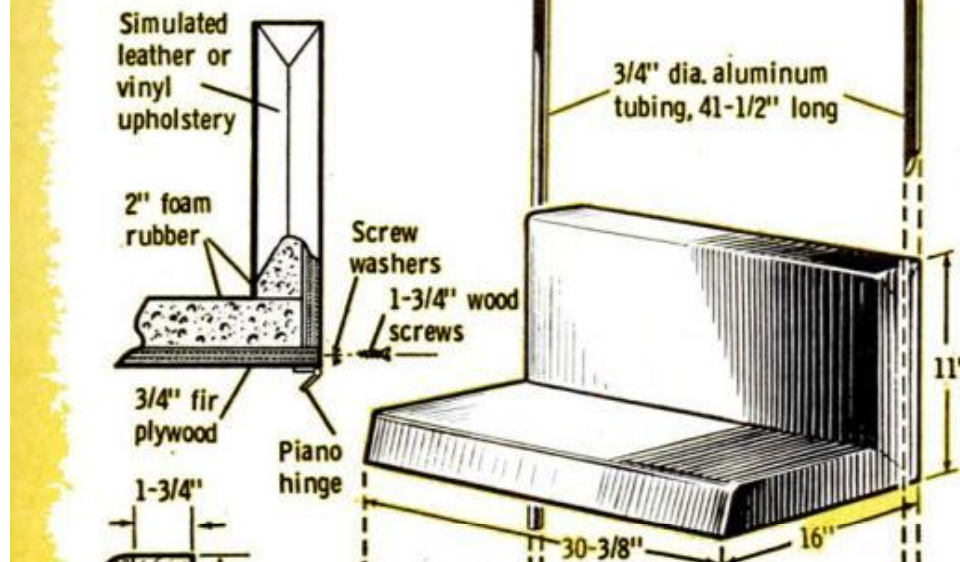
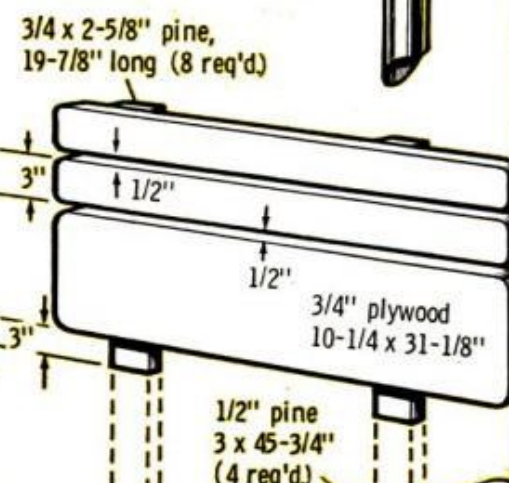
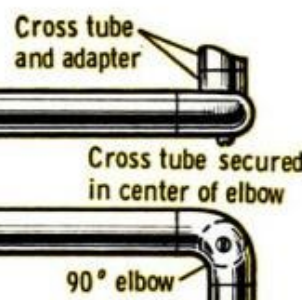
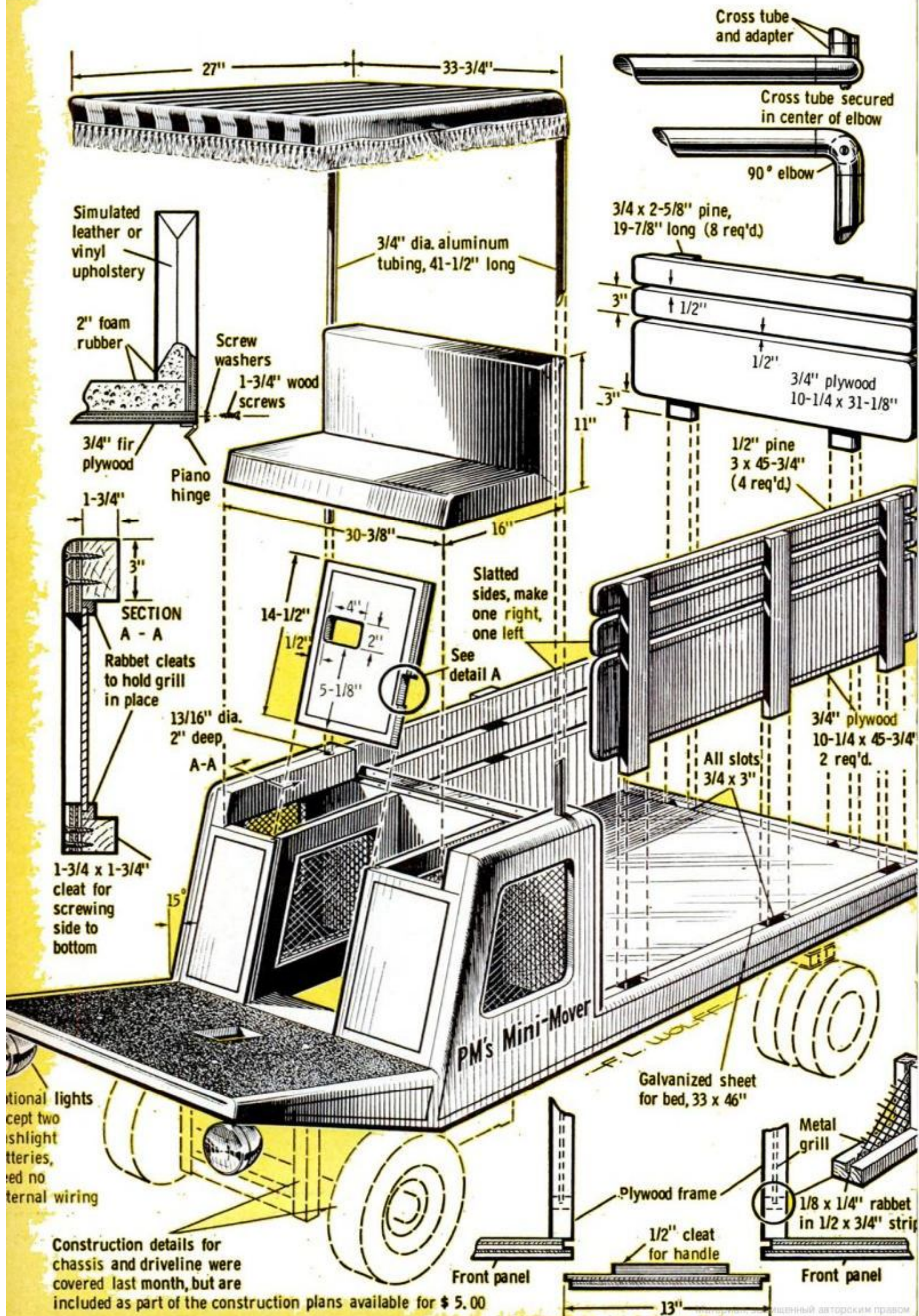

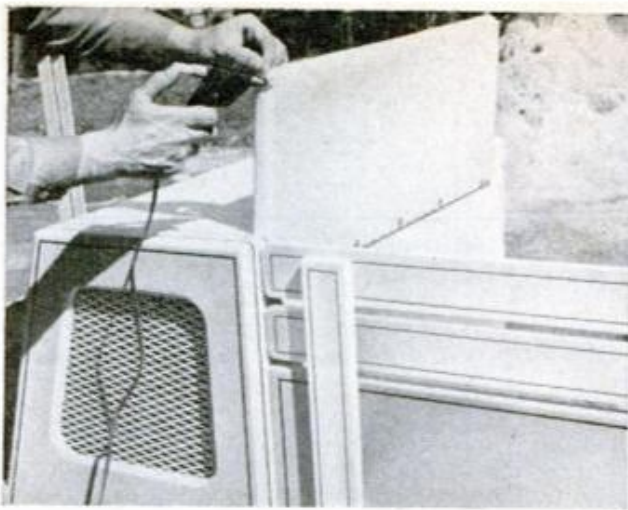

USE SIMULATED LEATHER or vinyl to cover foam-padded seat, and attach it with tacks or glue gun

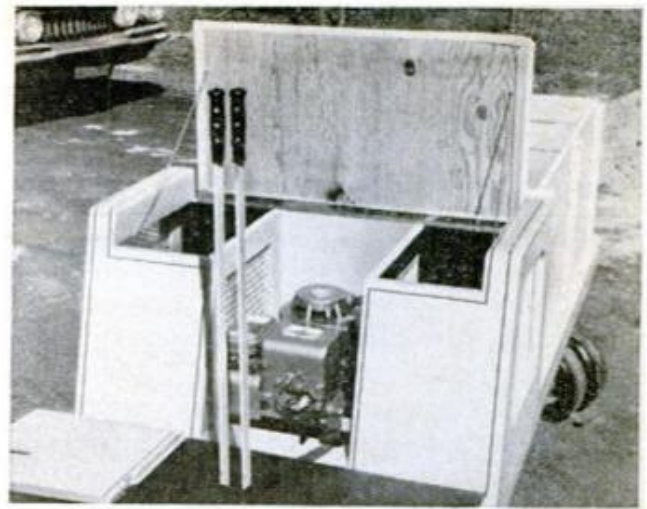

FINAL TOUCHES include chain keepers for seat, mat for floorboard, bicycle grips for control handles

use a wooden guide to assure uniform vertical placement of the sideboard posts, which are set slightly below the top rail.

The canopy frame is made of Reynolds aluminum tubing and fittings. Note, however, that the T-butt connector is placed directly in the center of a 90° elbow. The final effect is that of a three-way elbow, which, unfortunately, is not a part of their do-it-yourself aluminum line.

Finishing the vehicle consists of applying

a coat of primer, followed by several coats of exterior paint. Striping, $\frac{1}{8}$ or $\frac{1}{4}$ -in. wide, adds a professional look. To complete the job, cement rubber floor mats to the footboard and to the bottom of the tool compartments. ★★★

PLANS AVAILABLE

For complete instructions and large detailed plans, send \$5 to Mini-Mover, Popular Mechanics, 575 Lexington Ave., New York, N.Y. 10022.

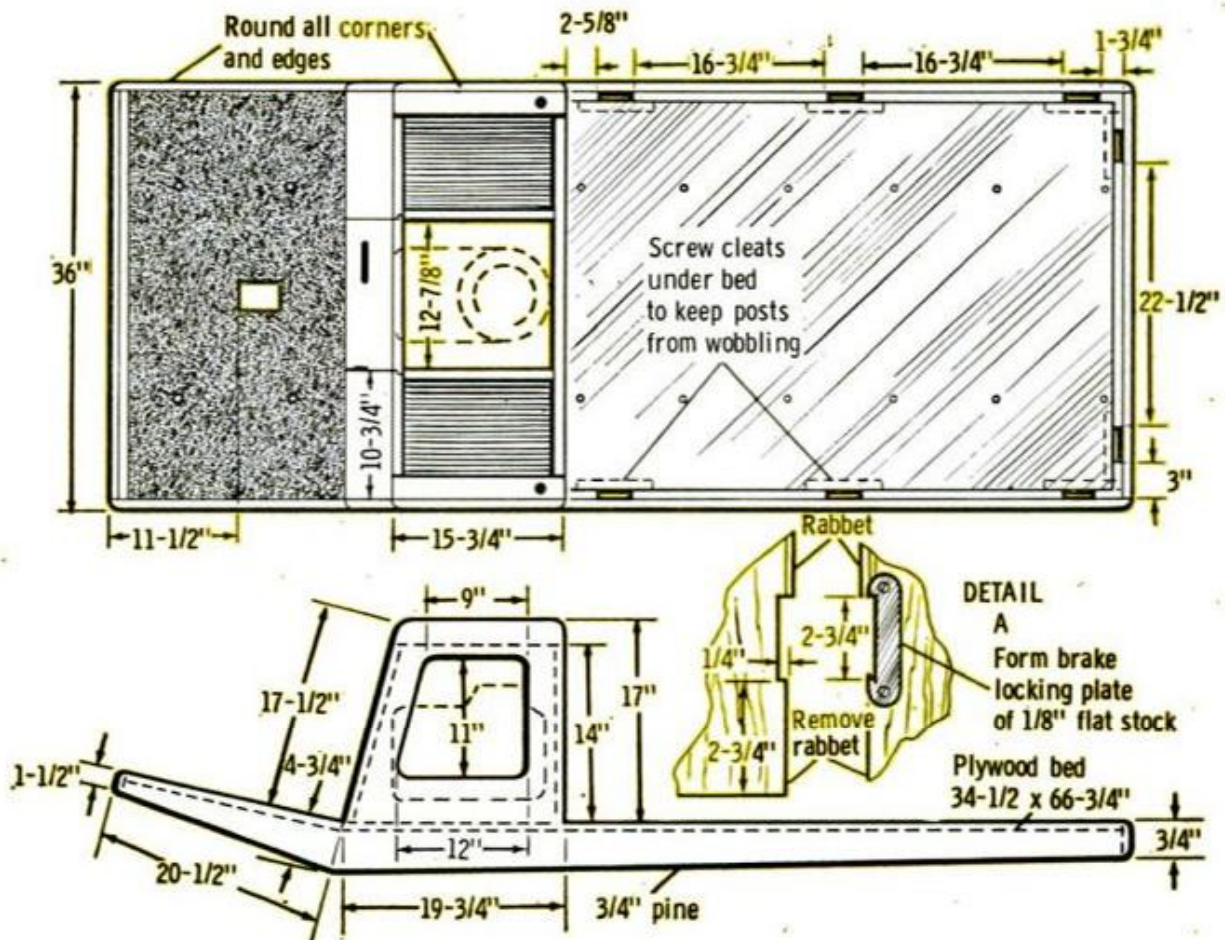

HINTS FROM READERS

Shop-made stud driver

When you find it necessary to drive a stud, but don't have the proper tools at hand, try improvising a driver from a matching nut. Drill a hole completely through the nut and drive a tapered pin into it. Be sure to leave enough room below the hole to allow for a good grip with the wrench. The pin stop will prevent the nut from jamming on the stud. To remove, just back the nut off the stud.

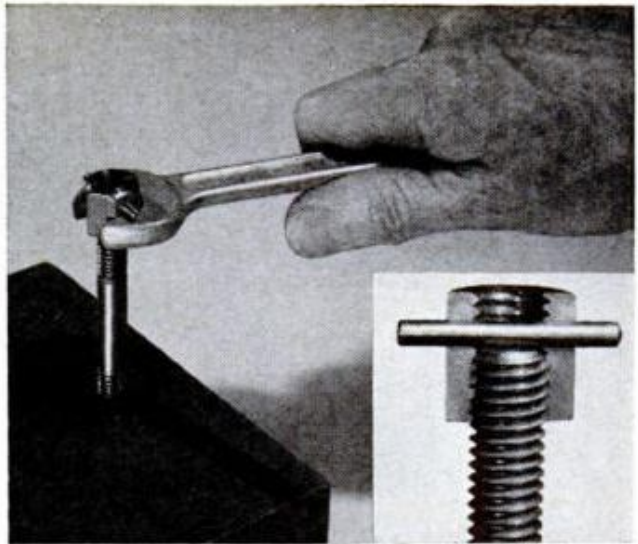

Tape masks glue joints

Some glue is always squeezed out of a joint once clamping pressure is applied. To eliminate the job of scraping away this excess, mask both sides of the joint with cellulose tape. Lay the tape close to the edge of the joint and press it firmly to insure good contact. Once the glue hardens, pull off the tape and the glue will come with it. This is especially good when regluing finished joints which might be scratched during clean-up.



Automatic tailstock oiler

When working with your metal lathe, you can forget about the need to oil the tailstock center repeatedly if you slip an oil-saturated felt washer on the spindle before you clamp the work in the lathe. If the job is very large, it may be necessary to give the washer an occasional extra dose of oil. However, for the average job, the original oiling is sufficient. When not in use, store washers in a small bottle with enough oil to cover them.

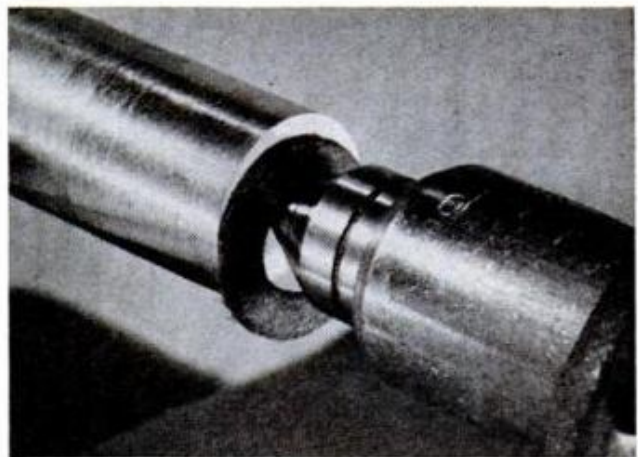

Step block for pulling nails

Use of the simple step block shown at right is a big improvement over the usual practice of placing a scrap of wood under the hammerhead when pulling nails. As a nail is pulled, you can move the hammerhead up the steps for the best possible leverage. The block shown was cut with steps slightly less than 1 in. high. For stubborn jobs, make shallower steps. Another advantage of this block is that nails come out straight so they can easily be redriven if the job requires it.

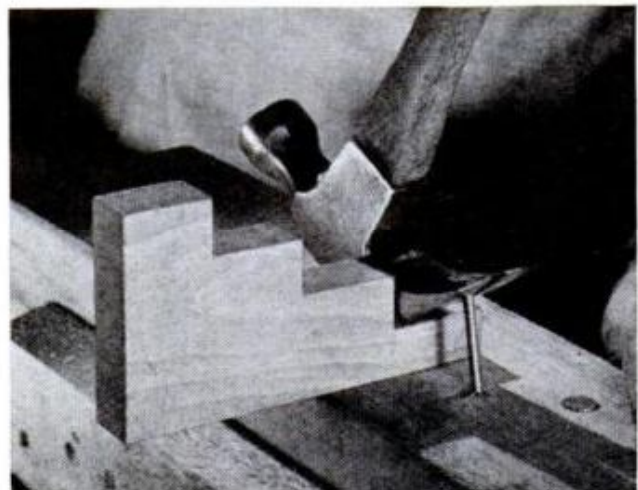

New Tools You Should Know About

Guide for cutting miters

Designed as an on-site substitute for a miterbox, a compact new miter-cutting guide called Trim Square features a beveled lower edge to prevent the saw teeth from coming in contact with the guide during cutting. It's small enough to fit your pocket, fine for cutting all types of molding. Sells for \$2.98 from Estwing Mfg. Co., Rockford, Ill. 61101.

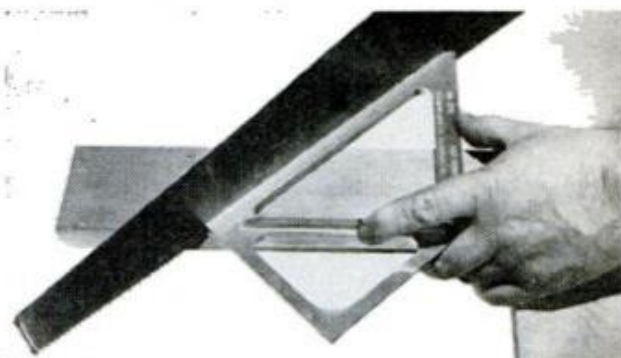

Orbital jig saw

To increase cutting performance, the new Bosch-Lesto jigsaw features orbital saw-blade movement. You can select any of four different degrees of orbital movement to achieve maximum cutting efficiency with different materials. If desired, it can also be set for straight reciprocating movement. The new model (8554) is designed for cutting wood up to 2 1/4 in. thick and metal up to 1/4 in. thick. It operates at 3000 strokes per minute and weighs only 5 3/4 lbs. Standard equipment includes three blades, a screwdriver, a spare blade-setting screw and a spare set of carbon brushes. It's \$99.50 from Robert Bosch Corp., 2800 S. 25th Ave., Broadview, Ill. 60153.

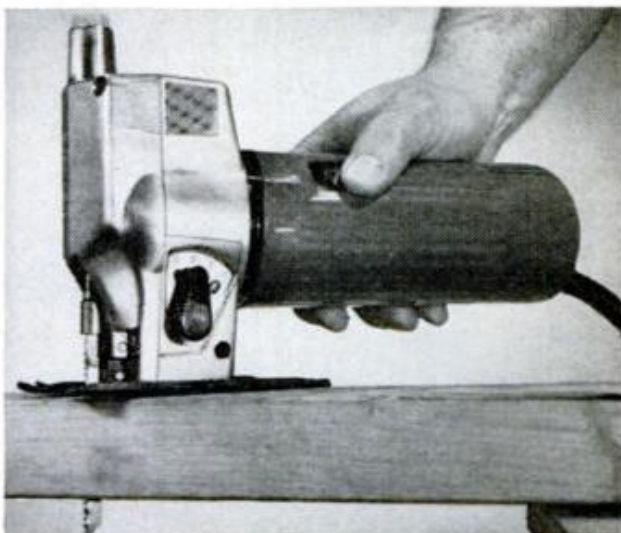

Heavy-duty glue gun

A new glue gun, the Professional Model 250, is a heavy-duty industrial-rated version of the original Thermogrip gun introduced by United Shoe Machinery two years ago. Designed for 60-second bonding of a wide range of materials, the unit employs sticks of hot-melt polyethylene-based glue which hardens through cooling in seconds, eliminating the need for clamping. The 1 1/4-lb. Model 250 sells for \$22.95, including 60 sticks of glue. It's made by United Shoe Machinery Corp., 221 Oley St., Reading, Pa. 10601.



Variable-speed reversing drills

Two new Green Line portable drills from Rockwell are described by the company as "the world's first all-insulated, shockproof, variable-speed reversing drills." As the drawing shows, both 1/4-in. and 3/8-in. drills are insulated at seven points: 1) nonconductive case, 2) structural frame, 3) structural gear housing, 4) nonconductive armature shaft sleeve, 5) nonconductive phenolic brush holders, 6) hard nylon fan, and 7) remote control safety switch with nonconductive thermoplastic shield. The 1/4-in. Model 72 sells for \$29.99 and the heavy-duty 3/8-in. Model 79 for \$34.99 from Rockwell Mfg. Co., 886 N. Lexington Ave., Pittsburgh, Pa. 15208.

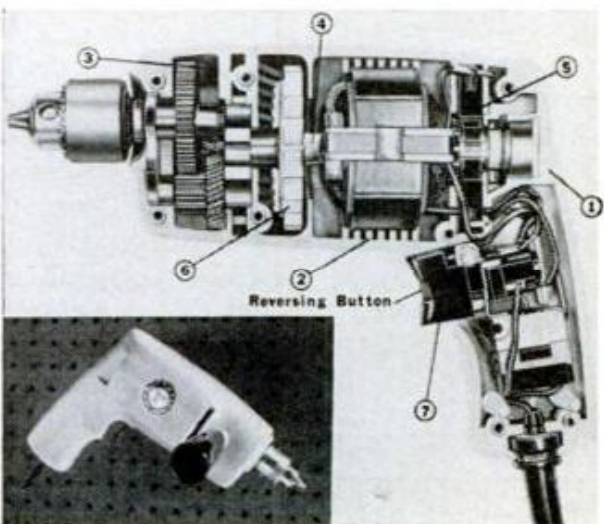

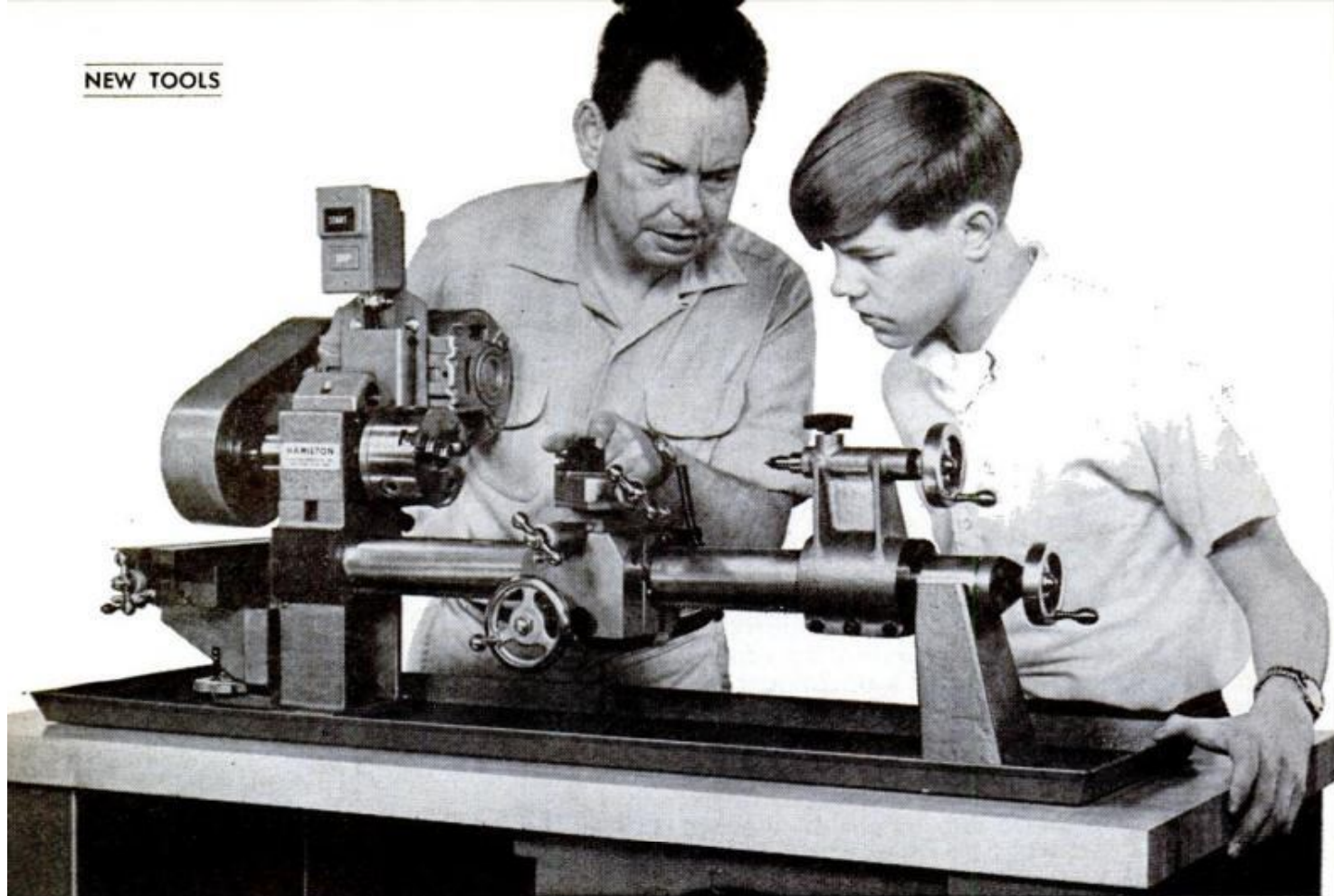

Versatile Package Combines Lathe and Milling Machine

By JOHN BURROUGHS

ALTHOUGH IT WAS DEVELOPED to help teach teenagers basic machining skills, the Hamilton Lathe/Miller would make a great addition to any home workshop.

Just rotate the motor-and-spindle assembly 180° to convert the tool from a 6-in.-swing lathe to a small horizontal milling machine. Set up one way or the other, the beautifully built 150-lb. unit will enable you to perform all basic turning, milling and drilling operations; yet it's compact enough to fit a small bench top.

Used as a lathe, the tool has a 15-in. capacity between centers. Its way is a honed, 2-in. diameter solid steel shaft that can be dressed smooth with an oil-stone if damaged. The carriage has standard pattern, gibbed-dovetail cross and compound-rest slides.

The spindle is a lubed-for-life (but re-

placeable) ball-bearing cartridge with a 3/8-in. bore and a No. 1 Morse taper turned after the unit is assembled. The step-pulley drive features a 3/16-in.-wide Gates Polyflex V-belt with a rated life of 10,000 hours and can be adjusted for eight speeds from 360 to 2820 rpm.

Rotated for milling, the spindle indexes squarely above the 14-in.-long milling table. The entire table slides vertically on the headstock casting, providing a height adjustment of 4 1/4-in. Calibrated feed-screws allow the table to travel 8 in. longitudinally and 3 in. transversely. A drawbar secures the milling arbor in the spindle's taper. Adapters to hold end mills or shell mills are available as accessories. For more information, write to: Hamilton Associates, Inc., Machine Tool Div., 1716 Whitehead Rd., Meadows Industrial Park, Baltimore, Md. ★★

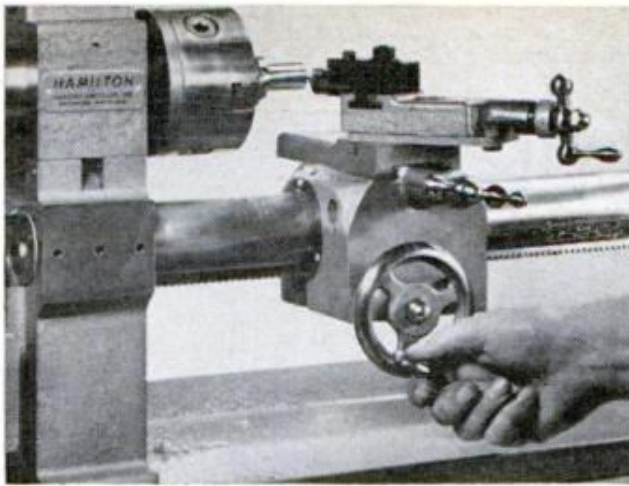

LATHE'S WAY is solid 2-in. dia. steel shaft. Carriage has dovetailed cross feed and compound slides

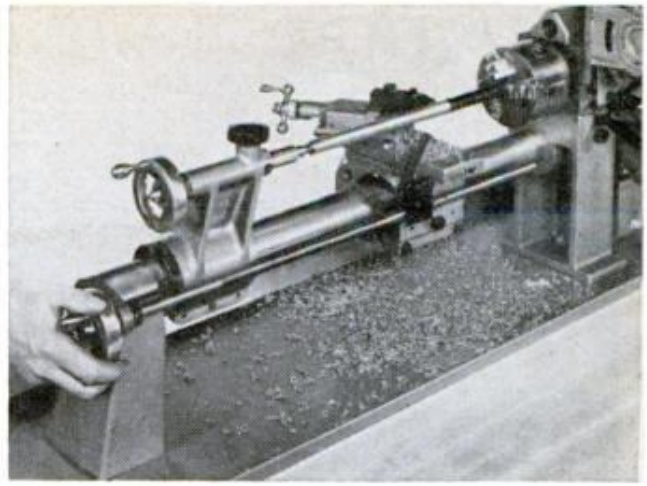

HAND-CRANKED LEAD SCREW provides even feed for finish cuts. Half nut on carriage back engages screw

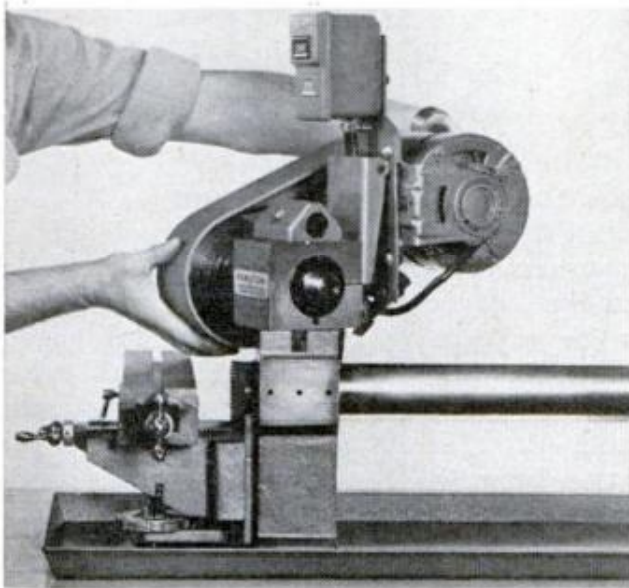

CONVERT LATHE TO MILLER by rotating spindle and motor 180°. Headstock assembly indexes accurately

TABLE OF SPECIFICATIONS

DIMENSIONS

| | |
|--|---------|
| Overall length of machine | 38½ in. |
| Overall width | 17 in. |
| Overall height | 21 in. |
| No. 1 Morse taper in spindle and tailstock, with ⅜-in. hole through spindle. | |

LATHE

| | |
|--------------------------|--------|
| Swing over bed | 6 in. |
| Swing over cross slide | 3 in. |
| Distance between centers | 15 in. |

MILLING MACHINE

| | |
|---------------------|--------|
| Table length | 14 in. |
| Table width | 2¾ in. |
| Table travel | 8 in. |
| Cross travel | 3 in. |
| Vertical adjustment | 4¼ in. |

T-slot ⅜-in. wide along table center. Cost of basic machine without motor or switch is \$650 f.o.b. Full line of accessories available.

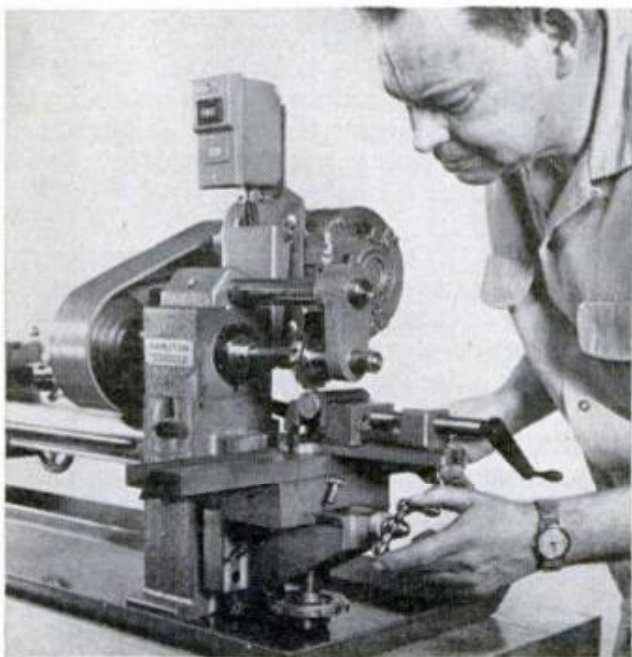
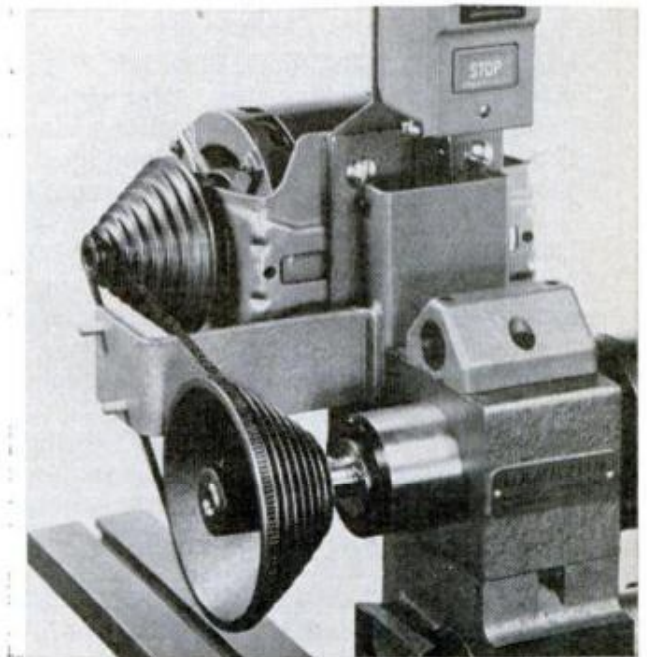

TABLE FEATURES VERTICAL, four-way horizontal feed. Auxiliary overarm assembly supports arbor cutter



EIGHT SPEEDS from 360 to 2820 rpm are provided by unusually narrow belt riding in the step pulleys

HINTS FROM READERS



Barn-door handle

Closing the upper part of a stable door from the inside is usually a job involving a lot of unnecessary effort. The only place to grip is the bottom edge. An ordinary doorstop midway on the crosspiece offers a more efficient grip and cuts the risk of pinched fingers. —G. E. Hendrickson



Hammer pad

When pulling nails with a claw hammer, you may find there isn't enough room to slip a block of wood under the head to protect the surface of the wood. At such times, try using a broad-bladed putty knife in place of a block. It offers protection, and is handy to hold. —L. C. Schultz

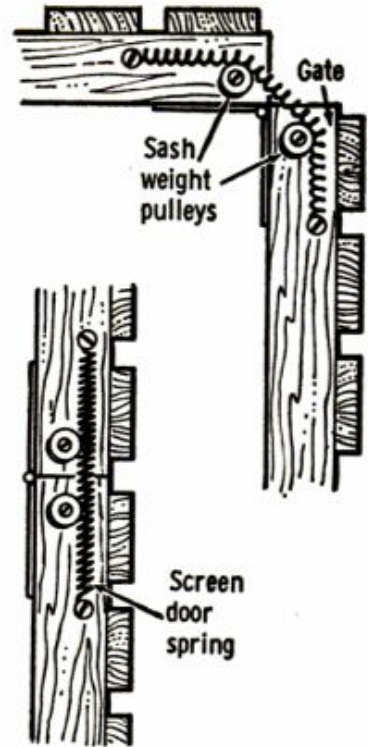

Gate closer

Using a couple of old sash pulleys and a screen-door spring, you can make a simple mechanism which will close any gate automatically. Mount one pulley on the gate and the other on the gatepost, stretch spring across both and anchor ends. Spring closes gate. —W. B. Rasmussen

NEXT MONTH IN SHOP AND CRAFTS

HOW TO LAY CONCRETE BLOCKS. Even if it's your first attempt, you can easily turn out a professional-looking wall. After all, the best jobs are often produced by an interested beginner who cares enough to pay close attention to the important details. In the October issue you'll find a profusely illustrated how-to story covering all these details, so be sure to get a copy. Here's one you'll want to clip and file.

HOME-BUILT FLIGHT SIMULATOR FOR UNDER \$200. Powered by a paint-sprayer compressor, this "Duncan Trainer" uses salvaged aircraft instruments that have been modified to operate by air pressure. With surprising realism, it simulates cross-country and instrument approach flight, while an instructor-operator outside cranks in headwinds or rough air conditions to keep you alert. If you like flying, don't miss it.

DOWN-TO-EARTH FACTS ABOUT PREFINISHED SIDING. PVC, aluminum, hardboard, plastic-coated wood—all those ready-to-go sidings have their pros and cons. The October issue contains an in-depth comparison, covering everything from price to performance. It's a must if you've been thinking of putting on new siding.

HOW TO USE A SOLDERING GUN. Sooner or later, every do-it-yourselfer finds himself faced with a soldering job. Next month's PM has a full rundown on the different types of guns, how they work and which one is best for which job. Chances are it includes a tip or two you're not familiar with, so be sure to read this one.

How much can one motor oil be expected to do?



- exceed all car manufacturer specifications.
- protect your new car warranty requirements.
- offer better protection in spite of tougher demands placed on new car engines.
- give better protection at high operating temperatures.
- include engine-protecting features of a heavy 40 weight, with easier-starting quality of a 30 weight.
- be suited for all types of driving, interstate or "Aunt Minnie" and-go driving.



This new
one
does it!



SUNRAY DX OIL COMPANY
*Known by the
customers we keep*

ORDER THESE PM PAINTINGS!

Four outstanding PM illustrations printed in full color on heavy paper suitable for framing.

RACING CARS

The finest painting ever made of racing cars. 32 types in 8 major classes—Championship, Stock, Sports, Formula, GT, Drag, etc. Includes summary of specifications. A great argument settler.

Size: 35 x 23 inches.

\$1.50 each postpaid

SATURN V

The world's biggest rocket.

Size: 19 x 25 inches.

\$1.25 postpaid

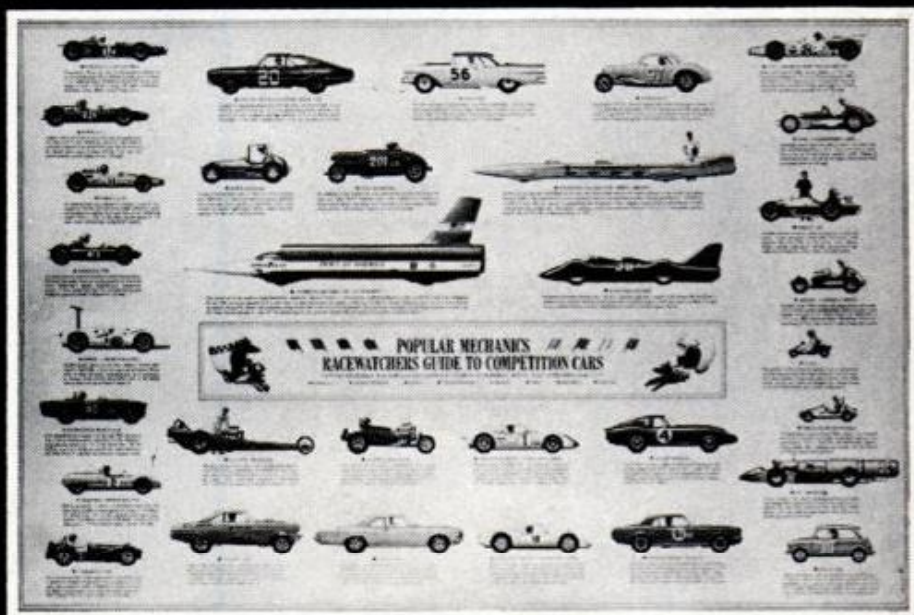

THE SATURN V
LARGEST ROCKET IN THE WORLD
POPULAR MECHANICS
BY FREDERICK L. WOOD STARR



U.S. PLANES IN VIETNAM
POPULAR MECHANICS
BY ROBERT A. FOSTER



U.S. HELICOPTERS IN VIETNAM
POPULAR MECHANICS
BY ROBERT A. FOSTER

VIETNAM COMBAT PAINTINGS
U. S. Planes in Vietnam and U. S. Helicopters in Vietnam. All latest models shown in blazing action.
Each 18 x 24
Both for \$1.95

Use the coupon below to order your paintings.

Pictures, Popular Mechanics, 575 Lexington Ave., New York, N. Y. 10022

Please mail PM paintings as indicated below:

Racing Cars _____ Copies @ \$1.50 ea. Name _____

Saturn V _____ Copies @ \$1.25 ea. Street _____

Planes and Helicopters _____ Copies @ \$1.95 set City _____ State _____ Zip Code _____

Enclosed find _____



"Changed My Life"

"My CIE course and new job have changed my life completely. Before getting into electronics, I drove a cab, repaired washers, rebuilt electric motors and was stuck at \$1.50 an hour. Now that I'm an electronics technician, I work eight hours a week less and earn \$228 a month more. We have a new home and two good cars. We also have color TV. My CIE training was worth every minute and every dollar I spent on it."

EUGENE W. FROST
Columbus, Ohio

Swamped With Job Offers



"I completed my CIE course and passed my FCC exam while in the Navy. On my discharge, I was swamped with job offers from all over the country. My only problem was to pick the best offer, and I did—engineer with Indiana Bell Telephone. CIE made the difference between just a job and a management position."

THOMAS E. MILLER, JR.
Indianapolis, Indiana

ENROLL UNDER NEW G.I. BILL

All CIE courses are available under the new G.I. Bill. If you served on active duty since January 31, 1955, or are in service now, check box in coupon for G.I. Bill information.



His Own 2-Way Radio Business

"Prior to my CIE course, my only professional skill was as a crop dusting pilot. Today I own my own 2-way radio service business. I manufacture radio equipment and employ seven men. I found the training thorough and easy to understand. My CIE course is undoubtedly the best investment I've ever made."

EDWARD DULANEY, Scottsbluff, Nebraska

Who else wants to make big money in Electronics?

CIE's home training helped these men change their lives —it can help you too

"You Make Electronics Easy"



"I give CIE credit for my Government FCC (Federal Communications Commission) License. Even though I had only six weeks of high school algebra, your lessons make electronics easy. I now have a good job... enjoy my work and am on my way up."

MATT STUCZYNSKI
Senior Transmitter Operator
Radio Station WBOE

WANT TO CHANGE YOUR LIFE like the men shown here? Get into today's big "growth" field—Electronics! The flood of electronic "miracles" pouring out of laboratories and factories has created a growing demand for trained men in TV and radio broadcasting...mobile communications...electronic automation...computer technology...the aerospace program...and many other high-pay areas.

You can be one of these "men in demand." You don't even need a high school diploma. You will need a good grasp of basic Electronics—but we can teach you that, at home, in your spare time. Even if you know nothing about Electronics today, our home-study courses make it easy to prepare for the high-paying job of your choice in this booming field.

Get the full details on the rich new life waiting for you in Electronics. Mail the bound-in postpaid card for two FREE books. If card has been detached, just send your name and address to CIE at the address below.

CIE **Cleveland Institute of Electronics**
1776 E. 17th St., Dept. PM-17, Cleveland, Ohio 44114

HURRICANES

(Continued from page 64)

eye—is 10° to 15° warmer than air just 20 miles away.

Until now, the spiral-shaped disturbance—which probably sports torrential rains and gale force winds—is only a cyclone, Weather Bureau parlance for any great storm where air spirals into a low pressure area. To become a full-fledged hurricane, the storm needs at least one more element: high-altitude winds. “You have swift tropospheric wind currents to carry away the warm exhaust,” explains Dr. Gentry. “Otherwise it would be like covering a chimney. The hurricane would fill up with its own heat and die out.”

With water vapor whirling up from below for fuel, and a chimney draft created by winds above, the storm resembles a huge, inverted whirlpool in which air whips up the vortex and out the top at a steadily increasing rate. When the winds reach 75 mph the cyclone is officially a hurricane. It's at about this point that the storm starts a self-perpetuating feedback system. The screaming winds churn the sea into a fine spray, aiding evaporation, and increasing the hurricane's fuel supply—and fury—even more.

A few years ago, meteorologists estimated that a mature hurricane gulped up one million tons of water each second. Recent evidence suggests they were wrong. The figure is perhaps four times that.

One fact is certain. In a fully developed hurricane, water-sogged air spirals up the storm's vortex close to 300 mph. Happily, friction slows ground-level wind speeds. Anemometers have nailed a hurricane's windspeed at 200 mph. But the instruments break off at about this point, and no one doubts that the speed is much higher. Estimates peg top velocity at 250 mph, even more. One ship captain, caught at sea, logged it: “Winds infinite.”

Typhoons—hurricanes originating in the

Pacific ocean—are feared even more. Because typhoons travel greater distances before striking land, they often rev up to even more ferocious heights. A damage-control petty officer aboard an aircraft carrier during a typhoon reported: “Our flight deck was about five stories high, and waves were spraying over it. The destroyers were plunging into huge troughs, leaving the ship's rear half poking out of the wave. Then, the stern would bury itself while the bow hung in space. It was dangerous for the smaller ships, but it was also a majestic sight.”

The wildest winds are usually within a 50-mile radius of the eye. Beyond that, their savagery falls to a mere gale. The change is often abrupt. One of the most intense hurricanes on record, on Labor Day of 1935, cut a swath of destruction through Miami only 40 miles wide. Just one-half mile made the difference between houses reduced to splinters and those suffering only broken windows.

Recently, I visited the sleek Computer Center Building at the University of Miami where I met Dr. Gentry. There, with the help of a nearby blackboard which he covered with diagrams, he told how long a hurricane takes to build up.

“Hurricanes don't form at all at the equator, there's no Coriolis force there. They have to be at least 350 miles away. But not too far, since they need to pass over sea water of at least 85°. When conditions are just right, a hurricane can bloom in 24 hours. In lower latitudes, where the Coriolis force is weaker, they may need several days.”

An average hurricane travels 12 to 14 miles an hour, Gentry explained, although some have been clocked at 60 mph. Over warm water, hurricanes last anywhere from a few days to a month before a shift in the tropospheric winds or atmospheric pressure kills them off. If they run any distance over land or cold water, the life

(Please turn to page 178)

WHAT TO DO WHEN A HURRICANE THREATENS

The United States Department of Commerce suggests that residents of Gulf and Atlantic coastal areas take these steps before and during a hurricane:

- Every June through November recheck your supply of boards, tools, batteries, nonperishable foods, and other equipment you'll need when a hurricane strikes.
- After the first radio alert, keep listening for warnings that the hurricane is heading for your town. Make plans well ahead of the storm's arrival. Being marooned is a dangerous situation.
- Leave low-lying areas that might be covered by the storm surge. Moor your boat securely and leave it. Don't return to check it once wind and waves are up.
- Board up windows, close storm shutters or, use tape to prevent flying glass slivers.
- Store outdoor objects that might become lethal

missiles: garbage cans, toys, garden tools, signs, porch furniture.

- Store drinking water in clean bathtubs and large jars. Flooding may contaminate the supply.
- Check all battery-powered equipment: radios, lights especially. A portable radio may be your only link with the world once the hurricane strikes.
- Keep your car fueled. Service stations may be inoperable for several days due to flooding.
- Remain indoors during the hurricane, even if the calm eye passes over your area. The winds will lull for a few minutes to a half an hour. But then they'll rise abruptly from the opposite direction. Stay away from river banks and streams. Flooding can be severe and sudden.

Meet another good sport.

This is the Homelite XL-101 chain saw, a light 10½ pounds* of pure muscle. It cuts through a 12-inch hardwood log in 12 seconds, and fells trees up to four feet in diameter. Perfectly balanced, easy to handle, with a new narrow bar that virtually eliminates pinching. Great for cutting firewood and pruning trees. See it at your nearby Homelite Dealer. He's listed in the Yellow Pages.

*less bar and chain

HOMELITE

10209 RIVERDALE AVE., PORT CHESTER, N.Y.

A **Textron**
DIVISION

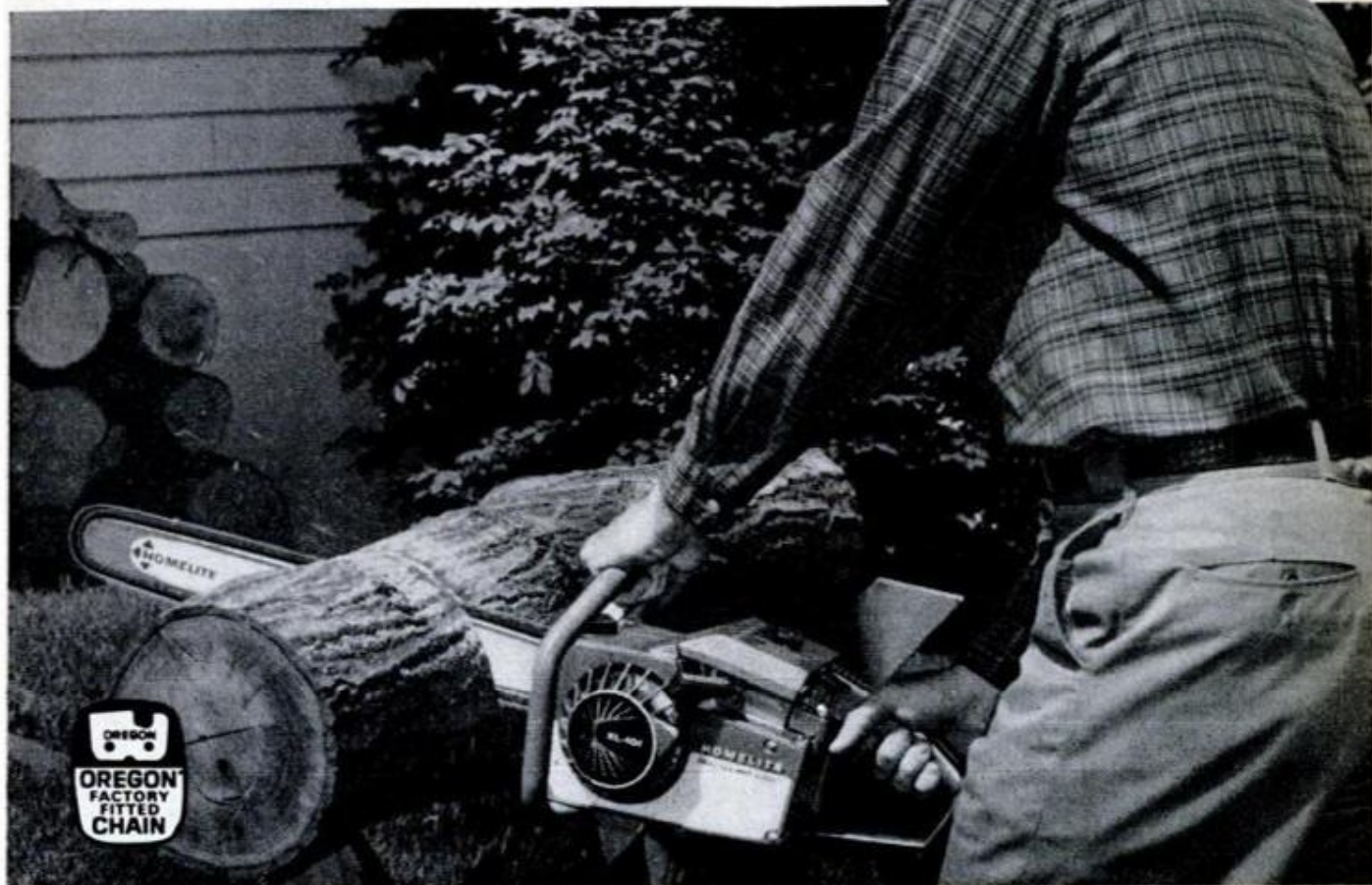

Other Homelite chain saws are priced as low as \$129.95.

3 tools that stop leaks permanently.



Now you can waterproof, repair, seal and insulate virtually anything — with these three Silicone rubber sealers from Dow Corning!

Pick the one you need for your job. These are tough sealers, like those developed by Dow Corning to help keep Gemini spacecraft in orbit. All are silicone rubber, so they're guaranteed for ten years against shrinking or cracking.

Whatever the job, there's a Dow Corning® silicone rubber sealer that will get it done. Pick up some today at your hardware, paint supply or specialty store.

Use aluminum **Dow Corning® metal sealant** for sealing casement and storm windows; gutters, ducts and downspouts; air conditioners and exhaust fan casings; etc.

Use **Dow Corning® clear sealer** for sealing basement wall cracks; window frames; awnings, tarpaulins, tents; rubber garments; etc.

Use black **Dow Corning® glass caulk** for sealing headlight gaskets; gas tanks; flashing and roof vents; electrical insulation; models; car tops, windshields.

DOW CORNING

DOW CORNING

HURRICANES

(Continued from page 176)

expectancy is short. "Dry land or cold water cuts off a hurricane's moisture supply."

A hurricane's whimsical route is decided by prevailing seasonal winds and giant high and low pressure systems that begin as far away as Alaska or Africa. Generally, Atlantic and Gulf hurricanes are nudged towards land by the trade winds. But when they meet a high-pressure region, they veer off in an erratic, vexing path that meteorologists can predict with complete accuracy only 24 hours in advance. Hurricanes form off the southern coast of California, too. Luckily, west-moving winds usually blow them to sea.

Veteran hurricane watchers along a seacoast don't need Weather Bureau reports to know that trouble is on its way. A hurricane's battering winds generate long, lazy sea swells that roll out from the fury at 30 mph or so. During summer, a swell ordinarily strikes land along the Gulf of Mexico every four or five seconds, and along the Atlantic coastline about every eight seconds. Swells from a hurricane 2000 miles away slow this tempo to one about every 12 seconds.

"You can feel the crash of a hurricane's swell a mile inland, especially when the storm is only 300 or 400 miles away," claims Ferdinand Quentha, a suntanned, 65-year-old Portuguese fisherman living on the Florida keys. "The day may be sunny, the sky clear of clouds. But when I hear that beat I get ready to beach my boat and lay away food and water."

Paradoxically, the greatest damage from hurricanes isn't made by wind. Much more dangerous is the storm surge. The low pressure under a hurricane's center sucks up the sea one foot or more above normal level. In addition, the winds pile up water 10 or more feet above *this*. The combination—the storm surge—is added to daily high tides. Much of the highly populated Atlantic and Gulf Coasts is only 10 feet above average sea level. Consequently, the storm surge of a healthy hurricane advances over land like a slow-moving tidal wave. But not always so slow moving. One storm surge mounted a narrow creek bed in Galveston, Tex., forming a wall of water 20 feet high that carried barges upstream like toy boats.

Storm surges have killed more people at one time than any other single catastrophe. In 1737, a hurricane's storm surge snuffed out 300,000 lives in Calcutta, India. In 1900, more than 6000 people drowned in Galveston, and as late as 1957, 380 persons drowned when Hurricane Audrey blasted Louisiana. The hurricane warning service

of today has cut down this toll drastically.

Even major property damage may be avoided if a joint Navy-Department of Commerce program—Project Stormfury—pans out. A hurricane's wind force is a measure of the barometric difference between its low-pressure center and higher-pressure outskirts. The bigger this difference—called pressure gradient—the greater quantities of soggy air whip into the vortex. The gradient and the storm's fury drop if pressure around the vortex rises or the pressure 15 to 20 miles away falls. Project Storm-fury aims at the latter. Its weapons: silver iodide bombs.

Silver iodide particles released by the bombs offer nuclei around which cool vapor can condense into raindrops. The resulting squalls release heat, which warms the air and causes it to rise, dropping the barometric pressure well behind the vortex. The hurricane isn't stopped. But the gradient is lowered and its force abated.

"Remember, the destructive power of wind is proportional to the square of its velocity," explains Dr. Robert Simpson, director of the Miami-based National Hurricane Warning Service. "Cut that windspeed by only 10 percent and you've done a real service."

Since its formation in 1962, Project Stormfury has seeded two hurricanes. Results were encouraging, but not conclusive. "We need more monitoring flights to show us the best time and place to seed clouds," says Cecil Gentry, who also heads Stormfury. "Hurricane seeding is a complex task and we need to know a lot more about the best way to do it."

During the last four years, no hurricane came within the range of Stormfury's planes at the moment for best seeding results. This year, about 20 aircraft can be mustered from the military and government agencies to bomb and monitor likely storms. (Planes are no longer used to find storms; satellites do the job.) "Man's weapons against hurricanes aren't yet very potent. But at least if one threatens the U.S. this year meteorologists just won't stand around cursing the bad luck," said one young meteorologist at Miami.

Project Stormfury is investigating only cloud seeding, and admittedly not with the striking or monitoring force it would like to wield. The problem: money.

"We have less than one million dollars for our program," explains Gentry. "The average hurricane dollar damage per year is \$300 million, and some single hurricanes have cost \$1 billion. What we're spending on research to understand and control hurricanes is insignificant compared to what real modification could save. Just insignificant." ★ ★ ★



You're working too hard if you don't have a new Nicholson Teflon-S® saw.

To help you do a faster, easier, and better cutting job, we've added a selection of handsaws and pruners coated with new, tough Du Pont Teflon-S.

Friction can't grab hold of a Nicholson saw coated with Teflon-S. Tree sap and goo can't stick to it. And rust can't get a grip on it.

Put down that old-fashioned saw and switch to a new Nicholson Teflon-S-coated handsaw. Start working easy.

There's never a dull moment with

Nicholson

Nicholson File Co., Providence, R. I.



SEALAB III

(Continued from page 99)

be reduced and carefully metered out to compensate for the added pressure. After months of simulated dives in pressure chambers, Navy doctors formulated what they consider the optimum breathing mix for a depth of 600 feet: 2 percent oxygen, 4 percent nitrogen and 94 percent helium.

One of Sealab III's main objectives is to test this mix and its effect on the body. "Each time we go deeper and add more pressure," explains Cmdr. Larson, "we face a new set of problems. The main question is simply this: Can man live and work safely and efficiently at such depths for long periods?"

To find out, Sealab will send five separate teams of eight aquanauts to the bottom. Each team, consisting of Navy divers and civilian scientists, will stay down for a 12-day span. Nearly every waking hour of these total 50 days is packed with performance tests.

Cmdr. M. Scott Carpenter, the second astronaut to orbit the earth, and a team leader during Sealab II, will be the senior aquanaut, directing each team's effort during the experiment.

TEAM 1: as soon as the habitat is lowered, Team 1 follows down in the PTC. Its first job is to level the habitat, using turnbuckles on a huge anchor block to which it is attached. Then the men enter the habitat through a special chamber—a kind of foyer that looks like a small indoor swimming pool. The pressure of the habitat, equal to outside sea pressure, keeps the water from bursting in, and the pool forms the "door" between the dry world inside the habitat and the wet vastness all around.

What is normal under such pressure? As yet we don't know. Certain enzymes in the blood rise far above their usual level. Is that dangerous? Or is it a natural body adjustment to pressure? Sealab may provide the answer to many such questions. Heartbeat, breathing, temperature, urine, saliva, blood pressure and composition, sweat rate, and other body functions for the men below will be constantly monitored aboard the *Elk River*.

Setting up housekeeping will be the next job for Team I. It will check every part of the habitat—ports, hatches, drains, ballast—then try to determine the right temperature for comfort, still unknown because pressurized helium carries off body heat much faster than surface air. Various heating systems will be tested, including radiant heaters, duct heaters and heat supply through the recirculating breathing mix.

Cooking is a special problem. Open flames are out. There's not enough oxygen to make them burn. Besides, they'd foul the atmosphere. Hot plates don't work either. The helium draws off so much heat that they never get hot. Sealab uses an infrared oven for cooking.

The first few days will be a constant round of testing. "Even simple gadgets act strangely down there," Larson laments. "And the more complex ones become quite unpredictable. For instance, the television cameras through which men topside monitor the habitat often go haywire in helium. So we had to redesign them with high-pressure seals. Similar problems crop up for almost every piece of gear. Floodlights, electronic gear, navigation systems, cameras, sensors, depth gauges, compasses—everything had to be modified for the added depth."

After this equipment shakedown, the divers swim out on their first job: Setting up an undersea weather station to register tidal changes, currents, turbulence, salinity and water temperature.

While these data are telemetered topside, the divers themselves have their breathing, temperature and heartbeat monitored by telemeter circuits. "This is essential," says Capt. George Bond, Sealab's chief medical officer. "The diver himself may not notice anything wrong, yet he may be heading for trouble. For example, the first sign of oxygen deficiency is when you black out. But through physiologic monitoring we can give the diver advance warning."

Next come the lobsters. Instead of taking lobsters out of the sea, the Navy plans to put them in. They're bringing a group of live lobsters all the way from Maine. The idea is to see if Maine lobsters will thrive in the Pacific.

TEAM 2 immediately gets to work on its main mission: salvage. In the last Sealab the salvage test consisted of raising a sunken aircraft by blowing it full of buoyant foam. This time the task is trickier. It calls for lifting a solid mass of concrete and steel by attaching cables and flotation gear.

Because divers, like spacemen, are nearly weightless, they can't work with regular tools. A hammer might swing an aquanaut; a wrench might twist him around. Special zero-reaction tools had to be developed for underwater use.

No sound escapes. All of it is trapped in special silencers. For in the sound-magnifying sea, a pistol crack might deafen an aquanaut.

While working on their salvage project, Team 2 aquanauts will test three different

(Please turn to page 182)

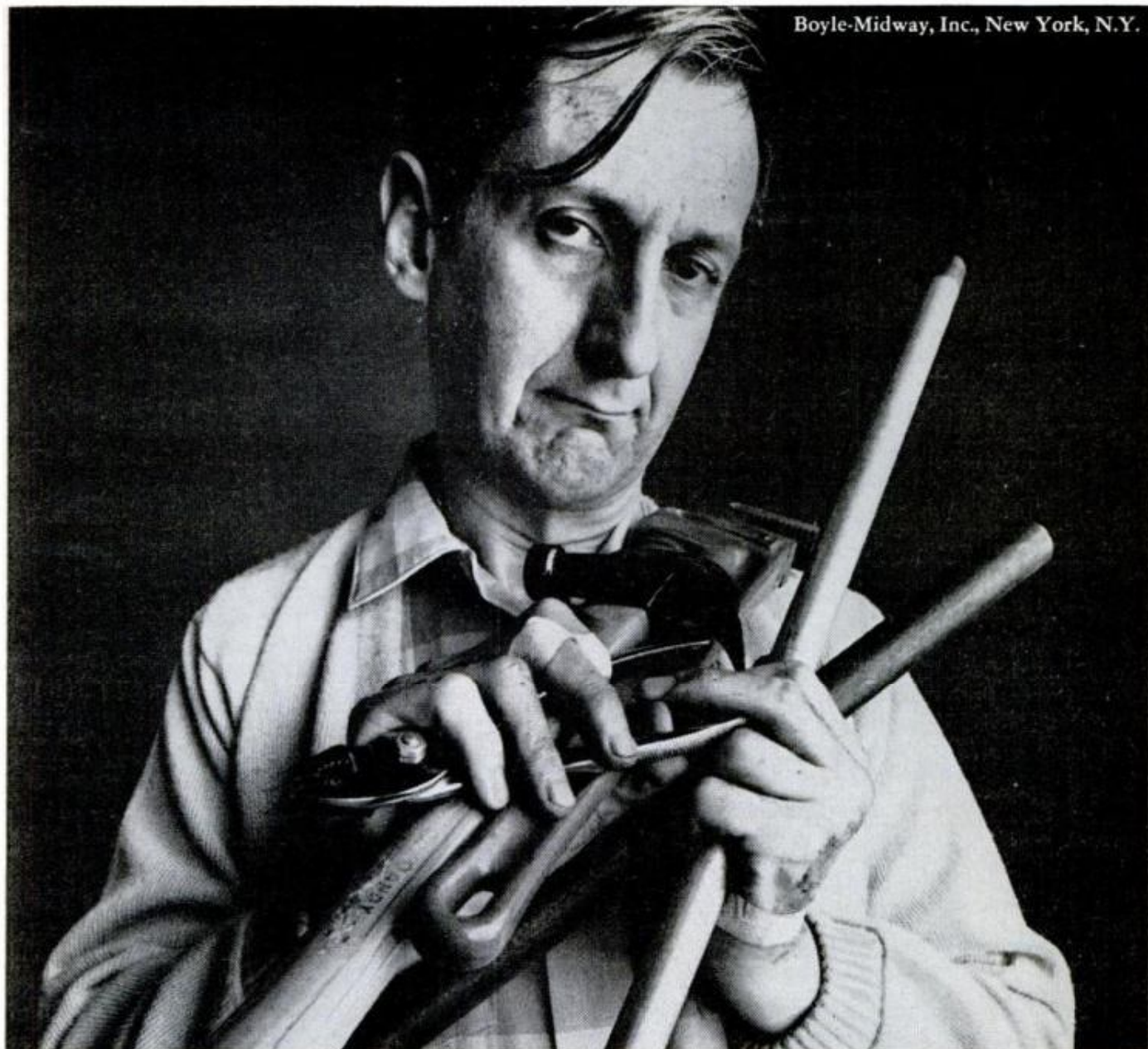

For the unhandy handyman

All you wanted to do was loosen the rust on the bolt. And what happened?

The kid was in tears. The bike was in pieces. Every tool in the toolchest was out.

A shame, because if you'd sprayed on 3-In-One Household Oil in the first place, there wouldn't be any rust to unrust.

It's a good idea to spray

3-In-One Household Oil on guns, garden tools, lawn mowers, anything you normally store. 3-In-One Household Oil sprays on a complete rust-preventing coat of oil.

Suppose you forget to use 3-In-One

Household Oil? Nothing to it. Just spray on 3-In-One Penetrating Oil. The pinpoint spray even lubricates hard-to-reach places. Penetrating Oil loosens accumulated rust on bikes. Hinges. Screws. Machinery. Stuff like that.

It's for guys who hate the words "fix it." **Household Oil and Penetrating Oil:** Two of many ideas from the makers of 3-IN-ONE® For The Unhandy Handyman.



SEALAB III

(Continued from page 180)

kinds of rubber wetsuits. One is electrically heated, the other is heated by a web of tubing constantly flushed with warm water from the umbilical. The third suit has its own heat source—a radioactive isotope which warms the water in the suit.

Out on the job, the diver normally gets his breathing mix from the habitat via umbilical. A special regulator adjusts the oxygen to the extra body demand during hard work. But each diver also carries an emergency supply on his back in a scuba-like system with several special features.

To keep up 275-p.s.i. pressure at normal breathing volume takes great amounts of gas. Ordinary open-circuit scuba would last only a few breaths. But Sealab's Mark VIII breathing gear recirculates about half of the diver's exhaled breath, scrubbing it clean of carbon dioxide and refreshing it with small amounts of oxygen. This stretches the diver's backpack emergency breathing to at least 20 minutes, giving him a chance to get back to the habitat.

"We could make it last even longer if none of the exhalation had to be dumped out into the sea," says David Harrell of the Navy's Ocean Engineering Branch. "But so far, our gas mixture controls just aren't accurate enough to permit closed-loop operation."

Special tools

TEAM 3 concentrates on building underwater structures. It plans to build a livable bottom habitat 15 feet tall from parts lowered by crane. The site will be lit by a gigantic chandelier of high-penetration iodine-vapor floodlights dangling from a topside crane. Much of the assembly work will be done with a newly developed multipurpose tool that can drill, cut, saw holes, grind, tap and tighten bolts. Powered by a $\frac{3}{8}$ -hp motor, it is the first such tool with epoxy seals to keep out water even under high pressure. As a special safety device, it has a 30-millisecond cut-off switch to prevent electrocution of a diver by a possible short. The second habitat will be built with a new kind of quick-connect structural fastener, and the divers will try to determine what size bolts, screws, rivets and other hardware are most convenient to handle.

Anticipating the future building of large sea-bottom factories and mining installations, Team 3 will test the bearing strength of the bottom soil to see if it can support such structures.

TEAM 4, handling ocean technology, will

conduct underwater visibility tests, evaluate systematic search patterns, and to try a new hand-held sonar. Scanning the bottom with this miniaturized sonar, the diver hears sounds which reveal objects and terrain features in murky water. "Sometimes we can't even see two feet ahead down there," grumbles a Sealab diver. "That portable sonar will be a big help in finding our gear—or just finding our way back to the habitat."

TEAM 5 does the cleaning up. Its job is to find and retrieve various pieces of equipment left on the ocean floor previously. This gives it a chance to take a fish census, record fish talk, film and photograph fish with remote-control cameras and measure bioluminescence—the eerie light given off by many undersea organisms. The data will aid in "ocean farming"—the building of abundant herds of marine animals to assure adequate food supplies for an increasingly hungry world.

One sea creature in particular will be part of the marine biology program. Tuffy the porpoise—an old friend of the aquanauts—will again act as general helper, carrying messages, tools and supplies, and retrieving lost divers like a Saint Bernard. "Man's best friend in the water," quips a sailor. "A regular undersea-dog."

Tuffy has already gone down as far as 550 feet, and everyone hopes he can make it to 600. He may be able to go that low partly because he doesn't have to breathe under water. One big gulp of air lasts him the whole trip. However, the deeper he goes, the less time he can stay on the bottom. If he can go to 600 feet, he may be limited to 1½ minutes. In any case, Tuffy will enjoy company on this mission. Harbor seals and sea lions may join the act as messengers and carriers.

All five teams will repeat basic physiology tests so they can be cross-checked against each other. And all five will share in experiments designed to overcome a major problem: communication.

Plain talk is impossible. Helium and pressure raise the pitch of a man's vocal cords and alter the acoustics of his mouth. When he speaks he squeaks. Unless his speech is "unscrambled" by complicated electronic gear topside, it's hard to understand what he says.

It may take many months to analyze and evaluate the whole mass of experimental data logged by the five teams. But when the results are in, they will help open up the vast area of the ocean floor—an area three times as large as the United States, an immense storehouse whose riches still lie untouched. Whatever we learn from Sealab III, it will be a key to a vital extension of man's domain. ★ ★ ★

0 TO 40 KNOTS IN 75 SECONDS

(Continued from page 73)

make the gunboats rough riders in a heavy sea. The USS *Asheville*, which was first to report to San Diego, ran into such rough weather moving down the coast that it had to steer for shelter in a northern California port. "They ought to rename us USS *Cork*," one haggard crewman said.

In Vietnam the *Gallup* has been operating out of Da Nang and Cam Ranh Bay, something of a lone wolf among the Coast Guard cutters and Navy Swift boats that are the mainforce of the Market Time Patrol. "The others can't keep up with a PG," Spane said.

One day the Market Time commander sent out the *Gallup* and the 82-foot Coast Guard patrol boat *Point Orient* to shadow a steel-hulled trawler moving down the coast from North Vietnam. "The *Point Orient* had to get under way six hours ahead of us in order to be at the rendezvous point when we arrived."

A sharp-eyed pilot on air patrol had put them on the tail of the trawler. He thought the vessel was riding too low in the water for a trawler heading toward the southern fishing grounds.

His tip turned out to be a good one. The *Gallup* and the *Point Orient*, along with a destroyer and a Swift boat, followed the trawler for three days. At 2 a.m. on the fourth day they saw its dark shape moving toward the South Vietnamese shoreline.

The *Point Orient* used blinker-signals in International Morse to demand that the trawler stop. It didn't. Then the Coast Guardsmen turned a searchlight on the suspect, and a Vietnamese interpreter used a bull-horn to call out an order to surrender. Still no response. The *Point Orient* pulled back and fired a shot across the trawler's bow. The trawler kept moving, and its doom was sealed.

Bill Spane wheeled the *Gallup* into firing range and his men let go with all they had—the 3-incher, the 40-mm and the .50-cals. The *Point Orient* and the Swift began plastering the trawler, too.

Guns concealed on the trawler's deck made a brief, feeble response but the fight was too one-sided to last more than a few minutes. By the time the trawler nosed onto a bar, fires breaking out on deck, the crew was swimming for shore.

The trawler yielded 1500 weapons—machine guns, submachine guns, rocket launchers and rifles—a million rounds of ammunition, some mines, plastic explosives and detonators. There was also 5000 pounds of TNT which appeared to be rigged for scuttling the ship—something the crew never got around to doing. ★★★

NOW — THIS CAN BE YOU!



BUILD, FLY YOUR OWN

BENSEN

Enjoy the fun of flying . . . in your own Gyrocopter! Simplest, safest form of aircraft. Acclaimed by pros and novices alike from Alaska to New Zealand. Interchange floats with wheels for extra fun. Costs no more to operate than a car. Build with ordinary hobbyshop tools. Copter flying instructions come with construction plans. Kits and parts available. Take the first step—send \$3 for 3-View Drawings, specs, photo.

BENSEN AIRCRAFT CORP., Dept. PM-98
Raleigh-Durham Airport, Raleigh, N. C. 27602

NAME _____

ADDRESS _____

COASTAL®
ZIPPIDI-DO
ALL-PURPOSE CUTTING AND SANDING DISC

Zippidi-Do
even cuts a file

The advertisement features a large, bold title "ZIPPIDI-DO" with "COASTAL®" above it. Below the title is the subtitle "ALL-PURPOSE CUTTING AND SANDING DISC". A photograph shows a person's hands using the Zippidi-Do disc to cut through a metal file. The disc is mounted on a power tool, and the person is holding the handle.

The most versatile power tool accessory... ever!

You can cut through ceramic tile, fiberglass, brick, slate, stone, all metals . . . even a hard file in minutes with the Zippidi-Do cutting and sanding disc. Silicon carbide grains embedded in nylon mesh give it amazing cutting ability. And the Zippidi-Do makes a great sanding and shaping disc for use on old paint, rust, wood, tile, all metals. The Zippidi-Do can be used with any electric drill or flexible shaft. It wears and wears and never clogs.

Complete kit contains Zippidi-Do disc, molded backing disc, arbor and flanges . . . only \$4.00 at hardware stores and depts. Coastal Abrasive and Tool Co., Inc., Trumbull, Conn. 06611.



Awakens Sleeping Beauty



A coating of STRYPEEZE Semi-Paste is the magic touch that awakens the sleeping beauty of natural wood hidden under layers of unsightly old finishes. An excellent all-purpose paint remover containing a protective "jell" that slows evaporation, giving volatile cutting agents time to cut deeper into seemingly unpenetrable coatings. Available in pints, quarts and gallons at your local hardware, building supply and paint and wallpaper dealer.

SAVOGRAN
NORWOOD, MASSACHUSETTS 02062



PROFIT IN YOUR SPARE TIME



SMALL ENGINE REPAIR PAYS BIG!

Outboard • Powermower • Chain Saw • Tractor

MAKE EXTRA MONEY — or fix your

own engines and **SAVE!** Illustrated, easy-to-

learn Home Study Course qualifies you as expert.

Approved for Veterans. Write today!

LINCOLN TECHNICAL INSTITUTE

SUITE 9-E, 427 MARKET STREET, NEWARK 5, N.J.

LICKITY SPLITTER

Splits Big Profits from toughest woods — Ends Splitting Drudgery with 18 ton hydraulic power!

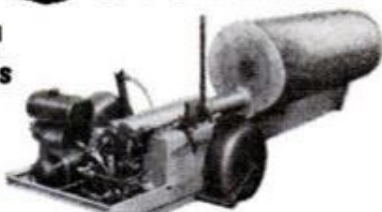

7 H.P. trailer unit squats under power to load logs without dead lift. Has 2 speeds, auto-shift, auto-stroke. 26" ram travel splits logs up to 34", any diameter — with extended frame and adjustable wedge splits up to 60". **NEW LOW COST** Economy model for farmers and small wood lots. Also ask about the 60L Series for logs up to 8½ ft. long—Details free.

Piqua Engineering Inc., Dept. P, Box 605, Piqua, Ohio

A BUSINESS OF YOUR OWN REPAIR HYDRAULIC JACKS



Earn while you learn at home. Millions of jacks in gas and auto service stations, trucking firms, body shops, riggers, factories and farms need servicing... most of which you can learn to repair. We show you **HOW**. Start spare time in your basement or garage. Big opportunity for mechanics. **ACT NOW!** Write for folder **PM-9**, and free bonus offer

HYDRAULIC JACK REPAIR MANUAL CO., INC.

G. P. O. BOX 3 • STATEN ISLAND, N. Y. 10314



3 1/2" x 9 1/4"

Let's Do LEATHERCRAFT!

HERE'S A GENUINE LEATHER BILLFOLD KIT AS A STARTER

WORTH \$5.00 AFTER YOU ASSEMBLE AND LACE!

ONLY **50¢** with coupon below

ONLY 50¢ IF YOU ACT NOW!

Tandy
LEATHER COMPANY

1001 Foch, Dept. CW, Fort Worth, Texas, 76107

A TANDY CORPORATION COMPANY

Yes, send me your embossed billfold kit and 112-page catalog. I'm sending 50¢ as full payment. (Limit one per family.)

NAME _____

ADDRESS _____

CITY _____ STATE _____ ZIP _____

ONLY 50¢ IF YOU ACT NOW!

Get all the features of expensive billfolds... hidden money pocket, four-unit card case and two side pockets. Handsome design already embossed. Kit complete. Easy 'n fun to assemble and lace. You'll also receive a 112-page Leathercraft catalog and easy-to-follow instructional manual. **Order yours today!**

BILL PROBLEMS?

WE CAN HELP YOU — TODAY

NOBODY REFUSED UP TO \$18,000.00

Bad Credit No Problem ■ Not a Loan Co.

Send Your Name and Address

For **FREE** Application To Nearest Office

INTERNATIONAL ACCEPTANCE, dept. M-8

★ 5133 N. Central Ave., Phoenix, Ariz. 85012, ★
★ 711 - 14th St. N.W. Washington, D.C. 20005 ★
★ 507 Carondelet St., New Orleans, La. 70130 ★



*MAG BUILD YOUR OWN WHEELS

No drilling, cutting or welding. **\$595 ea.**
Precision die made — Beautifully finished in Mag and polished Chrome. Clear illustrated instructions included. **4 for \$2200**

Plans only \$2.00 refunded with order
MAG STYLE U S Pat. #3,312,505 POSTAGE PAID

MONEY BACK GUARANTEED To Make Your Wheels Look Like a \$150.00 Set.

Send tire size 13", 14", or 15" with Check or Money

Order to **HOUSE of CHROME** DEPT. P. 3050 Hwy. 94 No. ST. CHARLES, MO. 63301

FREE!

Learn how you can buy used engines \$15 up, new engines \$30 with **FREE** confidential list and coupons when you order your plans

• BUILD THIS MINI-BIKE!

Plans reveal step by step details!

• BUILD A RACING KART!

Complete frame for less than \$10!



RUSH \$2 for plans (Indicate type) or send 25¢ for circular describing plans **PLANS**, Box 517, Omaha, Nebr. 68101



LEARN MEAT CUTTING

Train quickly in 8 short weeks at Toledo for a bright future with security in vital meat business. Big pay full-time jobs — **HAVE A PROFITABLE MARKET OF YOUR OWN!** Time payment plan available. Diploma given. Job help. Thousands of successful graduates. **OUR 45th YEAR!** Send now for big new illustrated **FREE** catalog. No obligation. **G.I. Approved.**

NATIONAL SCHOOL OF MEAT CUTTING
Dept. 50-L, Toledo, Ohio 43604

HEAVY DUTY BALL-BEARING PUMP

IRRIGATE • DRAIN • SPRAY • CIRCULATE • Famous all-metal, rust-proof XB pump with stainless shaft. Use 1/4 HP or larger. 1 HP for up to 5,200 GPH 60' high or 3,000 GPH from 25' well. 1 1/4" inlet, 1" outlet.

For belt or direct drives. Only \$12.95

Famous Type P won't rust or clog. Bronze bearing. Hundreds of thousands in use. Up to 2,400 GPH. 1" inlet. 3/4" outlet. Only \$8.95

Postpaid cash with order. Money Back Guarantee.

LABAWCO, Box 2, Belle Mead, N. J. 08502

\$5.50



Dial telephone Special. Factory reconditioned, Complete, guaranteed. Add \$1.00 if plug required. Shipments F.O.B. Waymart. Write for complete telephone list.

SURPLUS SAVING CENTER

Dept. PM 968 Waymart, Pa. 18472

Money Back Guarantee

HEAVY DUTY-ARC WELDER

Life Time Guarantee

New Advanced 1968 Model 110 Volt Arc Welder. You cannot buy a better welder anywhere at this low price. **NO EXPERIENCE NEEDED.** With our easy-to-understand welding book, anyone can braze, solder and weld any metal, even aluminum, **NOTHING ELSE TO BUY.** Comes complete with rod holder, helmet, ground clamp, twin carbon torch which generates over 11,000 degrees heat to braze, solder, cut, melt and bend all metals. Also included **FREE \$2.00** supply of 1/16" and 1/8" welding rods, 3/4" carbons and flux. **LIFE TIME GUARANTEE.** Never a repair charge for parts or labor. **10 DAY MONEY BACK GUARANTEE.** SEND ONLY \$2.00 and when delivered pay postman \$10.95 plus postage, or send full price \$18.95 and we pay postage.

Order Direct from factory: **NATIONAL ELECTRIC, Dept. PM-9, Box 48-544 Miami, Fla. 33148**



SEND ONLY \$2.00

GOVT. SURPLUS BARGAINS SAVE TO 90%



MINIATURE HYDRAULIC PUMP

Electrically Driven. Rated 24 V.D.C. 3 1/2 gal. per min. @ 1000 PSI. Also runs well at 12 V.D.C. at reduced pressure. Compact, only 8" L x 5" W x 3 1/4" H. Inlet port 9/16", outlet port 7/16". Tested prior to shipment. **GOVT COST \$184** Shpg. wt. 7 lbs. Only **\$17.50** (Stk. #2167)

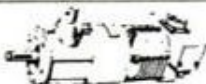

DUAL SHAFT GEAR MOTOR

Heavy duty. Turns 125 RPM on 12 V.D.C. and 270 RPM on 24 V.D.C. Auxiliary 90° shaft turns at double speeds. Gear reduction 33 to 1. Reversible 5/8" keyed output shaft. 1 1/8" L x 5" dia. Exc. for use in small electric cars, winches & capstans. Shpg. wt. 39 lbs. **GOVT COST \$580.** Tested prior to shipment. **\$29.50.** (Stk. #2398)



HEAVY DUTY BATTERY WINCH

Rugged, deluxe winch. Ball bearing construction thruout motor & gear train. High gear reduction. Rated cap 3000 lb. pull. Reversing switch. Rugged 3/8" plate steel mounting base with outrigger support. 22" L x 9" W x 8" H. Handles 250' of 1 1/4" cable. Built for 12 V battery operation; also operates on 6 V at reduced cap. & speed. For Scouts, Jeeps, Trucks, Boat loading trailers, etc. Shpg. wt. 80 lbs. Approx. **GOVT COST \$490.** NEW, 90-day guarantee, Model E-D. **\$89.50** (Stk. #692)

NEW! BIG! 1968 CATALOG



Send 25¢ for amazing catalog with 1000's of bargains in hydraulics: electrical, marine, automotive items, etc. Order from this ad. All prices FOB Culver City, 50% deposit required for all COD sales. Cal. res. add 5% sales tax. Must include your zip code number. **Satisfying mail order customers thru-out the world for 23 years.**

AIRBORNE SALES CO. Dept. PM968

8501 Stellar Dr., Box 2727 • Culver City, Calif. 90230



PLANER • MOLDER • SAW!

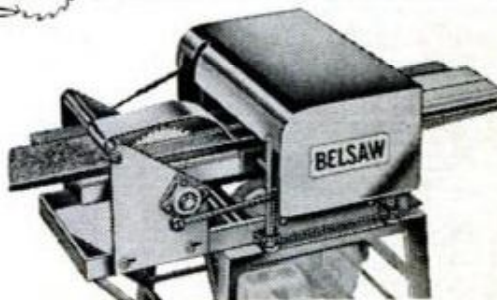

Now you can use this **ONE power-feed** shop to turn rough lumber into moldings, trim, flooring, furniture... **ALL** popular patterns. **RIP... PLANE... MOLD... separately or all at once** with a one HP motor. Use 3 to 5 HP for high speed output. Low Cost... You can own this power tool for only **\$30.00 down.**

Send postcard today for complete facts.

BELSAW POWER TOOLS, 909-S Field Bldg., Kansas City, Mo. 64111

BIG PAY! TOP SECURITY!

Start out as a Professional Auto-Diesel mechanic in a good pay job. Many advance to supervisory jobs earning \$200 a week & up.

You'll learn fast in one of the best equipped, most up-to-date shops in the country. We locate student part time jobs, housing... Free national job placement. Send today for free **CAREER KIT** and **CAMERA TOUR** showing Bailey students in action.



Name _____ Age _____
Street _____
Town _____ State _____ Zip _____
Telephone _____

1645 S. Grand, Dept. P.M., St. Louis, Mo. 63104

BAILEY TECH SCHOOL

WILDEST SHOW ON THE ROAD

(Continued from page 82)

to suit this formula than any other engineer and builder in the world."

The "Formula" sets the limits on car design. Formula 1 is for Grand Prix cars; Formulas 2 and 3 are lesser levels for smaller and slower cars. Most of the Formulas down the years have regulated engine size above all and the current one is no exception. Supercharged engines may be of a displacement no larger than 1.5 liters (91.5 cu. in.), while unsupercharged engines have to be no larger than 3.0 liters (183 cu. in.). All the engines so far have been 3 liters, unsupercharged.

The cars may not be lighter than 1102 pounds, must run on pump gasoline, carry a self-starter, and have basic safety features such as a rollover bar and dual master cylinder. They're not allowed to enclose the wheels with fenders or bodywork, so they've all taken on a simple cigar-like shape, from which the first variations are appearing this year.

Grand Prix cars are incredibly compact, wrapped tightly around their drivers. Tall Dan Gurney literally "puts on" his Eagle, twisting down under the 12-inch steering wheel to recline almost flat on his back in a form-fitting magnesium container filled with gasoline. Fuel tanks act as the frame in most Grand Prix cars, just as the engine is also a part of it. From front to rear these machines are intricate sandwiches of alloy steel, aluminum, magnesium and titanium, each costing between \$60,000 and \$75,000. A Ford-Cosworth V8 engine—one of the simpler designs—costs \$25,000.

Supertight competition in Grand Prix racing is bringing the cars closer together in design. The V12 engine is favored by all except Repco of Australia, maker of Jack Brabham's engines, and Ford of Britain, whose Cosworth-built engines power Lotus, McLaren and some French Matra cars. Both use V8s. All but B.R.M. use four valves for each cylinder—two intake and two exhaust—an arrangement from the '20s and '30s.

All Grand Prix cars today are rear-engined, independently suspended with coil springs, fully disc-braked and fueled by injection systems. About the only body work they've needed is a fiberglass nose cone covering the radiator and front end (many cars at the Glen will run with no cover around the engine). But some drivers will follow the examples of Lotus and McLaren, who use the power of air flow to press the tires tight to the road. McLaren started the season with a modified "wedge" shape. Colin Chapman car-

ried it to an extreme with his Indianapolis turbine cars and latest Grand Prix cars.

These new aerodynamic ideas will work very well at Watkins Glen. At 2.3 miles, it's a short track. Only Monaco and Jarama in Spain on this year's calendar are shorter. But it's also fast, exceeded in average speed only by Belgium's Spa circuit and Italy's Monza. On the five right-hand turns and three lefts of Watkins Glen, the high speeds will generate the maximum downward pressure from a wedge-shaped body.

A racer who crosses that narrow line between control and disaster at the Glen will find fewer obstacles this year. Responding to suggestions from the Grand Prix Drivers Assn., an informal but effective alliance of top drivers, Watkins Glen director Cameron Argetsinger moved back earth banks and modified guard rails to add safety for drivers and spectators alike. A new, enlarged Kendall Technical Center will house the cars for the inevitable changes of broken engines after practice.

Grand Prix teams like the informal hospitality of Watkins Glen—and the rewards. The U.S. Grand Prix is the only one that pays no starting money, instead guaranteeing prize money to every entrant in the 20-car invited field. From a purse of \$105,400, the winner will collect \$20,000, the G.P. season's largest prize.

Nineteen sixty-eight is Enzo Ferrari's 20th-anniversary year in Grand Prix racing using cars bearing his own name. His is one of the classic team organizations—providing the cars for drivers who are motivated to race for a pittance plus the glory of holding the wheel of a blood-red Ferrari. Chris Amon and Belgian Jackie Ickx will drive two of the three cars Ferrari will bring to the Glen.

Britain's B.R.M. cars first raced two years after Ferrari. For '68, B.R.M. abandoned a complex and controversial 16-cylinder car to build an orthodox V12 that's been going very fast in the hands of Pedro Rodriguez and Dick Attwood. A private team will enter a third B.R.M. at Watkins Glen for Britain's Piers Courage.

John Cooper, whose simple and effective cars started the rear-engine revolution in Grand Prix racing, is trailing the development trends today. He has built lighter cars around the 390-hp B.R.M. engine this year, and engaged Belgian Lucien Bianchi and Briton Brian Redman as drivers.

Another classic team with tremendous financial resources has been formed by France's Matra, a leading aerospace supplier. One blue car in the U.S. Grand Prix will be all-Matra, to be driven by

Jean-Pierre Beltoise. Another will have a British Ford V8 engine entered privately by Jackie Stewart.

John Surtees has been helping Japan's Honda develop its latest Grand Prix design. With a roller-bearing crankshaft, the car's V12 engine will shriek to 15,000 rpm and develop over 450 hp. Another loner will be Dan Gurney with his latest, slimmest Eagle. By Glen time Dan hopes to develop 480 hp from his compact V12.

Goodyear helped Gurney become a builder as well as a driver, as it had earlier helped Jack Brabham. The light Brabham cars have collected championships in the first two years of the current Formula and would be favored to repeat if Brabham were not grappling with new development growing pains.

Another Goodyear beneficiary is Bruce McLaren. Bruce, a Brabham protege, first built sports cars in his own name and then graduated to Grand Prix cars in 1966. McLaren starred in the Can-Am series last year, seizing Denny Hulme as a teammate and keeping him for the '68 Grand Prix season. The orange McLarens use the 408-hp Ford-Cosworth V8. An older McLaren, with B.R.M. engine, is entered by Sweden's Joakim Bonnier.

McLaren admits his best hope for Grand Prix wins this year lies in fielding better-prepared cars than Team Lotus, which uses the same light, compact Ford engine. When it stays together, the Lotus-Ford is almost unbeatable. Jim Clark won with it at the Glen last year, and Graham Hill has taken on new life with his fine Lotus victories this year.

The mustachioed Hill, with three previous Glen wins, is an odds-on favorite to collect his fourth silver trophy filled with New York State champagne. Lotus major domo Colin Chapman will back Hill with Mario Andretti of the U.S. in a second car, and a third may go to Mexican Moises Solana. A fourth Lotus-Ford will be entered by whiskey scion Rob Walker, driven by Switzerland's Jo Siffert.

Something new always happens in the month between the German Grand Prix and the Italian G.P., the last European event before the "Circus" begins its three-race North American tour.

There could be a new Honda, or a new four-wheel-drive car from Ford of Britain, or an Indy-style turbine-powered Lotus. Whatever they are they'll be coming to Watkins Glen to send the sound of their shrill exhausts ringing across Seneca Lake. At their wheels will be 20 of the worlds' bravest men, in search of every available championship point in the season's next-to-last race. That's when the Grand Prix "Circus" gets serious. ★★

You can make money in



WATCH REPAIR

Learn at home the low cost Sweazey Way

Watch repairing pays up to \$6 an hour, part time watch makers report on survey. Unique and modern Sweazey home study System starts you making repairs right away on Swiss and American watches. Professionally prepared training. No previous experience needed. Special tools provided for practice. Diploma Awarded. Free sample lesson and opportunity book give all facts. Write today. No obligation.

CHICAGO SCHOOL OF WATCHMAKING

Dept. 198, Fox River Grove, Illinois 60021

FREE BOOK and SAMPLE LESSON

CHICAGO SCHOOL OF WATCHMAKING
Dept. 198, Fox River Grove, Illinois 60021
Please rush FREE BOOK and Sample Home Study Lesson.

Name _____ Age _____

Address _____

City _____ State _____ Zip _____

75 POWER TELESCOPE \$498

NEW 3 in one telescopes, 3 variable 25X-45X-75X magnification. Brass bound. 25 power for ultra bright images 45 & 75 power for long range. Guaranteed to bring distant stars, moons, objects, sports 75 times closer.



Most powerful scope anywhere at this amazing-low price. 5 sections. Opens 36" closes 1 ft.; contains 4 ground & polished lenses. Can also be used as powerful microscope. American made. Mass production enables us to offer telescope complete including case \$4.98 post paid. Money back guarantee.

CRITERION CO., Dept. PBM-47, 331 Church St., Hartford, Conn. 06101

MAKE \$20 to \$30 A WEEK EXTRA MONEY

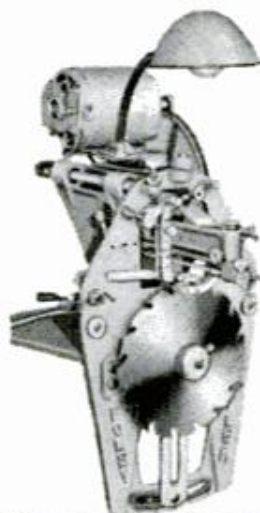

Need extra cash to keep up with the bills? Turn your spare time into dollars this fast, easy, sure way. Make \$3 to \$6 an hour sharpening saws with a Foley Automatic Saw Filer.

START IN YOUR BASEMENT OR GARAGE. Build your own business without special training or experience. "The first saw I sharpened with my Foley Filer came out 100%", writes Clarence E. Parsons. Small down payment puts a Foley Automatic Saw Filer in your hands. Pays for itself with profits. No canvassing.

Every saw you sharpen brings you more customers. Hundreds are making big money the Foley way right now. You can too.

FREE BOOK Shows You How to Start

It explains how you can get business immediately from home owners, farmers, carpenters, schools, factories, etc., and keep on getting it every week. Don't wait. Mail coupon now for "Money Making Facts" and easy pay plan details. No salesman will call.



Mail Coupon for FREE BOOK Now!

FOLEY MANUFACTURING CO.
943-8 Foley Bldg., Minneapolis 18, Minnesota

Rush free book, "MONEY MAKING FACTS", and Easy Payment Plan details.

Name _____

Address _____

City _____ State _____

THOSE NEW TURNTABLES

(Continued from page 87)

automatics slash these disturbances well below levels of older changers.

Speed accuracy of the turntable also reflects quality. While many listeners won't detect small changes in record speed, a turntable should spin at a constant rate. Equipment makers use two types of motors (hysteresis-synchronous and the induction motor), but there's general agreement on one point. Either motor can deliver good performance in a well-designed system. Unlike early changers, most automatics won't start out at one speed, then vary as the tone arm nears the center of the record.

Checking turntable speed is easily done by viewing a strobe disc (included with some models) as it rotates under a fluorescent light. An accurate turntable should freeze the strobe markings to signify true speed.

Another sign of a good automatic is the ability to trip the record-changing cycle when the pickup cartridge is adjusted to an extremely low tracking force. Old changers needed a strong jolt as the record ended to trigger the cycling mechanism. High forces, though, are disastrous to today's delicate stereo cartridges. These pickups often track at the low force of about a gram or so, which leaves precious little mechanical action for tripping the changer. Trip devices in the automatics should cycle at such low pressure.

Special features to look for

Besides these basic requirements, there is a welter of other features appearing on automatics. Many improve operating convenience, while others answer the complex problem of making a stereo cartridge operate with extreme precision. And here is where individual differences between models become increasingly apparent. Let's consider these features in some detail to see what manufacturers offer.

Anti-skating. Today's trend is toward lighter tone arms and needle forces to reduce distortion and record wear. But as weight and friction disappear, a new force creeps in. It's termed "skating." As the arm rides the record groove, it develops a mechanical force that tends to thrust the needle toward the center of the record. The sidewise action causes uneven wear in the groove walls and some distortion.

To counteract the force, manufacturers install "anti-skating" devices that apply a slight offsetting push on the arm in the opposite direction. It's usually a weight or spring that's adjusted in the home to accommodate different cartridges. In the

typical model, a knob is adjusted until it agrees with the number of grams recommended by the cartridge manufacturer for his specific pickup.

If you choose an automatic capable of operating at low needle force, say 1 gram, the anti-skate feature could help extract the last bit of fidelity from the system. A low-cost changer would hardly improve since high needle force and friction wipe out the skating effect.

Stylus force. Nearly all automatics go to considerable lengths in the matter of stylus force. It's the weight or pressure that bears down on the stylus (needle). Old changers had a coarse spring for this adjustment, but the new automatics boast elaborate counter-balance systems for far more precise control. Most current cartridges are designed to operate at a force of about 1 to 5 grams, and the arm should be adjusted to the number recommended by the manufacturer. If force is excessive, there'll be increased distortion and wear. Too little force causes groove-jumping when someone walks near the turntable and also some increase in distortion.

In many automatics, there's a two-step stylus force adjustment. First a counterweight on the rear of the arm is adjusted until the arm is perfectly balanced (hovering in air). Then the recommended stylus weight (in grams) is dialed with a knob. If a scale of weight isn't provided, a separate stylus gauge is used.

The arm counterweight, incidentally, does more than control stylus force. By balancing the tone arm assembly, the arm becomes resistant to changes in level. It means your mounting shelf or turntable base won't have to lie perfectly level.

Turntable speed. Although all automatics aim for great precision in controlling motor speed, several models introduce an additional control to allow the listener to readjust turntable speed. This could prove valuable to serious listeners, music students and instrumentalists. By adjusting the control, the pitch of recorded music can be matched to that of a live, solo instrument (piano or organ, for example).

The control varies disc speed by some 6 percent, about a half-note change. If the listener wants the turntable to rotate at normal speed, he places a strobe disc on the turntable to make the adjustment. Other changers latch on to the 60-cycle line frequency as the reference for turning a disc at rated speed.

Most machines provide four basic turntable speeds used in recording—16 $\frac{2}{3}$, 33 $\frac{1}{3}$, 45 and 78 rpm. Some units drop the 78 since music is no longer recorded at that speed. This may be a factor if you have a collection of old 78s. The 16 $\frac{2}{3}$

speed is mostly for "talking book" discs.

Cueing device. This is one handy accessory featured in most automatics. It overcomes the touchy job of grasping a tone arm by hand and setting down a fragile needle at a desired point on the record. It could prevent damage caused by a needle skidding across the grooves.

The cueing control usually works like this: You press a lever that elevates the tone arm a slight distance above the record. Once the arm is clear, it's safe to grasp it by hand and move it to any section of the disc. Release the lever and the arm gently descends onto the record surface.

The same lever also acts as a "pause" control. If you wish to stop the music any time, just operate the cueing control. After the desired pause, release the arm and the music resumes at precisely the same point.

Cartridge and arm adjustments. Makers of automatic turntables construct tone arms to cope with "tracking error." It's a mechanical wrinkle that starts when the original master disc is cut. Since the disc-cutting point rides on a lead screw, it travels a straight line over the disc from start to finish. But once the disc reaches the home turntable, it's played back with a tone arm. The arm swings over an arc that doesn't quite agree with the straight path taken by the original cutter.

To minimize this discrepancy, tone arms have a bend, or offset, at the cartridge end. The cartridge, however, must be installed with careful alignment to keep tracking error at a minimum. This has led to a number of mounting aids that serve as installation guides. Some turntable makers provide a special plastic form that's temporarily snapped onto the cartridge. An adjusting screw is then manipulated until the stylus is positioned opposite a reference notch.

Another source of error is "vertical tracking angle." Again, there's a discrepancy between the original disc cutter and the home playback system. It develops as the stylus changes angle as records pile up on the turntable. One maker provides a dial that changes the angle according to the number of records on the turntable; another supplies a special wedge to achieve a similar effect. These features could hold appeal for someone looking for the ultimate in cartridge adjustment.

One welcome feature of most automatics is a comprehensive instruction manual that details critical adjustments. If the needle skips opening bars of music or fails to clear the top record of a stacked turntable, you won't have to call the serviceman. Most manuals provide clearly illustrated instructions on how to readjust these settings. ★★★

Build Your CAMPER

SAVE UP TO 50%

Complete, easy to follow Camper or Trailer Plans, \$3.95 ea.
Instructions, Material List, SATISFACTION GUARANTEED
Pickup Cover Plans \$2.00
Econoline Van or Bus Conversion Plans—indicate choiceea. \$2.95



EQUIPMENT CATALOG \$1.95

Refundable on first order.
SEND DIME FOR DETAILS
SAVE 50% ON CAMPER KIT
All items from our catalog to build a \$1,795 camper, 8', 10', 10'6" or Chassis Unit.



VIKING

VIKING CAMPER SUPPLY, INC.
94-8P Glenwood Ave.,
Minneapolis, Minn. 55403

Please send _____ for which I enclose \$_____

NAME _____
ADDRESS _____
CITY _____
STATE _____ ZIP _____



"Sta-Trim" WAIST BELT !!!

Designed for the person desiring a trimmer waistline appearance. Ruggedly constructed belt covers the entire waist area. Special exercise program and instructions.

Send waist size—and \$2.98

"Sta-Trim," Suite 1204-PM-1

28 East Jackson
Chicago, Ill. 60604

RECHARGE ALL BATTERIES

Only Everlite

- Charges 6 batteries
- Charges 3 times faster
- Charges all batteries

Including hearing aid, flashlight, lantern, radio, in fact any battery up to 12V. Save Money and have the convenience of fresh batteries always. Simple and 100% Safe. Plugs into any 115V. outlet. Guar. for one year. Send \$6.95 plus \$.65 for shipping.....

695



Model 75

MASTER MECHANIC MFG. CO., Dept. A-98, Burlington, Wis.
Southern Customers write Dept. A-98, Box 65, Sarasota, Florida

Fox Mini Bike

DO IT YOURSELF
OR FULLY ASSEMBLED

FROM

\$79⁵⁰



12 MODELS
3 TO 5 HP

SEND \$1 FOR BIG CATALOG

Shows new 1968 line of the world's finest **MINI-BIKES** (most are licensable for street use), plus parts, accessories and plans. Big selection! Amazingly low prices! There's a Fox **MINI-BIKE** for everyone — from age 10 and adults.

EXTRA BONUS — Catalog shows radios, watches, walki-talkies, cameras, models, tools, pool tables and many other items you can buy at practically wholesale prices.

FOX CORP., Box 797 PM Janesville, Wis. 53545

FREE

Window Planning Guide



to help you make the right window decisions for your new home or remodeling project. Send today for full-color folder packed with helpful hints plus a description of the Andersen Window line.

Clip and Mail Today!

- I plan to build.
 I plan to remodel a _____.

Mr. _____
Mrs. _____

Address _____

City _____ State _____ Zip _____

Andersen Windowalls

Andersen Corporation • Bayport, Minnesota 55003

PM-98

FREE!

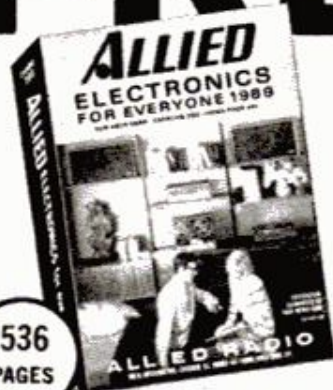

536
PAGES

Shop by mail and save at Allied, world's largest electronics headquarters. Hundreds of money-saving values. **NO MONEY DOWN.** Up to 2 years to pay!

MAIL COUPON BELOW

ALLIED RADIO, Dept. 074
P.O. Box 4398, Chicago, Ill. 60680 (Please Print)

NAME _____

First Middle Last

ADDRESS _____

CITY _____

STATE _____ ZIP _____

1969 ALLIED CATALOG

SAVE ON:

- Electronic & Hobby Kits
- Stereo Hi-Fi
- Tape Recorders, Tape
- CB 2-Way Radios
- Walkie-Talkies
- FM-AM & AM Radios
- Shortwave Receivers
- Portable TV
- Phonographs
- Amateur Gear
- Intercoms & PA
- Automotive Electronics
- Test Instruments
- TV Antennas & Tubes
- Power Tools, Hardware
- Tubes, Transistors
- Parts, Batteries, Books

HAVE HOUSE, WILL TRAVEL

(Continued from page 91)

off, unless restrained by agreement ahead of time.

Two-story houses present varying problems. They are always more expensive to move because more overhead wires and other obstacles must be dealt with. Where state height limits exist, the situation is more drastic. There is a standard cure: Cut the roof off and move it separately. Fireplaces and outside chimneys call for special handling. Where the masonry is old, movers hesitate to guarantee results.

Foundations affect costs at both ends of a moving job. From a crawl-space block foundation to another just like it is simplest. From an old basement to a new basement is nearly as easy, but the new basement is expensive. Putting a slab on a crawl-space foundation is simple enough once the house is at the new site, but moving a heavy slab costs plenty.

The final judgment on the feasibility of moving a house, particularly where it might need surgery, should be left to the man who'll move it. Movers can move anything, but sticking to basic do-it-all-the-time types of houses is the best way to save money.

Depending on where you move to, there may be special deed restrictions, zoning ordinances and regulations concerning setbacks. These must all be reviewed before the deal is set.

How the house will be placed on the lot should also be taken into consideration. Taking a house that was built to face north and moving it to where it faces south will change the lighting and the heating. Be sure, too, that there is sufficient clearance between trees and other obstructions on the new property to get the house in. There must be an opening about 12 inches wider than the narrowest dimension of the house, but a good mover can even shave it closer than that.

Oddly enough, despite all the application of brute force, nothing inside the house is harmed. If I were to move my house again, I wouldn't even take the dishes out of the cabinets or the pictures off the walls. It isn't done with mirrors—the house is simply kept rigidly level with itself during the entire job. It tilts and swings, but it neck racks or twists. It is suspended on three points, and these keep it always moving as a unit.

Getting a mover to move a house, or buying a house from a mover, is just like any other business deal, with give and take on both sides. One can bargain hard

(Please turn to page 196)

It's easy to convert your basement to 'family living' with versatile Masonite products.

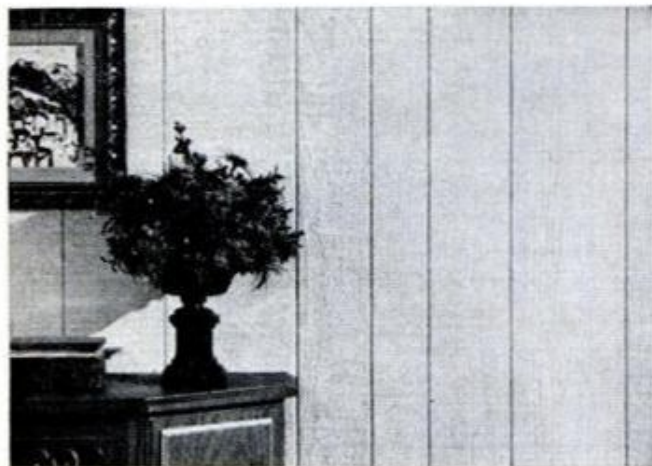

The newest member of the Royalcote paneling family features a beautiful embossed texture that you can see and feel. Ideal for informal living, Royalcote textured panels come in a choice of popular colors.



Royalcote Living Wall . . . a unique concept in decorative wall paneling—beautiful and functional, but with an important difference: Hidden slots in the grooves hold shelf brackets and picture hooks . . . high up or low down. Change them in seconds. No nails, screws, standards or drilling.

Masonite, Royalcote and Peg-Board are registered trademarks of Masonite Corporation.



You can put your basement walls to work and organize your work areas quickly and easily with Peg-Board and dozens of handy fixtures. Available in $\frac{1}{8}$ " and $\frac{1}{4}$ " thicknesses, Peg-Board is also ideal for garages or utility rooms.

There is no limit to the uses of Masonite hard-board products . . . walls, sliding doors, counter tops, what-have-you. These panels won't split, splinter or check. They go up fast with adhesive or nails on studs or furring strips. For more information send in the coupon.

MASONITE CORPORATION Dept. PM-9
Box 777, Chicago, Illinois 60690
In Canada: Masonite Company of Canada, Quebec
Send me free of charge your full-color Interiors
booklet.

Name _____

Address _____

City _____ County _____

State _____ Zip Code _____

WHAT GUN FOR WHAT GAME?

(Continued from page 94)

kill deer every year—mostly in the heavier-settled states east of a line running generally north and south along the west boundaries of Arkansas and Missouri. In this area, a short, light, fast and easy-handling carbine is your best bet. No higher degree of accuracy is required to hit a deer less than a football field length away, so lever, pump, or automatic will do just as well as a bolt gun. And, most hunters can get repeat shots off faster from them than with the bolt action. All the major manufacturers turn out guns in this class, so there are many models to pick from.

Relatively light cartridges are fine for eastern deer hunting, and they also do fine for the occasional small black bear or southern hog you might decide to hunt. The popular .30-30 Winchester is a favorite, as are the .300 Savage, .35 Remington, and the .44 Magnum. The .308, .284, and .243 Winchester do a very fine job, but really have more velocity and power than necessary. However, the more modern guns of the type best suited to eastern hunting are chambered for them. So, don't hesitate to use them.

Bigger game

Moving westward, we start running into more open country and longer ranges. The game gets bigger and tougher, too, though deer still outnumber all other species. And, we find the big mule deer, as well. More powerful, flatter shooting rifles of greater accuracy are needed. Generally speaking, this means a bolt-action rifle with 22 or 24-inch barrel. The bolt gun is chambered for the most powerful cartridges. And because of rigid one-piece stock construction, it has long ago proven its ability to shoot closer than lever, automatic and pump guns. A western gun will be heavier than a carbine for eastern hunting, but the weight will pay for itself. Classic examples of the western rifle are the Winchester Model 70 and Remington Model 700, though all other makers produce similar models. You'll have no trouble picking one that suits you.

It goes without saying that on all the longer ranges of western hunting a scope is highly desirable, if not downright essential. The 4X seems to be about the best choice.

A cartridge of the .30-06 and .270 Winchester class will handle every animal to be found in the Western states. With the heavier-bullet factory loads, they'll stop elk and grizzly. And, they shoot flat and

accurately enough to take medium-to-large game out at 300 yards or so. Expert riflemen use lighter calibers such as the .308 and .243 Winchester and the 6-mm Remington on big western animals, but they aren't recommended for the average once-or-twice-a-year hunter.

We can't pass by the Magnum calibers. Of course, they are good—more power for heavy game, flatter trajectory for long-range shots. And, if you already know you can handle the kick and noise of a 7-mm or .300 Magnum, either is better than the .270 or .30-06. But, most hunters don't shoot well enough to handle the "big bruiser" cartridges. If you can't shoot a 7-mm Magnum as well as you can a .270—use the .270. Missed or poorly-hit game doesn't often wind up in the freezer, so pick an adequate cartridge that you can hit with well.

Far North

Outside the 48 contiguous states, we have Alaska and portions of Canada where the biggest and meanest North American game is found. Moose in these areas are big, but not particularly hard to kill nor are they likely to eat you if you just make them mad. Grizzly, brown and polar bears in these areas take plenty of power. They run frighteningly big, and there's quite a list of deceased hunters who didn't have enough gun to put the big bears down quickly.

The ideal bear gun isn't to be had. It should be short, fast-handling and very powerful. Nearly all the extremely powerful guns today are bolt actions which aren't as fast-handling as other types. Consequently, short-barreled bolt guns are the rule, though the discontinued Winchester M-71 lever gun works out well. So does the Marlin .444 lever gun, but its high trajectory and relatively low energy beyond 100 yards limit its use.

Bear cartridge

A short bolt gun such as the Remington M-660 or Winchester M-670 is an excellent choice, but don't forget to get in plenty of bolt manipulation practice so as to be able to ram in fast follow-up shots.

The bear cartridge should be the heaviest you can shoot well enough to keep all your bullets on a dinner plate at 100 yards. The 7-mm Remington Magnum, .300 Winchester Magnum, and .338 Winchester Magnum are excellent, as is the .350 Remington Magnum. If you can handle it, the old .375 H&H Magnum isn't too much. If you *must* use a lever gun, the only current model worthwhile is the Marlin in .444 caliber, but don't try any long-range shots—energy and velocity

drop off very rapidly away from the muzzle.

Hawaii has goats, deer and wild pigs, all rather small, and they are hunted in mountains. A flat-shooting rifle easy to carry is the best choice. Take your choice of action types since ranges aren't too great, and moderately good accuracy is all that's required.

A relatively light, high-velocity cartridge is best. The .243 Winchester and 6-mm Remington are perfect for Hawaii use, so why look further?

If all this makes you think you'll need a half-dozen guns to get in reasonably varied hunting, don't despair. We've already indicated the .243 Winchester and 6-mm Remington do fine on deer and black bear, and they'll take elk and moose if carefully used. And they have the velocity and flat trajectory, even with the heaviest factory-loaded shells, to do well in the western states. When we look at their light-bullet load performance, we find they aren't far behind the hot .22 centerfires for varmint use.

This means simply that if economics do limit you to one good centerfire rifle, you can accept that fact and still be able to hunt everything but the big bears without being very seriously handicapped. A medium-weight .243 or 6-mm bolt gun with 22-inch barrel and a 3X-9X variable scope will do well by you in all the states, so long as you use it with care on elk and moose, and learn to live with its roar when varmints are the order. ★★★

VOLKSWAGEN OWNERS REPORT

(Continued from page 111)

tell someone my back hurts."—Maryland business machine serviceman.

Comfort and driver visibility (and therefore, safety) aren't the only complaints. Passengers in the back feel "isolated" as a Maryland technician complains. They don't see much of the road either.

Owners sound off freely about various small things: hard-to-use vent window knobs, the notoriously inadequate heater, and so on. But when it comes to engineering, workmanship and durability, they are hushed with respect. Many say they'll keep their Beetles "for the life of the car," "til it wears out" and "as long as it lasts."

Whether they plan to go all the way with their VW or trade-in American style before the tires and battery poop out, almost all compare the quality of VW workmanship to that of cars made in the good ol' U.S. of A. And that's one reason they say they buy a Volkswagen. Is anyone at home listening? ★★★

ARROW

HEAVY DUTY T-50

STAPLE GUN

Uses 6 staple sizes from 1/4" to 9/16", including CEILTILE



\$12.95

A HANDY CHECKLIST OF HOUSEHOLD FASTENING USES

- Install ceiling tile
- Apply insulation
- Fasten weatherstripping
- Reupholster chairs
- Fasten fence wire to posts
- Repair window screens
- Secure antenna wiring
- Tack down stair treads
- Replace worn window shades
- Attach vines to trellises
- Tack carpet underpadding

- Apply polyethylene vapor barriers
- Make window boxes
- Trim kitchen shelves
- Line closets
- Fasten burlap around tree trunks
- Cover valances
- Hang drapes
- Affix wall decorations
- Install plastic wall brick

SHOOT A STAPLE WHEREVER YOU'D DRIVE A NAIL!
FASTER . . . BETTER . . . CHEAPER . . .

At Hardware, Lumber and Building Supply, Stationery and other retail outlets

ARROW FASTENER COMPANY, INC., Saddle Brook, N. J. 07663

TRAIL-BIKE FACTORY DIRECT!

159⁹⁵
as shown

\$10 Dn.
\$10 Mo.*



BUY DIRECT SAVE HALF

Also available in welded kit form for only \$149.95



- 3 1/2 hp engine
- Spark arresting muffler
- Automatic clutch
- Twin shock suspension
- Goodyear pneumatic tires
- Weight: 80 lbs.

Send only \$10!

TIME PAYMENT
With Bird engineering's Time Payment plan, you can pay-as-you-ride. Just send \$10 down with completed coupon on the right.

*Plus interest (rate varies with local state).

RUSH YOUR ORDER!

RUSH information (I enclose 25c) PM-9
HURRY and RUSH trailbike (I enclose \$10)
(I enclose 50% Dn. Bal. COD)

Name _____
 Street _____
 City _____ State _____ Zip _____

BIRD engineering
 Box 427 DTS
 Omaha, Neb. 68101

START A MONEY-MAKING BUSINESS FOR LESS THAN \$50!



You can have your own lifetime business right at home . . . work in spare time . . . and make up to \$200 a month CASH! My FREE PLAN gives you all the facts: How to start, how to grow. You don't need previous experience. You don't have to sell. I'll even finance you. People bring you the work and pay cash. Over 90¢ of every dollar you collect is clear cash profit. And you work when you want to. Let me prove you can't find a more certain, lower cost, higher paying business of your own.

Just Mail Coupon—No Salesman Will Call

BELSAW SHARP-ALL CO., Stan Field, Pres.
719-S Field Bldg., Kansas City, Mo. 64111

Name _____
Address _____
City _____ State _____ Zip _____

FREE BOOK

INSTANT METAL PARTS WITH UNMATCHED

No waiting. With this 5-in-1 machine tool (lathe, miller, borer, drill press, grinder) you make your own precision parts in metal, plastic or wood. Anyone can use—no special training needed. Complete unit in store-away case only \$139.50.



Write for free literature to American Edelstaal, Inc. Dept. B18, 350 Broadway, New York, New York.



LABORATORY TESTED!
U.S. PATENT 3,159,140

TRAINS ANY DOG INSTANTLY!

* PUPPIES, DOGS OF ALL AGES. NEVER FAILS!

TEACHES

- Come—at all times!
- Sit
- Heel
- Guard
- Drop, etc.

STOPS

(even in your absence)

- House soiling
- Jumping-up
- Chewing
- Barking, etc.

40,000 satisfied users. Hundreds of unsolicited testimonials. 4 times with Art Linkletter. CBS-TV News. Johnny Carson, Mike Douglas, To Tell The Truth, Joe Pyne: "It really works." Recommended by leading veterinarians, breeders.

Hi-Fido, "Pavlov's Bell" is a small scientifically developed chain-tuning fork, bell-like device. Just shake or toss, controls dog near or far, permanently by a unique sound-association. Kind, not electric.

Includes FREE 353-pg. reference manual. Illustrated. Indexed

Guaranteed. Write, wire or phone for information. Fascinating!

CANINE BEHAVIOR INSTITUTE

11927 Montana Avenue
Dept. PM9-9 Los Angeles, California 90049

This little yellow plug proves your car is worth \$200 more.



See your Ziebart Rust Specialist. Assembly lines can't . . . undercoating doesn't

. . . Ziebart gives your new car complete, innercoated rust protection. Guaranteed 5 years/50,000 miles. That's why Ziebarted cars are worth up to \$200 more at trade-in time! Take your car to your Ziebart Rust Specialist. He'll seal out rust, dust and road sound from within, and you'll see the Little Yellow Ziebart Plugs that close the innercoating access points. They're proof your car is totally rustproofed for lasting looks, greater safety, higher resale value! Look up "Ziebart" in your Yellow Pages, or write Ziebart, 16135 Harper, Detroit, Mich. 48224 for your Rust Specialist's address. (Certain choice Ziebart franchise territories still available.)



ZIEBART

AUTO • TRUCK RUSTPROOFING

World's Leading • World's Largest



* Reg. U.S. Pat. Office



TO CLEAN ROLLER, hold it by the handle and spin it in a strong blast of water from your garden hose

PAINT HOUSE WITH A ROLLER

(Continued from page 150)

like lamb's wool and mohair will soften and lose body in water-base paint. Stick with Dynel, Dacron, Pronel, Bak-O-Nel or one of the other man-made fibers. These not only stand up to water, but are tailored to suit the job (For instance, fibers for use in long-nap rollers are given more body than those commonly used in short-nap rollers).

Quality of construction is relatively easy to judge. The roller core should be plastic, or at least plastic-impregnated, in order to stand up under heavy use. The ends should be beveled slightly so they won't spread beyond the edge of the core and become overloaded with paint.

Be sure to get a roller frame with a threaded handle, so you can use it with extension poles. Sectionalized poles are best since they can easily be tailored to the desired "reach."

Start painting in the morning, as soon as the dew has evaporated. Begin on the north or west side and work around to the south or east side. Always start at the top and paint down, so you can cover drips and spatters.

When you take a break, saturate the roller with paint to offset drying until you return to the job. Also, watch for paint setting up in the roller while you're using it. This sometimes happens in hot dry weather, and many painters alternate two rollers to avoid it. The one not in use is dunked in a pail of water.

For overnight storage, just wrap the rollers in foil and put them in the refrigerator. At the end of the job, though, give them a thorough cleaning. A good roller is no throwaway tool. ★★★

New Improved HEAVY DUTY FOUR-WAY AMERICA'S ORIGINAL LOW-COST ARC WELDER AND ELECTRIC TORCH

10 DAY
TRIAL

LIFETIME
GUARANTEE



Only \$18.95 Prepaid Complete Ready To Use
WELD, BRAZE, SOLDER, CUT
All Metals Including Aluminum

FREE EXTRA BONUS GIFT
with your order. Choice of:

1. 10-piece wrench, plier and screw driver kit in case, or,
2. Wire forming tool. Forms wire to weld valuable items, or
3. Big pack welding & brazing rods, carbons, flux & solder.

Every home, shop, and hobbyist needs this quality metal working machine. Anyone can use. *No experience needed.* Use up to 1/8" welding rods and 1/4" carbons to make or repair 1001 items including furniture, garden tools, toys, auto bodies, fenders, trailers, boats, farm equipment. Operates on 110 V. line for pennies — replaces torches — no tanks or refills to buy — produces to 11,000° heat to weld, braze, solder, cut, melt, bend all metals, also sweats pipes, softens and removes paint, softens asphalt tile. **YOU CAN PAY MORE BUT YOU CAN'T GET A BETTER LOW COST WELDER.** Over 500,000 in use. Manufacturers of welders for over 30 years. **LIFETIME UNCONDITIONAL GUARANTEE.** Simply return. We will repair or replace and ship **FREE** of charge. **YOU GET: FULL FACE SHIELD, heavy metal cabinet, combination ground and work clamp, heavy duty cables, SPECIAL combination carbon arc torch & rod holder, carbons, welding and brazing rods, flux, solder, welding manual. ORDER TODAY ON 10-DAY UNCONDITIONAL MONEY BACK TRIAL.**

SEND ONLY \$2.00 and pay \$16.95 plus C.O.D. charges on delivery, or send only \$18.95 for postpaid shipment in U.S.A. Specify gift.

FOUR-WAY WELDER CO.

1810 S. Federal St., Dept. R2-J, Chicago 60616



GUNK
**ENGINE
BRITE**

ENGINE CLEANER
and DEGREASER

Just spray it on...
hose it off!

GUNK LABORATORIES, INC.
5813 N. STATE, CHICAGO, ILL. 60630

A FISHERMAN'S DREAM BOAT

(Continued from page 114)

to the bottom of the boat—almost like a trim tab.

The recording indicator needs a more permanent and sensitive installation. They solved that by cutting out a 6 by 8-inch area of deck just ahead of the engine box, then removing the closed-cell foam beneath it to form a box but leave the outer fiberglass hull intact. With the box sealed with fiberglass and filled with water, the transducer works as if the remaining hull weren't there at all, even with the boat moving. A Plexiglas lid, sealed with an oversized O-ring and held down with thumbscrews, permits easy checking on the water inside, and easy removal when necessary. Result: Both depth indicators work at optimum, but with no drag on the hull at speed. You may decide only one type depth recorder is best for your boat.

Between the fixed seats and the fighting chairs, the engineers left a space that just fits a big portable ice chest on the starboard side and four to six buoyant cushions on the port. Nonswimmers aboard wear buoyant vests, however; they are issued to all hands in rough weather. But the 191 hull contains 32 cu. ft. of built-in, closed-cell plastic flotation, which is enough to float 2000 pounds—even when the boat is completely filled with water.

For navigation—as well as for keeping a straight trolling course—a big Airguide marine compass (\$30) was installed in a gimbal mount on the driver's dashboard. He can watch the engine instruments, the compass, and the flashing-dial depth indicator without turning his head.

For emergency navigation—as well as for receiving weather, marine, and broadcast band radio—a Ben-Mar RDF (\$220) radio direction finder was installed on a bracket behind the fixed port seat.

For two-way conversations, and for calling help in an emergency, they installed a 150-watt Ben-Mar marine radio (\$525, Skipper 750 with antenna) on the dash facing the fixed port seat. The radio also permits conversation with Coast Guard monitors, aircraft, and other marine radios, an important feature when fish are being hunted over wide areas. A 10-foot whip antenna, mounted on a retractable base bracket, folds back out of the way when not in use, or when passing under low bridges. The radio unit itself was simply installed by cutting through the dashboard fiberglass with a saw and using the brackets provided with the radio.

All that electronic equipment makes it essential to eliminate static from the engine's ignition system. And the snug en-

gine box of the inboard-outdrive makes that a simple job. The engineers bought 32 feet of ordinary 24-inch copper screen (\$10) at a hardware store, and stapled it inside the engine box like upholstery fabric to completely surround the engine. The screen was grounded to the engine block, and static disappeared.

To ground each depth finder, two standard Ben-Mar grounding plates were installed on the hull bottom, near the transom. All other electronic gear is grounded to the battery.

Other safety gear packed in the boat's commodious storage areas include:

- A Danforth anchor, big enough for a 25-foot boat, with 200 feet of half-inch nylon line, to insure a long line and a good bite for the anchor.
- A three-foot-diameter, collapsible canvas sea anchor, which opens like an umbrella in the water to hold the boat's bow to the wind in case of an engine failure in water too deep for anchoring.
- An emergency flare kit, with six red flares.
- A hand bilge pump and a plastic bailing scoop.
- A spare propeller and a small tool kit.

With a good hull and a tight top, plus its emergency equipment, this Johnson boat can handle most waters in any fishable weather. What's more, its features can be applied to almost any seaworthy hull, for fishing on *any* potentially dangerous water. ★★★

HAVE HOUSE, WILL TRAVEL

(Continued from page 190)

when buying the house from the mover who will also move it. Often, movers are working against a deadline for removing a house and clearing the ground. The closer they are to that deadline, the readier they are to shave the price or make other concessions.

In any event, get a lawyer. He is needed either to draw a contract or to pass on the mover's contract. The contract should specify money payments—most moving jobs are handled like construction work with the contractor drawing money as he completes certain phases—damage adjustments, quality of work, type of foundation and time of completion.

In no case should there be a final payment without proof of waiver of lien rights. The many other details—such as well digging, city water hookup, heating and electrical service—are all the same as with a new house. The one big difference with house-moving is that it's always cheaper, if you work it right. ★★★

HOW WOULD YOU DO IT?

(Continued from page 163)



The chief and his helper built a platform about 10 ft. long and 1 ft. high inside the hangar. When the plane was rolled up one end of the platform, the tail was lowered enough to clear the lintel. When rolled down the other end, the craft then set level.

Second "pulley" reel



The old hoist pulley was mounted on the rear of the vehicle and the supply spool was staked into the ground. The wire was then run around the pulley and anchored to the first fence post. Thus, as the Jeep pulled away, it unreeled two strands of wire at the same time.

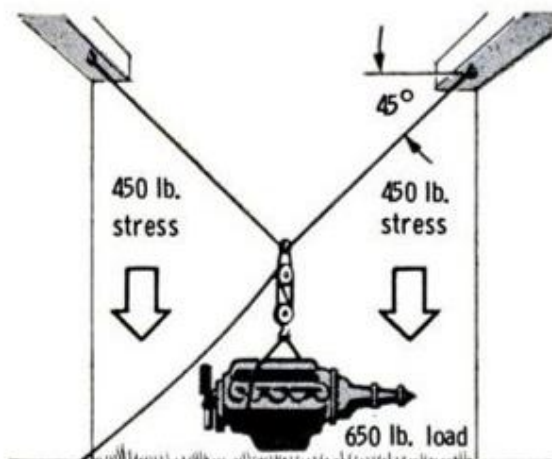

A single line fastened directly above the engine would have held it, but when stretched between two points and then loaded, the line is subjected to vector forces greater than the actual weight. Jim increased the sag angle and the line easily lifted the load.



*How
super
can
super 8 get?*

We make a lot of super 8 KODAK INSTAMATIC Movie Cameras. All drop-in loading, no winding, uninterrupted shooting. But one's got to do the most for you. This one—the brand-new KODAK INSTAMATIC M9 Movie Camera!

It gives you a broad zoom range—5 to 1—either automatically by power zoom or manually. And four shooting speeds. And through-the-lens viewing with visible zone-focus indicator for easier focusing as well as sports finder for fast action. Through-the-lens CdS automatic exposure control, too. And a super-sharp focusing $f/1.8$ lens! Provision for remote control and single frame exposure.

Get the most for your money. The new KODAK INSTAMATIC M9 Movie Camera in handsome wood-grain vinyl finish, less than \$230, at your Kodak dealer's. Price subject to change without notice.

Kodak Instamatic® M9
Movie Camera

Kodak



more
SOCK
less shock

with the
PLUMB®
FA57

A "Proven Performer"

Swings easy and hits hard.
Dura-Cushion Grip absorbs shock.
And Plumb Fiber-Glass Handles are
guaranteed not to break, bend or
collapse in normal use.

They have been for over 13 years!

Advertised
Price
\$6.49

FAYETTE R. PLUMB, INC. • PHILADELPHIA, PA. 19137

BUILDING AN EXTRA CLOSET

(Continued from page 125)

joint compound. Just how you do this, as well as tape joints, is explained in detail in a booklet called *How to Remodel With Drywall*, a copy of which can be obtained by writing to Popular Mechanics, 575 Lexington Ave., New York, N. Y. 10022 and enclosing 35 cents, plus 15¢ for postage and handling.

Louvered bifold doors are ideal for shallow closets. They open wide for full access, help ventilate the closet and are good-looking. Two pairs of 15-in. doors will fit a 60-in. opening perfectly. They come complete with hardware and full instructions for hanging. Some even come ready-hinged and primed.

Completion of your closet requires adding matching baseboard along the floor and molding at the ceiling, and, of course,

either papering or painting the walls if you used plasterboard.

Popular standards and brackets provide the easiest way to add shelves to your closet. Being fully adjustable, you can place the boards wherever you want them, and add as many as you want. Solid support is assured by locating the standards over studs. Where this can't be done, plastic screw anchors or fiber plugs should be used in plastered walls.

I used 1/2-in. plywood for the six shelves and supported each one with five brackets. The trick in getting the 8-ft.-long shelves in place is to first put all six boards on the floor of the closet (resting them on edge) and then raise them one at a time as each of the five brackets is hooked in the standards. The brackets shown are of the heavy-duty type which features a plastic clip that's used for screwing the shelves to them. ★ ★ ★

How to make money in MAIL ORDER

Free Copy! "How to Make Money in Mail Order" shows men, women, families how to start full or spare time big profit home mail order business. See how you get best products to sell by mail. Discover how your pocket profits in advance. Newest mail order techniques revealed. Start without experience or product investment. No salesman will call. Write for Free Copy. MAILCO, 1554 S. Sepulveda, Dept. B2259, Los Angeles, Ca. 90025.

\$70 AIR-GUN only \$29.95

Complete with chisel this 3 lb. Air-Gun fits into metal, chips concrete, drives pins, etc. Delivers 5500 2" strokes a minute. Operates on 3 to 5 hp compressor. Made especially for govt. and manufacturer made too many. At only \$29.95 ppd. while they last, a \$70 value. 3 extra accessories for exhaust pipe cutting, riveting, etc. \$9 ppd.



Meredith Separator Co. Dept. 968, 310 W. 9th St. KANSAS CITY, MO. 64105

TREASURE

Find buried gold, silver, coins, treasures.

5 Powerful models.

Write for free catalog



RELCO DEPT. D-3 \$19.95 UP
BOX 10839, HOUSTON, TEX. 77018

WANT MORE MONEY? GET INTO PHOTOGRAPHY

Coast-to-coast, high-paying jobs in photography are waiting for people with the "know-how" to fill them. You can quickly, easily qualify at home with the world-famous NYI Learn-by-Doing Method. Write today for free catalog. Also resident training in New York. Our 58th Year.

NEW YORK INSTITUTE OF PHOTOGRAPHY
Dept. 49-9, 10 West 33 St., New York, N.Y. 10001

MEN: Caulk jobs are a snap with DAP Butyl-Flex.[®] Stays flexible. Seals tight for 20 years. Best you can buy.

THINK ABOUT IT



DAP[®]



DAP Inc., Dayton, Ohio 45401 / SUBSIDIARY OF Plough, Inc.

NEW RUBBER STAMP BUSINESS PAYS BEGINNERS UP TO \$16.50 AN HR.

START AT HOME IN SPARE TIME with Table Top Machine!

We Help Finance You ... at less than bank rates!

The multi-million dollar Rubber Stamp business—once controlled by a few big companies—is now being taken over by small operators—one in each community throughout the United States. Men and Women who have this inexpensive machine can turn out huge quantities of Rubber Stamps with special wording that buyers once were forced to buy from big cities. Material costing only 27c makes a stamp that sells for \$2.75. The machine that does the work is simple and easy to operate and it turns out as many as six Rubber Stamps at a time, each with different wording such as names, addresses, notices, stock numbers, prices and other "copy" needed by offices, factories and individuals. Working full capacity, it can earn as much as \$33.00 an hour for the operator! Now you can get into the big-pay business yourself, with your own home as headquarters. You don't need experience. We supply everything, including complete instructions and eight ways to get business coming in fast. We even help finance your start. Start making up to \$16.50 an hour from the very beginning. Cash in on the profitable Rubber Stamp business in your community, right away. We'll mail full particulars FREE and no salesman will call. Be first in your locality. Rush coupon today or send your name on postcard to:

RUBBER STAMP DIV., Dept. R-2-KO
1512 JARVIS AVENUE • CHICAGO, ILL. 60626



RUBBER STAMP DIV.
1512 Jarvis Ave., Dept. R-2-KO
Chicago, Illinois 60626

FREE!

Please rush full particulars about your financing plan and the little machine that can get me started in the profitable Rubber Stamp business at home in spare time. Everything you send me is FREE and no salesman will call.

NAME

ADDRESS

CITY STATE Zip Code



EARN HIGH WAGES as a HEAVY EQUIPMENT OPERATOR

Train your way to high pay in the booming construction industry! Learn the skills you need to qualify, by actual field training on machines like the ones used by the industry. Huge training grounds in North Carolina, a million dollars worth of school-owned diesel-engined machines, experienced instructors, full 220-hour and 440-hour courses. National, the original school of heavy equipment operation, is a recognized leader. Member American Road Builders Assn., Services and Supply Division. Associate Member A.G.C. Full-time job Advisory and Counseling Director on staff. VA approved. For men ages 17 to 56. Train Now-Pay Later plan . . . other payment plans also available. Write TODAY for FREE catalog and FREE copy of school newspaper reporting news of National School graduates. Accredited member NATTS.

**NATIONAL SCHOOL
OF HEAVY EQUIPMENT OPERATION, Dept. D-19**
P. O. Box 1686, Moores Chapel Road, Charlotte, N. C. 28201
Please send me FREE illustrated school catalog and complete information. I understand there's no obligation.

Name _____ Age _____
Address _____ Phone _____
City _____ State _____ Zip Code _____

outdoor storage plans



Get more space for outdoor storage. 1. Two-room unit separates sports and garden gear. 2. Storage shelter with 8 closets. 3. Compact cabinet on a wall for tools. For 3 plans send 10c to American Plywood Assn., Dept. PM, Tacoma, Wash. 98401.

WORLD'S FINEST CORED SOLDER

ERSIN MULTICORE 5-CORE SOLDER

BUY IT AT
RADIO-TV
PARTS STORES

EASY DISPENSER
ONLY 69¢

EVERYONE'S A SKILLED NAVIGATOR
AT HULL DIRECTIONAL DRIVING



ROUTE-GUIDE
Charts your course!
CAR COMPASS
Keeps you on course!



At your dealer's or write.
THE QUALITY COMPASS...IT WORKS!

HULL MFG. CO. • Box 246-D-9 • Warren, Ohio 44482

At Last a New Amazingly Simple

GAS TURBINE JET ENGINE



Build from easy to follow plans. Length 15",
Dia. 8 1/2", Wt. 15 lbs. Fuel: Gasoline or Kero.

"Screamin Demon" develops 20 H.P. Ideal project for serious-minded hobbyists, students; scientific and industrial arts classes. Make on 9" metal cutting lathe with milling attachment. For use on small racing boats, midget cars, etc. Full size assembly drawings with critical dimensions, bill of materials and photos. Price \$5.00. No C.O.D.
SAVOY SCIENTIFIC, BOX 1398, SANTA MONICA, CALIF. 90406

WARNING



U.S. Surplus High Speed Milling
Files going fast. New, in G.I. Packs.
Hardened steel, for filing, milling,
routing, drilling—any work in metal
or wood. Use in 1/4 in. drill, etc. Big tools, from 1/4 to 1 1/2
in. wide. Get these most useful tools now.

22 tool set—government cost \$109 \$ 9.00 to you!
46 tool set—government cost \$265 \$15.00 to you!
100% GUARANTEED. WE PAY POSTAGE. A LIFETIME BUY!!

THE SURPLUS CENTER
LANCASTER, TEXAS 75146

BE A TAX CONSULTANT



Earn big money in ever growing profession.
Our students are earning lucrative fees in
digitized full or part time home-office busi-
ness-preparing income tax returns. Pays BIG
in a very short time! No bookkeeping expe-
rience necessary. We train you at
home and help you start. Licensed
by N.Y. Education Dept. Write for
free literature. Accredited Mem-
ber NHSC. Vet Approved.
National Tax Training School
Monsey, 20VA, N. Y. 10952

TYPEWRITER REPAIRMEN



Step into a high-paying job or earn big
sparetime or fulltime earnings on your own.
Over 25 million typewriters need servicing.
FIRST TIME you can get industry-approved
training at home! Earn while learning. Type-
writers, all tools SUPPLIED! Fully acc'd.
Vet app'r'd. FREE BOOK! Write

TYPEWRITER REPAIR SCHOOL

Dept. 3110-098

Little Falls, N. J. 07424

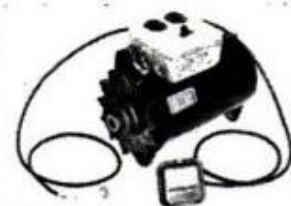

**110-112 VOLT A.C. LIGHT
PLANTS—60 CYCLES**

Fanbelt driven from pickup or
small gas engine. Operates saws,
drills, pumps, freezers, T.V.
X1000 Watts—Needs No Battery.
Reg. \$99.50, Now \$62.50. 1500
Watts—6 or 12 volt vehicles.
Reg. \$89.50, Now \$52.50. 3000
Watts—12 volt vehicles only. Reg.
\$179.50, No. \$99.50. Guaranteed.
Check or Money Order.

VIRDEN PERMA-BILT, Box 7066 P.M., Amarillo, Texas 79109

ENROLL—EARN YOUR DEGREE

of Bachelor of Bible Philosophy (B.Ph.B.), Master of Bible
Philosophy (M.Ph.B.), Graduate of Bible Philosophy
(G.Ph.B.), Doctor of Metaphysics (Ms.D.), or Doctor of
Divinity (D.D.). Chartered by State, Correspondence
Courses only. Please write for FREE BOOKLET.

AMERICAN BIBLE INSTITUTE

Dept. PM, Post Office Box 8748, Kansas City, Missouri 64114

make your own Gems 39.50
F.O.B.

The Gem Maker comes complete with all
necessary equipment, including a super-charged
diamond blade for sawing, and all the wheels for
grinding, shaping and polishing; also complete
instructions. The complete equipment as shown,
less motor and belt for only \$39.50.
C.o.b., Burlington, Wisconsin. Write to-
day for information and litera-
ture.

B&I MANUFACTURING CO.
Dept. P, Burlington, Wis. 53105

The modern Army goes to school, and there's a place in class for you.

In fact, high school graduates have more than 300 job training courses to choose from.

And if you qualify for the Army's enlistment program, we guarantee your course selection *before* you step forward and raise your hand.

There's still another plus. The training is great. A leading American university credits the Armed Forces with one of the most advanced and comprehensive educational programs in the world.

Job training in the Army could be the opportunity you need to acquire a vital and rewarding skill. At the same time, you fulfill your military obligation.

We can give you more than 300 good reasons for joining the Army.

But all you need to choose is one.

Your future, your decision...choose **ARMY**.

Army Opportunities
Dept. 200
Hampton, Va. 23369

PM 9-68

Please send me your free 40-page booklet. I understand there's no obligation attached to this request.

Name _____ Age _____

Address _____

City _____ County _____

State _____ Zip _____

Phone _____ Education _____

Enroll in the Army.



'CHARGING' THROUGH OLD MEXICO

(Continued from page 79)

sun begins to play tricks on your eyes.

It beats down on the asphalt surface and creates a glare that looks like the sky—thus, you may be heading for the top of a hill, or heading into a curve or towards a straight section of road. In any event, the glare is potentially dangerous.

If there's a passing car or cattle on the other side of the hill, you're in trouble. If you're heading into a curve with cattle on the other side, you're in trouble. And if you're heading straight for the mirage and there are cattle on the other side, you're in trouble. In short, you must *always* remain alert and always expect the unexpected. Needless to say, the unexpected is usually a small herd of cattle or a frightened (but frightening) vulture with a 5 to 8-ft. wingspan.

Since Mazatlán is basically a fishing and tourist town, any of the hotels along the seawall or beach are recommended. Shopping facilities for souvenirs are excellent, with prices hard to beat in other Mexican towns. Your best bet for dining is either one of the seafood or Italian restaurants.

Day's tally: 493 miles, 6.7 driving hours. Average: 74 mph, 11.4 mpg.

D-Day plus four: Mazatlán-Mexico City. For the last two days, the roads have been well-paved and empty of traffic, permitting a bit of high-speed driving. Thus, we covered the 330 miles to Guadalajara, our next scheduled stop, well before noon—and decided to continue on to Mexico City that same day. That was a mistake, because Guadalajara marks the end of the open roads and the beginning of a twisting, winding and hazardous 420-mile stretch ending finally, in Mexico City. Maximum speeds drop from 60 and 70 mph down to 20 to 40 mph, tiny but crowded towns crop up one after the other, and the fumes from impassable diesel-burning trucks and buses create a horrible headache.

This was the only time spent on Mexican highways at night—and I wouldn't try it again. Buses seem to take up more room, cars run up behind you without any lights, you can't help but think there's something on the road in front of you, and you know that if you have a mechanical failure, Mexico's emergency Green Squad won't start patrolling again until nine in the morning.

Finally, however, we did arrive—tired, hungry and edgy—only to find that our paid-in-advance reservations at the Ambassador Hotel didn't mean a thing, because 15,000 Rotarians and their families were in town. After more than an hour-and-a-half of telephone calls, it became

obvious that every hotel in the city was booked solid with the conventioners—and so we happily accepted the desk clerk's kind invitation to stay with his family until an open room could be found.

Day's tally: 756 miles, 17 driving hours. Average: 44.5 mph, 12.3 mpg.

The great Mexican tragedy

Once a cosmopolitan and sophisticated center, Mexico City is being ruined by, and for, the Olympics. Streets are being torn up for a subway system, hotels are hastily being erected, traffic through the city is almost always at a standstill, and tourists are shaming some of the best restaurants in the world by dining in their shirtsleeves.

The population of Mexico City now exceeds 7 million; another 1000 to 100,000 Mexicans will either be working or visiting in the city during the Olympics; the subway system likely won't be finished, and it's doubtful that hotel accommodations will be sufficient for the many thousands of American and European tourists, athletes and officials.

Thus, many will find themselves in situations similar to ours—except we were fortunate because our plans were flexible. It took only three days to learn how much Mexico City has changed—and so we left for Acapulco as soon as possible. There, a few days at the beautiful El Mirador Hotel restored my faith in Mexican charm, and allowed us to rest up for the long but uneventful trip back to the United States via routes 57 and 85. In fact, after the drive down Mexico's western 15, routes 57 and 85 seemed dull, with only an occasional panic stop for goats and cattle.

Points to remember

Mexico City hopefully will revert back to a marvelous metropolis once the Olympic fever subsides, in which case, there will be a restful haven at the end of your journey south. But to get there safely, you'll have to use common sense, concentration and a well-prepared and well-maintained car. The battery level, oil, water and tires should be checked each morning. Keep a running log of mileage and route progress (if only to keep the passengers occupied). When leaving your car in any hotel garage, note the odometer reading—youngsters have been known to take guests' cars for nightly joyrides, especially if they're as impressive as the Charger. Impressive, indeed—for when it came time to return the R/T to the Dodge Boys in New York, my wife firmly refused to come along. Her reason: "I hate to see a grown man cry." ★★

TO YOUR OWN DOCTOR'S PRESCRIPTION



EYEGLASSES BY
MAIL AT GREAT
SAVINGS!

Mail orders filled by **\$9.95**
licensed optician from

(Including single vision lenses, frame and case).

Doctor's prescription will be filled by a skilled, approved and licensed optician or your own prescription duplicated. Lenses are ground and manufactured to U. S. optical standards. Choose from complete catalog of men's, women's and children's glasses. Bifocals, trifocals, sunglasses or SAFETY HARDENED LENSES at low additional cost. We guarantee accuracy, perfect fit.

SEND FOR YOUR FREE CATALOG TODAY
PRISM OPTICAL INC.

Dept. PM-19 136 Liberty St., New York 6, N. Y.

SKINNY OR FAT?



Trade in that skinny, scrawny, milktoast or overweight body of yours for a new Weider Jet-Charged body, rippling with mountains of muscles, loaded with energy, drive and virility—the envy of every man and admiration of every woman, **NOW!** In only 15 minutes I'll prove you can slap on 4 inches of muscle to your chest—3 inches to each arm—give you life-guard shoulders, trim your waist to athletic size—give you speedy, athletic legs. I don't care if you're short or tall (skinny or fat), young or not so young, expect a muscle building miracle when you send for my **FREE** book. Send only 25c to cover postage and handling and write to the Trainer of "Mr. Universe," "Mr. America," "Mr. Europe"—

JOE WEIDER, Dept. 38-98-D2

531-32nd St., Union City, N. J. 07087

BE YOUR OWN BOSS!

A SPACE AS SMALL AS 10" X 13" CAN MAKE YOU INDEPENDENT in the high profit (low investment) rubber stamp field. Increase your income; full or part time basis. Deal direct with manufacturer offering lowest prices on professional SIMPLE-X presses & supplies, plus valuable aid. For **FREE** full facts write



CUSTOM MFRS.

406PM E. Elm, Springfield, Mo. 65801



Pipe just can't slip when it's in the steel jaws of a **RIDGID** Bench Vise.

Nothing grips pipe like a RIDGID vise. Our full width, tool-steel jaws have specially cut hardened teeth that positively anchor the work.

Malleable iron base and yoke can't break or warp. And when the work's finished, your RIDGID releases instantly. Integral bender and rear pipe rest make everything easy.

RIDGID Bench Yoke Vises come in 8 sizes, 1/8" through 6", can be set up for fast right or left hand opening.

See and buy one at your Dealer's. He carries a complete line of Work Saver Tools from The Ridge Tool Company, Elyria, Ohio 44035.

RIDGID

BUY GOV'T SURPLUS SAVE TO 85%

FISH/WORM SHOCKER



\$7.95
FOR

Cost Gov't Over \$11.00

• (ITEM #670) -- Harvest worms without digging, clear private ponds of coarse fish. Hand cranked unit puts out 110-VAC. Creates powerful electrical field in ground or water. Ideal for experiments, shocking fun at parties, etc. SAFE, 2" x 3" x 4". Shpg. wt. 3 lbs.

BATTERY GEAR MOTOR



Cost Gov't Over \$175.00

\$25.95 FOR

• (ITEM #571-A) -- Powerful, ball bearing unit. Use with worm gear winches, build hoists, electric cars, etc. Operates on 6 to 12 volts DC. 20 to 1 gear ratio, fully reversible. 130/270 RPM ± 6-12 VDC. Shaft 5/8" d. x 1-1/2" l. 6" diam x 15". Shpg. wt. 30 lbs.

WALL TYPE TELEPHONE



Orig. Cost Over \$27.50

\$7.95 FOR

• (ITEM #715W) -- Genuine Automatic Electric dial telephones. Ideal for use as extension phones, for use on private systems, etc. Work on any commercial telephone system. Reconditioned, tested, guaranteed. Excellent condition, work like new. Shipping weight 9 lbs.

Send 25¢ (Coin or Stamp) For BIG BARGAIN CATALOG

1000's Of Bargains; Surplus, Excess Inventory, Brand Name Equipment
Hydraulics • Power Plants
Winches • Gear Motors • Surveying Instruments • Pumps • Welders
Compressors • Telephones • Binoculars • Electronics • Many Others
"SATISFACTION OR MONEY BACK GUARANTEE"

SURPLUS CENTER

PM-098

Lincoln, Nebraska
Zip Code 68501

SET YOUR SITE

Under This
VACATION
HOME . . .

or one of over
80 great designs.

PRICES START AS
LOW AS \$615



Lindal, world's largest manufacturer of cedar homes, offers you custom quality, kiln-dried Canadian Cedar homes. All pre-cut, ready for quick, easy assembly on your favorite site. Save hundreds of hours—and dollars. Our all-new, full color Home Planning Kit includes more than 80 exciting designs—Chalets, A-Frames, Lodges, Year-Around Homes. Dealer Inquiries Invited.

LINDAL CEDAR HOMES
9004 So. 19th
Tacoma, Wash. 98465

Enclosed is \$1.00 for my complete Lindal Cedar Homes Planning Kit.

Name _____

Address _____

City _____

State _____ Zip _____

PM 9

NIGHT DRIVING

(Continued from page 67)

beams shine no more than 100 feet ahead.

So what can you do?

● **Reflection driving.** You must learn a whole new technique of driving by reflection. Quit relying on your own lights (which are really quite feeble, even on high beam) and learn to see by other means. For example:

1. **Steer by other driver's lights.** Cars ahead of you cast a good deal of side glow. Let this "sweep" the road for you.

2. **Read the reflector-posts.** These form a corridor of light against which a stalled car or truck shows up black.

3. **Read the road-striping** (edge-stripe and lane-stripes) as far ahead as possible. Debris, dogs, even pedestrians show up as a black break in the stripe.

4. **Read the reflection of oncoming lights in the road.** And watch for the night mirage effect—"puddles" of reflected headlights. Eyeing these closely tells you much about the road beyond your headlights.

Many drivers don't let reflections work for them. The side sweep of approaching headlights is not bright, but it can tell you a great deal about what is ahead in your lane if you'll read it carefully in the last quarter-mile before a pass. Even taillight reflections show lane stripes and bumps before your own lights pick them up. Today's bright red lights actually help illuminate many high-speed roads.

● **If your headlights ever go out,** you'll never forget the experience. On a deserted road far from lights it's terrifying. On a busy road, other car lights will help you and your big problem will be to get to the shoulder fast before you're hit. Here's what you can do to survive:

1. **Get your left turn signal on—quick!** If there's a center line, most turn flashers will pick it up and guide you to a stop. Practice this trick mentally and often, or when the time comes you'll be so shocked it may take precious seconds to remember.

2. **If no center line,** hunt for the edge with your right-turn flasher.

3. **If all your lights go out** (as when a battery cable parts), steer by the lights of other cars—if any.

4. **In dire emergency** (only) put a passenger out with a flashlight to walk the shoulder and lead you.

5. **On deserted roads** in critical emergency remember that you can also run backward using your backup lights. Never try this when other traffic is moving. It's very hazardous because those feeble lights can look like two beer cans to drivers coming from behind.

In general, should your lights go out,

proceed cautiously if they suddenly come on again. A loose wire may have made contact. In any event, the lights may go off again in seconds. Prepare for it.

Never assume other drivers can see you. At 30 mph they may; but at 60 they'll hit an unlighted car before they'll see it. **Best bet:** Pull far off the road and wait for help.

● **What about the fellow who won't dim** or, worse, throws his brights into your eyes just before he meets you? Most of us get sore and fight back with our own brights. And we wonder: "Why did he do it? How could any driver be that dirty?"

The answer, I have learned in roadside interviews, is: The "won't dim" driver usually doesn't even know he offended you! He didn't mean it. And sometimes he thought he was dropping his beams instead of raising them. Another cause: headlights out of adjustment. If he can't dim, blinding him with your highs won't make him less of a hazard to you.

Maryland police have found that when a driver won't dim for you, he may be drunk. He doesn't notice you at all.

I have also found that he is sometimes cold sober but dog-tired. After many hours on the road, a tired driver acts a little like a drunk. He's dazed.

Some drivers who suddenly blind you actually haven't touched the foot switch at all. Here's what happens. Say you come up one side of a hill, some other fellow comes up the other side. He's using brights. As he gets to the top he politely kicks the beams down for you—pouring his low beams straight into your eyes because he's above you. If he's on a right curve (a left curve, to you) you get it all the worse.

Remember this at hilltops. Sometimes it pays to keep your beams up a few seconds longer so they will sweep the sky over his car as he ascends the slope.

● **What to do when tired.** We've all been given lots of advice: open the windows, turn on the radio, stretch, shout, drink coffee. Forget it. If a sudden need for sleep overwhelms you, there's only one thing to do—*sleep!* Stop in a safe place. A 30-minute nap works wonders.

The other antisleep tricks, Dr. Moseley says, actually increase your danger. They may work for five minutes. But then sleep moves in again—with no warning, no nodding head, no sudden presleep quiver.

Never fight sleep, Moseley says. It fights back and tricks you. Stop and let sleep take over. On a long vacation trip you may need *two* short naps, a half hour apart. After that you should feel great. Two naps often seem as good as a night's sleep. ★★★

I-N-V-E-N-T-O-R-S WE NEED INVENTIONS

Sell your invention for cash—need money for Patent?—Are technical problems holding you back? Universal Inventions has helped inventors all over the world—just like yourself—why not you? Inventions provide the magic spring-board to sudden riches. REMEMBER, we either sell your invention or pay you a cash bonus. Write for details.
UNIVERSAL INVENTIONS, Dept. 13, Marion, Ohio

EARN \$20.00 PER HOUR

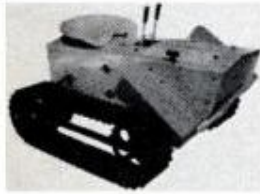

Assemble MINI-DOZERS for resale and make big money in your spare time! It's easy. Just order this unique garden-tractor kit at our low, factory-direct price, assemble (in 6 hrs. avg.) and resell profitably

to local customers. Keep one to enjoy and demonstrate. Order complete kit or any parts desired. Full line of attachments.

To see how Dozer works, send for Plans and Parts Price List — only \$5.00. Cost deducted from kit purchase price. 16-page illustrated Catalog — 50c. Order now!

C.F. STRUCK CORP.,
Dept. PM-98, Cedarburg, Wis. 53012

UP TO \$**688** PROFIT
A RACE DAY
WITH \$60!

PENCLIFF the world's greatest horse-race computer predicts BIG wins—easily. Payoffs up to \$79 with \$2 stakes. Level stake profits at meetings on the day up to \$688. Average outlay \$60. Full details plus our remarkable guarantee: Full refund if no level stake profits with PENCLIFF at any track.
R.H.P. CO. BOX 5715, PE-MA Carmel, Calif. 93921.
Tear out this ad NOW & mail with name, address, & zip.

TO BE A TOP GUN, WEAR ONE!

Try on the TOP GUN, a remarkable new dimension in hunting garments. See for yourself how AMERICAN FIELD has built in more of the style, comfort, and convenience features you've always wanted in your hunting clothes.

TOP GUN, made only by AMERICAN FIELD
HETTRICK MFG. CO., Statesville, N. C. 28677

LIVE-CATCH ALL-PURPOSE TRAPS

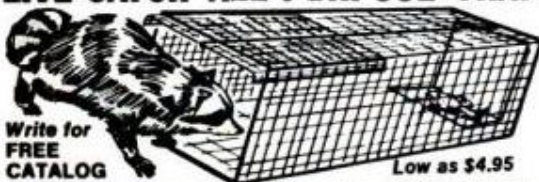

Write for
FREE
CATALOG

Low as \$4.95

Trap without injury squirrels, chipmunks, rabbits, mink, fox, raccoons, stray animals, pests, etc. Sizes for every need. Also traps for fish, sparrows, pigeons, crabs, turtles, quail, etc. Save 40% on low factory prices. Send no money. Free catalog and trapping secrets.
TRAP FACTORY, Dept. M14 Box 10880, Houston, Texas 77018

GET INTO ELECTRONICS

V.T.I. training leads to success as technicians, field engineers, specialists in communications, guided missiles, computers, radar, automation. Basic & advanced courses. Electronic Engineering Technology and Electronic Technology curricula both available. Assoc. degree in 29 mos. B.S. obtainable. G.I. approved. Start Sept., Feb., Dorms, campus. High School Graduate or equivalent. Catalog.

VALPARAISO TECHNICAL INSTITUTE
DEPARTMENT D, VALPARAISO, INDIANA 46383



SEPTEMBER 1968

INVENTORS

**INVENTIONS—NEW PRODUCTS—IDEAS
DEVELOPED & PREPARED**

For Commercial Appeal & Sales
DESIGN—MARKETING—PATENT SEARCHES—DRAWINGS

United States Patent Office former Patent Examiner
United States Government former Patent Adviser
Member: United States Chamber of Commerce
Second Decade of Reliable Service to

INVENTORS—MANUFACTURERS—ATTORNEYS

THE RAYMOND LEE ORGANIZATION

230-Z Park Ave., New York 10017 (212-MU 6-8500)

SEND FREE "INVENTION RECORD" Form & "IMPORTANT PATENT INFORMATION"

Name _____

Address _____

City _____ State _____ Zip _____

Two or four-wheel drive
JEEP OR SCOUT
OWNERS

REPOWER with a 6 or V-8. H.D. ADAPTORS for using Car, Compact and some Truck engines. Conversion Kits \$45.35 to \$56.90. Want fast action? Give us FULL INFORMATION. Send \$15.00 Dep. and we will ship correct kit, bal. COD. Send full amount for prepaid shipment. Wire, phone or write today. Details FREE

HOOSIER MACHINE PRODUCTS CO.

312 S. E. 6th St., Phone 276-3442, Pendleton, Oregon 97801

Opportunities in
ACCOUNTING



THIS VALUABLE
BOOKLET GIVEN

Free

TO PEOPLE WHO
WANT TO EARN
MONEY IN AN

Accounting Career

LaSalle will train you in your spare time

The demand for trained Accountants far exceeds the supply. Salaries are at an all-time high. Accounting-trained men move up to big positions in business. LaSalle's distinguished faculty prepares you at home, in your spare time—at remarkably low cost. You work with actual Accounting problems, acquire real experience. Thorough, practical, enjoyable—and quick in results. Many students report up to 56% pay increases even before completing training. Mail coupon for free booklet and sample lesson.

LA SALLE EXTENSION UNIVERSITY

A Correspondence Institution

417 S. Dearborn, Dept. 81-054, Chicago, Illinois 60605

Please send free booklet "Opportunities in Accounting" and interesting sample lesson.

Name.....Age.....

Address.....

City.....State.....

County..... Zip No.....

104

205

FIVE MILLION DOLLARS WORTH OF CHEVROLETS!

**1400 BRAND-NEW CARS! 400 CORVETTE STING RAY CONVERTIBLES!
400 CAMARO "HUGGER" CONVERTIBLES! 200 IMPALA SPORT COUPES!
200 CHEVELLE MALIBU SPORT COUPES! 200 CHEVY II NOVA COUPES!**
All with 8-cylinder engines, automatic transmission, power steering, push-button radio, white walls!
PLUS 100,000 2-record "BROADWAY MELODIES" Record Albums to runner-up winners!

*Now laugh your way down memory lane...
with wonderful old-time radio!*

COMEDY • DRAMA • SPORTS • HISTORY!



WHAT A GRAND AND GLORIOUS TIME YOU'LL HAVE as these great, golden memories thrill you again and again! Actual broadcasts just as you heard them.



Do you remember Senator Claghorn, Titus Moody and all the uproarious goings-on in Allen's Alley? Do you remember how you split your sides laughing when Amos 'n Andy got on the telephone? Remember Fibber McGee and that famous overflowing closet? Remember how Baby Snooks (Fanny Brice) drove her Daddy wild? Vas you dere, Sharlie? as Baron Munchausen (Jack Pearl) would say—and he's here too! All the magnificent humor, the breathtaking adventures, the nostalgic music of the old-time radio years... wrapped up for the first and only time in this historic Treasury.



HEAR AGAIN THE WORLD'S GREATEST NEWSCASTS! The Duke of Windsor renounces his throne... Hitler declares war on Poland... Chamberlain declares war on Germany... Arthur Godfrey's account of FDR's funeral... World War II ends... **AND SPORTS!** Dempsey-Tunney long-count... Babe Ruth's farewell to baseball... and more!

SEND NO MONEY! Listen to the entire Treasury for 10 days FREE. Keep a FREE album of radio theme songs, even if you return the six-record set. Return the card or coupon today!

Over 80 original broadcasts!

The Shadow
The Easy Aces
Bing Crosby
Fred Allen
Allen's Alley
Bob Hope
Jack Benny and
Mary Livingston
Jack Armstrong

Baby Snooks
The Lone Ranger
Sgt. Preston
Terry and The Pirates
May Noble, Back Stage Wife
The Romance of
Helen Trent
Lorenzo Jones
Just Plain Bill
... and more!

6 purest vinyl records
worth up to \$29.70
in fine stores

ONLY \$5 A MONTH
OR JUST \$14.98

FREE Record Album



20 OF RADIO'S FAMOUS THEMESONGS you'll greet with delighted recognition!

Keep this FREE Record Album—even if you return the Six-record Treasury!

Now sweepstakes works... The Longines Symphonette has reserved the described gifts for holders of lucky numbers, selected by electronic computers under the direction of the D. L. Blair Corporation. Each Lucky Number entry submitted will be checked against the official list of winning numbers. Employees of The Longines Symphonette, its affiliates and suppliers shall not be eligible. Your entry must list the official lucky number, and must be received by January 4, 1969. This sweepstakes is subject to all Federal, State and Local regulations. Prize winners will be notified by mail. If you send a self addressed stamped envelope, a representative list of prize winners will be sent you. Unless you return your Lucky Number, you will be giving up your chance to win valuable FREE prize. Winning Lucky Numbers must be returned before prizes can be awarded.

MAIL CARD OR COUPON TODAY

The Longines Symphonette Society

SYMPHONETTE SQUARE • LARCHMONT, N. Y. 10538

YES, send my FREE BONUS RECORD ALBUM along with the six-record Treasury, GOLDEN MEMORIES OF RADIO. I may return the Treasury within 10 days and owe nothing, or send just \$5 a month until \$14.98 (plus modest postage and handling) is paid. I keep my FREE bonus record album, Radio's Famous Theme Songs, no matter what I decide.

CHECK ONE: High Fidelity Stereo Edition (electronically engineered for Stereo effect) just \$1.80 more

Mr.
 Mrs.
 Miss

Home Address _____

City _____ State _____

NO—Do not send FREE record, but let me know if I have won. I have copied number from card bound in this magazine.

Number _____
© C.S., Inc. (Please print carefully) 01990-030

5 milliseconds in the life of a "Power Piston" wad.

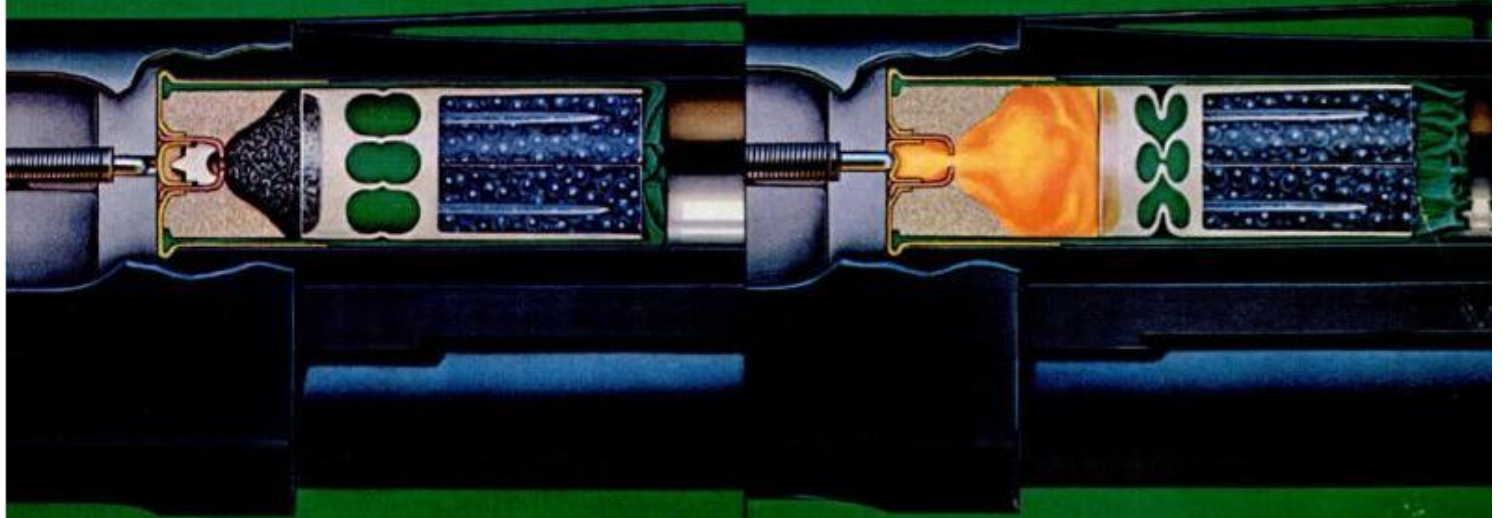

1 This is what the "Power Piston" one-piece wad (loaded in a Remington Express plastic shell) looks like from the time it leaves the factory until you pull the trigger.

2 Right after firing. The built-in shock absorber in the "Power Piston" compresses and absorbs the initial impact of the explosion, so the shot won't be crushed together.



3 Halfway down the gun barrel. The back end of the Remington "Power Piston" opens up to seal the barrel and keep the expanding gas from leaking past and losing power.

4 At the muzzle. Though the shot column is moving at top speed, the sides of the Remington "Power Piston" have kept it from touching the barrel and flattening the pellets.



5 A few feet past the muzzle. The "Power Piston" now peels back and drops away, but the shot column is on its way at full power, with no flattened pellets to spoil the pattern.

For some time we've been telling you that Remington and Peters "Power Piston" wad shot shells shoot harder, keep your barrel clean longer and put up to 10% more shot in the pattern. But let's face it—you were just taking our word for it.

That's why this little demonstration. We feel that if we can show you what a "Power Piston" does, you'll have more confidence in our shells. Also we can clear up a common misunderstanding. The "Power Piston" does not make the pattern smaller. It just puts more pellets into it by eliminating "flyers"—flattened shot that goes wild. No matter what gauge you shoot—12, 16, 20 or 28. And that's a fact.



Remington  **PETERS**

Try a box of Remington/Peters shells with "Power Piston." See how good a shot you really are.

"Remington," "Peters," "Power Piston" and "Shur Shot" are Reg. U. S. Pat. Off. and "Express" is a trademark of Remington Arms Company, Inc., 500 Remington Road, E. Windsor, Ontario, Canada. Remington Arms of Canada Limited.





You can
take Salem
out of the
country
but...



you can't take the
"country" out of Salem.

Wherever, whenever you light up—Salem gently air-softens every puff for a taste that's country soft, country fresh. Take a puff... it's springtime!