

Fantastic party carts you can build

Tempest|Plymouth test—to the screeching limit

POPULAR FEB. 1966 MECHANICS 35 CENTS

BREAKTHROUGH: you can watch both sides of this flat-tube color TV!

Bonus Tearout! Wall Fasteners



More and More People Prefer
Miller High Life

The Champagne of Bottle Beer

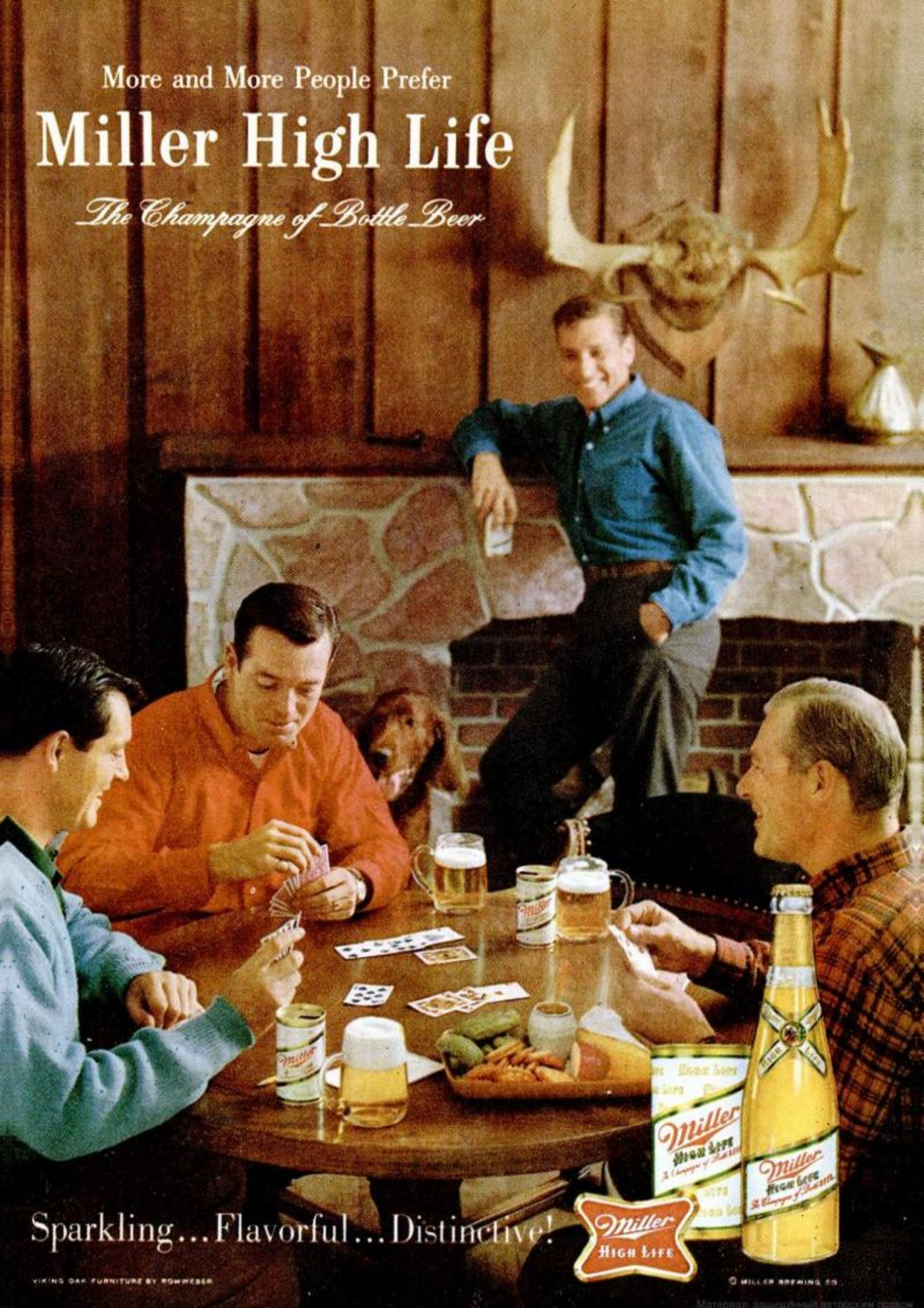

Sparkling... Flavorful... Distinctive!





Here's how you can trim time and shorten steps (with a handy tool for every shop)

Equip yourself with an extension telephone near your workbench.

When calls come in, reach—don't run.

Ordering materials? Do it on the spot where you can spot what you need.

And if you don't object to being a household hero, here's an idea: Share the telephone convenience.

Find a spot for your extension where the

family can use it too. Near your bench and near the laundry room or game room, for instance.

Remember, an extension phone really gives you your money's worth. It costs only a fraction of the monthly cost of your first phone.

Get one fast. Just call our Business Office or ask your telephone man.



Bell System

American Telephone & Telegraph
and Associated Companies

What goes like a bat on regular fuel... digs salt water, large loads and a hard time? Answer: the new Sea-Horse 40

Want action? Here's action. Forty big horses in a 43.9 cubic inch corral. Theoretically, the new Johnson 40 is a medium-sized engine. But the truth is, under full gun, it takes off like a flicked whip. It's at its hottest and happiest on light to medium runabouts, utilities and workboats.

Three new high-performance 40's! Most posh is the Electramatic 40. With its exclusive electromagnetic transmission, it shifts elec-

trically—automatically—as you move the throttle forward or back. The Electric 40 is electric starting as well, with a new, mechanical, single-lever control as an accessory. Anchor man is the Manual 40 which offers the same thrills but less frills.

There are 16 new Johnson engines this year in 10 power classes. All stay carbon free on a 50 to 1

gas-oil diet. All are library quiet. All are round-trip dependable. For the right engine for your boating needs, see your Johnson dealer. Start a beautiful friendship now. Look him up in the Yellow Pages.

P.S. Johnson also makes a full line of

Johnson Boats and the fast, exciting, new Johnson Skee-Horse snowmobiles.

From 3 to 100hp, every '66 Johnson features:

- Famous 2-year warranty*
- Full corrosion protection
- 50 to 1 gas-oil mix

*For 24 months after purchase, Johnson Motors will replace, without cost to the original purchaser, any part of its manufacture which upon inspection proves to have failed in normal use due to faulty material or workmanship.

 **Johnson**
first in dependability
Johnson Motors, 2168 Pershing Road, Waukegan, Ill. Division Outboard Marine Corporation





49 out of 50 Chevrolets performed better with Champion spark plugs!

Acceleration tests at the famous Sebring Race Track proved how much the brand of spark plug can affect engine performance! In 49 cases out of 50, Chevrolets performed better with Champion spark plugs than with the plugs that originally come in Chevies. Other tests proved Champions gave better gas mileage, too! No wonder Champions are first choice with engine experts the world over!



78Z9-U4D-XWOW

HERE'S HOW THE TESTS WERE CONDUCTED • 50 brand-new Chevrolets (including Corvairs, Chevy IIs and Chevelles) were used in each test. • All spark plugs used were brand-new. • Nationwide Consumer Testing Institute—an independent company—conducted both tests. • All results were certified by the United States Auto Club. • Acceleration tests were run from a standing start with professional drivers at the wheel. • All runs were timed electronically. • Gas mileage tests were made on ultra-precise dynamometers. **RESULTS: 49 out of 50 Chevies accelerated faster with Champion—48 out of 50 gave better gas mileage!**



CHAMPION
SPARK PLUG COMPANY
TOLEDO, OHIO 43601

POPULAR MECHANICS

INTERNATIONAL EDITIONS: AUSTRALIAN, SPANISH, CARIBBEAN, FRENCH, DUTCH, PORTUGUESE, DANISH, SWEDISH

PM SPECIALS THIS MONTH!

- 90** FANTASTIC NEW MIDGET PORTABLE COLOR TV
Flat picture tube can be viewed from both sides
- 110** ROAD-TESTING THE TEMPEST SIX AND PLYMOUTH FURY
PM wrings out two of the '66s
- 149** SEVEN SLAVES ON WHEELS
Service cart plans adaptable to host, hobbyist and handyman
- 157** HANG ANYTHING ON ANY WALL
Everything you need to know about wall fasteners

FEATURES OF SPECIAL INTEREST

- 96** Lost Radium: Killer at Large
- 100** Hunting with a Cheetah
- 106** New and Hot from Overseas
- 116** A Great Hangout—Right over a Canyon
- 118** The Wild Transistorized West
- 120** Clinic for Sick Missiles
- 126** Dioramas Out of the Deepfreeze
- 132** Never Mind the Answer; What's the Question?
- 136** Shut the Windows; Keep in the Fire Suds
- 140** Which Type of Home Freezer for You?
- 144** Six Trick Billiard Shots You Can Make

FOR THE SHOP CRAFTSMAN

- 149** Seven Slaves on Wheels (File Flag)
- 157** Hang Anything on Any Wall
- 163** Tob-Sled
- 168** Bike Skis
- 170** Winter Tuneup for Your Cycle, Part 2 (File Flag)
- 174** Fun for Junior Mailmen
- 178** Tip-up Ski Rack
- 179** Bad Ball Joints Can Bury You (File Flag)
- 186** Pee-Wee Saws
- 190** Sheet-Metal Former (File Flag)
- 196** Get the Microphone That's Right for You

REGULAR DEPARTMENTS

- | | |
|--|---|
| 6 <u>Letters to the Editor</u> | 52 <u>What's New Outdoors</u> |
| 10 <u>Science Worldwide</u> | 54 <u>New Products</u> |
| 12 <u>News from the Military</u> | 56 <u>Worth Writing For</u> |
| 14 <u>Aviation Jetstream</u> | 89 <u>Editor's Page</u> |
| 20 <u>Career Barometer</u> | 142 <u>New for Your Home</u> |
| 29 <u>New Inventions</u> | 169 <u>Camera Buffs</u> |
| 30 <u>Detroit Listening Post</u> | 166 <u>Solving Home Problems</u> |
| 36 <u>Spotlight: Triumph 2000</u> | 177 <u>Tips from Readers</u> |
| 44 <u>Homeowners' Clinic</u> | 184 <u>Automobile Clinic</u> |

Published By The Hearst Corporation
RICHARD E. BERLIN, PRESIDENT
 President, Mag. Division:
RICHARD E. DEEMS
 Publisher:
JOSEPH F. KERN

Editorial Director:
WALTER IAN FISCHMAN
 Executive Editor:
RICHARD F. DEMPEWOLFF
 Managing Editor:
JOHN A. LINKLETTER
 Shop Crafts Managing Editor:
WAYNE C. LECKEY
 Art Director:
RAYMOND A. SCHULZE

CLIFFORD B. HICKS _____ Midwest Editor
 THOMAS E. STIMSON _____ Western Editor
 KEVIN V. BROWN _____ Aviation
 ALFRED W. LEES _____ Home Workshop
 RICHARD HOWE _____ Building and Landscape
 ARTHUR MIKESELL _____ Boating
 JOHN F. PEARSON _____ Science
 STUART JAMES _____ Outdoors
 LARRY STECKLER _____ Electronics
 JIM DUNNE _____ Detroit Automotive
 FRANK X. SMITH _____ Production
 TERRY HONIGFELD _____ Assistant Prod.
 MURRAY COOPER _____ Assistant Art Director
 LEO R. WEEKS _____ Assistant Art Director
 GEORGE W. BLOW _____ Staff Artist
 PHILIP F. HUY _____ Staff Artist
 JAMES V. MEDLER _____ Staff Artist
 BONNIE J. ANDERSON _____ Staff Artist
 DANIEL J. COOK _____ Art Assistant
 FRANK P. FRITZ _____ Chief Photographer
 EUGENE A. COLANGELO _____ Staff Photographer
 RALPH L. CLAAR _____ Photographer
 GARRY WINTER _____ PM Books
 FRANKLYN JACOBY, ASID/IDI _____ Design Consultant
 EVERETT JOHNSON _____ Cabinetmaker

ADDRESS COMMUNICATIONS TO: 575 Lexington Ave., New York, N.Y. 10022.
 For additional sources of information on the articles and products in
 this issue, write to Bureau of Information, Popular Mechanics, for free
 "Where-to-Find-it" list.

L. PARK BENJAMIN, Advertising Director

ADVERTISING OFFICES: New York: 575 Lexington Ave., Murray Hill 8-8500;
 Chicago: 520 N. Michigan Ave., 527-2400; Detroit: General Motors Bldg.,
 Trinity 5-8711; Cleveland: Hanna Bldg., 1422 Euclid Ave., Prospect
 1-0456; Los Angeles: 3460 Wilshire Blvd., DUnkirk 2-8458; San Fran-
 cisco: 1101 Hearst Bldg., YUkon 2-0823.

SUBSCRIPTION SERVICE: Mail all subscription orders, changes of address,
 correspondence concerning subscriptions, and Postmaster notices of
 undeliverable copies to Popular Mechanics, Box 646, New York, N. Y.
 10019.

Popular Mechanics is published monthly by The Hearst Corporation,
 57th St. at 8th Ave., New York, N.Y. 10019, U.S.A. Richard E. Berlin,
 President; George Hearst, V-Pres.; Richard E. Deems, President of Maga-
 zines; John R. Miller, V-Pres. and Gen. Mgr. of Magazines; G. Harry
 Chamberlaine, V-Pres. for Research and Marketing; William S. Camp-
 bell, V-Pres. and Director of Circulation; Joseph F. Kern, V-Pres. for
 Popular Mechanics; Frank Massi, Treasurer; R. F. McCauley, Secy.
 Single copy in the United States and Canada, 35 cents. Subscription
 prices: United States and Possessions, \$4.00 for one year; \$7.00 for two
 years; \$10.00 for three years. Canada, add \$0.50 for each year. Pan
 American Postal Union countries, add \$1.00 for each year. All other
 countries, add \$2.00 for each year. When changing address, give old
 address as well as the new, with postal-zone number, if any, and allow
 six weeks for change to become effective. Second-class postage paid at
 New York, N.Y., and at additional mailing offices. Authorized as second
 class mail by the Post Office Department, Ottawa, and for payment of
 postage in cash. Registered as second-class matter at the Post Office at
 Mexico, D.F., Mexico, June 20, 1950. © 1966 by The Hearst Corporation.
 All rights reserved. Printed in U.S.A.



The famous Homelite XL
 is so light it can be
 balanced on one hand!

OUTDOORSMEN!

**Get a Homelite XL Chain Saw
 ...save time, money and muscle**

If you have a home with trees, a campsite or hunting cabin — a
 HOMELITE XL Chain Saw is for you! Choose from 6 extra-light HOMELITE
 XLs, weighing as little as 12 lbs., 12 oz., less bar and chain. Cut your own
 firewood; prune and trim; clear dead, diseased or unwanted trees and
 brush; landscape, cut rough lumber. Powerful HOMELITE XLs
 start easily — controls are simple, positive and safe. Find
 your nearest HOMELITE dealer in the Yellow Pages — get
 a demonstration — then take a HOMELITE XL home!

FREE! Write for your copy of colorful, 8-page booklet,
 "Man's Guide to Woodcutting"



HOMELITE

10202 Riverdale Ave., Port Chester, N.Y. **A Textron
 DIVISION**

Famous Homelite XLs are world's fastest selling chain saws!

South Bend®

10" LATHES

with new
welded steel
floor legs

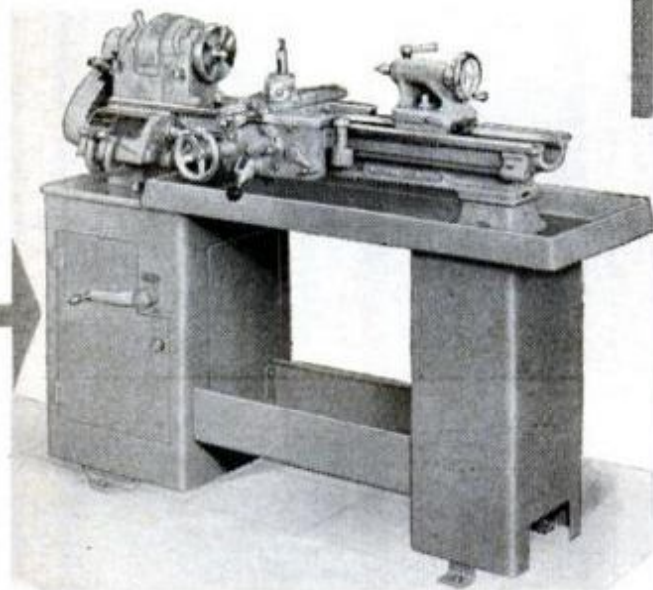

- New, trim floor legs . . . reinforced construction of welded, heavy gauge steel . . . maximum rigidity with minimum weight . . . no increase in price!
- Famous South Bend dependability.
- Superfinished spindles and bearings for uniform accuracy and fine finishes.
- 70 screw threads (4 to 480 per in.) . . . 70 longitudinal feeds . . . 70 cross feeds.
- Tool room and Engine Lathe models.

WRITE FOR CATALOG

*of South Bend Lathes, Milling Machines,
Shapers, Drill Presses*

SOUTH BEND LATHE

South Bend, Indiana 46623

Building Better Tools Since 1906

up to 36 months to pay



LETTERS TO THE EDITOR

No Monster

In conjunction with your *Suburba-Car Contest* (page 88, Nov. *PM*), you might like to see my car. It consists of a Fiat 500 Topolino body on a chopped Fiat 1100 chassis, with a tuned Fiat CisItalia racing engine.

Although it looks ridiculously small, this car can carry four comfortably, has



excellent road-holding, and does over 100 mph. Why people drive those oversized Detroit dinosaurs is beyond me!

San Francisco, Calif. VAUGHN M. GREENE

Tab for Tabs

It's annoying after reading an issue of *PM* to thumb through the pages again, hoping not to miss the File Flags. Some symbol should be placed in the table of contents beside the flagged features.

Brookfield, Ill.

JOHN JURANEK

We've done it—beginning with this issue. In the table of contents you'll find "File Flag" beside the title of each feature which has a flag.

Not French—but Good

That FWD you show as a *French Troop Carrier* on page 109, Oct. *PM*, is strictly an American truck. My service battery of the Fifth Field Artillery, had about 60 FWDs. They were the most reliable and versatile trucks the U.S. armed forces ever possessed.

Tiffin, Ohio

WILLIAM B. NOGGLE

Everybody Has Fun

The kids have a lot of fun riding the *Sidewalk Classic* (page 146, November 1963 *PM*), and I had a lot of enjoyment building it.

(Please turn to page 8)

WHO ELSE WANTS A BIG RAISE IN PAY?

"My salary has increased 400% as a direct result of my LaSalle studies"
Rudolph Urbatis, Port Chester, N.Y.

"Salary more than doubled since enrolling"
William T. Black, Capoga Park, Calif.

"Income has increased 100 per cent since graduation"
James L. Yonning, Manhattan, Kansas

"I now earn three and a half times my former pay"
Robert Fisher, Holbrook, Ariz.

Stuck in a rut? Tired of your dead-end job? Here's proof you can step up to a high-salary position with prestige and security through LaSalle spare-time training.

JUST LOOK at these enthusiastic reports. Have you ever seen anything like them? They are just a few of many hundreds of similar statements in letters that come from LaSalle students week after week, month after month, year after year.

LaSalle students have one ambition in common — to get out of the ranks of the untrained and earn big money, prestige and security in a key job. Isn't that your goal too?

Without interfering with your present work — and by devoting only a little of your spare time — you too can qualify rapidly for advancement in the field of your choice through LaSalle home study. The cost is surprisingly low.

LaSalle has been an acknowledged leader in home education for more than half a century. It has provided training in business, high school and technical subjects to more than 1,000,000 ambitious men and women. Its distinguished faculty includes some of the country's most outstanding authorities. That is why your LaSalle diploma is recognized and respected by employers.

Check the subject you are interested in — then send the coupon below for FREE booklet. No obligation. Mail to LaSalle, 417 South Dearborn, Chicago, Illinois 60605.

(Confidential — please answer all questions)

LA SALLE EXTENSION UNIVERSITY

A Correspondence Institution • 417 South Dearborn, Dept. 50-087, Chicago, Illinois 60605

I have answered the questions in this confidential questionnaire. Please send me full information on how I may prepare for a choice position in the field I have checked below.

MY NAME

ADDRESS

CITY & ZONE..... STATE.....

COUNTY..... AGE.....

EDUCATION: Grammar School..... years
 (Fill in number of years completed) High School..... years
 College..... years
 Other..... years

PRESENT EMPLOYMENT:

Kind of position.....
 Hours of work..... A.M. to..... P.M.

GENERAL INFORMATION:

Single Married
 Estimated spare hours per week available for study

ACCOUNTING

- Complete Accounting with CPA Training
- Complete Accounting
- Federal Income Tax
- Accounting Systems
- Auditing Procedure
- Controllorship
- CPA Training
- Modern Bookkeeping

LAW COURSES

- Bachelor of Laws Degree
- Business Law
- Insurance Law
- Claim Adjusting Law
- Law for Police Officers
- Law for Trust Officers

SALESMANSHIP

- Sales Training

BUSINESS MANAGEMENT

- Complete Business Management
- Credit and Collections
- Office Management
- Personnel Management
- Business Correspondence

STENOTYPE

- Machine Shorthand

TRAFFIC AND TRANSPORTATION

- Complete Traffic Management
- Rate and Tariffs
- Agency and Services
- Motor Truck Traffic

DRAFTING

- Basic Drafting
- Electrical Drafting
- Mechanical Drafting
- Architectural Drafting
- Structural Drafting
- Aeronautical Drafting

REAL ESTATE

- Complete Real Estate
- Real Estate Brokerage
- Real Estate Management
- Real Estate Sales

TECHNICAL COURSES

- Auto Body Repair
- Refrigeration
- Air-Conditioning
- Diesel
- Welding
- Motor Tune-up

HIGH SCHOOL

- High School Diploma
- Vocational Course

**MY SPARE TIME HOBBY
MAKES ME
\$5⁰⁰ an hour
CASH PROFIT**

— Grover Squires



START YOUR OWN SPARE TIME BUSINESS

You can turn your spare time into Big Cash Profits with your own **COMPLETE SHARPENING SHOP . . .** Grind saws, knives, scissors, skates, lawn mower blades . . . all cutting edges. Your Own Cash Business with no inventory . . . right at home . . . no experience needed.

FREE BOOK tells how you can start your own spare time business while you are still working at your regular job. Low Cost — time payments only \$15.00 a month. Send coupon today.

FREE BOOK

BELSAW SHARP-ALL CO. 716H Field Bldg., Kansas City 11, Mo.
Send Free Book "LIFETIME SECURITY". No obligation.

Name _____
Address _____
City _____ State _____

**NEW DREMEL
ELECTRIC
ENGRAVER**

with
solid carbide
engraving point



Permanently marks any material

This new compact Dremel permanently engraves names or identification numbers on steel, copper, brass, silver, aluminum, glass, wood, plastic. Handy for marking tools, personal and business valuables, jewelry, industrial tools and dies — anything requiring permanent identification. Weighs only 7 ozs. Exclusive calibrated stroke adjustment regulates depth of engraving. Solid carbide engraving point. Diamond points also available.

See your dealer or write for literature.

Model 290 with molded storage case . . . **\$14.95**

DREMEL MFG. CO.

Dept. 86-B • Racine, Wisconsin

LETTERS continued

I made a few changes in the size, plus adding white-wall tires, fur-coated steer-



ing wheel and a 7-volt generator and 12-volt battery to run it.

McGregor, Ont.

ULRIC RENAUD

And Is He a Sailor or Pilot?

My most critical comment on the Fournier avion/planeur article (*I Cut My Engine at 9000 Feet . . .*, page 110, Dec. PM) concerns the definition of the terms *gliding* (descending in powerless flight) and *soaring* (descending in powerless flight in a mass or parcel of air which is going up faster than you are going down, thus resulting in a net gain). Thus, at 600 to 700 fpm down, Kevin Brown, the author, was gliding, not soaring.

The other major point: The powered sailplane has had a long history, going back at least to the 1890s.

Soaring Society of America

RICHARD MILLER,
Editor, *Soaring*

Los Angeles, Calif.

Mr. Brown, long-time throttle jockey who prefers to have an engine constantly chugging on his flying machines welcomes your precise definitions of soaring and flying. He contends, however, (and Fournier insists) that the RF-3 is an airplane and glider—and a better airplane than glider, at that. Fournier emphatically denies that his machine is a powered sailplane, so it does not have a long history.

THE EDITORS

KEEP PACE WITH SPACE AGE! SEE MANNED MOON SHOTS, SPACE FLIGHTS, CLOSE-UP!



AMAZING SCIENCE BUYS

for FUN, STUDY or PROFIT

SCIENCE FAIR
HEADQUARTERS!
FREE! CATALOG

'FISH' WITH A WAR SURPLUS MAGNET

Go Treasure Hunting On The Bottom

Great idea! Fascinating fun and sometimes tremendously profitable! Tie a line to our 5-lb. Magnet—drop it overboard in bay, river, lake or ocean. Troll it along the bottom—your "treasure" haul can be out-board motors, anchors, fishing tackle, all kinds of metal valuables. 5-lb. Magnet is war surplus—Alnico V Type—Gov't. Cost—\$50. Lifts over 125 lbs. on land—much greater weights under water. Order now and try this new sport. Stock No. 70.571-H. 5 lb. Magnet \$12.50 Postpaid
Stock No. 70.570-H. 3 1/2 lb. Lifts 40 lbs. \$ 8.75 Postpaid
STOCK NO. 85.152-H ... (lifts over 350 lbs.) \$33.60 F.O.B.



See the Stars, Moon, Planets, Close Up!

3" ASTRONOMICAL REFLECTING TELESCOPE

60 to 180 POWER! Famous Mt. Palomar Type! An Unusual Buy! See the Rings of Saturn, the fascinating planet Mars, huge craters on the Moon, phases of Venus. Equatorial Mount with lock on both axes. Aluminized and overcoated 3" diameter high-speed f 10 mirror. Telescope equipped with a 60X eyepiece and a mounted Barlow Lens. Optical Finder Telescope included. Hardwood, portable tripod. FREE with Scope: Valuable STAR CHART plus 272-page "HANDBOOK OF HEAVENS" plus "HOW TO USE YOUR TELESCOPE" BOOK.

Stock No. 85.050-H \$29.95 Postpaid

4 1/4" Reflecting Telescope—up to 225 Power
Stock No. 85.105-H \$79.50 F.O.B.

Superb 6" Reflector Telescope
Up to 576 Power. Equatorial mount and Pedestal Base.
Stock No. 85.086-H \$199.50 F.O.B.

OPAQUE PROJECTOR
Projects illustrations up to 3" x 3 1/2" and enlarges them to 35" x 30" if screen is 6 1/2 ft. from projector; larger pictures if screen is further away. No film or negatives needed. Projects charts, diagrams, pictures, photos, lettering in full color or black-and-white. Operates on 115 volt, A.C. current. 6-ft. extension cord and plug included. Operates on 60 watt bulb, not included. Size 12" x 8" x 4 1/2" wide. W. 1 lb., 2 oz. Plastic case. Stock No. 70.199-H \$7.95 Postpaid



Fascinating New Kaleidoscope Insert. Same unit as above, but provides endless additional projects with everchanging kaleidoscope patterns.
Stock No. 70.714-H \$10.00 Ppd.

SOLVE PROBLEMS! TELL FORTUNES! PLAY GAMES!
NEW WORKING MODEL DIGITAL COMPUTER
ACTUAL MINIATURE VERSION OF GIANT ELECTRONIC BRAINS
Fascinating new see-through model computer actually solves problems, teaches computer fundamentals. Adds, subtracts, multiplies, shifts, complements, carries, memorizes, counts, compares, sequences. Attractively colored, rigid plastic parts easily assembled. 12" x 3 1/2" x 4 3/4". Incl. step-by-step assembly diagrams, 32-page instruction book covering operation, computer language (binary system), programming, problems and 15 experiments.
Stock No. 70.683-H \$5.98 Ppd.

WAR SURPLUS AMERICAN-MADE 7x50 BINOCULARS
Big savings! Brand new! Crystal clear viewing—7 power. Every optical element is coated. An excellent night glass—the size recommended for satellite viewing. Individual eye focus. Exit pupil 7mm. Approx. field at 1,000 yds. is 376 ft. Carrying case included. American 7 x 50's normally cost \$274.50. Our war surplus price saves you real money.
Stock No. 1544-H Only \$78.40 Ppd.
8 x 30 Binoculars—similar to above.
Stock No. 963-H \$40.00 Postpaid
7 x 35 American Made Binoculars.
Stock No. 964-H \$55.00 Ppd.



Diagnose Hidden Trouble with PROFESSIONAL STETHOSCOPE
Designed for use by physicians, this super-sensitive stethoscope is ideally suited for detecting faults in machines and engines, and in fluid, air and gas leakage. Dozens of uses in auto repair shops, labs, hobby, educational applications.
Stock No. 50.270-H \$6.95 Postpaid
BARGAIN PRICE STETHOSCOPE—excellent value.
No. 50.223-H \$2.95 Postpaid



MAKE YOUR OWN POWERFUL ASTRONOMICAL TELESCOPE
Grind Your Own Astronomical Mirror. Kits contain mirror blank, tool, abrasives, diagonal mirror and eyepiece lenses. You build instruments ranging in value from \$75.00 to hundreds of dollars.

Stock No.	Diam.	Mirror Thickness	Price
70.003-H	4 1/4"	3/4"	\$ 7.50 ppd.
70.004-H	6"	1"	11.95 ppd.
70.005-H	8"	1 3/8"	19.50 ppd.
70.006-H	10"	1 3/4"	30.75
70.007-H	12 1/2"	2 1/8"	59.95 f.o.b.

ORDER BY STOCK NUMBER SEND CHECK OR MONEY ORDER SATISFACTION GUARANTEED
EDMUND SCIENTIFIC CO., BARRINGTON, N. J.

NEW! SCIENCE FAIR PROJECT KITS
Edmund Kits are carefully planned to give any boy or girl the fun and excitement of discovering science facts. Such carefully planned projects can lead the student to awards or scholarships. Adults too will find them an excellent introduction to the various fields of science.
Write for Free Bulletin 47-H "Your Science Project" covering all phases of Science Fair projects.

MINIATURE WATER PUMP
Wonderful for experiments, miniature waterfalls, fountains, Christmas gardens, 110 gage railroad backdrops, hobbyists, labs, schools. Pumps continuous flow of water etc. Tiny (2 3/4" x 1 3/4") electric motor and pump ideal for hobbyists, labs, schools. Pumps continuous flow of water at rate of one pint per minute at a 12" head. With 2 D Batteries in series will pump to 24" high. Works in either direction. Stock No. 50.345-H \$2.25 Postpaid

WOODEN SOLID PUZZLES
12 Different puzzles that will stimulate your ability to think and reason. Here is a fascinating assortment of wood puzzles that will provide hours of pleasure. Twelve different puzzles, animals and geometric forms to take apart and reassemble, give a chance for all the family, to test skill, patience, and best of all to stimulate ability to think and reason while having lots of fun.
Stock No. 70.205-H \$3.00 Postpaid

SCIENCE TREASURE CHESTS
For Boys—Girls—Adults!
Science Treasure Chest—Extra-powerful magnets, polarizing filters, compass, one-way mirror film, prism, diffraction grating, and lots of other items for hundreds of thrilling experiments, plus a Ten-Lens Kit for making telescopes, microscopes, etc. Full instructions included.
Stock No. 70.342-H \$5.50 Postpaid
Science Treasure Chest DeLuxe—Everything in Chest above plus exciting additional items for more advanced experiments.
Stock No. 70.343-H \$10.50 Postpaid

BUILD A SOLAR ENERGY FURNACE
A fascinating new field. Build your own Solar Furnace for experimentation—many practical uses. Easy! Inexpensive! Use scrapwood! We furnish instructions. This sun powered furnace will generate terrific heat—2000° to 3000°. Fuses enamel to metal. Sets paper aflame in seconds. Use our Fresnel Lens 11" sq. F.L. 19".
Stock No. 70.533-H \$6.00 Postpaid

WAR SURPLUS ELECTRIC GENERATOR
Brand new Signal Corps Electric Generator for scientific experiments, electrical uses, demonstrations. Generates up to 90 volts by turning crank. Use in high impedance relays. Charge ground and bring up tight crawlers for bait or study. 2 Alnico Magnets alone worth original price. Wt. 2 lbs. Cost to Gov't. \$15.
Stock No. 50.225-H \$6.95 Pstd.
Same type generator, with light, as electricity demonstrator.
Stock No. 50.365-H \$11.95 Postpaid

Brand New, Quick-Charge, Industrial Surplus NICKEL-CADMIUM BATTERY
Unparalleled Value
For the first time a 6-volt, light-weight nickel-cadmium battery in stainless-steel, strap type casing, 4-amp hour capacity. Almost unlimited life—thousands of discharge-charge cycles with minute deterioration—charges fully in approx. 1 hr. with Edmund charger kit. Just a few drops of water per year provide full maintenance. Hundreds of uses for hobbyists, amateur photographers, campers, model builders, etc. Unequaled for rechargeable lanterns; cycle scooters, and boat lights; portable fluorescent and ultra-violet lights; electronic flash units. Battery requires minimum of electrolyte; is sealed to prevent loss; delivers nearly 100% of output below freezing temperatures compared to 50% by lead-acid batteries. No corrosive fumes under any stage of recharge. Can't be damaged by accidental charge in reverse (but not recommended). Stud type terminals on top 1 1/8" apart marked for polarity. 6/32 thread, nuts and lock-washers. 6 1/2" x 4 1/2". Wt. approx. 2 lbs.
Stock No. 70776-H \$15.00 Ppd.
CHARGER KIT FOR 6-VOLT BATTERY. Charges in approx. 1 hr. Shuts off automatically, attaches to Stock No. 70.766 battery case. Includes transformer, ballast resistors, charge circuit board, mounting hardware. 8-ft. cord, plug switch, assembly instructions.
Stock No. 79.807-H \$8.00 Ppd.
ONE 1.2 VOLT NICKEL-CADMIUM CELL
Stock No. 40.798-H \$3.95 Ppd.

Order by Stock No.—Send Check or M.O.—Money-Back Guarantee
EDMUND SCIENTIFIC CO., Barrington, New Jersey

MAIL COUPON FOR FREE CATALOG "H"
Completely new 1966 Edition, 148 pages
Nearly 4000 Bargains.
EDMUND SCIENTIFIC CO., Barrington, N. J.
Please rush Free Giant Catalog "H".

Name.....
Address.....
City..... Zone..... State.....



BY JOHN F. PEARSON
SCIENCE
WORLDWIDE

From medicine cabinet to workbench:

Iodine is the key ingredient in a new family of lubricants for space-age metals. Titanium, which is as strong as steel but only half as heavy, is notorious for its resistance to standard lubricants. Stainless steel, cobalt and nickel are ornery, too.

It's believed by General Electric scientists, who developed the new lubricants, that the iodine reacts with the metals at the surface to produce a protective film only a few atoms thick.

Food from coal is a future possibility.

Bureau of Mines researchers have isolated yeasts that thrive on certain chemicals obtained from coal tar. It's conceivable, say the scientists, that material synthesized from coal by microbes could be added to conventional foods as a high-vitamin, high-protein supplement.

Are you an elm fancier? If so, Elms

Unlimited should be of interest. It's a nonprofit organization whose sole objective is to keep the American elm from becoming extinct. The group sends out free literature on how best to protect the trees from the ravages of disease and distributes elm seedlings at cost. Individuals and organizations can obtain seedlings for 50 cents apiece or for \$15 a hundred.

If you want to strike back at the Dutch elm blight, write: Elms Unlimited, 60 West Prospect St., Waldwick, N.J.

Sharpshooting scientists. Bureau of

Standards researchers have been firing rifle bullets at high-strength yarns and recording the results with flash photography. The tests, they say, are leading to modifications of theories on how high-speed impact affects textiles and will aid in the design of even stronger materials for space suits.

Heated grass. The turf at the new

Busch Stadium in St. Louis will contain electric cables placed eight inches deep and spaced one foot apart. The system will heat the soil when the outdoor temperature drops below 40° F., or when the soil temperature one inch deep falls below 44° F.

Tests by the Department of Agriculture show that this type of installation stimulates grass growth and keeps soil and

turf in top condition, a plus for any stadium used throughout long baseball and football seasons.

Something in the ocean depths between New Guinea and the British Solomon Islands is affecting the orbits of artificial satellites. An Australian geophysicist, who heads a team investigating the phenomenon, thinks that exceptionally dense rock on the ocean floor in the area has such a strong gravitational pull that it drags satellites off course.

Medical palm-reading may prove a good way to detect cancer. That's the theory of three University of Oregon doctors who noted a frequent characteristic of cancer patients: many had small, horny growths on the palms of their hands. But the presence of the growths (called keratoses) is not an absolute indication, the doctors warn. Patients without cancer are found to have the growths, too, but less frequently.

A new alloy of exotic metals has been developed which is being pressed into immediate use to raise the operating temperature limits of certain components of rocket engines. Scientists at the Illinois Institute of Technology, where the alloy was developed, said the combination of hafnium and tantalum may have many aerospace applications because of its ability to withstand temperatures as high as 4000° F.

Forecasting earthquakes is the goal of a new government agency called the Institute for Earth Sciences. It will incorporate three existing government laboratories and will be headquartered at Boulder, Colo. The institute will do research on the earth's interior and its magnetic fields. The new knowledge gained may lead to foolproof techniques of prediction.

Vast reservoirs of 40,000-year-old rainwater have been found beneath the desert of Saudi Arabia. Geologists say that the water, in saturated layers some 1500 feet below the surface, has been slowly accumulating as rainfall has seeped downward over thousands of years. They believe that the reservoirs can be tapped to provide the arid country with extra water.

EARN-WHILE-YOU-LEARN APPLIANCE REPAIR AND AIR CONDITIONING

THESE TWO FREE BOOKS

CAN START YOU ON YOUR WAY TO:

- * new high-pay skill
- * business of your own
- * spare time income
- * savings on appliance repairs

THIS NEW, SHORT EASY COURSE TRAINS YOU AT HOME

THE BEST WAY TO GET AHEAD is to make yourself better qualified than the next man. You can prepare quickly to do *professional* appliance servicing at home in your spare time.

NEW EASY COURSE shows you step-by-step professional methods for repair of all types of appliances...including air conditioning, even small gasoline engines, farm and commercial equipment.

AMAZING PROFITS in your spare time...in improved job opportunities...in a business of your own. You earn-as-you-learn *professional* methods of appliance repairs...are ready to start servicing appliances after only a few lessons.

LOW COST TRAINING COVERS everything...special equipment is included in your course at no extra cost.



APPLIANCE DIVISION, NATIONAL RADIO INSTITUTE
3939 Wisconsin Ave., Washington, D.C. 20016

FEB. 1966



SEND FOR FREE BOOKS

MAIL THIS COUPON TODAY!

Appliance Division, Department 600-026
National Radio Institute
3939 Wisconsin Avenue, Wash., D.C. 20016

Send me the illustrated free book that tells about opportunities in Electrical Appliance Repair and details of NRI's new course—plus a sample lesson. I understand there is no obligation and no salesman will call.

Name Age
Address
City State Zip Code

Accredited Member National Home Study Council



NEW! 100
WORLDWIDE
STAMP
COLLECTION
just released

plus WINSTON CHURCHILL MEMORIAL ISSUE

GET THIS giant new collection of 101 different stamps — from the world's far corners. NEW ISSUES — commemoratives, pictorials, multi-colors. Lincoln, JFK, Churchill — Tristan da Cunha, Afghanistan, Rwanda, many more. PLUS exciting older issues showing beasts of prey, ancient life, jungle scenes. Supply limited. All only 10c. EXTRA! Other exciting stamps to examine; returnable, no obligation.

GARCELON STAMP CO., Dept. 2PM7, Calais, Maine

GARCELON STAMP CO., Dept. 2PM7, Calais, Maine
 Enclosed is 10c. Rush 101 Worldwide Stamp Collection.
 EXTRA! Other exciting stamps to examine; returnable, no obligation.

NEWS FROM THE
MILITARY
 BY WILLIAM R. KREH

A goldfish's heartbeat, or that of a human fetus only 10 weeks old, can be detected with a new device under development at the Navy's National Medical Center. Invented by a Naval Research Laboratory scientist, it will be used at the Medical Center for research into adult cardiovascular diseases.

A kid's toy recently helped put an Army missile on the production line. Technicians ran up against a problem in developing an antitank weapon. They needed igniters to set off the propellant in test missiles, but it would cost several hundred dollars and take weeks to get the first igniter manufactured and ready for use. Then the technicians came up with a gambling idea. They had heard about a new children's toy, selling for \$12.95, that plugs into a 110-volt line and moulds almost any kind of design out of sheet plastic. They bought one and turned out more than 50 of the needed igniters for rockets that were later successfully test-fired.

A bamboo network has been set up by Marine communicators around Chu Lai, Vietnam. They've strung telephone wire on bamboo poles. The Marines found that the regular 14-foot telephone stakes normally used to run the wire overhead, sank into the fine sand until they were nearly out of sight. The hollow bamboo poles, however, fill with sand until a joint in the pole is reached. There it stops, anchoring the pole firmly in the ground.

Hover jockies. Four Navy men have become pioneers in a program that's literally up in the air. They are the first enlisted men to qualify as operators of the VA-3 hovercraft—a futuristic vehicle which travels on a cushion of air over land or sea at high speeds. The vehicle is being tested by the Navy for possible use. The hovercraft potential as an amphibious vehicle seems virtually unlimited. If current tests prove out the air-cushion vehicle, men and materials could be shuttled ashore at speeds of more than 50 knots. The vehicles are nearly immune to surf conditions, underwater obstacles and mines. The Navy is also eyeing the versatile craft for antisubmarine warfare, patrol and reconnaissance work, and rescue roles.

RIGID®
Drop Head Pipe Threaders
 give you Easy-To-Reverse Dies ...

LET YOU THREAD
 RIGHT UP
 TO A WALL ...
 EVEN THREAD
 CLOSE NIPPLES!

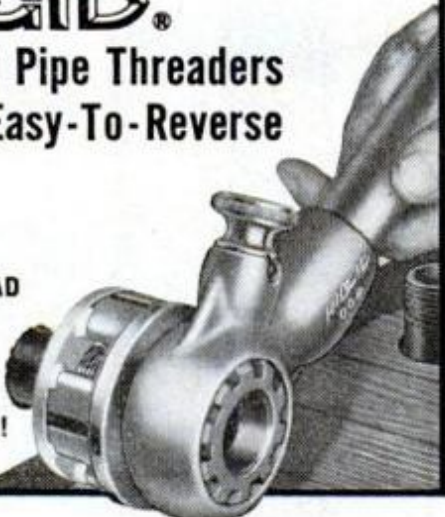

With a **RIGID** DOR Threader in your hands, you're ready to tackle every home pipe threading job. Six die heads are available for all 1/8" through 1" pipe. These can be purchased individually or in any desired combination. Head locks into ratchet and handle ... can't fall out until released. Reversible ratchet action gives fast, easy threading even in tight spots. All dies are work-tested before shipment. Accuracy is guaranteed.

See the complete line of **RIGID** Work-Saver Tools at your Dealers!



RIGID® THE RIDGE TOOL COMPANY, ELYRIA, OHIO, U. S. A.



**Certain parts of
Ford Motor Company
cars are engineered to tolerances
100 times thinner than this page.**

**So fine a piece of machinery
can be cared for best by
the specialist—your Ford
or Lincoln-Mercury dealer.**

See him and be sure.



Your dealer has special equipment, such as this "Rotunda" oscilloscope engine analyzer, for the care of Ford-built cars.



Only at Ford and Lincoln-Mercury dealers



EARN WHILE YOU LEARN DIESEL AUTO MECHANICS and AUTO BODY

**LATEST DIESEL FUEL PUMP
CALIBRATING MACHINE**

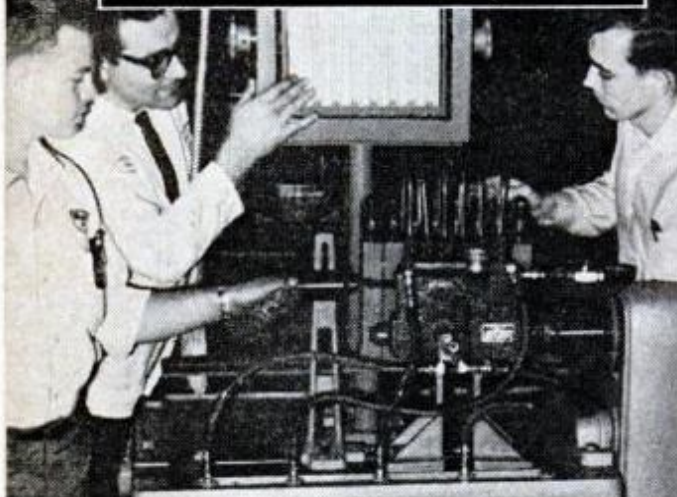

Prepare NOW for BIG PAY JOBS in industry or ratings, with MORE PAY, in the service.

96.4% graduates placed in big paying jobs! Start about \$5,000 a year . . . rapidly advance to \$10,000 a year. Earn to \$2,200 a month if you start your own business with 75% financing!

More BIG PAY JOBS than we can fill. Let us show you actual waiting list of Diesel dealers who have tried Bailey graduates, found them outstanding & keep coming back for more.

**Both DIESEL & AUTO training
for PRICE OF ONE!**

See the most beautiful school in the country with best equipped modern shop.

Get free booklet showing step-by-step tour thru our big shops. See students as they Learn-By-Doing with Famous Bailey Method of training. Housing & part time jobs provided—national placement for graduates.

BAILEY Technical SCHOOLS

1645 S. GRAND Dept. PM ST. LOUIS 4, MO.

MAIL TODAY FOR FREE BOOKLET

- DIESEL MECHANIC
- AUTO MECHANIC
- MASTER MECHANIC
- AUTO BODY



Name _____

Address _____

City _____ State _____

Telephone _____ Age _____

BY KEVIN V. BROWN AVIATION JETSTREAM

Non-flyers are losing the battle. A recent Gallup poll, conducted for Trans World Airlines, shows that more than 42 million Americans—38 percent, or nearly two of every five persons—have flown on a commercial airliner.

The old myth was that only 10 or 20 percent had flown.

TWA thinks it's the new jets that are attracting them. Whatever the reason, the most encouraging factor is that the number of young people, those between 21 and 34 years, are leading the way. Almost half their number have flown, and that's where future air travelers come from.

Broken down further, the poll shows that the most consistent travelers are professional or business people, that they come from medium or large cities, especially in the East, and that they earn \$10,000 or more per year. The least traveled are those with low incomes from rural areas in the South.

Sour grapes must now be thrown at all this happy news. In its annual preference poll among its members, the Airways Club has chosen the "most favorite" and "least favorite" airlines. The club consists of people who travel a lot on commercial airlines. In the poll, the members could vote on both their favorite and least favorite airlines.

Among the big trunk (nonlocal) lines, American Airlines was first, 89 percent calling it their favorite and only 10 percent their least favorite. Next were Continental (86 percent and 14 percent) and United (85 percent and 14 percent).

One significant jump was TWA, which climbed from seventh place to fourth place this year.

At the bottom of the list, in reverse order, were Northeast Airlines (17 percent "favorite" and 82 percent "least favorite"), Eastern (18 percent and 81 percent) and National (20 percent and 79 percent).

Just above them was Braniff International which has just embarked on a passenger-luring campaign (page 20, Jan. '66 PM). It will be interesting to see how well its newly decorated planes and stewardesses do in the passenger-coddling contest.

The Airways Club members who voted in the poll, mostly business and professional types, average 28 flights per year.

- For Action, Security, Big Pay -

WE CHALLENGE YOU TO TOP THIS JOB!



Earn To \$15 An Hour ★ Work Part-Time Or Full-Time ★ Car Furnished — Expenses Paid ★ No Selling — No Previous Experience Needed ★ Only Average Education Required

**NO OTHER CAREER OFFERS YOU
A BRIGHTER FUTURE**

Consider this fact. In the short time it takes you to read this page 1,100 accidents will take place. Over 440,000 will occur before this day ends. *These accidents must be investigated.* The law demands it. Yet in 4 out of 5 cities, towns and rural communities, no one has been trained for this vital work.

**KEEP PRESENT JOB
UNTIL READY TO SWITCH**

Step into this fast-moving Accident Investigation field. *Already* hundreds of men we have trained are making big money. Joe Miller earned \$14,768 his first year. A. J. Allen earned over \$2,000 in ten weeks. Robert Meier says "I'm now earning \$7.50 to \$15.00 an hour in my own business... Universal's course is wonderful."

FREE EMPLOYMENT HELP GIVEN

We CAN and WILL show you how to rapidly build your own full-time or part-time business. Or if you wish a big-pay job as Company Claims Investigator, our Placement Service will give you *real* assistance. Hundreds of firms needing men call upon Universal. *We place far more men in this booming field than any other individual, company or school.*

WE FINANCE YOU

Write today for complete information. Costs are less than you'd imagine. And even on these low costs you need pay only a portion—less than half—in order to complete your training. We finance the rest for you. You may pay out of actual earnings. And you can keep present job while learning. Send now for free book. No salesman will call. You are not committed in any way.

EARN WHILE YOU LEARN

Let us show you how easy it is to get into this exciting new career in just a matter of weeks. You need NO prior experience or higher education. There's NO investment in expensive equipment. You do NO selling. Furthermore, this fast-growing Accident Investigation field has no seasonal layoffs... no time out for strikes... no oversupply of men... no worry about automation. We ask you to compare these terrific advantages with the job you now have! Cash in on this big demand for trained men NOW. *Write today!*

Mail Now for FREE BOOK

M. O. Wilson, Dept. PM-2
Universal Schools,
6801 Hillcrest, Dallas, Texas 75205
Please rush me your FREE BOOK on Big Money in
The Booming Accident Investigation Field. I will be
under no obligation — and no salesman will call upon me.

Name
Address
City State Zip Code



ACCOUNTING

Accounting for Business Programmers
 Accounting (Canadian)
 Auditing
 Business Law
 Cost Accounting
 C.P.A. Review
 Estate & Trust Accounting
 Executive Accounting
 Federal Tax
 General Accounting
 Industrial Accounting
 Junior Accounting
 Legal Accounting
 Office Accounting
 Personal Income Tax & Social Security
 Practical Accounting
 Public Accounting
 Small Business Accounting
 Starting & Managing a Small Bookkeeping Service

ARCHITECTURE AND BUILDING

Architectural Drawing & Designing
 Architecture
 Building Contractor
 Building Estimator
 Building Inspector
 Building Maintenance
 Carpenter-BUILDER
 Carpentry & Millwork
 House Planning & Interior Design
 Mason
 Painting Contractor
 Reading Arch. Blueprints
 Review in Arch. Design & Practice
 Review of Mech. Systems in Buildings

ART

Amateur Artist
 Commercial Art
 Commercial Cartooning
 Interior Decorating
 Oil Painting for Pleasure
 Show Card & Sign Production
 Show Card Writing
 Sign Painting & Designing
 Sketching & Painting

AUTOMOTIVE

Automatic Transmission Specialist
 Automobile Body Rebuilding & Refinishing
 Automobile Electrical Technician
 Automobile Engine Tune-Up
 Automobile Technician
 Automotive Mechanic
 Diesel-Gas Motor Vehicle Engines

BUSINESS

Advertising
 Basic Inventory Control
 Business Administration
 Business Management & Marketing
 Business Management & Production
 Canadian Business Courses
 COBOL Programming
 Condensed Business Practice
 Direct Mail & Mail Order Advertising
 Industrial Psychology
 Magazine & Newspaper Advertising
 Managing a Small Store
 Marketing
 Marketing Research
 Modern Executive Management
 Office Automation
 Office Management
 Programming for Digital Computers
 Programming the IBM 1401 Computer
 Purchasing Agent
 Retail & Local Advertising
 Retail Business Management
 Retail Merchandising
 Retail Selling
 Systems and Procedures Analysis

CHEMICAL

Analytical Chemistry
 Chemical Engineering
 Chemical Engineering Unit Operations
 Chemical Laboratory Tech.
 Chemical Process Operator
 Elements of Nuclear Energy
 General Chemistry
 Instrumental Laboratory Analysis

CIVIL ENGINEERING

Civil Engineering
 Construction Engineering
 Highway Engineering
 Principles of Surveying
 Reading Highway Blueprints
 Sanitary Engineering
 Sewage Plant Operator
 Structural Engineering
 Surveying and Mapping
 Water Works Operator

DRAFTING

Architectural Drafting
 Design Drafting
 Drafting Technology
 Electrical Drafting
 Electrical Engineering Drafting
 Electronic Drafting
 Introductory Mechanical Drafting
 Mechanical Drafting
 Pressure-Vessel and Tank Print Reading
 Sheet Metal Layout for Air Conditioning
 Structural Drafting

ELECTRICAL

Electric Motor Repairman
 Electrical Appliance Servicing
 Electrical Contractor
 Electrical Engineering (Power option or Electronic option)
 Electrical Engineering Tech.
 Electrical Instrument Tech.
 Industrial Electrical Tech.
 Power Line Design and Construction
 Power Plant Operator (Hydro or Steam Option)
 Practical Electrician
 Practical Lineman
 Reading Electrical Blueprints

**CAST
 YOUR
 BALLOT
 FOR
 A
 SUCCESSFUL
 FUTURE!**

253 I.C.S.

Convenient Payment Plan

Special in-plant training programs for industry

New! Special Package for Women



I.C.S. is the oldest, largest school of its kind. Over 200 courses for men and women. High school, business, secretarial, interior decorating, engineering. One for **you**. Direct, job-related. Bedrock facts and theory plus practical

application. You learn from experts. Diploma to graduates.

Clip and mail the coupon **now**. You'll receive, absolutely FREE, 3 valuable booklets that have helped thousands. But don't delay. Cast **your** "ballot" today!



**ENGINEERING
(Professional)**

Chemical
Civil
Electrical
Industrial Management for Engineers
Mechanical

ENGLISH AND WRITING

Better Business Writing
Free Lance Writing for Fun & Profit
Introductory Technical Writing
Modern Letter Writing
Practical English
Short Story Writing

HIGH SCHOOL

High School Business
High School (Canadian)
High School College Prep. (Arts)
High School College Prep. (Engineering & Science)
High School General
High School Mathematics
High School Secretarial
High School Vocational

LANGUAGES

(Edited by Berlitz)
French
German
Italian
Spanish

LEADERSHIP

Basic Supervision
Industrial Foremanship
Industrial Supervision
Personality Development
Personnel-Labor Relations

MATHEMATICS

Advanced Mathematics
Mathematics and Mechanics for Engineering
Mathematics & Physics for Technicians
Mathematics and Physics for Engineering
Modern Elementary Statistics

MECHANICAL

Aircraft & Power Plant Mechanic
Industrial Engineering
Industrial Instrumentation
Machine Design
Mechanical Engineering
Quality Control
Safety Engineering Tech'n'gy
Tool Design
Value Analysis

PETROLEUM

Natural Gas Production & Transmission
Oil Field Technology
Petroleum Production
Petroleum Production Engineering
Petroleum Refinery Operator
Pipeline Engineering

PLASTICS

Plastics Technician

**PLUMBING, HEATING,
AIR CONDITIONING**

Air Conditioning
Air Conditioning Maintenance
Domestic Heating with Oil & Gas
Domestic Refrigeration
Heating
Heating & Air Conditioning with Drawing
Industrial Air Conditioning
Industrial Heating
Plumbing
Plumbing & Heating
Practical Plumbing
Refrigeration
Refrigeration & Air Conditioning
Steam Fitting

PULP AND PAPER

Paper Machine Operator
Paper Making
Pulp Making
Pulp & Paper Engineering
Pulp & Paper Making

SALESMANSHIP

Creative Salesmanship
Real Estate Salesmanship
Sales Management
Salesmanship

SECRETARIAL

Clerk-Typist
Commercial
Legal Secretary
Medical Secretary
Professional Secretary
Shorthand
Stenographic
Typewriting

SHOP PRACTICE

Drill Operator
Foundry Practice
Industrial Metallurgy
Lathe Operator
Machine Shop Inspection
Machine Shop Practice
Machine Shop Practice & Toolmaking
Metallurgical Engineering Technology
Milling Machine Operator
Multicraft Maintenance Mechanic
Practical Millwrighting
Reading Shop Prints
Rigging
Tool Engineering Tech'n'gy
Tool Grinder
Toolmaking
Turret Lathe Operator
Welding Engineering Technology

**STEAM AND DIESEL
POWER**

Boiler Inspector
Industrial Building Engineer
Power Plant Engineering
Stationary Diesel Engines
Stationary Fireman
Stationary Steam Engineering

TEXTILES

Carding
Carding and Spinning
Dyeing & Finishing
Loom Fixing
Spinning
Textile Designing
Textile Mill Supervisor
Textile Technology
Warping and Weaving

TRAFFIC

Motor Traffic Management
Railway Rate Clerk
Traffic Management

TV-RADIO-ELECTRONICS

Communications Techn'gy
Electronic Fundamentals
Electronic Fundamentals (Programmed)
Electronic Fundamentals with Electronic Equipment Training
Electronic Instrumentation & Servo Fundamentals
Electronic Principles for Automation
Electronics and Applied Calculus
Electronics Technician
First Class Radiotelephone License
Fundamentals of Electronic Computers
General Electronics
General Electronics with Electronic Equip. Trng.
Hi-Fi Stereo and Sound Systems Servicing
Industrial Electronics
Industrial Electronics Engineering
Industrial Electronics Engineering Technician
Practical Radio-TV Eng'g
Practical Telephony
Principles of Radio-Electronic Telemetry
Principles of Semiconductor-Transistor Circuits
Radio Servicing with Equipment Training
Radio & TV Servicing
Radio & TV Servicing with Equipment Training
Second Class Radiotelephone License
Sound Systems Specialist
Telephony, Electronics and Radio Communications
TV Receiver Servicing
TV Technician

COURSES

Clip coupon—and take your first big step to real success! I. C. S., Scranton, Penna. 18515

In Hawaii: P. O. Box 418, Honolulu
In Canada: I. C. S. Canadian, Ltd.
In other countries: I. C. S. World, Ltd.

FREE! THE I. C. S. SUCCESS KIT!

Three valuable booklets sent to you free when you mark and mail the I. C. S. coupon. No obligation.

1. "How to Succeed"—A new, exciting booklet that lets you evaluate yourself and your future in an entirely different way!
2. Complete catalog outlining job opportunities and outlook in your field of interest.
3. Sample lesson to demonstrate the success-proved I. C. S. method of spare-time study.

Accredited Member, National Home Study Council

INTERNATIONAL CORRESPONDENCE SCHOOLS ICS

Dept. 1474, Scranton, Penna. 18515

Without cost or obligation, send me "HOW to SUCCEED," the opportunity booklet about the field I have indicated below, and a sample lesson.

Course in which I'm interested: _____
(Select from listing above)

Name _____ Age _____
(Indicate Mr., Mrs., or Miss)

Address _____

City _____ State _____ Zip code _____

Occupation _____ Working hours _____ A.M. to _____ P.M.

Employed by _____ I am in the U.S. Armed Forces.
Tell me about special low rates.

CAREER BAROMETER

BY CREIGHTON PEET

IF YOU ARE OF AN AGE to be called in the draft—and this age may change from time to time—it is to your advantage to find out if your job will qualify you to receive a deferred-status classification from your local board of selective service.

In many cases men in engineering or technical jobs—even if they have nothing to do with defense production or military activity—may qualify for a deferment. However, there are no hard and fast rules to follow.

The Selective Service Administration in Washington lays down guide lines, but your local board, made up of older men in your neighborhood, has a good deal of latitude. If they classify you 1-A and you feel you are engaged in essential

work, you have the right to appeal from this decision.

The Engineering Manpower Commission in New York and the Scientific Manpower Commission in Washington have jointly prepared a booklet, "Employer's Inventory of Critical Manpower" (2101 Constitution Ave., Washington NW, D.C. \$3) explaining the rules, but it is complicated to follow.

What is 'critical'?

The basic paragraph states: "Men having *critical occupations* will be deferred so long as the need for them exists. . . in the event of a national emergency and mobilization resulting in heavier calls it (Please turn to page 22)

JOB TITLE	CURRENT NATIONAL DEMAND	3-MONTH TREND	STATES WITH HIGHEST DEMAND						
Chemists, Biological	21	Slight reduction	N.J. 5	N.Y. 2	Pa. 2	Ohio 2	Ill. 3		
Chemists, Organic	55	Demand steady	N.J. 10	N.Y. 4	Pa. 3	Ala. 11	Ohio 7		
Chemists, Inorganic	10	Some increase	Conn. 2	Md. 1	Pa. 1	Tenn. 1	Ky. 2		
Engineers, Metall.	59	Good increase	D.C. 5	Pa. 4	S.C. 10	Ind. 11	Calif. 9		
Engineers, Civil	463	Good increase	Conn. 32	D.C. 67	Ohio. 36	Cal. 80	Wash. 39		
Engrs., Elect & Electron.	961	High increase	Conn. 45	Md. 58	Fla. 46	Ariz. 41	Calif. 296		
Engineers, Industrial	407	High increase	N.J. 31	Fla. 40	Ohio 61	Ill. 34	Calif. 35		
Engineers, Mechanical	1197	High increase	Conn. 66	Pa. 74	Fla. 84	Ohio 133	Calif. 215		
Engineers, Aero.	518	High increase	Pa. 11	Fla. 49	Ohio. 51	Cal. 190	Wash. 120		
Engineers, Mining	12	Some increase	D.C. 3	Pa. 3	Fla. 1	Kan. 1	Calif. 2		
Natural Scientists	122	Good increase	N.J. 3	D.C. 30	Mo. 5	Calif. 11	Wash. 51		
Draftsmen, Architectural	117	Nearly tripled	Mass. 7	Fla. 13	Ohio 20	Calif. 19	Wash. 9		
Draftsmen, Electrical	116	High increase	Mass. 9	Pa. 3	Ill. 5	Mo. 20	Calif. 67		
Draftsmen, Mechanical	291	High increase	Pa. 38	Ohio 58	Ill. 16	Wis. 42	Calif. 46		
Draftsmen, All Other	326	High increase	Conn. 37	Mass. 27	Mo. 41	Calif. 69	Wash. 40		
Tool Designers	91	Some decrease	Conn. 7	Vt. 6	Ill. 11	Calif. 16	Wash. 30		
Lab. Tech. & Assistants	109	Good increase	Mass. 8	N.Y. 12	Va. 11	Ky. 9	Fla. 6		
Sports Instr. & Officials	116	Good increase	Me. 4	Vt. 40	N.Y. 6	Pa. 13	Mich. 30		
Surveyors	21	Slight decrease	Conn. 3	Mass. 5	Vt. 2	N.C. 2	Ohio 2		
Techs. Eng'g & Phys. Sci.	509	High increase	Ala. 77	Fla. 36	Ohio 41	Calif. 83	Wash. 183		
Tool Planners	30	Good increase	Ohio 22	Ind. 7	Iowa 1	————	————		
Systems Engineers	22	Steady	N.Y. 2	Ind. 2	Mo. 10	Nebr. 2	Calif. 2		
Programmers	346	High increase	N.J. 48	D.C. 15	Ohio 15	Calif. 112	Wash. 80		
Systems Analysts	73	Some decrease	Conn. 5	N.J. 19	D.C. 5	Calif. 14	Wash. 8		
Inspectors Pub. Service	8	Slight decrease	Md. 1	Calif. 1	Wash. 6	————	————		

PM's Career Barometer Chart, above, gives the actual number of men currently needed for specific jobs. "Current Demand" figures are true as of our closing date. Check this chart each month and it will tell you where your talents are needed, and how badly. For names of actual employers represented by these listings, contact the state employment agency in the cap-

ital city of the state indicated. Mention that you saw this in **POPULAR MECHANICS**.

Today, with proper schooling, you can qualify for many of the job categories shown. For a list of accredited correspondence and residence schools, write to **POPULAR MECHANICS' Information Bureau, 575 Lexington Ave., N.Y. 10022**.

ELECTRICITY

**EARN as you LEARN—
In Your Spare Time at Home**

This is a "Push Button Age" — everything is becoming automatic — men with Electrical "Know How To" are needed everywhere — and will always be needed.

HERE IS MY OFFER

If you want to increase your income — by having a part or full time business of your own — or a big paying career job in Electricity — I will send you everything you need to get started NOW.



S. T. Christensen
President

Professional trouble shooting electronic equipment — quickly locate electrical problems (shorts, open, power failures, etc.); professional electric repair tools; audio recordings that bring the instructors' voices into your home, making things easy to understand; thousands of exploded views, photographs and drawings showing how parts fit together, how buildings and electrical equipment are wired — charts telling you how to fix things quickly, correctly — ALL ARE SENT TO YOU.

REPAIR ALL APPLIANCES

ATS (Advance Trades School) training is complete training, is easy training, is approved training. You learn how to fix irons, toasters, coffee makers, washing machines, refrigerators, air conditioners, etc. There are over 400 million appliances in use. Over 160 different appliances! ALL eventually need servicing and repair. ATS shows you how to fix all of them! !! Hundreds of my students, the country over, in cities and small towns alike, have reported earnings of \$15, \$25, \$50 and even more per week while training. Would you like to do the same?

INDUSTRY NEEDS MEN who can service electric equipment. Top wages are paid to Electrical Maintenance Men, Electric Technicians, Plant Engineers, Electric Construction Men, etc. ATS trains you quickly, trains you well. ATS has no fancy frills, no wasted time. You get practical training, actually do 17 shop projects in your own home. Many ATS graduates hold "key" positions in Industry. Start your training NOW.

MOTOR REWINDING homes today have ten, fifteen or more motors. Electric shavers, washing machines, food mixers, vacuum cleaners, refrigerators, power tools, to name but a few. Without motors factories could not operate. ATS teaches you to put motors in good repair — you even build your own rewinding and testing equipment as part of your training program. You learn with ATS by working with your hands. You make and keep valuable testing equipment.

LEARN WIRING You learn how to completely wire or rewire homes, garages, barns and factories — their lighting and power equipment. There are no half ways with ATS training.

NO EXPERIENCE NEEDED

ATS shows you how, gives you the equipment to do it. Your own kitchen table can be where you first "set up shop." ATS men are nationally recognized by wholesale suppliers of parts and materials. We show you how to get repair business, how to charge fair and profitable prices for your work. ATS keeps graduates informed as new appliances, improved electrical techniques develop. It is a regular part of the continuing ATS training program and why ATS training is preferred by so many. You owe it to yourself to investigate the complete ATS Electrical Training Program.

**FREE 36 page—4 color book
"EARNINGS BY ELECTRICITY"**

This seal certifies full accreditation by the National Home Study Council the official accrediting agency of the U. S. Office of Education.



**MAIL COUPON
FREE BOOK**

No Cost or Obligation

ELECTRIC APPLIANCE REPAIR

**Industry Pays
Trained Electricians
Top Wages**

Some of the
Equipment I send
YOU



LET ATS MEN TELL YOU IN THEIR OWN WORDS

"Earning \$50.00 more weekly. Made over \$1,000 while training." O. Harless, St. Charles, Ill.
"Received two promotions — worker to foreman to assistant manager." J. Swanton, Oaklawn, Ill.
"My work piles up and I get behind with my studies." M. Bobo, Sr., Tacoma, Wash.
"I am now maintenance man at a large motel at a much higher salary." J. Martin, Kansas City, Mo.
"2 raises in pay since I started with the State Highway Dept. in electrical maintenance." C. DeHut, Phoenix, Ariz.
"Should have taken your course 20 years ago." A. Knoll, Michigan City, Ind.
"Chief maintenance man now at double my former income besides having a

profitable sideline business." R. DeWitt, McHenry, Ill.
"One job more than paid for the training." E. Hutson, Chicago
Former \$2.30 hour mechanics — "Now Head Maintenance man at Heineman's Bakeries — wages are nearly \$200.00 a week." C. Fontenot, Hales Corner, Wis.
"Not a high school graduate but I find the lessons easy to understand." W. Wolf, Grand Rapids, Mich.
"Until my disability I was a tool maker. Your course is a new life to me." W. Haebig, Kenosha, Wis.
"\$1,000 Christmas for my family. Got everything we wanted. Will now return to my studies." D. Behrmann, Two Rivers, Mich.

ADD TO YOUR INCOME—MAIL TODAY

S. T. Christensen, President Dept. E-603
Advance Trades School
5944 N. Newark Ave., Chicago, Ill. 60631

Send me your FREE BOOK "Earnings by Electricity." I want to add to my income.

Name Age

Address

City Zone State

FREE GIANT NEW CATALOG

100'S OF BARGAINS NOT IN ANY OTHER CATALOG

TOP VALUES IN POWER & HAND TOOLS

SAVE ON CAMERAS FILM & PHOTO EQUIPMENT

1966 ANNUAL CATALOG RADIO-TV-ELECTRONICS

TUBES PARTS ETC. AT LOWEST PRICES

EVERYTHING IN HI-FI AND STEREO

SAVE UP TO 50% ON CHOICE KITS

100'S OF BIG PAGES CRAMMED WITH SAVINGS

BURSTEIN-APPLEBEE CO.

Dept. PM, 1012 McGee, Kansas City, Mo. 64106

Rush me FREE 1966 B-A Catalog.

Name

Address

City..... State.....

Please be sure to show your Zip No.

SEND FOR IT TODAY

FREE

CAREER BAROMETER

(Continued from page 20)

is assumed that men having critical occupations (or who are in training for them), and are engaged in essential activities, would be eligible for continued occupational deferment."

There are two key phrases here, "critical occupations" and "essential activities." A critical occupation might be work in an aircraft or electronics or arms plant—or a city water works, electric generating station, or sewage treatment plant. But to be identified with such an operation isn't enough.

You must also be in essential activity in this plant. An office boy, building superintendent, bookkeeper, custodian or cafeteria cook, would not rate a deferment. The Manpower Commission's book defines the essential activities in detail and they cover a wide range of professions from astronomer to glass blower ("blows glass into intricate parts of scientific instruments"), to "health physicist" ("...directs research training to protect plant personnel from radiation hazards. . .").

The 'boss' has a vote

Your boss' estimation of your value to his operation is a big factor in deciding whether you will actually get the deferment—provided of course you are in a critical industry.

If you think you might be in such a spot, but have been classified 1-A, you must (if you wish to appeal your case) file an appeal within 10 days of the time you receive your classification notice. The Manpower Commission strongly advises that every man now engaged in technical employment should make such an appeal.

A local board may interpret the Selective Service guide lines rather freely but an appeal board is more likely to follow them closely. In any event, remember that the local board is not bound by law to follow the Washington recommendations completely.

Some students on a limb

As for students: "Full-time college students satisfactorily pursuing their studies may be deferred as long as they get good grades. . ." Obviously there is some little latitude here. Draft boards have been known to advise poor students to pull up their socks and, if need be, take summer school work to bring up their grades. If they don't do something to boost their marks they'll shortly find themselves in uniform.

Full-time day-time graduate students
(Please turn to page 24)

BUY THE

BIG

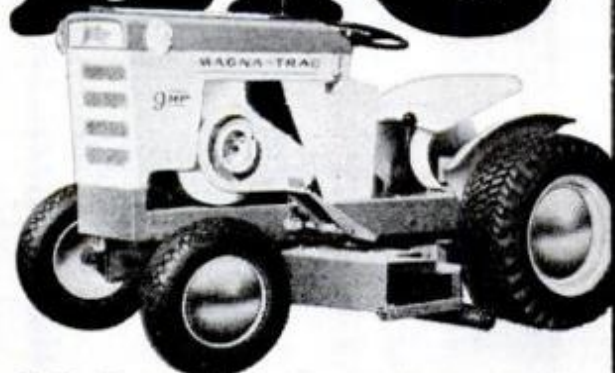

MAGNA-TRAC

The man-size tractor that looks like a tractor, not a toy. Big on power. Big on performance. Big on features that men want most in a garden tractor. Low cost 7 1/4 H.P. model; two rugged 9 H.P. models. Think big . . . buy Magna-Trac! Write today for literature.

MAGNA AMERICAN CORPORATION
Dept. MP2
Interstate 75, Cincinnati, Ohio 45215

Choremaster &
Tillsmith Garden Tillers
Snow-Mowers • TEC Electric
Trimmer-Edger/Cultivator
Shopsmith • Sawsmith

Can't afford a \$12,000 GT machine?

Fake it.



Pontiac Motor Division • General Motors Corporation

Just say "sports package" when you're ordering any Tempest, Tempest Custom or LeMans but a wagon, and we'll slap on goodies you thought came only on the continental jobs.

To start with, a spiffier 4-BBL version of our European-inspired 6. (Its overhead cam makes it some 200 pounds lighter than a comparable horsepower V-8. Deep skirt block makes it strong. And a removable cam cover and permanently lubed timing belt simplify service.) All of which gives you 207 horsepower at a delirious 5200 rpm. And sounds like it if you're

standing anywhere near its special split manifold exhaust, believe us.

More? Sure. We stiffen the shocks, lay in heavier springs and a special stabilizer bar. Put a 3-speed all-synchro shift on the floor. Sportstripe its flanks. Throw in a set of special emblems, and that's it. The OHC 6 sports package. (Padded dash, visors, seat belts and other safety items are standard, of course.)

And knowing it's by Pontiac, you know the one big difference between ours and the one wrapped in Europe. About \$9,000.

Wide-Track Pontiac/'66

Prepare Now For **\$7,500** **BIG MONEY!**



THE TRAINED AUTO MECHANIC IS TOMORROW'S "BIG WHEEL"

You can aim as high as you want when you are an expert Auto Mechanic. Foreman, Fleet Superintendent, Engine Rebuilder, Automotive Distributor, Technical Expert in Detroit...name it...your basic qualification in Auto Mechanics opens the door!

Lincoln Tech graduates have advanced to all of these jobs. They learned by **DOING...not home study**. There are 80,000 big pay jobs open right now for graduate Auto Mechanics, Ignition Tune-Up and Transmission Specialists. Lincoln Tech training will qualify **YOU!** You learn by actually working with live engines, automatic transmissions, power steering, brake systems, etc.

FREE PLACEMENT SERVICE

There are **LINCOLN TECHNICAL INSTITUTE** schools in principal cities. You can train in the one nearest you, knowing your Lincoln Tech diploma is nationally recognized for excellence in training and individual student instruction. There are no fees for placement of graduates.



Act **NOW!** Get your start in America's industry of unlimited opportunity. New classes start every four weeks. Write for **FREE** catalog.

LINCOLN TECHNICAL INSTITUTE

472 Market St., Newark, N.J. 07105

Lincoln Technical Institute, Suite 2-E
472 Market St., Newark, N.J. 07105

Please send me full information on the Lincoln Tech Automotive School nearest my home. I am interested in the courses checked below.

- Automotive Mechanics
- Automatic Transmission
- Ignition and Tune-Up

Name _____

Address _____

City _____ State _____

CAREER BAROMETER

(Continued from page 22)

are also deferred, but boards are inclined to look skeptically on men who have been graduated some years, and have just recently started graduate work. Part time students or those night school courses do not get a deferment. Correspondence school students do not rate a deferment either although any type of study may get you into an essential activity or a full-time college.

Facing the draft for sure, engineering or technical students can, as a rule, enlist and choose service in their special field. But if he waits to be processed through the regular Selective Service System a man with technical interests may be assigned by the Army to any activity it chooses.

Qualifying Jobs in West

Figures on job openings in the accompanying chart have indicated for some months that California and Washington often have two to three times more opportunities in a given field than most eastern states. While this is true, the Department of Labor agrees, it does not mean that you can go west and walk into any kind of a job with ease. Most of these extra jobs are in aircraft and space work for these states, which have been getting some of the fattest contracts. So unless you have one of the special skills needed in these fields and a firm offer of a job, don't sell your home and load the family into the car.

Instead, consult your state employment office. It does not have the names of employers in other states, but if you hanker to move to California or Washington, it will forward your resume or application to the employment office of one of the western states where somebody will canvass the local field for a job you can fill. In any event, it will pay you to be sure of a job before you start. Already there is a small trickle of dissatisfied people leaving glamorous California—chiefly because they lack the highly specialized skills needed.

Another factor in West Coast employment is the high mobility of jobholders. While a man in Connecticut or New Jersey might think several times before he picked up and moved away from his home town, Westerners are quick to go to what they hope will be a better job. These moves make job vacancies show up on the charts, but they don't necessarily mean there are fewer available people about. It's a kind of game of musical chairs and there always are plenty of players.

★★★

Need More Money? Want to Be Your Own Boss?

START SAW SHARPENING BUSINESS

Of Your Own - in Your Sparetime



Turn your spare hours in the evening or week-ends into extra dollars, this proven practical way—start your own money-making sharpening business—No selling or canvassing—No experience required. You can do it automatically with the Foley Saw Filer or Lawn Mower Sharpener.

Beginners Earn \$3 to \$6 an Hour

People, just like yourself, all over the United States are making extra cash—\$20 to \$30 a week—right now in their spare time. "My sparetime saw filing business has made me \$952 these first ten months," says R. T. Chapman. Many start part-time, find it so profitable that they build year-round service business. You can, too, simply by following easy Foley plan.

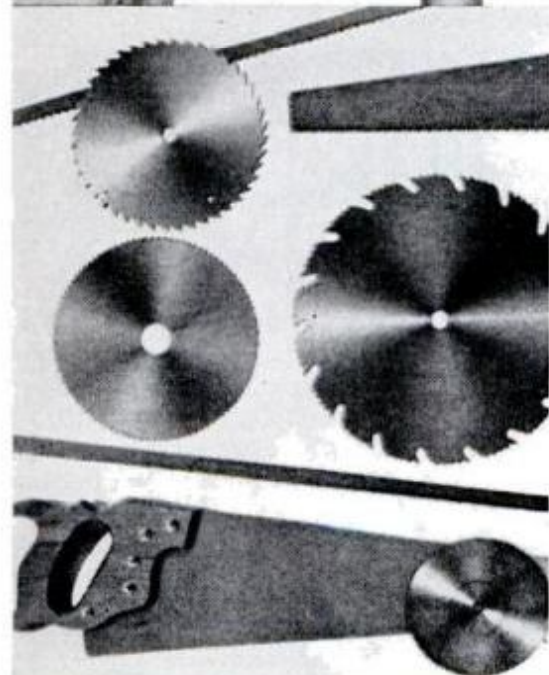

Town of 150 Supports Profitable Business

Here's the story from Dick and Jo Ann Koester after being in business less than a year. "We have acquired another Foley Saw Filer and for the past two months we have been in full-time operation. As we live in a small town of 150 population in farm area we use our truck to pick up saws in five nearby towns. With a family to support and plans for building to our house we had to pick up a business fast and already sharpen an average of 15-20 saws a day. Business for the future looks even better as good machine filing is our best advertising."

CASH for Sharpening Mowers

Every neighbor with a lawn needs his lawn mower sharpened at least once a year. No experience is needed to start—anyone can operate and turn out professional jobs. All operations are handled quickly, easily and accurately.



Sharpen These Professionally with amazing Foley Saw Filer

You can sharpen combination (rip and crosscut) circular saws, band saws, hand saws, crosscut circular saws—and do a perfect job every time without experience or special training. The precision Foley Filer does it for you automatically! A complete repair shop in one machine! Set up in basement or garage, work your own hours in your own way and earn big sparetime profits.



FREE

BOOKLET TELLS HOW! Free Book "Money Making Facts" shows just how you can start at home in spare time. Small investment—time payments if desired. Get this booklet—study it! Send coupon today. No salesman will call on you.

Foley Manufacturing Co., 216-6 Foley Bldg.
Minneapolis, Minnesota 55418

Send Free Booklet on Saw Sharpening Business Lawn Mower Sharpening

Name _____

Address _____

City _____ State _____ Zipcode _____

Buy Below Wholesale

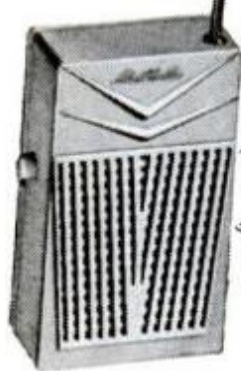

WALKIE TALKIE \$4⁹⁵

Transmits, receives. Fits in shirt pocket. Aerial extends for more distant reception.



JEWELLED CALENDAR WATCH \$2³³
WITH-OUT BAND

Swiss movement. Beautiful styling. Tells time and date, too. Sweep second hand, gift case, stainless steel back, water resistant, and antimagnetic. METAL EXPANSION BAND 11¢.



ELECTRIC RAZOR \$1⁷⁰

Product of Swiss craftsmanship... Shaped to shave the heaviest beard. Maker guarantees for 2 full years. With cord, head guard and brush.



ELECTRIC POWERED 8mm MOVIE CAMERA \$4⁴⁰

No winding. Drop-in loading. Simple exposure system eliminates focusing. Black and white or color movie film. Pistol grip houses tiny batteries.



Fabulous 2-Piece KNIT SUIT
ONLY \$4⁵⁰

Fine wool. Beautifully tailored abroad.

DERRINGER PISTOL \$5⁹⁹



Beautiful blued finish. Double barrel fires two shots. Product of West Germany's precision craftsmanship.

- Short cut plan guides you step by step
- Previous experience unnecessary
- Start without investment in merchandise
- Start anywhere—city, town, rural area



I SHOW YOU WHAT TO DO — HOW TO DO IT

B. L. Mellinger, Jr., Famous World Trader, says: "I reveal secrets of Import-Export that have made a fortune for me. My plan gives you hundreds of overseas suppliers—opportunities for thousands of exciting imports."

GET DETAILS ABOUT

8 FREE IMPORTS

FACTS SENT FREE

Send no money! Do not order products from us

... Plan shows where you get buys like these for big profit sales. Prices shown are direct from suppliers abroad. Put post card in mail today!

START YOUR OWN BIG PROFIT HOME IMPORT BUSINESS
with DAZZLING BARGAINS LIKE THESE...

AMAZING NEW PLAN STARTS YOU FAST

Thousands of amazing import bargains can lead you to opportunities far beyond your wildest dreams. Start now at home, spare or full time. Cash in now without previous experience or capital investment. Pocket cash even before ordering merchandise! Sparkling imports bring first day profits. Beginners—make your first import transaction 10 minutes after you receive my drop ship plan. Bargains go fast to stores, premium users, to friends and others.

... And, these are only a few of the hundreds of import bargains you can get to make fantastic profits of 200% and more... here are examples of other high profit imports:

MAN'S BRIEFCASE	\$.85	DOZEN GOLF BALLS	\$1.83
HUMAN HAIR WIG	12.00	KNITTING MACHINE	4.20
FISHING ROD50	BADMINTON SET60
FM HI-FI RADIO	8.80	TENNIS RACKET50
RIFLE SCOPE	1.85	BEER STEIN13
MOVIE TITLE KIT	1.00	SEWING MACHINE	3.15
BEADED HANDBAG	1.01	BLACK FOREST CLOCK63
FLASHLIGHT10	ELECTRIC TRAIN SET	1.50
TRANSISTOR RADIO	1.70	CIGARETTE LIGHTER21
CARDIGAN SWEATER	2.00	ELECTRIC CARVING KNIFE	1.50
SPINNING REEL96	8 mm MOVIE PROJECTOR	2.80
STOP WATCH	1.12	TEAKWOOD CHEST90
WRIST RADIO	2.90	WINDBREAKER JACKET	1.40
MODEL BOAT KIT65	STAR SAPPHIRE RING	6.00
WATER PISTOL65	ELECTRIC HAIR DRYER	1.37
ELECTRIC SHOE SHINER			\$1.55
LAMINATED SKIIS (2)			13.66
20-PC. DINNERWARE			1.15

Products subject to availability, price fluctuation

RUSH POST PAID CARD TODAY FOR FREE BOOK!



MELLINGER CO., Dept. X252, 1554 S. Sepulveda, Los Angeles, 90025

FROM THE PATENT OFFICE **NEW INVENTIONS**
BY M. J. PEDERSEN

Sweet-smelling incinerator for cities and towns consists of a line of underground "pits" and a movable above-ground chimney that reburns all the smoke to eliminate the customary foul odors surrounding city dumps. Situated on a track that runs from pit to pit, the chimney moves by remote control over refuse ready for burning, while the furnace is ignited. The giant incinerator was awarded patent 3,199,475 for Harold Siagel, Granby, Mass.

Cost-saving rocket has inner components that are themselves aerodynamically stable and capable of flying to earth in sections. Basically, two fuel tanks, divided lengthwise, are fitted together into a single cylinder for blast-off. In space the outer cover will peel off, allowing the tanks to separate and assume their fly-back shape. Patent 3,202,381 went to Dr. Hans F. Wuenscher, Huntsville, Ala.

Geodesic domes, as designed by R. Buckminster Fuller of Carbondale, Ill., have been built by the thousands around the world. But the patent, 3,202,144, came through only recently. The invention is particularly useful for making lightweight domes of paperboard or plastic materials that have thin inner and outer facing sheets.

A safety bottle with several built-in warning signals promises to substantially reduce the number of tragedies resulting when medicine bottles unwittingly are emptied. A dummy cap at the top and a reverse-screw (clockwise motion) in the real cap at the bottom are features designed to foil children and give pause to adults. J. M. Waisberg, Toronto, Canada, received patent 3,124,264.

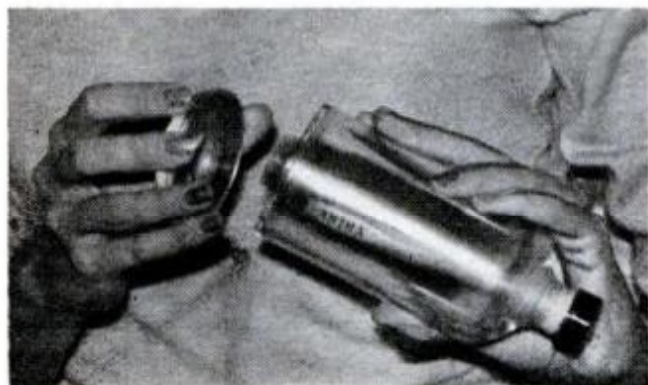

FREE! NEW CATALOG
Big Savings...
FAMOUS MAKES!
ACCORDIONS



**BUY DIRECT... at
Importer-to-You Prices**
... save middlemen's profits!
5 DAY FREE TRIAL!

**E-Z
TERMS**
**LOW DOWN
PAYMENT**
Balance-Little as
\$8⁷⁷ a Month

Over 40
Standard and
Electronic
**Accordions-
Amplifiers**
for Students,
Teachers,
Professionals

SAVE UP TO 1/2
**OFF RETAIL PRICES of
Comparable Accordions**

TRADE-IN
Your Old
Accordion
BIG ALLOWANCE!

WORLD'S LARGEST EXCLUSIVE ACCORDION DEALER saves you more than you ever hoped possible on new famous-make Italian Accordions of your dreams! Because you buy DIRECT... Importer-to-You... save up to 50% OFF retail prices of comparable accordions. Compare our low prices... see and judge for yourself. Rush coupon for FREE Color Catalog and low Importer-to-You price list. See America's most exciting selection... *over 40 models*. Exclusive features! Full range of Colors! Newest styling! Get FREE 5-DAY PLAYING TRIAL IN YOUR HOME. If you decide to keep instrument, pay for it only pennies a day on E-Z terms. 100% Satisfaction Assured. Get FREE BONUS GIFTS for promptness... Free Home Study Course. Trade-in allowance.

FREE BONUS GIFTS

- for promptness in ordering
- Year's Supply of Music
 - Home Study Course
 - Sturdy Music Stand
 - Name in Chrome Letter
 - Bellows Protector
 - Music Portfolio

Let us prove how much more you save—thanks to our money saving Importer-to-You plan. You pay NO Teacher's or Salesman's commissions. We buy for less, save on high overhead... and pass the savings on to you. Mail coupon today for FREE Color Catalogs and Importer-to-You prices. No obligation.

ACCORDION CORPORATION OF AMERICA

Dept. R-26, 5535 West Belmont Ave., Chicago 41, Illinois

FREE

Color Catalogs
... Low Direct
Importer-to-You
Prices... Rush
Coupon Now!

Accordion Corp. of America, Dept. R-26
5535 W. Belmont Ave., Chicago 41, Ill.
Rush color catalog and "Importer-to-You" prices.

Name.....

Address.....

City & Zone..... State.....

Check if you have instrument to trade in.

DETROIT

LISTENING POST

BY JIM DUNNE

Front-drive Cadillac for next year. Cadillac's front-drive car, rumored earlier in this column, is now scheduled for introduction in the next model year. It's the first hard reaction to Oldsmobile's Toronado. The new sporty Cadillac will use many of the same components that go in the Toronado—things like transmission, chain drive, differential, drive shafts. **First unofficial word is that the car will be built on the same General Motors "E" body as the Toronado and Riviera.** No name's available as yet, but one buff has suggested Cadillac bring back LaSalle. Cadillac has no room to build this car on its regular assembly lines so speculation has it that Toronado, Riviera and the new car may be produced in one common facility.

New safety game: steering post squash. Under pressure from Washington to make cars safer, GM's Saginaw Steering Div. has developed a new, collapsible steering column that will be offered as standard equipment on all GM cars. The column is designed with a purposely weakened section that collapses like an accordion when a strong force is exerted against the steering wheel. The weakened section, located between dash and floorboard, has the same general appearance as a heat shield around the exhaust muffler on big diesel trucks. It is tubular sheet steel, with sections like lightning holes punched out. The design will be available to all auto makers under an industry agreement to share safety developments. **Another safety feature to be used by all auto makers soon is the split master-brake hydraulic system,** pioneered by American Motors and Cadillac, and virtually demanded by the federal government.

Identical twins in the Mustang corral. You may be disappointed to find Chevrolet's Mustang-like Panther—scheduled for introduction next fall—so similar to the car it is competing against. It will have a long hood and short rear deck. Most of its mechanical parts and power train will come from existing combinations in the Chevrolet model lineup. Both V8 and six-cylinder engines, plus automatic and four-speed transmissions, hardtop and fastback styling—all the things that have made Mustang a success—are part of the plan for Panther. Wheelbase will be about 108 inches, where Mustang and Corvair are now. But the **new Panther will force Corvair to undergo a major change.** Right now, auto insiders are looking for tooling contracts to be let for the 1968 Corvair. So far none have been reported.

New lion for Ford's tigers. Added V8 power will be ready for most Ford Motor Co. cars next year. The company is preparing a 385-cubic-inch engine for use in Galaxies, Mercurys and smaller Fords. This engine is planned for the standard powerplant in the upper horsepower range, just as the popular 289 is standard in the lower range. **The 385 will replace Ford's 352 and 390-cubic-inch V8s** which have been around for 10 years. More modern design is the simple reason for the new engine. It will feature more efficient cooling through use of bigger water passages in the block; a comparatively new block design which all but eliminates the skirt below the tapered V-section; casting for better weight-to-power ratios.

Smooth, velvet curves for tomorrow. Car styling follows trends and the trend now is to softer body lines, longer hoods, shorter rear decks. However, big sedans remain essentially unchanged in room. Next year the Galaxie, for example, will have even softer lines with more curves. Over-under headlights will be retained, but the grille will have a rounder outline. The roof of its four-door will sweep into the rear deck more gradually with a flowing line. Now, soft-sculptured lines will be pressed into the side sheet metal. But overall, the 1967 Ford will have the same proportions

(Continued on page 32)

○ From an AC Engineer's notebook:

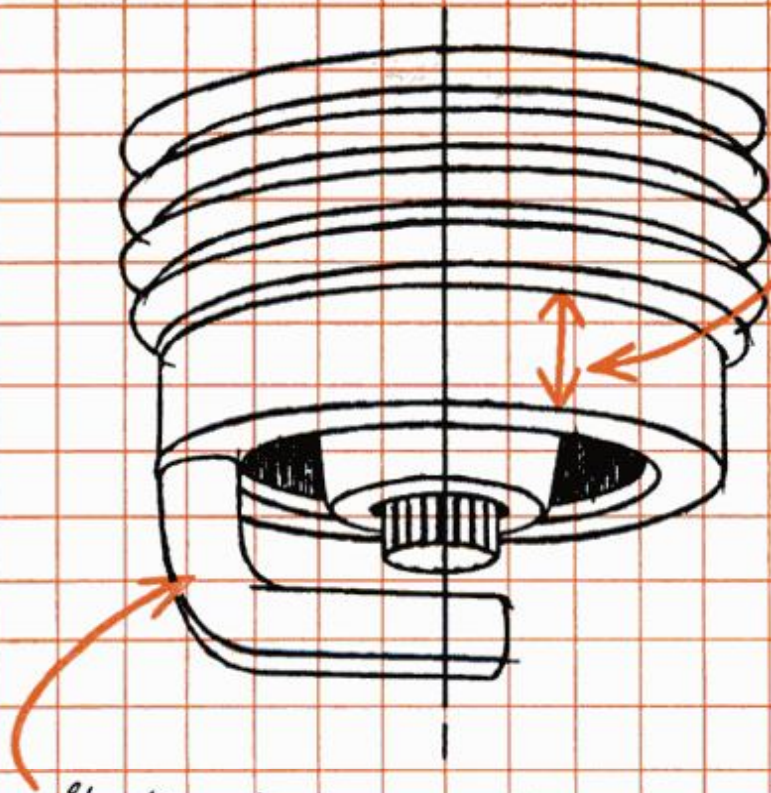

AC's extended shell shields insulator tip from raw gas, assuring fast starts, guards against excessive heat blasts.

○ *Shorter, sturdier ground electrode reduces burning during extreme temperatures, is also more resistant to erosion.*

○



How AC's exclusive Extended Shell Design improves extended tip spark plug performance

AC Fire-Ring Spark Plugs with the extended tip design feature AC's exclusive extended shell. This puts the spark plug tip deeper in the combustion chamber closer to the center of the fuel charge. The result is a combustion pattern that promotes greater engine power and economy. AC's extended shell protects the tip from excessive heat blasts. It also guards against "drowning" during false starts. If your car's engine is designed to use extended tip spark plugs, gain the benefits of AC's exclusive extended shell with the shorter, sturdier ground electrode. Insist upon AC Fire-Ring Spark Plugs at your next engine tune-up.

AC SPARK PLUG DIVISION OF GENERAL MOTORS



DETROIT LISTENING POST

(Continued from page 30)

as the present model, making them difficult to tell apart at a distance. **It's all part of the industry trend to evolutionary change instead of radical departures.** Maybe that's why new models like Mustang and Toronado, with fresh and imaginative styling, attract so much attention.

Chevy is bucking the Bronco. Chevrolet will also follow Ford with its answer to Ford's moderately successful four-wheel-drive Bronco. Look for it as a 1967½ or 1968 model. Another rugged vehicle Chevy will introduce soon is a newly-styled Suburban Carryall version. The big wagon will get a complete appearance change.

Bigger roar for Lincoln, too. Another new engine for Lincoln is coming up. Already powered by a 462-cubic-inch engine, the big car will get a supersize powerplant for 1968 models. Due to some weird production scheduling, Ford will build no engines for the 1967 Lincoln during its model run. All will be built this year, stored and assembled as needed. Thus, Ford can make full use of engine-building capacity for the big changeover.

Top secrets in the double whammy dept. Racing groups at Chrysler and Ford run operations like military commanders. Each wants to blast away at the other with its most powerful punch, but still not reveal just what its No. 1 weapon is. Right, now, **Chrysler is sitting on a double overhead-cam, hemi engine of awesome power, just waiting for Ford.** And **Ford is rumored to have a double overhead-cam hemi of its own on the shelf.** Neither is talking much, but both claim they are acting in self-defense. "If Ford comes out with a double OHC," a Chrysler engineer told me, "we want to be ready." At present, engines of this type are prohibited in track races. Look for them on dragways initially.

Little American with big hopes. American Motors' new little show car may be the forerunner of a future production model. Two years ago, the company introduced the Tarpon as strictly a show car, and later brought out a near copy—Marlin. If AM is to concentrate on small cars, this 100-inch-wheelbase model could be what it is pinning its hopes on. It has all features people like in a sporty car—V8 engine accommodation, bucket seats, long hood, short deck, flow-through vent system—will also have a low price tag.

CAULK TUBS!

DAP®
KWIK-SEAL®

Squeeze the tube and pull nozzle along joints around tubs, tile, shower, sink. Get a neat, smooth, white, water-proof bead that seals tight, stays flexible, lasts for years. Looks professional. Money back guarantee.



SET GLASS



DAP® "33"
GLAZING

Good for wood or metal sash. Seals glass tight—stays flexible to prevent cracking—outlasts ordinary putty by years. Excellent for filling nail holes before painting.

REPAIR WOOD



DURATITE®
FORMULA 99 PLASTIC
WOOD DOUGH

Low shrinkage saves time—only one fill for most deep holes. Dries hard as wood. You can saw, sand, drill, stain, paint and shellac it. Natural and 8 matching wood colors.

PATCH WALLS



DAP Ready-Mixed
SPACKLING

Just dip in and apply. DAP Vinyl-Paste Spackling knives smoothly into cracks, breaks and joints in plaster, drywall, wood. Dries white. Takes paint almost immediately. Saves the mess and waste of mixing dry patch powder.

DAP

At leading hardware, paint, building supply, and specialty stores

DAP INC., Dayton, Ohio 45431. Subsidiary of *Plough, Inc.*

Plymouth Dodge Chrysler Imperial

The only American- made cars with a 5-year/50,000-mile warranty.

HERE'S HOW CHRYSLER CORPORATION'S 5-YEAR/50,000-MILE ENGINE AND DRIVE TRAIN WARRANTY PROTECTS YOU: CHRYSLER CORPORATION WARRANTS FOR 5 YEARS OR 50,000 MILES, WHICHEVER COMES FIRST, AGAINST DEFECTS IN MATERIALS AND WORKMANSHIP AND WILL REPLACE OR REPAIR AT A CHRYSLER MOTORS CORPORATION AUTHORIZED DEALER'S PLACE OF BUSINESS, WITHOUT CHARGE FOR REQUIRED PARTS AND LABOR, THE ENGINE BLOCK, HEAD AND INTERNAL PARTS, INTAKE MANIFOLD, WATER PUMP, TRANSMISSION CASE AND INTERNAL PARTS (EXCLUDING MANUAL CLUTCH), TORQUE CONVERTER, DRIVE SHAFT, UNIVERSAL JOINTS, REAR AXLE AND DIFFERENTIAL, AND REAR WHEEL BEARINGS OF ITS 1966 AUTOMOBILES, PROVIDED THE OWNER HAS THE ENGINE OIL CHANGED EVERY 3 MONTHS OR 4,000 MILES, WHICHEVER COMES FIRST, THE OIL FILTER REPLACED EVERY SECOND OIL CHANGE AND THE CARBURETOR AIR FILTER CLEANED EVERY 6 MONTHS AND REPLACED EVERY 2 YEARS, AND EVERY 6 MONTHS FURNISHES TO SUCH A DEALER EVIDENCE OF PERFORMANCE OF THE REQUIRED SERVICE, AND REQUESTS THE DEALER TO CERTIFY (1) RECEIPT OF SUCH EVIDENCE AND (2) THE CAR'S THEN CURRENT MILEAGE.

The warranty is good for 5 years or 50,000 miles. The repairs or replacements it covers are made without charge—parts and labor. It's the longest, strongest protection ever offered by any American car manufacturer. And because the warranty is transferable from owner to owner, it can mean more money when you trade. Why settle for less?



**CHRYSLER
CORPORATION**

Spotlight on the **Triumph 2000**

By Alex Markovich

SOPHISTICATION and temperament—that's the new Triumph 2000. It corners impeccably and rides comfortably. Its interior is plush, especially for a car with a \$2895 base price. But there are crudities—relatively minor ones, we admit—that should have been ironed out.

Body styling is clean and tasteful, if not quite inspired. In the cabin are handsomely pleated front bucket seats with a fantastic amount of fore and aft adjustment and some rake control. The rear bench seat, complete with folding center armrest, is comfortable except for its minimal headroom. Kick pads are neatly carpeted.

The sloping hood would have helped visibility but an unusually high steering wheel gets in the way. The huge glovebox has an adjustable vanity mirror, and the padded sun visors can be swung over the side windows.

The wood-inlaid dash is handsome enough, but it harbored a mysterious rattle in our test car. And the speedometer didn't work; but we found that a gentle knock would usually coax it back into operation.

(Please turn to page 36)



U.S. GOV'T SURPLUS

DIRECT FROM GOV'T. FOR ONLY A FRACTION OF ORIGINAL COST. BUY FOR AS LITTLE AS 2¢ AND 3¢ ON THE DOLLAR!!

Examples:

- JEEPS \$63.00
- BOATS \$178.00
- BICYCLES \$5.50
- TELESCOPES \$4.00
- LEATHER BOOTS 65¢
- TYPEWRITERS \$8.79
- AIRPLANES \$159.00
- REFRIGERATORS \$5.00
- PASS. BUSES \$208.00



COMPLETE SOURCES AND INFORMATION ON HOW YOU CAN BUY THOUSANDS OF ITEMS FROM GOV'T - ONLY \$1.00



FREE!! FREE!! EXTRA 48 PAGE SECTION WITH PICTURES AND PRICES OF MORE THAN 500 ITEMS. YOU CAN ORDER DIRECT BY MAIL AT RIDICULOUSLY LOW SURPLUS PRICES. YOURS FREE WHEN YOU SEND \$1.00 FOR THE DIRECTORY. **THIS IS THE WORLD'S LARGEST STOCK!!**

- RIFLES 10.95
- PARACHUTES 21.95
- BOATS 16.45
- SHOES 1.65
- JACKETS 3.25
- TENTS 6.55
- BAYONETS 2.15
- HAND GRENADES 1.60
- COMMANDO KNIVES 1.38
- COMPASSES 1.05
- HOLSTERS 2.15
- MACHETTES 2.15
- GOGGLES 61c

- PISTOL BELTS 1.05
- STEEL HELMETS 2.15
- GIANT BALLOONS 1.38
- MODEL CANNONS 1.38
- BAYONETS 1.65
- CARTRIDGE BELTS 1.05
- STEEL AXES 2.70
- CANTEENS 67c
- FOLDING STOVE 1.38
- FIELD PACK 1.05
- MIRRORS 61c
- FIELD JACKETS 3.25
- AND Bunk Beds.

- Life Rafts, Walkie Talkies, Swords, Paratrooper Boots, Flags, Sleeping Bags, Cots, Phones, Mine Detectors, Bugles, Hand & Leg Irons, Blankets, Bullet Proof Vests, Flares, Cartridge Belts, Ammo, Rifle Scopes, Maps, Shovels, Canteens, Saddles, First Aid Supplies, Sunglasses, Mess Kits, Haversacks, AND HUNDREDS MORE!

BUY ONE, TWO OR A DOZEN OF ANY ITEM YOU WANT. MINIMUM ORDERS AS LOW AS \$3.00 ACCEPTABLE

FREE HOME TRIAL COUPON

SURPLUS BARGAINS, DEPT. 134-2
605 THIRD AVENUE
NEW YORK 16, N. Y.

I enclose \$1.00. Send the combined catalog and directory immediately. I understand that my money will be refunded if I am not completely satisfied. Also I will receive a full refund with my first order of \$10.00 or more.

Name _____
(Please Print)
Address _____
City _____ State _____

FULL PURCHASE PRICE OF \$1.00 REFUNDED WITH FIRST ORDER OF \$10.00 OR MORE

Learn
DRAFTING
at home



SAY GOODBYE TO THANKLESS, LOW-PAY JOBS!

GOOD NEWS for men working in low-paying, no-future jobs. We offer you the opportunity, without a penny of cost, to find out what it takes to become a draftsman.

The Draftsman is the key man in industry

Practically everything that is built or manufactured is constructed from drawings prepared by the draftsman. Machines can never replace his skilled work. Today there is a shortage of men trained in drafting and the nation's fast technical growth will require many more. This adds up to good salaries and job security for the trained draftsman.

Work is clean, pleasant Drafting is interesting, professional work—the kind you'll like. As a draftsman, you will command respect in business and community activities, enjoy more of the good things of life through additional earnings, and be able to look forward to promotion and a secure future.



Drafting does not require unusual talents or artistic ability. So if you're discontented in any way—or concerned about your future—consider the advantages of this high-pay field. Chicago Tech's practical method of teaching makes it easy for you to learn drafting at home in your spare time.

YOURS FOR THE ASKING

So get the facts right away about Chicago Tech's college-level training at home—plus a free trial lesson. See for yourself how your own natural abilities measure up to the needs of this high-paying profession. Learn how you can become a draftsman the Chicago Tech way. Act now! MAIL THIS COUPON TODAY.

SEND FOR FREE TRIAL LESSON AND ILLUSTRATED BOOK

**CHICAGO
TECHNICAL
COLLEGE**

ESTABLISHED 1904
Accredited Member Nat'l Home Study Council

B-204 Tech Bldg., 2000 So. Michigan Ave.
Chicago, Ill. 60616

Yes, please send Free Trial Lesson and illustrated book on drafting and its opportunities. No obligation.

Name _____ Age _____
Address _____
City _____ State _____ Zip _____

U.S. STAMPS

Plus NEW COMPLETE U.S. CATALOG!



4 SENSATIONAL OFFERS IN ONE—ONLY 10¢!

To Introduce You to the World's Largest Stamp Firm and America's Favorite Hobby:

1. Genuine centennial postage stamp, as illustrated, picturing first U.S.A. (issued in 1847!).
2. Big collection of 25 all-different United States—Ancient 19th century, \$1.00 stamp, etc.
3. Collection prized Commemoratives: 1775 Revolution, Wild West, 1893 Columbian, many others.
4. Collectors Guide; Bargain Lists; fine stamps from our approval service returnable without obligation; NEW Complete U.S. Catalog.

Send only 10¢—TODAY!

H. E. HARRIS, Dept. C-8 Boston, Mass. 02117

ELECTRONICS

COYNE ELECTRONICS INSTITUTE

A quarter million dollars worth of equipment. Non-Profit Institute—Est. 1899. Courses: Electronics • Electricity • TV-Radio • F.C.C. • Electronics Engineering Technology. Mail coupon or write for FREE BOOK, "Your Opportunities in Electronics." No Salesman will call.

COYNE ELECTRONICS INSTITUTE Educ. Serv. Dept. 26-S
1501 W. Congress Parkway, Chicago, Ill. 60607

NAME _____ PHONE _____

ADDRESS _____ AGE _____

CITY _____ STATE _____



WE'LL SEND YOU
A MONEY-MAKING
"SHOE STORE BUSINESS"
FREE

Rush postcard today for
free sales outfit



Run your own profitable shoe store at home. Sell to friends, neighbors, folks where you work. Earn \$217.00 EXTRA monthly on just 2 easy orders a day. You feature 230 styles of quality shoes for men and women. Famous Air Cushion Mason Shoes that sell themselves. Sizes 2½-15. Widths AAAA to EEEE. Many comfort features—stock of over 250,000 pair to draw from. Also horse-hide jackets. Represent fast-growing million dollar shoe firm in spare or full time and big profits are yours. Everybody is a customer. You don't need to invest a cent in this wonderful sales opportunity. We'll rush you FREE a complete starting outfit that contains everything you need to begin making money. Just send us a postcard today!

MASON SHOE, Dept. G-203 Chippewa Falls, Wisc.

SPOTLIGHT ON THE TRIUMPH 2000

(Continued from page 34)

Other instruments include an ammeter and water-temperature and gas gauges. The latter has a steady needle, but requires almost a full minute to reach a true reading.

Rear-passenger hand straps are spring-loaded to swing up out of the way. Somewhat less comfortable to reach was our radio, mounted at the far right of the dash—only because it had been squeezed out of its central spot by airconditioning.

Cold-weather starting is excellent, but the starter sounds like three churning garbage trucks. And even after several minutes of warmup, the car is balky the first couple of miles.

Steering is slow and heavy at low speed. The brakes (discs in front) were noisy, but they felt strong, light and sensitive. Several panic stops induced little fade. The floor-mounted emergency brake also proved effective.

The all-independent suspension (single lower wishbone and coil, front; semi-trailing wishbone, rear) gives a comfortable, well-controlled ride, especially at higher speeds. Cornering is fast and completely predictable and lean is mild.

Before picking up our automatic-transmission-equipped test car, we had a brief go at a stick shift. The gears are beautifully synchronized in all four speeds, but shift travel is long and vague. And the clutch doesn't seem up to its job; ours developed slippage and a strong odor after a few minutes of not-too-hard driving. The slushbox, however, is efficient and fairly smooth.

The little 122-cu.-in. Six isn't the strong-
(Please turn to page 40)

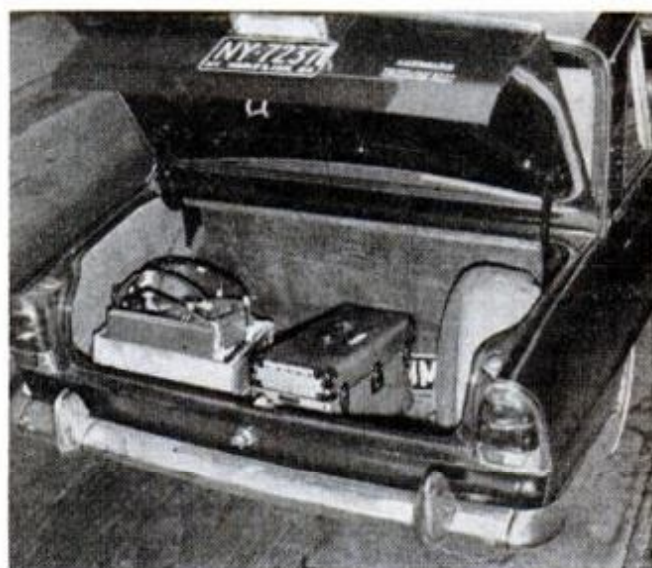

UNUSUALLY DEEP TRUNK holds far more than most foreign cars of this size. It's easy to load, too. Spring-loaded lid pops up when it's unlocked

SWORN STATEMENT FROM CHAS. LEMMING:

"After starting my own business

I've averaged
\$100⁰⁰
A DAY

—most of it
clear profit!"

Here's your chance to start a money-making year 'round business of your own and make the success you've dreamed about

• In a city of less than 50,000, Mr. Lemming started his own business after filling in coupon like one below. He averaged \$100 a day during first year, some days \$200. F. E. Doran grossed \$1050 in single month. Geo. Held grossed \$300 in one week.

How much you earn depends largely on you. No special skill, no large investment required for our electric upholstery cleaning machine. Start spare-time until full time justified. Hire helpers as needed.

NO SHOP NECESSARY • You clean upholstered furniture on customers' premises—homes, hotels, motels, etc. Auto upholstery, too. No hauling; operate from your home. Watch business grow as satisfied customers tell friends. Supplies cost little, profits high. We will help you to start and work with you for your success. Training and consulting with experts is available at no extra cost.

OURS IS NOT A LEASE ARRANGEMENT • You are free to operate independently. You sign no contract. You own the detergent and are your own boss...every dollar you take in is yours. You pay no fees, or dues, or royalties, and enough supplies come with it to return far more than your investment. Many earn the cost of the detergent in a week or two. It costs nothing to get details... write **TODAY**.

VON SCHRADER MFG. CO. 210 "D" PL., Racine, Wisconsin

Send at once (no obligation) your **FREE** booklet containing information about your **ELECTRIC UPHOLSTERY DETERGENT** and how I can start my own permanent, profitable business.

Name _____
Address _____
City _____ State _____ Zip _____



READ WHAT SOME OF OUR ASSOCIATES SAY

ROY NELSON, Indiana • "I'm doing real well with the Upholstery Deterger. I grossed \$204 in four days last week. Everyone is very well satisfied."

F. C. NEWMAN, Pennsylvania • "My Von Schrader method beats anything we have here for competition."

BILL RICE, Florida • "Certainly your equipment is better than anything on the market. I know and so do my customers."

HOMER KENDALL, Indiana • "Your training, business helps and all have gone a long way in making my business the success it is."

JIM KOVATS, Rhode Island • "I just washed some upholstery that had been slip covered and was very dirty. After I was through they decided to discard the slip covers because they said the

upholstery looked like new. Let me commend you on the wonderful job that you are doing in getting people started in this lucrative business."

BOB RUSSELL, Florida • "Your Upholstery Deterger does a better job than any other equipment on the market. I recently got contracts from the two largest motels in the area. They had been cleaned in the past by one of my competitors with different type machines. I got the job through recommendations from my satisfied customers."

VERNE GOODALL, Illinois • "I would like to tell you about one of my customers. While I was cleaning his furniture, he called up four friends and I got three orders out of the four calls. I am pleased with the way business is going and so are the people I have done work for."

SEND COUPON TODAY!

VON SCHRADER MFG. CO.

AUDEL

FIX ANY CAR FAST!

ALL-NEW

NEW FROM COVER TO COVER...

Here is all the latest basic know-how you need to repair any part or system in any make or model car...*easier and faster!*

AUTO GUIDE

1966 EDITION

Most instructive auto repair guide available today! Explains in easy-to-understand detail every single part of the automobile. Describes trouble symptoms you may come up against in every part or system. Tells you the probable cause of the trouble, then shows you step-by-step how to repair, overhaul, or rebuild the defective part or system. You do the work faster, easier, and it turns out right!

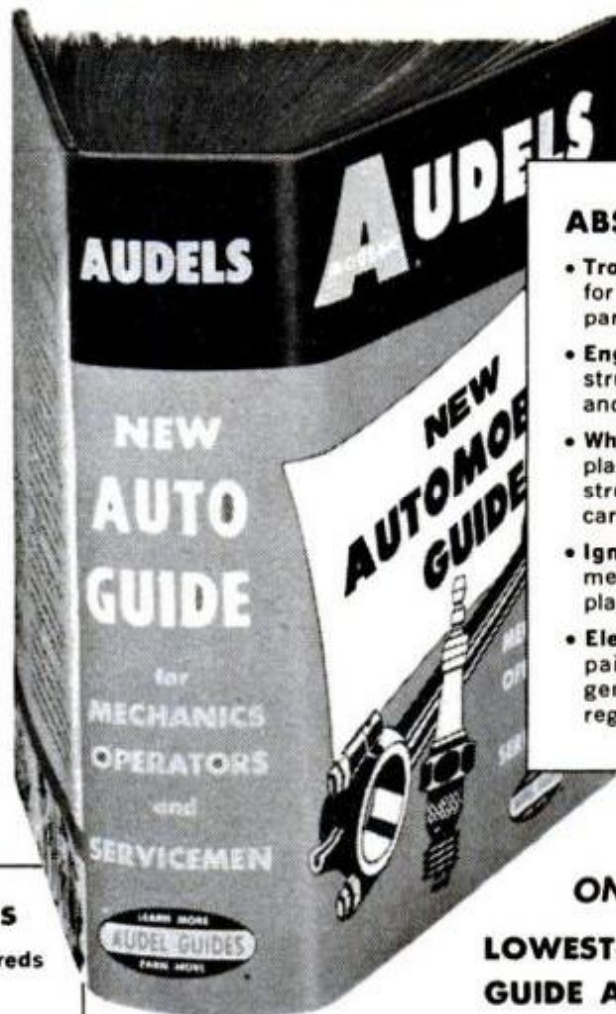

736 PAGES

EVERY DETAIL ILLUSTRATED

ABSOLUTELY COMPLETE!

- **Troubleshooting**—latest techniques for fast location of trouble in any part or system
- **Engine Tune-Up**—step-by-step instructions for electrical, mechanical, and ignition tune-up
- **Wheel Balancing & Alignment**—explains principles; gives detailed instructions for all modern domestic cars
- **Ignition Systems**—covers all elements; explains use of testers; explains latest transistor systems
- **Electrical Systems**—operation, repair, and adjustment of lighting, generators, starters, alternators, regulators, and batteries

Brand-New Features

- Complete charts, showing hundreds of trouble symptoms, the most likely causes, and the right procedure to repair the trouble.
- Describes, illustrates, and tells you how to use the special tools required to do the repair job. Helps you work like a factory-trained and equipped mechanic.
- Shows you a complete, practical method for fast, successful troubleshooting and repair of any car.

\$6.95
ONLY

LOWEST-COST AUTO REPAIR GUIDE AVAILABLE TODAY!

Twenty-Seven Fact-Packed Chapters Cover Everything:

Troubleshooting—symptoms and causes • Engine Tune-up • Spark Plugs • Storage Batteries • Distributors • Ignition Testing • Starters and Generators • Lighting Systems • Tire Servicing • Brakes • Power Brakes • Front Suspension • Steering Systems • Front-Wheel Alignment • Chassis, Springs and Shocks • Fuel Pumps • Carburetors • Cooling Systems • Engine Lubricating Systems • Pistons and Rings • Crankshafts and Connecting Rods • Camshafts • Valves • Manual Transmission and Clutches • Automatic Transmissions • Drive Shafts and Universal Joints • Rear-Axle Assemblies—**ABSOLUTELY EVERYTHING YOU SHOULD KNOW TO FIX ANY CAR!**

TRY THIS BOOK

FREE

FOR 10 FULL DAYS

ORDER TODAY—
use coupon on
opposite page!

SPECIAL NO-RISK OFFER

Examine the NEW AUDEL AUTO GUIDE for 10 days. Let it help you on any auto repair, tune-up, or maintenance job. You must be satisfied with the book, or you may return it within 10 days for a full refund. Audel's 85-year-old reputation for publishing quality how-to-do-it guides is your best guarantee of practical help.



THEODORE AUDEL & CO.
division of HOWARD W. SAMS & CO., INC.
Indianapolis • New York

AUDEL Skill-Building PRACTICAL GUIDES

LEARN MORE—
EARN MORE!

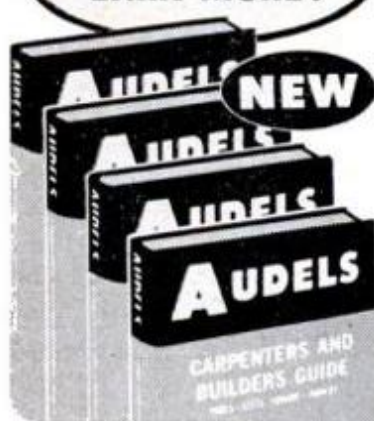

NEW! CARPENTERS & BUILDERS GUIDES

Four all-inclusive volumes provide latest practical inside trade information on modern construction for carpenters, builders, home owners—anyone wanting to know how to master the carpentry trade. ALL-NEW AND ABSOLUTELY COMPLETE! Vol. 1—Tools, Steel Square, Joinery. Vol. 2—Builders Math, Drawings, Specifications. Vol. 3—Layouts, Foundations, Framing. Vol. 4—Millwork, Power Tools, Windows, Doors, Roofing, Flooring. Most practical guide available. Thousands of diagrams, charts, graphs, photos. 1616 pgs. Set \$16.95

Circle No. 8 in Coupon

NEW

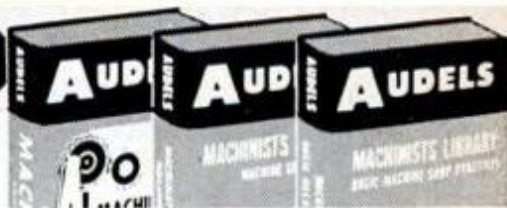

MACHINISTS & TOOLMAKERS GUIDES

Latest shop practices for machinists and toolmakers.

Vol. 1. Basic Machine Shop Practice. Practical fundamentals of machine shop operations. Illus. 416 pages. \$4.95
Circle No. 12A in Coupon

Vol. 2. Setup & Operation of Machines. Covers all important types of shop machines. Illus. 512 pages. \$4.95
Circle No. 12B in Coupon

Vol. 3. Toolmakers Handybook. Practical data on layouts, jigs, dies, gears, etc. Illus. 384 pages. \$4.95
Circle No. 12C in Coupon

All 3 volumes, \$13.50—Circle No. 12N in Coupon

Home Appliance Service Guide

How to fix refrigerators, washers, ranges, toasters, and all other electric & gas appliances. Fully illus. 608 pages. \$6.95
Circle No. 2 in Coupon

Refrigeration and Air Conditioning

Servicing, operation and repair of all systems and machines, freezers, lockers, water coolers, etc. Illus. 1090 pages. \$6.00
Circle No. 14 in Coupon

Masons and Builders Guides

Four practical vols. for bricklayers, stone masons, cement workers, plasterers. 2000 illus. 1440 pages. Set \$10.50
Circle No. 26 in Coupon

Plumbers & Steamfitters Guides

4 vols. of ready reference for plumbers, steam fitters, gas fitters, sheet metal workers. 3600 ill. 1833 pages. Set \$10.50
Circle No. 6 in Coupon

New Electric Library

10 volume electrical encyc. Answers questions on thousands of electrical problems. 9000 ill. 5558 pgs. Set \$25.00
Circle No. 15A in Coupon

Welders Guide

Practical guide to theory, operation. Maintenance of all types of electric, oxy-acetylene & Thermit welding. Ill. 608 p. \$4.95
Circle No. 10 in Coupon

Practical Electricity

Complete handbook; practical, simplified ready reference on all electrical subjects. 1300 illus. 1052 pages. \$5.95
Circle No. 4 in Coupon

TV-Radio Library

Two vols. on TV & radio circuits & how to install and repair all radio and TV including color. Illus. 960 pages. Set \$9.50
Circle No. 3 in Coupon

AUDEL PUTS MORE SKILL IN YOUR HANDS—MORE MONEY IN YOUR POCKET!

Diesel Engine Manual

Complete practical guide to modern Diesel engines. Explains principles & how to maintain & oper. Illus. 544 p. \$6.00
Circle No. 9 in Coupon

Outboard Motor & Boating Guide

Practical details on all phases of outboard motor repair, maintenance and operation. Up-to-date. Illus. 414 pages. \$4.00
Circle No. 49 in Coupon

Mathematics for Mechanics

A complete guide to the mastery of practical math. Simplified method makes learning fast and easy. Ill. 672 pgs. \$4.95
Circle No. 11 in Coupon

Sheet Metal Pattern Layouts

Modern guide to all phases of sheet metal work, including pattern development. 350 layouts. Illus. 1152 p. \$7.50
Circle No. 29 in Coupon

Blueprint Reading

For mechanics and construction men. Step-by-step explanation of how to read all types of blueprints. Ill. 430 pgs. \$3.95
Circle No. 25 in Coupon

Electric Motor Guide

Covers hookups, control, maintenance and troubleshooting of all types of motors. Complete; 617 illus. 1036 pages. \$5.95
Circle No. 27 in Coupon

Millwrights & Mechanics Guide

Practical information on plant installation; operation and maintenance data for foremen & workers. Illus. 1248 pgs. \$6.95
Circle No. 42 in Coupon

Painting & Decorating Manual

Latest inside trade information for painters, apprentices, home owners. Complete; practical. Illus. 592 pages. \$4.95
Circle No. 7 in Coupon

Truck and Tractor Guide

A guide for mechanics, drivers and maintenance men. Gas & Diesel repair, service and operation. Illus. 908 pages. \$5.95
Circle No. 5 in Coupon

Wiring Diagrams for Light & Power

Hundreds of typical diagrams illustrated and fully explained. A big help for every electrical worker. 320 pages. \$4.00
Circle No. 13 in Coupon

Q & A for Electricians Examinations

A practical book to help you prepare for all electrician licenses. Complete Questions & Answers. 288 pages. \$3.50
Circle No. 34 in Coupon

Pumps, Hydraulics, Air Compressors

Three practical books in one complete volume. Latest repair & maintenance data for mechanics. Illus. 1248 pgs. \$6.95
Circle No. 40 in Coupon

Foreign Auto Repair Manual

Up-to-date service data for all popular imports: English, French, German, Italian, Swedish. Illus. 592 pages. \$5.00
Circle No. 53 in Coupon

Oil Burner Guide

Latest practical book on all home and industrial oil burners. Electrical hookups and wiring data. 320 illus. 420 pgs. \$3.95
Circle No. 28 in Coupon

10-DAY FREE EXAMINATION

SEND NO MONEY—Pay the postman nothing! We are glad to send you any of the Audel Guides for absolutely FREE examination in your own home. We take all the risks and leave all the decisions up to YOU. There is no obligation! If you decide to keep the books of your choice you may pay for them under our astounding easy-pay plan of only \$3 a month.

HERE IS ALL YOU DO—IT'S EASY TO ORDER: In the No-Risk Mail Order Coupon at the right just draw a circle around the number of Audel Guides you want us to send you for FREE EXAMINATION. We will send them to you at once to help you build a brighter future by increasing your SKILL. If you are not COMPLETELY satisfied, return the books, and that will end the matter! NO STRINGS OR CATCHES TO THIS OFFER.



THEODORE AUDEL & CO.
division of HOWARD W. SAMS & CO., INC.
Indianapolis • New York

MAIL THIS NO-RISK COUPON TODAY!

THEODORE AUDEL & CO.—Self Improvement Publishers Since 1879—
4300 W. 62nd Street, Indianapolis, Indiana 46206

P-26

Please mail me for 10 days' FREE EXAMINATION the books I have circled at right. I agree to mail \$3 in 10 days on each book or set ordered, and to further mail \$3 a month on each book or set ordered until I have paid the purchase price, plus shipping costs. If I am not completely satisfied with my Audel Guides I may return them.

Name _____
PLEASE PRINT
Address _____
Occupation _____
Employed By _____

SAVE SHIPPING COSTS! Check here if you enclose complete payment with order (plus sales tax, if any). We pay postage charges. You have same return privilege.

1 New Auto Guide

2	3	4	5
6	7	8	9
10	11	12A	12B
12C	12N	13	14
15A	25	26	27
28	29	34	40
42	49	53	

I have bought Audel books before

You can train to be an announcer or D.J.



FREE VOICE ANALYSIS

Exciting new way to find out if you have the hidden talent to train for a career in radio and TV broadcasting. Urgent demand for qualified graduates. Unique, nationally recognized course supervised by John Cameron Swayze, Fran Allison, and five other broadcasting "greats" opens new horizons of high pay and fame in your life. Train in our fully equipped studios or at home in your spare time. Career Academy "reinforced learning" technique based on principles developed at Harvard and Columbia speeds training. Mail coupon today. No obligation. Training studios located in major cities.

CAREER ACADEMY

825 North Jefferson Street, Milwaukee, Wis. 53202

Please rush free, colorful 32-page brochure and arrange for Voice Analysis in my community.

Name _____ Age _____
 Address _____
 City _____ State _____ NI 9:2-66

ATTENTION AIR-MINDED AMERICANS

WORK and FLY at PIPER

Piper needs hundreds of new air-minded employees to help meet the growing world-wide need for Piper airplanes. Come join the team that's built more airplanes than any other company in the world. No special skills needed. We'll train you at our expense.

LEARN TO FLY at the same time at below-cost rates. Prepare yourself for the most rapidly growing segment of aviation — private flying!

If you're 18 years or older and are a high school graduate you may qualify for this new Piper "Work and Fly" program. Write for further details. Positively no "walk-in" interviews.

PERSONNEL DEPARTMENT, Dept. PM-1

PIPER

AIRCRAFT CORPORATION
 Lock Haven, Pennsylvania
 17745



At Piper you'll help build such famous airplanes as the Twin Comanche — world distance record holder.

SPOTLIGHT ON THE TRIUMPH 2000

(Continued from page 36)

est two-liter engine; our sample wasn't the smoothest either. From rest to 60 consumed an unexciting 15.5 seconds. 40-60 took 7-9 and 50-70 took 11.4 seconds. A bit frustrating was the engagement of the kickdown shift by flooring the accelerator. There would be a great roar, but not much else would happen. In all fairness, the stick version did feel more lively.

Useful features in the car include child-proof locks on the rear doors—flick a lever and they can be opened only from outside. And the windshield wipers are nicely engineered to cover a large area. Besides the regular gauges, there are warning lights for choke, ignition, low oil pressure and even low gas level. A rheostat allows instrument illumination intensity to be varied. There's a canceling trip mileage recorder and an ashtray with a pop-out shield that protects the dash from cigarette burns. And the trunk lid is counter-weighted so it swings up by itself when it's unlocked. Also included in the base price is an ineffective heater and defroster servo-assist for the brakes and a cigarette lighter.

Our car was loaded with options, including front shoulder harnesses (whose operation we had a hard time figuring out) and rear belts, heavy-duty tires, a beautifully sharp radio, grille guards and the previously mentioned airconditioning and automatic transmission.

These extras raised the list price by nearly \$800 to about \$3700. We can't help feeling that this is somewhat steep for this class of car—even though the sports-car-like handling characteristics almost make it worth the money. ★★★



GUARD ON ASHTRAY prevents cigarette burns on dash, is also handy for snuffing out cigarettes. Wood trim adds luxury touch. Seats give good support

Stay with Your Job till Profits in Own Business Exceed Present Salary

We'll Finance You for all but a few hundred dollars

You gross \$6 hourly profit on each serviceman plus \$9 per hour on service you may render in spare time. Income is almost unlimited. The 24 page illustrated booklet we'll mail you (with no

obligation) explains how easy, how simple this business is to run... how most of your gross profit becomes a *clear net profit* to you... how we guide you step by step to success.

Postage Stamp brings FREE book telling how.

If you've wanted to *be your own boss*... to be financially independent... have a growing business, now **YOU CAN**.

Many men have said to us, "I can't afford to give up my job till I know I have a sure thing... a sound business that will provide both *security* and a *better way of life*."

That made sense. So we built such a plan. Now hundreds of men have upped their scale of living with a Duraclean dealership. You don't experiment. You use tested, *proven* methods. You have our backing and know-how.

You keep your job while a customer list grows. When your business profits exceed

your job salary, go full time lining up jobs for your servicemen.

Would you like this? Don't guess. Don't decide now. Mail the coupon so you'll have facts to decide wisely... and **KNOW** if this is what you want.

You operate from a shop, office or home. This business is easy to learn... easy to start... so easy to service that women dealers often do it.

We are *now* enlarging this world wide system of individually-owned service businesses. If you are reliable, honest and willing to work, we invite you to mail the coupon. No obligation.

It's Easier than You Think to Start Your Own Business

In our illustrated booklet, you'll see the way we show you *step by step* how to quickly get customers... how recommendations multiply customers.

Your carpet and upholstery service not only cleans it enlivens fibers... revives dull colors, raises pile. It eliminates soaking and fiber breaking from machine scrubbing. Mild aerated foam lightly applied lifts dirt, grease and unsightly spots. *Customers become your best salesmen*.

The booklet explains all 6 services which are rendered "on location." You have six ways for profit on every job.

National advertising explains your superior services, builds customer confidence... brings job leads to you.

We train and assist you. We show you 15 ways to get customers.

Don't delay! Get the facts **TODAY** before your location is taken.

Start Small, Grow Big... in this Booming Business

A third century ago Duraclean was an idea... but it caught fire and spread rapidly to a worldwide service. Why? Superior methods *plus tested, proven* ways to get customers. Our dealers, too, start small... and **GROW**.

A few hundred dollars establishes *your own* business. We furnish electric equipment and materials to return your **TOTAL**

investment. Men take partners.

If you have good habits and like to please customers, you will likely qualify for a Duraclean dealership.

It's been said, "Opportunity knocks but once at each man's door." This may be that *rare opportunity* in your life.

You can quickly decide from facts we'll mail you. So, find out now.

Dealerships Resell at Big Profits

If, because of illness, moving, or for any reason a dealer wants to sell, we maintain a service to locate buyers and to help him sell.

Dealerships resell at up to 10 times the dealer's cost. R.D.K., after 5 months, sold for \$2,000 above his cost. L.L., after 30 months, got \$7,116 more than he had paid. The **value** of your dealership and franchise **grows monthly**.

FREE BOOKLET tells how to start Your Own Business

With no obligation, we'll mail you a letter and 24 page booklet explaining the business... how and why your income grows... how we help finance you.

Then decide if this opportunity fulfills your dream of independence and a much **bigger income**.

Your location could be taken tomorrow...so mail coupon **today**.



Your Services Are Endorsed by

McCall's Magazine, Parents; American Research & Testing Laboratories... and by leading Carpet Mills & Furniture Makers

What Dealers Say:

Langdon Lawson: National advertising is tops, creates leads. In September, working alone, jobs totaled \$1,475.

Charles Randal: Business keeps growing. Made as much as \$120 in one day.

D. Kern: Duraclean's proven-best process and the continuous help from headquarters gave me a big jump on all competition.

George Byers: For a University, my total billing was \$2,416. Total expenses \$814.

Gerald Wehrauch: Three persons called me—saw Duraclean advertised in magazines.

Edward Hoy: A smoke damage insurance claim bill was \$186. All work was done by me in exactly 8 hours and 2 minutes.

W.C. Smith: Earned \$650 one week. Volume keeps getting bigger.

Service man for dealer C. Weed: Furniture was filthy black. When through, I was amazed how clean.

Loren Farris: I'm proud to be independent at 30. I wish I had known about Duraclean earlier.

Earl Davis: Our sales increased \$17,660 this year.

Ed. Kramsky: In 2 years, now have two assistants, a nice home and real security for my family.

DURACLEAN COMPANY
6-162 Duraclean Bldg.,
Deerfield, Illinois 60015

Mail this coupon TODAY
It may put you in business

Duraclean Co. 6-162 Duraclean Bldg., Deerfield, Ill. 60015
With no obligation mail 24 page illustrated booklet explaining how I can increase my income with a Duraclean Dealership.

Name _____
Address _____
City _____ State _____ Zip _____

Find Out with No Obligation

Johnny Magazine Rack

Demonstrates Unique Features of Skil's New Drill

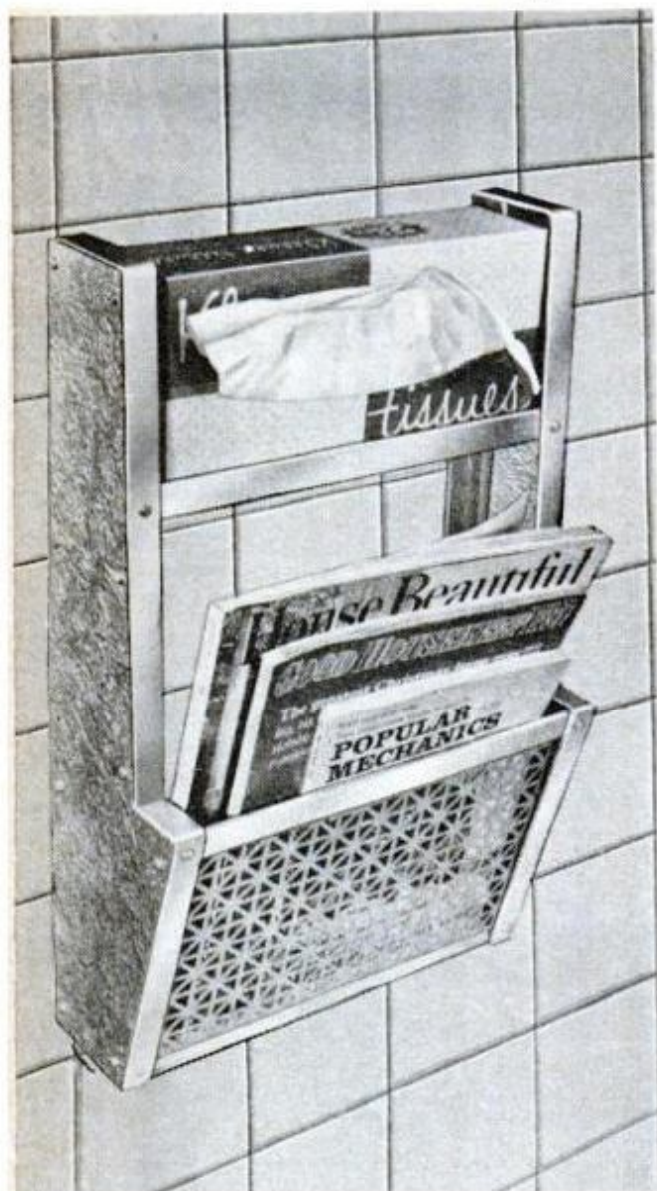

CATCHING UP on your reading is made more convenient in the bath or powder room when there's a rack handy to hold your favorite magazines, and this one is doubly useful in also providing a place to keep a box of cleansing tissues.

The original rack was made entirely of Do-It-Yourself aluminum, but there's no reason why brass angle cannot be teamed up with end pieces of walnut plywood if such a marriage goes better with the room's decor. Of course, where the silver look of aluminum conflicts, you can go ahead and spray the completed rack to provide a colorful accent.

Aluminum is easy to work with, both in cutting it and in bending it. In fact, you'll



SWITCHING DIRECTION of the drill's rotation is done with a flick of a lever. Lever cannot be moved accidentally while the squeeze trigger is depressed



THE REVERSIBLE FEATURE added to Skil's variable-speed drill now makes it practical to tap holes with the drill alone as the tap can be backed out



THE DRILL'S SLOW SPEED lets you bore Molly-bolt hanger holes in ceramic tile without first having to chip a starting point in the highly glazed surface

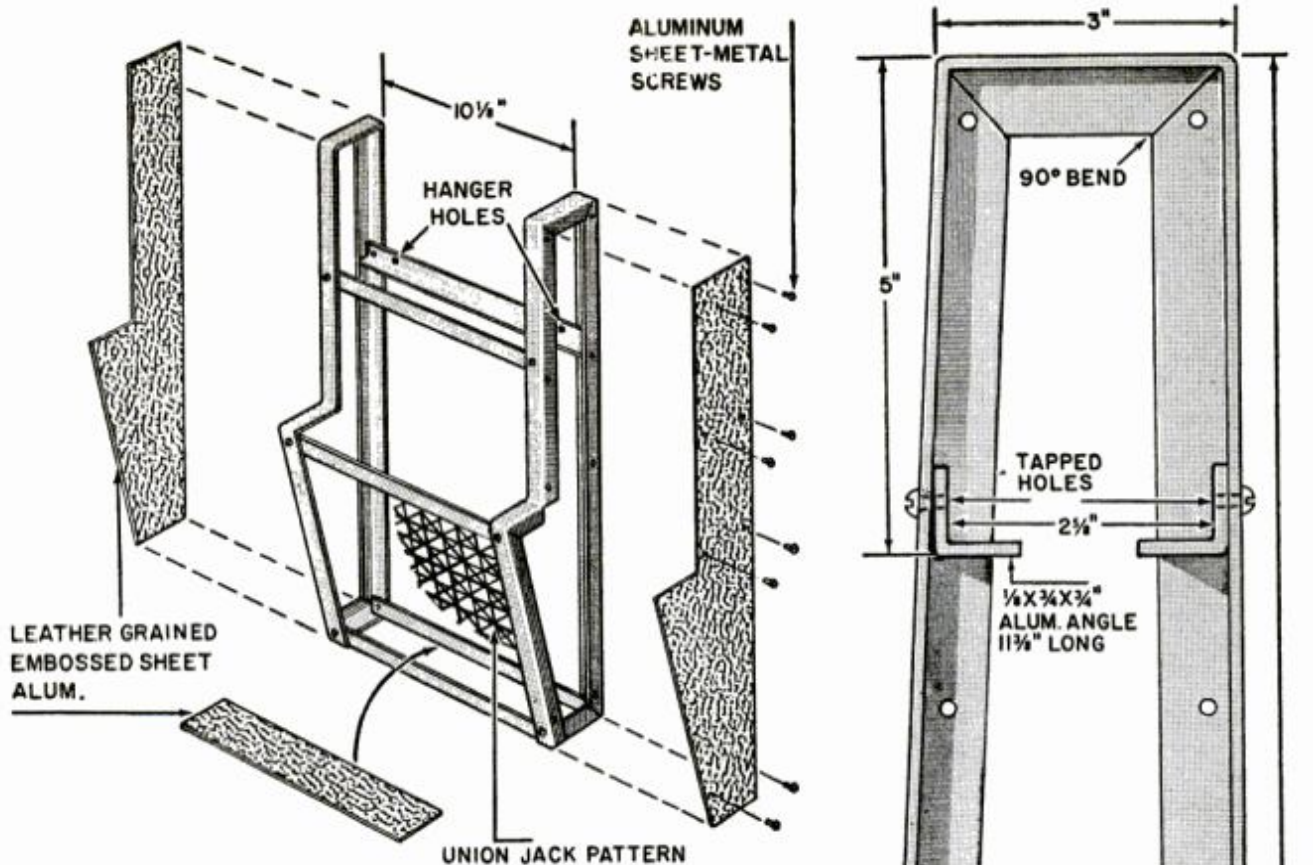

find that you can cut aluminum sheet with common household scissors. Any drill, of course, will bore the holes, but only Skil's new variable-speed, trigger controlled drill will let you *tap* them, since it's the first slow-speed portable that can be reversed to slowly back out the tap.

Its slow speed, combined with its reversing action, makes the drill a boat builder's dream. For now without any speed reducing attachment, planking screws can be driven in and backed out with the drill alone. Switching from forward to reverse is done quickly with a flick of a lever conveniently located on the underside.

As for drilling the holes through the glazed surface of ceramic tile when it comes to hanging the rack, you just can't beat the variable-speed feature of a 0 to 2000 rpm drill. The single high speed of a regular portable drill raises Cain with the cutting edges of masonry bits, but when you're able to drive the bit at a snail's pace through its squeeze-trigger switch, you can't possibly burn up the tip. The bit won't wander off the spot either.

Bending the ends of the rack is the hardest part. Here you should lay out both lengths of angle at the same time so that the V-cuts made at the points of bend will be identically spaced. A vise will be helpful in making sharp bends. The joint at the front is made as in the detail. ★★★

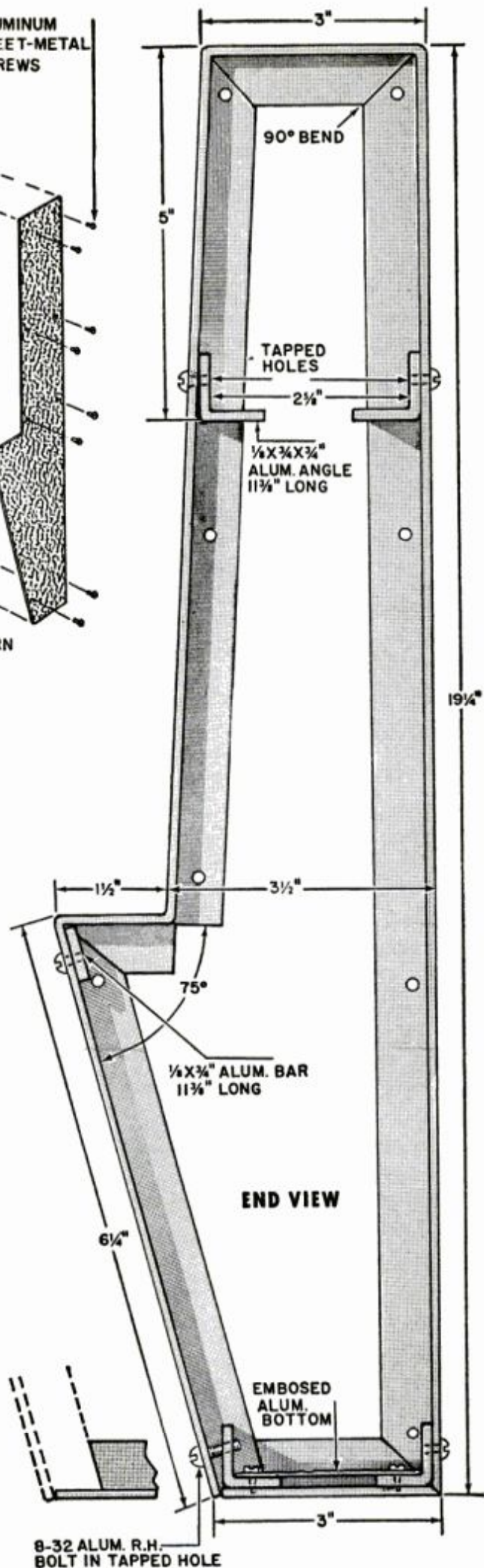

Now! It's easy to have Bruce Oak Floors



PREFINISHED... just lay over subfloor or old floor

Now you can give your living room, bedrooms or added-on room the lasting beauty and style of famous Bruce Floors. This highest quality Oak flooring, completely finished at the factory, can be laid over new subfloor or old floor. Bruce Blocks are installed in adhesive (see above). Ranch Plank with pegs and Strip floors are blind nailed. No sanding or finishing.

ECONOMICAL! A new Bruce Oak Floor will cost you less than a good rug... and will last the life of your home. The beautiful Bruce Prefinish doesn't chip or mar, and is so easy to care for. Mail coupon below for booklet in color.



MAIL FOR FREE FLOOR BOOKLET

E. L. Bruce Co.
1522 Thomas Street
Memphis, Tenn.—38101

Send information on Bruce Prefinished
Oak Floors to:

Name _____

Address _____

BRUCE Prefinished Oak Floors

QUESTIONS ANSWERED

HOMEOWNERS' CLINIC

BY W. CLYDE LAMMEY

Squeaky, the furnace pan

I'm getting squeaks and rattles from the fan compartment of my forced warm-air furnace. For a while, after it was serviced, it operated silently; but now the racket has started up again. Any ideas?—S.E., Wyo.

Presuming the fan was lubricated when it was serviced, you can probably discount dry motor bearings or shaft bearings as a cause of the noise. My guess is that the fan mountings have loosened or that the fan compartment has been dented. Or a fan blade might be bent.

Remove the access panels to the fan compartment; then, very carefully, press outward at several points on the compartment while the fan is cycling. If this determines the cause, bend the offending metal away from the fan. If not, turn off the fan, then slowly rotate it by hand. By listening and by watching the blades as they turn, you may be able to discover where they are striking other metal.

No luck? Okay, check your filters—especially if they're the type that are held in place with wedge-shaped metal strips. They may need rewedging.

P.S. Run all the above tests *after* you have carefully tightened all screws, nuts and bolts which hold the fan and frame in place.

Wood-lathe woes

Recently I acquired an old wood lathe with a headstock spindle socket that seems to be undersize—at least I can't get a new spur center to seat in it properly. The socket is scored about halfway up the taper. There is no hole through the spindle. How can I remove the scoring to permit the spur center to be seated?—R.P., Ohio.

Using the spur center as a "lap," reach into the taper with a very fine (Swiss-pattern) file and file out any existing spalling or ridges, taking care you don't flatten or otherwise alter the original taper appreciably.

Now seat the spurs of the center in a short round of hardwood and coat the taper of the center with fine valve-grinding compound, then seat the center lightly in the taper socket and bring up the tailstock center to support the free end of the wood round. Use your palm to roll the

(Please turn to page 49)



The tuned car. For young people of all ages.

What makes a car a car is styling, performance, ride and handling. Only when they're all tuned together is the car a Buick. Like this '66 Wildcat Gran Sport.

We have a secret formula for rejuvenating tired drivers. It's called "Buick tuning."

You know how well your car's engine runs after a tuneup? Buick tuning has the same effect on the whole car. Not just the engine.

Where the tuned car comes from. It comes from ideas, yes. But we don't really trust ideas until we see how they prove out. So we put our ideas in cars and take them out on the road for exhaustive testing.

Do we use orthodox proving grounds? Sure—in Phoenix, Arizona, for example. But since we couldn't tune a car on a proving ground alone (and since you won't be driving on one, either), we don't ship our cars out there. We drive them—testing all the way.

Where else do we test and tune, test and tune? The answer is: everywhere. Anywhere a road can teach us something about the roads

you drive. In the mountains—up and down. In New Orleans where the humidity can be fierce. In Bemidji, Minnesota, where the temperature can sag to thirty below.

What the tuned car can do for you. Will a new 325-hp Wildcat make a new driver out of you? We think so. With the 340-hp Wildcat Gran Sport version (it has the larger engine, a special ride and handling package, Positraction rear axle and—naturally—everything tuned to match), you may just find yourself arranging to forget things so you can go back again. Don't blame us. Just think how much fun it will be to feel like you've just gotten your driver's license.

Ah, youth.

Wouldn't you really rather have a Buick?

1966 Buick.

The tuned car.

What's so different about a GMC pickup?

It's priced \$49* more than others.

And it's packed with a lot more value.

Did we say value?
Let's start with a wood floor.
Unlike metal, it's quiet.
Resists rust and corrosion.
And it's strong and long-lasting.

With a GMC pickup, you get two walls of steel and a thick pad of insulation over you. Call that security. Call it longer lasting. Check the seats, too. They're foam padded for extra comfort, and the seat backs are fully adjustable.

Only GMC has an instrument panel like this. For instance, there's no tangle of wires. A printed circuit does the trick.

Notice the dual headlamps? Most others have only two. Remember — we said value.



*Based on manufacturers' suggested retail prices, the GMC I-6 model pictured above is never priced more than \$49 over comparable competitive base models. Often the difference is less.

Let's get to the heart of this beautiful brute — GMC's power-packed I-6 engine. It has more torque, more cooling and lubricating capacity than most competitive engines, which means it will trim the fat off your maintenance budget.

The suspension's engineered to take the sting out of the harshest roads. We do it with independent front and progressive leaf rear springs. You get a smoother ride even with maximum loads. And it hugs the road like the two were in love.

See the name plate on front? GMC. It stands for "built, sold and serviced by truck people — men who know how to give you a lot more truck for your money." And why not. After all, they're specialists.



TUNE UP ELECTRONICALLY ANY CAR EVER MADE...

domestic or foreign; compact or limousine; 4 cylinder, 6 cylinder or 8 cylinder; 6 volt or 12 volt.

With New
Improved
Model BT-162

DWELL TACHOMETER



NOTE:
GIANT 6½"
METER FOR
EASY,
ACCURATE
READINGS

At last a streamlined instrument designed to provide the most important services for "tuning up" any and every car ever made from a Model A Ford up to and including the current automatic transmission cars produced today.

The Model BT-162 includes the very latest design Dwell Meter, working in conjunction with a dual range Tachometer and incorporating all modern improvements in circuitry design.

Assure easy starts, optimum performance and maximum gas economy with Model BT-162.

The Model BT-162 will perform the services specified below in addition to many other tasks too numerous to mention:

- Assure precise adjustments of points that are slightly worn or pitted.
- Indicate the most effective point setting without removing the distributor cap.
- Indicate the correct settings for external adjustment type distributors. (A feeler gauge cannot be used for making correct adjustments on this type of distributor since many manufacturers' specifications do not list the point gap in inches. They list only the dwell angle in degrees.)
- Insure maximum gas economy and quiet engine running. Read the exact RPM while the engine is in neutral position. Then adjust the carburetor in conformity with the car manufacturer's recommendations.
- To locate a "miss" you need only disconnect or "short" the spark plugs one at a time with the Model BT-162 switched to the Tachometer position.
- Cars with automatic transmissions function efficiently only if the fluid pressures are correctly maintained and since manufacturer's instructions always refer to RPM, the Model BT-162 (or an equivalent tachometer) is required to properly service automatic transmissions.

The Model BT-162 is the most complete unit in its price range ever produced. It comes absolutely complete, ready to use. Only

\$29⁹⁵

SEND NO MONEY WITH ORDER **PAY POSTMAN NOTHING ON DELIVERY**

Try it for 10 days before you buy. If completely satisfied then send \$5.00 and pay the balance at the rate of \$5.00 per month until the total price of \$29.95 (plus small P.P. and budget charge) is paid. If not completely satisfied, return to us, no explanation necessary.

ACCURATE INSTRUMENT CO., INC.

Dept. D-442 911 Faile St., Bronx, N.Y. 10474

Please rush me one Model BT-162. If satisfactory I agree to pay \$5.00 within 10 days and balance at rate of \$5.00 per month until total price of \$29.95 (plus small P.P. and budget charge) is paid. If not satisfactory, I may return for cancellation of account.

Name _____

Address _____

City _____ Zone _____ State _____

Save Money! Check here and enclose \$29.95 with this coupon and we will pay all shipping charges. You still retain the privilege of returning after 10 day trial for full refund.

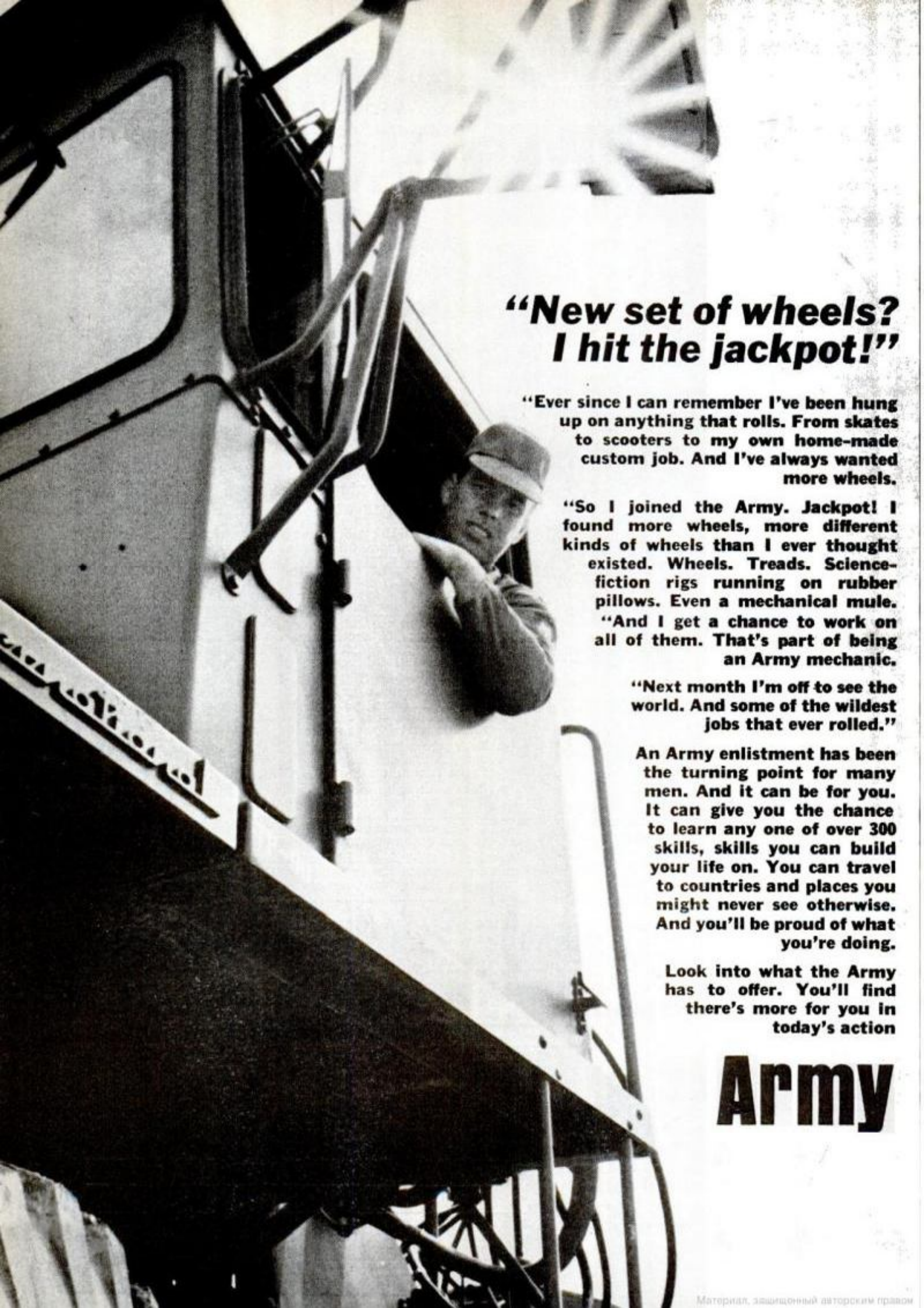

**“New set of wheels?
I hit the jackpot!”**

“Ever since I can remember I’ve been hung up on anything that rolls. From skates to scooters to my own home-made custom job. And I’ve always wanted more wheels.

“So I joined the Army. Jackpot! I found more wheels, more different kinds of wheels than I ever thought existed. Wheels. Treads. Science-fiction rigs running on rubber pillows. Even a mechanical mule.

“And I get a chance to work on all of them. That’s part of being an Army mechanic.

“Next month I’m off to see the world. And some of the wildest jobs that ever rolled.”

An Army enlistment has been the turning point for many men. And it can be for you. It can give you the chance to learn any one of over 300 skills, skills you can build your life on. You can travel to countries and places you might never see otherwise. And you’ll be proud of what you’re doing.

Look into what the Army has to offer. You’ll find there’s more for you in today’s action

Army

HOMEOWNERS' CLINIC

(Continued from page 44)

wood round in a back-and-forth movement, going a trifle more than a full revolution each way. Follow up at intervals with the tailstock to keep a light pressure on the spur center.

After about a dozen such polishings, remove the lap (spur center) and carefully wipe out the taper socket. If necessary, repeat the procedure until the spur center seats properly. If the socket proves to be a bit short, cut off the tapered end of the spur-center taper to a length that will provide ample clearance.

Cleaning smoke-stained marble

How do I remove smoke stains from the face of a marble fireplace?—G. McG., Mont.

To be honest, I must tell you that there now are commercial cleaners available for this specific job, though I can't think of any of the brand names at the moment. I'm sure your paint or hardware dealer will be able to steer you onto one, however.

Or, try the good old-fashioned way:

First scrub all the marble with powdered pumice and water. Badly stained areas will require the application of a special, stronger solution. This consists of 2 lbs. of trisodium phosphate dissolved in 1 gal. of water. Twelve oz. of chloride of lime is then made into a paste—in a pottery vessel—then mixed with the former solution in a stoneware jar, adding water to make 2 gal. Stir well, then cover the jar until the lime settles to the bottom. Into the now-clear liquid dip a thickly folded piece of flannel. When saturated, the flannel is laid or pressed against the stained area. If possible, place something over it to retard evaporation. Rewet and re-apply the cloth when necessary.

Tattletale gray—tile

A room in my basement has an asphalt-tiled floor. Recently the room was flooded to a depth of 3 or 4 in. We soon got rid of the water and the tiles didn't loosen, but the flood did leave a grayish coating on the tiles which defies removal with soapy water or detergents. When the floor dries after washing we still have some areas of gray. What can I do to remove this film?—N. H., Ga.

Try rubbing the tile with a large pad of very fine—000-grade or finer—steel wool. Dampen the floor as you rub, then wipe each tile clean as you finish. Here, too (as in the marble-cleaning problem above), our old friend trisodium phosphate can help. Add about a teaspoonful to the water used to dampen the floor. The procedure may have to be repeated.



Here's how to find out what the Army can do for you

The quickest way is to go see your local Army Recruiter. He'll answer any questions you have about your opportunities in the Army. If he doesn't have an answer right there, he'll get it for you.

And it'll be a straight answer. After all, it's his job to be sure the Army's the right place for you. He knows where the opportunities are...and can tell you where you'll fit in.

You can easily find your local Army Recruiter listed in your telephone book. Call him today. And, in the meantime, fill out this coupon and you'll receive a copy of the helpful and informative 40-page booklet, The Secret of Getting Ahead. No obligation on your part, of course.

Army	PM 2/66
OPPORTUNITIES Box 1040 Westbury, N. Y. 11591	
Please rush me your 40-page booklet, "The Secret of Getting Ahead."	
NAME _____	AGE _____
ADDRESS _____	
CITY _____	STATE _____ ZIP CODE _____
PHONE _____	EDUCATION _____

See how **FAST** and **EASY** you can with the **Big New 1966 MOTOR'S**



IGNITION SYSTEMS. Clear, easy-to-follow text, diagrams, tables take out the "mystery."

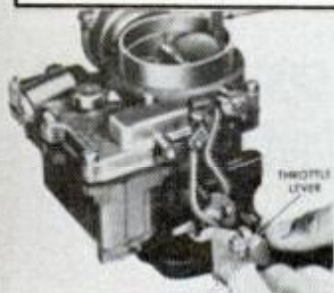

FUEL SYSTEMS. You get illustrated, step-by-step adjustment procedures for all types.

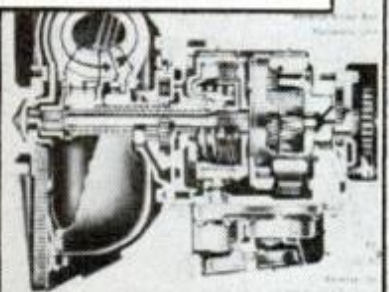

AUTOMATIC TRANSMISSIONS. All transmissions since 1959 fully covered.

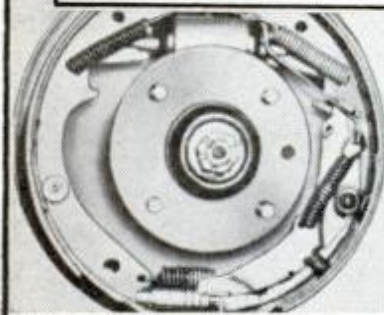

BRAKES. Close-up pictures simplify brake adjustment and repair problems.

FIX THESE PARTS
ALTERNATORS **STEERING**
ENGINES **SUSPENSIONS**
FUEL SYSTEMS **DIFFERENTIALS**
DISTRIBUTORS **... AND MORE!**

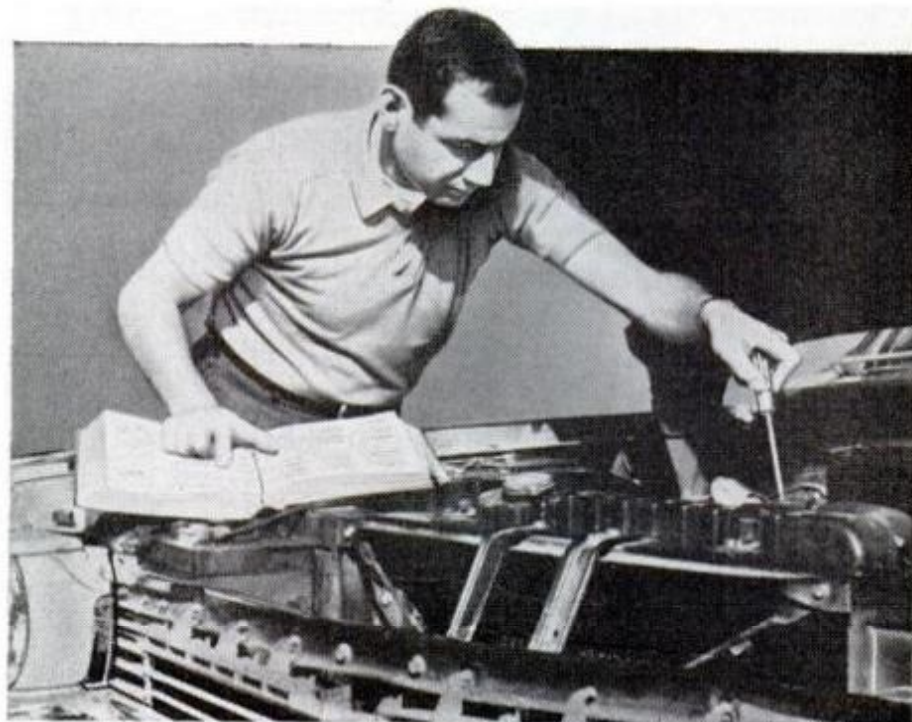

Here's the Sure-Fire Way to Whiz Through Car Repairs!

That's right — now YOU can fix just about *any* part of *any* car! Tough repairs come easy with Motor's big new 1966 **AUTO REPAIR MANUAL**. Now you can tackle anything from carburetors to front ends on any of 2,300 models (1959-1966), and do it *quickly, easily, right the first time!* Clear, "this-is-how" directions and thousands of close-up illustrations — the "meat" of 300 official shop manuals — make even the most difficult repair procedures easy to follow. Here's the greatest time, work, and money saver you could ever get your hands on! No wonder this Manual is called the "Auto Repair Man's Bible." No wonder *over 5,000,000 copies* have been sold to repairmen, schools, U.S. Armed Forces!

YOU GET ALL THIS

- 2,300 Models Covered (1959-1966)
- 1,350 Huge Pages
- "Meat" of 300 Official Shop Manuals
- 3,800 "Here-is-How" Pictures and Diagrams
- 457 Charts
- 225,000 Service and Repair Facts
- 55,000 Repair Specifications

COVERS ALL THESE CARS 1959-1966!

Volkswagen	Mercury	Comet
Mustang	Ford	Corvair
Barracuda	Fury	Buick
Jeep	Chevelle	Special
Chevy II	De Soto	American
Pontiac	Chevrolet	Olds F85
Thunderbird	Edsel	Falcon
Buick	Chrysler	Fairlane
Imperial	Plymouth	Lancer
Cadillac	Studebaker	Tempest
Lincoln	Rambler	Corvette
Dart	Dodge	Valiant
Continental	Oldsmobile	Meteor
Toronado	Bronco	Marlin



MAKES REPAIR JOBS EASY. "With rapid advancement in auto industry, Motor's Manual makes it easy to keep the pace, and makes repair jobs easy."

—Dave Fulgenzi (Mechanic)
Windber, Pa.

DEPENDS ON IT FOR BREAD AND BUTTER. "Only through the knowledge obtained from the Manual can I carry on my guaranteed work. I depend on it for my bread and butter."

—Ernest Schmidt (Mechanic)
San Dimas, California



FIX ANY PART OF ANY CAR AUTO REPAIR MANUAL

Guides You Step-By-Step Through Every Auto Repair From Start To Finish!

First, Motor's Special "Trouble-Shooter" Section Helps You Spot in a Flash Over 2,300 Causes of Car Problems . . . Then 3,800 Pictures and 225,000 Service and Repair Facts Show You Where to Start, Which Tools to Use, Exactly What to Do to Get Repairs Done Fast and Right!

WITH Motor's new AUTO REPAIR MANUAL at your side when you take on a repair job, it's just like having factory-trained experts looking over your shoulder—showing you *what* to do and *how* to do it—fast, easy, and *right* the first time! Whether it's a simple carburetor adjustment or a complete transmission overhaul, your hands are guided through every step of the repair.

3,800 Pictures Make Repairs Easy!

Motor's Manual immediately identifies 2,300 models, built from 1959 through 1966. Just look up make, model and repair in the huge Instant-Reference Index—and then go to it!

Easy-to-understand directions . . . 3,800 pictures and diagrams . . . 225,000 service and repair facts, 55,000 repair specifications . . . hundreds of tables and charts . . . they all make every procedure easy as A-B-C! You also get tune-up and adjustment charts, tables of measurements and clearances, overhauling and replacement facts, adjusting and

servicing guidance, and *much, much more*. A special trouble-shooter section pinpoints over 2,300 causes of car trouble!

Here is the step-by-step help every beginner needs. And here are the labor-saving methods and shortcuts that get old pros through the "tight spots," saving them time and money!

SEND NO MONEY

Use Manual FREE for 10 Days

We'll send this giant illustrated Manual to your home or shop, so you can see for yourself how great it is. Use it for 10 days. If it doesn't pay for itself in that time, return it and owe nothing. MAIL COUPON AT ONCE to: MOTOR Book Dept., 250 W. 55th St., New York, New York 10019. (SCHOOLS, BOOKSTORES write for discounts.)

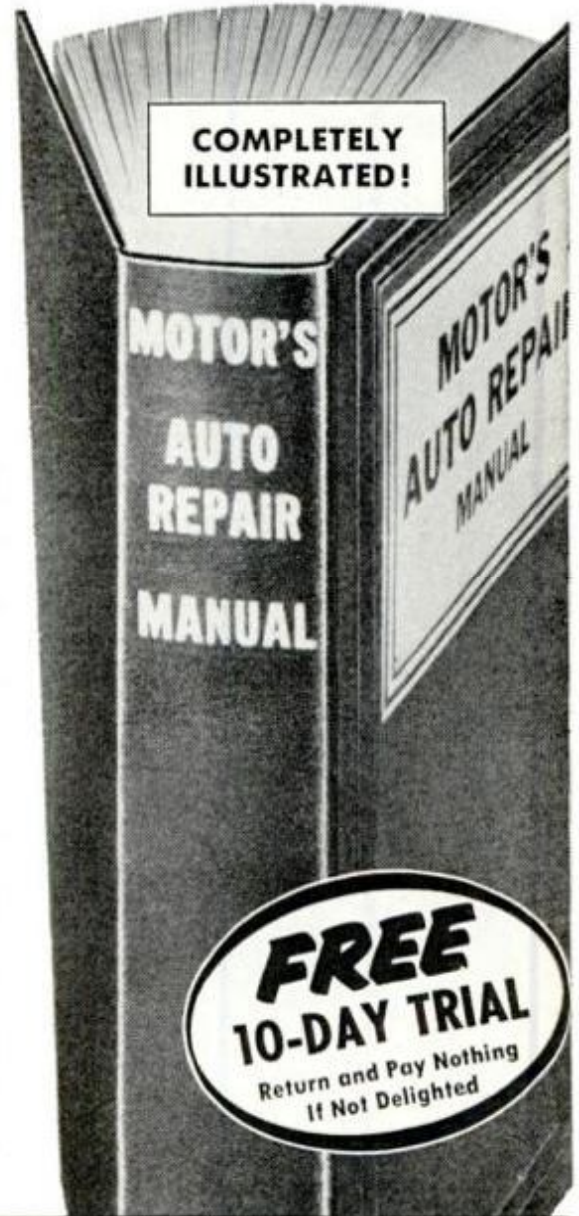

MAIL COUPON NOW FOR 10-DAY FREE TRIAL

(Attach to Postcard for Faster Action!)

MOTOR BOOK DEPT., Desk 612
250 West 55th Street
New York, N. Y. 10019

Rush to me at once (check box opposite book you want):

MOTOR'S new AUTO REPAIR MANUAL. If O.K., I will remit \$2 in 10 days, \$3 monthly for 2 months and a final payment of \$1.95 (plus delivery charge and sales tax, if any) one month after that. Otherwise I will return book postpaid in 10 days.

Also send me for 10-day Free Trial MOTOR'S new TRUCK REPAIR MANUAL. If O.K., I will remit \$11, plus delivery charge and sales tax, if any, in 10 days. Otherwise I will return book postpaid in 10 days.

Print Name.....Age.....

Address.....

City.....

State..... Zip Code.....

Check box and save shipping charge by enclosing WITH coupon payment of \$9.95 for Auto Manual (or \$11 for Truck Manual) plus sales tax, if any. Same 10-day return-for-refund privilege.

Same FREE 10-Day Trial on New TRUCK Repair Manual



Covers 2,800 truck models — 1955-1966. More than 1,000 pages crammed with 300,000 repair facts, 2,000 illustrations, tens of thousands of specifications and adjustments! Covers gas and diesel engines both!

FREE ALLIED

MONEY-SAVING 508-PAGE
1966 ELECTRONICS CATALOG

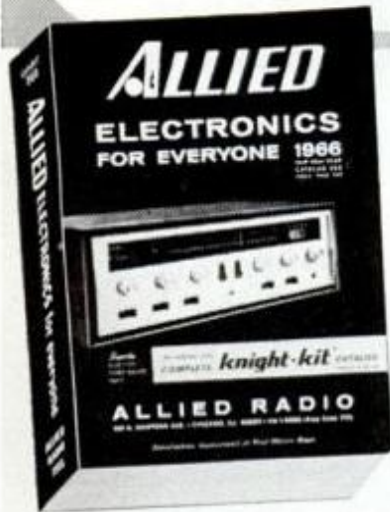

send for it today!
SAVE MOST ON:

Stereo Hi-Fi; Famous Knight-Kits®; Tape Recording; CB Radios; FM & AM Radios; Portable TV; Ham Gear; Automotive Electronics; Test Instruments; Tools, Parts, Tubes, Transistors—including products and values available only from Allied! Easy terms on the Allied Credit Fund Plan. Write for FREE Catalog today!

ALLIED RADIO

FREE

ALLIED RADIO, Dept. 6-B
100 N. Western Ave., Chicago, Ill. 60600

Send FREE 1966 Allied Catalog

Name _____

PLEASE PRINT

Address _____

City _____ State _____ Zip _____

SEND
COUPON
TODAY

PLANER • MOLDER • SAW!



Now you can use this ONE power-feed shop to turn rough lumber into moldings, trim, flooring, furniture... ALL popular patterns. RIP... PLANE... MOLD... separately or all at once with a one HP motor. Use 3 to 5 HP for high speed output. Low Cost... You can own this power tool for only \$30.00 down payment.

Send postcard today for complete facts.

BELSAW POWER TOOLS, 906 Field Bldg., Kansas City 11, Missouri

BOAT PLANS

FULL SIZE PATTERNS • FRAME KITS

Over 60 sail, inboard and outboard designs... catamarans, houseboats, dragsters, hydros... "Glen L" has the most complete selection of build-it-yourself boats from an 8' dinghy to a 35' cabin cruiser. And, only "Glen L" includes written and pictorial step-by-step instructions and material listings specially prepared for amateurs with all Plans, Patterns and Frame Kits.

Send for new 80-page catalog completely illustrating the full selection of over 60 boats.

MAIL 50¢ TO:

GLEN L—9152T Rosecrans, Bellflower, Calif.

WHAT'S NEW OUTDOORS

BY STUART JAMES

It's amazing how statistics have a way of bringing home the grim realities. When I see a polluted stream, for instance, I'm annoyed. But not nearly as much as when I read a report from the Public Health Service which states that 18.4 million fish were killed in 1964 as a result of water pollution. This is 18 fish per creel for one million fishermen.

On the other hand, statistics have a way of stunning you with the magnitude of some things you accept casually. I was aware that recreation equipment was big business, but the report that it accounted for almost \$3 billion in 1964 floored me. Boats and accessories (not including luxury yachts) accounted for \$659 million! This is incredible when you consider that in 19 years the CARE relief program has expended a total of \$750 million. And if that's not enough to startle you, how about this? In 1964 somebody spent \$6 million on Ping-Pong equipment! And a letter from Karl Keeler in Cleveland notes that "38,530,460 fishing licenses were sold last year as against 1,926,523 marriage licenses. This proves that 20 times more people would rather fish than fight."

Shooters will welcome this handy ballistic drop chart. You sight your rifle in for a variety of loads at different distances, record this information, stick the label on the floor plate or stock of the rifle, and it's there for quick reference in the field. They're free from: Redfield Gun Sight Co., 1359 So. Clarkson, Denver, Colo.



BALLISTIC drop chart is a handy field reference

Who's got everything for your Ford

from Compasses An accurate, dependable device for getting bearings in unfamiliar territory. Attaches to windshield, instrument panel or garnish molding. Illuminated for nighttime driving. \$7.95*

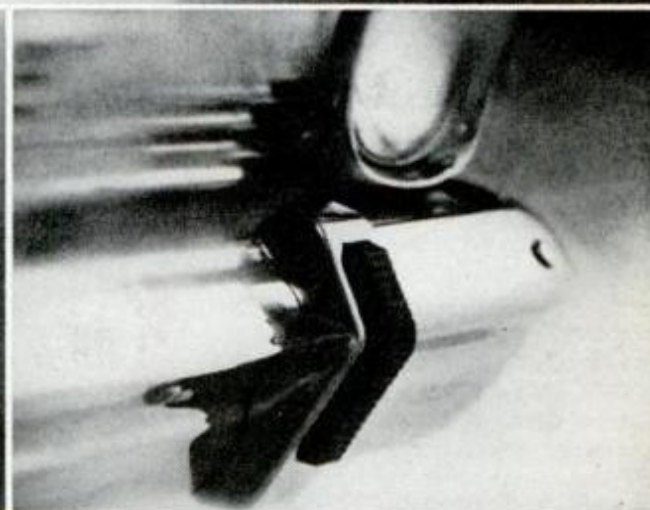

to Spotlights This stylish addition features a long-distance sealed beam lamp to help you pick out addresses and read roadside signs on the darkest night. Can be adjusted to any position from within car. \$29.95*

*Manufacturer's suggested retail price. Installation charges, state or local taxes, are extra.

to Bumper Guards These heavy gauge, chrome-plated steel guards with thick rubber inserts help absorb shocks, reduce bumper dents and scratches, lessen the possibility of bumper locking. \$14.60* a pair (front). \$18.35* a pair (rear).

Your local Ford Dealer of course!

You'll get the most for your driving pleasure from your Ford Dealer.

Not everyone does as well,
but C. E. Nevin, who started a
business of his own, reports...



—most of it Clear Profit for Me!

• Mr. Nevin expressed his grateful thanks for the opportunity to have a fine business of his own. Many men have discovered how to be independent, to be freed of bosses and layoffs—to build their own future on a steady, dependable foundation. G. Mundt made more than \$400 one week. A father-son combination grossed \$33,000 first year. H. Lemon says, "I netted \$133 in one 8-hour day."

How much you make depends largely on you. You need no special skill, no large investment. Start part-time if you wish. We will help you get started and work with you for your success. Training and consulting with experts is available at no additional cost.

No shop necessary • Our **ELECTRIC RUG WASHER** cleans rugs and carpets like new right on the floor... removes dirt and grime and helps to show their natural color and beauty. So efficient and safe for carpets, it is used by largest hotels and railroads.

Don't delay. Mail coupon today for complete information including how to start making big profits in **YOUR OWN** business. **BIG** opportunity.

Ours is Not A Lease Arrangement • You are free to operate independently. You sign no contract. You own the detergent and are your own boss... every dollar you take in is yours. You pay no fees, or dues, or royalties, and enough supplies come with it to return far more than your investment. Many earn the cost of the detergent in a week or two. It costs nothing to get details... write **TODAY**.

Mail coupon today for interesting

↓ **FREE BOOK**

VON SCHRADER MFG. CO.
210 "R" PL., Racine, Wisconsin

Send at once (no obligation) your **FREE** booklet containing information about your **ELECTRIC RUG WASHER** and how I can start my own permanent, profitable business.

Name _____
Address _____
City _____ State _____ Zip _____

VON SCHRADER MFG. CO.

EXCITING NEW PRODUCTS

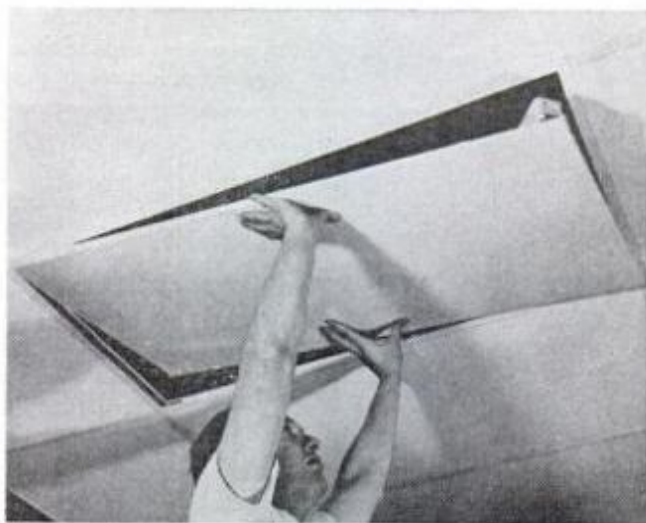

A new radiant heating panel from General Electric is shown being "popped" into T-Bar ceiling of a commercial building. Panel's built-in conduit box permits its installation without the use of fasteners. Coupled with a room thermostat, panels give a room its own heating system with its own control. Entirely silent, they radiate sunny warmth and permit the fullest use of floor space.

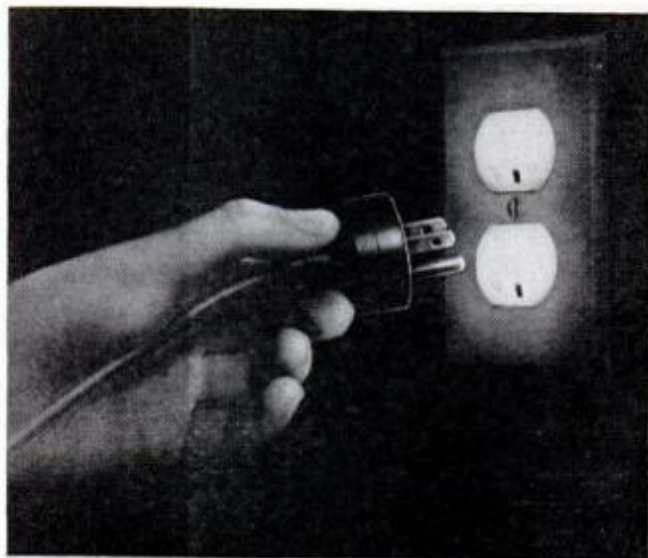

Illuminated plug-in outlet makes it easy to find the slots for plugging in lamps and appliances, even in the dark. A small neon bulb located just behind the parallel slots of each outlet throws a soft glow of light on adjacent floor and wall areas so that the unit also doubles as a permanent night light. Homeowners should go for this. By Harvey Hubbell, Inc., Bridgeport, Conn.

SAW SHARPENING IS EASY

Super Filer No. 11 joints and sharpens circular saws 6" to 10" with all teeth correct in height, depth, pitch, bevel. When file hits steel roller, teeth are finished. Saw runs true with no side pull. Includes 8" file. **\$9.95** PPD.

FREE LITERATURE

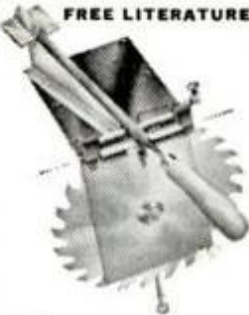

"TRU-CIRCLE"

saw set automatically sets teeth at 10° **\$2.95** or more. PPD.

MONEY BACK GUARANTEE

A. D. McBURNEY, 1610 Victory Blvd., Glendale, Calif. 91201, Dept. A-26

BE A MAGICIAN!

Get started today! Become a popular man of mystery. Earn and learn in spare time. Magic is fun and profitable too. Be the Life of the Party. Astonish your friends!

RUSH **10¢** now for

PROFESSIONAL MAGIC CATALOG

160 pages thick • 800 illus. • 1000 Mysteries
Also Jokes, Puzzles, Secrets, Illusions.
HOUSE OF 1000 MYSTERIES DEPT. PM26
4018 N.E. Fifth Ave., Ft. Lauderdale, Fla.



BOAT KIT Catalog FREE

FIBERGLASS OR PLYWOOD



Save \$1000 to \$2500 on 18', 20', 22' Luger Luxury Cruisers... save to \$4000 on 22' Houseboat and 26' and 30' Cruisers... to \$500 on speedy 14' or 16' Molded Fiberglass Runabouts! Over 50 Models! Easily assembled. Every part and every section pre-cut, pre-assembled or precision molded. Just put together! 3 Years to Pay! MONEY BACK GUARANTEE! Rush name, address for full color catalog—56 pages—FREE!

Low Down Payment EASY TERMS

LUGER BOAT KITS, Dept. B-26
9200 Access, Minneapolis, Minn. 55431

Learn Profitable Profession in few months at Home

MEN AND WOMEN, 18 TO 60

\$4.00 to \$5.00 for 1-hour treatment is the established charge for a skilled operator. Easy to learn and do. Diploma awarded. Open your own office or earn good income from Doctors, Hospitals, Clubs and other health or recreational centers. Wonderful part-time profession. Low monthly payments. Write today for free Anatomy Charts and catalog. No obligation.

ANDERSON SCHOOL OF SCIENTIFIC MASSAGE
Dept B-1, Princeton, Illinois



MACHINE TOOL RECONDITIONING & THE ART OF HAND SCRAPING

REWINDING SMALL MOTORS, OPTICAL TOOLING, INDUSTRIAL HYDRAULICS, MACHINE SHOP ESTIMATING.

Book catalog free to machinists, toolmakers, engineers.

MACHINE TOOL PUBLICATIONS

215-P Commerce Bldg., St. Paul, Minn. 55101

FREE CATALOG



MAKE YOUR OWN RODS AND LURES

Send for FREE Wholesale Catalog. The most complete and fully illustrated catalog of reels, rods, beads, spinners, jigs, lure bodies and parts, sinker molds, feathers, tools, hooks, rod blanks, rod parts, swivels, wire, etc.

FINNYS SPORTS
2066X SPORTS BUILDING TOLEDO, OHIO 43614

FREE!

Learn how you can buy used engines \$15 up, new engines \$30 with FREE confidential list and coupons when you order your plans

- BUILD THIS MINI-BIKE!
Plans reveal step by step details!
- BUILD A RACING KART!
Complete frame for less than \$10!



RUSH \$2 for plans (indicate type) or send 25¢ for brochure describing plans: PLANS, Box 478, Dept. PM2, Denver, Colo.

Buying a Power Drill? Look for a SUPREME CHUCK UP FRONT!

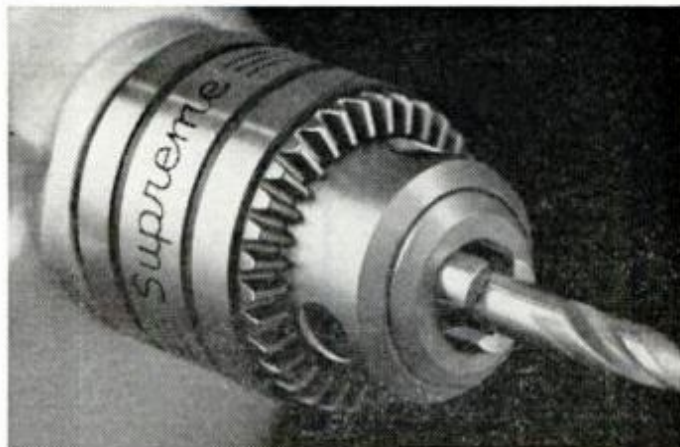

It's not hard to select a fine power drill—there are any number of them on the market. You can, however, assure yourself of the finest of the fine if you choose a drill equipped with a Supreme Brand Chuck. Supreme Chucks are case-hardened throughout to provide unmatched precision, smoother action, and a rugged efficiency that will hold up—practically forever. Look for Supreme up front.

ANOTHER LINE OF RIDGE® WORK SAVER TOOLS
THE RIDGE TOOL COMPANY, ELYRIA, OHIO, U.S.A.

Speedy Sprayer

7 times faster than brushing!

Handy, efficient sprayer for dozens of jobs around the house. Does an hour's work in minutes. Handles most paints, varnishes and insecticides. Speedy Sprayer "Compact 404" Outfit complete with gun, hose and compressor. **\$39.95** only

Slightly higher Denver West



Write for "How to Spray" booklet and catalog.

W. R. BROWN CORP.

2701 N. Normandy Ave., Chicago, Ill. 60635.

PUBLICATIONS **WORTH WRITING FOR**

BY MARION MOREY

Catching cold? January and February are likely months for viruses to strike. If you want to find out some interesting facts about the all too common cold and how to take care of one if you're caught, send for a free copy of "The Five-Billion Dollar Thief," an excellent small booklet on the subject. It's put out by Charles Pfizer & Co., Dept. PM 1, 235 E. 42nd St., N.Y., N.Y.

Wall storage units you can make yourself are shown in complete plan form in a five-cent booklet from Western Wood Products, Dept. 520-L, Yeon Bldg., Portland, Oregon. The four basic units include a study center, girl's vanity, catch-all and an adjustable

wall. Text goes step-by-step, diagrams are clear and material lists inclusive.

Avoid wrestling with nondescript knots; read "How to Tie Knots You Can Depend On," a ten-page pamphlet prepared for new crew instruction or those interested in knots for the fun of it. Knot technique shown and described covers the tug boat hitch to the figure of eight. Copies are available free from the Direct Mail Division, Dept. PM 7 Du Pont Company, DM 16690, Wilmington, Delaware.

"**There's no substitute** for a magnetic compass on a small boat." This statement has

POPULAR MECHANICS SHOPPING GUIDE

Investigate Before
You INVEST

SINCE 1920



A radiator service business can be a profitable one! If you are thinking of a business of your own or adding a department write Barbee for details. No investment of \$1500 to \$3000 will pay greater dividends. Two weeks free schooling masters fundamentals. Small down payment starts you. Our easy pay plan lets you pay from profits.



The BARBEE Co.,
P. O. Box 323PM,
Louisville, Ky.

SECRETS of Teaching Yourself MUSIC

revealed in your own home
this money-saving way



YES! Teach yourself Piano, Guitar, Accordion, Violin, ANY instrument—even if you don't know a single note now! No special "talent," no previous training needed. Famous low-cost U.S. School of Music Course, with step-by-step pictured lessons, make it simple as A-B-C. Everything is in print and pictures. First you are told what to do. Then a picture shows you how. No boring exercises, no tedious scales. You start by playing actual pieces. Sooner than you may imagine you'll amaze friends by playing your favorite music—popular, classical, jazz, country music, dance tunes, etc. Over 1,250,000 students all over the world.

Stop Cheating Yourself of These Joys

Popularity. New friends. Gay parties. Musical career. Extra money. Banish worries, frustrations. Satisfy self-expressions, creative urge. Gain self-confidence.

Write today for 36-page illustrated FREE book, U.S. SCHOOL OF MUSIC, Studio 302, Port Washington, N.Y. 11050. (Est. 1898. Licensed by N.Y. State Education Dept.)

Print Name.....
Address.....
City.....
State..... Zip Code.....



Today let these
AMAZING SHOES
ADD INCHES TO
YOUR HEIGHT!

Nothing like a pair of "ELEVATORS" to help you get up in the world! In seconds, these miraculous height-increasing shoes make you almost 2 inches taller!

And no one will suspect that you're wearing them because "ELEVATORS" look just as smart and feel just as comfortable as any other fine shoes.

Write for FREE CATALOG today.



ELEVATORS® HEIGHT-INCREASING SHOES

Brockton Footwear, Inc.
Dept. 1102G Brockton 68, Mass.
Please send free catalog

Name.....
Street.....
City..... State.....

CLIP AND MAIL COUPON NOW

MAKE MORE MONEY AT HOME IN YOUR OWN BUSINESS

in spare time

LEARN UPHOLSTERY



**MEN ...
WOMEN ...
ALL AGES**

PROFITABLE BUSINESS

BIG PAY JOB

SECOND INCOME

**NO EXPERIENCE OR
BIG CAPITAL REQUIRED!**

EARN AS YOU LEARN RIGHT FROM THE START - Make beautiful Custom Furniture. Turn old furniture into new for **BIG PROFITS**. Reupholster chairs, divans, footstools. Repair furniture of all types. Make Slip Covers, Drapes, Cushions. Your home is your workshop. No overhead and no expensive equipment.

SKILLED UPHOLSTERS URGENTLY NEEDED NOW! Shops desperate for help! Can't satisfy Upholstery demand created by population explosion, gigantic new home, apartment, hotel, motel, office, restaurant construction. Upholsters earn **TWO MONEY**, are needed *Everywhere*.

WE WILL GIVE YOU EVERYTHING: 1) Most Modern, Complete Course ever offered. 2) Complete Set of Tools. 3) Practical "Learn-by-Doing" Projects. 4) Professional guidance every step of the way.

FREE TOOLS



GET THIS **FREE BOOK** YOURS FOR THE ASKING!

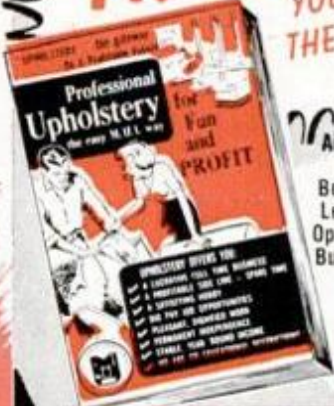

Air Mail Coupon for **FREE** Illustrated Book, Useful Sample Lesson and Plan for Operating a Profitable Business at Home ...

All 3 are Yours FREE!

FREE materials, fabrics, tools, supplies to make a **ROOM-FULL** of beautiful furniture like this... **YOURS TO KEEP or SELL!**



BE YOUR OWN BOSS - Start small, at home ... Enjoy a good income for life! • Send for your FREE ILLUSTRATED BOOK and SAMPLE LESSON ... TODAY!

MODERN UPHOLSTERY INSTITUTE
Box 899-WD, Orange, California
Please send **FREE** Illustrated Book and **SAMPLE LESSON**. No obligation - No salesman will call.

Name _____ Age _____
Address _____
City _____ Zone _____ State _____

MODERN UPHOLSTERY INSTITUTE, Box 899-WD, Orange, California

FOLBOT

fits in every home or car

CHOICE of CHAMPIONS

belongs to You



FACTORY BUILT \$146

Most inexpensive too

PREFAB from \$55

GENUINE Folbot RECREATION for just **ONE** small investment, **WITHOUT** the continuous burdens of complicated 'big rig' operation. You **GO CAREFREE** anytime with **COMPACT Folbot** . . . rocky streams, lakes, marsh, surf & open sea. Superior non-sinkable designs provide **SAFEST** low gravity center, balanced low & high seating, substantial construction, protective decks & **EXCLUSIVE** swivel-back **COMFORT**. ALL within your reach. In handy Folbot **YOU GLIDE** smoother, faster & **NOISELESS** with paddles, oars, or sails and ride softly w. 1 to 10 HP. motors. Many styles & sizes from 1 to 4 seaters, **FOLDING** or rigid **PORTABLE** come in **PREFAB KIT**, or expertly **FACTORY BUILT**

NOW at SPECIAL SAVINGS
YACHT-SMART
large **DACRON** Sail Rig **\$99**

NEW Fabulous 16 foot \$119

Factory BUILT Folding from \$179 Factory finished

NATIONAL SAFETY RECORDS
WORLD RECORD FISHING

FREE ACTION CATALOG

Mail coupon or address to: **FOLBOT CORP.** Dept. PM-266 Charleston, S. C. -29405



for YOUR SPORT & FAMILY FUN

Name _____
Address _____
City _____ State _____



**McGREGOR
GOES
KING-SIZE!**

FOR TALL OR BIG MEN ONLY

McGregor Jackets, Slacks, Sweaters . . . all extra long. Dress, Sport Shirts with bodies 4" longer, sleeves to 38". Also 80 SMART SHOE STYLES in Sizes 10 AAA to 16 EEE. Hush Puppies, Boots, Dress, Sport, Casual shoes. Mail only. 100% Guaranteed. Send for FREE 64 Page CATALOG.

KING SIZE, Inc.

1526 Forest St., Brockton, Mass.

END THE SOAP SEARCH!



Here's your soap . . . hanging in air wherever you want . . . hung magnetically on this stylish, strong MAGNAGRIP SOAP HOLDER. Easy to install on any wall . . . in permanent polystyrene

Keep your kitchen knives before your eyes with handsome, permanently magnetized MAGNAGRIP MARK X.



Only **\$198 P.P.**

Only **\$349 P.P.**

Want information on other Magnagrip wife-savers? Guaranteed or money back. Send check to Dept. C

PHELON MAGNAGRIP COMPANY, INC.
East Longmeadow, Massachusetts

**MEN! 60 STYLES FOR
W-I-D-E
F E E T !**

**E to EEEEE Only
Sizes 5 to 13**

Men only. Casual, dress, work shoes that really fit. Top quality, popular prices. Money Back Guarantee.



Not sold in stores

Write Today for FREE CATALOG
HITCHCOCK SHOES, Hingham 28-B, Mass.



**FREE
GIANT
MURAL
CATALOG**

PAINT YOUR OWN WALL MURAL!
Enjoy the beauty, creative satisfaction of painting a lovely 5 to 14 ft. wide mural directly on your wall! New "paint-by-numbers" method is fun. Incredibly easy. Takes just 3 to 5 hours. Artists charge up to \$350; wallpaper scenes cost \$100 and more. Our complete kits, \$12.95 up! Also fabulous "Black Light" mural kits. Many exquisite modern, provincial, oriental, etc. designs. A stunning prestige touch! Send for FREE Color Catalog. "How to" details incl. 10¢ for postage handling. MURAL ART CENTER, Dept. 172, 6816 W. Romaine St., Hollywood 38, Calif.

DOLLS!

**A THRILLING
CAREER AWAITS YOU**

We teach you how to operate a Doll Hospital, repair, dress and make dolls of all kinds. Start your own profitable part or full time business—we show you how. Or, enjoy an enchanting hobby. May we send free and without obligation the information on our fascinating home study course?

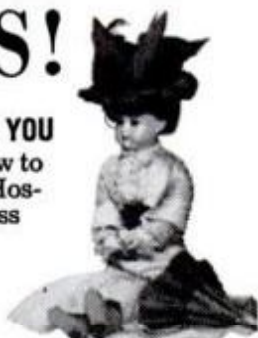

**Norm & Sue Morris
LIFETIME CAREER SCHOOLS • Studio M-26
11824 San Vicente Blvd., Los Angeles, Calif. 90049**

**FREE
GASKET
MANUAL**

Valuable Facts for those who value Top Performance:

- Rear End Gasket Installation Tips
- Correct Way to Install Pump Gaskets
- New Type Gaskets for Valve Covers
- Important Steps in Head Gasketing
- Metal Shim Gaskets
- How to Make Sure Gaskets Fit

32 pages of tips—hints—facts about gaskets and how to improve engine performance

Published as a service to the nation's mechanics, schools and car owners by Fel-Pro, Inc., one of the world's leading gasket manufacturers.

Write:
FEL-PRO, INC.
7452 N. McCormick Blvd., Skokie, Illinois
Dept. PM-2

FEL-PRO 663
Division of Felt Products Mfg. Co.



Art LESSONS \$6 a month

Study Art for pleasure and profit. Learn Drawing, Painting, Advertising Art at home in spare time for only \$6 a month. Assignments corrected with overlays and returned to you by mail. Write for FREE BOOK. No obligation.

WASHINGTON SCHOOL OF ART, Studio 142, Port Washington, New York 11050. Established 1914. Accredited, National Home Study Council. Tear out ad.



Money Back Guarantee HEAVY DUTY-ARC WELDER Five Year Guarantee

The New 1966 Model Heavy Duty 110 Volt Arc Welder works on any 110 volt house line. You can not buy a better welder anywhere at this low price. No experience necessary. Now anyone can braze, solder, cut and weld any metal up to 1/4" thick. Generates heat up to 10,000 degrees for cutting through steel plate, etc. **NOTHING ELSE TO BUY.** Comes complete with 12 ft. of heavy duty power cable, 1/16" and 1/8" welding and brazing rods, rod holder, twin carbon torch, helmet, instruction book, etc. **MONEY BACK GUARANTEE.** Try it for 10 days, if you are not completely satisfied we will immediately refund your money without question.—**FULLY GUARANTEED FOR FIVE YEARS.** If inoperative, we will repair or replace it free of charge. **SEND ONLY \$2.00.** and when delivered, pay postman \$12.95 plus COD postage, or send \$14.95 and we will ship postpaid. Over 10,000 National Electric Welders are in use throughout the world. (For an extra large supply of rods, carbons and flux, send an additional \$2.00.)

ONLY \$14.95

Order Direct from factory: **NATIONAL ELECTRIC, Dept. PM-2, DELRAY, FLORIDA**

What if I'm laid off?
Will automation take my job?
How can I ever afford to retire?
Am I too old to change jobs?
Can I learn a new skill?
Could I succeed as my own boss?
How can I earn extra money fast?
Will my job ever pay more?

FINDS 3-WAY INCOME INSURANCE

"I earned \$2,901.72 while learning locksmithing and now make \$5000 a year—doubling my income. Worries about layoffs, retirement, more money are over for me—thanks to the Locksmithing Institute Course!"—Stanley Nowak, Saginaw, Mich.



MAIL COUPON NOW

Be a SKILLED LOCKSMITH

... and Solve ALL Your "FUTURE" Problems

No question about it... with Locksmithing YOU HAVE IT MADE! You'll do light, clean, fascinating work—take your choice of steady, high-pay job opportunities, or your own big-profit spare-time or full-time business! As a locksmith you have your own "built-in" pension plan. Say "goodbye" to layoffs, automation, slack times, forced retirement! **EARN MORE, LIVE BETTER** in good times and bad. **LOCKSMITHING IS SO EASY TO LEARN—EARN Extra Money RIGHT FROM THE START!** Regardless of age, education, experience, minor physical handicaps, fun and earnings begin **AT ONCE** as you learn quickly, easily at home to **CASH IN** on all kinds of locksmithing jobs. Experts guide you—locks, keys, parts, picks, special tools and equipment as well as complete fully illustrated lessons all supplied with course.

FREE Illustrated Book, FREE Sample Lesson Pages Give Exciting Facts. Find out how being a skilled Locksmith can put a quick end to your worries. Locksmithing Institute graduates now earning more, enjoying life. Send coupon **TODAY** for **FREE** illustrated book and sample lesson pages. No salesman will call. Only school of its kind. Licensed by N.J. State Dept. of Education, Accredited Member National Home Study Council.

LOCKSMITHING INSTITUTE Division of Technical Home Study Schools
Dept. 110-026, Little Falls, New Jersey 07424



306 pieces of equipment **LOCKS, PICKS & TOOLS** supplied for use with course.

LOCKSMITHING INSTITUTE, Dept. 110-026
Little Falls, New Jersey 07424

Please send **FREE** Illustrated Book—"Your Big Opportunities in Locksmithing," complete Equipment folder and sample lesson pages—**FREE** of all obligation—(no salesman will call).

Name (Please Print)
Address
City State Zip

NOW! GET 3 REAL OLD LINCOLN CENTS
— for only **10¢**



Only 10¢ brings you 3 old Lincoln pennies — America's most sought-after collector's coin. 1929S, 1916, 1918. (Offer limited — only one set to a customer.) For all 3 Lincoln Cents, plus free catalog illustrating coins and supplies, plus other offers on approval, send name, address and 10¢ to **LITTLETON COIN CO., Dept. 2-PM, Littleton, New Hampshire 03561.**

ENROLL—EARN YOUR DEGREE

of Bachelor of Bible Philosophy (B.Ph.B.), Master of Bible Philosophy (M.Ph.B.), Graduate of Bible Philosophy (G.Ph.B.), Doctor of Metaphysics (Ms.D.), or Doctor of Divinity (D.D.). Chartered by State, Correspondence Courses only. Please write for **FREE BOOKLET.**

AMERICAN BIBLE INSTITUTE
Dept. PM, 408A W. 75th St., Kansas City, Mo. 64114

I-N-V-E-N-T-O-R-S WE NEED INVENTIONS

Sell your invention for cash—need money for Patent?—Are technical problems holding you back? Universal Inventions has helped inventors all over the world—just like yourself—why not you? Inventions provide the magic spring-board to sudden riches. **REMEMBER,** we either sell your invention or pay you a cash bonus. Write for details.

UNIVERSAL INVENTIONS, Dept. 13, Marion, Ohio

Big Profits in UPHOLSTERY

Get Your Share... **FAST!**

EARN BIG MONEY 3 NEW EASY WAYS



FREE Deluxe Illustrated Book and Sample Lesson Pages

1. Be your own boss, make up to 85% profit.
2. Start earning right away at home in spare-time—keep furniture you make, or sell for hundreds of dollars.
3. Today's home and office upholstery, re-upholstery, slipcover boom make it easy to take your pick of big-pay jobs.

LEARN FAST—EARN FAST
You get expert instructions, plus all tools, new wooden frames, materials, fabrics, business tips, wholesale privileges, decorating magic **AT NO EXTRA CHARGE, FREE** Book, sample lesson pages show you how—no obligation—no salesman. Write **TODAY.**



UPHOLSTERY TRADES SCHOOL
(Div. of Tech. Home Study Schools)
Dept. 510-026, Little Falls, New Jersey 07424
(N. J. State Approved. Accredited Member National Home Study Council. Vet Approved.)

Tools, Equip., Frames, Materials, Fabrics, Supplies yours with course.

MAIL COUPON TODAY

UPHOLSTERY TRADES SCHOOL, Dept. 510-026,
(Division of Technical Home Study Schools)
Little Falls, New Jersey 07424

Please send me **FREE** book, "Your New Way to a Successful Career," and **FREE** sample lesson pages. No obligation—no salesman will call.

Name
Address
City State Zip

Established **1939**

If there are 10 businesses in your town, you can

MAKE UP TO \$50 EXTRA A WEEK!



Line includes hundreds of items businesses need & use!

By supplying just 10 business, political and professional men in your town with the office supplies, business forms and printed material they need — and use up — every day, you can make extra money every week in just a few hours of your spare time! National's great line of business necessities and advertising specialties makes it easy for you to earn \$50, \$100 a week—and more!

NO EXPERIENCE NEEDED YOU DON'T SPEND 1¢

We send you FREE everything you need to start making TOP COMMISSIONS right away. Send coupon below for FREE Kit that tells you how to start making extra money in spare hours you'll never miss. MAIL COUPON FOR FREE DETAILS. No obligation.

Home Office, National Press, Inc., Dept. 133, North Chicago, Ill. 60064

Yes, I want your big line of BUSINESS PRINTING, BUSINESS NECESSITIES, and ADVERTISING SPECIALTIES FREE AND POSTPAID so I can earn extra money week after week in my spare time.

Name _____

Address _____

City _____ State _____ Zip _____

HOT SHOT HOT SHOT

Amazing New BENJAMIN 30 30 CO₂ GAS BB CARBINE REPEATER

— Packs a PUNCH that's so POWERFUL it will Drive STEEL BBs thru Both Sides of a 5 Gal. Steel Pail at close range! (26 ga. .018")

You're in for a thrill you'll never forget the first time you shoot HOT SHOT! The Hardest Shooting CO₂ Gun on the market— New Model 30 30 embodies features that also assure Flawless Performance: Permanent Alnico V Cast Magnet Shot Holder . . . a Positive, Jam-proof method of loading Ammo in firing position; Convenient, Positive Hammer Safety; 30-BB Mag.; 30 Shots per cartridge; Quality Built. Lightweight—Accurate—Field Tested—Lowest Shooting Costs—use Indoors/Outdoors.

\$21.00 Ask Dealer for Demonstration.

BENJAMIN AIR RIFLE COMPANY
896 Marion St., St. Louis, Mo. 63104

FREE Catalog Benjamin Single Shot and Repeaters—Cal. BB or 177 or 22. Also Special Hunting Knife Offer. Write today!

You Can DEPEND on BENJAMIN

REAL ESTATE

BE A BROKER

PAYS BIG! SEND FOR FREE, BIG, ILLUSTRATED CATALOG NOW! Graduates report making substantial incomes. Start and run your own business quickly. Men, Women, all ages, learn easily. Course covers Sales, Property Management, Appraising, Loans, Mortgages, & related subjects. **STUDY AT HOME** or in classrooms in leading cities. **DIPLOMA AWARDED. Write TODAY for FREE Booklet!** Accredited Member National Home Study Council. (Established 1936)

WEAVER SCHOOL OF REAL ESTATE
3521-P Broadway Kansas City, Mo. 64111

FREE BOOK TELLS HOW

BE LANDSCAPE CONTRACTOR

A LANDSCAPE CONTRACTOR
LEARN MODERN LANDSCAPING for exciting hobby or profit. Thousands of spare or full time money making opportunities. Start a profitable business—we show you how. Study and earn your certificate at home. Write today for Free Book. **LIFETIME CAREER SCHOOLS**
Dept. M-26
11826 San Vicente Blvd.
Los Angeles, Calif. 90049

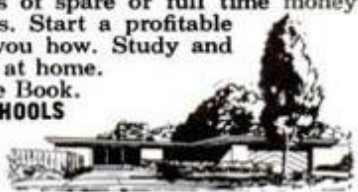

GET INTO ELECTRONICS

V.T.I. training leads to success as technicians, field engineers, specialists in communications, guided missiles, computer, radar, automation. Basic & advanced courses. Electronic Engineering Technology and Electronic Technology curricula both available. Assoc. degree in 29 mos. B.S. obtainable. G.I. approved. Start Feb., Sept. Dorms, campus. High School Graduate or equivalent. Catalog.

VALPARAISO TECHNICAL INSTITUTE
DEPARTMENT D. VALPARAISO, INDIANA

PROFIT IN YOUR SPARE TIME

SMALL ENGINE REPAIR PAYS BIG!
Outboard • Powermower • Chain Saw • Tractor
MAKE EXTRA MONEY — or fix your own engines and SAVE! Illustrated, easy-to-learn Home Study Course qualifies you as expert. Free information. Write today!

LINCOLN TECHNICAL INSTITUTE
SUITE 2E, 472 MARKET STREET, NEWARK 5, N.J.

Build BEAUTIFUL CLOCKS

Send just 25¢ for 1966 illustrated clock book—the most complete available, describing plans for grandmother, grandfather, wall and shelf clocks easily and inexpensively made with simple tools. Also pictured are a wide selection of finest dials, quality movements, and kits in high-grade cherry, mahogany and walnut.

CRAFT PRODUCTS, Elmhurst, (1) Illinois

TAPE THIS AD TO THE BACK OF YOUR TV SET

ALL TV-RADIO RECEIVING TUBES

\$1 ea.

ALL BRAND NEW, all at a flat discount price of only..

No exceptions . . . all tubes \$1, regardless of list price. Virtually all types available, including the new color tubes.

- All Tubes 1st QUALITY MADE IN U.S.A.
- All Sold on Written 24-MONTH WARRANTY
- All Orders SHIPPED 1st CLASS SAME DAY REC'D.!

• If you know for sure which tubes are defective, order them @ \$1 each, plus 25¢ postage and handling on your entire order.

• If uncertain which tubes need replacing, send for our FREE leaflet "How To Save On TV-Radio Repair Costs." This valuable leaflet should be taped to back of your TV set, and kept handy . . . Write today to, Dept. PM-26.

UNIVERSAL TUBE CO.
Ozone Park, N. Y. 11417

PROOF! WATCH REPAIRMEN Earn Good Money!



"The fourth week I was open I took in two hundred dollars," writes CHICAGO SCHOOL OF WATCHMAKING graduate William E. Botkin of Muncie, Indiana.

Read what Bill says and you'll know it could happen to you:

"After receiving the school diploma in May of 1961, I took the Indiana State license examination. I have now quit the factory where I was working and started my own shop. . . . The fourth week I was open I took in two hundred dollars. The next highest week I've had was one hundred and eighty dollars. I've now been open eight months and the shop is growing more all the time."

TRAIN AT HOME IN YOUR SPARE TIME

Make Rapid Progress The Sweazey Way

Complete professional instruction for only \$5.00 a month.

Send today for free sample lesson and illustrated booklet. No obligation. No salesman will call.

No previous experience necessary. Chicago School of Watchmaking's exclusive Sweazey System shows you step by step how to repair all types of Swiss and American watches. You get practical shop training right in your own home—work with watches from your very first lesson. Diploma awarded.

FREE SAMPLE LESSON

CHICAGO SCHOOL OF WATCHMAKING

Dept. 126, Fox River Grove, Illinois 60021

Please rush FREE SAMPLE LESSON and full information to tell me how I can learn watch repairing at home.

NAME _____ AGE _____

Address _____

City _____ State _____ Zip Code _____

CHICAGO SCHOOL OF WATCHMAKING

Founded 1908

FOX RIVER GROVE, ILLINOIS 60021

**FREE
20-PG BOOK
REVEALS
HOW...**

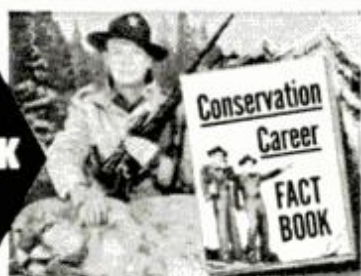

You can prepare in spare time for Wildlife-Forestry Dream Career. Positions as bounty hunter, game warden, forester, aids, etc., open ages 17-40. Adventure, thrills, public service, plus good pay, low living cost, security. Plan to live the life you love.

Accredited member National Home Study Council. Write for FREE BOOK today. State your age. NORTH AMERICAN SCHOOL OF CONSERVATION Campus Drive, Dept. 172, Newport, Calif. 92660

"\$8,500 PROFIT MY FIRST YEAR

WITH INLAND 3-IN-1 RADIATOR SHOP"

—John Burrus, Sr., Fredericksburg, Va.

Inland shop owners make good money testing, cleaning, repairing auto-truck-tractor radiators. You can too! Compact shop only 11'7" x 3'6". Inland, world's largest radiator equip. mfr., trains you free in 2 weeks or less. Pay-As-You-Profit purchase plan. Proved merchandising assures volume. Write for FREE BOOK, owner letters, details on Inland's complete program. Profitable dept. for garage or gas station.

NEW!



FREE! INLAND MFG. CO., Dept. PM-2
1108 Jackson Street, Omaha, Nebr. 68102
Send free 42-page booklet and money-making plan.
Print Name _____
Address _____
City _____ State _____

My name is Charles Atlas. I can't promise you'll win the title of "World's Most Perfectly Developed Man" as I did. But I do believe I can make a powerful He-Man of you -- in a very short time. You can prove it to yourself -- at my risk. My big free book tells how to do it.



FREE BOOK Mail coupon now for free 32-page book. Tells how I can give you "Stand-Out" muscles —how "Dynamic-Tension" can make you a new man—confident, popular, successful. Rush coupon to me personally: CHARLES ATLAS, Dept. 8B, 115 E. 23 St., N.Y. 10010

CHARLES ATLAS, Dept. 8B,
115 East 23rd St., New York, N.Y. 10010

Dear Charles Atlas—Here's the Kind of Body I Want:
(Check as many as you like)

- | | |
|---|---|
| <input type="checkbox"/> Broader Chest, Shoulders | <input type="checkbox"/> More Powerful Arms, Grip |
| <input type="checkbox"/> More Weight, Solid | <input type="checkbox"/> More Powerful Legs |
| <input type="checkbox"/> Slimmer Waist, Hips | <input type="checkbox"/> Better Energy, Sleep |

Send me, absolutely FREE, a copy of your famous book showing how "Dynamic-Tension" can make me a new man. 32 Pages, crammed with photographs, answers to vital questions, and valuable advice. No obligation.

Print Name _____ Age _____

Address _____

City & State _____ Zip Code _____

In England send to: Charles Atlas, Chitty St., London W. 1



EARN \$1,000 A MONTH

LEARN A TRADE YOU LIKE

Start as a mechanic in a good paying job; then advance to shop service manager. Many make \$1,000 a month and up. You learn fast in our shop because you learn with tools on real equipment. Some students earn part of their expenses while going to school.

CHECK AND MAIL COUPON

- | | |
|---|--|
| <input type="checkbox"/> AUTO MECHANICS | <input type="checkbox"/> AUTO BODY REPAIR |
| <input type="checkbox"/> DIESEL MECHANICS | <input type="checkbox"/> AUTOMATIC TRANSMISSIONS |
| <input type="checkbox"/> GAS, ARC WELDING | <input type="checkbox"/> MOTOR TUNE-UP |
| <input type="checkbox"/> HELIARC WELDING | |

Mail to: **AUTO-DIESEL COLLEGE**
226 7th Ave., No., Dept. 86, Nashville, Tenn.

Please send without obligation free catalog

NAME _____
(please print or write plainly)

ADDRESS _____

CITY _____ STATE _____

"WILL YOU SMOKE MY NEW KIND OF PIPE ..."

30 Days at My Risk?"

New principle that contradicts every idea you've ever had about pipe smoking. I guarantee it to smoke cool and mild hour after hour, day after day, without rest, without bite, bitterness or sludge. To prove it, I'll let you try a new Carey Pipe. Send your name and address today for my FREE complete trial offer. Write to: **E. A. CAREY**, 1920 Sunnyside Ave., Dept. 252B, Chicago 40.

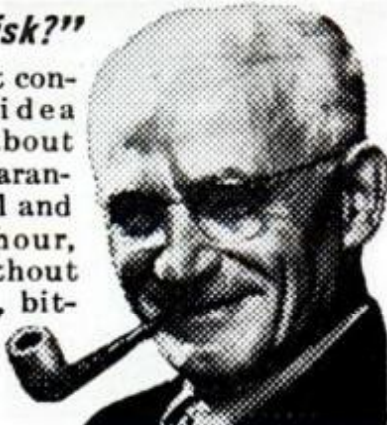

MAKE BIG MONEY—ALL PROFIT—AT HOME

INVISIBLE MENDING

Pays up to \$10 in an Hour!
Make moth holes, cigarette burns, tears, rips, disappear from all fabrics. Little-known craft pays extra spare-time profits at home. Write today for exciting details FREE!

FABRICON, 1555 Howard St.
DEPT. 322, CHICAGO 26, ILLINOIS



At Last a New Amazingly Simple

GAS TURBINE JET ENGINE

Build from easy to follow plans. Length 15", Dia. 8 1/2", Wt. 15 lbs. Fuel: Gasoline or Kero.

"Screamin Demon" develops 20 H.P. Ideal project for serious-minded hobbyists, students; scientific and industrial arts classes. Make on 9" metal cutting lathe with milling attachment. For use on small racing boats, midget cars, etc. Full size assembly drawings with critical dimensions, bill of materials and photos. Price \$5.00. No C.O.D.

SAVOY SCIENTIFIC, BOX 1398, SANTA MONICA, CALIFORNIA



MAKE BIG MONEY

MAKING COSTUME JEWELRY AT HOME!
Thrilling spare-time, MONEY-MAKING hobby! Make newest, beautiful jeweled earrings, necklaces, bracelets, pins, pendants, cuff links, tie clips! Quick, easy to make—easier to sell to friends, neighbors, stores, at big profit! Details FREE!

DON-BAR CO., Dept. B-196
2934 W. Fullerton Ave., Chicago, Ill. 60647



UNITED STATES HISTORICAL STAMP COLLECTION Only 10¢

Includes 1893 Columbian plus 24 different commems, plus U.S. Mint and USED stamps included on approval. Send 10¢.



K & B STAMP CO., Dept. "M," Box 70, Brooklyn 23, New York

1965 FORD or DODGE Only \$899
1964 CARS Only \$599

AMAZING SAVINGS!

4-door, 6-cylinder, automatic trans.; with good tires, spare, heater. Ex-taxi-cabs. All signs, markings removed. Present appearance no different than regular passenger cars.

FREE PHOTO CATALOG!

Phone, Write, Wire or visit premises. **UNIVERSAL AUTO WHOLESALERS, Inc.** Est. 1959 • Larry Shandel, Pres.

235-66 Penhorn Ave., Secaucus, N. J. 07094
(Only 10 minutes from N.Y.C., off U.S. 1 & 9)
PHONE: (Code 201) 866-7500 • N.Y.C.: (212) 244-1580

AUTOMATIC 60-SHOT PELLET STINGER

Dogs, Other Animals, Assaultants Instantly Repulsed. The pellet is harmless but STINGS. Holds and fires 60 pellets automatically as fast as you can pull the trigger to knock most stubborn assaultants off guard. Portable. Fits easily in pocket or purse. Made of high impact styrene for long life, trouble-free use. Fully guaranteed. More humane to animals than kicking or hitting. Send \$1.98 cash, check or money order plus 27¢ to cover handling and we include 50 stinging pellets. Not sold in N.Y.C. (100 pellets \$1) (250 pellets \$2) (1000 pellets \$5) **BARGAIN CO., Self-Defense Dept. 2-PM5, 1 Park Ave., New York, N.Y. 10016.**



\$1.98

LEARN MEAT CUTTING AT NATIONAL

Pay After Graduation



The steady dependable trade of Meat Cutting taught easily in 8 short weeks. **YOU LEARN BY DOING** under actual meat market conditions in big modern school at Toledo.

For beginners or men with experience. Get a profitable store of your own. Remember, **PEOPLE MUST EAT!** Big pay jobs. Free employment help. Thousands of successful graduates.

Buying, cutting, percentage, pricing, advertising, selling, etc. A complete retail meat education. National School established 43 years. Get National training NOW. Pay your tuition in easy weekly

payments after you graduate. Send coupon for **FREE** school catalog—**TODAY**. G.I. approved.

National School of Meat Cutting, Inc., Dept. 50-D, Toledo 4, Ohio

Send me your **FREE** school catalog on National Training at Toledo in Meat Cutting, Meat Merchandising and Self Service Meats. No obligation. No salesman will call.

Name..... Age.....

Address

City..... State.....

Approved for Veterans

EXCLUSIVE DOUBLE-BEARING HEAVY DUTY PUMPS

IRRIGATE • DRAIN • CIRCULATE • SPRAY
Use 1/4 HP motor or larger . . . 1 HP for up to 5,200 GPH; 1,000 GPH 60' high; or 3,000 GPH from 25' well. 1 1/4" inlet; 1" outlet. Stainless shaft.

TYPE X—2 oil-less bronze bearings. **\$10.95**

TYPE XB—Ball bearing model. **\$12.95**

Best for belt drives. . .

Postpaid if cash with order.

Don't delay—send for yours today!

MONEY BACK GUARANTEE

Centrifugal and Gear Pumps in All Sizes.

LABAWCO PUMPS, Belle Mead 2, N. J.



Renew it with COLORCRETE



YOU CAN MAKE GOOD MONEY re-surfacing stucco, concrete, other masonry with Colorcrete. Easy to apply with spray-gun, becomes a permanent part of the masonry. Wide choice of colors. Write for free Colorcrete Opportunity Book.

W. E. DUNN MFG., CO., 570 Ottawa Ave., Holland, Mich.



PELLET FIRING "45" AUTOMATIC

ONLY **\$1.98**

- Fires 8 Rounds
- Magazine Clip
- 8 Moving Parts

Most authentic full-size model of a "45" we have ever seen. A pull on the trigger fires it and automatically works the slide to reload just like a real automatic. Comes with full instructions for easy assembly, a generous supply of pellets and scoring target. Full money back guarantee. Send \$1.98 plus 27c shipping charges or order C.O.D.
Honor House Products Corp. Dept. 96AU14 Lynbrook, N.Y.



Excitement! Security! Good Pay! CRIME DETECTION

LEARN AT HOME IN SPARE TIME—START NOW!

Crime everywhere is on the rise! Learn now, in your own home, the profitable profession that enables you to track down criminals and bring them to justice! Hundreds of Identification Bureaus employ I. A. S. graduates . . . trained in finger printing, police photography, handwriting identification, firearms and investigation. Our 44th year! **FREE** "Blue Book of Crime" . . . packed with crime facts and the full story of famous I. A. S. training. State exact age. No salesman will call. Rush Coupon!

A Correspondence School Founded in 1916.

FREE

Blue Book of Crime

MAIL COUPON

INSTITUTE OF APPLIED SCIENCE, Dept. 1352
1920 Sunnyside Avenue, Chicago 40, Ill.

Rush Blue Book of Crime . . . **FREE!**

NAME.....Age.....

ADDRESS.....

TOWN.....STATE.....

VACUUM MOLD AT HOME

MEN! WOMEN!

"Business rolling in! Left home 8 A.M. at 5:30 P.M. had taken orders that totalled \$24,000!"

R. J. Hora, Kansas

Learn just the one Nationwide process and **make money** — in spare time at home — vacuum molding plastic items and products in your choice of over fifty different kinds of businesses! Imagine! With this one process, which we teach you, and with equipment which we give you **FREE**, you can make the following plus many more — 3-D colored toys, dolls, animals, guns, desk signs, nameplates, wall plaques, artificial flowers, laminations, two-piece molds for wax, candy and chocolate. Christmas tree decorations, Easter rabbits, chicks, eggs, bubble-paks, boats, cars, models — and that is just a starter! All colors plus metallics. You learn with material we supply **FREE!** With just the equipment we give you, you can make \$96 worth of merchandise in one eight hour shift. Anyone can do it, it takes no previous training or special skills. **FIND OUT TODAY! WRITE FOR FREE SAMPLE AND BIG FREE FACT PACK WITH ALL INFORMATION!**

NATIONWIDE PLASTICS CO.

Box 23321—NS, Los Angeles, Calif. 90023.



FREE Key Machine

Kind master locksmiths use. Sells for \$125, but yours FREE with Locksmithing Course



You Can Learn To Be A LOCKSMITH

in your spare time

There's a big demand for skilled locksmiths. You can earn big money either full or part-time in your own home. Be your own boss; earn steady, year 'round income with no layoffs. The BELSAW INSTITUTE training, recommended by professional locksmiths, teaches you to make keys, open and repair locks on homes, cars and buildings. Easy, step-by-step illustrated lessons complete with all tools and supplies. We tell you how to get servicing jobs, how much to charge, how to earn while you learn and how to build a secure cash profit business.

Mail Coupon for FREE Book Today!

BELSAW INSTITUTE, 106H Field Bldg., Kansas City 11, Mo.

Send FREE book, "Keys To Your Future!"

No obligation. No salesman.

Name.....

Address.....

City..... State.....

Now Free To Inventors! ...this \$2⁰⁰ Book

Thousands of inventors gladly paid \$2.00 for a copy of this valuable book, written by one of America's greatest authorities and published by the Inventors Press. Tells everything an inventor needs to know about protecting his ideas with or without a patent and—most important—how to go about finding a buyer for your invention on royalty or for cash. As our company has performed sales services for hundreds of inventors we bought up the entire remaining inventory of these books and, while they last, will send a copy free and without obligation to any inventor who wants to find a buyer for his invention. Just put your name and mailing address in the coupon and the book will be mailed free and postage paid. We will also mail, free, complete information on the sales services we have performed for other inventors. Supply limited. To be sure of getting your free copy write at once to: Kessler Sales Corp. Dept. D52, Fremont, Ohio 43420



Kessler Sales Corp., Dept. D-52, Fremont, Ohio 43420

I have an invention which I would like to sell. Please mail me a copy of the book, "How to Cash In on Your Invention" free and postage prepaid. Also mail information concerning the sales services of your organization. No obligation. No charge now or ever.

Name.....

Address.....

City..... State..... Zip.....

MAGIC MAIL PLAN

that comes with this Little Machine
CAN MAKE YOU \$12⁰⁰ AN HOUR



The machine is turning out a job that will bring operator \$2.58, by mail. Material cost, only 11c

Write today for free facts about the newest and most fascinating of all new home operated businesses. For the first time, a simplified machine brings the fabulous profits of Plastic Sealing and Plastic Laminating within reach of the small operator. Anyone can learn to operate it with a few minutes practice. Then—with our MAGIC MAIL PLAN—can get mail orders pouring in daily with cash in every envelope.

No Convassing or Selling

Fill orders at home in spare time to start. Then expand to full time business. We even supply circulars to bring back cash and orders. Rush name for all the facts you need to start. A postcard will do. No charge.

WARNER ELECTRIC CO., Dept. L2-8X
1512 Jarvis, Chicago, Ill. 60626

PLAY GUITAR IN 7 DAYS OR MONEY BACK



TOP GUITARIST ED SALE'S famous 66 page secret system worth \$3.00 teaches you to play a beautiful song the first day and any song by ear or note in seven days! Contains 52 photos, 87 finger placing charts, etc. plus 110 popular and western songs, (words and music); a \$1.00 Chord Finder of all the chords used in popular music; and a \$3.00 Guitarist Book of Knowledge.

TOTAL VALUE \$7.00 \$2.98

—ALL FOR ONLY

SEND NO MONEY! Just your name and address, pay postman: \$2.98 plus C.O.D. postage. Or send \$3.00 with order and I pay postage. (Sorry, no C.O.D. outside Continental U.S.A.—please remit with order.)

Unconditional Money-Back Guarantee

ED SALE Studio 153-B AVON BY THE SEA, N. J.

NO JOB WORRIES

PLASTEX INDUSTRY needs manufacturers on small scale for big production of Lamps, Clock Stands, Art Goods, Novelties in Plastic Marble imitation. No experience necessary. The material makes regular 10¢ store sellers. Moulds furnished for fast production. Small investment brings good profit. Big wholesale orders now being placed. Ambitious men have chance for real prosperity and job security. Our NEW FREE booklet will interest and benefit you.

PLASTEX INDUSTRIES, Dept. A
3400 Third Ave. New York 56, N. Y.

High School at Home

MANY FINISH IN 2 YEARS

No classes. No time wasted going to and from school. Progress as fast as your time and abilities permit. Standard H.S. texts supplied. Thousands enroll each year in this 69-year-old school. Send for FREE descriptive book

AMERICAN SCHOOL, Dept. H245
Drexel at 58th St., Chicago Ill. 60637

Without obligation, please send FREE descriptive booklet.

Name.....

Address..... Zip.....

Accredited Member NATIONAL HOME STUDY COUNCIL



LEARN CARTOONING AND COMMERCIAL ART. In weeks you'll be able to draw. We teach you how with easy-to-learn at home course. Turn your creative talent into a well paying commercial art career—we show you how! No previous training or art ability needed. Wide demand for full or part time commercial artists, cartoonists, etc. Gain professional prestige, turn your spare time to profit. Low monthly tuition. Write for Free Informative Booklet. No Salesman will call. Continental Schools, Dept. 6A-1; 1330 W. Olympic Blvd., Los Angeles, Calif. 90015.

Two or four-wheel drive

JEEP or SCOUT

owners

REPOWER with a 6 or V-8. H.D. ADAPTORS for using Car, Compact and some Truck engines. Conversion Kits \$45.35 to \$56.90. Want fast action? Give us **FULL INFORMATION.** Send \$15.00 Dep. and we will ship correct kit, bal. COD. Send full amount for prepaid shipment. Wire, phone or write today. Details **FREE**

HOOSIER MACHINE PRODUCTS CO.
312 S. E. 6th St., Phone 276-3442, Pendleton, Oregon

AUTOMATIC HUBS for your 4-WHEEL DRIVE!

NOT EVEN A BUTTON TO PUSH on these amazing Lock-O-Matic selective drive hubs that automatically engage the front wheels in 4-w.d., automatically disengage them for 2-w.d. They stop front drive drag, save gas, gears, tires in 2-w.d.—automatically! For Lock-O-Matics—or popular Warn® Locking Hubs—see your dealer.

be happy—GO LOCK-O-MATIC!

WARN MANUFACTURING CO., INC.
9050-A Empire Way So. Seattle, Wash. 98118

*Not made for some 4-w.ds.

PREPARE FOR A WONDERFUL WELL PAYING PRESTIGE CAREER AS A JEWELER

Jewelers from coast to coast need trained men and women to buy, sell, grade and appraise beautiful merchandise—diamonds, emeralds, pearls, rubies, other gems. Our easy-to-understand home-study course prepares you for a well paying prestige career with a wonderful future as a professional jeweler. Profit from the growing demand for diamonds. More than 14,000 jewelers have studied through GIA—training headquarters of the jewelry industry. Write today for complete details; you'll also receive free full-color illustrations of beautiful gems.

GIA Gemological Institute of America Dept. PM-26
11940 San Vicente Blvd., Los Angeles, Calif. 90049

Thinking of college and a space age career?

Send for this booklet on **ENGINEERING TECHNOLOGY AND ENGINEERING**

Learn how you can prepare for a dynamic career as an electrical or mechanical engineering technician or engineer in such exciting, growing fields as avionics, missiles, reliability control, fluid mechanics, data processing, metallurgy, microelectronics, and advanced aerospace research. MSOE offers residence study programs leading to these degrees in engineering technology and engineering:

- 2 years — Associate in Applied Science
- 4 years — Bachelor of Science

Also get facts about scholarships and financial aids, job placement and other student services, plus photographs of MSOE technical laboratories and student activities. For your copy, just mail the coupon — no obligation.

MSOE

Milwaukee School of Engineering

Milwaukee School of Engineering
Dept. PM-266, 1025 N. Milwaukee Street
Milwaukee, Wisconsin 53201

Please send the "Your Career" booklet. I'm interested in

Electrical fields Mechanical fields

Name..... Age.....

Address.....

City..... State..... ZIP.....

MS-227

TRIANGLE STAMPS ONLY 10¢!



Get this big valuable collection of gorgeous, multi-colored, triangle-shaped postage stamps—brought to you from strange and mysterious lands in the wilds of Africa, enchanting Europe, exotic Orient: Congo, Monaco, Chad, San Marino, Malaya, many others—ships, birds, animals, airplanes, etc. All for 10¢. Also, other fine stamps from our approval service returnable without obligation—plus FREE Illustrated Catalog. Send today!

Jamestown H26PM, Jamestown, N. Y. 14701

Jamestown H26PM, Jamestown, N. Y. 14701

Rush my "Triangle" Collection and other offers. I enclose 10¢.

Name

Address
City, State
& Zip Code

20 COURSE
HOME STUDY
PROGRAM

KARATE!

JUDO BOXING! MUSCLEBUILDING! YOGA!
STRONGMAN STUNTS! STRENGTH &
ENDURANCE! HANDBALANCING! etc.



YOU GET ALL THESE COURSES! *20 illustrated KARATE blows *SAVATE foot fighting *Secret NERVE CENTER and ANATOMY charts *20 lethal JUDO throws *20 terrific STRONGMAN STUNTS *Complete MUSCLE-BUILDING course *Ancient YOGA secrets *HANDBALANCING stunts *Complete BOXING course. Secrets of ENDURANCE *WRESTLING holds *WEIGHTLIFTING *TENSION-FLEX COURSE *HEALTH & FITNESS EXERCISES *KEEP FIT PROGRAM *K-MAN Karate Dummy Chart. No C.O.D.'s. Canadian 75¢. YOU GET THE LOT.

ONLY
50¢

COMPLETE HOME GYM PLANS—Build gym equipment: vault horse, rowing machine, etc. Convert basement, garage to gym. ONLY 50¢ with courses. Total \$1.00 compl.

OXFORD STUDIO, 146 Blake (PM-5), Mattapan, Mass.
NAME (print) **50¢ PROGRAM**
Address
City State **\$1.00 with GYM**

Free K-Man Practice Dummy showing attack points.

EARN BIG MONEY!

Learn
**APPLIANCE
REPAIRING**



Send for
**FREE
BOOK!**

Learn at home in your spare time how to fix electrical appliances using Christy Electronic Trouble Tracer, how to wire homes and stores, rewind motors, how to get business, what to charge. Make \$5-6 per hour in your kitchen, or basement. Operate your own fix-it shop. Pay later from earnings.

CHRISTY TRADES SCHOOL
Dept. A-7803, 3214 W. Lawrence Ave., Chicago 60625

SAILBOAT KITS



Send for free complete color catalog of popular Snipe, Windmill, and Blue Jay sailboats and accessories. Also cruisers, runabouts, catamarans, hydrofoils, etc.

TAFT MARINE WOODCRAFT
Dept. PM26, 636 39th Avenue N.E.
Minneapolis, Minnesota 55421



FACTORY DIRECT!

MINI-BIKE KIT! \$109⁹⁵

Build your own mini-bike in about 2 hours! No welding! Speeds to 30 mph.

You get:

- * 2 1/2 hp 4 cycle engine
- * Precision welded frame
- * Complete instructions

**\$10 Down
\$ 7 Month**

Assembled \$119.95

RUSH 25¢ for brochure to:

BIRD engineering, Box 427, Dept. PM2 Omaha, Nebr. 68101

FIRES 70 ROUNDS

**ZIP GUN AUTOMATIC
RAPID FIRE REPEATER**



\$2⁹⁸

Amazing new 1966 model WALTHER automatic... Holds and fires 70 rounds automatically from oversize chamber at incredible firing speed. Peak accuracy firing power to distances of 40 feet and more. Smooth jam-proof action guaranteed. No recoil. Non-lethal. Safe. No permit needed but not sold to minors under 16 years of age.

Use for target practice indoors and outdoors. Stops animal pests fast. Walnut-Color stock is contoured to fit the hand. Send \$2.98 cash, check or money order plus 27¢ shipping charge. We include free ammo. Satisfaction guaranteed or money back.

STANDARD AMERICAN—Dept. 2-PMZ, 1 Park Ave., N.Y. 10016
(200 rounds \$1.) (400 rounds \$2.) (1000 rounds \$5.)



Earn **HIGH WAGES** as a
HEAVY EQUIPMENT OPERATOR



... and years of future security in the multi-billion dollar construction industry, in this country and overseas! Learn how at National, the original school of heavy equipment operation. For men ages 17 to 56. National is NOT a correspondence school. You train on school-owned diesel-engined machines at National's huge proving ground in North Carolina. Full 220 and 440 hour courses. Full-time Job Advisory and Counselling Director for the exclusive benefit of graduates. VA approved. Payment plans available. Write TODAY for FREE catalog. National School is a Member of American Road Builders Association Service and Supply Division.

Since National School was founded 11 years ago, students from all 50 states and 28 foreign countries have been enrolled. Hundreds of graduates are now working in construction for higher wages than they ever made before.

Ask about our Train Now—Pay Later Plan!

**NATIONAL SCHOOL
OF HEAVY EQUIPMENT OPERATION Dept. D-72**
P. O. Drawer 1686, Charlotte, N. C.

Please send me FREE illustrated school catalog and complete information. I understand there's no obligation.

Name Age

Address Phone No.

City Zone State

LEARN WELDING AT HOME WE SEND YOU A WELDER

A trade with a future—In demand everywhere
We have trained thousands—Men who earn up to \$4.50 an hour. Learn Arc, Heli-Arc and Gas Welding. We supply equipment that lets you earn while you learn. Practical lessons on brand new, industrial rated machines. Both arc and flame welding. On completion the equipment is yours. Set up your own shop or work in any shop on any job. Send today for full information.
AMERICAN INSTITUTE OF ENGINEERING & TECHNOLOGY
1131 W. Fullerton Parkway, Chicago, Illinois

NEW LIGHTWEIGHT TIRE GAUGE

Guaranteed accurate — and only
\$2.19 ppd.

Send check or money order to:

JAY of Chicago

Dept. H, 919 N. Michigan Ave.
Chicago, Ill. 60611



NEW Improved Scope-Shot

SCOPE-SHOT COMPLETE WITH 50
DISINTEGRATING PELLETS
They crack like a rifle
when they hit—leave
mark—puff of smoke!
\$1.95 P.P.

World's Finest Precision
SLINGSHOT
Scope-type
sight!
Patent No. D-178,837

ROUTES
PESTS!
Price
without
pellets
\$1.50 P.P.

Big Bag of
250 EXTRA Pellets
98c P.P.

Pure gum
rubber slings.
Beautifully polished
cast aluminum stock.
Pistol grip. So powerful it kills
small game. Fits pocket perfectly!
Guaranteed. **FREE** shooting manual.

EXTRA RUBBER SLINGS, 4 pairs \$1.00 p.p. Leather Pouch
& Sling assembly only 40c p.p. Order NOW from:

GENERAL SPORTS
4184-MB Apple Street, Cincinnati, Ohio 45223

Order
Now!

You Can Develop A Profitable Business on A Shoestring

Make \$5.00 an Hour in
Your Own Home

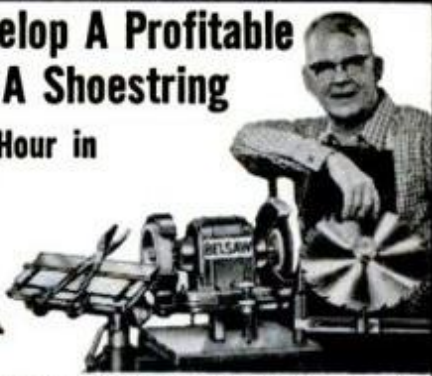

I wish there was space here to print the hundreds of letters received from men I've put in business with the Belsaw Sharp-All. With this precision machine you can sharpen all popular household, garden and shop tools easily and quickly. You need no previous experience . . . no inventory, no selling, no space to rent.

I've Done It for 40,000 Men

I have been helping men get into this profitable business for over 30 years. I'll finance you to get started . . . give you all the instructions and help you'll need to really succeed. I'll keep you informed HOW others are making big cash profits every day. No obligation.

So don't delay. Send coupon for FREE book today.

STAN FIELD, President
Belsaw Sharp-All Company
716Y Field Bldg., Kansas City, Mo. 64111



Name _____
Address _____
City _____ St. _____ Zip _____

"LIFETIME" CONCRETE INCINERATORS

MAKE IT YOURSELF WITH 88¢ WORTH
OF SAND AND CEMENT
every home a prospect

SELL IT FOR
\$2000

A VAST EVER-GROWING MARKET

Nearly 80% of all homes have inadequate, unsatisfactory or unsafe incineration facilities. Experience shows that even steel incinerators are prone to rusting out and burning out. This is your market . . . a huge one that keeps growing year after year as the population explodes . . . and more and more new homes continue to mushroom in all directions.

A SUPERIOR "LIFETIME" INCINERATOR—VOLUME PRICED

Imagine . . . for only 88¢ worth of sand and cement, you can manufacture "LIFETIME" CONCRETE INCINERATORS that are rustproof, fireproof, weatherproof, frost-resistant . . . almost indestructible . . . AND SELL THEM FOR \$20.00 each . . . and more . . . by far the best value of its kind.

SELL THRU RETAIL STORES, TOO

TOR franchises are manufacturing "LIFETIME" concrete incinerators in large quantities for large department stores, hardware stores, mail order houses and garden supply stores, with tremendous success.

NO SPECIAL EXPERIENCE OR PLANT

Just follow the simple instructions . . . all needed equipment, welded steel, heavy duty lifetime molds, literature and other selling aids supplied. Set up shop in your own basement, backyard or garage.

FULL INFORMATION WILL BE RUSHED TO YOU

T. C. TOR Dept. 34-1
318 Rancocas Avenue, Delanco, New Jersey

Gentlemen:

Please rush full information about your Concrete Incinerator Protected Franchise Offer . . .

Name _____

Address _____

City _____ Zone _____ State _____



TELEVISION RADIO COLOR TV

Let COYNE Train You at Home in Spare Time MAIL COUPON FOR FREE BOOK

Coyne Electronics Institute
1501 W. Congress Pkwy., Dept. 26H3, Chicago, Ill. 60607
Send FREE Book and details on HOW I CAN GET Coyne Quality Television Home Training at Low Cost and Easy Terms. No obligation or salesman.

NAME.....

ADDRESS.....

CITY..... STATE.....

Tiny "Sleeper" Pays Men \$64,000 a Day Rush Name for Money Facts FREE



A "Sleeper" is a little goldmine that not too many salesmen know about. The tiny Matchbook is one of the most spectacular "Sleepers" ever discovered by Salesmen. That's because it's one of the biggest and fastest sellers of all times. Businessmen give Salesmen orders for ONE BILLION Matchbooks every day. And for handling these orders the salesmen make a profit of \$64,000—every day. If you have missed this amazing "Sleeper", make up for lost time. Get the money making Matchbook story now. A letter or postcard brings them to you free and postage prepaid. Write right now to me, Robert E. Oakes, Matchcorp of America, 3433 W. 48th Place, Dept. 1'M26 Chicago, Illinois 60632.

missed this amazing "Sleeper", make up for lost time. Get the money making Matchbook story now. A letter or postcard brings them to you free and postage prepaid. Write right now to me, Robert E. Oakes, Matchcorp of America, 3433 W. 48th Place, Dept. 1'M26 Chicago, Illinois 60632.

Start Your Own Profitable SERVICE BUSINESS with Minimum Investment



"Took in \$9000 Last Year in Sparetime"

A.I., Minnesota

Free Booklet Tells How!

If you're interested in a business of your own and are short on capital, this may be the opportunity you've been seeking. Here's your chance to get into the profitable rug cleaning service business. Free booklet tells all about



Foley CARE

Foley Care Dept. 202-6, 3333 Fifth St. N.E., Mpls., Minn. 55418

Please send Free "Business of Your Own" Booklet

Name.....

Address.....

City, State, Zip code.....

KENNEDY Gold Stamps

Fantastic New J.F. Kennedy memorial local set of 3 round gold foil coin-shaped stamps from Santa Island plus 48-page Stamp Dictionary—only 25¢!! Bargain approvals included.

STAMPEX CO.

Box 47-KM

White Plains, N.Y.



Kelsey Presses

Print Your Own

Cards, Stationery, Advertising, Circulars, labels, photo and movie titles, church work, tags, etc. Save money. Sold direct from factory only. Raised printing like engraving, too.

Own a Printing Business

Print for Others, Good Profit. Have home shop. Junior press \$15; Senior \$35 up. We supply everything. Easy rules. Pays for itself in short time. Write now for free details.

KELSEY PRESSES, Z-37 Meriden, Conn.

LAW FREE BOOK THE LAW TRAINED MAN

Write today for a FREE copy of illustrated law book, "THE LAW TRAINED MAN," which shows how to earn the professional Bachelor of Laws (LL.B.) degree through home study of the famous Blackstone Law Course. All necessary books and lessons provided. Moderate cost; convenient monthly terms. Write for FREE law training book today.

Blackstone School of Law, 307 N. Michigan Ave. Dept. 52, Chicago 51, Illinois

Founded 1890



HOW TO BREAK AND TRAIN HORSES

SEND FOR THIS FREE!

Make money. Know how to break and train horses or ponies. Write today for this book FREE, together with special offer of a course in Animal Breeding. If you are interested in Gaiting and Riding the saddle horse, check here (). Do it today—now.

BEERY SCHOOL OF HORSEMANSHIP Dept. 1102-D Pleasant Hill, Ohio

INSTALL BURGLAR ALARM SYSTEMS... BIG PROFIT HOME BUSINESS

PROFITS! Protect men's shop Gross Profit \$188 Protect Flooring Co. Gross Profit \$411

The burglar alarm service profits need more explanation. 100 clients pay \$8,000 to \$12,000 a yr. Get details.

Start spare time. No mechanical experience or costly equipment. Expert shows beginners way to big profits installing in stores, homes. Big demand. Write for FREE PLAN now. NASCO, 11071 Massachusetts, Dept. X252, Los Angeles 25, Calif.



FREE

MUSCLE BUILDING INFORMATION

Sensational New Isometrics Less Time—Less Effort—Better results BODY-TONE, Box 638, North Miami, Fla. 33161

BUY DIRECT • SAVE ON • TILLERS • TRACTORS

Full line of attachments for mowing, gardening, farming. Over 40 years experience. FREE CATALOG & PRICE LIST

8 and 12 H.P.

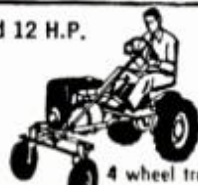

4 wheel tractors

RED-E TRACTOR CO.

4th Street, Richfield, Wis.



Build This Beautiful Grandfather Clock

We show you how at price you can afford. Send only \$1.00 for complete plans and instructions plus information-packed catalog of clock movements, dials, blueprints and kits for constructing Grandfather, Grandmother, Terry and other fine clocks.

MASON & SULLIVAN CO. DEPT. PM OSTERVILLE, MASS.

NEW RUBBER STAMP BUSINESS PAYS BEGINNERS UP TO \$16.50 AN HR. START AT HOME IN SPARE TIME

The multi-million dollar Rubber Stamp business—once controlled by a few big companies—is now being taken over by small operators—one in each community throughout the United States. Men and Women who have this inexpensive machine can turn out huge quantities of Rubber Stamps with special wording that buyers once were forced to buy from big cities. Material costing only 27c makes a stamp that sells for \$2.75. The machine that does the work is simple and easy to operate and it turns out as many as six Rubber Stamps at a time, each with different wording such as names, addresses, notices, stock numbers, prices and other "copy" needed by offices, factories and individuals. Working full capacity, it can earn as much as \$33.00 an hour for the operator! Now you can get into the big-pay business yourself, with your own home as headquarters. You don't need experience. We supply everything, including complete instructions and eight ways to get business coming in fast. We even help finance your start. Start making up to \$16.50 an hour from the very beginning. Cash in on the profitable Rubber Stamp business in your community, right away. We'll mail full particulars FREE and no salesman will call. Be first in your locality. Rush coupon or send your name on postcard now to:

**RUBBER STAMP DIV., Dept. R-2-BX
1512 Jarvis Ave. • Chicago, Illinois 60626**

THIS LITTLE TABLE TOP MACHINE
MAKES EVERYTHING SIMPLE & EASY



MAIL
THIS

RUBBER STAMP DIV. FREE!

1512 Jarvis Avenue Dept. R-2-BX, Chicago, Ill. 60626

Please rush full particulars about your financing plan and the little machine that can get me started in the profitable Rubber Stamp business at home in spare time. Everything you send me is FREE and no salesman will call.

Name _____
Address _____
City _____
State _____ Zip Code _____

A BUSINESS OF YOUR OWN REPAIR HYDRAULIC JACKS



Earn while you learn at home. Trained and qualified mechanics needed NOW to service inoperative hydraulic jacks. BIG opportunity for ambitious men. We show you HOW—in your basement or garage, spare time cash income in an expanding industry. Don't wait, ACT NOW! Get the facts.

Write for folder PM2 and free bonus offer

**HYDRAULIC JACK REPAIR MANUAL CO.
P. O. BOX 50 • BLOOMFIELD, N. J.**

ADVERTISING MEN NEEDED!

(No previous experience, writing or art ability necessary)

Advertising is booming—will increase 100% in the next decade. Train now for a profitable prestige career in this fascinating exciting field. Earn quickly—step into a well-paid job or start your own full or spare time business. Let professional advertising executives teach you step-by-step right in your own home. Diploma given. Send for FREE ADVERTISING CAREER KIT including illustrated Book, "Opportunities in Advertising," Job Opportunities Chart and full Home-Business Details—ALL FREE! Write: NORTH AMERICAN SCHOOL OF ADVERTISING, University Plaza, Campus Drive, Dept. 172, Newport, Calif. 92660.

TABLE-TOP CAR RACING



A Popular Mechanics book tells how the fun started . . . how you can build the scale model cars, realistic track and scenery . . . and how to race these free wheeling little cars in a wide variety of scale sizes.

It is all here including a list of manufacturers of parts and components. \$4.95 plus postage. Popular Mechanics Books, 575 Lexington Ave., New York, N.Y. 10022

ARE YOU MAKING ALL THE MONEY YOU CAN?

U.S. DEPT OF
LABOR CITES
IMMEDIATE NEED FOR
SKILLED TECHNICIANS

Prepare for the better paying jobs at the World's largest, most modern and best equipped Trade School. Greer's expert instruction and actual shop training teaches you how. Job placement aid and help in obtaining convenient living accommodations nearby. Resident training and Home Study courses. Over 100,000 successful graduates.

ACT
TODAY

CHECK JOB
YOU WANT
AND RUSH
THIS
COUPON

- | | |
|---|---|
| <input type="checkbox"/> AUTOMOTIVE MECHANICS | <input type="checkbox"/> ENGINEERING DRAWING* |
| <input type="checkbox"/> AUTOMATIC TRANSMISSIONS* | <input type="checkbox"/> BLUEPRINT READING* |
| <input type="checkbox"/> MOTOR TUNE UP* | <input type="checkbox"/> TWO YEAR AUTOMOTIVE |
| <input type="checkbox"/> BODY & FENDER REPAIR* | <input type="checkbox"/> AND DIESEL TECHNOLOGY* |
| <input type="checkbox"/> DIESEL MECHANICS | <input type="checkbox"/> TRUCK DRIVER TRAINING |
| <input type="checkbox"/> MACHINIST, TOOL & DIE* | <input type="checkbox"/> HEAVY EQUIPMENT |
| <input type="checkbox"/> REFRIGERATION & AIR | <input type="checkbox"/> OPERATORS |
| <input type="checkbox"/> CONDITIONING | <input type="checkbox"/> CONSTRUCTION |
| <input type="checkbox"/> GAS & ARC WELDING | <input type="checkbox"/> EQUIPMENT MECHANICS* |
| <input type="checkbox"/> HELIARC WELDING | |

NAME Age
ADDRESS
TOWN STATE

*Resident Courses Only. Resident Home Study

GREER TECH Est. 1902
INSTITUTE
Box 2236 S. Michigan Ave., Chicago, Ill. 60616

ARROW T-50
ALL PURPOSE
STAPLE GUN

HEAVY DUTY



Model T-50
\$12.50

OTHER MODELS FROM \$4.95

Uses 6 Staple Sizes — 1/4" to 9/16" and Ceiltite™

SHOOTS A STAPLE WHEREVER YOU'D DRIVE A NAIL!

FASTER! CHEAPER! BETTER!

for 1001 Home Improvement Fastening Jobs: Ceiling Tile, Insulating, Upholstering, Screening, etc.

Available at hardware, lumber, building supply, stationery and other retail outlets.

ARROW FASTENER CO., INC.
One Junius Street • Brooklyn 12, N. Y.

NOW! WARN OVERDRIVE gives 'Jeeps' more Go!



New approved accessory cuts engine RPM 33% at any speed, reduces noise, vibration so you can drive your Jeep 4-w.d. comfortably at freeway speeds. Amazing synchromesh OD lets you shift up or down, on the go, anytime, in any gear, at any speed. Adds six forward speeds, two reverse. At Jeep dealers, or write us.

WARN SALES CO., Inc.
9050-A Empire Way South
Seattle, Washington 98118

How can UNIMAT be exciting if it bores?



Simple. It also mills, drills, grinds, polishes and more. That's UNIMAT, a miniature machine shop that operates both as a precision lathe and multi-functional tool on metal, plastic and wood. Converts in just seconds. Only 17" long. UNIMAT has satisfied thousands of exacting hobbyists with its versatility and tool-room accuracy (up to .0005"). Performs like costly big equipment while taking up a minimum of space. No prior experience is necessary to use this valuable tool. The basic unit plus lots of extras sells for \$139.50. Send for free literature, or \$1.00 and get the whole story in 'Miniature Machining Techniques', a 40-page photo-packed manual.

Write: American-Edelstaal, Inc., Dept. GB-6, 350 Broadway, New York, N. Y. 10013.



LIQUIDATION SALE... ONLY \$3,995

ORIGINAL PRICE \$12,500



Food & Soft Ice Cream Mobile Unit

Publicly owned corp. offers (while supply lasts) 1-ton Chev. food and soft ice cream mobile units, completely reconditioned LIKE NEW. FULLY GUARANTEED. Highest quality restaurant equipment serving hamburgers, hot dogs, french fries and coffee, PLUS complete line of soft ice cream cones, sundaes, shakes, etc. No obsolete equipment. Replacement parts always available. This is a "Once-in-a-Lifetime" opportunity. Will finance with small down payment. Act promptly for best selection. Give phone No.

TASTEE - FREEZ, 1200 N. Homan, Chicago, Ill. 60651, Dept. PM

DRAINS collars, cisterns, wash tubs; **\$8.95**
IRRIGATES - CIRCULATES - SPRAYS



1,001 uses. Stainless shaft. Won't rust or clog! Use 1/8 HP motor or larger... 3/4 HP for up to 2,400 GPH; 450 GPH 80' high; or 1,800 GPH from 25' well. 1" inlet; 3/4" outlet. Coupling included free. \$8.95. **HEAVY DUTY BALL-BEARING PUMP.** Up to 5,200 GPH; or 3,000 GPH from 25' well. 1 1/2" inlet; 1" outlet. \$12.95. Postpaid if cash with order. **MONEY BACK GUARANTEE**

Centrifugal and Gear Pumps in All Sizes
LABAWCO PUMPS, Belle Mead 7, New Jersey

SCUFFED FLOORS? SEND FOR FREE SAMPLE



Removes heel marks, stains, adhesive from asphalt, vinyl, vinyl asbestos. Send name of hardware or linoleum dealer.

MY-RO TILE CLEANER & ADHESIVE REMOVER

MY-KO CHEMICAL CORP., Dept. PM
1736 N. Second St., Milwaukee, Wis. 53212

BASEMENT TOILET FLUSHES UP



TO OVERHEAD SEWER OR SEPTIC TANK.
NO DIGGING UP FLOORS. Write **McPHERSON, INC. BOX 15133 TAMPA, FLA.**

PUMP 6 GALLONS per MINUTE with your Electric Drill!

ALL YOU NEED IS A 1/4" DRILL!



Quick, easy liquid transfer for auto, industry, marine, home and farm. Change engine oil, gear box oil. Self-priming. Complete with 4 sizes of suction hose and all accessories.

MEREDITH DRILL PUMP
17 Combs Street, Cleveland, Mo. (Missouri) 64734

If you have a drill, you have a pump. **\$14.95** ppd.

LEARN TO EARN!



NO CORRESPONDENCE • NO HOME STUDY • CONTRACTOR OWNED • VA APPROVED

- Students train on the machines they will operate
- All training by fully qualified instructors
- Students live at the school
- Western's graduate students are readily accepted for employment
- Many courses of study are offered

WRITE TODAY FOR FREE SCHOOL CATALOG

WESTERN SCHOOL

OF HEAVY EQUIPMENT OPERATION

Associate member of Associated General Contractors and A.R.B.A.

BOX 510 • WEISER, IDAHO

Dept. M-19

NAME

ADDRESS

CITY STATE

PROFESSIONAL TAX CONSULTANTS

▶ EARN BIG MONEY FASTER ◀

Clean, dignified, high pay Tax Consultant Practice waiting for trained graduates. Busy tax season pays \$1,000 to \$3,000 for spare time work . . . leads to profitable year 'round Tax Service Business with monthly fees of up to \$50 per client. No previous experience. Low cost home training course, shows you the way. Licensed by N. Y. Education Dept. and Acctd. by Nat'l. Home Study Council. Write for FREE LITERATURE. No obligation. No salesmen.

NATIONAL TAX TRAINING SCHOOL, Monsey, K-20, N.Y.

Don't put up with bad-tasting water!

SEND FOR FREE 16 PAGE BOOKLET

You can eliminate excess chlorine, sulphur, other bad tastes or odors from home drinking water. Simple. Inexpensive. Write: Cuno Engineering Corporation, Meriden, Conn.

▼ CUNO® AQUA-PURE® filters



BILL TROUBLES?

NOBODY REFUSED UP TO \$9,000.00

BAD CREDIT • NO PROBLEM - NOT A LOAN CO.

SEND YOUR NAME FOR FREE APPLICATION

ATLANTIC ASSOCIATES - DEPT. 43

144 WESTMINSTER ST., PROVIDENCE 3, R. I.

New Portable LIGHT PLANTS

110-120 V. A. C. 1500 watts, 60 cycles. Weight 24 lbs. Size 10" x 5". Fanbelt driven from car, pickup or gas engine of 2½ or 3 h.p. Operates ½" Drills, Saws, T.V. Brand new. Money back guarantee. Regular \$89.50 now \$39.50. With switch, pully and voltmeter. Send check or money order.

VIRDEN PERMABILT CO.

Box 7066

Amarillo, Texas 79109

DRAFTING PAYS BIG MONEY



The need for skilled draftsmen is tremendous. Learn at home in your spare time. You can receive Christy's professional drafting training, portable drafting table, professional drafting instruments and equipment on PAY-LATER plan. FREE BOOK.

CHRISTY TRADES SCHOOL INC., Dept. D-8003
3214 West Lawrence, Chicago, Illinois 60625

FREE MUSCLE COURSE!

Trade in that skinny scrawny, milk toast or overweight body of yours for a new Weider Jet-Charged body, rippling with mountains of muscles loaded with energy, drive and virility, the envy of every man and admiration of every woman, now! In 15 minutes I'll prove you can slap on 4 inches of muscles to your chest,—3 inches to each arm—give you life-guard shoulders, trim your waist to athletic size—give you speedy athletic legs. I don't care if you're short or tall, (skinny or fat) young or not so young, expect a muscle building miracle when you send for my FREE course. Send only 25 cents to cover postage and handling and write to the Trainer of "Mr. Universe", "Mr. America", "Mr. Europe".

JOE WEIDER, Dept. 38-26D
531 32nd St., Union City, N. J.



YOUR OWN BIKE

\$119.50 to 179.50

Even Mom'll go for this one—costs less, runs for just pennies (nearly 100 miles on a gallon of gas). And it's American made! It's the popular CAMPUS BIKE!

Literature FREE • Parts Catalog \$1.00
Box 797PM • Janesville, Wis. 53546



FOX

300 POWER.....

Complete Telescope Lens Kit

only \$3.98

Conquer Space, Explore the Universe. Planets, Moon craters, New Stars etc. Complete Lens Kit consists of 80 inch focal length ground and polished objective lens, eyepiece lenses for 50 POWER, 100 POWER, 150 POWER, 200 POWER, 250 POWER, 300 POWER, and all necessary lens fittings. Easy to make from simple step by step instructions. (Tripod and mount not included.) Money back guarantee.

BUSSE SALES CO., Hartford, Conn., Dept. PM-88

Famous WITCH Automatic Needle Threader



25c SAMPLE (\$1 Retail)

Make up to \$10 an hour in your spare time just showing this amazing little invention that threads a needle simply by pressing a button. Show it to women (men, too) and watch them grab it out of your hands for only \$1.00. No sales experience needed. Introductory offer: Rush 25¢ for sample or \$3 for 1 doz. in 3-color store display carton, and money making facts, plus other self-selling moneymakers.

UNIQUE PRODUCTS, Dept. T-1462
216 W. Jackson Blvd., Chicago, Ill. 60606

CLASSIFIED ADVERTISEMENTS

Rate: \$1.40 per word payable in advance each insertion. Minimum insertion ten words. To be inserted under the proper classification, copy must be in our office by the 15th of the second month preceding date of issue. The next available issue to place an advertisement in America's No. 1 Classified Section is April. The closing date is February 15. Send remittance and order to C. A. Martin, Popular Mechanics, 575 Lexington Avenue, New York, New York 10022.

POPULAR MECHANICS

AUTOMOBILES, MIDGET CARS

1927 REO Fire truck. Original motor and body. Runs good. \$500.00. Contact City of La Harpe, Kansas.

AUTOMOBILE Literature, antique, classic, rare reprints. Non-profit hobby club. Free information. Enthusiasts, Box 451B, Mt. Clemens, Mich. 48043.

JEEPS! Broncos? 98 pages information on dealer costs. Cars—pickups—foreign—domestic—Gov't. surplus. Save hundreds. Only \$2. Auto Costs, Box 187, Abbottstown, Penna.

AUTO SUPPLIES AND EQUIPMENT

JEEP Owners—V8 conversions. Read Jeep Owners ad, page 67.

AUTO Welding repair training in world's largest non-profit welding school. Low tuition. Free booklet. Hobart Welding School, Box M-26, Troy, Ohio.

ANTIQUE Car pistons, gaskets, gears, valves, etc. Catalogue \$1.00. Antique Auto Parts, Milwaukee, Wisconsin 53204.

FOREIGN Car parts. Discounts. Catalog. Box 7, Elmont, N.Y.

CROSLY. New, used, parts. Discounts. Catalog. Box 7, Elmont, N.Y.

JUST Out! New 244-page auto parts, accessories catalog. Save up to 50% on over 100,000 items for all makes models of cars, trucks, foreign and sports cars. Model "A", "T" from 1909 thru 1966. Latest Hollywood accessories, custom and hi-speed equipment. Rush 25¢ for postage, handling—refundable on first order. Whitney, 1919-PM1, Archer, Chicago, Ill. 60616.

NEWLY Invented Snowmat gets your stuck car out of snow—no rolling—no throwing. Moneyback guarantee, \$1.50 postpaid. Box 617A, Franklin, Michigan.

SAVE \$150! Ring-valve job while driving, \$6.00 postpaid. Safe! Guaranteed! Many mechanics recommend. Motaloy, Grantham, Penna. 17027.

HYDRAULIC Jack repair kits and supplies. Catalog 35¢ (in coin). Hydraulic Jack Packing & Tool Co., P.O. Box 50, Bloomfield, N.J.

RADAR Sentry \$39.95. Free info. Young Sales, Box 41133, Sacramento, Calif. 95841.

JEEP Parts! For military and civilian. At great savings. Largest inventory. Catalog for owners and dealers. Inquiries invited. American Auto Parts Co., 1830-PM Locust, Kansas City, Mo.

AUTO TRAILERS

BUILD Inexpensive compact bus camper unit; Volkswagens, Econoliners, Dodge, ChevyVan, Literature. Dot Campers, Box 67M, Saugus, California.

PICKUP Camper, trailer or pickup-cover. Build yourself, save! Complete plans \$3.95 each. Bus conversion (and houseboat interiors) Drawings \$2.95. Equipment catalog, \$1.00 (refundable). Satisfaction Guaranteed. Details 10¢. Viking Camper Supply, 94-F Glenwood, Minneapolis, Minn. 55403.

BUILD Your pickup camper. Precut kits. Blueprints. Supplies. Literature, 10¢. Comstock Trailers, Dept. 664, Parsons, Kansas 67357.

BUILD Aluminum pickup camper over-cab, hi-boy, lo-boy, blueprints, material, list, 3 models included, \$3.00. Bennett Custom Camper, 1500 S. Dallas, Auburn, Indiana 46706.

BUILD And save hundreds. Pre-cut pickup camper kits, 6 ft. covers to 14 ft. self contained. Only handyman tools required. Complete plans \$3.95 each, drawings, \$2.95, catalog \$1.00 (refundable). Guaranteed. Details \$1.00. Complete financing available. King Camper and Supply, 1405P Mitchell Boulevard, Fort Worth, Texas.

ECONOLINE, Chevy, Van Box-A-Kamper blue prints, \$5.00. MWM, Route 1, Box 706, Mt. Olive, Alabama 35117.

BUILD Your own—save! Econoline camper plans, foldout trailer, or bus conversion drawings, including materials catalog, \$2.95 each. Guaranteed satisfaction. Catalog, \$1.00 (refundable). Details, dime. Campers, Box 263-F, Hopkins, Minn.

PRE-Cut pickup camper kits. Ready to assemble. Literature, 15¢. Snowy Mountain Campers, Lewistown, Montana.

MOTORCYCLES, BICYCLES, MOTORSCOOTERS AND SUPPLIES

RECONDITIONED Motorcycle motors. Large stock Indian Cushman Vespa Mustang NSU parts. Indian Motorcycle Sales, Kansas City, Missouri. 64127.

Kart Frame \$12. Three wheeled motor-scooter \$29. Vespa \$30. Sears Kart \$40. Hydroplane \$20. Snowmobile. Engines \$5 up. (Mailorder only.) Send 25¢ (35¢ for first class mailing) for directory-catalogue number 127 listing these and hundreds of other bargains, homebuilders parts, plans, etc. Midget Motors Directory, Athens, Ohio.

BUILD Motorbike from Bicycle! Plans, \$1.00: Go-Byc Industries, Rothsay, Minnesota 56579.

HARLEY-Davidsons — Used bargains. New, used parts, accessories, all models. Bulletin 25¢. Knuth's (Factory Dealer), 1753 Muskego, Milwaukee, Wis.

AVIATION

HOT Air balloon kit 10', \$4.00 pp. complete. U.S. Sportcraft, Box 847, Woodland Hills, California.

HOMEBUILT. Real enclosed helicopter, 24 pages ideas, information, \$2.00. Build "executive" helicopter, drawings, specifications, \$1.50. Helicopter Development, Box PM147, Washington, New Jersey.

PROPELLERS, Plans, kits, supplies for airboats, snowplanes, Gauges, spark plugs, gas-oil hose, oil coolers, primers, wrenches, switches, propeller hubs, engine mounts, Corvair-Volkswagon conversion parts, 125-190 Lycoming engines, manuals, gaskets, parts. Catalog, 50¢. Banks-Maxwell, Box 3301E, Ft. Worth, Texas 76105.

BE A Government licensed aviation mechanic. Practical training. Free information. Aero Mechanics School, Municipal Airport, Kansas City 16, Missouri.

BOATS

BUILD Your own boat from our large-scale blueprints. Books of plans give how-to-build help. Hundreds of professional designs—motor, sail or auxiliary—for amateur builders. Free catalog. MoToR Boat-ing, 959 Eighth Ave., Dept. RS, New York 19, N. Y.

WORLD'S Finest boat kits! Frame kits! Models from 8' to 24'. Prams—skiffs—runabouts—cruisers. All leaders in styling and performance. Send 50¢ for catalog, \$1.00 for catalog plus boat building handbook. Custom Boat Designs, 1709-P Niagara Street, Buffalo, New York 14207.

BOAT Plans, world's largest selection. Frame kits and full size paper patterns. Designed for the amateur. Over 200 proven designs from all over the world. Fishing boats—cruisers—sailing—inboard and outboard hydroplanes. Send \$1.50 for catalog, \$2.00 for catalog plus boat building handbook. Custom Boat Designs, 1709-P Niagara Street, Buffalo, New York 14207.

BOAT Kits. Factory molded fiberglass or pre-assembled plywood. 50 models, 12' to 40'. Runabouts, Cruisers, Houseboats. Free catalog. Luger, Dept. BC-66, 9200 Access Road, Minneapolis, Minnesota 55431.

FIBERGLASS Canoes. Three exciting models. Easily assembled kits, \$34.95 up (factory direct). Free literature. Riverside Canoes, 5816 Victoria Ave., Riverside, Calif.

SAILS—U.S. dacrons, quality, economy, satisfaction. Bowen, 12 Jackmuir, Scarborough, Ontario, Canada.

BOAT Plans, frame kits, full size patterns all prepared specially for amateurs. Send 50¢ for new catalog illustrating 55 proven designs including sail, inboards and outboards from 7' to 28'. Glen Designs, 9152 Rosecrans, Bellflower, Calif.

BETTER Bonding dnyel fabric for lamination. Send for brochure. Noone Fabrics, 1495 Westport Turnpike, Westport, Conn. 06883.

FULL Size, cut-to-shape boat patterns, blueprints. Send .50¢ for big new illustrated "Build a Boat" catalog includes fishing boats, garrives, cruisers, catamarans, houseboats—outboards, inboards, sailboats—7½ to 38'. "How to Build a Boat" booklet, \$2.50. Cleveland Boat Blueprint Co., Box 18250, Cleveland, Ohio.

FREE Plans catalogue—kayaks, canoes, sailing rigs, accessories. Bruce Clark, PM, 115 McGavock Pike, Nashville, Tenn. 37214.

WATER Ski blanks. Solid ash. Design your own. Postpaid. \$9.95, two \$18.95. Mission Bay Skis, Box 15263, San Diego, Calif. 92115.

205 **BOAT** Plans, patterns, kits, catalogs. Powerboat, large \$1.00, condensed 50¢. Sailboat 40¢. Marinecraft, Box 161-M, Brighton, Mass. 02135.

FIBERGLASS Cloth and resin. World's finest cloth and non-run resin, at direct mill prices. Flotation foam. Complete line of plastics, silicon bronze and brass screws, save 60%. No sales tax. Boat Plans. Free catalogue. Freight prepaid. Stiles Boat Supply, Box 11P, Linden Ave., Mantua Hts., N.J.

KAYAKS—One man \$16.50; two-man \$22.50; sailboat \$39.00. Exciting Sitka Kayak kits known world wide for speed and safety. Assembled in one afternoon. Free pictorial literature. Box 78-P, Brecksville, Ohio 44141.

MARINE EQUIPMENT AND SERVICES

KITS—Build your own inboard engine from Chevrolet, Ford, etc. Big catalog shows how, 50¢. Star Marine, Berkeley 10, California.

MARINE Conversions. Ford, Chevrolet, Jeep engines. Catalog 25¢. Lehman Manufacturing Company, 800 Elizabeth Avenue, Linden 4, N.J.

FIBERGLASS Boat covering. Wholesale prices. Free literature and sample. Seifert's, Box 1206-M, Green Bay, Wis.

NEW, Used, rebuilt marine motors. Marine conversions, fittings. Free catalog. Stokes Marine Supply, Dept. 24, Coldwater, Michigan.

ATHLETIC AND BODY BUILDING COURSES

"**GIANT** Arms." Dr. Young's, D.C. revolutionary discovery. \$2. Satisfaction or refund. Gaucho, Box 9309-S7, Chicago 90.

WEIGHT Exercising Equipment, free literature. Jubinville, Box 622, Holyoke, Mass.

WEIGHTLIFTERS. Adjustable super deluxe power stands, \$18.85, F.O.B., C. Walsh, 13 Driscoll Ave., Maynard, Mass.

INCREASE Your power. Broad shoulders. Big arms. Piston legs. Same methods used in luxury gyms charging hundreds of dollars. Receive in plain wrapper. Charts, photos, instructions. Only \$5 postpaid. No C.O.D. Make payable to: LBA, Box 452, Teaneck, N.J.

BAR BELLS. Exercise equipment, key to health, strength, physique, 25¢. Reading Barbell Co., West Reading, Pa.

POWERFUL Muscles fast! Free brochure! Universal, Box 4327-C, Northeastern, Dearborn, Michigan 48126.

SPORTING GOODS AND EQUIPMENT

SILENCERS: Pistol, rifle details. Simpler, cheaper! New design for .22s, \$1.00. Twin Enterprises, Box 192, Dunellen, New Jersey 08812.

BIG Money raising crickets and 12 inch African fishworms. Free literature. Carter Ranch, Plains, Georgia.

FREE Wingshooter's handbook. New helpful facts on shotgun shooting, shotgun chokes and how to save ammunition. Write to Poly-Choke Co., Dept. 245C, Hartford, Conn. 06101.



FISHING, TACKLE, LURES

MOLDS For fisherman's sinkers, jigs, squids, casting and spinning lures. Free catalog. Sweet's Molds, Tonawanda 1, New York.

MOLDS For casting your own fishing sinkers. Free illustrated booklet. Reading Instrument Co., Box PM78, Reading, Penna.

"**NEW!** New! Transistorized pocket size fish call for guaranteed record catches." Free details. TR-Fish Call, P.O. Box 144, Kearny, N.J.

FREE . . . Wholesale catalog. Beads, Spinners, Lure parts, Sinkers, jigs, Reels, Finny sports (ME), Toledo, Ohio 43614.

EARTHWORMS, LIVE BAIT

EARN Money raising fishworms for us! Exciting details free! Oakhaven—56, Cedar Hill, Texas.

MEN!—Women! Make money raising Bait for us at home. Wigglers, Warsaw 45, Indiana 46580.

REDWORMS. Tough, lively, handpicked. 2500—\$5.00, 5000—\$8.50, 10,000—\$15.00. Postpaid. Live count guaranteed. Hall Farm, Hilton, Georgia 31758.

SUCCESS For you! Raise fishworms and crickets. Write for free literature and our success story in Life Magazine. Let us teach you our secrets of success. Hybrid redworms 3000, \$5.95. Carter Redworms, Plains, Georgia.

HYBRID Redworms 1000—\$3.00, 3000—\$5.75, 5000—\$8.00, 10,000—\$14.00. Bedruns 20,000—\$20.00. Postpaid with raising instructions. Brazos Worm Farms, Route 9, Waco, Texas.

NO Digging or breeding worms anytime. Copyrighted instructions \$1.00 and addressed stamped envelope. Ehlert, Box 751, Warwick, R.I. 02888.

RED Wigglers: Select breeders or fishing size \$3.50—1,000; \$14.25—5,000; bed-run \$9.95—10,000. Postpaid. Free folder "Growing Fishbait." Fain's Bait Farm, Box 56C, Fdison, Georgia.

FROGS, FISH, REPTILES

FROG Raising. Young frogs and ziant breeders. Stock your lakes, pond. Nu-Tex Frog Farm, Box 4029, Corpus Christi, Texas.

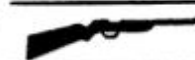

HUNTING, GUNS, DECOYS

YOUR Ad in this space will be read by more than 1,400,000 active mail order buyers. Join the march to greater profits, place your products and services in front of them today with a small low cost classified ad. For further details, write: C. A. Martin, Dept. 13N, Popular Mechanics, 575 Lexington Avenue, New York, New York 10022.



DOGS AND KENNELS

TELL The more than 1,400,000 avid readers of Popular Mechanics about your products and services. It costs very little to place your classified message in front of these proven mail order buyers. For further details, write: C. A. Martin, Dept. 14N, Popular Mechanics, 575 Lexington Avenue, New York, New York 10022.



GAME BIRDS

YOUR Ad in this space will be read by more than 1,400,000 active mail order buyers. Join the march to greater profits, place your products and services in front of them today with a small low cost classified ad. For further details, write: C. A. Martin, Dept. 15N, Popular Mechanics, 575 Lexington Avenue, New York, New York 10022.

RABBITS—FUR BEARING ANIMALS

RAISE Rabbits on \$500 month plan. Free details. White's Rabbitry, Mt. Vernon, Ohio.

MINK Raising information free. Lake Superior Mink Farm, Inc., Superior EE1, Wisconsin.

EARN \$10,000 Yearly raising Angora rabbit wool for us. Information 25¢ coin. American Angora Company, Malta 12, Montana.

RAISE Rabbits successfully by knowing facts. 48 page illustrated book describing 25 breeds. Housing, breeding, feeding, markets, marketing etc. 25 cents. American Rabbit Association, 36 Arba Building, Pittsburgh, Penn.

PETS—BIRDS, CATS, HAMSTERS, ETC.

MAKE Money raising chinchillas, mink, rabbits, covies for us. Free catalog. Keeney Brothers, New Freedom 2, Penna.

PETS. Hamsters, mice, monkeys, squirrels, chipmunks, guinea pigs, skunks, raccoons. Picture catalog twenty-five cents. Moore's Hamster Ranch, Shepherdstown 25, West Virginia.

HAWKS, Reptiles, raccoons, skunks, squirrels. Catalogue 25¢. Trails End Zoo, St. Stephens, S.C.

MONKEYS \$10.00. Up. Mammals, birds, reptiles. Confidential wholesale list \$1.00. Dale Logston, Box 682, Saint Joseph, Missouri 64502.

LIVE Seahorses, marine specimens, aquarium supplies. Illustrated catalog 15¢. Marine, Box 248-110, Dania, Florida.

CAMPING EQUIPMENT AND TENTS

CAMPER Jacks, guaranteed fit any camper, \$57.45. Free literature. Mail Order Manufacturing, Box 851E, Spokane, Washington 99210.

CAMPING Equipment, tents, sleeping bags, air mattresses, packs, trailer awnings, dining canopies, axes, knives, lanterns, stoves, refrigerators, compact camp furniture, dehydrated food, toilets, nested cook sets, poles, stakes. Every camping accessory imaginable. Free 100 page catalog. Morsan, 810R Route 17, Paramus, New Jersey.

TRAVEL AND RESORTS

NEWS Of Boating, Fishing, Vacations, Campers on South Carolina's Grand Strand in "Hog Island Beach News" column. Come visit us before you retire. 10 issues \$1.00. SWCYC, Route 1, Box 428, Ocean Drive Beach, S.C. 29582.

ELECTRICAL SUPPLIES

LAMP. Electrical parts, wholesale. Thousands of items for repairing, converting. Catalog 35¢. Brown Lamp, Box 305, Clayton 5, Missouri.

LAMP Parts. Catalog, prices, wiring instructions. 50¢. Refunded first order. Gyro, 5208P N.W. 35 Ave., Miami 42, Fla.

PARTS For refrigerators, freezers, washers, dryers, ranges, oil burners, etc. Mail-order Parts, 117 Broadway, Hicksville, N.Y.

METERS—Surplus, new, used, panel and portable. Send for list. Hanchett, Box 5577, Riverside, Calif.

BATTERIES, GENERATORS

DOUBLE And strengthen life auto, truck, golf car batteries guaranteed. A. & G. Equipment Co., Mayville, Wis.

COMPLETE Rebuilding Manuals! Batteries \$3.00. Hydraulic jacks \$3.00. C.O.D. accepted. Bayer Publications, 938 Betty Avenue, Neenah, Wisconsin.

DIESEL & gasoline powered electric generator sets. 10-KW to 60-KW, 110-220 volts, 60 cycle, excellent condition government surplus. K. A. Weimer, 2300 Richard Road, Decatur, Georgia 30032.

BATTERY Reconditioning kit, includes molds, material, complete instructions. The Battery Shop, P.O. Box 416, Palm Desert, Calif.

ENGINES, MOTORS, DYNAMOS

REWIND Motors yourself. Complete instructions. \$1.00. Lewis Manufacturing, Howell, Michigan.

DIESEL Injector parts and fuel pumps wanted. GM51-53-71-110. Bares, 2093 East 19 Street, Cleveland 15, Ohio.

REWIND Electric motors! Details free! Modern, Box 10025, Kansas City, Mo. 64111.

MOTORS, Large quantity surplus small motors, various sized wheels, sprockets, differentials, etc., bargain prices, write for list. EMI, P.O. Box 8301, Memphis, Tenn.

WINDING Data. 275 motors, single and three phase \$1.10. Data Company, 512 Kensington, Kansas City 24, Mo.

MACHINERY, TOOLS AND SUPPLIES

STANLEY, Millers Falls, Skil, Daston, Wiss, Plumb, Channellock, Bonney, Herbrand, Ridgid, and hundreds of other nationally advertised brands at prices hard to beat. Send 25¢ for our big tool catalog today! Silvo Hardware, 107PM Walnut, Phila. 6, Penna.

BRONZE, Aluminum foundries, 5 sizes. Free information. Pyramid Products, Box 65, Fayetteville, Arkansas.

PAT. 3191.471 Lathe toolholder. Does everything. Box 387, Benicia, Calif.

FACTORY Prices! Brand new, first quality, fully guaranteed saw chain low as \$10.00; hardnose bars from \$14.00. Big savings on parts, accessories for all makes of chain saws. Free catalog. Zip-Penn, Box 179NB, Erie, Pennsylvania 16512.

"RAFTERULE" Solves any rafter cutting problem. Free literature. Emmert, Sycamore, Illinois 60178.

MACHINISTS, Toolmakers chests, Circular free. Cepuder, 4715 Spencer, Lisle, Ill.

MAGNETIC Chuck V blocks & parallels, edge finders, center finders, thread measuring wires, sine bars, Hi-precision—first quality—low prices. Factory distributors wanted. Be the dealer in your locality. Buy for yourself and sell to others. Liberal discount, products guaranteed. Est. 1943. Write for brochures. Fisher Machine, 11704 Inglewood, Hawthorne, Calif.

"SMALL Shop Supplies." Production—hobby. Machinist Tools, 1424 Barclay, Springfield, Ohio 45505.

WELDING, SOLDERING, PLATING

CHROME Plating equipment, supplies. All other finishes. Home workshop and production sizes. Send \$1.00 (refundable) for formulas, operating data, equipment guide and catalog. HBS Equipment Division L50, 3543 East 16th, Los Angeles, Calif. 90023.

WELDERS, 150 Amperes. \$49.50. Paul Morris, 1070 Inner, Schenectady, N.Y. 12303.

GOVERNMENT SURPLUS

JEEPS Have sold low as \$53.90 from U.S. Surplus. Bidders information and our over 400 item (order by mail) Surplus catalog, \$1.00. Quality Surplus, 422 (PM-2) Washington Building, Washington, D.C.

CHEEP Jeeps. Buy from Gov't. Full information, 25¢. Box 789PMTF, York, Penna.

JEEPS—Jeeps—jeeps. Direct from Government. Directory and our over 400 item (order by mail) surplus catalog, \$1.00. Quality Surplus, Dept. PM-2, 2646 W. Michigan, Indianapolis, Indiana.

GOVERNMENT Lands . . . low as \$1.00 acre. Millions acres! For exclusive copyrighted report . . . plus "Land Opportunity Digest" listing lands available throughout U.S., send \$1.00. Satisfaction guaranteed! Land Disposal, 2230-RN Wisconsin Avenue, Washington, D.C. 20007.

GOV'T. Surplus. How and where to buy in your area. Send \$1.00. Surplus Information, Headquarters Building, P.M., Washington 6, D.C.

JEEPS From \$52.50. Typewriters from \$4.15. Cars from \$31.50. Walkie-Talkies; Guns, Airplanes, Boats. Typical "As Is" bid bargains from Uncle Sam. Tremendous Variety. Exciting free list. Write: Enterprises, Box 402-X7, Jamaica, New York 11430.

JEEPS Typically from \$53.90 . . . trucks from \$78.40 . . . boats, typewriters, airplanes, sporting equipment, used. 100,000 bargains direct from Government nationwide. Complete sales directory and surplus catalog, \$1.00. Deductible first \$10.00 order. Surplus Service, Box 820-A, Holland, Michigan 49424.

GIANT Directory: How and where to buy Government surplus bargains at unbelievable savings. Plus free booklet: "How To Import At Tremendous Profits." Send \$1.00; Suttco, 2258-C Hepburn, Dayton, Ohio 45406.

GOVERNMENT Surplus sales directory . . . How and where to buy in your area! Send \$1.00. Surplus Guide, 2230-PB Wisconsin, Washington, D.C. 20007.

JEEPS Being sold at bargain Prices by Government. For latest information Regarding only 2 Sale Centers still open, send 25¢ to Government Surplus Jeeps, Box 177PM2, Abbottstown, Penna.

HOBBIES AND COLLECTIONS

50 JUNGLE butterflies \$2.00. Giant nature hobbies catalog 25¢. Collectors Wonderland, Box 1170, New York 8.

MATCHBOOK Covers—110 unused, all different, \$1.00. List 10¢. Harold Hamilton, 7150 South Cyril, Chicago, Illinois 60649.

INTRODUCTORY Five military emblems and illustrated catalog, 25¢; Foreign Medal, 50¢; 10 Military decals 25¢. Hobbies, Box 71-S, Rockaway 94, New York.

\$100.00 COMIC Books! We pay big money for comics listed in The Comic Book Price Guide. Over 5000 back issues priced. 25¢—\$100.00. Was \$5.00. Now \$1.98! Argosy Books, 1643A North Las Palmas, Hollywood 28, California.

EXCITING Fun. "Go Fly A Space-Bird" cloth kite. Free catalog. Kite Creations, 780-M State, New Haven, Conn. 06502.



STAMP COLLECTING

40,000 DIFFERENT. Amazing new plan builds your collection systematically, country by country. As low as 50¢ weekly. Ware, Monroe 75, Conn.

MILLION Foreign stamps! 2¢ each! Send for thrilling, giant approvals! ABC Stamps, Box 6000-MB, San Francisco 1, Calif.

FREE Surprise collection sent with approvals. Gould, 1784 Union, San Francisco 94123.

105 DIFFERENT U.S. Stamps, 25¢, approvals included. Shelron, Box 187, Hempstead, N.Y.

BREATHTAKING. 50 Mint Monaco pictorials, multicolors. \$1.00. Approvals, Stamp Exchange, Box 103, Fairfield, California.

50 YEARS Old, fifteen different United States, over fifty years old—10¢ with approvals. Jaxon, Box 145-P, Brooklyn, New York 11230.

PENNY Foreign stamps neatly mounted in jumbo books in Scott order. Bullot Approval, 1454 Coney Is. Ave., Brooklyn 30, New York.

"INVERTED Error," Dag Hammarskjold 5¢ with Approvals. Belmont Stamps, Washington, D. C. 20015.

RUSSIAN Space set 10¢. Russian approvals. Snedco, Box 68-P, Waldwick, N.J.

50 DIFFERENT Old U.S. Revenue stamps 50¢. Winchester stamps, Box 1592, Mansfield, Ohio 44907.

FIPEX, Tipex, Cipex, Ashville. Four miniature sheets used for \$1.00 if you ask for our bargain priced U.S. approvals. Triboro, 38 Park Row, New York, New York 10038.

133 DIFFERENT Colorful stamps 10¢, approvals. Krehl, 1708 Nebraska, Orlando, Florida.

FREE! Congo triangle set! Boy Scout beauty! 25 others, different. Approvals, Cambridge, Box 411, Cambridge, Ohio.

100 OLD United States between 1861 and 1935. \$1.00. Roush Stamps, 51 Chestnut, Mansfield, Ohio.

225 STAMPS For only 10¢! This mammoth value includes airmails, pictorials; stamps from strange countries cataloging up to 25¢ each! Also approvals. Mystic Stamp Company, Camden 80, New York.

SELL Your surplus good grade stamps. Write, describing fully what you have. Vanroy Shirk, Lebanon, Pennsylvania.

500 DIFFERENT Stamps, \$1.00. Smith, 508-A Brooks, College Station, Texas.

PENNY Stamps! 1000 Mounted in book at 1¢ each. Trust Stamp Company, P.O.B. 132-P, Jamaica, N.Y. 11435.

ONE Pound value Geo. VI Bermuda, plus 100 worldwide 10¢, approvals. Stevens, Box 105A, Homecrest Sta., Brooklyn 29, N.Y.

60 DIFFERENT U.S. (30 commemorative) 25¢. No approvals. Seidenberg, Salem 169, Oregon.

ABSOLUTELY Free 50 worldwide. Request inexpensive approvals. University Stamps, P.O. Box 326, Pompano Beach, Florida 33061.

AMAZING OFFER! 200 United States stamps—including commemoratives, airmails, high denominations to \$1.00. Only 10¢ to approval applicants! Illustrated bargain lists free. Mystic Stamp Co., Dept. 80, Camden, New York.

PENNY! Approvals! Regardless catalogue! Kloster, 4164 52nd St., San Diego 5, Calif.

64 PAGE U.S. and U.N. catalog free. Stone, 260 Washington, Boston 8, Mass.

FREE Stamp wallet with approvals. Wide selection collections by countries. Clark, Box 28-C, Wilmette, Illinois.

FREE Sample. Interesting, illustrated, informative National Stamp News, Anderson, South Carolina 29622.

INTRODUCING Our better United States approvals we offer 15 United States stamps including Columbian, Bi-Centennials, famous American, airs, others: only 10¢. Ocean Stamps, Box 64-PM, Brooklyn 29, New York.

1025 DIFFERENT, \$1.30 with approvals. Klondike, 682 Jefferson, Elgin, Illinois.

FREE Monaco nudes, Approvals, Stamp Ranch, 902 Addison, Chicago 13, Ill.

10 U.S. over sixty years old, 10¢. Robert Gallup, Albany, New York 12201.

UNITED States commemorative collection containing 33 different—10¢. Approvals, White, 516-A Avenue L, Brooklyn 30, New York.

UNITED STATES price list, 132 pages, price 30¢. Mark Hanna, 335 Fifth Ave., Pittsburgh 22, Pa.

DEFECTIVE, Old U.S., 1/5 Scott, Swarz, Box 373, Venice, Fla.

ATTRACTIVE—Mint Indonesian pictorials, plus bargain catalogue featuring U.S. stamps, packets, accessories, 10¢ with approvals, Bydahl, Box 1293-MB, Seattle, Washington 98111.

121 DIFFERENT Flag stamps free. Approvals, W-B Stamps, Wilkes-Barre, Pa.

1500 FOREIGN \$1.00, 5000 \$3.00, 5000 USA—commemoratives, airmails, high values, revenues, 19th Century, etc. \$3.00. No approvals, Meyers, 5321 Fleming, Richmond, California.

TEN Different nudes, 20¢, Approvals, Stamp Farm, 2M7, Oxford, Wisconsin 53952.

U.S. Mint specials! Flag set, complete \$1.00, 1¢, 2¢, 3¢ famous Americans (21 different) \$1.00. Free list, Brooks, 2601 Avenue "U", Brooklyn 29, N.Y.

FREE—World's greatest premium—5000 all different stamps, actual catalogue value over \$100.00 given approval buyers, Thrifty Stamps, Grossmont, Calif. 92030.

FREE 50 World wide plus Congo, Niger, Somalia, Mauritania. To approval applicants, Elkey Stamps, 210M Jewett Ave., Jersey City, N.J. 07304.

STAMP Collecting outfit, includes worldwide stamps, nine triangles, two diamonds, New African Nations, Topicals, package hinges, millimeter-perforation gauge. Everything, 25¢ with approvals, Lorraine Brown, Marion, Michigan 49665.

U.S. STAMPS, Giant discount catalog, 25¢, Raymax, 37-VR Maiden Lane, NYC 38.

230 DIFFERENT U.S. commemoratives, \$1.00 approvals, H. Holub, 18 East 198th Street, Bronx, N.Y. 10468.

"ERROR"—1935 United States Farley, 10¢ with approvals, Potomac Stamps, Washington, D.C. 20015.

315 DIFFERENT Worldwide stamps, including multi-color John F. Kennedy Memorial issue of Columbia, Russian space set, Communist propaganda, rockets, colorful big pictorials, high values, air mails, etc. Only 25¢. Other attractive stamps for sale on approval included, Capital Enterprises, P.O. Box 1914-PMA, Washington, D.C. 20013.

235 DIFFERENT U.S. commemoratives \$1.00, Approvals, Gordon Davison, Heniker, New Hamp. 03242.

U.S. Approvals, Low prices, Eagle, 2221 Romine Ave., Pittsburgh 26, Pa.

100 DIFFERENT Canada, 25¢ with approvals, Riverside Stamps, Box 1044, Riverside, California.

PENNY Approvals, large selection, Premiums with purchases, Penny Stamps, Orange, California 92669.

FREE! 222 Worldwide, 25¢ handling, Penny Approvals, Jung, 1601 North Stanley, Los Angeles 90046.

ISRAEL—Special value collection, 100 different Israel stamps, regular price \$3.00, yours for only \$1.00 while they last with approvals, Cornetta, P.O. Box 367, Olympia, Miami, Florida 33165.

12,000 PENNY Approvals waiting for you. Many from exotic countries, pictorials, airmails, new issues, Tilbury, Box 862, Newark 1, N.J.

FREE 20 different U.S. with approvals, Collier, Box 265, Chamblee, Ga. 30005.

CHINA, 25 Different 10¢, to buyers our foreign approvals, West Coast, Dept. "C", 1609 South Park, Santa Ana, California.

GERMAN Commemoratives, 10¢ with approvals, Schaefer, Box 1704, Washington 13, D. C.

FREE 50 Turkey, 25 Persia plus Kennedy Memorial, 10¢ handling, Approvals, Berchtold Stamps, Troy, Ohio.

THOUSANDS Of worldwide sets and singles on approval, Highest quality! Cole, Box 223A, Buffalo, N.Y. 14221.

105 SURPRISE Stamps and gift coupons with approvals 10¢, Trio Stamps, Box 1806-FM, New York, N.Y. 10017.

FREE—Mammoth collection, \$10,000 airmail, world's smallest stamp, Scott's International, master global albums given approval buyers, Bargain stamps, Tustin, California.

225 DIFFERENT U. S. Commemoratives, \$1.00, Rockefeller, 40 W. Market, Red Hook, N.Y. 12571.

12 HITLERS, Mint, 10¢, Approvals, Gallerys, Box 35291, Los Angeles, California 90035.

FREE! "Mystery" stamp packet, Premiums, Approvals, Dancer, 75-P62, Mansfield, Ohio.

FIRST Day cover approvals! Included free, valuable airmail cover, Myers, Coopersburg, Penna.

WOW! 110 All different Germany 10¢ Commemoratives, Airmails, high values, big catalog, bargain lists plus selections of fine stamps from our approval service, returnable without obligation, Jamestown Stamp, Dept. A26PM, Jamestown, N.Y. 14701.

FREE! Big bargain catalog—new edition listing thousands of bargains including U.S. & B.N.A. stamps, packets, albums, accessories and supplies. Plus selections of fine stamps from our approval service, returnable without obligation, Jamestown Stamp, Dept. E26PM, Jamestown, N.Y. 14701.

WORLD'S Most rare stamp—British Guiana =13. We do not have it but can furnish a facsimile for 10¢ to approval applicants, Capital Stamps, 2G, Ferrysburg, Mich. 49409.

QUEEN Elizabeth on stamps—A beautiful collection of 50 different stamps from 22 countries—all bearing the portrait of the Queen of England, 10¢ with approvals, Roseland Stamps, Spring Lake, 2C, Michigan.

BEAUTIFUL Topical collection includes olympic sports stamps, wild animals, bicolor triangles, colorful birds, outer space stamps, Poland kitten stamp and others, 10¢ with approvals, Sunny Stamps, Fruitport 2B, Michigan.

WOW! 1000 Different worldwide—valued over \$20.00 only \$1.00 with quality approvals, Universal, Box 6, Kenosha 5, Wisconsin 53141.

FREE! Complete Finland set, Ethiopia set, 26 Bavarian stamps; to those requesting approvals, W. Cleaveland, 806 North Humphrey, Oak Park, Illinois 60302.

SURPRISE Collection! Exotic mint British Colonials, absolutely free with approvals, Viking, Great Neck 8, N.Y.

VALUABLE Collectors' Items! John F. Kennedy commemorative envelope bearing portrait of famous President and highly-prized First Day Cancellation on his 47th birthday. Plus Assassination anniversary cover postmarked officially with scarce November 22nd Dallas, Texas Cancellation! As an introduction to the world's most rewarding hobby—rush 25¢ for both historic Memorial Treasures. We'll also send fine stamps from our approval service returnable without obligation—plus Free collectors' catalog and new offers of JFK stamp issues just released! Kenmore Stamp Co., Milford KP-931, New Hamp.

SPACE Collection and 200 different only \$1.00, Tiquet, Box 1496, Denver 1, Colorado.

100s' OF Stamps free !!! Empire Stamp Agency, 4048 Cabrillo, San Francisco, California.

CANADA: 1950, 50¢ oil well free with approvals, Add 10¢ handling, Lewis Stamp Co., 360 Pundy Drive, Lancaster, New Brunswick, Canada.

CANADA 50 Different including dollar totem 10¢ to approval applicants, Maritime, Box 662, Saint John, N.B.

50 DIFFERENT U.S. Commemoratives 25¢, No approvals, Earl Mills, Box 272-K, Auburn, Mass. 01501.

USA Mint flags Army, Navy C42-C44, All \$2.00, Cooper, Box 3751, Oak Park, Mich. 48237.

SENSATIONAL Clearance, Ten different packets only 25¢, Norge, Ho-Ho-Kus, N.J.

10 DIFFERENT Canal Zone 25¢, Approvals, Merkel, 30 Grandview, South Harley, Mass.

KENNEDY, Winston Churchill, Eleanor Roosevelt, Pope Paul stamps, 10¢, Approvals, Miller, Box 600F, Palo Alto, California.

CANADA: Outdoor Recreation set, 40¢ value, only 10¢, Approvals, Rheume, 6591 11th Ave., Montreal 36, Canada.

BRITISH Colonies 50 different, 5¢ approvals, Hijop, Box 505, Norristown, Pa. 19404.

FREE Mint set, Approvals accompany, Stamps, Box 22092, Memphis, Tennessee 38122.

SENSATIONAL Free offer: 20 different outer space stamps, Selected approvals, Louis Morrison, Folsom, Pa. 19033.

ROMANIA, Latest gigantic bicolor "Hunting Dogs" commemoratives plus 101 bonus sets—free! Approvals, William Deems, 226X Race, Ravenswood, West Virginia 26164.

ATTRACTIVE Triangle set free! Request approvals, Cutlass, Box 235P, Chicago 60645.

FREE 1966 U. S. list, mint =704-15 \$4, =740-9 \$2.10, =859-99 \$6, =909-21 \$1, Simmy & Co., 40 Court St., Boston, Mass.

COMMEMORATIVE United States stamps, better grade, 100 different only \$1.00; 200 different \$2.00; 300 all different only \$4.00, a fine starting collection, George Gregory, Box 156-M, Petoskey, Michigan 49770.

1500 WORLDWIDE—\$1.00—Bargain list, 25¢, Steele, Box 242-PM, Colorado Springs, Colorado 80901.

FIVE Different grab bags! Dollar bill, Bargain list, Satisfaction guaranteed, Stamp Service, 1498-05, Huntsville, Ontario, Canada.

COLORFUL Bird set free! Approvals, Gorliz, Drawer 388PM, Park Ridge, Illinois.

VALUABLE Stamps free! A special opportunity to get a package containing valuable and unusual stamps all fine mint, free. Send 10¢ for mailing, Marks Stamp Co., Dept. PM, Toronto, Canada.

STAMPS Free! New issues, new countries, triangles, rockets, Olympics, Scouts, birds, flowers, animals. Also old Canadian and U.S. stamps. Plus complete illustrated Canadian stamp catalog. Send 10¢ for mailing, Gray Stamp Co., Dept. PM, Toronto, Canada.

HAUTE-Volta, Dahomey, Chad, Mauritania, Cameroun, San Marino, Togo, French Polynesia, Paraguay, Turkey, Guaranteed 4 different, 25¢ and stamped envelope, No approvals, Mala Company, P.O. Box 218, Kingsbridge Station, New York 10463.

U.S. Bargain, 50 different 10¢, with beautiful worldwide approvals, Stamps, Kennebunk, Maine.

COINS, TOKENS, CURRENCY

RARE Silver Dollars, 1879, 80, 81 S mint \$3.00 ea. Uncirculated, New Catalogue, 50¢; Shultz, Salt Lake, Utah 84110.

25 BEAUTIFUL Coins from 25 countries. Mostly uncirculated, Terrific assortment, \$1.00 Hindley, Box 708, Aurora, Illinois. 60507

LARGEST Coin magazine. 288 pages. 50¢. Scrapbook, 7320-J Milwaukee, Chicago 31.

40 PAGE Illustrated United States and Canadian coin list 10¢. Stoney, 260 Washington, Boston 8, Mass.

LINCOLNS: 22 Different "S" including rare 1955S, \$1.60. 28 different before 1940, plus odd 1960D small date, \$1.60. 10 different "S" Jefferson nickels, \$1.60. All three \$4.50. Harris, Box 1147-P, Oceanside, California.

COIN Date guaranteed. Restores dates on worn nickels, \$1.00 bottle. Box 276F, Mooreville, N.C.

1966 **CATALOG** Now ready. 50¢ with refunding certificate. Hobby Sales, St. Paul, Minnesota 55116.

FREE Coin supplies! Giant coin list 10¢ (refundable). Economy Sales, Mansfield, Massachusetts.

SILVER Dollar \$1.85; 2¢ copper \$2.00; 3¢ nickel \$2.25; large cent \$2.00; 1/2-dime \$2.25; All five \$9.95. Fairway 121-P Rye, New York.

COIN Collectors! New scientific instrument detects buried coins, gold, silver, treasures, \$19.95 up. Free catalog. Reico-F40, Box 10563, Houston 18, Texas.

HIGHEST Prices paid immediately for coins. Send 10¢ for 1966 buying prices. Wilmot's, 1067-F Bridge St., Grand Rapids, Mich., 49504.

FREE Coins for collectors! Long list and information only 25¢. Gene Carlton, Chandler, Okla. 74834.

CIVIL War specials: 1863 cent, \$1.75; 1863 civil war token, \$1.75; 1864 genuine confederate states of America \$10.00 bill, \$2.00. All three \$5.00. Rarcoa, 31 North Clark, Chicago 60602.

GIGANTIC Coin Clearance. Illustrated lists 10¢ (refundable). Hutchinson's, Box 6256, Philadelphia, Pa. 19136.

3 **LINCOLN** Cents, 1929D, 1919, 1923 plus catalog only 10¢. Approvals. Littleton Coin Co., Littleton W1, New Hampshire.

UNCIRCULATED World dollars—Churchill \$1.65, Bermuda \$1.50, Norway \$2.65, Canada 1965 \$1.95, Yemen \$5.00. World's greatest bargain catalogue, \$1.00. Bebee's, Inc., 4514 North 30th, Omaha, Nebraska 68111.

30 **WORLDWIDE** Coins, \$1.00. Newcomers, Box 91, North Quincy, Mass. 02171.

DISCOUNTS. Buy, sell trade lists 10¢. AWM Coins, Box 14377, Orlando, Fla.

50¢ **CALIFORNIA** Gold pieces, 1849-1858. 75¢ each. Seven different \$4.00. 25—\$12.00. With holders. Metropolitan Coins, 1380 Penobscat Building, Detroit, Mich. 48226.

UNCIRCULATED, Brilliant, scarce United States silver dollars over 70 years old, for only \$3.00 each while supply lasts. Indian-head pennies, which are becoming scarcer every day, 10 different dates \$3.00; 20 different dates for only \$10.00. George Gregory, Box 156-M, Petoskey, Michigan 49770.

INDIANHEADS. Twenty different good coins, \$7.95. Cooper, Box 6628, Kansas City, Missouri 64123.

SPECIALS: Scarce date Lincoln cents. All good or better. Satisfaction guaranteed. 50¢ each 1916S, 1927S, 1939D, 1955S. 75¢ each 1915, 1915D, 1921S, 1924S, 1932, 1932D, 1933. \$1.00 each 1909VDB, 1913D, 1923S, \$1.50 each 1911D, 1912D, \$3.00 each 1913S, 1922D, 1931D, 1933D. \$4.50 each 1910S, 1915S, 1926S. \$5.00 each 1912S, 1914S, \$10.00 each 1911S, 1924D. Bryson Inc., 612A White, Toledo 5, Ohio.

GOLD—Silver crowns; Illustrated catalog, 10¢ postage. Schoeck, 4033—189th Street, Flushing 58, New York.

CLOSEOUTS! Indianheads—dollars! Terrific Bargains! List, 15¢. Nelson, 346-P Rye, New York.

UNCIRCULATED Year sets in plastic holders. 1964PD \$3.00, 1963PD \$3.25, 1962PD \$4.25, 1961PD \$4.50, 1960PD No SD \$4.75. All five sets \$18.98. Mickey Sales, Box 82, Brooklyn 11229.

SPECIAL: Brilliant uncirculated silver dollars, 1883, 1884, 1885 O Mint \$3.00 each. Gemcoins, Box 8374, Minneapolis, Minn. 55416.

ANTIQUES, RELICS, INDIAN GOODS AND CURIOS

ANTIQUES! Monthly magazine. Sample 25¢ or free circular. Antiques Journal, Uniontown, Penna. 15401.

SELLING 20,000 Ancient arrowheads, spearheads, etc. List free. Lear's, Glenwood, Arkansas.

ARROWHEADS. 10 for \$3.00. List free. Hyde's, Box 1788, Santa Fe, New Mexico.

10 **ASSORTED** Perfect arrowheads, \$3.00. George Smith, 9825 Conway Drive, Indianapolis, Indiana 46236.

ARROWHEADS: 3—\$1.00, 10—\$3.30; "Peace" pipe: \$9.75. H. Licklider, Wentzville, Missouri.

TONS Of antique gun parts and supplies. All reproduction muzzle loading guns. Send \$1.00 for enlarged illustrated catalog No. 115. Dixie Gun Works, Union City 12, Tennessee.

MODELS—SHIPS, TRAINS, PLANES, ETC.

SHIP and yacht model fittings; Pine construction hull kits; blueprints. Send 50¢ for illustrated catalog. A. J. Fisher, Inc., 1002 Etowah Avenue, Royal Oak, Michigan 48067.

SHIP Models. Kits, fittings, plans, books, tools, engines, motors. Big illustrated catalog, 50¢. James Bliss & Co., Dept. SM, Route 128, Dedham, Mass. 02026.

STEAM Engines for operating toys and models. Free catalogue. O'Connor, Box 775, Baker, Oregon.

BUILDING Materials, 1/4" & 1/8" scale, windows, doors, siding, roofing, lumber and structural shapes. Send 35¢ for catalog with samples. Small Sales Co., 6025 Martway, Mission, Kansas 66202.

ROCKETS: New illustrated catalog 25¢. Single and multistage kits, cones, engines, launchers, trackers, technical information, etc. Fast service. Estes Industries, Penrose 2, Colorado.

SHIP Model kits and fittings: clippers, frigates, etc. Catalog paint-tool list, book list, 35¢. Model Shipways, Box 85, Bogota, N.J.

GAMES, TOYS, NOVELTIES

BEAUTIFUL Bavarian Doll "Kathi." 8 inches tall. Handmade, authentic costume. Finest materials, \$3.98 ppd. J&B Sales, Box 127, Newport, Minnesota.

A NEW Year-around toy pastime for children. A bubble they can blow that actually bounces. For bouncy bubble kit send \$1.00 ppd. Papco, 1312 Wm. Flynn Blvd., Glenshaw, Penna. 15116.

GAMES Inventors! We are interested in new and novel child and adult game ideas. Nationally-known game manufacturing and marketing firm. Send for details. Hagglund and Associates Research, Dept. A, 650 Ottawa Ave. N., Minneapolis 22, Minnesota.

MAGIC TRICKS, PUZZLES, JOKER NOVELTIES

COMPLETELY Illustrated catalog, 84 pages, 25¢. Manhattan Magic, Box 334-M, N.Y.C. 11.

WORLD'S Finest professional magic tricks. Joker's Novelties, Giant illustrated catalog 10¢. Top Hat, Evanston, Illinois.

FUN'n Magic catalog, 10¢. (1,500,399 tricks, jokes, novelties, puzzles, disguises). Elbee, 7408-P, San Antonio, Texas 78207.

164 **PAGE** Giant surprise catalog! Over 1000 tricks, professional magic, jokers!! World's greatest! 800 pictures! Special only 10¢. Vick Lawston's Magic, Dept. PM6, Northeast Fifth Ave., Ft. Lauderdale, Florida 33308.

GIANT Magic Catalog and free trick only 10¢. Write today. Mailmart, M266, Box 616, White Plains, N.Y. 10602.

VENTRILLOQUISM For fun or money, new method, easy. R. Marlette, 554 Lynn Ct. Apt. A, Glendale Hgts., Ill.

VENTRILLOQUISM! Information free! Dummy catalog, 25¢. State age, Maher, Box 36-B, Kensington Station, Detroit 24, Michigan.

MAGIC Catalog. World's finest, 3000 tricks. (340) pages \$2.50. Beginners, amateurs, professionals. Kanter's, A-200 South 13th St., Philadelphia, Pa. 19107.

BE A Magician! Introductory catalog with free trick, only 35¢. Ireland Magic, 5082 Lincoln, Chicago, Illinois 60625.

500 **TRICKS.** Douglas famous catalog No. 36, only 10¢. Contains best in magic for pocket, parlor, club, stage. Fastest service to magicians for over 50 years. Douglas Magicland, Dept. 21, Dallas, Texas 75221.

VENTRILLOQUISM—Home study course by professional teacher. Dummies, dialogues. Write for details. P. Stadelman, 1449 Fargo, Chicago 26, Ill.

BOOKS, PERIODICALS

BOOKFINDERS! All subjects. Send wants! Sydney Jaher, 175-45 88 Ave., Jamaica, N.Y. 11432.

FREE Catalog unusual books. Murry Company, Dept. 365, 3000 Truman, Kansas City, Mo. 64127.

BOOKS. Free general catalog, 60 pages. Text, vocational, educational, instructional subjects. Millions of volumes, new and used. Bargain prices. Books bought, Est. 1902. Long's College Book Co., Dept. PM, Columbus 1, Ohio.

OUT-Of-print books at lowest prices! You name it, we find it! Fast service. No obligation. International Bookfinders, Box 3003-PM, Beverly Hills, Calif. 90212.

BOOKLOVERS. Seekers — subscription, \$1.00. Ivory Tower Journal, 444-M, Fort Lee, N.J. 07024.

FREE Catalog. Self-help books. Write Wilshire, 8721 Sunset, Los Angeles 69P.

FIVE Hundred thousand, out of print pocket novels, free catalog. Book Bin, 1247 Granville, Vancouver 2, B.C., Canada.

PUBLISH Your book! Join our successful authors. All subjects invited. Send for free appraisal and detailed booklet. Carlton Press, Dept. PMB, 84 Fifth Avenue, New York 10011.

1,000,000 **BOOKS!** Bargains! Catalog—dime. Bookanza, 6990 Aberdeen, Upper Darby, Penna. 19082.

NEW Indian magazine. Details free. Frederick Goshe, 314 College Ave., Palo Alto, Calif. 94306.

BOOKS All subjects. Free catalogs. F & E Specialties, Fenton, Michigan 48430.

HOW To make 6% or more on investments. Details free. Van's Mail Mart, 2372 Belmont, Long Beach, California 90815.

PROPHET Elijah coming before Christ. Wonderful book free. E. Megiddo Mission, Rochester, New York 14619.

PLAYS, STORIES, MANUSCRIPTS

WANT Your book published? Learn how we publish, advertise, promote, distribute. Many successes. Free booklet PM. Van-tage, 120 West 31, New York City.

YOUR Book in print! Low cost limited editions. Manuscripts quoted—no obligation. D & D Company, 973 West Exchange, Akron, Ohio.

WANTED Writers! Short stories, articles, books, plays, poetry. Will help place, sell your work. Write today, free particulars! Literary Agent Mead, Dept. 20A, 915 Broadway, New York 10, N.Y.

BUSINESS OPPORTUNITIES

SELL Advertising book matches. Write us today; we put you in business by return mail, handling complete line ad book matches in demand by every business right in your town! No investment; everything furnished free! Top commissions daily! Superior Match, Dept. MX-266, 7530 S. Greenwood, Chicago 19, Ill.

BAKE New greaseless doughnuts in kitchen. Stores buy output. Start spare time. Profit 29¢ dozen. Small appliance. Free recipes. Montgomery, 3605 South 15th, Minneapolis 7, Minnesota.

FREE "Franchise Profit Letter" tells how unique NFR service is helping thousands seeking profitable businesses. Write today. National Franchise Reports, W-528, 333 North Michigan, Chicago 60601.

PACKAGE At home for profit! We supply everything. No "selling." Free home business details. HPC 807HPH, Sunset, Los Angeles 12.

FREE Facts and descriptive bulletin. Be an air conditioning, refrigeration, and heating serviceman. High pay. Jobs open everywhere, operate your own service business, no school or correspondence necessary. Write Doolco, Trouble Shooter, 2016 Canton, Dallas, Texas.

\$70.00 WEEKLY—home, spare time. Simplified mail bookkeeping. Immediate income, easy. Auditax, 34741a, Los Angeles 90034.

MAKE \$46 From square foot plywood; jig saw necessary. Free details. Woodart, Bridgewater, Mass.

EARN Money raising fishworms for us! Write: Oakhaven-38, Cedar Hill, Texas.

IMPORT-Export opportunity, profitable world-wide, mailorder business from home, without capital; or travel abroad. We ship proven plan, for no risk examination. Experience unnecessary. Free details. Mellinger, Dept. X702, Los Angeles 90025.

PIANO Tuning learned quickly at home. Tremendous field! Musical knowledge unnecessary. Information free. Empire School of Piano Tuning, Box 327, Shenandoah Station, Miami, Florida 33145. (Founded 1935).

MAKE Money from old tires. Operators clearing \$400 weekly. Equipment costs \$800. Get facts. S & S Patents, Inc., 3511 N. Lincoln, Chicago 13.

READ Progressive Mailtrade, the magazine that tells how to make money by mail. Quarter brings sample and special offer. Mailtrade, P.O. Box 357, Sheboygan, Wis. 53082.

COPUBLISH "Mail Sale Advertiser," leading mailorder paper. Copy and details 25¢. Vanroy Shirk, Lebanon, Pa. 17042.

MAILORDER Catalogs. No inventory required. Discounts 40% up, postpaid. Send 25¢ for 32 page sample catalog, featuring 150 unusual, fast-moving products and complete details. Satisfaction guaranteed. Gaylords, North Adams 7, Mass.

BIG Money raising fishworms and crickets. Free literature. Carter Farms, Plains, Georgia.

\$400.00 MONTHLY Raising giant fishworms. Soilless method. Charlie Morgan, Bushnell, Florida.

COLORGLAZED Concrete pottery made without molds. Patented method. Cemetery products, novelties, tiles. Basement leak-sealing. Money-making projects. Booklet, details free. Men only. National Potteries Company, Grand Rapids, Minnesota.

PROFITABLE Catalog Mailorder Business! Vikari's, 835-PM, First Avenue, Salt Lake City, Utah 84103.

START Your own business on credit. Your own boss. Hundreds of dealers making \$100 to \$300 and more weekly. We supply stocks, equipment on credit. 300 home necessities. Sales experience unnecessary. Pleasant, profitable business backed by world-wide industry. Write Rawleigh, Dept. B-U-PPM, Freeport, Ill.

PLASTERCRAFT Molds, liquid rubber, plasters, flocks, candle supplies. Catalog and manual free. Blue Rapids Supply, Blue Rapids, Kansas.

I MADE \$40,000.00 year by mailorder! Helped others make money! Start with \$10.00—Free proof. Torrey, Box 3566-Y, Oklahoma City, Oklahoma 73106.

FREE Business "990 Successful, Little-Known Businesses." Work home! Plymouth-972T, Brooklyn, New York 11217.

WANT To make big money at home? \$10.00 profit in an hour possible with invisible mending. Make tears, holes disappear from clothing, fabrics. Steady year-round demand from cleaners, laundries, homes. Details free. Fabricon, 1585 Howard, Chicago 26, Ill.

BUILD Custom cases at home for profit. Get orders by mail. We supply materials, instructions, everything. Free home business details. Customcase, CPH, Sunset, Los Angeles 12.

FREE Booklet! Profitable, spare-time business bronzing, PearlKoting baby shoes! Complete set-up on credit. Kiktavi, Box 34861-B, Los Angeles, California 90034.

YOUR Own home business, interesting, profitable, different. Details free. Richey, 441 East Main, Greenville, Ohio 45331.

IMPORT-Export business made easy. Complete setup service. Not just instructions. Hermes, 152 West 42, New York City 10036.

EXTRA Money making plastic signs at home, free details. Napco, Box 23485-P, Los Angeles, Calif. 90023.

ADDRESSERS And mailers needed. Send stamp for information. Lindbloom, 1508 West Erie, Chicago, 60622.

VENDING Machines. No selling. Operate a route of coin machines and earn amazing profits. 32-page catalogue free. Parkway Machine Corporation, 715 PMB Ensor Street, Baltimore 2, Maryland.

SELL Books by mail. 400% profit. Royal, Box 450-X, Cleveland, Ohio 44127.

FREE! 128 Page illustrated catalog. More than 2000 name Brand items; below wholesale prices. Sell full or part time. Save hundreds of dollars on purchases for yourself! Watches, jewelry, cameras, radios, phonographs, tape recorders, appliances, housewares, cookware, hardware, power tools, luggage, musical instruments, sporting goods, toys, many others, 8 floors of Name Brands. Orders shipped within 24 hours. Continuous supply. Send for free catalog now! H. B. Davis Corp., Dept. PM, 145 West 15th Street, New York, N.Y. 10011.

MAIL Multi-colored catalogs printed with your address for big profits! Details. Sample 25¢ (refundable). Specialties, Box 148, Ypsil, Michigan 48197.

ARNOLD Palmer offers you unequalled opportunity to profit from tremendous popularity of golf and power of Palmer. Highly profitable exclusive Palmer Golf Franchises available. Complete national program. Hefty profits—minimum investment. Write for details. Arnold Palmer Enterprises, Dept. CR, Pleasantville, New Jersey. Tel. 609-646-3500.

DIFFERENT! Outstanding profits from high quality mailorder businesses. Complete setup services; not just instructions. Hermes Co., 152 West 42, New York City 10036.

CONCRETE Facts: Cement artists make big money at home. Simple equipment. Experience unnecessary. Copyrighted methods. Easy to make unlimited cement pottery designs, bird baths, wishing wells, rustic gardens, patio items, etc., without molds. Formulated, chemical coloring, marbleglazing. Free illustrated brochure. Holwood Cementcraft, 602 Athens, Altadena, California 91001.

WE Search the World over for the unusual, so that you may have something different to sell. Details free. Chandler's, Dept. 326, Wailuku, Hawaii 96793.

VACUUM Form at home! Mold plastic products for big profit. Fabulous new machineryless method. Free facts. Nationwide Plastics, Box 23321-NT, Los Angeles 90023.

SELL By mail. Interesting, profitable. Start small, grow big. Spare time, at home, free literature. Froner, P.O. Box 1624, Eugene, Oregon.

OPERATE Home mailorder business. Vosacek Printing, 4444AI Ute, San Diego, Calif. 92117.

PROFITABLE Home mail order business spare time. Write Gericke, Box 791, Milwaukee 1, Wisconsin.

SELL Champion, AC, Autolite spark plugs. Reconditioned, electroplated, guaranteed 10,000 miles. 100% profit. Free sample. Lee Plugs, 1608-A Roberts, Houston 3, Texas.

MEN—Women, Everybody likes fine candy. Make professionally home. (Our 51st year). Ragsdale Candies, B107, East Orange, New Jersey.

FREE Report, "Businesses You Can Launch At Home." Immediate earnings! Wyman Enterprises, B-45, Congers, N.Y. 10920.

WORLD'S Largest wholesale supply. Buy from 7853 American, European, Japanese wholesalers. Hong Kong tailored suits, 123 dropship catalogs. Rockbottom prices. Automobiles. Free details. International Buyers, 216-MM Jackson, Chicago 6, Illinois.

DOLLS! Dolls! Dolls! We teach you to repair, make, dress, also how to operate a Doll Hospital. Study at home. Earn while you learn. Or enjoy a fascinating hobby! Free informative booklet. Lifetime Career Schools, Studio MC-26, 11824 San Vicente Blvd., Los Angeles, Calif. 90049.

EARN Money at home, mailing postcards to new mothers. Particulars, 10¢. Westley, Western Springs 1, Illinois.

LEARN Speedometer repair. Earn top wages or own your own shop. Share secrets only few know. Always in demand. Train in spare time. Complete home study course covers both speedometers and tachometers. Instrument Training School, Speedometer Division, Box 5319, Tulsa 4, Oklahoma.

\$60.00 DAY. Manufacturing concrete posts. Carlayne, 1803 Fremont, Rapid City, South Dakota 57704.

"STREAMLINED Home-study mailorder course." \$2.00. Twenty-four complete lessons. Dealers wanted. Sample imprint circular free. Neil H. Tasker, Shamokin, Pennsylvania.

EARN Extra money selling advertising book matches. Sample kit furnished. Matchcorp, Dept. PM-26C, Chicago, Illinois 60632.

SELL Greeting cards, make extra money. All occasion assortments, Easter, Stationery, Gifts, Wrappings, Toys, Jewelry. Experience unnecessary. Salable samples on approval. Free catalog, bonus plan. Write Hedenkamp, 361 Broadway, Dept. CD-2, New York.

EARN \$12.00 an hour as Tax Advisor. Profitkeeping, 2909-A Sheridan, Chicago 60657.

HOW To get finance capital, loans, grants, cash to start a business. Free details. National Counselor, Harlingen 17, Texas.

INSTALL Burglar alarms without previous experience or costly equipment. Big profit. Free details. Nasco, 11071 Massachusetts, Dept. X702, Los Angeles 90025.

MAIL Baby catalogs to new mothers! Profitable! Northland Enterprises, Rhineland, Wisconsin.

"START-Operate Successful Small Business" reveals big, profitable ideas, plans, methods. Free eye-opening facts! Aladdin, Box 5183-B, Oakland, California 94605.

EARN Big money invisibly reweaving damaged garments at home. Free information. Eastern Reweaving School, PM-16 Main, Hempstead, New York 11551.

DISTRIBUTOR Wanted. New service station item. Marvin Fonville, 2401 Crocker, Houston, Texas 77006.

RED Carpet exclusive, copyrighted franchises available. Proven profitable—net over \$20,000 annually. Rapidly expanding market. Complete package: truck, equipment and training. Less than \$1000 cash required with approved credit. Write: Red Carpet Franchises, 2387 Peachtree Rd. Atlanta, Ga. 30305.

WORK Home, mailing our catalogs! Free details! Cam Company, Dept. 215, Verona, N.J.

INVESTIGATE Accidents. Earn to \$1,400 monthly, part or full time. Pick own location. Car furnished. Expenses paid. No selling. No college education necessary. We train you at home spare time. Keep present job until ready to switch. Men urgently needed now. We place far more men in this booming field than any other individual, company, or school. All facts free. Write: Universal, CPM-102, 6801 Hillcrest, Dallas, Texas 75205.

LEARN Bonsai! Duplicate exactly \$500 imported Oriental Tiny Trees in few hours! Grow living miniatures too; and tiny forests in bowls. Profitable home business! Request free fact pack, free sample seeds! Minitree, Box 23023-VL, Los Angeles 90023.

SECRETS! Secrets! Mail order success revealed by internationally famous expert who discovered how to make home business fortunes. Beginners: Get free copy "How to Make Money in Mail Order." Discloses free advertising, profitable products, everything! No obligation. Write Mallico, 1554 Sepulveda, Dept. X702, Los Angeles 90025.

RAISE Rabbits on \$500 month plan. Free details. White's Rabbitry, Mt. Vernon, Ohio.

TOP Commissions bring big income. Start a profitable business part or full time. Agents now being appointed for fast, easy selling, nationally advertised gift items. Send \$1.00 for complete information and full color catalog. World Wide Gifts, Dept. PM1, P.O. Box 2917, Long Beach, California 90801.

TREMENDOUS Opportunity! Sell service representing brand name items—below discount prices. Certified Merchandising Corp., 485 Fifth Avenue, New York, New York 10017, Suite 1042.

LIQUID Rubber, plastercraft supplies. Plouffe's, 82A Pleasant Street, Worcester, Massachusetts.

INVESTIGATE Fires, storm damage, accidents for insurance companies, pays up to \$1,000 a month, part or full time. No college necessary. Car furnished; expenses paid. We train you at home in spare time. Keep present job until ready to switch. Pick your location. Men badly needed now. Full information free. Write Liberty School, Dept. C-510, 1139 W. Park, Libertyville, Illinois.

OPERATE Restaurant or diner. Free booklet reveals profitable plan. Write Restaurant Business School, Dept. EC-26, 1920 Sunnyside, Chicago, Illinois 60640.

LEARN Landscaping and the growing of plants. Start a profitable business part or full time. Free information without obligation. Lifetime Career Schools, Dept. MC-26, 11826 San Vicente Blvd., Los Angeles, Calif. 90049.

FREE Book "Opportunities in Electricity." Advance Trades School, Dept. E-803, Chicago 60631.

BECOME Tax consultant. Our students earn \$1,000-\$3,000 every tax season preparing returns evenings. Accredited State approved National Tax Training School, Monsey K-2, New York.

IMPORT Outstanding novelties, gifts, premiums, from Formosan manufacturer. Sensationally low priced. Twelve different samples and many offers. \$2.00 money order. Satisfaction guaranteed. Free information. Taiwan Variety, Box 24029-PM, Taipei, Formosa.

MAILORDER. Make your fortune! Extraordinarily different! Henson, Box 593, Bettendorf, Iowa 52722.

FIFTY Amazing opportunities for your own business. Details free. Griffin & Knapp, 7624 Bay Parkway, Brooklyn, New York 11214.

400% PROFIT Selling books by mail. Free details. Anderson, Box 11544B, Kansas City, Missouri 64138.

\$UCCE\$—Via mailorder! Write: Mike, Box 12, Spokane, Wash. 99210.

\$15,000 YEAR Guaranteed (Minimum). Distinctive, exclusive, non-competitive. Patent pending. \$2.00 Brings descriptive booklet (returnable). Minimum investment. Results or money back. Write: Executives, P.O. Box 4080, FPM, New Orleans, Louisiana.

HUGE Profits! Mail order importing. Free information. ITIS-PM-2, Box 454, Hollywood, Calif. 90028.

NEED Part or full time Salespeople? 10 help wanted posters. Place on bulletin boards, registers, stores. \$2.00 with instructions. World Traders, 7821 Alameda, El Paso, Texas.

MAILORDER. Tremendous profitunities. Value House, 550 Fifth Avenue, N.Y.C. 10036.

OFFICE—Homework Opportunity! Start sparetime. Refundable detailed instructions—\$1.00. Interstate, 37-1 Besch, Albany, New York 12209.

MAKE \$32 From 49¢ piece vinyl. PMA-1934 Edgeland, Louisville, Ky. 40204.

RETIRING? Supplement income with mailorder. Details free. Rogers, 13205 Ridge Drive, Rockville, Maryland.

BUILD Profitable home mail order. Instruction manual, \$2.00. BMPPM1, St. Peters, Mo.

WRITE Letters that sell, persuade, get jobs. Mailorder expert tells how. Sends samples. Write ElJay, 615 South Alexander, Los Angeles, California.

WHERE And how to buy thousands of name brands household items, up to 35% below wholesale. Buy one item or more. Details one dollar. James Carlson, New Idria, Calif.

Manufacture Novelties, wall plaques, bookends, plastics, imitation marble, molds. Profitable full or part-time business. Free details. Marbleizing Company, Box 170, Dept. MP, Edwardsville, Illinois 62025.

BIG Profits raising large fishworms. Information free. Blevins Farm-1, Stevenson, Alabama.

"MAIL Order World Of Opportunities" latest issue; prints all kinds of bargains and new product sources. Rush only \$1 for your copy. Today! To: W. Wegener, 62-21—62Rd, Middle Village 79, L.I., New York.

YOUR Own home importing business—Free details. Livingston's, Box 5332, North Charleston, South Carolina 29406.

OPERATE Debt Re-finance Service. A.D.C.S., 1222 Pioneer Bldg., St. Paul, Minn. 55101.

MAIL Baby catalogs to new mothers for big profits! Details, catalog 25¢. Volz-PM, Ypsilanti, Michigan.

ALL Types of businesses coast to coast Over 350 local offices to serve you. Call or write for free "Business and Income Property Bulletin." United Farm Agency, 612-PM West 47th St., Kansas City, Mo. 64112.

FREE Report: "609 Unusual Successful Businesses!" Box 51-PO, Des Plaines, Illinois.

\$15.00 HOURLY Profit—Own Business with one serviceman. Quickly learned. Easy to do. Operate from home. Few hundred dollars builds your own nationally advertised business while continuing present job. Investigate immediately before your territory is taken. Free booklet explains everything. Send today then decide. Duraclean, C6-162, Duraclean Building, Deerfield, Illinois.

YOUR Photo on stamps! 200% profit. No investment. Free samples, details. National Photostamp, 34-11B Crescent St., LIC, N.Y. 11106.

ANALYZE Handwriting. Figure people out. Complete instructions, \$1.00. National Laboratories, Box 1531, St. Petersburg, Florida 33731.

CARTOONING And commercial art. Easy home-study drawing course. Art background not necessary. Excellent creative money making opportunities part or full time. We show you how. Low monthly tuition. Free booklet. Continental Schools, Dept. 6A-2, 1330 W. Olympic Blvd., Los Angeles, Calif. 90015.

FREE Furnished apartment, plus \$400-\$1000 monthly salary, if qualified as motel manager. Live graciously, meet VIPS. Train at home. Earn diploma from approved school. Free placement assistance. Openings for men, women, couples. If over 21, write for facts. Motel Management, Dept. PM, 2433 N. Mayfair Rd., Milwaukee, Wisc., 53226.

SPARE Time earnings. With your table-saw, bandsaw or jigsaw. Write: Workshop, A3800 Harney, Vancouver, Washington 98660.

MONEYMAKING OPPORTUNITIES

BIG Money raising fishworms and crickets. Free literature. Carter Hatchery, Plains, Georgia.

NEW Instant invisible mending. Learn in one hour, repair in five minutes. Make \$150.00 week. Literature free. Henson, P.O. Box 6136-6, Philadelphia, Pa. 19115.

AMAZING Successes through franchises! Become exclusive franchise holder your territory. Information rushed. National Franchise Reports, WP-528, 333 North Michigan, Chicago 60601.

WORK Home, part-time, mailing our catalogs! Free details! Cam Company, Dept. 53, Verona, N.J. 07044.

MAKE Money writing short paragraphs! No tedious study! I tell you what to write, where and how to sell, and supply list of editors buying from beginners. Many small checks add up quickly. Write to sell, right away. Send for free facts. Benson Barrett, Dept. C-27-A1, 6216 No. Clark, Chicago 26.

RAISE Rabbits and fishworms on \$500 month plan. Free details. White's Rabbitry, Mt. Vernon, Ohio.

CLIP Items from daily newspapers. Get \$1.00 to \$5.00 each. Details free. Walter, Box 1023-P, Erie, Penna.

WIN Cold cash! Prizewinner sizzles with terrific contests, torrid tips, impertinence! Free sample! Box 11569, St. Petersburg, Fla.

LEARN The secrets of repairing junk batteries. "Fabulous Profits" at home. Details. The Batteryman, P.O. Box 416, Palm Desert, Calif.

HAVE Your own good paying, money-making business! Full, sparetime. Particulars free! Ashe's, Box 62-PM, Elmhurst, New York 11373.

VENDING Machines. No selling. Operate a route of coin machines and earn amazing profits. 32-page catalogue free. Parkway Machine Corporation, 715 PMM Ensor Street, Baltimore 2, Maryland.

JEWELRYCRAFT For fun or profit! Details free! Write: Modern Craft, Box 3614-R, Cranston, R.I. 02910.

EARN Money evenings, copying and duplicating comic cartoons for advertisers. Adservice, Argyle-1, Wisconsin.

\$200.00 FROM Sheet 1/4" plywood (scrap). 25¢ refundable. Novelties, 610 So. 24th. Elwood, Indiana.

MINK Raising information free. Lake Superior Mink Farm Inc., Superior, EE1, Wisconsin.

MAKE Big money taking orders for Stark Dwarf fruit trees. Everybody can now grow giant size Apples, Peaches, Pears in their yards. Also Shade Trees, Shrubs, Vines, Roses, etc. Outfit free. Stark Bro's, Desk 30126, Louisiana, Missouri 63353.

HAVE Successful, home mailorder business! Celebrated professional tells "How!". Gain independence, security. Live better! Exciting details Free! Unicis, Box 735-PD, Norwalk, Conn. 06852.

SEASHELLS. Shellcraft and jewelry supplies. Wholesale catalog 25¢, refunded first order. Our 32nd year. Florida Supply House, Box 847M, Bradenton, Fla.

CIGARETTES—Make 20 plain or filter-top for 10¢. Facts free. Moberly, Box 922, Owensboro, Kentucky.

FABULOUS Opportunity for women, any age. Earn \$25 day or more as beauty advisor. No experience. Get details, sample Hollywood cosmetics: Studio Girl, Dept. OP359, 1510 N. Kostner, Chicago.

EARN Big commissions full or part time. Show America's largest line low priced business printing and advertising specialties plus big catalog union label political advertising items. Calendars in season. Big free sales kit samples hundreds items used daily by businessmen and political candidates. Merchandise bonuses for you. Free gifts for customers. Build profitable repeat business. Start now. National Press, Dept. 147, North Chicago, Ill.

BIG Money as management advisor. Profitkeeping, 2909-B Sheridan, Chicago 60657.

FREE. 206 Easy ways to make money taking orders for exciting new products—spare time. Send name, age for 5 months free subscription Opportunity Magazine, 850 N. Dearborn, Dept. 17-AM, Chicago.

OPPORTUNITY Seekers, homeworkers. Over 80 unique opportunities, \$1.00. Lee, Box 252P, Goleta, Calif.

AMAZING Income. Learn oil burner servicing. Free information. Mar-Lin Institute, Box 66095, Portland, Oregon 97266.

FREE Exciting details—mailorder profits and pitfalls. Webster's, Box 3878-O, Long Beach, California 90803.

DISC Jockey, \$10,000 year. \$1.00. Meades, Box 3364, Anaheim, California.

START Your own party plan business. Free details. Varietycraft, 6 Winston Lane, Terryville, N.Y. 11776.

QUICK Money by mail working with us. Details free. Worldwide, 694 Kerr St., Columbus, Ohio.

BUY A Thai wooden elephant and be lucky all through your life. Hand-made, 4 inches high. Send \$10.00 draft and be lucky right away. Remittance received, sent back through air parcel. Gun Phanch, Box 1955, Bangkok, Thailand.

AUTO Parts, tools, accessories, equipment. "Buyers Guide" 1,935 American manufactures, 25¢. CBS, Tarentum, Pa.

TURN Spare time into cash. Complete plan, \$2.00. Details, 10¢. C & H, Box 5037D, Santa Ana, California 92704.

MAKE \$5,000 Yearly sparetime, raising mink, chinchilla, nutria, etc. Free booklet reveals proven plant. Write: Furs, Dept. E, Bewdley, Ontario, Canada.

\$500.00 SELLING Books by mail spare time. Learn home. Instructions, \$3.00. Details free. New, Box 19, Mesquite, Texas.

MASTER Watchmaking at home. Free sample lesson. Chicago School, Dept. YBA, Fox River Grove, Illinois 60021.

ADD To your family income. Pleasant, friendly opportunity to make up to \$20 in week, showing friends food and household products, cosmetics. Free Trial Sales Outfit. Rush name. Blair, Dept. 31CB, Lynchburg, Va. 24505.

FLOWER Materials, artfoam, styrofoam, sequins, jewelry, novelties. Discount catalog 50¢ (refundable). Boycan's, Sharon 15, Penna.

SEND Postal for free book. Tells how you can learn to mount birds, animals, fish, gameheads . . . tan skins and make leather. All secrets revealed. Fascinating and profitable Hobby for all men and boys. We have taught over 450,000 successfully by Mail! Rush postcard today for your copy. No obligation. Please give your age. Northwestern Taxidermy School, 2581 Elwood Bldg., Omaha, Nebraska 68102.

SHARP \$\$\$ Opportunity! One low-cost machine sharpens—serrates knives, scissors, pinking shears. Earn \$6-\$9 hourly in spare time. Professional results without experience. Free details. Beaver Machine, Box 121, Gardena, California.

MAKE More money, where you work. Instruction booklet, \$1.00. Earn-Mar, Clermont, Florida 32711.

MEN—Women—Make extra money easily. Enjoyable, "Hobbylike" work. Homecrafts, 40-21KC Bell, Bayside, New York 11361.

"INSTANT" Sales; quicker repeats. New photo postcard. Your 4-line address with item photo, 500, \$6.95 and 65¢ postage, handling. Rush photo. Remit now. Repeat Sales, P.O. Box 153-PM2 Garwood, N.J. 07027.

HAVE Your Own Profitable Home Mailorder Business! Alfano, 19-P, Pine, Closter, New Jersey 07624.

MAKE To \$50 every day in Ad Market. Work home. Free details. Ad Market, Harlingen 4, Texas.

EARN Up to \$500.00 monthly clipping ads, your own home. No investment. No experience necessary. American, Box 56, Muncie, Kansas.

EARN—\$10,000 yearly repairing batteries at your home. Full or part time. No experience necessary. American, Box 56, Muncie, Kansas.

BOOKKEEPERS Operate profitable bookkeeping tax service. Universal, Box 664-M, Springfield, Missouri.

MAKE Money, spare-time sewing. Fashions, home items. Write: Berkman Co., 676 Irving Park Rd., Chicago.

"500 Ways To make money at home!" New! \$1.00. Refundable. Publishers, 407 PM Lincoln, Miami Beach, Florida 33139.

BIG Mail order profits. Learn from Success books. Write Feldor, Box 1375, Grand Central Station, N.Y. 10017.

GUARANTEED Buyer! We need common American coins to supply Canadian collectors. Hundreds wanted! Free details. Numismatic Associates, Suite 227, 1255 University, Montreal 2, Canada.

EARN \$240.00 a month at home, spare time, doing only two \$5.00 invisible mending jobs a day. Big money paid for service that makes cuts, tears disappear from fabrics. Steady demand. Details free. Fabricon, 1532 Howard, Chicago 26, Ill.

START A profitable subscription business in spare time! We need men and women (young and old) as representatives for all leading national magazines. Liberal commissions on all subscriptions. Supplies free. No experience needed. Send this ad with your name and address to: Popular Mechanics, Room 2-O, 250 W. 55th St., New York 10, N.Y.

PROFITABLE OCCUPATIONS

BECOME Independent with your own franchise business. Thousands earning handsome incomes. Request interesting facts today. National Franchise Reports, PM-528, 333 North Michigan, Chicago 1.

MAKE Money writing short paragraphs. Information free. Barrett, Dept. C-27-A2, 6216 N. Clark, Chicago 26.

CHROME Plating. Instructions, equipment and supplies. Platers' Supply, P.O. Box 565, Lugo Station, Los Angeles, Calif.

FREE Book "990 Successful, Little-Known Businesses." Work home! Plymouth-97T, Brooklyn, New York 11218.

YOUR Own sign shop—Signs, 1017 W. Mulberry, Springfield, Ohio.

BAKE New greaseless doughnuts in kitchen Sell stores. Free recipes. Michael, 3605 South 15th, Minneapolis 7, Minn.

BIG Money raising fishworms and crickets. Free literature. Carter Wormery, Plains, Georgia.

RAISE Pheasants on \$100 week plan. Little capital and space can make you independent. Free details. Great Central System, Columbus 1, Kansas.

EARN \$240.00 A month at home, spare time, doing only two \$5.00 invisible mending jobs a day. Big money paid for service that makes cuts, tears disappear from fabrics. Steady demand. Details free Fabricon, 1586 Howard, Chicago 26, Ill.

INVESTIGATE Accidents. Earn \$750 to \$1,400 monthly. Car furnished. Expenses paid. No selling. No college education necessary. Pick own job location. Investigate full time. Or earn \$8.44 hour spare time. Men urgently needed now. Write for Free literature. No obligation. Universal, CPM-2, 6801 Hillcrest, Dallas, Texas 75205.

LEARN Professional exterminating. Profitable new methods. Camco, Box 11355-A, St. Louis 5, Missouri.

YOUR Own bookkeeping service pays big. Profitkeeping, 2909-C Sheridan, Chicago 60657.

AUCTIONEERING—Resident and home study courses. Auction School, Ft. Smith, Ark.

LEARN! High paying Civil Service jobs, we have books, also self-improvement, hobbies. Free Catalog! Misner Library, Box 3190, Peoria, Illinois 61614.

MONEY: Become finance broker part or full time. Ra-Mar, P.O. Box 482, Desk 3, Oklahoma City, Oklahoma.

PROFESSIONAL Investigators needed everywhere! Many attain these prestige positions earning to \$1,000 monthly. Spare time training through fully approved home study course. College unnecessary. Operate own business, or become Insurance Company Investigator with car furnished, expenses paid. Employment help. Free booklet. No obligation. United Schools, 2628, 416 Louisville, Monroe, Louisiana.

AUSTRALIAN Opals. Agent wanted by genuine supplier. Good profits. J. D. MacDonald, Liverpool Street, Port Lincoln, South Australia.

VENDING Machines. No selling. Operate a route of coin machines and earn amazing profits. 32-page catalogue free. Parkway Machine Corporation, 715 PMP Ensor Street, Baltimore 2, Maryland.

START A magazine subscription business. Earn generous commissions on Popular Mechanics, Good Housekeeping and all others. Best commissions, bonus, all material sent free. No experience needed. Write Popular Mechanics, Room 2-P, 250 West 55th St., New York 19, N.Y.

SALESMEN—DISTRIBUTORS

ASTONISHING Automatic toilet bowl cleaner, deodorizer. Works when toilet is flushed. Housewives buy on sight for every bathroom, at only \$1.98 each. Make up to \$10.00 in hour, spare time. Free sales kit. Merlite, 114 East 32nd, Dept. G71U, New York 16.

\$1,000.00 a month for making dramatic 3-second demonstration of amazing Lightweight Presto Fire Extinguisher. New chemical used by Airforce snuffs out fires instantly. Only \$4.95. Terrific commissions. Millions want it. Free Kit. Merlite, 114 E. 32nd, Dept. P-66U, New York 16.

SENSATIONAL New longer-burning light bulb. Amazing free replacement guarantee—never again buy light bulbs. No competition. Multi-million dollar market yours alone. Make small fortune even spare time. Incredibly quick sales. Free sales kit. Merlite (Bulb Div.), 114 E. 32nd. Dept. C-73C, New York 16.

NEGRO People buy on sight. 100% profit. Nationally advertised cosmetics. Free sample offer. Valmor, Dept. BA. 2411 Prairie. Chicago 16.

LONG Needed invention. Man to contact service stations. Huge profits. Cyclo Mfg., 3816 Dahlia, Dept. 107, Denver, Colo.

EARN Big commissions full or part time. Show America's largest line low priced business printing and advertising specialties plus big catalog union label political advertising items. Calendars in season. Big free sales kit samples hundreds items used daily by businessmen and political candidates. Merchandise bonuses for you. Free gifts for customers. Build profitable repeat business. Start now. National Press, Dept. 146, North Chicago, Ill.

FREE. 206 Easy ways to make money taking orders for exciting new products—spare time. Send name, age for 5 months free subscription Opportunity Magazine, 850 N. Dearborn, Dept. 17-AS, Chicago.

WILL You test new items in your home? Surprisingly big pay. Latest conveniences for home, car. Send no money. Just your name. Kristee, 165, Akron, Ohio.

NEW Car thief signal. Lightning seller. Samples for trial. Northwest Electric, Ave. 126, Mitchell, S. Dak.

FINE European clocks, liberal commission. Frank Frazier, Jr., 4437 Camero Avenue, Los Angeles, Calif.

UP TO \$200 or more weekly. List accounts for collection. No collecting, selling or investment. Everything furnished. No experience needed. Full or parttime. United Financial Service, Merchandise Bldg., Dept. 243, Minneapolis, Minn. 55403.

MAKE Extra \$25 to \$75 spare time! Take orders for double air cushion Bronson Shoes. Amazing comfort. Terrific men's, women's line for dress, work, play. Highest commissions. Shoes for yourself. Big outfit free. Write Bronson, Dept. 500, Minneapolis, Minnesota 55408.

SELL Advertising book matches. Write us today, we put you in business by return mail; handling complete line ad book matches in demand by every business right in your town! No investment; everything furnished free! Top commissions daily. Superior Match, Dept. M-266, 7530 S. Greenwood, Chicago 19, Illinois.

AGENTS WANTED

MAKE Up to \$50.00 daily soliciting delinquent accounts. Terrific commissions. General Finance Co., Dept. LG-79, Pickwick Bldg., Kansas City, Mo. 64106.

PRINTING. Advertising salesmen—Excellent moneymaking sideline selling decalcomania name plates, small quantities. Automobile initials, sign letters. Free samples. Ralco, XL, Boston 19, Mass.

YOUR Own business—Used suits \$1.50; overcoats 65¢; mackinaws 35¢; shoes 12½¢; ladies coats 30¢; dresses 15¢. Enormous profits. Catalog free. Nathan Portnoy Associates, 2109-AA Roosevelt Road, Chicago 8, Ill.

ESTABLISH Your own business. Low prices on used clothing, shoes, household goods. Unlimited profits. Free catalog. Northwestern Distributors, 2129 No. Western Avenue, Chicago, Illinois 60647.

SALESMEN Make big profits selling "do-it-yourself" sign kits to merchants. Information free. Signmakers, Inc., Dept. PM4, Box 6626, Denver 16, Colorado.

MAKE \$50.00 Daily selling air operated vacuum cleaners to service stations. Free details. Inka Industries, 2401 Crocker, Houston, Texas 77006.

SELL Greeting cards, make extra money. All Occasion assortments, Easter, stationery, gifts, wrappings, toys, jewelry. Experience unnecessary. Salable samples on approval. Free catalog, bonus plan. Write Hedenkamp, 361 Broadway, Dept. CD-2, New York.

MEN! Show wife this amazing offer! Famous nationally, advertised Hollywood cosmetics pay big. Make \$25 day up. For free samples, details, write Studio Girl, Dept. OP357, 1510 N. Kostner, Chicago.

FREE. 206 Easy ways to make money taking orders for exciting new products—spare time. Send name, age for 5 months free subscription Opportunity Magazine, 850 N. Dearborn, Dept. 17-AA, Chicago.

GET New shirt outfit free! \$90 weekly on 5 average orders a day. Famous quality made-to-measure dress and sport shirts at \$4.50 up, sell to all men. No experience needed. Full or part time. Write: Packard Shirt Co., Dept. 414, Terre Haute, Indiana 47808.

WANT To make up to \$100 a week spare time, and get free shoes for life, too? No investment. Rush card for free details. Mason Shoes, K-545, Chippewa Falls, Wis.

MEN—If your wife wants more money show her this ad! Our plan pays up to \$3.50 an hour or more, spare time. Easy, pleasant! Just show quality cosmetics to friends, neighbors with gorgeous \$10.00 display kit. Write for free offer. Lucky Heart Cosmetics, Dept. 22XB Memphis, Tennessee 38102.

SENSATIONAL Photograph enlargements! Fast money daily! Outfit free! Nationwide, Box 3522, Los Angeles 90054.

INSTANT Profits! 40% advance commission taking orders for sensational new plastic photo enlargements, personalized photo-rings, compacts, bracelets. Sales kit free. Novelco, 3343 North Avenue, Chicago 60647.

SEAMLESS Nylons \$4.75 dozen. Victor's, Box 3818-A Cleveland 10, Ohio.

RAISE Rabbits for us on \$500 month plan. Free details. White's Rabbitry, Mt. Vernon, Ohio.

EMPLOYMENT INFORMATION

DIRECTORY Reports. Construction, aviation, shipping, oilfields, government, manufacturing, trucking, etc. foreign—stateside. Helpful information plus job-getting tips on preparing application letters. Unconditional money-back guarantee. Only \$3.00 (\$3.25 airmail) Research Services, Box 6768-PM, St. Louis, Missouri 63144.

TREMENDOUS Opportunities U.S.A.—Overseas. Choose jobs—locations—transportation. Free details. Occupations, International Airport, Box 100-C22, Jamaica 30, N.Y.

BOOMING Australia needs your skills! Government assisted passage. Details \$2.00. Irv Heyer, 2913 Chestnut, Costa Mesa, Calif.

FOREIGN Employment. Construction, other work projects. Good paying overseas jobs with extras, travel expenses. Write only. Foreign Service Bureau, Dept. PM, Bradenton Beach, Florida.

PANAMA Canal, various, \$1. Okie, 87 Balboa Heights, Canal Zone.

FLORIDA Job opportunities. Free newsletter. Courier, Box 15463, Tampa, Florida 33614.

CALIFORNIA Employment opportunities. Major crafts, engineering, clerical, etc. All open fields plus self employment opportunities anywhere. Complete details, \$1.00. Opportunities plus, P.O. Box 27, Redwood City, California.

FOREIGN Employment: South America, Africa, Europe, Australia, USA. Earnings to \$2,000.00 monthly. Construction, all trades, professions, occupations. Many companies pay fare, housing, benefits, bonuses. Write: Universal, Dept. A-2, Woodbridge, Connecticut 06525.

HELP WANTED

MAKE \$280.00 getting just 10 growers to try Campbell's Plant Food. Sample free. Campbell, Rochelle 24, Illinois.

FARMS—REAL ESTATE

CANADIAN Lands, seized and sold for taxes. Our 49th annual series of lists, describe many choice properties, situated from coast to coast, acquired by us through tax sale. Priced as low as five dollars per acre, guaranteed perfect title, small monthly payments, no mortgage. Beautifully situated hunting and fishing camps, where there is real sport; summer cottage sites, heavily wooded acreages. Now is the time to invest in Canada's minerals, forests and farms. Write today for free twenty page booklet with full explanation. Tax Sale Service, Room 301-D, 85 Bloor St., E., Toronto 5, Canada.

400,000,000 ACRES Government public land in 25 states. Some low as \$1.00 acre. 1966 report. Send \$1.00 National Land, 422PM2, Washington Building, Washington, D. C.

FLORIDA Campsites—deep in the heart of the great Ocala National Forest. Good hunting and fishing. Free maps and photos. Howard Verner, DeLand, Florida. AD646369D

\$1 ACRE—Canadian border—hundreds campsites, islands, farmlands, directly from tax authorities. (Non-profit). Lists, photographs mailed. Register, Room 203, 92 King St., E., Toronto 1, Canada.

ABANDONED Timber Leaselands! Choice 640 acre Sportsmen's paradises still available—\$20.00 plus \$6.50 Taxes yearly. Maps, pictures, \$1.00 (Refundable). Director, Erindale 4, Ontario, Canada.

CANADA'S Finest lands, \$4.00 an acre and up. Acquired through estate liquidations. Suitable for hunting, fishing, camps, cottages, farming, timber, minerals, investment. Small monthly payments. Free descriptive booklet. Canadian Estate Land, 2788-P Bathurst Street, Toronto, Canada.

FREE Strout catalog. Big 180 exciting pages of top value offerings. 490 offices in 35 States. Coast-to-Coast. Our 65th Year. Get your free catalog today. Strout Realty, 7-CJ S. Dearborn, Chicago, Ill. 60603.

GOVERNMENT Lands . . . low as \$1.00 acre. Millions acres! For exclusive copy-righted report . . . plus "Land Opportunity Digest" listing lands available throughout U.S., send \$1.00. Satisfaction guaranteed! Land Disposal, 2230-PB, Wisconsin Avenue, Washington, D.C. 20007.

ARIZONA—Large level lots, water, power, oiled streets, \$495 complete, \$10 down, \$10 month, no interest. Free pictures, maps. Write Box 486, Kingman, Ariz.

U.S. Government or Canadian land low as \$1.25 per acre. Own your own land for vacationing, speculation or retirement. Invest at amazing low prices. Send \$1.00 for fact-packed booklet with current listings. Satisfaction guaranteed! North American Land, P.O. Box 165-CA, Northtown, Chicago, Illinois.

CONCRETE Block homes, cottages. Plans folder "How to build" 10¢. Bailey Builders, 7213-A Missouri, Little Rock, Arkansas.

FLORIDA Water wonderland—home, cottage, mobilsites. Established area. \$590 full price, \$9.00 a month. Swimming, fishing, boating. Write: Lake Weir, Box KK 38, Silver Springs, Florida. AD 6-1070 (F-1)

FREE Spring catalog! Bargains galore! Coast-to-Coast! Low prices, easy down payments! Safe-Buy Real Estate Agency, 712-PM West Third, Little Rock, Ark. (Please include Zip Code).

FREE! 152-page Spring catalog! Over 1800 pictures! Farms, ranches, homes, businesses, vacation and retirement properties in 29 states coast to coast! United Farm Agency, 612-PM West 47th St., Kansas City, Mo. 64112.

THE Only "No-Risk land purchase plan" in America—10 year money back guarantee on any vacation, retirement or investment homesite in Boiling Spring Lakes—the multi-million, 14,000 acre development on the Carolina Coast. All facilities, electricity, roads, shopping center, motel, golf course, country club, already in. Private ocean beach. 1/4-acre homesites as low as \$435.00; \$5.00 down. Write for free literature. Boiling Spring Lakes, Southport 1-P, North Carolina 28461.

"CAL-ORE Ranches" in Oregon's Rogue River Valley near Medford and Grants Pass. \$2995 to \$5995. Pay \$150 down, \$35 monthly. Free catalog. Cal-Ore Ranches, 1054PM South Riverside, Medford, Oregon.

CALIFORNIA Land for investment. Virgin, undeveloped property still available inexpensively. Write: Sunset Valley Department B-2, Box 48333, Los Angeles 48, Calif., for details.

FLORIDA Land—Small parcels, odd lots low as \$49.00. Casper Corporation, 3970 N.W. 177th Street, Miami, Florida.

MONTANA—Riverfront lots for sale in the heart of the Montana Rockies—fish, hunt, swim, camp on your own land. \$10.00 down and \$10.00 per month. Mountain Empire Company, Box 203-P, Libby, Montana.

CANADIAN Vacation lands: Full price \$385.00. 40 acres. \$10 month. Suitable cottage sites, hunting, fishing, investment. Free information. Land Corporation, 3768-C Bathurst, Downsview, Ontario, Canada.

FARM AND GARDEN EQUIPMENT

YOUR Ad in this space will be read by more than 1,400,000 active mail order buyers. Join the march to greater profits, place your products and services in front of them today with a small low cost classified ad. For further details, write: C. A. Martin, Dept. 43N, Popular Mechanics, 575 Lexington Avenue, New York, New York 10022.



PLANTS AND NURSERY SUPPLIES

WANT Greatest cash crop working for you? Write Ginseng, Asheville 53, N. C.

HOME CRAFTSMEN

FREE! Big 80 page Leathercraft catalog. 100's of new items! MacPherson Bros., Dept. K, 730 Mission St., San Francisco, Calif. 94103.

SKIL-CRAFTS New '65-'66 catalog. Largest and finest selection of leathercraft, artist, hobby-craft supplies in the world. Free gift with first order. Send 50¢. Refundable with first order. Skil-Crafts, Box 105-P, Joplin, Missouri.

PLANS. Bird houses, feeders. Ready built houses and feeder. Illustrated catalog. 25¢ coin. Yeager, 1665 Linden, Homewood, Ill. 60430.

WOODWORKING Catalog and manual. 25¢. Plus free "101 Project Ideas." World's most beautiful veneers, lumber, plywood! Wood finishing, upholstery supplies. Furniture hardware. 2,000 needed workshop products. Constantine, 2051-B Eastchester Road, Bronx 10461.

WALNUT. Cherry, silver maple, gun stocks, squares lumber, picture frame moulding. Midland Lumber Company, Box 262, Savannah, Missouri.

WOODWORKERS—Home craftsmen! Catalog containing lamp parts, veneers, lazy susan bearings, Swiss movements, chair cane, folding metal legs, wooden legs, mouldings, furniture hardware, finishing materials, etc., only 15¢. Barap Specialties, Box 2044-DK, Chicago 60609.

MAKE \$100.00 Formica counter tops with few dollars' material. Complete instructions \$1.00. Build cabinets like professionals, with new manual. "Cabinet-making Made Easy." \$2.00. Japs, 126-P Seventh North, Hopkins, Minn. 55343.

FREE "Do-it-yourself" Leathercraft catalog. Tandy Leather Company, 1001 Foch, N56, Fort Worth, Texas.

KNOCKDOWN Cedar chests, also over fifty kits. Catalog 25¢. Giles Kendall Co., Huntsville 2, Alabama.

2512 PLANS. Patterns, things to make, do. Fun. Profit. World's greatest selection. Catalog 10¢. Craftplans, 18250-A Harwood, Homewood, Ill.

101 PATTERNS Of smart gifts, novelties, shelves, action windmills plus "Make Money Jig Sawing." \$1.00. Mastercraft, 25M, 7041 Olcott, Chicago 60631.

PLANS for pool table with extra two-face top for table tennis and model railroad. Blueprints B1209 and building instructions \$3.50. Popular Mechanics Service Bureau, 575-M Lexington Ave., New York, N.Y. 10022.

DO-IT-YOURSELF

AUTOMATIC Washer repair manuals for: Frigidaire, General Electric, Hamilton, Hotpoint, Kelvinator, Kenmore, Norge, RCA Whirlpool, Speed Queen, Westinghouse, Maytag. \$2.50 ea. PPD, Major Appliance, 13106 Caine Ave. (Dept. M), Cleveland 5, Ohio.

CHAIN Link fence. Posts, fittings, gates, kennels. Discount prices. Install—earn to \$5.00 hour. Detailed instructions, catalog 50¢. Cordry Manufacturing, Dept. PM, 2400-06 Truman Rd., Kansas City 6, Missouri.

CONCRETE Block homes, cottages. Plans folder "How to build" 10¢. Bailey Builders, 7312-B Missouri, Little Rock, Arkansas.

HAND Carved Black Forest clock kit. Easy to assemble. Sent direct from West Germany to you. \$4.95. Milwaukee House of Values, 3010 South 39th Street, Milwaukee, Wis. 53215.

PLANS For good solid furniture anyone can build. Save hundreds. Dressers, Chests, Headboards, Coffee, End tables. Send \$5.00. Norman Bros., 5117 Norwich, Toledo, Ohio 43615.

PAINT Your own wall mural! Inexpensive, easy paint-by-numbers pattern kit, includes oils, brushes—everything! 35 decorator designs. Color catalog. 10¢. Muralart, 4401-AZ Birch, Newport, California 92660.

FLUORESCENT Tubes rejuvenated at no cost. Instructions \$1.00. Rejuvenators, 172 Bolton St., Portland, Me.

EXERCISE At home on build-it-yourself physical fitness equipment, including bicycle exerciser, rowing machine, belt massager, and abdominal board. Send \$2.50 for blueprints B1208 and instructions. Popular Mechanics Service Bureau, 575-K Lexington Ave., New York, N.Y. 10022.

FREE Check-list covering more than 300 classifications of projects, plans, instructions, service and repair information detailed in Popular Mechanics famous series of instructional booklets, books, patterns, and blueprints. List covers an extremely wide variety of do-it-yourself data on home remodeling, repair and improvement, hobbies, crafts, boating, games, lawn and garden, and hundreds of others. For your free copy of this helpful list, write: Service Bureau, Popular Mechanics, 575 Lexington Ave., New York 22, New York.

ARTS AND CRAFTS

MAKE Figurines, plaques, lawn ornaments, Molds, plastercraft kits, liquid rubber. Sample and catalogue 10¢. Wooley Company, Box 29-B, Peoria, Illinois.

BINOCULARS, TELESCOPES, MICROSCOPES, MAGNIFIERS

BINOCULAR Sale! Free color catalog 100 models \$9.95-\$250.00. Write, United, 9043 So. Western BCAT-6108, Chicago 60620.

SCIENCE Bargains! Lenses, telescopes, binoculars, microscopes, kits, parts, war surplus. Send \$1.00 for beginner's 10-lens kit with instruction booklet. Order Stock 2-CH. Request free 148 page Catalog CH. Edmund Scientific Co., Barrington, New Jersey.

BINOCULARS Direct from manufacturer. Finest quality, tremendous savings! Request catalog. Koyu, 3860 Crenshaw Blvd., Los Angeles, Calif.

BUILD Your own reflector telescopes: Complete kits; Mirrors, eyepiece, tripods, Free Catalog F describing other accessories sent on request. Also free brochure describing amazing line, World Famous "Dyna-scope" Reflector Telescopes. Criterion Manufacturing, Dept. KPM 35; Hartford, Connecticut.



CAMERAS AND EQUIPMENT

CAMERA Bargains—Excellent Japanese cameras direct. The saving is amazing. Camera Imports, Shell Knob, Missouri.

YOUR Ad in this space will be read by more than 1,400,000 active mail order buyers. Join the march to greater profits, place your products and services in front of them today with a small low cost classified ad. For further details, write: C. A. Martin, Dept. 49N, Popular Mechanics, 575 Lexington Avenue, New York, New York 10022.

PHOTO SUPPLIES

PHOTOGRAPHY For pleasure or profit. Learn at home. Practical basic training. Long established school. Free book. American School of Photography, 835 Diversey Parkway, Dept. 3451, Chicago, Illinois 60614.

PHOTO FINISHING

A **FREE** Kodak roll returned with each black and white or Kodacolor developed and printed, fast service, lowest prices, guaranteed quality send for free mailers. Economy Photo Service, Dept. P. M., Box 1111, Albany 1, N.Y.

TRIAL Offer. 8 enlarged prints from roll 40¢; 12—50¢. 8 Kodacolor prints from roll \$1.50; 12—\$2.00; 20—\$3.00. Guaranteed highest quality. Young Photo Service, 45M, Schenectady 1, N.Y.

SAVE UP to 45% over free film prices! Yes, you can definitely save enough to buy a fresh roll of Kodak film and still have money left over. Compare our prices for processing: 12 Ex. Kodacolor \$2.25. Black and white 49¢. All jumbo size. \$1.10 for 8MM. \$1.15 for Kodachrome 20 Ex. Over 28 years of service with ultra modern processing facilities enables us to give you highest quality, lowest prices and same day service. Send now for free mailer and processing price list. Best Photo Service, Inc., PMI PO Box 497, Syracuse, New York.

FAST, Hi-quality finishing. Kodacolor rolls: eight jumbo prints \$1.98. Twelve \$2.49. Twenty \$3.49. Reprints 15¢. Also low B&W prices. Custom Quality Studio, Box 4838-PM, Chicago 60680.

COLOR SLIDES

TRANSPARENCIES Wanted! Learn free-lancing. American Color, Box 46372, Hollywood, California.

WESTERN Scenery; nature. Choose singles economically. Quality Approvals. 711 Columbia Road, Colorado Springs, Colo. 80904.

MOTION PICTURES AND SOUND EQUIPMENT

FREE Catalog! Save on 8/mm.-16mm. film and supplies. Superior, 448 N. Wells, Chicago 10.

CAPTURED Nazi film. Guaranteed authentic. Sample 50¢. Sanford, Fairview, Pennsylvania.

16MM sound-projectors, films, new, used for sale. Free catalog. National Cinema, 71 Dey Street, New York City, N.Y.

16MM SOUND Shorts, cartoons, features. Cinemax Films, 10134 Perry Ave., Chicago, Ill. 60628.

MOVIE Film! Free catalog! ESO-R, 47th Holly, Kansas City 12, Missouri.

5,000 8-16 MM. Movie films. Free catalogues. International, Greenvale, N.Y.

16MM Sound films features and shorts. Bedner, 5300 So. Talman, Chicago.

8MM SPECIAL Offer: 50' Old time comedies, cartoons, hunting, fishing, travel, \$1.25 each. Send \$5.00 for 5. Movieland, 6039-M Hollywood Blvd., Hollywood, Calif.

8MM MOVIES, 2"x2" Color slides—biggest selection anywhere! Hollywood classics, railroad, antique automobiles, circus, World War II, travel, wildlife, many others. 16mm films also. Big catalog free. Blackhawk Films, 24 Eastin-Phelan Bldg., Davenport, Iowa 52808.

8mm. MOVIES, 2"x2" Color slides—biggest selection anywhere! Hollywood classics, railroad, antique automobiles, circus, World War II, travel, wild life, many others. 16mm. films also. Big catalog free. Blackhawk Films, 24 Eastin-Phelan Bldg., Davenport, Iowa 52808.

RADIO, TELEVISION AND HAM EQUIPMENT

BRAND New tubes. World's lowest prices on radio, TV-industrial, special purpose tubes. Write for free parts catalog. United Radio, Newark, N.J.

FREE Electronics catalog. Tremendous bargains. Electrolabs, Department C-639B, Hewlett, New York 11557.

BEGINNERS Kits, Diode radio, \$1.50. Solar powered radio, \$3.95, no soldering. Lectronix, Box 1067, Southgate, Michigan 48195.

3 1/2" RADIO & TV tubes. Free list. Cornell, 4213-17 University, San Diego 5, California.

CONVERTERS For automobile radios, receive Marine, Police, Fire, 2-3, 30-50, 100-200 megacycles. Any kit \$5.00. Meshna, Lynn, Mass. 09104.

TESLA-COIL—giant forty-inch sparks; plans, photo \$5.00. Details 30¢. Huntington Electronics, Inc., Box 9 Huntington Station, Shelton, Conn., 06486.

TACHOMETER! Transistorized. For all engines. Send 50¢ for detailed plans. Group Laboratory, Box 87, Prospect Heights, Illinois 60070.

CODE Instruction, beginner's tape recordings, three 5" reels, 3 1/4 IPS, Complete \$12.95. Halvorson Associates, Box 9975 Chevy Chase, Maryland 20015.

COUPON Book—Special offers from various firms for members of Electronic Experimenters' Club. Dues \$2.00 or write for further particulars. Box 5332-EE, Inglewood, Calif. 90310.

HIFI, RECORDS AND ELECTRONICS

EXCLUSIVE Free catalogue: extraordinary hard to find hobby party records. Record Suppliers, 300 Chelsea, Louisville, Kentucky 40207.

FREE — Free — Free — Free — Free — Free — Free. Send in for your Free one year subscription to Olson Electronics' fantastic value packed catalog, unheard of low, low prices on brand name speakers, changers, tubes, tools, Stereo, amplifiers, tuners, CB and other values. Credit plan available. If you have a friend interested in electronics send his name and address for a Free subscription also. Olson Electronics, Inc., 462 S. Forge St., Akron, Ohio 44308.

NEW Mfrs B.S.R. record changers, UA15 model with stereo cartridge \$13 each. Parts guaranteed or units exchanged. Quantity discount. Changers, Box 144 Jerome Ave. Sta., Bronx N.Y. 10468.

STEREO Tapes. Save up to 60% (no membership fees, postpaid anywhere USA). Free 60-page catalog. We discount batteries, recorders, tape accessories. Beware of slogans "not undersold," as the discount information you supply our competitor is usually reported to the factory. Saxitone, 1776 Columbia Road, Washington, D.C. 20009.

McGee Radio Company. Big 1966 catalog sent free. America's best values, hi-fi—amplifiers, speakers, electronic parts. Send name, address and zip code number to McGee Radio Company, 1901 McGee St., Dept. PM, Kansas City, Missouri 64108.

RECORDS! Discounts on all LP's. Free details. Citadel Record Club, 545 Fifth Ave., Dept. 2, New York 17, N.Y.

RECORD Jackets. Replace old, torn, dirty LP covers with clean, glossy, pure white jackets. Inner sleeves available. Free details or send 50¢ for samples. Cardboard Co., Room 904, 89 East Woodruff, Columbus, Ohio.

L P Records, 35-55% discount. Disclub, 1 Fisher, Mt. Vernon, N. Y. 10552.

TAPE Recorders, hi-fi components. Sleep learning equipment, tapes. Unusual values. Free catalog. Dressner, 1523 Jericho Tpk., New Hyde Park 3, N.Y.



MUSIC AND MUSICAL INSTRUMENTS

ELECTRIC Guitar kits, patterns, parts. Send 25¢. Kits, 3526 California, Peoria, Illinois.

USED Professional guitar, amplifiers, drums. Send 25¢. Hills, 3526 California, Peoria, Illinois.

INCOME Guaranteed two years for song-poems accepted! Free public releases! Castle's, 203PM West 46th Street, New York City 10036.

SONGS, Songpoems: Wanted for radio show. Hollywood Music Productions, 6425-B16, Hollywood Boulevard, Hollywood, California 90028.

PLAYER Piano books. Free catalog. Vestal Press, Vestal 11, N.Y. 13850.

SONGPOEMS Wanted. Send poems for offer. Nashville Music Institute, Box 532-PM, Nashville, Tennessee.

ACCORDIONS, Guitars, band instruments! Save to 50%. Famous makes. Easiest terms. Trades accepted. Free home trial. Free discount catalog. Mention instrument. International Music Mart, 5535-R Belmont, Chicago 60641.

SONGS And song poems wanted. Royalties. Tin Pan Alley, Inc., 1650 Broadway, New York, N.Y. 10019.

SONGS Or song ideas wanted by new commercial recording company for release to disc jockeys and public. Preview Records, 6311-B Yucca, Hollywood, California 90028.

VIOLIN And guitar makers, send for latest Free catalogue of woods & accessories. International Violin, PM-2, 414 East Baltimore St., Baltimore 2, Md.

POEMS Wanted for musical setting and recording. Send poems. Free examination. Crown Music, 49-C West 32, New York 1.

ELECTRIC Guitars, amplifiers, wholesale. Free catalog. Carvin, P.M.M. Covina, Calif.

GUITAR. Banjo Making books. Plans, woods, necks, tools. List 15¢. Satinwood, 510 East 11th Street, New York 9, N.Y.

POEMS Wanted for new songs and records. Send poems. Five Star Music, 6M Beacon, Boston 8, Mass.

All Instruments buy, sell, trade. Write for lists. Carter Instrument Exchange, Saunemin, Illinois 61769.

SUCCESSFUL Songwriting. Details free. Melody Writers, 2 Emma Street, Greenville, S.C.

SONGS, Poems wanted! Accepted songs published, recorded at our expense! Ted Rosen, 17-PM Longwood Road, Quincy, Mass.

RECORDING Stars need lyrics, for hit records. Rush poems. Kalin Twins, 438 Woodward Building, Washington, D.C.

LEARN To play guitar at home. Lead or accompaniment. Clifton's Guitar School, 943 Woodlawn Ave., Rockford, Ill. 61103.

ACCORDION Manufacturing, 6343-P South Ashland, Chicago, Illinois 60636. Piano Accordions, Chromatics, Hohners, Concertinas. Wholesale catalogs free.

SONG Ideas wanted. Write with active professional songwriters with publisher contacts. Records made. Share royalties. Send ideas—free examination. Songwriters' Associates, 236 W. 55th, N.Y. 19-P.

EDUCATION AND INSTRUCTION

LEARN Civil and criminal investigation at home. Earn steady, good pay. State age. Institute Applied Science, 1920 Sunnyside, Department 162, Chicago, Illinois 60640.

USED Correspondence courses and books sold and rented. Money back guarantee. Catalog free. (Courses bought.) Lee Mountain, Pisgah, Alabama.

HIGH School diploma at home. Licensed teachers. Send age, highest grade completed for free detail. No salesman will call. Southern States Academy, Professional Bldg., Dept. 16, Decatur, Ga.

PENMANSHIP Corrector. Improve poor penmanship quickly. Details free. Ozment, Box 665-34, St. Louis 88, Mo.

COMPLETE Your high school at home in spare time with 69-year-old school. Texts furnished. No classes. Diploma. Information booklet free. American School, Dept. X-245, Drexel at 58th, Chicago, Illinois 60637.

MEN Wanted. Earn \$125 a week and up. Master a trade with a future. Learn auto diesel mechanics in our shops. You learn with tools on real equipment. Earn while you learn. Many of our graduates earn \$125 a week and up. Write for free bulletin: Dept. 256, Auto Diesel College, Nashville 3, Tenn.

OWN Collection agency, "Little Gold Mine!" Franklin Credit, Roanoke, Virginia.

LEARN To drive tractor, trailer, trucks, buses. Short concentrated courses available. Write for free brochure. Driver Training Institute, 794 Bedford Ave., Brooklyn, N.Y. Ja 2-5080.

BOOKKEEPERS. Operate your own "Dollar-A-Week" system. Ellis, Box 200, Cedar Grove, North Carolina.

INVESTIGATOR'S Course. Credentials, diploma. Free information. Southwestern Institute Criminology, Box 201, Geronimo, Oklahoma.

BE A real estate broker. Insure security for yourself and your family. Study at home. Prepare for state examination. Write for free book today. Weaver School of Real Estate, 3519-P Broadway, Kansas City, Mo. 64111.

PIANO Tuning pays. Big money in spare time. Learn at home. No musical knowledge necessary. Phonograph, records, tools and instructions furnished. Electronic tuning also taught. Free catalog. Capital Tuning School, 3160 S.W. 16th Court, Ft. Lauderdale, Fla.

MISSOURI Auction School. Free catalog! 1330-03 Linwood, Kansas City, Mo. 64109.

B.Sc. DEGREE (Engineering) or College Entrance by home study. Send \$1 for 1966 prospectus. CIST, Suite 804, 263 Adelaide St., W., Toronto, Canada.

LEARN Special investigation. 20 Lessons, credentials, diploma, future. International Academy of Police Science, Oklahoma City, Oklahoma.

GET A British degree. Divinity, Philosophy, Radionics. 35 courses. Prospectus free. Brantridge Forest School, USA Representative, Box 357, Lincoln, Montana.

DETECTIVES—Secret investigations. Experience unnecessary. Detective particulars free. George Waggner, M125 West 86th, New York 10024.

FCC License in 6 weeks. First class radio telephone. Results guaranteed. Elkins Radio School, 2603D Inwood, Dallas, Tex.

DETECTIVE Course. Free information. Universal Detectives, Box 8180-F, Universal City, California, 91608.

PROFITABLE National Camera Repair School training at home! PM2, Englewood, Colorado.

SWEDISH Massage and Physical culture pays big profits. Learn at home. Diploma. Free catalog. National Institute, Dept. E26, 307 North Michigan, Chicago 1.

"STAMMER—Stutter—no more." (Dr. Young.) Write: Gaucho, Box 9309-S7, Chicago 90.

GAME Warden, Government hunter, forestry, park and wildlife services announce job openings regularly. Prepare at home for outdoor work, good pay, security. Complete information free! Write North American Schools of Conservation, 941-AZ North Highland, Los Angeles, Calif. 90038.

IDEAS—Think them up yourself! 30-step course with slide chart, \$5.00. Ritberby, 660 Pinecrest, Holland, Michigan.

"HOW To Train Horses"—Everyone who likes horses or ponies should have this book; free. Send name, zip code. Beery School, 1102-C, Pleasant Hill, Ohio 45359.

ENGINEERING And Art Degrees earned through home study. Electronics, Mechanical, Liberal Arts. When writing specify course desired. Pacific International College of Arts & Sciences, primarily a correspondence school. Resident classes also available. 5507-B Santa Monica Blvd., Hollywood, California 90038.

LEARN Electronics, Radio, Television, by practicing at home. Train with accredited school for important jobs in fast growing field. Use special equipment furnished at no extra cost to acquire new skills. Make extra money fixing sets in spare time. Write for Free catalog. National Radio Institute, Dept. 119-016, Washington, D.C. 20016.

BECOME Licensed real estate broker or salesman quickly. Highly profitable. Thorough, practical training including real estate salesmanship. Home study. Free information. Wall Realty Institute, 477-M Jackson, Pasadena, California 91104.

PENMANSHIP Book: Improve poor writing quickly, plus ornamental. T. Tevis, Chillicothe, Mo.

LEARN Auctioneering. Term soon. Free catalog. The Reisch American School of Auctioneering, Inc., Box 12, Mason City 1, Iowa.

LEARN Asleep or awake! Records, tapes, equipment! Free catalog! Drawer, PM-400, Ruidoso, New Mexico.

AUTOSUGGESTION, Sleep-learning headquarters! Tapes, records, books. Gigantic catalog free. Research Association, Box 24-PM, Olympia, Washington.

YACHT Captain school trains you for professional command. 10 weeks—practical—classroom—cruises. Write Holiday Harbor 7740 S. Trail, Sarasota, Florida.

LEARN Japanese conversation and kana. Easily understand training for businessmen, travelers, students. Write Nippongo Gakko, Dept. MC-26, 6950 Haynehurst Ave., Van Nuys, Calif. 91406.

LEARN Expert cake decorating, candy making. Free details on home instruction method. Candy & Cake, Box 54-AFL, Redondo Beach, Calif.

FREE Book "Opportunities in Electricity." Advance Trades School, Dept. E-903, Chicago 60631.

NEW Home radio course only \$26.95 complete. Tubes, components, tools, books included. Free literature. Edu-Kits, Department 638B, Hewlett, New York 11557.

WATCH Repairing. Swiss and American watches. Develop skill step by step in spare time at home. Tuition only \$5 monthly. Diploma awarded. Free sample lesson. Chicago School, Dept. YB, Fox River Grove, Illinois 60021.

WRITE For money—Free Confidential Directory of magazines that pay money for jokes, recipes, etc. Writing ability unnecessary. Cash in spare time or become full-time writer of stories, articles, television scripts, etc. Palmer Institute-AZ, University Plaza, Newport, California 92660.

LEARN Bookkeeping. Simplified complete course by CPA \$1.98 ppd. Free circular. Wilcox Co., PM-1, 7910 Pershing, Kenosha, Wisconsin 53140.

ADVERTISING Needs 18,000 new people each year. Prepare at home for profitable prestige career—or start your own advertising agency. No writing or art ability necessary. Free: Advertising Career Kit! North American School of Advertising-AZ, University Plaza, Newport, California 92660.

SLEEP Learning! Sensational record introduces revolutionary discovery! Instant self-power . . . control others. Free trial offer!! Forum, 333-JX2 Michigan, Chicago 1.

FREE Sleep-learning catalog. Fletcher, 2407 Catherine, Dallas, Texas 75211-PM.

"SLEEP Learning—Mental Magic of Modern Science." For copy send self-addressed stamped envelope. Crest, Box 993, Mount Royal, New Jersey 08061.

FREE List. TV servicing books. Thomas Garber, 104 Ashley St., Korn Krest, Wilkes-Barre, Penna.

LOOK Ahead. Men, Women. Make a better future for yourself. Study business courses at home. Earn promotions, higher pay. Free literature. Aladdin Home Study Courses, Dept. A, 409 St. Louis Street, Springfield, Missouri 65806.

PIANO Tuning quickly learned with home study course. Diploma granted. American Tuning School, Gilroy, Calif.

FOR INVENTORS

SAVE High fees! Prepare your patent application yourself! New "Do-It-Yourself" patent kit now makes it easy! Free "Registration Form." Miss Blaine, 306A Carry Building, Washington 5, D.C.

IMMEDIATE Cash, for patent applications. Free patent searches. Write for details. Universal Patents, 184-D, Marion, Ohio.

PATENT Searches, including copies of related U.S. patents, \$6.00. Inventors, attorneys, manufacturers use my "worldwide" airmail service! "Invention Record" form and "Information Every Inventor Needs," sent free! Miss Hayward, 1029P Vermont, Washington 5, D.C.

INVENTORS: Save time and money. Prepare and file your own patent application. Our complete "Patent Kit" makes it easy. Includes detailed instructions and all necessary material. Only \$14.75. Money back guarantee. Don't delay. Send check or money-order today to National Inventors Service, 1244—19th Street, N.W., Washington, D.C.

U.S. Patent Office Searches, 234 Broadway, Room 3615, New York. Free invention certificates.

TREMENDOUS—Savings! Prepare your patent application yourself—easily, with our New "Patent Kit." Complete instructions, materials, sample application—send \$8.95 for immediate delivery. Money-back guarantee! Congress Invention Company, 210 McKim Building, Washington 5, D.C.

INVENTORS: Your ideas and inventions (patented; unpatented) expertly searched and developed for commercial appeal and cash/royalty sales to manufacturers by professional Invention Developer with excellent record of experience. B.S., Industrial Engineering; U.S. Patent Office former Patent Examiner; U.S. Government former Patent Adviser. Second decade of reliable service! Free "Invention Record" and important information. Airmailed! Write: Raymond Lee, Invention Developer 130-N W. 42nd, New York City 10036.

"INVENT & Get RRich." A new book for inventors. \$2. per copy. Check or M.O. Wilbro Publications, P.O. Box 507, Muncie, Indiana.

PATENT And invention development, by licensed professional patent engineer and U. S. Patent Office former examiner, and engineering specialists. Your inventions and ideas engineered for patent protection and commercial value. Inventions developed by us negotiated for cash or royalties with our nationwide contacts. Send for free protection "Invention Certificates" and further interesting, valuable patent information. George Spector, Licensed Professional Patent Engineer, Woolworth Building, New York.

INVENTORS Complete guide book tells you how to develop and perfect your ideas, what to invent for profit. Free brochure. Castellazzo, 3257 Kansas, PM-2, Oakland, California 94602.

PATENT Pitfalls! New law hurts! Free help! Write Flipper, Geneva, Illinois.

HOW To find out exactly what your invention is worth. Details free. Locke, 3913 Castro Valley Blvd., Castro Valley, Calif. 94546.

IF Your invention is adaptable to promoting we will contract for selling on cash or royalty. Free booklet outlines royalty rates, requirements. Kessler Corporation, C-52-FI, Femont, Ohio.

PROFESSIONAL Patent searches, \$6.00, including official U.S. Patent Office copies of related U.S. patents! Prompt, dependable service. Certified, airmailed! For free "Invention Record Folio" and important patent information every inventor should have, write: United States Inventors Service Company, 1311 "G" Street NW, Washington 5, D.C.

INVENTIONS WANTED

INVENTORS Wanted: Manufacturers need new items! Your inventions, ideas developed for cash/royalty sales. Free "Invention Record": Information, Raymond Lee, 130-P W. 42nd, New York City 10036.

INVENTORS Needing Help with any problem, financial, development, securing manufacturer, obtaining patent. Write the organization that delivers action and results—not promises. Pioneer Invention Service, Dept. 83, 150 Broadway, New York 38, N.Y.

INVENTIONS Wanted. Patented; unpatented. Tremendous manufacturers lists. Global Marketing Service, 2420G 77th, Oakland 5, California.

WE Have markets for worthwhile inventions. Harvey Engineers, Cambridge, Maryland 21613.

INVENTORS: Protect your ideas! Free "Recommended Procedure." Washington Inventors Service, 422F, Washington Building, District of Columbia 5.

INVENTIONS Wanted: Patented, unpatented. Responsible manufacturers available. Progress Enterprises, 1109 S.W. Fifth Ave., Portland, Oregon 97204.

INVENTORS—Do you want to sell or license your invention on cash or royalty basis? Write: Kessler Corporation, C-52-IW, Fremont, Ohio.

WE Either sell your invention or pay cash bonus. Write for details. Universal Inventions, 298-E, Marion, Ohio.

MANUFACTURING

INVENTORS Services, Models, Manufacturing, Research, Consultants all fields available. William Parker, 32 Westminster, Worcester, Mass. 01605.

SANDBLASTING—Small metal parts. Wilbur Wantz, Route 3, Sykesville, Maryland 21784.

MODELS—Small lot manufacturing. Metals, plastics, etc. Milburn, Burlington, Kentucky.

BUY IT WHOLESALE

ELECTRIC Guitars, amplifiers, wholesale. Free catalog. Carvin PMW, Covina, Calif.

BARGAINS! Buy wholesale! Save money! Free catalog! Norris, 273 Merrick, Dept. 115 Lynbrook, N.Y.

SAVE \$\$\$\$\$\$ Buy wholesale or below, thousands of items direct from U.S. and Foreign Manufacturers. Many items free! Write: Global, Box 18216 RN, Indianapolis, Indiana 46218.

NEW 6-Color deluxe below wholesale catalog. Automobile catalog and others. Housewares, clothing, furs, furniture, appliances, refrigerators, washers, dryers, vacuum cleaners, polishers, cookware, dinnerware, strollers, cribs, radios, stereos, phonographs, recorders musical instruments, organs, typewriters, books, binoculars, luggage, sporting goods, bowling, golf, game tables, motor scooters, motor golf carts, power mowers, chain saws, boats, motors, bicycles, clocks, watches, diamonds, jewelry. Huge discounts, hundreds name-brand items. For free list (factory prices) postcard: Selbyco-5, Decatur, Illinois.

USED And new watches \$2 up. Free list. Southern Watches, 5-PM So. Wabash, Chicago 3

WORLD'S Largest wholesale supply. Buy from 7853 American, European, Japanese wholesalers. Hong Kong tailor-made suits. 123 dropship catalogs. Rockbottom prices. Automobiles. Free details. International Buyers, 216-M Jackson, Chicago 6, Illinois.

MEN'S Dress shirts. Any size white, color. Samples. Dozen, \$6.88. Postpaid. Frank Cirella, Waldoboro, Maine 04572.

WHOLESALE LARAMA, Bargain catalog. 20¢. Fair Sales, Box 5152-PM, Kingsport, Tennessee.

100,000 PRODUCTS Wholesale! Tremendous selections! Fantastic savings! Nationally advertised merchandise! Also closeouts, imports! Free details! Wholesalers, 1265-MB Broadway, New York, N.Y.

BARGAINS! Buy wholesale and below. Name brands. Appliances, furniture, sports equipment, televisions, cameras, watches, jewelry, thousands more. Huge discounts to \$1,000.00 on new automobiles. All makes. Free details. Write today: Worldwide Bargainhunters, Box 730-A, Holland, Michigan.

EXPORT-IMPORT

JAPAN: Mail-Order 26 page catalog. dolls, novelties. Manufacturers' names, addresses \$1.00; 1000 products illustrated trade directory \$3.00. Send cash. Yamagata Office, 814 Togin Bldg., Marunouchi, Tokyo.

SWISS Watch. Money-clip direct from Holland. \$8.95 postpaid, plus small duty charge. Wayne Johnson, Dell Rapids, South Dakota 57022.

FAMOUS Successful world trader, traveler offers beginners Free book, "How to Import." Make big home profit. Write, Mellinger, Dept. X382, Los Angeles 90025.

FOR THE HOME

TELL The more than 1,400,000 avid readers of Popular Mechanics about your products and services. It costs very little to place your classified message in front of these proven mail order buyers. For further details, write: C. A. Martin, Dept. 63N, Popular Mechanics, 575 Lexington Avenue, New York, New York 10022.

OF INTEREST TO WOMEN

WOMEN! Make big money at home. \$10.00 profit in an hour possible with invisible mending. Make holes, tears disappear from clothing, fabrics. Steady year-round demand from cleaners, laundries, homes. Details free. Fabricon, 1533 Howard, Chicago 26, Illinois.

\$200.00 MONTHLY Possible, sewing babywear! Write: Cuties, Warsaw 9, Indiana 46580.

HAVE Your own home moneymaking business! Addressing, sewing, other easy ways! Exciting "Opportunities Packet," 25¢. Jones Opportunity Mart, 40-PM, Ministerial Branch, Bedford, New Hampshire 03102.

DOLLS! Ideal husband and wife business—never tied down. Money-making opportunities everywhere! Start in home—open shop later. We teach you at home to make repair and sell all kinds of dolls and accessories. Free information. Lifetime Career Schools, Studio MC-16A, 11824 San Vicente Blvd., Los Angeles, Calif. 90049.

DRIVE New car, wear new clothes, buy color TV. Get daily cash income. Put spare hours to work. Write for 5 months free subscription Opportunity Magazine; see hundreds easy ways to make money. Opportunity, Dept. 17-AO, 850 N. Dearborn, Chicago.

BEAUTY Demonstrators—To \$5.00 hour demonstrating Famous Hollywood Cosmetics, your neighborhood. For free samples, details, write Studio Girl, Dept. OP358, 1510 N. Kostner, Chicago.

SHOP Your Thai handicrafts at home. Free samples airmailed postage \$1. Spectrum Ltd., G.P.O. Box 2133, Bangkok, Thailand.

SIAM Hand-woven Thai silk dress made-to-order, lined, \$25. Measurement form, samples available. Neck-Ties, four \$6. Temple-rubbings (21" x 23") four \$5. All airmailed, ppd. Spectrum Ltd., G.P.O. Box 2133, Bangkok, Thailand.

MAKE Money writing short paragraphs. Information free. Barrett, Dept. C-27-A3, 6216 North Clark, Chicago, Illinois.

WATCHES, OLD GOLD, JEWELRY

CASH Immediately for old gold, watches, diamonds and jewelry. Write Bill, Joseph Bros., 5 South Wabash, Chicago 60603.

WANTED, Gold, silver, platinum, scrap (any form), coins. Information free. Wilmot's, 1067-D Bridge St., Grand Rapids, Michigan 49504.

CASH Immediately for old gold, jewelry, gold teeth, watches, diamonds, silverware, spectacles, platinum, mercury. Free information. Rose Industries, 29-A East Madison, Chicago 2.

HIGHEST Cash for gold, jewelry, gold teeth, rings, diamonds, watches, silver, platinum. Mail articles today. Free gift with information. Chicago Gold & Precious Metals, 6 E. Monroe, Dept. 2858, Chicago 60603.

WATCH And clock repairing books. Free catalog. North American, Box 77-AP, Fox River Grove, Illinois 60021.

WEARING APPAREL

TELL The more than 1,400,000 avid readers of Popular Mechanics about your products and services. It costs very little to place your classified message in front of these proven mail order buyers. For further details, write: C. A. Martin, Dept. 66N, Popular Mechanics, 575 Lexington Avenue, New York, New York 10022.



SCIENCE AND CHEMISTRY

CHEMICALS And apparatus for industrial, analytical, and private laboratories. Catalog 35¢. Dept. M-50, Biological Supply Co., 1176 Mt. Hope Ave., Rochester 20, N.Y.

ROCKETS: New illustrated catalog 25¢. Single and multistage kits, cones, engines, launchers, trackers, technical information, etc. Fast service. Estes Industries, Penrose 7, Colorado.

SEARCHING For economically priced chemicals and apparatus? Gift with catalog. 25¢. Starr Scientific, Manitowoc, Wisconsin 54220.

SCIENCE Fair booklet listing experiments, information, suggestions, \$1.00. Hagenow Laboratories, Manitowoc, Wisconsin 54220.

ILLUSTRATED Catalog: Chemistry, mineralogy, biology 25¢. Tracey Laboratories, Evanston, Illinois.

ROCKET-Liquid Propellants, 10-lb. Payload. Plans, \$2.98. Kits, \$34.95. Star Space Systems, 605 West Hyde Park Blvd., Inglewood, California. (Formerly Missile Research of Anaheim.)

UNUSUAL Chemistry courses, kits! Information booklet, 25¢. National, Box 94, Redwood City, Calif. 94064.

FREE, Science catalog. Chemicals, glassware, physics, biology. Frey Scientific, 465 S. Diamond, Mansfield 11, Ohio.

CHEMICALS. Apparatus, Biology. Catalog 25¢. Mid-States Scientific, 7053 N. Clark, Chicago, Ill.

UNDERWATER Fuse 3/32" diameter 60 feet with fireworks information. \$1.00 postpaid. 125 feet \$2.00. Wayne, Box 1182, Addison, Mich.

FREE! Two 17" x 22" color science charts when ordering illustrated science catalog: Chemicals—glassware—apparatus, send 10¢. Lionel-Porter, Box 980-A, Hagerstown, Maryland 21740.

ROCKETS. New 1966 designs. Single, multistage kits, engines, ignition materials, bargains! Catalog, 25¢. Central Rocket Company, Waupaca 89, Wisconsin 54981.

SKYROCKETS. Firecrackers, fireworks—Make your own! 60 simple formulas \$1.00; 30 smoke formulas, 15 colors \$1.00; 10 fuse formulas 50¢. Paloma Pyrotechnics, Box 247, Auburn 5, California.

FIREWORKS—Explosives—detonators new manual reveals formulas, preparations, only \$2. Free with order, \$2 certificate for fuse. Pyrochem, Box 169, Berlin, New Jersey 08009.

FIRECRACKER. Rocket fuse. Regulated burning. 50 feet, \$1. Fireworks, explosives formulas, free information. Edcolabs, Box 99, Berlin, New Jersey 08009.

ANTI-Gravity research. Theories, ideas, concepts from hundreds of latest reports. \$1. Refundable. Champe, Box 303, Manhattan Beach, California.

CHEMISTRY Catalog, 25¢. Expendibles kit offer. Laboratory Sales, Box 161-A, Brighton 35, Mass.

ROCKETS! Flight kits, testing equipment. Catalog 25¢. Rocket Development Corporation, Route 3, Seymour, Indiana 47274.

AMAZING New book of science experiments, formulas, and catalogue of laboratory supplies. Only 35¢. National Scientific Co., 13 S. Park Avenue, Dept. PM-2, Lombard, Illinois.

FORMULAS, PLANS, ETC.

PROFITABLE Manufacturing formulas. Literature free. Pontesso, 2625 South Eighth, Terre Haute, Indiana.

FORMULAS—All kinds. Amazing big catalog. 10¢. Kemixal, Park Ridge, Ill.

FOR Proof of what you can do in specialty manufacturing get our literature. It's free! Miller, Chemist, 1517-P, Tampa, Florida.

MAKE Your own rust remover for .10¢ a gallon. Formula and Instructions \$1.00. Tradewind, Box 57-A Tekonsha, Mich. 49092.

OUTSTANDING Encyclopedia of formulas, processes, trade secrets. Free information, Cassill, Box 1535, Eugene, Oregon 97401.

FREE Catalog of formulas, home business and money-making plans galore! No charge, no obligation. Western Chemicals, Box 19718-C, Los Angeles 90019.

SKYROCKETS, Fireworks, Manual, 100 formulas, \$2.00, Skymail, Box 874-BB, Sunnyvale 88, California.

LATE, Modern manufacturing formulas. List free. Moon Chemical, Martville, New York.

PLASTICS

NEW Liquid casting plastic clear colors. Embed real flowers, butterflies, photos, coins. Send 25¢ for two handbooks "How to Cast Liquid Plastics" and "How to Make Extra Money at Home." Castolite, Dept. 66-101-B, Woodstock, Illinois.

BOXES, Plastic, 200 sizes. Free list. Althor, 2260 Benson Ave., Brooklyn, N.Y.

NEW! Low priced plastic laminating machines & supplies. Details, Burr, 7645 Oakland, Kalamazoo, Mich. 49002.

FREE Details—Start your own plastic laminating business. We supply everything. Jiffy, Box 23485P, Los Angeles, Calif. 90023.

PLASTIC Embedders, jewelry workers. We have everything. Findings, moulds. New catalog 25¢, David Co., 861 Broad St., Dept. M, Providence 3, R.I.

TREASURE FINDERS

TREASURE. Find gold, silver, relics with super, powerful Detectron locators. Free information. Detectron, Dept. 2-PM, P.O. Box 243, San Gabriel, California.

COMPLETELY New prospecting technique developed by Relco. New transistor models detect buried gold, silver, coins, treasures, \$19.95 to \$129.50. Write for free catalog and "guide for beginners". Relco-A40, Box 10563, Houston 18, Texas

SAVE! Build transistorized treasure finder. Details free. Del Research, Box 347-B, Alden Manor, Elmont, N.Y.

NEW. Coin locator! Free literature! Howe, 811-C Kansas, Atchison, Kansas.

POWERFUL Metrotech locators detect gold, silver, coins, relics. Moneyback guarantee, terms. Free information. Underground Explorations, Dept. A, Box 793, Menlo Park, California.

TREASURE, Gold, silver, relics. New 1966 detectors now available. Free information. Rayscope, Box 715, North Hollywood, California.

TREASURE-Pone automatic. A new principle in electronic metal detection. Patent Pending. Write: Highlander Co., Dept. 23, 10308 Brenda Way, Rancho Cordova, Calif.

FIND Buried coins, treasures, gold, silver with sensitive new 1966 transistor metal detectors. Free information. Sensitronix, 2225-C Lou Ellen, Houston, Texas. 77018.

UNDERWATER Metal detector designed for diving. Transistorized small, sensitive. Find coins and small objects 3" to 3' beneath bottom. Valuable tool—\$245. ppd. Complete diving catalog, \$1.00. M & E Marine, Camden, 1, N.J.

EXCITING Adventure locating hidden loot, treasure, relics, etc., with powerful, electronic M-Scope locator. Lightweight. Guaranteed. Very easy terms. Send for Free booklet, interesting customer reports. Fisher Research, Dept. AAY, Palo Alto, Calif. 94302.

GOLD, Treasure, coin locators, \$3.00 complete. Guaranteed. Locators, Ashland, Oregon.

TRANSISTOR Treasure detectors, underwater detectors. Many models. Free catalog. Gardiner Electronics Co., Dept. 9, 4725 N. 7th Avenue, Phoenix, Ariz.

PRECIOUS STONES AND MINERALS

U.S. AND foreign mineral specimens, lists 10¢. Minerals, Winston, New Mexico 87943.

EARTH Science, Educational magazine. Subscription, \$2.50. Sample, 35¢. Box 550-PM, Downers Grove, Ill. 60515.

GET Free catalog no serious rockhound, gem cutter, jewelry maker, hobbyist or craftsman can be without. Full of bargains, exclusive items, low prices from largest suppliers and authorities in the field. Free new catalog just off the press, yours for the asking. Write Grieger's, Dept. C-12, 1633 E. Walnut, Pasadena, California.

JADE Tie tack, rockhound catalogs, \$1.00. Daley, Box 405C, Driggs, Idaho.

REAL Gold and silver ore. Famous comstock lode packed prospectors poke. Satisfaction guaranteed, \$2.00 postpaid. Bonanza Enterprises, Virginia City, Nevada.

AUSTRALIAN Opals. Agents wanted by genuine supplier. Good profits. J. D. Macdonald, Liverpool Street, Port Lincoln, South Australia.

SEMI-Precious uncut gems. Ten different for \$1.00. Request list 30, Prospectors Shop, 201 San Francisco, Santa Fe, New Mexico.

CARTOONING, COMMERCIAL ART, SHOWCARD & SIGN PAINTING, TATTOOING

YOU Can entertain with chalk talks. Catalog 10¢. Balda the Cartoonist, Oshkosh, Wis.

LEARN Sign painting at home. Free talent test. Ben Kerns, Box 812-PM, Greenville, S.C.

LEARN Profitable magazine cartooning. Free details. Hartman, Box 3097, Lincoln 10, Nebraska.

LIKE To draw? Splendid opportunities in professional cartooning. Write for free catalogue. No obligation. National School of Cartooning, Studio-H, Box 8958, Cleveland 36, Ohio.

How To make money with simple cartoons. Everyone who likes to draw should have this book! Free. Send name, zip code. Cartoonists' Exchange, 92 Pleasant Hill, Ohio 45359.

"KEY to a Cartoon Career." Send for booklet, 50¢ handling. Cartooning, Box 3176, Colorado Springs, Colorado 80907.

SIGN Painting. Fascinating system. Straley, 410 South Western, Springfield, Ohio.

SIGN Painting and art. Instructions, brushes, equipment, everything. Free catalogue. Kaufmann Supply, Centertown, Missouri.

ADVERTISING AGENCIES, ADV. SERVICE, MAILING LISTS

ADVERTISING Ratebook leading newspapers, magazines, free. Chicago Advertising Agency, 28-E Jackson, Chicago 4.

MAILING Lists most all kinds 1000 \$5.00. Free folder. Your circulars mailed \$4.00 1000. Dixie Mailers, King, N.C.

MAILORDER Record Book, 30 pages. Records inquiries, orders, advertising expense, etc. Most complete. Just send dime for postage and handling. C. A. Martin, Popular Mechanics, Dept. RB2, 575 Lexington Ave., New York, N.Y. 10022.

TYPEWRITERS, DUPLICATORS, OFFICE EQUIPMENT

OFFSET, Letterpresses, varitypers, typewriters, mimeograph, multigraph machines. Bargains. DixieGraph, King, North Carolina.

RUBBER STAMPS AND OFFICE SUPPLIES

FREE Catalog: Rubber stamps, printing, Dowling Products, Dept. PMC5, Pitts town, N.J.

CATALOG: Rubber stamps, dates, printing. Martin, 1425 Major, Jefferson City, Missouri 65101.

PRINTING, MULTIGRAPHING, MIMEOGRAPHING, GUMMED LABELS

AMAZING Business printing values. Samples Print Shop, Box 576, Greenville, R. I. 02828.

PRINTING—8 Page catalog—1½¢; 5M 8½ x 11, =1 S. \$15.00. Free price list. Copen, 337 Butler Street, Brooklyn 1, N.Y.

QUALITY Printing: Lowest prices. Samples. Dowling Press, Dept. PMC5, Pitts town, N.J.

1,000 THERMOGRAPHED (Raised letter) business cards, \$3.75. Free samples! Griffin, 322 West State, Ithaca, New York 14850.

1000 GUMMED Address labels, \$1.00. Wait's, Box 966-A, South Bend, Indiana 46624.

100 PRINTED 5½x8½ letterheads and 100 =6¼ envelopes \$2.75. Price list free. Purple Enterprises, Box 16291-BO, Jacksonville, Florida 32216.

SELFSTICK Labels. Business, personal. Samples 10¢. Columbus, 719 East Pike, Seattle 98122.

BARGAIN! 100 Printed 5½x8½ letterheads and 100 =6¼ envelopes \$2.75. Satisfaction guaranteed. Glass, Wampum, Pennsylvania.

QUALITY Offset printing. Introductory offer—500-8½ x 11's \$3.25 postpaid. Cisco's Duplicating, Atlanta, Illinois.

1,000 CARDS Raised, \$3.85; Two-Color, \$4.95 Delivered. Samples free. Wedding invitations. Bixler, 752 Bensen, Frankfort, Kentucky 40601.

THOUSAND Embossed business cards, \$3.30. Dealers wanted! American, Box 166G, NYC 10459.

500 PERSONALIZED Address labels, 50¢. Catalog, 10¢. Merchant, P.O. Box 445, Flint, Michigan 48501.

BUSINESS Envelopes, letterheads, cards. Free brochure. Prestige Press, Box 146-M, Newton, Iowa 50208.

100 TWO Color porcelain finish business cards, \$1.00. Eslick's Craft Studio, Delavan, Wisconsin.

BUSINESS Printing. Catalog Free. Bill's Press, 538-P Leffingwell, Kirkwood, Missouri 63122.

PRINTING & RUBBER STAMP OUTFITS—SUPPLIES

DO Your own printing. Save money. Simple rules. We supply everything. Print for others: good profit. Raised printing like engraving too. Have home shop. Details free. Kelsey Presses, V-11, Meriden, Connecticut.

NEW Type Catalog No. 11, 96 Pages. Send One Dollar. Deductible First Order. Acme Type, 732 Federal, Chicago, Illinois.

RUBBER Stamp outfits, supplies. Kiewiet, 2025 Barney Road, Kalamazoo, Mich. 49007.

TYPE And supplies for rubber stamp makers. New wholesale price list No. 3 free. Star Stamp Supply, 732 Federal, Chicago 5, Ill.

RUBBER Stamp manufacturers supplies. New products. Low prices. Catalog. Jackson Supply, 1433 Winnemac, Chicago, Illinois 60640.

DEEP Faced, hard type for better rubber stamps—buy direct from manufacturer, 20% discount for limited time only. Send for brochure. Barco Type Manufacturing, 237 S. Evergreen, Bensenville, Ill.

MAKE Your own self-molding rubber stamps and printing cuts. Plexirubber, Argyle 1, Wisconsin.

RUBBER Stamp presses, hydraulic operated, electrically heated. Sizes 5" x 8", 8" x 12", 10" x 15". Starting outfits, supplies. Printing presses, Type cases and cabinets. Custom Manufacturing, 1464-P East Commercial, Springfield, Missouri.

REMAILING SERVICE

MIAMI Remails 25¢. Monthly Rates. Marie, P.O.B. 1266, Coral Gables, Florida 33134.

HAWAII Secret address. Remails 25¢. Receiving—forwarding \$3.00 monthly. Postcards, gifts, slides. Coe, Box 984, Kailua, Hawaii 96734.

PRIVATE Address, information 25¢, remails 25¢. Horton, 68 Kensington, Greenville, South Carolina 29609.

OLD Established, 25¢, \$3.00, monthly. DeGraff, Box 14156-P, San Diego, California.

ST. Petersburg, Florida remails, 25¢. Monthly rates. Confidential. 4505-80th Avenue, Pinellas Park, Florida 33565.

LOS Angeles address, remails. Confidential. Enarkay, 1805 Wilshire, Suite 206, California 90057.

SECRET Receiving and remailing. Discreet and confidential. Remail 25¢ single. 8050 S. Main, Houston, Texas.

SAIGON Air remails \$1.00. Unaddressed picture postcards available \$2.00 dozen. Tschepel, PO Box 1482, Saigon, Vietnam.

MASSACHUSETTS, Remails 25¢ single, \$3.00 monthly. Confidential. R. J. Piazza, 2 Valleywood Circle, Winchester, Mass.

PANAMA Re-airmail, 40¢ incl. stamps. Okie, 87 Balboa Heights, Canal Zone.

SECRET, Receive, remail, 25¢, \$2.75 Monthly. Skymail, Box 874-B, Sunnyvale 88, California.

N.Y.C. (Times Square) address. Reasonable. Information 25¢. Roberts, 1170 Sixth Avenue, N.Y. 10036.

REMAILS 25¢, Richards, 222—17th Avenue South East, Calgary, Canada.

SECRET Mail receiving system. Hedgpath, 406-M South Second, Alhambra, California 91802.

REPAIRS AND SERVICING

HEARING Aids repaired, 6 month guarantee, \$15.00. Florida Hearing Aid Repair, Box 11233, Ft. Lauderdale, Florida 33306.

HOME Repairs made easy. Details free. Lewis, Box 224-PM, Prosser, Washington 99350.

SPECIAL SERVICES

FACTS, Any subject—product. Research reports. Plan, \$1.00. Box 1431, Greenville, South Carolina 29602.

FREE Sales producing product write ups in national magazines; \$75 includes story; photos; postage; Howe Advertising, 11720 Edgewater Drive, Cleveland, Ohio 44107.

INFORMATION On anything. Ferguson Research Specialists, 83-45 Vietor Ave., Elmhurst, N.Y.

OIL Paintings made on request, portraits, animals, scenery, etc. Helen Ashworth, Rt. 2, Heuvelton, N.Y. 13654.

TECHNICAL Translations, English—Spanish, 5¢/word, P. E., Box 1325, Mission, Kansas.

OLD Stock certificates may be worth fortunes. We investigate; report findings. Reasonable. Any state. Details free. Securities Search, 631 South Gaylord, Denver, Colorado 80209.

LOCATING Service! Any items or product. Jake Barraco, 478 Gardner, South Beloit, Illinois.

EYEGASSES! Wholesale laboratory established 25 years. Mail eyeglasses or prescription for quote. Global Opticians, 16 East 23 St., New York, N.Y.

TOBACCO

FREE Catalog. Big Savings on Meerscham and Briar pipes, tobacco. Smoker's accessories. Pipes, Box 125P, St. Ann, Mo. 63074.

RAZORS

NORELCO Shavers repaired by mail, factory authorized. Estimates given if requested. Norelco Shaver Service, 8348 Vine St. Cincinnati, Ohio 45216.

WANTED—MISCELLANEOUS

STAMP Collections, accumulations. Eagle Stamp Co., 2221 Romine, Pittsburgh 26, Penna.

MERCURY, Gold, Silver, Platinum: Ores assayed. Wholesale Terminal, Norwood, Mass.

PERSONAL

BLITZ Reducing! 5 pounds overnight! Guaranteed! Bijou, Box 1727-BM, Hollywood, California 90028.

BORROW \$1,233 Airmail! Repay \$54 for twenty-nine months. State licensed. Postal Finance, Dept. 17-M, Kansas City, Kansas 66117.

BIBLE Questions answered. Stamped envelope. Bylon, 17167 Bentler, Detroit, Michigan 48219.

SUBCONSCIOUS Conditioning remakes personality while you sleep. Free details. Sleep-Learning, Box 34N, Olympia, Washington.

FREE Details solution to all financial problems. Amazing results. Loans available. Write Financial Consultants, 28 E. Jackson, Suite 1204-PM, Chicago 4.

LOANS By mail, \$100-\$1000. Anywhere. Confidential. Write Union Finance, Dept. PM, 222 W. Osborne, P.O. Box 7457, Phoenix, Arizona.

RUPTURED, Relief and comfort. No understraps, elastic or steel. Write Hand-Lock Products, Preston 4, Ont., Canada.

INTELLIGENCE, Aptitude, personality tests. Complete self-test set \$3.95. Free sample. Spencer Co., 5307 West 8th St., Los Angeles, Calif. 90036.

BORROW \$100 to \$1000 by mail. Quick, easy, private. No co-signers. Repay in 36 small monthly payments. For the amount you want write today to Dial Finance Co., 410 Kilpatrick Bldg., Dept. 2-214, Omaha, Nebraska, 68102.

LOW-Cost loans by mail, \$6.00 monthly repays \$104.50; \$56 monthly repays \$1,321.39. Borrow any amount. Guaranteed fast, confidential. Write today! Bankers Investment 67-C, Box 1648, Hutchinson, Kansas 67501.

EYE Glasses slip? Invisible corrective aids, \$1.00. Fitrite, Box 22101, St. Louis, Mo. 63116.

NEED Money? Borrow \$100-\$1000 by mail. Confidential, repay in 36 months. Free loan application. World Finance Co., Dept. BW-146, 620 Symes Bldg., Denver, Colo.

FREE, Booklet "Wills How To Make & Break Them," with 3 will forms \$1.00. Urban-Rural, Box 293, Fort Lee, N.J.

INVESTIGATORS, Free brochure on (Snooper) new wireless listen in device (unnoticed). Hear two way conversation through FM Radio. TV Sales Company, 3191 N. Watkins, Memphis, Tenn.

ESCAPE Debts—Clear credit—Legally. Free details. Counselor Reports, Harlingen 7, Texas.

INVESTIGATORS, Free brochure, latest subminiature electronic surveillance equipment. Ace Electronics, 11500-P NW 7th Ave., Miami, Florida 33168.

MISCELLANEOUS

SUPER Memory overnight! Success guaranteed! Bijou, Box 1727-M, Hollywood 28, California.

FREE Wholesale catalog! 100,000 products. Tremendous discounts! Taylor Distributors, Newton 2, New Jersey.

YOUR Name sent to 1000 importers, publishers, mailers, wholesalers, etc. on our mailing list. Year \$1.00. Dixie Mailers, King, N. Car.

HEARING Aid batteries wholesale. Free list. Habs, Box 51, York, Penna.

CIGARETTES—Make 20 plain or filter-tip for 9¢. Factory-fresh pipe tobaccos. Mild tropical flavored Philippine cigars. Facts free. Moberly, Box 905, Owensboro, Kentucky.

HEARING Aid batteries wholesale. National Wholesale Battery Company, P.O. Box 825, Wichita, Kansas 67201.

SAFEGUARD Privacy! New instrument detects electronic "bugs," wire-tapping and snooping devices. Free information. Dee Equipment, Box 7263-E4, Houston 8, Texas.

ORNAMENTAL Iron designs. Book of 1600 beautiful, practical designs for railings, columns, etc. Free literature. Cunningham, 3881 South 3200 West, Salt Lake City, Utah 84119.

LOG Cabins: Ship anywhere; 35 plans, specifications and prices. Send \$1.00. Write Bloch Brothers, Waterford 4, Michigan.

WANT Greatest cash crop working for you? Write Ginseng, Asheville 53, N. C.

LOANS By mail, \$100-\$1000. Anywhere. Confidential. Write Union Finance, Dept. PM, 222 W. Osborne, P.O. Box 7457, Phoenix, Arizona.

COMBINED F.I.C.A. and withholding chart for 1966 thru 1968. Weekly only, 9 3/4 x 13. Easy to handle, \$3.00 each. Send check or M.O. to Duffy Duplicating Service, 1159 Encanto Way, Pacifica, California 94044. 30-Day money-back guarantee.

UNUSUAL Refuse container. Mail 10¢ for brochure. Como, Box 128, Totowa, N.J.

EXPOSED! Bleach sales' profits. Plan, \$2.00. Neal Hendrix, Springhill, Louisiana, 71075.

HAPPY Feet tie tack, unique novelty. Outrageously funny. Gets a thousand laughs. Send only \$1.00. Worth lots more. Free catalog. Federal, 6652PM North Western Avenue, Chicago, Illinois 60645.

CUSTOM Built Martin birdhouse plans. Send \$1.00 to; Birdhouse, 3230 St. Joan Lane, St. Charles, Mo. 63301.

"PASS Easily." Raise grades. Pass exams, \$3.00. Satisfaction or refund. Clarion, Box 9309-87, Chicago.

SUPERSENSITIVE Listening-In-Device picks up any telephone conversation in vicinity. No connection to telephone necessary. \$2.98 complete. Consolidated Acoustics, 1302K Washington, Hoboken, N.J.

YOUR Swap, sell or want ad published Free in our big monthly magazine! No strings to this offer! No commercial ads. Limited time offer. Swap-Sell ads, Box 591D, Lynn, Mass.

BOOKS On antiques and their prices. Free circular! P. Warman Publishers, Uniontown, Penna.

BIRTH Certificates, Marriage Certificates, Diplomas! 2 blank forms \$1.00. Sample 10¢. Standard Forms, Box 482-M, Washington, D.C. 20044.

They laughed.



3000 B.C. Somebody invented the wheel. It was round and funny. And since the road wasn't invented yet, everybody laughed.



1879. The electric light bulb. It was so dim, people had to use a gas lamp to see it. They laughed.



1875. The telephone. Who'd want to stand and talk to a box full of wires? They laughed.

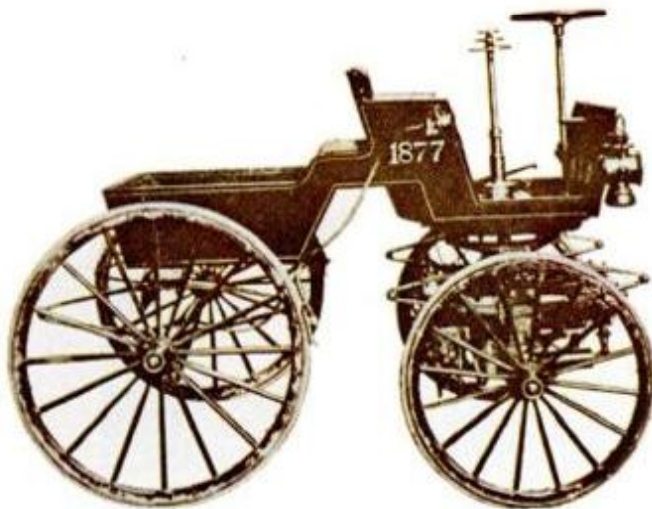

1877. The automobile sputtered down the road. The horse and buggy passed it like it was standing still. And it usually was.



1807. The first steamboat in America made it from New York to Albany in 32 hours. A small boy could've beat it in a rowboat. They laughed.

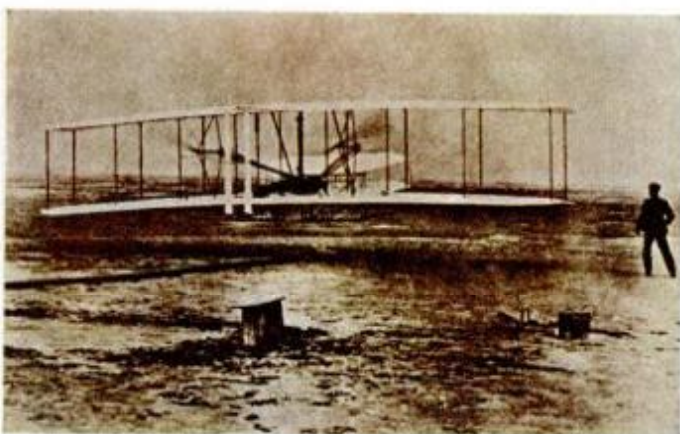

1903. The airplane. Off it soared into the wild blue yonder; down it came 59 seconds later. They laughed.



1950. The Volkswagen Station Wagon. It was square and homely. But it held almost twice as much as un-funny station wagons, took 4 feet less space to park, never froze up or boiled over, and cost about half as much money to run.

The VW is still a pretty funny sight. And people are still laughing. But the laughter is dying down.



Executive's Action Suite

By Marion Morey

Free the executive from a confining desk, give him the latest equipment to arrange according to his specific needs, and you stimulate top creativity, say the designers of a new "action office."

After three years of studying how executives work, researchers at Herman Miller and designer George Nelson came up with their new office design.

Key to office action is a communications center (top photo) swivel distance from the executive perched at his special high desk. He's able to roll out a dictating machine which also switches to record his phone conversations. The speaker-phone has its own sound buffering compartment, assuring privacy.

The center photo shows a secretary at her modified desk taking dictation from a transcribing machine at her convenience. In the background are movable shelf units for quick recovery of filed items.

A wooden tambour top rolls down over center files in this work desk (bottom photo), leaving work in progress undisturbed for the next day.

Low rollable conference tables complete this modern, mobile plan for the executive in action.



Independent tests prove Ford Pickups ride best. Be independent. Test-drive one yourself.



Don't take our word. Test reports by a leading independent research firm show Ford pickups rode more smoothly than the other leading makes. And scientific techniques assured testing accuracy. But no need to take *their* word, either. Check out Ford's ride yourself. Look into Ford's Twin-I-Beam suspension at your Ford dealer's. See how the two front axles work independently, so that shocks at one wheel aren't passed to the other. Or to the driver. Next, get behind the wheel. Give that pickup as independent a ride test as you can. You'll feel better. And so will we. Because either way—our independent tests or yours—you'll have the word.



Each of Ford's two front axles is a forged steel I-beam. Husky radius rods help hold wheel alignment. Together, they make the most durable independent suspension in any pickup.

FORD/66



Solid funpower! **New 'Jeep' V-6!**

Nobody makes 'em like this one. It's solid all the way through—solid build, solid looks, solid performance. Choose hot new V-6 engine or world-famous 'Hurricane' 4. You really 'fly' down the highway with that 160 h.p. 'Jeep' V-6—that's why we call it the Flying

'Jeep' Universal. And snow, ice, rugged country just add to the fun. Take your pick: familiar "little guy" or jaunty 'Jeep' Tuxedo Park Mark IV. Both offer 81" or 101" wheelbases, choice of tops, new colors, even bucket seats. You've got to drive it to believe it. See your 'Jeep' dealer. Look him up in the Yellow Pages.

The Flying 'Jeep'
Universal
with 4-wheel drive



KAISER Jeep CORPORATION
TOLEDO 1, Ohio

EDITOR'S PAGE

Flat-tube color TV is news in anybody's book. But when it hits first production in a miniature portable you can tote anywhere—with a rectangular screen carrying the same image on both sides of the set—it's a phenomenon. That's why, when our electronics editor, Larry Steckler, began getting signals about it on his alert antennae, we didn't spare the horses. The result is our exclusive cover story on page 90—a genuine first report on one of the most dramatic electronic developments for you in a long, long time. To make the earliest possible issue, we built a fire under our West Coast editor, Tom Stimson. Tom made arrangements for our art director, Ray Schulze, to stage the spectacular cover on this issue. They rented some beach and hired a lovely young model named Bobbie Whitby (below). Larry and Ray flew to the Coast on a few hours' notice. While Larry served up the story with the developers of the set, Ray, Tom and photographer Bob Smith were shooting the cover pictures. There's nothing new about flat TV tubes. The military has been using them in aircraft for some time. But, until now, they've been prohibitively expensive. This new consumer breakthrough may be *the* forerunner of a whole new world of TV—that can be mounted in picture frames on the wall.



Photographers don't always use their heads, as any editor will tell you. The picture at right, above, might seem—at face value, if you'll pardon the expression—to

prove it. The visible nether regions belong to *PM's* staff photographer, Gene Colangelo. It was snapped by Bob Berger, unbeknown to "Gino" who was busy shooting some fancy angles for an upcoming automotive feature. But appearances can be deceiving. Gino *always* uses his head, as he is quick to admit. We have to admit it,



too. There have been times when he's used not only his head, but everything he's got. He's been soaked to the skin in muddy water, trying to get close-ups of cars coming through the trough on test tracks; he's survived roll-overs in cars that were being limit-tested; he's teetered on skyscraper perches to achieve exciting angles on run-of-the-mill subjects. In the case of this picture, Gino was using his coat to shade his reflex camera. The head was there, all right. Figuring angles. All kinds.

Exploding cigars and itching powder once comprised the pinnacle of cornball practical jokes. It is a relief to know that such cloddish buffoonery is now as square as the fox-trot. Today, *geniuses* are at work in the practical joke department, and the results are not only fascinating—they're hair-raising. Consider the Caltech whiz kids who glued a classmate's furniture upside down, with epoxy, on the ceiling. The way-out stunts of modern day practical jokers, are included in *Genius at Play* in next month's *PM*.



Fantastic new portable color tv set has flat picture tube you can watch from both sides. New flat-tube development is first step toward practical hang-on-the-wall television for your living room. BY Larry Steckler

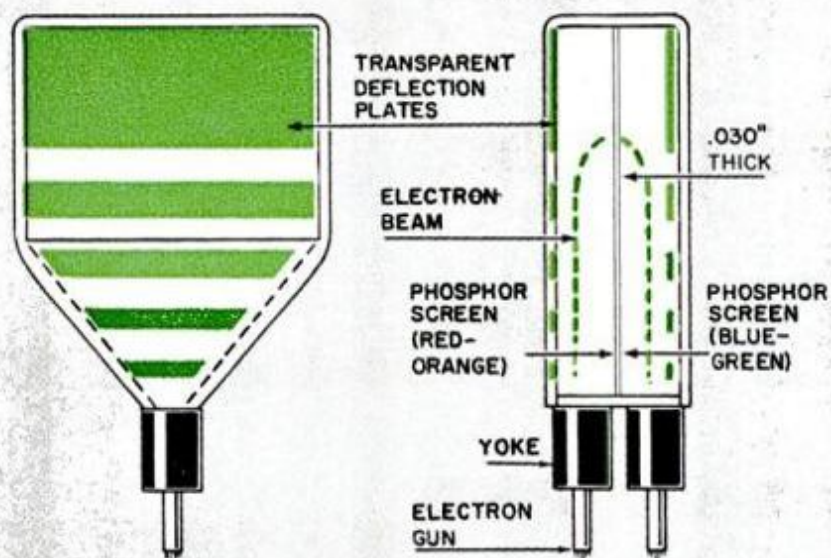

THINNEST COLOR picture tube gives up its secrets in detailed PM sketches

FLAT TV PICTURE TUBES ARE REALLY HERE. There are both color and black-and-white versions. I know. I've seen them in action. I've held them in my hands. And you'll soon be seeing them in a new breed of portable TVs sporting a famous maker's label around the end of this year.

Now settle back and we'll let you in on the news. Out in the suburbs of Los Angeles are the business offices of the Intertel Corp. And inside these offices some remarkable things have been going on. They've developed a flat color-picture tube like the one diagramed above. It has a 6-inch screen that gives a perfectly rectangular viewing area, $4\frac{3}{4} \times 3\frac{1}{2}$ inches. Best of all it's a tiny $2\frac{3}{8}$ inches thick. When combined with a transistor color TV chassis it makes a color set that's a mere $10 \times 6 \times 3\frac{1}{2}$ inches, weighs six pounds and costs about \$200. Just the right size to take along on your next trip. They've come up with a monochrome (black-and-white) portable too, and it's even smaller— $9 \times 4\frac{1}{2} \times 2\frac{1}{4}$ inches—and costs \$150.

While only small-screen versions of the flat picture tubes have been built so far, there is no limit to the size tube that



can be built. Scaling-up, a 23-inch rectangular tube would be about 4 inches thick. You could certainly hang it on your living room wall and probably will.

The Intertel sets are unique in several ways other than their use of the flat tube. To me, the most fascinating feature of all is that the picture can be viewed from either side of the tube. Of course, it appears in reverse on the back side, but it's a great way of making a small-screen portable viewable by a greater number of people.

Early models of the set will be viewable only from the front as the space behind the picture tube will be taken up by some electronic circuitry. Later versions may include the two-sided viewing if the public demands it. I think it will. The cabinet will be enlarged slightly to make room for the wiring that would otherwise block off the rear of the tube.

The color tube is unique in itself. It is a two-color tube that uses two electron guns and two phosphor screens instead of the three-gun system now accepted as the standard. It does this by combining the colors (red orange and blue green), following a specially developed additive system inside the tube, to give full color reproduction. Actually, at least to my eye, there are some discrepancies in the color reproduction. The two-color flat tube cannot deliver a true purple or a dark, intense blue. But flesh tones are more real than anything I've seen before and if these tones are right I doubt if you'll even know that the female singing star is wearing a purple dress and not the reddish-blue one you see.

Even more important is that the two-color tube gives a considerably brighter picture than the conventional color tube. This is vital to a portable TV that will be used outdoors every so often. The picture on a standard color set can barely stand up against normal room lighting. Outdoors it would be completely washed out and impossible to view.

Since the flat tube is quite different from conventional picture tubes, it works a bit differently too. Look at the diagram at the top of page 91. You'll note that

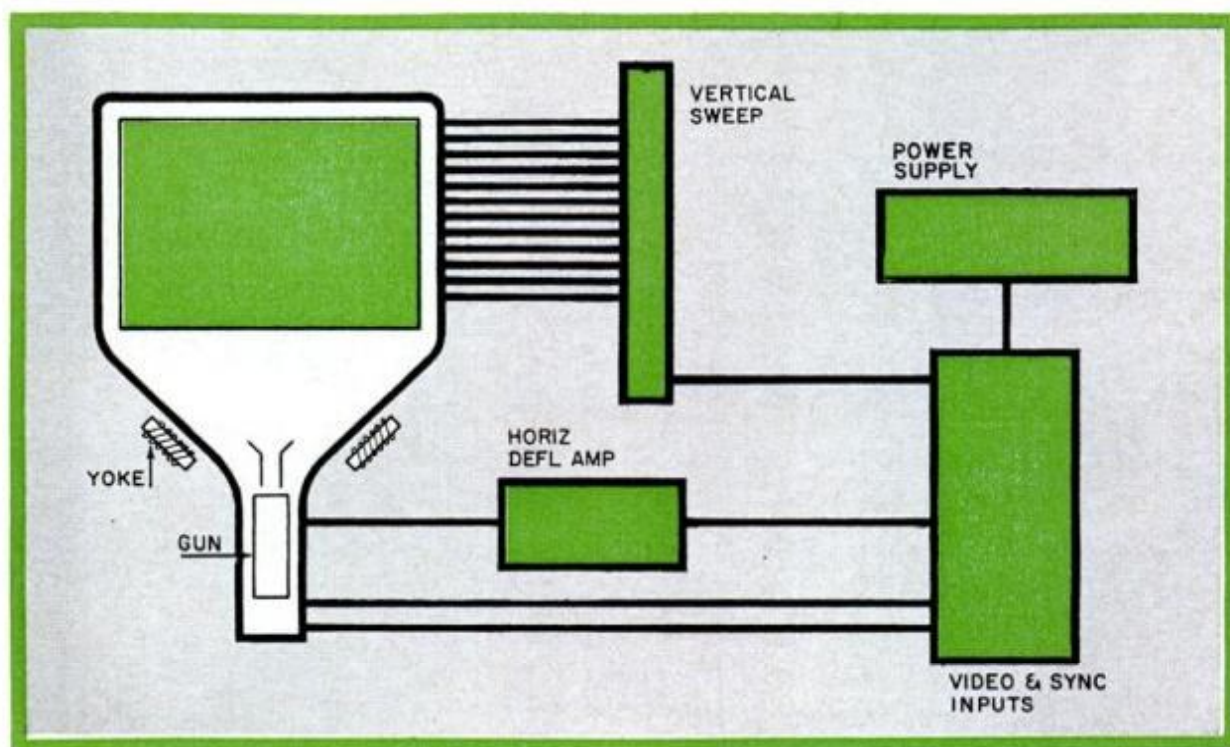

SCANNING CIRCUITS ARE DIFFERENT. Block diagram shows the basic arrangement of horizontal and vertical sweep circuits required by the new flat tube. Each corner of the screen is perfectly square

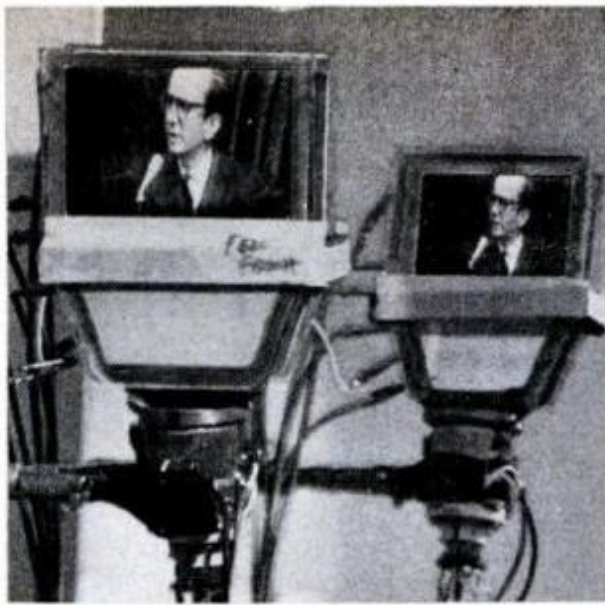

MONOCHROME TUBE IN ACTION. Mirror behind tube lets you see image on the rear. It appears right side up as mirror inverts reverse picture

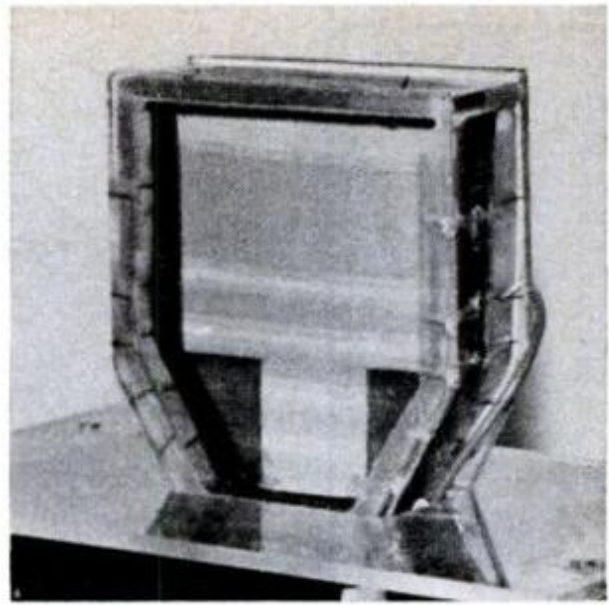

FLAT COLOR TUBE is two monochrome tubes back-to-back. Dual phosphor screen is in middle. Electron beams are directed to it from both faces



INVENTOR WITH HIS BRAINCHILD. Leo Shanafelt, top-notch engineer behind the flat tube, works at his laboratory bench where he has the monochrome tube set up for another round of experiments

there are two electron guns at the bottom of the tube: one for each of the two phosphor screens. These screens are deposited on opposite surfaces of a thin (.030-inch) sheet of glass.

This dual screen is firmly fastened in the exact center of the tube. The electron guns fire a beam of electrons straight up behind the screen from either side. The yoke around the neck of the tube deflects the beam from side to side. The transparent deflection stripes on each face of the tube, directed by signals from the set's deflection circuits, deflect the beams against their respective phosphors to produce a picture.

The monochrome tube is a bit simpler as it has only one electron gun and one set of deflection stripes. On the crude handmade tubes I watched, these stripes are just barely visible as slightly darker portions of the screen while a picture is being viewed. In production versions of the tube these stripes should be completely invisible.

The advantages of a flat tube are many and varied. Some are quite obvious;



some not quite so apparent. Here are the most important ones:

- Flat-tube sets are extremely thin, especially when compared to present-day models. They are easier to fit into a crowded room and do not take up floor space.
- Smaller, more compact TVs are possible. This means greater portability, lighter weight.
- Picture tubes are less complex. Specially blown glass envelopes are no longer needed. Ordinary plate-glass screens are easy to make.
- Two-sided viewing can be provided, if desired.
- Truly miniature, book and pocket-size sets become feasible. You may be looking for one soon.

Now let's look at a tiny flat-tube portable and see what we can do with it. Like a transistor radio, it can go anywhere. It's light and extremely portable. You can pass it to the kids to keep them occupied during long auto trips. You can take it with you to the beach or take it along on your winter ski tours. Or, for that special-occasion telecast you would give anything to see, bring it with you to your job—if you have an understanding boss.

In your home, large-screen sets will be built into the walls; they can be that thin. Those who like to watch TV in bed will be able to fit a set into the ceiling. Exotic styling for tabletop sets will become standard and remote controls for operating the set from your seat will be a must.

Other changes in set design resulting from the flat tube, as well as innovations in the tube itself, are bound to outreach my imagination. I'm sure that one day we'll have wall-sized screens made out of a flexible luminescent material that we can roll up out of sight when not in use. We may even end up with three-dimensional color TV.

But no matter which direction TV may take in the future, the industry is—right now—accomplishing a major breakthrough. The set manufacturers have been given a new ball to play with and I, for one, intend to keep tabs on what they do with it. ★★★

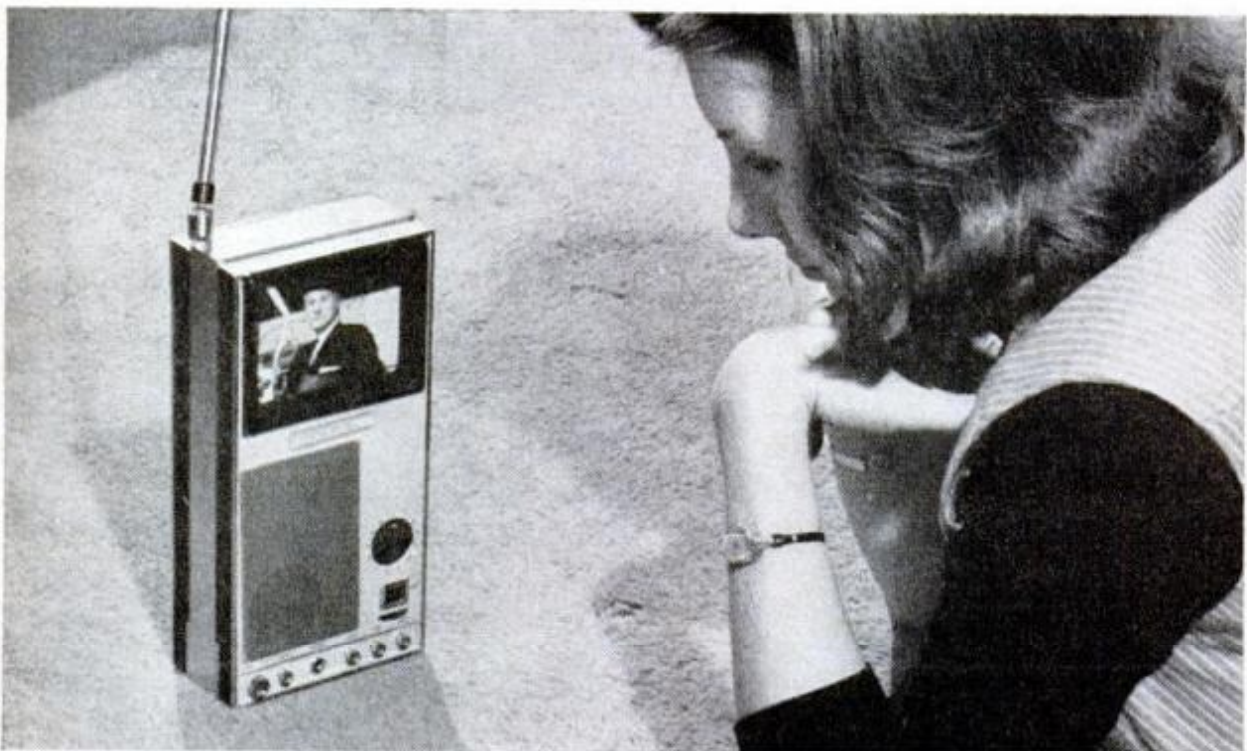

HER FIRST CLOSE-UP GLIMPSE of a flat TV portable in action utterly fascinates pretty *PM* secretary Millie Pedersen. Now, all she wants to know is how soon she can get one and how much it will cost

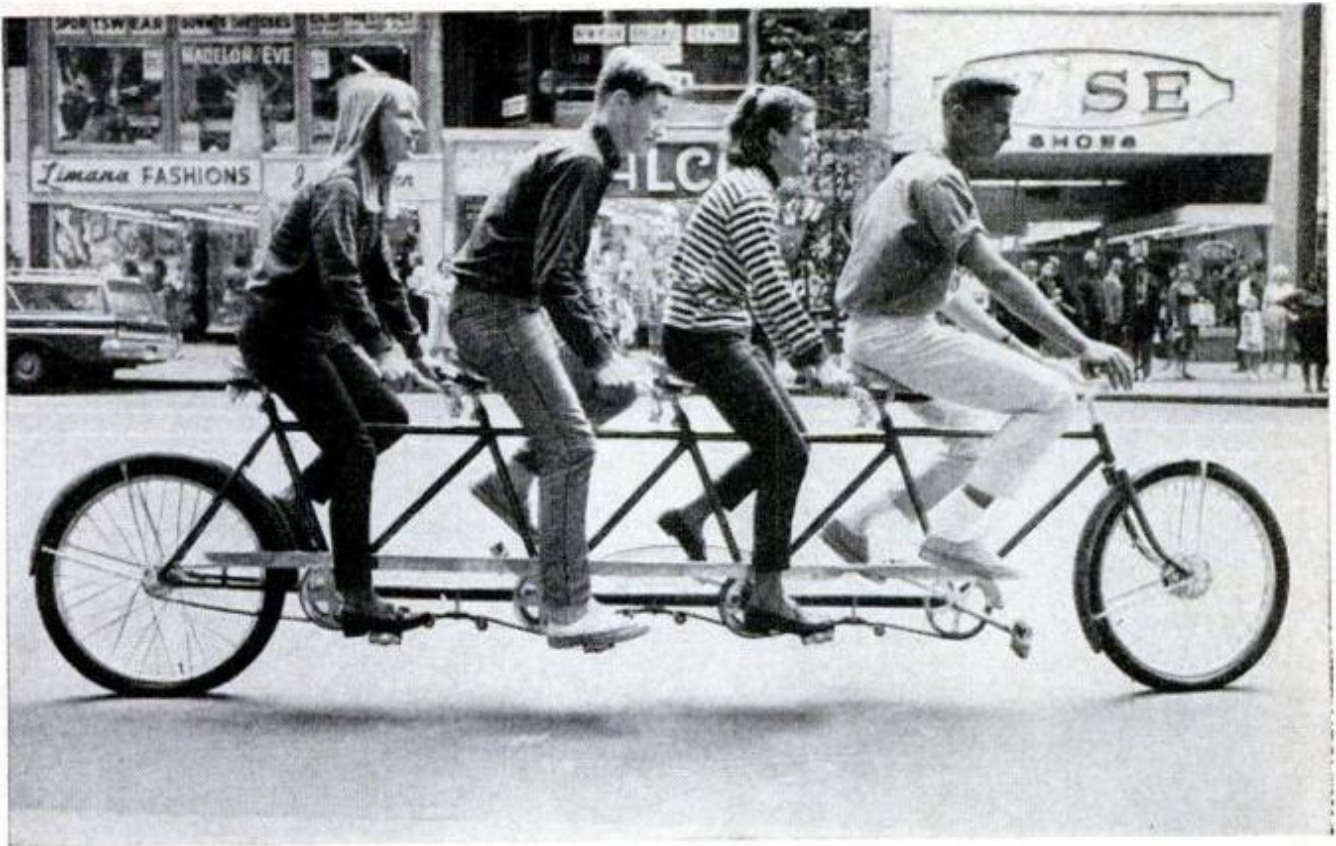

Doubling the pleasure of a tandem bike, this cycle carries four riders at a time. What Daisy never had on the one built for two: Bendix two-speed brake in back, drum-type brakes up front, Columbia-style roller idler chain and heavier wheel spokes. It's about \$100 a seat from Macy's, New York, and is made by Worksmen Cycles, Brooklyn, N.Y.



Fold-down handle makes this power mower easy to store under a garage workbench or to transport in the trunk of your car. All you have to do is loosen two wingnuts (seen at left) and handle folds in half. The machine also offers four-blade rotary cutting and a grass catcher (at no extra charge). The mower is made by the Jacobsen Manufacturing Co. of Racine, Wis.

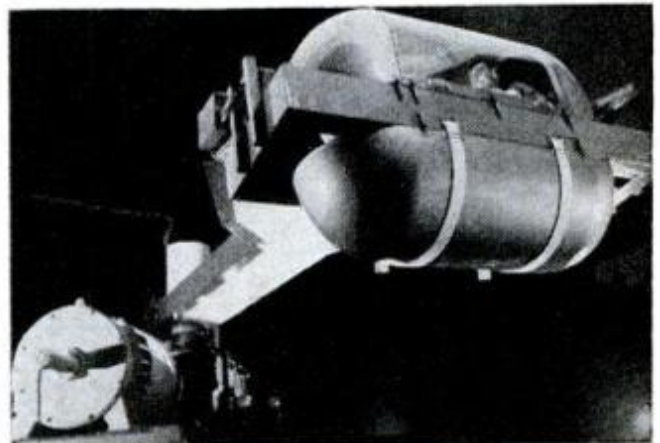

Big ride in a small centrifuge. West German engineers built high performance into this research centrifuge by combining a 120-kilowatt motor with a two-ton flywheel. According to the manufacturer, Siemens & Halske AG, the relatively small device is capable of producing forces up to 40 Gs.



hunting with a





CHEETAH!

Here's a weapon that does what no rifle, sling or arrow can do. Once "launched," it homes in on elusive game like a lethal guided missile

BY Arthur Whitman; PHOTOS BY Curt Gunther

A RABBIT BREAKS COVER. Fat and saucy, it skitters a hundred yards over short grass, then stops. It advances cautiously, then stops dead still, its head darting from side to side. Sensing danger, it advances hesitantly. Suddenly, it leaps like a dervish and runs in full panic. After it streaks the predator—a 110-pound male African cheetah.

The cheetah, who had spotted the rabbit from 300 yards, closes the distance in seconds. To the eye, his legs are a blur, his body an elongated, strangely spotted meteor. As the enemy closes in, the rabbit dodges, skids, tears back toward cover, zigzagging wildly. But the run is over. With the barest movement of a paw, the cheetah knocks the rabbit sprawling. A quick movement of his head and it's finished. The rabbit is killed, its head severed cleanly in one bite.

The cheetah, named Pusspuss, is one of two that live outside public zoos in Scotland. Both are the prized property of Tom Spence, a farmer *cum* zoologist-veterinarian, who lives and works on his 800-acre sheep-and-grain farm near Cupar Fife, about two hours from Edinburgh, and keeps a collection of rare animals as a hobby.

"I had a friend bring Pusspuss back from South Africa about two-and-a-half years ago," explains Spence. "Domesticated cheetahs go back to Babylonian times, but with the spread of civilization, they've grown understandably less popular. Today, they're the rarest pets, the ultimate ones. I guess

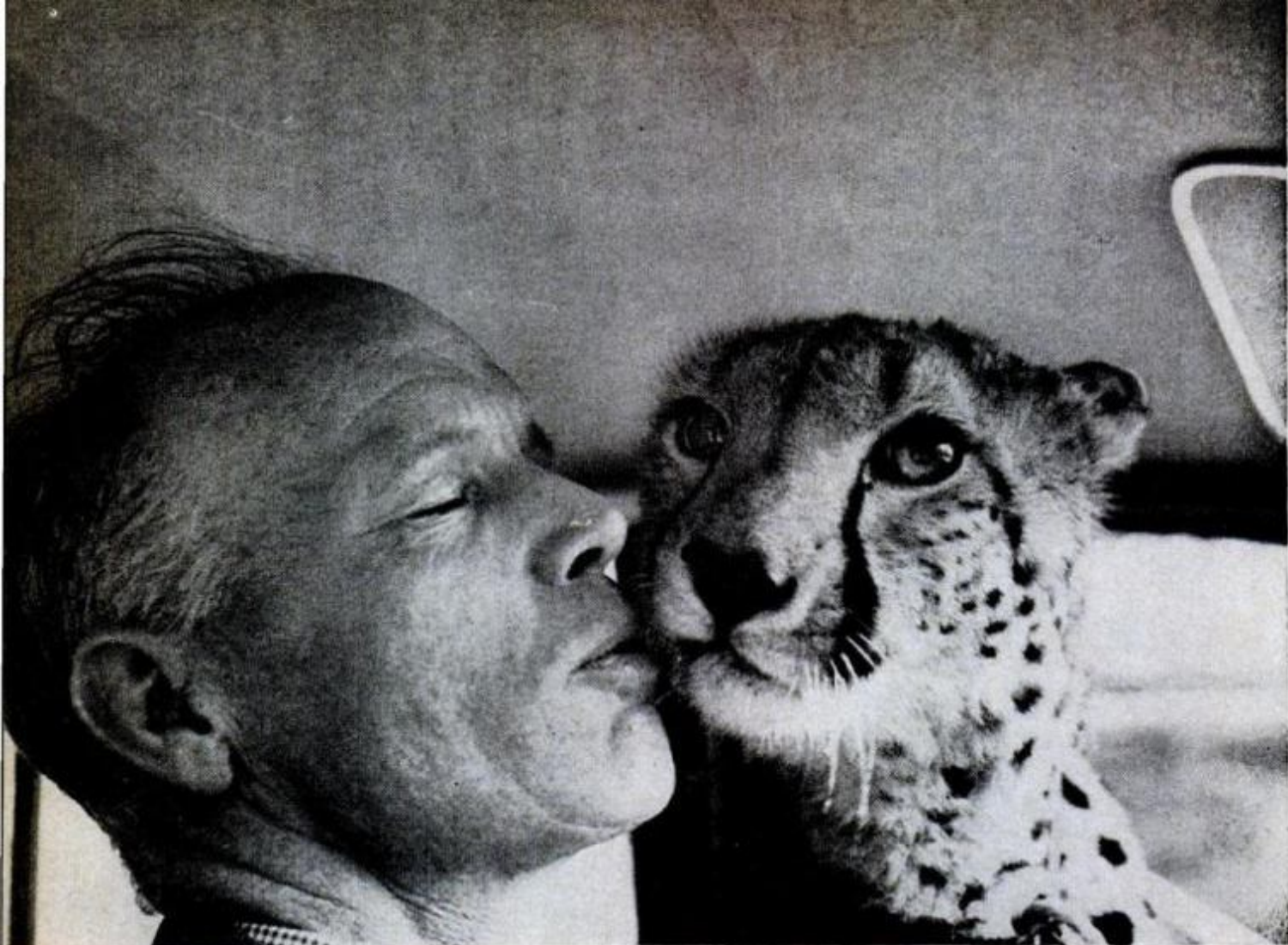

FELINE FORM OF RUSSIAN ROULETTE, zoologist Tom Spence gives his pet cheetah a buss on the whiskers. He claims that the big cat can be handled and trained like a dog, and is equally docile

I'm a bit of an exhibitionist, and the thought of keeping one rather appealed to me. They're dumb as Adam, you know, but they can be tamed down to be quite good friends."

The taming process amounts to little more than keeping them in a strong kennel and feeding them regularly until they associate food with human friendship. This is, of course, very much like training a dog, and Spence treats Pusspuss as he would a dog, walking him on a leash, curling up with him for an occasional nap before the fire, clouting him in a friendly way when he disobeys, and taking him for rides in a cat of another sort—his four-year-old Jaguar car. He lets him hunt occasionally just for the exercise, usually starving him for a few days beforehand since, like all wild animals, Pusspuss will hunt and kill only when he is hungry.

Animal handlers generally agree that a cat—no matter how long it has been tamed—cannot be fully trusted. Spence agrees with this to a degree, but he also feels

that he takes this into consideration whenever he handles Pusspuss.

After 30 months in captivity, Pusspuss is confused about his identity. Though he's never said it in so many words, he seems to think he's human. He snarls at his own image in mirrors, and has begun rubbing up against some of the farm help as well as Spence. Far worse, he attacks Duma, a lady cheetah that Spence bought a few months ago hoping to see him wed down happily. Closed into a large pen with her he attacked at once. The two nearly killed each other before half a dozen men managed to pry them apart.

As a predator, though, he is all cheetah. He can see small game from hundreds of yards and stalk it so skillfully he can't be seen even in low grass and weed shrubs. When attacking, he goes from a frozen crouch to 50 mph in seconds. Dramatic as this is, it's bad time for cheetahs, indicating that Pusspuss is somewhat out of practice. Back home in Africa, other cheetahs have been clocked for short stretches at 75 miles an hour. ★ ★ ★



PUSSPUSS TAKES A RIDE in the family Jaguar, a favorite pastime. Although rare in these days, the taming of cheetahs goes back to Babylonian times

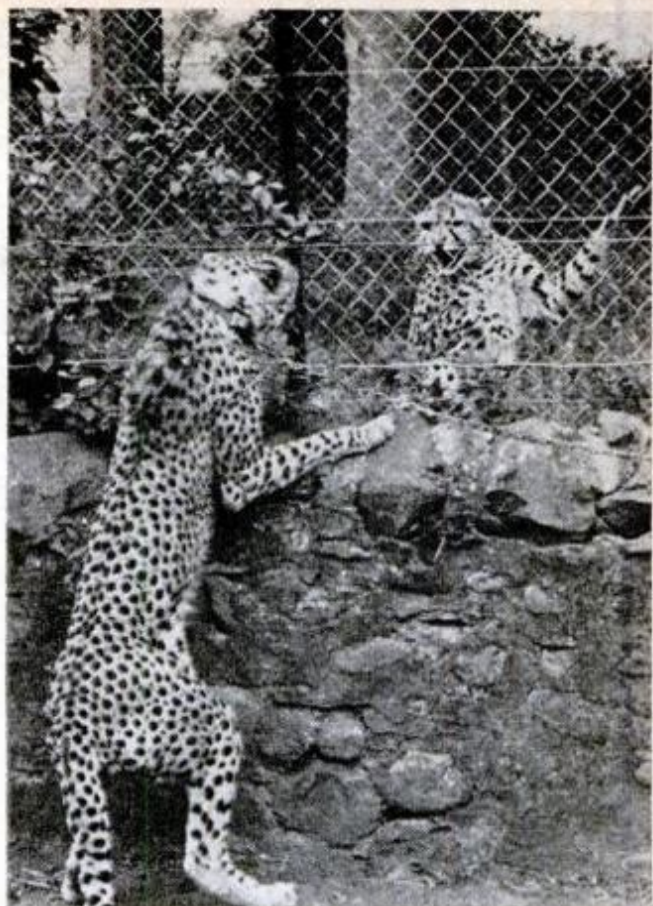

CAN CHEETAH CHANGE SPOTS? Pusspuss flew into a rage when confronted with a female named Duma, regarding the newcomer as a strange, hostile animal

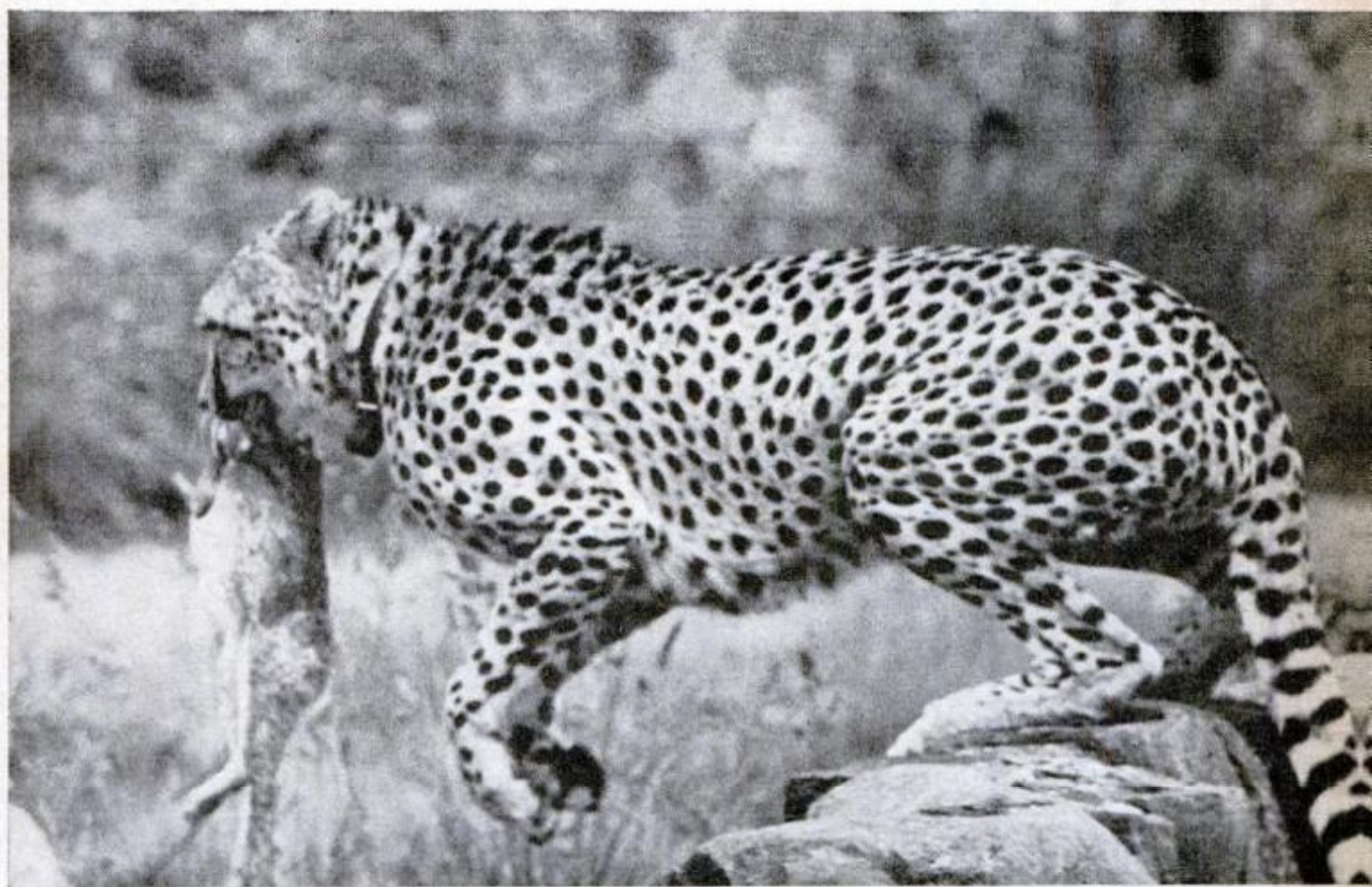

BACK TO NATURE, the usually gentle cheetah brings home his kill. To make the animal hunt, Spence has to starve him for several days, but once hungry, he quickly reverts to jungle instincts

LOST RADIUM...

One-fifth of our radium lies lost or hidden across the country, silently emanating death.

LAST SUMMER a doctor died in Florida. His bank, as trustee for his estate, opened his safe-deposit box. Among other things in it was a small metal container. Taped to that was a note, explaining that it contained 36 milligrams of radium.

The bank officials were horrified. So were the local public health officials. The find meant that for some years—probably decades—bank employees and box renters had received rather high doses of radiation every time they walked into the vault.

The case is not so unique. Two similar caches of radium were discovered several years ago in Seattle safe-deposit boxes—where they had lain for more than 20 years, irradiating all and everyone around them.

Radium, milligram by milligram as dangerous as the most toxic drugs, peculiarly turns up this way or other ways twice a month, on the average. And not only in bank



CONTAMINATED WITH RADIUM, basement of home in Lansdowne, Pa., is surveyed by crew in protective suits

KILLER AT LARGE

Often it turns up in the hands of curious, exploring children.

BY THEODORE BERLAND

vaults. Children find it in old barns and abandoned warehouses. It also turns up in old basement laboratories. And it has the most insidious way of becoming lost. Drop a speck of highly radioactive radium and it is a constant danger for thousands of years to all who come within a yard of it.

The frightening truth is that lots of radium has been lost in this country (and overseas) which has never been found. It lies silently in dozens or hundreds of places, losing only half its radioactive powers every 1622 years.

Recently the U.S. Public Health Service's Division of Radiological Health launched a search for this lost radium. Such misplaced radioactivity, it reasons, can be manyfold more dangerous than the fallout and X-ray levels it also constantly monitors. According to government experts in the division, radium has been lost in 1200 incidents in

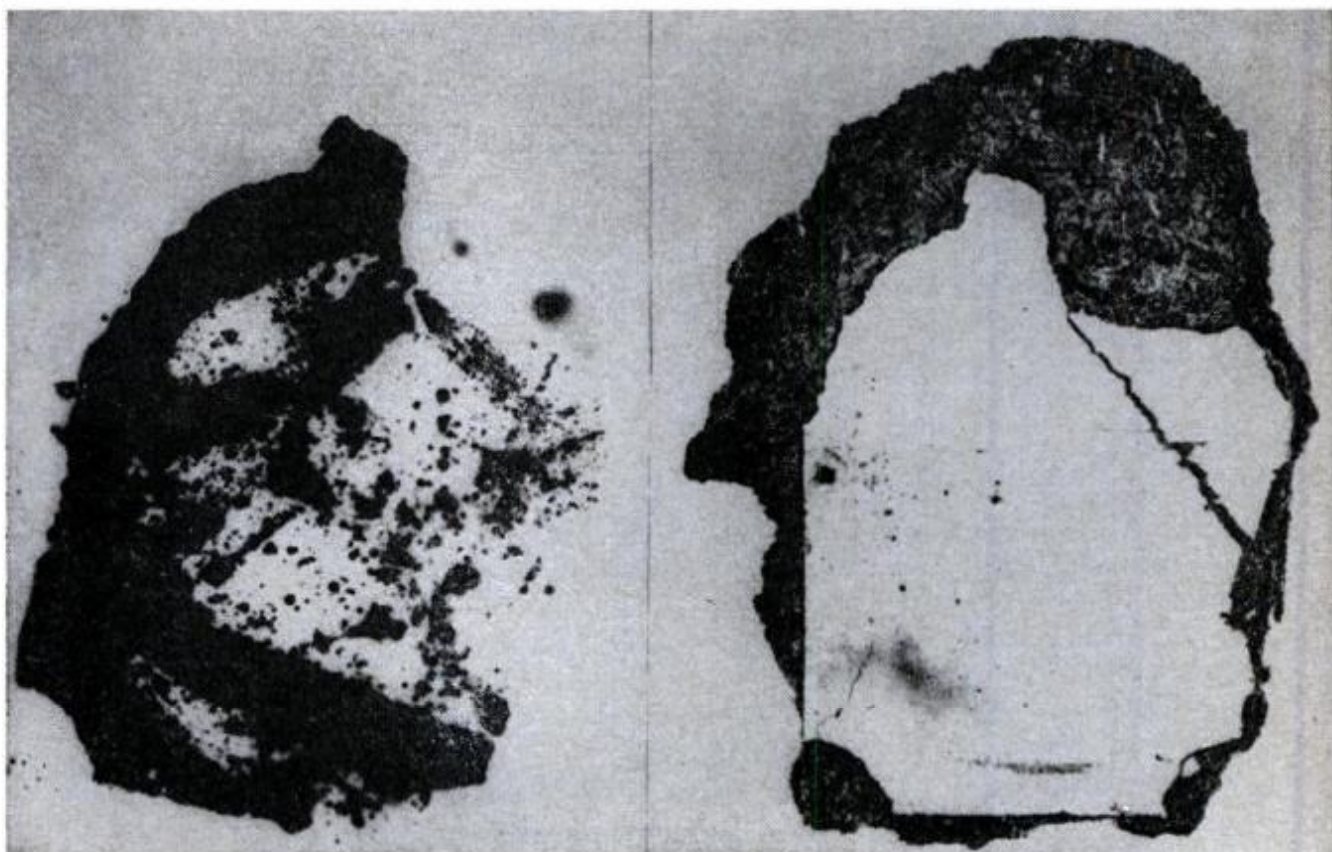

"HOT" WALLBOARD (right) from Lansdowne home reveals radium content in 5-hour autoradiograph (left)



CONTAMINATED MATERIAL from Lansdowne house was removed in drums and shipped to special burial site. Total of 180 55-gallon drums containing about 30 milligrams of radium was removed during 3½-month project

the United States in the last half century.

How much is missing has been calculated by John C. Villforth, chief of the PHS Assistance to State Radioactive Materials program.

The first radium was imported to America in 1902. Since then, says Villforth, 1800 grams have been imported. Another 200 grams was produced here. This 2000 grams—about four pounds—represents what he calls the national inventory of radium. If it weren't so incredibly radioactive, you could hold this amount in your hands. The four pounds become significant when you realize that radium is administered by the milligram like drugs, that it takes tons of ore to produce one gram of radium, that even old radium is worth \$1 million a pound.

"The radium problem becomes more significant," Villforth explains, "when you consider that we have been able to account for only about 700 of the 2000 grams in the U.S." He estimates that of the remaining 1300 grams, "perhaps 65 to 70 percent has gone into various luminous compounds for wrist watches, instruments, etc." Thus, two thirds of this lost radium is on luminous dials in torpedoed ships at the bottom of the sea, in airplane and tank graveyards, and under rows of white-crossed graves.

That still leaves 400 grams of radium lost. Finding it is one of Villforth's jobs. His quarry is vicious and versatile. If you get too near it for too long, it can burn your skin, or cause radiation sickness that can lead to death. If some happens to get

inside your body, it will seek out your bones and eat them away.

This, in fact, is what happened to the scores of women in New Jersey and Illinois factories who during the 1920s tongued their brushes to give them fine points when they painted luminous watch dials. The radium concentrated in jaws and hips and induced massive cancers.

Radium changes its form easily and quickly. Atoms of the heavy metal change into atoms of the heavy gas, radon—which is also highly radioactive. When radium is enclosed in a vial, the pressure of this radon gas builds up. If the vial is not strong enough, the radioactive gas can seep



RADIUM SOURCES used in medicine include (left to right) capsule, needle, tube, cell and a gold radon seed for permanent implantation in tissue



LOST IN TRASH DUMP, a radium source is as difficult to find as proverbial needle in a haystack. It takes a Geiger counter to locate this dangerously radioactive material after it has been carelessly discarded

out, or even explode the vial. Radon is readily inhaled. And it soon changes form to become a fine dust that falls as radioactive fallout.

The 400 grams of radium was lost simply because it was never kept track of. It has never been controlled like narcotics, for instance, or such poisons as arsenic. And because it is a naturally-radioactive substance, and not a product of nuclear reactors, its users do not have to be licensed by the U.S. Atomic Energy Commission, or by most state commissions.

Thus it has been since the beginning of radium. Physicians and quack doctors both were eager to buy radium then for two

reasons. One was that it was attributed wondrous curing powers. The other was that it was a swell investment. The most precious metal in the world, it took millennia to lose its magical powers.

Radium's price just prior to World War I peaked at \$180 per milligram. Both tremendous demand and limited supply combined to pump up this price to the limit.

It has been sliding ever since. As new sources of ore were found and better production techniques developed, and as other sources of radiation were found and perfected (like cobalt-60), radium dropped to today's price of \$16 to \$21 a milligram. This is for new radium. Old, used radium goes for as little as \$2 per milligram, and it's a buyer's market.

The result is that radium became a white elephant. Doctors and others who bought it when the price was high hated to let it go at a small fraction of what they paid for it. That's why, Villforth explains, "We might look for these 'white elephants' in safe-deposit boxes and in attics. And oddly enough, radium sources have been found in these locations."

Some of this lost radium has been accidentally found by children.

Two years ago five Long Island school children went rummaging through the attic of an old barn. There they found 13 boxes curiously-labeled "Radium Emanators." These quack radioactive devices were made as cures for rheumatism and arthritis, then outlawed 30 years ago. Inside each were small glass vials of radium



250 MILLIGRAMS of radium are in this industrial radiographic radium source. In use, it's suspended from a wire held by special long-handled tongs

crystals. The children could have absorbed in 72 hours as much radiation as would be their maximum safe dose for a year.

An even worse case of radium discovery occurred in Toronto more than four years ago. Fourteen children playfully chased a white hamster into a warehouse. There, 1000 vials of radium lay in storage, put there after World War II by a company which made luminous instrument dials.

According to a report of the incident in *Canadian Nuclear Technology*, "The children had broken into the lead-lined boxes containing the vials and smashed 100 of them inside the warehouse. About 50 vials were found broken outside. Radium powder was scattered around the block where the warehouse was located. Some of it was eaten on an orange peel by one small boy. The children showered it on their clothes. Some was found in their hair.

Mistaken for sinkers

And in New Jersey, two schoolboys took four radium pellets off a flatcar with the intention of using them as fishline sinkers. They were sure that's what they were for because the pellets were top-shaped and had strings attached. One boy carried two of the pellets in his pocket for a half-hour before hiding them in a crack in the sidewalk in front of his home. The pellets were actually intense radium sources used for gamma-raying welded steel drums during routine inspection for flaws.

In none of these instances did the radium exposure directly cause a child's death. However, the overall health effects of such exposure takes years to determine.

Public health radium seekers have uncovered incredible amounts of "hot" metal in old clinics and laboratories.

One team found a nest of lost radium sources in an unshielded safe located in a suite of rooms that for decades housed the old Kelly Clinic in Baltimore. Some of the vials were in a strongbox, the key to which had been misplaced many years before. A Geiger counter survey showed that furniture, carpets, floors, offices, and medical equipment were contaminated.

Likewise, an old four-story cancer clinic building in Atlanta was found hot more than a year ago. Abandoned for years, it had housed a laboratory in which radio gas was pumped into needles for stitching into cancer tissue. A Georgia public health team found radium stored in the wall of one room. They also found 43 hot radon

needles imbedded in the walls under layers of paint in a filthy room that had long before been taken over by pigeons.

One of the most famous radium finds occurred in a house in Lansdowne, Pa., a suburb of Philadelphia. It all started when a state radium hunter uncovered some notes left behind by a deceased physics professor. The notes told how the professor had made radium from ore in the basement of his home 40 years before. A Geiger counter survey of the home showed it to be quite hot indeed.

The public health team, headed by Villforth, tore hot areas of walls and floors away and hauled the debris off in sealed steel drums for disposal as radioactive waste. He estimates 30 milligrams of radium, mostly in fine dust, were removed.

Here, as in the other hot buildings, the task of getting the radium out was assigned to specialists, clothed in what look like space suits, who used special vacuum cleaners for sucking up radioactive dust.

Most of the radium around today is housed in hospitals, so it is from hospitals that most radium is now lost or stolen.

Too hot for thieves

Two summers ago, for instance, 100 milligrams of radium were stolen by persons unknown from Kansas City (Kans.) City Hospital. After a year of detective work, Federal Bureau of Investigation agents and state health officials discovered that the thieves had dropped it into a strip mine, after which it was covered by 50 feet of shale—where it safely sits.

The incident is typical. When eight 10-milligram radium capsules were stolen from Sunnyside Hospital, Pittsburgh, the local newspaper warned the thieves, "If you have a strange, unexplained burn on your body and it seems to be getting worse, it may be that little gold-colored slug you picked up." Seven of the capsules were soon found in a phone booth.

A Tyler, Tex., student endangered himself and others when he "borrowed" a radium needle for home experiments from the county hospital. A Miles City, Mont., janitor came across a heavy hunk of unmarked lead in a drugstore basement and decided to have some fun with it. He took out five 10-milligram radium capsules and tossed them into a waste can. Then he melted the lead and poured it into empty beer cans to fool anyone who might pick

(Please turn to page 235)

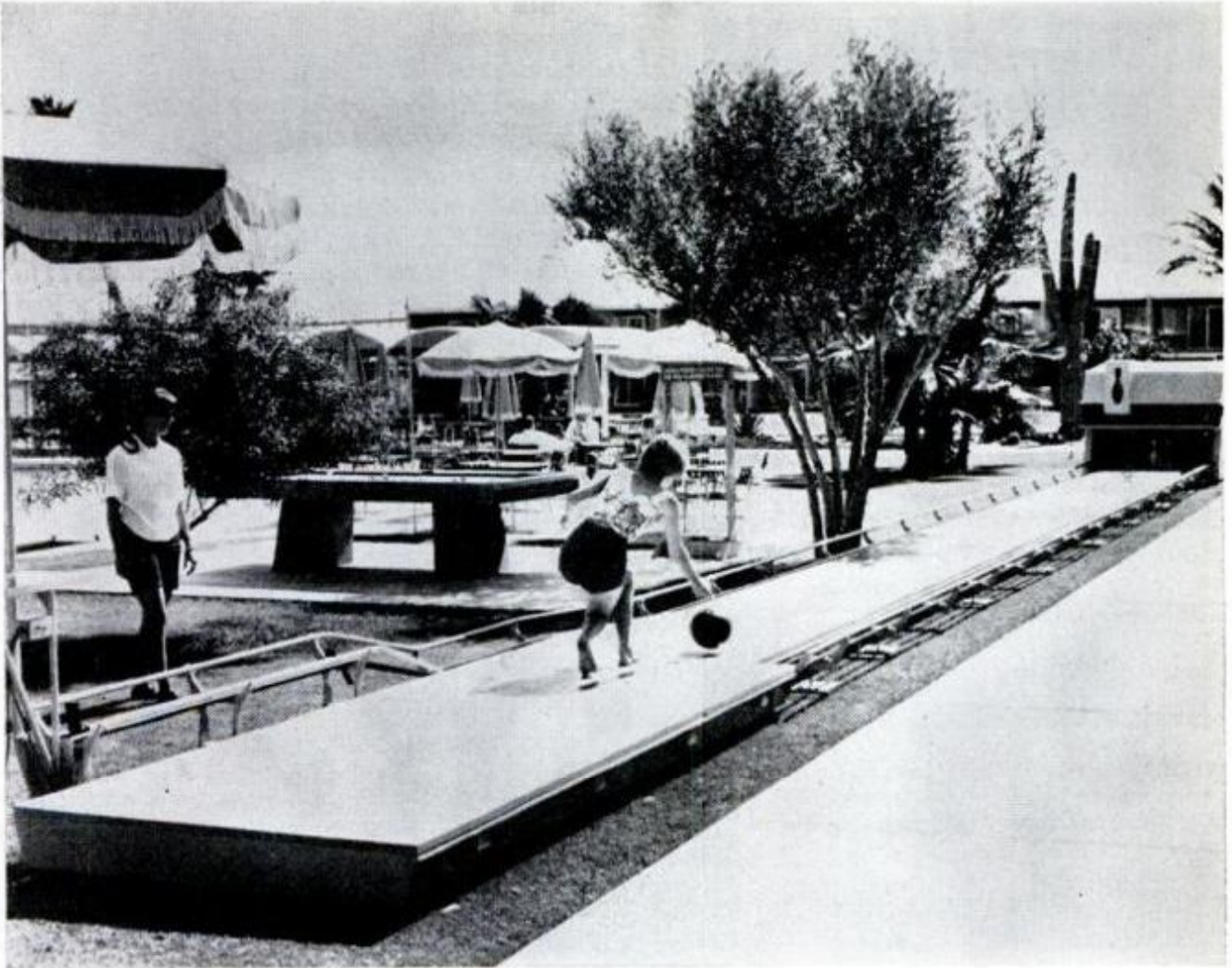

Bowling on the green has been updated with a hard-surfaced weather-resistant plywood that has made it possible to move a bowling alley outdoors. Made by Garland Industries of Phoenix, Ariz., the alley comes in eight-foot sections, making it portable, and is equipped with a simplified automatic pinsetter and ball return. Already in use in several areas, the alleys will be part of complete outdoor recreation centers.



Fiberglass pontoons turn a motor scooter into a sea-going amphibian, then rise out of the way for land travel. A few adaptations prevent water damage to the engine. Otherwise the scooter-boat is the same as conventional scooters, being propelled in the water by revolutions of the rear wheel, to which a rotary paddle is attached. Douglas Bedford converted the scooter, which was first exhibited at a cycle and motor cycle show in England.

New and hot from overseas

A 150-mph station wagon, a four-wheel-drive coupe, "floating" headlights and a manual-automatic transmission are goodies from "over there"



FLOATING HEADLIGHTS in the French Citroen DS 21 seem to be firmly set in fenders, but are counterbalanced to focus on road despite car's pitching

EUROPEAN AUTO ENGINEERS are doing some wacky and wonderful things in performance, safety and comfort accessories. All-new models reflect a blooming European economy, with increased horsepower and plushy luxury in many new models.

Probably the most advanced car is a sleek, sexy, ground-hugging hardtop—the Jensen FF. It's the first production sedan ever delivered with four-wheel drive and anti-lock disc brakes front and rear. Road-

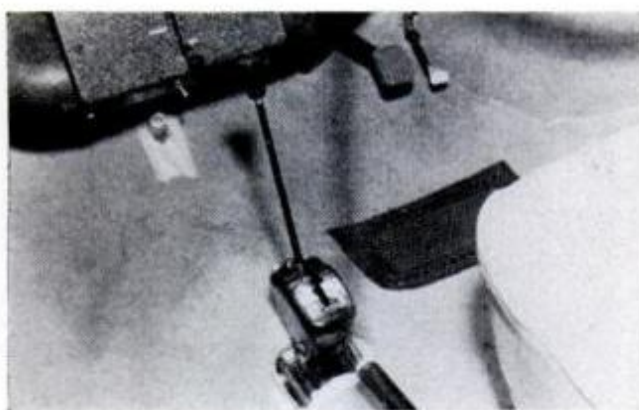

OPTIONAL automatic transmission on British Motor Corp. Minis and 1100s lets you shift manually. Selecting 1, 2, 3, or 4 holds that gear indefinitely

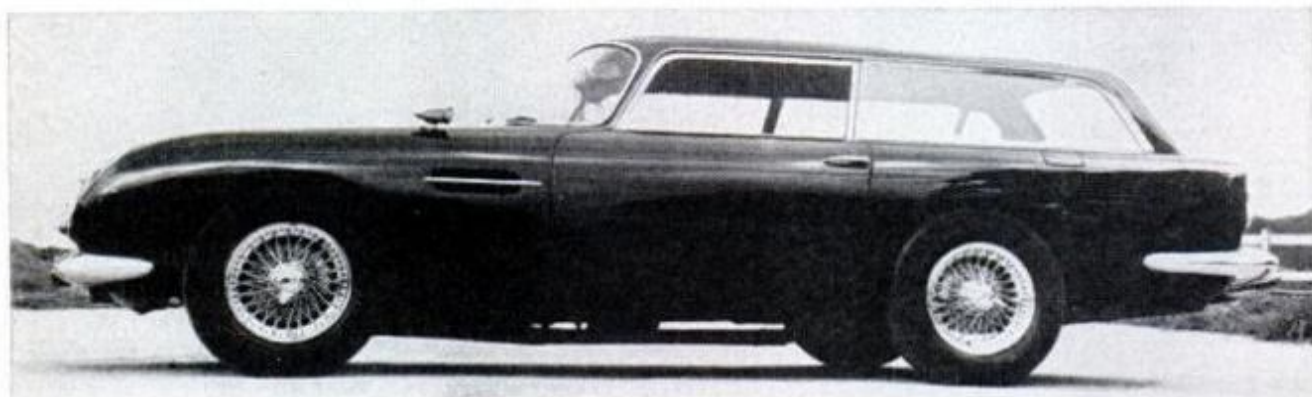

WORLD'S FASTEST STATION WAGON is 150-mph Aston Martin from England. Basic price is well over \$17,000



"POOR MAN'S MUSTANG" is German Opel Kadett deluxe, a 92-mph fastback that will be sold here soon

holding is said to be uncanny. The British manufacturer says that a driver who makes an overambitious approach to a bend "simply lifts off the accelerator, with out fear of breakaway at the front or rear." Another benefit: More of the Chrysler engine's 330 hp will reach the road, without wheelspin.

The four-wheel-drive system, developed by Harry Ferguson Research Organization consists of a master differential and two one-way clutches. In this design, the master

differential is a planetary gear that permits a speed variation between front and rear output. It also divides the torque unequally—37 percent to the front wheels, 63 percent to the rear.

Since maximum braking efficiency is achieved just before the wheels lock, the Dunlop Maxaret antilock brakes do for the novice what cadence braking achieves for the skilled rally driver. Driven by the planet carrier, the system senses the mean

(Please turn to page 238)

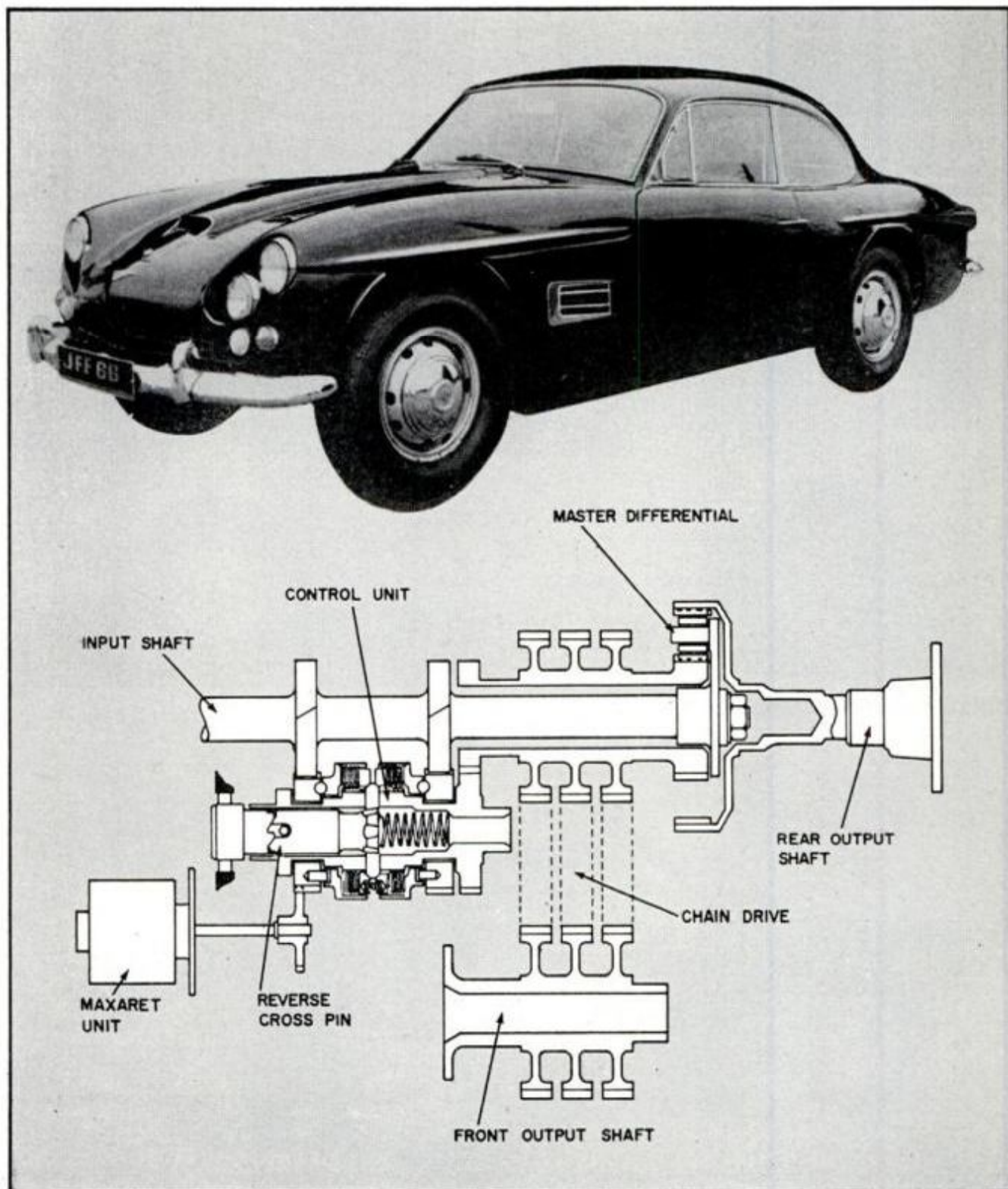

RACE-TESTED FOUR-WHEEL DRIVE powers England's Jensen FF 140-mph sedan with aircraft-type antilock brakes
FEB. 1966



STEERING ADJUSTS for rake and height in front-wheel-drive Triumph 1300 to accommodate any size driver. The \$2200 English car has disc brakes

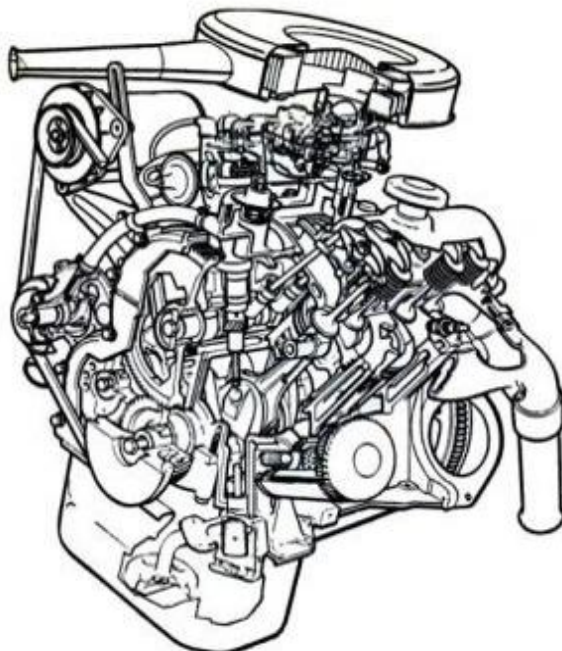

NEW V4 ENGINE for British Ford Corsair comes in two sizes, developing 81.5 and 93 hp. New Corsair styling is unchanged except for rear louvers



OOPS! FORGOT THE HEADLIGHTS. Special-bodied coupe uses German NSU Prinz 1000 TT chassis, does 105 mph

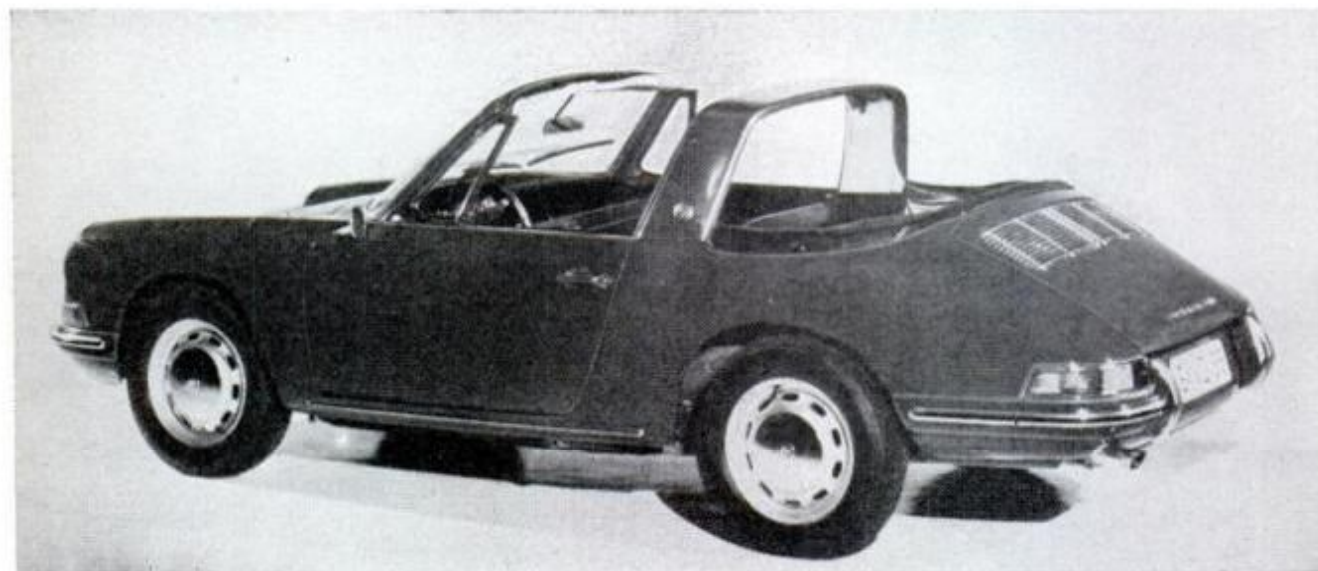

FRONT AND REAR SECTIONS of top are removable on German Porsch Targa. It's a new model of Type 911



Raise your eyebrows and slip these eyeglass frames into the folds of the upper lid, then lower your brows. That's all there is to putting on and keeping on these lightweight plastic cling frames; they work like a monocle. Transparent projections on the upper ridge of the frames let you wedge them on easily. Kono Manufacturing Co., 69-24 49th Ave., Woodside, N.Y., makes them.



An instant igloo lets ice fishermen enjoy their sport in comfort. Made of fiberglass sections, the room-size shelter can be bolted together by two men in less than two hours, and it is easily taken apart for storage. It is windproof and will not collapse under any snow fall. Weighing 400 pounds, it can be carried across the ice by four persons. Designed originally for the Canadian Alpine Club, it is made by Century Fibreglass Ltd., Calgary, Alta., Canada.



Tempest Overhead-Cam Six

It's a tidy set of wheels, but no jackrabbit—and don't wear your hat or expect to see who's tailgating

By Jim Dunne

A SIX IS A SIX IS A SIX . . . no getting away from it. A six-cylinder engine that puts out 165 horsepower can't be anything else, no matter how different the configuration or gimmicks.

The Six I'm talking about is Pontiac's new overhead-cam, 230-cubic-inch job that is available in all the new Tempests. It's a nice design, and has some advantages over other Sixes on the market. But don't compare it to a V8. They're two different breeds of cat.

I picked up a sleek Tempest two-door coupe to see if all the talk about the engine was academic, or if the engine really made a difference.

First, the sample car was equipped with GM's two-speed automatic transmission which is all you can get on the corporation's smaller-than-standard size cars. When this is coupled with the low output engine, acceleration is soupy smooth, and slow. It takes 14.4 seconds to get from a dead stop to 60 miles per hour; inferior by most comparisons, and especially disappointing on a car that looks like it is one of the fastest on the road.

This car reminds me of some girls I've met. It is styled like a real winner, but once you get to know it better, it doesn't appeal.

The slow acceleration times were constant throughout the range of speed runs. 0-90 was 35.5 seconds. Quarter-mile runs were made in a slightly more perky average time of 19.7 seconds when the car was doing 71 mph.

Top speed average for two ways (just like Bonneville) was 98.5 miles per hour, but it took most of the 2½-mile straightaway to get this teaser up that far.

Let's spend a little more space on this new engine, because it is a pioneer design for American motoring and it does offer some real benefits. First of all, there is room under hood to service the powerplant without taking half a day to get at it. Most do-it-yourselfers will get itchy fingers looking at the easy accessibility of

filters, distributor, sparkplugs, valves and pumps. It's almost like the good old Model T days. Minor service chores should be a snap for home garage mechanics.

The size of the engine plus the weight of the car adds up to good fuel economy. That's one thing you can't take away from Sixes; they have two less mouths to feed than the V8s. Our test car fuel results ranged from 25.24 mpg at a steady 30 mph down to a respectable 18.24 mpg at 70 mph.

Another good feature is the steady power output all the way through the wide usable rpm range. Pontiac engineers say you can safely wind up to 5000 rpm without fear of harming the engine. I discovered what this means in driving when I held the accelerator to the floor from a start to see how long the transmission would stay in first gear. I had to back off twice because highway traffic was not going fast enough to allow me to get up to shifting speed. The transmission shifts at 73 mph if you keep your foot on the floor all the way, and the quietness of the engine at that speed indicates that nothing is being strained.

While the OHC Six does have the characteristic six-cylinder sound, it still runs smoothly and quietly. Valve train noise was nonexistent. Pontiac people say that you can expect the engine to need adjustment periodically, like any other engine.

General Motors cars have always been known for their boulevard ride; this one was no exception. The body was tight, making the car pleasantly quiet at

(Please turn to page 232)



WATCH OUT for this trap. Seat-belt holster leaves little room for moving the seat positioning lever. Slide the seat back—crunch!

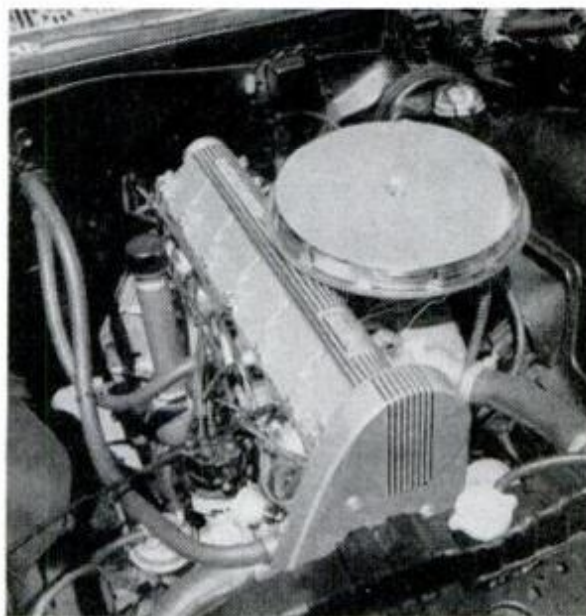

OHC SIX takes up little room under the hood. Minor service and adjustments are a cinch with distributor, plugs, pumps in full view

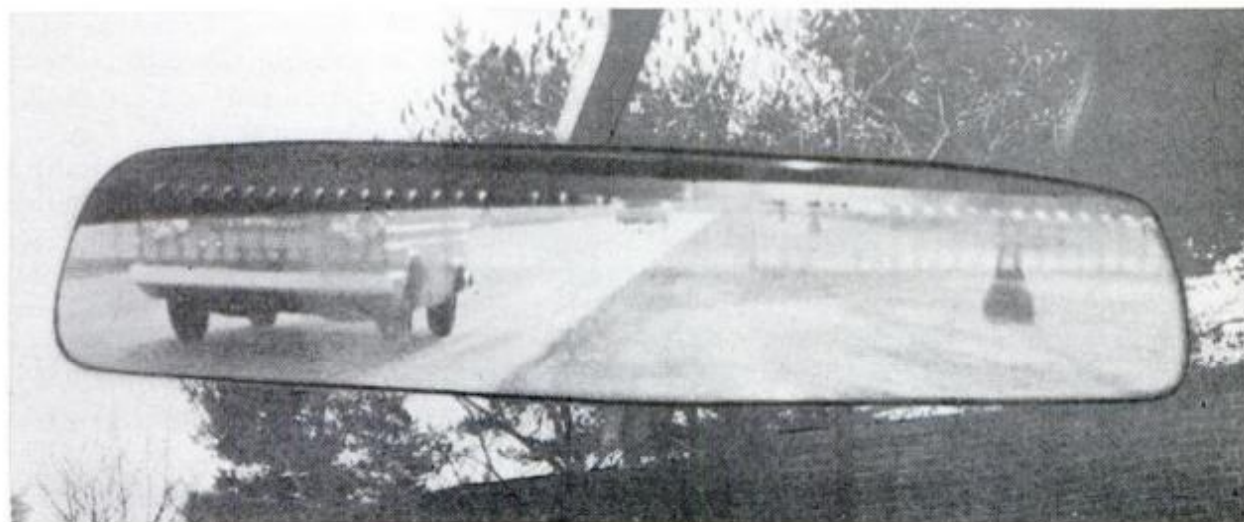

VIEW THROUGH MIRROR is cut off by the low Tempest roof line. Day-night design adds to the problem



Plymouth Sport Fury

It's a hot performer with little to gripe about beyond fat roof pillars and an immovable ash tray

By Alex Markovich

FEW "BAD" CARS are being built today. Plymouth is a good automobile. Ask any Plymouth owner. For every make of car there's a buyer whose driving needs make that car ideal for *him*. This is especially true of the "popular three."

Ford, for instance is for "practical" people. It's a compromise car, combining ride, handling, construction, resale value. Chevrolet is for "pampered" people. It offers an ultrasoft ride, and the devil take the handling. And there's a bonus in excellent resale value.

But Plymouth is for "performance" people. Its ride is hard, and its resale value just average. For a sedan of its size, however, it's fast and stable through corners. It leans less. And with any of the V8s it goes like a frightened cartoon character.

Of course, when you try to categorize cars, options are a complication. You can equip a Ford or Chevy with heavy-duty suspension and a fat engine and make it handle and move. But put these options in a Plymouth and you still have an edge.

Our test car, a Sport Fury, had heavy-duty suspension, a 383-inch engine and limited-slip differential. It also had a heap of pampered people's options, including TorqueFlite transmission, power brakes and steering, AM-FM radio, power seat and windows and lots more—over \$1000 worth. A stripped Fury I lists for \$2426; a Sport Fury for \$3006. Our test car was tagged at \$4058.

The interior was modern and businesslike. A big round speedometer enjoyed a place of honor in the uncluttered dash, directly in front of the driver. The water-temperature gauge and ammeter were both easy to see, but had no numbered graduations. A little light warns of low oil pressure.

A console topped with phony but realistic wood ran between the bucket seats,

and that's where the designers hid the optional tachometer. Unless you're going to the drags a tach is as handy on an automatic-shift car as an oven in hades; but if you do want one, buy an accessory unit and mount it on the dash or steering column, where you can see it.

Also sprouting from the console was a shift lever with a push button detent. That TorqueFlite transmission, incidentally, is still one of the most positive and efficient automatics on the market. It's a three-speed with torque converter, and it can be controlled manually. If allowed to shift for itself, it's quite smooth.

Front seats are comfortable, but offer little lateral support in fast corners. The power-seat setup would have helped me to get the just-right seating position—except that the up-and-down adjustment was on the fritz.

The heater pumped in great volumes of hot air. Within a couple of minutes I had it to turn it down. The door handles, I thought, were less successful. The flush buckle-type latch may be safer, but it takes an awkward twist of the wrist. Even after several days I couldn't get used to it.

Headroom front and rear was good. Legroom was good in front, adequate in the rear. The cabin was neatly appointed with pleated Leatherette and fully carpeted floors. The chromed windshield molding could make a glare problem, though it never bothered me while I had the car. But that ashtray could help anyone kick the tobacco habit. It was unbelievably stiff.

For the performance tests, I drove the car to Lime Rock race track in Connecticut. Acceleration runs from rest were made by first revving up the engine in gear while holding the brake, then letting go. In Drive, 0-60 mph averaged 8.5 seconds. The one-two upshift came at around 4000 rpm. But by holding it in first to 5000 rpm, I got the time down to 8.2 seconds. The 40-60 run took 4.1 seconds in Drive, 3.7 seconds shifting manually from first to second. And 50-70 took 5.0 seconds in Drive, 4.7 locked in second.

As mentioned before, cornering is superb. My first lap around the track was a timid one, but soon I was throwing the car through the corners with brio. It's no sports car by any means, but handling was always predictable. And surprisingly, ride didn't differ too badly from the heavy-duty suspension. Most people—including my mother-in-law—praised the ride. People are simply unwilling to believe that a new car can have a harsh ride.

Gas mileage was good for a large V8. At steady speeds I logged 13.7 mpg at

(Please turn to page 228)



WHILE YOU'RE SEARCHING under the dashboard for the tachometer, you can get into trouble. Shift lever and other controls are easy to reach

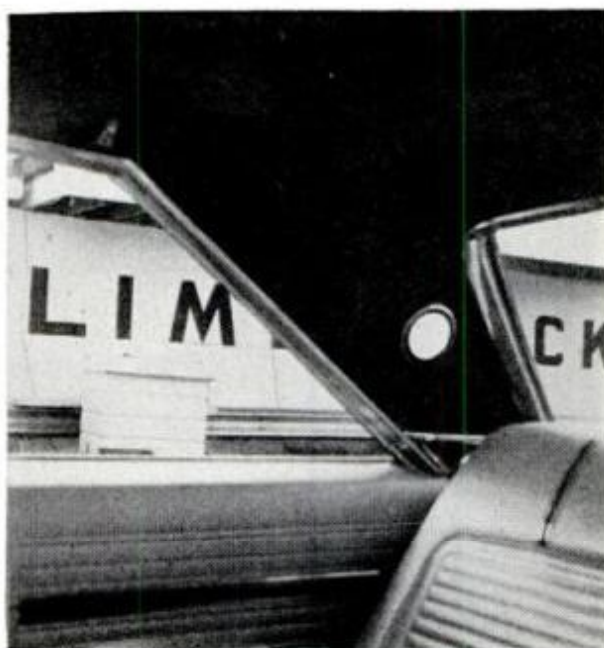

WIDE, TAPERED PILLARS may look sexy, but they don't help you see out. Courtesy lights are fine for rear-seat passengers, but not for front

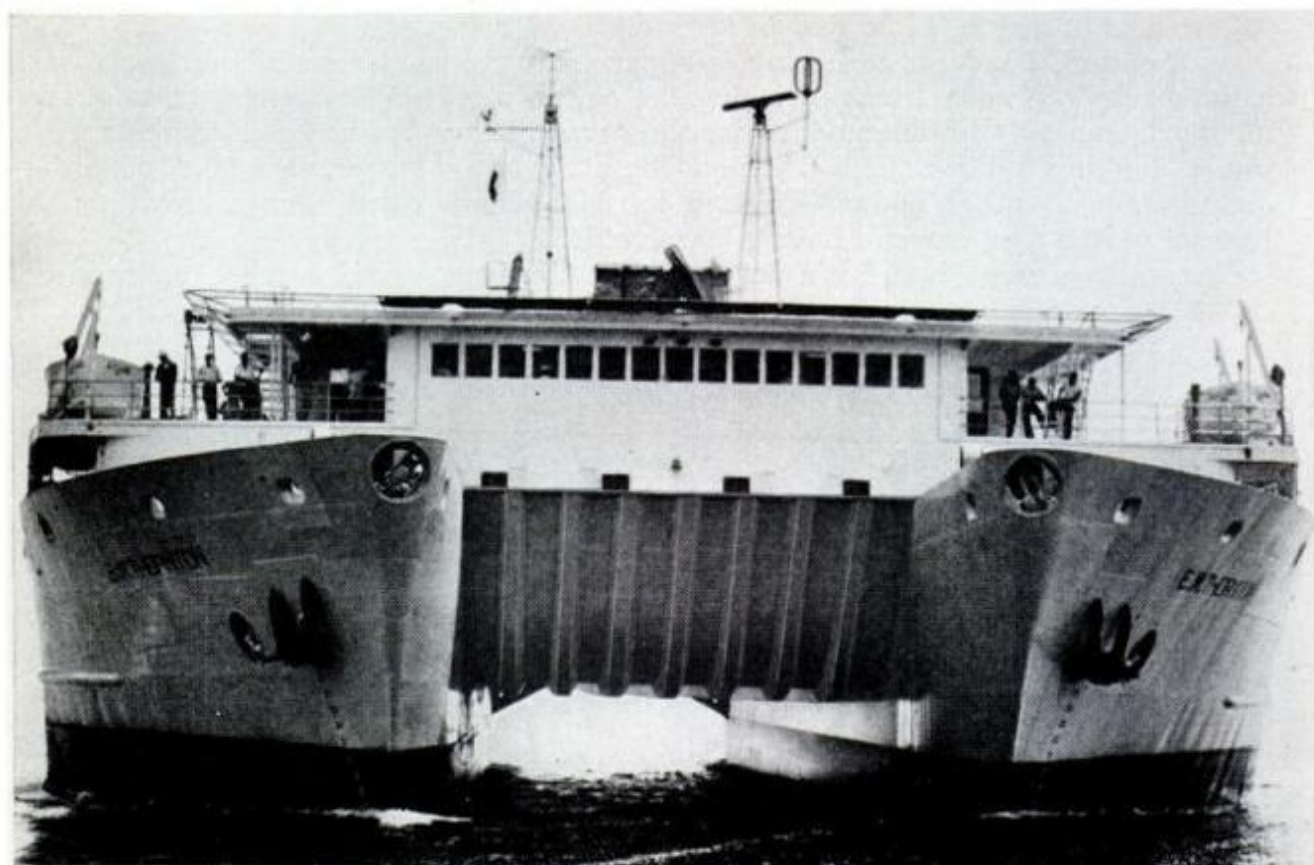

Twin-hulled hunter. Probing the ocean floor for oil, a new 278-foot catamaran drilling vessel is capable of boring more than four miles beneath the bottom when anchored in 600-foot depths. The *E. W. Thornton* gains both added stability and extra working deck surface from its catamaran design. During drilling, it's held in place by eight 10-ton anchors.



A plastic lobster trap is the newest thing in waters off Canada's east coast. Called the Igloo (because of its shape), the trap has a polyethylene dome and a base composed of a steel ring coated with epoxy to prevent rusting. Lobsters enter through the top, where flexible fingers permit entry but spring back into position to block exit. The trap weighs 25 pounds, only a quarter as much as a conventional trap made of wood and wire, and is expected to last three times as long. Maker is Markland Works, Ltd., Nova Scotia, Canada.

FEB. 1966



Mulch making machine is an electric grinder that shreds leaves, trimmings and other garden trash fine enough to reduce their bulk from 16 bushels to four. Powered by a 110-volt, 3/4-hp electric motor, the portable mill has six cutting edges for chopping material, which is then blown into a plastic bag for disposal or for use as mulch. It costs \$89.95 from Sears, Roebuck and Co.



Blowproof water has given the Navy the weapon it needed to fight fires with helicopters. Previously, the downwash from the rotor blades blew the foam, or whatever agent was being used, off the fire, nullifying its effect. Now a new extinguishing agent, a carbon chemical compound called "light water", forms a film on the fuel, the usual cause of fire in crashes, suppressing the flames in less than 18 seconds.

A Great Hang-Out!

Right Over a Canyon

By Curt Gunther



YOU CAN just about imagine what the realtor's pitch will be to prospective buyers if Mr. and Mrs. Paul Sheats ever decide to sell their house . . .

" . . . it has an underwater bedroom, the swimming pool is upstairs, and on a clear day you can see the bottom of the canyon."

Of course, it's unlikely that Mr. and Mrs. Sheats will sell their house. It took them about 18 months to get it built exactly the way they wanted it.

It's perched on the side of a hill in the Benedict Canyon area of Los Angeles—and, to the timid, it seems precariously perched. But you can't beat the view!

The view from the bedroom is something else—it's out of "*Twenty Thousand Leagues Under the Sea*." The windows look into—not over—the swimming pool.

There are other features. The living room is separated from the hillside by a wall of air. The dining room and the remainder of the house swing out over the hillside into the open air. Outside one of the windows is a hammock which swings out over—nothing. To get to the master suite, the Sheats have to go along an outside walk. But it's no problem, even on rainy nights. They keep a well-stocked refrigerator in the suite.

In an area of showplaces, the Sheats (he's dean of the University of California at Los Angeles) have something unique. You might say it's a cliff-hanger. ★★

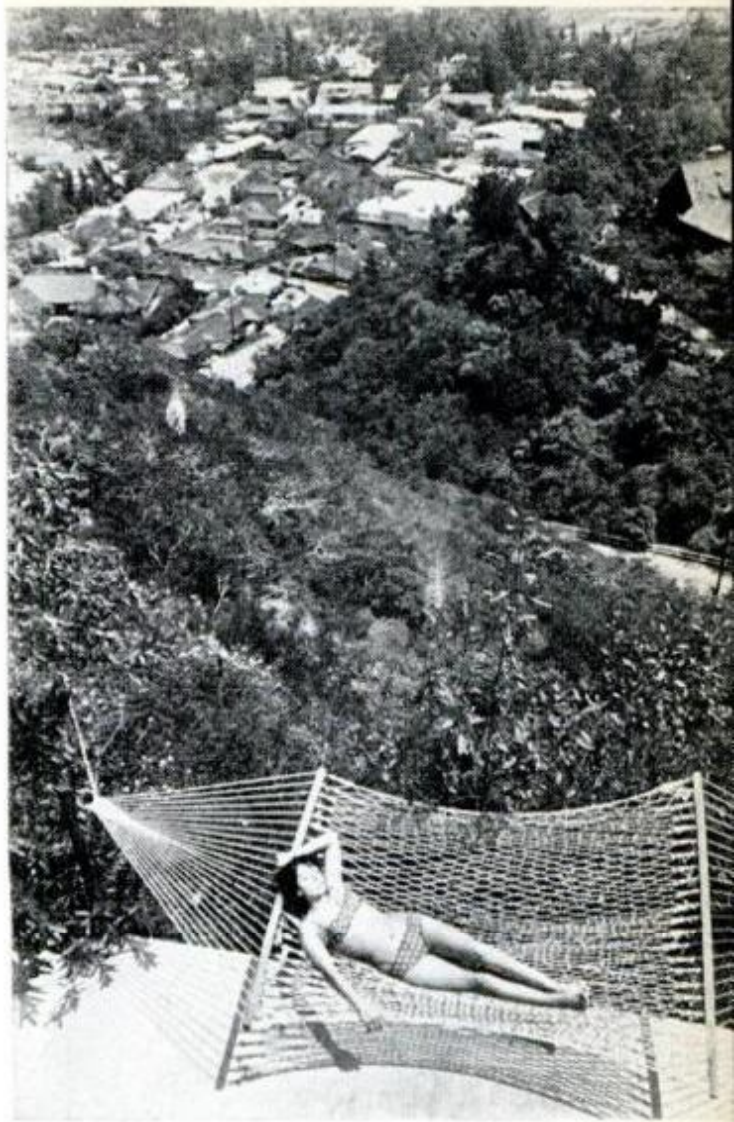

CLIFFSIDE HOUSE overlooks Benedict Canyon and on a smogless day in Los Angeles it's a lovely, if breathtaking, view. Hammock supports only the brave



OPEN-AIR POOL has overhanging shelf that serves as roof over remainder of home. The pool is on the same level with master bedroom with windows at end

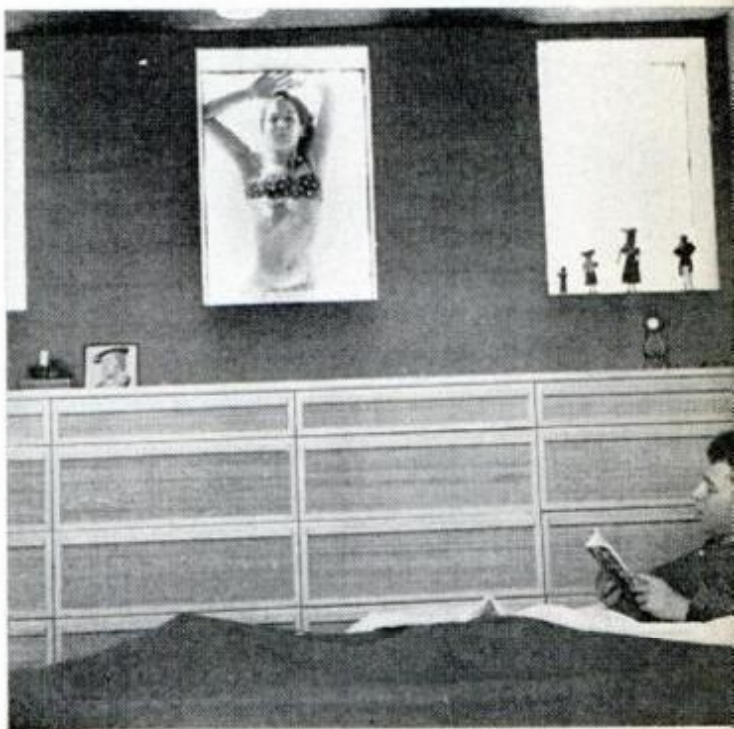

UNDERWATER BEDROOM has windows that look into and out from swimming pool. Girl in bikini and bookish man are young friends of Mr. and Mrs. Sheats

The Wild Transistorized West

Now radio-controlled mechanical calf trains cutting horses in record time

By John E. Boykin

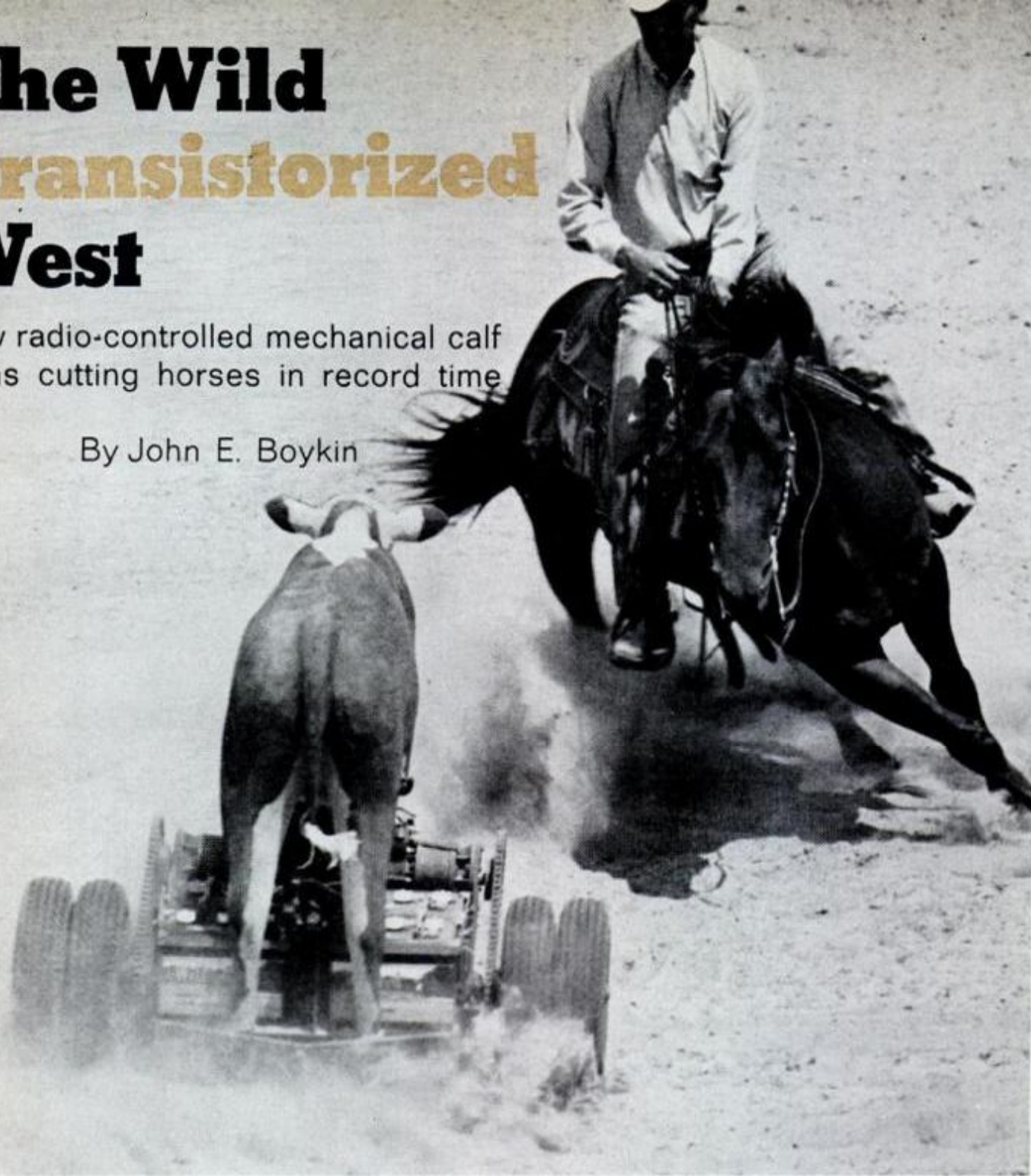

THE TROUBLE with trying to train horses to cut calves out of herds is that, while the horses want to learn, the calves don't want to teach.

Lee Roy Harris, a Texan who spends most of the year on the rodeo circuit, spends the rest in his workshop. There he developed a mechanical calf, controlled remotely by radio, that would make all the moves made by sure-enuf' calves on the range but, more important, would make them on cue.

Now a novice cutting horse can be trained from the ground up or a veteran horse can be worked out to polish up

some weak spots. The calf can make specific moves, again and again, until the horse gets it just right.

The stuffed calf has three wheels, with the front wheel caster-mounted. The rear two have separate sprockets and chains linked to separate motors, so each can be driven independently for sharp turns. Solenoids, activated by signals from a radio receiver in the calf's body, control the wheels. The transmitter has 10 channels. Prices range up to \$2500.

The horses, after some initial suspicion, take beautifully to training with the mechanical mavericks.

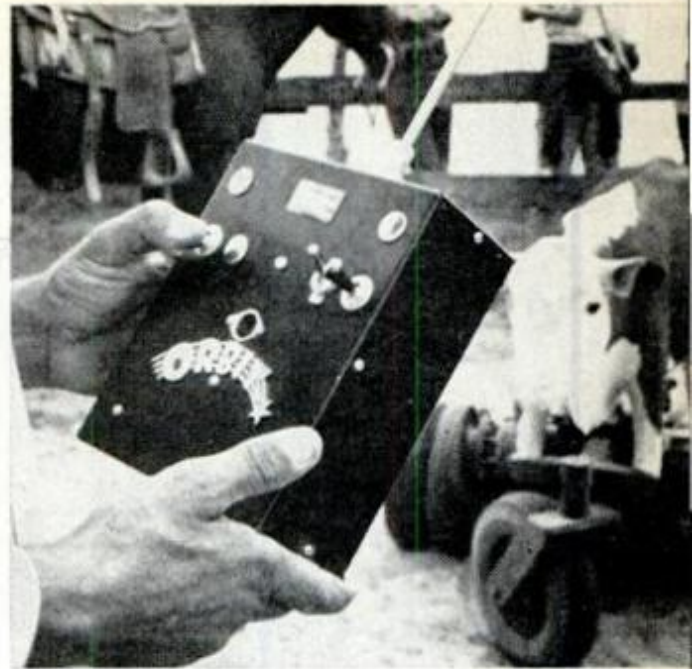

LEE ROY HARRIS, INVENTOR of mechanical maverick, poses with his friend (left) and demonstrates remote transmitter (right). Front wheel is free-swinging and rear wheels are controlled independently so calf can make sharp turns within its own radius. Some models have dual rear wheels for better traction in sand

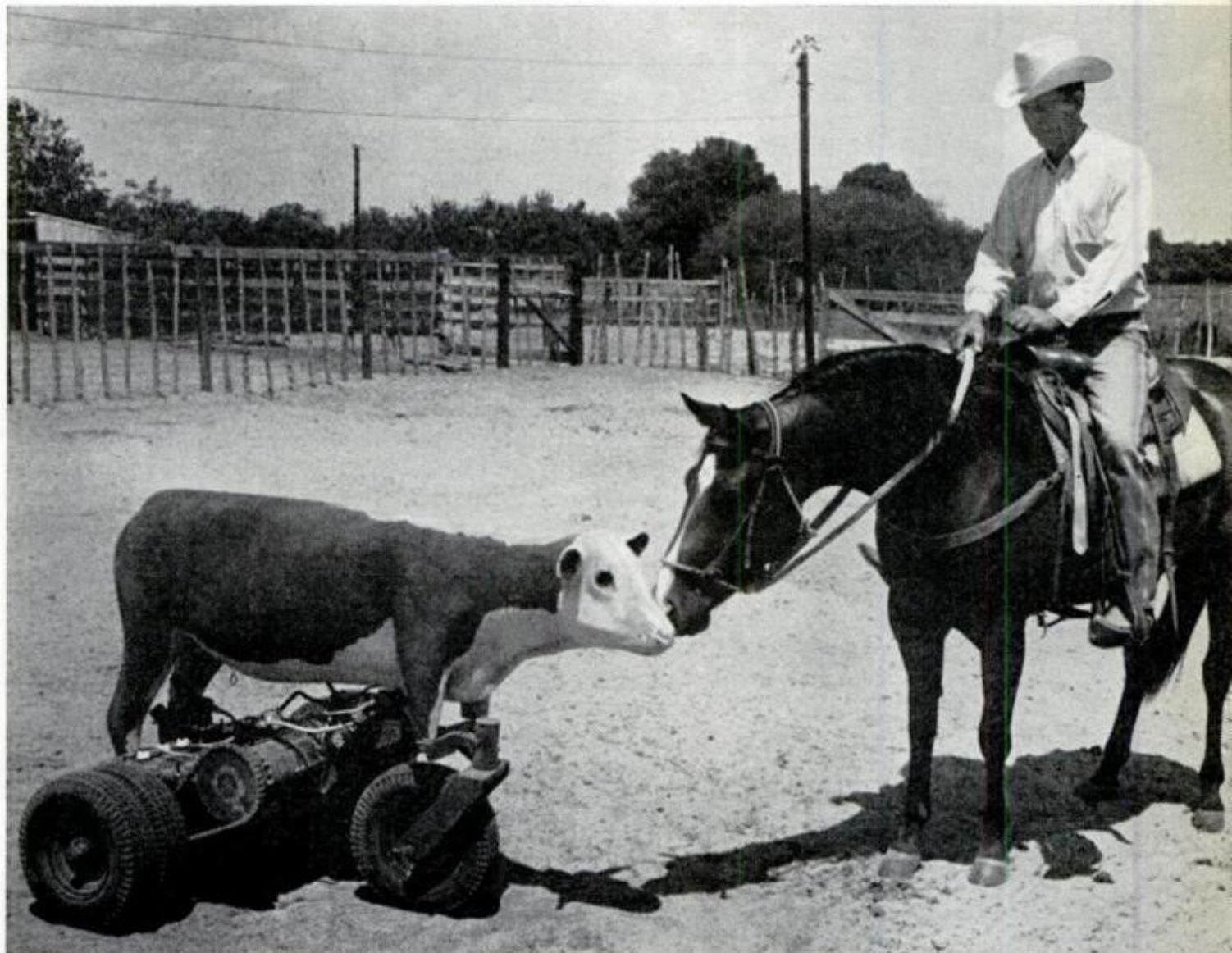

CUTTING HORSE SNIFFS SUSPICIOUSLY at mute model, but once calf goes into action horse's instincts make him treat it like the real thing. Original prototype of calf was stuffed, but now Harris is using fiberglass models with same results. Harris is also working on roping calves and models for wild-cow milking contests

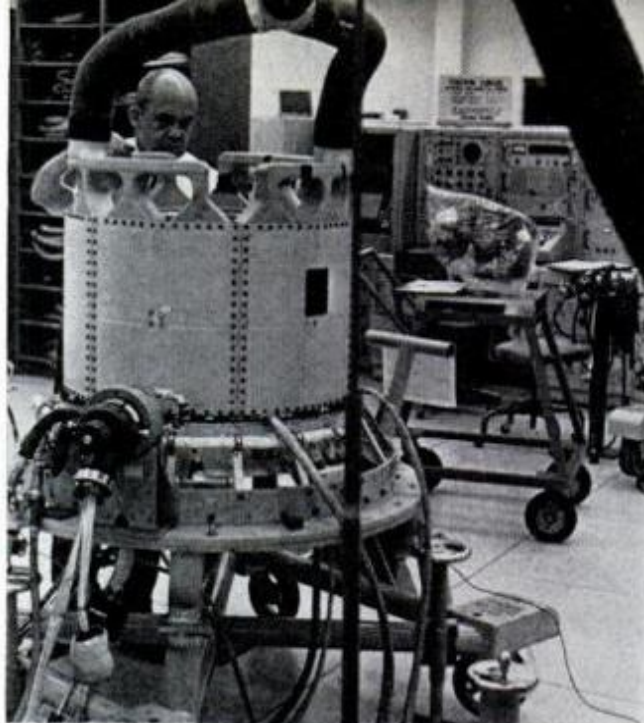

GUIDANCE SYSTEM of a sick Minuteman Missile is set on a vibration platform for malfunction diagnosis. Right, tooling a beryllium part for gyro assembly

Clinic for Sick Missiles

The complex defense weapons do develop kinks that have to be diagnosed and treated by experts at this \$50 million "hospital."

By Arthur Whitman
Photos by Curt Gunther

YOU'VE KNOWN FOR YEARS the day was coming. Now you can let out your breath. It's here. With machines growing daily more intricate, more delicate, more sensitive, it was inevitable that they would one day develop aches, pains and neuroses. Just as inevitable was the fact that they would have to be treated for their illnesses. After all, you don't throw away a \$5 million to \$10 million machine just because it's got a little distemper of the gyro anymore than you throw away a baby who's got the croup. No, you send it to a hospital for treatment. And though a few years ago it would have been thought a fit subject for one of the farther-out science-fiction movies, the government today has just such a hospital.

It's the \$50 million Newark Air Force Station, built three years ago at Newark, Ohio—a sort of Mayo for missiles, where some 2500 civilian missile doctors and a



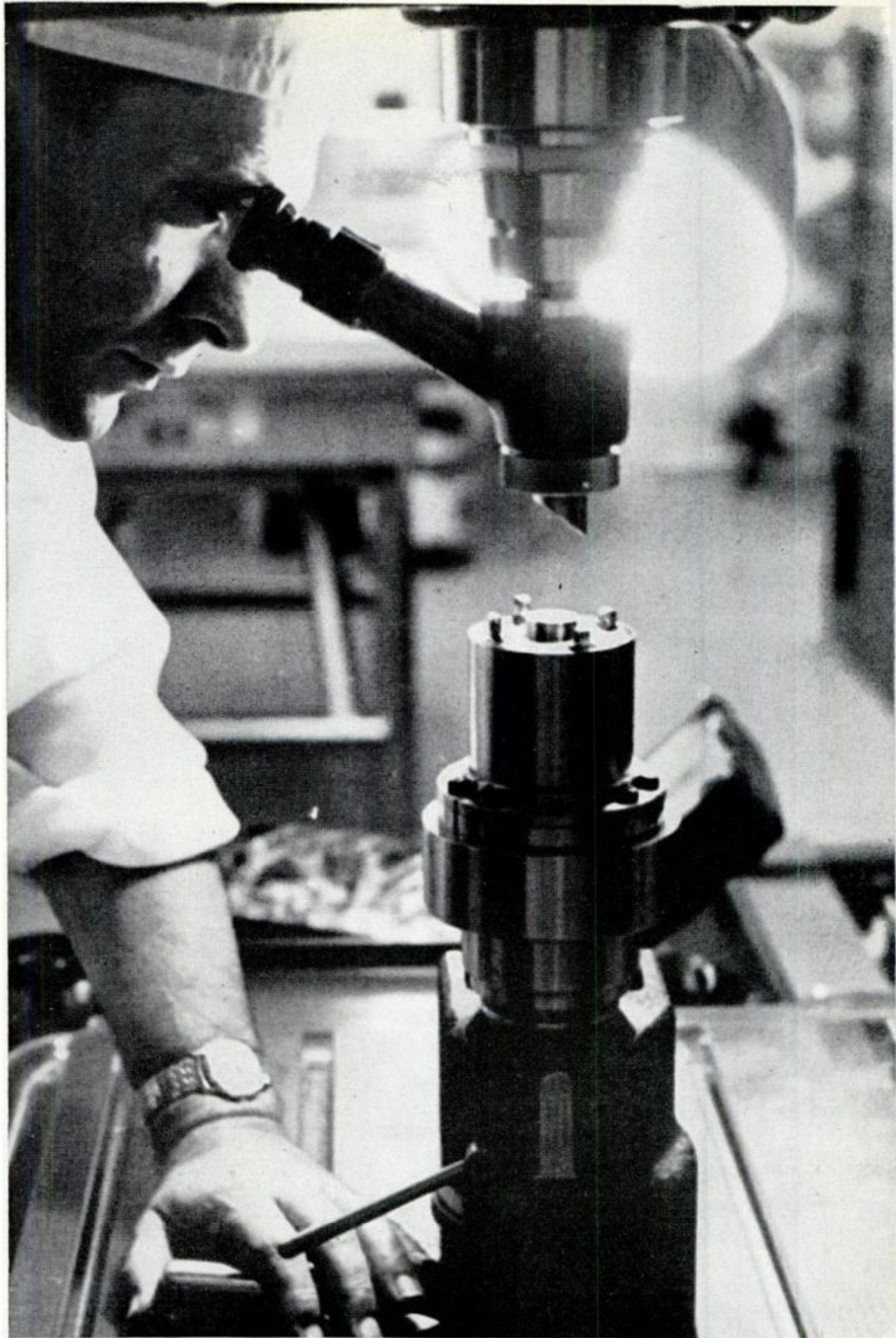

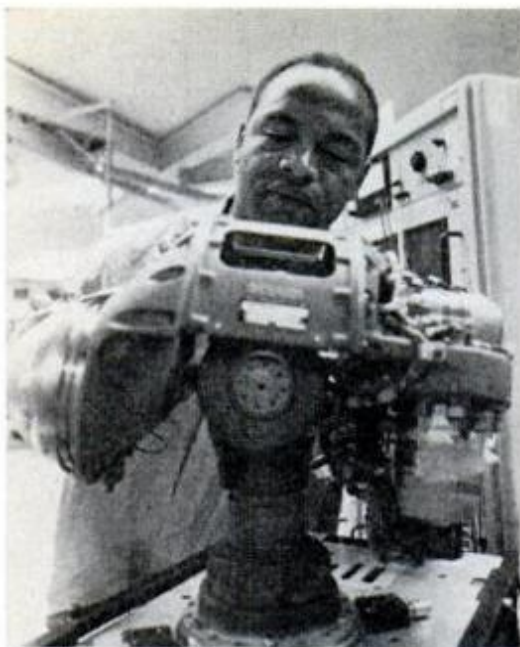

CALIBRATION TESTER at Newark AFB hooks up missile "brain" for series of tests that are run automatically by computers



ADJUSTING the memory disc of an inertial guidance system inside a sterile glass shield free of dust and static electricity

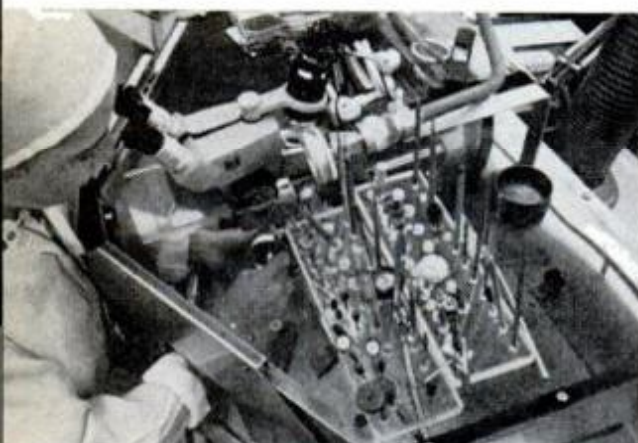

DEBURRING newly machined beryllium parts inside vacuum shield. Vacuum pressure carries off all poisonous beryllium dust



BEFORE ENTERING clean rooms, technicians in lint-free coveralls pass through two filtered air showers that "wash off" dust

handful of Air Force administrators are set up to test and diagnose some 98 cases of missile malaise a month, treat them, and send their patients back to duty full of their usual zip and vinegar.

The missiles, still the backbone of our defense and deterrence system, are given regular examinations in the field. Very little goes wrong with the missiles themselves—they are just projectiles. But "Green Board" field checks, in which every operating part of on-duty missiles are checked periodically, often do show up sickly guidance systems. These are the effective brains and nerve centers of the missiles, designed to do everything from steering their projectiles unerringly to blowing them up in mid-air, if that's the way the signal bounces. Sick systems, when spotted, are yanked from their mis-

siles, "canned," or placed in huge cylindrical containers that look like the biggest old-fashioned washtubs you ever saw, and flown to Wright-Patterson Field, just outside Cincinnati. From there they are trucked to Newark AFS for treatment.

The first step, after "uncanning," is malfunction verification—testing the accuracy of the field reports that have put the system on the sick list. This amounts to taking a medical history of the system, and has no more actual bearing on what will be done to it than what you tell a hospital admissions clerk about last year's backache has to do with curing your presently fractured wrist. The system will be broken down and tenderly reassembled in any event, on the reasoning that something must be wrong with it or it wouldn't be in the hospital. The verification is a

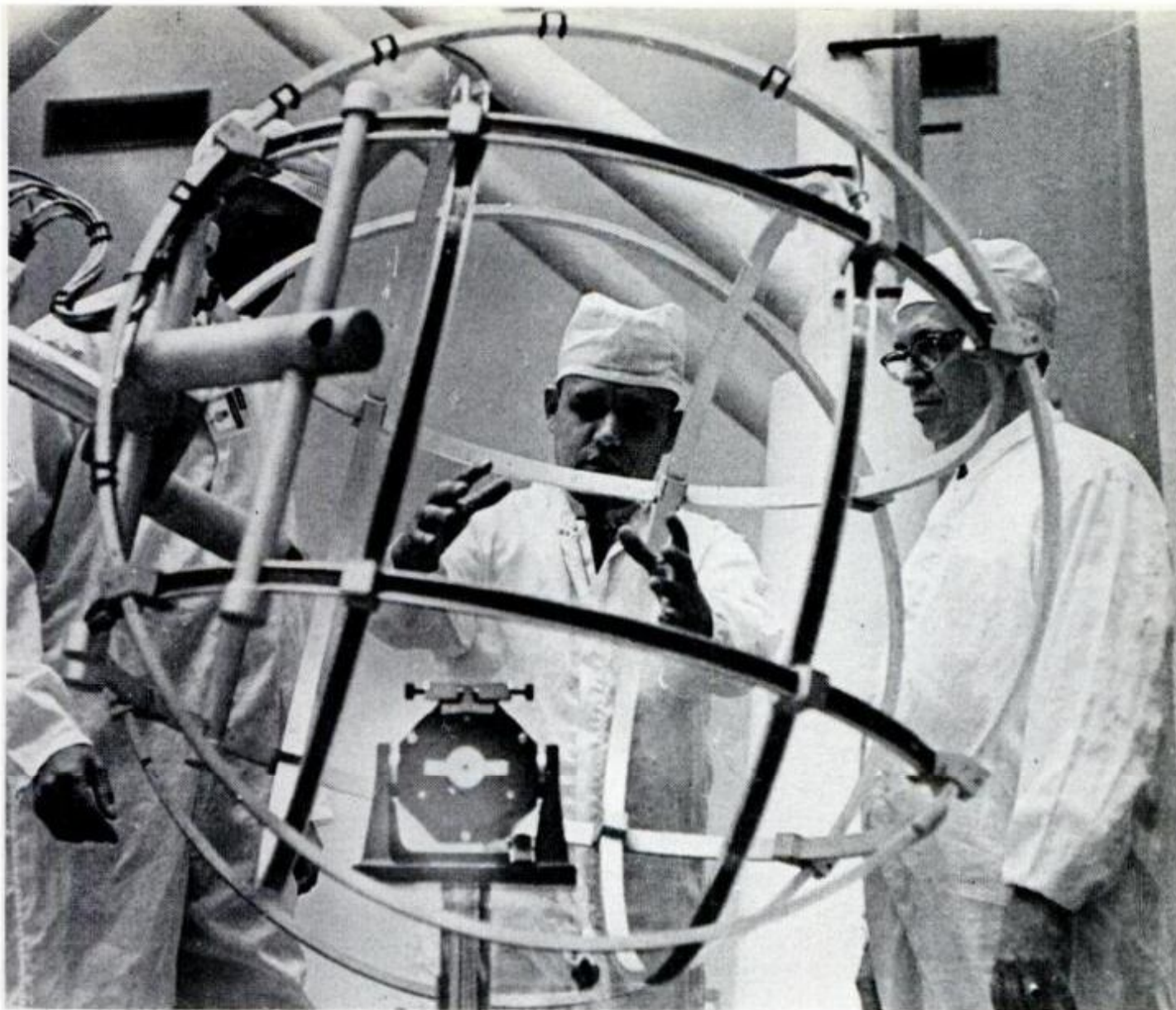

MISSILE DOCTORS IN DEEP UNDERGROUND LAB check a missile accelerometer inside Helmholtz coil that is used to shield the system from electricity in atmosphere. Slightest misadjustments can throw missiles hundreds of miles off course

statistical matter, part of a plan to determine what can go wrong with missiles, for field reports are often unreliable. Even when they are accurate, they can only say what's wrong, not what's causing the problem. They will report, for example, that a system goes into test calibration sequences without having been set for them, or that it goes into automatic restart cycles in the same spooky fashion. Either of these symptoms can be caused by any or all of a half a dozen ailments: There might be a bad bearing in a gyro motor; there might be a slightly fractured weld in the skin, allowing a leak of the helium in which the systems are pressure-packed to prevent oxidation. Or maybe it's not a bad weld, but a micro-hole in the skin caused by an imperfection in the metal of which it is made. There might

(Text continues on page 124)

Postmortem for Agena

What was the flaw that spelled disaster for the Agena launched last October 25? The rocket was to go into an earth orbit, where a manned Gemini vehicle would try to link up with it. But six minutes after launch, the Agena disintegrated, scrubbing a key mission. Then NASA and Air Force scientists began a painstaking study of a stack of tapes. As in all such flights, readings of instruments aboard the rocket had been telemetered to earth and recorded. On those tapes were moment-by-moment readings of the attitude and speed of the rocket, internal pressures and temperatures, and other critical data. Preliminary finding: an excess of fuel in the thrust chamber caused something like a backfire in a car, a jolt apparently strong enough to burst the fuel tanks.



CURED MISSILES ARE "CANNED" for truck and air trip back to duty after treatment and convalescence. The big hospital treats 90 missiles every month

metal of which it is made. There might be a faulty bubble in the level-seeking mechanism, a beryllium dust particle in a component, a computer module failure.

Once the verification function is complete, actual diagnosis can begin. Pressure domes are removed and skins checked for possible leaks. The systems themselves are transferred to test platforms. There, while subjected to the exact number and type of vibrations they will generate and respond to in operation, they are bathed in dust-free air of the exact temperature at which every one of their operations is expected to take place. All of their functioning parts are hooked to banks of computers and other sophisticated automatic test devices that will electronically inspect and document their precise reactions under all conditions.

By this stage, faults are most apt to be discovered in velocity meters, computer memory discs and gyroscopes and their attendant devices. Depending on the diagnosis, they are sent either to components labs for further checkups, or to repair installations, where parts are meticulously cleaned and rebuilt.

But the word "rebuilt" hardly conveys

the sense of what takes place. This is not a matter of taking new gizmos out of a bin to replace old ones, but, usually, of remachining parts to tolerances so fine there's almost no way to conceive them. Typical is the reboring of float assemblies for Pendulous Integrated Gyros—they're called "Pigs," naturally, and are the parts of a part that keeps the missiles pointed in the right direction. After cleaning and before reassembly, the float and its chamber must be machined to 25 millionths of an inch. Yes, that's .0000025!

By comparison, the innards of the finest watches made on earth are machined to tolerances of .0005! To compound the problem, the Pig parts are made of beryllium, which is lightweight and has fantastic tensile strength, but is so brittle it is all but impossible to work with, and is poisonous to boot, when inhaled as dust. Because of these factors, machinists work through microscopes in super-clean conditions, with the air constantly changed, filtered and monitored.

Clean-room conditions obtain in most other Newark repair shops, and in some, operations are actually performed within sterile shields—ultraclean glass cages kept absolutely free of dust and static electricity, either of which could throw off the delicate adjustments made within.

After repair and subassembly, the rehabilitated missile organs are sent to the calibration lab, which contains the most delicate calibration equipment on earth. Built on solid rock, with its top 60 feet below the ground, the lab contains 10-ton suspended platforms so stable they balance objects at 1/1,000,000 the force of gravity. Here the parts are allowed to operate for varying periods of time till the doctors are sure all symptoms are cured.

Before reassembly, each treated unit is checked once more to be sure it has responded to treatment. Most prove to have done nicely. The occasional difficult cases are sent back for further treatment or surgery, as indicated.

Once reassembled, the systems are still not sent to the field. They are put on light duty first, for five rehabilitary days during which computers put them through alternating rest and operating cycles. Only when everyone is satisfied that the patients are fully cured and full of the old zing again are they returned to the field.

★★★

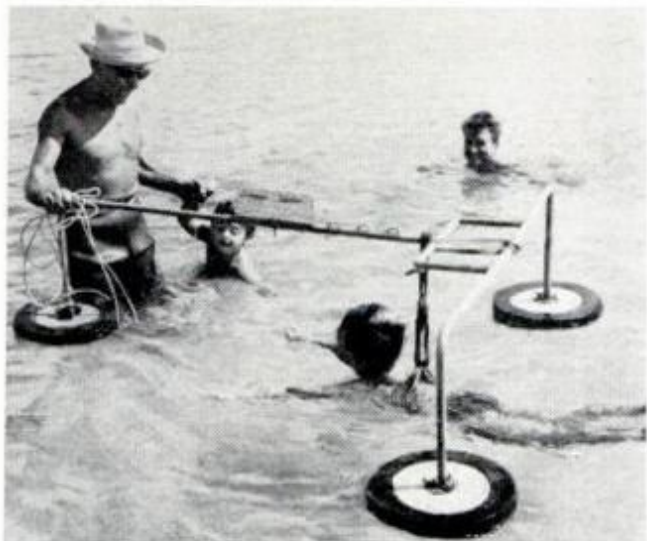

Safe and secure. Youngsters learning to swim can keep their noses comfortably above water with the help of the floating device being demonstrated by its inventor, French swimming instructor M. Lillamand. The inflated, tirelike platters are the floats for the rig.



Treetop boating. Tom Johnson sets a new world's record for offbeat boating accidents in Paramount Pictures recent short subject release, "Lubber Afloat." In spite of careful planning, faking these accidents required plenty of on-scene ingenuity and sometimes just pure muscle. For instance, the script required that at one point both Johnson and boat end up in the top of a cypress tree. Undaunted by the lack of a floating crane, the crew hoisted the runabout onto a high platform mounted on a photo boat, ran this teetering load across the lake to a tree and shoved it off into the branches. A painless push for boating safety, the unusual footage was filmed at Cypress Gardens, Fla., by Mattco Productions in conjunction with Johnson Motors.

FEB. 1966



Ambitious amphibian. "Walking" through deep muck proved as easy for this one-fifth scale model as paddling through water or rolling along paved roads, so the Lockheed Aircraft Service Co. plans to build a full-scale prototype for major tests. Key to the versatility are wheel assemblies called major wheels, each with three minor wheels on secondary axles. Major wheels do the walking and paddling while the vehicle runs on its minor wheels, carrying wide-base Goodyear Terra-Tires, over roads and hard ground.

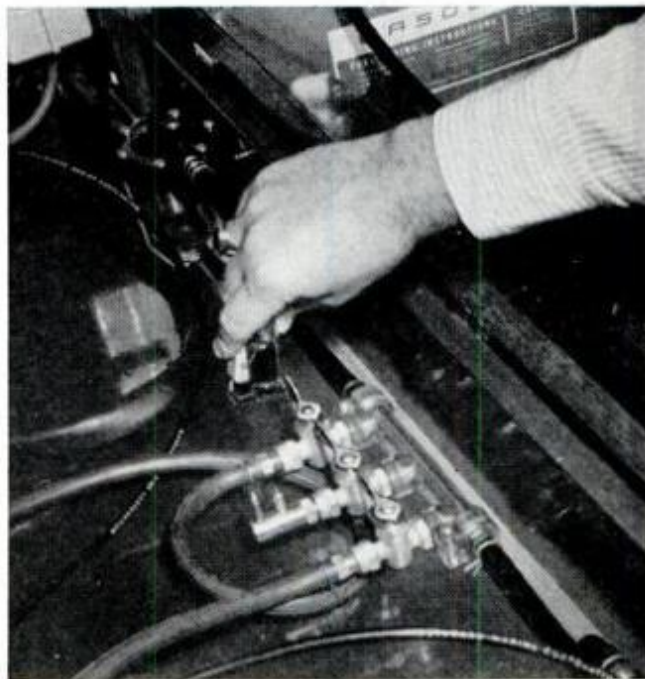

Quick switch. A new transparent fuel-connector block makes it possible for boaters to perform split-second switching of fuel flow from as many as three separate tanks to one or two engines without spilling a drop of fuel. By varying connector fittings, any combination of permanent and portable fuel tanks can be used. Called "View-Flow," the device is made by Tempo Products Co., 6200 Cochran Rd., Cleveland, Ohio. It sells for \$3.95.

Dioramas out of the

A brand-new method of freeze drying everything from bats to bunnies is producing extraordinary, lifelike exhibits for the updated Smithsonian Institution.

A RESEARCH SCIENTIST working with cell structure at the Naval Research Institute in Bethesda, Md., found a cardinal that had just died near his home and had a sudden idea.

Why not freeze the bird's body to preserve it for a conversation piece?

As a trained physician, Dr. Harold T. Merryman knew that freezing alone would not protect the bird from bacteria after it thawed. However, if removing the water from the bird's body after it was frozen might also remove the bacteria problem, he would indeed have a conversation piece. So he placed the cardinal in his home freezer and pondered the problem. The



deepfreeze

answers he found have revolutionized the taxidermy field.

Dr. Merryman knew that water boils at 212° F. He also knew that water can be vaporized at any lower temperature, if the pressure is changed proportionately, and that the lower the temperature the slower water vaporizes. Since fast vaporization causes tissue to shrivel and distort a specimen, he decided he had to use very low temperatures.

For less than \$1000 he built an insulated chamber from an autoclave to keep the bird during preparation. To this he connected an old refrigerating unit with temperature control. This would keep the

By Chuck West



FROZEN RACCOON, posed in lifelike position, is typical example of results of new method of taxidermy, said to be more realistic than old way



SMITHSONIAN TAXIDERMIST, R. J. Gurnese, poses specimens using tape, wire or even liquid nitrogen to freeze limbs locally to desired exhibit positions



FREEZE-DRY CHAMBER used at Smithsonian can hold several small animals, but largest single one handled was a fox. Unit is exceptionally well insulated

bird frozen while being dehydrated. He added a vacuum pump to maintain constant pressure on the specimen to vaporize its fluids.

When ready, he quickly removed the cardinal from the home freezer to his chamber, where temperature had been lowered to minus 4° F. and a vacuum pump was exerting a pressure of 10 microns of mercury. As the water vaporized it was collected by a chemical desiccant. He estimated that his freeze-dry chamber would take about one week of treatment for every 30 grams of specimen weight, so a bird the size of a cardinal would require about three weeks.

Looking back, Dr. Merryman thinks those weeks were the longest in his life. His

hands were actually shaking when he took the cardinal from the chamber and placed it on his laboratory desk. After several more weeks' observation and examination of the bird's tissue, he knew the experiment was a success. Today, that cardinal is a conversation piece among taxidermists everywhere.

The Smithsonian Institution's Museum of Natural History in Washington built a lab similar to Dr. Merryman's, only much larger and with more complete controls. The London Museum has also begun to use the freeze-dry method to prepare specimens for its exhibits. And, as the result of a paper published in a professional journal, Dr. Merryman has received more than 2000 queries from professional taxidermists everywhere.



OLD METHOD of taxidermy would not allow stuffing specimens small as caterpillar, now done easily by freeze-dry system. This specimen is exactly as in life

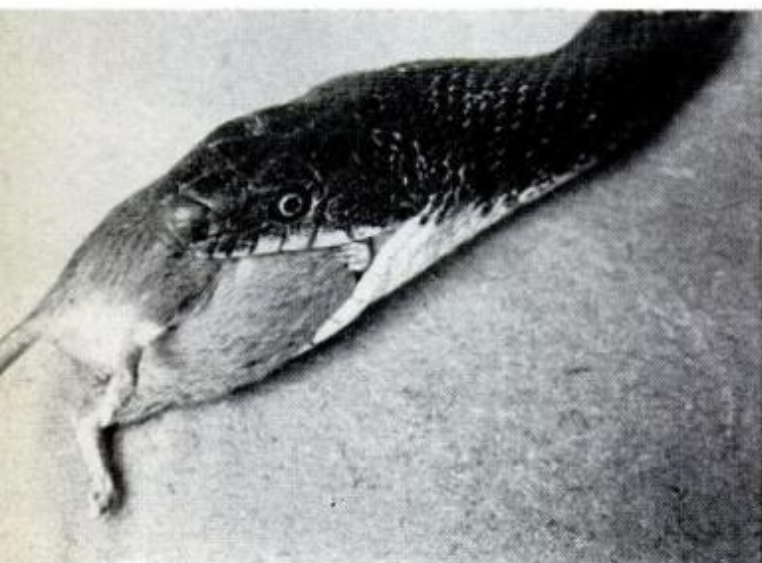

ACTION SPECIMENS, such as snake swallowing field mouse, is another advantage of freeze-drying. Natural activity, if gory, can be captured realistically



SQUIRREL CHEWING NUT is another outstanding example of lifelike quality of the freeze-dry method. The unstuffed exhibit will last almost indefinitely

dermists asking how to use his method in their business of preparing specimens for sportsmen.

Many important advantages of the freeze-dry system over regular taxidermy methods have become apparent since that first specimen was popped into the chamber. In Dr. Merryman's words, "It eliminates the grubbing and gives the taxidermist an opportunity to devote his time to the real art of taxidermy—the posing of specimens in lifelike situations."

No cleaning of the animal is necessary. Fixed into the pose that is wanted for exhibit, the specimen is simply placed into a deepfreeze unit until solidly frozen, and then in the freeze-dry chamber for the time required. It looks more lifelike after

this treatment because its tissue has undergone minimum shrinkage.

Tiny specimens such as spiders with hair-thin legs simply could not be prepared for exhibit under conventional methods. No taxidermist could "stuff" anything this small. He had to make molds from the specimens and then cast duplicates. Now small specimens are popped in and out of the freeze-dry chamber by the hundreds. Animals lose 70 percent of their weight, which makes larger ones easier to manage while setting up an exhibit.

There is one "way-out" advantage, too. If scientists in the next century for example, were to find there were no longer any robins on Earth and they wanted to study

(Please turn to page 216)



DR. HAROLD MERRYMAN, developer of freeze-dry system of taxidermy, shows fox that, to date, is largest specimen to have been prepared by his method. Larger animals need bigger chamber



Mobile home afloat is a 45-foot New Moon trailer mounted on the deck of a 64-foot pontoon barge. Built by Lester Gard, Blue Island, Ill., executive, the novel houseboat is powered by a pair of 120-hp marine engines, one in the stern of each pontoon. All controls are located in the fore part of the trailer.



Rough-country trail bikes have become a common item the past few years, and they also have a common problem. When piled high with equipment or used for packing out a large deer, they are difficult to balance. Trail Truk, a vehicle made by Wayne DeCou, Rt. 1, Corning, Calif., eliminates the problem with a basket-like frame that carries loads between the wheels and under the rider. Powered by a four-hp Briggs & Stratton engine, it has an automatic clutch, two-speed automatic transmission and sells for \$285.

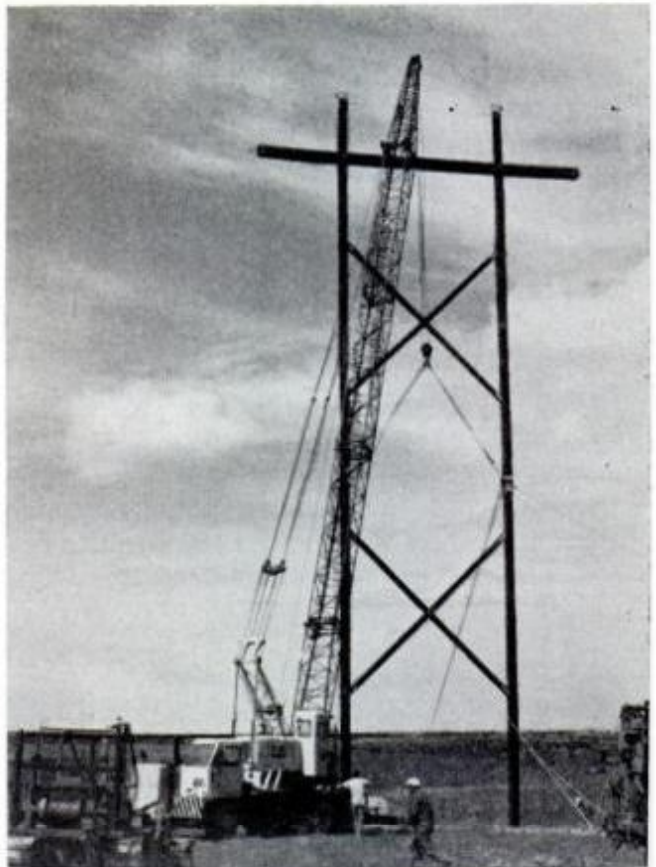

New high voltage line put up by the Idaho Power Co. is suspended from a new kind of tower—its poles, crossarms and X-braces are all made of laminated wood. The poles, some as high as 105 feet, are far stronger than conventional cedar poles. Only 86 were needed for the 18-mile stretch the new line covers instead of the 138 cedar-pole structures normally required. The laminated poles are tapered from bottom to top and are bonded with a tough, lifetime glue. They're also resistant to insects and fire.



Floating globular greenhouse. In Ito, Japan, a 105-foot-diameter, steel-framed hot-house displays three floors of tropical plants and animals nonindigenous to the country. Located on a foundation in the middle of a pond and accessible only through a transparent, plastic tunnel, the greenhouse was built by the Totaku Izu Development Co.



Floating truck. Old boll weevil has always flourished during the irrigation season when spray trucks would bog down in the fields, but a new rig is numbering his days. With the help of Shell Development Co. of Houston, Tex., a California farmer, Gordon Thomas, has equipped a spray truck with Goodyear Terra-Tires. They spread the 15,500 pound weight of the truck so that the force against the ground is only 12 pounds per square inch, allowing the rig to literally float across the soggy fields.



Car washer made in West Germany takes but a minute—30 seconds per side—to do a full-sized car. The fully automatic unit rolls on tracks and moves around the car, which remains stationary. Vertical and horizontal brushes scrub as two nozzles spray the car with water. A chemical in the rinse water is said to speed drying and prevent spotting. Made by Messerschmitt, the washer is distributed here by the Gilbert & Barker Manufacturing Co. of West Springfield, Mass.

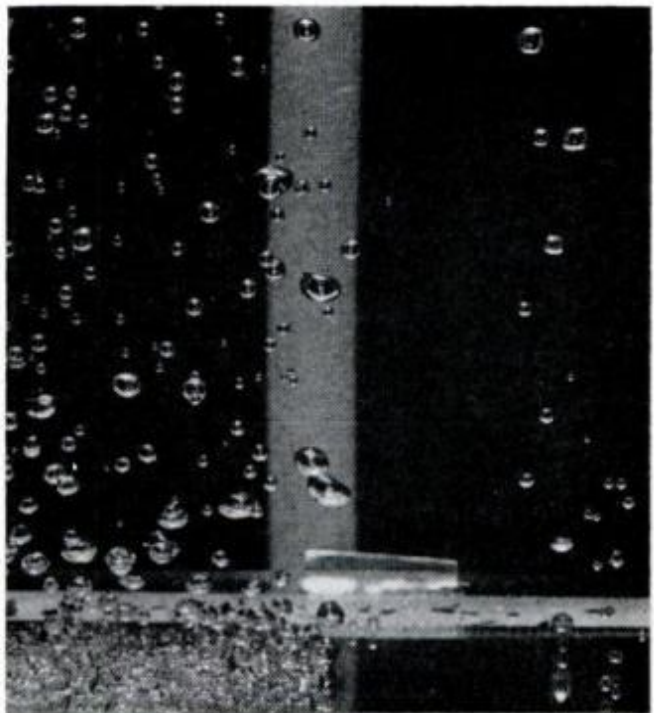

Teflon makes the difference. It was used to coat the left side of the heat plate at the base of a water-filled test tank set up by University of Toronto researchers. Result: The same amount of heat produced many steam bubbles on the treated side, few on the other. Scientists think Teflon-coated heating units would greatly increase efficiency of ocean desalting plants.

NEVER MIND THE ANSWER; WHAT'S THE QUESTION?

By Murray Teigh Bloom

We all waste time finding the right solution to the wrong problem. The key to efficient answers in home or office is to ignore marginal questions. The rest is easy (it says here)

FOR 20 YEARS Prof. Edwin R. Keedy of the University of Pennsylvania Law School used to start his first class by putting two figures on the blackboard:

4
2

"What's the solution?" he would ask. A student would call out, "six." Another would say, "two," but Keedy would pass them by. Several men would shout the final possibility, "eight," and the teacher would shake his head.

Finally, Keedy would point out their collective error. "All of you failed to ask the key question, *What is the problem?* Gentlemen, unless you know what the problem is, you cannot possibly find the answer."

Dr. Keedy's classroom gambit was deadly serious. He knew that in law, as in everyday life, too much time is spent trying to solve the wrong problem—like polishing brass on a sinking ship.

Large corporations often have this inability to pinpoint their real problems and spend millions trying to solve purely marginal problems.

"In three-fourths of the cases we handle," E. Everett Smith, director of McKinsey & Co., a leading international management consultant, told me, "The first part of our work is hammering out the essential item—just what is their problem."

"Sometimes a client will come in and say, 'What's a fair price for this company we want to buy?' And before long we will discover that their real problem is should they buy the company at *any* price. Or they may ask us 'Should we spend \$1 million or \$5 million pushing a new product?' when their real problem is how big a market is there for the product?"

Experts agree that four pitfalls trap most people trying to find the problem:

- Too often, identifying the problem is merely the one that sticks out—like trying to get rid of measles by working on the spots.

- Sometimes, viewing a personal problem as everyone's problem. For example, a tight-budgeted, social-work agency was moving to larger quarters and the office manager asked the executive director whether they should spend \$90 or



\$120 for two standing ashtrays near the elevators? The director, noticing the office manager's nicotine-stained fingers, smiled. "Neither," he replied. "Let's spend \$1 for a 'No Smoking' sign."

- Concluding that the main problem is really the one that annoys you most. Dr. Lawrence Stessin, professor of management at Hofstra University on Long Island, was called in by a factory with production difficulties. One supervisor, whose section of women employees had a particularly low output, told Dr. Stessin the real problem was talking. "The women just kept yakking so now I walk up and down the aisle and they're quiet." But production had not risen.

"This is a common case of misidentifying the problem," Dr. Stessin points out. "The talking women annoyed him so he decided that was the real trouble. By 'solving' this minor and irrelevant problem he completely overlooked the basic one—increased production. Eventually, it was solved by rearranging the machinery and letting the women talk."

- Proposing a solution and calling it a problem. For example, consider the department head who finds that stenographers in his section aren't keeping up with the workload. He wonders, "How can I get more stenographers assigned?" In effect, he's already leaped ahead to a solution when his real problem is how can they keep up with their workload? If he puts his problem that way he begins thinking in terms of electric typewriters, dictating machines or copying devices rather than hiring more help.

Probably no one has made the ability to find the real problem pay off as handsomely as Simon Marks, multimillionaire head of the huge British store chain, Marks & Spencer. Their 239 green and gold-fronted stores cover the British Isles. In the past six years, by finding the real problems facing his firm, Lord Marks and his associates were able to cut prices, raise wages and increase sales.

"Why do we have time clocks in our main offices and branches?" Marks asked one day. "None of our employees are paid on an hourly basis."

The problem, said an assistant, is that they had to keep track of their employees, making sure they put in a full day.

Marks shook his head. "The problem really is you don't trust our supervisors,"



he said. "Don't *they* know who's putting in a good day's work?" In one week, hundreds of Marks & Spencer time clocks were sold. The firm was able to throw away a million time cards—and punctuality improved.

Marks now asked why the stockrooms in each store were locked and guarded.

"Thefts by employees," said a director. "There are only a few thieves among them, but still we have to guard ourselves."

Marks thought a while and said, "Let me see if I understand this correctly. Because a few among our 28,000 employees might pilfer we have to act as if every one of them is a thief. To solve this problem we set up guarded stockrooms and elaborate withdrawal forms at great cost—probably greater than the pilferage involved."

The hundreds of stockrooms were opened wide. Pilferage was no worse and millions of expensive forms were abandoned.

The saving gave Lord Marks another idea. He formed a committee of eight and called in all store managers to find out what problem each paper form had been designed to solve originally. But this procedure was too slow—too often no one remembered the original problem—and the committee turned the question around. Instead of bothering about what a form had solved, they simply asked: "If we didn't have this form would the whole business collapse?" Within a year, Marks & Spencer safely eliminated 26 special form sheets weighing 120 tons.

The habit of asking "What's the real problem?" eventually brought executives to the chain's 13 thick operation manuals. These company "bibles" were being revised continually to cover every conceivable eventuality.

"These manuals," recalled one executive, "were created to help the local store manager solve problems as they arose. They assumed unless things were carefully provided for everything would go wrong. Belatedly, we realized this was a stupid assumption and we were trying to solve the wrong problem. About 99 percent of the time everything goes right. Why should we spend so much time and effort preparing these manuals on the assumption that everything will go wrong most of the time?" The manuals were eliminated and managers told

(Please turn to page 218)



World's largest tank car, with a capacity of 60,000 gallons, is almost three times as long and seven times the volume of the typical tank car in use at the end of World War II. The 96-foot-long car rides on four four-wheel rail car trucks. Introduced as a "rolling laboratory" by General American Transportation Corp., the giant tank will develop working data to indicate its marketing demand.



High-kicking antics designed to slim down legs and tummy are easier on the Rucken-Roll. And you can take those "kinks" out of your back by rolling your body back and forth across the padded roller. Priced at \$14.95, the Rucken-Roll is sold by New Horizons Book Distributors, Box 5, Pacific Palisades, Calif.

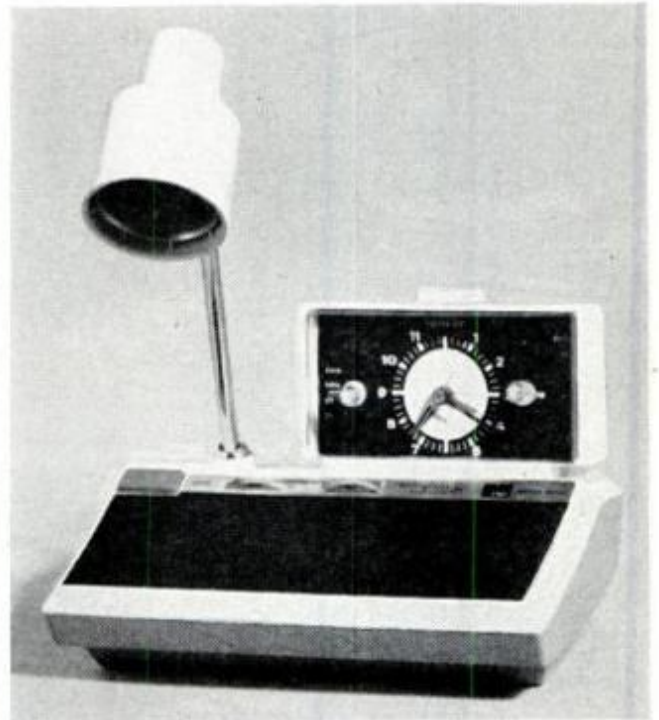

Sound, light and time are combined in the Crescent, a new Lumina Series lamp by Westinghouse. Featuring a high-intensity lamp, a powerful AM transistor radio and a wake-to-music electric clock, the radio is available in ivory and beige. Price: \$49.95.



Shut the Windows!

The Fire Suds Are Coming Through the Doors

Now the same foam that billows in washing machines and sewers is filling buildings to smother fires in minutes

BY PAUL W. KEARNEY

THE OUT-OF-CONTROL BLAZE in a windowless cellar is the fireman's nightmare. But Philadelphia firefighters saw such a nightmare turn into a pleasant dream in a restaurant appropriately named the Open Hearth.

Choking smoke and searing heat made entry impossible. Under ordinary circumstances the building would have been doomed by flame, smoke damage and the hundreds of tons of water poured into it to prevent the blaze from racing down the block.

But this time the circumstances weren't ordinary. At hand was a new type of equipment, loaned by the manufacturer for testing, and it was promptly put to

work. Fire buffs who saw it roll up may have mistaken it for a service rig for vacuum-cleaning chimneys, or even the latest thing in garbage trucks.

The driver jumped from the cab and began to unlimber a bulky muslin tube from the rear end. A member of an engine company crew, already there, connected a short line from his pumper to the strange truck. As the driver guided the fabric tube toward the door of the restaurant, it swelled to several feet in diameter, dribbling what looked like soap suds as it snaked along the ground. Tossed inside the door, the bell-shaped end of the tube ballooned under the pressure of the foam it conveyed.

In more ways than one, this was not the orthodox firefighting. There were no throbbing hose lines gushing water. But very soon the filthy black smoke belching from the building changed to gray, then to white, then to steam. And when the pressure behind the steam began to abate, the firemen knew that the blaze was as good as out.

As fire engines go, the new rig is nothing to look at. But what it does more than makes up for that. What it accomplished in the fire just described was summed up by Philadelphia's fire commissioner:

"This is the kind of fire in a confined space that firemen fear the world over. Yet quick application of this new method snuffed it out in three minutes flat—even up under the main floor joists."

The miracle was performed with 4½ gallons of chemicals (costing \$27) mixed with about 300 gallons of water!

River of fire

In January, 1964, a few months before the Philadelphia "test," a diesel locomotive plowed into a gasoline tank-trailer at a grade crossing in Dominguez, Calif., killing the trucker and four trainmen in the ensuing inferno. Liquid fire flowed for 100 yards along the right-of-way, with operations hampered by burning and arcing high-tension lines. But the major problem was the furiously burning trailer. Standard fog applicators were making little progress when the Los Angeles County Fire Department's new Foam Unit No. 3 rolled up and went into action. In exactly two and a half minutes the leaping flames were out.

Similar experiences in Cleveland, Pittsburgh and other cities have caused veteran firemen to marvel at the new weapon. Yet housewives the country over have berated it when they've seen it surge up in their washing machines in an avalanche of bubbles or back up in the sink all the way from the septic tank. For the new extinguishing agent is simply a high suds detergent, more accurately called "high expansion foam."

Perhaps the most dramatic example of how it works on a fire was provided in Dayton, Ohio, where the fire department staged a tough test. It involved a large brick-and-masonry church which was to be razed in an urban renewal project. The building was perfect for giving the suds a real workout in the most difficult of all



TOUGH TEST: Firemen in Dayton, Ohio, touched off the basement of this church scheduled to be razed, and allowed the fire to gain headway for 30 minutes



THEN CAME THE SUDS. Pumped into the church by means of a fabric tube, they soon filled the structure and poured from its windows, engulfing firemen



FIRE OUT, SUDS GONE. As the church's interior shows, the foam speeds clean-up operations. Unlike water, it doesn't add to damage inside a structure



CHEMICAL FOAMING AGENT AND WATER are mixed in "mechanical proportioner" in truck, then shot through nozzles into a heavy nylon netting to produce uniform bubbles. Powerful fan on top of truck then forces the foam through the big cotton tube at a rate of 1000 gallons of bubbles for each gallon of water used

nonindustrial occupancies: the church with its vast, unbroken areas.

Two fires were set in the basement and allowed to burn for 30 minutes. "It is now completely out of control," said the fire officials. "Let's see how good this stuff really is."

Inside the truck a mechanical proportioner accurately mixed water with 1½ percent of a chemical foaming agent which was shot through several nozzles onto a heavy nylon netting to make uniform bubbles. Powerful fans then forced these suds through a cotton tube at the rate of 1000 gallons of bubbles for each gallon of water. (For comparison, the familiar protein foam that firemen have long used effectively,

especially on oil fires, has an expansion rate of only 8 or 10 to 1.)

A tidal wave of suds rolled through the tube into the structure, tumbling across the main floor. Finding two stairways at the opposite ends of the building, the deluge poured down into the basement, then rapidly built up around the burning fuel from floor to ceiling.

In 36 minutes the huge involved area was completely filled with foam and the fire was out, quenched and smothered. But the pumps kept running, to prevent any possibility of a rekindle, until the mountain of suds backing up in the sanctuary above measured 60 feet deep.

This intense blaze was blacked out using

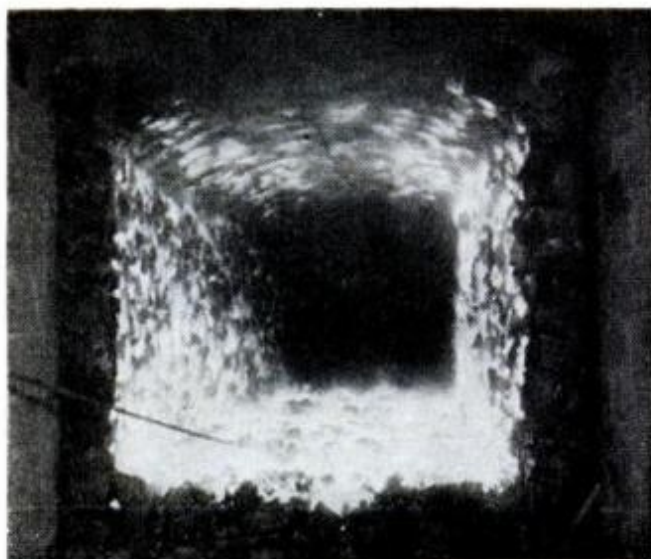

HIGH EXPANSION FOAM originally was developed to fight fires in mines. This blaze was set by Bureau of Mines engineers to test the fire-eating suds



EVEN MORE TENACIOUS than their washday cousins, the detergent suds flow from tube to smother fire by forcing air away from it, depriving it of oxygen

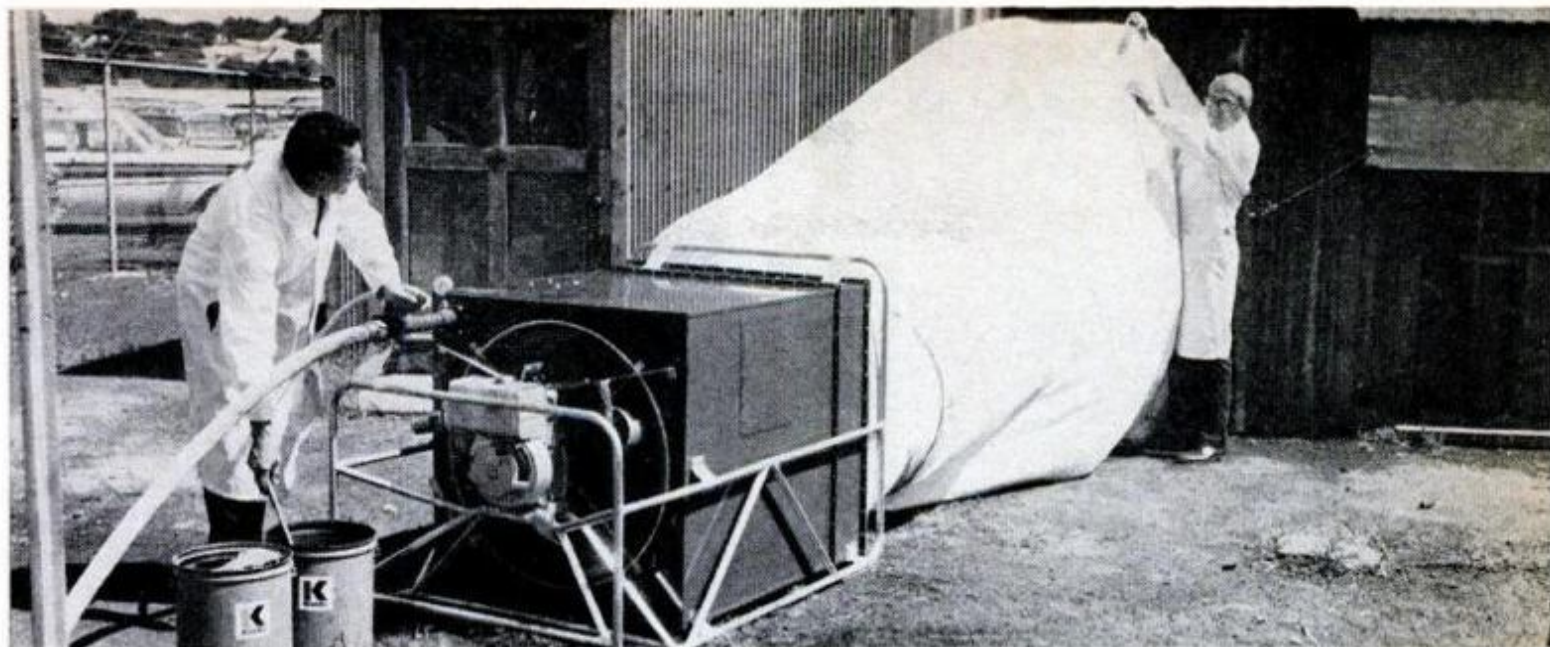

PORTABLE FOAM UNIT IS SET UP BY ENGINEERS on the manufacturer's testing grounds. In this case the high expansion foam was forced into the workshop to smother both gasoline and wood fires in seconds. Suds later dissipated, leaving the shop's interior and its equipment moist but completely undamaged

only 4000 gallons of water mixed with \$360 worth of foaming agent. Laymen may consider this a lot of water. Yet in that same time a single standard fire hose would have delivered 8640 gallons which would have accomplished nothing but damage because it couldn't be applied directly to the seat of such an intense fire. It is a far too common experience, in church outbreaks of this type, for firemen to work seven or eight hours pouring millions of gallons of water into a building, only to end up with a gutted shell.

As for the application of this method to a fire in *your* home, the answer is self-qualifying. Today firemen take care of about three-quarters of all dwelling out-

breaks with portable extinguishers, which the householder should have had himself, but didn't. However, the potential killers—those belatedly discovered blazes that occur at night—are another matter. They're jobs for the new foam. So is our most common cold weather threat, the overheated or defective furnace, or flooding oil burner. Here is that untenable basement situation again. And here is where the suds will find their own way downstairs and stop that inferno before it engulfs the whole house. The same would apply to the attached garage.

The running fire in the notorious hollow wall is another household hazard on which the suds are very effective. And the well-known attic fire which has gotten a good start unnoticed is likewise well within its scope. On many occasions the cotton tube has discharged efficiently through openings four and five stories above street level.

Of course, for fires in schools, churches, supermarkets and movie theatres the method is ideal. Likewise, its role is pretty obvious in rural areas where shortages of equipment, manpower and water are traditional. Requiring a relatively small investment, a skeleton working force and a minimum of water, high expansion foam will be a boon to residents of those sections of the country where the typical fire ends as a total loss.

The idea of high expansion foam (Hi-Ex, for short) was originally conceived for [\(Please turn to page 210\)](#)



SUDS ARE SAFE, so inspector moves in quickly to evaluate results. Persons forced to seek refuge in foam can get oxygen from the bursting bubbles

Which Type of Home



Now they fit under the counter, in a tall corner, along the basement wall—and also within your

BY KEN WARNER

HOME FREEZERS HAVE CHANGED. Manufacturers are taking notice that upwards of one family in four own separate freezers. Once the ideal buy was the biggest box at the lowest price. Now there are more than a few complicating factors:

- New insulations have paved the way for thinner walls, making more freezer

space available within conventional outside dimensions. There are price differences on the basis of insulation.

- Upright freezers have come down in price. Size for size, they're as low as chest freezers in many brands.

- No-frost models are on the market (at deluxe prices). They eliminate a chore for the housewife.

- Undercounter models have appeared.



Freezer for You?



budget. List your requirements and this article will help you find the freezer for your home

They can solve some real space problems.

One thing hasn't changed about freezers: Space is still the biggest obstacle. A freezer is an "extra" that many a kitchen wasn't built to accommodate. If there's no room in your basement or utility room, the garage or even a carport may be the best spot. Most full-size freezers come equipped with locks, eliminating worry about raids on your frozen pantry.

A 32-inch square is all it takes, plus another 32 inches in front to open the door, for an upright unless it's the very biggest. A chest-type unit stretches from four to six feet along the wall, sticks out about 30 inches and takes up a few inches at the rear to allow room for the lid hinges. The upright needs more height, up to six feet.

An undercounter unit will take from *(Please turn to page 206)*



NEW FOR
YOUR HOME
 BY MARION MOREY

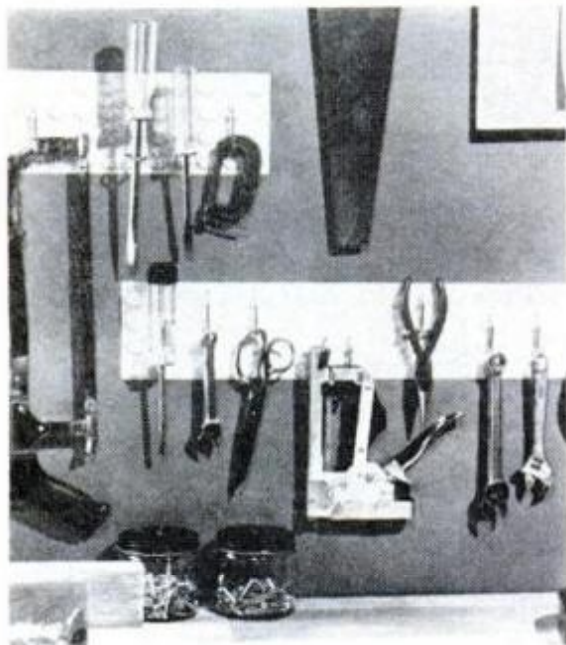

PEG TAPE, a flexible plastic board, self-adheres to any surface, cuts into any shape. Each 4 by 24-inch panel (99 cents) can hold 50 pounds of household items. By Selfix, Inc., 233 W. Erie, Chicago, Ill.

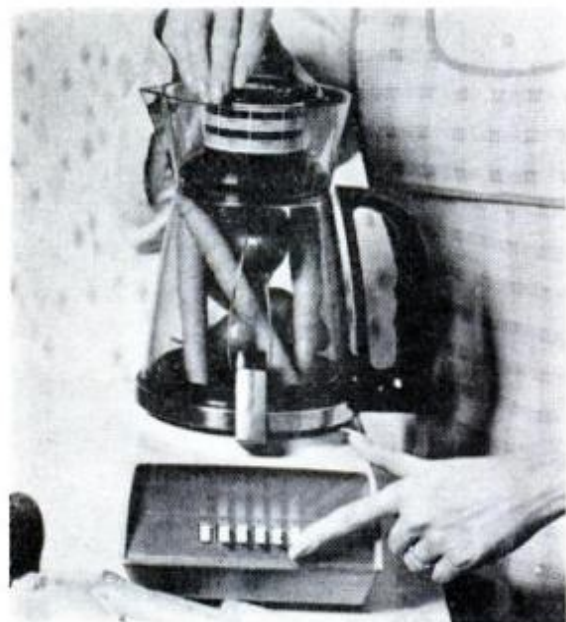

ELECTRIC BLENDER cooks as it stirs, crushes ice, pops popcorn. Automatic thermostat sets up to 350° F., switches off for cold blending. A 48-ounce glass container doubles as serving piece. \$70 from Ronson.

AIRLIFT FOR REFRIGERATORS operates from a vacuum cleaner. Air is dispersed evenly through a lifting pad, forming a cushion as air escapes through pad ports. Refrigerator floats, is easy to push around to clean or remodel behind it. \$19.95 from Frigidaire.

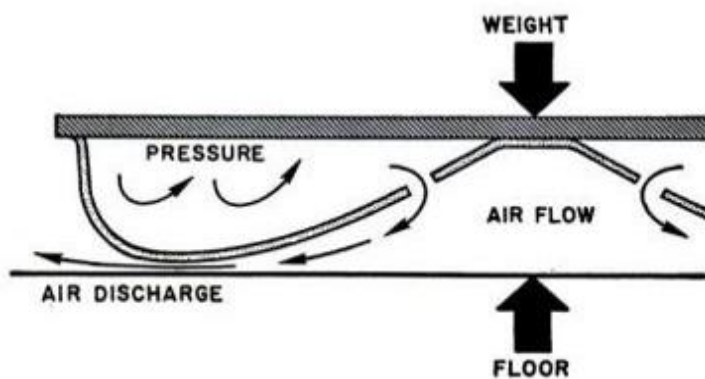

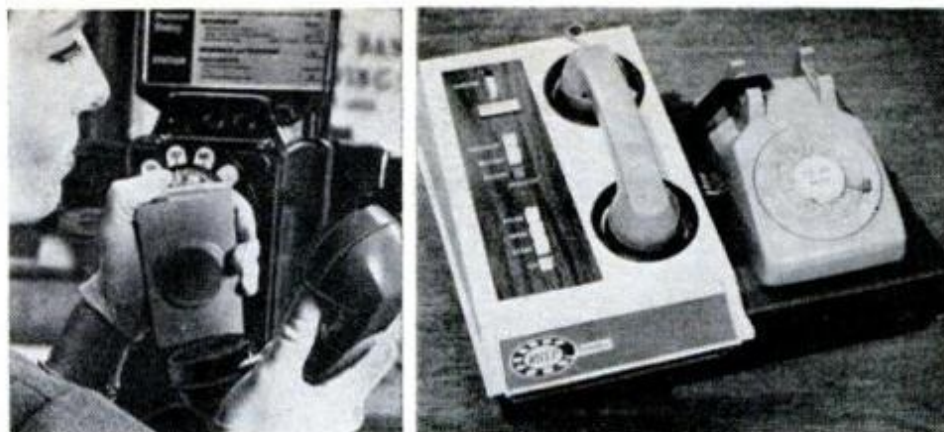
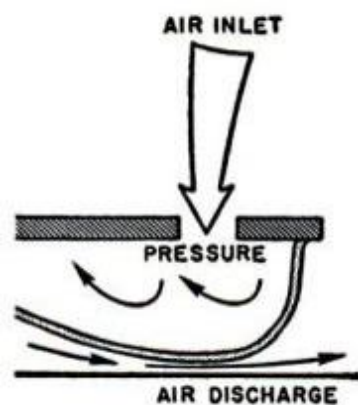

ELECTRONIC ANSWERING SERVICE hooks up with your telephone when you're away to broadcast an 18-second personal greeting to incoming callers and record messages. A palm-sized trigger unit lets you dial your own number and collect your messages, or record a fresh greeting. \$595 from RSVP Mfg. Co., Culver City, Calif.

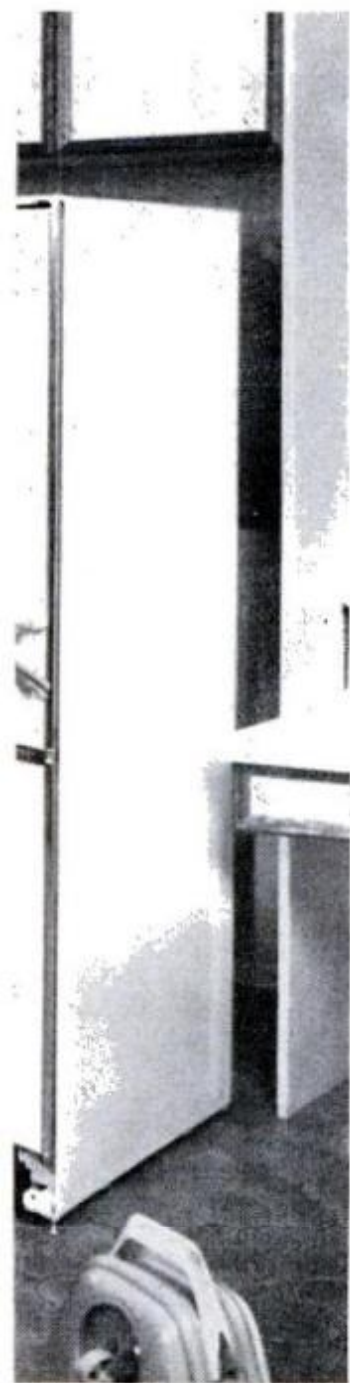

SMOKE AND FIRE DETECTOR sounds a rousing alarm when smoke appears before the fire spreads. It works automatically (test it with cigaret smoke) plugs into AC outlet. Plastic case houses solid state circuitry with hermetically sealed contacts. Unit costs \$39.95. Trolz & Wibling Control Corp., 3013 N.E. 12th Terr., Ft. Lauderdale, Fla.



BARBEQUE SKILLET sets up anywhere ready for cooking in 12 minutes, using self-starting hardwood charcoal sheets. Heavy-gauge aluminum, unit comes with a three-position chrome grill and detachable handle. \$11.95, it stands barely 5 inches high, is 12 inches square, weighs 5 pounds. By Timberland Products, Stamford, N.Y.

6 trick billiard shots

Feel like you're always behind the eight ball? Well, here are six spectacular Billiard Champion, Willie Mosconi, that will make you—with plenty of practice

By Robert A. Kelly

ONCE YOU'VE LEARNED to hold that billiard cue just right, address the ball with confidence, and sink those shots on a regular basis, *maybe* you'll be ready for the challenging trick shots outlined here by the best cueman of them all, Willie Mosconi, world's billiard champion.

The trick shot by itself, while it draws "oohs and ahs" from onlookers, is like eating dessert minus the meal—it doesn't do much good without the main course. And in billiards, that means learning the basics plus practice, practice, and more practice. Mosconi, perhaps the greatest billiard player of all time, points out that his many championships were won as a result of just-plain-hard-work, the deepest kind of concentration, continuously sharpened

skills and a certain amount of luck.

But, for Mosconi, there have nevertheless been moments of truth. For example, asked what he remembers as his most difficult tournament shot, he replied, "Against Andrew Ponzi in the 1948 World Billiards Tournament at Navy Pier in Chicago, I needed one ball and Ponzi needed three to win a crucial game and move into the next round. Ponzi left me a blocked shot situation and I could not risk another scratch (miss). My two previous shots had been scratches and a third in succession means a 15-point penalty. My only alternative was to attempt to score so I planned out a five-cushion shot and made it to win the match and, ultimately, the world title."

As to the new crop of billiards champions now circling the colorful new tables,

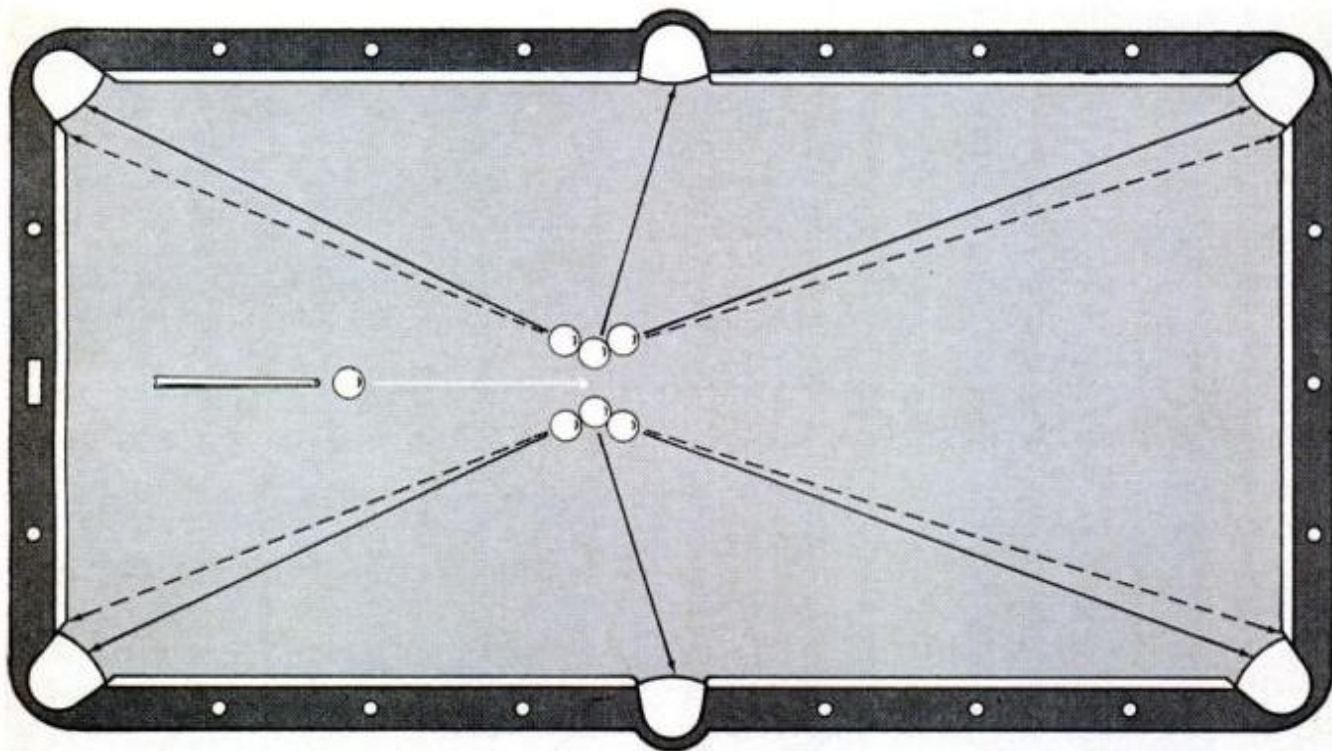

SIX BALLS IN SIX POCKETS . . . Place 3 and 13 balls in center of table, halfway between the side pockets and diamond. Allow space for cue ball to pass through. The end balls should be aimed for the corners of the end pockets. Hit cue ball low center using a hard stroke and balls will go into pockets traveling the white lines illustrated in the photo on opposite page

you can make

trick shots from a master, World
—a dazzling expert at pocket billiards

Mosconi adds, "The trend among the new champs today is to be less cautious in attempting shots, and for this reason. Common table size now is 4½ by 9 feet as compared to 5 by 10 championship size in former years. The smaller table permits a player to make a variety of shots easier and he plays a more exciting game."

"Not only that, defensive play is noticeably less important in their approach to the game. On the 5 by 10 tables, defensive play was more vital. Don't misunderstand, I am in favor of the smaller size official table. It permits a beginner to learn the game easier and still is an exacting challenge to all players."

While trick shots add spice and color to the game of billiards, Willie is cautious in their use during a championship match.

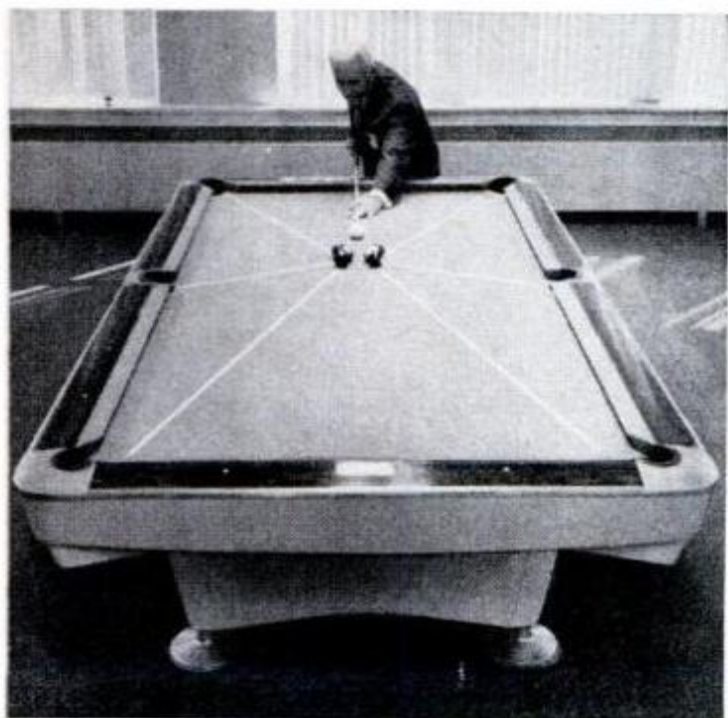

Mosconi: "Aiming the corner balls to the inside edges of the corner pockets is the critical factor in this shot. Tap each ball on top with the cue ball to set the cluster in a 'frozen' position."



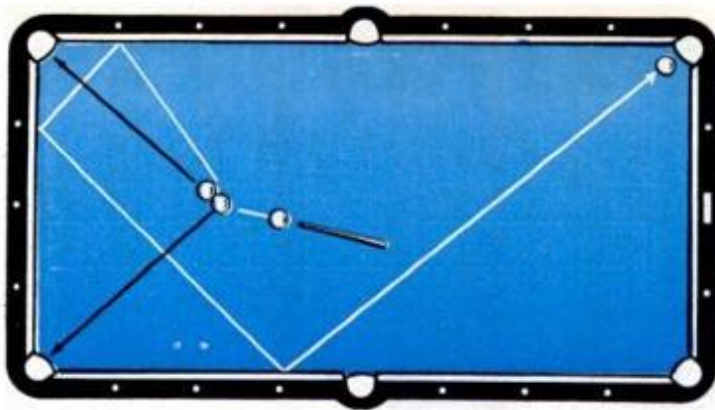

CRISS CROSS SHOT . . . Place 10 ball at second diamond about 1 inch below and to left of head spot making sure it is aimed for inside corner of pocket. Place 3 ball in direct line with and behind 10 while 8 is spotted on center of lower left pocket. Strong high left cue ball stroke to strike 3 ball $\frac{1}{4}$ right sending ten ball (as you face photo) into left pocket, 3 ball into right pocket. Cue ball then travels black lines to pocket 8 ball in lower left pocket.

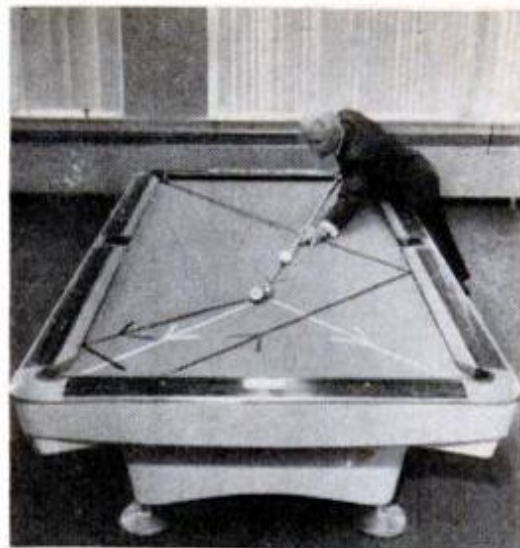

Mosconi: "Make sure the balls are 'frozen,' or touching, and aimed at the inside edge rather than the center of the pocket."

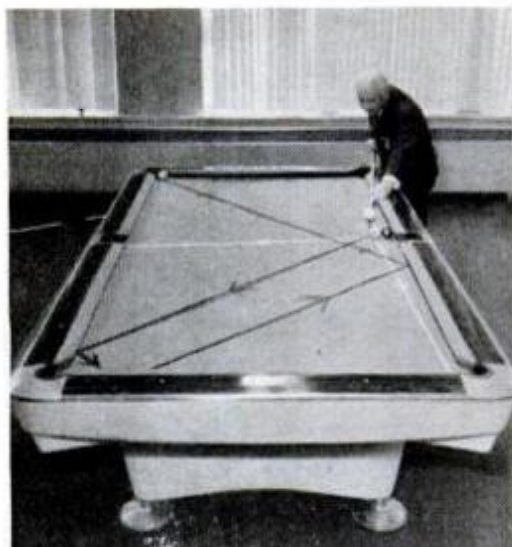

Mosconi: "A sharp stroke is required here to force the 8-ball across the table and bring the cue ball off three cushions to make the 15-ball."

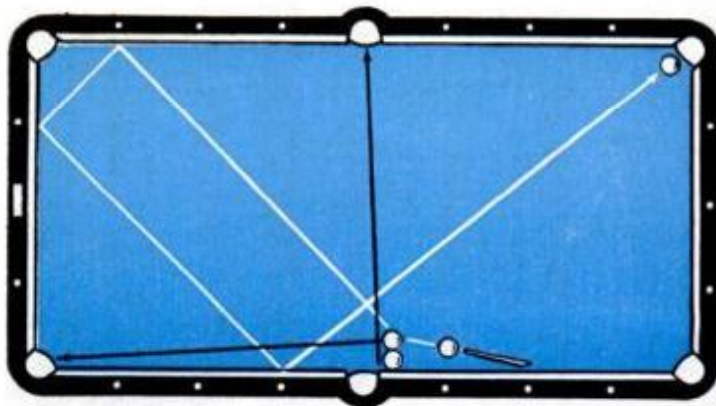

THREE BALL SHOT . . . Place 8 ball against cushion and about 1 inch below side pocket. Thirteen ball is placed against 8 ball while 15 ball is centered on lower left corner pocket. Strong high left stroke on cue ball to strike 13 ball $\frac{1}{4}$ right. Action of shot propels 13 ball to upper corner; 8 ball makes one carom into side pocket while cue (follow black arrows) ball makes three caroms to pocket 15 ball in lower left pocket.

"The only trick shot I use in tournament is an occasional masse shot in which the cue is raised perpendicular to the table to produce drastic English on the cue ball."

But, for those with a burning desire to excel at billiards and to taste the appreciation of the gallery, outlined on these pages are 1) Three Balls In Rotation; 2) The Spectacular Shot; 3) The Three Ball Shot; 4) Line-up Shot; 5) Six Balls In Six Pockets; and 6) The Criss-Cross Shot.

Before you step up to address the ball, however, be sure that you have chosen the right cue. Actually, they range in weight

from 15 to 21 ounces and average 55 inches in length. In selecting a cue, however, advises Mosconi, always stay within your own physical limitations. Probably the best guide is to choose a cue that has that right "feel" to it. Give special attention to selecting a cue with the right taper. For some players, a thick shaft will have that feel to it; for others, a slender shaft.

As to the weight of your cue, never select one that is too heavy. This will tend to adversely effect the estimate of force needed for the stroke. On the other hand, a too light cue will cause you to over-

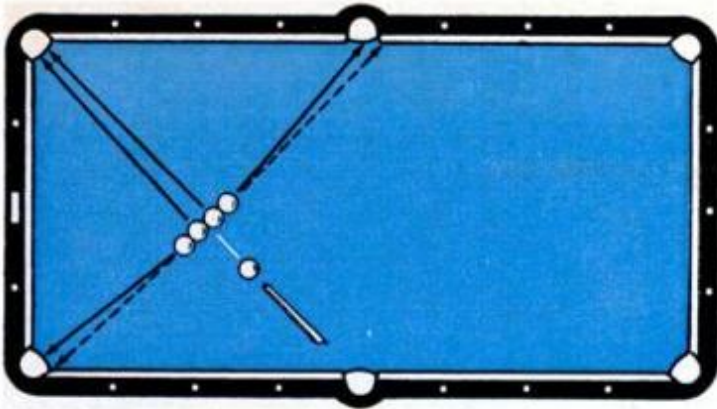

LINE-UP SHOT . . . Center 8 ball at 2nd diamond, place ten ball next to it. Making sure 8 is aimed for center of upper left pocket while 10 ball is aimed at inside corner. Three and 13 should then fall into line for upper right and side pocket. Stroke cue ball low right using moderate stroke. Cue ball should strike 8 ball $\frac{1}{3}$ left, then carom to 10 ball propelling both to upper left pocket while 13 goes into side pocket and 3 drops in upper right.



Mosconi: "Because 8-ball and 10-ball travel to same pocket, 8-ball must be hit first, on left side, which sends the cue ball into 10-ball, sending both into corner pocket in that sequence."



Mosconi: "Again, all three balls must be 'frozen.' The high left stroke is necessary to make the 15-ball hug the cushion on the way to the pocket."

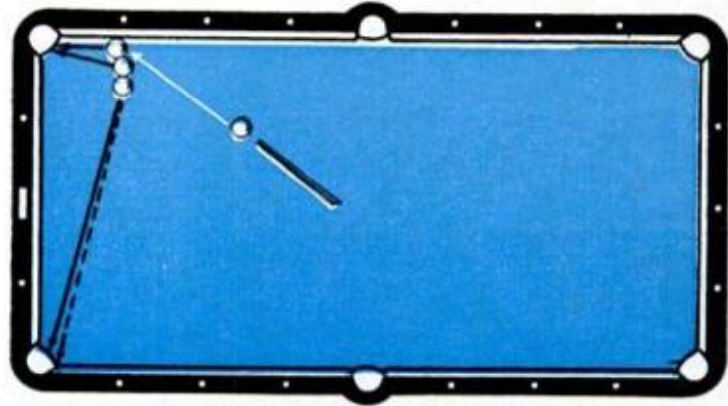

THREE BALLS IN ROTATION . . . Place 15 ball against cushion at first diamond. Three ball should be against 15 but $\frac{1}{2}$ ball behind and at a light angle from 15. Line-up 10 ball so it is aimed for the outside corner of right corner pocket. Hit cue ball with high left stroke using moderate force. Strike 15 ball on the cushion for corner pocket; three ball will follow while 10 ball goes into opposite pocket.

estimate the force needed for the stroke.

The right *stance* is as important to a good pocket billiards performance as to an outstanding golf score. The goal, very simply, is balance and comfort.

Your feet should be slightly apart. With your body weight well-balanced, bend forward at the hips with your head directly over and in line with the cue. Your left hand should be as far forward and as straight as possible. The right hand should be as vertical as possible.

To check your stance, swing your right arm free forward and back. If it's in

line with the shot, your stance is correct.

How you form, and use your "*bridge*"—the finger structure which guides the cue—often affects the outcome of the game. It's the firm guidance of the bridge that gives accuracy to a billiard shot.

In forming a bridge, first make a fist with your left hand and rest it on the table, palm side down. Form a circle with the index finger and thumb resting it against the middle knuckle of the middle finger, holding the cue firmly but not so tightly that you can't move it easily.

(Please turn to page 244)



Rescue ball the size of a softball contains a full-size self-inflating life preserver with enough buoyancy to support a 250-pound man for several hours. The ball pops open within three seconds after hitting the water and, at the same time, a small anchor is dropped to keep the inflated life preserver from drifting out of reach. Called Sav-a-Life, it sells for \$6.95 from Inventor's Products Co., 5309 Edina Industrial Blvd., Minneapolis, Minn.

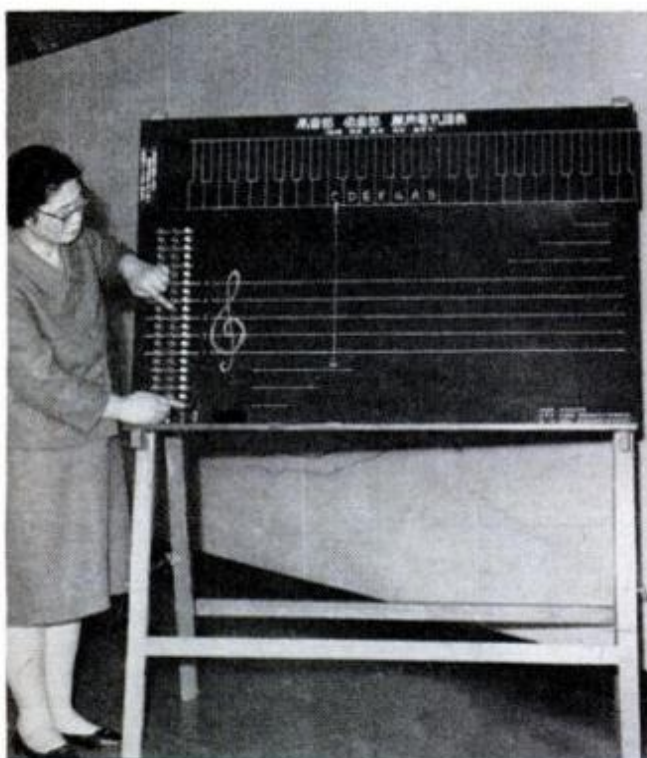

Mysteries of musical notation are clarified by this blackboard, invented by a Japanese teacher. The small lights set in rows at the left of the musical staff are hooked up with keys of a wired piano. When the teacher hits a key, the bulb representing that particular note lights, allowing students to connect sight with sound instantly.



Jet gloves may propel space-walking astronauts of the future. Now under test by the Air Force, the gloves are fitted with nozzles that provide fore and aft thrust. Throttles have fingertip controls. Power is provided by nitrogen propellant carried in a tank on the astronaut's back.

7

SLAVES ON WHEELS

For the Man of the House, PM presents plans for a deluxe host-helper, plus six variations — service carts all: for patio fun, auto tuneup, yard work

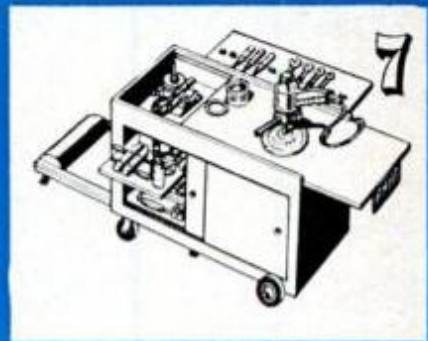

1. Hot cart for

By Alfred W. Lees, PM Home Workshop Editor

LEAVE THE LADIES' HATS ALONE—and don't don any lampshades, either. You won't *need* such stunts to be the life of your next party. Just coolly roll out that sleek surprise you see on the next page, and freeze your guests in the middle of a sentence. Then, when the admiring ooohs and whistles subside, remark offhandedly, as you whisk out the extension cord: "Thanks; made it last week."

It'll be your Finest Hour—and we speak from experience. We've given this cart the ol' PM Test by springing it on groups of widely-varied tastes. The response is always *Pow!* And frankly, we *designed* the cart for show-off impact. You'd often

CUT,
FOLD,
TAPE

SERVING
CART

asked us for a serving cart that *did* something, besides just truck around. So we set out to build the hottest host-helper on wheels, yet kept the cost low enough so you wouldn't have to mort-

gage that *other* vehicle of yours to finance *this* one. Where economy's concerned, it's in specialty projects like this that the do-it-yourselfer really comes into his own. You can't *buy* a cart as handsome and useful as this one, and if you *could* it'd cost



THE MORNING AFTER the party, our hostess enjoys the convenience of tableside waffle-making—with coffee and bacon kept hot throughout a leisurely breakfast. Last night's carving tray stores neatly in the cupboard



the host



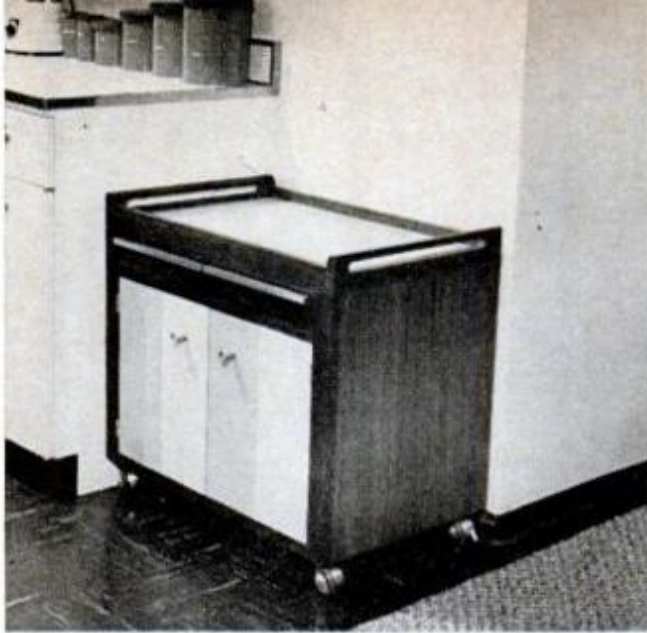

you a couple weeks' wages. Just check these features:

- A recessed hot tray keeps hors d'oeuvres warm, lets you take the chill off serving plates, and features a "hot spot" with a temperature high enough to keep a pot steaming—ending the embarrassment of serving lukewarm coffee. It's tucked beneath a sliding plastic-faced top that provides full serving space even when the hot tray's in use.

- A 15-ft. extension cord lets you wheel the cart to the heart of the party, yet retracts automatically on a hidden reel that also provides outlets for all those appliances (electric carving knives, broil-

CORNER JOINT TREATMENT

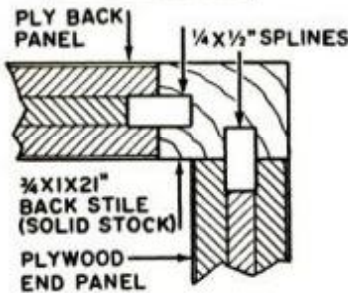

ALTERNATE TREATMENTS

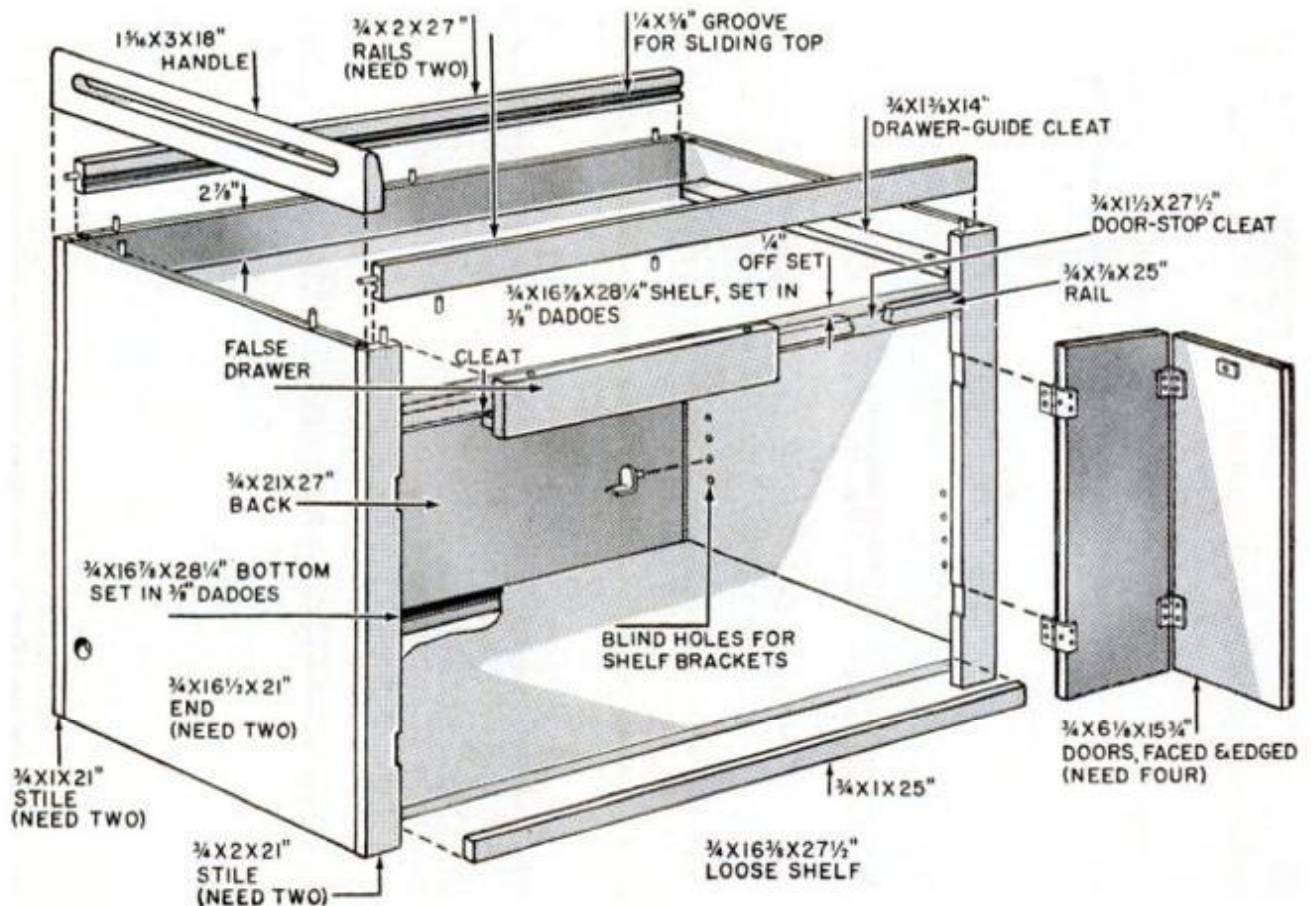
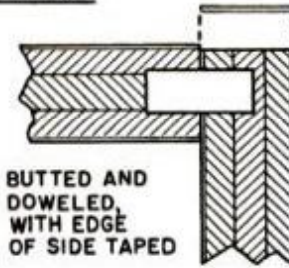
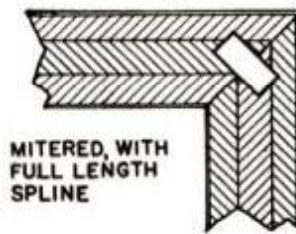

ers, grilles, wafflers) you can store behind the bifold cupboard doors. And all this involves no wire-splicing; you just plug the "built-in" units together.

● Two of the four ball casters have step-on locks that anchor the cart and convert it into a sturdy buffet island for "come-and-get-it" service.

After assembling our accessories and sketching up the plans, we dispatched the whole bundle to *PM's* cabinetmaker, Bud Johnson, whose shop perches atop a Connecticut mountain. As a New England craftsman, Bud took special pains with the construction that you can shortcut if

(Please turn to page 228)

SIX MORE CARTS

Since the basic chassis of the Hot Cart can be adapted to other functions, we asked the Franklyn Jacoby staff of industrial designers to sketch us up a half a dozen variations—household service carts that explore other potentials of a counter-on-wheels to lighten the homeowner's load or contribute to his hostmanship.

These designs may vary widely from the Hot Cart's construction, but could all be built to its basic dimensions, often from less expensive material, such as exterior fir plywood. For six novel ideas which may well send you to your drawing board to work out the details, turn the page.

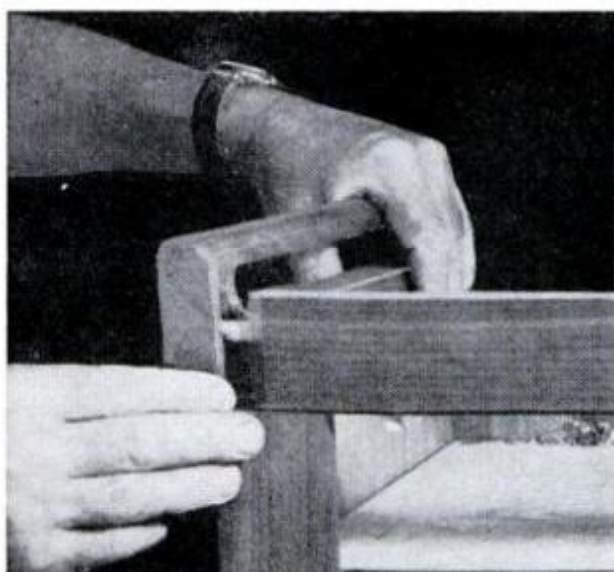

STATIONARY HANDLE is doweled to both rails; they're set in to bring handle flush with end, and are, in turn, doweled to stiles

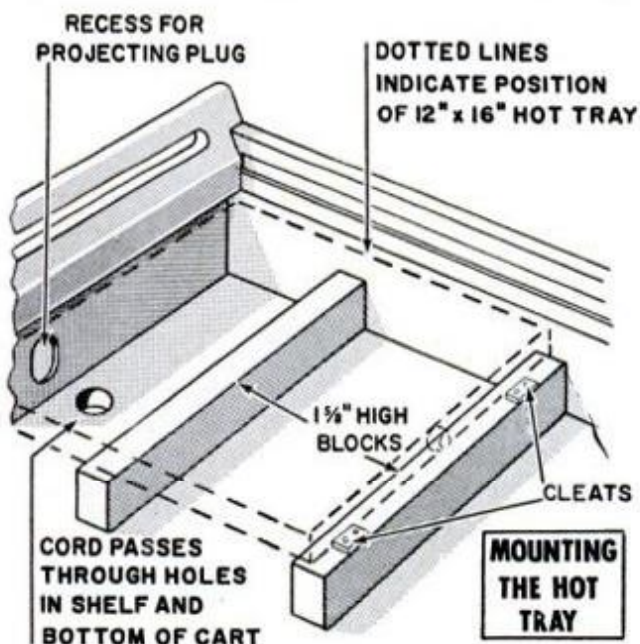
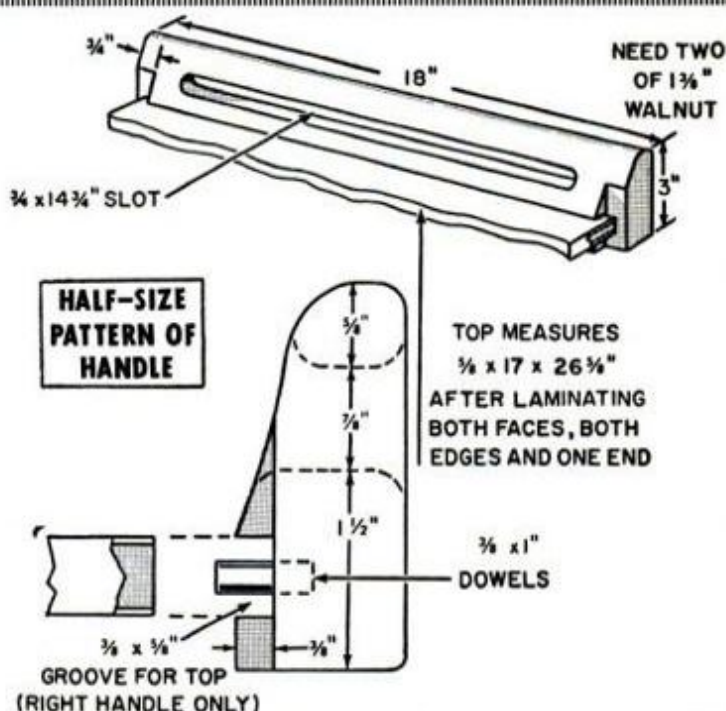

TRAY STAYS LOOSE for easy removal, is kept from shifting by press fit against tiny cleats. Sliding top is removed, here, exposing utensil drawer (left)

THREE MORE FOR FUN...

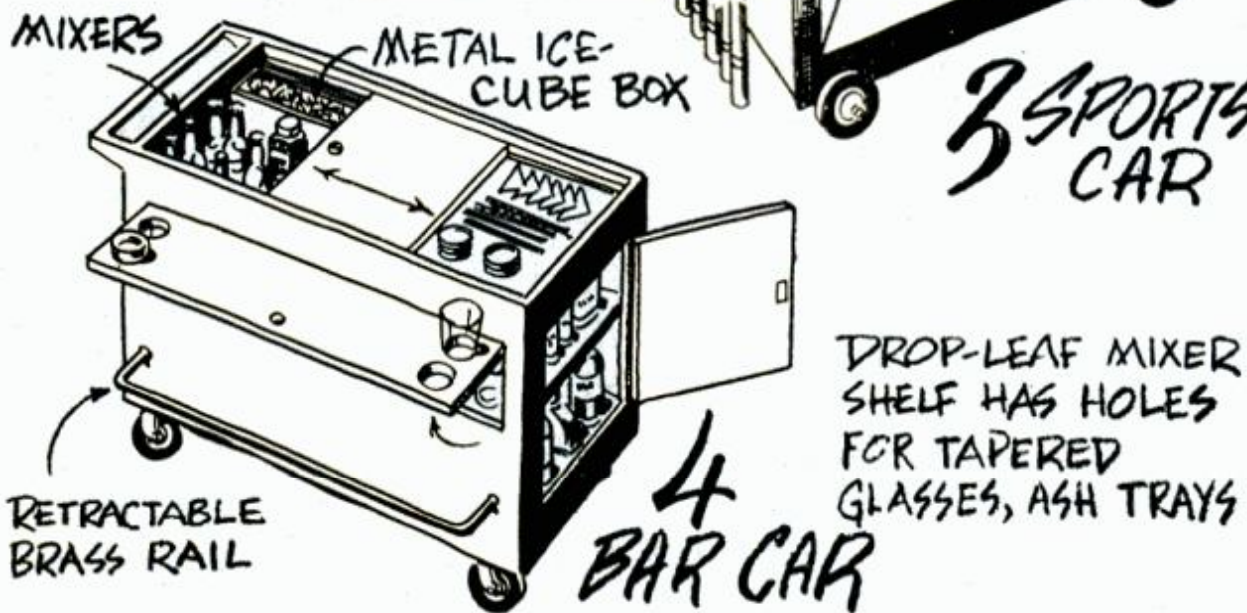
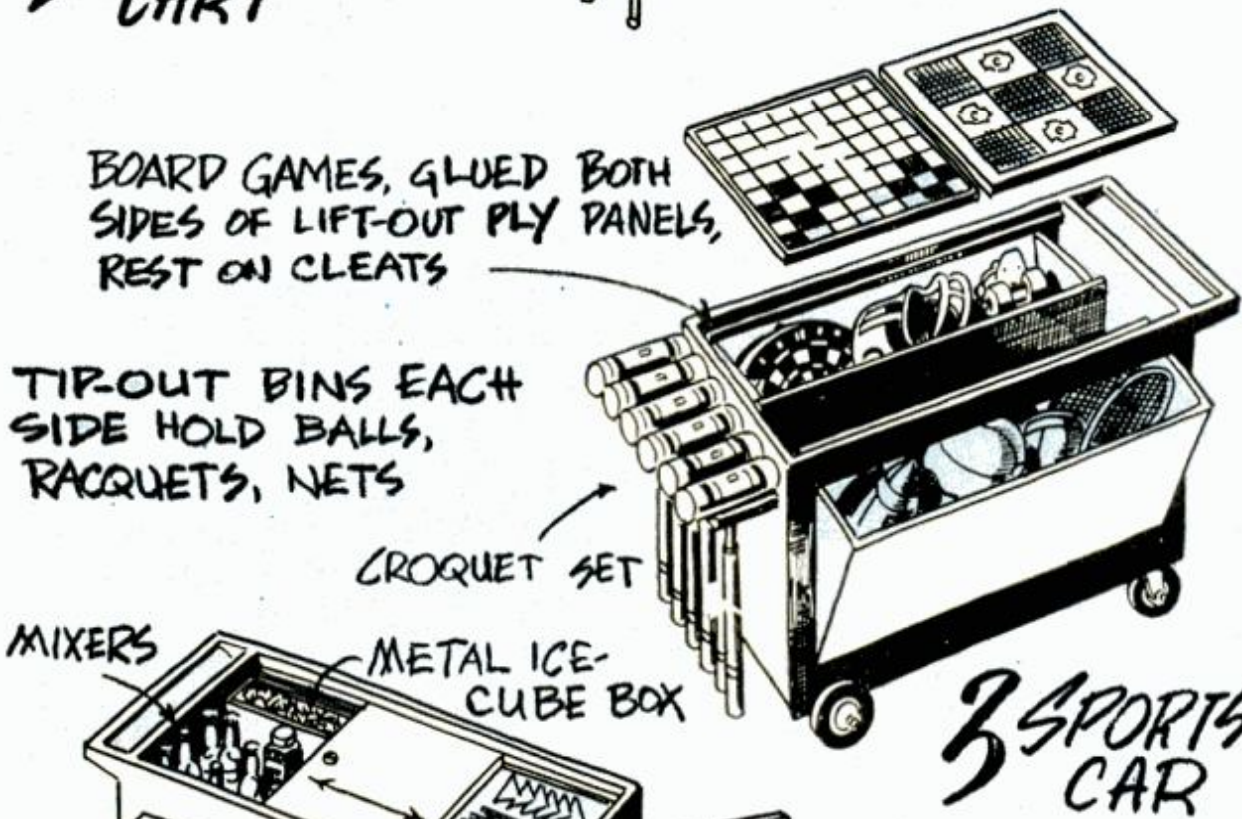
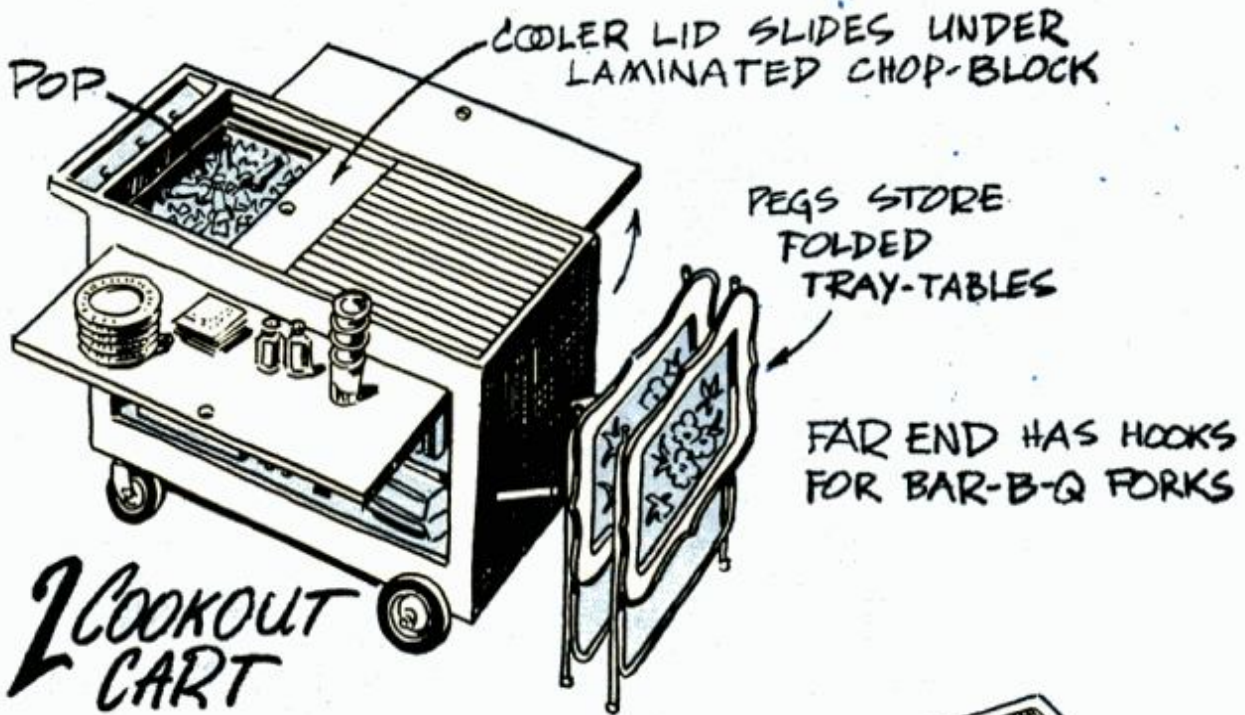

... PLUS THREE TO EASE OUTDOOR JOBS

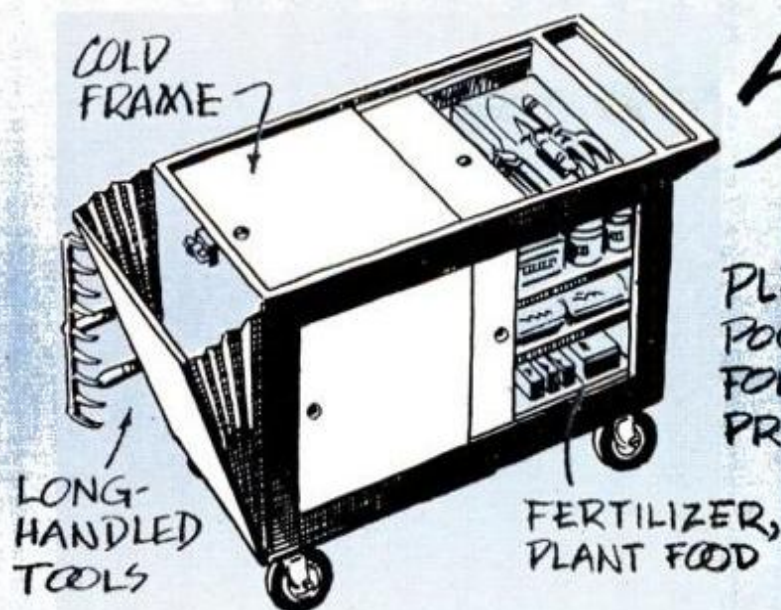

5 POTTING BENCH

PLEATED-CANVAS POCKET ON FRONT FOLDS OUT FOR PRUNED TWIGS

COLD FRAME

LONG-HANDLED TOOLS

FERTILIZER, PLANT FOOD

6 ROLLING SHOP

LONG CORD BRINGS POWER TO JOB SITE

STRIP OUTLETS

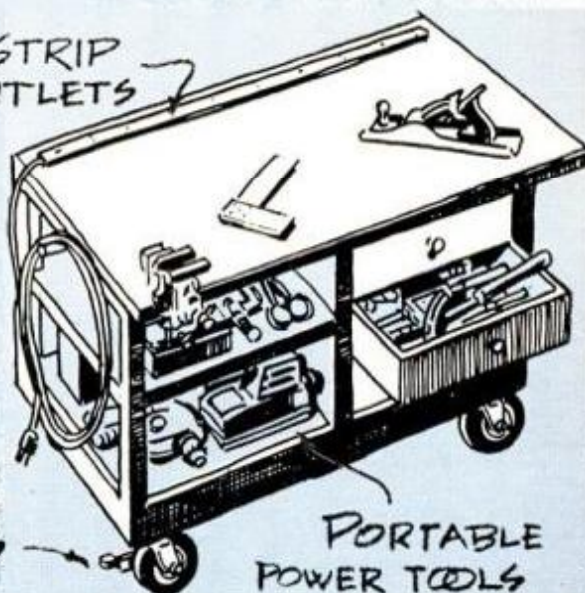

LOCKING CASTERS

PORTABLE POWER TOOLS

SPRING-CLIP STORAGE FOR SMALL TOOLS

SLIDE-OUT TOOL TRAYS

CREEPER UNDER-SLUNG ON CLEATS

STORAGE FOR VOLTMETER

7 SATURDAY MECHANIC'S CART

SLIDING TOP IS LIKE HOT TRAYS, BUT EXPOSES STORAGE WELL FOR TOOLS & OWNERS MANUAL

LICENSE PLATE HANDLE

TIPS FROM READERS



SECTION OF SAW BLADE

TO ADD A SCRAPER to a hammer, mount a short section of saw blade on it as shown. It's great for quickly removing concrete scale from form boards

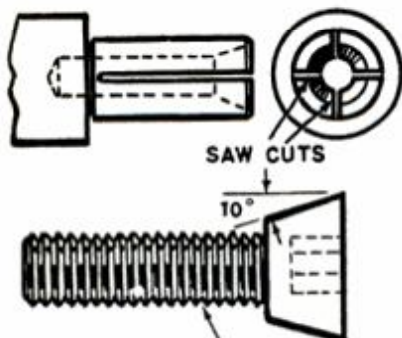

SOCKET-HEAD MACHINE SCREW

EXPANSION ARBOR for working with short tubular shapes lets you finish the inside as well as the outside surface. To make it, follow the diagram

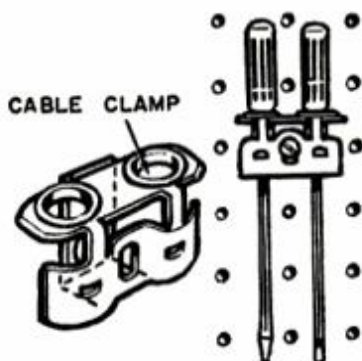

CABLE CLAMP

CABLE CLAMPS from switch boxes can be put to work to serve as neat tool holders for screwdrivers, chisels and the like when mounted on Peg-Board

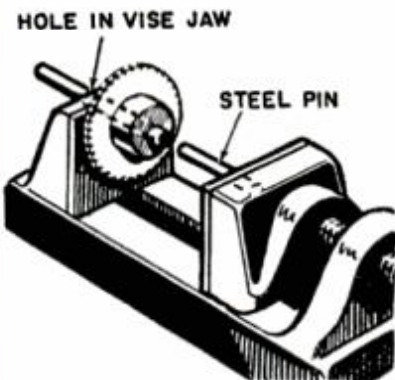

HOLE IN VISE JAW

STEEL PIN

PRESSING SHAFTS in or out of small gears is easy with a drill-press vise. Just drill a hole through one jaw and corresponding blind hole in the other

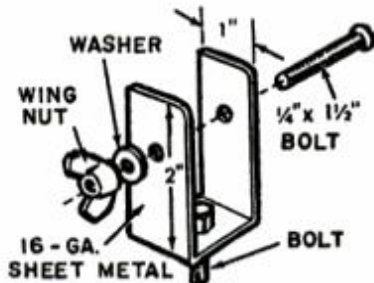

PITCH-GAUGE attachment clamps to the end of your level. Bend it from sheet metal, as shown, and solder hex nut to upper surface of lower section

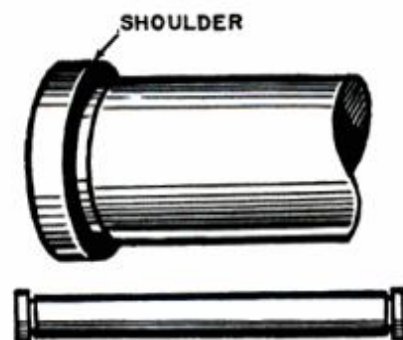

TO PROTECT test bars from being nicked or burred if dropped accidentally, add press-fit end collars. New bars can be machined with such shoulders

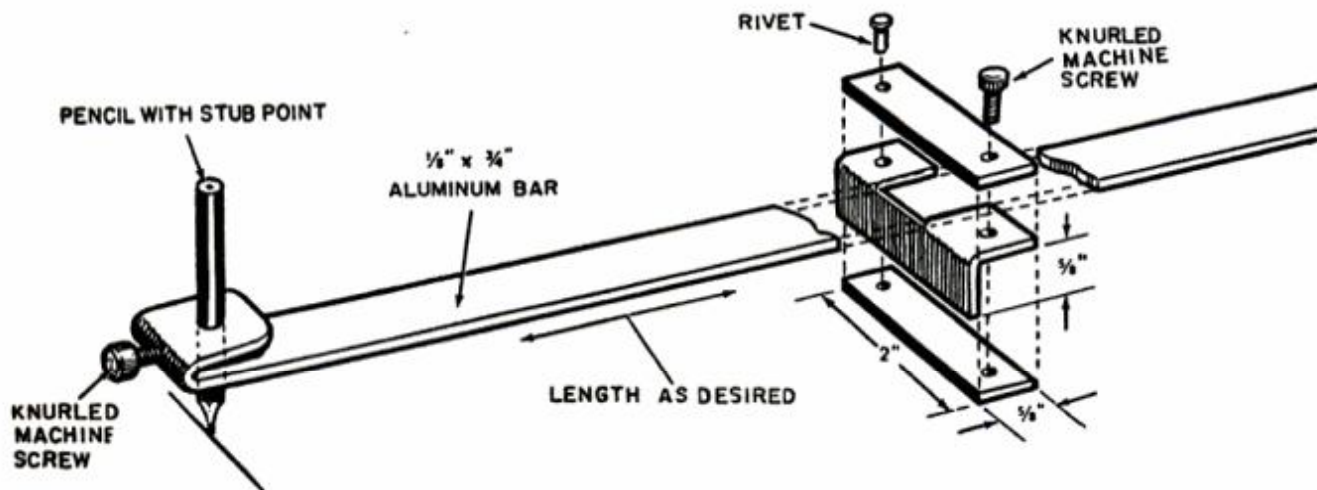

MARKING GAUGE made from DIY aluminum uses a stubby pencil instead of a steel pin, eliminating any danger of gouging. The marking bar can be any length desired, and can easily be calibrated with accurate rule

Hang Anything on Any Wall

Whether you're mounting a pin-up lamp or a suspended bar—on a hollow frame wall or on solid masonry—you must choose the type and size of fastener that fits the job.

By Alfred W. Lees, PM Home Workshop Editor

MORE AND MORE, the walls of our homes are being put to work. Today we hang dozens of things from walls—including buffets—and new fasteners have been developed for specific jobs.

Yet many home owners aren't even familiar with the old standbys, such as toggle and "Molly" bolts. A comprehensive "selector chart" is needed on all wall fasteners, old and new, and on the next five pages you'll find just that—in a form you can detach from the magazine and file for permanent reference.

The first thing to consider, in choosing a fastener, is the *type* of wall it's going into. In most homes, this will be a hollow wall *above* grade and a poured or block wall in the basement. In hollow walls you want a fastener that passes through the plaster or drywall face (or the wall of cinder block or hollow tile) and spreads out to anchor against the back. In solid walls, you want a fastener that holds by expanding against the sides of the hole you sink it into, whether in concrete, brick or stone.

Two additional considerations determine your choice of fastener: the weight of the fixture you're hanging, and the type of load it presents. A *light* load is under 10 lbs. (picture frames, pin-up lamps, metal soap dishes) while a load of 25 lbs. or more is *heavy*. A *shear* load is one which exerts a straight-down pull (such close-to-the-wall items as mirrors or wall clocks) while *combination* loads exert an outward pull, as well (shelves, cabinets), and require stronger anchorage. *Dead* loads, where the pull is constant, need less anchorage than *shock* loads which must withstand sudden impact or increased weight, and *vibration* loads (such as air conditioners) call for special treatment—usually a fastener that can be retightened.

We've listed those "Load in Concrete" figures only to provide a *comparison* between types of fasteners; as quoted by the manufacturers, these figures represent *test* loads in "first-quality" concrete—not safe working loads. The latter are usually calculated at one-fourth test load. When in doubt, use *more* fasteners or a *heavier-duty* type. Over-fastening can't hurt, but

under-fastening can be disastrous.

Except for a couple of *driven* types listed, fasteners must be set into a drilled hole. A carbide-tipped masonry bit in an electric drill (particularly a variable-speed type) makes fast work of this in plaster, ceramic tile, brick and concrete. Large-diameter masonry anchors, however, call for hand-hammering with a star drill.

To select the right *length* hollow-wall fastener, you must know the thickness of the surface wall. You can determine this by drilling a small trial hole at the mounting location and inserting a crochet hook or sturdy wire with a hook bent at one end. Catch the hook against the back of the wall and jamb your thumb against the face of the wall. Back the hook out and measure between its lip and your thumbnail. This is the thickness the fastener must penetrate before its anchoring device can function. Where the fastener must pass through the mounting plate you must add that thickness, too.

Manufacturers' Directory

Listed alphabetically are the manufacturers whose products are covered in the chart on the next five pages. Asterisks indicate major companies offering a full line of fasteners, including most types shown. As there are few industry standards, not all these manufacturers make every type of fastener, nor every *size* listed for each fastener. Where a specific fastener in the chart is available from only one source, that fastener is identified, below, in parentheses, and the manufacturer is named in the chart. If such a fastener is not available locally, you can write for further information.

- *Ackerman-Johnson Co., 625 W. Jackson Blvd., Chicago (Giant Grip Toggle)
- *Arro Expansion Bolt Co., Box 388, Marion, Ohio
- *Diamond Expansion Bolt Co., Inc., Garwood, N.J.
- *Jordan Industries, Inc., 3030 NW 75th St., Miami, Fla. (Spacer Anchor)
- Miller Mfg. Co., 1523 Altamont, San Jose, Calif. (Wedge Anchors)
- *Rawlplug Co., Inc., New Rochelle, N.Y.
- Retriever Toggle Bolt Co., Winamac, Ind. (Retriever)
- Ramset, Winchester-Western Div. of Olin, New Haven, Conn.
- A. A. Rice, Inc., Port Washington, N.Y. (Nycam)
- *Star Expansion Bolt Co., Mountainville, N.Y.
- United Shoe Machinery Corp. Fastener Div., Shelton, Conn. (DriveTool)
- *Molly Div., Box 1139, Reading, Pa.
- Rockwell Div., 455 W. Market St., Newark, N.J. (Well-Nut)
- *U.S. Expansion Bolt Co., Box 1589, York, Pa.

"ALL-PURPOSE" FASTENERS



PLASTIC ANCHOR



NYLON EXPANSION (NYCAM)

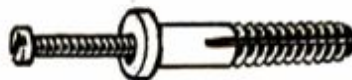

NYLON DRIVE ANCHOR

SIZE RANGE AND LOAD CAPACITY

Screw† Size	Anchor # & Length	Holding Power
4, 6, 8	#1, 7/8"	650
10, 12	#2, 1"	850
14, 16	#3, 1 1/2"	1075

†Although most brands come in three sizes, the recommended screw ranges differ. Where screws are not packaged with the anchors, use size recommended on package. Jordan offers a 2 1/2" length for 3/8" lag screws.

One size (about 1" long, requiring a 3/8" hole) serves all applications, comes with 1 1/8" self-tapping screw.

Shear load tests: 280 lbs. in cement block, 50 in 3/8" plasterboard.

Dia.	Lengths
1/4"	3/4, 1, 1 1/2"
3/16"	1, 1 1/2"

Both Tap-It (U.S. Expansion Bolt) and Jif-Eze (Jordan) come in choice of head style (round, flat, mushroom) and not all lengths avbl. in all head styles.

Shear tests: 800 lbs. in solid wall, 365 in hollow.

INSTALLATION PROCEDURES

Except for larger sizes, anchors are molded in strips; break one off and force into hole of size recommended on card; insert screw through fixture and drive into anchor.

Drill hole at least 1 1/2" deep, pinch anchor between fingers and tap in place with hammer. Insert screw through fixture and tighten.

Insert fastener through fixture's mounting hole and push into wall hole. Tap nail until its head seats against fastener's.

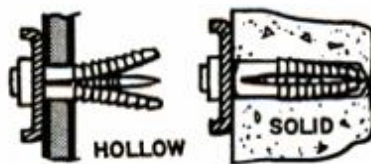
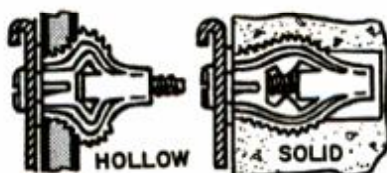
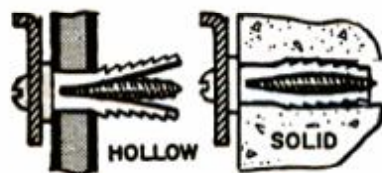

RECOMMENDED USES

Mounting any item normally held with wood screws—large pictures, mirrors, shelf brackets, drapery hardware, kitchen and bath accessories, awnings, mailboxes, Peg-Board hang-up panels . . . on concrete, tile, brick and hollow plaster walls.

Mounting any item such as drapery hardware, brackets and fixtures to any type wall: plaster, drywall, brick, marble, concrete, cinder block, stone, or even wood.

Drapery hardware, shelf brackets, mirrors, pipe straps, outlet boxes—anything with mounting hole that will pass anchor—to plaster, brick, stone, tile, concrete, composition or hardboard.

ADVANTAGES OVER OTHER TYPE

Since anchor is rustproof, it's fine for bathroom fixtures, outdoor installations. Small hole means little wall damage. Strips keep supply handy for quick use. Screw can be removed and reinserted.

One type and size of fastener for all light hanging needs. very thin lip lets you mount flush to wall. 1-pc. nylon construction.

Average installation time: 12 seconds, compared with 25 for the simplest wood-screw anchor. Comes with nail ready for tapping.

DISADVANTAGES

Hole size is critical—anchor must fit snug, and is only as good as the wall material. For light shear loads only. Won't hold against much horizontal pull, especially in crumbly masonry.

Fairly large hole required; not satisfactory in hollow wall more than 3/8" thick, so won't expand behind most plaster walls.

Fixture can't be removed without withdrawing entire anchor, as well. Mounting hole in fixture must be at least 3/16" in dia. White nylon head shows around nail. More expensive than plain plastic anchor.



NEOPRENE SLEEVE (WELL-NUT)

One standard size: shank dia. is $\frac{1}{4}$ "; length $\frac{15}{16}$ ".

Load in concrete: 370; in brick: 440; in cinder block: 470.

Over a dozen other dia.-length combinations avbl. on special order (without screws).

Drill hole same diameter as neoprene shank (in solid wall, drill just deeper than length of screw); push Well-Nut in, up to flange, hold fixture against it while tightening screw through mounting hole. Shank bulges as nut draws up, forms rivethead against back of hollow wall or pressure fit in solid wall.

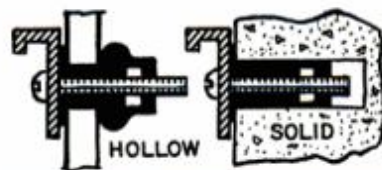

Coat hooks, drapery hardware, shelf brackets, bathroom fixtures, electrical equipment, auto accessories and trim, hi-fi speakers on dry wall, tile, glass, marble, masonry, plaster, metal, or wood.

Ideal for mounting hi-fi speakers, window fans, other installations where vibration should be dampened. Creates watertight seal, will plug leaks; insulating quality in electrical installations. Neoprene stays flexible so fastener is removable, reusable.

Standard size not suitable to all situations (hollow walls can only be $\frac{3}{8}$ to $\frac{9}{16}$ " thick). Over-tightening ruins fastener.

FOR HOLLOW WALLS ONLY

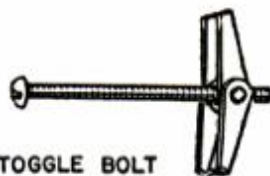

TOGGLE BOLT



EXPANSION BOLT

SIZE RANGE AND LOAD CAPACITY

Bolt Length	Dia.	Load (lbs.)
2,3,4"	$\frac{1}{8}$ "	200
2,3,4,5,6"	$\frac{3}{16}$ "	450
3,4,5,6"	$\frac{1}{4}$ "	925
3,4,5,6"	$\frac{5}{16}$ "	1150
3,4,5,6"	$\frac{3}{8}$ "	1500
4,6,8"	$\frac{1}{2}$ "	1800

†Some makes have $2\frac{1}{2}$, $3\frac{1}{2}$ & $4\frac{1}{2}$ " as well

Overall Size*	Length	For Wall Thickness	Load Capacity
XS	$\frac{3}{4}$ - $\frac{7}{8}$ "	0 to $\frac{1}{4}$ "	200
MS	$1\frac{1}{2}$ "	$\frac{1}{16}$ to $\frac{1}{2}$ "	to
S	$1\frac{1}{2}$ - $2\frac{1}{4}$ "	$\frac{1}{8}$ " to $\frac{3}{4}$ "	500
L	$2\frac{3}{4}$ "	$\frac{5}{8}$ " to $1\frac{1}{4}$ "	Difs.
XL	$2\frac{1}{2}$ - $3\frac{1}{2}$ "	$\frac{1}{4}$ " to $1\frac{3}{4}$ "	with make

*There is no industry standard so these are compromise listings. Some brands have each length in several diameters

INSTALLATION PROCEDURES

Insert bolt through fixture and spin the toggle head on several turns. Fold wings and push them through proper size hole in wall. Tighten bolt to draw wings snug against back of wall.

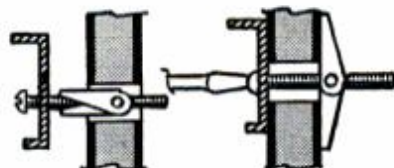

Insert unit in drilled hole, tap to embed cap teeth in wall surface, turn screw to draw split sleeve into "spider" against back of wall; remove screw and reinsert after passing through mounting hole of fixture.

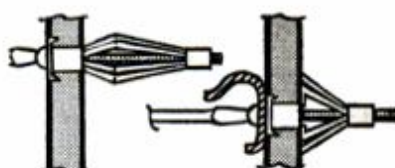

RECOMMENDED USES

Large hanging cabinets, heavy-duty shelf standards, wall radiators or vent fans, bathroom grip bars.

Mirrors, wall cabinets, lamps and clocks, adjustable shelf brackets, window cornices, shades and blinds, coat hooks.

ADVANTAGES OVER OTHER TYPE

Simple, immediate-action installation, great strength for combination loads. Alignment of mounting holes with wall holes isn't critical.

Requires smaller hole than toggle, centers bolt precisely. Remains in place for reuse if fixture is removed. Bolt is easily inserted through fixture after positioning on wall.

DISADVANTAGES

Requires large insert hole to pass wings, so bolt "floats", does not position fixture precisely. Mounting plate must be big enough to hide hole. If fixture is removed, wings drop off, are lost in wall (See Variations). Installation awkward where fixture requires several bolts, since all must be inserted through fixture before positioning.

Slower installation (unless special tool is used). Less strength, since smaller bolt and thinner anchor metal is involved. Mounting holes must exactly align with fastener—tricky where several are involved.

MASONRY WALL FASTENERS



FIBER ANCHOR (LEAD CORE)



LEAD SCREW ANCHOR



LAG SCREW SHIELD

SIZE RANGE AND LOAD CAPACITY

Screw Size	Anchor Lengths	Load in Concrete
5-6	5/8, 3/4, 1	550
7-8	5/8, 3/4, 1, 1 1/4, 1 1/2, 2	885
9-10	3/4, 1, 1 1/4, 1 1/2, 2	1150
11-12	3/4, 1, 1 1/4, 1 1/2, 2	1525
14	1, 1 1/4, 1 1/2, 2	1590
16	1, 1 1/2, 2	2150
20	1, 1 1/2, 2	2830
22	2	3500

Screw Size	Anchor Lengths	Load in Concrete
6-8	3/4, 1, 1 1/2	to 400
10-12-14	1, 1 1/2	to 900
16-18	1, 1 1/2	to 3000
20-22-24	1 3/4 or 2	1600 up

Screw Size	Shield Lengths	Load in Concrete
1/4	1, 1 1/2	450, 600
5/16	1 1/4, 1 3/4	800, 1200
3/8	1 3/4, 2 1/2	1200, 2000
7/16	2 1/4 only	1650
1/2	2, 3	2000, 3000
5/8	2 or 2 1/2,*	2500, 3500
3/4	2 1/2, 3 1/2 or 3 3/4*	3000, 4000

*Long Standard Sizes differ with brands

INSTALLATION PROCEDURES

Use drill, plug and screw of same size. Clean hole of loose particles. Insert plug just below surface, drive screw through fixture into lead core. Only threaded section should enter plug, so use proper-length plug, recess in deeper hole if necessary.

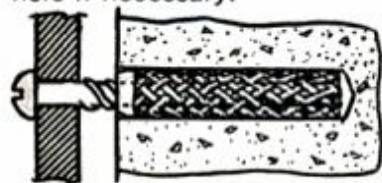

Screw length = thickness of mounting plate + length of anchor + 1/4". Drill hole 1/4" deeper than anchor, set it flush with wall surface, drive screw through fixture.

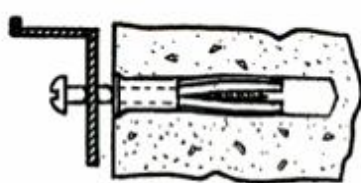

Drill hole same size as outside dia. of shield. Set in shield flush with or slightly below surface, insert screw through fixture and into shield, which expands as screw enters.

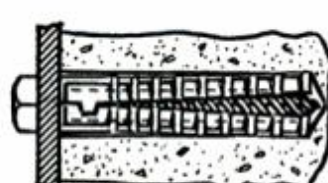

RECOMMENDED USES

Mounting any item you'd normally attach with wood, sheet metal or lag screws (for latter, there are larger sizes than listed)—outlet and fuse boxes, mirrors, bathroom fixtures, fireplace tools, awnings, etc.

Same as fiber anchor.

Mounting any item too heavy for plain screws—especially to a brick wall where hole can be drilled into mortar joint without marring brick.

ADVANTAGES OVER OTHER TYPE

Easy, inexpensive, versatile. Screw may be removed and replaced without affecting anchorage. Once screw is in, plug grips wall firmly.

Flared end prevents loss of fixture through drilled hole in concrete block, etc. also makes it easier to start screw.

Heavy ribs assure powerful gripping action. Choice of long or short for each screw dia. lets you minimize drilling in hard masonry, or use long size for more strength in weak masonry and brick.

DISADVANTAGES

Hole size is more critical than with most fasteners. Holding power depends on strength of wall material; poor in crumbly concrete, plaster.

Size for size, less holding power than fiber anchor; hole in wall must be exact fit.

Requires fairly large masonry bit, greater installation time since screw must be driven with wrench.

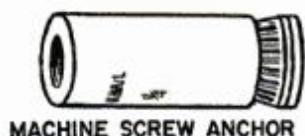

MACHINE SCREW ANCHOR

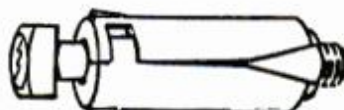

MACHINE BOLT SHIELD

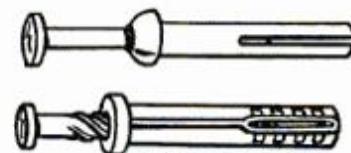

NAIL ANCHORS

Screw Size	Dia. (Inches)	Min. Hole (Inches)	Load in Concrete (Pounds)
6-32	1/4	3/8	625
8-32	5/16	1/2	950
10-24	3/8	5/8	1100
12-24	7/16	3/4	1750
1/4-20	1/2	7/8	2275
5/16-18	5/8	1	2850
3/8-16	3/4	1 1/4	3670
7/16-14	7/8	1 1/2	5500
1/2-13	7/8	1 1/2	7200
5/8-11	1 1/8	2	7800
3/4-10	1 1/4	2 1/4	8300
7/8-9	1 1/2	2 3/4	10000
1-8	1 3/4	3 1/2	12000

Bolt Size (Inches)	Shield Lengths* (Inches)	Dia. Hole* (Inches)	Working Loads (Up to:)
1/4	1 1/2	1/2	500
5/16	1 1/2-2	5/8	800
3/8	1 1/2-2 3/8	3/4	1000
7/16	2-2 1/2	7/8	1000
1/2	2-2 7/8	7/8	1500
5/8	2 1/2-3 1/4	1-1 1/8	2000
3/4	3 1/2-4	1 1/4-1 3/8	2000
7/8	4-4 1/4	1 3/8-1 1/2	2300
1	4 1/4-4 1/2	1 3/8-1 3/4	2400
1 1/4	5 1/2-6	2 1/8	2500

Shield Dia. (Inches)	Shield Length (Inches)	Working Load (Pounds)
3/16	7/8	375
	1 1/4	110
	1	200
1/4	1 1/4	240
	1 1/2	325
5/16	1 1/4	300
	1 3/4	350
	2 1/4	375
	2 3/4	375
3/8	2	450
	3 1/4	485
1/2	2 1/4	525
	3 1/2	625

Drill indicated hole (in weak or soft masonry, go deep enough to set anchor just below surface); push anchor into hole, nut first, then "calk" with special tool. Pass screw through fixture and tighten into nut.

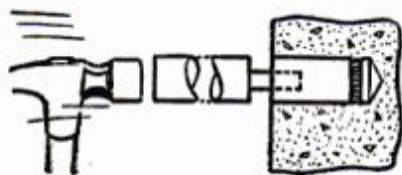

Insert shield in snug, press-fit hole, its top flush with surface. Pass bolt through fixture's mounting hole and turn into shield. As bolt is tightened, it draws nut (usually wedge-shaped) forward, expanding split sleeve.

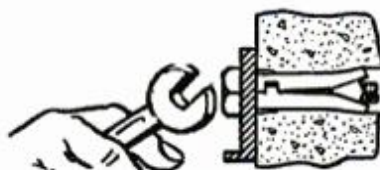

Drill hole same dia. as shield, insert anchor through fixture's mounting hole and into wall. When flange is seated firm against fixture, drive nail home with a couple blows.

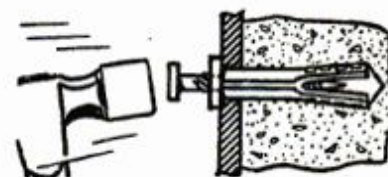

Heavy jobs such as construction (anchoring coal-bin wall stud—or floor plate to foundation when adding room).

For any heavy fixture to be bolted fast—cabinets, hanging shelves, ducts, hand rails—on solid masonry. *Some brands come in Short or Long sizes in same dia.; use long size for softer masonry.

Light, dead loads: furring strips, pipe, metal window frames, downspouts, outlet boxes—to concrete block, brick, mortar, stone.

Sleeve is precision-cast lead alloy—soft enough to press itself into the rough sides of the hole, but hard enough to give great holding power. Hard-alloy nut-cone prevents thread-stripping. Cannot be installed incorrectly; the heavier the load the stronger the grip.

Sure, heavy-duty anchorage; shields are tough, rustproof alloy casting. Wide choice of types, including closed-end (to protect threads from drill dust) and double-expansion types (with wedge-nut at both ends) for heaviest loads.

Fast—small hole means quicker drilling—and economical. Choose aluminum type for outdoor jobs, spiral-nail type for vibrating loads.

Though free calking tool is included in each box of anchors, you must buy one separately if you need less than a box (50 or 100 anchors), and you need a different tool for each size anchor: Length of screw critical.

Large, deep hole and wrench-tightening mean slower installation, and shields are relatively expensive, so use only where strong anchor is needed. Can loosen under vibration, so for that type of load, choose type that can be retightened.

Limited holding power; fixture can't be removed once nail is set. Mounting hole must be large enough to pass shield. Except for one type with spiral nail, poor resistance to vibration or jarring.

MASONRY (CONCLUDED)

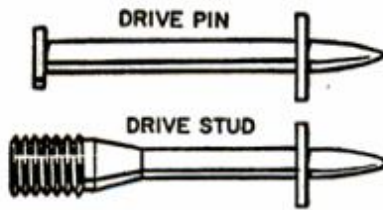

SIZE RANGE

Not completely standard from brand to brand, but pin shanks range in dia. from $\frac{3}{8}$ " (in shorter lengths) to $\frac{3}{16}$ " and include following lengths: $\frac{1}{2}$, $\frac{3}{4}$, 1, $1\frac{1}{4}$, $1\frac{1}{2}$, 2, $2\frac{1}{2}$, 3". Studs are available in some brands in 8-32, 10-24 and $\frac{1}{4}$ "-20 threads in overall lengths of $1\frac{3}{8}$, $1\frac{1}{2}$ and 2".

INSTALLATION



Choose length to let pin penetrate $\frac{1}{2}$ -1" in concrete, $\frac{3}{4}$ - $1\frac{1}{4}$ " in masonry block or mortar joint. (If pin bends, try next shorter length.) Pull drive rod out, press pin into anvil end, tap protruding point to seat pin in anvil, set point on installation spot and drive pin home with 2 or 3 lb. hammer. Washer holds fastener in tool, then slips up shank to provide support at point and keep material from pulling away between blows.

RECOMMENDED USES

Fastening pipe straps, brackets, junction boxes, mail boxes, furring strips, 2x4s or plywood, to concrete or masonry block.

ADVANTAGES

Eliminates all drilling, making for quickest possible masonry anchoring. Each fastener specially heat-treated for extreme hardness. Studs permit removal of fixture.

DISADVANTAGES

All fasteners must be installed with drive tool (retailing from \$2.50 up, depending on make), can be used only in good-quality concrete (not usually recommended for brittle materials like stone, brick or tile), are limited to relatively thin fixtures (brackets, furring) where a number of fasteners can be driven.

VARIATIONS AND IMPROVEMENTS

TOGGLE BOLTS

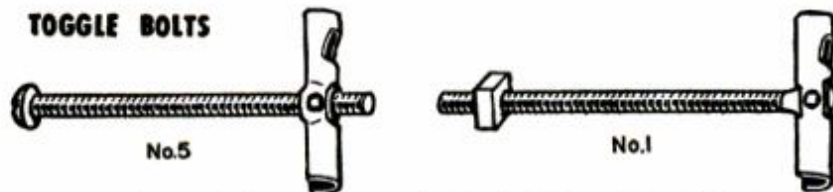

Not all standard types have spring-loaded wings. Gravity types shown above have "tumble" heads, pivoted off-center, creating strong, one-piece bearing bar. No. 5 is otherwise identical to a spring-wing, but type No. 1 has head riveted directly to stud

JORDAN SPRING-WING



Recent innovations in toggle design include spring-wing with teeth (left) that bite into back of wall to keep nut positioned so bolt can be removed and replaced. Simplified tumbler, below, is lowest-price toggle, with S-head in constant tension so bolt never loosens up

ACKERMAN-JOHNSON GIANT GRIP

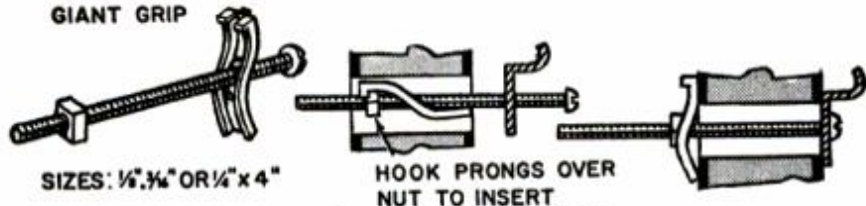

SIZES: $\frac{1}{2}$," $\frac{3}{4}$ " OR $\frac{1}{2}$ " x 4"

HOOK PRONGS OVER NUT TO INSERT

RETRIEVER

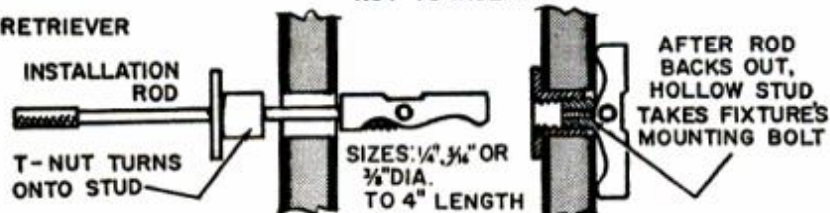

INSTALLATION ROD

T-NUT TURNS ONTO STUD

SIZES: $\frac{1}{2}$," $\frac{3}{4}$ " OR $\frac{3}{8}$ " DIA. TO 4" LENGTH

AFTER ROD BACKS OUT, HOLLOW STUD TAKES FIXTURE'S MOUNTING BOLT

As name implies, here's a toggle that stays locked in wall like an expansion anchor when fixture is removed, yet can be retrieved for reuse by reinserting installation rod. Rod makes long bolt unnecessary. Also comes with longer stud to project from wall for nut

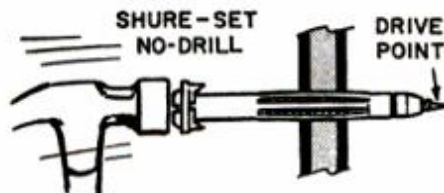

SHURE-SET
NO-DRILL

DRIVE POINT

Pointed expansion anchor eliminates drilling step. Just drive it through wall till flange teeth embed, then turn screw to expand sleeve as with standard type. Ideal for softboard, other drywall

New addition to plastic anchor line has $\frac{3}{8}$ -in.-thick flange for mounting perforated storage panels. When shoulder seats against wall, flange automatically—without separate spacers—creates proper clearance for insertion of hanging hooks



JORDAN
SPACER
ANCHOR

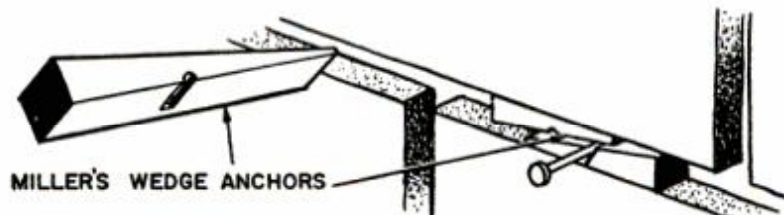
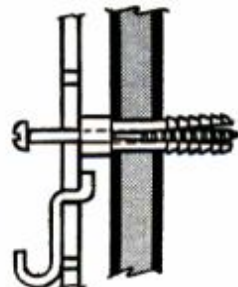

MILLER'S WEDGE ANCHORS

For any laid masonry with recessed mortar lines. Two (or more) lead tapers are wedged between bricks or stones, nail driven into best edge-notch for positioning fixture. No damage to masonry, and anchors can be removed without a trace by withdrawing nail

TOB-SLED

HALF TOBOGGAN and half sled, Tob-Sled offers the best of both to give you the ride of your life. Its three conduit runners give it incredible speed, and its upturned nose lets it plane swiftly over deep, packed snow.

Bending the upturned ends of the runners is easy with a pipe bender which you can rent. Getting all three alike is important; after bending the first one, use it as a pattern for the other two. The three are ganged together at front and rear with flat steel crossbraces, then each runner is attached to the plywood bottom with 6 sheet-metal screws, using the $\frac{1}{4}$ -in. holes in the plywood to spot the $\frac{1}{8}$ -in. pilot holes in the conduit runners.

The rest goes easy, the plywood edges are covered with aluminum trim, a sheet-metal snow shield is added to the runners at the front and ropes are entwined through four sash handles attached to each side.—James Simack and Gordon Hoffman

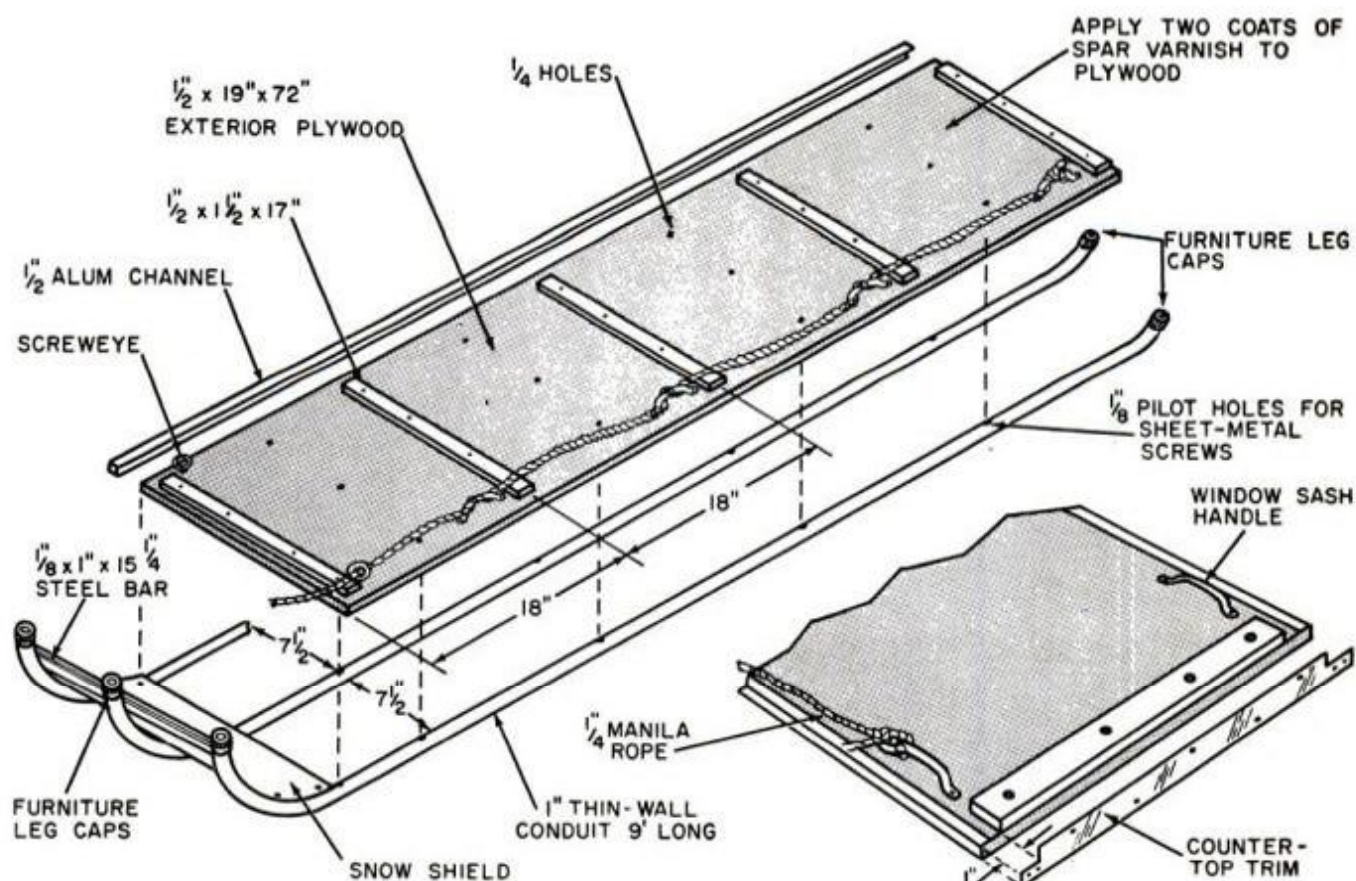
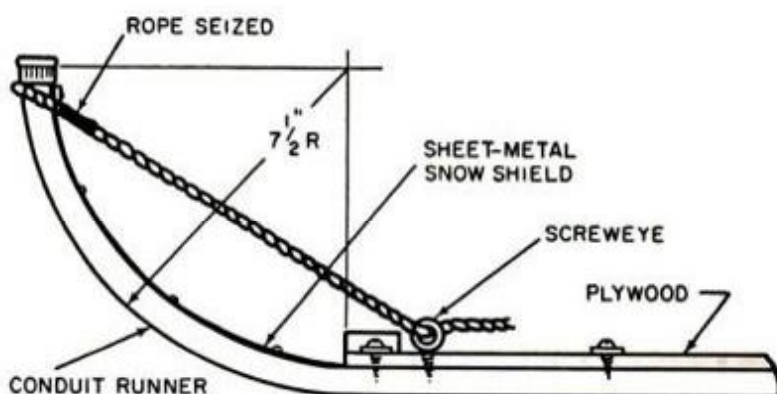

TIPS FROM READERS

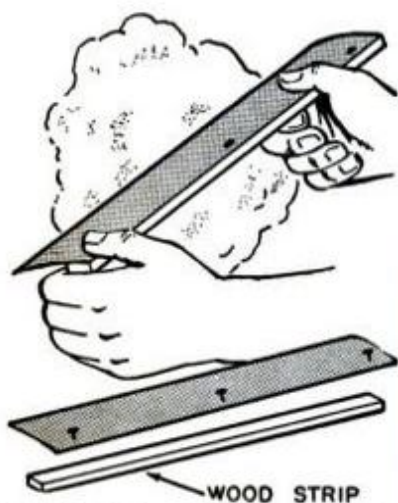

HOMEMADE finishing trowel gives professional results for just a few cents. Make it by cutting a length of steel venetian blind slightly wider than patch and backing it with a wood strip

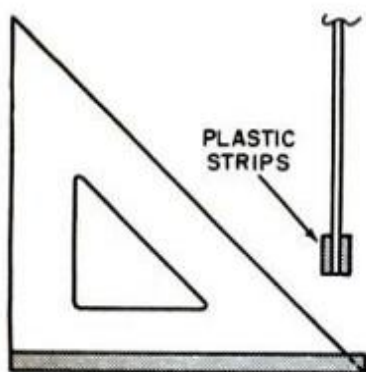

COMBINATION triangle and T-square can produce vertical, horizontal and angular lines. Just cement $\frac{1}{8}$ -in.-thick plastic strips along one edge of triangle, one on either side of it



TO STORE an opened quart can of motor oil, seal with the plastic lid from a one-pound coffee can. It fits perfectly, both protecting contents and eliminating any danger of spilling the oil

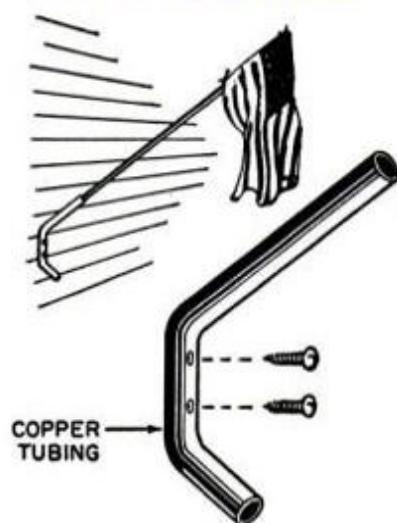

OLD GLORY can be flown proudly from a simple socket made by bending and drilling copper tubing. Choose tubing with an inside diameter slightly larger than the staff of your flag

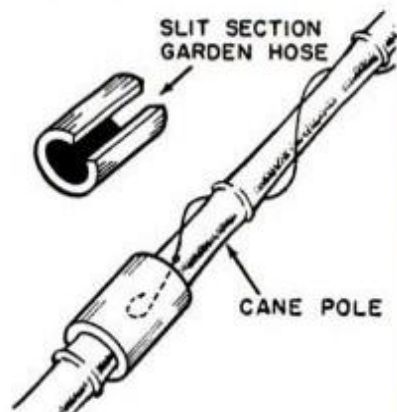

FOR HUCK FINN fishermen who still prefer a cane pole, a sleeve made by slitting a short length of garden hose is perfect for covering the hook when carrying or storing the fishing pole

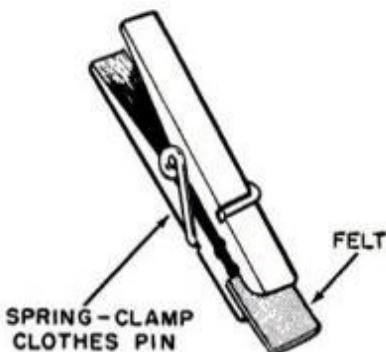

THROW-AWAY BRUSH for touch-up painting is made by clamping a piece of felt between the jaws of a spring-type clothespin. It's also great for lettering and for neat one-stroke striping

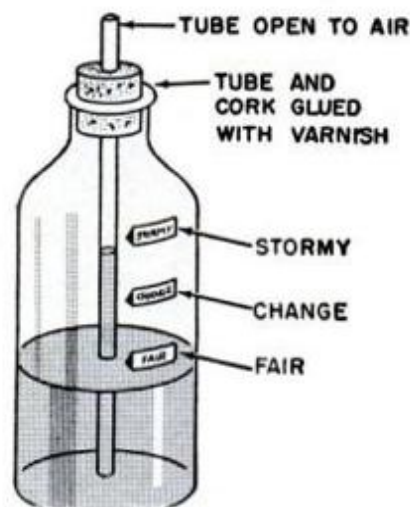

BOTTLE BAROMETER forecasts weather by level of colored water in tube. High level means low pressure and approaching storm; low level means high pressure and pleasant weather

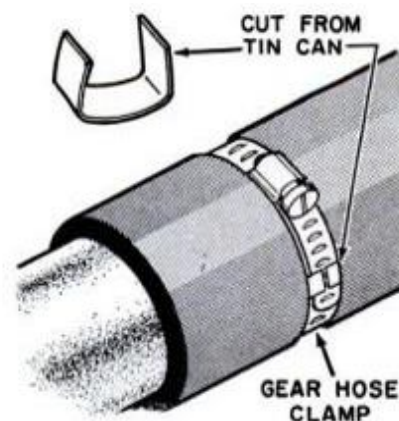

WHEN YOU HAVE TO run a gear-type hose clamp up so tight that a long end is left hanging loose, make a small retainer clamp from a sheet-metal strip to hold that end

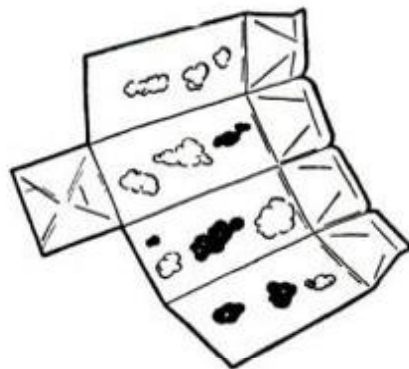

IMPROVED artist's palette can be made by rinsing out an empty milk carton, cutting it down one side and opening it out flat. The treated cardboard won't absorb the oils in paints

You've Never Seen a Key Like This!

THE FIRST MAJOR CHANGE in lock cylinders since the introduction of the pin tumbler a century ago, has been announced by Sargent & Co. of New Haven, Conn. Known as the Sargent Maximum Security System, the new cylinders completely baffle picking because the multiple rows of interlocking pins bar the way.

To actuate these pins, you need a key that's radically different in appearance from the house key in your pocket; this new key has precision-milled depressions on its edges and flat faces. Now, no one can borrow your door key and have it copied. It can only be copied by the manufacturer, and only authorized persons can order a duplicate. This means that if you live in an apartment, only the management can have a duplicate made for you.

Unlike the conventional wavy-edge key which unlocks the cylinder when it raises a *single row* of pins to the "sheer line," this revolutionary new dimpled key positions every pin in *three different rows* to a predetermined height before the cylinder will unlock. Moreover, the three rows of pins which form a fan-shaped pattern within the cylinder, overlap when the key is withdrawn.

Since these pins converge on the key from three different angles, the notches and grooves common to the conventional key have been replaced by a number of precisely milled hollows. This makes the key reversible so you don't have to hold it right side up to insert it into the cylinder. And because of the precise tolerances, the key does not lend itself to duplication by impression. Even with an actual blank key at hand, it would require great skill to duplicate it precisely with any guarantee it would work.

Furthermore, because of the number of pins used and the number of pin locations available within the cylinder, there is no chance of one keying system duplicating another—each individual system is a one-of-a-kind installation.

This ingenious pick-resistant cylinder is available in all Sargent architectural locks in standard, removable-core and construction-core cylinders. ★ ★ ★



LOCKED



UNLOCKED



SOLVING HOME PROBLEMS

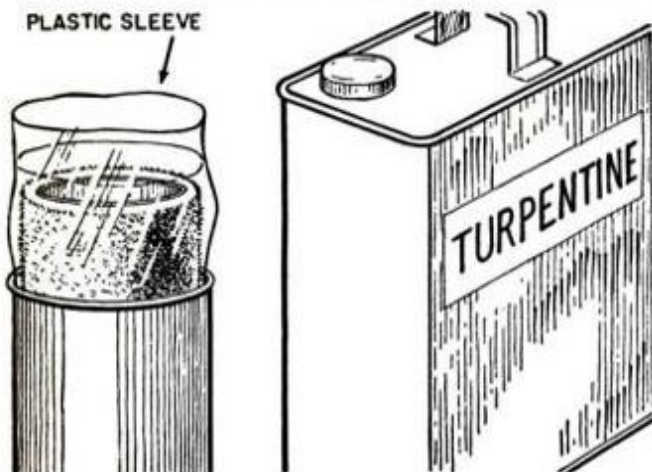

PAINT ROLLER which you plan to use the next day can be kept from hardening by slipping it into its original plastic sleeve, pouring in enough turpentine to cover it and storing upright in a tall juice can



TO HOLD COINS which must be sent through the mails, try using photo corners designed for mounting snapshots in albums. If you are sending a number of coins, attach them to a piece of light cardboard

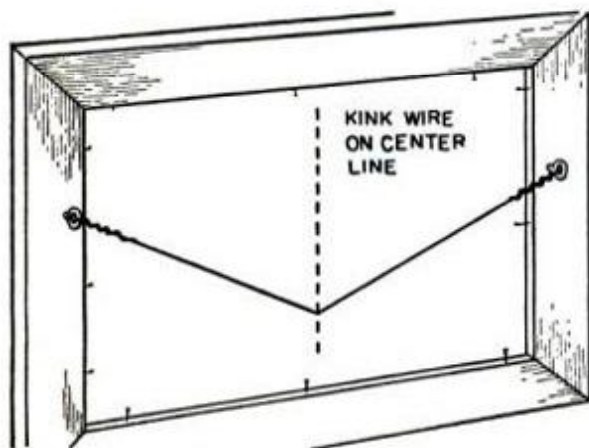

WHEN HANGING PICTURES, rule a vertical center line down the back and kink the wire slightly where it crosses this line. Slip the kinked point in the wire over the hook and the picture will hang level

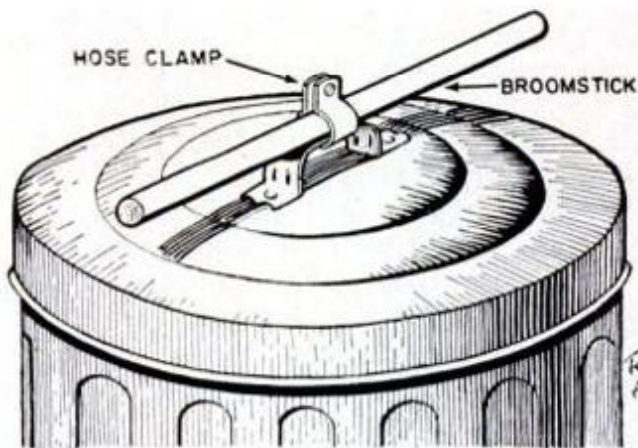

EXTENDED HANDLE on a tightly fitting garbage-can cover lets you remove it easily with one hand. To make it, cut a length of broom stick to match the diameter of lid and attach with a hose clamp



TO HELP PREVENT the colors in cotton goods from running when washed the first time, soak garments for twenty minutes in cold water to which you have added a handful of salt. This sets the colors

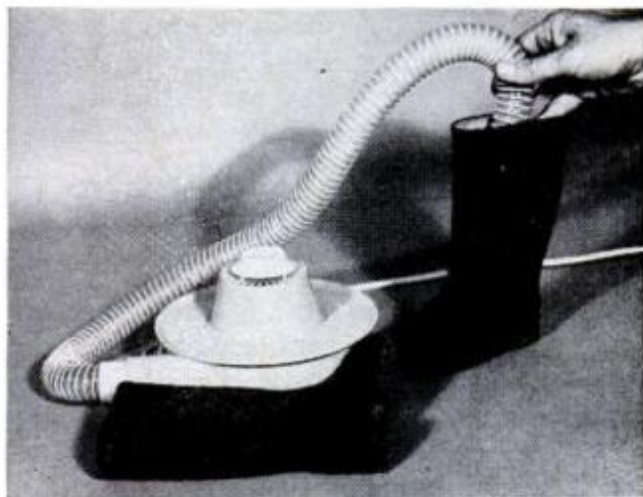

QUICKEST WAY of drying hunting boots or overshoes involves borrowing your wife's electric hair dryer. Simply turn the dryer on, place the end of the hose in the boot and hot air will dry it in no time



ANY CABINET of sufficient depth can masquerade as an elegant woodbox for your fireplace

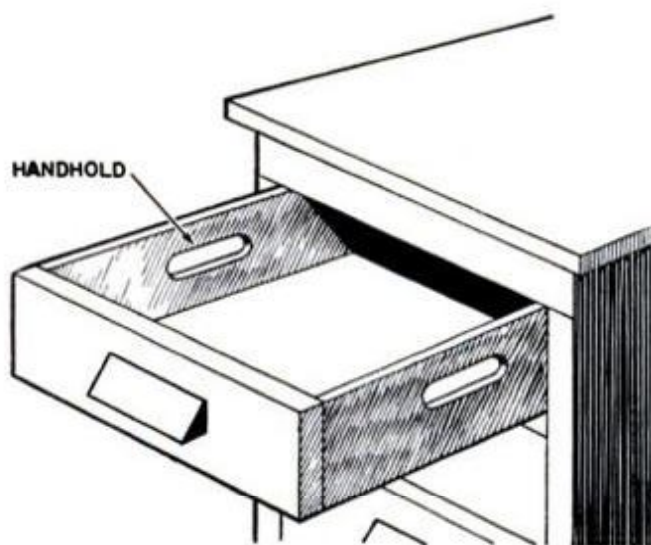

GRIP SLOTS cut in the sides of workbench drawers make it easy to pull any drawer all the way out and carry it, contents and all, to your work site. The return trip and replacing the drawer is just as easy

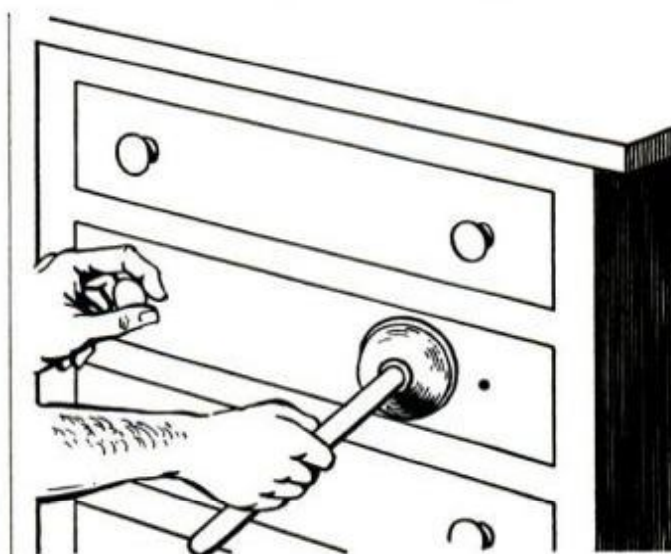

IF A DRAWER PULL comes off and the drawer is stuck, press a rubber plunger against the drawer near the end lacking a pull. This permits you to exert an even pull on both sides and will often free drawer

BIKE SKIS

IF YOU THINK COASTING down a steep hill on wheels is a hairy experience, wait till you try it on a bike fitted with skis! The whole family will be eager to try it, and it's a good way to make an old bike earn its keep.

The bike is stripped of its wheels, fenders, sprocket and chain, and then a large washer is brazed to each side of the front fork to convert the slots to holes. The skis are laminated in a simple bending form by gluing three layers of $\frac{1}{8}$ -in. hardboard together and leaving them in the form for two days. Brackets for attaching the skis to the bike forks are made as shown in the details.

Similar ski runners can be made for a coaster wagon. Here the skis are slipped on over the axles.

—Masonite Corp.

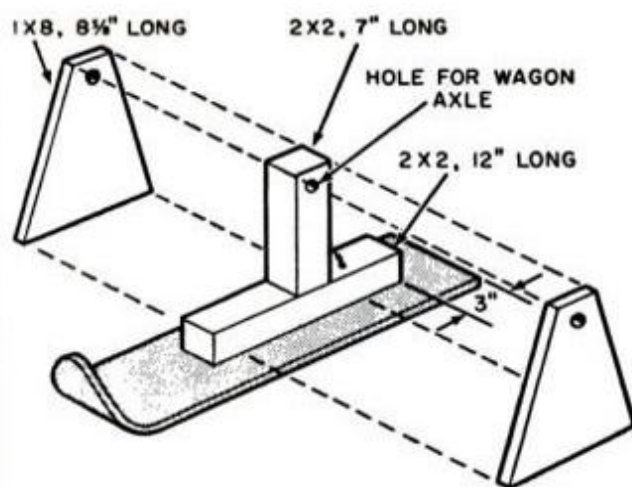
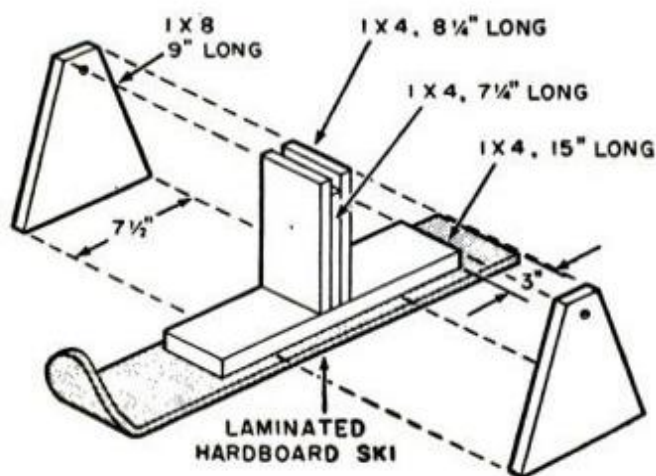

END
ROUNDED

BIKE SKIS

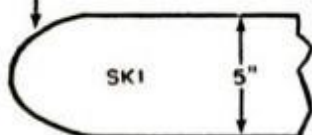

WAGON SKIS

SKI BENDING FORM

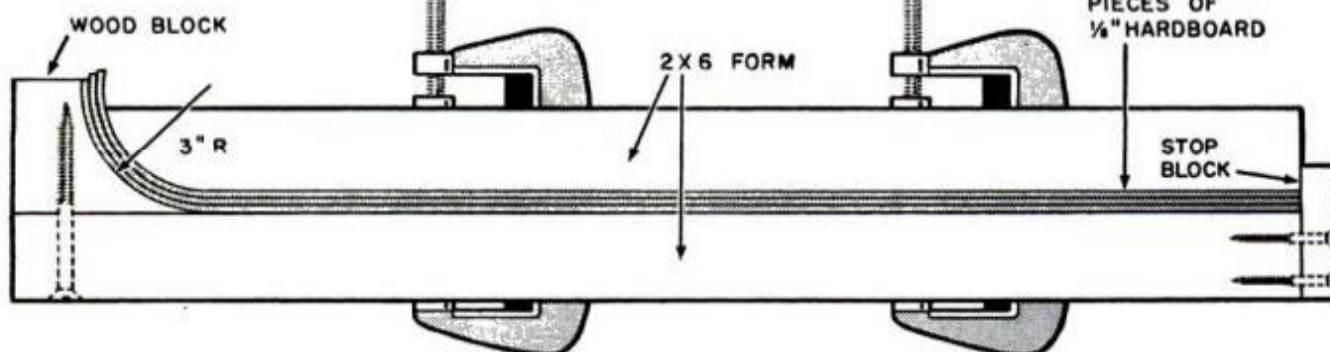

NEW FOR CAMERA BUFFS

BY ROBERT B. BERGER

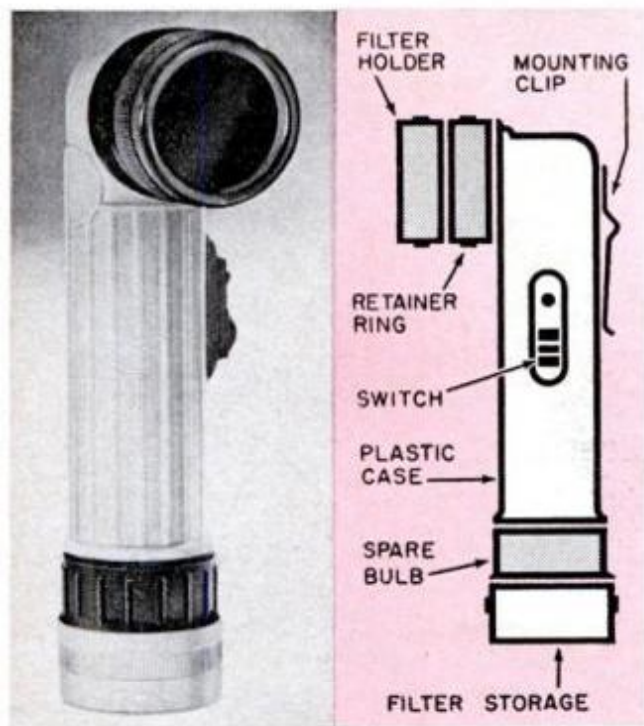

Film-loading light puts an end to dark-room groping by producing filtered, low intensity light for loading holders, developing and printing. When the filter is removed, the unit, which is powered by two D-cells, may be used as a conventional flashlight. Price is \$6.95. Bright Star Industries Inc., 600 Getty Ave., Clifton, N.J.



Trip your camera shutter from as far away as 12 ft. by simply squeezing the bulb on this air-powered remote release. It may be used on any camera having a cable release socket. The remote release is especially handy for portraits and candid shots. It sells for \$6.95 postpaid. Uniphot Inc., 1272 Broadway, New York, N.Y.

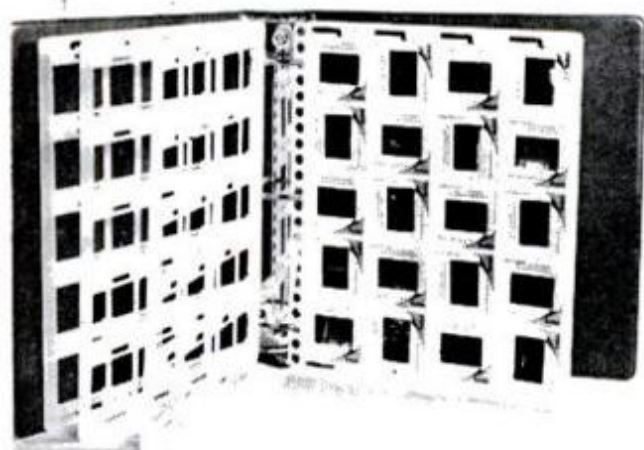

Nifty new way to file your collection of color transparencies is provided by the slide sheet. Made of plastic, the sheet measures 9½ x 11¼ in. and is punched along one side for insertion into a standard ring binder. The sheet has a capacity of twenty 35-mm slides and costs 75 cents. Plastican Inc., Box 157, Butler, N.J.

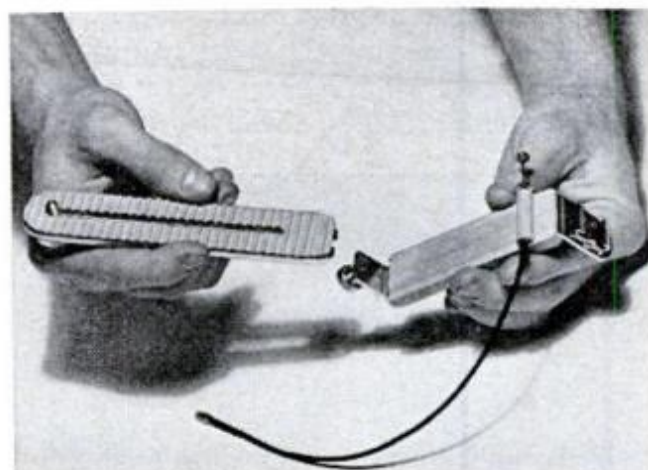

Neat rig for attaching a flashgun to a camera not fitted with an accessory shoe is provided by this new flashgun bracket and camera grip. When not in use, the bracket can be instantly taken apart for compact storage. Price complete with cable release is \$2.95 postpaid from Uniphot Inc., 1272 Broadway, New York, N.Y.

Winter Tune-Up For Your Cycle

CHECKING OUT THE HEAVYWEIGHTS

Part 2

The best bad bike is worse than none (it can kill you) . . . so put that high-powered two-wheeler in tip-top shape before roaring onto the road next spring. Here's how—

By Morton J. Schultz

I DON'T AGREE with the cycle-cat who thinks he's gotta strip his bike down to "shorts and socks" to get it in tip-top shape for the coming season.

Neither do I go along with the guy who claims all you've gotta do is fill up the tank of a bike that's been cooped up all winter. *He's* the guy you see broken down by the side of the road while his buddies are out stirring up the dust.

So the question is: How far should a guy go in preseason servicing of a heavy-weight motorcycle?

My answer to this question is twofold:

(1) Do everything you can *yourself* to get your machine in good riding order.

(2) Closely examine the bike to determine if it needs any *major* repair work that will have to be handled by a cycle

repair shop equipped for such servicing.

All set? Let's go. Start to work on the following areas *in the order* in which they're listed, checking off each job as you finish it in the check-off boxes provided.

Give the cycle a thorough washing with hot water and detergent to make it easier to spot the more obvious defects.

Cooling fins filthy? If they are, your engine will run too hot. Take a putty knife and scrape all accumulated gook from the cooling fins.

Starting from the front and working toward the rear, tighten every nut and bolt in sight. Remember, vibration is a bike's worst enemy—and yours too as far as safety and riding comfort are concerned.

At the same time, keep an eye peeled for oil leaks. A little seepage is nothing to



CAKED-ON MUD AND DIRT between the cooling fins will cause engine to run hot. Use a metal-cleaning solvent to loosen dirt so it can be scraped away

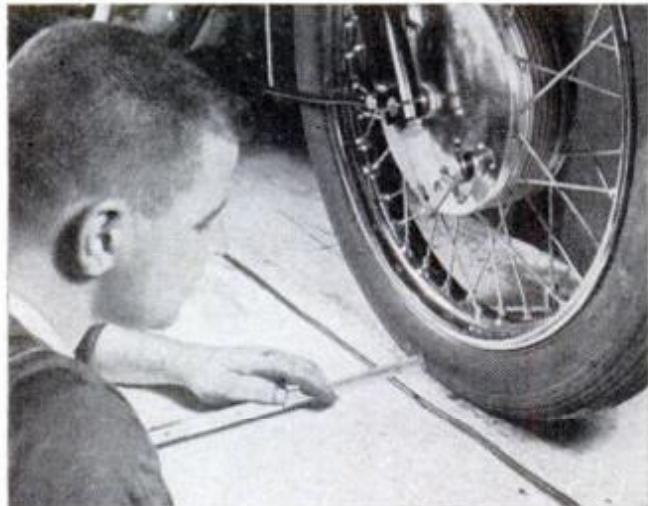

CHECK WHEEL ALIGNMENT with two straight alignment guides of wood or metal in parallel on each side of wheels. Wheels-to-guides distances must be equal



Photo courtesy Whitey Loud

worry about, but a largish leak means that a seal has probably failed. If so, hike your bike to your favorite shop. Replacing seals on a heavyweight requires special equipment which few bike owners possess.

□ If the battery's been left in the cycle all winter, remove it now and check the electrolyte level. Scrub the battery clean, then charge it on a trickle charger for seven hours. A gas station can do this job if you lack a charger.

Check battery cables and terminals. Get

new cables if the old ones are frayed or worn. File down cable terminals till they're clean and bright. Trace the battery ground cable back to the frame, disconnect it, then file down the terminal and the ground spot on the frame, then reconnect the cable, making sure it's tight.

□ Drain old oil from the crankcase and transmission and put in new. Using a hand grease gun and an oil can—and referring to the lubrication chart you'll find in your owner's manual—lubricate the bike with

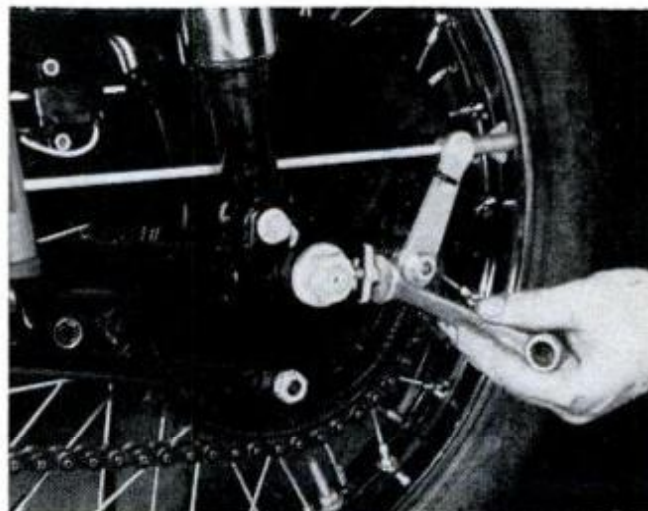
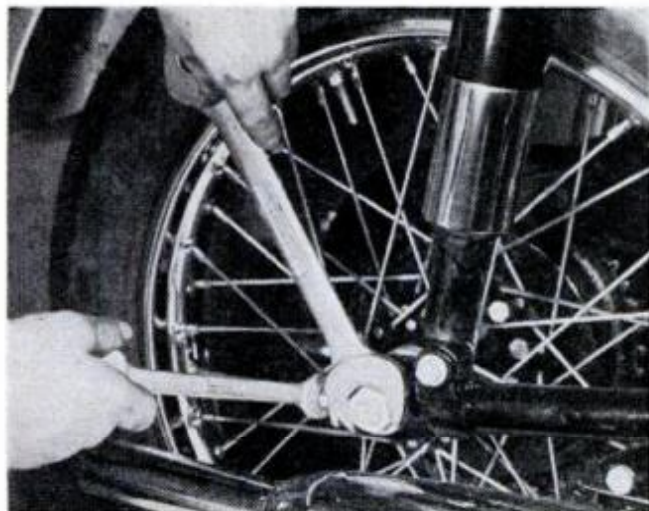

IF MEASUREMENTS SHOW that wheels are out of alignment, turn the adjusting nuts at the rear wheel until front tire is centered between the two guides

FREE PLAY IN REAR CHAIN should be exactly $\frac{3}{4}$ in. Turn rear-chain adjusting nut until this amount of play can be measured at two points on this chain



ADJUSTMENT OF REAR BRAKE is accomplished by taking up on brake-rod adjusting nut while testing pedal's free play. When you get 1 in. pedal play—that's it

the manufacturer's suggested lubricants.

□ Check the tires. They're critical. So don't tolerate worn spots or any cracks in the sidewalls. Replace any tire that shows damage or is badly worn.

If a tire is worn more on one side than on the other, it's a pretty good sign your wheels are out of alignment. This can be corrected with the aid of alignment guides in the form of two straight metal bars or two straight strips of lumber.

Set the bike up straight, then lay an alignment guide on each side of the cycle in a perfectly straight line so both are parallel to and touching the back tire. Using a rule, check the distance between the *front* tire and both alignment devices. The distance between the front tire and each alignment device should be the same. If these distances are not the same, loosen up the *rear* wheel adjusters and adjust the wheel until the front tire is exactly cen-

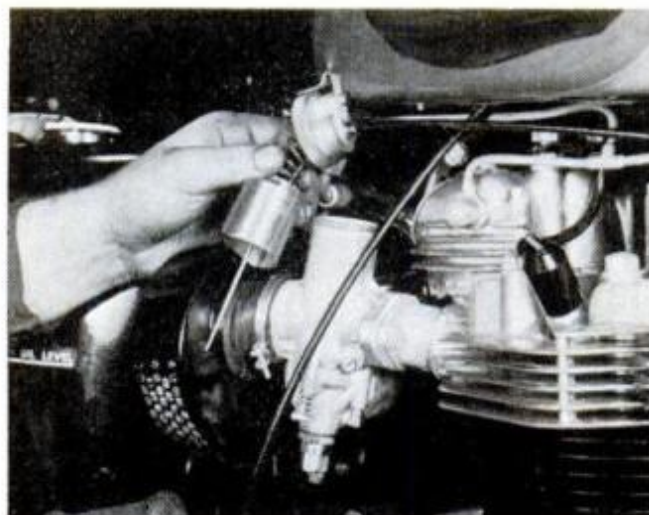

PERIODICALLY REMOVE AND CLEAN the main jet of a cycle's carburetor. On some foreign models, remove top cover of carb to reach and clean slides (above)

172



FRONT-BRAKE ADJUSTMENT is made by taking up on the knurled nut while activating brake lever. Proper adjustment here calls for ½ in. of free play in lever

tered between the two alignment guides.

Uneven wear may be corrected also by "flipping" the tires. Flipping a tire means taking the tire off and turning it around. If the worn area, for example, is on the left-hand side of the tire, it will be on the right-hand side after it's turned around. Tire wear is thus equalized.

□ Check spokes. Replace any that are broken or rusted. Loose spokes can be detected by lightly tapping each in turn with a wrench. A taut spoke will give off a musical "ping." A dull "klank" indicates a loose spoke that should be tightened with a spoke nipple wrench.

□ Check the rear chain for tight spots while someone is sitting on the bike. Adjust the chain until you get ¾ in. free play at *two* points on the chain.

□ Inspect the rear sprocket for broken or worn teeth. If it's bad, replace it; bad sprockets chew up rear chains fast. Your

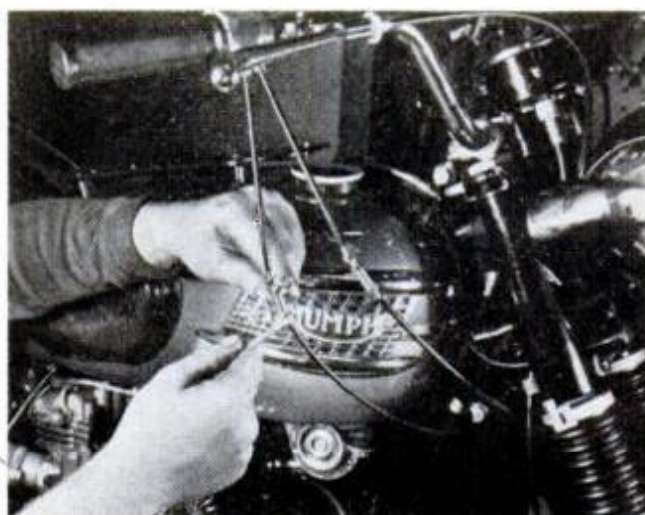

SLIDE ADJUSTMENTS on dual carbs (above) are made at the slide-control cable. Adjust until needle of one slide aligns with its counterpart in the other carb

PM



CHECK CLUTCH WEAR by removing access plate on primary case, backing off locking nut of outer clutch plate, adjusting pressure plate as described in text

owner's manual shows how to replace the sprocket on your particular make bike.

□ Check adjustment of the primary chain. This is the chain which links engine to clutch. Adjustment procedures differ according to the make of motorcycle.

Generally, though, the job is done by first pulling the bottom plug of the primary case and letting the oil run out. This is the access hole to the chain in which the chain-adjusting tool is inserted. Using this tool, turn the adjusting nut clockwise while checking the adjustment through the top plug in the case. Loosen or tighten the chain until you get 1/2 in. of play.

Replace the bottom plug and replenish the oil by unscrewing the check plug and pouring oil in through the fill plug until it begins to run out the check plug.

□ Check the brakes. This is easier to do on a big bike than on a lightweight; on the heavyweights you don't have to pull



DO YOUR OWN TIMING. It's easy enough using a \$3 timer obtainable from your cycle shop. You'll save money too; cycle shops charge up to \$10 for this job

a wheel unless the need for new brake linings is indicated.

Have someone apply the brake pedal fully while you check the brake arm at the rear wheel. If the arm goes beyond a 90° angle, the linings have worn to the point where they require replacing.

Similarly, if there's no more adjustment left in the brake cable of the front brake, you need front brake lining.

To adjust the rear brakes, take up on the nut on the end of the brake rod until you get 1 in. of free play in the brake pedal.

Adjust the front brakes by taking up on the knurled nut where the brake cable connects to the brake lever. The brake lever should have just 1/2 in. of free play.

□ Check clutch pressure-plate wear. Most cycles have an inspection hole on the primary case. To check clutch pressure plates of most cycles, back off the locking nut of the outer clutch plate, then turn out the screw to release tension on the plate. Now turn the screw back up until you begin to feel tension on the screwdriver. This means the screw is *just touching* the clutch rod (the correct tension).

With the screw in place, tighten up on the locknut. A locknut that doesn't tighten indicates a worn clutch plate. The proper clutch pressure-plate adjustment is reached when the screw has the slightest tension on it and the locknut tightens.

□ Adjust the clutch lever. This is done in a similar manner to adjusting the front brake. You'll find the knurled clutch-adjuster nut near the handlebar where the clutch cable connects to the clutch lever. Adjust the nut until you get a play of 1/4 in. in the lever.

□ Check out the carburetor. Remove the main jet bottom nut from the carburetor and check for any deposits of dirt. If it's really dirty take the carburetor apart and clean it. If not just remove the main jet and clean that.

[Dual carburetor models of British and Japanese cycles present a distinct service problem. Make sure that both slides are clean and open easily. If they're dull with carbon deposits remove them and clean them with crocus cloth.]

□ To check the points, remove the point cover. If they're not too badly pitted, run a fine point file through them. If they *are* badly pitted, replace 'em.

A properly timed engine is essential
(Please turn to page 205)

Fun for Junior Mailmen

By Steve Ellingson

COME RAIN OR HAIL, Junior will see that the mail goes through if Dad will only see that this cute panel truck is built for the family's "special delivery."

It's a nifty sidewalk toy that is sure to make the ice-cream-cone set come running—not only to take a turn at being the

driver, but also to provide the push-power to make it go. Where Junior would prefer to deliver milk, bread or laundry rather than mail, the changeover involves nothing more than painting and lettering the body to suit.

Except for a couple of scraps of tem-



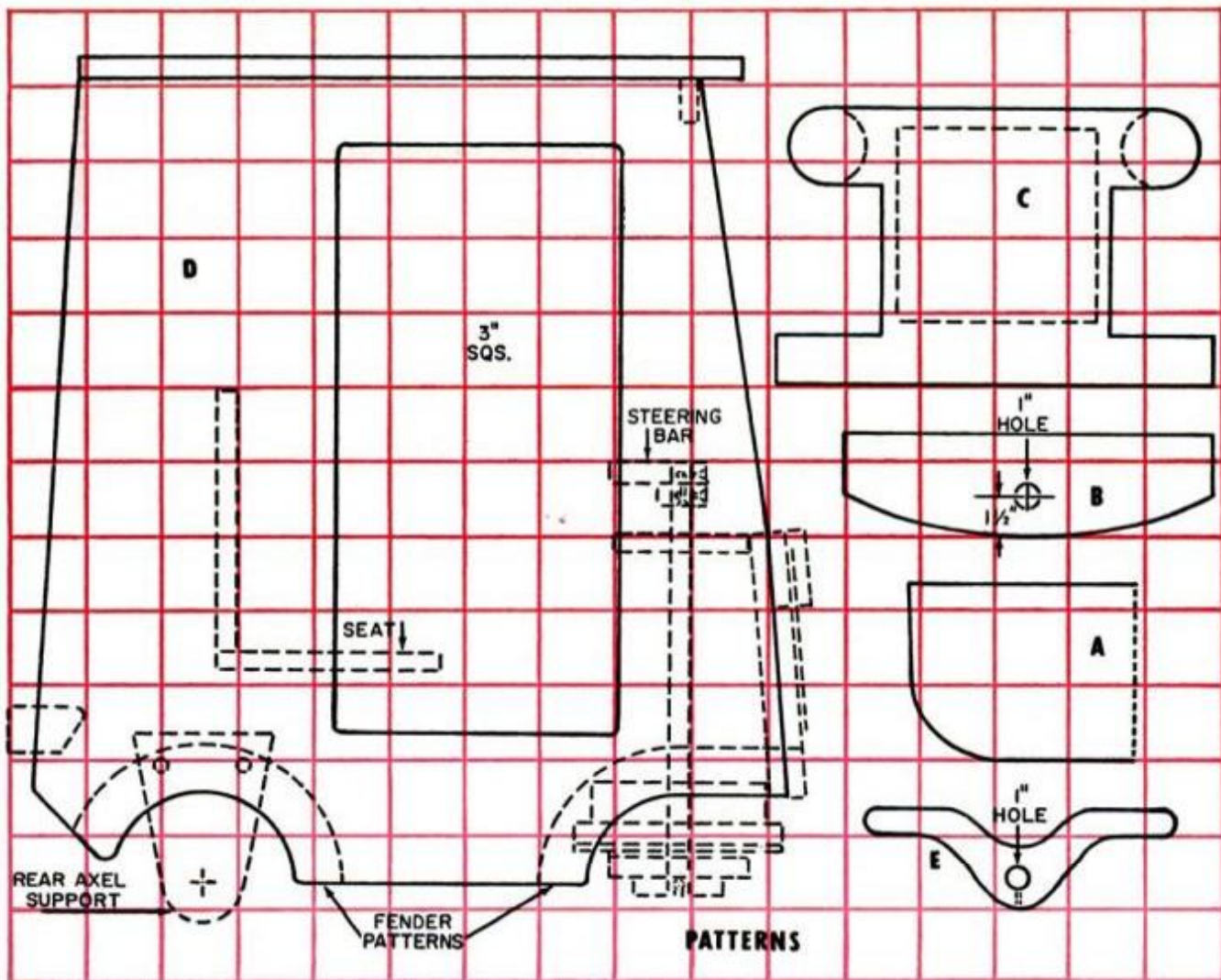

pered hardboard, perforated and plain, the complete toy is made from $\frac{3}{4}$ -in. fir plywood. The 6-in. wheels and their axles can be found at Sears or Wards.

Both sides of the body are alike, as are both sets of front and rear fenders, and paper patterns for these parts are enlarged full size from the grid drawing above. A sabre saw makes quick work of cutting the door and fender wells, but you can do it with a keyhole saw if you have to. A hole bored first at each corner of the door will form a neat opening. Parts that fit between the side panels are all cut $1\frac{1}{2}$ in. wide. The roof is cut 16 in. wide since it laps the sides.

When you have the seven parts cut that fit between the sides, you can start assembling the cab. Dotted lines in the side-view pattern show where they go. First, glue and nail the front and rear cutouts squarely to a side panel. Then place the assembly flat on the floor and stand other parts in position, using only adhesive (quick-setting white glue) to hold them. Then when the glue is dry, go back and nail them. In this way they won't get out of position as

(Please turn to page 232)

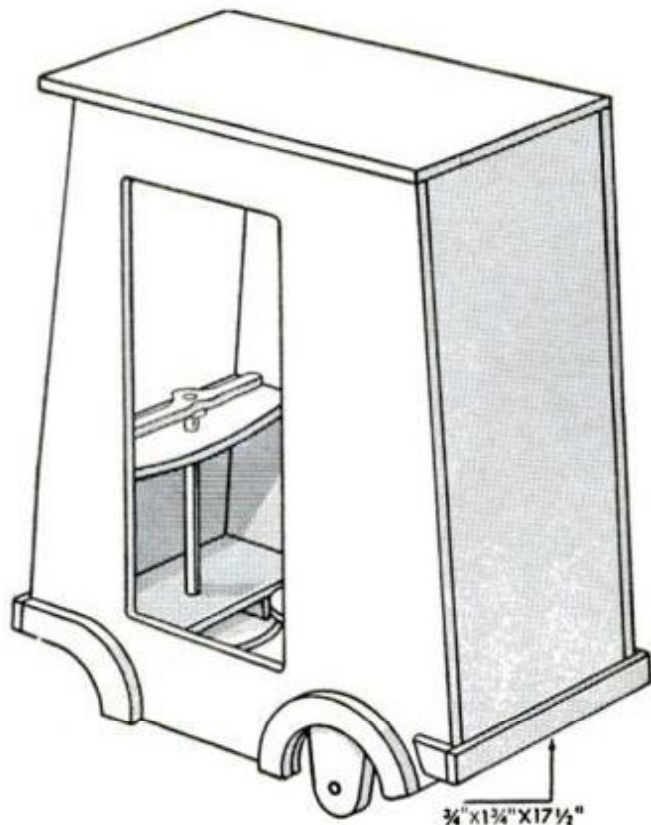

REAR VIEW OF THE CAB shows how the 1 x 2 rear bumper "wraps" around corners to join side blocks

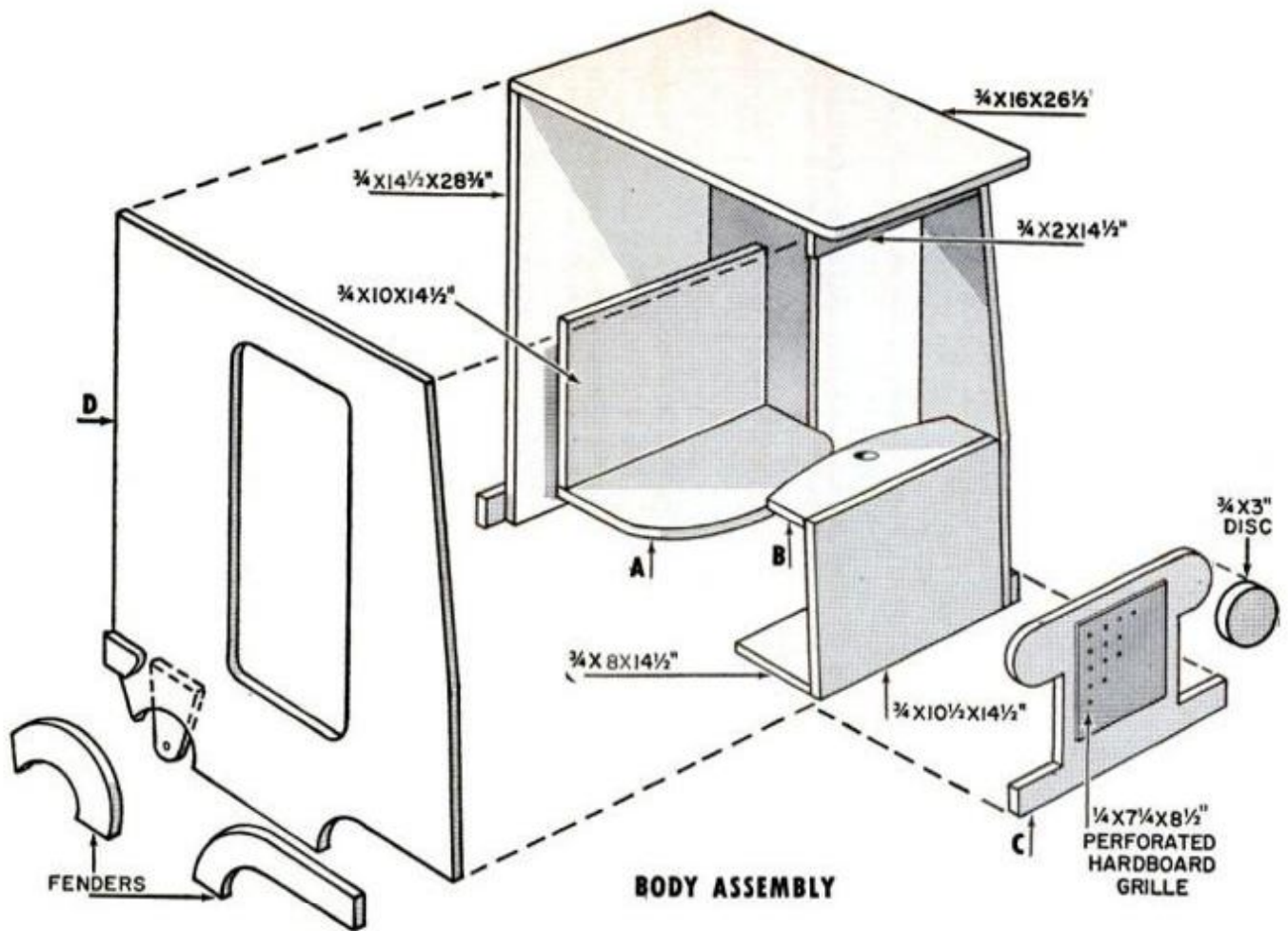

BODY ASSEMBLY

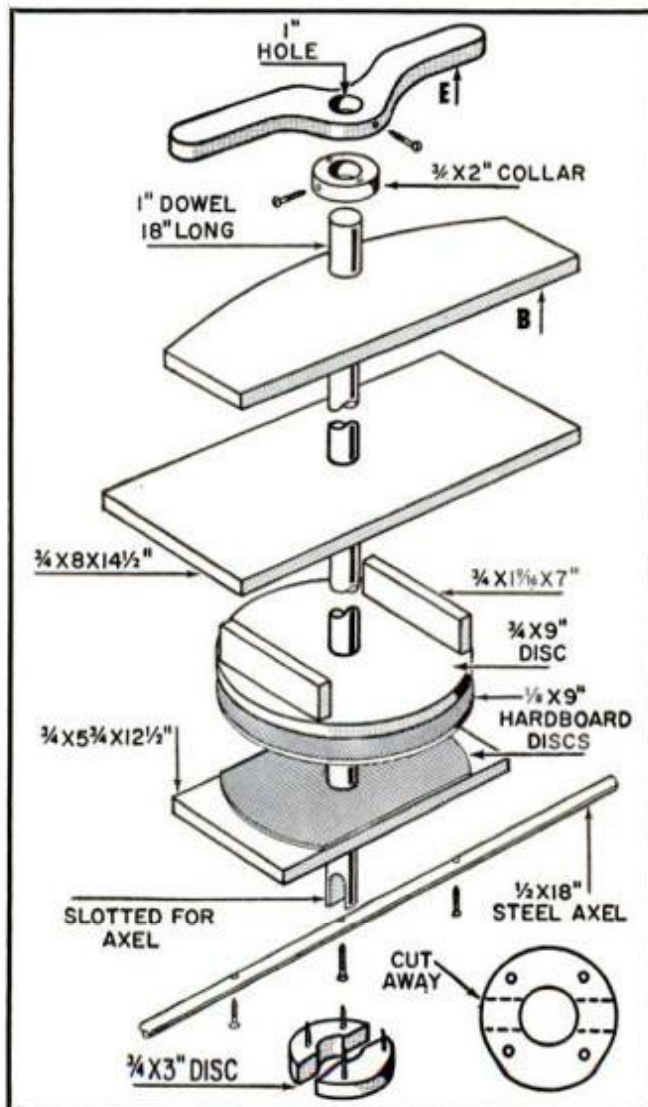

they might if you tried to glue and nail them at the same time. It's a simple thing, then, to glue and nail the remaining side and roof panel to the rest of the assembly.

The rear axle is supported by two tapered members which are centered in each fender well and glued and screwed to the inside of the body. The pattern for these is given in the grid drawing. A 1/2-in. hole is bored in each for a steel axle 18 in. long. Fender cutouts and rear bumper are merely glued to outside of the body.

Your next step is to lay out and saw out the radiator, headlight and bumper cutout, part C. This is centered on the front of the cab and fastened with glue and screws. The headlights are built up with extra 3-in. discs, and the grille is simulated with a piece of perforated hardboard.

Now for the steering assembly: As you see at left, a 1-in. dowel, 18 in. long, passes freely through holes in dash, footrest, a 9-in. plywood disc and a 5 3/4 x (Please turn to page 23)

If you want to save yourself the work of enlarging the patterns, you can get a full-size pattern ready to trace by sending \$1.00 to Steve Ellingson, Popular Mechanics Pattern Dept., P. O. Box 2383, Van Nuys, Calif., and ask for pattern 383.

TIPS FROM READERS

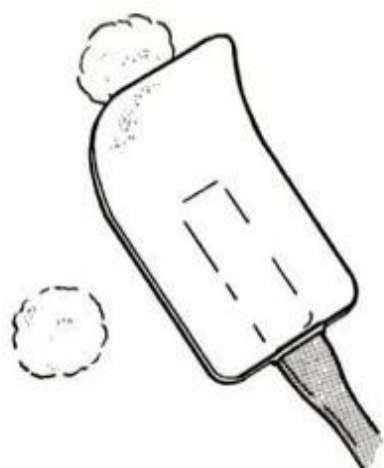
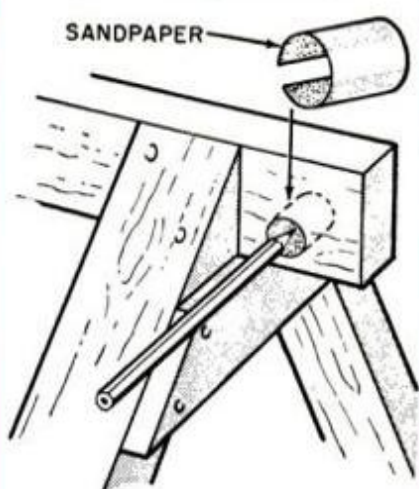

PLATE SCRAPER makes an excellent trowel for small plaster-patching jobs. The soft edge won't leave streaks or grooves



DRILL BLIND HOLE in your sawhorse, line it with a rolled strip of sandpaper and use it to keep a sharp point on layout pencils



TO MIX PAINT more efficiently, drill several relief holes in the blade of the paddle. This breaks up clumps of pigment as you stir



WHEN YOU HAVE to use a hacksaw blade without the frame, tape a length of umbrella rib over the back to stiffen blade

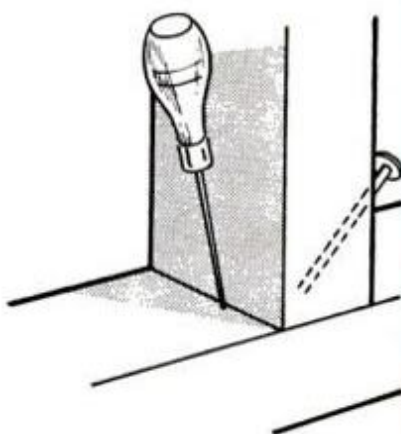

TO HOLD STUDDING in place for nailing, force an ice pick into the sole plate, then drive the nail from the opposite side

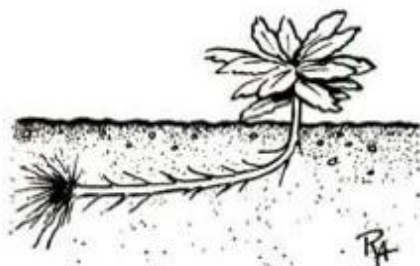

TRY LAYING tomato plants in furrows instead of setting them upright. Many gardeners claim this strengthens the root system



TO MAKE A tool holder for your stepladder, cut off the bottom of a worn-out carpenter's apron and tack to front of top step

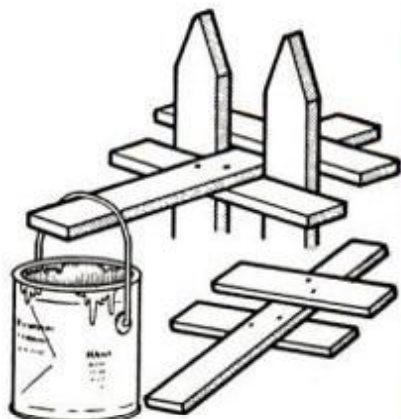

DOUBLE-CLEATED board makes a fine hanger for holding paint bucket while painting a picket fence, especially on a slope

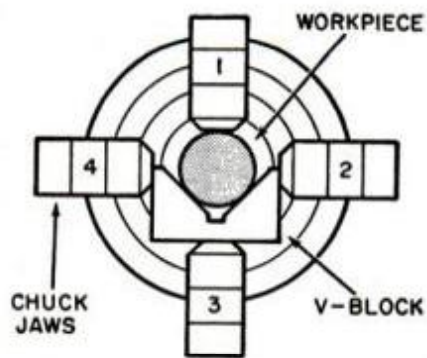

WHEN TURNING duplicate workpieces in a four-jaw chuck, it won't be necessary to first true each one if a V-block is used

TIP-UP SKI RACK

STATION BUSES, foreign and domestic, are always well represented in the parking lots of busy ski resorts. They're the favorite "get-there" vehicles of the swinging Slope Set. And with good reason. They'll pack in nine stocking-capped skiohiles with room left over for all the weekend's duffel—except for maybe the skis (considered by some as necessary to the sport).

Of course, most manufacturers of station buses offer rooftop luggage racks as op-

tionals, and these are very nice indeed for lashing skis. Unfortunately they cost money—money most *schuss* enthusiasts would rather spend on important things like ski wax, parkas, chairlift fees and snow bunnies.

You don't have to be 7 feet tall to load this tip-up rack. You just drop it down by the side of the bus, load the skis on it, clamp the cushioned top piece over 'em, then flip the whole works up on the roof

(Please turn to page 226)

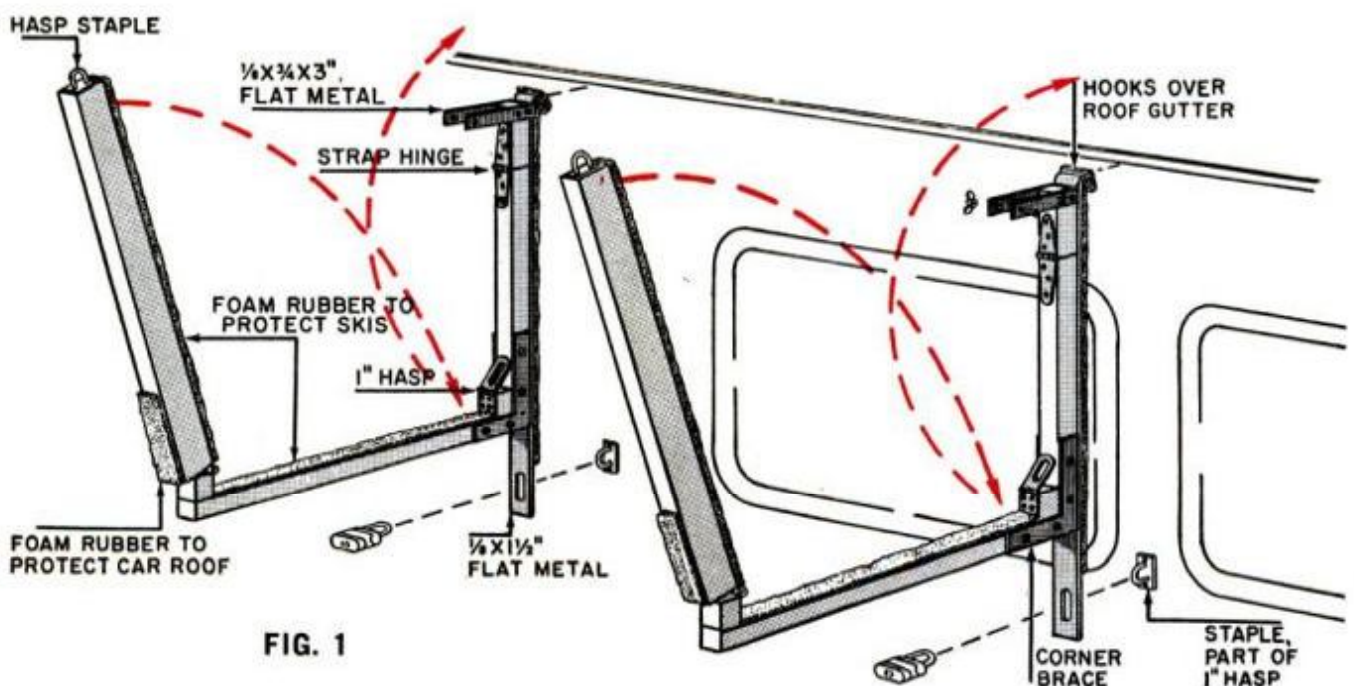
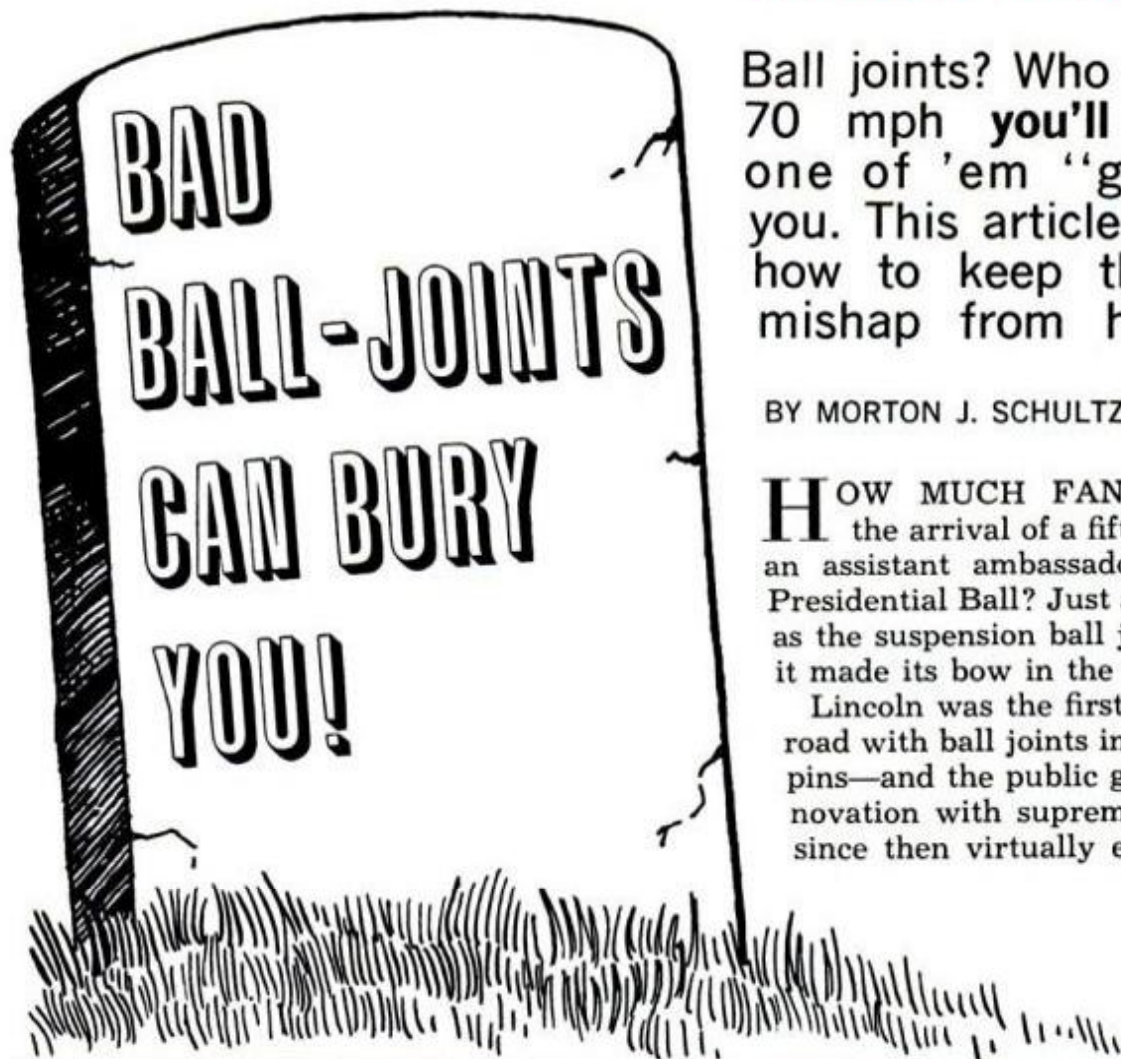

FIG. 1



Ball joints? Who cares! At 70 mph **you'll** care—if one of 'em “goes” on you. This article tells you how to keep that hairy mishap from happening

BY MORTON J. SCHULTZ

HOW MUCH FANFARE would the arrival of a fifth secretary to an assistant ambassador get at the Presidential Ball? Just about as much as the suspension ball joint got when it made its bow in the early 50's.

Lincoln was the first car to hit the road with ball joints instead of king-pins—and the public greeted the innovation with supreme apathy. Yet since then virtually every automo-

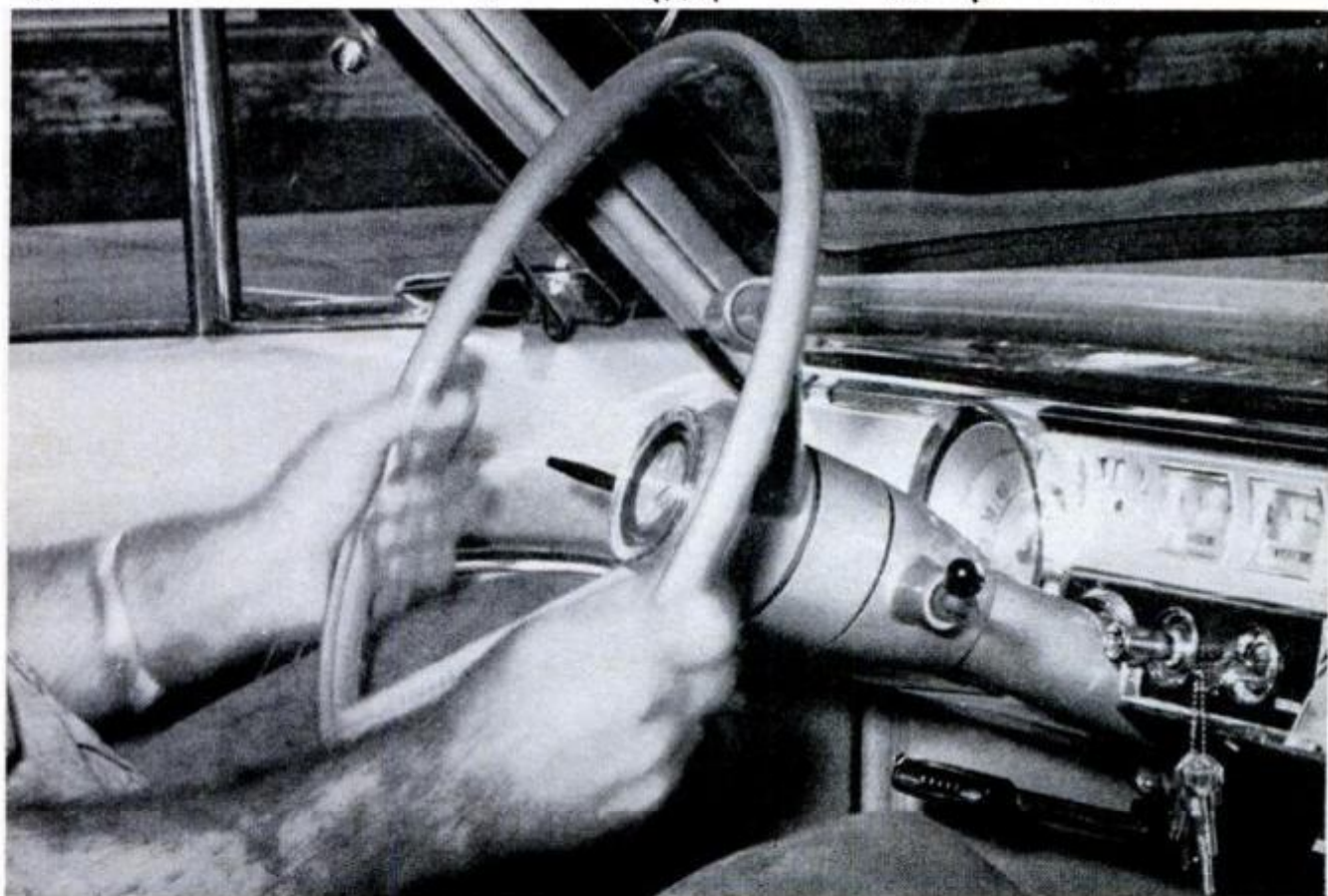

THAT STEERING WHEEL'S QUIVERING like a handful of jelly. Could be shocks . . . or front-end alignment . . . or drive-line shimmy . . . or a dying ball joint. Don't tarry, Harry. Get those joints checked fast!

CUT,
FOLD,
TAPE

AUTO BALL JOINTS

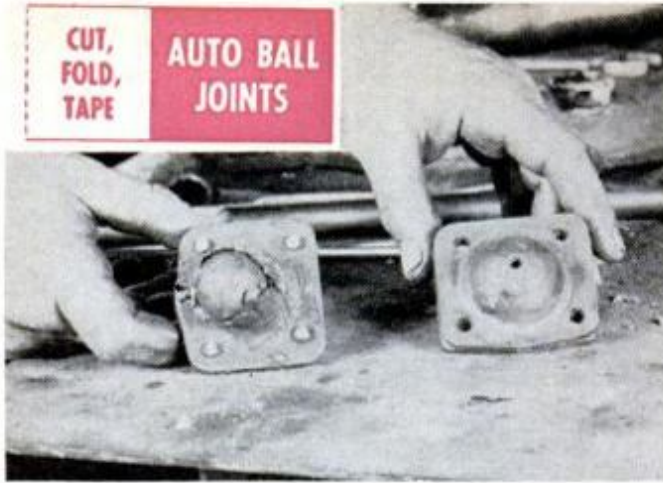

A GOOD EXAMPLE of a very busted ball joint is the one at left (above). Luckily, it quit in the driveway. Had it popped through when the car was doing 60 per . . . don't ask! Joint at right is a good one

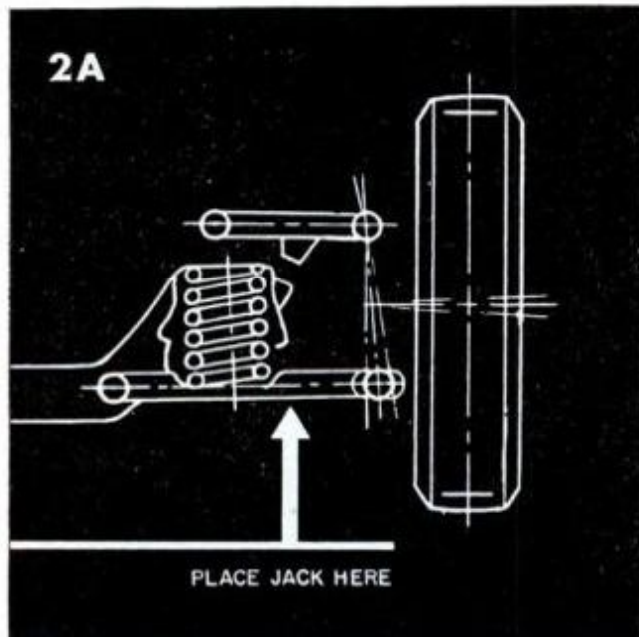

TO CHECK BALL JOINTS in cars with spring located between upper and lower control arms, place jack as shown in Fig. A. Place jack as shown in Fig. B for cars with springs positioned above upper control arms

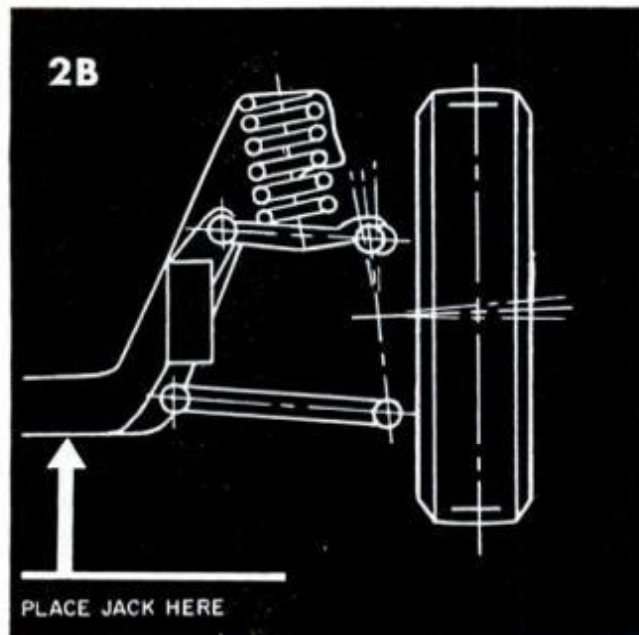

bile produced in this country has made the changeover to ball joints.

The fact is, ball-joint front suspension has proved to be one of the most significant automotive engineering advances in a decade. But chances are it first came to your attention when you were told by the new-car salesman that you no longer had to have your car greased every 1000 miles.

Now, look, I'm not kidding myself. I know darn well that most of you Saturday Mechanics aren't going to undertake the job of replacing your car's ball joints should they go bad; primarily because so much special—and expensive—equipment is required. So you'll probably go to a pro and let him make an honest \$40 or so for doing the job.

So why this article? Three good reasons:

(1) To acquaint you with the importance of checking ball joints—or having them checked—occasionally.

(2) To let you know how to tell when they are starting to "go."

And (3) to acquaint you with the danger that exists when such trouble starts.

Their strengths—and weaknesses

Lubrication intervals in cars with ball-joint front suspension vary according to the car—and to the manufacturer's recommendations. You may have heard that

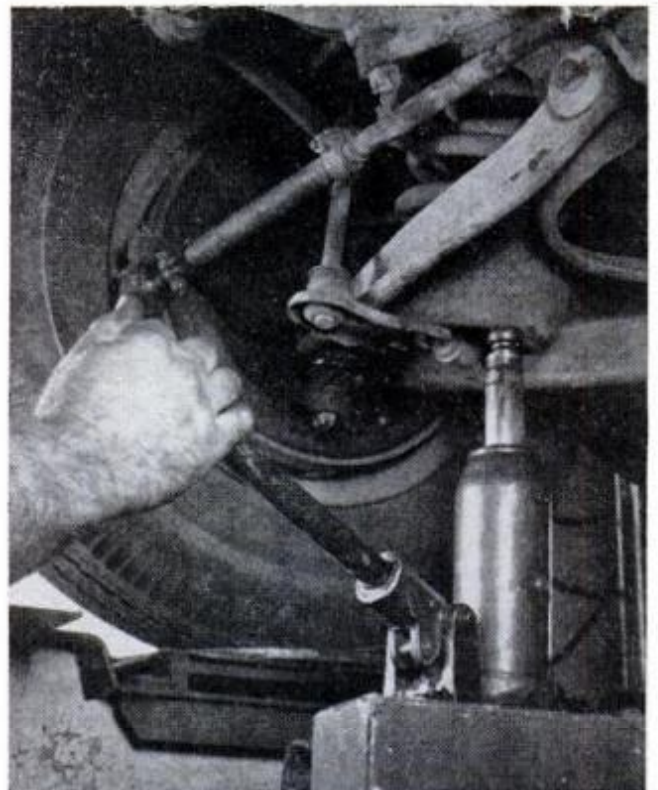

WE'LL SPELL IT OUT. Here's jack position as shown in Fig. A. Place a jack on each side of front end beneath lower suspension arms. This raises wheels off floor, takes load off ball joints to permit checking.

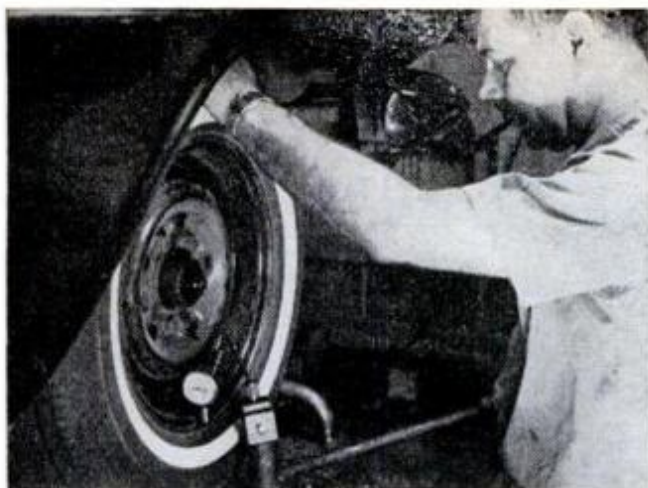

CHECK BALL-JOINT AXIAL PLAY by gripping top of tire with one hand while using a pry bar to force up the wheel with the other. Dial indicator on rim shows if joint looseness is within allowable limits ball joints should be checked and lubricated twice a year . . . or once every 100,000 miles . . . or that they never need lubrication. As a result, too many car owners have gotten the crazy idea that they can pretty much ignore these vital elements of their suspension system.

"What the heck," I've heard many say, "If the manufacturer tells me not to lube my car for umpteen miles, I'm just not gonna do it."

I say this is a dangerous attitude—because *your life literally depends on your car's ball joints and their ability to hold grease.*

Ball joints can—and do—wear out Oh sure, where driving is limited to good roads and a *dry* climate, a ball joint might last longer than even the car itself

The bug that infects and kills a joint faster than anything else is—*water* So unless you live in a desert, your ball joints are not immune. When you splatter through puddles, water can get into the joints. This will begin to dilute the grease and finally wash it out.

A new ball joint is a perfectly shaped cylinder. When water seeps in, rust begins to form on this highly polished surface—and that's all a ball joint needs to begin grinding up seals so that its life (grease-wise) literally oozes away.

Another thing affecting ball joints is the load placed on them. Suspend two tons of car on anything and run it at high speeds over bumps and ruts and *anything*—no matter how strong it is—will begin to wear.

When a ball joint does fail, I'd just as soon be caught paddling through a typhoon in a concrete canoe. The chances of sur-

vival would be just about as good.

These joints have a tremendous affect on your ability to steer and control the car. If one decides to pop at the wrong time—like when you're doing 70 per on the pike—you'll find yourself steering in one direction with the car headed in another.

Neither do you have braking action in the wheel that loses a joint. As a matter of fact, slamming on the brakes is the worst thing you could do . . . it would probably throw you into a spin as whirlish as a kid's top.

Now, knowing all this, you can see why it is important that every driver become aware of the way in which a worn ball joint will telegraph its punch. And this they do, seldom failing completely all at once or without warning.

When you drive over a bump, for instance, and the steering wheel starts to quiver in your hand, it could very well be a warning sign that a ball joint's going bad.

Another sign is excessive play in the steering wheel, and wander or weave while driving.

A third telltale signal that ball joints are going bad is a noise from the front that you would generally attribute to the need for greasing. A crunching or squeak-

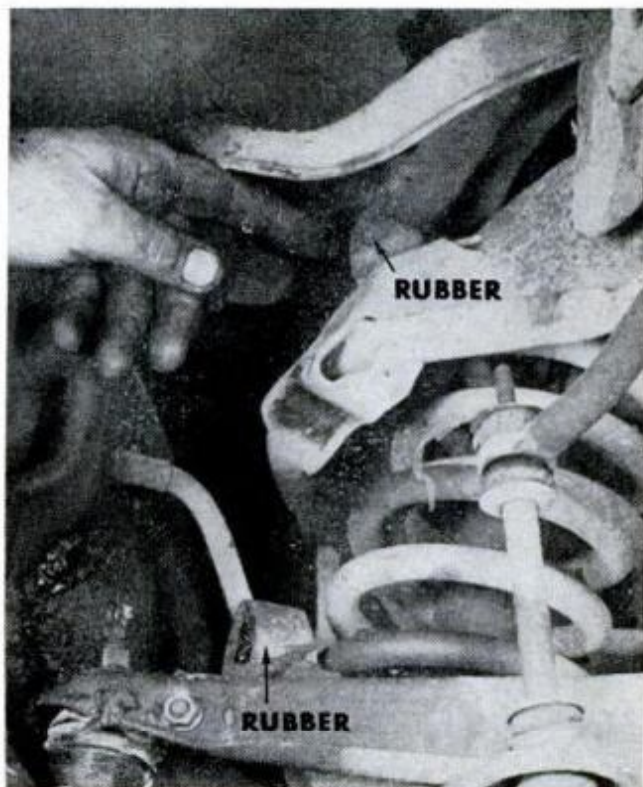

THE BOUNCE AND REBOUND rubber bumpers (two to a side) must not rest on any part of the frame while you're checking out the ball joints. For some cars you may have to use metal spacers to keep them off



THIS CHEVY HAD RIVETED BALL JOINTS as original equipment. After removing the spindle from the joint, the rivet head had to be chiseled off as shown so that the joint could be taken from the car.

ing sound when the front end is bounced up and down will alert you that these joints should be checked for excessive play.

But don't wait for these symptoms of trouble to appear. My advice is to have the ball joints inspected every time the car's oil is changed—that's every 4000 to 6000 miles in today's cars.

Checking Out Ball Joints

How ball joints are checked depends on the car's suspension system. There are

two types of suspension systems:

(1) The type which has the front springs attached to the upper arms is found in Comets, Meteors, Falcons, Fairlanes and some Thunderbirds and Chevy IIs.

(2) The type where the springs are applied to the lower suspension arms. This type is common to all Chrysler products, and to most Ford and General Motors cars.

Getting an accurate indication of ball-joint wear can be done only when there

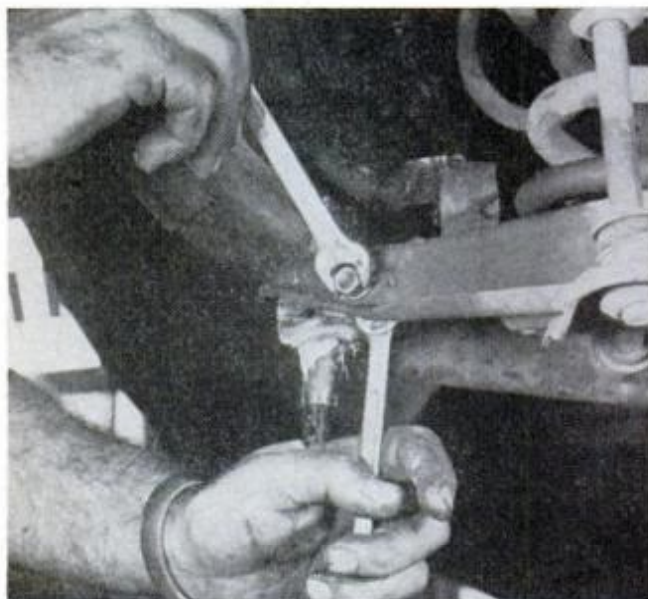

BALL-JOINT REPLACEMENT KITS come with all the nuts, bolts and lock washers required to make the installation. Occasionally, though, bolt holes have to be enlarged slightly to accommodate new hardware

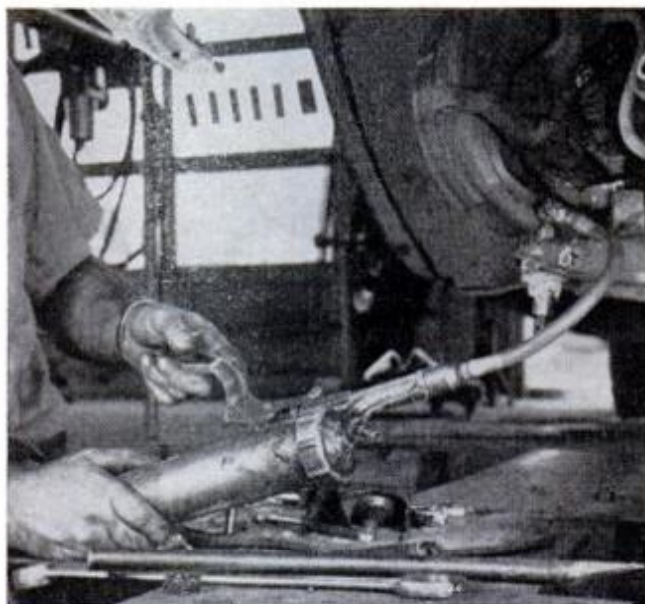

GRAB THE GREASE GUN as soon as you've completed the installation of the replacement ball joints (they'd soon burn up if you forgot the grease). Always use a hand gun to avoid rupturing the seals

is no load on the joints. On suspension system (1) the upper ball joints carry the load and thus are subject to greater wear than the lower joints. On suspension system (2) the lower ball joints take the load. Hence, to get an accurate check of ball-joint wear, you must know how to jack up your car, and this is determined by its suspension system.

To check joints of a lower-arm-spring system, the car must be supported off the floor by putting jacks or trestles beneath the lower suspension arms so that the wheels hang free. Position a dial indicator against the wheel rim, then position a pry bar between the floor and the bottom of the tire.

Keep an eye on the dial indicator, then hold your hand at the top of the tire to keep it from turning and pry upward with the bar. This is a check of ball-joint axial (up and down) play.

Follow this with a check of radial (in and out) play. This is done by placing your hands on each side of the tire and moving it from side to side. In all cars, radial play should never be more than 1/4 in. Every car has a specified amount of allowable axial play. The Automobile Manufacturers Association has established a set of standards for maximum allowable ball-joint wear. These are listed for you in the Table at the right.

To check joints of an upper-arm-spring system, place jacks or trestles under the *front cross members* and follow the same procedure described above.

When checking out ball joints, certain conditions can lead to an erroneous evaluation of ball-joint conditions. These are:

- *Wheel-bearing end play.* Wheel bearings should be properly adjusted so their play isn't added to the ball-joint reading. If you don't adjust them, then have someone apply the foot brake when checking the ball joints to keep the readings accurate.

- *Vehicle movement.* Be careful how the vehicle is jacked up. Have the car firmly supported at four points so it doesn't shift when you force the pry bar against the wheel. Shifting can cause a faulty reading.

- *Interference of rebound rubber bumpers.* Make sure the suspension arms aren't resting on the bounce and rebound rubber bumpers when readings are taken. If these bumpers flex enough, they can af-

Springs Positioned on Lower Arms (Jacks Go Under Lower Arms)

Make of Car	Year	Axial Play in Inches (Up & Down)	Radial Play in Inches (In & Out)
All Chrysler Corp. Cars	'57-'65	.050	1/4"
Ford	'54-'56	.000	1/4"
	'57-early '61	.200	
	late '61-'65	.000	
Lincoln	'52-'56	.000	1/4"
	'57-'64	.200	
Mercury	'54-'56	.000	1/4"
	'57-early '61	.200	
	late '61-'64	.000	
Thunderbird	'55-'57	.000	1/4"
	'58-'60	.200	
Buick	'57-'60	.150	1/4"
	'61-'65	.100	
Buick Special	'61-'63	.080	1/4"
	'64	.060	
	'65	.070	
Cadillac	'57-'65	.062	1/4"
Chevrolet	'55-'63	.093	1/4"
	'64-'65	.0625	
Chevelle	'64-'65	.060	1/4"
Corvair	'60-'64	.093	1/4"
	'65	.030	

Maximum Allowable Limits Of Ball Joint Looseness

Oldsmobile	'57-'64	.125	1/4"
	'65	.060	
Olds F-85	'61-'63	.090	1/4"
	'64-'65	.060	
Pontiac	'58-'64	.050	1/4"
	'65	.093	
Tempest	'61-'63	.060	1/4"
	'64	.060	
	'65	.050	

Springs Positioned on Upper Arms (Jacks Go Under Cross Members)

Comet & Falcon	'60-'62	.200	1/4"
	'63-'65	.000	
Fairlane	'62-'65	.000	1/4"
Meteor	'62-'63	.000	1/4"
Thunderbird	'61-'65	.000	1/4"
Chevy II	'62-'65	.093	1/4"
Rambler	'62-'65		

SOLUTIONS FOR MECHANICAL HEADACHES

AUTOMOBILE CLINIC

BY MORT SCHULTZ

Very Negative Neutral

Okay, Doctor, what's your prescription for this one? The neutral button of my '62 Plymouth automatic transmission control has detached itself from the pushbutton slide box. I'm listening.—Martin Fenton, Oklahoma City, Okla.

Okay—I'm prescribing. This particular breakdown occurs as a result of the pulling action exerted on this button when the parking sprag is applied. The other buttons will also loosen up occasionally because of excessive spreading of the slide tangs. Often the trouble can be corrected simply by squeezing the slide tangs and pressing the button back on. However, if the plastic has been sheared, repair will involve the following procedure:

(1) Fashion a pin of $\frac{3}{32}$ -in. dia. welding rod $\frac{9}{32}$ in. long with square, flat ends.

(2) Drill a $\frac{3}{32}$ -in. hole in the plastic button $\frac{1}{2}$ in. from the inner end.

(3) Press the pin into the drilled hole in the button until it protrudes about the same distance from each end of the hole.

(4) Squeeze the pushbutton's box slide tangs to a $\frac{1}{4}$ -in. gap.

(5) Press the button in place on the slide tangs.

Unsticking a Throttle Cable

With the advent of cold weather, the throttle cable of my '64 Dodge wagon has started to stick. What can I do to keep it moving freely?—Mark Crandall, Washington, N.J.

Wash the cable thoroughly with acetone, then lubricate it with a very light oil or glycerine. This should get it back to normal.

Watered Gas

After a good rain my '63 Studebaker station wagon coughs and bucks like an expiring bronco. It looks dry enough when I check under the hood. None of the mechanics around here can explain it; they've checked out everything and all

is according to specs. Any ideas?—Carlton Hayes, Lockport, N.Y.

Too many of the '63 and '64 Study wagons came off the line with gas-tank caps that didn't fit the filler neck properly. Result: water in the gas tank when it rained (and water makes a lousy fuel for internal combustion engines).

Consequently, Studebaker has since come out with a fuel-tank filler-neck water deflector (Part No. 1562555) which you should have installed. Production-wise, Studebaker started factory-installing this part on all '64 wagons carrying serial numbers 64S-4460 to 64V-4685.

Black Coil=Burnt Points

Why, pray tell, do I keep burning up the points in my '64 Olds? My mechanic keeps swearing that everything's as it should be. Recently I had another guy do the job—same results. Now I'm swearing! Something's giving those points a kick. What the devil is it?—Art Meyer, Canton Ohio.

It could be—and probably is—the coil. Some maverick coils that provided too little resistance were originally installed in these cars. You can tell if the correct coil is installed on your car just by looking at it. The correct coil is colored brown—not black.

Moanin' Low

A vibrating, moaning-like noise is coming from the front of my '63 Pontiac with standard 389 CID engine when I get up to about 25 mph. Got any ideas about what it might be?—Al Bengivenga, Easton, Pa.

In a number of complaints like yours, this trouble has been traced to vibration of the alternator belt. This applies to V8 Pontiacs and Tempests with the 326 as well as the 389 engine, without airconditioning. Check out the trouble as follows:

(1) Check that the alternator and power steering pump mounting are good and tight.

(2) Adjust the alternator and power

steering belt tension. Correct power steering belt tension in the big-sized Pontiac is 140-145; tighten the alternator drive belt to 110-115. Tempest specs for both belts is 110-115.

(3) Still no results? Okay, take off the alternator mounting-bracket lower bolt and install a drive-belt bumper (Part No. 9772713), leaving off the flat washer. Tighten up on the bolt while holding the bumper, so that the bumper clears the belt by $\frac{1}{32}$ in.

Gotta Light?

This may sound ridiculous compared to the serious problems you get from readers, but I can't open the ashtray door of my '63 Caddy. Could you throw some light on this problem for me? I'd sure appreciate it.—George Fuller, St. Paul, Minn.

Sure. And I'll throw that light right on the probable culprit—the cigar lighter itself. The last time it was returned to its socket after use it was probably pushed down in the "heat-up" position. With the ashtray closed, it then popped up a little too energetically, jamming the door.

You should still be able to open the door, at least enough to admit the blade of a small screwdriver or similar tool with which you can depress the lighter, then remove the door. To prevent the ashtray jamming again, file down the threaded portion of the lighter knob $\frac{1}{32}$ of an inch, and the flange $\frac{1}{16}$ of an inch.

(By the way, no problem is "ridiculous" if it's bugging an *Auto Clinic* reader. We love you all dearly. All we ask is that you describe the problem as accurately as possible. It's those "Hey-my-car-acts-funny-what'll-I-do?" questions that stump us.)

Service Tips

- **OWNERS OF '65 CHEVY** convertibles should know about the availability of two back-window support rods for supporting the back window and preventing the glass striking the rear seat-back retainer when the back curtain is lowered. Your Chevy dealer has the word on this and will do the job as outlined in Chevrolet Service News 8.
- **IT ISN'T YOUR FAULT** if the gas station guy cramps his fingers trying to lift the hood of your '65 Mercury when he goes to check the oil. Either there is inadequate output force in the hood assist spring, or too much friction due to improperly adjusted hood latches, lock dowels and hinges. Service Bulletin 44 tells your Merc dealer how to fix it.
- **SOME OF THE GROWLS**, whines, chatters and knocks that have reportedly developed in the rear ends of '64 and '65 Dodges—including Darts—are being attributed to the use of improper lubricant. Never use an all-purpose rear-axle lube. The only lube recommended is MoPar Sure Grip Differential lubricant (Part No. 2585318). If this fails to stop the noise, the differential should be disassembled and Repair Kit 2404427 applied.
- **OWNERS OF '66 STUDEBAKERS** with disc brakes will be interested in learning about the availability of a new rear brakeshoe return spring (Part No. 1565641) which is designed to put pressure on the parking-brake link. Lack of such pressure in the '65s has been the cause of rattles. The new spring must be installed with the short hooked end attached to the forward shoe, and the long hooked end attached to the rear shoe. You'll need two springs per car—natch; one for each rear brake.
- **DON'T FREEZE THIS WINTER** because of a sticking heater door that prevents the flow of warm air through the heater slots of factory-installed air-conditioning units on your '65 Plymouth Fury or Chrysler. Pay a visit to your friendly neighborhood dealer. He's been given the word on how to fix the trouble.

Each month *Auto Clinic* answers your questions on car repair. For a personal reply, please enclose 25 cents in coin to cover mailing and handling. Address questions to *Auto Clinic*, Popular Mechanics, 575 Lexington Ave., New York, N.Y. 10022.

Pee-Wee Saws

Make Hard Jobs Easy

Better known as slitting and slotting saws, these midget circular blades make play of tricky shop projects.

By Walter E. Burton

IF YOU DON'T have a screw-slitting cutter or some other midget circular saw in your shop, you're probably doing a lot of things the hard way.

In case you've never used one, a screw-slitting cutter is a midget circular saw designed as a milling cutter for slotting screw heads. With a little ingenuity, however, you can devise dozens of other ways of putting it to good use. In addition, there are many similar saws made for all-around use by the craftsman. The term "slitting saw" sometimes is applied generally to screw-slitting cutters and similar small circular saws.

In the home shop, such cutters can be used in a drill press, lathe and milling machine. Some craftsmen use them in portable electric drills and small hand grinders, though it's not easy to produce smooth cutting with a hand-held tool. Because of the instability of such arrangements, extra care is usually required.

Pee-wee saws come in a wide range of thicknesses and diameters. For the model-maker, and the jewelry craftsman who wants to slit chain links or saw coiled

wire into rings, there are blades as thin as .006 in. For all-around work in metal, wood and other materials, a more practical thickness is .032 in. or so.

Diameters most likely to interest the craftsman range from less than $\frac{1}{2}$ in. to $2\frac{3}{4}$ in. or perhaps slightly larger. Various mounting-hole sizes are available. In operations such as precision wood cutting, the larger diameters are desirable since they can handle thicker material. (The photos here show a tiny .008-in.-thick saw $\frac{1}{16}$ in. in diameter, and two .032-in.-thick cutters in diameters of 2 in. and $2\frac{1}{2}$ in.)

For milling-machine use, the cutter can be mounted on the regular arbor supported by an overarm, or on a short arbor gripped in a collet. Likewise, for use in drill press and lathe, saws usually are provided with shanks by mounting them on arbors.

A useful arbor for the larger-diameter saws has a $\frac{1}{2}$ -in. shank 2 to 3 in. long. Saws should, of course, be clamped securely on their arbors and rotate with uniform contact of teeth against work.

While the photos show only a few of

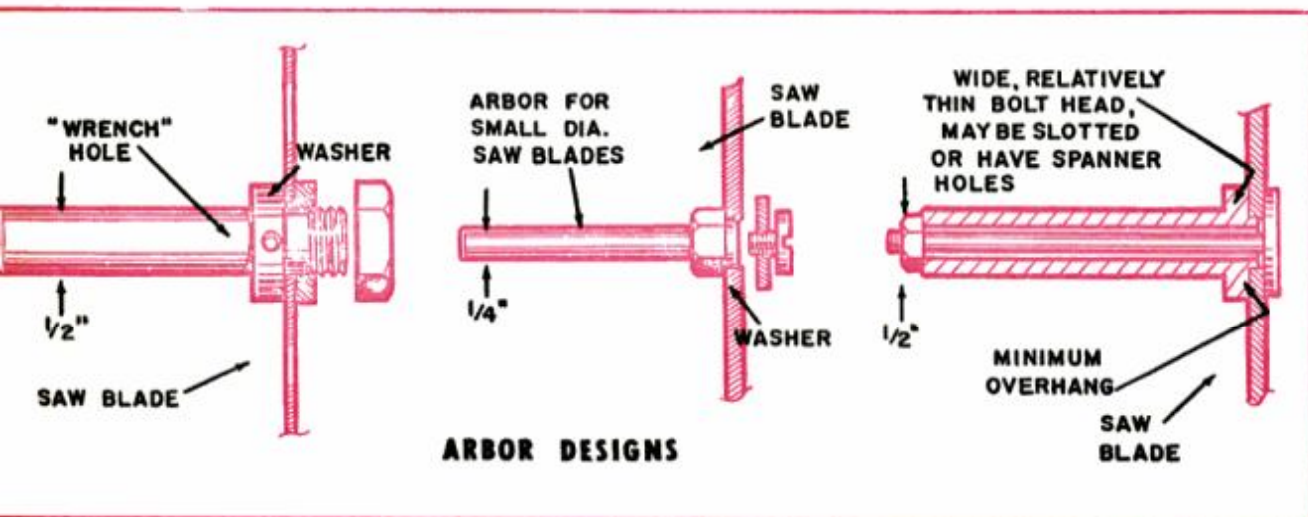

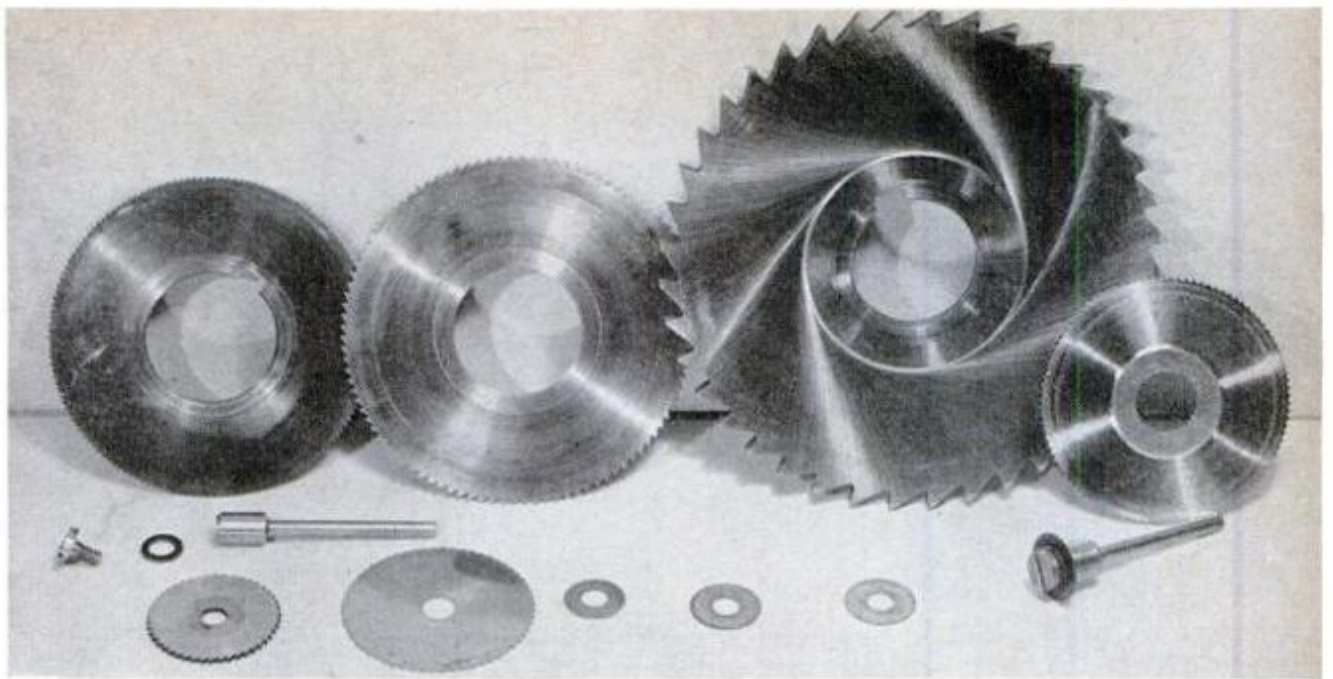

SLITTING AND SLOTTING saws come in a number of different diameters and thicknesses in various mounting-hole sizes. Perfect for precision cutting jobs, they should normally be run at fairly low speed to avoid the danger of overheating. When sawing metal, it's a good idea to lubricate with sulphurized cutting oil

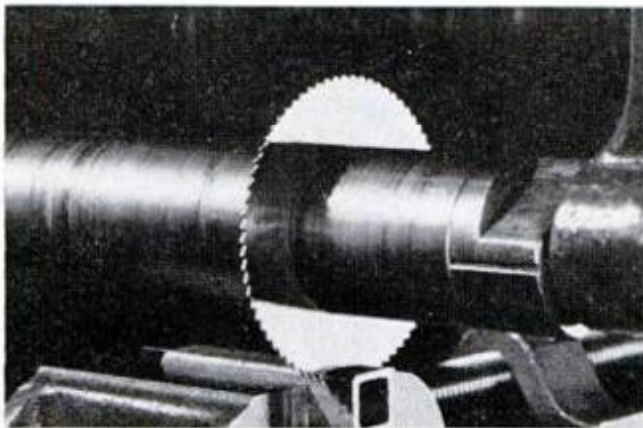

CUTTING SQUARE aluminum tubing to precise lengths is easy with this .032-in. saw mounted on a milling machine. For angle cuts, angle the vise or the work

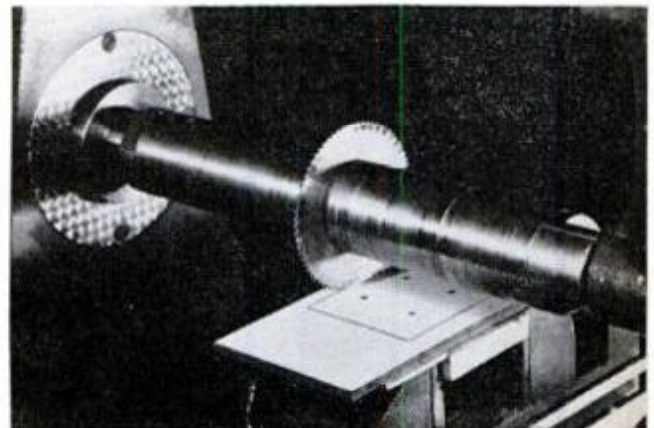

STRAIGHT-SIDED openings can be cut precisely square with a slotting saw in a milling machine. Nail through scrap area to a wooden block held in vise

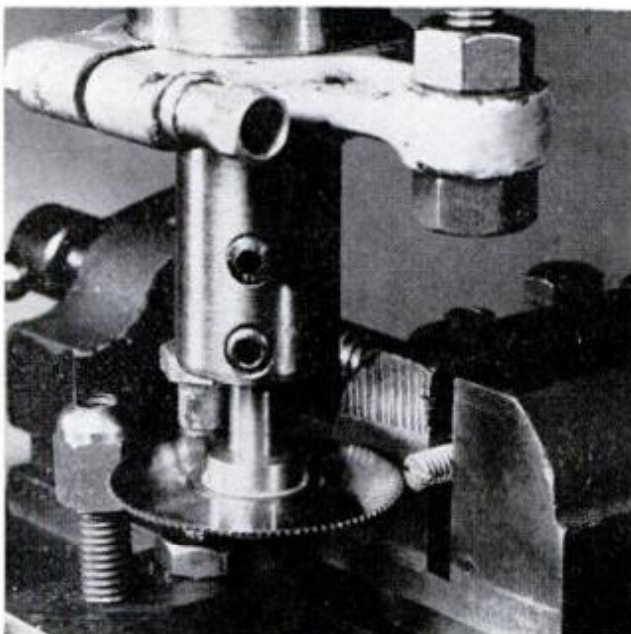

ORIGINAL PURPOSE for slotting saw makes it a useful drill-press accessory. Here it's mounted on arbor to cut a driver slot in a headless screw held in vise

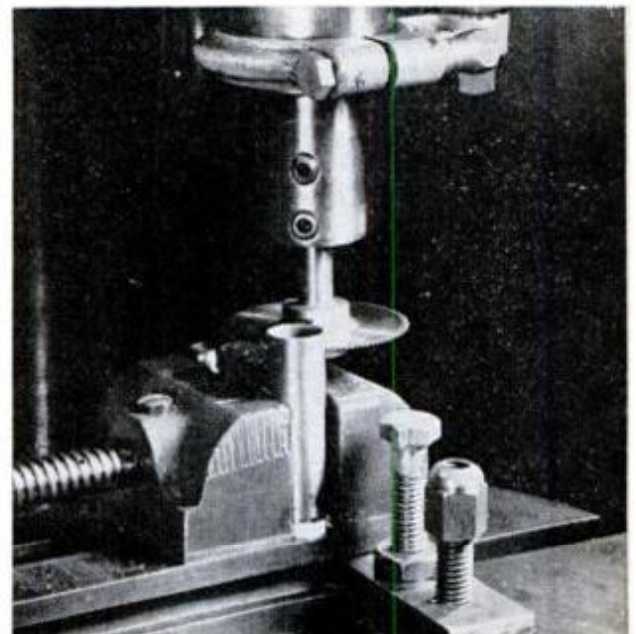

USING SAME SETUP as shown at left, you can also cut short sections from brass tubing. Drive a wooden plug into tubing to support it against grip of vise

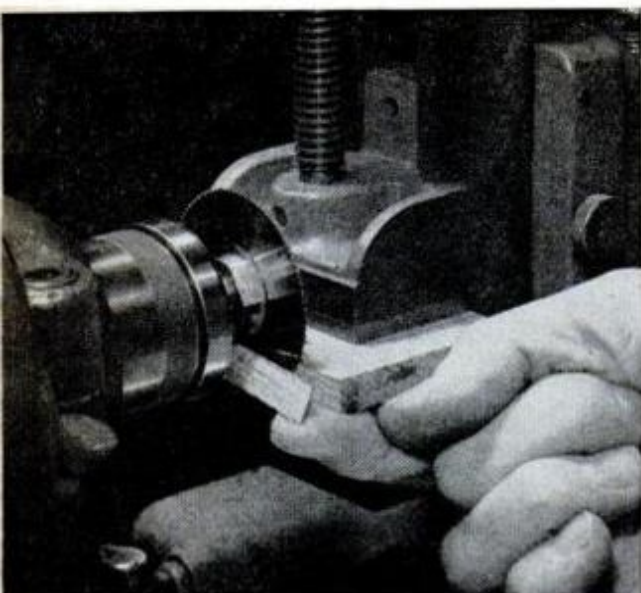

MODEL BUILDERS find many uses for these thin smooth-cutting saws. This bench-lathe setup produces splinterless veneer strips by feeding wood past saw

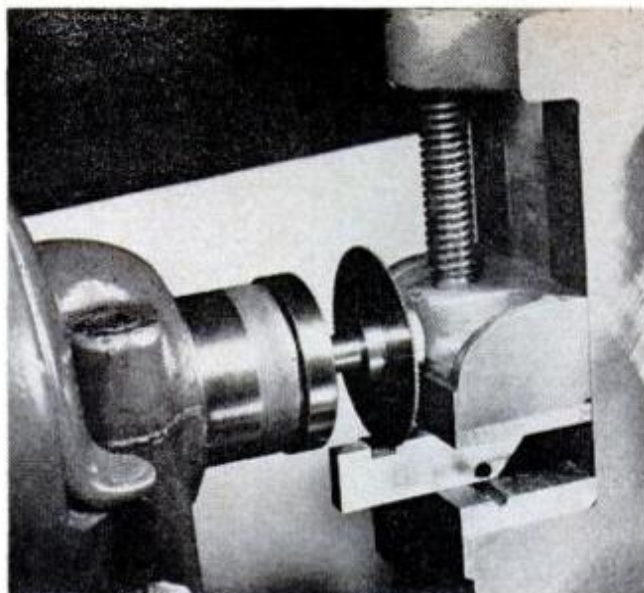

WHEN CUTTING bars, the stock must be clamped square to the saw and the vise properly aligned. Spacers support work until it's gripped by vise jaws



ONLY .008 IN. THICK, this tiny saw used on a small lathe neatly slits the metal ring clamped in the toolpost. Cylindrical bushings are slit same way

the possible uses for slotting cutters, they should suggest many more. For larger equipment than that usually found in the shop, metal-slitting saws can be obtained in diameters from 2 in. to 8 in., and thicknesses from $\frac{1}{32}$ in. to $\frac{3}{16}$ in. One type has ground sides with a greater thickness at the teeth; another is toothed for side chip clearance.

Usually, these small saws should be run at fairly low speeds. If run fast, especially when cutting non-metals, they may over-heat.

In metal-sawing, it is desirable to use a cutting lubricant, such as sulphurized cutting oil. And to keep chips from jamming the cutter, especially if it is a little dull, a piece of soft wood touched occasionally against the saw will help. ★ ★ ★

Improved Replacement for Misplaced Toolpost Wrench

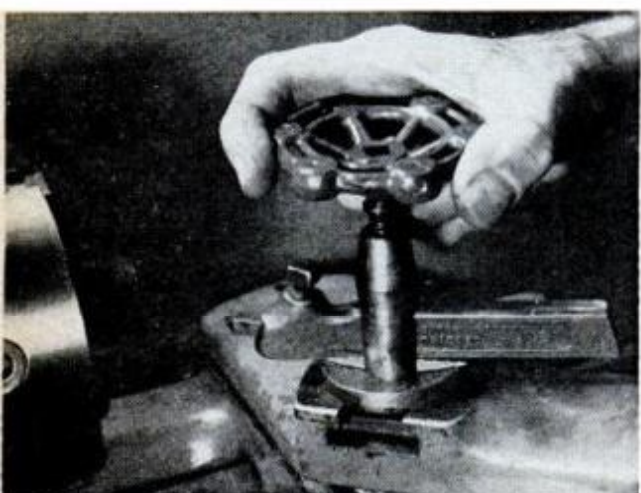

While working with my lathe one evening, I discovered that I had misplaced the toolpost wrench. I searched all over the shop without success, and was about ready to give up for the night when I noticed that the handle on a plumbing valve in the corner had a square hole in the center which looked about the right size. I removed the handle, tried it on the toolpost and, sure enough, it worked fine.

Before starting any metal turning job requiring tool changes, place a surface gauge on the lathe bed and set the needle to the height of the tailstock center.

Stick 'Em Up!

A new hot-melt glue gun promises better and faster glue jobs for home handy-men and hobbyists.



GLUING DOWN a loose auto carpet is a cinch with this new electrically heated glue gun.

THE USMC HAS A NEW GUN—but chances are the Viet Cong will never see it. Because *this* USMC stands for United Shoe Machinery Corporation, and their new *Thermogrip Glue Gun* is lovingly aimed straight at the heart of the home handyman and hobbyist.

Operating the Thermogrip gun is a simple matter of plugging it in, inserting sticks of solid, polyethylene-based glue, waiting a few minutes for the "slugs" to be reduced to quick-flow liquid in the gun's melting chamber, then applying the liquid adhesive to the surface to be glued.

A strong, waterproof bond is completed approximately 60 seconds after the glue is applied. The adhesive is designed for use on practically all materials—wood, plastic, fabric, leather and paper. It's great for plugging gaps between tile and tub.

The gun weighs just 8 ounces and is molded to fit the hand. The only effort involved in operating the gun consists of pressing the thumb on the glue or caulking stick to feed it into the hot-melt chamber.

The Thermogrip Glue Gun comes with four slugs of glue and three slugs of white caulking sealant. It retails for \$7.95. ★ ★ ★

Sheet Metal Former

By Manly Banister

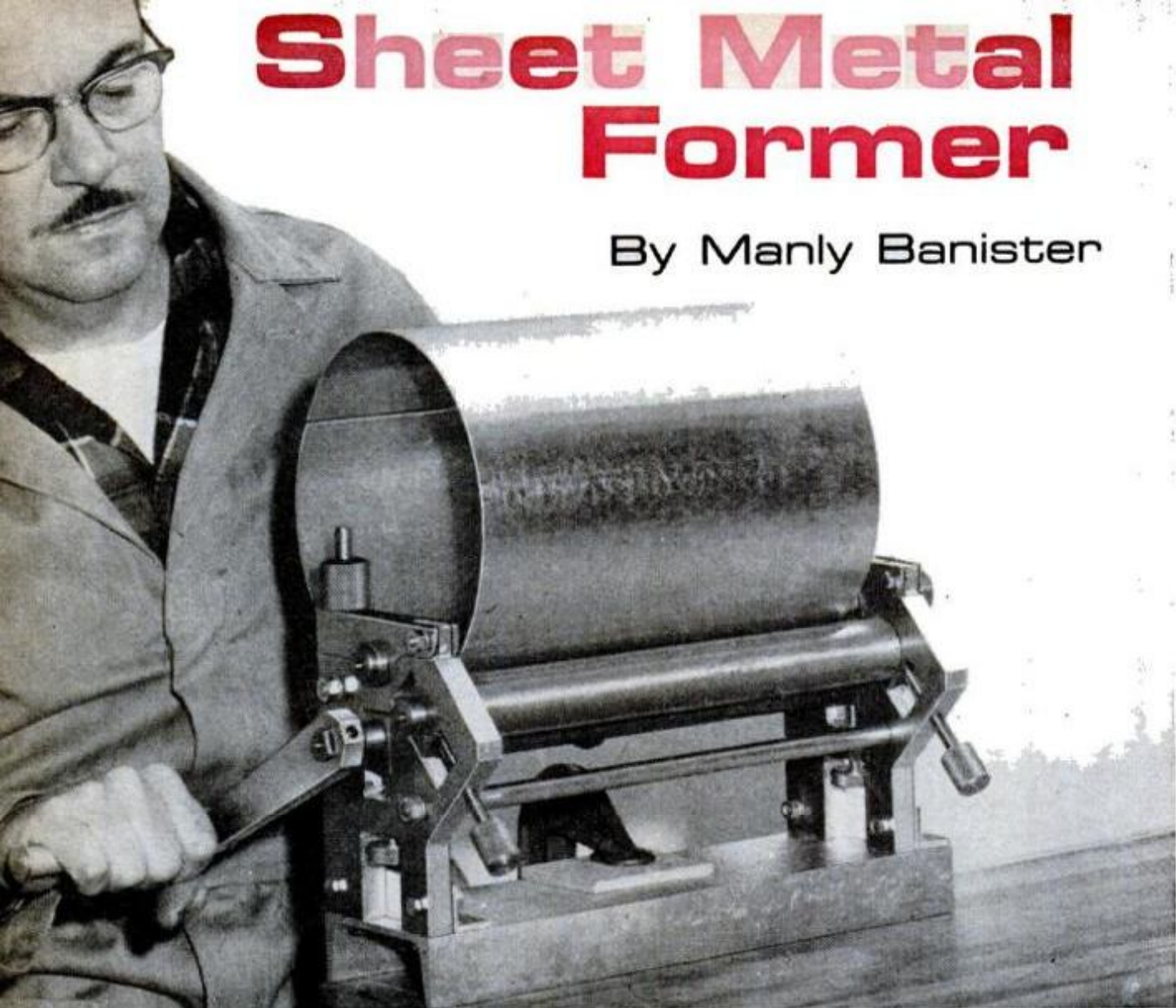

A PERFECT CYLINDER every time, in diameters ranging from copper bracelets to custom-made galvanized tubs—that's what this slip-roll former gives you. It makes a fine school-shop project, although its easy enough to make in your own shop, with minimum machining equipment. The former will handle 20-ga. sheet iron up to the full 12-in. capacity of its rollers, and even heavier gauges in narrower widths, or in copper, aluminum and brass. It's fully adjustable to let you spin out lock-joint, riveted or welded tubing in any diameter from 1 $\frac{5}{8}$ in. up, and makes fast work of such sheet metal projects as garden lanterns and half-round troughs.

Before starting construction, gather all the materials listed on page 195. The 6024-T4 aluminum alloy plate recommended for the ends has a greater tensile strength than steel, yet machines so well that it can be worked with light equipment. The unit shown here was built on a 12-in. lathe with 18-in. capacity between

centers, and a 15-in. drill press equipped with a rotary-table milling vise.

The first step is to mill one side of each end-plate blank square with an adjacent side (the shorter side will become the bottom; the longer, the front). Blue the face of the metal and lay out the pattern by scratching with a scribe. The pattern on page 192 is for the inner face of the left end; just flop it for the right end.

After rough-cutting the bearing-slide sockets as shown in Steps A and B, next page, center-drill the top roll bearing seat, starting with the smallest practical drill (to assure accurate centering) and working up to $\frac{1}{4}$ in. Drill another $\frac{1}{4}$ -in. hole anywhere on the centerline in the waste area between the legs and bolt the plates together, back-to-back, through a grip bar, as shown at D—this gives you something to clamp in the milling vise.

Now drill all the $\frac{1}{4}$ - and $\frac{5}{16}$ -in. holes through both plates. Next, mill out the slide sockets (using a $\frac{3}{8}$ -in. end mill with 1 $\frac{1}{2}$ -in. flutes) to the 1-in. marks through

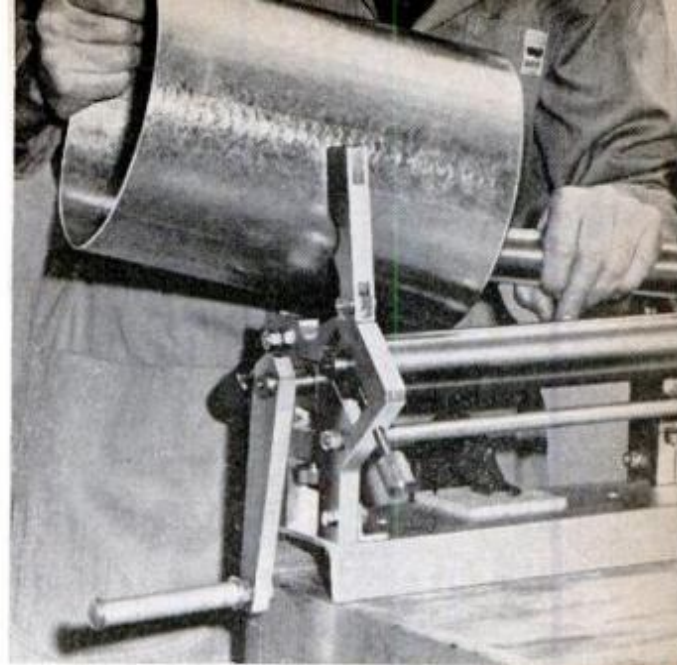
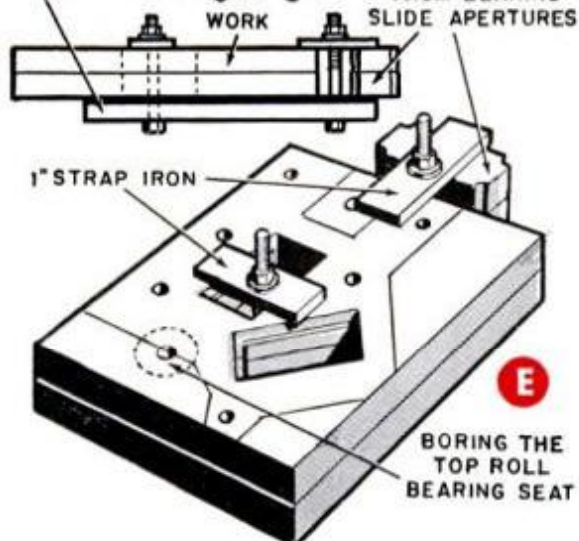
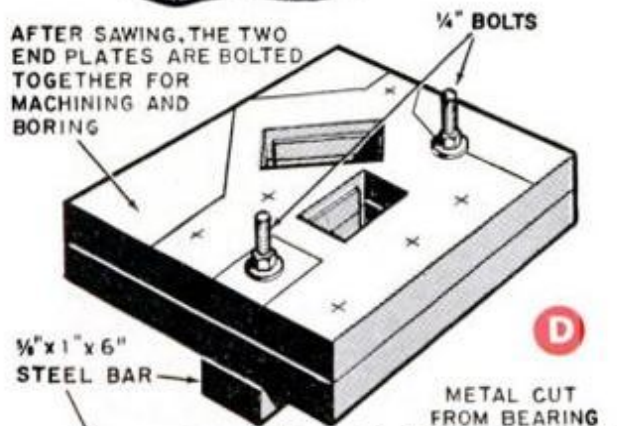
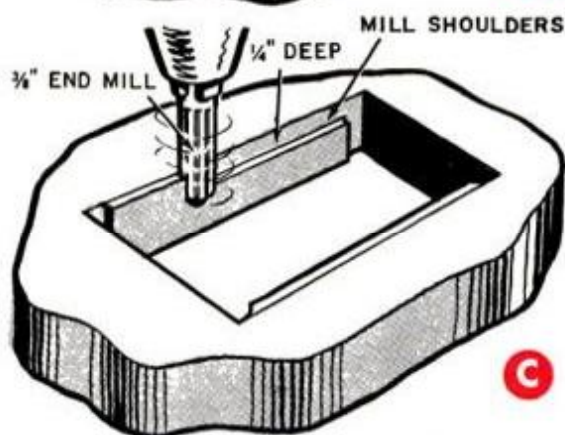
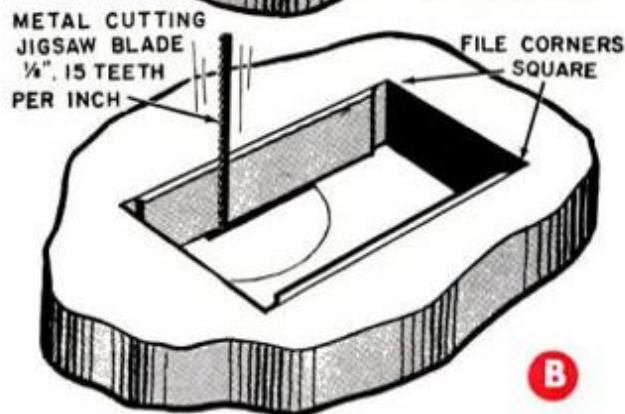
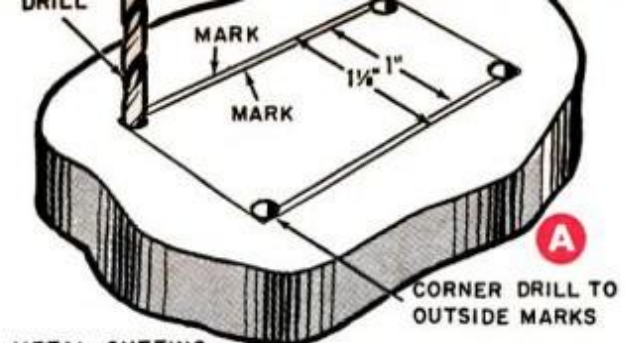

REMOVING FORMED CYLINDER is simple matter of unlocking top roll and lifting one end to slip cylinder free. Note base is clamped (or permanently bolted) to bench so handle overhangs end for clearance

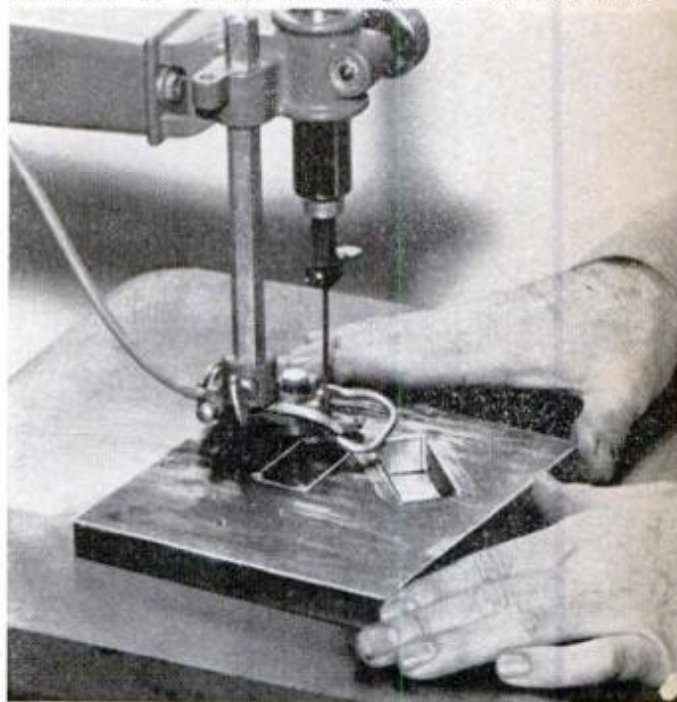

CUTTING BEARING SLIDE SOCKETS

- A** LAY OUT BOTH APERTURES on inner face of end plates as shown next page, then drill corners
- B** JIGSAW JUST INSIDE inner marks, then file or mill sawed edges for precision; square corners
- C** CUT 1/16-IN. SHOULDERS on drill press with work in milling vise to widen socket to 1 1/8-in.
- D** BEST MEANS of clamping both end plates for simultaneous machining: bolt on a grip bar
- E** BEARING SEAT for top roll can be cut in both plates at once by re-bolting bar, using waste

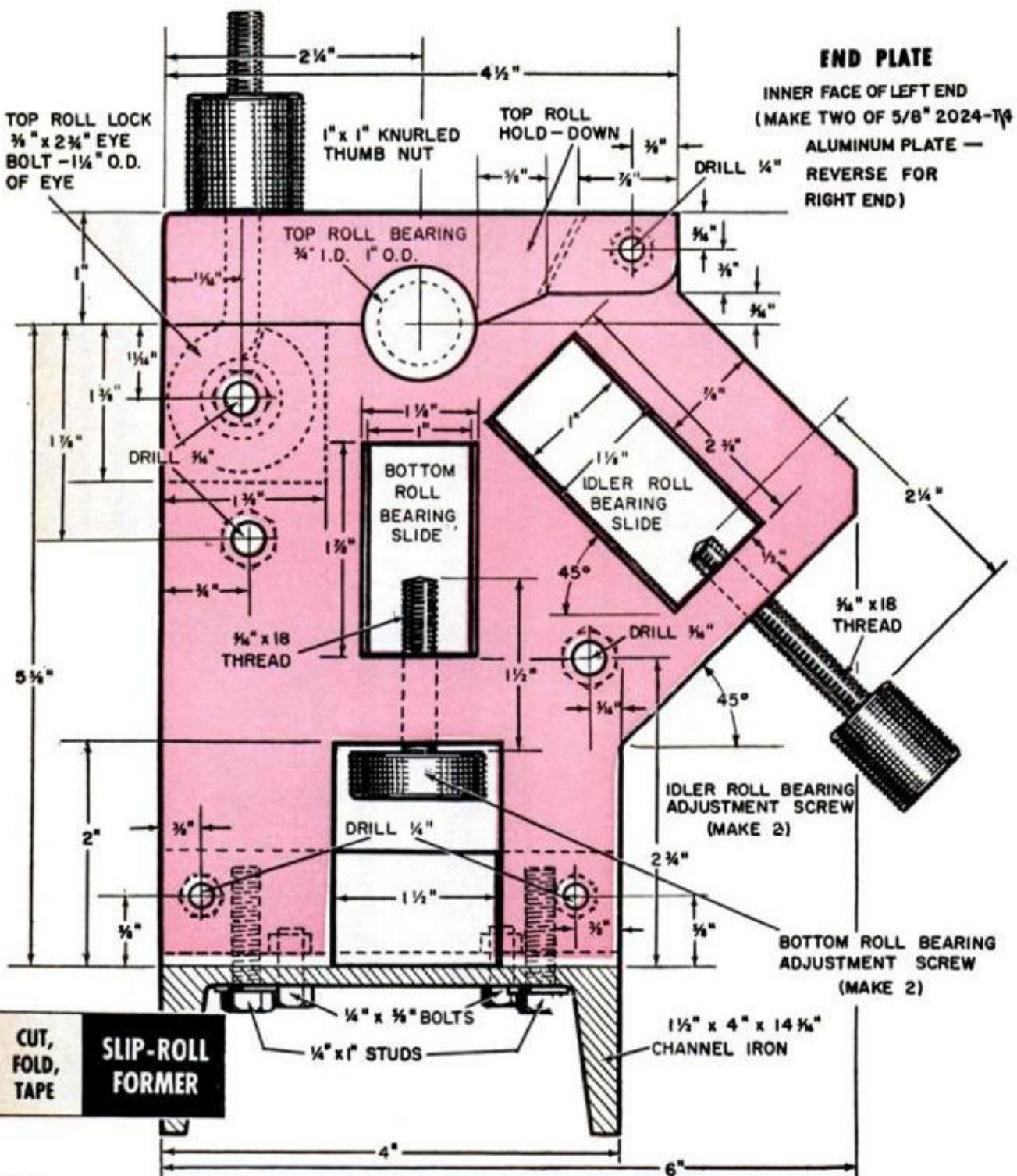

END PLATE
 INNER FACE OF LEFT END
 (MAKE TWO OF 5/8" 2024-T4
 ALUMINUM PLATE —
 REVERSE FOR
 RIGHT END)

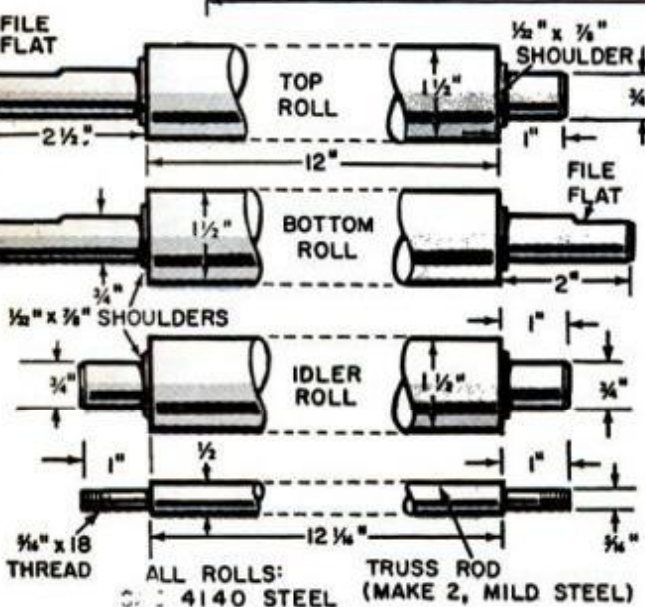

both plates, feeding the work to the cutter with the milling-vise crossfeed. Now mill the shoulder in the top plate's sockets, switch the grip bar to this top face and flip the unit over to mill the shoulders into the opposite face.

Next, re-bolt the plates (sketch E shows one method) to bore and ream the top roll bearing seat. The top of the plate is then sliced away and discarded. Whether you do this with a power saw or a hacksaw, cut through both plates at once. Leave the plates bolted together, also, for sawing the outer shape, then separate for milling the hinge studs and eye-bolt pockets to the dimensions shown at right.

HOW TO FEED THE FORMER

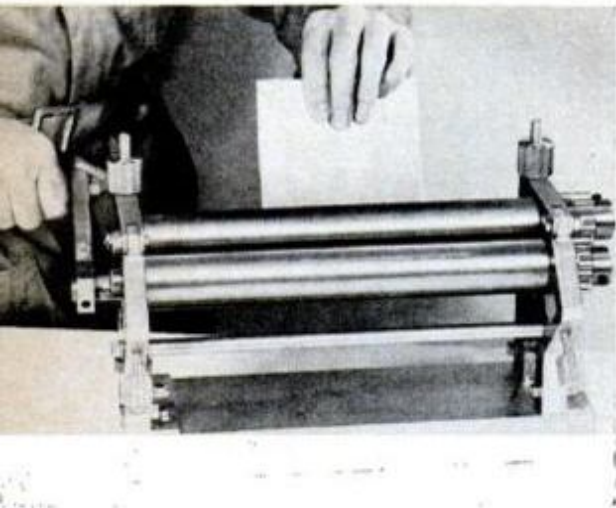

Light Gauge

START IDLER ROLL FIRST, estimating proper position, then feed metal between two front rollers. Bend sheet upward with fingers, as shown in photo and Sketch 1. As you turn crank, metal will feed upward over idler roll by itself, as shown in Sketch 2. If curve is not sharp enough to form full circle, don't work all the way through; turn crank backward to starting position, adjust idler roll upward, then work back through until ends meet each other

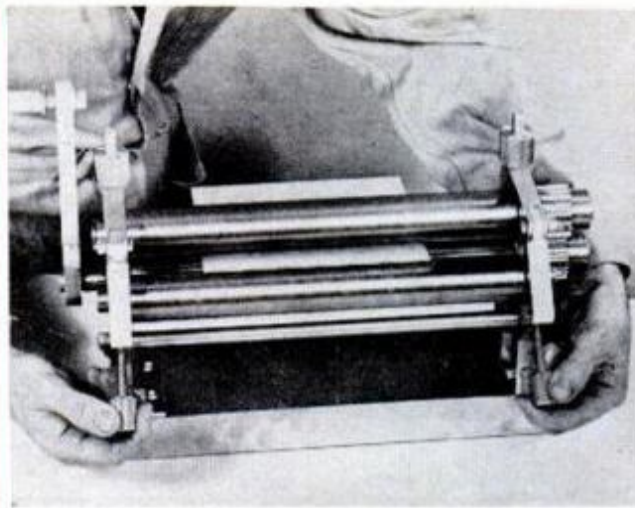
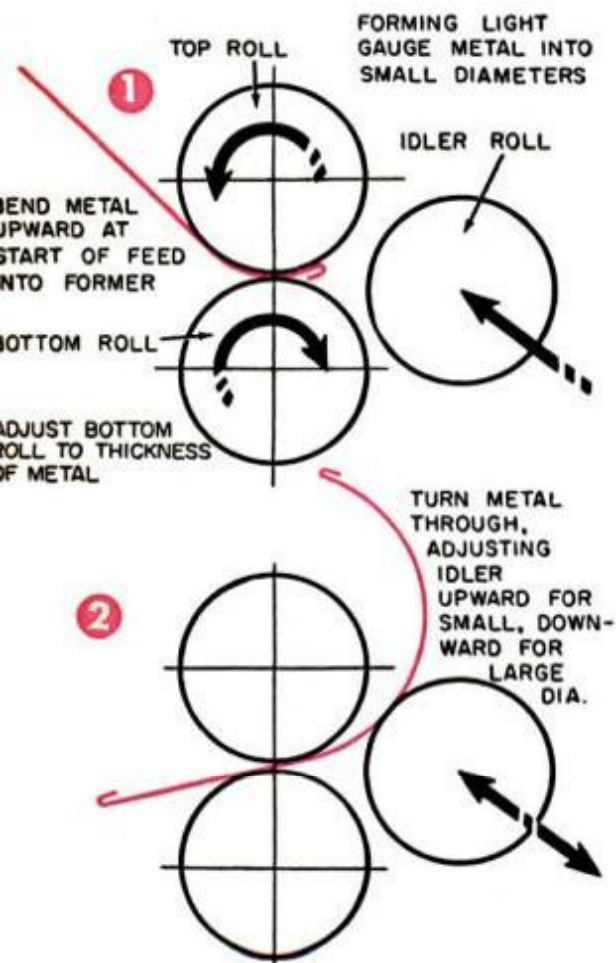

Heavy Gauge

START SHEET THROUGH front rollers until leading edge contacts retracted idler roll. Then raise latter by a few turns of adjusting screws, as shown in photo, and run metal through till trailing edge is about to pass front rollers. Reverse action to bring leading edge back to starting position, then adjust idler up again. Repeat process, turning metal back and forth until idler has reached height that will curve leading edge around to meet trailing one

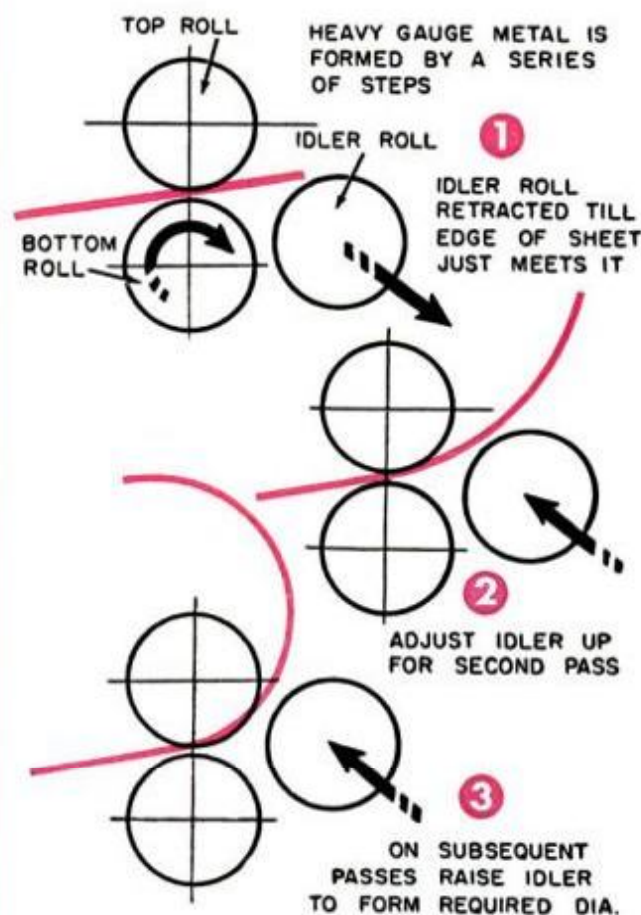

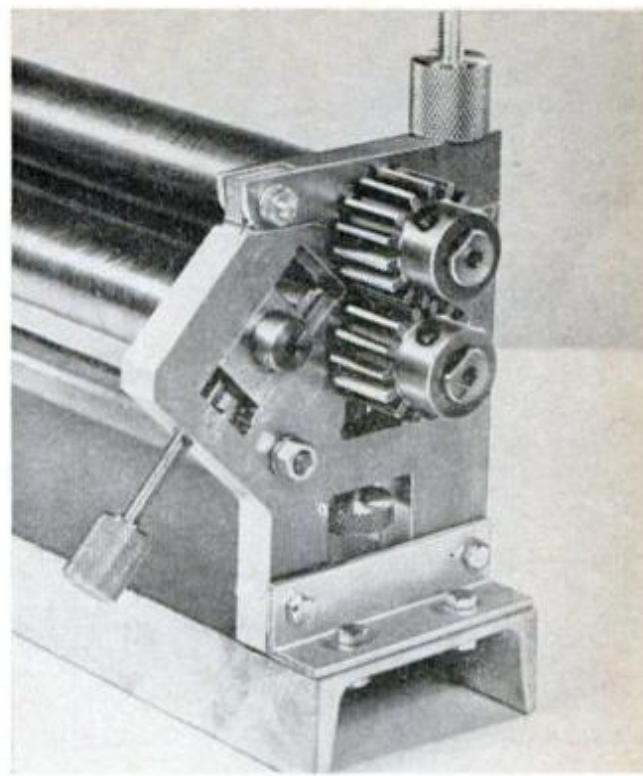
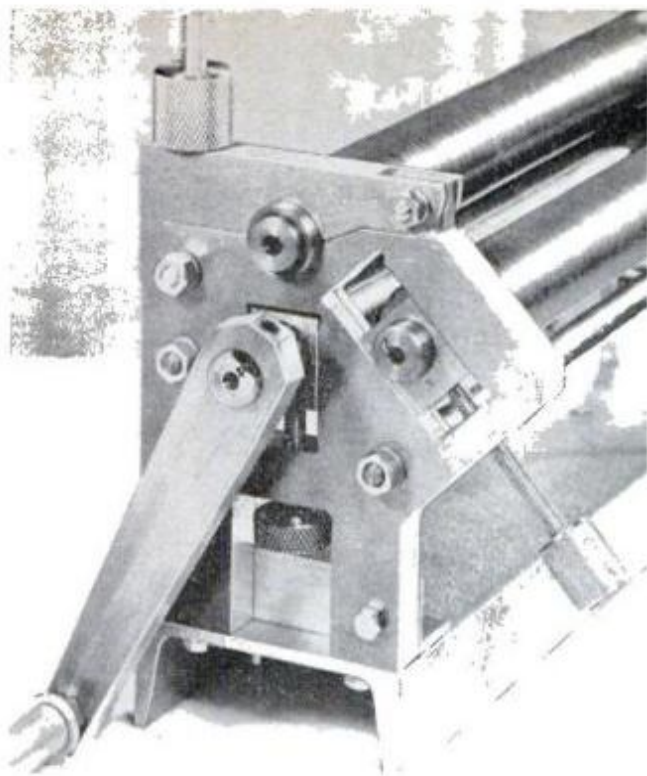

To make the two adjusting screws, fasten the knurled heads to the $\frac{3}{16}$ -in. brass-rod screws by tinning the rod's threads at one end and running the tapped head on while the work is hot. The thumb nuts for the hold-down locks are also knurled brass rod—center-drilled and tapped to fit the eye-bolt threads.

Make the three rolls to the specifications given on page 192; turn them to their maximum diameters ($1\frac{1}{2}$ in.) first, then decrease each end to the shaft diameter, [\(Please turn to page 226\)](#)

Material List

- 2 pcs. $\frac{5}{8}$ " thick 2024-T4 aluminum alloy plate, 6" x $6\frac{5}{8}$ "—end plates
- 2 pcs. $\frac{5}{8}$ " thick 2024-T4 aluminum alloy plate, 2" x $4\frac{1}{2}$ "—top roll hold-downs
- 1 pc. $\frac{1}{2}$ " thick x $1\frac{1}{4}$ " wide x 7" long 2024-T351 aluminum bar stock—handle
- 3 pcs. $1\frac{5}{8}$ " steel rod, SAE 4140, 14", $15\frac{1}{2}$ " and $16\frac{1}{2}$ " long—rolls
- 2 pcs. $\frac{1}{2}$ " mild steel rod, each $14\frac{1}{16}$ " long—truss rods
- 1 pc. $1\frac{1}{2}$ " x 4" x $14\frac{5}{16}$ " channel iron
- 4 pcs. bronze, $\frac{5}{8}$ " x $1\frac{1}{4}$ " x $1\frac{1}{4}$ "—adjustable bearing blocks
- Two eyebolts, bolts, nuts, lockwashers and brass rod as called for in plans
- Two Boston Spur Gears, No. NF-15B, 15 teeth, 1.50 pitch dia.; $\frac{3}{4}$ " bore; 1" face; 10 pitch; $14\frac{1}{2}^\circ$ pressure angle, $\frac{5}{8}$ " hub projection

NEXT MONTH IN SHOP AND CRAFTS



Add a cupola to your garage. More than just decorative, a louvered cupola provides an escape hatch for the excessive heat build-up under the roof. You'll find complete plans for building three different styles in a March craft feature.

Vertical spinning wheel. Fast becoming a collector's item, this reproduction of a rare antique makes it a fine project for the lathe enthusiast and the lover of fine old pieces of another era.

Self-Reading shop gauge. A unique pistol-grip caliper which lets you take any O. D. measurements—even where the workpiece is turning. You'll want to make one to hang by your lathe or workbench.

Get the microphone

The best tape recorder, CB set or PA system is no better than

by Art Zuckerman

A HIGH PRICE TAG is no surefire proof that a particular microphone is just the one you should buy. A superluper high fidelity job, perfect for tape recording, would probably be a horrible choice for CB work, for instance. Even a microphone designed specifically for ham use in a home station can become a cropper if you try using it aboard a noisy power boat or on the road. And even in broadcasting and recording, the pickup that does one job best can be all wrong for another.

So why don't we start out by taking a look at the various kinds of mikes and how they work?

The carbon microphone is a sort of living fossil. Still a highly-respected workhorse in telephone and other communications jobs, it was the pickup used for the very first wireless voice transmissions, and it was the instrument through which entertainment was funneled into the living rooms of pioneer radio owners.

You might call the carbon mike an electrical valve. A button of carbon granules is attached to its diaphragm, and an elec-

tric current is passed through this button. As the diaphragm is pushed in and out by the sound waves hitting it, the granules are alternately squeezed together and released. Since this action changes their electrical resistance, current flow is modified, or modulated, by the movement. The resulting modulated current serves as the audio signal.

Carbon mikes aren't very long on frequency range. Most of them huddle fairly close to a 400 to 4000 cycle spread. This is fine for getting out a clear voice message. Carbon pickups are also pretty efficient, so you don't have to yell to get your point across the airwaves. However, prolonged exposure to vibration can ultimately "age" the carbon pickup and destroy its usefulness.

Crystal and ceramic mikes have a lot in common, including a generally low price tag. This explains their popularity as original equipment shipped with lower priced tape recorders.

More important, they are both piezoelectrics. That's the word for a material that, when twisted, compressed or other-

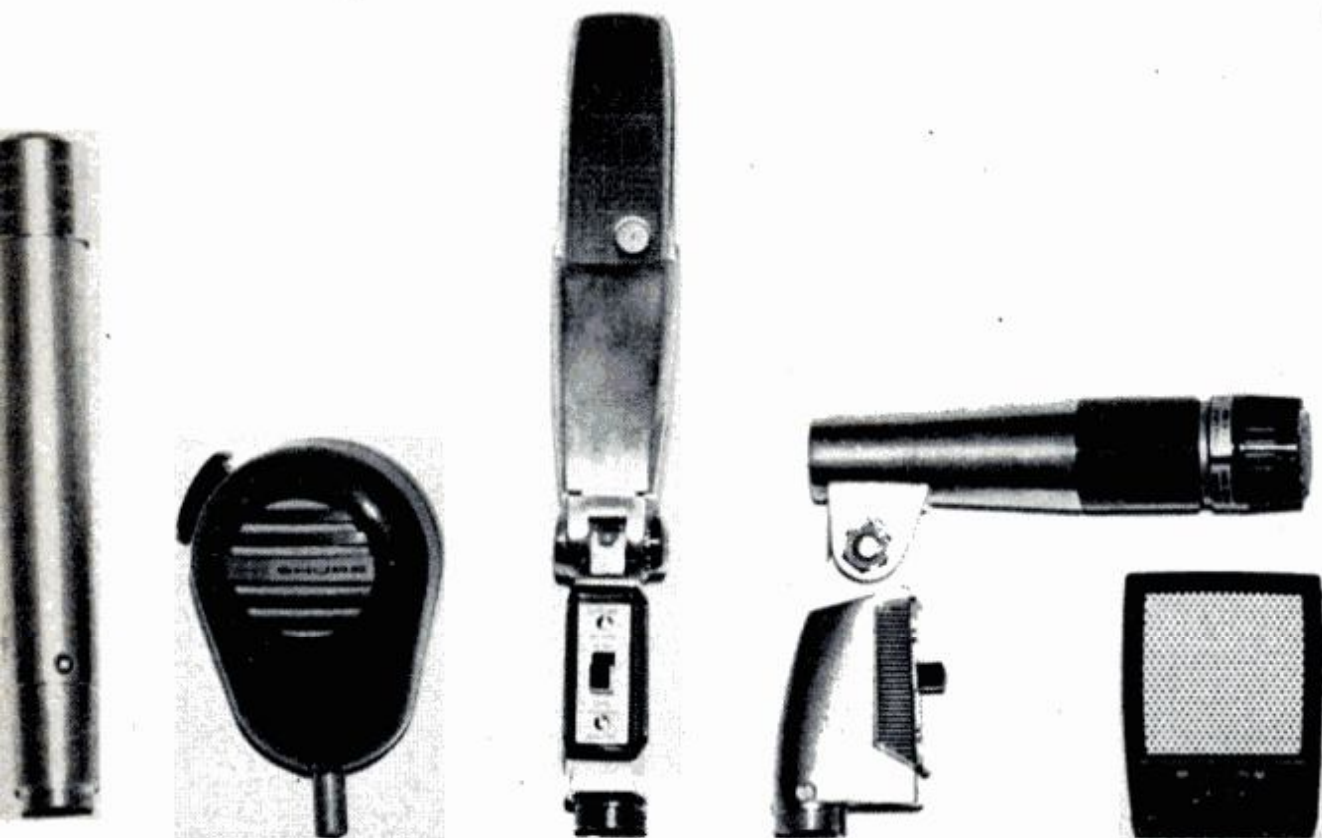

that's right for you

its microphone. Here's how to select the best one for the job

wise tortured, generates electricity. The amount generated is in direct proportion to the degree the crystal is stressed. This talent for changing mechanical energy into electrical form gives piezoelectrics the right to membership in the transducer clan.

A slab of piezoelectric material in a microphone is attached directly to the diaphragm, which pushes it around in response to incoming sound vibrations.

Crystal mikes kick out a lusty audio signal in return for the merest whisper of input, so microphone manufacturers can honestly brag about their great sensitivity. When it comes to tonal range, the best of them can reach as high as 10,000 cycles. But most don't get beyond 7000 to 8000 cycles. And it's a rare crystal that doesn't favor certain frequencies over others, a characteristic that creates some degree of tonal coloration. Furthermore, crystal mikes don't take kindly to rough handling, and extreme heat or humidity can ruin them.

Ceramic mikes get around the heat-humidity barrier, and they aren't quite as likely to bruise from physical shock. Some

even manage to capture tones well above 10,000 cycles. But they aren't quite as sensitive as crystals.

By far the most popular kind of microphone sold today is the dynamic, also known as the moving-coil microphone. Essentially, it is a permanent-magnet loudspeaker in reverse. A coil of wire is attached to the microphone's diaphragm. As the diaphragm moves, the coil glides back and forth through the field of a permanent magnet. Now any conductor suddenly finds itself carrying an electrical current when it is moved through a magnetic field. The varying current thus produced in a dynamic mike is the audio signal.

Dynamic mikes come in all sizes, shapes, and price categories. They can be made to cover the whole range of audible sound, or they can be restricted to a rather limited frequency range. While a shade less sensitive than piezoelectrics, they are very, very rugged and completely unaffected by heat or humidity.

Dynamics cost more than piezoelectrics, but this price difference has been trimmed steadily in the past few years and some



Moving coil dynamic mike

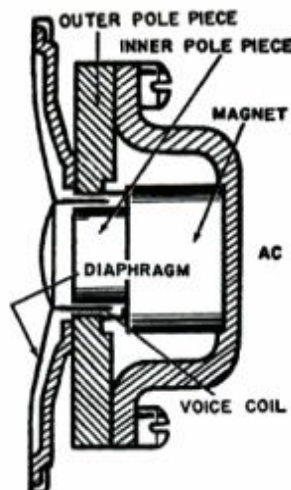

MOST POPULAR mike made is the dynamic, which is extremely rugged and not a bit affected by heat or humidity. It can be tailored to fit any frequency spectrum

Crystal mike

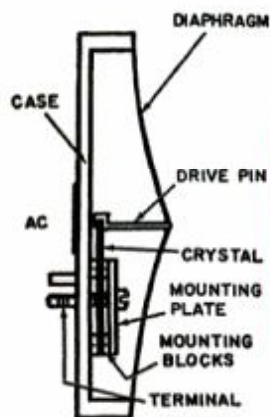

LEAST COSTLY of all is the crystal mike, but severe disadvantages come with it. Heat and moisture can ruin it in very short order, and it is easy to damage in use

better home recorders now come with less expensive dynamic models.

For years ribbon microphones were a mainstay of the networks. They are similar in operating principle to dynamics. But instead of a diaphragm and coil combination, they merely have a corrugated ribbon of electrically-conductive metal foil suspended in the field of a permanent magnet. When sound waves make it vibrate, the audio signal is generated within the ribbon diaphragm itself.

Because it has little mass, the ribbon mike is exceptionally compliant and responds to each nuance of sound, translating it directly into an audio signal with the greatest fidelity.

Unlike their dynamic cousins, ribbon mikes are usually open on both sides. Performers can be grouped on either side of this instrument, so one mike can do the

work of two with the greatest of ease.

Unfortunately, the ribbon microphone's great delicacy of response is matched by an even greater mechanical delicacy. Many a ribbon element has been ruined because a microphone boom rig was pivoted too rapidly through the air by a studio crew. Ribbon mikes are seldom used outdoors, where they can be undone by a strong wind. And ribbon microphones don't come cheap.

Another expensive pickup is the condenser microphone. Like the quite-different carbon mike, it requires its own power supply. Just as a dynamic mike is the mirror image of a PM speaker, the condenser mike is sort of an electrostatic speaker, backwards.

Its diaphragm is actually one of a condenser's two plates. A change in position of the diaphragm alters the capacitance of

Controlled reluctance mike



RIBBON MIKE with an alias is what this type unit is. It is excellent where exacting frequency response is a must. However, such a unit can be quite expensive

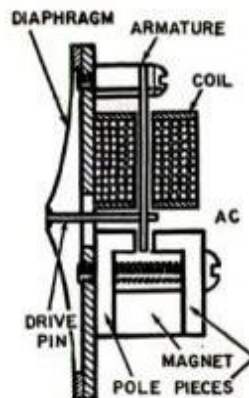

Carbon mike

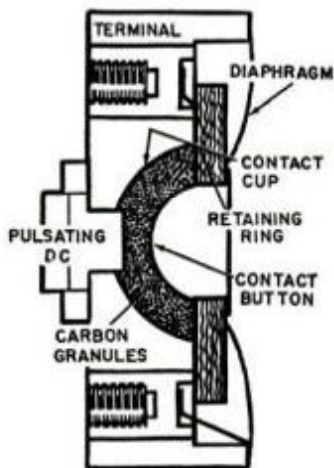

WORKHORSE of the microphone world, the carbon mike is used in the telephone. For general-purpose work, it's rapidly being replaced by dynamics

the instrument. The constantly-changing capacitance creates the audio signal, but this signal is so weak that it needs the help of a preamplifier, which is part of the microphone system.

The condenser mike is possibly the truest of all to original sound. It is the choice of many pros who must have perfection. Some current models are surprisingly compact, but they sport hefty price tags.

Beware the 'perfect mike'

When shopping for a mike, make absolutely certain you know what the merchandise you're shown really is. A fancy-looking case may actually conceal a cheap, low-performance crystal pickup.

Above all, watch out for the salesman who shows you *the perfect microphone* for any and every job. It doesn't exist. Beware of oversell, too.

If you want a mike for a battery-portable recorder, for example, there's no sense in buying a fancy ribbon mike that can't take a beating and gives you more frequency range than you can use.

Then there's the joker who tells you a microphone is superterrific because it is so fantastically sensitive that it will pick up anything. This is virtually the hallmark of all lower priced mikes, especially when you're working with equipment that has a rather insensitive mike input. But *it is not* a quality hallmark.

As a matter of fact, you may discover that the high-quality mike you want for a modestly-priced recorder lacks the necessary output. So always check input sensitivity of your unit and output voltage of the microphone you choose. Sometimes it may pay you to invest in a microphone preamplifier. In that event, you will at



TALK-AROUND lavalier mike hangs on a neck cord. Convenient when mobile hands-free operation is a must. Talk normally.



PUSH-BUTTON on hand-held mike is a help when you're using a tape recorder and a must with a radio transmitter. Makes possible instant cutoff without having to reach for switches.



GOOSENECKS fit most any mike. Ideal at fixed locations used by several different people. Makes for convenient flexible adjustment to most any level or position your needs might demand

MATCHING THE MICROPHONE TO THE JOB

Microphone Type	Job	Advantage
Carbon	Communications (especially mobile)	Good voice clarity, low cost, good output
Crystal	Communications, recording, limited frequency broadcasting, PA	Inexpensive, high output, possible fair quality in non-shock situations
Ceramic	Communications, recording, limited-frequency broadcasting, PA	Inexpensive, high output, less susceptible to shock, climate problems than crystal
Dynamic	Communications, recording, broadcasting, PA	Wide price range, capable of high-fidelity performance, extremely rugged
Ribbon	High-quality recording and broadcasting (studio only)	Superb frequency response, inherent directional control, ability to group performer on both sides
Condenser	High-quality recording and broadcasting	Top frequency response, fairly rugged
Omni-directional	General applications	Broad-area pickup
Cardioid	Public address, broadcasting and recording	Highly directional, providing feedback control, pronounced stereo effects, noise and reverberation control
Noise-canceling	Communications (especially mobile)	Maximum speech clarity under adverse conditions

at least get the benefit of a superior pickup. Now for the \$64 question. How do you know the microphone you select will really be the right one for you?

In-store tests to try

In this day of the tape recorder, the answer is in-store testing. If the shop is fairly substantial, chances are it has at

least one recorder on display with a mike input that suits the instrument you're ogling.

You can also be reasonably sure that a high-fidelity system is available to help in the testing process. Here are some things you should do.

If you're trying a noise-canceling mike, *(Please turn to page 224)*

*Great new taste,
rich aroma...
pipe tobacco does it.*



**Enjoy America's best-
tasting pipe tobacco
in a filter cigarette!**

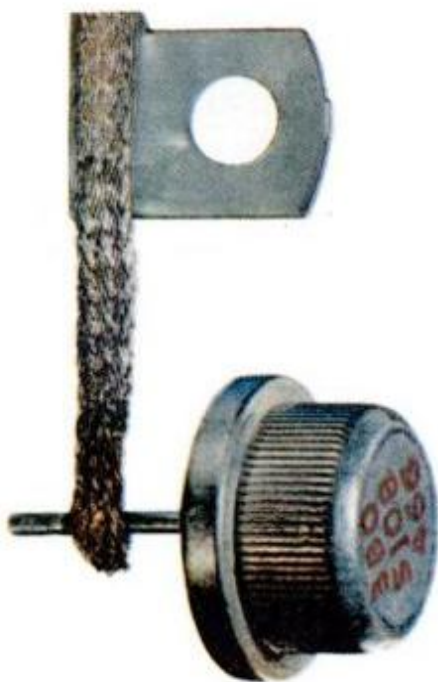

**This is a GM Original:
It works like
an electrical check valve.**

General Motors rectifying diodes—three positive and three negative—change the alternating current from a high-output Delcotron generator to the direct current used in the electrical systems in today's cars and trucks.

And the GM Replacements look, work, and are just like the GM Originals.



**This is a GM Replacement:
Check.**

Good parts and good service go together. So always replace GM Originals with Genuine GM Replacements.

Go where you know they use Genuine General Motors Parts. They're available all over the country, wherever you see the distinctive GM and United Delco packages. Check.

GENUINE GENERAL MOTORS PARTS



CHEVROLET • PONTIAC • OLDSMOBILE • BUICK • CADILLAC • GMC TRUCKS

United
Delco



Bronco:

new kind of
sports car!



NEW 4-WHEEL DRIVE Bronco takes you where the action is. Deep into woods for hunting, through snow to good skiing, over sandy beaches to where the fishing is best. Plenty of oomph from a smooth six-cylinder powerplant and 4-wheel traction take Bronco wherever you dare to drive it. Transmission is fully synchronized for smooth downshifting. Bronco is a great performer on the road too. No annoying whine in 2-wheel drive, even at highway speeds. You get a soft, sedan-like ride from Bronco's rugged Mono-Beam coil-spring front suspension. Try the Wagon, Roadster or Sports Utility at your Ford Dealer's now. One's just right for you.



New
fun one
from **Ford**

ESCAPE is a Chevy Custom Camper!



Here's a most practical way to make life more enjoyable for yourself and your family: Get a Chevy Custom Camper pickup that's specially equipped for outdoor living. You can use it for work with the camper body detached, then quickly mount your camper body and head for the great outdoors. It's simple and easy. You don't have to phone ahead for reservations or worry about

where you're going to sleep or eat. Free as the breeze, you go where you want, stop when you like. And come home refreshed. You'll find it doesn't cost much, so you can do it often. So why not do it?—see your Chevrolet dealer about the fun of owning a Custom Camper.... Chevrolet Division of General Motors, Detroit, Mich.



WINTER TUNE-UP

(Continued from page 173)

to good performance, yet most cyclists shy away from this job. I don't know why, because timing is easily done with a timing disc, obtainable for about \$3 from the shop that sells your make of bike. It comes complete with a booklet of easy-to-follow instructions. And it pays to do your own timing. Cycle shops charge up to \$10.

□ Check the sparkplugs. In fact, play it safe and replace 'em with new ones.

□ Check the coil and secondary wiring. The easy way to do this is to ground a plug and crank the engine. A fat spark should jump the plug gap. If it doesn't, you know you have a bad or loose wire, or a bad coil.

□ Check valve adjustment—with the plugs out. Shift into top gear, then turn the engine over manually until the valves farthest from you are wide open. Then adjust the valves nearest you with a feeler gauge. Generally this adjustment will be from 2/1000ths to 4/1000ths of an inch.

Turn the engine again until the valves nearest you are open all the way, then repeat the adjustment procedure on the remaining (now-closed) valves.

Compression test by ear

□ Check engine compression. You can do this yourself if you have a compression tester. Good compression is 160 pounds in both cylinders. If you don't have your own tester, you can get a pretty good idea of the internal condition of your engine by using your ears:

Start the engine and let it warm up. Get it to a slow, smooth idle, then place a gloved hand lightly over the end of the muffler to drown out exhaust noise. Now listen carefully. A regular tick-tick-tick sound might mean a worn wrist pin—not too serious. It could also indicate a piston slap, which is a major ailment.

To determine whether it's the piston, advance the ignition—if this is possible on your make cycle—and look at the exhaust; a lot of smoke indicates back pressure past the piston. Also, run your hand beneath the lower part of the engine. Oil there could indicate back pressure.

Retard the ignition. Both wrist-pin noise or piston slap will disappear if either of these are your problem. If ticking persists, suspect the valves. However, a deep booming knock coming from inside the engine is likely to be a connecting rod, and this will *not* disappear by retarding the ignition.

An engine that rumbles and sounds very rough generally means worn main bearings. If you can rule out worn bearings, look for a too-tight primary chain. ★★

Brand new leader in value and features!

MARKSMAN

Pencil Soldering Iron

by *Weller*

- Extremely light in weight.
- Highly efficient.
- Stainless steel barrel has long reach.
- Maximum tip temperature is 750°F.
- 1/8" diameter tip is replaceable—gets into tight places.
- Screwdriver, chisel and cone shaped tips available.
- Handle remains cool, resists breakage.

Get a MARKSMAN Pencil Soldering Iron or complete kit at your hobby or hardware dealer.

MARKSMAN IRON with screwdriver tip and cord in vinyl pouch. Model SP-23. \$2.98 list.

MARKSMAN KIT with iron; screwdriver, cone and chisel type tips; soldering aid and solder. Model SP-23K. \$4.44 list.



WELLER ELECTRIC CORP., Easton, Pa.
WORLD LEADER IN SOLDERING TECHNOLOGY

HOME FREEZER

(Continued from page 141)

24 to 30 inches in width, depending on model and brand, and thus eliminate that much cabinet space.

Having found space, make sure you can move the freezer into it. A too-tight door or stair turn can give trouble. And make sure that a right-hand door—the latch is to the left as you face it—will work out. Only some deluxe models offer choice of door-opening direction.

When it comes to a choice between upright and chest, the average housewife votes for the upright. It resembles a refrigerator, so is a familiar-looking appliance, and is easier to use. Food is stored on the inside face of the door as well as on the shelves and is easier to see and handle. Defrosting takes less effort.

The chief merit of the chest—a big box with a lid on it—once was its low price. Until recently, a chest could be \$100 or more cheaper than the same size upright. But with the sales volume of upright freezers well above that of chests, upright prices have come down to nearly the same level as chests.

There are reasons for owning a chest freezer, some users feel. For one thing, since the food is piled in one heap, most of the capacity is used. For another, the chest's operating expense generally is lower. And, of course, what price advantage there is favors the chest-type freezer.

Finally, in choice of types, there is the combination refrigerator-freezer. Since it essentially is a refrigerator with an over-size freezer section, it appeals to the small family, whose needs are minimal, or to the family having no room to spare.

Frost-free unit

Current deluxe upright freezers have a new feature that has a lot of appeal—frostless operation. This one is the salesman's bell-ringer, whether or not it is actually worth any price differential to avoid four to six defrostings a year.

There are advantages, however. Packages are never frozen together nor does frost obscure labels. No space is lost to layers of ice.

The standard unit freezes by more-or-less direct contact between the food and the freezing coils in the walls and top. Chest freezers make do with coils in the walls only. The system that has made frostless freezing possible is called the circulating air freezer. No coils are in contact with the food or in the walls; the chill comes from the air.

Here's how it works: There is a baffled false rear wall, one heavy freezing coil

and a small fan. Ordinarily, the fan is in the top of the false rear wall and blows into the food compartment. Behind the wall is the coil. The fan pulls air up through the wall and across the coil, which chills the air. The fan runs most of the time, and the system, if properly made, will hold an interior temperature of 0° F.

To make this frostless is simple. All the frost gathers on the freezing coil. At regular intervals, everything stops while a heating element that's activated by a time switch melts all the frost off the coil. The water is piped to an evaporating pan.

Cost of operation

In terms of operating expense, there is some difference between the various types. The chest freezer does not lose a great deal of cold air when opened, thus doesn't have to work hard to stay chilled; it is the most economical. The contact-freezing type is next in expense. The most costly to operate is the no-frost type since something (the fan, freezing coil, heating element) is almost always drawing current.

Meaningful figures are hard to come by. But a power company engineer put it this way: "If it costs you \$2 a month to run a 17 cu. ft. chest freezer, a 17 cu. ft. upright contact-type will run \$3.50 and a frostless about \$6."

Inevitably, when comparing types and models of freezers, the question of size comes up. All makers have the same yardstick, so use it. NEMA (National Electrical Manufacturers Assn.) Net Capacity is in cubic feet. This is supposed to allow for the space that fittings and shelving take up. NEMA Storage Capacity is in pounds, using a more-or-less standard mixed load. NEMA Net Shelf Area is in square feet. You'll find these designations in catalog literature, and often attached to the unit on the sales floor. There are probably not 19 usable cubic feet of storage in the 19 cu. ft. freezers, but there will be about the same amount of storage space in all the freezers described as being 19 cu. ft. in capacity.

There aren't any surprises in freezer fittings. The various brands seem to have pretty much standardized their buying. Inside the boxes, there is less flimsiness than there used to be. Shelving and braces are soundly constructed in most models.

Interiors are porcelain, aluminum, or enamel over steel. As with other appliances, porcelain is best. A freezer that frosts is next best with an aluminum interior—if the inside surface is scraped during defrosting, aluminum won't damage as enamel will.

There are three kinds of insulation now

(Please turn to page 208)

DISSTON

"Diss-Chrome" Circular Saw Blades

have an edge on them all



"Diss-Chrome"® circular saw blades make any home workshop project easier. Cuts are cleaner and faster; work goes together neater.

There is a Disston "Diss-Chrome" blade style for any kind of cut—rip, cut-off, combination, planer, flooring and a special plywood blade. All popular sizes available with universal arbors for use with most bench or portable saws. Each

blade is hardened, tempered and chrome-plated to provide extra long life. Blades are individually packaged.

Add to your ability with Disston "Diss-Chrome" blades. Your hardware dealer stocks them and will help you select the right blade for your job. Or write: Hardware and Industrial Products Division, H. K. Porter Company, Inc., Porter Building, Pittsburgh, Pa. 15219.

Look for this new Disston Saw Blade Center at your dealers. It contains a full line of Disston quality circular saw blades, hack frames and blades. If your dealer doesn't have the blade center, ask him to order one for your convenience.

PORTER HARDWARE AND INDUSTRIAL PRODUCTS DIVISION
H. K. PORTER COMPANY, INC.



DULL FILES IN YOUR BASEMENT GIVING YOU NIGHTMARES?



REPLACE THEM WITH CLEAN, SHARP, LONG- LASTING, EFFICIENT NICHOLSON FILES, AND SLEEP NIGHTS.

Send for your free copy
of the filer's handbook,
"File Philosophy."

NICHOLSON
U.S.A. **NICHOLSON** **BLACK DIAMOND**
U.S.A.

Nicholson File Company, Providence, Rhode Island
Files • Rotary Burs • Hacksaw and Band Saw Blades
Hole Saws • Ground Flat Stock • Industrial Hammers

HOME FREEZER

(Continued from page 206)

used in freezer walls. They all do a job; you just need more of one than another.

The old standard—expanded fiberglass—makes for a 3 to 4-inch wall. A compressed fiberglass combined with a plastic foam material like polyurethane mat makes for the medium, 2 to 3-inch wall; and the thin walls, from 1 to 2 inches thick, have polyurethane plastic insulation which is poured in as a liquid, gets a shot of activator and promptly bubbles up to fill the cavity.

Of course, the slimmer walls make a difference in capacity. In some brands, the same outside box is differently trimmed, furnished with an appropriate liner and comes out 13, 15 or 17 cubic feet inside, depending on the type of insulation. There is often a price difference involved: thinner walls cost more. But there is no proven practical difference in use between insulations when each is used properly.

How about service?

Though freezers aren't foolproof, they don't offer much of a service problem. The standard warranty on everything but the refrigeration system is one year, and it should cover both parts and labor. The basic system—freezing coil and compressor—is guaranteed for five years by the manufacturer. Most brands offer a guarantee against loss of freezer contents due to an "act of God" power failure or from mechanical failure of the freezing unit. All such guarantees should be plainly stated in the sales contract or in a separate contract.

In shopping for a freezer, you have to plan to spend somewhere between \$150 (or slightly less) and about \$400. In the low end, under \$200, are 10 and 12 cu. ft. models, largely non-fancy except those built to match refrigerators. Undercounter freezers of small capacity and small chest freezers also come in this price bracket.

Between \$200 and \$250 are the plain contact-type jobs in sizes from 12 to 17 cu. ft. From \$250 to \$300 buys frostless freezing in relatively plain models, and contact freezers in big sizes and fancy features. Over \$300 buys either monster contact units or fancy frostless units. In some brands, under \$350 will get you a 16 or 18 cu. ft. no-frost model with library-type shelf adjustment, half-width shelves, icemaker, choice of color and choice of door-opening direction.

Plain or fancy, there's probably at least one deepfreeze on the market that will suit your taste, space requirements and pocketbook. ★★★

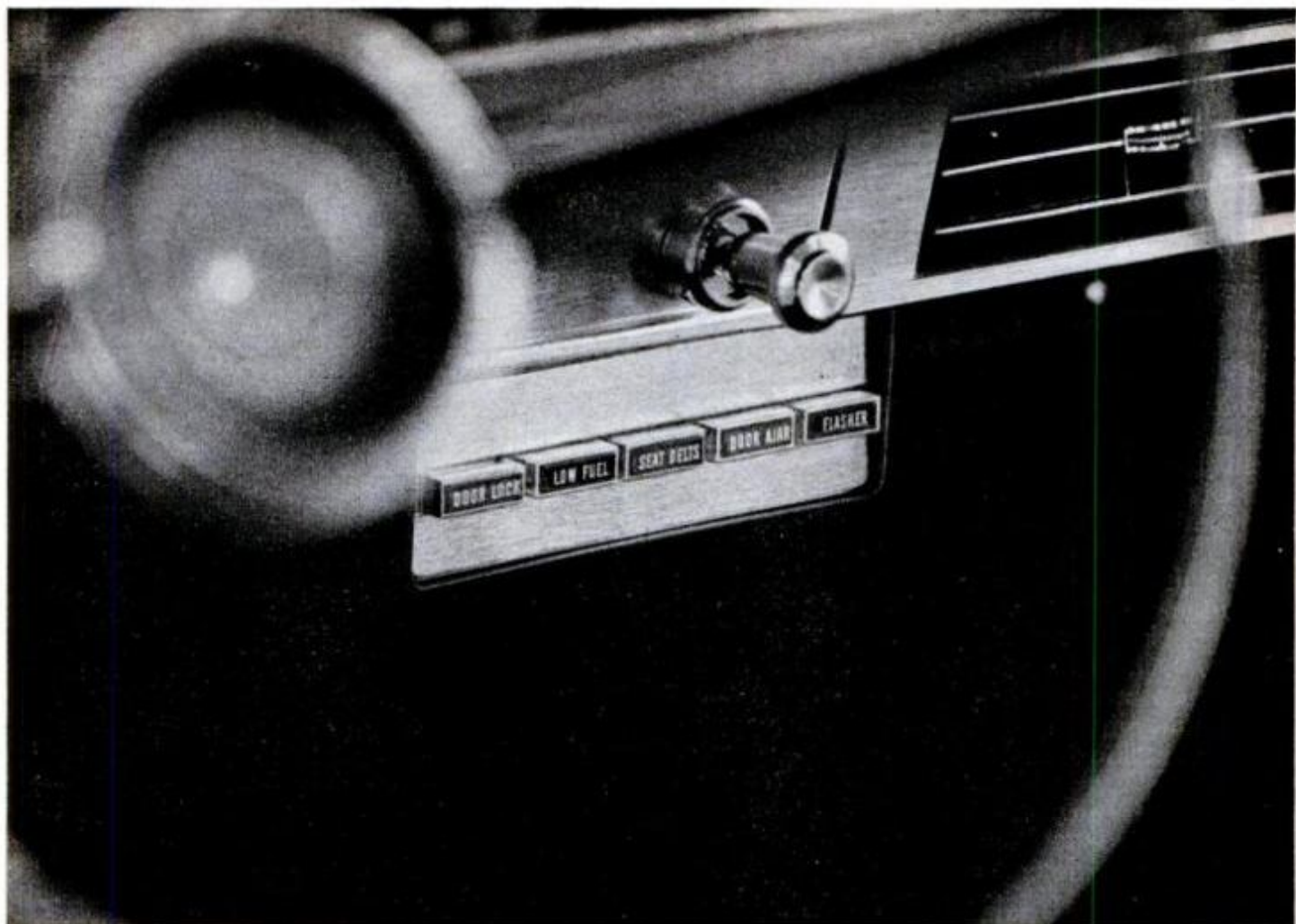

Data Control Center for drivers

"Fasten seat belts, sir!"

"Roger!"

"Secure all door locks!"

"Roger!"

"Fuel is low, sir!"

"Roger! We'll stop at the first gas station."

You can't always drive with an alert, infallible co-pilot . . . but now Ford offers a practical alternative, a "co-pilot" that goes on duty instantly every time you switch on the ignition. It is

Ford's optional Safety-Convenience Control Panel. This miniaturized 2 x 6 inch "data center," jeweled with warning lights and control buttons, mounts immediately to the right of the steering column for high visibility and easy access. What does this automatic control panel do? The first button, on the left, locks or unlocks all doors in a single operation. The second button flashes when the fuel is

low. The third button lights up to remind you to fasten your seat belt. The light in the fourth button warns you when a door is ajar, and the fifth button simultaneously flashes front and rear turn signals when you stop for emergency road situations.

Test drive a new Ford, with our automatic co-pilot on board. See if it isn't a tremendous improvement over a back-seat driver. 



SHUT THE WINDOWS!

(Continued from page 139)

fire control in mines by safety experts in England. Reading a report about it in a mining journal in 1952, Will B. Jamison, a Pennsylvania mining engineer, wrote for full details. Study of the method convinced him that further refinement could not only improve the technique for mine protection, but also make it valuable for general firefighting.

Two years of extensive experimental work with the U. S. Bureau of Mines achieved the former objective. Among other things, no less than 400 different surfactants were tried before the ideal foaming agent was found. And in this period two big mine fires were fought with outstanding success.

Then, forming the Safety Development Corp., Jamison devoted another six years to research and development before he felt ready for the general firefighting fields. In August, 1964, the SDC patents and production methods were acquired by the fire protection firm of Walter Kidde & Co., with Jamison in charge of operations.

Now available in fixed installations, or in portable and mobile equipment, the new system has won wide favor in industry. And even the Atomic Energy Commission is installing a Hi-Ex deluge system in its Lawrence Radiation Laboratory, Livermore, Calif. The system is designed to flood, in minutes, the entire area from floor to ceiling without damage to the millions of dollars worth of electronic equipment, the reactor itself or any personnel involved. The last is vital to people who may be caught in an automatic discharge of the foam, or are forced to seek refuge in it, for the suds form a mighty barrier against the lethal heat and toxic smoke of a blaze. And since each bubble, breaking upon contact with your face, contains air with 21 percent oxygen, breathing is no problem.

The speed with which the foam builds up to required depths is a little hard to visualize. But a major Pittsburgh corporation has a two-unit fixed installation in its hanger for executive planes. And these units can flood that 27,000 square-foot building to a depth of 19 feet in less than 7 minutes. This is an output of 90,000 cu. ft. per minute.

The tedious cleanup operations of conventional firefighting methods are re-

duced to a minimum by this type of foam. For one thing, the enormous volume of suds remaining after a fire is out will "decay" in a few hours. Or it can be blown out of the building much sooner by the same fans which blew it in. A cursory sweeping or vacuuming will then suffice, often leaving the premises cleaner than before the fire. For this is a detergent.

The method's exceptional frugality with water makes it particularly useful not only where sensitive electronic equipment is involved but also for grain elevators, record storage facilities, printing plants, supermarkets, museums and libraries. It is also "the method of choice" where fire is beyond the reach of hose streams; where an explosion hazard exists; or where high-piled stock, machinery or partitions hinder the penetration of water streams. It is well recognized that when firemen cannot gain entry to a building for any reason, they are licked. And this is exactly the situation prevailing in over three-quarters of our large-loss fires where belated discovery has allowed the building to become heavily involved before firemen are called.

Seeks heart of the fire

Then their sole hope is to pour thousands of tons of water in from the street, 75 percent of which is totally wasted in runoff that never reaches the blaze, but cascades back to the sidewalk. Now, without trying to enter the building, the man can direct the foam to the hottest part of the fire, where it will accomplish something.

Once there, the water content of the bubbles is converted into steam, expanding 1700 times in volume. This terrific expansion forces air out of the area until the oxygen content is less than 7.5 percent, or well below the ratio that will support flame. This is the smothering effect.

Simultaneously, the conversion of water into steam consumes so much heat that the fire is quenched. This is understandable from the fact that one gallon of water will consume 1250 B.T.U. in raising its temperature from 62° to the boiling point. But in the instant it changes from boiling water to vapor, it uses up another 8080 B.T.U. This is what is meant by the "cooling effect" of water on a blaze: the conversion breaks the fire's back.

Although Hi-Ex is at its maximum efficiency in enclosed areas, a mobile unit, carrying its own water and discharging

(Please turn to page 212)

Don't buy batteries—Save \$—Recharge them!

over and over up to 15 times or more
the **EVERLITE**—the best
charges more
than all the rest.

Only the New **EVERLITE**

- Charges 6 at one time.
- Charges 3 times faster.
- Charges all batteries.

Be prepared. Always have fresh batteries when you need them. The **EVERLITE** is the only charger made which charges all batteries, flashlight, lanterns, toys, radio, telephone, hearing aids, cameras—yes even mercury cells. Save money and have the convenience of fresh batteries always.

The **EVERLITE** is the best—the only charger built with a powerful magnetic energy winding. This power enables it to charge big lantern batteries and even car batteries. Also plays transistor radios on 115V. house current charging the batteries at the same time. Charges all batteries better.

Two models—the **EVERLITE 75** for all dry cell batteries up to 12 volts and the **EVERLITE 76** for all dry batteries plus a special charge for car batteries to assure fast starts on cold mornings. Simple, safe, fool-proof and unbelievably efficient. Plus into any 115 volt outlet. Guaranteed for one year. Send for your **EVERLITE** now—10 day money back guarantee.—You must be satisfied.

only \$6.95

New
Transistorized
Model
only
\$6.95



Free battery tester and adapter for special batteries included.
The **EVERLITE 75**—Send \$6.95 plus \$.65 for shipping.
The **EVERLITE 76** (including car battery kit)—Send \$8.95 plus \$.75 for shipping.

CONTOUR COPY

PATENTED

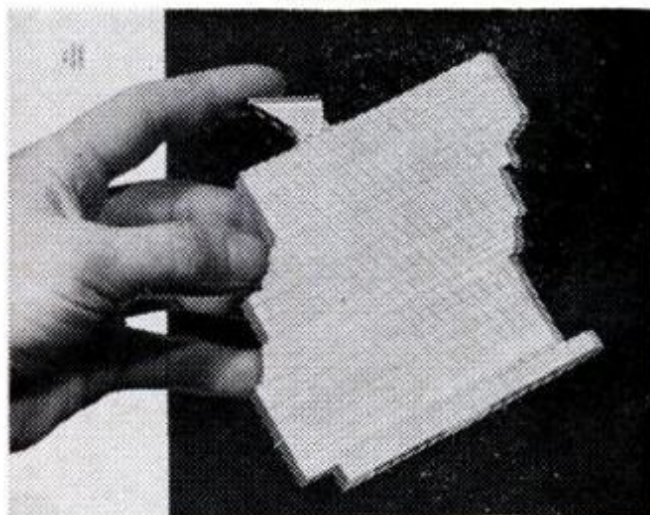

A PRECISION LIFETIME TOOL—\$6.90

Made of hardened aluminum alloy—will retain its accuracy indefinitely.

Size No. 1 is 4¼" x 4¼" **\$6.90**
Size No. 2 is 7½" x 4¼" **\$9.90**



DOOR CASINGS



MOLDINGS



TEMPLATES

COPY ANY CONTOUR INSTANTLY Perfectly Accurate Every Time.

SAVES HOURS—SAVES MATERIAL. Can pay for itself on one job. The perfect tool for fitting in against door casings, bath fixtures, mouldings, pipes, sinks, masonry, etc. A real boon to pattern makers, sheet metal mechanics, tool makers and body men.

EASY TO USE—just push the gauge leaves against any contour and lock. A perfect template every time. Works against any surface or any material. Immediate delivery guaranteed.

Order now from MASTER MECHANIC CO.

Send \$1.00 deposit if you wish C.O.D. shipment.
All items guaranteed for 1 year plus 10 day moneyback guarantee.

Mail order to Master Mechanic Co., Dept. A26
Box A, Burlington, Wisc., or Box 98, Sarasota, Fla.

Send _____ EVERLITE 75 chargers \$6.95 ea. plus .65 shipping.

Send _____ EVERLITE 76 chargers \$8.95 ea. plus .75 shipping.

Send _____ No. 1 Contour Copies \$6.90 ea. plus .55 shipping.

Send _____ No. 2 Contour Copies \$9.90 ea. plus .65 shipping.

Name _____

Address _____

City _____ State _____ Zip _____



Of Course... Red Top Air Filters Are Better!

WIX didn't put the "Red Top" on Polymite Air Filters for "kicks." That distinguishing feature identifies a technically improved product...one which is nearly impossible to install in the car upside down. The part number is imbedded in the "Red Top"—not stamped on. That's mighty useful when it's time to change the Filter.

The technical improvements that save you money are: positive seals to prevent leaking dirty air and "Arch Pleats" for greater efficiency, more mileage and greater savings on gasoline. "Arch Pleats" are important where the pleats of ordinary filters pinch together and impede the flow of air half-way down the fold, the "Arch Pleat" does not collapse. Thus, you get a bonus in extra value and substantially greater mileage.

Ask your service man for WIX Polymite Air Filters. Don't let him kid you about all Air Filters being the same. If he doesn't have WIX, call up a local WIX jobber...he'll tell you where you can get them.



WIX CORPORATION • GASTONIA, N. C.
THE GOLD STANDARD IN FILTRATION

SHUT THE WINDOWS!

(Continued from page 210)

foam while moving along at 5 to 8 mph, has been successfully used to extinguish a running grass fire. It is evident that this type of equipment has considerable potential for brush, grain field and forest fires.

As indicated by the Los Angeles County incident, the foam is also extremely effective on fires involving flammable oils and grease. It has proven its superiority not only on 140-octane gasoline, but on acetone; ethyl, methyl and isopropyl alcohols; lacquer, paint thinners, and other chemicals.

Tames updrafts

Despite its feather-like weight, the foam overcomes the furious updraft of a large-scale flammable oil blaze, and also resists dissipation by ordinary wind velocities. It has been used with marked success on spill fires covering 15,000 square feet and in temperatures as low as minus 20° F. It has also extinguished 8000 square feet of fire involving high octane gasoline in a 35-mph wind in about 6 minutes with only two men handling the equipment.

Several of these adverse conditions existed at a fire in a 75 by 35-foot warehouse and exposed loading dock of a bulk oil plant in Youngwood, Pa. In the area at the time were a delivery truck; 11,000 gallons of lubricating oil; 10,000 pounds of grease. When Chief Neal of the Youngwood Volunteer Fire Dept. saw the extent of the blaze, he radioed the Greensburg volunteers, five miles away, for the loan of their Hi-Ex truck. When it reached the scene some 10 minutes later, flames were belching through the roof of the building. Yet the high suds squelched the outbreak so fast that the loss was held to \$7,000. The labels on many of the oil cans were merely discolored.

"Without that truck," Chief Neal declared, "we certainly would have been in trouble."

Notwithstanding many such spectacular performances, Will Jamison does not consider high expansion foam a panacea. "It is," he says, "the weapon firemen have long hoped for to safely combat the belated-discovery, deep-seated outbreak. Its stellar role is in control of that notorious 10 percent of fires which cause 90 percent of our losses."

★★★

The Original "Wedge-type" Screwdriver

QUICK-WEDGE®

SCREW-HOLDING SCREWDRIVER



Easier to use:
NEW BEVELLED TUBE* slides easier to grip and to release the screw.



Firmer grip: new tube, combined with **NEW STRONGER BLADES** provide a more positive wedge-action to grip the screw.

More rugged construction: **NEW EXTRA-STRONG TIPS** won't bend or distort in normal use.

14 sizes Unconditionally Guaranteed!
© 1966 by Kedman Company * patented

KEDMAN COMPANY
233 South 5th West P.O. Box 267
Salt Lake City, Utah 84110



nuts & bolts

Jig saws, abrasive bands, auto parts, skilled mechanics... anything? Just let your fingers do the walking. **Action-People do.**

Save Money on WOOD

Hardwood Veneers . . . Hardware . . .
Wood Shop Supplies and Equipment
. . . Power Tools

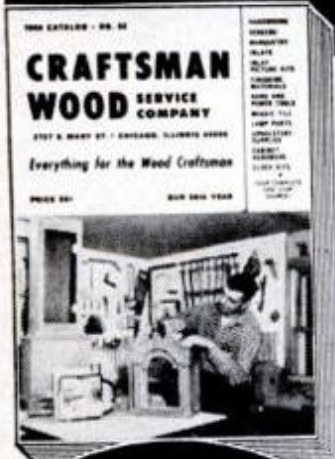

Hardwoods, Fine Plywoods, Inlays, Mouldings, Mosaic Tile, Tools, Lamp Parts, Upholstery Supplies

Your new MONEY SAVING wood and workshop buying guide now ready! 140 page. Full color! Your best "one stop" source for finest kiln dried domestic and imported hardwoods, veneers, plywoods, modern and traditional legs . . . over 1500 items.

STANLEY TOOLS at Discounts
Startling savings on top name power tools, hard to find cabinet hardware, lamp and upholstery supplies. New projects and kits. Enclose 35¢ to help pay mailing and handling costs. Mail coupon.

New Catalog
over 1500 items
Now Ready!

CRAFTSMAN WOOD SERVICE COMPANY

2729 South Mary, Chicago, Illinois 60608. Dept. A-26
Rush new Craftsman WOOD Catalog. I enclose 35¢ to help pay mailing cost.

NAME _____
ADDRESS _____
CITY _____ STATE _____ ZIP CODE _____

BAD BALL JOINTS

(Continued from page 183)

fect readings. In some cases, as with Chevy IIs, Falcons and Comets, it's suggested that metal spacer blocks be used to prevent this from happening.

Installing replacements

Ball joints are positioned in their various support arms in several ways. They may be bolted in, riveted in, screwed in, pressed in or, in some replacement cases, installed by a combination of techniques.

Units having joints which are screwed into the control arms will require large sockets (1⁹/₁₆ in. to 1⁵/₈ in.) and plenty of leverage to remove them.

When replacing screwed-in ball joints, make sure you start the new ball joint straight and true into the threads in the control arm. The joints must go into the thread with a heavy drag and be torqued to manufacturer's recommendations—at least 125 ft.-lb.

Pressed-in joints are removed with special pullers, or with special driving sleeves and a heavy hammer, or by pressing them into place with a hydraulic press if control arms are out of the car.

If riveted joints are used, rivets are

center-punched and hollow-drilled before cutting off rivet heads with a chisel. This is done so the rivet will cut easily and not offer resistance that causes elongation of rivet holes.

If a power-operated chisel and sharp cutting blade are used, rivet heads can be snapped off without hollow drilling.

Ball-joint replacement kits contain nuts, bolts and lock washers to facilitate replacement.

With the replacement installed, check the fit of the bolt in the hole. It should fit easily, but not sloppily. The hole might require just a bit of enlarging by drilling or reaming, or by driving a pin punch into it to knock off rough edges.

As soon as new ball joints are installed, make sure they're filled with the lubricant recommended by the manufacturer. Usually this grease is a molybdenum disulfide type. Never apply it with a high-pressure gun. This could burst the seals.

When new ball joints are installed, check the front end for correct geometry. The wheels should be checked, too, for both static and dynamic balance.

In summary, a familiarity with this essential component of your car can save you money, time and trouble—and *may* even save your life! ★ ★ ★

MAKE \$30 TO



\$100 A DAY

Some make more, some less

MAKE BIG MONEY • With an easily operated, highly efficient WALL WASHER, H.D. Hart makes \$30 to \$100 every day he works. E. Goss took in more than \$10,000 in one year. C. H. Jones wrote, "I made a net profit of \$1200 on one job." And no wonder — this machine washes walls 6 times faster and better than by hand and with no mess — no drop cloths needed.

Your Money-Making Opportunity • We want more men to go into this profitable business for them-

FREE BOOK! MAIL COUPON TODAY

VON SCHRADER MFG. CO.
210 "W" Pl., Racine, Wisconsin

Send at once (no obligation) your **FREE** booklet containing information about your **WALL WASHING MACHINE** and how I can start *my own* permanent, profitable business.

Name _____

Address _____

City _____ State _____ Zip Code _____

We help you to start your own all-year business

selves and enjoy independence — freedom from layoffs and bosses. Customers everywhere — homes, offices, schools, churches, hotels, etc. How much you earn depends largely on you, but we help you to start and work with you for your success. Training and consulting with experts is available at no additional cost. What you take in is mostly profit. No need to rent shop or office; operate from home. Can start spare-time until full time is justified.

Ours is NOT a lease arrangement • You are free to operate in an independent manner. You sign no contract. You own the detergent outright and are always your own boss... and every dollar you take in is yours to keep. You pay no fees, or dues, or royalties to anyone, and enough supplies come with it to return far more than your investment. Many earn the cost of the detergent in a week or two. It costs nothing to get details... write **TODAY**.

Lose No Time — Send Coupon Today for All the Facts



Why are we painting all our engines blue?

Will it make them start faster on a cold morning?

Not one bit. Ford-built engines earned their reputation for quick starts long before blue paint. We keep our test facilities running 24 hours a day, 6 days a week, to prove out engines in broiling heat and freezing cold.

Will our new blue engines save on gas?

Not because of the paint. It's what's *under* the paint—cylinder blocks, manifolds and pistons designed to save gas. A Ford-powered Falcon is still America's all-time economy champion for either sixes or eights.

Will Ford-built engines give better performance?

Positively yes. (Whether they're red, white or blue.)

Ford Motor Company took over first place in V-8 engine leadership back in 1932 . . . the year we introduced our first mass-production V-8. Since then, we've built and sold over 35 million V-8's—more than any other manufacturer.

So, why blue?

Because we want you to know the instant you see a Ford-blue engine in a car . . . truck . . . or tractor . . . it's *Powered by Ford*—built to the highest standard of engineering excellence.

If you don't happen to like blue engines—just quietly close the hood. Chances are you won't have to raise it again for a long, long time.

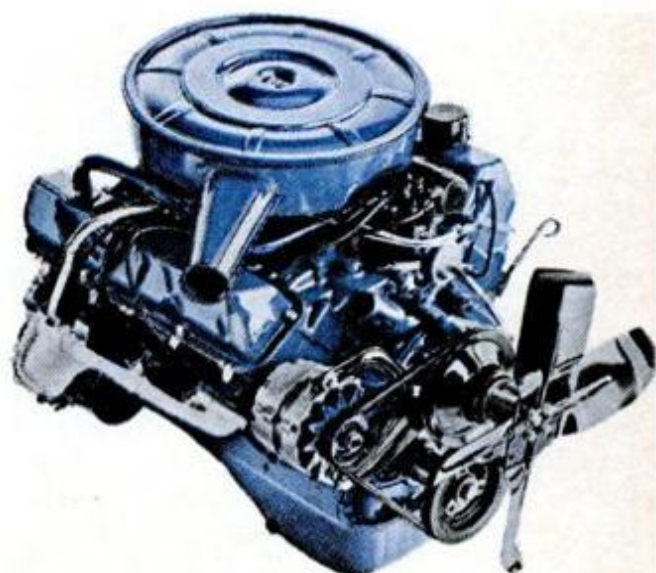

"You've heard of green giants . . . white tornadoes . . . so why not blue horses?"

DIORAMAS

(Continued from page 129)

one, all that would be needed would be one given the freeze-dry treatment a century ago. Water would be added to the robin's body, and—presto!—a “freshly killed” robin!

Science-fiction writers have taken this last advantage one step farther. In their stories people are frozen and placed in a state of suspended animation until brought back to normal a few centuries later. There is even a worldwide society, with 119 members, dedicated to this theory. Members of the Life Extension Society feel that if a person is frozen immediately upon death from some disease, he can be brought back to life and restored to health after a cure has been discovered.

“This is impossible under our present knowledge of science,” say the scientists who work with the freeze-dry system. A salamander was once frozen in liquid nitrogen at minus 319° F. Solid as brick while frozen, he was alive and kicking when he thawed out. However, Rolland Hower, head of Smithsonian's lab, explains that when he performed this experiment only the salamander's shell was frozen, not his vital organs. “Any living body frozen by conventional means will be just as dead as if he were hit by a bullet,” the scientists insist. They also state that a dead body that is frozen is merely given another form of embalmment.

Eyes give trouble

As with every new method, the freeze-dry system still has some bugs. Eyes of the frozen specimens, all flowers and fish present problems. Tadpoles also are troublesome, but when they become frogs they make fine specimens. Hower has studied the discoloration in fish caused from fat in their bodies. Bacteria injected into a fish before it is frozen will attack the fat in the fish's body and decrease the amount which causes the discoloration after the fish has been frozen. Hower grew and tested many hundreds of bacteria strains before he found one that would work swiftly enough and would not attack the other flesh of the fish. “I think we have the problem licked now,” he confided.

Shriveling of the skin in fish specimens has also been a puzzler. Dr. Merryman thinks this is being overcome by dropping the temperature in the freeze-dry chamber to minus 58° F. which slows the drying of the fish considerably and practically eliminates shriveling. Eyes are either painted or replaced with glass or plastic.

Flowers become too dry to handle with the freeze-dry treatment, posing a real

headscratcher for the lab men, but they feel they will have this licked within a short time.

To date, the largest animal specimen prepared by the freeze-dry method has been a fox. A giant turtle was frozen, but the legs had to be removed first. Smithsonian's freeze-dry chamber takes most of the floor space in one room. To handle a specimen the size of an elephant, or even a lion, would require a unit many times this size.

Most of the space is taken up by the tremendous amount of insulating material required to keep the chamber at constant temperature. Also, the vacuum pump required for larger animals would have to be of great size and very costly. As the process is refined, these problems may be overcome.

Speed balks bacteria

Smithsonian exhibits are world-famous for lifelike realism. R. J. Gurnee of the staff, the unseen hand behind many of these exhibits is considered a real artist in posing animals in their natural positions, using tape or wire, or locally freezing the parts with liquid nitrogen.

Speed is vital. The longer the animal remains unfrozen, the more damage bacteria has done to its body, so after Gurnee positions the animal it is quickly placed, wire braces and all, into a deepfreeze chest. The lid is slammed shut and the freeze-drying begins.

After a few days of 5° F. cold, the frosted animal is taken out. The door to a chamber—it looks like the round door of a washing machine—is swung open and the animal placed inside. The door is then clanged shut, bolted in several places, and the temperature continues its frigid work on the animal while the vacuum pump literally pulls every drop of fluid from its body during the next several weeks. High atop the chamber, a dome conceals the container for the chemicals that absorb every speck of moisture. When the bolts are spun and the door opened, a new specimen is ready to greet visitors at the Smithsonian.

What about the fisherman or hunter who wants to prepare his own trophies? It's entirely possible. The expense of setting up equipment for small-sized specimens is no more than that of other hobbies. (Photography, for example, often requires an outlay two or three times as great.) It will certainly expand a sportsman's knowledge and interest in nature, and look at the pleasure he will get from bragging how he not only bagged his trophy but also mounted it himself—with the help of the family deepfreeze! ★★ ★

The big news isn't the gauges... it's what the gauges connect to!

The real news about Impala is the 427-cu.-in. Turbo-Jet V8 that's on the other side of the firewall. The street version generates 390 hp on hydraulic lifters. A special edition turns out 425 hp and 415 lbs.-ft. of torque on solid (ah, what sounds!) lifters.

Both engines are of the same new design that inspired our successful Turbo-Jet 396, now rated at 325 hp. Intake and exhaust

ports feed directly to the combustion chambers with little interference from valves and pushrods. As a result, the Turbo-Jets breathe in a way that makes ordinary engines feel asthmatic by comparison.

As for the gauges — they're important, too. With this much happening in the engine compartment, you'll undoubtedly want to stay tuned in on the action.

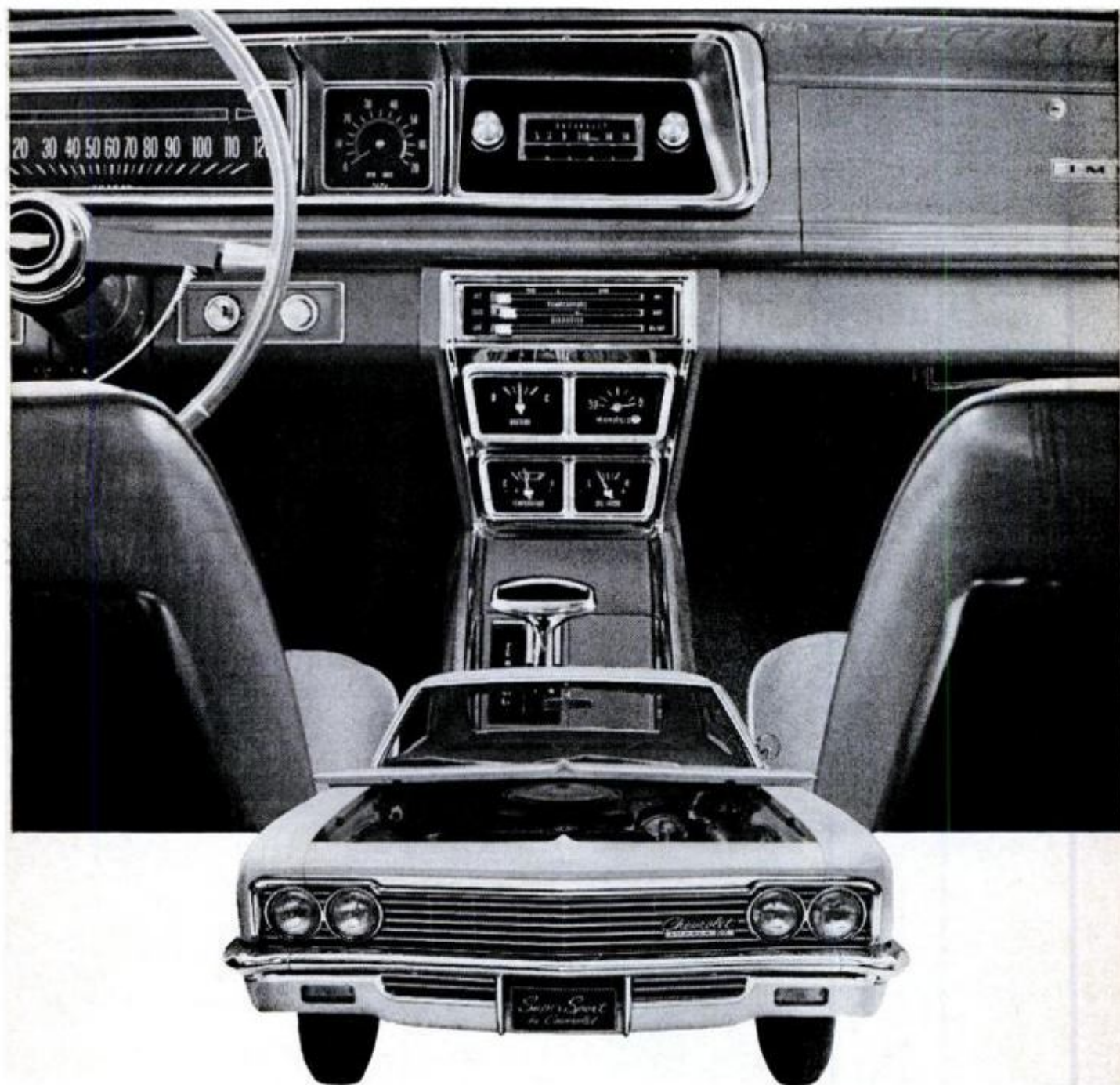

'66 IMPALA by CHEVROLET 
Chevrolet Division of General Motors, Detroit, Michigan.

FREE

WINDOW PLANNING IDEAS



to help you make your home more beautiful, more valuable. Send today for new, full-color folder packed with illustrated ideas and a complete description of the Andersen Window line.

(Clip and mail today!)

I plan to build. PM-26
 I plan to remodel a _____

Mr. _____
Mrs. _____

Address _____

City _____ State _____

Andersen Windowalls
ANDERSEN CORPORATION • Bayport, Minnesota

WHAT'S THE QUESTION?

(Continued from page 135)

to use their common sense and not worry about what rule 164, paragraph B, said.

The store chain's adventures took place shortly after a distinguished British psychologist, Sir Frederick Bartlett of Cambridge University, had conducted some experiments in the varying ability of people to pinpoint the problem. Recently, in his comfortable, old-fashioned office in St. John's College at Cambridge, he discussed his experiments.

He began testing students on what he calls "gap-filling processes." In simplest form this could be: 3—9. Nearly everyone readily sees the gap could only be filled intelligently with a 6. Sir Frederick's tests were far more difficult and sophisticated.

"In all these gap-filling puzzles," Sir Frederick said, "the essential thing is to find out what is the problem. You are given some minimal clues and from those you must determine what you are required to do and how you do it."

In one test given 300 bright Cambridge students, only 2 got the answer the first time. The puzzle has a deceptively simple look. Try to fill the gap in the words below in any way you think is indicated:

A, BY, HORRIBLE.

In another test, only 2 of 100 students got the answer. They were given a card bearing the following words:

A, GATE, NO, I, DUTY, IN, CAT, BO, EAR, O, TRAVEL, ERASE, BOTH, GET, HO, FATE.

E R A S E
F A T E

They were told: "From the group of words at the top of the card complete the vertical arrangement indicated by the two words, 'erase' and 'fate,' taking 'erase' as the middle word of the column. Not all the words given need be used." (Answers to both tests will be found on page 220.)

"Year after year," Sir Frederick said, "I found that students who got the answers were also those who were generally regarded as the most intelligent. Obviously, they possessed a special ability to determine the problem because in both these tests finding it out is the key to the solution."

Sir Frederick's work is being followed up by several American psychologists who *(Please turn to page 220)*



LONG ARM SCRAPER

The rugged scraper for wood — painted surfaces. 11" Long hardwood handle with red knob grip. Adjustable, removable 2½" double edge steel blade.

No. C81 C-81

1.39

¼" of blade exposure on each side of tool head to scrape into hard to reach corners.

On sale in paint and hardware stores or send \$1.39 tool sent postpaid.

HYDE TOOLS
SOUTHBRIDGE, MASS., U.S.A.

Write for Free Catalog



UTOPIA

He's *meditating* yesterdays...*speculating* tomorrows.

Immersed in his thoughts, he revels in the sounds of green-necked mallards and black-billed canvasbacks...
...high-flying pintails... low-planing widgeons.

His heart is where his dreams are.

Within these pages he finds information and products that whet his selective appetites... satisfy his unusual hungers... fulfill his natural instincts.

He combines ingenuity with imagination...

...and he reads this magazine, just as you do.

MPA

MAGAZINES/YOUR WORLD OF IDEAS AND PRODUCTS!



This point lets you bore holes up to 1 1/2" with small electric drill

It's hollow ground to bore cleaner, faster at any angle

NOW YOU CAN increase the boring range of your small electric drill or drill press. New Irwin Speedbor "88" bits bore faster, cleaner holes up to 1 1/2" in any wood. 1/4" shank chucks perfectly. No wobble, no run-out. Sharp cutting edges on Irwin exclusive hollow ground point start holes faster, permit spade-type cutters to bore up to 5 times faster. All Irwin Speedbor "88" wood bits are forged from single bar of special bit steel, tempered full length and machine-sharpened for extra accuracy, longest life. 17 sizes, 1/4" to 1 1/2". Buy individually or in sets from your Irwin hardware or building supply dealer.

Only 75¢ each, sizes 1/4" to 9/16"

5/8" to 1", \$.85 ea., 1 1/8" to 1 1/2", \$1.30 ea.

IRWIN SPEEDBOR "88" WOOD BITS
at Wilmington, Ohio, since 1885

EVERY NEIGHBOR IS A CUSTOMER

Earn \$5 An Hour

during spare time in profitable

**LAWNMOWER
Sharpening
BUSINESS**

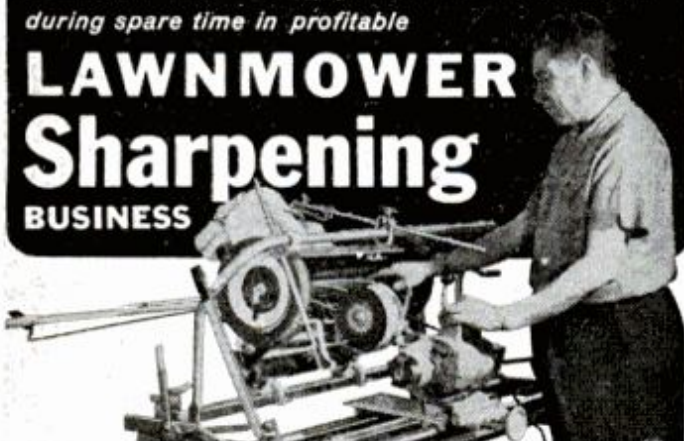

Complete Shop in One Machine

No experience needed to start—anyone can operate it—and it turns out professional jobs every time.

Start Spare Time Business

An ideal spare time business—alho many find it so profitable, they devote full time to it. For complete fact-filled booklet telling you how to start and how others have succeeded, send coupon. No salesman will call.



Foley Mfg. Co. 207-6 Foley Bldg., Mpls., Minn. 55418

Send information on Lawn Mower Sharpening business.

Name _____

Address _____

City _____ State _____ Zip Code _____

WHAT'S THE QUESTION?

(Continued from page 218)

are equally convinced that the ability to find the problem might be the real determinant of a person's intelligence. If his percentages are a fair guide, few of us have this special ability. But there is an effective way to find out *what is the problem*. It's based largely on advice of two of this century's outstanding thinkers: John Dewey and Albert Einstein. "A problem well stated," said Dewey, "is half-solved." Einstein went further: "The formulation of a problem is even more essential than its solution."

How can you apply this to everyday problems? One simple workable device is taught at the Air University at Maxwell Air Force Base, Ala.:

"The best evidence that an idea has not been clearly thought out is the inability of the thinker to express it adequately and definitely. Write the problem down in clear, grammatically correct and complete sentences. A few minutes spent puzzling out a statement of the problem *which cannot be misunderstood* may save many a false step later. Once you have what seems a concise, logical statement *write another*. You will be astonished at how many different ways a simple problem can be stated, and how each different statement clarifies a different aspect of the situation."

For particularly elusive cases, the teachers recommend writing the problem in such a simple, direct way it would be clear even to an intelligent child, particularly one with the maddening propensity for asking "why?"

Then you should know "What Is The Problem."

Solutions to puzzles on page 218.

1. A, BY HORRIBLE.

One answer is: A, BY, CAR, DIVE, EATER, FRIGHT, GASKETS, HORRIBLE. (What was called for was an alphabetic succession with each following word having another letter added.)

2. ERASE
FATE

The answer is:

A
BO
CAT
DUTY
ERASE
FATE
GET
HO
I

★★★

FREE CATALOG.

*250 "Do-It-Yourself"
Electronic Kits At
Up To 50% Savings*

WHY BUILD HEATHKIT ELECTRONICS? A desire for top-quality products at 50% savings, to be sure. But it goes beyond that. The reason people choose Heathkit is pride. Not just the pride of owning something new, but something a bit better that you have created yourself! From watching your Heathkit grow and take shape from your own efforts. It's a labor of love and a lot of fun. The large pictorial diagrams and simple, step-by-step instructions make it easy. And when you finish and turn it on you'll know that unique self-satisfaction that comes with "do-it-yourself." You will have joined the millions of people, from ages 11 to 79, people with no special electronic skills or knowledge, who successfully build Heathkits. People like you! Give it a try. Your FREE Heathkit catalog is waiting for you now.



World's Largest Selection Of Electronic Kits



NEW Low Price On Heathkit
21" Color TV . . . Only \$375.00



NEW Transistor FM Stereo
Tuner That Assembles In 6
Hours Or Less . . . Only \$49.95



NEW Low Prices On
Many Heathkit Stereo/Hi-Fi
Components



NEW Deluxe Shortwave
Radio . . . Only \$84.95



NEW 23-Channel, 5-Watt
All-Transistor CB Transceiver . . .
Only \$89.95

- ★ See The Vast Selection Of Portable And Table Model AM, FM and Shortwave Radios
- ★ See The Famous Heathkit/Thomas Transistor Electronic Organs
- ★ See A Complete Selection Of Home & Hobby Items . . . Intercoms, Garage Door Opener, Automotive Kits, Tools, Color TV Sets
- ★ See All Heathkit Stereo/Hi-Fi Components . . . Tuners, Amplifiers, Speakers, Turntables, Cartridges, Furniture
- ★ See The Full Complement Of Heath Marine Electronics
- ★ See The Complete Line Of Citizen's Band Radio Gear . . . Transceivers, Walkie-Talkies, Accessories
- ★ See The Wide Selection Of Heath Educational Kits For Home Or Classroom Study
- ★ See The World's Largest Line Of Amateur Radio Gear
- ★ See The Full Line Of Heathkit Lab & Test Instruments For Home Workshop, Industrial & Educational Use



**MAIL
COUPON
FOR YOUR
FREE
COPY** ▶



HEATH COMPANY, Dept. 17-2
Benton Harbor, Michigan 49023
In Canada: Daystrom, Ltd., Cooksville, Ontario
 Please send FREE 1966 Heathkit Catalog

Name _____

Address _____

City _____ State _____ Zip _____

Prices & specifications subject to change without notice.

CL-215

If the people you
work with don't
notice the aroma of
your Field & Stream
Pipe Tobacco,

you must be working
in the North Woods.



GET THE RIGHT MIKE

(Continued from page 200)

point it toward a hi-fi speaker working full blast. Then talk into the mike, using correct close-talking procedure. On playback, the music should be next to inaudible, while you come through loud and clear.

Where you want to be sure a communications mike will overcome severe radio or electronics noise, use the lowest tape speed available on the recorder—ideally 15/16 i.p.s.—and record your voice with the level set too low. This should create lots of background noise to compete with the pickup. If your voice knifes through it all, you have reason to assume it will do a fair job under rotten transmission conditions.

Checking out a cardioid mike requires the services of the store's demonstration hi-fi system. Start with the mike facing dead away from the speaker. Holding it a normal distance from your mouth and at a normal angle, talk into it. Retaining this same mike-to-mouth relationship, turn about 45°, calling off your position into the microphone. Then turn another 45° and repeat this procedure until you've boxed the compass.

The playback should give a quick clue to the relative sensitivity of the microphone to background noise emanating from different positions.

Do you need a pickup that will render faithful, wide-range reproduction? The obvious test is to lug your instrument down to the store and try it. If this is not practical, the hi-fi system in the store can again be pressed into service.

Record and listen

Use the best speaker in the store and ask the salesman to play a colorful symphonic record through it. Assuming you are choosing between two mikes or more, record this discotheque performance with each, then compare the playback results.

A record-and-listen test will also check features such as long-range pickup, wind effect filtration, pop removal and compensatory frequency peaking.

In all these tests the tape must be played back through the hi-fi music system you've been using, with its tone controls set in the "flat" position.

It is always wise to ask for return privileges when you buy anything as individualistic as a microphone. A reputable store will be willing. Especially if the mike is expensive.

Lastly, you should seek a guarantee—and be darned sure you know precisely what's guaranteed, and for how long. ★ ★ ★

BUILD REFINISH RESTORE
...anything of wood

LET Constantine's picture-packed Catalog & Manual help you build new furniture—refinish and restore beat-up cabinets, chests, tables, chairs, etc. See everything you need for better, easier woodworking. All materials plus plans, books, instructions. 60 glamorous woods in natural color. Hundreds of products found nowhere else. 8-ft veneers! Fabulous glue that needs no clamps. Tool bargains. Cabinet hdwe, etc. Unsurpassed values since 1812.

2,000
CRAFTSMAN PRODUCTS
World's Beautiful Woods & Veneers
Newest Workshop Tools & Materials
Wood Finishes — All Kinds
Lamp Parts — Upholstery Supplies
Period & Modern Furniture Hardware
Colonial Clock Kits — Case Kits
500 Project Plans! Instructions!

Tear out ad. Mail with 25¢
for vast new CATALOG
Plus New "101 Project Ideas"

CONSTANTINE
2050 Eastchester Rd., Bronx N.Y. 10461 Dept. B-5

MAIL AD

Supercarmarket.

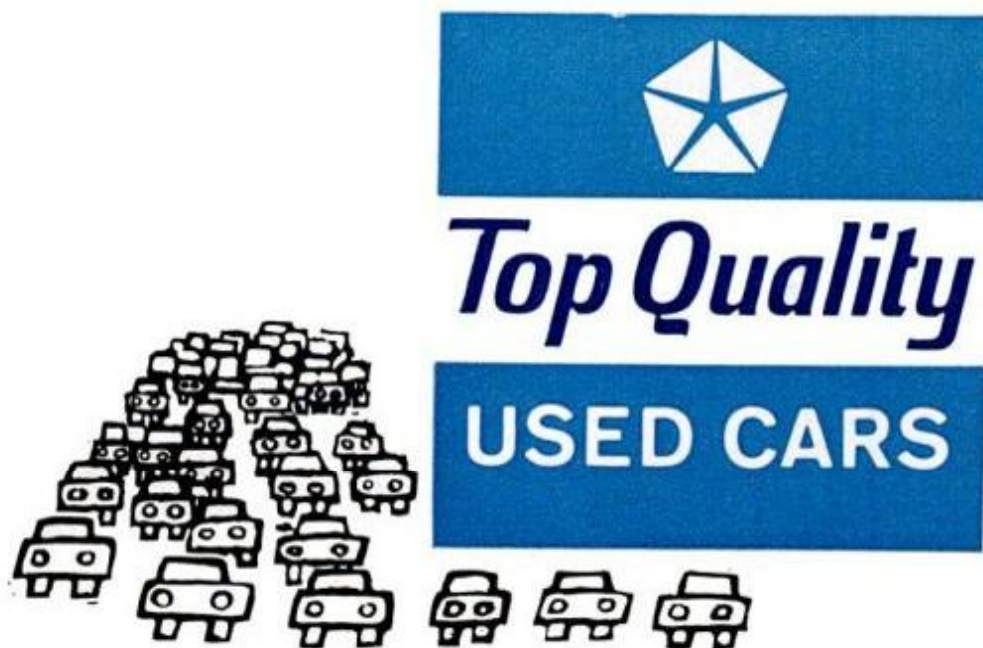

Quality, yes. And quantity, too.
Super cars. And a super selection.
The Top Quality sign is the
first sign of a good used car. Why?
Your Chrysler and Plymouth Dealer's reputation
rides on every sale he makes.
Come along for the ride.

CHRYSLER - PLYMOUTH DIVISION



CHRYSLER
MOTORS CORPORATION

TIP-UP SKI RACK

(Continued from page 178)

of the bus and lock it in place with pins. Dimensions have been purposely omitted because of roof-line variance of different station buses (see "Y" and "Z," Fig. 2).

The original was made of 1¼-in.-sq. straight-grain mahogany. The two primary mounting members for each section of the rack are suitable lengths of 1½-in. strap metal which are hooked at the tops to fit over the roof gutter. Rectangular cutouts in their lower ends permit them to fasten like hasps to 1½-in. staples bolted to the side of the bus.

Calculate the dimensions for the wood sections—including the two short sections (Fig. 1, and "X" of Fig. 2)—cut them to size, varnish 'em and hang 'em out to dry.

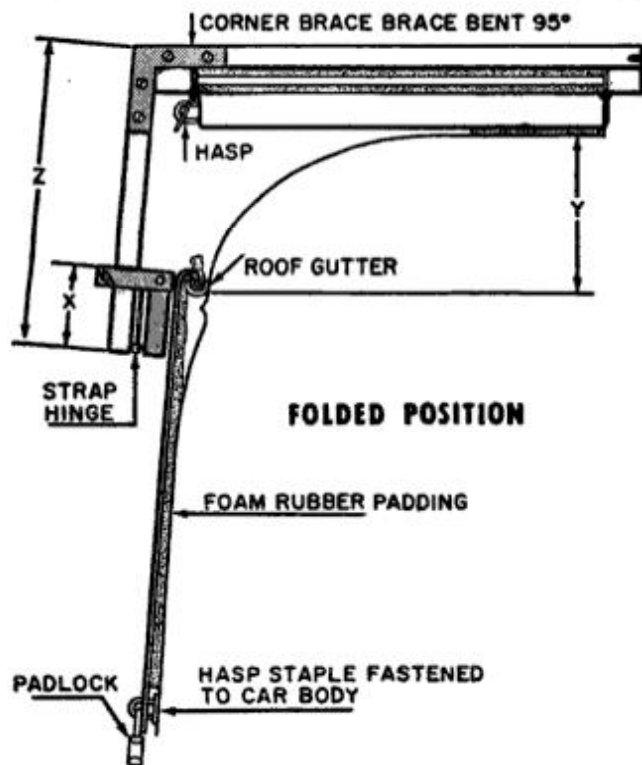

Now take the four corner braces that connect the two horizontal sections to the inside vertical sections, clamp them in a vise, heat their corners till red hot, then use a Vise-Grip or similar tool to enlarge the corner angles from 90° to 95°, taking care not to distort their flatness.

Cut the four ¾x3-in. flat braces which are bolted to the tops of the primary supports as shown. Later the short wooden sections are bolted between these braces.

When the varnished wood sections have dried, use waterproof glue to apply strips of carpeting or foam-rubber padding to all surfaces that come in contact with the skis or the bus top. Apply the same material to the sides of the primary metal supports that lie against the side of the bus.

Now use the 95° corner angles to con-

nect the horizontal members of the rack to the vertical bus-side members with stove bolts and nuts, installing 1-in. hasps at the angles where the sections meet.

The 1¼-in.-sq. pieces of stock, from which the inside vertical sections of the rack are suspended by hinges, are now secured between the two strap-metal braces with stove bolts and nuts, and side sections attached to them with hinges.

Finally, attach outer sections of rack to the horizontal sections with butt hinges.

Both units of the rack are suspended from the metal braces which are secured to the primary supports. These, in turn, hook in the gutter and then are bolted in place at the bottom through each hasp.

—Allen Macaulay

SHEET METAL FORMER

(Continued from page 195)

remembering to lathe a small shoulder at both ends to serve as a clearance "washer."

Naval bronze is best for the sliding bearing blocks, since it is long-wearing. Rough-cut the blocks, then mill them in your lathe milling attachment to maximum outside dimensions. Make all four 1¼ in. long, but fit each one individually to the width of its own slot, using metal number stamps to key them. Also stamp corresponding sockets and the shaft ends of the bottom and idler rolls (such numbers can be seen at the ends of the shafts on page 195). This aids precision assembly.

Form the shoulders with your lathe milling attachment, making a rough, undersized, one-pass cut to start. Try the block in its socket and use a dial indicator to shave down each side until the block fits without binding.

The bottom roller adjusts up and down to match roller spacing to the thickness of the metal being worked. If your cylinder is to have a lock joint, turn the locks on the metal first and adjust the bottom roll so it will just pass the lock without squeezing it shut. The adjustment of the idler roll, of course, alters the diameter of the cylinder to be formed.

The rig will form semi-cylinders or troughs, as well—in case you want to make a section of half-round eaves gutter. This same shape can be put into the middle of a length of sheet metal by fully retracting the idler roll and feeding the metal through flat to the point where the curve is to begin. Adjust the idler upward and roll the work back and forth the length of the curve until it bends back on itself, bringing the straight sides parallel. Such a shape is useful in the shop as a cover for shafting, gears or pulleys. ★★★

"Charging's fine, but don't overdo it," says Mario Andretti, USAC National Champion in his rookie year.

Any savvy car owner can tell you how to help a battery work efficiently longer: Keep it filled with water, free of corrosion, and fully charged. But not one in 10 realizes that, just like on the race track, the charging bit can be overdone.

One survey indicates that overcharging causes 28 percent of battery failures, the result of too high a voltage regulator setting. Regulators are adjusted for so-called "normal" driving, but maybe you do more over-the-road driving at fairly high speeds than average. Or drive mostly in warm weather; temperatures above 80° help cause overcharging. A tip: Batteries being overcharged use extra water. If this happens, make sure your serviceman

checks out the charging rate with a volt-amp meter. Here's another tip: Autolite sta-ful batteries hold as much as three times the usual amount of water above the plates for extra protection. And their new one-piece covers eliminate electrical leakage and top corrosion. Plus they're vibration guarded to keep material from shaking out of energy-producing plates. It costs more to build in these quality features, but Autolite feels they're worth it. So do I. You're Always Right With Autolite.



HOT CART

(Continued from page 153)

you're in a hurry to throw that first party. You'll note from the plans that he's joined the walnut-veneered plywood (for the side and back panels) to the solid-stock walnut stiles and rails so that no laminated edge is exposed.

"Only had to resort to veneer tape once," he proudly pointed out. "Just on the front edge of that adjustable shelf." But maybe *you* flinch at the thought of splining and doweling the way *Bud* winces at exposed nails or screws, even when they're set (or countersunk) and puttied (or plugged). If so, you can simplify joint treatments even more than our back-corner alternates suggest. The handles, of course, must be sturdily attached. If you *do* dowel the stationary one to the front and back rails, you'll find it easier to glue up these three parts and join them, as a unit, to the assembled chassis. And if you dowel the rails to the back panel and front stiles, be sure to locate

these dowels so they won't block the $\frac{1}{4} \times \frac{5}{8}$ -in. grooves for the sliding top.

The top, too, can be simplified. The overall dimensions given in the handle-detail sketch are for a $\frac{1}{2}$ -in. plywood panel *after* a plastic laminate has been applied to all faces and edges except the end that's doweled into the movable handle's groove. Bud did it this way to avoid all possibility of warp, to dress up the edges that show when the hot tray is in use, and to provide slick movement in the grooves. You could get by with laminate on the top surface only, using a chip-board panel to prevent warp, and simply sand and wax the long edges. You'd then need to adjust the size of the panel and width of the grooves for a snug sliding fit.

We chose Formica's Pumpkin (Color No. 872) for the top and alternated it with a light gray-green called Celadon (No. 884) on the four plastic-faced-and-edged door panels. The dimensions given for these panels are *before* any laminate is applied. If you cement strips of plastic

(Please turn to page 230)



DOUBLE EXPOSURE dramatizes how cord retracts till plug nests inside hole. White cord goes to hot tray

LOCATING REEL HOLES (From Outside)

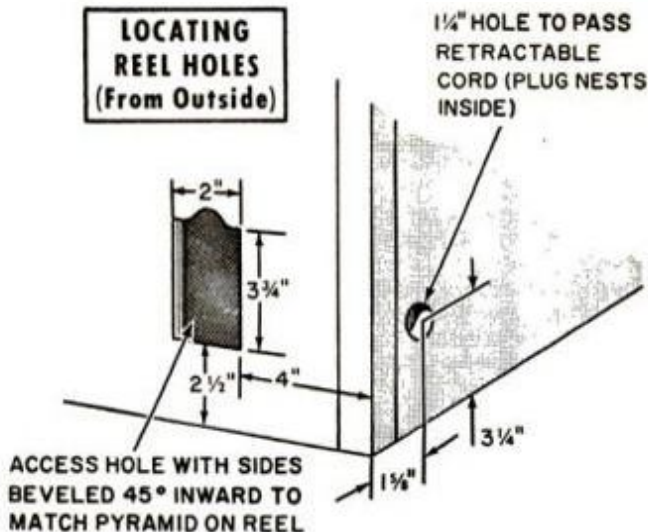

MOUNTING CORD REEL (Inside)

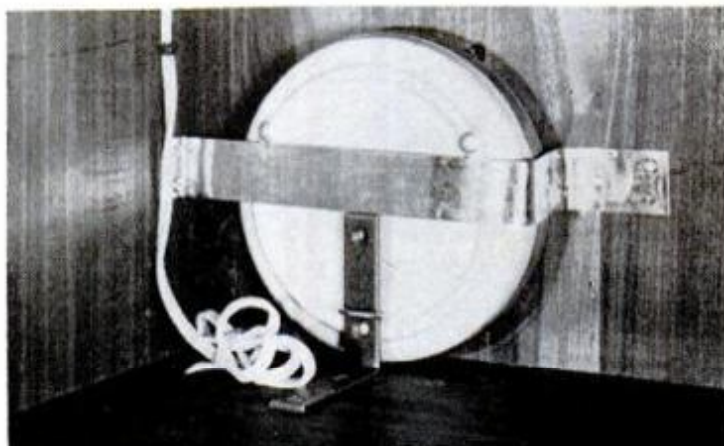
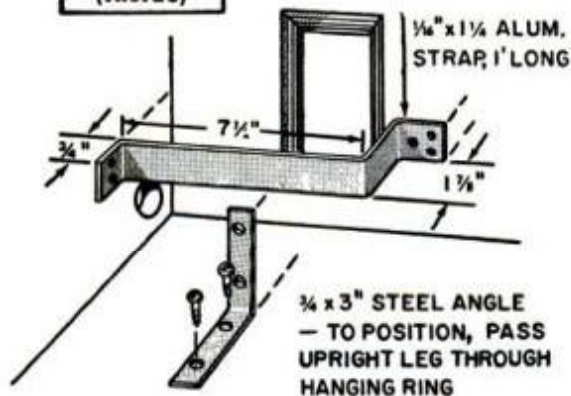

PUSH REEL FLAT against panel before marking for lead holes through strap and bottom leaf of angle

HOW TO BUY THE ACCESSORIES

For your convenience PM has arranged mail order purchasing for all units so you can duplicate the cart exactly even when these accessories or their equivalents are not available in local stores.

HOT TRAY: The Cornwall Corp., 48 Wareham St., Boston 18, Mass., will ship their 12x16-in. Model S-102 Simmer-Server precisely as shown on page 153, ready for mounting, if you mention PM when ordering. (As sold in stores, this model has feet and handles that would be difficult to remove.) Price: \$14.95 ppd.

CORD REEL: Cordomatic, 1724 W. Indiana Ave., Philadelphia 32, Pa., makes the Portable Outlet Reel with a 15-ft. cord, shown below. It's model 510-D and can be ordered direct if not locally available. Price: \$8.95 ppd.

CASTERS: Shepherd Casters, Inc., Benton Harbor, Mich. 49023, supplies spherical casters in several models to hardware stores from coast to coast. We chose the Saturn—a 3-in. caster with rubber tread—in the plate-mounted Model SN1, with satin brass finish. If your cart will be rolled mostly on carpet, substitute the all-metal Planet, Model P1. Two of the four casters should be equipped with brakes. Price: around \$3 each.

PULLS: The brushed-brass feature strip which forms the drawer pull was ordered from M. Wolchonok & Son, Inc., 769 Third Ave., New York City 10017. It's 1/2-in.-sq. solid bar, in two 12-in. pieces, and (since it was a single custom order) each piece, complete with spacers and bolts, cost \$5. The company has offered, however, to supply the pieces for \$2.75 each if the volume of orders warrants. The door pulls are \$1 each from the same source, if your local stores don't stock a similar brushed-brass knob.

GOVT. SURPLUS AND OTHER BARGAINS SAVE UP TO 90%



MOBILE POWER UNIT

Carry your own AC power (115 V., 60 cycle, AC, 1500 W. @ 3600 RPM). This compact Generator is 11" L x approx. 5 1/2" W x 8 1/2" H. Mount on any 12 V. car, truck or boat. Fan belt driven. Has dual plug-in outlets with rheostat voltage reg. Will adapt to most vehicles. Excellent for camping or wherever lights or other standard accessories are desired. Sealed lifetime ball bearing construction. Others sell for twice the price. Shpg. Wt. 36 lbs. NEW \$72.50



HIGH SPEED TURBINE BLOWER

Designed for operating at speeds up to 50,000 RPM. Has large volume output with delicately balanced turbine blades. Air driven. Can be adapted for motor drive, or as blower, exhaust, fan, super-charging mechanism, etc. Approx. GOV'T COST \$649. Wt. 12 lbs. Like NEW. \$5.95



HEAVY DUTY BATTERY WINCH

Rugged, deluxe winch with ball bearing construction throughout motor & gear train. High gear reduction. Rated cap 3000 lb. pull. Contains reversible switch. Rugged 3/4" plate steel mounting base with outrigger support. 22" L x 9" W x 8" H. Handles 250' of 1/4" cable. Built for 12 V battery operation; also operates on 6 V. at reduced cap. & speed. A must for Scouts, Jeeps, Trucks, Boat loading trailers, etc. Shpg. wt. 80 lbs. Approx. GOV'T COST \$490. NEW. 90-day guarantee. Model E-D \$79.50



ELECTRIC PUMP WITH CONTROL SWITCH

For boats, campers & trailers. Output 200 GPH. Can be used in fuel or water. 1/2" pipe bronze inlet. 12 or 24 V.D.C. Explosion proof motor. Shpg. wt. 9 lbs. Complete with wiring diagram. Approx. GOV'T COST \$200. NEW \$10.95

NEW! BIG! 1966 CATALOG



Send 25c for amazing catalog with 1000's of bargains in hydraulics; electrical, marine, automotive items, etc. Order from ad. Prices FOB. 50% deposit for COD. Pls. include your zip code number. Satisfying mail order customers thru-out the world since 1945.

AIRBORNE SALES CO. Dept. PM266

8501 Stellar Dr. • Box 2727 • Culver City, Calif. 90231

You Can Develop A Profitable Business BY ENGRAVING

DOOR PLATES
DESK PLATES
BADGES, ETC.

On Plastic up to 2 inches wide.

Material and supplies available from us



SM-100

WRITE TODAY

With this precision machine
You need no previous experience



SCOTT MACHINE DEV. CORP.

215 PROSPECT AVENUE, PM-4
WALTON, NEW YORK 13856

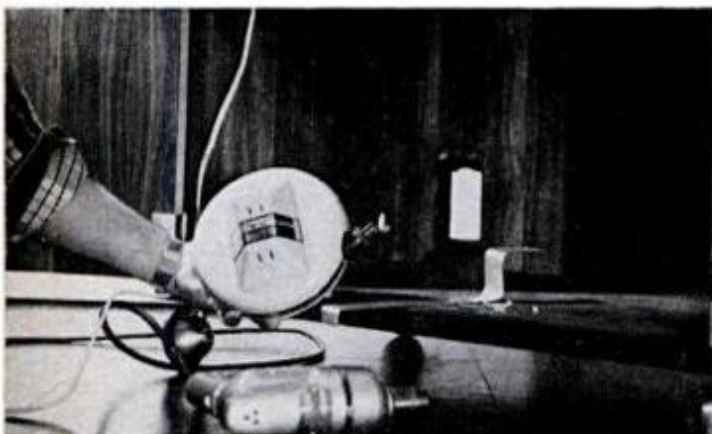

ACCESS HOLES—small one for cord, other for outlet pyramid—must be accurately located in corner

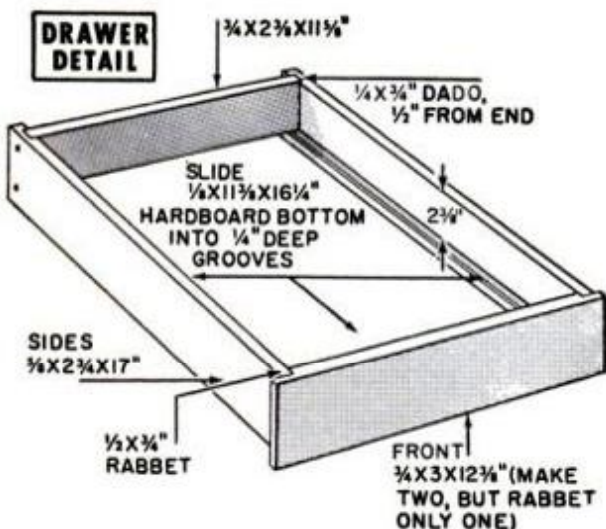

HOT CART

(Continued from page 229)

to both long edges (as well as the top), you'll actually want to cut each panel slightly narrower than $6\frac{1}{8}$ in. to allow for clearance. Both leaves of the offset hinges are set into the stiles, and the doors are held shut by a pair of magnetic catches—one on each central panel. We chose the bifold arrangement for fuller access to the storage space than two sliding panels would provide, and to avoid the wide swing two hinged panels would require; the latter might prove awkward when the cart is wheeled close to a dining table to serve as a sideboard. The alternating colors also add to the design, but to simplify construction, try another door treatment.

The "sculptured" handles also add a lot of style. You make the slot by drilling $\frac{3}{4}$ -in. holes at each end and cutting out the waste between them with two passes of a jig, sabre or keyhole saw. The taper is a simple bevel cut made on the bench saw with the slotted handle blank held upside-down and snug against the fence. This bevel is then "concaved" with a half-round rasp or coarse file, before softening corners with a flat rasp and sandpaper.

The false drawer is a panel the same size as the actual drawer front, and is held in place with two dowels up into the rail plus a cleat tacked to the top "shelf" and glued to the back of the panel. The trim rail beneath the drawers covers the joint line between the top "shelf" and the doorstep cleat to which the magnet sections of the catches are screwed. This trim rail creates a rabbet that serves as a stop for the drawer front.

Note that both the top "shelf" and the bottom panel are glued into dadoes cut into the back and end panels. The upper groove is $2\frac{7}{8}$ in. from the top, the lower one $\frac{1}{4}$ in. from the bottom of these panels.

The handsomest finish for walnut is, happily, also the simplest: you just rub in boiled linseed oil with a saturated cloth and wipe off the excess with a dry, lint-free cloth.

The mounting of the accessories is shown in the details. Since the cord reel's outlet cluster is in the shape of a flattop pyramid, when we cut the hole that lets this pass through the back panel we held the saw at a 45° angle. With the face of the reel pressed firmly against the inside of the panel, this beveled hole nests the pyramid snugly and lets all three outlets protrude far enough outside to take an appliance plug. (The arched top edge of the hole is optional, to provide access for a large, round plug. The plug on the end of the hot-tray cord is merely passed

through holes in the top "shelf" and bottom panels and brought around for insertion in the lowest outlet of the pyramid.) The dimensions for locating these holes, as given on page RO, will position the retracted plug inside the $1\frac{1}{4}$ -in. hole so that the plug's prongs can just be gripped with the fingers. Black enamel applied to the edges of the holes gives a neater effect.

Before placing the hot tray on its blocks, flip the chassis over onto its handles and fasten a caster at each corner. We used a scrap of $\frac{1}{4}$ -in. plywood beneath each plate, for greater clearance.

Now you're all set to roll your cart right where the action is, and watch it become the focus of the fun. And when it has served its purpose, snug it back into its berth—in a kitchen niche, as shown on page 152, a corner of the dining room, or into an unused closet. Its compact size (it measures only 18 in. wide, 29 long and 27 from the floor to the top of its handles) makes it easy to store unobtrusively until it's ready to wow your next party or serve your next meal. ★★

PLYMOUTH ROAD TEST

(Continued from page 113)

70 mph; 15.5 at 60; 17.4 at 50; 18.4 at 40; 19.0 at 30. The speedometer, incidentally, proved remarkably accurate. It was just one mph fast throughout the 30-70 test range except at 50 mph, where the error went up to 1.5 mph.

The brakes fared worse. During a succession of near-panic stops from 60 mph at 30-second intervals, pedal pressure nearly quadrupled after eight stops. Our poundage readings went in this order: 17; 20; 23; 25; 35; 40; 47; 63. After the third stop, the brakes pulled noticeably to the right. They're adequate for normal use, but if you drive hard or in mountainous country, you'd better get the optional front disc brakes. They cost an extra \$109.70, plus \$41.75 for servo assist.

Trouble is that, at this writing, availability is a hangup. I called several dealers in the New York area. None had a disc-equipped car in stock. Delivery, they said, would take from three to six weeks.

The Plymouth is a pleasant car to drive. Visibility is good except for minor blind spots in the rear quarters. Blinkers on the front fender ends indicate to the driver when directional signals are on. Workmanship in our test vehicle was excellent inside and out, except for excessive "orange peel" in the paint finish. All panels and trim matched perfectly.

All in all, the car should make all you performance people happy. ★★

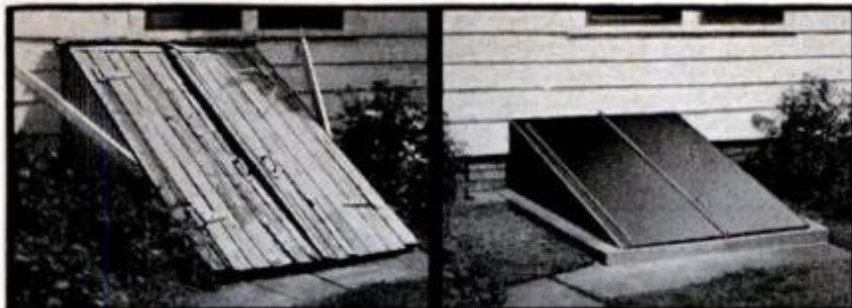

Here's the way to add amazing new beauty and convenience to your home. Replace that troublesome wood door with a modern Bilco. All steel, permanent, watertight, opens and closes at a touch. A new Bilco Door will do wonders for your home . . . and for you!

The Bilco Co., Dept. R-62 New Haven 5, Conn.
Please send me your free illustrated folder and name of local dealer.

Name _____
Address _____
City _____ Zone _____ State _____

EASY TO REPLACE

THIS MODERN WAY

Bilco

AMERICA'S FINEST
BASEMENT DOOR



**GENUINE ALNICO
MAGNETS**

AMAZING, PERMANENT, NON-ELECTRIC, HIGHLY PRACTICAL. Conduct interesting experiments. Hundreds of uses. Retrieve valuable steel items such as guns, tackle from fresh or salt water, tools from tanks and drains. **GUARANTEED.** Try any magnet one week. Money back if you are not well pleased.

- M-710 (Wt. 53 oz.) Has pull of 225 lbs. on steel block \$18.50
- M-625 (Wt. 49 oz.) Has pull of 125 lbs. on steel block \$12.50
- M-575 (Wt. 18 oz.) Has pull of 75 lbs. on steel block \$ 7.10
- M-500 (Wt. 13 oz.) Has pull of 50 lbs. on steel block \$ 5.10
- M-90 (Wt. 5 oz.) Has pull of 15 lbs. on steel block \$ 3.50
- M-44 Rod Magnets for Electric Guitars 1/4" DIA. x 1 1/4" 12 for \$ 4.87
- M-47 Hot pad Magnets 10 for \$1.00 50 for \$ 4.87
- SPECIAL INTRODUCTORY PRICE ON RUBBER MAGNETS
- M-R-110 Rubber Magnet Kit 10 Assorted pairs \$ 2.25
- M-R-24 Flexible Strip Magnet (easy to cut)
1/32" x 3" x 24" \$2.00 each 2 for \$ 3.70

SEND M.O. OR CHECK—WE PAY POSTAGE—SORRY NO C.O.D.'s
MIAMI MAGNET COMPANY, 3240 N.W. 27th Ave., Miami, Fla. 33142

To Make and Sell Ornamental Concrete Items

You Need **MOLDS**

For Thorough Info
On Over 300
Different Molds
You Can Buy And
Use Plus Complete
Start To Finish
Professional Instructions
RUSH \$2.00 for book



TURN CONCRETE INTO GOLD

CONCRETE MACHINERY COMPANY, INC.
839 Lenoir Rd. - P. O. Box 99 - Hickory 2, N. C.

**Shrinks Hemorrhoids
New Way Without Surgery
Stops Itch - Relieves Pain**

For the first time science has found a new healing substance with the astonishing ability to shrink hemorrhoids and to relieve pain - without surgery.

In case after case, while gently relieving pain, actual reduction (shrinkage) took place.

Most amazing of all - results were so thorough that sufferers made astonishing statements like "Piles have ceased to be a problem!"

The secret is a new healing substance (Bio-Dyne®) - discovery of a world-famous research institute.

This substance is now available in suppository or ointment form under the name Preparation H®. Ask for it at all drug counters.

**Handy, the amazing
new hand cleaner,
removes PAINT**

AEROSOL
DISPENSER

Hard-to-clean soil disappears like Magic. Handy removes grease, grime, stains, ink - even office duplicator ink. No water needed. Leaves skin soft and smooth. Get Handy at your paint or hardware store, or send \$1. Satisfaction guaranteed.

WILSON-IMPERIAL CO.
123 Chestnut Street
Newark, N. J. 07105



FILLS CRACKS

AND HOLES

FIX IT QUICK!

No muss - no fuss with easy-to-use Plastic Wood. Resists grease and water.

For surest results always use GENUINE

PLASTIC WOOD

Handles like putty - hardens into wood!



TEMPEST SIX

(Continued from page 111)

city driving speeds. On gravel roads, or on roads with surface irregularities, the body shake is moderate to severe. The Tempest has a tendency—verified by test personnel—to carry a shock to the front suspension all the way back to the rear of the car, sort of like a whiplash effect. When the front wheel hits a chuckhole, for instance, strong vibrations reverberate clear back to the rear of the car. At least that's the feeling you get.

Lowness has limitations

Part of the reason for the good ride on surfaced streets is the low center of gravity. It prevents extreme leaning in corners, adding to a feeling of security as well as flattening out the ride. But lowness is not all good. It caused one of the biggest objections I had to this car. Visibility through the back window via the rear-view mirror was little short of maddening. The roof line at the rear window is so low that only half of the vertical view of the road behind is visible in the glass. I never did get to see if somebody was really behind me. And the nighttime part of the day-night mirror kept reflecting the

top of the rear seat, so that interfered with daytime driving, too. If you can leave this car after a long drive without a crick in the neck you are related to a rubber man.

The car is superbly finished inside and out. Interior trim is especially well done with good fits, attractive materials and color scheme. Placement of controls is well conceived. Bright vinyl covers the seats, while floors and scuff panel areas are finished in loop pile carpeting. The instrument section of the dashboard has a black, camera-case finish that contrasts sharply with the rest of the interior.

Interior room is barely adequate for six adults, so you wouldn't want to take any long trips in this car with a full passenger load—especially if you worry about claustrophobia. I'm slightly above average height, but I still can rub the headliner with the top of my scalp while sitting in the back seat at either side. If you wear a hat, forget it. This car is no different from most others on the road, so leave the lid at home.

I skinned my knuckles a few times moving the driver's seat back from a close position because, by some glaring oversight, the seat adjustment lever is right behind the seat belt holster on the driver's side. Every time you move the seat back,

It's child's play to mend practically anything in your home with Weldwood adhesives.

1



2



3



5



you get a painful reminder of this. I think the Fisher Body engineer who's responsible should run it back and forth 100 times before he is allowed to go home at night.

At speed there is some wind noise from the right vent window, though the car is noticeably better than others in this respect. The left front vent window was loose on its hinge and would not stay open in place, once the wind hit it. I'd push it halfway open to catch a breeze, and it would swing around to a closed position as the airstream pressed against it.

For some reason this car had the most efficient antenna I have ever seen on a car radio. I picked up stations from as far away as Chicago, Quebec and Elyria, Ohio, one morning in Detroit and they came in without interference. Perhaps the fact that the antenna was power-operated and mounted on the rear fender had something to do with the reception. Amazing.

Paint passes tough test

Tempest's exterior finish is excellent. The car I tested had over 13,000 miles on it and had been put through Pontiac's highly-corrosive salt bath 96 times, but the paint was just as shiny and clean as new. Pontiac says the salt-bath procedure is equivalent to three years' driving in De-

troit streets, during the winter. Pontiac hopes to pinpoint the places on the car finish where salt does the most harm. The test car showed one area in particular—at the rearmost point of the side window trim—rusting through the body metal.

The gravel road portion of Pontiac testing showed that those fancy wheel covers will get old-looking in a hurry if you drive on secondary roads. The protruding center section of the rear wheel covers on this Tempest showed obvious stone damage.

Pontiac did not equip this car with power steering, an oversight I strongly recommend you avoid. With nearly seven turns on the steering wheel from lock to lock, the car is not easy to handle in turning maneuvers.

The manual brakes were a different story. Aside from the high position of the brake pedal, you'll never notice that braking is not power-assisted. So, save your money on that option.

I was also surprised at the stopping power of the brakes. The car weighed a total of 3728 pounds with all equipment and two passengers aboard, and I ran seven tests of stopping power from 60 mph to zero. Stops were made at a constant rate of 16 feet per second and tests were *(Please turn to page 234)*

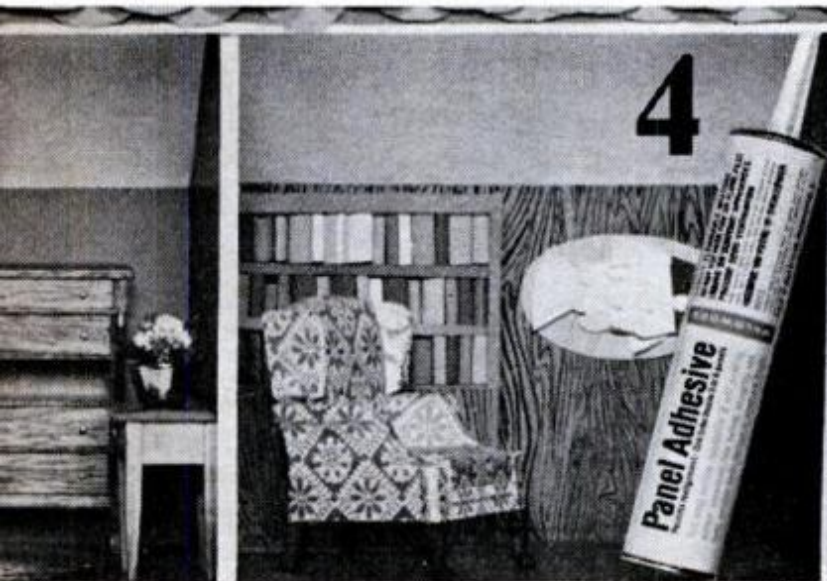

1 The 100% waterproof glue for wood is **Weldwood Resorcinol**. Permanent bond withstands boiling, freezing. For outdoor furniture, sports equipment, toys, home repairs.

2 No job is too tough for **Weldwood Epoxy Glue**, the most versatile glue in the house and by far the strongest. It literally supports tons. Use it for iron, steel, aluminum, brass, copper, bronze, stone, glass, porcelain.

3 For furniture, **Weldwood Plastic Resin** makes a bond stronger than the wood itself. It will not stain and is highly water-resistant.

4 For putting up wood paneling, **Weldwood Panel Adhesive** is the successor to hammer and nails, and 50% faster. No dents, no nail holes.

5 **Weldwood Contact Cement** bonds instantly, holds permanently, is versatile enough for 1,001 other jobs around the house. Ideal for ceramic tilework and counter-top lamination.

6 **Weldwood Presto-Set® White Glue** is safe even for children; ready for use and bonds like magic; wood, paper, leather and fabrics set fast and stay set.



**Weldwood® adhesives from
U. S. Plywood Corporation.**
2305 SUPERIOR AVENUE,
KALAMAZOO, MICHIGAN

A New FREE BOOK for

MEN PAST 40

**Troubled With Getting Up Nights,
Pains in Back, Hips, Legs,
Nervousness, Tiredness.**

This new Free Book tells that if you are a victim of the above symptoms, the trouble may be traceable to Glandular Inflammation . . . a condition that very commonly occurs in men of middle age or past and is often accompanied by despondency, emotional upset and other mental and nervous reactions.

The book explains that, although many people mistakenly think surgery is the only answer to Glandular Inflammation, there is now a non-surgical treatment available.

NON-SURGICAL TREATMENTS

This New Free Illustrated Book tells about the modern, mild, Non-Surgical treatment for Glandular Inflammation and that the treatment is backed by a Lifetime Certificate of Assurance. Many men from all over the country have taken the NON-SURGICAL treatment and have reported it has proven effective.

The Non-Surgical treatment described in this book requires no painful surgery, hospitalization, anesthesia or long period of convalescence. Treatment takes but a short time and the cost is reasonable.

REDUCIBLE HERNIA | HEMORRHOIDS

Non-Surgical treatment for both Reducible Hernia and Hemorrhoids, the book explains, can usually be taken at the same time as treatment for Glandular Inflammation.

This new Free Book is fully illustrated and deals with diseases peculiar to men and women. It tells HOW and WHY New Modern NON-SURGICAL Methods are so successful today. Fill Out Coupon.



Excelsior Medical
Clinic, Dept. M 6150
Excelsior Springs, Mo.

Gentlemen: Kindly send me at once, your New FREE Book. I am interested in full information. (Please Check Box)

- | | |
|---|---------------------------------|
| <input type="checkbox"/> Glandular Inflammation | <input type="checkbox"/> Hernia |
| <input type="checkbox"/> Hemorrhoids | |

Name.....
Address.....
City..... State.....

TEMPEST SIX

(Continued from page 233)

run without pause. As soon as the car came to a stop, I accelerated to 60 again as fast as possible. I wanted to see how much harder I had to push the brake pedal each test to stop in the same rate of time.

The first time, I stopped with 50 pounds pressure on the pedal. Subsequent stops were made with 60, 70, 70, 80, 85 and 90 pounds pressure. The car behaved normally throughout the test, with no swerving from uneven brake pull.

Pontiac had one especially embarrassing thing happen to the car out at its proving grounds. The right rear side window slipped out of its track and dropped into the well when I was cranking it down to remove some fuel hoses. Fisher Body had to remove the interior trim panel to replace the glass on its cranking arm, a procedure that took only a matter of minutes. If this happened to your car though, you could waste hours going to and from the dealership and waiting for a mechanic. Pontiac wanted to blame Fisher Body, but the customer only knows his dealer, and that's whom he puts the finger on.

Overall, this car with its great styling, but low power, will appeal to a particular group of people who do a lot of city driving and who are interested in economy of operation. It will look great to women who want a nice looking car to drive to club meetings, but still have to take the car shopping with a load of kids in the back seat. Young people who can't afford the price and operation cost of a GTO, but still want a Pontiac, will like it, too.

If you can get used to the combination of low power and high styling, the Tempest Six may be your baby. ★★★

FUN FOR JUNIOR MAILMEN

(Continued from page 176)

12½-in. bottom board to which the front axle is attached from below with screws. The lower end of the steering column is slotted to fit over the axle and is glued and pinned to a slit wooden hub.

Cleats placed on edge are used to support the 9-in. disc 1⅞ in. below the footrest. To provide an easy-turning bearing surface, discs of tempered hardboard are glued to the underside of the 9-in. disc and to the top side of the 5¾-in. board. A little wax applied to both will make the truck steer freely. The wooden hub which straddles the front axle is made by boring a 1-in. hole in the center and then splitting it by sawing a ½-in. section from the middle. ★★★

LOST RADIUM

(Continued from page 104)

one up. When doctors went to use the radium and found it missing, they triggered a search which ended when the radium was found in the city dump.

Garage piles and city dumps are a frequent haunt of radium hounds. Radium mistakenly and casually tossed away ultimately finds its way here. Only the trusty Geiger counter can find such radium needles in refuse stacks. The clicking counter has also found lost radium in bed linens and in such unlikely places as trouser cuffs, taxicabs, the stomach of a pig, and a roll of toilet paper in which the radium was hidden by a mental patient.

Frantic search for vial

One of the most hair-raising episodes involved a five-milligram vial of radium that was mistakenly tossed into a wastebasket a year ago. It traveled along with the wastepaper to a baling plant. Such bales are sent to paper mills for processing. If the radium went through the mill, it could turn up in stationery, magazines, and photographic prints across the country! Luckily, a five-state search of boxcars loaded with wastepaper ended happily.

Lost radium sometimes is found in the oddest way. For instance, a package was left on the counter of an electronics store in Chicago. No one paid attention to it until a salesman demonstrated a radiation detector for a customer. The instrument's needle flipped to the end of the scale. It took but a few minutes to determine that the radiation came from that package. It was opened and found to contain 70 milligrams of radium. Vial serial numbers taken by Illinois health officers traced the radium to an Ohio hospital robbery.

Wherever radium is handled and used, it is bound to be lost. A radium needle was dropped in a California operating room; thanks to a fast-acting health physicist with a ready Geiger counter, it was found in a fold of cloth draped over the patient. A 40-milligram glass vial was dropped on the floor of a Navy laboratory; the radioactive powder was spread around by countless shoes. Similar events occurred in two hospitals several years later. It cost thousands of dollars to recover and clean up the radium tracked around by contaminated shoes.

Much radium is flushed down toilets with bandages by patients who don't feel their loss until too late. When such lost radium is reported, rescue teams search up and down sewer lines, and the rivers into which they empty, with Geiger

(Please turn to page 236)

YOU CARRY MIXER CUP THIS WAY

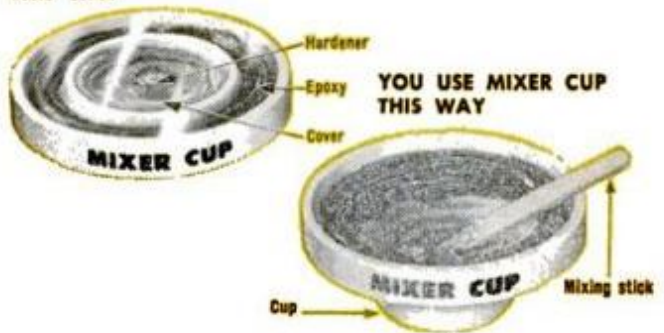

New messproof MIXER CUP supplies QUIK-MIX EPOXY GLUE in exact amounts for extra-strong repairs

You get super-strong joints every time with Quik-Mix Epoxy Glue in a messproof Mixer Cup. One Mixer Cup delivers exactly the right amount of epoxy and hardener for highest strength. Just form the cup with the stick and stir. When the amber hardener and blue epoxy turn gray, the mix is perfect. Two Mixer Cups of Quik-Mix Epoxy Glue cost only 59¢ at hardware stores. Keep a couple in your shop, car, camp, boat, or knapsack for emergency repairs.

Handy 2-cup card fits your shop pegboard
2 Cups
59¢



A product of
LOCTITE CORPORATION
480 N. Mountain Rd., Newington, Conn. 06111

BUILD YOUR OWN POWER TOOLS

METAL PARTS KITS AT LOW FACTORY DISCOUNT PRICES FOR:

- 10-IN. TILT ARBOR SAW
- COMB. DRILL PRESS-LATHE
- 12-IN. BAND SAW
- 18-IN. BAND SAW
- 6-IN. BELT SANDER
- SPINDLE SHAPER

SAVE \$50 OR MORE

PLANS \$1.00 EACH
Full Size Patterns **DEDUCTIBLE**

Kits from \$15.50 to \$39.95. Satisfaction guaranteed. Built and sold for 18 years. 45,000 units in use. Send for Plans today!

FREE CATALOG
GILLIOM MFG. CO. Dept. PM-2 St. Charles, Mo.

Bean's Free Spring Catalog



Ready February 15

Fully illustrated 100 pages of camping specialties, fishing tackle, clothing and footwear for men and women. Featuring practical outdoor items, many of our own manufacture.

L. L. Bean, Inc.
247 Main St., Freeport, Maine 04032
Fishing, Camping and Hunting Specialties

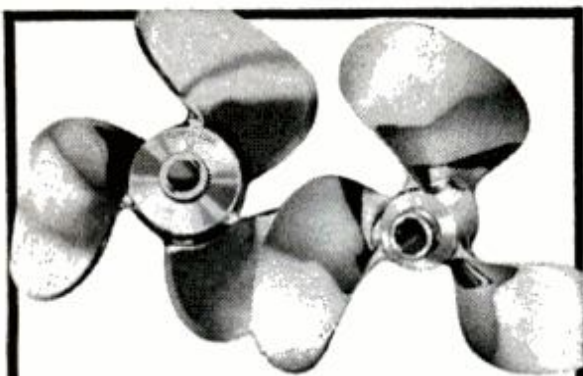

**You should know about these
PROPELLERS!**

Very fast cupped-edge outboard props . . . trophy winners that will increase the speed of your outboard. "Featherweight" props cast of Mich-alloy-K bronze . . . so strong that you get a lifetime guarantee against blade breakage at the hub. Standard bronze and aluminum props featuring new pitch generation principle . . . dynamically balanced. Hundreds of propeller styles and sizes; one to exactly suit your motor, boat and use combination. See your Michigan dealer now; ask to see the all new Michigan catalog with factory engineered recommendations that make you a propeller expert. You'll be delighted at performance improvements when you use the right prop. Michigan Wheel Co., Grand Rapids, Michigan 49502.

MICHIGAN

LOST RADIUM

(Continued from page 235)

counters. Often the radium is found; more often it is not, because the water and lead pipes shield the telltale rays.

Carelessness by trained doctors can also be responsible for lost radium. Not long ago, for instance, a surgical resident at a New York hospital untaped a patient's bandages and carefully removed a radium capsule which was being used to treat a cancer. He then returned the 30 milligrams of radium to its heavy lead storage container. What he didn't realize was that there was a second, 20-milligram container of radium entangled in the bandages he had tossed aside. Despite thorough searches it has never been found.

He filed and forgot!

At about the same time, another New York doctor had some old filing cabinets picked up in exchange for new ones, then remembered he had stashed some radium away there years ago. Neither cabinets nor radium were ever found.

According to the New York health department, radium losses in one recent year totalled 302 milligrams. "In spite of diligent searches of incinerators, vehicles, and dumps by health and sanitation department employees, only 12 of the 302 mg. have been recovered."

Industry also loses radium. The radio-isotope is used in the field in place of X-ray to take pictures of the insides of heavy castings and of welds. It is also used in well-logging to analyze the deposits being drilled through. Neutrons from the encapsulated radium strike the side of the drill hole and cause the chemicals there to emit back characteristic radiation, which is instantly detected. Many of these radium sources are at the bottom of both the Gulf of Mexico and the Mississippi River on barges and Texas Towers sunk during hurricanes and fires.

All of these cases, says Villforth, point out two vital needs.

One is that people who have radium must be well educated in its use, dangers and storage. Many private doctors don't realize that their vials may be leaking the deadly radon gas, that vials can easily explode as the glass ages and the gas pressure builds, and that the containers the radium originally came in are inadequate shielding. Lots of patients get unknown blasts of radiation from radium that sits in their doctors' desk drawers. The shielding required for radium is not that required for X-ray protection. A half-inch of lead will reduce the radiation from radium only by half.

Liquid
WRENCH

LOOSENS RUSTED NUTS, BOLTS, PARTS IN SECONDS
at Service Stations, Auto and Hardware Stores
RADIATOR SPECIALTY COMPANY, CHARLOTTE, N. C.



BUILD YOUR OWN CAMPER AND SAVE!

Complete, easy to follow Camper Plans, instructions, materials list... **\$3.95**

PICKUP COVER PLANS with removable rear panel... **\$2.00**

EQUIPMENT CATALOG Refundable on first order... **\$1.00**



SATISFACTION GUARANTEED! Also Factory Built Units
Send Check or M.O.—For Details Send Dime!

MAIL TODAY

CAMPER COVER CATALOG

NAME.....

ADDRESS.....

CITY..... STATE.....

VIKING CAMPER SUPPLY 94-B Glenwood Ave. Minneapolis, Minn. 55403

The health department of one eastern state recently inspected the offices of 54 private physicians who use radium and found that almost half of the vials leaked radon or radium; Kansas health inspectors on a similar survey found half the radium vials inspected were leaking. Like findings have come from surveys in Florida, Kentucky, and Georgia.

More state controls urged

The second need is that states impose rigid controls on radium storage and use through rules and registration. Four years ago, the U.S. Atomic Energy Commission told state governments they could take over its licensing of isotopes. The move was opposed by the American College of Radiology and others who live with radiation. They wanted firmer federal control.

They and Villforth believe now that the states have the power to license isotopes, they should also license radium. Only eight states—representing a third of the U.S. population—have taken over the A.E.C.'s licensing role.

Until there is greater control and better records kept, the search for lost radium is going to go on—as more radium is suddenly and alarmingly found each year and more suddenly and irretrievably lost. Until radium is regulated on the same level as cobalt-60, iodine-131, and other man-made isotopes, innocent discoverers are bound to keep getting their fingers burned by unfelt invisible rays.

Radium warning!

If you knew any old radium processors, tell your local health department.

If you should come across what you have reason to believe is undiscovered radium, here's what to do and not to do:

1. Don't touch it, don't douse it with water, don't blow air over it. If indoors, seal the room it's in and shut off the fan or ventilating system. If it has spilled on the floor, don't try to clean it up.

2. Anything that has come in contact with the radium should be left in the room—such as clothing, etc.

3. Keep curious bystanders away.

4. Call your local health department immediately and tell them of your find.

5. Call your physician and tell him of your find and your possible exposure. He'll want to examine you.

Remember, radium is extremely dangerous and should be so treated.



FOUR-WAY
BEST LOW COST
ARC WELDER
YOU CAN BUY
only \$14.95 Complete

WELD, BRAZE, SOLDER, CUT. Tops in performance and value. Ideal gift, educational, profitable, enjoyable. No experience needed. Use 1/8" welding rods and 1/4" carbons to make or repair auto bodies, fenders, trailers, boats, toys, furniture, farm equipment; garden tools, anything of metal. Operates on 110 V. line.

WORLD'S GREATEST WELDING VALUE. Over 500,000 in use by home owners, farmers, hobbyists, mechanics. **5-Year Unconditional Guarantee.** If inoperative will repair or replace without charge. **You Get: FULL FACE SHIELD,** heavy metal cabinet, ground clamp, 12 ft. of heavy duty welding cables, twin carbon arc torch, rod holder, carbons, welding and brazing rods, flux, solder, instructions. Order on 10-DAY UNCONDITIONAL MONEY BACK TRIAL.

SEND ONLY \$2.00 and pay \$12.95 plus C.O.D. charges on delivery. Or send only \$14.95 and we will ship prepaid. Order today.

FOUR-WAY WELDER CO. DEPT. W2-B
1810 S. FEDERAL ST.
CHICAGO, ILL. 60616



ALUMINUM SIDING

Learn how you can earn up to \$1000.00 per sale, showing our quality aluminum siding on your home.

TO: ALUMINUM INDUSTRIES, Dept. P-26
KANSAS CITY 11, MISSOURI

Please send me complete information

My Name _____

Street _____

City _____ State _____

MAN-SIZE! NOT A TOY!
10 & 12 hp, all-gear drive

Mows lawn up to 60" swath ... handles tough jobs others can't. Sized for bigger tools, extra leg room. Automotive clutch, transmission, and differential — no belts. Implements for mowing, dozing, gardening, snow. Own the best, at modest cost! Write for catalog.

ECONOMY TRACTOR
1005-K-02 Anoka Avenue
Waukesha, Wisconsin

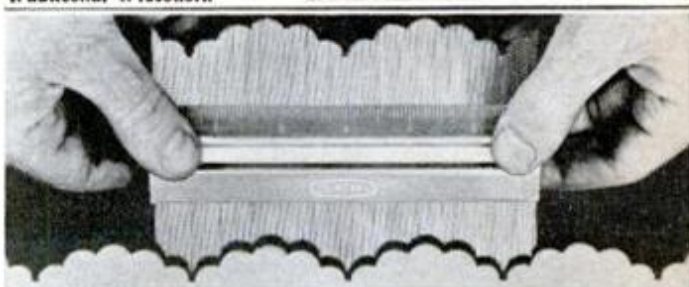
COPY-CAT CONTOUR GAGE

Great for every workshop. Gives you exact contour to match irregular shapes. Just press 175 steel teeth against surface to pick up contour. Then pencil outline shape on tile, linoleum or wood and cut for perfect match and fit. 6" long with inch scale. Only \$5.00 postpaid. Send check or M. O. (no C.O.D.'s) to:

Workshop Tools, Inc. 42-33 Northern Blvd. Long Island City, N.Y.

CARS FROM OVERSEAS

(Continued from page 107)

deceleration of front and rear wheels. The luxury four-seater costs \$12,500 in England.

Just the thing for a suburban housewife to take to the market is the latest Aston Martin station wagon. Better warn her first that there are 350 hp on tap, which will take the car to 150 mph. Either an automatic or a five-speed manual transmission is available. With rear seat folded down, there is over 40 cu. ft. of cargo space. Basic price is \$17,600 plus taxes.

Another British development is a "throwaway" car designed to replace the rickshaw in developing countries. It will be extremely simple, and would be replaced after five years' hard use in city traffic. A prototype now being built will have a 500-cc motorcycle engine, but later models will have a throwaway engine that will be so cheap to make that it won't be worth repairing. The five-seater will be about seven feet long and will sell for about \$700. Its creator, John West, runs a design consultancy in London, Germany and Pakistan.

The new, big Citroen from France, the DS 21, looks similar to last year's model, but its headlights, actually floating in the fenders, are delicately counterbalanced to

keep the beams pointing in the proper direction, no matter how rough the road. Another Citroen safety feature: When the brakes reach a certain wear stage, a dash light warns the driver. The big Citroens also have a warning on the speedometer panel that tells how many yards you need for stopping at your current speed.

The English-made Rover 2000s, sold in North America, all have an electronic sensing probe mounted in front that warns of possible icy conditions. The "Icelert" starts flashing an amber dash signal when outside temperature falls to 36° F. As temperature drops, flashes come faster. At 32° the light stays on. Other car owners can buy it from Rover dealers for \$29.95.

Rover, incidentally, now expects to go into production with its gas turbine within two or three years. The 24-hour race at Le Mans this year has convinced Rover that the biggest obstacle up to now—poor fuel mileage—has been overcome. Rover expects to get 24 miles per U.S. gallon of kerosene, and 120 mph top speed. The body would be like the Rover 2000.

Engines more sophisticated. The new V4 for the British Ford Corsair comes in a 1663-cc size for the basic car and a 1966 cc size for the GT. The engines use a
(Please turn to page 240)

WE'VE GOT the FORMULA For Solving Your Problems

Planning to build your own garage? Need instructions to make a burglar alarm or beds? Want help on household hints or workshop projects? Looking for plans for a model clipper ship or child's car?

SEND FOR YOUR FREE POPULAR MECHANICS SERVICE FILE

More than 300 subjects covered in Popular Mechanics library of books, booklets, blueprints, and patterns are listed in this tremendous reference file. Here's the handy guide which shows you where to find the answers to almost any do-it-yourself problem.

POPULAR MECHANICS, Service Bureau PM2
575 Lexington Ave., New York, N. Y. 10022

Please send your free SERVICE FILE to:

Name

Address

City Zone State



Custom Build Your Own FROM FIBERGLAS AND PLASTIC RESIN



- Turn full or spare time to profit with new plastics.
- Our 56-page illustrated handbook shows costs, materials, directions

Write to

Fiberlay

LONG BEACH, CAL., 2053 SANTA FE
SEATTLE, WASH., 1158 FAIRVIEW N.

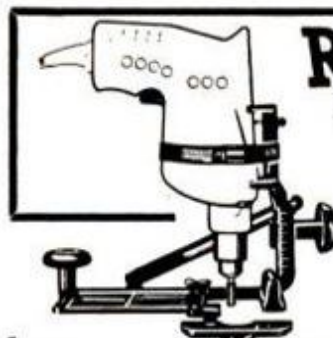

ROUTERMATIC MAKES EVERY MAN AN EXPERT WOODWORKER

Clamp this amazing tool to your electric drill and route, mortise, trim, shape, mitre and tenon like a professional cabinetmaker. Handles any job better by

letting you take the tool to the work. Just like having an electric chisel. Routermatic is precision made, sturdy, lightweight. Use it once and you'll wonder how you ever got along without it. ONLY \$6.95 including \$1.50 router bit. No C.O.D.'s. Can't be sold thru stores at this low price. Descriptive folder on request.

COMP-TOOL, Inc. 355 Prospect Rd., Ashtabula, Ohio

Hey Kids!

NEW GAS ENGINES \$25

Amazing directory tells where to buy discount mini-bike, kart parts etc.!

RUSH \$2 for directory or send 25c for brochure describing new edition!

BARGAINS, PO BOX 4408, DEPT. PM 2 CHICAGO, ILL. 60680



RUPTURE!

An amazing Air-Cushion Invention allows body freedom at work or play. Light, neat, cool, sanitary. Durable, cheap. Day and night protection helps Nature support weakened muscles gently but surely. No risk. Sent on Trial! Write NOW for free Booklet and Proof of Results. All correspondence confidential.

Brooks Company, 346-C State St., Marshall, Mich.



FREE FISHING

CATALOG

170 PAGES

OVER 5,000

FISHING ITEMS

Hard to find Fishing Specialties and Kits

WRITE TODAY
NETCRAFT CO.

Dept. 32
Toledo, Ohio 43613

8 times more power to relieve pain of HEMORRHOIDS!

Soothing Nupercainal concentrates on pain!
Prolonged relief of pain, burning and itching starts in minutes.

If you suffer from the misery of hemorrhoids, remember this about remedies you can buy for temporary relief. The leading "shrinking" preparation contains no anesthetic to relieve pain.

No wonder so many doctors recommend Nupercainal. Soothing Nupercainal relieves pain, itching, burning fast...gives prolonged relief...because it has *over eight times more pain-killing power* than the other most commonly-used topical anesthetic!

Nupercainal quickly puts raw nerve ends to sleep...thus puts pain to sleep. Lets you go about your business...relieved of the pain, burning and itching torment of hemorrhoids. Get Nupercainal Suppositories today—with free, handy pocket-pack. Start to live again, in comfort! (Ointment also available.)



Nupercainal®

Now...Eat better and faster with FALSE TEETH



When false teeth get on your nerves many dentists give special FASTEETH powder. It helps hold teeth in place—helps keep them from slipping or dropping down when you talk—makes you feel more secure. FASTEETH cushions tender gums so you can bite harder and eat easier, faster with greater comfort. FASTEETH helps you laugh and speak more clearly without embarrassment. FASTEETH is alkaline (non-acid). Checks "plate odor" (denture breath). At drug counters everywhere.

CARS FROM OVERSEAS

(Continued from page 238)

crossflow head, where inlet ports are on one side and exhaust ports are on the other to give unrestricted gas flow. The combustion chamber takes the form of a bowl machined in the crown of the piston. This allows a completely flat cylinder head with vertical valves. Other improvements include self-adjusting brakes (discs in front), an all-synchromesh, four-speed gearbox and an optional automatic.

There are more engine improvements. The ubiquitous Volkswagen 1200 is up from 40 hp to 50 hp. It also has vented wheels for better brake cooling, front ball joints instead of link pins, and an improved defroster. Two new VW 1600s, a squareback and a fastback have also been introduced in the United States.

Swedish Saab's standard engine is up from 44 to 46 hp, thanks to triple carburetion. Or for \$230 extra you can get the Monte Carlo 60 hp engine in the standard sedan or station wagon. Also, the three-speed transmission is no more; all cars have the four-speed transmission.

Besides extra horsepower in Sweden's Volvo line (the 122S is up from 90 to 95, the 1800S from 108 to 115), all cars have a safety valve that balances brake pressure front and rear and prevents rear-wheel lockup. And the 544 sedan—the one that looked like a '46 Ford—is no more.

The popular Fiat Spyder 1500 is sportier than ever. Horsepower is up from 80 to 83; a five-speed gearbox is available.

For \$20 extra you can get folding double beds in your French Renault-8. The new R10 and R16 models will not be sold in this country in the near future.

The popular British Motor Corp. Mini, and 1100 (MG Sports Sedan), now offer a new four-speed-plus-torque-converter automatic transmission. Let it shift for itself, or slip the floorshift into 1, 2, 3 or 4 and the transmission will remain locked in the gear selected.

New additions to the BMC 1100 range are the Riley Kestrel and the Wolseley 1100, both luxury versions of the MG Sports Sedan. Leather upholstery, walnut dashes and distinctive grilles are featured.

A new version of the big-selling MGB is the GT coupe, which has two occasional rear seats and stronger springs to cope with extra passenger weight. The engine remains the current 95-hp Four.

Britain's Rootes Group, in which Chrysler now has a big stake, has beefed up its middle range of cars. A new 1725-cc engine in various stages of tune replaces the old 1592 in the Sunbeam Alpine sports car, the Sunbeam Rapier, the Humber Sceptre,

the Singer Vogue and Gazelle and the Hillman Minx. The five-bearing crankshaft gives smoother performance. Power output of the Alpine is up from 88 to 100 hp, and torque is up 10 percent. The gear box has closer ratios, too. Top speed is now about 100 mph. All four cars have 35-amp. alternators—a slowly developing trend in European cars.

Long-awaited hot Imp is out. Its engine is bored out to 988 cc and has a high-lift overhead cam, twin carburetors, large valves, an oil cooler and improved plumb-ing. The Rootes product puts out 65 hp—50 percent more than does the standard model. Factory conversion costs \$840 in Britain with power brakes and modified suspension. Top speed is said to be 100 mph and acceleration to 60 mph takes 14.8 seconds.

One star of Europe's recent auto shows is the Opel Kadett Deluxe, the German subsidiary of GM. It has Mustang-like fastback lines and a 59-hp engine that takes you 92 mph for \$1815. It is a true five-passenger car and, in a brief PM test run conducted in the suburbs of Paris, proved comfortable, with good braking (discs in front), neat finish inside and plenty of legroom front and back. The valve-in-head Four has large areas for coolant flow around valve stems. Antifreeze coolant is hermetically sealed and circulates under pressure. The camshaft is powered by a chain belt with a self-adjusting feature.

Another Opel entry is the luxurious Diplomat hardtop, which looks much like a Detroit car. Its 5354-cc (326.7-cu.-in.) V8 develops 270 hp and reaches 60 mph in 10.5 seconds. Automatic transmission, power steering and windows are standard. Price is \$7850.

Still another German newcomer is the BMW 2000 CS, whose 135-hp Four is said to do better than 115 mph. Handling is reported to be excellent. Price will be about \$5000.

Thin-blooded sports-car buffs will be happy to know that the English Lotus Elan roadster now comes in a hardtop version. The body continues to be plastic over a steel backbone frame. And there's a new front-wheel-drive from Triumph of England. The 1300 has a 1296-cc engine that develops 61 hp, and independent suspension all around. The clutch can be replaced without removing the engine or transmission—simply by unbolting a cover plate and withdrawing the quill shaft running from the clutch to the transfer gears. British price is about \$2200.

Even Rolls-Royce is on the new model kick. Its Silver Shadow was described in *Luxury Cars* (page 94, Jan. '66 PM). ★★

HOME WORKSHOP ARC WELDER!



**ELECTRIC
WELD BRAZE,
SOLDER, CUT
ALL METALS**



New 1961 Model

LIFETIME BURNOUT GUARANTEE—10 day money back trial. Works on any 110 volt "Plug in". Welds up to 3/4" steel with 1/16" to 1/8" rods. **EXTRA** Special twin pressure type arc torch (shown) develops up to 10,000 deg. heat—**HAS A MIL-ION USES**—for **CARS—HOME—FARM—FACTORY**. No experience needed—**FREE** Welding book teaches **YOU**. Thousands of users. **SEND ONLY \$2.00** (cash, Ck, MO) and pay postman \$12.95 COD Post. or send \$14.95 for postpaid delivery in USA. **COMPLETE** ready to use with 12 ft. H.D. Cables, Arc torch rod holder, carbons, welding and brazing rods, flux solder, work clamp and full face mask. **FREE EXTRA** "Dark" eye goggles—if you order at once. **This BEST FOR THE MONEY** welder sold **ONLY** by **MIDWAY WELDER**, Dept. 193M-2, Kearney, Neb.

BUILD A LOW COST PONTON BOAT WITH THIS KIT



Perma-D DIVISION
CENTRAL MACHINE WORKS COMPANY
Established 1921

It's Fun, It's Easy Too! If you can use a saw, hammer and wrench you can build a rugged pontoon boat that will provide years of fun for your family at an amazingly low cost to you. Write for complete catalog, free.

1235 Central Avenue
Minneapolis 13, Minnesota

130,000 CANDLE POWER FLAME THROWERS



WARREN AUTOMOTIVE

Fits all 4 light systems—bright sockets. American made for American cars. 65,000 candle power in each sealed beam unit. Over 2 1/2 times as bright as the factory stock brights. Lets you really see where you are going.

\$995 pair

Prepaid U.S.A. No C.O.D. please
Box 563 Skokie, Illinois 60076



**NOW WE MAKE
THE WORLD'S
FINEST
WOOD STAIN,
TOO!!**

BRONZE FOUNDRY



Since 1935

Schools • Home Workshops • Inventors
Make your own castings of aluminum, copper, bronze, silver. Foundry sets are available in six sizes, capacity 1 1/2 lb. to 48 lb. of red brass. 2400 Deg. F. blast furnace included with each. Write for Free Circular.

KANSAS CITY SPECIALTIES CO.

Dept. P-2, P.O. Box
193, Middleton, Wis.

LAMINATED TOPS

For Counters, Work Benches, Tables



Beautiful, laminated yellow pine, treated and ready for finishing. Originally manufactured as durable boxcar flooring, treated with non-toxic preservatives. Any thickness up through 3", 11" width, and lengths up to 10'. Dressed size 2" x 11" x 4'6". \$5 c.o.d. freight collect.

ALGER-SULLIVAN LUMBER COMPANY / Century, Fla.

Sure beats smoking!



Enjoy Copenhagen: Place a small pinch between cheek and gum. No chewing.

United States Tobacco Company

PROFESSIONAL STYLE • BUILT TO LAST

HUOT TOOL CHEST

Lowest priced full size chest. For professional or handy man. 4 sliding drawers, rugged steel cabinet—blue or red—26" x 12 1/4" x 12 1/4". Write for **FREE BULLETIN** on this and 15 other models.

HUOT MFG. CO. 555 N. WHEELER ST., ST. PAUL 4, MINN.

MODEL
107



Model B-2
2 Ton

\$117.50
job
less
Motor

ALVA ALLEN *Swaine* Power Punch Presses 1 to 150 Ton Capacity

Complete line of Punch Presses in hundreds of different style and model combinations. Write for **FREE** literature on presses and complete line of punch Press accessories as—Feeds, Punch Units, Dies, etc.

Alva Allen Industries, Dept. PM, Clinton, Mo.

ALL FAMOUS BRANDS! **FARM TRUCK AUTO** **AT LESS THAN WHOLESALE**

TIRES! SAVINGS NEVER LESS THAN 50% up to 70% OFF REG. PRICE!

HEADQUARTERS for ALL SPORT CAR TIRE SIZES
FREE • SEND FOR YOUR FREE CATALOG • FREE!

RELIABLE TIRE DIST., 1111 Chestnut St., Camden, N. J.

FAMOUS



TEENUT®
FASTENERS



Can't slip, flush-mounted, strong. ONLY nut that gives steel threads in wood!

- Now available in bright NEW finish!
- NEW red and yellow, skin-pack cards!
- Look for colorful NEW display carton, too!
- Handymen need TEENUTS!
- Sold at hardware stores.

**COLUMBIA
FASTENER**

TEENUTS is a registered trademark of United-Carr

SUBSIDIARY OF UNITED-CARR
3229 South Ashland Avenue
Chicago, Illinois 60608



The green trigger identifies the greatest advance in electric drills in 50 years!

Amazing! New! Skil

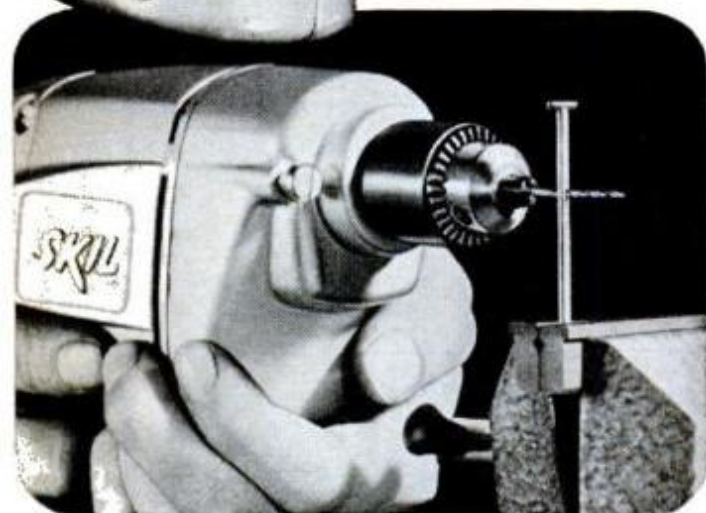

HOLE IN NAIL DEMONSTRATES THE AMAZING CONTROL OF NEW SKIL DRILL. We did it with the $\frac{1}{4}$ " Skil Trigger Speed Control (TSC) Drill. TSC drills also available in $\frac{3}{8}$ " and $\frac{1}{2}$ " sizes.



A PRECISION DRIVER, TOO! With the versatile Skil Trigger Speed Control Drill the variable speed feature lets you start screw at low speed, run it down at high speed, set it by slowing to a stop.

Go with the pick of the pros...

Skil Corporation, 5033 Elston Ave., Chicago, Illinois 60630

POWER TOOLS

SQUEEZE THE DRILL SPEED YOU NEED

With Trigger Speed Control you actually sense the correct speed with your trigger finger—much as you sense your car's speed with your foot on the accelerator.

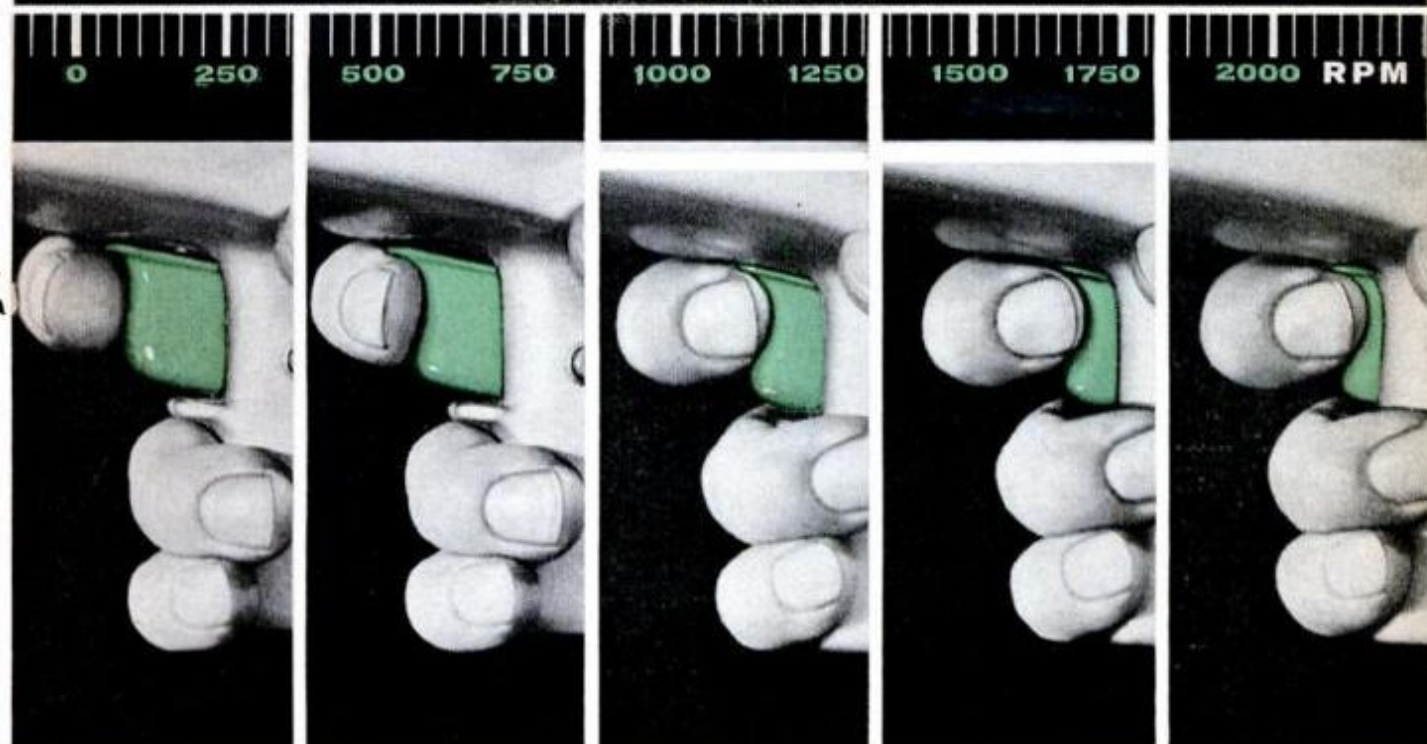

Trigger Speed Control Drill

For the first time, you regulate speeds, from 0 to 2,000 rpm's, with your trigger finger

You get stepless speed control to drill plastics, composition materials, wood or metal by varying finger pressure. No buttons or dials to fool with.

Start with light trigger pressure which keeps rpm low, makes bit placing easy—even on convex surfaces.

Exchange drill bit for driver bit, drive screws to exact depth you want. Even drive self-tapping metal screws—without center punching.

SEE NEW SKIL TSC DRILLS AT BETTER DEPARTMENT, HARDWARE AND LUMBER STORES EVERYWHERE



AUTOMOTIVE



RADIO-TV



MAINTENANCE

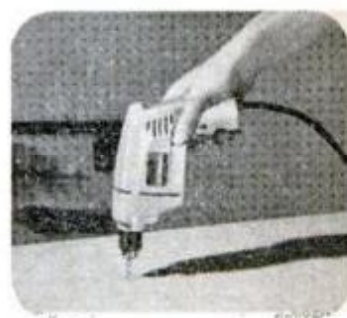

WORKSHOP

6 TRICK BILLIARD SHOTS

(Continued from page 147)

To form the base of your bridge, rest the heel of the hand on the table, then extend the last three fingers outward.

In billiards, occasions will arise where the cue ball will come to rest against the rail. In these cases, it's easier to use the rail of the table as part of your bridge (hence, the term "rail bridge") rather than attempt the shot with a conventional free-standing bridge.

With the rail bridge, the index and middle finger are used to guide the cue along the thumb. The ring and middle finger render firm support to the middle finger. In a shot of this nature you will also have to raise your cue slightly for positive stroke and contact of the cue ball and cue.

For the sake of safety, always chalk your cue before attempting a rail-bridge shot.

Even fundamentals have their share of variations. We've studied the regular bridge, the rail bridge, and now the *mechanical bridge*.

Stick bridge for long reach

Too many times, a billiard player will overextend himself in reaching for a shot. The result is often a miscued ball.

For the "stretch" shot, the player wisely employs the mechanical or stick bridge. He maintains a firm grasp on the butt end of the bridge. His cue rides the middle slot of the bridge and he keeps the distance as short as possible between his cue and the cue ball.

Finally, as he grasps the cue with his

thumb and forefinger, the player is in complete control and can now place a well-directed stroke at the cue ball.

No game is complete without an object, and pocket billiards is no exception. The *object ball*—the ball you wish to "sink"—spotlights the simple formula used to determine exactly where the cue ball must strike the object ball to send it into the pocket. The player draws an imaginary line from the center of the pocket to the object ball. Where this line bisects the object ball is his point-of-aim, or where the cue ball must strike it. *Always* keep your eyes on the object ball target.

Just how accurately you hit the cue ball is determined by your *cue stroke*.

Next time you watch a good billiard player, note the smooth rhythm of his arm swinging back and forth in a pendulum arc as he addresses the cue ball.

Keep your cue as level as possible and your bridge firm. Your shoulder, elbow and wrist joints should move in a free and easy action. And when you stroke the cue ball, make sure you follow through. Make sure you're not rigidly poking the ball, but stroking it with a light, springy action.

Cueing the ball properly gives it accurate direction and correct speed. As your game develops, the importance of these two elements will become apparent.

Most professional players avoid "english" as much as possible. Their play emphasizes stroking the cue ball dead center, and applying the follow (or draw) shot for position. Since a standard billiard ball is only $2\frac{3}{8}$ inches in diameter, your best target is the dead center.

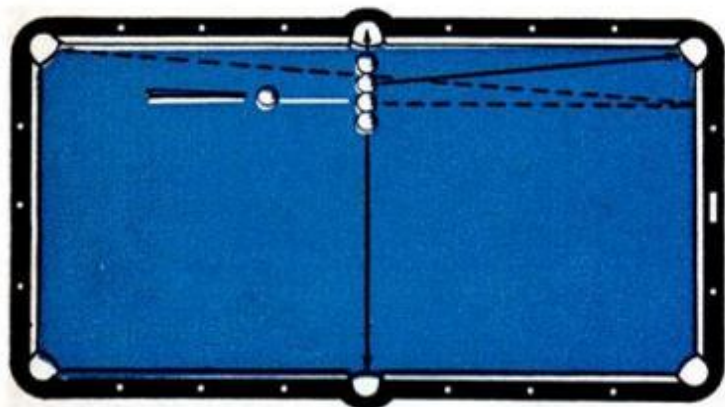

SPECTACULAR SHOT . . . Starting with 3 ball about $\frac{1}{2}$ inch from and in direct line with side pocket, line-up all 4 balls. Using a hard stroke, hit cue ball low center. Cue ball should strike 8 ball $\frac{1}{3}$ left; then carom into 10 ball. Action will see 3 ball drop into left side pocket; 13 into right side pocket, 10 in upper left pocket while 8 ball will make one carom and sink in lower left pocket.



Mosconi: "A draw stroke on the cue ball, hitting it below center, is vital to keep the cue ball out of the path followed by the 8 ball."

As you play, take the time to practice stroking the cue ball dead center, and concentrate on accuracy and speed required for scoring and position.

As your game develops and you apply more emphasis on position of your cue ball for the next shot, certain situations will require the cue ball to come back towards you rather than follow the object ball. This calls for the "draw" shot.

To perform this shot, rather than cueing the ball dead center, your point of aim is lowered and "reverse english" is applied. As the cue ball strikes the object ball, the reverse spin applied by the low cueing of the ball, forces it to return to you after impact with the object ball.

Occasionally, situations will arise where you will want the cue ball to follow the object ball so that it will stop in good position for your next shot. This is called the *follow shot*. Where for the draw shot you cue the ball about 1/2-inch below center, the cue ball will do the exact opposite and "get legs" if you cue it about 1/2-inch above center.

Be careful when you apply this cue-ball action. Should you give too much speed to the cue ball in a straight-in shot, you might miss the ball entirely.

Playing 'position'

In billiards it pays to look ahead. Therefore, when the words *playing position* are used, it merely means that the billiard player is looking ahead to his next shot.

The player tries to place his first object ball into the corner pocket, but looks ahead to the best position for his cue ball when the time arrives to "bank" (or ricochet) the next object ball against the rail.

His playing strategy tells him that if he hits the first object ball lightly on the right side, he will sink it, at the same time benefiting from the correct speed on the cue ball which places him in excellent position to bank his next object ball.

Remember that a billiard ball is round—it has no flat surfaces. Therefore, it becomes vital to increase the friction between cue-tip and the ball's surface. *Chalking the cue* provides this friction. Be careful not to apply too much by absentmindedly rubbing the chalk against the cue while considering the next shot. A thin film is sufficient.

"Practice and concentration on details like bridging, grip, stroke and stance," says Willie Mosconi, "offer the only chance for improving your billiards game. Coupled with a solid knowledge of the fundamentals discussed here, you can realistically aspire to championship in the highly competitive, colorful and exciting game of pocket billiards." ★ ★ ★

SAVE UP TO 85%

GOV'T SURPLUS and NEW EQUIP'T

Send 25c For 3 Big Catalogs

**PUMPS
WELDERS
WINCHES
SURVEYING
TELEPHONES
HYDRAULICS
GENERATORS**

**ELECTRONIC
BINOCULARS
GEAR MOTORS
COMPRESSORS
SPEED REDUCERS
WEED SPRAYING
MANY OTHERS**



SURPLUS CENTER Dept. PM-026 Lincoln, Nebraska

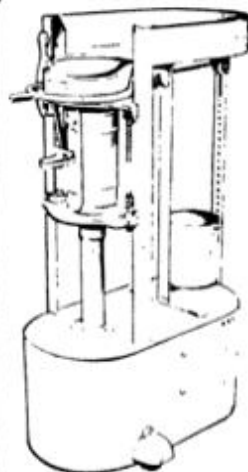

Turns CONCRETE into DRAIN TILE

This machine's a MARVEL. Costs less than \$500 and lets you make 100 or more top-quality tile per hour at a unit cost (including labor) of 4¢-5¢. Sell your tile at 10¢ to 15¢ each. Earn extra or full income making and selling a product that is in constant demand. Booklet with complete details free. Don't wait! Write for yours now.

CONCRETE MACHINERY

Box 99, Hickory 2, N. Car. 28601



CARRY YOUR KEYS ON A KEY-BAK® KEY REEL

KEY-BAK is worn on the belt. It reels back your keys, keeps them safe, handy and out of your pocket. Pocket-watch size steel case, chrome-plated. Patented reel. 24" long stainless steel chain. Ruggedly built. Factory guaranteed. Many MILLIONS now in use. At Retail or Postpaid

\$295

Buy KEY-BAK at your hardware or key shop or send to Dept. A

WEST OF MISSISSIPPI
LUMMIS MFG. CO.
2242 E. Foothill Blvd. Pasadena, Calif.

EAST OF MISSISSIPPI
CTL COMPANY
1710 W. Stewart Ave. Wausau, Wis.

IF YOU HAVE HERNIA

Get this NEW FREE BOOK

Tells how Rupture can be treated by a mild Non-Surgical method that is backed by a Life Time Certificate of Assurance. This treatment method has a long history of use and is recognized by Authorities today. Men and Women from all over the country have taken the Non-Surgical Treatment and reported it is effective. Why put up with wearing a griping, chafing, unsanitary truss?

Write today for this FREE BOOK. Tells How, explains Why more and more Rupture Sufferers are using Modern Non-Surgical Treatment Methods. Act Now. No Obligation.

EXCELSIOR MEDICAL CLINIC
Dept. E6129 Excelsior Springs, Mo.

DANA ANDREWS, Star of Stage, Screen and TV . . . Reports on AMERICA'S MOST REMARKABLE BUY IN PROFESSIONAL QUALITY POWER TOOLS . . .

DANA ANDREWS . . . Star of "CRACK IN THE WORLD" in Technicolor—a Paramount Release—writes . . . "Like most people, I guess, I sure had my doubts about how anyone could sell machines that are supposed to do so much . . . for so very little. I was never more pleasantly surprised! Every claim for them—and more—is true. Putting them through the most rugged workouts, has convinced me that the AMCO people know something no other manufacturer in America has been able to find out. These machines are, without question, a most remarkable buy in professional quality power tools."



BUY DIRECT FROM OUR FACTORY  **POWER TOOLS** **SAVE AS MUCH AS 80%**

8" TILT ARBOR POWER SAW
\$14.95

f.o.b. factory. Wt. 25 lbs.
Includes completely assembled cast iron and steel 8" tilt arbor power saw with ground cast iron table . . . less blade. If desired, RIP FENCE for easier work alignment, \$3.50 additional



REVOLUTIONARY PATENTS DECREASE COSTS, INCREASE EFFICIENCY
Full scale power tools of heavy duty 100% cast iron and steel. Streamlined design reduces weight, cuts material and production costs. Special patents provide added efficiency, accuracy, savings. Parts made, assembled, tested and packed right in our own factories, shipped direct . . . save store profits.

DOES WORK OF \$75 BENCH SAW as is. Converts easily to equal any \$300 floor model cabinet units! Crosscuts, rips, mitres, cuts compound angles, dadoes, makes coves and mouldings.
FREE CABINET BASE PLANS
Use as portable bench saw as received (inset photo) . . . or transform easily and inexpensively into floor model (as shown) guar. to do work of floor models costing \$300. FREE plans . . . sheet of 3/4" plywood and 3-4 hours are all you'll need. Use your AMCO saw for cutting. Plans provide 27" x 24" work surface, 33" height, pullout sawdust bin, tool storage compartment.
10-YEAR FULL SERVICE GUARANTEE *

BLADE TILTS . . . TABLE STAYS LEVEL
• Locks securely at any angle to 50°, raises, lowers 0"-2 1/4"
• Patented tilt mechanism, accurate etched scale
• Patented motor mount takes std. 1/4 h.p. or larger motor, keeps belt tight, assures perfect alignment at any angle, transmits full power
• Takes std. blade, saw insert removes to take dado heads, cutters, etc. (not incl.)
• Accurate mitre gauge assembly
• Ground spindle
• Enclosed steel base • "Compo" bearings
• Accessories available at factory prices
• RIP FENCE, if desired for easier work alignment: Std. size (for bench saw) \$3.50; larger fence (for cabinet base, as ill'd.) \$4.50.

6" SWING 3-FT. LATHE
\$9.85

f.o.b. factory
Optional Faceplate for turning bowls, trays, lamp bases, rosettes, etc. \$2.50



Complete as shown
DOES THE WORK OF \$40 UNITS—
Sturdy all cast iron power tool turns wood or plastics with the precision and speed of machines selling for 4 times as much. Tubular steel bed, ball thrust cup center, spur center. T-Rest assembly, lever action tail stock. 2 speed pulley. Fits any motor.
10-YEAR FULL SERVICE GUARANTEE *

FULL 22" LONG, 4 1/8" JOINTER-PLANER
\$19.95

F.O.B. Factory Complete as shown
100% precision ground cast iron and steel.



DOES WORK OF \$60 UNITS
Now, at little more than a hand tool price, a guaranteed professional quality precision machine which does same work as skilled hand planing . . . much faster, more accurately. Make accurate glue joints; rabbeting cuts for doors, window frames, table drawers; square taper cuts for chair legs; accurate beveling.
• Precision ground cast iron tables, adjustable for depth of cut
• Rigid cast iron base
• New patent-pending design holds clearance between knives and tables at any depth
• Rabbet depth 3/8"
• Hardened, ground high speed steel knives
• Patent-pending fence adjustable to any position, any angle 0°-50°
• Patent pending lift-off guard (nothing to loosen!)
• Balanced steel cutter head.
10-YEAR FULL SERVICE GUARANTEE *

UNCONDITIONAL 10-DAY MONEY BACK GUARANTEE

You must be fully satisfied. If not, return in 10 days, freight collect. Money refunded in full, no questions asked.

 OR  **1/2 HP ELECTRIC MOTOR**
SPECIAL AMCO PRICE (when purchased with any unit in this ad)
\$12.95
f.o.b. factory
If purchased separately, \$18.95

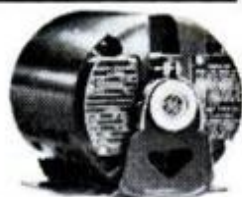

SPECIAL LIMITED TIME ONLY
Brand new factory-fresh motors for use with any of the units on this page. Limited quantity purchase . . . first come, first served. Wt.: 17 lbs.
FULL SERVICE 1-YEAR WARRANTY
Otherwise, as described below *

MAIL COUPON TODAY!

AMERICAN MACHINE & TOOL CO., Dept. PM-266, Royersford, Pa.

Please send me the units checked. Payment in full enclosed \$. . . or \$3 deposit each item enclosed, balance C.O.D. I MUST BE FULLY SATISFIED OR WILL RETURN UNIT WITHIN 10 DAYS FOR FULL REFUND. No questions asked.

- 8" Power Saw at \$14.95 Jointer-Planer at \$19.95
 Standard Rip Fence #354 at \$3.50 Lathe at \$9.85
 Long Rip Fence #354C at \$4.50 Drill Press at \$29.95
1/2 hp GE Motor: \$12.95 (purchased with other item)
 \$18.95 (if purchased separately)

32" RADIAL DRILL PRESS
\$29.95

F.O.B. Factory 1/2" Cap. Jacob's Chuck Inc Shipping Wt. 30 lbs.

DOES WORK OF \$90 UNITS . . . AND A GREAT DEAL MORE

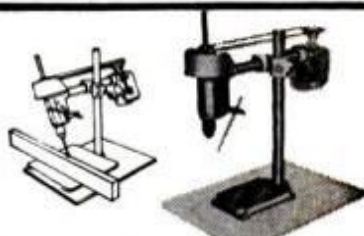

Industrial quality precision machine with all features of standard drill press, many extras. Head raises, lowers. Greatly increased depth of throat. Can be pre-set to any angle or position for on-or-off table drilling . . . even horizontal drilling. All cast iron and steel.
10-YEAR FULL SERVICE GUARANTEE *

*** 10-YEAR FULL SERVICE GUARANTEE** Any part or parts of any AMCO power tool which may become inoperative for any reason within ten years after the purchase date will be repaired or replaced by the factory without cost to the purchaser. Your only cost: for postage.

For the man who has everything



but the best fishing boat built

Some fishermen say Evinrude's Sportsman is the best all around fishing boat ever built.

Far be it from us to disagree.

It's a new breed of all-purpose boat that's convertible in minutes for all kinds of fun.

Snap on the deck cover and it's a smart runabout. Face a front seat aft and it's a ski boat. Turn the rear seats around and it's a big water fishing boat.

The walk-through folding windshield makes docking or going ashore easy as stepping off a curb. And gives you easy access to the foredeck fishing platform.

It's 16'-2½" long. But it has more cockpit space and walk-around room than the roomiest "18's."

It's a dry boat on any heading. When a conventional boat hits a wave, it throws spray up. The Gull Wing hull rides the spray. Its spray tunnels turn it down — creating hydraulic lift . . . greater riding comfort.

The more you know about boats, the more you'll appreciate what the Sportsman does for fishing.

See it at your Evinrude dealer (listed in the Yellow Pages). Catalog free. Write Evinrude Motors, 4221 N. 27th Street, Milwaukee, Wisconsin 53216.

EVINRUDE
first in  outboards
DIVISION OF OUTBOARD MARINE CORP.

MEN OF THE SEA

Masters of many skills. Busy men. Men with a job to do...and they do it well. Camel smokers? Lots of them. They like a real taste that satisfies longer!

Join the smokers who know
Camel has more flavor.

Camel's real taste satisfies longer!

