

How UHF Will Affect Your TV

POPULAR MECHANICS

DEC. 1962
35 CENTS

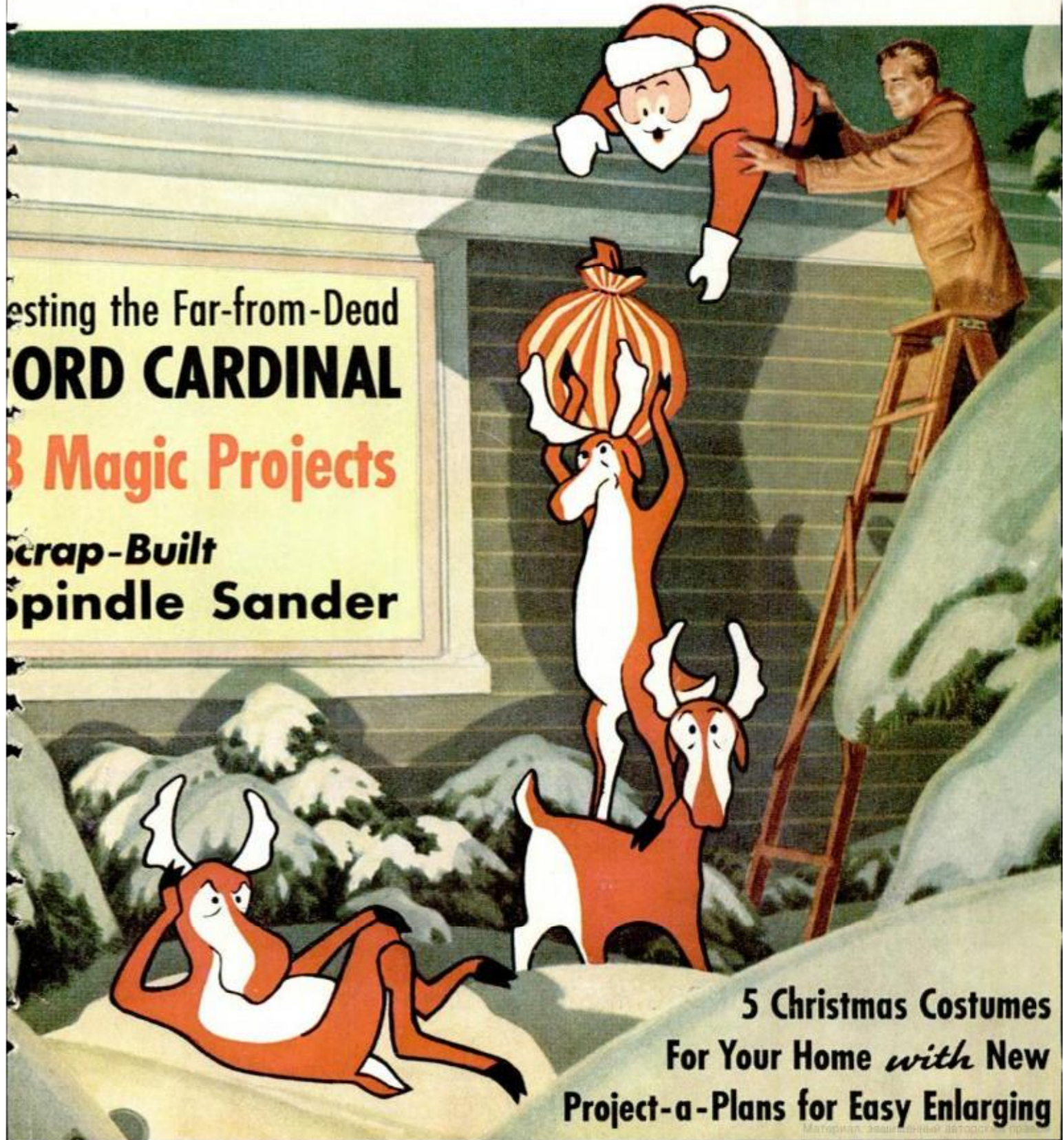

Testing the Far-from-Dead
FORD CARDINAL

3 Magic Projects

**Scrap-Built
Spindle Sander**

**5 Christmas Costumes
For Your Home *with* New
Project-a-Plans for Easy Enlarging**

Get Lucky

THE TASTE TO START WITH . . . THE TASTE TO STAY WITH



Give Luckies

IN THE HANDSOMEST HOLIDAY CARTON OF ALL

© A T Co

Product of *The American Tobacco Company* - "Tobacco is our middle name"

WILDCAT!



All new! All muscle! All glamour! The exciting '63 Buick WILDCAT! America's only luxury sports car with Advanced Thrust engineering now features three new models—convertible, hardtop, coupe; room for five adults; smart vinyl bucket seat interior; and an almost neurotic urge to get going! Very definitely for the sports-minded male and his equally adventuresome mate. There's a WILDCAT! at your Buick dealer's now—rarin' for someone like you to give it a brisk workout. Like, this weekend?

**'63 BUICK
WILDCAT**

Anatomy of a Buick WILDCAT!

Engine: 90° V-8 valve in head. Displacement: 401 cu. in. Maximum h.p.: 325 @ 4400 rpm. Maximum torque: 445 ft.-lb. @ 2800 rpm. Compression: 10.25:1. Bore and stroke: 4.1875 x 3.64. Carburetor: one 4-bbl. down-draft. Valves: hydraulic lifter type. Rear Axle: hypoid semi-floating. Gear ratio: 3.42. Transmission: automatic, torque converter type. Brakes: 12" Duo-servo. Finned aluminum up front. Advanced Thrust: Re-positions engine forward. Gives straight tracking, flat cornering, easy handling.

Buick Motor Division—General Motors Corporation

DECEMBER 1962

1

REPAIR BOOTS—OR FILL A MITER JOINT

with a Weldwood Fix
and Finishes shelf
in your workshop



Fix the family's foul weather gear. It's easy to mend tears and cuts in rubber or plastic boots—rain coats, too—with Weldwood® Contact Cement. Ideal for bonding leather, cloth, and semiporous surfaces, too.

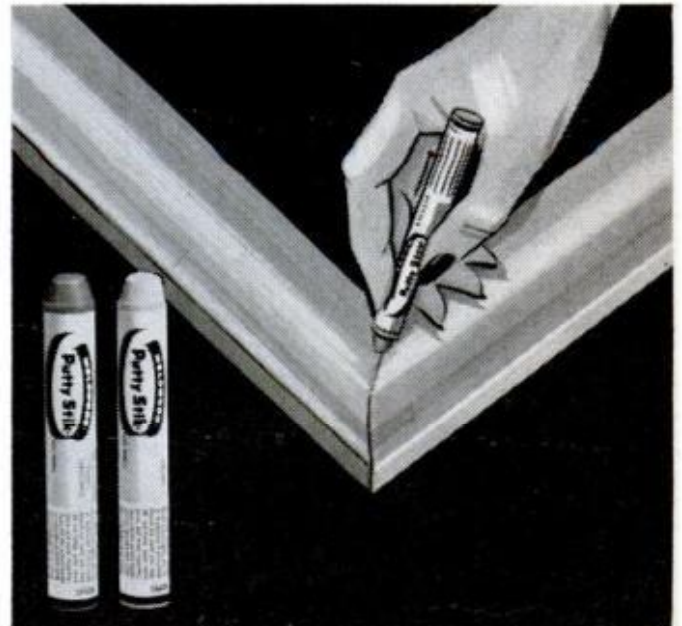

When a miter joint gapes slightly, don't despair. Complete the piece, apply the finish, and then fill the crevice with a Weldwood Putty Stik® of the right color—25 wood colors available.



Restore an heirloom. Bring out the rich color and grain of fine old wood with Weldwood Satinlac®. Remove old finish completely, sand, apply Satinlac. Dries quickly—apply subsequent coats in 4 hours.

You'll have more fun using your workshop when you're prepared, and ready to go when jobs come up. Put in a stock of the Weldwood products shown on this page. They're basic materials for the great majority of gluing, repairing, and finishing jobs. Get yourself set for this winter's jobs and projects. Pick up the Weldwood products at your local lumber yard or at your paint or hardware store.



Products of United States Plywood,
55 West 44th Street, New York 36, N.Y.

POPULAR MECHANICS



BRAND NEW ECONOMY CAR

THIS 1914 MODEL T FORD GETS BETTER GASOLINE MILEAGE TODAY THAN WHEN IT WAS BUILT. HOW ABOUT YOUR CAR? Forty-eight years ago this Model T got 18 miles to the gallon of gas. Today, thanks to better gasoline, better ignition, it gets 19 miles to the gallon. What's the point? Just this. Almost any car can be an economy

car if you'll only give it a little help.

How? Easy. Just drive "Old Faithful" down to see the guy who sells Autolite parts. He's got a whole shelf full of nifty items that will make any moocher a miser in the miles-per-gallon marathon.

Spark plugs that clean themselves while you drive. Factory-quality tune-up

parts. Sta-ful Batteries that offer up to three times the protection against dry-out failure. And a friendly way of doing business that is every bit as economical as it is efficient.

This One



FB9B-L6B-48HN

PRODUCTS OF  MOTOR COMPANY

DECEMBER 1962



AUTOLITE

THE NAME TO REMEMBER WHEN YOU CARE FOR YOUR CAR

3

POPULAR MECHANICS®

DECEMBER 1962

VOL. 118

NO. 6

INTERNATIONAL EDITIONS • SPANISH: Mexico-Caribbean, Southern Hemisphere • FRENCH •

Features of Special Interest

The Crazy Things They're Doing with Glass	- - - -	71
UHF—What It Will Do to Your TV Viewing	- - - -	78
PM Tests Ford's Revived Cardinal	- - - -	84
The Condor—A Luxury Camper	- - - -	88
A New Concept: The Boiling Engine Car	- - - -	91
Boat Trailer Becomes Camping Shelter	- - - -	95
Bid Your Way to Bargains	- - - -	96
What It Takes to Build Airplanes	- - - -	102
We're Fighting a Measurement War	- - - -	106
World's Toughest Target Shoot	- - - -	114

For the Craftsman

Flip-Over Chess Set	- - - -	126
Project-a-Plan Christmas Cutouts	- - - -	130
Toothpick Cheer for Christmas	- - - -	138
8 Magic Tricks	- - - -	142
Snowflakes to Order	- - - -	148
Twin Lens Reflex—Easy Focusing	- - - -	152
Cook Yourself a Rubber Stamp	- - - -	158
Fix-It File—Electric Heater	- - - -	162
Scrap-Built Spindle Sander	- - - -	168
Circular Saw Blade Dispenser	- - - -	171
Build a Toboggan	- - - -	172
Sun-Powered Lamp Pole Radio	- - - -	179

Address communications to: 575 Lexington Ave., New York 22, N. Y. **SUBSCRIPTION SERVICE:** Mail all subscription orders, changes of address, correspondence concerning subscriptions, and Postmaster notices of undelivered copies to Popular Mechanics, 250 West 55th St., New York 19, N. Y.

Published by Popular Mechanics Company, RICHARD E. BERLIN, *President*

DON DINWIDDIE
Editor

RICHARD E. DEEMS
Executive Vice-President

JOSEPH R. BUELL, JR.
Publisher

Executive Editor: RICHARD F. DEMPEWOLFF
Managing Editor: JOHN A. LINKLETTER

Assistant Managing Editor: WAYNE C. LECKEY
Midwest Editor: CLIFFORD B. HICKS
740 N. Rush St., Chicago 11, Ill.

Western Editor: THOMAS E. STIMSON
Suite 1003, 3460 Wilshire Blvd., Los Angeles 5, Calif.

Art Director: HENRY M. NEHRBASS

Automotive Editor: JAMES R. WHIPPLE

Associate Editors: KEVIN V. BROWN, W. CLYDE LAMMEY,
ALFRED W. LEES, ARTHUR MIKESSELL

Assistant Editors: STUART JAMES, JOHN P. MCNEEL,
ED NELSON, JOHN L. SCHERER

Art Editor: MURRAY COOPER

Assistant Art Director: LEO WEEKS

Chief Photographer: FRANK P. FRITZ

Editorial Assistant: JOHANNA L. PUGNI

International Editor: HEINZ P. SCHLICHTING

Ritterstrasse 26, Karlsruhe/Bd., Germany

Advertising Director: L. PARK BENJAMIN

If you wish additional sources of information for the articles in this issue, or if you wish the name and address of the manufacturer of a particular product shown here, write to Bureau of Information, Popular Mechanics, 575 Lexington Ave., New York 22, N.Y. Ask for the free "Where-to-Find-It-List" for this issue.

DANISH • SWEDISH • PORTUGUESE • DUTCH

Departments

Over the Editor's Desk	- - - -	10
Science Worldwide	- - - -	20
Items From All Outdoors	- - - -	24
Tune In on the Inventors	- - - -	28
Sidelights on Aviation	- - - -	30
Pentagon Sidelights	- - - -	34
Worth Writing For	- - - -	40
Detroit Listening Post	- - - -	64
On the Market	- - - -	68
What's New for Your Home	- - - -	124
New for Shutterbugs	- - - -	151
Solving Home Problems	- - - -	164
Clinic for Homeowners	- - - -	186
Shopping for Tools	- - - -	220

Next Month . . .

THE WILD ONES—Sting Ray, Avanti, Riviera, T-Bird—are test matched at Lime Rock by John Fitch, former Mercedes team driver; PM raises the curtain on the startling new look in brass trim; Alexis Sakhnoffsky turns his dream car sketch pen to the sleekest features on the '63s; a Detroit engineer takes you behind the scenes for a look at this year's major breakthroughs and how they were wrought. Also, Sir Edmund Hillary reveals "what's left to explore."

NOTE OUR NEW ADDRESS!

ADVERTISING OFFICES—New York: 575 Lexington Ave., MUrray Hill 8-8500; Chicago: 740 N. Rush St., WHitehall 4-0100; Detroit: General Motors Bldg., TRinity 5-8711; Cleveland: Hanna Bldg., 1422 Euclid Ave., PRospect 1-0456; Los Angeles: 3460 Wilshire Blvd., DUmkirk 2-8458; San Francisco: 111 Sutter St., YUKon 2-0823.

Published monthly by Popular Mechanics Company, 575 Lexington Ave., New York 22, N. Y. Richard E. Berlin, President; Richard E. Deems, Executive Vice-President; Fred Lewis, Vice-President and General Manager; John R. Miller, Vice-President; Joseph R. Buell, Jr., Vice-President; G. O. Markuson, Treasurer; R. F. McCauley, Secretary. Single copy in the United States and Canada, 35 cents. Subscription prices: United States and Possessions, \$4.00 for one year; \$7.00 for two years; \$9.00 for three years. Canada, add \$0.50 for each year. Pan-American Postal Union countries, add \$1.00 for each year. All other countries, add \$2.00 for each year. When changing address, give old address as well as the new, with postal-zone number, if any, and allow six weeks for change to become effective. Second-class postage paid at New York, N. Y., and at additional mailing offices. Authorized as second class mail by the Post Office Department, Ottawa, and for payment of postage in cash. Registered as Second Class matter at the Post Office at Mexico, D.F., Mexico, June 20, 1950. ©1962 by Popular Mechanics Company. All rights reserved. Printed in the United States of America.

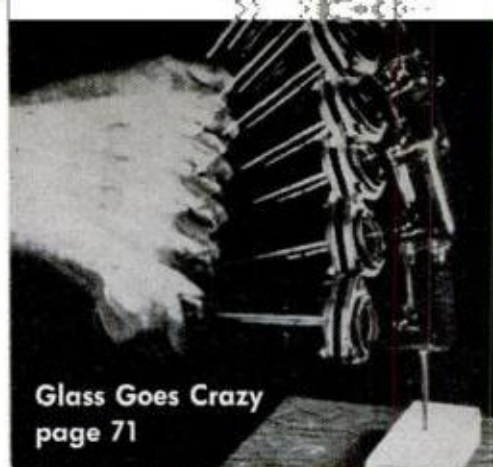

Glass Goes Crazy
page 71



UHF-TV
How Good?
page 78



Christmas Cutouts — page 130



Presto! Here's How
page 142

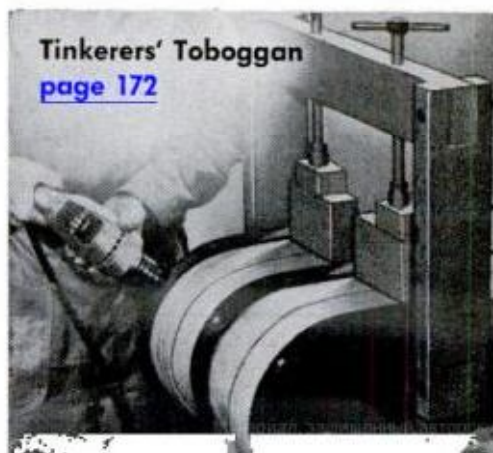

Tinkerers' Toboggan
page 172

EASIEST GOING SLIDE PROJECTOR EVER!

☆ JUST WON'T JAM ☆ ALWAYS STAYS IN FOCUS ☆ EXCLUSIVE POP-UP SLIDE EDITOR ☆ LOWEST COST NON-SPILL SLIDE TRAYS ☆ BETTER SCREEN PICTURE WITH BETTER OPTICAL SYSTEM ☆



new BALOMATIC 656 by BAUSCH & LOMB

Choose a slide projector that gives you all the fun of showing slides with none of the fuss. The pure entertainment of seeing your slides in their very best light on the screen is what you want. Lever-pushing, slide-tugging and lens-focusing are old hat. Here's a new projector that makes your slide-showing life *easy*.

Easy on your favorite slides! You can keep running through your slides until the cows come home (and after!) and there's nary a jammed slide. Balomatic 656 *just won't jam!* All your 2x2 slides, no matter whether they're mounted in cardboard, glass, metal or plastic, are safely filed in non-spill 40-slide trays where you never have

to touch them again. And Balomatic trays cost *less* than any other non-spill trays.

Easy on the eyes! Slides are as sharp and bright and clear as if they were *printed* on your screen. That's because Balomatic has a superior optical system designed and developed by Bausch & Lomb's Cinemascope engineers. Focus just once. You never have to re-focus again during your slide showings. Balomatic always *stays* in focus slide after slide.

Easy to relax with like an old friend! Balomatic doesn't fight back. Once you set it, your slides show *themselves* as quickly or as slowly as you like. You can even answer the doorbell... the show

goes on without you. Or you can project slides by manual or remote control, forward or reverse. At the touch of the edit button, you can eject slides out of the projector and into your fingers *instantly*.

Easy to have everything you'll need in a fine projector! Balomatic 656 shown here is one of four models starting at under \$100. Knowledgeable photographers can't find a better projector at any price, anywhere. At your dealers. Or write for Balomatic booklet, "The Slide Projectors with *Extra Features*". Then get your own Balomatic. Bausch & Lomb Incorporated, Rochester, N. Y. 



Pontiac Motor Division • General Motors Corporation

*Optional at extra cost

“Don’t tease the pretty panther, Clive.”

We drew our new Grand Prix low and sleek and road-hungry on the drawing board, and son of a gun—it came out that way in the metal! And on the road, a nicer thing couldn’t happen to a Pontiac-watcher.

With the looks coming through loud and clear, we concentrated on making the car driveable. What’s our idea of a driveable car? One with steering and suspension that accept a “that-a-way” command without arguing the point. One with pedals, levers, switches and knobs that are placed just so and work right now. (A steering wheel adjustable for height and rake helps, too. Ask Clive.)*

What’s connected to the right-hand pedal is between you and your dealer. We will say this: the result of pressing that pedal will range from mere bravery to a reenactment of the charge of the light brigade. The lever between the bucket-type seats connects to a choice of Roto Hydramatic or 4-speed floor shift.**

Now for the final connections: Your hands to the wheel and your . . . er, nether region to the driver’s seat. The keys are tinkling in your dealer’s hand. Watch his hand twitch. He’s driven one.

Wide-Track Pontiac

DECEMBER 1962

7



"My salary has more than doubled since enrollment with LaSalle and due to my fine training is still growing."—William T. Black, Canoga Park, Cal.



"I am pleased to say that I am now Traffic Supervisor with Johns-Manville. I owe much to your course in Traffic and Transportation."—J. F. Sanders, Natchez, Miss.



"Without the opportunity to study I could not qualify as controller of a concern with millions of assets and sales. Thanks to LaSalle."—Walter Zielke, Bridgeman, Mich.



"Salary is double what I earned when I enrolled. At 52, I feel that a new life is beginning, thanks to the opportunity you offered."—Robert Hughes, Costa Mesa, Cal.



"My selection for my position was based primarily on the fact that I held LaSalle's LL.B. Degree."—William F. Hornbeck, Grand Junction, Colo.



"The knowledge I have gained from LaSalle I consider of major importance. My salary in over three years has increased \$3000."—Dale E. Updegraff, Richmond, Ind.

Why more than 20,000 men in LaSalle's career

Which one of these famous La Salle training programs interests you?

LA SALLE SCHOOL OF ACCOUNTING

Training in one of the most highly paid professions in the business world today—leading to positions as General Accountant, Auditor, Controller, Tax Specialist, CPA.

LA SALLE SCHOOL OF LAW

The Law-trained man has become the indispensable man in the world of business. LaSalle offers training leading to the LL.B. degree, also specialized Law courses.

LA SALLE SCHOOL OF TRAFFIC & TRANSPORTATION

Training in one of the most exciting and profitable careers in modern industry, leading to managerial positions in the shipping of goods all over the world.

LA SALLE SALES TRAINING

Many of today's corporation heads have come straight from the sales department. LaSalle offers courses in Basic Selling Principles and Techniques, as well as Sales Executive Training.

LA SALLE SCHOOL OF BUSINESS MANAGEMENT

Training for executive careers, including Advertising and Marketing, Production Management, Financing, Credit and Collections, Office Management, Foremanship.

LaSalle also offers home study courses in such high-pay technical fields as Refrigeration, Air Conditioning, Diesel, Drafting and others, plus High-School Diploma courses. Choose from the complete list in the coupon provided on the opposite page.

LA SALLE students live in every state in the Union, in every part of the world. They are to be found in every occupation you can think of. Yet all of them have one goal in common; to advance from a hum-drum, insecure job to a *prestige position with high pay and unlimited future.*

They enroll with LaSalle because they can train for advancement without interfering with their regular work and without the loss of a single day's pay. They study in spare time—at home—during hours that suit their convenience. They pace themselves as they wish—always under expert and attentive supervision.

The direct practical results of LaSalle home study—in terms of pay increases, promotions, and broadened opportunity—are truly remarkable, as student reports show. Many are able to pay for their training out of the extra money they earn the *first year.*



As a LaSalle home-study student, you are a class of one . . . you set your own hours, at your convenience.

If you are ready to move ahead, LaSalle offers you a choice of profitable studies

If your present job is just a dead-end street—if you are ready to get started on a program of self-advancement, LaSalle can help you achieve your highest ambitions.

LaSalle offers you training in an attractive choice of today's best paid, fastest growing fields. The demand for qualified people in each of these fields is at an all-time high. Many fine jobs are actually going begging. Salaries keep growing; promotions are rapid. *And LaSalle graduates are eagerly welcomed—for good reasons.*

LaSalle Extension University, a correspondence institution since 1908, has become a world



"8 months after I started the course I got a job in Accounting. I now earn 3 1/2 times my former pay as service station attendant." —Robert Fischer, Holbrook, Ariz.



"By employing principles I learned in LaSalle Sales Training I have been able to increase the number of my clients by over 100%." —Leroy G. Zajicek, Cicero, Ill.



"I appreciate the training received from your Accounting course. Since the transition from the oilfield to my present work my salary has doubled." —Loren Dinkel, Russell, Kan.



"I have recently been appointed Sales Representative. The confidence gained through my LaSalle Law training has been responsible." —Paul F. Lorenz, San Rafael, Cal.



"My salary has increased 400% as a direct result of my LaSalle studies." —Rudolph Urbatis, Port Chester, N. Y.



"To me your correspondence course is the only way for a person, working, and with limited means, to study Law." —James E. Whetmore, Anaheim, Cal.

and women enroll every year advancement courses

leader in business education. More than 5,500 Certified Public Accountants have received



Individual correction and guidance—your instructors give your work personal attention.

training—in spare time at home—from LaSalle's School of Accounting. LaSalle's School of Law enrolls more students each year than any other Law School in the world. LaSalle trains thousands of people in such rewarding fields as Business Management, Traffic and Transportation Management, Sales Management. Altogether, more than 1,000,000 students have enrolled in LaSalle's many types of training courses.

LaSalle's distinguished faculty includes some of the country's foremost practicing specialists

and instructors. That is why your training is in good experienced hands . . . why your LaSalle diploma will be respected by every employer. *The cost of training is remarkably low—with a payment plan to fit your budget.*

Mail the coupon for free booklet

Take the first step in getting a more important job, higher pay, a future filled with opportunity. Simply check the field in which you are interested, and LaSalle will send you a valuable free booklet describing the opportunities in that field. Mail to LaSalle, 417 South Dearborn St., Chicago 5, Ill.



LaSalle students receive a cordial welcome in the business world.

LASALLE EXTENSION UNIVERSITY

A Correspondence Institution • 417 South Dearborn St., Dept. 12-092, Chicago 5, Ill.

Send me, without cost or obligation, free booklet and full information on the field I have checked below:

ACCOUNTING

- Complete Accounting with CPA Training
- Basic Accounting
- Cost Accounting
- Federal Income Tax
- Accounting Systems
- Auditing Procedure
- Controllorship
- CPA Training
- Modern Bookkeeping

LAW TRAINING

- Bachelor of Laws Degree
- Business Law
- Law of Contracts
- Insurance Law

- Claim Adjusting Law
- Law for Police Officers
- Real Estate Law
- Law for Trust Officers

BUSINESS MANAGEMENT

- Complete Business Management
- Basic Management
- Advertising and Sales Promotion Management
- Production Management
- Business Financing
- Credits and Collections
- Office Management
- Business Correspondence
- Personnel Management
- Foremanship Training

TRAFFIC AND TRANSPORTATION

- Complete Traffic and Transportation
- Organization and Management
- Transportation Law
- Classification, Rates and Tariffs

- Transportation Agency and Services

TECHNICAL COURSES

- Drafting
- Refrigeration
- Air Conditioning
- Diesel
- Welding

SALESMANSHIP

- Sales Management
- Sales Training

HIGH SCHOOL

- Commercial Course
- High School Diploma
- College Preparatory

Name Age

Address County

City & Zone State

325

Over the editor's desk

A Vote for the Deep V

I am most grateful for your article on "Two New Hulls Meet Two Old Problems" (Sept. PM). It changed my whole conception of small-craft design.

I'm planning to buy a 20- or 22-foot fiberglass cruiser which will be used for offshore fishing on the South Jersey Coast. I need a boat designed for rough water, and I was almost sold on a catamaran. However, after reading the above-mentioned article, I firmly believe that the Hunt-designed Deep V is the boat for me.

Churchville, Pa.

C. H. MARTIN

Thanks for the kind words, reader Martin. However, before buying any boat, we advise you to take out a number of different designs for test runs. This can't do any harm, and even if it only confirms your choice of the Deep V, you'll enjoy some pleasant boat rides.

Good Coverage

About two years ago the farm manager complained that the manure spreader mired down when the fields were wet, and the front cover (Sept. '60 PM) furnished an idea. The enclosed picture is the result.

The frame is white oak. Power is a 1947 Ford six-cylinder engine . . . the drive shaft from the engine drives the rear set of wheels and also a jack shaft which drives



the other three sets of wheels. The hand brake locks the side toward which a turn is to be made. The body is on a hydraulic dump bed which is raised to slide the load to the rear where it is ejected.

Louisville, Ky.

FRANK B. THOMPSON

We've always bragged about the way PM gets around, but this adaptation is in a class by itself when it comes to getting coverage.

Well-Coached Team

Thought you might like to see a picture of the stage coach I built from your plans (p. 166, March PM). We thoroughly enjoyed building this project and, needless to



say, the neighborhood children enjoyed the finished product.

Malibu, Calif.

H. IRVING KERR

Yes, we do like to hear about projects that turn out so happily; even that "team" appears enthusiastic about it.

Delicate Rolls-Royce

In your March issue you ran an article about the Rolls Royce over which my uncle and I got into an argument. He said a Rolls would never stand up under 'teen-age driving. What is your opinion?

Bainbridge Is., Wash.

E. CHRIS WILLIAMSON

Any 'teen-ager with a sane attitude about driving, who is willing to learn from pros rather than experiment wildly, would probably do an excellent job in a Rolls Royce. But no car can stand up under the calculated abuse of a driver ('teen-age or otherwise) who tries to turn public highways into the Daytona 500.

Can Inventors Succeed, Even Trying?

I greatly appreciated the sound common sense of Eugene Raudsepp's article, *Develop Your Inventing Ability* (p. 100, June PM). Unfortunately, I cannot envisage any reliable means for a nonwealthy individual to protect his ideas.

The dice are, surely, loaded against in-

Good News for the Man Who Needs
a Better Job or Is Ambitious
for a Business of His Own

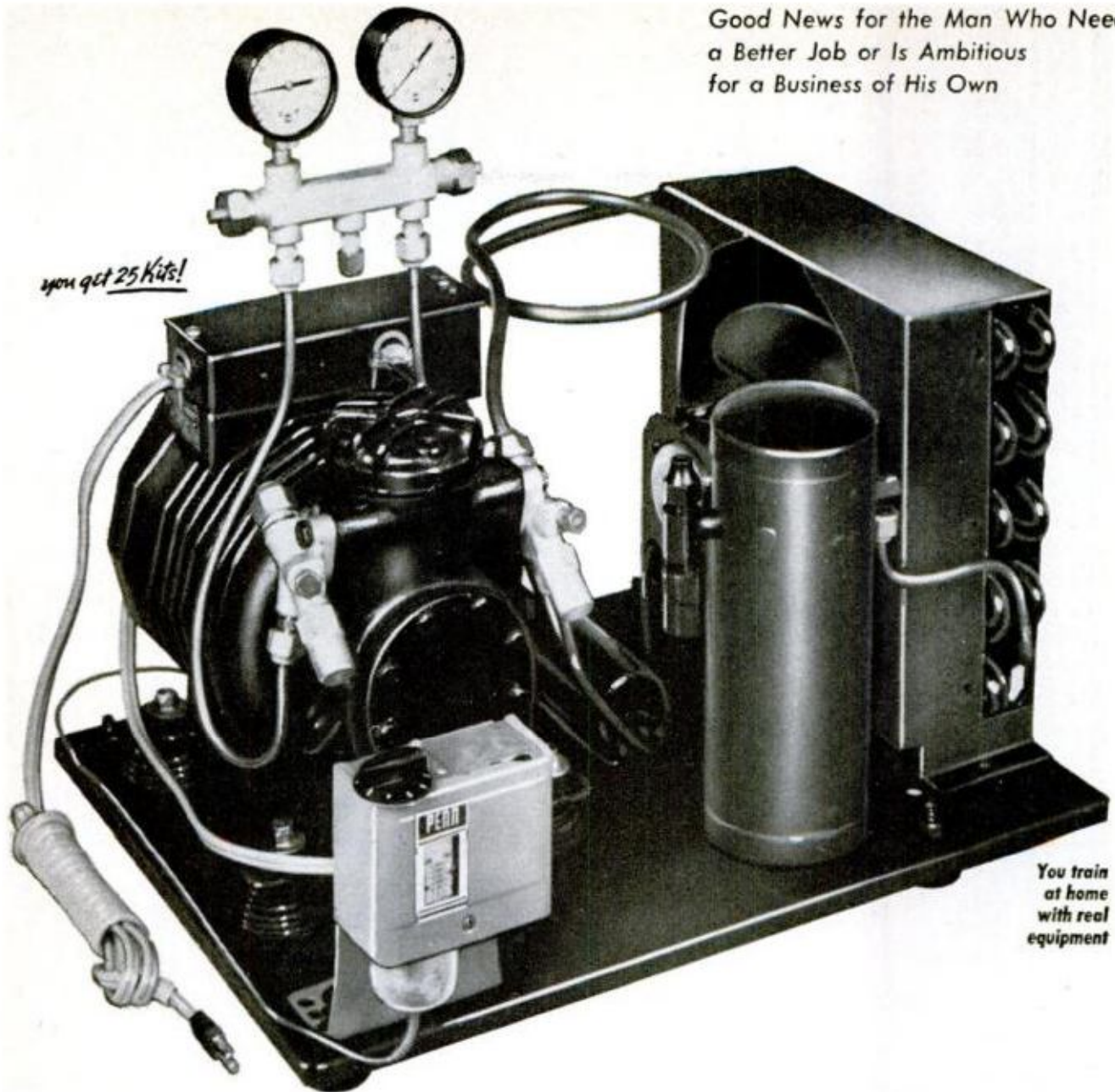

You train
at home
with real
equipment

Learn REFRIGERATION and AIR CONDITIONING

Thousands of men have found a short-cut to a good job, big money and security—even a business of their own—in the Air Conditioning and Refrigeration field.

This short-cut method is available to you as well. The only investment you make is a few hours of your time each evening and a few dollars of your income each month. And when you're ready for your big-pay job in Air Conditioning and Refrigeration—as a technician or mechanic—you switch over.

You'll find the key to a better future in the condensing unit above. It's the heart of the exclusive CTI Home Training Method. CTI sends you illustrated lessons which supply the knowledge and know-how. However, during your training, CTI also sends you 25 kits of parts and tools to build the condensing unit. With it you work on 20 practical projects. You develop your skill in trouble-shooting, using tools, making repairs and servicing. You learn by practicing!

Many CTI students earn money in spare time as they train. This extra income helps meet tuition payments, buys extra equipment.

Yes, CTI Home training has many parts. We'd like to tell you all about it—and the marvelous opportunities that are waiting. (Did you know that each year the Air Conditioning and Refrigeration industry needs 20,000 more newly-trained men?)

This information is free. You can have it just by filling out and mailing the coupon. Act today! — Commercial Trades Institute, Chicago 26, Ill.

COMMERCIAL TRADES INSTITUTE

1400 GREENLEAF AVE. • CHICAGO 26, ILL.

Dept. R-147

Mail me your three free booklets: *Success in Air Conditioning & Refrigeration*; *Proof from Graduates*; and *Lesson Samples*. No obligation.

Name _____ Age _____

Address _____

City _____ Zone _____ State _____



—Accredited by National Home Study Council—

New Goodyear

outwears...

any other...

**ALL-WHEEL,
ANY POSITION,
STANDARD LEVEL**

truck

Super Hi-Miler

yes, outwears...

yes, any other...

tire made!

For the reasons why, turn page

yes, outwears! yes, any other!

The new Goodyear Super Hi-Miler outwears any other truck tire of its kind! Here's why:



1. New, wide tread.

Reduces the rate of wear because tread wear is distributed over a much wider area.



2. All ribs continuous.

Not broken into lots of small segments that squirm and scuff away mileage. Wear is smooth and even.



3. New shoulder design.

Open grooves safely dissipate tire-destroying heat - flex easily - resist tearing.



4. All grooves full depth.

Run right down to undertread. Extra-deep outer grooves insure extra traction and extra safety.



5. Dual Compounded tread.

Two treads in one. Resilient inner tread cuts heat buildup. Permits compounding outer tread for maximum wear.



6. And, New "Muted Sound."

Zigzag groove length varies in each quarter of tire. Acoustically engineered to mute high-speed tire noise.

plus Tufsyn

... new Goodyear wonder synthetic... proved in millions of highway miles, the toughest, longest-wearing rubber Goodyear ever developed! • Whether you have 4 wheels or 4,000 on the road, you'll save with the all-new Super Hi-Miler with TUFSSYN. Get the full story from your Goodyear Representative, your Goodyear Dealer or Goodyear Service Store. And specify Super Hi-Miler on your next equipment order. Then start saving with Super Hi-Miler. Goodyear, Akron 16, Ohio.

GOODYEAR

Hi-Miler, Tufsyn - T. M.'s The Goodyear Tire & Rubber Company, Akron, Ohio

For giving or getting... Quality **DISSTON** tools for Christmas



Buy now for Christmas and save. Your dealer has all these Disston gift tools at special, Christmas money-saving prices. **1.** All-Purpose Kitchen Saw . . . \$1.80. **2.** Countryside Hand-saw . . . \$4.30. **3.** D-100 Handsaw . . . \$12.98. **4.** Pocket-Handbag 6-foot Steel Rule . . . \$1.19. **5.** DAGGER Sabre Saw with carrying Case and 9 Blades . . . \$54.50. **6.** DIRK 1/4-inch Power Drill . . . \$26.95. **7.** DRAGON Shrub and Hedge Trimmer with 62-foot Cord . . . \$44.50. **8.** DISCUS 6 1/2-inch Circular Saw with Carrying Case and Blade . . . \$54.50.

See these DISSTON CHRISTMAS SPECIALS at your local hardware, building supply or department store. Disston—Master Toolmaker since 1840.

Disston Division, H. K. Porter Company, Porter Building, Pittsburgh 19, Pa.



DISSTON DIVISION
H. K. PORTER COMPANY, INC.

dividual inventors, and the current craze for invention amongst amateurs is as much of an amusing waste of time as crossword puzzles.

Salisbury, South Rhodesia A. J. G. EVANS

Judging from our mail, U.S. inventors seem to be able to get patents on their ideas without too much trouble (other than the long wait to have patents processed). The big problem seems to be that of finding someplace to market the ideas.

Gooneys Are Still Ahead

I am surprised that the Navy couldn't think of a simple way to get rid of those birds ("The Gooney Birds Are Winning the Second Battle of Midway," p. 102, Sept. PM). Tell them to get rid of the eggs as fast as they can. With no eggs to hatch, the birds would die off. They could put in china eggs to keep them from laying more.

Brockton, Mass. R. L. JOHNSON

The Navy has already tried that, reports PM staffer Kevin Brown, who wrote the article. The sailors found that it would take the biggest egg-collecting job in history to do it effectively. The problem is that gooney birds nest and hatch eggs all up

and down a 1200-mile chain of islands, so all the eggs on all the islands would have to be collected at one time to stop the gooney birds.

Rare Bird

I am aware of the great choice of body styles which Detroit offers today, but isn't the 1963 Valiant half two-door hardtop, half four-door sedan (pp. 88-89, October PM) a bit ridiculous? What is the purpose of the split personality of the Valiant as it was shown?

Kimberley, B.C.

MAURICE FREER

Sharp-eyed reader Freer has spotted one of Detroit's rarest of birds, the untamed three-door prototype. Such cars are hand-built long before production lines start up to provide photographers something to snap and editors something to drive and evaluate. Since hand-built prototypes cost upwards of \$50,000, thrifty Valiant gets a two-door hardtop (left side) and a four-door sedan (right side) for half the \$100,000 that complete models of both would cost. Cars like this are not for sale.

The Editors

LOOKING FOR LONG WEAR IN OUTDOOR BOOTS?

TRY **RANGER** BOOTS

WITH **NEOPRENE SOLES!**



RANGER No. 1154-1 by
Endicott Johnson Corp.



"RANGER" slip-on boots just naturally take to the great outdoors. Made of the finest grade rawhide, these boots resist all kinds of weather . . . yet remain soft and flexible. Other popular features of this boot: lined vamp, full leather insole, pull strap backstay.
Sizes 7/12-D and 6/12-EE.

Soles and heels of tough Du Pont Neoprene give extra-long wear . . . more miles to the pair.

Neoprene resists oil, grease, chemicals and cold-weather cracking . . . helps reduce fatigue because of its lasting resilience. Write Du Pont, Dept. PM-12-NS, Wilmington 98, Del.

Ask for Neoprene soles the next time you buy outdoor boots!

Better Things for Better Living . . . through Chemistry

Satellites to Map Earth

Space satellites carrying scientifically advanced cameras will map Earth with unprecedented precision early in 1963. A new method of triangulation, based on optical tracking of Echo-type satellites from three or more mobile camera stations, will be used. The satellites, inflated in space, will be tracked against stars whose positions are known. The camera shutters can be timed with an accuracy of 1/1000 second.

The first mapping project of the U.S. Coast and Geodetic Survey's program will be to measure the distance across the U.S. with less than a 33 foot error. The positions of Hawaii, Alaska and the Aleutian Islands will then be located, followed by other areas.

Other objectives of the system are the development of Earth-satellite navigation and the positioning of oceanographic ships where other aids are not available.

May Detect Porpoise "Talk"

Sound dissection is shedding light on what causes metals to wear out and break—and also promises to help man talk to porpoises.

Frank R. Stevens of the Spectran Corp., whose organization makes \$15,000 sound analyzers which break wavelengths into 480 parts for display on cathode ray oscilloscopes, says:

"Metals are known to 'scream' when torn apart; analysis of these screams will further the understanding of fatigue and rupture. Indeed, there is hope that specialized versions of these analyzers will help predict ruptures."

The analyzers have not yet been used on porpoise sounds but they have been used on human speech. "From what has been learned," says Stevens, "we believe that if man ever does talk to porpoises, this analyzer will have helped him to do it."

Take a close look at the flakes

IN REVELATION, YOU'LL SEE
FIVE OF THE WORLD'S GREAT TOBACCOS

Notice the different cuts and colors in the flakes? Each one adds its own personality, and when they're all together, a secret recipe does something rare for the flavor. Try it soon and get some new pleasure in your pipe.

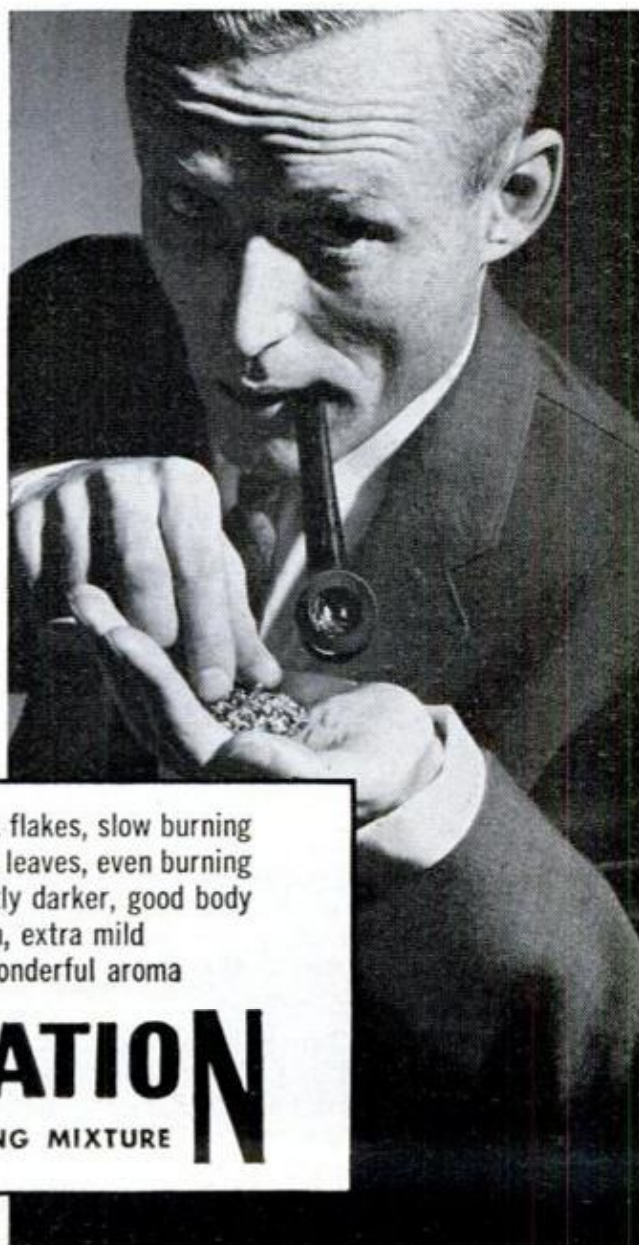

Kentucky Burley—dark flakes, slow burning
Virginia Bright—bright leaves, even burning
Old Belt Bright—slightly darker, good body
Latakia—deeper brown, extra mild
Perique—very dark, wonderful aroma

REVELATION

MILD SMOKING MIXTURE



Does a chicken know when she lays an egg? Probably not, says a Scottish scientist. He claims that a hen's biological clock tells her when to lay an egg—and that she probably doesn't even feel it. He operated on several hens so that they laid their eggs before the shells were formed—and without going to a nest. But at the time the shells normally would have been formed and the egg ready to emerge, the hens went through the routine of going to their nests and cackling, even though they didn't lay anything.



What's the moon like? Do the experts know? It's porous and grainy like sand, said one astronomer at a recent Lunar Exploration Conference at Virginia Polytechnic. Another said it was deep in dust; still another theorized that the surface was hardened lava. We won't know the answer, said Nobel scientist Dr. Harold C. Urey, until men actually land on the moon.



Silent substitute for a pneumatic drill? A firm in England is using a "drill" which emits radio microwaves to split rocks with concentrated heat. In tests, the machine cracked a concrete slab five feet square and nine inches thick.



A German professor believes he has dug from the clay banks of the Elbe River the world's oldest known art objects. At a depth of about 40 feet, he found pieces of rock showing crudely outlined faces—both animal and human—and says they date from the Ice Age, more than 100,000 years ago. Until now, the earliest known art work by man was believed done in the Aurignacian period, 30,000 to 40,000 years ago.



A method of "tuning" laser beams, recently announced by General Telephone & Electronic Labs, may provide the means for linking space craft in orbit. The beams are controlled by directing light through two electro-optic crystals while a modulating voltage is applied from a generator.

Even the canines are counting calories in England. A British firm is marketing a prepared reducing diet for overweight dogs. Available only through veterinarians, it comes complete with a chart so a fat dog's reducing program can be checked.



The subzero temperatures associated with superconductors may provide astronauts with protection from the deadly charged particles of the upper atmosphere. The magnetic field generated in a superconductor shield would, according to Dr. Richard L. Garwin of Columbia University, bounce the particles back into space.



Synthetic detergents, which often foam up in springs and brooks because of their tendency to accumulate in water supplies, may now be removed through improved ways of applying activated carbon to waste water, followed by treatment with an alum solution and filtration, according to the American Chemical Society. The special form of carbon used is made from either coal, peat or wood; it can be re-used by burning off accumulated material.



Whether or not Noah's Ark is encased in a glacier on Mount Ararat in Eastern Turkey may be known for certain within three years. A team of international archaeologists, the first scientific group to systematically search for the vessel, recently found several pieces of wood which they believe to have been part of the giant boat. During the next annual thaw of the glacier, the group plans to use an ice camera and infrared rays to take photographs of the glacier's interior.



An underground sea, said to be as big as the Sea of Azov, has been located by Ukrainian geologists near the Dnieper River. The sea, more than 300 feet deep in places, is being studied to see if the water can be used for irrigation.



They're using toothbrushes and butterknives to look for the bones of the Viking explorer, Leif Ericson, near a fjord in Greenland. Scientists from the Danish National Museum are digging with these unlikely instruments in an ancient Viking cemetery to keep skeletal remains as intact as possible. After more than nine centuries in the moist soil, little is left of the scores of Vikings buried there. The only hope for identifying Leif is the chance that he might have been buried in armor or with some distinctive emblem in metal or stone. So far, 10 skeletons have been unearthed.

(Continued on page 22)

GET READY FOR THE SPACE and SCIENCE ERA! SEE SATELLITES, MOON ROCKETS



AMAZING SCIENCE BUYS

for FUN, STUDY or PROFIT

See the Stars, Moon, Planets Close Up!

3" ASTRONOMICAL REFLECTING TELESCOPE

Study Venus—the brightest star—
Probed by Mariner II Spacecraft

60 TO 180 POWER!
Famous Mt. Palomar Type!
An Unusual Buy!



See the Rings of Saturn, the fascinating planet Mars, huge craters on the Moon, phases of Venus, Equatorial Mount with lock on both axes. Aluminized and over-coated 3" diameter high-speed f/10 mirror. Telescope comes equipped with a 60X eyepiece and a mounted Barlow Lens. Optical Finder Telescope included. Hardwood, portable tripod. FREE with Scope: Valuable STAR CHART plus 272-page "HANDBOOK OF HEAVENS" plus "HOW TO USE YOUR TELESCOPE" BOOK.

Stock No. 85,050-H \$29.95 Postpaid
4 1/4" REFLECTING TELESCOPE—Up to 255 Power.
Stock No. 85,105-H \$79.50 F.O.B., Barrington, N.J.

BUILD A SOLAR ENERGY FURNACE



A fascinating new field. Build your own Solar Furnace for experimentation—many practical uses. Easy! Inexpensive! Use scrapwood! We furnish instructions. This sun powered furnace will generate terrific heat—2000° to 3000°. Fuses enamel to metal. Sets paper aflame in seconds. Use our Fresnel Lens—14" diameter . . . f.1. 14".

Stock No. 70,130-H Fresnel Lens \$6.00 Postpaid
11" Sq. Fresnel Lens F.L. 19".
Stock No. 70,533-H \$4.75 Postpaid

SPELLBINDING EXPERIMENTS with SILICON SOLAR CELL AND SUN BATTERY!



Experience endless fascination in converting sunlight into electricity to power small motors, amplifiers, etc. (See July '61 Popular Science article—"The Boat That Runs on Sunlight" for latest techniques). Plastic case 1 1/4" x 1 1/4" x 3/16". Produces .3 to .45 volts—10-16 milliamperes. 24-page Handbook gives full data on 12 pat experiments.

Stock No. 60,216-H \$2.25 Postpaid
Selenium Photozell. Lower power, lower price than Silicon Cell.
Stock No. 30,411-H \$1.50 Postpaid
Solar Cell and Photozell Handbook. Fascinating 112-page Handbook on Silicon-Cell and Selenium projects, demonstrations, etc. Explains photo-voltaic theory, performance. Gives infrared and ultra-violet applications. Paperbound, 6"x9".
Stock No. 9230-H \$2.00 Postpaid

MINIATURE WATER PUMP



Wonderful for experiments, miniature waterfalls, fountains. Christmas gardens, HO gage railroad backdrops, hobbyists, labs, schools. Pumps continuous flow of water etc. Tiny (2 3/8" x 1 3/4") electric motor and pump ideal for hobbyists, labs, schools. Pumps continuous flow of water at rate of one pint per minute at a 12" head. With 2 D Batteries in series will pump to 24" high. Works in either direction. Stock No. 50,345-H \$2.25 Postpaid

'FISH' WITH A MAGNET

Go Treasure Hunting On The Bottom

Great idea! Fascinating fun and sometimes tremendously profitable! Tie a line to our 5-lb. Magnet—drop it overboard in bay, river, lake or ocean. Troll it along the bottom—your "treasure" haul can be out board motors, anchors, fishing tackle, all kinds of metal valuables. 5-lb. Magnet is war surplus—Alnico V Type—Gov't. Cost—\$50. Lifts over 125 lbs. on land—much greater weights under water. Order now and try this new sport.
Stock No. 70,570-H. 3 1/2 lb. size \$ 8.75 Postpaid
Stock No. 70,571-H. 5 lb. Magnet \$12.50 Postpaid
Stock No. 85,152-H. 15 lb. size, \$33.60 FOB Barrington, New Jersey.



OPAQUE PROJECTOR



Projects illustrations up to 3" by 3 1/2" and enlarges them to 35" x 30" if screen is 6 1/2 ft. from projector; larger pictures if screen is further away. No film or negatives needed. Projects charts, diagrams, pictures, photos, lettering in full color or black-and-white. Operates on 115 volt, A.C. current, 6-ft. extension cord and plug included. Operates on 60 watt bulb, not included.

Size 12" x 8" x 4 1/2" wide. Weight 1 lb., 2 oz. Plastic case with built-in handle.
Stock No. 70,199-H \$7.95 Postpaid

ORDER BY STOCK NUMBER. SEND CHECK OR MONEY ORDER. SATISFACTION GUARANTEED.
EDMUND SCIENTIFIC CO., BARRINGTON, N. J.

SCIENCE TREASURE CHESTS



Extra-powerful magnets, polarizing filters, compass, one-way-mirror film, prism, diffraction grating, and lots of other items for hundreds of thrilling experiments, plus a Ten-Lens Kit for making telescopes, microscopes, etc. Full instructions included.

Stock No. 70,342-H \$5.00 Postpaid

Science Treasure Chest DeLuxe—Everything in Chest above plus exciting additional items for more advanced experiments including crystal-growing kit, electric motor, molecular models set, first-surface mirrors, and lots more.

Stock No. 70,343-H \$10.00 Postpaid

ASTRO-COMPASS AND TRANSIT



War surplus! Astro Compass alone cost Govt. \$75. We have added a Sighting Level to improve versatility. Hundreds of uses in carpentry, brick laying, foundation work, grading, irrigation or drainage. Much below cost of ordinary surveying instruments. Ideal for do-it-yourselfers. 10 1/4" high, 6" long, 4" wide. Adjustable leveling platform—2 spirit levels for aligning—also spirit level in sighting attachment, tremendous bargain.

Stock No. 70,267-H \$19.95 Postpaid

LARGE SIZE OPAQUE PROJECTOR

Ideal for photographers, this low-cost unit projects 3 1/2 ft. sq. image at 6 ft.—7 1/2" ft. sq. image at 12 ft. Projects photos, drawings, sketches, clippings, any opaque copy up to 6" x 6"—larger pieces in sections. Lenses are 2 plano-convex, 3 1/2" dia. mounted in 5 1/4" barrel. Projector is 11 1/2" high, 13 1/4" wide, 9" front to back, pressed steel in black wrinkle finish, bakelite handle. Uses two 200 watt bulbs—not included. Complete with side platform to hold illustrations, 6 ft. elec. cord, heat resist. plate glass mirror.



Stock No. 80,066-H \$42.00 Postpaid

WAR SURPLUS AMERICAN-MADE 7x50 BINOCULARS

Big savings! Brand new! Crystal clear viewing—7 power. Every optical element is coated. An excellent night glass—the size recommended for satellite viewing. Individual eye focus. Exit pupil 7mm. Approx. field at 1,000 yds. is 376 ft. Carrying case included. American 7 x 50's normally cost \$274.50. Our war surplus price saves you real money.

Stock No. 1544-H Only \$74.80 Postpaid

(Tax included)

6 x 30 Binoculars—similar to above and a terrific bargain.

Stock No. 963-H . . \$33.00 Postpaid (Tax inc.)



MYSTERIES OF SPACE BROUGHT TO EARTH



Fascinating assortment of materials introduces you to space science—the mysteries of the universe. Includes full-color pictures of Mars, Saturn, Jupiter, sun spots, solar prominence; 3 giant star and space maps; completely illustrated "Story of Space"; "How to Use Your Telescope"; "Astronomy and You"; plus Diffraction Grating Replica that breaks up white light into all the glorious hues of the rainbow.

Stock No. 9341-H \$2.50 Postpaid

WOODEN SOLID PUZZLES

12 Different puzzles that will stimulate your ability to think and reason. Here is a fascinating assortment of wood puzzles that will provide hours of pleasure. Twelve different puzzles, animals and geometric forms to take apart and reassemble, give a chance for all the family, young or old, to test skill, patience, and, best of all to stimulate ability to think and reason while having lots of fun. Order yours now.



Stock No. 70,205-H \$3.00 Postpaid

Order by Stock No.—Send Check or M.O.—Money-Back Guarantee

EDMUND SCIENTIFIC CO., Barrington, New Jersey

MAIL COUPON FOR FREE CATALOG "H"

New! 1000's of Bargains 164 Pages

EDMUND SCIENTIFIC CO., Barrington, N. J.

Please rush Free Giant Catalog "H"

Name

Address

City..... Zone.... State.....



Science Worldwide

(Continued from page 20)

A new type of tire to combat skidding on snow and ice has been developed in England. It has a special chopped steel wire strand milled into the tread compound and bonded into place. The surface looks like suede and is rough like a wire brush.

Scientists in Czechoslovakia want to make the moon more habitable by giving it a 24-hour day just like the earth's. A scientific report says the moon could be made to rotate on its own axis once every 24 hours by setting off nuclear explosions in deep holes around its equator at proper angles to the horizon. The blasts, the Czechs say, would set the moon spinning and let the sun heat its surface more uniformly.

Why do some winged insects spend more time flying than others? It's because of an enzyme called alphasglycerol phosphate dehydrogenase, say two nimble-tongued New Zealand scientists. This enzyme is located in the muscles of insects, they say, and without it, even with bugs that have wings, they seldom take to the air. The researchers found that insects like the bumblebee, which flies a lot, were loaded with

the substance. Other insects, like the praying mantis and the katydid, which do very little flying, had the material in their muscles but in much smaller amounts.

A relatively inexpensive periscope is now giving British technicians a direct illuminated view into normally inaccessible parts of machinery. The "intropiscope" is three feet long and has a viewing angle of nearly 100 degrees. The angled end, consisting of a lens and an electric light bulb, can be inserted through any opening that's at least two inches in diameter.

A recently announced technique for making diamonds directly from graphite may not make General Electric "a girl's best friend" but it should make industrial users happy. The method involves a combination of extremely high temperatures (9000 degrees F) and pressures (up to 3 million pounds per square inch). The new method eliminates a catalyst previously needed.

John P. McNeel

STEWART-WARNER ELECTRIC FUEL PUMPS

No stalling! No flooding! No vapor lock! Stewart-Warner Electric Fuel Pumps provide positive delivery of fuel instantly, under all conditions, all temperatures. This means quick, sure starts on the coldest winter days or when temperatures soar. Stewart-Warner Electric Fuel Pumps are available for engines with 6 or 12-volt electrical systems. See them at your nearby service station, garage or automotive parts store today!

*always on the job
when your engine
calls for fuel!*

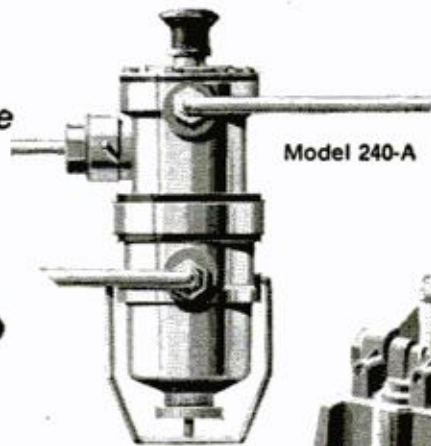

Model 240-A



Model 220-A



INSTRUMENT DIVISION
STEWART-WARNER
CORPORATION

Dept. C-122
1840 Diversey Parkway
Chicago 14, Illinois

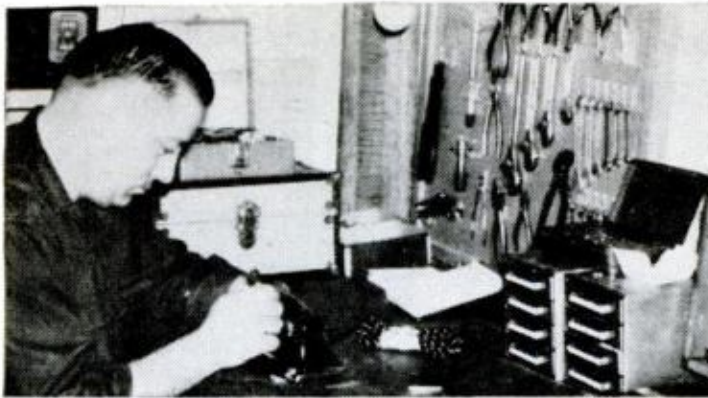

**Has shop in basement — gets
“more and more work all along”**

I HAD PRACTICALLY no knowledge of any kind of repair work. One day I saw the ad of NRI in a magazine and thought it would be a good way to make money in my spare time. Now I am busy almost all my spare time and my day off—and have more and more repair work coming in all along. I have my shop in the basement of my home.”

—JOHN D. PETTIS,
172 N. Fulton, Bradley, Illinois

IF YOU'VE BEEN WANTING TO START “A LITTLE BUSINESS OF YOUR OWN” IN YOUR BASEMENT OR GARAGE

CHECK the advantages of NRI training in Servicing Electrical Appliances

- STEADY DEMAND** for your services. Over 400 million appliances in U.S. — 6 million sold last year alone — mean shortage of trained appliance service men.
- NO ELABORATE EQUIPMENT NEEDED** — just simple hand tools, and Appliance Tester which we provide at no extra charge.
- START SMALL — GROW BIG.** You can start out in your own basement or garage, in spare time. Gradually expand until you open your own shop.
- NO NEED TO RISK YOUR SAVINGS.** Many businesses require a sizable investment. But here you can build up a following of customers *first*, then open a full-time shop if you wish to.
- EARN \$3 TO \$5 PER HOUR.** Fixing appliances is a high-paying skill because the demand for trained men is so great.
- ENJOY SEMI-RETIREMENT ON A GOOD INCOME.** When you're ready to retire, you can devote a few hours a day to this work. Live and work anywhere you please.
- NO PREVIOUS EXPERIENCE OR TRAINING NEEDED.** We tell you and show you everything you need to know, in plain English and clear pictures.

IF YOU'RE like so many men today, you've been “hankering” to start “a little home business of your own.” In spare time at first, then maybe full-time later on. Something you'd enjoy — and that pays well. Something that fills an existing need in your neighborhood or town — that “sells itself,” without any high pressure arguments — that doesn't take a big investment or elaborate equipment.

This is it—Servicing Electrical Appliances! Now is the perfect time to get into it. Sales of electrical appliances have skyrocketed. Look how **YEARLY SALES** have risen since 1950: Coffee Makers — from 900,000 to 4,750,000. Room Air Conditioners—from 200,000 to 1,800,000. Clothes Dryers—from 318,000 to 1,425,000. Floor Polishers — from 240,000 to 1,090,000. No wonder that men who know how to service appliances properly are making \$3 to \$5 an hour—in spare time or full time!

**Your Skill Always in Demand
— “Set Up Shop” Anywhere**

People need their appliances fixed in good times or bad. Once word gets around that you are trained to service them, you'll have plenty of work.

Your training costs less than 20¢ a day. And you need only the few basic tools you may already have — and an Appliance

Tester which we provide at no extra charge. You can work anywhere—in a corner of your basement or garage, even on the kitchen table. If you like, you can open up your own shop, have others work for you. And you can save money by fixing your own appliances.

**FREE BOOK
and Sample Lesson**

Our 24-page Free Book tells how you can “cash in” on America's “Electrical Appliance Boom”—the money our students are making, what they say about us.

Free Sample Lesson shows how simple and clearly illustrated our instruction is—how it can quickly prepare you for a profitable future in this big field. Mail coupon, letter, or postcard to: *National Radio Institute, Dept. AN2, Washington 16, D.C.* (No obligation — and no salesman will call on you.)



EARN WHILE YOU LEARN

with this

**APPLIANCE
TESTER**

—Yours
at No Extra
Charge



Your NRI Course comes *complete* with all the parts to assemble a sturdy, portable Appliance Tester that helps you earn while you learn. Easy-to-follow manual tells how to assemble and use the Tester *right away*. Locate faulty cords, short circuits, poor connections, etc. in a jiffy; find defects in house wiring; measure electricity used by appliances; many other uses.

With this Tester you save time and make money by doing jobs quicker, making sure appliances operate correctly after repairs.

**NATIONAL RADIO INSTITUTE
Dept. AN2, Washington 16, D.C.**

Please send me Free Book about your Electrical Appliance Repair Course and a free Sample Lesson. I am particularly interested in:

Spare Time Earnings Business of My Own Better Job

I understand there is no obligation on my part; and no salesman will call.

Name.....

Address.....

City..... Zone..... State.....

Accredited Member National Home Study Council

DRAFTSMEN



ARE NEEDED!

LEARN AT HOME IN YOUR SPARE TIME

Check the want ads in any newspaper. See the big-pay opportunities open to you as a draftsman. What's more, you can learn this well-paid, prestige profession at home—quickly, easily! No special talent needed! Get complete, step-by-step Chicago Tech

lessons in the mail, spend a few pleasant hours studying each week. In a short time you'll be a well-trained draftsman, ready to take your pick of many good jobs. Decide now to get ahead. Mail coupon today!

SEND FOR FREE TRIAL LESSON TODAY!

Get FREE TRIAL LESSON plus information about C.T.C. practical training. Learn what successful Chicago Tech graduates say about high pay and opportunities in drafting. No charge, or obligation. It's yours free.

Est. 1904 • Accredited National Home Study Council

CHICAGO TECHNICAL COLLEGE

S-200 Tech. Bldg., 2000 So. Michigan Ave.
Chicago 16, Illinois

Mail me FREE Lesson with information about big opportunities in DRAFTING.

Name _____ Age _____

Address _____

City _____ Zone _____ State _____

REPAIRING OR REMODELING? All the subjects in Popular Mechanics books, booklets, plans and patterns are listed in our free Service File. Write Service Bureau, Popular Mechanics, 740 Rush St., Chicago 11, Ill.

\$6.44 AN HOUR IN YOUR OWN BUSINESS

STEP INTO THIS BOOMING \$19 BILLION A YEAR INDUSTRY



Hundreds of accidents and losses will happen this year in your community.

We'll show you how to investigate and adjust these losses for insurance companies, railroads, government offices. You buy NO tools or equipment. You do NO selling. You need NO prior

experience or higher education. And you can operate out of your own home. Right

now independent Accident Investigators average \$6.44 an hour. We'll train you quickly to do the same. Start part-time if now employed. Fill the need for an Accident Investigation specialist in your area. Colorful booklet explains everything. Absolutely no obligation on your part. No salesman will call. Write TODAY for FREE Booklet.

UNIVERSAL SCHOOLS, PM-12, 6801 Hillcrest, Dallas 5, Texas

Items from all outdoors

Star of the world shooting matches at Cairo was Cpl. Gary Anderson, who won four of the U.S.'s five gold medals. (See story on p. 114.) Although the Russian team won the meet, the U.S. pressed them all the way for a close second. Anderson, a member of the Army's Marksmanship Training Unit, set three world records, scoring 395 in the 300-meter free rifle prone position and 1138 in the aggregate. He won the standing 50-meter small bore with a 376 and set a world record for the aggregate with 1157. The USA's only other gold medal was won by the skeet team. West Germany placed third in the meet and Switzerland was fourth.

A glass-barreled gun lured us out for a day of trap and skeet shooting at the Winchester Gun Club, in New Haven, Conn., and we can report that the new Winchester 59 shotgun is a beauty. Although partial to the pump gun, we have to admit that the automatic action on the 59 helps to get that second bird on the skeet course. It has more kick than other models we tried, but the glass barrel cuts the weight down to 6½ pounds, making it an ideal gun for the field, where you have to carry it for five or six hours.

Still have some of last season's deer in the freezer? Here's a recipe from Mrs. Agnes Laska of St. Paul, Minn., that will add a deliciously different touch. *Venison chops in beer gravy*: Brown thick venison chops in bacon fat in a large skillet. When chops are nearly browned, add two sliced onions and continue browning the chops. Slice in a garlic clove, add half a small can of tomato paste and a cup of beer. Cover and simmer for half an hour until tender. Use beer again to make the gravy. Salt and pepper to taste.

Game counts are important to regulate each season's bag limits, but they are difficult to administer. Many states have found a good system. They ask the rural mail carrier. He travels the same route every day and can keep tabs on general game-population trends. South Dakota has 700 mail carriers keeping tally on everything from deer to grouse and pheasants.

Stuart James

POPULAR MECHANICS

TUNE UP ELECTRONICALLY ANY CAR EVER MADE...

domestic or foreign; compact or limousine; 4 cylinder, 6 cylinder or 8 cylinder; 6 volt or 12 volt.

With New
Improved
Model AT-162

DWELL TACHOMETER



NOTE:
GIANT 6½"
METER FOR
EASY,
ACCURATE
READINGS

At last a streamlined instrument designed to provide the most important services for "tuning up" any and every car ever made from a Model A Ford up to and including the current automatic transmission cars produced today. The Model AT-162 includes the very latest design Dwell Meter, working in conjunction with a dual range Tachometer and incorporating all modern improvements in circuitry design.

Assure easy starts, optimum performance and maximum gas economy with Model AT-162.

The Model AT-162 will perform the services specified below in addition to many other tasks too numerous to mention:

- Assure precise adjustments of points that are slightly worn or pitted.
- Indicate the most effective point setting without removing the distributor cap.
- Indicate the correct settings for external adjustment type distributors. (A feeler gauge cannot be used for making correct adjustments on this type of distributor since many manufacturers' specifications do not list the point gap in inches. They list only the dwell angle in degrees.)
- Insure maximum gas economy and quiet engine running. Read the exact RPM while the engine is in neutral position. Then adjust the carburetor in conformity with the car manufacturer's recommendations.
- To locate a "miss" you need only disconnect or "short" the spark plugs one at a time with the Model AT-162 switched to the Tachometer position.
- Cars with automatic transmissions function efficiently only if the fluid pressures are correctly maintained and since manufacturer's instructions always refer to RPM, the Model AT-162 (or an equivalent tachometer) is required to properly service automatic transmissions.

The Model AT-162 is the most complete unit in its price range ever produced. It comes absolutely complete, ready to use. Only

\$29⁹⁵

SEND NO MONEY WITH ORDER **PAY POSTMAN NOTHING ON DELIVERY**

Try it for 10 days before you buy. If completely satisfied then send \$5.00 and pay the balance at the rate of \$5.00 per month until the total price of \$29.95 (plus small P.P. and budget charge) is paid. If not completely satisfied, return to us, no explanation necessary.

ACCURATE INSTRUMENT CO., INC.

Dept. D-226, 911 Faile St., New York 59, N.Y.

Please rush me one Model AT-162. If satisfactory I agree to pay \$5.00 within 10 days and balance at rate of \$5.00 per month until total price of \$29.95 (plus small P.P. and budget charge) is paid. If not satisfactory, I may return for cancellation of account.

Name _____

Address _____

City _____ Zone _____ State _____

High School "GRADS"

You don't need college to have a fascinating job, a bright future, big pay and advancement.

Those who don't know the facts say that only the college trained men get the good jobs in industry. Wrong! But it is true that the average high school graduate gets only the poorest kind of job—unless he has additional training in a specialized field.

For these men the biggest and fastest growing field open today is Electronics—all branches. Jobs are looking for men. You can train in as short a time as 35 weeks in the Electronic Labs of Coyne in Chicago, the Electronics Center of the Country. Low cost room and board; part time work, arranged for by Coyne's Employment Department, often covers living expenses; and most of your tuition can be paid *after you graduate*.

Like the great universities, Coyne School is an educational institution *not for profit*. A Coyne diploma gives you high standing with employers. Coyne graduates hold top jobs in Electronics all over the world.

Send your name for the Free Book, "Your Opportunities in Electronics." Read about the exciting job opportunities open to the Coyne Trained Man, the security, the future, the big pay and advancement offered by Electronics. See how little it costs to get the training you need. Then make your own decision. No salesman will bother you at your home. But, don't put off what may be a great future for you. Send your name today. A postal card will do. All information is free.

Coyne Electrical School, Chicago 7, Ill., Dept. 92-S

Coyne Electrical School, Dept. 92-S
1501 W. Congress Pkwy., Chicago 7, Illinois

Please send Free Book "Your Opportunities in Electronics." I am under no obligation—no salesman will call at my home.

Name

Address

City..... RR No. or
Zone..... State

YOU CAN OPERATE A GARDENCRETE CENTER

GC-4

New Wayside Enterprise Offers High Income on Low Investment

You can make, display and sell Gardencrete — a line of decorative masonry rich in eye-appeal and use appeal. Many items — traditional and contemporary. Bird baths, lawn seats, flagstones, vases, screen block, brick and stone for building patios, walks, planters, barbecue pits, etc. Large color range. Easy to make; no experience necessary.

This is a franchise opportunity, giving you exclusive privileges in protected territory. Broad markets . . . generous profit potentials. A timely business, with fascination, interest and opportunity to capitalize on personal vision and aggressiveness. We supply all necessary instructions and much sales cooperation. Thousands of good territories now open. Write at once for prospectus "The Gardencrete Center Idea".

COLORCRETE INDUSTRIES, INC.
726 Ottawa Avenue
HOLLAND, MICHIGAN



Coated Pills for Plants

Fertilizers wrapped in tiny capsules to make them release nutrients slowly promise to make possible farming in the tropics.

University of California scientist O. R. Lunt, who has studied the beneficial effects of membrane-enclosed fertilizers in promoting growth of flower crops, says such granules offer "exciting possibilities" for feeding a future hungry world.

Placed in plant soil, the granules release nutrients to roots slowly for a period of up to six months, despite the leaching losses caused by heavy watering or the tropics' torrential rains.

Coated granules cost 50 percent more than conventional fertilizers, making them economical for use only with high-value crops in the near future.

But 20 years from now, says Lunt, the pills, if sufficiently cheap, could be dropped in tropical soils—where rains usually wash out soil nutrients in two or three years—and make regular crop-harvesting possible.



be sure your holiday mail is signed, sealed and delivered with

CHRISTMAS SEALS

TO FIGHT TB AND OTHER RESPIRATORY DISEASES

answer your Christmas Seal letter today.

POPULAR MECHANICS

Here's the "STRAIGHT DOPE" on HOW TO FIX ANY PART OF ANY CAR from the Men Who Build 'Em!

Engineers from every American car factory put their know-how at your fingertips in this giant 1,100-page, picture book!
COVERS ALL THESE MAKES — 1955 thru 1962!



Plus Buick Special, Comet, Corvette, Lancer, Lark, Olds F-85, Pontiac Tempest, Rambler American

BRAND-NEW EDITION!

MOTOR'S
AUTO
REPAIR
MANUAL

TRY BOOK

FREE

FOR 10 DAYS!

Now — the "meat" of 176 shop manuals makes practically any car repair or service job child's play for beginner or expert mechanic!

Now you can "breeze thru" the toughest car repair jobs — in DOUBLE-QUICK time. If you're a beginner mechanic you can tackle jobs you never dreamed you could handle. And if you're already an expert, you'll save yourself hours of back-breaking work... and save money, to boot!

It's easy with the big brand-new Edition of famous MOTOR'S Manual. You get the expert help of 176 Official Factory Shop Manuals — the time and work-saving methods developed by factory engineers in every auto plant in America for their own motor car lines—boiled down in one handy, indexed book.

Factory Experts Practically Guide Your Hands

NO guesswork! NO false starts! MOTOR'S Manual starts you from

"This wonderful book has paid for itself time and time again."
—P. Pempfer, Wis.

"Have been a mechanic for 25 years. MOTOR'S Manual still takes me out of the tight spots."
—V. Lauria, Nev.

"So complete, easy to understand—have done jobs with Manual I would not have attempted without it."
—C. L. Vanerstrom, Mich.

"scratch" — expert "know-how" guides your hands through every step of practically every job. With clear illustrations and 1-2-3 instructions, these experts show you how to "polish off" any repair on any car listed—1955 thru 1962, including all the new compacts.

NEW, REVISED Edition gives you everything you need to know to repair 2,219 models. Over 1100 giant-size pages, 2,850 "this-is-how" pictures and diagrams, 195 "Quick-Check" Charts, 30,000 essential repair specifications, 225,000 Service and Repair FACTS. Instructions and pictures so clear you CAN'T go wrong!

Here's how to make fast, expert repairs on Automatic Transmissions, Engines, Ignitions, Carburetors, Steering Gears, Generators, Alternators, Distributors, Power Steering and Brakes, Starter Motors, Starter Switches, and much, much more. No wonder well over FOUR MILLION copies have been sold. No wonder it's used by the U.S. Armed Forces.

Try It FREE 10 Days

SEND NO MONEY! Just mail coupon. (Paste it to a postcard for faster action.) Use the Manual for 10 days, free. If you don't agree that it is the greatest time-saver and work-saver you've ever seen—return book in 10 days, pay nothing. Mail coupon today! MOTOR Book Dept., Desk 21Y, 250 West 55th St., New York 19, N. Y. (Schools, Bookstores: Write for discounts.)

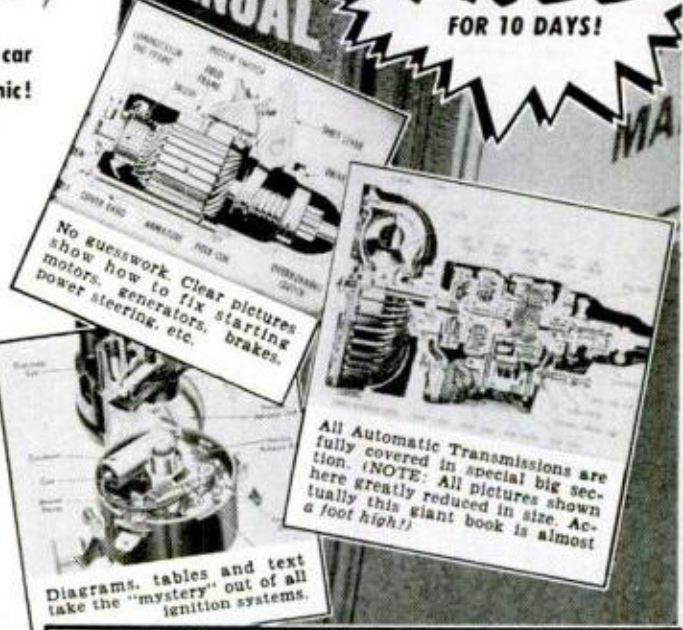

MAIL COUPON NOW FOR 10-DAY FREE TRIAL (Attach to postcard if more convenient)

MOTOR BOOK DEPT.

Desk 21Y, 250 W. 55th St., New York 19, N. Y.

Rush to me at once (check box opposite book you want):

MOTOR'S New AUTO REPAIR MANUAL. If O.K., I will remit \$2 in 10 days, \$3 monthly for 2 months and a final payment of \$1.95 (plus 45¢ delivery charges and sales tax) one month after that. Otherwise I will return the book in 10 days.

Print Name.....Age.....

Address.....

City.....Zone.....State.....

Also send me for 10 days Free Trial MOTOR'S New TRUCK REPAIR MANUAL. If O.K., I will remit \$11, plus delivery charges and sales tax in 10 days. Otherwise I will return book post-paid in 10 days.

Check box and save 45¢ shipping charge by enclosing WITH coupon in envelope entire payment of \$9.95 for Auto Repair Manual (or \$11 for Truck Repair Manual) plus sales tax. Same 10-day return refund privilege applies.

Same FREE 10-Day Trial on TRUCK REPAIR MANUAL

Covers every job on every popular make truck, 1952 thru 1962, including Chevy, Ford & International "Midgits," plus GM, International, Mack, Cummins Diesels, Engines, fuel systems, ignition systems, starters, generators, transmissions, axles, brakes. For FREE TRIAL, check box in coupon.

AUDELS GUIDES

No. 1	AUTOMOBILE MECHANICS GUIDE. 1132 Pages	\$ 6.00
No. 2	HOME APPLIANCE SERVICE GUIDE. 864 Pages	6.00
No. 3	TV & RADIO SERVICE LIBRARY. 2 Book Set	8.00
No. 4	HANDY BOOK OF ELECTRICITY. 1052 Pages	5.00
No. 6	PLUMBERS & STEAMFITTERS GUIDES. 4 Book Set	9.00
No. 7	PAINTING & DECORATING MANUAL. 585 Pages	4.00
No. 8	CARPENTERS & BUILDERS GUIDES. 4 Book Set	9.00
No. 10	WELDERS GUIDE. 608 Pages	4.00
No. 11	MATHEMATICS MADE EASY. 672 Pages	4.00
No. 12	MACHINISTS & TOOLMAKERS HANDBOOK. 1250 Pages	6.00
No. 14	REFRIGERATION & AIR CONDITIONING. 1360 Pages	6.00
No. 15	ELECTRIC LIBRARY. 10 Volume Set	22.50
No. 26	MASONS & BUILDERS GUIDES. 4 Book Set	9.00
No. 27	ELECTRIC MOTOR GUIDE. 1056 Pages	5.00
No. 29	SHEET METAL PATTERN LAYOUTS. 1152 Pages	7.50
No. 43	DO-IT-YOURSELF ENCYCLOPEDIA. 2 Book Set	8.95
No. 44	NEW MECHANICAL DICTIONARY. 712 Pages	6.95
No. 46	WATER SUPPLY AND SEWAGE. 436 Pages	4.00
No. 47	PRACTICAL CREATIVE PHOTOGRAPHY. 416 Pages	3.95
No. 48	GAS ENGINE MANUAL. 480 Pages	4.00
No. 49	OUTBOARD MOTORS & BOATING GUIDE. 400 Pages	4.00

7-DAY FREE EXAMINATION

SEND NO MONEY—Pay the postman nothing! We'll send you any of the Audel Guides for FREE examination. If you decide to keep the books you pay for them under our easy-pay plan of only \$2 a month.

HERE IS ALL YOU DO

IT'S EASY TO ORDER: In the No-Risk Mail Order Coupon below draw a circle around the number of Guides you want. We will send them to you at once. If you are not completely satisfied, return the books to us.

MAIL THIS COUPON TODAY!

THEO. AUDEL & CO. — Self Improvement Publishers Since 1879
49 W. 23rd Street, New York 10, N. Y. P12

Please mail me for 7 days' FREE EXAMINATION the books I have circled below. I agree to mail \$2 in 7 days on each book or set ordered, and to further mail \$2 a month on each book or set ordered until I have paid the purchase price, plus shipping costs. If I am not completely satisfied with my Audel Guides I may return them.

NAME _____

ADDRESS _____

EMPLOYED BY _____

1 2 3 4 5 6 7 8 10 11 12 14 Check Here for Free Complete Catalog
15 25 26 27 29 43 44 46 47 48 49

SAVE SHIPPING COSTS! Check here if you enclose complete payment with order. We pay postage charges. You have same return privilege.

NEW! TEN POWER TELESCOPE



THE BALSCOPE TEN
at only **\$9.95**

■ For the first time, due to a manufacturing breakthrough... a *quality* telescope for only \$9.95! Ideal instrument for all kinds of nature study, for vacations, for all outdoors. No clumsy draw tube—focus with a single turn of the eyepiece. Only 10¼" long, and weighs just 9 ounces. Belt holster accessory at 98¢. See it at optical, photographic and sporting goods dealers. Made to American standards of quality by America's most respected optical craftsmen, Bausch & Lomb Incorporated, Rochester 2, N. Y.

BAUSCH & LOMB



Tune in on the inventors

by J. L. Pugni

Are two steering wheels better than one? Inventor Matthew Vacante, Syosset, N. Y., whose patent is pending, thinks so. Here's how it works: The wheels are interconnected to rotate in opposite directions. If the driver wants to make a right hand turn, he rotates the right hand wheel so its top

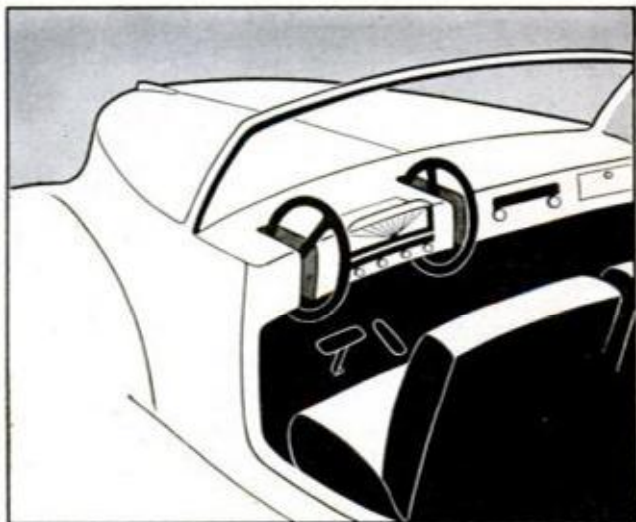

edge moves forward. At the same time, the wheel at the driver's left hand is rotated with its bottom edge moving forward. The dual wheel is supposed to remove the hazard of a steering column in case of an accident and afford the driver an unobstructed view of the road and the instrument panel.

* * *

Youngest inventors in the country are thought to be Paul and Nanette Gomory, Washington, D. C. They invented a storm window four years ago when they were 10 and 15 years old. The window is made by first removing the screen from the frame and wrapping thin sheets of plastic tightly around it. The plastic covered screen is then re-inserted in the frame. It won patent 3,057,401.

* * *

Bank robbers will be surprised when George S. Harner's new detector is marketed. When a teller hands over a package of money with the detector concealed inside, he presses a button on the side of the package. Minutes later, when the thief is making his getaway, a stop watch sets off an explosion of dye which splashes over the money, the robber and perhaps his car. Patent 3,053,416 was granted on this idea.

New Table Top Invention Puts You In...
**PROFITABLE RUBBER
 STAMP BUSINESS**

Home Operators now make
\$9.20 AN HOUR in Business
 once monopolized by
 a few big companies

Special rubber stamps bring high prices—cost only pennies to make on new, low-cost table top machine. Take 27 cents worth of material, make perfect stamps, the kind businesses and offices now buy by the dozen at \$1.80 each. Make up to \$9.20 an hour. Start in spare time in your own home. Run machine on kitchen table using ordinary electrical outlet. Make any kind of stamp. We'll send you free information without obligation about this established, highly profitable business. **We'll even help finance your start.** For free information send name and address today on a postcard to:
 Rubber Stamp Div., 1512 Jarvis Ave., Dept. R-2-P, Chicago 26

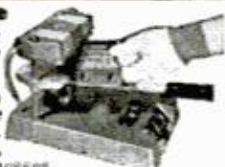

LEARN FIBERGLASSING
 at Home in Spare Time

Interstate's complete home training course in Plastics Fabrication teaches fiberglassing, plastic molding, casting, laminating, internal carving, etc. Shows how to make hundreds of salable articles of plastic. Professionally prepared. Special materials furnished. Send postcard for FREE booklet.

INTERSTATE TRAINING SERVICE
 Dept. C-3, Portland 12, Oregon

LAW FREE BOOK THE LAW TRAINED MAN

Write today for a FREE copy of illustrated law book, "THE LAW-TRAINED MAN," which shows how to earn the professional Bachelor of Laws (LL.B.) degree through home study of the famous Blackstone Law Course. All necessary books and lessons provided. Moderate cost; convenient monthly terms. Write for FREE law training book today.

Blackstone School of Law, 307 N. Michigan Ave.
 Founded 1890 Dept. 59, Chicago 1, Illinois

**MY SPARE TIME HOBBY
 MAKES ME
 \$5⁰⁰ an hour
 CASH PROFIT**

—Grover Squires



START YOUR OWN SPARE TIME BUSINESS

You can turn your spare time into Big Cash Profits with your own **COMPLETE SHARPENING SHOP . . .** Grind saws, knives, scissors, skates, lawn mower blades . . . all cutting edges. Your Own Cash Business with no inventory . . . right at home . . . no experience needed.

FREE BOOK tells how you can start your own spare time business while you are still working at your regular job. Low Cost — time payments only \$15.00 a month. Send coupon today.



BELSAW SHARP-ALL CO., 713 Field Bldg., Kansas City 11, Mo.
 Send Free Book "LIFETIME SECURITY". No obligation.

Name _____

Address _____

City _____ State _____

RCA FOR A BETTER JOB WITH BETTER PAY
LEARN ELECTRONICS AT HOME

Choose from these seven
 complete up-to-date courses

- Radio and Electronic Fundamentals
- TV Servicing • Color TV
- Communications Electronics
- Automation Electronics
- Computer Programming • Transistors

Each lesson a complete training package! Practical application begins with your first lesson — you get prime quality equipment as required to keep and use on the job. Courses for beginners and advanced students.

Voluntary Tuition Plan — pay for each lesson only when you order it! You never have to pay for the whole course if you don't complete it; courses can be interrupted at any time you wish—resumed later!

Approved for veterans.
SEND FOR THIS FREE BOOK NOW!
64-PAGES OF CAREER IDEAS IN ELECTRONICS!



RCA **RCA INSTITUTES, INC.**
 A Service of Radio Corporation of America
 The Most Trusted Name in Electronics

Resident School Courses in New York City and Los Angeles offer comprehensive training in Television and Electronics. Day and Evening classes start four times each year. Detailed information on request.

RCA INSTITUTES, INC. Home Study School, Dept. PM-D2
 350 West Fourth Street, New York 14, N. Y.

Rush me the FREE 64-page illustrated booklet "Your Career in Electronics" describing your electronic home study training program. No salesmen will call.

Name _____ Age _____

Address _____

City _____ Zone _____ State _____

CANADIANS — Take advantage of these same RCA courses at no additional cost. No postage, no customs, no delay. Send coupon to: RCA Victor Co., Ltd., 5581 Royalmount Ave., Montreal 9, Quebec.

**ENGINEERING
SCIENCE
MATH**

**B.S. DEGREE
IN 36 MOS.**



U.S. NEEDS 50,000 NEW ENGINEERS EVERY YEAR
EARN ACCREDITED B.S. DEGREE in Science or Engineering in 36 months — year-round program optional. 27-month engineering diploma also available. *Classes start January, March, June, September.* **QUALITY EDUCATION.** Graduates employed throughout U.S. and foreign countries. Government approved for veteran training. Students from 50 states, 40 countries. 20 buildings; dorms, gym, Campus. New library and laboratories. Employment help provided. **SAVE TIME AND MONEY.**

Write for catalog and complete information.

INDIANA TECHNICAL COLLEGE

1612 E. Washington Boulevard, Fort Wayne 2, Indiana

Please send free information on accredited B.S. Degree programs in Engineering and Science as checked:

- | | |
|---|--|
| <input type="checkbox"/> Aeronautical Engineering | <input type="checkbox"/> Mechanical Engineering |
| <input type="checkbox"/> Chemical Engineering | <input type="checkbox"/> Metallurgical Engineering |
| <input type="checkbox"/> Civil Engineering | <input type="checkbox"/> Physics |
| <input type="checkbox"/> Electrical Engineering | <input type="checkbox"/> Chemistry |
| <input type="checkbox"/> Electronic Engineering | <input type="checkbox"/> Mathematics |

Name _____

Address _____

City _____ State _____



**MANUFACTURE this BEAUTIFUL
OUTDOOR FIREPLACE
in YOUR OWN BACKYARD**

\$4.00 worth of sand and cement produces this attractive fireplace. Sells on sight from \$60 to \$80. Easy to start your own profitable business in your backyard. No experience necessary. Big profits. Exclusive manufacturing territories. Write immediately for full details. General machines sold to U.S. Government. Dealer inquiries invited.

GENERAL ENGINES CO., INC. Dept. MF-122 Rt. 130
Thorofare, N. J.



DRAINS cellars, cisterns, wash tubs; **\$7.95**
IRRIGATES - CIRCULATES - SPRAYS

1.001 in. dia. Stainless shaft. Won't rust or clog! Use 1/8 HP motor or larger . . . 3/4 HP for up to 2,400 GPH; 450 GPH 80' high; or 1800 GPH from 25' well. 1" inlet; 3/4" outlet. Coupling included free. **\$7.95.**
HEAVY DUTY BALL-BEARING PUMP. Up to 5,200 GPH; or 3,000 GPH from 25' well. 1 1/4" inlet; 1" outlet. **\$12.95**
Postpaid if cash with order. **MONEY BACK GUARANTEE**

Centrifugal and Gear Pumps in All Sizes

LABAWCO PUMPS, Belle Mead 7, New Jersey

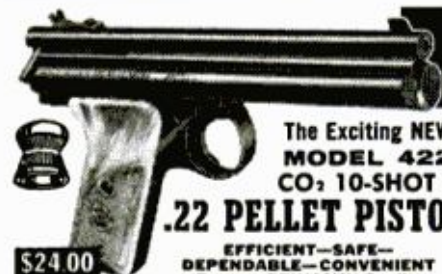

**NEW HI-FI
PERFORMANCE**

The Exciting NEW **BENJAMIN
MODEL 422
CO2 10-SHOT SEMI-AUTOMATIC**

.22 PELLET PISTOL

\$24.00

Ask Dealer for Demonstration

EFFICIENT—SAFE—DEPENDABLE—CONVENIENT
Famous BENJAMIN Quality

AT LAST—an Amazing New Handgun that incorporates the Characteristics Wanted for Serious Training, Plinking and Match Competition — Indoors and Outdoors — at **LOWEST SHOOTING COSTS!** Handsome, Dynamic, Mechanically Reliable, MODEL 422 combines Traditional BENJAMIN PEAK POWER and ACCURACY with Incredible Firing Speed — Smooth **JAM-PROOF ACTION** (no ramrod for cleaning pistol bore required)

WITH EXTRA MARGIN
BENJAMIN'S Unique **DOUBLE SAFETIES**



KEEPS SHOOTING & SHOOTING & SHOOTING & SHOOTING AS FAST AS YOU CAN SQUEEZE THE TRIGGER!

FREE Write today! Complete Catalog Benjamin Rifles & Pistols — Single Shot & Repeaters — .22 or .177 or .22. Also, Special Offer on Hunting Knives.
BENJAMIN AIR RIFLE CO. 896 MARION ST., ST. LOUIS 4, MO.

**Sidelights
on aviation**

Military parachutes, declared surplus, are being offered for sale to the public—specifically, to sky divers.

The Parachute Club of America, in fact, was instrumental in persuading the Department of Defense to relax its rules on disposing of phased-out chutes.

Surplus parachutes are now offered at auction after they have been inspected and found airworthy.

The Federal Aviation Agency has 15 parachute lofts throughout the country where these inspections and auctions are held.



Community airports, trailblazers in new subdivisions, apparently are sowing seeds of their own destruction.

They are built in undeveloped areas on the outskirts of town. Roadways and utility services are put in to accommodate the port, then other developers follow to take advantage of the new facilities. Shopping centers, homes, service stations and drive-ins, even factories grow up around it. First they squeeze off any future growth, then increase the real-estate values of the area and finally raise taxes to the point that the airport is priced out of business.



Speaking of parachuting, as we were a moment ago, the speed at which paratroopers can be dropped have been increased and lowered, respectively.

In World War II, troops were dropped at about 115 m.p.h. from 1000 feet. The exits, however, were widely spaced. New studies show that a fully equipped soldier, with a total dead weight of 300 pounds, can be dropped from as low as 300 feet at up to 450 m.p.h. And a new system is used to get the men out faster. The closer together they exit from the troop carrier, the closer together they will land on the ground. This is essential for fast regrouping.

The system consists of a continuous moving cable with hand stirrups, similar to those on buses and subway cars. Each paratrooper grabs one, moves along with it and jumps when he reaches the door. The present system allows the paratrooper to set his own pace going out the door.

Kevin V. Brown

POPULAR MECHANICS

Материал, защищенный авторскими правами



STOP FRONT DRIVE DRAG AND WEAR ON 4-WHEEL-DRIVES!

**WARN
HUBS**

Free-wheeling 2-wheel drive with Warn Hubs means big savings in gear, engine, tire wear, gas—plus more pep, performance, power in high, and easier steering. Rugged, dependable, proven, with over 400,000 in use. Iron-clad guarantee. Choose Lock-O-Matics that change drive as you shift, or manual Locking Hubs. Models for all 4-w. ds. at dealers, or write for literature.

WARN MFG. CO. Riverton Box 6064-A
Seattle 88, Wash.

JEEP OWNERS

RE-POWER NOW WITH A V-8 OR 6 CYL. ENGINE — USE FORD—CHEV.—MERCURY—GMC—PONT—STUDE—DODGE OR PLYMOUTH In Jeeps, Jeepsters, Sta-Wgn, trucks, Kaiser & H. J. cars. Conversion Kits \$45.35 to \$56.90. Want fast action? Give us full information, send \$15.00 Dep. and we will ship correct kit. Bal. COD. Send full amount for prepaid shipment. Wire, phone or write today. Details FREE.

HOOSIER MACHINE PRODUCTS CO.
312 S. E. 6th St. Phone CR 6-3442 Pendleton, Oregon

Antique TELEPHONES

As is complete, decorative purpose \$12.00. Working order, inter-comm. \$15.00. Ext. on dial \$17.50, talking circuit only. Write for complete list. All shipments FOB, Simpson, Pa.

TELEPHONE ENGINEERING CO.
Dept. 12B2, Simpson, Pa.



MORE THAN 600 specific craft, home and shop problems solved with Popular Mechanics' do-it-yourself instructional materials. For a free Service File listing by subject, write Service Bureau, Popular Mechanics, 740 Rush St., Chicago 11, Ill.

Would You Like to Make **\$1,000 A MONTH?**



That's what Stanley Hyman made selling the amazing new Presto Fire Extinguisher! Many others "cleaning up"—so can you! Amazing tiny new extinguisher ends fires fast at 2 seconds. Guaranteed for 20 years! Sells for only \$4.95. Write for Free sales kit.

Merlite Industries, Inc., Presto Div.,
114 E. 32nd St., Dept. P-15B, New York 16, N. Y.



Shrinks Hemorrhoids New Way Without Surgery Stops Itch—Relieves Pain

For the first time science has found a new healing substance with the astonishing ability to shrink hemorrhoids and to relieve pain—without surgery.

In case after case, while gently relieving pain, actual reduction (shrinkage) took place.

Most amazing of all—results were so thorough that sufferers made astonishing statements like "Piles have ceased to be a problem!"

The secret is a new healing substance (Bio-Dyne®)—discovery of a world-famous research institute.

This substance is now available in suppository or ointment form under the name Preparation H®. Ask for it at all drug counters.

DECEMBER 1962

Learn Electronics Radio-Television

by Practicing at Home
in Your Spare Time

WITHOUT EXTRA
CHARGE you get
kits to make
training easier,
faster.

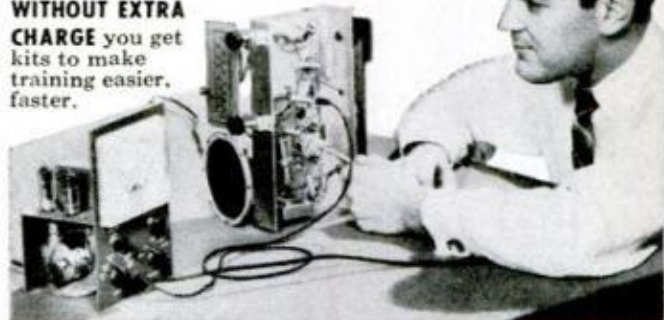

Fast Growth Offers Prestige High Pay—Bright Future

Above average jobs with bright futures await men with Electronics training . . . jobs for which YOU could qualify through NRI. Train right at home in spare time, while you hold your present job. Earn high pay in jobs with TV and Radio Stations, industrial plants, or in a profitable business of your own.

Train with the Leader

NRI TRAINED THESE MEN

Own Business:
I could hardly make ends meet. Now I have my own service business.
J. HILLENBRAND,
Bklyn., N. Y.

Broadcasting.
"I am now chief engineer of Station WARA. NRI was the foundation."
R. ARNOLD,
Attleboro, Mass.

Industrial.
"Four months after starting your course I went to work at Raytheon. Now I am an engineering assistant in Microwave Power Tube Research."
L. J. BLOOM,
Newton Centre, Mass.

For 45 years NRI has featured the best Radio-TV Electronics training for beginners—for men without high school diplomas or previous experience. NRI is the oldest and largest home-study Radio-TV Electronics school. NRI "learn-by-doing" training is supplied at low cost. It's the easy way to get into the field of Electronics.

Start Soon to Earn More

Soon after enrolling, NRI shows you how to earn extra money in your spare time repairing sets. Many start a profitable business this way. Others get good paying jobs within a year. Take the first step to a new career NOW. Mail coupon for descriptive catalog. National Radio Institute, Washington 16, D.C.

**64 PAGE
CATALOG
FREE**



MAIL THIS COUPON NOW

NATIONAL RADIO INSTITUTE, Washington 16, D.C. 2NA
Send me full information without cost or obligation. No salesman will call. (Please print)

Name.....Age.....

Address.....

City.....Zone.....State.....

Accredited Member National Home Study Council



Earn **HIGH WAGES** as a **HEAVY EQUIPMENT OPERATOR**

... and years of future security in the multi-billion dollar construction industry, in this country and *overseas!* Learn how at National, the original school of heavy equipment operation. For men ages 17 to 56. Amount of previous education *no barrier*. National is NOT a correspondence school, you train on school-owned diesel-engined machines at National's huge proving ground in North Carolina. Full 220 and 440 hour courses. Job Advisory and Counselling Dept. VA approved. Payment plans available. Write **TODAY** for **FREE** catalog.

Even if you are presently taking a course in heavy equipment operation, send for our catalog and compare the training you are receiving with ours.

**NATIONAL SCHOOL
OF HEAVY EQUIPMENT OPERATION Dept. D-35
P. O. Drawer 1686, Charlotte, N. C.**

Please send me **FREE** illustrated school catalog and complete information. I understand there's no obligation.

Name Age
Address
City Zone State

HIGH SCHOOL DIPLOMA

**FASTER
EASIER** from **Britannica** ACADEMY
FOR
ADULTS

division of Encyclopaedia Britannica Press, Inc.

Exclusive home study high school features: fresh new courses; revolutionary math; "automated learning" teaching machine; personal tutors. Individual subjects up to 4 year course. Work at your own speed, earn meaningful diploma in months, many do. Moderate tuition and terms. Send for catalog. **No salesman will call.**

**BRITANNICA ACADEMY FOR ADULTS • DEPT. PM-122
14 E. Jackson Blvd. • Chicago 4, Ill.**

Name
Address
City Zone State

engineering degree in 27 months

Industry demands graduates. Enjoy higher income . . . advancement. Major corporations regularly interview and employ seniors. *Bachelor of Science Degree in 27 Months* in Electrical, Mechanical, Aeronautical, Chemical, Civil Engineering. **IN 36 MONTHS** a B.S. Degree in Business Administration (General Business, Accounting, Motor Transport Administration majors). Small classes. More professional class hours. Well-equipped labs. Campus. New dorms. *Low costs.* Founded 1884. Enter January, March, June, September. Write J. E. McCarthy for Catalog and "Your Career in Engineering and Commerce" Book. Learn more and you'll earn more.



TRI-STATE COLLEGE

4122 College Avenue • Angola, Indiana

Atomic Wastes to Help Fish

Atomic wastes may be used to help furnish food for the rapidly disappearing supply of fish in the ocean's depths. According to members of the Food & Agriculture Organization, nutritive matter and oxygen are trapped on the ocean's floor under layers of stagnant water, silt and mud.

FAO experts have suggested that sealed containers of atomic wastes be dropped in the water where they would generate heat and warm the surrounding water. When the water warmed sufficiently, it would rise and suck up silt containing food and oxygen toward the surface within easy reach of the fish.

Huge Waves Stir Sun's Surface

Huge 40 to 50-mile high atmospheric waves rising and falling at the rate of 1000 miles per hour constantly agitate the sun's surface. Dr. Robert B. Leighton, California Institute of Technology, discovered and photographed the waves through the 65-foot solar telescope at Mt. Wilson Observatory with a "Doppler-effect" camera.

This technique translates movements of solar matter toward and away from the observer into black, white and gray on film. Further studies of the waves will reveal the general nature and detailed properties of motions in the solar atmosphere.



"Let me know when you hit \$25."

POPULAR MECHANICS

NEW WESTERN HAIG
.12 CALIBER
SPECIAL FACTORY OFFER!



\$3.00
 post-paid

USES POWDER CHARGE

This small bore gun shoots .12 cal. lead bullets fired by small 4.4 mg. powder charge. Not a CO₂ gun! You'll like the handsome lines, grip, and balance. Western in style, but patented ball and cap action allows this low price. 9 3/4" steel barrel cased in knurled styrene stock, overall 13 1/2". Develop pistol form, accuracy at a fraction of cost of large caliber pistols. Comes with 50 lead bullets. Satisfaction guaranteed. Send \$3 to: HAIGMFG. CO., P.O. Box 4-X, Alhambra, Calif.

A BUSINESS OF YOUR OWN
REPAIR HYDRAULIC JACKS



Earn while you learn at home. Millions of jacks in gas and auto-service stations, truckers, body-shops, riggers, factories, farms need servicing. We show you HOW - easy step by step directions and what tools to use. EARN UP TO \$5 an hour, in spare time, in your basement or garage. Start your own business NOW! Write for folder PM-12 and free bonus offer

INSTITUTE OF HYDRAULIC JACK REPAIR
 P. O. BOX 50 • BLOOMFIELD, N. J.
 A Correspondence School Licensed by N. J. Bd. of Ed.



Print Your Own

Cards, Stationery, Advertising, Circulars, labels, photo and movie titles, church work, tags, etc. Save money. Sold direct from factory only. Raised printing like engraving, too.

Own a Printing Business
 Print for Others, Good Profit. Have home shop. Junior press \$15; Senior \$35 up. We supply everything. Easy rules. Pays for itself in short time. Write now for free details.

KELSEY PRESSES, Z-37 Meriden, Conn.



HOME-IMPORT BUSINESS - Make Big Profits

New Drop Ship Plan offers you first day profits! Deal direct with overseas sources at prices shown. Dazzling bargains with no investment. Full or spare time. Write for FREE BOOK today to...

MELLINGER, 1554 S. Sepulveda, Dept. D25C Los Angeles 25



Given to men who want to get into CRIME DETECTION FINGER PRINT IDENTIFICATION

Train at home, spare time. Join hundreds of I. A. S. graduates now employed by police and identification bureaus in every state. Learn finger print identification, crime investigation, firearms identification, police photography, other subjects vital to qualifying for good paying, secure, interesting jobs. "Blue Book of Crime" and details Free. Must state age.

Institute of Applied Science, Dept. 1359
 A Correspondence School Founded in 1916
 1920 Sunnyside Ave., Chicago 40, Ill.

Helps You Overcome FALSE TEETH Looseness and Worry

No longer be annoyed or feel ill-at-ease because of loose, wobbly false teeth. FASTEETH, an improved alkaline (non-acid) powder, sprinkled on your plates holds them firmer so they feel more comfortable. Avoid embarrassment caused by loose plates. Get FASTEETH at drug counters everywhere.

BUY DIRECT FROM OUR FACTORY

AMAZING **Amco** 8" TILT ARBOR

Save 80%

POWER SAW KIT

RUGGED PROFESSIONAL QUALITY
 HEAVY DUTY LIFETIME ENGINEERED

UNCONDITIONAL 10 YEAR GUARANTEE

\$9.95

If desired: for easier work alignment, RIP FENCE \$3.50 add'l.



f.o.b. Factory wt. 12 lbs.

YOU GET:

Complete blade carrying mechanism with depth of cut control • Ground spindle with saw flanges • Pre-oiled bearings • Tilt control • Etched metal tilt indicator • Mitre gauge • Motor mount assembly • Brackets, screws, nuts and bolts • ABC assembly plans, plans for sturdy base, massive 20" x 24" table • Full operating instructions.

REVOLUTIONARY NEW PATENTS

... NEW DESIGN

Top quality full scale power tool with speed and accuracy of \$100 machines! Even if you've never cut a piece of wood in your life, you can put this saw together in jig time. All you need are common household tools, about 1/2 sheet 3/8" plywood for table and base... about 2 hours of spare time. Metal saving economy design. We save expensive assembly labor costs. Special patents add to efficiency, accuracy, savings. Metal parts made, sub-assembled, tested in our own factories. Buy direct from maker... enjoy a truly fantastic saving.

TABLE STAYS LEVEL, BLADE TILTS

Patented motor mount takes any standard 1/4 h.p. or large motor... keeps belt tight, assures perfect alignment at any angle, transmits full power. Table stays level—blade tilts, locks securely at any angle to 50°, raises, lowers 0"-2 1/4". Patented tilt mechanism. Takes standard blade, saw insert removes easily for insertion of any STANDARD dadoe heads, cutters, etc. Accessories, when wanted, at factory prices.

PERFORMANCE PROVED BY MORE THAN 500,000 USERS!

AMERICAN MACHINE & TOOL COMPANY
 DEPT. PM-122, ROYERSFORD, PA.

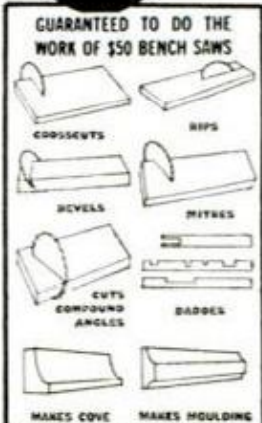

- BUILD ALL THESE**
- INDOOR FURNITURE
 - OUTDOOR FURNITURE
 - SHELVES & CLOSETS
 - CHILDREN'S TOYS
 - ALL HOME IMPROVEMENTS
- AND SAVE AS YOU SAW**

NO RISK TO YOU 10 DAY MONEY BACK GUARANTEE

You must be completely satisfied or return 8" power saw kit for full refund. Fair enough?

SEND FOR YOURS TODAY!

CLIP AND MAIL THIS MONEY SAVING COUPON TODAY! FREE CATALOG!

American Machine & Tool Co., Dept. PM-122, Royersford, Pa.

Send 8" Tilt Arbor Power Saw Kit at \$9.95

Incl. Rip Fence at \$3.50 (both for 13.45)

Payment in full enclosed \$..... or

\$3 dep. enclosed, balance C.O.D. I MUST BE FULLY SATISFIED OR WILL RETURN WITHIN 10 DAYS FOR FULL REFUND, no questions asked.

Please send free catalog of America's greatest power tool values.

NAME _____

ADDRESS _____

CITY _____ ZONE _____ STATE _____

(Please print)

Pentagon sidelights

By William R. Kreh

Instant barbed wire is being tested now by the Marines. It consists of a hand-held wire gun which can play out a couple of hundred feet of barbed wire in seconds. Weighing only 11 pounds, the gun is intended for use in helping to stop riots or to set up quick barricades.

Mounting spider webs is the novel form of art practiced by a soldier at Fort Ord, Calif. When Pvt. James Shipley finds an intricate web spread among bushes or trees, he sprays it with white paint, then transfers it to a sheet of heavy black paper and then preserves it with a spraying of clear shellac.

Speech predicts cancer. Air Force scientists involved in a speech research program leading to development of new communications systems have found that cancer in the larynx can be detected at an early stage by analyzing speech signals of individuals.

Those cars "bugged" him! Failing to get the "bugs" out of the Pentagon, Defense Secretary Robert McNamara is now recognizing they exist and is putting them in their place. He has established a special parking area for "bugs"—small cars—in the Pentagon's vast parking lot. One whole lane is now reserved for the bugs, just as long as they're not more than 168 inches long or 61 inches wide. Pentagon traffic cops now carry tape measures with their night sticks and guns as regular equipment.

A chapel of solid ice in the middle of a Greenland glacier has been built by the Army. Located at the Army's Camp Tuto, the chapel is 12 feet high and 10 feet wide, and has a 700-pound altar formed from a single block of ice. Even the candlesticks are of pure crystalline ice, hand rubbed until they are as clear as fine glass.

Making money vanish is no trick for a wife on a shopping spree. But even she can't get rid of money as fast as the Army can. Chemical officers at Edgewood, Md., recently destroyed a ton of cash trying to find a new way of destroying money rapidly to keep an enemy from using it in the

event of attack. The money, about \$7 million worth, came from the Treasury Department and was in the form of worn-out and imperfectly printed bills that were going to be destroyed anyway. Details of the destruction process are classified, but an Army spokesman said it involves a chemical that disintegrates the money.

A new white flight suit, made of a fabric called HT-1, is being tested by the Navy. It has about the same properties as nylon at room temperature, yet will not melt. The fabric chars slowly at around 750 degrees.

The old 16-inch gun used by Navy battleships in World War II is again coming into its own. The "obsolete" guns won't be hurling customary 2000-lb. high explosive shells at enemy targets, though. Instead, they'll be loaded with scientific ammunition packed with instruments. The firings will take place in the British West Indies where specially designed scientific projectiles are expected to be fired from the guns to heights of 900,000 feet.

Skinny-screen television is here. Army missile engineers have developed a tiny TV camera only three inches wide to track space objects automatically. The midget transistorized camera, weighing only seven pounds, is part of a system to predict the impact of space vehicles.

Ships without wheels—that's what the Coast Guard is planning to build. Next new ship for the service will be a 157-foot coastal buoy tender that will be steered by a lever that looks like an old-fashioned tiller. Reason: it's easier for a helmsman leaning out the pilot house window to maneuver close to a buoy with a lever.

Pre-shrinking computers are next. In case you want to know how much your socks shrink in the laundry, an Army civilian employee at Fort Lee, Va., has invented a machine that will do it. The device accurately measures the shrinkage, after washing, of garments including hats, gloves, shirts and stockings. The Army will use it to make sure manufacturers of GI clothing live up to standards.

Ten-thousand-point landing. An Air Force sergeant at an air base in France recently guided 5000 pigeons to a perfect landing on the runway in a dense fog. The birds were inside a C-47 transport plane. They were flown in to be released by the Danish Society of Pigeon Trainers for a race from France to Denmark. ★ ★ ★



"I Have My Own Shop Now!"

Says FREEMAN J. JEFFRESS, Oklahoma City, Okla.

"Your locksmithing course is so good, I wouldn't take back the money I paid for it. I have a nice little shop set up in my home and it has already paid for itself!"

Be a LOCKSMITH

Train at HOME—Earn While You Learn. Add 50%-100% to YOUR INCOME with easy spare time earnings. Cash in on the nation-wide shortage—trained locksmiths in great demand! Quickly step into a big pay opportunity job or start a high-profit shop of your own.

Earn Extra Money RIGHT AWAY! All Master Locksmiths Special Tools, Equipment and Supplies Furnished FREE for use with course.

Age, education, minor physical handicaps don't matter in this growing trade. You can quickly qualify as a skilled locksmith. It's like a fascinating hobby. Study at home as little as one hour a week. Gain practical experience through complete well-illustrated lessons. Do real jobs on car locks, house locks, padlocks and safe locks, under the guidance of experts. FREE Illustrated Book, write now.

LOCKSMITHING INSTITUTE,

(Div. Technical Home Study Schools)

Dept. 112-2 Little Falls, New Jersey

306 pieces of professional equipment
FREE for use with course.
 Professional Equipment includes
LOCKS—PICKS—PARTS—KEYS
SPECIAL TOOLS & SUPPLIES
 all FREE for use with course.

MAIL COUPON for FREE ILLUSTRATED BOOK

For a future as your own boss or in a high-pay job, write now for FREE Illustrated Book. Only school of its kind. Licensed by State of New Jersey. Approved for Veterans.

Accredited, National Home Study Council.

MAIL COUPON NOW

LOCKSMITHING INSTITUTE, Dept. 112-2 Little Falls, New Jersey

Please send FREE Illustrated Book—"Your Big Opportunities in Locksmithing," complete Equipment folder and sample lesson pages—FREE of all obligation—(no salesman will call).

Name.....
 Address.....
 City.....Zone.....State.....

75 POWER TELESCOPE \$398

NEW 3 in one telescopes, 3 variable 25X 45X-75X magnification. Brass bound, 25 power for ultra bright images 45 & 75 power for long range. Guaranteed to bring distant stars, moons, objects, sports 75 times closer. Most powerful scope sold anywhere near this amazing low price. American made, 5 sections. Opens 36", closes 1 ft.; contains 4 ground & polished lenses. Can also be used as powerful compound microscope. Mass production enables us to offer telescope complete at \$3.98 postpaid. Money back guarantee.

CRITERION CO., Dept. PM87; 331 Church St., Hartford, Conn.

METAL CASTING MACHINE

ELECTRIC! AUTOMATIC!

Good PROFITS and FUN with this fine casting equipment! Makes lead soldiers in beautiful 2½" high detail. Many poses and different uniforms.



Makes ARMIES of Soldiers

100 an Hour, AT LOW COST only

with automatic machine above: New 3-figure Commando mould, 24 pigs of metal, paints, brush, mould handles, smoking candle, electric cord, instructions. Ready to operate.

\$15 postpaid

Electric Hand Caster

Electric stove and all accessories shown with 3-soldier mould.

\$10



New Moulds:
 3 Confederate Soldiers . . \$3
 3 Union Soldiers . . \$3
 Add \$1 if West of Rockies, in Can. or Mex. (No COD's)
 Write Dept. 122.

HOME FOUNDRY MFG.

1826 S. Washtenaw Ave., Chicago 8, Ill.

STATEMENT REQUIRED BY THE ACT OF AUGUST 24, 1912, AS AMENDED BY THE ACTS OF MARCH 3, 1933, JULY 2, 1946 AND JUNE 11, 1960 (74 STAT. 208) SHOWING THE OWNERSHIP, MANAGEMENT, AND CIRCULATION OF Popular Mechanics published monthly at New York, N. Y., for October 1, 1962. 1. The names and addresses of the publisher, editor, managing editor, and business managers are: Publisher, Popular Mechanics Company, 575 Lexington Ave., New York 22, N. Y.; Editor, Don Dinwiddie, 575 Lexington Ave., New York 22, N. Y.; Managing editor, John A. Linkletter, 575 Lexington Ave., New York 22, N. Y.; Business manager, Joseph R. Buell, Jr., 575 Lexington Ave., New York 22, N. Y. 2. The owner is: Popular Mechanics Company, sole stockholder, The Hearst Corporation, 100 West Tenth Street, Wilmington, Delaware. All of the stock of The Hearst Corporation is held by the following Voting Trustees, namely: Richard E. Hefflin, 959 Eighth Avenue, New York, New York; Harold G. Kern, 5 Winthrop Square, Boston, Massachusetts; G. O. Markuson, 959 Eighth Avenue, New York, New York; Charles Mayer, Third and Market Streets, San Francisco, California; William Randolph Hearst, Jr., 959 Eighth Avenue, New York, New York; Randolph A. Hearst, Third and Market Streets, San Francisco, California; David W. Hearst, 270 North Canon Drive, Beverly Hills, California; J. D. Gortatowsky, 57th Street at Eighth Avenue, New York, New York and Herbert W. Beyea, 410 Park Avenue, New York, New York under Voting Trust Agreement dated as of February 28, 1958; the beneficial owners of the stock deposited under the aforesaid Voting Trust are: The Hearst Foundation, Inc., the William Randolph Hearst Foundation, William Randolph Hearst, Jr., Randolph Apperson Hearst, David Whitmire Hearst, George Hearst, John Randolph Hearst, Jr., Joanne Hearst Herndon, William Randolph Hearst II and Deborah Hearst. 3. The known bondholders, mortgagees, and other security holders owning or holding 1 percent or more of total amount of bonds, mortgages, or other securities are: None. 4. Paragraphs 2 and 3 include, in cases where the stockholder or security holder appears upon the books of the company as trustee or in any other fiduciary relation, the name of the person or corporation for whom such trustee is acting; also the statements in the two paragraphs show the affiant's full knowledge and belief as to the circumstances and conditions under which stockholders and security holders who do not appear upon the books of the company as trustees, hold stock and securities in a capacity other than that of a bona fide owner. 5. The average number of copies of each issue of this publication sold or distributed, through the mails or otherwise, to paid subscribers during the 12 months preceding the date shown above was: 1,375,193. Joseph R. Buell, Jr. (Signature of business manager.) Sworn to and subscribed before me this 27th day of September, 1962. Andrew E. Macyko, Notary Public, State of New York No. 41-2461900 Qualified in Queens Co. Certificate filed in New York County (My Commission expires March 30, 1963). (SEAL)

MAGIC MAIL PLAN

that comes with this Little Machine
CAN MAKE YOU \$5.00 AN HOUR



The machine is turning out a job that will bring operator \$2.58, by mail. Material cost, only 11c!

Write today for free facts about the newest and most fascinating of all new home operated businesses. For the first time, a simplified machine brings the fabulous profits of Plastic Sealing and Plastic Laminating within reach of the small operator. Anyone can learn to operate it with a few minutes practice. Then—with our MAGIC MAIL PLAN—can get mail orders pouring in daily with cash in every envelope.

No Canvassing or Selling

Fill orders at home in spare time to start. Then expand to full time business. We even supply circulars to bring back cash and orders. Rush name for all the facts you need to start. A postcard will do. No charge.

WARNER ELECTRIC CO., Dept. L-2-P
1512 Jarvis, Chicago 26, Illinois



BARBELLS

140-Pound, CHROME DELUXE Barbell-Dumbbell set only \$19.80. This is our feature set and is the finest ever manufactured.

Training with adjustable weight is the BEST way to keep fit; the ONLY way to develop great strength and a perfect body. As the oldest and best equipped barbell company, BUR gives value and prices no one can equal.

SEND FOR FREE CATALOG
BUR BARBELL CO.
Lyndhurst 9, New Jersey

100 POUND SET \$12.80
Extra Plates Only 12c Pound

MEN...Get that Job!

OPERATING HEAVY EQUIPMENT



Thousands of additional men will be needed to operate the Heavy Construction Equipment that will be used to build the new Roads, Bridges, Dams, Industrial Parks, Subdivisions, Irrigation Systems, Pipe Lines, Missile Sites, Shopping Centers, Home Sites, Airfields in a rapidly growing America!

Complete practical training on OUR modern machines, at either of OUR Florida or California Resident Training Centers, gives you the background you need to get that job you want as a HEAVY EQUIPMENT OPERATOR with the help of our NATIONALLY RECOGNIZED PLACEMENT SERVICE.

LEARN TO OPERATE

- BULLDOZERS
- SCRAPERS
- GRADERS
- BACK HOES
- POWER SHOVELS
- CLAM SHELLS
- DRAG LINES

CONTRACTORS

Write to our Placement Department for information about our trained operators. Men who spend their own money and time to learn to operate and maintain equipment, make your best operators.

ASSOCIATED HEAVY EQUIPMENT SCHOOLS, INC.
38-638 LITTLE RIVER STATION, MIAMI, FLORIDA

Please send full details immediately on your program of training for operators of Heavy Equipment

Name _____ Age _____
Street _____
City _____ County _____ State _____
Phone Number _____ Time Usually Home _____

MAIL THIS COUPON FOR COMPLETE INFORMATION

We're Going to Fetch Freshly Fallen Stars

Meteorites falling into the Midwest from now on will be tracked and quickly recovered for scientific study.

The Smithsonian Astrophysical Observatory in Cambridge, Mass., is building a network of 16 observing stations, which will scan a recovery area of about 2½ billion acres in seven states.

Each station, to be tended by an on-the-scene assistant, will have a four-windowed shelter to house cameras aimed in the four directions. Each camera will operate automatically from sunset to sunrise, taking pictures of the sky.

Stars as faint as magnitude eight will register, but fast-moving meteors must be of zero magnitude (brighter than the Big Dipper stars) to be recorded. Meteors brighter than the planet Venus will be analyzed for the possibility that they may have fallen to Earth and be recoverable.

Freshly fallen meteorites are invaluable to scientists, since they are the only solid material reaching Earth from interplanetary space. They are important for determining their ages from their radioactivity and as a possible clue to life beyond Earth.

Museum specimens usually are contaminated from having been on the Earth's surface for some time, hence the need for the network.

Stations will be at: Havana, Ill.; Milan and Vienna, Mo.; Vinton and Maple River, Iowa; Liberty, Alma, Neligh and Mullen, Neb.; Farlinville, Goessel and Kalvesta, Kans.; Ward and Lower Brule, S.D.; and Cederdale and Hominy, Okla.



You do a world of good by sending \$1 Food Crusade packages to hungry people through CARE, New York 16.

POPULAR MECHANICS

EXCLUSIVE 3-WAY HEAVY KNIT HOOD, HAT OR UNDER CHIN

Storm Hood \$1
 Comparable \$2.49 Value
 plus 20c postage and handling for each hood

Anyone who goes outdoors, when it's cold and damp, needs this sensational new design. Wonderfully warm, it protects your head, mouth, neck and ears, keeps out cutting wind and biting cold. Available only by mail, in red, blue, black, green. Fits men, women, children. Money back guar. 70% wool (backed with 30% cotton—no itching).

Barclay Distributors, Dept. 59-N
 6 for \$6 ppd. 170-30 Jamaica Ave., Jamaica, N. Y.



BIG Throwing Knife \$1.00 Special

PIERCES METAL

Specially weighted & balanced point zeroes right into bull's eye with a wallop! Positive accuracy! Deep penetration! Easy throwing! Hard hitting! Excellent for hunting game, self-defense, fun. Cutlery steel, double edge. Big 10" long. Leather handle. You must be delighted or your money back. Price Postpaid \$1.00. DeLuxe Chrome Finish Model for Exhibition Purposes \$2.50. Leather Sheath 50c. Professional Knife Throwing Book 25c.

JOHNSON SMITH & CO., Dept. 218, Detroit 7, Mich.



LEARN MEAT CUTTING

Train quickly in 8 short weeks at Toledo for a bright future with security in the vital meat business. Big pay, full-time jobs—HAVE A PROFITABLE MARKET OF YOUR OWN! Pay after graduation. Diploma given. Job help. Thousands of successful graduates. Our 39th year! Send NOW for FREE catalog. No obligation. GI approved.

NATIONAL SCHOOL OF MEAT CUTTING, Dept. 50-M, Toledo 4, Ohio



REAL ESTATE BE A BROKER

PAYS BIG! SEND FOR FREE, BIG, ILLUSTRATED CATALOG NOW! Graduates report making substantial incomes. Start and run your own business quickly. Men, women of all ages, learn easily. Course covers Sales, Property Management, Appraising, Loans, Mortgages, and related subjects. **STUDY AT HOME** or in classrooms in leading cities. Diploma awarded. Write TODAY for free booklet! No obligation. Approved for World War II and Korean Veterans

WEAVER SCHOOL OF REAL ESTATE (Est. 1936)
 3521P Broadway Kansas City, Mo.

FREE BOOK TELLS HOW

*After the city,
 Before the state
 The ZONE keeps your mail
 From being late*



The Post Office has divided 106 cities into postal delivery zones to speed mail delivery. Be sure to include zone number when writing to these cities; be sure to include *your* zone number in *your* return address — after the city, before the state.

DECEMBER 1962

FREE CAREER BOOKLET



To guide you to a successful future in

**ELECTRONICS
 RADIO-TV
 COMPUTERS
 ELECTRICAL
 ENGINEERING**

This interesting pictorial booklet tells you how you can prepare for a dynamic career as an Electrical Engineer or Engineering Technician in many exciting, growing fields:

- MISSILES • AVIONICS • AUTOMATION
 SALES • DEVELOPMENT
 ELECTRICAL POWER • ROCKETRY
 RADAR • RESEARCH**

Get all the facts about job opportunities, length of study, courses offered, degrees you can earn, scholarships, part-time work — as well as pictures of the Milwaukee School of Engineering's educational and recreational facilities. No obligation — it's yours free.

MILWAUKEE SCHOOL OF ENGINEERING

MAIL COUPON TODAY!

Milwaukee School of Engineering
 Dept. PM-1262, 1025 N. Milwaukee St., Milwaukee, Wis.

Please send FREE "Your Career" booklet

I'm interested in
 Electronics Radio-TV Computers
 Electrical Engineering Mechanical Engineering

Name _____ Age _____
PLEASE PRINT

Address _____

City _____ Zone _____ State _____

I'm eligible for veterans education benefits.
 Discharge date _____ **MS-117**

POPULAR SHOPPING

worth
writing
for...

SAVE MONEY TWO WAYS
ON PHOTO-TAKING!

SEND TODAY FOR FREE FILM MAILERS
AND LIFETIME OFFER OF

FREE
KODAK
FILM

Everytime you send us a roll of film for quality low-cost developing, we return unexcelled negatives and jumbo prints AND, at no extra charge, a new roll of fresh dated Kodak film of the same size and type (black & white, color, movie, etc.)! Save up to 50% on film processing — get new film free of charge! Write today for FREE film mailers, price list and details!

LIFETIME FILM SERVICE.
BOX 1112-E BOSTON 3, MASS.

Winter boat care may get you and your craft back in the water faster and in better shape come spring. "Painting Handbook for Boatowners," a 33-page booklet, offers 16 helpful hints to start and discusses in detail selecting the right paint, preparing surfaces and applying fresh coats to each particular section of your boat. Special tips are included for salt or fresh water, cruising or racing enthusiasts; two pages provide a guide for winter boat lay-up. Copies are free upon request from Du Pont Co., AP-612, Wilmington 98, Delaware.

Arms and armor authority, Harold Peterson, has just authored a well-documented book, "The Treasury of the Gun," which traces the story of important guns from the discovery of gunpowder to the late nineteenth century. Four-color portraits of matchlocks, wheel locks, flintlocks, breechloaders, repeaters and magazine arms in historical settings bring the text into focus. Its 252 pages also hold prints and drawings from museums and collections here and abroad. Published by Golden Press, 630 Fifth Avenue, Rockefeller Center, New York 20, N.Y., this worthwhile library addition is

available for \$12.50 until December 24, 1962; \$15.00 thereafter.

Photomicrography—the art of photographing magnified objects through the microscope—is a fascinating hobby for those camera buffs who have an interest in recording startling detail. Six well-stated sections cover optical considerations, light sources, cameras, films and filters, exposure determination and specialized techniques . . . at low, medium and high magnifications. Write Eastman Kodak Co., Sales Service Distribution, 343 State Street, Rochester 4, N.Y. Cost: \$1.00 prepaid.

Fireproof your home before getting your fingers burned. Though most every homeowner feels that his abode is fire-safe, a double check with the pamphlet, "How to Make Your Home Fireproof," by Paul Kearney, member of the National Fire Protection Assoc., will help make this a certain fact. Fifteen pages tell you how to treat decorative materials to retard flames, detect fire automatically, plan escape for your family, and which hazards to avoid. This pamphlet is available from the William Frederick Press, 55 East 86th St., New York 28, N.Y., for 25 cents.

Treat Yourself to this

Hand-built over resilient urethane foam two inches thick at front and sides, to give the support, comfort and security of a custom-built bucket seat. Use it anywhere—in car, station wagon, jeep, truck, boat or stadium; camp, trailer, home or office. Handsome, decorative, reversible. Your choice,—brown, black, gray, beige, white, red, blue or green. \$16.95 postpaid.



**INSTANT
BUCKET
SEAT**

An
**IDEAL CHRISTMAS
GIFT**

We will Giftwrap, mail, and enclose your card.

THE WILSON SEAT COMPANY Box M, West Main St., Batavia, Ohio

PLAY RIGHT AWAY!

Piano, Guitar, ANY Instrument

PLAY real tunes on ANY instrument right from the start—even if you don't know a single note now! Amazing course lets you teach yourself at home, in spare time. No boring exercises. You play real notes. Make rapid progress. Easy as A-B-C. Low cost. Over 1,000,000 students.

FREE BOOK describes this famous course in full. See how easy learning music can be. No obligation. Write TODAY to:
U. S. SCHOOL OF MUSIC,
Studio 3012,
Port Washington, N. Y.
(Est. 1898) Licensed N. Y. State
Dept. of Education. Tear out as reminder.



THAW FROZEN WATER PIPES FAST



Thaw pipe without digging or creating fire hazards. Just plug this low cost PORTA-THAW into a regular 110/220v AC power line. It's completely safe. Has no connection between power line and output terminals. Provides low, medium, high currents. Clears lines in 5 to 20 minutes. Complete with power cable, plug, receptacles, two thawing cables. Ask for data sheet TH-3-10.

PORTA-THAW
TH-3-10



TROJAN
TIG-182-S

WELD • SOLDER • CUT METAL



Battery
Charger
Attachment
Optional

Repair parts and equipment, build railings, furniture, trailers, hardsurface tools, braze, solder, cut, burn holes. Low cost 180 amp. "TROJAN" has 18 current control steps. Delivers top results in small repair, sheet metal, hobby, plumbing and heating shops, garages. Meets REA requirements. Accessories included. Ask for data sheet A-520-G.

HOBART BROTHERS COMPANY, BOX M-122, TROY, OHIO, PH. FE: 2-1223

**BUY
DIRECT**
Importer-
to-You



ACCORDIONS! SAVE UP TO 1/2

SAVE UP TO 50% OFF RETAIL PRICES of comparable accordions! Buy **Direct** from World's Largest Dealer! **5-Day Free Trial!** Low Importer-to-You Prices! Over 30 models—finest Italian makes. New easier terms! Bonus gifts **FREE**. Rush coupon for **Free Color Catalogs** and **Direct Importer-to-You** prices! Write today!

ACCORDION CORPORATION OF AMERICA,
Dept. R-122, 2003 W. Chicago Ave., Chicago 22, Ill.
Rush Free catalog and Importer-to-You prices.

**FREE
Color
Catalog**

Name _____
Address _____
City _____ State _____

GET INTO ELECTRONICS

V.T.I. training leads to success as technicians, field engineers, specialists in communications, guided missiles, computers, radar, automation. Basic and advanced courses. Electronic Engineering Technology, an ECPD accredited Technical Institute curriculum. Assoc. degree in 29 mos., B.S. obtainable, G.I. approved. Start Feb., Sept. Dorms, campus, H.S. graduate or equivalent. Catalog.

VALPARAISO TECHNICAL INSTITUTE
DEPARTMENT D, VALPARAISO, INDIANA



Make Money with Your Telephone

NEW HOME BUSINESS. Men, women—no experience needed. No selling! Choose your own hours, full or spare time. We show you everything—tell you who to call, what to say, how to make money without ever leaving your telephone. **Free Copy, "How to Make Big Profits by Phone,"** full details, write **TELEPHONE INSTITUTE, Dept. H17C** 1038 S. La Brea - Los Angeles 19, California

Train Now For BIG Pay Jobs!

**EARTHMOVING
EQUIPMENT
OPERATOR**

**HEAVY EQUIPMENT
REPAIR-REBUILDING**

Green
TECHNICAL INSTITUTE
Atten. V. N. Hutch, Box 368, Braidwood, Ill.

Get ready for a man's job in the booming road and construction industry. Operate cranes, "dozers," earth-movers, etc. Train "on the job" in 5 to 13½ weeks. Classes start weekly; reserve space now. Approved for vets. Complete catalog and reservation facts **FREE**. Write today!



Miniaturized, Electric Hi Speed VACUUM CLEANER

SAVER for vacuuming where clumsy vacs can't reach. Gulps up dirt and dust in one big swoosh! No wires to tangle! No jugging or tugging! Built in spot light illuminates corners, behind radiators for easy cleaning. Stores in drawer. **SPECIAL PRICE! \$3.33** plus 50c shipping. Total \$3.83. 2 for \$7.

CLEANS Cars, Uphol., Clothing, Closets, Workbench, Carpets, Blinds, Shades, Bookshelves etc. A life-saver!

OXFORD A10, 44 Bromfield, Boston 8, Massachusetts

WHERE-TO-FIND-IT LIST

WHERE-TO-FIND-IT List for this issue, free on request, gives sources of supply or further information on all editorial items for which this information is available. Send a stamped, self-addressed envelope to



SERVICE BUREAU

740 N. Rush St. Chicago 11, Illinois

DECEMBER 1962

★ ★ ★ ★ ★ ★ ★ ★ ★ ★ ★ ★ ★ ★ ★ ★

U.S.A.F. JET GYROSCOPE

★ GOVT COST \$2000—YOUR COST \$4.95 ★

This is a marvelous piece of equipment. Brand new 4x6x3" Sperry gyro works on wind principle, can even be started by an ordinary dry cell. Exciting and instructive, it has many uses, tremendous play value. In original waterproof foil and oilcloth lined paper, its mass of mechanical parts makes it a solid bargain. Gov't cost, \$2000. Your cost \$4.95 ppd. **BANNER SUPPLY HOUSE, Dept. PM: 125 East 41st St., N. Y. 17**

★ ★ ★ ★ ★ ★ ★ ★ ★ ★ ★ ★ ★ ★ ★ ★

LEARN UPHOLSTERY

in your spare time
run your own
business
AT HOME

FREE TOOLS WITH COURSE

FREE BOOK with sample lessons

With Course You Make

- SLIPPER CHAIR
- CLUB CHAIR
- OTTOMAN

PLUS SLIP COVERS
Yours to Keep or Sell

BE YOUR OWN BOSS

Earn more from the start in spare time. **STOP** worrying about layoffs, enjoy a steady growing income and independence for life in the booming field of Custom Furniture Upholstery. Right off, you start upholstering with the tools, complete frames, fabrics and materials, included **FREE** with N. Y. State-approved UTS Home Study Course. You learn skilled professional custom upholstery, reupholstery, furniture finishing, repairs, how to make valuable custom slip covers, cushions and draperies **EARN WHILE YOU LEARN**, in your spare time **AT HOME**... the UTS easy way. **FREE ILLUSTRATED BOOK—FREE SAMPLE LESSON** Get ready for well-paid job and big profits, from steady work, as your own boss, running your own business. Training in N.Y. School also available. Mail coupon **NOW** for **FREE BOOK!** **VET APP'VD. ACCREDITED BY N.H.S.C.**

UPHOLSTERY TRADES SCHOOL
TX-310, 721 B'way, N. Y. 3, N. Y.

Please send me **FREE** book, "Your New Way to a Successful Career," and **FREE** sample lesson. No obligation—no salesman will call.
 Home Study Training in N. Y. School

Name _____
(Please Print Plainly)
Address _____
City _____ Zone _____ State _____
 Check if Korean Veteran

OWN a BUSINESS

Be a Specialist in a Booming Industry



Get in on the ground floor of a booming \$750 million a year industry. Fill the need in your area for safe, effective "on location" cleaning of carpets and upholstery. Every home houses a customer! We'll train and establish you in your OWN lifetime business. Start part-time if employed. You'll be trained by a nearby dealer and at 50-hour school. You provide 6 services to multiply profits. You get exclusive use of process which cleans without harmful scrubbing, soaking, shrinkage. It's acclaimed by housewives, manufacturers and backed by famous McCalls and Parents Seals. No shop needed. Just 2 jobs a day nets \$8,750.00 first year.

WE HELP YOU GROW Our whole program is cooperative; thus, your training is only the beginning of a continuous assistance program designed to build your business. You receive continuous counseling from specialists at Hdqtrs. You're backed by *National Advertising in Parents', House & Gardens, McCalls, others;* ads in national trade magazines target retailers in your town to refer customers to you. Others among 25 regular services you receive are conventions, regional conferences, product development, sales letters, advertising kits, monthly magazines. Free booklets explain everything. No obligation. No salesman will call. So write for *Free Booklets* today!

DURACLEAN CO., 2-16D, Duraclean Bldg., Deerfield, Ill.

"OWN A BUSINESS" COUPON

DURACLEAN CO., 2-16D, Duraclean Bldg., Deerfield, Illinois

Without obligation, rush me **FREE** 16-page booklets giving full details on a dealership in my town.

Name.....
Address.....
City..... State.....

AVIATION CAREER

SPECIALIZED EDUCATION / PROFESSIONAL TRAINING . . . only 3 years and 4 months

Top-pay prestige positions, bright future in aviation. Job opportunities waiting for you as soon as you're ready. Airframe and Powerplant Technician, Aeronautical Engineering degree course, Business or Executive, Pilot. Classes in Miami.

SEND FOR FREE 80-PAGE BOOK

Embry-Riddle Aeronautical Institute
Miami, Florida (Founded 1926)

Name.....
Address.....
City..... Zone..... State.....

3-PM-122

BE A REAL ESTATE BROKER



PAYS BIG! SEND FOR FREE, BIG, ILLUSTRATED CATALOG NOW! Graduates report making substantial incomes. Start and run your own business quickly. Men, women of all ages, learn easily. Course covers Sales, Property Management, Appraising, Loans, Mortgages, and related subjects. **STUDY AT HOME** or in classrooms in leading cities. Diploma awarded. Write **TODAY** for free book! No obligation.

Approved for World War II and Korean Veterans
WEAVER SCHOOL OF REAL ESTATE (Est. 1936)
3523H Broadway, Kansas City 11, Mo.

FREE BOOK TELLS HOW

Monstrous Mosquitoes

Giant male mosquitoes as big as houseflies have been found in the South Pacific. They were discovered during a continuation of the Army's World War II malaria program, in which 110,000 specimens of mosquitoes were collected representing 189 species.

Existing since ancient, geologic times, the giant insects are equipped with horns and claws—probably for mating battles.

Among the 189 species were 53 new species, classified and named; and 23 new species, which are still unnamed. Only 50 of the 189 species attack man, and of these, 23 are involved in the spread of diseases such as malaria and filariasis.

Green-Thumbed Bacteria

Tiny bacteria have been discovered to have the talent of converting sunlight into energy—a process normally attributed only to green plants.

The process, called photosynthesis, is described as a flow of electrons set up when sunshine falls on a green leaf containing the green substance, chlorophyll. Similarly, when the enzyme hydrogenase, from the sulfur bacterium Chromatium, is influenced by light, a flow of electrons results. Thus, the first step in the photochemical act of the green leaf is identical with that of the bacterium.



EASY TO GET STARTED

with **LEATHERWORK**

Make your "off-time" hours pay off with fun and profit in Leathercraft. Tandy's big new CATALOG shows you how easy it is to get started, plus 1221 money-making, money-saving ideas.

112 PAGE CATALOG is yours **FREE** for asking . . . a postcard will do!

FREE

TANDY LEATHER CO. Since 1919
Write Today — P. O. Box 791-SR Fort Worth, Texas



MEN!! HEAVY EQUIPMENT

EARN UP TO \$4.50 PER HOUR!

Learn to operate Bulldozers, Motor Scrapers, Loaders, Graders, Shovel, Drag Line, others. Training includes **ACTUAL EXPERIENCE** on heavy equipment at our field training center. Free employment guidance. Write Today!

TRAINING SERVICES

120-P City Line Center Philadelphia 51, Penna.

TURN 58c INTO \$6.00 CASH PROFIT AT HOME IN SPARE TIME—METALIZING

Now you can invest 58c in material and get back \$6.95 and make \$6.00 for your time in this fascinating home business. Hundreds make good extra money in sideline work. So Easy—so much Fun! "Eternalize" baby shoes, other keepsakes. Big market everywhere. No face-to-face selling. Write for facts **FREE**, plus financing plan. No obligation. No salesman will call.
WARNER ELECTRIC, 1512 Jarvis, Dept. M2P, Chicago 26, Ill.

POPULAR MECHANICS

If You Want to Make up to \$1,000 a Month

Mail this Certificate NOW with name and address

Get FREE Details of Amazing Light Bulb with No-Time-Limit Free Replacement Guarantee

Tear out this certificate, mail with name, address to learn how you can make up to \$50 and more in a day, spare or full time, introducing sensational longer-burning Merlite Light Bulbs in your area. Simply say . . .

"Once you buy Merlite Bulbs, you never again have to buy light bulbs." Friends, neighbors, others order 12 to 24 and more at a time on astounding Free Replacement Guarantee without time limit! **FREE SALES KIT!** Everything you need to start making good money first day. Rush your name and address with this Certificate—TODAY!

MERLITE INDUSTRIES, Bulb Div., 114 E. 32nd., N.Y. 16, Dept. C-15B
In Canada: Mopa Co., Ltd., 371 Dowd St., Montreal 1, P. Q.

BRONZE FOUNDRY



Since 1935
Schools • Home Workshops • Inventors
Make your own castings of aluminum, copper, bronze, silver. Foundry sets are available in six sizes, capacity 1½ lb. to 48 lb. of red brass. 2400 Deg. F. blast furnace included with each. Write for Free Circular.

KANSAS CITY SPECIALTIES CO. DEPT. P-12
MARYSVILLE, KAN.

FAST DRAW

START your gun collection with an authentic replica of a Frontier .44 Colt. Solid Cast aluminum. Used in movies and TV. **\$3.95** each ppd.

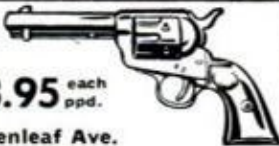

LYTLE Novelty Co., 9909 Greenleaf Ave.
Box 2146, Whittier, Calif., Dept. PM212

PROFIT IN YOUR SPARE TIME



SMALL ENGINE REPAIR PAYS BIG!

Outboard • Powermower • Chain Saw • Tractor
MAKE EXTRA MONEY — or fix your own engines and **SAVE!** Illustrated, easy-to-learn Home Study Course qualifies you as expert. Free information. Write today!

LINCOLN TECHNICAL INSTITUTE
SUITE 12-E, 472 MARKET STREET, NEWARK 5, N. J.



Repair any watch

... SWISS OR AMERICAN

Unique, modern Sweazey System starts you making repairs right away. Develops skill step by step at home in spare time. Tuition \$5 monthly. Diploma awarded. Free sample lesson. No obligation.

CHICAGO SCHOOL OF WATCHMAKING
2330 Milwaukee, Dept. 1122, Chicago 47, Ill.

MEN PAST 40

**Afflicted With Bladder Trouble,
Pains in Back, Hips, Legs,
Nervousness, Tiredness.**

If you have these troubles, particularly bladder trouble, then your condition may be traced to Glandular Inflammation . . . a constitutional disease. Neglect of this condition often leads to premature old age and sometimes incurable conditions.

The Excelsior Medical Clinic has a **New Free Book** that tells how thousands of men have been successfully treated here at Excelsior Springs for Glandular Inflammation by **NON-SURGICAL Methods**. They found soothing relief and a new outlook in the future of life.

This **Free Book** may prove of utmost importance in your life. Write Today. There is no obligation.

Excelsior Medical Clinic, Dept. B6129, Excelsior Spgs., Mo.

DECEMBER 1962

**94.6% OF BAILEY
GRADUATES ARE EMPLOYED
AT TOP PAY IN THE FIELDS
WHICH THEY WERE TRAINED!**



DIESEL-AUTO MECHANICS DESPERATELY NEEDED!

We have a far greater demand for our students than we can fill!

We can show you an actual waiting list of leading companies throughout the world who have tried Bailey graduates — found them outstanding, and are coming back for more!

Bailey Graduates are Successful . . . **RECEIVE BIG PAY — HAVE SECURE FUTURE!**

The Famous Bailey Course prepares you for **BOTH Diesel and Gasoline Mechanics.**

This is a must—due to the advent of using Diesel principles, such as 'Fuel Injection' on passenger cars . . . use of gasoline engines for starting Diesel engines, etc. You learn all this at Bailey in the amount of time ordinarily required to learn just one of these subjects, **ALL FOR THE PRICE OF ONE.**

Don't be satisfied with a 'futureless', one-type job — learn how you can make **big money** now!

Write today for Free Booklet that takes you on a step-by-step camera tour through our spacious, modern shops — See Bailey students in action as they Learn-by-doing with the Famous Bailey Method of training!

We provide you with housing and part time jobs while in school, plus nation-wide placement service for graduates.

BAILEY Technical SCHOOLS

1634 S. GRAND ST. LOUIS 4, MO.

MAIL TODAY!

Please mail immediately this free booklet without obligation.

FREE BOOKLET



Name.....

Address.....

City..... State.....

APPROVED FOR VETERAN . . . NON-VETERAN

ENGINEERING



Heald's Micro-wave and Radar Laboratory Equipment.

ENROLL NOW FOR NEW TERM

HEALD Engineering College

Van Ness at Post, Dept. PM San Francisco, California

NAME _____
STREET _____
CITY _____ STATE _____

AMERICAN INDUSTRY NEEDS TRAINED ENGINEERS NOW
BACHELOR OF SCIENCE DEGREE, 30 MONTHS

SAVE 2 YEARS' TIME

B.S. Degree Courses:

- Electronic Engineering
- Mechanical Engineering
- Electrical Engineering
- Civil Engineering
- Architecture

Diploma Courses:

- Radio-Television Plus Color **TECHNICIAN**
- Architectural Drafting
- Electronic Technician
- Mechanical Drafting
- Structural Drafting

APPROVED FOR VETERANS

Send for **FREE** Information

Styrofoam Redskin



A seven-foot Indian is one of five such statues in front of the Old Spinning Wheel Restaurant in Hinsdale, Ill. Made of fibreglas-coated Styrofoam, it was designed at the Robert Snyder studio in Chicago.

FREE **EICO** CATALOG



Build your own stereo and mono hi-fi, radios, walkie-talkies, ham gear, test instruments—save 50% with famous EICO kits. No technical knowledge needed. Simple, step-by-step "Beginner-Tested" pictorial instructions guide you all the way. Choose from 108 beautiful kits. Mail coupon now!

EICO Electronic Instrument Co., Inc. PM-12
3300 Northern Blvd., L.I.C. 1, N. Y.

Please send free catalog and name of local dealer.

Name _____
Address _____
City _____ Zone _____ State _____

"\$7,108⁵⁰— FIRST YEAR
CLEANING - REPAIRING RADIATORS!"

-Hank Konter, Newcastle, Wyo.



Make \$6,000-\$9,000 a year servicing auto-truck-tractor radiators with Inland's new 1-Piece Radiator Shop. Does entire job—TESTS, CLEANS, REPAIRS. Only 11'7" long. Inland, world's largest radiator equipment manufacturer, trains you free. Small down payment starts you. Easy-pay plan lets you pay from profits. Proved merchandising assures volume. Profitable dept. for garage or service station. Many set up Radiator Shop in garage at home, make good money working evenings. **WRITE** for 32-page Free Book. **INLAND MFG. CO., Dept. PM-12 1108 Jackson St., Omaha 2, Nebr.**



"When you phoned about patenting a device to look through walls Mr. Duntley, I assumed..."



STROMBECKER

Model Road Racing...

fun and adventure for the entire family!

Join the action, thrills and breathtaking speeds of America's fastest growing family hobby—Strombecker Model Road Racing. You control your own 1/32 scale racing cars as they "fishtail" around turns of the huge 6 foot "figure 8" track—then flash down the straightaways at 200 MPH scale speed! Now 3 new sets, complete with authentic electrically operated racing cars, throttles, track, transformer and everything you need to put the race on the road! Strombecker's American Racing Set—less than \$25.00.

Send 10¢ for Road Racing Guide and "Table Top Topics".

STROMBECKER—Box PM-12

600-608 N. Pulaski Rd., Chicago 24, Ill.

High School Course at Home

Many Finish in 2 Years

Go as rapidly as your time and abilities permit. Course equivalent to resident school work—prepares for college entrance exams. Standard H. S. texts supplied. Diploma. Credit for H. S. subjects already completed. Single subjects if desired. High school education is very important for advancement in business and industry and socially. Don't be handicapped all your life. Be a High School graduate. Start your training now. Free Bulletin on request. No obligation.

American School, Dept. H945, Drexel at 58th, Chicago 37

NOW! EARN BIG MONEY IN CARTOONING AND COMMERCIAL ART

Now you can enter this highly-paid field quickly and easily. Learn in your own home, in spare time. No previous training or art ability required. Own your own business—urgent demand for artists everywhere! Earn 100% profit on all drawings—we show you how! Send for your FREE Catalog today!

Continental Schools, Inc. Dept. E-175



4201 S. BROADWAY, LOS ANGELES 37, CALIF.

FREE Catalog and Discount Prices. Write

CHORD ORGAN Close-OUT SALE



ALL MODELS! SAVE TO 1/2
Out they go! Once in a lifetime chance to save up to 1/2 and more on all famous makes. Newest consoles, spinets, portables. Italian hand crafted. *Play at sight—no lessons needed.* Low down payment, easy terms. Money Back Guarantee. FREE catalogs. Close-out discount price list. **PHILHARMONIC ORGAN CORP.**
2003 West Chicago Avenue
Dept. R-122 - Chicago 22, Illinois

5-DAY FREE HOME TRIAL

RUPTURE!

An amazing Air-Cushion Invention allows body freedom at work or play. Light, neat, cool, sanitary. Durable, cheap. Day and night protection helps Nature support weakened muscles gently but surely. No risk. Sent on Trial! Write NOW for free Booklet and Proof of Results. All correspondence confidential.

Brooks Company, 346 State St., Marshall, Mich.



NO JOB WORRIES

PLASTEX INDUSTRY needs manufacturers on small scale for big production of Lamps, Clock Stands, Art Goods, Novelties in Plastic Marble Imitation. No Experience necessary. 1/2¢ material makes regular 10¢ store sellers. Molds furnished for fast production. Small investment brings good profit. Big wholesale orders now being placed. Ambitious men have chance for real prosperity and job security. Our NEW FREE booklet will interest and benefit you.

PLASTEX INDUSTRIES, Dept. A
3400 Third Ave. New York 56, N. Y.



1000 TRICKS 10¢

AMAZE! ENTERTAIN! START NOW!
BIG EXCITING MAGIC & FUN CATALOG! 160 Pages! Tricks, Jokes, Magic, Illusions, Secrets! Puzzles, Stunts, etc.! Rush name, address and only 10¢.

FREE MAGIC TRICK GIVEN

House of 1000 Mysteries • Dept. PM12-62 • Trumbull, Conn.



How would you like a snow boat for the kids this winter? It can be yours for the building. Complete plans for making a small toboggan-like sled from a sheet of galvanized iron and a few scraps of lumber are among the many interesting craft features in January PM.

DARLING PET MONKEY

Play with and caress this almost human pet. Children and adults love this Squirrel Monkey as a gift. Enjoy companionship and fun with its heart shaped face and friendly eyes. Approximately 6 months old, grows to about 12 inches tall. It loves affection. Easy to care for and train, will eat what you eat. Free instructions & cage included. Guaranteed live delivery. Only \$19.95 express collect. Mail check or money order for \$19.95 to: **Animal Farm, Dept. 138, Box 1042, Miami Beach 39, Fla.**



BUILD, FLY ONE-MAN COPTER



Fun to build, inexpensive, easy to fly. Factory kits available. Order 3-view drawings, specs, photo of Gyro-Copter \$2 or motorless Gyro-Glider \$1. Send coupon today.

BENSEN AIRCRAFT CORP., Dept. PM-122
Raleigh-Durham Airport, Raleigh, N. C.
NAME
ADDRESS

KNOW YOUR COINS!



this Indian Cent—in circulation now is worth \$400.00—Got one?

Don't let a fortune slip thru your fingers. The change in your pocket may be worth hundreds... even thousands of dollars. To know what it's worth and how to start this profitable hobby, send for Meghrig's COIN COLLECTORS KIT. Contains giant 128-page 1963 COIN PREMIUM BOOK worth \$1.00 which lists every U. S. Coin, quantity, what they're worth, a NEW REF. CATALOG of latest coin and stamp info, supplies, etc.; PLUS "HOW TO COLLECT COINS"—tells you the inside "tips" on collecting, conditions of coins, glossary, etc. In addition you get 3 COIN ALBUMS worth \$1.05, a CERTIFICATE worth 25¢ toward purchase of any item of \$1 or more in Meghrig's catalog... AND A FREE MEMBERSHIP CARD which entitles you to 10% discount on future purchases. COMPLETE KIT and all these advantages... ONLY \$2. ppd. Satis. Guar. No C.O.D. Send cash, check or M.O.

We pay top prices for your coins and stamps
M. MEGHRIG & SONS,
Dept. PM-12
535 S. Western Ave., Los Angeles 5, Calif.



"MADE \$1200 ON ONE JOB"

Some make more, some less...

We help you start Your Own All-Year Business

Make BIG Money! • With our easily operated, highly efficient Wall Washer, G. H. Jones made \$1200 on one school job. E. L. Goss took in more than \$10,000 in one year. E. C. Taber wrote, "I made \$400 gross in two weeks." And no wonder... this machine washes walls 6 times faster and better than by hand—with no mess...no drop cloths.

Your Money-Making Opportunity • We want more men to go into this profitable business for themselves and enjoy independence...freedom from layoffs and bosses. Customers everywhere—homes, offices, schools, churches, hotels, etc. How much you earn depends largely on you, but we help you to start and work with you for your success. What you take in is mostly profit. No need to rent shop or office; operate from home. Start spare time until full time is justified.

Ours is NOT a Lease Arrangement • You are free to operate in an independent manner. You sign no contract. You own the detergent outright and are always *your own boss*...and every dollar you take in is *yours* to keep. You pay no fees, or dues, or royalties to anyone. And you take no risk. Your detergent is fully guaranteed and enough supplies come with it to return far more than your investment. Many earn the cost of the detergent in a week or two. It costs nothing to get the details...write TODAY.

MAIL COUPON TODAY FOR FREE BOOK

VON SCHRADER MFG. CO.
W10 "W" Pl., Racine, Wisconsin

Please rush your **FREE** booklet about your WALL WASHING MACHINE and how I can start my own permanent, profitable business.

Name _____

Address _____

City _____ Zone _____ State _____

Loss No Time!—Send Coupon Today for All the Facts!

**EARN \$125
A WEEK AND UP**

**BE AN AUTO DIESEL
EXPERT—LEARN
A TRADE YOU LIKE**

You learn fast in our shops because you learn with tools on real equipment. Students short of money may earn most of their expenses by doing part-time work. Experienced instructors explain WHY and show you HOW, then you DO IT YOURSELF. Many of our graduates earn \$125 a week and up. Approved for veterans. Day and evening classes. Free bulletin-write today.

MAIL THIS COUPON TODAY!

NASHVILLE AUTO-DIESEL COLLEGE
226 7th Ave., No., Dept. 86, Nashville, Tenn.
Please send without obligation free catalog.

NAME _____
(please print or write plainly)

ADDRESS _____

CITY _____ STATE _____



Clock Plans & Movements

Build this beautiful grandmother clock from kit which includes plans, 110V movement and dial,—only \$9.95, Fed. Tax included.

Send 10c for 24-page booklet describing other plans, movements, dials and moldings.

CRAFT PRODUCTS, ELMHURST 1, ILL.



ALL FAMOUS BRANDS!

**FARM
TRUCK
AUTO**

AT LESS
THAN
WHOLESALE

SAVINGS NEVER LESS THAN 50% up to 70% OFF REG. PRICE!

HEADQUARTERS for ALL SPORT CAR TIRE SIZES

FREE • SEND FOR YOUR FREE CATALOG • FREE!

RELIABLE TIRE DIST., 730 Morgan Blvd., Camden 4, N. J.

RUPTURED

BE FREE FROM TRUSS SLAVERY

Surely you want to THROW AWAY TRUSSES FOREVER, be rid of Rupture Worries. Then Why Do you put up with wearing a griping, chafing and unsanitary truss the balance of your life? If you do, it will NOT be through necessity but through choice on your part.

Now there is a new modern Non-Surgical treatment that is designed to permanently correct rupture. These Non-Surgical treatments are so dependable, that a Lifetime Certificate of Assurance is given. Write today for our new FREE BOOK that gives facts that may save you painful, expensive surgery. Tells HOW and explains WHY NON-SURGICAL Methods of Treating Rupture are so successful today. No obligation.

Excelsior Medical Clinic
Dept. H6125, Excelsior Springs, Mo.

POPULAR MECHANICS



CLASSIFIED ADVERTISEMENTS



Advertisements in this section \$1.35 per word, each insertion, minimum 10 words, payable in advance. To be inserted under proper classification, copy must be in our office the 18th of the second month preceding date of issue
F. W. Johnson, Manager, Classified Advertising
Popular Mechanics, Classified Adv. Dept., 740 Rush St., Chicago 11, Illinois

YOU'LL PROFIT

By reading and answering the classified ads in this section. Hundreds of opportunities for you to make and save money

AUTOMOBILES, MIDGET CARS

AUTOMOBILE Literature, antique, modern; catalogs, photos, manuals. Monthly bulletin. Non-profit organization. Free information. Enthusiasts, Box 451B, Mount Clemens, Mich.

1961 FORDS \$549.00. Send 10¢ for information. National Auto, 16841 Brookpark, Cleveland 42, Ohio.

AUTO SUPPLIES AND EQUIPMENT

STELLITE Valves Seats for highest performance. Custom made any type engine. Dealer inquiries invited. Box 1145, Clearwater, Florida.

RING-Valve job while driving, \$6.00 postpaid. Guaranteed! Nothing like it! Many mechanics recommend! Motaloy, Grantham, Penna.

WILLYS Jeep tops, \$95.50. Mor-Nan, Box 141, Beverly, Mass.

2500 WATT 110 volt AC power plant mounted on car truck tractor motor. Free literature. Kennell's Transit Power, Parsons, Kansas.

FREE Trial. Ring-valve job while driving. If satisfied owe \$3.00, otherwise nothing. Motor, 5 Lander, Pittsburgh 20, Penna.

TRANSISTOR Ignition coil — instructions. Special \$8.50. Anderson Engineering, Wrentham, Mass.

SNO-DRIVES. Replaces tire chains forever. Fits on wheel lugs. Taxicabs, police use Sno-Drives. For American cars. Thousands in use. Amazing Xmas gifts, \$9.95-\$11.95 postpaid. Automotive dealers, 33 1/2% off. Distributors wanted. Bateson's Incorporated, 4408 Market, Wilmington 2, Delaware.

JEOP Parts! For military and civilian. At great savings. Largest inventory. Catalog for owners and dealers. Inquiries invited. American Auto Parts Co., 1830-PM Locust, Kansas City, Mo.

NEW And used parts at savings. Complete guaranteed parts service for all models cars and trucks. Largest in the West. Jeep and army parts specialists. Newest type shifting hubs for all jeep and all military and latest production front end drive vehicles. \$27.50 and up. Also, foreign car parts. Write. Pioneer Auto and Truck Parts Co., 734 W. 13th Avenue, Denver 17, Colo.

PARTS, Model "A." List 25¢. (Refundable) Matco, Box 135, San Pedro, Calif.

BATTERY Chargers. Home type. Electrotrone's famous line. Wholesale prices. Same day delivery. Free catalog. Doron Enterprises, Inc. Box 7214, Chicago 80, Ill.

FORD T and A parts? Try best source old model parts, all makes. Pistons, gaskets, gears, valves, waterpumps, etc. "World's Largest Antique Auto Parts Corporation," Milwaukee 4, Wisconsin.

1909-1934 FORD Parts illustrated catalogs 75¢. Mark Auto, Layton, N. J.

CROSLEY And foreign car parts. Discount club, Box 7B, Elmont, N. Y.

FENDER Covers. Terrific gift. Full protection during engine work. Heavy grease-proof vinyl with built-in tool tray. Dacron stitched for years of wear. Non-slip trudging 1/4" backing. Black, red trim, yellow-bordered tool tray. Money-back guarantee. \$4.50 prepaid in U.S.A. — no C.O.D.'s please. Acid-proof mechanics battery cover free with each fender cover. Order today. Moro Co., Dept. B, 3516 No. Verdugo Rd., Glendale 8, Calif.

HYDRAULIC Jack repair parts. "Sava-Jack" genuine metal replacement parts; "Econo-Park" bulk items; Jackmaster repair kits; catalog 25¢ in coin. Hydraulic Jack Packing & Tool Co., P.O. Box 50, Bloomfield, N. J.

CRANKSHAFT Grinder, hand operated. Makes bearings fit without taking engine apart. \$5.00. Literature. L. D. McGee, 719 Cascade, Wenatchee, Wash.

LARGEST Stock of guaranteed used car parts in east. Bob's Auto Parts, Route 9W, Kingston, New York.

AUTO Shop welding repair training in world's largest non-profit welding school. Low tuition. Free booklet. Hobart Welders, Box M-1221, Troy, Ohio.

COMPACT Oil re-claiming unit. Plans \$2.00. Holcomb, Box 681, Pampa, Texas.

BRAND New. Car key sets. Literature 10¢. Keys, 4643PM Philadelphia 27, Penna.

SAVE Up to 50% on auto parts, accessories! Get new 356-page illustrated catalog, just out. Over 100,000 items to renew, rebuild, renovate all makes, models, domestic, foreign cars, trucks, sports cars, from 1920 to 1963's; '28 to '31 Model A! Latest Hollywood accessories, custom and hi-speed equipment. Rush 25¢ for postage, handling—refundable on first order. Whitney, 1919 PM-12 Archer, Chicago 16.

FORD Parts 1928-1953. Largest stock new Ford parts for the restorer. Send \$1.00 for catalog 1928-1948. Specialized Auto Parts, 301 Adams, Houston 11, Tex.

END Oil changes. Double engine life. Guaranteed. Refills, 10¢. Write: Box 1655, Glendale, California.

JEOP Owners — V8 conversions. Read Jeep Owners ad, page 31.

TIRES. Spectacular savings. National brands. All types for farm equipment, auto, trucks. Write today: Romar Tire, 10 Penn St., Woodbury, N. J.

AUTO TRAILERS

BUILD Camping travel trailers. Illustrated circulars 20¢. Kamcraft, Box 1153, Milwaukee 1, Wis.

PICKUP Campers. Pre-cut Kits. Blueprints. Supplies. Literature 10¢. Comstock Trailers, Parsons, Kansas.

MOTORCYCLES, BICYCLES, MOTORSCOOTERS AND SUPPLIES

BICYCLE Motorizing plans. Send \$1.00, converts bike to motorbike: Go-Byk Industries, Fergus Falls, Minnesota.

"NIMPOW" \$19.95 Kit converts bicycle to motorbike. Rear engine, low center of gravity. Literature 50¢, refundable. Roycraft, Box 5864-E, Kansas City 11, Mo.

BUILD Motorscooter from bicycle frame. Plans, parts catalog \$1.50. Refundable. Gilliom Manufacturing, St. Charles 20, Missouri.

HARLEY-Davidsons — Used bargains. New, used parts, accessories, all models. Bulletin 25¢. Knuth's (Factory Dealer), 1753 Muskego, Milwaukee, Wis.

RECONDITIONED Motorcycle motors. Large stock Indian Cushman Vespa Mustang NSU parts. Indian Motorcycle Sales, Kansas City 27, Missouri.

GO Cart \$10. Jawa motorcycle \$15, less engines. Briggs engine \$3. Allstate scooter \$20. Moped \$35. Electric car \$50. Crosley pickup \$125. (Mailorder only.) Send 25¢ (35¢ for first class mailing) for Directory-Catalogue Number 110, listing these and hundreds of other bargains, homebuilders parts, plans, etc. Midget Motors Directory, Athens, Ohio.

MOTORCYCLE Parts. New, used. List 25¢. Ballak, 811 N. 9th, St. Louis 1, Mo.

AVIATION

BE A government licensed aviation mechanic. Practical training. Free information. Aero Mechanics School, Municipal Airport, Kansas City 16, Missouri.

PROPELLERS. Plans, supplies for airboats, snowplanes, 125 h.p. Lycoming engines. Prompt delivery. Catalog 25¢. Banks-Maxwell Propeller Co., Box 3301E, Ft. Worth 5, Texas.

HOMEBUILT Helicopter handbook \$1.00. Directory \$1.00. Urshanair, Box 250, Santee, California.

PROPELLERS For airboats, snowplanes, ice sleds. Beautiful colors. Boat kits, mounts, worlds best. 25¢ for catalog. Aerial Propeller Co., Box 692, Greenville, Texas.

BATTERIES, GENERATORS

HEARING Aid batteries, accessories. Wholesale. "Hearing," Box 1020, Harrisonburg, Virginia.

REBUILDERS Introductory operating manual \$1.00. Batteries, starters, generators, regulators. Modern, Box 8715, Kansas City 14, Mo.

REBUILD Batteries! Complete manual \$3.00. Chrysler Corp. Alternator guide \$3.00. Hydraulic Jack Repair manual \$3.00. C. O. D. accepted. Bayer Publications, 938 Betty Avenue, Neenah, Wisconsin.

BATTERY Reconditioning kit, molds, instructions. Old batteries like new. Batteryman, P.O. Box 193, Prunedale Station, Salinas, California.

ELECTRICAL SUPPLIES

FREE, Appliance—lamp parts wholesale bargain lists. Get on our mailing list, save money. Seco, 112 South 20th Street, Birmingham 3, Alabama.

LAMP, Electrical parts, wholesale. Thousands of items for repairing, converting. Catalog 35¢. Brown Lamp, Box 305, Clayton 5, Missouri.

LAMP Parts. Catalog, prices, wiring instructions, 50¢. Refunded first order. Gyro, 5208P N.W. 35 Ave., Miami 42, Fla.

ELECTRO-SCRIBE! Engraves all metals. \$2.00. Beyer Mfg., 10511-H Springfield, Chicago 55.

LIVE Modern with "dim-switches" in your home. Incandescent, 600 watts, off to 100%. Full control. Limited quantity at \$12.95 ppd. Money back guarantee. Fendrock's Surplus, Box 83, Simpson, Penna.

NEW Quality lamp socket. Operating ring slides up & down. Eliminates fumbling in dark. Simple installation. Specify single or 3-way. \$1.25 Ppd. Lampel, Inc. Dept. PM-1262 New Hartford, Conn.

WELDING, SOLDERING, PLATING

ARC Welder manual only 50¢. Regular \$1.00 value. Tells how to weld every job. Emerson Electric, 8100 Florissant, Dept. PM-12, St. Louis, Missouri.

CHROME Plating equipment, supplies. All other finishes. Home workshop and production sizes. Send \$1.00 (refundable) for formulas, operating data, equipment guide and catalog. HBS Equipment Division L50, 3445 Union Pacific Avenue, Los Angeles 23, Calif.

WELDERS, 110/220, \$39.50. Morris, 1070 Inner Drive, Schenectady 3, New York.

ACETYLENE Outfits, new \$59.50; used \$40.00. Arcwelders \$69.50. Eagle Welding, Dept. PM, 5085 Broadway, Chicago 40, Ill.

FREE Catalog, welders, kits. Build 350-ampere welder using aircraft generator, plans 25¢. Dunbar, Minneapolis 8, Minn.

MACHINERY, TOOLS, SUPPLIES

40 NEW Machinist tools. Campbell Tools, 1424 Barclay, Springfield, Ohio.

MAKE Own light duty lathe grinder. Low cost. High quality. Free instructive folder. Kimbrough, 304 Oriole Dr., Chattanooga 11, Tenn.

METAL Supplies. Texas tubing. P.O. Box 11105, Fort Worth, Texas.

SPRINGS, Inventors—mechanics assortment. Compression, extension, torsion. Over 500 pieces. \$4.95 postpaid. Connor Spring Manufacturing Company, 75-14th Street, San Francisco 3, California.

ANGLE Plate Universal 3"x3"x4" casting \$4.50 ppd. Model Tool Service, Rock Falls, Ill.

ENGINES, MOTORS, DYNAMOS

REWIND Motors yourself. Complete instructions, \$1.00. Lewis Manufacturing, Howell, Michigan.

WINDING Data. 275 motors, single and three phase \$1.10. Data Company, 512 Kensington, Kansas City 24, Mo.

DIESEL Injector parts and fuel pumps wanted. GM51-53-71-110. Bares, 2093 East 19 Street, Cleveland 15, Ohio.

ELECTRIC Motor supplies, instruction, diagrams. Modern, Box 8715, Kansas City 14, Mo.

MOTORS: 1/4 H.P. General Electric \$7.50. 1/2 H.P. Wagner \$14.50. Send M.O. Rebuilt. Sizes to 5 H.P. List 10¢. A.C. Motors, 3101 N. 32nd St., Philadelphia 32, Penna.

GOVERNMENT SURPLUS

JEeps \$111.68. Airplanes \$75.20. Boats \$6.18. Many others direct from U. S. Government. For complete "Directory", send \$1.00 to Quality Surplus, Box 22163-PM12, Indianapolis, Indiana.

GOVERNMENT Surplus, jeeps, walkie talkies, airplanes, guns. Locations & Procedures 75¢. Satisfaction guaranteed. Delta, Box 227, El Paso 42, Texas.

FREE Valuable war surplus bargain information. Box 8F, Thomasville, Penna.

GOVERNMENT Surplus. How and where to buy in your locality. \$1.00. Surplus, Box 1402-PM, Englewood, Colorado.

SURPLUS Bargains! Complete information. Send \$1.00. Surplus Service, Box 820, Holland, Michigan.

GOVERNMENT Surplus. Send \$1.00 to: Information, 1526 Northview, Mobile, Alabama.

JEeps \$223.83. Typewriters \$4.15. Radios \$2.65. Boats \$6.18. Televisions, guns, recorders. Typical surplus prices. Free exciting details. N. Y. Enterprises, Box 402-X4, Jamaica 30, New York.

JEeps \$278. Airplanes \$159, boats \$7.88, generators \$2.68, typewriters \$8.79 are typical government surplus sale prices. Buy 10,001 items wholesale, direct. Full details, 627 locations and procedure only \$1.00. Surplus, Box 177-C30, Abbottstown, Penna.

U.S. Government surplus—Jeeps, \$264.00, radios, \$2.53, guns, typewriters, cameras, tools, thousands of items. Fabulously low surplus prices. Complete information sent immediately. Send \$1.00 to—Surplus, P.O. Box 50512, Dept. E, New Orleans 50, Louisiana.

GOV'T Surplus. How and where to buy in your area. Send \$1.00. Surplus Information, PM, Headquarters Building, Washington 6, D. C.

JEeps, Boats, airplanes, helicopters, walkie-talkies, radar, tents, typewriters, tires, tools, cameras. Individuals can buy now direct from government. "U.S. Depot Directory & Procedure" \$1.00. Brody, Box 425-PM, Nanuet, N. Y.

BOATS, OUTBOARD MOTORS

FIBERGLASS Cloth, Matt, Polyester and Epoxy resins. Lowest prices. Seifert's, Box 1206-M, Green Bay, Wisconsin.

200 BOAT Plans, kits. Catalogs; Powerboat 85¢, Sailboat 40¢. Marinecraft, Box 161-M, Brighton 35, Mass.

LARGE Scale boat plans. Full size frame parts layouts. Easily built plywood boats to 18 feet. Literature 35¢ refundable on purchase. Dolfin, Box 1764, Boise, Idaho.

SAVE Money. New, used outboard motor parts. Send wants. Stamp appreciated. Outboard Motor Mart, 229 State Street, Boston 9, Massachusetts.

NEW, Used, rebuilt marine motors. Marine conversions, fittings. Free catalog. Stokes Marine Supply, Dept. 24, Coldwater, Michigan.

MARINE Conversions. Ford, Chevrolet, Jeep engines. Catalog 25¢. Lehman Manufacturing Company, 800 Elizabeth Avenue, Linden 4, N. J.

BUILD Your own boat from our large-scale blueprints. Books of plans give how-to-build help. Hundreds of professional designs—motor, sail or auxiliary—for amateur builders. Free catalog. MoToR Boat-ing, 959 Eighth Ave., Dept. RS, New York 19, N. Y.

FULL Size, cut-to-shape boat patterns, blueprints, 7 1/2-38 feet. Big new illustrated "Build a Boat" catalog of 64 designs, including catamarans, cruisers, runabouts, skiffs, outboard boats, sailing, racing, houseboats, 50¢. "How to Build a Boat" booklet, \$2.50. Cleveland Boat Blueprint Co., Box 1651, Cleveland, Ohio.

MAKE Your dream of owning a boat a reality. Build one now! The 20th Anniversary boat kit catalog by Custom Craft offers the means of selecting a style best suited to you. Pram to cruiser, sailing dinghy to dragster—each engineered by the originator of kit boats to be the best value a boat builder can buy. Financing available. Send 50¢ for 1963 catalog to Custom Craft, Buffalo 7N, New York.

SUPPLIES For boats interior: Finest plastics, foam rubber, tools. La Scala Textile, Box 1490, Albany, New York.

BOAT Plans, frame kits, full-size patterns prepared specially for amateurs. Send 50¢ for new 80-page catalog illustrating over 40 build-it-yourself power boats from 7' to 28'. Glen Designs, 9152 Rosecrans, Bellflower, Calif.

FIBERGLAS Your old wooden boat. Make it waterproof. Repaint over fiberglass, wood, or metal with new Poly-Aqua Epoxy paint. Free literature. Ajax Plastic Co., Dept. 6, P.O. Box 1323, Ft. Worth, Texas.

SPORTING GOODS, GUNS, FISHING, SKIN DIVING, ARCHERY

154 PAGE Catalog—A real dream book for fishermen. It's free. Netcraft Company, Dept. B-12, Toledo 13, Ohio.

NEW Firearms, scopes, reloading supplies, accessories, shop tools. Quick service. Lowest prices. Large catalog free. Walter Oliver Assoc., Box 55-M, Auburn, Indiana.

JAP Rifle altering to 30-06, \$6.00. Japshells, \$3.95. Catalog 10¢. T. P. Shop, West Branch 11, Mich.

MOLDS—For casting your own fishing sinkers. Free illustrated booklet. Reading Instrument Co., Box PM78, Reading, Penna.

FREE—Wholesale catalog. Beads. Spinners. Lure parts. Sinkers. Molds. Jigs. Reels. FinnySports (ME), Toledo 14, Ohio.

BIG Money raising crickets and 12 inch African fishworms. Free literature. Carter Ranch, Plains, Georgia.

MOLDS For fisherman's sinkers, jigs, squids, casting and spinning lures. Free catalog. Sweet's Molds, Tonawanda 1, New York.

10,000 GUN Bargains! Modern-antique guns, accessories. Giant 128 P, Bargain catalog \$1.00. Agramonte's, Yonkers, N. Y.

WALKIE-Talkies, free wholesale catalog. Follett, Box 175, Oshkosh, Wisconsin.

ATHLETIC EQUIPMENT, BODY BUILDING COURSES

PHYSICAL Perfection. Reducing, gaining, muscles, longevity. Mail 25¢ for all 4 courses. Big deal \$3.00. Guaranteed. Personal supervision. Agents wanted. Sid's System. (PM-L62) 8421-C. Evergreen, Southgate, California.

"GIANT Arms." Dr. Young's, D.C. revolutionary discovery. \$2. Satisfaction or refund. Gaucho, Box 9309-S7, Chicago 90.

BIG Muscles fast—gain up to 4" on arms, 10" on chest in just 7 weeks. Free details. Sinkram Body Builders, Dept. ME-7, Box 11, Brooklyn 36, N. Y.

WEIGHT Exercising equipment. Free literature. Ed Jubinville, Holyoke 9, Mass.

RUNNING. For happier life. Description free. Harold Ashworth, Heuvelton, N. Y.

"KUNGFU Karate" iron poison hand fighting. Break bricks in 100 days \$5.00. Oriental Book Sales, P. O. Box 1183, Oakland 4, Calif. Free literatures.

CAMPING EQUIPMENT AND TENTS

CAMPING Equipment, tents, world's largest selection. Send 25¢ for new giant catalogue—handbook—camp site directory (print name—address). Morsan Tents, 10-21R 50th Ave., Long Island City 1, New York.

KEEP Warm. Send 10¢ for handbook catalog of down clothing and lightweight camping equipment. Gerry, Dept. 245, Boulder, Colorado.

BINOCULARS, TELESCOPES, MICROSCOPES, MAGNIFIERS

BUILD Your own reflector telescopes. Complete kits: mirrors, eyepieces, tripods, all other accessories. Request free illustrated literature. Criterion, Manufacturing, Dept. KPM-95, Hartford, Connecticut.

CUSTOM Telescopes, lenses, tripods, equatorials and accessories; magnifiers. UPCO, Sunbury, Penna.

SCIENCE Bargains! Lenses, telescopes, binoculars, microscopes, kits, parts, war surplus. Send \$1.00 for beginner's 10-lens kit with instruction booklet. Order Stock 2-CH. Request free 144-page Catalog CH. Edmund Scientific Co., Barrington, New Jersey.

BARGAINS! Zoom binoculars! Rifle scopes! Telescopes! Microscopes! Free catalog. Adventure Company, Box 2133, San Diego 12, California.

DYNASCOPE — Amazing world-famous reflector telescope. Request free brochure. Criterion, Dept. DP-98 Hartford, Conn.

TAXIDERMY

SEND Postal for this free book. Tells how you can learn to mount birds and animals. Also fish, gameheads. Tan skins, make leather. All secrets revealed. Fascinating and profitable hobby for all men and boys. Rush postcard today for your copy. Tells how we have taught over 400,000 successfully by mail! No obligation. Write today. Please state your age. Northwestern Taxidermy School, 2572 Elwood Bldg., Omaha 2, Nebr.

EARTHWORMS, CRICKETS, FROGS

YOUNG Jumbo frogs and giant breeders. Stock your lakes and ponds. Nu-Tex Frog Farm, P.O. Box 4029, Corpus Christi, Texas.

HYBRED Redworms. 1000—\$3.00, 2000—\$5.00, 5000—\$8.00, 10,000—\$14.00. Bedruns—\$1.00. In 20,000 orders only. Postpaid. With raising instructions. Brazos Bait Farm, 60 Lincoln, Waco, Texas.

BIG Money raising fishworms and crickets. We teach you how to raise and where to sell. Free literature. Medium redworms, 3000, \$5.95; 10,000, \$16.95. Carter Redworms, Plains, Georgia.

MEN! — Women! Make money raising bait at home for us! We buy your crop! Details free. Red Wigglers, Warsaw 45, Indiana.

EARN Money raising fishworms for us! Exciting details free! Oakhaven—56, Cedar Hill, Texas.

PLANTS, SEEDS, BULBS, NURSERY SUPPLIES

DWARF Trees (Bonsai) available. Price list, photographs free. Tinytrees, Box 10, Coral Gables, Florida.

PETS—DOGS, BIRDS, HAMSTERS, ETC.

PETS. Hamsters, mice, rabbits, squirrels, chipmunks, guinea pigs, skunks, raccoons. Picture catalog twenty-five cents. Moore's Hamster Ranch, Shepherdstown 25, West Virginia.

HAWKS. Reptiles, raccoons, skunks, squirrels. Catalogue 25¢. Trails End Zoo, St. Stephen, S. C.

MAKE Money raising chinchillas, mink, rabbits, cavies for us. Free catalog. Keeney Brothers, New Freedom 2, Penna.

WHOLESALE Pricelist. Tropical fish, pets. Free information. Pets, P.O. Box 5185, Augusta, Ga.

HAMSTERS. Ideal pets. \$2.95 pair. Booklet 10¢. Jer-Fre's Hamstery, R.R.#2, Shelby, Michigan.

FARMS, FARM LANDS, REAL ESTATE

STROUT Big free catalog. 148 pages chuck-full of values. Write for your copy. Strout Realty, 7-CJ S. Dearborn, Chicago 3, Ill.

BAHAMA Island sunswet homesites (125'x80'). Sandy beach, fishing, water sports, \$895. No taxes, \$10 month. Suitable investment, vacationing, retirement. Free information. Bahama Estates, 1006-F Prudential Bldg., Buffalo 2, N. Y.

CAROLINA Coast. \$5.00 down, \$5.00 monthly, buys large homesite, 70x150, in beautiful Boiling Spring Lakes. Satisfaction guaranteed! 14,000 acres! 50 freshwater lakes! Excellent fishing, hunting, championship golf course open for play, country club completed, resort motel open year round! Free literature. Boiling Spring Lakes, Southport 1-E, North Carolina.

ON Popular Missouri Lake. Exciting 211 acres with over mile frontage on cove of lake as well as some on main lake itself going for an unbelievably low \$4,000 down payment! Wonderful opportunity for building resort, boy's or girl's camp, dude ranch, sub-division, enough land to give necessary seclusion from other resort area activities and even run few head livestock. Rustic 5-room native stone home, good condition, modern bath, fireplace, right below is natural park-like beach area gently sloping to lake. Good 4-room furnished guest or rental cabin with bath, stone garage, well house, storm cellar. On private all-weather road, 1/2 mile county highway, 3 to village. Owner has been transferred to out-of-state job. \$30,000, only \$4,000 down. Big free illustrated Fall-Winter catalog, bargains coast to coast! United Farm Agency, 612-PM West 47th St., Kansas City 41, Mo.

OPPORTUNITIES! Government land, U. S. Alaska, Canada. Sledge Surveys, Macon, Mississippi.

FLORIDA Campsites—deep in the heart of the great Ocala National Forest. Abundance of game, best fishing. Warranty deed. Unrestricted—pitch tent, park trailer, build lodge. Free maps and photos. Howard Vernor, DeLand, Florida, AD60088(Q-O).

MONTANA — Fishing, hunting, cabin sites and campsites on beautiful Kootenai River in Montana Rockies. \$595 at \$10 down and \$10 a month. Mountain Empire Company, Box 203-P, Libby, Montana.

\$1 ACRE Canadian border. Hundreds campsites, islands, farmlands, directly from tax authorities. Lists mailed: Bureau, 282 Davonport, Toronto 5, Canada.

\$5 MONTHLY Buys 5 acres. Near town, good building site, excellent fishing. Price \$125.00. Free list. Box 425-P Carthage, Missouri.

CENTRAL Florida lots lake and citrus region, near Orange City. Total price \$99.00 each. \$2.50 down and monthly. Free literature. Casper Corporation, 3970 N.W. 177st, Carol City, Miami, Florida.

40 ACRES \$395, 80 acres \$695, 160 acres \$1295. Many with creeks, streams, near lakes. Continental United States, not Brazil or Canada. Send \$10 down. Nick Hughes, Tax Land Locator, Box 777, Phoenix, Arizona.

CANADIAN Vacation lands: Full price \$385.00. 40 acres. \$10 month. Suitable cottage sites, hunting, fishing, investment. Free information. Land Corporation, 3768-C Bathurst, Downsview, Ontario, Canada.

RABBITS—FUR BEARING ANIMALS

MINK Raising information free. Complete. Lake Superior Mink Farm, Superior, E.E.I. Wisconsin.

RAISE Rabbits successfully by knowing facts. 48 page book. 38 illustrations describing 25 breeds. Housing. Breeding. Feeding. Markets and Marketing. Bulletin etc. 25 cents. American Rabbit Association, 36 ARBA Building, Pittsburgh, Penna.

EARN \$10,000 Yearly raising Angora rabbit wool for us. Information 25¢ coin. American Angora Company, Malta 12, Montana.

RAISE Rabbits on \$500 month plan. Free details. White's Rabbitry, Mt. Vernon, Ohio.

PROFITABLE OCCUPATIONS

AUCTIONEERING—Home study course. Diploma granted. Auction School, Ft. Smith, Ark.

VENDING Machines. No selling. Operate a route of coin machines and earn amazing profits. 32-page catalogue free. Parkway Machine Corporation, Dept. #25, 715 Ensor Street, Baltimore 2, Maryland.

BAKE New greaseless doughnuts in kitchen. Sell stores. Free recipes. Michael, 3605 South 15th, Minneapolis 7, Minn.

BIG Money raising fishworms and crickets. Free literature. Carter Wormery, Plains, Georgia.

BECOME Independent with your own franchise business. Thousands earning handsome incomes. Request interesting facts today. National Franchise Reports, PM-528, 333 North Michigan, Chicago 1.

EARN \$240.00 A month at home, spare time, doing only two \$5.00 invisible mending jobs a day. Big money paid for service that makes cuts, tears disappear from fabrics. Steady demand. Details free. Fabricon, 1586 Howard, Chicago 26, Ill.

EARN Money raising fishworms for us! Write: Oakhaven—58, Cedar Hill, Texas.

SHARPEN Scissors, pinkers, clippers. Inexpensive machines, supplies. Blackhaws, Sheldahl, Iowa.

FREE Report: "609 Unusual, Successful Businesses." Box 1001-PT, Evanston, Ill.

CHROME Plating. Instructions, equipment and supplies. Platers' Supply, P.O. Box 565, Lugo Station, Los Angeles, Calif.

PIANO Tuning quickly learned with home study course. Diploma granted. American Tuning School, Gilroy, Calif.

INVESTIGATE Auto accidents. Earn up to \$750 monthly. Investigators needed in every state. No selling required. Car furnished; expenses paid. Or start a business of your own. Associate with interesting, important people. We train you at home. You hold present job until ready to switch. Get free information. No obligation. Write Liberty School, Dept. T-911, 1139 West Park, Libertyville, Illinois.

INVESTIGATE Accidents. Earn \$750 to \$1,000 monthly. Men urgently needed. Car furnished. Business expenses paid. No selling. No college education necessary. Pick own job location. Investigate full time. Or earn \$6.44 hour spare time. Write for free literature. No obligation. Universal, CPM-12, 6801 Hillcrest, Dallas 5, Texas.

AMAZING Trade secrets will appear here soon. Spectacular crafts.

SUCCEED In franchising, mail order business. Four manuals show you how. \$5.95 complete. Rosario, P.O. Box 234, Brooklyn 12, New York.

RAISE Nightcrawlers, redworms, garage, basement. Soilless method. Three Oaks, Dresden, Tenn.

BARGAINS! Buy wholesale! Save money! Free catalog! Norris 273-X Merrick Road, Lynbrook, N. Y.

WHOLESALE Magazine subscriptions. Highest commissions. Bonus! Qualified Agencies, 451 AA, Kingston, Brooklyn 25, N. Y.

SEEING Is believing. Earn exceptional living. Will send free kit with particulars. Weidner, 310-P West 85, New York City.

REPAIR Hydraulic jacks. Easy, profitable. Write: Hydraulics, Box 4104, El Paso, Texas.

BOOKS, PERIODICALS, PICTURES, POSTCARDS

FREE Catalog specialized magazines and self-help books. Commercial Publications Company, P.O. Box 55429, Indianapolis 5, Indiana.

100,000 BOOKS! Bargains! Catalog dime. Treasure-Site, 6990 Aberdeen, Upper Darby, Penna.

BOOKS, Free general catalog, 100 pages. Text, vocational, educational, instructional subjects. Millions of volumes, new and used. Bargain prices. Books bought. Est. 1902. Long's College Book Co., Dept. PM, Columbus 1, Ohio.

SAVE TO 84% on books, records. Free catalogue. Discount Reader's Service, MJ-5435 Upland Way, Philadelphia 31.

NATIONAL Geographic magazines, 1888-1960, any issue. Periodical Service, Box 465-PM, Wilmington, Delaware.

FREE Catalog. Self-help books. Write Wilshire, 8721 Sunset, Los Angeles 69P.

BOOKHUNTERS! Scarce, miscellaneous books supplied! Atlantic Book Service, Cedar Street, Charlestown 29, Mass.

BRITISH Book bargains—Any subject. Catalogues free. Transatbooks, Wantagh, N. Y.

BOOKFINDERS! All subjects. Send wants! Jaher Book Service, 183 Hazelwood Drive, Westbury, N. Y.

PROPHET Elijah coming before Christ. Wonderful book free. E. Megiddo Mission, Rochester 19, N. Y.

DORE Ogrizek. "The Winter Book of Switzerland." Illust. color. 383 pages. \$2.50. Midnight Books, Box 101, Wyckoff Heights Sta., Brooklyn 37, N. Y.

BOOKFINDING Our specialty. Send wants. Brown, Box 12, Kechi, Kansas.

BOOKS. Elusive. Located. Free lists. Del, 12725 Flatbush, Norwalk, California.

PUBLISH Your book! Join our successful authors: All subjects invited. Send for free appraisal and detailed booklet. Carlton Press, Dept. PML, 84 Fifth Avenue, New York City 11.

LANDING Of the U.F.O.'s Prophecies; other mysteries solved! 20 thrilling, new booklets! Free catalog and "Next Great World Event." Write: Research Publishers, 4529 45th Avenue S., Minneapolis 6, Minn.

GAMES, TOYS, NOVELTIES

MAGIC-Seal balloons. Trickiest invention ever. Surprise yourself! \$1.25 brings 30 large assortment. Rock, P.O. Box 85, Allentown, Penna.

GET Your novelties, tricks, gags wholesale. Sell friends. Free catalog, 50 gag samples 25¢. Dohn-TI-Marks, Broadview, Illinois.

MAGIC TRICKS, PUZZLES, JOKER NOVELTIES

VENTRILOQUISM For fun or money. New method. Easy. R. Marlette, 2N-075 Mildred, Glen Ellyn, Illinois.

HOUSE Of 1000 Mysteries! World famous! Professional magic! Pocket tricks! Secrets! Illusions! Joke novelties! New giant surprise catalog! 160 pages! 800 pictures! December special 10¢. Vick Lawton, Dept. PM12C-82, Trumbull, Conn.

VENTRILOQUISM! Information free! Dummy catalog 25¢. State age. Maher, Box 36A, Kensington Station, Detroit 24, Michigan.

MAGICAL Tricks, jokes, gags. Send stamps for catalog. Mag's House, 186-D N. Broadway, Fresno 1, Calif.

"VENTRILOQUISM Selftaught." Complete book 25¢. Greenview, Box 61-BY, Whitestone 57, New York.

AMAZING Device! 100 perfect smoke rings from one puff of smoke. Win bets, astonish friends. Send \$1.00. Lock Box 232, Tomahawk, Wisconsin.

WORLD'S Finest professional magic. Joker novelties. Giant illustrated catalog 10¢. Top Hat. Evanston 12, Illinois.

500 TRICKS. New 1962 edition, famous Douglas catalog of magicians tricks and supplies now available just 10¢. Fastest service. Douglas Magician, Dept. 61, Dallas, Texas.

WORLD'S Finest magic catalog, \$2.50 (\$2.00 magic included free). 3000 tricks, pocket, stage (408 pages). Kanter's, M-200 South 13th, Philadelphia 7.

CATALOG. Free tricks, 25¢. (1,500,399 tricks, jokes, novelties.) Magico, 7408-P, San Antonio 7, Texas.

PROFESSIONAL Catalog, 175 pages, 25¢. Williams, 900 Plymouth, Ellwood City, Penna.

84 PAGES. Completely illustrated catalog, 25¢. Manhattan Magic, Box 334-P, N. Y. C. 11.

BE A Magician! Introductory catalog with free trick, only 35¢. Ireland, 109-P North Dearborn, Chicago 2.

"INVISIBLE Whistle Trick." "84 Card Tricks." "Magic Made Easy." Everything \$1.00. Art Fowler, Box 345, Vineland, New Jersey.

USED Magic, magazines, books. Bargains. Samples 25¢. Sylvian's, Hoxsie, Rhode Island.

MAGIC Tricks book \$1. Be party live-wire. Free catalogue. Mandel, 1200-PM Avenue H, Brooklyn 30, New York.

ANTIQUES, RELICS, INDIAN GOODS, CURIOS

3 WAR Arrowheads, scalping knife, thunderbird \$4.00. List. Arrowhead, Glenwood, Arkansas.

ISHKABILE! Have fun, make money collecting and selling antique relics of all sorts, and guns. Send 35¢ for large listing circular. Wooden Indian, Wenona, Illinois.

SELLING 20,000 Ancient arrowheads, spearheads, etc. List free. Lear's, Glenwood, Arkansas.

4 ARROWHEADS \$1.00. George Smith, 841 N. Tacoma, Indianapolis, 1, Indiana.

BUTTERFLIES 50. Fossils 15 or 8 relics \$2.00. Free lists. Tervo's, 14 Nassau, Garden City South, New York.

LARGE Photo-illustrated Indian relic catalog, plus free book offer 10¢. Al's Relics, Box 393, Bellmore, New York.

COINS, TOKENS, CURRENCY

CONFEDERATE Half dollar. Original worth \$500. Replica 25¢. Spruceland-P, 115 State, Springfield 3, Mass.

RARE 1882 silver dollars, B.U. bargain \$2.00. Hano, 1598 Third Ave., New York.

STARTER Collections. 40 Lincoln cents 1941-1962 \$2.00. 20 Jefferson nickels \$3.00. 10 Roosevelt dimes \$3.00. All different in folders. Milstead, Box 345, Bacliff, Texas.

SILVER. Two uncirculated Mexican dollars \$1.00. Universal, Box 866, San Antonio 6.

RARE 1899 Philadelphia silver dollar, uncirculated, \$6.00. Butts, Torrington, Wyoming.

OLD Coins wanted. Catalogue 25¢. Lacheen, Box 1355, Philadelphia, Pa.

INTRODUCTORY: Colonial dollar, Pine-tree shilling, Confederate cent (authentic replicas) all 3, \$2.00. Coin, medal catalog, 25¢. Hobbies, Box 71-B, Rockaway 94, N. Y.

LINCOLNS: 40 Different 1909-1940 plus 1960D small date \$1.95. 25 different "S" (including rare 1955S) \$1.50. Harris, 9011B Presidio, San Francisco 29, California.

UNCIRCULATED 1935 Silver pony express commemorative medal \$1.00. Coin lists free. Sayers, 1000 Unaka, Johnson City, Tennessee.

TWENTY-Four page 1963 retail price list of USA and Canadian coins 10¢. Our selling prices on thousands of coins and coin collectors' supplies. Bryson Incorporated, 612A White, Toledo 5, Ohio.

TEN Different Indian cents \$2.50. Two different large cents \$2.50. With lists. Hutchinson's, Box 6256, Philadelphia, Penna.

12 DIFFERENT Lincolns before 1921 \$1.00. 24 before 1931 \$1.50. Gene Carlton, Chandler, Okla.

FREE Coin supplies! Giant coin list 10¢ (refundable). Economy Sales, Mansfield, Massachusetts.

LARGEST Coin magazine. 288 pages, 50¢. Scrapbook, 7320-J Milwaukee, Chicago 31.

NUMISMATICS Largest newspaper. Semi-monthly. Sample 25¢. \$2.00 yearly. Numismatic News, Box 452, Iola, Wis.

RARE 1878 CC mint dollar uncirculated \$5.00. 100pg. catalogue 50¢. Shultz, Salt Lake City 10, Utah.

BARGAIN List! U. S. coins, accessories. Stamp please. Hugh's, Hickory, N. C.

40 PAGE Illustrated United States and Canadian coin list 10¢. Stoney, 260 Washington, Boston 8, Mass.

COIN Collector's magazine. On your newsstand or direct. Sample 35¢. \$3.00 yearly. Coins Magazine, Box 274, Iola, Wis.

GIANT Illustrated catalog listing hundreds of bargains in coins and supplies, only 25¢. Ben's Coin Company, 31 North Clark, Chicago 2.

INDIANS, Lincoln, Liberty nickels. List free. Coins wanted, stamp please. Evans, Box 9912p, Atlanta 19, Ga.

25 BEAUTIFUL Coins from 25 countries. Mostly uncirculated. Terrific assortment. \$1.00. Hindley, Box 708, Aurora, Illinois.

MAJOR Variety-Oddity Coin Guide. 200 photos 50 pages \$1.60 copy. 231 North 18th St., East Orange, N. J.

FREE Bargain coin lists. The RJR Company, Astoria 1, Oregon.

CONFEDERATE Note \$1.00. Obsolete banknote \$1.00. We buy paper money. Americana Gallery, 810 East Broward, Fort Lauderdale, Florida.

PROOF Sets 1961 \$2.90 5 @ \$2.80 1962 \$2.70 5 @ \$2.60. Tom Norman, Corinth, Mississippi.

COIN Collectors greatest magazine and wooden nickel 10¢. Lawrences, Anamosa, Iowa.

LINCOLNS! "S" mint. 12 different; after 1941, our choice, \$2.00. List included. Stroud's Coins, Kinston, N. C.

PAYING Highest prices anywhere! Get our 126-page, illustrated "Handbook of United States Coins," \$1.25 postpaid. Williams, 146 Ninth, Oshkosh, Wisconsin.

ANY Five Jeffersons except 38SD, 39SD, 50D, \$1.10 insured. Trayce, 25 Quinlan, Staten Island 14, New York.

7 DIFFERENT Exotic oriental coins, bills, 25¢. Jolie, Roslyn Heights, N. Y.

2¢ COPPER With list 75¢. 2x2 Kraft envelopes 500 \$1.25; \$2.30M. Fairway, 121-M, Rye, N. Y.

COIN Cleaner. Free sample. Enclose 25¢ handling charge. V. G. Coin Products Co., 401 Main, Hobart, Indiana.

TERRIFIC Bargain list with V-nickel 30¢. Nelson, 346-P, Rye, N. Y.

TRUNKFUL 25,000 Indian-Lincoln cents mixed (from the 1920's & older). Will pack "grab-bag" style, 800 mixed \$50.00. Sample bag of 23—\$2.00. Mrs. Fisher, Box 5490, Sherman Oaks 23, Calif.

TOPS! Fascinating coin collection from Camerons, Formosa, Vatican, etc., and foreign banknote. Catalog price over \$1.50! Only 10¢ with exciting coin approvals! Littleton Coin Company, Littleton T1, New Hampshire.

\$18,000 FOR 1913 Liberty head nickel. Uncirculated dollars 1804-1839, 1893-S, 1895-P, 1903-O pay \$200.00-\$15,000.00. Certain dates—Lincoln cents before 1932, \$250.00; Flying eagle cents, \$950.00; Indian cents, \$1,750.00; Dimes before 1943, \$5,250.00; Quarters before 1924, \$5,250.00; Half dollars before 1929, \$7,500.00; 2¢ pieces, \$200.00; 3¢ pieces, \$200.00; half-dimes, \$3,250.00. Hundreds of others worth \$10.00-\$10,000.00. Canadian coins, 1921, 5¢ Silver, \$300.00. 1875 quarter, \$500.00. 1921, 5¢, \$2,000.00. Wanted 20¢ pieces, gold coins, paper money, etc. Our large illustrated guaranteed buying-selling catalogue, giving complete allcoin information. Send \$1.00. Purchase catalogue before sending coins. Worthycoin Corporation K-181-C, Boston 8, Massachusetts.

35¢ BRINGS Buying & Selling list #6 and scarce 1954 cent. Investment details. Kenwood Coins, 6513 Langdale Road, Baltimore 6, Md.

COMMEMORATIVE \$½ uncirculated. Daniel Boone, Oregon Trail, Texas Centennial, each \$12.95; Carver, \$2.25. Brilliant proof sets—1957, \$3.95; 1960, \$3.95; 1961, \$2.95; 1962, \$2.85. Retail "Red-book", \$1.75; World's coinages, \$4.25. Bebee's, 4514 North 30th, Omaha, Nebraska.

ALASKA Commemorative trade dollar now in use at Sitka, Alaska, can be obtained from Chamber of Commerce, \$1.00 postpaid. Write Dept. PM.

THE First time in history. The five civilized tribes have released their sacred seals to the public commercially. Authentic history accompanying each seal. Housed in deluxe plastic holder. Set of 5 complete. 14k, yellow gold plate, \$7.50; solid sterling silver, \$12.50. Five Civilized Tribes Mfg. Co., 231 Equity Bldg., Muskogee, Oklahoma.

GOLD Coins. 250 different foreign. USA. Lists free. Agimpex, Box 65, Snowdon-Montreal, Canada.

SAVE Your slick nickels where date is worn off. Order a bottle of Coin Date. It will bring the date out on Buffalo, V. Shield nickels. It's easy to use. Satisfaction guaranteed. \$1.00 postpaid. Box 276-F, Mooresville, No. Carolina.

WANTED! Will pay 18¢ each Indian head pennies. \$1.00 for large cents. \$2.00 for half cents. 12¢ for 1955-S Lincolns. \$15.00 for \$1 to \$5 gold pieces. Others. Gabsa, 4565-170 St., Laundale, Calif.

2 U.S. Indian cents and 2 Indian wampum coins \$1.00. Franklin Thomas Wooden, Route 2, Munfordsville, Kentucky.

LUCKY Silver dollar. 75 years old. \$1.50. Silver Dollar King, Box 4051, Las Vegas, Nevada.

50 BRILLIANT Uncirculated U.S. coins \$1.10. Lincolns \$1.00 each lot. 1955S (4), 1930S (10), 1954P (12), 1949S (15), 1954S (20) PDS Coins, 114P Nassau Road, Massapequa, N. Y.

LINCOLN Cents: 23S, 24S, 21SP, 16SD, 17SD, 18SD, 19SD, 20SD, 25SD, 29SD, 30SD, 28SD, 27SD, 55S, 54SP, 32D, 33P, 39SD, 49S. Good to Fine. Complete lot \$8.50. Rolls 55S \$12.50. Fine to X. Fine. 49S \$3.50 roll. Berry, Box 306, Westminster, Calif.

STAMP COLLECTING

FREE! Congo triangle set! Boy Scout beauty! 25 others. Different! Approvals. Cambridge, Box 411, Cambridge, Ohio.

FREE Mint set! Approvals accompany. Stampco, Box 737, Memphis 1, Tenn.

EUROPEAN Pictorials. 10¢ with approvals. Schaefer, Californiastrasse 16, Wiesbaden, Germany.

PENNY! Approvals! Regardless catalog! Kloster, 4164-52nd Street, San Diego 5, California.

FREE! Beautiful pictorial packet! Approvals. Conklin, Box 388-PM, Osage, Iowa.

ASTRONAUT Shepard mint Africa space set only 10¢ with approvals. Lithor, Box 51, Canoga Park, Calif.

225 DIFFERENT Worldwide 25¢. Laos, Korea, Iceland, etc.! Approvals. Bobb's, Box 3045, Saint Louis 30, Missouri.

TERRIFIC Value. Seven complete mint sets 10¢ with approvals. Beatties, Box 4503, Fort Lauderdale, Florida.

U. S. approvals. Low prices. Eagle Stamps, Romine Ave., Pittsburgh 26, Penna.

SPACE—25 Rocket stamps two dimes. Modern Approvals, Box 543, Norwalk, Connecticut.

80,000 DIFFERENT! Amazing new plan builds your collection systematically. As low as 50¢ weekly. Free details. L. G. Ware, Monroe 75, Conn.

100 DIFFERENT 3¢ U.S. commems \$1.00. Kenneth McCaskie, 26712 Wolf Rd., Cleveland 40, Ohio.

GIANT Stamp collection including Boy Scout set, moonrocks, astronauts, satellites, complete U.N. set, Olympics, sports issues many countries; plus big stamp dictionary and approvals. Everything 10¢! Stampex, Box 47-LM, White Plains, N. Y.

FREE Stamps to buyers of worldwide approvals. Sets and singles. Handy Stamps, 460 Handy, Orange, California.

TOPICALS, Beautiful stamps, 25 different, only 10¢, approvals. Stamac, 108 Park Place East, North Charleston, S. C.

FREE! 25 Egypt, 10¢ handling. Approvals. Bellet, Mapledale, Hazel Park, Michigan.

U.S. Stamps. Giant discount catalog 25¢. Raymax, 37-VZ Maiden Lane, NYC 38.

FREE—25 large beauties with request for approvals. Al Gray, 506-15th St., Moline, Illinois.

FREE! Antique autos! Complete! 10¢ handling. Approvals included. W. Shaver, 3075 Vamana, Pomona, California.

25 DIFFERENT U. S. commemoratives, 1893 up, 10¢ approvals. K & B Stamp Co., Box 70, Brooklyn 23, N. Y.

FREE Sample. Interesting, informative, illustrated. National Stamp News, Anderson, South Carolina.

200 STAMPS. 25¢ With approvals. Smith, 508A Brooks, College Station, Texas.

FREE! 222 worldwide. 10¢ handling. Penny approvals. Jung, 1601 North Stanley, Los Angeles 46.

U.S. Mint specials! Flag set, complete \$1.00; 1¢, 2¢, 3¢ famous Americans (21 different), \$1.00. Free list. Brooks, 2323 Avenue X, Brooklyn 35, New York.

80 DIFF. U. S. stamps includes 19th Century commemorative. High values. Plus 1943 flag stamp of occupied nations. All for only 25¢. Approvals included. Willett Co., Box 338-C, Yorktown Heights, N. Y.

UNITED Nations 15th anniversary sheet with first day cancel, as commemorated by Russia. Free! While they last, with approvals, Philatelics, R-J, New Paltz, N. Y.

PENNY Approvals. Thousands. Bargains for pennies. Gifts with purchases. Penny Stamps, Orange, California.

UNITED States commemorative collection containing 33 different—10¢. Approvals. White, 516-A Avenue L, Brooklyn 30, New York.

INTRODUCING Our better United States approvals we offer 15 United States stamps including Columbian, Bi-Centennials, famous American, airs, others; only 10¢. Ocean Stamps, Box 64-PM, Brooklyn 29, New York.

AMAZING OFFER! 200 United States stamps — including commemoratives, airmails, high denominations to \$1.00. Only 10¢ to approval applicants! Illustrated bargain lists free. Mystic Stamp Co., Dept. 80, Camden, New York.

100 OLD United States between 1861 and 1935. \$1.00. Roush Stamps, 51 Chestnut, Mansfield, Ohio.

FREE Monaco nudes. Approvals. Stamp Ranch, 902 Addison, Chicago 13, Ill.

60 DIFFERENT U. S. (30 commemoratives) 25¢. No approvals. Seidenberg, Appleton, Wisconsin.

225 STAMPS For only 10¢! This mammoth value includes airmails, pictorials; stamps from strange countries cataloging up to 25¢ each! Also approvals. Mystic Stamp Company, Camden 80, New York.

1000 DIFFERENT, \$1.00 With approvals. Louis Golden, 6721 Eastwood, Philadelphia 49, Penna.

SELL Your surplus good grade stamps. Write, describing fully what you have. Vanroy Shirk, Lebanon, Pennsylvania.

U.S. Bargain. 50 different 10¢, with beautiful worldwide approvals. Stamps, Kennebunk, Maine.

UNCOMMON Old U.S., defective. Bargain prices. K. Swartz, Malden Bridge, New York.

FREE Stamp wallet with approvals. Wide selection collections by countries. Clark, Box 28-C, Wilmette, Illinois.

STAMP Collecting outfit, includes, packet worldwide stamps, package hinges, watermark detector, millimeter gauge. Everything 10¢ with approvals. Loraine Brown, Marion, Michigan.

LOOK! U.S. commemorative collections! 100—\$1.00, 200—\$2.00, 300—\$3.00. Ewing, 2133 Lunt, Chicago 45.

100 DIFFERENT Norway, 25¢! Bargain approvals. Carling, 1262-A, Howard City, Michigan.

FREE 400 Genuine postage stamps! Worth \$10.00 at catalogue prices. Africa, Europe, Asia, British Emp.—a fascinating, valuable mixture from foreign convents, banks, etc. Who knows what you will find. Also free valuable booklet. Adults only. Approvals enclosed. Frasek Co., PM-12, White Plains, N. Y.

"POPE" Triangle! Diamond butterfly! Multicolored flag set! 50 others, 10¢. Approvals. C & R, Box 522, Hicksville, New York.

WOW! 110 all different Germany 10¢! Zeppelins, semi-postals, airmails, high values, etc. Giant catalog, bargain lists included with beautiful approvals. Jamestown Stamp, Dept. A122PM, Jamestown, N. Y.

U.S., Canada price list 130 pages, 700 illustrations, stamp identification 15¢. Thom, 4808-15th Avenue, Minneapolis 17, Minnesota.

100 FOREIGN 10¢, approvals. Allman, 620 West 47th, North Little Rock, Ark.

STAMP Wallet, space, rocket, pictorial stamps, bargain bulletin 40¢. Pontiac Press, Pontiac, Rhode Island.

NICE Mixture. Bargain list. 25¢. Stamps, B-1498, Huntsville, Ontario, Canada.

50 ATTRACTIVE Worldwide stamps 10¢; approvals. Thiese, 9320-H San Juan, South Gate, California.

SPECIAL Grab bag, approvals, 10¢. Want lists filled. De Laney, P.O. 445, Las Cruces, N. M.

INDONESIA 50 different 25¢. Thompson, 502 S. Broadway, Santa Ana, California.

25 AUSTRALIAN Commemoratives 15¢. Approvals. Cooper, Box 75053, Los Angeles 5, California.

701 U.S.A. 25¢ (plenty commemoratives). Request approvals. Horace Gatewood, Winston-Salem, N. C.

169 DIFFERENT U.S. commemoratives \$1.00. Carstamps, 739 Ordway, Freeport, Illinois.

FREE! Giant bargain catalog. New edition listing thousands of bargains including U.S. and B.N.A. stamps, packets, mixtures, albums, accessories and supplies; sent with beautiful approvals. Jamestown Stamp, Dept. E122PM, Jamestown, N. Y.

FREE—Mint British Colonials from Maldives, Solomon Islands, Pahang, St. Christopher, Nevis, Sarawak, Cayman Islands, Gilbert Ellice. Free with approvals. Viking, Great Neck 8, N. Y.

FREE United States list for beginners. Edward Eckhardt, 6734 Beckwith, Morton Grove, Illinois.

FREE 25 Different India. Approvals. Paul Demske, R.#1, Box 322, New Era, Michigan.

200 DIFFERENT U.S. stamps, \$1.00. Approvals, included. Shelron, P.O. Box 187-KP, Hempstead, N. Y.

TRIANGLES 14 Different, only 30¢ with foreign approvals. E. Square Stamps, Box 1404, Boulder, Colorado.

100 BEGINNER'S Stamps, dime. Discounts. Felco, Box 532, Santa Rosa, Calif.

U. S. Mint comm 3¢ & 4¢—#934 to date face plus 1¢ mint pair #1058 free with \$2.00 order. Want list filled for Germany. H. J. Rabb, 16678 Cruse, Detroit 35, Mich.

SURPRISE Set free with approvals. Broad, Box 866, Lexington, Kentucky.

U.S. Mission mixture. Guaranteed un-picked. 2 lbs. \$4.00, 5 lbs. \$8.50. Skytop, Box 1022PM, Binghamton, N. Y.

FREE U.S. pricelist. Pitt Stamp Service, Box 195-P, Greenville, N. C.

FREE! Mystery "surprise" packet. Approvals. Premiums. Dancer, 75-P39, Mansfield, Ohio.

LARGE Pictorials 50 different 10¢ with packet approvals. Griffin, Box 265, Campbell, California.

VATICAN Airmail set 20¢. Lists free! Approvals. Zidek, Layton, N. J.

ALL Diff. 200 Argentine 85¢. 200 Bulgaria 85¢. 200 Spain 90¢. 200 Italy 75¢. 25 Philippines 20¢. Double A Stamp Co., GPO Box 491, Brooklyn 1, N. Y.

100 DIFFERENT U.S. commemorative plus 6—8¢ Champions \$1.00. 75 different U.S. revenues \$1.00. Flamingo Stamps, 1099 NW 3rd Avenue, Miami 36, Florida.

101 DIVERSIFIED British Commonwealth 10¢. Approvals included. Niagara Stamps, St. Catharines 501, Ontario.

"OLD Glory" in flaming colors! U.S.A. flag giant beauty from Honduras. Enormous United Nations Mexican stamps. Plus strange gorilla issue. Duke of Windsor, Morocco lovely Macao flowers, wild buffalo stamp and others, 10¢ with approvals. Sunny Stamp, Apopka 2, Fla.

AMERICAN Historical collection! Enormous George Washington beauty, F. D. Roosevelt diamond, giant Abe Lincoln U.S.A. flag commemorative, plus midget soldier. Latin orchid issue, old IPNI overprint, etc. 10¢ with approvals. Roseland Stamps, Spring Lake 2A, Mich.

SMASHING Collection free. Includes triangles, early United States, rockets, sports, British Colonies, high value pictorials, etc. Complete collection plus big, illustrated magazine, all free. Send 10¢ for postage. Gray Stamp Co., Dept. PM, Toronto, Canada.

FREE First day cover. Approvals. Gall, Box 96, Coopersburg, Penna.

50 DIFFERENT Central and South America, 10¢ with worldwide approvals. Cole, Box 223-A, Buffalo 21, N. Y.

100 ENCHANTING Different large pictorials \$1.00. Charles Esteve, East Setauket, N. Y.

PHILATELIC Jungle 10¢. Fifteen zoological specimens. Approvals included. Free watermark detector. Crown Stamps, Virgil 301, Ontario.

10 GORGEOUS Space stamps 40¢ for collectors requesting approvals. Stereo Stamps, 2727 N. Milwaukee, Chicago 47.

200 DIFFERENT U.S. commemoratives and regulars \$1.00. Coppola, 17160 Meyers, Detroit 35, Michigan.

50 FREE With U.S. approvals. Rayworth, 321 South Cicero, Chicago 44.

200 DIFFERENT! Includes pictorials. 25¢ with approvals. J-B Stamps, 2319 Fenwick, Dallas 28, Texas.

300 DIFFERENT, Includes pictorials. 25¢. Knopp, Box 1381, Bristol, Conn.

101 ITALIAN Commemoratives only. Republic issues. Over 70 varieties, \$1.00. Robert Cavalli, 6611 17 Avenue, Brooklyn 4, N. Y.

25 LARGE American commemoratives 10¢. Accompanying approvals. Free perforation gauge. Linstamps, St. Catharines 101, Ontario.

AVIATION Stamps, 10¢ with approvals. Stavars, 23 Palmer, Grand Rapids 5, Michigan.

THIRTY Mint different 3¢ U.S. commemoratives \$1.00. Ace, Jamesburg, N. J.

NEW ZEALAND, Beautiful bicolored "Xmas Story" commemoratives—free! Approvals. William Deems, 226 Race, Ravenswood, West Virginia.

FINEST Stamps cheaper. Catalog \$1. Telsen, Eva, Memphis 12, Tenn.

WINTER Special 1000 worldwide stamps \$1.00. 3500, \$3.00. No approvals follow. Harrison's Stamps, 1435 First Ave., Oakland 6, Calif.

QUEEN Elizabeth on stamps. A beautiful collection of 50 different stamps from 22 countries—all bearing the portrait of the Queen of England. 10¢ with approvals. Capital Stamp Co., Ferrysburg 2A, Michigan.

12,000 PENNY Approvals waiting for you. Many from exotic countries, pictorials airmails, new issues. Tilbury, Box 862, Newark 1, N. J.

U.S. Mint #929-1205 face plus 1¢ each: #907-928 face plus 2¢ each. Stamps over 4¢ plus 2¢. Postage extra. Wilhelm, 16566 Mendota, Detroit 21, Michigan.

THREE Hundred different stamps 25¢. No approvals. Norge, Ho-Ho-Kus, N. J.

TWO \$5.00 United States stamps, 20 others 10¢ with United States approvals. Irwin, Box 1105, Brooklyn 30, New York.

500 FINE Mixed U.S. 15¢. Wright, Box 753M, Hagerstown, Md.

10 VALUABLE Civil War American, representative confederate collection, illustrated pricelist 25¢. Minuteman, 127 Lincoln, Lexington 73, Mass.

PORTUGUESE! 25 Different free. Approvals. Elkhart, Box 33, Elkhart, Ind.

100 DIFFERENT 10¢. Approvals. Bell, Box 279, Manchester, N. H.

HOBBIES AND COLLECTIONS

AMERICAN Newspaper, complete, original, dated before 1860, \$1.50. 25¢ stamps brings catalogue. D. R. Spaight, Book-seller, Tall Timbers 1, Maryland.

50 ORIENTAL Butterflies \$2.50. Free pricelist. Haas, Box 1170, New York 8, N. Y.

COLLECT Medals. Introductory: 5 French \$4.00, 4 British \$3.00, 3 Belgium. \$2.00. Catalog 25¢. Insignias, Box 71-M, Rockaway 94, N. Y.

30 EXOTIC Butterflies \$2.00. 12 guaranteed different. Williams, 150 East Superior, Chicago 11.

ORIGINAL Newspapers before 1860, 10 \$13.50, 5 \$7.50, Civil War 5 \$13.75, 10 \$25.00, 1864 soldier letter sheets 2 \$1.75, 3 Richmond Danville R.R. tickets 1880's \$1.25, 2 Confederate bond coupons \$1.00. Penna. orders 4% tax. Moore, Box 243, Wynnwood, Penna.

PRECIOUS STONES, MINERALS

FREE Bargain gem list. New lapidary and silversmith tool catalog. 50¢. O'Brien's, 116B Wilcox, Hollywood 38, Calif.

SEMI-Precious uncut gems. Ten different for \$1.00. Request list 28. Prospectors Shop, 201 San Francisco, Santa Fe, New Mexico.

EARTH Science. Rockhound's National Magazine. Subscription \$2.50. Sample 35¢. Box 1357-PM, Chicago 90, Ill.

GET Free catalog no serious rockhound, gem cutter, jewelry maker, hobbyist or craftsman can be without. Full of bargains, exclusive items, low prices from largest suppliers and authorities in the field. Free new catalog just off the press, yours for the asking! Write Grieger's, Dept. C-12, 1633 E. Walnut, Pasadena, California.

GOLD. Nuggets, \$2.00. Lester Lea, Box 1125-PM, Mt. Shasta, California.

MINERALS 20—\$1.00. Rough gems 16—\$2.50. Free lists—silver specimen. Tervo's, 14 Nassau, Garden City South, New York.

PHOTO FINISHING, CAMERAS, PHOTO SUPPLIES

YOUR Photo stamps \$2.00 hundred. Clyde Fussell Jr., Dickson, Tennessee.

KODACOLOR Films developed and printed, plus new roll, 12 exposures, only \$2.95. MBG Photo, Box 537, Toledo 1, Ohio.

COLOR Movie fans! Low cost—high quality processing our specialty, 8mm. just \$1 (or \$3 with fresh film). Mailed back next day. Craftsmanship guaranteed. Send exposed reel or request free mailers and price list of complete photo-finishing services. Direct Mail Photo, Box 8352-PM, Pittsburgh 18, Penna.

A FREE Kodak roll returned with each black and white or Kodacolor developed and printed, fast service, lowest prices, guaranteed quality send for free mailers. Economy Photo Service, Dept. P. M., Box 1111, Albany 1, N. Y.

PAST Hi-quality finishing. Kodacolor rolls: eight jumbo prints \$1.98. Twelve \$2.49. Twenty \$3.49. Reprints 15¢. Also low B&W prices. Custom Quality Studio, Box 4838, Chicago 80.

EKTACHROME-Anscochrome 35mm. 20 exp. 620, 120, 127, developed, mounted, \$1.00. Exceptional low prices on Kodacolor films. Prompt service. Complete price list-free mailers. Write Trycolor, P.O. Box 123, So. Windsor, Conn.

DOUBLEWEIGHT Enlargements from your films. 5x7, 30¢, 8x10, 40¢, 11x14, 80¢; 16x20, \$2.50. Minimum \$1.00. Gemby, 203 Woodward, Buffalo 14, N. Y.

MOTION PICTURES AND SOUND EQUIPMENT

VICTOR 16MM used sound projector. 1000 watt lamp, 2000' reel. Guaranteed excellent condition. \$89.50. Abbe Films, 417 West 44 Street, NYC.

8MM. Valentino, Fairbanks, Keaton, others. 16mm. sound features, shorts, silent classics. Large assortment. Entertainment Films Co., 236 W. 55th, New York City.

5,000 8-16 MM. Movie films. Free catalogues. International, Greenvale, N. Y.

MOVIE Camera film: 8mm. roll \$1.50. 16mm. 100' \$3.00. Free processing. Better Films, 742 New Lots, Brooklyn, N. Y.

MOVIE Film! Free catalog! ESO-R, 47th Holly, Kansas City 12, Missouri.

LADY Wrestling. Movies, photos. Free list. Peerless, Box 171-M, New York 13, N. Y.

BARGAINS 16MM. sound features \$16.00. Bedner, 5300 So. Talman, Chicago.

16MM. Sound, projectors, films. Sale, rental, exchange. Stereo Tapes. Rental and sale. Visit store or write for catalog. National Cinema, 71 Dey St., New York City.

USED-New movies. Free bulletin. Lee Movies, Box 4752, Chicago 80.

FREE Catalog! Save on 8/8mm.-16mm. film and supplies. Superior, 448 N. Wells, Chicago 10.

SHORT Subjects—cartoons, travel, comedy, sports. Free listing. Thunderbolt Productions, Dept. 33, P.O. Box 360, Buffalo 5, New York.

GIANT Bargain bulletins, 16MM-8MM sound, silent films. Gaines, 13735-PM Victory, Van Nuys, California.

COLOR SLIDES

SEND \$1.00 for color slides, from beautiful scenic Guatemala. Write B. Couderc, 11 avenida 14-CO Zona 1, Guatemala.

8MM., 16MM. Movie subjects. Silent, sound. New, used. 2"x2" color slides. Biggest selection anywhere! Free each month, big 24-page newspaper-size catalog. Blackhawk Films, Davenport 14, Iowa.

35MM Color duplicate slides from your originals. Fast service. Quantity discounts. Colind, Box 165A, Peoria, Illinois.

LINCOLN Lore in color slides. Kentucky, Indiana, Illinois, Washington, others. Sample slide, 35¢. Catalogue for stamp. Willems, Box 1515-A, Chicago 90.

TRANSPARENCIES Wanted. Up to \$500.00 each. For information write American Color, P.O. Box 46372, Hollywood 46, Calif.

MICHIGAN color slides. Catalog 10¢. Hiawatha Gridley, Box 56, Ypsilanti, Michigan.

MUSIC & MUSICAL INSTRUMENTS

SWISS Musical movements—boxes. Mechanical, electrical. Tunes to order. Spielman, 131 West 42nd, New York 36.

ACCORDIONS, Organs. Buy direct. Big savings. Terms. Free catalog. Accordion Import Center, 7120 Galli Dr., San Jose 29, California.

"PRACTICAL Violin Making" with patterns \$1.00. Supplies. Chelsea Fraser, 2025 Stark, Saginaw 5, Michigan.

ACCORDIONS, Guitars, chord organs! Save ½. Famous makes. Free home trial. Easy terms. Trades. Free catalogs. Mention instrument. International Music Mart, Dept. R, 2003 Chicago Avenue, Chicago 22.

RECORDS! Discounts on all LP's. Free details. Citadel Record Club, 545 Fifth Ave., Dept. 2, New York 17, N. Y.

GUITARS, Amplifiers. Buy at wholesale. 6 picks. Details 25¢. Treasurecraft 4B2, Box 2296, Carmel, Calif.

ACCORDIONS. Piano. Chromatics. Buttontype. Concertinas. Wholesale catalogs free. Italian Accordion Mfg. Co., 7600-C Cottage Grove, Chicago 19, Illinois.

LOW Quotes: Stereo tapes, components, recorders. HIFI, Roslyn 6, Penna.

POEMS Wanted for musical setting and recording by America's largest song studio. Send poems. Free examination. Five Star Music Masters, 630 Beacon Building, Boston.

SONGPOEMS Wanted for musical setting. Free examination. Get "The Nashville Sound" in your songs and records. Send poems: Music City Songcrafters, 6145-N, Acklen Station, Nashville, Tenn.

ELECTRIC Guitars, amplifiers, wholesale. Free catalog. Carvin, PMM, Covina, Calif.

POEMS Wanted for musical setting and recording. Send poems. Free examination. Crown Music Company, 49-C West 32 Street, New York 1.

GUITAR Making books, plans, imported woods, tools. List 10¢. Satinwood, 510 East 11th Street, New York 9, N. Y.

SONGS Wanted. Pays royalties. Enclose postage. Olenik Records, Mount Morris, Michigan.

ACCORDION-O-RAMA, 874 Broadway, New York 3, N. Y. Tremendous discounts. Top brands. Free brochure.

POEMS Wanted. Surprising offer. Free recordings. Successful Songs, 6 North, Danbury, Conn., Phone 748-6603.

SONGPOEMS And songs wanted! Mail to: Tin Pan Alley, Inc., Box 405, Radio City Station, New York 19, N. Y.

USED Electric guitars, amplifiers, drums, bargains. Write: Hills, 1215 War Memorial, Peoria, Illinois.

VIOLINMAKERS, Repairers. Fine tone woods and supplies. Also headquarters for violins, guitars (regular and electric) cellos. Send for wholesale price lists. International Violin Co., 414-MPM E. Baltimore Street, Baltimore 2, Maryland.

VIOLIN Making supplies. Free catalog. Fred Artindale, 1243 Palm, San Luis Obispo, Calif.

RADIO, TELEVISION AND ELECTRONICS

SAVE Dollars on radio, TV-tubes, parts at less than manufacturer's cost. 100% guaranteed! No rebrands, pulls. Request bargain bulletin. United Radio, 1000-M, Newark, N. J.

TAPE Recorders hi-fi components. Sleep learning equipment, tapes. Unusual values. Free catalog. Dressner, 1523 Jericho Tpke, New Hyde Park 3, N. Y.

QUALITY Recording tapes. 1800' Mylar \$2.00 postpaid. Towers, Lafayette Hill, Penna.

TELEVISION Tuners rebuilt. Western Tuners, 4130 El Cajon Blvd., San Diego 5, Calif.

SAVE 30% Up! Blank-stereo recorded tape-recorders, Norelco speakers. Saxitone, 1776 Columbia Road, Washington 9, D. C.

INTERCOMS, Two station, 3 transistor, battery, 60' wire. Office, plant, home, hear baby. \$25. Guaranteed. Trader Jim, 6715 E. 25, Tulsa.

GOVERNMENT Surplus radios, parts. Picture catalog 10¢. Meshna, Malden 48, Mass.

FIX Your own TV. Save 80%! Send for free illustrated chart showing how! We'll include giant electronics catalog. Zalytron, 220-M West 42 St., New York City.

RADIO Course only \$14.95. Includes all tubes, parts, tools, instructions. Write for full information. Progressive "Edu-Kits" Inc., Dept. 578B, Hewlett, N. Y.

GRAPHITE Radio kit, \$1.00. Exegesis Industries, Box 5064, Tulsa, Oklahoma.

MIRACLE Hi-Fi enclosure. Free information. Gough & Company, Box 254, San Carlos, California.

TEST Your own TV and radio tubes. This handy professional type tester also tests home appliances. Plug into any 110 AC outlet. Send \$4.95 to Knox Electronic, Galesburg, Illinois.

EXPORT — IMPORT

MAKE Big profits importing, dropshipping, buying wholesale. Our 1963 directories, folios, journals show how. Importico, Enka, N. C.

BEAUTIFUL Leather purses and wood carvings. Imports, Box 146, Angola, Ind.

BUSINESS OPPORTUNITIES

FRANCHISE In Ohio and Michigan. Atind Steel prefab. buildings. Ten, twenty and thirty feet wide. Easy to erect and well built. Write Metal Building Sales Co., 33709 Gratiot Ave., Mt. Clemens, Michigan.

GOLD, Silver, platinum; refining, testing, make alloys, solders, etc. Learn wonderful business. Frank J. Herman, Metallurgist, 1529 Liberty Street, Los Angeles 26, Calif.

"MAILORDER Laws and Regulations." Explains necessary licenses, taxes, etc. \$2.00. Neil H. Tasker, Shamokin, Penna.

PROFITABLE Catalog mailorder business. Vikari, 468-P Third Avenue, Salt Lake City 3, Utah.

PACKAGE At home for profit! We supply everything. No selling. Free home business details. HPC 2212BC, Jesse Street, Los Angeles 23.

IT'S True. It's free. Successful mail order our way. Just write. Worldwide, Box 4026, Station H, Columbus, Ohio.

START A \$50,000 management service through mail order! Write: Slater, P.O. Box 1195-T, Winnipeg 1, Manitoba, Can.

MAKE \$3,000 Year spare time, selling books by mail. Write: American Distributors, Box 409, Niles, Michigan.

SECURITY, Good pay? 1,000,000 new Federal jobs. Civil Service guidebook (128 pages). \$2.00. Dunn's, 3559-H, Washington 7, D. C.

ENTER Business. Expand, save, invest, become wealthy. Detailed instructions. High profit franchise, patent, stock, taxation. Information free. Livingstone, Shadyside, Maryland.

\$40 A Week spare time. Bour, 926-A Lincoln Way, McKeesport, Penna.

ASSEMBLE Artificial lures at home for stores. Materials supplied free. Profitable! Write: Lures, Ft. Walton Beach 11, Fla.

FREE "Franchise Profit Letter" tells how unique NFR service is helping thousands seeking profitable businesses. Write today. National Franchise Reports, W-528, 333 North Michigan, Chicago 1.

BUSINESSES, Resorts, motels, investment property, ranches. Our special service dept. at your disposal. No obligation. World's largest. 62 years service. Strout Realty, 7-MB S. Dearborn, Chicago 3, Ill.

EARN \$10,000 Selling books by mail. Box 51-BY, Des Plaines, Ill.

IMMEDIATE Profits with no capital or experience. Take orders for all magazine subscriptions. Friends and neighbors are your prospects. Write now for complete, free kit. McGregor Magazine Agency, Dept. CB2, Mount Morris, Illinois.

MAKE Money making leathers. 1148 ideas. Free information. Tandy Leather Co., Box 791-Q3, Fort Worth, Texas.

SELL Champion, AC, Autolite spark plugs. Reconditioned, electroplated, guaranteed 10,000 miles. 100% profit. Free sample. Lee Plugs, 1608-A Roberts, Houston 3, Texas.

HOW And where to obtain capital. Reliable Service, Rome City, Ind.

VENDING Machines. No selling. Operate a route of coin machines and earn amazing profits. 32-page catalogue free. Parkway Machine Corporation, Dept. #27, 715 Ensor Street, Baltimore 2, Maryland.

BIG Money raising fishworms and crickets. Free literature. Carter Farms, Plains, Georgia.

TO \$100.00 Weekly. Sparetime, home operated mailorder business. Successful beginner's plan. Everything supplied. Lynn, 10420-M National, Los Angeles 34.

PIANO Tuning learned quickly at home. Tremendous field! Musical knowledge unnecessary. Information free. Empire School of Piano Tuning, Champaign, Ill. (Founded 1935).

OPERATE Profitable mail order business. Write Walter Service, 4159A East 112th, Cleveland 5, Ohio.

BAKE New greaseless doughnuts in kitchen. Sell stores. Free recipes. Montgomery, 3605 South 15th, Minneapolis 7, Minnesota.

MAKE \$46 From square foot plywood; jigsaw necessary. Free details. Woodart, Bridgewater, Mass.

\$400.00 MONTHLY Raising giant fishworms. Soilless method. Charlie Morgan, Bushnell, Florida.

PLASTERCRAFT Molds, liquid rubber, plasters, floccs, candle supplies. Catalog and manual free. Blue Rapids Supply, Blue Rapids, Kansas.

WORLD'S Largest wholesale supply. Buy from 679 American, European, Japanese wholesalers. Tailormade suits from Hongkong. 123 dropship catalogs. Rock-bottom prices. Free details. International Buyers, 216-MM Jackson, Chicago 6, Ill.

11,000 NEW Prospects daily. Baby record books, shoes, albums. Sell mailorder. Use our literature. Write: No-Co-Ro, Capitola, Calif.

OPERATE Home mailorder business. Vosacek Printing, 4444AI Ute, San Diego, 17, Calif.

COLORGLAZED Concrete pottery made without molds. Patented method. Cemetery products, novelties, tiles. Basement leak-sealing. Money-making projects. Booklet, details free. Men only. National Potteries Company, Grand Rapids, Minnesota.

WANT To make big money at home? \$10.00 profit in an hour possible with invisible mending. Make tears, holes disappear from clothing, fabrics. Steady year-round demand from cleaners, laundries, homes. Details free. Fabricon, 1585 Howard, Chicago 26, Ill.

EARN Money raising fishworms for us! Write: Oakhaven—38, Cedar Hill, Texas.

LEARN Sewing machine repairing. To \$125 weekly. Sparetime. Supplies. Add to present business. Write today! Taylor Service, Box 484, Cupertino, Calif.

35 MILLION Viewers saw it on "The Price Is Right!" Earn \$12,000 in 7 months with a freezer-fresh "Dairy Bar on Wheels," most complete soft ice cream mobile unit available. No franchise, no royalties. Also available, oven-fresh pizza-refreshment units and Shake 'N Burger food-drink vehicles. Distributors needed. Dept. PM, Tri Metal Works, Riverton, N. J.

VENDING Machine catalog. Rakes, 609P Spring Garden, Philadelphia 23, Penna.

BRONZE Baby shoes. Genuine electroplating process. Equipment, mountings, instructions. Send \$1.00 for valuable book "Your Guide To Success" bronzing baby shoes, plus complete catalog. Hollywood Bronze Supply, Dept. B60, 3445 Union Pacific Avenue, Los Angeles 23, California.

RAISE Rabbits on \$500 month plan. Free details. White's Rabbitry, Mt. Vernon, Ohio.

\$200.00 MONTHLY. Spare time. With tablesaw, bandsaw or jigsaw. Write. Holiday House, A3800 Harney, Vancouver, Washington.

SIMPLE, Pleasant mailorder can net \$12,000 year. Write: Rutward, 2010 Bryant, Columbia Station, Ohio.

LAUNCH Profitable mailorder business. Write: Kozar, 159 Belleville, Belleville, N. J.

SELL Books by mail. 400% profit. Royal, Box 450-X, Cleveland 27, Ohio.

MOLDING Rubber. Free information. Chaney's, 5415-A San Jose Blvd., Jacksonville 7, Fla.

STOP Throwing away box-tops! They're worth money! Some, 25¢! Inquire: Box-tops-MB, Cedar Hill, Texas.

BUY Direct from factories. Appliances, cameras, watches! Free details! Cam Co., 436 P.M. Bloomfield Ave., Verona, N. J.

COPUBLISH Mail Sale Advertiser, leading mail order paper. Details, latest copy, dime. Vanroy Shirk, Lebanon, Penna.

OPERATE Own collection agency. Spare time extra cash: Satellites, Box 172PM Manhattanville Station, New York 27, N. Y.

MAILORDER Catalogs. No inventory required. Full profits. Operate from home. Send 25¢ for 32-page sample catalog featuring 150 unusual fast-moving products and complete details. Satisfaction guaranteed. Gaylords, North Adams 6, Mass.

CAST Beautiful trays, vases, salad bowls, etc., with sawdust, woodchips. New, easy process, only \$1.00 (refundable). Plaston Company, Box 105-A, Grove City, Pa.

STRIP Furniture finishes commercially. N-K Equipment Co., Lima, N. Y.

AMAZING Profits in exterminating. Full time—part time. Free details. Baylab, 21-V, Cambridge, Maryland.

MONEYMAKING Opportunities galore! Full, spare time! Details free. Harvey's, Box 1402-PM, Englewood, Colorado.

MAKE Money from old tires. Operators clearing \$400 weekly. Equipment costs \$800. Get facts. S & S Patents, Inc., 3511 N. Lincoln, Chicago 13.

SELL Business cards by mail. 1000 \$2.85. L&D, 109 W. 42nd, N. Y. C. 36.

\$70.00 WEEKLY—home, spare time. Simplified mail bookkeeping. Immediate income—easy. Auditax, 34741E, Los Angeles 34.

OPERATE Profitable employment service. Your home or downtown. Details \$2.00. Help Associates, 607 Eighth, Rapid City, South Dakota.

MANAGE Motel or resort. Men, women, couples can make \$400 to \$1,000 monthly plus apartment. Pick own location with our employment assistance. Learn at home. Free booklet. Motel Managers Training School, Dept. PMC-122, 612 So. Serrano, Los Angeles 5, Calif.

BIG Money, snow flocking Xmas trees, centerpiece, gifts. Course \$1.00. Maegus, 5337 W. Nelson, Chicago 41.

GET The real facts about mail order. Details free! Hayley, Box 931, Atlanta 1, Georgia.

OPERATE Profitable "inexpensive" mailorder business! Liberty, 210 Fifth Ave., New York 10, N. Y.

EXPORT-Import business made easy. Complete setup service, not just instructions. Hermes, 152 West 42, New York City 36.

START Your own Magazine Subscription Agency. Big profits. Details. Goldy, P.O. Box 3396, Long Beach 3, Calif.

OPERATE Profitable mail order business. Splendid opportunity. Write: Mail Service, 7919 Renfrew, Indianapolis, Ind.

\$15.00 AN hour possible in new home manufacturing business. Spare or full time. Amazing velvet-spray transforms hundreds of old items into money-making products. Write for samples, free "50 Business Opportunities Booklet". Coast Industries, Dept. JNC, Los Angeles 61.

MAKE Extra money. Big steady earnings, repeat business. Sell advertising book matches, full or part time. New 1962 line. Show glamour girls, colorama, tenorama; dozens more. All sizes. Free master outfit, sales helps, leads, no experience necessary, no investment. Write today. Superior Match, Dept. MX-1262, 7530 Greenwood, Chicago 19, Ill.

START Your own business on credit. Your own boss, 1199 dealers sold \$5,000 to \$22,500 in 1961. We supply stock, equipment on credit, 200 home necessities. Sales experience unnecessary. Pleasant, profitable business backed by world-wide industry. Write Rawleigh, Dept. L-U PPM, Freeport, Ill.

MAKE Big money. Own and operate your own fix-it shop. Service household appliances, motors, mowers, etc. Every neighbor, every stranger your prospect. Millions of appliances everywhere need fixing. \$5.00-\$6.00 per hour often charged by appliance service technicians. Christy's shop manual home training program, illustrated lesson manuals, professional testing equipment sent on special pay later plan. Write for free book. No obligation. Christy Trades School, Dept. A-3203, 3214 W. Lawrence, Chicago 25.

SELL Champion, AC, Autolite spark plugs. Precision reconditioned, electroplated, guaranteed 10,000 miles. Up to 308% profit. Free samples. Indy 500 Spark Plug Co., Plant 3, 4620 N. Braeswood, Houston 35, Texas.

LIQUID Rubber, plaques, figurines, plastercraft supplies. Sample, details free. Lavin Novelties, Box 296-B, Leavittsburg, Ohio.

DOLLS! Dolls! Dolls! We teach you to make, repair, dress and sell. Study at home. Earn while learning. Free booklet. Doll Hospital School, Studio MC-122, 11826 San Vicente Blvd., Los Angeles 49, Calif.

EXPORT-Import opportunity, profitable, world-wide mail-order business from home, without capital; or travel abroad. Established world trader ships instructions for no-risk examination. Experience unnecessary. Free details. Mellinger, D70C, Los Angeles 25.

MAKE Telephone surveys spare time! Free home-business details. No selling, choose your own hours. Telephone Institute, Dept. NC, 1038 So. La Brea, Los Angeles 19.

BECOME Tax consultant. Graduates earn \$1,000-\$3,000 every tax season preparing returns evenings. State approved. Union Institute, Lakewood T-2, N. J.

BIG Profits. Hand crafted jewelry business. Free details. LPS, Dept. 1B, 1706 Argon, Mesa, Arizona.

EARTHWORM Growers needed! Big money! Free information. California Bait Co., 10416 Fair Oaks Boulevard, Fair Oaks, California.

BIG Money! Learn TV repairing! Easy! Write: Television, 2300 S. Jefferson, St. Louis 4, Mo.

MOTIVATED Archery lanes. Promote league competition. Sponsored bowmen. Twenty-four hour business. Morton-Brockway, Box 6624, Portland 66, Oregon.

WANT Big money? Spare time mail order at home. No stock investment. No experience. We show you how. Exciting details free. N. Y. Enterprises, Box 160-X2, Jamaica 30, New York.

LEARN Landscaping and the growing of plants. Start a profitable business part or full time. Free information without obligation. National Landscape Institute, Dept. MC-122, 11826 San Vicente Blvd., Los Angeles 49, Calif.

MAIL-ORDER Home business. Get free copy. "Make Money in Mail Order." Malico, 1544 S. Sepulveda, Dept. D70C, Los Angeles 25.

PROFITS With or without tape recorder. Jay, Box 52287-P, New Orleans 50.

CASH From sawdust, tin-cans, newspapers. Over 200 methods. Instructions \$1.00. Charles Company, 42-AT, Norwood, Ohio.

PROFIT With Popular Mechanics' subscription plan. No investment, no experience needed. Earnings begin immediately when you obtain subscriptions for Popular Mechanics, Good Housekeeping and others. High commissions, bonus. No experience needed. Deal directly with the publisher. Write Popular Mechanics, Room 12B, 250 West 55th St., New York 19, N. Y.

OWN Your own Western Auto store. Over 3,800 now operating. Minimum investment \$14,000. Free training. No retail experience necessary. For complete details write: C. M. Wilson, Room 951, Western Auto, 2107 Grand, Kansas City, Missouri. (Indicate geographical area preferred.)

BOOM! In babies. We furnish/finance shoe bronzing setup. Free booklet. Box 5036A, Inglewood, California.

\$50-\$250 WEEKLY. Home mailorder. Expert advice. Free details. Dunne's, 3559-G, Washington 7, D. C.

\$34.70 TWO Hours manufacturing concrete products. No selling. Castings ±3. 4013 W. Chicago St., Rapid City, So. Dakota.

\$10,000 POSSIBLE Selling cars. Over 400 "how to" approved pages. \$10-10 day trial. Free details. PM3 Box 130, Scarborough, Ontario, Canada.

MAILORDER. Lowest-priced catalog house in U.S.A. 25¢. Holliday 914 Burnside Rd., Sharon Hill, Penna.

BIG Profits in mail order. Literature furnished. Roland, 3738-PM Wilton, Chicago 13.

OPERATE Your own home mail order business. Best sellers are made available. We drop-ship your orders, if you prefer. Complete mail order set-up offers. For free details, write to: Direct Mail Order Service, Riverdale Sta., Box 529, Dayton 5, Ohio.

BECOME A notary public. Easily accomplished. Enjoy extra income. Prestige. Free details. Stationers Exchange, Box PM-542, Cleburne, Texas.

AMAZING New home plastics business! Up to \$10.00 hour if you qualify. Pleasant, easy. No selling. Secrets revealed in free plan. NPC, Box 23321-PE, Los Angeles 23.

\$250.00 WEEK spare time profit possible. Earn at home with new fascinating printing method. \$5.00 starts you. Send no money now. Free confidential facts and valuable sample. Screenprint, Dept. JNC, Los Angeles 61.

MONEYMAKING OPPORTUNITIES

400% PROFITS. Stamp social security plates, ball pens. Sample 50¢. Bonomo, 54 Jefferson St., Brooklyn 6, N. Y.

SEA Shell price guide. Recognize valuable shells! 1200 illustrated, described, evaluated. American and foreign. \$3.00 postpaid. Lee Publishing, Wellesley Hills, Massachusetts.

LEARN Window trimming at home. No schooling. Free details. Trimming, Box 557, Whittier, California.

MAKE Money with mailings. Starting kit, dime. Terrific. Brown, 184-P, McClellan, New York.

START Good pay business at home in spare time. No experience needed to operate little table-top machine for bronzing baby shoes. Make \$6.00 profit on every pair. Full particulars free. Send postcard to Warner, 1512 Jarvis, Room CM-2-L, Chicago 26, Illinois.

SMALL Service. Monthly pay check. United, 2205 W. 15th, Sioux Falls, South Dakota.

MAKE Exclusive jewelry, novelties. Plate baby shoes. Make \$100 weekly spare time. Details free. Jo-Ca, 468-D Northwest 79th Street, Miami 8, Florida.

FREE Advertising for mallorder items. Branvold, 5718 Troost, North Hollywood, California.

INCOME Skyrockets. Wealth acquisition secrets revealed. Details. Natu-Rex, Yucaipa 9, California.

PHYSICAL Culture and massage pays big profits. Learn at home. Free catalog. Write National Institute, Dept. A-1, 874 N. Wabash, Chicago 11, Ill.

MAKING Beautiful plastic products, per our easy instructions, your greatest money-making opportunity. Write for proof, Plasticon Company, Box 105, Grove City, Penna.

HOME Mallorder "manufacturing." Everything supplied. Glenso Products, 184 Oakview, Winnipeg 15, Manitoba.

EARN Money evenings, copying and duplicating comic cartoons for advertisers. Adservice, Argyle 1, Wisconsin.

MAKE Plastic novelties for extra income. Low cost home training now available. Write for free booklet. Interstate Training Service, Dept. D-3, Portland 12, Oregon.

BAKE New greaseless doughnuts in kitchen. Sell stores. Free recipes. Melvin, 3605 South 15th, Minneapolis 7, Minn.

CIGARETTES—Make 20 plain or filter- tip for 9¢. Facts free. Moberly, Box 4012, Owensboro, Kentucky.

MINK Raising information free. Complete. Lake Superior Mink Farm, Superior, EEl, Wisconsin.

VENDING Machines. No selling. Operate a route of coin machines and earn amazing profits. 32-page catalogue free. Parkway Machine Corporation, Dept. #26, 715 Ensor Street, Baltimore 2, Maryland.

EARN Money raising fishworms for us! Write: Oakhaven—59, Cedar Hill, Texas.

YOUR Own, easy-to-start, home mail- order business, sparetime. Fascinating; profitable! Information free. Alfano, 19-PM Pine, Closter, N. J.

BIG Money raising fishworms and crickets. Free literature. Carter Hatchery, Plains, Georgia.

AMAZING Successes through franchises! Become exclusive franchise holder your territory. Information rushed. National Franchise Reports, MP-528, 333 North Michigan, Chicago 1.

SEASHELLS, Shellcraft and jewelry supplies. Wholesale catalog 25¢, refunded on first order. Our 28th year. Florida Supply House, Box 847M, Bradenton, Florida.

EASY To start rubber stamp business at home in spare time. Make up to \$9.80 an hour without experience. Facts free. Write Roberts, 1512 Jarvis, Room CR-2-L, Chicago 26.

MEN — Women! Start money-making plastic laminating business at home in spare time. Material that costs 11¢ brings back \$2.58. No canvassing or selling but mail orders bring in \$20 a day. Write for full particulars free. Rush name on postcard to Warner, Room CL-2-L, 1512 Jarvis, Chicago 26, Ill.

BECOME A notary public! Win extra income, prestige, business contacts. Details free. Stationers Exchange, Box 552-P, Kermit, Texas.

AMAZING Trade Secrets will appear here soon. Spectacular Crafts.

MAKE \$5,000 Yearly sparetime raising mink, chinchillas, nutria, etc. Free booklet reveals proved plans. Write: Furs, 588 Mt. Pleasant Road, Toronto 1, Canada.

LEARN Jewelry making at home. Inexpensive art metalcraft course teaches how to make all types cuff links, earrings, tableware, etc. of silver, gold, copper. Send postcard for free booklet. Interstate Training Service, Dept. L-3, Portland 12, Oregon.

LEARN The secrets of repairing junk batteries, generators, starters, profitable, easy, at home. Free particulars. Batterymen, P.O. Box 193, Prunedale Station, Salinas, Calif.

WIN Contest money. Our contest bulletin gives hundreds of tips. Lists current contests, rules. Sample magazine. 25¢. General Contests, 1609½ East Fifth, Duluth, Minn.

DOLLARS For pennies! Hunt coins for me. Equipment furnished free. Send \$1.00 deposit (refundable). Griffin, Box 1850, Cleveland 6, Ohio.

AMAZING Home profits possible with our magazine—50¢. Vista Sales Co. HBD, 1230 Purcell Ave., Cincinnati 5, Ohio.

FREE Book: "609 Unusual, Successful Businesses." Box 1001-PW, Evanston, Illinois.

LENTNER'S Advertiser — "Land of Fruit, Nuts & Cream!" goes nationwide. Remit \$2.00 (yr's. sub.). Margie Lentner, Box 3187, Modesto, California.

LIFETIME Opportunity! Earn \$50,000.00 Simple; easy. Box 123, Indian Valley, Va.

SCIENCE & CHEMISTRY

ROCKETS: New illustrated catalog 25¢. Single and multistage kits, cones, engines, launchers, trackers, technical information, etc. Fast service. Estes Industries, Penrose 7, Colorado.

CHEMICALS And apparatus for indus- trial, analytical, and private laboratories. Catalog 35¢. Dept. M-50, Biological Supply Co., 1176 Mt. Hope Ave., Rochester 20, N. Y.

ILLUSTRATED Catalog: Chemistry, mineralogy, biology 25¢. Tracey Laboratories, Evanston, Illinois.

UNUSUAL Chemistry books, courses, kits! Rare chemicals, cheap! Catalog 25¢. NSC, Box 11133, Palo Alto, Calif.

ROCKETS, Pyrofuze® amazing new Exothermic material. Sample sent with illustrated catalog, rocket kits, engines, etc. 25¢. United Scientific Corp., Waupaca, Wisconsin.

FREE Chemical catalogue. Enclose 10¢ postage. Fairview, Box 1116, New York City 8.

FREE, ¼ pound Sulphur or 3 Pyrex test tubes with purchase, \$3.00 or more. Catalogue 25¢. Chemicals, apparatus. Biology, Dept. PM-12, Mid-States Scientific, 7053 N. Clark, Chicago, Ill.

MICROSCOPES, Accessories, prepared slides, supplies, etc. Free brochure. New England Science Service, P.O. Box 315, Peterborough, New Hampshire.

AMAZING New book of science experi- ments, formulas, and catalogue of laboratory supplies. Only 35¢. National Scientific Co., 13 S. Park Avenue, Dept. PM-12, Lombard, Illinois.

CHEMICALS In small quantities, laboratory apparatus, biology supplies. Catalog 25¢. Winn Chemicals, 124-M West 23 Street, New York 11, N. Y.

CATALOG. 25¢. Used glassware, books, Laboratory Sales, Box 161-A, Brighton, Mass.

EXPERIMENTERS: New catalogue, discount prices. Also useful laboratory instrument—25¢. Hagenow Laboratories, Manitowoc, Wisconsin.

PLASTICS

NEW! Low priced plastic laminating machine. Details. Burr, 7645 Oakland, Kalamazoo, Michigan.

LIFE Lasting fiberglass signs 3¢ square inch up. Boettger, 961, Dorothy, N. J.

BOXES. Plastic. 200 sizes. Free list. Althor, 170 Bay 23 Street, Brooklyn, N. Y.

NEW Liquid casting plastic, clear, col- ors. Embed real flowers, butterflies, photos, coins. Send 25¢ for two handbooks, "How to Cast Liquid Plastics" and "How to Make Extra Money at Home." Castolite, Dept. P-101, Woodstock, Illinois.

NATCOL Resins are best for casting and laminating. Catalog 25c. Natcol Plastics, Box 227, Redlands 3, California.

FORMULAS, PLANS, ETC.

FORMULAS For latest money-making discoveries. New! Good! Valuable literature free! Miller, Chemist, 1517-D, Tampa, Florida.

10,000 PROFITABLE Formulas, recipes, etc. Details free. Harvey's, Box 1402-C1, Englewood, Colorado.

FORMULAS—All kinds. Amazing big catalog, 10¢. Kemixal, Park Ridge, Ill.

LATE, Modern manufacturing formulas. List free. Moon Chemical, Martville, New York.

AGENTS WANTED

PRINTING. Advertising salesmen—Ex- cellent moneymaking sideline selling decalcomania name plates, small quantities. Automobile initials, sign letters. Free samples. Ralco, XL, Boston 19, Mass.

FREE Sample. Beautiful curios! Sell on sight! Apartado 9036, Mexico City.

YOUR Own business—Used suits \$1.50; overcoats 65¢; mackinaws 35¢; shoes 12½¢; ladies' coats 30¢; dresses 15¢. Enormous profits. Catalog free. Nathan Portnoy Associates, 2109-AA Roosevelt Road, Chicago 8, Ill.

\$2.98 INVENTION Changes black-and- white TV into beautiful colors. Terrific, profitable seller. Write Excellent Buys, Dept. PM, 34 E. 12th, NYC.

MAKE Profitable men's-women's wear. Sample free. Sunmade, Brockton 64, Mass.

DIRECT From manufacturer. Lowest prices. Highest quality. Exclusive deal. Hilbor Products, 650 Pierce Street, Gary, Indiana.

EXOTIC Earrings! Details free. Pair \$1.00. Ohga, PM-401, Sigakenkusatu, Japan.

"FOG-STOP" Windshield cloth. Instantly removes blurry mist, frost, sleet, snow. Stops windshield fogging. Samples sent on trial. Kristee, 128, Akron, Ohio.

AGENTS—300% Profit selling GENUINE gold window letters; stores and offices. Free samples. Metallic Sign Letter Co., 1217-D West Newport, Chicago.

AUTOMATIC Bed warming sheet, you sleep on, not under. Outsells electric blankets 10 ways, costs less. Generous profits. Patented Products Corp., Dept. PM-122, Danville, Ohio.

SELL Bibles. Write for sample. Lee. Box 174, Romoland, California.

BUY IT WHOLESALE

FREE! Name brands catalog! Your own high profit business. Sell name brands, full or part time. No inventory, no investment. More than 2,000 name brand items: lowest wholesale prices. Watches, jewelry, cameras, hi-fi, stereo radios-phonos, appliances, housewares, hardware, power tools, luggage, musical instruments, garden equipment, sporting goods, toys, many others. 8 floors of name brands. Million dollar inventory. Orders shipped complete in 24 hours! Send for free, beautifully illustrated catalog now! Separate wholesale price list. H. B. Davis Corp., Dept. PM, 145 W. 15 St., New York 11, N. Y.

OVERHEAD Door parts. Wholesale prices. List. Door Supply, 101 County Street, Somerset, Massachusetts.

BARGAINS! Buy wholesale! Save money! Free catalog! Norris, 273-AX Merrick Road, Lynbrook, N. Y.

NEW Deluxe below wholesale catalog. Automobile catalog and others. Furniture, clothing, housewares, appliances, refrigerators, freezers, washers, dryers, television, radios, luggage, binoculars, hi-fi, stereo, phonographs, recorders, cameras, projectors, musical instruments, sporting goods, toys, tools, typewriters, watches, jewelry. Huge discounts on thousands of name brand items. For free specimen list of actual factory prices—postcard: Selbyco, Decatur 15, Illinois.

FREE Catalog. Largest wholesale supply source in the U.S. We're in business to save you money on anything you buy—for self or resale. Write Associated Wholesalers, Box 108-DD, Lincoln 1, Nebraska, for catalog and money-saving details.

BUY Direct from factories! Appliances, cameras, watches! Free details! Cam Company, 436PA Bloomfield Ave., Verona, N.J.

WORLD'S Largest wholesale supply. Buy from 679 American, European, Japanese wholesalers. Tailormade suits from Hongkong. 123 dropship catalogs. Rockbottom prices. Free details. International Buyers, 216-M Jackson, Chicago 6, Illinois.

USED And new watches \$2 up. Free list. Southern Watches, 5-PM So. Wabash, Chicago 3.

ELECTRIC Guitars, amplifiers, wholesale. Free catalog. Carvin PMW, Covina, Calif.

SWISS Watches through established importer. Beautiful ladies' calendar watch \$6.48. Exquisite men's model, ultra-thin. Incabloc, \$12.33, air parcel post inc. Free catalog. Mercury Export, Dept. P-12, Munich 42, West Germany.

FREE Wholesale catalog. Merchandise, housewares, jewelry, toys, gifts. Bargains, A14 Farr Road, Columbus 3, Georgia.

PREWAR Prices! Combs 1¢; Hit records, Presley, Fabian, etc. 23¢; Ballpoint refills 1 1/2¢; Pocket adding machines 64¢; Pinking shears 67¢; 43-piece dinnerware \$8.93; Flashlights 26¢; Leather billfolds 45¢; Hundreds more. Catalog 50¢. Redeemable. Sumpter Factory Distributors, Wapella, Illinois.

SAVE Up to 300%. 1000 bargains catalogue free! Dicaprio, 1312P South 35th Street, Philadelphia 46.

NYLONS: Luxurious non-run seamless. \$7.92 dozen. Sell \$1.50 pair. All shades. Dunne's, Washington 7, D. C.

TOOL Catalog. Send 25¢. Silvo Hardware, 107-PM Walnut, Phila. 6, Penna.

NEW Watches \$2.95. Bulova, Benrus watches like new \$5.95. Wallets dz. \$4.95. Big catalog with hundreds of bargains jewelry, watches, free. Cosmos, New York 35, N. Y. Dept. 547.

100,000 PRODUCTS Wholesale! Terrific bargains! Wholesalers, 1265-Mr Broadway, New York 1, N. Y.

FREE Merchandise! 350,000 items wholesale! Goldmine, 240-PM, Planetarium Station, New York City 24.

FREE Lists—less than cost. Surplus electrical, hardware, model train parts at sacrifice prices from manufacturer. Write Kusan, Inc., Dept. WRC, Box 9277, Nashville, Tennessee.

SALESMEN—DISTRIBUTORS

HELP! \$50 to \$100 a day introducing new plastic windshield cover to service stations, car dealers, etc. Will sell on sight in most cases as it is needed by every motorist during winter. Territories on first come basis so don't delay. Free information or send \$3.00 for postpaid sample. New Products Distributor, 117 Moore St., Danville, Illinois.

SENSATIONAL New longer-burning light bulb. Amazing free replacement guarantee. Never again buy light bulbs. No competition. Multi-million dollar market yours alone. Make small fortune even spare time. Incredibly quick sales. Free sales kit, Merlite (Bulb Div.), 114 E. 32nd, Dept. C-74B, New York 16.

MAKE Extra money selling advertising matchbooks. Free catalog and sales outfit. Matchcorp, Dept. PM-122, Chicago 32.

70 MILLION Cars need this Saftee See automatic light switch. Avoid an accident by letting the other driver see you. List \$7.50. Liberal discounts. Geneva Mfg. Corp., Geneva, Florida.

INCREDIBLE! Crystal spray paint. Decorative, beautiful, profitable. Send \$1.50 for sample. Satisfaction guaranteed. Crystal-Magic of California, A Division of Technical Marketing Associates, 2124 Sepulveda Boulevard, Los Angeles 25, California.

\$1,000.00 A Month for making dramatic 3-second demonstration of amazing lightweight Presto fire extinguisher. New chemical used by Airforce snuffs out fires instantly. Only \$4.95. Terrific commission. Millions want it. Free kit, Merlite, 114 E. 32nd, Dept. P-66B, New York 16.

IF You're interested in making money in selling, see the hundreds of exceptional opportunities in Salesmen's Opportunity Magazine. Send name for your copy, absolutely free. Tell us what you're selling now. Opportunity, 848 N. Dearborn, Dept. 17, Chicago 10, Illinois.

FLIPPER, New game riot! One minute demonstration sells it. Big profits! Rinco, Geneva, Illinois.

EARN Big commissions full or part time. Show America's largest line low priced business printing and advertising specialties. Big free sales kit samples hundreds items used daily by business people. Build profitable repeat business. Start right now. National Press, Dept. 8, North Chicago, Illinois.

IF You are calling on farmers, specialty growers, golf courses, factories or estates, we can show you how to add big money to your present income. Campbell Company, Rochelle 5, Illinois.

NEW Apollo hearing aid. Half price. Planned sales. PM Dunne Co., 7707 Chapel, Chicago.

MONEY. Take orders for colonial gifts. Send \$10 for 5 different gifts valued at \$24. Guaranteed. Colonial, 533 Nassau Rd., Roosevelt, N. Y.

HIGH Commission and bonus. Earn \$100 to \$300 weekly. 30 year old company has openings. List delinquent accounts for collection. Experience not necessary. Permanent. Write Merchants Protective Agency, Dept. PM-12, 1015W Walnut, Kansas City, Mo.

MAKE Up to \$200.00 weekly. Every business has slow accounts. Send us names. We collect. National Credit, Dept. BP-12, 903 McGee, Kansas City 6, Mo.

MAKE Extra money. Big steady earnings, repeat business. Sell advertising book matches, full or part time. New 1962 line. Show glamour girls, colorama, tenorama; dozens more. All sizes. Free master outfit, sales helps, leads, no experience necessary, no investment. Write today Superior Match, Dept. M1262, 7530 Greenwood, Chicago 19, Ill.

MAKE Big money taking orders for Stark dwarf fruit trees. Everybody can now grow giant size apples, peaches, pears in their yards. Also shade trees, shrubs, vines, roses, etc. Outfit free. Stark Bro's, Desk 30163, Louisiana, Missouri.

PROFITS Unlimited. Every home a prospect for amazing floor-care product; nothing else like it. Not a wax or polish. Full details free or send \$2.00 for sample and demonstrator kit. Cataract Chemical Co., Box 162P, Buffalo 5, N. Y.

EMPLOYMENT INFORMATION

MERCHANT Marine. Men and women. Top wages. Travel. Information. Captain, Box 501-P, Reading, Massachusetts.

FOREIGN Employment. Construction, other work projects. Good paying overseas jobs with extras, travel expenses. Write only: Foreign Service Bureau, Dept. PM, Bradenton Beach, Florida.

RESUMES By Richton open doors to the best jobs. Expertly prepared, professionally written, custom printed. Analysis and evaluation. Free bonus features. By mail or personal visit. Write, free literature. The Richton Company, Dept. PM, 11 Hill Street, Newark 2, New Jersey.

FOREIGN Employment information. Europe, Africa, Asia, South America. Free transportation. Up to \$1600.00 monthly. Sensational opportunities. Construction workers, clerks, truck drivers—every occupation. Complete information, application form, sent immediately by return mail. Satisfaction guaranteed. Only \$2.00 (\$2.25 airmail) (C.O.D.'s accepted) to: Jobs, P.O. Box 50512, Dept. E, New Orleans 50, Louisiana.

DIRECTORY Reports. Construction, aviation, shipping, oilfields, government, manufacturing, trucking, etc. Foreign-stateside. Helpful information plus job-getting tips on preparing application letters. Unconditional money-back guarantee of satisfaction. Act today. Only \$3.00. (\$3.25 airmail). (C.O.D.'s accepted). Research Services, Meramec Building, St. Louis 5-PM, Missouri.

JOBS ON ships. Age 18 to 55. Experience not required. National Seafaring. Box 78453-B, Los Angeles 16, California.

JAPAN! Korea! Okinawa! Many hi-paying jobs available. Complete, detailed reports \$2.00. Japan Reports, Box 2202-C, Newport Beach, California.

TREMENDOUS Opportunities U.S.A., overseas. Choose jobs, locations, transportation. Free details. Occupations, International Airport, Box 100C-11, Jamaica 30, N. Y.

IMMEDIATE Openings with many overseas employers. Act now, opportunities for almost every skill and trade. Complete details, directory and applications. \$2.00 (\$2.25 airmail) (C.O.D.'s accepted) Satisfaction guaranteed. "Employers Directory," Box 6091-B, Dallas 22, Texas.

VALUABLE Employment tips 25¢. Comprehensive personal portfolio \$1.00. Neaco, Batavia, Illinois.

EXECUTIVE Recruiting organizations are seeking management talent. Information plus Nationwide Directory of 200 top recruiters \$1.00. Jobologists, Box 454, Rutherford, New Jersey.

CALIF. Jobs. Thousands. Also business large or small. Complete. \$1.00. Hupat, 6707 LaTijera Blvd., Los Angeles 45, Calif.

FOREIGN-U.S.A. jobs. All occupations. Up to \$1600.00 monthly. Free transportation, benefits. Complete information, application form. Send \$1.50 (\$2.00 airmail). C.O.D.'s accepted. Satisfaction guaranteed. International Employment, P. O. Box 307, Bedford 4, Indiana.

SPECIAL SERVICES

HERE'S Key to higher pay, greater job satisfaction! Completely confidential service uncovers your hidden talents and abilities. Write for free brochure describing unique method that uses IBM computers to help you know yourself. No obligation. Institute for Vocational Research, Inc., Dept. 12 PM, Drawer 2335 Ocean View Branch, Miami Beach, Fla.

GRAVE Markers ground level at price basket of flowers beautifully custom made write details free miniature. Fead Buildings Co., 1635 Poplar St., Port Huron, Michigan.

RESEARCH Service. Any subject! Product information. Jake Barraco, 478 Gardner, South Beloit, Illinois.

RESEARCH. Reservations, investigation, remailing, filming. Arizona Information & Service Bureau, 5001 North 61st Drive, Glendale, Arizona.

INFORMATION Concerning any matter. Folborg Research Agency, Wyckoff Heights, Brooklyn 37, New York.

INFORMATION On anything. Ferguson Research Specialists, 59 Lent Ave., Hempstead, N. Y.

EDUCATIONAL AND INSTRUCTION

PROFITABLE National Camera Repair School training at home! 174PM, Englewood, Colorado.

"ERROR Guide." Amazing book for bookkeepers, auditors, accountants, cashiers. Details free. Error Guide, P.O. Box 253, Minot, N. Dak.

BOOKS — Practical help for trades, skills, profession. Ramey, 19-B South Martin, Waukegan, Illinois.

LEARN Fascinating, profitable invisible reweaving at home. \$10.00 earnings in an hour possible making tears, holes disappear from clothing, fabrics. Steady demand from cleaners, laundries, homes. Details free. Fabricon, 1534 Howard, Chicago 26, Illinois.

GUARANTEED America's finest and most complete line of slide rules. Wholesale prices. You save 30 to 50%. Post card brings our catalog. Lewis M. Crawford & Sons, Joanna, South Carolina.

ENGINEERING And Art degrees earned through home study. Electronics, Mechanical, Liberal Arts. When writing specify course desired. Pacific International College of Arts & Sciences, primarily a correspondence school. Resident classes also available. 5719-B Santa Monica Blvd., Hollywood 32, California.

INVESTIGATOR'S Course. Credentials, diploma. Free information. Southwestern Institute Criminology, Box 201, Geronimo, Oklahoma.

PENMANSHIP Corrector. Improve poor penmanship quickly. Details free. Ozment, Box 665-34, St. Louis 88, Mo.

SPEAK, Sing with power. Self-training records. Canfield, 2018-A Fifth Avenue South, Minneapolis 4, Minnesota.

FREE Literature, self-help books, sleep learning. Fletcher, 2407-PM Catherine, Dallas 11, Texas.

BE A Real Estate Broker. Insure security for yourself and your family. Study at home. Prepare for state examination. GI approved. Write for free book today. Weaver School of Real Estate, 3519P Broadway, Kansas City, Missouri.

SWEDISH Massage. Foot technique. Post graduate. Home study. Residential. Diploma. Dr. Swanson's Illinois Licensed School, 3809-PL Alta Vista, Chicago 13.

USED Correspondence courses and books sold and rented. Money back guarantee. Catalog free. (Courses bought.) Lee Mountain, Pisgah, Alabama.

HIGH School diploma at home. Licensed teachers. Approved materials. Southern States Academy, Station E-16, Atlanta, Ga.

WOODWORKING And cabinetmaking course for beginning and advanced home craftsmen. Only complete low-cost home training program available. Write for free booklet. Interstate Training Service, Dept. G-3, Portland 12, Ore.

BOOKKEEPERS. Operate your own "Dollar-A-Week" system. Ellis, Box 200, Cedar Grove, North Carolina.

LEARN Asleep or awake! Records, tapes, equipment! Free catalog! Drawer PM-697, Ruidoso, New Mexico.

MEN Wanted. Earn \$125 a week and up. Master a trade with a future. Learn auto diesel mechanics in our shops. You learn with tools on real equipment. Earn while you learn. Many of our graduates earn \$125 a week and up. Write for free bulletin: Dept. 256, Auto Diesel College, Nashville 3, Tenn.

LEARN Ventriloquism. Amazing-entertaining! Easy! Details free. B. Davis, B-38, Safety Harbor, Florida.

LEARN While asleep with your recorder, phono. Details, catalog free. Sleep-Learning, Box 24-PX, Olympia, Wash.

PROFESSIONAL Investigator. Home study. Lapel pin, certificate, future. Box 41197-F, Los Angeles 41, California.

OPERATE Collection agency. Little gold mine. Franklin Credit, Roanoke, Virginia.

USED Courses! Books! List 10¢. Smith's, 124 Marlborough, Salem, Mass.

PIANO Tuning pays. Big money in spare time. Learn at home. No musical knowledge necessary. Phonograph, records, tools and instructions furnished. Electronic tuning also taught. Free catalog. Capital Tuning School, 3160 S.W. 16th Court, Ft. Lauderdale, Fla.

SECRET Investigations. Experience unnecessary. Investigators particulars free. George Wagner, M125 West 86th, New York City 24.

INVESTIGATORS Trained, men-women. Fascinating, profitable profession, spare time study. Big pay. Details to open own agency any state. Free booklet. Investigator, Box 490PM, Times Square Station, New York 36, N. Y.

WANT A diesel job? Higher pay? Advancement? We can help you qualify! Complete diesel, tractor and heavy equipment and Cummins Diesel Engine Shop-method home-training courses available. Write today. Interstate Training Service, Dept. B-3, Portland 12, Ore.

FCC License in 6 weeks. First class radio telephone results guaranteed. Elkins Radio School, 2603D Inwood, Dallas, Tex.

FINISH High School at home. Better jobs, more pay for high school graduates. Get your diploma thru simplified home study course. Personal attention. Write for free book, read about our "Guarantee of Success." Wayne School, Dept. 12-549, 417 S. Dearborn, Chicago 5, Illinois.

MASTER Watch making at home. Free sample lesson. Chicago School, 2328-YM Milwaukee, Chicago 47.

REAL Estate course. Economical home-study. Literature free. Howard Schools, Box 8394-A, Kansas City 5, Missouri.

TEACHERS. Parents, children need 44 colored alphabet numerals \$1.90. 3/4", 1" or 1 1/2". 25¢ postage. Plastic Plaque Products, 1635 Poplar, Port Huron, Michigan.

DRAFTING. Blueprint reading, schematics. Send \$2.00 first lesson. Complete home course \$25.00. Prior Inc., 23-09 169 Street, Whitestone 57, New York.

GET A British degree. Divinity, Philosophy, Radionics, Biochemistry. 35 courses. Prospectus free. Brantridge Forest School, "Lodge", Brantridge, Balcombe, Sussex, England.

MISSOURI Auction school. Free catalogue. 1330 Linwood, Kansas City 9-x3, Missouri.

LEARN Touch typewriting. Fast easy! Manual containing complete instructions. \$1.00. Empire, Box 151, Dubuque 8, Iowa.

LEARN Collection business. Complete instructions, samples. Send \$2.00. Money back guarantee. Patterns for Success Institute, Box 1133, Boston 3, Massachusetts.

CIVIL Service opportunities—city, state, federal. 200 low-cost preparatory home-study guides for higher ratings. Literature 10¢. Jorgensen, Box 5023-3122, Seattle 7, Washington.

COURSES Written to specifications by home-study specialists. All fields. Pokross, Central Valley, New York.

DENTAL Technicians. Simplified home study. Accredited ACSC Certificate. Den-shire School, Box #762, Boston 2, Mass.

PRESIDENT'S Booklet of the United States. Pictures and descriptions of each president. Educational. 50¢. Presidents, Box 83, Ephrata, Penna.

EARN High School equivalency diploma. \$35 home study course. Free booklet. Write Roberts Tech, 517 West 57 St., New York, N. Y.

LEARN Civil and criminal investigation at home. Earn steady, good pay. State age. Institute Applied Science, 1920 Sun-ny-side, Department 169, Chicago 40, Ill.

GOOD Paying jobs open! Operate, repair heavy earth moving equipment! Learn "on the job" operating latest cranes, bulldozers, earth carriers! V.A. approved. Free catalog. Write N. P. Hutch, Greer Technical Institute, Braidwood, Illinois.

LEARN Morse Code easily, quickly never to forget it! Amaze your friends! Send 50¢ for remarkable booklet "How to Learn the Morse Code in Ten Minutes." C. Yatee, Dept. 63, P.O. Box 2373, San Francisco, California.

DRAFTING Pays big money. Leads to position in automotive, aeronautical, construction, mechanical fields. Learn at home in spare time. All equipment supplied. Pay later plan. Free book. Christy Trades School, D-6603, 3214 Lawrence, Chicago 25, Ill.

PIANO Tuning pays. Learned easily at home. GI approved. 59th year. Free booklet. Niles Bryant School, Dept. P, 3731 Stockton, Sacramento 20, Calif.

COMPLETE Your high school at home in spare time with 65-year-old school. Dept. X945, Drexel at 58th, Chicago 37, formation booklet free. American School, Texts furnished. No classes. Diploma. In-Illinois.

"How To Train Horses." A book everyone who likes horses or ponies should have. Free. No obligation. Simply address Beery School, Dept. 11012, Pleasant Hill, Ohio.

GAME Warden, Government hunter, Forestry, Park and Wildlife Services announce job openings regularly. Enjoy outdoor work, good pay, real security. Complete information free! Write North American School of Conservation, Dept. 17C, 810 Dodsworth, Covina, Calif.

USED Correspondence courses, books. Satisfaction guaranteed. Catalog 10¢ refundable. Courses bought. Bayles, 78-B Courtright, Wilkes-Barre, Penna.

OPERATE Bookkeeping service. Personal coaching. Whiteley, 1645 Warwick, Warwick, Rhode Island.

STOCK Market page made simple, instructions. Send \$2.00. Martin-Moore, Box 15326, Atlanta 19, Georgia.

PIANO Tuning pays. Learned easily at home. GI approved. 59th year. Free booklet. Niles Bryant School, Dept. P, 3731 Stockton, Sacramento 20, Calif.

PLAYS, STORIES, MANUSCRIPTS

POEMS Needed for poetry books. Inquire: Young Publications, Appalachia 1, Virginia.

WRITERS Send your books, articles, stories, plays for free evaluation, screening and sale. Write today! Literary Agent Mead, 915 Broadway, New York City 10.

WANT Your book published? Learn how we publish, advertise, promote, distribute. Many successes. Free booklet PM. Vantage, 120 West 31, New York City. Or 6253 Hollywood Blvd., Hollywood 28, Calif.

ADVERTISING AGENCIES, ADV. SERVICE, MAILING LISTS

ADVERTISE: 24 words, 50 Canadian newspapers, \$5.50. Lists free. Advertising Bureau, 10511-C Springfield, Chicago 55.

MAILORDER Record Book. 30 pages. Records inquiries, orders, advertising expense, etc. Most complete. Just send dime for postage and handling. F. W. Johnson, 740RB Rush St., Chicago 11.

ADVERTISING Ratebook leading newspapers, magazines, free. Chicago Advertising Agency, 28-E Jackson, Chicago 4.

MAILING Lists most all kinds 1000 \$5.00. Free folder. Your circulars mailed \$4.00 1000. Dixie Mailers, King, N. C.

AMAZING New Book—"Profits From Classified Advertising." Tells how and what to advertise. Be sure to read this book before you invest one cent in advertising. Write for your copy now. F. W. Johnson, Classified Advertising Manager, Popular Mechanics, 740-PR Rush St., Chicago 11, Illinois.

RUBBER STAMPS AND OFFICE SUPPLIES

FREE 32 Page rubber stamp catalog. Signature stamps \$3.50. Youngers Stamp Shop, Princeton, Iowa.

RUBBER Stamp. Cushioned. Indexed. 3 lines, \$1.00. Moneyback guaranteed. Literature, sample impressions free. Ellico, 920 Southlawn, East Lansing, Mich.

THREE-Line pocket rubber stamp, self-inking, plastic case. \$1.00. L. Watson, P. O. Box 162, St. Charles, Illinois.

4 LINE Pocket stamp \$1.00. Free economy business stamp catalog. Claydons Rubber Stamps, Red Wing, Minn.

3 LINES. Rubber stamp \$1.00, 25 cents each additional line. Whitney's Rubber Stamp Shop, 18 Washington Ave., Chat-ham, N. Y.

POCKET 3 Lines \$1.00. Office stamps \$1.50. Free catalog. Specialty, 8464 Manhattan, Detroit 11, Michigan.

POCKET 3 Lines 80¢. Folder free. Dennis Beckley, Cold Springs Road, Baldwinsville 5, New York.

FREE—Rubber stamp catalog. Lowest prices! Hildreth, 1047-A Inner, Schenectady 3, New York.

3 LINES \$1.00. Extra lines 25¢ each. Cushioned mount, knob handle. One day service. Wallace, Box 146, Hanover, Penna.

3 LINES \$1.00. Signature stamps \$3.25—ideal gift. Satisfaction guaranteed. Goldberger, 3967 Sacramento, San Francisco 18, Calif.

3 LINE Quality stamp, \$1. Felco, Box 532, Santa Rosa, Calif.

THREE—Line self-inking pocket stamp 50¢. Meese, Dept. F, 42 "E", Keyser, W. Va.

PLASTIC Three-line pocket stamp \$1.00. Eagle Ind., 3303 Denison, Cleveland 9, Ohio.

CARTOONING, COMMERCIAL ART, SHOWCARD & SIGN PAINTING, TATTOOING

SIGN Painting. Easy method. Ellis, 10533—121 Ave., Largo, Florida.

INEXPENSIVE Mechanical aids teaches better. De-Signs, Box 2024-A, Davenport, Iowa.

PAINT Signs! Letter patterns, hundred selections. Paulow Signs, Crystal Falls, Michigan.

YOU Can entertain with chalk talks. Catalog 10¢. Balda the Cartoonist, Oshkosh, Wis.

LEARN Sign painting at home. Free talent test. Ben Kerns, Box 812-PM, Greenville, S.C.

LEARN Sign painting with fascinating system. Straley, 410 S. Western, Springfield, Ohio.

LEARN Profitable magazine cartooning. Free details. Hartman, Box 3097, Lincoln 10, Nebraska.

PAINT Artistic showcard-signs by new number method. Free Strok-O-Graph and details. Idea clipbook \$1. Midwest School of Art, 103 East Main, Fort Wayne, Indiana.

SIGN Painting—for profit. Free information. Kaufman Sign Company, Centertown, Missouri.

"KEY To a Cartoon Career." Send 50¢ for booklet. Cartooning, Box 3176, Colorado Springs, Colorado.

"HOW To Make Money with Simple Cartoons." A book everyone who likes to draw should have. It is free; no obligation. Simply address Cartoonists' Exchange, Dept. 912, Pleasant Hill, Ohio.

LEARN Profitable, fascinating tattooing. Illustrated information \$1. Zeis, 728-C Leslie, Rockford, Illinois.

ART Learn at home. Earn big money. Learn commercial art, cartooning, lettering, figure drawing, painting, TV art, in spare time. All for 20¢ a day. Send for free 36-page book. No obligation. Washington School of Art, Studio 1412X, Port Washington, N. Y. Tear this out as reminder.

PRINTING OUTFITS AND SUPPLIES

NEW 1962-63 Illustrated printing equipment and supply catalog. This 9"x12", 336-page book is the most complete catalog of the century. Contains everything used in the graphic arts industry including thousands of offset, letterpress, binders, rubber plate and stamp, composing room, silk screen, art and engraving supplies and equipment. Includes paper cutters, folding machines, printing and proof presses, padding presses and many more. Send \$2.00 to cover mailing. Refund with first order. Also available is our latest 184 page type catalog—add \$1.00. American Printing Equipment & Supply Co., Dept. PM 42-25 Ninth Street, Long Island City 1, N. Y.

COMPLETE Supplies for rubber stamp makers. Send for free brochures. Star Stamp Supply, 633 Plymouth Court, Chicago 5, Ill.

HARD Type for rubber stamp making, printing. Introductory offer 10 or 12 pt. 20th Century Medium caps or L.C. \$2.50. Free catalog. Barco Type, 232 Evergreen, Bensenville, Ill.

PRINTING Presses, type, supplies. Lists 4¢. Turnbaugh Service, Mechanicsburg, Penna.

TYPE Cases. Manufacturer. Catalog. King McKay Company, 23179 Telegraph, Southfield, Michigan.

MAKE Your own self-molding rubber stamps and printing cuts. Plexirubber, Argyle 1, Wisconsin.

RUBBER Stamp presses, hydraulic operated, electrically heated. Sizes 5"x8", 8"x12", 10"x15". Starting outfits, supplies. Printing presses. Custom Manufacturing, 1464-P East Commercial, Springfield, Missouri.

DO Your own printing. Save money. Simple rules. We supply everything. Print for others; good profit. Raised printing like engraving too. Have home shop. Details free. Kelsey Presses, V-11, Meriden, Connecticut.

RUBBER Stamp outfits, supplies. Klewiet, 2025 Barney Road, Kalamazoo, Mich.

SILK Screen dry photo stencils. Photo, art service. Boettger, 960, Dorothy, N. J.

BUY Postpaid rubber stamp materials. Free Press, Duckman, Avoca, Arkansas.

TYPEWRITERS, DUPLICATORS, OFFICE DEVICES

MIMEOGRAPH Duplicator and addressing set with complete supplies. Multi-purpose. Up to 35 words. Also replaces 15 custom rubber stamps. Best results guaranteed. Only \$6.95. Flex-Add, 106 Galloping Hill, Roselle Park, N. J.

RECONDITIONED Typewriters, mimeograph, printing presses \$25.00 up. Write Dixigraph, King, N. C.

PRINTING, MULTIGRAPHING, MIMEOGRAPHING, GUMMED LABELS

LABELS, Blank, Self-adhesive. Stock sizes. Free list. Althor, 2301 Benson Ave., Brooklyn, N. Y.

SAVE On mimeographing. Samples. Fuesing's, 6522 West Center, Milwaukee 10, Wisconsin.

PERSONALIZED Correspondence cards, white or colored, neatly printed. 100 \$1.25; 1000 business cards \$3.95, postpaid. May Printers, Box 1703, Gary, Indiana.

MIMEOGRAPHING, Offset printing. Free samples. Pennway, Drawer 1340, Scranton, Penna.

OVERNITE Offset printing 1000 8 1/2" x 11"—\$6.50. Postage extra. Evergreen, 9420 Trumbull, Chicago 42.

AMAZING Business printing values. Samples. Print Shop, Box 576, Greenville, R. I.

FREE Catalogs postpaid printing. Rubber stamps. DM Press, Sebastopol, Calif.

DISTINCTIVE Mimeographing. Lowest prices. Samples sent. Perkins Printing Service, Fremont, Nebraska.

ENVELOPES Brown Kraft unprinted. 6 1/2"x9 1/2": 100-\$1.75, 200-\$3.00, 500-\$5.00, 1000-\$9.00. 9x12: \$3.00, \$5.00, \$9.50, \$16.00. Arco Products, Box 61, Forest Hills 75, N. Y.

250 8 1/2"x11 HAMMERMILL Letterheads \$2.75. 250 envelopes \$2.75. Samples. Patton, Box 248H, South Haven, Mich.

1000 BUSINESS Cards \$3.00 ppd. Agents wanted. Box 1890-P, Long Beach, California.

MIMEOGRAPHING \$1.50 Hundred. Samples. Theo Krause, Route 4, Peoria, Illinois.

FREE Catalog! Low-cost quality printing. Steinbergen, Box 2354C, N. Y. C. 8.

TWO-Color stationery. Samples. Arch Printing, 216E West Jackson, Chicago 6.

ATTRACTIVE Printing. Everything. 1,000 two-color cards, raised, \$4.90 delivered. Calendar A.D. 1 to 2399, any year, \$1.00 delivered. Bixler, Benson Avenue, Frankfort, Kentucky.

1000 PERSONAL Printed, gummed name and address labels in handsome reusable plastic box. Amazing value \$1.00 postpaid. Toppaul Co., 6587-P Pearl, Cleveland 30, Ohio.

OFFSET Printing. Some shipped day received. Mimco Press, Rocky Mount, N. C.

PRESTIGE Letterheads. Samples. Superior Printing Co., P.O. Box 503, Chattanooga 1, Tennessee.

1000 BUSINESS Cards, raised letters \$3.75 postpaid. Samples. Routh, PM-12, 3910 Kipling, Greensboro, N. C.

LETTERHEADS, Billheads, statements, envelopes. Complete set \$9.95 postpaid. Two color \$12.95. (Samples.) Okay Printing, Martin's Ferry, Ohio.

PRINTLIKE Overnite mimeographing. 8 1/2"x11 Snowwhite 50—\$1.00, 100—\$2.00, 250—\$3.00, 500—\$4.50, 1,000—\$6.50 postpaid. Samples. Scher, 707 South Wells, Chicago 7.

100 8 1/2"x11 WATERMARKED Bond letterheads \$1.45. 6 3/4 envelopes same. Samples. Cooper's, Box 471, Ypsilanti, Michigan.

LOW Price advertising scratch pads. Free sample. Prices. Richards, Box 707, Sharon, Pa.

300 BUSINESS Cards \$1.50. Samples. Johnson, Box 5321, Phila. 42, Penna.

REASONABLE Electro print mimeographing. Free samples. Box 102-PI, Whitestone 57, N. Y.

FOR INVENTORS

INVENTORS: Save time and money. Prepare and file your own patent application. Our complete "Patent Kit" makes it easy. Includes detailed instructions and all necessary material. Only \$12.95. Money back guarantee. Don't delay. Send check or money order today to National Inventors Service, Box 88, Benjamin Franklin Station, Washington, D. C.

PATENT Searches—48 hour airmail service, \$6.00, including nearest patent copies. More than 200 registered patent attorneys have used my service. For free invention protection forms and sample patent application, write Miss Ann Hastings, P. O. Box 176, Washington 4, D. C.

PATENT Searches, including copies of related U.S. Patents, \$6.00. Inventors, attorneys, manufacturers use my "Worldwide" airmail service. "Invention Record" form and "Information Every Inventor Needs," sent free! Miss Hayward, 1029 Vermont Ave. NW, Washington 5, D. C.

PROFESSIONAL Searches of the Patent Office. Dependable—reliable \$6.00 including airmail report and related patents. For free protection forms and "Patent Information" write Trans-World Patent Service, 500 Walker Building, Washington 5, D. C.

PATENT Searches, professional patent development of inventions by licensed professional patent engineer and U.S. Patent Office former examiner with staff of engineering specialists in all fields of inventions. Expert searches performed in the U.S. Patent Office. Your inventions and ideas engineered for maximum patent protection and greatest commercial value. Inventions developed by us negotiated for cash or royalties with our nationwide contacts. Send for free protection "Invention Certificates" and further interesting, valuable patent information. George Spector, Licensed Professional Patent Engineer, U.S. Patent Office Former Examiner, Woolworth Building, New York.

SAVE High fees! Prepare your patent application yourself! New "do-it-yourself" patent kit now makes it easy. Free "Registration Form." Miss Blaine, 306 Carry Building, Washington 5, D. C.

U.S. Patent office searches—\$5.00. Free invention record. Patents engineered. Patent Office Searchers, 233 Broadway, Room 3615, New York.

PATENT Searches including full, airmail report and closest patent copies, \$6.00. Quality searches, expertly administered. Free protection forms and "Patent Information." Write Professional Patent Office Search Bureau, 709 Albee Building, Washington 5, D. C.

PATENTS Skillfully prepared for maximum commercial value, with useful product development. High record of success in proving and claiming patentability. Valuable market service. Patent prepared for a fee as low as \$200.00. Send for self-protecting record of invention forms free. Patent search with valuable engineering report \$10.00. Foreign patents filed at low cost. Thirty years established. Joseph O'Brien, Patent and Development Engineer, 132 Nassau St., New York 38, N. Y.

PATENT Searches, prompt complete \$6.00. Patent office copies of related patents airmailed. For free "Protection Forms" and "Patent Information" write to Anne Hamilton, 711 14th Street N. W., Suite 507, Washington 5, D. C.

PATENT Searches, \$6.00, including official patent office copies of related U. S. patents. Certified, airmailed! For free "Invention Record" and "Patent Information," write: United States Inventors Service Company, 1311 "G" Street NW, Washington 5, D. C.

PROFESSIONAL Patent searches, \$6.00, including official copies of related U.S. patents. Prompt, dependable airmail service! For free "Invention Record Folio" and "Information Every Inventor Should Have," write: Congress Invention Institute, 210 McKim Building, Washington 5, D. C.

INVENTORS: Test the commercial value of your patented or unpatented inventions, quickly and inexpensively. Write for free information. Institute of American Inventors, Dept. 40-B, 635-F St., N.W., Washington 4, D. C.

PATENTS Professionally prepared for maximum commercial value. Patent searches including report \$6. Valuable market service. Cash or royalty sales. 10 years dependable service. For free self-protective Record of Invention forms write: H. Lawrence Blasius, 19 Park Row, New York 38, N. Y.

INVENTORS! Searches of the patent office \$6.00 including airmail report, related copies. Free protection forms, "Patent Information." Washington Patent Office Search Bureau, 1426 G Street, N.W., Washington 5, D. C.

WANT To sell your invention, cash or royalty! Write for information #1212F, Riddle Engineering, 2661 Northwood, Toledo 6, Ohio.

INVENTORS: Expanding toy manufacturer has need for outstanding new toys. Write: Steven Manufacturing Co., 5939 St. Louis Ave., St. Louis 20, Mo.

AMAZING Booklets! Inventors selling and financing guides. Details free. Gallean, 27 School, Boston 8, Massachusetts.

INVENTIONS Wanted immediately for promoting on cash or royalty. Patented, unpatented. Free booklet outlines royalty rates, requirements. Write Kessler Corporation, C-512-FI, Fremont, Ohio.

SAVE High fees! Get patent protection for less than 50¢ Write: "Protection", 4105 Metropolitan, Dallas 10, Texas.

PATENTS Searches, complete and thorough. Related copies airmailed with maximum speed \$6.00. Free "Protection Forms," and "Patent Information." Write: Mercury Patent Office Searchers, Washington Bldg., Suite 422, Washington 5, D. C.

INVENTIONS WANTED

INVENTION Engineers have manufacturers waiting for patented, unpatented inventions. Inventors Creative Service, 354 South Spring, Los Angeles 13, Calif.

INVENTIONS Wanted. Patented: unpatented. Tremendous manufacturers lists. Global Marketing Service, 2420 77th, Oakland 5, California.

CASH Or Royalties for inventions! Consider our offer first before licensing or selling your patented or unpatented invention. Write Aladdin Industries, 80 Wall St., New York 5, N. Y.

INVENTORS: Hundreds of manufacturers have requested our assistance in locating marketable new products. Complete information free. Institute of American Inventors, Dept. 40-D, 635-F St. N.W., Washington 4, D. C.

SELL Your invention for cash. No commissions. Milburn, Burlington, Kentucky.

INVENTORS! Outright cash sale or royalties for your inventions. Patented. Unpatented. Constant demand from our client manufacturers. Write: United States Invention Brokerage, 78 Wall Street, New York 5, N. Y.

INVENTORS! Sell your invention for cash or royalties! Our manufacturers constantly seeking new items. Patented. Unpatented. For free information write Gilbert Adams, Patent Broker, 80 Wall Street, Financial District, New York, N. Y.

INVENTIONS Promoted-for cash-royalty sales with manufacturer contacts. George Spector, Licensed Invention Engineer. Woolworth Building, New York.

IF Your invention, patented, unpatented, is for sale, write for information #1212W, Riddle Engineering, 2661 Northwood, Toledo 6, Ohio.

INVENTIONS Wanted immediately for promoting on cash or royalty. Patented, unpatented. Free booklet outlines royalty rates, requirements. Write Kessler Corporation, C-512-I, Fremont, Ohio.

INVENTORS Needing help with any problem, financial, development, securing manufacturer, obtaining patent. Write the organization that delivers action and results—not promises. Pioneer Invention Service, 150 Broadway, New York 38, N. Y.

INVENTORS! Let us help develop, sell your idea or invention to our client-manufacturers seeking new items for outright sale or royalties. Financial assistance if needed. Write Wall Street Invention Brokerage, 79 Wall Street, Financial District, New York 5, N. Y.

MANUFACTURING

FOR Inventors. Model building. Manufacturing. Research. William Parker, 32 Westminster, Worcester 5, Mass.

MODELS—Small lot manufacturing. Metals, plastics, etc. Milburn, Burlington, Kentucky.

MODELS—SHIPS, TRAINS, PLANES, ETC.

LIONEL Or American Flyer train catalog 25¢. Free discount bulletin. Hobbies, 2609 North, Chicago 47.

ROCKETS: New illustrated catalog 25¢. Single and multistage kits, cones, engines, launchers, trackers, technical information, etc. Fast service. Estes Industries, Penrose 2, Colorado.

SHIP And yacht model fittings; blueprints. Send 40¢ for illustrated catalog listing hundreds of items. A. J. Fisher, Inc., 1002-1 Etowah Ave., Royal Oak, Mich.

"POWER Drives Handbook"—36 pages illustrating many types motor drives for model autos, boats, displays, turntables, etc. Mail 25 cents cash, returnable first order \$3.00 or more. Wilson's of Cleveland, Dept. PM, P.O. Box 8995, Ft. Lauderdale, Fla.

MODEL Hobbyists! Send 10¢ for catalog. Our 70 powered model plane and boat kits, many radio-control operated, also accessories. Sterling-M, 501 Wister, Philadelphia 44, Penna.

SHIP Models. Kits, fittings, plans, books, tools, engines, motors. Big illustrated catalog 50¢. James Bliss & Co., Dept. SM, 342 Atlantic Avenue, Boston 10, Massachusetts.

SHIP Model kits and fittings: clippers, frigates, etc. Catalog paint-tool list, book list, 35¢. Model Shipways, Box 85, Bogota, N. J.

LIONEL Trains. Big discounts bulletin 10¢. Catalog 25¢. Mack-Bros., 2043P, Chicago Ave., Chicago 22.

MODEL Steam engines, ready to run. Catalogue 25¢. Gun Shop, Baker, Oregon.

CARVE Wooden Sea Captain Complete kit \$1.00 postpaid. Scientific Company, Newark 5, N. J.

COMPLETE Line Stationary, marine, Corliss, tractor, locomotive live steam engine castings, prints, tools, accessories for building. Some machined, finished Illustrated, 100 page catalog \$1.00 Cole's Power Models, Ventura, Calif

ALL American, steam engines tractors, boilers, fittings, castings Catalog manual \$1.00. Tiny Power, Junction City Oregon

RADIO Control for model planes, boats and cars. Send 10¢ for 3 issues of out used and closeout equipment, Stanton R/C, Inc., 4734-P Milwaukee Avenue, Chicago 30, Illinois.

PRECISION Needle files 4 1/2"-Swiss Set 6 popular shapes. Excellent for modeler-jeweler, #PM60 \$2.50. Free tool circular Triangle, Box 109, Bayside 61, N. Y.

ROCKETS. Send for our free catalog. Spreen, Tuxedo, New York.

TRAIN Bargains: 25¢ (refunded) brings catalogue over 1200 Lionel, Gilbert, Atlas etc., all gauges. Aurora, Strombecker Scaletrix slot racing. Hobby Surplus, Box 1106, New Britain, Conn.

LIVE Steam engine castings kits. Boilers. Modeler's lathes, low priced, compact, motorized. Photo-packed catalog, 35¢. HPK Models, P.O. Box 34, Centeck Station, Yonkers, New York.

ROCKETS, Powerful multistage Illustrated catalog new items 25¢ Central Rocket Company, Waupaca, Wis.

LIVE Steam powered backyard railroads! All sizes. Complete "bolt-together-kits," and rough castings Excellent drawings. 100 page catalog \$1.00 Little Engines, Lomita, Calif.

HOME CRAFTSMEN

KNOCKDOWN Cedar chests, also over fifty kits. Catalog 25¢. Giles Kendall Co., Huntsville 2, Alabama.

POOL Tables, Build; repair Plans, cushions, cloth, balls, cues, all materials available. Catalog 25¢. Campbell Billiard, 1607 W. Lawn Ave., Milwaukee 9, Wisconsin.

PLANS For pool table with extra two-face top for table tennis and model railroad. Blueprints B1209 and building instructions \$3.50. Popular Mechanics Service Bureau, 740-M Rush St., Chicago 11, Illinois.

GRANDFATHER Clock movements, case plans, kits. Catalog 25¢. Mason-Sullivan, Osterville 7, Mass.

PICTURE Frame moulding, squares and lumber. Kiln dried walnut, cherry, silver maple. Midland Lumber Company, Box 262, Savannah, Mo.

WOODWORKERS. Free information. New uses for drill press, radial arm saw. Gilmore, 1164 N. Utica, Tulsa, Okla.

FREE "Do-It-Yourself" leathercraft catalog. Tandy Leather Company, Box 791-A46, Fort Worth, Texas.

SKIL-CRAFTS New 62-63 catalog. Largest and finest selection of leathercraft, artist, hobbycraft supplies in the world. Free gift with first order. Send 50¢. Refundable with first order. Skil-Crafts, Box 167-P, Joplin, Missouri.

WOODWORKERS—Home workshop catalog 132 pages. Save on fine woods, hardware, power tools, 25¢. Craftsman, 2719 S. Mary, Chicago 8, Ill.

FREE. New catalog. 2447 plans, patterns. World's greatest selection things to do, make. Fun. Profit. Craftplans, 18250-A, Harwood, Homewood, Ill.

101 PATTERNS Of smart gifts, novelties, shelves, action windmills plus "Make Money Jig Sawing." \$1.00. Mastercraft, 125M 7041 Olcott, Chicago 31.

YOU Can have your drills, taps, end mills, saws sharpened by David Myers Box 43, Northfield, Ohio.

PATTERNS For home improvements. 1500 projects. Catalog, supply booklet 35¢. Walters Hobby Shop, 207-PM French, Utica 4, New York

VENEERS. 1/28" Thick Send \$1.75 for two square feet each of cherry, mahogany, maple, oak and walnut. Catalog of wood-working supplies 10¢. Barap Specialties, P. O. Box 2044, Dept. P-12, Chicago 9.

SAVE: Raw picture frame moulding, all species, all styles. We will miter corners. Bauerle Cabinet Works, Inc., Hammond, Louisiana.

CRYST-L-CRAZE Paint for beautiful amazing crystallizing effects. Sample 10¢. Metal tooling catalog 10¢. Groundmaster, Boulder, Colorado.

DO IT YOURSELF

COCONUTS With the husks on. These giant nuts can easily be made into beautiful lamp bases, ashtrays, candy dishes and novelties. Make unusual gifts for everyone. \$2.00 each, 3 for \$5.00, postpaid. "Coconuts Hawaii," Honolulu.

BROKEN Cords? 50 ft. drapery rod cord replacement kit, tension pulley. \$2.00 postpaid. Lockmiller, 14707 84th N. E., Bothell, Wash.

RESILVER Mirrors; plate. Literature catalog 25¢. Mirrocraft, 18518 Winthrop, Detroit 35.

BUILD Your own tractor plans. Free information. Eltraco, Dept. A, Camptonville, Calif.

INSTANT Laminating; photos, cards. Self-adhesive plastic. Sample, details. Hughes Company, PM, Middletown, Conn.

OPERATE Own investigation agency. Make extra cash. Satellites, Box 172PM, Manhattanville Station, New York 27, N. Y.

200 PERSONALIZED Gold Initials. Self-adhesive. \$1. Best Values Co., Webster, Mass.

BE Prepared. Revolutionary do-it-yourself plumber Preon gas spinning action. Released automatically. Frees drains & toilets in 5 seconds. Gun with one cartridge \$8.50, cash with order. 10 day trial. Raydon Distributors, 333 N. Pennsylvania Street, Suite 501, Indianapolis, Indiana.

FREE Check-list covering more than 500 classifications of projects, plans, instructions, service and repair information detailed in Popular Mechanics famous series of instructional booklets, books, patterns, and blueprints. List covers an extremely wide variety of do-it-yourself data on home remodeling, repair and improvement, hobbies, crafts, boating, games, lawn and garden, and hundreds of others. For your free copy of this helpful list, write: Service Bureau, Popular Mechanics, 575 Lexington Ave., New York 22, New York.

EXERCISE At home on build-it-yourself physical fitness equipment, including bicycle exerciser, rowing machine, belt massager, and abdominal board. Send \$2.50 for blueprints B1208 and instructions. Popular Mechanics Service Bureau, 740-K Rush St., Chicago 11, Illinois.

OF INTEREST TO WOMEN

EARN To \$100 weekly. It's fun to create and sell decorative jewelry. No experience, no tools needed. Hundreds of styles and stones. Rush 50¢ for catalog and beautiful sample. Dept. 8, Richard Downes, 11 West 30th St., New York 1, N. Y.

WOMEN! Make big money at home. \$10.00 profit in an hour possible with invisible mending. Make holes, tears disappear from clothing, fabrics. Steady year-round demand from cleaners, laundries, homes. Details free. Fabricon, 1533 Howard, Chicago 26, Illinois.

FROM Darkest Africa. Elephant hair bracelet \$4.00. Fertility fetish necklace \$3.00. Native drum \$5.00. Airmail. Tom, 676, Kenya, Africa.

WORK At home packaging merchandise. Very profitable. No selling. Everything supplied. Details free. HBE, 1148 W. Grand, Chicago 22.

HOUSEWIVES, Teachers, students, office workers. If you need extra cash each week but household or other duties prevent you from taking a part-time job, learn how you can earn by accepting orders to Popular Mechanics, Good Housekeeping and all other magazines. No experience needed. Write Popular Mechanics, Room 12W, 250 West 55th St., New York 19, New York.

WATCHES, OLD GOLD, JEWELRY

WATCH And clock repairing books. Free catalog. North American, 2320-AZ Milwaukee, Chicago 47, Illinois.

BANKRUPTCY Sale. \$2.50 gold, \$1.50 Silver expansion watch bands. Bargain price \$1.00 for both. Also diamonds. Watchbands, 7 South Springfield, Chicago 24.

FREE Giant jewelry and gift catalog in full color. Now you can buy the finest nationally advertised brands at wholesale prices. Each item fully described and illustrated. Parker Distributors, 3516 White Plains Road, Bronx 67, N. Y.

WANTED, Gold, silver, platinum, scrap (any form), coins. Information free. Wilmot's, 1067 Brige St., Grand Rapids 4, Michigan.

PERSONAL

BIBLE Questions answered free. Bible Research, 1819 La Posada, National City, Calif.

"LISTEN-In-Coil" picks up any telephone conversation in vicinity. No connection to telephone necessary. Easily concealed. \$2.98 complete. Acoustical Research, 512-Q East 80, NYC 21.

BIBLE Questions answered. Stamped envelope. Bylon, 17167 Bentler, Detroit 19, Michigan.

LOANS By mail. \$100-\$600. Anywhere. Confidential. Write Union Finance, Dept. PM. 323 E. Camelback, Phoenix, Arizona.

DEVELOP Mind power, personality while asleep. Details free. Research Association, Box 24-N, Olympia, Washington.

NEW! Borrow \$1000. Anywhere. Increased loan limit. Air mail service. Postal Finance, 374 New Brotherhood Building, Dept. 17-D, Kansas City, Kans.

INVESTIGATORS, Free brochure, latest miniature electronic listening devices. 11500-P NW 7th Ave., Miami 50, Florida.

LOANS By Air Mail, \$100-\$600. Anywhere. Confidential. Easy payments. Write Security Finance Co., 898 Van Ness Ave., Dept. PM, San Francisco 9, Calif.

NEED Money? Borrow \$100-\$1000 by mail. Confidential, repay in 24 months. No endorsers; necessary. Free loan application. American Loan Plan, Dept. TA-252, City National Bldg., Omaha 2, Nebr.

HANDWRITING Analyzed \$2.00. Complete personality sketch. Send 50 words and birthday. M. Fisk, 1001 S. Pickwick, Springfield, Missouri.

BORROW \$100 to \$1000 by mail. Quick, easy, private. No co-signers. Repay in 24 small monthly payments. For the amount you want write today to Dial Finance Co., 410 Kilpatrick Bldg., Dept. N-1, Omaha 2, Nebraska.

"LISTEN-In-Coil" picks up any telephone conversation in vicinity. No connection to telephone necessary. Easily concealed. \$2.98 complete. Acoustical Research, V512 East 80, NYC 21.

TREASURE FINDERS

FUN And profit finding buried treasure, relics with Transistor M-Scope. Booklet, interesting customer comments free. Terms. Fisher Research, Dept. AX, Palo Alto, Calif.

DISCOVER Gold, silver, platinum. Small inexpensively built dry process separator. Perfect for weekend prospecting or small mining operation. Complete plans and instructions \$2.00. Southwestern Mining, Box 6091-B, Dallas 22, Texas.

TREASURE. Find gold, silver, relics with super, powerful, Detectron locators. Free information. Detectron, Dept. PM-12, San Gabriel, California.

NEW, Precision, printed circuit board, assembly instructions, diagrams, and parts list help you build four transistor metal locator with range up to three feet. Easy and inexpensive to build. Complete set \$9.95. Dalco, P.O. Box 12242, Dallas 25, Texas.

NEW Coin locator! Free literature. Howe, 811-C Kansas, Atchison, Kansas.

EXPLORE Underground, years ahead transistor locators detect gold, silver, coins, relics. Information free. Curt Fisher, Dept. A, Box 793, Menlo Park, Calif.

GOLD Silver indicators. Pamphlet free. Geo. Simpson, 18788 Cajon Blvd., San Bernardino, Calif.

METAL Locator kits and assembled models from \$39.90. Terms. Transistorized and underwater models available. Free catalog. Electronic Applications, Dept. M, Box 8, Arlington 10, Virginia.

GOLD, Silver, coins, Civil War relics, treasures. Choice 5 locators. Established 1933. Free literature. Write The Goldak Company, 1541 W. Glenoaks Blvd., Glendale 1, California.

REMAILING SERVICE

HAWAII Secret address. Receiving, forwarding 25¢, \$3.00 monthly. Postcards. Coe, 44-143 Bayview Haven, Kaneohe, Hawaii.

HOLLYWOOD Remails 25¢. Tole House, Box 2521X, Hollywood 28, California.

REMAILING, Forwarding, permanent address. Other services. Everett, 1613 Bradley, High Point, N. C.

CONFIDENTIAL Forwarding, receiving address. Remails 25¢. Box 1890-P, Long Beach, California.

CONFIDENTIAL Southern remailings. 25¢ each, \$3 monthly. Packages 50¢. Dixie, Box 9781-M, Atlanta 19, Georgia.

CONFIDENTIAL Remailing 25¢. \$3 monthly. SCC, Box 891, Albany 7, New York.

CONFIDENTIAL New York City mailing, receiving, forwarding address. Business personal mail \$3.00 month. Remails 25¢. Details free. Birnhan, 152 West 42, New York City 36.

NATION-Wide remails, \$3.00. United Remailing Service, Box 53, Wilmington, California.

CONFIDENTIAL Mail address. Letters, cards, remailed 25¢ each or \$3.00 month. Remailing from foreign capitals arranged. Details stamp. West, 2617-PA Armacost, Los Angeles 64, California.

SECRET-Confidential. 25¢, \$3.00 monthly. Also Europe, Far-East. Ben-Sun, Meeting Street, Wayzata, Minnesota.

SECRET-Permanent address. Nationwide service. Remails 25¢. Remailers, A14 Farr Road, Columbus 3, Georgia.

UNIVERSITY Of Wisconsin remails 25¢ or \$3.00 monthly. Box 652, Madison, Wis.

CONFIDENTIAL Texas remailing, 25¢, monthly \$3.00. Holben, Box 5054, Ft. Worth 8, Texas.

MAIL Received-forwarded. \$3 month. Hedgpath, Box 830, Alhambra 23, Calif.

SPECIAL Service remails, 25¢ single, \$3.00 monthly, confidential, receiving-forwarding system. Free literature. Write Kenneth Fischer, Box 1207, Newark 1, New Jersey.

REMAILS 25¢. \$2.00 monthly. Confidential. Box 10651, Riviera Beach, Florida.

LOS Angeles, Hollywood, San Fernando Valley 25¢ single, \$3.00 monthly. Confidential. 10437-P Lanark, Sun Valley 3, Calif.

RAZORS, BLADES, SHARPENING

300 GUARANTEED Best, double-edge blades, \$7.00. Lifetime opportunity offered. Deck, Box 331, Fremont, Ohio.

100 DON Juan double-edge razor blades \$1.00. Guaranteed. Wholesale for \$2.00. Don PM, Box 233, Smith Center, Kansas.

WANTED—MISCELLANEOUS

STAMP Collections, accumulations. Eagle Stamp Co., 2221 Romine, Pittsburgh 26, Penna.

QUICKSILVER. Platinum, silver, gold. Ores analyzed. Wholesale Terminal, Norwood, Mass.

CANCELLED Stamps wanted. Also collections and coins. Send stamp for details. Dryz, 3015-21st Ave. S., St. Petersburg 12, Fla.

FOR SALE—MISCELLANEOUS

REAL Sea creature from Orient incased plastic on keychain 50¢. South Seas, Box 3206, Harrisburg, Penna.

FIFTY U.S. made double-edge razor blades for \$1.00. Satisfaction guaranteed. Write for sample. Earcel Warth, 401 Washington, El Segundo, Calif.

VENETIAN Blind tapes. All sizes. Marrier Bros., 132 Hayward, Burlington, Vt.

XMAS Gifts. Religious combination pen-letter-opener, 4 color. Christ picture one side, other God Bless Our Home, \$1.00. Western Associates, Box 1155, Twin Falls, Idaho.

HEARING Aid batteries wholesale. Free list. Habs, Box 51, York, Penna.

MISCELLANEOUS

EARN Money raising fishworms for us! Write: Oakhaven—60, Cedar Hill, Texas.

CIGARETTES—Make 20 plain or filter-tip for 9¢. Facts free. Moberly, Box 785, Owensboro, Kentucky.

SEND Us wool for blankets. Write Eldorado Woolens, Eldorado, Texas.

WANT Your name with 1000 mailers? 25¢ lists your name year with our mailings every month. Dixie Mailers, King, N. C.

BOOKS On antiques and their prices. Free circular! P. Warman Publishers, Uniontown, Penna.

SUPER Memory overnight! Success guaranteed! Bijou, Box 1727-M, Hollywood 28, California.

AT Last! Hearing aids only \$28.95. Free trial, terms. Write Cary-B Sales, Inverness, Fla. Salesmen wanted.

"STAMMER, Stutter, No More." (Dr. Young.) Write: Gaucho, Box 9309-S7, Chicago 90.

FREE Wholesale catalog! 100,000 products... Tremendous discounts! Taylor Distributors, Newton 2, New Jersey.

RECEIVE Worldwide mails. Lifetime 25¢. Bagby, Box 144-E, Coos Bay, Oregon.

AUSTRALIAN Novelties from kangaroo skin, cuddly Koala bears, lambswool rugs, boomerangs. Samples and catalogue \$3.00. U.S. manufacturers represented in Australia. Details to Pendle Products, P.O. Pendle Hill South, Sydney, N.S.W.

CESSPOLS, Septic tanks restored to newness by miracle crystal pellets. Free literature. Electric Sewer Cleaning Co., Allston 34, Mass.

SPARKLING Figurines, shellcraft for consignment. Samples 50¢ refundable. Shopper's Delight, Garden Plain, Kansas.

NEW Method for mending eliminates re-weaving holes in slip covers, clothes, rugs. Simple to operate. Invisible. Results guaranteed. Free samples. Mend Master, 4408 Sillman Place, Dayton 40, Ohio, Dept. 14.

"ROOT Beer" instructions, others. Free catalog. CalBrew Supplies, Box 1005-A23, Seaside, California.

ARTIFICIAL Eyes (human). Expert selection sent. Write for free booklet. Established 1906. Denver Optic, 1101 University Bldg., Denver 2, Colorado.

CUCKOO Clocks. Free catalog. Simmons Bros., 10575 Robinson, Arlington, California.

53% OFF! Masterpieces of Greek art! Authentic museum reproductions. Beautiful ancient pottery, sculpture, unique handcraft treasures, direct from Athens. Two-color catalog 25¢. Aladdin Imports, Box 12-P, Ipswich, Mass.

V-BELT Variable transmission 1:4 to 4:1 Go-carts, tote-goats, motor-bikes, power tools. Plans and instructions \$1.00. Thomas Transmission Co., Box 1131M, Marysville, California.

REPRODUCTIONS 8½ x 11; Photocopies: 30¢ each; 100 Ditto: \$2.50; 250 Mimeo: \$3.50; 500 Offset: \$6.00; Typing: 75¢ per page. MTL Services, Box 947, Chicago 90, Ill.

REMEMBER All dates for office, home, business. Extremely simple plan, absolutely never fails. \$1.00. Orr, 461 Greenwood Ave., Akron, Ohio.

FIRE Warning system. Sounds central alarm continuously when temperature at any of five household locations reaches 140°F. Complete system ready to plug in. Reusable. Easily checked. \$49.50. Denker Research Co., 10523 White Oak Ave., Granada Hills, Calif.

BIRTH Certificates, marriage certificates, high school diplomas (blank forms) \$2.00 each. McGrath, Box 314-P, Brooklyn 17, N. Y.

RECEIVE Mails, magazines, samples. Your name in numerous mailing lists 25¢. Greenwood, Box 1116-KE, New York City 8.

1,000's SOLD. New kitchen gadget. Prevents cracking, leaking eggs when boiling. \$1.00. Egg-Puncher, P.O. Box #533-PM, Ossining, N. Y.

YOUR Name or Secret Club name in Chinese. Copy on books, jackets, etc. or frame. Sent to you from Singapore. \$1.00. 246 Woodcrest, Kenmore 23, N. Y.

CALENDAR Girl playing cards \$2.00. Samples 25¢. Evergreen Printing, Box 854, Chicago 42.

KEEP Your mail box loaded. Get listed 25¢. Frankland Enterprises, P.O. Box 112, Chicago 17, Ill.

HUMOROUS Caricature of Pres. J. F. Kennedy. Mail \$5.00 today. In black-and-white, suitable for framing, 11x14. Free caricature of first lady. Mail \$5.00 to: Cecil E. Lowen Studio, Dept. JJ, P.O. Box 138, Brooklyn 16, N. Y.

SWEEPSTAKES Winners information on sweepstakes contests. Block letters illustrated. Send \$1.00. Mr. Singleton, Box 331, Athens, Georgia.

BUY One square foot of land in Texas, Oklahoma, New Mexico, Colorado, Nevada, Brazil, Canada. \$1.00 each. Notarized deed (undivided interest in approximately 2½ acres) made out to you or any name you choose and mailed ready to frame. Ideal gift for the "one who has everything." Universal Land Company, Box 5605-A, Denver, Colo.

FREE! Exciting new catalog—Western wear, saddles, riding accessories. Western Saddlery, Box 1864-V6, Fort Worth, Tex.

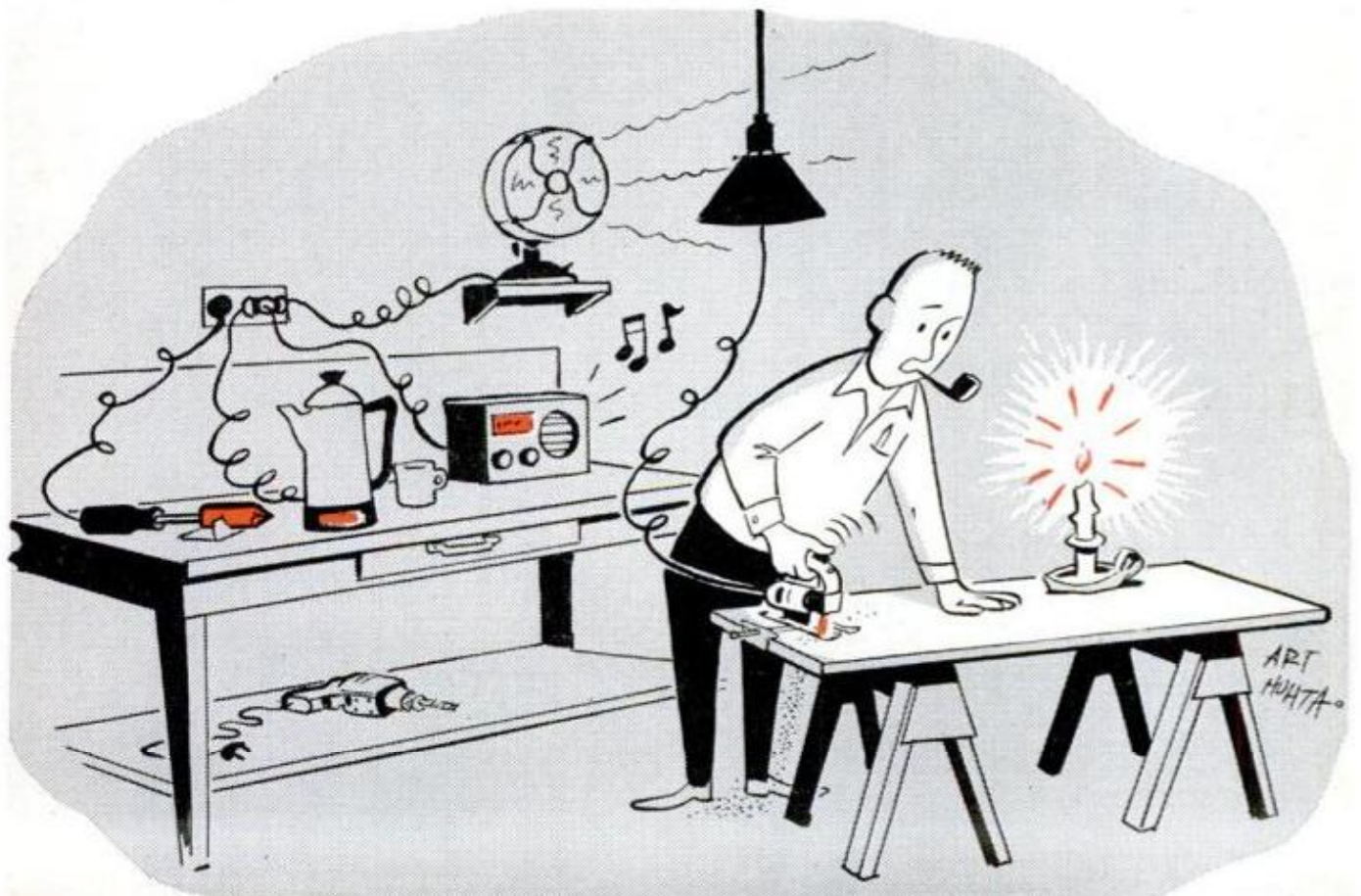

FREE BOOK Tells How You Can Prepare For Good Job or Business of Your Own in **AIR CONDITIONING** HEATING and REFRIGERATION

Allied will train you to install, repair, service air conditioning, heating, refrigeration equipment in homes, offices, factories. Allied's National Industrial Co-Op Placement Service will assist you in any section of the U.S.A. You can study at home and get additional training at Allied Institute at no extra cost. Mail coupon today.

ALLIED INSTITUTE OF TECHNOLOGY
1338-42 South Michigan Avenue, Dept. PM-122, Chicago 5, Illinois
Send me free book describing Allied's combined Resident and Home Study training program, also *Opportunities in Air Conditioning, Heating and Refrigeration.*

Name..... Age.....
Address.....
City..... County..... State.....

6-IN-1 ONLY MACHINE OF ITS KIND! **UNIMAT**

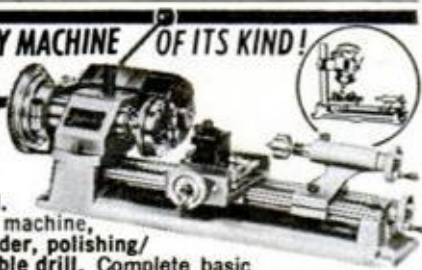

Compact workshop for all metal, plastic, wood. Precision lathe, milling machine, drill press, surface grinder, polishing/grinding machine, portable drill. Complete basic unit, \$139.50 **WRITE FOR FREE CATALOG.**
AMERICAN EDELSTAAL, INC., DEPT. GM-350 BROADWAY, N.Y. 13, N.Y.

WHAT'S YOUR DO-IT-YOURSELF PROBLEM? Free Service File lists, by subject, all projects in Popular Mechanics books, booklets, plans and patterns. Write Service Bureau, Popular Mechanics, 740 Rush St., Chicago 11, Ill.



**MAKE
\$20 to \$30
A WEEK
EXTRA
MONEY**

Here's a practical way to increase your income and build security for your family. Earn extra money every week sharpening saws with a Foley Automatic Saw Filer. You can actually build your own business with it—without special training or previous experience.

TURN YOUR SPARE TIME INTO CASH. Make from \$3 to \$6 an hour evenings, week-ends. Start in your basement or garage. No canvassing. "I advertised in our local paper and got in 83 saws"—says M. L. Thompson. Every saw you sharpen with the Foley Filer brings you more customers. Hundreds are making extra money this sure, fast, easy way. You can too.

"Money Making Facts" explains how you can get business from home owners, farmers, carpenters, schools, factories, etc., how to build your business and expand—every step of the easy way. Don't wait. Mail coupon now for this exciting book and easy pay plan. No salesman will call.

**FREE
BOOK
SHOWS
YOU HOW
TO START**

MAIL COUPON FOR FREE BOOK

FOLEY MANUFACTURING CO.
1216-2 Foley Bldg., Minneapolis 18, Minn.
Rush free book, "MONEY MAKING FACTS", and details on easy pay plan.

Name.....
Address.....
City..... State.....



Uncolored View

Sunglasses with eye-shaped slits in them enable the wearer to view objects directly while his eyes are protected from reflected glare by tinted lenses. Made by Magnus Oceanic Corp., Washington Valley Rd., Morristown, N. J., the price is \$4.95.

Make your gutters ice-free this winter! Stop those ice dams before they form, by installing electric heating cables that will prevent water from backing under the shingles and damaging plaster. Simple step-by-step procedures in January PM. Don't miss it.

RETARDED CHILDREN CAN BE HELPED



**SUPPORT YOUR LOCAL ASSOCIATION
FOR RETARDED CHILDREN**

Sworn statement from CHAS. LEMMING reads:

**"After starting
my own business**

Not everyone does as well...
Mr. Lemming owns two machines

**I'VE
AVERAGED**

\$100 A DAY
—most of it clear profit!"



• In city of less than 50,000, Mr. Lemming started his own business after filling in coupon like one below. He averaged \$100 a day during first year, some days \$200. F. E. Doran grossed \$1050 in a single month. Geo. Held grossed \$300 in one week.

How much you earn depends largely on you. You need no special skill, no large investment. Start spare time until full time justified. Hire helpers as needed.

NO SHOP NECESSARY • You clean upholstered furniture with efficient **PORTABLE ELECTRIC DETERGER** on customers' premises—homes, hotels, motels, etc. Auto upholstery, too. No hauling; operate from your home. Watch business grow as customers tell friends. Supplies cost little; what you take in is mostly profit. If you want to be independent—free from layoffs, bosses—start this profitable year-'round business of your own. We will help you to start and work with you for your success.

OURS IS NOT A LEASE ARRANGEMENT • You are free to operate in an independent manner. You sign no contract. You own the detergent outright and are always your own boss... and every dollar you take in is yours to keep. You pay no fees, or dues, or royalties to anyone. And you take no risk. Your detergent is fully guaranteed and enough supplies come with it to return far more than your investment. Many earn the cost of the detergent in a week or two. It costs nothing to get the details... write **TODAY**.

**MAIL COUPON TODAY
FOR FREE BOOK**

VON SCHRADER MFG. CO.
W10 "D" Pl., Racine, Wis.

Without obligation rush your **FREE** booklet about how I can start my own permanent, profitable electric Upholstery Cleaning business.

Name _____

Address _____

City _____ Zone _____ State _____

COMPLETE ADDRESSES of manufacturers, inventors, and sources of information for items mentioned in the editorial pages of this issue are listed in the free **WHERE-TO-FIND-IT** list. Send self-addressed, stamped envelope to

SERVICE BUREAU
740 Rush St., Chicago 11, Illinois

**FREE GIANT NEW 1963
CATALOG**



BURSTEIN-APPLEBEE CO.

Dept. PM, 1012 McGee St., Kansas City 6, Mo.

SEND FOR IT TODAY

Rush me **FREE** 1963 B-A Catalog.

Name _____

Address _____

City _____ State _____

FREE

CARBORUNDUM **STANLEY** **SKIL** **DUPONT** **WEN**
MILLERS FALLS TOOLS **Crestliner** **Speedgrinder**

**DISCOUNTS to
40% BY MAIL
NEW CATALOG READY!**

More than 1000 famous U.S. products for home workshop, garden, boat... plus paint and painting supplies—all at great savings—in our new, expanded catalog! 80 fully illustrated pages. Each item guaranteed. Send only 25¢ for your copy.

GATES GENERAL CORPORATION
P.O. BOX 355PM FARMINGTON, CONNECTICUT



By Jim Whipple



Why Detroit Hasn't Gone All Out for Aluminum Engines. Hot Research Project: "Glued" Auto Bodies

As the hoopla of new car announcement time dies down, we can begin to take stock of the 1963 model year. Sometimes the features that are not added to the new models make bigger and better stories than the new items that are shouted about.

Take for example, the aluminum engines. They're still around, but nobody's pushing 'em as they were two years ago when five cars, **Buick Special**, **Olds F-85**, **Tempest**, **Valiant**, **Lancer** and **Rambler**, first offered aluminum V8's or sixes.

All this activity looked like the forerunner of a landslide, but it wasn't. There were foundry problems with GM's sand-cast aluminum V8 (**Special**, **F-85**) which were solved by all-out effort. The biggest problem, however, was non-technical; people simply haven't cared whether or not their cars' engines were aluminum or cast iron as long as the particular engine delivered performance and economy.

This meant that the extra cost of aluminum engine blocks couldn't be passed on to car buyers. **Pontiac's Tempest** is a case in point. For two years, the aluminum V8 engine was optioned at \$216 dollars extra. It went on less than 2% of all **Tempests**.

Reason for the extra cost is twofold. Aluminum itself is a more expensive metal and it requires cast-iron liners or sleeves inside the cylinder bores. These liners provide needed wear resistance that aluminum lacks. However, cast aluminum can take the heat and scuffing dished out by the flying pistons if it is hardened by addition of alloys, or chrome plated.

But because the alloys must be added to the entire melt of aluminum used in the casting even though it is needed only for the lining of the cylinder bores, the costs here are prohibitively high.

Most engineers agree that if there were a low-cost method of toughening up the cylinder bores, the die-cast aluminum engine would be low enough in cost to compete with the iron engine. The great plusses of aluminum that the engineers are eager for are of course, the savings in weight, which can be passed on to the consumer in the form of better handling due to lighter front ends, as well as fuel economy, better per-

formance, and last but not least, production cost cuts resulting from die-casting.

A breakthrough in the coating of aluminum cylinder bores may come in the not-too-distant future through the use of ceramic compounds which have proven to have satisfactory heat and wear resistance. When this ceramic lining process becomes a practical reality, the aluminum engine could make a real showing.

Joining of body parts is another area where automakers are searching for a technical breakthrough. There have been rumors recently about use of adhesives instead of spot welds to join sheet metal stampings into completed bodies.

Potential advantages of adhesive-bonded bodies stagger the imagination—particularly the imaginations of Detroit's cost-conscious engineers. Instead of expensive welding guns using tremendous amounts of electric power, a quick application by roller of an adhesive would do the joining job.

Also, adhesives would permit fastening of stampings in "blind" areas not accessible to welding guns. Today, body parts must be designed with flanges or "hems" of exposed steel to permit the "stitching" by spot welding guns. Elimination of these "hems" will permit more compact, lighter and stronger bodies.

If you've ever worked with epoxy resins in fiberglass reinforced plastics, you'll have an idea of how strong a bond is possible. Greater strength would result as a continuous bonded seam offers much greater contact than the weld spots. Of particular interest to car owners are the advantages of adhesives as a better means of replacing damaged panels in the field.

However, there's a major problem holding up the "glued" auto body. Chrysler Corporation's Cyclebond Division has found that a proper bond requires so smooth a mating of surfaces that the clearance for adhesive be no greater than .0020 inch. When the layer of adhesive becomes thicker than .0020, Cyclebond has found, the bond fails. Accuracy of body stampings is at the moment not in the area of .0020 inch, so the search for a more tolerant adhesive continues.



It pays to keep your Chevy the Chevy-est

WITH GENUINE GM CHEVROLET REPLACEMENT PARTS

You should care what parts go into your Chevrolet, because your Chevy does! Take Chevrolet truck drivers, for example. Dependability is what they're after. That's why they're particular about the parts that go into their Chevies. They know that Chevrolet cars and trucks last and last when carefully maintained with *genuine Chevrolet replacement parts* that are engineered and built especially for Chevrolets. By being equally particular about the brand of parts that go into your Chevy, you'll be protecting your car investment with the finest care possible. Genuine Chevrolet parts are available at all Chevrolet dealers and leading independent garages and service stations. . . . Chevrolet Division of General Motors, Detroit 2, Michigan.



LOOK FOR THIS SIGN

MULTI-SPEED SABRE SAW

THERE'S HARDLY A MATERIAL you can't cut with Sears' new Craftsman sabre saw. You just dial the appropriate speed and a silicon controlled rectifier (SCR) gives full power at any load, by means of a feedback signal. At high speed, you get standard 2700 one-inch strokes per minute—for ripping or cross-cutting lumber up to 4 in. thick. Medium speed (1900 SPM) is for non-ferrous metals—aluminum chips



won't melt to clog the teeth. Low (1000 SPM) lets you tackle sheet steel, bar stock and low-temperature plastics. These have previously been hand-cutting chores, since high-speed blades burn upon steel, and fuse their cuts in plastic.

The seven-pound tool sells for \$49.95, with seven different blades, including a hollow-ground one for chip-free sawing of veneers and laminates, plus a circle-cutting and edge-guide attachment. There's an extra accessory that shifts the blade to the side of the base for flush-to-wall trimming.

The vibration-reducing gear drive is shown in the cutaway at right. The saw's not for DC; when an SCR is added to a universal motor, as here, the motor will operate on alternating current only.

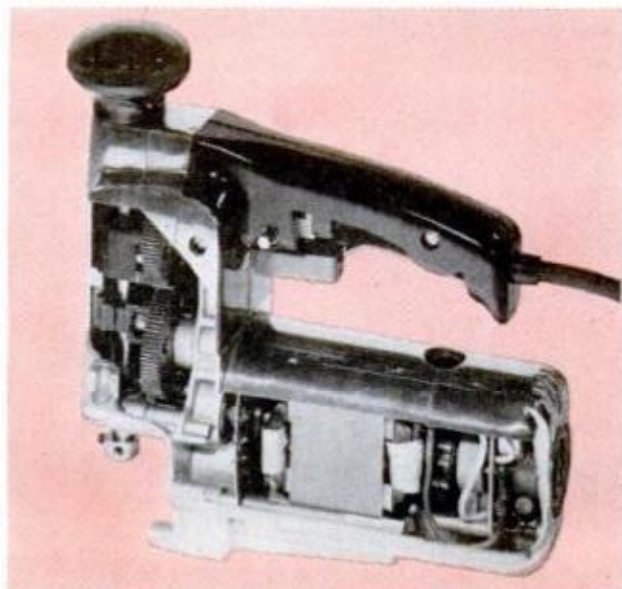

The NEW ROTATING Drill Holder

SPIN-A-BIT

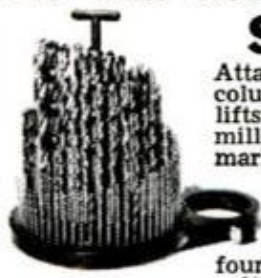

Attaches to standard drill press column, wall or bench. Portable—lifts off bracket for use on bench, mill, lathe, etc. Sizes plainly marked. Saves time and losses in misplaced bits. Hold your Number drills 1 to 60; Letter drills A to Z; Fract. Drills 1/16 to 1/2 in sixty fourths; Center drills 1/8"—3/16"—1/4"—total 118.

Precision formed from high impact styrene.

SHIPPED PREPAID \$9.00

"In Cal. add 4% tax."

Satisfaction guaranteed or money refunded.

Manufactured and sold by:

CARDONA CO. 6867 FARMDALE AVE.
N. HOLLYWOOD, CALIF.

\$29.95
Full Price

SPORTS-KART

LESS ENGINE



FEATURES INCLUDE
• All welded tubular chassis • Upholstered seat and back • Foot brake pedal • Welded motor mount • 10" puncture proof wheels • Bright baked enamel finish • Complete—ready to run • Full price \$29.95 less engine

SPORTS-KART Also available with engine and automatic clutch. Full price—complete... **\$79.95**
Send check or money order or \$10.00 deposit—Balance C.O.D. to—

SPORTSMOBILE CORP., 905 N. BROAD STREET, PHILA. 23, PA.



"A new insect-killing device will be manufactured as soon as they get the bugs out of it!"

MAIL ORDER RECORD BOOK

30 pages. Records inquiries, orders, advertising expense, etc. Most complete. Just send dime for postage and handling.

F. W. JOHNSON, 740 Rush St., Chicago 11, Illinois

BUY WHOLESALE

FREE NAME BRANDS CATALOG WITH CONFIDENTIAL PRICE LIST

Your own high profit business full or part time. More than 2000 items: power tools, sporting goods, jewelry, cameras, hi-fi, appliances, housewares, hardware, almost everything! Orders shipped same day. Send for your Free catalog today.

H.B. DAVIS CORP. Dept. PMD

145 West 15th Street, New York 11, N.Y.



GUNK® removes grease

-- scourfully!

cleans -- degreases -- freshens



- power mowers • engines
- cement floors • kitchen walls • ovens • exhaust ducts
- paint brushes • furnace filters • barbecue grills
- implements • machinery

AT AUTO SUPPLY, FARM & HARDWARE STORES!

GUNK CHICAGO CO., River Forest, Illinois
serving the Midwest and Southwest
RADIATOR SPECIALTY CO., Charlotte, N.C.
serving the East, Southeast and far West

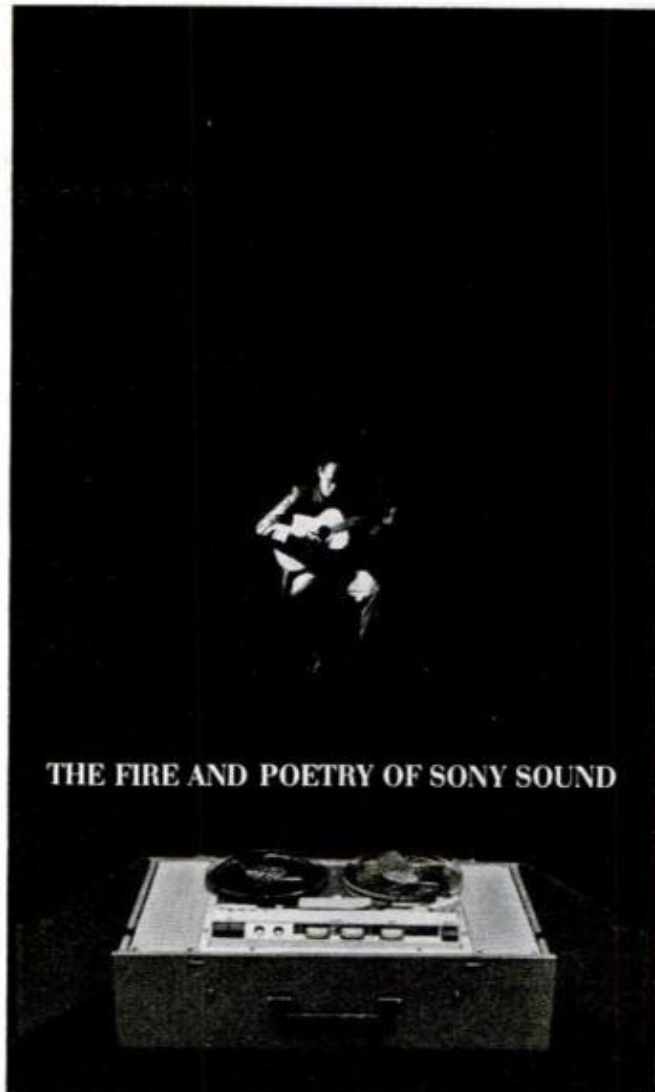

THE FIRE AND POETRY OF SONY SOUND

NEW SONY STERECORDER 464 CS: A COMPLETE, PORTABLE STEREO RECORDER AT A REMARKABLY LOW PRICE

Another Sony triumph in tape recorder engineering, the new Sony 464 CS Stereorecorder records and plays back stereo tapes with the professional purity of studio recording. Whether it's the delicate tone of a Stradivarius, the fire and poetry of Flamenco, the resounding blare of seventy-six trombones, or the full magnificence of a London Symphony—all the richness of stereo sound—yours to command for only \$299.50. All Sony Stereorecorders are Multiplex Ready!

The new Sony 464 CS is a completely self-contained stereo system with two microphones, two extended range stereo speakers and such additional features as sound-on-sound recording, push button channel selection, dual recording indicators, automatic tape lifters, digital counter, pause control and FM stereo recording inputs. Also available, model 464-D for custom installation, (464 CS less case, speakers and microphones) \$199.50. ■ Sony, the world's most respected name in quality tape recording equipment, manufactures a complete line of monophonic and stereophonic recorders, priced from \$79.50 to \$595.00. ■ Sold only at Superscope franchised dealers, the better stores everywhere.

For literature or name of nearest dealer, write Superscope, Inc., Dept. 9 Sun Valley, California

SUPERSCOPE

The Tapeway to Stereo

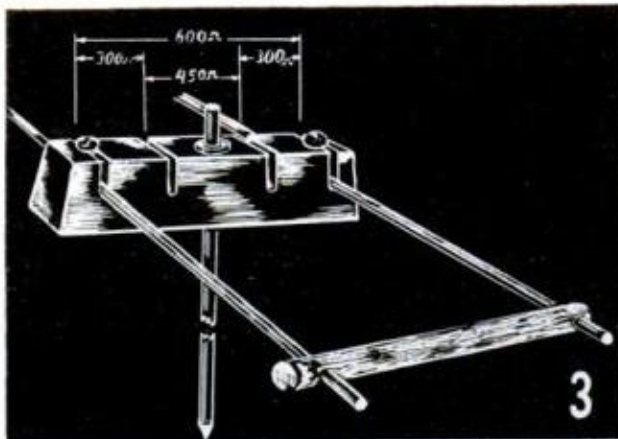
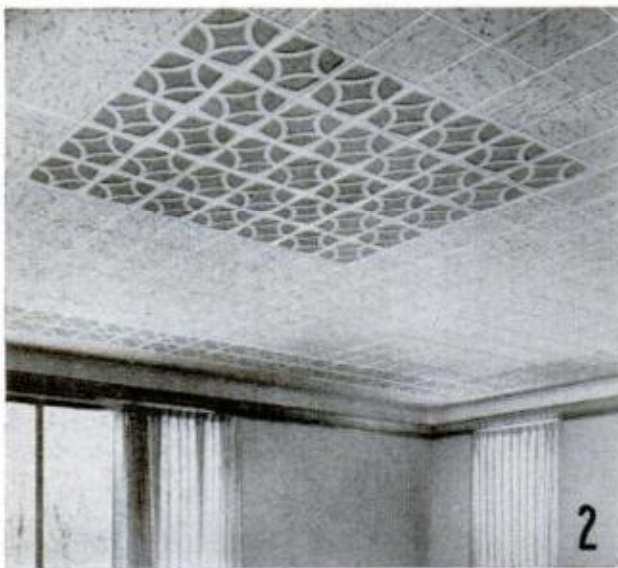

On the market

1. PLASTIC-COATED galvanized fencing in snow white or lawn green adds beauty and charm to yard areas while providing safety for youngsters and pets. Erected with ordinary tools, it is available in 50-ft. rolls, 36 or 38 in. high with 2 x 2½-in. mesh spacing. Can be rolled for winter storage without flaking or chipping the plastic coating. Tot-And-Lot fencing by Northwestern Steel & Wire Co., Sterling Ill.

2. SCULPTURED CEILING of wood-fiber tiling offers custom beauty coupled with sound-muffling benefits. The textured tiles can be painted over in later years without spoiling the pattern or acoustical qualities. Available in several distinctive patterns, the tiles can be readily installed by using the manufacturer's Clip-Strips, nails and a hammer. Produced by National Gypsum Co., Buffalo 2, N. Y.

3. OPEN-LINE TRANSMISSION wire installations can be improved with Tappee Standoff Insulators. Holds #12 to #18-ga. wire for 300, 450 and 600-ohm installations. Setscrews permit free movement of wire in the slots, lessening danger of line breaks due to movement caused by wind. Block is polystyrene with hardware of double-dip steel. Available from Saxton Products, Inc., 4320 Park Ave., Bronx 57, New York

4. PLASTIC FORMS for casting Hacienda imitation quarried stone are now available in corner shapes, as well as multiple-size straight stones. No form coating is required, the masonry mixture is simply poured into the forms and left for 24 hours before removal. Rinsing the forms with water cleans them for the next job. Stone may be painted in colors. Forms, Inc., 554 West Adams Street, Chicago 6, Ill.

5. AUTOMATIC INTERIOR DOOR CLOSER is made of high-tenacity Nylon plastic in ivory or walnut coloring. Only six screws are required for installation and no oiling or other maintenance is necessary. Closing speed is adjustable and the door may be kept open by pushing a button that disconnects the two lever arms. Price is \$7.95 from Columbia International Corp., 10-35 44th Drive, Long Island City 1, N. Y.

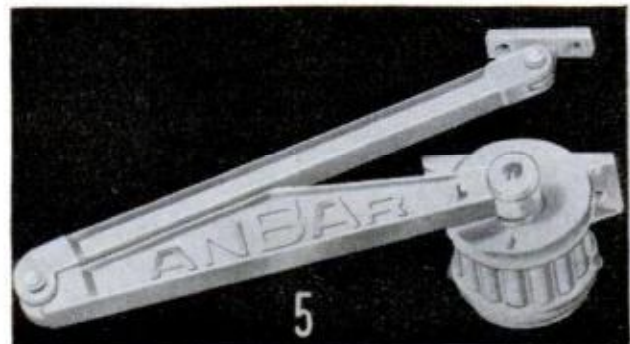

Look what you get—for less than any popular conventional panel!



LOW LOADING HEIGHT...LONG FLAT FLOOR



MORE LOADSPACE...MORE VISIBILITY



**MORE MILES
PER TANKFUL
AND PER TIRE**



NEW 1963 FORD ECONOLINE VAN

The more you look into Ford's Econoline Van the more you understand its popularity! Priced well below old-style panels, it gives you more capacity, loading ease, maneuverability . . . more

of everything you want. More economy, too. Savings can easily average \$100 a year. And for 1963 you get new reliability . . . a new transmission that's synchronized in *all* forward gears

. . . an 8-door option that puts big double doors on *both* sides. Look into Ford's new Econoline today . . . at your Ford Dealer's.

PRODUCTS OF  MOTOR COMPANY

Tastes great because the tobaccos are!

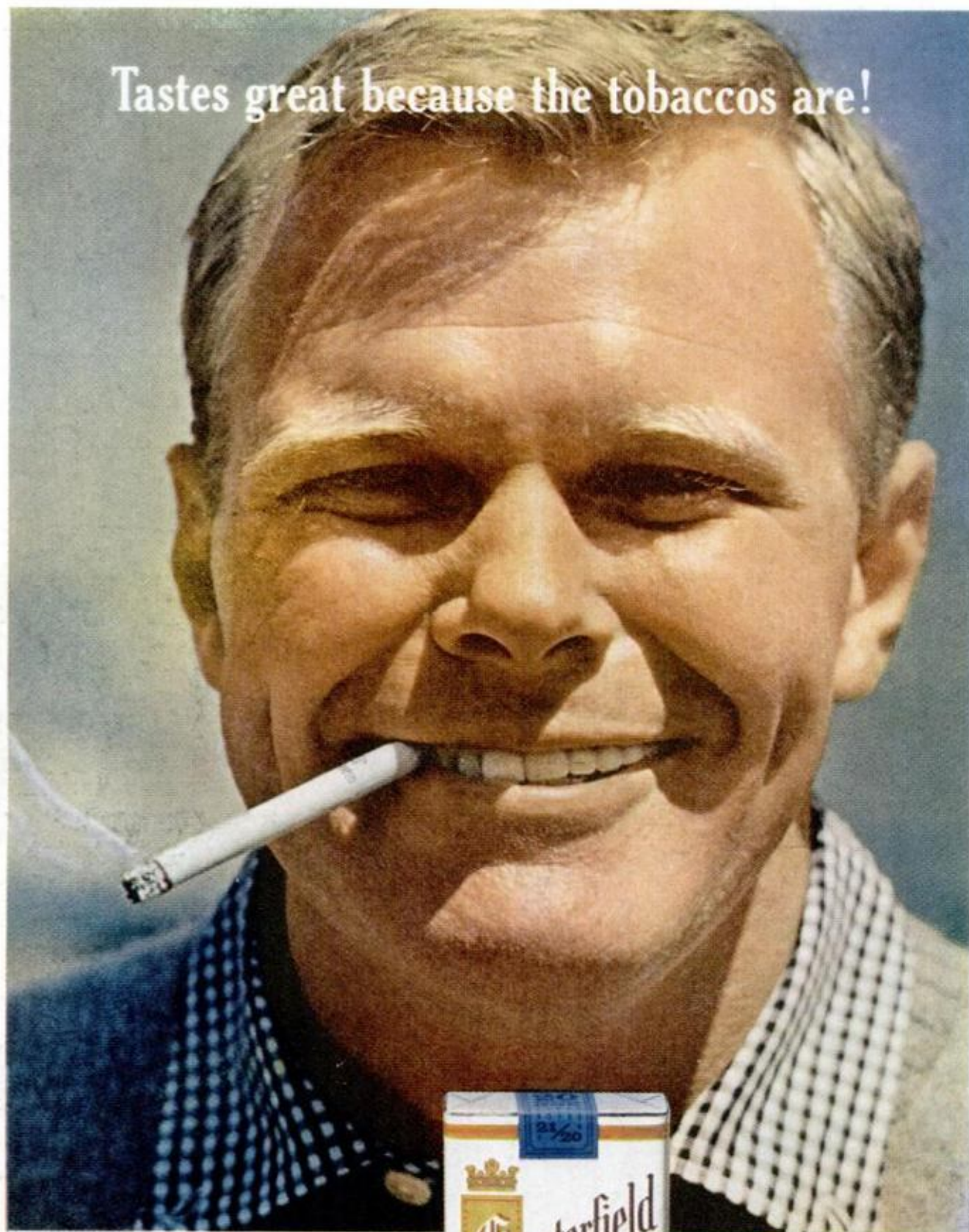

**21 GREAT TOBACCOS MAKE
20 WONDERFUL SMOKES!**

Vintage tobaccos grown, aged, and blended mild... made to taste even milder through the longer length of Chesterfield King.

CHESTERFIELD KING

TOBACCOS TOO MILD TO FILTER, PLEASURE TOO GOOD TO MISS



FOR A
GENTLER,
SMOOTHER
TASTE

ORDINARY CIGARETTES



CHESTERFIELD KING

ENJOY THE
LONGER
LENGTH OF
CHESTERFIELD
KING

The smoke of a Chesterfield King mellows and softens as it flows through longer length... becomes smooth and gentle to your taste.

**LOOK AT THE CRAZY THINGS
THEY'RE DOING WITH...**

GLASS

By Lloyd Stouffer

Remember when glass was considered the most delicate of materials? Those days are gone forever.

There is a sheet glass in production today so elastic that it can be bent to fit the curve of a drum and, when released, will snap back to its original shape.

There is a coil spring made of glass that depresses to one-third its length and springs back again.

There is a glass so

The ultra high strength of chemically treated sheet glass is demonstrated by bending it over a 20 inch radius and having it snap back to shape.



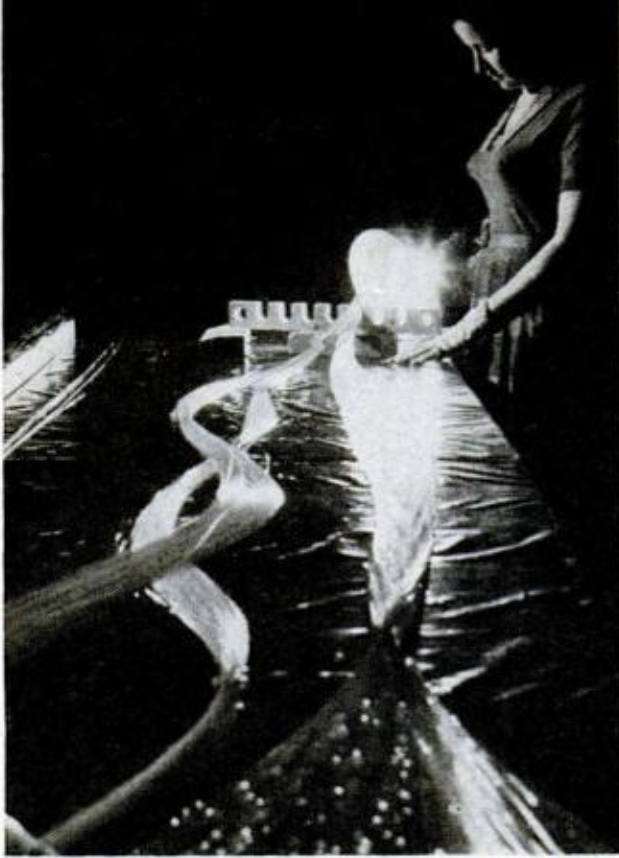

tough that it can be used to hammer a nail into an oak plank: a glass that resists heat of tremendous temperature, and a glass so porous that smoke can be blown through it, and it soaks up water like a sponge.

In use as a material for 3500 years, glass is only now coming into its own as one of the most exciting "new" materials.

The molecular make-up of glass is unique. Like many other materials, it is a liquid suspended in the solid state. But, unlike most, it is a solid that is not really a solid. The strange make-up affects the strength of glass, which theoretically should have strengths as high as three million pounds per square inch—much higher than the strongest steel. But the crystalline patterns of molecules that give strength to other solid matter do not appear naturally in glass, and only one percent of the potential strength could be realized.

Glass Freight Cars?

Now, however, through new techniques that change the fundamental nature of glass, six percent of the ultimate strength (180 thousand pounds per square inch) is being realized. Oscar Burch, technical director at Owens-Illinois Glass Co., predicts that his company will eventually produce a glass that is 10 percent of ultimate strength; a glass that will be used as a structural material in bridges, freight cars, airplanes and skyscrapers.

Through a process described as "nucleating," Corning Glass Works researchers were able to combine glass and ceramic to create a material known as Pyroceram. This de-

velopment solved a major problem for the National Aeronautic and Space Authority when they were searching for a guided-missile cone that would withstand the intense heat and buffeting of supersonic speeds through the earth's atmosphere.

Harder than carbon steel and lighter than aluminum, Pyroceram glass-ceramic looks like fine white porcelain. It is now available in hardware and department stores in the form of pots, pans and casseroles. It is named Corning Ware. It can stand empty all day on an open burner without harm, and it costs less than good stainless steel.

Thomas Edison would be astounded at what has been happening to his light bulb. At Corning's Hall of Science in Corning, N.Y., demonstrators mystify visitors with a light bulb that burns brightly when touched to what looks like a pane of ordinary glass. The secret: a thin, transparent coating of a metallic oxide that carries current from a wire at the edge. When a coat of special phosphor is added, and electricity applied, the frosty-white panels glow with a soft, cool light. This is known as electroluminescent glass, and unlike any other light source, there are no filaments, tubes or vapors, and practically no heat.

With electroluminescent glass it may soon be possible to produce a television picture—even in color—on a perfectly flat pane that you can hang on your wall. Already manufacturers are producing glowing glass table tops and walls that light.

A surprising property of glass is its elasticity. A rubber band, for instance, loses elasticity each time it is stretched, while

← **BUNDLES** of loose fiber-optical glass (far left) are woven into flexible tubes. When light is applied, light rays follow the tube's curves, making it possible to see around corners

← **USING OPTICS ROPE**, glasses (left) superimpose scenes on trichroic-coated lenses, will allow a pilot to read instruments and keep watch on where he's going at the same time

ELASTICITY and strength of glass is dramatically demonstrated by U. S. Marine John Uelses (right) as he vaults to a new world record using a fiber glass vaulting pole →

SCIENTISTS created a photo-sensitive glass (below) that reproduces a photo simply by placing the negative over the treated plate glass and then exposing it to the light

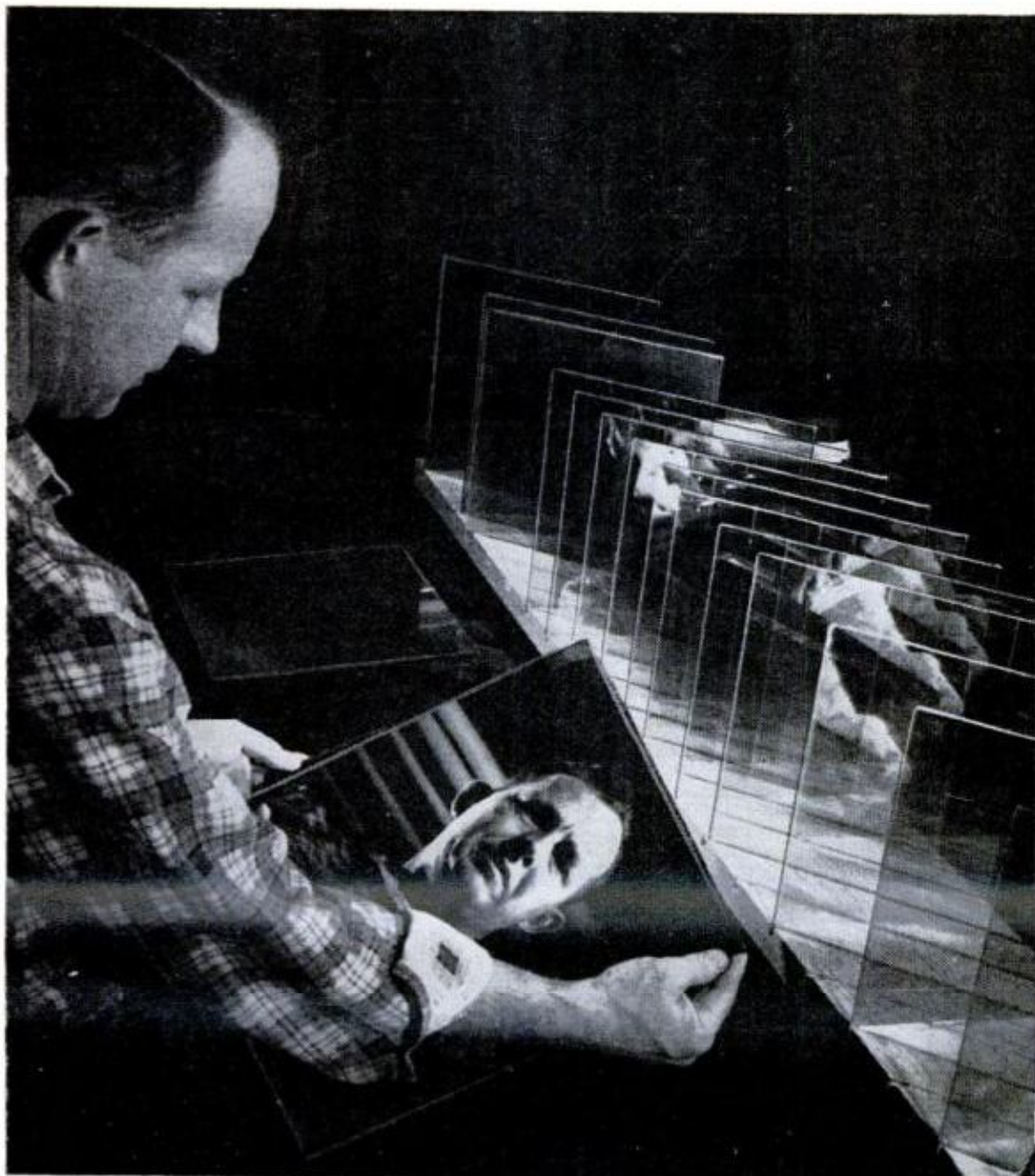

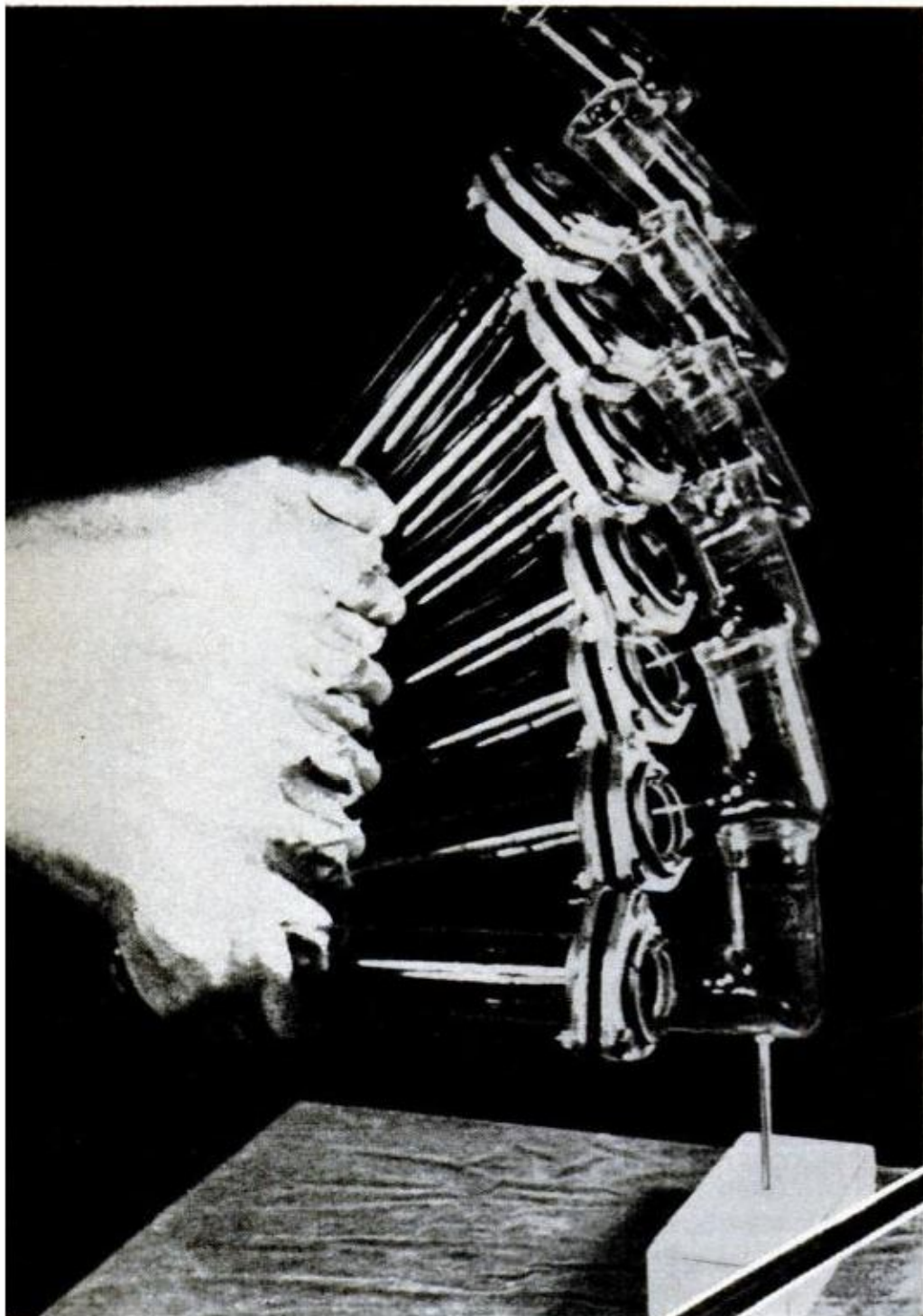

GLASS DRAINPIPE is not only rust resistant, it is extremely tough. In Corning, N.Y. this strength is demonstrated by using a length of glass pipe to hammer a ten-penny nail into wood block



GUN BARREL of glass was first introduced in the Winchester model 59. It boasts some 5 miles of glass fibers

SOLARGRAY, a glass that lets light in and keeps heat out, was developed for people who live in glass houses



glass will retain its total elasticity until it is broken. A high-strength glass rod will bend three times as far as a steel rod of the same size and length before breaking.

In Corning's Hall of Science they demonstrate elasticity with a 13-coil glass spring mounted in a showcase. Visitors are invited to push a button actuating a mechanism which depresses the coil to about one-third its length, then lets it spring back. To date, this glass spring has been depressed more than seven million times.

An even more dramatic demonstration of the strength and elasticity of glass was made during the 1961 Milrose Games. Using a vaulting pole composed of a myriad of glass fibers surrounded by plastic, the Marine Corps' John Uelses was literally catapulted to a new pole vaulting record of 16 feet, $\frac{1}{4}$ inch. The principle behind the unique vaulting pole was simply the utilization of the tremendous tensile strength of a single glass fiber, tensile strength being the resistance of a material to forces of rupture and longitudinal stress. Wound spirally into a pole, each fiber of glass was surrounded by plastic that acted as a restraining agent to keep the glass short of the fracture point, while maintaining the elasticity or "snapping power" of the pole.

This development in the world of glass created a storm of controversy in the sports world, but the identical principle has long been used in fishing rods, and is now being applied to golf club shafts.

Fiberglas boats and automobile bodies are common items today, but now a Cleveland company is manufacturing fiberglas front fenders to fit most popular American automobiles, and there is a new insect

screening made of fiberglas that will not dent, shrink, sag, ravel, corrode, rust or stain woodwork.

Among the most remarkable of the new glass-ceramics is Corning's Cercor, which has a structural make-up of tiny, continuous honeycomb cells. A puff of cigarette smoke will pass through Cercor with ease. Because it has this perfect cellular structure, giving an immense amount of surface area for its bulk, and at the same time has the ability to resist temperatures over 2,000 degrees Fahrenheit, it can be used to pipe searing exhausts from rockets and turbines where no other material would serve. Used as a heat exchanger, it appears to have solved one of the remaining problems in the application of the gas turbine engine—like the airplane jet—to passenger cars.

In the field of optics, Corning has been the first to produce a 100 percent-pure silica glass by condensing vaporized silica without the other constituents normally found in glass. Optically perfect, this glass has been cast into a 62-inch mirror that will be used in the U.S. Naval Observatory at Flagstaff, Ariz., to track stars up to 600 trillion miles from the solar system.

Thirsty Glass

To create a glass porous enough to absorb water, Corning uses acid to leach out almost all elements until it is 96-percent silica. Tiny disks of this "thirsty" glass—like miniature confetti—are placed in electronic components to trap trouble-making moisture. So voracious is the thirst of this glass, the disks are shipped immersed in deionized water, then dried out prior to use. Each

[\(Continued on page 198\)](#)

VERSATILITY of glass is practically limitless. There is a tough thermal glass (left) into which molten metal can be safely poured while the glass bowl sits on a block of ice. Among the many uses of molded fiberglas is the "tonneau cover" for the Ford Thunderbird. One company produces tiny porous glass disks (right) that absorb moisture at a fantastic rate. They are used in electronic devices to keep them dry.



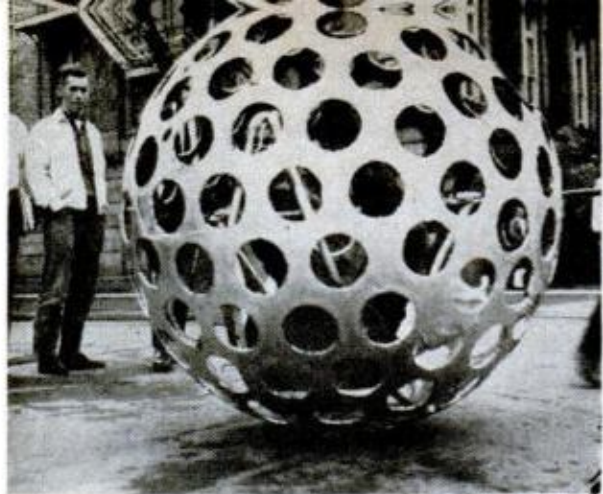

On the Ball

Conceived as an inter-city vehicle to be spun through pneumatic tubes, a perforated spherical vehicle also operates on road surfaces. The driver sits suspended from a horizontal bar; pedals cause his weight to be swung forward, in turn, causing the giant ball to roll.

Stephen Berni designed it for the Alcoa Student Design program.

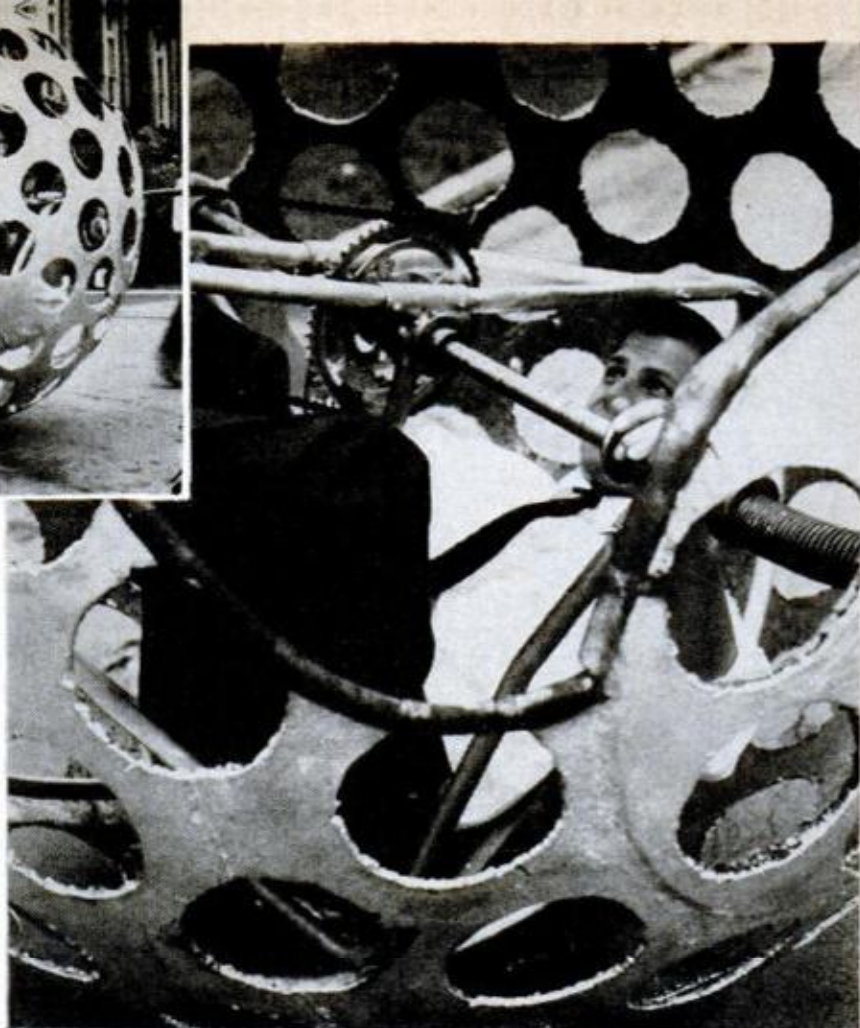

For Fishing Fever

Temperatures of water at various depths can be found by lowering the sensing tip of the Fish-O-Therm and reading a dial on the handle. Fishermen then know how deep to fish for a particular species. The Minneapolis-Honeywell instrument sells for \$29.95.



Doghouse on Wheels

Dog-lover Charles Tumbridge determined to take his dog, Susie, along on scooter rides into the country; so he built her a "doghouse" sidecar. The mobile kennel has a sliding door, an observation hatch on the roof and blue-checked curtains.



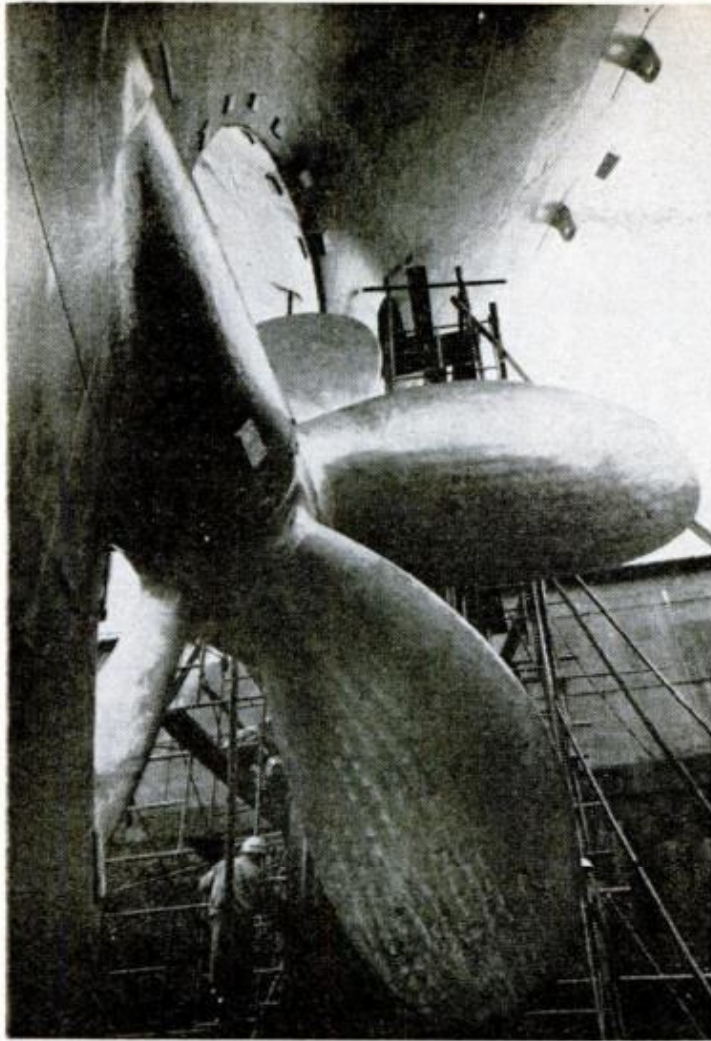

Newly Launched Japanese Tanker Is a Giant

With the recent launching of the *Nissho Maru*, world's largest oil tanker, Japan set afloat a ship that can carry 35 million gallons of crude oil.

Built by Sasebo Heavy Industries Co.

for the Idemitsu Kosan Co., the 954-foot tanker carries the oil in her 40 tanks.

Shipyards workers (photo left) are dwarfed by the huge propeller on the 130,000-ton ship.

Reads Handwriting

An optical scanning machine designed to "read" handwritten material recently passed its first test with a near-perfect score. The experimental IBM unit is the forerunner of equipment the company hopes will some day feed handwritten data directly into high-speed computers.

To test it against a variety of handwriting styles, 150 students at Tufts University fed more than 100,000 random numbers into the unit on IBM cards. A light beam recorded them on an oscilloscope—with 98.5 percent accuracy.

Future units will transfer data to computer punchcards.

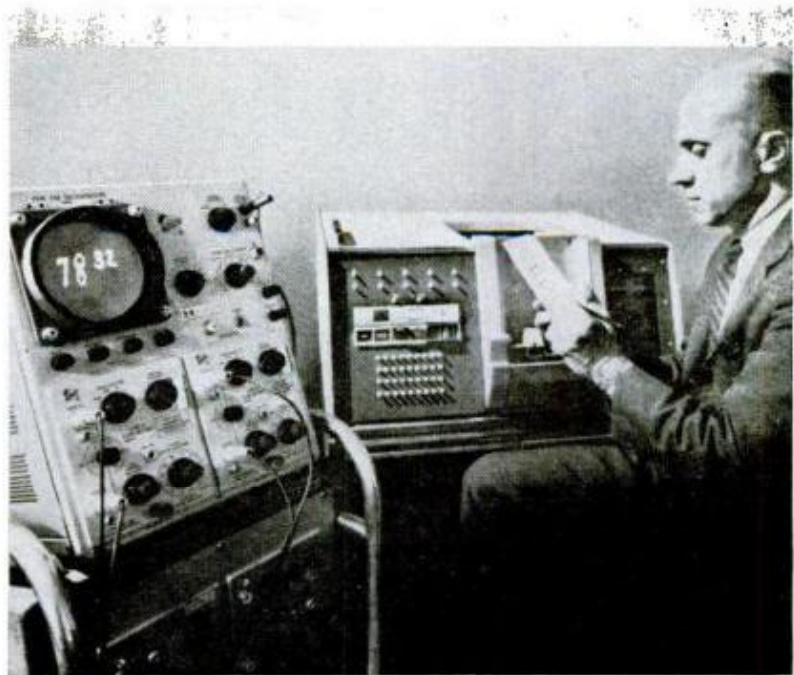

here comes UHF- TV!



How Will It Affect Your Viewing?

READY OR NOT, we're going to get UHF-TV. It's the law.

After more than a decade of offering UHF channels to prospective broadcasters—and getting only lukewarm response or none at all—the Federal Government, for all practical purposes, has *ordered* their use.

What does it mean? Is it good or bad? For the average viewer, it's an average of both. It means an additional cost, but a potentially better picture and a wider choice of programs.

(We'll pause here to allow the average disgruntled viewer to grouse about the choice of programs he has *now*. He would

probably settle for less quantity and more quality.)

The whole subject of UHF-TV, while basically simple, has been bogged down in controversy and confusion. Mostly, it has just been bogged down. To clear up some of the confusion and sort out the controversy, this report will discuss the significance of the new channels and the kind of picture and program quality you can expect from them, depending on location.

First of all, let's clarify what we are talking about. VHF (very-high frequency) and UHF (ultra-high frequency) are convenient names pinned on those portions of

the frequency spectrum on which television operates. AM and FM radio, for instance, occupy other portions of the spectrum. A chart on page 80 lists all the television channels and their frequencies.

The thing to remember is that VHF channels (2 through 13) operate on lower frequencies than UHF channels (14 through 83). This plays a part in the controversy.

So here comes UHF-TV? So what?

The average viewer—and more than 90 percent do their viewing on VHF—can buy a new set, convert his old set or ignore the whole thing.

If he buys a new set that will receive all channels, both VHF and UHF, it may cost up to \$30 more than his VHF-only set cost when new. If he converts, a conversion kit that will allow him to watch both VHF and UHF channels on his VHF set will cost about \$30, considerably less expensive than buying a new set. In either case, though, he will need a UHF antenna (UHF channels can't be received on VHF antennas) that will cost from \$4 to \$30 (see pictures).

If he ignores the whole thing, he might be 1) lucky, or 2) unlucky. If he's lucky, no new UHF channels will spring up in his area and he can go right on watching the old VHF channels as before. If he's unlucky, new UHF programs will be offered which he can't watch. So let's say he buys, or converts as indicated on page 82. What does he get for his money?

He gets what many experts believe is a superior picture, especially in color. Some



INDOOR ANTENNAS for UHF give poor pictures in fringe areas. Weak signals need outdoor antenna



OUTSIDE ANTENNA produces excellent UHF picture. Even electric razor does not distort it, as it would VHF



VHF PICTURE picks up interference readily from an electric motor, marring picture with splotchy horizontal lines. Test was in good reception area



UHF PICTURE, taken about same time as VHF picture at left, picks up hardly any interference, yet both sets were equidistant from station and interference

VHF		UHF					
CHANNEL	FREQ.	CHANNEL	FREQ.	CHANNEL	FREQ.	CHANNEL	FREQ.
	50	14	476	38	620	62	764
Ham		15	482	39	626	63	770
2	54	16	488	40	632	64	776
3	60	17	494	41	638	65	782
4	66	18	500	42	644	66	788
Fixed Radio	72	19	506	43	650	67	794
5	76	20	512	44	656	68	800
6	82	21	518	45	662	69	806
	88	22	524	46	668	70	812
FM, Aero, CAB, Gov't, Ham, etc.		23	530	47	674	71	818
7	174	24	536	48	680	72	824
8	180	25	542	49	686	73	830
9	186	26	548	50	692	74	836
10	192	27	554	51	698	75	842
11	198	28	560	52	704	76	848
12	204	29	566	53	710	77	854
13	210	30	572	54	716	78	860
	216	31	578	55	722	79	866
Misc. Gov't. CB, Ham, Radio-sonde, etc.		32	584	56	728	80	872
	470	33	590	57	734	81	878
		34	596	58	740	82	884
		35	602	59	746	83	890
		36	608	60	752		
		37	614	61	758		

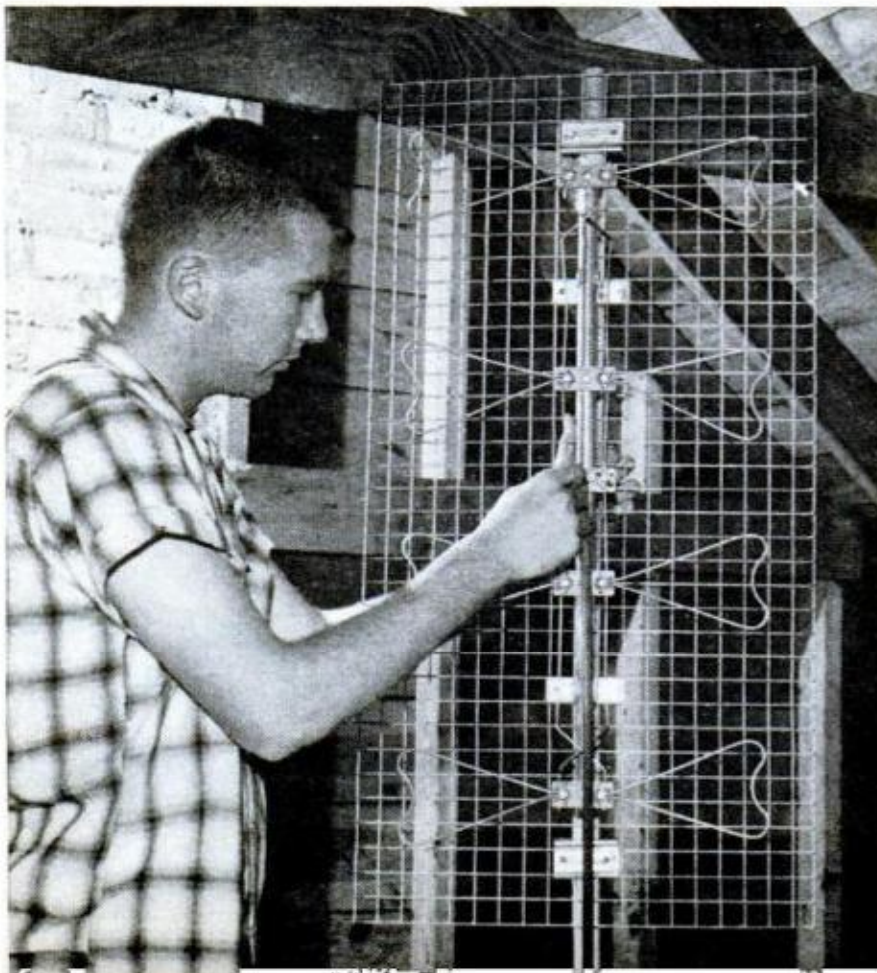

FREQUENCY CHART shows positions of VHF and UHF on frequency spectrum, plus some of the other users—FM radio, government agencies (police and fire), amateur radio, etc. Frequencies are given in megacycles. AM radio, operating on kilocycles, is much lower than anything shown on this chart

FOUR-BAY ANTENNA, installed in attic, will be four times as efficient for UHF reception as single antenna. Additional surfaces increase its sensitivity

even predict that, once UHF is established, we might eventually become an all-UHF nation. The drawback is that, now at least, VHF stations generally have about a 50-percent greater range than UHF. This means that viewers in the fringe areas (say beyond 30-40 miles from the station) might not reap the full benefits of UHF.

Why these differences? Well, the lower frequencies of VHF have longer wave lengths and every meter of wave length gives you a certain number of miles of telecasting (or viewing) range. VHF also uses more antenna area in sending out (and receiving) signals than UHF does. As a result, VHF signals cover the telecast area more completely than UHF signals do, and VHF signals are usually less affected by obstructions such as hills or buildings.

Without obstructions, VHF signals generally carry about 50 percent further than UHF signals. With obstructions, VHF will usually bounce off and keep going. UHF will usually dissipate.

This sounds like a serious drawback, but it has hidden advantages.

The problem of range was a large factor in the early stagnation of UHF. Advertisers were much more interested in programs that would reach further (and consequently more viewers) with the same message.

Range even affected early VHF. You'll note from the chart on page 80 that VHF stations are divided in two groups. There is

a large gap of 94 megacycles between Channels 6 and 7. (The gap is occupied by FM radio and others.) So Channels 2 through 6 operate on much lower frequencies than Channels 7 through 13, and most of the major stations (CBS and NBC affiliates, for instance) are on the lower channels, primarily because of the greater range. Economics, rather than esthetics, dictated the choice.

However, now that UHF is being forced upon the broadcasters, esthetics might win.

Interference-Prone VHF

VHF, even though it has greater range, also has its weaknesses. Because it operates at lower, more common, frequencies, it runs into considerably more man-made interference. Electric razors, vacuum cleaners and airplanes, to name a few, all use similar frequencies close enough to distort or destroy the VHF picture when both are operating. Such interference is almost nonexistent on the rarified, isolated frequencies of UHF. (On the other hand, some reflective objects may affect the UHF signal, especially in fringe areas. A UHF picture that was great during the summer, may grow fuzzy and snowy when the leaves come off the trees. Or the opposite may happen.) Actually, while VHF's ability to bounce off obstructions such as mountains sounds advantageous, the phenomenon can also produce annoying double (or "ghost") images in the picture you are getting.

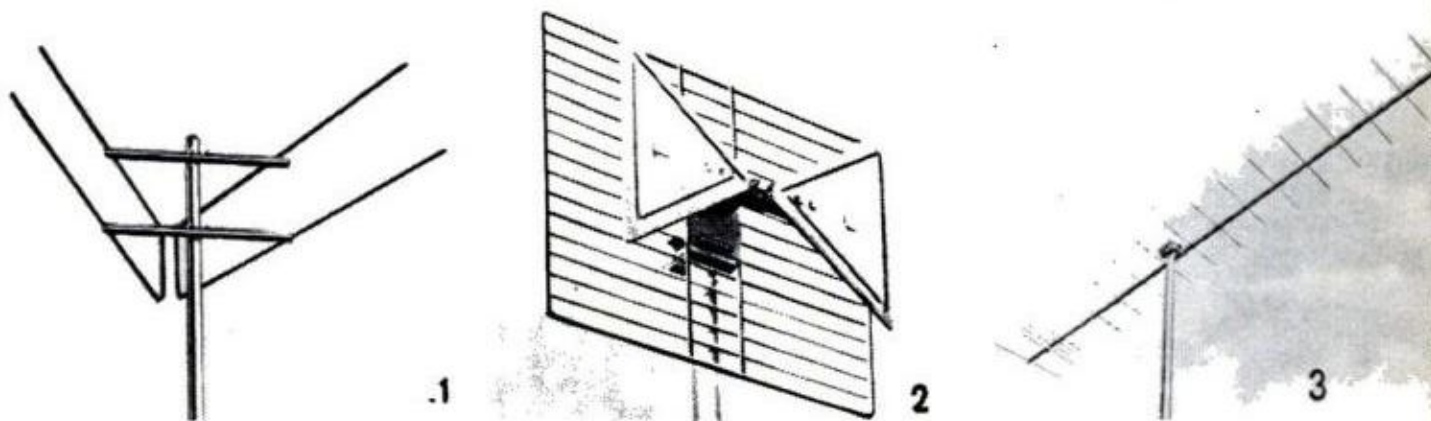

1. DOUBLE-V, simplest of UHF antennas, is adequate for close-in areas. It measures about one-foot across, and is least-expensive type. Approximate price: from \$4 to \$6

2. BOW-TIE antenna with flat reflector, also for local reception, is more elaborate and slightly more expensive. Also measuring one foot across, it lists from \$6 to \$8

3. YAGI antenna (named for Japanese inventor) measures up to 12-feet long and is designed for reception beyond local area. Arms measure one foot. Price: \$15 to \$20

4. PARABOLIC antenna with extra backward reflector, most elaborate of UHF antennas, is designed for extreme fringe areas. Large bowl measures 12-feet across. \$20-\$30



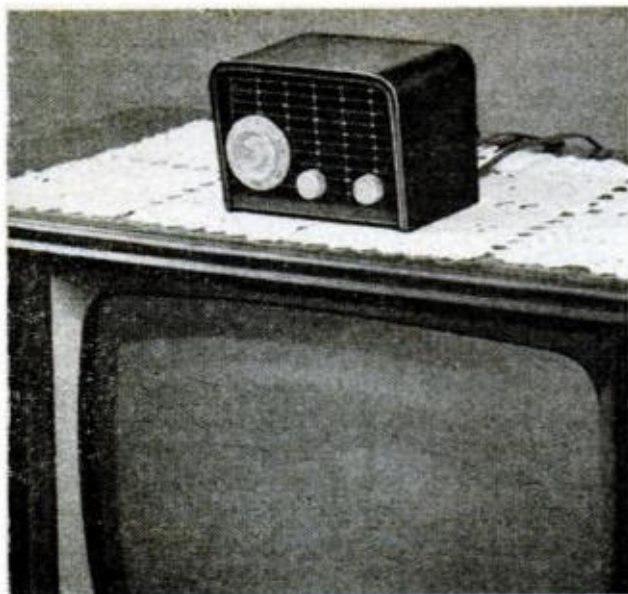

UHF CONVERTER, costing up to \$30, will enable VHF set owners to receive UHF pictures on their old set. Additional UHF antenna is also needed

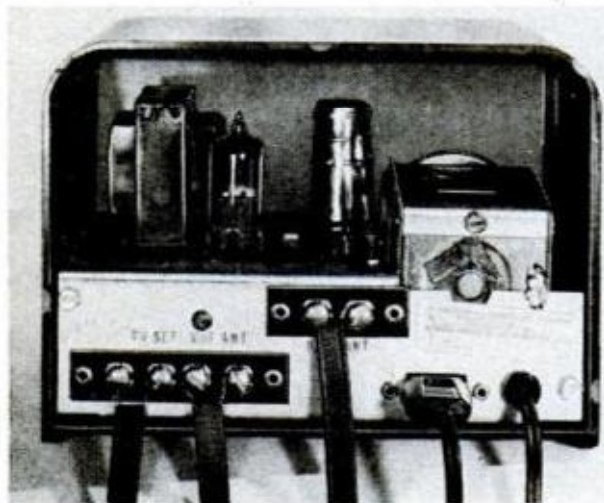

REAR-END VIEW of converter shows where wires and plugs go. Full explanation for converting to UHF is given with diagram below. Or you can buy new set

Some people see an advantage to the shorter range of UHF. It could mean more and more small-town TV stations to serve more and more local areas, bucking the trend toward programming everything from New York or Los Angeles.

While it's possible more—many more—local UHF-TV stations will spring up, the experts see more hope for improving the range of UHF itself.

Once UHF catches on, there will be more money to spend, and more time and effort can be put into research and development, extending the range and improving the reception. More power and taller towers could extend the range, and more experience could improve UHF-set manufacturing and servicing in much the same way VHF sets improved after the early years of 7- and 10-inch screens.

Even now, UHF reception is not as bad as supposed. Good pictures—much better than VHF—can be received up to 30 or 40 miles from the station, with marginal coverage up to 70 miles. And where community cable systems are used (more on these later), some signals are being received 140 miles away. With two-thirds of the nation living in or near urban areas, well within “good reception” areas for UHF, the current state-of-the-art of UHF-TV is not bad. And it's bound to get better.

Why so sure? Because current UHF areas have done it.

Indiana-Pennsylvania UHF Tests

We mentioned that most of the nation watches VHF television. There are several isolated areas, however, that have been carrying UHF television exclusively for six years or more.

Two of them, in the flatlands of Indiana

[\(Continued on page 200\)](#)

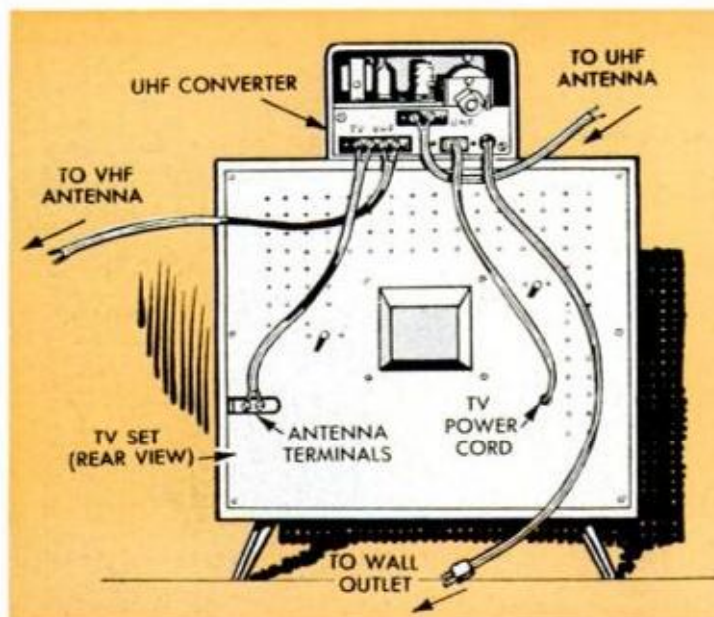

The simplest way to make a VHF set do double duty is to add a UHF converter.

Place the converter atop the set, and disconnect the TV line cord from the outlet. Plug this cord into the convenience outlet on the converter. Connect your VHF antenna lead to the VHF terminals on the converter. Then connect the TV antenna terminal on the converter to the antenna terminals on the TV.

Add a UHF antenna to your antenna mast and run its lead-in wire to the UHF terminals on the converter. Now plug the converter into the wall outlet, and the conversion is complete.

To view normal VHF television, turn the TV set on, and the converter off. To see UHF channels, you must turn both units on, automatically switching over to UHF.

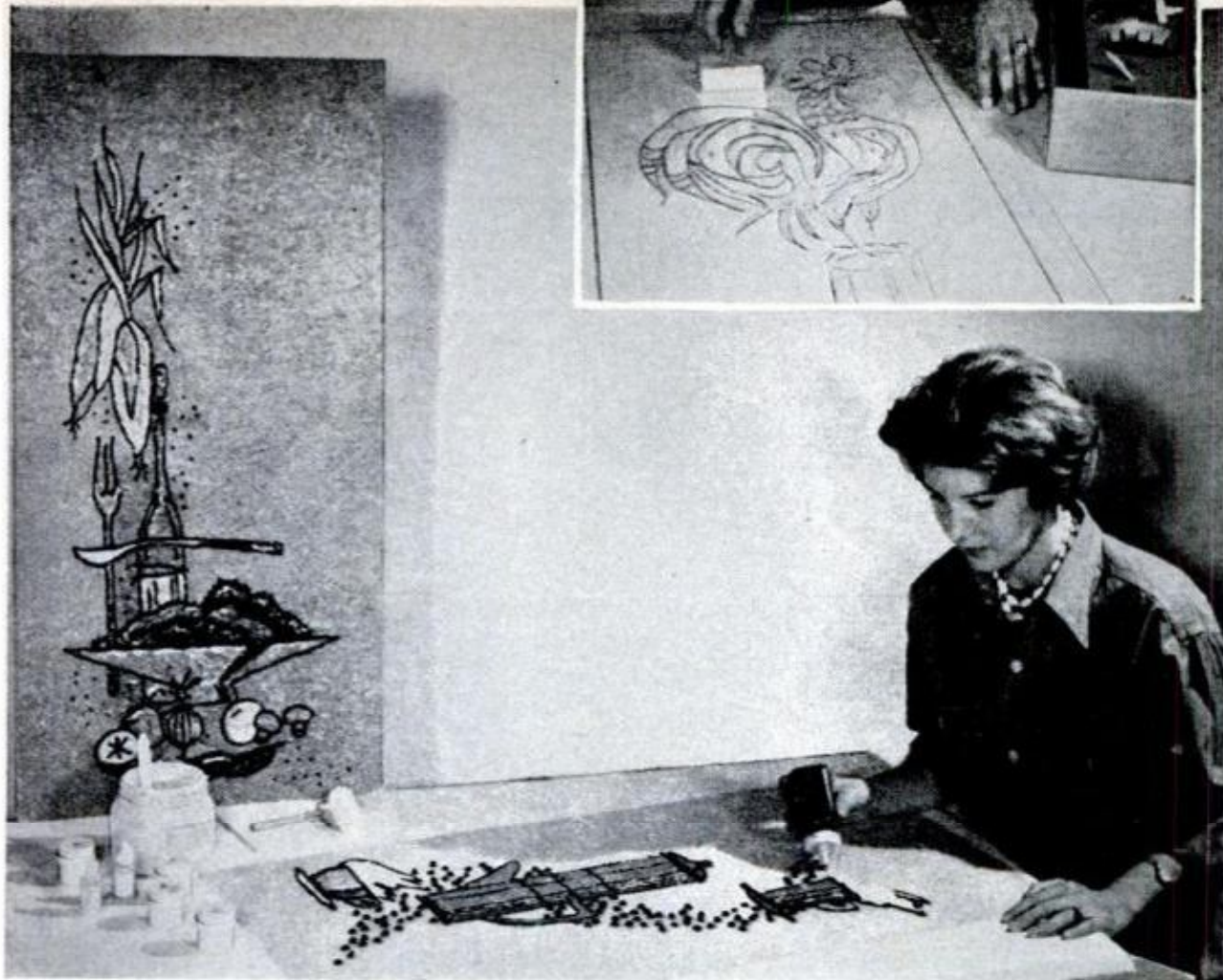

Make Your Own Decorative, Translucent Panels

With a kit of colored resins and a glass mat, you can produce in a couple of hours a weatherproof translucent panel that can be used indoors or out.

The panel itself is made by smoothing resin over the glass cloth (inset). When it

hardens, the colored resins are spread and squeezed on to make the design, which bonds permanently to the panel.

Illustra-Art kits, made by Inlay Design, Inc., 10117 Franklin Ave., Franklin Park, Ill., sell for \$10.95 each.

Floating Heliport

Solving the congestion of downtown Pittsburgh, the local helicopter service built its heliport on a barge. It boasts a ticket office, waiting room, office and landing pad measuring 54 by 90 feet.



DECEMBER 1962

Springy Teeter-Totter

Youngsters are treated to slides, jerks and slithers on a "silver pretzel" designed for them by University of Cincinnati students. Material used was a springy aluminum alloy structural tubing.



83

Road Testing **FORD'S CARDINAL**



By Heinz P. Schlichting, PM's International Editor

WE DROVE THE CAR that was supposed to be dead. That's right, the Ford Cardinal was buried some months ago.

But here it is—far-from-dead and in mass production at Ford of Germany's huge factory in Cologne, West Germany. There's just one important difference—the Cardinal now has a new name, the Taunus 12M.

Until last April, Ford had plans under way to bring this car into the U. S., knocked down into its component parts. In this way it would be much cheaper to ship by water and rail to assembly plants in the U. S.

Only the nameplates and instruments would have been changed from Taunus 12M to Ford Cardinal, while body stampings were to be welded together and painted. For reasons best known to its board of directors, Ford shelved this Cardinal operation and concentrated on bringing the Taunus 12M into the European Common Market where it will compete with Volkswagen, Renault's new R8 and the Kadett which is made by Opel, General Motors German subsidiary.

At first glance the Cardinal or Taunus looks very much an American design. It might have been a prototype for the Falcon that did not win approval from top management. Of course it is scaled down in size, being 167 inches long with a 99-inch wheel-

base compared to Falcon's 181-inch length and 109½-inch wheel base.

Compared to Volkswagen, Cardinal is a bit larger in exterior dimensions, some seven inches longer over-all with a five-inch longer wheelbase. Interior dimensions are close to VW's with the major difference being four inches more knee-room for rear seat passengers with the Cardinal's bench-type front seat adjusted to its rear-most position.

Beneath its conventionally-shaped body however, the Cardinal is quite as unique as the VW. First of all it is a front-wheel drive car with the engine placed forward of the front axle. The differential is located between the clutch and the four-speed synchronized transmission. The engine itself is a four-cylinder overhead valve watercooled unit with cylinders arranged in banks of two, set at a 60 degree angle.

Controls are conventional in arrangement with the gearshift lever located on the steering column.

The V-type engine with cylinders placed opposite one another instead of in a line makes for a very short engine and a larger passenger compartment, with the rear seat forward of the rear wheel wells. Then, too, the absence of driveshaft tunnel or transmission bulge allows a flat floor in both front and rear compartments.

SHORT DISTANCE between banks of two cylinders on Cardinal's V4, right, makes for even distribution of fuel mixture, requires only single-barrel carburetor

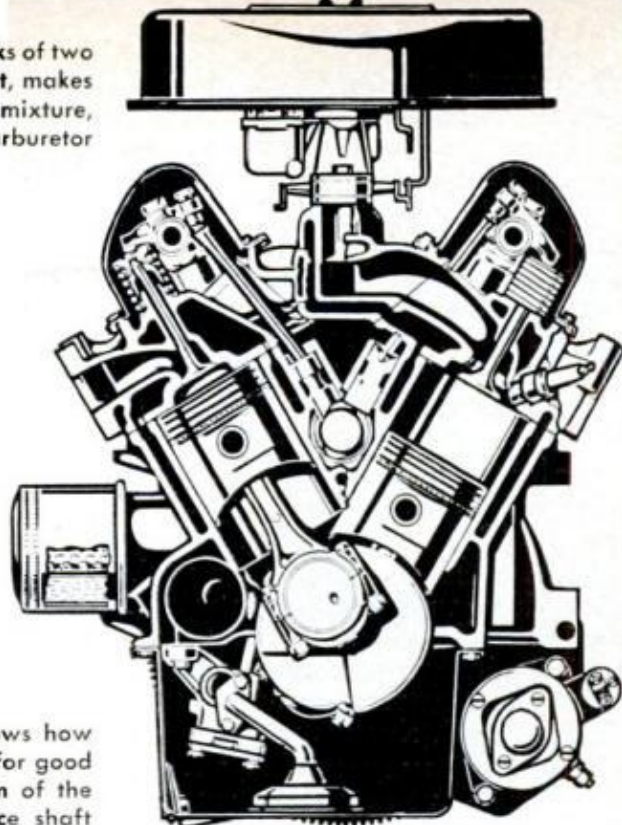

SIDE VIEW of compact V4 shows how valves sit directly over pistons for good breathing. Black bar at bottom of the crankcase cutout is the balance shaft

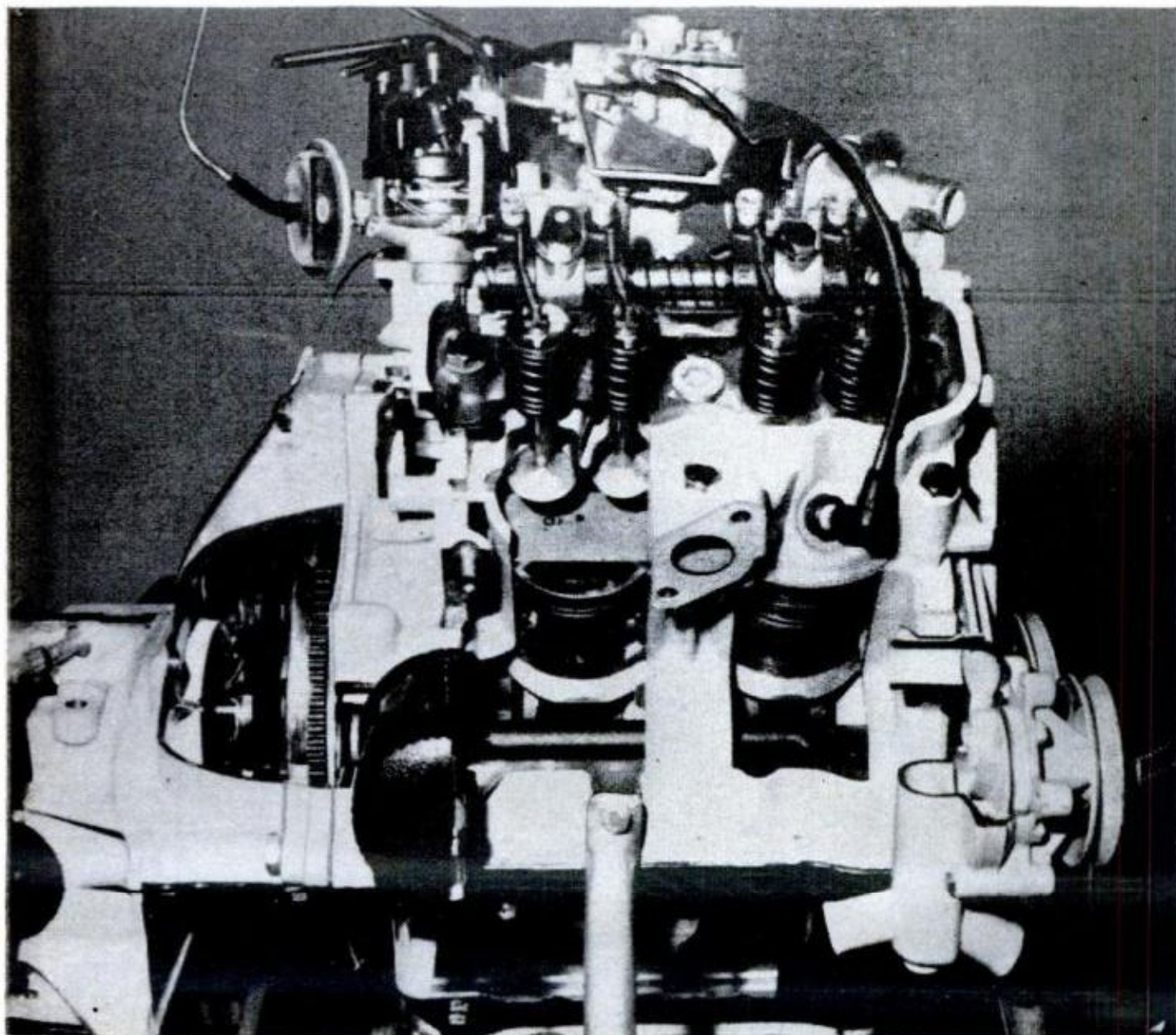

In normal driving you cannot tell that the Cardinal is a front wheel drive car. The universal joints at the front wheels are of the Rzeppa constant velocity type, permitting smooth power flow even when the wheels are turned on their vertical axis to an extreme angle. The power surges or percussions sometimes felt through the steering wheel of a front wheel drive car were totally absent although we felt that slightly more steering effort was needed when cornering under full throttle in a lower gear.

The steering is recirculating ball gear (similar to U. S. types) with a 22 to 1 ratio requiring 3½ turns from right to left lock.

Quite often the geometry of the front wheel drive universal joints cuts down the turning angle of the front wheels, necessitating a larger turning circle. But Cardinal's 35 foot turning circle is just two feet greater than Volkswagen's.

Handling is very good. The Cardinal can be cornered quite hard without any loss of control. There is no excessive understeer or body lean, thanks to a rear anti-roll stabilizer bar and an even distribution of weight.

Unlike some front wheel drive cars the Cardinal does not slew around when braked hard. It stopped as straight as if on rails, in a hands-off-the-wheel panic stop.

The car's ride is comfortable, due in part to the low amount of unsprung weight remaining to impart shocks into the body.

Front suspension is a single transverse leaf spring (an old favorite with Ford) coupled to the wheels via ball joints and acting together with a lower control "A" arms to locate the wheels. Rear suspension is through parallel-leaf springs attached to a hollow bar axle.

Brakes are drum-type hydraulic with a

total of 100 square inches of lining, quite enough to provide fast stops for the car's 1863 pounds of curb weight (2300 pounds test weight) with low pedal pressure requirement.

The four-speed transmission shares the gearing with the larger Taunus M17 which is generally rated the best shifting transmission on any European small car (better than most U. S. synchromesh jobs).

The four-cylinder engine runs smoothly thanks to a counterrotating balance shaft driven from the engine's crankshaft at the same speed. This shaft dampens out potential vibration inherent in a V4 of 60 degrees with counterweights out of rotation phase.

Although it can wind up smartly to over 5000 rpm in order to drive the Cardinal at its top speed of 78 m.p.h. through a 3.7 to 1 final drive ratio, there is little noise, due to the absence of a belt-driven fan. The fan's place is taken by a secondary radiator which is actually the heater core! A belt-driven pump constantly circulates water through the conventional front-mounted radiator and this heater core once the thermostat opens at 175° F.

When the temperature gets near the boiling point, as in summer traffic, a thermostatic switch turns on the heater blower which sends cool air from the cowl intake through the heater core then out through the bottom of the engine compartment.

The Cardinal's unit construction body and sheet metal seemed strong. Sitting on the engine hood or decklid we could not depress the sheet metal significantly.

The Cardinal requires little routine maintenance, has no grease nipples. The two universal joints on each driveshaft provide four points to be greased every 6000 miles. ★ ★ ★

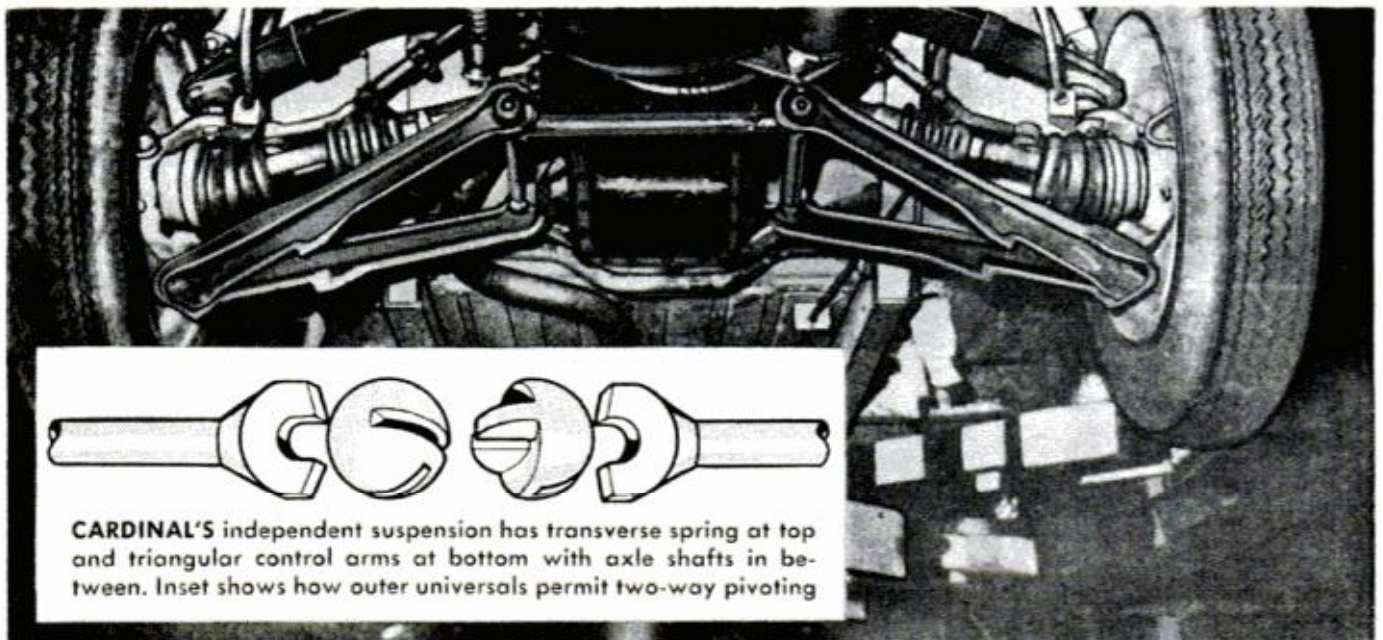

CARDINAL'S independent suspension has transverse spring at top and triangular control arms at bottom with axle shafts in between. Inset shows how outer universals permit two-way pivoting

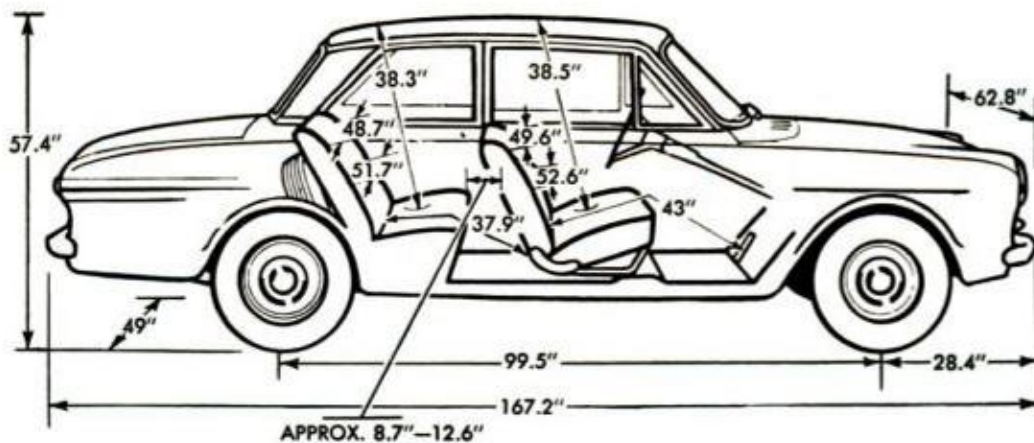

The Cardinal is over 7 inches narrower than Rambler American, but rear seat hiproom, at 52.7, is 7½ inches greater

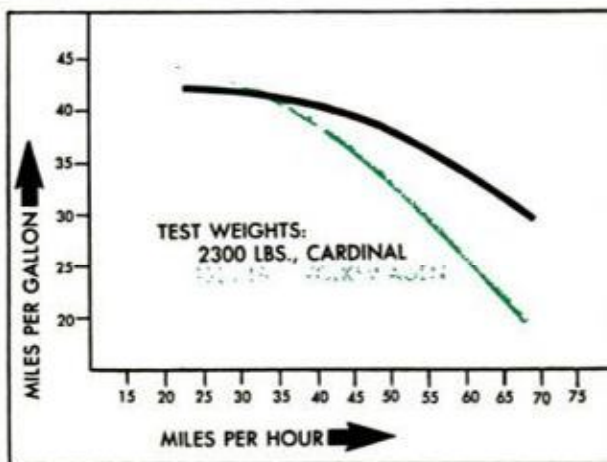
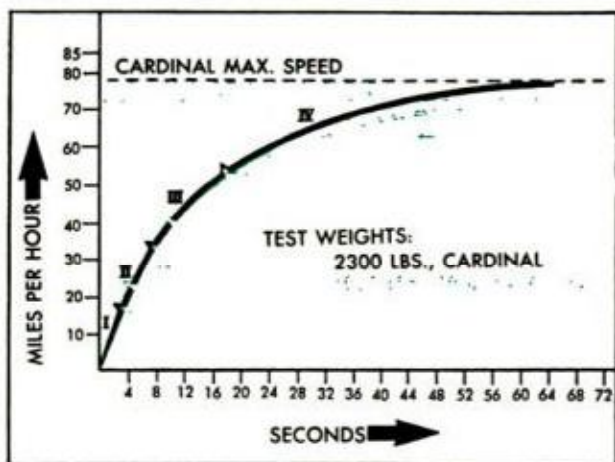

Although a bit heavier than the Volkswagen, the Cardinal has slightly better top speed, acceleration, and road-speed gas mileage. Roman numerals indicate gear speed ranges

At 99.5 inches, the Cardinal's wheelbase is just 5 inches longer than VW's. Over-all length is 7.2 inches greater and width 2.2, but the VW stands 1.6 inches higher than Cardinal





CONDOR'S BODY is aero-crimped, all-aluminum, fully-insulated and has a baked-enamel finish. For travel in all seasons, heat is furnished by a butane gas furnace, and an optional air-conditioning unit is available



BENCH-TYPE SEATS allow four diners to eat at the plastic-topped table. Driver's and other front seat swivel and recline



KITCHEN INCLUDES four-burner stove with oven and broiler, refrigerator, laminated-plastic counters, cupboard and drawers

The Condor Luxury Camper

Latest answer to "why not just pick-up-and-go?" is the Condor, a completely self-contained mobile home now available on order from any Ford dealer.

Developed by the Kelson Engineering Co. of El Monte, Calif., the Condor uses a modified Ford truck chassis and the 292-cubic-inch V8 engine with Cruise-O-Matic transmission. Wheelbase is 178 inches. The Condor is 26 feet long, with six feet, four inches of headroom inside.

Complete kitchen, bathroom, dining and sleeping facilities accommodate six people. Interior appointments include walnut-grain plywood walls and ceiling and a vinyl-tiled floor.

Other features are: Shower with pressure water system; roomy cabinets and closets; dual-speaker radio; aluminum combination windows and screens; safety glass; and standard trailer-court hook-ups for electricity, drinking water, sewage and heavy-duty battery and alternator.

An optional 110-volt generator provides the luxury of using a full range of kitchen appliances, television, shaver, etc.

The vehicle will also double as a mobile office or showroom, movie or TV location dressing room, repair unit, or laboratory.

POPULAR MECHANICS

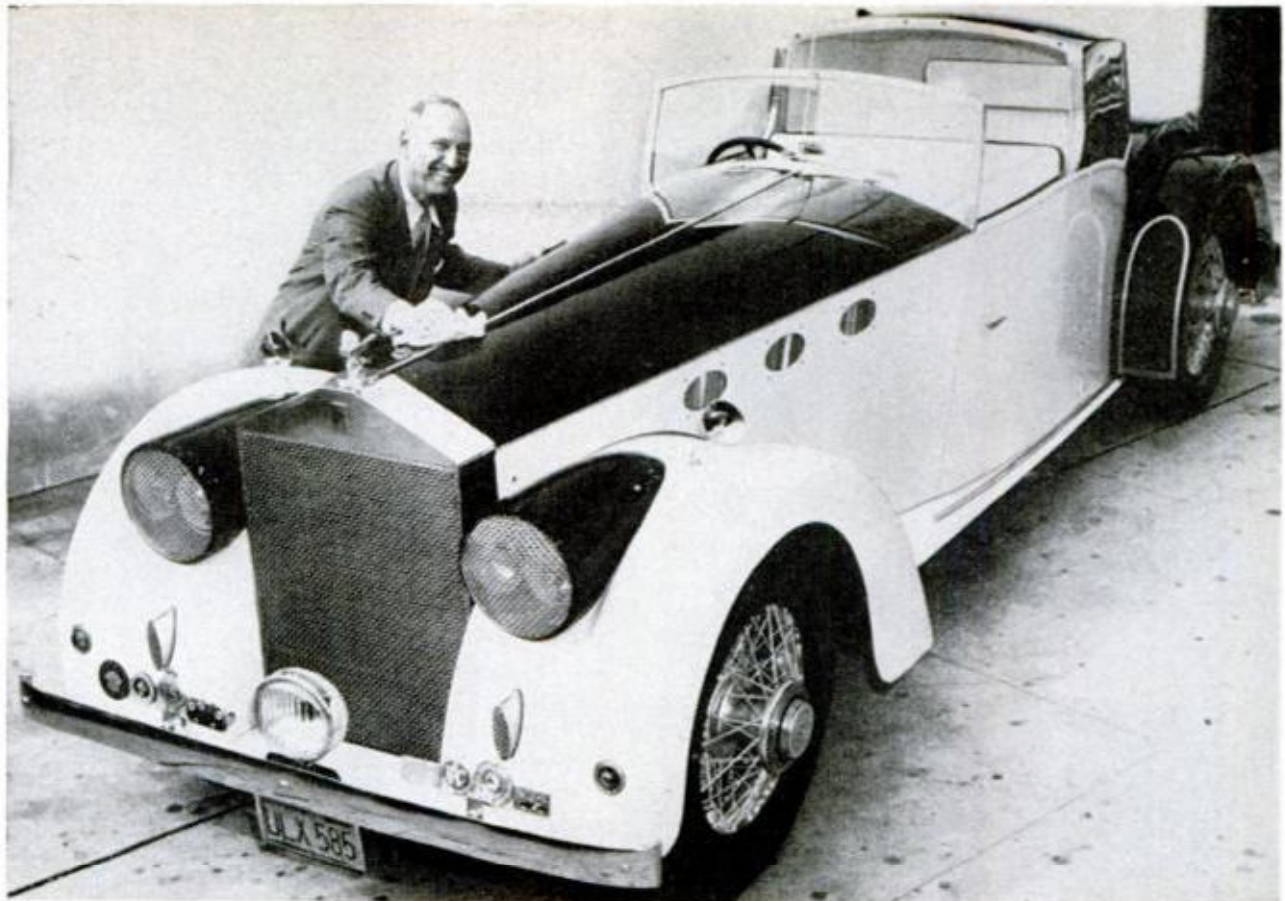

Driver of This Car Should Have a Pilot's License

Hardly any parts of this car were manufactured for an automobile; the classy vehicle is made of pieces of airplanes plus the engine from a fire truck.

The entire frame and skin of the car were formed from unused aircraft materials left over from World War II. The headlight cowlings are starter-motor housings from

a German jet engine; the engine magneto is the type used on Spitfire fighters. The door handles outside are flying wires from a biplane; inside handles are throttle levers from a Lancaster bomber. The 7.5-liter engine came from a London fire truck. Built by an RAF pilot, the car is owned by M. L. Cohn of Beverly Hills, Calif.



Transparent Hub Caps

Transparent boat-trailer hubs not only let you see the amount of lubricant available to the bearings, but they use 30-weight motor oil instead of conventional wheel-bearing grease and will survive countless dunkings without repacking. The maker guarantees the bearings for two years.

The Visi-Lube hubs are used primarily for original equipment, but changeover kits can be had at \$18 and \$20 from Visi-Lube, P.O. Box 10651, San Diego 10, Calif.



See/Hear Combo

Radio reception and a rear view are combined in Kar Tenna-Mirror which the maker claims is adjustable from the driver's seat and less susceptible to vandalism. Available with either 11 or 17-inch antenna for \$4.95 and \$6.95 from Wren Prods., 14680 Rochelle, Detroit 5, Mich.



No-Snow Snowmen

In San Diego, Calif., where it hardly ever snows, local residents create their own brand of snowmen by gathering tumbleweed from nearby desert areas, spraying it with whitewash and decorating the resultant figures just as if they were the real thing.

Apart from the sticky business of collecting the tumbleweed, these dry snowmen have several advantages. There are no frozen fingers or muddy boots, and the tumbleweed doesn't melt.



Artificial Sounds Soothe

Synthetic sounds to tranquilize or even induce sleep are produced by a transistorized, battery-operated instrument called the Soundsleeper.

Four press buttons give the sounds of surf, pattering rain, "white" sound, which is a mixture of all audible sounds blended at equal intensities, and modified white sound, which is ordinary white sound with the higher frequencies removed. The unit is intended for background use with the volume set to counterbalance distracting noises.

The Soundsleeper costs \$90 and is made by C. P. Electronics, Columbus, Ohio.

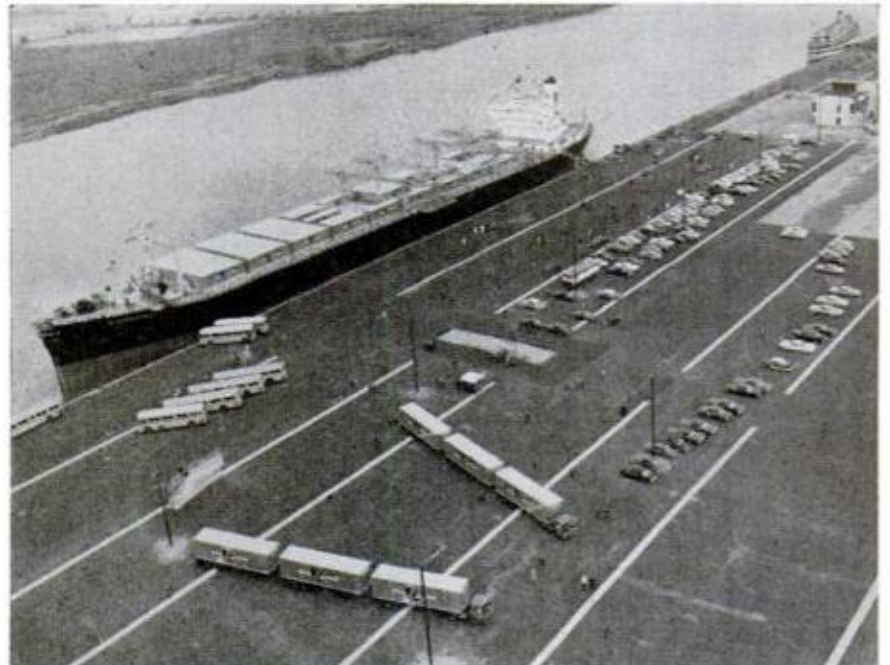

Piggyback Trailers Go Down to the Sea in Ships

Transcontinental cargo, normally shipped cross country by rail or truck, may now be floated from coast to coast by special container ships equipped to handle up to 476 fully loaded truck trailers.

Lifted unopened from the trailer bed, the containers are stacked neatly aboard

ship and sailed, via the Panama Canal, between Atlantic and Pacific coast ports.

Sea-Land Services of Newark, N. J., recently inaugurated the sea-going system. The railroads have been using the piggyback system of trailers over inland routes for many years.

a fresh concept:
**the
'BOILING
ENGINE'
car**

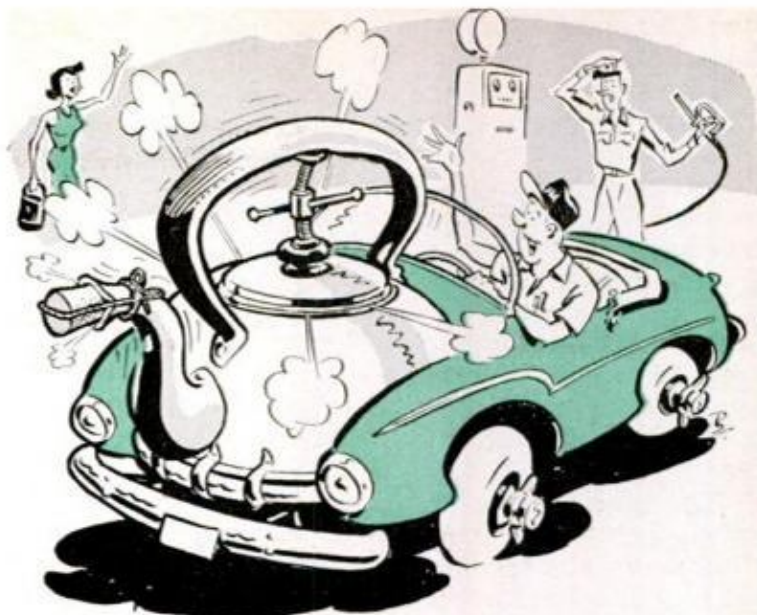

'Let 'er boil,' say the inventors. 'It's good for the car'

By James Joseph

UP TO 10 TIMES the engine life and a virtual end to the build-up of carbon, varnish, and sludge—these are promised benefits from a new approach, Uni-Temp, which turns your car's cooling system into a "heating" system.

It splits the cooling system in two stages,

with the primary stage always boiling.

Uni-Temp, developed by inventors A. N. Anderson and A. A. Tacchella, helps lubricants flow at proper viscosity all year, doing a made-to-measure job of cushioning metal bearing surfaces that are kept within closer limits and have less tendency to ex-

SILVER-PAINTED parts on its top are all that's necessary to convert this diesel into a boiling engine

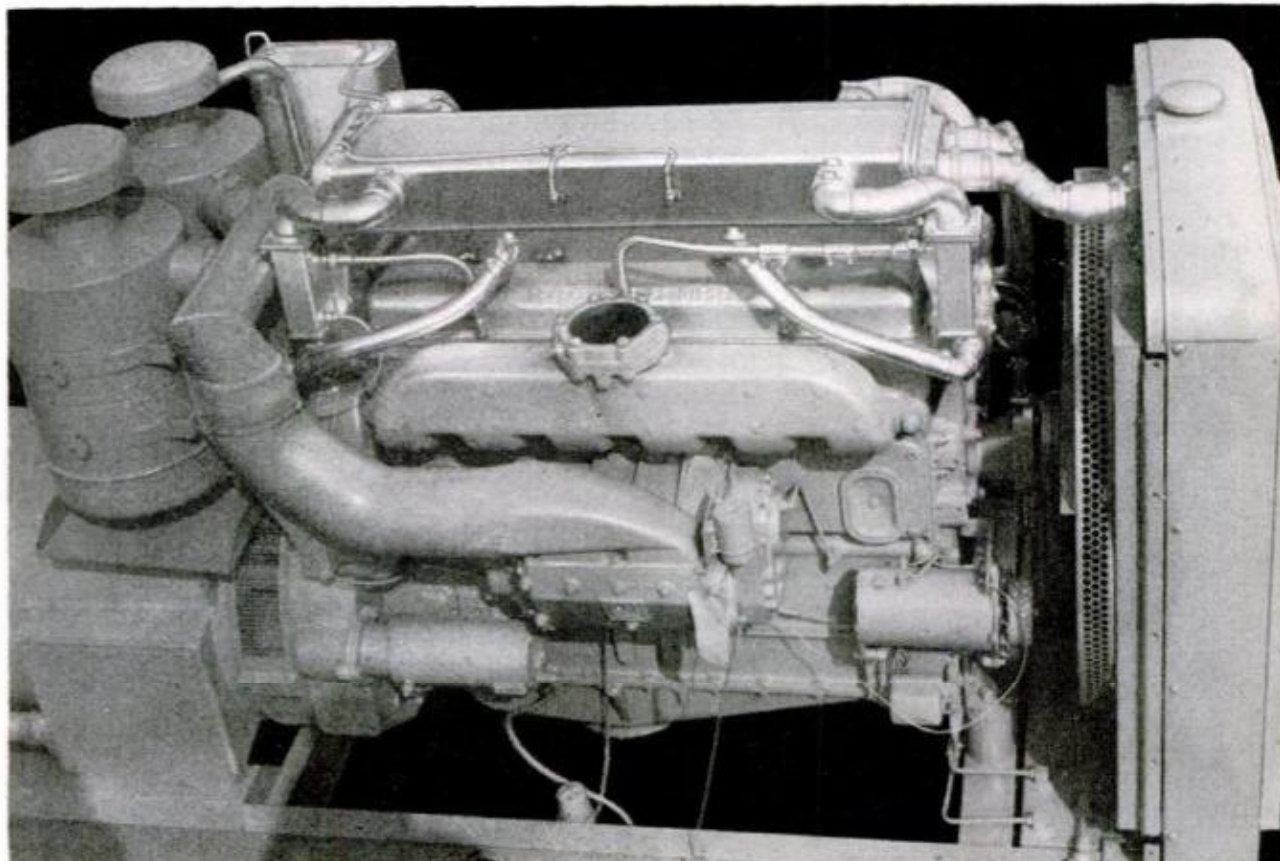

pand and bind, or contract and scuff. It also helps solve the problem of designing carburetors and intake manifolds as a compromise between winter driving, when the fuel-air mix requires preheating, and summertime, when a cooler induction system is desirable. The inventors even claim a seven to ten percent improvement in fuel economy is possible with Uni-Temp.

With a constantly hot engine, water vapor—a by-product of combustion—never gets a chance to condense in the crankcase and merge with sulphurous gases blown past piston rings to form bearing-eating acid.

The inventors' solution is to use coolant water's change of state to a gas as a built-in thermostat, by setting their operating level at 212° or a few degrees above.

When water surrounding the engine (in the primary of Uni-Temp's two systems) reaches 212° and boils, it rises as steam and carries heat up and off to a surface condenser where it is drawn off. Condensation cools this boiling vapor only a few degrees, however. As soon as the vapor condenses back to water, at or very near 212°, gravity pulls it back down into the engine block and the cycle continues, just as in your coffee percolator.

Uni-Temp's secondary system is the conventional radiator, fan, and circulating pump. It provides the cooling water that enables the condenser to remove heat from the boil-off steam and turn it back to water.

Uni-Temp limits the temperature spread from the top to the bottom of the cylinder to 2° to 5°. Conventional systems, besides having an operating temperature that can vary from about 180° to 205°, can have a top-to-bottom differential of 10° or even 20° within the engine block itself.

Thus Uni-Temp reaches the goal of higher engine operating temperatures that Detroit has been approaching with its pressure cooling systems and high-temperature thermostats.

The principle of running an engine hot for more efficiency has long been followed with industrial units. The Marine Corps Base at Twenty-Nine Palms, Calif., went to hot-engine operation for water pumps about five years ago to solve the problems of wear and extreme carbon build-up in the exhaust ports of truck-type diesel engines. Experimental boiling-engine trucks have been operating for some time. But it will be a while yet before Uni-Temp is ready for your car.

One kit just completed fits a General Motors truck engine. Another is in the works for inboard marine engines. Eventually others are planned for pickup trucks and cars. The cost isn't likely to pass \$100.

CONDENSING TUBES
RADIATOR & CONDENSING TUBES FILLER CAP
SAFETY FLOAT SWITCH
FAN SHROUD

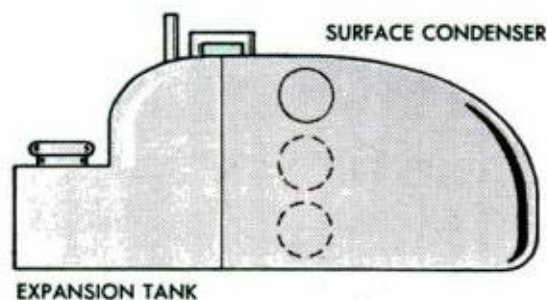

FRONT VIEW UNI-TEMP SYSTEM

STEAM AND BOILING WATER (broken arrows above) surge up from the water manifold to the condenser where tubes of cooler water (solid arrows) cool the vapor, condense it back to water. Condensate drains back to block, still close to 212°. Front view of the condenser shows the extra filler pipe, required because Uni-Temp's primary and secondary systems are separated

SCHEMATIC DIAGRAM at right includes the oil cooler which uses radiator water. A device of this kind is often necessary when a Uni-Temp kit has been installed

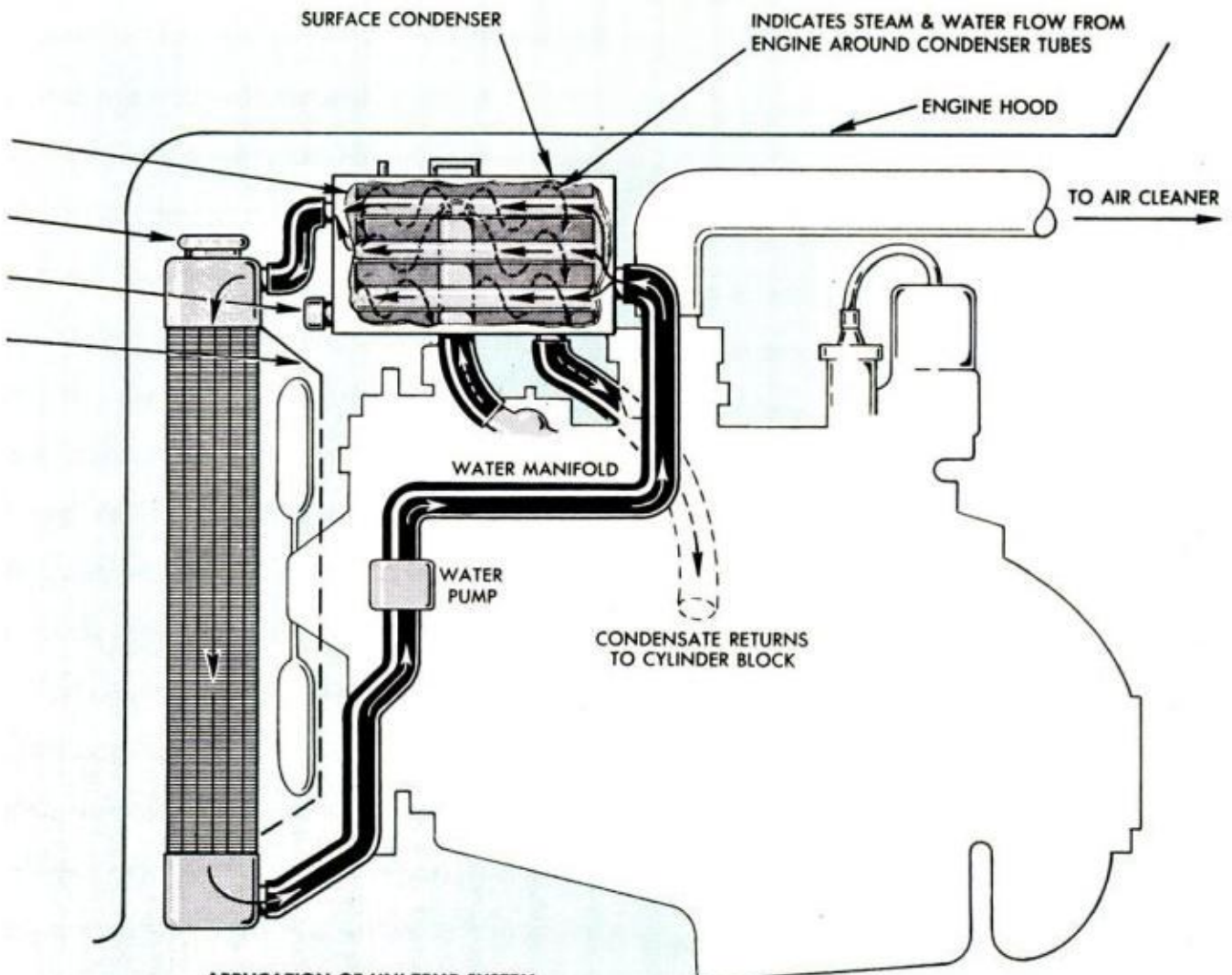

APPLICATION OF UNI-TEMP SYSTEM TO A GASOLINE-POWERED AUTOMOBILE

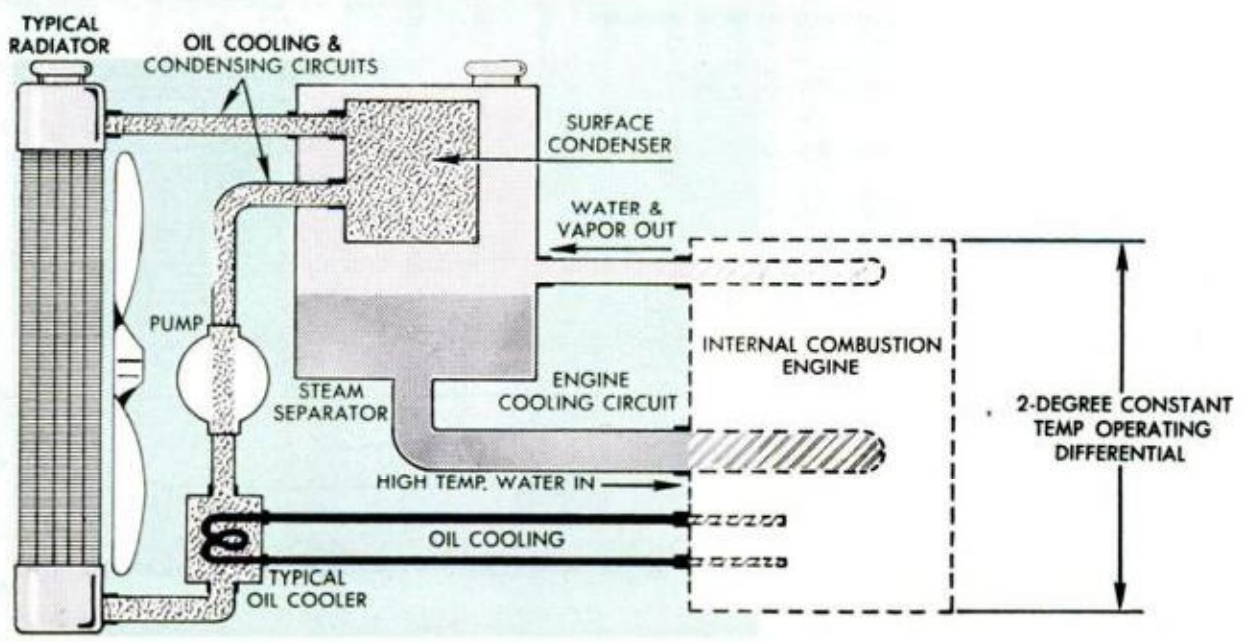



Front-Seat Locker For Vacation Trips

Maps, camera, film, vacuum bottle, sandwiches and other odds and ends all fit into snug compartments in a homemade car locker.

The locker rests on the front seat and is bolted in place with wing nuts through two unused holes in the dashboard. The lower unit, which holds four unbreakable glasses, sits on the shaft housing.

A plug-in coffee pot, hot plate and portable razor (in use) are also part of the catch-all. W. K. Northrup, Cleveland, Ohio, built the unit for his car.



Raise the Roof For Camping

Britain's sturdy utility vehicle, the Land-Rover, becomes a camper with the addition of an elevating fibreglas roof and a dormitory interior.

The Dormobile, a joint product of the Rover Co., Ltd., and Martin Walter, Ltd., sleeps four, has two upper and two lower berths six feet long, a two-burner stove, sink, storage cabinets, a collapsible dining table and plastic water tanks.

Sold in the U.S. by Land-Rover dealers, the camper is priced at \$5280 on the East Coast.



Assembly-Line Eggs

Wringers from an old washing machine and a belt of ordinary hardware cloth make an egg-gathering system for a Fruitville, Fla., poultryman.

The eggs roll down a slanted incline onto the belt, which is pulled through the wringer rolls. The rig is used to collect eggs in chicken houses as long as 300 feet. Regulating the pressure on the rolls determines the speed of the hardware-cloth belt.

● Frogs with built-in parachutes glide from tree to tree in some parts of Africa and southern Asia. Membranes between their toes, when spread rigidly, act as "wings" enabling the frogs to jump 50 feet.

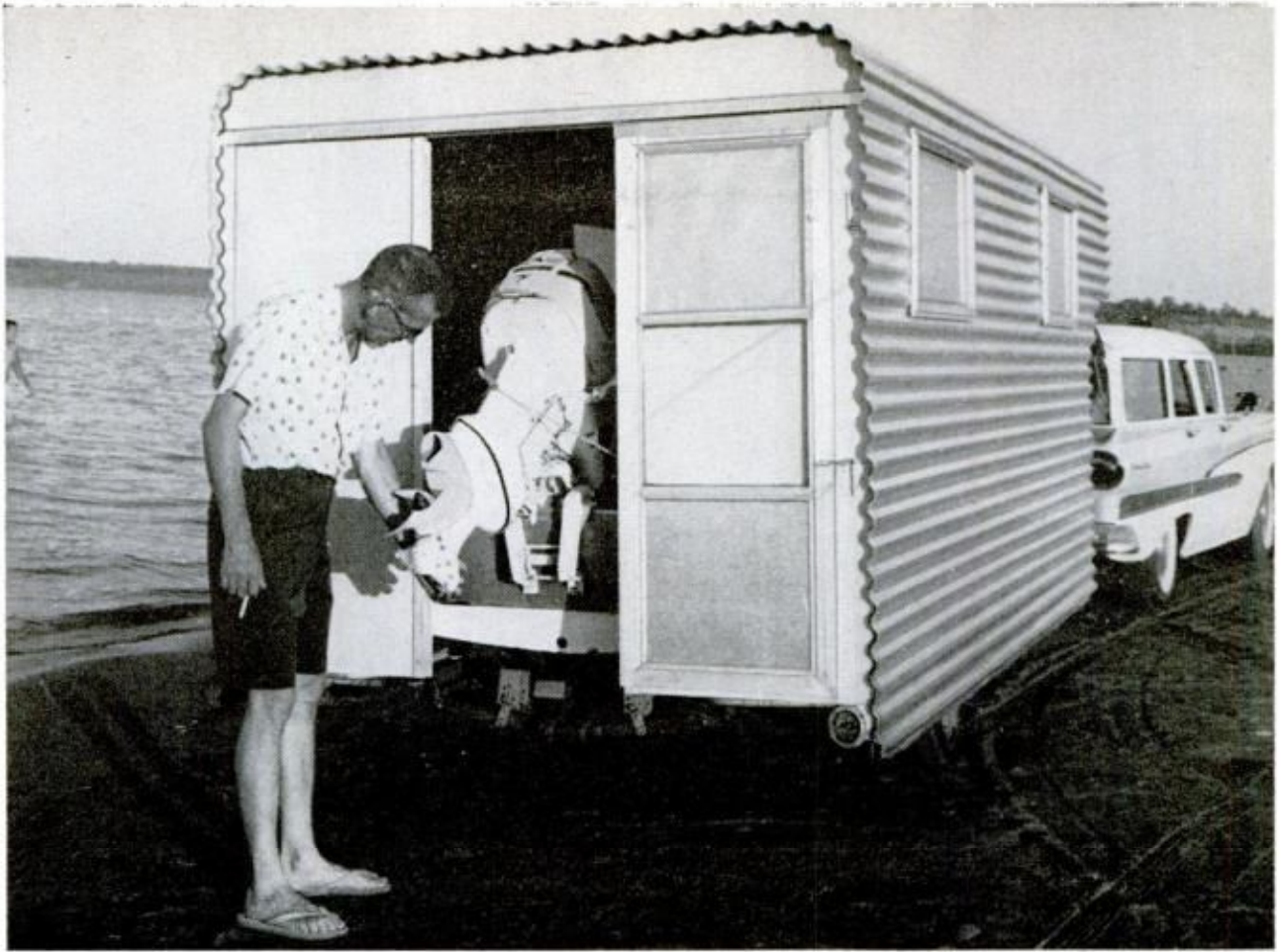

Boat Trailer Doubles as Camping Shelter

Tired of the nuisance of getting caught in the rain when setting up or breaking a camp, an Oklahoma outdoorsman built a shelter over his boat trailer in such a way that it would serve as sleeping and living quarters, too.

Using corrugated aluminum siding, aluminum tubing for support and a folding rear door that can be locked, he built the shelter

long enough and wide enough to house the boat. These dimensions gave ample room for four folding bunks and kitchen gear, plus storage room for all his camping equipment while traveling.

A bonus benefit of the boat shelter is that it serves as its own garage during the off season. The aluminum siding needs little maintenance.

BOAT SHELTER, rigged for boat loading with floor boards and bunks out of way

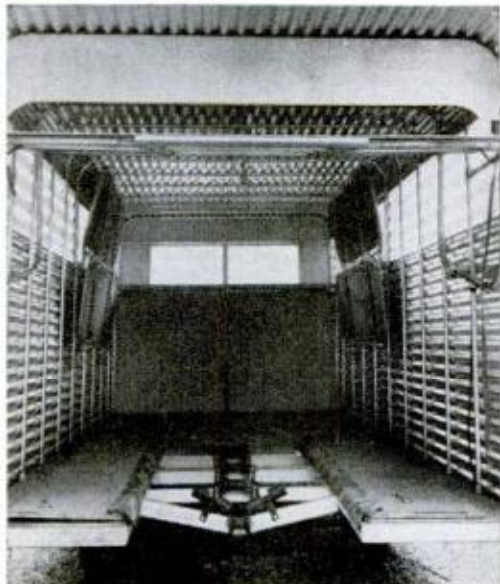

AFTER LAUNCHING boat, shelter is turned into living quarters. Bunks, cooking unit (foreground) and shelves are set in place



BID YOUR WAY TO BARGAINS

Public Auction Sale

Of Lost, Stolen & Unclaimed Property Recovered By

CHICAGO POLICE DEPARTMENT

WEDNESDAY, MAY 9th, 1962 - 11:00 a.m.

321 W. Lake Street Chicago 6, Ill.

AIR CONDITIONER — POWER LAWN MOWER — LADIES & GENTS WATCHES — RINGS — JEWELRY — TABLE MODEL RADIOS — CAMERAS — T.V. SETS — GOLF CLUBS — MISCELLANEOUS TOOLS — SHOES — MEN'S & LADIES' COATS — SUITS & FURNISHINGS — LUGGAGE — ROCKLATH — STATUE — RECORD PLAYER & RECORDS.

**AUTO ACCESSORIES AND TIRES WILL BE SOLD AT 11:00 A.M.
JEWELRY WILL BE SOLD AT 12:00 NOON**

TERMS OF SALE: Everything to be sold on an as is where is basis without any warranties of any nature whatsoever. All sales are for cash. Checks must be certified. No claims for shortages will be recognized after the merchandise leaves the premises.

Proceeds of Auction go to the Patrolman's Annuity & Benefit (Pension) Fund

Honorable RICHARD J. DALEY
Mayor

ORLANDO W. WILSON
Superintendent of Police

JAMES C. HOLZMAN, Director, Department Custodian

ACE AUCTIONEERS & LIQUIDATORS, INC.

LOUIS GOODMAN & ALBERT PALETZ
Auctioneers

321 West Lake Street

Telephone FI 6-5955



TYPICAL NOTICE of an auction, above, lists the merchandise that will be offered and the terms of sales. Below, registered bidders make their offers





GOING, GOING, GONE. The auctioneer calls for bids on a wide variety of goods at a U.S. Government sale

Here's a wonderland for shoppers. At public and private auctions you can pick up anything from automobiles to zircons—at astonishing savings

By M. Robert Beasley

RECENTLY A DETROIT man bought a \$350 German camera for \$25 from the police department, and drove home in a station wagon he had purchased for \$700 less than market value. In another section of the city, a private trucking company sold, among other things, a new \$300 refrigerator, with a few scratches on the side, for

\$45; a new 20-foot boat complete with out-board motor for \$75, and a table saw for \$35.

Bargains such as these are available to everyone in all major cities throughout the U.S. The simple secret is to find out when and where auction sales are being conducted by various Federal, state and local agencies and numerous private organiza-



BARGAIN HUNTER inspects jewelry and watches prior to auction, noting lot numbers and planning for bids

tions that warehouse goods.

Police departments in large cities hold regular public auctions, where everything from automobiles to zircons is offered to the highest bidder. Generally, material from this source is used. However, occasionally some confiscated merchandise, recovered stolen goods or objects abandoned for which no owner can be located, will be brand new. Whatever condition or value, all items in property storage are auctioned. Sports equipment, automobiles, cameras, typewriters, recording machines and tools are some of the many things available through these sales. A police auction, incidentally, is an ideal place to find a bicycle for Junior. There are always a number of bikes at a few dollars each. Through smart bidding, it is possible to buy a car, drive it a year, then trade it in on a new model, receiving a trade-in allowance higher than the auction price of the original car.

Items for sale can usually be examined before the auction begins. Mechanical objects sometimes require repair, but a general estimate of their condition is listed. No items are offered that are beyond easy repair, since derelict material is sold in bulk to junk dealers.

Public transportation systems and conservation and sanitation departments all require a wide range of articles that have been lost, recovered from theft, abandoned or otherwise unclaimed. These must be liquidated due to lack of storage space and complicated accounting. The price received for merchandise is incidental to the real problem of disposing of the goods as

quickly and easily as possible, so public auction is the logical outlet.

The U.S. Post Office Department holds the most frequent Federal Government sales. Each year the Post Office acquires upward of a half-million unclaimed or damaged packages, which will eventually be sold through auction. These sales include books, clothing, jewelry, tools and sports equipment—almost anything that can be shipped through the mails. As with all government sales, postal auctions are open to the public, and everything goes to the highest bidder over a dollar.

At all Federal Government sales, where there are similar items, they are often packaged and sold in lots. For instance, you might find three different cameras in one package, or a portable power saw grouped with an electric hand sander, or a typewriter and tape recorder as one lot. Although you might want only one item, the price for the entire package will usually be sufficiently low to warrant purchase. It is possible to sell the items you do not want, and wind up making money on the deal.

Notices of forthcoming Post Office auctions are listed in all newspapers and advertised on Post Office bulletin boards. Catalogues of merchandise are distributed free at the gallery before each sale. Persons who request their names be added to regular auction lists can receive advance notice and catalogues through the mail.

A 50-percent deposit is required on all purchases, payable upon acceptance of a bid. Merchandise cannot be claimed during the sale, but must be picked up within a few

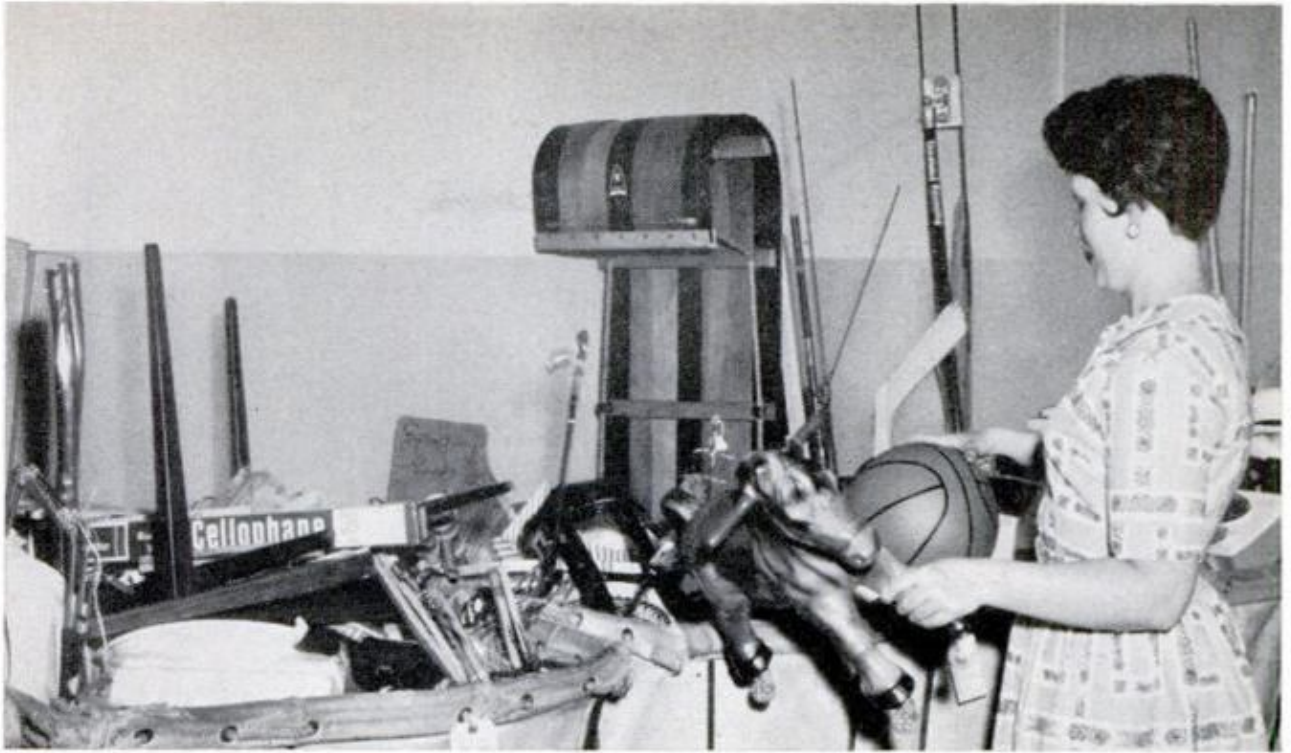

SPORTING GOODS, furniture, bric-a-brac—there is no limit to merchandise offered at public auction

days and the balance paid in cash or certified check.

New York and Chicago have the largest "dead parcel" branches, requiring three or four auctions annually. Most major cities will hold two auctions a year, depending upon volume of goods accumulated. During January and February there are sales in almost every city to dispose of the mountain of merchandise acquired during the holiday season. Your local post office will have information regarding time and place of sales.

Excellent bargains can be found at sales conducted by the U.S. Customs Service. Public notice of these sales is posted in Federal buildings and advertised in local newspapers, usually in the classified section. For personal advance notice, send a letter to the Collector of Customs, in the nearest

ORNATE GLASSWARE and silver are examples of what this smart housewife may buy at fantastic prices





LOADED HAMPERS hold the wide range of goods on display prior to a U.S. Post Office sale. Items bought in lots may be resold individually to realize a profit

LUCKY FISHERMAN finds a typical public auction value. The new rod and spinning reel that he inspects will be bought for just a fraction of its retail value

port of entry. A complete list of the locations of the collectors of customs can be received by writing to: Bureau of Customs, Treasury Department, Washington, D.C. All sales are conducted locally and information pertaining to dates of sales must be obtained from the local port of entry.

Most items purchased at a Customs sale are new. There are exceptions, of course, such as luggage that might have been abandoned or confiscated, and automobiles seized in illegal activities. Practically anything can turn up at a Customs sale: jewelry, furs, clothing, cameras, imported wines and liquors. This merchandise has been seized from smugglers, or abandoned on docks or ships in lieu of customs payments. It is possible to purchase \$50-ounce French perfume for as little as two dollars, or a \$1000 watch for \$50.

In addition to Customs and Postal sales, the government holds auctions through the General Services Administration, the Internal Revenue Service and several other agencies. The local office of any government agency will give you required information about all sales of their organization.

Some government auctions require that a small deposit, ranging from \$10 to \$25,

[\(Continued on page 188\)](#)



Steering Wheel for Sleds

Something for the future Olympic champion is a steering wheel that converts a regular sled into a bobsled.

Developed by S. L. Allen & Co. of Philadelphia, the steering wheel is available in a converter kit adaptable to the Flexible Flyer and Yankee Clipper sleds, and is priced at \$6.55.

Easily installed and removed, the steering assembly allows a youngster to sit erect and steer his sled like a regular bobsled.

Besides offering more thrills on the neighborhood hill, the converter is a safety feature. In the sitting position face and head have greater protection.



Mixed-Up Corn Combo

Adjusted combines can now be used to harvest two types of corn-cob mix as well as shelled corn, report John Deere engineers.

One adjustment adapts the combine to shell the corn, break the cobs into pieces about one inch long, and deliver the mix to the grain tank. Other adjustments adapt the combine to crack the kernels and break the cobs into smaller pieces.

One basic harvesting machine reduces the investment in farm equipment, spreads fixed costs over more acres, and makes more money available for other farming enterprises.



Self-Feeding Art Pen

Artists and letterers have an ample reservoir of ink when using a new pen that eliminates the need to load the point with quills or droppers. It is filled by a plunger mechanism in the side of the barrel, like a fountain pen, and can be used with any size or style of Speedball point.

The pen is molded of lightweight black plastic with gold trim and has a screw-on cap with a pocket clip.

The pen costs \$2.95 and is made by C. Howard Hunt Pen Co., Statesville, N. C.

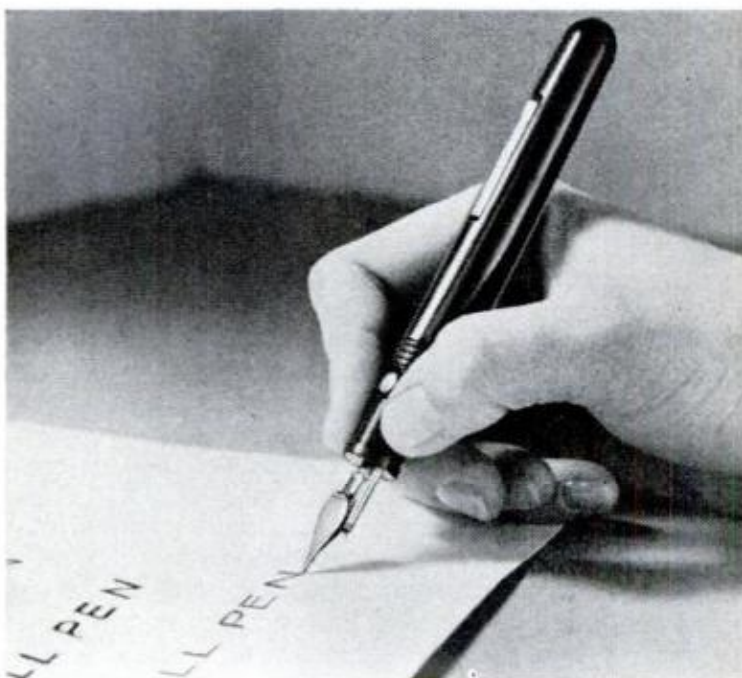

● Seven of the world's ten highest mountains are in Nepal, Asia.

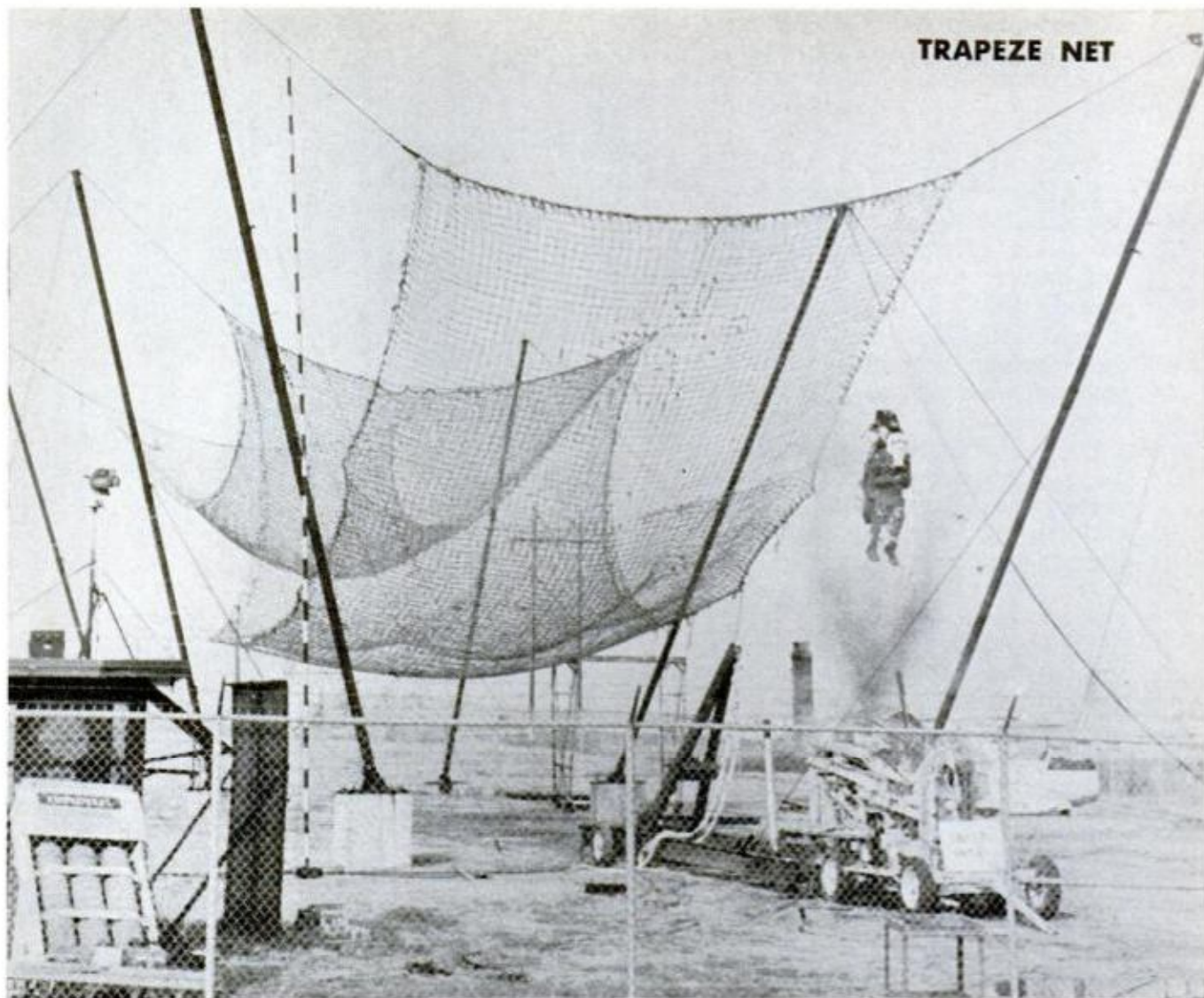

TRAPEZE NET stands ready to catch dummy pilot during tests of supersonic jet's rocket ejection seat

Look What It Takes to Build Airplanes!

THE WRIGHT BROTHERS used bicycle chains to turn the propellers of their first airplane and Glenn Curtiss used inner-tubes as wing floats for his first seaplane.

Aviation hasn't changed much since. Commonplace items still find uncommon use in the making of even today's supersonic jets.

At the Ling-Temco-Vought plant in Texas, where they make the Navy's F8U *Crusader* carrier fighter, such things as...

Table-tennis balls are tossed in acid baths used to chrome-plate aircraft parts. They absorb the highly poisonous acid fumes.

Honey bees and house flies are blasted against windshields in tests to find ways to remove insects in flight.

Dentists' mirrors help aircraft inspectors peer into small openings; stethoscopes help detect air leaks in pressurized-plane cockpits; tongue depressors spread gummy sealants on joints; and hypodermic needles squirt oil on small ball bearings.

Circus-trapeze nets catch dummies shot from cockpits in ejection-seat tests.

Undertakers' gloves are used by men in "clean rooms" to keep the infinitesimal stain of their fingerprints from critical airplane parts.

Plain smoking tobacco is used to blow smoke into pressurized cockpits to test the tightness.

Meat hooks suspend metal templates.

Cupcake tins and cardboard cuspidors are used by the thousands to store rivets, nuts and bolts.

Goopy liquid soap lubricates honeycomb material used in machining parts for the huge new RS-70 supersonic bomber.

Liquid shoe polish takes the glare off instrument panels.

Ground-up pecan shells are tossed into jet engines to "clear their throats" of dirt and oily accumulations.

No one yet, however, has found a use for the kitchen sink.

PALLBEARERS' GLOVES are worn by engineers to keep fingerprints off metal in aircraft "clean rooms"



STETHOSCOPE

AIR LEAKS are more easily detected by using physician's stethoscope to listen for small irregularities

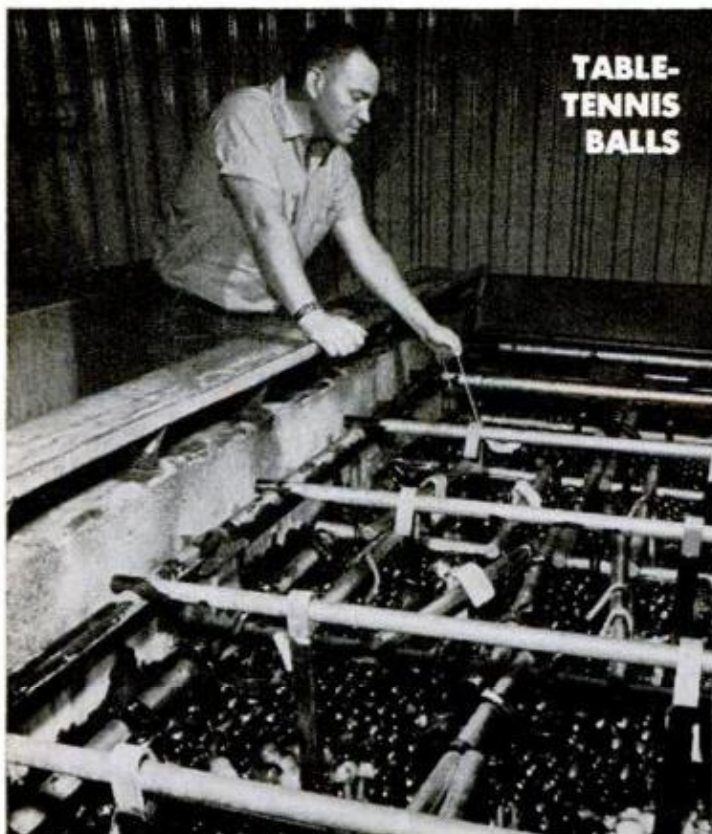
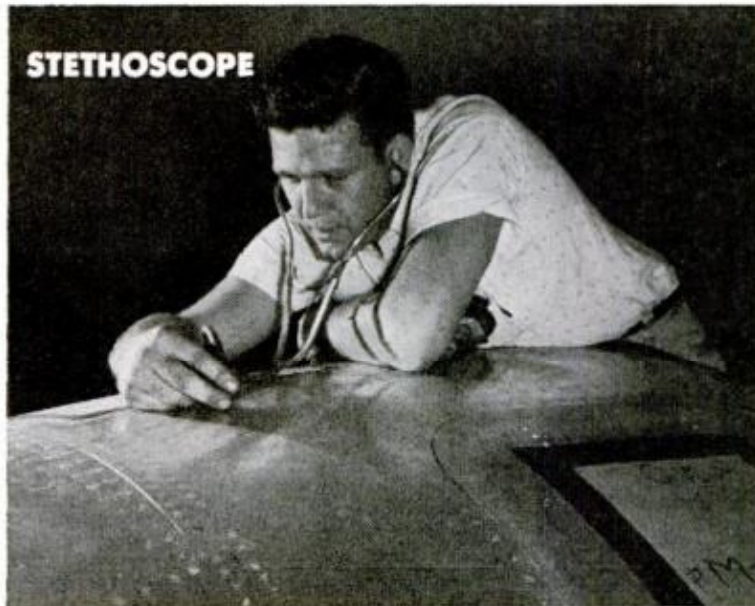

TABLE-TENNIS BALLS

BALLS float in vat of acid, absorbing deadly gas fumes



BEEES

BEEES, sucked out of container, blast against windshields



Jonah Never Had It So Good

Men have gone down to sea in some strange-looking ships, but few as strange as one now cruising off southern California. It is a replica of a sperm whale and is made of glass fiber on a steel frame. Three water jets, powered by a 95-horsepower diesel, drive the 51-foot boat and swivel for steering. A blowhole in the whale's head spurts water.

"Sharp Up" by Degrees

For the man who likes to keep a check on the temperature, there's a set of cuff links and tie clasp inset with tiny thermometers. The dials read from 20 degrees below zero to 120 above. The \$7.95 set is made by Cary Thermometer, 100 W. 42nd St., New York 36.

Swiss Aircraft Is Hauling Cargo in Alaska

Gaining favor among Alaskan bush pilots is a plane designed and built by the Swiss for use in mountainous areas.

The Pilatus Porter has an unusually large cargo door so that bulky items can be taken aboard. Powered by a 340-horse-

power Lycoming engine, the craft will seat seven passengers and pilot. With only a pilot and fuel aboard, it will carry a 937-pound payload. The wide, fixed landing gear is equipped with wheels and skis so the plane can land virtually anywhere.



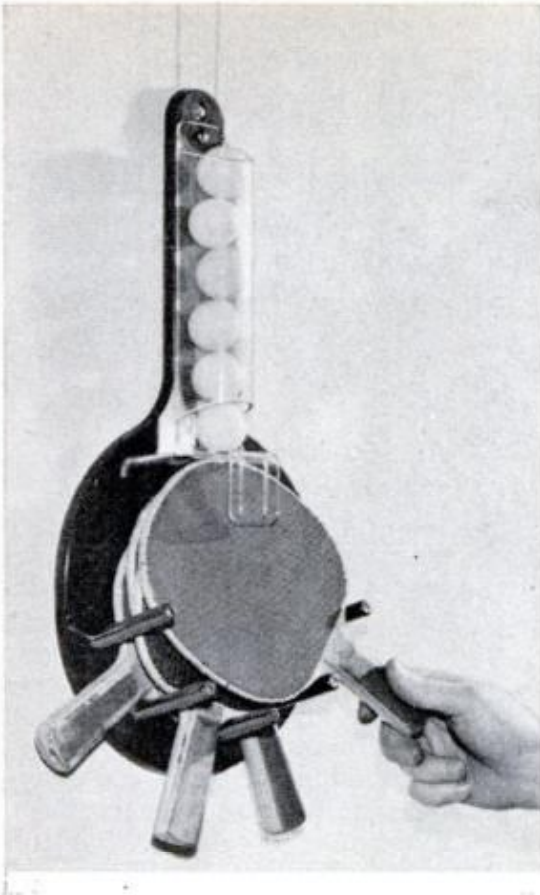

Table-Tennis Rack

Table-tennis balls and paddles are held neatly in place with a new plastic storage rack. The wall-mounted rack dispenses balls one at a time.

Made by F & M Mfg. Co. Inc., 1653 Northeast Parkway, Wichita, Kan., it costs \$3.98.

Formidable Footwear

Aerating a lawn is simply a matter of strolling across it when you're wearing a set of steel spikes strapped to one foot. Five spikes enter the ground every time the wearer of a strap-on aerator takes a step.

The aerator is available from Hurst, Kelvedon House, Artillery Lane, London E. 1., England.

● **Lake Baikal** in Russia, with a depth of 5315 feet, is the world's deepest lake and Eurasia's largest body of fresh water.

● **Mexico's Pyramid of the Sun**, rising as high as a 20-story building, was ascended in pre-Columbian times by priestly processions to pay homage to their supreme god, Quetzalcoatl. An archeologist has estimated that construction occupied 10,000 laborers for 20 years.

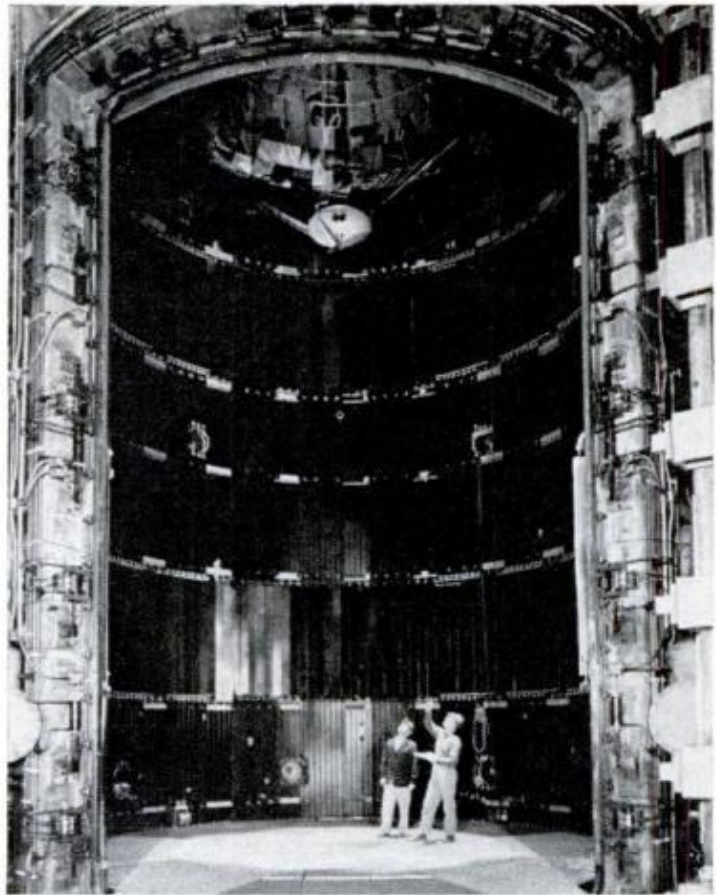

Space Brought Down to Earth

Towering 80 feet high and 27 feet in diameter, a space simulator will expose spacecraft to be used in probes to Venus and other planets to the heat, light and vacuum conditions they will encounter on these long space voyages.

Artificial sunlight is generated by 131 compact lamps through a system of mirrors.

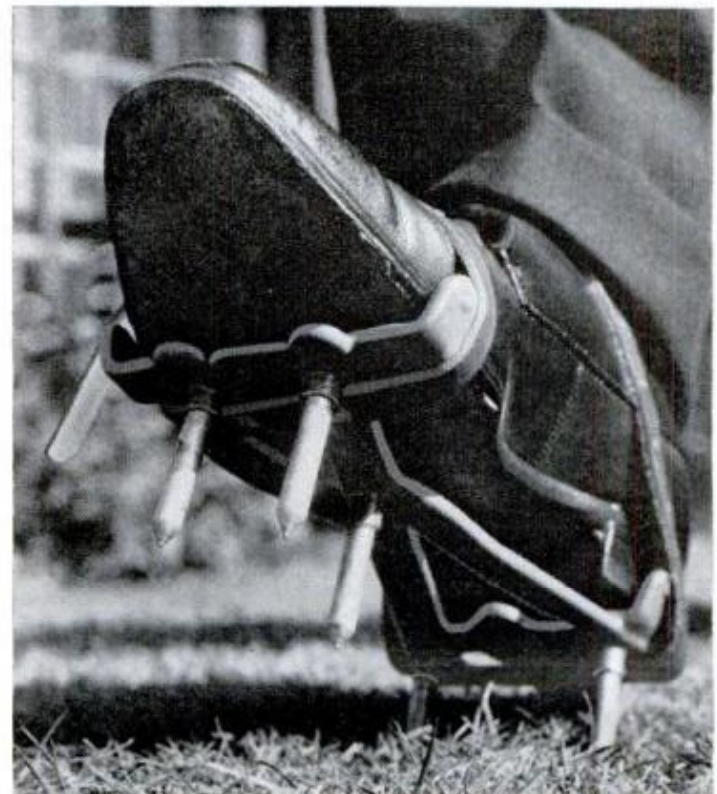

We're Fighting a Hot

Old standards of calibration, once more than enough for the state of the art, are now hopelessly outdistanced in the Space Age that requires infinitely greater precision in measuring "the pint, the peck and the pound"

By Theodore Berland

WHEN THE RUSSIANS rocketed Sputnik I into orbit in 1957, they caught us with our space program down. In our national state of shock, the "sour grapes" reaction was that it was just a publicity stunt.

As the Soviets continued to launch larger and larger satellites—and stay far ahead of us in the race for space—the easy excuse was that their rockets were merely big, capable of big payloads, nothing more.

Even when they sent the first man into orbit, and followed it up with a 24-hour manned orbit, the die-hards were still scowling that the Reds had plenty of missile muscle and were just showing off.

But last August, when Russia launched two separate manned satellites on two successive days, and sent them traveling around the earth so close together that the cosmonauts could see and communicate with one another, even the die-hards had to admit that there might be more to Russian achievements than mere muscle.

As long ago as the first Sputnik, however, the more sober voices among us were warning that it took more than sheer power to orbit an artificial satellite—that the power had to be regulated, and to very close tolerances.

The scientists who said this had seen us make the same mistake before. In 1949, when the U.S.S.R. exploded its first atomic bomb, the excuse was that Soviet scientists had stolen our secrets. But even with all the information that spies had funneled to them, the Russians could not have made an atomic bomb, and then a hydrogen bomb, unless they could measure certain things ultra-accurately.

Looked at one way, the Cold War is a Measurement War, a battle of skills and of more and more precision.

For decades, our National Bureau of Standards—the nation's custodian of "the pint, the peck and the pound"—had all of the precision anyone could want. It could measure things far more accurately than

America's—or any other country's—technological needs.

During World War II, when precision manufacturing and electronics made big steps forward, the standards people were there, helping industry. After the war, while the bureau's budget was chopped down and measurement research crawled, industry's precision requirements raced on.

Sputnik was the big eye-opener. For one thing the Russians were evidently able to measure million-pound rocket thrusts to great accuracy, while we could measure accurately a top of 111,000 pounds.

At a million-pounds thrust (which we didn't have) we could measure within half a percent, for an error of 5000 pounds of thrust. Yet an error of only 1500 pounds of thrust would be enough to throw a lunar or interplanetary rocket off target.

To travel to Mars, Venus and beyond, rockets must have thrust accuracies of .001 percent.

It was the rocket builders, in fact, who first complained that a "measurement pinch" threatened space and military projects. For the first time in the nation's history, technology was ahead of calibration. Specifications for new gadgets called for closer tolerances than anyone could accurately measure at the time.

Flintlock Moon Shot

"We seem to be shooting for the moon with a flintlock," said one member of the Aerospace Industries Association. "Horse-and-buggy measurements aren't good enough for space work," said another.

And the measurement pinch was costing us money. One manufacturer of gears for inertial guidance systems was charging the Government \$80 per item, though each gear cost only \$5 to make. The reason for the difference was simple: the gears couldn't be measured within the 50-millionths of an inch tolerance required. So the gears were made in lots, then fitted. Those that fit best were accepted, the others thrown away.

Measurement War

NEW LOAD CELL at NBS has the capacity for testing rocket engines with thrusts of up to 1,500,000 pounds

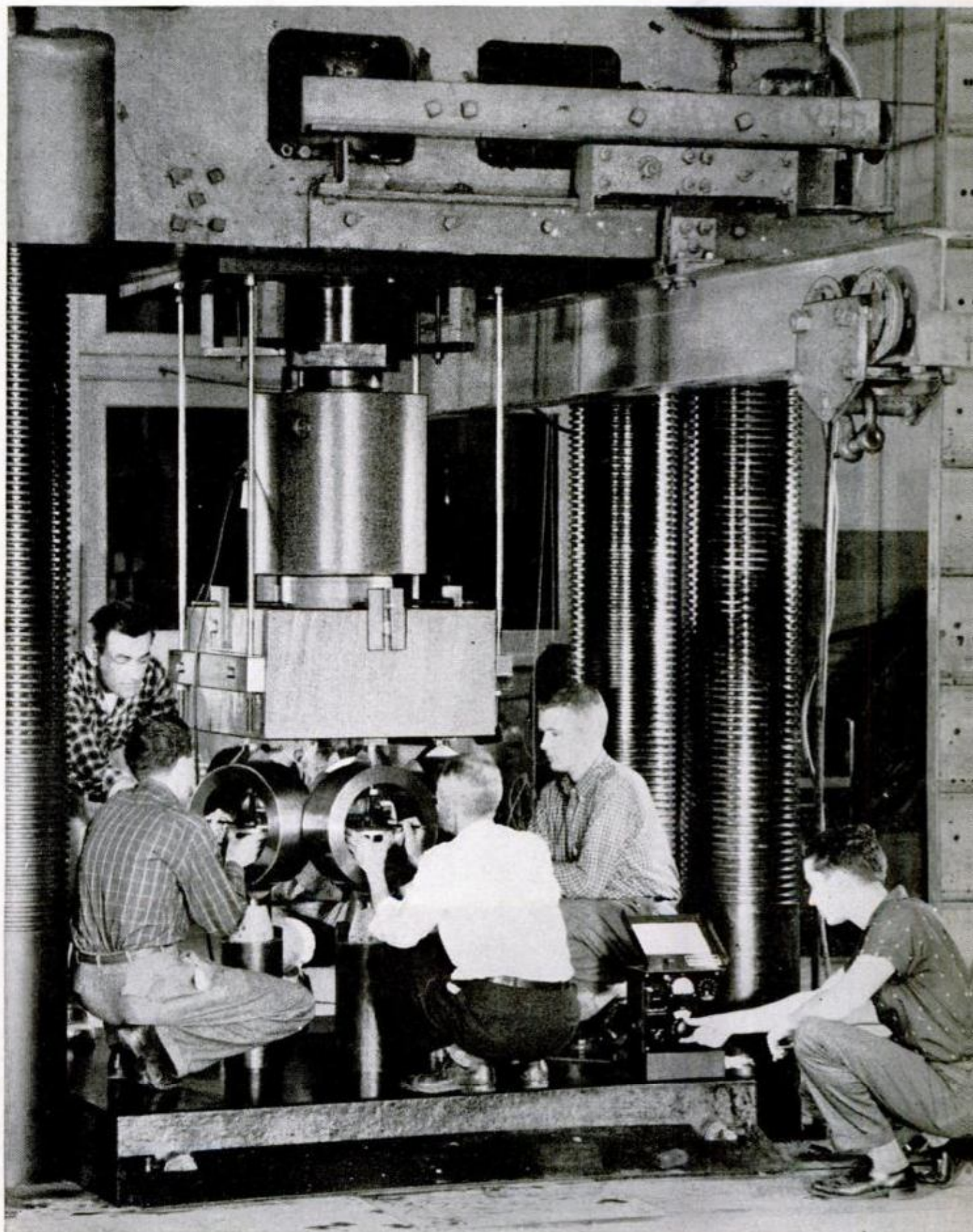

Last year members of the AIA met near Phoenix, Ariz., to air their measurement problems. The meeting was a milestone in a way, because until then aerospace manufacturers were afraid to talk about their problems, for fear they would lose big Government missile-and-plane contracts. But everyone in the industry had the same problems.

Take the case of a manufacturer of radar power tubes who complained that, "As yet, the methods for measuring peak power are not sufficiently accurate."

What happened? "As a result, overdesign is required. Time is lost both in rechecking production and in research and development. Expensive tubes, which may cost from \$30 to \$40, may be rejected unnecessarily." And if the tube accepted didn't perform perfectly, \$37,000 worth of radar equipment built around it would have to be scrapped.

Confessed another large electronics manufacturer: "In specifying modulator transformers, an error due to inadequate measurement information could cost \$100,000 or more."

And, said another, "Of the 10,000 components per month that must be inspected, up to 30 percent may be rejected. But, the biggest problem is that they are not absolutely sure that the accepted items meet all the requirements. . ."

There was also the \$50,000,000 contract to develop a spacecraft to make a soft landing on the moon. The whole project was in jeopardy because there was doubt that its electronics could be made accurately enough to transmit a distortion-free TV picture back to earth.

The measurement pinch pointed up an old truism: American industry is based on measurement. The whole secret of mass production of interchangeable parts—which made assembly lines possible—was that a bolt made in Chicago would fit into a cylinder block in Detroit. Or that a vacuum tube made in New Jersey would fit mechanically and electronically into a chassis in Los Angeles.

And science, which gave industry its ideas, was based on measurements, too.

To assure that all of its measuring instruments were synchronized, each big manufacturer for years had its own master standards. To calibrate an inch micrometer caliper, it kept an inch gage block. The block used by the field unit had to be accurate, say, to plus-minus .003. Periodically, this field block was checked against a block at the company's base office, accurate to plus-minus .001. And, every so often, this base block was checked against the company's

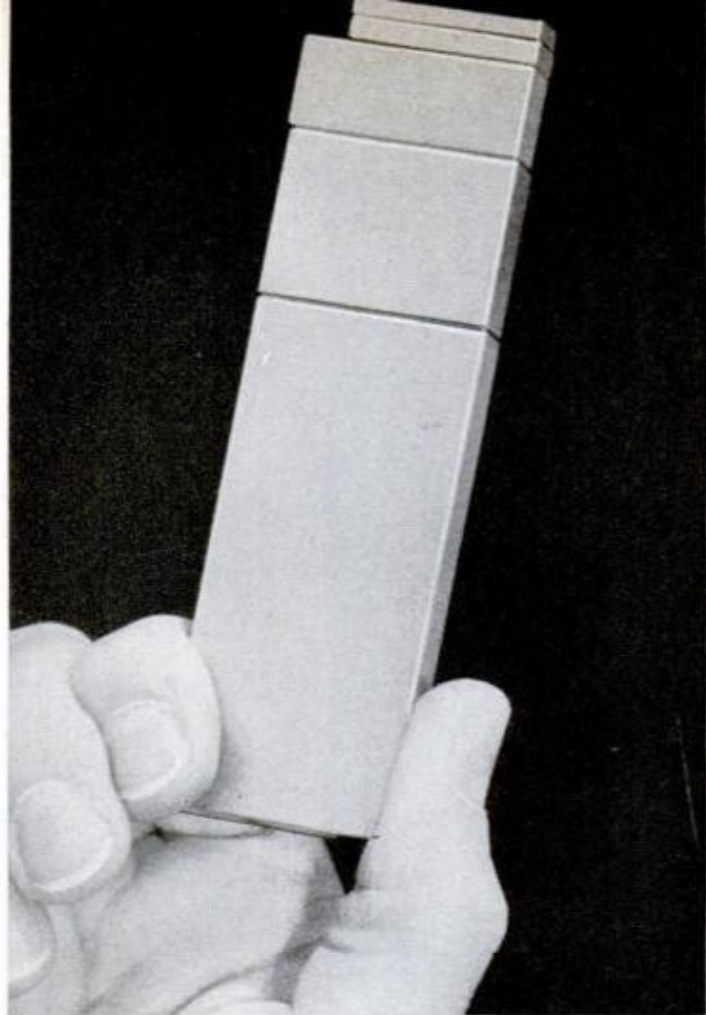

master inch block, accurate to plus-minus .0003. Every few years, the master company block was taken to Washington and checked against the National Bureau of Standards's block, which had an accuracy of .0001. NBS thus calibrated some 6000 gage blocks annually.

This range of precision was fine in the old days. Today, the field block is likely to have a plus-minus .0001 accuracy. This means the NBS's block must be accurate to two millionths of an inch (.000002 in.)!

The revolution in measurement needs wrought a revolution in measuring things.

Take length. For over 70 years two finely engraved lines on a platinum-iridium bar defined the meter. Periodically our well-guarded national meter was flown to Paris and checked against the International Meter Bar.

Today, the standard of length is the unalterable wavelength of the orange-red light of krypton-86 gas. A meter is now 1,650,763.73 krypton-86 wavelengths. An inch is 41,929.399. Length (and gage blocks) can now be measured more accurately than ever before. And the national standard doesn't have to be checked in Paris.

Time, too, has gone atomic. The NBS (and the nation's official timekeeper, the U.S. Naval Observatory at Washington) measures time by the beatings of cesium atoms. So constant is this beat, that a

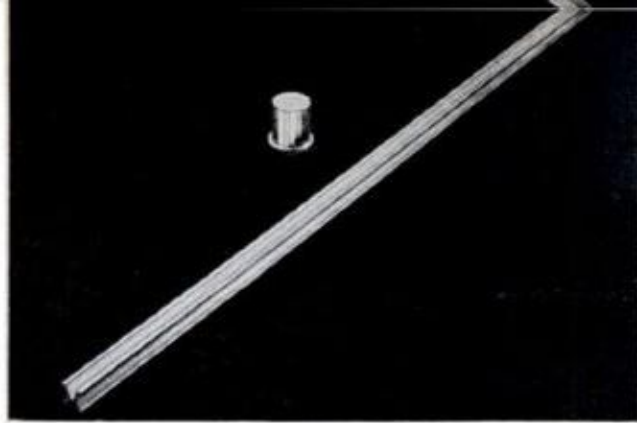

PLATINUM-IRIDIUM BAR (above) was replaced as national standard of length. It is shown with standard of mass

GAGE BLOCKS (left) are kept by every industry to calibrate measuring instruments, and checked periodically with NBS

KRYPTON-86 LAMP (right) emits orange-red light and light's wavelength is now used as national standard of length

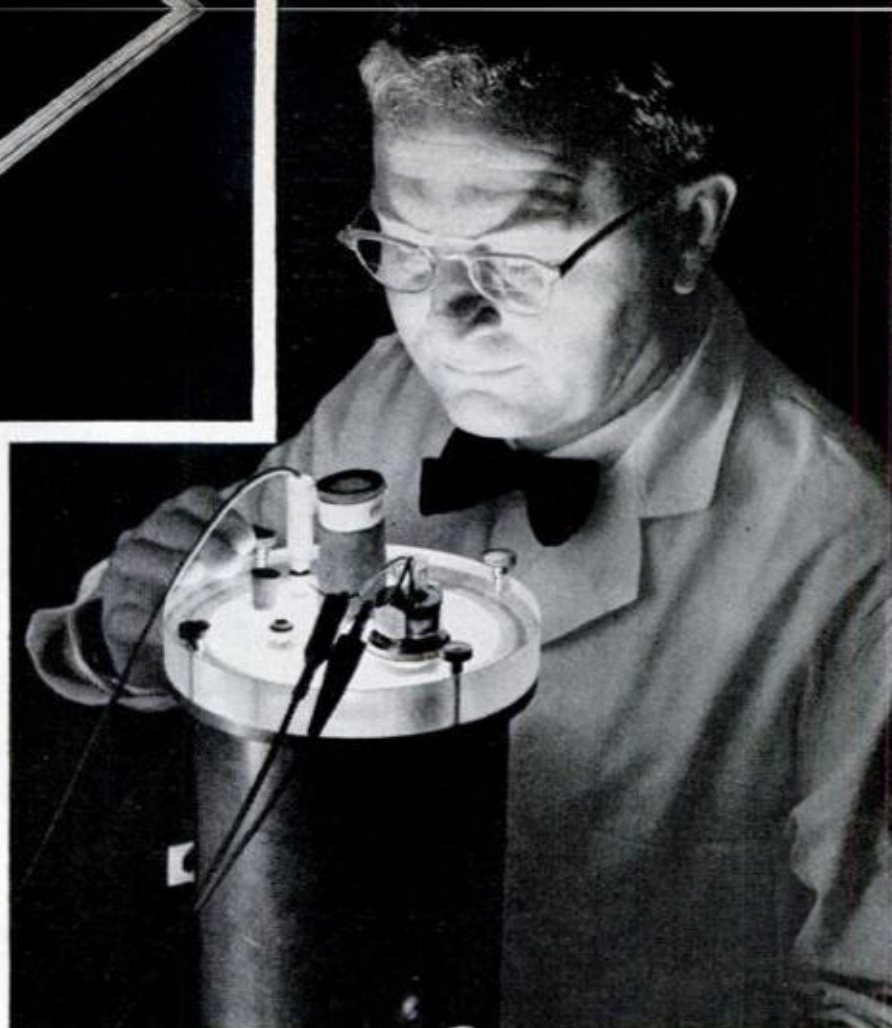

watch, comparably accurate, would lose less than one second in 3000 years.

Why such accuracy? Try tracking a satellite orbiting at a speed of 25,000 feet per second. If your watch is but a tenth of a second off, the position you report for the satellite is a half-mile off. And if you're navigating by satellite, watch out!

Measurements based on the atom are just part of the new NBS look during its war on the measurement pinch.

Take the simple question: how hot? At room temperatures, thermometers are fine—and the Bureau calibrates these regularly. But to get an accurate temperature at thousands and millions of degrees, your measurements, for one thing, have to be remote.

Light can do this, too. Unfortunately, present measurements at 15,000 degrees are only accurate to within 1000 degrees. At a million or more degrees, they are even more inaccurate.

Yet temperatures in the million-degree range are a must for inducing fusion for cheap atomic power. Uncertain temperature measurements are seriously hampering today's fusion research.

Rocket engineers, too, want to measure extremely high temperatures accurately. In one case, reduction of uncertainty from 10 degrees to 2 degrees F. resulted in a savings of 250 pounds in a missile, with an

increase in range or warhead size.

Help along this line is coming in a project that's been under way at NBS for some five years.

Take the rainbow, or color spectrum of light, and stretch it and in most cases you'll find it's made of thin lines of distinct colors and hues.

Now most "excited" atoms—and heating an atom is one way of exciting it—give off such fine lines of distinct color. And the nature of the lines can be used to estimate the temperature of the source.

Bureau physicists have been identifying which spectral lines belong to which atoms at which excitation states. And to appreciate the size of this job, all 92 natural elements are being looked at; the average chemical element has 15,000 possible lines.

Apparently far afield, too, is the Bureau's research with advanced electronic computers. But, as one computer scientist pointed out, "Computers are becoming more of the rule rather than the exception, a requirement rather than an option" in research.

Research with computers at NBS helps in the design of new mathematical tools for our new technology and also helps test reliability and life of computer parts—all aimed at more precision.

Much of the work the NBS scientists do with their computers is sponsored by other government agencies. Examples are mathe-

matical weather prediction for the Weather Bureau and population statistics for the Census Bureau (like NBS, both are arms of the Department of Commerce). NBS scientists have even used computers to automatically translate Russian for the Army (PM, December, 1960).

Another part of the NBS's new look to relieve the measurement pinch is its research in near-space. The primary purpose of this research—conducted mainly by its Boulder, Colo., lab—is to learn more about the ionosphere. This is the layer at the top of the atmosphere that bounces conventional radio waves back to earth or bends microwaves that flash out to space.

To measure the ionosphere's effects on radio waves, NBS has built a model missile-tracking set-up in the Colorado mountains and a giant 22-acre radar antenna (made of more than 9000 dipoles) in Peru. Also, a "Topside Sounder" satellite (to bounce radio waves off the top of the ionosphere) was due to be put into orbit in 1962.

The Boulder labs also have made a big step forward in precise measurement and control of frequencies. With the help of a cesium "clock," radio frequencies can be produced accurate to two parts in a billion. But Boulder scientists still are not satisfied. One points out: "For radio communications, the tracking of satellites, the control of long-range rockets and astronomical observations, timing accuracies of one part in a billion or better will be required."

Other lacks in radio measurement are still causing unnecessary expenses and some dangers.

At last year's aerospace industrial conference, a *Minuteman* missile maker declared:

"Each launching control center consists of an array of buried dipole antennas. The missiles themselves are also buried in silos. The control center radiates signals to several *Minuteman* launching sites at least 20 miles away."

Because of the frequencies used, each buried antenna is several hundred feet long. "The deeper the antenna is buried, the safer the system is from enemy attack," said the engineer. "However, the missiles will not be triggered if the radio field strength is too low and the entire system then becomes worthless."

Because engineers couldn't measure the sensitivity of the antennas accurately enough, they overdesigned them. The result: "This causes an increased cost in each installation of \$150,000. Multiply this figure by 45 installations and the increased cost goes into the millions."

There's also the problem of the shortcomings in measuring radio interference.

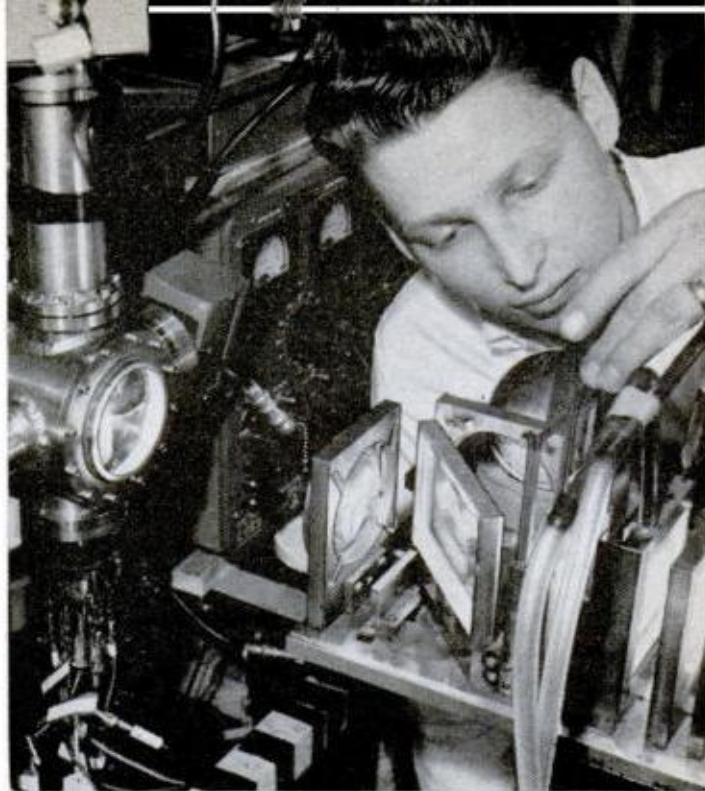

PHOTON-BEAM equipment was designed by NBS for studies in relatively new field of plasma physics

Unless you can measure accurately enough the radio signal that's blocking yours, you can't do anything about it.

Another missile engineer told the conference, "Whenever a missile is prematurely detonated, it is probably due to radio interference. We read in the newspapers only that the missile failed. A future enemy will be the first to learn of your weakness regarding interference—for example, we could cite the lessons learned about radar jamming during World War II. There are some serious doubts in my mind that many missiles will ever be launched during the next war, because of electronic countermeasure activities."

Such problems as interference standards and measurements, while urgent enough, seldom come to public attention. But there was a dramatic instance when it did. The same engineer is talking:

"A certain Navy cruiser blanked out the 'Howdy Doody' television program by its radar in the New York area. When the 'Howdy Doody' program disappeared from the air, then everyone agreed that something must be done immediately.

"I think our program is far more serious than that, but it points out the need for greater interest in radio-frequency interference. When people discover that missile programs are being delayed due to radio interference, it may be too late. We need better interference measurements."

A similar eye-opener appeared in *Industrial Research* magazine earlier this year. Dr. W. Crawford Dunlap, director of semiconductor research at the Raytheon Corp.,

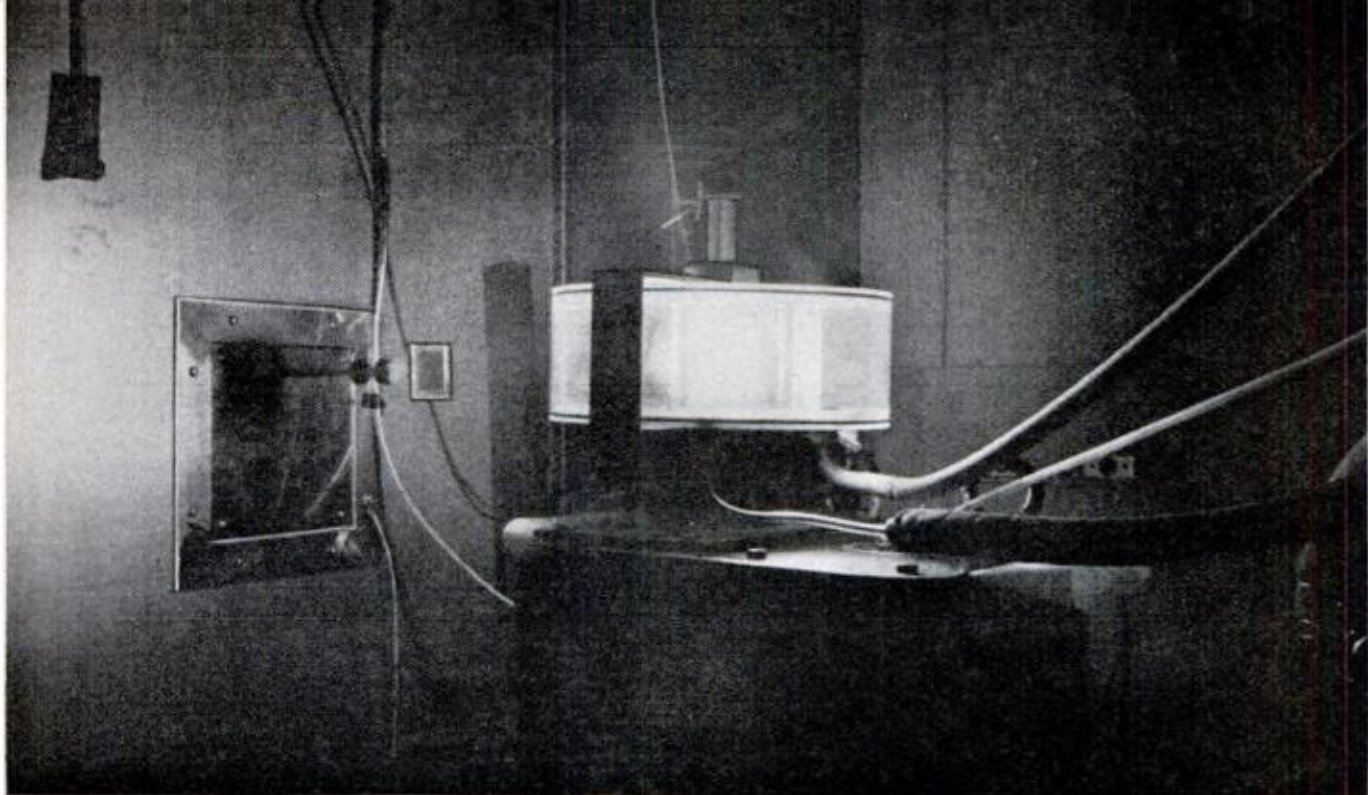

EXPLODING WIRE discharges eerie light. Cylindrical shock waves generated by this technique are being studied at National Bureau of Standards to provide high-temperature data for plasma and astrophysics

said modern miniature electronic parts were not so sophisticated as has been claimed. Virtually every case "is a mixture of science . . . and witchcraft."

As for the solid state materials—grains of which were supposed to replace every bulky vacuum tube—he says, "Preparation and purification methods still leave much to be desired. . . There is but hazy understanding of the imperfections and impurity states."

Establishing standards for measuring the impurities in such materials—which is what makes them usable as transistors—is another of the new programs of the NBS. It is a combined physics and chemistry problem. So, too, points out the bureau's associate director, William A. Wildhack, is research into more precise measurements of acidity, which would mean more precise control in chemical, drug, metal and food industries, more efficiency and less waste and, conceivably, better products and lower prices.

Also, points out Wildhack, medical research has felt the new measurement pinch. The ability to measure weak amounts of radiation first had to be acquired before pinpoint radiation of cancers were possible.

There's also the assaying of sodium and potassium in body fluids. This is important information for the physician whose patient is in shock, or out of surgery. It used to take a day to measure these. Sometimes a day was the difference between recovering and not. Now the test—thanks to new measurement techniques—takes 15 seconds.

Medical research benefits in a big way from the measurement problems solved for industry. More precise electronics can mean better electron microscopes used to study viruses and parts of living cells. And further measurement breakthroughs could push along efforts to make practical such devices as artificial pumps to replace faulty hearts and membranes to replace damaged kidneys.

"It is no accident of history that measurement and technological progress seem to go hand-in-hand," said Dr. Allen V. Astin, NBS's director.

Symbolic of its move from steam-engine technology to that of the ballistic missile, NBS next year will start leaving its Washington, D.C., buildings—some of which date back to its founding in 1901—for new ones in Gaithersburg, Md., 20 miles away.

On the new 550-acre campus will be a million-pound deadweight machine for calibrating such devices as those that measure rocket thrust and missile load. The new machine will be more in line with today's rocket thrusts than is today's 111,000-pound one. It will also be more accurate: .005 percent vs. .02 percent.

At the Gaithersburg site, too, will be a complex of atomic-age equipment, including the world's most intense beam linear electron accelerator, a betatron, a synchrotron and a nuclear reactor.

Measurement, Dr. Astin said, is more than the language of science; it is "the means for applying research for the advancement of our general welfare." In short, we need a more accurate inch.



Rocket Shoot, Laos Style

Each spring, in spite of civil wars and other disturbances, the villagers of the tiny kingdom of Laos hold a rocket festival, called "Bang Phai." It's part of a rite to pray for rain and a good crop.

While spectators line the hillside to watch, others carry the long-tailed and often gaily colored rockets to the bamboo launch gantry. Then the countdown begins, in a figurative way.

It may last anywhere from a few seconds to several minutes, depending on how dependable the fusing is. And, like their big-brother missiles at Cape Canaveral on the other side of the world, sometimes the rockets fizzle on the pad.

No one seems to mind, however, because Bang Phai is a time of merry-making. Songs and dances accompany the rocket shoots, and sometimes one gets off the ground—as high as 200 feet.

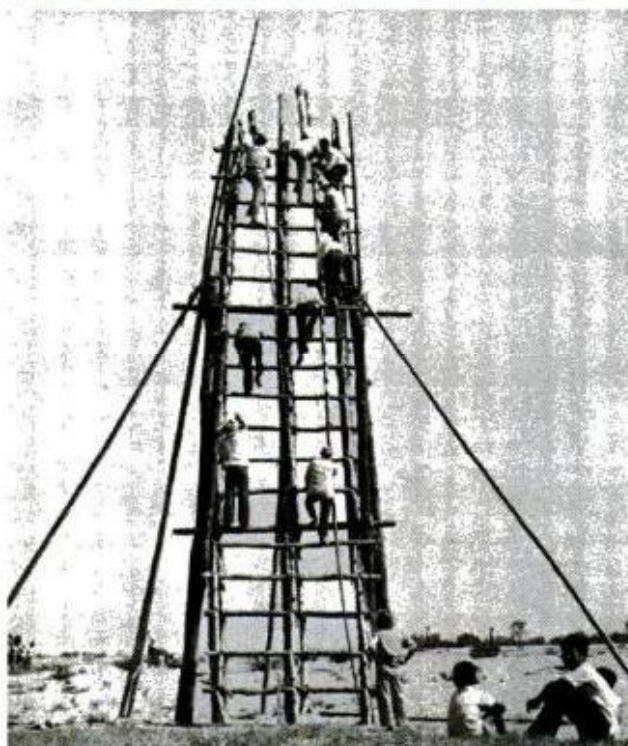

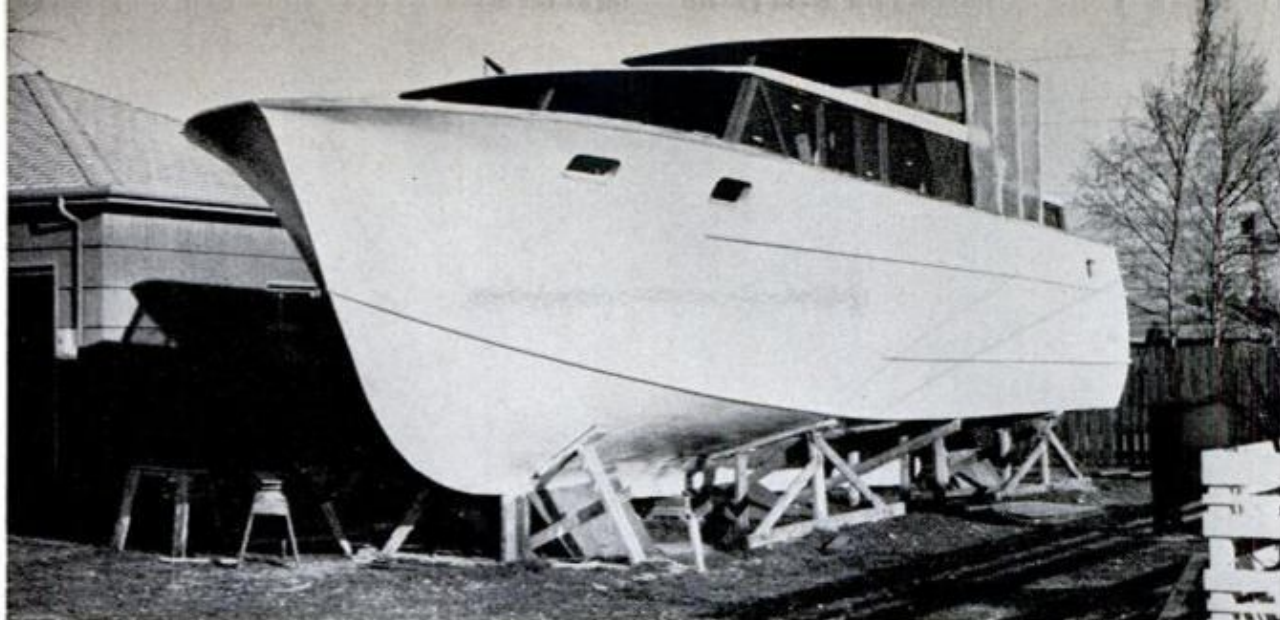

Homemade 40-Footer

With no previous experience in boat building, businessman Ted Hill of Tacoma, Wash. decided to build a 40-foot fiberglass-hulled twin-screw cabin cruiser.

First, he found a picture of the boat he wanted and bought a set of the plans. The next step was to adapt the drawings, which were for a conventionally built wood-planked hull, to fiberglass construction. A fiberglass hull would involve less work if he could think of a practical way to make the mold, he figured.

Working from the plan's table of offsets, he cut light plywood frames for the mold and staked them up on level ground. Next, longitudinal battens were tacked across hull-section cutouts in these frames. Sheets of one-inch thick plastic foam were then nailed to the battens to develop the hull form. A touch of battle-ship flare was added to the bow.

To give the foam-plastic mold a smooth surface, a coat of molding plaster was applied with a squeegee, sanded and painted.

Checking with the designer verified that a $\frac{3}{4}$ inch-thick fiberglass hull would have strength equal to a wood-planked hull. After building the hull up to thickness, wooden deck beams were cemented in place with fiberglass gussets, then the mold framing and plastered-foam mold were stripped away. A mahogany cabin and engines finished the job.

Today, Ted Hill is skipper of one of the sleekest, least-expensive 40-foot cruisers on the waters of Puget Sound.

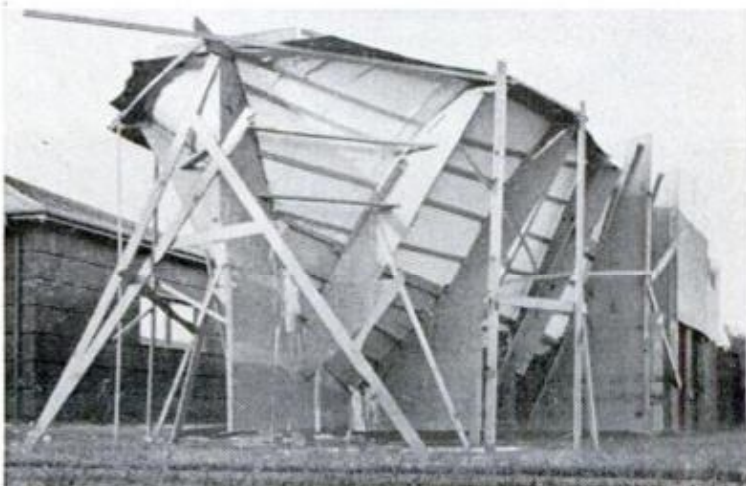
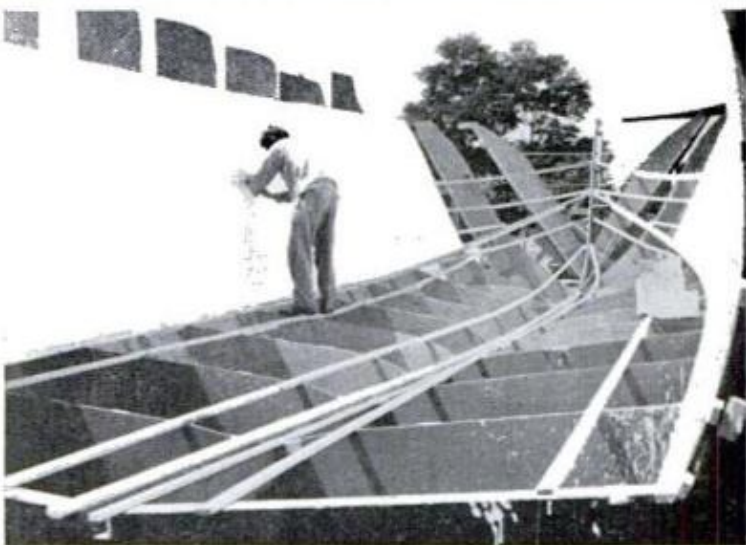
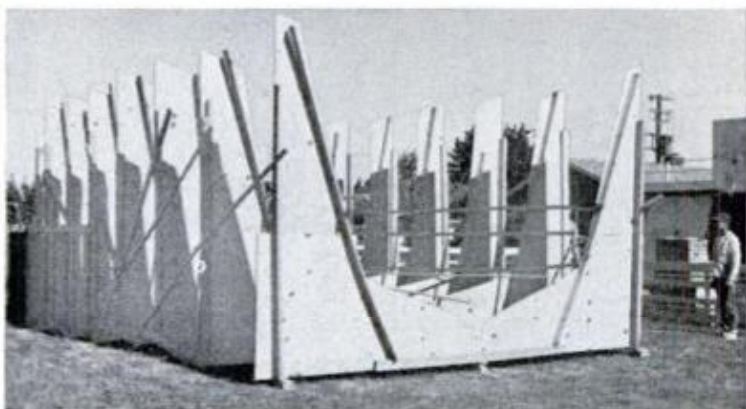



National Rifle Association photo
RUSSIAN FREE-RIFLE TEAM, firing .22s at the 36th World Championships in Caracas, Venezuela, shows typically "relaxed-but-tense" style in shooting booths

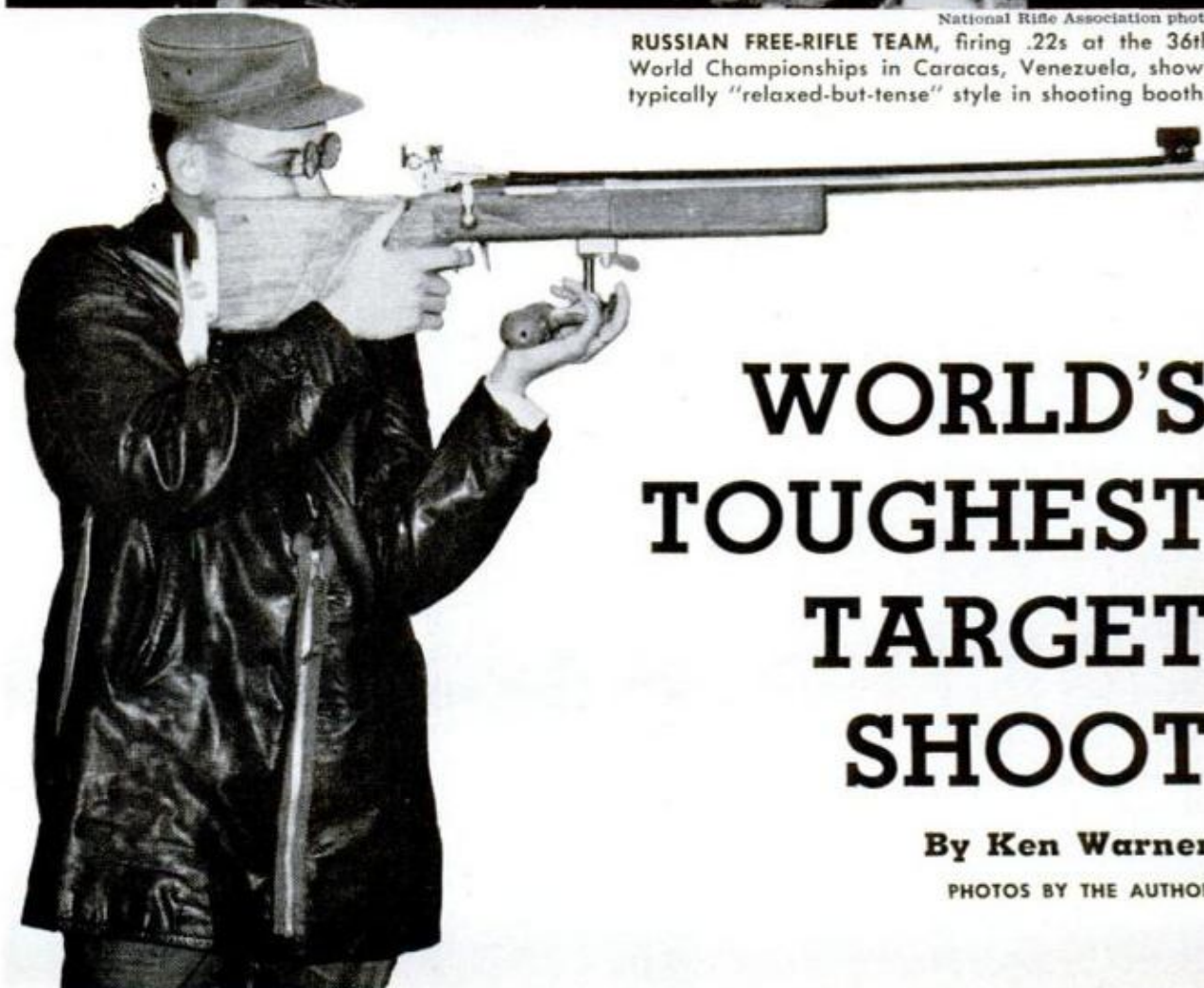

WORLD'S TOUGHEST TARGET SHOOT

By **Ken Warner**

PHOTOS BY THE AUTHOR

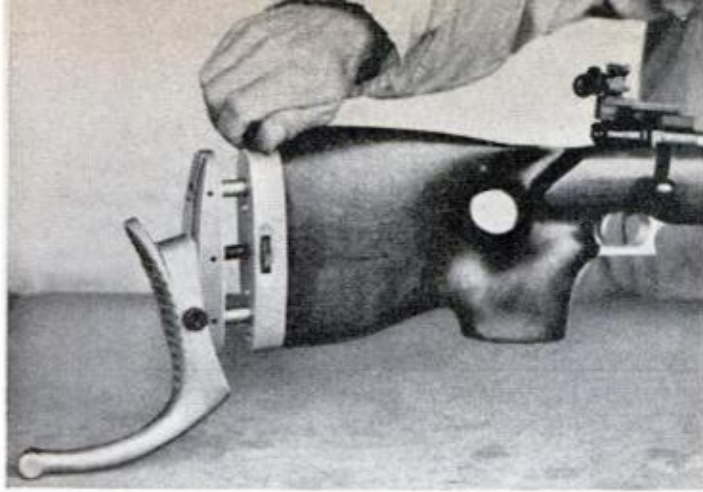

ADJUSTABLE-HOOK BUTT PLATE permits adjustment in any shooting position; saves shooter moving head



RIGHT-HAND POSITION on free rifle shows "saw-handle" pistol grip and double set triggers. Natural fit aids right hand's single task — squeezing trigger

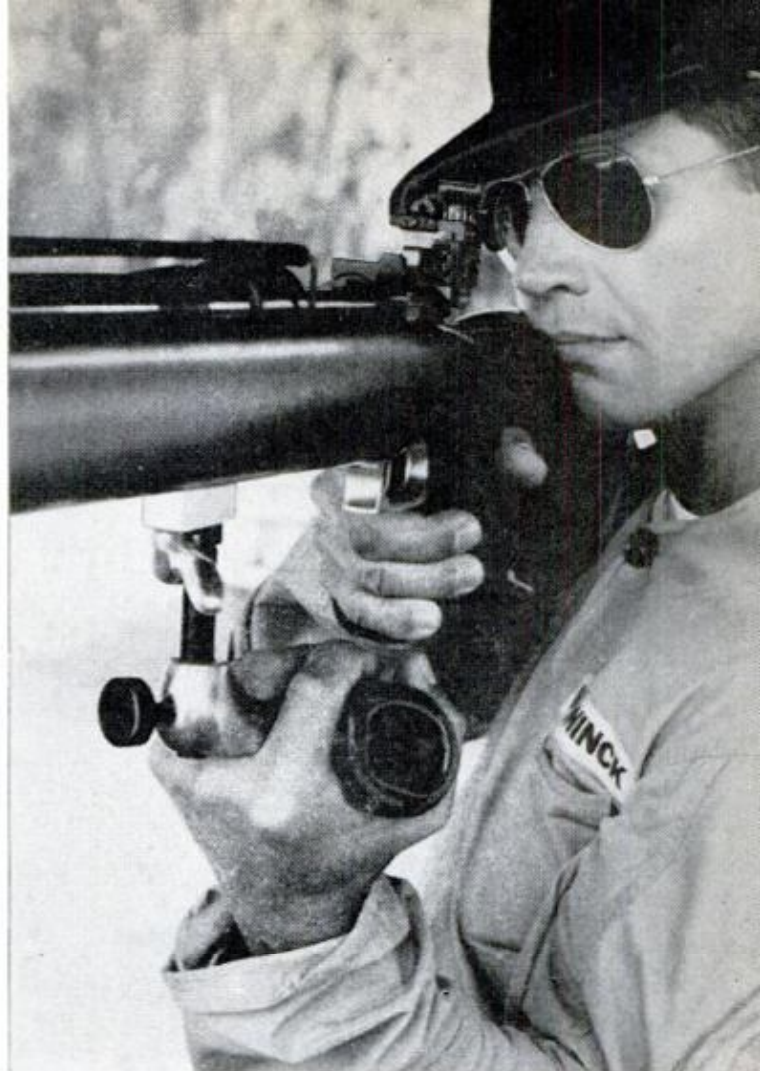

LEFT ARM AND HAND, braced against left hip, hold entire weight of rifle in standing position. The adjustable palm rest gives less fatigue, better control

Lifting a total of three tons to his shoulder during a match, the free-rifle marksman must be good enough to hit a bull's-eye the size of a coffee cup over 300 yards away. Perhaps the world's most demanding sport, free-rifle shooting was America's weak spot in International competition — until we produced a champion this year

WHEN THE SMOKE CLEARED at Cairo, Egypt, in mid-October, Gary Anderson, shooting for the U. S., emerged from the World Shooting Championships toting not only a free-rifle championship but a brand-new record to boot.

In small-bore competition, he scored 1157 out of a possible 1200 points — breaking a Russian-held world mark.

Anderson's performance is a happy reversal of form for this "nation of riflemen" which, since 1930, hasn't been able to bring home the drumsticks from an international turkey-shoot. Almost everyone else who competes—the Swiss, Swedes, Finns, Hungarians, Germans and especially the Russians—has been out-shooting us time after

time. If Cairo is any indication, things may start going our way. (See *Items from All Outdoors*, this issue, for the scores.)

If numbers were shooting scores, we'd have been winning all along, for we're still a nation of gun-toters, hunters and shooters. We sell over 12 million hunting licenses a year; the National Rifle Association has 460,000 members, 130,000 of whom are registered competitors; there are 4800 senior and 5500 junior rifle clubs, and 2100 registered matches were held last year.

But for the great mass of competitive shooters, the style is strictly our own, and it's too easy for International competition. Furthermore, it's based on military needs, not competitive sporting needs.

Most of us are still shooting for sport on targets developed 60 years ago to train run-of-the-mill recruits with untuned military rifles. We use a 12-inch bull's-eye at 200 and 300 yards, and a 20-inch bull at 500 and 600 yards—easy marks by European standards.

In International Shooters Union (ISU) shooting, they use a 3.93-inch bull's-eye at 300 meters (330 yards). On their 50-meter target for .22 rifles, the center ring is just half an inch across. In 64 years of competition, nobody has shot a perfect score. With our existing equipment, experts doubt that anyone ever will.

The targets, the ranges, the equipment and the people in free-rifle shooting are fascinating. They add up to the most diffi-

cult shooting there is, and our past weakness at that division points up the reasons for our lean years in International competition. Let's take a look at free-rifle shooting.

The rifle is "free" in the sense that there are few real restrictions on either the rifle or the shooter. The only limits—aside from a mess of regulations designed to keep competitors from resting the rifle on anything but themselves—are three: The rifle must be a center-fire caliber up to 8mm. (except for the .22 for 50-meter work) the weight must be under 8 kilograms (17.4 pounds) and the sights may not use glass—no optical sights. The only external difference between a 300-meter rifle and a 50-meter rifle is the size of the hole in the barrel.

The target at 300 meters has a 10-centimeter 10-ring. The 50-meter target for .22s is simply a scaled down 300-meter mark. Its 10-ring is almost precisely half an inch across.

This means the 300-meter shooter is aiming at a mark the size of a coffee cup sitting $3\frac{1}{3}$ football fields away! The 50-meter shooter is shooting at less than a dime, which measures $\frac{7}{10}$ of an inch, at 55 yards.

The standard position match calls for not 10, not 20 shots, as most U.S. matches do, but for 120 shots at this size target. And it also requires that the shooter use three different positions—prone, kneeling and stand-



ISU'S THREE POSITIONS

1. STANDING position is toughest, though a good free-rifle shooter is as steady standing as an ordinary sporting rifleman is with a rest. "Straight up" position here is near perfect. Note tall spotting scope

2. PRONE position. Note drawn-up right leg, to free abdomen and make breathing easier. Very low position—rifle is only six inches above ground—adds to steadiness over long (40-shot) course

3. KNEELING position, with small cushion under right ankle for comfort and stability. Shooter is Captain Daniel Puckel, one of the best free-rifle shots in the U.S. He tied world record during this practice round.



ing—shooting 40 shots in each position.

How good can the International people be? Well, they're getting better all the time. Over the past 34 years, they've jacked the record up a bit at a time. At 10 points per shot, 120 shots adds up to 1200 points.

World records now are 1149 and 1157 (Anderson's score). In 1928, 114 was tops. Even in 1994, it still won't be 1200. Most of that gain in 32 years has been made scientifically by improving the men.

Most of this progress has been made in other countries. The scientific treatise that is the "bible" of free-rifle shooting was written by a Russian. Titled "Sprtivnaya Strel'ba Iz Vintovki" (which means "Competitive Marksmanship with the Rifle and Carbine") it was written by one A. A. Yur-yev. Yur-yev's book is so good that the U.S. has translations for its shooters. Graphing the heart beat, for example, told Yur-yev and then all free-rifle shooters that they should shoot fairly quickly. His graphs said the heart took 4 seconds to slow down after the exertion of lifting the rifle to the shoulder, then it runs smoothly for 6 to 7 seconds, and then gets ragged due to fatigue.

Science was one of the factors that has left the Russians holding every existing team record with the free rifle. The other was time—time for the individuals to spend learning, practicing, shooting. In Russia, of course, a top athlete may earn his living

at being an athlete and still remain, for the purposes of international competition, an amateur.

And in the U.S., too, our chief hopes for International shooting wins lie with men whose business is to shoot—the men in our armed services' special marksmanship units.

It started in 1956, when the Army organized the U. S. Army Advanced Marksmanship Unit. Although the name was changed this year to Marksmanship Training Unit, the mission hasn't changed any. The MTU's first job is to train marksmanship instructors. Its secondary job is to train shooters to represent the Army in any and all shooting competitions, and these most definitely include those competitions that are held to select International shooting teams.

The MTU is at Ft. Benning, Ga. It is equipped and staffed to support its teams of shooters completely. There are gunsmiths and a shop good enough to build rifles from scratch, there are supply rooms stacked with rifles and handguns, there are ammunition bunkers full of match-grade ammunition. When the available ammunition isn't good enough, the MTU builds its own.

The MTU's shooters are our best. The other services have good men in their special outfits, but not so many of them. There are top-level civilians, too. But the majority



FULL KIT for free rifle includes .22 and big-bore rifles and accessories, leather coats (one for prone shooting) and ski-type boots for the kneeling position



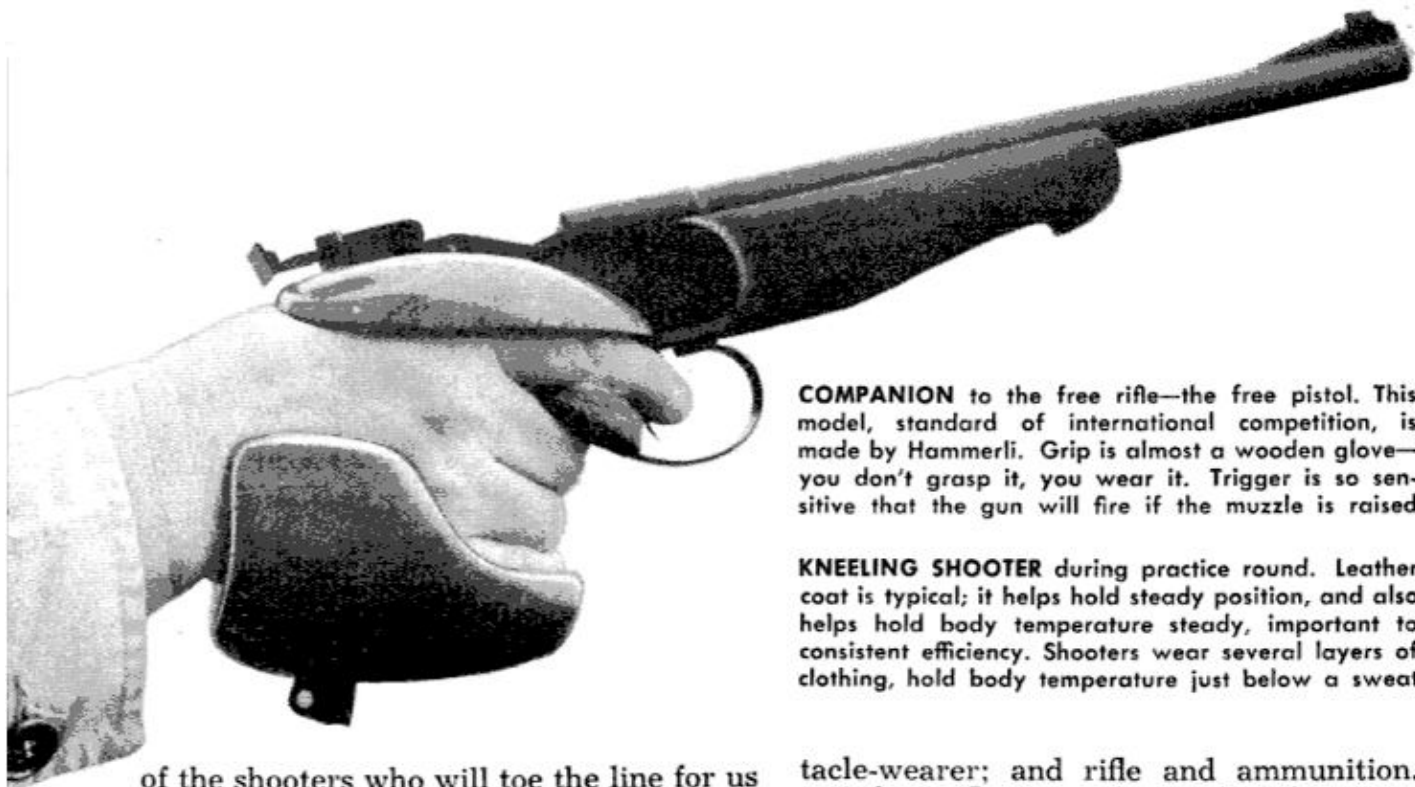

COMPANION to the free rifle—the free pistol. This model, standard of international competition, is made by Hammerli. Grip is almost a wooden glove—you don't grasp it, you wear it. Trigger is so sensitive that the gun will fire if the muzzle is raised

KNEELING SHOOTER during practice round. Leather coat is typical; it helps hold steady position, and also helps hold body temperature steady, important to consistent efficiency. Shooters wear several layers of clothing, hold body temperature just below a sweat

of the shooters who will toe the line for us at world shoots will be MTU people.

In 1958, MTU men were on the team we sent to Moscow. They scored no significant wins. A pistol-shooting Marine captain did bring home one gold medal.

The next year, 1959, was a bell-ringer. MTU shooters cleaned the boards at the Pan-American Games in Chicago. The whole Western Hemisphere was there. The Russians were not.

The Olympic Games in 1960 were disappointing. In Rome, with the world on hand, our team scored nicely, but was no winner. That same Marine captain with his pistol brought home our only gold medal.

Here are some of the things that make the contest the world's toughest shooting game:

A free-rifle shooter lifts, in a match, about three tons just getting the rifle up to his shoulder. To get those shots off just right, he'll suspend his breathing for a total period of 50 to 75 minutes—enough so that he must take special care not to suffer from oxygen starvation. In a big match, he'll lose six to eight pounds.

The free-rifle position match is a test of shooting skill and nothing else. Each shooter gets a sheltered shooting space; he is furnished with standard mats and pads; he gets 6½ hours to shoot his 120-shot string. In fact, he is allowed to determine for himself in which order he will fire his positions.

A kit for a free rifleman fills half a jeep. There are shooting coats of leather, gloves, spotting scope, special boots for the kneeling position if he wishes; there are special adjustable shooting glasses for the spec-

tacle-wearer; and rifle and ammunition.

A free rifle is not the kind of thing you select for stalking squirrels. It looks rather like a marriage between a 2 by 8 and a long gas pipe. The result is a big bolt-action single-shot musket with a barrel about an inch in diameter and about 28 inches long. The stock is angular in general form, with a loglike forearm, a pistol grip like an automatic handgun, a thumbhole in the butt-stock and an elaborate butt plate.

Any gadget that will help the scores is hung on the free rifle. The butt plate adjusts for length several inches, and permits the use of an under-the-arm hook in kneeling and standing positions and a rubber cushion for prone. A palm rest locks into the forearm to extend the shooter's arm and help him balance the rifle. A sling hooks in, too, for use in kneeling and prone.

Aside from the barrel's accuracy, the two mechanically marvelous items in the inventory of a free rifle are the sights and the trigger. The sights are often adjusted between every shot, as conditions change, so they must be rugged. At the same time, they have to move the bullet strike as little as an eighth of an inch at the target and do it the same way every time.

The trigger is all-important. The reason for this becomes apparent when you see free riflers in practice. They work that trigger pretty hard. In getting ready for a match, a shooter may work his trigger 25,000 times. And he can't use it if it changes its character at all.

The trigger must be delicate, too. If it's a set-trigger, it has to adjust down to a one-ounce pressure, and show no movement when pressed to turn the shot loose.



Because of the difficulty with set-triggers, some MTU men use regular single-stage triggers, such as are found on good sporting rifles.

That lack of movement at the time of discharge is important to the shooters. It's so important that they'll use a three-pound trigger that doesn't move in preference to a one-ounce trigger with a little creep.

And above all this, there's the rifle. It must consistently shoot into 10-shot groups smaller than the 10-ring. That means half an inch at 50 meters; about three and a half at 300 meters. Such performance is almost incredible by normal standards, but free rifles do it all the time.

Naturally, such firearms are expensive.

Before last year, he who wished to play with the big boys in this sport had to go where they got their rifles — to Europe. Now, Remington offers a free rifle, and a pretty good one, for a mere \$361.05, which isn't much, considering that a really good hunting rifle can push \$200. Winchester is reported ready with a free rifle, too.

For a 50-meter rifle, those who don't want to pay Remington \$361.05 (which buys either kind) can get an Anschutz for about \$240. This is good enough for the MTU, so it ought to be a fair shooting iron.

Ammunition is another big factor. For the 300-meter rifle, the only course is handloads, very careful handloads. That's what the MTU uses. For the 50-meter rifle, our own standard brands of match ammunition at \$1.25 per 50 are good enough. They are so good, in fact, that the foreign factories use them to test rifles.

The MTU, because it has many rifles,

buys many lots of ammunition and matches it to the guns in test firings. They get pretty good matches — the goal is .33-inch groups in test barrels and .4-inch groups in match rifles at 50 meters. The 300-meter rifles must shoot to a three-inch standard, which, strangely, is easier than the 50-meter goal.

So much for the technical side of free-rifle shooting. It is expensive and it is difficult to learn the tricks that make the guns perform. That's part of the problem. The rest is in the shooting, and in the shooters. Our team win record has been bad for two reasons: We haven't fully learned how yet and there isn't enough competition at home to push the men to their limits.

The shooters at the MTU and other ISU aspirants around the country cry for competition. "One match is worth two weeks of practice," they say.

It is a little demoralizing. The free-rifle shooters are dedicated shooters—like any top athletes, they eat, sleep and breathe their sport. They practice hard — every day — even though they need competition worse than practice. Once a man like MTU's Capt. Daniel B. Puckel is shooting scores like 1153 in practice, what he needs is competition, not more practice.

The NRA has just made available a reduced 50-meter target for use on 50-yard and 25-yard ranges. This is one step. The next is to encourage young shooters to go the ISU route.

Despite the problems, we've made heartening progress in this tough sport; the team we sent to Cairo in October was the best we've ever had in ISU competition.

★★★

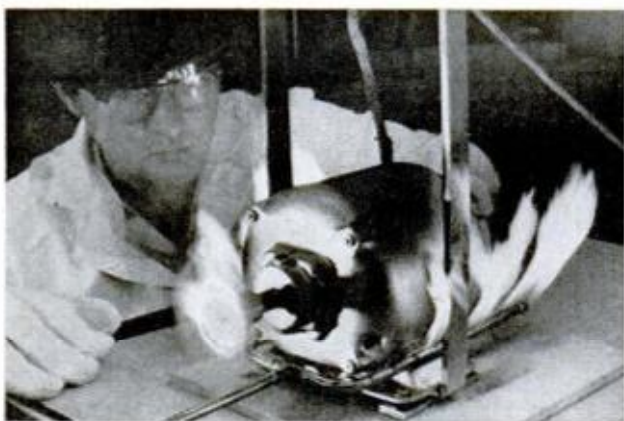

Hot-Cold Electric Motor

Operating continuously, a specially insulated electric motor can be plunged from a temperature of 320 degrees below zero into an oven and baked to red heat at temperatures above 1100 degrees F.

The insulation system, developed for use in space by Westinghouse, is inorganic, being composed of ceramic-type materials.



Rough Landing

Pigeons are prevented from perching on ledges and window sills by an aluminum bird chaser that can be attached with adhesive or metal straps. Two rows of blunt spikes set at angles discourage birds from settling, but do not cause injury.

The maker is G. A. Harvey and Co. Ltd., Woolwich Rd., London SE 7, England.

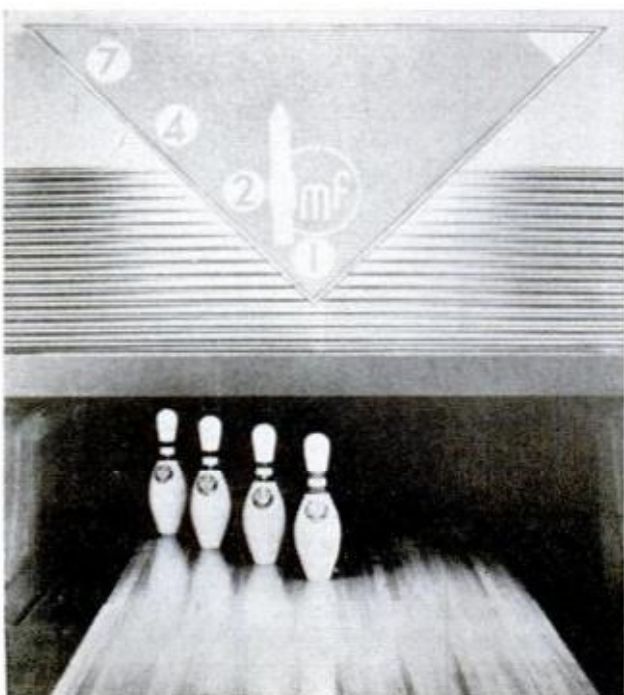

Pin Setter Shows Where to Aim

Bowling duffers are now told where to aim the ball on a new pin setter, taking all the guesswork out of making spares.

After it sweeps away the pins that have been knocked down on the first roll, the pin setter shows on its lighted board which pins are still standing and marks the spot the bowler should aim to knock them down.

Called the Sparemaker by the manufacturer, AMF Pinspotters, Inc., the indicator works for any spare combination—all 1023 of them—including the splits. It even indicates when the ball should be thrown at an angle.

AMF, which also introduced the lighted board, or Pindicator, cautions—with tongue in cheek—that the Sparemaker only shows the bowler where to aim the ball. The bowler still has to throw it. It also makes no guarantee on splits.

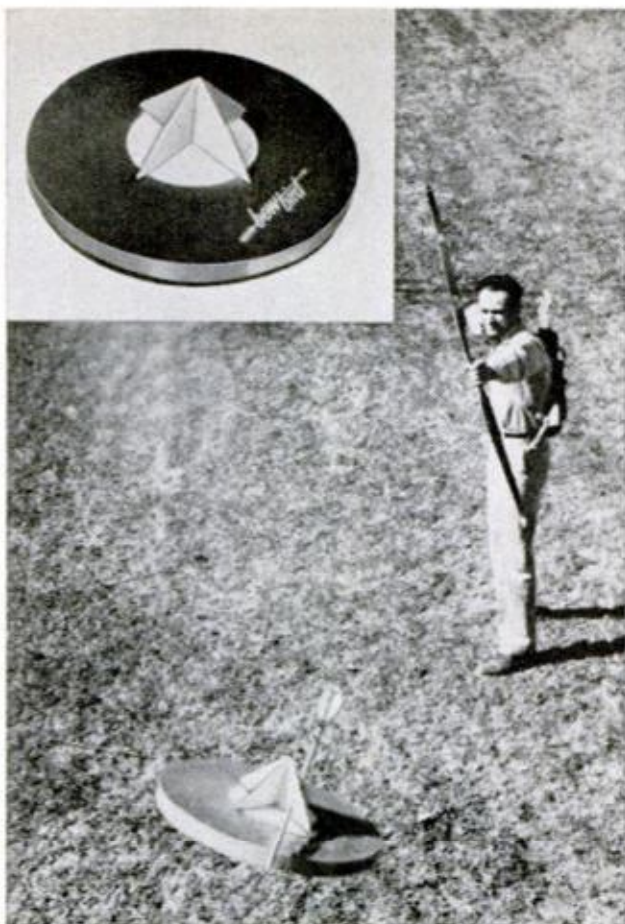

Trap Shooting for Archers

Moving targets for bow-and-arrow sharpshooters are 15-inch clay pigeons that simulate the body of a bird. They are thrown into the air by a special trap or by hand.

A raised center, seven inches in diameter, adds a three-dimensional effect to the target. The target simulates a pheasant in size and flying characteristics. The Bow Bird is made by the Saunders Archery Target Co. of Columbus, Neb.

Drip-Dry Inflatable Hanger

Faster drying of synthetic fabric shirts, sweaters and blouses without rust stains or creases is possible with a new, inflatable hanger. The plastic hanger can also be used to retain the correct shoulder form of garments while they're not being worn.

For traveling, it can be deflated to fold compactly into a small package. The hanger costs \$1.10 and comes in white, yellow, pink, blue or green.

It's available from Artan's Buying Service, 158 Shelly Dr., Claymont, Del.

● All penguins do not live in regions of ice and snow. Some species inhabit the east and west coasts of South America, the shores of South Africa, areas of Australia, New Zealand and Pacific islands. No penguins live north of the equator.



Portable Fluorescent Light

Beaming for 15 hours on power supplied by ordinary flashlight batteries, a new, portable fluorescent lamp gives light equivalent to that of an ordinary 50-watt incandescent bulb.

The lamp weighs 7½ pounds, is 18 inches high and is contained in a plastic case. The fluorescent tube is good for 7500 hours. Developed by International Telephone and Telegraph Corp., it sells for about \$55.



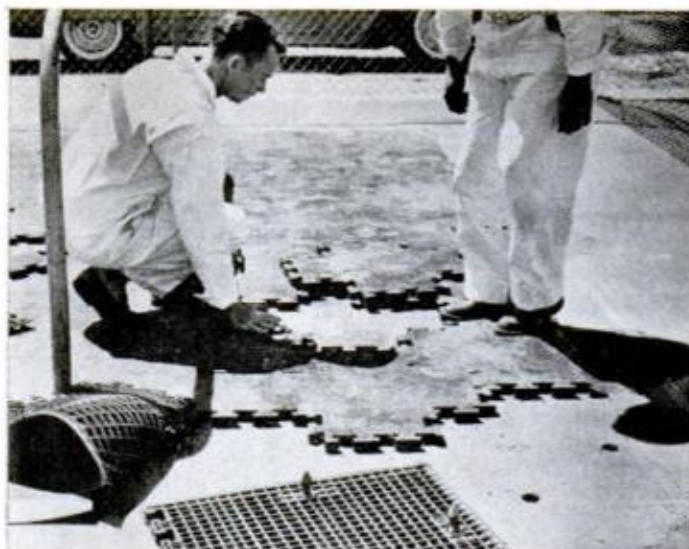

Wind-Driven Water Craft

Two propellers, one above the waterline and the other below it, combine to propel a unique water craft that can travel *into* the wind that powers it.

The large above-water propeller, powered by the wind, is geared to the small below-water prop, which in turn furnishes the thrust.

Built in the form of a catamaran to avoid unnecessary keel structure and to distribute buoyancy, the craft can be propelled into the wind because the thrust is below water.

The maker, John S. LeLacheur of Chester, Pa., plans to build a man-carrying version. The small prototype has been clocked at 5 m.p.h. into a 25 m.p.h. wind. The large version could be used for sport.

Rubber Mats for Playgrounds

Put together like a puzzle, a rubber mat can be created to cover any dimension and provide a bouncy floor cushion for playgrounds. Manufacturer is Mitchell Rubber Products, Box 65587, Glassell Park Sta., Los Angeles, Calif.

Experimental Winged Hull



Two skis in front and a conventional outboard motor behind are all that touch the water when a boat with a 16-foot wing gets under way.

The experimental "winged hull" is being tested by Lockheed-California Co., a division of Lockheed Aircraft Corp. It has reached a speed of 45 knots and may be a prototype of much larger winged boats that will travel entirely free of the water, crossing oceans and reducing cargo costs per ton mile.

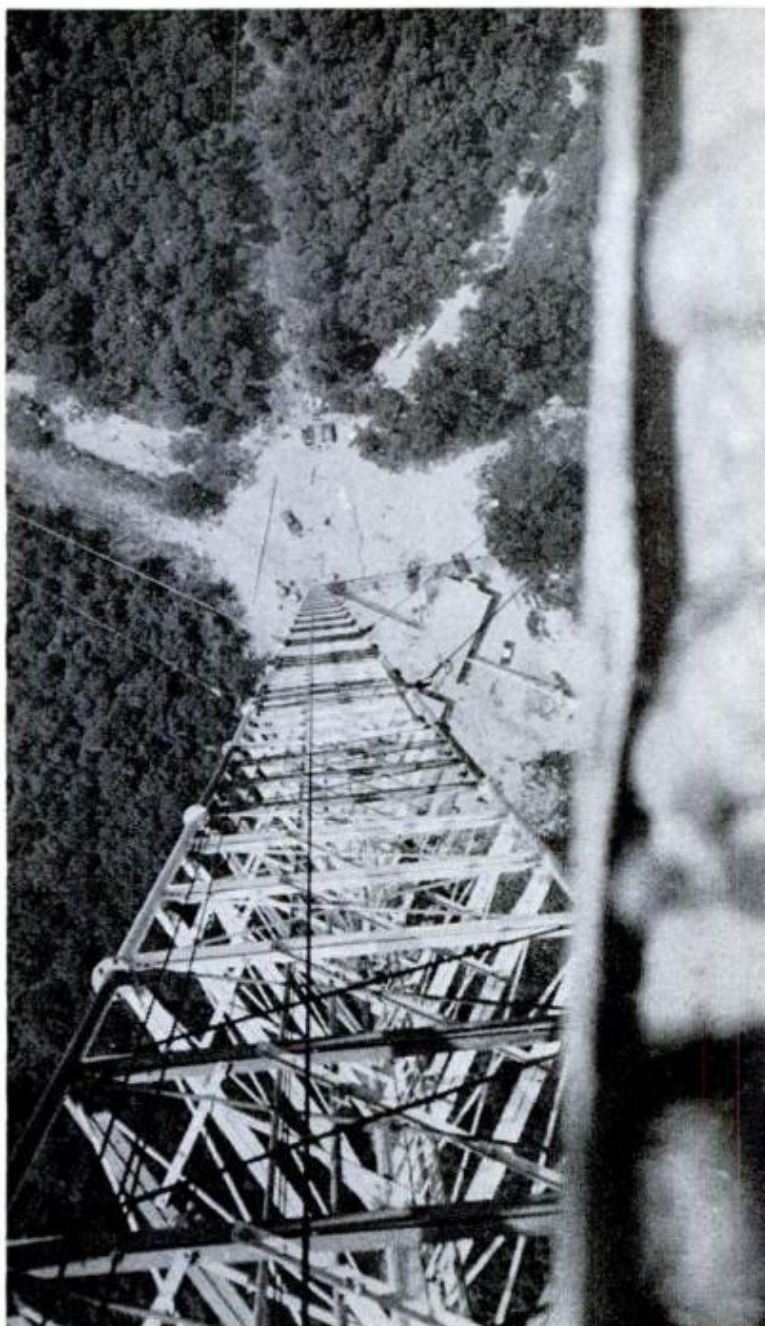

Is This the World's Tallest Structure?

Well, it's in Missouri, so you'll have to "show me."

Anyway, the natives claim the new television tower near Cape Girardeau is the world's highest man-made structure. It's 1676 feet tall, more than 200 feet higher than the mast on top of the Empire State Building. Built for KFVS-TV, it beams programs to a six-state area. Eighteen guy cables help support the triangular tower.



WHAT'S NEW FOR Your Home

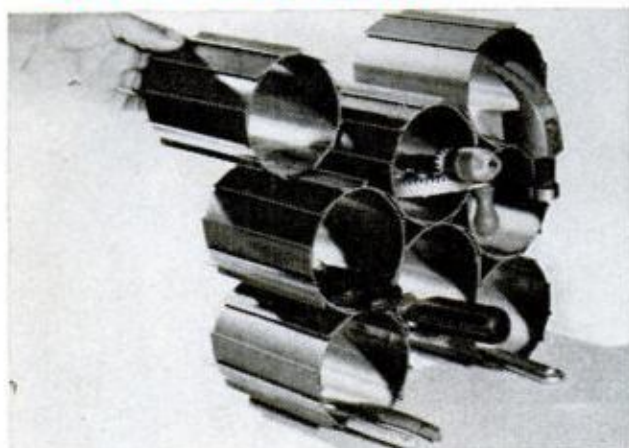

COLORFUL INTERLOCKING TUBES provide expandable storage space for kitchen utensils, tools, beverages. Set of 12 plastic tubes: \$6. Also in aluminum. Made by Add-A-Comb, Inc., Box 1114, Weston, Conn.



NONSTICK BROILER-FRY PAN fries, broils, roasts and bakes without fat. Nonstick surface penetrates metal and lasts for appliance's lifetime. Pan is completely immersible in water. \$40, Westinghouse



FOOD GRINDER lets baby enjoy table foods with the rest of the family. Made of molded nylon, the grinder is easy to wash and sterilize. It can also be used to puree food for aged or ill members of the family. Made by Van Enterprises, Box 414, Waynesboro, Pa., it costs \$4.25 and comes in pink or blue



HANDY TUBE HOLDER can be used for toothpaste, cosmetics, shave cream or drugs. It makes one-handed dispensing easier, helps stop waste, and can be used to stand tube in upright position. Holder sells for 59 cents. The manufacturer is the Teem Company, 243 W. Fox Dale Rd., Milwaukee 17, Wis.



PERSONAL TV SPEAKER permits television watching at any hour without disturbing others. The speaker carries the sound of the 19-inch TV set only to the ear of the person using it. The speaker may be held by the listener or placed on the pillow or chair-back. The viewer may also change channels and turn the TV set on or off via the remote control in the case. It's made by General Electric Co., Syracuse, N. Y.



CLEANING LIQUIDS, SOAPS, POWDERS, are hidden, yet within easy reach in an aluminum tray that attaches to left or right-hand cabinet doors. The containers will not spill when door is slammed. Tray costs \$3.50, with attaching screws; maker is Better Home Products, 285 N.W. Ninth St., Boca Raton, Fla.



REVOLVING KITCHEN-UTENSIL HOLDER includes potato masher, deep ladle, turner, two-tine fork, basting spoon and icing spatula. The tools are stainless steel with dishwasher-proof bakelite handles. Sets are priced from \$14.95 to \$16.95 and are made by Ekco Products Co., 1949 N. Cicero Ave., Chicago, Ill.



X166

SHOP AND CRAFTS

FLIP-OVER CHESS SET

On the wall it's a decorator shadow box for displaying a prized chess set. Off the wall the box serves as a fancy inlaid playing board. Slide-in locking feature prevents removal of chessmen on display

By Howard Whitecotton

AS DECORATIVE as it is useful, this novel wall rack not only provides for visible storage of your favorite chess set, but when removed from the wall and laid face down it becomes an attractive playing board. The design permits easy removal of the chessmen, yet prevents their toppling from the shelves when the rack is taken down for play.

In the chess set illustrated here, the king measures $4\frac{5}{8}$ in. high and has a $1\frac{1}{2}$ in. diameter base. The pawns are $3\frac{1}{8}$ in. high and have a $1\frac{5}{16}$ in. diameter base. These dimensions control the over-all size of the rack shown, and if they differ from the di-

mensions of your chessmen, the rack will have to be altered accordingly. As is evident in the drawings, the grooved rims of the chessmen's bases slide over hardwood beading on the shelves, which holds the chessmen in place even if the rack is turned upside down when removing it from the wall.

For the playing squares, 2 in. was selected as a good size, since the dark and light hardwood veneers come in strips $2\frac{1}{8}$ in. wide by 8 in. long. Black walnut and white-birch veneers were used in the rack shown. Some brands of veneer are precoated with a dried contact cement, but for a better

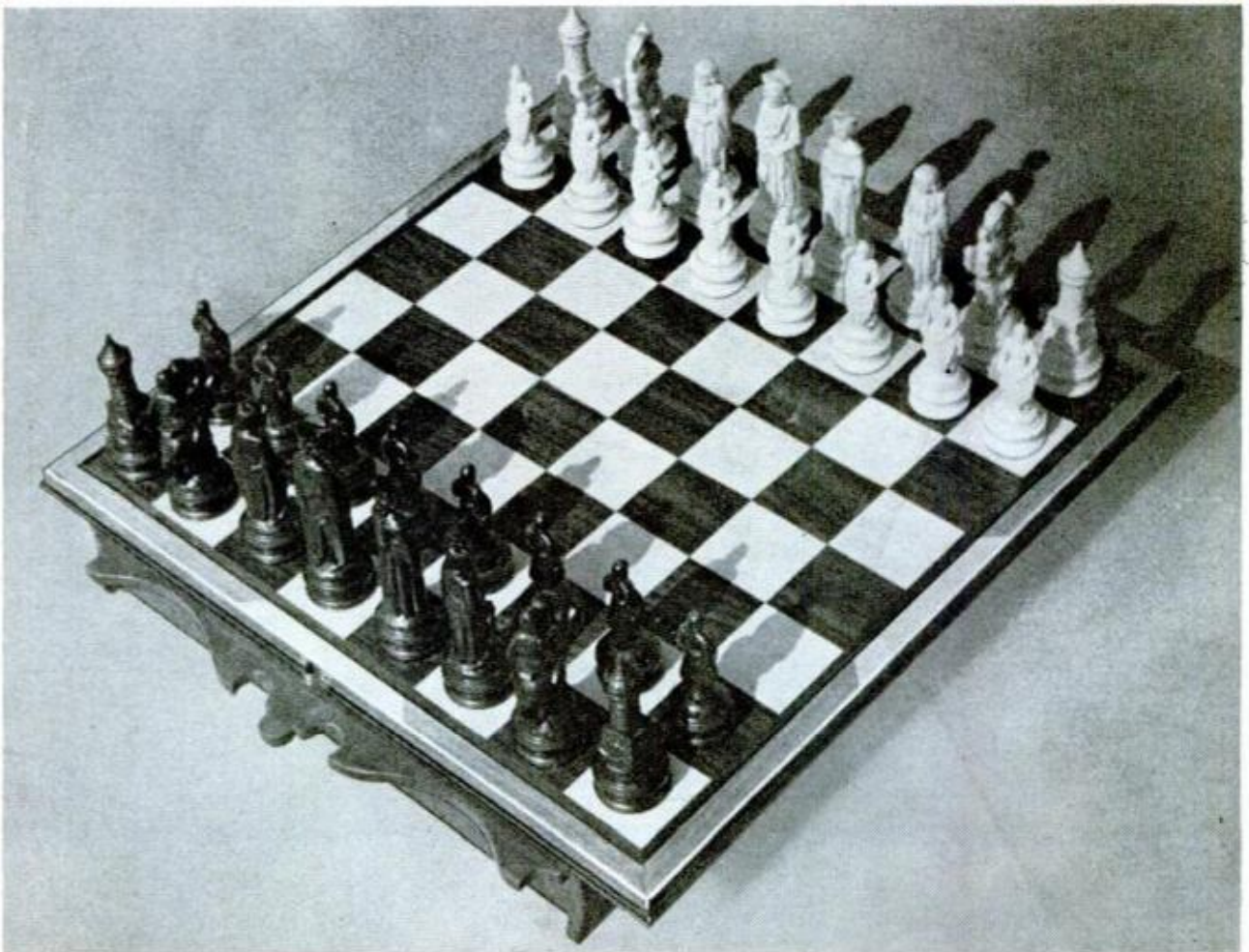
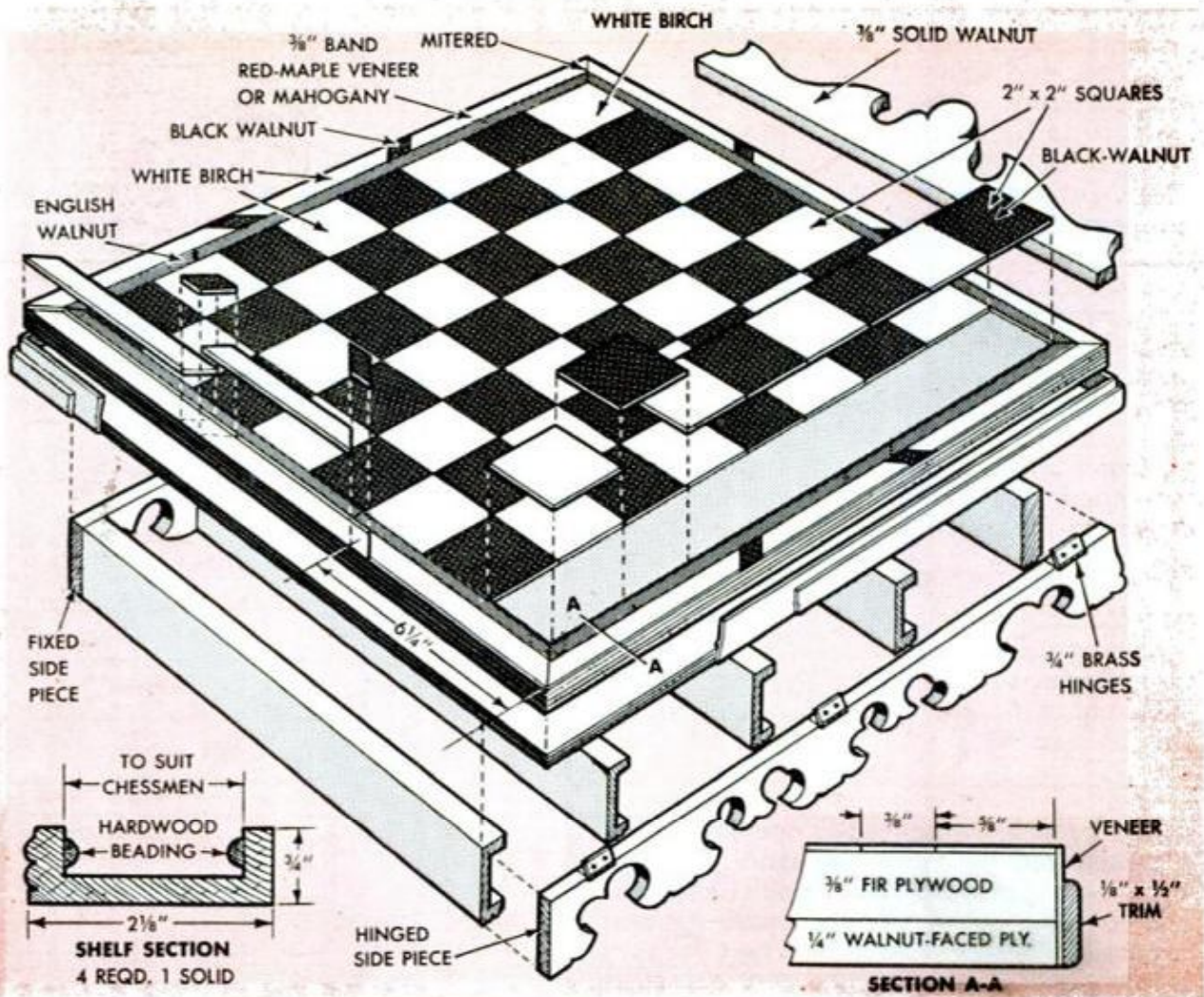

bond remove this coating with a solvent and use fresh contact cement in its place. Be sure to fill the pores of the wood with paste filler before the squares are set in place. Otherwise, the dark filler would be likely to stain the light wood, marring its beauty.

The base board is made from $\frac{3}{8}$ or $\frac{1}{2}$ in. fir plywood and faced on the front with a second panel of $\frac{1}{4}$ in. walnut-faced plywood. The playing field is eight squares wide. Adding 1 in. all around for a border gives an over-all size of 18 in. Square the plywood up on the saw, leaving the edges unsanded. Draw a fine line across the exact center of the board, both ways, on the fir-plywood side. Then coat this surface with a liberal amount of contact cement. Coat the unfilled side of the veneer squares too. Let the cement dry until it is not the least bit tacky to the touch.

Clamp a steel straightedge along one of the division lines on the plywood side and start laying a row of squares against the straightedge. Use a piece of waxed paper as a separator between the cement-coated plywood and the veneer squares. As each square is jockeyed into place, slip the waxed paper out slowly from under it and proceed to the next square. When the row is completed, re-clamp the straight edge along the other divisional line and continue as before. These two rows of squares form the base lines and the rest of the squares are merely laid against the adjoining

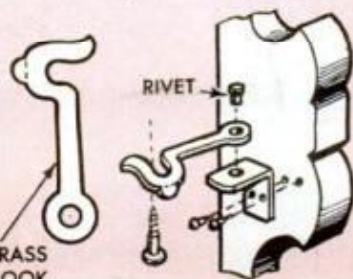
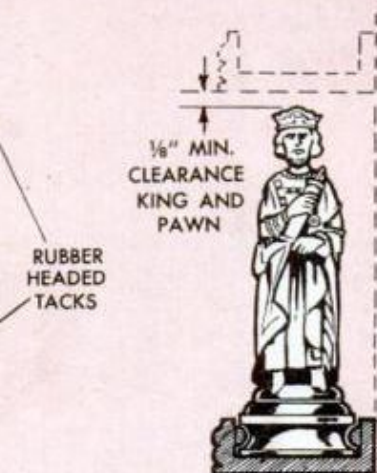
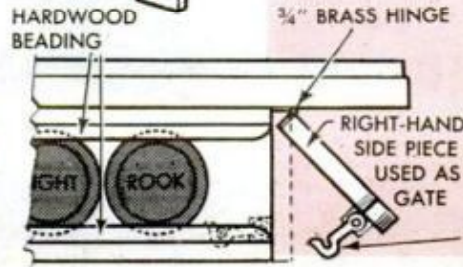
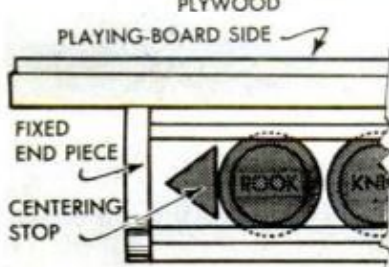
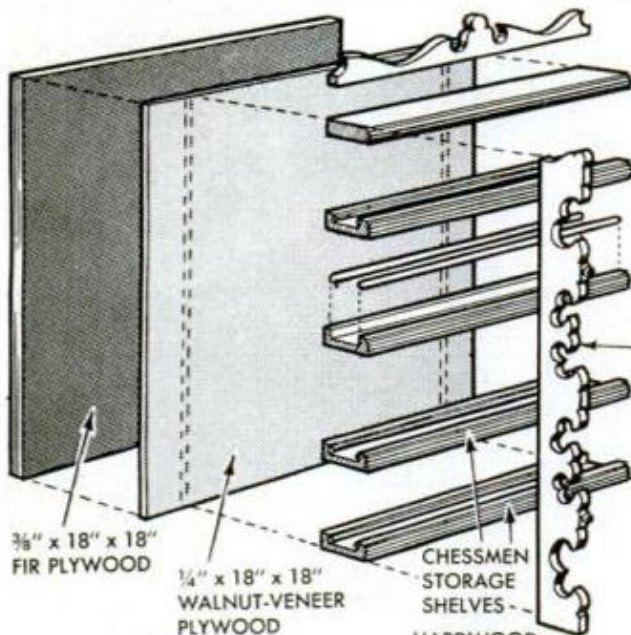
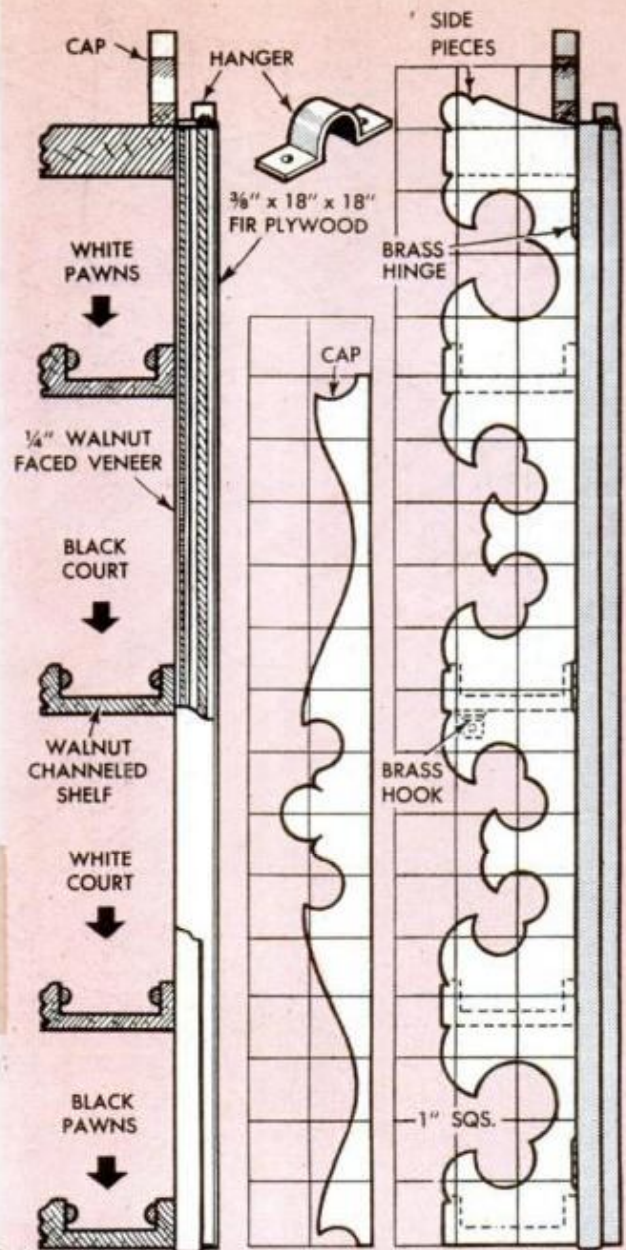

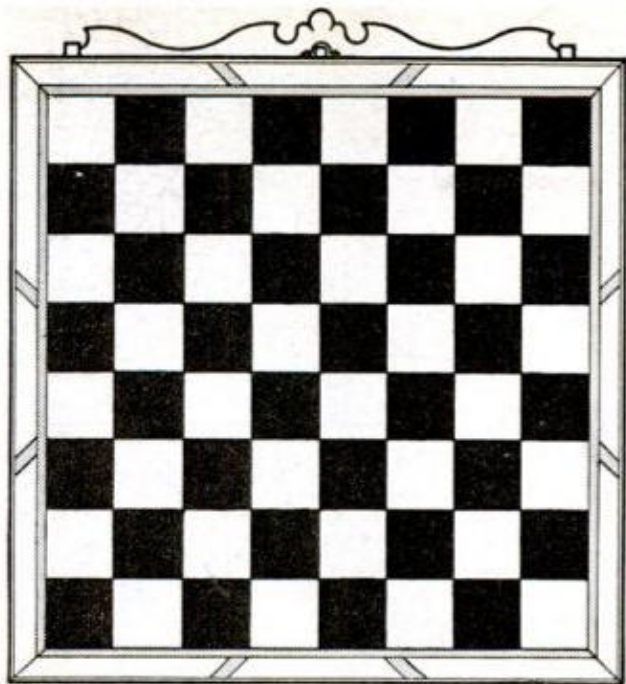

squares. The border veneers should fit snugly against the outer rows of squares.

After the border is completed, cement a strip of veneer along the raw edge of the plywood. Use a household pressing iron to weight the squares. If there are any cracks between the squares after a light sanding, fill with a neutral-tone filler. If the grains of both birch and walnut squares are laid in the same direction, the final sanding will not prove a problem.

Walnut was used for the original shelf because it contrasted well with the chess set shown. Maple might be more appropriate for use with a more modern chess set. The channel in the shelves is best routed out with a straight knife in a molding head, although a dado cutter also can be used. Note that the pawns take a narrower channel than the other pieces. If a shaper is not available, ready-made molding may be glued to the front edges of the shelves. Except for the contact cement used with the veneers, white glue is used throughout. No nails or screws are necessary. Be sure to allow enough clearance so that the chessmen may slide in and out easily, clearing the shelf above. Use $\frac{3}{8}$ in. solid walnut for the scroll-cut sidepieces and cap. Note that one side piece is hinged to serve as a door for removing the chessmen.

Pre-drill holes for the small brass hinge screws or they may twist off in the hardwood. The same applies to the small brass hook assembly shown in the drawing. After a final sanding, spray the rack with three coats of lacquer, rubbing between coats with 000 paper. After the final coat, finish with 000 steel wool and paraffin oil. You'll have a beautiful display case for your chessman, plus a board. ★ ★ ★

DECEMBER 1962



Planing Stop

This planing stop drops flush with the bench top when not in use. It consists of a hardwood strip 6 in. long and about $\frac{5}{8}$ -in. wider than the thickness of the bench top. Slot the piece as in the detail and attach it to the bench top with hanger bolts and wingnuts.—F. Krucker

Sure Kill

To get rid of sprouts from the root systems of trees that have been cut, snip off the sprout about 2 in. above ground, fill a No. 2 tin can about half full of rock salt and invert over the sprout. Drive the can into the ground to anchor it and then punch several holes in the bottom to admit moisture.—W. C. Wilhite



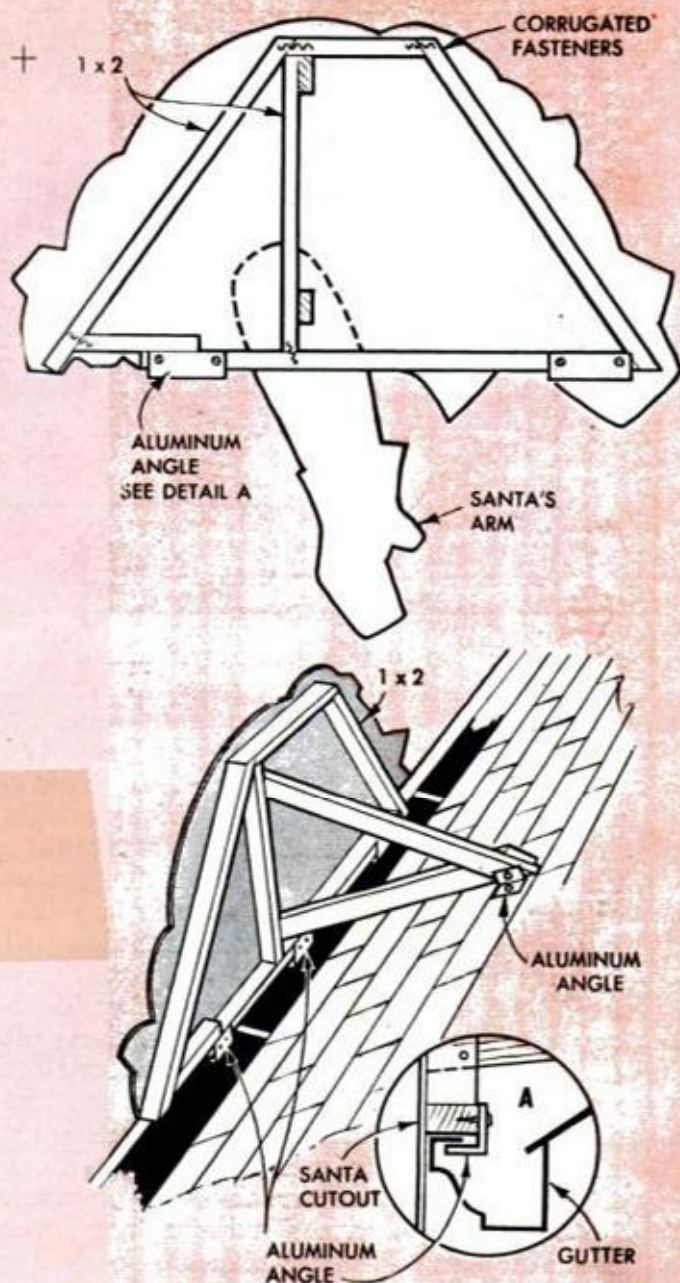

CHRISTMAS CUTOUTS — 1962

Using PM's new Project-a-Plan "transparencies" you can enlarge cutout patterns to full size in minutes with your 35-mm slide projector. Here they're presented for the first time, along with new ideas for saying Merry Christmas to passersby

By David M. Swartwout

THIS YEAR SANTA comes in—of all things!—a space-capsule cutout, along with those traditional cutouts he's always approved for use during the Christmas Season. But, as you'll see, some of the cutouts cast Old Santa and his reindeer in new roles, and there's something else that's new. PM's Project-a-Plan lets your slide pro-

jector serve as your draftsman, and eliminates the tedious job of enlarging magazine patterns by the grid method.

Here's how it works: clip any one of the paper "transparencies" on page 133, coat both sides with clear nail polish and insert between glass in a 35-mm mount. Then drop into your projector and blow up the

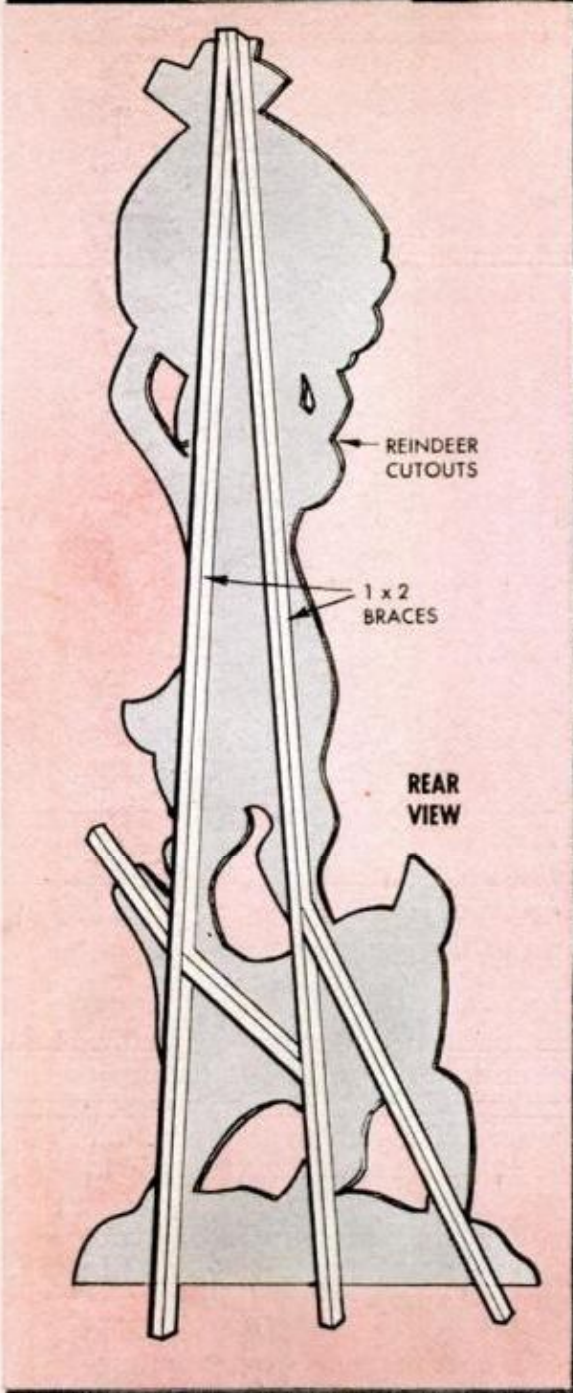

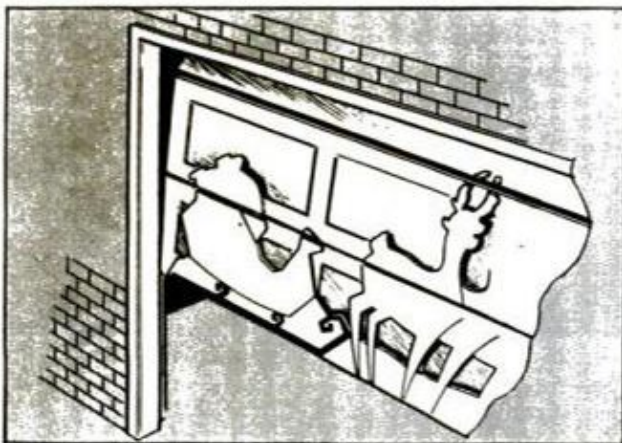
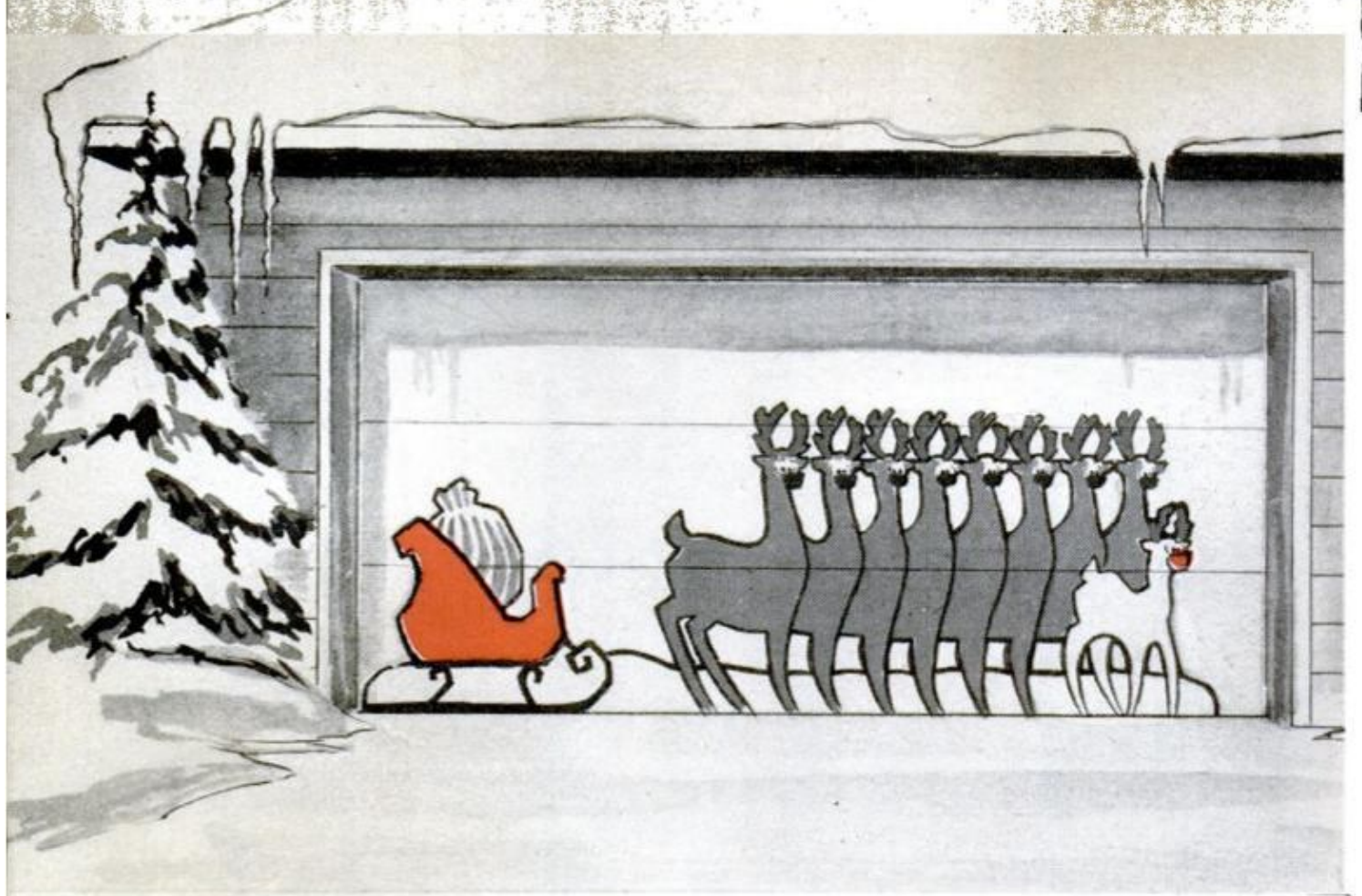

tiny pattern to the size you want directly onto your plywood or white-primed hard-board. When you get the size right, by moving the projector nearer or farther away, trace around the outline of the image with a heavy pencil and there's your pattern, ready for cutting out with a portable saber saw or keyhole saw. It's as simple as that.

On the other hand, if a projector is not available, you can enlarge the patterns in the conventional manner by ruling off the required area in squares of the size called for on a piece of tracing paper or medium-

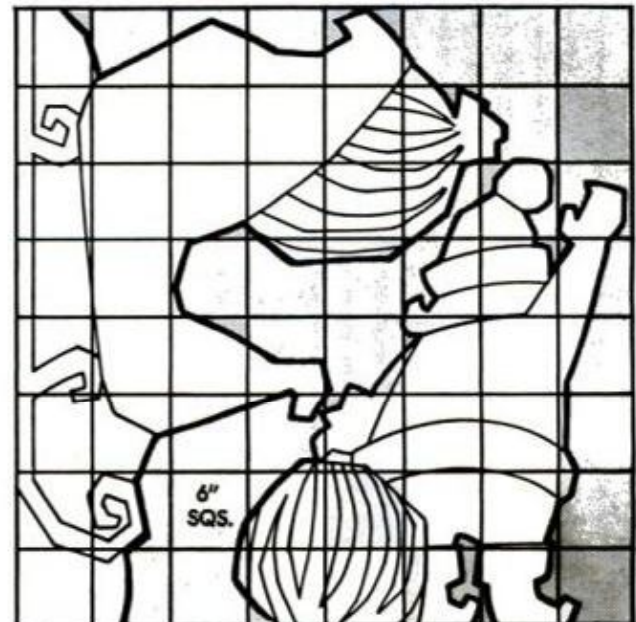
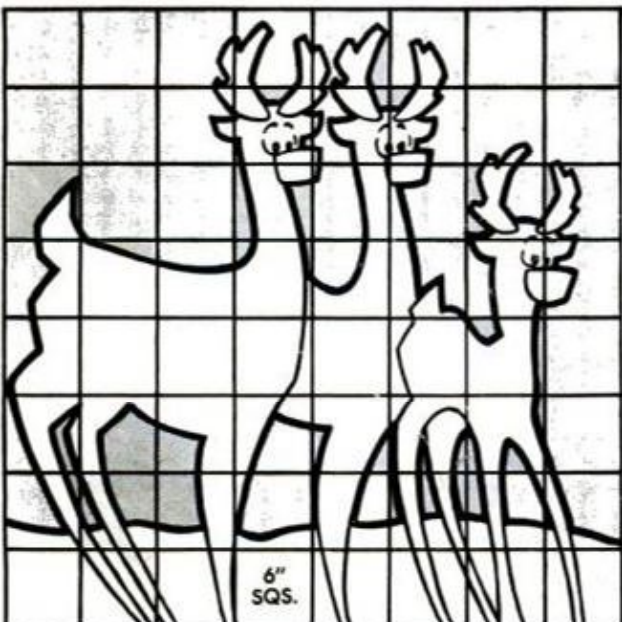



- CUT -



- CUT -



- CUT -



- CUT -



- CUT -

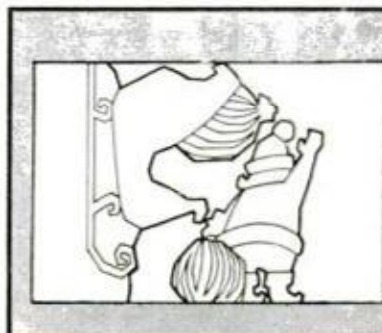

- CUT -

How To Use PM's Project-a-Plans

The paper "transparencies" along the right-hand side of the page are designed to fit a standard 35-mm slide mount when cut apart on the dotted lines. Before inserting them in the mount, coat each side with clear fingernail polish or shellac to make them more transparent. If your slide projector is not air cooled, it is best to insert the paper transparency between glass when inserting in the mount. You have a choice of projecting the patterns full size directly on your panel or on paper thumbtacked to the wall. Some of the patterns require the use of two transparencies to project the complete pattern. Simply trace the projected outline. Simply align one with the other without disturbing the projector setup.

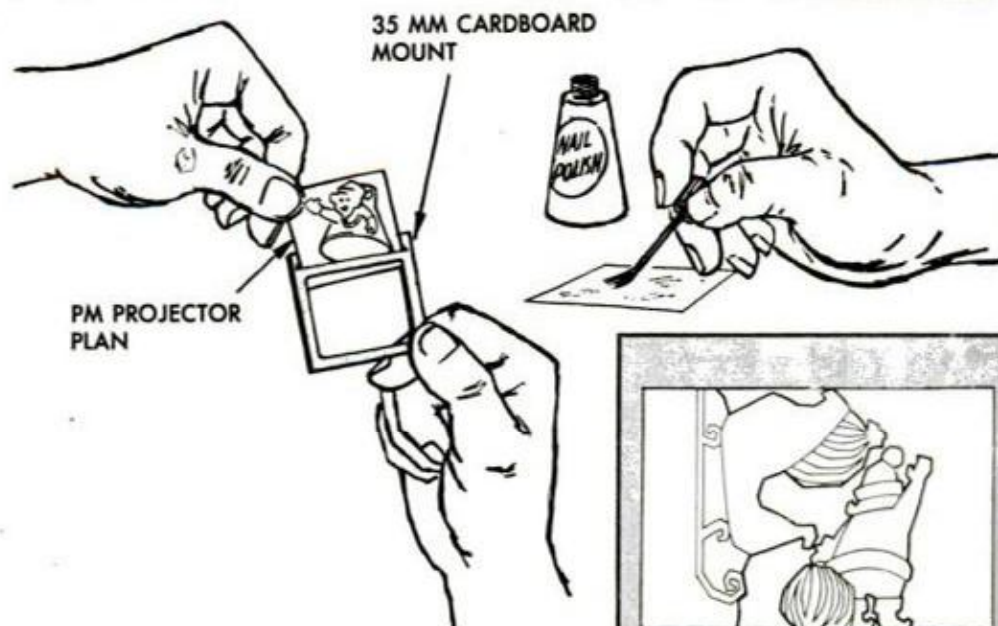

SEE REVERSE



SIDE OF PAGE

FOR CLIP-OUT

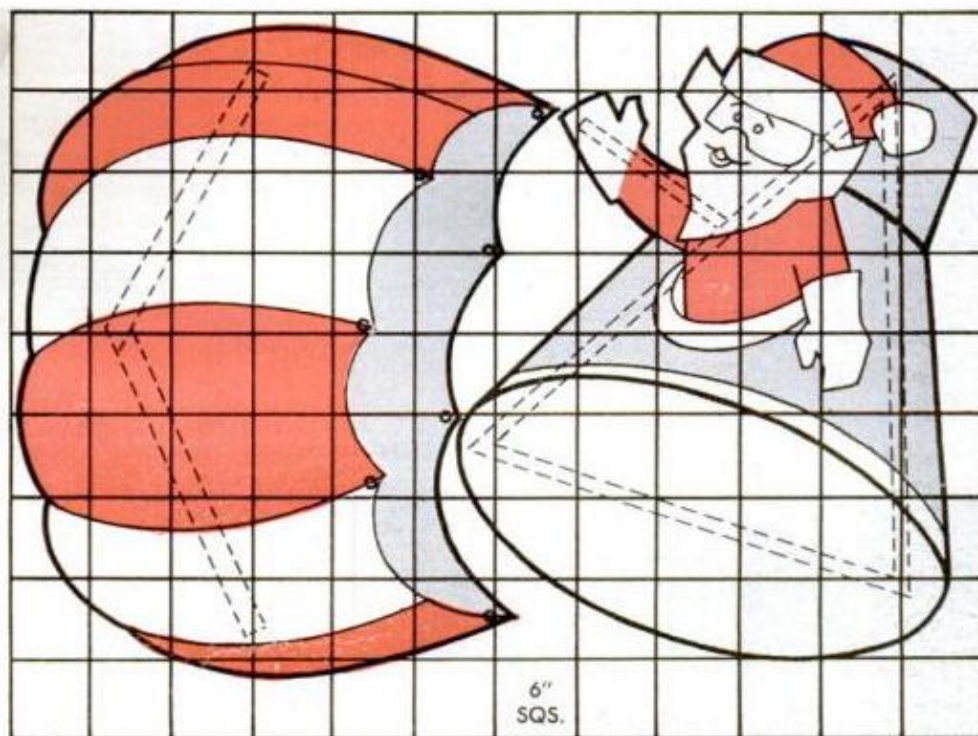

PROJECT-A-PLANS

FOR ENLARGING

heavy, wrapping paper. Wherever the pattern line is indicated as crossing the border-line of a square, pencil a dot. When the pattern lines are all dotted-in, draw the curved lines through the dots and you've got the full-size pattern on paper. Next, run over the pattern lines with a dress maker's perforating wheel, then place the paper on the plywood or hardboard panel and tape it in place.

Partially fill an old sock with talcum—use dry lampblack on plywood—and pat it along the perforated lines to transfer the pattern to the hardboard. Lift the paper carefully and there's your pattern outline. Be careful not to smudge it. Or if you prefer, use carbon paper to transfer the lines. Cut the parts to size with your saber saw and sand the cut edges smooth.

Coat all the parts, including the edges, with a flat-white undercoater applied with a paint roller. When this is thoroughly dry apply the finish colors, using an outdoor enamel. You'll need red and black enamels as well as white for most of the projects. For Santa's ruddy face mix a small quantity of red and white to make pink. A small quantity of black and white makes a good gray for the reindeer horns, and for the reindeer body mix red and black and lighten with white. After these coats have dried, outline certain areas in black as indicated on the patterns. Where the cutouts are to be located outdoors, it's a good idea to paint the backs as well. This is not necessary with the Nativity Scene and the Wise-Men cutouts which are set up indoors.

Going through the construction and mounting details you'll see how the cutouts are set up and how they are braced. Use brackets cut from aluminum angles and be sure to attach the brackets with aluminum nails or screws. Note especially the detail A on page 130 which shows how the frame supporting Santa is attached to the box gutter and roof. It's permissible to drive the small nail through the shingles as later on when you remove the frame you can lift the shingle tab and seal the hole with roofing cement. Note also that the frame is assembled with corrugated fasteners.

FINAL PAINTING is done over an undercoat of flat white applied to jigsawed cutout with paint roller



DECEMBER 1962

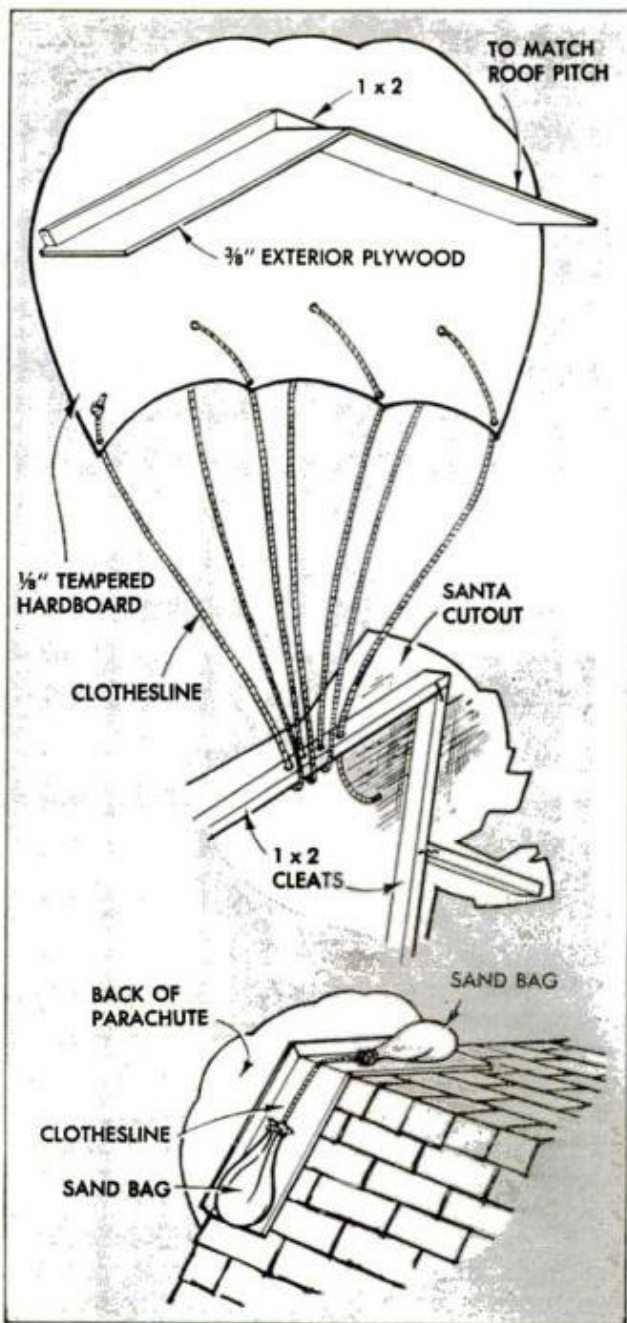

SABER SAW makes quick work of sawing out cutout. Go over outlines with white when using hardboard





If you plan to use the Nativity scene as a window display, first tape large sheets of paper together and trim to fit the window opening. If your window has divided panes like that pictured, then, when you project the images, note carefully the placement of these in relation to the dividers so that the profiles of the figures and other details are not broken up. Transfer the patterns to 1/8-in. hardboard by using either of the methods described. To complete this display and give a feeling of animation, arrange a rotating color wheel and floodlight the back of translucent curtains or drapes. Spray-paint the figures in gold and add whites and browns to give highlights and shadows for day time effect.

The Nativity scene also can be mounted

on a garage door. If the door is a light color, then paint the figures a deep blue or black so that they silhouette sharply against the background. If the door is of the roll-up

[\(Continued on page 192\)](#)

Like To See More?

We're interested in receiving your comments on our new Project-a-Plan method of enlarging magazine patterns the easy way. Would you drop us a card telling us whether you have found these paper "transparencies" helpful and what other projects you would like to have us present in Project-a-Plan form?—Thanks.

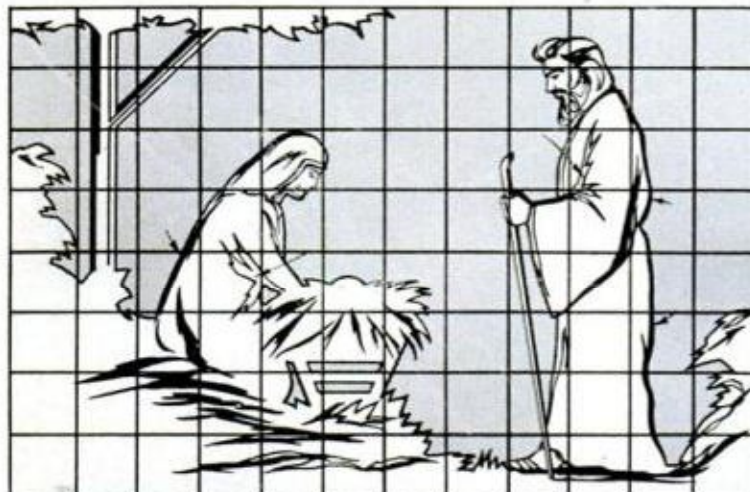

DECORATIONS FOR CHRISTMAS

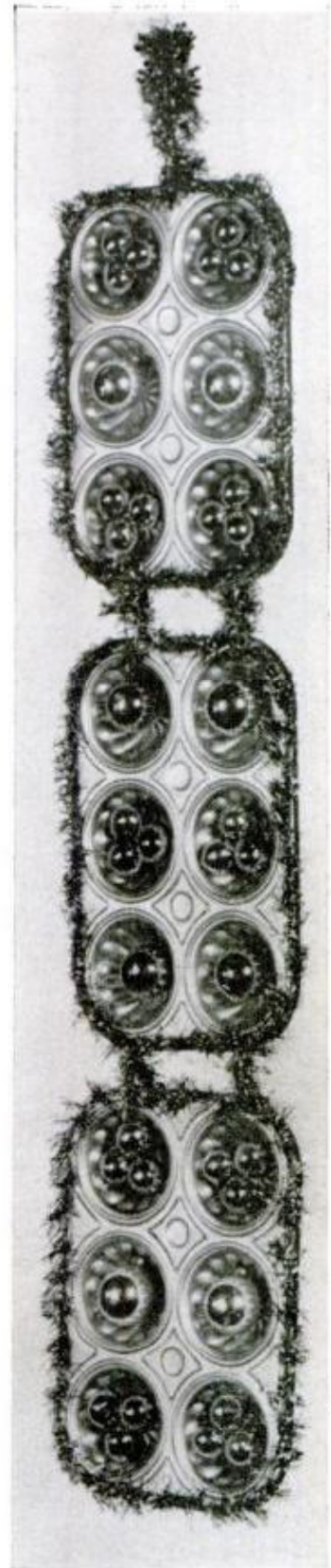
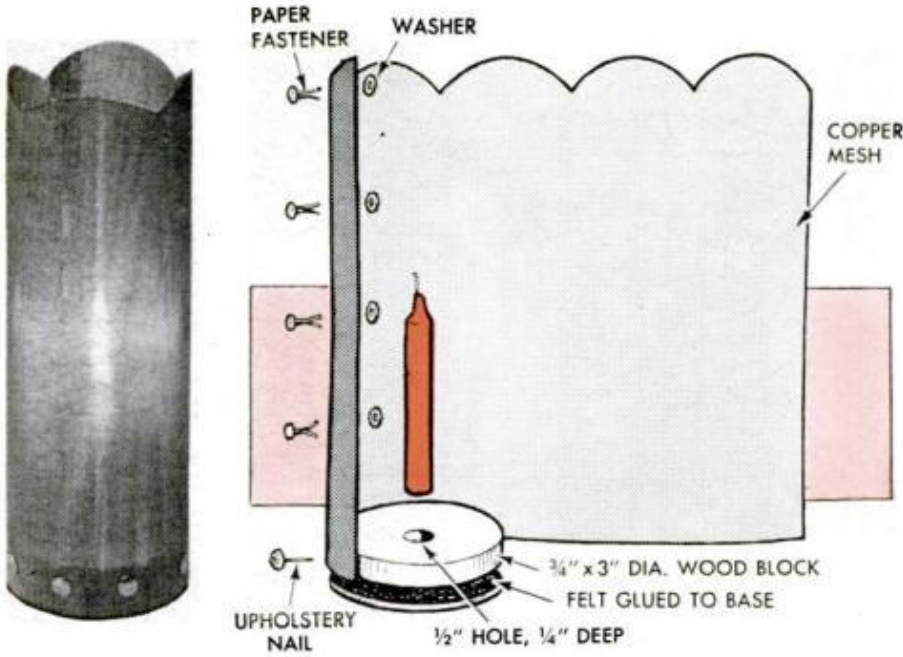

HURRICANE LAMPS of fine copper mesh permit candle light to shine through in soft glow. Each lamp is made by cutting scallops along one edge of $8\frac{1}{2} \times 10\frac{1}{2}$ -in mesh and tacking to wooden base prebored for candle. Lapped edges are joined with brass paper fasteners and washers. Bottom is covered with felt to prevent marring.—Bob Joselyn



EGG-CARTON TREE is made by stacking, nesting and gluing sliced containers pyramid fashion. Use the one-dozen-size carton, cutting each one in half lengthwise. Cut "windows" in the front, spray with gold paint and fill individual egg compartments with small ball ornaments. Perch tree on base of styrofoam and then cover with pine branches.—Louise Price Bell

HANGING DECORATION with a Yuletide note can be fashioned from toy muffin tins. Punch holes in the tins so they can be joined together with lengths of tinsel. Spray the tins with gold paint and then glue assorted red, green and gold baubles in the cups, as shown. Glue green tinsel around the edges of the metal tins and use a loop of tinsel for a hanger

TOOTHPICK CHEER



1. WREATHS may be left starkly simple, above, or ornamented with beads and artificial leaves, below

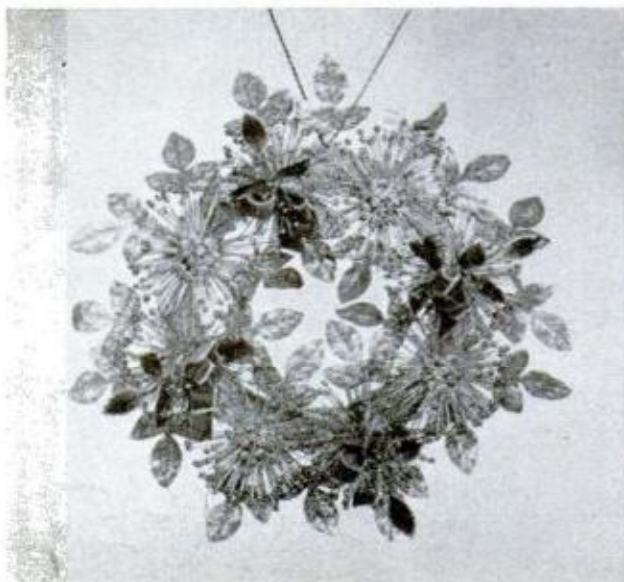

By Theodosia Carpenter

WANT TO GIVE your home an extra-special holiday sparkle this season without straining the Christmas budget? The basic materials for these glittering wreaths and ornaments are common round toothpicks and 1-in. Styrofoam balls, available at any ten-cent store. A wide range of striking effects may be obtained by spraying them with metallic paints and adding any number of imaginative decorations—sequins, gold or silver wire mesh, artificial leaves, glass beads, velvet ribbons, etc.

Dip the tip of each toothpick in glue before inserting it, and for a more professional result, cover one section of the ball at a time, Fig. 2, rather than placing toothpicks at random all over the ball. If you plan to decorate the foam ball itself with sequins

POPULAR MECHANICS



2. TOOTHPICKS should be inserted in one section at a time rather than haphazardly over the entire ball

or wire mesh, do this before you begin inserting the toothpicks.

The base of the bejeweled Christmas tree, Fig. 3, is made of seven interlocking balls pressed into a foam disk. Place a drop of glue wherever toothpicks from two different balls touch so as to hold the centerpiece solidly together. Coat the whole tree with white flock spray and decorate it

with tiny beads from an old necklace.

To make a wreath, stick the balls into a foam ring, Fig. 1. You can create an infinite variety of designs by varying the decorations. If the wreath is to be hung in a window where it will be viewed from two directions, leave those parts of the balls next to the ring free of toothpicks and cover both sides of the ring.

3. CENTERPIECE, right, consists of seven balls pressed into a foam disk to form the base. For the second and third layers, use five and three balls

4. TREE ORNAMENTS are easiest to make. Decorate the ball itself with sequins, then glue extra sequins to the tips of toothpicks as a finishing touch

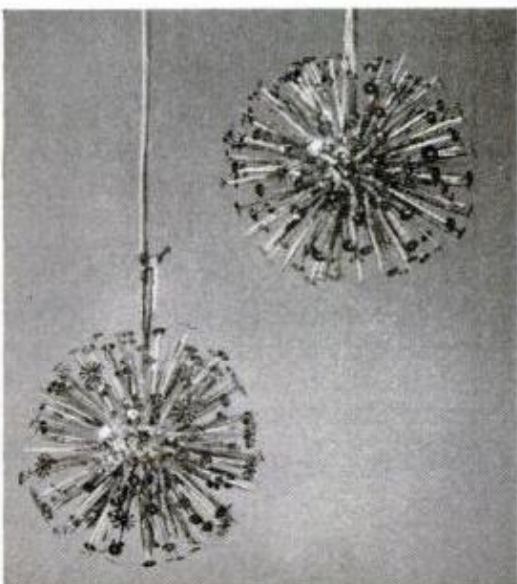
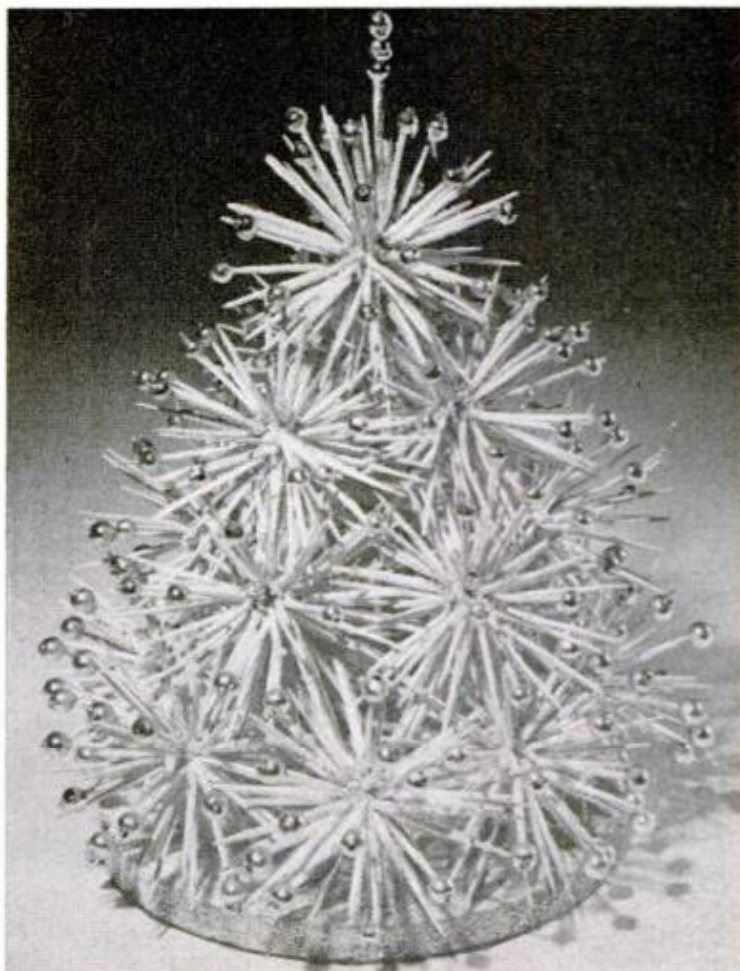



Elbow-Length Mitts

One of the discomforts of running a trapline is making underwater sets in cold weather. Badly chapped hands can result from too much of this sort of thing, if nothing worse. One trapper carries two plastic bags of the kind you buy popcorn. Before making an underwater set he slips hands and arms into the bags and fastens the open ends just above the elbows. These "mitts" take the edge off that chilling plunge of hand and arm into ice-cold water when placing a submerged trap, yet they do not interfere measurably with hand and finger movement.—*G. E. Hendrickson*

A small piece of copper fly screen laid in your log fire gives the flames the brilliance of burning driftwood. A small piece will last several months as the metal oxidizes quite slowly. Just place the piece under the kindling when you start the fire.

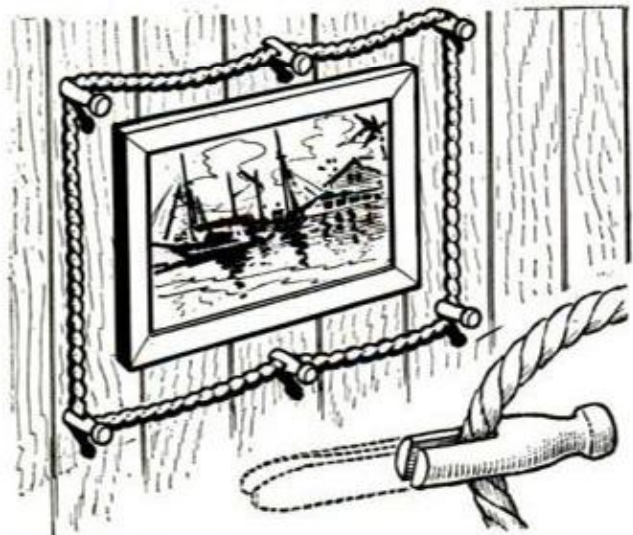

Nautical Touch

Here's a novel decorative idea for that paneled rec room or that corner devoted to the nautical. Only one application is illustrated which should be enough to spark one's imagination in the development of others. All you need to carry it out are an appropriate framed picture, a length of nylon rope and about six wooden clothespins. Just cut off the legs of the pins as detailed, drill holes in the wall around the hanging picture, then grip the rope in the shortened legs of the pins and drive the latter into the holes. Of course, the holes must be equally spaced and equidistant from the frame.—*Thomas P. Ramirez*



Ice Chips Afloat

Chipping fishing holes in ice a foot thick can get to be quite a chore when you have to stop every inch or so and scoop out the ice chips. Concentrate all effort on getting one hole through the ice. Then scoop up a pail of water and keep it handy for floating the loose chips as you cut the other holes. Just keep each hole partially filled with water and the chips won't impede progress. And you save the time consumed scooping them out every minute or so.

—*George Goodwin*

Ever try to cut sheet rubber with scissors? If you have, then you'll appreciate this suggestion: Tape a piece of cellophane to each side of the rubber sheeting where the cut is to be made. The cellophane prevents the rubber sheet from creeping while cutting.

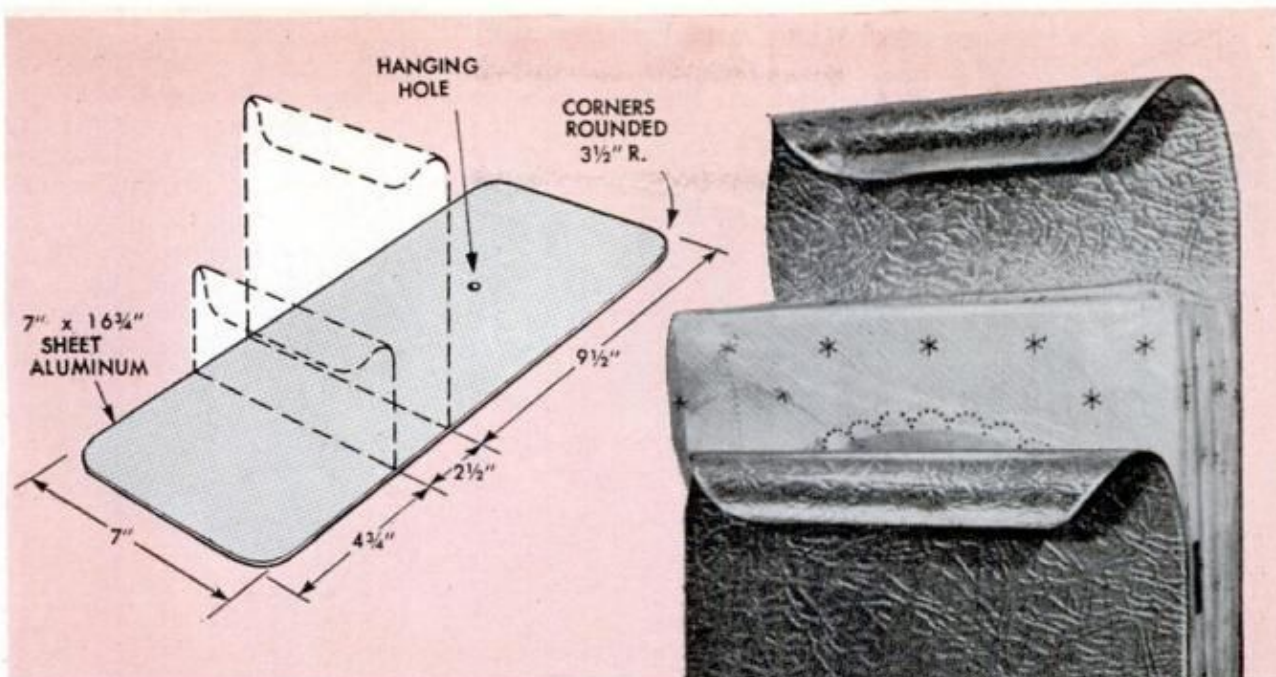

ALUMINUM NAPKIN RACK

PAPER NAPKINS are always conveniently at hand when kept in this attractive one-piece, kitchen wall rack. It's a simple one-evening project and a quickie last-minute gift for the house. The rack is fashioned from a single piece of embossed sheet aluminum, measuring 7 x 16 $\frac{3}{4}$ in., which is available in different designs from self-service racks in many hardware stores. Begin by cutting the four corners on a 3 $\frac{1}{2}$ -in. radius as shown. Ordinary scissors can be

BENDING the soft aluminum is easily and quickly accomplished by holding the sheet firmly over the edge of a table (right) with one hand while applying a downward pressure with the other

ROLLING the curled ends of the aluminum sheeting around a broomstick imparts a distinctive styling to the completed napkin rack which is in keeping with the embossed design of the sheeting itself

used for this. Then curl the two ends by rolling the soft material around a broomstick. Make the two right-angle bends in the sheet by forming them over the sharp edge of a table or workbench. Finally, punch a hole at the point indicated for hanging the completed rack with a thumbtack. Leave the napkins in their plastic wrapper, but slit the top for easy removal. The same rack could be put to use as a place to store pot holders.—Ken Murray



8 MAGIC TRICKS

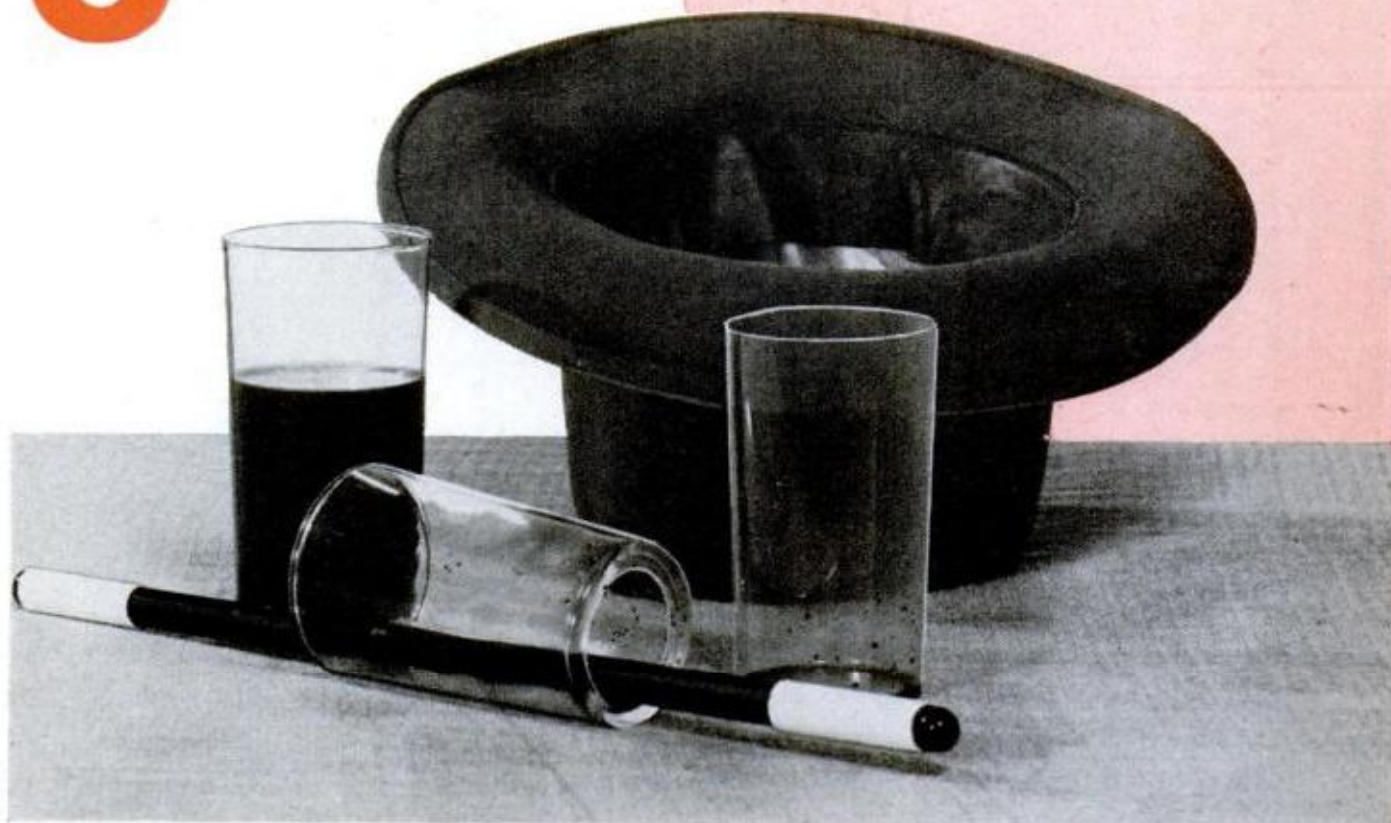

By **Byron G. Wels**

MAGIC! The word has an exciting ring to it, for everybody enjoys the fun of fooling, being fooled and trying to out-guess the magician. It's easy to master the mechanics of these tricks, the difficult part is convincing people that you really *are* a magician. Obviously, the boy wearing everyday clothes is an everyday boy, not a magician. But put him in a turban or a top hat and . . . well, *there's* a magician.

Remember that an important ingredient in any magic act is "patter," a steady flow of words to distract the audience. Misleading actions also play a big part. Wave a handkerchief high in the air while shouting "Look!" and you can slip the (supposedly) disappearing object into your pocket without the audience ever noticing. They'll be too busy watching the handkerchief!

MAGIC WINE GLASS For this humorous trick you'll need a straight-sided drinking glass with the bottom removed and a thin-walled clear plastic tumbler large enough to hold the bottomless glass. Borrow a hat from the audience, place it brim-up on the table and put the nested glasses inside. Pretend that you are about to pour wine (colored water) into the glass inside the hat, then hesitate and explain that you



can't seem to remember the trick, but you think that the glass belongs outside the hat. Slip the bottomless glass out of the plastic tumbler, place it on the table, and pour the liquid into the supposedly empty hat. Next, glance down into the hat, act embarrassed and mutter something about a "mistake." Then brighten up, put the bottomless glass back in the hat (slipping it inside the full tumbler), make a few passes with the wand and lift the full glass(es) out of the hat. Finally, hold up the hat to show that it's empty and unharmed.

YOUR MAGIC WAND Here are a couple of quick tricks in which the wand itself is the apparatus. Offer to allow a member of the audience to do the next trick, but as you hand him the wand make it jump away from him, toward you. Then explain that you will have to do the trick yourself, as the wand doesn't want to work for him. Or you can roll the wand up in a newspaper, tear the paper to shreds, toss the pieces into the air and the wand will have vanished.

The trick wand is a hollow plastic tube fitted with a button at each end. The two buttons are connected by a rubber band running through the tube. To make the wand jump, hold one of the buttons between your fingers, pull the wand to stretch the rubber and grasp the body of the wand with thumb and forefinger of the same

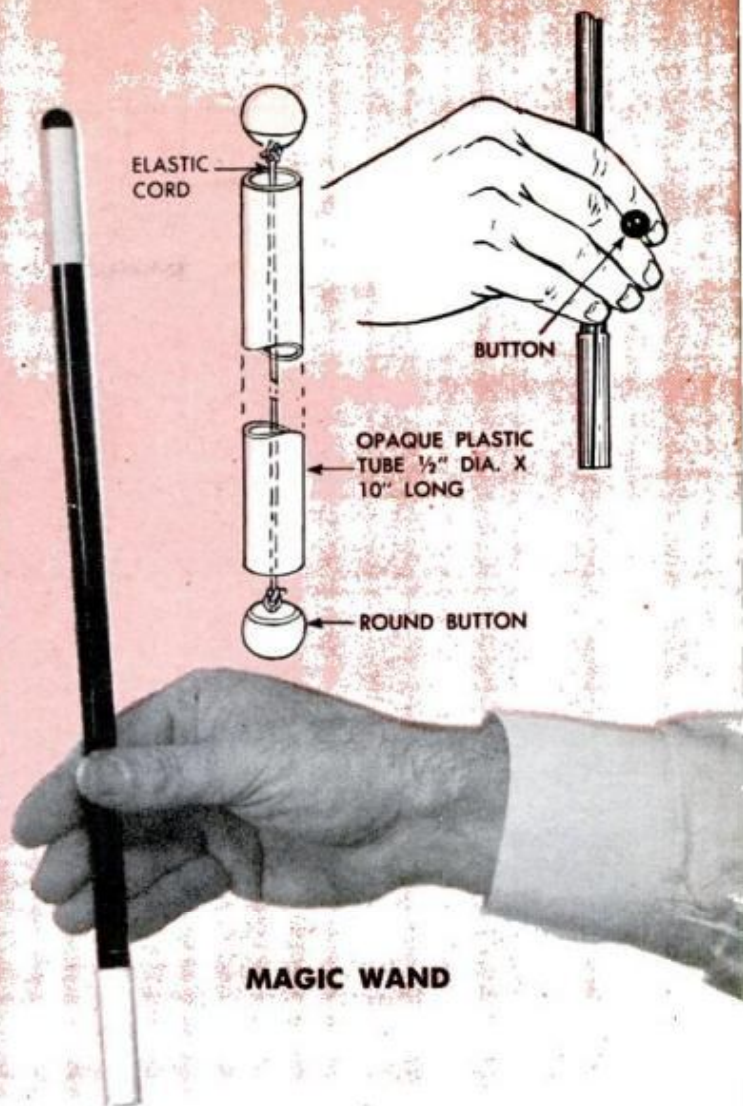

MAGIC WAND





hand. Release the thumb pressure and the wand will move.

For the newspaper trick, pin one button inside the sleeve of your jacket and stretch the rubber band so that you are holding the base of the wand. When you release it the wand will jump back into your sleeve.

ELBOW PUMP People always watch the magician very closely, so when you can fool the victim of your trick, you have really accomplished something.

Call for a volunteer and ask him to roll up his sleeve. Examine his arm and exclaim, "Why you poor man! You have water-on-the-elbow." Then grasp his elbow with one hand, hold his wrist with the other and work his forearm like a pump handle. A steady stream of water will spurt from his elbow, much to his own amazement and the delight of the audience.

The secret is a small rubber sponge, filled almost to capacity with warm water. Conceal this loaded sponge in your palm and press it against the elbow to make the water flow.

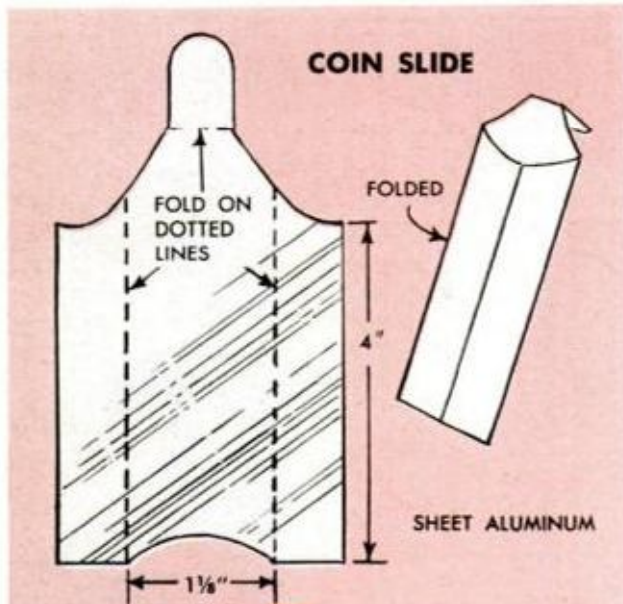

COIN SLIDE The magician borrows a coin from a member of the audience and asks that it be marked in such a way that it can be identified later. A soft lead pencil works well for such marking. Quickly, the magician puts his hand behind his back and brings out a small box bound with rubber bands. The marked coin is no longer in sight.

The magician gives the box to the volunteer and directs him to remove the rubber bands. Inside, he finds a smaller matchbox, also bound with rubber bands. Upon removing these rubber bands and opening the matchbox, he discovers a small cloth pouch securely sealed with another rubber band. When he opens this pouch, there is the marked coin!

The secret of this trick is a special coin slide made from sheet aluminum. The top of the slide is bent to form a hook. Prepare this trick by placing the straight end of the slide inside the small pouch, and secure the pouch to the slide with a tight rubber band. Next, place the pouch and straight portion of slide in the matchbox and bind with more bands. Don't worry about the box not being fully closed, as the bands will snap it shut when the slide is removed. Place the matchbox inside the last box, and bind it shut. Then suspend the box-slide unit from your belt by the hook. When you receive the marked coin, drop it into the top of the slide and in the same motion, pull the box from the slide. The slide will remain suspended from your belt concealed by your coat.

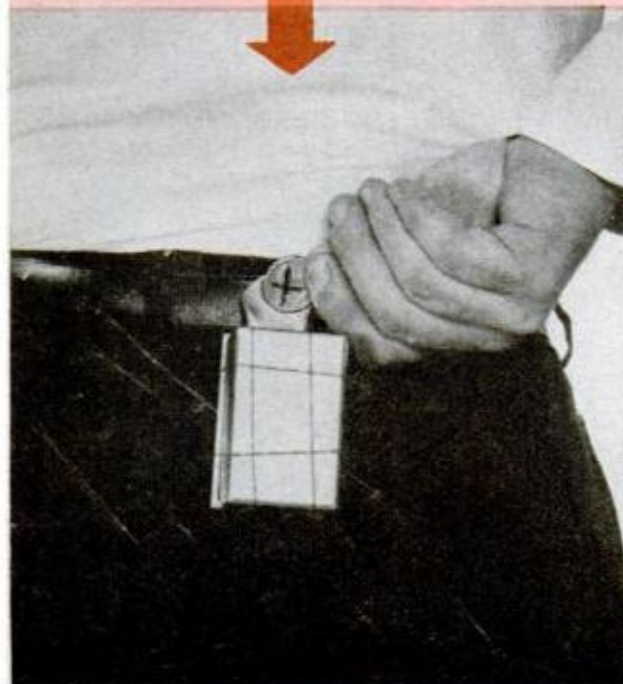

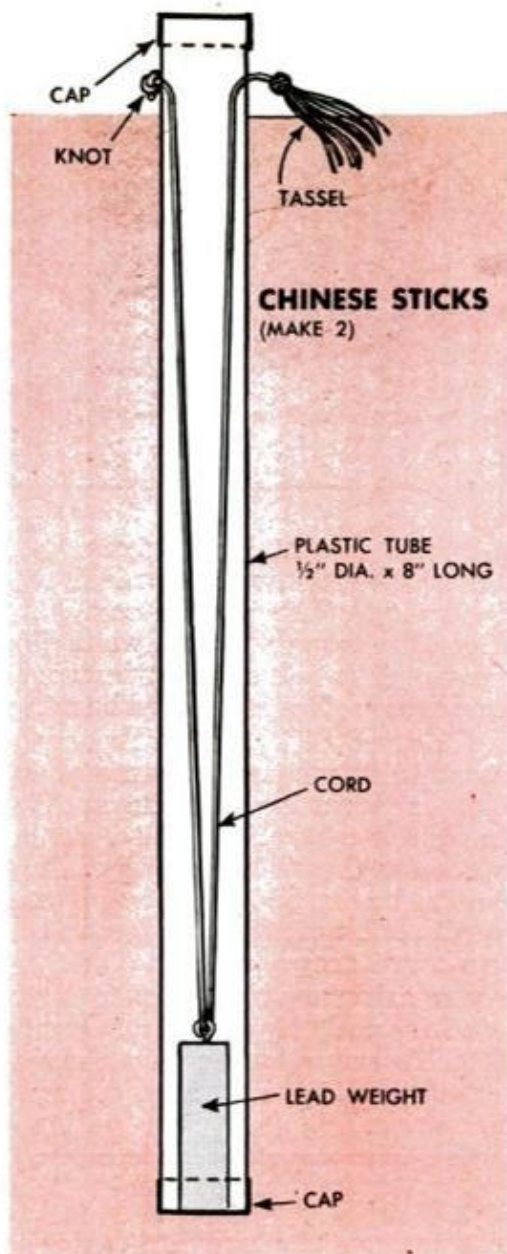

CHINESE STICKS The magician displays a pair of parallel sticks, each with a tassel dangling from one end. As he pulls on one tassel, the other one rises. Then he separates the tasseled ends of sticks and repeats the tassel-pulling routine. The audience suspects that the string runs through the rear ends of the sticks, and shouts, "Separate the sticks," but the magician pretends to misunderstand and separates the tasseled ends still more. When the audience shouts again, he suddenly appears to understand their meaning and places one stick in his mouth to show that there is no string connecting the two. He pulls the tassel dangling from the stick in his hand, and the other tassel rises!

The sticks are constructed from plastic tubing about 1/2 in. in diameter, and the movement of the tassels is controlled by small lead weights inside the sticks.

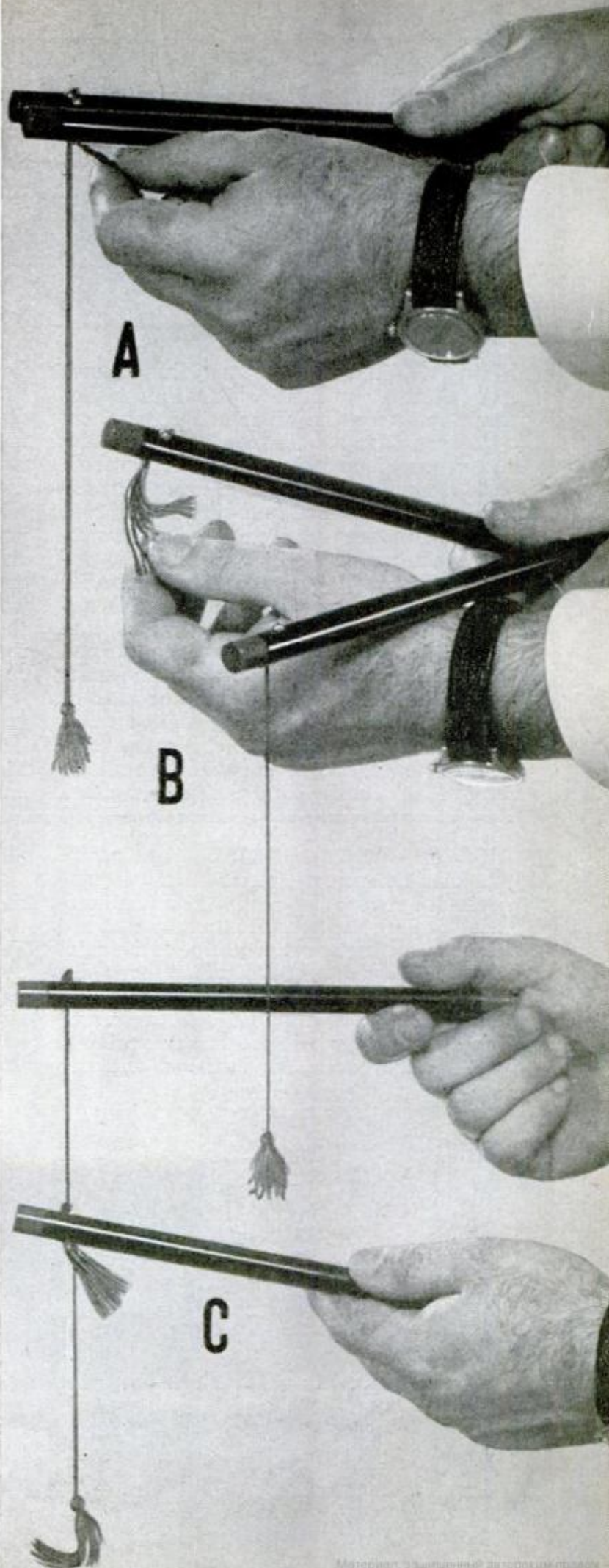

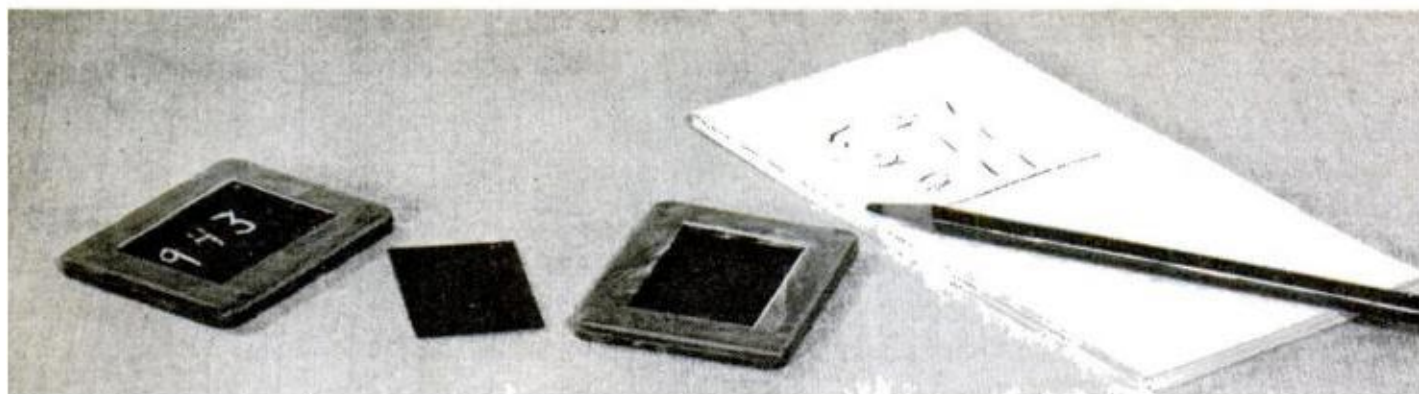

SPIRIT SLATES The magician shows sides of a pair of blank slates, then places them one upon the other and binds them together with a rubber band. After putting the slates on a table and covering them with a handkerchief, he walks out into the audience with a pad and pencil. He then asks a volunteer to write a three-digit number at the top of the pad, moves on to another person who writes a second number under the first and to a third who adds another number. The magician draws a line under the last number and gives the pad to a fourth volunteer who adds up the numbers. When he has arrived at the sum of the three numbers, he calls it out so that the audience can hear it. The magician then returns to the stage, uncovers the slates, removes the rubber band and there, written

for all to see, is the total just given.

To prepare the trick, write three three-digit numbers in a column on the pad. Find the total of these numbers and write this number on one of the slates. Now turn over the pad and remove the cardboard backing.

Prepare a piece of black cardboard or poster board to fit inside the frame of the slates. This cardboard covers the number and looks like a part of the slate. Thus, when you show the slates the first time, they appear to be blank. When you unwrap them, tap the back of the numbered slate so the cardboard drops to blank slate.

When you ask the volunteers to write numbers on the pad, they will write on the blank side. However, when you recover the pad, draw the line under the numbers *on the other side*.

DISAPPEARING QUARTER Again, the magician borrows a quarter from the audience. He covers the coin with a handkerchief, pulling the kerchief tight so that the audience clearly sees the outline of the coin. Then, holding the handkerchief over the mouth of a glass, he releases the coin and the audience hears a "clink" as it drops into the glass. But when the handkerchief is removed, the coin has vanished and the

glass is empty!

Actually, the magician substitutes a glass disk the size of a quarter, and slips the quarter into his pocket while the audience is looking at the handkerchief. It is this disk that drops into the tumbler, and as the audience is looking for a coin, the glass disk is invisible. You'll find that the flat lens from a small flashlight is an ideal substitute for the quarter in this trick. ★★★

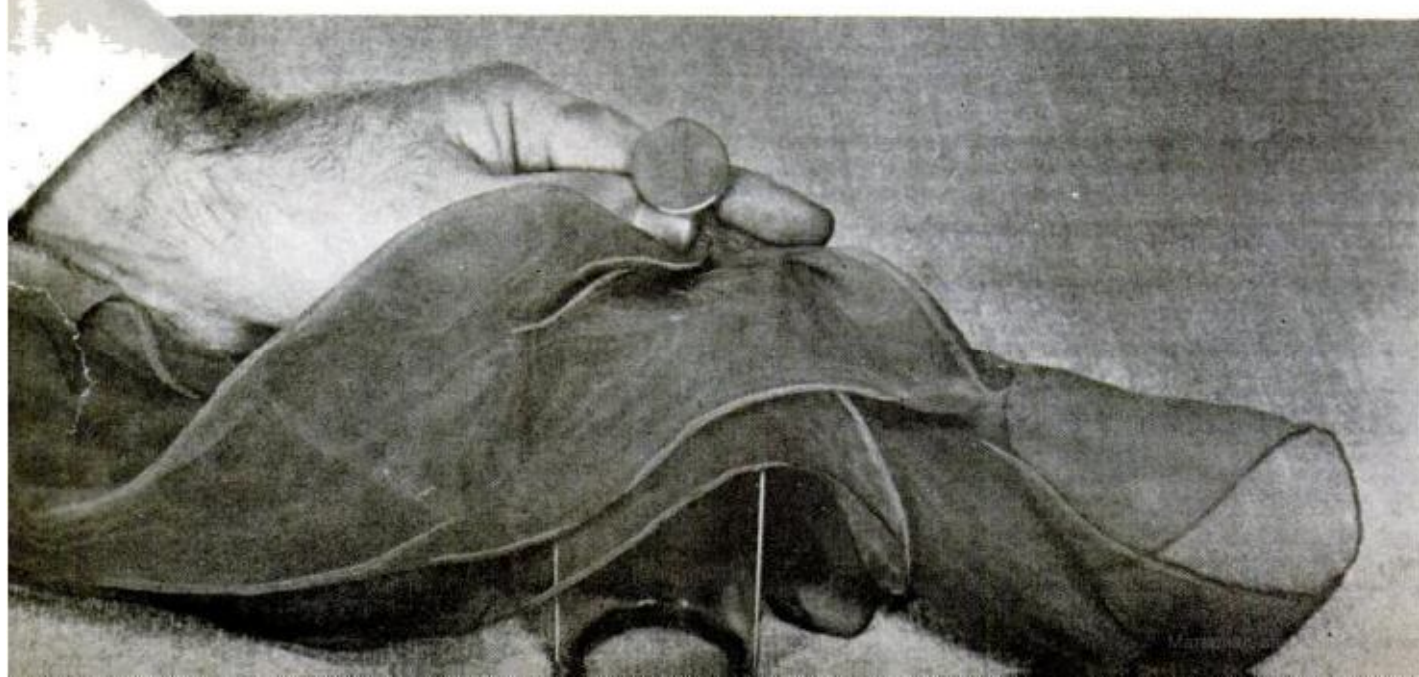

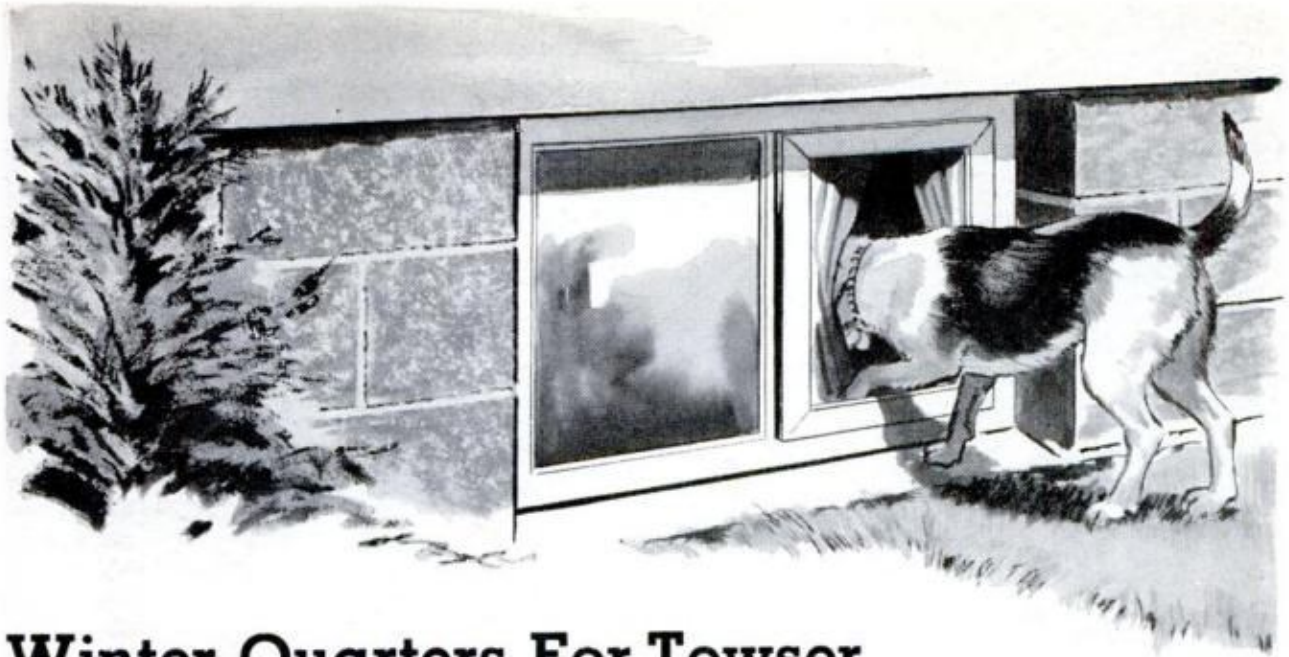

Winter Quarters For Towser

THIS FREE ACCESS, basement-window dog-house enables Towser to come and go as he pleases while providing him with warmth and comfort on wintry days. Suspended from the floor joists at a window near the furnace it benefits from basement heat. Self-closing canvas curtains and a baffle keep out drafts. A hinged door on the basement side provides for feeding the dog, as well as for cleaning the interior of the doghouse.

The curtained doorway frame fits in the glass rabbet of the removed window pane. Rubber bands to hold and activate the curtains may be cut from an old inner tube. Base all dimensions on the size of your basement window and your pooch.

—Hi Sibley

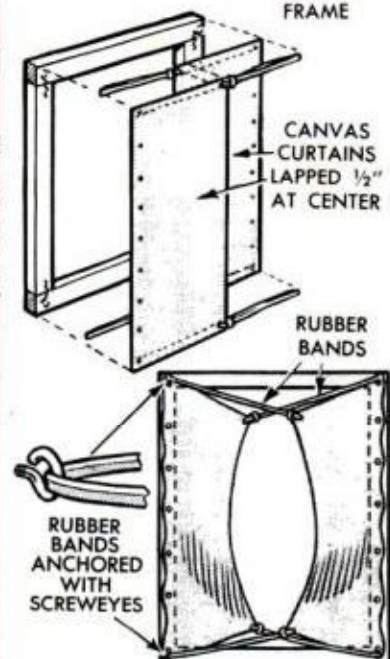
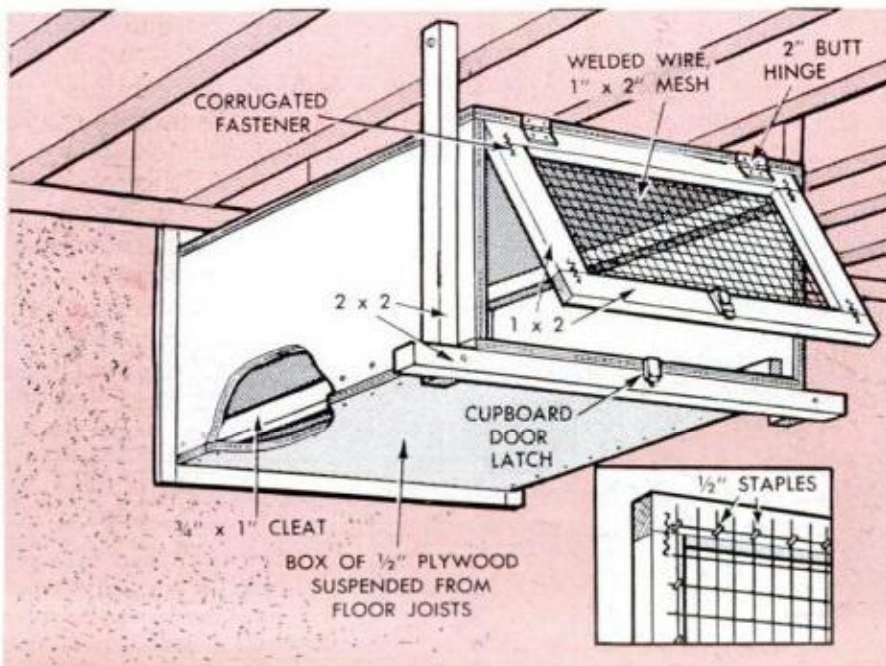
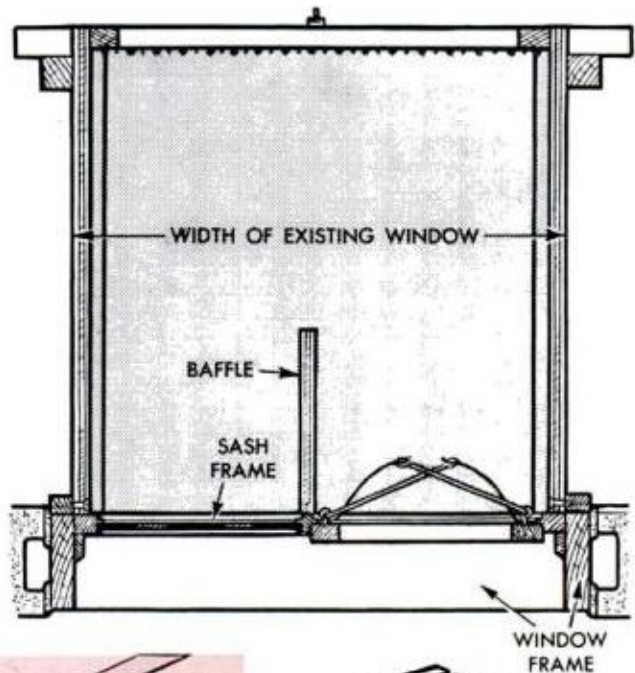



SNOWFLAKES TO ORDER

By R. J. DeCristoforo

THESE PAUL BUNYAN-SIZE snowflakes may look like they were snatched right out of a North Woods blizzard, but underneath all that sparkle, they're made of scrap wood. And in spite

of the complex appearance, construction couldn't be simpler.

Begin by making several lengthwise cuts and holes in a scrap piece of wood to obtain an interesting cross-sectional shape. Any type of wood may be used, although hardwoods should be avoided, if possible, since they are more difficult to work. After shaping, cut the block into thin slices and assemble these sections with staples or glue on a flat surface. Then finish and decorate with sequins, "canned snow," colored gravel, mica flakes—any colorful material, but the more glitter the better.

When making the more complicated star-shaped clusters, be sure that you cut the bottom bevels so that a specific number of pieces will form a complete circle when



USE SPACER between blade and saw fence to gauge thickness when cutting shaped block into sections

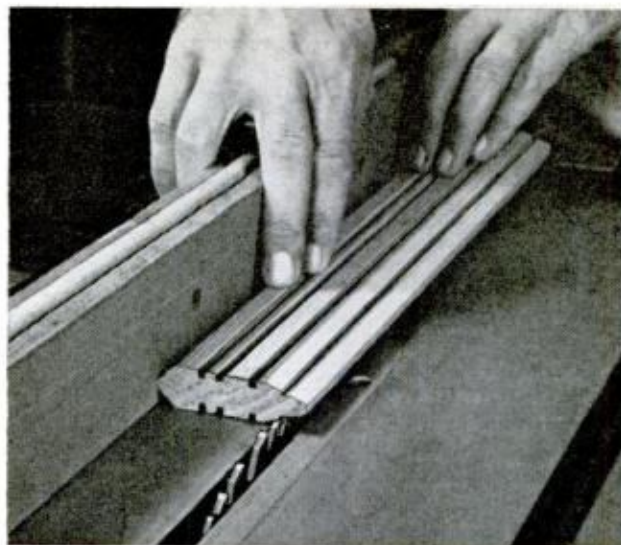

MAKE SEVERAL longitudinal cuts in block to obtain desired cross-sectional shape for snowflake pieces

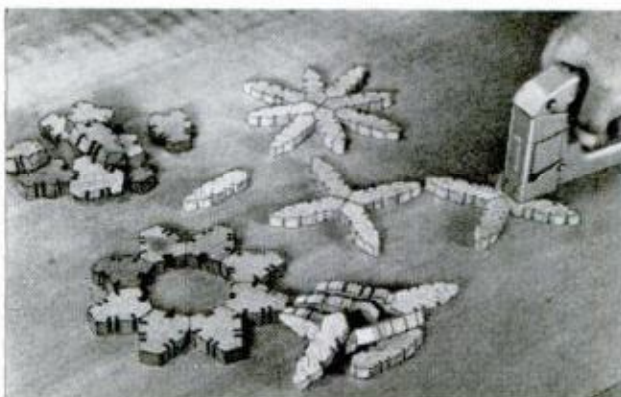

STAPLE SECTIONS together to form snowflakes, then seal, finish and cover with glittering decorations

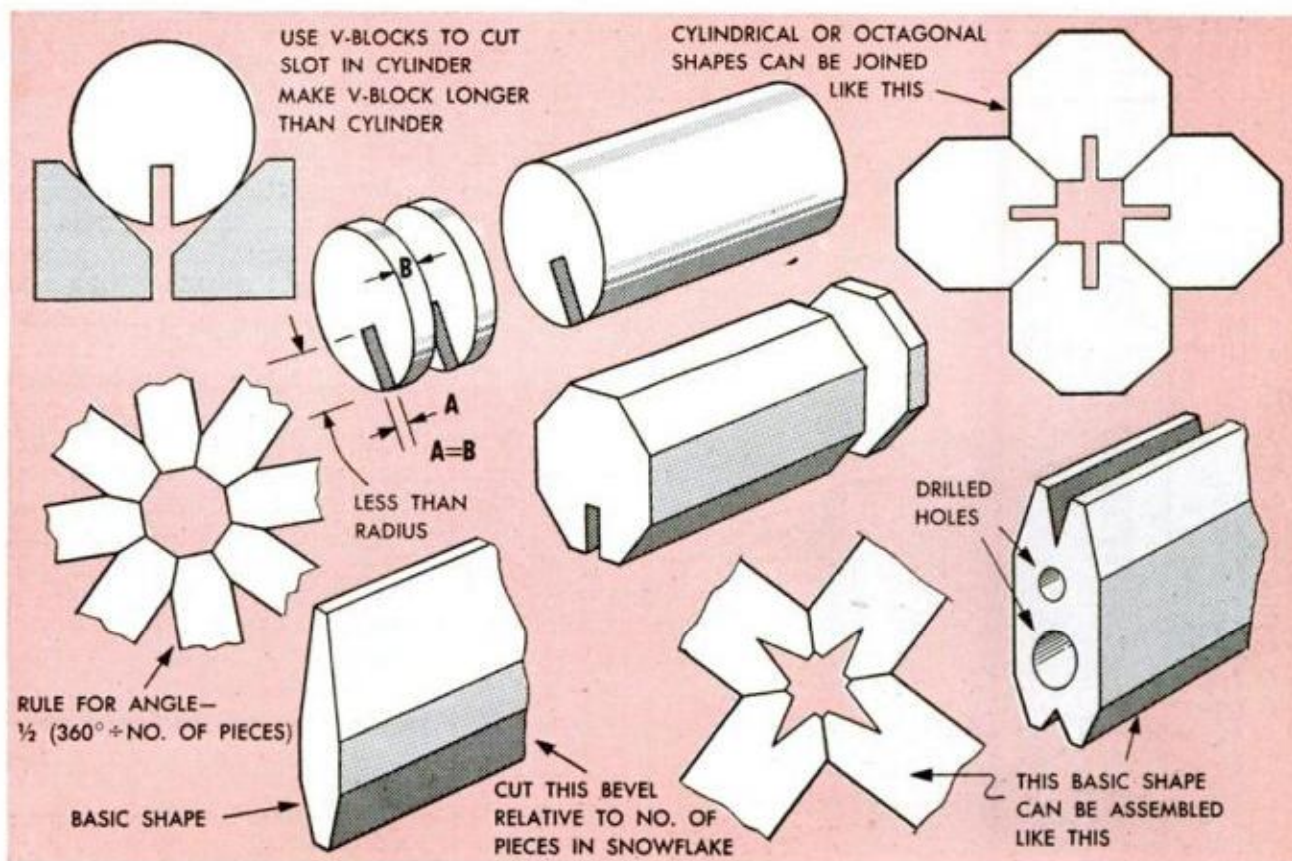



ADD GLITTER to your snowflakes by coating them with clear adhesive, then sprinkling with sequins, etc.

joined. First, decide how many pieces you want to use. Then divide 360 by this number to obtain the total number of degrees for the two bevels of each piece. Half of this number will be the correct angle to set the saw blade for cutting each bevel.

If you plan to staple the sections together, work on a soft surface (a piece of foamed plastic makes an ideal work surface), and use staples about $\frac{1}{8}$ -in. longer than the thickness of the sections. When you drive the staples, they will protrude on the opposite side of the material, allowing you to bend the ends over for a stronger assembly. If you don't have a staple gun, the sections may be joined with glue or contact cement.

It's a good idea to seal the assembled flakes before finishing and adding the decorations. Pour some shellac into a shallow pan and dip the entire flake. You can paint the flakes before decorating.

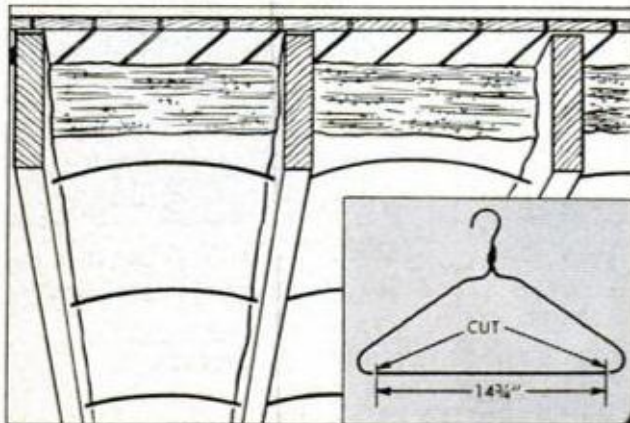

Coathangers Support Insulation

One of the problems of applying insulation in an electrically-heated home has been solved with the old, familiar wire clothes hanger. It was discovered that lengths of wire cut from clothes hangers and wedged up against the insulation worked perfectly for holding the 6-in. batts in place under the floor with the vapor barrier on the warm side. This lets the insulation retain its desired thickness, but holds it firmly.

—Marvin Stacken



How to Spoil Your Dog

Even dogs enjoy a little taste of luxury, and here's an economical air mattress for Fido that will be an instant hit. Just inflate an old inner tube inside a burlap bag and tie the bag shut. Any dog prefers a comfortably "hollowed-out" bed, so don't make the top drum tight. Since burlap bags are available in several sizes, you can even tailor the mattress to fit your dog. Just use a tube from a compact car for a small dog, and a standard tube for a larger dog.

—C. L. Furr

● Birds sometimes learn each other's languages. In France, the rook, carrion crow, and jackdaw spend the winter in mixed flocks where they learn one another's calls. Yet, American eastern crows, which are members of the same species, do not understand the calls of others of their kind living in a different area.



NEW FOR SHUTTERBUGS NEW

1. HOME MOVIE PROJECTOR features a Magi-Cartridge for 8-mm. film that eliminates threading, re-winding, reels and sprockets, making operation child's play. Snap-in cartridge can be loaded with 50 ft. of film. Has Technor f:1.5 precision-ground zoom lens. Produced by Technicolor Corp., Hollywood, Calif.

2. MICROFILM CAMERA records documents or drawings up to 12 $\frac{3}{8}$ in. wide on 16 mm. film. Reduction ratio is 24 times. Operates on 115 volts AC, weighs 21 pounds. Exposed film can be removed at any point in operation with loss of only 6 ft. of unexposed film. Available from Microdealers, Inc. Waltham, Mass.

3. EXPOSURE METER is activated by on-off switch to conserve mercury battery in bottom. YEM-35 fits many cameras with standard shoes, is 2 x 1 x 1 in. in size. Speeds range from 1/1000 to 8 sec.; apertures from f:1.0 to f:32; ASA values from 6 to 12,000. Product of Yashica, 50-17 Queens Blvd., Woodside 77, N.Y.

4. SLIDE VIEWER handles up to 25 slides without reloading. Ikoscop is 3 x 5 x 6 in., can be used in a fully lighted room. Uncut and unmounted transparencies and negatives may be viewed by means of a filmstrip holder accessory. The price is \$14.70. Carl Zeiss, Inc., 444 Fifth Ave., New York 18, N.Y.

5. INSTANT FILM DRYER is applied for two minutes after usual processing and washing, drying film instantly after squeegeeing excess solution. Hardens emulsion and makes it scratch resistant. Does not deteriorate with use. Pint costs \$2.25. Yankee Photo Prod., 3325 Union Pacific Ave., Los Angeles 23, Calif.



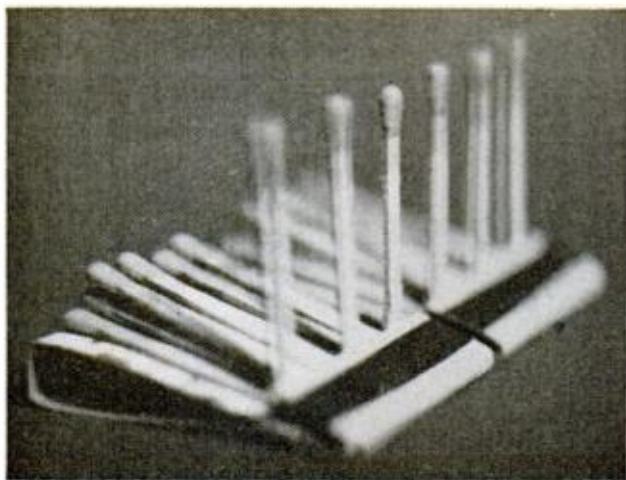

1. **DOUBLE IMAGES** appear at points that are out of focus when light block is placed over viewing lens

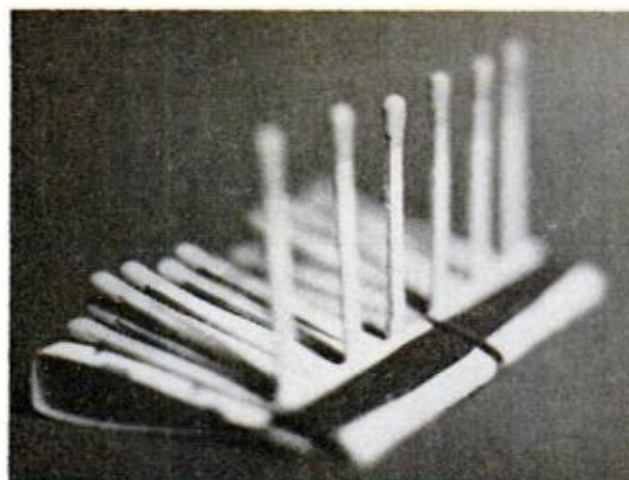

2. **SAME VIEW** as it appears without the light block where sharpness of focus must be determined by eye

Easier Focusing with Twin-Lens Reflex

SHARPLY FOCUSED IMAGES are assured with a twin-lens reflex camera, without eyestrain or guessing, by using a simple, X-shaped light block such as shown in Figs. 3 and 4. It is held in front of the viewing lens by means of a filter adapter, and produces double images of objects in areas that are not in focus as is shown in Fig. 1. As soon as you adjust the focus so the two images merge together to form a single image, you have reached the point of maximum focus.

This is much easier on your eyes than focusing in the usual manner to bring an image such as that shown in Fig. 2 into sharpness visually. However, an exception to this technique is the focusing of large, uniform areas such as a lake surface or a stretch of sandy beach. In such cases, focusing must still be done in the usual manner without the light block.

A temporary light block can be cut from stiff cardboard such as Bristol board, and a permanent one from light sheet aluminum. Use the filter adapter ring as a guide in making it. First scribe a circle equal to

the inside diameter of the ring at the point where the filters are held. Mark two diametric lines at right angles to each other to serve as centerlines for the cross bars. These differ in width for various lenses as indicated in the table. Pencil the widths with fine lines on cardboard, or scribe them on aluminum. Use a razor blade in a suitable holder and a steel rule as a straight-edge to cut the cardboard accurately. To cut aluminum, back the piece with wood, grip both in a vise and use a fine metal-cutting saw. A metal-cutting snips tends to curl and distort the bars.

A light block made to proper size as indicated in the table produces a pronounced double image while reducing the light transmission of the viewing lens less than one f-stop. This light loss is not objectionable in any but the dimmest lighting conditions in which case the light block can be removed as easily as a filter. If your camera produces a ground-glass image which is bright in the center and dark on the edges, its viewing system probably is not equipped with a field lens. Then you can improve

3. **X-SHAPED LIGHT BLOCK** is placed in filter adapter ring and is held securely with the retaining ring

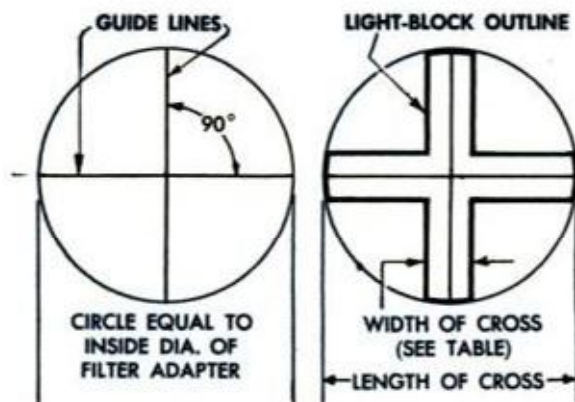
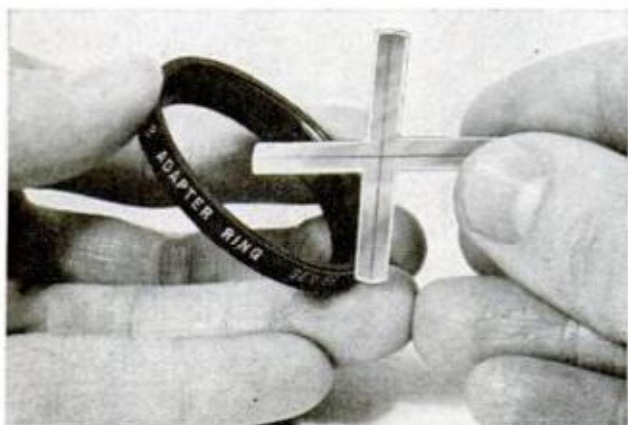

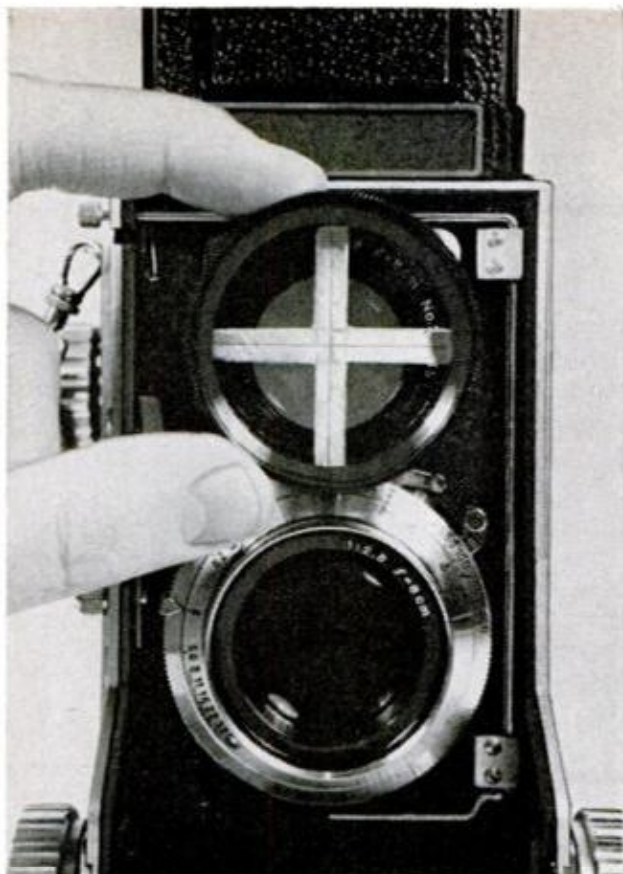

4. BARS OF LIGHT BLOCK should be set vertically and horizontally to get the best double-image effects

dim-light focusing with a Fresnel type field lens. This costs only a few dollars and can be installed by yourself or a camera repairman. It will produce a more evenly lighted and easily viewed image, whether or not you use a light block.

To get the best double-image effects, adjust the adapter so that the light-block bars are vertical and horizontal. Then the vertical segment produces double images of the vertical elements in a scene such as telephone poles, and the horizontal segment produces a double image of the horizontal elements in the scene.

For your first test of the light block's effectiveness, set the camera 5 or 6 ft. from a Venetian blind and focus on the slats, both with and without the light block. You'll notice the difference at once and how easy focusing is with the light block.

—Joseph R. Noonan

WIDTH OF CROSS BARS

(Read across)

Aperture of Viewing Lens	Focal Length	Width of Cross Elements
f/3.5 or 3.2	75 to 80mm.	5/32"
f/2.8	75 to 80mm.	7/32"
f/3.5	60mm.	7/64"
f/2.8	60mm.	5/32"

DARKROOM HINTS

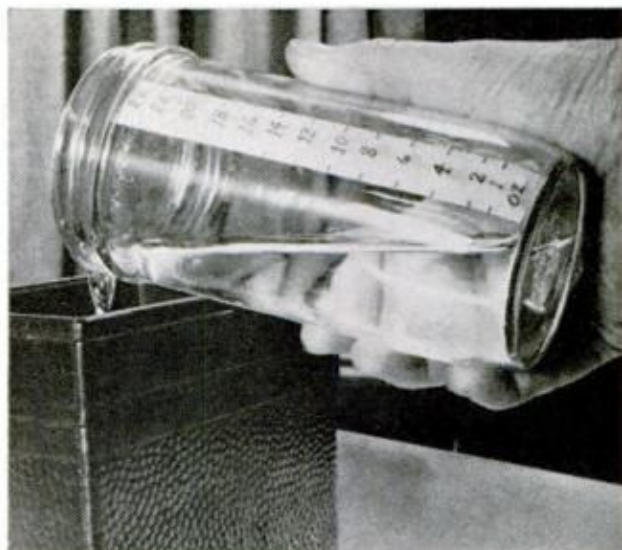

Fruit-Jar Graduate

Measuring of chemical solutions can be done accurately with a fruit jar of either pint or quart size. Attach a strip of masking tape vertically to the outside of the jar and mark this in ounces. To determine the correct location of the marks, pour known quantities of water into the jar as measured with a graduated cup or a nursing bottle. Add one or two oz. of water at a time and mark, or else add six oz. or more to two already marked, and then divide the distance on the tape equally to correspond to the number added. Coat the tape with clear lacquer or nail polish to keep it clean.—Wayne Floyd

Sheets to Weigh Chemicals

Instead of throwing away the paper separators that come from boxes of sheet film, keep them for weighing chemicals. Use two sheets of identical size, one in each pan of a balance. The one used for the chemical should be creased centrally at right angles thus forming a depression that will hold it. The sheets should not be reused but should be discarded after serving this purpose.

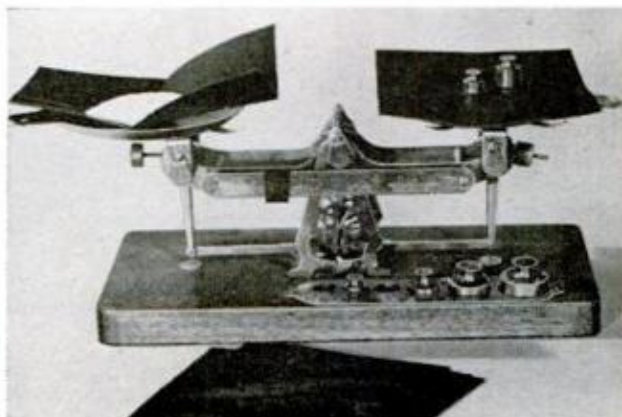

SHOP SHORT CUTS

Plaster Catcher

Before you cut an opening in a plastered wall for an outlet box, or for some other purpose, tape a cardboard box to the wall just below the point where the opening is to be made. The box will catch the bits of plaster, pieces of lath and most important, that flour-fine plaster dust that is so difficult to get up off the floor. Even the vacuum cleaner won't pick up all of it.

Wooden drawer knobs that have worked loose can be tightened. Remove the screw, then dip a length of small cotton cord in shellac and wind in the spaces between the threads. Replace the screw, turning it in tightly.

Solder Cache

No serious handyman or modeler ever runs out of solder at a critical stage of the project he's working on—or does he? To prevent this ever happening unwind a length of wire solder from that new spool you just bought and rewind it—not too tightly—on the soldering-iron cord. Wound on the cord the extra supply is never in the way and does not interfere with normal use of the iron.—*Louis Yates*

Steel-Wool

Fine steel wool can serve as a carrier, or bridge, when it is necessary to fill a hole with solder. Use a pinch of wool just large enough to fill the hole loosely, dip in liquid (acid) flux and heat slightly to flow the flux through the wool. Pre-heat the metal around the hole very nearly to soldering temperature. Then press the wool in place and flow solder over it. As soon as the work cools file the solder patch flush with the surface. Use of a torch will make this job easier and faster.

Wrenching Problem

You have a set of socket wrenches but obviously you can't use them to loosen that stubborn locknut you see in the photo. It's turned down too far on the stud. You have no open wrench that fits and you can't use the pipe wrench as the alligator jaws will burr the corners of the hex nut, which, in this case is not permissible. What to do? Simple. You just drop the socket down over the stud and onto the nut. Then turn it with the pipe wrench. This solves the problem and does no damage to the socket, as it's hardened.

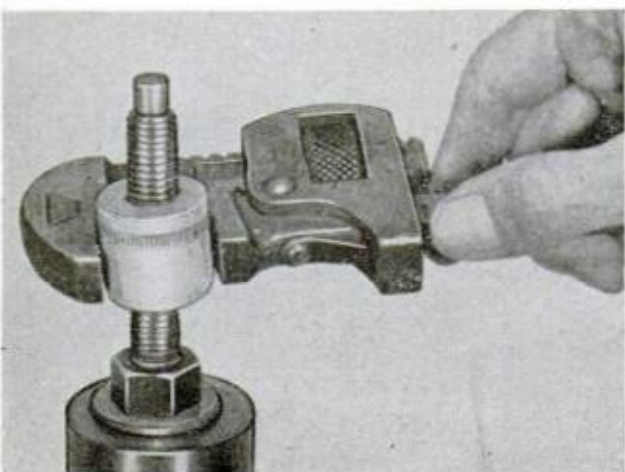
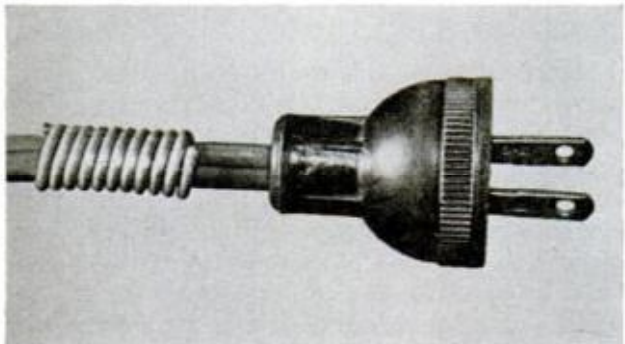



Jiffy Bobsled Uses Clamp-on Sleds for Runners

What's the hardest part of making a bobsled?—the runners. But that's not the case with this bobsled. You simply clamp on two regular sleds for the front and back runners, jump on and away you go. The bob part is a plank affair fitted with running boards and stiffened down the center with a 2 x 4. Pivoting clamp assemblies provide

rocker action to both sleds, and steering is done with the feet placed against the foot-rest. Note that the steering bar of the sleds must be made immovable by making secure with cord bound around the sled rails. Circular detail shows how grooves in the ends of the clamping assemblies are fitted with rubber to grip securely.—Hi Sibley

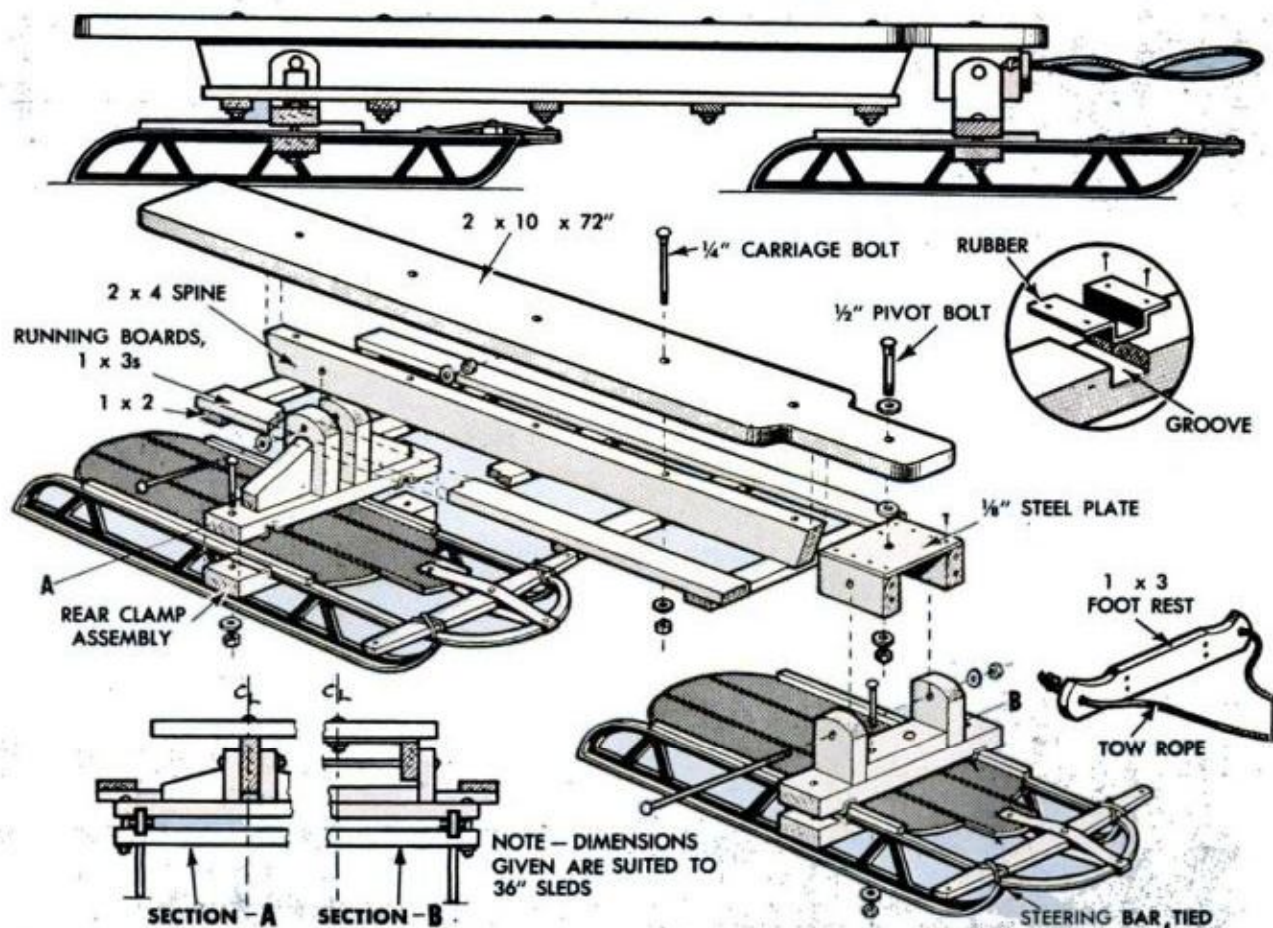

SHOP SHORT CUTS

Shoot a Miter

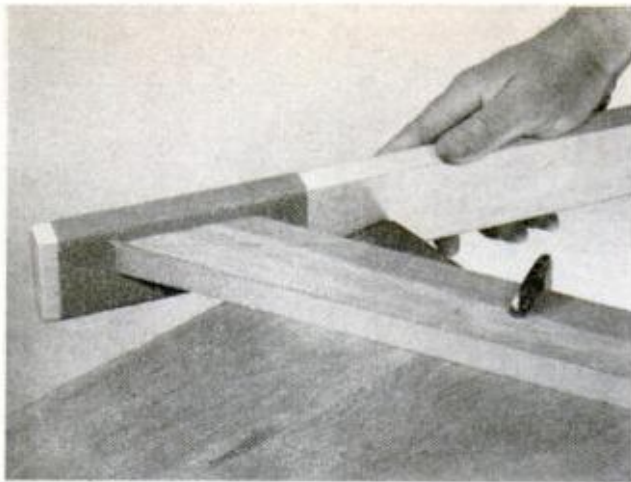

This stunt works similar to the old miter plane, except that you use a long sandpaper block instead of a plane. Just clamp the mitered workpiece diagonally across the corner of the bench, wrap the sandpaper around a 1 x 2 about 12 in. long and then, as you sand, let one race of the long block ride the corner of the bench. In this way you can sand the rough miter cut flat and perfectly straight. Use short sanding strokes.—*Burton L. Woolenzien*

Ball V-Block

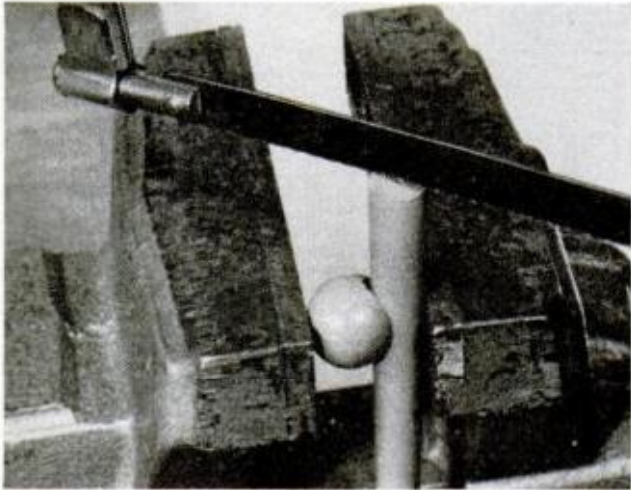

An ordinary bench vise won't hold a tapered rod or shaft in either the vertical or horizontal position but fit it with a V-block made from a steel ball and you can grip the workpiece at any desired angle. Grind the Vee in the ball deep enough to span about one fourth to one third the circumference of the workpiece and you've got it made. Set up the work as pictured, clamp the vise jaws moderately tight and the workpiece will stay put for filing, sawing, or polishing with a strip of abrasive. A piece of leather or fabric placed in the Vee will prevent scoring.—*Robert Hill*

Square Corner

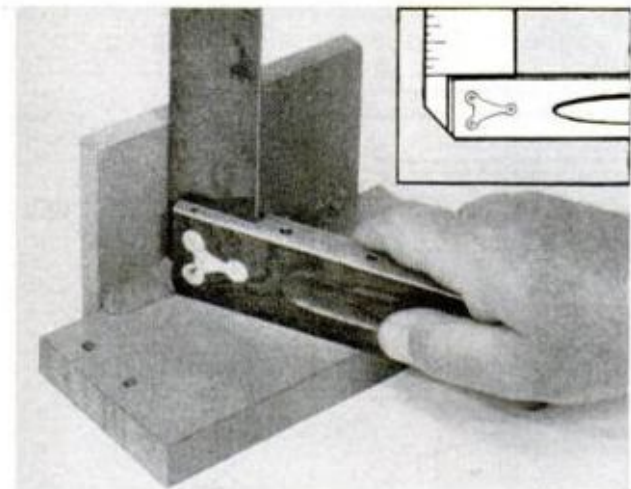

Grind a corner off the blade of a try square at the handle end and the square will span the weld bead when you want to check the squareness of an inside corner on welded workpieces. Even if you have to use your best and only try square for this purpose, you won't make it useless for most of its normal applications. Just don't take off more than is necessary to span the average weld bead. And take it easy when you grind so that you don't draw the temper of the blade. Keep a container of water handy and dip it frequently.—*H. J. Gerber*

Spaced Staples

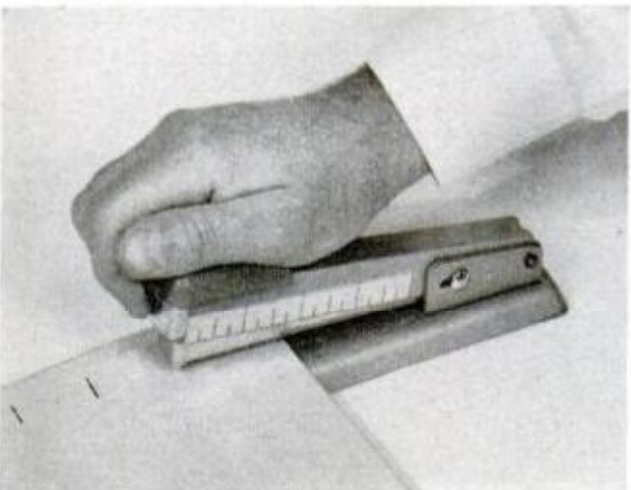

Rule divisions in inches on a piece of tape and attach to the head of your stapler with the starting line at the stapling position and you can space the staples by sight instead of by guess. Just think of the number of times you've been called upon to do this trick and you can easily see how practical the idea becomes. The spacings can be inked on the tape in any number of divisions desired from $\frac{1}{8}$ in. up. Spacings under $\frac{1}{8}$ in. are rarely practical, of course. Masking tape can be used, but ordinary gummed paper tape usually is best as it takes and retains the ink better.—*H. Hanscom*

Better CARKEEPING

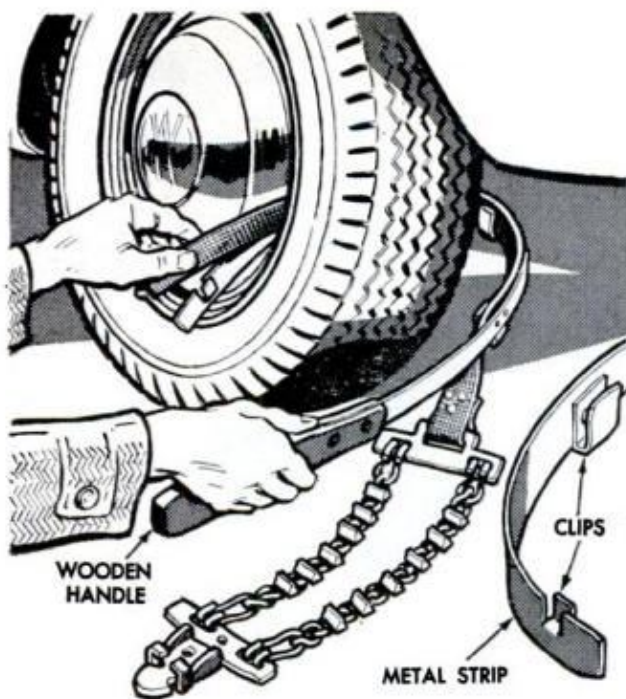

● **MOUNTING** emergency tire chains is a dirty job, but here's a simple tool you can keep in your trunk which will take much of the work out of this task. It's just a curved metal strip with clips riveted to the inner surface. To use it, slip the webbed strap from the chains into these clips and hook the tool around the wheel through the spokes. This places the end of the strap within easy reach for fastening

● **MANY OLDER-TYPE** automobile lifts release an ear-splitting blast of air when lowered. Noticing that this sudden loud noise frightened a number of his lady customers, one service station operator tried diverting the discharging air stream through an automobile muffler. Result? Just a quiet 'shhhhhhhh' when the lift is lowered, and no more frightened customers



● **CAR WINDOWS** will last longer and operate more smoothly if you lubricate the gears periodically. To do this, flare one end of a length of copper tubing and push the other end down through the space between the window glass and frame until it rests on the gear. Then squirt a few drops of oil into the tube so it will run over the gear

● **WHEN REPLACING** a generator or voltage regulator which has been disconnected from the circuit, be sure to polarize the generator with the regulator. Before starting the engine, momentarily short the generator and battery terminals from one to the other. This permits a flow of current through generator, correctly polarizing it with regulator

● **REPAIRING** an otherwise good muffler in which the inner shell has broken loose takes only a few minutes. To stop that annoying rattle, simply punch a small hole in each end of the muffler and turn in self-tapping screws. Be sure to use screws that are long enough to go up snugly against the muffler's inner shell so it will be locked firmly in place

● **COMMON PROBLEM** with dual exhaust systems is rusting of the muffler and tailpipe on the side where the heat-riser unit is installed. Since this is due to condensation, you can correct it by bending the flat striker spring on the heat riser slightly to make the valve stay about one quarter open. The hot exhaust blow-by will prevent condensation

● **CLUTCH CHATTER** is often caused by oil leaking into the clutch housing around the flywheel mounting bolts, especially on older models. One mechanic, who ran into this problem repeatedly, discovered that the simplest and most effective method of stopping such leakage is to paint the bolt or stud threads with one of the liquid gaskets sold in squeeze tubes

● **TO BLEED** brakes after overhauling cylinders, replacing lines, etc., press the pedal down firmly and block it in that position. Then, taking one wheel at a time, open each wheel cylinder bleeder valve just enough to let a few drops of brake fluid escape. This will clear the whole system of air even more efficiently than using a pressure bleeder

COOK YOURSELF

X547

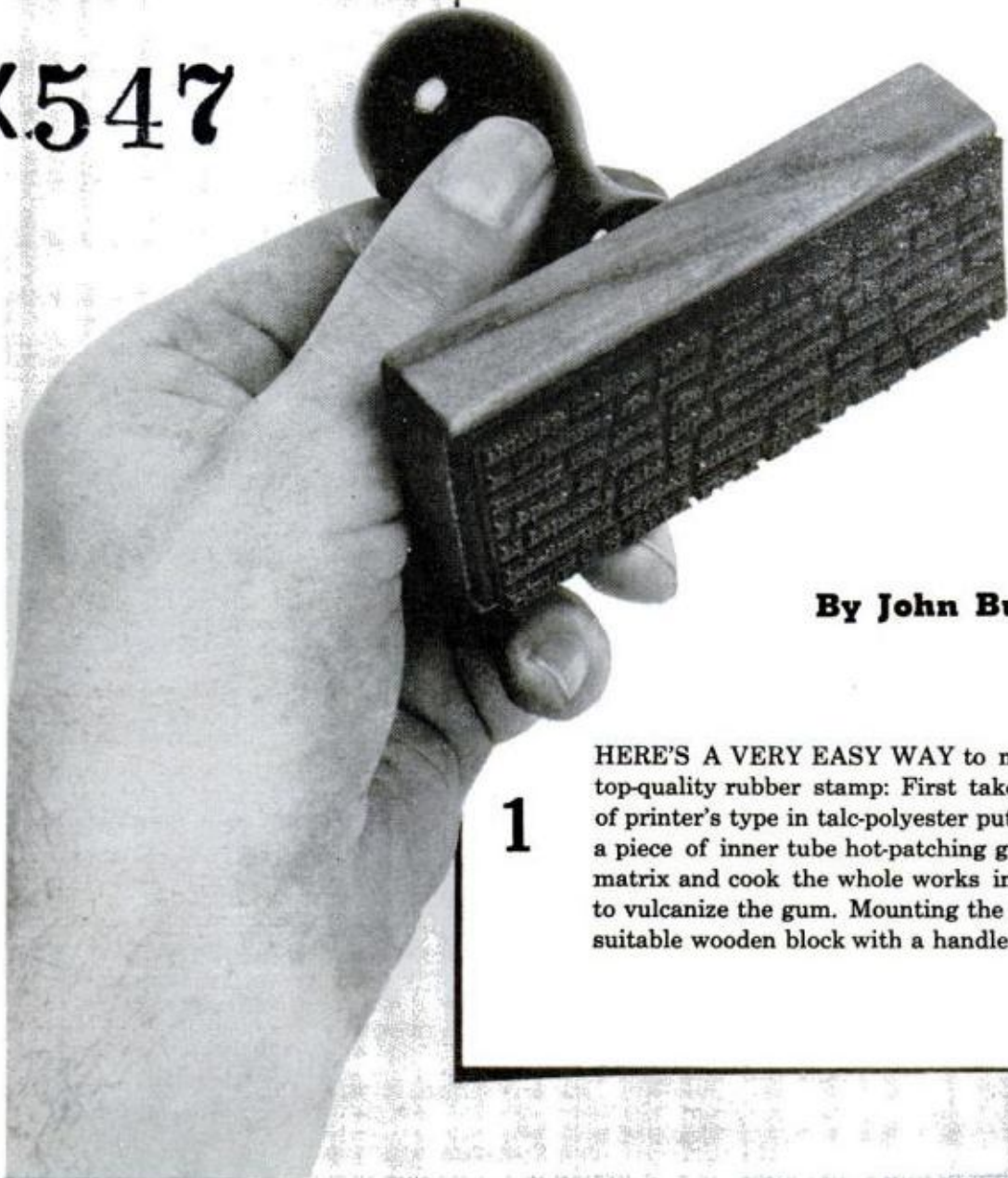

By John Burroughs

1

HERE'S A VERY EASY WAY to make yourself a top-quality rubber stamp: First take an impression of printer's type in talc-polyester putty. Then clamp a piece of inner tube hot-patching gum against this matrix and cook the whole works in a kitchen oven to vulcanize the gum. Mounting the cured gum on a suitable wooden block with a handle finishes the job.

COULD YOU USE a custom-made rubber stamp of your signature? Or a stamp with your name and address to personalize stationery? By modifying the procedures of commercial stampmakers, you can cook up top-quality low-cost rubber stamps right in your own kitchen.

The normal routine in a commercial shop is to set the stamp copy in type, then take an impression of this in plastic. (In the case of a signature or drawing, an engraving must be made and the impression taken from this.) Next, a chunk of uncured gum rubber is squeezed against the

plastic matrix in a hot-platen press. The heat and pressure vulcanizes the gum rubber, curing what is actually a rubber reproduction of the original type or engraving. After curing, the die is trimmed, cemented on a sponge-rubber mount to provide cushioning and mounted on a block.

To make stamps at home, you follow this same basic procedure, but substitute readily available materials and improvised equipment for the stampmaker's special plastics, presses and molds. For a stamp of your name and address (or any

A RUBBER STAMP

other number and letter combination), go to a job printing shop and have them run off the copy on linotype slugs. You'll find that most such shops have a variety of type styles to select from, and the cost of having three or four lines set will be nominal.

To make a signature stamp, write your signature on a piece of bond tracing paper and glue this drawn-side-down on a linoleum block, which may be purchased at any art store. The signature will show through the paper in reverse, and with a steady hand and sharp knife, it's a simple job to cut away the background leaving the signature in relief, Fig. 3.

To take an impression in plastic from your original, clamp the slugs of type between two $\frac{7}{8}$ -in.-high wooden bearer strips with C-clamps. Next, saw a rectangular cutout a bit larger than your block of type in a piece of $\frac{1}{8}$ -in. hardboard, and glue this frame to a $\frac{3}{4}$ -in. plywood block. To make the plastic putty, add hardener to small amount of polyester resin, which is used to fiberglass boats. Mix in enough talc to give it a smooth, buttery consistency. Before taking the impression, brush both type and bearer strips with a parting agent sold for use with polyester, Fig. 2. Then fill the hardboard retaining frame with putty, Figs. 4 and 5, and work left-over putty into the face of the type with your fingertip to avoid entrapped air bubbles. Finally, press the plywood block down over the type until the putty-filled hardboard frame rests on the wooden bearer strips.

Allow at least 24 hrs. for the polyester to harden, then gently separate the metal

(Continued on page 190)



2. CLAMP TYPE SLUGS between $\frac{7}{8}$ -in.-high wooden bearer strips and paint them with a parting agent

3. FOR SIGNATURE stamp, cement pattern face down on linoleum block and cut away background

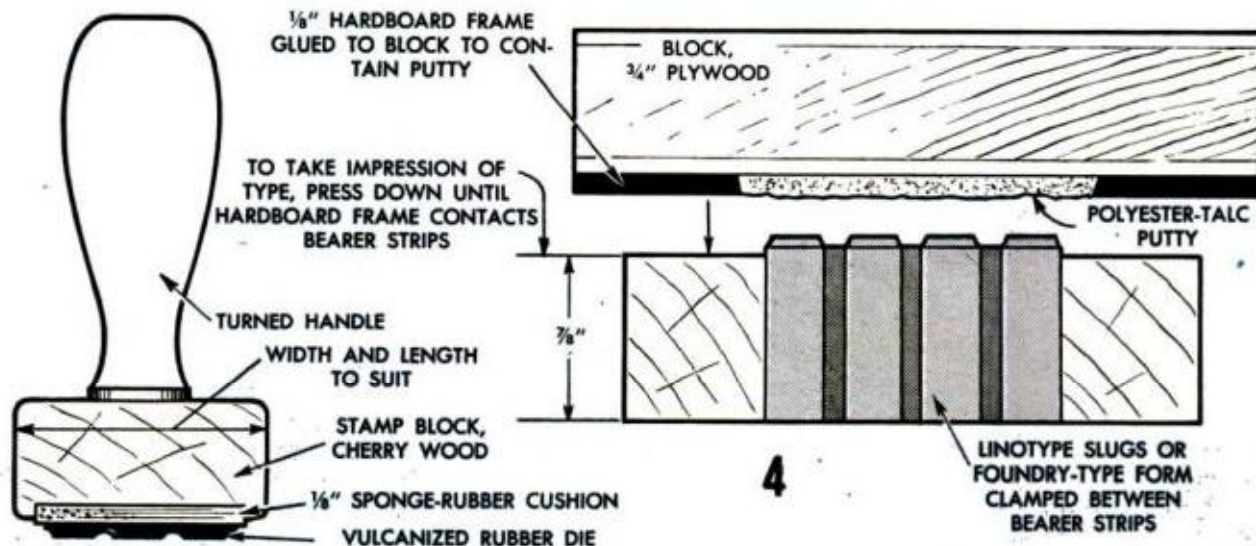

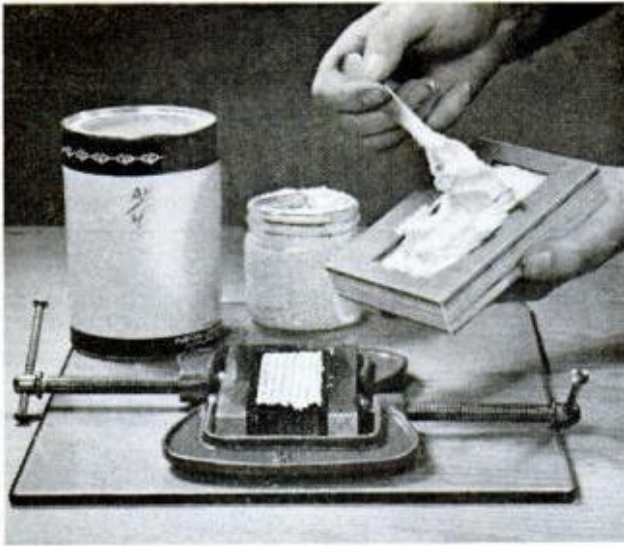

5. TO TAKE IMPRESSION, fill hardboard frame with polyester putty and press extra putty over type face

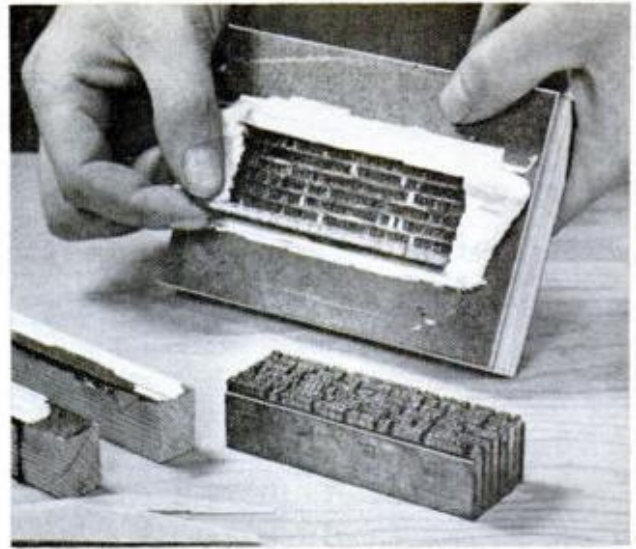

6. WHEN PUTTY HARDENS, gently remove type, sand face of matrix flush and wash with soap and water



7. CUT GUM RUBBER to approximate size of stamp, and place two layers over the talc-polyester matrix

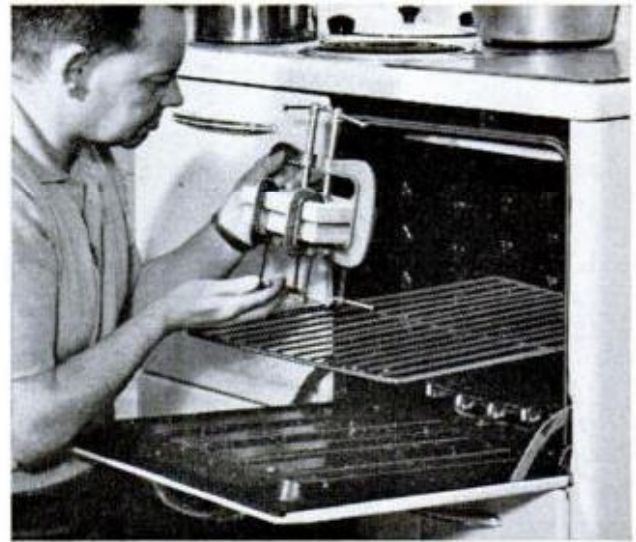

8. AFTER CLAMPING metal plate and plywood backing block over gum rubber, cook this sandwich in oven

9. MOUNT CURED DIE on block over 1/8-in. sponge-rubber cushion, using a thin-bodied rubber adhesive



10. SIGNATURE STAMP does away with writer's cramp from signing Christmas cards, makes good gift



Quick Steps—No Form

Do-it-yourselfers who like to climb fast when it comes to concrete-step construction on a terrace will find much in this method to recommend it. There are no forms to fit; no fill to bother with. Just remove the topsoil from the slope, dig out a dirt form on which to lay standard-size concrete blocks, place the blocks, level with sand or fine gravel and there you are—almost. Steps can be one or two blocks in width. One block makes a narrow but adequate flight; two blocks to each step, placed end to end, make a wide stair. See that the blocks are laid level and in the proper relation to form risers and treads of uniform height and width. Fill each hollow block with a sand-cement mortar (one-part cement to three-parts sharp sand, or buy it ready-mixed) and trowel smooth to a thickness of about 1 in. across the top of each block.

—Archibald Black

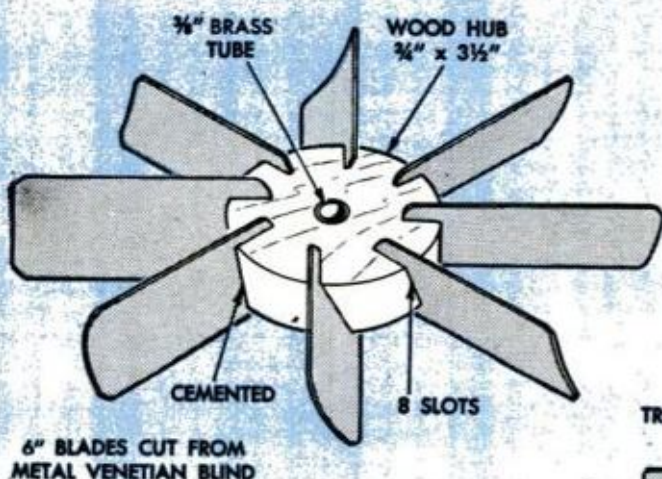

6" BLADES CUT FROM METAL VENETIAN BLIND

VENETIAN-BLIND WINDMILL

Got some metal slats from an old or shortened Venetian blind? Snipped into 6-in. lengths, they make ideal windmill blades. To space slots evenly around a wooden hub, fold a same-size paper pattern into a pie-wedge shape, flatten the pattern on the hub and mark off the fold lines. Cut the slots at a 60-deg. angle (a tilt-table jig or band saw speeds this job) and use water-proof cement to hold the blades in the slots and the brass-tube bearing in the center hole. Add a tail-board for an attractive weathervane—or hook the windmill up to an animated lawn ornament.—P. Casperson

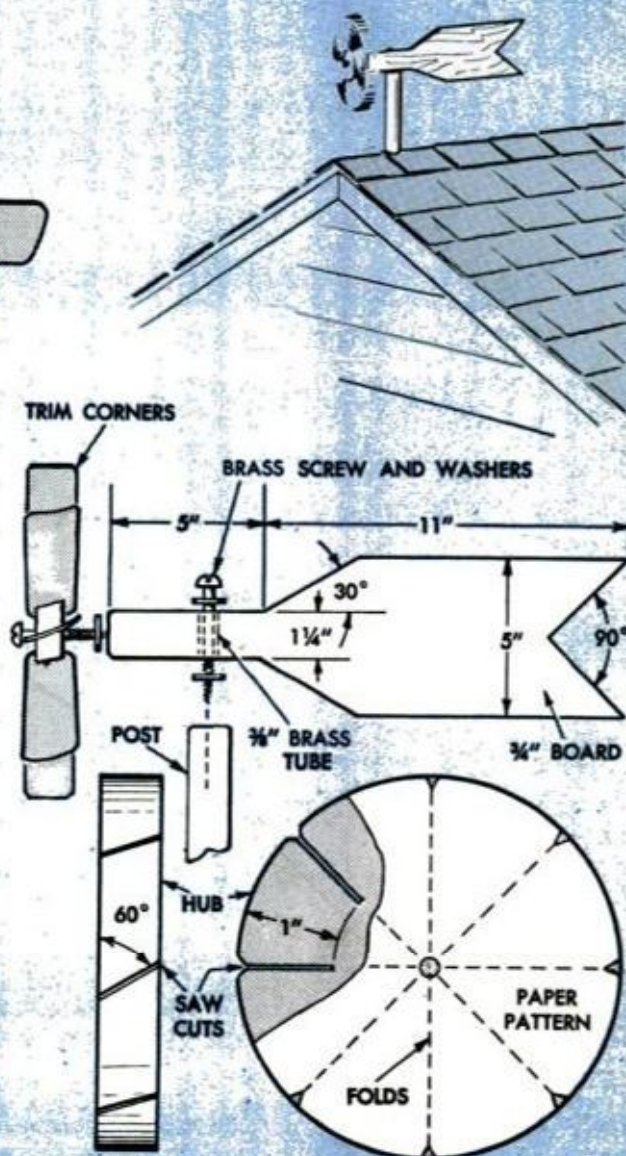

ELECTRIC HEATER

Household

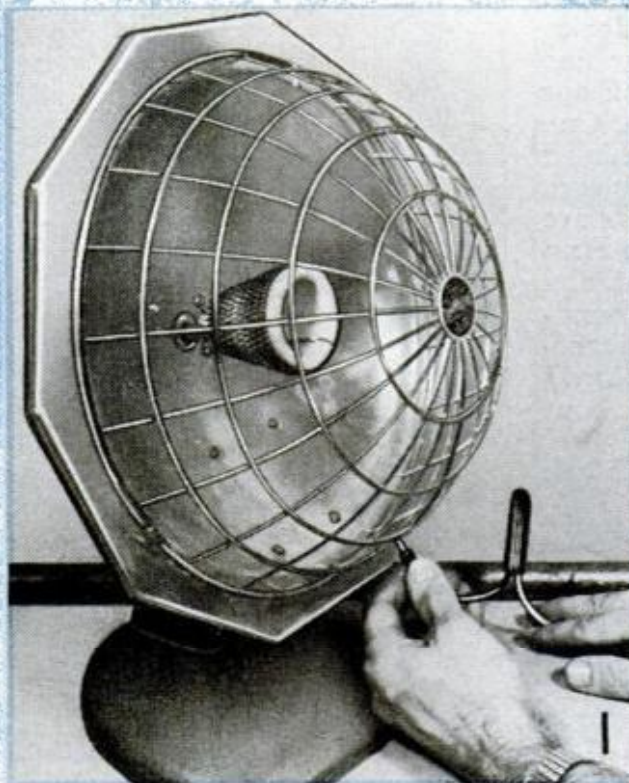

WHEN YOU HOP out of bed on a cold morning it's nice to snap a switch and feel the warmth from a small electric heater. But using an electric heater to take the chill from a small room can create a safety hazard if the heater develops a partial or complete internal ground. The slightest brush of a bare arm or leg against the heater frame could then produce a bad shock. In using such heaters you should always take these precautions: First, never handle the heater with wet hands or while touching any plumbing fixtures. Second, check the heater for possible grounds.

With the heater plugged in connect the leads of a test lamp between the heater frame and a known ground, such as a water pipe, Fig. 1. If the lamp lights, even faintly, it means trouble. Trace the electrical circuit from the plug end of the power cord, around through the heating coil and back to the plug. Any break in the cord insulation where the wiring could touch the heater frame, as in Fig. 2, is a source of danger.

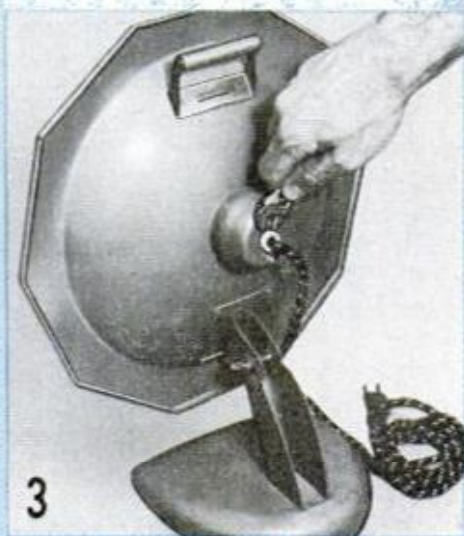

Appliance Fix-It File

Heating elements will eventually burn out. The resistance wire will also lose its heating efficiency as it gets old. When a burnout or lowering of efficiency is indicated, replace the element. First remove the protective wire guard at the front of the heater and then remove the screws which hold the element, Fig. 3. Loosen the terminal screws for the heating element and strip the resistance wire from the ceramic core as pictured in Fig. 4. Replace the old resistance wire with new wire obtainable at your local appliance repair center.

Though construction details vary with different heater models, the basic operating principle holds true for all such heaters. Careful inspection of the model at hand will enable you to carry out the replacement of new resistance wire or elements on any heater without much trouble.

Equally important to the efficiency of an electric heater is the shiny reflector behind the heating coil. If this becomes dull or corroded, either from age or other cause, it cannot do a good job of reflecting the heat produced by the heating element. While you have the wire cage removed from the front of the heater, it is a good time to polish the reflector with a soft cloth, as demonstrated in Fig. 5.

If the reflector has lost its high polish you might have to apply a fine-action metal cleaner to restore its brightness.—*John Pennington*



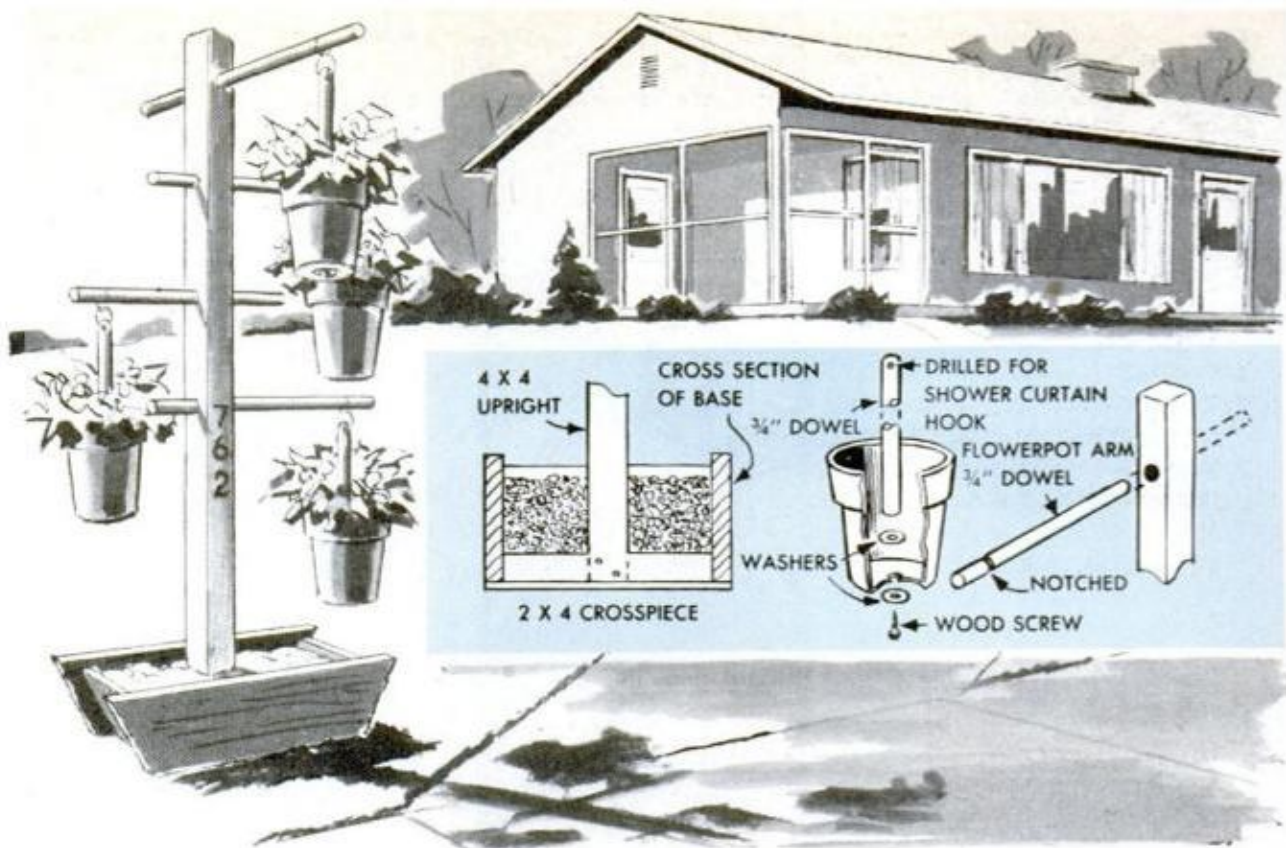

Solving HOME PROBLEMS



FLOWERPOT TREE provides a decorative yard planter for displaying house number. Height of the "tree" and size of gravel-filled wood base are determined by number and size of flower pots to be hung on dowels

CURTAIN ROD is easily made from a length of dowel and two cup hooks. Slip the curtain over the dowel and slide dowel into place on hooks. Twist the hooks to bear against dowel and prevent sliding off hooks



PLASTIC BAG worn over the hand while holding a shoe for polishing will keep hand clean. If preferred, wear the bag over your foot while polishing, instead of hand, thus avoiding getting polish on your sock.

HEAVY PICTURES or mirrors with two hanger rings at the back are more easily placed on wall hooks if the rings are held in outward position by spring wire supports. Wire is held with cellulose tape as shown

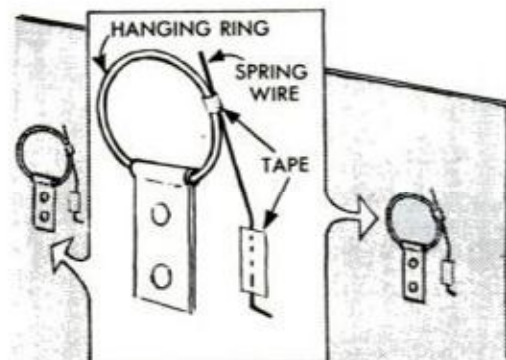

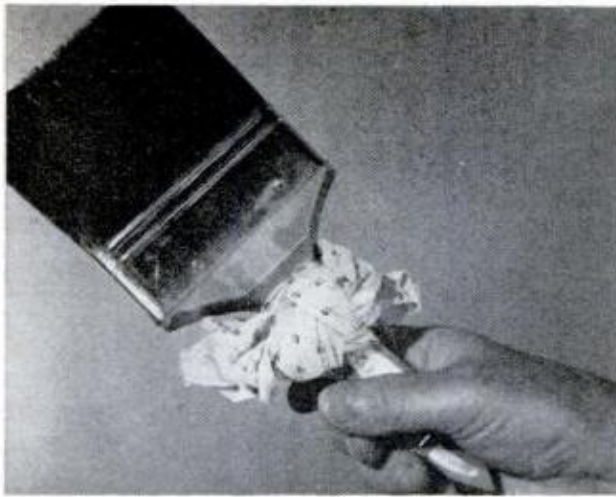

DRIP CATCH eliminates the messy condition that occurs when paint runs down the handle of a brush when in use. Simply tie a cloth around the handle. Put used rags in a metal container until burned.

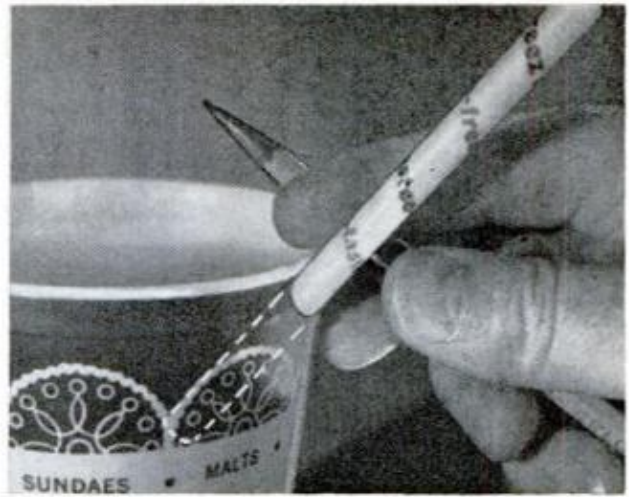

STRAW HOLDER for a paper cup can be made by using the point of a pencil to punch a hole under the cup rim. Inserting the straw through the hole will make it easier for a child to manage the cup and straw

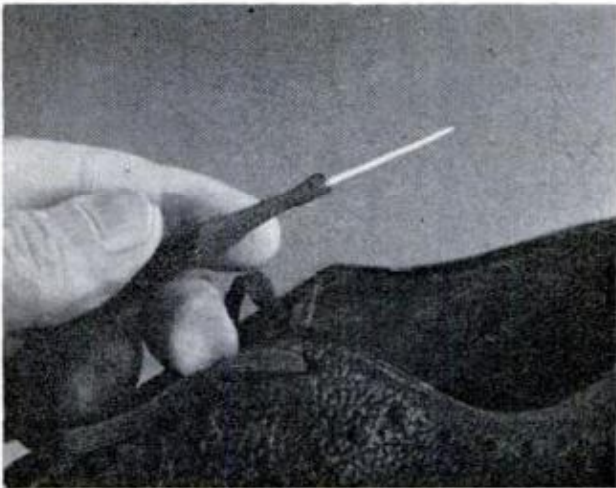

WHEN METAL TIP is lost from shoelace a wooden toothpick makes a quick emergency repair. Dip one end of the toothpick in glue, insert in end of shoelace and then break off the end to provide about 1/2-in. tip

WATER YOUR PLANTS with a dispenser made from an empty bleach jug. Drill small holes in cap and a larger hole in top side of the hollow handle. Thumb pressure over the hole creates a vacuum to control flow

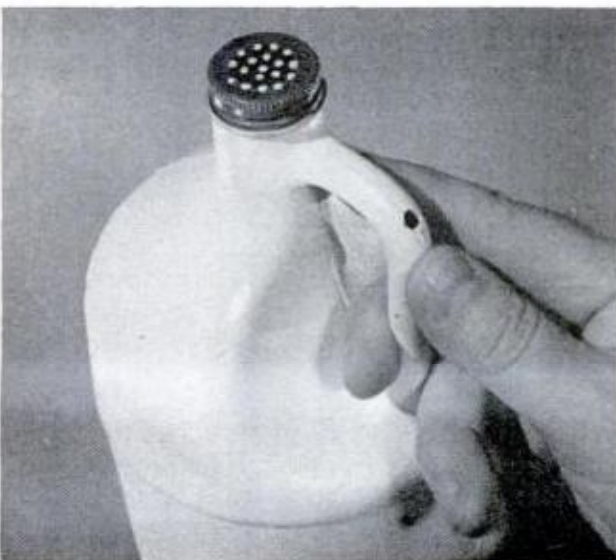

DECEMBER 1962

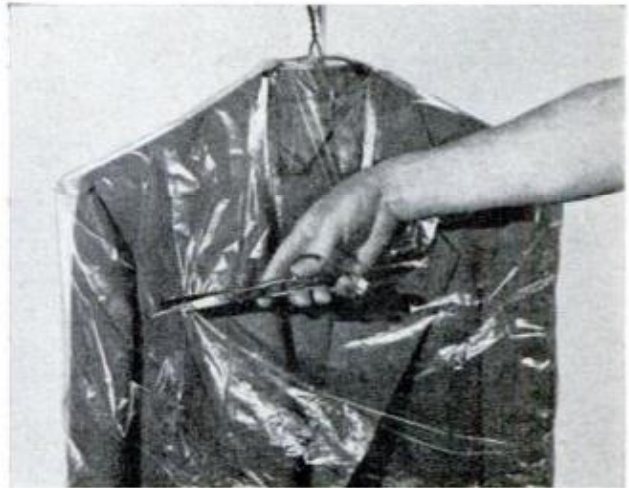

SHOULDER SHIELD made from the top third of a dry cleaner's plastic bag prevents dust from settling on garment while hanging in closet. Tie bag neck to the hanger to facilitate quick removal of the garment

SCREW CAP of an empty 100-tablet aspirin bottle is the right size for measuring enough flavored powder to make an 8-oz. glass of beverage. Transfer the powder and label from its regular packet to the bottle

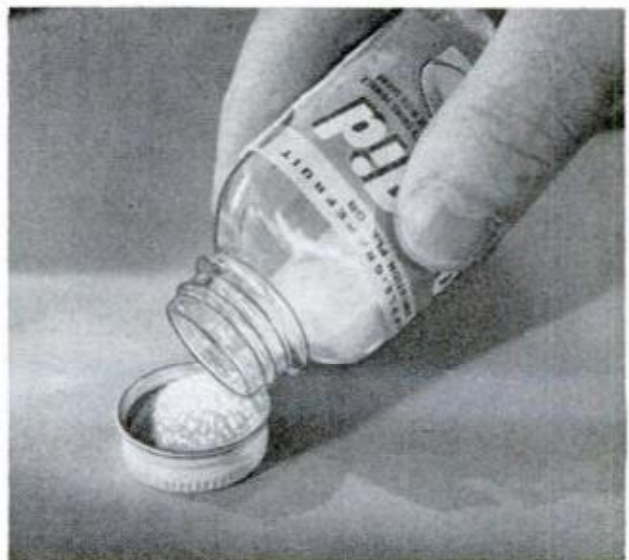

165

SHOP SHORT CUTS



Ball Anvil

Work in job shops often requires that the machinist know the exact wall thickness of tubing. Although stock specifications usually give this as inside and outside (I.D. and O.D.) diameter, if a light cut has been made inside or outside it still may be necessary to know the precise thickness of the wall. You can take this measurement with an ordinary mike by taping a steel ball to the anvil with cellophane tape. This serves the purpose and when removed, the accuracy of the mike will not be affected.



Draw Nailing

You need to join two boards edge to edge—no glue, no corrugated fasteners at hand. What to do? There are other ways, of course, but they take time, and time you haven't got. So you make use of an old, old trick—draw nailing, they called it. You butt the boards edge to edge and stand or kneel on each one to hold in position. You bend the tip end of the nail by catching it in the hammer claws as pictured, and then start and drive the nail at an angle as in the detail. Final driving home of the nail should be done with a nailset to avoid denting the surface with the hammer head.

—Bert Moon

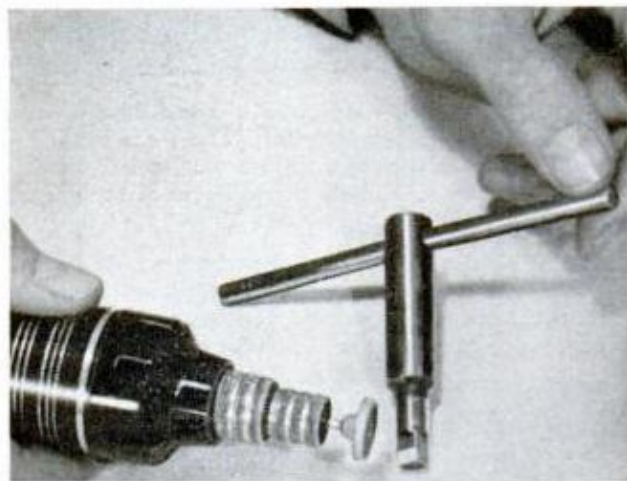

Taper Fit

Perhaps you have thought about it, and again maybe not. At any rate you've never got around to grinding a slight taper on the four flats of the squared end of your chuck wrench. The squared end of the average chuck wrench is purposely sized to a fairly close fit in the socket head of the chuck screw. That means the wrench must be closely aligned with the screw before it will drop in place. Grinding a slight taper on the four flats will cause it to slip easily in place and will not in any way impair its efficiency.

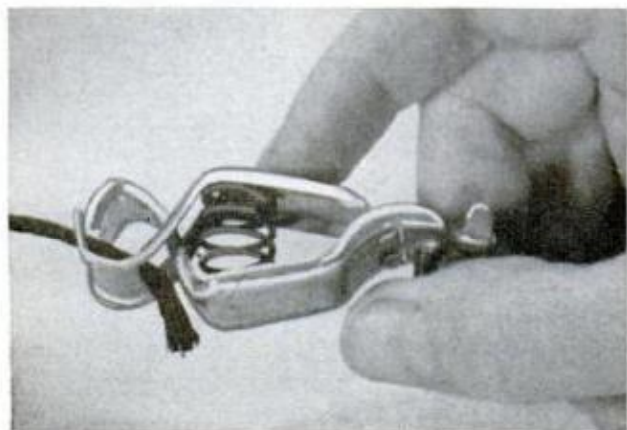

Wire Stripper

Rather than cut and pare insulation from wires with a pocket knife when making electrical connections use a battery clip as an emergency stripper. File the notched grippers, or jaws, of the clip to a sharp edge. Then just slip the opened clip over the wire, release the jaws and give the clip a slight twist. It will cut through the insulation cleanly. Then pull lightly on the clip and off comes the insulation, just as it would if you used wire strippers. Regular use of the clip is not impaired.



Floor-Lamp Work Support

DON'T THROW AWAY that old floor lamp. Remove the shade, add an adjustable clamp-on arm and you have a handy work support for your drillpress and other workshop tools. The clamp-on arm can be made in one of two ways, either by hinging or bolting as shown

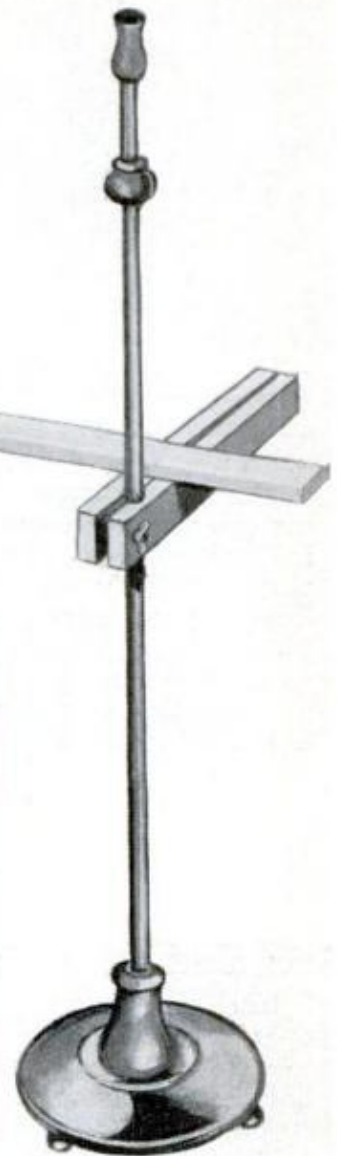
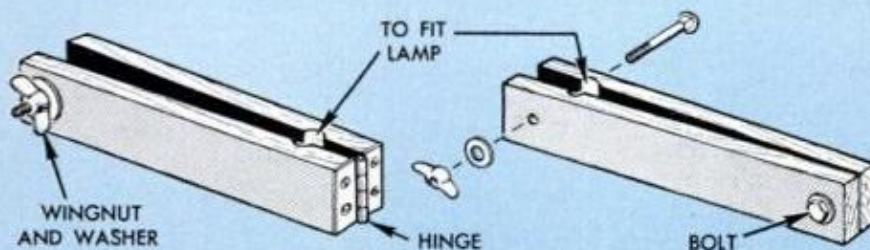

Just-So Setting of Planer Cutters

If you've ever tried setting the cutters of a rotary-planer head without a jig, you know what a trick it is. Set one cutter too high and the other two are doing the work; too low and one is doing all the work. Either way the head is unbalanced and may vibrate at high speed. You can easily make a jig that will enable you to set all three cutters just so, every time. It consists of a hardwood block slightly larger in the square than the diameter of the head. Screw a piece of brass, 16 gauge will do, to one face of the block and center a counterbored hole through both block and brass facing for a 1/4-in. machine screw. Drill and tap a hole at the center of the head for the screw. Set the planer head on the jig, insert the screw and tighten it. Then you can set the three sharpened cutters at precisely the same depth.—*E. R. LeSage*

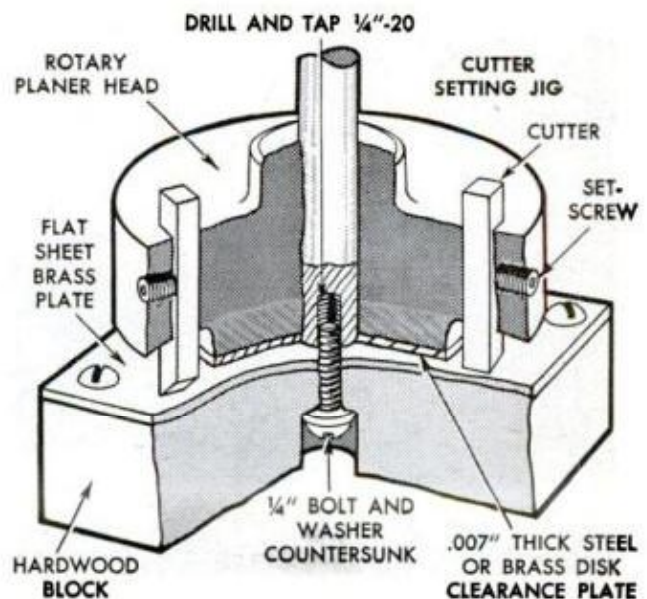

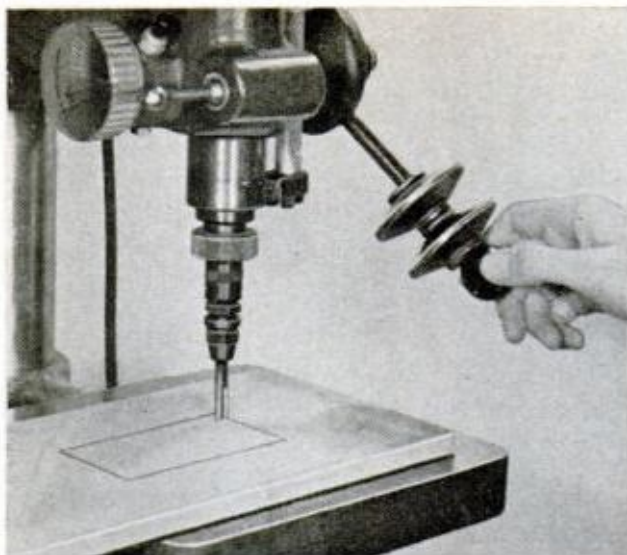

Helper Weights

When you use your drill press for a routing job your problem is to hold the work in position, feed the router bit into the work and lock the spindle at the correct depth, three things to do simultaneously. That's when, if ever, you need that third hand. One way is to unscrew the feed handle and slide two small weights over it as pictured. The weights can be cast-iron pulleys, large shaft collars—anything with a hole through the center. Just preset the spindle for depth and lower the handle. The weights will hold the spindle at the preset depth.—*Richard Hanscom*

Single-Throw Clamp

Here's a new use for the blade clamp, or chip breaker, from your hand plane. It makes a handy quick-acting clamp for holding small parts. Center a $\frac{1}{4}$ -in. hole through a piece of $\frac{1}{2}$ -in. hardwood, insert a $\frac{1}{4}$ -in. carriage bolt and drive it in tight. Then drop the clamp over the bolt and provide a washer and wingnut. To use, adjust the wingnut so that the work will just slide under the wide end of the blade clamp. Then snap the cam lever down to hold the work securely. Pull up the cam lever to release.

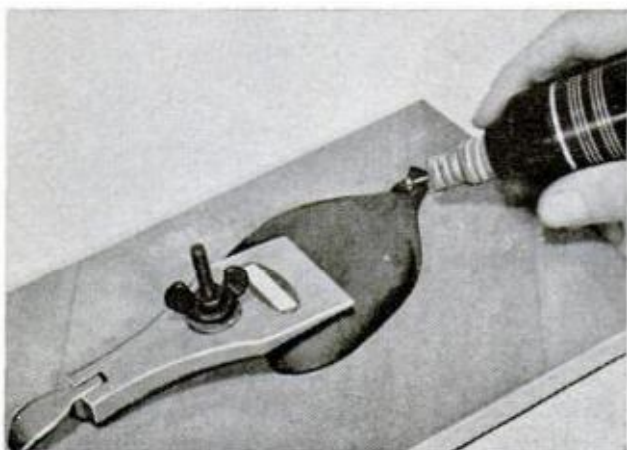

SPINDLE-SANDER IN AN EVENING

Need a sander for your shop? This one beats hand sanding all hollow when it comes to smoothing the curved edges of scroll work and other irregular work and it can be made for a song if you should happen to have a $\frac{1}{4}$ -hp. motor lying around.

A glance at the details on the opposite page shows you how it's made. The motor is mounted vertically by substituting steel rods threaded at each end for the long bolts that normally hold the motor-end shields in place. The threaded upper-ends of the rods (upper when motor is in vertical position) pass through holes drilled in the horizontal plywood member, and also through holes drilled in a steel plate. Note how the nuts are run on the upper ends of the rods to space the motor from its support and to adjust it for height. Note also that the rods serve as bolts holding the motor-end shields.

The sanding drum can be any desired diameter and should be of the type having a tapped hub which will screw onto a threaded motor arbor.

The motor support is simply an open box of plywood which is screwed to a base of the same material. The motor support carries two slotted members which are held in any desired position by carriage bolts and wingnuts. The table is attached to these members by corner irons and screws. This permits adjusting the table for height, allowing use of all the abrasive area of the sanding drum.—*John Burroughs*

TABLE can be raised and swung out of the way for free-hand sanding. Note open-end slots in supports

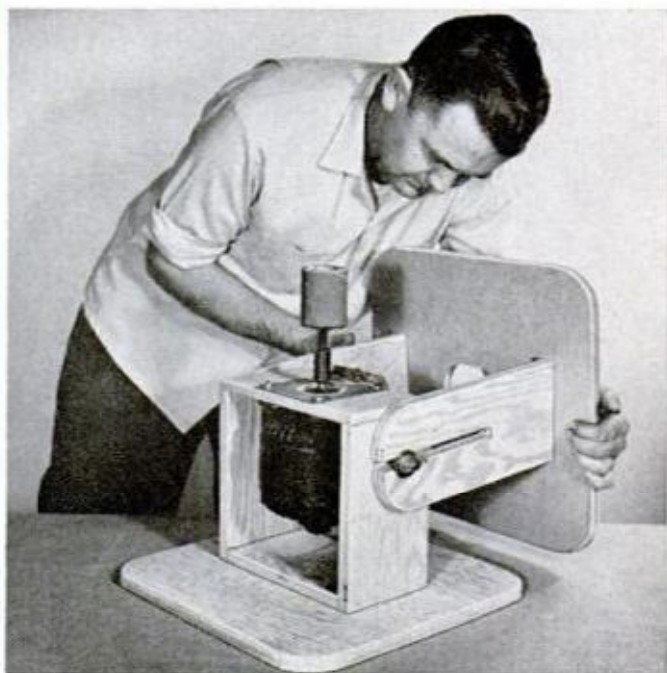



FAST SANDING of such difficult work as a bandsawed cabriole leg. Table can be raised or lowered easily

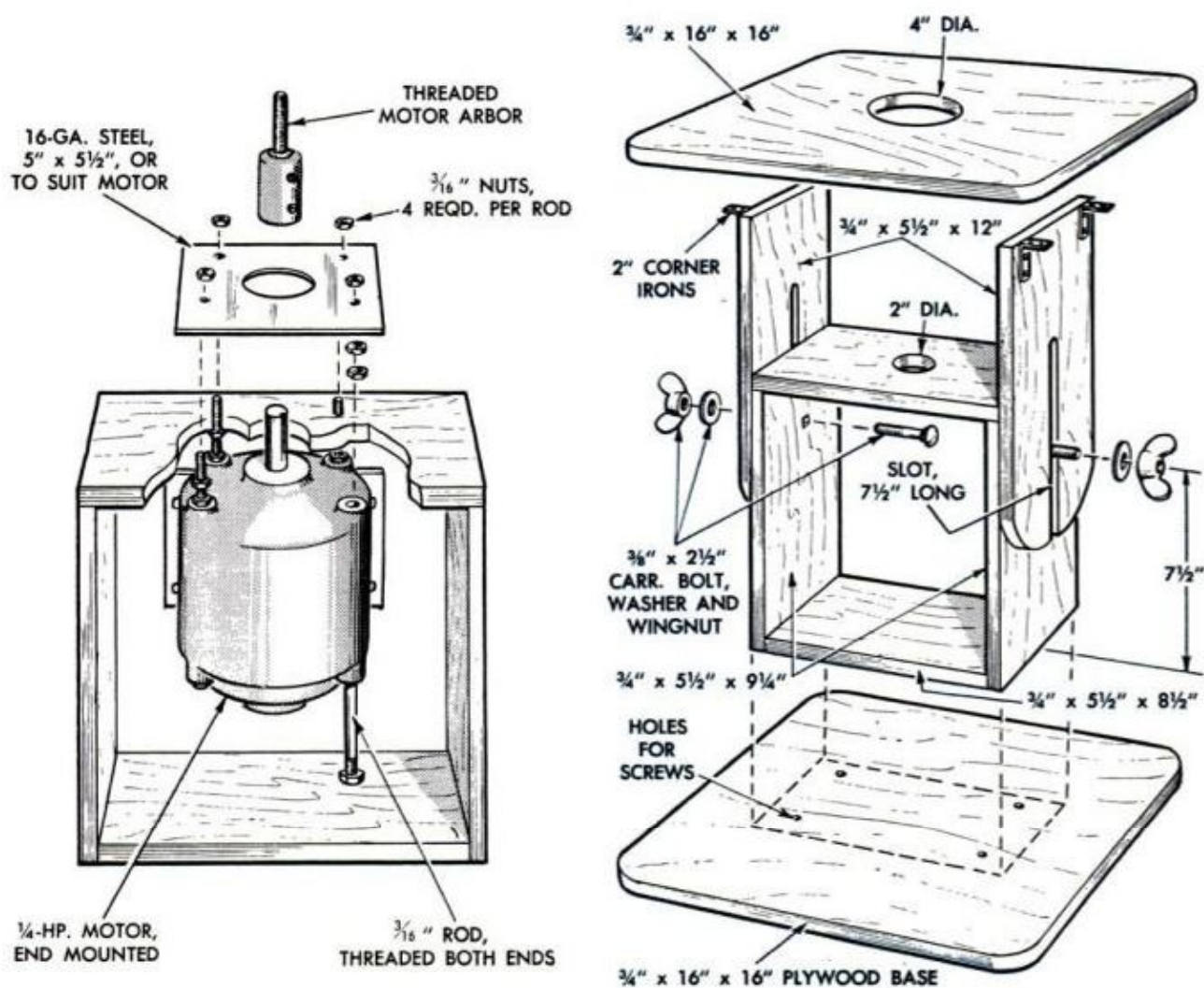

SHOP SHORT CUTS

On Guard

There are switch guards and switch guards but this one does two things—prevents the switch from being turned on accidentally and makes it easy to bat the handle to the off position in an emergency. You make and fit it to suit the switch, using a piece of sheet metal. Simply cut it to the shape indicated and bend on the dotted lines. Mount the guard so that the switch handle will snap to the off position when it is at a point just above the wings.

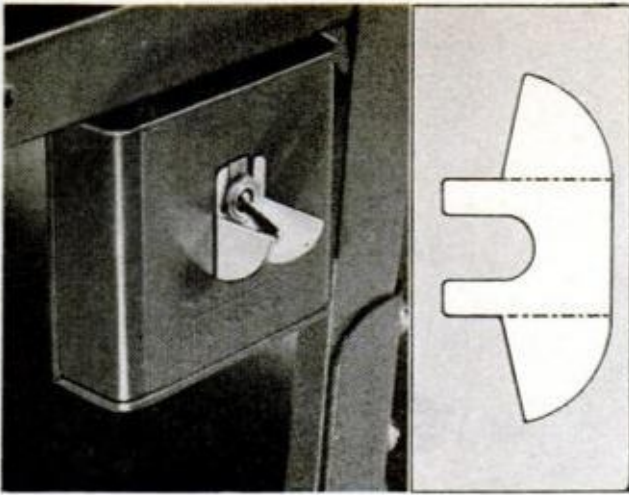

Self Feeder

By fitting a strong spring between the rollers and the frame on the adjusting screw of a tubing cutter, you get an automatic, uniform feed of the cutter at each turn. Make sure there's at least 1/16 in. endplay between the roller casting and the shoulder of the adjusting screw. If there is not this amount of endplay, remove one screw which holds the roller casting and file down the shoulder of the adjusting screw. Then fit the spring over the screw as pictured. In cutting, start the cut, and tighten the screw. The spring saves advancing the screw with each turn.



Tubing Splint

In butt welding or brazing two pieces of tubing end-to-end the main problem is to hold the two parts butted and in line. An easy way to do this is to cut three or four lengths of drill rod, all from the same piece, and then obtain two hose clamps of the type that tighten with a thumbscrew and worm. Slip the hose clamps over the ends of the tubes, butt together and then place the rods across the joint with the ends under the hose clamps. Space the rods, tighten the clamps and you're in line.

—H. J. Gerber

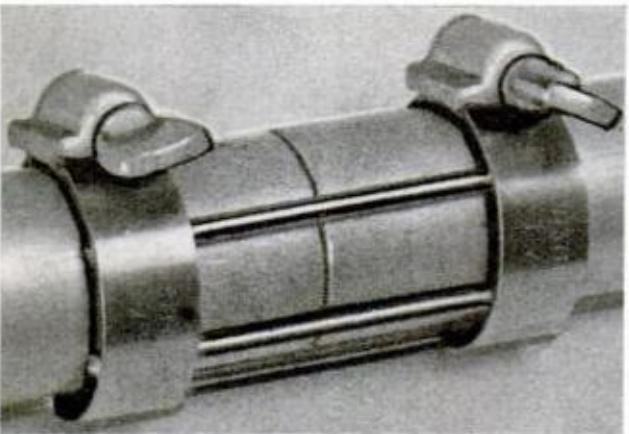

Drop by Drop

When turning steel or other metal free-hand such as you often have to do when turning ornamental shapes, a drop of oil applied occasionally gives the carbide tool a smoother, more uniform bite. Cutting lubricants, such as sulphurized oils, are best. Lard oil is a good substitute, but if neither is available, then use a light mineral oil, applying a drop at a time with a squirt can as pictured, or "painting" the work with oil with a small brush. The important thing is to keep the work wet with oil to provide lubrication at the cutting point and to dissipate excessive heat.

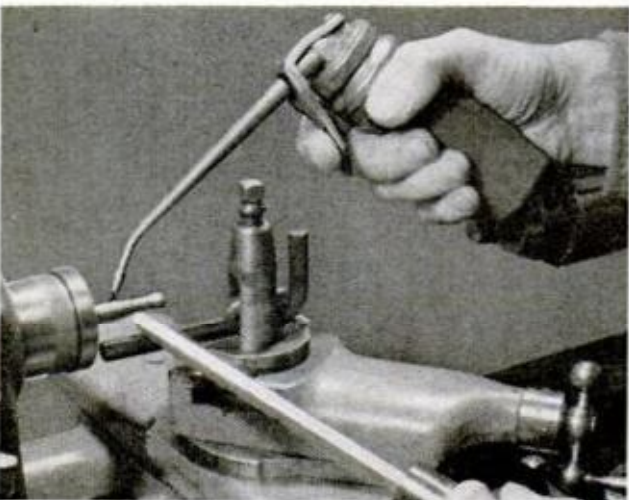

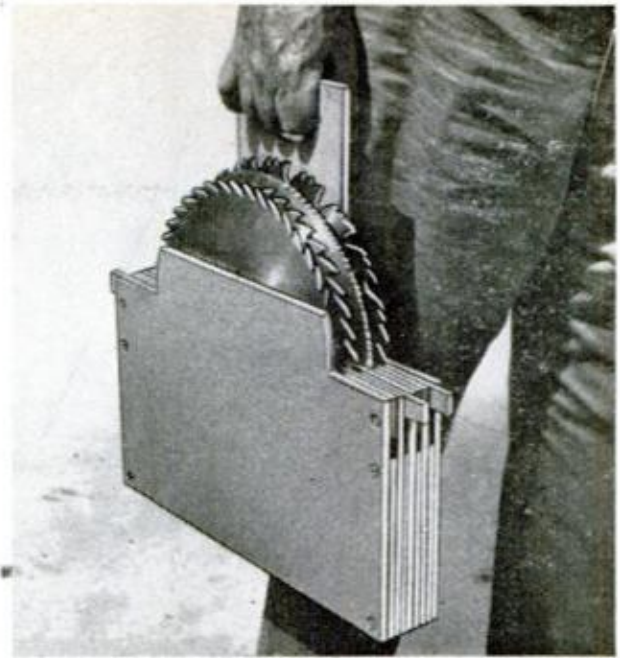
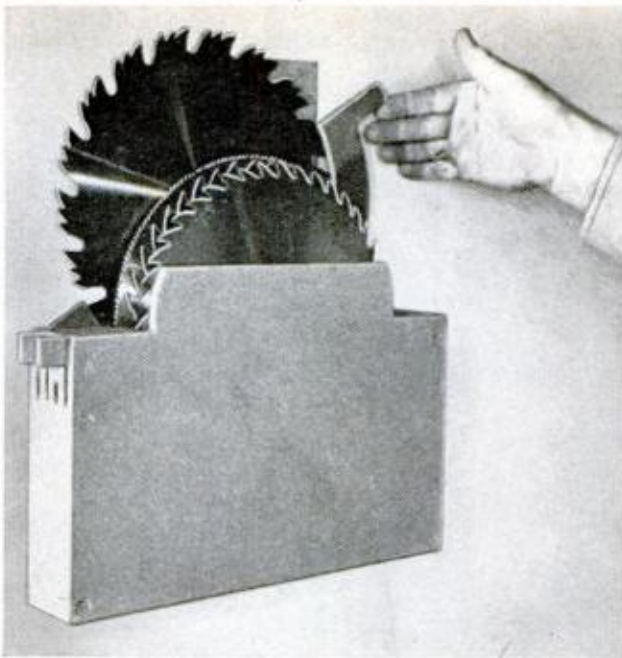

Circular Saw Blade Dispenser

HUNG ON THE WALL convenient to your circular saw, this storage-dispenser unit permits ready selection of the blade wanted, and provides a separate compartment for each blade to avoid dulling points by rubbing contact. Any blade can be lifted into position for easy removal without

danger of cutting your fingers on blades in the other compartments. The hanger-handle makes it a handy carrying case for taking blades to and from the sharpening shop. Add as many compartments as you need, cutting each blade carrier from 1/4-in. hardboard.—William G. Waggoner

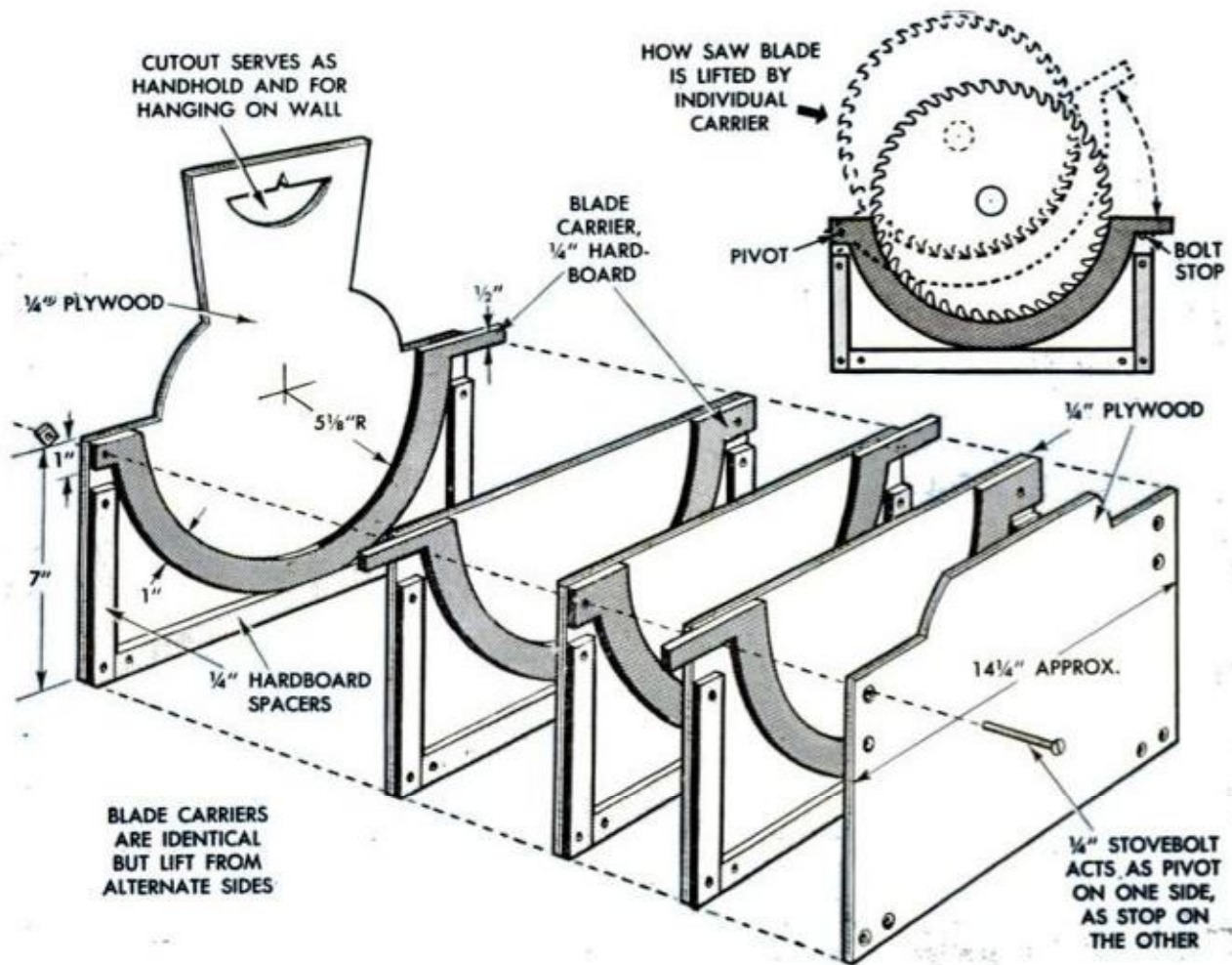

FOR FAMILY FUN BUILD A TOBOGGAN

By Manly Banister



STACK-SAWING the bending caul can be done on a bandsaw or by hand, using common key hole saw

AFTER RESAWING the stock, sand the slats and runners to remove saw marks. Keep thickness uniform

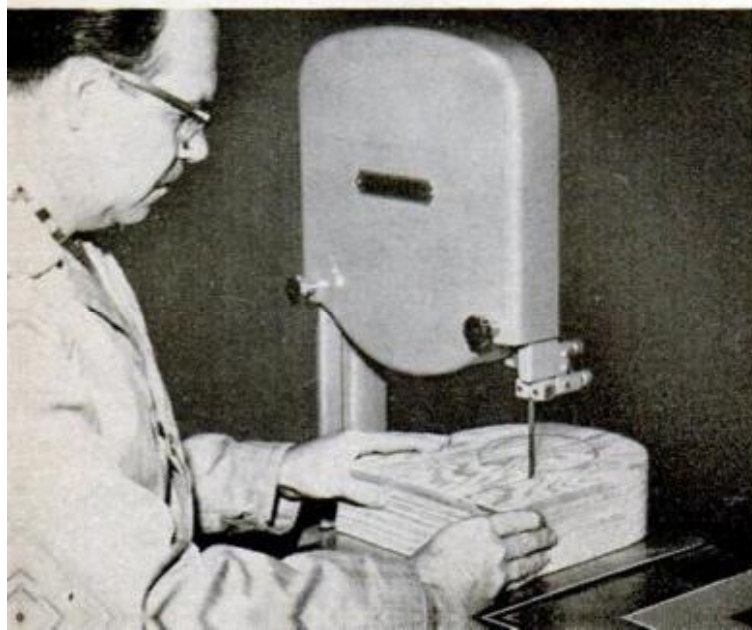



LAUGH AT THIS SETUP if you like but it can do the bending job required on the toboggan slats and runners. Both need to be boiled from 1½ to 2 hours

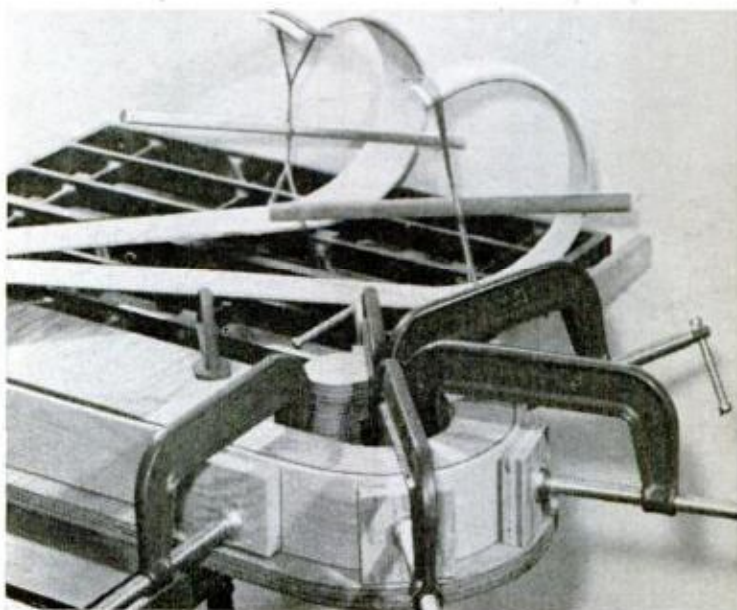

SLAT (OR RUNNER) clamped in place on bending caul. Note position of clamps, also the finished bends

NEW, FREE-CUTTING WOOD RASPS speed up the job of making crossbars. Use white oak or ash for the bars

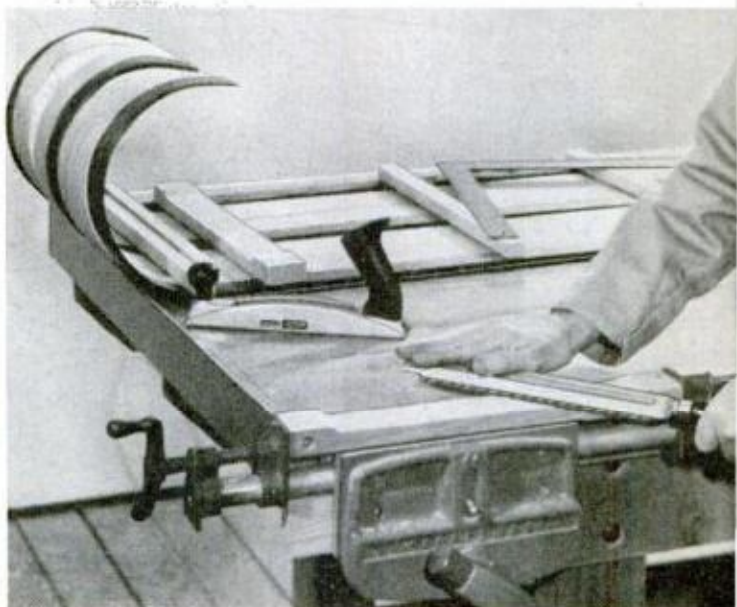

THERE'S NOTHING LIKE a toboggan for family fun. Large enough for several members to climb aboard, a toboggan lets mom, dad and the kids participate in a winter sport as a group and brings about a togetherness which youngsters truly enjoy. Unlike a sled with runners, a toboggan rides the top of the snow with lightning speed and the added weight of four or five only seems to make it go faster.

Fun actually starts with the building of the toboggan since it involves the interesting job of bending wood. Here the ends of



ROUNDING OVER edges of slats and runners is quickly done with a router-shaper, or with sanding block

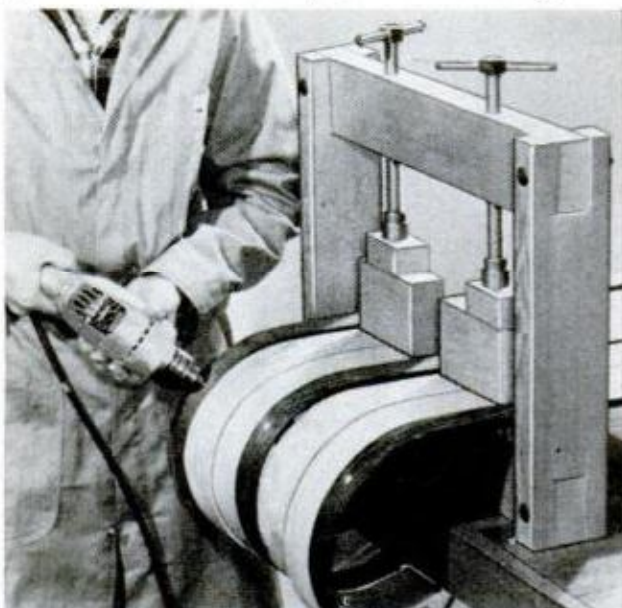

DRILL and countersink holes for screws holding the crossbars. Screw heads should be slightly below flush

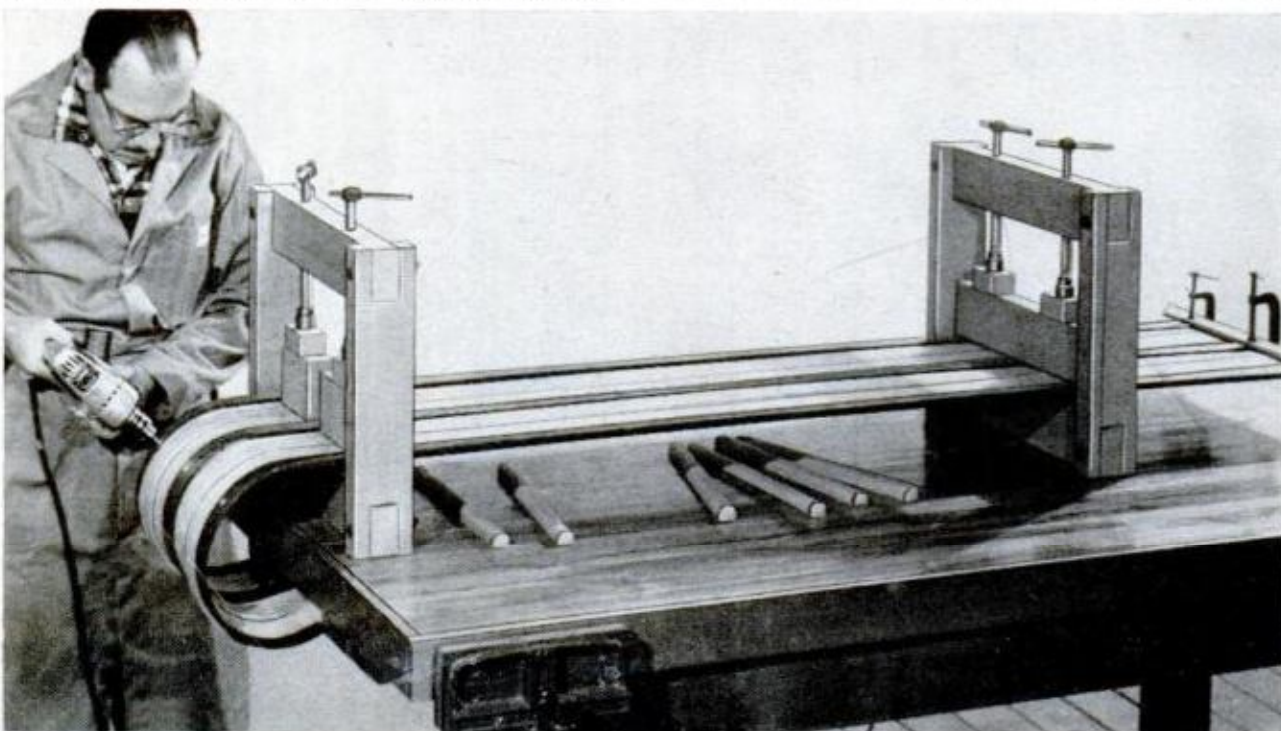

the four slats and three runners are first made pliable by boiling in water and then bending and clamping around a jig to dry. After the slats and runners are bent, it's a simple job of fastening them side by side to crossbars which in turn carry the stirrups which anchor the grab ropes. As for length, your toboggan can be made whatever length you wish—remembering that when it comes to carrying, it is as far back up the hill as it is down.

Bending Jig

Before you do any boiling and bending, however you'll need a bending caul, or jig, made from a 2 x 3 and four pieces of 3/4-in. plywood as in Fig. 1. Cut the plywood pieces oversize, stack them with glue on the joining faces and when dry, saw to contour as shown in the lower left-hand photo on page 172. The surfaces that take the slats and runners should be sanded to fine smoothness. Then assemble by screwing the two members to a 3/4-in. plywood base as in Fig. 1, making sure that the 2 x 3 is lined up with the straight extension of the plywood caul. Now, note the difference in thickness between the runners and slats and that the runners are tapered from 3/8 to 3/16 in. at the ends that are to be bent. Have these items as well as the crossbars, or cleats, made and at hand. Use white oak or ash for crossbars, Fig. 2. With all this done, you're ready for bending.

White ash is also the best wood for both the slats and runners. You need three runners and four slats. The runners are 7/16 in. thick; the slats 1/4 in. Most dealers in
(Continued on page 194)

HERE'S CONVENIENT WAY of holding runners and slats for assembly. Veneer-press clamps are homemade

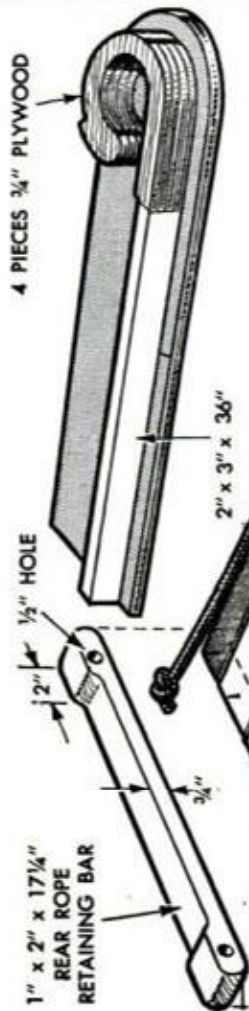
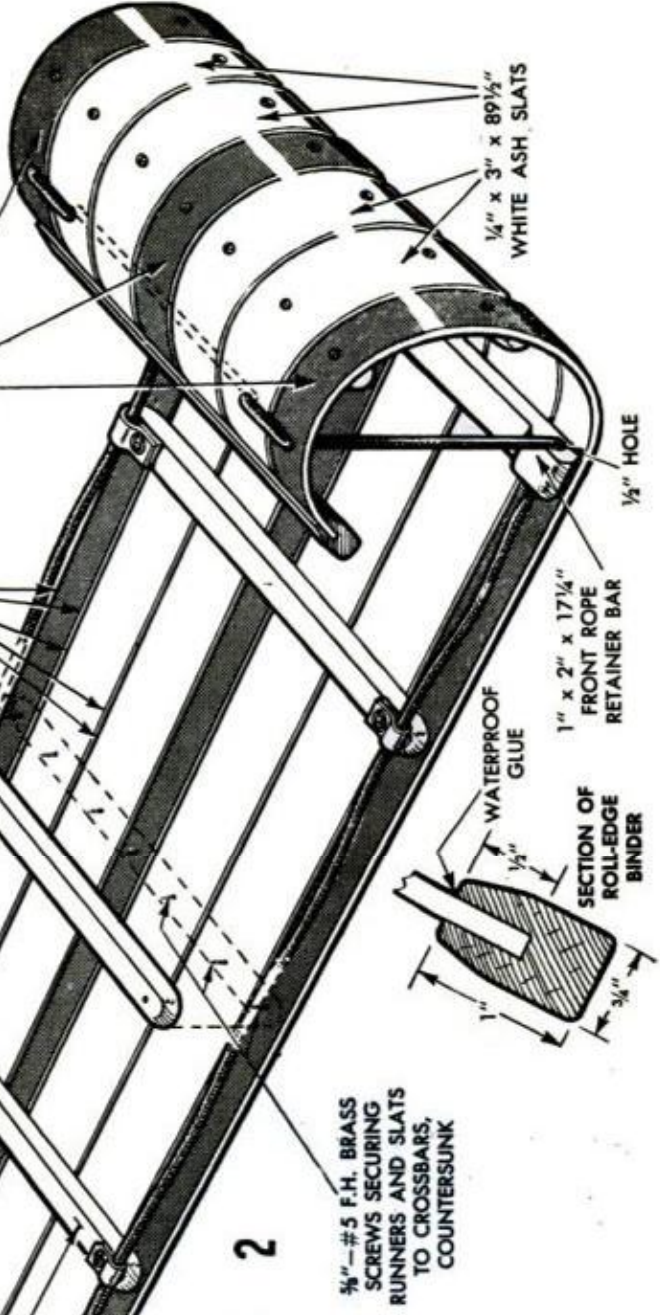
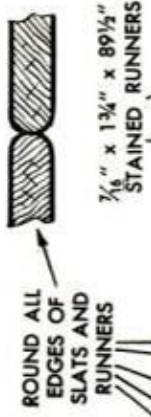
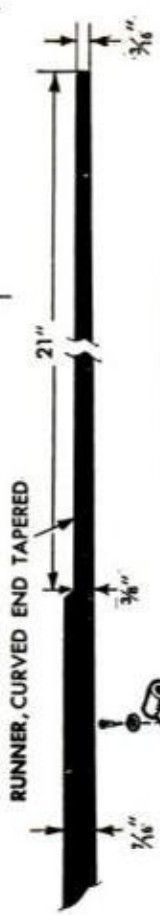
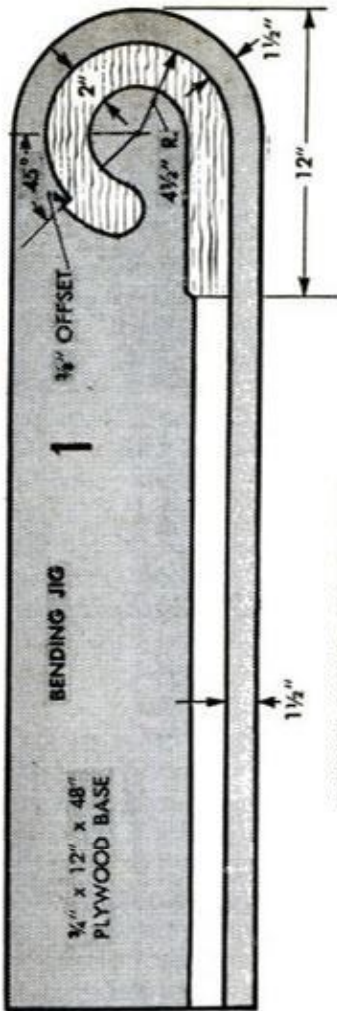

ROPE STIRRUPS

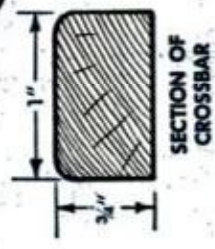

3/4" x 1" x 17 1/4"
CROSSBAR

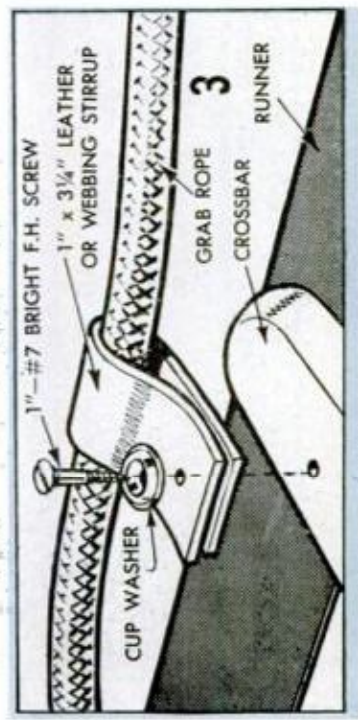



Birds Away!

Those pesky starlings and other gregarious birds that persist in roosting in that big tree that spreads over your walk—what to do about 'em? Shooing does little good, but here's a way to scare the daylights out of 'em: Drill or punch small holes near the tops of several tin cans, attach wire bails and string on a wire about 12 ft. long. Space the cans about a foot apart and kink the wire at these points to hold the cans in place. Put two or three marble-size pebbles in each can and suspend the whole thing between two branches. Attach a pull wire or cord long enough to reach handily from the ground. When the birds have settled for the night sneak up and give the pull wire a few sharp jerks. The racket will banish every bird from the tree for good.—*Blythe Decker*



Score First

When you need to make a box from cardboard for some special purpose, don't try to make a straight fold in cardboard or corrugated board. You just can't do it. Rather, first score the board along the line of the fold with a letter opener or the back of a table knife. Don't cut through the board or into the surface; just score a shallow depression on the pattern line. The board will fold perfectly.—*Michael Ligocki*



Paint Saver

When painting wooden fence pickets—a tedious, thankless job at best—the lid of the paint pail can serve a dual purpose. Just place it, inside up, under each picket as you go along. It will keep your brush free from dirt and grass clippings and catch any paint that drips from the brush or picket while you're painting. Occasionally you pull the lid out from under the pickets and clean up any drips that accumulate on the lid with a sweep or two of the brush. Result: No waste and no unsightly paint drips on the ground or grass at the lower ends of the pickets.—*G. E. Hendrickson*



Stain-Wax Finish

You can do a modern stain-wax finish on small surfaces by using shoe polish of the colored paste-wax type. First, do a very thorough job of sanding, producing as smooth a surface as possible, as a wax finish will show up every slight imperfection. Then apply the wax in the color desired as it comes from the container. Keep applying and rubbing until the wax builds uniformly on the surface. Then allow to dry and polish in the regular way.—*Richard Hanscom*

FARM TIMESAVERS

Dutch Door

Ventilation and shade are two essentials rather difficult to build into portable farrowing houses of conventional types. One hog raiser solves the problem in the fashion pictured. He builds a modified dutch-type door, the lower half being hinged to swing horizontally while the upper half is hinged at the top, swings upward and is held in the open position by two pivoted props. The lower end of each prop is slotted to drop over the projecting end of a lagscrew turned into a hole in the stud. As will be noted from the illustration, the upper half door is larger than the lower and covers an additional opening on each side of the door opening.



Hose Tunnel

Hydraulic hose connecting the tractor to the trailer hoist requires protective storage when not in use. To avoid having to disconnect, coil and store the hose separately each time after use, one farmer attached a length of pipe to the side of the trailer bed. Then he bent one end of a length of heavy wire to a U-shape and welded it to the upper end of the pipe. To store the hose it is fed into the pipe and caught in the U-shaped, friction clamp.

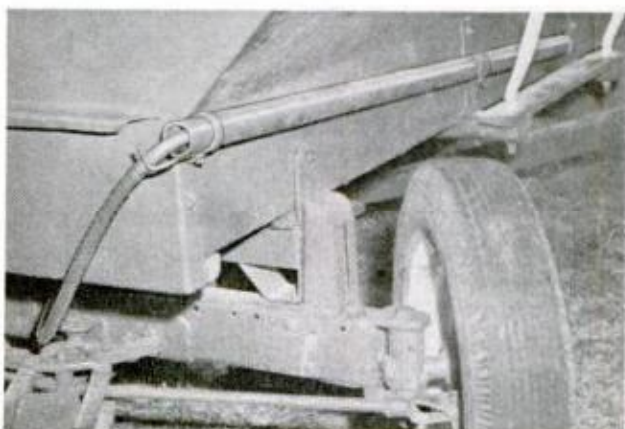

Stem Guard

Hogs, when they aren't scrambling for whatever feed is immediately available, delight in biting off unprotected valve stems of any rubber-tired trailers that may be parked in the feedlot. One sure way to prevent this kind of pig vandalism is to bend a U-shape from $\frac{1}{4}$ or $\frac{5}{16}$ -in. steel rod and weld to the wheel rim as pictured. Be sure, of course, that you allow enough space inside the U-shape to back off the valve cap and reach the valve with the air hose when inflating the tire.



Flip Top

No turkey can walk the length of this feed trough or perch above it as turkeys and other barnyard fowl are wont to do. The reason is the rust-proof reel you see pictured just above the trough. It's sturdy, made by welding rings cut from discarded 4-in. well casing to three $\frac{3}{8}$ -in.-diameter steel rods. The reel thus made is assembled in sections, the ends of each section being supported by two posts which in turn support a wide ring cut from 6-in. well casing. The ends of the sections turn in the wider rings.—A. M. Wettach



One-Minute Layout for Diametral Holes

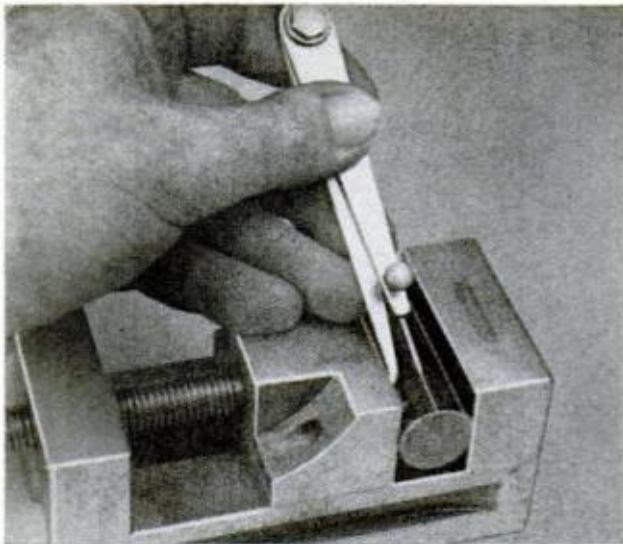

There are several methods of making accurate layouts for drilling diametral, or transverse, holes through round stock. But here's a way to do it in less than 60 seconds flat. It's accurate, too. Grip the work in a drill-press vise, then set a pair of "morphy" (hermaphrodite) dividers to slightly less than half the known diameter of the work. Set the hooked leg of the dividers against one vise jaw and scribe a line on the stock as in the left-hand photo. Flip the dividers over with the curved leg bearing against the opposite vise jaw and scribe a second line parallel with the first. Then center the hole between the two scribed lines and center-punch to start the drill. If the hole is small relative to the diameter of the stock, then you generally can go through with the given drill size,

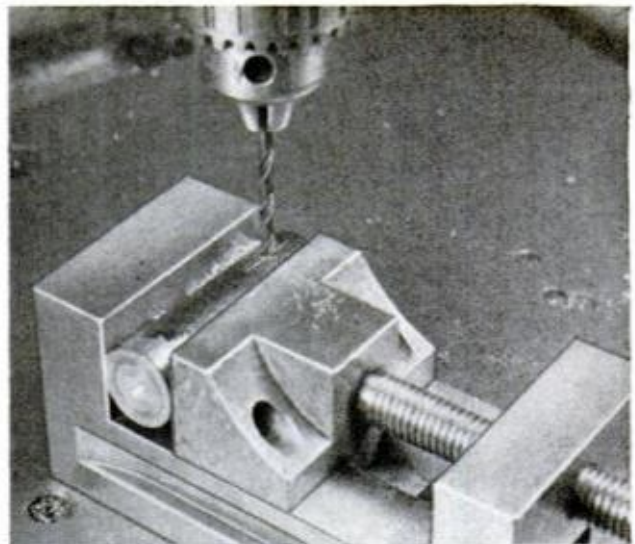

as in the right-hand photo. But if the hole is to be relatively large, then you will generally find it best to drill a pilot hole first, using a small-diameter drill bit. The pilot hole will hold the larger drill bit true, preventing any tendency to wander off center due to the curvature of the stock. A cutting oil, such as lard oil, is a real help when drilling in round stock.—H. J. Gerber

WRITE FOR POPULAR MECHANICS

Readers are paid cash for ideas printed on these pages. You, too, may know of a simpler, faster or better way to do some daily chore about the home, farm, office, shop or garage; an aid to amateur photographers, modelmakers, workshop fans, car owners, hobbyists and others. Just send a short but complete description of your idea, plus a sketch or photo, to Shop and Crafts Editor.

COMING UP NEXT . . .

STEAM ENGINE. There's something fascinating about watching a model steam engine hissing and puffing away. This vertical-type one which is made without castings, runs on steam generated in a boiler assembled by screwing pipe caps to the ends of a pipe nipple. Engine and boiler are detailed separately in a two-part story beginning in the January issue.

SNOW BOAT. Looks like a boat, steers like a boat, but actually it's a sled midway between tot and teen size. Steers by means of a lever controlling twin rudders. Sheet-metal bottom skims packed snow. Just in time for fun galore on slick hills.

OVERLOADED ELECTRICALLY? A blown fuse in your home is like a fever in your body. It's a warning that something is wrong and not to be ignored. Chances are you've plugged-in more appliances than the circuit will handle. How can you check? Play it safe and read "Is Your Wiring Overloaded?" in the January issue.

WORKING WITH MARBLE. Restoring an antique table is easy enough but what about one with a marble top? How do you polish marble? How do you get rid of bad stains? How do you glue a broken top together again? You'll find the answers in a craft feature you won't want to miss in the January issue.

V375

RADIO TV HI-FI

ELECTRONICS

Sun-Powered Lamp Pole Radio

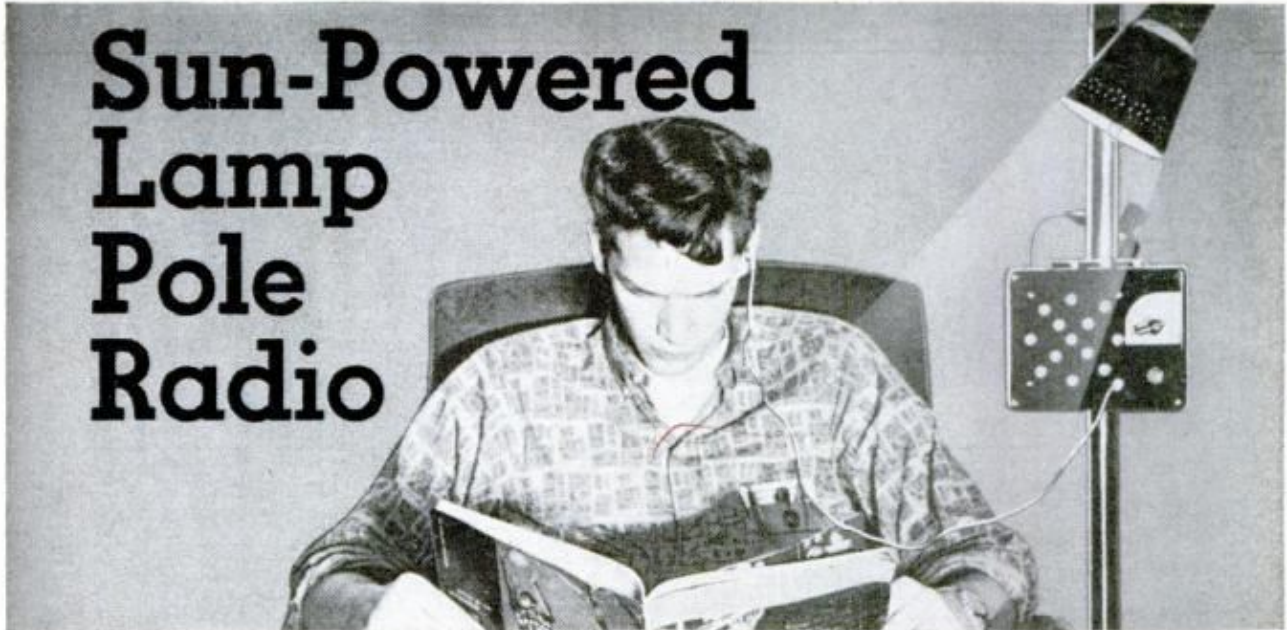

LIGHT MUSIC is what you get when the pole lamp and solar cells get together. No batteries are needed

HERE'S A TRANSISTOR RADIO that solves many problems. It uses earphones so that blaring music, sports announcing and other noisy programming you may prefer need not grate on family nerves. It generates its own electricity from ordinary light sources. Hence, no batteries are needed and costs are minimized. You can build it easily, at a cost of less than ten dollars.

Following the diagrams, lay out the parts on a perforated board. You will have to wind coil L2 yourself, but there's an easy way to do it. Start by tying one end of the Litz wire loosely to a door knob. Back away with the other end until the wire is fully extended. If you haven't enough room, you can start by tying the wire at its middle.

SPEAKER HOLES are for ventilation only. The set operates with an earphone, jack is left of volume

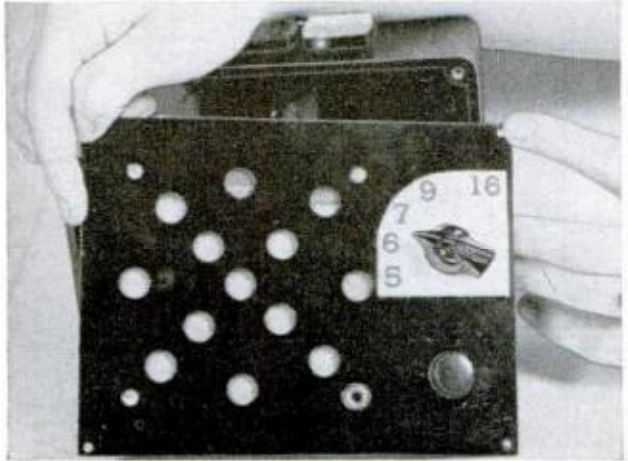

Apply a drop of fast drying cement, such as Polystyrene radio cement to the Ferrite core. Now, leaving some wire loose for later connections, cement one end of the wire to the core. When this has hardened, pull the core and wire taut, and start winding. As you wind the wire, move slowly toward the door. This will keep the wire taut and will produce a properly wound coil. Continue to apply the cement as you wind, so the coil can't unravel.

After bolting L1 in place, adjust the position of L2 while the set is operating, so that the entire broadcast range is covered.

The set is attached to the pole lamp by means of a small bracket. Place the radio at least a foot from the bulb, and adjust it up or down while listening for maximum volume. You will find that a 60 watt light bulb is ample to operate the radio. If you have L1 and L2 mounted too closely together, a squealing "feedback" will result. Should this happen, simply move the coils further apart until the squeal disappears and the stations come in again.

You can improve the reception considerably by using an additional antenna wire. While a good outside antenna at least 50 feet long is recommended, you may be able to get adequate reception simply by clipping the antenna lead to bare metal on the lamp pole. Be sure, however, that all lacquer is removed before attempting to make such a connection.

Since the radio operates with sun "bat-

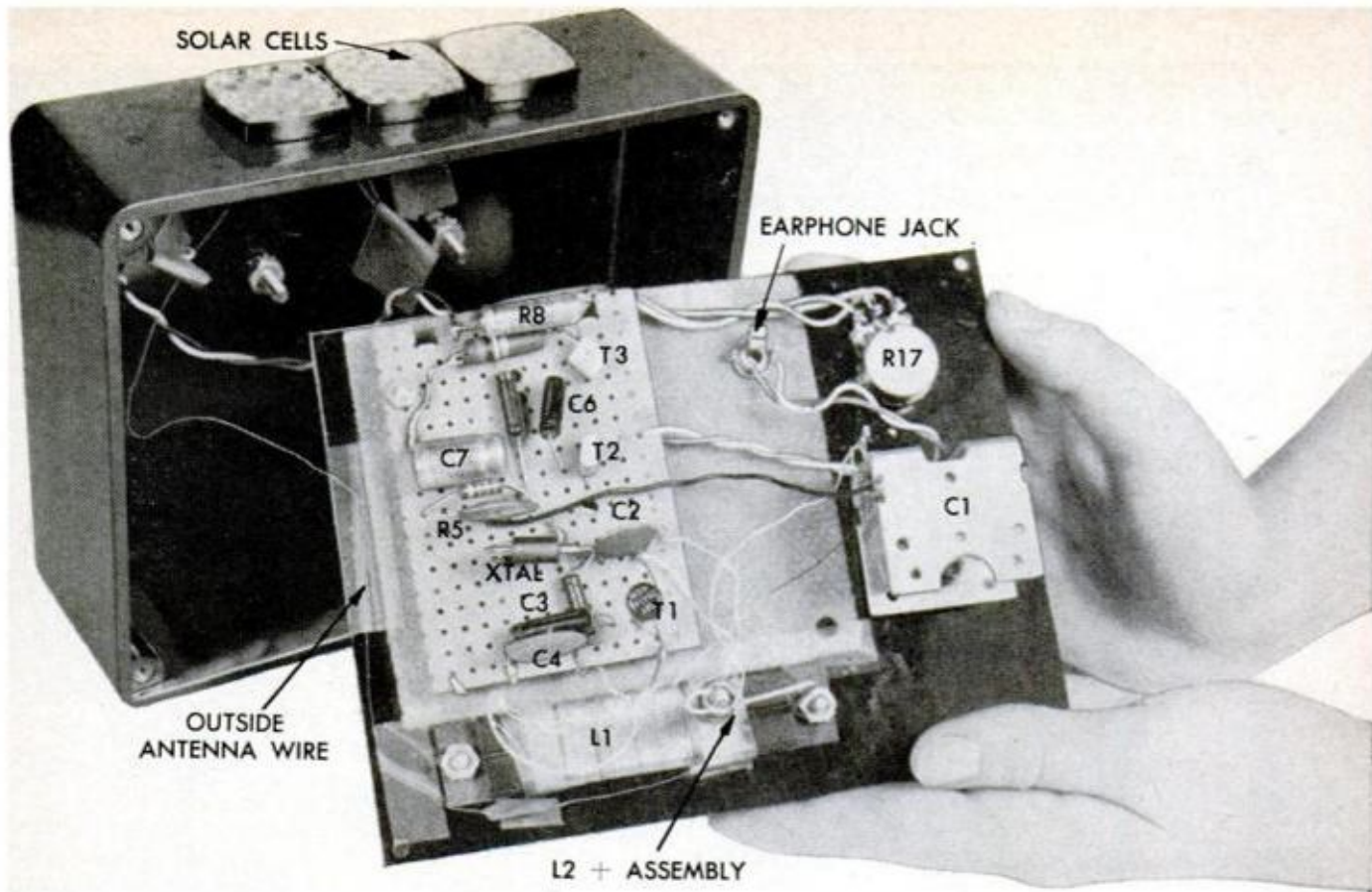

PARTS PLACEMENT is clearly shown above. Follow the layout carefully. Schematic diagram is shown below.

series" or solar cells (these are silicon type, though any kind will work) you can use any white light source to make it work. When wiring the unit, be sure to observe the polarity of the capacitors. Make sure the + is connected where it should be and not to the - terminal.—Homer L. Davidson

PARTS LIST	
C1	365 mmf var. capacitor MS214
C2	.005 mfd ceramic discs C601
C3—C6—C9	2 mfd miniature electrolytic CF100
C4—C5	.01 mfd ceramic disc C601
C7	100 mfd 6 volt elec. CF106
C8—C10	30 mfd 6 volt elec. CF104
R1—R4	15 k ohm fixed resistors 1/4 watt
R2	470 ohm fixed resistors 1/4 watt
R3	22K ohm fixed resistors 1/4 watt
R5	47K ohm fixed resistors 1/4 watt
R6	2.7K ohm fixed resistors 1/4 watt
R7	10K volume control VC34
R8	100K ohm fixed resistor 1/4 watt
R9	280 ohm fixed resistor 1/4 watt
R10	4.7 ohm fixed resistor 1/4 watt
R11	10K ohm fixed resistor 1/4 watt
R12	68K ohm fixed resistor 1/4 watt
L1	Miller 2004 transistor antenna coil
L2	400T 5x44 Litz wire-WR417 1/4" ferrite form
Earphone—Argonne dynamic AR46 with earphone jack	
XTAL—1N34 or equivalent	
Q1—2N414 Raytheon transistor	
Q2—Q3—RCA 26408 transistor	
1 cabinet—MS 218 Art front panel MS845	
Solar sun cells—3 International Rectifier Corp. S3M	
Parts obtained from Lafayette Radio, Syosset, L. I., New York	

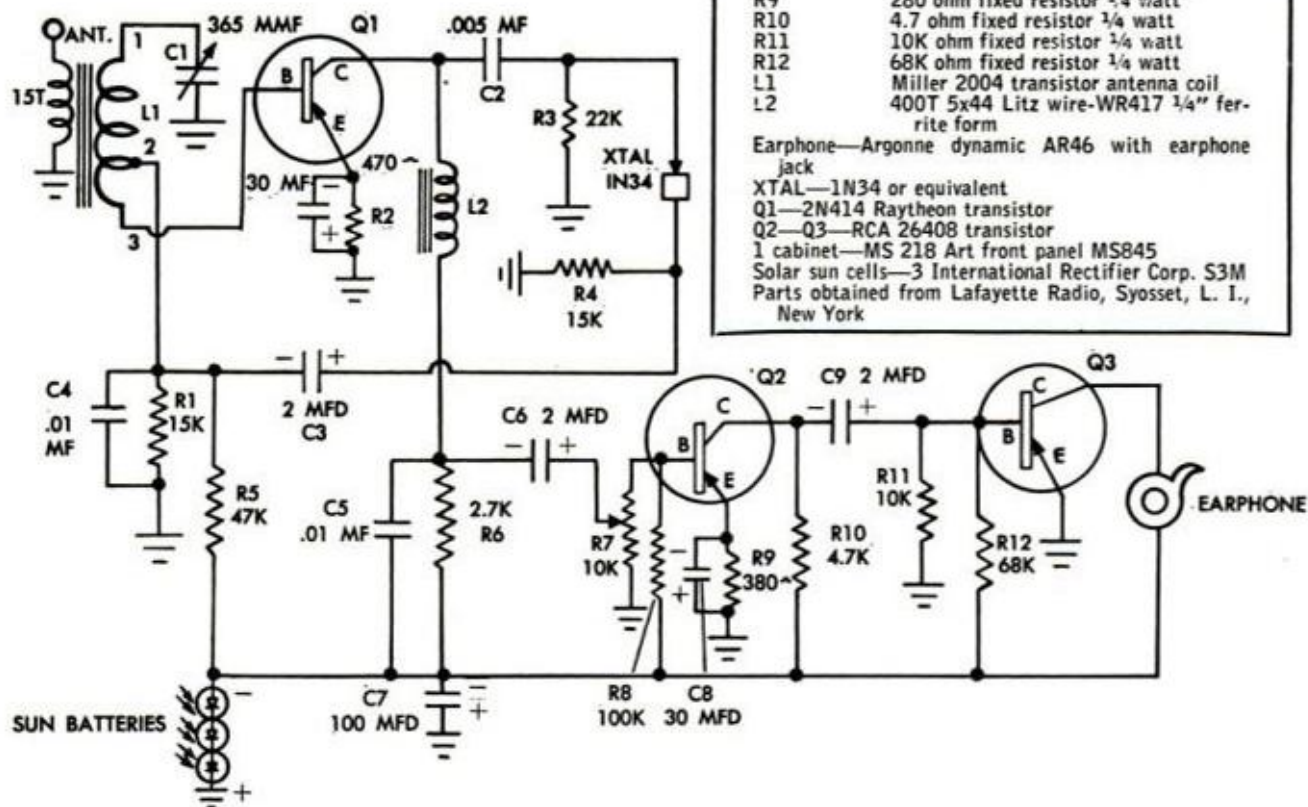

TOUCHY SWITCH TRIGGER

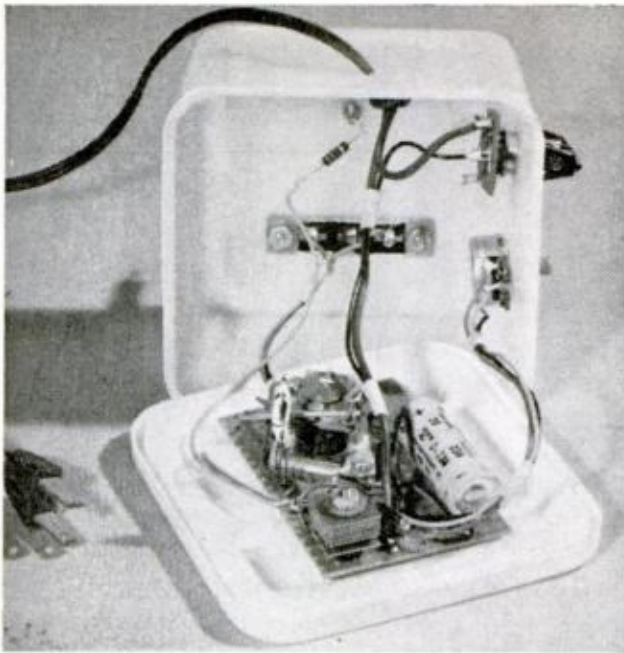

PARTS PLACEMENT is not critical as sensitivity control adjusts bias. Terminal strip connects to relay

SWITCH GROPERS in the dark can now turn on the lights just by waving an appendage somewhere in the general vicinity of where a switch ought to be. It's as effective as a proximity fuse, and can be used in many applications. The trigger is a sensing antenna. When wired to a lamp, the antenna can be looped around the shade, for instance. A groper need only brush the wire while fumbling, and on goes the lamp. By running the sensing antenna around a window frame any unwelcome visitor using that mode of access to the house can be announced by sound or light alarm.



CLOSE RESET SWITCH (knob) and adjust sensitivity just below firing point. Touching closes relay

The touchswitch consists of 10 components and is easily assembled, as shown, in a standard wall switch box. No current is used until the switch is activated—if you like to save standby current. This is not a rehash of the old capacity switch. It operates on a little used principle. We all pick up 60 cycle current from the power lines that surround us. The sensitivity of the touchswitch is set until it almost fires the neon lamp. Touching the antenna applies enough of your built-in 60 cycles to the center electrode to fire the lamp and close the relay.

—John Potter Shields

WIRING DIAGRAM (left) shows typical application. Schematic diagram (right) shows simplicity of circuit

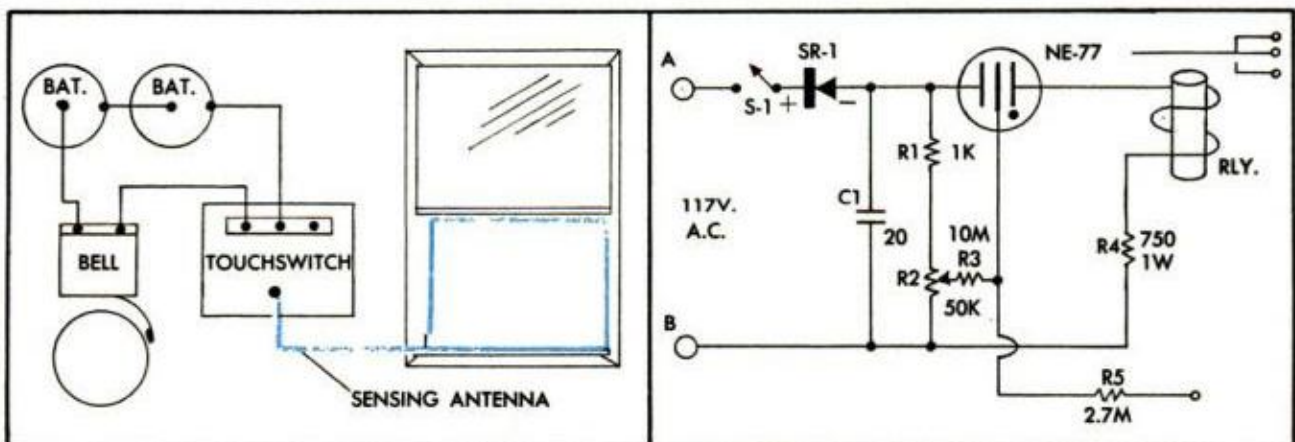

PARTS LIST

R1—1K, ½ watt carbon resistor
 R2—50K ½ watt carbon potentiometer, linear taper
 R3—10 megohm ½ watt carbon resistor
 R4—750 ohm 1 watt carbon resistor
 R5—2.7 megohm ½ watt carbon resistor

C1—20 mfd 150 volt tubular electrolytic capacitor (Olson #C-138)
 SR1—65 milliampere selenium rectifier (Olson #RE-36)
 RLY—relay, 2K coil, SPDT contacts (Olson #SW-186)
 S1—SPST rotary switch
 NE-77—NE-77 neon lamp

Electronically New

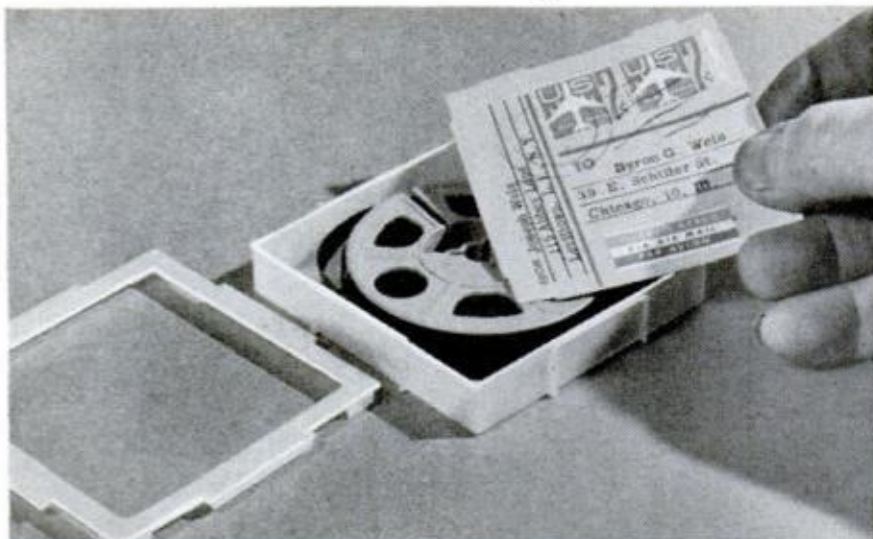

TAPE CORRESPONDENCE is facilitated by a permanent, impact resistant plastic box. The card insert is addressed on both sides, permitting the recipient to simply reverse the card and return the box with the answer tape. The plastic cover frame snaps off with a flick of the thumb nail. From 64c depending on tape length. Ferrodynamics Co., Lodi, New Jersey

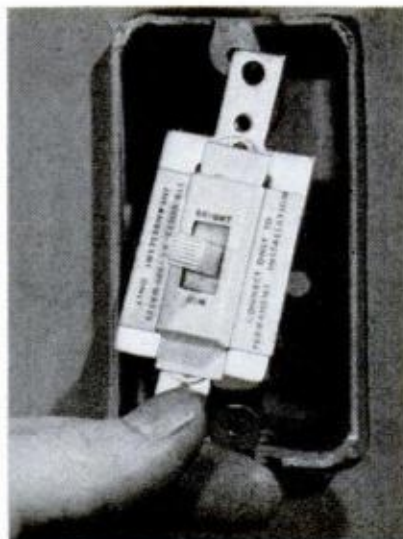

SUBDUED LIGHTING is available without rewiring with Dim-A-Light. Reduces voltage 50%. \$3.95. Edco Corp., 19302 Grand River, Detroit, Michigan



TRANSPARENT INSULATION serves double function. In addition to picking up wall color, the inside wire is plainly visible. One lead is copper, the other tinned. Makes for easy polarization. \$2.95 per 200 feet. Olson Electronics, Inc., 260 S. Forge St., Akron, Ohio. A great convenience when hooking up loudspeakers in proper phase or wiring any DC electronic circuits

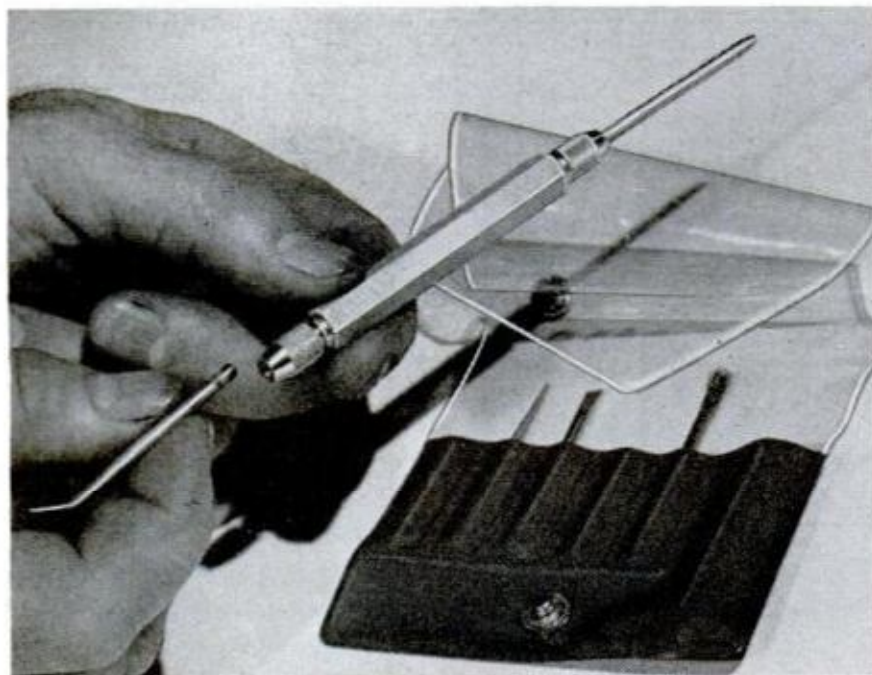

SOLDERING AID has replaceable tips for various jobs. Contains wooden handle with chuck at each end, five different tips. Complete with plastic bag, \$3. X-Acto Tools, Inc., 48-41 Van Dam St., Long Island City, N. Y. Set provides straight tip, a bent tip for angled work, split tip for de-wrapping wires, chisel tip for clipping and scraping, also stiff wire brush tip for removing any melted solder



HE'LL LOVE THE FLAVOR...AND EVERYONE WILL LOVE THE AROMA!

When Dad lights up a pipeful of HALF AND HALF, the people around him enjoy it almost as much as he does. That's because no other pipe tobacco has such a delightful aroma—and such a distinctive taste.

HALF AND HALF is a mixture of choice aromatic tobaccos . . . specially selected and blended for mild taste and friendly aroma. So this Christmas give your pipe smoker HALF AND HALF. Everyone enjoys the aroma.

©THE AMERICAN TOBACCO COMPANY



MEMO TO SANTAS!
 Show this to your better half—
 She'll love the aroma of
HALF AND HALF!

A CARGO OF CONTENTMENT IN THE BOWL OF ANY PIPE!

DECEMBER 1962

183

NEW!

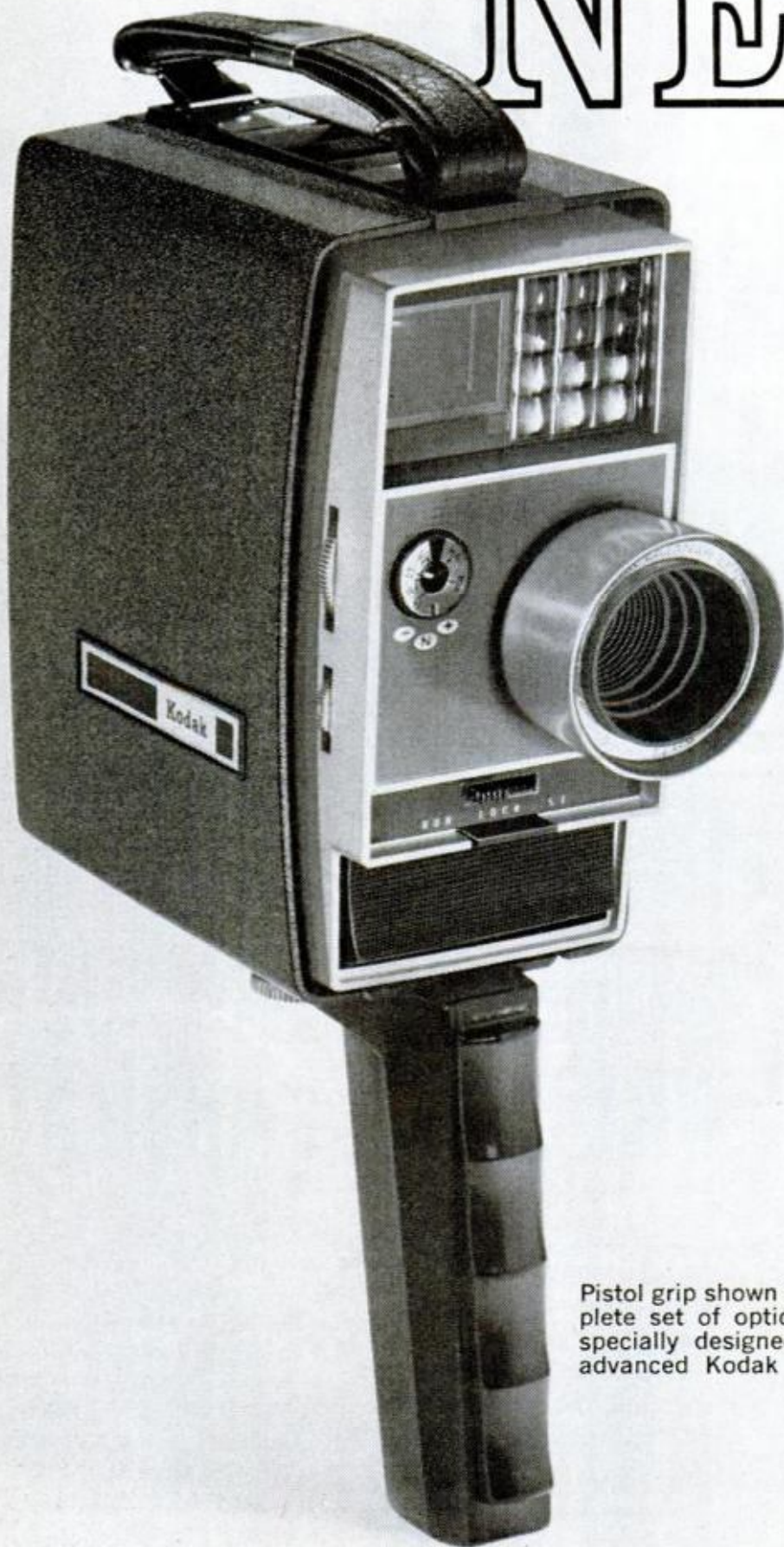

Pistol grip shown is one of a complete set of optional movie aids specially designed for this new, advanced Kodak movie camera.

KODAK Electric 8 Automatic Camera



BATTERY-DRIVEN! No winding—ever. Four powerful manganese alkaline batteries—penlite size—drive the camera motor for you. You can keep shooting as long as action lasts with no chance of a scene-spoiling slowdown in power. One set of batteries will drive up to 10 rolls of film through camera. A signal in the viewfinder gives you long-range warning when batteries need replacing.



DROP-IN LOADING! New KODAK DUEX 8 Cassette speeds loading. You place regular 8mm roll film in the cassette in seconds. Drop cassette into the camera and it's loaded! When you finish the first side of the roll, just turn the cassette over to shoot the second side. (You can do it faster than a football team can huddle!) Pre-load several cassettes to film a whole game or other continuous action.

You're always ready for action!

The new KODAK Electric 8 Automatic Camera is ready to go the distance in any action. Ready to whirr into action as fast as you can put it to your eye.

No winding! It's battery-powered. No lens setting. An electric eye automatically adjusts the super-fast $f/1.6$ lens to the light.

For extra versatility you can lock the lens at any setting. Set the meter for intentional under- or overexposure for spe-

cial effects. A built-in filter lets you use the same roll of Type A KODACHROME Film indoors and outdoors.

Isn't this the kind of movie camera you've always wanted to own . . . a camera always ready to capture the action and color that's now passing you by? See it soon at your Kodak dealer's. Own it in time to save your Christmas in colorful movies! With hand strap, one cassette, less than \$100. Batteries extra.

Price subject to change without notice.

EASTMAN KODAK COMPANY, Rochester 4, N. Y.

Enjoy Walt Disney's "Wonderful World of Color" Sunday evenings, NBC-TV

Kodak
TRADE MARK

CLINIC FOR HOMEOWNERS

Noisy Furnace

Q—I have a forced, warm-air heating system which has been in operation five years. During the latter part of last year's heating season I began to notice, when the burner went on, a loud, snapping or cracking sound from the furnace. This fall I'm hearing the same thing. I had never heard the sound before it began last spring. Is this damaging? How can it be stopped?—F.D., Mich.

A—You do not say but we are assuming that the furnace is gas-fired and that the heat exchanger is of sheet metal rather than cast iron. If these assumptions are correct, then the sound you hear is likely due to expansion of the metal in the exchanger, although it could originate in the plenum or elsewhere and still appear to be in the exchanger. No harm is likely to result, but, unfortunately, there is little, if anything, you can do to silence the annoying sound. The interval between burner cycles in the moderate weather of fall and spring allows the exchanger to cool to near room temperature before the burner kicks on again. The quick expansion of the exchanger causes it to give off the sounds you hear, but it is quite likely that as the heating season advances and the intervals between burner cycles shorten, the noise will be minimized and possibly eliminated altogether.

Cleaning Old Brass

Q—I have an old brass kettle (I presume it is of the type used for making apple butter) on which I have spent many hours of effort trying to clean and polish both the outside and inside. I've used a number of different polishes without much effect. What to do now?

—N.O., Conn.

A—Cleaning and polishing old brass, also copper and iron, is a seasonal problem of collectors. There just isn't any simple, easy way to clean and polish old brass, unless of course, you take the items to a shop equipped to handle this sort of thing. The shops clean the metal with power-driven wire wheels and polish with cloth buffs charged with an abrasive at a nominal cost. We'd recommend that you seek out such a shop in your locality and save yourself a lot of tedious work. But if you'd rather do the job yourself there are a number of good polishers available for hand application. But don't expect the

polish to remove the coatings you usually find on old brass, especially old kettles. You have to get down to the metal with a wire brush.

Mystery Leak

Q—We live in an older home having a large inside chimney. In spring, summer and fall during and after a heavy rain-storm a damp spot appears on the wall in an upstairs bedroom. The chimney forms a part of this wall, the plaster apparently being applied over the chimney bricks. I've examined the flashing closely and there seems to be no signs of leakage here. The bricks need pointing but the cap seems to be perfect. Where else should I look?—E.S., Kan.

A—There are several possibilities, but your mention of the chimney needing pointing, narrows them down to the good chance that the water from a driving storm enters the chimney flue through the bricks at some point above the roof. If the chimney has a tile liner (you did not say), then it is just possible that the water from above runs between the bricks to the liner and down the liner to that point where the damp spot shows on the wall. This is only a guess, of course, but it does seem a strong possibility.

Calk Expansion Joints

Q—My concrete driveway is about 50 ft. long and consists of several slabs with expansion joints. During very cold weather these joints open so that the strips are loose. I've been advised to calk the joints but this does not seem to me to be the right thing to do. How about it?

—P.N., Minn.

A—When the slabs expand during warmer weather it is likely that any calking compound would be forced out of the joints. The only reason for calking would be to keep out water which would freeze during cold weather. But if the driveway shows no signs of damage from this source and if the slabs are still level and not cracked, then we would see no reason to calk the joints as suggested.

As a service to Popular Mechanics readers in solving the hundreds of problems pertaining to a home—inside or out—you are invited to present your problems to The Clinic Editor for his helpful advice. Address your questions to The Clinic Editor, Popular Mechanics Magazine, 575 Lexington Ave., New York 22, N.Y.

GIFT SUGGESTIONS



For his "Horse" in the basement...

If woodworking gives him pleasure, give him Stanley Power Tools for Christmas. He'll get year-round pleasure from these quality tools . . . the heavy-duty H75 Sabre Saw (\$44.95) that cuts 2" planking —is perfect for scrolls, curves, cabinets, plastics, veneers; the new, low-cost H271 Power Saw (\$44.50) with Stanley "Motor Saver" drive and other quality features; and the H81S Drill Kit (\$43.25 value for only \$29.95), a sturdy, metal carrying case containing a Stanley H131 Drill, drill stand, 8 bits and every other needed drilling accessory. Drill, without kit and

accessories, is available at special price during the Christmas season.

See these quality Stanley Power Tools at your nearby hardware store and make your Christmas gift selections . . . sure to please.

STANLEY POWER TOOLS

THE **STANLEY** WORKS

®

NEW BRITAIN, CONNECTICUT

South Bend

10" LATHES

*with new
welded steel
floor legs*

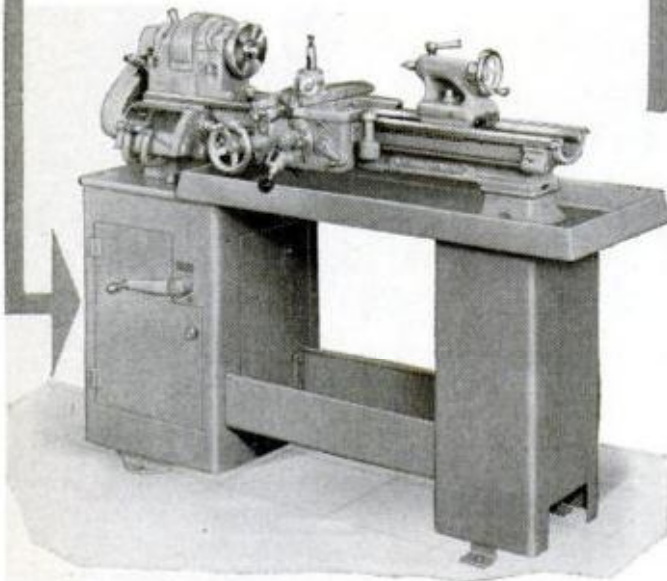

- New, trim floor legs . . . reinforced construction of welded, heavy gauge steel . . . maximum rigidity with minimum weight . . . no increase in price!
- Famous South Bend dependability.
- Superfinished spindles and bearings for uniform accuracy and fine finishes.
- 70 screw threads (4 to 480 per in.) . . . 70 longitudinal feeds . . . 70 cross feeds.
- Tool room and Engine Lathe models . . . prices start at \$1346 f.o.b. factory.

WRITE FOR CATALOG

*of South Bend Lathes, Milling Machines,
Shapers, Drill Presses and Pedestal Grinders*

SOUTH BEND LATHE, INC.

South Bend 22, Indiana

Building Better Tools Since 1906

Time payment plan
available. Up to 36
months to pay.



Bidding For Bargains

(Continued from page 100)

be made prior to the sale. This money is applied to purchases, and if nothing is bought, the deposit is returned at close of sale. All sales are by cash or certified check. To prevent carrying large sums of cash, where expensive purchases are contemplated, have certified checks made payable to yourself, and indorse them over at time of purchase.

Railroads, trucking lines and other shipping agencies hold periodic public sales, offering a variety of merchandise at extremely low prices. These items are acquired through damage in shipment, confiscation for lack of payment on shipping charges and unclaimed C.O.D. packages. The damages in most cases are scratches, water marks and blemishes that are easily repaired. An example of this is cases of canned foods that have been dented or the labels stained. Most commonly available are furniture, appliances and radio and TV sets. Information pertaining to these sales can be obtained from each agency.

Many people fail to investigate these auctions on the assumption that dealers with unlimited financial backing buy up anything worth having in large job lots. This is not necessarily true, particularly in Government sales. Dealers have no more rights or priority than other citizens, and they must enter their bids like any private citizen.

It is true that a dealer has an advantage in buying large shipments, but he seldom bids on single items, which are the prime interest of the individual bidder.

In addition to auctions being potential gold mines for bargains, you will find them a source of fun and excitement. It is a form of shopping that can become a fever, and once you try it, you will want to investigate all the private and government sources.

Plan New Portraits of Sun

Detailed radio pictures of the sun will be taken by a radio heliograph soon to be built in Australia. The instrument will consist of 100 saucer-shaped aerials, each 42 feet across, arranged in a circle two miles wide.

Its radio pictures are expected to give information about the giant explosions and storms that occur in the sun. These solar storms disrupt radio communications throughout the world and also produce cosmic rays that could endanger space travelers of the future.

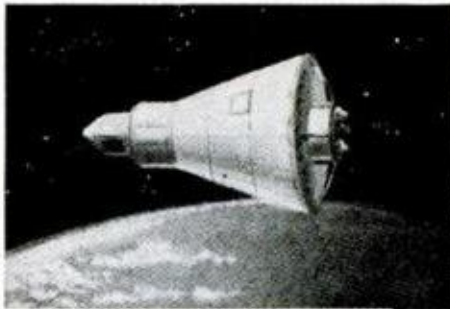

*It's already tomorrow
on the other side of the world...*

*Hear the modern
pioneers in action!*

Hallicrafters World Range Radios bring the words and sounds of adventure into your living room direct—from a huge liner fog bound at sea to a giant bomber on Arctic patrol. Even America's Astronauts may be heard on some models!

*Your "listening post" for
hundreds of countries!*



You're truly in tune with the whole world through your Hallicrafters. On-the-spot news broadcast in English from over 200 foreign stations... and there's nothing like the real thing for foreign language study!



Beautiful S-120 Hallicrafters World-Range Receiver—Standard Broadcast plus three short wave bands. Foreign, amateur, aviation, marine and emergency frequencies. Has "bandspread" for razor-sharp tuning of close-together stations.

...and *tonight*, you can hear what's happening
on your Hallicrafters world range radio!



*"Hear radio 'hams'
melt the
iron curtain!"*

No tyrant in history has yet been able to crush the free exchange of good will that occurs every day among the radio amateurs of the world. "Hams" (250,000 strong in the U.S.A. alone) are our first line of communication in time of disaster, too. Hear them on your Hallicrafters!

*S. O. S. !
S. O. S. !*



When emergency strikes, you may be on the scene with your Hallicrafters World Range radio. Marine... fire... police... civil defense channels... all at your fingertips.

Before you retire tonight, a new dawn of critical world events will begin in the major capitals and trouble spots around the globe.

Yet tonight, through Hallicrafters World Range Radio, tomorrow's history springs to life in your own home. *While it is happening.*

With a twist of a knob, you could be listening to Moscow one minute... Berlin... Africa or New Delhi the next. You tune easily through the decisive voices of varied world reaction and opinion—hundreds of English, as well as foreign language, broadcasts from the four corners of the earth.

Never before have you been so *thoroughly informed*. Never before have you grasped *so quickly* the full impact of momentous events. Or felt so much a part of them.



It's incredible...

what you'll hear on a

hallicrafters

Chicago, Illinois

Prices higher outside U.S.A.

Copyright 1962 by Hallicrafters Co.

DECEMBER 1962

189

Test your automotive I.Q!

QUICK QUIZ BY QUAKER STATE

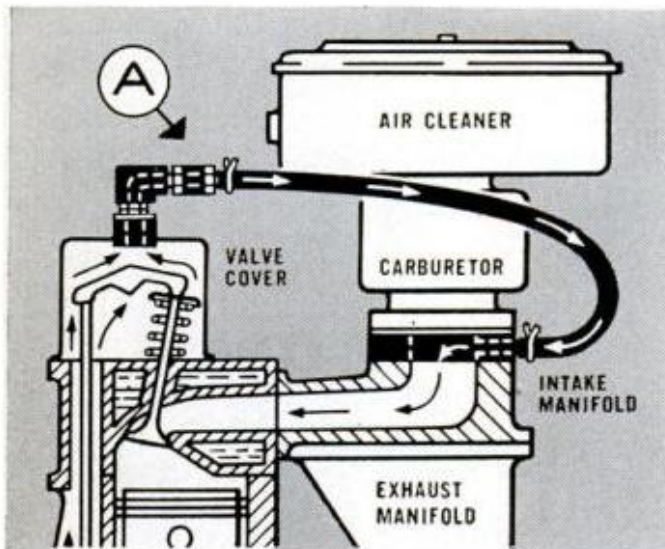

1. What is this device (A)? What is its purpose?

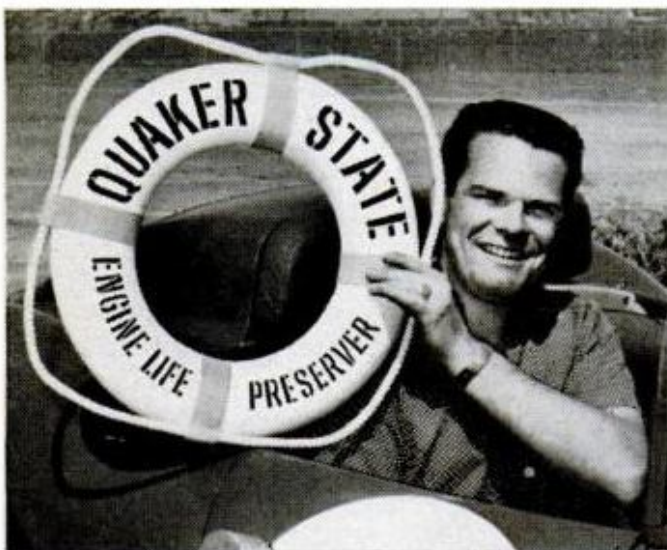

2. What does this symbol stand for?

Pictured at top is an "anti-smog" type crankcase ventilator which prevents crankcase blow-by fumes from escaping to the atmosphere. The life preserver stands for Quaker State Motor Oil—because it is the best engine life preserver. Refined from 100% pure Pennsylvania Grade Crude Oil, it keeps your car on the road, out of the repair shop. Insist on Quaker State—the best engine life preserver.



QUAKER STATE OIL REFINING CORP., OIL CITY, PA.

RUBBER STAMP

(Continued from page 159)

type and pull it out of the plastic, Fig. 6. Sand off any excess polyester from the face of the hardboard frame, and wash the matrix with soap and water to remove any parting agent adhering in the impression.

Next, cut two pieces of inner-tube hot-patching gum (the uncured rubber a garageman uses to seal punctures), making these slightly larger than the impression in the matrix, Fig. 7. Position these two layers over the impression and cover with a piece of sized cambric or plastic-coated cloth to prevent sticking. Back this with a smooth metal plate, $\frac{1}{8}$ in. or thicker, and a $\frac{3}{4}$ -in. plywood clamping block. Squeeze this sandwich together with several C-clamps, Fig. 8, tightening them gradually and evenly to compress the gum rubber into the matrix. Then cook the whole thing in your kitchen oven for at least three hours at 250 deg., allowing the heat to penetrate both plywood and polyester and completely cure the gum rubber, Fig. 8. After cooking, set the sandwich aside to cool before releasing the clamps and peeling the vulcanized die from the matrix.

Stamps up to 5 in. wide generally are mounted on flat-bottomed blocks, Figs. 1 and 10. However, wider stamps will require a rocker-type block in order to make an even impression on the paper. You can buy the $\frac{1}{8}$ -in. sponge rubber for cushioning from a rubber goods supplier. To avoid lumps when mounting the die and cushion on the block, use a thin-bodied rubber adhesive, Fig. 9.

You can also use this stamp making technique to make special rubber grommets or gaskets which can't be obtained locally. Simply make a clay model of the part you need, take a polyester-putty mold from it, load the mold with gum rubber and vulcanize in the oven.

Electronic Space Welder

High-energy beams of electrons concentrated in a small area can be used for emergency welding repairs in outer space.

Since all of outer space is a near vacuum, the usual welding techniques requiring oxygen or heavy liquids are impractical.

The electron beam is a ray like form of high-speed electrons, according to Robert Bakish of Alloyd Electronics Corp.

He predicted that on future space flights structural components joined by electron beams will be part of the space vehicles. He said astronauts will be able to make repairs in space or on lunar bases.

NOW! A REAL 6/12 VOLT BATTERY BOOSTER

Now you can own a genuine **SCHAUER** 6&12 volt battery booster at a low, low price! The Model H612 is *positively not just a battery "warmer"*, as are so many "economy" models on the market! It delivers a full 1 1/4 amps of power at **BOTH** voltages, that will charge car, boat, motorcycle and lawnmower batteries. Has full-wave Selenium rectifiers... automatic circuit breaker... 6 or 12 volt selector switch... rugged steel case with handsome red finish. Money-back guarantee. Buy yours now. If your dealer can't supply, send check or money order.

Automotive Division
SCHAUER MANUFACTURING CORP.
4532 Alpine Avenue, Cincinnati 42, Ohio

ONLY
\$9.95

Postpaid
Model H612



SAY MERRY CHRISTMAS
and a **HAPPY NEW**
FREEDOM FROM WRONG TURNS!



WITH A **HULL**
AUTO OR BOAT COMPASS
\$5.95 to 7.50 at your dealer's or write
for literature



HULL MFG. CO., BOX 246 - D-12, Warren, Ohio

"**POP!**"
Mechanics SAYS:

"That no kid would ever believe that the shortest days of the year come before Xmas."

Can Even Be Applied Under Water!



Seals Metals • Wood • Tile • WATERPROOF
W. J. RUSCOE CO., Akron 1, Ohio



New ALVA ALLEN
Power Punch Press
HANDBOOK Catalog

100 pages. Shows 1 to 25 Ton Capacity Punch Presses in hundreds of different model combinations. Full of general detail information on Punch Presses. Gives information on accessories as—Feeds, Punch Units, etc. Most complete Punch Press and Accessories Handbook Catalog. \$1.00 postpaid. Alva Allen Industries, Dept PM, Clinton, Mo.

ECONOMY POWERFUL!
Thousands in Use!
TRACTOR Since 1946

UNEQUALLED LOW PRICE! TERRIFIC VALUE!

America's finest tractor. Ruggedly built. Easy to operate. 790 lbs. Borg-Warner clutch, trans. and diff. 140 to 1 reduction. 40% more drawbar pull than ordinary tractors. 9 H.P. engine. 20 quick change implements. HOOD-FENDERS.

Write for Catalog.

Engineering Products Co.
1005 K-12 Anoka Avenue
Waukesha, Wisconsin



DECEMBER 1962

WANTED

(most)
for Christmas

"Here's just a pair of the best doggone gifts ever branded. Better see 'em all, Pardner!"

"A real steal!"



MILLERS FALLS SANDER

12 times faster than hand sanding. Ball bearings. Powerful Millers Falls-built motor. Ideal for cabinetmakers, craftsmen, painters and hobbyists. 4500 non-scratching orbits per minute.

(Reg. \$39.95)
ONLY \$34.95

"Save-um 5 bucks!"



MILLERS FALLS SABRE SAW

Full 1/2" stroke. Cuts all types of intricate patterns in wood and metal. Automatically blows sawdust from guide line. Cuts its own hole without predrilling. Powerful Millers Falls-built motor.

(Reg. \$29.95)
ONLY \$24.95

"Look for this brand."



MILLERS FALLS CO., Greenfield, Mass.

191

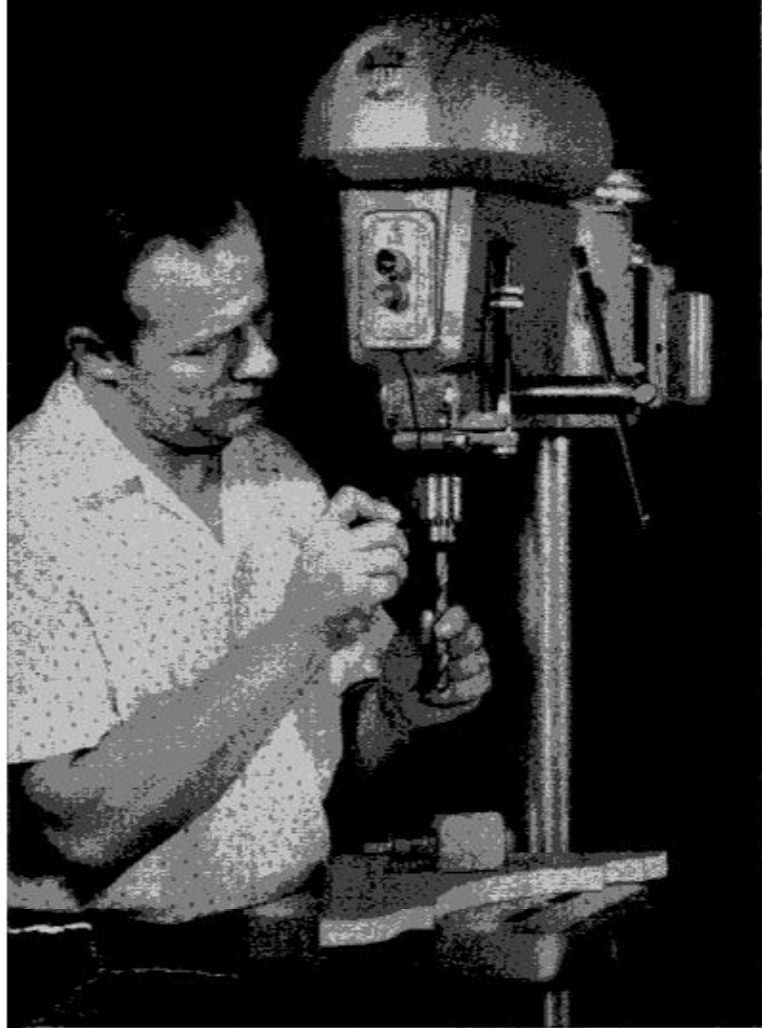

What's so great about Delta's new 15" drill press besides the price—\$124⁰⁰*?

Just this. Delta quality features and standard Delta industrial construction. For you, it adds up to accuracy and versatility you can't match at this low price. Check these advantages:

- Husky 2" quill with 4 7/16" stroke
- Lubricated-for-life ball bearings
- Dynamically balanced spindle pulley

Machine converts in seconds with any of six interchangeable spindle adapters to do dozens of jobs in wood, metal or plastic.

See this big value soon. Your Delta dealer is listed under MACHINERY in the Yellow Pages. For FREE BROCHURE with full details, write: Rockwell Manufacturing Company, Delta Power Tool Division, 502M N. Lexington Ave., Pittsburgh 8, Pennsylvania.

*Bench model less electricals

Rockwell
MANUFACTURING COMPANY



Christmas Cutouts

(Continued from page 136)

type consisting of several hinged panels, then tape the cutouts to the door, locate the breaks, or hinge points, mark and saw apart on the lines. Then replace on the door panels. Then when the door is opened the display will roll up with the door without any interference. Other scenes such as the Wise men, can be treated in the same way.

Almost any high point on the house will be the place to mount the Astronaut Santa and his capsule. Frame the cutouts as indicated and use 3/8-in. white nylon rope or 1/4-in. plastic clothesline for the shroud lines. You'll need about 30 ft. of the rope. Start at the chute, lead the rope to the capsule and back to the 'chute and so on. Build the framework to support the display as indicated in the details and anchor in place with sandbags laid over the ridge as shown.

Frame the free-standing displays, such as the stacked reindeer and the "lazy" reindeer, with 1 x 2s. Join with corrugated fasteners. When setting up the displays use 1 x 2s painted to match for stakes. Then tack the display frames to the stakes. For those groups that are braced to the house wall, attach the frames to stakes and extend braces to the siding or to a carport post.

Before storing the displays between seasons wash off any accumulation of dirt and grime, wrap each one in heavy paper, taped in place to keep out dust, and store overhead in the garage where the displays can be laid flat.

Heredity Changes in Orbit

Changes in heredity of plants and animals that orbited Earth in Sputniks have been reported by Soviet scientists.

Dry onion seeds grew faster than normal.

Accelerated cellular division in sprouts of pea, corn and wheat seeds occurred.

Gene mutations of fruit flies were 10 times that of other groups.

Chromosome changes in marrow cells of mice appeared in about 10 percent of the cells examined, compared to 3 percent in normal groups.

All plants and animals sent into orbit were compared with control groups that were subjected to all the physical stresses of space except the flight itself.

Biochemical changes were evident in the blood, urine and nervous system of rats, dogs and mice following flight, but these variations disappeared after some time.

The scientists said men and dogs experienced no pathological changes.

Cave Man a Cultured Citizen

After years of being regarded as something of a social slob, the Neanderthal man is now getting warmer attention.

Recent discoveries show that this prehistoric cave dweller walked slouched over, not because he resembled an ape, but because he suffered from arthritis; that he had artistic instincts, using paints for pictures; that he made superior flint tools; that he cared for the old and feeble, even pre-chewing food for toothless cripples; that he respected the dead, building sepulchers for them and providing a store of food and tools; and that he worshipped a deity.

Eyes Need Exercise, Too

Trying to "save" your eyes by not using them is a great misconception, a University of Colorado ophthalmologist says.

Dr. Morris Kaplan claims that eyes are like other parts of the body; unless they get a certain amount of exercise, this lack of usage can do more harm than good.

Watching television and movies is good exercise, he says. Glasses, while they have no curative power, can improve sight and eliminate headaches.

On the negative side, Dr. Kaplan says reading in the dark or while lying down can cause discomfort but does no harm.

The proof is in the puffing!

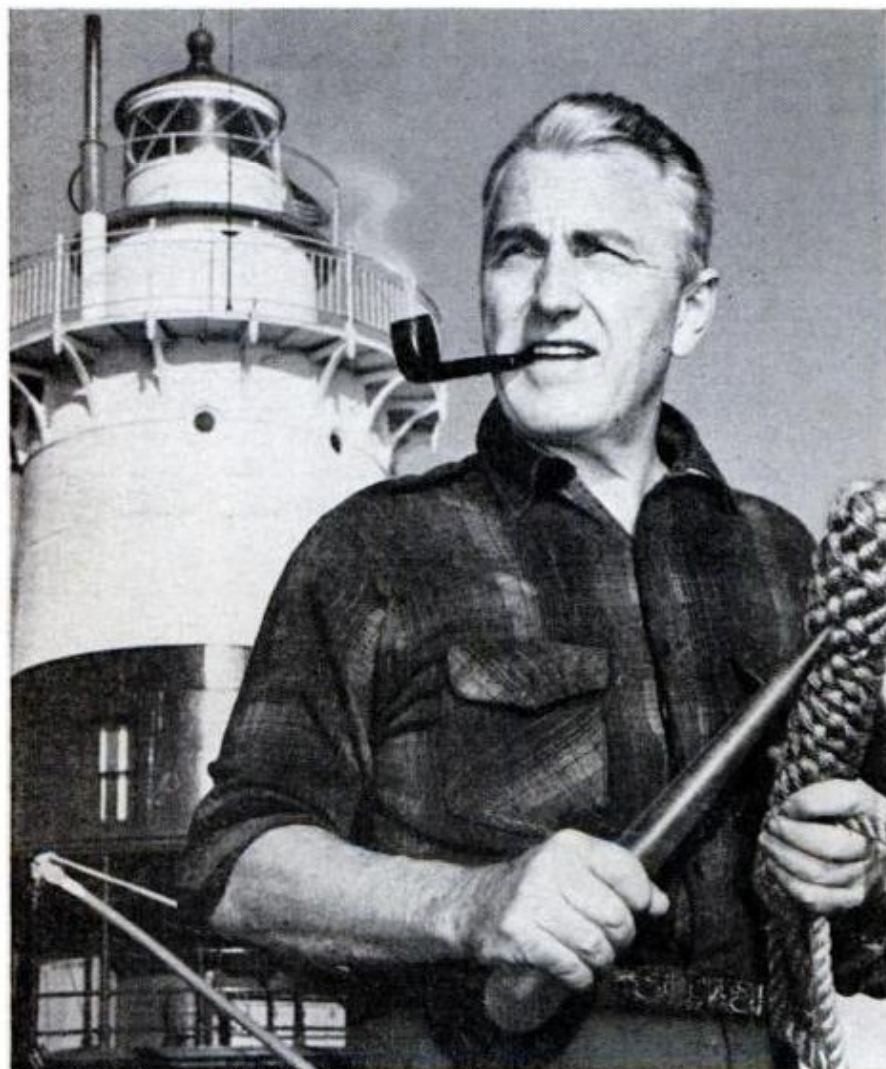

© 1962 R. J. Reynolds Tobacco Company, Winston-Salem, N. C.

- TASTES FRESH
- SMOKES COOL
- BURNS STEADY

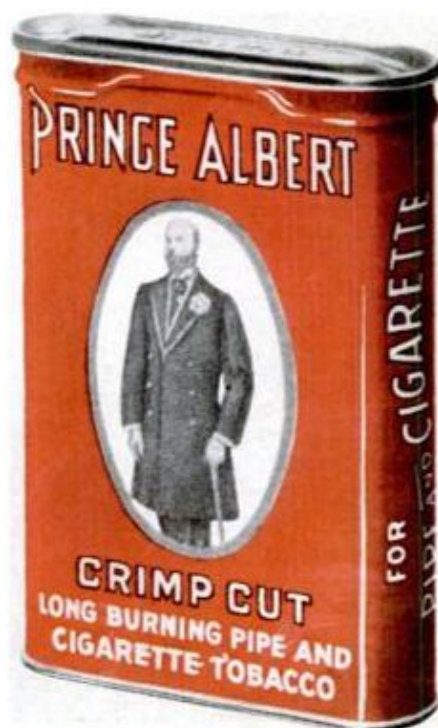

The flavor most favored in the U.S.A.

PRINCE ALBERT

Build a Toboggan

(Continued from page 174)

hard woods can supply what is known as "ski stock", which is selected, straight-grained air-dried white ash 1 in. (also 1 1/4 in.) thick and 4 in. wide. The pieces come 96 in. long. These you can easily resaw on your table saw to the required thicknesses. Allow a little for finishing the sawed faces with a belt sander or a sharp hand plane.

Preparing For Bending

After the slats and runners have been sawed, sanded smooth and tapered at one end, fill the wash boiler about three-fourths full of clean water. Place the tapered end of one slat or runner in the boiler and weight it. Bring the water to a rolling boil and in the meantime heat an equivalent amount of water in other containers. It takes 1 1/2 to 2 hours of boiling to soften the wood and you'll need to replenish the original supply in the boiler, once, and perhaps twice. Keep close watch on the process for if the container boils dry, the wood will be ruined for the purpose. Keep the boiler filled to about the original level, adding only the boiling water from the supply container to maintain the temperature.

Bending

After about 1 1/2 hours make a bending test of the tapered end of the runner. If it yields fairly easily when bent over the edge of the bench top, it probably is safe to bend over the caul. To do this you place the tapered end of the runner against the offset in the caul, Fig. 1, and clamp in place with a C-clamp, using a block of wood under the clamp pad. At this point make sure you have the runner in line with the caul. Then bend a few degrees farther around the caul and place another C-clamp. Proceed in this fashion clamp by clamp until the bend is complete. The clamps should be spaced as shown in the center photo on page 173. Keep the runner clamped in place for 24 hours before releasing it. Even then there'll be some springback, so you tourniquet the bent ends by wrapping three or four turns of fairly heavy twine around the bend and twisting tight with a length of dowel. Bent ends tourniqueted in this fashion are also pictured in the center photo on page 173. And that's it, for one runner or slat.

Duplicate Bending

You can only work one slat or one runner at a time with the one bending caul, or jig. By doubling the thickness of the jig you could work two runners or two slats, given clamps large enough to reach. Or—and here's an idea for someone who wishes to

make more than one toboggan, possibly for sale—if you have seven cauls (four for slats and three for runners), and a sufficient number of clamps, you can bend a complete toboggan in one operation. Using this equipment tied in with the clamping units pictured in the center and lower photos on page 174 you're in business. The latter will hold slats and runners securely in place and make quick, easy work of the assembly. But without this equipment you can make two bar, or cross, clamps using four pieces of 2 x 2 hardwood. One piece of each pair has one face planed slightly convex so that when you clamp each pair in place the convex face will exert pressure equally throughout the length.

Assembly

Assemble as in Fig. 2, beginning with the front rope-retaining bar. Drill screw holes through the slats and runners from the underside (with the curved ends overhanging the end of the bench as in the center photo, page 174) and countersink the holes so that the screw heads are just slightly below flush with the surface. Spread a line of resorcinol (water-proof) glue on the joining face of the retainer bar and screw in place, using flat-head brass screws as indicated. Proceed in the same way with all the bars, using your improvised clamps to hold the slats tightly together and in line while locating and screwing each bar in place. The bars are spaced 12 in. apart on centers as indicated, with one screw being used for attaching each slot.

Rope And Stirrups

With the assembly at this stage, all that remains to be done is to make the roll-edge binder strip, install the grab rope and stirrups, and finish the wood. The edge binder is a strip shaped as in the sectional view, and grooved 3/16 x 1/4 in. This is forced over the curved ends of the runners as in Fig. 2. Use glue in the joint. Drill holes for the grab rope in the curved ends of the outside runners and adjacent slats as indicated. Attach rope stirrups to the ends of each crossbar as in Fig. 3. Then tie a knot in one end of the rope—you'll need about 15 ft. of polyethylene rope—and pass it through the stirrups and holes in the curved end as indicated. Pull tight and tie a knot in the finish end.

Finishing

If desired, the three runners can be stained as indicated and the slats finished in natural color. Or you can finish both slats and runners in natural color by first applying a sealer and following with two coats of spar varnish. ★ ★ ★

CRAFTSMAN SOCKET SETS...

Gifts You Give with Confidence Because They're

SEARS
ROEBUCK AND CO.

**UNCONDITIONALLY
GUARANTEED**

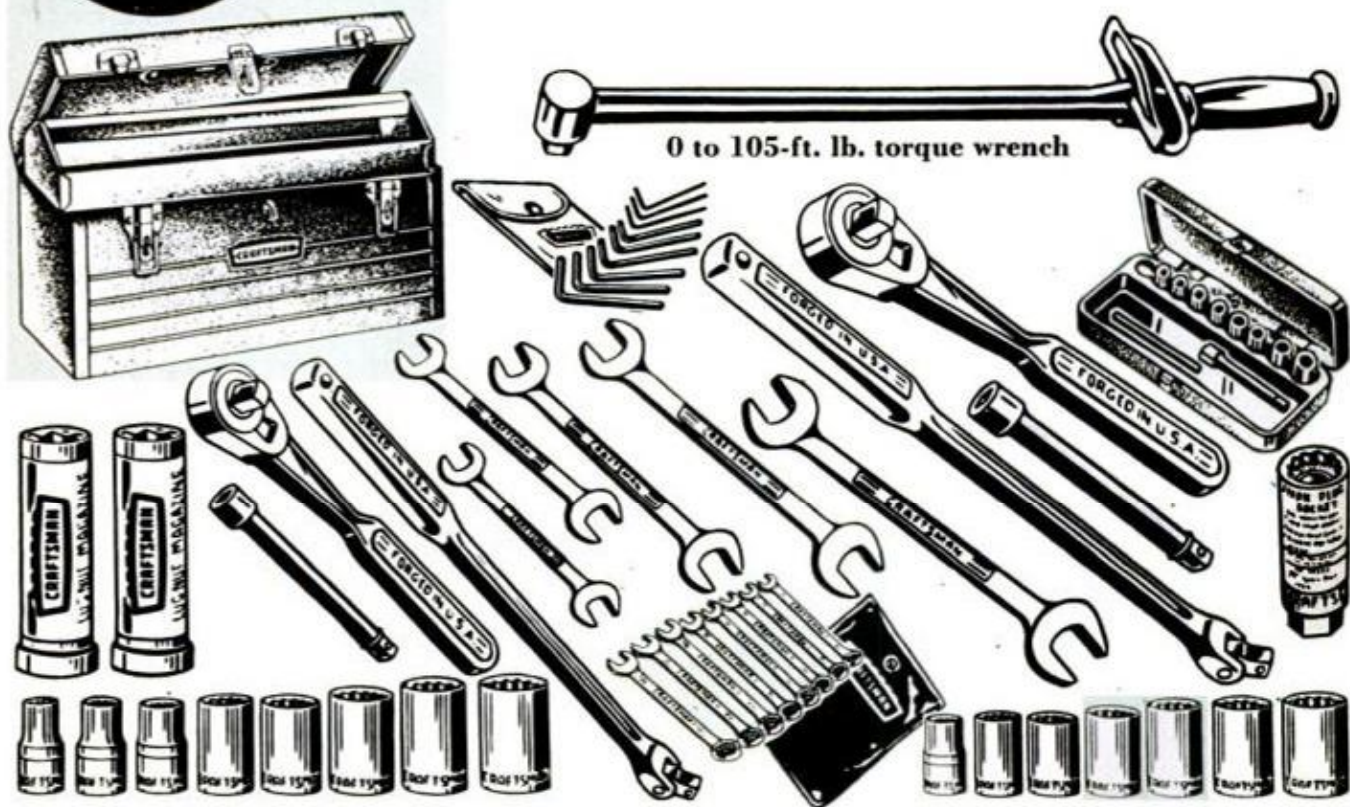

Save \$29.97! Craftsman 59-pc. Set

Regular separate prices total \$69.96! Includes 0 to 105-ft. lb. torque wrench—tightens studs or engine head bolts to exact tension. 1/2, 3/8 and 1/4-inch drive sockets and accessories. All tools fit in 18x8x9-in. steel tool box.

39⁹⁹
NO MONEY DOWN
on Sears Easy Payment Plan

Save \$8.40! Craftsman 29-pc. Socket Set

Regular separate prices total \$28.39! 1/2-in. drive parts. 19 1/2 x 6 x 3 1/2 in. tool box.

19⁹⁹

Save \$16.63! Craftsman 47-pc. Socket Set

Regular separate prices total \$46.62. 1/2 and 1/4-in. drives. Also, 6-pc. propane torch kit.

29⁹⁹

Save \$31.76! Craftsman 87-pc. Socket Set

Regular separate prices total \$81.75. 1/2, 3/8, 1/4-in. drive parts plus many extra tools.

49⁹⁹

UNSURPASSED QUALITY

Made of molybdenum steel, heat treated, hardened to increase strength and wear-resistance. Chrome-plated over nickel.

Craftsman hand tools are *unconditionally guaranteed*. Any tool that fails to give complete satisfaction will be replaced free of charge.

Available at Your
Nearest Sears Store



This offer good until Dec. 25, 1962

PROTECT AGAINST IMPROPER VOLTAGE THAT CAN SERIOUSLY DAMAGE YOUR CAR

Install a New

HOLLEY PEP[®] VOLTAGE REGULATOR

FOR ALL
U.S. CARS,
TRUCKS—
6-V OR 12-V



IF YOUR CAR'S voltage regulator is defective, it will pay you to replace it *now* with a new Holley PEP Voltage Regulator, and avoid costly damage to the battery and other electrical components. Holley PEP Voltage Regulators are designed for *Preferred Electrical Performance*, backed by Holley's long reputation for quality. They are fully temperature compensated, individually calibrated and tested for performance and accuracy. There's a Holley PEP Voltage Regulator to fit your car or truck!

[®]Registered Trademark

HOLLEY
Carburetor Co.

C-10

11955 E. Nine Mile Road • Warren, Michigan

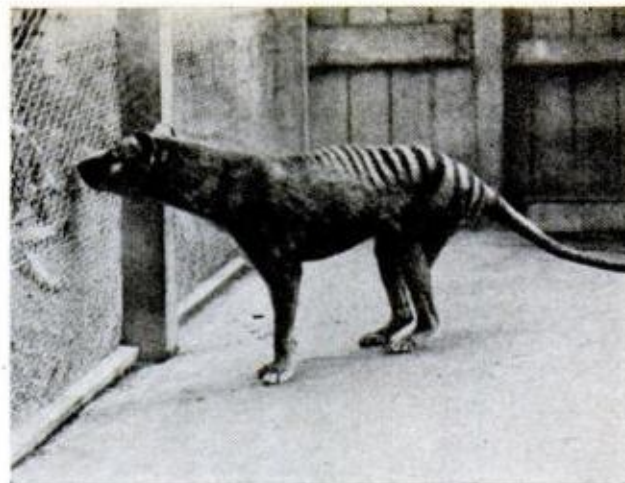

Hold That Tiger!

Is the Tasmanian tiger extinct? Naturalists and at least one famous explorer would like to find out for sure if any members of this prehistoric species are still alive. Last seen and positively identified 16 years ago, at least a few of these rare animals have been reported still roaming the remote fastnesses of the Australian island state of Tasmania.

If so, they've succeeded in eluding capture. Two sightings of the animal were reported in 1957 by helicopter crews over the southwest part of the island, but the reports were never confirmed.

The most publicized expedition to find the beast was carried out by Sir Edmund Hillary, conqueror of Mt. Everest. As in his attempt to find the fabled Abominable Snowman of the Himalayas a few years later, Sir Edmund returned from his tiger hunt empty-handed.

Thylacinus cynocephalus (thylacine, for short), is, or was, the largest of the Australian carnivorous marsupials. It dates back millions of years, virtually unchanged, as fossil remains show.

The thylacine has a wolflike head, tiger-like stripes across its rump, and a rigid tail somewhat like a kangaroo's. Like the kangaroo, it has permanently bent hind legs, causing it to hop on the tips of its five-clawed paws, instead of running like a Bengal tiger.

Being a marsupial, the animal carries its young—up to four in number—in a pouch. But here again, thylacine is different; its young face rearward in the pouch, a safety principle only now being rediscovered by modern plane designers.

Even if specimens are captured, the night-prowling beast won't ever be a zoo attraction. It is fully protected by the Tasmanian Wildlife Service and may not be molested. But naturalists would like to take one alive for a few days in order to obtain close-up photographs.

Magna-Lite

Magnetic Base
SHOP LIGHT

puts the light

where it's needed!

45 lb. pull permanent Alnico V magnet base holds the light on machines, pipes, under car hood—on any ferrous metal surface. Ball-swivel allows full adjustment of light.

Complete with 5" spun aluminum spot-type reflector, 8' oil resistant GE cord. **\$6.95**



Each, Postpaid

Send Check or Money Order to
DeMambo Laboratories Mayville, N. Y.

KING MIDGET FOR 1963

"World's Most Exciting
Lowest Priced Car"

Drive it for 75¢ a week. Rider Agents Wanted. Send 25¢ for 32 page book, full details, dealer price. Or send \$1 (refunded first order) for this plus Service and Repair Manual and 16 5x7 photos of car and factory.



MIDGET MOTORS CORP., Athens 1, Ohio

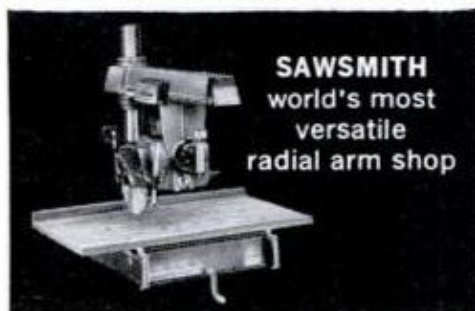

SAWSMITH
world's most
versatile
radial arm shop

Here's your passport to happy, hobby evenings: detailed instructions for completing useful, attractive items in one evening apiece. Pick up your free copy at your nearest power tool dealer or Montgomery Ward store. Ask about Free Dream Shop contest. See SHOPSMITH and SAWSMITH in action while you're there.

"Practical POWER TOOL PROJECTS"

FREE at your
SHOPSMITH and SAWSMITH
Dealer (Limited time offer)

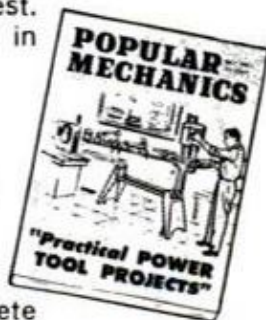

SHOPSMITH
the only complete
5-in-1 power shop

SHOPSMITH is the only complete multi-purpose home power shop: saw, lathe, horizontal drill, vertical drill press and sander. . . ALL IN ONE. Fits in a bicycle's parking spot.

SAWSMITH is the world's most versatile radial arm shop. Performs 14 basic woodworking operations with 7-speed power selection. Gives built-in precision for every job!



AMERICAN CORPORATION

Interstate 75—Evendale, Cincinnati 15, Ohio

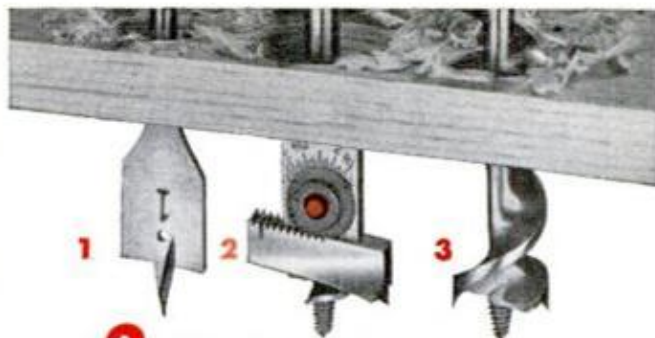

3 easy ways to bore holes faster

1. Irwin Speedbor "88" for all electric drills. Bores up to 5 times faster in any wood, at any angle. Sizes 1/4" to 1", \$.75 each. Sizes 1 1/8" to 1 1/2", \$1.25 each.

2. Irwin No. 22 Micro-Dial expansive bit. Fits all hand braces. Just dial your size. Bores 35 standard holes, 7/8" to 3". Only \$4.00. No. 21 small size bores 19 standard holes, 5/8" to 1 3/4". Only \$3.60.

3. Irwin 62T Solid Center hand brace type. Only 16 turns to bore 1" holes through 1" wood. Double-cutter boring action. Sizes 1/4" to 1 1/2". As low as \$1.05 each.

EVERY IRWIN BIT made of high analysis tool steel, heat tempered, machine sharpened and highly polished, too. Buy from your independent hardware, building supply or lumber dealer.

Strait-Line Chalk Line Reel Box
only \$1.25 for 50 ft. size

New and improved Irwin self-chalking design. Durable aluminum alloy box. Practically damage-proof. Fits pocket or hand. 50 ft. and 100 ft. sizes.

IRWIN every bit as good
as the name

at Wilmington, Ohio, since 1885



Crazy Glass

(Continued from page 75)

disk contains billions of submicroscopic holes that have an average diameter of one-sixth of one-millionth of an inch. One pore would have to be enlarged 12,000 times to admit a human hair.

Subjected to intense heat treatment, this microporous glass shrinks about two-thirds and forms a solid glass that has an exceptional combination of strength, optical clarity and heat resistance. Called Vycor brand glass, it provided the window in Col. John H. Glenn's Mercury capsule.

Gamma Ray Barrier

There is a glass for almost every use. For the new glass-walled skyscrapers there is a glass that admits the sunlight, but stops the heat. There is glass that will pass or absorb rays of the light spectrum or of nuclear energy—the heat of infrared, the glare of ultraviolet, the peril of deadly gamma rays. For the atomic scientist observing "hot cell" nuclear reactions, there is a glass with a high lead content that is eight feet thick and is still optically clear.

A new field of fiber optics utilizes long glass fibers to bend light, enabling a viewer to see around corners. The Air Force is experimenting with a glass-fiber optical surveillance system that would allow the pilot of the Dyna-Soar tactical glider to detect leaks, smoke and other hazards in remote parts of the glider and its Titan booster.

Space scientists are experimenting with a glass device called a "laser" (light amplification by stimulated emission of radiation). By piping rays and amplifying them hundreds of millions of times, this remarkable device may some day control the course of satellites and provide communication with men on the moon. Preliminary experiments indicate great possibilities for the laser in surgery because of its ability to focus intense heat from light in a tiny spot. A light beam produced from a laser can be focused through a hole 30 millionths of an inch in diameter.

There seems to be an unlimited future for glass. According to scientists, it is just a matter of time before everyone will be living in glass houses. The walls will automatically adjust themselves to changing intensities of light, and can be made opaque by the flick of a switch. They will be lighted and heated by electroluminescence and electroconduction, and will be air-conditioned by the rays of the sun focused on thermoelectric converters. That, at least, is the word from the glass experts. ★ ★ ★

1963 SAAB ... built so well

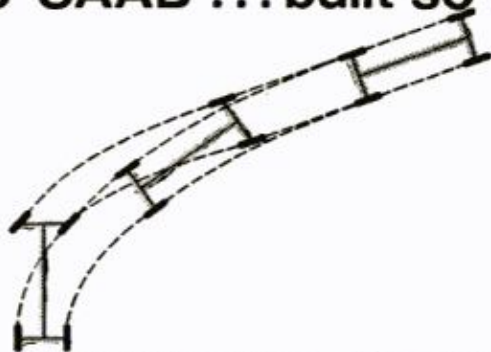

SAAB FRONT WHEEL DRIVE, carefully calculated understeering, low center of gravity, and advanced suspension design work together to optimize roadholding ability and safety in motion. Self-centering action of directly driven front wheels (see diagram) provides best possible roadholding ability at high speeds. Positive traction of front wheel drive at lower speeds makes cornering easier, dangerous skids virtually impossible. Front wheel drive pulls SAAB safely—on any road, at any speed, through ice, snow, and mud.

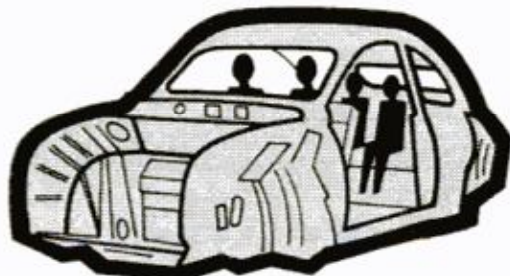

SAAB BODY SHELL is engineered to encase driver and passengers in a practically uncrushable steel airfoil on wheels. SAAB is unitized for rigidity. 18- to 20-gauge steel (heavier than most American cars) is used throughout. Additional steel members, $\frac{1}{8}$ inch thick, brace trunk and engine compartments. A crash bar, usually a racing car exclusive, surrounds the windshield for tremendous extra strength—where you need it most. Result: SAAB is as safe or safer than most large cars.

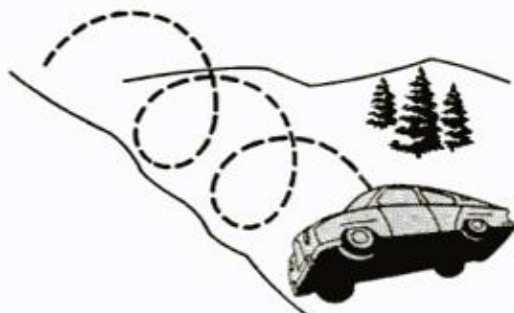

SAAB HAS BEEN SAFETY TESTED the hard way. It was rolled down Scandinavian ski slopes. Its basic over-all reliability has been proved in laboratory tests which simulate the roughest driving imaginable. Purpose: to make SAAB one of the safest cars you can drive. On the basis of test results, for example, SAAB provides as standard equipment such safety extras as: collapsible steering wheel, safety-padded dashboard and visors, positive locking seats, shatterproof glass in every window, and safety belt attachments.

that it has a 24,000-mile/24-month written warranty*

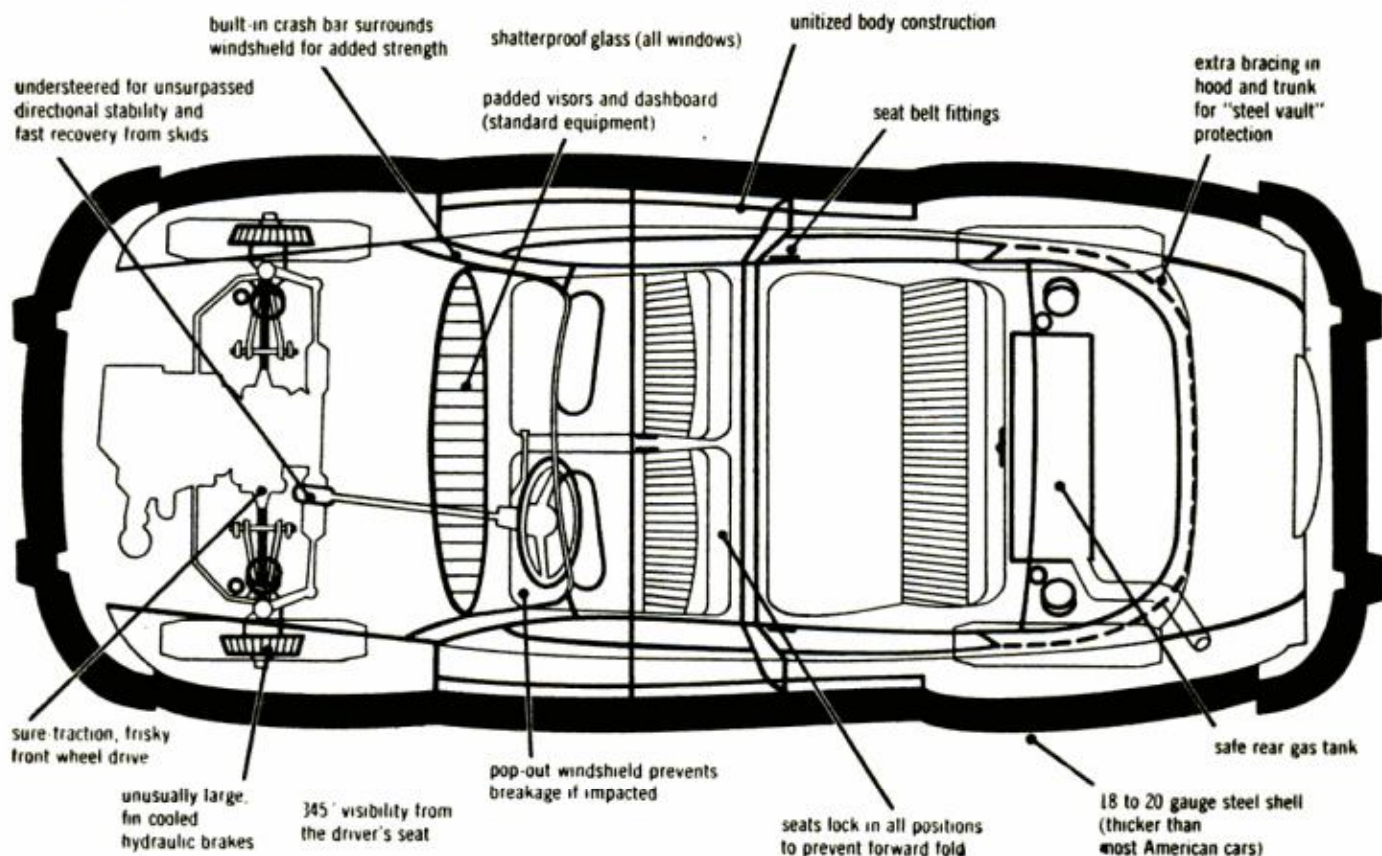

Take a critical look at SAAB safety

Aircraft reliability and performance standards are blended with an entirely new approach to over-all automotive design in the Swedish SAAB 96. This car was built to be better and safer, not different... built by one of Europe's leading aircraft manufacturers... built

for those who enjoy mechanical excellence, technical uniqueness, and extraordinary craftsmanship.

A critical look at *all* the facts and specifications will prove that SAAB is unquestionably one of the world's best engineered cars.

*Engine, transmission (3- or 4-speed gear box available), and differential have a written warranty for 2 years or 24,000 miles.



\$1895 P.O.E. (little enough for one of the world's best engineered cars)

Arrange a test drive at your nearest SAAB dealer. Or write for more information—and the SAAB North American Road Atlas, a 64-page comprehensive travel guide valued at \$1.00, but yours for only 25¢ to cover postage and handling. SAAB Motors, Inc., Dept. 512, 405 Park Avenue, New York, New York.



SAAB MOTORS, INC. — NEW YORK • NEW HAVEN • JACKSONVILLE • ST. LOUIS

DECEMBER 1962

199

UHF-TV

(Continued from page 82)

and the hills of Pennsylvania, have both solved the problems of telecasting on these upper frequencies under diverse conditions.

Stations in the flat South Bend-Elkhart and Fort Wayne areas installed higher transmitting towers, and bunched them together on antenna farms so the home viewers had to point their receiving antennas in only one direction to get all available UHF channels. When the towers had been separated, viewers had to rotate their antennas and point them at each transmitter to get best possible reception from each.

Stations in the hills and valleys of Scranton and Wilkes-Barre combined extra-powerful transmitters and hilltop antennas to push signals into almost every nook and cranny of that up-and-down region. And those few nooks and crannies that got bypassed were filled in by community cable systems that set their receiving antennas on the nearest hill and fed the signals to the viewers.

In each area, after more than six years of experience, the transmitters are stronger, the signals are better, the reception is more efficient, the sets are improved, and the

servicemen are now more familiar with UHF and all its problems and solutions. Most of all, the viewers themselves have expressed almost total satisfaction with what they have been receiving.

Here's more on these cable systems.

They consist of large and privately owned receiving antennas, some set on mountain tops, that invariably get better reception than the average individual home antenna. Individual viewers then subscribe to the service, pay a monthly fee, and get their reception, via cable, from this one, mammoth master antenna.

One advantage, of course, is better reception, especially in fringe or difficult receiving areas, such as communities in hilly country. Another advantage is that the community system often gets special programs not shown over regular station and network television. Subscribers in Ithaca, N. Y., for instance, sat at home recently and watched the Patterson-Liston heavyweight-championship fight, a fight shown elsewhere by theater television.

Analyzing an Egg-Laying

You might wonder, if UHF has so much promise, why didn't it grow naturally?

Apparently it needs artificial irrigation. The Federal Communications Commis-

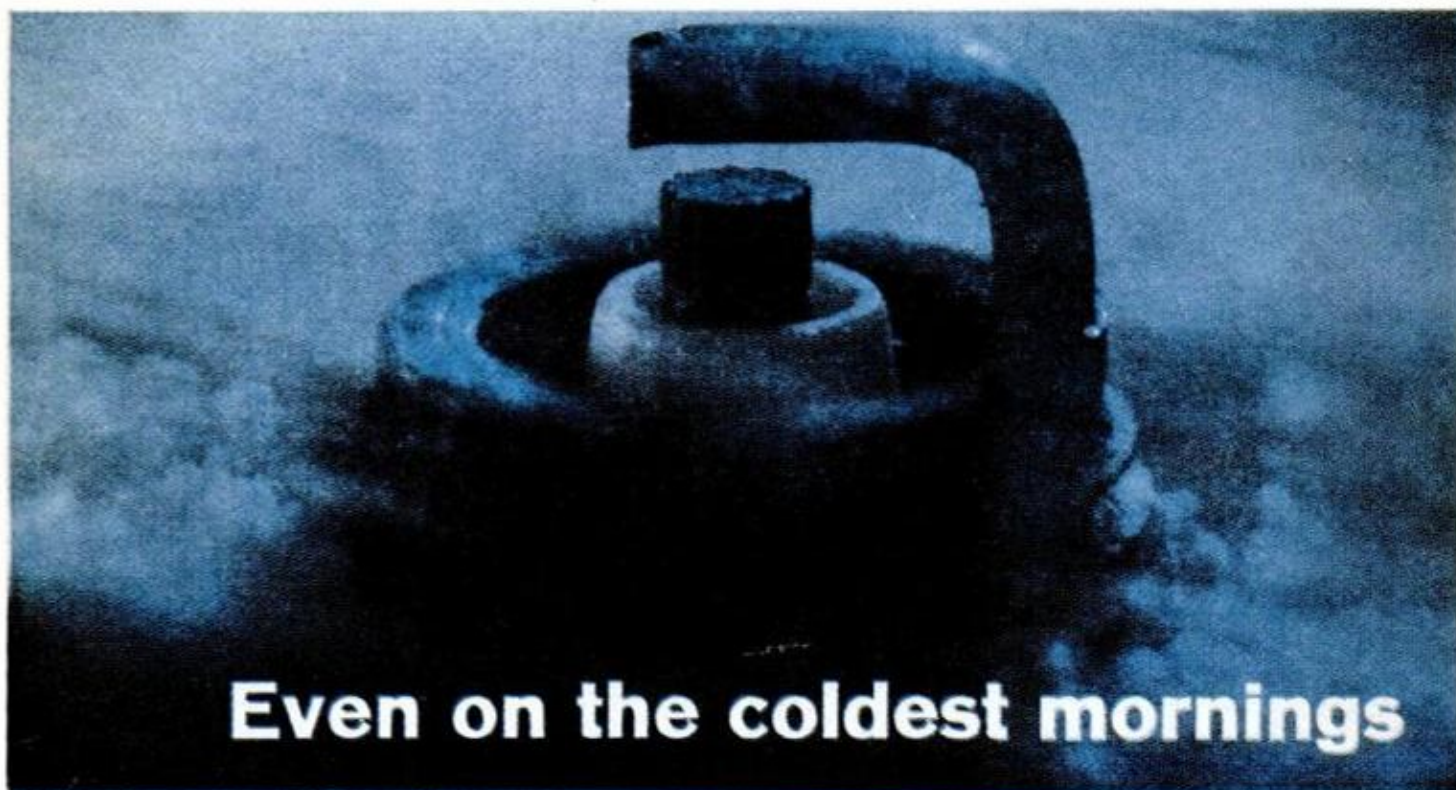

Even on the coldest mornings

Regardless of the weather, you get fast starts with AC Fire-Ring Spark Plugs. AC's potent spark provides the punch to get maximum power from every drop of gasoline. What's more, the searing heat at the exclusive AC tapered insulator tip burns away harmful carbon deposits before they have a chance to form — the insulator

sion, which controls the airways on behalf of the people, authorized the original 12 VHF channels in 1945. Even then, experts in and out of government predicted that these would not be enough. So in 1952 it authorized another 70 UHF channels.

The offer laid an egg. More than 1400 UHF stations were licensed by the FCC, but over the years these shrank to about 100 stations. VHF, meanwhile, grew.

The big bugaboo was that up to 1952 all television sets were made for VHF reception only. When UHF was created, most areas were saturated with VHF stations and UHF just didn't sell.

The viewers didn't buy the more expensive all-channel (VHF and UHF) sets because there weren't enough programs to watch, and there weren't enough programs to watch because there weren't enough viewers to watch them. And the advertisers weren't going to sponsor programs that nobody was going to watch. So, except for isolated areas, UHF died a natural death.

This is where the FCC stepped in. Technically, the new law forbids the interstate shipment of television sets that are unable to receive all channels—both VHF and UHF. But this is just a cute way of forcing

TV set manufacturers to start making all-channel sets exclusively—it would be foolish for each manufacturer to set up 50 factories in 50 states to make VHF-only sets just so they wouldn't have to ship them over state lines.

So, once the VHF-UHF sets are on the market, broadcasting on UHF might finally become more attractive, both to broadcasters and advertisers. And once the broadcasters and advertisers start putting on programs, owning a VHF-UHF set might become more attractive to the viewer.

Has the federal government the right to force UHF on broadcasters and public?

Whether it has or not, at this point it's irrelevant. The law exists and the electronics industry, while it may issue pious protests about government regulation, might also be secretly happy because it opens up a market for new antennas.

Also, potential broadcasters who were unable to get licenses for the saturated VHF channels, have 70 new channels to choose from. And more competition from UHF stations may well lift what has been called the "vast wastelands" level of television programming.

(Continued on page 202)

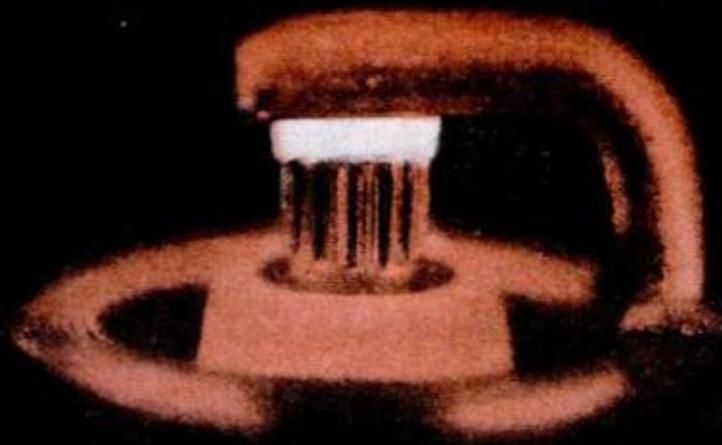

ACs give you hot starts

AC SPARK PLUG  THE ELECTRONICS DIVISION OF GENERAL MOTORS

actually cleans itself. Then there's AC's exclusive precision-ground knurled center electrode. Its sharp edges give you a crisper, more evenly distributed spark for more power and increased economy. The next time you install a new set of spark plugs insist on ACs. The Hot Tip is just the ticket for fast starts on those cold days.



THE POCKET SIZE MACHINE SHOP Dremel MOTO-TOOL

Handiest tool you'll ever own. Moto-Tool's high speed (27,000 rpm) is ideal for precision grinding, drilling, polishing, carving, engraving, deburring, sharpening. Does fine detail work with pin-point accuracy. Eliminates time consuming hand work, gives the finished job a professional look. Weighs only 13 oz. — handles easily as a pencil. Fastest, most powerful tool of its kind. Widely used by tool and die makers, model builders, gunsmiths, repair men, schools



No. 2 Moto-Tool only\$19.95
No. 2 Moto-Tool Kit..... 29.95
(Incl. No. 2 Moto-Tool & 23 assorted accessories in steel case)

NEW HEAVY DUTY NO. 3 MOTO-TOOL

New high torque motor designed for industrial use. Same features as No. 2 plus 50% increase in power. Weighs only 18 oz. Complete with 1/4" and 3/32" collets and finger grip in steel case...\$29.95

SEE YOUR DEALER OR WRITE FOR CATALOG
DREMEL MFG. CO. DEPT. 112M, RACINE, WIS.
QUALITY POWER TOOLS SINCE 1934

UHF-TV

(Continued from page 201)

So, even if a legal protest is tried in the courts, it might be some time before any decision is made, and by that time UHF should be pretty well established.

Right now, the future of UHF looks good.

The controversy over government intervention might die a natural death, and the controversy over the advantages and disadvantages of VHF and UHF might be resolved, in time, by the happy marriage of both—or by the emerging dominance of UHF. Advocates in and out of the FCC would like to see this day.



VHF, UHF KNOBS usually differ. VHF knob jumps from notch to notch. UHF knob is dialed smoothly

The beautiful picture possible on UHF is probably its greatest attraction, and some predict that color television will come into its own on the higher frequencies.

Others see a real breakthrough in programming, with greater potential for educational television, live telecasts of many more sports events, municipal events (city council meetings, police and fire work), even live Broadway shows and first-run movies, plus foreign-language programs for minority groups.

There are certainly plenty of channels available for this now. With all these new channels, is there a chance that new national networks will grow to challenge the three big networks?

The boys over at ABC, CBS and NBC lie awake nights thinking about this. ★ ★ ★



THERE'S A REMARKABLE DIFFERENCE IN SPRAY-O-NAMEL[®]

For decorating, remodeling, protection, or hobby work, no other aerosol has near the quality of new Spray-O-Namel. Complete, super-opaque coverage in one coat; super fast drying in less than five minutes. Goes twice as far as ordinary spray paints. See the difference, feel the difference for yourself.

WORTH DOING WELL?

WORTH SPRAY-O-NAMEL[®]

At quality paint and hardware stores

ILLINOIS BRONZE POWDER CO. • CHICAGO 16, ILL.

Sensitive Sniffers

Whatever odors a dog gives off, his sense of smell is about 10,000 times better than his deodorant-protected master's.

Recent tests showed that dogs can detect human odors outdoors as long as two weeks after the person has left the scene. Indoors, they can detect them up to six weeks.

In the tests human fingerprints were made on glass slides and stored both indoors and outdoors, along with slides which no human had touched. In every case the dogs could spot the difference.

They were weaker in detecting such pungent odors as clove and anise which man detects easily.

Transmit Light Beyond Horizon

Light and infrared signals can be transmitted and received at distances up to 200 miles even when the transmitter and receiver are at sea level, according to studies made by the Naval Research Laboratory.

The light and infrared signals are indirectly transmitted and received because they are scattered by tiny, aerosol-like particles in the earth's low atmosphere. Infrared is superior to visible light because it is not scattered as much.

A high-intensity xenon flash tube was used as a projector and an infrared sensitive photoelectric cell as the receiver.

Air Source for Spacemen

One idea for supplying exploring spacemen with oxygen has resulted in a mouse going 80 hours, at a simulated altitude of 75,000 feet, without breathing any oxygen other than that made when the carbon dioxide and water vapor of its breath reacted with a handful of potassium superoxide to release oxygen.

In the experiment at the Lockheed Missiles and Space Co., Sunnyvale, Calif., the one-ounce mouse was kept in a bell jar. It apparently suffered no ill effects. The mouse required an ounce of potassium superoxide for each 20 hours in the cell. A 150-pound astronaut, thus, would use 47 pounds of material in the same time.

● A diamond, nature's hardest known substance, could be even harder. Since the atoms in the carbon molecule of a diamond are loosely arranged, less than half the available space is used.

If the unused space were occupied by more atoms, as in hard metals, the density of the diamond would be increased, and its hardness would be much greater.



FINE WISS® GARDEN TOOLS FOR CHRISTMAS

Now! Cut toughest grass with ease with these floating blade, mechanically assisted power Wiss/Wizz® 711-G Grass Shears (Boxed). Hardened, hand-edged blades, honed to lasting keenness. Only \$3.25 with molded comfort grips. At hardware & garden supply stores.



Hedge Shears No. 8-D \$7.95
Exclusive tubular steel handles with special Wiss grips and new neoprene shock absorber make this the easiest, fastest cutting hedge shears ever.



Pruning Shears No. 708 \$3.25
Powerful 8" size. Chrome plated. Makes one-hand pruning easy. New latch speeds up light pruning. Molded non-slip grips. 7" model No. 707 only \$2.75.

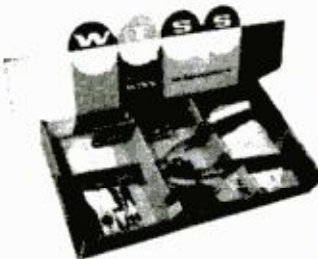

Lawn, Hedge and Shrubbery Kit No. GT-101 \$15.95
Everything the gardener needs in one handsome gift package. Grass shears, hedge shears, pruning shears shown above plus pruning guide, garden gloves.

J. WISS & SONS CO., NEWARK 7, N. J.

World's Largest Manufacturer of Shears, Scissors, Pinking Shears, Skalloping Shears, Metal Cutting Snips and Garden Shears

REMOVE SNOW FASTER with **MONARCH** Power Hydraulic Controls

Don't delay! Now, before winter comes, install a Monarch Power Hydraulic Control on your snow removal equipment. Instant snow plow action—raise, hold or lower—right from the cab with the flick of the wrist. Thousands in use!

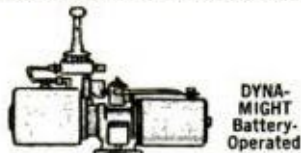
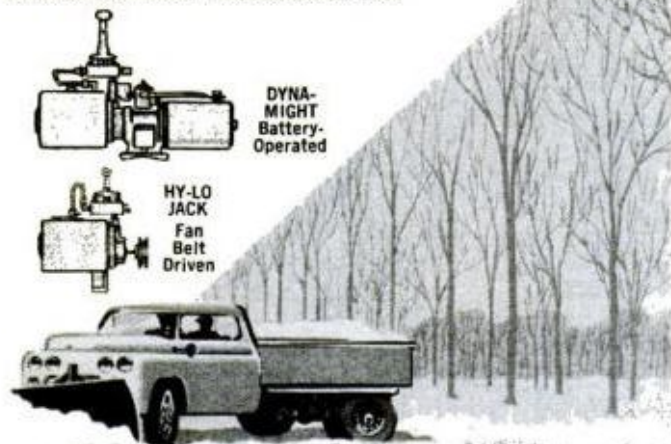

DYNA-
MIGHT
Battery-
Operated

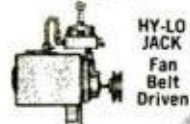

HY-LO
JACK
Fan
Belt
Driven

A Monarch Control can be quickly installed.
See your dealer. Write for illustrated folder.



MONARCH ROAD MACHINERY COMPANY
1363 Michigan St., N.E., Grand Rapids 3, Mich. U.S.A.

STOP WATER DAMAGE...



Wood
Plywood
Shingles
Asbestos siding
Concrete blocks
Concrete
Mortar
Stucco
Linoleum
Plaster
Brick
Paint
Wallboard
Tile
Canvas
Leather
Fabrics

Prevents warping, swelling, mildew, mold,
water stains, seepage, dampness, rot.

Keeps moisture out 5 years and longer.

Use on all woodworking jobs, boats, patio furniture, planter boxes, shutters, screen doors, window sash, shingle roofs. Stops seepage in basement walls, concrete silos, foundations. Waterproofs canvas, tarps, tents, awnings, leather boots, shoes, outdoor clothing. Won't harden or crack leather or fabrics. Perfect underseal for oil base or alkyd paints. Deep penetrating, colorless. Apply by brush, spray or roller. At paint or hardware stores or order direct. 16 oz. spray can \$1.89, Qt. \$1.75, Gal. \$5.35, 5 Gal. \$25.25, ppd., tax incl. Send check or money order to E. A. Thompson Co 1355 Market St., San Francisco 3, Calif. No COD's please. (Since 1929.) Dealer and jobber inquiries invited.



BUY GREAT NECK HAND TOOLS

... for long-lasting performance



GREAT NECK SAW MFRS., Inc.

MINEOLA, N. Y. — SEE YOUR LOCAL STORE

Constantine's Catalog & Manual for WOODWORKERS

ALL-NEW! 1963 Edition. More than a catalog—a manual too! 130 pages—exciting new items! Since 1812, world's most complete source for rare imported & domestic woods at rock-bottom prices. Inlays, bandings, carvings, hard-to-find hardware, inlaid wood picture kits, new brass hardware, etc. Plus tools, plans, projects. Enclose 25c for postage and mailing. Write for Catalog and Manual now.
ALBERT CONSTANTINE AND SON, INC.
2050 Eastchester Rd., Dept. T-5, New York 61, N. Y.



G E A R S

In Stock — Immediate Delivery

Gears, speed reducers, sprockets, thrust bearings, flexible couplings, pulleys, etc. A complete line is carried in our Chicago stock. Can also quote on special gears of any kind. Send in your blueprints and inquiries.

Send for Complete Catalog No. 10
CHICAGO GEAR WORKS
440-50 N. Oakley Blvd., CHICAGO 12, ILL.

INVEST IN



make your own Gems 36⁵⁰ FOR

The Gem Maker comes complete with all necessary equipment, including a super-charged diamond blade for sawing, and all the wheels for grinding, shaping and polishing; also complete instructions. The complete equipment as shown, less motor and belt for only \$36.50, f.o.b. Burlington, Wisconsin. Write today for information and literature.

B&I MANUFACTURING CO.
Dept. P, Burlington, Wis.

Works
in
seconds!



Loosens Rusted Bolts
nuts, screws, "frozen" parts!

**LIQUID
WRENCH**
SUPER-PENETRANT

The super-penetrating rust solvent that quickly loosens rust and corrosion.

AT ALL HARDWARE
AND AUTO STORES
RADIATOR SPECIALTY COMPANY
CHARLOTTE, N. C.



POPULAR MECHANICS

It seems there's no end of uses for



made with aluminum powders from **ALCOA**

Atomized aluminum metal in putty form, DURO-PLASTIC Aluminum is a home repair kit in a tube. According to users, it seals, solders, repairs—adheres to virtually any surface. Made by Woodhill Chemical Co., Cleveland, Ohio, with Alcoa® Aluminum Powders, DURO-PLASTIC Aluminum is applied like paste, dries to a metal-like hardness in three hours. Users write that it fixes anything. Here's a sampling from their letters:

Household — "I've used DURO-PLASTIC Aluminum to rescue leaky utensils, solder toys, steady pot handles, hush plumbing leaks, tighten tool handles, you name it." —Los Angeles housewife.

Car Radiator — "DURO-PLASTIC Aluminum sealed my radiator after a fan belt went through it . . . saved a \$15-\$20 charge at a shop." —Pennsylvania motorist.

Fragile things — ". . . repaired antique vase with DURO-PLASTIC. It enabled me to outline skillfully, seal securely, enhance the beauty of the design." —El Paso aesthete.

Trailers — ". . . waterproofed the seams of our house trailer . . . very easy to apply . . . not a leak since." —Seattle trailer owner.

Art — "I dribble it on wire-sculpture figures for interesting effects. It provides creative activity for children, yet is challenging to adults." —Canadian hobbyist.

Gutters and Downspouts — "It quickly repairs gutters and downspouts, and solders gutter joints." —California apartment manager.

Plumbing — "Frequently I use DURO-PLASTIC to save customers' money. It's standard equipment on my service truck." —Knoxville master plumber.

Alcoa does not make aluminum putties, but Alcoa Aluminum Powders are used in all the best brands. Cold solders are easy to use; require no tools, heat or flame. They adhere to metal, wood, plastic, glass or concrete . . . are not affected by water, oil or gasoline . . . can be burnished to a high luster or even painted. Send coupon for more information.

Aluminum Company of America
1743-M Alcoa Building, Pittsburgh 19, Pa.

Please send more information on cold solders made with Alcoa Aluminum Powders.

Name _____

Address _____

City _____ Zone _____ State _____

Entertainment at Its Best
ALCOA PREMIERE with Fred Astaire as Host
Tuesday Evenings, ABC-TV

ALCOA ALUMINUM

PIGMENTS, PASTES & POWDERS

DECEMBER 1962

205

SANDS TWICE AS FAST

as any other sander at its price

Weller® Hi-Powered Sander

Powerful performance at low price, thanks to Weller's new heavy-duty, 4.8 ampere reciprocating motor. 14,400 strokes of $\frac{1}{32}$ " a minute and big 26 square inch sanding plate get jobs done fast. Never bucks or scars the surface. Sands with grain for smooth finish unobtainable with disc and orbital sanders. Safest sander available. Housing is high-impact plastic. No exposed metal parts can be energized. No electric shock hazard. Trouble-free. UL approved. Model 77.

WELLER ELECTRIC CORP., Easton, Pa.

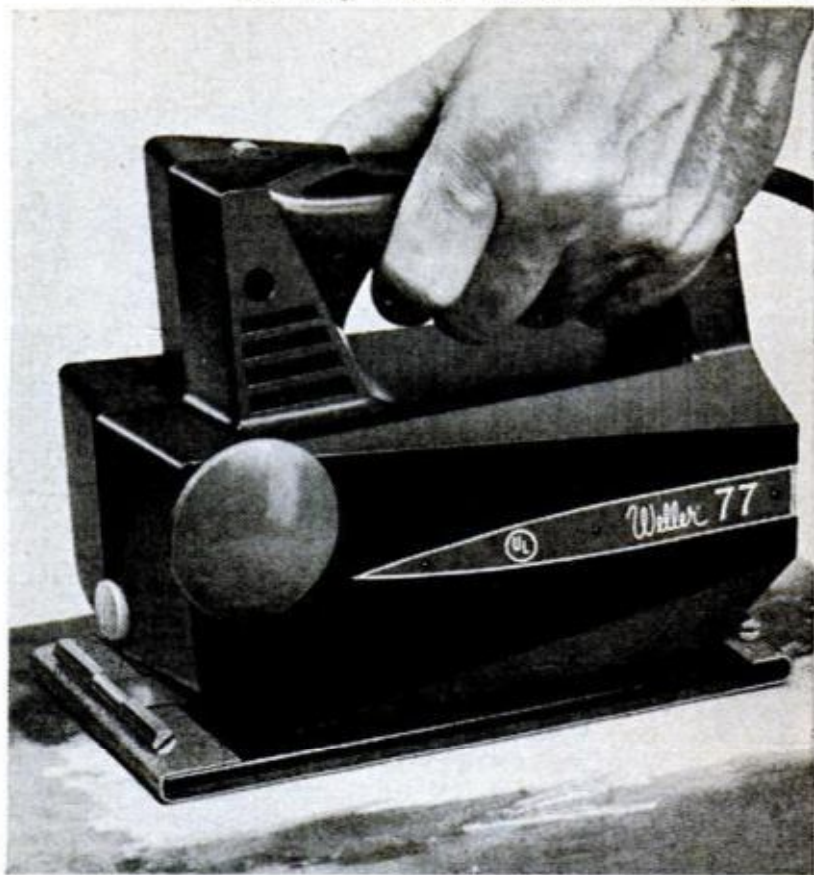



Brand New Jet Star for '63
... one of five 15 ft.
runabouts

STARCRAFT

gives you the widest choice!

38 fiberglass and aluminum cruisers, runabouts and fishing boats—Pick your favorite for price, style and use. Choose from three cruisers, five 15 ft. runabouts, four 16 ft. runabouts, 19 fishing boats, and more. Look them over in the new 1963 Starcraft catalog. Write today for your free copy.

STARCRAFT BOAT COMPANY
Dept. PM-1 • Goshen, Indiana

EVERLITE* World's **THRIFTIEST** Light Plants

(Item 869-10T)

**NEW TRANSISTOR ALTERNATOR
REPLACES GENERATOR**



Now a Service Free Light Plant built with a transistorized alternator. Offers 30% greater efficiency—more power for less fuel. Terrific service life—no brushes to arc and burn. No more commutator to wear, no collector ring trouble. And best of all it costs no more to "go modern with Everlite." Thrifty 1000 watt, 115v. AC plant powered by a rugged easy starting 4 cycle engine—leader priced. Model 869-10T. Wt. 65 lbs. as illustrated

\$179.50

*Trade-Mark Registered

All sizes available—can finance. Write for catalog. Special models for public utilities—Approved for Civil Defense. Write.

MASTER MECHANIC MFG. CO., Dept. A-122, Burlington, Wis.

Southern Customers write Dept. A-122, Box 65, Sarasota, Florida

MARCH
Give for the life of a child
OF DIMES
POLIO • BIRTH DEFECTS • ARTHRITIS
AND THE SALK INSTITUTE

"Rubber Bands" Circle Earth

The Earth's magnetic field varies from night to day. The changes can be explained by visualizing the magnetic field as invisible lines of force encircling the Earth from pole to pole. These lines act like extremely long rubber bands, stretching up to 18,000 miles above the surface, says Dr. G. J. F. MacDonald, University of California, Los Angeles.

The invisible "rubber bands" vibrate when plucked with a characteristic frequency of vibration called a period. During the day, the part of the magnetic field facing the sun is pushed in while the part facing away from the sun is dragged out. Therefore, the periods during the day are shorter than those at night.

DECEMBER 1962

NOW
LUFKIN
**WHITE CLAD® TAPE RULES ARE
 EASIER THAN EVER TO USE!**

NEW END HOOK won't "climb" off work when blade is held at an angle. Self adjusting. Slides to compensate for hook thickness on both hook-over and butt-end measuring.

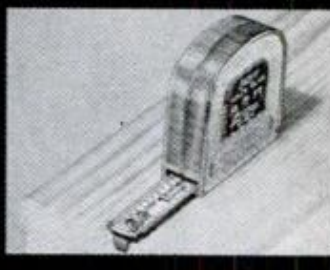

FREE NEW BELT POUCH for convenient carrying. Made of strong, light-weight plastic.



Plus
EASY-TO-READ RED AND BLACK MARKINGS protected with new, super-durable Lufkote finish.

MEZURALL® TAPE RULE is pocket size for quick, handy measuring. 6, 8, 10, 12-ft. lengths, 1/2-in. blades, 6-ft. **\$1.19** (Also available in 3/4-in. heavy-duty 12-ft. blade.)



MEZURMATIC® TAPE RULE has press-button blade return. 6, 8, 10, 12-ft. lengths, 1/2-in. blades, 6-ft. **\$1.49** (Also available in 3/4-in. heavy-duty 10-ft. and 12-ft. blades.)



Look for Lufkin measuring tools on display wherever you buy hardware or building supplies.

Measure for
 measure,
 the finest made

LUFKIN
 SAGINAW MICHIGAN

Dr. Grabow Continentials



The Dr. Grabow
Symbol of
Quality

World's Finest
Imported Briar

Starfire ... \$ 3.95

Viscount ... \$ 5.00

Eldorado ... \$10.00

Pipes shown available
in all three price ranges.

Dr. Grabow Pipes
need no breaking in.
They are mechanically
pre-smoked and ready for
you to enjoy the most in rich,
sweet, cool, satisfying smoking.

Write for free booklet
Dr. Grabow Pre-Smoked Pipes • Greensboro, N. C.



Portable Light in a Tube

Encased in a tough plastic tube, a new fluorescent inspection lamp lights hard-to-get-at places. Priced at \$18.50, the lamp is made in Denmark and sold in the U.S. by Technico, 122 Van Brunt St., Brooklyn 31, N. Y. It has a 24-foot cord.

Meteoroid Hazard on Moon Trip

Spaceships traveling to the moon will run the risk of being punctured by meteoroids and perhaps seriously damaged. Estimates on the probability of being hit range from once in every 11 days to once in every 57,000 days. The trip to the moon will take 14 days.

The probability of being hit depends on meteoroid distribution, velocities, and spacecraft structures, report Drs. C. Robert Nysmith and James L. Summers, Ames Research Center, Moffett Field, Calif. Scientists believe that effective shielding can be designed to lessen the meteoroid hazard.

Noisemaker Maps Ocean Floor

A noisemaker to study the ocean's floor has been developed by Dr. Harold E. Edgerton at the Massachusetts Institute of Technology. Called the "boomer," the instrument will take the place of explosive charges for mapping and seismic studies of sediment layers on the ocean floor.

The "boomer" consists of a flat coil between two aluminum plates. When a current is sent into a coil, the plates fly apart producing a small explosion. Reflections of the sound are picked up with seismic apparatus towed behind a ship and used to record the ocean bottom's profile.

The 'All-Purpose' Oil For Home Workshops

Cleans • Lubricates • Prevents Rust

3-IN-ONE® OIL

REGULAR—OIL SPRAY—ELECTRIC MOTOR

FOR TOP VALUE... INSIST ON

Folding Wood RULES

Steel White TAPES
with belt holsters
6 ft. to 100 ft.

Evans RULE CO. 400 Trumbull Street, Elizabeth, N. J.

HANDIEST SAW YOU EVER HELD!

Cuts Wood -- Metal -- Plastic -- up to 4 1/4" thickness
with Finger-Tip Control



Just \$14.75 including 6 assorted blades, lubricant and wrench

GRIP-TORC Saw gives YOU control of the blade because of its right angle pivoting on electric drill. Compact 6 1/4" length gets at hard-to-reach places . . . cuts squares, circles, bevels, and close to wall or floor. Reversible blade for right or left hand use, with push or pull movement. Provides unexcelled cutting speeds. Unconditionally guaranteed. In Cal. add 4% tax.

**GRIP
TORC**

tools 17480 SHELburnE WAY
LOS GATOS, CALIFORNIA

NO C.O.D.'s F.O.B. Los Gatos (postage prepaid if cash with order). Wt. 2 1/2 lbs.

● **The longest, driest coastal desert in the world** stretches along the Pacific shore of Peru and northern Chile. Several weather stations in the area have recorded no rainfall for 20 years. However, brief torrential rains sometimes fall in spots and melt clusters of baked-mud houses.

● **The behavior of some animals may be contrary to their reputations.** In battle, a wolf will not kill another wolf that offers its throat in a gesture of submission; but a dove, the symbol of peace, will ruthlessly peck a helpless opponent to death.

**FREE
FOR
'63**

**LAFAYETTE
RADIO
ELECTRONICS**



**1963 CATALOG
NO. 630**

388 GIANT SIZE PAGES

**The Largest Catalog in
our 42-Year History**

**It's New—It's Big—
It's Better Than Ever**

**It's from the "World's Hi-Fi
& Electronic Shopping Center"**

Here it is—the exciting, all-new 1963 Lafayette Catalog. 388 giant sized pages—everything in hi-fi and electronics for the audiophile, technician, hobbyist, student, engineer and serviceman. Thousands of items at lowest prices.

Now—buy the Easy Way with Easy-Pay.
No money down . . . up to 24 months to pay.

LAFAYETTE LOCATIONS

SYOSSET • JAMAICA • NEW YORK CITY • BRONX • SCARSDALE
NEWARK • PLAINFIELD • PARAMUS • BOSTON

MAIL THE COUPON FOR YOUR FREE CATALOG

Lafayette Radio, Dept. LL-2
P.O. Box 10, Syosset, L. I., N. Y.
Rush My FREE 388 Page 1963 Lafayette Catalog

Name _____

Address _____

City _____ Zone _____ State _____

PRECISION FORMING AT ONE THIRD THE PRICE

A new lightweight, economical line of Shears, Brakes, Rolls for industry and home workshops . . .

Here's the biggest value in metal machinery today. All the precision, performance, convenience, speed and versatility you want at one third the cost. Made of aluminum alloys instead of bulky cast iron, Kwik-Form tools are one third the weight, yet provide the rigidity and strength for any product. Will perform wonders in light industry, great for engineers and designers, perfect for home workshops.

PRECISION SHEAR



Designed for extreme accuracy and closest tolerances. Steel alloy blade will cut steels, plastics, leather, rubber, chrome, brass, copper, aluminum and mica. Table is slotted for a cross gauge. Maximum shearing width 12 inches. Will cut up to 20 gauge mild steel. **\$85**

PRECISION BOX BRAKE



Easy to operate for any forming or duplicating operation. Can be used as a straight brake, or by cutting up the forming nose, it can be converted into a forming brake. Forms boxes up to 12 inches. 20 gauge mild steel. **\$50**

All parts are unconditionally guaranteed for one year with the exception of the shear blade and the forming nose on the brake.

PRECISION ROLL



You can literally make sheet metal do what you want it to with this quick forming tool. Perfect circles if you like. Or bend a sheet of metal at any point in a wide variety of shapes, or duplicate parts. Maximum forming width, 12 inches. Roll diameter, 1 inch. **\$35**

Save \$20! Buy as set!

You save \$20 when you buy Kwik-Form tools as a set. Three pieces only **\$149.95**

Choice franchise territories available. Write for information.

Send check or money order and we prepay freight. For COD orders send \$25 deposit. Freight and collection charges added.

KWIK-FORM TOOL CO.
201 N. 4th STREET • PHILADELPHIA 6, PA.

NEW HYDRAULIC CYLINDERS
2000 PSI air-oil FOB KC

Bore	stroke	D. shaft	long	Double Action	Weight
1"	1 1/2"	1 1/2"	6 1/2"	1 1/2 lbs.	\$ 2.75
1 1/8"	3 1/2"	1 3/8"	13"	6 lbs.	\$ 3.75
1 1/4"	2 1/2"	1 1/4"	3 1/2"	6 lbs.	\$ 7.95
1 1/2"	8 1/2"	1 1/2"	13"	8 lbs.	\$ 6.95
1 3/4"	4 1/2"	1 3/4"	10"	3 1/2 lbs.	\$ 2.95
1 7/8"	2 5/8"	1 7/8"	3 8/8"	1 1/2 lbs.	\$10.95
2"	4 1/2"	2"	13"	5 lbs.	\$ 7.75
2 1/4"	1 3/4"	1 1/4"	30"	1 1/2 lbs.	\$14.50
2 3/8"	1 3/4"	1 1/4"	30"	1 1/2 lbs.	\$14.75
3 1/8"	8 3/8"	1"	20"	12 lbs.	\$12.95
3 1/4"	10"	2 1/8"	23"	29 lbs.	\$15.50
*3 5/8"	2 1/2"	2 1/8"	41"	50 lbs.	\$32.50
4 1/8"	8"	2 1/2"	22"	35 lbs.	\$24.50

Plus 15% on P.P. *good condition

Arc Stabilizer for R-1, P-1 or G-1... \$12.00
P-1 gen 200 A \$15.50, R-1 300 Amp \$16.50,
Gen. 1250 watt AC 200 Amp DC... \$17.50
Throttle Solenoid \$7.95

Accessories Kit For Arc Welder for above generators has helmet, gloves, elect. holder, volt reg. rheostat, voltmeter, Gr. Clamp, switch, 30' cable & ACDC gen with Accessories \$38.50
R-1 300 Amp. Gen. with accessories kit plus reactor coil \$47.50

GENERAL SALVAGE CO. Check or M.O.
2922 E. 27 St., Dept. 112, Kansas City 27, Mo.

9 TON Hydraulic PRESS KIT
has new D.A. cylinder 3" x 10 1/4" bore x 10 1/4" stroke hyd. hand pump, 2500PSI, control valve, tank, hose & fittings, instr. incl. \$125.00 value sale \$57.50 (frame not incl.)

Hydraulic snow plow lift kit
has new D.A. cylinder 3" x 10 1/4" 1 stratopower pump .450 cu.in. 1400P.S.I. control valve, tank, filter hose & fittings \$80.25 value sale \$44.50

AUTOMATIC RETOOTHING
MAKES NEW PROFITS

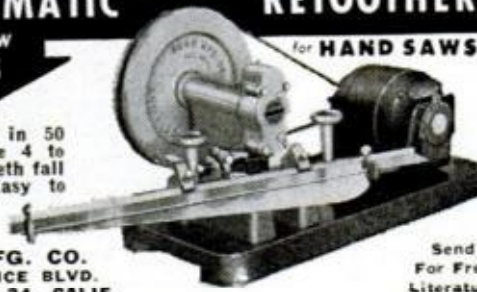

Cuts new teeth in 50 seconds—any size 4 to 16 points. Old teeth fall off as chips. Easy to operate. A perfect job.

BURR MFG. CO.
8933-D VENICE BLVD.
LOS ANGELES 34, CALIF.

Send For Free Literature

Ask For —

CHANNEL LOCK

THE HANDIEST PLIERS OF THEM ALL

TALK THRU ANY RADIO WITH THIS WALKIE TALKIE!

YOUR OWN POCKET SIZE RADIO STATION
Sends your voice to any car or house radio. Works up to 1-2 miles from car to car or 1-5 or more blocks house to house depending on local conditions. Just Push Button to Talk—No Complicated Hookups or Wires—Anyone can use it. Transistor powered by flashlight batteries. No License or Permits Needed. Guaranteed to Work. 1 yr. Service Guarantee. Should Last for Years! (cash, ch. mo) and pay postman \$9.95 C.O.D. postage or send \$12.99 for postpaid delivery. Ready to operate, with clear instructions. Order your Radio-Talkie today—Now! WESTERN RADIO, Dept. TPM-12, Kearney, Neb.



NEW CATALOG WOOD

Everything for the Craftsman
Over 1,500 Items
Finest Domestic and Imported Woods... Kits... Ornaments... Tools... Special Hardware... Tile.
LOW MONEY-SAVING PRICES
Stanley Power Tools — Big Discounts!



Workshop Supplies, Equipment
Send for Craftsman's NEW 182-page catalog... get big discount prices on Stanley Power tools! Finest kind-dried domestic and imported woods, wood and metal legs, ornaments. Over 1,500 items! Big values on tools, craftsman hardware, Mosaic Tile, upholstery supplies, lamp parts. **Glue injector.** Send 25c to help pay postage and handling.
Craftsman Wood Service, Dept. A12
2729 S. Mary St., Chicago 8, Ill.

MAIL COUPON NOW!

CRAFTSMAN WOOD SERVICE CO., Dept. A-12
2729 South Mary Street, Chicago 8, Illinois
Enclose find 25c. Rush new CRAFTSMAN Wood Catalog.

NAME _____
ADDRESS _____
CITY _____ ZONE _____ STATE _____

An Introduction to Wonderful Worlds for Young Americans!



One pound Uranium Equal to 2,600,000 pounds of coal

the Boy Scientist

A Space Platform May Look Something Like This

New Popular Mechanics Book Packed With Thrilling Facts and Fascinating Information

Get this thrilling Popular Mechanics book for every boy you know. In it, your own boy scientist can pore over the world-shaking discoveries in astronomy, physics, chemistry, sound, electricity, atomic theory and relativity. In the same thrilling pages, he can meet the greats of the world of science such as Galileo, Newton, Franklin, Faraday, Einstein and many others. With its help, he can participate in monumental discoveries by performing the many experiments which are suggested in the book and explained in word and picture.

The Spark That Opens Up a New World

Written by John Lewellen, noted writer of a dozen books on science and natural history, Preface by Dr. Wilbur Beachamp, Professor of Education, University of Chicago, who says "The Boy Scientist may well be the spark that starts some boy on the way to becoming a scientist and the Nation's need for scientists is very great."

Meet These Greats . . . Know Their Achievements

Galileo . . . the first modern scientist
Newton . . . the law of gravity and famous three laws of motion
Boyle . . . and how gases behave
Archimedes } . . . and
Pascal } Liquids
Bernoulli }
Huygens . . . and light
Benjamin Franklin . . . and electricity
Bequerel . . . radioactive fog
Einstein . . . theory of relativity
Rumford . . . heat
Mersenne . . . the laws of sound
Tomorrow . . . will bring new discoveries

★

Prepared in the famous Popular Mechanics easy-to-read and easy-to-understand style. Adults too, will find this a fascinating book.

Finest Gift for Boys Use "Money Back" Coupon

Is there a boy in your family? Then get him the Boy Scientist. It could be one of the most important books he ever reads. Want to send the supreme gift to some boy you know? Then give him the Boy Scientist too. There is no finer gift for any occasion. Sent postpaid to any address for only \$3.99. Order on Money Back coupon now. If not immensely pleased with the book return in 5 days and the entire purchase price will be refunded.



Library Cloth Binding
6 3/4 x 10 In.
264 Pages
277 Illustrations

Use This "On Approval" Coupon

POPULAR MECHANICS PRESS
Dept. 1262, 740 N. Rush St., Chicago 11

Send at once _____ copies The Boy Scientist, \$3.99 each. I understand I may return books in 5 days and you will refund full purchase price.

Remittance for \$ _____ enclosed. Send postpaid.

Name _____
Address _____
City _____ Zone _____ State _____

Bull's-Eye in Helmet Automatically Aims Helicopter Weapons

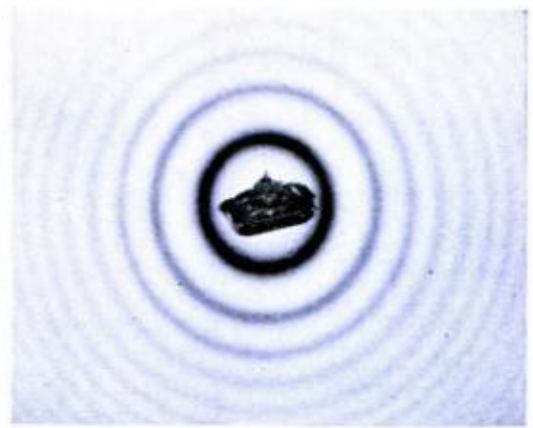

Army helicopter pilots can automatically aim their weapons just by looking at the targets and lining them up in a bull's-eye sight built into their helmets.

The weapons are controlled through mechanical pick-offs clipped to the helmet. They swing around when the pilot swings his head. This allows the pilot more time for handling the aircraft.

The system, developed by Sperry Gyroscope Co., is lined up before takeoff, but can be disengaged during flight and re-engaged just before use.

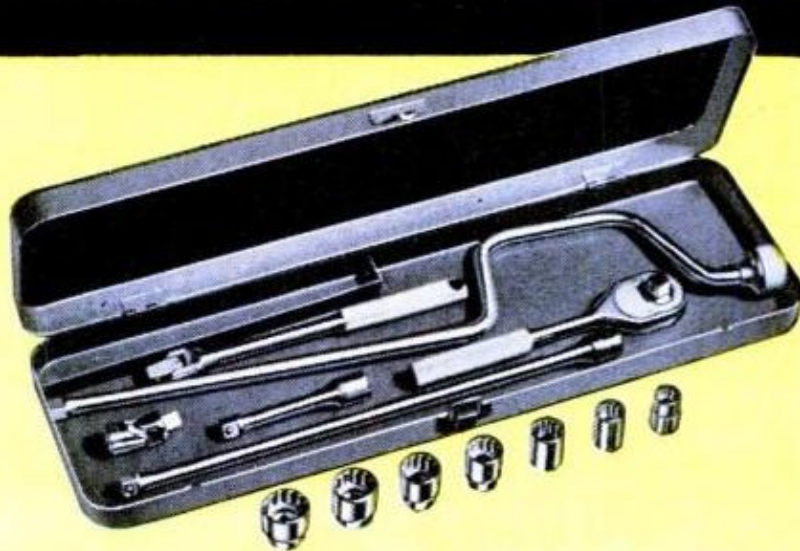

PROTO 3/8" DRIVE SOCKET SET NO. 5200AB—A beautiful basic socket set for the amateur or professional mechanic, with the most needed sockets, handles and attachments. All forged or hot formed in Protoloy® alloy steel for professional performance; heavy chrome plate; all guaranteed. Contents: Seven 12-point Sockets—3/8" thru 3/4" opening. 7" Ratchet. 3 1/2" and 12" Extension. 7 3/8" Hinge Handle. U-Joint. 16 7/8" Speed Handle. In Red Steel Box with extra space for other tools.

Get yours at your local Proto Hardware or Auto Parts Dealer

PROTO TOOLS
PROFESSIONAL QUALITY TOOLS

Division of Pendleton Tool Industries, Inc.

2202 Santa Fe Avenue, Los Angeles 54, California • 502 Allen Street, Jamestown, New York • 1702 Oxford East, London, Ontario, Canada

Now there's a plastic wood filler that gives professional results with do-it-yourself ease!



better buy **DURATITE**[®]

WOOD DOUGH

Molds like dough,
hardens into wood

Write for free Wood Dough folder

DURATITE Division 13, DAP inc., Dayton 31, Ohio

Map Antarctica's Mountains

A two-pronged expedition is now heading deep into the Antarctic to take a closer look at some of the icy continent's virtually unknown mountains during the brief southern summer months.

One seven-man team under geologist Dr. Arthur B. Ford of the U.S. Geological Survey will study the rock layers—heretofore seen only from the air—in the Patuxent Range of the Pensacola Mountains. The geologist will map mineral deposits, and look for meteorites and fossils. An expedition led by Dr. Ford last year discovered a fresh meteorite several hundred miles east of the Pensacolas. Fossil remains, if found, could date the formation of the mountain chain.

A second four-man party is preparing to map the mountains from Hallet Station west and from the Beardmore Glacier east to the Thiel Mountains. The team will travel nearly 2000 miles of unmapped country by helicopter and motor toboggan. They'll use a special radio mapping technique, in which radio signals will be bounced off 12,000-foot mountain peaks to record the exact heights of the rugged coastal mountains. The process will also give accurate distances between peaks for precise horizontal mapping of this virgin territory.

The geological and mapping expeditions are part of the fourth year of the Operation Deep Freeze studies of the Antarctic. Other scientific teams will continue explorations of the continent's glacier and ice formations, its upper atmosphere physics, and its biology, chemistry and weather.

Warm Blooded Bodies Vibrate

Tiny vibrations, detected in the bodies of mammals, may be the secret of regulated body temperature. Experiments indicate that the microvibrations, resulting from permanent, alternating muscle contractions, remain constant from birth to death.

Man's body vibrates with 7 to 13 impulses per second, even during sleep. The amplitude is increased by psychological shock, stress, and physical exertion and decreased by sedatives. Guinea pigs show impulses continue 50 to 70 minutes after the heart has stopped.

Because the vibrations are constant in warm-blooded animals and absent in cold-blooded animals, it is likely that they are the mechanism which allows mammals to maintain a precise body temperature despite outside temperatures, reports Dr. H. Rohrer, Institute of Psychology, University of Vienna.

16" size
0" to 4 1/4"
parallel jaws.

**BIGGEST
PLIER
MADE**

DIAMALLOY[®]

Ask for
HL 116P
Diamalloy
Groove-
Joint
Pliers

Sizes down to 4
in. Handiest tools in
your kit. Chrome finished.
"There is nothing finer
than a DIAMOND". Made
only by makers of famous
Diamond Wrenches and
Pliers.

Write for free tool catalog
DIAMOND TOOL
and Horseshoe Co.

DULUTH MINNESOTA EST. 1908 TORONTO ONTARIO

DREMEL MOTO-SHOP

Complete All-Family Power Work Shop

Dremel Moto-Shop is the first real multi-purpose workshop designed for the whole family. In one compact, portable unit you have a jig saw, disc sander, buffing wheel, bench grinder, and a flexible shaft machine. 5 power tools in 1 unit that do 1,001 jobs. For the kids it provides hours of constructive, creative recreation. It's invaluable to Dad, and even Mom, for hobby work and home maintenance. Moto-Shop is not a toy, but a professional-quality power tool with a ball bearing rotary motor. It's super-safe; cuts 1 3/4" wood, metal, plastics, etc.; sets up anywhere, can be carried from room to room. Outperforms heavier, more expensive jig saws. See your power tool or hobby dealer today.



JIG SAW



DISC SANDER



BUFFING WHEEL



BENCH GRINDER



FLEXIBLE SHAFT

FREE! Moto-Shop Catalog. Write Today!
Dremel Mfg. Co., Dept. 112-M, Racine, Wisconsin

Model 571 (jig saw with disc sander)... \$33.95
Model 572 (all attachments shown)... \$49.95

154

INCREASE HOME VALUE—MAKE NEEDED IMPROVEMENTS NOW



FOUL WEATHER DRIVING SAFETY

RITE OFF removes all dirt, oil and road film from windshields. One application is good for hundreds of safe driving miles. FOG OFF keeps inside of windshields fog free.

Regular \$2.95 Value
SEND TODAY ONLY \$1.99 POSTPAID
SCHRADER CHEMICAL CO.
(Since 1915)
P. O. BOX 426, ANTIOCH, CALIFORNIA

Is your wiring overloaded? Do you know how to figure the load on any particular circuit in your house? How can you tell if a blown fuse means an overload or a short circuit? January PM provides the answers in a good basic article on home wiring; shows you how to make an outlet-by-outlet, circuit-by-circuit check of the whole house. It's as good as fire insurance.

Keep Tools in Tip-Top Condition

Lubricate · Clean · Prevent Rust

3-IN-ONE® OIL

REGULAR—OIL SPRAY—ELECTRIC MOTOR

DECEMBER 1962

WAR SURPLUS AND OTHER BARGAINS SAVE UP TO 90%



HYDRAULIC PUMP & MOUNTING BASE

Pump has built-in pressure relief in head, positive displacement piston-type. Rated 1400 PSI @ 2 gal. per min. Continuous duty @ 1500 RPM. Rotates in either direction without adjustment. Base mounts directly to front flange of pump, has a 3/4" shaft with keyway bronze bushing and snap ring for either direct or pulley drive. Inlet & outlet size 3/4" pipe. Great for hydraulic presses, loaders, steering, etc. 9 3/4" long x 6" wide. Shpg. Wt. 12 lbs. Like new. Approx. GOVT. COST \$195. Terrific value. \$17.95.



DOUBLE-ACTION HYDRAULIC CYLINDERS

Can be air or oil operated. Ideal for shop, production machinery, hydraulic steering and 100's of other uses. Steel barrel aircraft quality, precision built. 7 3/4" stroke, 5/8" shaft, 1 1/4" bore, 15" overall length. Shpg. Wt. 7 lbs. per pair. Special AIRBORNE price — 2 for \$7.

AIR COOLED WELDING KIT — Contains Farouss F-2 generator (200 amps/30 V.D.C.) with built in fan. Also in kit — D.C. Voltmeter, Control Rheostat, Switch, 300 amp. Electrode holder, welder's gloves, adjustable welder's helmet, 30 ft. rubber covered welding cable and wiring diagram. All units pre-tested prior to shipment. A terrific value. All units guaranteed pre-tested. Shpg. wt. 73 lbs. Approx. GOVT. COST \$475. Most items new — all perfect. \$47.50.



DC JET GENERATOR ARC WELDING KIT Complete with GE Type CM-77 Generator (30 volts D.C., 400 Amp., 3000 RPM up; ampere rating is for continuous duty, intermittent amperage is 500 to 600 amps.), also 2 rheostats, 1 voltage reg., 1 voltmeter, 1 electrode holder, 1 welder's mask, 1 toggle switch, 10 lb. vacuum packed 1/8 in. welding rods, pair welder's gloves & spline coupling. All units guaranteed pre-tested. Wt. 110 lbs. Approx. GOVT. COST \$700. All items, now only \$64.50.

*G.E. Generator noted above can be purchased separately. Makes deluxe heavy-duty welder comparable to the finest commercial welders available. Wt. 90 lbs. Approx. GOVT. COST \$600. Gen. alone — \$49.50.



BIG NEW 1963 CATALOG!

Send 25c in coin for amazing new catalog with 1000's of surplus bargains in hydraulics, electrical, precision tools, marine items, automotive, etc. for hobbyists or industrial. Or order from this ad and receive a free copy. All prices F.O.B. Culver City, Calif. 50% dep. for C.O.D. Send check, cash or money order. Order today!

AIRBORNE SALES CO., INC. DEPT. PM1262
8501 Stellar Drive • Culver City, California

213



Foot Soldiers Become Sailors

Walking on water can be done on rigid urethane-foam shoes which support 350 pounds and allow a man to move at three miles per hour. Soldiers can walk across

rivers or swamps with both hands free. Several shoes can be lashed into a raft.

For recreational purposes, the shoes can be used to walk, race or joust on water.

The shoes cost \$40 per pair and are made by Water Shoes, Inc., Buffalo, N. Y.

How would you like a

SIDE LINE BUSINESS IN YOUR GARAGE?



Walter M. Ringer, Jr.

Ever thought about owning a small business in your home that would net you an extra \$100 to \$200 a month? A business that did not need a large investment and one that you could operate whenever you wanted to work? If you have a small space in your basement or garage, here's an exceptional money-making opportunity. Hundreds of others, just like you, have started such a business in their spare time, found it so profitable (90c out of every \$1.00 is clear profit) that they have quit their regular job to devote full time to this unique business. Since 1932 we have shown hundreds of men how to build a profitable service business with Foley Saw Filing equipment.

FREE BOOKLET TELLS HOW—This fact-filled booklet explains how you can start, how to get business from hardware stores, home owners, carpenters, schools, factories. It tells actual results of others whom I have helped start in business. Send coupon today. No salesman will call.

Walter M. Ringer, Jr., President, Foley Mfg. Co.
1243-2 Foley Building, Minneapolis 18, Minn.

Please send me free booklet with complete information about this profitable home business.

Name _____

Address _____

City _____ Zone _____ State _____

HYDE TOOLS

Finest Quality Fix-Up Paint-Up Tools

WRITE FOR FREE CATALOG

HYDE TOOLS, SOUTHBRIDGE MASS.

Picture your new car with all brass trim instead of familiar chrome. What would it look like? In January, Popular Mechanics lifts the curtain on the startling new look for tomorrow's cars—brass trim from stem to stern. Don't miss this spectacular first!

PLANER • MOLDER • SAW!



Now you can use this ONE power-feed shop to turn rough lumber into moldings, trim, flooring, furniture... ALL popular patterns. RIP... PLANE... MOLD... separately or all at once with a one HP motor. Use 3 to 5 HP for high speed output. Low Cost... You can own this power tool for only \$30.00 down payment.

Send postcard today for complete facts.
BELSAW POWER TOOLS, 903 Field Bldg., Kansas City 11, Missouri

SURPLUS SALE

GOVT. SURPLUS
EXCESS INVENTORY
BANKRUPT STOCK



HEALTH CHAIR MASSAGE MOTOR

• Item #1019. Brand new unit. Same used on expensive contour health chairs. Make vibrating chair. Useful for insomnia, aches, pains, sore muscles, etc.
• Consists of 115-v ac motor with double eccentric weight, etc. Easy attachment to chair. Wt. 6 lbs. Size 7"x2"x4". List \$16.95. SALE



AC-DC ELECTRIC GENERATOR

• Item #675. New Govt. unit. Generates 115-v (800 cycle) AC (1200-w) and 30-v up to 200 amps DC.
• Use for 115-v AC lights or stove or for DC 200-amp welder. Size 14"x8"x6". Wt. 55 lbs. Cost over \$250. SALE



DIAL TELEPHONE

• Item #716. Std. phone, same used on all phone systems. Use as extension to main phone and on private systems. Directions furnished. Wt. 8 lbs. Cost \$25. SALE



AIR COMPRESSOR EQUIPMENT

• Make your own outfit. For painting, tires, shop use, etc. Save to 60%.
• Compressor, \$21.50. Govt. Tank, \$10.95. Gauge, \$1.75. Paint Gun, \$10.50. Auto switch, \$4.75. Air Regulator, \$3.95.



STORAGE BATTERY WINCHES-HOISTS

• Item #311. 12-v Govt. reversible, ball bearing 2000-lb. capacity winch. Holds 40' 1/4" cable. For trucks, docks, boats, etc. 55 lbs. Cost over \$250. SALE



Many other types battery winches-hoists.

115-V A-C GENERATORS

• Many other Surplus Plants.
• Item #626. Brand new 3-wire heavy duty 1,200 rpm 115-v 60-c 3000-4000-w/ball bearing generator. Wt. 260 lbs. Govt. cost over \$600. SALE



HYDRAULIC SURPLUS BARGAINS

• Great savings. Build loaders, diggers, presses, etc. Brand new equipment.
• 895 Pump, 1000 lb., 12 rpm... \$33.95
• 12-v Battery Hyd. Pump... 18.49
• Hand Hyd. Pump System & reservoir 29.50
• 869 Hyd. Cyl. 2 1/2"x16"... 19.95
• Hyd. 2-way 1000-lb. Valve... 18.00



SPECIAL OF THE MONTH!

MILITARY SUPER-LOUD SPEAKER

• Item #2252. Wonderful buy 25-watt loud speaker. Dynamic permanent magnet float coil type. Excellent for paging in large or noisy areas. Ideal for 360° dispersion paging-intercom installations in warehouses, industrial locations, sports fields, arenas, docks, terminals, etc.
• Outstanding clarity on music, remarkable penetration on voice. Single speaker can replace several trumpet or baffie type speakers. Makes sensitive pick-up for talk-back on intercom remote stations. Built-in multi-tap matching transformers accommodate wide range of impedances.
• A 4 star surplus buy! Brand new in original box. Size 8 1/2" deep, 11" diam. Wt. 18 lbs. Original cost over \$40. SALE



GOVT AIR COMPRESSOR

• ITEM #453. Expensive Gov't. Compressor, G.E. motor, 115-v, 60-c. Built-in air filter, relief valve, etc. Very compact and efficient.
• For paint spraying, insecticides, air brush, etc. A "Super Buy." Wt. 55 lbs. Gov't. cost over \$250. SALE



GENERATOR-3000W-115V

• ITEM #633. D.C. ball bearing compound-wound Delco unit 1" dia. shaft. 2800 RPM. Ideal for portable tools, light, boats, etc. Will run any 115-v 2DC-AC tool. 100 lbs. Govt. cost over \$175. SALE



EXAMPLE BARGAINS IN 1962 CATALOG

- \$175 Gov't 12-Line Tel. Sw. Board... \$13.29
- \$90 Two Station Phone Inter-Com... 22.95
- \$85 Fire-Burglar Alarm System... 12.95
- \$16 AC-Volt meter 250-v... 7.95
- \$52 Cathode Ray Exp. 5" Tube... 4.91
- \$75 1 1/2" Bronze Water Pump... 19.95
- \$40 Transformer 115 to 230 Volts-1KW... 15.61

ALL FOB LINCOLN.
Write today for large 1963 catalog.
SURPLUS CENTER
Dept. 814, LINCOLN, NEBR.

GOV'T. CABLE AND WIRE

Save 75% on multi-pair cable, copper wire, power cords, etc. For intercom, private telephone system.



• Item #757. 6-pr. #22 gauge copper-weld color coded, insulated cable. Use aerial or buried. Gov't. cost 18c. Only 7c per ft.

• Item #759. 11-pr. #22 gauge copper color coded rubber insulated cable. Only 9 1/2c per ft.
• Item #760. 1-pr. #14 gauge copper rubber insulated electric wire. Use for conduit wiring, outside lights, etc. 3300-ft. per reel. Full reel, \$29. Per ft. 1c.

• Item #761. Flexible #8 ga. 2-cond. stranded power cable. Length 30-ft. For power tools, generators, etc. Wt. 11 lbs. Cost over \$20. SALE

FOLDING WIRE REEL

• Item #735. Army units. Use for stringing or rolling up power wire, barb wire, etc. Compact, easy to use. Makes neat factory type coils. Fits any size coil.



• Useful for construction companies, farmers, electricians, generators, etc. Wt. 39 lbs. Govt. cost \$36.50. SALE

POOL WATER FILTER

• Item #2019. Provides filtered water for small home swimming pools, for business, industry, etc. Consists of multi-section filter in steel tank with clamp-on cover. Filter pads and plates are easily removable for cleaning. Provides up to 420 g.p.h. of filtered water. Complete with valves, etc. Inlet outlet fit garden hose threads. Data furnished. Size 14 1/2" high, 19" diam. Wt. 18 lbs. Cost Gov't. over \$95. SALE



SHOOTS A STAPLE WHEREVER YOU'D DRIVE A NAIL!



ARROW FASTENER COMPANY, INC. 1 Junius St. • Brooklyn 12, N. Y.

PENN LINE'S INDIANAPOLIS 500 RACE CAR SET



TOPS ON EVERY BOY'S CHRISTMAS LIST

Real racing type cars, powered by real 12-volt D.C. motors. Individual rheostat speed controls, big 20" x 72" two-lane over-and-under track layout. Complete with power pack, ready to go, just \$29.95. Other sets from \$19.95 to \$39.95, at toy and hobby stores. Cars and accessories available separately.

Send 25c for 2 FULL COLOR CATALOGS of Race Cars and Train Sets

Penn Line Mfg. Co., Dept. PM, Boyerstown, Penna. MAKERS OF FAMOUS PENN LINE HO TRAIN SETS

SAVE on DESK LAMPS for HOME • SHOP STUDENT

Now a drafting light or desk light at a price anyone can afford. Newly adapted from a Swedish design... ideal for drafting table, office desk, etc. Precision made and balanced. Reflector will swing to light desk or table up to 6 ft. long x 3 ft. wide. Extension arms are fully universal with surgical steel springs for counterbalance with finger-tip movement. Finished in baked enamel. In K-D kit to save shipping cost... takes but a few minutes to assemble.

No. ID-118 — MECH LYTE — Gives concentrated light for work bench, shop, etc. Gray finish only... \$9.95
No. ID-118B — COOL LYTE — Insulated lamp hood reduces heat. Ideal for draftsman, artist, etc. Colors: gray, brown or black (specify)... \$10.95
No. ID-MAG 1 — ILLUMINATED MAGNIFIER Has 5" dia. lens. Power of 3 diopters. 13" focal lgh. For stamp or coin collectors, etc... \$28.95



4" SLIDE RULES

Non-warp with 2-color scales on white nitrate face. Has A, B, C, D and K scales on face — S, L and T on the back. Edge has rule divided in 32nds, other edge rule divided in m/m to 10cm. In leather case... 295

AIR FORCE CRASH HELMETS

Made of high impact plastic for safety and protection... Inside padded with foam rubber. Ideal for motorcycle or auto racing, bob sledding, etc. Originally cost Gov't approx. 85.00. Used but good condition — SAVE!

HIS CATALOG! 260 PAGES OF BARGAINS

Includes: Hand & Power Tools, Sports & Outdoor Equip., Electric Motors & Generators, New and Used Hydraulic Equip. of all types

HER CATALOG! 64 PAGES OF GIFTS

Featuring Gift and Decor items from 'round the World. Primitive carvings from Africa, brassware from India, art objects from Italy, fantasies and furniture from the Orient PLUS budget priced gift items from the U.S.

SEND ONLY 50¢ AND GET BOTH CATALOGS! to cover cost of handling and mailing both catalogs!

TO ORDER: Send check or M.O. 1/2 dep. with C.O.D.'s. All items sent freight or postage collect.
palleys 2263 E. VERNON AVE., Dept. PM-122 LOS ANGELES 58, CALIFORNIA

Briggs & Stratton — Clinton New Gas Engine Sale

Never before and perhaps never again—this offer of brand new genuine Clinton and Briggs & Stratton engines including 1 yr. factory warranty at less than cost. Perfect power for go-carts, scooters, tractors, mowers, generators, pumps, sprayers, etc. We bailed out 3 big factories who needed cash and the savings are yours while quantities last. Act fast.



Clinton 2 1/2 hp. Mdl. A400—Re-coil starter Std. 3/8 shaft w. keyway—ready to go. Reg. price \$49.50 Special (item 1002)

\$29.95

2 for \$57.50
6 for \$150.00



Briggs & Stratton 2 hp. Mdl. 60101 Rope start, std. 3/8 shaft w. keyway. Sturdy 4 cycle power. Regular price \$49.80 Special (item 106a)

\$29.75

2 for \$57.40
6 for \$149.50

\$67.50

5 3/4 hp.

**Briggs
&
Stratton**



Briggs & Stratton 5 3/4 hp. Mdl. 143302. Re-coil start. Std. 1" shaft w. keyway, aut. choke & throttle control—a rugged big engine ready to tackle any job.

Regular price... \$92.60

Special (item 1059) ... **\$67.50**

2 for **\$130.00** 6 for **\$350.00**

Remember these engines are absolutely perfect and standard and under factory warranty. Money back guarantee. Order now while stocks are complete. Factories—write us on any new items that are surplus to your needs.

STANDARD DIAL PHONES WITH BELL

Western Electric late model dial phones same as used by all telephone companies. Ideal as extensions on any system. Easy to connect. Several may be connected on one line. Easily modified for private inter-com system. Cost \$40.00 new—guaranteed excellent condition.

ITEM 855 NC, Wt. 8 lbs. **\$6.95**



HEATING AND VENTILATING FAN

(Item 10) Easily installed in furnace pipes. Forces even heat to all rooms. Over range removes kitchen smoke and odors. Powerful, continuous duty motor, 110-120 v. AC. Mount in wall or ceiling to ventilate any area. Quiet, super-efficient fan moves huge volume of air. (400 to 600 CFM).

8" Pipe, wt. 5 lb. **\$6.85**
9" Pipe, wt. 6 lb. **\$7.85**
10" Pipe, wt. 7 lb. **\$8.85**
12" Pipe, wt. 8 lb. **\$9.85**



HEAVY DUTY FAN. Semi-enclosed motor, suitable for spray booths, restaurant exhausts, poultry houses, etc.

10" Fan, wt. 8 lbs. (Item 10E) **\$11.95**
12" Fan, wt. 10 lbs. (Item 10D) **\$12.95**

Send 10c for 100 page Catalog FREE with order. Prices f.o.b. factory—send check or MO.

MASTER MECHANIC MFG. CO., Dept. A-122, Burlington, Wis.

Southern Customers write Dept. A-122, Box 65, Sarasota, Florida

STARTING A MAIL ORDER BUSINESS?

STOP—First read the amazing booklet "Profits from Classified Advertising." Brim full of valuable information. What to sell—Where to advertise—How to write good pulling copy—How to handle inquiries—and why many ads fail. Send dime to cover handling and postage. Worth dollars to any livewire. F. W. Johnson, 740PD Rush St., Chicago 11, Ill.

THE PERFECT CHRISTMAS GIFT

DYNAMIC INDUSTRIAL TYPE TRANSFORMER WELDER

**WELD-CUT-BRAZE-SOLDER-HEAT
IRON-STEEL-BRONZE-BRASS
ALUMINUM AND OTHER METALS**



Professional Electric Arc Welder. Ideal for Home, Shop, Farm or Industrial use. The handiest tool in your workshop. Weld, Braze, Solder, Cut, Bend all metals. Do expert work on your first job. Build or repair Boats, Trailers, Auto Bodies, parts, fenders, metal and ornamental iron furniture, fixtures, farm equipment, garden tools, bicycles, toys, etc. Operates on any properly wired 110 V. A.C. line. Complete with helmet, arc torch, electrode holders, flux, rods, cables, instruction book. **FULL YEAR GUARANTEE, 10 day money back trial. ONLY \$38.50 f.o.b.**

Only **\$38.50 f.o.b.** Send only **\$6.00** check or m.o. Pay postman balance plus charges. **EASY PAY PLAN.** Low down payment. Pay as you weld.

**DYNAMIC WELDER CO. 1808 SOUTH FEDERAL STREET
Dept. D2-N, CHICAGO 16, ILL.**

Rocket May Capture Asteroid

Capturing an asteroid by landing a rocket on it for the purpose of studying the origin of the solar system may be possible, according to Dr. Su-Shu Huang of the National Aeronautics and Space Administration's Goddard Space Flight Center.

The last stage of a multistaged rocket would be landed on the asteroid, slowing it sufficiently to bring it into an orbit around the Earth.

Once in orbit, the rocket would continue firing to speed up the asteroid's velocity as much as necessary to make it an Earth satellite.

Russians Plan Huge Telescope

Russian scientists are planning to build the world's largest telescope. It will be set up on one of the Northern Caucasus summits surrounded by other equipment in a proposed institute of theoretical astronomy, according to Dr. L. Artsimovich, USSR Academy of Science.

The purpose of the institute is for research and development of new equipment for satellites and spaceships.



Quick Sharpener for Skates

A pocket-sized ice-skate sharpener developed by Canadian General Electric Co. can be adjusted to put a perfect edge on both hockey and figure skates with just six strokes across the blade. The egg-shaped tool uses a cemented carbide disk to cut into the steel. It sells for \$3.50.

Second Childhood Joke Valid

Man's growth rate increases again after he passes 70, thus providing some "slight justification" for the second childhood joke.

The rate of shrinkage is greatest between 60 and 70 years of age, Dr. A. E. Needham of Oxford University reported. The shrinkage is slower in the very old while the specific growth rate increases again in old age.

"There is direct evidence of this," Dr. Needham said, "in the rate of cell division in some tissues. Other properties also reverse their trend in later life."

Here's Why the Worm Turns!

Earthworms seem to have the talent for determining the direction of the earth's magnetic field, as it changes with moon and season.

According to Dr. Frank A. Brown, professor of biology at Northwestern University, if it's winter and the moon is full or waning, a southbound worm will turn right to get around an obstacle. During the new moon, he'll turn left to get around the same obstacle. In spring, the reverse is true. The microscopic paramecia and snails react the same way; the turn seems to depend on the direction of the earth's magnetic field.

SUCCESSOR TO VARNISH

Mirror Gloss

You'll marvel at this super-tough, super-gloss, clear, protective coating. Highlights the beauty of all interior wood surfaces, bare or finished. Magic resin formula applies smoothly . . . dries fast. Insures maximum resistance to dirt, grime, stains. At Paint, Hardware, Lumber Stores. Pierce & Stevens Chemical Corp., Buffalo 3, N. Y. In Canada: Pierce & Stevens Canada, Ltd., Fort Erie, Ont.

NATURAL
WOOD
FINISH

Made by the makers of famous FABULON

FABULOY

SUPER-GLOSS NATURAL WOOD FINISH

CIRCULAR & HAND SAW FILER



No. 11 Gives correct height, depth, pitch, bevel to any 6" to 10" hand or circular saw with no side pull. Includes 8" file. \$9.95 ppd.



DRILL GRINDER
Sharpens round shank drills like new with hand or power grinders. \$2.95 ppd.



#44 CORNER
CLAMP
& MITER
BOX
COMBINED

Adjustable to any angle. Accurate cuts with any handsaw from 0° to 180°. Full 3" capacity. Sides exposed for nailing and gluing. \$2.75. No. 33 corner clamp, only, \$1.75 ppd.

SAW SET

automatically sets teeth at 10° more \$2.95 ppd.



WRITE FOR FREE CATALOG

A. D. McBURNEY, 5908 Hollywood Blvd., Hollywood 28, Cal. Dept. A122

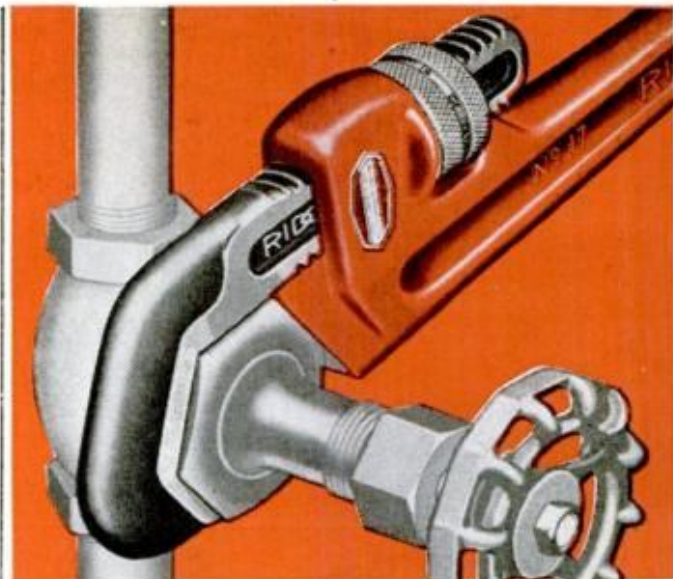

... No wrench grips hex nuts, unions and valve packing nuts tighter than a

RIDGID[®] HEX WRENCH

Available in 10 sizes and 3 shapes to give slip-proof, mar-proof grip!

RIDGID Straight Hex Wrenches

6 Sizes with Maximum Jaw Openings from 1 1/4" to 4 1/4"

At least 3 jaw faces grip every hex nut, union and valve packing nut. Jaws also grip square nuts and even flathead gas cocks. Thin and smooth, they won't even mar plated finish. Housing is guaranteed.

RIDGID End Hex Wrenches

3 Sizes with Maximum Jaw Openings of 1 1/4" to 3 1/2"



Here's a wrench that's ideal to work with close to walls or in tight quarters. Housing is guaranteed. Warp-proof handle has handy hang-up hole.

RIDGID No. E-110 Offset Hex Wrench

Maximum Jaw Opening 2 1/2" to Handle up to 1 1/2" Drain Nuts



This special-purpose wrench is ideal for sink and tub drain nuts. Wide-opening offset hex jaw and short handle give easy-on, non-slip grip . . . easy work in close quarters. Thin, smooth jaws won't scratch chrome finish.

Save time on all home, equipment and toy repairs. Get a RIDGID Hex Wrench from your Hardware or Building Supply Dealer today!

RIDGID[®]

THE RIDGE TOOL COMPANY, ELYRIA, OHIO, U.S.A.

CUT-TO-FIT HOMES CUT BUILDING COSTS

CHOICE OF 57 DESIGNS

ORDER NOW

SAVE UP TO 1/3

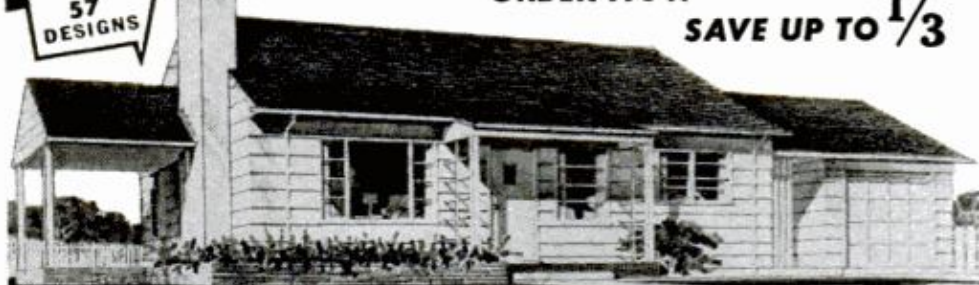

Build your own home and save the builders' profit — plus savings in lumber and labor with Sterling Ready-Cut-Homes. Anyone can assemble with simple, easy to follow plans furnished. Every house complete with all lumber, roofing, nails, glass, hardware, paint, doors and windows marked ready to erect. Freight paid. Complete building plans ready for filing at low cost. Sold separately if desired. Write today!

PRICED FROM \$2295 UP

Five Easy Payment Plans

Send 25c for NEW COLOR CATALOG

INTERNATIONAL MILL AND TIMBER CO.
DEPT. PM122 BAY CITY, MICHIGAN

CHOOSE A POCKET-SIZE
Kirsten
"COMPANION"
PATENTED "RADIATOR" STEM MEANS
Cool Smoking!

\$3.95
POSTPAID

WEIGHS ONLY 1 OUNCE!

WRITE FOR FREE CATALOG
other pipes 5.00-7.50-10.00

Write to: **Kirsten** PIPE CO. Seattle 7, Wash. Dept. C

How does it feel to take the new Corvette Sting Ray through a power drift on a road racing course? What's the comfort quotient of Studebaker's sporty-looking Avanti? What happens when you run the new T-Bird and Buick Riviera through a high speed slalom? The answers to these questions—and many more—about the sporty '63s are lined up for you in January PM.

ELECTRIC WELD - BRAZE & CUT

REPAIR MOST EVERYTHING MADE OF METAL



Home Appliances, Auto parts. Make and repair lawn chairs, tables, ornamental iron work, gates, wagons, etc. Solder, heat, bend, and straighten, with terrific heat from arc torch. Cut and weld up to 1/4" steel plate. A million uses for Home, auto, farm, inventors, factories, etc. Works from any home 110 volt plug-in. Complete with dark welder's mask, arc torch, supply of carbon steel welding and brazing rods and complete Welding Instruction Book. 1 year guarantee.

SEND ONLY \$3 (cash, ck. mo.) and pay postman \$11.95 plus COD postage on arrival or send \$14.95 and we will send postpaid. Ideal gift for mechanically minded, relatives, friends. Order now. Available only from:
MIDWAY WELDER, Dept. DPM-12, Kearney, Neb.

This is for You... IF...

... you want a profitable hobby, a rewarding sideline, or your own full-time business. Perhaps you have seen Ornamental Concrete Items and wondered how they are made. You can make them, and in a professional manner. All you need is Molds and Knowledge. We'll sell you BOTH and you'll know what you are doing even before you start.

We manufacture and sell on a direct basis the industry's best molds, Durable, Dependable, High Quality, and of Aluminum. 96-pg. "How To Turn Concrete Into Gold" includes 29 pgs. of priceless instructions for professional results. Describes and Prices over 300 molds for Bird Baths, Benches and Tables, Flower Urns, Statues, Animals, Religious Items, and many more from 2" to 68" high. It gives the full story. Order yours TODAY—Rushed to you by First Class Mail. It's only \$2.00.



No. 447 Grecian Jr. Mold makes concrete item 9 3/4" high. Price of Mold only \$30.00 AND, there are over 300 others to select from.

HOW TO TURN CONCRETE INTO GOLD
SEND \$2

Manufacture And Sell Your Own Ornamental Concrete Items OVER 300 DIFFERENT DESIGNS

Concrete Machinery Co., Inc.
839 Lenoir Road, N. W. • Hickory 2, N. C.

EVERY GOOD GUY

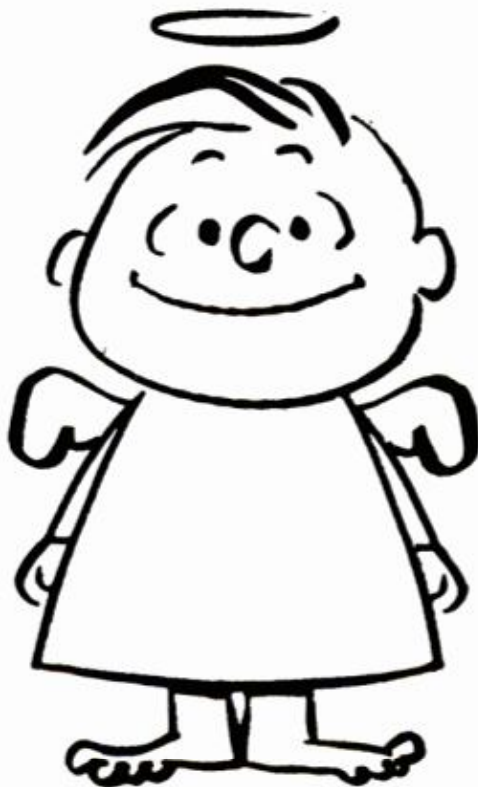

GIVES THE UNITED WAY

POPULAR MECHANICS

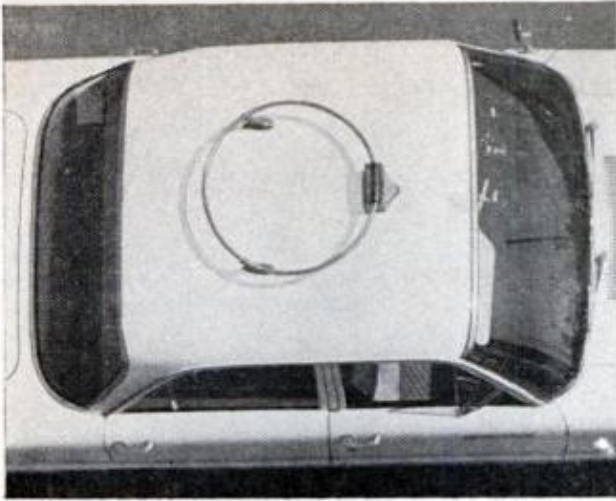

Circular Antennas

A hoop-shaped cartop antenna that may replace the familiar whip antenna has been successfully tested for two-way radio communications. Known as DDRR (for Directional Discontinuity Ring Radiator), circular shaped units could also take the place of high-tower ground antennas.

On cars, the low-profile ring is said to be equal to or superior to whip antennas; it radiates equally all around the horizon, and does not change its pattern at high speed, as a whip antenna does in a high wind. It can be switched instantly to any adjacent frequency. A 27 mc.-unit would be 27 inches in diameter, mounted two or three inches above the car roof. One end of the ring is grounded directly to the vehicle for protection from lightning or contact with high-voltage power lines.

For ground installations, a circular unit 20 feet in diameter (below) and only two feet high would be equal to a tower antenna 60 feet high. The developers of DDRR, the Ventura Division of the Northrup Corp., are now designing huge ring antennas a mile in diameter and more than 100 feet high. These, according to Northrup, would be much more efficient than the best long-wave antennas now in use.

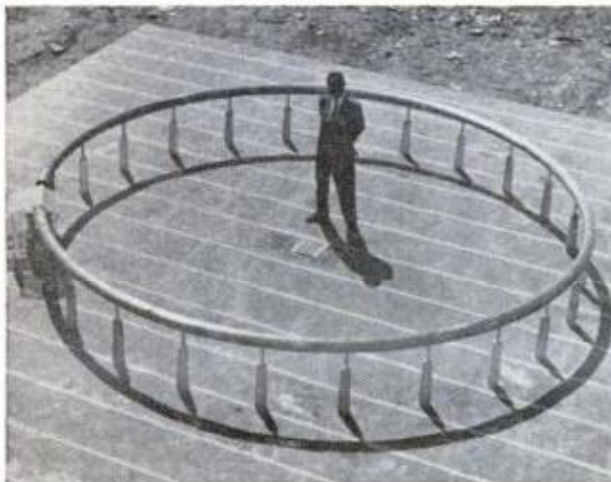

DECEMBER 1962

Useful, Dependable, High Quality
Starrett tools

for HOME IMPROVEMENT
HOME WORKSHOP
DO-IT-YOURSELF
CARPENTRY & WOODWORKING

No. 132 Precision Bench Level
4", 6", 9", 12", 18", 24" sizes



No. 9 Combination Set, with square head, center head and non-reversible protractor head. 12", 18", 24" sizes

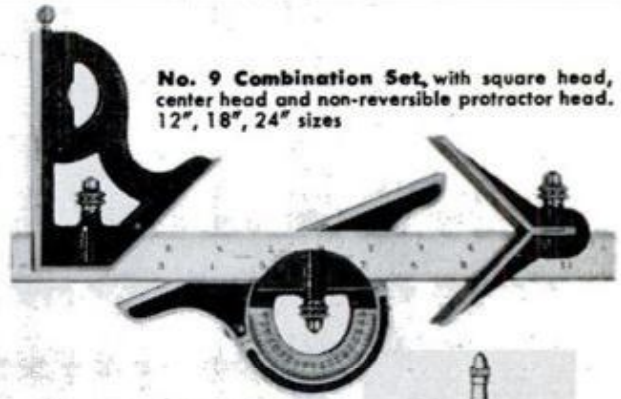

No. 800 Square Head Nail Sets. Five point sizes — $\frac{1}{32}$ " to $\frac{5}{32}$ "



Starrett Tool and Instrument Oil has countless uses around the house

No. 604-R Steel Rules, 1" to 72" lengths, 8ths, 16ths, Quick Reading 32nds, 64ths
No. 439 24" Combination Tool—seven useful tools in one
No. 47 6" Universal Bevel
No. 92 Dividers 6" to 9"
No. 85 Improved Extension Dividers, 7" to 12"
No. 50 Improved Trammels
No. 59 Precision Trammels and Attachments
No. 108 Aluminum Line Level
No. 116 Bevel End Nail Sets
No. 111 Stair Gage Fixtures
No. 470 Hexagonal Stair Gage Fixtures

No. 87 Mercury Plumb Bob
No. 99 Popular Priced Transit
No. 101C Leveling Instrument
No. 999 Leveling Rod and Plastic Target
No. 554 "Eyeglass" Screw Driver
No. 425 Pocket Slide Caliper
No. 530 SATIN-CHROME and WHITE Steel Tapes
No. 129 Bench Block
No. 819 Lightweight Automatic Centering Punch
No. B51214 Bluestripe High Speed Hacksaw Blades
SAFE-FLEX High Speed Hole Saws

FREE Starrett Catalog displaying all these and many more Starrett precision tools, tapes, hacksaws, band saws and band knives. Write Dept. AP.



THE L. S. STARRETT COMPANY
Athol, Massachusetts, U. S. A.

219

Shopping for tools

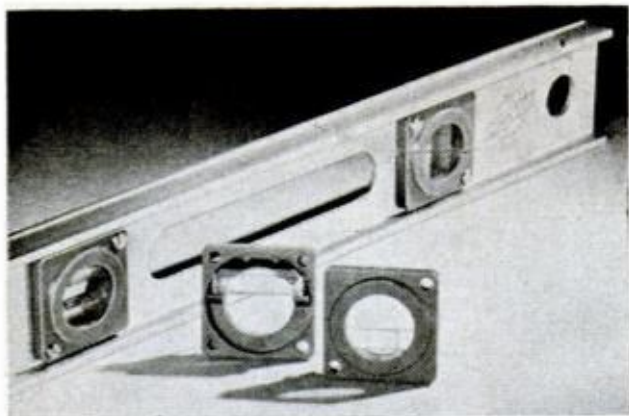

ALUMINUM LEVEL has replaceable glass bubble vials mounted in pronged, plastic holders that snap firmly in position on the frame. Assembly is dust and moisture proof. Johnson Products Co., Milwaukee, Wis.

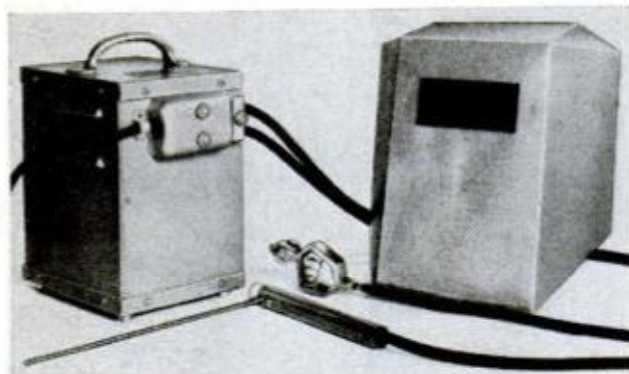

WELDING TRANSFORMER for light farm and home workshop jobs can be plugged into a 220-volt power line. Can be set for 50, 70 or 90 amperes. Netherlands Consulate, 10 Rockefeller Plaza, New York 10, N. Y.

SHARPENING SHOP on a 24 x 27-in. base is provided by Servicemaster Model 331. Handles cutlery, scissors and medical needles as well as tools and saws. Treycor Products, 330 Niagara St., N. Tonawanda, N. Y.

LATHE ATTACHMENT bolts on any wood-turning lathe. Its free-sliding metal arc, cutting edge and pattern guide improve duplicate and freehand work. Gizco, 11705 Washington Blvd., Whittier, Calif.

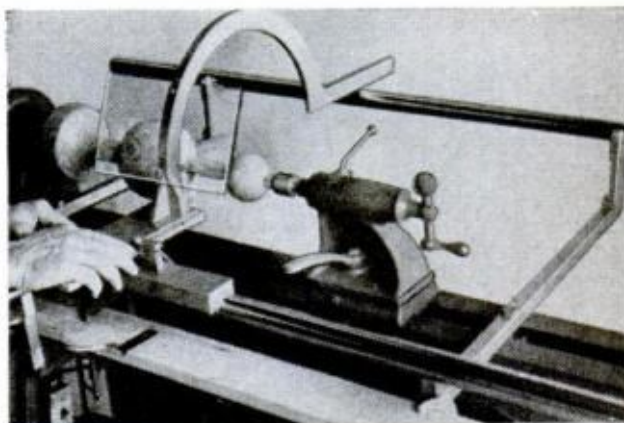

POSITIVE-ACTION RACHET has a multiple-tooth pawl that is engaged by a wedge that prevents jamming and enables the action of the ratchet to be reversed immediately, as needed. Bonney Tools, Alliance, Ohio

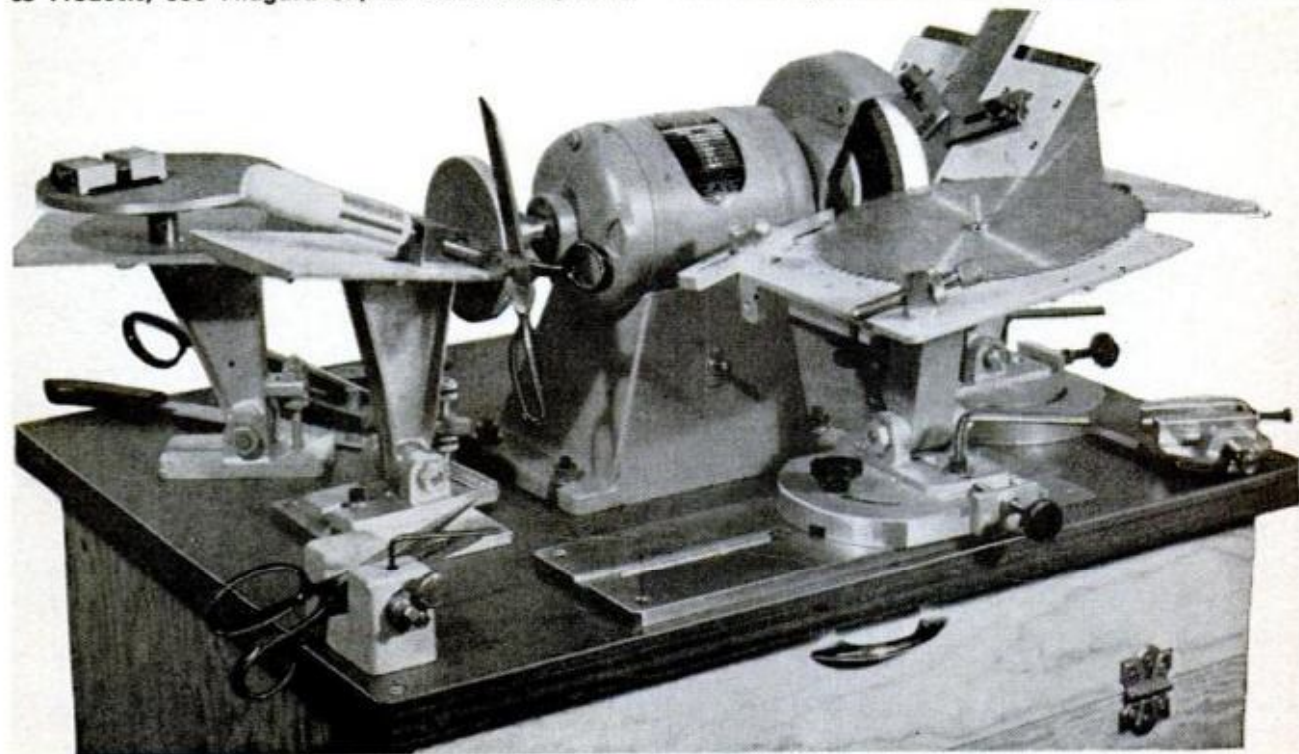

END HIDDEN DANGERS OF FRONT-END SAG



"Bottoming" on bumps and potholes is eliminated by Front Load-Leveler stabilizing units.



Rolling on sharp turns and "wind sway" end with stability of Front Load-Levelers.

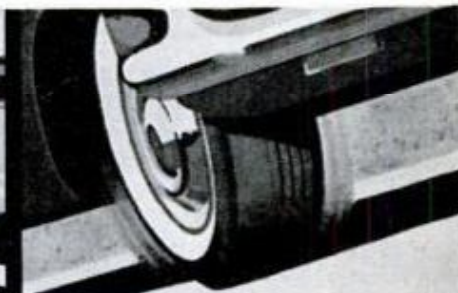

Wheel shimmy at high speeds is ended with Front Load-Levelers holding wheels in alignment.

WITH NEW MONROE *FRONT* Load-Leveler[®] STABILIZING UNITS

Front-end sag takes its toll on *every* car. It begins when springs take a "set," and changes the entire geometry of your steering system. Wheels continually get out of line, and shimmy at high speeds. Tires are virtually destroyed. Steering becomes difficult. Control of your car is dangerously reduced. Now you can end front-end sag, without costly spring repair, make your car ride *better* than brand new, and prolong tire life with new Front Load-Leveler

stabilizing units by Monroe. Installed in place of your present front shock absorbers, Front Load-Levelers give firm support to sagging springs and compensate for "set." They give your car extra stability, for sure-footed cornering and a safer, more comfortable, more economical ride. You'll marvel at the improved roadability you'll get with new Monroe Front Load-Levelers. Have a set installed in less than thirty minutes where you have your car serviced.



LOOK FOR THE MONROE DEMONSTRATOR BARREL!

World's largest maker of ride control products including Monro-Matic[®] shock absorbers.

MONROE AUTO EQUIPMENT COMPANY, Monroe, Michigan • In Canada, Monroe-Acme Ltd., Toronto, Ont. • In Mexico, MEX-PAR, Box 28154, Mexico City

FOR REAL JOB SECURITY —GET AN I.C.S. DIPLOMA



"You can stop worrying, Jane. My job's secure now! And here's the insurance policy to prove it—my I.C.S. diploma!"

This feeling of security is probably typical of every I.C.S. graduate. Because—as the job situation gets tighter, the man with I.C.S. training has the advantage.

Why? Your I.C.S. diploma tells your present employer three important things: (1) You want to make the most of your present job.

(2). You have the training you need for advancement. (3) You look for better ways of doing things on your own.

What you do about your future is up to you. Do nothing and stay at your present job at the same old pay. Or earn an I.C.S. diploma in your spare time for security, promotions, more pay! Your first step is to mark the course that interests you in the coupon below, and mail it to us.

Three Free Booklets

We'll send you three interesting booklets: (1) "How to Succeed" is a career guide of helpful tips that point out many small things in your personality and behavior that can make the difference between success and failure; (2) A booklet telling you about the opportunities in the field of your choice; (3) Sample I.C.S. lesson.

Small investment now means big gains later

Many an I.C.S. student has reported a substantial increase in pay after only a few months of training. By studying at home in your spare time and applying what you learn on the job, you pay yourself many times an hour more than you're now making.

The security of your present job—or the success in finding the new job you've always wanted—is in your hands. Move ahead with I.C.S. training while others stay behind on the routine, small-pay jobs. Remember, your first step to security and success is to mail this coupon. Take a few minutes and do it now. Putting it off will put you further behind in the race for higher pay and real job security.

Clip coupon here—and take your first big step to real success! I.C.S., Scranton 15, Penna.

Fully Accredited Member
National Home Study Council

INTERNATIONAL CORRESPONDENCE SCHOOLS I C S

Box H0419M, Scranton 15, Penna.

(In Hawaii: P. O. Box 418, Honolulu. In Canada: I. C. S. Canadian, Ltd., Montreal.)

Without cost or obligation, rush me FREE Success Kit, with 3 valuable booklets: (1) How to Succeed; (2) opportunity booklet about the field I've checked below; (3) Sample I.C.S. Lesson.

ARCHITECTURE and BUILDING TRADES

- Air Conditioning
- Architecture
- Arch. Drawing
- Building Contracting and Estimating
- Carpentry & Millwork
- Heating
- House Planning
- Painting
- Plumbing

ART and DESIGN

- Commercial Art
- Fashion Illustrating
- Interior Decorating
- Magazine Illustrating
- Show Card & Sign
- Painting
- Sketching and Painting

AUTOMOTIVE

- Auto Body Rebuilding
- Auto Electric Technician
- Automobile Mechanic
- Engine (Gas & Diesel)
- Engine Tune-Up

- Transmission Specialist

AVIATION

- Aero Engineering
- Aircraft Drafting
- Aircraft Mechanic

BUSINESS

- Accounting
- Cost Accounting
- Public Accounting
- Bus. Administration
- Executive Training
- Marketing
- Personnel-Labor Relations
- Programming for Digital Computers
- Purchasing Agent
- Real Estate
- Salesmanship
- Sales Mgmt.
- Small Business Mgmt.
- Traffic Mgmt.

CHEMICAL

- Analytical Chemistry
- Chem. Engineering
- General Chemistry

- Lab. Technician
- Nuclear Energy
- Plastics
- Pulp, Paper

CIVIL ENGINEERING

- Civil Engineering
- Construction Engrg.
- Highway Engineering
- Reading Structural Blueprints
- Sanitary Engineering
- Structural Engineering
- Surveying & Mapping

DRAFTING

- Architectural
- Electrical and Electronic
- Mechanical
- Sheet Metal

ELECTRICAL

- Elec. Appliance Servicing
- Electrical Engineering
- Elec. Eng. Technician
- Elec. Motor Repairman
- Industrial Electronic Technician

- Industrial Telemetering
- Instrument Technician
- Practical Electrician
- Practical Lineman

ELECTRONICS

- Automation
- Basic Electronics
- Electronic Computers
- Electronics Technician
- Hi-Fi Stereo and Sound Systems
- Industrial Electronics
- Ultrasonics

ENGINEERING (Professional)

- Chemical
- Civil
- Electrical
- Mechanical

ENGLISH and WRITING

- Better Business Writing
- Introductory Technical Writing
- Short Story Writing

- Practical English

HIGH SCHOOL (Diploma)

- High School General
- High School Math
- High School Secretarial
- High School Vocational
- College Preparatory

MECHANICAL and SHOP

- Gas and Electric Welding
- Industrial Engineering
- Industrial Instrumentation
- Machine Design
- Machine Shop Practice
- Mechanical Engineering
- Reading Shop Blueprints
- Tool Design
- Toolmaking
- Safety Engineering

SECRETARIAL

- Clerk-Typist
- Professional Secretary

- Shorthand
- Stenographic
- Typist

STEAM and DIESEL POWER

- Boiler Inspector
- Power Plant Engineering
- Stationary Diesel Engineering
- Steam Engineering

SUPERVISION

- Industrial Superv'n
- Personnel-Lab. Rel'n's

TV-RADIO

- Radio and TV Servicing
- Radio-Telephone License
- TV Technician
- Practical Radio-TV Engineering

MISCELLANEOUS

- Railroad
- Textile
- Other (please specify)

Name _____ Age _____ Sex _____
 Home Address _____
 City _____ Zone _____ State _____
 Occupation _____
 Employed by _____ Working Hours _____

Special low rates to members of U. S. Armed Forces!



**OWN your own business
and GROW with . . .**

DYNA-KLEEN

**EXCLUSIVE
FRANCHISE**

If you qualify, you can now own and operate your own DYNA-KLEEN SERVICES UNLIMITED franchise and earn up to \$20,000 per year, and more, as many other Dyna-Kleen dealers are doing. Dyna-Kleen is the world's largest, exclusive cleaning service contractor. It was established in 1955 and now has over 400 successful, independent Dyna-Kleen franchises operating in 38 states. Franchises have increased in value each year.



You are completely equipped with your own Dyna-Kleen power cleaner mounted on a new truck, plus our modern portable steam cleaner. Both units have all special Dyna-Kleen accessories required to perform our proven methods of high-power vacuum cleaning, steam cleaning, new concept of carpet cleaning, grease removal and fireproofing.

Dyna-Kleen is growing fast in North, East, South and West. Every building is a prospect for one or more Dyna-Kleen services. Cleaning contracts range from \$25.00 to \$60,000.00.

No experience required. We train you and assist you in setting up your business in your area. You're on your own but never alone. We furnish you proven advertising that assures you of success. No inventory to carry — no products to sell — low overhead — high profits.

Are you qualified to be Mr. Independent Dyna-Kleen Businessman in your area? If you believe you are, mail the coupon below, today, for our free, fact-filled booklet about our exclusive plan for your financial security with Dyna-Kleen. This may be the big opportunity you've been looking for. Total investment is \$13,750.00. Down payment of \$6,750.00. We will finance balance at bank rates, or we will assist you in arranging local financing on \$7,000.00 balance.

DYNA-KLEEN SERVICES UNLIMITED — PM 12-62
Delamater Manufacturing Co., Rockford, Illinois

Yes, I'm qualified . . . rush the free, fact-filled booklet to me that tells how I can OWN my own business and GROW with DYNA-KLEEN.

NAME _____

ADDRESS _____

CITY _____ STATE _____



This is the story of an automobile only 2 inches long.



The car shown above is "the active ingredient" in a new hobby sweeping the country. Called "MODEL MOTORING", it involves scaled-down automobiles remote-controlled for competition on electrified roadways. The cars themselves, handsome replicas of real vehicles, are rear wheel-driven, just like their prototypes. A tiny miracle motor purrs under every hood.

Remember when every boy had to have a set of electric trains for Christmas? Nowadays it's MODEL MOTORING, and no wonder. Who would prefer a pokey loco going around in circles to the pulse-pounding action of a road race? Imagine then how exciting it can be when you're actually *in* the race, actually "driving" your own 2-inch car, zooming pell mell into the straightaways, spinning out dangerously on the turns, battling for the lead at scale speeds up to 250 mph? Can't you just see his eyes light up when he opens that MODEL MOTORING package on Christmas morning? ("What do you say, Dad? Want to race?") Designed in HO scale, MODEL

MOTORING is wonderfully compact, easy to assemble, and just as easy to take apart when Mom simply has to have the bridge table. Choose the set that best fits your budget—from \$21.98 for a lane-changing CRISS-CROSS layout, to \$49.98 for the deluxe 4-lane CLASSIC '50. All sets come equipped with vehicles, speed controls, transformer, curved and straight road sections. One word of caution: genuine MODEL MOTORING, made only by AURORA, will be in short supply as the holiday approaches. Reserve the set you want TODAY — at a hobby, toy, variety or department store nearby.



AURORA PLASTICS CORP.
WEST HEMPSTEAD, N.Y.

MODEL
MOTORING

AURORA

