

Add-On Entertainment Center: Complete Plans

POPULAR MECHANICS

NOV. 1962
35 CENTS

Crisis: How Can We Store Scientific Knowledge?

10 Head-Start Projects for Christmas

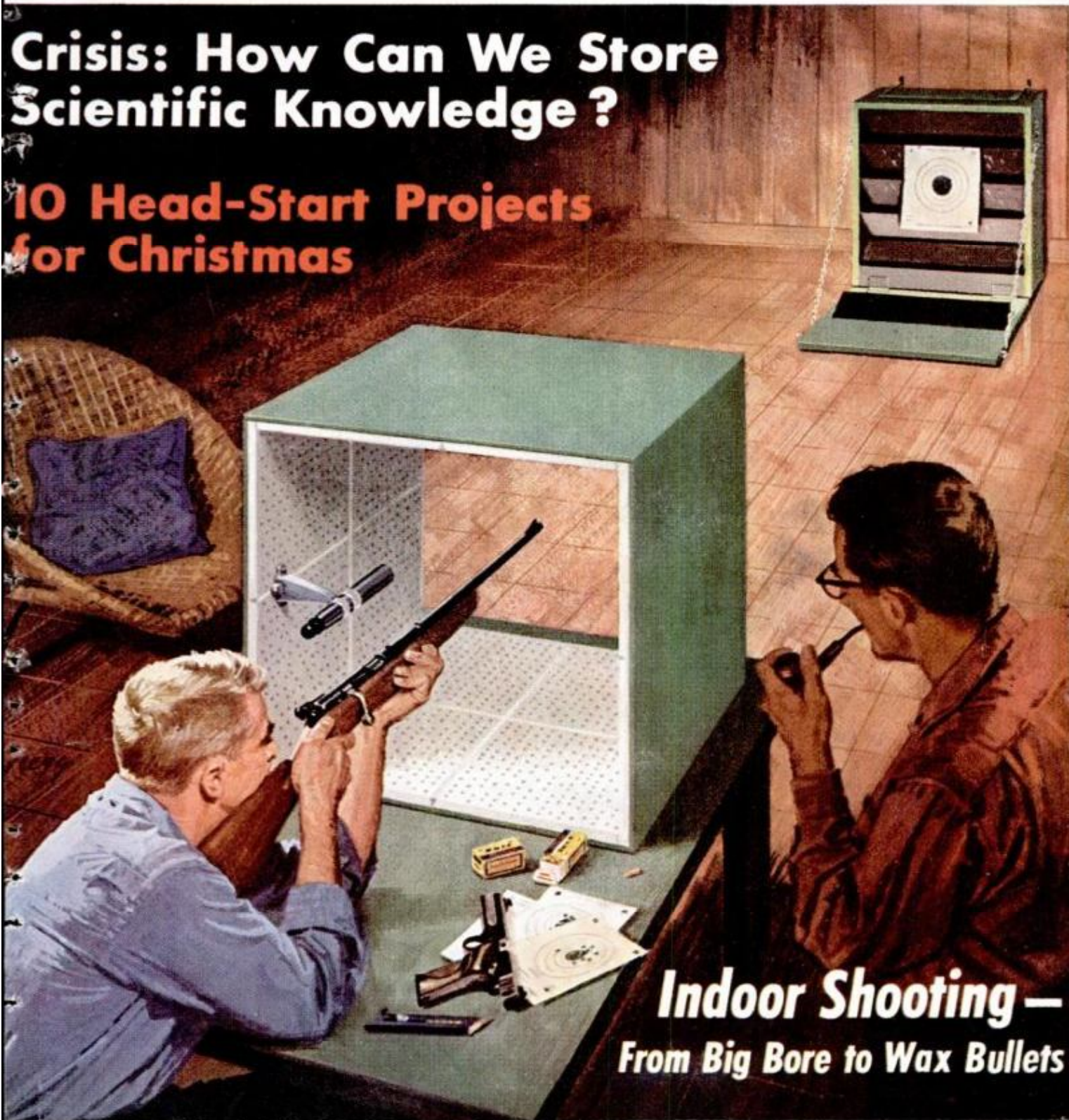

**Indoor Shooting —
From Big Bore to Wax Bullets**

*Here comes the
only one
of its kind!*



JETFIRE 

an exclusive from **OLDSMOBILE**

You can lift the hood of any other car in America . . . but you'll never see the kind of engine the 1963 Oldsmobile JETFIRE carries back of its stylish grille. It's the aluminum Turbo-Rocket V-8—the only fluid-injected, turbocharged engine ever to power a production automobile! On top of that, JETFIRE boasts foam-padded bucket seats. A sporty control console. Plus a rakish look and road-sure maneuverability that label it pure sports car from tip to taillights! Slide into a JETFIRE today and find out what "one of a kind" really means! Oldsmobile Division • General Motors Corporation.

There's "Something Extra" about owning an **OLDSMOBILE!**

TURBO-ROCKET V-8 uses exhaust gases to boost power nearly 40%. Delivers 215 h.p.—one horsepower for every cubic inch of displacement!

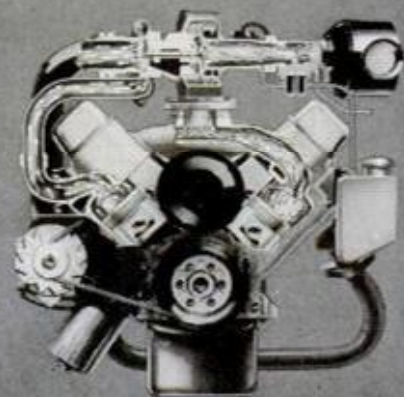

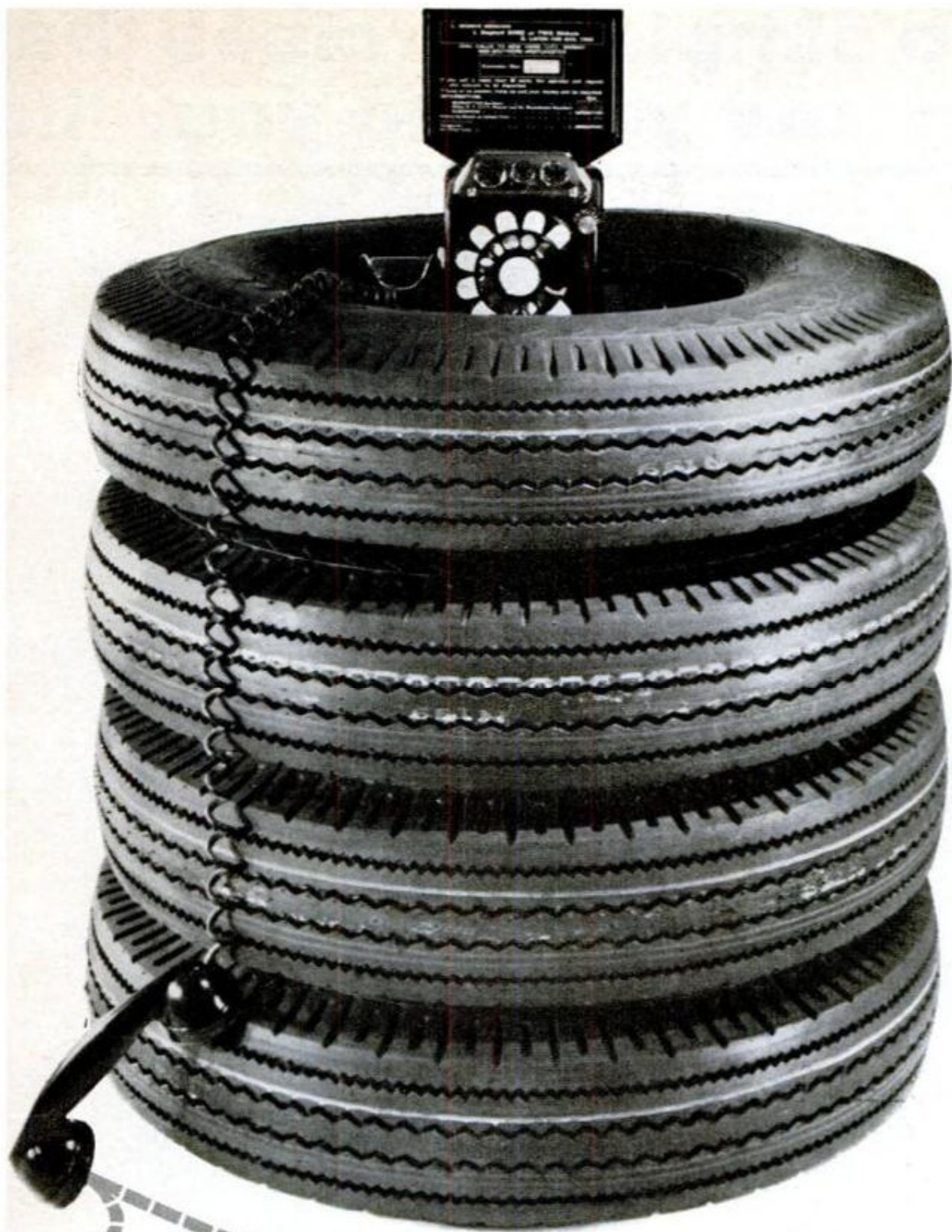

Talk about low cost! For less than the price of a local phone call a day, you can ride on four Goodyear Nylon Hi-Miler R-C truck tires. *(Get the message?)*

Hi-Miler—T. M. The Goodyear Tire & Rubber Company, Akron, Ohio

GOODYEAR
TRUCK TIRES

This One



A9DE-56L-33Q1

NOVEMBER 1962

1

Two simple exercises that can add years to your life

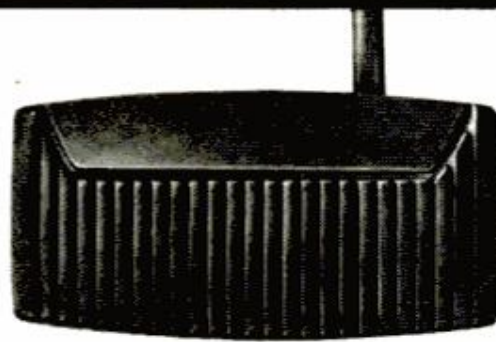

PUSH

This evening, while at home, get into your car and push the brake pedal. Have someone in your family make sure both your stop lights are working. If one is out, replace it tomorrow. You'll make it easier for the other driver—safer for yourself.

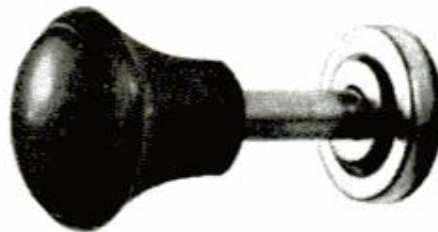

PULL

Then pull the light switch. Make sure all your headlamps (don't forget the upper beam) and your rear lights are working. And while you're at it, check your turn signals. These Push-Pull exercises will do you good—especially if you find a burnout. It's very possible you will—because one out of every six cars needs a new bulb.

When you find a burnout, replace it with a dependable General Electric lamp, the brand most people prefer.
Miniature Lamp Dept., Nela Park, Cleveland 12, O.



Progress Is Our Most Important Product

GENERAL  ELECTRIC

ANNOUNCING RAMBLER FOR '63

The New Shape of Quality



ALL NEW! Come see and drive the most beautiful Ramblers ever built—the all-new 1963 Rambler Classic Six and the 250 HP Rambler

Ambassador V-8. Built a brand-new way, they look longer but aren't. Nearly 3" lower, yet easier to enter. Full room for six 6-footers.



ALL NEW! Twin-Stick Floor Shift with Instant Overtake for sports-car action. Available.



ALL NEW! Chair-Height Bucket Seats with smart, handy Console. Available.



ALL NEW! Tri-Poised Power—vibration-free ride. Engine is seated in deep rubber!



ALL NEW! Advanced Unit Construction. Major breakthrough in car construction—massive one-piece uniside of galvanized steel (white above). Stronger, safer, longer lasting.



ALL NEW! Curved side windows as in \$6,000 cars. Cut wind noise, add new beauty.

AMERICAN MOTORS — Dedicated to Excellence

NOVEMBER 1962

3

POPULAR MECHANICS®

NOVEMBER 1962

VOL. 118

NO. 5

INTERNATIONAL EDITIONS • SPANISH: Mexico-Caribbean, Southern Hemisphere • FRENCH •

Features of Special Interest

How Thinking Factories Aid Defense - - - - -	87
Ford Builds a Bomb—The Mustang - - - - -	93
PM Selects the Toys of the Year - - - - -	96
Crisis! How to Store Human Knowledge - - - - -	104
Pioneer Planes Head for the Blue - - - - -	114
Unknown Menace: Germs From Outer Space - - - - -	124
Modern Gun Slinger - - - - -	132
PM Shopping Guide: Insulated Clothing - - - - -	133
Two-Man Submarine - - - - -	137
Three-Wheel, 150 mph Car - - - - -	138

For the Craftsman

Armchair Target Shooting - - - - -	142
Mancala: Africa's National Game - - - - -	151
10 Gifts You Can Make for Christmas - - - - -	152
Darkroom Timer Light - - - - -	168
Making Your Car Burn All It's Gas - - - - -	170
Robot Keeps Parked Car Warm - - - - -	174
Teaching Machine for Home Use - - - - -	177
Surface Grind with a Radial Saw - - - - -	181
Mandrel for Tricky Knurling Jobs - - - - -	184
Belt Sander Mounts on Lathe - - - - -	186
Add-on Entertainment Center - - - - -	191

Address communications to: 575 Lexington Ave., New York 22, N. Y. **SUBSCRIPTION SERVICE:** Mail all subscription orders, changes of address, correspondence concerning subscriptions, and Postmaster notices of undelivered copies to Popular Mechanics, 250 West 55th St., New York 19, N. Y.

Published by Popular Mechanics Company, RICHARD E. BERLIN, *President*

DON DINWIDDIE
Editor

RICHARD E. DEEMS
Executive Vice-President

JOSEPH R. BUELL, JR.
Publisher

Executive Editor: RICHARD F. DEMPEWOLFF
Managing Editor: JOHN A. LINKLETTER

Assistant Managing Editor: WAYNE C. LECKEY

Midwest Editor: CLIFFORD B. HICKS
740 N. Rush St., Chicago 11, Ill.

Western Editor: THOMAS E. STIMSON
Suite 1003, 3460 Wilshire Blvd., Los Angeles 5, Calif.

Art Director: HENRY M. NEHRBASS

Automotive Editor: JAMES R. WHIPPLE

Associate Editors: KEVIN V. BROWN, W. CLYDE LAMMEY,
ALFRED W. LEES, ARTHUR MIKESELL

Electronics Editor: BYRON G. WELS

Assistant Editors: STUART JAMES, JOHN P. MCNEEL,
ED NELSON, JOHN L. SCHERER

Art Editor: MURRAY COOPER

Assistant Art Director: LEO WEEKS

Chief Photographer: FRANK P. FRITZ

Editorial Assistant: JOHANNA L. PUGNI

International Editor: HEINZ P. SCHLICHTING

Ritterstrasse 26, Karlsruhe/Bd., Germany

Advertising Director: L. PARK BENJAMIN

If you wish additional sources of information for the articles in this issue, or if you wish the name and address of the manufacturer of a particular product shown here, write to Bureau of Information, Popular Mechanics, 575 Lexington Ave., New York 22, N.Y. Ask for the free "Where-to-Find-It-List" for this issue.

DANISH • SWEDISH • PORTUGUESE • DUTCH

Departments

Over the Editor's Desk - - - -	6
Science Overseas - - - - -	14
Tune In on the Inventors - - - -	16
Items From All Outdoors - - - -	20
Science Bulletins - - - - -	24
Sidelights on Aviation - - - - -	28
Pentagon Sidelights - - - - -	34
Worth Writing For - - - - -	40
On the Market - - - - -	52
Detroit Listening Post - - - - -	82
Shopping for Tools - - - - -	86
What's New for Your Home - - - -	140
Solving Home Problems - - - - -	148
Clinic for Homeowners - - - - -	202
Spotlight on the Alfa Romeo - - - -	246

Next Month . . .

CHRISTMAS COSTUMES for your house can be cut from panelboard in jigtime, using new Project-A-Plans for full scale tracing. December PM brings you a grab bag of Santa patterns, reindeer and Nativity scenes to choose from, plus a host of features including a road test report on Ford's Cardinal, which is far from dead; a hard look at UHF and what it will do to your TV picture; a rundown on the weird things they're doing with glass.

NOTE OUR NEW ADDRESS!

ADVERTISING OFFICES—New York: 575 Lexington Ave., Murray Hill 8-8500; Chicago: 740 N. Rush St., Whitehall 4-0100; Detroit: General Motors Bldg., TRinity 5-8711; Cleveland: Hanna Bldg., 1422 Euclid Ave., PProspect 1-0456; Los Angeles: 3460 Wilshire Blvd., DUNkirk 2-8458; San Francisco: 111 Sutter St., YUKon 2-0823.

Published monthly by Popular Mechanics Company, 575 Lexington Ave., New York 22, N. Y. Richard E. Berlin, President; Richard E. Deems, Executive Vice-President; Fred Lewis, Vice-President and General Manager; John R. Miller, Vice-President; Joseph R. Buell, Jr., Vice-President; G. O. Markuson, Treasurer; R. F. McCauley, Secretary. Single copy in the United States and Canada, 35 cents. Subscription prices: United States and Possessions, \$4.00 for one year; \$7.00 for two years; \$9.00 for three years. Canada, add \$0.50 for each year. Pan-American Postal Union countries, add \$1.00 for each year. All other countries, add \$2.00 for each year. When changing address, give old address as well as the new, with postal-zone number, if any, and allow six weeks for change to become effective. Second-class postage paid at New York, N. Y., and at additional mailing offices. Authorized as second class mail by the Post Office Department, Ottawa, and for payment of postage in cash. Registered as Second Class matter at the Post Office at Mexico, D.F., Mexico, June 20, 1950. ©1962 by Popular Mechanics Company. All rights reserved. Printed in the United States of America.



Testing New Toys
page 96



Old Timers
Still Fly
page 114



Two-man
Cub Sub
page 137



Christmas
Crafts
page 152



Lathe Spins
The Sander
page 186

Over the editor's desk

Lifetimers

I have read POPULAR MECHANICS since I was 12 years old. I am 68 and retired last August by company policy. The trouble with modern practice is that they judge a person's worth by his birth date.

Going through my third collection of PM I came across a December 1905 issue. On page 1246 was an item: *Life subscription to POPULAR MECHANICS may be purchased for \$10. Have you any living person with a life-long subscription?*

Downsview, Ontario, Canada

GEORGE W. POTTER

There are twelve such lifetime subscribers still living, George.

Plastic Hat for Pool Table

Have been buying PM for years with a great deal of enthusiasm. Something in it appeals to me and the first thing I know I am busy making it.

A few years ago, you had a boat on your pages called *Crusette*. I made it and it turned out to be a lovely craft I am quite proud of. Last January, you introduced a game table which I also made. It gives my wife and I, and our friends and family, no end of enjoyment. It is surprisingly accurate and I did not find it too expensive. I made a polyethylene top to put on the pool table when not in use. Thought this note would interest your many readers.

Sarnia, Ontario, Canada

LEN WILLS

It should, Len. So would pictures of the projects you built.

Slighted Platypus

Your July issue states that wild dogs are the only carnivorous mammals native to Australia. Not true. The platypus is a native of Australia, is a true mammal, and eats worms, bugs, etc.

Evansville, Ind.

R. B. ROBERTS

Also crustaceans. You're right and if we knew how to speak the platypus language, we'd apologize to them directly for the oversight.

Finding Telephone Poles

A hearty pat on the back for *Scuba Search* (July, PM). It proved to be a gold mine of information for our club, particu-

larly the info on search patterns and the construction of diving planes. We made a couple of the planes, and they were instrumental in helping us locate two telephone poles which had been lost in some 70 feet of water.

57th Air Rescue Squadron

WILLIAM J. HISSON

1st Lt. USAF

Glad to be of help, Bill, but what is your club planning to do with those poles? They might have made fine toothpicks for the passing whales.

Inventive Archeologists

The August PM article, *Life Again in Mummy Cave*, ably presents some of the work of archeologists in our Service. Stabilizing these prehistoric ruins of the Southwest is a highly specialized job and frequently the archeologists have to invent their own solutions to unique problems with whatever materials are on hand. Congratulations to author Richard Dunlop on a job well done.

National Park Service U. S. Dept. of Interior

JOHN M. CORBETT

Chief Archeologist

Carbon Tet Versus Ammonia

On page 200 of the September PM you mention using carbon tet to clean an oil-stone. Most households do not have carbon tet on hand. Most do have household ammonia which, when used with a rag to scrub the stone, will make it come clean like new.

Minden, La.

MAXWELL B. JESTER

Good idea, Max, though you may find when the stone is pretty well glazed that steel wool will work better than a cloth.

Tire Cutups

One of your readers asked (Sept. PM) how to turn tires inside out and make scalloped planters of them. Here is the way my father does it: Cut bead from one side of tire; cut V-shaped scallops along edge where bead has been removed; turn tire wrong side out with the aid of a strong helper.

Hoosick Falls, N. Y.

SANDRA PINE

It is easier (to turn inside out) and works as well with both beads cut out.

Crestview, Cal.

R. H. HATHCOCK

Use 4-ply tires. Trim bead and scallops with a sharp linoleum knife. Mr. Davison made a base for turning tires which consists of two tire rims welded on each end of a 4-in. pipe 27 inches long. Stand this on end and place tire on top. Mr. Davison turns a

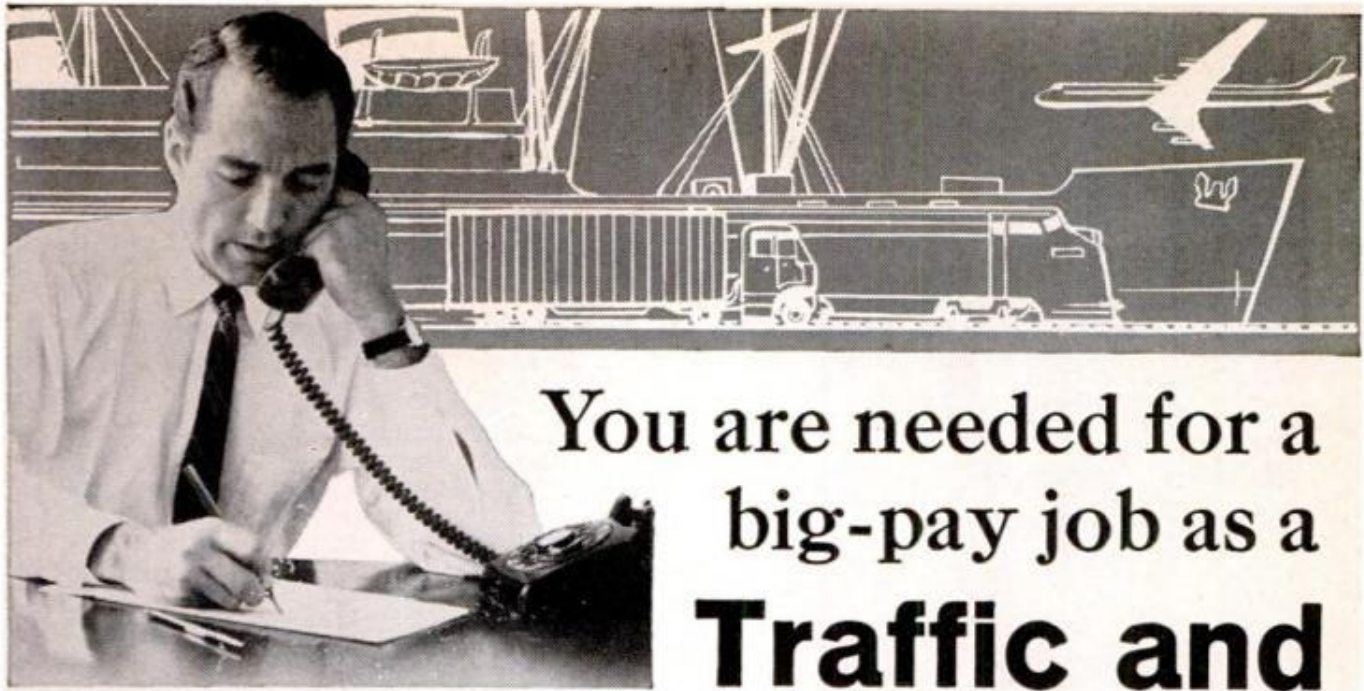

You are needed for a big-pay job as a Traffic and Transportation Expert

LA SALLE WILL TRAIN YOU IN YOUR SPARE TIME AT HOME

TAKE advantage of today's demand for men trained in Traffic and Transportation management. Qualify as the key executive who knows how to direct the movement of goods—quickly, efficiently and economically — interstate, transcontinent, and overseas. Unlimited opportunities with national manufacturers, raw material producers, leading transport lines. Learn at home under LaSalle's practical instructors—while you continue on your present job.

No previous experience required

LaSalle helps you become an expert on Rates, Classifications, Tariffs, Routing, Methods of Shipping, Claim Adjusting, Government Regulations, and all other transportation subjects. Instruction includes Motor-Truck Traffic Management, Air Transportation, Rail-roading, Water Transportation. Tuition cost is remarkably low.

LaSalle, a world leader in business education, has trained thousands for careers in Traffic

and Transportation. It can do the same for you—even if you have had no previous experience in this field. Why remain in a dead-end job when you can enjoy a future with high salary, and continuing security?

Send for Free Booklet

You owe it to yourself to read the interesting LaSalle booklet: "Opportunities in Traffic and Transportation" and to learn about LaSalle's home training program. Mail the coupon to LaSalle, 417 S. Dearborn St., Chicago 5, Illinois.

WANTED:

Trained men with fingertip answers to questions like these:

- Shall we ship by boat, plane, train, truck?
 - What combination of these is most practical?
 - What are the best routes?
 - Shall we use cartons? crates? knocked-down? assembled?
 - What does the law require?
 - Shall we set up warehouses? factories? branches? jobbers?
 - How shall we handle claims?
- ... and many more traffic questions

LA SALLE EXTENSION UNIVERSITY

An Approved Correspondence Institution
417 South Dearborn St., Dept. 11-092, Chicago 5, Ill.

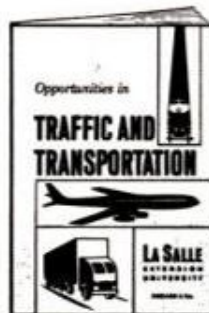

Please mail me your free booklet
"Opportunities in Traffic and Transportation."

Name Age.....

Address County.....

City & Zone..... State.....

418

I'M SICK AND TIRED OF WAITING!



1. **EVERYTHING** COMES TO HIM WHO WAITS? THAT'S A LAUGH. I WAITED FOR THE BREAK. WAITED 'TIL I WAS SICK OF IT. HOW LONG CAN A GUY WITH A WIFE AND 3 KIDS GO ON DREAMING?

THIS IS THE TRUE LIFE STORY OF JOHN W. HARVIN, JR. DAYTONA, FLORIDA. FROM OUR I.C.S. SUCCESS FILES

HONEY, THERE'S NO OTHER WAY, I'VE JUST GOT TO GET MORE TRAINING. OTHERWISE, I'M STUCK

BUT JOHN, YOU CAN'T AFFORD TO STOP WORK AND GO TO COLLEGE NOW. THERE JUST HAS TO BE ANOTHER WAY



2. MY WIFE AND I THOUGHT ABOUT IT, TALKED ABOUT IT, WORRIED ABOUT IT. WE WERE STUMPED. WE THOUGHT WE HIT A DEAD END

3. LOOK AT THIS: I.C.S. HAS A COURSE IN SURVEYING AND MAPPING. DO YOU SUPPOSE IT'S ANY GOOD?

WELL, JANE'S HUSBAND TOOK AN I.C.S. COURSE IN ACCOUNTING—AND SHE SAYS IT WAS THE SMARTEST THING HE EVER DID!



ONE DAY—MY LUCKY DAY—I TOOK A CLOSE LOOK AT THAT FAMOUS I.C.S. COUPON. I'D SEEN IT BEFORE A THOUSAND TIMES. BUT THIS TIME I REALLY LOOKED

I.C.S. IS THE OLDEST AND LARGEST CORRESPONDENCE SCHOOL IN THE WORLD. 256 PERSONALIZED-INSTRUCTION DIPLOMA COURSES

LOOK—IT SAYS THEY'LL SEND YOU A CAREER KIT FREE. THREE BIG SUCCESS BOOKS

I'M GOING TO SEND THAT COUPON. THIS MIGHT BE JUST WHAT WE'RE LOOKING FOR!



4. THAT SETTLED IT! I DECIDED TO FIND OUT WHAT I.C.S. WAS ALL ABOUT. AFTER ALL, WHAT DID I HAVE TO LOSE?

5. WHEN I SAW THE THREE FREE BOOKS, I KNEW I'D FOUND THE ANSWER. I ENROLLED —AND I WAS ON MY WAY!

THIS STUDYING AT HOME SURE IS SAVING ME TIME. LOOK HOW FAR I'VE GOTTEN ALREADY

FROM THE WAY THEY HELP WITH YOUR INSTRUCTIONS, YOU'D THINK YOU WERE I.C.S.'S ONLY STUDENT



6. JOHN HARVIN'S SUCCESS STORY CAN COME TRUE FOR YOU, TOO. HERE'S THE FAMOUS I.C.S. COUPON. LOOK IT OVER. CLIP IT. MAIL IT NOW!

THAT RAISE WAS JUST THE BEGINNING, IT'S SO GOOD TO LOOK AHEAD WITHOUT WORRYING. WE'RE ALL SO PROUD OF YOU, JOHN!

HONEY. THE BOSS TOLD ME I'VE GOT A REAL FUTURE NOW!



FREE!

I. C. S. CAREER KIT

Send coupon now . . . get all these:

- 1 "HOW TO SUCCEED"
A 32-page gold mine of ideas
- 2 CAREER CATALOG
Opportunities in the field that interests you most
- 3 SAMPLE LESSON (MATH)
Shows the famous step-by-step I. C. S. teaching method

For Real Job Security—Get an I. C. S. Diploma!

I. C. S., Scranton 15, Penna.

Accredited Member,
National Home Study Council

INTERNATIONAL CORRESPONDENCE SCHOOLS I C S

BOX GO419L, SCRANTON 15, PENNA.

(In Hawaii: P. O. Box 418, Honolulu. In Canada: I. C. S. Canadian, Ltd., Montreal.)

Without cost or obligation, rush me FREE Success Kit, with 3 valuable booklets: (1) How to Succeed; (2) opportunity booklet about the field I've checked below; (3) Sample I. C. S. Lesson.

ARCHITECTURE and BUILDING TRADES

- Air Conditioning
- Architecture
- Arch. Drawing
- Building Contracting and Estimating
- Carpentry & Millwork
- Heating
- House Planning
- Painting
- Plumbing

ART and DESIGN

- Commercial Art
- Fashion Illustrating
- Interior Decorating
- Magazine Illustrating
- Show Card & Sign
- Painting
- Sketching and Painting

AUTOMOTIVE

- Auto Body Rebuilding
- Auto Electric Technician
- Automobile Mechanic
- Engine (Gas & Diesel)
- Engine Tune-Up

Transmission Specialist

AVIATION

- Aero Engineering
- Aircraft Drafting
- Aircraft Mechanic

BUSINESS

- Accounting
- Cost Accounting
- Public Accounting
- Bus. Administration
- Executive Training
- Marketing
- Personnel-Labor Relations
- Programming for Digital Computers
- Purchasing Agent
- Real Estate
- Salesmanship
- Sales Mgmt.
- Small Business Mgmt.
- Traffic Mgmt.

CHEMICAL

- Analytical Chemistry
- Chem. Engineering
- General Chemistry

Lab. Technician

- Nuclear Energy
- Plastics
- Pulp, Paper

CIVIL ENGINEERING

- Civil Engineering
- Construction Engrg.
- Highway Engineering
- Reading Structural Blueprints
- Sanitary Engineering
- Structural Engineering
- Surveying & Mapping

DRAFTING

- Architectural
- Electrical and Electronic
- Mechanical
- Sheet Metal

ELECTRICAL

- Elec. Appliance Servicing
- Electrical Engineering
- Elec. Eng. Technician
- Elec. Motor Repairman
- Industrial Electronic Technician

Industrial Telemetering

- Instrument Technician
- Practical Electrician
- Practical Lineman

ELECTRONICS

- Automation
- Basic Electronics
- Electronic Computers
- Electronics Technician
- Hi-Fi Stereo and Sound Systems
- Industrial Electronics
- Ultrasonics

ENGINEERING (Professional)

- Chemical
- Civil
- Electrical
- Mechanical

ENGLISH and WRITING

- Better Business Writing
- Introductory Technical Writing
- Short Story Writing

Practical English

HIGH SCHOOL (Diploma)

- High School General
- High School Math
- High School Secretarial
- High School Vocational
- College Preparatory

MECHANICAL and SHOP

- Gas and Electric Welding
- Industrial Engineering
- Industrial Instrumentation
- Machine Design
- Machine Shop Practice
- Mechanical Engineering
- Reading Shop Blueprints
- Tool Design
- Toolmaking
- Safety Engineering

SECRETARIAL

- Clerk-Typist
- Professional Secretary

Shorthand

- Stenographic
- Typist

STEAM and DIESEL POWER

- Boiler Inspector
- Power Plant Engineering
- Stationary Diesel Engineering
- Steam Engineering

SUPERVISION

- Foremanship—Suprv'n
- Personnel—Lab. Rel'ns

TV-RADIO

- Radio and TV Servicing
- Radio-Telephone License
- TV Technician
- Practical Radio-TV Engineering

MISCELLANEOUS

- Railroad
- Textile
- Other (please specify)

Name _____ Age _____ Sex _____
 Home Address _____
 City _____ Zone _____ State _____
 Occupation _____
 Employed by _____ Working Hours _____

Special low rates to members of U. S. Armed Forces!

The Pipe Smoker's MISCELLANY

*Tidbits, Tips & Trivia on
the art of Pipesmanship*

HOW TO CAKE A NEW PIPE



Take your pick. You can coat the inside of the bowl with honey or black molasses (wiping off excess). Or fill the bowl with good dark rum and let soak overnight. Or simply scrape it and moisten with water. Then smoke up a good caking.

A cake thickness of 1/16 to 1/8 inch is the usual recommendation—but who's measuring? Depends on how you like it.

An old-timer we know suggests: "If your little finger won't fit in the bowl, it's time to ream—but go easy. You can have your cake and smoke it too."

*The man who smokes thinks like a sage
and acts like a samaritan.*

BULWER-LYTTON

THE PIPE TOBACCO THAT STAYS LIT



Bond Street Pipe Tobacco keeps burning because of its old English cut—a combination of flakes for even-burning and cubes for slower-burning. You'll like its aroma of fine imported and domestic tobaccos, too.

**A good pipeful
is better than
a quiet wife.**

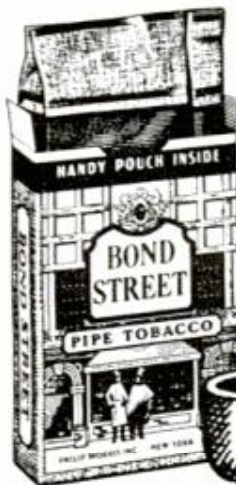

BOND STREET

A product of Philip Morris Inc.



little at a time while I hang on to it to keep it from turning back.

San Jose, Cal.

MRS. ARTHUR DAVISON

Place scalloped tire on a 20-gallon garbage can (cut side up). Peel down over can, turning tire inside out.

Westwood, N. J.

M. R. MYLES

And there you have it—right from an enthusiastic group of old "pros" in the inside-out tire planter business.

The Grease Is Flying

You must have been high when you wrote that grease monkey article (September *Detroit Listening Post*). I've operated a service station for 22 years. Never has inadequate servicing been performed here. Instead of condemning all grease monkeys, why not recommend that your readers take their cars to a long-time neighborhood dealer? Come on, now, start thinking before writing or we'll have to call you a "grease columnist"!

New York, N. Y.

AL FISHMAN

Your September *Listening Post* on greasing interested me. In almost 50 years I found only one service station that did a thorough lubrication job. One time I paid \$7.50 extra on a lube job to have the universal joints packed. Drove to the West Coast and on the way back a U-joint went bone dry. The service people later admitted they "must have missed it." Usually some untrained kid pokes around putting grease on any nipple with no reference to a check chart. Now I have a car which, according to the factory, will require lubrication after 32,000 miles. I should drive so far!

Kansas City, Mo.

BILL DAVIDSON

With the long term lube periods manufacturers now recommend, instead of watching over every service station lube jockey, all we need do now is to watch the man who does it at the factory!

PM Pays Its Way

Your magazine has become a must in my house. The money I have saved on things I have picked up in your magazine has more than saved the price of the magazine—one of the best I have ever subscribed to.

Milton, Del.

ROBERT E. FURROUGHS

Yours is not the first letter to point out the saving grace of reading PM. Have any other readers kept records of the savings they have achieved by using the information and instructions they find in our pages?

The Editors

POPULAR MECHANICS

Important news for the inexperienced man who needs a short cut to a better job, more money and greater security.

AMAZING NEW HOME TRAINING PLAN IN AIR CONDITIONING AND REFRIGERATION

...the exclusive CTI Learn-and-Practice method which enables many students to earn money in spare time — as they train for a top-pay job or their own business



You build an operating condensing unit

This Is Your "Home Training Shop"



REAR VIEW

25 Kits
20 Shop Projects

Learn by Practicing—Get Experience

The new CTI semi-sealed condensing unit. You build this heavy-duty commercial-type unit from 25 kits that CTI sends without extra cost. You complete 20 Shop Projects. After assembling unit, you may then build an air conditioner, freezer, refrigerator or milk cooler.

Mechanic's Tools

You get wrenches, tube flaring tools, hammer, tubing, fittings, gauges and other items used by the experienced mechanic. Everything is of professional quality. Best of all, CTI trains you to use tools with speed and skill.



"A demand for many thousands of additional mechanics who can install, maintain, and repair air-conditioning and refrigeration equipment is expected in the 1960s," the U.S. Dept. of Labor reports. "The use of air-conditioning in offices, stores, and theatres is increasing tremendously. In homes, the number of centrally installed air conditioning units doubled between 1957 and 1960." The growth of refrigeration in food preservation and in the manufacture of synthetic rubber, oil, high-test gasoline, medicine and drugs is also stressed by the Labor Dept. Want to be a mechanic in this great-growth field? Find out how—by mailing coupon below for complete information! No obligation.

Easy and Interesting Course

CTI's exclusive home study course is expertly written, clearly illustrated, easy to understand. It offers up-to-date knowledge and includes kits of tools and parts that you assemble into a working unit. It provides job experience projects which help you put knowledge to practical use. It's prepared especially for men who've had no previous experience. You'll enjoy CTI lessons.

Go in Business—Be the Boss

Opportunities to go in business are available because air conditioning is one of America's two fastest-growing industries. Start in a small way working from your home, and gradually expand. In time, you may want to add a sales division. Manufacturers offer attractive franchises and aids to ambitious and qualified men. Many CTI graduates report they are starting repair shops.



Make Money as You Train

Many CTI students earn money in spare time. Some handle servicing for food stores, restaurants, taverns, etc., on a monthly fee basis. Others work part time with local dealers. Many make service calls to homes on their own.



Graduates Praise Training

"I started my own business. Earn from \$800 to \$900 a month."—Dale Landsberger, Okla. "Have gone into trucking refrigeration. My wages have tripled."—James Wiest, Minn. "I quit my \$75 a week job and am now making \$120 a week in a refrigeration shop."—Roy Goldsworth, Wyo. "Am a repair man and earn \$200 a month over what I used to."—Albert Baum, Ill.

Over 50,000 Graduates

CTI is one of the nation's largest home study institutes and has graduated over 50,000 men. CTI is the only school in this field that sends parts-kits to build real equipment.



FREE! THREE VALUABLE OPPORTUNITY BOOKLETS

Investigate your opportunities for a better-pay job or your own business in an industry that has grown by 400% the past 12 years. Just fill out and mail coupon and we'll send our school catalog, lesson samples and a booklet of testimonials from grateful graduates. Act today.

CLIP COUPON BEFORE YOU TURN THIS PAGE—MAIL TO CTI TODAY

COMMERCIAL TRADES INSTITUTE CHICAGO 26, ILLINOIS
Accredited by National Home Study Council

COMMERCIAL TRADES INSTITUTE

1400 GREENLEAF AVENUE DEPT. R-139
CHICAGO 26, ILLINOIS

Send me your 3 free booklets, Success in Air Conditioning and Refrigeration; Lesson Samples; and Proof from Graduates. No obligation.

NAME _____ AGE _____

ADDRESS _____

CITY _____ ZONE _____ STATE _____





IT'S EXCITING!

GO JET-SMOOTH CHEVROLET for '63

▼'63 Chevrolet Bel Air Station Wagon

▲'63 Chevrolet Impala Sport Sedan

▼'63 Chevrolet Impala Convertible

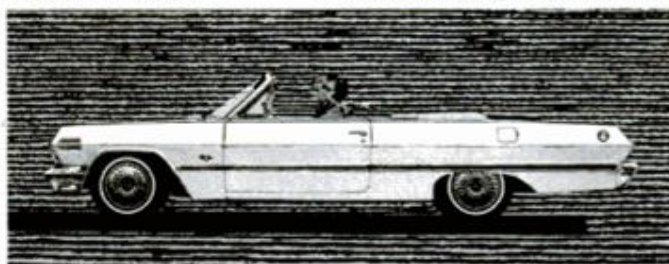
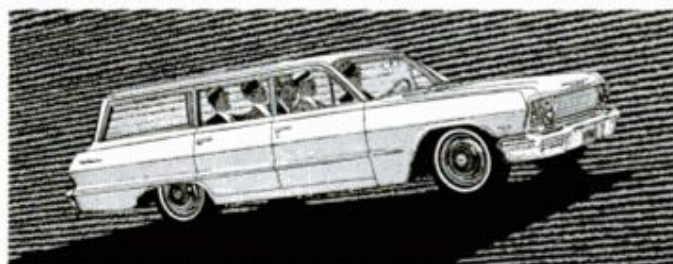

GO CHEVROLET FOR THE GREATEST GOING EVER—Cover this car's price tag and you might think it cost a thousand dollars more. It offers luxurious styling, extremely comfortable, spacious and silent interiors . . . plus ways to keep it looking and running like a new car when a lot of others have started to sag and sigh: new air-washed rocker panels under the doors of its Body by Fisher to guard against rust and help protect its beauty . . . self-adjusting brakes to save you time and expense . . . Delcotron generator for longer battery life. There's a lot *more* to find out about the Jet-smooth '63 Chevrolet. Best way is to *drive* one.

It's Chevy Showtime '63! Come to the



'63 Chevy II Nova 400 Sport Coupe

Hard to believe, but this year's Chevy II is better than last year's. It shares the new easy-care features of the big Chevrolet and adds its own attributes of parkable size, four- or six-cylinder economy, and interiors that'll match cars with twice the price and half the charm. If you want maximum car for minimum dollars, Chevy II is your car. . . . Chevrolet Division of General Motors, Detroit 2, Mich.



'63 Corvair Monza Convertible

Change it? Calm yourself, nobody's going to mess with a winner like this one! We did add self-adjusting brakes and a more fully aluminized muffler; interiors are refined a bit, and you'll notice some trim changes, but the rest is pure untampered-with Corvair with all the over-the-road goodness that implies. Oh yes, we changed the rings around the tail-lights so all those people you pass will know you're driving a '63.

Go Show at Your Chevrolet Showroom



Science overseas

By William Kreh

The sun will soon become the object of a worldwide scientific study. Countries all over the globe are busily preparing for the IQSY—the International Quiet Sun Year. It may turn out to be the most extensive world cooperative scientific program yet attempted. It'll take place in 1964-65 when there's to be a minimum of sunspots. A lull in sunspot activity occurs every 11 years.

World data centers are being established and a series of special days will be designated when identical observations of the sun will be made from all over the earth.

Countries lined up so far are Argentina, Belgium, Canada, Czechoslovakia, Denmark, Finland, France, West Germany, Hungary, India, Ireland, Japan, Korea, Malagasy Republic, the Netherlands, Poland, South Africa, Spain, Switzerland, Taiwan, United Kingdom, the United States and Russia. Others may join later.

IQSY will be devoted to studying the sun's activity and its effects on the earth, including weather, communications and the composition of the stratosphere.

Speaking of sunspots, a Greek scientist at the University of Athens has uncovered evidence that solar flares definitely affect the growth of trees. He recently studied pieces of cypress used in the construction of the Parthenon. The wood had about 200 annual rings visible and microscopic measurement of them showed regular fluctuations, the most prominent being every 11 years—the sunspot cycle. This same period has been seen in modern trees, but never has wood so ancient been examined.

A Dutch company has developed a plastic tube that fits on a faucet to filter out radioactivity. Filled with removable resin charges that take out contamination, it can produce five and a quarter gallons of cleansed water an hour.

How much noise does a car make? Researchers in Great Britain's automobile industry now can tell exactly by using a new portable, transistorized noise meter developed by an instrument maker in London and designed especially to measure the noise made by a vehicle.

Russian scientists have found they can open ice-locked harbors by spreading coal dust. The dark dust absorbs the sun's heat, which melts the ice.

A table fork has solved an underseas mystery in Italy. The identity of a submarine hulk dredged up from the Adriatic Sea was in doubt until a fork with a name engraved on it was found inside the craft. The name proved to be that of a young sailor assigned to the Austrian submarine U-20 which disappeared in 1918.

Quit worrying and save your teeth. So say Australian dental researchers who have completed statistical evidence that worry causes tooth decay. They questioned 660 patients over three and a half years and found that 96 percent of those with acute caries reported having suffered a period of severe mental stress just before their tooth troubles started.

Even without a Liz Taylor picture playing, Danish air-conditioning experts have found that during an average-length film, a movie theater filled with about 1500 people gives off enough heat to warm 10 single-family homes.

Cartographers from 43 countries are pooling their knowledge to make a new, detailed map of the world, first project of its kind since 1913. When finished, the new map will have 2000 sheets that will cover an area of 700 square yards or make a globe with a 42-foot diameter.

Kids are learning to read twice as fast in England with a new experimental alphabet which eliminates Qs and Xs and adds 19 new letters. A test worked so well on 1000 students in 24 British schools that education officials are now teaching the "Augmented Roman" alphabet to 1500 more five-year-olds. It's expected to help children read in half the normal time and eliminate all failures.

The new alphabet is designed to avoid the confusion of usual letters which are combined in more than 2000 ways to form the 40 or so basic sounds of the English language. For example, one new symbol stands for the O sound found in such words as owe, hoe, though, no, sew, coal and yolk. In the same way, different symbols represent the different sounds of the O as it's used in done, gone, bone, one.

Children learn to read with the new alphabet and then change to conventional books when they are ready, usually about age seven.

GET READY FOR THE SPACE and SCIENCE ERA! SEE SATELLITES, MOON ROCKETS



AMAZING SCIENCE BUYS

for FUN, STUDY or PROFIT

See the Stars, Moon, Planets Close Up! 3" ASTRONOMICAL REFLECTING TELESCOPE



GO TO 180 POWER!
Famous Mt. Palomar Type!
An Unusual Buy!

See the Rings of Saturn, the fascinating planet Mars, huge craters on the Moon. Equatorial Mount with lock on both axes. Aluminized and overcoated 3" diameter high-speed f/10 mirror. Telescope comes equipped with a 60X eyepiece and a mounted Barlow Lens. Optical Finder Telescope included. Hardwood, portable tripod. FREE with Scope: Valuable STAR CHART plus 272-page "HAND-BOOK OF HEAVENS" plus "HOW TO USE YOUR TELESCOPE" BOOK.

Stock No. 85,050-H \$29.95 Postpaid
4 1/4" REFLECTING TELESCOPE—Up to 255 Power.
Stock No. 85,105-H \$79.50 F.O.B., Barrington, N.J.

BUILD A SOLAR ENERGY FURNACE



A fascinating new field. Build your own Solar Furnace for experimentation—many practical uses. Easy! Inexpensive! Use scrapwood! We furnish instructions. This sun powered furnace will generate terrific heat—2000° to 3000°. Fuses enamel to metal. Sets paper alight in seconds. Use our Fresnel Lens—14" diameter . . . f.l. 14".

Stock No. 70,130-H Fresnel Lens \$6.00 Postpaid
11" Sq. Fresnel Lens F.L. 19".
Stock No. 70,533-H \$4.75 Postpaid

SPELLBINDING EXPERIMENTS with SILICON SOLAR CELL AND SUN BATTERY!



Experience endless fascination in converting sunlight into electricity to power small motors, amplifiers, etc. (See July '61 Popular Science article—"The Boat That Runs on Sunlight" for latest techniques). Plastic case 1 1/8" x 1 1/8" x 3/16". Produces .3 to .45 volts—10-16 millamps. 24-page Handbook gives full data on 12 pat experiments.

Stock No. 60,216-H \$2.25 Postpaid
Selenium PhotoCell. Lower power, lower price than Silicon Cell.
Stock No. 30,411-H \$1.50 Postpaid
Solar Cell and PhotoCell Handbook. Fascinating 112-page Handbook on Silicon-Cell and Selenium projects, demonstrations, etc. Explains photo-voltaic theory, performance. Gives infrared and ultra-violet applications. Paperbound, 6"x9".
Stock No. 9230-H \$2.00 Postpaid

MINIATURE WATER PUMP



Wonderful for experiments, miniature waterfalls, fountains. Christmas gardens. HO gauge railroad backdrops, hobbyists, labs, schools. Pumps continuous flow of water etc. Tiny (2 5/8" x 1 3/4") electric motor and pump ideal for hobbyists, labs, schools. Pumps continuous flow of water at rate of one pint per minute at a 12" head. With 2 D Batteries in series will pump to 24" high. Works in either direction. Stock No. 50,345-H \$2.25 Postpaid

'FISH' WITH A MAGNET

Go Treasure Hunting On The Bottom

Great Idea! Fascinating fun and sometimes tremendously profitable! Tie a line to our 5-lb. Magnet—drop it overboard in bay, river, lake or ocean. Trawl it along the bottom—your "treasure" haul can be out board motors, anchors, fishing tackle, all kinds of metal valuables. 5-lb. Magnet is war surplus—Alnico V Type—Gov't. Cost—\$50. Lifts over 125 lbs. on land—much greater weights under water. Order now and try this new sport. Stock No. 70,571-H 5 lb. Magnet \$12.50 Postpaid



OPAQUE PROJECTOR



Projects illustrations up to 3" by 3 1/2" and enlarges them to 35" x 30" if screen is 6 1/2 ft. from projector; larger pictures if screen is further away. No film or negatives needed. Projects charts, diagrams, pictures, photos, lettering in full color or black-and-white. Operates on 115 volt, A.C. current. 6-ft. extension cord and plug included. Operates on 60 watt bulb, not included.

Size 12" x 8" x 4 1/2" wide. Weight 1 lb., 2 oz. Plastic case with built-in handle.
Stock No. 70,199-H \$7.95 Postpaid

ORDER BY STOCK NUMBER. SEND CHECK OR MONEY ORDER. SATISFACTION GUARANTEED.
EDMUND SCIENTIFIC CO., BARRINGTON, N. J.



SCIENCE TREASURE CHESTS

Extra-powerful magnets, polarizing filters, compass, one-way-mirror film, prism, diffraction grating, and lots of other items for hundreds of thrilling experiments, plus a Ten-Lens Kit for making telescopes, microscopes, etc. Full instructions included.

Stock No. 70,342-H \$5.00 Postpaid
Science Treasure Chest DeLux—Everything in Chest above plus exciting additional items for more advanced experiments including crystal-growing kit, electric motor, molecular models set, first-surface mirrors, and lots more.
Stock No. 70,343-H \$10.00 Postpaid



ASTRO-COMPASS AND TRANSIT

War surplus! Astro Compass alone cost Govt. \$75. We have added a Sighting Level to improve versatility. Hundreds of uses in carpentry, brick laying, foundation work, grading, irrigation or drainage. Much below cost of ordinary surveying instruments. Ideal for do-it-yourselfers. 10 1/4" high, 6" long, 4" wide. Adjustable leveling platform—2 spirit levels for aligning—also spirit level in sighting attachment, tremendous bargain.

Stock No. 70,267-H \$19.95 Postpaid

LARGE SIZE OPAQUE PROJECTOR

Ideal for photographers, this low-cost unit projects 3 1/2 ft. sq. image at 6 ft.—7 1/2" ft. sq. image at 12 ft. Projects photos, drawings, sketches, clippings, any opaque copy up to 6" x 6"—larger pieces in sections. Lenses are 2 plano-convex, 3 1/2" dia. mounted in 5 1/4" barrel. Projector is 11 1/2" high, 13 1/4" wide, 9" front to back, pressed steel in black wrinkle finish, bakelite handle. Uses two 200 watt bulbs—not included. Complete with side platform to hold illustrations, 6 ft. elec. cord, heat resist. plate glass mirror.



Stock No. 80,066-H \$42.00 Postpaid

WAR SURPLUS AMERICAN-MADE 7x50 BINOCULARS

Big savings! Brand new! Crystal clear viewing—7 power. Every optical element is coated. An excellent night glass—the size recommended for satellite viewing. Individual eye focus. Exit pupil 7mm. Approx. field at 1,000 yds. is 376 ft. Carrying case included. American 7 x 50's normally cost \$24.50. Our war surplus price saves you real money.

Stock No. 1544-H Only \$74.80 Postpaid (Tax included)
6 x 30 Binoculars—similar to above and a terrific bargain.
Stock No. 963-H \$33.00 Postpaid (Tax inc.)



NEW! CIRCULAR SLIDE RULE!

Pocket Size—Fast—Easy to Use!



Multiplies, divides, figures fractions, percentages, squares, cubes, roots, proportions, circumferences, areas, prices, fuel consumption. Faster, easier to learn and use. Directions included.

Stock No. 30,336-H \$4.95 Postpaid

WOODEN SOLID PUZZLES

12 Different puzzles that will stimulate your ability to think and reason. Here is a fascinating assortment of wood puzzles that will provide hours of pleasure. Twelve different puzzles, animals and geometric forms to take apart and reassemble, give a chance for all the family, young or old, to test skill, patience, and, best of all to stimulate ability to think and reason while having lots of fun. Order yours now.



Stock No. 70,205-H \$3.00 Postpaid

Order by Stock No.—Send Check or M.O.—Money-Back Guarantee
EDMUND SCIENTIFIC CO., Barrington, New Jersey

MAIL COUPON FOR FREE CATALOG "H"

New! 1000's of Bargains 164 Pages

EDMUND SCIENTIFIC CO., Barrington, N. J.

Please rush Free Giant Catalog "H"

Name

Address

City..... Zone.... State.....



Tune in on the inventors

by J. L. Pugni

Shoppers who can't resist testing products in aerosol cans will be disappointed when patent 3,049,263 is marketed. To prevent tampering with goods before purchase, a disposable lock especially for aerosol can tops has been developed by Sigmund E. Edelstone, Chicago, and Manley K. Hardison, Glenview, Ill.

For a light-footed feeling, try an inflatable attachment for sole and heel that gives a comfortable cushioning effect. It inflates by means of a self-sealing valve, and is held magnetically in place when attached to any shoe or boot. Patent 3,044,190.

Air pollution resulting from evaporating gasoline fumes can be reduced by fitting the float bowl of an ordinary carburetor with a fuel drain that returns the fuel to the gasoline tank as soon as the automobile engine is turned off. The invention won pat-

ent 3,048,157 for James B. Gregory, Charles C. Moore and Howard D. Emerson of Fullerton, Calif.

Continuous weighing of smoked products so the process can be stopped when the desired weight loss is reached is a food-processing method that earned patent 3,050,144 for Owen Rice, Allegheny County, Pa., and Donald M. Stough of Pittsburgh.

To lessen frost damage to plants and fruit trees, a chemical spray using a polymer of N-vinyl-2-pyrrolidone is applied with ordinary spraying equipment. The chemical reportedly gives protection for extended periods of time and is effective for all sizes of plant life. Inventor Thomas H. Coulter, Jackson, Miss., was assigned patent 3,045,394.

Drowsy drivers might avoid automobile accidents by using an automatic brake that stops the car when the motorist falls asleep and releases a hand lever. For his invention, Anthony Giannetti, Paterson, N. J., won patent 3,049,188.

Copies of the original patents may be ordered for 25 cents each from the Commissioner of Patents, Dept. of Commerce, Washington 25, D. C.

LOOKING FOR LONG WEAR IN SERVICE SHOES?

TRY Thom McAn SHOES WITH NEOPRENE SOLES!



Ask for
Style No. 01675
Mahogany



BETTER THINGS FOR BETTER LIVING... THROUGH CHEMISTRY

Thom McAn "Dynawork" service shoes are made for men who want day-long comfort and extra ruggedness on the job. Soft, flexible uppers... one-piece, molded heel and sole, eliminating heel separation... fully cushioned insoles are yours when you invest in hard-working "Dynawork" service shoes.

Long-wearing soles and heels of Du Pont Neoprene give the extra service life that means more wear for the money. Neoprene resists oil, grease, chemicals and cold-weather cracking... helps ease you through your working day because of lasting resilience. Write Du Pont, Dept. PM-11-NS, Wilmington 98, Delaware.

Try Thom McAn "Dynawork" shoes with Neoprene soles the next time you buy.

POPULAR MECHANICS

"OWN a Business" Coupon

DURACLEAN CO. 2-16N Duraclean Bldg., Deerfield, Ill., U.S.A.

Without obligation to me, send booklet and letter giving full details. Tell me how I may OWN a growing business of my own built upon satisfied customers.

Name _____
Address _____
City _____ State _____

Start Now
while
employed



Are You The Man?

If you have longed for the prestige and financial independence of YOUR OWN business, you can now realize this goal . . . if you can qualify for a Duraclean dealership. We are now enlarging this world-wide chain of independently-owned service dealerships.

You must however be reliable, honest, diligent and able to make a small investment in a business we assist you in establishing. It's a profession we will personally and quickly teach you. We will help finance you. You can build your business

while still employed.

This is a sound, lifetime business that grows from REPEAT ORDERS and customer RECOMMENDATIONS.

Alert dealers, using national price guide, can gross an hourly profit of \$9 on own service plus \$6 on EACH service man.

We want to assure your success. A Duraclean dealer will train and assist you. He'll reveal his successful plan of building customers. He will work with you. This business is easy to learn . . . quickly established. Coupon will bring full details.

You are Trained in a New Profession... to Revive, Clean, Protect Home Furnishings

Duraclean's growth to a worldwide service resulted from the safer, quick-drying ABSORPTION process rendered in-the-home by courteous, trained craftsmen. Aerated foam created by the electric Foamovator vanishes dirt, grease and many unsightly spots.

Customers appreciate upholstery and floor coverings cleaned with a new consideration for life and beauty. No more soaking, harsh scrubbing, or strong soaps. Instead of scrubbing soil down into upholstery or rug pile, it is REMOVED.

Customers tell friends how Duraclean eliminates the customary soaking and breaking of fibers . . . how the mild quick-action foam, lightly applied, revives colors and enlivens fibers . . . how fabrics look fresher, brighter and cleaner . . . how furnishings are back in use in a few hours. Customers become your best salesmen.

You Have 6 Complete Services

DURASHIELD, applied to new or freshly cleaned fabric, retards soil and stains . . . retains the fresh, new look MONTHS longer.

DURAPROOF kills moths and carpet beetles. It makes upholstery, rugs, blankets, clothing repellent to both. 6-YEAR WARRANTY.

DURAGUARD flameproofs . . . prevents fire starting from cigarettes, candles, etc. Reduces fire damage in homes, theaters, hotels.

SPOTCRAFT safely removes most stubborn spots and stains.

TUFTCRAFT enables you to repair cigarette burns, moth damage.

What Dealers Say

L. Lawson: "National advertising is tops, creates leads. In September, working alone, jobs totaled \$1,475."

Ed Kramsky: "In 2 years, I now have two assistants, a nice home and real security for my family."

John Jaffe: "There's a huge demand for good carpet and upholstery cleaning. If you tell enough people about Duraclean, you have to make good."

Hiram L. Brown: "Made \$105 in one day cleaning sorority house."

Thomas C. Mason: "Cleaned two rooms for a stock broker. He was so impressed he had 7 jobs lined up for me and from those seven came 4 more."

Russel C. Blue: "Customer called a prominent competitor. They said they could not clean her badly soiled furniture . . . to contact me because 'if anyone could get it clean, I could.'"

Ward Whitbeck: "In my fifth year am making as much as \$225 in one day."

L. Broersma: "Have now completed 5 years with Duraclean. We have never had one complaint."

We'll work WITH You... No Shop Needed

You'll have a close relationship with our staff and with other dealers. We see our dealers often at regional meetings, training schools and conventions. We all work together . . . exchange ideas and swap experiences. We show you effective ways to bring customers to you.

You will have pre-tested newspaper and yellow-page ads, store display cards, radio and TV commercials, folders, sales materials and a complete mailing program. Magazine ads explain the superior merits of YOUR modern services and develop customer confidence in YOUR business. Your services are backed by Parents' Magazine Seal, the Use-Tested approval of McCall's and recommendations of textile manufacturers.

You not only have the opportunity to quickly increase your income . . . the growing dealership value is increasing your net worth. G. F. Monroe, after 12 months, sold his Texas dealership for 10 times his cost. Leo Lubel after 30 months sold for \$8,308 above cost. If for any reason you should want to sell your dealership, we maintain a resale service.

Almost every building houses a customer. Furniture stores, department stores, interior decorators, upholsterers and carpet stores secure jobs from their customers. Auto dealers have used cars Duracleaned and take orders for you. Some dealers have shops or offices . . . others operate from home with no overhead expense.

We prefer that you have no cleaning experience so you don't have to "unlearn" old scrubbing methods. We and an experienced dealer will show you everything you need to know to succeed and build your dealership.

A few hundred dollars establishes your business . . . pay balance from sales. We furnish electric machines, sales aids, and enough materials to return your TOTAL investment. This may be your life opportunity.

Just mail the convenient coupon today. There is no time like the present to find out whether this is the business that will increase your income and secure your future. We'll send you all the facts with no obligation whatever. Then, if you decide you would like to become a Duraclean dealer, you can mail your application and, if you qualify for acceptance, we'll have you actively operating in a few days.

FREE Booklet... Send for it NOW

Our first letter and illustrated booklet will explain everything . . . modern services, waiting market, how business grows, your large profit and territory. Mail coupon today while you can still get a dealership in YOUR location.

OWN
a Growing
BUSINESS



FREE
Booklet
tells how

Duraclean Co.
2-16N Duraclean Bldg.
Deerfield, Ill.

BUY DIRECT FROM OUR FACTORY

AMAZING **Amco** 8" TILT ARBOR

Save
80%

POWER SAW KIT

RUGGED . . . PROFESSIONAL QUALITY
HEAVY DUTY . . . LIFETIME ENGINEERED

UNCONDITIONAL
10 YEAR
GUARANTEE



\$9.95

If desired: for easier work alignment, RIP FENCE \$3.50 add'l.

f.o.b. Factory wt. 12 lbs.

YOU GET:

Complete blade carrying mechanism with depth of cut control • Ground spindle with saw flanges • Pre-oiled bearings • Tilt control • Etched metal tilt indicator • Mitre gauge • Motor mount assembly • Brackets, screws, nuts and bolts • ABC assembly plans, plans for sturdy base, massive 20" x 24" table • Full operating instructions.

REVOLUTIONARY NEW PATENTS

... NEW DESIGN

Top quality full scale power tool with speed and accuracy of \$100 machines! Even if you've never cut a piece of wood in your life, you can put this saw together in jig time. All you need are common household tools, about 1/2 sheet 3/4" plywood for table and base . . . about 2 hours of spare time. Metal saving economy design. We save expensive assembly labor costs. Special patents add to efficiency, accuracy, savings. Metal parts made, sub-assembled, tested in our own factories. Buy direct from maker . . . enjoy a truly fantastic saving.

TABLE STAYS LEVEL, BLADE TILTS

Patented motor mount takes any standard 1/4 h.p. or large motor . . . keeps belt tight, assures perfect alignment at any angle, transmits full power. Table stays level—blade tilts, locks securely at any angle to 50°, raises, lowers 0"-2 1/4". Patented tilt mechanism. Takes standard blade, saw insert removes easily for insertion of any STANDARD dadoe heads, cutters, etc. Accessories, when wanted, at factory prices.

PERFORMANCE PROVED
BY MORE THAN 500,000 USERS!

AMERICAN MACHINE & TOOL COMPANY
DEPT. PM-112, ROYERSFORD, PA.

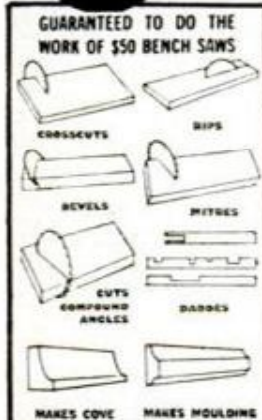

BUILD ALL THESE
• INDOOR FURNITURE
• OUTDOOR FURNITURE
• SHELVES & CLOSETS
• CHILDREN'S TOYS
• ALL HOME IMPROVEMENTS
AND SAVE AS YOU SAW

NO RISK TO YOU 10 DAY MONEY BACK GUARANTEE

You must be completely satisfied or return 8" power saw kit for full refund. Fair enough?

SEND FOR YOURS TODAY!

CLIP AND MAIL THIS MONEY SAVING COUPON TODAY! FREE CATALOG!

American Machine & Tool Co., Dept. PM-112, Royersford, Pa.

- Send 8" Tilt Arbor Power Saw Kit at \$9.95
- Incl. Rip Fence at \$3.50 (both for 13.45)
- Payment in full enclosed \$..... or
- \$3 dep. enclosed, balance C.O.D. I MUST BE FULLY SATISFIED OR WILL RETURN WITHIN 10 DAYS FOR FULL REFUND, no questions asked.
- Please send free catalog of America's greatest power tool values.

NAME _____

ADDRESS _____

CITY _____

ZONE _____ STATE _____

(Please print)

Items from all outdoors

The outdoorsman is regarded not only as big business these days, he has official recognition in Washington. The new Bureau of Outdoor Recreation is initiating a plan to turn 18 million acres of farm land into game preserves, camping and fishing areas and general sports centers. A pamphlet, Forest Recreation for Profit, is available from the Dept. of the Interior and it shows a farmer how to turn "resting" farm land into a profitable recreation business.

An interesting wildlife connection with the recent furor over the evils of insecticides, is a report from National Geographic Society naturalists that the bald eagle is being poisoned by eating small birds and mammals that feed on contaminated grain, leaves and insects.

K. D. Gilbert of Fort Benning, Ga., ran a consecutive 450 birds to win the All-Gauge Championship in the National Skeet Shoot last August. This brings to mind a bit of history about trap shooting. It started in England in 1750, and in the early 1800's the most popular group was named the "High Hats." The members all wore "toppers." A live pigeon was placed under the high hat, and at a given signal the shooter raised his hat to release the bird. He replaced his hat and then took his shot at the bird.

We lunched with the people from Johnson Outboard Motors not too long ago, and they announced that there will be no horsepower changes in their motors for 1963. But they did say that there are more than 100 under-the-hood improvements. We have word from Bundy Outboard Motors to the effect that their distribution of the 30 and 20 hp. motors has been expanded to cover the East from Minnesota to Texas. Outboard Marine Corp. has discontinued making private label outboards.

Fishermen and hunters always have yarns, and we like this one. A hunter in Manitoba, Canada was asked if he had seen any ptarmigan, and he answered: "See one? I can't even spell one."

Stuart James

POPULAR MECHANICS

Record-Shattering Boom in Electrical Appliances Opens Up Exciting Profit Chances for Men Who Can Repair Them

OVER FOUR HUNDRED MILLION electrical appliances are in use right now in American homes—and are increasing at the rate of 76 MILLION a year! No wonder that men who know how to service them properly are making \$3 to \$5 an hour—in spare time or full time. FREE BOOK tells how you can quickly and easily get into this profitable field.

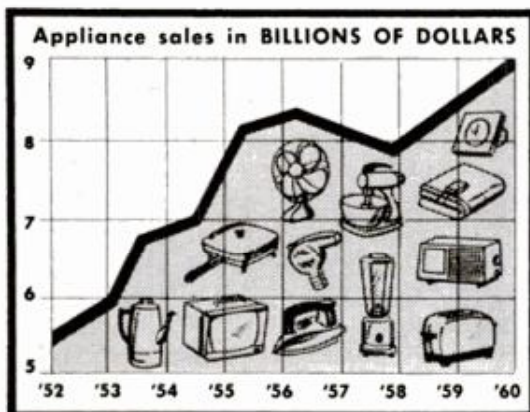

(Above) Based on chart in *Electrical Merchandising Week Magazine*.

Just look at how dependent American homes have become on electric appliances!

Here are some of today's common appliances, and the number of U.S. homes containing each.

Air Conditioners (Room).....	6,500,000
Bed Coverings.....	10,800,000
Clocks.....	40,268,000
Coffee Makers (automatic).....	27,000,000
Freezers.....	11,200,000
Frypan Skillets.....	20,600,000
Heaters, Portable (Elec.).....	14,415,000
Heating Pads.....	19,925,000
Hotplates.....	12,105,000
Irons (Standard).....	44,850,000
Steam Irons.....	28,200,000
Mixers.....	27,000,000
Ranges.....	17,200,000
Refrigerators.....	49,605,000
Sandwich-Waffle Comb.....	17,615,000
Shavers.....	34,500,000
Toasters.....	40,195,000
Vacuum Cleaners.....	36,700,000
Washers.....	47,100,000

EARN WHILE YOU LEARN



with this
**APPLIANCE
TESTER**
—Yours at No
Extra Charge

Course includes all parts to assemble a portable, sturdy Appliance Tester. Use it to locate faulty cords, short circuits, poor connections, etc. in a jiffy; find defects in house wiring; measure electricity used by appliances; many other uses. Helps you earn while you learn.

THE "ELECTRICAL APPLIANCE BOOM" is in full swing. For example, annual sales of coffee makers have zoomed in the last decade from 900,000 to 4,750,000. Room air conditioners have gone from 200,000 a year to 1,800,000 a year. In just the last five years Americans have bought 26 million electric fans, 9 million electric heaters, 5 million deep-fat fryers!

The coming of the auto created a multi-million dollar service industry, the auto repair business. Now the same thing is happening in the electrical appliance field. But with this important difference: anybody with a few simple tools can get started in appliance repair work. No big investment or expensive equipment is needed.

We Tell You Everything You Need to Know

If you'd like to get started in this fascinating, profitable, rapidly growing field—let NRI give you the home training you need in Servicing Electrical Appliances. Here's your chance to build up "a little business of your own" without big investment—open up an appliance repair shop, become independent. Or keep your present job, turn your spare time into extra cash.

You can handle this work anywhere—in a corner of your basement or garage, even on your kitchen table. And you can earn \$3 to \$5 an hour—get back the cost of the course before you finish it. No technical experience, or



higher education necessary. We tell you and show you everything you need to know, in plain English and clear pictures. And the training costs you less than 20¢ a day!

FREE BOOK and Sample Lesson

Our 24-page Free Book tells about America's "Electrical Appliance Boom"—how we train you to "cash in" on it. Free Sample Lesson shows how simple and clearly illustrated our instruction is—how it can quickly prepare you for a profitable future. Mail coupon, letter, or postcard to: *National Radio Institute, Dept. AM2, Washington 16, D.C.* (No obligation—and no salesman will call on you.)

NATIONAL RADIO INSTITUTE
Dept. AM2, Washington 16, D.C.

Please send me Free Book about your Electrical Appliance Repair Course and a free Sample Lesson. I am particularly interested in:

Spare Time Earnings Business of My Own Better Job

I understand there is no obligation on my part; and no salesman will call.

Name.....

Address.....

City..... Zone..... State.....

Accredited Member National Home Study Council

FREE!



Trial lesson in **DRAFTING & DESIGN**

LEARN AT HOME IN SPARE TIME

Check the want ads in any newspaper — SEE the big-pay opportunities open to you as a draftsman. What's more, you can learn this well-paid, prestige profession at home — quickly, easily! No special talent needed! Get complete, step-by-step Chicago Tech lessons in the mail, spend a few pleasant hours studying each week. In a short time you'll be a well-trained draftsman, ready to take your pick of many good jobs. Act now!

FREE INFORMATION—MAIL COUPON TODAY!

Get FREE TRIAL LESSON plus information about C.T.C. practical training. Learn what successful Chicago Tech graduates say about high pay and opportunities in drafting. No charge, or obligation.

Est. 1904 Accredited National Home Study Council

CHICAGO TECHNICAL COLLEGE

P-200 Tech Bldg., 2000 So. Michigan Ave.
Chicago 16, Illinois

Mail me FREE Lesson with information about big opportunities in DRAFTING.

Name..... Age.....

Address

City..... Zone..... State.....



Coin Viewer for Collectors

Coin collectors now can view their collections much the same way photographers examine their color slides—with a viewer.

Operation is manual. Coins are slid under the magnifying glass one at a time, turned over, and ejected by a shuttle arm.

Illuminated by a six-watt lamp, the unit can be plugged into any 110-115-volt outlet. Either of two tubes—one accepting pennies or dimes, the other nickels and quarters—can be inserted into the unit.

The Scan-o-matic is made by Advanced Product Development Corp., Mentor, Ohio.

INVESTIGATE ACCIDENTS

Train quickly in your own home for repeat income in the exciting, secure Claim Investigation and Claim Adjusting field. Our students and graduates are already earning \$4, \$5, \$6 an hour extra SPARE TIME — and up to \$10,000 a year Full Time. You need NO prior experience or higher education. Your age does NOT matter.

HERE IS YOUR CHANCE FOR ACTION AND REAL JOB SECURITY

As a trained Claim Investigator you will (1) INVESTIGATE FACTS and (2) DISTRIBUTE MONEY as the representative of wealthy organizations.

No other business offers you greater opportunities for success and security. Here's why: The huge, rapidly expanding Claim Investigation and Adjusting Profession right now distributes more money than any other service industry. And it's growing fast. Over 200 MILLION ACCIDENTS must be investigated this year for Insurance Companies, Airlines, Railroads, Steamship Lines, and Government Offices.

MAIL NOW for FREE BOOK ➡

SEND TODAY for Big, FREE, Illustrated Catalog. Learn the exciting facts about Universal Schools' low cost training. No obligation. No salesman will call. GI APPROVED.



UNIVERSAL SCHOOLS
6801 Hillcrest Ave.

Dept. PM-11, Dallas 5, Texas

Please rush me your FREE book on Claim Investigation. This does not obligate me and no salesman will call.

Name..... Age.....

Address.....

City..... Zone..... State.....

Approved by Government for Korean Veterans

WHAT ALL AUTO MECHANICS WANT TO KNOW

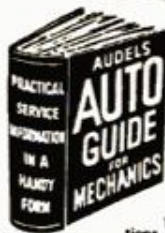

This Big Practical Book gives full information, with working diagrams, covering the principles, construction, ignition, service and repair of modern cars, trucks and buses.

Air Conditioners, Hydromatic & Fluid Drives Fully Explained.

A complete guide of 1132 Pages, with over 1000 Illustrations showing inside views of working parts, with instructions for service jobs. Completely up-to-the-minute! Priced at only \$6.



CIRCLE No. 1 IN COUPON

HOW TO FIX HOME APPLIANCES

REFRIGERATORS WASHERS

TOASTERS DRYERS IRONERS RANGES VACUUMS FREEZERS

Master other GAS AND ELECTRIC APPLIANCES

Handy Reference for Electric & Gas Servicemen, Mechanics, Dealers and Homeowners. Explains clearly and simply how to locate troubles, how to test, reassemble and connect. Wiring diagrams. 1000 Facts. Easy to read. Answers ALL your questions. 864 Pages. Illustrated. Only \$6.

CIRCLE No. 2 IN COUPON



TV TELLS HOW TO ANSWER RADIO TV QUESTIONS SERVICE LIBRARY

HERE IS LATE INFORMATION IN A HANDY FORM FOR RADIO AND TELEVISION REPAIRMEN, SERVICEMEN AND STUDENTS

TWO COMPLETE VOLUMES - 1568 Pages - 1085 Illustrations and Diagrams. 1001 Important Facts and Figures on Modern T.V. Radio Electronic Devices. INCLUDES TRANSISTORS & Transistors Circuits. Rectifiers, Record Changers, P.A. Systems, Phonograph Pick-ups, F.M. Auto Radio. Short Wave.

Basic principles of Construction, Installation, Operation, Shooting. How to get Sharp, Clear T.V. Pictures. Install Aerials. How to Test, Explains COLOR SYSTEMS, Methods of Conversion, Terms, etc. Includes Ultra High Frequency. Quick ready reference or use as a home study course. Only \$8 for BOTH volumes.

CIRCLE No. 3 IN COUPON

OUTBOARD MOTOR & BOATING GUIDE

Brand New Title! An essential tool for every outboard boating operator. Provides all information to maintain, adjust and repair all types of outboard motors. Covers: operating, starting, control, motor construction, power head and lower unit, cooling, carburetors, fuel, ignition systems, electrical system, etc. Also deals with trouble shooting, repairs and spare parts needed on board. Gives exploded views of the various parts assemblies, with relative position of each component. Profusely illustrated. 400 Pages only \$4.

CIRCLE No. 49 IN COUPON

PLUMBERS AND STEAMFITTERS GUIDES



Practical Trade Assistant & Reference Set. Explains in plain language and by clear illustrations, diagrams, charts, graphs and pictures the principles of modern plumbing practice including Pipe Fitting and Air Conditioning. 4 Vols. - 2624 Pages - 3642 Diagrams & Illustrations. Only \$9 for the complete set of 4 vols. Sold individually \$2.50 each.

CIRCLE No. 6 IN COUPON

7-DAY FREE EXAMINATION

SEND NO MONEY - Pay the postman nothing! We are glad to send you any of the Audel Guides for absolutely FREE examination in your own home. We take all the risks and leave all the decisions up to YOU. There is no obligation! If you decide to keep the books of your choice you may pay for them under our astounding easy-pay plan of only \$2 a month.

HERE IS ALL YOU DO

IT'S EASY TO ORDER! In the No-Risk Mail Order Coupon at the right just draw a circle around the number of Audel Guides you want to send you for FREE EXAMINATION. We will send them to you at once to help you build a brighter future by increasing your SKILL. If for any reason at all you are not COMPLETELY satisfied, return the books to us, and that will end the matter! NO STRINGS OR CATCHES TO THIS OFFER.

THEO. AUDEL & CO.
49 West 23rd Street, New York 10, N.Y.

GAS ENGINE MANUAL

Just off the press! A helpful, practical guide for mechanics, students and homeowners. Maintenance and repairs of modern gas engines of all types and sizes used in almost every field, from motor transportation, to appliances around the home. Includes marine and aircraft engines.



FOR THE EXPERT OR THE DO-IT-YOURSELFER

THE FIRST PART explains the operating principles of various types of gas engines, and the function of engine parts and accessories: carburetors, fuel injection methods, cooling and lubrication systems, etc. THE SECOND PART covers trouble-shooting, modern service operations and engine tune-up procedures. Ignition system items are fully listed and illustrated. 468 pages. Only \$4.

CIRCLE No. 48 IN COUPON

PAINTING AND DECORATING MANUAL

NEW TITLE



gives the practical know-how you have been looking for. Concise and late information on the many phases of house painting and decorating. Complete from A to Z.

INSIDE TRADE INFORMATION!

Outside and inside work, how to mix paints, preparation of surfaces, paper-hanging, wood finishers, tools and their proper use, synthetic paints; where and how to use them, the brush care, spray painting, scaffolds, rigging, costs, estimating, better methods and a dictionary of trade terms. Over 585 Pages. Fully illustrated. Only \$4.

CIRCLE No. 7 IN COUPON

MASONS & BUILDERS GUIDES

A PRACTICAL ILLUSTRATED 4 VOL. SET - Explaining in clear, simple language and profuse illustrations, principles, advances, short cuts, trade secrets, based on modern practice - including how to figure and calculate various jobs. Vol. 1 - Brick work, bricklaying, bonding, designs. Vol. 2 - Brick foundations, arches, tile setting, estimating. Vol. 3 - Concrete mixing, placing forms, reinforced stucco. Vol. 4 - Plastering, stone masonry, steel construction, blueprints. 4 Vols. 1440 Pages. 2067 Illustrations. Complete Set only \$9.

CIRCLE No. 26 IN COUPON Sold individually \$2.50 each

MATHEMATICS MADE EASY

A COMPLETE HOME STUDY COURSE - Starting with the first principles of arithmetic, advancing step by step through the various stages of mathematics, including the rules and calculations for mechanical and electrical problems. New EASY correct methods. Includes plane and solid geometry, trigonometry, algebra, calculus, etc. Practical tests, reference tables and data. How to use slide rule. 672 Pages. 550 Illustrations. Priced at only \$4

CIRCLE No. 11 IN COUPON

NEW MACHINISTS AND TOOLMAKERS HANDBOOK

MODERN MACHINE SHOP PRACTICE - For every Machinist, Toolmaker, Draftsman or Student. Tells how to set up and operate lathes, screw and milling machines, shapers, drill presses and all other machine tools. A COMPLETE INSTRUCTOR AND REFERENCE BOOK 1250 Pages. Fully Illustrated. Priced at only \$6.

CIRCLE No. 12 IN COUPON

ELECTRIC MOTORS

THIS GUIDE covers the construction, hook-ups, control, maintenance and trouble shooting of all types of motors. Includes armature winding. Explains entire subject in great detail in simple language. Over 1056 Pages of information. 617 Diagrams. All types of motors fully illustrated and indexed for ready reference. Priced at only \$5.

CIRCLE No. 27 IN COUPON

REFRIGERATION & AIR CONDITIONING

FOUR BOOKS IN ONE - basic principles, servicing, operation, repair of: 1. Household Refrigeration. 2. Special Refrigeration Units. 3. Commercial & Industrial Refrigeration. 4. Air Conditioning Systems. A GOLD MINE of essential information. Completely up-to-date. 1360 Pages. Fully illustrated and indexed. Priced at only \$6. CIRCLE No. 14 IN COUPON

CARPENTERS AND BUILDERS GUIDES



PRACTICAL STOREHOUSE OF MODERN CONSTRUCTION INFORMATION (4 vol. set) for carpenters and all woodworkers. Explains in easy language and by profuse illustration principles, advances, short cuts, trade secrets, all based on the NEWEST information. Vol. 1 - Tools, steel square, saw fitting, joinery, furniture, etc. Vol. 2 - Builders' mathematics, drawing plans, specifications, estimates, etc. Vol. 3 - House and roof framing, laying out, foundations, etc. Vol. 4 - Doors, windows, stair building, millwork, painting, etc. 4 vols. 1904 Pages. 3700 Illustrations. Whole set only \$9. CIRCLE No. 8 IN COUPON

PRACTICAL ELECTRICITY

A COMPLETE HANDBOOK - Quick, simplified, ready reference. Complete instruction and practical information on the rules and laws of electricity - Maintenance of Machinery - A.C. and D.C. Motors - Armatures - Wiring Diagrams - House Lighting - Power Wiring - Meters - Batteries - Transformers - etc. Simple to understand. 1052 Pages. 2600 Illustrations. Priced at \$5. CIRCLE No. 4 IN COUPON

DIESEL

ALL THERE IS TO KNOW ABOUT MODERN DIESEL ENGINES - Basic principles, starting valves, timing, fuel pumps, fuel injection compressor, air compressors, pistons, cylinders, lubrication, cooling systems, etc. Answers on operation, calculations. 640 Pages. Fully Illustrated. Priced \$4

CIRCLE No. 9 IN COUPON

THE NEW ELECTRIC LIBRARY

A COMPLETE ENCYCLOPEDIA explaining in the simplest terms the fundamental principles, rules and applications of applied electricity.

A COMPLETE COLLEGE EDUCATION!

Fully illustrated with diagrams and sketches, calculations and tables for ready reference. Questions and answers. Trial tests for practice study and review. All based on the most modern theory.

- Vol. 1 - Principles and rules of electricity, magnetism, armatures, repairs. No. 15
- Vol. 2 - Dynamos, DC Motors, construction, installation, maintenance, etc. No. 16
- Vol. 3 - Testing instruments and tests, storage battery constr. and repairs. No. 17
- Vol. 4 - Alternating current, power factor, alternators, transformers. No. 18
- Vol. 5 - A.C. Motors, windings, maintenance, converters, switches, fuses, etc. No. 19
- Vol. 6 - Relays, condensers, regulators, rectifiers, meters, switchboards, etc. No. 20
- Vol. 7 - Wiring, house light and power, circuits, high

tension, plans, code, etc. No. 21

Vol. 8 - Railways, signals, elevators, ignition, etc. No. 22

Vol. 9 - Radio, telephone, telegraph, television, motion pictures. No. 23

Vol. 10 - Refrigeration, illumination, welding, x-ray, electrical appliances, etc. No. 24

6,000 fully illustrated pages.

Priced at only \$22.50 for the ENTIRE SET. Also sold individually for \$2.50 each.

CIRCLE No. 5 IN COUPON



ADDITIONAL IMPORTANT TITLES

The following Audel Guides are all the best in their field, written in clear simple fashion, all lavishly illustrated. Circle the numbers wanted in the MAIL ORDER COUPON below. All books are sent for FREE EXAMINATION.

- No. 5 TRUCK & TRACTOR GUIDE, 1276 Pages \$5.00
- No. 10 WELDERS GUIDE, 608 Pages 4.00
- No. 13 WIRING DIAGRAMS (Light & Power), 304 Pages 2.50
- No. 25 BLUEPRINT READING, 448 Pages 3.00
- No. 28 OIL BURNERS, 416 Pages 3.00
- No. 29 SHEET METAL PATTERN LAYOUTS, 1152 Pages 7.50
- No. 30 SHEET METAL HANDY BOOK, 448 Pages 3.00
- No. 31 MECHANICAL DRAWING GUIDE, 192 Pages 2.50
- No. 32 MECHANICAL DRAWING & DESIGN, 410 Pages 3.00
- No. 34 ELECTRICIANS EXAMINATIONS, 272 Pages 2.50
- No. 35 ELECTRIC POWER CALCULATIONS, Page 480 3.00
- No. 36 ELECTRIC DICTIONARY, 9000 Terms 3.50
- No. 37 POWER PLANT ENGINEERS GUIDE, 1566 Pages 6.00
- No. 38 ENGINEERS AND FREEMANS EXAMS, 544 Pages 3.50
- No. 39 OPERATING ENGINEERS LIBRARY, 3 Book Set 14.00
- No. 40 PUMPS, HYDRAULICS AND AIR COMPRESSORS 6.00
- No. 41 HOUSE HEATING GUIDE, 966 Pages 5.00
- No. 42 MILLWRIGHTS & MECHANICS GUIDE, 1248 Pages 6.00
- No. 43 DO-IT-YOURSELF ENCYCLOPEDIA, 2 Book Set 8.95
- No. 44 NEW MECHANICAL DICTIONARY, 712 Pages 6.95
- No. 45 MAGIC OF LANDSCAPING, 128 Pages 1.49
- No. 46 WATER SUPPLY & SEWAGE DISPOSAL, 436 Pages 4.00
- No. 47 GUIDE TO CREATIVE PHOTOGRAPHY, 400 Pages 3.95

MAIL THIS NO-RISK COUPON TODAY!

THEO. AUDEL & CO. - Self Improvement Publishers Since 1879 - P-11
49 W. 23rd Street, New York 10, N.Y.

Please mail me for 7 days' FREE EXAMINATION the books I have circled at right. I agree to mail \$2 in 7 days on each book or set ordered, and to further mail \$2 a month on each book or set ordered until I have paid the purchase price, plus shipping costs. If I am not completely satisfied with my Audel Guides I may return them.

NAME _____

ADDRESS _____

CITY _____ STATE _____

EMPLOYED BY _____

SAVE SHIPPING COSTS! Check here if you enclose complete payment with order. We pay postage charges. You have some return privilege.

1	2	3	4	5
6	7	8	9	10
11	12	13	14	15
16	17	18	19	20
21	22	23	24	25
26	27	28	29	30
31	32	34	35	36
37	38	39	40	41
42	43	44	45	46
47	48	49		

Science bulletins

Should the lady wear a derby? A London pathologist says such plug hats would provide the same protection as a crash helmet in street accidents—for both men and women. He notes that many pedestrian fatalities result from head wounds suffered as the victims hit the pavement—not from initial impact injuries.

A blank spot in the heavens will soon be plugged, astronomers say. A new 20-inch telescope, which will be installed by 1963 on top of an Andes Mountain peak in Argentina, will give U.S. astronomers a window on southern hemispheric skies, according to Columbia University's Dr. Jan Schilt. Most observatories are located in the northern latitudes, he said, leaving about a third of the total sky area inadequately covered.

All that surplus grain in midwestern storage bins may not add up to a vast boondoggle, as many people think. The State of Utah, for instance, recently drew uncon-

taminated dairy feed from storage to feed cattle whose milk was showing alarmingly high levels of radioactive Iodine 131 fallout from atmospheric nuclear tests. In an atomic war, our surplus grain might become invaluable life insurance.

Even if Roger Maris could hit a line drive into space, he'd still be tagged out by a powerful Air Force pencil-beam radar that's to be completed at White Sands Missile Range next year. The 24 million-watt beam will trace and analyze missile test targets during re-entry—and can track baseball-sized objects for 1000 miles.

Someday it may be old-fashioned to get milk from a cow. Using weeds, cabbage leaves and pea pods, British scientists have fabricated milk that one titled lady says is "much nicer than ordinary milk."

It's made by extracting proteins from green leaves, then adding vitamins, minerals, carbohydrates and vegetable fats. The only remaining puzzle is to eliminate a slight vegetable flavor.

John P. McNeal

STEWART-WARNER "VOLT-GUARD"

New from Stewart-Warner—"Volt Guard"—the gauge that checks the complete electrical system. Warns of impending trouble in battery, generator or voltage regulator. Alerts you against costly and time-consuming breakdowns and electrical system failures. For all cars, trucks, buses and engines with 12-volt ignition systems. Ideal for boats, too. See the Stewart-Warner "Volt-Guard" at your nearby service station, garage or automotive parts store.

the "look-out" that helps you prevent trouble!



Symbol of
SW
Excellence
INSTRUMENT DIVISION
STEWART-WARNER
CORPORATION

Dept. C-112, 1840 Diversey Pkwy., Chicago 14

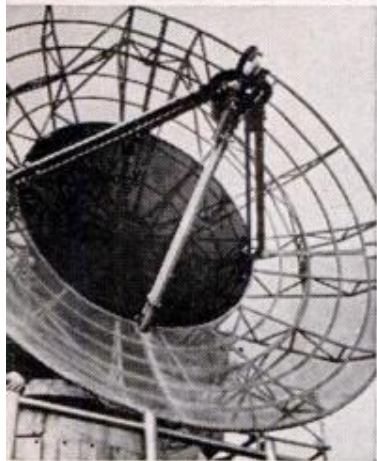
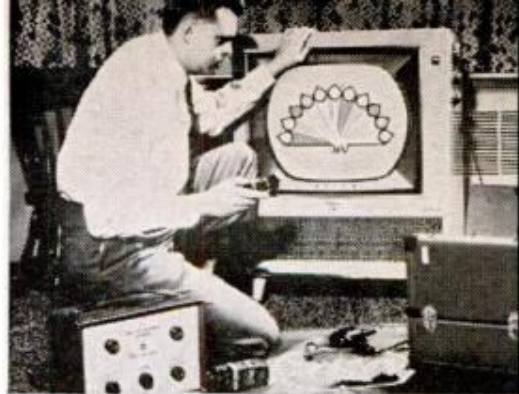
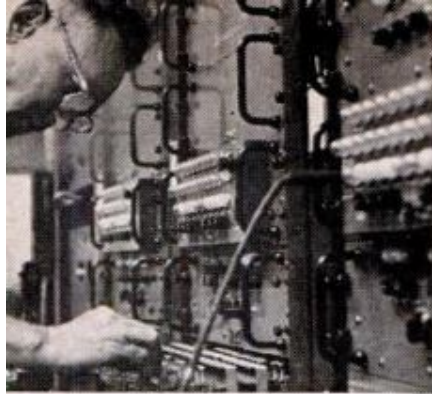

Turn Your Spare Time into a Better Paying Job in Electronics!

Train at home with internationally-known

RCA INSTITUTES

You can use your spare time to prepare yourself for an exciting and profitable career in Electronics. You need no special technical background. Even if you do not have high school training, you can start your training at home under the guidance of RCA Institutes, by choosing one of these courses: Radio & Electronic Fundamentals, TV Servicing, Color TV, Communications Electronics, Automation Electronics, Computer Programming, Transistors.

Practical work starts with the very first lesson. You get prime quality equipment that you can keep and can later use on the job. And, under the Voluntary Tuition Plan, you can interrupt your training at any time, and you do not owe one cent. No installment payments required. Licensed by the New York State Department of Education. Approved for Veterans.

Act today. Fill out the coupon below, and you'll be taking the important first step towards turning your spare time into a career in Electronics.

*Send for this 64-page
Home Study book*

FREE! ▶

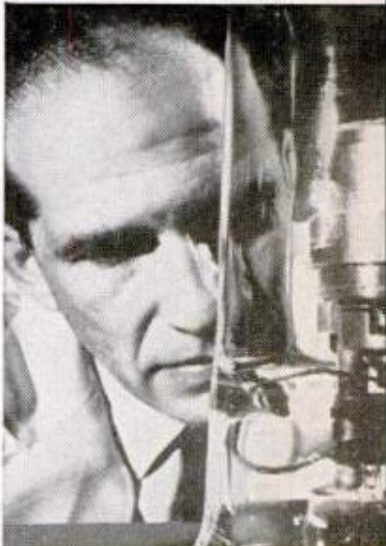
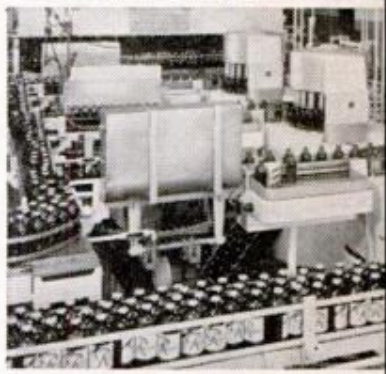

Classroom Training in New York City and Los Angeles. Day and Evening Classes start four times a year. In addition, Radio Corporation of America offers a limited number of basic courses in Chicago, Philadelphia, and Cherry Hill, N. J. (near Camden). Detailed information on request.

RCA INSTITUTES, INC. Dept. PM-N2

A Service of Radio Corporation of America
350 W. 4th Street, New York 14, N. Y.
610 S. Main St., Los Angeles 14, Calif.



The Most Trusted Name in Electronics

(To save time paste coupon on postcard)

RCA INSTITUTES, INC.

Home Study School Dept. PM-N2
A Service of Radio Corporation of America
350 W. 4th Street, New York 14, N. Y.

Please rush me your FREE illustrated 64-page book describing your home training programs. No obligation. No salesman will call.

Name _____ Age _____

(please print)

Address _____

City _____ Zone _____ State _____

CANADIANS—Take advantage of these same RCA courses at no additional cost. No postage, no customs, no delay. Send coupon to: RCA Victor Company, Ltd., 5581 Royalmount Ave., Montreal 9, Quebec

Материал, защищенный авторским правом

Guaranteed against burn-out

AIR GRATE

YELLO-BOLE

1. Smokes sweeter!

Imported briar bowl lined with *real honey*. Starts caking the instant you light up. Hence, no break-in.



2. Smokes drier and healthier!

Metal grate condenses moisture, tars, nicotine. No wet heel.



3. Smokes cooler!

Air-vented chamber draws in fresh air. Aluminum fins and shank throw off heat, cool the smoke.

Famous honey-lining!

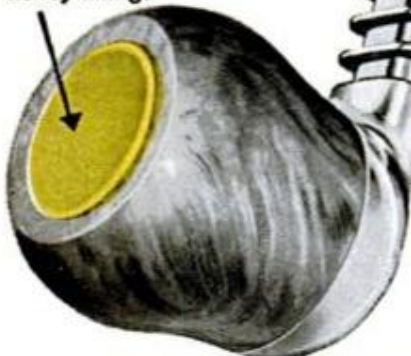

\$350

Extra interchangeable bowls — \$1.95 each
Guaranteed against burn-out for life

"Icepak" Set—Airograte Yello-Bole Pipe plus one extra bowl, \$5.45

Other Yello-Bole Pipes, also of imported briar \$1.95 to \$4.95.

Send for FREE FOLDER YELLO-BOLE PIPES, Inc., Dept. Y7, N.Y. 22

engineering degree in 27 months

Industry demands graduates. Enjoy higher income . . . advancement. Major corporations regularly interview and employ seniors. *Bachelor of Science Degree in 27 Months* in Electrical, Mechanical, Aeronautical, Chemical, Civil Engineering. IN 36 MONTHS a B.S. Degree in Business Administration (General Business, Accounting, Motor Transport Administration majors). Small classes. More professional class hours. Well-equipped labs. Campus. New dorms. *Low costs*. Founded 1884. Enter January, March, June, September. Write J. E. McCarthy for Catalog and "Your Career in Engineering and Commerce" Book. Learn more and you'll earn more.



TRI-STATE COLLEGE

4112 College Avenue • Angola, Indiana



Neat Heat

Flameless, smokeless and producing no fumes, a new portable heater can be used in closed rooms. Heat is produced by a catalytic combustion of the fuel; the catalyst is a platinum screen.

The heater is available in two sizes. The smaller (shown) weighs two pounds and sells for \$29.95. The larger weighs 11 pounds and sells for \$69.95.

The units are available through Therm's Co. of Calif., World Trade Center, Ferry Bldg., San Francisco 11, Calif.

No Fast Talk in Space

Calls to the folks back home are going to involve some long pauses in the Space Age.

Light travels at 186,000 miles per second, and the known communications media are limited to that speed. A radio message from the moon, roughly 250,000 miles from Earth, would take 1 1/4 seconds to arrive.

According to Dr. M. L. Stehsel, Aerojet General Corporation, Advanced Research Division, the time lapse increases as man moves farther and farther to the other planets. By the time a Pluto pioneer radioed back to home, he would have to wait 10 hours to get an answer!

The answer does not lie in letter-writing. It would take a 25,000-mile-per-hour mail missile over 15 years to make the three-billion mile trip to Pluto!

On aerospace, highway, building and bridge projects, men

EARN HIGH WAGES as Heavy Equipment Operators!

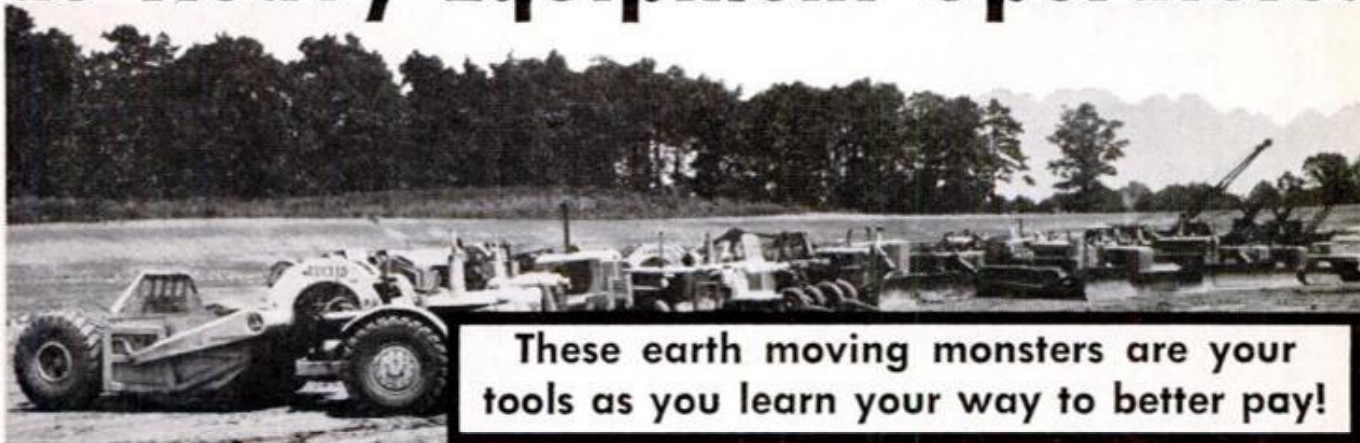

These earth moving monsters are your tools as you learn your way to better pay!



New Yorker, on a project in South, says:
". . . job will take at least a year to complete . . . my accomplishments changed me from a \$60-a-week man to a \$150 to \$350-a-week man."

Jon E. Oppenheim
Great Neck, N. Y.

California graduate reports:

". . . new contract gives 83¢ an hr. raise over the next three years; now getting \$4.53½ an hr. . . . also paid holidays."

Paul Van Wattering
Van Nuys, Calif.



From Virginia, this graduate says:
". . . Thanks to National School training, I can handle bulldozers and scrapers equally well, whenever and wherever required."

Charles P. Maddox
Ringgold, Va.

You, too, may be able to fill one of these high-paying jobs in this multi-billion dollar construction industry which open up daily in this country and overseas . . . *if you are trained!* Being a heavy equipment operator qualifies you for a job paying up to ten thousand dollars a year and more! Field-train on 3/4 million dollars' worth of diesel-engine machinery at industry-endorsed National School, the world-famous original school of heavy equipment operation. Choose your course. Learn safe operation and basic maintenance of 'dozers, self-propelled or tractor-drawn scrapers, motor graders, cranes, draglines, shovels . . . the same type modern machines now in use by the industry.

National is NOT a correspondence school . . . qualified, job-experienced instructors teach you in person. If your application is accepted, you will live and learn on a vast proving ground in the Piedmont section of North Carolina. Full 220-hr. and 440-hr. courses, VA approved. Ages 17-56. Payment plans available. National School maintains full-time Job Advisory and Counselling Department for *exclusive* use of its graduates.

Decide NOW to train for higher wages and job security as a heavy equipment operator. Amount of previous education no barrier. Mail coupon TODAY for FREE illustrated School Catalog. You are under NO obligation.

Even if you are taking a course in heavy equipment operation, write for our free catalog. Compare the training you are getting now with ours.

MAIL TODAY
For FREE Illustrated School
Catalog and complete information

NATIONAL SCHOOL OF HEAVY EQUIPMENT OPERATION
Dept. D-34, P. O. Drawer 1686, Charlotte, N. C.

Please send FREE illustrated school catalog and complete information. I understand there's no obligation.

NAME..... AGE.....

ADDRESS.....

CITY..... ZONE..... STATE.....



Pays Up to \$8 an Hour. No Selling

Compare THIS Job to the One You Have NOW

Then, if you'd like to switch, I'll Show You How to DO It

Let me show you how to get into one of the fastest-growing professions in America—Auto Claim Investigating & Adjusting. Here's why insurance companies are glad to pay top prices to men in this particular field:

This year more than 25 million accident claims will have to be settled, and every year the number increases! No wonder insurance firms are glad to pay big sums for experienced men; provide such extras as a car, private office and secretary, free insurance, pensions, ent. expenses, other benefits. Even with only an average education you can go far in this exciting new field. We can teach you all the basic facts you need right at home to get started in your spare time. Just 3 or 4 months pleasant study reading case histories, learning procedures. You can set up your own office or work for a company. No need to change present location. No tedious office hours. We even supply FREE employment help! It costs nothing to find out all about this fascinating new profession for men from 20 to 60. Write to Liberty School of Claim Investigating, Dept. 911, Libertyville, Illinois. (Liberty School of Claim Investigating is Approved as a Private Business School by the State of Illinois).

— SIMPLY MAIL THIS COUPON NOW! —

**Eric P. McNair, President, Dept. 911
LIBERTY SCHOOL OF CLAIM INVESTIGATING
1139 W. Park, Libertyville, Illinois**

Show me how I can quickly become an Automobile Claim Investigator & Adjustor, and explain the many important social and financial benefits I can gain by switching into this exciting new profession now.

My Name

Address

City Zone State



NEW HI-FI PERFORMANCE

The Exciting NEW **BENJAMIN**
MODEL 422
CO₂ 10-SHOT SEMI-AUTOMATIC
.22 PELLET PISTOL

EFFICIENT—SAFE—DEPENDABLE—CONVENIENT
Famous BENJAMIN Quality

AT LAST—an Amazing New Handgun that Incorporates the Characteristics Wanted for Serious Training, Plinking and Match Competition—Indoors and Outdoors—at **LOWEST SHOOTING COSTS!** Handsome, Dynamic, Mechanically Reliable, MODEL 422 combines Traditional BENJAMIN PEAK POWER and ACCURACY with Incredible Firing Speed—Smooth JAM-PROOF ACTION (no ramrod for cleaning pistol bore required)

KEEP SHOOTING & SHOOTING & SHOOTING & SHOOTING AS FAST AS YOU CAN SQUEEZE THE TRIGGER!

FREE Write today! Complete Catalog Benjamin Rifles & Pistols—Single Shot & Repeaters—BB or 177 or 22. Also, Special Offer on Hunting Knives.

BENJAMIN AIR RIFLE CO. 896 MARION ST., ST. LOUIS 4, MO.

WITH EXTRA MARGIN BENJAMIN'S Unique DOUBLE SAFETIES

Press TRIGGER SAFETY "OFF"

Release Hammer Safety as Illustrated.



TRIGGER SAFETY SAFETY ON SAFETY OFF

Sidelights on aviation

Following up September's column on why so many model numbers are pinned on the same basic aircraft—the use the airliner will be put to determines the modifications—here is some information on how the original model takes the size and shape it does.

One of the aircraft manufacturers is planning a compact jet for short-haul routes. First, it analyzed the traveling patterns in the United States. They showed that 70 percent of the passengers and 50 percent of the revenues were involved in flights of 600 miles or less. These short routes had few modern aircraft. So the market was open for a short-haul jet.

Traffic density on these routes indicated that the most efficient vehicle would provide about 50 first-class seats and 75 in the tourist section, influencing the size.

Because of the short hops the plane would make, there was no necessity for designing it to fly at high speeds at high altitudes. The difference in start-to-stop time amounted to about two minutes on an average flight. So the compact jet was designed for a cruising mach of .75, or about 550 m.p.h. at 25,000 feet, somewhat less and lower than the big jets.

Another major factor was the availability of runways to handle the jetliner. Most short-haul routes involve small or medium-size cities with small or medium-size airports, many of them with runways 5000 to 5500-feet long. So the design was based on takeoff runways of 5000 feet or better. The big jets need 8000 to 10,000 feet.

With range, size, speed and takeoff requirements settled, the designers could now concentrate on operating costs. Simplicity was decided upon, because the short trips would not require the luxury features needed on big jets for long flights.

While engineering ideals are not ignored, aircraft design is much more a matter of necessity than art.

Safety statistics pop up annually along the air lanes, usually in the wake of some spectacular aircraft accident. No one listens, but aviation experts still maintain it's safer to fly—five times safer—than to go by automobile. In 10 years, 2.56 persons have died every year in autos, compared to .50 in airplanes, per 100 million passenger miles.

Kevin V. Brown

POPULAR MECHANICS

What's it worth to feel like a man?

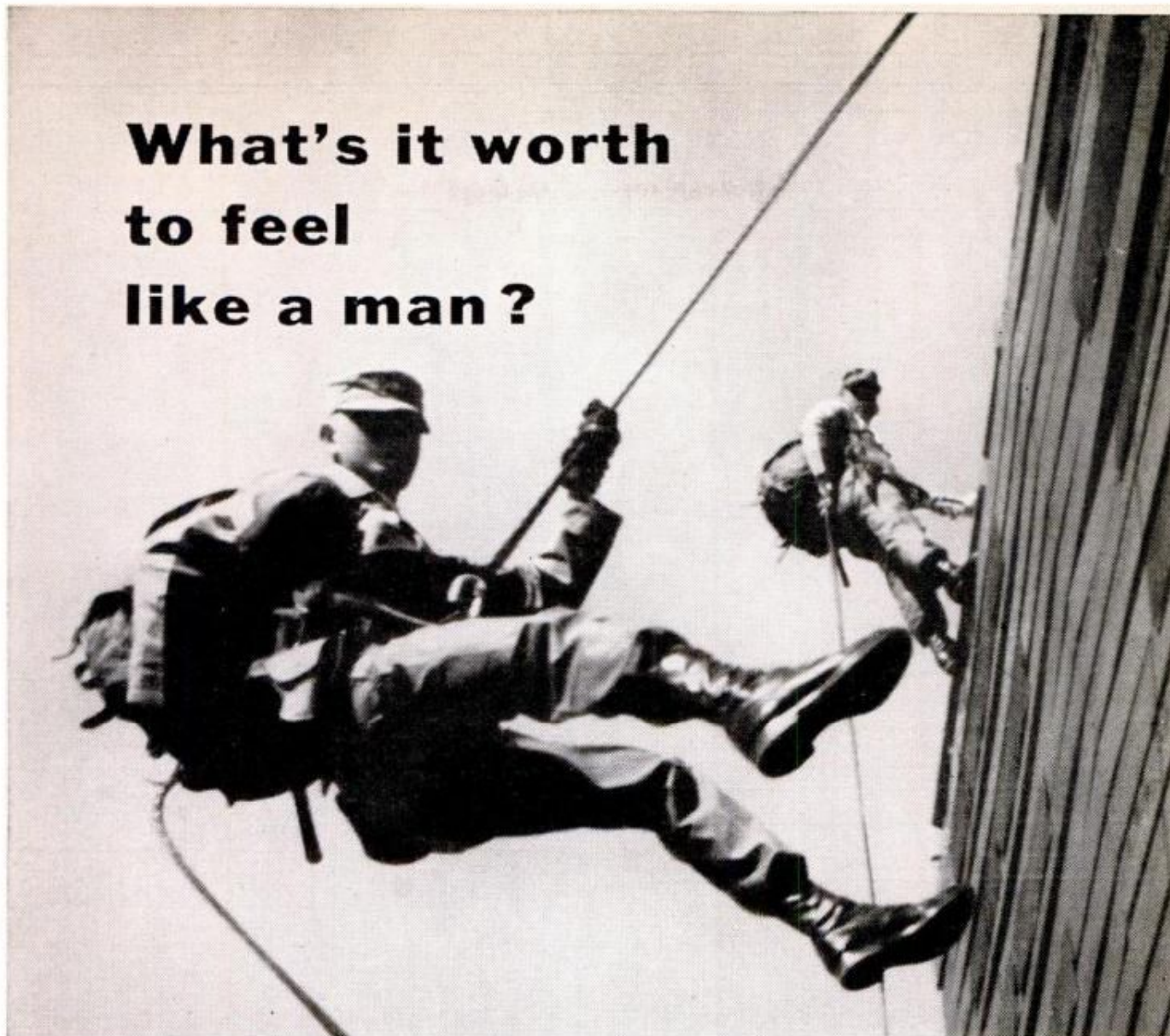

If you won't settle for less, the Army's the place for you

You feel like a man

when you can do a man's work, put your mind and muscle into a job you can be proud of . . .

when you can live a man's life, get out of the rut, travel clear across the world . . .

when you can decide for yourself what you want from life, what kind of work, what kind of play, what kind of future.

You feel like a man in the Army

because you can prove yourself physically, mentally and emotionally fit to do a man's work. You can have the satisfaction of helping to keep America so strong the war the whole world dreads need never happen . . .

because you can visit strange and romantic countries while you're still young enough to see everything, do everything, get all that travel has to give you . . .

because you can decide your own future. You can get a good education, you can get training in your choice of many different fields. The opportunities for advancement, the chance to become a leader as a commissioned or non-commissioned officer, the retirement prospects . . . all are better than most men think.

You can try the Army on for size . . .

There's nothing quite like an Army career; you don't have to gamble years in a job that may not work out for you. Fulfill your military obligation in the Army, and you'll have a chance for a good, close-up look at Army life, Army men, and Army opportunities. Then you may decide it's Army for you all the way. (Choice of job training before enlistment for those who qualify. See your local Army Recruiter or write: Army Careers, Dept. of the Army, Washington 25, D. C., Attn. E.P.P.P.)



FREE!
100
WORLDWIDE
STAMPS...
just
released!

We'll send you this spectacular collection of new issues, FREE! 100 different stamps from world's far corners — new countries, new commemoratives, new pictorials. Get new issues shown PLUS giant multi-colors from Comoros, Mali, Senegal, Congo, many more. Wild beasts, exotic fish, famous people, savage warriors. EXTRA! New bargain stamp offers included. Send today for your valuable collection — enclose 10c handling.

GARCELON STAMP CO., Dept. NPMX
Calais, Maine. Rush free 100 Different Stamps, other offers. Enclosed 10c for handling. (PLEASE PRINT)

Big Pay For Men Who Don't Want College

Coyne's Faster, Lower Cost Training in Electronics Can Open the Door to an Exciting Career as a Technician in Industrial Electronics—Television—Missiles—Automation and Computers.

If you don't want the loss of time and expense of college, The Coyne School can open an exciting career on the ground floor of the fastest growing industry in America. Coyne can give you the training in electronics that will permit you to specialize in any of dozens of good paying positions in the expanding field of electronics.

You receive your training in Coyne's shop-labs under skilled instructors. You can live as cheaply as at home in Chicago the electronics center of the world. Part time work is available for those who need extra money. Biggest part of your tuition can be paid *after you graduate!*

FREE BOOK: Send name, for free illustrated book "Your Opportunities in Electronics." No obligation. No salesman will call at your home.

Coyne Electrical School, Dept. 82-S, Chicago 7, Ill.

Coyne Electrical School, Dept. 82-S
1501 W. Congress Pkwy., Chicago 7, Illinois
Please send Free Book "Your Opportunities in Electronics."
I am under no obligation — no salesman will call at my home.

Name.....
Address.....
City..... RR No. or Zone..... State.....

BUILD YOUR OWN FUEL CELL.

For years, in laboratories across the country, scientists have sought to perfect the Bio-Fuel Cell — a source of electrical energy derived from molecular decomposition of organic material. Now, the Fuel Cell is available in kit form. Build your own and have a near free source of power that will operate a 6 volt transistor radio . . . run small "advertising type" motors . . . many other uses. Send for 12 cell kit. No outside source of power needed. Simple directions. Only \$14.95 (plus 2% tax in Texas). No C.O.D.'s.



Pat. Pend.

ELECTRON MOLECULE RESEARCH, INC.

414 South Medina • Dept. A
San Antonio 13, Texas



MANUFACTURE this BEAUTIFUL OUTDOOR FIREPLACE in YOUR OWN BACKYARD

\$4.00 worth of sand and cement produces this attractive fireplace. Sells on sight from \$60 to \$80. Easy to start your own profitable business in your backyard. No experience necessary. Big profits. Exclusive manufacturing territories. Write immediately for full details. General machines sold to U.S. Government. Dealer inquiries invited.

GENERAL ENGINES CO., INC. Dept. MF-112 Rt. 130
Thorofare, N. J.

EARN MORE THRU DRAFTING

Modern Teaching Machine methods provide ideal home instruction course. Credit applies toward A.S.M.E. (Mechanical Engineering) Degree, which is also available thru home study. Approved school, founded 1934, over 25,000 successful graduates. Send for

FREE SAMPLE LESSON
AMERICAN INSTITUTE OF ENGINEERING & TECHNOLOGY
1145 West Fullerton Parkway, Chicago 14, Ill.



EARN a SMALL FORTUNE IN YOUR SPARE TIME...

Make \$100, \$250, \$500 and MORE introducing amazing 5-Year Guaranteed light bulbs . . . to homes and businesses in your area. Show it and the sale is made! Earn over 100% profit on each sale! Rush your name, address now for special FREE Starting Offer and money making details. Write

SUNMASTER ELECTRIC PRODUCTS, INC.
(In Canada, 675 King St. W., Toronto, Ont.)
Dept. PM-112, 366 Fifth Avenue - New York 1, New York

RUPTURED

BE FREE FROM TRUSS SLAVERY

Surely you want to THROW AWAY TRUSSES FOREVER, be rid of Rupture Worries. Then Why Do you put up with wearing a griping, chafing and unsanitary truss the balance of your life? If you do, it will NOT be through necessity but through choice on your part.

Now there is a new modern Non-Surgical treatment that is designed to permanently correct rupture. These Non-Surgical treatments are so dependable, that a Lifetime Certificate of Assurance is given. Write today for our new FREE BOOK that gives facts that may save you painful, expensive surgery. Tells HOW and explains WHY NON-SURGICAL Methods of Treating Rupture are so successful today. No obligation.

Excelsior Medical Clinic
Dept. H6125, Excelsior Springs, Mo.

Whatever the trouble...

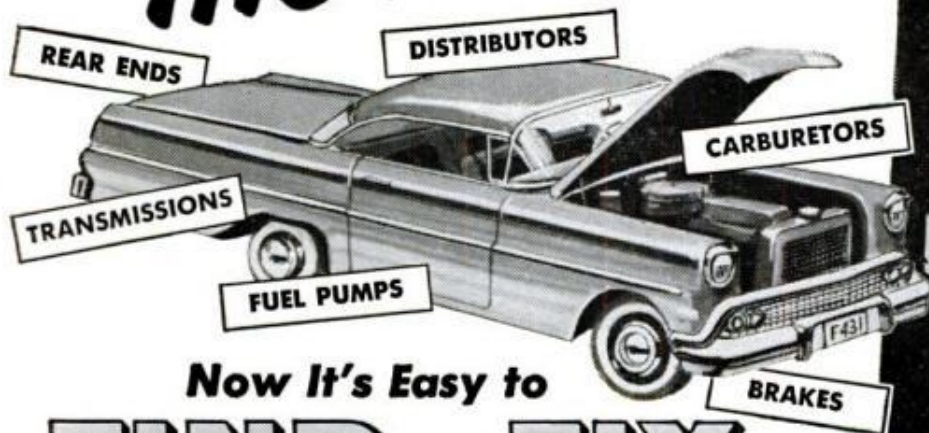

Now It's Easy to
FIND and FIX
What's Wrong With
ANY PART of ANY CAR!

Automobile Factory Experts Show You Step-by-Step
How to Service or Repair Almost Every Car Built Since 1955

NO LONGER need you knock yourself out...waste time, money, effort trying to fix a car. Now, thanks to new MOTOR's Auto Repair Manual, you can breeze through the toughest repair jobs like an expert. Whether it's a simple carburetor adjustment or a complete overhaul - you simply look up the job in the handy index... then follow clear, illustrated step-by-step instructions. MOTOR's Manual tells you where to start... what tools to use. You'll be amazed at how easy it all is!

Over 2800 Pictures!
Everything You Need to Know
Right at Your Fingertips!

It's like having auto factory experts at your side showing you exactly what to do. You get the meat of 176 Official Factory Manuals... thousands of time-saving procedures worked out by the men who built the cars - boiled down into one big crystal-clear, picture-packed book.

NEW, REVISED, ENLARGED edition covers 2,219 American-made models from 1955 through 1962, including all the new compacts. Over 1,100 double-size pages... 2,850 "This-Is-How" pictures... more than 30,000 essential repair specifications... 195 "Quick-Check" charts... over 225,000 service and repair facts... tune-up data for 36 different

OVER
4 MILLION
COPIES
SOLD

foreign car makes. Big, handy Trouble-Shooting section helps you spot the cause of any of 2,300 car troubles in a jiffy. You get so many clear, complete facts and figures you CAN'T go wrong, even if you're a green beginner. And if you're a top-notch mechanic you'll find short-cuts that will amaze you.

Used by Armed Forces Schools

No wonder more than 4,000,000 copies have been sold and are saving time, money, wear and tear for mechanics all over the country. No wonder MOTOR's Auto Repair Manual is used by the Armed Forces and in schools. No wonder we get enthusiastic letters like these:

"MOTOR's has saved us a lot of time and money - cannot do without it" - H. Hartman, Baltimore.

"Since using MOTOR's I can overhaul any car. It's a book I can't be without." - W. Harold, Julesburg, Colo.

SEND NO MONEY

Use MOTOR's Manual FREE For 10 Days

We're so convinced MOTOR's Manual must save you time, energy, and money that we will send you a copy of the new 1962 edition at our risk. Use it FREE for 10 days. If it doesn't pay for itself on the very first job, return it and owe nothing. You don't risk a penny. Rush coupon today to MOTOR Book Dept., Desk 21X, 250 West 55th St., New York 19, N. Y. (Schools, Bookstores: Write for Discounts.)

Same FREE 10-Day Trial on MOTOR's
New TRUCK REPAIR MANUAL



Covers 98% of all trucks, 1952 thru 1962, including Chevy, Ford & International "Midgets." Over 2,000 illustrations; 300,000 facts. Covers all types of gasoline truck engines, as well as GM, International, Mack and Cummins Diesels. Over 800 big pages. For FREE Trial, check coupon box.

Beginner Raves About Book
... "Never knew anything about repairing cars until I got this wonderful book. Has paid for itself time and time again."
- P. Pempers, Wis.

... So Does Expert. "Have been a mechanic for 25 years. MOTOR's Manual still takes me out of the tight spots. And it's simple enough to be understood by average person."
- V. Lauris, Nev.

COVERS ALL THESE MAKES 1955 thru 1962

Buick	Lancer
Buick Special	Lark
Cadillac	Lincoln
Chevrolet	Mercury
Chevy II	Meteor
Chrysler	Nash
Comet	Oldsmobile
Continental	Olds F-85
Corvair	Plymouth
Corvette	Pontiac
Dart	Pontiac Tempest
De Soto	Rambler
Dodge	Rambler American
Edsel	Rambler American
Fairlane	Studebaker
Falcon	Studebaker
Ford	Thunderbird
Imperial	Thunderbird
Jeep	Valiant

- GENERATORS
- STEERING
- IGNITION
- AXLES

Try Book
FREE
For 10 DAYS

MAIL NOW FOR 10-DAY FREE TRIAL
(Attach to postcard for faster action)

MOTOR BOOK DEPT.
Desk 21X, 250 W. 55th St., New York 19, N. Y.

Rush to me at once MOTOR's New **AUTO REPAIR MANUAL**. If O.K., I will remit \$2 in 10 days, \$2 monthly for 2 months and a final payment of \$2.95 (plus 45¢ delivery charges and sales tax) one month after that. Otherwise I will return the book postpaid in 10 days.

Also send me for 10 days Free Trial MOTOR's New **TRUCK REPAIR MANUAL**. If O.K., I will remit \$10 plus delivery charge and sales tax in 10 days. Otherwise I'll return book postpaid in 10 days.

Print Name..... Age.....

Address.....

City.....Zone....State.....

Check box and SAVE 45¢ delivery charge by enclosing WITH coupon in envelope entire payment of \$8.95 for Auto Repair Manual (or \$10 for Truck Repair Manual) plus sales tax. Same return-refund privilege.

Let Me Show You How To Develop A Profitable Business On A Shoestring

Make \$5.00 an hour from the Start — in Your Own Home

WITH BELSAW SHARP-ALL YOU CAN SHARPEN HOUSEHOLD, GARDEN, SHOP TOOLS WITHOUT PREVIOUS EXPERIENCE

I wish there was space here to print the hundreds of testimonials received from men I've put in business with the BELSAW SHARP-ALL. This precision machine sharpens most household, garden and shop tools easily and quickly. You do not need previous experience or special ability. Anyone can learn to operate the SHARP-ALL expertly. Whether you want a spare time income or a full-time business, the SHARP-ALL is your answer. There's no inventory investment, no selling, no store space to rent. You operate out of your own home on a strictly cash basis. Age and physical handicaps are no barrier to success in this business.

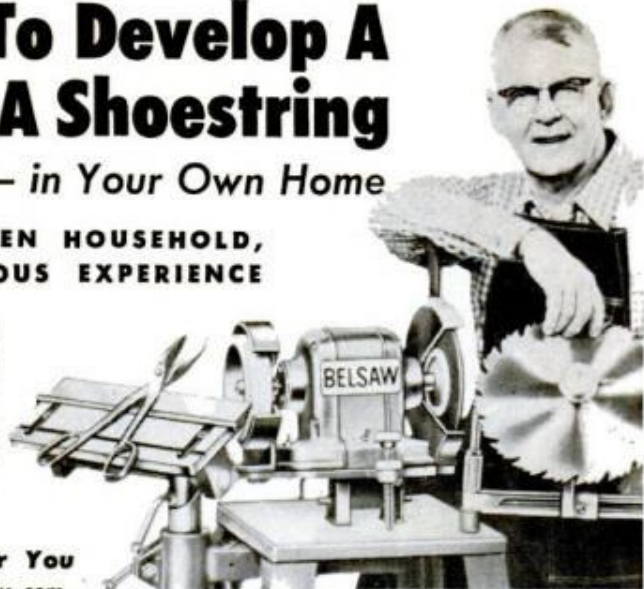

What I've Done For Over 40,000 Men I Can Do For You

I want to help you own this profitable business of your own. My company has been doing this for over 30 years, so I know your problems and how to guide you. I'll even finance you while you're getting started. You'll receive complete, easy-to-understand instructions on how to operate your SHARP-ALL, how to get business rolling in, how to handle advertising and direct mail. I'll keep you informed on how hundreds of other SHARP-ALL owners are bringing in extra income every day.



Stan Field, President
BELSAW SHARP-ALL CO, 713 Field Bldg., Kansas City 11, Mo.
Send Free Book "LIFETIME SECURITY." No obligation.

Name _____
Address _____
City _____ State _____

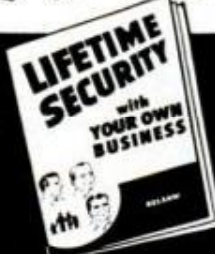

Send Coupon Today for **FREE BOOK**

HEAR A WHISPER
A BLOCK
AWAY



THE BIG EAR

ONLY
\$17.98

Transistor Device Amplifies Sound

"Big Ear" disk reflector makes possible ship-to-shore or ship-to-ship conversations. Use it at meetings to pick up questions from the floor. Aim it at a group of friends a block away and join them in their conversation without moving a step . . . picks up voices loud and clear that seem too far away to be heard. You can even do unbelievable "magic" tricks at parties and gatherings. The big 18" reflector disk concentrates sound waves into a transistor unit that amplifies right into your stethoscope-type earphone. Complete with tripod and balanced aiming handle. Full Money Back Guarantee. Only \$17.98 plus 88c shipping charges. Send cash, check or money order or order C.O.D.

GUARANTEED DISTRIBUTORS

35 Wilbur St. Dept. BE-9 Lynbrook, N. Y.

29 YEARS IN BUSINESS AT THE SAME ADDRESS.

NOWHERE CAN SUCH QUALITY BE FOUND AT SUCH LOW PRICE!

We Bought Tires by the Truck Loads— TO SAVE YOU MONEY

OUR ENTIRE STOCK OF GOOD USED PASSENGER TIRES ARE ALL FULL 4 PLY

850x14	\$4.75	670x15	\$4.75	700x17	\$9.05	900x20	\$16.95
600x16(6)	7.55	710x15	4.75	750x17	10.75	1000x20	17.95
650x16(6)	8.55	760x15	5.55	650x13	4.75	1100x20	16.95
750x14	4.75	800x15	5.55	700x20	10.55	1000x22	18.95
800x14	4.75	820x15	5.55	750x20	12.25	1100x22	18.95
700x15(6)	9.75	640x15	4.75	825x20	17.85	Whites	\$1.00 EX.

SNOW TIRES \$6.82 AND \$5.00 SIZE ANY BLACK WALL PASS.

Thousands of tires shipped all over the U.S.A. All tires shipped F.O.B. Phila. Send Check or M.O. with this ad. Dept. 5. No C.O.D. STANDARD TIRE CO., 834 North Broad Street, Philadelphia 30, Pa.

JEEP OWNERS

RE-POWER NOW WITH A V-8 OR 6 CYL. ENGINE — USE FORD—CHEV.—MERCURY—GMC—PONT—STUDE—DODGE OR PLYMOUTH In Jeeps, Jeepsters, Sta-Wgn, trucks, Kaiser & H. J. cars. Conversion Kits \$45.35 to \$56.90. Want fast action? Give us full information, send \$15.00 Dep. and we will ship correct kit. Bal. COD. Send full amount for prepaid shipment. Wire, phone or write today. Details FREE.

HOOSIER MACHINE PRODUCTS CO.

312 S. E. 6th St. Phone CR 6-3442 Pendleton, Oregon



STOP FRONT DRIVE DRAG AND WEAR ON 4-WHEEL-DRIVES!

WARN HUBS

Free-wheeling 2-wheel drive with Warn Hubs means big savings in gear, engine, tire wear, gas—plus more pep, performance, power in high, and easier steering. Rugged, dependable, proven, with over 400,000 in use. Iron-clad guarantee. Choose Lock-O-Matics that change drive as you shift, or manual Locking Hubs. Models for all 4-w. ds. at dealers, or write for literature.

WARN MFG. CO. Riverton Box 6064-A Seattle 88, Wash.

Homemade Photosynthesis?

HOW PLANTS capture solar energy and transform it into the stuff that sustains all life on earth is close to being solved. Two biochemists at the University of California at Berkeley, Dr. Kunio Tagawa and Dr. Daniel Arnon, recently completed a series of experiments that tie up most of the loose ends concerning the process known as photosynthesis.

Much of the photosynthetic procedure had been explained in earlier experiments, specifically the chemical reactions by which carbon dioxide is changed into sugar, or plant substance. But a mystery remained. How did the process begin, and what role did sunlight play in it?

In solving this scientific whodunit, the scientists at California played a trick on nature. The researchers suspected that light energy triggered the whole process, and figured that if they could reproduce, or "kick off" the chain reactions of photosynthesis in the dark—by chemical means—they'd solve the riddle.

The two scientists started with a theory of their own that the whole process is set off when light energy is transformed into chemical energy by a flow of electrons among several compounds.

In earlier experiments Dr. Arnon's group had discovered that two key compounds, adenosine triphosphate (ATP), and reduced pyridine nucleotide (PNH₂) are formed in plants at the expense of light energy. These two compounds then carried out the chemical reactions of photosynthesis.

But what chemical transported the electrons released by light energy? The researchers found their answer in the recent discovery of an iron-rich compound called ferredoxin, which had been isolated from soil bacteria. They identified ferredoxin in the chlorophyll of spinach plants and found that it had tremendous electron-carrying capacity.

They then used ferredoxin to reverse the usual photosynthetic result—they succeeded in producing hydrogen gas instead of the usual oxygen that is normally "exhaled" by plants. The next step was to use hydrogen instead of light energy to trigger the photosynthetic process. The result was the production of ATP and PHN₂, the two chemicals necessary in the production of plant substance.

According to Dr. Arnon, the findings show a basic unity between photosynthesis and the chemical reactions found in certain bacteria that grow in the soil.

GET A KEY JOB WITH BIG PAY

Train at home in spare time. Low cost. Mail coupon for FREE illustrated booklet.



LA SALLE EXTENSION UNIVERSITY

An Approved Correspondence Institution • 417 So. Dearborn St., Dept. 11-093 Chicago 5, Ill.

- | | | |
|---|---|--|
| <p>ACCOUNTING</p> <ul style="list-style-type: none"> ■ Modern Bookkeeping ■ Basic Accounting ■ Cost Accounting ■ Federal Income Tax ■ Accounting Systems ■ Auditing Procedure ■ Controllership ■ CPA Training ■ Complete Accounting <p>BUSINESS COURSES</p> <ul style="list-style-type: none"> ■ Complete Business Management ■ Basic Management ■ Advertising and Sales Promotion Management | <p>PRODUCTION AND FINANCE</p> <ul style="list-style-type: none"> ■ Production Management ■ Business Financing ■ Credits and Collections ■ Office Management ■ Business Correspondence ■ Personnel Management ■ Foremanship Training ■ Sales Management <p>LAW TRAINING</p> <ul style="list-style-type: none"> ■ Bachelor of Laws Degree ■ Business Law ■ Law of Contracts ■ Insurance Law ■ Claim Adjusting Law ■ Law for Police Officers ■ Law for Trust Officers | <p>TRAFFIC AND TRANSPORTATION</p> <ul style="list-style-type: none"> ■ Complete Traffic and Transportation ■ Organization and Management ■ Transportation Law ■ Classification, Rates and Tariffs ■ Transportation Agency and Services <p>HIGH SCHOOL</p> <ul style="list-style-type: none"> ■ High School Diploma ■ Commercial Course ■ College Preparatory ■ Secretarial Course |
|---|---|--|

Please send me FREE booklet of information on the subject I have checked at the right.

Name

Address

City & Zone

County..... State.....

310 Age

Pentagon sidelights

By William R. Kreh

They de-greased a duck the other day at the Naval Ordnance Laboratory, along with the footbones of an elephant and the upper skull of a gopher. The strange job for Navy technicians came about at the request of the Smithsonian Institution. The museum had some specimens it acquired which had not been prepared properly and were being ruined by fats still in the skin and bones. If the grease could be removed, the plumage and structures of the specimens could be saved. The Navy ordnance experts did it with the lab's trichlorethylene vapor degreaser, a machine normally used to clean the surfaces of metal which are to be electroplated.

Feet cold? Then keep your head warm. The Army, working to develop an ultra-warm uniform for soldiers in the Arctic, says that a hat will do as much to keep your feet warm as an extra pair of socks. The medics say that if your head's cold, Mother Nature automatically sends more warming blood to protect the brain. What's left goes to the other extremities, and this often isn't enough to do much warming.

Rolling salutes. The Navy had a problem out at its San Francisco shipyard. The saluting batteries, which by military tradition must sound off whenever an admiral, general or other VIP makes an official visit, were located too far from where the welcoming ceremonies were often held. Some of the shipyard technicians got their heads together and came up with a novel solution. They mounted the two three-inch guns on a truck so now they can travel anywhere on the yard's 1000 acres to bestow the proper honors.

Lamb bones were used by Army scientists to help develop a new boot designed to protect soldiers from land mines exploding underfoot. The bones were used to simulate a human foot and X-ray cameras recorded the effects of various types of explosions on the bones. Result of the experiments is a new wedge-shaped deflector that's embedded in the rubber lower part of an other-

wise conventional military boot. The footwear now deflects blasts from the heel, arch and lower parts of the leg.

Governmentese added a new word to its rolls recently when an Air Force study group concluded that a proposed scientific project was "feaseless."

A raincoat sleeping bag is being tested by the Army. The garment is a water-resistant poncho with a liner. The liner can be removed and used as a ground cover, or when used with the poncho, can be made into a sleeping bag. It's lighter to carry and easier to roll and pack than the standard poncho and wool blankets now in use.

Fire-fighting foam will keep intense direct sunlight from melting ice runways in the Arctic if spread on in two-inch layers, the Air Force has found.

A steel ball slightly larger than a marble reached the highest re-entry speed ever attained by a man-made object when it was shot back down into the earth's atmosphere recently from 200 miles up. The ball became an artificial meteor, creating a bright trail visible in two states before it burned up. Air Force Cambridge Research Laboratory scientists used a six-stage rocket for the experiment at Wallops Island, using two stages to get the pellet into the air and four stages to fire it back down at a speed of nearly 12 miles a second. Special instruments measured its brightness and electrical charge as the marble descended.

Billy goat bleats may replace the groans of some sea buoys. The Coast Guard is experimenting with an electric horn designed to be used on the buoy that's farthest out in a river channel. Usually, this buoy is made to groan by the rocking action of the waves, but sometimes, especially in fog, the water is calm and the buoy remains silent. The new electric buoy with the bleat, however, needs no waves.

Two electronic tube patients visited an Army dentist recently. They were referred to him, believe it or not, by the Air Force. When a radar squadron found two of its special transmitter tubes out of order because they had become pitted on the outside, they took them to a nearby Army dental clinic where an ingenious dentist spent two hours drilling the cavities into a proper shape and then filling them with plastic. Dental bills are usually costly, but this one saved the Air Force about \$7000.

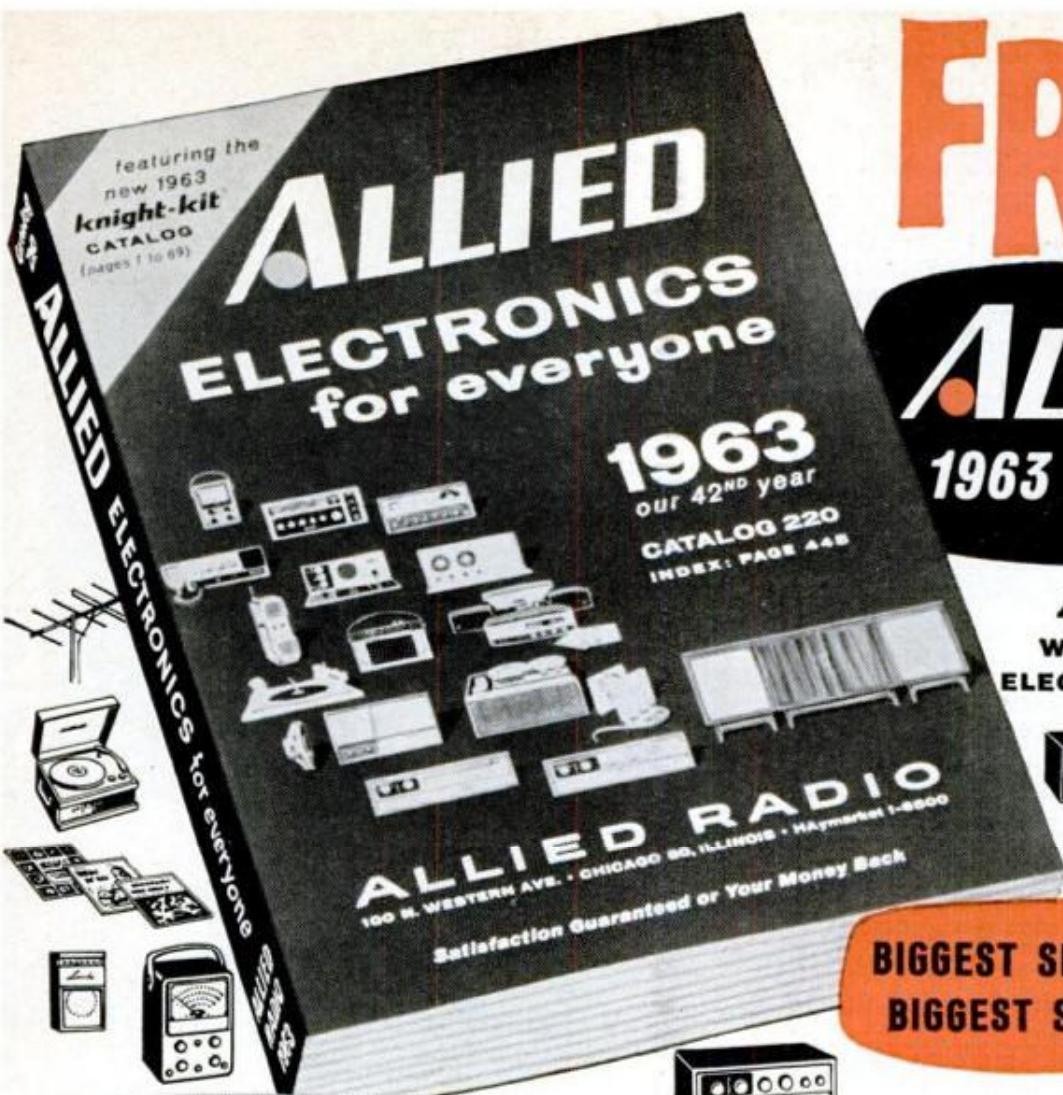

FREE



**464 PAGES
WORLD'S LARGEST
ELECTRONICS CATALOG**



**BIGGEST SELECTION
BIGGEST SAVINGS!**

see what's new in
STEREO HI-FI

top buys in
TAPE RECORDING

latest values in
**CITIZENS BAND &
SHORTWAVE RADIOS**

exciting build-your-own
knight-kits®

NO MONEY DOWN: Now! Get More
Buying Power with your
Allied Credit Fund Plan!

Satisfaction guaranteed or your money back

ALLIED RADIO
The World's Largest Electronic Supply House

SAVE MOST ON:

- Everything in Stereo Hi-Fi
- New All-Transistor Stereo
- KNIGHT® Super-Value Hi-Fi
- Tape Recorders & Tape
- Citizens Band 2-Way Radios
- Transistor & FM-AM Radios
- Phonographs & Records
- Ham Station Equipment
- PA Systems, Intercoms
- Latest Test & Lab Instruments
- TV Tubes, Antennas, Accessories
- Parts, Tubes, Transistors, Books, Tools



ALLIED EXCLUSIVES:
See special products
and values available
only from Allied—plus
all the famous makes!

FREE

SEND FOR YOUR COPY TODAY!

ALLIED RADIO, Dept. 22-19-L
100 N. Western Ave., Chicago 80, Ill.

Send FREE 1963 ALLIED Catalog

Name _____
PLEASE PRINT

Address _____

City _____ Zone _____ State _____



EARN MORE - LEARN AUTO DIESEL MECHANICS

OR TRAIN WITH OTHER GREER DIPLOMA COURSES

- | | |
|---|---|
| <input type="checkbox"/> AUTO MECHANICS | <input type="checkbox"/> REFRIGERATION |
| <input type="checkbox"/> DIESEL MECHANICS | <input type="checkbox"/> AIR CONDITIONING |
| <input type="checkbox"/> BODY & FENDER REPAIR | <input type="checkbox"/> MACHINIST-TOOL & DIE |
| <input type="checkbox"/> GAS, ARC WELDING | <input type="checkbox"/> AUTOMATIC |
| <input type="checkbox"/> HELIARC WELDING | <input type="checkbox"/> TRANSMISSIONS |
| <input type="checkbox"/> DRAFTING | <input type="checkbox"/> MOTOR TUNE-UP |

Civ. or G.I.

Skilled men are needed in every part of the country. Earn top pay in established shops or start your own business. Greer's expert instruction and actual shop training teaches you how. You learn by doing—quick, easy courses using the latest tools and equipment. Day, evening and part time instructions available.

Job placement aid and convenient living accommodations are yours while training. Contact **GREER'S FREE JOB PLACEMENT SERVICE** when you enroll if you wish part time or full time employment assistance.

TECHNICIAN COURSES

- | |
|---|
| <input type="checkbox"/> DIESEL AUTOMOTIVE TECHNICIAN—21 MONTHS |
| <input type="checkbox"/> REFRIGERATION & AIR COND. TECHNICIAN—17 MONTHS |
| <input type="checkbox"/> WELDING TECHNICIAN—14 MONTHS |

Please rush me free literature on the trade indicated at no obligation.

NAME _____ AGE _____

STREET _____

TOWN _____ ZONE _____ STATE _____

Established 1902

GREER SHOP TRAINING

BOX K, 2236 S. Michigan Ave. Chicago 16, Ill.

EXCLUSIVE DOUBLE-BEARING HEAVY DUTY PUMPS

IRRIGATE • DRAIN • CIRCULATE • SPRAY

Use 1/4 HP motor or larger . . . 1 HP for up to 5,200 GPH; 1,000 GPH 60" high; or 3,000 GPH from 25' well. 1 1/2" inlet; 1" outlet. Stainless shaft.

TYPE X—2 oil-less bronze bearings. **\$10.95**

TYPE XB—Ball bearing model. **\$12.95**

Best for belt drives. . . .

Postpaid if cash with order.

Don't delay—send for yours today!

MONEY BACK GUARANTEE

Centrifugal and Gear Pumps in All Sizes
LABAWCO PUMPS, Belle Mead 2, N. J.



C-14



COLORCRETE CAN BE YOUR OPPORTUNITY

All over the country, men are making money as applicators of Colorcrete—the beauty treatment for old, drab, time-worn masonry surfaces. Stucco, concrete and the like can be transformed in brief time and at relatively low cost into surfaces that gleam in colorful beauty. Colorcrete is good for homes, stores, schools, motels, garages, service stations and other public and commercial buildings. Range of 16 colors.

Every community can support a Colorcretor — and many territories are still available. Investment required is very moderate. Write at once for Opportunity Book.

COLORCRETE INDUSTRIES, INC.
570 Ottawa Avenue, Holland, Mich.



Mach-3 Tire Boils Water

In tests to prove the durability of B-70 tires built to withstand the heat of friction at three times the speed of sound, engineers exposed them to temperatures of 360 degrees F. then simulated a landing.

The tires stood up under it, and to prove they were still hot, a kettle of water was placed on one of them. It boiled.

New compounds and new carcass construction (not announced) are responsible, according to the manufacturer, B. F. Goodrich Co.

ARE YOU MOVING?

**SIX WEEKS IS REQUIRED
to change your magazine address.**

A new regulation of the Post Office effective January 10, 1962 requires that you pay the extra postage if copies of **POPULAR MECHANICS** are forwarded to you at your new address. Copies will not be forwarded free and we cannot replace lost copies. To insure delivery at your new address please notify us at least six weeks in advance of your moving. Send us your old and new address and if possible the address label from your last issue . . . include your postal zone number. Thank you.

Write to:

POPULAR MECHANICS
Subscription Dept.
250 West 55th St., New York 19, New York

Learn PACKAGING!

MAKE TO 2500% PROFITS AT HOME
YOU PACKAGE WE DO YOUR SELLING!

HERE'S PROOF
that Packaging means
Big Profits for You!

Item	Bulk Cost	Sells For
Safety Pins	2 1/2¢	15¢
Balloons	3 1/2¢	19¢
Fish Hooks	2¢	50¢

Make profits like these on over 100,000 other products you can package right in your own home. We show you how!

Package products at home for nationwide sales force. You package bulk items in your own home. We do your selling coast-to-coast. FREE 'No Selling Plan' reveals thousands full, spare time big profit opportunities for beginners in self-service packaging, contract packaging, gift wrapping. We guide you step by step. Everything furnished.

Write today for FREE "10-STEP PACKAGING PROFIT PLAN", and full details. No salesman will call.



HOME PACKAGING CO., Dept. A-253
807 Sunset Blvd., Los Angeles 12, Calif.

FREE OUTFIT STARTS YOU IN BIG MONEY SHOE BUSINESS!



Run your own profitable "shoe store" business from home! Represent fast growing million dollar firm in spare or full time. We give you—FREE—complete Starting Outfit that makes you \$217 EXTRA each month for just 2 easy orders a day. Feature 195 fast-selling dress, sport, work shoe styles for men, women. Air-cushion shoes, many special features! Sizes 2 1/2-15—AAAA to EEEE. Sell to friends and folks where you work. Rush postcard for FREE Outfit!

MASON SHOE, Dept. H-558, Chippewa Falls, Wisconsin

Amazing TEAR GAS PENCIL

BLASTS MOLESTERS ...THUGS!

100% PROTECTION!

Discharges tear gas to instantly stop, stun and incapacitate the most vicious man or beast. Effective substitute for firearms; leaves no permanent injury. No selling experience needed. Handle as profitable sideline, soon you'll sell it full time. Start now, 5 easy sales net \$25.00 a day up. Send \$5.95 for demonstration kit of Automatic Tear Gas Pencil, 10 Demonstration Blanks and 3 Tear Gas Cartridges. NOT SOLD TO MINORS. State age with order.

Hagen Supply Corp.: Dept. PM112, St. Paul 1, Minn.

BIG PROFITS, SELLS EASY TO GAS STATIONS, NIGHT WORKERS, MOTORISTS, NURSES, STORES, BANKS, HOMES

Shrinks Hemorrhoids New Way Without Surgery Stops Itch - Relieves Pain

For the first time science has found a new healing substance with the astonishing ability to shrink hemorrhoids and to relieve pain - without surgery.

In case after case, while gently relieving pain, actual reduction (shrinkage) took place.

Most amazing of all - results were so thorough that sufferers made astonishing statements like "Piles have ceased to be a problem!"

The secret is a new healing substance (Bio-Dyne®)—discovery of a world-famous research institute.

This substance is now available in suppository or ointment form under the name Preparation H®. Ask for it at all drug counters.

NOVEMBER 1962

There is an immediate growing need for trained technicians in

- ELECTRONICS
- RADIO-TV SERVICING
- COMMUNICATIONS

For higher pay and a brighter future, investigate training at home in your spare time with NRI—oldest and largest home study school of its kind.



SPECIAL TRAINING EQUIPMENT INCLUDED

Except for FCC License training, all NRI courses include—at no extra cost—special training equipment for actual practice at home building circuits, working experiments. Makes theory you learn come to life in interesting, easy-to-grasp manner. NRI catalog we send gives facts about the field of your choice, shows equipment you get and keep. Act now.

MAIL COUPON NOW FOR FREE CATALOG

The Amazing Field of Electronics



NATIONAL RADIO INSTITUTE

Washington 16, D.C. 2MA

Please send me free 64 page catalog. (No representative will call. Please print.)

Name Age

Address

City Zone ... State

ACCREDITED MEMBER NATIONAL HOME STUDY COUNCIL

POPULAR SHOPPING



PLAY RIGHT AWAY!

ANY INSTRUMENT— even if you don't know a single note now!

NOW it's EASY to learn ANY instrument. No boring exercises. Even if you don't know a single note now you can play delightful pieces — from your FIRST lesson! BY NOTE. Make amazing progress. No special "talent" needed. Learn at home in spare time. Without a teacher. Low cost! Soon you can play popular music, hymns, classical and any other music. Over 1,000,000 students, all over the world.



FREE BOOK. Fill in ad, send to: U. S. SCHOOL OF MUSIC, Studio 3011, PORT WASHINGTON, N. Y. (No obligation, no salesman will call.) Chartered by N.Y. State Education Dept. Established 1898.

Name.....
Address.....
.....
Include Zone No., if any.



House lighting with luminous ceiling panels can add unique warmth to any room. A 4-page brochure gives tips on the types of residential lighting possible with translucent fiberglass reinforced plastic panels. It lists sizes and accessory items as well. Installation pointers provide the how-to for the home handyman. Maintenance is just as easy. Write the Consumer Relations Dept., Filon Corp., 333 N. Van Ness, Hawthorne, Calif. for your free copy of "FiLite-Luminous Ceiling Panels."

Model Railroading can be a fascinating hobby. Linn Westcott, editor of "Model Railroader" magazine, has written an 80-page book, "HO Primer," which covers the various problems which would be encountered by a newcomer to this field. The book starts with the purchase of a train set, goes through the selection of individual parts, and includes kinks to ease the process of track laying, wiring and operation. Fully illustrated, the book is available for \$2 from the Kalmbach Publishing Co., 1027 N. Seventh St., Milwaukee, Wis.



Satellites are discussed in all areas of their achievements in the "Complete Guide to Orbiting Satellites," a four-chapter book published by Space Products Corp. The U.S. successfully orbited 58 earth satellites from 1958 to 1961. How are these weather, communications, navigation and reconnaissance satellites functioning since they were launched? This guide presents the latest facts and fundamentals on earth satellites in understandable terms, with a diagram of how each satellite works, as well as an illustration of each in orbit, and how to find it in the heavens. Also included is a glossary of terms. Designed in loose-leaf binding to be kept up-to-date by periodic additions, the guide is available for \$2 from Space Products Corp., 38 East 57th St., New York 22, N.Y.

Buried gold, lost mines, pirate loot—do they interest you? A "Treasure Map of the United States," 21 by 33 inches, shows locations of over 445 caches and gives a brief history of each. A weekend of treasure-hunting with the family might yield a fortune in doubloons. Price of the map—\$1.00 from Edward O. Burns, 2303 Emporia St., Denver 8, Colo.

Treat Yourself to this

Hand-built over resilient urethane foam two inches thick at front and sides, to give the support, comfort and security of a custom-built bucket seat. Use it anywhere—in car, station wagon, jeep, truck, boat or stadium; camp, trailer, home or office. Handsome, decorative, reversible. Your choice,—brown, black, gray, beige, white, red, blue or green. \$16.95 postpaid.



An IDEAL CHRISTMAS GIFT

We will Giftwrap, mail, and enclose your card.

THE WILSON SEAT COMPANY Box M, West Main St., Batavia, Ohio

ONLY **\$135** complete with accessories

You can **make Big Money** with this low cost **arc welder!**



EASY TO USE "Trojan" 180 amp. welder fabricates parts, ornamental railings, furniture. Makes repairs on the spot. Hardsurfaces machinery, tools. Solders leaks. Brazes fenders. Heats metal for bending. Has no moving parts. Permanently quiet operation. Line switch disconnects power. Light weight,

compact (23" h. 13 1/4" w. 13 1/2" d.). Meets REA power line requirements. Provides 18 welding heat steps. Complete package includes electrode holder; 15' ground cable, clamp; 20' electrode cable; headshield, lens; 8' power connection; electrodes. Write for data sheet A-521-F today.



HOBART BROTHERS CO., BOX M-112 TROY, OHIO, U.S.A., Ph. 332-1223

New Table Top Invention Puts You In...

PROFITABLE RUBBER STAMP BUSINESS

Home Operators now make \$9.20 AN HOUR in Business once monopolized by a few big companies

Special rubber stamps bring high prices—cost only pennies to make on new, low-cost table top machine. Take 27 cents worth of material, make perfect stamps, the kind businesses and offices now buy by the dozen at \$1.80 each. Make up to \$9.20 an hour. Start in spare time in your own home. Run machine on kitchen table using ordinary electrical outlet. Make any kind of stamp. We'll send you free information without obligation about this established, highly profitable business. **We'll even help finance your start.** For free information send name and address today on a postcard to: Rubber Stamp Div., 1512 Jarvis Ave., Dept. R-2-M, Chicago 26

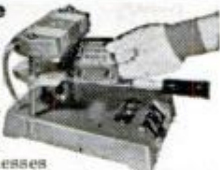

Selsi YOUR BEST BUY Since 1854
FINE OPTICAL GOODS AT BUDGET PRICES SEE YOUR DEALER
BINOCULARS MICROSCOPES TELESCOPES BAROMETERS

SELSEI CO., Inc., 29 East 22nd St., New York 10, N. Y.

Would You Like to Make **\$1,000 A MONTH?**



That's what Stanley Hyman made selling the amazing new Presto Fire Extinguisher! Many others "cleaning up"—so can you! Amazing tiny new extinguisher ends fires fast at 2 seconds. **Guaranteed for 20 years!** Sells for only \$4.95. Write for Free sales kit.



Merite Industries, Inc., Presto Div., 114 E. 32nd St., Dept. P-15A, New York 16, N. Y.

MORE THAN 600 specific craft, home and shop problems solved with Popular Mechanics' do-it-yourself instructional materials. For a free Service File listing by subject, write Service Bureau, Popular Mechanics, 740 Rush St., Chicago 11, Ill.

INVENTORS

If you have an invention that you believe has merit, write us at once for copy of copyrighted booklet "How to Go About Selling Your Invention." FREE—Just send name. Kessler Sales Corporation • Dept. D-511 • Fremont, Ohio

PELLET FIRING LUGER AUTOMATIC

- MAGAZINE LOADING CLIP
- OVER 15 MOVING PARTS
- FULLY AUTOMATIC

Automatic full size model of a Luger Automatic pistol—contains over 15 moving parts. Loads 8 complete rounds which snap into the hard butt simulating a Luger. Fires 8 bullet shaped pellets Has automatic slide action.

ONLY \$198

MOST AUTHENTIC MODEL GUN WE'VE EVER SEEN

Comes to you with working parts disassembled with cleverly engineered springs, full instructions, supply of pellets and specially designed belt holster. **Full Money Back Guarantee.** Simply send \$1.98 plus 27c shipping charge or order C.O.D. From:

HONOR HOUSE PROD. CORP., Dept. LL-22, Lynbrook, N. Y.

94.6% OF BAILEY GRADUATES ARE EMPLOYED AT TOP PAY IN THE FIELDS WHICH THEY WERE TRAINED!

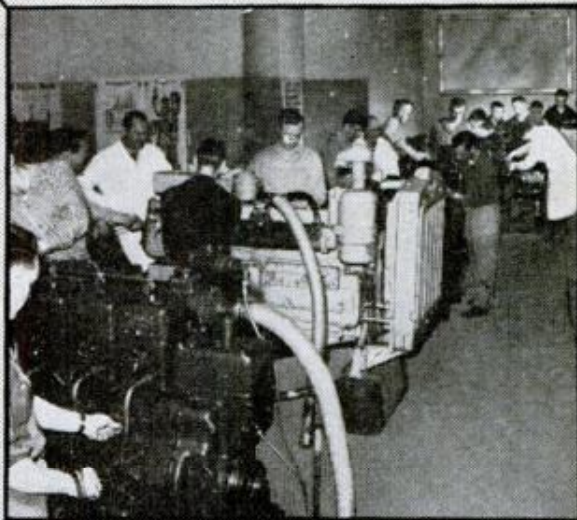

DIESEL-AUTO MECHANICS DESPERATELY NEEDED!

We have a far greater demand for our students than we can fill!

We can show you an actual waiting list of leading companies throughout the world who have tried Bailey graduates — found them outstanding, and are coming back for more!

Bailey Graduates are Successful . . . RECEIVE BIG PAY — HAVE SECURE FUTURE!

The Famous Bailey Course prepares you for BOTH Diesel and Gasoline Mechanics.

This is a must—due to the advent of using Diesel principles, such as 'Fuel Injection' on passenger cars . . . use of gasoline engines for starting Diesel engines, etc. You learn all this at Bailey in the amount of time ordinarily required to learn just one of these subjects, **ALL FOR THE PRICE OF ONE.**

Don't be satisfied with a 'futureless', one-type job—learn how you can make big money now! Write today for Free Booklet that takes you on a step-by-step camera tour through our spacious, modern shops — See Bailey students in action as they Learn-by-doing with the Famous Bailey Method of training!

We provide you with housing and part time jobs while in school, plus nation-wide placement service for graduates.

BAILEY Technical SCHOOLS

1634 S. GRAND ST. LOUIS 4, MO.

MAIL TODAY!

Please mail immediately this free booklet without obligation.

FREE BOOKLET



Name.....

Address.....

City..... State.....

APPROVED FOR VETERAN . . . NON-VETERAN

Painting your home may seem like an overwhelming project. However, with accurate information on paints, surface preparation, brush care and proper tools for the job you can start the work with assurance. "How to Save Money When Painting Your Home," a 12-page pamphlet, offers these facts for the handyman. It's free upon request from Sherwin-Williams Co., General Office, Cleveland 1, Ohio.

Underwater photographers will be interested in the recent publication, "How to Build Your Own Underwater Camera Housing," by Mart Toggweiler, well-known skin diver and photographer. Seventy-four packed pages give detailed information on camera features, housings, controls and lenses best suited for shooting sharp pictures in watery depths. The how-to ma-

terial is backed up with photos both within the workshop and underwater. Available for \$1.00 from Dive-Rite, P.O. Box 14444, Long Beach, Calif.

Carburetor problems? "Know Your Carburetor," a 47-page booklet, diagrams what carburetors are, what they do and how to handle single, double, or four-barrel carburetor trouble. In addition, carburetor care, cleaning and adjustment are discussed. Send 25 cents for your copy to Pennsylvania Refining Co., 2686 Lisson Rd., Cleveland 4, Ohio.

Sentinel of the Mediterranean—Turkey; city of canals—Bangkok; African herdsmen—the Masai; all are covered in natural color with fascinating text in the "Geographic School Bulletin." This 16-page weekly booklet features articles on nature, scientific developments and lands in the news, as well as regular columns such as "The Old Explorer," "Word of the Week," and "Geo-Graph." Worthwhile for classroom or home, it's available at \$2.00 a school year in the U.S. from the



Service Division, National Geographic Society, Washington 6, D.C.

Drivers are often plagued by the unexpected on the road. What do you do when you're driving on a two-lane highway and a bicycle rider swerves in front of you? The answer to this and other situations which may face every driver are presented in sketched scenes from the driver's point of view in "Ten Common Driving Emergencies," a 24-page booklet published by Nationwide Mutual Insurance Co., Columbus, Ohio, free upon request. The booklet also contains a chart on what to do if you have an accident; it's a wise glove-compartment item.



New Idea For Your Car

Auto "Tissue Tender"

Easy-to-install aluminum bracket holds tissues at your fingertips - neatly, safely. No groping, no looking, no stretching. Saves space under dash or in glove compartment. Costs so little compared to other tissue holders. No holes to drill . . . attach to existing screws. Just \$1.00 ppd. tax incl.

KEIPER DISTRIBUTING CO.
914 Sycamore - Waterloo, Iowa

**ROAD RACING
& H. O. TRAINS**

Sets . Parts . Track

▶ SEND FOR FREE CATALOG ◀

SAVE TO
30%

**TOY
WORLD**
1 Fairview Terrace
Paramus 1, N. J.

**Operate Your Own . . .
IMPORT-EXPORT
Business at Home**



Complete Export-Import mail order course tells you how to start your own profitable business and operate it from your home. Full details include overseas supply sources for wonderful low cost values that appeal to everyone. Send no money, write for full information today to **GLOBAL EXPORT-IMPORT MAIL ORDER CO.**, Dept. M, Box 9584, Northside Station, Jackson 6, Mississippi.

LICKITY LOG SPLITTER

Ends Wood Splitting Drudgery

Dealer Inquiries Invited

Smooth 18 ton hydraulic power splits big profits for you from the toughest woods, including American Elm. 7 HP trailer unit squats under own power to receive large logs without "dead" lift. Has 2 speeds, auto-shift and auto-stroke. 26" ram travel splits up to 34" lengths, any diameter—or, with extended frame and adjustable wedge, splits up to 52" lengths, any diameter. Write for details.

THE WACO AIRCRAFT CO., Dept. D, Troy, Ohio



ZOOM MOVIE CAMERA
Lets you "move in" instantly
\$21.70
Electric Eye guides exposure

BUY BELOW WHOLESALE

Long Range Hi-Fi Reception
AM-FM RADIO
only **\$10.95** 6 tubes, 2 diodes



DISCOVER THE SECRETS OF IMPORT!

See what to buy—how to buy it at rock bottom prices. Cut out the middleman profit! Buy direct from manufacturers abroad. Thousands of items available.



CARDIGAN SWEATER
Australian Wool, Fancy Buttons Hand Framed, Carefully Sized
ONLY \$2.02

Start your own big profit business with hundreds of bargains like these



TAPE RECORDER
Only **\$9.76**
Complete with speaker, microphone, tape, reels, etc. Records—Plays Back—Erases Rewinds

and these are only four of hundreds of import bargains you can get to make fantastic profits of 200% and more . . . here are examples of other high-profit imports:

Transistor Radio . . \$1.96	Electric Razor with Case \$ 3.40
Derringer Pistol . . 5.74	Cigarette Lighter . . .17
Star Sapphire Ring 6.00	Tailor Made Silk Suit 22.50
Binoculars 1.20	Teakwood Chest90
17 Jewel Watch . . 2.87	Electric Food Mixer . 1.70

Prices subject to market fluctuation

Mellinger Co., Dept. D25B 1554 S. Sepulveda, Los Angeles 25, Calif.

BIG MONEY BUSINESS
You Can Start in Your Spare Time

Whatever you do for a living, whether you have your own business or work for someone else, importing offers you profits beyond your wildest dreams. You need no previous experience or capital investment. You don't even pay for merchandise in advance. The profits are all yours because you deal *direct* with overseas suppliers. When we give you our secrets of Import profits, we reveal everything you need to know. Rush coupon for FREE BOOK, showing how others have followed this plan to success.

RUSH COUPON FOR FREE BOOK

MELLINGER COMPANY, Dept. D25B
1554 S. Sepulveda Blvd., Los Angeles 25, Calif.

Send Free Book showing how I can start a business of my own and make big profits and how I can get bargains like these and thousands more direct from overseas suppliers.

Name _____
Address _____
City _____ Zone _____ State _____

MEN!! HEAVY EQUIPMENT

EARN UP TO \$4.50 PER HOUR!
Learn to operate Bulldozers, Motor Scrapers, Loaders, Graders, Shovel, Drag Line, others. Training includes ACTUAL EXPERIENCE on heavy equipment at our field training center. Free employment guidance. Write Today!

TRAINING SERVICES
120-P City Line Center Philadelphia 51, Penna.

make your own Gems 36.50

The Gem Maker comes complete with all necessary equipment, including a super-charged diamond blade for sawing, and all the wheels for grinding, shaping and polishing; also complete instructions. The complete equipment as shown, less motor and belt for only \$36.50, f.o.b., Burlington, Wisconsin. Write today for information and literature.

B&I MANUFACTURING CO.
Dept. P, Burlington, Wis.



NEW WESTERN HAIG
.12 CALIBER
SPECIAL FACTORY OFFER!



\$3.00 post-paid

USES POWDER CHARGE
This small bore gun shoots .12 cal. lead bullets fired by small 4.4 mg. powder charge. Not a CO₂ gun! You'll like the handsome lines, grip, and balance. Western in style, but patented ball and cap action allows this low price. 9 3/4" steel barrel cased in knurled styrene stock, overall 13 1/2". Develop pistol form, accuracy at a fraction of cost of large caliber pistols. Comes with 50 lead bullets. Satisfaction guaranteed. Send \$3 to: **HAIG MFG. CO., P.O. Box X-4, Alhambra, Calif.**

WIREFORMER Works Wonders with Wire
It Bends — It Cuts — It Straightens



Any wire, any size up to 5/32" dia. in any metal—mild steel, copper, aluminum, etc. (piano wire up to 3/8"). This includes coathangers, coiled or straight wire, including 5/32" cold rolled rod. It cuts cleanly and neatly, any wire except spring steel or piano wire. Wireformer will also straighten wire. With these combined features in one tool, you can make your own peg board hooks, all types of hangers, clamps, handles, braces, chains, racks, shelf and equipment brackets, mobiles, letters, numerals, or any shape you want. A simple, precision made, vise held tool of innumerable uses. Forms an eye of 3/16" inside diameter (just right for any nail, screw, or bolt up to that size). No pliers needed. Wireformer does the work with the pressure of one finger. Straighten the wire if you make a mistake. Cuts the wire just where you want it. Fits in your pocket. Case hardened, plated, with a plastic handle. Forms any angle, arc, or circle. Bends both right and left. Opens a whole new field of endeavor for anyone who makes or fixes things. Wireformer is a tool a woman or a child can use, and it's safe. You need a vise, but the dime-store variety will do. You have never seen anything like it before. We guarantee you'll love it, or your money back. Very complete instructions for precision forming, (fully illustrated), special adapter for small size wire, and brochure showing many things you can make included. Wireformer is the most useful tool you can buy for your home, shop, cottage, farm, factory, garage, studio, or wotavu. As a gift, it's sure to please. Three dollar bills will get you **\$2.98** one. Otherwise send check or money order for just We pay postage in U.S.A. Foreign countries \$3.50 via 1st class mail.

ORDER WIRE DIRECT FROM LARGE STOCK IMMEDIATE DELIVERY

9 ga. (.148" dia.) galvanized steel wire. 24 pieces each 24" long.	\$1.95 ppd.
5/32" dia. (.156") hardened aluminum wire. Bright finish. 20 pcs. 24" long. \$2.25 postpaid. Sorry, no wire to foreign countries.	
SPECIAL ONE-TIME OFFER (save 43c)	
1 Wireformer	\$2.98
1 package galvanized steel wire	1.95
1 package aluminum wire	2.25
	\$6.75
	\$7.18 limited time only

Same with 2 Wireformers \$9.50 (save 66c)

VINKEMULDER MFG. CO.
915 Princeton S.E., Grand Rapids 6, Michigan
NOVEMBER 1962

WHAT SECRET POWER DID THIS MAN POSSESS?

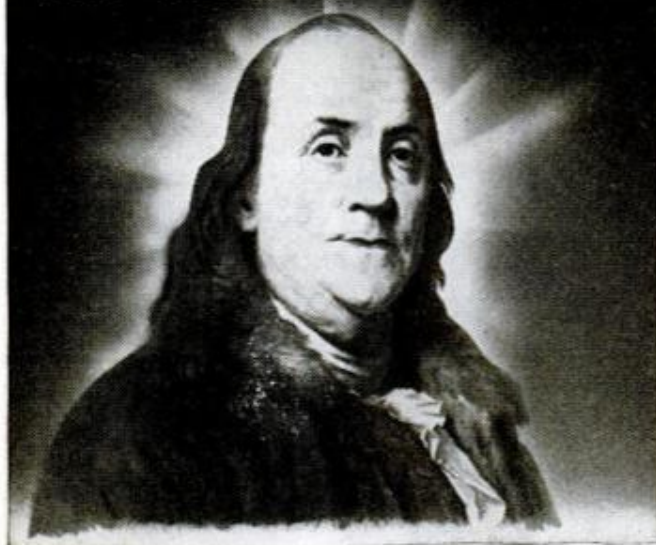

BENJAMIN FRANKLIN
(A Rosicrucian)

WHY was this man great? How does anyone—man or woman—achieve greatness? Is it not by mastery of the powers within ourselves?

Know the mysterious world within you! Attune yourself to the wisdom of the ages! Grasp the inner power of your mind! Learn the secrets of a full and peaceful life!

Benjamin Franklin—like many other learned and great men and women—was a Rosicrucian. The Rosicrucians (NOT a religious organization) first came to America in 1694. Today, headquarters of the Rosicrucians send over seven million pieces of mail annually to all parts of the world. Write for YOUR FREE COPY of "The Mastery of Life"—TODAY. No obligation. No salesmen. A non-profit organization. Address: Scribe N.Z.J.

THIS BOOK FREE!

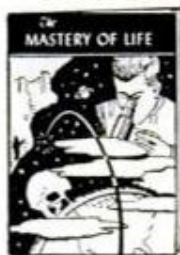

The ROSICRUCIANS
SAN JOSE • (AMORC) • CALIFORNIA

SEND THIS COUPON

Scribe N.Z.J.
The ROSICRUCIANS (AMORC)
San Jose, California
Please send me the free book, *The Mastery of Life*, which explains how I may learn to use my faculties and powers of mind.

Name _____

Address _____

City _____

6-IN-1 ONLY MACHINE OF ITS KIND!

UNIMAT
Compact workshop for all metal, plastic, wood. Precision lathe, milling machine, drill press, surface grinder, polishing/grinding machine, portable drill. Complete basic unit, \$139.50 **WRITE FOR FREE CATALOG.**
AMERICAN EDELSTAAL, INC., DEPT. GL-350 BROADWAY, N.Y. 13, N.Y.



WANT MORE MONEY? GET INTO PHOTOGRAPHY

Coast-to-coast, high-paying jobs in photography are waiting for people with the "know-how" to fill them. You can quickly, easily qualify at home with the world-famous NYI Learn-by-Doing Method. Write today for free catalog. Also resident training in N. Y. Our 53rd Year. Approved for Veterans.

NEW YORK INSTITUTE OF PHOTOGRAPHY
Dept. 49 10 West 33 St. New York 1, N. Y.

LAW FREE BOOK THE LAW TRAINED MAN

Write today for a FREE copy of illustrated law book, "THE LAW-TRAINED MAN," which shows how to earn the professional Bachelor of Laws (LL.B.) degree through home study of the famous Blackstone Law Course. All necessary books and lessons provided. Moderate cost; convenient monthly terms. Write for FREE law training book today.

Blackstone School of Law, 307 N. Michigan Ave.
Founded 1890 Dept. 58, Chicago 1, Illinois



Antique

POLISHED BRASS TELEPHONE LAMP!

Mouthpiece and receiver bakelite. Less shade and bulb.....\$19.95.

All shipments FOB Simpson, Pa.

TELEPHONE ENGINEERING CO.
DEPT. 11B2 • SIMPSON, PENNSYLVANIA

GET INTO ELECTRONICS

V.T.I. training leads to success as technicians, field engineers, specialists in communications, guided missiles, computers, radar, automation. Basic and advanced courses. Electronic Engineering Technology, an ECPD accredited Technical Institute curriculum. Assoc. degree in 29 mos. B.S. obtainable. G.I. approved. Start Feb., Sept. Dorms, campus. H.S. graduate or equivalent. Catalog.

VALPARAISO TECHNICAL INSTITUTE
DEPARTMENT D, VALPARAISO, INDIANA

BRONZE FOUNDRY

Since 1935

Schools • Home Workshops • Inventors

Make your own castings of aluminum, copper, bronze, silver. Foundry sets are available in six sizes, capacity 1 1/2 lb. to 48 lb. of red brass. 2400 Deg. F. blast furnace included with each. Write for Free Circular.



KANSAS CITY SPECIALTIES CO. DEPT. P-11
MARYSVILLE, KAN.

Now Many Wear

FALSE TEETH

With Little Worry

Eat, talk, laugh or sneeze without fear of insecure false teeth dropping, slipping or wobbling. **FASTEETH** holds plates firmer and more comfortably. This pleasant powder has no gummy, gooey, pasty taste or feeling. Doesn't cause nausea. It's **alkaline** (non-acid). Checks "plate odor" (denture breath). Get **FASTEETH** at drug counters everywhere.

Not everyone does as well, but T. N. CODY, who started a business of his own, reports...

For 12 months
I've averaged

\$800

**PER
MONTH
INCOME**



—most of it clear profit for me!

Many men have discovered how to be independent, to be free of layoffs and bosses. C. G. Naples grossed more than \$200 his first week. A father-son combination grossed \$44,000 their second year. H. Lemon says, "I netted \$133 in one 8-hour day."

How much you earn depends largely on you, but we help you to start and work with you for your success. You need no special skill, no large investment. Start part time if you wish. Hire helpers as needed.

NO SHOP NECESSARY • Our **PORTABLE ELECTRIC DETERGER** shampoos rugs, carpets right on customer's floor. Wonderful results bring you repeat business, large fees. So efficient and safe, it is used by largest hotels and railroads.

OURS IS NOT A LEASE ARRANGEMENT • You are free to operate in an independent manner. You sign no contract. You own the detergent outright and are always *your own boss* ... and every dollar you take in is *yours* to keep. You pay no fees, or dues, or royalties to anyone. And you take no risk. Your detergent is fully guaranteed and enough supplies come with it to return far more than your investment. Many earn the cost of the detergent in a week or two. It costs nothing to get the details... write **TODAY**.



MAIL COUPON TODAY FOR FREE BOOK

VON SCHRADER MFG. CO.
E10 "R" Pl., Racine, Wis.

Without obligation send me **FREE** booklet about your **RUG DETERGER** and tell me how I can start *my own* permanent, profitable business.

Name _____

Address _____

City _____ Zone _____ State _____

MAKE \$3000 EASILY IN NEXT 120 DAYS

Amazing patented Fuel Oil Activator saves home owners 30-40% on fuel bills. 150% profit for you. **FREE** kit. You'll be glad that you wrote — no obligation.

Fuel Activator, Dept. PM-11, 874 Broadw'y, NYC 3
In Canada--3680 St. Lawrence Blvd., Montreal

High School at Home

No classes...interesting spare-time home study; standard texts; credit for previous schooling; diploma awarded. Equivalent to resident school work. If you've completed 8th grade and are over 17, write for free catalog and Sample Assignment in English Review.

Accredited Member, National Home Study Council

WAYNE SCHOOL

A Correspondence Institution

417 So. Dearborn St., Dept. 11-593, Chicago 5, Ill.



Excitement! Security! Good Pay!
CRIME DETECTION

LEARN AT HOME IN SPARE TIME—START NOW!

Crime everywhere is on the rise! Learn now, in your own home, the profitable profession that enables you to track down criminals and bring them to justice! Hundreds of Identification Bureaus employ I. A. S. graduates... trained in finger printing, police photography, handwriting identification, firearms and investigation. Our 44th year! **FREE "Blue Book of Crime"**... packed with crime facts and the full story of famous I. A. S. training. State exact age. No salesman will call. **Rush Coupon!**
A Correspondence School Founded in 1916.

FREE
Blue Book
of Crime
MAIL
COUPON

INSTITUTE OF APPLIED SCIENCE, Dept. 1358
1920 Sunnyside Avenue, Chicago 40, Ill.
Rush Blue Book of Crime... **FREE!**

NAME _____ Age _____

ADDRESS _____

TOWN _____ STATE _____

LEARN MEAT CUTTING AT NATIONAL
Pay After Graduation

The steady dependable trade of Meat Cutting taught easily in 8 short weeks. **YOU LEARN BY DOING** under actual market conditions in big modern school at Toledo.

For beginners or men with experience. Get a profitable store of your own. Remember, **PEOPLE MUST EAT!** Big pay jobs. Free employment help. Thousands of successful graduates.

Buying, cutting, percentage, pricing, advertising, selling, etc. A complete retail meat education. National School established 39 years. Get National training now. Pay your tuition in easy monthly payments after you graduate. Send coupon for **FREE** 40 page school catalog — **TODAY** G.I. approved.

National School of Meat Cutting, Inc., Dept. 50-L, Toledo 4, Ohio

Send me your **FREE** school catalog on National Training at Toledo in Meat Cutting, Meat Merchandising and Self-Service Meats. No obligation. No salesman will call.

Name _____ Age _____

Address _____

City _____ State _____

Approved for Veterans

ENGINEERING



Heald's Micro-wave and Radar Laboratory Equipment.

ENROLL NOW FOR NEW TERM

HEALD Engineering College

Van Ness at Post, Dept. PM

San Francisco, California

NAME _____
STREET _____
CITY _____ STATE _____

AMERICAN INDUSTRY NEEDS TRAINED ENGINEERS NOW

BACHELOR OF SCIENCE DEGREE, 30 MONTHS

SAVE 2 YEARS' TIME

B.S. Degree Courses:

- | | |
|---|---|
| <input type="checkbox"/> Electronic Engineering | <input type="checkbox"/> Mechanical Engineering |
| <input type="checkbox"/> Electrical Engineering | <input type="checkbox"/> Civil Engineering |
| <input type="checkbox"/> Electronic Technician | <input type="checkbox"/> Architecture |

Diploma Courses:

- | | |
|--|---|
| <input type="checkbox"/> Radio-Television Plus Color | <input type="checkbox"/> Architectural Drafting |
| <input type="checkbox"/> Electronic Technician | <input type="checkbox"/> Mechanical Drafting |
| | <input type="checkbox"/> Structural Drafting |

APPROVED FOR VETERANS

Send for **FREE** Information

SAVE 1/2 ON FINE ITALIAN CHORD ORGANS

BUY DIRECT FROM IMPORTER! BIG DISCOUNTS!

5 DAY FREE HOME TRIAL



PLAY AT SIGHT! NO LESSONS NEEDED!

Now everyone can play and enjoy this new musical sensation. Buy direct from importer . . . **SAVE up to 1/2 off mfr's list prices.** Hand-crafted in Italy . . . finest Swedish Steel Reeds, plus many other exclusive features. Has famous easy-play DA-MAR Music System. **E-Z Terms**—Small down payment. Free Bonus Gifts. 24 models including piano-keyboard models. Money back guarantee. Rush coupon for **FREE** Color Catalogs and Low Discount Prices.

PHILHARMONIC ORGAN CORPORATION • DEPT. R-112
2003 West Chicago Avenue, Chicago 22, Ill.

Rush Color Catalogs and Lowest Discount Prices.

Name _____
Address _____
City _____ Zone _____ State _____

THE NEW . . . FASTER WAY TO EARN YOUR HIGH SCHOOL DIPLOMA AT HOME

Britannica ACADEMY FOR ADULTS

a division of Encyclopaedia Britannica Films Inc.

Now, the Encyclopaedia Britannica family offers you the chance for a bright and prosperous future. A new kind of home study high school where you can get a solid education and earn a meaningful diploma easier and faster. Modern courses . . . many in the new "automated learning" technique you've read about. You work at your own pace . . . personal tutoring . . . take single subjects or up to a full 4 years. Many earn diploma in months. Write for catalog. **No salesman will bother you with calls.**

BRITANNICA ACADEMY FOR ADULTS • Dept. PM-112
14 EAST JACKSON BLVD. • CHICAGO 4, ILLINOIS



Inside-Outside Chain Lock

Combining the features of a cylinder lock and conventional chain-and-slide unit, a new lock enables a householder to chain her door when at home or away. The slide is used when the house is occupied; a key releases the chain from the outside when the family returns.

The lock can be installed with a screwdriver. Priced at \$5.98, it comes with two keys and mounting screws.

Manufacturer is the Truson Corp., 146 Old Country Road, Mineola, N. Y.

Heavy Loads Move on Air

A "magic carpet" for moving heavy loads has been developed by Bell Aerosystems Company. The method enables a load of any weight to float on a film of air across a specially-fitted floor.

Pressure-sensitive air valves beneath the floor are actuated and deactivated automatically as the pallet containing the load moves across small apertures in the floor. When the pallet is above any one of the air valves in the floor, the pallet load is supported by relatively low air pressures which are distributed evenly beneath the pallet. The pallet is lifted a fraction of an inch above the floor and the load is moved easily with almost no friction in any direction without the need for skids or wheels.

This method for moving loads can be used for loading and unloading aircraft, ships, trucks, rail cars or for movement and rearrangement of material in warehouses.



"I'M MAKING \$1000 MORE A YEAR

—and I'm just getting started!"

says William E. Myers, Jr., Philadelphia

"...I am now making my full income from Locksmithing. It's more than \$1000 a year higher than before. All my thanks to your Locksmithing Institute Course."



306

pieces of professional equipment

FREE

for use with course.

MAIL COUPON for FREE ILLUSTRATED BOOK

For a future as your own boss or in a high-pay job, write now for FREE Illustrated Book.

Only school of its kind. Licensed by State of New Jersey. Approved for Veterans.

Professional Equipment includes **LOCKS—PICKS—PARTS—KEYS SPECIAL TOOLS & SUPPLIES** all FREE for use with course.

Accredited. Nat'l Home Study Council.

MAIL COUPON NOW

LOCKSMITHING INSTITUTE, Dept. 111-2 Little Falls, New Jersey

Please send FREE Illustrated Book—"Your Big Opportunities in Locksmithing," complete Equipment folder and sample lesson pages—FREE of all obligation—(no salesman will call).

Name..... (Please Print)

Address.....

City.....Zone.....State.....



Be a LOCKSMITH

Train at HOME—Earn While You Learn. Add 50%-100% to YOUR INCOME with easy spare time earnings. Cash in on the nation-wide shortage—trained locksmiths in great demand! Quickly step into a big pay opportunity job or start a high-profit shop of your own.

Earn Extra Money RIGHT AWAY! All Master Locksmiths Special Tools, Equipment and Supplies Furnished FREE for use with course.

Age, education, minor physical handicaps don't matter in this growing trade. You can quickly qualify as a skilled locksmith. It's like a fascinating hobby. Study at home as little as one hour a week. Gain practical experience through complete well-illustrated lessons. Do real jobs on car locks, house locks, padlocks and safe locks, under the guidance of experts. FREE Illustrated Book, write now.

LOCKSMITHING INSTITUTE,

(Div. Tech. Home Study Schools)

Dept. 111-2 Little Falls, New Jersey

MONEY IN WORMS

Success for you! 5000 of our hybrid red wiggler fishworms produce 5,000,000 in one year using our successful method of worm raising. Read our success story in LIFE MAGAZINE, Dec. 28, 1959 issue. Let us teach you our secrets of success. Write today for FREE INFORMATION on how to raise and sell fishworms and crickets.

Special Today—Hybrid Red Wigglers—3000—\$5.95, 5000—\$8.95, 10,000—\$16.95. Postpaid.

CARTER WORM RANCH, PLAINS, GEORGIA

REPAIRING OR REMODELING? All the subjects in Popular Mechanics books, booklets, plans and patterns are listed in our free Service File. Write Service Bureau, Popular Mechanics, 740 Rush St., Chicago 11, Ill.

MEN PAST 40

Afflicted With Bladder Trouble, Pains in Back, Hips, Legs, Nervousness, Tiredness.

If you have these troubles, particularly bladder trouble, then your condition may be traced to Glandular Inflammation . . . a constitutional disease. Neglect of this condition often leads to premature old age and sometimes incurable conditions.

The Excelsior Medical Clinic has a **New Free Book** that tells how thousands of men have been successfully treated here at Excelsior Springs for Glandular Inflammation by **NON-SURGICAL Methods**. They found soothing relief and a new outlook in the future of life.

This **Free Book** may prove of utmost importance in your life. Write Today. There is no obligation.

Excelsior Medical Clinic, Dept. B6129, Excelsior Spgs., Mo.

EARN \$125 A WEEK AND UP

BE AN AUTO DIESEL EXPERT—LEARN A TRADE YOU LIKE

You learn fast in our shops because you learn with tools on real equipment. Students short of money may earn most of their expenses by doing part-time work. Experienced instructors explain WHY and show you HOW, then you DO IT YOURSELF. Many of our graduates earn \$125 a week and up. Approved for veterans. Day and evening classes. Free bulletin-write today.

MAIL THIS COUPON TODAY!

NASHVILLE AUTO-DIESEL COLLEGE
226 7th Ave., No., Dept. 86, Nashville, Tenn.
Please send without obligation free catalog.

NAME..... (please print or write plainly)

ADDRESS.....

CITY.....STATE.....

**ENGINEERING
SCIENCE
MATH**

**B.S. DEGREE
IN 36 MOS.**



U.S. NEEDS 50,000 NEW ENGINEERS EVERY YEAR
EARN ACCREDITED B.S. DEGREE in Science or Engineering in 36 months—year-round program optional. 27-month engineering diploma also available. Classes start January, March, June, September. QUALITY EDUCATION. Graduates employed throughout U.S. and foreign countries. Government approved for veteran training. Students from 50 states, 40 countries. 20 buildings; dorms, gym, Campus. New library and laboratories. Employment help provided. **SAVE TIME AND MONEY.**

Write for catalog and complete information.

INDIANA TECHNICAL COLLEGE

1612 E. Washington Boulevard, Fort Wayne 2, Indiana

Please send free information on accredited B.S. Degree programs in Engineering and Science as checked:

- | | |
|---|--|
| <input type="checkbox"/> Aeronautical Engineering | <input type="checkbox"/> Mechanical Engineering |
| <input type="checkbox"/> Chemical Engineering | <input type="checkbox"/> Metallurgical Engineering |
| <input type="checkbox"/> Civil Engineering | <input type="checkbox"/> Physics |
| <input type="checkbox"/> Electrical Engineering | <input type="checkbox"/> Chemistry |
| <input type="checkbox"/> Electronic Engineering | <input type="checkbox"/> Mathematics |

Name _____
Address _____
City _____ State _____



You can make money in

**WATCH
REPAIR**

Learn at home the low cost Sweazey Way

Watch repairing pays up to \$6 an hour, part time watch makers report on survey. Unique and modern Sweazey home study System starts you making repairs right away on Swiss and American watches. Professionally prepared training. No previous experience needed. Special tools provided for practice. Tuition only \$5 a month. Diploma Awarded. Free sample lesson and opportunity book give all facts. Write today. No obligation.

CHICAGO SCHOOL OF WATCHMAKING
2330 N. Milwaukee Avenue, Dept. 1112, Chicago 47, Illinois

FREE BOOK and SAMPLE LESSON

CHICAGO SCHOOL OF WATCHMAKING
2330 N. Milwaukee Ave., Dept. 1112, Chicago 47, Illinois
Please rush **FREE BOOK** and Sample Home Study Lesson.

Name _____ Age _____
Address _____
City _____ Zone _____ State _____

**At Last a New Amazingly Simple
GAS TURBINE
JET ENGINE**

Build from easy to follow plans. Length 15", Dia. 8 1/2", Wt. 15 Lbs. Fuel—Gasoline or Kero.

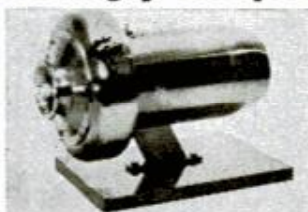

'Screamin Demon' develops 20 H.P. Ideal project for serious-minded hobbyists, students; scientific and industrial arts classes. Make on 9" metal cutting lathe with milling attachment. For use on small racing boats, midget cars, etc. Full size assembly drawings with critical dimensions, bill of materials and photos. Price \$5.00. No C. O. D. **SAVOY SCIENTIFIC, Box 1398, SANTA MONICA, CALIF.**

"\$7,108⁵⁰ NEW!"
FIRST YEAR
Cleaning-
Repairing
RADIATORS."



—Hank Konter, Newcastle, Wyo.

Make \$6,000-\$9,000 a year servicing auto-truck-tractor radiators with Inland's new 1-Piece Radiator Shop. Easy to do entire job — TEST, CLEAN and REPAIR radiators. Only 11' 7" long. Inland, world's largest radiator equipment manufacturer, trains you free. Small down payment starts you. Easy-pay plan lets you pay from profits. Proved merchandising assures volume. Profitable department for garage or service station. Many set up Radiator Shop in garage at home, make good money working evenings. Write.

INLAND MFG. CO., Dept. PM-11, 1108 Jackson St., Omaha 2, Nebr.

REAL ESTATE
BE A BROKER

PAYS BIG! SEND FOR FREE, BIG, ILLUSTRATED CATALOG NOW! Graduates report making substantial incomes. Start and run your own business quickly. Men, women of all ages, learn easily. Course covers Sales, Property Management, Appraising, Loans, Mortgages, and related subjects. **STUDY AT HOME** or in classrooms in leading cities. Diploma awarded. Write TODAY for free booklet! No obligation.



Approved for World War II and Korean Veterans
WEAVER SCHOOL OF REAL ESTATE (Est. 1936)
3521P Broadway Kansas City, Mo.

New Jet Engine Burns Gasoline



Powerful continual thrust for models; boats, cars, planes. No moving parts. Easy to start. Runs on regular gas. 6-in. long. Complete, Only **\$1.50**

JOHNSON SMITH COMPANY, Dept. 218, Detroit 7, Mich.
Send 10c for Catalog of 2800 Novelties, Hobbies, Gadgets

**MIGHTY BATTLE
OF MICRONS**

A miss is as good as a mile— and on moon shots through space it's as good as a million miles. Did you know that winning the space race may hinge on a micro-second or a micron? That's why we're fighting a measurement war. If we win, it will be by less than a hair's breadth. Read about it in

**DECEMBER
POPULAR MECHANICS**

POPULAR MECHANICS

MEN... Get that Job!

OPERATING HEAVY EQUIPMENT



Thousands of additional men will be needed to operate the Heavy Construction Equipment that will be used to build the new Roads, Bridges, Dams, Industrial Parks, Subdivisions, Irrigation Systems, Pipe Lines, Missile Sites, Shopping Centers, Home Sites, Airfields in a rapidly growing America!

Complete practical training on OUR modern machines, at either of OUR Florida or California Resident Training Centers, gives you the background you need to get that job you want as a HEAVY EQUIPMENT OPERATOR with the help of our NATIONALLY RECOGNIZED PLACEMENT SERVICE.

MAIL THIS COUPON FOR COMPLETE INFORMATION

LEARN TO OPERATE

- BULLDOZERS
- SCRAPERS
- GRADERS
- BACK HOES
- POWER SHOVELS
- CLAM SHELLS
- DRAG LINES

CONTRACTORS

Write to our Placement Department for information about our trained operators. Men who spend their own money and time to learn to operate and maintain equipment, make your best operators.

ASSOCIATED HEAVY EQUIPMENT SCHOOLS, INC.
38-638 LITTLE RIVER STATION, MIAMI, FLORIDA

Please send full details immediately on your program of training for operators of Heavy Equipment.

Name _____ Age _____
 Street _____
 City _____ County _____ State _____
 Phone Number _____ Time Usually Home _____



BARBELLS

100 POUND SET

\$12.80

Extra Plates Only 12c Pound

140-Pound, CHROME DELUXE Barbell-Dumbbell set only \$19.80. This is our feature set and is the finest ever manufactured.

Training with adjustable weight is the BEST way to keep fit; the ONLY way to develop great strength and a perfect body. As the oldest and best equipped barbell company, BUR gives value and prices no one can equal.

SEND FOR FREE CATALOG

BUR BARBELL CO.
Lyndhurst 9, New Jersey

FREE GIANT NEW 1963 CATALOG



HI-FI & STEREO COMPONENTS AND SYSTEMS

SAVE UP TO 50% ON B-A SELECTED KITS

TOP VALUES IN POWER & HAND TOOLS

30 PAGES OF BARGAINS NOT IN ANY OTHER CATALOG

BURSTEIN-APPLEBEE CO.

Dept. PM, 1012 McGee St., Kansas City 6, Mo.

SEND FOR IT TODAY

FREE

Rush me FREE 1963 B-A Catalog.

Name _____

Address _____

City _____ State _____

NOW FOR THE FIRST TIME AT THIS RIDICULOUSLY LOW PRICE \$5.95

Not sold to Calif. or N. Y. res.

22 Cal. Blank Cart. 6 Shot Revolver

No Permit Required

Imported from ITALY

"BLACK VENDETTA" Send \$1.00 on C.O.D.'s. Latest model, not a toy. Gun is of solid steel construction. Lightweight and perfectly balanced. Fires 6 rounds in 2 seconds! Double or single action. Precision crafted, 5 1/2 inches long. Ideal for stage, sporting events, boating, protection. Revolver \$5.95, deluxe leather holster \$2.25.



BIG THREE ENT. INC. 1109 Sixth Ave., New York 36, N. Y. Dept. PM-112



EASY TO GET STARTED

with LEATHERWORK

Make your "off-time" hours pay off with fun and profit in Leathercraft. Tandy's big new CATALOG shows you how easy it is to get started, plus 1221 money-making, money-saving ideas.

112 PAGE CATALOG is yours FREE for asking . . . a postcard will do!

FREE

TANDY LEATHER CO. Since 1919

Write Today - P. O. Box 791- RP Fort Worth, Texas

NOW! EARN BIG MONEY IN COMMERCIAL CARTOONING AND ART!

Amazing new system teaches you the secrets of professional drawing! Learn in your home—in spare time. Own your own business! Advertising, TV, Magazines, Card Co.'s, Printers, many more urgently need new art talent. Earn while you learn—we show you how! Many of our students start earning after a few lessons. This is your big opportunity to enter this exciting, highly-paid field. Artists in big demand! Send for your FREE Catalog. No salesman will call.

Continental Schools, Inc., Dept. E-166 4201 S. BROADWAY, LOS ANGELES 37, CALIF.

Continental Schools, Inc., Dept. E-166 4201 S. BROADWAY, LOS ANGELES 37, CALIF. Please rush me your FREE Catalog. No obligation, no salesman will call.

NAME _____ AGE _____
 ADDRESS _____
 CITY _____ ZONE _____ STATE _____

PROFIT IN YOUR SPARE TIME

FIX Small Gasoline Engines
 OUTBOARD • POWER MOWER • CHAIN SAW • TRACTOR

Harry F. Peters, Spokane, Wash., says:
 "... your Course led me into a very profitable and enjoyable business."

Be a small engine expert . . . earn **EXTRA MONEY** . . . own your own business. Easy-to-learn **LINCOLN Home Study** method qualifies you. Write for full particulars.

LINCOLN TECHNICAL INSTITUTE
 Suite 11-E, 472 Market St., Newark 5, New Jersey

WANTED!

Mechanically Inclined Men to Qualify for BIG PAY JOBS AND SPECIAL FACTORY TRAINING IN DIESEL

"We need qualified repairmen, operators, mechanics NOW!" say Diesel Manufacturers, Highway Builders, Truck Line Operators in every corner of America. Can you qualify for these High Pay Jobs? We can help you! Interstate's General Course and Cummins-approved Diesel home-training courses are internationally recognized. Advisory placement service for trainees. Don't wait. Men are needed NOW!

Get the Facts Today!

WRITE INTERSTATE TRAINING SERVICE
 Dept. A-3, Portland 12, Oregon

Rush information on I.T.S. Diesel Courses, Special Factory Training and Diesel Job Opportunities.

Name _____ Age _____
 Address _____
 City _____ Zone _____ State _____

SAMURAI SUICIDE WARRIORS KARATE!

JUDO BOXING! MUSCLEBUILDING! YOGA! STRONGMAN STUNTS! STRENGTH & ENDURANCE! HANDBALANCING! ETC.

YOU GET ALL THESE COURSES! *20 illus. FOR ONLY 35¢
 *Secret NERVE CENTER and ANATOMY charts
 *20 lethal JUDO throws *20 terrific STRONGMAN STUNTS *Complete MUSCLE-BUILDING course *Ancient YOGA secrets *HANDBALANCING stunts *Complete BOXING course. Secrets of ENDURANCE *WRESTLING holds *WEIGHTLIFTING *Giant wall charts. All picture packed. No C.O.D. Canadian 50¢.

K-MAN Huge KARATE PRACTICE DUMMY Life like! Shows attack points, nerve centers, weak spots. 15¢ with 35¢ order only. Total 50¢. **35¢** you get the lol! Plus FREE 16 Page Book

OXFORD STUDIO, 44A9 Bromfield St., Boston 8, Mass.

NAME (print) _____ 35c Program
 Address _____ 50c with K-man
 City _____ State _____

TELEPHONE HANDSETS

Genuine telephone Handsets—NOT TOYS. Use as inter-room phones, house to garage, etc. Handset has transmitter, receiver. 3 conductor 4 1/2' cord. Simple, illustrated installation diagram. Priced 2 for \$5.00 plus 95¢ for postage and handling.

TELEPHONE REPAIR AND SUPPLY CO.
 Dept. PM-141 1760 Lunt Ave., Chicago 26.
 "Telephones of all descriptions"

TURN 58c INTO \$6.00 CASH PROFIT AT HOME IN SPARE TIME—METALIZING

Now you can invest 58c in material and get back \$6.95 and make \$6.00 for your time in this fascinating home business. Hundreds make good extra money in sideline work. So Easy—so much Fun! "Eternalize" baby shoes, other keepsakes. Big market everywhere. No face-to-face selling. Write for facts FREE, plus financing plan. No obligation. No salesman will call.

WARNER ELECTRIC, 1512 Jarvis, Dept. M2M, Chicago 26, Ill.

Train Now For BIG Pay Jobs!

EARTHMOVING EQUIPMENT OPERATOR **HEAVY EQUIPMENT REPAIR-REBUILDING**

Green TECHNICAL INSTITUTE
 Atten. P.M. Hutch, Box 368, Braidwood, Ill.

Get ready for a man's job in the booming road and construction industry. Operate cranes, "dozers," earth-movers, etc. Train "on the job" in 5 to 13 1/2 weeks. Classes start weekly; reserve space now. Approved for vets. Complete catalog and reservation facts FREE. Write today!

Will UHF change your TV picture? December Popular Mechanics examines the many facets of ultra high frequency, legislation that will bring it to you, the technical difficulties, how it varies from VHF. What is the truth about range, picture quality and interference on the 70 new UHF channels? You will find the answers and a comprehensive analysis of this controversial subject in December PM.

Make Money with Your Telephone

NEW HOME BUSINESS. Men, women—no experience needed. No selling! Choose your own hours, full or spare time. We show you everything—tell you who to call, what to say, how to make money without ever leaving your telephone. **Free Copy**, "How to Make Big Profits by Phone," full details, write **TELEPHONE INSTITUTE, Dept. H178** 1038 S. La Brea • Los Angeles 19, California

FREE COPY

BUY WHOLESALE

FREE NAME BRANDS CATALOG WITH CONFIDENTIAL PRICE LIST

Your own high profit business full or part time. More than 2000 items; power tools, sporting goods, jewelry, cameras, hi-fi, appliances, housewares, hardware, almost everything! Orders shipped same day. Send for your Free catalog today.

H.B. DAVIS CORP. Dept. PMD
 143 West 15th Street, New York 11, N. Y.

Eyes to Steer Spaceship

Electrical current in a man's eyes may be used to steer a spaceship during takeoff. Scientists at the Naval Electronics Laboratory in San Diego, Calif., have found that there is a change in electrical charge when a person's eyeball moves from side to side.

When electrodes are taped on a person's skin above, below and at each side of his eyes, the voltages from four sides of the eyeball can be compared. These voltages are in the millivolt range, but can be amplified to actuate a pointer or produce a record of eye movements on an oscilloscope, an electronic measuring device.

A tracking system has been devised by which a beam of light can be pointed by the rotation of an eyeball following a target.

An eye-control system might be used during rocket takeoff when a man's limbs are pinned because of rapid acceleration forces.

Dig Salt From Frozen Mine

A gigantic salt dome is being mined in the bayou country of Louisiana by freezing the ground above and around the huge hump. Formed aeons ago by a saline upthrust through fissures in the earth's basement rock, the dome was covered with 200 feet of porous soil, saturated with subsurface water. Present-day excavation crews using ordinary mining methods were threatened with constant flooding and cave-ins.

Before the 16-foot-diameter shaft was sunk, an area of ground about 34 feet in diameter was literally frozen solid. This was done by circulating calcium chloride brine at minus 33 degrees F. through a network of steel tubing and casing set in 30 holes centered about the mine shaft and drilled 250 feet deep through the overburden. A two-stage 80-ton ammonia refrigeration system was installed at the job site to produce the subzero brine. After the brine reaches the bottom of each freeze hole, it is returned to the surface through the casing for recirculation.

In a joint venture, three American companies are mining the dome which is believed to have saline deposits sufficient to sustain mining operations for centuries, with about 35 million tons at first mining level alone. Its depth is theorized by geologists to reach about 30,000 feet beneath the earth's surface.

The salt will be distributed to warehouse points in north central, southern and southeastern states. It will be sold as a de-icing agent for highways, and to the chemical, meat-packing and water-softening industries.

NOVEMBER 1962

Available after 400 years!

valuable acreage on Old Spanish Land Grant



Amazing land bargain at
booming ALBUQUERQUE, N.M.
—as little as \$10 monthly

With 274,000 people now and streaking toward a million, fast-growing Albuquerque, New Mexico, now offers you the opportunity of a lifetime to own choice big-city homesite land for pennies on the dollar—far below current market prices. Learn how you can actually be a big landowner here for only \$10 monthly and get in on the fortune-building potential of big-city land in this booming sunshine resort metropolis, famed for the best climate in the U.S.A.

For the first time in history, this beautiful old Spanish Land Grant is now being subdivided into big Western-size half-acre and full-acre homesites, and offered to land investors at discounts from all other current land prices in the entire Albuquerque area. Guaranteed ideal land for building, with roads, power, phones, water system already available to those desiring to build homes now or later.

RIO RANCHO ESTATES is located directly on the banks of the romantic Rio Grande River, only five minutes from metropolitan Albuquerque, and right next to a \$12,000-a-acre golf course development. Schools, churches, theatres, big-city shopping all just a few minutes downtown from property.

FOR INVESTMENT-RETIREMENT

Nowhere else in the entire Southwest can you buy choice land in such a prime location—so close to a major city—for as little as \$10 monthly. Complete price only \$795 per half-acre, \$1,495 per full-acre ranch estate. Remember—this is big-city land, with adjacent property already priced at \$4,500 to \$12,000 per acre. Act now! Land prices are starting to skyrocket in this "Sunshine Paradise" of the great Southwest. Rush coupon for FREE fact book, land maps, photos. No cost or obligation.

RIO RANCHO ESTATES

A Division of American Realty & Petroleum Corp.

RIO RANCHO ESTATES, Dept. 230A
1429 Central Avenue, N.W.
Albuquerque, New Mexico

Please rush FREE fact book, land maps, photos, and details on the big-city land opportunity you offer at far-below-market prices, at Albuquerque, New Mexico.

Name.....

Address.....

City.....Zone.....State.....

© 1962 Rio Rancho Estates, Inc.

HOW TO
INVEST
PROFITABLY
IN
SOUTHWEST
REAL ESTATE

5R

51

On the market



1. ALL-ALUMINUM GUTTER SHIELD, or guard, keeps gutters free from leaves, twigs and other wind-blown debris. Comes in 36-in. sections, each section designed to snap in place on any box-type or half-round gutter. Stays in place, never needs painting, lengthens life of gutters. HC Products Co., Box 68, Princeville, Ill.

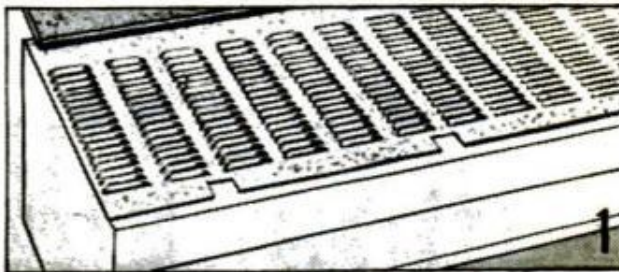

2. METAL THRESHOLD is fitted with a retracting draft stop. It's also adaptable for use by photo studios in constructing darkrooms. Stop lifts as door is closed, retracts when door is opened. Available in 32 and 36-in. lengths in all-purpose and high-carpet types. Roberts Co., 842 Seward, Los Angeles 38, Calif.



3. SAFETY SASH LOCK prevents forcible entry through partially open or closed windows. Automatically locks double-hung sash, prevents children from opening windows from inside. Attaches to the lower sash. Locking is effective in open or closed position. Priced at 35c. Shelby Metal Products Co., Shelby, Ohio



4. DUAL ADAPTER permits making line-voltage connections from output receptacles to binding posts. Useful where quick, safe connections must be made to equipment lacking a parallel blade plug and cord. Captive thumb nuts are mounted on $\frac{3}{4}$ -in. centers. Rated 15 amps. Superior Elec. Co., Bristol, Conn.



5. ELECTRICALLY POWERED POTTER'S WHEEL turns at variable speeds ranging up to 133 r.p.m.; positive speed variation through a knee control, no belts, pulleys, or cables. Pan is of fiber glass and throwing wheel of machined aluminum. Available in 3 models. Walker-Jamar Co., 365 S. First Ave., E., Duluth, Minn.



NOW, from our Accident Division you get:

\$1,000 cash a month

even for the rest of your life while hospitalized from any accident.

No, this is not a misprint. You get an iron-clad guarantee which pays you at the rate of \$1,000.00 CASH a month beginning the first day you are in a hospital (other than a sanitarium, rest home or government hospital) from any accident. Even if you're so confined only one day, you still get \$33.33.

There are no gimmicks. There are No Exceptions, No Exclusions, No Limitations, no waiting periods, no ifs, ands or buts.

And what's more - - -

This plan is NON-CANCELLABLE and GUARANTEED RENEWABLE for Life.

1. Use your policy as often as you need to—you own it, it can never be taken away as long as you pay your premium on time. Your premium can never be raised; your benefits can never be reduced.
2. You are paid even though you have other insurance or compensation. You get CASH . . . use it for any purpose: pay bills, buy groceries, pay rent, etc. When you are hospitalized your everyday living expenses still go on. Help meet them with the TAX FREE cash this policy provides.
3. THIS PLAN PAYS CASH WHILE YOU ARE HOSPITALIZED FOR ANY ACCIDENT, ANYWHERE, ANYTIME, TWENTY-FOUR HOURS A DAY. You DON'T have to be hurt in any particular kind of accident such as: Auto, Pedestrian, Bus, Traffic, Train, etc. ALL Accidents are covered.

You get a full month's coverage for 25¢. Send no money. When you receive your policy, read it carefully. Only after you agree it does everything we claim, send in your quarter. This doesn't even cover our cost, but we'll gamble that you will continue at the low price of only \$5.00 a month - - - just as thousands of others have done. Remember for each day you are in the hospital, you get \$33.33.

How can this policy be offered at such a low cost? The answer is simple. You are buying directly from the company through the mail and the savings are passed on to you. No agent or salesman will call or bother you.

Compare this with others. We welcome comparison because this policy pays from the first day, we can't pay any sooner; it pays forever, we can't pay any longer. Policy issued ages 1 through 80 to residents of the United States if you qualify.

Don't wait until it's too late. Fill out the application and mail it today. There are no strings attached; you are under no obligation.

Sincerely yours,



NATIONAL BENEFIT LIFE INSURANCE CO.
Insurance Center Bldg.
330 S. Wells Street
Chicago 6, Illinois

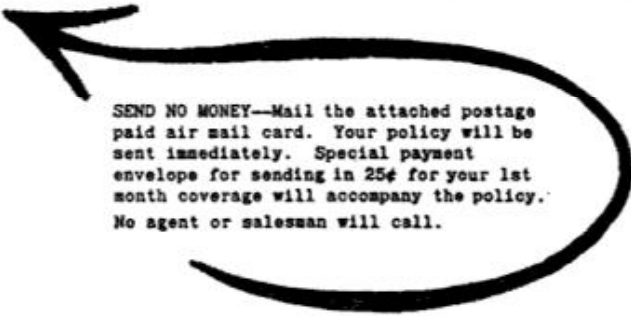

SEND NO MONEY—Mail the attached postage paid air mail card. Your policy will be sent immediately. Special payment envelope for sending in 25¢ for your 1st month coverage will accompany the policy. No agent or salesman will call.

© NATIONAL BENEFIT LIFE INSURANCE CO., 1962

CAREER TRAINING

JET / GAS TURBINE MECHANICS

Learn how you can cash in on the fabulous future for gas turbines—the engine that's revolutionizing air travel and now in miniature form is starting to power autos, trucks, tractors, boats. If you're mechanically inclined, here's the career opportunity with unlimited possibilities.

MARINE

AIRCRAFT • AUTOMOTIVE

MAIL COUPON NOW

Find out how Jetma—the nation's oldest training school for jet/gas turbine mechanics—can train you in your spare time at home for only a few dollars a week.

JTI JETMA TECHNICAL INSTITUTE, Dept. PM 112
103 So. Airport Blvd.,
South San Francisco, Cal.

Please rush free bulletin on gas-turbine course.

Name _____
Address _____ Phone _____
City _____ Zone _____ State _____

LEARN UPHOLSTERY

in your spare time
run your own
business
AT HOME



FREE TOOLS WITH COURSE

FREE BOOK with sample lessons

With Course You Make



PLUS SLIP COVERS Yours to Keep or Sell

BE YOUR OWN BOSS

Earn more from the start in spare time. STOP worrying about layoffs, enjoy a steady growing income and independence for life in the booming field of Custom Furniture Upholstery. Right off, you start upholstering with the tools, complete frames, fabrics and materials, included FREE with N. Y. State-approved UTS Home Study Course. You learn skilled professional custom upholstery, reupholstery, furniture finishing, repairs, how to make valuable custom slip covers, cushions and draperies EARN WHILE YOU LEARN, in your spare time AT HOME . . . the UTS easy way. FREE ILLUSTRATED BOOK—FREE SAMPLE LESSON Get ready for well-paid job and big profits, from steady work, as your own boss, running your own business. Training in N. Y. School also available. Mail coupon NOW for FREE BOOK! VET APPV'D. ACCREDITED BY N.H.S.C.

UPHOLSTERY TRADES SCHOOL
TS-310, 721 B'way, N. Y. 3, N. Y.
Please send me FREE book, "Your New Way to a Successful Career," and FREE sample lesson. No obligation—no salesman will call.
 Home Study Training in N. Y. School

Name _____ (Please Print Plainly)
Address _____
City _____ Zone _____ State _____
 Check if Korean Veteran

DISCOUNTS to 40% BY MAIL
NEW CATALOG READY!
More than 1000 famous U.S. products for home workshop, garden, boat . . . plus paint and painting supplies — all at great savings — in our new, expanded catalog! 80 fully illustrated pages. Each item guaranteed. Send only 25¢ for your copy.

GATES GENERAL CORPORATION

P.O. BOX 355PM FARMINGTON, CONNECTICUT



Clock Plans & Movements

Build this beautiful grandmother clock from kit which includes plans, 110V movement and dial, — only \$9.95, Fed. Tax included.

Send 10¢ for 24-page booklet describing other plans, movements, dials and moldings.

CRAFT PRODUCTS, ELMHURST 1, ILL.

"TAPEREDGE" JOINT-R-DISC
for CIRCULAR SAWS
Saves buying a jointer. Makes perfect joints, and mitres finishes perfect circles. Made of hard temper aluminum alloy. Feed work as you would to a saw blade. Complete with 6 extra assorted abrasives and special cement. To order—give arbor size, 8" — \$4.00, 9" or 10" — \$5.50 POSTPAID. Sold on a money back guarantee. Free catalog.

M. D. LEE TOOL CO.
Box 8122M, Irondequoit Branch, Rochester 17, N. Y.

High School Course at Home

Many Finish in 2 Years

Go as rapidly as your time and abilities permit. Course equivalent to resident school work — prepares for college entrance exams. Standard H. S. texts supplied. Diploma. Credit for H. S. subjects already completed. Single subjects if desired. High school education is very important for advancement in business and industry and socially. Don't be handicapped all your life. Be a High School graduate. Start your training now. Free Bulletin on request. No obligation.

American School, Dept. H845, Drexel at 58th, Chicago 37

EARN MONEY FAST! REPAIR HYDRAULIC JACKS
Earn while you learn at home. Millions of jacks in gas and auto-service stations, trucks, bodyshops, riggers, factories, farms need servicing. We show you HOW — easy step by step directions and what tools to use. EARN UP TO \$5 an hour, in spare time, in your basement or garage. Start your own business NOW!
Write for folder PM 11 and free bonus offer

INSTITUTE OF HYDRAULIC JACK REPAIR
P. O. BOX 50 • BLOOMFIELD, N. J.
A Correspondence School Licensed by N. J. Bd. of Ed.

YOU HELP MORE
THE UNITED WAY

Magic Mail Plan-Make up to \$5 an Hour!



Get **ORDERS** and **CASH** from your mailman—do work in **SPARE TIME** at home—or expand into **FULL TIME** business. Send coupon for Free facts about the newest and most fascinating of all home operated businesses. For the first time a simplified machine brings the fabulous profits of **Plastic Sealing** and **Plastic Laminating** within the reach of the small operator. Anyone can learn to operate the machine with a few minutes practice—then with our **Magic Mail Plan** can get mail orders pouring in daily with cash in every envelope. **No canvassing—no selling.** We even

Get into **PLASTIC LAMINATING** at home

WE'LL EVEN HELP FINANCE YOU supply the circulars you mail to bring back cash and orders, financing help, too. Rush name. We'll send you **FREE** and postpaid, pictures, prices, details, finance plan, all the facts you need. Mail coupon or send name on postcard. No charge. Warner Electric Co., 1512 Jarvis Av., Dept. L-2-M, Chicago 26, Ill.

Make Thousands of Beautiful Art Creations

COSTUME JEWELRY • CIGARETTE BOXES TRAYS • CANDLESTICKS • COASTERS LAMP BASES • BOOK ENDS...ALL IN SPARKLING COLORED PLASTIC



THIS MAN... is taking out of the machine a Plastic Sealing Job—ordered by mail—only 11¢ in material cost brings back \$2.58 in cash by mail. Capacity of machine: **\$25.00 profit per hour of operation.**

WARNER ELECTRIC CO., 1512 Jarvis Av. Dept. L-2-M, Chicago 26, Ill.

At no cost to me, please rush full details and financing plan, postage prepaid. No obligation.

Name _____
Address _____
City _____ Zone _____ State _____

RUPTURE!



An amazing Air-Cushion Invention allows body freedom at work or play. Light, neat, cool, sanitary. Durable, cheap. Day and night protection helps Nature support weakened muscles gently but surely. No risk. Sent on Trial! Write NOW for free Booklet and Proof of Results. All correspondence confidential.

Brooks Company, 346 State St., Marshall, Mich.



"Best TV aerial in all New York City."

SAVE ON NEW FAMOUS BRAND GUITARS

Direct from Wholesaler-to-You ... Low Discount Prices! **OVER 100 Models** for students and professionals... yours at **BIG DISCOUNTS!** All nationally advertised makes... finest quality, Regular or Electric! E-Z Terms. Spanish, Hawaiian and Cutaway models. Low as \$19.95 up to \$240 for glorious professional models. Try before you buy on No-Risk 5-Day Free Trial Plan. Terms low as \$5 down; balance now low as \$1 per week!

5-DAY FREE TRIAL
Easy Terms!



FREE BONUS GIFTS

FREE Home Study Lesson Course Get our low discount prices before you buy! Extra discounts on mandolins, ukes and banjos; amplifiers and pick ups. **Money back guarantee.** Rush coupon today! **GUITAR WORLD, Dept. R112** 2003 W. Chicago Ave., Chicago 22, Ill.

GUITAR WORLD, Dept. R112
2003 W. Chicago Ave., Chicago 22, Ill.

Rush free Color Catalog and Discount Prices.

Free Color Catalog — Discount Prices

Name _____
Address _____
City _____ Zone _____ State _____

LEARN TO EARN

HIGH WAGES AS A HEAVY EQUIPMENT OPERATOR OR MECHANIC

- WORLD'S ONLY CONTRACTOR OWNED AND OPERATED SCHOOL
- MODERN EQUIPMENT, HIGHLY QUALIFIED INSTRUCTORS
- V.A. APPROVED FOR GI TRAINING

Learn to operate bulldozers, draglines, cranes, back hoes, scrapers and motor graders **ON ACTUAL CONSTRUCTION PROJECTS!**

Learn by **doing**... no impractical correspondence courses.

WESTERN SCHOOL OF HEAVY EQUIPMENT OPERATION

WRITE TODAY FOR FREE SCHOOL CATALOG

DEPT. B-22, BOX 510
WEISER, IDAHO
PHONE 549-1112



Member American Road Builders Association
Associate Member Associated General Contractors



HOW MUCH MORE MONEY DO YOU NEED RIGHT NOW?

How much will you need next year? Two, three, five years from now? Will you still be skimping along, "sweating it out" from one paycheck to the next? Or will you be moving up steadily, earning "boom-time" pay?

To earn more, you've got to be worth more. This is true today as never before. That's why, for men sincerely interested in getting ahead, I. C. S. is the answer to a prayer! For here's the proven way to acquire the skills demanded in any of today's most rewarding job opportunities.

No commuting. No time away from your job. Just practical, step-by-step instruction, presented in a way that enables you to master any subject as fast as time and ability permit. Does it work? I. C. S. has more graduates in supervisory and managerial positions than any other school! Isn't it worth the few cents for a stamp to find out what I. C. S. can do for you?

Mail coupon for 3 valuable booklets — FREE!

INTERNATIONAL CORRESPONDENCE SCHOOLS 

Box U2419L, Scranton 15, Pa.

(In Canada: I. C. S. Canadian, Ltd., Montreal. In Hawaii, P. O. Box 418, Honolulu)

Without cost or obligation, send me "How to Succeed," the opportunity booklet for the field I've checked, and a sample study lesson.

- | | |
|---|---|
| <input type="checkbox"/> Architecture & Building Trades | <input type="checkbox"/> Eng'r'g Drawing |
| <input type="checkbox"/> Automobiles | <input type="checkbox"/> High School |
| <input type="checkbox"/> Art | <input type="checkbox"/> Interior Decorating |
| <input type="checkbox"/> Business | <input type="checkbox"/> Math & Physics |
| <input type="checkbox"/> Chemical Eng'r'g | <input type="checkbox"/> Mechanical Eng'r'g |
| <input type="checkbox"/> Civil Eng'r'g | <input type="checkbox"/> Professional Eng'r'g |
| <input type="checkbox"/> Electrical Eng'r'g | <input type="checkbox"/> Shop Practice |
| <input type="checkbox"/> Electronics-TV-Radio | <input type="checkbox"/> Textiles |
| | <input type="checkbox"/> Other _____ |

Name _____

Age _____ Home Address _____

City _____ Zone _____ State _____

Working hrs. _____ Employed by _____

Special low rates to members of U. S. Armed Forces

PROCESSING OF KODACHROME (Licensed by Eastman Kodak)

KODACHROME I & II
8mm Roll or 35mm 20 Exp. Mtd.

\$ 1.00

also: EKTACHROME
ANSCOCHROME
KODACOLOR

8mm MAGAZINE75
35mm 36 EXP. MTD. 1.75

SEND FOR FREE MAILERS and our big FREE 25th Anniversary CATALOG of Film and Processing, Splicers, Titlers, Screens, Viewers, Cameras, Projectors at low discount prices.

SOLAR CINE PRODUCTS, Inc.
4247 S. Kedzie • Chicago 32, Ill. • DEPT. PM

SOLAR 25th Anniversary

HELP WANTED—SPARE TIME

SENSATIONAL NEW LONGER-BURNING LIGHT BULB. Amazing Free Replacement Guarantee—never again buy light bulbs. No competition. Multi-million dollar market yours alone. Make small fortune even spare time. Incredibly quick sales. Free sales kit. MERLITE (Bulb Div.), 114 E. 32nd, Dept. C-15A New York 16, N.Y.

In Canada: Moga Co., Ltd., 371 Dowd St., Montreal 1, P.Q.

NO JOB WORRIES

PLASTEX INDUSTRY needs manufacturers on small scale for big production of Lamps, Clock Stands, Art Goods, Novelties in Plastic Marble imitation. No Experience necessary. 1/2¢ material makes regular 10¢ store sellers. Moulds furnished for fast production. Small investment brings good profit. Big wholesale orders now being placed. Ambitious men have chance for real prosperity and job security. Our NEW FREE booklet will interest and benefit you.

PLASTEX INDUSTRIES, Dept. A
3400 Third Ave. New York 56, N. Y.

75 POWER TELESCOPE \$398
25X-45X-75X

NEW 3 in one telescopes, 3 variable 25X, 45X-75X magnification. Brass bound. 25 power for ultra bright images. 45 & 75 power for long range. Guaranteed to bring distant stars, moons, objects, sports 75 times closer.

Most powerful scope sold anywhere near this amazing low price. American made, 5 sections. Opens 36", closes 1 ft.; contains 4 ground & polished lenses. Can also be used as powerful compound microscope. Mass production enables us to offer telescope complete at \$3.98 postpaid. Money back guarantee.

CRITERION CO., Dept. PMB-6, 331 Church St., Hartford, Conn.



Now, every active outdoorsman can Keep Warm Even in Arctic Weather!

Brand New, FLITE PANTS All Wool

Made for U.S.A.F., cost Govt. \$19 pr. . . . now offered at fraction of original cost!

Step into warmth and comfort in these all-wool, 18 oz. serge Air Force FLITE PANTS, when working, hunting, hiking, or at football games, etc. Seat and knees reinforced with wool & nylon to keep you warm! Draftproof zipper fly, adjustable belted back, knitted cuffs, snap top closures, side pockets. First time offered at this incredibly low price, maybe never again! **Only \$5.95 pr.**, plus post., 50¢ east of Miss.; 75¢ west of Miss. In Sage Green, sizes 30 & 34; Air Force Blue, sizes 28, 32, 34, 36, 38, 40, 42. Send check or M.O. today—sales guaranteed. Free 116 page catalog included.

I. GOLDBERG & CO. Our 43rd Year
Dept. P. M. 429 Market St., Phila. 6, Pa.



WORLD'S
BEST
WANT-AD
MEDIUM

CLASSIFIED ADVERTISEMENTS



Advertisements in this section \$1.35 per word, each insertion, minimum 10 words, payable in advance. To be inserted under proper classification, copy must be in our office the 18th of the second month preceding date of issue
F. W. Johnson, Manager, Classified Advertising
Popular Mechanics, Classified Adv. Dept., 740 Rush St., Chicago 11, Illinois

YOU'LL PROFIT

By reading and answering the classified ads in this section. Hundreds of opportunities for you to make and save money

AUTOMOBILES, MIDGET CARS

GO-KARTS \$29.95 Full price less motor. Details 10¢. Sportsmobile, 905 N. Broad, Philadelphia 23, Penna.

AUTOMOBILE Literature, antique, modern; catalogs, photos, manuals. Monthly bulletin. Non-profit organization. Free information. Enthusiasts, Box 451B, Mount Clemens, Mich.

WHY Pay more? Oil Filter refills, 10¢. Free particulars. E. L. C. Enterprises, Box 1655, Glendale, California.

AUTO SUPPLIES AND EQUIPMENT

ECONOLINE, Corvair wagons, vans, etc., gasoline heaters, southwind army model, 12 volt, 20,000 BTU output. Brand new. \$69.95. Cash with order. Delivery extra. T-W Sales, Box 2183, Kansas City 10, Kansas.

MIRROR, Adjustable side view. Makes nice Christmas gift. Door mounted. Fully adjustable from inside of car. Like late Cadillacs, Lincolns and Chryslers. For compact cars and others without dog-leg wraparound windshield. Excellent quality. Made to retail at \$7.95 each. Special price direct to consumer, postpaid—send \$2.55 each. Matching pair (left and right)—send \$4.75. Money back guarantee. Modern Chrome Parts, 3663 E. Gage Ave., Bell, Calif.

STELLITE Valves Seats for highest performance. Custom made any type engine. Dealer inquiries invited. Box 1145, Clearwater, Florida.

RING-Valve job while driving, \$6.00 postpaid. Guaranteed! Nothing like it! Many mechanics recommend! Motaloy, Grantam, Penna.

WILLYS Jeep tops, \$95.50. Mor-Nan, Box 141, Beverly, Mass.

PARTS And accessories catalog for Ford Model "A". Everything to renew, rebuild, and renovate your '28-'31 Model "A" Ford. Send 10¢. J. C. Whitney, 1919 QM-11, Archer, Chicago 16, Ill.

AUTO Shop welding repair training in world's largest non-profit welding school. Low tuition. Free booklet. Hobart Welders, Box M-1121, Troy, Ohio.

2500 WATT 110 volt AC power plant mounted on car truck tractor motor. Free literature. Kennell's Transit Power, Parsons, Kansas.

FREE Trial. Ring-valve job while driving. If satisfied owe \$3.00, otherwise nothing. Motor, 5 Lander, Pittsburgh 20, Penna.

BARGAIN Catalog. Automobile shop manuals. Manager, Box 8715, Kansas City 14, Mo.

STOP, Oil pumping \$4.95. Reay Sales, 16161 Mark Twain, Detroit 35, Mich.

SAVE Up to 50% on auto parts, accessories! Get new 356-page illustrated catalog, just out. Over 100,000 items to renew, rebuild, renovate all makes, models, domestic, foreign cars, trucks, sports cars, from 1920 to 1963's; '28 to '31 Model A! Latest Hollywood accessories, custom and hi-speed equipment. Rush 25¢ for postage, handling—refundable on first order, Whitney, 1919 PM-11 Archer, Chicago 16.

TRANSISTOR Ignition coil — instructions. Special \$8.50. Anderson Engineering, Wrentham, Mass.

SNO-DRIVES. Replaces tire chains forever. Fits on wheel lugs. Taxicabs, police use Sno-Drives. For American cars. Thousands in use. Amazing Xmas gifts, \$9.95-\$11.95 postpaid. Automotive dealers, 33 1/2% off. Distributors wanted. Bateson's Incorporated, 4408 Market, Wilmington 2, Delaware.

JEOP Owners — V8 conversions. Read Jeep Owners ad, page 32.

JEOP Parts! For military and civilian. At great savings. Largest inventory. Catalog for owners and dealers. Inquiries invited. American Auto Parts Co., 1830-PM Locust, Kansas City, Mo.

NEW And used parts at savings. Complete guaranteed parts service for all models cars and trucks. Largest in the West. Jeep and army parts specialists. Newest type shifting hubs for all jeep and all military and latest production front end drive vehicles. \$27.50 and up. Also, foreign car parts. Write, Pioneer Auto and Truck Parts Co., 734 W. 13th Avenue, Denver 17, Colo.

PARTS, Model "A." List 25¢. (Refundable) Matco, Box 135, San Pedro, Calif.

1909-1934 FORD Parts illustrated catalogs 75¢. Mark Auto, Layton, N. J.

AUTO Testing equipment, 1963 Line available now. Free catalog. Power Lights, Tachometers, etc. Arco, Box 148, Desplaines, Ill.

BATTERY Chargers. Home type. Electroline's famous line. Wholesale prices. Same day delivery. Free catalog. Doron Enterprises, Inc. Box 7214, Chicago 80, Ill.

FORD T and A parts? Try best source old model parts, all makes. Pistons, gaskets, gears, valves, waterpumps, etc. "World's Largest Antique Auto Parts Corporation," Milwaukee 4, Wisconsin.

TRANSFIRE Transistor electronic ignition. Points, plugs last longer. Top performance, economy. Kits from \$34.95. Parts. Literature. Palmer Electronics, P27M, Carlisle, Mass.

CRAZY Customizing! Newest craze! Free info. Sample 25¢. Craft, 3008-M Montrose, Chicago 18.

CROSLLEY And foreign car parts. Discount club, Box 7B, Elmont, N. Y.

AUTO TRAILERS

BUILD Camping travel trailers. Illustrated circulars 20¢. Kamcraft, Box 1153, Milwaukee 1, Wis.

PICKUP Campers. Pre-cut Kits. Blueprints. Supplies. Literature 10¢. Comstock Trailers, Parsons, Kansas.

MOTORCYCLES, BICYCLES, MOTORSCOOTERS AND SUPPLIES

HARLEY-Davidsons — Used bargains. New, used parts, accessories, all models. Bulletin 25¢. Knuth's (Factory Dealer), 1753 Muskego, Milwaukee, Wis.

RECONDITIONED Motorcycle motors. Large stock Indian Cushman Vespa Mustang NSU parts. Indian Motorcycle Sales, Kansas City 27, Missouri.

GO Cart \$10, Jawa motorcycle \$15, less engine. Briggs engine \$3. Allstate scooter \$20. Moped \$35. Electric car \$50. Crosley pickup \$125. (Mailorder only.) Send 25¢ (3¢ for first class mailing) for Directory-Catalogue Number 110, listing these and hundreds of other bargains, homebuilders parts, plans, etc. Midget Motors Directory, Athens, Ohio.

"NIMPOW" \$19.95 Kit converts bicycle to motorbike. Rear engine, low center of gravity. Literature 50¢. Rovcraft, 222M West 39th, Kansas City 11, Missouri.

MOTORCYCLE Parts. New, used. List 25¢. Ballak, 811 N. 9th, St. Louis 1, Mo.

BUILD Motorscooter from bicycle frame. Plans, parts catalog \$1.50. Refundable. Gilliom Manufacturing, St. Charles 29, Missouri.

PATENTED Bicycle motor mount. Converts bicycle to motorbike. Send \$9.95. Plans included, otherwise \$1.00. Go-Byk Industries, Fergus Falls, Minnesota.

BMW Motorcycles, shaftdrive. U.S. distributor Butler & Smith, Inc., 160 West 63rd St., New York 24, New York.

NOVEMBER 1962

AVIATION

PROPELLERS. Plans, supplies for airboats, snowplanes. 125 h.p. Lycoming engines. Prompt delivery. Catalog 25¢. Banks-Maxwell Propeller Co., Box 3301E, Ft. Worth 5, Texas.

AUTOGYRO Blades for gyrocopters. Solid aircraft spruce. Terrific! Vancraft, 7246 North Mohawk, Portland 3, Oregon.

HOMEBUILT Helicopter handbook \$1.00. Directory \$1.00. Urshanair, Box 250, Santee, California.

BATTERIES, GENERATORS

REBUILDERS Introductory operating manual \$1.00. Batteries, starters, generators, regulators. Modern, Box 8715, Kansas City 14, Mo.

BATTERY Reconditioning kit, molds, instructions. Old batteries like new. Apex, 1127 Auzerais, San Jose, Calif.

REBUILD Batteries! Complete manual \$3.00. Chrysler Corp. Alternator guide \$3.00. Hydraulic Jack Repair manual \$3.00. C. O. D. accepted. Bayer Publications, 938 Betty Avenue, Neenah, Wisconsin.

ELECTRICAL SUPPLIES

LAMP. Electrical parts, wholesale. Thousands of items for repairing, converting. Catalog 35¢. Brown Lamp, Box 305, Clayton 5, Missouri.

APPLIANCE. Lamp, vacuum parts wholesale. Illustrated distributors catalogue 25¢. Seco, 112 South 20th Street, Birmingham 3, Alabama.

LAMP Parts. Catalog, prices, wiring instructions. 50¢. Refunded first order. Gyro, 5208P N.W. 35 Ave., Miami 42, Fla.

1000's APPLIANCE, Lamp parts, electrical specialties, wiring devices. Wholesale only. Catalog 50¢. Lamp Specialties, Dept. PM, 322 Washington Street, Newark 2, New Jersey.

FLUORESCENT Lighting. Buy fixture kits, fixtures, midget lights, parts direct. Catalog 10¢. Shoplite, 650-M Franklin, Nutley 10, New Jersey.

ELECTRO-SCRIBE! Engraves all metals. \$2.00. Beyer Mfg., 10511-H Springfield, Chicago 55.

WELDING, SOLDERING, PLATING

CHROME Plating equipment, supplies. All other finishes. Home workshop and production sizes. Send \$1.00 (refundable) for formulas, operating data, equipment guide and catalog. HBS Equipment Division L50, 3445 Union Pacific Avenue, Los Angeles 23, Calif.

WELDERS. 110/220. \$39.50. Morris, 1070 Inner Drive, Schenectady 3, New York.

ACETYLENE Outfits, new \$59.50; used \$40.00. Arcwelders \$69.50. Eagle Welding, Dept. PM, 5085 Broadway, Chicago 40, Ill.

FREE Catalog, welders, kits. Build 350-ampere welder using aircraft generator, plans 25¢. Dunbar, Minneapolis 8, Minn.

ARC Welder manual. Only 50¢. Regular \$1.00 value. Tells how to weld every job. Emerson Electric, 8100 Florissant, Dept. PM-11, St. Louis, Missouri.

FREE Welder catalog. Kits, build 350-ampere welder using aircraft generator, plans, 25¢. LeJay, Minneapolis 20, Minn.

MACHINERY, TOOLS, SUPPLIES

40 NEW Machinist tools. Campbell Tools, 1424 Barclay, Springfield, Ohio.

TOOLS And gear. Hand and electric. Catalog: Ward's, Box 203, Los Alamos, N. Mex.

ENGINES, MOTORS, DYNAMOS

MOTORS: ¾ HP. General Electric \$7.50. ½ hp. Wagner \$14.50. Send M. O. Rebuilt. Sizes to 5 hp. List 10¢. A. C. Motors, 3101 N. 32nd St., Philadelphia 32, Pa.

REWIND Motors yourself! Details free! Modern, Box 8715, Kansas City 14, Mo.

REWIND Motors yourself. Complete instructions, \$1.00. Lewis Manufacturing, Howell, Michigan.

WINDING Data. 275 motors, single and three phase \$1.10. Data Company, 512 Kensington, Kansas City 24, Mo.

DIESEL Injector parts and fuel pumps wanted. GM51-53-71-110. Bares, 2093 East 19 Street, Cleveland 15, Ohio.

GOVERNMENT SURPLUS

GOVERNMENT Surplus. How and where to buy in your locality. \$1.00. Surplus, Box 1402-PM, Englewood, Colorado.

GOVERNMENT Surplus. Send \$1.00 to: Information, 1526 Northview, Mobile, Alabama.

JEEPS \$223.83. Typewriters \$4.15. Radios \$2.65. Boats \$6.18. Televisions, guns, recorders. Typical surplus prices. Free exciting details. N. Y. Enterprises, Box 402-X4, Jamaica 30, New York.

TERRIFIC Surplus bargains. Information \$1.00. W. Dunn, 2020 Long Ridge Rd., Stamford, Conn.

GOVERNMENT Surplus clothing, etc. Pricelist 50¢. Medford Surplus, Medford, Wisconsin.

JEEPS \$111.68. Airplanes \$75.20. Boats \$6.18. Many others direct from U.S. Government. For complete "Directory", send \$1.00 to Quality Surplus, Box 22163-R11 Indianapolis, Indiana.

WAR Surplus bargains! New government releases arrive constantly. Save up to 80%. Blankets, boots, cots, tents, wearing apparel, etc. Send for free war surplus catalog. Sioux Falls Surplus Store, Sioux Falls, South Dakota.

JEEPS \$278. Airplanes \$159, boats \$7.88, generators \$2.68, typewriters \$8.79 are typical government surplus sale prices. Buy 10,001 items wholesale, direct. Full details, 627 locations and procedure only \$1.00. Surplus, Box 177-C30, Abbottstown, Penna.

U.S. Government surplus—Jeeps, \$264.00, radios, \$2.53, guns, typewriters, cameras, tools, thousands of items. Fabulously low surplus prices. Complete information sent immediately. Send \$1.00 to—Surplus, P.O. Box 50512, Dept. E, New Orleans 50, Louisiana.

GOV'T Surplus. How and where to buy in your area. Send \$1.00. Surplus Information, PM, Headquarters Building, Washington 6, D. C.

JEEPS. Boats, airplanes, helicopters, walkie-talkies, radar, tents, typewriters, tires, tools, cameras. Individuals can buy now direct from government. "U.S. Depot Directory & Procedure" \$1.00. Brody, Box 425-PM, Nanuet, N. Y.

BOATS, OUTBOARD MOTORS

LARGE Scale boat plans. Full size frame parts layouts. Easily built plywood boats to 18 feet. Literature 35¢ refundable on purchase. Dolphin, Box 1764, Boise, Idaho.

PLYWOOD Boats, 21 plans book. \$1.95. Plans and book catalog, 35¢. Rudder, Dept. P., 575 Lexington Ave., New York 22, N. Y.

200 PLANS. Kits, Catalogs: powerboat (2), 35¢; sailboat 40¢. Marinecraft, Box 161-M, Brighton, Mass.

OUTBOARD Motors \$79.96. Hundreds sportsman items wholesale. Club, 5117 East 22nd, Tulsa 14, Okla.

SAIL Fin kit \$67.50 complete. 11½' sailboat. Free literature. Box 78A, Cleveland 41, Ohio.

10' KAYAK Kit complete. Free literature. Box 78B, Cleveland 41, Ohio.

SAVE Money. New, used outboard motor parts. Send wants. Stamp appreciated. Outboard Motor Mart, 229 State Street, Boston 9, Massachusetts.

INCREASE Outboard speeds 20-30%. Same boat, motor. No cost. Results guaranteed. \$1.00. Boats, Box 21-M, Cambridge, Maryland.

FULL Size, cut-to-shape boat patterns, blueprints, 7½-38 feet. Big new illustrated "Build a Boat" catalog of 64 designs, including catamarans, cruisers, runabouts, skiffs, outboard boats, sailing, racing, houseboats, 50¢. "How to Build a Boat" booklet, \$2.50. Cleveland Boat Blueprint Co., Box 1651, Cleveland, Ohio.

NEW. Used, rebuilt marine motors. Marine conversions, fittings. Free catalog. Stokes Marine Supply, Dept. 24, Coldwater, Michigan.

MARINE Conversions. Ford, Chevrolet, Jeep engines. Catalog 25¢. Lehman Manufacturing Company, 800 Elizabeth Avenue, Linden 4, N. J.

BUILD Your own boat from our large-scale blueprints. Books of plans give how-to-build help. Hundreds of professional designs—motor, sail or auxiliary—for amateur builders. Free catalog. MoToR Boat-ing, 959 Eighth Ave., Dept. RS, New York 19, N. Y.

CONVERT Any electric bilge pump to automatic. Kit \$6.95. KG Marine, Box 107, Arlington, New Jersey.

STOP Paying ridiculous prices for your boat's interior. Finest, latest style plastics, foam rubber, tools. Send for free brochure. La Scala Textile, Box 1490, Albany, New York.

MAKE Your dream of owning a boat a reality. Build one now! The 20th Anniversary boat kit catalog by Custom Craft offers the means of selecting a style best suited to you. Pram to cruiser, sailing dinghy to dragster—each engineered by the originator of kit boats to be the best value a boat builder can buy. Financing available. Send 50¢ for 1963 catalog to Custom Craft, Buffalo 7N, New York.

SPORTING GOODS, GUNS, FISHING, SKIN DIVING, ARCHERY

NEW Firearms, scopes, reloading supplies, accessories, shop tools. Quick service. Lowest prices. Large catalog free. Walter Oliver Assoc., Box 55-M, Auburn, Indiana.

FISH Better. Eliminate bait. Self-propelled fish lure, \$2.98. Emm-Ess Company, Dept. SK-11, 15 West Price, Linden, New Jersey.

ARMY Surplus—Many items under \$1.00. Free list. Marvin, Box 141, Ellenville, N. Y.

GUNS. Buy wholesale. Complete instructions \$1.00. Gunsco, PM-11, Fulton, California.

JAP Rifle altering to 30-06. \$6.00. Japshells, \$3.95. Catalog 10¢. T. P. Shop, West Branch 11, Mich.

WATER Skis. Banana Combos, tow rope, and belt. Special X-Mas offer, \$49.95 value for \$24.95. Send for full information. Nationally advertised brand. Fully guaranteed. Water Skis, Dept. 192, Box 661, Willernie, Minn.

ARCHERY Headquarters. All phases: Bows, arrows, raw materials, tools, books (some autographed). Rush orders, no waiting. Howard Hill's newest catalog. Send 50¢ (coin only). Receive also free illustrated archery catalog. Shoshone Archery, 10115 San Luis, South Gate, California.

MOLDS—For casting your own fishing sinkers. Free illustrated booklet. Reading Instrument Co., Box PM78, Reading, Penna.

I Want to send you proof of the wonderful pulling power of Popular Mechanics classified pages. What's your proposition? Write me today. Include literature if possible. F. W. Johnson, Manager Classified Advertising, Popular Mechanics Magazine, 740-G Rush St., Chicago 11, Ill.

FREE—Wholesale catalog. Beads. Spinners. Lure parts. Sinker molds. Jigs. Reels. Finny sports (ME). Toledo 14, Ohio.

BIG Money raising crickets and 12 inch African fishworms. Free literature. Carter Ranch. Plains, Georgia.

MOLDS For fisherman's sinkers, jigs, squids, casting and spinning lures. Free catalog. Sweet's Molds, Tonawanda 1, New York.

10,000 **GUN Bargains!** Modern-antique guns, accessories. Giant 128 P, Bargain catalog \$1.00. Agramonte's, Yonkers, N. Y.

ATHLETIC EQUIPMENT, BODY BUILDING COURSES

PHYSICAL Fitness booklets. "Physical Conditioning" 40¢. "Physical Culture for Boys" 50¢. "Physical Training" 60¢. Thomas Garber, 104 Ashley St. Korn Krest, Wilkes-Barre, Pennsylvania.

BIG Muscles fast—gain up to 4" on arms, 10" on chest in just 7 weeks. Free details. Sinkram Body Builders, Dept. ME-6, Box 11, Brooklyn 36, N. Y.

DEADLY "Kungfu Karate" fighting. Break bricks within 100 days. \$5.00. Oriental Book Sales, P.O. Box 1183, Oakland 4, Calif. Free literature.

FREE Brochure! Lightest easiest exercise ever invented. Circulizer, 2515 Euclid, Santa Monica, California.

PHYSICAL Perfection. Reducing, gaining, muscles, longevity. Mail 25¢ for all 4 courses. Big deal \$3.00. Guaranteed. Personal supervision. Agents wanted. Sid's System, (PM-L62) 8421-C. Evergreen, Southgate, California.

"GIANT Arms." Dr. Young's, D.C. revolutionary discovery. \$2. Satisfaction or refund. Gaucho, Box 9309-S7, Chicago 90.

CAMPING EQUIPMENT AND TENTS

KEEP Warm. Send 10¢ for handbook catalog of down clothing and lightweight camping equipment. Gerry, Dept. 245, Boulder, Colorado.

CAMPING Equipment, tents, world's largest selection. Send 25¢ for new giant catalogue-handbook-camp site directory (print name-address). Morsan Tents, 10-21R 50th Ave., Long Island City 1, New York.

TAXIDERMY

SEND Postal for this free book. Tells how you can learn to mount birds and animals, also fish, gameheads. Tan skins, make leather. All secrets revealed. Fascinating and profitable hobby for all men and boys. Rush postcard today for your copy. Tells how we have taught over 400,000 successfully by mail! No obligation. Write today. Please state your age. Northwestern Taxidermy School, 2511 Elwood Bldg., Omaha 2, Nebr.

BINOCULARS, TELESCOPES, MICROSCOPES, MAGNIFIERS

SCIENCE Bargains! Lenses, telescopes, binoculars, microscopes, kits, parts, war surplus. Send \$1.00 for beginner's 10-lens kit with instruction booklet. Order Stock 2-CH. Request free 144-page Catalog CH. Edmund Scientific Co., Barrington, New Jersey.

BARGAINS! Zoom binoculars! Rifle-scopes! Telescopes! Microscopes! Free catalog. Adventure Company, Box 2133, San Diego 12, California.

CUSTOM Telescopes, lens, tripods, equatorials, and accessories. UPCO, Sunbury, Penna.

BUILD Your own reflector telescopes. Complete kits: mirrors, eyepieces, tripods, all other accessories. Request free illustrated literature. Criterion, Manufacturing, Dept. KPM-94, Hartford, Connecticut.

DYNASCOPE. Amazing world-famous reflector telescope. Request free brochure. Criterion, Dept. DP-97, Hartford 1, Connecticut.

MICROSCOPES Varimex brand (European). Educational, research, industrial, other. Scientific catalog 25¢. Magnification Instrument, 2 East 45th, New York 17, OX 7-8978.

EARTHWORMS, CRICKETS, FROGS

HYBRED Redworms, 1000—\$3.00. 2000—\$5.00. 5000—\$8.00. 10,000—\$14.00. Bedruns—\$1.00. In 20,000 orders only. Postpaid. With raising instructions. Brazos Bait Farm, 60 Lincoln, Waco, Texas.

GEORGIA Redworms. Count, live delivery guaranteed. 2500—\$4.95, 5000—\$8.95, 10,000—\$16.85. Postpaid. Free literature. Hall Farm, Hilton, Georgia.

BIG Money raising fishworms and crickets. We teach you how to raise and where to sell. Free literature. Medium redworms, 3000, \$5.95; 10,000, \$16.95. Carter Redworms, Plains, Georgia.

MEN!—Women! Make money raising bait at home for us! We buy your crop! Details free. Red Wigglers, Warsaw 45, Indiana.

EARN Money raising fishworms for us! Exciting details free! Oakhaven—56, Cedar Hill, Texas.

PLANTS, SEEDS, BULBS, NURSERY SUPPLIES

GINSENG Bringing \$14 pound. Have seeds, plants, Goldenseal. Full information. K. Collins, Viola, Iowa.

PETS—DOGS, BIRDS, HAMSTERS, ETC.

REGISTERED German shepherd puppies, older dogs, shipped anywhere. George Gober, Jacksonville, Texas. Telephone 3227.

HOW To "Produce and Sell" (booklet) bobwhite quail and "Sportsmen and Game Breeders Catalogue" of game breeding equipment. Send 10¢ G.Q.F. Mfg., Dept. P.M., P.O. Box 152, Savannah, Georgia.

PETS. Hamsters, mice, rabbits, squirrels, chipmunks, guinea pigs, skunks, raccoons. Picture catalog twenty-five cents. Moore's Hamster Ranch, Shepherdstown 25, West Virginia.

HAMSTERS. Ideal pets. \$2.95 pair. Booklet 10¢. Jer-Fre's Hamstery, 1447 Apple, Muskegon, Michigan.

HAWKS. Reptiles, raccoons, skunks, squirrels. Catalogue 25¢. Trails End Zoo, St. Stephen, S. C.

MAKE Money raising chinchillas, mink, rabbits, cavies for us. Free catalog. Keeney Brothers, New Freedom 2, Penna.

FARMS, FARM LANDS, REAL ESTATE

A Most unique buy! 168-acre Florida beauty with 2 lakes and frontage on popular fishing river, sacrificed by widow who has drastically reduced price to **ONLY \$16,500!** Has established fish camp with 10 boats included. Boats can be stored and launched in lakes as there are 2 passageways to the river. On county road, ¼ mile to paved highway, 5 town. New 4-room 2-bedroom home with tub-and-shower bath. Ideal place to build bait shop and rental cabins for weekend fishermen. 50 acres cropland, some good timber. Established business with excellent expansion possibilities. Hurry at low \$16,500 price, terms, too! Big free illustrated Fall-Winter catalog, bargains coast to coast! United Farm Agency, 2825-PM Main St., Kansas City 41, Mo.

STROUT Big free catalog. 148 pages chuck-full of values. Write for your copy. Strout Realty, 7-CJ S. Dearborn, Chicago 3, Ill.

HOMESTEADS. Government lands. U.S. and Alaska. Enclose dime. Write: Clyde Lee, Mountain View-1, Oklahoma.

LAND Bargains everywhere: From \$10 down, \$10 monthly. Free catalogue: Grandee Realty, Route 1, Box 587-P, Lakeport, California.

FLORIDA. Big, beautifully wooded tracts on prominent highway in famous Green Hills pleasure resort area 28 miles north Panama City. Also choice ¼ acre lakeside homesites. \$10 monthly. Free maps, photos. Owen Wood, Fountain 15, Florida. AD62005(K)(0)

CAROLINA Coast. \$5.00 down, \$5.00 monthly, buys large homesite, 70x150, in beautiful Boiling Spring Lakes. Satisfaction guaranteed! 14,000 acres! 50 freshwater lakes! Excellent fishing, hunting, championship golf course open for play, country club completed, resort motel open year round! Free literature. Boiling Spring Lakes, Southport 1-D, North Carolina.

OPPORTUNITIES! Government land, U. S., Alaska, Canada. Sledge Surveys, Macon, Mississippi.

FLORIDA Highway frontage 55x115 only 4 miles from Suwannee River, \$499 total \$10 monthly. High, wooded. Hurry! Gilchrist, P.O. Box 163-H, Miami 37, Florida.

FLORIDA Lake living. Silver Springs, Orlando area. \$195.00 lots, \$5.00 month. Free colored photos. Bloch Brothers, Belleview 7, Florida.

FLORIDA Campsites—deep in the heart of the great Ocala National Forest. Abundance of game, best fishing. Warranty deed. Unrestricted—pitch tent, park trailer, build lodge. Free maps and photos. Howard Vernor, DeLand, Florida, AD60088(Q-O).

\$5 MONTHLY Buys 5 acres—near clear-water lake. Price \$125. Excellent fishing, good cabin sites. Free list. Box 425-P, Carthage, Mo.

CANADIAN Vacation lands: Full price \$385.00. 40 acres. \$10 month. Suitable cottage sites, hunting, fishing, investment. Free information. Land Corporation, 3768-C Bathurst, Downsview, Ontario, Canada.

MONTANA—Fishing, hunting, cabin sites and campsites on beautiful Kootenai River in Montana Rockies. \$595 at \$10 down and \$10 a month. Mountain Empire Company, Box 203-P, Libby, Montana.

BAHAMA Island sunswept homesites (125'x80'). Sandy beach, fishing, water sports. \$895. No taxes. \$10 month. Suitable investment, vacationing, retirement. Free information. Bahama Estates, 3768-F Bathurst, Downsview, Ontario, Canada.

RABBITS—FUR BEARING ANIMALS

MINK Raising information free. Complete. Lake Superior Mink Farm, Superior, EE1, Wisconsin.

RAISE Rabbits successfully by knowing facts. 48 page book. 38 illustrations describing 25 breeds. Housing. Breeding. Feeding. Markets and Marketing. Bulletin etc. 25 cents. American Rabbit Association, 36 ARBA Building, Pittsburgh, Penna.

EARN \$10,000 Yearly raising Angora rabbit wool for us. Information 25¢ coin. American Angora Company, Malta 12, Montana.

RAISE Rabbits on \$500 month plan. Free details. White's Rabbitry, Mt. Vernon, Ohio.

PROFITABLE OCCUPATIONS

INVESTIGATE Auto accidents. Earn up to \$750 monthly. Investigators needed in every state. No selling required. Car furnished; expenses paid. Or start a business of your own. Associate with interesting, important people. We train you at home. You hold present job until ready to switch. Get free information. No obligation. Write Liberty School, Dept. C-99, 1139 West Park, Libertyville, Illinois.

WHOLESALE Magazine subscriptions. Highest commissions. Bonus! Qualified Agencies, 451 YA Kingston, Brooklyn 25, N. Y.

MAIL Order. Illness forces sale of exclusive money maker. Free details. Fortner, Box 104, Phoenix 1, Arizona.

INVESTIGATE Accidents. Earn \$750 to \$1,000 monthly. Men urgently needed. Car furnished. Business expenses paid. No selling. No college education necessary. Pick own job location. Investigate full time. Or earn \$6.44 hour spare time. Write for free literature. No obligation. Universal, CPM-11, 6801 Hillcrest, Dallas 5, Texas.

START A magazine subscription business. Earn generous commissions on Popular Mechanics, Good Housekeeping and all others. Best commissions, bonus, all materials sent free. No experience needed. Write Popular Mechanics, Room 11-P, 250 West 55th St., New York 19, N. Y.

SETTLE Accident claims. Insurance companies pay investigators up to \$8 an hour, full or part time. Chance to set up own business. No selling. Only average education required. Good openings almost everywhere. We train you at home in spare time. Send for Free information. Liberty School, Dept. T-911, 1139 West Park, Libertyville, Illinois.

BARGAINS! Buy wholesale! Save money! Free catalog! Norris, 273-K Merrick Road, Lynbrook, N. Y.

AUCTIONEERING—Home study course. Diploma granted. Auction School, Ft. Smith, Ark.

VENDING Machines. No selling. Operate a route of coin machines and earn amazing profits. 32-page catalogue free. Parkway Machine Corporation, Dept. #25, 715 Ensor Street, Baltimore 2, Maryland.

BAKE New greaseless doughnuts in kitchen. Sell stores. Free recipes. Michael, 3605 South 15th, Minneapolis 7, Minn.

BIG Money raising fishworms and crickets. Free literature. Carter Wormery, Plains, Georgia.

BECOME Independent with your own franchise business. Thousands earning handsome incomes. Request interesting facts today. National Franchise Reports, PM-528, 333 North Michigan, Chicago 1.

EARN \$240.00 A month at home, spare time, doing only two \$5.00 invisible mending jobs a day. Big money paid for service that makes cuts, tears disappear from fabrics. Steady demand. Details free. Fabricon, 1586 Howard, Chicago 26, Ill.

EARN Money raising fishworms for us! Write: Oakhaven—58, Cedar Hill, Texas.

SHARPEN Scissors, pinkers, clippers. Inexpensive machines, supplies. Blackhaws, Sheldahl, Iowa.

FREE Report: "609 Unusual. Successful Businesses." Box 1001-PT, Evanston, Ill.

CHROME Plating. Instructions, equipment and supplies. Platers' Supply, P.O. Box 565, Lugo Station, Los Angeles, Calif.

PIANO Tuning quickly learned with home study course. Diploma granted. American Tuning School, Gilroy, Calif.

BOOKS, PERIODICALS, PICTURES, POSTCARDS

BOOKS. Free general catalog, 100 pages. Text, vocational, educational, instructional subjects. Millions of volumes, new and used. Bargain prices. Books bought. Est. 1902. Long's College Book Co., Dept. PM, Columbus 1, Ohio.

NATIONAL Electrical code, new 1962 edition, complete, unabridged, 75¢. Trade Publications, Box 1328, Worcester, Mass.

FREE! 1065 items. Write for details. Worman & Son, Box 54, Berkeley Heights, New Jersey.

BOOK Carrier. Unusual new design. Write Box 145-B, Plymouth, Massachusetts.

BOOKPOST Finds books best. Box 3251M, San Diego 3, California.

SAVE To 84% on books, records. Free catalogue. Discount Reader's Service, MJ-5435 Upland Way, Philadelphia 31.

25 DIFFERENT San Antonio post cards. \$1.00. Smith, 506 Sprucewood, San Antonio 16, Texas.

LANDING of the U. F. O.'s, prophecies, truth and other mysteries solved! 20 thrilling, new booklets! Free catalog plus "Next Great World Event". Write Research Publishers, 4529 45th Avenue S., Minneapolis 6, Minn.

BOOKS. Elusive. Located. Free lists. Del. 12725 Flatbush, Norwalk, California.

BACK Issues magazines reasonable. Books, 950 Columbus Ave., New York, N. Y.

NATIONAL Geographic magazines. 1888-1960, any issue. Periodical Service, Box 465-PM, Wilmington, Delaware.

BOOKS Located! You name it—we find it. Book Mark, 89A Macomb, Mt. Clemens, Mich.

FREE Catalog. Self-help books. Write Wilshire, 8721 Sunset, Los Angeles 69P.

BOOKHUNTERS! Scarce, miscellaneous books supplied! Atlantic Book Service, Cedar Street, Charlestown 29, Mass.

BRITISH Book bargains—Any subject. Catalogues free. Transatbooks, Wantagh, N. Y.

BOOKFINDERS! All subjects. Send wants! Jaher Book Service, 183 Hazelwood Drive, Westbury, N. Y.

PROPHET Elijah coming before Christ. Wonderful book free. E. Megiddo Mission, Rochester 19, N. Y.

GAMES, TOYS, NOVELTIES

CHESS By mail; Play a professional; Information, equipment, literature. El Cowan, Driggs, Idaho.

GET Your laugh gags, tricks, novelties wholesale. Sell friends. 50 gag samples 25¢. Free catalog. Dohn-TH-Marks, Broadview, Illinois.

PLAY Ringball, indoors, outdoors. A game of skill and 100 tricks. It changes color as it ticks and clicks. Play it standing, play it walking. The more tricks you learn the more you will enjoy it. For ages 6 to 60. \$1.50 postpaid, check or money order. Lakes & Shores Co., P.O. Box 56, St. Clair Shores, Mich.

MAGIC TRICKS, PUZZLES, JOKER NOVELTIES

WORLD'S Finest professional magic. Joker novelties. Giant illustrated catalog 10¢. Top Hat, Evanston 12, Illinois.

500 TRICKS. New 1962 edition, famous Douglas catalog of magicians tricks and supplies now available just 10¢. Fastest service. Douglas Magician, Dept. 61, Dallas, Texas.

WORLD'S Finest magic catalog, \$2.50 (\$2.00 magic included free). 3000 tricks, pocket, stage (408 pages). Kanter's, M-200 South 13th, Philadelphia 7.

CATALOG. Free tricks, 25¢. (1,500,399 tricks, jokes, novelties.) Magico, 7408-P, San Antonio 7, Texas.

PROFESSIONAL Catalog, 175 pages, 25¢. Williams, 900 Plymouth, Ellwood City, Penna.

1000 LATEST Tricks, jokes, magic! New deluxe giant edition! Hot off press! 160 pages thick! Bigger-better! Special for November! Only 10¢. House of 1000 mysteries, Dept. PM11C62, Trumbull, Conn.

"IMPOSSIBLE." They'll say when you knock a card through the table before their very eyes. A most amazing trick which anyone can master. Full instructions. Send \$1.00 to Jolaine, Box 115, Appleton, Wisconsin.

VENTRILOQUISM! Information free! Dummy catalog 25¢. Maher, Box 36A, Kensington Station, Detroit 24, Michigan.

84 PAGES. Completely illustrated catalog, 25¢. Manhattan Magic, Box 334-P, N. Y. C. 11.

BE A Magician! Introductory catalog with free trick, only 35¢. Ireland, 109-F North Dearborn, Chicago 2.

"INVISIBLE Whistle Trick." "84 Card Tricks." "Magic Made Easy." Everything \$1.00. Art Fowler, Box 345, Vineland, New Jersey.

USED Magic, magazines, books. Bargains. Samples 25¢. Sylvian's, Hoxsie, Rhode Island.

FUNNY, 15 Phony colored likker labels—\$1.00. Saler, 10232 Surf Drive, Saint Louis 37, Mo.

MAGIC Tricks book \$1. Be party live-wire. Free catalogue. Mandel, 1200-PM Avenue H, Brooklyn 30, New York.

ANTIQUES, RELICS, INDIAN GOODS, CURIOS

FOSSILS 15 or butterflies 50—\$2.00. Free lists. Tervo's, 14 Nassau, Garden City South, New York.

3 WAR Arrowheads, scalping knife, thunderbird \$4.00. List. Arrowhead, Glenwood, Arkansas.

6 ARROWHEADS. Archaic knife, scraper, \$2.00. Smith, 841 N. Tacoma, Indianapolis 1, Indiana.

ISHKABIBLE! Have fun, make money collecting and selling antique relics of all sorts, and guns. Send 35¢ for large listing circular. Wooden Indian, Wenona, Illinois.

SELLING 20,000 Ancient arrowheads, spearheads, etc. List free. Lear's, Glenwood, Arkansas.

"ANTIQUE Collector's Manual," 14,000 prices, data book, identification, \$5.00. Satisfaction guaranteed! Ruddel's, Box 461, Washington 4, D. C.

COINS, TOKENS, CURRENCY

BARGAINS—Rare 1885 Carson City dollar uncirculated \$19.00. \$5.00 gold very fine \$19.85; \$20.00 gold uncirculated \$69.50; 2 types \$135.00. Roosevelt dime set uncirculated \$39.50; In deluxe album \$41.00. Retail "Redbook" \$1.75. Premium "Bluebook" \$1.00. Bebee's, 4514 North 30th, Omaha 11, Nebraska.

LINCOLNS For sale 20¢ each: 1909, 1910, 1911, 1912, 1913, 1914, 1916PD, 1917PDS, 1918PDS, 1919PDS, 1920PDS, 1925PDS, 1926D, 1927PD, 1928PDS, 1930DS, 1931, 1934PD, 1938DS, 1943PDS, 1954PDS, 1955S. All 43 \$7.00. John Gardner, Box 408, Colorado Springs, Colorado.

25 UNCIRCULATED Foreign coins, each coin from different country, plus two uncirculated Mexican silver dollars \$2.85. McMahon, 2626 Westheimer, Houston 6, Texas.

U.S. Proof sets for sale, 1961 or 1962—\$2.40 each. Postage extra. Aaron Belofsky, 1237 Stanley Avenue, Brooklyn 8, New York.

FREE Coin holder with purchase of Lincoln cents, 1941 thru 1962, 61 coins, \$3.00. O'Malley, Box 592, West Covina, California.

CASH For Canadian coins. Write for free buying list. Lawrence Tyler, 25418 Davidson, Loma Linda, Calif.

CONFEDERATE Half dollar. Original worth \$500. Replica 25¢. Spruceland-P, 115 State, Springfield 3, Mass.

7 DIFFERENT South American coins, bills—25¢. Jolie, Roslyn Heights, New York.

RARE 1882 silver dollars, B.U. bargain \$2.00. Hano, 1598 Third Ave., New York.

PAYING—\$4.00 Per coin for 1922-1923-1925 Canadian cents. Dwayne Heisterkamp, 726 West 4th St., Cedar Falls, Iowa.

STARTER Collections. 40 Lincoln cents 1941—1963 \$2.00. 20 Jefferson nickels \$3.00. 10 Roosevelt dimes \$3.00. All different in folders. Milstead, Box 345, Bacliff, Texas.

ANY Five Jeffersons except 38SD, 39SD, 50D. \$1.00. Trayce, 25 Quinlan, Staten Island 14, New York.

COINS Wanted. Highest prices paid. Cash waiting. Send for illustrated buying catalog 25¢. Norr's Coin Service, Box 921-B, Salt Lake City 10, Utah.

SILVER. Two uncirculated Mexican dollars \$1.00. Universal, Box 866, San Antonio 6.

RARE 1899 Philadelphia silver dollar, uncirculated, \$6.00. Butts, Torrington, Wyoming.

OLD Coins wanted. Catalogue 25¢. Lacheen, Box 1355, Philadelphia, Pa.

WANTED! Lincoln, Indian cents, other coins. Paying sky-high prices! List, 20¢. Evans, Box 222, East Chicago, Indiana.

MAIL Auction. Interested send stamp. Amalgamated, Box 718, Sioux Falls, S. Dak.

INTRODUCTORY: Colonial dollar, Pine-tree shilling, Confederate cent (authentic replicas) all 3, \$2.00. Coin, medal catalog, 25¢. Hobbies, Box 71-B, Rockaway 94, N. Y.

PAYING TO \$50.00 for certain Lincoln and Indian cents. Buying list 20¢. Thompson, 3933 S. Fox, Englewood, Colo.

TWO-Cent copper with bargain list 50¢. Nelson, 346-P, Rye, N. Y.

\$18,000 FOR 1913 Liberty head nickel. Uncirculated dollars 1804-1839, 1893-S, 1895-P, 1903-O pay \$200.00-\$15,000.00. Certain dates—Lincoln cents before 1932, \$250.00; Flying eagle cents, \$950.00; Indian cents, \$1,750.00; Dimes before 1943, \$5,250.00; Quarters before 1924, \$5,250.00; Half dollars before 1929, \$7,500.00; 2¢ pieces, \$200.00; 3¢ pieces, \$200.00; half-dimes, \$3,250.00. Hundreds of others worth \$10.00-\$10,000.00. Canadian coins, 1921, 5¢ Silver, \$300.00. 1875 quarter, \$500.00. 1921, 50¢, \$2,000.00. Wanted 20¢ pieces, gold coins, paper money, etc. Our large illustrated guaranteed buying-selling catalogue, giving complete allcoin information. Send \$1.00. Purchase catalogue before sending coins. Worthycoin Corporation K-161-C, Boston 8, Massachusetts.

LINCOLNS: 40 Different 1909-1940 plus 1960D small date \$1.95. 25 different "S" (including rare 1955S) \$1.50. Harris, 9011B Presidio, San Francisco 29, California.

HANDBOOK of United States coin values, 126 pages, illustrated, \$1.25 postpaid. Williams, 146 Ninth, Oshkosh, Wisconsin.

SILVER Dollars uncirculated! 1878, 1885, 1896, 1897, 1925, \$2.50 each. List included. Stroud's Coins, Kinston, N. C.

WE Guarantee buy all pennies before 1935. Complete information 25¢. Notowitz, 976 Norton, San Mateo, California.

UNCIRCULATED 1935 Silver penny express commemorative medal \$1.00. Coin lists free. Sayers, 1000 Unaka, Johnson City, Tennessee.

5 INDIAN Cents \$1.00; 6 Liberty nickels \$1.00. Doktor, P.O. Box 35151, Los Angeles 35, Calif.

TWENTY-Four page 1963 retail price list of USA and Canadian coins 10¢. Our selling prices on thousands of coins and coin collectors' supplies. Bryson Incorporated, 612A White, Toledo 5, Ohio.

BARGAIN Pricelist, coins, supplies, 10¢ (refundable) Ron Farley, Metamora, Illinois.

TEN Different Indian cents \$2.50. Two different large cents \$2.50. With lists. Hutchinson's, Box 6256, Philadelphia, Penna.

12 DIFFERENT Lincolns before 1921 \$1.00. 24 before 1931 \$1.50. Gene Carlton, Chandler, Okla.

FREE Coin supplies! Giant coin list 10¢ (refundable). Economy Sales, Mansfield, Massachusetts.

LARGEST Coin magazine, 288 pages, 50¢. Scrapbook, 7320-J Milwaukee, Chicago 31.

NUMISMATICS Largest newspaper. Semi-monthly. Sample 25¢. \$2.00 yearly. Numismatic News, Box 452, Iola, Wis.

RARE 1878 CC mint dollar uncirculated \$5.00. 100pg. catalogue 50¢. Shultz, Salt Lake City 10, Utah.

BARGAIN List! U. S. coins, accessories. Stamp please. Hugh's, Hickory, N. C.

40 PAGE Illustrated United States and Canadian coin list 10¢. Stoney, 260 Washington, Boston 8, Mass.

COIN Collector's magazine. On your newsstand or direct. Sample 35¢. \$3.00 yearly. Coins Magazine, Box 274, Iola, Wis.

GIANT Illustrated catalog listing hundreds of bargains in coins and supplies, only 25¢. Ben's Coin Company, 31 North Clark, Chicago 2.

NORWEGIAN Animal set, seven pieces brilliant uncirculated dollar with coin approvals. Molzan, Box 275, Alameda, Calif.

INDIANS, Lincoln, Liberty nickels. List free. Coins wanted, stamp please. Evans, Box 9912p, Atlanta 19, Ga.

25 BEAUTIFUL Coins from 25 countries. Mostly uncirculated. Terrific assortment. \$1.00. Hindley, Box 708, Aurora, Illinois.

25¢ BRINGS Lincoln buying-selling list. Refunded with \$5.00 purchase. Investment details. Free cent (scarce). Kenwood Coins, 6513 Langdale Road, Baltimore 6, Maryland.

MAJOR Variety-Oddity Coin Guide. 200 photos 50 pages \$1.60 copy. 231 North 18th St., East Orange, N. J.

FREE Bargain coin lists. The RJR Company, Astoria 1, Oregon.

WONDERFUL Bargain! 32 different foreign coins, older and larger pieces included. \$1.00. Catalog free. Szego, Box 427, Oakdale, N. Y.

STAMP COLLECTING

FREE! Giant bargain catalog. New edition listing thousands of bargains including U.S. and B.N.A. stamps, packets, mixtures, albums, accessories and supplies; sent with beautiful approvals. Jamestown Stamp, Dept. E112PM, Jamestown, N. Y.

SEALED Kilo stamps. Poland \$9.65. France \$7.80. Finland \$7.20, postpaid. Bernard Fair, Box 5057, Detroit 35, Michigan.

WORLDWIDE, 50 different plus 10 Cuba, 10¢ to introduce approvals. Kline Co., Box 8337, Mobile, Alabama.

OLD Scarce U.S. seconds on approvals. Slight imperfections, lowest prices. Hernefield, Clintonhill Sta., Newark 8, N. J.

U.N. Commemorative set 10¢ to approval applicants. Fine Stamp Co., Box 71-P, Detroit 24, Mich.

CANADIAN Approvals, your want lists filled. Valley Stamps, Little Valley, New York.

FREE! Congo triangle set! Boy Scout beauty! 25 others. Different! Approvals. Cambridge, Box 411, Cambridge, Ohio.

160 DIFFERENT U.S. commemoratives \$1.00. Carstamps, 739 Ordway, Freeport, Illinois.

FREE Mint set! Approvals accompany. Stampco, Box 737, Memphis 1, Tenn.

MINT Connoisseur packets \$1.00! No approvals. Ross, 1127 Nichols, Stratford, Conn.

1000 DIFFERENT U. S. stamps only \$2 with approvals. Wm. Rice, 10230 Martinique Dr., Miami 57, Fla.

FREE List. Economical mint Formosa. Schroeder, 411 Lombard, New Haven, Conn.

40,000 VARIETIES Available priced 1/4¢ upwards. Kelgwin, 933, Daytona, Florida.

EUROPEAN Pictorials, 10¢ with approvals. Schaefer, Californiastrasse 16, Wiesbaden, Germany.

FORTY Different packets only \$1.00. Norge Company, Ho-Ho-Kus, New Jersey.

DEALERS—Wholesale list. Postage 4¢. Frank, 5031 Queensberry, Baltimore 15, Maryland.

100 DIFF. Used U.S. large commemoratives \$1.00. Edmund LeDoux, P.O. Box 428, Eunice, La.

105 DIFF. U.S. only 25¢. Approvals inc. Shelton, P.O. Box 187-KP, Hempstead, N. Y.

300 DIFFERENT Given free with approvals. Particulars. Windsor Stamps, P.O. Box 735, Santa Clara, California.

WOW! 110 all different Germany 10¢! Zeppelins, semi-postals, airmails, high values, etc. Giant catalog, bargain lists included with beautiful approvals. Jamestown Stamp, Dept. A112PM, Jamestown, N. Y.

WHITE ACE Stamp Albums in brilliant color. Send for free catalog. Washington Press, Maplewood, N. J.

30,000 DIFFERENT 1¢-3¢ each. Howard Davison, Surcook 6, New Hampshire.

RUSSIA. 25 exotic beauties. Nudes! 10¢ approvals. Illustrated nudes, rocket lists. Paul, 24-1R Lime Street, Boston 8, Massachusetts.

XMAS Present, 75 South-Afr. and Protectorates only \$1.00 note. Register airmail free. F. Stein, Box 10348, Johannesburg (Africa).

AFRICA Independent nations. Beautiful collection, 11 sets, 9 countries, 36 stamps only 25¢. Approvals. Berchtold, Troy, Ohio.

FAMOUS American #859-93, mint, complete \$6.35. Free 40 page U.S. price list. Parasco, Box 229-T, Brooklyn 1, N. Y.

1847, FIRST USA variety! Goliath foreign beauty shows Ben Franklin in this outstanding issue! Plus Congo freedom stamp, unused 1/2 inch midget stamp freak, real cigar issue, icy Greenland, Free China Bomber airmail giant, etc. only 10¢ with approvals. Capital Stamp Co., Ferrysburg 2D, Mich.

FREE Lists: of United States plates, mint used singles, packets, supplies. Shultheis, 214 Devonshire, New Hyde Park, N. Y.

START Fascinating approval business. Newest methods! Exciting details 25¢! Steele, Box 553-PX, Pacific Grove, Calif.

PENNY! Approvals! Regardless catalog! Kloster, 4164-52nd Street, San Diego 5, California.

FREE! Beautiful pictorial packet! Approvals. Conklin, Box 388-PM, Osage, Iowa.

ASTRONAUT Shepard mint Africa space set only 10¢ with approvals. Lithor, Box 51, Canoga Park, Calif.

327 WORLDWIDE Different 25¢. Bargain approvals. Niagara Stamps, St. Catharines 201, Ontario.

FREE! Surprise "mystery" packet. Premiums. Approvals. Dancer, 75-P38, Mansfield, Ohio.

25 LARGE Stamps free with foreign approvals. Centennial Stamp Company, Box 1587C, Anniston, Alabama.

NINETEENTH Century Austrian offices Turkey. Seven stamps cataloging \$1.99—only 30¢ to approval applicants. Extensive lists. Walter Torgesen, Cornelia, Georgia.

NO Gimmicks. No gadgets. No giveaways. Just attractive approvals at attractive prices. Sunny Stamps, Apopka 2B, Florida.

25 LARGE American commemoratives 10¢. Accompanying approvals. Free perforation gauge. Linstamps, St. Catharines 101, Ontario.

TERRIFIC Stamp bargain! Israel, Iceland, San Marino, plus triangle set, plus Antigua, Borneo, Virgin, Scots, Congo, Russia, plus large stamp book. All four offers free. Send 10¢ for mailing cost. Empire Stamp Corporation, Dept. PM, Toronto, Canada.

103 DIVERSIFIED British Commonwealth 10¢. Approvals included. Crown Stamps, Virgil 601, Ontario.

FREE 100 Worldwide with penny approvals. 10¢ handling. Skytop, Box 1022-PM, Binghamton, N. Y.

1001 DIFFERENT Worldwide collection \$1.00. Garrow, 2141-P Crest, El Cajon, California.

FREE 101 Worldwide with request for approvals, 10¢ handling. Eggert, Marysville, Michigan.

EXCHANGE. Send 100 different foreign, 20¢. Receive different. Raymond, 310 Douglas, Providence 8, R. I.

150 WORLDWIDE 10¢. Colorful bargain penny approvals. Bischmann's, Box 4389-A, Chicago 80, Ill.

200 MIXED U.S. including large Commemoratives, 10¢. Monjar, Cincinnati 14, Ohio.

FREE! 25 different Portuguese, colorful, inexpensive approvals. Elkhart, Box 33, Elkhart, Indiana.

PRICE LIST U.S., foreign. No approvals. Stamps, 5000 Miami, St. Louis 9, Mo.

GOYA Nude (1) 10¢ approvals. Hanay's, 186 West Lawrence, Albany 3, N. Y.

GERMANY. 70 beautiful different stamps. Send \$1.00. Knoop, 520 Dovercourt Road, Toronto, Ontario.

LOOK! 200 different U.S. commemorative collection! Special \$2.00! "Stamps by Mail." 233 Lunt, Chicago 45.

POSTCARD Brings packet trade plan details. Levittown Stamps, Box 621, Levittown, Penna.

FANTASTIC Fish triangles! Valuable "Ben Franklin" on Canal Zone! Flaming bi-colored volcano triangle! Lovely Olympics triangle! Plus icy Greenland, weird wild beast issue and others. 10¢ with approvals. Roseland Stamps, Spring Lake 2, Michigan.

FREE Unusual U.S. \$5 stamp. Approvals. White, Box 485, Flemington, New Jersey.

12,000 **PENNY** Approvals waiting for you. Many from exotic countries, pictorials airmails, new issues. Tilbury, Box 862, Newark 1, N. J.

225 **DIFFERENT** Worldwide 25¢. Laos, Korea, Iceland, etc.! Approvals. Bobb's, Box 3045, Saint Louis 30, Missouri.

TERRIFIC Value. Seven complete mint sets 10¢ with approvals. Beatties, Box 4503, Fort Lauderdale, Florida.

EXTRAORDINARY! Free! 20 different Finland to those requesting approvals. Rossenburg, Box 1303, Chicago 90.

125 **DIFFERENT** U.S. 50¢. Rayworth, 321 South Cicero Ave., Chicago, Ill.

COLORFUL Collection. 111 different, including triangles, diamonds, multicolors, sports, airmails. 10¢. Request approvals. Valley's, Box 414PM, Spring Valley, California.

FREE! British Peace issue with approvals. Fischer, 1530 Metropolitan, New York 62.

U. S. approvals. Low prices. Eagle Stamps, Romine Ave., Pittsburgh 26, Penna.

SPACE—25 Rocket stamps two dimes. Modern Approvals, Box 543, Norwalk, Connecticut.

MINT U.S. approvals—25¢ handling includes gift surprise. Ley Company, 14 East Warren St., Washington, N. Jersey.

200 **DIFFERENT** Used U.S. \$1.00. J. Beeken, Rt. 1, Howell, Mich.

NEW ZEALAND. 20 different including giant Christmas and centennials. 10¢. Approvals. Reinhardt's, Box 93-MK, Troy, Michigan.

5000 **STAMP** Grab bags! \$1.00 each. World, mint sets. Bargain list. Guaranteed satisfaction. Stamp Service, 1438-N, Huntsville, Ontario, Canada.

THEMATICS. 100 different, 25¢, refundable. Approvals. Rev. Hawley, Alcorn, Hot Springs, Arkansas.

80,000 **DIFFERENT!** Amazing new plan builds your collection systematically. As low as 50¢ weekly. Free details. L. G. Ware, Monroe 75, Conn.

100 **DIFFERENT** 3¢ U.S. commems \$1.00. Kenneth McCaskie, 26712 Wolf Rd., Cleveland 40, Ohio.

THREE Spaceman sets. Approvals, 10¢. Erickson, 736 Cottage, St. Paul 6, Minnesota.

200 **DIFFERENT** U.S. stamps \$1.00. 200 different foreign pictorials \$1.00. Approvals. Chartier, North Haven, Conn.

TRADE Your duplicates. (Toward approvals.) Write: VSS, Box 98-P, Newton Highlands 61, Mass.

GIANT Stamp collection including Boy Scout set, moonrocks, astronauts, satellites, complete U.N. set, Olympics, sports issues many countries; plus big stamp dictionary and approvals. Everything 10¢! Stampex, Box 47-LM, White Plains, N. Y.

99 **DIFFERENT** Latin American stamps, 10¢ with approvals. Fred Pittsley, South Montgomery, Napa, California.

100 **DIFFERENT** U.S. commemoratives 25¢. Approvals. Gordon Davison, Henniker 8, N. H.

ATTRACTIVE U.S. approvals. discount prices. Gables, Box 898, North Miami 61, Florida.

FREE! Mint set with approvals. Bergman, 78 Dorchester, Worcester 4, Mass.

50 **PICTORIALS** 10¢ With approvals. Anarden, 6041 Columbus, Minneapolis 17, Minnesota.

INEXPENSIVE Approvals. Thousands available. Worldwide bargains! Carling's, BB-112, Howard City, Michigan.

TEN Airmails! 10¢ with approvals. Ericpaul, 18515 Allendale, Saratoga, California.

TOPS! Mystery lot of over 500 different world-wide only 35¢. Catalogs over \$15.00! Approvals included. Offer to adults only. Littleton Stamp Co., Littleton Q1, N. H.

FREE 10 different U.S. Army, Navy issues. 10¢ Handling. Loral Stamps, Box 11, New York 67, N. Y.

90,000 **STAMPS** sale! Bargain lot: sets, packets, rare stamps \$1.00. Giant assortment \$5.00. High value packet \$3.00. Persile, 436 N. Y. Ave., Brooklyn 25, N. Y.

FREE Stamps to buyers of worldwide approvals. Sets and singles. Handy Stamps, 460 Handy, Orange, California.

PHILIPPINES. 20 commemoratives 10¢. Approvals. Rofa, Box 648, Orange, California.

"**EUROPAS**", 25 different \$2.00. Including sets, catalogue. Langheinrich, Munchen 23, Germany.

TOPICALS. Beautiful stamps, 25 different, only 10¢, approvals. Stamae, 108 Park Place East, North Charleston, S. C.

Buy Your U.S. stamps at 10% less than most other places. Catalogue 20¢. New-Way Stamp, Lawrence, Mass.

FREE! 25 Egypt, 10¢ handling. Approvals. Bellet, Mapledale, Hazel Park, Michigan.

U.S. Stamps. Giant discount catalog 25¢. Raymax, 37-VZ Maiden Lane, NYC 38.

FALL Special 1000 worldwide stamps \$1.00. 3500, \$3.00. No approvals follow. Harrison's Stamps, 1435 First Ave., Oakland 6, Calif.

EXCHANGE. Send 100-200 different stamps with 20¢. Receive different. Patterson, Lancaster 10, New York.

FREE—50 different stamps, with approvals. Fahsing, Dept. PM, Atascadero, California.

300 **DIFFERENT**. Includes pictorials. 25¢. Knopp, Box 1381, Bristol, Conn.

FIRST Day cover approvals! Included free, valuable airmail cover. Myers, Coopersburg, Penna.

FREE—25 large beauties with request for approvals. Al Gray, 506-15th St., Moline, Illinois.

FREE! Antique autos! Complete! 10¢ handling. Approvals included. W. Shaver, 3075 Vamana, Pomona, California.

25 **DIFFERENT** U. S. commemoratives, 1893 up, 10¢ approvals. K & B Stamp Co., Box 70, Brooklyn 23, N. Y.

21,000 **ALL** Different, only pennies a day using our systematic payment plan. Details free. Sjoquist, 1435 Cherrydale, San Jose 25, California.

FREE Sample. Interesting, informative, illustrated. National Stamp News, Anderson, South Carolina.

OVER \$20.00 Catalog value for just \$1.00. 1000 different worldwide. Approvals included to adults only. Universal, Box 6, Kenosha 5, Wisconsin.

200 **STAMPS**. 25¢ With approvals. Smith, 508A Brooks, College Station, Texas.

FREE! 222 worldwide. 10¢ handling. Penny approvals. Jung, 1601 North Stanley, Los Angeles 46.

U.S. Mint specials! Flag set, complete \$1.00; 1¢, 2¢, 3¢ famous Americans (21 different), \$1.00. Free list. Brooks, 2323 Avenue X, Brooklyn 35, New York.

80 **DIFF.** U. S. stamps includes 19th Century commemorative. High values. Plus 1943 flag stamp of occupied nations. All for only 25¢. Approvals included. Willett Co., Box 338-C, Yorktown Heights, N. Y.

UNITED Nations 15th anniversary sheet with first day cancel, as commemorated by Russia. Free! While they last, with approvals. Philatelics, R-J, New Paltz, N. Y.

PENNY Approvals. Thousands. Bargains for pennies. Gifts with purchases. Penny Stamps, Orange, California.

UNITED States commemorative collection containing 33 different—10¢. Approvals. White, 516-A Avenue L, Brooklyn 30, New York.

INTRODUCING Our better United States approvals we offer 15 United States stamps including Columbian, Bi-Centennials, famous American, airm, others; only 10¢. Ocean Stamps, Box 64-PM, Brooklyn 29, New York.

AMAZING OFFER! 200 United States stamps — including commemoratives, airmails, high denominations to \$1.00. Only 10¢ to approval applicants! Illustrated bargain lists free. Mystic Stamp Co., Dept. 80, Camden, New York.

100 **OLD** United States between 1861 and 1935. \$1.00. Roush Stamps, 51 Chestnut, Mansfield, Ohio.

FREE Monaco nudes. Approvals. Stamp Ranch, 902 Addison, Chicago 13, Ill.

60 **DIFFERENT** U. S. (30 commemoratives) 25¢. No approvals. Seidenberg, Appleton, Wisconsin.

225 **STAMPS** For only 10¢! This mammoth value includes airmails, pictorials; stamps from strange countries cataloging up to 25¢ each! Also approvals. Mystic Stamp Company, Camden 80, New York.

FREE 50 Worldwide, mailed with inexpensive approvals. University Stamps, P.O. Box 44-592, Miami 44, Florida.

MILLION Foreign stamps! 2¢ each! Send for thrilling, giant approvals! ABC Stamps, Box 6000-MB, San Francisco 1, Calif.

FREE—When you buy our foreign approvals, you receive absolutely free stamps equaling your purchases. Coast, 1609 S. Park, Santa Ana, California.

1000 **DIFFERENT**. \$1.00 With approvals. Louis Golden, 6721 Eastwood, Philadelphia 49, Penna.

SELL Your surplus good grade stamps. Write, describing fully what you have. Vanroy Shirk, Lebanon, Pennsylvania.

APPROVAL Applicants special. 1025 different stamps \$1.00. Klondike, Harrisburg, Illinois.

U.S. Want list specialist. Approvals. Catalog 10¢. Bogle, Avondale, Mo.

U.S. Bargain. 50 different 10¢, with beautiful worldwide approvals. Stamps, Kennebunk, Maine.

SOUVENIR Sheets Czechoslovakia 1937 plus Japan 1947, 10¢ with approvals. Kingman, 30 Empire, Yonkers 4, N. Y.

10 **DIFFERENT** Canal Zone 25¢. Approvals! Merkel, 30 Grandview, South Hadley Falls, Mass.

U.S.—Foreign price lists free. Request foreign approvals. Somith, Box 83-PM (Rugby), Brooklyn 3, N. Y.

UNCOMMON Old U.S., defective. Bargain prices. K. Swartz, Malden Bridge, New York.

GLORIOUS Bathing beauty. Miss Universe stamp. Nine sparkling colors. "PhotoNotes" subscription. Free! While they last, with approvals. Philatelics, RM, New Paltz, New York.

FREE Gifts: Penny approval purchases. Ross, Box 341, Yonkers, New York.

25 **COLUMBIA** 20¢. Approvals included. Reed, Box 980, Chicago 90, Illinois.

FOOTBALL. Latest gigantic bicolored Hungary commemoratives. Free with approvals. William Deems, 226a Race, Ravenswood, West Virginia.

EXOTIC Orchids. Long complete mint set, 10¢ with exciting approvals. Stamp Imports, Peterborough, Canada.

FREE Stamp wallet with approvals. Wide selection collections by countries. Clark, Box 28-C, Wilmette, Illinois.

STAMP Collecting outfit, includes, packet worldwide stamps, package hinges, watermark detector, millimeter gauge. Everything 10¢ with approvals. Loraine Brown, Marion, Michigan.

SELL Stamps to our readers. Your ad in this space will be read by thousands of stamp buyers. I'll prove that to you. Write now for Folder "S." P. W. Johnson, Classified Advertising Manager, Popular Mechanics, 740-ST Rush St., Chicago 11, Ill.

HOBBIES AND COLLECTIONS

AMERICAN Newspaper, complete, original, dated before 1860, \$1.50. 25¢ stamps brings catalogue. D. R. Spaight, Book-seller, Tall Timbers 1, Maryland.

AUTOGRAPHS Of famous people bought and sold. Write for details. Charles P. Hamilton, 25 East 53 St., New York 22, N. Y.

50 ORIENTAL Butterflies \$2.50. Free pricelist. Haas, Box 1170, New York 8, N. Y.

PLAY Chess by correspondence. World wide membership. Beginners. Advanced. International Chess Club, Box 1502, Manhattan Beach, California.

COLLECT Medals. Introductory: 5 French \$4.00, 4 British \$3.00, 3 Belgium, \$2.00. Catalog 25¢. Insignias, Box 71-M, Rockaway 94, N. Y.

PRECIOUS STONES, MINERALS

GEMS More brilliant than diamonds. Phillips Gem Co., Brady Lake, Ohio.

USA And foreign mineral specimens. Lists 10¢. Minerals, Winston, New Mexico.

FREE Bargain gem list. New lapidary and silversmith tool catalog, 50¢. O'Brien's, 116B Wilcox, Hollywood 38, Calif.

KIMBERLITE Or lodestone. Half pound \$1.00. Free lists. Tervo's, 14 Nassau, Garden City South, New York.

GET Free catalog no serious rockhound, gem cutter, jewelry maker, hobbyist or craftsman can be without. Full of bargains, exclusive items, low prices from largest suppliers and authorities in the field. Free new catalog just off the press, yours for the asking! Write Grieger's, Dept. C-12, 1633 E. Walnut, Pasadena, California.

20 POLISHED gem stones \$1.00. Eberles, 2727 West Slauson, Los Angeles 43, Calif.

SEMI-Precious uncut gems. Ten different for \$1.00. Request list 28. Prospectors Shop, 201 San Francisco, Santa Fe, New Mexico.

EARTH Science Rockhound's National Magazine. Subscription \$2.50. Sample 35¢. Box 1357-PM Chicago 90, Ill.

PHOTOGRAPHY. CAMERAS, PHOTO SUPPLIES

"METALFILM". Print your favorite negative on patented photosensitive anodized aluminum. Complete instructions and samples \$2.00. Roycraft, 222M West 39th, Kansas City 11, Mo.

FREE! Send now for circular of new and used photographic bargains. Dept. 1-H-11, Central Camera Company, 230 So. Wabash Ave., Chicago, Illinois.

PHOTO FINISHING

PHOTO Christmas greeting cards. Black and white, 25 for \$1.50 with envelopes. Mail any snapshot, portrait or negative. (50¢ extra if negative is not supplied.) Color, 10 for \$2.25. Send color negative or slide to: Christmas Cards, Box 155, Hillside, N. J., Dept. P.M.

NO Negative? Send photo and \$1.99 for three 8x10 or 24 wallet custom enlargements. Alpha, Box 6315, Dallas 22, Texas.

Send Any photo or negative. Receive 100 professional glossy gummed photo-stamps, postpaid \$2.00. Tole House, Box 2521X, Hollywood 28, California.

KODACOLOR Films developed and printed, plus new roll, 12 exposures, only \$2.95. MBG Photo, Box 537, Toledo 1, Ohio.

COLOR Movie fans! Low cost—high quality processing our specialty, 8mm. just \$1 (or \$3 with fresh film). Mailed back next day. Craftsmanship guaranteed. Send exposed reel or request free mailers and price list of complete photo-finishing services. Direct Mail Photo, Box 8352-PM, Pittsburgh 18, Penna.

A FREE Kodak roll returned with each black and white or Kodacolor developed and printed, fast service, lowest prices, guaranteed quality send for free mailers. Economy Photo Service, Dept. P. M., Box 1111, Albany 1, N. Y.

FAST, Hi-quality finishing. Kodacolor rolls: eight jumbo prints \$1.98. Twelve \$2.49. Twenty \$3.49. Reprints 15¢. Also low B&W prices. Custom Quality Studio, Box 4838, Chicago 80.

EKTACHROME-Anscochrome 35mm. 20 exp. 620, 120, 127, developed, mounted, \$1.00. Exceptional low prices on Kodacolor films. Prompt service. Complete price list-free mailers. Write Trycolor, P.O. Box 123, So. Windsor, Conn.

MOTION PICTURES AND SOUND EQUIPMENT

8MM, 16MM. Movie subjects. Silent, sound. New, used, 2"x2" color slides. Biggest selection anywhere! Free each month, big 24-page newspaper-size catalog. Blackhawk Films, Davenport 14, Iowa.

VICTOR 16MM used sound projector, 1000 watt lamp, 2000' reel. Guaranteed excellent condition. \$89.50. Abbe Films, 417 West 44 Street, NYC.

MOVIES—Rented and sold. Sound—silent. Huntoon Rentals, Bellows Falls, Vt.

8MM, Valentino, Fairbanks, Keaton, others. 16mm. sound features, shorts, silent classics. Large assortment. Entertainment Films Co., 236 W. 55th, New York City.

5,000 8-16 MM. Movie films. Free catalogues. International, Greenvale, N. Y.

MOVIE Camera film: 8mm. roll \$1.50 16mm. 100' \$3.00. Free processing. Better Films, 742 New Lots, Brooklyn, N. Y.

MOVIE Film! Free catalog! ESO-R, 47th Holly, Kansas City 12, Missouri.

LADY Wrestling, Movies, photos. Free list. Peerless, Box 171-M, New York 13, N. Y.

BARGAINS 16MM. sound features \$16.00. Bedner, 5300 So. Talman, Chicago.

16MM. Sound, projectors, films. Sale, rental, exchange. Stereo Tapes. Rental and sale. Visit store or write for catalog. National Cinema, 71 Dey St., New York City.

USED—New movies. Free bulletin. Lee Movies, Box 4752, Chicago 80.

FREE Catalog! Save on 8/8mm.-16mm. film and supplies. Superior, 448 N. Wells, Chicago 10.

8MM-16MM Movies. Special. 50' reel \$1.25 each. Comedies, cartoons, fishing, hunting, airplanes, thrills. Send \$5.00 for 5 subjects. Movieland, Box 10-M, Van Nuys, Calif.

COLOR SLIDES

LINCOLN Lore in color slides. Kentucky, Indiana, Illinois, Washington, others. Sample slide, 35¢. Catalogue for stamp. Willems, Box 1515-A, Chicago 90.

TRANSPARENCIES Wanted. Up to \$500.00 each. For information write American Color, P.O. Box 46372, Hollywood 46, Calif.

HAWAII Or Alaska. Ten color slides \$1.00. Discount movies. Eddings, 8PM Roberts, Corning, N. Y.

WESTERN Scenes. nature, Indians. Write: Quality Approvals, 711 Columbia Road, Colorado Springs, Colorado.

MICHIGAN color slides. Catalog 10¢. Hiawatha Gridley, Box 56, Ypsilanti, Michigan.

MUSIC & MUSICAL INSTRUMENTS

RECORDS! Discounts on all LP's. Free details. Citidel Record Club, 545 Fifth Ave., Dept. 2, New York 17, N. Y.

ACCORDIONS—Save 1/2. Famous makes. Free home trial. Easy terms. Trades accepted. Free catalog. Accordion Corporation, Dept. 112-R, 2003 Chicago, Chicago 22.

GUITARS, Amplifiers. Buy at wholesale. 6 picks. Details 25¢. Treasurecraft 4B2, Box 2296, Carmel, Calif.

ACCORDIONS. Piano, Chromatics. Button-type Concertinas. Wholesale catalogs free. Italian Accordion Mfg. Co., 7600-C Cottage Grove, Chicago 19, Illinois.

SONGS Poems wanted for publishing recording consideration on royalty sharing basis. Ted Rosen, 17 Longwood Road, Quincy, Massachusetts.

LOW Quotes: Stereo tapes, components, recorders. HiFi, Roslyn 6, Penna.

GUITARS. Big discounts! Wholesaler-to-you. Famous makes. Free home trial. Easy terms. Free catalog. Guitar World, Dept. 112-R, 2003 W. Chicago, Chicago 22.

SONGS, Poems. offer, details. Newart Pubs, Box 693, Syracuse, N. Y.

TUNE Your own piano. All necessary tools plus simple instructions. \$7.95 complete. Ace Corp., Eatontown, N. J.

USED: Electric guitars, amplifiers, bargains. Write: Hills, 1215 War Memorial, Peoria, Illinois.

SONGWRITERS Handbook—only \$1.00. Valuable information. Songwriters Service, 1619-D Broadway, New York 19.

POEMS Wanted for musical setting and recording by America's largest song studio. Send poems. Free examination. Five Star Music Masters, 630 Beacon Building, Boston.

SONGPOEMS Wanted for musical setting. Free examination. Get "The Nashville Sound" in your songs and records. Send poems: Music City Songcrafters, 6145-N, Acklen Station, Nashville, Tenn.

ELECTRIC Guitars, amplifiers, wholesale. Free catalog. Carvin, PMM, Covina, Calif.

POEMS Wanted for musical setting and recording. Send poems. Free examination. Crown Music Company, 49-C West 32 Street, New York 1.

GUITAR Making books, plans, imported woods, tools. List 10¢. Satinwood, 510 East 11th Street, New York 9, N. Y.

SONGS Wanted. Pays royalties. Enclose postage. Olenik Records, Mount Morris, Michigan.

ACCORDION-O-RAMA. 874 Broadway, New York 3, N. Y. Tremendous discounts. Top brands. Free brochure.

SONGPOEMS Wanted! Collaborate with professional songwriters on equal basis. Share royalties. Songwriters Contact Co., 1619-D Broadway, New York 19.

ACCORDION Exchange plan. Catalog terms. Accordion Import Center, 7120 Galli Dr., San Jose 29, Calif.

POEMS Wanted. Surprising offer. Free recordings. Successful Songs, 6 North, Danbury, Conn., Phone 748-6603.

SWISS Music boxes, movements. Mechanical, electrical. Tunes to order. Spielman, 131 West 42nd, New York 36.

RADIO, TELEVISION AND ELECTRONICS

QUALITY Recording tapes, 1800' Mylar \$2.00 postpaid. Towers, Lafayette Hill, Penna.

TELEVISION Tuners rebuilt. Western Tuners, 4130 El Cajon Blvd., San Diego 5, Calif.

SAVE 30% Up! Blank-stereo recorded tape-recorders, Norelco speakers, Saxitone, 1776 Columbia Road, Washington 9, D. C.

INTERCOMS. Two station, 3 transistor, battery, 60' wire. Office, plant, home, hear baby. \$25. Guaranteed. Trader Jim, 6715 E. 25, Tulsa.

GOVERNMENT Surplus radios, parts. Picture catalog 10¢. Meshna, Malden 48, Mass.

FIX Your own TV. Save 80%! Send for free illustrated chart showing how! We'll include giant electronics catalog. Zalytron, 220-M West 42 St., New York City.

SAVE Dollars on radio, TV-tubes, parts at less than manufacturer's cost. 100% guaranteed! No rebrands, pulls. Request bargain bulletin. United Radio, 1000-M, Newark, N. J.

NEW—16 tested Transistor plans 25¢, with experiments, catalog. Laboratories, 1131-C Valota, Redwood City, California.

BOOKS! "Radio Builders Handbook," "Understanding Transistors," "Radio Circuit Handbook." \$1.00 each. PeLong, 129 Cooper, Santa Ana, Calif.

DIAGRAMS: Radio \$1.00, television \$2.00. Send make, model. PeLong, 129 Cooper, Santa Ana, Calif.

TAPE Recorder accessories \$17.95; retail \$29.95. Guaranteed. Florenz, 439 Race St., Cincinnati 2, Ohio.

TRANSISTORIZED Automobile tape recorders, use in, out of car—batteries, microphone, earphone, case, tape, dash mounting bracket, automobile speaker adaptors. \$29.95, free trial. Ellington Enterprises, 1000-10 S. Maiden, Fullerton, California.

SEND Today for the largest and most complete listing of new and used aircraft radios available anywhere. All makes and models available. Graubart Avionics, Porter County Airport, Valparaiso, Indiana, Area 219, Howard 2-4105.

ADD Thrilling colors to black & white TV with "Color-V" filter screen. Attach it yourself in seconds. Mention screen size. \$2.98 postpaid. Color-V, 4601½ N. Franklin Road, Lawrence, Ind.

RADIO Course only \$14.95. Includes all tubes, parts, tools, instructions. Write for full information. Progressive "Edu-Kits" Inc., Dept. 577B, Hewlett, N. Y.

TAPE Recorders hi-fi components. Sleep learning equipment, tapes. Unusual values. Free catalog. Dressner, 1523 Jericho Tpke, New Hyde Park 3, N. Y.

EXPORT — IMPORT

IMPORTING Simplified. Step by step instructions. \$3.00. Importunity, 4229 Jasper, St. Paul 11, Minnesota.

JAPAN: Mail order catalogue business informations, dolls, kimonoes, etc., \$1.00; Trade Directory, 3000 firms listed \$3.00; Japan Tour Guide \$1.00; Send cash. Clarence Yamagata, 814 Togin Bldg., Marunouchi, Tokyo.

BUSINESS OPPORTUNITIES

ASSEMBLE Artificial lures at home for stores. Materials supplied free. Profitable! Write: Lures, Ft. Walton Beach 11, Fla.

"MAKE Big Profits by Mail." Write: American Distributors, Box 409-P, Niles, Michigan.

PLASTERCRAFT. Sample kit, catalog \$1.00. Eureka, 2717 N.W. 10th, Oklahoma City, Oklahoma.

\$50 PER Day. New process wall washing. Details free. Box 5406, Minneapolis 8, Minn.

INTERNATIONAL Mailorder business made easy. Complete setup service, not just instructions. Hermes, 152 West 42, New York City 36.

FREE "Franchise Profit Letter" tells how unique NFR service is helping thousands seeking profitable businesses. Write today. National Franchise Reports, W-528, 333 North Michigan, Chicago 1.

BUSINESSES. Resorts, motels, investment property, ranches. Our special service dept. at your disposal. No obligation. World's largest. 62 years service. Strout Realty, 7-MB S. Dearborn, Chicago 3, Ill.

EARN \$10,000 Selling books by mail. Box 51-BY, Des Plaines, Ill.

OPERATE Mailorder bookshop. Free details. Ballard, 1834 Edgeland, Louisville 4, Ky.

IMMEDIATE Profits with no capital or experience. Take orders for all magazine subscriptions. Friends and neighbors are your prospects. Write now for complete, free kit. McGregor Magazine Agency, Dept. CB2, Mount Morris, Illinois.

MAKE Money making leathersgoods. 1148 ideas. Free information. Tandy Leather Co., Box 791-Q3, Fort Worth, Texas.

SELL Champion, AC, Autolite spark plugs. Reconditioned, electroplated, guaranteed 10,000 miles. 100% profit. Free sample. Lee Plugs, 1608-A Roberts, Houston 3, Texas.

HOW And where to obtain capital. Reliable Service, Rome City, Ind.

VENDING Machines. No selling. Operate a route of coin machines and earn amazing profits. 32-page catalogue free. Parkway Machine Corporation, Dept. #27, 715 Ensor Street, Baltimore 2, Maryland.

BIG Money raising fishworms and crick ets. Free literature. Carter Farms, Plains Georgia.

TO \$100.00 Weekly. Sparetime, home operated mailorder business. Successful beginner's plan. Everything supplied. Lynn, 10420-M National, Los Angeles 34.

PIANO Tuning learned quickly at home. Tremendous field! Musical knowledge unnecessary. Information free. Empire School of Piano Tuning, Champaign, Ill. (Founded 1935).

OPERATE Profitable mail order business. Write Walter Service, 4159A East 112th, Cleveland 5, Ohio.

BAKE New greaseless doughnuts in kitchen. Sell stores. Free recipes. Montgomery, 3605 South 15th, Minneapolis 7, Minnesota.

MAKE \$46 From square foot plywood; jigsaw necessary. Free details. Woodart, Bridgewater, Mass.

\$400.00 MONTHLY Raising giant fishworms. Soilless method. Charlie Morgan, Bushnell, Florida.

PLASTERCRAFT Molds, liquid rubber, plasters, floccs, candle supplies. Catalog and manual free. Blue Rapids Supply, Blue Rapids, Kansas.

WORLD'S Largest wholesale supply. Buy from 679 American, European, Japanese wholesalers. Tailormade suits from Hongkong. 123 dropship catalogs. Rock-bottom prices. Free details. International Buyers, 216-MM Jackson, Chicago 6, Ill.

11,000 NEW Prospects daily. Baby record books, shoes, albums. Sell mailorder. Use our literature. Write: No-Co-Ro, Capitola, Calif.

OPERATE Home mailorder business. Vosacek Printing, 4444A Ute, San Diego, 17, Calif.

COLORGLAZED Concrete pottery made without molds. Patented method. Cemetery products, novelties, tiles. Basement leak-sealing. Money-making projects. Booklet, details free. Men only. National Potteries Company, Grand Rapids, Minnesota.

WANT To make big money at home? \$10.00 profit in an hour possible with invisible mending. Make tears, holes disappear from clothing, fabrics. Steady year-round demand from cleaners, laundries, homes. Details free. Fabricon, 1585 Howard, Chicago 26, Ill.

EARN Money raising fishworms for us! Write: Oakhaven—38, Cedar Hill, Texas.

LEARN Sewing machine repairing. To \$125 weekly. Sparetime. Supplies. Add to present business. Write today! Taylor Service, Box 484, Cupertino, Calif.

VENDING Machine catalog. Rakes, 609P Spring Garden, Philadelphia 23, Penna.

BRONZE Baby shoes. Genuine electroplating process. Equipment, mountings, instructions. Send \$1.00 for valuable book "Your Guide To Success" bronzing baby shoes, plus complete catalog. Hollywood Bronze Supply, Dept. B60, 3445 Union Pacific Avenue, Los Angeles 23, California.

RAISE Rabbits on \$500 month plan. Free details. White's Rabbitry, Mt. Vernon, Ohio.

\$200.00 MONTHLY. Spare time. With table saw, bandsaw or jigsaw. Write. Holiday House, A3800 Harney, Vancouver, Washington.

SIMPLE. Pleasant mailorder can net \$12,000 year. Write: Rutward, 2010 Bryant, Columbia Station, Ohio.

\$34.70 TWO Hours manufacturing concrete products. No selling. Castings #3, Box 1721, Rapid City, South Dakota.

LAUNCH Profitable mailorder business. Write: Kozar, 159 Belleville, Belleville, N. J.

EVERYBODY Likes fine candy and popcorn specialties. Make professionally home. (Our 50th year.) Ragsdale Candies, B107 East Orange, New Jersey.

AVOID Trouble. Order latest mailorder business "Legal Guide." Explains all about licenses, taxes, etc. \$2.00. Neil H. Tasker, Shamokin, Pennsylvania.

EARN \$100.00 Weekly. Unusual home business. Fourteen magic methods. Derco, Box 494-B, Muncie, Indiana.

SELL Books by mail. 400% profit. Royal, Box 450-X, Cleveland 27, Ohio.

MOLDING Rubber. Free information. Chaney's, 5415-A San Jose Blvd., Jacksonville 7, Fla.

STOP Throwing away boxtops! They're worth money! Some, 25¢! Inquire: Box-tops-MB, Cedar Hill, Texas.

FREE Book: "609 Unusual, Successful Businesses." Box 1001-PX, Evanston, Illinois.

BUY Direct from factories. Appliances, cameras, watches! Free details! Cam Co., 436 P.M. Bloomfield Ave., Verona, N. J.

COPUBLISH Mail Sale Advertiser, leading mail order paper. Details, latest copy, dime. Vanroy Shirk, Lebanon, Penna.

OPERATE Own collection agency. Spare time extra cash: Satellites, Box 172PM Manhattanville Station, New York 27, N. Y.

HONEST Help for home mailorder. \$1000 monthly possible. Write: Murray's, Litchfield, Maine.

MAIL Order Magazine free plus unusual mail order offer. Egyptian, Box 168, Anna, Illinois.

MAIL Order beginners. Start small, grow big. Send for interesting literature. Roy Thacker, 220 S. Mission Ridge Dr., Rossville, Ga.

\$10.00 IN An hour spare time at home possible with amazing "Magic Wonder Method" invisible reweaving. Details free. IRI, Dept. P-1, 8411 La Mesa Blvd., La Mesa, Calif.

MAILORDER Catalogs. No inventory required. Full profits. Operate from home. Send 25¢ for 32-page sample catalog featuring 150 unusual fast-moving products and complete details. Satisfaction guaranteed. Gaylords, North Adams 6, Mass.

EARN \$12,000 in 7 months with a freezer-fresh "Dairy Bar on Wheels," most complete soft ice cream mobile unit available. No franchise, no royalties. Also available, oven-fresh pizza-refreshment units and assorted food-drink vehicles. Distributors needed. Dept. PM, Tri Metal Works, Riverton, N. J.

MAKE Extra money. Big steady earnings, repeat business. Sell advertising book matches, full or part time. New 1962 line. Show glamour girls, colorama, tenorama; dozens more. All sizes. Free master outfit, sales helps, leads, no experience necessary, no investment. Write today. Superior Match, Dept. MX-1162, 7530 Greenwood, Chicago 19, Ill.

CAST Beautiful trays, vases, salad bowls, etc., with sawdust, woodchips. New, easy process, only \$1.00 (refundable). Plasticon Company, Box 105-A, Grove City, Pa.

WEAVE Rugs. Make good profits. No experience necessary! Free catalog, sample card, and low prices on carpet warp, rug filler, looms, parts, inexpensive beam counter. If you have loom—advise make, weaving width please. OR, Rug Company, Dept. N225, Lima, Ohio.

PEST Control. Start own part, full time business. Charge \$10.00 hour! Elston, 4035 Lake-Cook, Northbrook 1, Illinois.

FRANCHISE Opportunities! Want profitable business of your own? Franchising is open door. Write for free current list available, exclusive, in your area. Partake, Inc., PM2, Oak Brook, Illinois.

START Your own profitable mail order business. Information free. Burkett, Box 901, El Paso, Texas.

STRIP Furniture finishes commercially. N-K Equipment Co., Lima, N. Y.

WE Are not sure why so many thousands of successful saw and lawnmower shops use Acme equipment, but then there just might be a connection between the good judgement needed in buying the right machines and the good sense needed to operate a successful shop. For free literature write Max Manufacturing Company, 138 Stockton Avenue, San Jose 26, California.

AMAZING Profits in exterminating. Full time—part time. Free details. Baylab, 21-V. Cambridge, Maryland.

MONEYMAKING Opportunities galore! Full, spare time! Details free. Harvey's, Box 1402-PM, Englewood, Colorado.

"**PROFITS** In Mail Order." Priceless information. \$2. Data 4¢. Sharon, Box 5114-P11, Kansas City 32, Missouri.

PROFESSIONAL Photography course. Earn while you learn at home. Gassaways, Rt. 1, Box 365, Grass Valley, California.

HOME Producers needed desperately in exploding new plastics business. Sell your spare time. No selling—most territories still open! Hurry. NPC, Box 23321-P, Los Angeles 23.

CANDLEMAKING And decorating. Terrific hobby. Great business: Learn fascinating molding, dipping, creating and decorating candles for year-round demand—holidays, birthdays, weddings, anniversaries. All events. Spare time fun and extra income now; expand to colorful candle shop later. No age limit. Write for free facts on home instruction method. Candle Institute, Dept. X-840, Fallbrook, Calif.

PAWNBROKER. Be one. I'll teach you. Amazing profits. Pawnbroker Thayer, Bath, Maine.

MAKE Money from old tires. Operators clearing \$400 weekly. Equipment costs \$800. Get facts. S & S Patents, Inc., 3511 N. Lincoln, Chicago 13.

PRACTICAL Mail order. Two packets materials 50¢. Moneymaker, 722-P11 East Silver Spring, Milwaukee 17, Wisconsin.

OPERATE Profitable inexpensive mail-order business. Write: Liberty, 210-PMN2 Fifth Ave., New York 10, N. Y.

START Your own business on credit. Your own boss. 1199 dealers sold \$5,000 to \$25,500 in 1961. We supply stocks, equipment on credit. 200 home necessities. Sales experience unnecessary. Pleasant, profitable business backed by world-wide industry. Write Rawleigh, Dept. K-U-PPM, Freeport, Ill.

FREE—Money-making plans. Work home. Beynon Enterprises, 14 Lorne Ave., Collingwood 1, Ontario, Canada.

BIG Money, snow-flocking Xmas trees, centerpieces, toys, gifts. Illustrated course \$1.00. Maegus, 5337 W. Nelson, Chicago 41.

MOLD Statuary, pottery, tiles, novelties. 5¢ materials makes dollar sellers! Particulars free. Marbleizing Service, Edwardsville, Illinois.

INVESTIGATE New mail order drop shipment plan. OPACO, 13389 23rd Place, Golden, Colorado.

GOOD Check protector, economical, practical, \$1.00. Goodall, 68-N Joost, San Francisco 12.

SELL Business cards by mail. 1000 \$2.85. L&D, 109 W. 42nd. N. Y. C. 36.

BECOME Tax consultant. Graduates earn \$1,000-\$3,000 every tax season preparing returns evenings. State approved. Union Institute, Lakewood S-2, N. J.

LEARN Landscaping and the growing of plants. Start a profitable business part or full time. Free information without obligation. National Landscape Institute, Dept. MC-112, 11826 San Vicente Blvd., Los Angeles 49, Calif.

DOLLS! Dolls! Dolls! We teach you to make, repair, dress and sell. Study at home. Earn while learning. Free booklet. Doll Hospital School, Studio MC-112, 11826 San Vicente Blvd., Los Angeles 49, Calif.

BIG Money—Operate your own fix-it shop. Service all household appliances; irons, fans, refrigerators, automatic washer-dryers, etc. Do house wiring, commercial wiring. Rewind motors of all sizes. Sharpen mowers, skates, saws. Buy needed spare parts wholesale. Free book. Christy Trades School, A-3103 3214 W. Lawrence, Chicago 25.

SELL Products. Mailorder. 400% profit. Work home. Catalogue free. "International", 6347 Parnell, Chicago 21, Illinois.

GET Samples, magazines, offers galore! Your name in 5000 mail directories, 25¢. Results guaranteed. Muskoka Mailers, 1438-NI, Huntsville, Ontario, Canada.

BEGINNERS Low cost mailorder plan. Barr, 24-A Phyllis, West Orange, New Jersey.

MAIL Catalogs to new mothers for big-time profits. 4,000,000 prospects yearly. Free details. Write: J. Samuels, 68 You St., N.W., Washington 1, D. C.

FOR Less than \$15.00 learn carpet laying at home. Earn \$250.00 week all year work. Write T. Jaasund, 396—7 Avenue, Brooklyn 15, New York.

BIG Profits in mailorder. Literature furnished. Write: Roland, 3738-PM Wilton, Chicago 13.

PROFITABLE Catalog mailorder business. Vikari, 468 Third Avenue, Salt Lake City 3, Utah.

\$70.00 WEEKLY—home, spare time. Simplified mail bookkeeping. Immediate income—easy. Auditax, 34741E, Los Angeles 34.

LIQUID Rubber, plaques, figurines, plastercraft supplies. Sample, details free. Lavin Novelties, Box 296A, Leavittsburg, Ohio.

"**UNLIMITED** Opportunities Report," Enterprise guide. Subscription, 4 issues, 25¢. O'Donnell, Sewanols, Lincoln Park, New Jersey.

FREE Mailorder, homework plans. Linco, 5117 East 22nd, Tulsa 14, Okla.

OPERATE Profitable Equipment Rental. Don't guess at rental rates! International copyrighted "Blue Book" for rental operations gives world's most comprehensive coverage of suggested rates of items for rent. This 9" x 11½" "bible" of the rental trade contains over 2200 items cross-referenced, 200 pages rental items with average rates, 26 sections rental equipment. In deluxe cover \$24.95, pressboard cover \$19.95. Deduct 3% if check sent with order. Rental Estimator, Dept. H, P.O. Box 1328, Chico, California.

MAKE \$1,858.50 Yearly with \$89.95 investment. Yearly contracts. Hubbard, 3757 Wilshire, Los Angeles 5.

OPERATE Profitable employment service. Your home or downtown. Details \$2.00. Help Associates, 607 Eighth, Rapid City, South Dakota.

MAIL Order items that sell. Seven complete offers. Orders drop shipped. Beginners—established dealers welcomed. Emmess Company, Dept. BBJ, 15 West Price, Linden, New Jersey.

GO-KARTS. Start your own business with less than \$100.00. Fabulous profits. Full or spare time. Details 25¢. Sportsmobile Corp., 905 N. Broad, Philadelphia 23, Penna.

\$50-100 WEEK Possible with herbs. Grow inside—outside or gather wild. Free details. Whitlow, Dept. A-9, 726 Fairwood, Dallas 32, Texas.

BRONZING Business. Furnished financed completely. Free success plan. Box 5036A, Ingleswood, California.

FREE Seventy foreign directories. Import from Asia, export to Africa. Detail 10¢. Benko, Box 188-A, New York 21.

\$40 A week spare time. Bour, 926 Lincoln Way, McKeesport, Pa.

MONEY Manufacturing, distributing. \$5.00 investment. Lewis Specialties, Box 6163, Spokane 28, Wash.

BIG Profits. Hand crafted jewelry business. Free details. LPS, Dept. 1A, 1706 Argon, Mesa, Arizona.

PACKAGE At home for profit! We supply everything. No selling. Free home business details. HPC 2212BB, Jesse Street, Los Angeles, 23.

MAIL-ORDER Home business. Get free copy. "Make Money in Mail Order." Malico, 1544 S. Sepulveda, Dept. D70B, Los Angeles 25.

HOW And when to start or buy a small business in your town. \$1.00. Buyers Guide, 493 East 8th Street, Chico, Calif.

"**MAIL ORDER** Buyer's Guide." Lists hundreds of sources, listings, addresses. Shows where to buy items, to sell at a profit, where to get nearly everything at rock-bottom prices. Only \$1.00 postpaid. Tommy Wooden, Route 2, Munfordsville, Ky.

EXPORT-Import opportunity, profitable, world-wide mail-order business from home, without capital; or travel abroad. Established world trader ships instructions for no-risk examination. Experience unnecessary. Free details. Mellinger, D70B, Los Angeles 25.

OWN Your own Western Auto store. Over 3,800 now operating. Minimum investment \$14,000. Free training. No retail experience necessary. For complete details write C. M. Wilson, Room 956, Western Auto, 2107 Grand, Kansas City, Missouri. (Indicate geographical area preferred.)

HOW To become wealthy in the campsite business. Send \$1.00 and I will send you the exact easy procedure. Clyde D. Middleton Jr., P.O. Box 719, Palatka, Florida.

MAKE Telephone surveys spare time! Free home-business details. No selling, choose your own hours. Telephone Institute, Dept. NB, 1038 So. La Brea, Los Angeles 19.

FREE World-wide mailorder opportunities magazine. Mailorder Headquarters, PM112, Lawndale, California.

MAILORDER Businesses and beginners. Something new, different. Send \$1.00 for sample and details. Box 445, Bedford Hills, N. Y.

MONEYMAKING OPPORTUNITIES

MAKE Exclusive jewelry, novelties. Plate baby shoes. Make \$100 weekly spare time. Details free. Jo-Ca, 468-D Northwest 79th Street, Miami 50, Florida.

LEARN Window displaying at home. Free information. Write Window Trimming, P.O. Box 557, Whittier, California.

MAKE \$5 Hour sharpening scissors. Details free. Flory, 3741 Rufesnow, Fort Worth 18, Texas.

HUSBANDS And housewives wanted! Big money. Spare or full time cake decorating and candy making. Turn your kitchen into a gold mine. No age, education limits. Complete instruction. Learn and earn at home. Write for free facts. Candy and Cake, Dept. D-490, Fallbrook, Calif.

FREE Advertising for mailorder items. Branvold, 5718 Troost, North Hollywood, California.

MAKE Money with guaranteed hosiery. Free trial. W. V. Art Co., Fort Dodge, Iowa.

25¢ INVESTED Today can return \$7.50 by 1966. Information free. Matherly, Box 3311, El Paso, Texas.

START A profitable subscription business in spare time! We need men and women (young and old) as representatives for all leading national magazines. Liberal commissions on all subscriptions. Supplies free. No experience needed. Send this ad with your name and address to: Popular Mechanics, Room 11-O, 230 W. 55th St., New York 10, N. Y.

MAILORDER. Lowest-priced catalog house in U.S.A. 25¢. Holiday, 914 Burnside Rd., Sharon Hill, Penna.

MAKE Money raising nightcrawlers, redworms. Soilless method. Three Oaks Ranch, Dresden, Tenn.

LIFETIME Security making non-competitive food product at home. Dr. Sutton, Dinuba, California.

HOW To sell cars. \$10. Money-back guarantee. Free details. Dept. PM2, Box 130, Scarborough, Ontario, Canada.

INCOME Skyrockets. Wealth acquisition secrets revealed. Details. Natu-Rex, Yucaipa 9, California.

BIG Profits in figurines, lawn ornaments. World's best liquid rubber for molds. Sample and catalogue free. W. Wocley, Peoria, Illinois.

\$2000.00 CLUB, Church, school, fund raising blueprint. \$1.00 brings complete tested plan. Universal-Unique, 1531G, Ft. Madison 1, Iowa.

MAGAZINE, 100 Ways, make spare money, 50¢. Catalog money plans 35¢. Vista Sales Co. HBD, 1230 Purcell Ave., Cincinnati 5, Ohio.

VENETIAN Blind cleaning simplified. Make and sell tool. Patent rental \$5. Iori, 14 Baker St., Poughkeepsie, N. Y.

SEEING is believing. Earn exceptional living. Will send free kit with particulars. Weidner, 310 West 85, N. Y. C.

PHYSICAL Culture and massage pays big profits. Learn at home. Free catalog. Write National Institute, Dept. A-1, 874 N. Wabash, Chicago 11, Ill.

FREE Catalog beautiful selling jewelry. Jacobs, 1715 East Mercer, Seattle 2, Wash.

WANT The best sure-fire time-tested ways to make money? Wolfe, Box 441, Burlington, Iowa.

\$3,000.00 FUTURE; Inventions; Tool. Patented Lure. 2% royalty paid from sales for each \$500.00; 1% \$250. Send check, references. Investments, Suite B-106, 210 5th Ave., New York 10.

MAKING Beautiful plastic products, per our easy instructions, your greatest money-making opportunity. Write for proof. Plasticon Company, Box 105, Grove City, Penna.

HOME Mailorder "manufacturing." Everything supplied. Clenso Products, 184 Oakview, Winnipeg 15, Manitoba.

DOES Well-paying research interest you? Or operating telephone answering service? Write: Murray's, Litchfield, Maine.

FABULOUS Profits raising earthworms. Picture folder free. Excello, Kosciusko 6, Mississippi.

EARN \$240.00 a month at home, spare time, doing only two \$5.00 invisible mending jobs a day. Big money paid for service that makes cuts, tears disappear from fabrics. Steady demand. Details free. Fabricon, 1532 Howard, Chicago 26, Illinois.

EARN Money evenings, copying and duplicating comic cartoons for advertisers. Adservice, Argyle 1, Wisconsin.

MAKE Plastic novelties for extra income. Low cost home training now available. Write for free booklet. Interstate Training Service, Dept. D-3, Portland 12, Oregon.

BAKE New greaseless doughnuts in kitchen. Sell stores. Free recipes. Melvin, 3605 South 15th, Minneapolis 7, Minn.

CIGARETTES—Make 20 plain or filter tip for 9¢. Facts free. Moberly, Box 4012, Owensboro, Kentucky.

MINK Raising information free. Complete. Lake Superior Mink Farm, Superior, E11, Wisconsin.

VENDING Machines. No selling. Operate a route of coin machines and earn amazing profits. 32-page catalogue free. Parkway Machine Corporation, Dept. #26, 715 Ensor Street, Baltimore 2, Maryland.

EARN Money raising fishworms for us! Write: Oakhaven—59, Cedar Hill, Texas.

YOUR Own, easy-to-start, home mail-order business, sparetime. Fascinating; profitable! Information free. Alfano, 19-PM Pine, Closter, N. J.

BIG Money raising fishworms and crickets. Free literature. Carter Hatchery, Plains, Georgia.

AMAZING Successes through franchises! Become exclusive franchise holder your territory. Information rushed. National Franchise Reports, MP-528, 333 North Michigan, Chicago 1.

LEARN The secrets of repairing junk batteries, generators, starters, profitable, easy, at home. Free particulars. Batteryman, 3465 Forrest, Santa Clara, Calif.

ELECTRIC Blankets easily repaired. Free information. Electric Blanket, Hubbard, Texas.

SEASHELLS, Shellcraft and jewelry supplies. Wholesale catalog 25¢, refunded on first order. Our 28th year. Florida Supply House, Box 847M, Bradenton, Florida.

START Good pay business at home in spare time. No experience needed to operate little table-top machine for bronzing baby shoes. Make \$6.00 profit on every pair. Full particulars free. Send postcard to Warner, 1512 Jarvis, Room CM-2-L, Chicago 26, Illinois.

EASY To start rubber stamp business at home in spare time. Make up to \$9.80 an hour without experience. Facts free. Write Roberts, 1512 Jarvis, Room CR-2-L, Chicago 26.

MEN—Women! Start money-making plastic laminating business at home in spare time. Material that costs 11¢ brings back \$2.58. No canvassing or selling but mail orders bring in \$20 a day. Write for full particulars free. Rush name on postcard to Warner, Room CL-2-L, 1512 Jarvis, Chicago 26, Ill.

\$50,000 POSSIBLE In mail order. Details free. Harle, Decatur, Mich.

MONEYMAKING Opportunities galore! Details free. Berthoff's, 739-PM Sylvania Avenue, Toledo 10, Ohio.

OUTSTANDING Profit possibilities at home. Experience unnecessary. No canvassing. Few hours weekly. Start on \$5 monthly. Free information. The Den, Box 3003, Long Island City 3, New York.

CO-PUBLISHERS Wanted. Details and sample magazines 25¢. Unified Publications, P.O. Box 3030-J, Tampa 1, Florida.

BECOME A notary public! Win extra income, prestige, business contacts. Details free. Stationers Exchange, Box 552-P, Kermit, Texas.

MAILERS' Opportunity mart. Starting kit, dime. Terrific. Brown, 184-P McClellan, New York 56.

WE Purchase items you make at home for us. Enclose stamp for details. Wolfe Specialties, Box 171, Center Line, Michigan.

SCIENCE & CHEMISTRY

AMAZING New book of science experiments, formulas, and catalogue of laboratory supplies. Only 35¢. National Scientific Co., 13 S. Park Avenue, Dept. PM-11, Lombard, Illinois.

CATALOG Still 25¢. Free kit, details. Laboratory Sales, Box 161-A, Brighton, Mass.

3,000 SCIENCE Items. Chemistry, Biology catalog 25¢. Winn Chemical, 124M West 23rd, New York 11, N. Y.

SUN Battery, converts sunlight directly into 1/2 volt at 5 MA. Instructions for powering radios, making light meters, etc., included. Bargain priced \$1.00 each, 5 for \$4.00 postpaid. Custom 11 Service, 5071 Pico Blvd., Los Angeles 19, Calif.

ROCKETS: New illustrated catalog 25¢. Single and multistage kits, cones, engines, launchers, trackers, technical information, etc. Fast service. Estes Industries, Penrose 7, Colorado.

ROCKET Amateur supplies. Chemicals, engines, instruments. Big new catalog 25¢. Central Rocket Co., Waupaca, Wis.

CHEMICALS And apparatus for industrial, analytical, and private laboratories. Catalog 35¢, Dept. M-50, Biological Supply Co., 1176 Mt. Hope Ave., Rochester 20, N. Y.

ILLUSTRATED Catalog: Chemistry, mineralogy, biology 25¢. Tracey Laboratories, Evanston, Illinois.

UNUSUAL Chemistry books, courses, kits! Rare chemicals, cheap! Catalog 25¢. NSC, Box 11133, Palo Alto, Calif.

USEFUL Laboratory instrument, with bigger catalogue, 25¢. Hagenow Laboratories, Manitowoc, Wisconsin.

FUTURE System of Mathematics. Guaranteed. \$1.00. Knowledge, 2900-9th Street, Rock Island 17, Illinois.

FORMULAS, PLANS, ETC.

FORMULAS—All kinds. Amazing big catalog, 10¢. Kemical, Park Ridge, Ill.

EASY To follow plan for convertible sledding or ski slope playhouse, for yard. See picture in "Skiing" \$2.00. Write Skiddle Slope, c/o Fucher's Yodeling School, 2265 West Ford Pl., Denver 23, Colorado.

SUMMER Homes, cabins. Plans, specifications, material list illustrated literature 50¢. Summer Homes, Box 2265, Boise, Idaho.

10,000 PROFITABLE Formulas, recipes, etc. Details free. Harvey's, Box 1402-C1, Englewood, Colorado.

RESILVERING Mirrors. Lookout Mirror, Copper Mirror. All \$1.00. Nelko, 3462-K Merchandise Mart, Chicago 54.

FORMULAS For latest money-making discoveries. New! Good! Valuable literature free! Miller, Chemist, 1517-D, Tampa, Florida.

LATE, Modern manufacturing formulas. List free. Moon Chemical, Martville, New York.

PLASTICS

BOXES, Plastic. 200 sizes. Free list. Alther, 170 Bay 23 Street, Brooklyn, N. Y.

NEW Liquid casting plastic, clear, colors. Embed real flowers, butterflies, photos, coins. Send 25¢ for two handbooks, "How to Cast Liquid Plastics" and "How to Make Extra Money at Home." Castolite, Dept. M-101, Woodstock, Illinois.

NOW! Plastic vacuum forming machines. Hobby. Easy. Profitable. Details. Burr, 7645 Oakland, Kalamazoo, Mich.

NATCOL Resins are best for casting and laminating. Catalog 25¢. Natcol Plastics, Box 227, Redlands 3, California.

PLASTIC Melttable granules, reusable, non-toxic. Free brochure. Plastics catalog 25¢. Instruction manual \$1.00. Castacraft Corp., Dept. M-1162, Box 555, Palo Alto, Calif.

EMBEDDING, Casting secrets free. Sample, 25¢. Crystal, 4350-J N. Whipple, Chicago 18.

AGENTS WANTED

YOUR Own business—Used suits \$1.50; overcoats 65¢; mackinaws 35¢; shoes 12 1/2¢; ladies' coats 30¢; dresses 15¢. Enormous profits Catalog free. Nathan Portnoy Associates, 2109-AA Roosevelt Road, Chicago 8, Ill.

PRINTING. Advertising salesmen—Excellent moneymaking sideline selling decalcomania name plates, small quantities. Automobile initials, sign letters. Free samples. Ralco, XL, Boston 19, Mass.

FREE Sample. Beautiful curios! Sell on sight! Apartado 9036, Mexico City.

BIG Profits. Stamp social security plates, key protectors. Sample 50¢. Catalog free. General Products, 11 No. Pearl St., Albany 7, N. Y.

SELL Advertising pens. New, fast selling line! Quick profits! Free sample, literature. Hanover Pen Co., Hanover 11, Pa.

REAL Diamond rings. Nationally advertised. Sell direct. Make big middleman's profit. No investment. Experience unnecessary. Free catalog, details. Gleamlight, 111-B11 North Columbus, Mount Vernon, N. Y.

\$2.98 INVENTION Changes black-and-white TV into beautiful colors. Terrific, profitable seller. Write Excellent Buys, Dept. PM, 34 E. 12th, NYC.

BIG Money taking approval orders; guaranteed hosiery, no collecting. Free catalog. Leon Howard, Steelville, Ill.

"FOG-STOP" Windshield cloth. Instantly removes blurry mist, frost, sleet, snow. Stops windshield fogging. Samples sent on trial. Kristee, 127, Akron, Ohio.

MAKE Profitable men's-women's wear. Sample free. Sunmade, Brockton 64, Mass.

DIRECT From manufacturer. Lowest prices. Highest quality. Exclusive deal. Hilhor Products, 650 Pierce Street, Gary, Indiana.

GENUINE English chamois. High profits. Steady repeat orders. Hill & Hill Co., 1254-MP Gardenia, Houston 18, Texas.

GEMS More brilliant than diamonds. Agents wanted. Phillips Gem Co., Brady Lake, Ohio.

AUTOMATIC Bed warming sheet, you sleep on, not under. Outsell electric blankets 10 ways, costs less. Generous profits. Patented Products Corp., Dept. PM-112, Danville, Ohio.

MAKE Most extra cash with world's biggest line Christmas cards, wrappings, gifts. Introduce friends, neighbors to 150 Christmas, everyday box assortments. 600 big money-making novelties. Pocket up to 50% profit plus liberal bonus. Free giant color catalog; samples on approval. Arrow Greetings, 513 Fourth Ave., S., Dept. 83-X, Minneapolis, Minn.

EXTRA Cash aplenty! Show 'em and you'll sell 'em—sensationally beautiful, handpainted plastic photo enlargements, personalized compacts, costume jewelry. Take orders—collect 40% commission. Self-selling sales kit free. Novelco, 3343 North Avenue, Chicago 47.

BUSINESS Kit free! Postcard puts you in business! Complete line 230 shoe styles, jackets! New discoveries pay big commissions. No investment. Send for free kit. Mason, Chippewa Falls K-438, Wisconsin.

NEW "Magic Knife" slices frozen foods, even bone—pays up to 100% profit! Rush postcard for free double-your-money details, special starting assortment discount offers. Dalo, Dept. G-602, 4333 N. Pulaski, Chicago 41, Ill.

EXTRA Profit. General wholesale. Terrific free catalog. Department forty. 100 North Greene Street, Baltimore 1, Maryland.

BUY IT WHOLESALE

NEW Watches \$2.95. Bulova, Benrus watches like new \$5.95. Wallets dz. \$4.95. Big catalog with hundreds of bargains jewelry, watches, free. Cosmos, New York 35, N. Y. Dept. 546.

OVERHEAD Door parts. Wholesale prices. List. Door Supply, 101 County Street, Somerset, Massachusetts.

FREE! Name brands catalog! Bonus gifts! Fosters, 2109 Payson, Quincy, Illinois.

BARGAINS! Buy wholesale! Save money! Free catalog! Norris, 273-AX Merrick Road, Lynbrook, N. Y.

FREE Wholesale catalog. Merchandise, housewares, jewelry, toys. Bargains, PHA-14, Farr Road, Columbus 3, Georgia.

BUY At factory cost plus 5%! Thousands of top quality, nationally famous merchandise items; appliances; furniture. Mammoth Chicago warehouse. Moore-PM, 1832 North 5th, North Las Vegas, Nevada.

100,000 PRODUCTS Wholesale! Terrific bargains! Wholesalers, 1265 Broadway, New York 1, N. Y.

BALL Pens. Leatherette photo cases. Social Security plates. Bonomo, 54 Jefferson St., Brooklyn 6, N. Y.

PROFITS In mailorder guide. World import drop-ship directory. Retailers wholesale directory. Write: Buyers Service, 3702 Aurora, Indianapolis 27, Indiana.

BARGAINS. Xmas gifts, toys, catalog 25¢. Ronaldo, P.O. Box 295, Allentown, Pa.

FREE Catalog! Gifts, necessities! Jiffy Sales, R-2, Rhinelander, Wis.

FREE Catalogs! Big discounts on Lionel trains, toys, accessories, 50% off on new Gruen and Benrus watches. Separate wholesale price lists. Send 10¢ for postage and handling. Bargain Boys, 2606 Bergenline Avenue, Union City 6, N. J.

SHOP By mail and save! Buy National and International advertised Christmas gifts at discount prices. Catalog \$1.00 refundable. Hurry! Morgin Imports, 443 Euclid Pm, Akron 7, Ohio.

WHOLESALE Buyers service. Name brands. Free details. Buehlers Bargains, Millersville 6, Ohio.

FREE Catalog. Largest wholesale supply source in the U.S. We're in business to save you money on anything you buy—for self or resale. Write Associated Wholesalers, Box 108-DD, Lincoln 1, Nebraska. for catalog and money-saving details.

TERRIFIC Sale. Hundreds of bargains. Appliances, cameras, jewelry, many other gifts. Catalog 25¢. Trading Unlimited, 12, Ginger Dr., Milledgeville, Ga.

2,000 PAGES Wholesale catalogs! Write: Mosaser, Box 47-B, Newark, Ohio.

BUY Direct from factories! Appliances, cameras, watches! Free details! Cam Company, 436PA Bloomfield Ave., Verona, N.J.

WORLD'S Largest wholesale supply. Buy from 679 American, European, Japanese wholesalers. Tailormade suits from Hong-kong. 123 dropship catalogs. Rockbottom prices. Free details. International Buyers, 216-M Jackson, Chicago 6, Illinois.

NEW Deluxe below wholesale catalog. Automobile catalog and others. Furniture, clothing, housewares, appliances, refrigerators, freezers, washers, dryers, television, radios, luggage, binoculars, hi-fi, stereo, phonographs, recorders, cameras, projectors, musical instruments, sporting goods, toys, tools, typewriters, watches, jewelry. Huge discounts on thousands of name brand items. For free specimen list of actual factory prices—postcard: Selbyco, Decatur 15, Illinois.

FREE! Name brands catalog! Your own high profit business. Sell name brands, full or part time. No inventory, no investment. More than 2,000 name brand items; lowest wholesale prices. Watches, jewelry, cameras, hi-fi, stereo radios-phonos, appliances, housewares, hardware, power tools, luggage, musical instruments, garden equipment, sporting goods, toys, many others. 8 floors of name brands. Million dollar inventory. Orders shipped complete in 24 hours! Send for free, beautifully illustrated catalog now! Separate wholesale price list. H. B. Davis Corp., Dept. PM, 145 W. 15 St., New York 11, N. Y.

USED And new watches \$2 up. Free list. Southern Watches, 5-PM So. Wabash, Chicago 3.

ELECTRIC Guitars, amplifiers, wholesale. Free catalog. Carvin PMW, Covina, Calif.

SALESMEN—DISTRIBUTORS

IF You're interested in making money in selling, see the hundreds of exceptional opportunities in Salesmen's Opportunity Magazine. Send name for your copy, absolutely free. Tell us what you're selling now. Opportunity, 848 N. Dearborn, Dept. 17, Chicago 10, Illinois.

HAND-MADE Genuine leather billfolds. Assorted designs; \$11.00 dz. \$120.00 gross. Write for free pamphlet. Southeastern Leather Co., P. O. Box 573, La Grange, N. C.

MAKE Extra money. Big steady earnings, repeat business. Sell advertising book matches, full or part time. New 1962 line. Show glamour girls, colorama, tenorama; dozens more. All sizes. Free master outfit, sales helps, leads, no experience necessary, no investment. Write today. Superior Match, Dept. M-1162, 7530 Greenwood, Chicago 19, Ill.

FLIPPER. New game riot! One minute demonstration sells it. Big profits! Rinco, Geneva, Illinois.

SELL Our playing cards and other novelties. Free samples and wholesale price list. Nina, 624 So. Michigan, Chicago 5.

MAKE Extra money selling advertising matchbooks. Free catalog and sales outfit. Matchcorp, Dept. PM-112, Chicago 32.

REVOLUTIONARY Machine stamps, seals envelopes! Retail \$19.95, Commission \$10.00. Details. OPPCO, 13389 23rd Place, Golden, Colorado.

DISTRIBUTORS Wanted. New rug 'n room freshener. Sell to hotels, motels, stores, etc. Repeat business. Free sample. Dorothee Products, 8 Grafton Street, Worcester 4, Mass.

MABEL. Instant typing error corrector. Jobbers wanted, 20 states. Frenette, Box 181, Sorel, Que. Canada.

CALENDARS. Novelties. Full or part time. Liberal commissions. Fleming, 6535-A Cottage Grove, Chicago 37.

MAKE Big money taking orders for Stark dwarf fruit trees. Everybody can now grow giant size apples, peaches, pears in their yards. Also shade trees, shrubs, vines, roses, etc. Outfit free. Stark Bro's, Desk 30153, Louisiana, Missouri.

HIGH Commission and bonus. Earn \$100 to \$300 weekly. 30 year old company has openings. List delinquent accounts for collection. Experience not necessary. Permanent. Write Merchants Protective Agency, Dept. PM-11, 1015W Walnut, Kansas City, Mo.

SUCCESS Opportunity. Sell famous Spring-Step cushion shoes. Earn big money daily plus cash bonus. Write Ortho-Vent Shoe Company, 11211 Brand Road, Salem, Va.

NEW needed business professional service. \$150 cash guarantee closes sales. Free details. Nation Wide, Box 104, Phoenix 1, Arizona.

SELL Quality credit collection system. Top commissions plus expense allowance! No investment. Write to Master System, Dept. 11, Box 52, Appleton, Wisconsin.

SENSATIONAL New longer-burning light bulb. Amazing free replacement guarantee—never again buy light bulbs. No competition. Multi-million dollar market yours alone. Make small fortune even spare time. Incredibly quick sales. Free sales kit. Merlite (Bulb Div.), 114 E. 32nd, Dept. C-74A, New York 16.

EARN Big commissions full or part time. Show America's largest line low priced business printing and advertising specialties. Big free sales kit samples hundreds items used daily by business people. Build profitable repeat business. Start right now. National Press, Dept. 8, North Chicago, Illinois.

\$1,000.00 A Month for making dramatic 3-second demonstration of amazing lightweight Presto fire extinguisher. New chemical used by Airforce snuffs out fires instantly. Only \$4.95. Terrific commissions. Millions want it. Free kit. Merlite, 114 E. 32nd, Dept. P-66A, New York 16.

SELL Sav-Cote quality "Liquid Plastic" coatings for home, farm, marine, industry. Free literature & color chart. Nelson C. Reid, Sav-Cote Chemical Labs., PO Box 207, Dept. M23, Brooklyn, N. Y.

SALESMEN. Sell personalized engraved permanent name plates. Big profits. Details free. Ladonco, Box 99, Boston 34, Mass.

MAKE Up to \$200.00 weekly. Every business has slow accounts. Send us names. We collect. National Credit, Dept. BP-11, 903 McGee, Kansas City 6, Mo.

TERRITORIES Available, nationally known, high quality cleaning appliance at popular prices. Sell on demonstration. Excellent profits on initial and repeat orders. Proven acceptance in homes, business, industry, institutions. Start small and grow big with us. Artmore, 1255 North Sixth, Milwaukee 12, Wis.

DISTRIBUTORS. Mailorder, retail and premium. Two new hot items. Closet item sample 50 cents. Business item sample 25 cents. Refundable. Specialty Enterprises, Dept. SSC, 5610 Division, Chicago 51.

IF You are calling on farmers, specialty growers, golf courses, factories or estates, we can show you how to add big money to your present income. Campbell Company, Rochelle 5, Illinois.

SAVE-A-LIFE. New portable oxygen unit with case. 90 minute supply. Only 11 lbs. Sensational moneymaker. Free details. Green Cross Products, 5019 E. Second, Tucson, Arizona.

EMPLOYMENT INFORMATION

WORK For the U.S. Government. Send \$1.00 for next five monthly issues containing announcements of Federal job examinations. Good pay plus fringe benefits. Civil Service Reporter, 330 Newbury Street, Boston 15, Massachusetts.

MERCHANT Marine. Men and women. Top wages. Travel. Information. Captain, Box 501-P, Reading, Massachusetts.

FOREIGN Employment. Construction, other work projects. Good paying overseas jobs with extras, travel expenses. Write only: Foreign Service Bureau, Dept. PM, Bradenton Beach, Florida.

FOREIGN Employment information. Europe, Africa, Asia, South America. Free transportation. Up to \$1600.00 monthly. Sensational opportunities. Construction workers, clerks, truck drivers—every occupation. Complete information, application form, sent immediately by return mail. Satisfaction guaranteed. Only \$2.00 (\$2.25 airmail) (C.O.D.'s accepted) to: Jobs, P.O. Box 50512, Dept. E, New Orleans 50, Louisiana.

RESUMES By Richton open doors to the best jobs. Expertly prepared, professionally written, custom printed. Analysis and evaluation. Free bonus features. By mail or personal visit. Write, free literature. The Richton Company, Dept. PM, 11 Hill Street, Newark 2, New Jersey.

WEST Coast boom! Government employment opportunities. All occupations. Current list \$2.50 airmail. Satisfaction guaranteed. Careers, 3534 N. Meridian, Fresno 3, Calif.

TREMENDOUS Opportunities. U.S.A.-Overseas. Choose jobs, locations, transportation. Free details. International Occupations, International Airport, Box 100C10, Jamaica 30, N. Y.

CHOICE Government jobs. Short-cut information 25¢. Sharon, Box 5114-10, Kansas City 32, Missouri.

DIRECTORY Reports. Construction, aviation, shipping, oilfields, government, manufacturing, trucking, etc. Foreign-statewide. Helpful information plus job-getting tips on preparing application letters. Unconditional money-back guarantee of satisfaction. Act today. Only \$3.00. \$3.25 airmail. (C.O.D.'s accepted). Research Services, Meramec Building, St. Louis 5-PM, Missouri.

ARO Civil Service tests—answers. Details free. Greerco, Roosevelt, New York.

JOBS On ships. Age 18 to 55. Experience not required. National Seafaring, Box 78453-B, Los Angeles 16, California.

CIVIL Service jobs. Overseas, U.S.A. Mechanical, clerical, professional. List \$1.00. Civil Service Bulletin, 115F Haypath Road, Plainview, New York. Satisfaction guaranteed.

JOBS On ships \$100.00 weekly. Beginners. Information free. Flagship, Box 111-P, Brooklyn 17, New York.

JOBS, Business opportunities. California, Arizona, Nevada, Oregon. Leading newspapers classified sections furnished revealing amazing opportunities. Save transportation. Free details. Airmail Austin Trousdale, 14 East Lake, Watsonville, California.

JOBS Galore! All trades. Los Angeles Sunday classifieds \$2.00. PeLong, 129 Cooper, Santa Ana, Calif.

FOREIGN-U.S.A. jobs. All occupations. Free transportation, benefits. Complete information, application form. Send \$1.50 (\$2.00 airmail) C. O. D.'s accepted. Satisfaction guaranteed. International Employment, P. O. Box 307, Bedford 2, Indiana.

OVERSEAS Jobs. All types, all countries. Free information. Hill International Publications, P.O. Box 79-M, East Islip, New York.

SPECIAL SERVICES

RESEARCH. Reservations, investigation, remailing, filming. Arizona Information & Service Bureau, 5001 North 61st Drive, Glendale, Arizona.

SCIENCE Baffling? Test yourself: Define Cryogenics; Explain Lasers. Get both right? Scientist answers your science questions, engineering problems. Free details. Science Forum, 35 Oakcliff Rd., Newtonville 60, Massachusetts.

INFORMATION Concerning any matter. Folborg Research Agency, Wyckoff Heights, Brooklyn 37, New York.

COMPLETE Spectrographic analysis of ore or mineral samples by modern, best equipped west coast institution. Send sample with \$10.00 money order to Hornkohl Laboratories, Inc., 714 Truxtun Avenue, Bakersfield, California.

INFORMATION On anything. Ferguson Research Specialists, 59 Lent Ave., Hempstead, N. Y.

EDUCATIONAL AND INSTRUCTION

GOOD Paying jobs open! Operate, repair heavy earth moving equipment! Learn "on the job" operating latest cranes, bulldozers, earth carriers! V.A. approved. Free catalog. Write M.P. Hutch, Greer Technical Institute, Braidwood, Illinois.

FINISH High School. Make more money. High school graduates earn more money, get better jobs. Finish school at home, in spare time. Personal help. Write for free book, "Graduate to Success," Wayne School, Dept. 11-581, 417 S. Dearborn, Chicago 5, Illinois.

MASTER Watch making at home. Free sample lesson. Chicago School, 2328-YL Milwaukee, Chicago 47.

HIGH Pay jobs in electronics waiting for you! Be an electronics technician, Missileman, automation expert, computer specialist, radio-TV-hi-fi serviceman. Massey home study training pays for itself in spare-time earnings. Accredited course with 7 kits. Write for free home study or residence catalog. Massey Technical Institute, Department PM-11, Jacksonville, Florida.

PROFITABLE National Camera Repair School training at home! 174PM, Englewood, Colorado.

LEARN Civil and criminal investigation at home. Earn steady, good pay. State age. Institute Applied Science, 1920 Sunnyside, Department 168, Chicago 40, Illinois.

COMPLETE Your high school at home in spare time with 65-year-old school. Texts furnished. No classes. Diploma. Information booklet free. American School, Dept. X845, Drexel at 58th, Chicago 37, Illinois.

MINISTERIAL Home study course. Free qualifying examination. Soms, 4 Plant Drive, Kent, Ohio.

"ERROR Guide." Amazing book for bookkeepers, auditors, accountants, cashiers. Details free. Error Guide, P.O. Box 253, Minot, N. Dak.

DRAFTING Pays big money. Leads to position in automotive, aeronautical, construction, mechanical fields. Learn at home in spare time. All equipment supplied. Pay later plan. Free book. Christy Trades School, D-6503, 3214 Lawrence, Chicago 25, Ill.

"HOW To Train Horses." A book everyone who likes horses or ponies should have. Free. No obligation. Simply address Beery School, Dept. 11011, Pleasant Hill, Ohio.

FINGERPRINTING And identification easily learned at home. Diploma awarded. Alabama School of Fingerprinting, Fairfield, Alabama.

INVESTIGATOR Training. Robert B. Phillips, Sr., founder. Former U.S.A. government special agent. For free information write to 1917-P North Kenneth Avenue, Chicago 39, Illinois.

EXTRAORDINARY Course! "Master Secrets of The Ages." Key to success and well-being. Dynamic formula! Free literature. Leavitt Science, Clinton, Illinois.

AUTOMATION Worries? Learn drafting, blueprint reading. Send \$2.00 first lesson. Complete home study course \$25.00. Prior Inc., 23-09 169 St., Whitestone 57, New York.

GAME Warden, Government hunter, Forestry, Park and Wildlife Services announce job openings regularly. Enjoy outdoor work, good pay, real security. Complete information free! Write North American School of Conservation, Dept. 17B, 810 Dodsworth, Covina, Calif.

BOOKS—Practical help for trades, skills, profession. Ramey, 19-B South Martin, Waukegan, Illinois.

LEARN Fascinating, profitable invisible reweaving at home. \$10.00 earnings in an hour possible making tears, holes disappear from clothing, fabrics. Steady demand from cleaners, laundries, homes. Details free. Fabricon, 1534 Howard, Chicago 26, Illinois.

GUARANTEED America's finest and most complete line of slide rules. Wholesale prices. You save 30 to 50%. Post card brings our catalog. Lewis M. Crawford & Sons, Joanna, South Carolina.

ENGINEERING And Art degrees earned through home study. Electronics, Mechanical, Liberal Arts. When writing specify course desired. Pacific International College of Arts & Sciences, primarily a correspondence school. Resident classes also available. 5719-B Santa Monica Blvd., Hollywood 36, California.

INVESTIGATOR'S Course. Credentials, diploma. Free information. Southwestern Institute Criminology, Box 201, Geronimo, Oklahoma.

PENMANSHIP Corrector. Improve poor penmanship quickly. Details free. Ozmant, Box 665-34, St. Louis 88, Mo.

SPEAK, Sing with power. Self-training records. Canfield, 2018-A Fifth Avenue South, Minneapolis 4, Minnesota.

DENTAL Technician's home study student's kits. Instruments, plastic, etc. Illustrated instructions. Write for free lesson. Grant Laboratory, Haas Bldg., Los Angeles 14, Calif.

FREE Literature, self-help books, sleep learning. Fletcher, 2407-PM Catherine, Dallas 11, Texas.

INVESTIGATOR Training. Free booklet covering approved home-study plan. Write National Detective Academy, 12812 Hazel Ave., Garden Grove, Calif.

BE A Real Estate Broker. Insure security for yourself and your family. Study at home. Prepare for state examination. GI approved. Write for free book today. Weaver School of Real Estate, 3519P Broadway, Kansas City, Missouri.

SWEDISH Massage. Foot technique. Post graduate. Home study, Residential. Diploma. Dr. Swanson's Illinois Licensed School. 3809-PL Alta Vista, Chicago 13.

USED Correspondence courses and books sold and rented. Money back guarantee. Catalog free. (Courses bought.) Lee Mountain, Pisgah, Alabama.

HIGH School diploma at home. Licensed teachers. Approved materials. Southern States Academy, Station E-16, Atlanta, Ga.

WOODWORKING And cabinetmaking course for beginning and advanced home craftsmen. Only complete low-cost home training program available. Write for free booklet. Interstate Training Service, Dept. G-3, Portland 12, Ore.

BOOKKEEPERS. Operate your own "Dollar-A-Week" system. Ellis, Box 200, Cedar Grove, North Carolina.

LEARN Asleep or awake! Records, tapes, equipment! Free catalog! Drawer PM-697, Ruidoso, New Mexico.

MEN Wanted. Earn \$125 a week and up. Master a trade with a future. Learn auto diesel mechanics in our shops. You learn with tools on real equipment. Earn while you learn. Many of our graduates earn \$125 a week and up. Write for free bulletin: Dept. 256, Auto Diesel College, Nashville 3, Tenn.

LEARN Auctioneering. Free catalog. Missouri Auction School, 1330 Linwood, Kansas City 9-X3, Mo.

LEARN Ventriloquism. Amazing-entertaining! Easy! Details free. B. Davis, B-38, Safety Harbor, Florida.

LEARN While asleep with your recorder, phono. Details, catalog free. Sleep-Learning, Box 24-PX, Olympia, Wash.

PROFESSIONAL Investigator. Home study. Lapel pin, certificate, future. Box 41197-F, Los Angeles 41, California.

OPERATE Collection agency. Little gold mine. Franklin Credit, Roanoke, Virginia.

USED Courses! Books! List 10¢. Smith's, 124 Marlborough, Salem, Mass.

PIANO Tuning pays. Big money in spare time. Learn at home. No musical knowledge necessary. Phonograph, records, tools and instructions furnished. Electronic tuning also taught. Free catalog. Capital Tuning School, 3160 S.W. 16th Court, Ft. Lauderdale, Fla.

INVESTIGATORS Trained, men-women. Fascinating, profitable profession, spare time study. Big pay. Details to open own agency any state. Free booklet. Investigator, Box 490PM, Times Square Station, New York 36, N. Y.

SECRET Investigations. Experience unnecessary. Investigators particulars free. George Wagner, M125 West 86th, New York City 24.

WANT A diesel job? Higher pay? Advancement? We can help you qualify! Complete diesel, tractor and heavy equipment and Cummins Diesel Engine Shop-method home-training courses available. Write today. Interstate Training Service, Dept. B-3, Portland 12, Ore.

COLLECTIONS—Bad accounts. Complete instructions \$1.00. Patterns for Success Institute, Box 1133, Boston 3, Mass.

FCC License in 6 weeks. First class radio telephone results guaranteed. Elkins Radio School, 2603D Inwood, Dallas, Tex.

PLAYS, STORIES, MANUSCRIPTS

WRITERS Send your books, articles, stories, plays for free evaluation, screening and sale. Write today! Literary Agent Mead, 915 Broadway, New York City 10.

WANT Your book published? Learn how we publish, advertise, promote, distribute. Many successes. Free booklet PM. Vantage, 120 West 31, New York City. Or 6253 Hollywood Blvd., Hollywood 28, Calif.

WANTED. Manuscripts for do-it-yourself booklets, car, homes owners guides, etc. Lynrex, Box 21, Madison 1, Wisc.

POEMS Needed for poetry books. Inquire: Young Publications, Appalachia 1, Virginia.

ADVERTISING AGENCIES, ADV. SERVICE, MAILING LISTS

MAILORDER Record Book. 30 pages. Records inquiries, orders, advertising expense, etc. Most complete. Just send dime for postage and handling. F. W. Johnson, 740RB Rush St., Chicago 11.

FREE! Red-hot book — "More Profit From Your Advertising." Lists best mail-order magazines, newspapers. Adservice, 516B Cornelia, Chicago 13.

ADVERTISING Ratebook leading newspapers, magazines, free. Chicago Advertising Agency, 28-E Jackson, Chicago 4.

MAILING Lists most all kinds 1000 \$5.00. Free folder. Your circulars mailed \$4.00 1000. Dixie Mailers, King, N. C.

AMAZING New Book—"Profits From Classified Advertising." Tells how and what to advertise. Be sure to read this book before you invest one cent in advertising. Write for your copy now. F. W. Johnson, Classified Advertising Manager, Popular Mechanics, 740-PR Rush St., Chicago 11, Illinois.

ADVERTISE: 24 words, 50 Canadian newspapers, \$5.50. Lists free. Advertising Bureau, 10511-C Springfield, Chicago 55.

TYPEWRITERS, DUPLICATORS, OFFICE DEVICES

RECONDITIONED Typewriters, mimeograph, printing presses \$25.00 up. Write Dixigraph, King, N. C.

MIMEOGRAPH Duplicator and addressing set with complete supplies. Multipurpose. Up to 35 words. Also replaces 15 custom rubber stamps. Best results guaranteed. Only \$6.95. Flex-Add, 106 Galloping Hill, Roselle Park, N. J.

OMEGA Pocket size adding machine, all metal. Adds, subtracts to 999,999 in seconds, no errors. Ideal for office, school, field. Wonderful gift. Special \$1.49. Wilcox, Box 833, Campbell, Calif.

MIMEOGRAPH Machines \$13.56. Wholesale printing. Club, 5117 East 22nd, Tulsa 14, Okla.

RUBBER STAMPS AND OFFICE SUPPLIES

FREE Catalog: rubber stamps, check-writer, Martin, 1425 Major, Jefferson City, Missouri.

THREE Lines, \$1.00. Free catalogue. Johnson, 443-PM McDonough, Brooklyn 33, N. Y.

QUALITY Stamps, 3 or 4 lines \$1.00. Prompt service. Satisfaction guaranteed. Goldberger, 3967 Sacramento Street, San Francisco 18, Calif.

FREE 32 Page rubber stamp catalog. Signature stamps \$3.50. Youngers Stamp Shop, Princeton, Iowa.

3 LINES \$1.00. Extra lines 25¢. Cushioned mount, knob handle. One day service. Wallace, Box 146, Hanover 1, Penna.

POCKET, 3 Lines \$1.00. Handle stamp \$1.50. Printers, Big Moose 9, New York.

NOVELTY Rubber stamps. Largest selection U.S., Canada catalog 25¢. Gregor's, 79 Cortlandt, Belleville 9, N. J.

NAME & Address pocket printer \$1.00. Gift, novelty catalogue free. Creations, Box 187-B, Brooklyn 12, N. Y.

RUBBER Stamps, complete printing sets. Booklet 10¢. Tabco, Tomkins Cove, New York.

POCKET 3 Lines \$1.00. Guaranteed. Catalog free. W. J. Specialty, 8464 Manhattan, Detroit 11, Michigan.

STAMP Makers' supplies. Lowest prices. O'Brien's, 421 Jackson, Toledo 4, Ohio.

CARTOONING, COMMERCIAL ART, SHOWCARD & SIGN PAINTING, TATTOOING

ART Learn at home. Earn big money. Learn commercial art, cartooning, lettering, figure drawing, painting, TV art, in spare time. All for 20¢ a day. Send for free 36-page book. No obligation. Washington School of Art, Studio 1411, Port Washington, N. Y. Tear this out as reminder.

SIGN Painting. Easy method. Ellis, 10533—121 Ave., Largo, Florida.

PAINT Signs! Using patterns! Trial alphabet \$1.00. Harwell's, PM-1162, Byrdstown, Tennessee.

SIGN Beginners! "Earn Faster Method." Catalog. Harris, Box 1567-R, Portland 7, Oregon.

INEXPENSIVE Mechanical aids teaches better. De-Signs, Box 2024-A, Davenport, Iowa.

WANTED—Cartoonists. Amateurs, professionals. Over 200 markets. Information free. Cartoon Markets—4-112; 11620 Lansdowne; Detroit 24, Michigan.

"HOW To Make Money with Simple Cartoons." A book everyone who likes to draw should have. It is free; no obligation. Simply address Cartoonists' Exchange, Dept. 911, Pleasant Hill, Ohio.

PAINT Signs! Letter patterns, hundred selections. Paulow Signs, Crystal Falls, Michigan.

YOU Can entertain with chalk talks. Catalog 10¢. Balda the Cartoonist, Oshkosh, Wis.

LEARN Sign painting at home. Free talent test. Ben Kerns, Box 812-PM, Greenville, S. C.

LEARN Sign painting with fascinating system. Straley, 410 S. Western, Springfield, Ohio

LEARN Profitable magazine cartooning. Free details. Hartman, Box 3097, Lincoln 10, Nebraska.

PAINT Artistic showcard-signs by new number method. Free Strok-O-Graph and details. Idea clipbook \$1. Midwest School of Art, 103 East Main, Fort Wayne, Indiana.

SIGN Painting—for profit. Free information. Kaufman Sign Company, Centertown, Missouri.

PRINTING OUTFITS AND SUPPLIES

HARD Type for rubber stamp making, printing. Introductory offer 10 or 12 pt. 20th Century Medium caps or L.C. \$2.50. Free catalog. Barco Type, 232 Evergreen, Bensenville, Ill.

PRINTING Presses, type, supplies. Lists 4¢. Turnbaugh Service, Mechanicsburg, Penna.

TYPE Cases. Manufacturer. Catalog. King McKay Company, 23179 Telegraph, Southfield, Michigan.

MAKE Your own self-molding rubber stamps and printing cuts. Flexirubber, Argyle 1, Wisconsin.

RUBBER Stamp presses, hydraulic operated, electrically heated. Sizes 5"x8", 8"x12", 10"x15". Starting outfits, supplies. Printing presses. Custom Manufacturing, 1464-P East Commercial, Springfield, Missouri.

DO Your own printing. Save money. Simple rules. We supply everything. Print for others; good profit. Raised printing like engraving too. Have home shop. Details free. Kelsey Presses, V-11, Meriden, Connecticut.

RUBBER Stamp outfits, supplies. Kiewit, 2025 Barnev Road, Kalamazoo, Mich.

SILK Screen dry photo stencils. Photo, art service. Boettger, 960, Dorothy, N. J.

FREE Rubber stamp press. Postpaid stamp materials. Duckman, Avoca, Ark.

PRINTING, MULTIGRAPHING, MIMEOGRAPHING, GUMMED LABELS

PERSONALIZED Stationery. A delight to use or give. Attractively boxed, beautifully printed in modern type on fine quality white bond with matching envelopes. Executive size 7¼" x 10½". Print clearly three line name and address desired. 100 sheets, 50 envelopes, \$2.95. 100 sheets, 50 second sheets and 100 envelopes, \$4.75. Free brochure. Lakeside Press, Whitmore Lake, Michigan.

POSTPAID Printing. Free catalog, samples. 10% deductible first order. Burgan Press, 1160 Namdad Ave., Bay Shore, N. Y.

LABELS. Blank. Self-adhesive. Stock sizes. Free list. Althor, 2301 Benson Ave., Brooklyn, N. Y.

SAVE On mimeographing. Samples. Fuesing's, 6522 West Center, Milwaukee 10, Wisconsin.

PERSONALIZED Correspondence cards, white or colored, neatly printed, 100 \$1.25; 1000 business cards \$3.95, postpaid. May Printers, Box 1703, Gary, Indiana.

PRINTED Scotch tape. Free price sheet. Kavanagh, 607 Knickerbocker Ave., Brooklyn 21, N. Y.

MIMEOGRAPHING. Offset printing. Free samples. Pennway, Drawer 1340, Scranton, Penna.

OVERNITE Offset printing 1000 8½" x 11"—\$6.50. Postage extra. Evergreen, 9420 Trumbull, Chicago 42.

AMAZING Business printing values. Samples. Print Shop, Box 576, Greenville, R. I.

FREE Catalogs postpaid printing. Rubber stamps. DM Press, Sebastopol, Calif.

OFFSET Printing. 100 8½" x 11" \$2.49. Additional 100's 43¢—add shipping. Parks, 1879 Dover, Wantagh, New York.

100 8½"x11 HAMMERMILL Bond letterheads \$1.45. 6¾ envelopes same. Samples. Cooper's, Box 471, Ypsilanti, Michigan.

DISTINCTIVE Mimeographing. Lowest prices. Samples sent. Perkins Printing Service, Fremont, Nebraska.

100 EACH 8½"x5½ Letterheads, 6¾ envelopes, \$2.00. Catalog free! Steinbergen, Box 2354B, NYC 8.

100 MEMBERSHIP Cards printed \$2. Samples. 1747 Selby, Saint Paul 4, Minnesota.

ENVELOPES Brown Kraft unprinted. 6½"x9½: 100-\$1.75, 200-\$3.00, 500-\$5.00, 1000-\$9.00. 9x12: \$3.00, \$5.00, \$9.50, \$16.00. Arco Products, Box 61, Forest Hills 75, N. Y.

REASONABLE Electro print mimeographing. Free samples. Box 102-P, Whitestone 57, N. Y.

250 8½"x11 HAMMERMILL Letterheads \$2.75. 250 envelopes \$2.75. Samples. Patton, Box 248H, South Haven, Mich.

PRINTLIKE Overnite mimeographing. 8½"x11 Snowwhite 50-\$1.00, 100-\$2.00, 250-\$3.00, 500-\$4.50, 1,000-\$6.50 postpaid. Samples. Scherer, 707 South Wells, Chicago 7.

LETTERHEADS, Labels, envelopes. Business cards \$3.95 thousand. Samples. Greszczuk, Box 3788-M, New York 17.

1000 BUSINESS Cards \$3.00 ppd. Agents wanted. Box 1890-P, Long Beach, California.

1000 NAME And address labels \$1.00. Chuck's, Box 343PM, Lorain, Ohio.

1000 BUSINESS Cards, raised letters \$3.75 postpaid. Samples. Routh, PM-11, 3910 Kipling, Greensboro, N. C.

BUSINESS Cards embossed \$3.75 thousand prepaid. Guaranteed. Mauney's, 1103 Fern Street N.W., Dept. PM, Washington 12, D. C.

SPECIAL Low introductory price. Stamped and personalized Qwik-Mail envelopes. For paying bills, so neat, so handy. No more hunting for envelopes, stamps. No more stopping to write your return address! Low cost includes the postage! 50 envelopes postpaid (with new 4¢ postage). Write name and address plainly. Send also for free catalog of unusual gifts and entertaining specialties. Gift-craft Company, 1234-P E. 47th Street, Chicago 53, Ill.

BUSINESS CARDS \$3.50 thousand. Pre-paid. Samples. Guaranteed. Juanita Route 3, Lincolnton, N. C.

1000 THERMOGRAPHED Business Cards, \$3.50. Shipped postpaid: Enterprises, Box 462, West Covina, California. Samples.

TWO Color printing. Quality letterheads, noteheads, envelopes, labels, forms, etc., postpaid. Free samples! Arch Printing, 216 West Jackson, Chicago 6, Illinois.

FOR INVENTORS

PUBLICITY For your invention! Profit! Prestige! Inventor's Syndicate, 4621 Locust, Bellaire, Texas.

SAVE High fees! Patent protection for less than .50¢. Free details: "Protection"; 4105 Metropolitan, Dallas 10, Texas.

IF Your invention is adaptable to promoting we will contract for selling on cash or royalty. Free booklet outlines royalty rates, requirements. Kessler Corporation, C-511-FI, Fremont, Ohio.

INVENTORS: Save time and money. Prepare and file your own patent application. Our complete "Patent Kit" makes it easy. Includes detailed instructions and all necessary material. Only \$12.95. Money back guarantee. Don't delay. Send check or money order today to National Inventors Service, Box 88, Benjamin Franklin Station, Washington, D. C.

PATENT Searches—48 hour airmail service, \$6.00, including nearest patent copies. More than 200 registered patent attorneys have used my service. For free invention protection forms and sample patent application, write Miss Ann Hastings, P. O. Box 176, Washington 4, D. C.

QUALITY Patent searches, \$6.00. Complete Patent Office report forwarded. Free "Protection Certificate." American Patent Search Co., 422 Washington Bldg., Washington 5, D. C.

PATENT Searches, including copies of related U.S. Patents, \$6.00. Inventors, attorneys, manufacturers use my "Worldwide" airmail service. "Invention Record" form and "Information Every Inventor Needs," sent free! Miss Hayward, 1029 Vermont Ave. NW, Washington 5, D. C.

PROFESSIONAL Searches of the Patent Office. Dependable—reliable \$6.00 including airmail report and related patents. For free protection forms and "Patent Information" write Trans-World Patent Service, 500 Walker Building, Washington 5, D. C.

SAVE High fees! Prepare your patent application yourself! New "do-it-yourself" patent kit now makes it easy. Free "Registration Form." Miss Blaine, 306 Carry Building, Washington 5, D. C.

PATENT Searches, professional patent development of inventions by licensed professional patent engineer and U.S. Patent Office former examiner with staff of engineering specialists in all fields of inventions. Expert searches performed in the U.S. Patent Office. Your inventions and ideas engineered for maximum patent protection and greatest commercial value. Inventions developed by us negotiated for cash or royalties with our nationwide contacts. Send for free protection "Invention Certificates" and further interesting, valuable patent information. George Spector, Licensed Professional Patent Engineer, U.S. Patent Office Former Examiner, Woolworth Building, New York.

U.S. Patent office searches—\$5.00. Free invention record. Patents engineered. Patent Office Searchers, 233 Broadway, Room 3615, New York.

PATENT Searches including full, airmail report and closest patent copies, \$6.00. Quality searches, expertly administered. Free protection forms and "Patent Information." Write Professional Patent Office Search Bureau, 709 Albee Building, Washington 5, D. C.

INVENTIONS Introduced to manufacturers. John M. Smith, Patent Consultant, Box 1004, Richmond, California.

PATENTS Skillfully prepared for maximum commercial value, with useful product development. High record of success in proving and claiming patentability. Valuable market service. Patent prepared for a fee as low as \$200.00. Send for self-protecting record of invention forms free. Patent search with valuable engineering report \$10.00. Foreign patents filed at low cost. Thirty years established. Joseph O'Brien, Patent and Development Engineer, 132 Nassau St., New York 38, N. Y.

PATENT Searches, prompt complete \$6.00. Patent office copies of related patents airmailed. For free "Protection Forms" and "Patent Information" write to Anne Hamilton, 711 14th Street N. W., Suite 507, Washington 5, D. C.

PATENT Searches, \$6.00, including official patent office copies of related U. S. patents. Certified, airmailed! For free "Invention Record" and "Patent Information," write: United States Inventors Service Company, 1311 "G" Street NW, Washington 5, D. C.

PROFESSIONAL Patent searches, \$6.00, including official copies of related U.S. patents. Prompt, dependable airmail service! For free "Invention Record Folio" and "Information Every Inventor Should Have," write: Congress Invention Institute, 210 McKim Building, Washington 5, D. C.

INVENTORS: Test the commercial value of your patented or unpatented inventions, quickly and inexpensively. Write for free information. Institute of American Inventors, Dept. 40-B, 635-F St., N.W., Washington 4, D. C.

INVENTORS. Write for free literature "Your Inventions Are Our Business." Inventors & Manufacturers Service, 3852 First Ave., San Diego 3, Calif.

PATENTS Professionally prepared for maximum commercial value. Patent searches including report \$6. Valuable market service. Cash or royalty sales. 10 years dependable service. For free self-protective Record of Invention forms write: H. Lawrence Blasius, 19 Park Row, New York 38, N. Y.

INVENTORS! Searches of the patent office \$6.00 including airmail report, related copies. Free protection forms, "Patent Information." Washington Patent Office Search Bureau, 1426 G Street, N.W., Washington 5, D. C.

INVENTIONS WANTED

INVENTIONS Sold, licensed. Cash-royalty basis. Inventions International, Box, 560 Wall Street, New York 5, N. Y.

INVENTORS! Consider our offer first before selling or licensing your invention on a cash or royalty basis. Patented. Unpatented. Write Wall Street Invention Brokerage, 79 Wall Street, New York 5, New York.

INVENTION Engineers have manufacturers waiting for patented, unpatented inventions. Inventors Creative Service, 354 South Spring, Los Angeles 13, Calif.

INVENTIONS Wanted. Patented: unpatented. Tremendous manufacturers lists. Global Marketing Service, 2420 77th, Oakland 5, California.

INVENTORS: Hundreds of manufacturers have requested our assistance in locating marketable new products. Complete information free. Institute of American Inventors, Dept. 40-D, 635-F St. N.W., Washington 4, D. C.

SELL Your invention for cash. No commissions. Milburn, Burlington, Kentucky.

CASH Or Royalties for inventions! Consider our offer first before licensing or selling your patented or unpatented invention. Write Aladdin Industries, 80 Wall St., New York 5, N. Y.

INVENTORS! Outright cash sale or royalties for your inventions. Patented. Unpatented. Constant demand from our client manufacturers. Write: United States Invention Brokerage, 78 Wall Street, New York 5, N. Y.

INVENTORS Needing help with any problem, financial, development, securing manufacturer, obtaining patent. Write the organization that delivers action and results—not promises. Pioneer Invention Institute, 150 Broadway, New York 38, N. Y.

INVENTORS! Sell your invention for cash or royalties! Our manufacturers constantly seeking new items. Patented. Unpatented. For free information write Gilbert Adams, Patent Broker, 80 Wall Street, Financial District, New York, N. Y.

INVENTIONS Promoted-for cash-royalty sales with manufacturer contacts. George Spector, Licensed Invention Engineer, Woolworth Building, New York.

IF Your invention, patented, unpatented is for sale. Write for information #1211. Riddle Engineering, 2661 Northwood, Toledo 6, Ohio.

INVENTIONS. Do you want to sell or license your invention on cash or royalty basis. Write Kessler Corporation, C-511-IW, Fremont, Ohio.

INVENTIONS Wanted immediately. Patented; unpatented. Nationwide manufacturers listings. Metro Company, Box 151, Oak Park, Illinois.

SALES Service for your ideas, inventions. Ketchum's Invention Service, Springfield, Illinois.

PROFESSIONAL Searching, evaluating, promoting. Excellent sales outlets. Hurst, 27 School, Boston 8, Massachusetts.

PATENTS FOR SALE

SHAVING Attachment for electric shavers for trimming hairs from nostrils and ears. Pat. 2,783,533 royalty or outright. Send \$1.00 for copy of patent and complete information. Mack Wilson, 5050 Arsenal St., St. Louis 39, Mo.

MANUFACTURING

MODELS—Small lot manufacturing. Metals, plastics, etc. Milburn, Burlington, Kentucky.

MODELS—SHIPS, TRAINS, PLANES, ETC.

NEEDLE Files. 4 1/2"-set 6 shapes \$2.50 pd. Triangle, Box 109, Bayside 61, N. Y.

LIVE Steam engines. Steam pipe fittings for all engines, locomotives; valves, injectors, pressure gauges, lubricators, metals, bolts, books. 100-pages crammed full, catalog #18, \$1.00. Cole's Power Models, Ventura, Calif.

LIONEL Or American Flyer train catalog 25¢. Free discount bulletin. Hobbies, 2609 North, Chicago 47.

LIVE Steam engine casting kits, boilers, variety. Model maker's lathe, low priced, compact, motorized. Illustrated catalog 35¢. HPK Models, P.O. Box 34, Centock Station, Yonkers, N. Y.

FREE Catalogs! Big discounts on Lionel trains, toys, accessories. 50% off on new Gruen and Benrus watches. Separate wholesale price lists. Send 10¢ for postage and handling. Bargain Boys, 2606 Bergenline Avenue, Union City 7, N. J.

ROCKETS: New illustrated catalog 25¢. Single and multistage kits, cones, engines, launchers, trackers, technical information, etc. Fast service. Estes Industries, Penrose 2, Colorado.

SHIP And yacht model fittings; blueprints. Send 40¢ for illustrated catalog listing hundreds of items. A. J. Fisher, Inc., 1002-1 Etowah Ave., Royal Oak, Mich.

"POWER Drives Handbook"—36 pages illustrating many types motor drives for model autos, boats, displays, turntables, etc. Mail 25 cents cash, returnable first order \$3.00 or more. Wilson's of Cleveland, Dept. PM, P.O. Box 8995, Ft. Lauderdale, Fla.

"WHITE Heat V" radio-controlled model hydroplane featured June 1962 Popular Mechanics. Full size plans, patterns, accessories and engine available. Literature for stamped addressed envelope. Oetura Models, 8144-P No. Milwaukee Ave., Niles 48, Illinois.

STEAM Engines, tractors, boilers, castings, prints. Catalog \$1.00. Tiny Power, Junction City, Oregon.

MODEL Hobbyists! Send 10¢ for catalog. Our 70 powered model plane and boat kits, many radio-control operated, also accessories. Sterling-M, 501 Wister, Philadelphia 44, Penna.

SHIP Models. Kits, fittings, plans, boats, tools, engines, motors. Big illustrated catalog 50¢. James Bliss & Co., Dept. SM, 342 Atlantic Avenue, Boston 10, Massachusetts.

SHIP Model kits and fittings: clippers, frigates, etc. Catalog paint-tool list, book list, 35¢. Model Shipways, Box 85, Bogota, N. J.

FREE Plan for miniature steam engine included in new illustrated comprehensive Model Engineering supplies catalog; largest selection model gasoline, steam-engine casting kits; 1962 catalog 35¢. Oetura Models, 8144 Milwaukee Ave., Niles 48, Ill. Dept. PM.

LIONEL Trains. Big discounts bulletin 10¢. Catalog 25¢. Mack-Bros., 2043P, Chicago Ave., Chicago 22.

MODEL Steam engines, ready to run. Catalogue 25¢. Gun Shop, Baker, Oregon.

ENGINEERING SERVICES

INVENTION Development. Industrial research: machinery, electronics, chemistry. Specific inquiries invited. Todd Consulting Engineers, 430 West 119th, New York 27.

HOME CRAFTSMEN

VENEERS, 1/28" Thick. Send \$1.50 for two square feet each of cherry, mahogany, maple, oak and walnut. Catalog of wood-working supplies 10¢. Barap Specialties, P.O. Box 2044, Dept. P-11, Chicago 9.

SAVE: Raw picture frame moulding, knocked-down-frames, from manufacturer. Ash, poplar, walnut, cherry, mahogany. All styles. Bauerle Cabinet Works Inc., Hammond, La.

101 PATTERNS Of smart gifts, novelties, shelves, action windmills plus "Make Money Jig Sawing" \$1.00. Mastercraft, 115M 7041 Olcott, Chicago 31.

TANNED Snake skin 3¢ per square inch. Send 50¢ for sample and price list. Snake Farm, Laplace, Louisiana.

NEED Metal to finish job. Let us know thickness, type, size. Metallic Operations, Inc., Warsaw, N. Y.

BUY Picture frame moldings at wholesale. All styles and widths. Necessary tools, too. Free deliveries in U.S.A. Free 1962 catalog. Chesapeake Picture Frame Company, 414-A East Baltimore St., Baltimore 2, Md.

102 FULL Size toy, novelty, lawn patterns \$1.00. Patterns, Medway 3, Mass.

KNOCKDOWN Cedar chests, also over fifty kits. Catalog 25¢. Giles Kendall Co., Huntsville 2, Alabama.

POOL Tables. Build; repair. Plans, cushions, cloth, balls, cues, all materials available. Catalog 25¢. Campbell Billiard, 1607 W. Lawn Ave., Milwaukee 9, Wisconsin.

FREE Necklace kit with jewelry parts catalog, 25¢. Designs, kits, instructions. Big profits! Easy to make and sell! Modern Craft, Box 11088-R31, Saint Petersburg 33, Florida.

WOODWORKERS. Free information. New uses for drill press, radial arm saw. Gilmore, 1164 No. Utica, Tulsa, Okla.

PLANS For pool table with extra two-face top for table tennis and model railroad. Blueprints B1209 and building instructions \$3.50. Popular Mechanics Service Bureau, 740-M Rush St., Chicago 11, Illinois.

GRANDFATHER Clock movements, case plans, kits. Catalog 25¢. Mason-Sullivan, Osterville 7, Mass.

PICTURE Frame moulding, squares and lumber. Kiln dried walnut, cherry, silver maple. Midland Lumber Company, Box 262, Savannah, Mo.

FREE "Do-It-Yourself" leathercraft catalog. Tandy Leather Company, Box 791-A46, Fort Worth, Texas.

SKIL-CRAFTS New 62-63 catalog. Largest and finest selection of leathercraft, artist, hobbycraft supplies in the world. Free gift with first order. Send 50¢. Refundable with first order. Skil-Crafts, Box 167-P, Joplin, Missouri.

FREE! Leathercraft catalog. Hundreds of new items. Write MacPherson Bros. Leather Company, Dept. E. 730 Mission St., San Francisco 3, Calif.

WOODWORKERS—Home workshop catalog 132 pages. Save on fine woods, hardware, power tools, 25¢. Craftsman, 2719 S. Mary, Chicago 8, Ill.

FREE. New catalog. 2447 plans, patterns. World's greatest selection things to do, make. Fun. Profit. Craftplans, 18250-A, Harwood, Homewood, Ill.

WATCHES, OLD GOLD, JEWELRY

FREE Giant jewelry and gift catalog in full color. Now you can buy the finest nationally advertised brands at wholesale prices. Each item fully described and illustrated. Parker Distributors, 3516 White Plains Road, Bronx 67, N. Y.

WATCH And clock repairing books. Free catalog. North American, 2320-AY Milwaukee, Chicago 47, Illinois.

WATCHMAKERS' Tools, materials, supplies, watches. Catalog. Gales, Box 1000, Chicago 90, Ill.

WANTED, Gold, silver, platinum, scrap (any form), coins. Information free. Wilmot's, 1067 Brige St., Grand Rapids 4, Michigan.

CASH Immediately for old gold, jewelry, gold teeth, watches, diamonds, silverware, spectacles, platinum, mercury. Free information. Rose Industries, Heyworth Building, Chicago 2.

HIGHEST Cash for gold, teeth, jewelry, rings, diamonds, watches, silver, platinum. Mail articles today. Free gift with information. Chicago Gold & Precious Metals, 6 E. Monroe, Dept. 4558, Chicago 3.

FREE Watchmaking course! Details, wholesale catalogue 25¢. Bengal's, Culver City, California.

WATCHES, Jewelry, perfumes, appliances, gifts, novelties. Terrific catalog free. Department forty, 100 North Greene Street, Baltimore 1, Maryland.

DO IT YOURSELF

BROKEN Cords? 50 ft. drapery rod cord replacement kit, tension pulley. \$2.00 post-paid. Lockmiller, 14707 84th N. E., Bothell, Wash.

CREATE U.S. map 6'x4' on floor. Use 9x9 tile. Lay bricks like an expert. Use Sigl Masonry Spacers, 603 Elmwood Ave., Buffalo 22, N. Y.

COMPLETE Details and instructions for making inexpensive fire or burglar alarm system. \$1.00 each. Shafer, 727 North 22nd Street, Allentown, Penna.

RESILVER Mirrors; plate. Literature catalog 25¢. Mirrocraft, 18518 Winthrop, Detroit 35.

BUILD Your own tractor plans. Free information. Eltraco, Dept. A, Camptonville, Calif.

SUPER Directional Microphone. Picks up a whisper at great distances. Used by intelligence agents and others. Hear conversations clearly through ordinary walls a block away. Inexpensively constructed with ordinary store materials. No electronics experience knowledge or tools needed. Full simple plans mailed to you for only \$1.00. Edward A. Burns, 2302 Emporia St., Denver 8, Colo.

INSTANT Laminating; photos, cards. Self-adhesive plastic. Sample, details. Hughes Company, PM, Middletown, Conn.

EASILY Build heavy duty twin or economy single shop vacuum cleaner. Many parts from your shop. \$3.00 cash, money order, or check brings complete fully illustrated plans for 3 different units. H. Dodge, 1308 McKinney College Place, Washington.

OPERATE Own investigation agency. Make extra cash. Satellites, Box 172PM, Manhattanville Station, New York 27, N. Y.

EXERCISE At home on build-it-yourself physical fitness equipment, including bicycle exerciser, rowing machine, belt massager, and abdominal board. Send \$2.50 for blueprints B1208 and instructions. Popular Mechanics Service Bureau, 740-K Rush St., Chicago 11, Illinois.

FREE Check-list covering more than 500 classifications of projects, plans, instructions, service and repair information detailed in Popular Mechanics famous series of instructional booklets, books, patterns, and blueprints. List covers an extremely wide variety of do-it-yourself data on home remodeling, repair and improvement, hobbies, crafts, boating, games, lawn and garden, and hundreds of others. For your free copy of this helpful list, write: Service Bureau, Popular Mechanics, 575 Lexington Ave., New York 22, New York.

OF INTEREST TO WOMEN

FREE Catalog. Spanking new gifts for Christmas. Murrey's, Litchfield, Maine.

SELL Fine fabrics. Get yours wholesale. Box 863, Norwalk, Conn.

WOMEN! Make big money at home. \$10.00 profit in an hour possible with invisible mending. Make holes, tears disappear from clothing, fabrics. Steady year-round demand from cleaners, laundries, homes. Details free. Fabricon, 1533 Howard, Chicago 26, Illinois.

CANDLE Making, decorating supplies, tools, equipment, instruction. Also full line of cake decorating, candy making items. Largest selection. Lowest prices. Send 25¢ today for big new catalog, applied to first order. General Supplies, Dept. G-294, Fallbrook, Calif.

"8 MISTAKES Parents Make." Every parent should have this new book about child training. It is free; no obligation. Simply address Parents Association, Dept. 6711, Pleasant Hill, Ohio.

DIET Problems? Read: "I Eat as I Please and Control My Weight." B.O.R. \$3.00. Satisfaction guaranteed. C.O.D. accepted. Bayer Publications, P938 Betty Avenue, Neenah, Wisconsin.

PERSONAL

NEED Capital to start your own business? Write for free details. Combined Business Services, 811 North Austin, Chicago 51.

THINGS You need, wholesale. Earnest Co., 101 Pine, Laramie, Wyoming.

SENSATIONAL, Truth-revealing, 12-lesson Bible course free. Bible Class, 2318 Champa St., Denver 5, Colo.

NEED Money? Borrow \$100-\$1000 by mail. Confidential, repay in 24 months. Free loan application. World Finance Co., Dept. RW-222, 620 Symes Bldg., Denver 2, Colo.

HANDWRITING Analyzed. One dollar. Lois W. Reading, 1731 New Hampshire Ave. N.W., Washington 9, D. C.

BORROW \$100 to \$1000 by mail. Quick, easy, private. No co-signers. Repay in 24 small monthly payments. For the amount you want write today to Dial Finance Co., 410 Kilpatrick Bldg., Dept. M-1, Omaha 2, Nebraska.

BIBLE Questions answered free. Bible Research, 1819 La Posada, National City, Calif.

RECEIVE Interesting mail. Many unique offers. Your name listed 25¢. Ed. Geffner, Box 63, New York 69, New York.

YOUR Handwriting analyzed \$2.00. Complete personality sketch. Send 50 words and birthdate. Personality, Box 330, Texhoma, Oklahoma.

"LISTEN-In-Coil" picks up any telephone conversation in vicinity. No connection to telephone necessary. Easily concealed. \$2.98 complete. Acoustical Research, 512-Q East 80, NYC 21.

LARAMIE, Wyoming. Confidential address. \$3.00 month. Write: Cepr, 104 Hodgeman.

BIBLE Questions answered. Stamped envelope. Bylon, 17167 Bentler, Detroit 19, Michigan.

LOANS By mail, \$100-\$600. Anywhere. Confidential. Write Union Finance, Dept. PM, 323 E. Camelback, Phoenix, Arizona.

LOANS By Air Mail, \$100-\$600. Anywhere. Confidential. Easy payments. Write Security Finance Co., 898 Van Ness Ave., Dept. PM, San Francisco 9, Calif.

DEVELOP Mind power, personality while asleep. Details free. Research Association, Box 24-N, Olympia, Washington.

NEW! Borrow \$1000. Anywhere. Increased loan limit. Air mail service. Postal Finance, 374 New Brotherhood Building, Dept. 17-D, Kansas City, Kans.

INVESTIGATORS, Free brochure, latest subminiature electronic listening devices. 11500-P NW 7th Ave., Miami 50, Florida.

REMAILING SERVICE

CONFIDENTIAL Remailing, 25¢ each, \$3.00 monthly. Alucard, 10203P 24 SW, Seattle 66, Wash.

HAWAII Secret address. Receiving, forwarding 25¢, \$3.00 monthly. Postcards. Coe, 44-143 Bayview Haven, Kaneohe, Hawaii.

REMAILS 25¢. Answers 75¢. Neal Hendrix, 715 Curry, Springhill, Louisiana.

CALIFORNIA Remails. Secret address, \$3.00. URS, Box 53, Wilmington, California.

SECRET-Permanent address. Complete nationwide service. Remails 25¢. Remailers, PHA-14, Farr Road, Columbus 3, Georgia.

LOS ANGELES Remails 25¢, confidential. Robert Carter, Box 742, Los Angeles 53, Calif.

COWBOY, Indian remails, 25¢. Monthly, \$3.00. Postcards, stationery. The Horseshoe, Holly 15, Sioux Falls, S. Dak.

GERMANY. Rearmails \$1.00. Sorenson, 332-B-3 Perlacher Forst, Munich, Germany.

PERSONAL Letters remailed from Washington, D. C., 25¢ each. Caldwell, Box 7716, Washington 4, D. C.

HOLLYWOOD Remails 25¢. Toie House, Box 2521X, Hollywood 28, California.

REMAILING, Forwarding, permanent address. Other services. Everett, 1613 Bradley, High Point, N. C.

ST. LOUIS Remails 25¢. \$3.00 monthly. P.O. Box 9536, St. Louis 12, Mo.

CONFIDENTIAL Mail address, receiving-remailing, West, 2617-P Armacost, Los Angeles 64, Calif.

REMAILS 20¢, \$2.75 Monthly. Continental, 447 S. Woodward, Birmingham, Michigan.

FREE Literature, special services, confidential. 25¢ single, \$3.00 monthly. Write: Kenneth Fischer, Box 1207, Newark 1, New Jersey.

CONFIDENTIAL Forwarding, receiving address. Remails 25¢. Box 1890-P, Long Beach, California.

SECRET Remails from sky-blue waters 25¢. Ben-Sun, Meeting Street, Wayzata, Minn.

HOWARD'S Remailing service. Confidential. \$3.00 month. Information, Box 81, Detroit 21, Mich.

BONDED, Exclusive service. Reese, Box 144, 1114 Ortega, Carlsbad, New Mexico.

CONFIDENTIAL Address, monthly \$3.00. Remails 25¢. Other services. Inquire. Bagley's, 158-18 Riverside Drive, New York 32.

CONFIDENTIAL Southern remailings. 25¢ each, \$3 monthly. Packages 50¢. Dixie, Box 9781-M, Atlanta 19, Georgia.

LETTERS Or cards remailed, 25¢. W. Edwards, Williamstown, Missouri.

SECRET Mail address, \$3.00 monthly. Stenseth, Box 246P, Hialeah, Florida.

SWITZERLAND Rearmails \$1. E. Guillot, Mousquines 23, Lausanne, Switzerland.

CONFIDENTIAL Remailing 25¢. \$3 monthly. SCC, Box 891, Albany 7, New York.

LOS Angeles, Hollywood, San Fernando Valley 25¢ single, \$3.00 monthly. Confidential. 10437 Lanark, Sun Valley 3, Calif.

CONFIDENTIAL New York City mailing, receiving, forwarding address. Business personal mail \$3.00 month. Remails 25¢. Details free. Birnhan, 152 West 42, New York City 36.

RENO, Nevada, confidential remails, 25¢. Monthly \$3.00. Garakontie, Box 2876-A.

CHICAGO Address \$3.00 month. Details. Continental, 64 E. VanBuren, Chicago 5.

SECRET Mail address. \$3 month. Hedgpath, Box 830, Alhambra 23, California.

TREASURE FINDERS

NEW Coin locator! Free literature. Howe, 811-C Kansas, Atchison, Kansas.

EXCITING Adventure locating hidden loot, treasure, relics, etc., with powerful, electronic M-Scope locator. Lightweight. Guaranteed. Easy terms. Send for free booklet, interesting customer reports. Fisher Research, Dept. AY, Palo Alto, Calif.

BURIED Treasure and lost mine map of the United States. Over 445 authentic locations, as accurate as history allows. Size 21x33. \$1.00 postpaid. Edward M. Burns, 2302 Emporia Street, Denver 8, Colorado.

TREASURE, Gold, silver, relics. Find them with new Detectron instruments. Free information. Raytron, Box 715, North Hollywood, California.

METAL Locator kits and assembled models from \$39.90. Terms. Transistorized and underwater models available. Free catalog. Electronic Applications, Dept. M, Box 8, Arlington 10, Virginia.

GOLD, Silver, coins, Civil War relics, treasures. Choice 5 locators. Established 1933. Free literature. Write The Goldak Company, 1541 W. Glenoaks Blvd., Glendale 1, California.

TRANSISTORIZED Treasure finder locates deep buried, sunken treasures. Easily, inexpensively built without previous electronic experience. Step by step illustrated plans, details, \$2.00. Dee Designs, Box 7263-A, Houston 8, Texas.

TREASURE Guide! Treasure signs, Indian symbols, treasure map. \$1.00 postpaid. R. O. Morgan, Box 344, Inyokern, Calif.

TREASURE. Find gold, silver, relics with super, powerful, Detectron locators. Free information. Detectron, Dept. PM-11, San Gabriel, California.

WANTED—MISCELLANEOUS

CASH For used paper backed pocket books, golf and tennis balls. American Company, Merrick 7, N. Y.

STAMP Collections, accumulations. Eagle Stamp Co., 2221 Romine, Pittsburgh 26, Penna.

QUICKSILVER. Platinum, silver, gold. Ores analyzed. Wholesale Terminal, Norwood, Mass.

FOR SALE—MISCELLANEOUS

HEARING Aid batteries wholesale. Free list. Habs, Box 51, York, Penna.

WONDERFUL Gift item. Pen that fills with water, writes with real ink. A quality product, fully guaranteed, \$2.98 postpaid. Inexpensive dry ink refills available. Berg, Box 4213, Spokane 31, Wash.

CHRISTMAS Gifts for Mother? New England crisp-flavor cold storage apples. \$8.00 per bushel box delivered. MacIntosh, Baldwins, Delicious. Potkay, 299 Stratford, Bridgeport, Conn.

LADIES Tool kit. Excellent gift item sized for the woman's hand. Send for full information. White Bear Co., Dept. 392, Box 8587, White Bear Lake 10, Minn.

MISCELLANEOUS

BURGLAR Alarm devices. Complete line. Catalog \$1.00. Full details. Sootin's, 321 Northwest Third Avenue, Miami, Florida.

EARN Money raising fishworms for us! Write: Oakhaven—60, Cedar Hill, Texas.

CIGARETTES—Make 20 plain or filter-tip for 9¢. Facts free. Moberly, Box 785, Owensboro, Kentucky.

SEND Us wool for blankets. Write Eldorado Woolens, Eldorado, Texas.

WANT Your name with 1000 mailers? 25¢ lists your name year with our mailings every month. Dixie Mailers, King, N. C.

BOOKS On antiques and their prices. Free circular! P. Warman Publishers, Uniontown, Penna.

SUPER Memory overnight! Success guaranteed! Bijou, Box 1727-M, Hollywood 28, California.

AT Last! Hearing aids only \$28.95. Free trial, terms. Write Cary-B Sales, Inverness, Fla. Salesmen wanted.

KEEP Your mail box loaded. Get listed 10¢. Frankland Enterprises, P.O. Box 112, Chicago 17, Ill.

"STAMMER, Stutter, No More." (Dr. Young.) Write: Gaucho, Box 9309-S7, Chicago 90.

UNUSUAL Gifts whole family. Free catalogue. Jordan's, 743 South Dorrance St., Philadelphia 46, Pa.

FREE Wholesale catalog! 100,000 products... Tremendous discounts! Taylor Distributors, Newton 2, New Jersey.

YOUR Family Coat of Arms researched, made. Write: Roy Hicks, Alpharetta 1, Ga.

RECEIVE Worldwide mails. Lifetime 25¢. Bagby, Box 144-E, Coos Bay, Oregon.

AUSTRALIAN Novelties from kangaroo skin, cuddly Koala bears, lambswool rugs, boomerangs. Samples and catalogue \$3.00. U.S. manufacturers represented in Australia. Details to Pendle Products, P.O. Pendle Hill South, Sydney, N.S.W.

CRYST-L-CRAZE Paint for beautiful amazing crystallizing effects. Sample 10¢. Metal tooling catalog 10¢. Groundmaster, Boulder, Colorado.

FASCINATING Sellout offers: pictures. Novelties. Stamps. Giant sample assortment 30¢. Books 11 different 41¢. Persil, 436 N. Y. Ave., Brooklyn 25, N. Y.

POPULAR Mechanics readers. Library files protect your copies. Each set holds one year. Complete with date labels. 50¢ per set postpaid. Walter Ashe Radio, 1125 Pine, St. Louis 1, Missouri.

PINE Products. Early American Maine-made products available. Free circular. Pine Cone-Tassel Shop, Litchfield, Maine.

BUFFIT Polishing pads give lustrous shine to copper, brass, chrome aluminum. \$1.50 jar postpaid. Hubbard-Hall, Box 790, Waterbury, Conn.

CESSPOOLS, Septic tanks restored to newness by miracle crystal pellets. Free literature. Electric Sewer Cleaning Co., Allston 34, Mass.

GENUINE Wholesale! General merchandise, dolls, games, toys. Dime brings 48-page catalogue. Hallows, 14 Drexel, Cahokia, Illinois.

EXQUISITE Mexican feather pictures. \$2.95. Guaranteed. Edwards, 3416B Morrison. Houston 9, Texas.

FREE, Unique catalogue. Gifts; specialties; accessories; etc. Stephen Sidella, Pottsville, Pennsylvania.

"HOW To Sell Your Own Home." Booklet guides you in preparations, showing, getting buyers, negotiating. Eliminates mystery of transaction. \$1.00. Homesale, Box 136, Deerfield 5, Illinois.

AUTHENTIC Guamanian "stick" dolls made by Chamorro natives. \$2.00 postpaid. Giant African snail shell from Guam \$1.00 postpaid. Air mail money to: Guam Rehabilitation and Workshop Center, Inc., Box 2113, Agana, Guam.

FREE: Send \$1.00 for information on how you can get 1,000 valuable things free. Allen Sales, P.O. Box 47743, Los Angeles 47, Calif.

FLAG, 50 Stars, durable soft plastic 5x3 \$1.95. Viking Service, 43, Blue Point 1, N. Y.

SURVEILLANCE, Investigative equipment, bugging devices. Information guide lists wholesale and retail sources. \$3.95. Dee, Box 7263-K, Houston 8, Texas.

BEST Quality gifts. Brochure free. Horizon, Box 187-A, Brooklyn 12, N. Y.

SELLING Your home? Wealth of helpful information. \$2.00. P. O. Box 3333, Youngstown, Ohio.

SPARKLING Figurines, shellcraft for consignment. Samples 50¢ refundable. Shopper's Delight, Garden Plain, Kansas.

MAGIC Seal balloons. Trickiest invention ever. Moneymaker kit \$1.00. Rock, P.O. Box 85, Allentown, Pa.

FREE! Exciting new catalog—Western wear, saddles, riding accessories. Western Saddlery, Box 1864-V5, Fort Worth, Tex.

TOOLS WHOLESALE

SELL TOOLS to your friends and neighbors, or buy tools for your own use and **SAVE MONEY \$\$\$**. Send \$1.00 for your **WHOLESALE CATALOG TODAY!!**

A MILLION DOLLAR INVENTORY AT YOUR FINGERTIPS. NO STOCK TO CARRY. ORDER AS YOU NEED IT.

BUY AT WHOLESALE PRICES. Extra \$25.00 profit on your accumulated purchases. \$1.00 refund on first purchase or refunded if you are not 100% satisfied.

THOUSANDS!! of Nationally Advertised items of Hand Tools, Power Tools, Machinist Tools, Tool Chests, Paint Sprayers, Light Fixtures, Appliances, Guns, Gifts, Toys and other items too numerous to mention.

WE SHIP COAST TO COAST Whise. Disc. up to 50% off

Dept. PM-11 **SILVO HARDWARE CO.,** 107 Walnut St., Phila. 6, Pa.

IDEAS for HANDICRAFTERS

FREE 112 page CATALOG from **AMERICAN HANDICRAFTS CO.**

Worlds Largest Suppliers of Handicrafts
Box 1643-PM | Fort Worth 1, Texas

RUPTURED?

TEST THIS TRUSS FREE FOR 30 DAYS



Wear a Web for strong support and lasting relief of reducible inguinal rupture. If not satisfied after 30-day trial, purchase price refunded in full. Write now for free book on rupture care.

WEB TRUSS CO. Dept. PM-11, Hagerstown, Md.

MAKE \$20 to \$30 A WEEK EXTRA MONEY

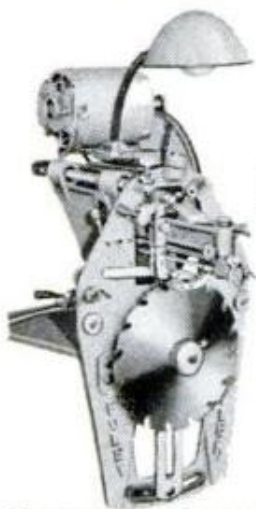

Need extra cash to keep up with the bills? Turn your spare time into dollars this fast, easy, sure way. Make \$3 to \$6 an hour sharpening saws with a Foley Automatic Saw Filer.

START IN YOUR BASEMENT OR GARAGE. Build your own business without special training or experience. "The first saw I sharpened with my Foley Filer came out 100%", writes Clarence E. Parsons. Small down payment puts a Foley Automatic Saw Filer in your hands. Pays for itself with profits. No canvassing.

Every saw you sharpen brings you more customers. Hundreds are making big money the Foley way right now. You can too.

FREE BOOK Shows You How to Start

It explains how you can get business immediately from home owners, farmers, carpenters, schools, factories, etc., and keep on getting it every week. Don't wait. Mail coupon now for "Money Making Facts" and easy pay plan details. No salesman will call.



Mail Coupon for FREE BOOK Now!

FOLEY MANUFACTURING CO.
1143-2 Foley Bldg., Minneapolis 18, Minnesota
Rush free book, "MONEY MAKING FACTS", and Easy Payment Plan details.

Name _____
Address _____
City _____ State _____

FREE! NEW CATALOG Big Savings... FAMOUS MAKES! ACCORDIONS



BUY DIRECT... at Importer-to-You Prices
...save middlemen's profits!
5 DAY FREE TRIAL!

E-Z TERMS

Low as **\$995** Down
Balance...
Just Pennies a Day

Over 30 Standard or Electronic **Models** for Students Teachers or Professional Musicians

TRADE-IN Your Old Accordion **BIG ALLOWANCE!**

SAVE UP TO 1/2 OFF RETAIL PRICES of Comparable Accordions

WORLD'S LARGEST EXCLUSIVE ACCORDION DEALER saves you more than you ever hoped possible on new famous-make Italian Accordions of your dreams! Because you buy **DIRECT... Importer-to-You... save up to 50% OFF** retail prices of comparable accordions. Compare our low prices... see and judge for yourself. Rush coupon for **FREE Color Catalogs** and low **Importer-to-You price list**. See America's most exciting selection... **over 30 models**. Exclusive features! Full range of Colors! Newest styling! Get **FREE 5-DAY PLAYING TRIAL IN YOUR HOME**. If you decide to keep instrument, pay for it only pennies a day on **E-Z terms**. 100% Satisfaction Assured. Get **FREE BONUS GIFTS** for promptness... **Free Home Study Course**. Trade-in allowance.

FREE BONUS GIFTS for promptness in ordering

- Year's Supply of Music
- Home Study Course
- Sturdy Music Stand
- Name in Chrome Letters
- Bellows Protector
- Music Portfolio

Let us prove how much more you save—thanks to our money saving **Importer-to-You** plan. You pay **NO Teacher's or Salesman's commissions**. We buy for less, save on high overhead... and pass these savings on to you. Mail coupon today for **FREE Color Catalogs** and **Importer-to-You prices**. No obligation.

ACCORDION CORPORATION OF AMERICA
Dept. R-112, 2003 West Chicago Ave., Chicago 22, Illinois

FREE Color Catalogs... Low Direct Importer-to-You Prices... Rush Coupon Now!

Accordion Corporation of America, Dept. R-112
2003 W. Chicago Ave., Chicago 22, Ill.
Rush color catalog and "Importer-to-You" prices.

Name _____
Address _____
City & Zone _____ State _____
 Check if you have instrument to trade in.

INDUSTRIAL OR TOOL ENGINEERING

BACHELOR DEGREE IN 31 MONTHS

HOME STUDY OR RESIDENT

DRAFTING ALL BRANCHES

TOOL & DIE DESIGNING & MAKING

AIR CONDITIONING HEATING & REFRIGERATION

AUTO MECHANICS

WRITE TODAY FOR FULL INFORMATION

Allied Engineering graduates are earning top money in industry and the national space program.

Engineers are always in demand! Start training now in short courses at home or at the Allied Institute, and earn your degree in 31 months.

Shorter courses available in Drafting, Tool & Die Making & Design, and Auto Mechanics. Air Conditioning Service-man's course in as short as 24 weeks.

ALLIED INSTITUTE OF TECHNOLOGY
1338-42 South Michigan Ave., Dept. PM-112, Chicago 5, Ill.

Send me without obligation information on your courses:

- | | | |
|---|---|-------------------------------------|
| <input type="checkbox"/> Drafting—All Branches | <input type="checkbox"/> Air Conditioning & Refrigeration | <input type="checkbox"/> RESIDENT |
| <input type="checkbox"/> Tool & Die Designing | <input type="checkbox"/> Auto Mechanics | <input type="checkbox"/> HOME STUDY |
| <input type="checkbox"/> Tool & Die Making | <input type="checkbox"/> Tool Engineering | |
| <input type="checkbox"/> Industrial Engineering | | |

Name..... Age.....

Address

City..... County..... State.....



Charges Hearing-Aid Battery

Nickel-cadmium hearing-aid batteries can be charged with an electric unit so they'll operate a full year. Placing the batteries in a drawer in the charger and plugging the unit into an a.c. wall outlet recharges batteries in eight hours.

Cost: about \$30. Made by the Fam Corp., 522 S. W. Fifth Ave., Portland 4, Ore.



shaw
SHOES FOR COMFORT —
in genuine KANGAROO leather

Get the comfort and long wear of genuine Kangaroo leather, in this popular conservative style by Shaw. It's one of the complete Shaw line of fine men's shoes for dress, work or casual wear. At good stores everywhere, or write us for details.



SID
Today's top value at \$11.95
other styles to \$14.95



"Over 40 Years of Quality Shoemaking"

M. T. SHAW, Inc., Coldwater, Michigan

UHF-TV GOOD OR BAD?

Ultrahigh frequency television is on the way—written into law. What will it do to your TV picture? How will it differ from your present VHF-TV in things such as range, picture quality, interference on the 70 new channels it will open? Find the answers in

**DECEMBER
POPULAR MECHANICS**

DO-IT-YOURSELF NEWS!

DAVOL RESP-R-AID MASK

T. M.

Filters Your Breathing Against
Dusts . . . Sprays . . . Pollens

Protects against common home workshop dust, non-toxic paint sprays, garden insecticides and allergy pollens.

Lightweight Resp-R-Aid has washable filter, foam cushioning, adjustable strap.

At Your Drug or Hardware Store
DAVOL RUBBER COMPANY

PROVIDENCE 2, R. I.

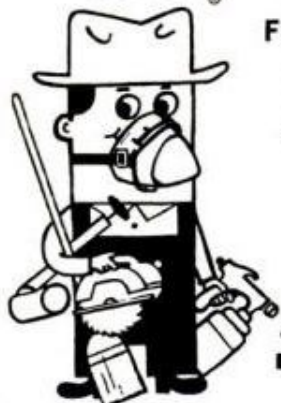

BE A REAL ESTATE BROKER



PAYS BIG! SEND FOR FREE, BIG, ILLUSTRATED CATALOG NOW! Graduates report making substantial incomes. Start and run your own business quickly. Men, women of all ages, learn easily. Course covers Sales, Property Management, Appraising, Loans, Mortgages, and related subjects. **STUDY AT HOME** or in classrooms in leading cities. Diploma awarded. Write TODAY for free book! No obligation.

Approved for World War II and Korean Veterans
WEAVER SCHOOL OF REAL ESTATE (Est. 1936)
3523H Broadway, Kansas City 11, Mo.

**FREE
BOOK
TELLS
HOW**

With only a large container for boiling water and the simplest hand tools, you can build a standard toboggan. Plans and method are featured in the December issue of Popular Mechanics



DAN LURIE WORLD'S BEST BARBELLS

Cast Iron Semi-Steel
50 lb. set— 9.48 10.48
100 lb. set—15.98 18.98
150 lb. set—23.49 27.48
Extra Wts.—16c 18c

Order by Mail. Send 50% Dep. Bal. COD **\$9.48** **FREE CATALOG**

1661-M11, Utica Ave., Dept. 259L, B'klyn 34, N. Y., Sold Everywhere

Enjoy Travel by Trailer READ...



TRAILER TOPICS MAGAZINE because it brings you all of the latest information on the pleasures of owning your own travel trailer. Discover, as thousands of others have, the fun and convenience offered you and your family through this new mode of traveling.

4-month subscription **ONLY \$1.00**
2-year subscription **ONLY \$5.00**

TRAILER TOPICS MAGAZINE

SUITE 1536, 28 E. JACKSON BLVD., CHICAGO 4, ILLINOIS

"TOOK IN \$217 FIRST 10 DAYS"

Some make more, some less...

We help you to start Your
Own All-Year Business

Make Big Money! With our easily operated, highly efficient Wall Washer, Charles Stelle took in \$217 in first ten days. E. L. Goss took in more than \$10,000 in one year. G. H. Jones wrote, "I made a net profit of \$1200 on one job." And



no wonder—this machine washes walls 6 times faster and better than by hand and with no mess—no drop cloths needed.

Your Money-Making Opportunity • We want more men to go into this profitable business for themselves and enjoy independence—freedom from layoffs and bosses. Customers everywhere—homes, offices, schools, churches, hotels, etc. How much you earn depends largely on you, but we help you to start and work with you for your success. What you take in is mostly profit. No need to rent shop or office; operate from home. Can start spare time until your full time is justified.

OURS IS NOT A LEASE ARRANGEMENT • You are free to operate in an independent manner. You sign no contract. You own the detergent outright and are always *your own boss*...and every dollar you take in is *yours* to keep. You pay no fees, or dues, or royalties to anyone. And you take no risk. Your detergent is fully guaranteed and enough supplies come with it to return far more than your investment. Many earn the cost of the detergent in a week or two. It costs nothing to get the details...write TODAY.

Lose No Time—Send Coupon Today for All the Facts

FREE BOOK! MAIL COUPON TODAY!

• **VON SCHRADER MFG. CO.**
• E10 "W" Pl., Racine, Wisconsin

• Send at once (no obligation) your **FREE** booklet containing information about your **WALL WASHING MACHINE** and how I can start my own permanent, profitable business.

• Name _____

• Address _____

• City _____ Zone _____ State _____

A PERFECT HOLIDAY GIFT

IDEA (Rocket Viewer can be worn with glasses. Keeps both hands free.)

A precision stereoscopic magnifier complete with 3 interchangeable lense strengths. Ideal for: Hobbyists, Doctors, Chemists, Artists, Dentists, Machinists, etc. Standard Unbreakable Watch Crystals, 123 E. 144 St., N.Y. 51, N.Y.



\$12.50

NOW! COPPER SWEAT JOINTS
THE EASY WAY!

SWIF SOLDER

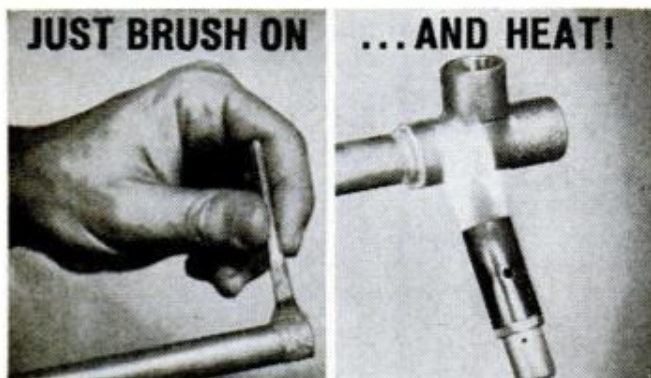

Make perfect leak-proof sweat joints every time with Hercules SWIF Solder, the real 50/50 tin-lead solder pre-mixed with flux in easy-to-use paste form. Save time and money, too. Just brush on, join, and heat for neat, strong joints. SWIF solders all common metals (except aluminum) and works with a torch, soldering iron, or soldering gun. This grade available in economical 4 oz., 1/2 lb., 1 lb., and 3 lb. cans at your plumbing supply or hardware dealer. See for yourself how easy any soldering job is when you use SWIF. WRITE FOR FREE TRIAL SAMPLE and a do-it-yourself soldering folder.



Hercules Chemical Co., Inc., 416 B'way N.Y. 13
SWIF—the solder featured in the Otto Bernz Plumbing Kits

WHAT'S YOUR DO-IT-YOURSELF PROBLEM? Free Service File lists, by subject, all projects in Popular Mechanics books, booklets, plans and patterns. Write Service Bureau, Popular Mechanics, 740 Rush St., Chicago 11, Ill.



'I'll Give You the Secrets FREE'

**HOW YOU CAN CASH IN
ON THE EXPLODING
PLASTICS INDUSTRY**

Space Technology Break-thru has developed new Plastic Materials, Processes and Methods. Now you can Fabricate, Mold, Shape, Laminate and Form new Plastic Materials with hundreds of wanted and needed Glamour Items at HOME! My New, easy-to-learn methods put you in high-profit Plastics Business overnight! Start small—grow big—I'll pave the way for you. Use my money. I'll set you up—help sell your products at good prices. guide you every step of the way and virtually pay you for your Spare Time. Stop wasting Time—get your share of the easy money available now in the BOOMING Plastics Business. HOME PRODUCERS needed desperately everywhere NOW! Send for FREE "No Selling Plan" Booklet and all the complete exciting details of this amazing new Home Business. Learn the hidden secrets of how YOU can cash in quickly on the Exploding Plastics Industry TODAY!

Air Mail for Quick Reply

Mr. William (Bud) Williams, Pres.,
Nationwide Plastics Co., Dept. P-11
Box 23321, Los Angeles 23, California

I want to make money FAST in my spare time.
Mail me FREE your "NO SELLING PLAN" Booklet.

Name:..... Age:.....

Address:.....

City:..... Zone:..... State:.....

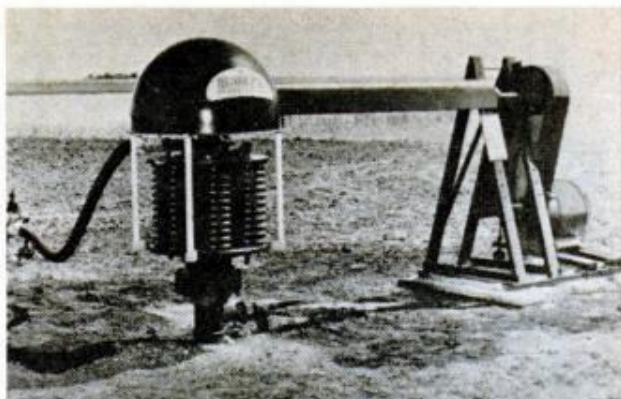

Sound Way to Pump Oil

Employing the principles of harmonics, a new pump for oil, gas and water operates by vibrating a string of tubing in such a manner that valves installed in the tubing collars will lift the fluid to the surface.

The pump is being marketed for wells with tubing lengths of 400 to 4000 feet.

The tubing, vibrated by an oscillator, allows fluid from below to pass through on the down stroke; on the up stroke, the valves close and through accelerated action of tubing, fluid is impelled upward at a high rate.

The pump is normally operated between 600 to 1200 strokes (pumping cycles) per minute. It is made by Johnson Testers, Inc., Houston, Tex.

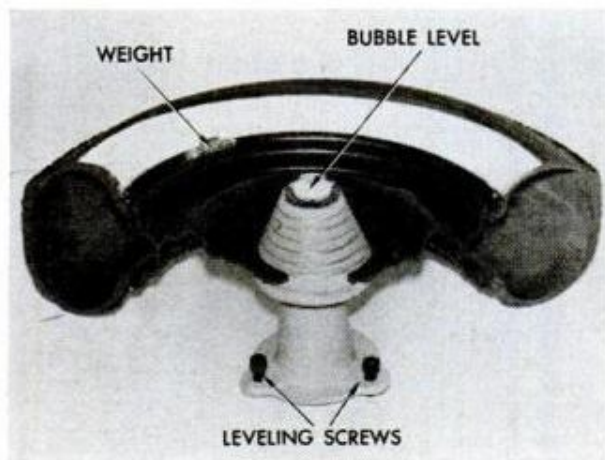

Low-Cost Wheel Balancer

Compact, precision-made and inexpensive, the Jacobsen Wheel Balancer is a mighty handy instrument for do-it-yourself car repairers, owners of small garages and service stations, and fleet operators. The cast aluminum balancer weighs only two pounds and stands but eight inches high. Its five-inch diameter base has two leveling screws and no special skill is required to use it. The unit statically balances most auto wheels and comes with an optional adapter for VW rims. Sold in auto supply stores, or direct from the maker (Jacobsen Mfg., 15029 Pacific Highway South, Seattle 88, Wash.) for \$14.95.

POPULAR MECHANICS

ONLY AC PUTS AN EXTENDED SHELL ON EXTENDED-TIP SPARK PLUGS FOR LONGER LIFE AND BETTER ENGINE PERFORMANCE

If your car uses extended-tip spark plugs, remember that *only* AC combines extended-tip with extended-shell design. This exclusive design combination permits insulator and tip to extend farther into the firing chamber for maximum combustion. It also protects them from excessive heat blasts which can cause pre-ignition. ACs have a further advantage in that the extended shell makes possible a shorter, sturdier ground electrode that wears away more slowly. Proper gap size is maintained longer. This reduces power-robbing misfire to give fast, sure starts with clean-burning, full-firing performance. AC makes both extended-tip and regular-tip spark plugs. Next time you change, ask for ACtion . . . ask for AC and get the spark plug engineered especially for your car.



AC SPARK PLUG  THE ELECTRONICS DIVISION OF GENERAL MOTORS

WHEN THE ROAD ENDS...



All nature is yours to explore when you take along a HONDA Trail "50"—the trail machine that needs no trail!

The Trail "50" is virtually indestructible and maintenance-free, yet so compact and light (121 lbs.) it'll fit on a car bumper with a simple attachment—or in a station wagon, camper, trailer or small boat. Super-powerful low gear ratio of 82 to 1! Speeds to 30 m.p.h., with quick-change sprocket for 45 m.p.h. touring! Powered by Honda's famous 50 cc 4-cycle O. H. V. engine!

For name of nearest dealer, phone Western Union and ask for OPERATOR 25.



HONDA
TRAIL "50"
only
\$275

plus destination and setup charge

HONDA

World's Largest Motorcycle Manufacturer

AMERICAN HONDA MOTOR CO., INC. Dept. PM62-11
P. O. Box 65816, Los Angeles 65 Calif.

Please send free literature on HONDA TRAIL "50" to:

NAME _____

STREET _____

CITY _____ ZONE _____ STATE _____

- Include information on the complete Honda "50" line.
 Include information on Honda motorcycle line (9 models, 125 to 305 cc).
 I am interested in dealer franchise information.

Synthetic Skin Grafts

Synthetic tissues made of orlon or nylon may soon replace human flesh-and-blood organs which have been injured or destroyed.

Artificial corneas developed by Dr. William Stone, Massachusetts Eye and Ear Infirmary, have been successfully transplanted into the eyes of rabbits where they were tolerated for five years. A similar operation, performed on rhesus monkeys, resulted in the corneas being tolerated for two years. "There is no overgrowth of tissues," says the report, and sight has been restored to the animals. This new method of implanting artificial organs will be next attempted on blind human volunteers.

Another new type of skin graft is being developed at the University of Padua, Italy, by Prof. G. Dogo. Skin is removed from the body and sustained in a material whose temperature is lower than that of the body. These skin grafts lasted for three months, whereas the normal skin grafts persisted for only 25 days.

An Old Favorite With a New Twist

In grandpa's day the prop on a windmill weather vane was nothing more than a whittled stick. Today the whirring prop is an eight-bladed affair which spins like crazy. It's made by inserting eight vanes cut from a metal Venetian-blind slat in a hardwood hub. The metal vanes are forced into saw cuts made in the hub at a 60-degree angle and cemented in place. Saw cuts are spaced equally by means of a paper pattern folded as indicated in the detail. The natural curvature of the metal blind give the blades an air scoop which makes the prop spin in the slightest breeze. The tail part of the weather vane is cut from a 3/4-in. board as detailed.—P. Casperson

Fish Prefer Prefabs

Fish prefer to live in prefabricated concrete shelters rather than sunken junk such as wrecked streetcars, boats and rock piles, say sea scientists. In an attempt to create better fishing in barren waters, marine biologists are making use of fish's preference for expensive housing.

Artificial reefs have been strung along the coasts of New Jersey, Delaware, North Carolina, Florida, Texas and California to lure fish into these waters. These reefs look like large inverted concrete boxes with circular windows for the fish to pass through.



PERFECT CIRCLE PISTON RINGS ARE INSTALLED AS ORIGINAL
FACTORY EQUIPMENT IN 95 BRANDS OF VEHICLES AND ENGINES

WHY THE "PROS" PREFER PERFECT CIRCLE PISTON RINGS

The superior craftsmanship that goes into Perfect Circle piston rings pays off in long lasting oil control. Leading vehicle and engine manufacturers, race drivers, fleet operators and mechanics the world over have proved it in billions of miles of use.

Perfect Circle oil rings are plated with thick, solid chrome to protect them against wear. Uniformly applied tension is additional assurance of extended, positive oil control. Special design provides straight-through drainage which resists clogging. And, Perfect Circle rings are made to a standard of precision that's measured in millionths of an inch.

To bring back the oil control and power your engine delivered when it was new, visit your Doctor of Motors—your skilled mechanic. He'll respect your judgment when you ask for the rings the "pros" prefer—Perfect Circle.



PERFECT  CIRCLE

PISTON RINGS • PRECISION CASTINGS • SPEEDOSTAT
ELECTRONIC PROGRAMING EQUIPMENT
HAGERSTOWN, INDIANA • DON MILLS, ONTARIO, CANADA

**THE DOCTOR
OF MOTORS—**
your skilled mechanic
—is the "pro" to
see to get superior
Perfect Circle
performance





By Jim Whipple



Chrysler's Five-Year 50,000-Mile Warranty — How Will It Work?

Chrysler Corporation has come up with what we think is the greatest aid to automobile ownership since time payments. All buyers of 1963 Chrysler Corporation cars and trucks will receive a five-year or 50,000-mile warranty covering principal components of engine and power train. Only items excluded will be clutches and components of the fuel, electrical and exhaust systems.

Already nicknamed "5-50," the new warranty plan provides that if any part in engine, transmission, driveshaft or rear axle (yes, even a sticky valve lifter or growling rear end gear), shall malfunction (that's Chrysler's word for fail), it will be replaced at no cost for either the part or labor.

Some of the parts included under the 5-50 warranty are oil pumps, valves, camshafts, waterpumps. Not included are ignition parts, carburetors, fuel pumps, distributors, generators, voltage regulators and radiators. The 5-50 warranty will be added to the 12-month, 12,000-mile warranty now in effect. The 5-50 applies in Canada too.

For guaranteeing you freedom from major breakdown expense for five years, Chrysler Corporation asks relatively little in return—no more, in fact, than the periodic maintenance that almost all of us intend to give our cars. The only difference is that before Chrysler Corporation will replace your Plymouth's engine or transmission for nothing, they will simply require you to guarantee that you've faithfully completed some simple service operations.

Here's how it will work: each '63 Chrysler product will have a warranty book of Car Care Certificates imprinted with the car's serial number. In addition to the certificates, there are blanks for the owner to fill out recording the periodic 4000-mile or two-month oil change intervals. These blanks are basically for owner convenience.

The life of the warranty is based on the Car Care Certificates which are to be filled out by the authorized Chrysler-Plymouth or Dodge dealer (service manager), countersigned by owner and sent to Detroit.

This certifies to Chrysler Corporation that the car has been inspected and properly serviced at initial 1000 and 4000 mile intervals, and at the sixth month of owner-

ship and every six months thereafter. These checkups, paid for by the owner, are just good maintenance practice and include oil change, oil and air filter changes, plus checkup and filling of automatic transmission, rear axle, etc.

Cost of the six-month checkup should average about \$12 throughout the U.S. according to Chrysler executives. The certificate mailed to Detroit will include not only checkoff of the required service but date and mileage at the time of inspection.

If an owner should neglect to get his certificate of inspection and maintenance, signed and mailed in, his 5-50 warranty will be voided. How will they know he missed? The certification will be recorded on a punch card coded to the serial number of his car.

This means that for about \$25 a year—money that would probably be spent on maintenance anyway—Chrysler will give you 5 years or 50,000 miles of driving free of major repair expenses.

It sounded so good that we felt there must be a catch or gimmick. So we questioned Chrysler's VP in charge of quality control, Harry E. Chesebrough, and learned that the warranty's key phrase limiting coverage to cars "properly used and maintained," simply means that a car that has suffered a part failure through obvious physical abuse (you drove it through a guard rail, for instance) will be voided according to the best judgment of the dealer.

We learned also that the 5-50 warranty is transferable even though the car is resold by a non-Chrysler Corporation dealer as long as the original warranty book is with the car and has been kept up to date. The second or third owner need only have the book re-registered with a Chrysler Corporation dealer and he's covered until the specified time and miles run out.

Chrysler Corporation is betting heavily on their own product because they have tried it out under the rules laid down by the warranty.

Starting right now, as the first '63 Plymouths, Valiants, Dodges and Chryslers take to the road, the jury is out. Within a year or so, we should begin to hear the verdict.

from **ALLIED**

EASY-TO-BUILD *knight-kit* ELECTRONIC MARVELS!



mounts on steering column or dash

Now! Drive As the Experts Do!
amazing **ELECTRONIC TACHOMETER KIT**

ONLY
\$21⁹⁵

\$5 per month

- Reads 0-8000 rpm; 3% Full-Scale Accuracy
- Zener Diode Regulation for High Stability
- 20,000 Ohm Hi-Z Input—No High Voltage Loss
- Transistor Circuit

Auto and power-boat experts agree that for best fuel economy, lower engine wear and peak performance, an accurate tachometer is a "must." Here's your best "tach" value. Registers engine speed in rpm—electronically! Transistorized switching and zener diode regulation; 3% accuracy; illuminated dial; adjustable red pointer. No ignition wiring required. For 1-8 cyl., 2-cycle or 1-16 cyl., 4-cycle engines using ignition coil and distributor—9.32 VDC; for magneto and 6-VDC Systems with external 9 v. battery (not supplied; below). Available in positive-ground and negative-ground models (most late-model American cars are neg. ground). With all cables, universal mounting base, tension strap, easy assembly instructions. 4 7/8 x 3 1/4 x 3 7/8". Shpg. wt., 4 lbs.

- 83 Y 944DJ. For Neg. Ground Systems.
83 Y 980DJ. For Pos. Ground Systems. Each . . . \$21⁹⁵
83 Y 909. 9-V Battery & Accessories. \$1.50

**BUILD YOUR OWN
WALKIE-TALKIE!
ALL-NEW
knight-kit
ALL-TRANSISTOR
TRANSCIVER**



101 USES
Outdoors & Indoors



C-100 WALKIE-TALKIE KIT **LOWEST KIT PRICE EVER**

- Talk to Neighbors, Family & Friends Up to 1/4 Mile Away
- Works Up to 75 Hours on Just One Battery—Weighs 9 Ounces
- No License, Exam, Permit, Age Limit—Anyone Can Use It!

\$9⁹⁵
EACH

Here's the 2-way Knight-Kit everyone wants! In a few fun-packed hours you'll have this 3-transistor beauty assembled and ready for reliable, on-the-move communication. The C-100 is great for camping, hunting, boating, picnic outings, or just talking to friends in your neighborhood. You'll find new uses for this exciting walkie-talkie every day. Just press the push-to-talk button and you're "on the air" (built-in 2" speaker also serves as mike). Release button to listen. Fits your hand snugly—only 5 1/2 x 2 7/8 x 1 3/4". Operates up to 75 hours on low-cost cell. With 40" telescoping whip antenna. Includes high-impact Caribbean blue case, parts, wire, solder, easy instructions. Less carrying case and battery. Wt. 9 oz. Buy two for a matched 2-way system!

- 83 Y 804DJ. C-100 Walkie-Talkie Kit, only \$9⁹⁵
83 Y 013. Leatherette Carrying Case. 98c
83 Y 002. 9-Volt Battery. 21c

**satisfaction guaranteed
or your money back**

NO MONEY DOWN! Now!
More Buying Power with
your Allied Credit Fund Plan

manufactured by
KNIGHT ELECTRONICS CORP.
A DIVISION OF
ALLIED RADIO

ALLIED RADIO

100 N. Western Ave., Chicago 80, Ill.

Ship me the following:

- C-100 Walkie-Talkie Kit (s) 83 Y 804DJ
 - Carrying Case 83 Y 013
 - 9-Volt Battery 83 Y 002
- Tach for Neg. Ground Systems 83 Y 944DJ
- Tach for Pos. Ground Systems 83 Y 980DJ
 - Ship No Money Down on Allied's Credit Fund Plan
 - \$ enclosed (check) (money order)

Name _____
PLEASE PRINT

Address _____

City _____ Zone _____ State _____

**ORDER
TODAY**

New Credit Customers Only:
Send name and address present employer, how long employed, position, monthly salary; rent or own home, how long at present address; give age (21 minimum for credit account).

Triple- Hull Dirigible

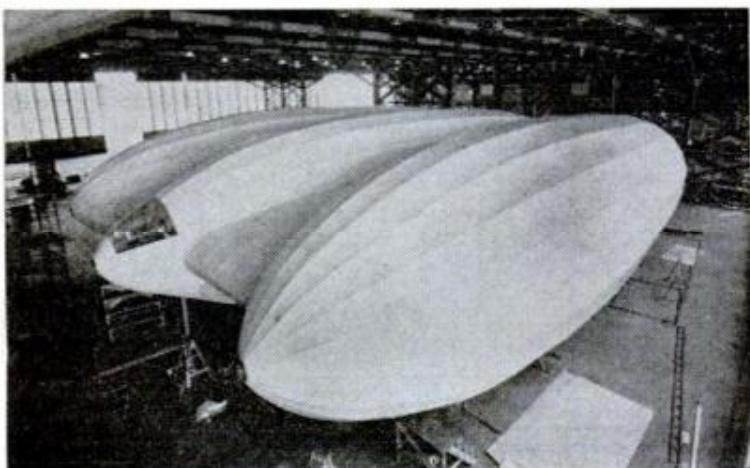
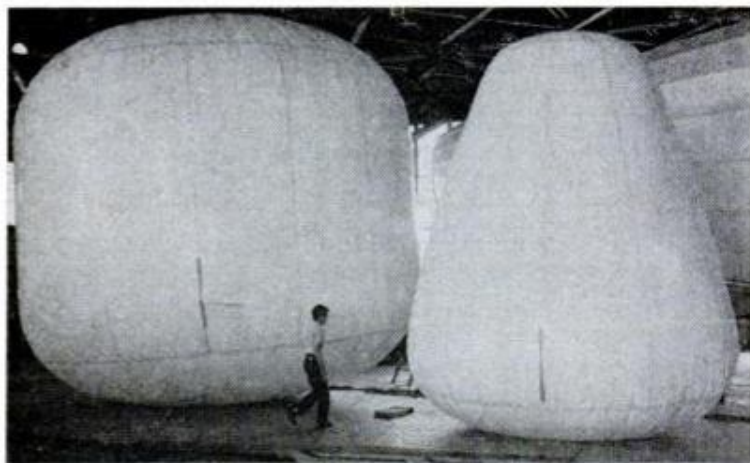
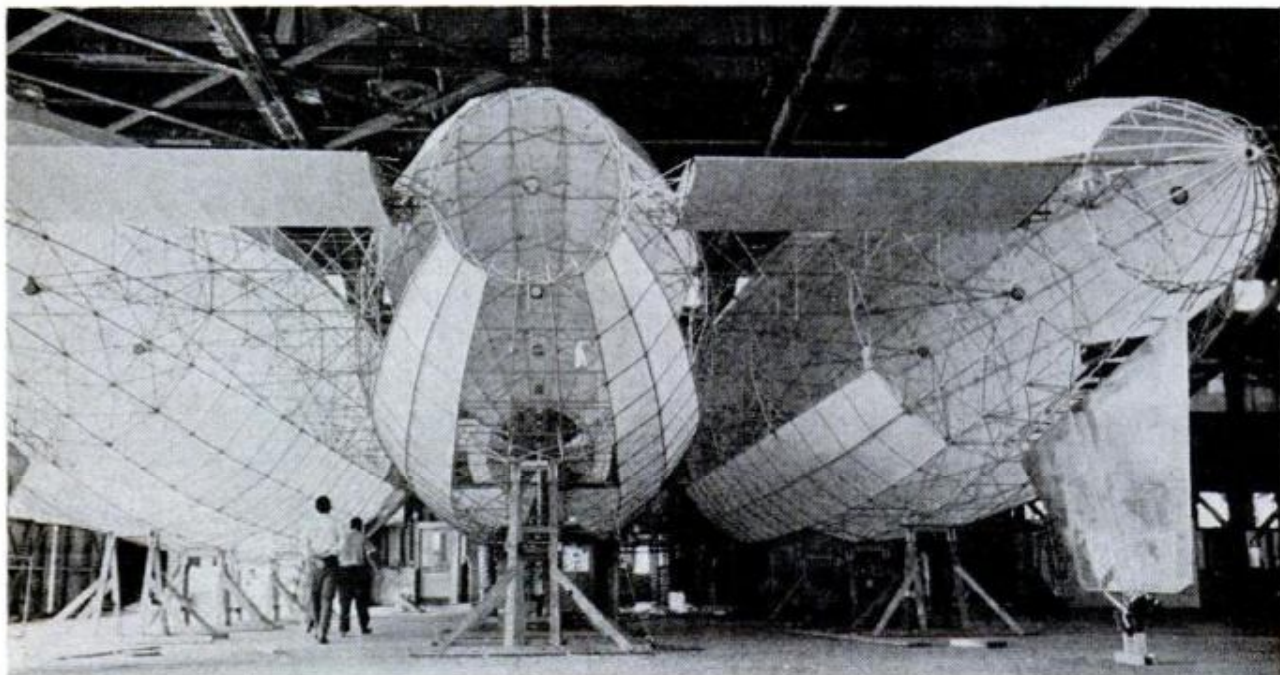
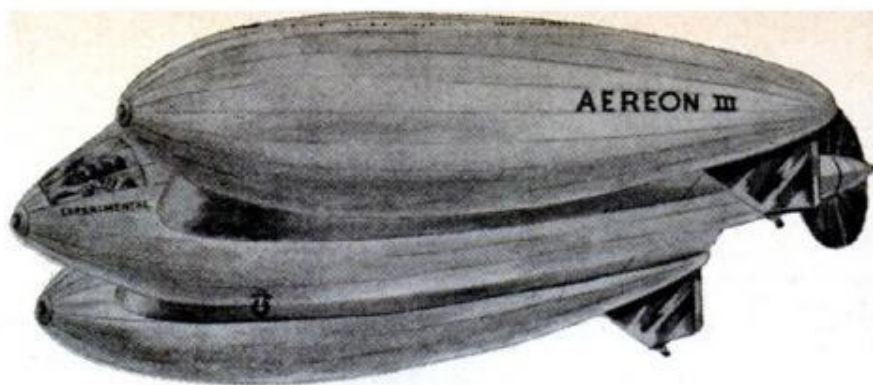

LIKE LAZARUS, the dirigible is rising from the grave.

Declared obsolete by all but the die-hards, the lighter-than-air ship may get new life from a test model put together by a group in Trenton, N. J.

Featuring three hulls and a host of other new and unusual ideas, the Aereon III may be the forerunner of a new fleet of cargo and passenger dirigibles.

It will get lift from aerodynamic forces (stubby wings between the hulls) as well as from helium bags in the hulls. It will get power from almost any kind of small engine.

It will land and take off from the ground, rather than from mooring masts, improving ground-handling characteristics. It will use helicopter rotor blades instead of propellers which, along with tail control surfaces, will improve maneuverability.

Most important, however, it will control ascent and descent by heating and cooling the helium, rather than dumping ballast or bleeding gas as in old dirigibles.

IDAHO WHITE
PINE

PONDEROSA
PINE

LODGEPOLE
PINE

SUGAR PINE

LARCH

WHITE FIR

DOUGLAS FIR

ENGELMANN
SPRUCE

RED CEDAR

INCENSE
CEDAR



Get ideas from this **FREE** booklet (available *now* at your building supply dealer's). Add to your home's value, increase its livability with attractive, practical built-ins. Here are easily-followed construction plans for many ways to increase the useful space within your house . . . room dividers, under-the stairway units, closet suggestions and many others. If your dealer is unable to supply you with this booklet, send 10c to the address below.

Western Pine Region Solid Lumber will add both beauty and value to your project . . . and these woods are a joy to work with . . . the world's best for sawing, shaping, sanding and finishing.

WESTERN PINE ASSOCIATION
Dept. M-11 Yeon Bldg., Portland 4, Oregon

Quality Graded Lumber

Shopping for tools

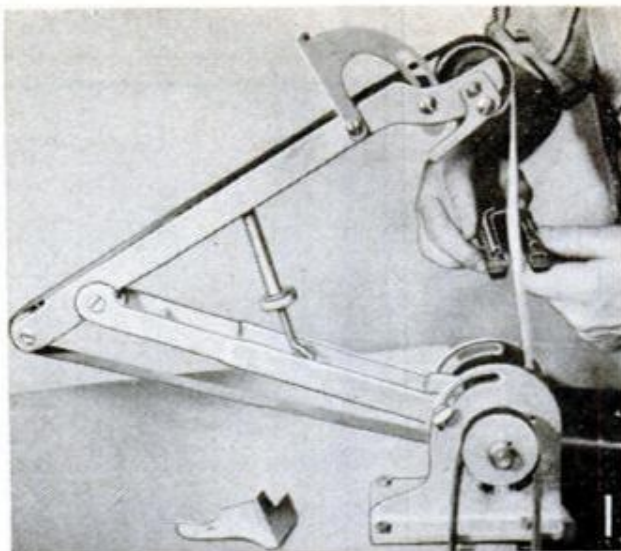

1. HIGH-SPEED SANDER has a narrow belt for getting into places on small, irregular workpieces that you can't reach with other belt sanders. Uses endless abrasive belt 1 in. wide and 40 to 50 in. long, for deburring, forming, polishing, contouring, grinding and lapping on wood, metals, ceramics. Price \$34.95. D & G Products Co., 339 Arden Ave., Glendale, Calif.

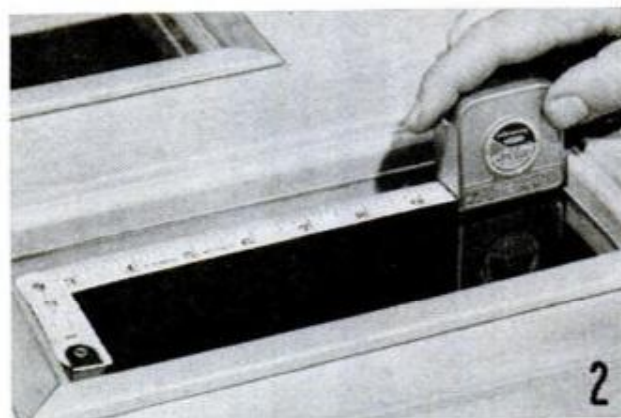

2. STEEL-TAPE RULE has 2-in. section at end that folds right or left, to compensate exactly for case width when measuring inside of openings. Eliminates error by enabling user to read exact opening size at point where rule leaves case without adding case width to measurement. Comes in 10, 12, 16-ft. lengths. H. K. Porter Co., Inc., Disston Div., Pittsburgh 19, Pa.

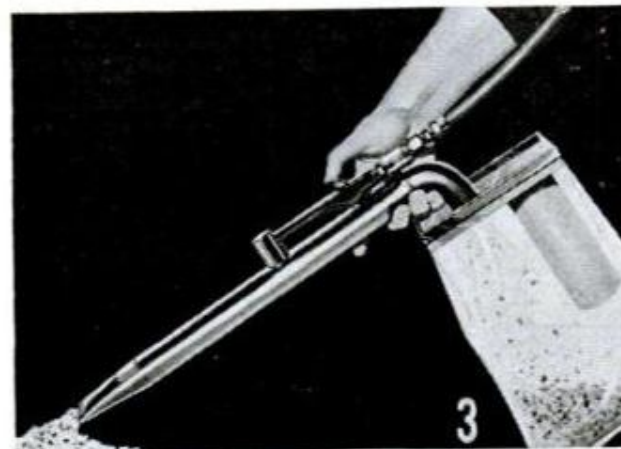

3. INDUSTRIAL VACUUM attaches to any shop air line, picks up wet or dry metal chips, dirt, dust and dry waste from floors and machines. Especially useful in reclaiming precious metal chips. Chips are collected in waterproof, leakproof, disposable plastic bag. One-hand operation, unit weighs 2 lbs. Price \$29.95. The Mettler Corp., 360 N. Michigan Ave., Chicago 1

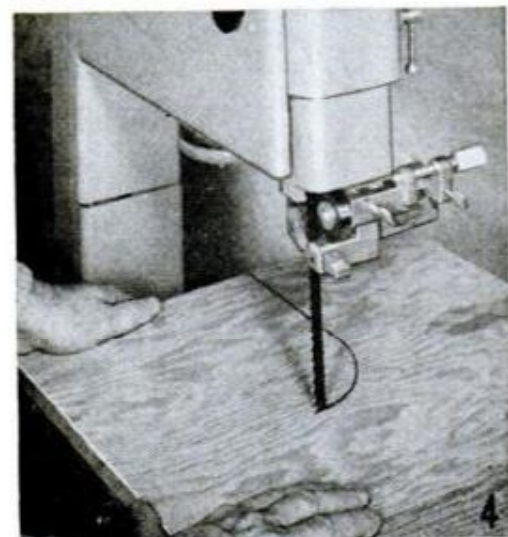

4. BANDSAW BLADE has skip tooth, each tooth having a positive rake, or hook. Compare tooth shapes A and B, the latter detail showing the new hooked tooth with 10-degree rake angle. Faster cutting, reduced feed pressures result, requiring less power and better dissipation of heat. Cuts metal or wood. Boice-Crane Co., 943 W. Central Ave., Toledo 6, Ohio



5. NEW MICROMETER has been designed to eliminate person-to-person variations when taking close measurements. Has a friction sleeve which turns freely only at a predetermined pressure, thus eliminating need to "feel" for the correct pressure. Has slanted barrel graduations for easier, more accurate reading. Brown & Sharpe Mfg. Co., Providence 1, R. I.



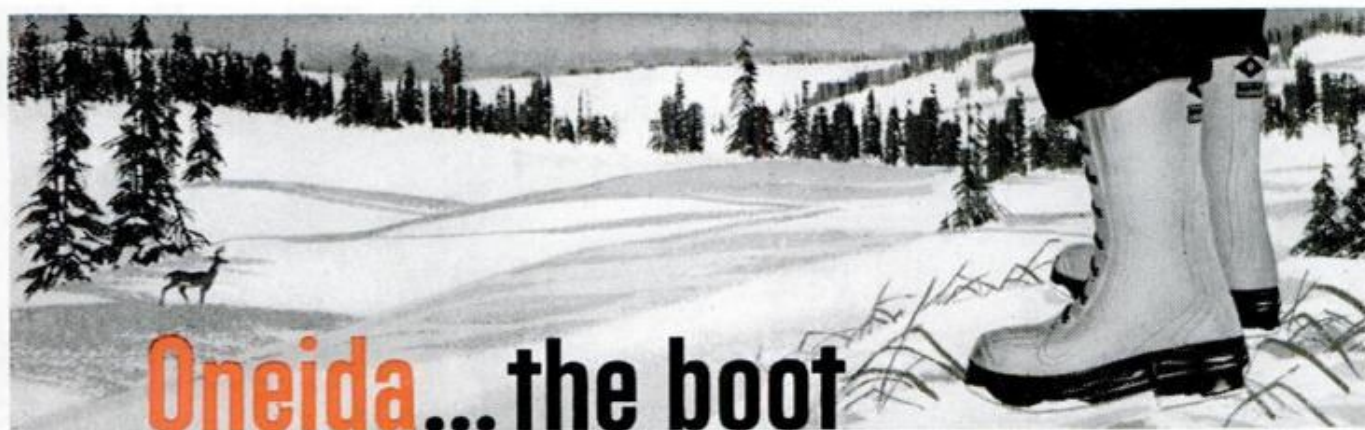

Oneida... the boot

with all 8 field proven features

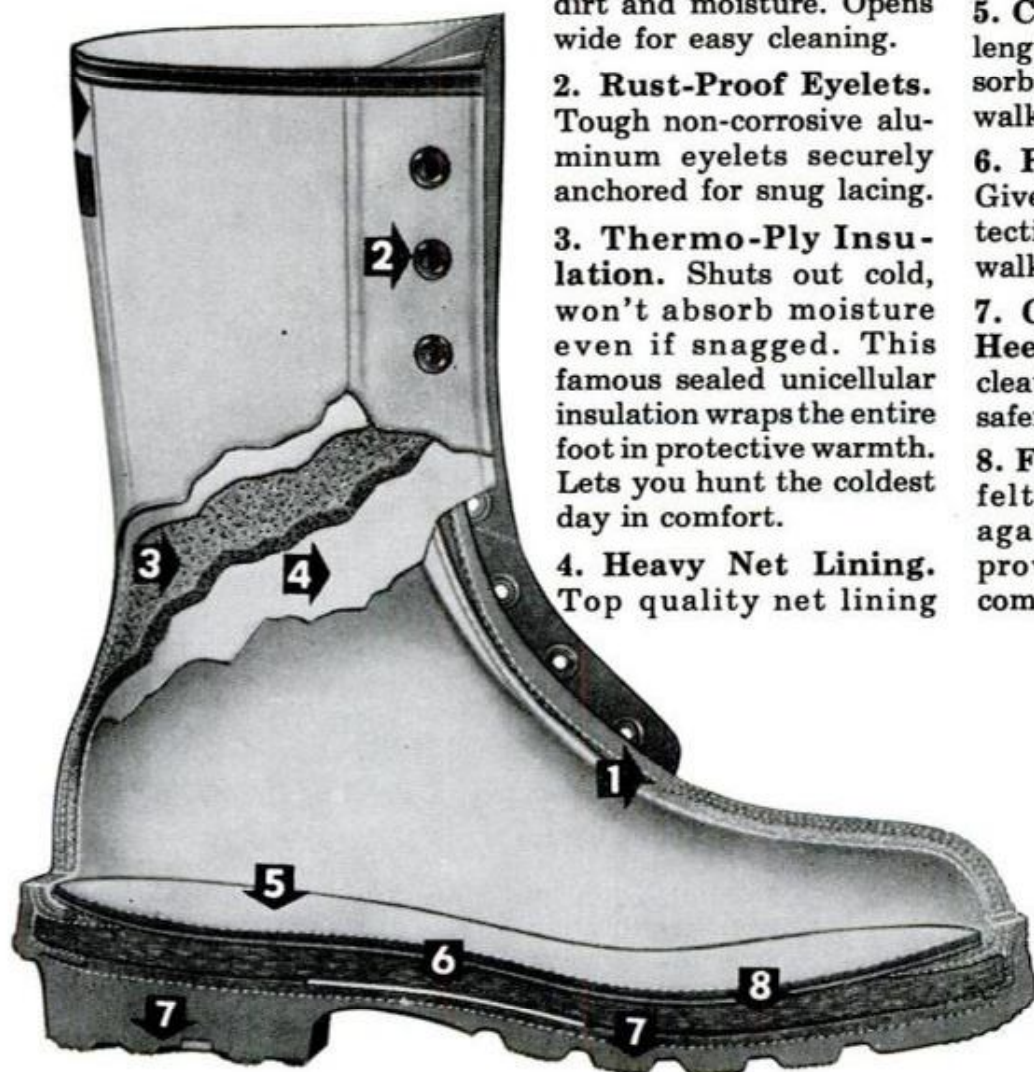

1. Self Cleaning Gusset. Prevents trapping of dirt and moisture. Opens wide for easy cleaning.

2. Rust-Proof Eyelets. Tough non-corrosive aluminum eyelets securely anchored for snug lacing.

3. Thermo-Ply Insulation. Shuts out cold, won't absorb moisture even if snagged. This famous sealed unicellular insulation wraps the entire foot in protective warmth. Lets you hunt the coldest day in comfort.

4. Heavy Net Lining. Top quality net lining

wears and wears, never loosens.

5. Cushion Insole. Full-length cushion insole absorbs shock, gives all-day walking comfort.

6. Rigid Steel Plate. Gives extra support, protection at arch for all-day walking comfort.

7. Cleated Sole and Heel. Husky sharp-edged cleats give better traction, safer footing, longer wear.

8. Felt Mid-Sole. Thick felt mid-sole insulates against frozen ground, provides maximum foot comfort.

New! Hunting Guide Book. Packed with useful information to help you get more hunting enjoyment. Get your copy now at your Red Ball Footwear dealers or write: Ball-Band, Mishawaka, Ind. Enclose 10¢ to cover handling, mailing.



Red Ball Oneida
for sportsmen

by Ball-Band, Mishawaka, Indiana

NOW— FOR '63 PICKUPS UN



Only Ford offers so many *different kinds* of pickups . . . so many body styles, capacities and power choices to custom-fit *your* pickup needs!



NEW FORD FALCON PICKUPS

For doing a job in style, Ford's Ranchero is in a class by itself! In styling, comfort, handling ease and economy, it's a '63 Falcon car. For work, a sturdy 6-ft. pickup with 800 lbs. capacity. Great for business, perfect for personal transportation.



NEW FORD STYLESIDE PICKUPS

Solid comfort in the cab, solid truck underneath. Built like big trucks for greater durability . . . Ford conventional pickups use the same type of axles, frame, springs you'll find in big trucks. 6½, 8, 9-ft. bodies; GVW's up to 7,800 lbs. Flareside bodies, too.

LIMITED FROM FORD!



NEW FORD ECONOLINE PICKUPS

No other pickup offers you such a combination of capacity and economy! Ford's Econoline takes payloads over $\frac{3}{4}$ ton in its big, easy-to-load 7-ft. box. And, thanks primarily to its thrifty Falcon engine, it can cut operating costs \$100 in a 16,000-mile year.



NEW IDEA! A "COVERED PICKUP"

Ford's new Econoline Van gives you 204 cu. ft. of loadspace under lock and cover. Big 4-ft. door openings at side and rear (both sides if you like) make loading practically as easy as in a pickup. All at a price below some open pickup prices!

FORD TRUCKS

For Outstanding Reliability & Durability

PRODUCTS OF  MOTOR COMPANY



**Pall Mall's
natural mildness
is so good
to your taste!**



*You can light
either end!*

**So smooth, so satisfying,
so downright smokeable!**

*For flavor and enjoyment you just can't beat
Pall Mall's natural mildness. It's so good
to your taste. Never too strong. Never too
weak. Always just right! Enjoy satisfying
flavor... so friendly to your taste.*

Outstanding... and they are Mild!

© A.T. Co. Product of The American Tobacco Company "Tobacco is our middle name"

COMPARE ALL THREE!

Regular

Filter-Tip

PALL MALL

Smoke "traveled" through fine tobacco tastes best. Pall Mall's famous length travels and gentles the smoke naturally... over, under, around and through the finest tobaccos money can buy. Makes it mild... but does not filter out that satisfying flavor!

Материал, защищенный авторскими правами

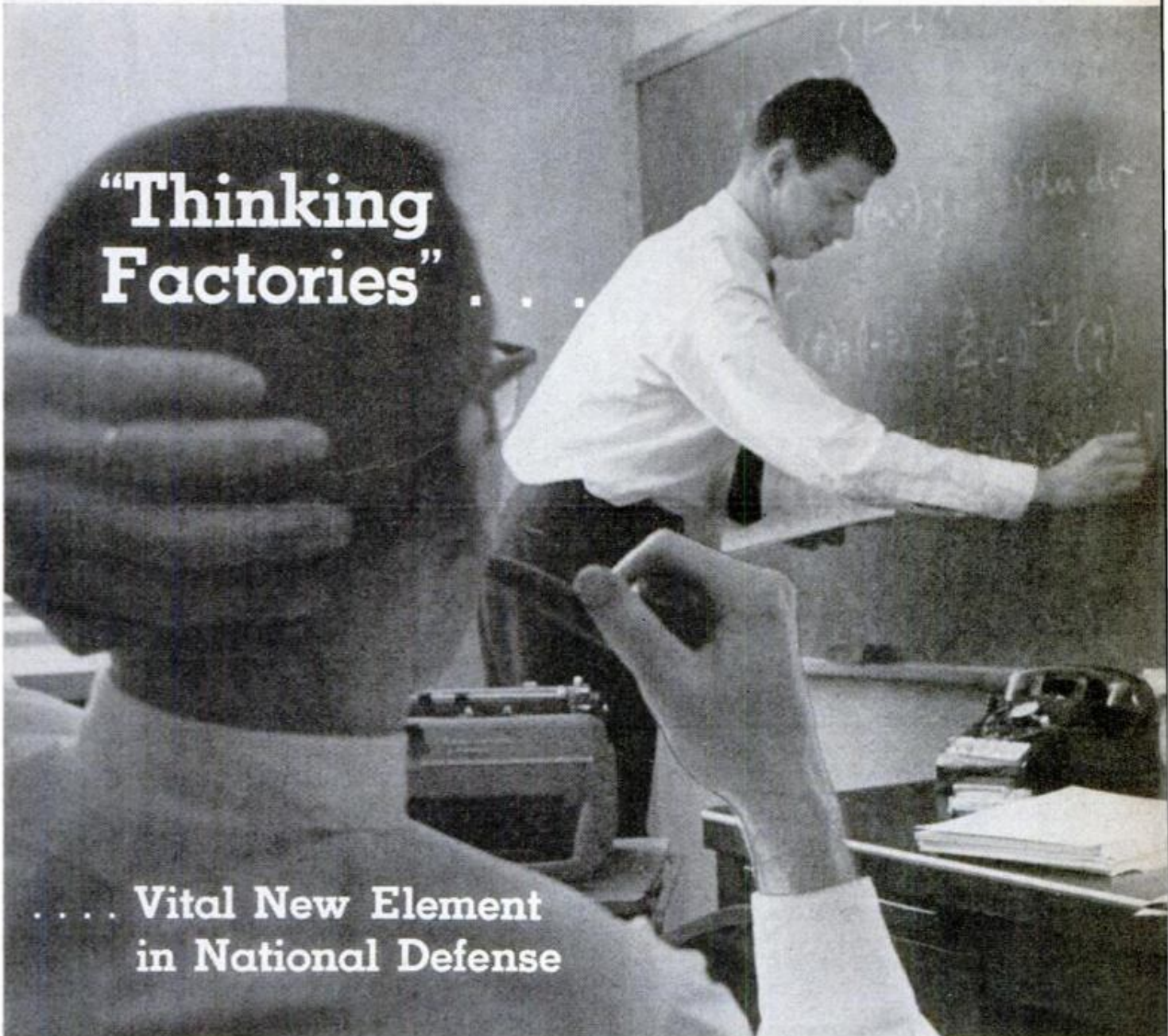

**“Thinking
Factories”**

**. . . . Vital New Element
in National Defense**

CIVILIAN ‘OPSEARCHERS’ use slide rules, blackboards and brains to find solutions to military problems

The opsearchers’ tools are slide rules, mathematical equations and “queuing theories”; their product is sharp advice

**By
S. David
Pursglove**

WHEREVER A U.S. NAVY fleet cruises, standing on the flagship bridge beside the admiral is an American civilian scientist. If the fleet makes a diplomatic port call, “our scientist aboard” suffers through the reception line. If the fleet engages an enemy, he braves the same dangers faced by the crew.

When U.S. Army troops land on foreign shores, many of their moves

Day in Life of Navy Opsearcher. . . .



DR. LEON POCINKI (right), analyst for Navy force, studies aircraft fueling operation, one of many he must understand



RADAR SCANNING is next. How close will subs get before operator sounds the alert?

are planned by unsung civilian scientists. If bullets are to be ducked, these scientists must duck their share. Whenever GIs maneuver in field exercises, these same civilians are right beside them, slogging through mud and eating at field kitchens.

These are a new breed of men, called operations analysts. They work for operations research firms—often dubbed “thinking factories” or “advice mills.” They advise Pentagon planners and military commanders on long-range strategy and short-range tactics. They help plan the defense of the United States against missile attack. They show commanders how to decide when a damaged or worn Jeep should be repaired and when it should be junked, and how to make chow lines move faster. They try to determine scientifically what world conditions will be like in 1975 so we can begin our long-range weapons research now. They study the problems that confront Special Forces advisers on guerrilla fighting in Southeast Asia and turn up ways of doing better jobs with limited manpower.

Today, when the Pentagon has problems that need thought, thinking factories tackle them. Critics charge that the mathematicians, physicists, sociologists, economists and other scientists in the ranks of operations research are trying to replace military commanders and substitute equations for

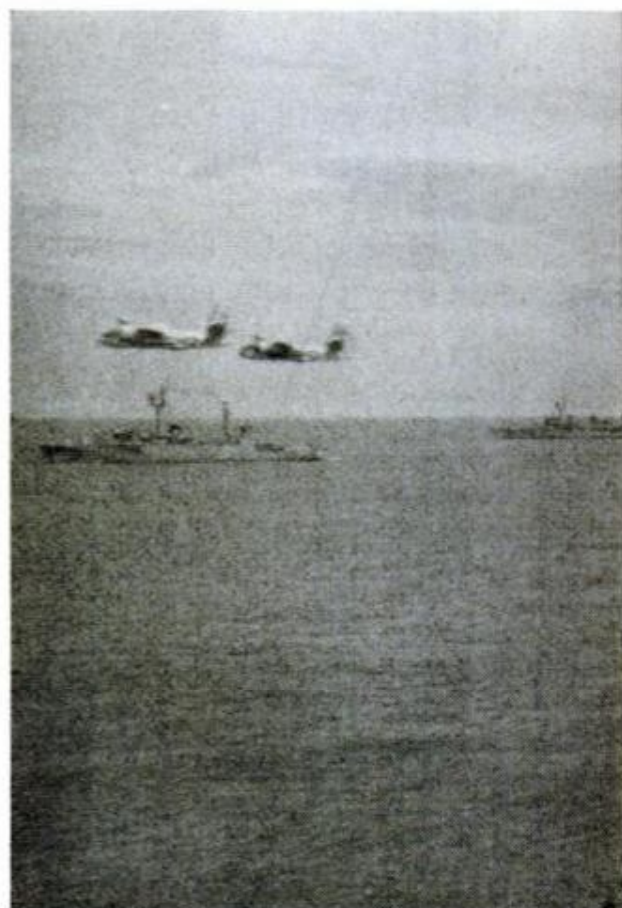

Studies Each Operation, Forms Plan



WAR GAMES begin. Analyst (above) checks maneuvering planes, subs, destroyers (below); computes results of exercise; produces data from which a rough plan is formulated for task force commander (top right)

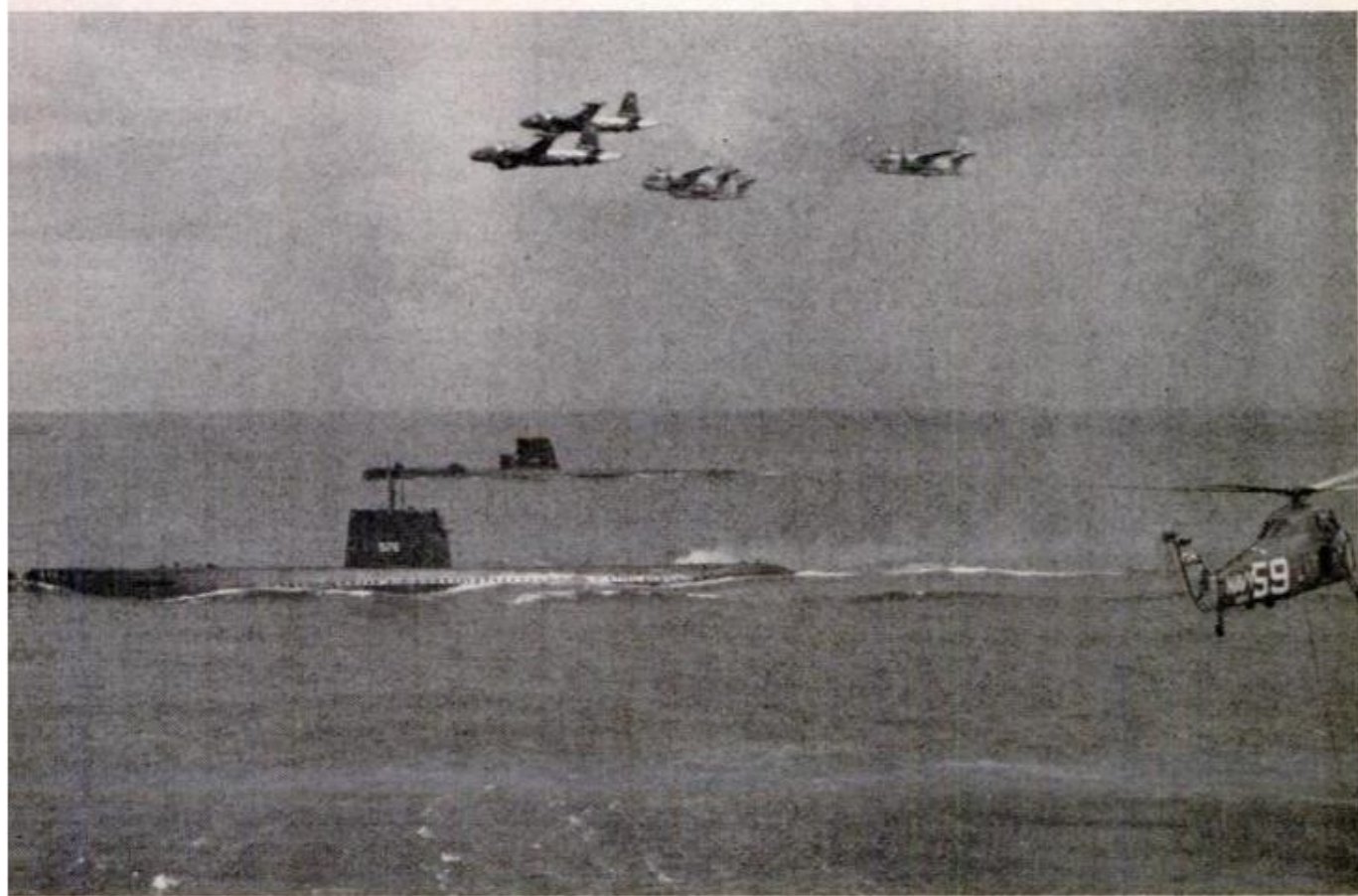

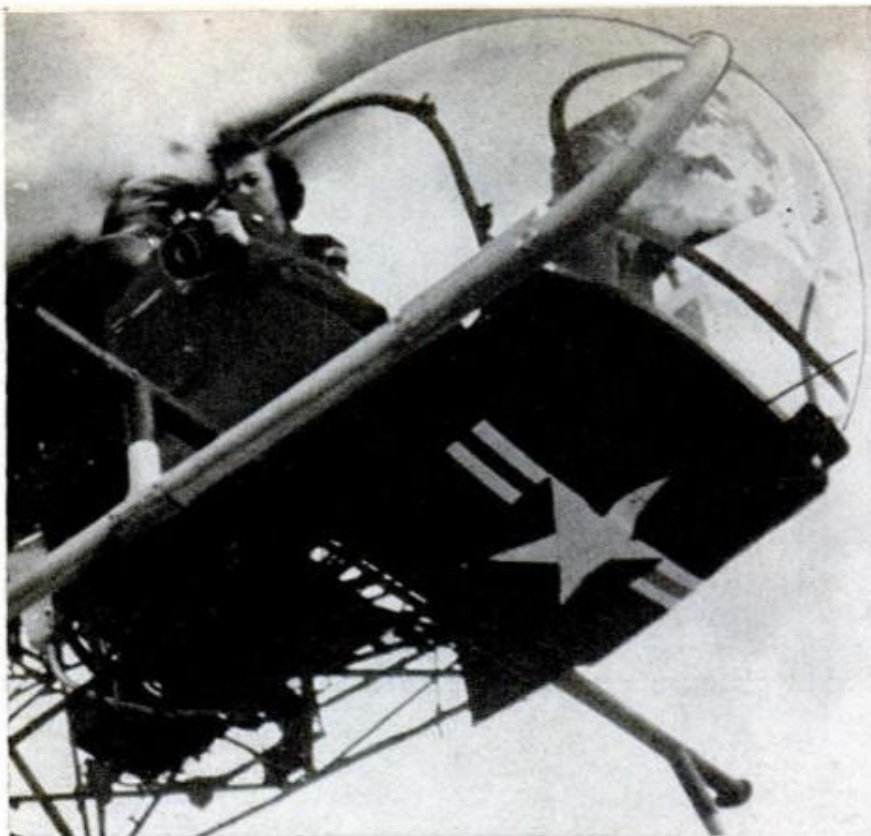

WOMEN, TOO! They travel same route, take same chances as men. Here, female opsearcher leans from helicopter to take aerial photos. Army needs to know at what altitudes pictures will show tanks, people

NORTH KOREAN surrenders, waving safe-conduct pass designed by opsearchers. Early in Korean Conflict, Army was advised that Red soldiers would defect if offered food, safety, rather than promise of vote

human judgment. The fastest rebuttal comes from the military men themselves. They point out simply that the thinking factories are saving lives and money by bringing fresh and analytical points of view to bear on military problems.

Field Marshal Sir William J. Slim, post-war chief of the British General Staff and World War II leader of the offensive in Burma, told a military planning meeting in London that, when he had asked commanders after certain operations what they had achieved, the answers were that "We have not achieved very much, but we have gained a lot of experience." The field marshal's reaction: "It struck me that the application of a little scientific method to finding out the answers is a much more efficient and quicker way than going off and risking several thousand men."

The thinking factories are applying that scientific method—not to make decisions themselves, but to produce factual data that helps their military bosses make better decisions.

Their principal tool is *operations research*, the term they have selected to cover the use of laboratory research methods in studying operations. The traditional five laboratory steps are used:

Observation of the operation and determination of the questions to be answered, preferably questions rephrased to ask "How much?"

Model formulation—or formulation of an

equation that represents on paper the exact way the operation has been observed.

Derivation of a theory that applies to the operation under all conditions—even conditions not yet encountered but which may someday face a commander.

Verification of the theory sometimes by testing it against conditions programmed into a computer, but preferably actually in the field.

Making conclusions and communicating recommendations—the most important step since the whole effort is wasted if recommendations do not reach people who can act upon them, or if the conclusions cannot be expressed in terms that the non-scientist officer can understand.

Almost every problem can be boiled down to a choice between alternatives. When World War II convoy commanders asked, "What is the best way for me to protect my convoy?" what they really meant was "Should I place my escort ships in a nice tight ring around the convoy, or should I move them farther away from the convoy so they can intercept enemy submarines earlier?"

When operations researchers actually tackled this problem, they observed that too many precious escort ships were being wasted. They were guarding the rears of convoys that often moved faster than submarines; U-boats usually could not attack from the rear. Moving those escorts to the forward two-thirds of the protective ring in effect gave convoy commanders 30 per-



cent more escort ships plus efficiency.

Escorts deployed *near* the convoy, analysts pointed out, could be closer together and keep submarines from sneaking between them. However, the scientists added, tight deployment would allow U-boats to approach close enough to launch torpedoes. When the escorts were deployed far enough away to intercept submarines outside of torpedo range, then the gaps between escorts would be so large that U-boats could sneak through.

Equations vs Wolf Pack

Navy men then planned to deploy their escorts at a "happy medium" arrived at by intuition. Operations researchers, though, gathered data on convoy speeds, submarine speeds, detection distances and response time to detection. They converted what naval intelligence knew about German U-boat tactics to mathematical values. They rode convoys to examine first-hand the chances for mechanical failures and human errors and assigned mathematical values to these chances. The results showed convoy commanders the best deployment of escort ships under almost all possible circumstances. Hitler's U-boat massacre of Allied convoys ended abruptly.

Most convoy commanders followed the analysts' advice closely, but Navy headquarters did not require them to. The chair-borne Navy in Washington was leery of letting civilians advise officers. It would not allow the antisubmarine warfare man-

ual based on the studies to be issued until it had been rewritten several times and all the "musts" had been removed.

Captain (later vice-admiral) Wilder D. Baker who organized the antisubmarine operations researchers was not allowed to give the "mere civilians" the classified data that they needed for their studies (but they did manage to get the data). He could not bring them into the main navy building, but had to hide them three blocks away in a dangerously creaking World War I temporary building. Getting them into the submarine room required subterfuges that might have placed Capt. Baker—and his civilians—before a firing squad had they been discovered in those days.

Today, nobody is really certain what all the fuss was about. "It was a security consciousness that surely must have failed if spies ever tested it," recalls one grinning operations analyst. "I left my office headed for a meeting one day with a brief case jammed full of the most highly classified data. Despite my vigorous protests that absolutely nobody was to see the contents, a Marine guard demanded that I open the case. He rifled quickly through the documents and waved me through the gate, remarking to his armed partner, 'It's okay, there aren't any blueprints in there.'"

By 1945, when the war ended, Fleet Admiral Ernest J. King and Navy Secretary James Forrestal were deeply impressed with the results that could be produced by rank-free scientists working at all com-



FRONT-LINE OPSEARCHERS (with binoculars) help machine-gun team in Korea find the best method of fire

mand levels. They persuaded the Massachusetts Institute of Technology to organize the group as its own. The Navy then contracted for its services and arranged quarters in the Pentagon. It became the first of the private operations research groups to do some of the Pentagon's thinking.

The Navy had reasons for wanting civilians rather than science-trained naval officers. The "opsearcher" must be free to seek information at all levels; talk with recruits and argue with admirals. They must be outside of the chain of command to escape pressures on their thinking and to avoid interfering administrative duties. They must be inquiring and skeptical rather than doctrine-oriented. Navy officers themselves admit that they are essentially links in a command chain and they cannot spend a substantial part of their time doing the *doubting* that is necessary to objective study.

Now called Operations Evaluation Group (OEG), the close-knit team numbers somewhat less than 200 persons, mostly scientists. OEG believes that its small size helps the all-important informality. Instead of growing larger to handle newer types of problems that the Navy faces, OEG this

year transferred its contract from MIT to a new Center of Naval Analysis organized by the Franklin Institute of Philadelphia. Under the Center's direction, OEG continues Navy contract work on the problems that it knows best, while the larger group takes on new types.

OEG keeps about 30 percent of its scientists in the field. Two are with each fleet—usually one at fleet headquarters or on the flagship, and one with an operating force. Others are with special units. They help local commanders solve immediate problems and they gather data on long-range problems under study in Washington. However, their biggest job in the field is to familiarize themselves with every aspect of Navy operations. How does a crew fuel a carrier jet fighter? Where in the operation can accidents happen and how often? Analysts need this information—converted to mathematical values—to make their equations realistic.

If a Navy aviator crashes at sea, a troubled fleet commander will turn to his OEG analyst and ask anxiously, "What are the chances of rescuing him?" What he really means is, "At this moment, what is the best of the many alternative ways of trying to

(Continued on page 204)

Ford Builds A Bomb THE MUSTANG

Ford engineers borrow
Cardinal's V4 engine and
driveline to make a
1500 cc sports car
with potentially
winning ways

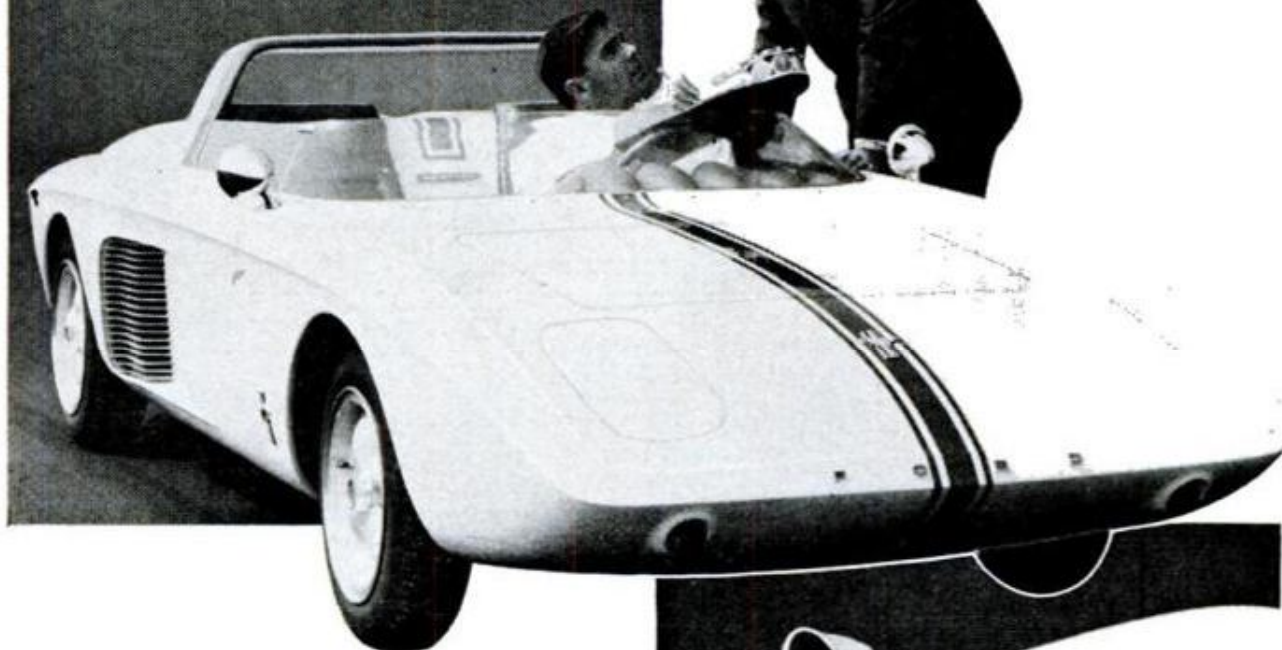

WITH ITS EXPERIMENTAL Mustang Ford Motor Company makes a tentative bid to fill the vacuum between the Go-Karts and the Corvette, up to now the sole examples of true competition sports cars in mass production in the U. S.

The Mustang is not in production at present and it exists only in prototype form, hand-built of .060-inch aluminum sheet on a steel tube framework. What makes it possible to visualize mass production of this "trial horse" at a competitive price is the fact that it utilizes both the 60° V4 engine and the transaxle unit of what would have been Ford's front-drive Cardinal which is now being manufactured by Ford of Germany as its new Taunus M-12.

As installed in the Cardinal (or Taunus), Ford's little overhead-valve V4 has a bore of 3.15 inches and an unusually short stroke of 2.3 inches. Total displacement is 73 cubic inches (1183 cubic centimeters) and with a conservative 7.8-to-1 compression ratio, horsepower developed is 50 at 5000 r.p.m., while torque is 57.7 ft. lbs.

By enlarging the bore from 3.15 to 3.54 on the Mustang version, Ford engineers have



MUSTANG'S COCKPIT is compact and complete with real bucket seats. Controls in center console to rear of shift lever are: horn button, turn signal and choke

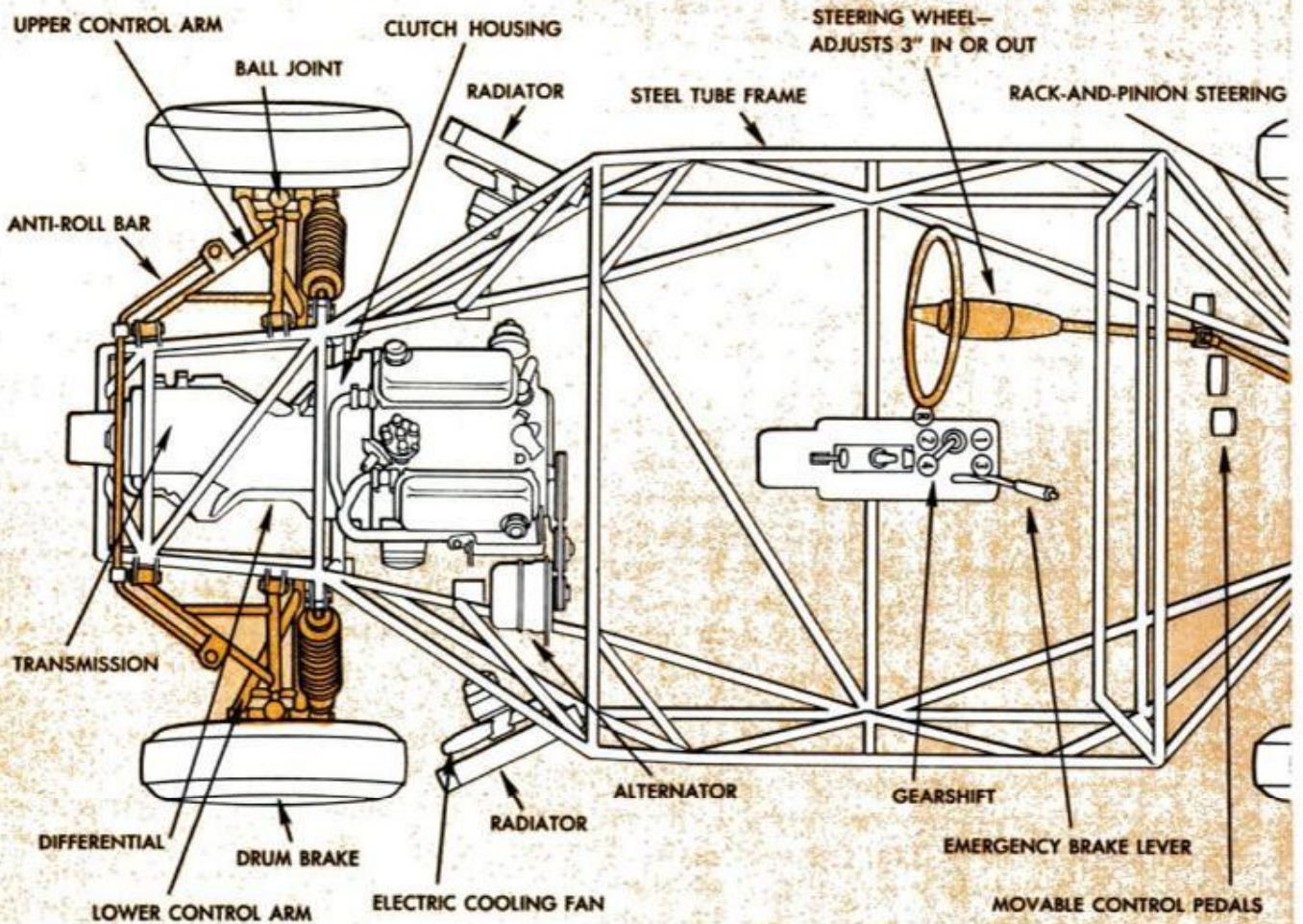

STEEL TUBES for the skeletal space frame of Mustang, in plan view above, to which aluminum body panels are fastened. Component parts of steering and suspension system are outlined in solid color. Cross-section from rear of chassis, top right, shows U-jointed swing axles which make possible the independent suspension. Chart at right compares Mustang with two other sports cars with which it will compete

raised displacement to 91 cubic inches or 1462 cc. This jumps compression to a hot 11-to-1 and output is raised to 106 horsepower at 6500 r.p.m. with torque up to 96 ft. lbs. These figures are with a racing-type two-barrel Weber carburetor.

For road use, Mustang will be equipped with a single-barrel carburetor which drops output to 90 horsepower and 89.5 ft. lbs. of torque.

With its 1500 (1.5 litre) displacement, Ford's sleek sports car is designed to compete in FIA category 9 (SCCA Class G).

With curb weight estimated at 1450 lbs., the Mustang will be more than competitive in performance with the popular imports in its class (see chart) as its power-to-weight ratio works out to around 10 or 12 pounds per horsepower. If it lives up to its blueprints it should be hot as a two-dollar pistol.

Mustang's chassis is patterned on the most advanced race car designs. Its engine is mounted ahead of the rear axle and drives through a transaxle and swing half shafts to independently suspended rear

[\(Continued on page 228\)](#)

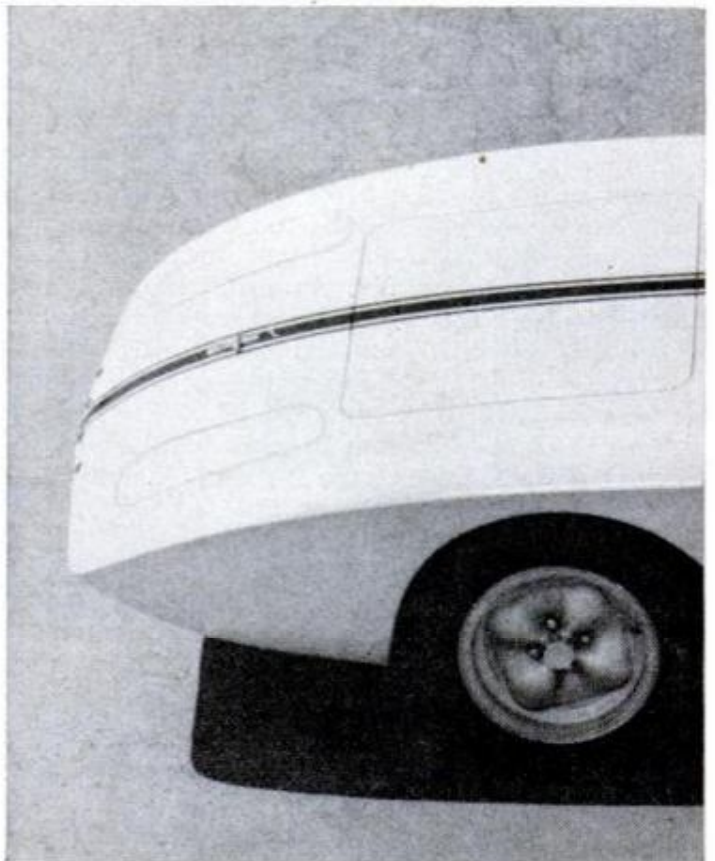

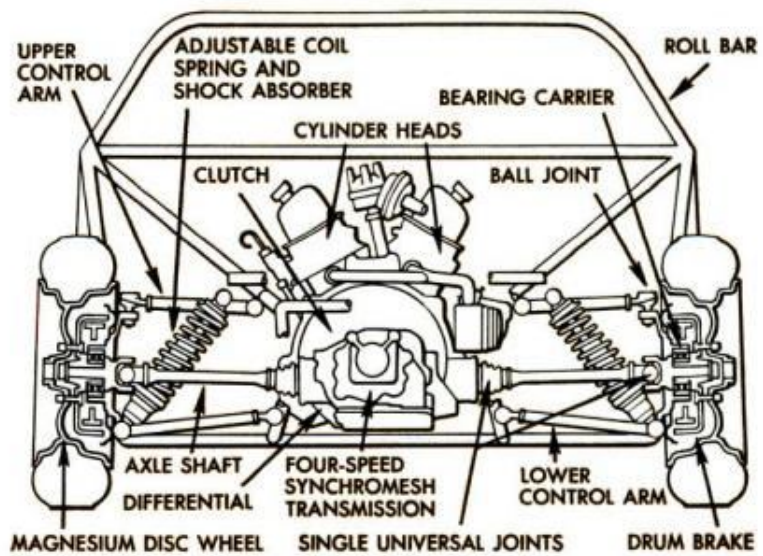
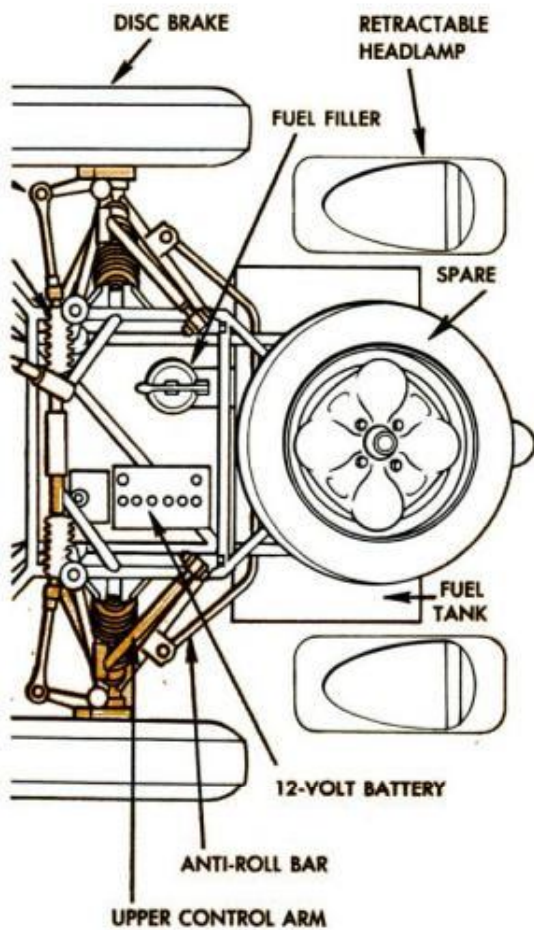

COMPARISON VEHICLE SPECIFICATIONS			
Make Model	MG 1600 Mark II	Sunbeam Alpine Mark II	Ford Mustang
Wheelbase	94.0	86.0	90.0
Tread, Front	47.5	51.2	48.0
Tread, Rear	48.8	48.7	49.0
Length	156.0	155.2	154.2
Width	58.0	60.5	61.0
Height	50.0	51.7	39.2 (a)
Displacement	1622 cc	1592 cc	1500 cc
Gross HP/RPM	93/5600	85/5000	106.5/6500
Torque/RPM	97/4000	94/3800	96/5200
Tire Size	5.60-15	5.90-13	5.00-13
Seating Capacity	2	2	2
Curb Weight	2050	2150	1450 (b)
P.O.E. Price	2444	2595	NA
Top Speed	105	100	108
Standing ¼ Mile	18.7 sec.	19.3 sec.	NA

(a) Over roll bar (b) Estimated

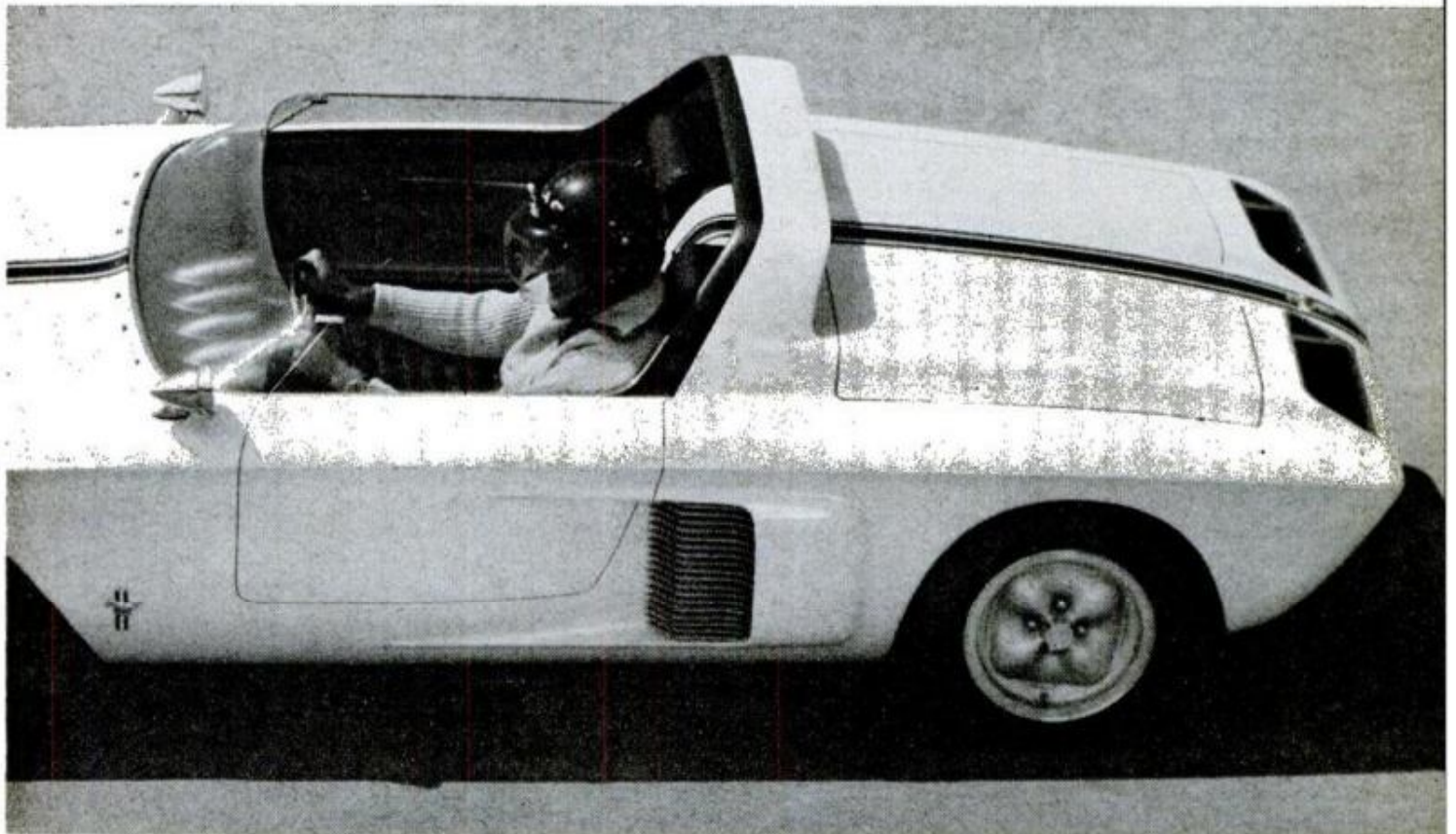



WILL



SHE

PM's

TOYS

OF THE

YEAR



SURVIVE?

When you drop a doll containing a remote control radio speaker from table top height (and how many times has your youngster knocked something off of the table?) you might wonder whether she could survive. Westinghouse's Saranade Doll not only survived the ordeal—she kept on singing! So did the record player which supplies her "voice"—when it was drop tested.



SHOCK CHECKING phonograph chassis (upper left) and heat testing toy vegetable (upper right) with temperature-indicating paints—two of the tests which supplemented an expert judging of the PM toys' play value

Here is our cream-of-the-crop selection, based on rugged testing and judging by experts and a very energetic Children's Panel

PITY THE BELEAGUERED PARENTS who each year select from groaning store counters the particular toys they are sure will gladden little Johnny's or Suzie's heart.

Comes the birthday, Christmas or some other special holiday, and too often the parents find that the toy which caught Dad's hopefully boyish attention—or Mom's sense of practical fun—was not what their independent youngster had in mind.

Or perhaps it *was* greeted with shouts of joy the day the gift was opened—only to end up in the nonfunctioning pile of discards shortly thereafter. It takes a rugged toy to withstand the impulsive workouts given it by eager youngsters. Toy manufacturers have become increasingly aware of this, and their products have been improving in wearability in recent years.

But which toys are the best ones—from both a youngster's and an expert adult viewpoint? Which are the most original, which have the greatest entertainment or educational value, the best design and engineering?

And are these choicest-of-the-choice toys durable enough to stand up to normal child abuse, safe enough for the age group that will use them, and also a good value for the money?

To find the answers to these questions, PM invited the nation's toy manufacturers to enter their best products in a Toy of the Year award program for playthings introduced to the market in 1962. Eighty-one companies responded by entering 145 new toys, hobby items, laboratory sets and amusement devices—each of which had some mechanical or scientific aspect.

A panel of 20 children ranging from three to 16 years in age

THE BIG BLAST Futura (\$10) showed good reaching power for a transistorized toy megaphone. It also survived hard, all-day-ON usage with batteries still working. For ages 4 and up, from Bell Products Co. The sturdy housing is made of high impact plastic



FACT FINDER, a pin-ball "teacher" for ages 6 to 14, makes math, sports facts, geography and other subjects exciting. As ball slowly zigzags down question slot it selects, player must quickly choose hole with corresponding answer to score. \$5, Milton Bradley

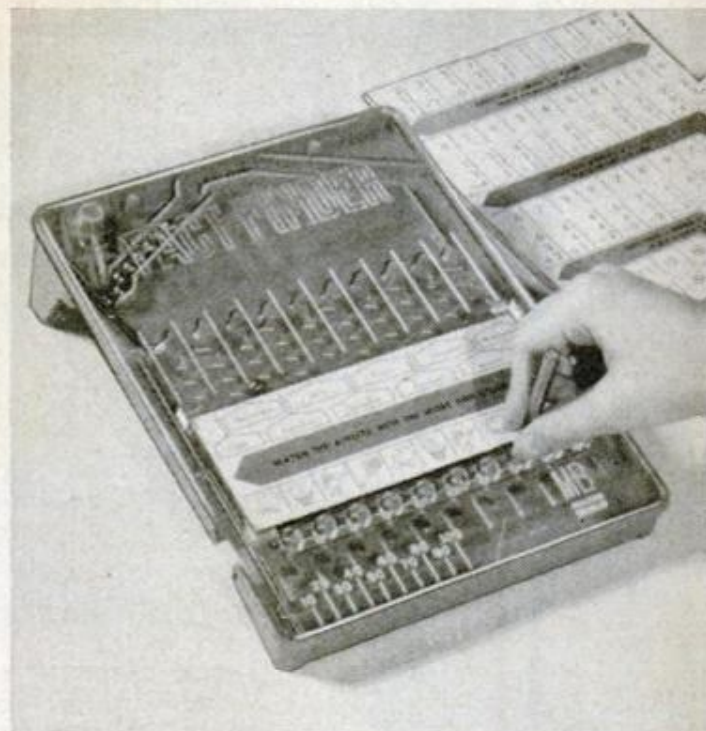

MIX YOUR OWN PERFUME

—and the girls on PM's Children's Panel found the process fascinating with this kit from Lisbeth Whiting Co. It includes: five bouquets, a perfume base, miniature labels, dropper, funnel, tiny bottles (which survived drop testing), gift boxes, ribbons and instructions. All for \$4. Good for ages 7 and up

MYSTERY SPACE SHIP is the name for this powerful, hand-wound toy gyroscope, which can be used in countless balancing and spinning experiments (see photos at right). "Missiles" can also be fired from the ship. For 4 to 9 year olds. Priced at about \$4.98 from Louis Marx & Co.

All of the toys for the very young entered in PM's award program were certified by the companies supplying them to be made of non-injurious materials and finishes

play-tested the toys for two days, while expert judges noted which toys drew the most spontaneous interest from the children, which were most successful in continuing to entertain, and which best survived the play ordeal.

Entries were drop-tested from table top height, and subjected to such heat as they would have to resist if left, for example, on the rear deck of a car in a hot sun. Electrical toys were tested for shock hazard and battery drain. Every entry was tested for efficiency in action, and its freedom from sharp edges or finger-trapping tendencies.

The official judges for the contest were Dr. Viola Theman, Professor, School of Education, Northwestern University, Evanston, Ill., and also Director of the Northwestern University Children's School; Phillip Dykstra, Chairman, Home Safety Committee, National Safety Council, and James Montague, Assistant Professor of Design, Illinois Institute of Technology, Chicago, Ill.

You'll find the top ten winners in the accompanying illustrations. A group of ten honorable mentions is listed on page 101.

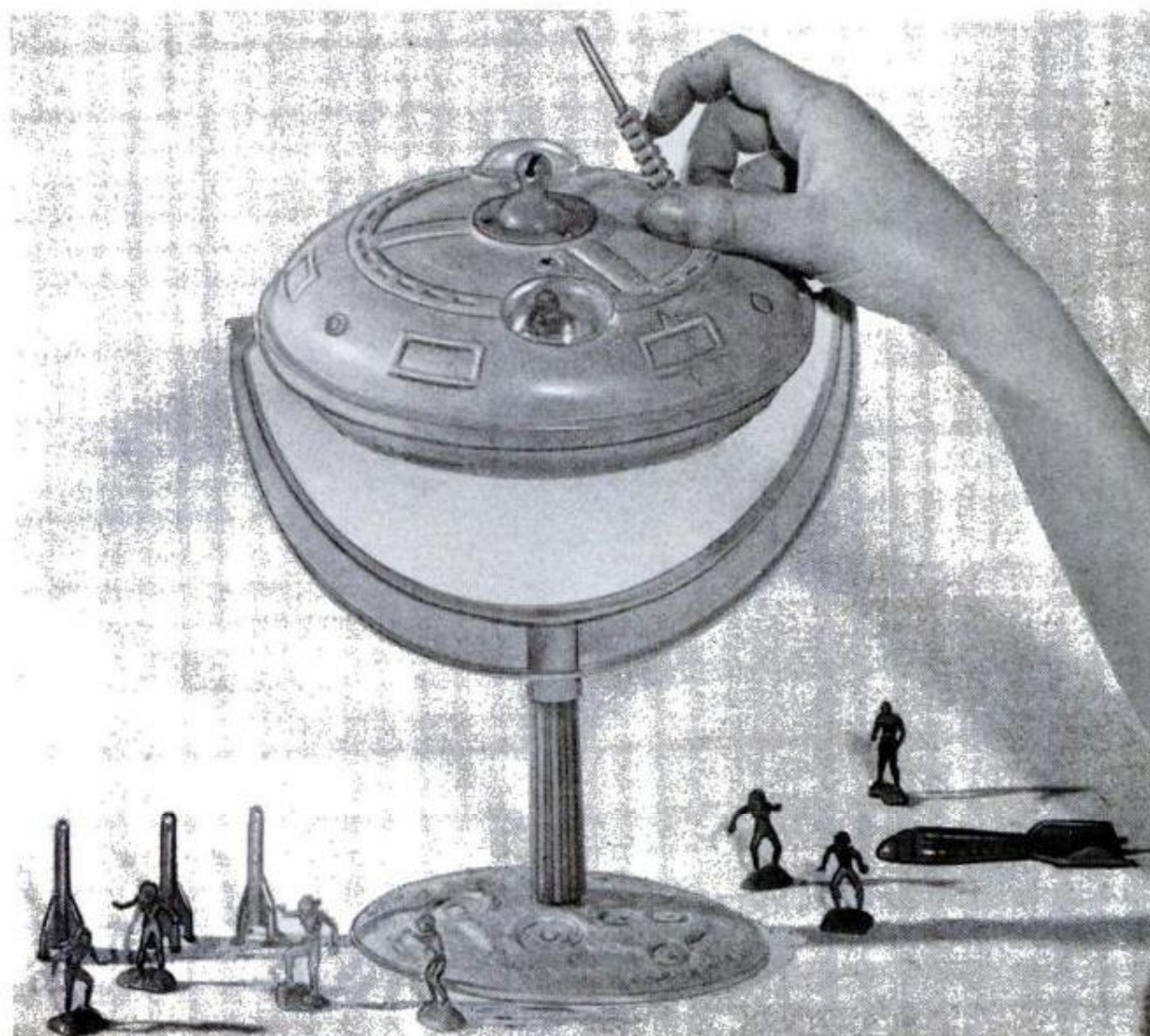
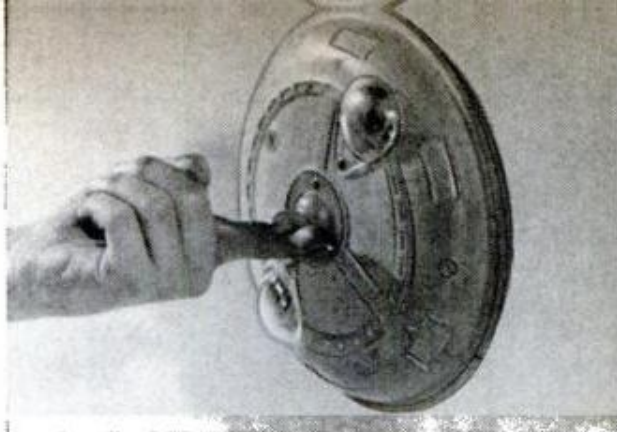

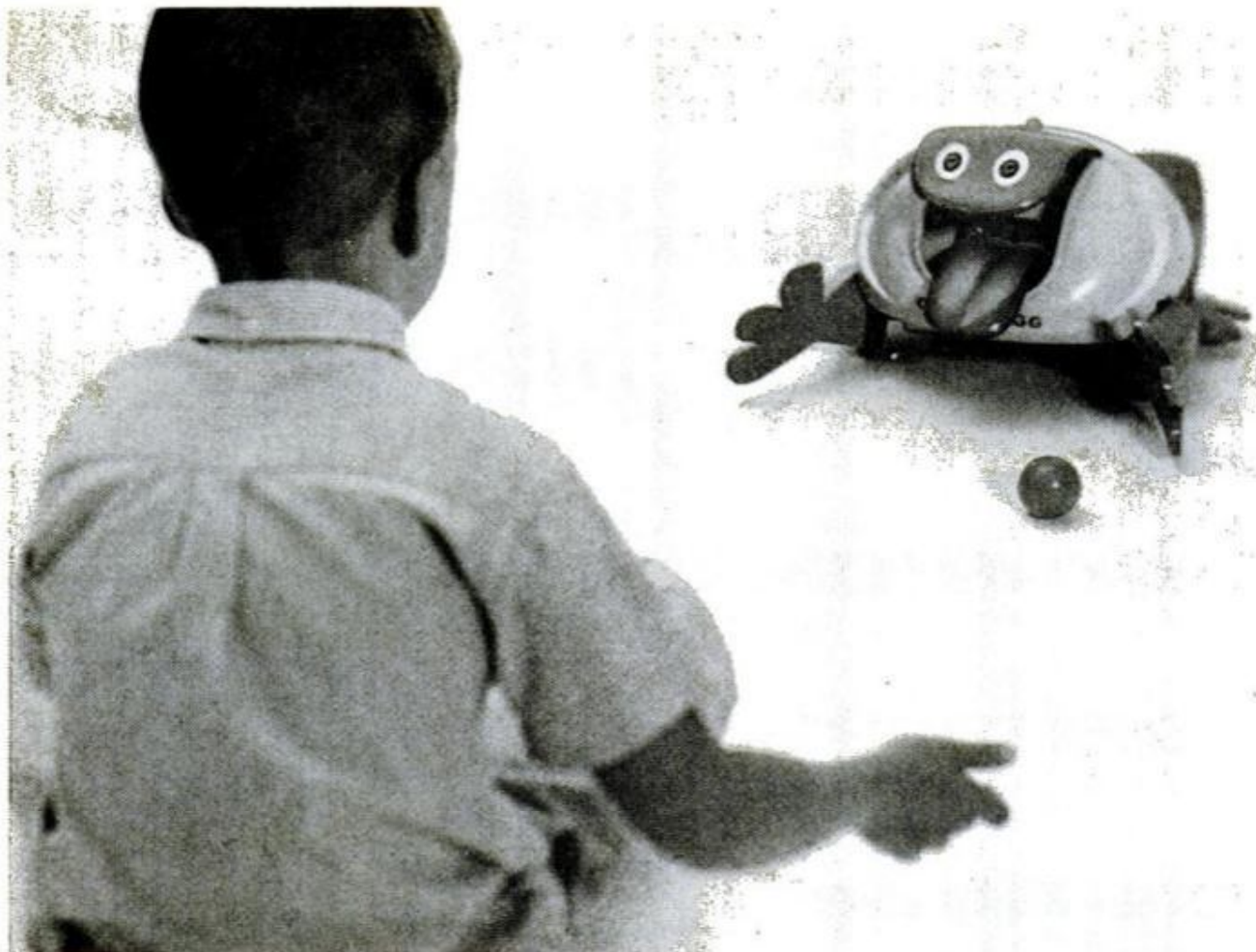

ODD OGG rolls croakingly forward when ball hits center bar beneath his mouth, but opens his mouth and sticks out tongue with razzing sound when ball misses. For 3 to 10 year olds. About \$13 from Ideal Toy Corp.

TINKER ZOO is an imaginative toy whose colored dowels and geometrically shaped sections of perforated polyethylene go together to make animals, cars, men from Mars or what have you. For 3 to 10 year olds. This Toy Tinkers toy retails in \$1 and \$2 sizes



SHORT-WAVE RADIO by General Electric is a 5-transistor set for experimenters 14 years and older. It has a clean interior layout and a superhet quality which separates stations well. Model EF 150 shown sells for about \$29.95 retail, has a plastic cover

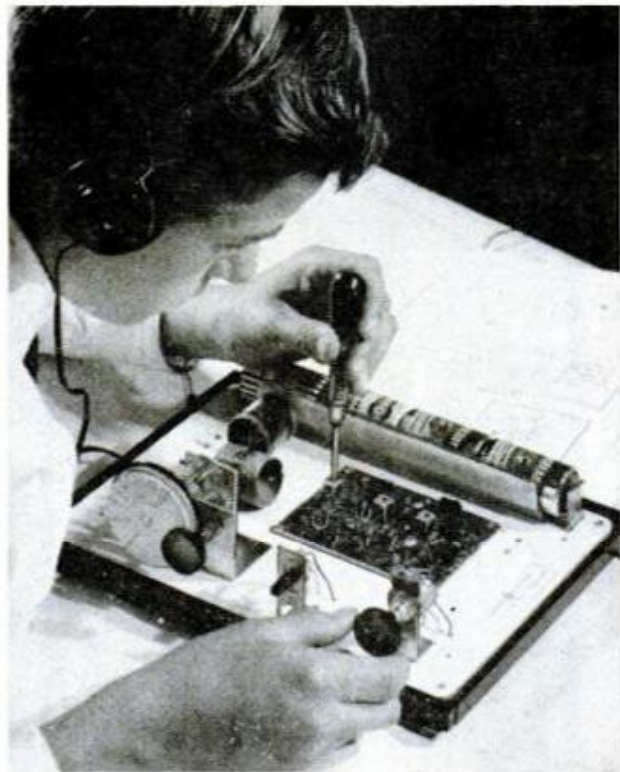

Honorable Mentions

Buddy L Horse Van, Buddy L Corp., \$6.98.

Spacephone Kit Model S-2100 Walkie Talkie, Electrosolids Corp., \$21.97 each unassembled.

Eldon Bowl-A-Matic Bowling Game, Eldon Industries, \$16.98.

Fisher-Price Musical Tick-Tock Clock #997, Fisher-Price Toys, \$5.00.

Scottie Bagpipe, Kenner Products, Co., \$2.98.

Dino, Battery operated replica of Hanna Barbera character, Louis Marx & Co., \$14.98.

Big T, detailed custom Ford car kit, Monogram Models, \$10.98.

Doodle Dash Board #3003, Multiple Products Corp., \$4.95.

Play Doh Force Press 3-D Toy-molder, Rainbow Crafts, \$4 and \$6.

The Science Book Lab of Chemistry, Science Materials Center, \$3.95.

NOTE DIFFERENCE in seedling growth inside and outside of Westinghouse's \$13 Little Garden electric greenhouse after one week (upper right). Lakeside Toys' \$6.95 "Vegetables That Grow in the Ground" toy (right) proved immensely popular and durable. Stems of its colorful plastic plants are shaped to fit correct vegetable. Saranade Doll (\$40) comes with phono which broadcasts remotely through doll speaker

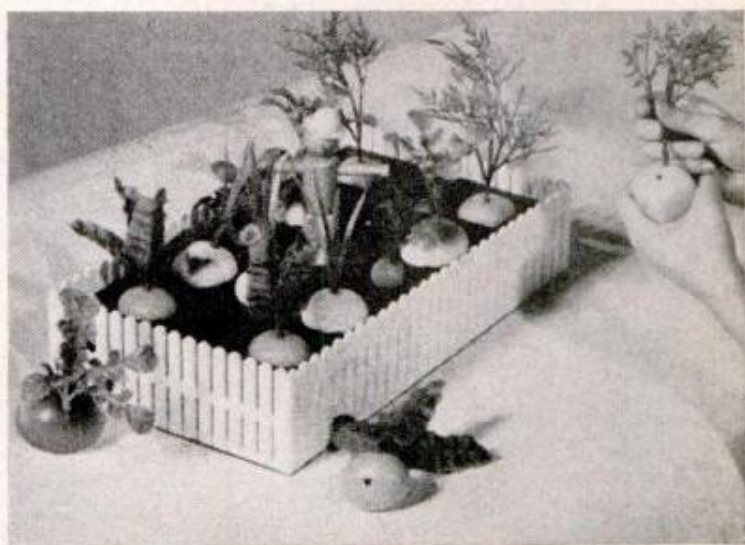
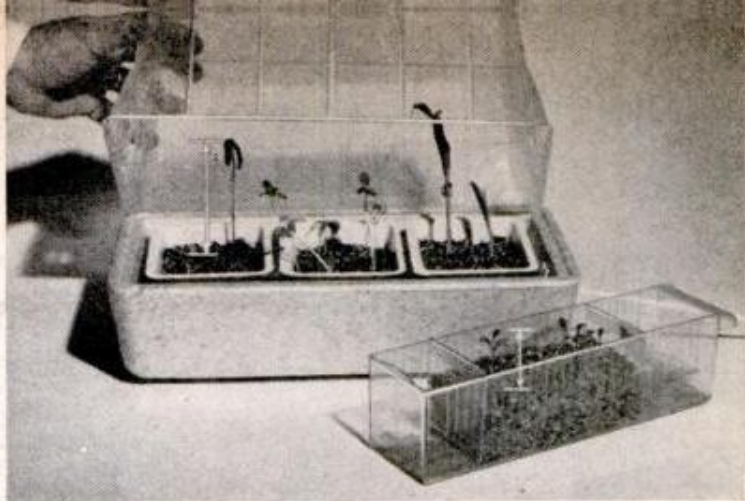

Imperial



COOLER FOR '63

ELIMINATION of last year's gun-sight tail lamps and the extension of the LeBaron's sharp roof line to the rest of the Imperial line are the major Chrysler Imperial styling changes for 1963.

They move the corporation's luxury car farther away from the heavily finned models of the late 1950s.

Use of the four-door's roof panel for both two- and four-door models permitted designers to move the back seat of two-door models well toward the rear, increase the seat's height slightly and still add a fraction of an inch to rear seat head-room. The change emphasizes the Imperial's length.

The parking brake, instead of acting on the transmission output shaft, now operates the rear service brakes. The change improved braking and allowed a reduction in transmission tunnel height. With the car in gear and the engine running, manifold vacuum automatically releases the parking brake. A manual override is provided for use in an emergency.

Total brake lining area is up almost 15 percent to 287.3 square inches from last

year's 251. Additional cast iron around the edge of the flared brake drums this year helps to cool the brakes faster, Chrysler says, to reduce brake fade.

The manufacturer expects most Imperial owners to be cool: The factory plans to install air conditioning in about 60 percent of the '63 Imperials built—about 90 percent of the LeBarons.

Other standard equipment for '63 Imperials includes power windows, a remote-controlled outside rear-view mirror, and small storage compartments hidden in the front arm rests.

Chrysler tests show a 4-percent improvement in engine breathing from a redesigned air cleaner, one of the few mechanical changes. The container is shallower, but outside diameter is up from 15 to 17 inches and the paper element (5/16 inch thinner) is 1/4 inch deeper.

The 413-cubic-inch, 340-hp. Imperial engine, a 90° V-8, and other mechanical details are basically unchanged. Wheelbase remains 129 inches. Over-all length is 227.8, up a fraction of an inch from 1962. ★★



LOOK ALIKES are '62 and '63 Cadillac (right) but new car has many changes including double U-joints, see inset

Cadillac Gets Lighter Engine, Double Universals

Cadillac stylists have an annual problem. Next year's Cadillac must look a lot like last year's, yet at the same time look brand new.

A glance at the '62 and '63 Cadillacs side by side should convince most people that the stylists have solved their problem for '63. The new car looks cleaner and crisper due principally to the removal of the "fin" that ran along the lower body of the '61 and '62, and to the switch to a straight windshield pillar.

What Cadillac calls a "modernized" engine for '63 has a new cast steel crankshaft with cored-out main bearings. The new engine is 1¼ inches shorter, but more important, 52 pounds lighter. The weight reduction is due to a new die cast aluminum

front cover on which water pump, oil pump, fuel pump, distributor oil filter and steering gear pump are mounted. Bore and stroke remain 4 x 3.875 inches leaving displacement at 390 cubic inches, and horsepower at 325 is unchanged from '62.

To eliminate high speed vibration and quieten the prop shaft, Cadillac for '63 has gone to a two-piece drive shaft with double constant-velocity universal joints at the rear axle and between the two shafts, and a U-joint at the transmission. Delcotron alternators and extended life lubrication are on all models.

Cadillacs are little changed in size for 1963. Wheelbase remains at 129.5 inches on all but the series 75 limousines, while overall length generally is up an inch to 223.

LONG LIVE THE FIN, at least the upper one which Cadillacs have worn since 1948. The 1963 car is at left





SCREENED IMAGE, left, of a Popular Mechanics cover illustrates a new method of storing and retrieving scientific data. Developed by the National Cash Register Co., the photochromic micro-image process can reduce images by a 40,000-to-1 ratio

MAGAZINE COVER, right, was reconstituted to full size from a speck on a glass slide. Scientists predict that whole libraries some day will be recorded by PCMI—with reading screens set up in every home

CRISIS! HOW CAN WE STORE HUMAN KNOWLEDGE?

By Joseph N. Bell

A steel executive insists it's less expensive to repeat a \$100,000 experiment than to pay for a search to determine whether the same work has already been done. Where can new information be stored and promptly recalled?



DURING WORLD WAR II, one of the most effective means discovered by the Germans to pass coded messages was the use of periods in otherwise innocuous documents. The message would be reduced by microphotography to the size of a single period; it could then be brought up through a microscope to decipherable proportions by the German agents on the receiving end.

The Germans accomplished this feat by blowing up the message, photographing it, then reducing it to the size of a period on a typewritten sheet of paper. It was a time-consuming and expensive—although highly effective—process, made possible only by the spend-whatever-we-must-to-get-the-job-done desperation of a nation at war.

Out of this wartime espionage technique has come an idea that may solve one of the growing problems of our technological society—that of the storage of scientific knowledge in such a way that it will be easy to find and instantly available. The accumulation of scientific data has gone forward at such a rapid pace since World War II that researchers are sometimes overwhelmed by sheer abundance. Libraries, especially, need a method of winnow-

ing out desired data from the mountain of material on hand. Scientists, as usual, have a cumbersome name for this cumbersome problem; they call it information storage and retrieval.

David H. Clift, executive director of the American Library Association, said recently, "The scientist and research worker can no longer keep up with, much less read, the published materials in his field."

How serious is this problem?

During the time it will take you to read this article, some 40,000 pages of books, newspapers or reports will have been published somewhere in the world. There are almost 100,000 technical journals being published in more than 60 languages—and new journals keep appearing at the rate of two a day. This year's journals will carry well over one million scientific and technical articles. Much of this material will relate to vital areas of human knowledge that are growing so fast that even the people most closely involved can't begin to keep pace.

Fortune magazine estimates that 10 percent of the nation's public and private \$13,000,000,000 research and development

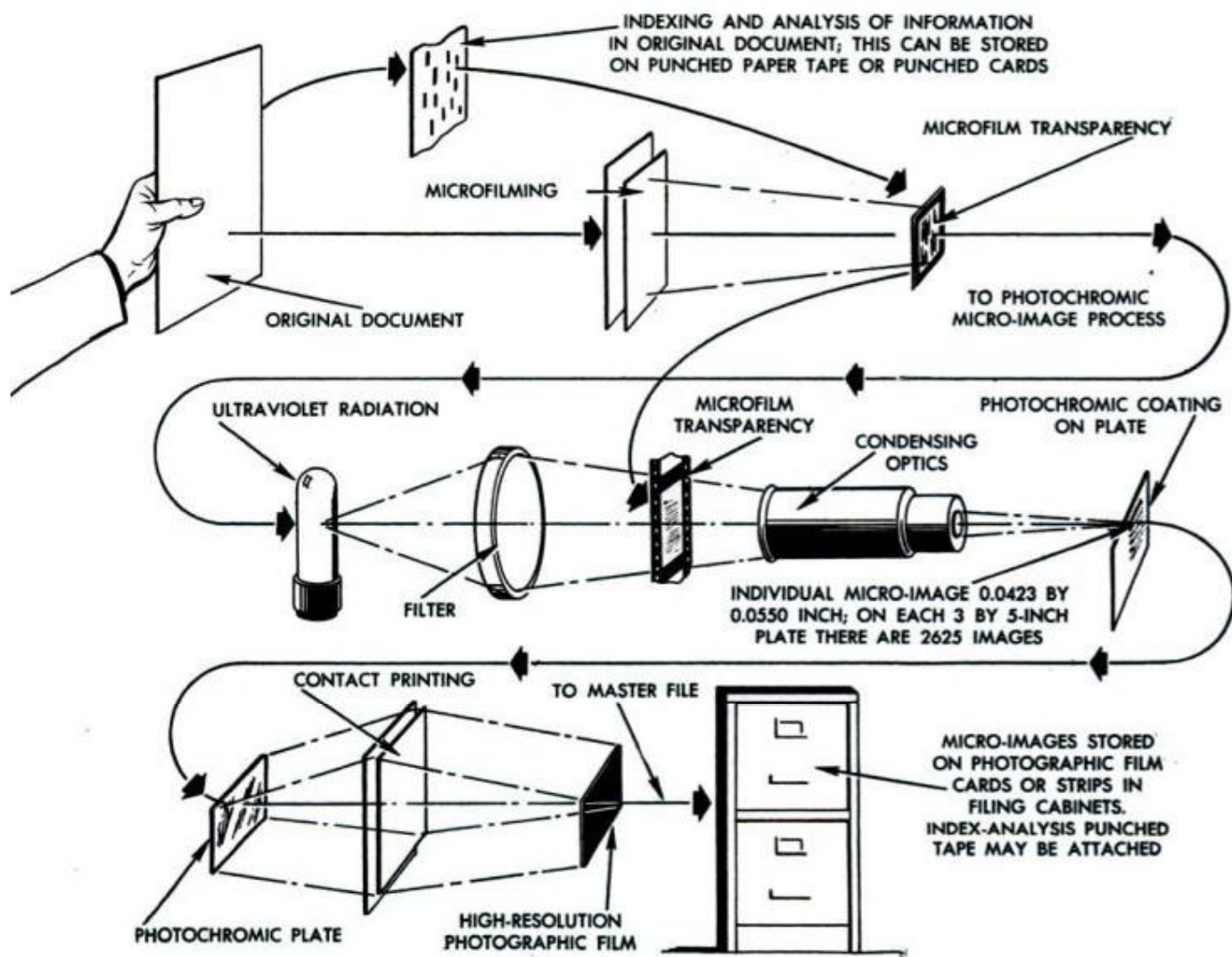

budget goes for pointless duplication of effort. Probably half of these funds would be spent differently, the magazine says, if the researchers had in hand all the facts that might be turned up from a thorough search of published material. Scientists and engineers live constantly with the fear that they are working on a problem that has already been solved and the solution published.

The ridiculous aspect of the problem is illustrated by a steel company executive who insists that it is cheaper to repeat an experiment costing less than \$100,000 than to pay for a search of existing information to determine whether it has been done before. Another company recently paid \$8,000,000 for two patented inventions only

ALREADY doing yeoman service in filming scientific and commercial data, the micro-film process was a forerunner of PCMI. Many firms, such as Thomas Publishing Co., provide subscription services for research personnel and engineers. The jumble of catalogues behind the secretary was reduced to the tidy stack of cards at right for quick viewing

..... and Retrieval

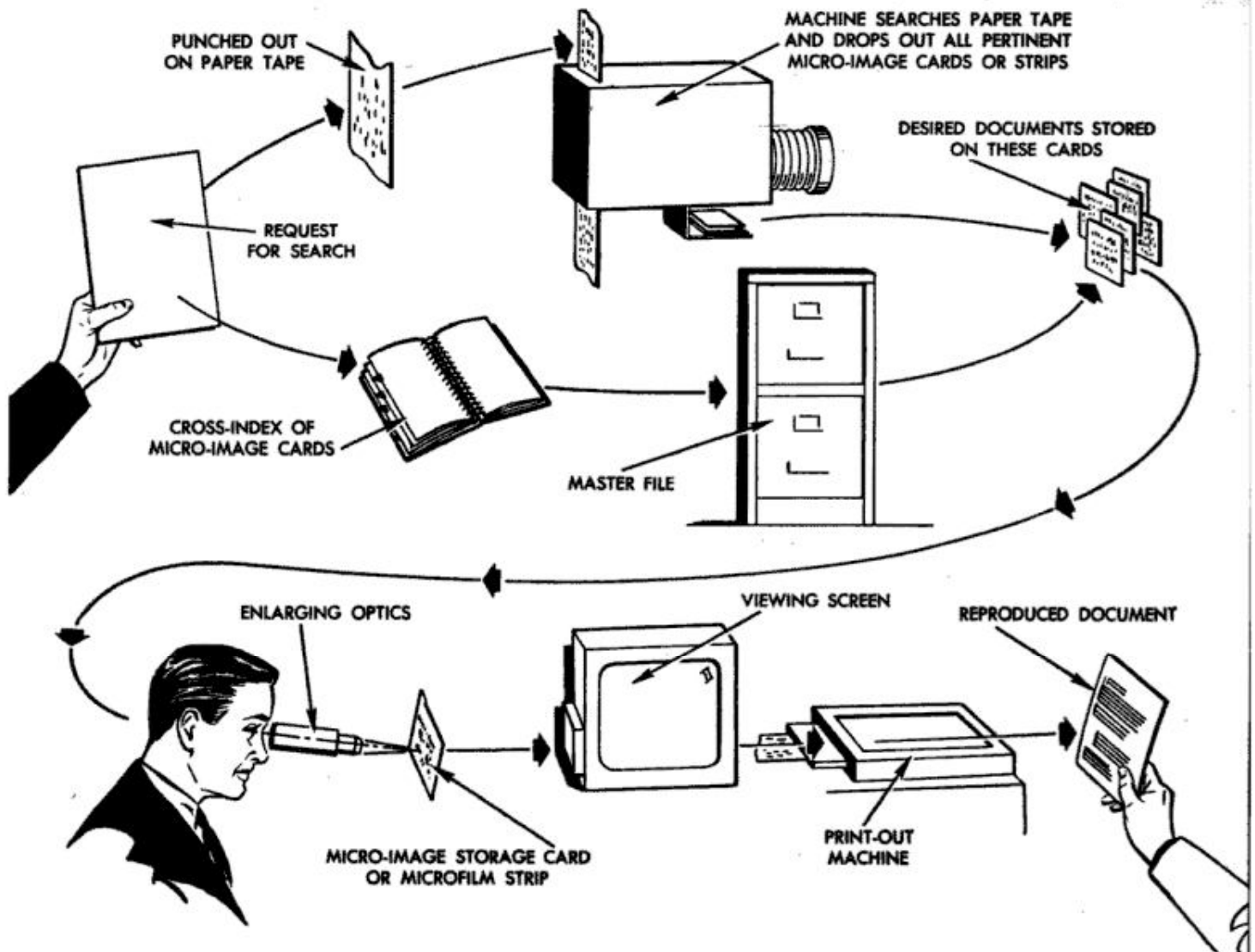

to find they were valueless; buried in the files of the U. S. Patent Office were old patents showing that both ideas had been registered by earlier inventors.

The problem has finally become so acute—and expensive—that electronic experts are searching for more efficient methods of storing, cataloguing and making use of accumulated information. Many of these efforts have been directed toward more efficient miniaturization.

One of the most promising developments in this field is the new photochromic micro-image process discovered by research scientists of The National Cash Register Co. The process permits a much greater reduction in scale of printed material and photographs than is possible with the familiar microfilm technique—in multiple quantities, at small cost, and with unrivaled clarity. PCMI promises to revolutionize the storage and retrieval of information (known as IR), and may even render our libraries obsolete.

An area reduction of about 900 to 1 is

the best that can be expected of microfilm because anything finer runs into costly mechanical problems. Photochromic micro-images, by contrast, can be reduced by 40,000 to 1 in a few seconds and at a low cost. Using a 40,000-to-1 PCMI process, it is possible to reduce 300 separate images the size of a page of *Popular Mechanics*, to one square inch of area—including 45 percent of white space around the images. This means, for example, that one three by five-inch file card could contain the equivalent of a full year of *Popular Mechanics*. A mechanical viewer would be able to pick out one of these minuscule dots and project it, a page at a time, for the reader.

Photochromic materials are *reversible*, light-sensitive dyes—meaning the information stored can be optically erased and rewritten repeatedly. Photochromic coatings resemble photographic emulsions in appearance; they can be made to retain two-dimensional images which are optically transferred to their surface. In addition, both positive-to-negative and direct-posi-

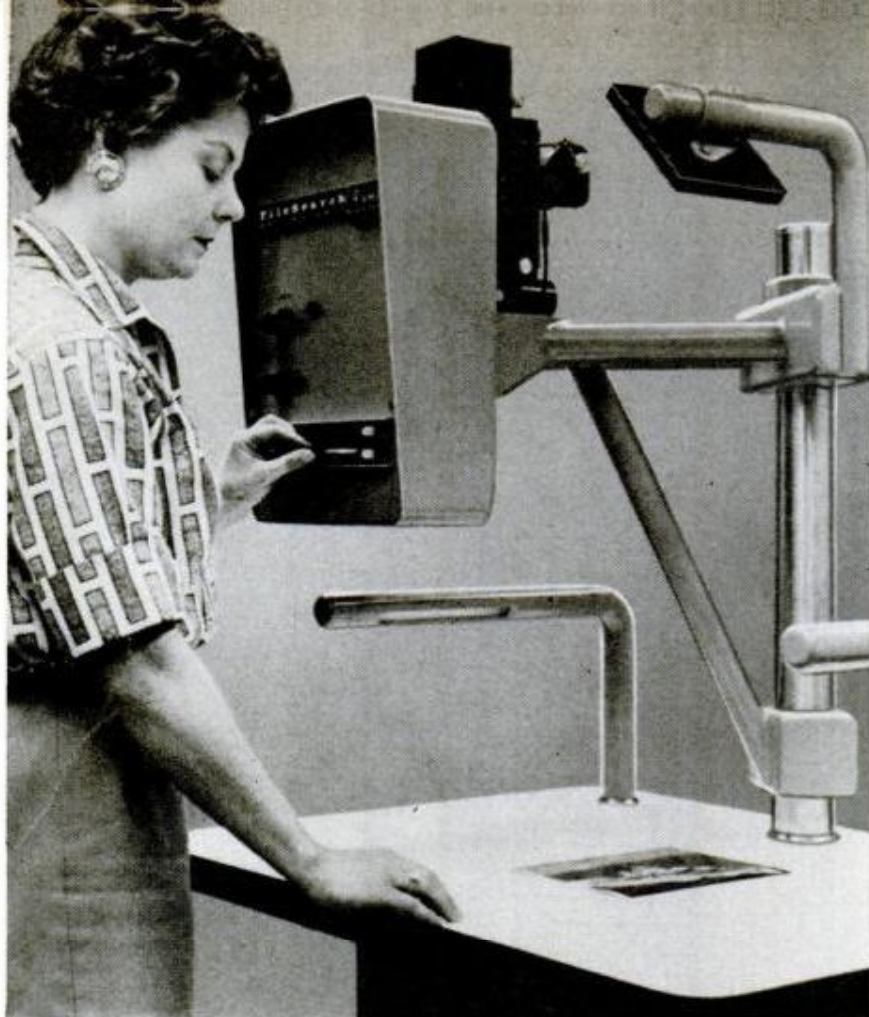

PCMI is touted by its discoverers as being the library of the future. Other electronic systems will supplement it for fast reference.

ANOTHER information retrieval (IR) unit, the FileSearch, is made by FMA, Inc. It can record a million and a half documents on film that fits easily into a single filing cabinet

tive transfers are possible. Photochromic materials are in no sense intended to replace either microfilm or photographic film. Rather, PCMI will extend the applications of these processes.

The properties of photochromics can best be understood by contrasting them with those of microfilm, which makes use of normal photographic emulsion. Here are the major points at which the two processes differ:

- Photographic film is grainy—in widely varying degrees—and thus is subject to much greater limitation in feasible reduction and enlargement. Photochromics are not dependent on clusters of molecules and thereby offer a much greater clarity of reproduction, making possible extreme reduction without loss of quality.

- Photographic film, if overexposed or out-of-focus, cannot be corrected. Photochromics can be, on the spot. The technician is able to see an immediate image, and if it is not completely satisfactory, it can be erased and replaced with a new image as many times as is necessary to get a satisfactory reproduction.

- Photographic film has to be developed before it can be read or examined. Photochromics do not; they provide an immediate image, either positive or negative, as the operator chooses. It should be noted, however, that photochromics

are brought out under ultraviolet light. They are not sensitive to natural light and therefore couldn't be used in ordinary cameras.

- While a photochromic image is being recorded, the technician is able to control the contrast and adjust it by direct reference to the image, itself. Thus, a technically near-perfect reproduction will consistently result.

- The life of the photochromic micro-image is dependent on the surface temperature of the coating. At room temperature, it will last only a few hours; as the temperature is lowered, image life extends rapidly to months and even years. However, this decay limits the use of photochromic images in their original form. To overcome this problem, NCR scientists have developed a means for transferring the micro-images to a high-resolution photographic film. Result: permanent micro-images that can be stored in minimum space.

This "master" can then be used to reproduce any number of duplicate three-by-five micro-image cards by contact printing on photographic film. When I asked, "Why not go direct to photographic film instead of using the PCMI process?" an NCR scientist pointed out:

"Technologists have tried to do that for years but have never been able to make more than a few micro-images at a time



IN RECORDING, the FileSearch codes documents for rapid selection and scanning when needed. It presents desired information within seconds, either on a viewing screen or in a hard copy. Other, and less complicated IR systems, include the familiar IBM and Remington Rand punched cards and sorters



ALL 32,000 pages contained in the above books can be recorded, at the rate of 15 books per minute, on a single 1000-foot reel of 35-mm. film by the FileSearch. IR systems vary enormously in cost. This unit sells for about \$125,000; the Minicard system, made by Eastman Kodak Co., costs up to \$3,000,000

without errors—resulting, for example, from a piece of dirt in the system or improper focus. The odds of producing a perfect three-by-five micro-image matrix containing more than 2600 separate images without error are almost astronomical. The PCMI process permits inspection and correction at every step.”

The PCMI process grew out of a broad research program conducted by NCR for many years in the fields of special papers, inks, dye chemistry, porous rubber stamps and micro-encapsulation—a process in which tiny capsules can be made by dispersing a liquid into fine droplets and surrounding them with a layer of encapsulating material. After drying, these micro-capsules form a fine powder, dry to the touch, although it may consist of up to 95 percent liquid. Inside the tiny capsule, the liquid is protected from its environment, being released only when the shell is crushed or dissolved.

The first practical application of this research was the commercially successful NCR (No Carbon Required) paper. This special paper provides multiple copies without the use of carbon paper. Basic researchers then extended their dye chemistry research to include light-sensitive dyes, seeking other unique applications.

What can PCMI accomplish? Let's look at some possible examples:

In 1961, taxpayers of Los Angeles spent

\$13,700,000 to erect a building for the sole purpose of storing old volumes of vital statistics and documents—accumulated for more than 200 years. The 13 floors of the new Los Angeles County Hall of Records will hold 81,500 books of records—and will probably be too small in another decade. Figuring an average of 500 pages per book and using the photochromic micro-image process, *all* of these records could be reproduced on approximately 16,000 three by five cards, filling a few filing cabinets instead of a 13-story building.

Probably the most aggravated example in the nation can be found at the U. S. Patent Office in Washington, D. C. The Patent Office has over three million patents, dependent heavily on bulky drawings to convey essential features—and the load is growing daily. The backlog of pending patents presently stands at about three years. The three million patents on file, averaging six pages per patent, represent about 18 million pages. A four-inch high stack of three-by-five micro-image cards would hold a million images. Thus, if all documents were reduced by the PCMI process, the entire contents of the U. S. Patent Office could be contained in a 72-inch-high stack of file cards.

Micro-images could also be used to revolutionize libraries as we know them today. With micro-images, an entire library could be reduced to a single filing cabinet of



COMPUTER FIRMS set up exhibits at the Seattle World's Fair to demonstrate how the library of the future might operate. Remington Rand's Univac was primed to answer visitors' questions based on "Great Books of the Western World"

three-by-five cards. These cards are expected to be so inexpensive to reproduce that the reader could afford to keep them. In order to read the books miniaturized on the card, he would, of course, have to have access to a micro-image viewer. Eventually it is expected that low-cost viewers will become available in all sizes and shapes. The one I examined at NCR's Electronics Division laboratory projects a picture about the size of a 17-inch TV screen. NCR engineers believe it will be possible in the future to develop a home viewer at a price within the reach of the average family reader.

PCMI could help in establishing libraries in the underdeveloped countries where one of the urgent needs is for educational materials and library resources. The cost of setting up a series of libraries in these countries using the PCMI process would eventually be very small. The same is true of parts of our own country where library facilities are either inadequate or nonexistent.

NCR engineers are not suggesting that books as we know them today would no longer exist. Obviously, some things will probably always appear in conventional book form. But the great mass of educational and technical data would lend itself well to micro-images.

However, the ability to produce and store micro-images economically and reliably represents but one step in the complex IR problem. Other vital steps include:

- Indexing the information to be stored;
- The mechanics of searching the stored file;
- The retrieval of the information after it has been found.

IR systems vary enormously in complexity and cost. Perhaps the most familiar systems are the IBM and Remington Rand punched cards and sorters. More complicated systems include:

FileSearch, made by FMA, Inc., uses an indexing code imprinted beside a microfilm frame of the original document. A reel of this indexed microfilm can then be searched serially until the proper frame is found. A hard copy print of the frame is available on demand. This system sells for about \$125,000.

Minicard, manufactured by Eastman Kodak, uses individual strips of special photographic film chips, 0.6 by 1-3 inch in size, each with its identifying index code. Information is stored on the film chip at an area reduction of 3600 to 1. This system costs from \$2,500,000 to \$3,000,000.

A number of companies, such as IBM, Remington Rand, Burroughs, Minneapolis-Honeywell, General Electric and RCA, offer IR systems in combination with their digital computer equipment. Many of these companies participated in the American Library Association's exhibit at Seattle's Century 21 World's Fair. The ALA exhibit projected features of the library of the future, many of them made possible by current research and development in information storage and retrieval. Most of these computer-type IR systems are both complex and costly.

The National Cash Register Co., recognizing that maximum use of PCMI will depend upon the parallel development of indexing, searching and retrieval techniques, is working with a slightly different

(Continued on page 224)

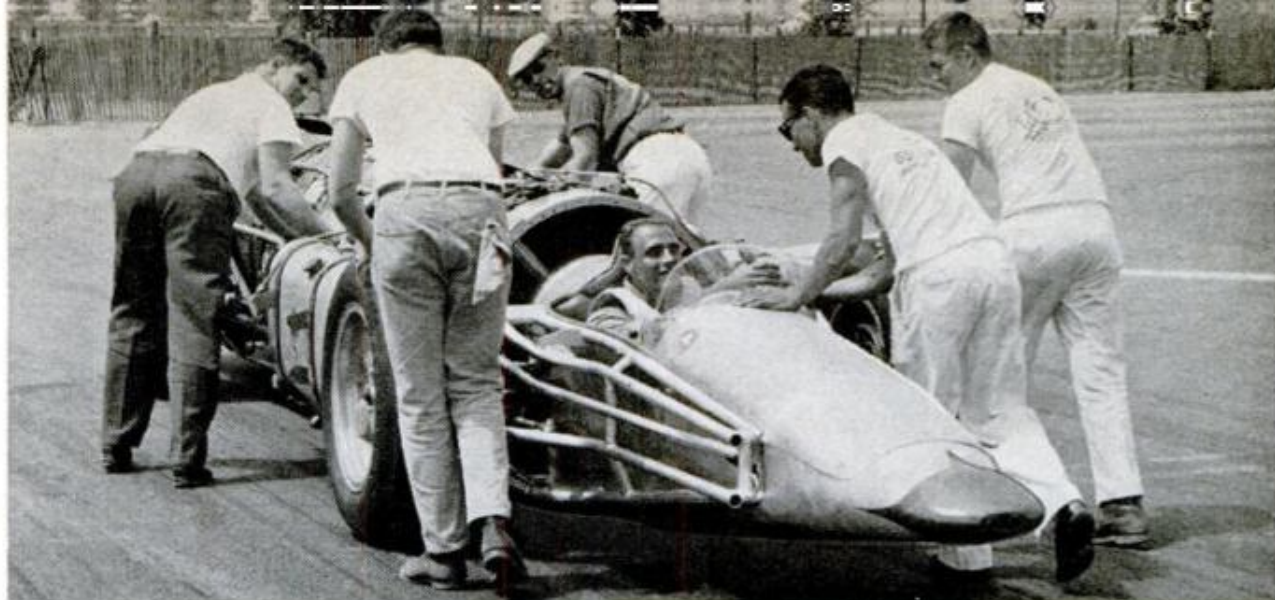

UNTOUCHABLE'S DRIVER, ex-fighter pilot Glenn Leasher, has set West coast dragstrips afire with the pet-engined creation, turning the standing-start quarter-mile in 7.4 seconds, with a top speed of 225 m.p.h.

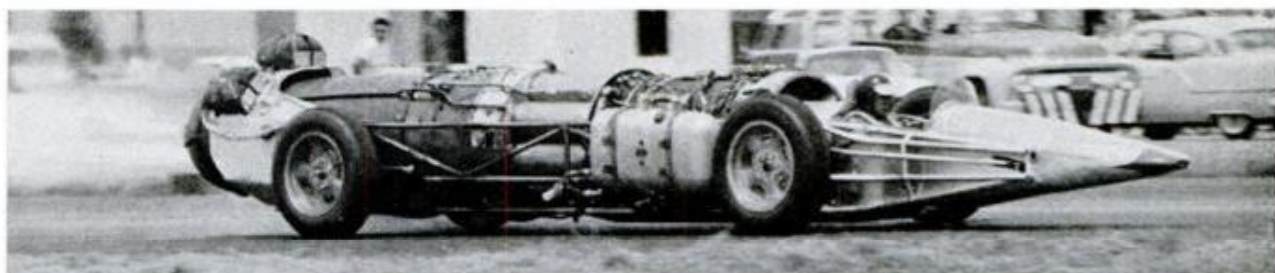

STEERING combines wheel and "dead man" control that shuts off everything if pilot relaxes grip

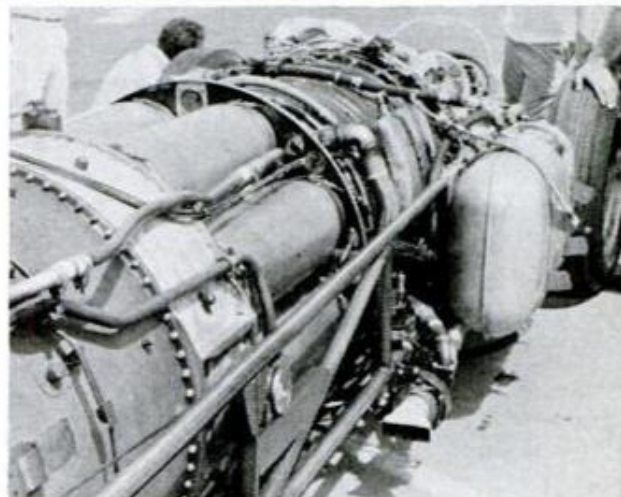

DRIVER SITS AHEAD of front wheels and the 5000-h.p. Sabre Jet engine which develops 5200 lbs. of thrust

Untouchable—At 225 m.p.h.!

The *Untouchable* is a dragster with an F-86 Sabre Jet engine with which Romeo Palamides of Oakland, Calif., plans to make an attempt on the world land speed record.

The 5000-hp. engine is an integral part of the vehicle's tubular frame. Suspension and brakes are modified truck parts, and the entire craft weighs 5000 pounds. A nose section for the driver is the only piece of bodywork. The car is held on the starting line by its brakes until enough power has been built up for a "takeoff." Palamides and co-mechanics Ken Kamb and Vic Elischer believe their creation can attain 500 m.p.h.

SPECIALLY DESIGNED, side-mounted parachutes are used for stopping, with third ready for emergency





Fluorescent Tube Changer

Even at ceiling height single-pin fluorescent tubes can be replaced by one man without a ladder. A grip holder lined with sponge rubber minimizes breakage, pivots to change tubes from any angle. With 12-foot handle, \$31.50. St. John Tube Changer, 2134 S.E. Harney St., Portland, Ore.



Hard Hat Protects Head

Strong enough to withstand a two-ton weight, a bowler hat doubles as an anti-thief helmet designed to protect the wearer from a robber's assault. It's lined with resin-bonded glass fiber and plastic foam.

The manufacturer is C. S. Transit Ltd., Farnham, Surrey, England.



Compact Carry-All

A strong, reuseable, heavy-gauge all-purpose container (which its maker claims won't deteriorate from any known chemical or petroleum product) can be used to carry gasoline, oil or acids.

The 10 by 18-inch bag holds 1 1/3 gallons and is designed not to spill when carried full. It has a nondrip pouring spout, yet seals itself so that fumes cannot escape. Empty, it can be rolled or folded for storage in a small space; it can also be used for permanent storage of dried foodstuffs, or filled with water and frozen to use in a cooler. The Emergen-See sells for 35 cents; Fairbanks Co., P.O. Box 74, Sugarhouse Station, Salt Lake City, 6, Utah.

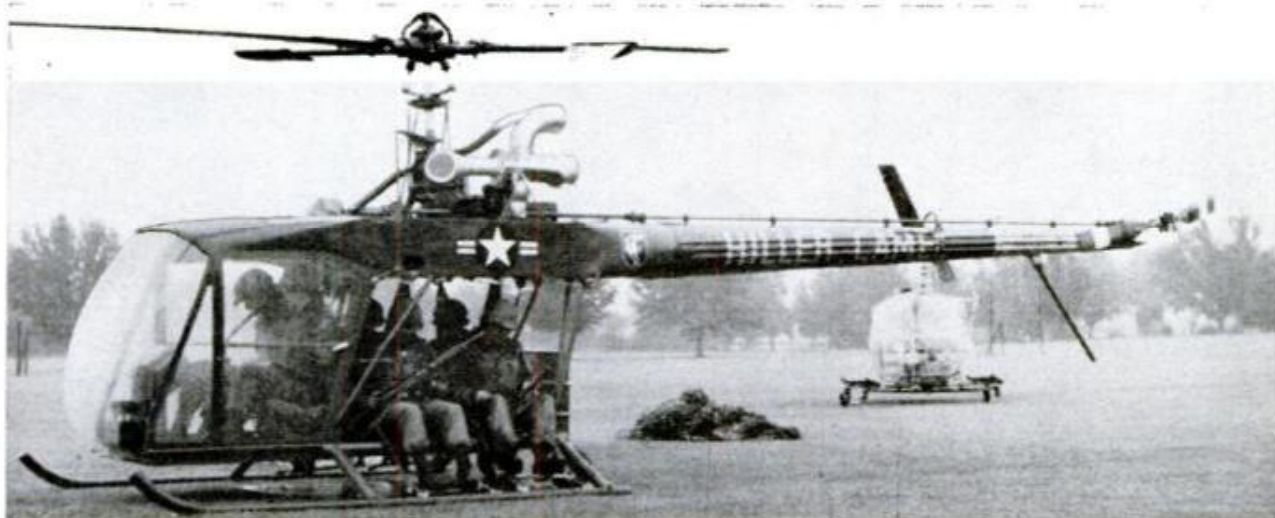

Instant Helicopter Can Be Carried Into Battle

Assembled from a small package that can be carried or air-dropped to the front lines, a collapsible helicopter can be put together without special tools and flown.

Called the *Camel* (collapsible airborne military-equipment lifter) by its maker, Hiller Aircraft Corp., it can also be camou-

flaged and cached by guerrilla forces. Sixteen of them can be carried in a C-130.

In flight, it can carry five troops or equivalent equipment, plus pilot. Not yet in production, the 3000-pound aircraft could be powered by any one of several light turbine engines now available.

Light on His Feet

Shoes with a bulb in the toe allow the wearer to walk in a dark room without a night light. The shoes can also be used by dancers to create special effects. The power source is a battery in the heel.

The shoes were designed by M. L. Dickens and S. W. Bilton, Orangeburg, S.C., but are not yet in production.



● Although the sun loses four million tons of mass per second, it is so enormous that its fuel should last for several billion more years.

Brought back to life by jet-age

PIONEER PLANES



By Chris Edwards

SEATTLE STROLLERS, gazing at the skies over Puget Sound, are likely to do a double take when the airplane that caught their attention turns out to be something right out of a *Tom Swift* novel. Clouds in the area frequently serve as a backdrop for an assortment of swooping monoplanes, biplanes and triplanes, held together with struts and wires, and powered by ancient pop-pop engines. These hangovers from turn-of-the-century avia-

tion are far from an illusion; nor are they "props" for some Hollywood World War I production. They are part of a flying menagerie of antique aircraft, duplicated or restored, and flown by a group of jet-age engineers. Some of the sputtering flying machines have a top speed less than one-third the take-off speed of a modern jet transport!

"We're a sort of throwback," explains Pete Bowers, founder of the group. "The

engineers ...

HEAD FOR THE BLUE

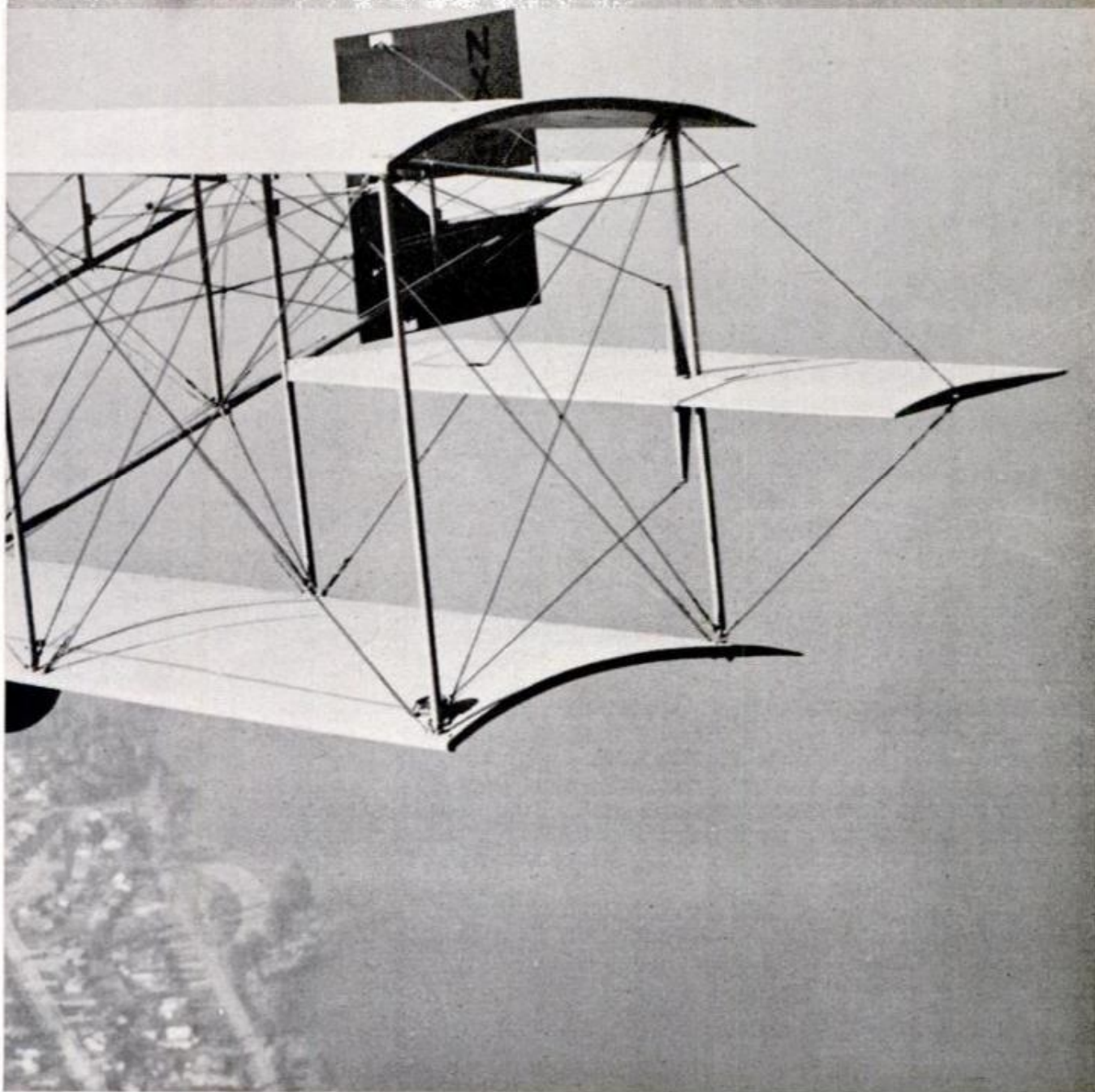

CURTISS 'PUSHER', Pete Bowers at controls, flies over Seattle. It's one of earliest replicas in air

faster we build and fly the jet transports—and they're crowding Mach 1—the more fun it is to restore and fly an antique with a cruising speed of 40 to 60 knots." Pete is a Boeing engineer who once piloted a replica of Glenn Curtiss' 1912 biplane pusher all over the United States. He took it off from an aircraft carrier in Puget Sound and wound up circling the Statue of Liberty.

Not all the old-style airplanes are true antiques. Most of the really old types now

flying, like the 1912 Curtiss and most of the World War I Spads, Nieuports and Fokkers, for example, are "replicas." That is, they are built to look like the old airplanes but otherwise are completely new. When possible, authentic drawings are used to build the replicas, but that doesn't mean that each airplane is like the original part-for-part. A Fokker triplane built by Pete looks identical to the original that scoured the skies of France in 1918 but has struc-



FLYING JENNY, a true antique, was found in old barn, its engine gone, its fuselage deteriorating. It's typical of antiques, prompting pioneer-plane enthusiasts to build new replicas rather than restore originals

tural improvements to increase performance and reliability. Like the original, however, it will use a now rare Le Rhone rotary engine actually built during World War I. The old power plant develops a husky 110 h.p. and will drive the three-winger at about 110 m.p.h.

When faded or cracked blueprints or drawings from yellowed magazine pages fail to turn up all the needed detail, the builders turn to Pete's file of antique airplane photos. By piecing together known dimensions from history books, and searching photos for proportional sizes of parts, an authentic replica can be developed. Pete's photo file which now includes more than 25,000 negatives probably is among the five largest private collections of old plane photos in the world. The pictures also aid in producing authentic markings of the period for the old timers. The camouflage on the World War I Spad was copied from one in the Smithsonian Institute.

Old Planes In Rafters

Some of the old craft restored by Pete's group are genuine "antiques". The Antique Airplane Association classifies airplanes as antiques if they are 25 or more years old, though most buffs now regard any airplane built before World War II as qualifying. Real antiques of World War I and earlier are rare, and most are in museums. Surprisingly enough, such originals usually are found in the rafters of old barns or attics.

"Old-timers, are too expensive to store around airports," Pete explains. "The place to find one is in an out of the way spot where the space does not cost anything."

Enthusiasts often build replicas simply because there are not enough bona-fide antiques available. Engines used to power the antiques are an even bigger problem. After World War I, boat owners took to stripping the engines off the planes for their boats, just as today's hydroplane builders are us-

ing World War II Allison and Rolls-Royce aircraft engines.

The old engines are almost always well worn, sometimes are rusty, and usually haven't run for years. Restoring these old power plants means hand production of many parts, a time consuming and costly job.

Building and repairing rickety old airplanes is fast becoming a lost art. "For example, how many of today's airplanes use the intricate wire-braced structure that was so common on early aircraft?" Pete asks. "A good wire rigger is hard to find. And another thing, self-starters have become so common that it is sometimes difficult to remember that the antiques are 100 percent hand-fired. The job of swinging the prop on a high-horsepower engine is another lost art except for the few antique airplane flyers."

Pete's Tiny Antique Airplane Association membership is part of the much larger Experimental Aircraft Association. The members trade information at monthly meetings in Pete's shop, only four miles from Boeing's main plant in Seattle. Some members are expert aerodynamicists, for example, and will work with other members to iron out problems of wing and tail design. Another member may be an expert on weight and balance—a science that often solves flutter or stability problems. Other specialists may overhaul engines for the pure fun of getting grease under their fingernails—it's a change from daytime jobs involving jet engine and missile problems.

In addition to swapping skills among their own group, outside specialists often are asked for advice. At one meeting, a modern paint chemist and engineer demonstrated the newest techniques for doping fabrics. Other experts recently updated the buffs on methods for reinforcing structural elements with glass-fiber cloth and plastic.

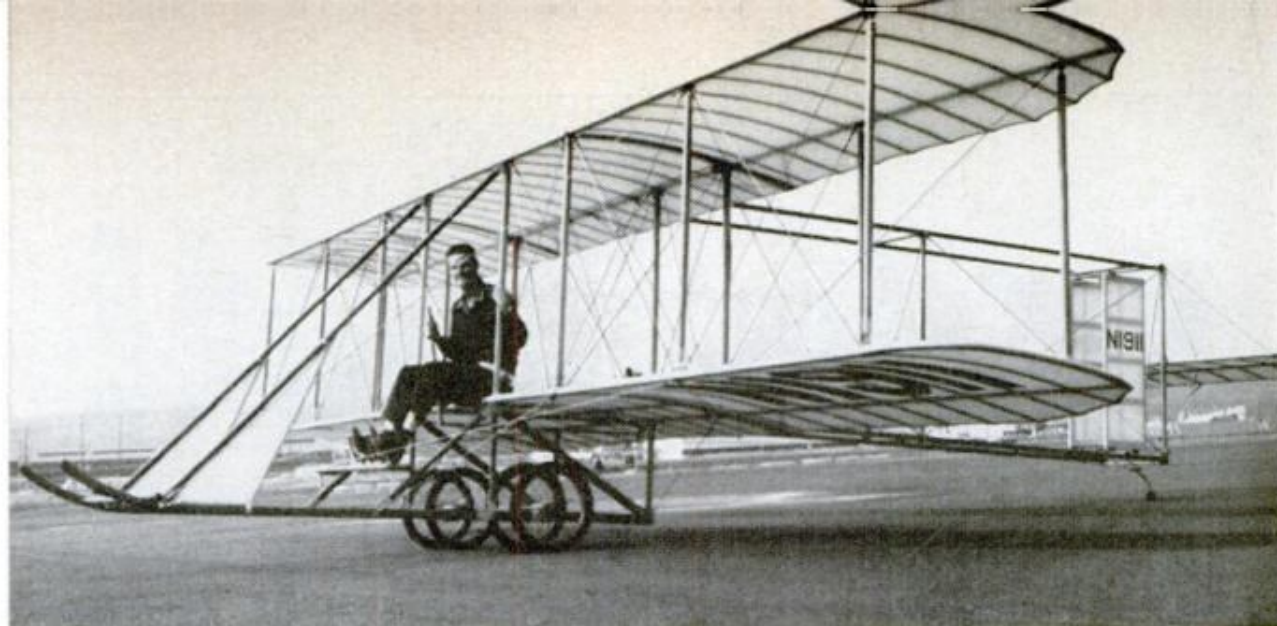

WRIGHT REPLICA was built new by Bowers. Original was first plane to cross United States. Below Bowers flight tests it, without engine, by tow rope hitched to car. Glider flights prove craft's airworthiness



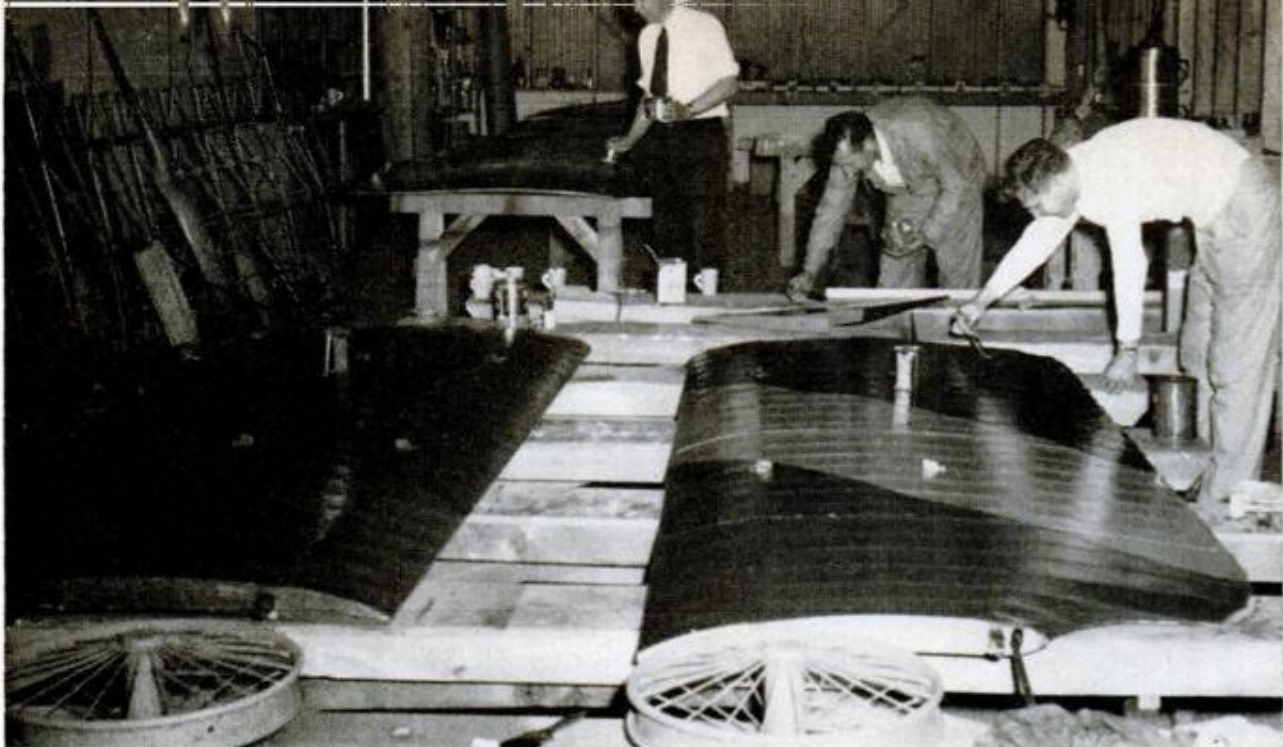

ANTIQUE AIRPLANES are recreated even to correct camouflage paint, this one for a World War I Spad

Oddly enough, restoring old-time planes is easier today than it was 30 years ago, Pete points out. Reason: better materials. "Back when wing ribs were hand assembled from small sticks, gussets and bent wood capstrips nail-glued together, the glues were not strong and didn't last long," he explains. "Once you stick ribs together with modern adhesives, they're stuck for good."

Some liberties are taken with original designs so the old-timers can fly with an acceptable degree of safety. One inimitable question asked by observers who have watched Pete "put put" over head in his

pictureseque collection of Curtiss-type sticks, wire and fabric, with pusher prop: "you do have a modern engine, don't you?"

"Yes," Pete replies. "It caused us the most trouble. When the original 'pusher' was designed and built, engines were heavy and slow. The airframe was designed to balance a heavy bulk where the engine was mounted. Our modern air-cooled engine is lighter, it turns over at twice the r.p.m. and is designed for a small diameter prop. Mounting it far enough aft for the propeller to clear the wing made the 'pusher' tail-heavy. To balance the airplane by moving the engine forward would have

ELDERLY AERONCA C-3, introduced in 1931, is genuine antique equipped with floats from another plane

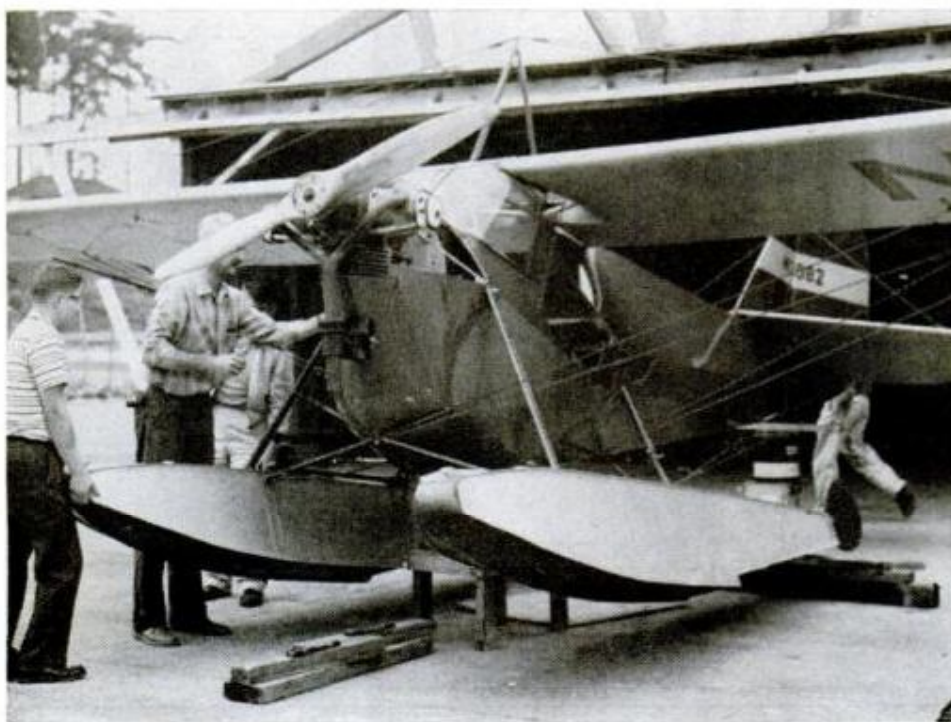



PINT-SIZE REPLICA of German Fokker Triplane was scaled down to $\frac{3}{4}$ -size, fitted with new 65-hp. engine

meant building a long extension shaft with attendant vibration and bearing problems. Instead, we put nearly 100 pounds of lead up forward by the rudder pedals."

Actually, the rudder pedals are new on this replica. Originally, there were none. The ailerons were operated by a shoulder harness worn by the pilot. To make a left turn, the pilot leaned to the left while turning the wheel to the left at the same time. Such a primitive technique was considered too drastic for pilots who learned on conventional controls. So rudder pedals were installed and ailerons were linked to the wheel.

"While complete authenticity is not always in the replicas, performance characteristics are usually faithful because of the basic design features," Pete reports.

Pete's most recent project is a full-scale replica of a twin-prop biplane designed and built in 1911 by the Wright brothers (page 117). The Model EX Wright was the first airplane to fly across the United States. The airframe is now complete and Pete has tested it as a glider. About 1200 man-hours of design and construction time went into the construction with the engine and propeller installation yet to go. Even the twin propellers were built by hand because nothing

WITHOUT FLOATS, Aeronca "Razorback" flies near Washington mountains. It originally sold for \$1000



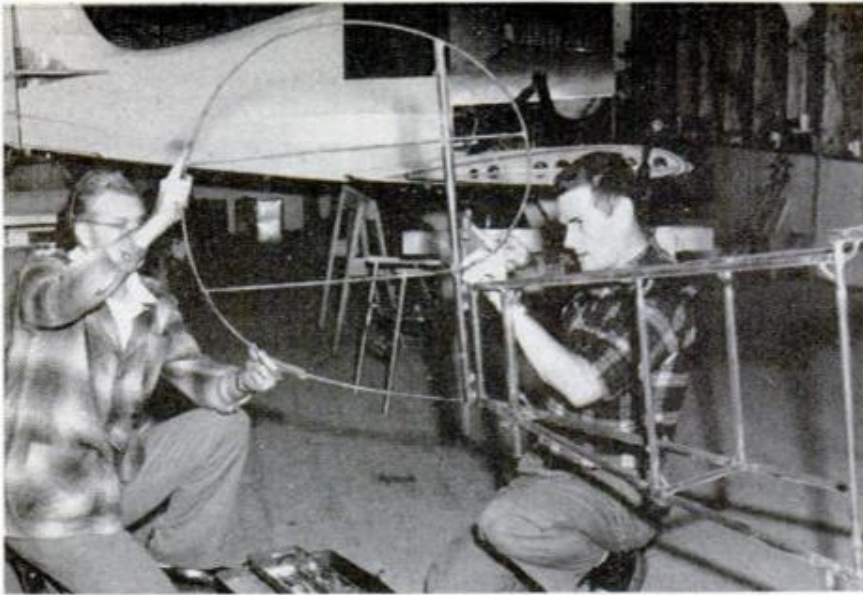

FULL-SIZE FOKKER is now under construction by antique group. Like original, its frame is made of welded steel tubing. Another experimental design is visible in background of Bowers' shop

similar is available today. Pete plans to use a Ford Model B auto engine because it is the nearest operating engine available to that which powered the original. The single engine will drive two 8½-ft. propellers.

Building the antiques could be expensive if all new parts and equipment were used. Actually, many materials are salvaged from airport junk piles and from salvage yards. Steel tubing for welding engine mounts, fuselage frames and control surfaces can be picked up with relatively little trouble. Instruments and wheels are a little harder to come by. Practically all of the old-timers were built from wood, and the straight-grain spruce spars that carry the main wing loads are bought new, along with new fabric for covering wings, body and control surfaces.

Old instruments are particularly hard to find. Few were used in early planes. A lavishly equipped craft might have an engine tachometer, water-temperature and

oil-pressure indicators, and that's about it.

Flying these antiques also presents problems. "Pilots in the old days flew by listening to the tune of the wire rigging strummed by the wind," Pete explains. "When a pilot who is trained to fly today's planes climbs into an antique or a replica, he invariably takes off and lands hot."

By 'hot' Pete refers to holding an airplane on the runway until well above lift-off speed, or bringing in an airplane for a landing well over its stall speed.

Why do the jet-age engineers and specialists spend their time building and flying rickety-looking airplanes that were outmoded years ago? Most admit their desire to recapture the "wind in the face" thrill of flying—something missing in today's efficient craft. As Pete says, "It's like sailing as opposed to power boating; flying an old-timer may not be the best way of getting from one place to another but, for some people, it's more fun!" ★ ★ ★

ANTIQUE GLIDER is also one of projects of group. This is restored Detroit Gull primary glider of 1930



Motorized Centipede

Crawling over the countryside near North Plains, Ore., is a queer assemblage of cars and a truck. It is the Centipede, a wagon-train conglomeration for traveling cross-country.

A pair of inventive brothers, Almer and Ervin Wagner, put it together. It consists of four rear halves of car bodies, and the front of a truck.

Each rear-half unit receives power from the front unit through a hinged, continuous drive shaft.



The Foamy Deep

For use in mines, a urethane foam has been developed to strengthen roofs and walls. Two commercially available chemical liquids are mixed together; they expand to 30 times their original volume within seconds.

Developed by the Bureau of Mines, the foam is being tested for binding structurally weakened roofs and ribs, sealing stoppings, inhibiting deterioration of mine surfaces due to moisture and for insulating against heat transfer.

The foam is not flammable. It bonds strongly to surfaces such as damp or dry coal, rocks, timber, cloth and concrete.

Vermin and mildew do not affect it and indications are that it will not deteriorate with age.



Gate Keeps Drive Clear

Moans from homeowners who find snowdrifts deposited by snowplows in newly shoveled drives can be silenced, residents of Edina, Minn., have found. They've done it by adding hydraulically operated gates to the community's snowplow blades.

In a raised position, the gate allows snow to spill out at the side. However, when the grader passes a driveway, the gate is lowered alongside the end of the blade, as shown, keeping the snow from forming a drift. Once past the drive, the operator raises the gate, and the snow is again deposited at the side of the road.

The gates were developed by Adam Batko, Edina's superintendent of public works.

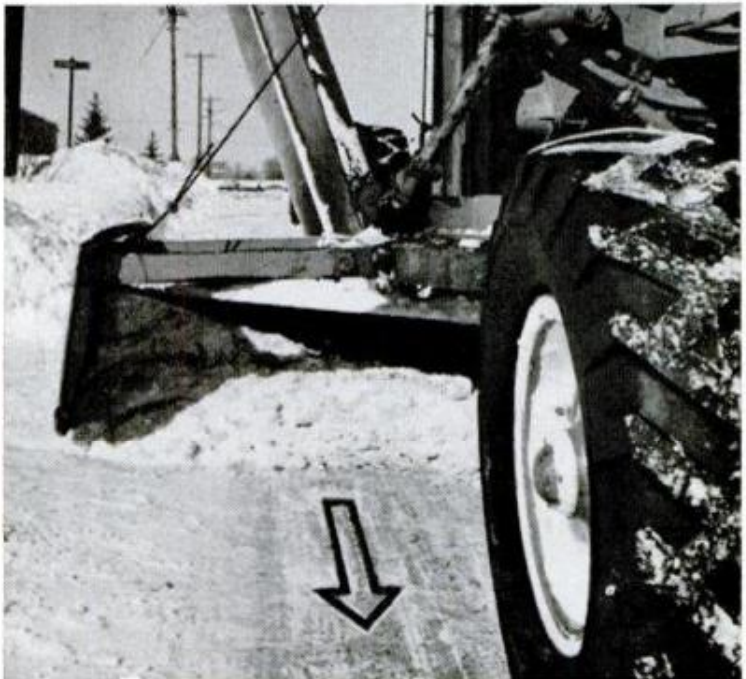

Giant Earth Chewer

Twenty feet in diameter, a giant wheel excavates 3600 cubic feet of earth per hour. It makes eight revolutions a minute, filling each of its six buckets with $1\frac{1}{4}$ cubic yards of dirt.

Shown at work along the historic Escalante Trail near the Chama River in New Mexico, the earth-devouring gargantua is the brainchild of F. K. Mittry, Jr., president of Mechanical Excavators, Inc., Los Angeles, Calif.

Its wheel swings back and forth in an arc of 180 degrees, and moves up and down via a boom. The revolving buckets are automatically emptied into a conveyor belt that continuously discharges the material through two spouts into waiting dump trucks.

The wheel operates nearly 24 hours a day, producing no peak loads and minimizing maintenance. It is diesel powered.

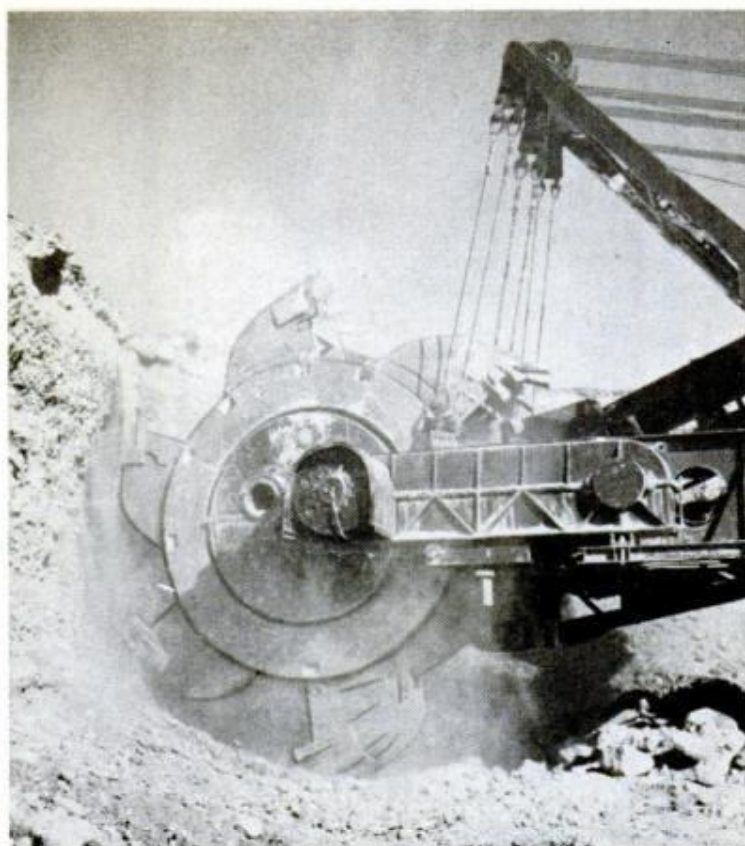

Portable Tree Freezer Tests Effects of Cold on Citrus Fruit

Down in Florida where an unexpected cold spell could ruin a season's citrus crop, they take their temperatures seriously.

A portable freezing machine, which can engulf an entire tree and produce subfreezing temperatures outside are in

the 90s, is being used in studies of the effects of cold on fruit.

The temperature chamber was designed for the Florida Citrus Commission, which is conducting the tests. Scientist, left, examines icicles produced by the machine.

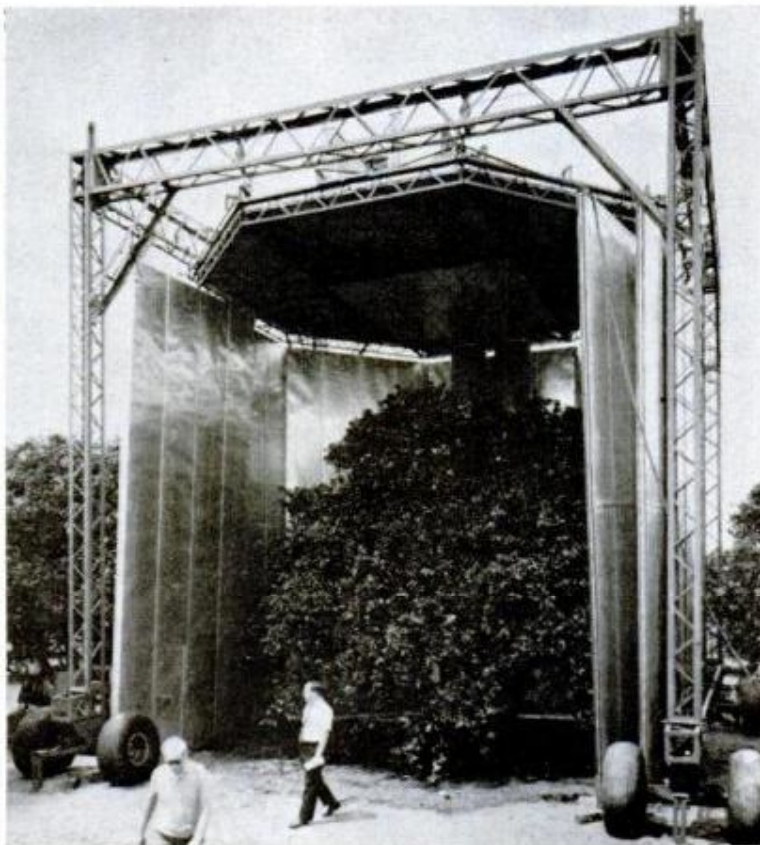



Flexible-Bladed Cutter Trims Underfoot or Overhead

With its blade bowed, a double-edged cutting tool serves as a grass and weed cutter; with its blade straight out, it's a trimmer for overhead brush and small tree limbs.

The tool, the Bow-Knifer, is designed

around a double-edged flexing blade of steel. The blade is attached to a light-weight hickory handle. The entire unit weighs about two pounds.

Made by the Jimsin Company, Franklin, La., the tool sells for \$4.95.



UNKNOWN MENACE: Germs from Outer Space

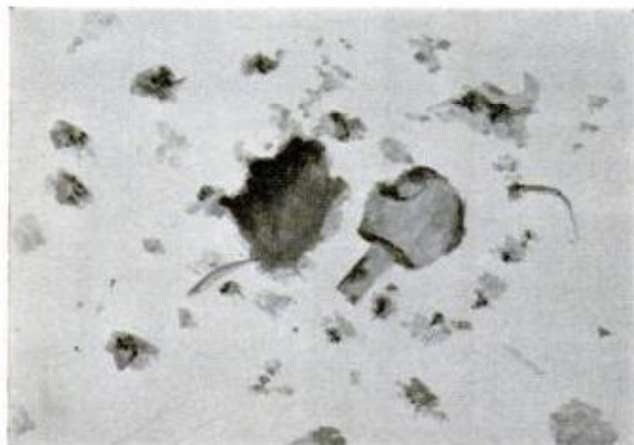
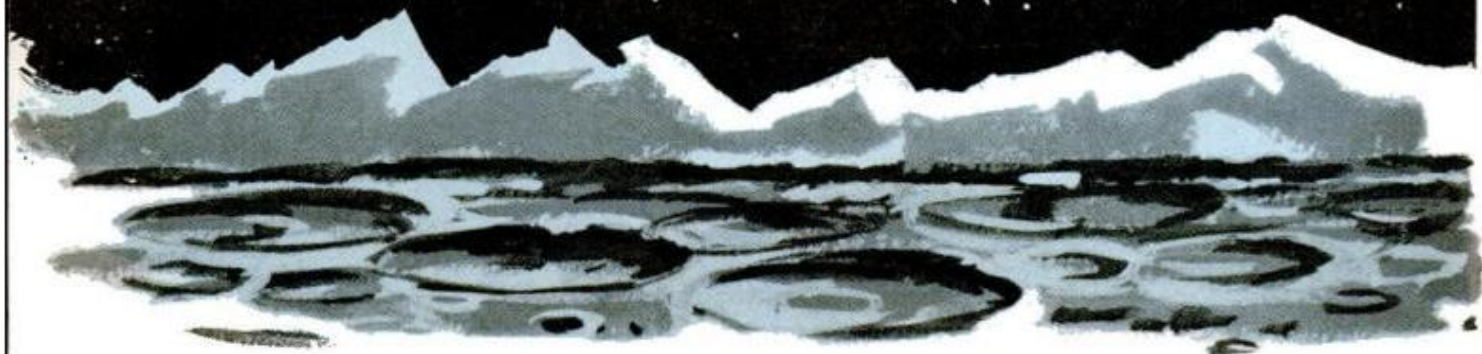

METEORITE FOSSILS (left) show striking resemblance to germs found on earth (above, right). Are they space germs? If so, spaceships will have to be equipped with germlocks to decontaminate spacemen (right)

By Theodore Berland

JETS WHINING, the shiny airliner settled smoothly on the runway at Washington National Airport near the nation's capital. It swung onto a taxi strip and stopped. A battery of trucks swarmed out to meet it.

Inside the cockpit, the sweating pilots worried about their deadly stowaway. Pink fluid alive with poliovirus had leaked from a two-quart jug being shipped from a Detroit vaccine maker to researchers at Johns Hopkins University at Baltimore.

The crew and passengers fled from the plane's emergency exits. (All were later given Salk shots and had their baggage scrubbed with alcohol.) Then a team of strangely-dressed Army chemists and technicians stepped into the plane and pumped a sweet-smelling but deadly gas called ethylene oxide into the cabin.

Within hours, all of the fugitive germs were dead. The next day, the DC-4 was back in service. A major epidemic in the nation's capital and on the airlines had been averted.

This incident—which actually happened—had a happy ending. So did the invasion of germ-carrying Martians in Orson Welles' infamous radio rendition of H. G. Wells' "The War of The Worlds," which panicked several million 1938 listeners who thought it was a factual news report. Wells' work was fiction, fortunately.

Both of these seemingly unrelated incidents may, however, have an ominous—and very real—space-age sequel. What will happen when expeditions from earth go to the moon or Mars and come back with as yet unknown germs from other planets? Such germs could cling to the spacecraft or

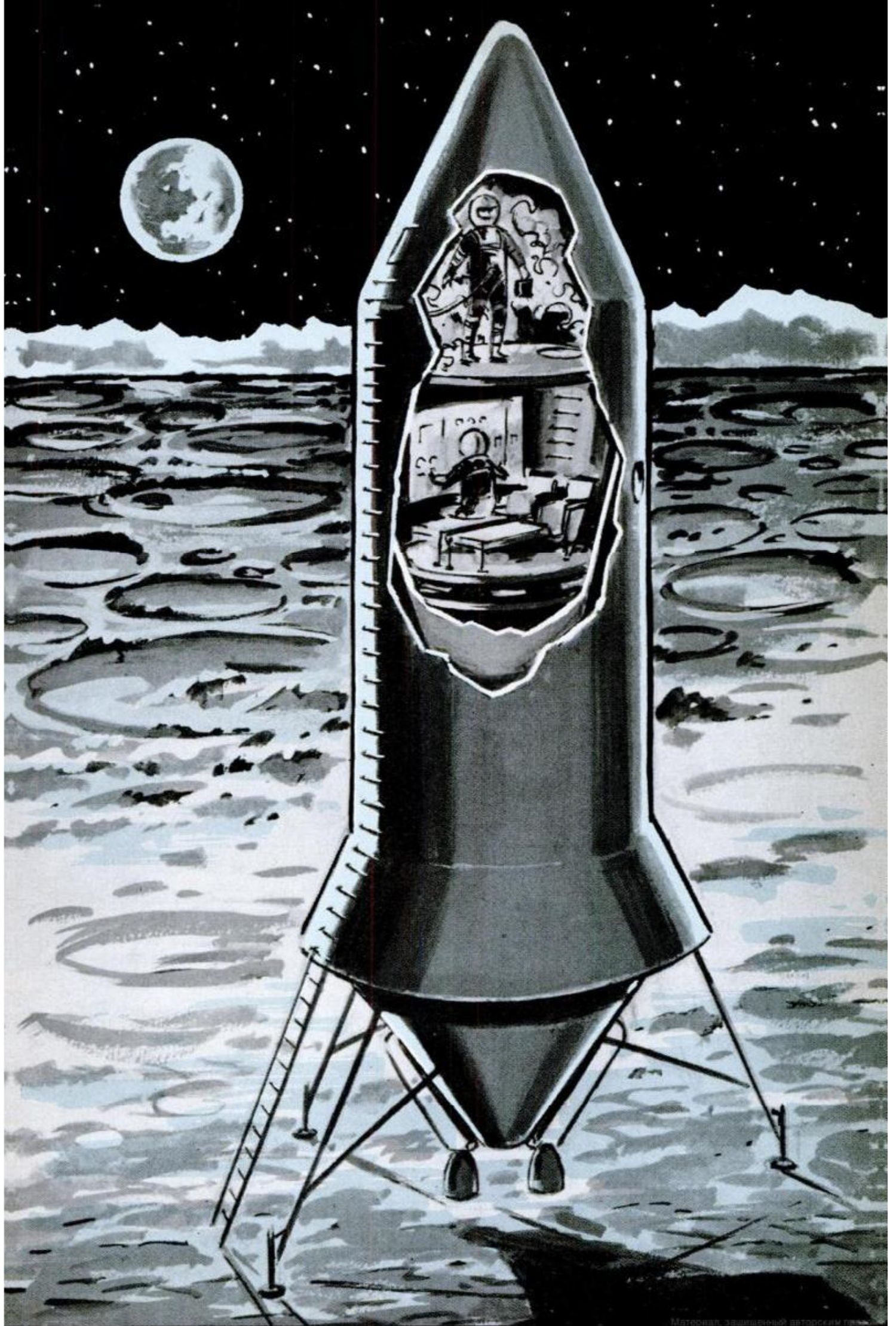

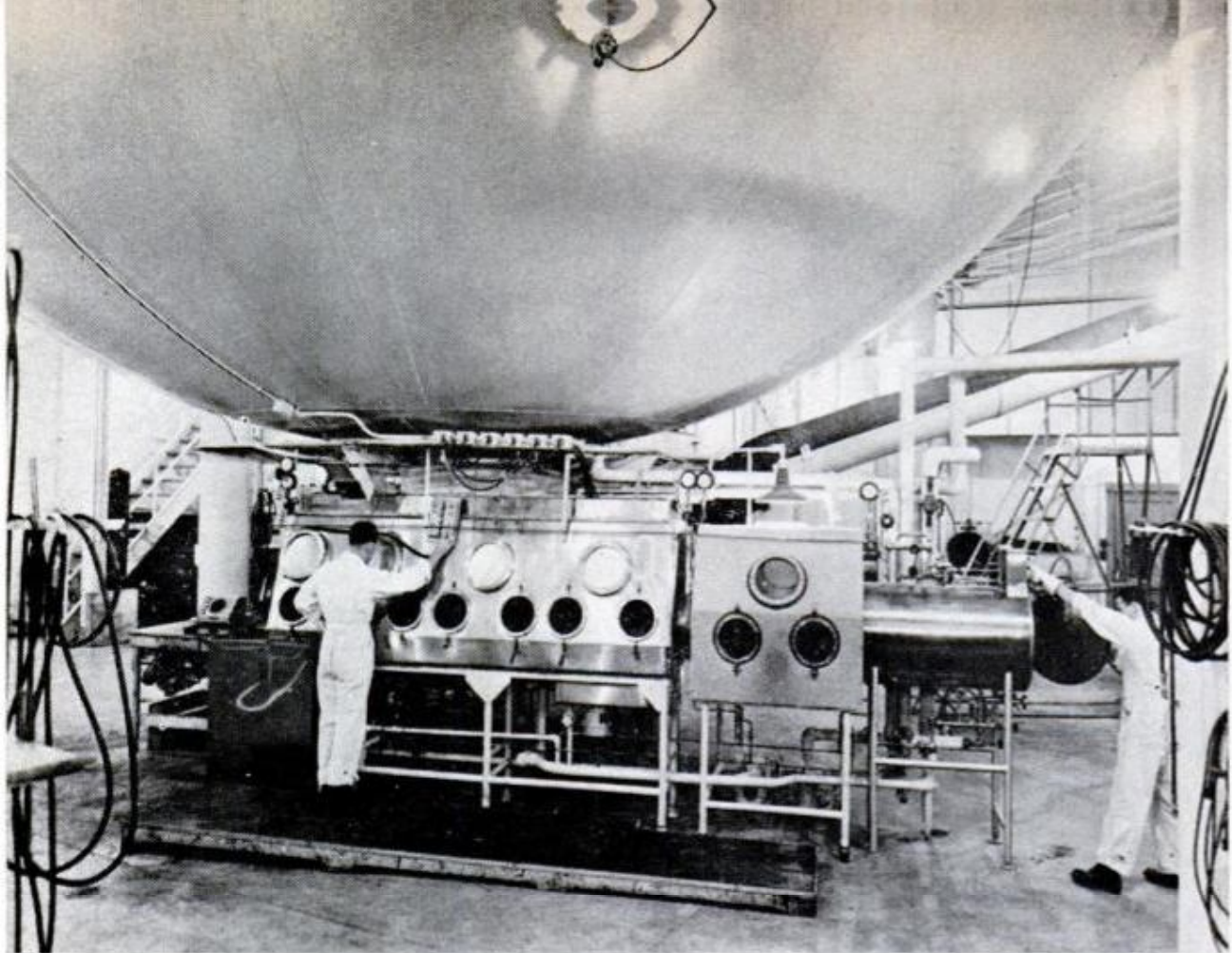

space men and be brought back accidentally. Other samples will surely be collected deliberately by scientists for laboratory analysis under rigidly controlled conditions.

In either case the danger is there. Dr. Joshua Lederberg, Stanford University's Nobel Prize geneticist warns, "The return of such samples to earth exposes us to a hazard of contamination by foreign organisms. The most dramatic hazard would be the introduction of a new disease which would imperil human life."

Around the world, other scientists, too, are becoming concerned about what might happen if a returning space ship brought back vicious space germs, to which there was no earthly immunity.

Scientists at Lockheed Missiles and Space Co., Sunnyvale, Calif., state flatly that "human life could be wiped out."

The Lockheed men point to measles which became a rampaging killer when introduced among innocent South Sea islanders during the 1700's; and less than 100 years ago, Hawaiians were almost wiped out by smallpox carried in by foreign sailors.

At least one other industrial lab is concerned about bringing back other-world germs. Physician Charles F. Gell, chief of Chance Vought's life-sciences division at Dallas, says that an astronaut returning from a visit to another planet could bring back strange diseases for which we have no names, no defense, no cures. He added:

"The possibility of dangerous expansion of these life forms depredating and destroying earthly life cannot be disregarded."

That extraterrestrial life exists has been guessed for more than a century. But in the last two years scientific evidence has pointed to that guess as being right. Fordham University researchers found what appear to be fossils of once-living microscopic life in meteorites (see picture on page 124), and a Washington scientist found that germs from meteorites will grow.

There's a good chance that life on other worlds will be similar to life on earth. One reason is that, according to theory, the entire solar system was formed from the same cosmic dust cloud.

However, astronomer Carl Sagan of the University of California says, "While the basic chemistry may be similar, the forms of living organisms on other planets must be intriguingly diverse. On each world a multitude of different environmental problems must be solved. From our standpoint, extraterrestrial life forms should be generally unfamiliar, exotic and bizarre."

Further, says Dr. Sagan, while conditions on the surface of the moon would probably kill any living thing, there could well be living organisms in deep, sheltered crevices. Famed Dr. Harold C. Urey of San Diego—who proposed the dust-cloud theory—concludes that life-bearing meteorites may well come from the moon.

FT. DETRICK CHAMBER (left) houses deadly germs for bacteria-warfare experiments, may be prototype for equipment to test unknown space germs. Animals are put into chamber through door at right and infected

GERM-FREE TECHNICIAN (right) works with built-in rubber gloves and peers through plastic window while working with solutions in germproof chamber. Anything that enters or leaves chamber is decontaminated first



Even further out is the University of Chicago's Dr. Edward Anders, who says that we may well have had Martian germs on earth for a millenia—and vice versa. When huge meteorites, such as those that formed the mile-wide Arizona Crater, collide with

the earth, they explode with the force of an H-bomb. Bits of earth are shot out at speeds exceeding that of escape velocity. So Mars may have some of our germs.

We're even more likely to get Martian germs, he says, because Mars has less grav-

FIRST, THERE WILL BE PRELIMINARY INVESTIGATIONS

Before sending the germ-collecting expedition into space, we will have a better idea of just what kind of microscopic life there is on the moon, Mars and Venus. Even sooner, we'll know whether there is any life at all in outer space.

According to Dr. Freeman H. Quimby, chief of exobiology in the Office of Space Sciences of the National Aeronautics and Space Administration, rocket probes to the planets have started this year.

- Under a NASA contract, General Mills is sending balloons from Minneapolis to the edge of space. There, giant turbines suck the thin air through filters designed to trap the smallest microbes. If germs live at these altitudes, they can live in outer space.

- A Mariner-R rocket probe to Venus will measure the planet's temperature—a key to whether or not life can exist there.

- Early in 1964, the first *Surveyor* instrument payload should make a soft landing on the moon. Chemical analyzers will send information back to earth. In its telemeter report may be informa-

tion about life chemicals on the moon.

- Also in 1964, we'll try a soft instrument landing, cushioned by parachute, on Mars. For this trip, Dr. Joshua Lederberg of Stanford University is designing a "multivator." It will have a sticky transparent tape to pick up germs from "any drop of water, pinch of soil or gust of wind." The germ-laden tape will automatically be run under the lens of a microscope and its image will be relayed by television to earth.

- American Machine and Foundry Co. has made a germ sample called *Gulliver* which it hopes to send to Mars, too. On landing, *Gulliver* shoots out two 100-ft. long pieces of sticky string, at 90 degrees to each other. A miniature electric motor reels the string back. As it recoils, the string dips into a special germ-growing broth. In this is radioactive carbon-14. As the germs grow, they take the C-14 from the broth and exhale it as radioactive carbon dioxide. This radioactive gas finds its way through a baffle system to the top of the device, where a detector "sees" its radiations and signals earth.

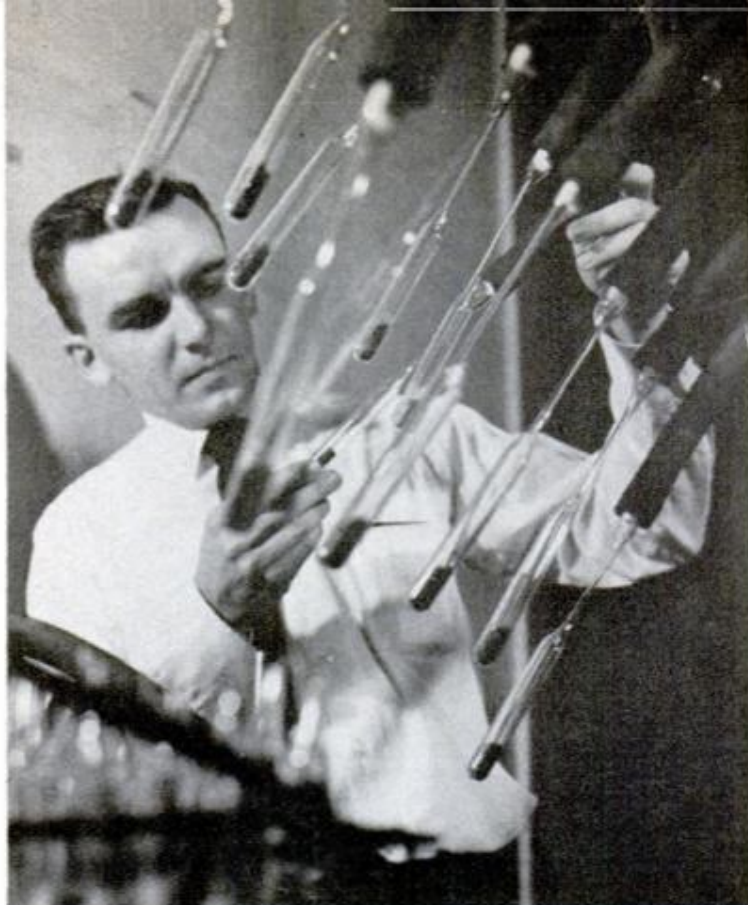

"CANALS" ON MARS, as well as occasional "green" areas lead many astronomers to think there may be some form of plant or other life on the red planet (above)

MARTIAN ENVIRONMENT is created in sealed test tubes at Illinois Institute of Technology to prove germs can grow there

MARTIAN GERMS may be captured with germ sampler, Gulliver (see box, page 127). Sticky string is shot out and reeled back

ity and is closer to the asteroid belt from which meteorites "fall."

What's more, at Illinois Institute of Technology, researcher Ervin J. Hawrylewicz has shown that moss-like lichens and some germs (those that cause food poisoning and a cousin of the one that causes anthrax) thrive under simulated Martian environments in test tubes.

Of all the planets, Mars and Venus are considered the best bets for having life. Reputable astronomers—such as Dr. Gerard P. Kuiper of the University of Arizona—are certain they have seen evidence of lowly plant forms on Mars. Venus, covered constantly by thick clouds, is still a puzzle.

Life on some planets may be completely different from life on earth. A National Academy of Sciences report says it is possible to have life based on silicon rather than on carbon, the basic chemistry of life on earth. A British astronomer, V. Axel Firsoff, says there could be life forms on Saturn and Jupiter that "breathe nitrogen and drink liquid ammonia."

Dr. Alvar P. Wilska of the University of Helsinki, Finland, says that other-world microscopic life may not come in neat cell packages as earth forms do. Such unusual germs, he says, "may not be sensitive at all to our usual sterilization procedures" and could, if brought back to earth, "profoundly alter the entire biosphere within a short time." The biosphere is that layer around the earth which holds life.

And, as California Institute of Technology's Normon Horowitz says, "We know

that if we import strange organisms from other places on the earth, into a new environment, they often find the new environment so satisfactory that they take it over and destroy the indigenous life."

The world's leading advocate of prevention of "back-contamination" (as he calls it) is a tall, husky daffodil-breeding bachelor who works for the Army Chemical Corps at its high-security biological laboratories at Ft. Detrick, near Frederick, Md. He is Dr. Charles R. Phillips, a chemist.

The reason for the secrecy at Ft. Detrick is that the Army conducts most of its biological warfare (BW) research there. Dr. Phillips, who heads up the physical-defense division, merely extends the principles of BW defense—kill it or contain it—to defense against germs from outer space.

To kill any germs an enemy might throw against us, Dr. Phillips's lab has turned to gases. Chief among these is ethylene oxide, which some of his technicians used to sterilize that polio-infested airplane that landed at Washington. This gas kills every known form of life, yet is harmless to the materials it sterilizes. "We at Detrick have used this method to sterilize all types of laboratory equipment," Dr. Phillips says. "We have even demonstrated that an Army 6-by-6 truck can be so sterilized, just in case you need a sterile truck."

Dr. Phillips believes, too, that ethylene oxide could probably kill other-world germs. And it penetrates besides, a good attribute of a gas used to sterilize things like the inside of a space ship. It can even

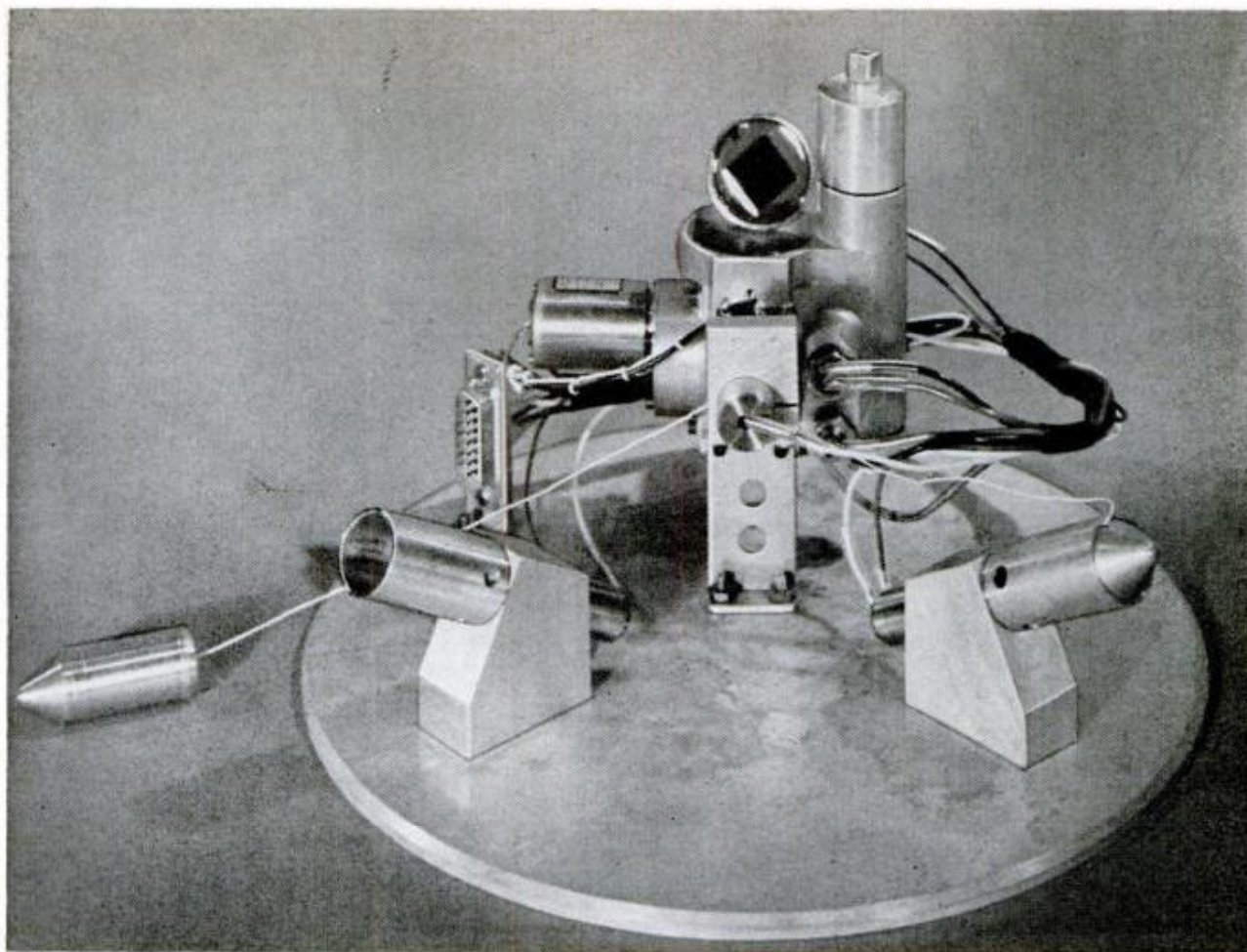

kill an unborn chick through its egg shell! But if ethylene oxide doesn't do the job, stronger—even corrosive—gases could be used.

To contain the dangerous germs of BW, his labs use chambers similar to those used to handle hot radioactive materials. They are similar, but opposite, to those at the germ-free labs of the University of Notre Dame. The chambers at Notre Dame keep bacteria out so that germless animals can be raised and tested. The chambers at Detrick—designed by Safety Director Arnold G. Wedum, a physician—keep germs in.

Detrick's pride is a several-stories-high hollow steel ball into which deadly bacteria are sprayed. Animals—guinea pigs, usually—are put inside to test the germs' potency. Around the sides and at the bottom of this sphere are plastic windows and ports with built-in heavy rubber gloves that enable technicians on the outside to manipulate the infected animals on the inside.

Air in and out of the sphere is passed through an ultrafine filter. And there are germs locks—similar to air locks—so that the guinea pigs, in their steel cages, can be put in and out.

There are also, at Detrick, laboratories filled with benchtop germ-proof chambers. Inside these chambers, the animals can be examined or autopsied; bacteria can be

taken from their bodies, grown in cultures, centrifuged and studied under the microscope through plastic windows.

And while the animals are soaking in vicious germs, the technicians handle them safely from the outside.

Detrick's containment procedures are highly perfected. So much so that, despite the fact that they are working every day with some of the most deadly disease germs known, its workers have a lost-time accident rate as good or better than most industries.

Some people believe that germs from other planets would be no danger because they would arrive dead—they couldn't withstand the rigors of space travel. Yet it was proven long ago that when bacteria find themselves in hostile conditions, they revert to small crusty spores. And, when conditions get better, they unfold and become cells again.

Dr. Phillips cites study after study which show that spores can stay in high vacuums or be frozen to almost absolute zero (-459.6°F.) and still come back fighting. He also points out that radioactivity in outer space is too mild to kill spores. As for ultraviolet light, it would kill only the outermost layer of germs; any in the shadow would be unaffected.

[\(Continued on page 218\)](#)

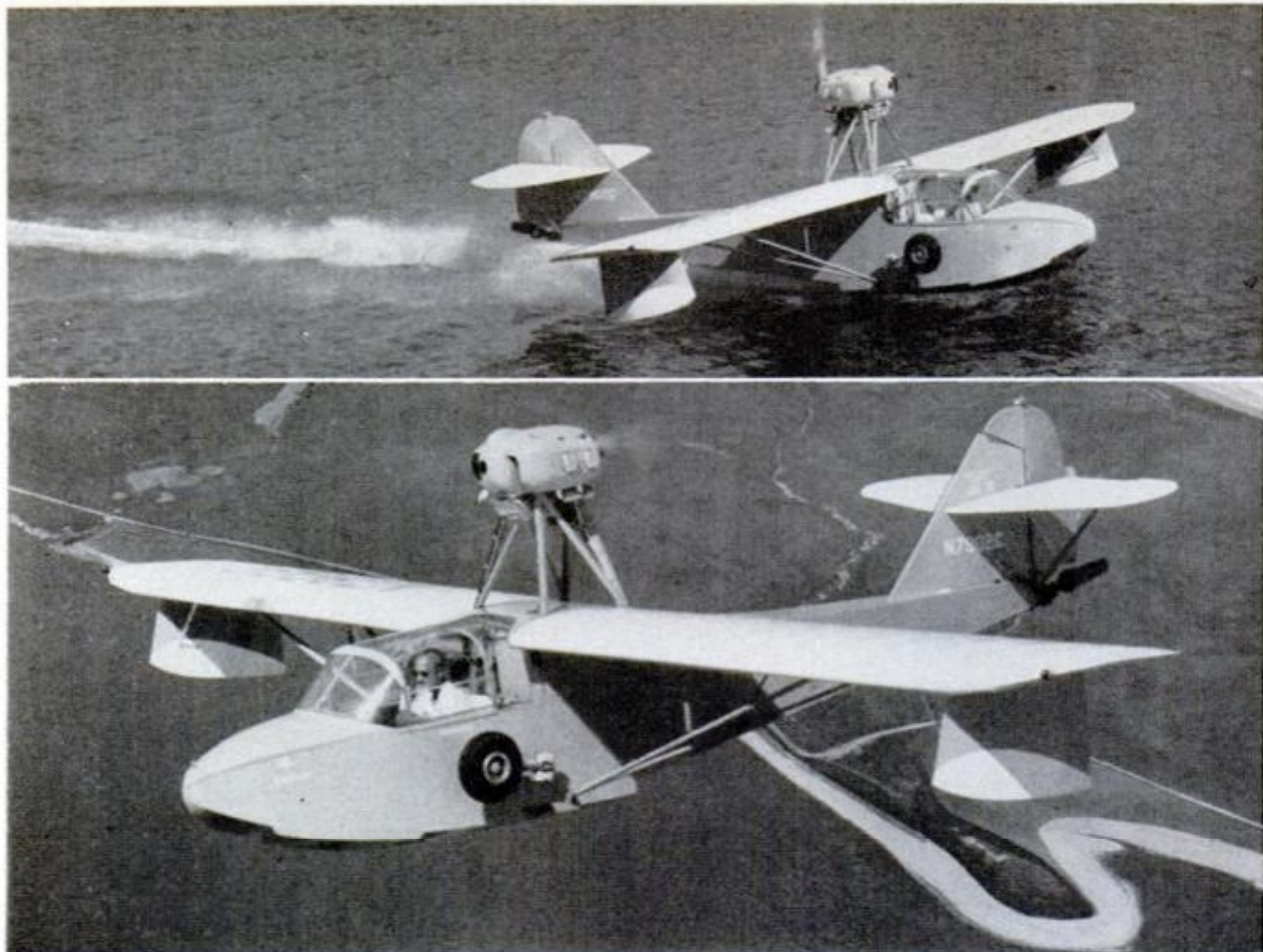

Designs and Builds Amphibian for Do-It-Yourselfers

Designed and built by a Californian who claims any do-it-yourself hobbyist could duplicate it in 1500 hours of spare time, a sports amphibian has a range of 320 miles and a cruising speed of 80 miles an hour. Its wing and tail structure are from used

Aeroncas, its hull is glass-fiber-covered plywood and its engine is an 85-horsepower Continental. If you think you would like to build one of these for yourself, plans are available from Volmer Jensen, 104 E. Providencia, Burbank, Calif.



Pedals for Pencil Pushers

Middle-age spread, the occupational hazard of sedentary office workers, can be pedaled away with a piece of British gymnastic equipment designed for office use.

The unit, which fits comfortably and unobtrusively under a desk, has a pair of bicycle pedals with crankshafts fitted to a disk. Office workers can secretly pedal away inches, nervous energy and ill temper while eating lunch, typing or balancing accounts. The pedal speed can be regulated to suit individual taste or typing rate.

● The term, "dog days," used to designate the warmest period of deep summer, originated in the time when ancients studied the stars. The Greeks and Romans observed that Sirius, known as the Dog Star, rose with the sun just before midsummer. Therefore, they associated it with the hottest, driest time of the year.



Instant Space Huts Will Be Lunar Living Quarters

Coated with a plastic-foam material which foams and hardens when exposed to solar radiation, space huts and even furniture can be carried to the moon in hip-pocket packages or small canisters.

The plastic material is applied while the structure is deflated. Tests in vacuum

chambers demonstrate that when the structure is inflated and exposed to infrared lamps, the material foams into a rigid structure. In space, the lunar explorers will only have to inflate their canned homes and let the sun do the rest. The foam material was developed by Hughes Aircraft.

Soviet Building Blocks

Huge prefabricated building blocks, equipped with doors, windows and plumbing facilities, are being used to solve the housing shortage in Krasnodar, U.S.S.R.

The concrete cubes can be lifted quickly and easily into place with a crane. Russian construction workers are able to erect prefabricated apartment buildings four stories high. Access corridors and stairwells are separate units. Water-shedding roof is added last.



● *Death Valley in California holds the record for the highest temperature ever officially reported in the U.S. On July 10, 1913, the mercury climbed to 134 degrees F.*



Modern Gun Slinger

To reduce arm strain during prolonged gun handling, a sling strapped around the neck or shoulders can hold up most shot-guns and rifles.

It fits all guns except double barrels and guns with full-barrel type stock. Called the Guntote, it is appropriate for upland birds, big game, skeet and trap.

A plastic-covered clip snaps down over the barrel at a point immediately in front of the fore-piece. The clip can be released for shooting merely by forcing the barrel down or out.

The sling can be adjusted to various lengths. It is listed at \$3.45 by the manufacturer, Dandale Sports Products Co., Box 403, Lincoln, Neb.

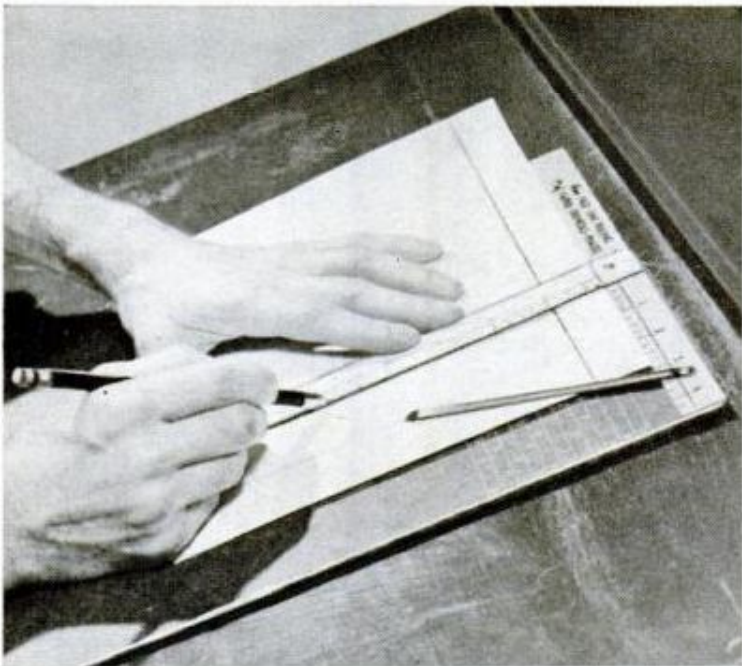

Flexible Rule Maker

Vertical lines, horizontal lines and squares, either equal or random, can be drawn with a special T-square board.

A special scale that accommodates all sizes of paper from 7½ to 17 inches long marks the spot to place the paper for the first line. A special pointer then marks the spot to place the paper for each succeeding line.

Stencils and plates may also be used with the board, or the T-square can be used for impromptu random lining.

The Speed-Ruler is listed at \$4.50 by Irwin Products, 403 N. Ridgeland Ave., Oak Park, Ill.

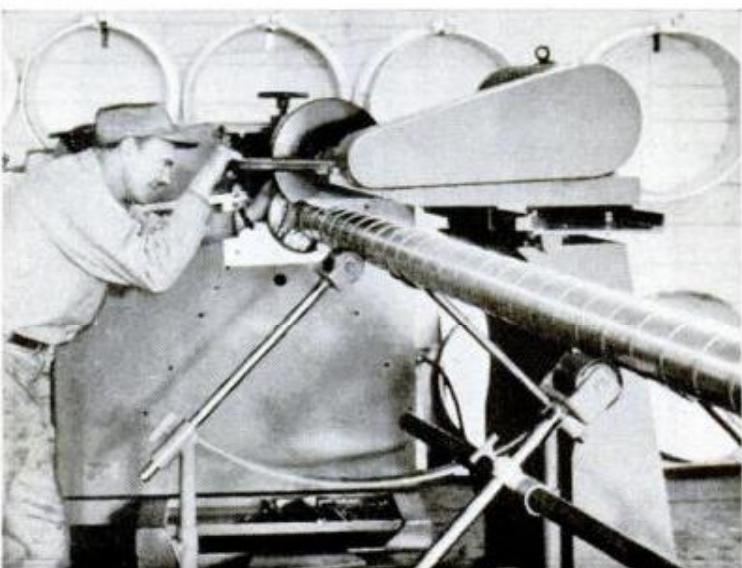

Pipe From Strip

Lightweight pipe, four to six inches in diameter, is being made from inexpensive metal strip by a machine that forms the strip into a spiral and creases the edges to form air- and watertight seams.

One operator produces up to 1700 feet of 12-inch pipe per day. The machine is transported to a job to make required lengths and diameters on the site.

This spiral pipe is used in heating and air-conditioning applications and in ventilation and dust collection systems. The manufacturer is Beall Pipe and Tank Corp., Portland, Ore.

PM Shopping Guide

Insulated Clothing



FEW PRODUCTS have changed American dress habits as much as the insulated garments that have appeared on the market. Though insulated gear had been known and sold for years, the development of inexpensive synthetic fiber fillers boomed the business until, last year, over a million and a half insulated garments were sold in this country. Sportsmen, outdoor workers, kids—everyone who spends any time outdoors in cold weather likes the idea of maximum warmth with a minimum of bulk and weight, and that's what insulated clothing does for you.

Key to this entire field of clothing manufacture is air—ordinary air. The simple rule of insulating efficiency in clothing is that the more dead air the garment traps between your body and the cold, the warmer you'll be inside. It's that simple, but there are a lot of ways to trap air, and the prices

per degree of comfort vary, too. Here's how to rate insulated clothing:

Most important factor in an insulated garment is the insulating filler that does the air-trapping. After that, the shell, or outer layer of fabric, ranks a poor second, with the lining material coming in third. Strangely, all the chemists in the business still haven't been able to produce an insulating filler as good—pound for pound—as goose down. The oldest of insulating fillers, it's still the best. Unfortunately, it's also the most expensive and hardest to buy, though experienced outdoorsmen, especially in very cold areas, insist that down is worth it.

Best synthetic fillers so far are the polyester fiber fills, downy materials that are 50 to 75 percent as efficient for their weight as down, and only about a third as expensive. In addition, the synthetics (all of them) are

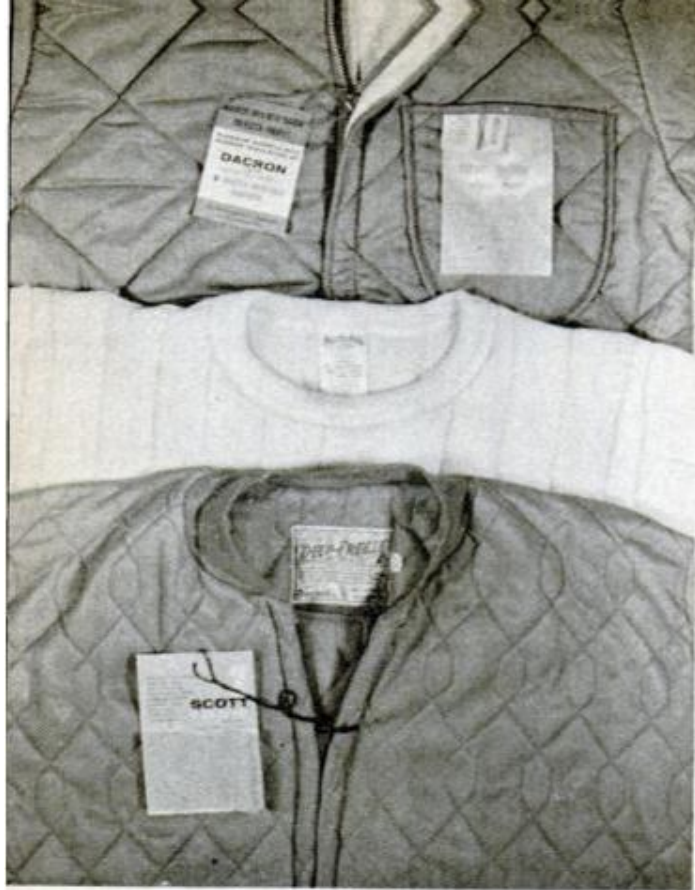

LABELS AND TAGS, required by law, list the filler, lining and shell materials. Read them

more durable, more washable, and are nonallergenic. They are often bonded in place with a light resin coating.

Polyester fillers usually come in two weights—3.3-ounce and 5-ounce (weight of the fiber batt used per 45-inch yard). Generally, the 3.3 is good enough for mild winter weather or on an active sportsman or worker; the 5-ounce is for very cold weather or more sedentary outdoorsmen. While some 6-ounce polyester fiber fill is used, the gain from increasing the

FIVE popular synthetic fillers, top down; acetate; 3.3-ounce fiber fill; polyurethane foam; foam-fiber combination; 5-ounce fiber

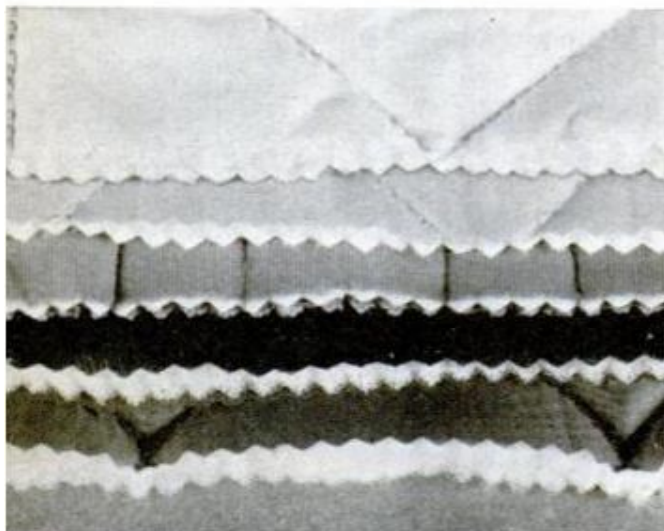

thickness above five ounces seems to be debatable.

Pushing polyester fillers in thermal efficiency—and probably their equal—are the new polyurethane foam insulators. A thin layer of light foam— $\frac{1}{8}$ to $\frac{3}{32}$ -inch thick—is approximately equal to the 3.3 and 5-ounce polyester fillers, respectively though no concrete research figures are available. The foams apparently match the polyesters in other desirable qualities, but so far are only available in higher-quality, higher-priced garments.

Another new idea, just out this year, is a combination of a thin layer of foam with a light layer of polyester fiber fill. The two-ply result has great insulating efficiency for its weight, less bulk than the fiber fillers, and less of foam's slight-but-sometimes-undesirable stiffness.

A very popular less expensive filler is acetate fiber, which rates as a good insulator for moderate climates—down to zero to 20 degrees. Five-ounce acetate is about equal to 3.3-ounce polyester in thermal value.

The poorest of synthetic fiber fillers is still almost twice as efficient as wool as an insulator. All the synthetics are good—but some are better than others.

Outside the insulating filler, a good garment will have a tightly-woven, water-repellent (even in underwear) shell fabric to help hold in heat, hold out wind, and protect the filler. Most experts agree that it is best to buy your insulation in the form of “under-

FOUR lining materials — top, conventional nylon-cotton mix; left, two-ply cotton-wool; center, raschel-knit cotton; right, nylon fleece

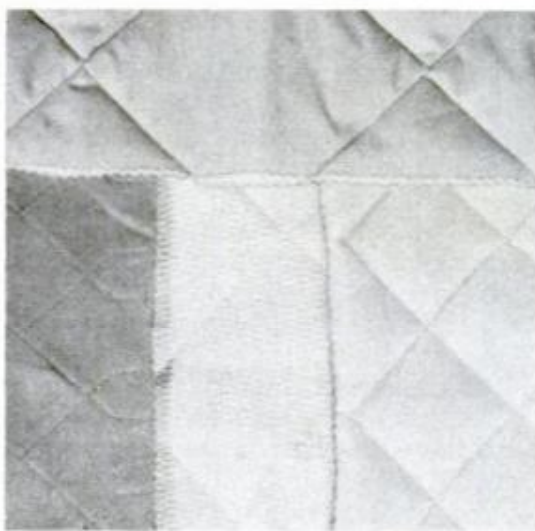

TIP-OFFS TO QUALITY



FREEDOM of motion is important. Look for a bellows back, diamond-shaped crotch insert, elastic shell fabric, or elastic insert panels

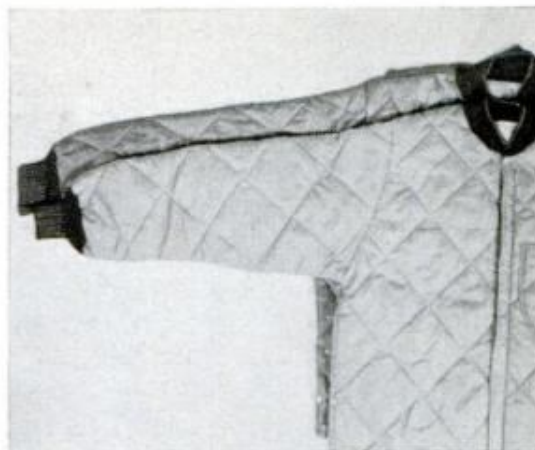

BETTER garments are cut fuller than cheap competitors; two jackets above are both medium. To be sure, try on both pants and shirt



WIND FLAP inside zipper is important. Also look for tubular knit cuffs (no seam), smooth zippers and snaps of self-lubricating materials



SNAPS connect pants and shirt to keep tail down while sitting. Even better is a long "kidney flap" shirt tail, or one-piece coverall

wear," to give maximum flexibility in choice of outer clothing, maximum life to the relatively expensive insulation, and to avoid the need to have the insulated garment cleaned any more than necessary. There are, however, many fine insulated outer garments, usually with a hard cotton, nylon or poplin outer fabric. Since they obey the same rules as the underwear, which is by far the most popular type of insulated clothing, we will concern ourselves with the latter.

Best shell fabric for underwear, almost all manufacturers agree, is "a high-denier filament synthetic"—a nylon or dacron material with around 70 threads per square inch in the weave. Less expensive underwear uses 50-denier shell fabrics; still lower-priced suits use rayon.

One fairly new—and promising—shell fabric is nylon tricot, an elastic weave that is much more flexible than the usual taffetalike fabrics, and which feels better to the touch—and therefore to the skin—of the wearer.

Good insulated underwear requires only a water-repellent windbreaker over it in ordinary winter weather. In extreme cold, a heavier wool shell is better (and quieter on a hunter, too). For all weather, especially heavy rain and extreme cold, it's hard to beat a good neoprene-coated nylon rain suit for complete wind and water protection. Only trouble is that they tend to be too hot, and to permit perspiration moisture to remain inside—a real danger in arctic cold. Many smart outdoorsmen wear a light nylon jacket and pants and carry

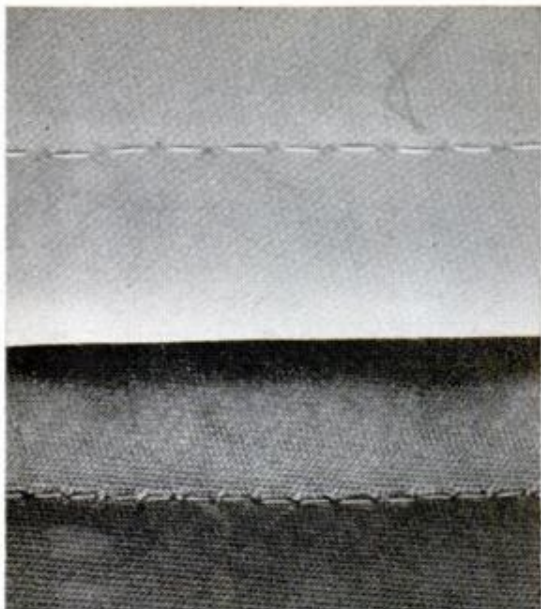

STITCHING is important. Look for nylon thread, 9 to 11 stitches per inch (top sample is $7\frac{1}{2}$; bottom 12), safety reinforcement

a rain suit along for wind, wet weather and sudden cold.

Inside the insulator, a lining helps hold it in place and protects it from wear and wearer. Almost all experts agree that a light set of ordinary cotton underwear is best beneath the insulated underwear, both for comfort and to avoid the cleaning problem that insulated gear is heir to. The lining material itself is usually nylon or a blend of nylon and cotton, though some less expensive suits are lined with rayon and some of the higher-quality suits are being lined with insulating liners for added warmth. Three good ones are soft nylon fleece, "raschel knit" cotton—a fish-netlike textured knit, and a two-ply cotton-and-wool sandwich that is a good insulated underwear fabric in itself. All three are good; all three add warmth (up to 10-15 percent more) and all three are marks of good insulated underwear.

It is generally agreed that some cotton is a good idea in the lining fabric, since pure nylon is not absorbent and is cold to the touch. A layer of wool outside the cotton-nylon lining helps the absorbency greatly, and adds its own insulating quality. Some nylon, however, is desirable for its fast-drying and long-wear qualities.

Though most insulated clothing comes in two-part suits, there are also some very good coveralls and

one-piece suits on the market. While the one-piece outfits won't let you wear the jacket alone in just-chilly weather, you won't have the tail sliding up and exposing your back with it, either. Choice of styles is pretty much up to the buyer.

Insulated accessory clothing includes hoods, socks, and mittens or semi-gloves. All work just as well as the body insulation, though the socks seldom fit well enough for long-distance walking and the mittens and gloves are bulky enough to restrict freedom of movement. Those with the elastic nylon-tricot shell fabric seem least restrictive.

Best way to tell good insulated clothing is by the labels and hang tags required by law. Though they seldom give the amount of batt weight of the materials listed and don't rate the garment for temperatures (users vary too much for that), they do identify all the materials used and show if satisfaction in the garment is guaranteed—a sure sign of good stuff.

The easiest tip-off to quality is color. Nylon is least expensive in buff and gray. A darker shell fabric costs more to make, won't show soil as easily as the lighter ones, and usually marks good underwear. The stitches can tell a lot, too.

Cost? Surprisingly low, considering what you get. You can buy a suit of insulated underwear for as little as five dollars. Not the best—but warm. A good suit of nylon-shelled, polyester-fiber-filled underwear will cost just over \$10 for 3.3-ounce filler and around \$15 for the 5-ounce weight. The best synthetic-insulated suit of underwear will cost around \$25—that gets 5 or 6-ounce polyester fiber fill or $\frac{3}{32}$ -inch polyurethane foam, with all the quality features. (Generally, suits under \$11, unless advertised as a special for a couple of dollars less by a large store or chain, are not likely to be suitable for long wear or low temperatures.)

A good suit of down underwear, in contrast, will cost around \$40—but it'll be the best, and nobody makes poor down-insulated gear. The cost of the down makes it foolish to put it in second-rate gear, and it takes good clothing to hold the down in, too.

Happily, all of it is good—though some is better. Decide what you need, and pay what you must to get it. ☆☆☆

Mirrors for Solar Power

Lightweight mirrors increase power in a solar panel by as much as 170 percent.

Developed by Electro-Optical Systems, Inc., the flat mirrors are designed to fold down over each solar panel during launch of a spacecraft and open up in space.

The 50 watts delivered by the combination of the mirror and panel is more than twice the power output of the panel itself. This lowers the weight of the unit compared to what it would weigh if solar cells alone were used. The mirrors, made of electroformed metal foil, reflect nearly 100 percent of incident light.

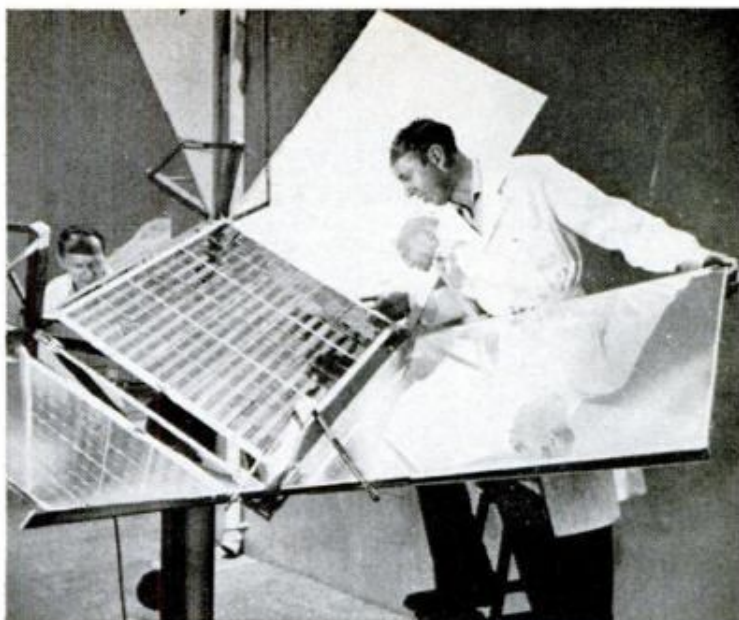

Two-Man Sub

Seating two persons comfortably, an 18-foot submarine can reach depths of 230 feet for observation of sea life.

The streamlined vehicle, called the *Cubmarine* by its maker, the Perry Submarine Builders, Inc., of West Palm Beach, Fla., has 12 plastic portholes.

Intended uses include exploration of underwater life and ocean floors, research, salvage operations, military reconnaissance and sport diving.

The *Cubmarine* can stay submerged for up to eight hours.



Lunar Pinball Machine

Space scientists can play pinball games with a circular table that includes a simulated Earth and a simulated moon and launches satellites (steel balls) from one to the other.

The Earth, complete with outlines of continents, revolves at a scale speed representing its daily rotation. The moon, complete with craters, is rotated around the earth by the moving table surface. Both earth and moon are set in depressions in the rubberized surface roughly equivalent to their gravitational fields. The steel ball is then launched from the earth to the moon by push-button action from a control panel.

Its flight is similar to that of an actual spacecraft flight.



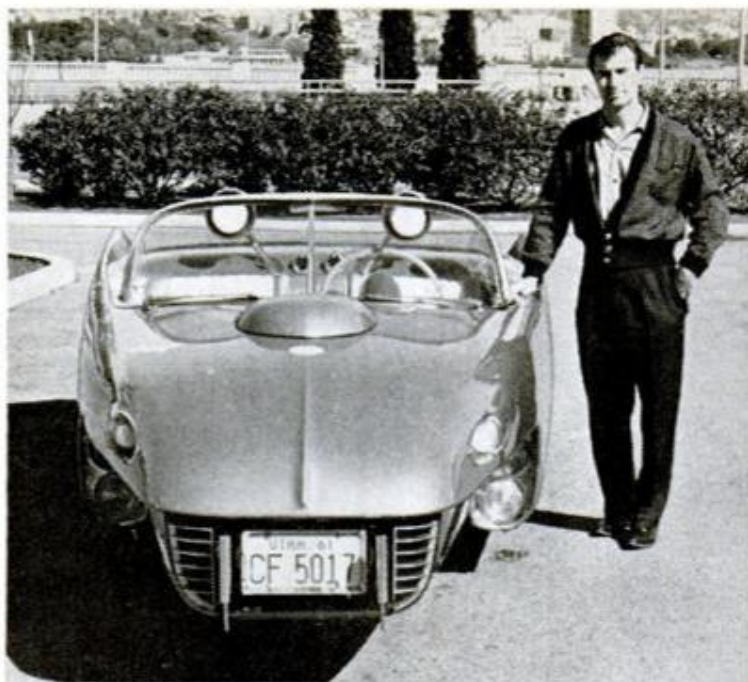

FRONT OF CAR sports three pairs of running lights in all. Futuristic headrests house radio speakers, protect against whiplash



Delta-Shaped Car Is Three-Wheeler

Delta-shaped, with a single wheel in front and two in the rear, the *Vortex-2000* is a sleek departure from conventional automobile building.

The windshield frame is also a roll bar, the taillights are the full width of the car, there are six forward driving lights, and electric locks on the passenger-side door are controlled by the driver.

The car was built by Jerry Woodward of Provo, Utah, who spent six years in the process. He has test driven the vehicle over 150 m.p.h., and he says that its unique construction "allows right-angle turns at 60 miles an hour with complete safety."

The *Vortex-2000* is 17½ feet long on a 133-inch wheelbase. Rear tread is 72 inches. The engine a modified V8 that produces 450 horsepower, is located in the rear.

Woodward says that there are no heating problems due to hill climbing and pulling as engine temperatures are thermostatically controlled by electric fans linked to the car radiator. He feels that the shape and innovations of his car make it ideal for high speed travel along the superhighways of the future.

Orchard Snorkel

Borrowing a good idea from the big-city fire fighters, who use snorkels to get access to awkward places on burning buildings, a Wisconsin apple grower uses a smaller version to prune the 2000 trees in his Oconomowoc orchard.

Called a *Travel Tower*, the unusual vehicle consists of a three-wheel power unit, an arm and the platform. All the controls—for raising and lowering the arm and for moving the entire machine forward—are operated from the platform.

The operator can raise the platform as high as 13 feet to use his air-powered pruning shears. The miniature version of an industrial monkey has other handy uses—as a mobile scaffold, for instance.

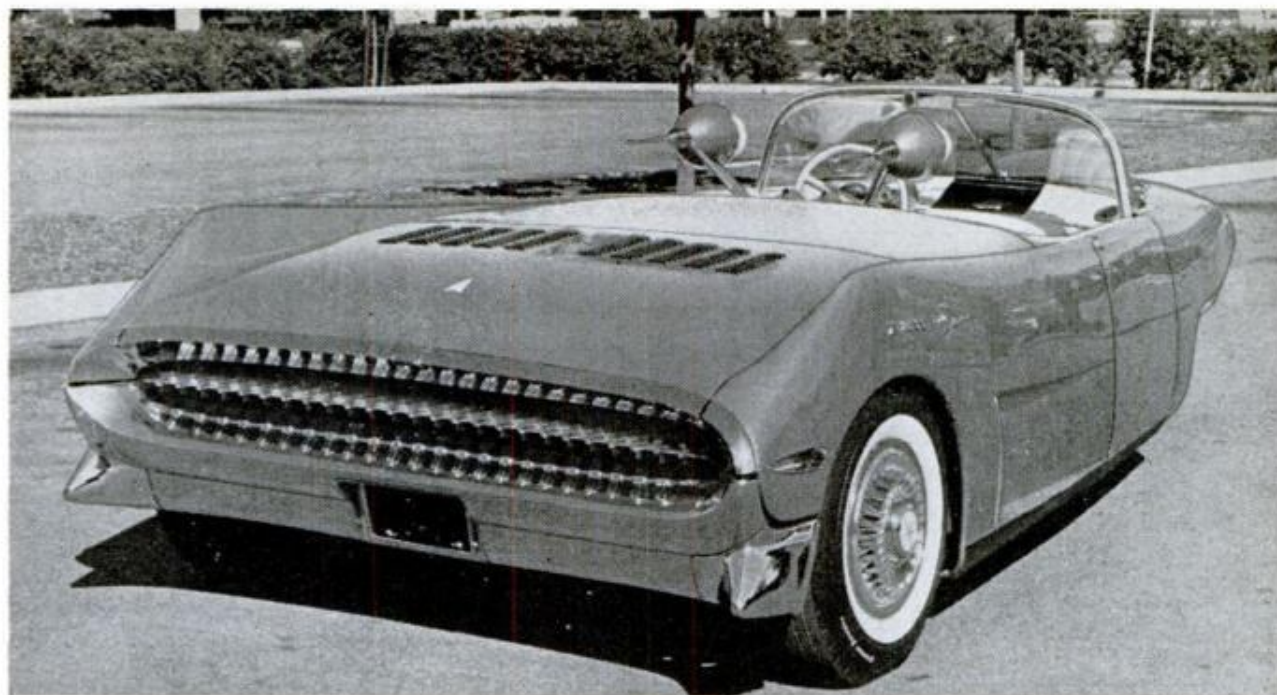

TRIANGULAR SHAPE of the Vortex emphasizes builder's use of full-width taillights which are encircled by the rear bumper. Door locks are electrically-operated by the driver. Windshield frame incorporates a roll bar



Piggyback Camper Is Contoured to Family Car

Tailored to fit the auto that carries it, a new camping unit clamps to the car without blocking the car doors. Turnbuckles on the rear bumper of the auto and a clamp-type luggage rack hold it firmly in place.

Able to sleep six and seat four at the breakfast table, the *Tourotel* has a butane stove, ice box, sink and its own water supply and electrical system. Maker is Sloat Mfg. Co., 111 W. Lowden, Fort Worth, Tex.

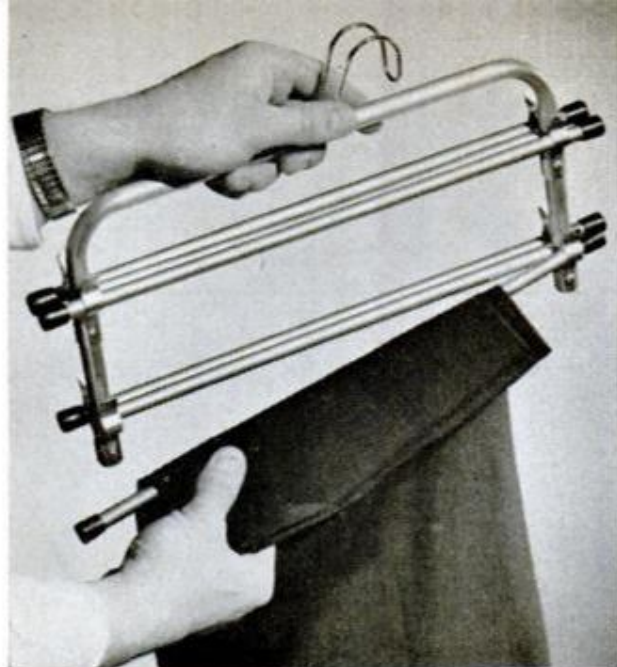

HANGER HOLDS TROUSERS, SLACKS and shorts without wrinkling. Swing-action of the hook keeps hanger on rod. It fits all lockers. Price: \$4 from Mar-Co Enterprises, PO Box 235, Toledo 1, Ohio



MAIL SLITTER opens envelopes. Tapping the automatic bar activates rotary blade. Costs \$18; Gifts by Terri, Larkin St., Springdale, Conn.



BATTERY-OPERATED PEPPERMILL grinds when a button is pressed. It's sold by Roberto Associates, Dept. 52, 2814 Gillham Rd., Kansas City 8, Mo., and costs \$6

OPENER WITH VISELIKE GRIP fastens to underside of shelf or cupboard. It gives a steady grip to work against and lifts lid even if container is glued shut. It opens several sizes while keeping one hand free and the container right side up. The opener is available from Uncapper, Box 1113, Palo Alto, Calif., and costs \$3





CONVERTIBLE BABY BED can be used as a conventional bed in the home or (with one set of legs extended) in a car. It is equipped with a sag-proof and wet-proof mattress. For storage, it can be folded flat. Carrying handles are part of the frame. Zipped apart, the bed converts into a safety seat that hooks over the back of front seat of car. Made by International Mfg. Co., 2512 Washington St., Roxbury 19, Mass., it sells for \$12.95



WALL-MOUNTED HOLDER keeps glasses when not in use; it attaches with glue or screws. Price: 59 cents; Roskam's Mfg. Co., 1148 SE Powell, Portland, Ore.



SAFETY SECURITY BOX can be installed in new or existing homes. Costs under \$30; Safe-T Products Co., Dept. SB-29, 3921 Xerxes Ave. S., Minneapolis, Minn.

RECESSED DRAPERY TRACK carries hand-drawn drapes; another similar track hides cords of cord-drawn drapes. Maker: Silent Gliss, Inc. Freeport, Ill.

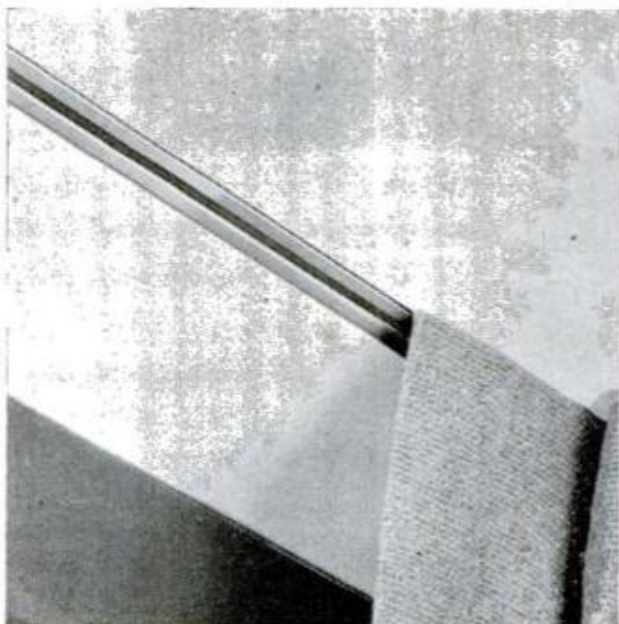

FLEXIBLE-SHAFT KITCHEN AID has eight attachments to mix foods; polish shoes, silver furniture. Costs \$29.95; Taylor Sales, 226 W. Wayne Ave., Wayne, Pa.

SHOP AND CRAFTS

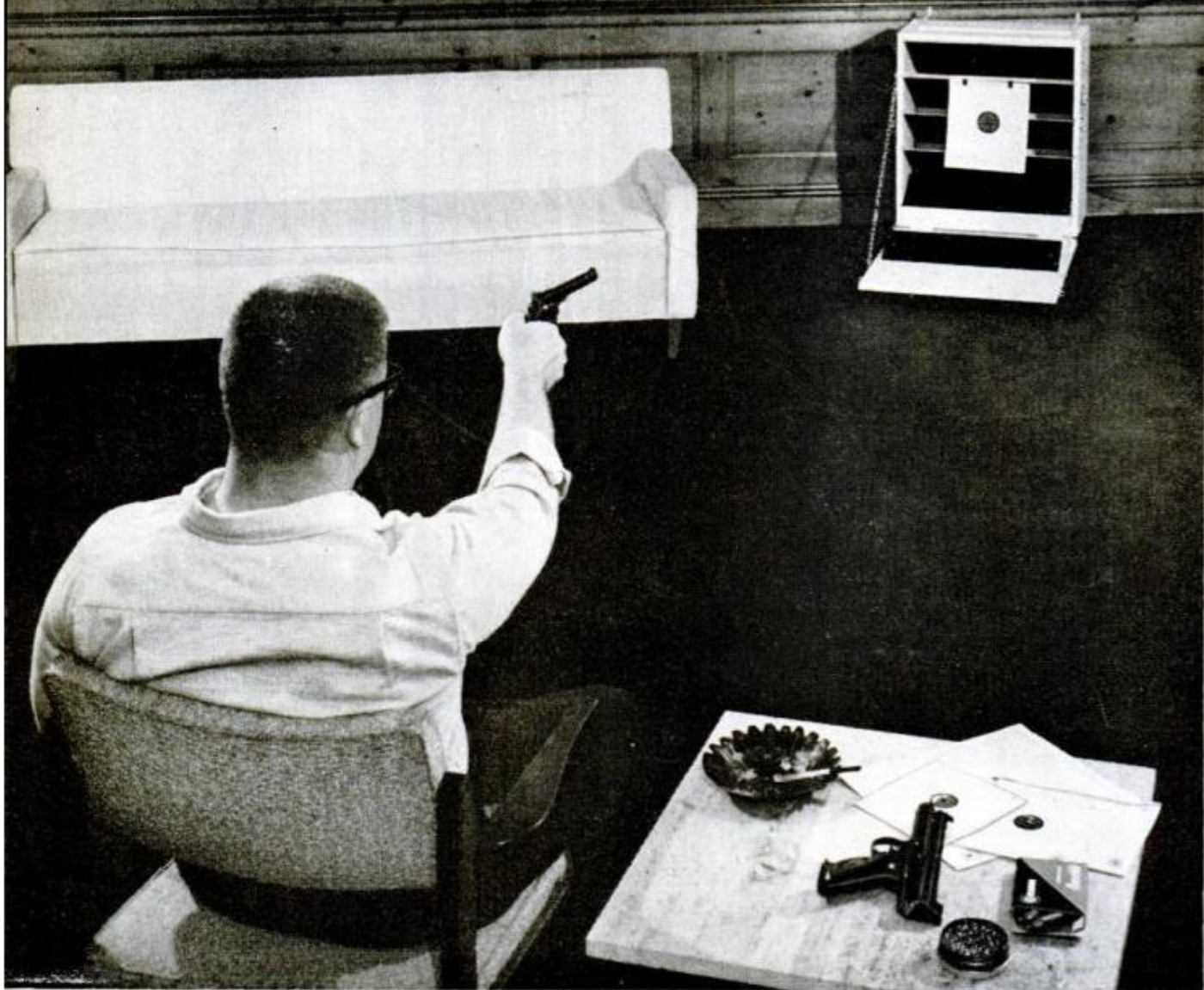

YOU CAN SHOOT ALL WINTER—indoors—if you have the right hardware and a proper trap. Below, some of the right hardware. Top to bottom, CO₂ target rifle; spring-powered BB gun; .22 rifle; .38 revolver



ARMCHAIR TARGET SHOOTING

By Dick Kirkpatrick

WHAT, FIRE THAT REVOLVER in the den? Sure, why not? He's shooting .22 shorts into a perfectly safe bullet trap that soaks 'em up with no danger of back spatter. It's cold outside, and he couldn't shoot safely in his suburban neighborhood anyway; it's comfortable indoors, and the thick paneled walls and acoustically tiled ceiling keep the noise down. And if his wife does complain about noise, he can always switch to the quieter CO₂ pistol on the table. They'll hardly hear that upstairs . . .

Indoor shooting, whether in an armchair or a regulation basement range, is becoming more and more popular. And more and more good equipment is becoming available for it. You can shoot anything from spring-powered BBs to big-bore handguns and rifles in your living room—if you can get away with it—in complete safety. With 15 feet of space, you can set up a range for BB guns, and the new spring-powered weapons are a far cry from the equipment you got in trouble with when you were a kid. With 25 feet, plus a little leg room, you can set up an official-scale NRA course for .22 target work. And 35 to 50 feet (plus an indulging family) is enough for your own indoor trapshooting setup if you like, using the efficient and inexpensive little .22 shotguns with eggshell birds and launching equipment to match. About the only thing you can't scale down to the living room or basement is full-sized shotgun shooting.

Living Room Rifle Range

Big-bore rifles—guns over .22 rimfire size—are no big problem, though. Too powerful to stop with a simple bullet trap, too noisy to fire indoors without acoustical help, and pretty expensive to shoot for fun. However, you can throw away the book and shoot them with wax, plastic, or small-bore insert bullets; then the big gun becomes very practical and quite inexpensive for indoor plinking. The power for all three systems is just the pistol primer—no regular powder charge at all. It provides power—and accuracy—enough for close-range indoor shooting, and still feels like the real thing. So you can shoot your .30-06 in the living room, too.

Wax bullets are probably the easiest, and certainly the least expensive. Starting with an empty cartridge, you fit in the proper-sized primer (large pistol or shotgun prim-

ers work best) for the power. You melt a pan of paraffin (or, better still, specially-made bullet wax you can buy at a sporting-goods store) and pour it into a shallow pan until it's about 5/16-inch deep, though the depth isn't critical. Shove the empty case down through the cooled wax like a cookie cutter, then lift it back out with a slight twist, and it's loaded and ready to fire. For serious wax-bullet shooting, you'll want to drill a few cases to take the big shotgun primers for maximum power, or buy pre-drilled cases designed for that kind of loads. There's a wax-loading kit on the market that contains all the equipment plus some simple tools to simplify reloading plus a supply of special wax that doesn't foul gun barrels as much as paraffin. In either case, you'll want to clean out the barrel frequently to remove wax deposits. For best results, the flash hole inside the primer pocket needs to be opened to about 1/10 inch, too. For the wax-bullet man, there are precast wax bullets that fit right into the cases, but they aren't reusable.

That factor brings up the second way to shoot big-bores indoors. You can buy molded nylon cases and bullets that work like the wax outfits, using the same primers for power. The nylon slugs, though, are tough enough that they're reusable indefinitely as long as you shoot into a fairly soft backstop. While neither wax nor plastic bullets will reproduce real-bullet accuracy, you can get three-inch groups at 25 feet with any of them and probably a little better with the nylon bullets.

One big advantage of wax bullets for western-style shooters: The fast-draw boys use low-primer loads and soft wax bullets and draw down against themselves in a heavy plate-glass mirror. The wax won't break the heavy glass, and it sticks where it hits for scoring. But don't try it out on the antique pier glass. Wax bullets do deliver a pretty good punch. They'll break ordinary glass, and can deliver a pretty good bruise—maybe even put out an eye. Whatever "soft" load you use, handle the gun as if it had real bullets in it.

Another way to shoot big-bore handguns indoors is to use the cylinder insert bullets that use a primer to fire a BB through a short barrel built into the case. They carry out through the barrel without touching it, hit hard enough to penetrate 3/4-inch plywood at 25 feet and deliver fair accuracy.

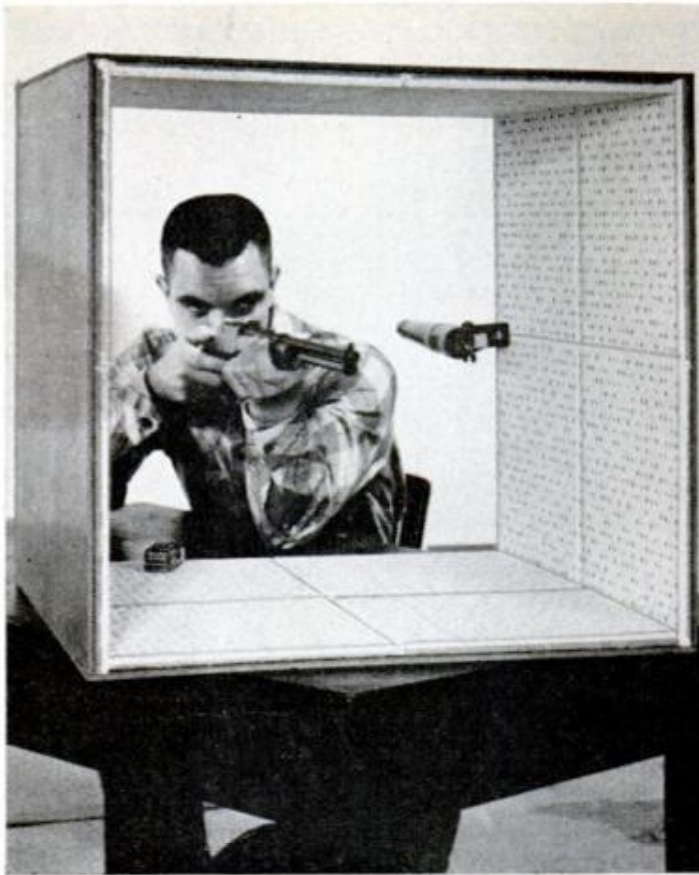

The cost of primer-powered shooting is very low. The primers themselves cost less than a penny apiece; a pound of good bullet wax costs about 60 cents and is reusable. Brand-new, specially drilled .38 cases for wax-bullet loading cost less than eight cents apiece, and the full reloading kit is under \$5.00. The nylon bullets cost from \$1.50 to \$2.00 for six (plus primers, which can't be mailed to you) and are reusable until you hit a hard surface with them. The set of six inserts to fire BBs through any size handgun costs under \$9.00, plus primers and BBs. None of the systems is very expensive compared to the real thing.

For pure fun-shooting, it's as hard to beat the old spring-powered BB gun now as it was 20 years ago. The new ones are a lot easier to use and harder-hitting than they were then, too, but the cost is still only the price of the BBs—and they're reusable if you shoot into a soft backstop like the one shown on page 144. The best BB gun you can buy costs around \$12.00, delivers good, consistent accuracy at BB-gun range (15 feet) and hits 350 feet per second for impressive punch at that range. With good, copper-coated steel BBs selling around 50 cents a pound and the power coming from your good right arm, it's a lot of shooting for as little as a dollar.

Next best for economy, but accurate enough to be used in National Rifle Association 25-foot competition, are the hand-pumped pneumatic guns. They use arm

power (and more of it) but shoot BBs, .177 caliber or .22 "skirted" lead bullets through a rifled barrel. You can pump them from 2 or 3 up to 10 or 12 strokes, and get low power for soft backstops and indoor shooting, or very good punch for long-range shooting or varmint hunting. The gun is more expensive than the spring-powered models (at \$25.00 to \$35.00 for a good pistol or rifle) but if you buy the .177-caliber models, you can still shoot BBs for plinking at a fraction of a cent per shot.

Plus Pellets For Plinking

Skirted pellets, or pellets, aren't expensive, either, at just under \$1.00 for 250 in .177; just over \$1.00 for that many .22s. They provide the best accuracy for the money of any of the indoor guns if you don't mind pumping them. The pumping isn't tough for most people, though some women and smaller kids find it difficult.

The liquid CO₂ bottle made the big breakthrough in pneumatic weapons right after the war, when pellet-gun manufacturers learned to use that inexpensive bottled power for their guns. Now you can get CO₂ powered rifles and pistols—even a simulated revolver—that'll fire from 20 to 40 rounds or more on a one or two-cartridge charge of CO₂, delivering effortless, consistent shots at up to 650 feet per second. The cost, of course, goes up, but not too much. A cartridge costs less than 20 cents.

You can buy CO₂-powered pistols for as

◀ **SHOOTING BOX**, lined with acoustical ceiling tile, gives a break on noise with .22s. The bigger the box, the better it works; 2 by 4-foot sides cut noise 15 percent NRA recommends 4 by 4 or larger. Shooting mat, pad, also helps

◀ **STOP FOR BBs, CO₂** and air-gun pellets and wax or plastic bullets is easy. This one's only a cardboard box with 4 in. of old telephone books at rear. Good for hundreds of rounds, it costs nothing at all. Let new targets cover old to close front

▶ **NEW CORK-FIRING** "trapshooting" outfit gives a new kind of indoor shooting. Foot on bulb releases a breakaway "bird", shooter fires to try to "break" it



little as \$15.00 or as much as \$49.00 and rifles from \$16.00 to \$75.00. The \$75.00 model has everything the big-time match .22 rifles have, including pinpoint accuracy. Both pistols and rifles are available in single shot, manual repeating and semi-automatic models just like powder weapons. They're tops for indoor shooting, with plenty of accuracy, big-gun sights and features, but a minimum of noise and no need for a bullet trap. The simple box stop shown at the bottom of page 144 will do nicely if you shoot carefully.

This winter most of the high-level indoor shooting is being done with the regular .22 rifle on 25 and 50-foot indoor ranges, as it has for years. The .22 is hard to beat for inexpensive precision shooting on regular ranges, and makes a perfectly practical indoor weapon—if you have an adequate bullet stop—or trap. You can buy a .22 handgun for \$20.00—or \$300.00; a rifle for \$16.00—or \$365.00. That's stock. You can pay more if you like custom goodies. Almost any of them will provide satisfying accuracy at indoor distances; at 25 feet the sights mean more than the gun as a rule.

The bullet trap isn't too big a problem. You can buy a commercial .22 trap for as little as \$10.00 and a heavy-duty model for any size handgun load for just over \$25.00. You can build the excellent PM "venetian-blind" trap on pages 146 and 147 for little more than the price of the steel plates. It'll stop .22s for years, and take an occasional

bigger load once in a while.

Maybe the biggest problem in shooting the .22 indoors is the noise. Especially in a concrete-floored basement, it does ring the ears a bit. An acoustical ceiling and acoustically tiled walls make a big difference. The acoustical shooting box shown on page 144 will be some help. Surprisingly, the normally quiet .22 shorts seem to make almost as much noise as the long-rifle loads when shooting indoors, though they have a definite price advantage—65 cents for 50 shorts, compared to 80 cents for the same number of long rifles. At 25 feet they're both more accurate than you will be for anything but formal target work.

Best place to go for information on shooting indoors—or anywhere else, for that matter—is the National Rifle Association, 1600 Rhode Island Avenue NW, Washington 6, D. C. For 35 cents you can have their excellent booklet on the 25-foot shooting program; better still, you can become an individual member for \$5.00. Still better, check out and join your local NRA-affiliated club. It's always more fun to shoot with friends, indoors, or outdoors.

PM's bullet trap is an inexpensive, easy-to-build home-range version of the excellent "venetian-blind" bullet traps designed for commercial and police range use by Joseph Nikoden of the Detroit Bullet Trap Company of Chicago. It's less likely to produce "splashback" than the traditional single-plate traps. It doesn't throw as much

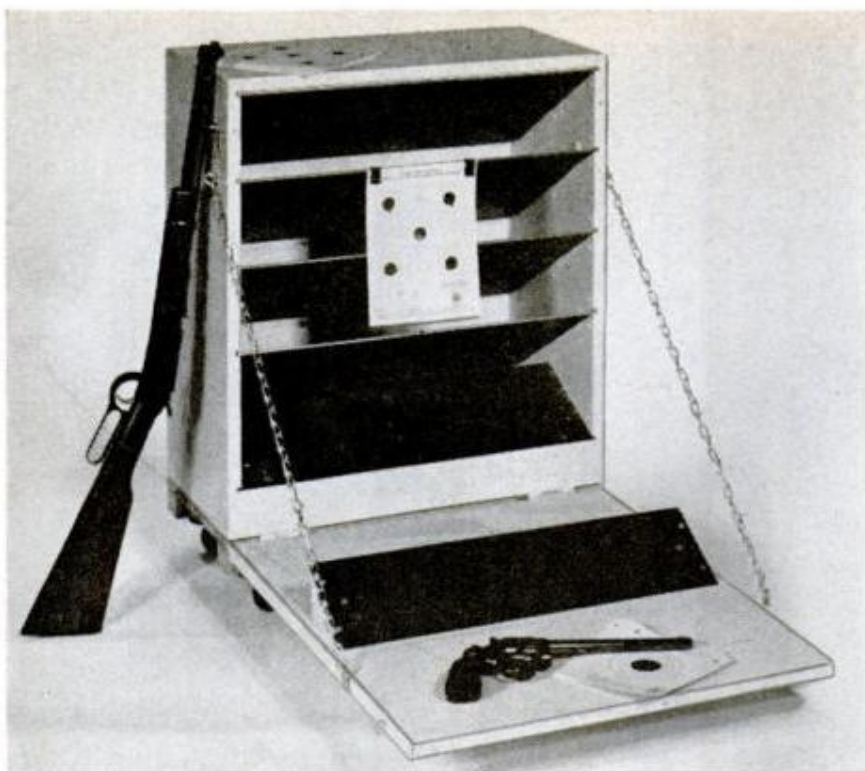

PM'S "VENETIAN-BLIND" bullet trap is designed to stop any rimfire .22, and will contain the lower-powered handguns up to .38 short for occasional shooting. This 24 x 26-in. size is big for beginners on the 25-foot range, and is perfectly safe and easy to build as shown at right

sand around the basement, nor does it take up so much floor space when not in use. This design can be scaled up or down to almost any size, and is flexible enough that it can be changed to fit the steel plates available to you. We show this one in detail, but mostly to give you the principles of venetian-blind trap design.

Key to the trap are the angled, overlapping plates that actually do the work of deflecting the incoming bullets. Key to *that* feature is that bullets don't bounce like billiard balls, but smear out and slide along a hard, smooth surface. The soft .22 slug smears down along the slanted plate, off onto the steel back plate, and down into the sand or wet sawdust in the base of the trap. The angle of the primary plates isn't very critical—30 to 45 degrees will do, though the shallower the angle, the less backspatter you'll get. However, the 45-degree angle soaks up more of the force of impact, reducing wear at other points. You'll get a slight, harmless (at five feet) powder spatter at any angle, however. When the bullet upsets against the plate, some of the metal is squeezed back in the direction of its flight. In any indoor shooting, where a bullet might strike something other than the backstop or trap, it's a good idea to wear glasses as a safety extra.

For frequent, heavy shooting, the side, top and bottom lining plates are a good idea, since spattering metal will wear the wood walls in time. Lining "plates" can be very light sheet metal of any kind. The 20-gauge steel used in the pilot model would last a lifetime. Heavy plate pays off on the louvered deflectors and the pro-

tective plate over the built-in lights.

It's important to make sure that each primary plate overlaps those above and below it enough that, no matter from what position you're firing, you can't see the backplate. (It's best to paint the backplate light grey to be sure you can see it if you work into a dangerous position.)

Mr. Nikoden's basic design holds, no matter how big—or small—you build a venetian-blind bullet trap. It could be six inches square or six feet square. About the only limiting factor would be its weight—it must be heavy enough to stay put under bullet impacts and light enough to be somewhat portable, though the latter isn't important if you have space to spare.

The paper target (another inexpensive item at less than a penny each) is easily attached by bending it over the leading edge of one of the primary plates, using masking tape to anchor it to the reverse side. Or a wire can be run across the face of the trap, passing through the coiled springs of two clamp-type clothespins, which in turn hold the target. Either way, there's nothing to deflect a bullet.

With the PM trap 30 inches tall (depending on your choice of targets), there is no reason to elevate it for shooting in the standing position. With smaller traps this may be necessary; it's an easy matter to set it on a box or table, or to hang the whole trap from the ceiling beams on chains.

One word of caution: The trap won't do for BBs. They don't slide—they bounce. They not only leave the trap, but flatten themselves out of reusability. Better to use a soft backstop. ★★★

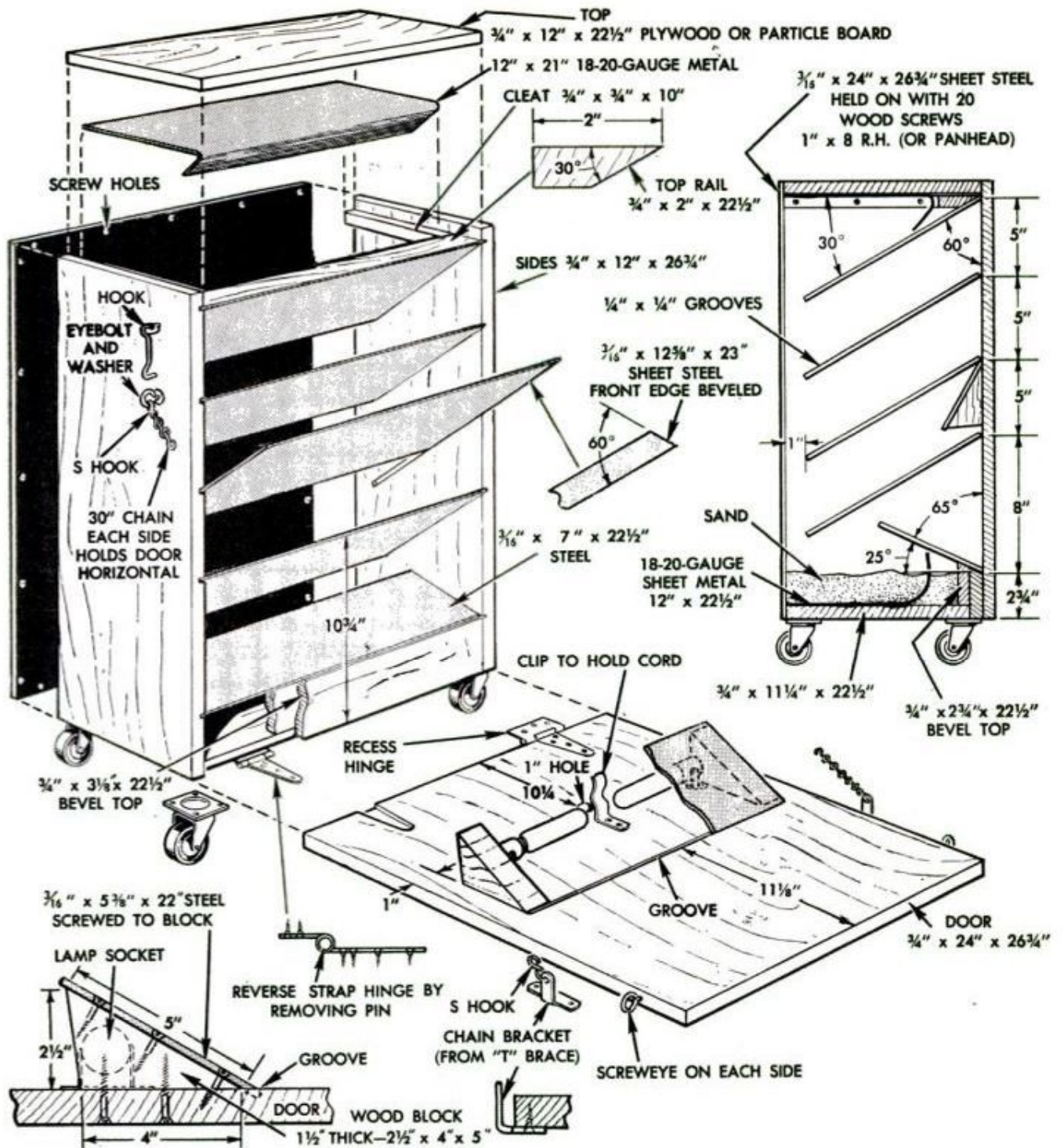

EXPLODED PLAN, above, shows details of construction of this particular trap, but sizes can vary to fit the available materials. Below, simple (but less efficient) one-plate trap; commercial spiral-drum trap at the right

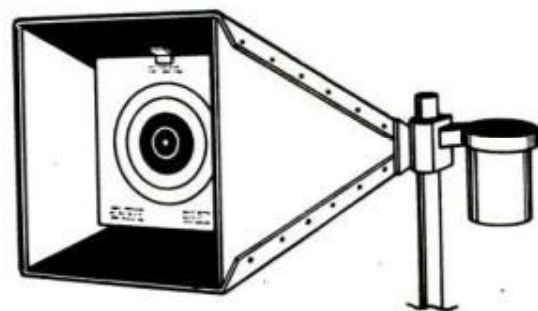

Solving HOME PROBLEMS



SPOT REMOVAL will be a breeze if you use a carpet-backed caster cup as an applicator for the cleaning fluid. The raised pile of the carpet insert is ideal for brushing the cleaning fluid into the soiled fabric



HEAVY FLOOR PLANTS can be moved from room to room or outdoors effortlessly with this simple plant dolly. Make it from 2 x 4 stock, using a half-lap joint at the center, and notch pieces to fit plant's tub

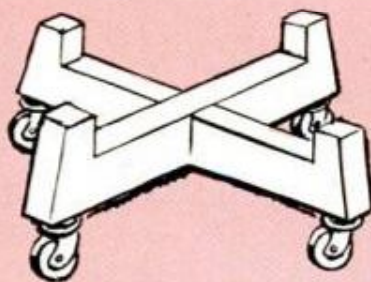

CARDBOARD STRIPS bent U-shaped to fit snugly into a rectangular cardboard box form shelves in this cabinet. Wings of U serve as supports for each succeeding shelf as in left-hand photos. Glue wings in place or hold with tape. Cover the cabinet with wallpaper

KITCHEN TOWEL HOLDER mounts in a minute and holds towel securely. Make it by driving a screw through a hole in handle of a plastic spoon so that bowl of the spoon is tight against the surface. Slip towel under spoon and tension will hold it in place

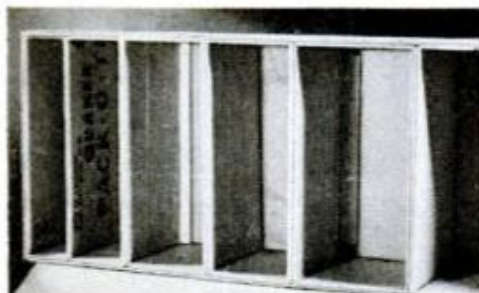

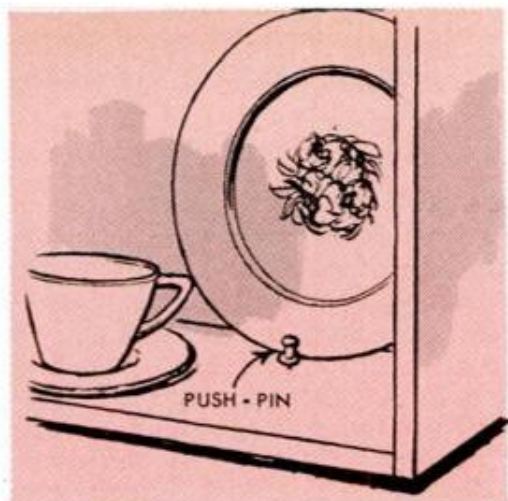

PUSH PINS can substitute for grooves to hold china plates standing edgewise on shelves. Press pins into wood so that only heads project. For large plates or platters use two pins, so that the piece cannot roll

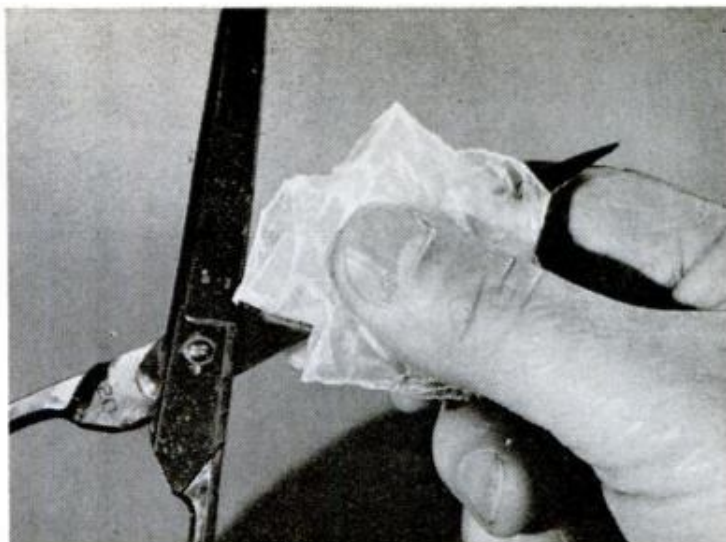

TO RUSTPROOF SHEARS, rub the unplated inner surface of each blade with a wad of ordinary wax paper. If you plan to store them for any length of time, you can protect the cutting edges by folding a piece of wax paper and cutting it with the shears



EMERGENCY ICE CREEPERS can be made from strips of fly screen. Wrap a strip around each shoe and tie with a cord looped around your ankle. They'll get you from house to garage, across street, safely

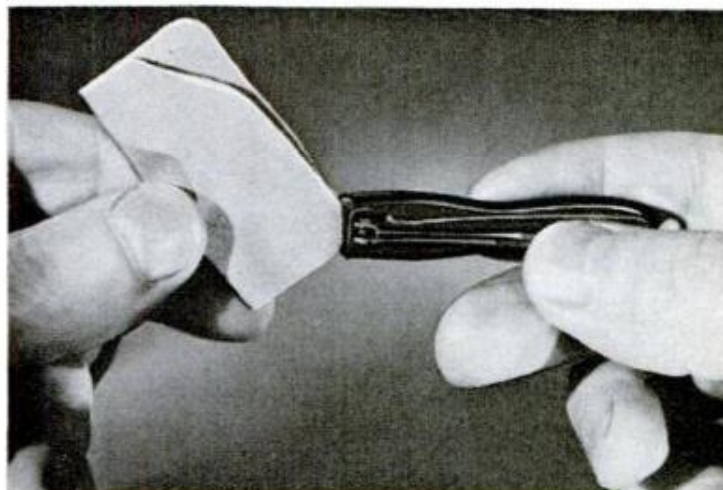

PRESS-ON MENDING TAPE holds better and won't lift if the corners of each patch are rounded. A quick, neat way to do this is to fold the patch over twice so that all corners are aligned and then snip them off with a fingernail clipper

HAVING TROUBLE keeping track of all those tubes of repair compounds in your workshop? You can tell at a glance how much is in each tube if you clip each one in a spring-type paper clip and hang

PULL-OUT SPOUTS on boxes of kitchen products often open so wide that you accidentally pour out too much material. To slow the pouring rate, run a strip of tape around the edge of the box so that it keeps the metal spout from opening completely

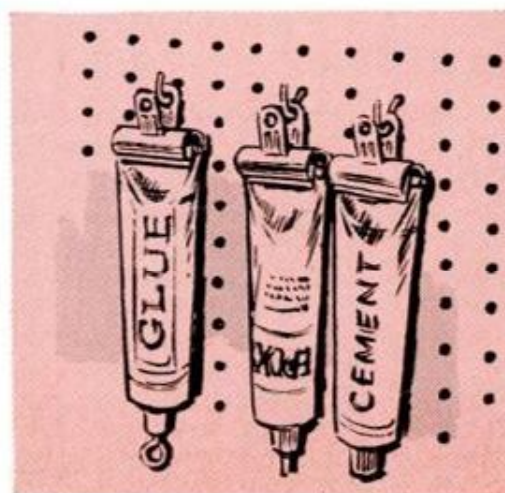



WORTH REMEMBERING

Chain Locker

There's just no suitable place for tire chains in a pickup truck, except perhaps somewhere in the cab, where they're usually underfoot. One pickup truck owner built a chain locker just back of the cab, the side members of the 2 x 2 frame extending so that they fit into the stake pockets. The hinged drop door is a frame of 1 x 2s covered with 1/8-in. hardboard, which also forms the back panel of the locker frame.—*R. B. Crook*

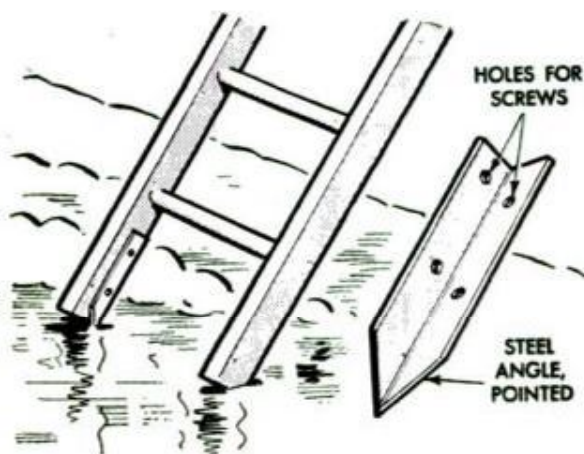

Ladder Creepers

To prevent a ladder from slipping when you must use it on ice in an emergency, cut two short lengths of steel angle, 1/8 x 1 x 1 in. or larger, and file the webs at one end of each piece to a sharp point. Then drill two holes in each web for screws with which the creepers are fastened to the lower ends of the ladder legs, or stringers, with the sharpened ends projecting.

—*William Longcor*

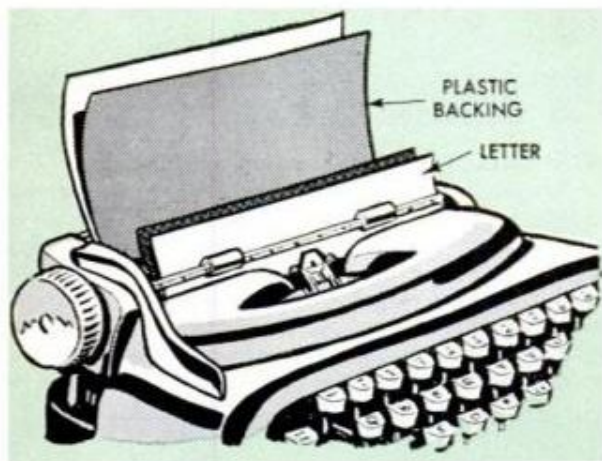

Tip for Stenos

When the platen on your typewriter ages and becomes indented with rows of type impressions, you can compensate temporarily for the loss of resilience by inserting extra sheets of typing paper in addition to the carbon and second sheets. But a better way is to cut a piece of plastic material of the type having an adhesive backing to the size of a sheet of typing paper and insert it along with the letter paper and the carbon. The comparative stiffness of this backing gives a clear imprint.

—*Frank Shore*



A Drop in Time

Solder the tip from a discarded mechanical pencil to the spout of a pressure, or squirt-type oil can and you've got a one-drop oiler for those hard-to-reach oil holes, oil cups, and small bearings that require just one drop, no more. For a longer reach and a larger drop, use the point, or tip, from a pencil of the type taking a large-diameter lead like that pictured in the right hand at the left. Of course, the same idea can be applied to any spout-type oil can for controlled one-drop oiling. It doesn't have to be a squirt type.

—*Robert Micals*

Mancala

THE NATIONAL GAME of Africa has suddenly caught on among Americans, and you can join in the fun by making a Mancala board in your home workshop, following the details below. One of the world's oldest games, Mancala is played by two people, and the object is to capture the most counters. Each player places the same number of counters (coins, marbles, etc.) in every one of the six holes on his side of the board. You can start with six and use more as you gain proficiency.

To begin, the first player picks up all the counters from any one of his six holes and distributes them to his right, placing one in each hole. If the last one lands in his scoring bin, he gets another turn, but otherwise the turn passes to his opponent. If he has enough counters to go beyond his scoring bin, after dropping one there, he proceeds from right to left along his opponent's side of the board. When he can go around the other end (skipping the other player's scoring bin) and drop the last counter in an empty hole on his own side of the board, he captures all the counters in the hole opposite. The game ends when all holes on either side of the board are empty, and the player with the most counters in his scoring bin is the winner.—*Volta Torrey*

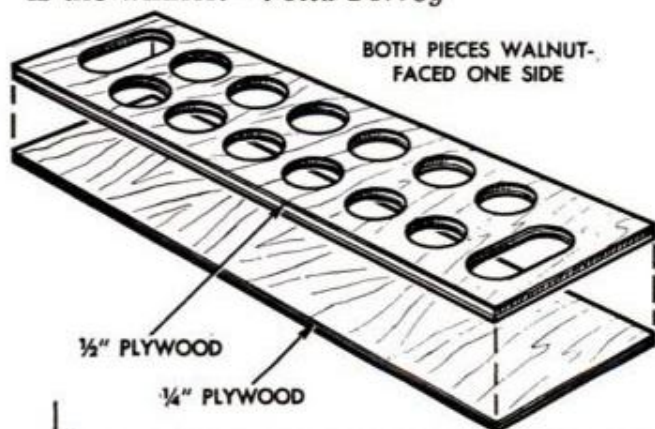
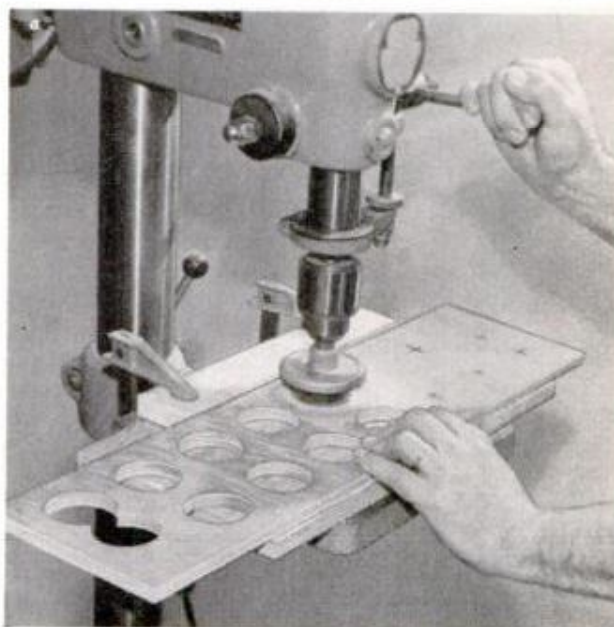

HOLE SAW is perfect tool for making the cutouts in the upper half of your Mancala board. If you don't have one, use a jigsaw for this job. To cut out scoring bins with hole saw, make two overlapping hole cuts and trim the waste to leave a smooth side

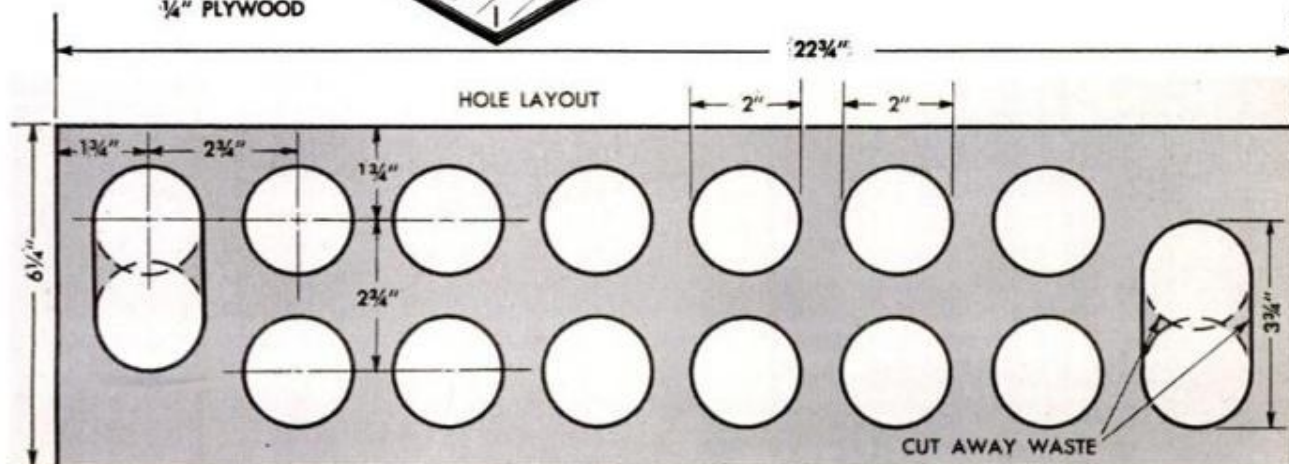

10 GIFTS YOU CAN

Novel Lamp Bases

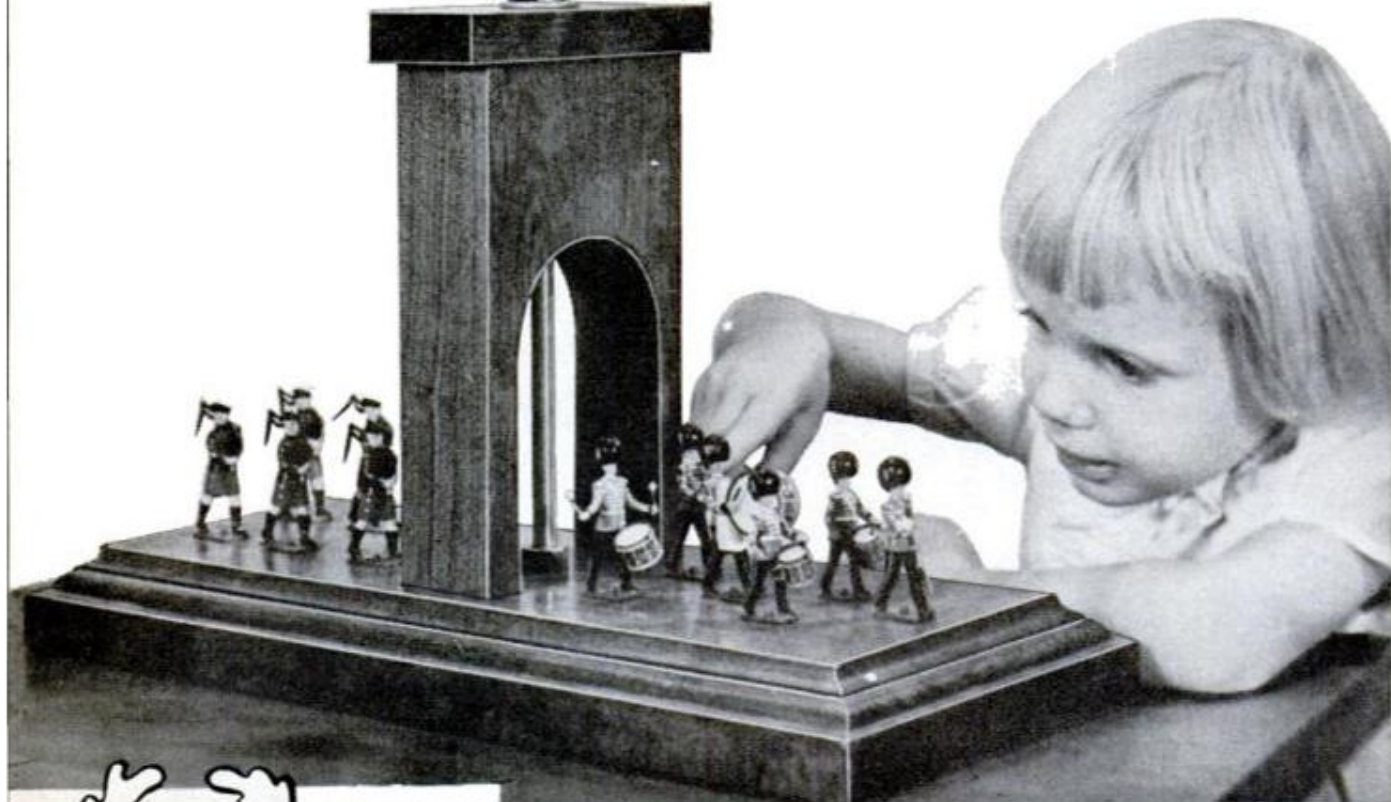

THE BOSS-MAN SAYS WE'RE
GONNA NEED HELP TO MEET OUR
DEC. 25 DELIVERIES. HERE ARE
14 PAGES OF OUR HOTTEST ITEMS.
ANY VOLUNTEERS?

YOU'LL BE THE LIGHT of your youngster's life if you tuck one of these intriguing lamps under the Christmas tree. Any of the five designs shown here will bring a touch of magic to a child's room. And though they all bristle with colorful detail, none of them should take more than an evening to assemble. The secret lies in dressing up simple materials with ready-made elements. In several cases, you may be able to make use of toy figures your child has already collected. By cementing or

MAKE FOR CHRISTMAS

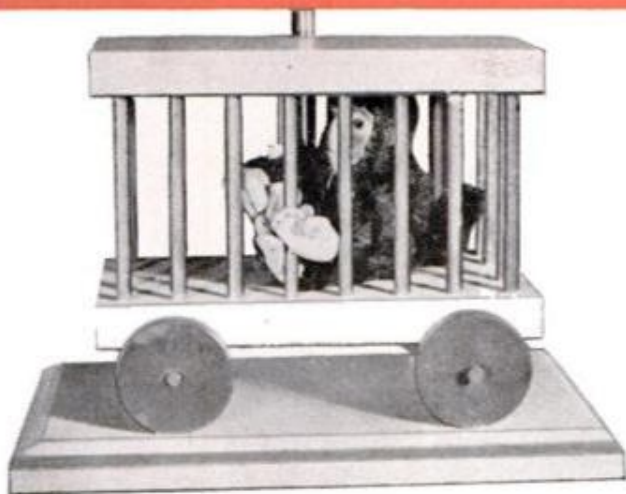

bradding them to a lamp base, you'll put them on permanent display. Otherwise, a little rummaging in a toy shop will turn up exactly what you need.

Standard 8 or 9-in. brass harps, rods, finials and base nuts are used for all but the circus tent and lighthouse lamps. The tent contains its own bulb, shaded by a quart-size freezer or ice-cream carton. Inverted, the translucent plastic makes an ideal night light. For brighter illumination, you can cut out the bottom.

Lay out and cut the two platform disks before cutting the center holes. The top canopy is turned on the lathe. Paint all parts before final assembly. White or light yellow platforms give the best illumination. Lightweight brass chain, run through dowel posts around the edge of the upper platform, lends a finishing touch.

The wood parts of the lighthouse are all

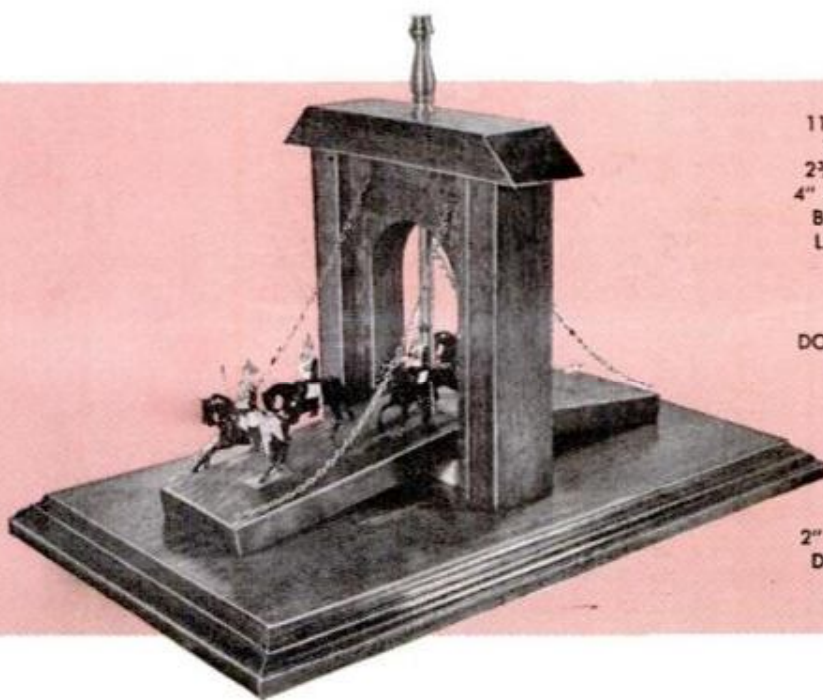
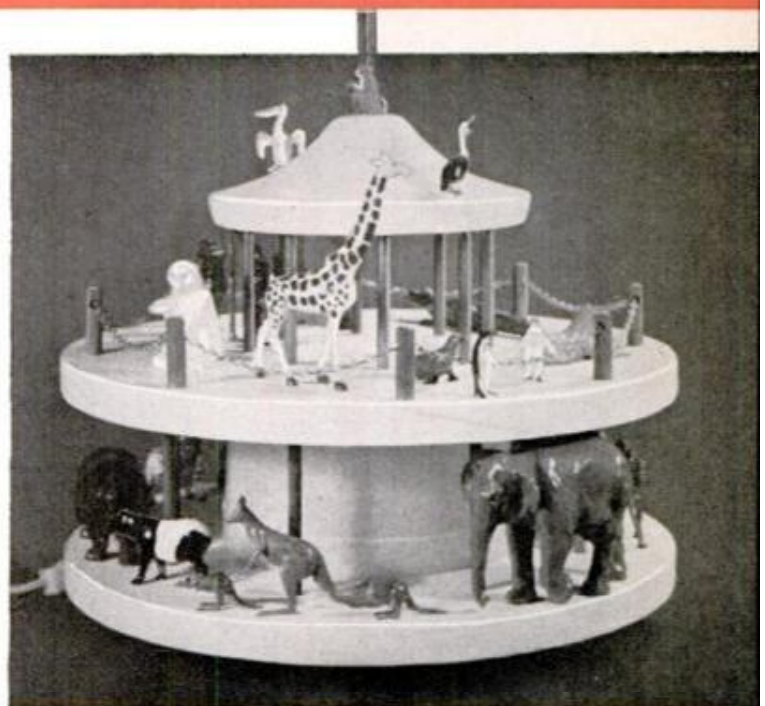

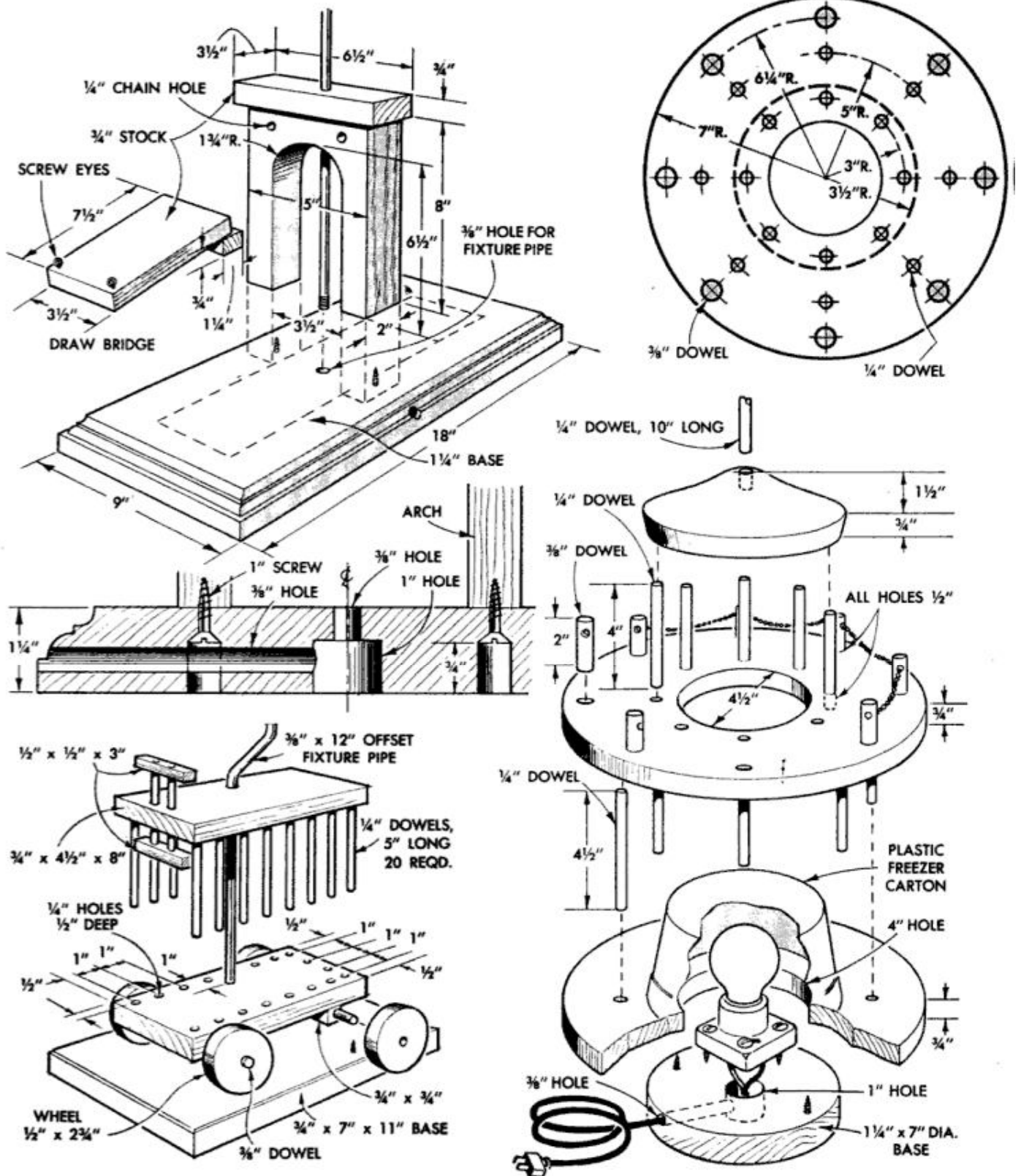

lathe-turned. The striping is easy if you paint the column white, then spiral wide masking tape around it before spraying or brushing on red paint. For a night light, use a 7½-watt bulb inside the lens. Or, make a conventional lamp by enlarging the base and running a lamp rod up through the top for a socket and harp.

Two of the lamp bases feature a lofty arch cut from a hardwood block. In one case, a drum and pipe band of the Irish Guards parades through it. As a variation, add an incline at each side, "hung" on

brass chain, and you've got a drawbridge that's an ideal setting for mounted knights.

To simplify construction of the cage lamp, you can omit the moving gate by inserting a stuffed animal at the time of assembly. Paint all the parts first.

Four of the lamps are wired by feeding the cord through a hole drilled in the edge of the base and into a well deep enough to recess the nut on the end of the fixture pipe. For the cage lamp, simply run the wire between the base and the bottom of the wagon.—Patrick K. Snook.



Portable Cradle

THE PERFECT GIFT for a new baby's first Christmas, this modern cradle is sized to use a standard 13 x 28-in. bassinet pad and styled for double utility. Lift the cradle out of its stand and you have a portable bassinet or car bed. Or if you have a little girl on your gift list, think how delighted she would be to discover a small-size version of this cradle under the tree on Christmas morning.

Use glue and countersunk screws to assemble the pieces, and fill the screw holes with wood putty or wood plugs. Either leave the wood natural or give it a light stain, then finish with several coats of shellac. For an interesting effect, enamel the edge grain of the plywood to fit the color scheme used in the nursery.

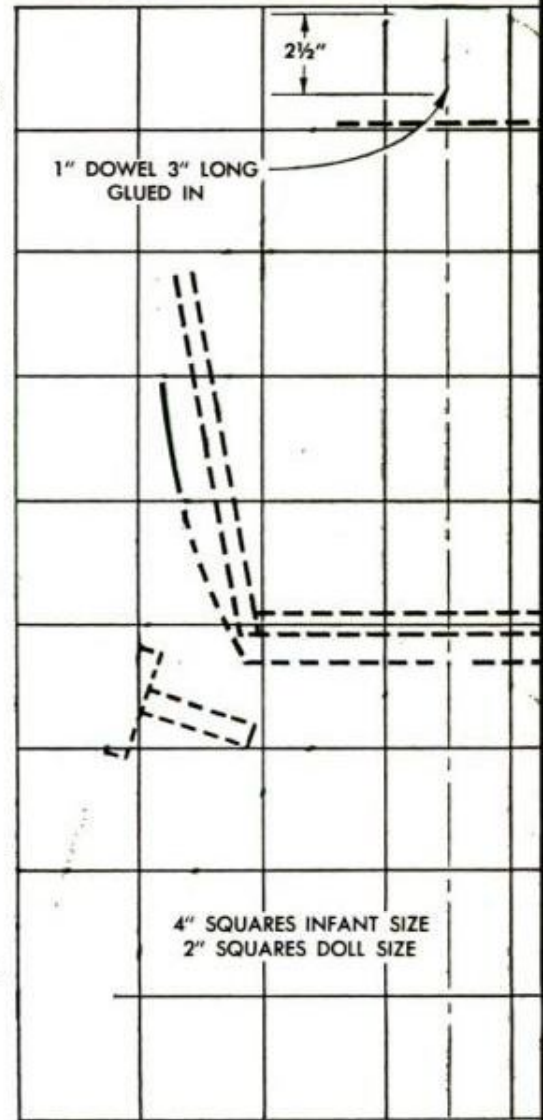
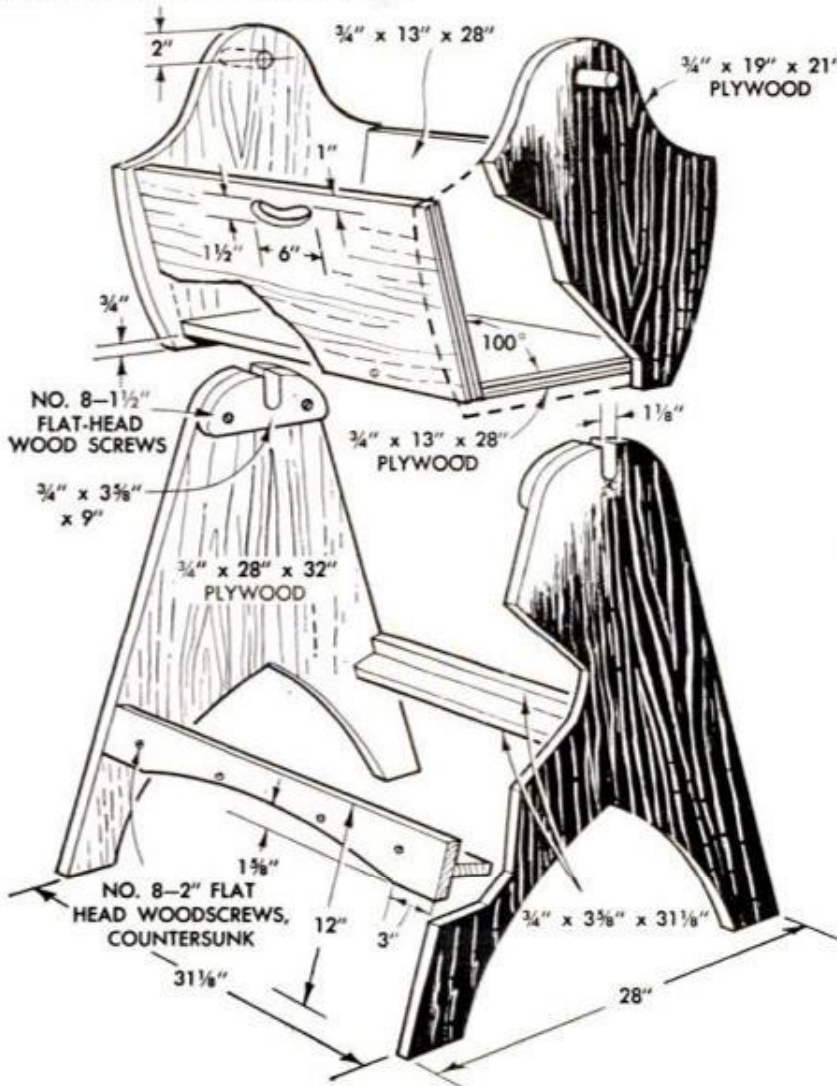

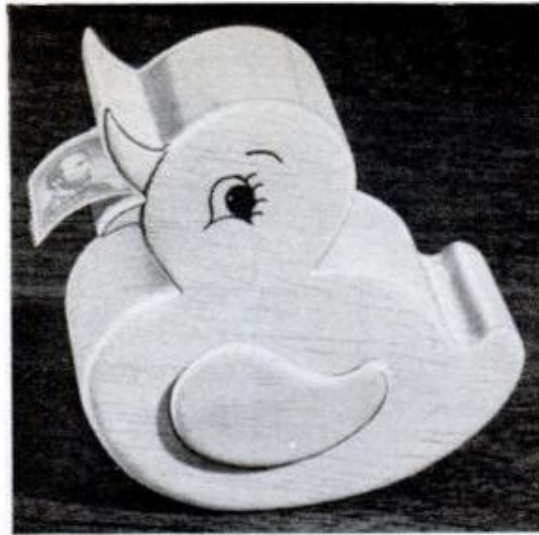
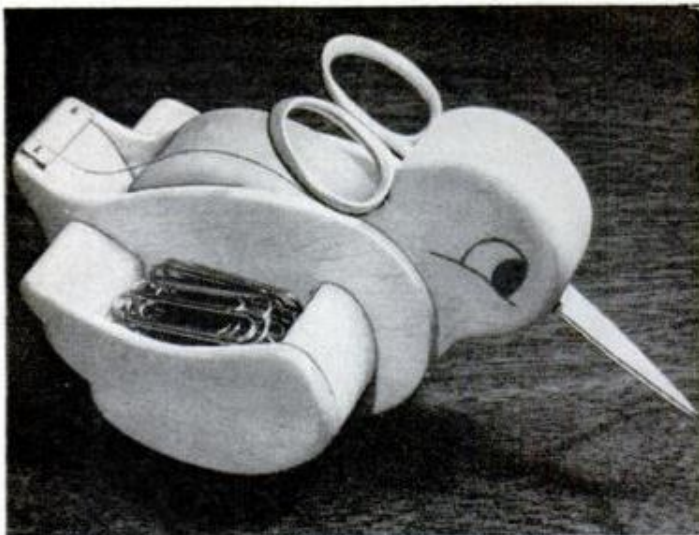

Desk Ducks

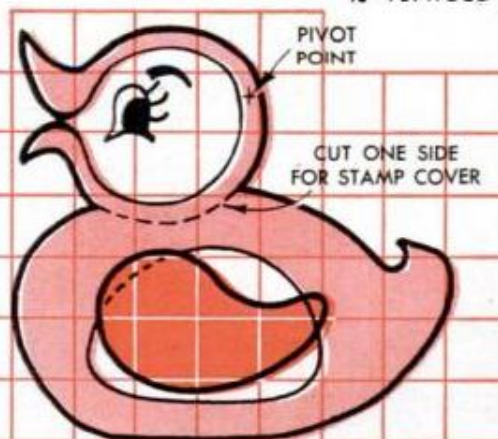
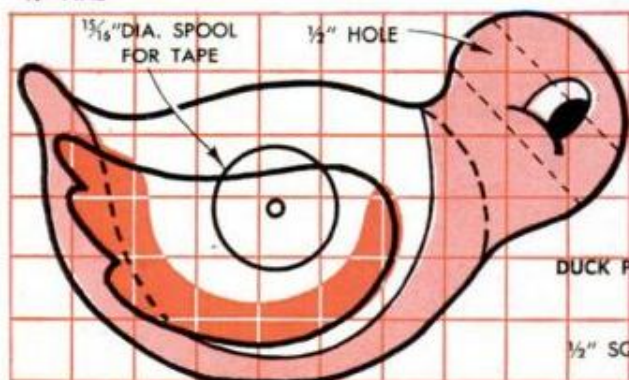
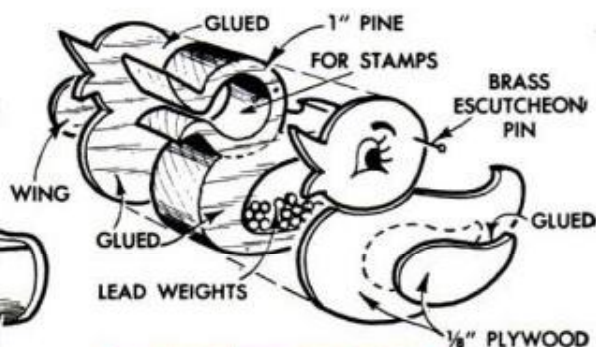
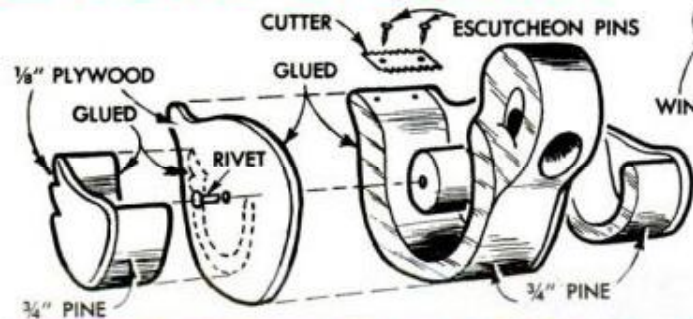

THESE TWO BRIGHT little birds will do a great job of keeping your kitchen desk neat and orderly. Scissors-Bill holds two wingfuls of paper clips, and cellophane tape rolls off his back like water. His cheerful friend, Stamp-Bill, has nothing on his mind but postage stamps. However, a heavy meal of lead sinkers turns him into decorative paperweight.

To make the scissors-holder duck, mark the cutting outlines of the various pieces on $\frac{3}{4}$ -in. pine and $\frac{1}{8}$ -in. plywood. Drill the scissors hole in the head at a 45-deg. angle to the base, and add press-fit holes in the sides for the rivets on which the tape spool turns. Cut out and assemble all pieces using a quick-setting white glue, then round all edges with sandpaper, ink in details and attach the cutter (which is salvaged from

an old dispenser). Finish with several coats of white shellac or colored enamel.

The second duck is designed to dispense postage stamps from a roll through a narrow slot in his bill. One side of the head pivots upward on an escutcheon pin to allow for refilling when empty. Since the width of a roll of stamps is slightly over $\frac{3}{4}$ in., use a clear piece of pine 1 in. thick for the center section. Trace the outlines of the different pieces and cut them out with a jigsaw or bandsaw. Before gluing the sections together, place lead sinkers or chunks of bar solder in the body cavity and pack the remaining space with crumpled aluminum foil to prevent them from shifting. After assembling, round off edges, ink in eyes, and finish with white shellac or enamel as you did the first duck.—Pat Sinapi

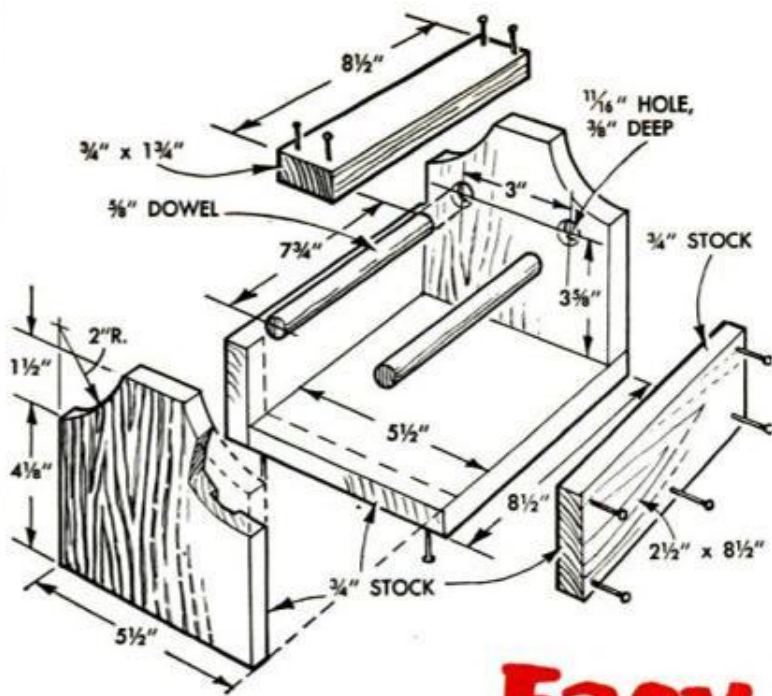

Easy Shoe Shine

THIS NOVEL LITTLE shoe-shine kit will give you twice the shine with half the work since the more you pull on the polishing cloth, the more friction you put on the shoe and the greater the shine. In itself it's a simple box fitted with two free turning

dowels which serve as rollers for the polishing cloth. Whole thing can be made in an evening with wood from your scrap box. Usual space is provided for cans of polish, daubers and brushes. Footrest can be covered with rubber.—Loring Burk



Copper-Walnut Fruit Bowl

DECORATIVE AND USEFUL is this fine bowl fashioned from 16-ga. copper and walnut. Cut the sheet copper into a 12-in. disk and file the edges smooth. Using a soft board and ball-peen hammer, dish the copper 1 in. deep. Leave the hammer marks for an antique effect. Cut the walnut into two pieces, notching and tapering each as shown. Drill two 1/4-in. holes in each piece at a 10-degree angle to hold lengths of copper tubing to which the bowl is soldered. Wax and polish the walnut parts and lacquer the bowl and tubes.

—Robert Micals

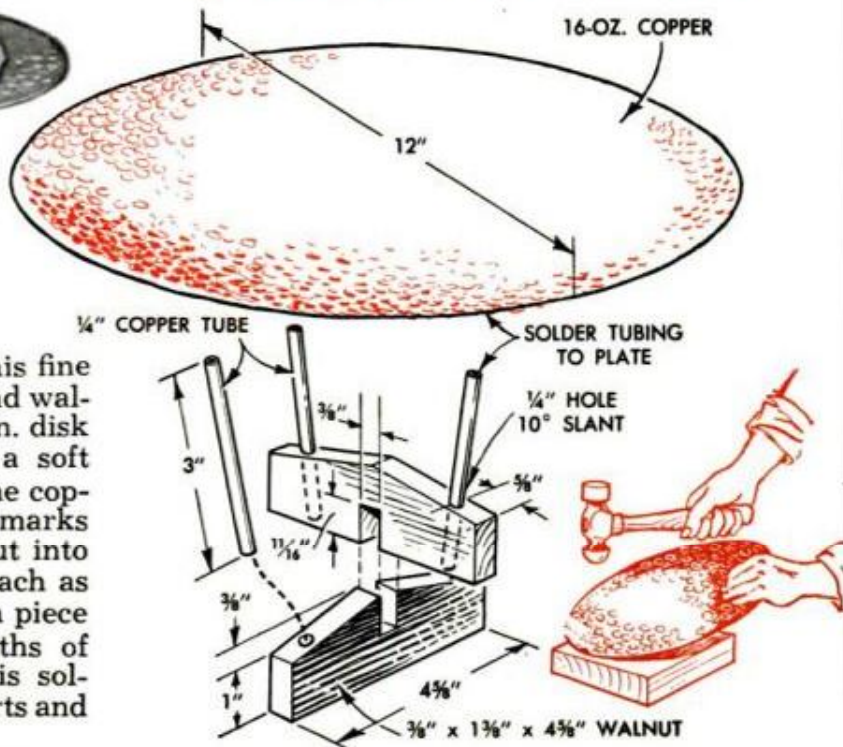

X234

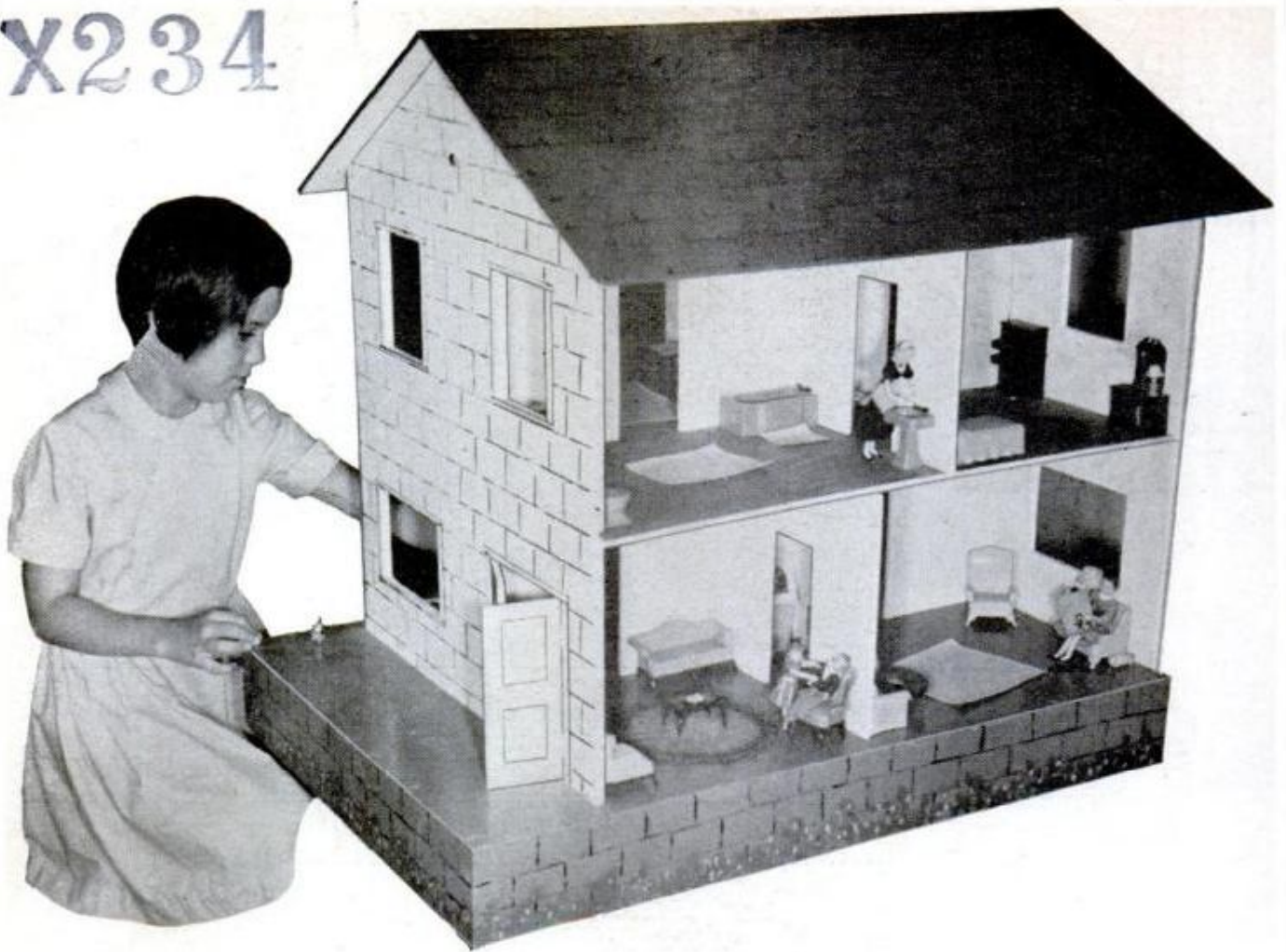

A DOLL HOUSE should be large enough to let the young home-maker indulge that feminine whim to shift furniture around. But this usually means a bulky unit that's awkward to store. This house solves the problem. It's big and sturdy enough for several youngsters to play with simultaneously—and is open on two sides so they won't get in each other's way. Yet it swiftly collapses to store inside its own inverted foundation, as shown below. If you wish, you can even hinge

a cover to this tray so the knocked-down house can be stood on edge, or carried to Grandma's like a suitcase. Re-assembling the house is child's play, almost as simple as setting up building blocks.

Floors, partitions and roof can all be cut from one panel of $\frac{1}{4}$ -in. plywood. A half-panel of $\frac{3}{8}$ -in. ply is plenty for the two end walls. The rear wall is 4 in. longer than the one at the front, so it will lap the base and can be secured by turning $\frac{1}{4} \times 1\frac{1}{2}$ -in. bolts into Teenuts driven inside the frame.



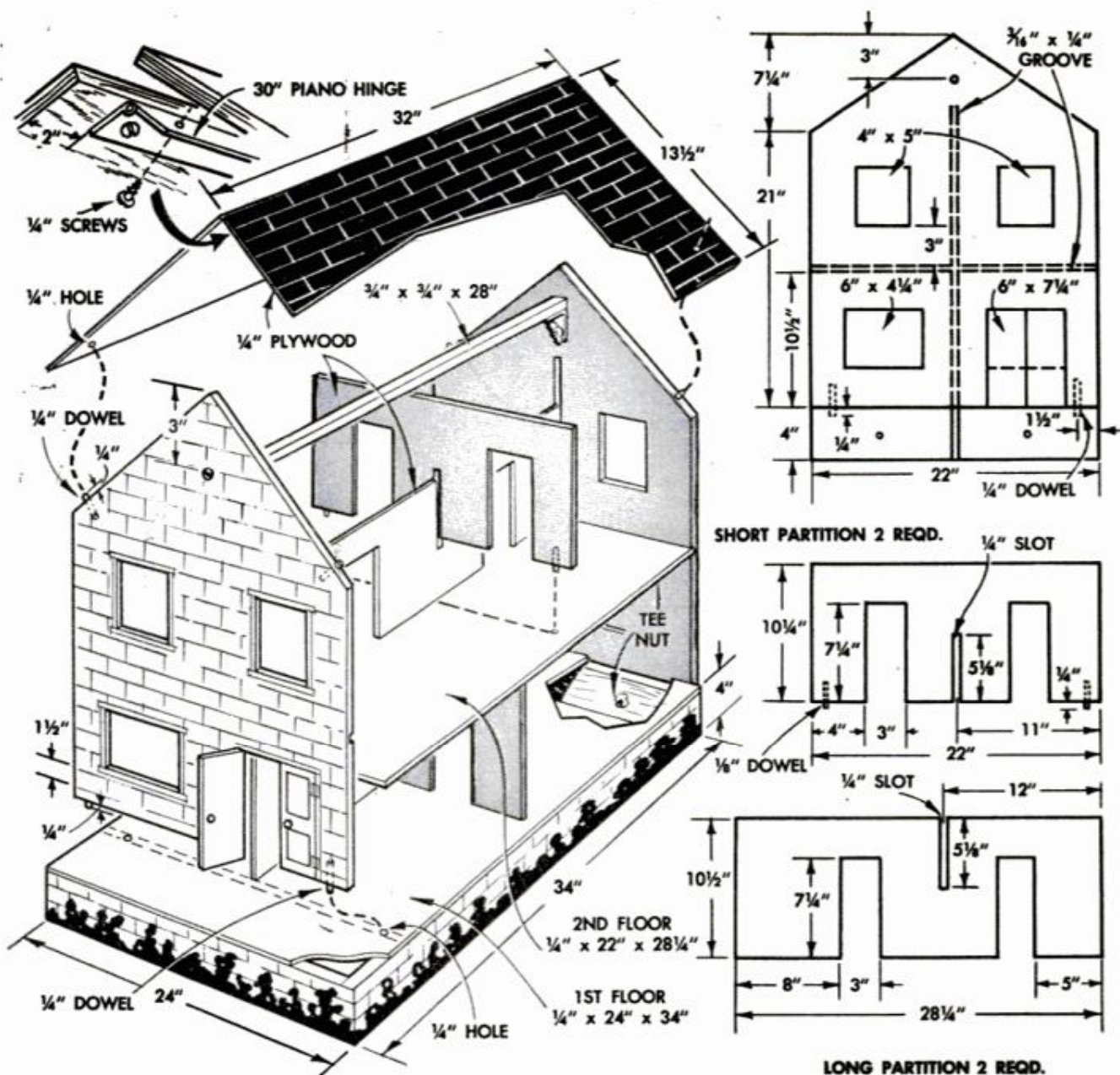

The opposite wall butts against the base platform, leaving a narrow porch across the front of the house. Two dowels project from its bottom edge to pin it in place.

Cut the 7¼-in.-high door opening in this wall only. Save the piece cut out, slice it in two, and mount the resulting door panels in the opening with ¾-in. hinges.

Both end walls have dowels in their gable edges that mate with holes through the folding roof panels. And the walls are further braced with a ridge beam fastened between their peaks with small angle brackets, as shown at right.

With the finished end walls assembled on the base, measure between the bottoms of facing grooves to determine exact length for the long partitions and second floor. Each partition is slotted half its height for "egg-crate" assembly. To keep the short partition from pivoting, dowels project ¼ in. from the bottom edge and pass through holes in the floor.—H. A. Fluchere

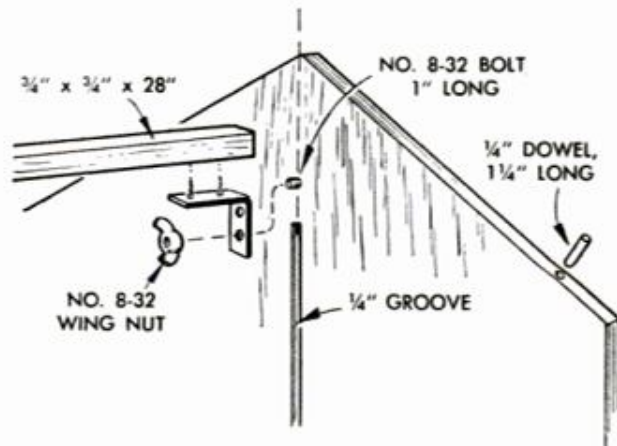

MAIN FLOOR	2ND FLOOR	ROOF
	LONG PARTITION	ROOF
BOX COVER	LONG PARTITION	SHORT PARTITION
	LONG PARTITION	SHORT PARTITION

PANEL LAYOUT FOR ¼" PLYWOOD, 4 x 8 SHEET



X342G

Galloping Horse

YOUNG COWBOYS will spend many happy hours riding the range on this trusty pinto, the sound of horses' hooves adding realism to their imaginative cow punching. Wooden balls tumbling around in a hexagonal box sandwiched between two circular pieces of $\frac{1}{4}$ -in. hardboard account for the "pounding hooves" when Junior pedals away.

The base consists of a piece of plywood supported by a rectangular frame of $\frac{3}{4}$ x $1\frac{5}{8}$ -in. solid stock. Assemble with glue and finishing nails. The hexagonal box, shown in section below, is assembled from $\frac{3}{8}$ x 2 x $2\frac{1}{4}$ -in. solid stock, each piece being beveled at an angle of 15 degrees on both edges. The box, which contains the wooden balls, is assembled between two disks cut from $\frac{1}{8}$ -in. hardboard, each disk having twelve spaced holes for dowels. The whole thing is then assembled on the pedal shaft as you see in the pulled-apart detail on the opposite page. The cranks are pinned to the shaft carrying the box and the pedals are pivoted on carriage bolts. The rest of the assembly is easily seen from the detail and you take patterns and sizes from the cross-hatched details below and on the opposite page. Round all exposed edges slightly and sand all parts smooth. Finish with two coats of lead-free enamel.—G. L. Widdicombe



RIDING THE RANGE on this stationary pinto toy horse will thrill any youngster. Simple construction drawings show only a few nails and screws are used in the otherwise all-wood assembly. Paint as desired

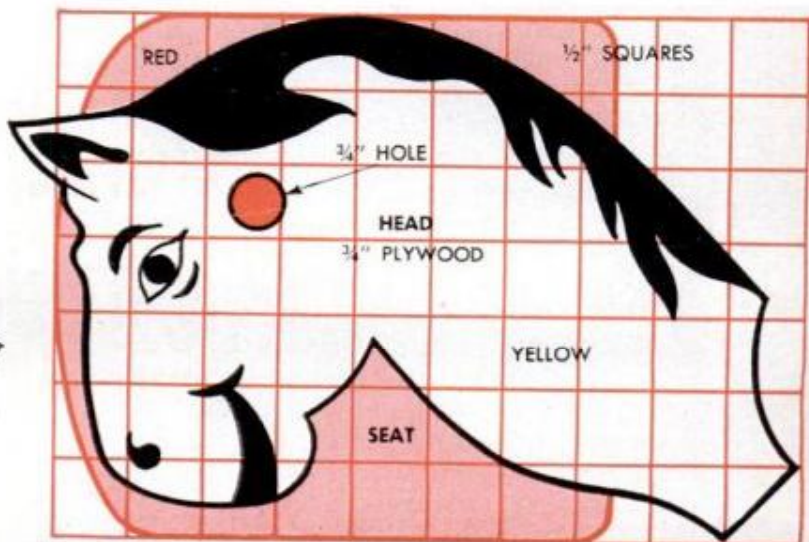
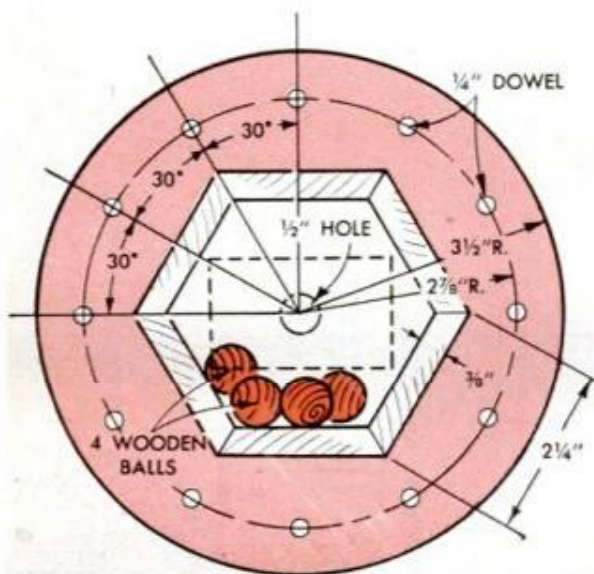

12584

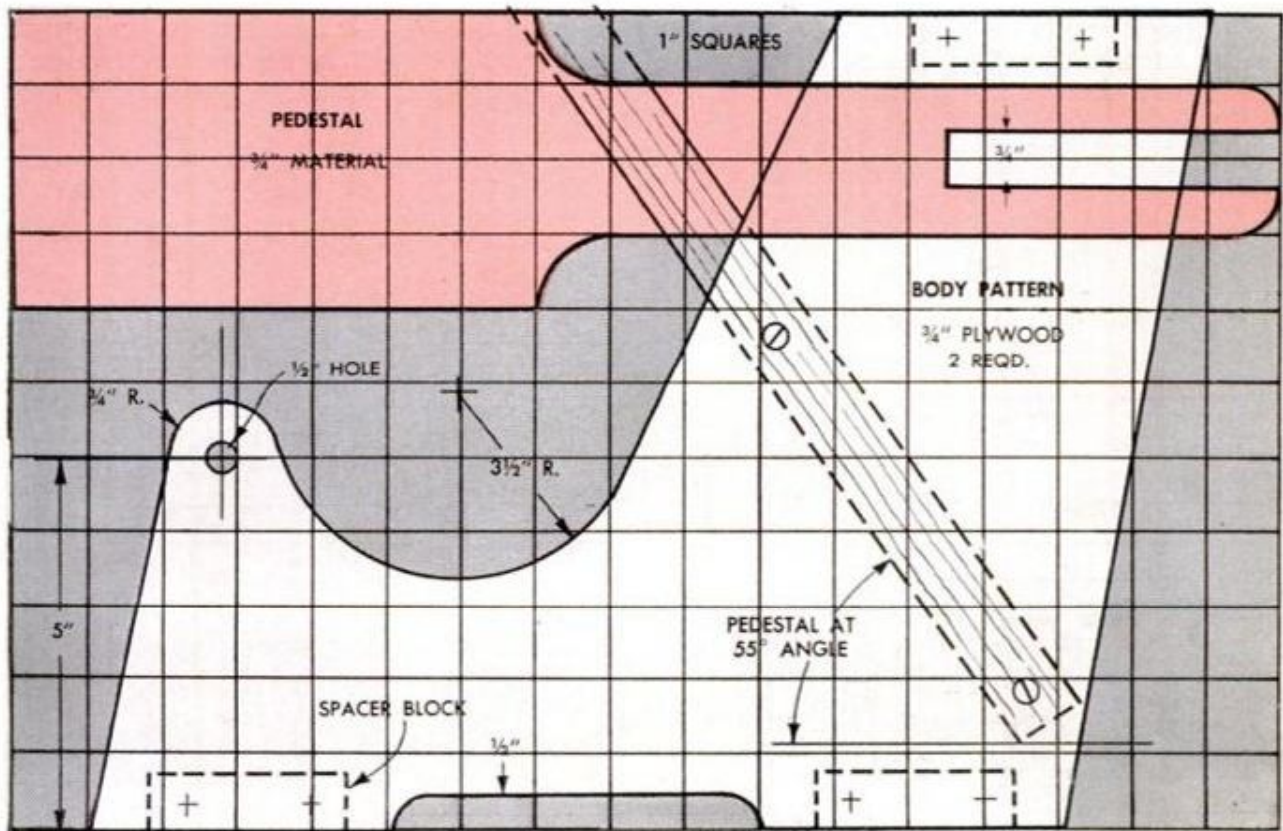
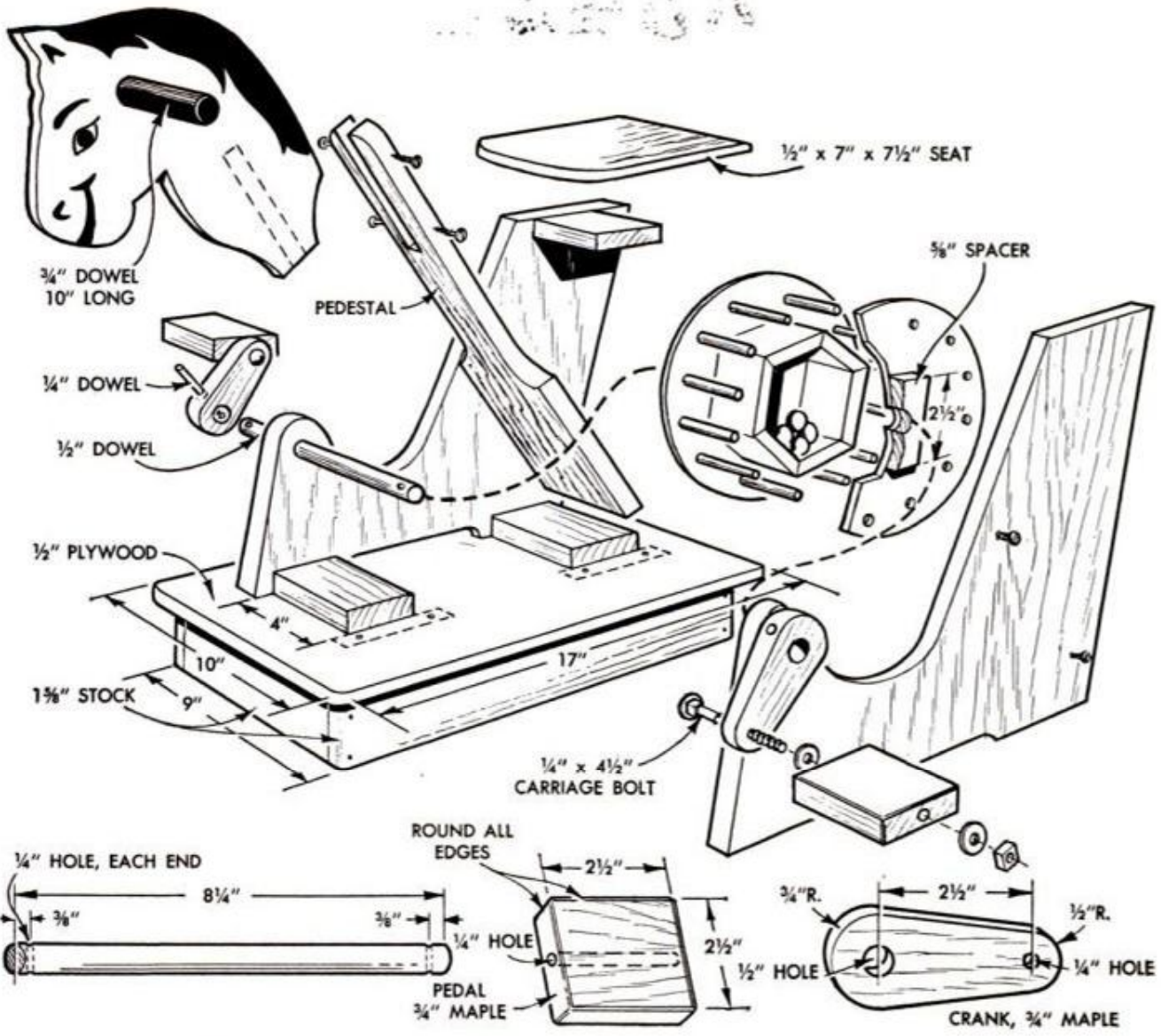

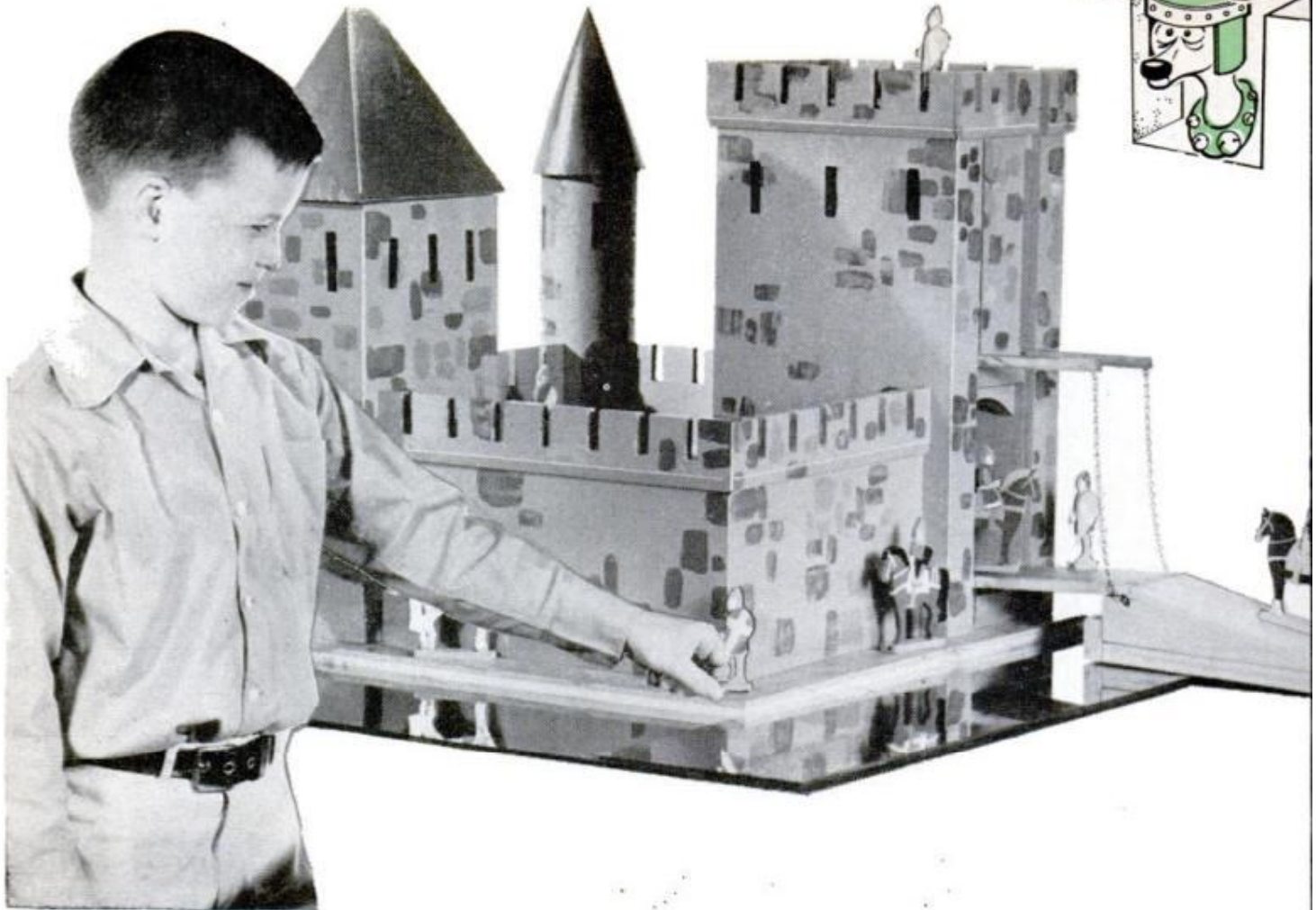

THIS HANDSOME MODEL, built largely of plywood, is at its best when centered on a heavy mirror bigger than its base. This has the novel effect of forming a water moat on all sides, to point up the purpose of the drawbridge in the entrance tower.

Since this tower is largest and most complex of the three, it's a good place to start construction. The front and two sides are $\frac{1}{2}$ -in. pine. The latter are grooved near their rear edge to take the two-section hardwood panel that forms the fourth side of the

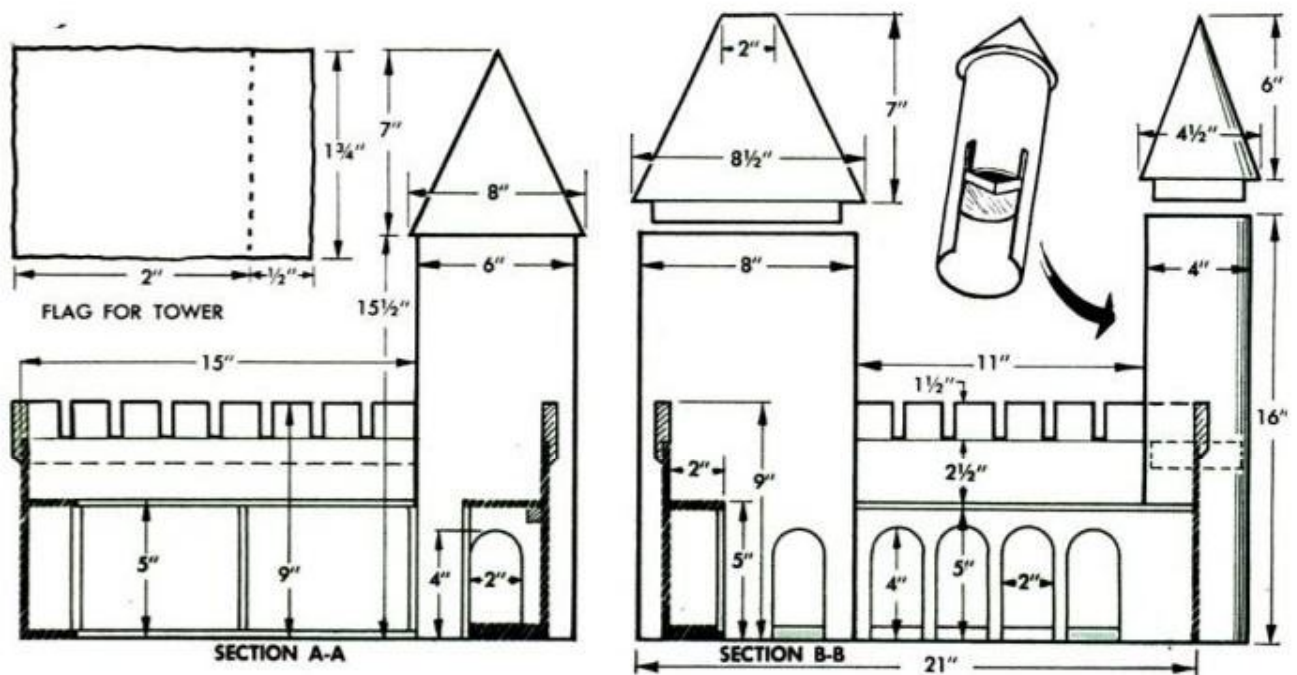

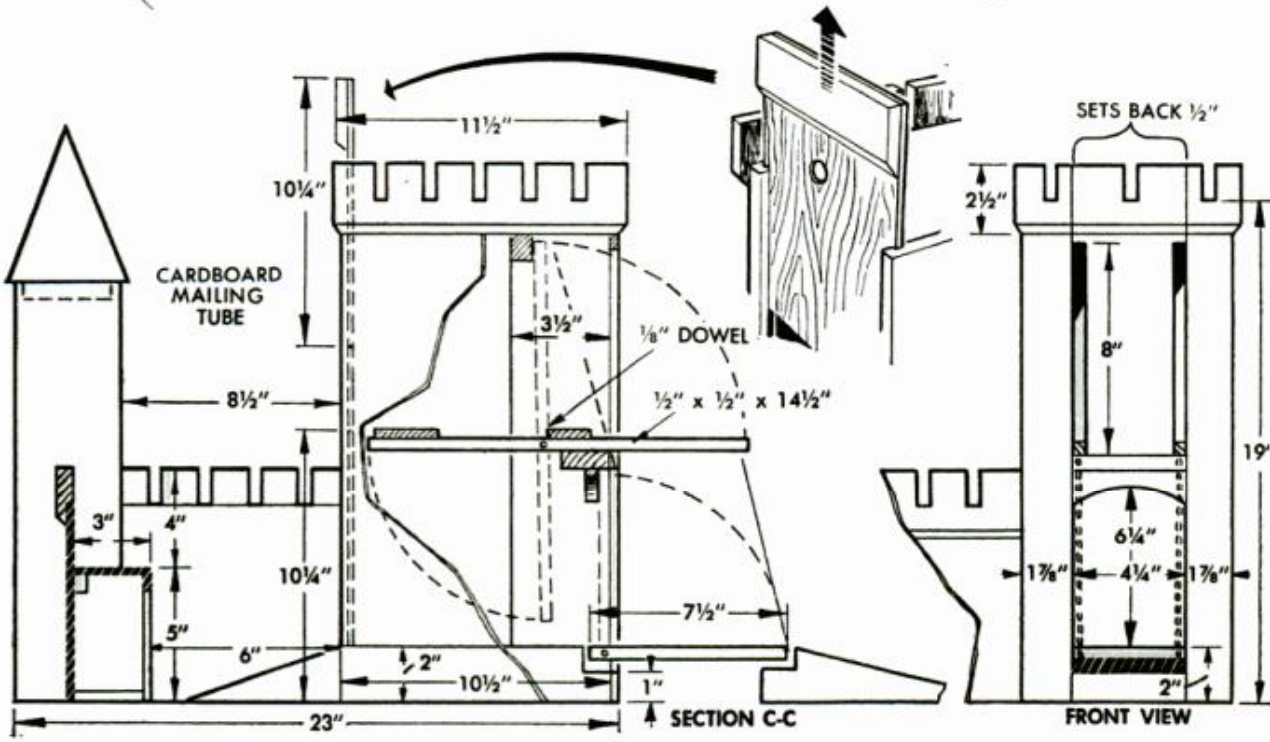
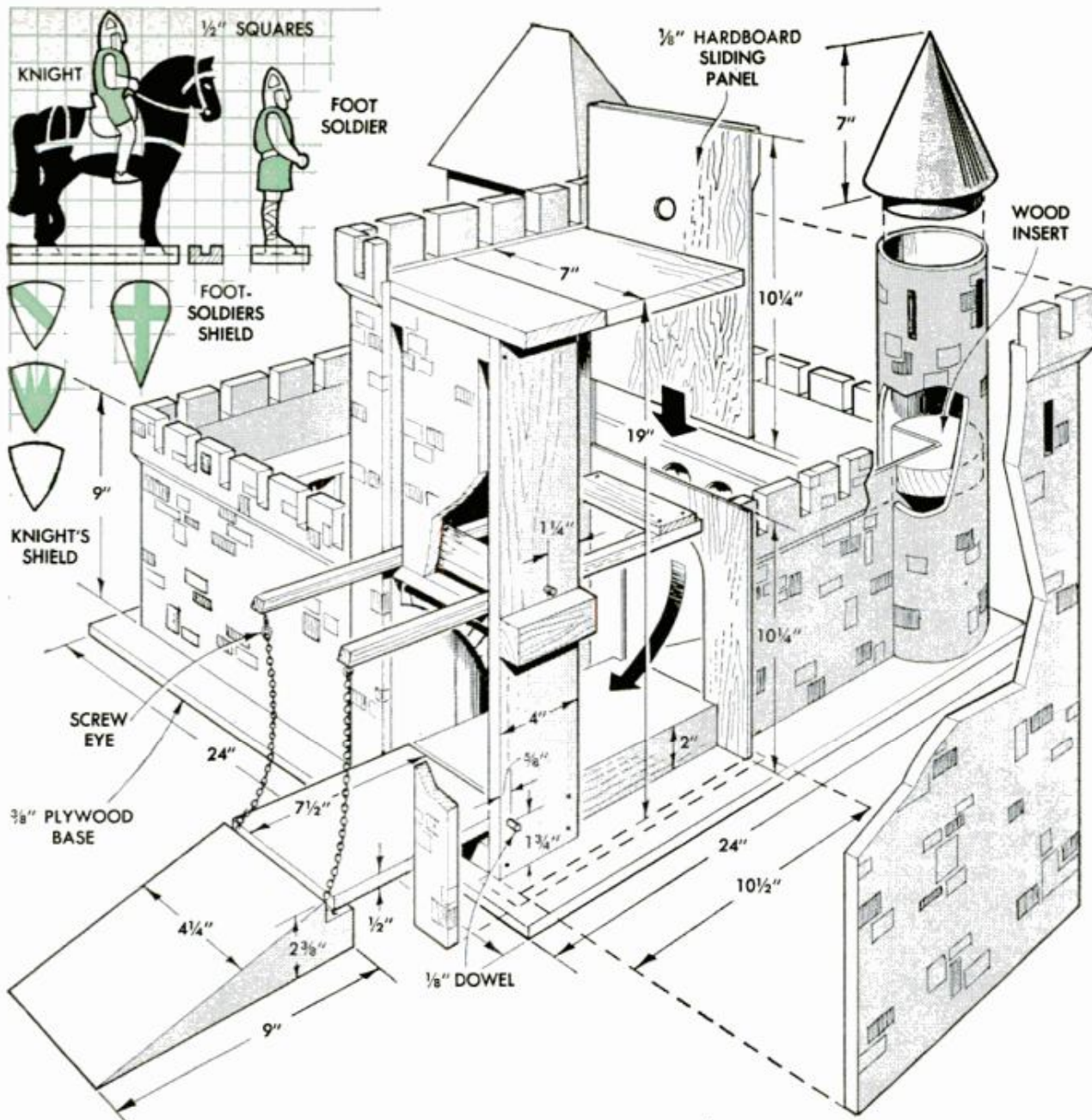

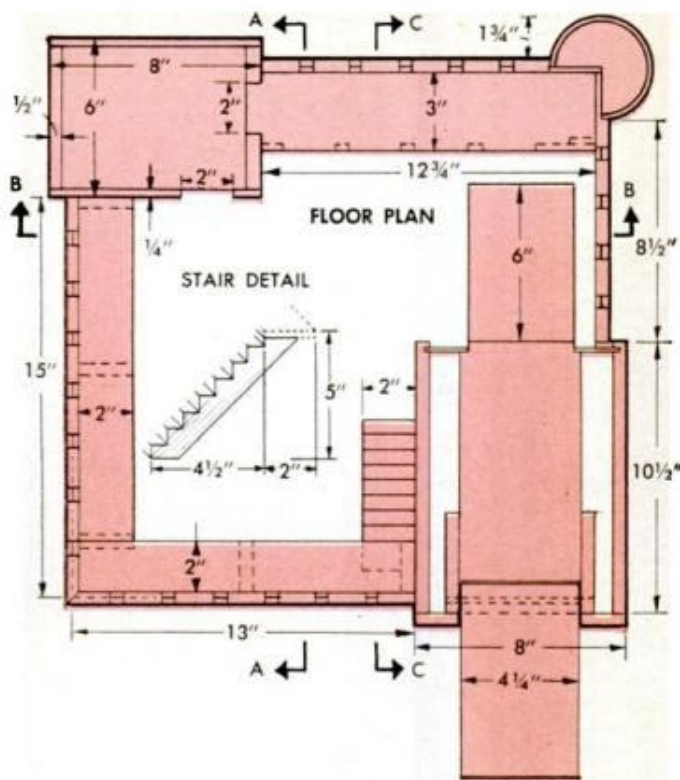

tower. The bottom half of this panel is glued in the slots, and has an archway cut in it. The top half lifts up to permit access to the drawbridge beams.

These beams pivot on dowel pins that pierce flanking frame members. The rear ends of the beams are joined by a brace that serves as a balance weight and keeps the beams parallel. When the beams are vertical, retracted into their slots, chains attached to the front ends lift the bridge so that it closes flat against the entrance.

The round tower is a 4-in.-dia. mailing

tube, cut away and slotted so it will fit over the plywood wall before the battlement strips are attached. The roof is a wooden cone turned on the lathe, with a shoulder to slip inside the tube. The roof of the other square tower is a beveled pine block, attached the same way.

Battlements are cut from 1/2-in. pine with crenels (slots) 1 1/2 in. apart. A 1/4 x 1-in. rabbet at the back fits over the top edge of the castle wall. The lower front edge of these strips is beveled.

Three walls have a narrow platform 5 in. above the castle courtyard, on which the defenders can stand during a siege. This level is reached by means of stairs, cut from 2-in. pine and glued to the left wall of the entrance tower. The platform connecting the two smaller towers is supported by a series of arches cut from 1/4-in. plywood. Doorways of the same size are cut in the 6 x 8-in. tower at courtyard level. The inner door of the entrance tower has a ramp down into the courtyard.

After assembling and sanding, brush on two coats of medium gray enamel. A few daubs of lighter and darker gray will suggest stones. Use black to paint on the narrow windows. The tower roofs can be red (for tiles) or gray-green (for slate).

Enlarge the patterns for the knight and foot soldier and paste them to stacks of 1/8-in. hardboard blanks, so you can jigsaw several at once. Glue these into slots cut into 1/2-in. pine bases. Snip shields from stiff cardboard and glue to the sides of the figures. Paint the designs in different colors to distinguish Sir Launcelot from Sir Gawain.—Philip L. Martin

Baraboo Bass

OLD LEADBELLY, here, stays frisky by never opening his mouth. But you'd better hook him on a line if you expect to retrieve him from a pond. The weight sinks his buoyant body enough to keep the rubber-band-powered prop in play. You just crank him up and launch him. A bend of the tail sends him circling right or left.—Hi Sibley

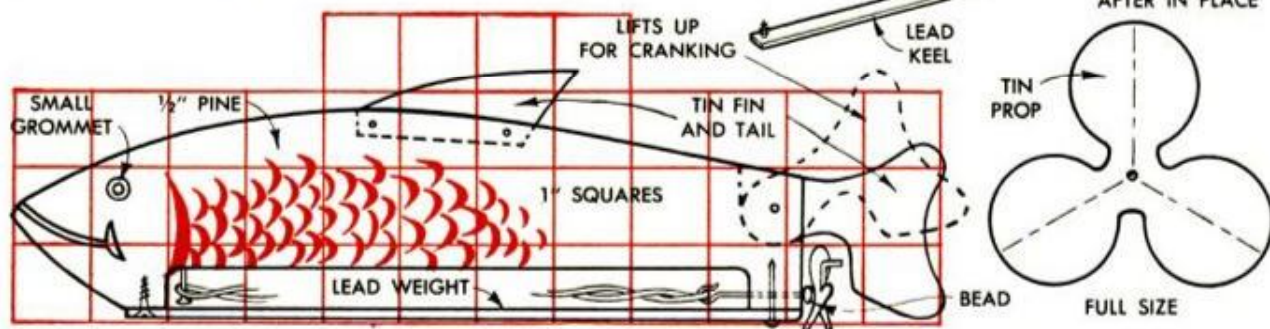

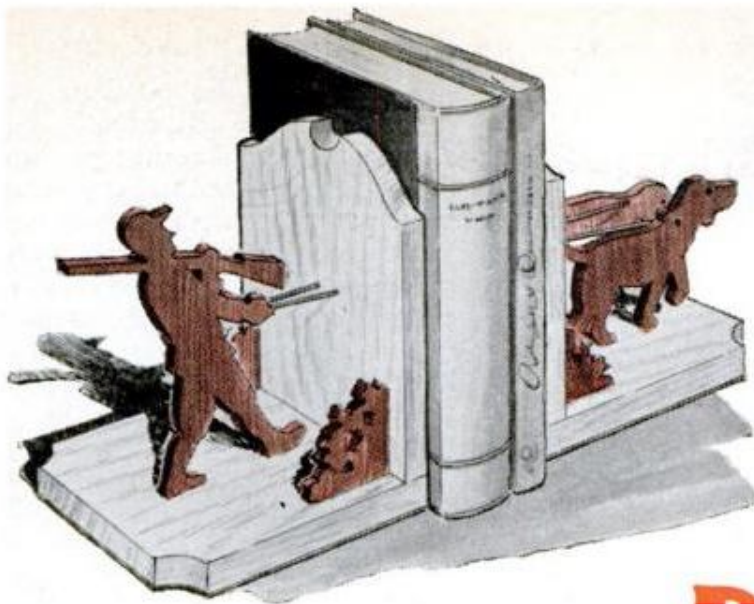

Hunter's Book Ends

HUNTERS, like bears, usually have dens, and these novel book ends will be a welcome addition to any such sportsman's lair. With the hounds straining at the leash on one side and the hunter digging in his heels on the other, the wire leashes appear to pass right through the books.

Made of walnut and blond maple, these book ends should be finished with shellac or some other clear finish to show the attractive grains of these woods. To add the necessary weight, cut a large recess in the underside of each base and fill with molten lead. Drive wire nails in these recesses before pouring the lead so that it will be held firmly in place once it solidifies. After finishing, cover the bottom surfaces with felt.

—Hi Sibley

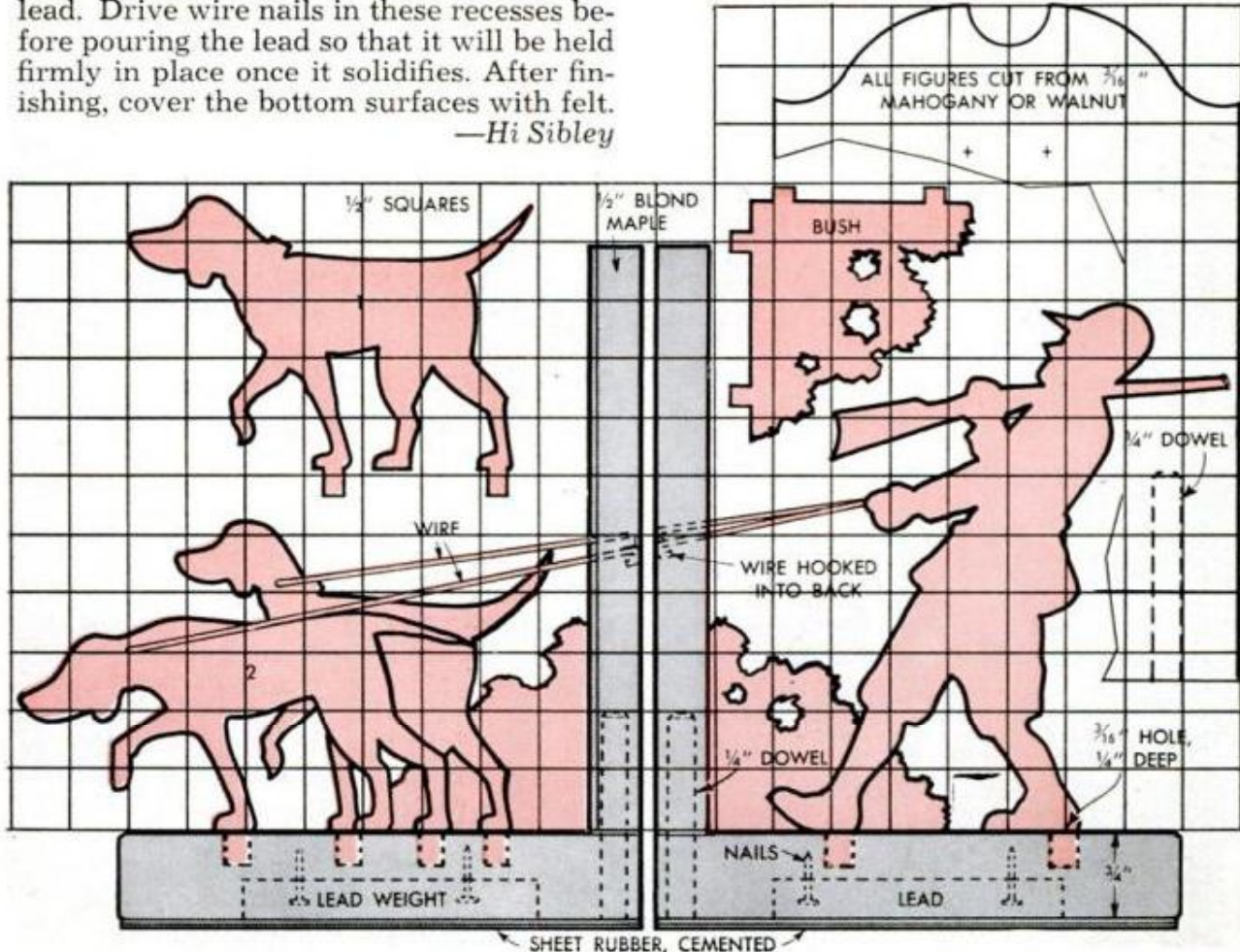
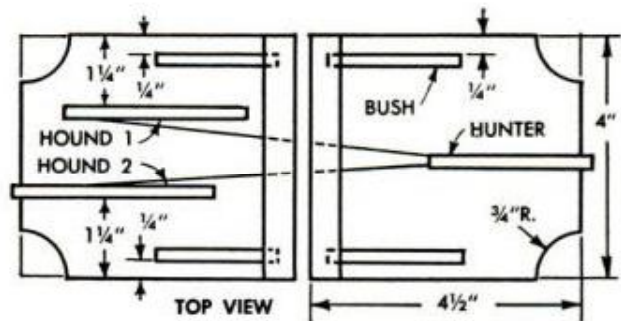

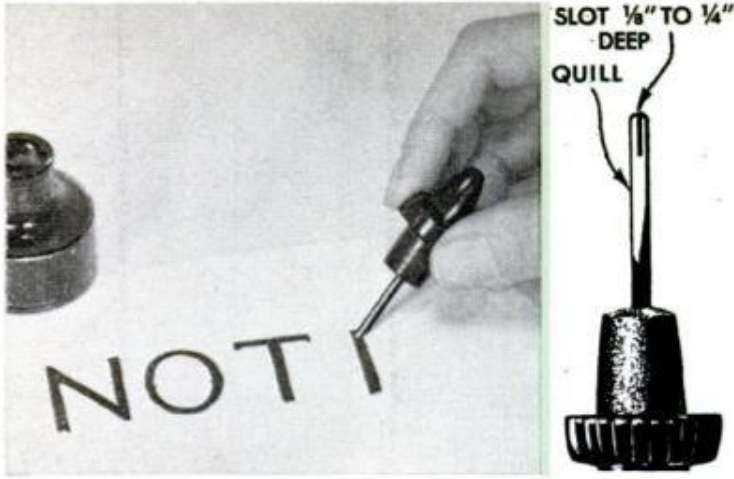

Make Your Mark

By altering the quill on the stopper of an India-ink bottle you can use it as a lettering pen in a pinch. Simply pare the end of the quill with a sharp penknife to a point and then slit it as shown in the detail. You can use it to make quite heavy lines as pictured, or you can draw fine lines with a little care.—*Richard Hanscom*



Longer Reach

There can come a time when you will need an extension for your socket wrench to get into an otherwise inaccessible place. With no extension at hand remember this one: Square the threaded end of a hex-head machine bolt as pictured and you've got the extension you need for the emergency job.

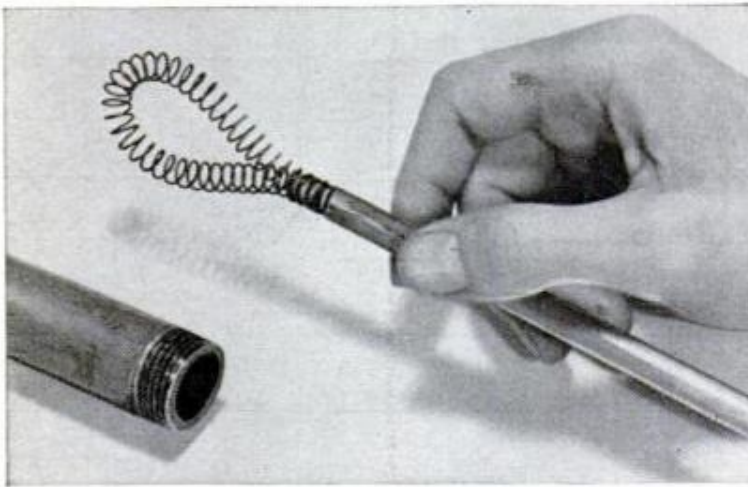

Pipe Cleaner

Ever try to clean rust and dirt out of a length of pipe? A cloth swab on a stick simply won't do it, but a length of coil spring attached to the end of the rod will even loosen scale as well as the dirt and rust. Just turn one end of the spring over the rod and turn the other end into the loops of the attached end as pictured.

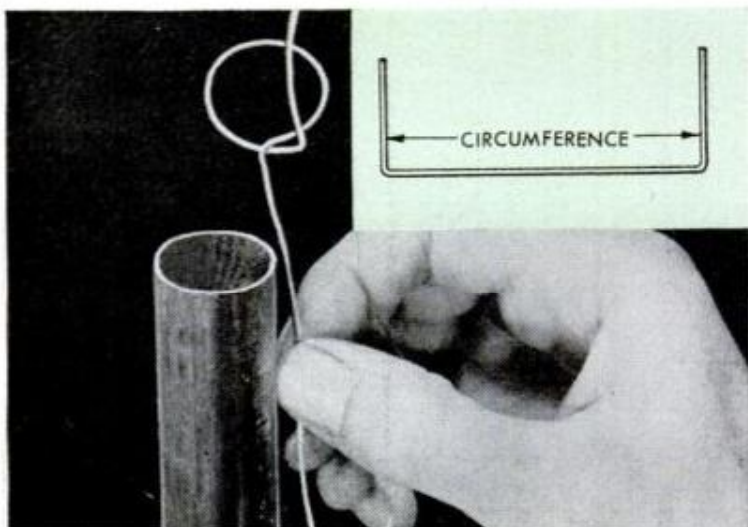

Long Way Around

It's possible to measure the circumference of a pipe, rod or tube with a cord or masking tape but a better, more accurate way is to wrap a length of light wire around the pipe, pull tight and twist the ends one half turn where they cross. Then remove from the pipe and carefully straighten to a U-shape as in the detail. Measure the distance between the legs of the U and you've got it.

FOR SHUTTERBUGS

1. 35-MM. CAMERA has electric eye built around lens to transmit exposure information to view-finder on manual setting. On automatic setting it is impossible to take incorrectly exposed picture. Under \$113.00. Bell & Howell, 7100 McCormick Rd., Chicago



2. UNIQUE MINIATURE FLASH GUN about the size of a 1½-in. cube adjusts from direct flash to 90-deg. full bounce. Accommodates AG-1 bulbs, exposure guide, ejector, 15-v. battery, shutter cord, lenses. Price \$6.95. Scopus Inc., 404 Park Ave., S., New York, N. Y.



3. NEW WHITE, NONCORROSIVE photo trays are of solid lightweight material that will stand much abuse and cost less than metal trays. Dimensions are generously oversized to suit prints. American Hard Rubber Co., Div. of Amerace Corp., Ace Rd., Butler, N. J.



4. INTERCHANGEABLE BACKS for some Zeiss Ikon 35-mm. cameras will make it just as easy to change films as you now do filters and lenses. No need to carry more than one camera. Price \$49.00 and \$55.00. Carl Zeiss Inc., 485 Fifth Ave., New York 17, N. Y.

5. EASY-TO-USE low-priced camera takes sharp color slides, color snapshots and black-and-white pictures of subjects five feet and beyond. No adjustments required—just aim and shoot, indoors or out. Less than \$6.00. Eastman Kodak Co., Rochester 4,



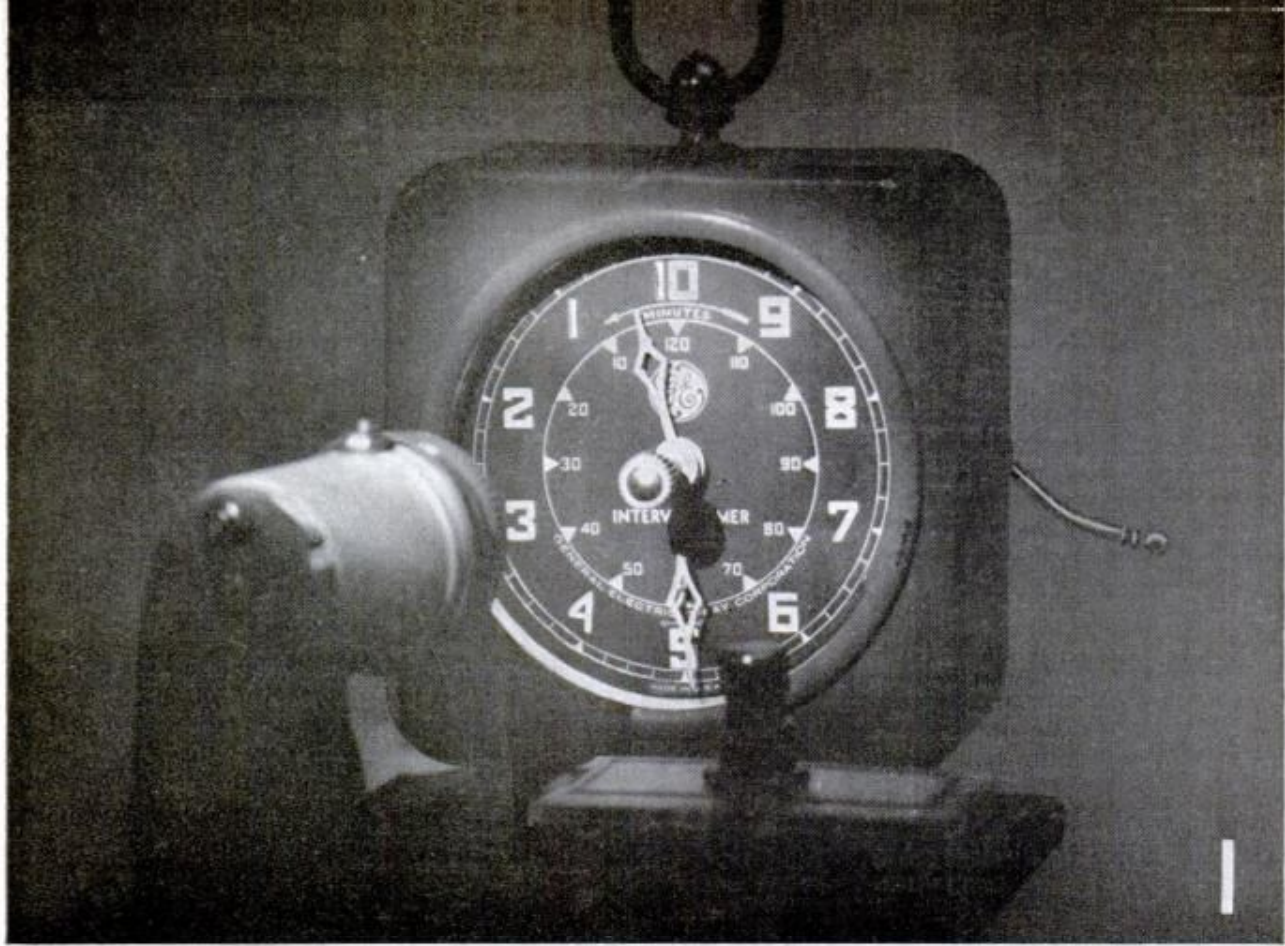

HERE'S HOW the light spotlights the dial of a darkroom timer. There's no guessing about the time

DARKROOM TIMER LIGHT

X 2 11

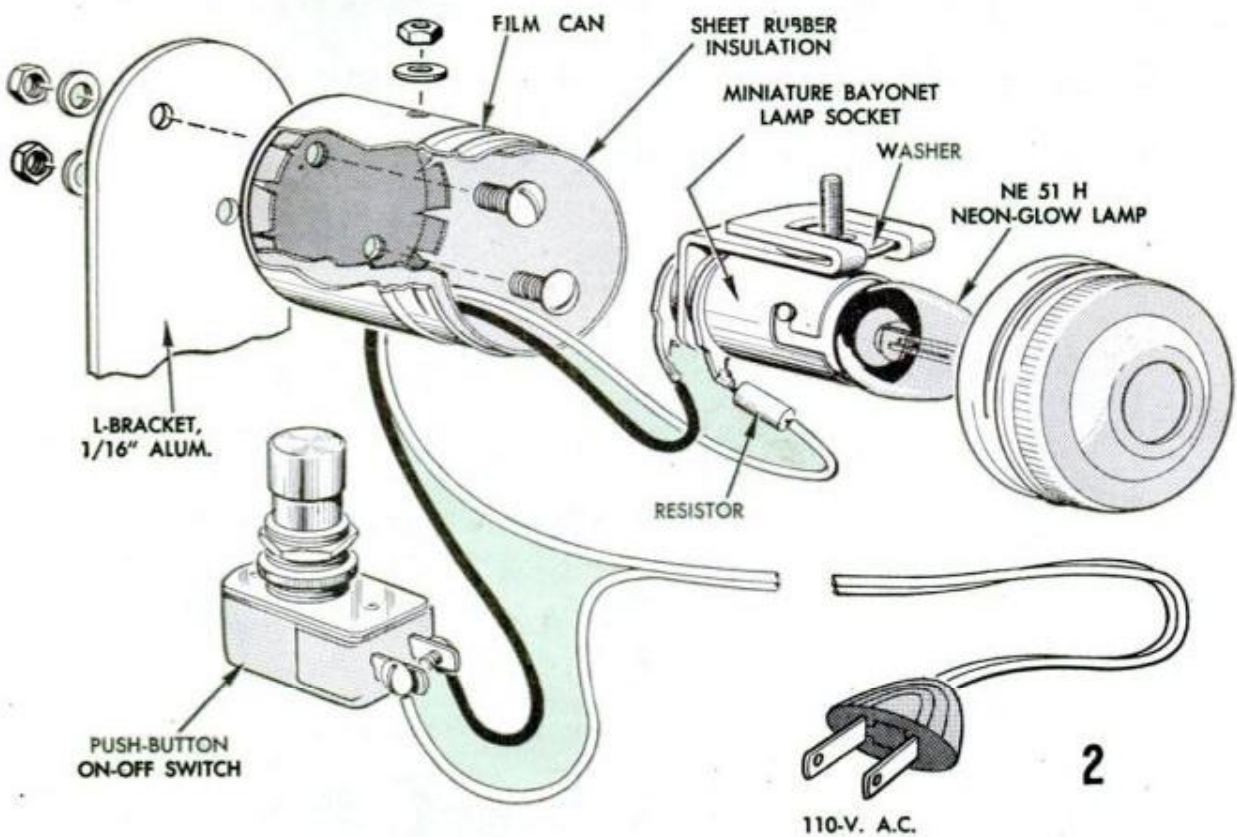

MANY QUESTIONS plague the photographer when developing films in total darkness. Like—where is that timer? How much more time have I got? Is the timer running? Did I or didn't I agitate properly? In many cases the proper agitation is 5 seconds every 30 seconds and although one may concentrate and count the seconds, more often than not the mind will wander to other subjects and agitation is either overdone or insufficient. Improper, erratic agitation may result in a poor negative—usable, but not perfect, according to the manufacturer's recommendation. Also, some negatives may need more developing time and the clock must be changed. This requires that the developing tank be covered, those bright room lights turned on and the timer reset. As a result, you are momentarily blinded. Here's where this timer light has proved to be the answer.

A 35-mm. film can is used for the lamp housing. Holes are drilled in the bottom for fastening it to an angle bracket; and in the side for the lamp cord and switch. A push-button switch is mounted on the cover of a plastic parts container found in radio and hardware stores. Use a 1/8-in. drill and press gently when drilling holes for the switch to avoid cracking the plastic. The holes are enlarged with a penknife or a reamer to the proper size. Then the box is permanently mounted on a base of hardboard with cement.

The lamp-socket bracket is bent to permit the socket and lamp to fit properly in the can. A washer of the proper screw size is inserted between and the bracket ends bent to prevent the washer and screw from dropping out before or during assembly. Before assembly of the lamp socket in the can, the inside and bottom of the can must be insulated to prevent the lamp socket from making contact with the can.

After assembly of the complete unit, a 3/8-in. hole is drilled in the cover and the hole flared by reaming with long-nose pliers. Flare the hole a bit at a time, testing in the dark, until the light output just covers the clock dial. The timer light is not to be used as a safe light. All safe lights will fog negatives during prolonged exposure to the light, and although the timer light output is weak and concentrated on the face of the timer, it too will fog high-speed films if exposure to the light is prolonged.

If the light output is too bright, insert a neutral density filter of tracing cloth inside the cap. Do not use green—it will kill the light entirely. Also, remove the clock face cover (glass or plastic) to avoid reflections and paint the clock body and all metal parts with dull black paint.—*Frank Fritz*

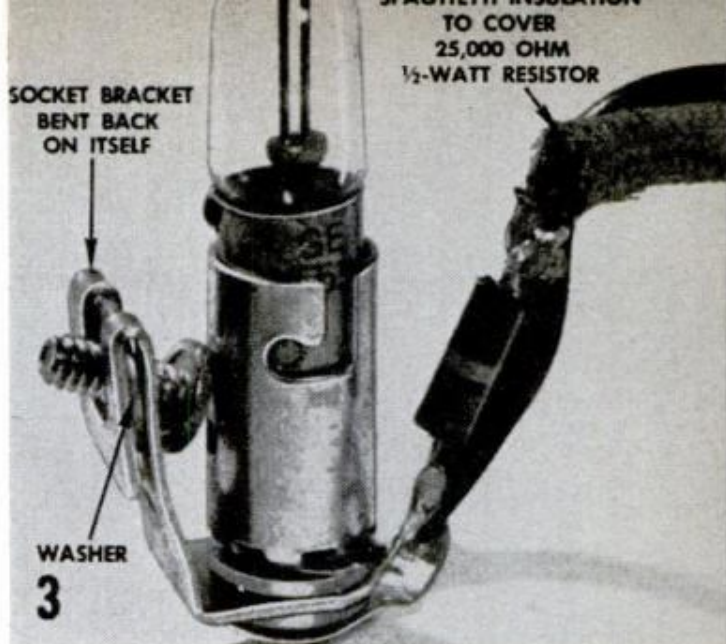

THIS ASSEMBLY, detailed on the opposite page, is fitted inside the film can. Note bend in bracket

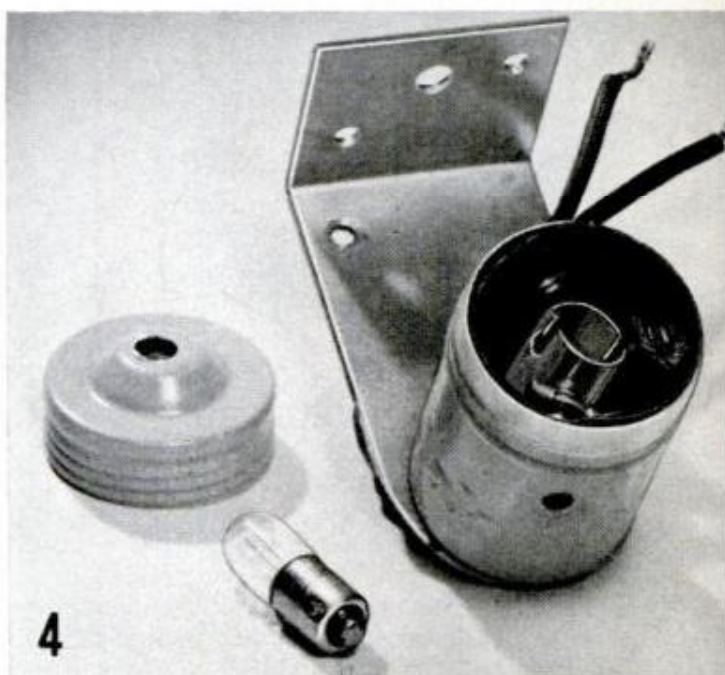

ABOVE IS COMPLETE UNIT mounted on its bracket and ready for installation on the base. Below, push-type switch is mounted in plastic box as pictured

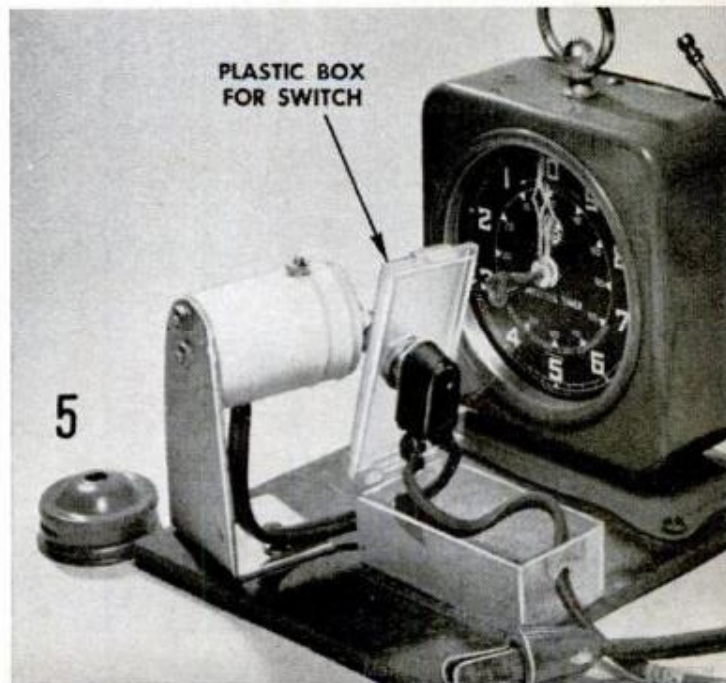

BURN ALL YOUR GAS!

By William J. Hector

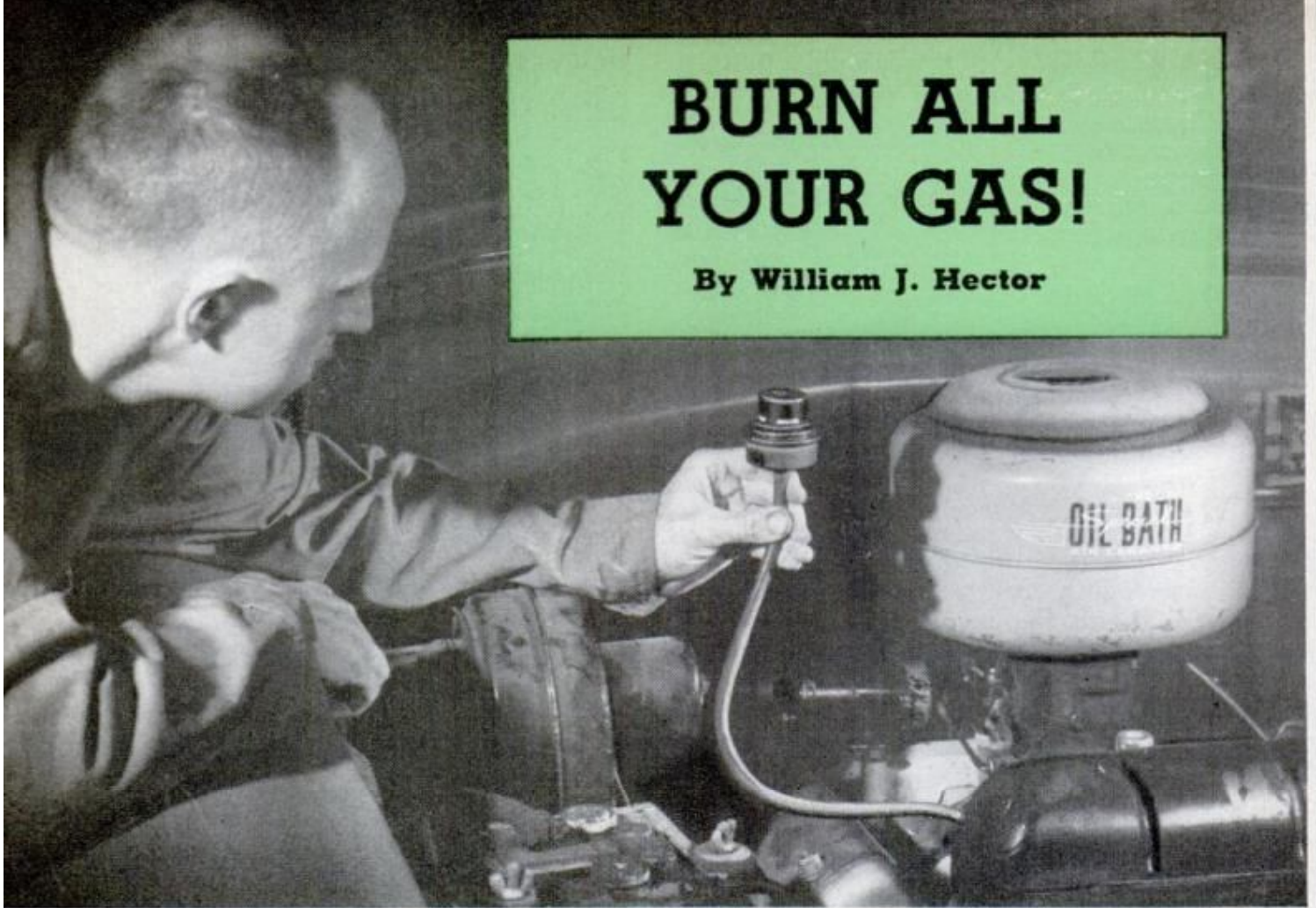

1. AFTER INSTALLING, system is checked out with this special vacuum tester. Proper vacuum is essential

UTILIZING UNBURNED hydrocarbons that originate in the engines of cars and trucks is a major concern of health researchers. Not all burnable elements in motor fuels are consumed in the engine cylinders at the instant of ignition. A portion of the unburned gases pass the pistons, enter the crankcase and are vented through the road-draft tube of the crankcase ventilating system. That portion that does not

enter the crankcase passes out through the exhaust system. These vented elements combine with nitrogen oxides in the air to produce what has come to be known as smog, a growing health problem in nearly all major cities.

Of the three methods of burning all the fuel—recirculating blow-by gases, fuel shutoff during deceleration and eliminating unused exhaust gases by means of an

2. FORCED VENTING SYSTEM shown diagrammatically. Note how fresh air is admitted through breather and how unburned fuel elements (blow-by) are recirculated back to intake manifold and to cylinders

3. VENTING VALVE of new system fully open. This valve compensates for vacuum variations, maintains adequate, continuous recirculation of unburned gases

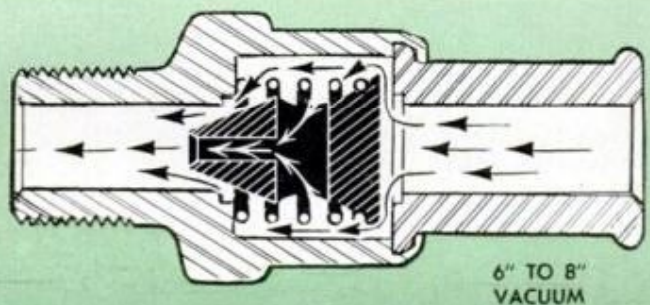
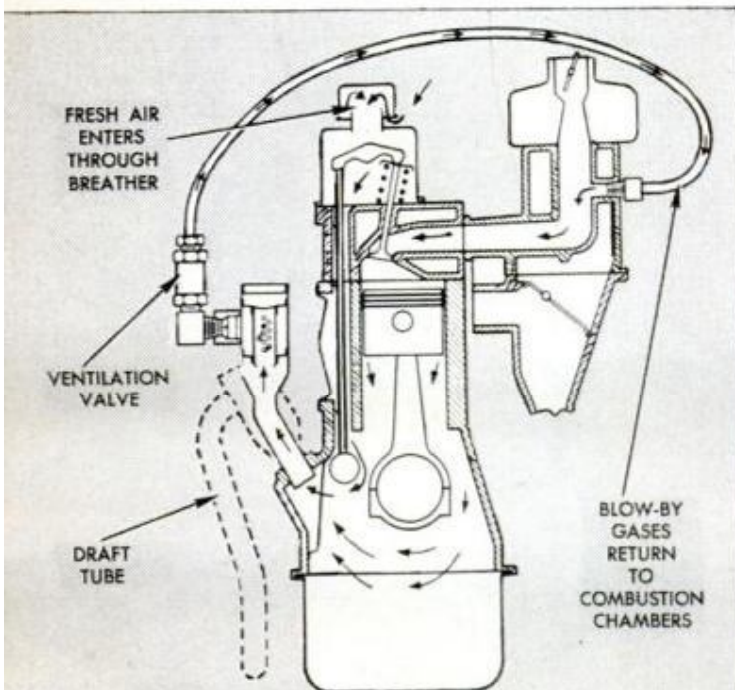

SATURDAY MECHANIC

afterburner—the first appears to be the most efficient under average conditions. A kit of parts for the installation, Figs. 1, 2, 3, 6, 7, 9 and 10, costs only a few dollars and the resulting protection is threefold. Here's the reason why: The regular crankcase ventilating system with which late-model cars are equipped removes blow-by gases—which consist mainly of unburned fuel remnants, oil and water vapor, and acids—from the crankcase at road speeds of 20 miles per hour or more. At lower speeds these contaminants remain in the crankcase and in time form sludge. Thus, forced crankcase venting by means of a recirculator system does three things—recirculates unburned fuel elements continuously back into the intake manifold; prevents contamination of the lubricating oil under all driving conditions and prevents the greater portion of the unburned hydrocarbons from entering the atmosphere via the exhaust system.

The recirculating installation utilizes manifold vacuum to withdraw gases from the crankcase and recirculate these back into the cylinders. Since the vacuum in the intake manifold varies with the motor speed, some compensation is necessary in the system to maintain adequate circulation. In other words, as the speed of the car increases the vacuum in the intake manifold decreases so a regulating valve is installed in the positive venting system to open completely, compensating for varying vacuum. As the motor slows down the vacuum increases and the valve closes with just a bleeder hole open, allowing the gases to circulate at a rate comparable with the production of blow-by. See Figs. 3, 6 and 7.

In making a typical installation there are several steps to be followed closely and in sequence. Basically these will hold for all cars. In general you clean the oil breather cap in a solvent by soaking for 10 or 15

6. AS MOTOR SLOWS vacuum increases and valve closes with only a bleeder hole open, permitting gases to circulate at rate comparable with the blow-by

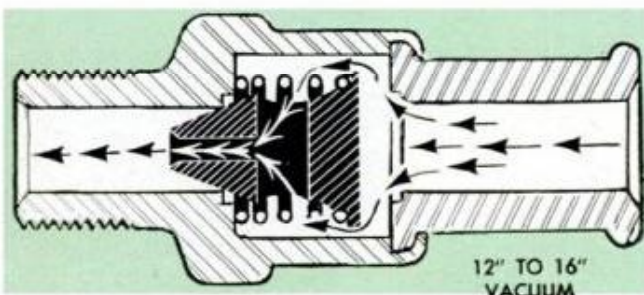

NOVEMBER 1962

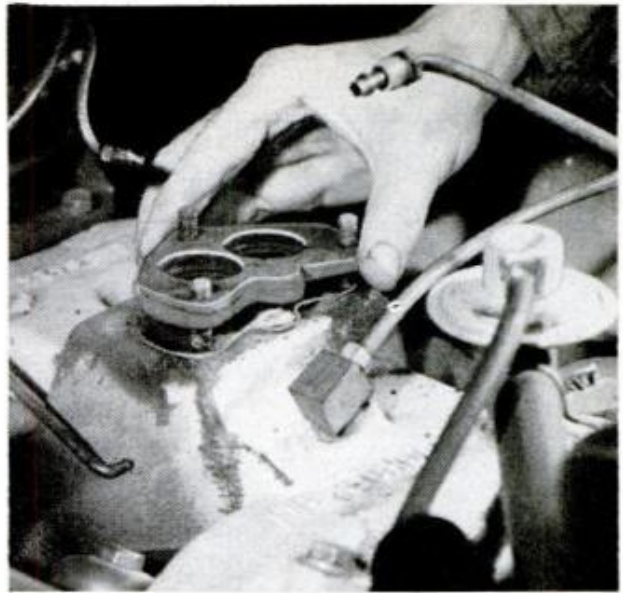

4. ON MANY CARS there is a special spacer, or riser, about $\frac{3}{8}$ in. thick under the carb. This must be removed and discarded. Also the old studs are removed and replaced by longer ones that come in kit. Take it easy with wrench and screwdriver. One slip, one too-hard twist, and you may buy a new part

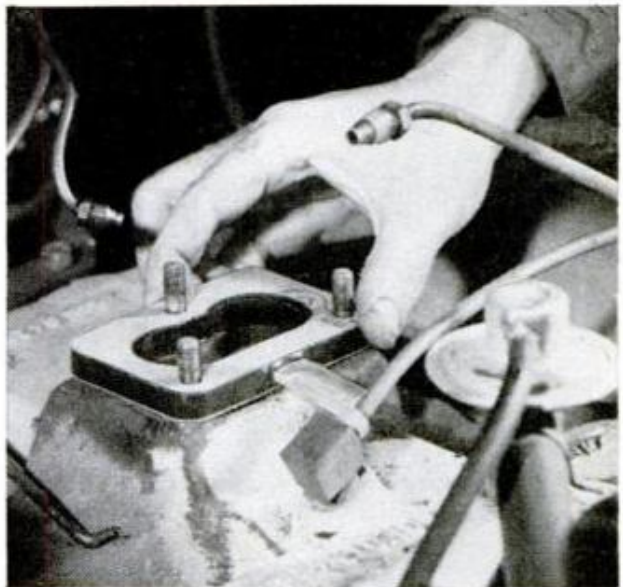

5. NEW CARB SPACER being installed. This spacer provides opening into intake manifold for passage of unburned gases from crankcase. Note also the new studs which are somewhat longer than the originals

7. WHEN ENGINE stops, valve closes completely, allowing no gases to pass. Condition is that of zero vacuum. Valve also is pictured in Figs. 9 and 10

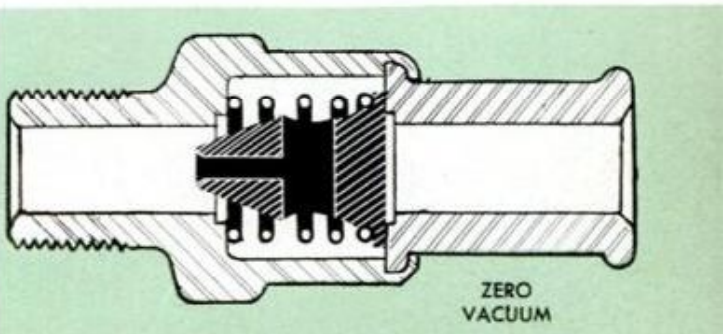

171

minutes, then agitate actively in the solvent and brush out any sediment, Fig. 8. Be sure to drain the cap dry and re-oil with engine oil. Remember the filter element won't perform properly without re-oiling since fresh air enters at this point and will carry dust with it unless this is done. Next, remove the air cleaner. Then, loosen the carb hex nuts, and remove the carb from the intake manifold. Remove the old gaskets, Figs. 4 and 5, and clean the gasket surfaces of both the carb and the intake manifold. Be sure you do not allow any dirt or grime to fall into the manifold when cleaning. On some cars there is a gasket block, or spacer, about $\frac{3}{8}$ in. thick. This must be removed permanently.

Remove the old carb studs. An application of penetrating oil can make the job easier. The studs that come with the kit have a longer thread than the original. Care should be used not to damage the threads when installing the new studs. Install in this order on the intake manifold the new carb gasket, carb spacer with tube pointing front and down, carb gasket, and finally the carburetor. Hook up the fuel lines and linkage. Do this before tightening down the carb on the manifold. It's best to use a torque wrench to assure tightening the carb nuts to correct specs.

Next remove the road-draft tube and crankcase filter base assembly by removing



8. AS FIRST STEP in making installation remove the breather cap, clean in solvent thoroughly and re-coil

the screw on the element shell and the two screws retaining the assembly on the motor block. The two latter screws often have Phillips heads. Discard the filter element and clean the base assembly in solvent. Flatten the lower end of the road draft tube several times in a vise in 1-in. folds, Fig. 13. Since this must be an airtight seal, place gasket sealing compound in the opening before you crimp the tube. Clean the gasket surfaces on the motor block and the filter-base assembly. As the opening on the motor block could be the

9. HERE'S COMPLETE KIT for do-it-yourself installation on all common makes of cars. Kit is inexpensive and simple to install

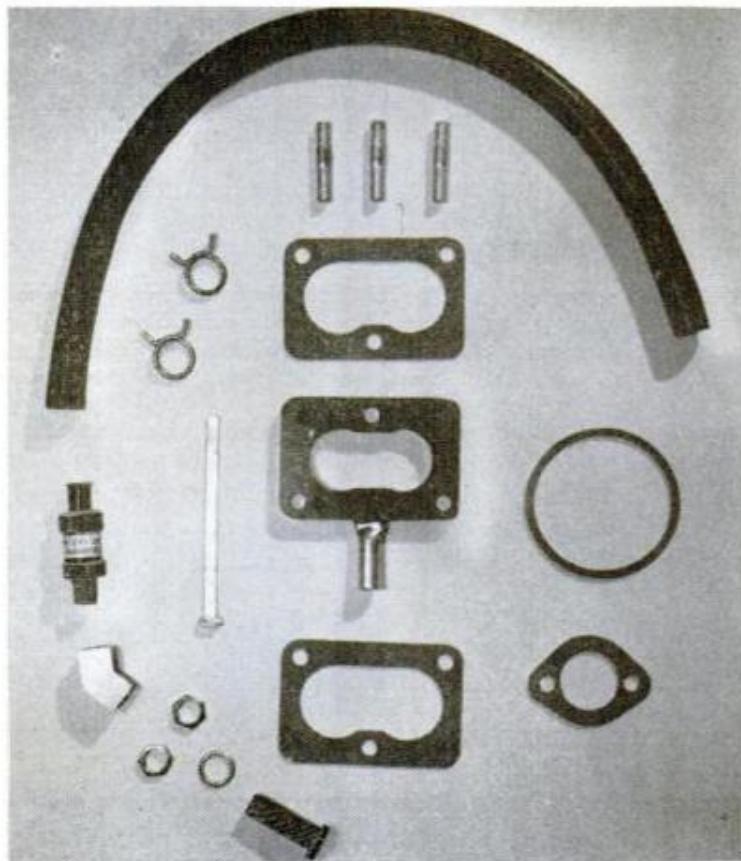

10. FINGER POINTS to valve which is the heart of the forced ventilating system

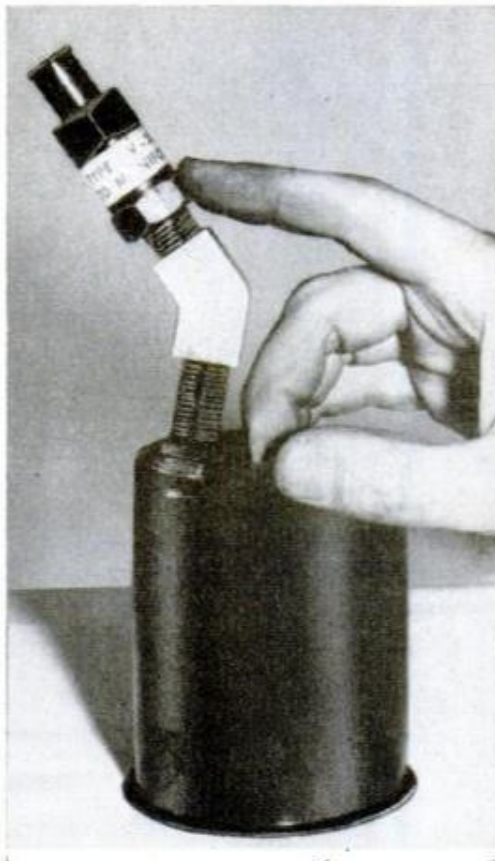

cause of a serious oil leak it's best to use a gasket sealer on these surfaces. Install on the motor block and tighten the screws carefully. Coat the filter-cover gasket with wheel-bearing grease and place in position.

Now drill a 17/32-in. hole in the element cover, Fig. 12. Slide the threaded sleeve (hollow screw) through the inside of the cover, through the hole, and slip the 14-mm. spark-plug gasket over the sleeve. Tighten one nut securely over the gasket, then tighten the second nut over the first to act as a lock nut. Coat the hex end of the screw inside the cover with gasket cement as a seal against possible leaks. Place the filter cover over the base assembly with the sleeve towards the front of the car. Tighten down with screw and washer. Thread the brass elbow onto the sleeve, tightening so it inclines up and toward the center of the car, Fig. 10. This will prevent any acute angles in the rubber hose, Fig. 9, as well as keep hose away from the hot motor. Since the fuel reclaiming valve, Fig. 10, will be removed for periodic servicing it will help if a slight bit of graphite grease is added to the valve threads before assembling and tightening on the elbow.

With the slightest bit of silicone grease on the tip of your little finger lubricate the inside of each end of the hose. Slip a clamp over each end and slide over the carb spacer and valve, then move the clamp in place over each input. Take the metal strap and place over fuel line and rubber hose, positioning the elbow for good clearance.

Replace the air cleaner, start the engine and run until warm. Then adjust the carb for smooth idle. On a simple carb there are two adjustments, idle speed and mixture. Turn out the mixture adjustment first a turn or so, then turn in until the engine starts to roll. At this point back off the screw until the engine idles smoothly. Because of the extra quantity of air entering the intake manifold through the new ventilating system it may be difficult to achieve the proper fuel mixture. If signs of lean mixture are apparent, and you can't get a correct adjustment, consult your auto parts dealer and a service manual regarding installation of richer main metering jets and proper adjustment.

Since the correct operation of this system depends on the proper vacuum existing in the intake manifold, check with the gauge made for the purpose, Figs. 1 and 11. Then check the entire vacuum system. This includes windshield wipers, washers, fuel pump, and check for possible leaks around the gasket of the intake manifold and carb. Make any corrections or replacements necessary as loss of vacuum will reduce circulation of gases in the new system. ★★★

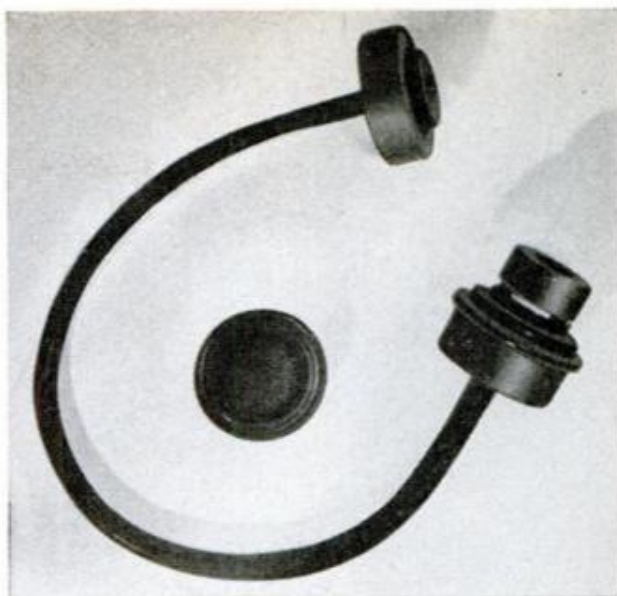

11. VACUUM TESTER, or gauge, gives accurate check on the vacuum in a new system. See Fig. 1

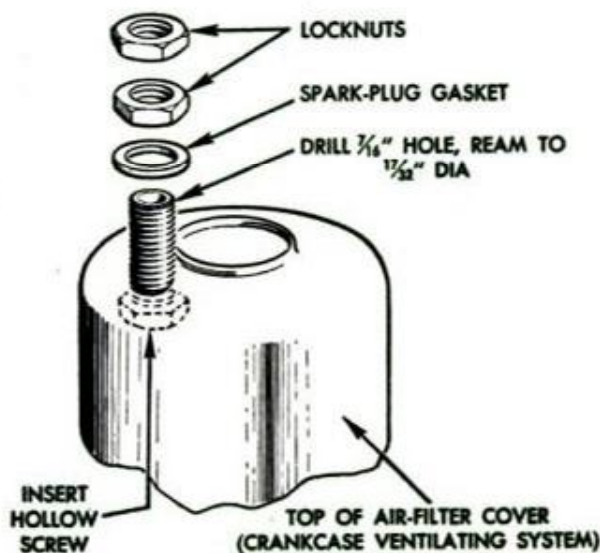

12. HOLLOW SCREW, or sleeve, is inserted through hole drilled in air-filter cover. Takes vacuum valve

13. ROAD-DRAFT TUBE is closed by flattening end, folding in three 1-in. folds and crimping in vise

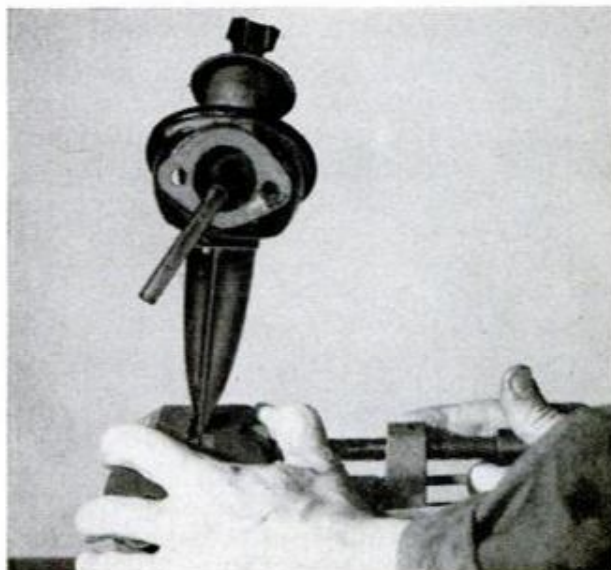

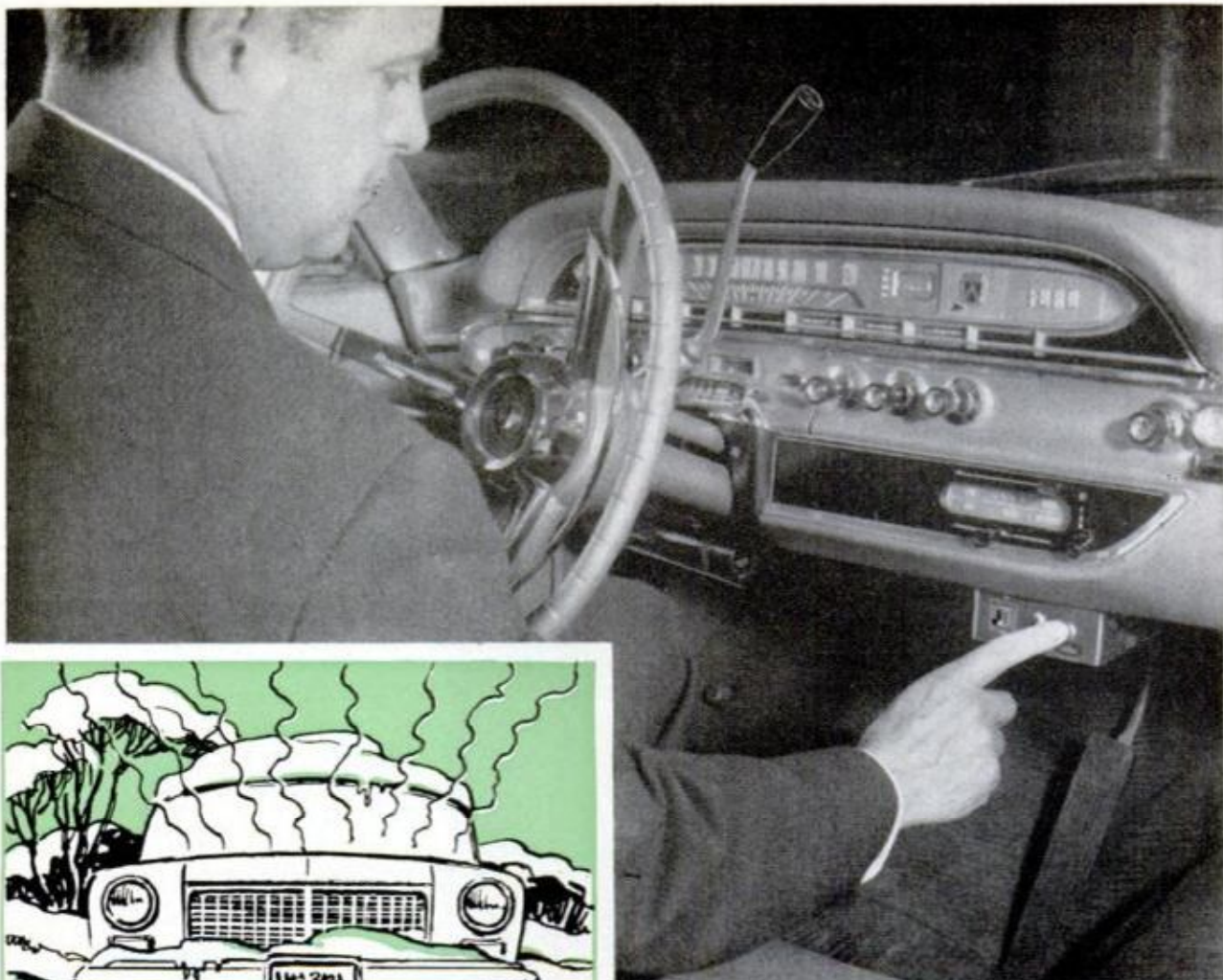

DRIVER PUSHES BUTTON at dash-panel unit to put robot in control of car's motor to run it intermittently and so keep motor and car warm. Indicator light near button shows car is under automatic control

Robot Keeps Parked Car Warm

Runs motor intermittently, eliminates cost of heated garage and makes carports "up north" more practical

HARD STARTING in frigid weather, discomfort of getting into a cold car and the frosting up of the windshield are troubles of the past. Now a car-control robot, designed for 12-volt electrical systems, starts and stops the motor, heater and defrosters automatically for easy starting and comfortable riding.

A parked car can be kept warm as long as the gas supply holds out. When leaving the car, you turn off the ignition, remove the key, push a red button on the dash-control unit that puts the robot in control, then lock the doors as usual. Nobody can drive the car away without the ignition key because shifting the transmission lever automatically disengages the unit and stops a

running motor. When you return you simply start up and drive off. You are not leaving your car running unattended in the sense meant by anti-theft ordinances, and therefore you are not violating them.

Persons with kind intentions to stop a running motor of an unoccupied car are informed by a sticker on the windshield that the car starts and stops by itself during cold weather and cannot be driven without a key. If, when the motor is placed under automatic control, it does not start within approximately 20 seconds after the starter has been switched on by the control unit, the device ceases to function, so the battery won't run down. When parking the car in a garage, you don't switch over to automatic

control. In this way, the unit cannot operate by itself. This eliminates danger of carbon-monoxide gas in a closed garage.

Called AutoStart, it consists of a dash-panel unit, a control assembly, a motor-block thermostat, a motor-speed solenoid, and either a safety switch or a vacuum switch. The dash-panel unit contains a pushbutton switch which puts the unit in control, an indicator light that shows when the unit is in control, a thermostat that turns on at 35 to 45 deg. F., and off at 70 deg. F., and a selector switch which allows you to select either the interior thermostat or the motor-block thermostat to function.

The control assembly contains all switching and time-limit relays. It is mounted under the hood where it is convenient to connect to the car's electrical system. The block thermostat is attached with heat-conducting cement to the motor block or a metallic part of the water line; turns on at about 80 deg. F. and off at 125 deg. F. It functions when the selector switch on the dash-panel unit is set to "block" position. The motor-speed solenoid connects to the accelerator linkage, steps up motor speed to 850-1000 r.p.m. This speed prevents battery discharge and also the rapid formation of carbon due to idling.

All cars except those having push-button transmissions require a safety switch connected to the "Park" or "Neutral" positions of the control lever. This disconnects the automatic control when the lever is shifted. Cars having alternator ignition systems, regardless of the type of transmission, require a vacuum switch which senses when



INTERIOR THERMOSTAT is held behind the dash-panel unit in free air out of airstream of the car heater

the car is self-running and shuts off the relay to the car-starting circuit.

Installation should be attempted only by those who have a good working knowledge of the car's electrical system. Available through your local new-car dealer, the unit is made by Systematics, Inc., 1821 University Ave., St. Paul 4, Minn., and costs from \$74 to \$85 approximately, varying with the items furnished, as dependent on the make and year of the car, the type of gearshift, whether it is alternator equipped and also if it is air-conditioned. ★ ★ ★

UNDER THE HOOD is the control assembly which connects to the car's electrical system, the block thermostat cemented to the motor block, and also the motor-speed solenoid which connects to the accelerator linkage

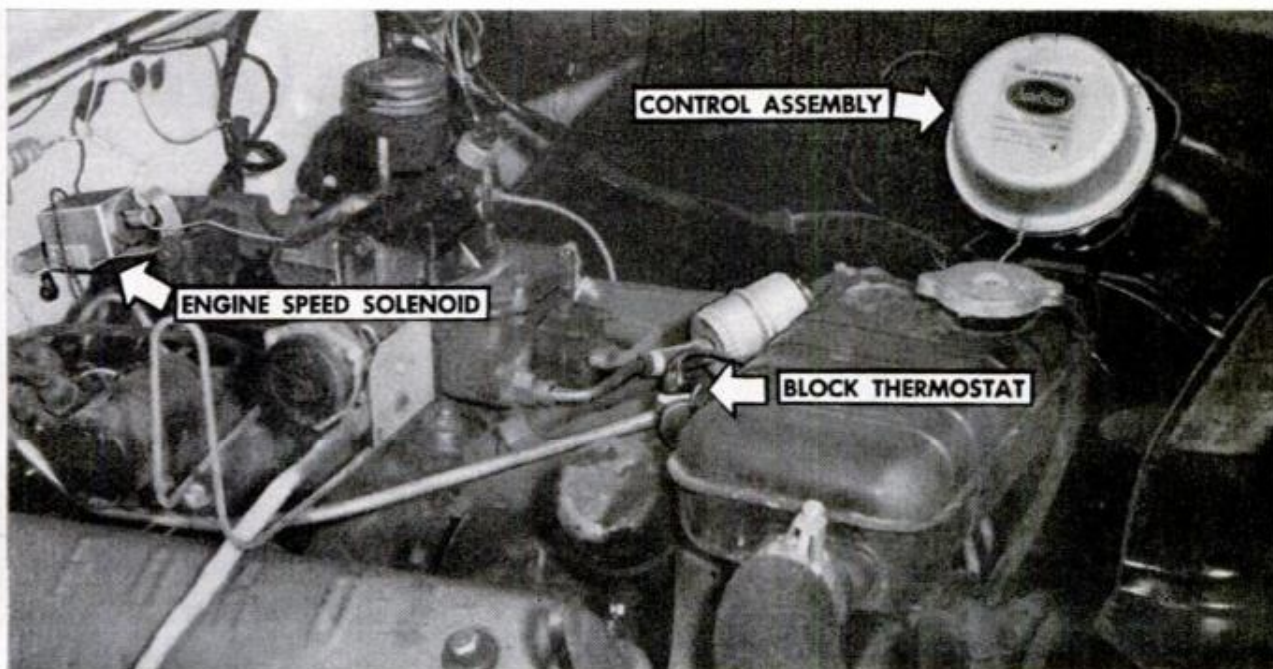

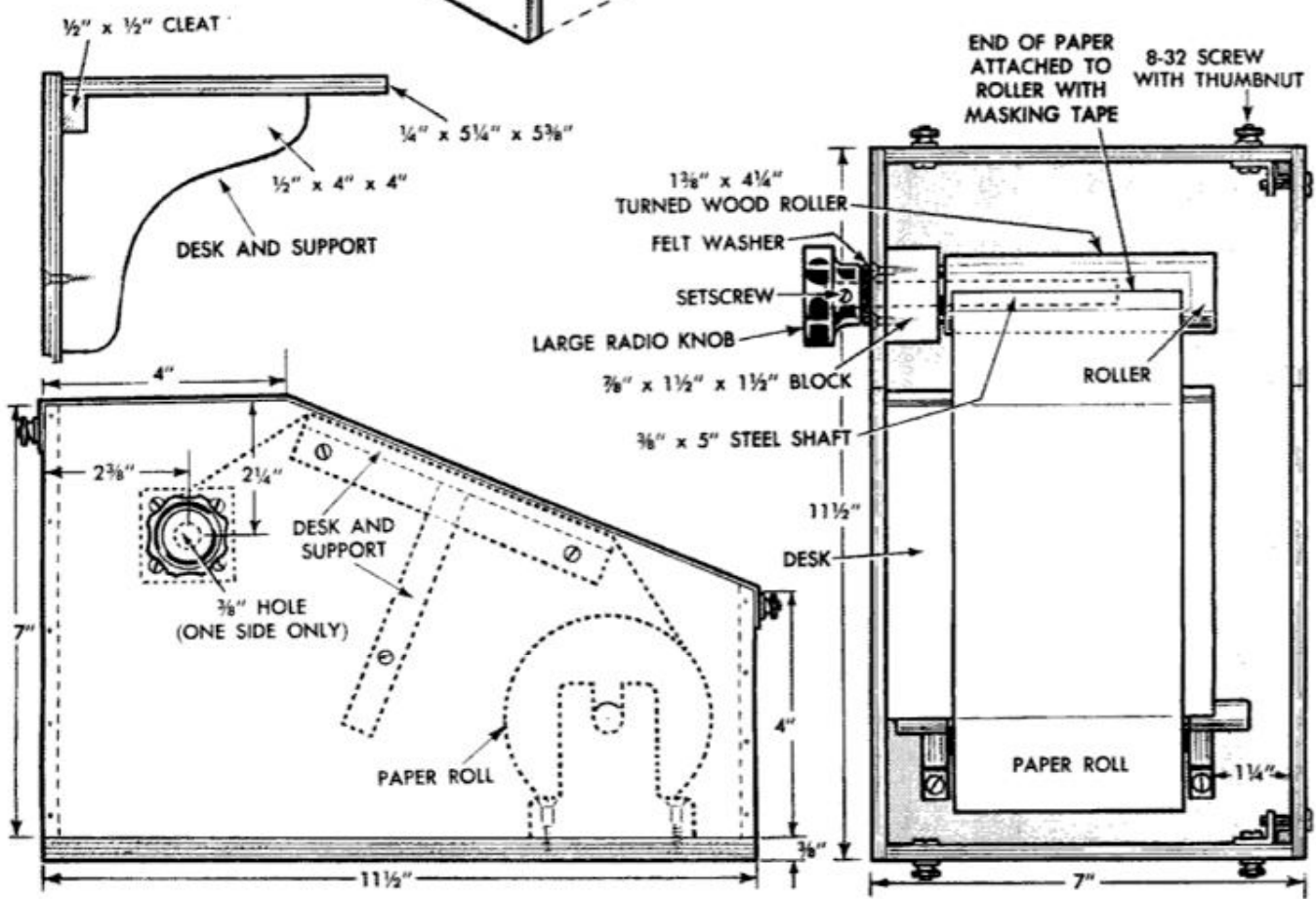
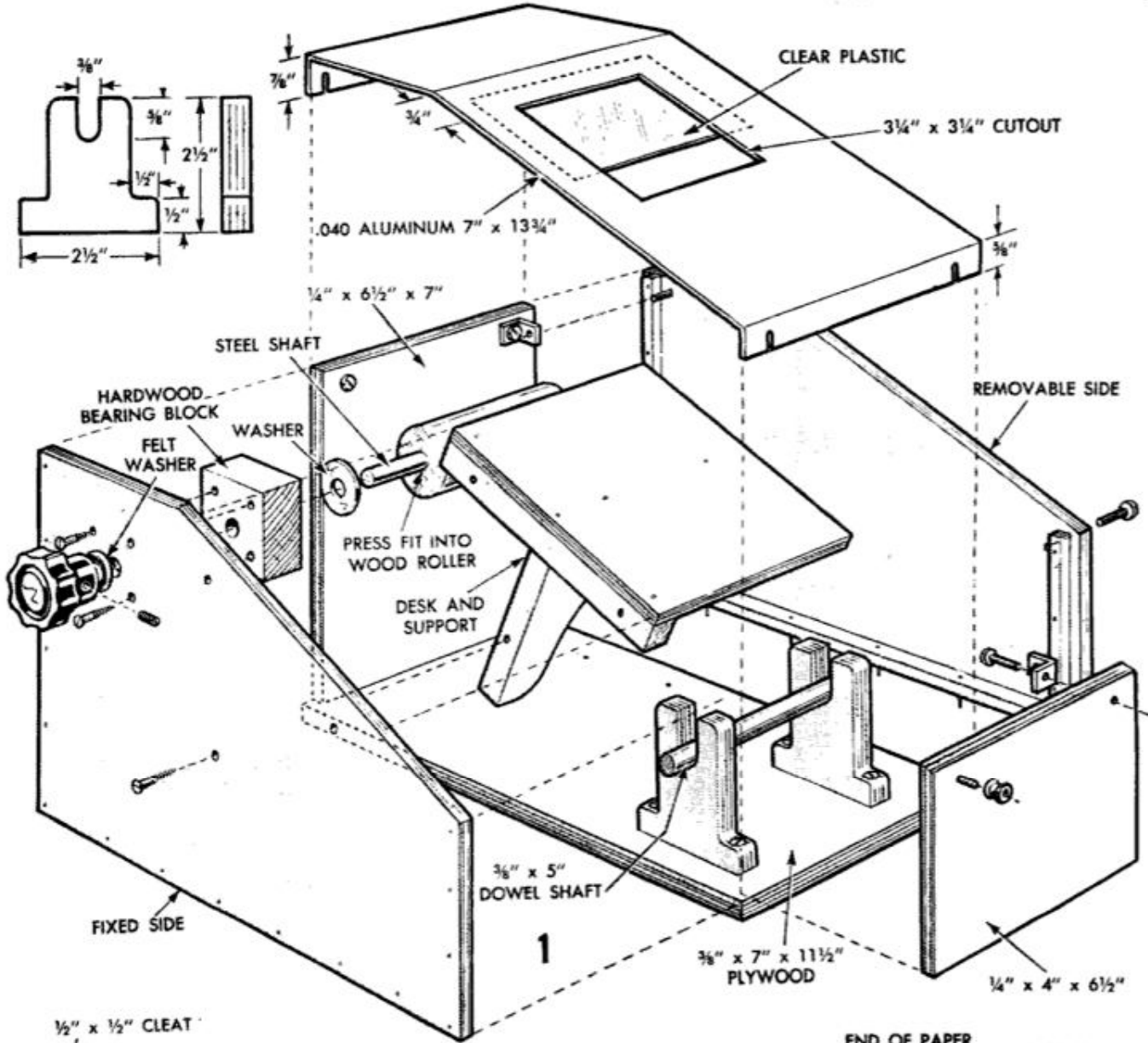

TEACHER'S HELPER

By Harold P. Strand



TEACHING MACHINES, now being used experimentally in schools all over the country, may well bring about a revolution in mass education (See "Will Robots Teach Your Children?", Oct., 1961). The many commercial models now available range from simple, inexpensive types to sophisticated versions costing several hundred dollars, some of which even involve the use of a computer. However, the basic idea behind all of these machines is the same: to give the student information in simple steps which include frequent test questions to determine his understanding of the material. After the student has recorded his answers to each question, the machine reveals the correct answer.

The most important feature of programmed learning is that the student finds out the correct answer to the question immediately. This elimination of the normal time lag between testing and grading has been shown to increase understanding and produce greater memory retention of the subject. In the case of problems, he can check his calculations against the solution included with the correct answer, and thus pinpoint any errors.

Naturally, most smaller school systems are reluctant to invest any large amount of money in experimenting with the use of teaching machines. The simple teaching machine detailed in Fig. 1 here can be built in the school shop for about \$5 and is well

2. PAPER TAPE being prepared by using typewriter without removing the paper roll from the unit



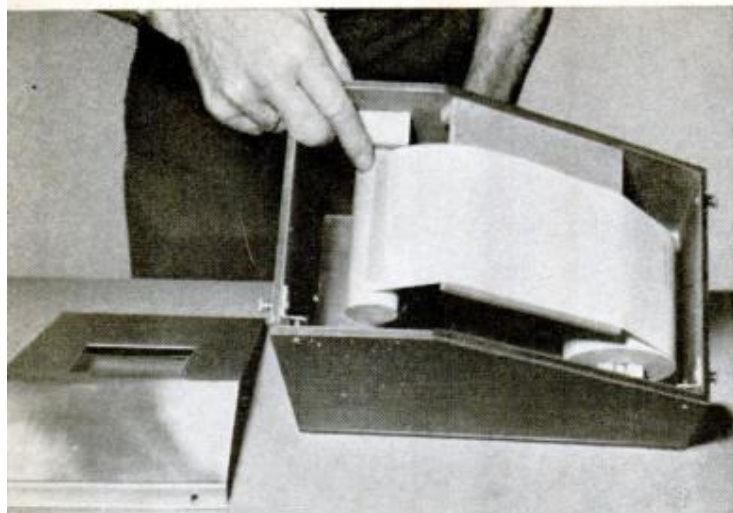

3. **END OF PAPER** is fastened to the winding roller with a strip of removable tape. It must be cut and attached squarely for good tracking. A 10-in. blank space is needed between end of roll and typing

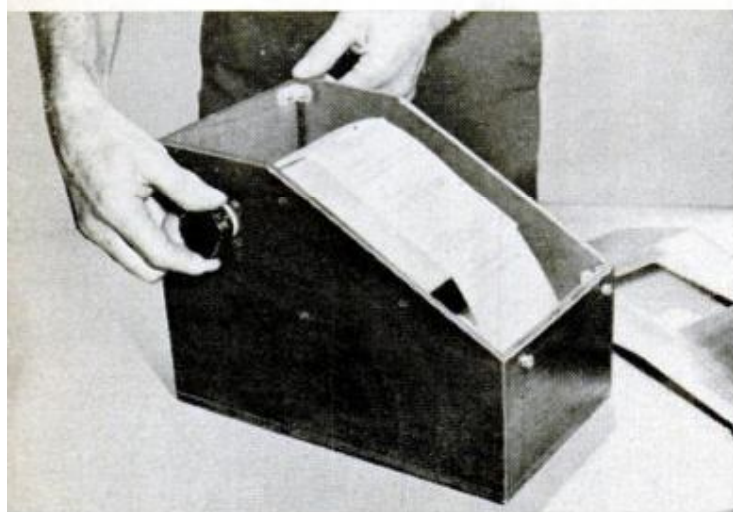

4. **TURNKNOB** on the left side of the housing is attached to shaft of winding roller with a setscrew. Here the roller is given one turn to test for proper tracking of the tape before the machine is put to use

5. **FULL ACCESS** to interior of the housing by easy removal of right side permits the quick insertion of the paper roll in the slotted supports from which tape is pulled across the "desk" and viewing window

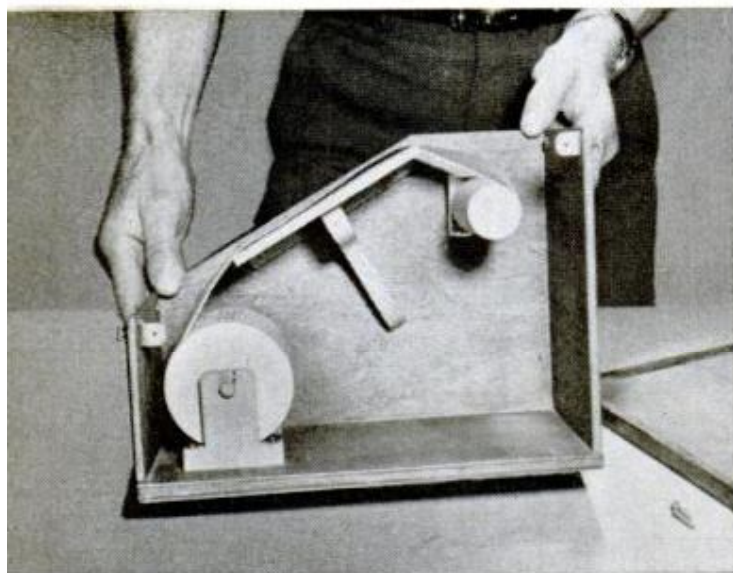

suitable to such experimental use. If encouraging results are obtained from a thorough test of the method using these economical machines, the school may wish to give some thought to the purchase of commercial machines for regular use.

The unit shown here holds a roll of paper tape containing the test questions. This tape is drawn across a "desk" under a viewing window, the top two thirds of which are covered by a piece of clear sheet plastic, and answers to the questions are written directly on the tape, using the opening just below the plastic sheet. The roll of paper tape is slipped over a dowel which is supported by two slotted blocks mounted on the bottom. Then the loose end is brought up over the desk surface and attached to the wooden take-up roller at the opposite end with masking tape. A knob on the outside turns the roller, thus winding the tape on it, Fig. 6.

Type Directly on Tape

Some copying machines can accommodate special roll stock, and while this will increase the cost of testing programmed teaching, the purchase of such stock should definitely be considered if a large number of machines are involved in the test. However, if only two or three machines are to be used, then lessons or tests can be typed directly on the tape, Fig. 2. The end of the tape is left blank for about 10 in. to reach the winding roller before the typed material appears at the window position, Fig. 3. The heading consists of space for the student's name, the subject of the test or lesson and the date space, Fig. 8. The first numbered question comes next, followed by spaces for the student's answer, and then the correct answer. These three items are grouped together so that they can all be seen at the same time through the window, as indicated by the dotted lines in Fig. 8.

Operation of Unit

The student turns the knob until the space for answering comes below the open portion of the window. An asterisk can be typed on the tape to line up with a dot or arrow on the plastic to indicate the stopping point. After writing his answer, the student turns the knob to bring the correct answer in view. In so doing, his written answer slides up under the plastic so that it cannot be altered but still permitting him to compare his answer with the correct one to know whether he is right or wrong. The correct answer should include some explanation of how the problem was solved. By turning the knob to the next question the process is repeated.

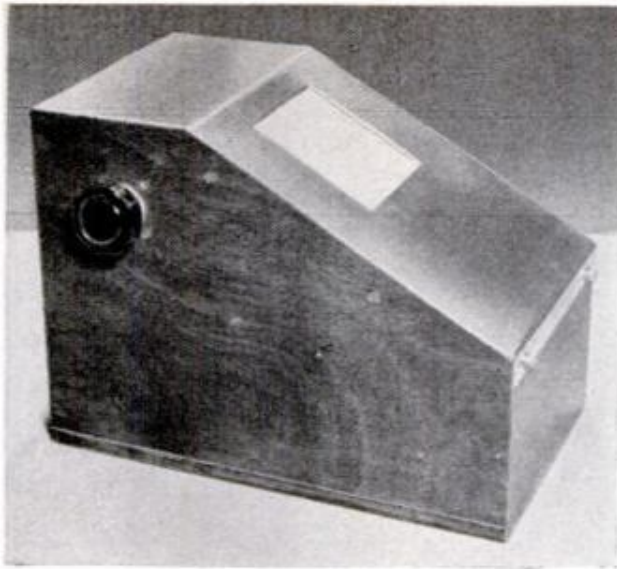

6. **READY FOR USE** after the top has been firmly secured with four thumbnuts which hold it in position

Details of construction and assembly are shown on the full page of drawings. The top is made of half-hard sheet aluminum .040 in. thick. It is fastened by means of four thumbnuts to permit quick removal. One side also is removable, being held in place with thumbscrews. This provides full access to the interior for installing the paper roll. Figs. 3 and 4 show the top removed, and Fig. 5 shows both top and side removed. If it is considered advisable to make the box tamperproof, other methods of fastening the removable parts can be improvised.

Permanent joints of the plywood are fastened with glue and brads. Angle brackets secured to the ends of the box, adjacent to the removable side, are tapped for the thumbscrews that hold it. The winding roller is a piece of wood drilled for a tight drive fit on a $\frac{3}{8}$ -in. steel shaft and then turned down in a lathe to $1\frac{3}{8}$ in. dia. A hardwood block serves as a bearing for the shaft and must be drilled true so that the shaft will be parallel to the paper roll. Otherwise the paper will run off one end of the winding roller. The end of the paper is attached to the roller with masking or drafting tape.

A piece of birch plywood, fastened to a cleat and bracket, forms the "desk" which holds the tape and also provides a smooth writing surface. The bracket and cleat are attached to the side of the housing with three screws driven in from the outside. A sheet of clear plastic about .040 in. thick is cemented to the underside of the top to cover the upper two-thirds of the window. When assembled, Fig. 7, the unit may be finished with a stain and at least two coats of shellac or simply given two coats of pastel enamel. ★ ★ ★

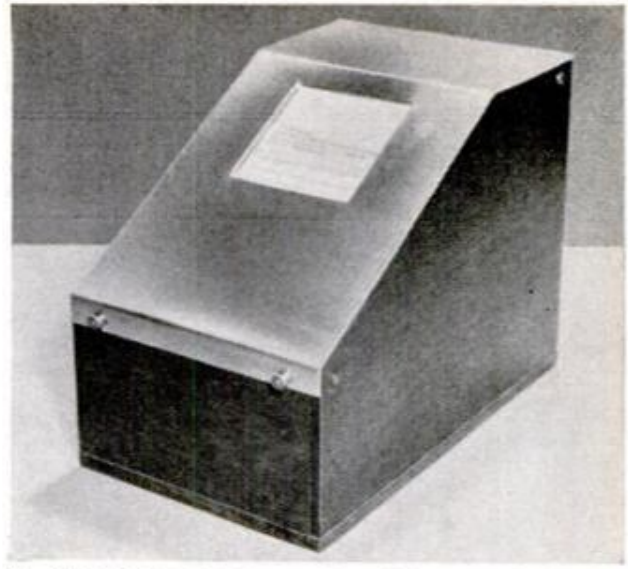

7. **ALUMINUM TOP** is smooth and sloping which adds to ease of writing answers in open part of window

8. **ACCURATE GROUPING** of copy on tape is important for student's easy observation and comparison

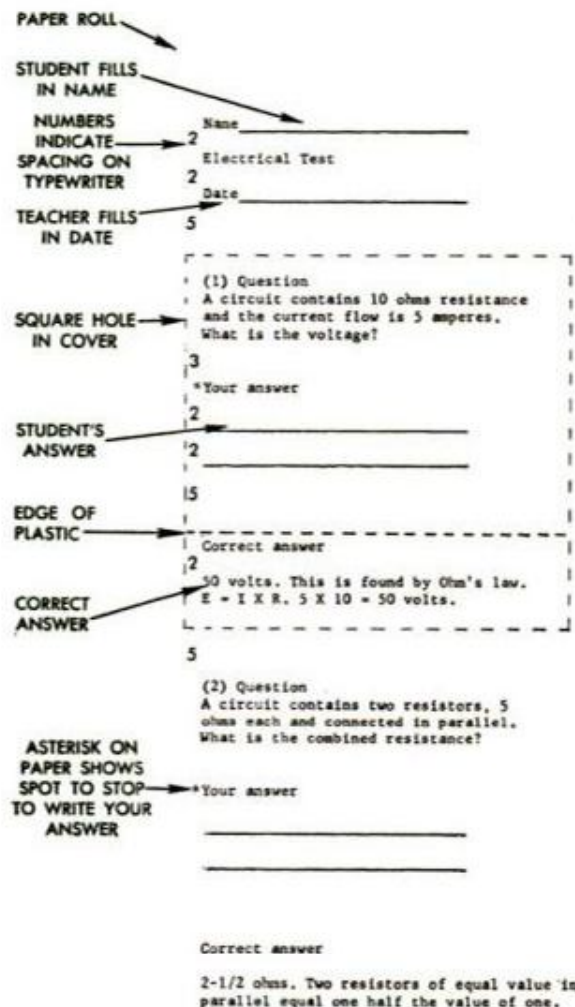



Ruled C-Clamp Aids Setting

White lines painted on the body of a large C-clamp at points spaced at $\frac{1}{2}$ -in. intervals from the stationary anvil, will simplify setting the jaws almost to the exact opening desired before putting the clamp on the work. This eliminates the inconvenience of holding the clamp and work pieces with one hand and turning the screw a considerable distance with the other—*R. Hanscom*

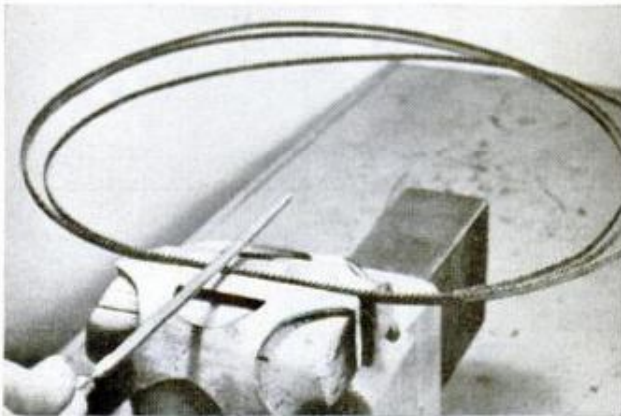

Gang-filing Bandsaw Teeth

By coiling a bandsaw blade to form three loops you can grip them side-by-side in a vise and file three teeth at once. Arrange the blade sections in perfect alignment in respect to width and tooth position. First grip them with two small C-clamps spaced slightly more than the length of the vise jaws and then mount them carefully in the vise so gullets come just above the jaws.

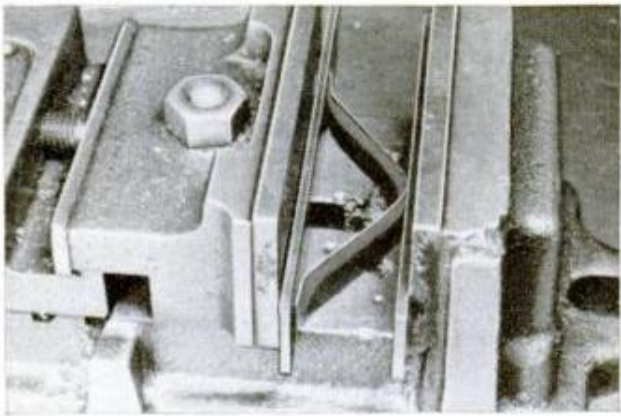

Spring Holds Parallels

Bent to a hat shape, a length of flat spring steel or old bandsaw blade will hold thin parallels in a drill vise from falling over, slipping around and permitting chips to get under them. The shape of the holder can be altered to accommodate various gap openings. The spring flattens when the vise jaws close. It is also handy for milling-machine setups.—*H. J. Gerber*

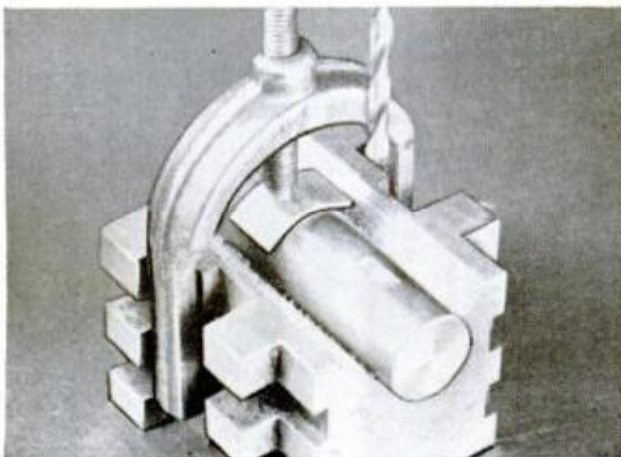

Centerpunching Shafts

Locating the center of a shaft accurately to centerpunch it for drilling a crosshole is easily done as follows: First use a small two-flute end mill in a drillpress to make a narrow flat on the side of the shaft while it is clamped in a V-block. Then locate the center of the flat by eye and centerpunch it. The narrower the flat is the easier it will be to locate its center.

How to Surface-Grind on a Radial Saw

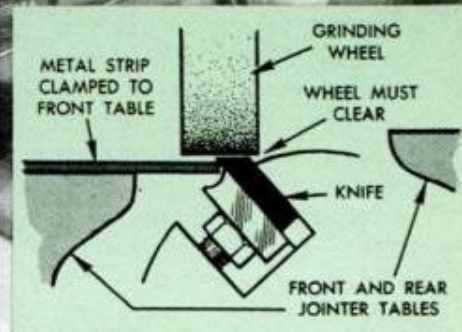
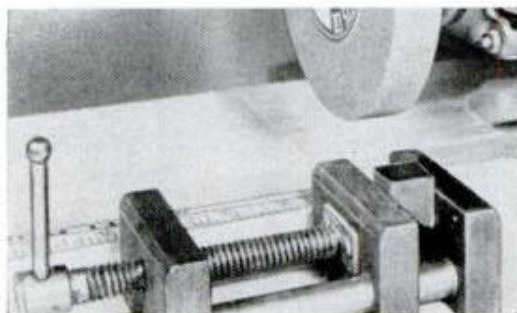
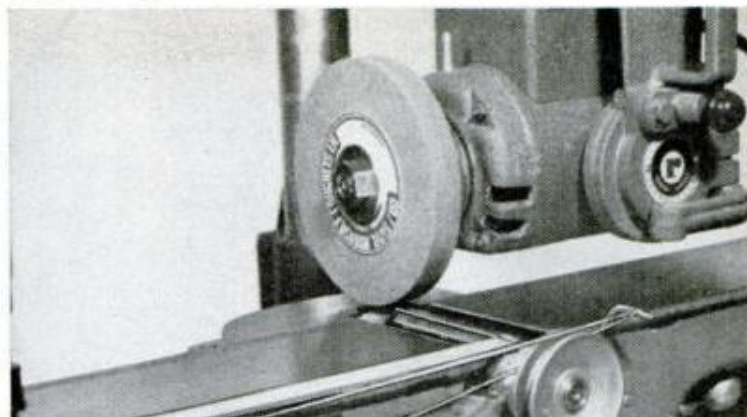
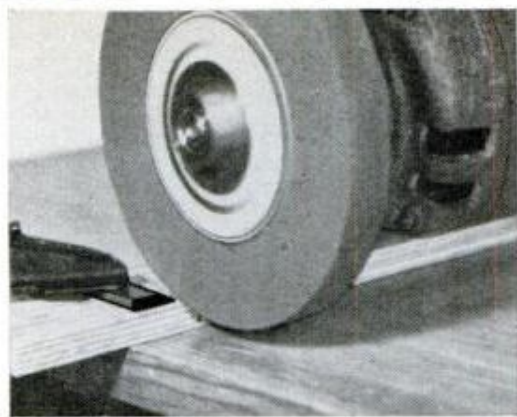

Surface grinding to a plane surface, also any grinding job where the work can be stationary and the wheel moved, can be done with your radial saw. Three examples are pictured above, the photo and detail at the right showing one way to grind jointer knives. Set the jointer on the saw table and then level it so that the travel of the wheel face is parallel with the bevel of one knife, as in detail. Then clamp a straightedge to the jointer front table in a position that will hold the cutter head with the knife bevel in position as in the detail. Loop a strong cord over a setscrew wrench which is inserted in the setscrew in the pulley and tie it around the slide projection at the front of the table as pictured. Then lower the overarm of the saw until the grinding wheel just touches the knife, make a pass or two and again lower the overarm slightly. Continue the

procedure until the knife edge tests sharp throughout the length. Repeat the setup for the remaining knives, turning the jointer head and locking as before.

To grind a bevel on a cutter, chisel or plane iron, clamp it to a piece of plywood which is in turn clamped to the saw table as in the upper left-hand photo. Once the work has been located, just back the rotating wheel slowly until it touches the bevel. An advantage of this method is that the curvature of the wheel will hollow-grind the bevel slightly. To grind a surface, clamp the work in a drill vise as in the lower left-hand photo and place the vise against the fence. Then lower the grinding wheel to a light contact and make as many passes as are necessary to finish-grind the entire surface. Ordinarily, it's best to use a fine-grit wheel.—Ben Quan

To Set a Nail

When you need to set the heads of common nails in soft wood for concealing with putty, don't use a nailset; use instead the head of a nail of the same size. Just place the head of the set nail on the head of the driven nail and strike with the hammer as illustrated. Usually one light hammer blow will sink the nail head sufficiently for concealing with putty. The one thing to make sure of in this method is that the head of the set nail is centered squarely on the head of the driven nail so it doesn't skid off when struck.—Robert Micals

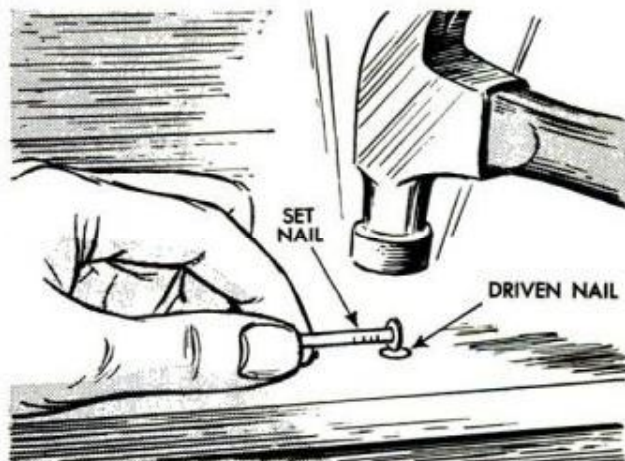

LIGHT— and POWER

Mount this unit on or near any power tool and you can control the motor and work light through one toggle switch. It's especially handy where one motor is used to service several small machines from a single mounting rail. With this switch on each tool, the motor can be interchanged easily and quickly and the light on each machine controlled with the one switch. Looking at the details you'll readily see how the unit is made and how it works. A cord from any nearby receptacle brings power to the box. Two taps enable you to plug in motor and work light. The one toggle switch, pictured at the right, controls both. Use $\frac{1}{4}$ -in. hardboard for the side panels of the box.

—F. L. Greenwald

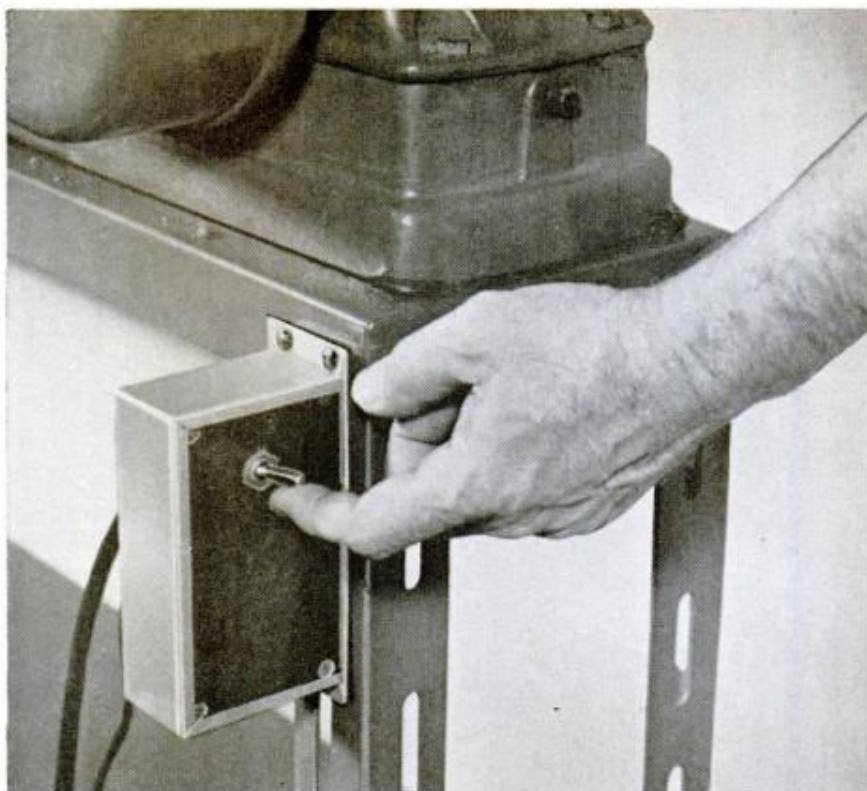

THIS TOGGLE SWITCH controls both motor and work light simultaneously

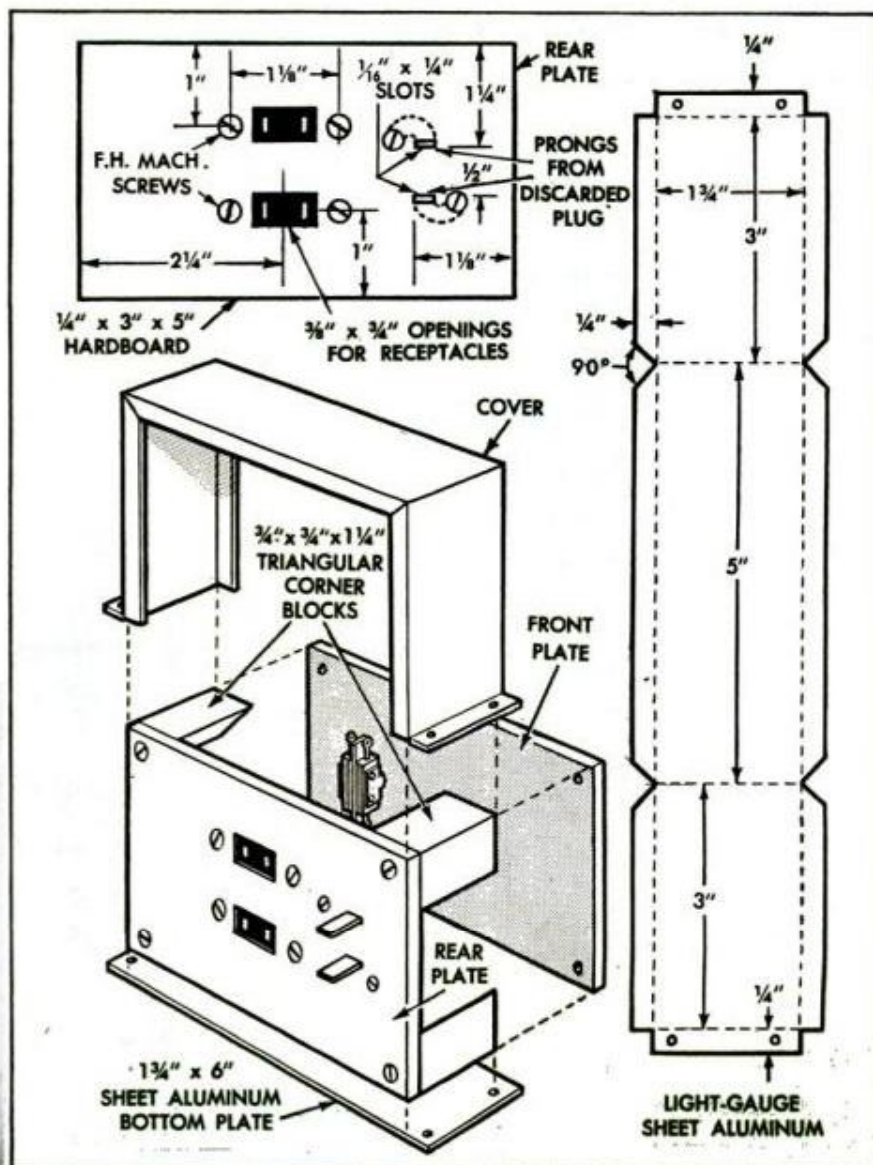
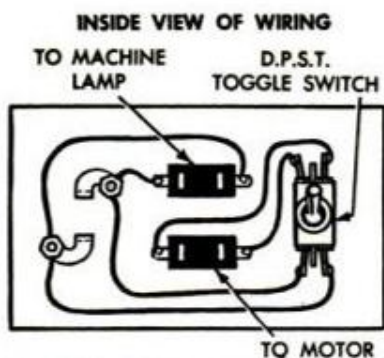

Multiple Cut-off Stop

Cutting duplicate pieces to length can be speeded up to a high-production rate by screw-fastening an extension to the miter gauge on your table saw. The extension is a 1 x 4 strip of hardwood having one, two or three vertical grooves spaced along the length. The extension pictured has three grooves, which means that it can be used to cut three different duplicate lengths. The grooves take a stop, which should be a close fit in each groove. Before screwing the extension to the miter gauge make sure that you have the grooves properly spaced to give the required lengths.

—R. J. DeCristoforo

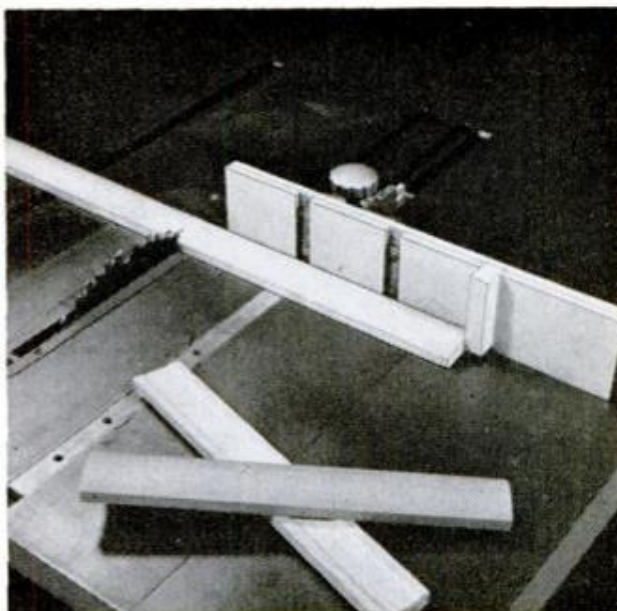

Non-Wear Turning Center

As you know, turning between centers in a lathe requires frequent advancement of the tail center to take up end play caused by the gradual enlargement of the hole in the end of the turning. This friction wear, of course, is all the greater in soft wood. Here a common metal furniture glide can be used to form a non-wear seat for the dead center. Simply drill a small hole through it after prick punching the center and countersink slightly to provide a bearing surface for the 60-deg. point of the dead center. In use, the glide is driven into the end of the turning blank and pried out after the turning is finished.

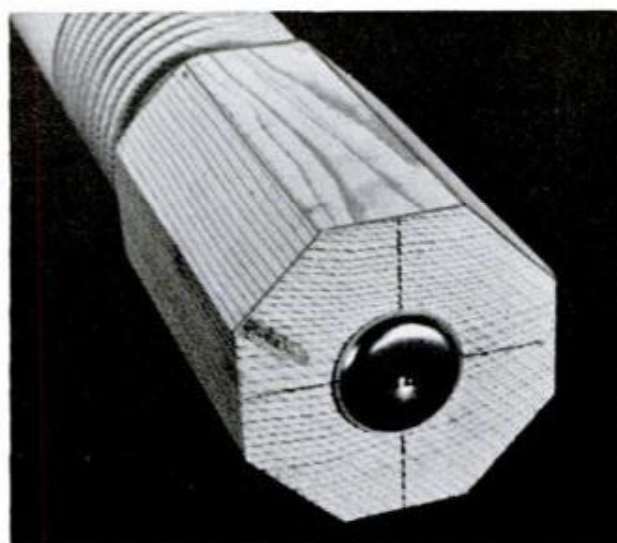

COMING UP NEXT...

CHRISTMAS DISPLAYS MADE EASY. What's the hardest part of making Christmas displays? Anyone will tell you it's enlarging the small magazine patterns to giant size. But what if you could do it with your 35 mm. projector? For the first time PM presents its readers with Clip-out Project-a-Plans which can be projected any size in any slide projector and merely traced. As for the patterns, you'll be eager to make one of these clever Christmas cutouts for decorating your home and yard. Watch for this PM "first."

BUILD YOUR OWN TOBOGGAN. Fun begins with a toboggan even when you're making one. Curling the ends of the slats, then joining with cleats and finally stringing with rope handles are fascinating steps which lead to fun galore for the entire family.

MAKING RUBBER STAMPS. Cooking a rubber stamp in the oven may sound a bit fantastic, but it can be done. And the rubber stamps made in this way can say anything you like, or sign your name with a flourish. Materials are inexpensive, the procedure very simple and the equipment, other than the rubber "dough" and the linotype slugs which carry the type and act as the matrix, can be almost anything at hand, including the oven.

PARTY MAGIC. There's lots of fun in fooling, being fooled and trying to outguess the magician. The mystifying bag of tricks we have up our sleeve for December includes such posers as pumping water from one's elbow, making an egg disappear, pouring "wine" into a hat. There's eight tricks in all—all designed for the beginner magician.

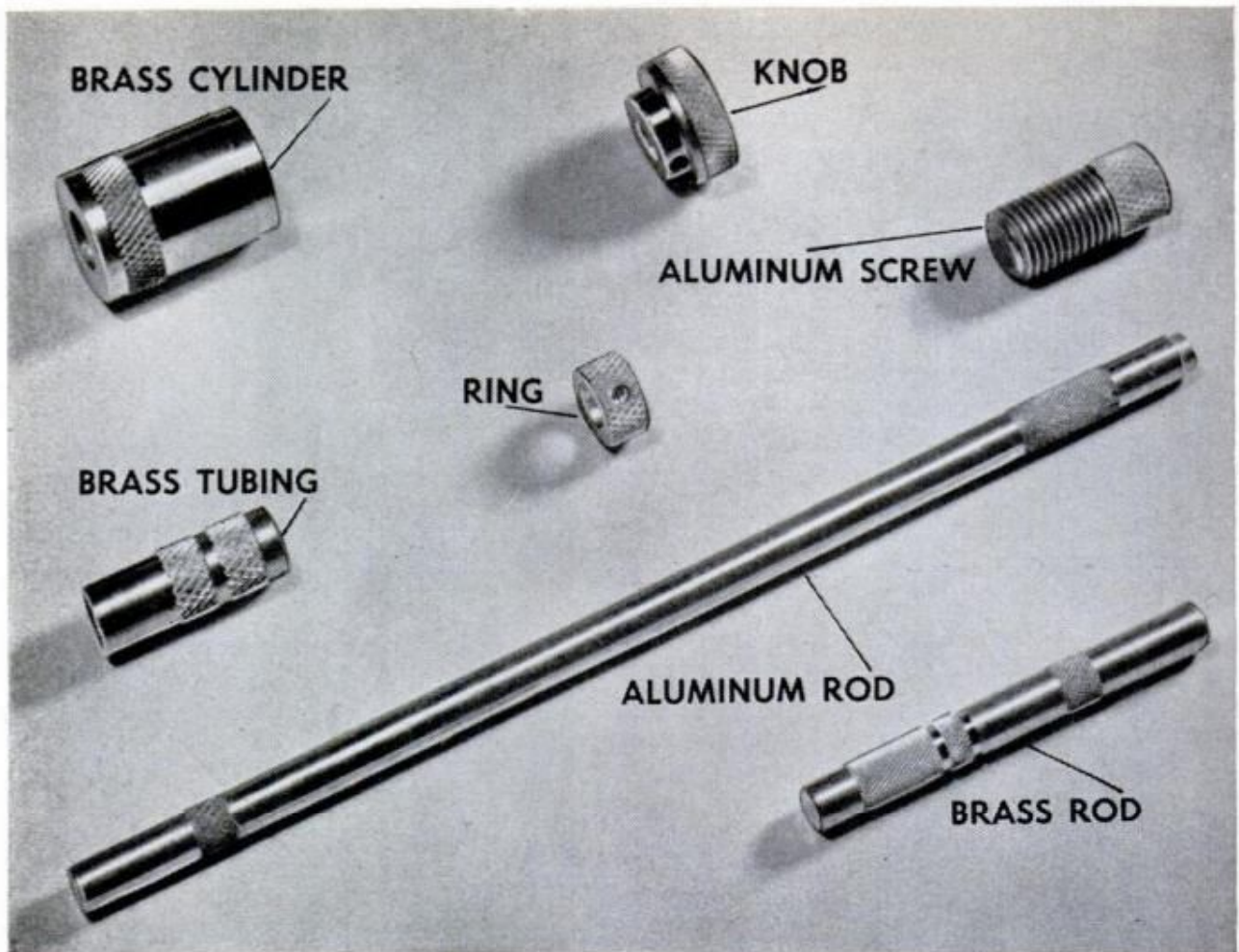

Mandrel for Tricky Knurling Jobs

Simplifies knurling of slender rods and tubes, formed knobs, rings, collars and screw heads

By Walter E. Burton

DIFFICULT KNURLING JOBS such as those shown above, which cannot be handled in the usual manner of mounting in a lathe chuck or between centers, are easy to do with a mandrel on which the work rolls. It is simply a shaft and two adjustable collars securely clamped to it. The collars prevent endwise movement of the work. Tape on the mandrel provides traction, and a two-wheel knurling tool holds the work in position.

Turn a steel shaft 1 to 1¼ in. in dia. and about 10 in. long. Center-drill the ends deeper than usual for more resistance to side pressure. Turn the collars to fit on the shaft snugly. They are about 1¾ in. outside dia., and about ⅝ in. thick. Drill and tap them for screws and saw a slit radially as shown in the drawing so the collars can be tightened on the shaft. This method is better than using set screws that bear against the shaft as was done in the original model,

because the screws then will mar the mandrel. Sides of the collars are polished smooth. For some special jobs you may later find it advantageous to have a mandrel and collars of other sizes.

Mount the mandrel between centers and drive it with a dog, or with one end in an accurate chuck and the other supported by the tailstock center. Adjust the collars so they will be separated about 1/32 in. more than the length of the work, or its thickness in case of a ring or disk. For lubrication of centers use a long-lasting lubricant such as light graphite grease, or an oil or grease containing a high-pressure additive.

Wrap two turns of ordinary electrician's friction tape around the mandrel between the collars, trimming the end back to avoid an overlap that forms a bump. Besides providing the traction to rotate the work when the mandrel turns, the tape also acts

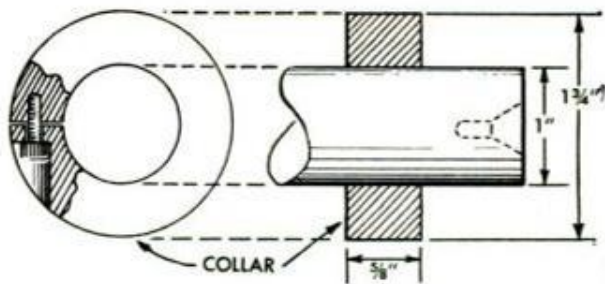

as a cushion to prevent flattening of the knurling from pressure against the mandrel.

After placing the work in position on the tape, a two-wheel knurling tool is adjusted carefully to hold the work firmly in its proper position. Adjust the tool so that its swinging head cannot move farther in the direction in which the work tends to force it. Position the tool squarely with the center axis between knurling wheels lined up with the center of the work and mandrel; also so that the knurls will be properly spaced. Faulty adjustment may cause the work to pop out. Because of this possibility it's wise to wear suitable goggles or a face shield. A film of oil on the inside surfaces of the collars minimizes friction. Do the knurling at the slowest back-gear speed of the lathe. When oiling bearings avoid getting oil on the work.

SQUARE ALIGNMENT of tool and work is very important as is clearance between work and collars

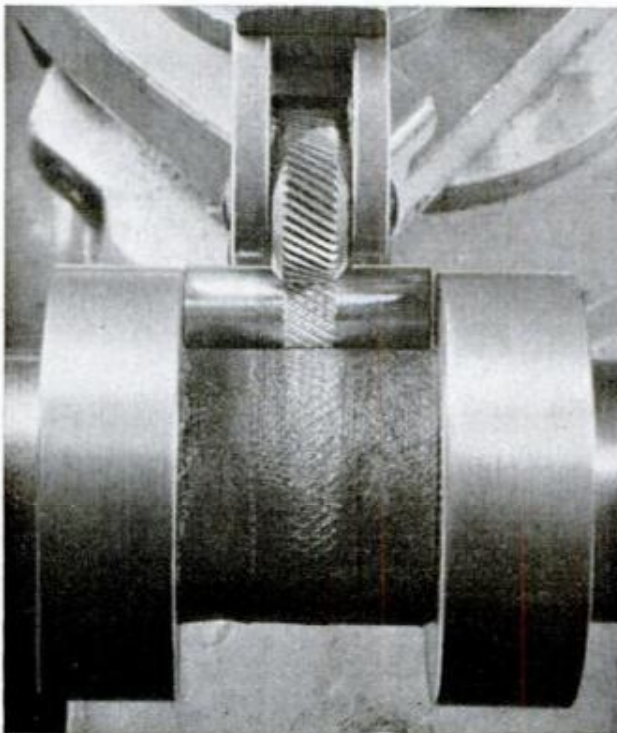

NOVEMBER 1962

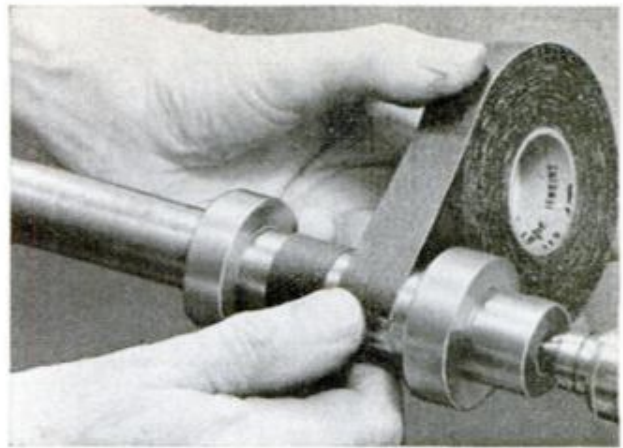

TAPE ON MANDREL to provide traction for work is wrapped so work will not tend to loosen end of tape

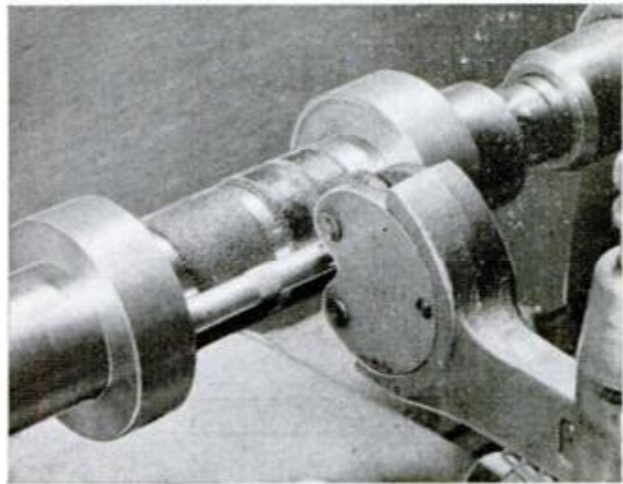

WORK HELD FIRMLY in position by a two-wheel knurling tool properly adjusted so it cannot pop out

FOR END KNURLS shift collar to insert rod slightly less than work dia., and rest end on lathe slide

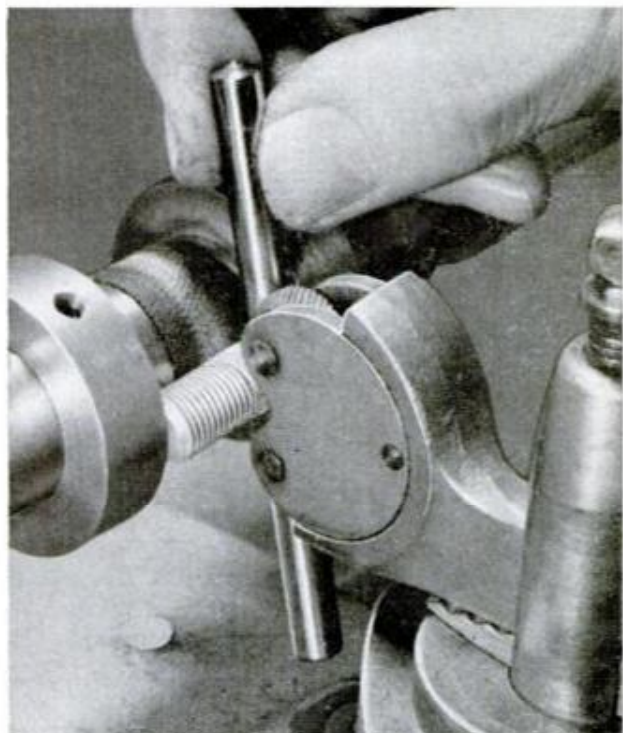

185

BELT SANDER MOUNTS ON LATHE

By **Howard R. Clark**

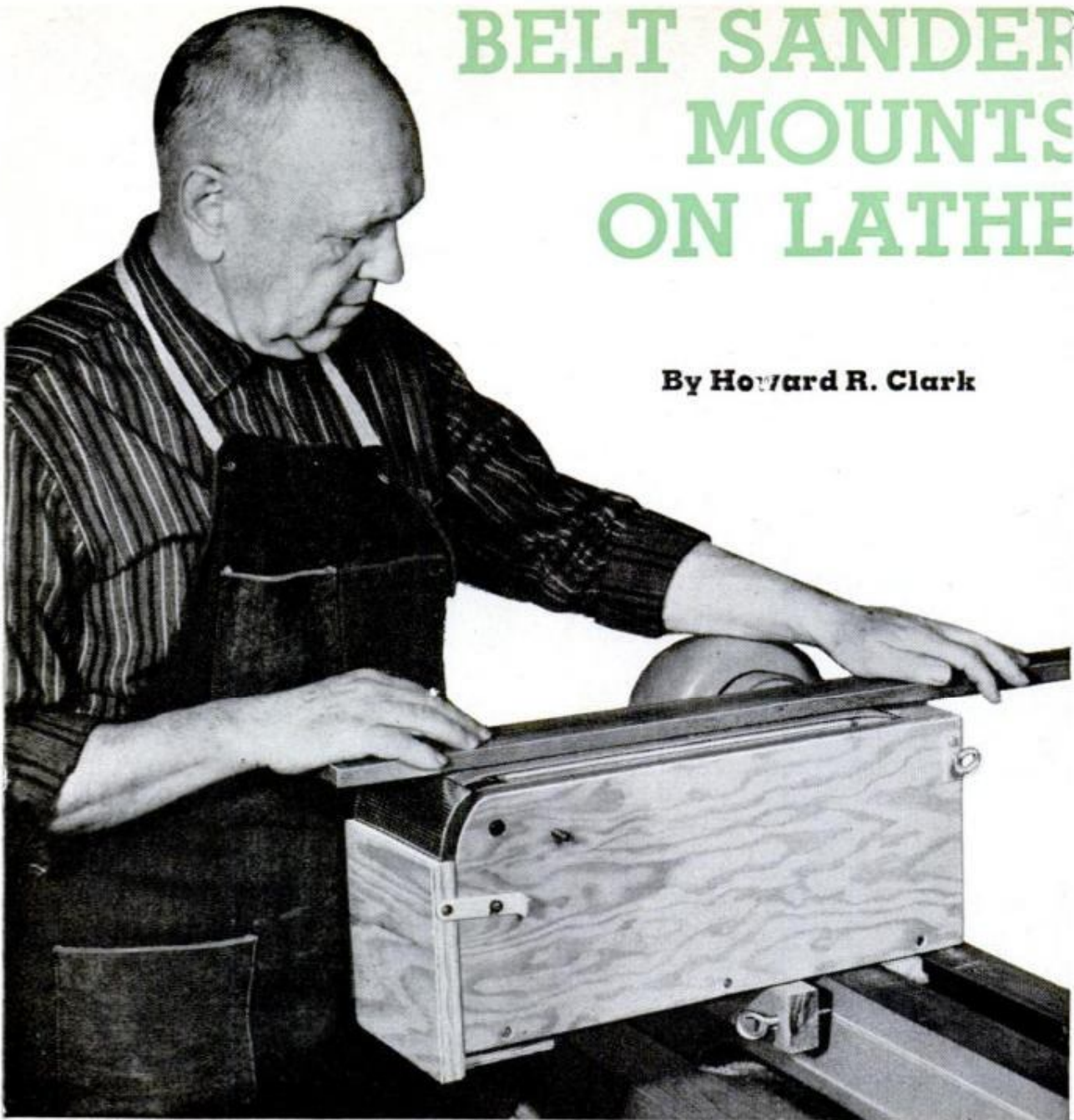

PRACTICALLY DUSTFREE, this little belt sander clamps on lathe bed; adjustable for belt tension and tracking

QUICKLY ATTACHED to a wood-turning lathe, this belt sander, measuring about 6 by 8 by 18 in. in size, is just the thing for occasional jobs in the home workshop. It costs only a few dollars, is sturdy in construction and accurate in tracking. An added feature is the provision for using a vacuum-cleaner hose so that you can enjoy belt sanding that is practically dustless.

The sander illustrated here was made to fit in a 12-in. Delta lathe, and uses 4 by 36-in. belts. Some of the dimensions may have to be altered to fit other makes. The driving drum is screwed onto a 3-in. faceplate which turns onto the lathe spindle. The faceplate should be an extra one so it can be left on the drum permanently. If you have to fasten the drum to a faceplate every

time that you want to use the sander, considerable time is lost in assembling even though you have marked both drum and faceplate, and have the same attachment screws conveniently at hand. The drum is held entirely by the lathe spindle and is not supported by a bearing on the sander.

The housing of the sander consists of a bottom, ends or access doors, two sides and a sanding table. All of these parts are made of $\frac{3}{4}$ -in. plywood except the left side, which is $\frac{1}{8}$ -in. hardboard as it serves only to enclose the housing and does not support other parts. A T-shaped clamping block slips under the lathe bed and holds the sander firmly in position. Two bolts passing through the clamping block fit slots in the bottom and are tightened by means of wing

nuts. The slots permit adjustment of the sander for belt tension and tracking. This adjustment is obtained by means of an aligning bar which is rigidly attached to the underside of the bottom. Two eyebolts that turn in nuts recessed in the aligning bar, bear against the side of the lathe bed to pull the belt tight. The bed should be spot drilled lightly to provide seats for the ends of the eyebolts.

Both ends or access doors are hinged at the bottom so that they can be swung open. The rear access door must be opened when the sander is being attached to the lathe. This door is held in the closed position securely with a spring latch, detail A. It is merely a pin made from an eyebolt and provided with a coil spring and a small plate screwed to the side of the housing. The pin enters a hole in the door edge thus locking it, but allows instant release by pulling the head. The front access door has a different locking arrangement as shown in detail C. It is a simple pivoted catch having a notch that slips over a screw projecting from the side. The end of the catch is bent at right angles to form a finger hold. Both doors are provided with deflectors or shields of No. 18-ga. sheet aluminum projecting inwards as shown, almost up to the surface of the belt where it passes over the sanding table.

Both the drive and idler drums are turned from hardwood and should be slightly crowned to keep the belt tracking centrally over them. In turning the idler drum, a true-running job is assured if the stock is first mounted on a $\frac{3}{8}$ -in. shaft and then turned to finish size. The shaft projects



ACCURATE RIGHT-ANGLE SANDING is assured by using fence held firmly by tool-rest support on lathe bed, and holding work against stop at end of fence

through two brass or bronze bearing sleeves as shown in details B and C, or through ball-bearing races, which are held in the housing side and a bearing support block. To assure boring the bearing holes in these pieces so that they will be in perfect alignment, they are first carefully stacked to-

IDLER DRUM after being turned and crowned. It is first drilled and pressed on a steel shaft which is mounted in lathe as shown here so drum surface will be concentric and true-running, assuring smooth operation

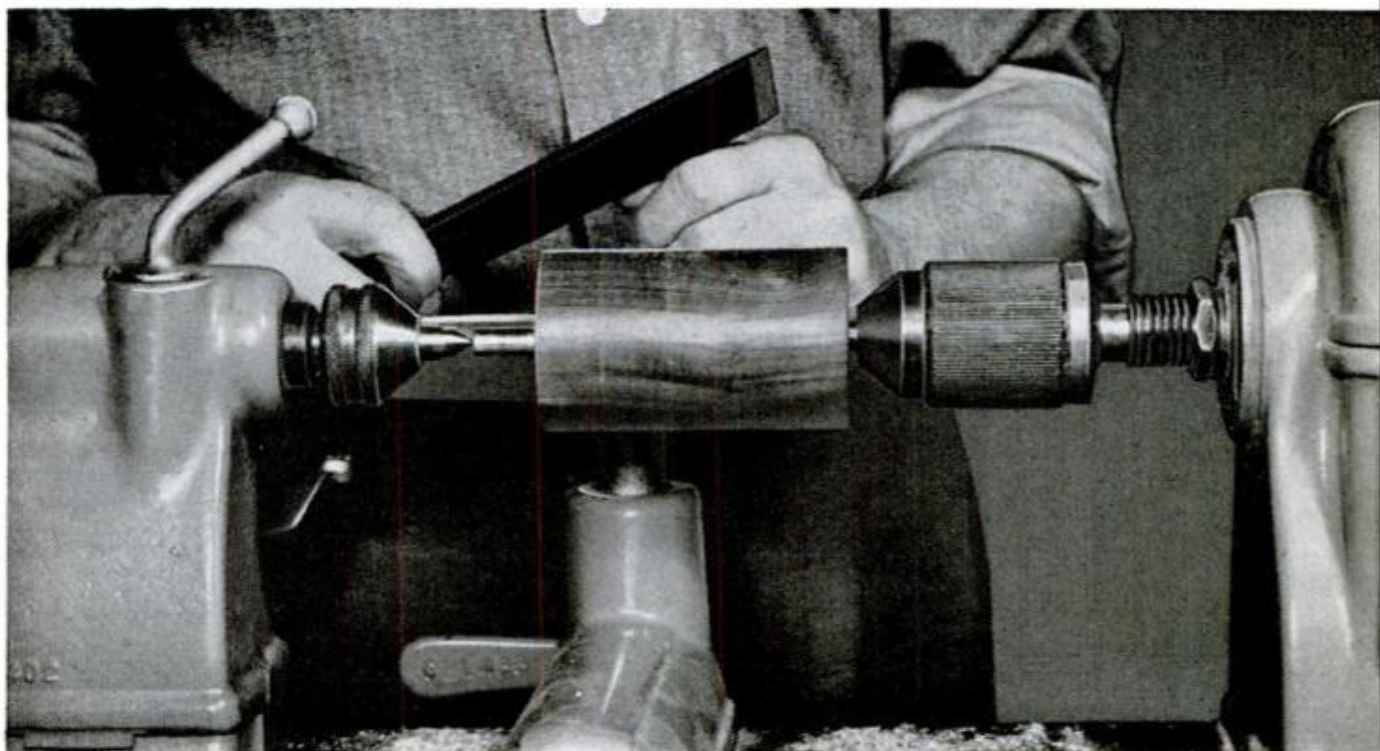

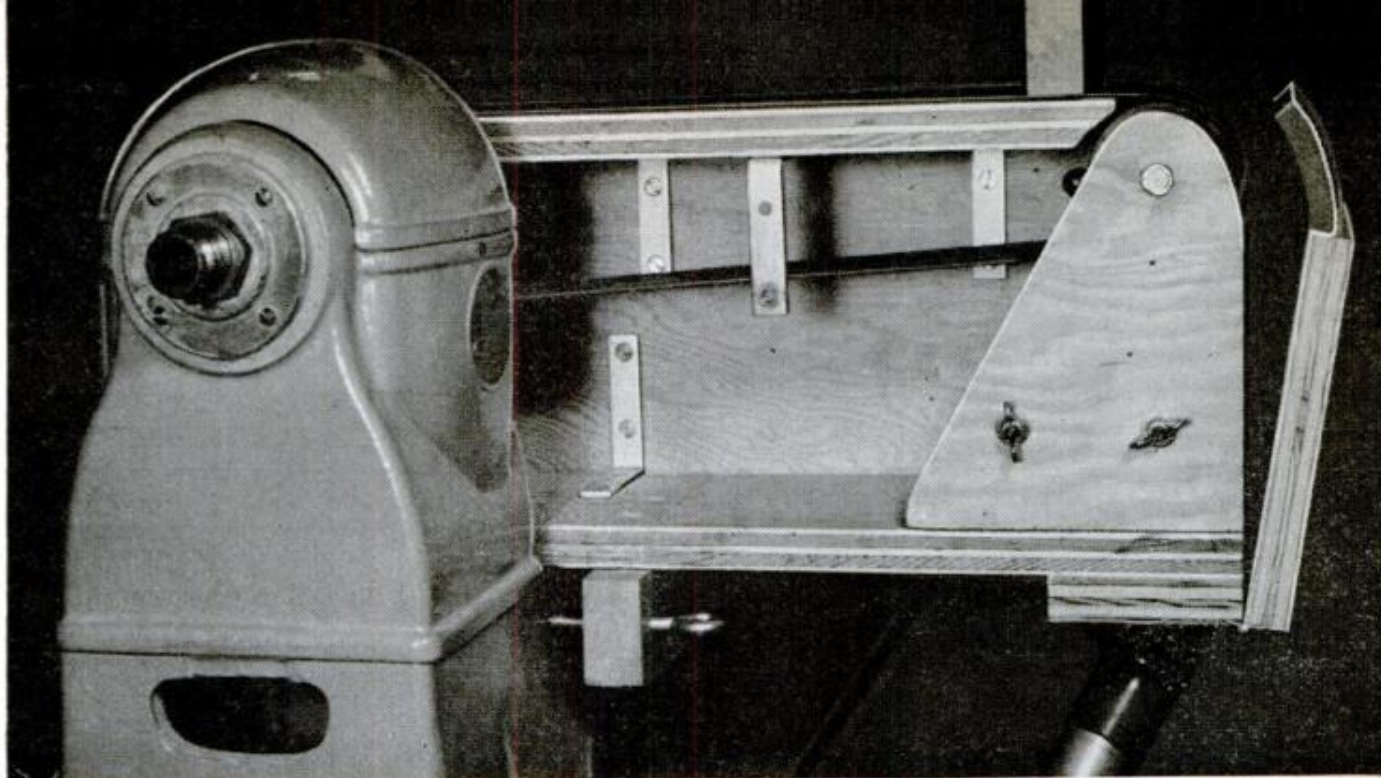

INSIDE VIEW of sander with hardboard side removed to show belt, sanding table and front access door open

gether in alignment, clamped in this position and then bored. The bearings should be a press fit in the plywood, and are locked with setscrews if they tend to rotate with the shaft. The bearing-support block is removable to permit installing sanding belts, and is held with bolts and wing nuts to another block which is permanently attached to the bottom.

The ends of the sanding table are shaped to a radius of $\frac{1}{8}$ in. more than the radius of the drums. The table is held by angle brackets and has an angle bracket (with nut soldered on) for holding the $\frac{1}{8}$ -in. hardboard side. The top surface of the sanding table comes slightly above the top line of the drums. When the table is in place the location of the hole in the hardboard side is marked from the inside after dropping down one of the access doors. In the arrangement shown, the end of a vacuum-cleaner hose was slipped up through a hole in the bottom, just below the idler drum, and a tapered wooden cylinder was used to wedge the hose in place. However, the exact method of attachment varies with the type of hose used.

A hardwood work stop is also shown. This attaches to a bolt projecting through the side (detail C) and rests firmly on the edge of the side so there is clearance between the stop and belt. This is handy for sanding end grain, in which case the work is held vertically against a fence to assure accurate 90-deg. sanding. The fence is provided with a bracket, floor flange and pipe nipple that fits the tool rest support.

One each of 40, 60, and 100-grit aluminum-oxide sanding belts will provide a

good assortment. Belts are marked with a directional arrow and should be installed to run in this direction. ★★★

STURDY FENCE attached to pipe floor flange and nipple that fits in tool rest support. Stock over 4 in. wide is run at slight diagonal over the sanding belt





1. MODULAR TWO-UNIT family entertainment center set up as wall console. Note placement of four cabinets, or modular boxes, arranged for convenience without the usual unfinished look of components

YOU CAN BEGIN with one unit and as your interest expands and the budget permits, the system can be expanded to suit. What you have built is never lost and nothing has to be discarded or rebuilt

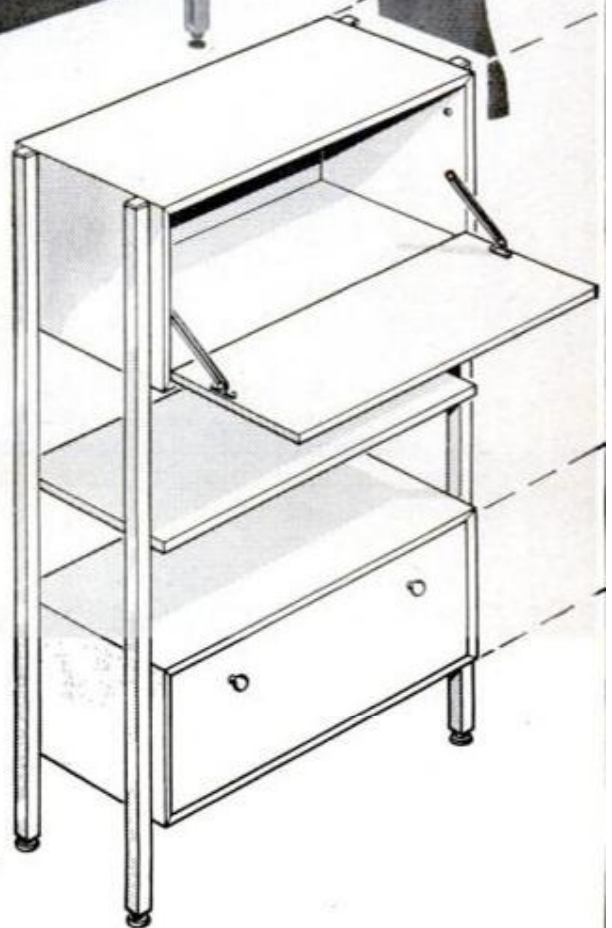

Add-On Entertainment Center

with a growth plan to spark the imagination of hi-fi fans and serious home recordists

By John Jefchek and Byron G. Wels

HERE IS NOT ONLY a tasteful addition to contemporary modern or traditional home furnishings, but an expandable system affording a complete home studio for all hi-fi activities. The single modular unit can be placed anywhere in a room as

a free-standing piece, or it can serve equally well as a wall unit, or console. The backs of the cabinets, or box models, have the same simple design feature on both sides, permitting use of the unit, or units, as a wall divider. You can begin with the mini-

THIS PULLED-APART VIEW indicates how you can add a second and even a third or fourth unit—whatever available space will permit—utilizing each one as the need arises for a wine cellar, bar or storage

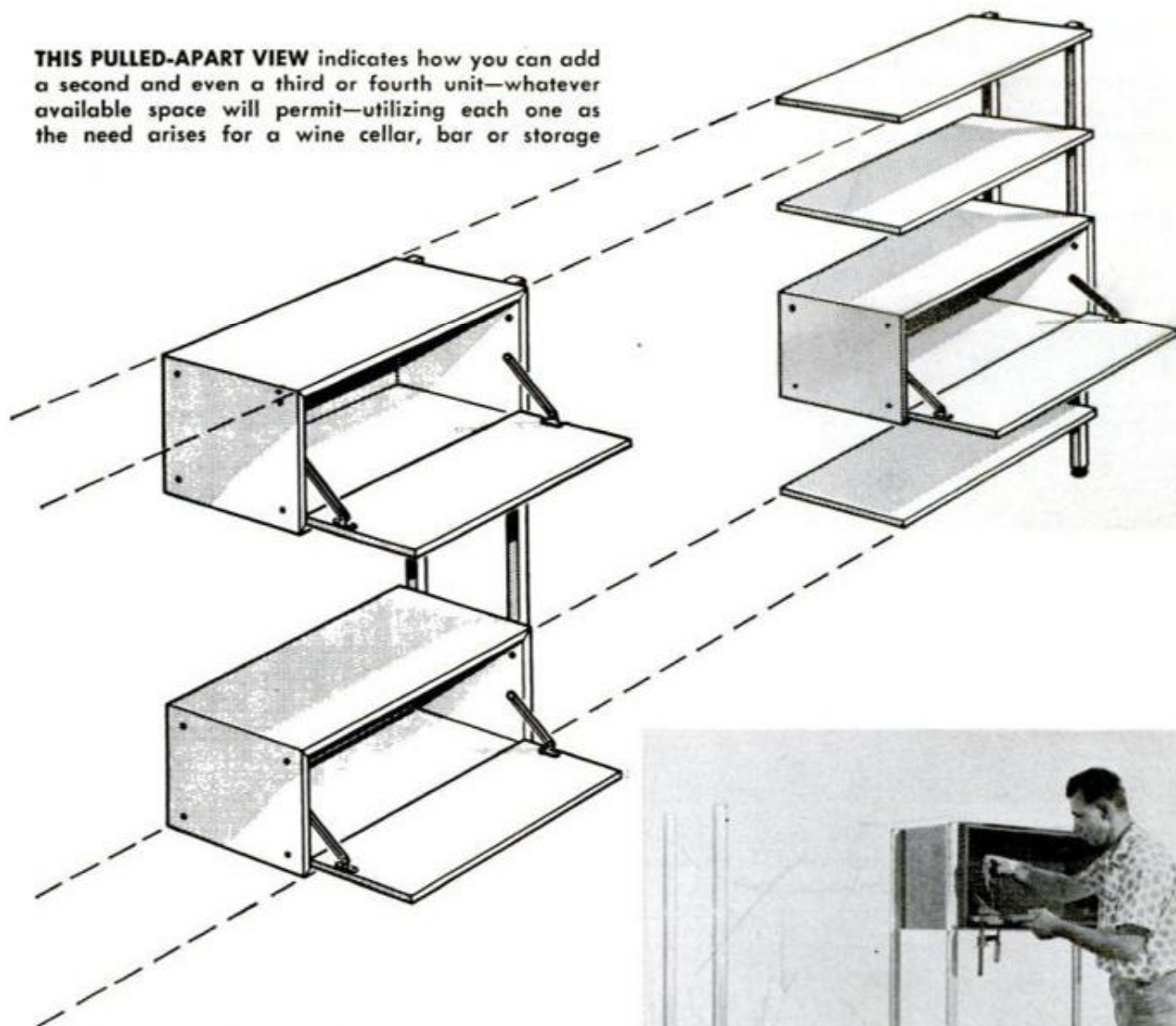

ADDING A SECOND UNIT gives you space for all the electronic components required for a home hi-fi studio, like that pictured in Fig. 1. Flexibility of the dual unit permits almost any arrangement of shelves, cabinets

2. DUAL-UNIT MODULAR in process of assembly shows three cabinets and two shelves in position, less the easel which is part of the phono shelf at the left in this view. Note the laminate-surfaced drop door



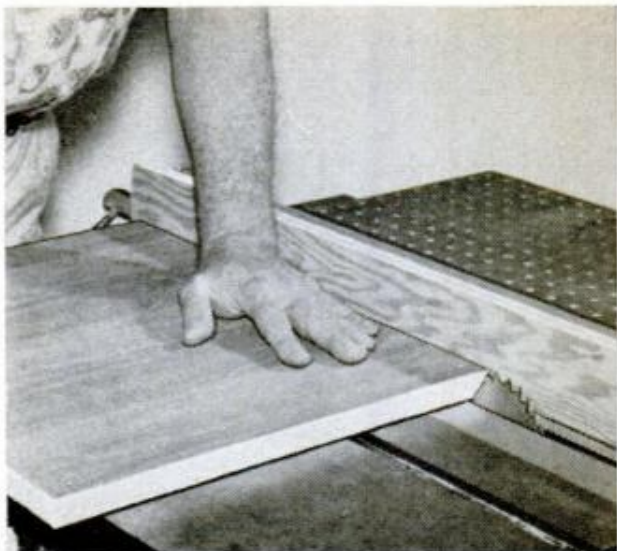

3. CUTTING MITER on a cabinet panel. All four corners of each cabinet are joined by 45-degree miters which are strengthened with hardwood splines. Note the facing strip screwed to the rip fence of table saw

4. AFTER CUTTING MITERS the spline grooves are cut with a similar setup on table saw. See also details A and B in Figs. 10 and 11. These show how setup is made and how a portion of miter is left uncut



5. ASSEMBLY OF CABINET with one miter joint clamped and a second being assembled. Note especially the spline in, unassembled miter and spacing of the four pairs of triangular clamping blocks

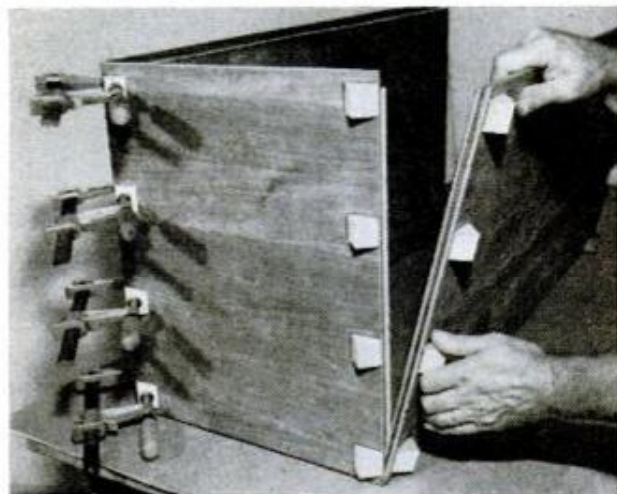

mum, a single modular unit, and as interest and budget expand you can add modules one by one to accommodate any electronic equipment you may acquire, or add units to serve as storage, a wine cellar or a bar.

With the modular system expanded to two units as pictured in Fig. 1 you have space for equipment to play stereophonic records, stereo FM and stereo tapes. You can play the shortwave receiver through the system and also the TV audio. You can tape any of these, or copy tapes for friends.

Assembly of the modular unit is detailed in Fig. 10 and the construction of the cabinets, or box modules, is shown in Fig. 11. The modular unit, Fig. 10, is supported on four columns, or legs, of extruded aluminum, one pair being U-shaped, the other I-shaped. The U-shapes form the end legs and the I-shapes the center legs of the two-module assembly, such as that pictured in Figs. 1 and 2. This same modular construction can be repeated to form a modular structure consisting of any number of units desired. If, on the other hand you wish to build only one unit, then you use four U-shapes for the legs. Both types of legs are available with end caps and the I-shapes with snap-in closures, Fig. 10, but in order to provide a leveling adjustment and more easy portability, all four legs of the basic modular unit are fitted with standard adjustable furniture glides in the manner shown in the lower left-hand detail, Fig. 10. In fitting the glides to the center legs, the web is cut away to take the spindle of the glide as in the right-hand detail, Fig. 10. The latter detail also shows how the cabinets and shelves are attached to the center legs by means of lugs, or spring nuts and brackets, which are ready-made parts available with the legs. Note also that a slot is provided in the web of the back center leg as a convenience in wiring. This can be located at any point, but in the original it was cut in the upper part of the leg, registering with slots cut in the ends of the two upper cabinets. The slot is shown in the upper cabinet in Fig. 10 and is located and dimensioned in Fig. 8.

Fig. 13 shows how to lay out and cut the stock for the four cabinets in the two-unit module in Fig. 1. When making the layout give special attention to arrangement of the grain of the wood, selecting the best, where possible, for the fronts, or drop doors, A, B, C, and D in Fig. 13. You may have to depart from the plan somewhat in order to take advantage of the best grain in your panels. All four corners of the four cabinets are joined with splined miters and the details in the lower panel, Figs. 10 and 11,

(Text continued on page 197)

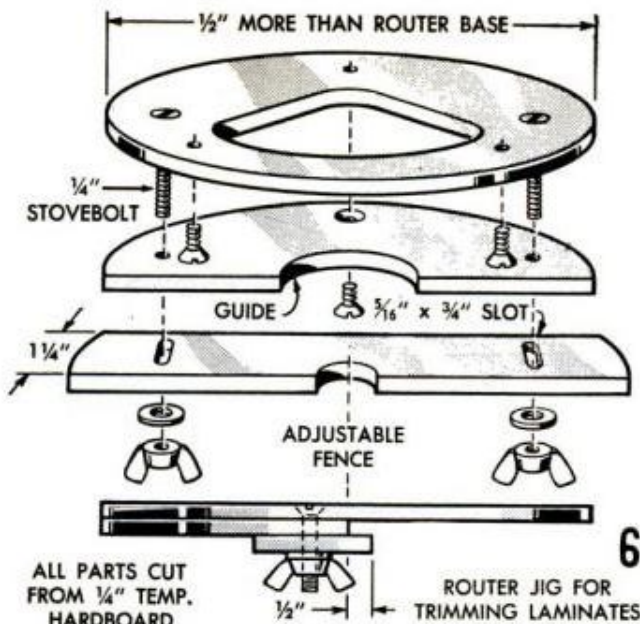

ALL PARTS CUT FROM 1/4" TEMP. HARDBOARD

ROUTER JIG FOR TRIMMING LAMINATES

SHOP-MADE ROUTER JIG for truing laminate cemented to backs of drop doors. Slots provide adjustment



ROUTER JIG in use. Care must be taken to set it so that edge of laminate will be trimmed flush, no more

THESE DETAILS become clear when you connect them with the assemblies shown in Figs. 10 and 11. Slide-out shelf, or easel, top detail, is fitted under phono shelf as in Fig. 10. It's made from grained hardboard

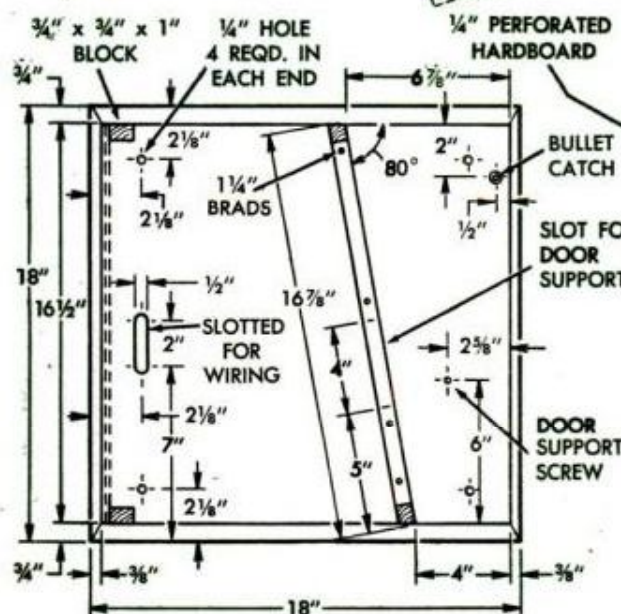
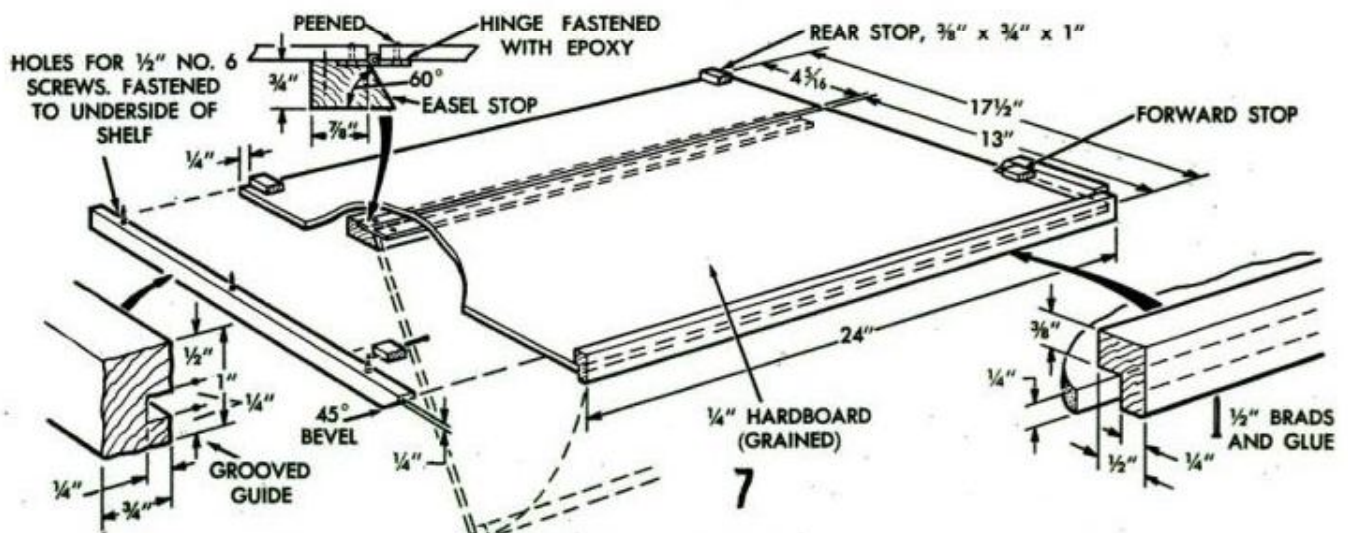

NOVEMBER 1962

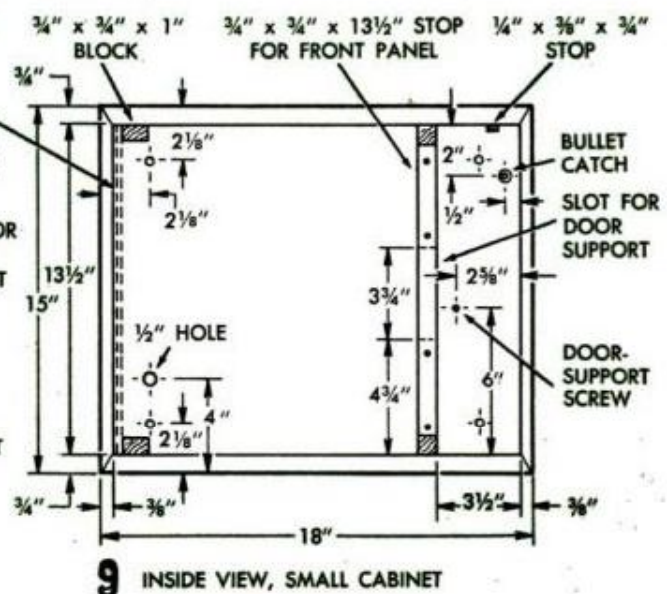

193

10 MODULAR UNIT

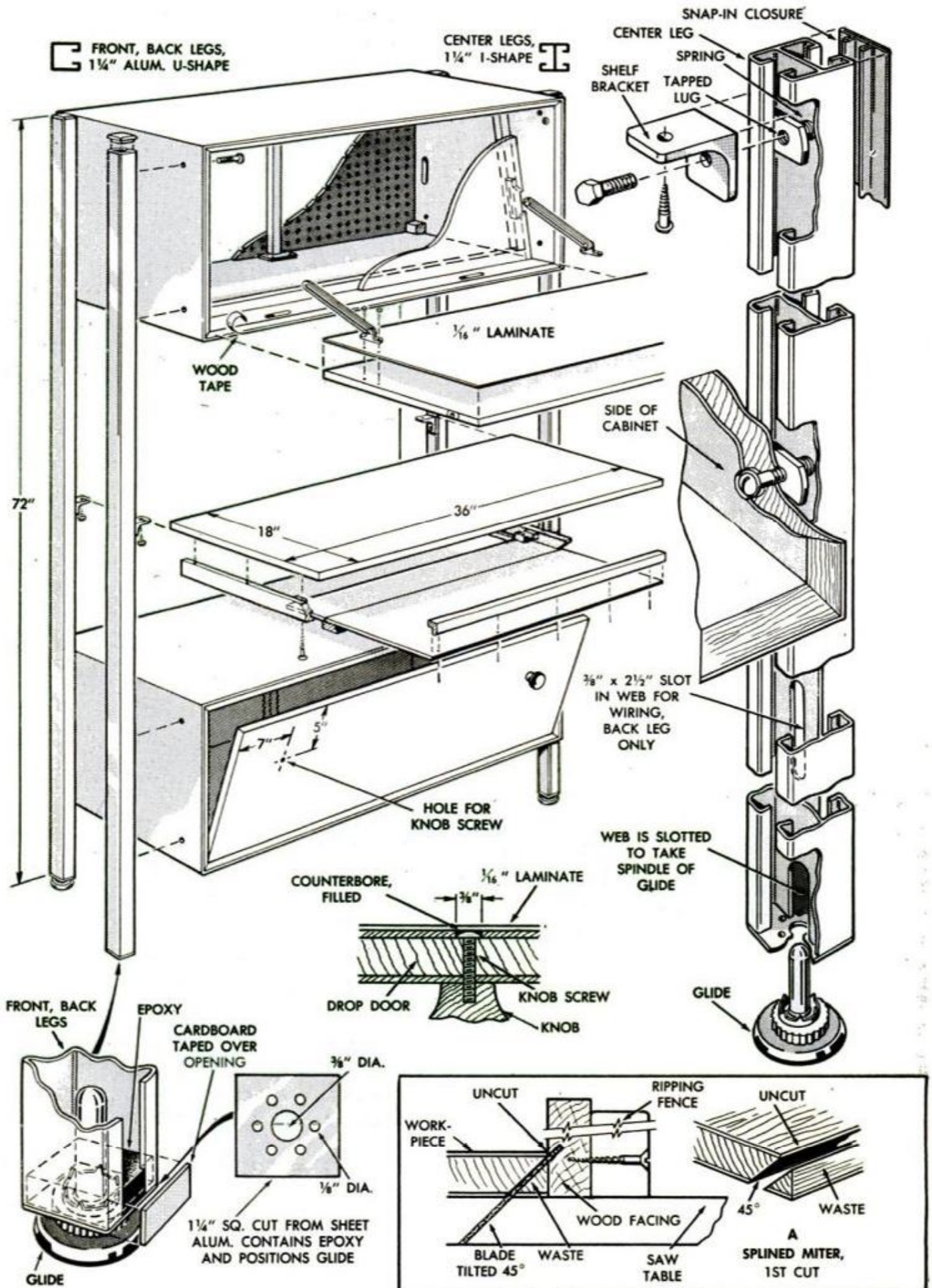

II BASIC CABINET

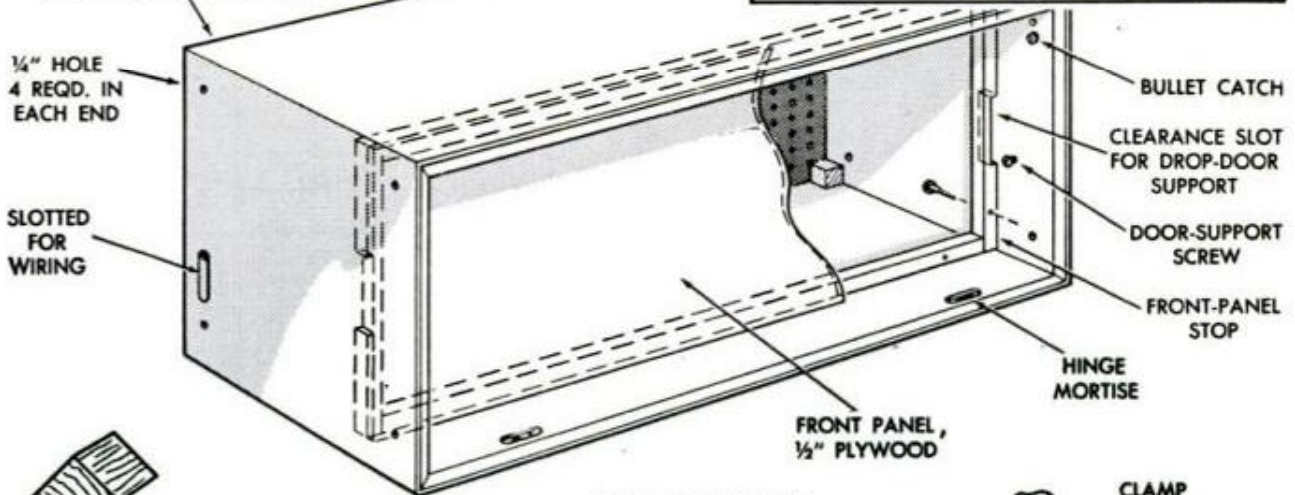
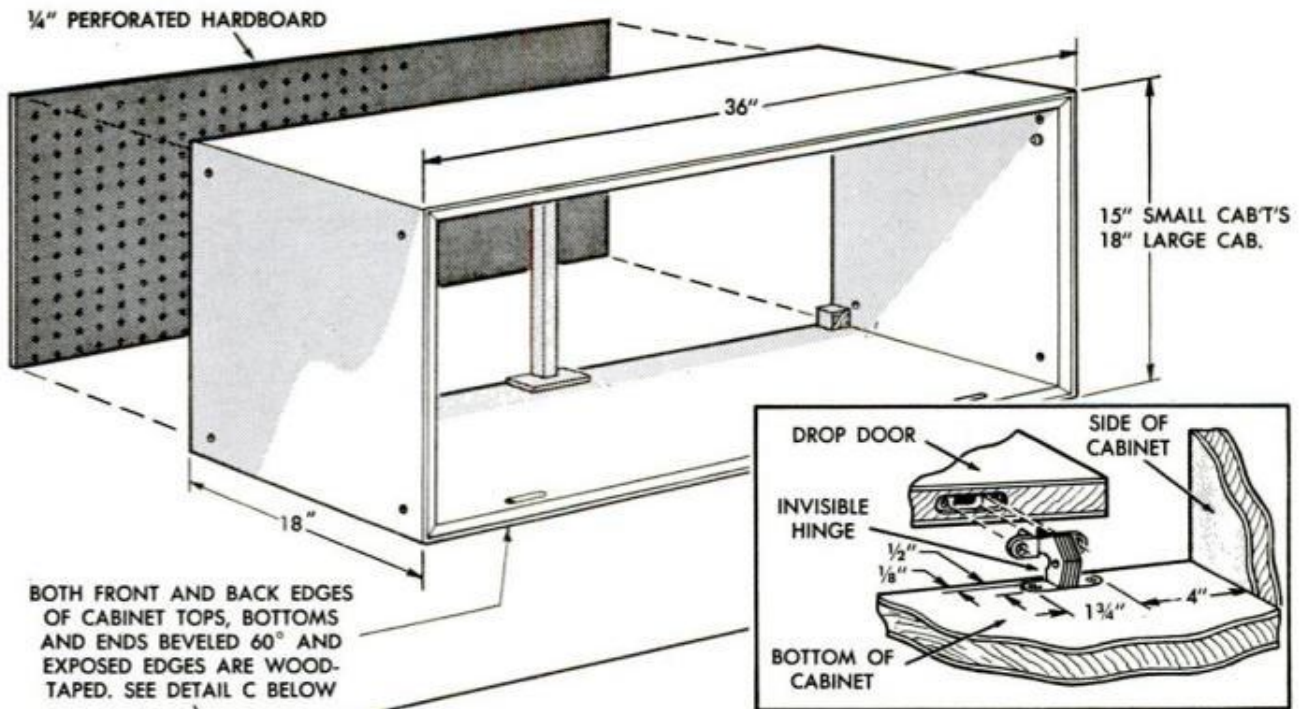

1 CLAMP TO EACH
PAIR OF BLOCKS

32 BLOCKS REQUIRED
FOR THE FOUR MITERED
JOINTS OF EACH CABINET

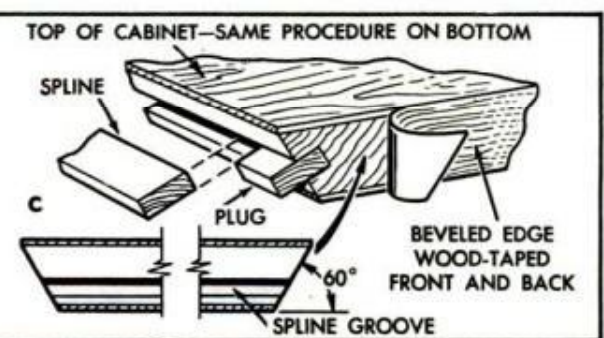
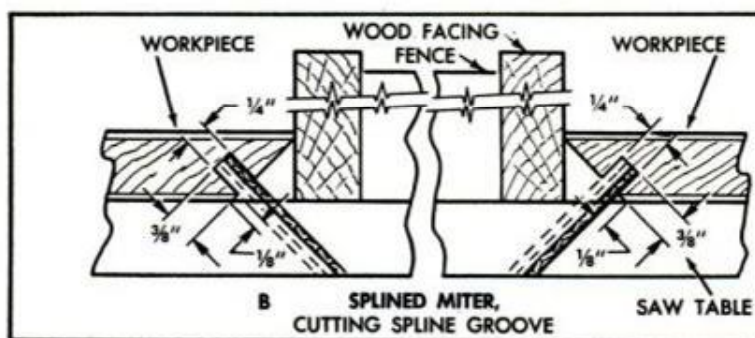
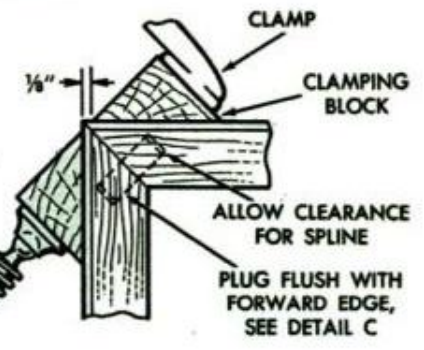
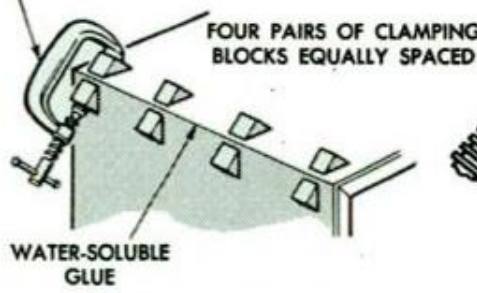
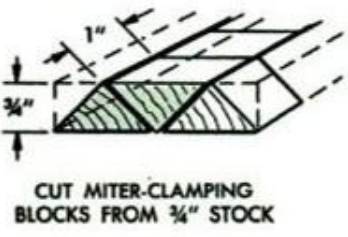

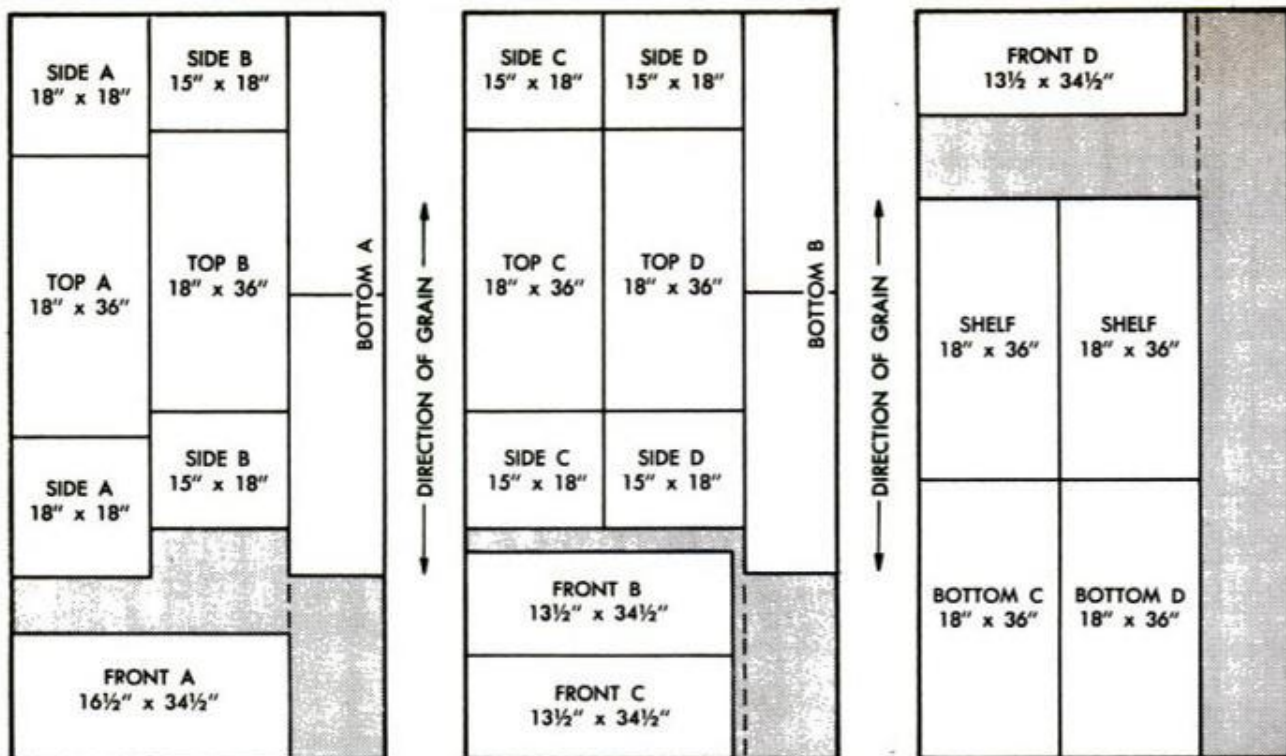

13 LAYOUT OF 3 PLYWOOD PANELS FOR CABINETS AND SHELVES
(EACH PANEL $\frac{3}{4}$ " x 48" x 96" LUMBER-CORE PLYWOOD)

show how to set up to cut these joints on your table saw. Note in the detail A, Fig. 10, that a wood facing is attached to the ripping fence and that the saw blade is raised until it cuts into this facing. Also note that the blade is adjusted for height to leave about $\frac{1}{32}$ in. or so of the workpiece uncut at the top edge of the miter. This gives you a bearing against the rip-fence facing when making the second cut on all pieces for the spline as in detail B, Fig. 11, also Figs. 3 and 4. Note that you keep the same setting whether the blade on your saw tilts right or left. Once the pieces have been mitered and grooved for the splines the edges are bevel-cut to 60 degrees, Fig. 11 and also Fig. 11, detail C. As

will be seen from detail C, the splines are not cut the full length, but are pieced out with a plug, or insert, which is more easily trimmed flush before taping the bevel as in detail C with a wood tape to conceal the exposed plywood edge.

The mitered joints are glued and clamped as in the three details in Fig. 11. Triangular clamping blocks are cut from $\frac{3}{4}$ -in. stock and glued to the ends of the panels forming the tops, bottoms and ends of the cabinets. The blocks are equally spaced, four pairs to each joint, as in one of the details, also Fig. 5. Use a prepared hide glue for attaching the blocks, but use water-soluble glue in the miter joints. The clamping blocks are easily removed without damage to the

14. HERE'S THAT EASEL you've seen detailed in Figs. 7 and 10. Note raised lip at lower edge for jackets



15. THERE'S PLENTY OF SPACE for your phonograph of whatever type. Note that edge of shelf is taped



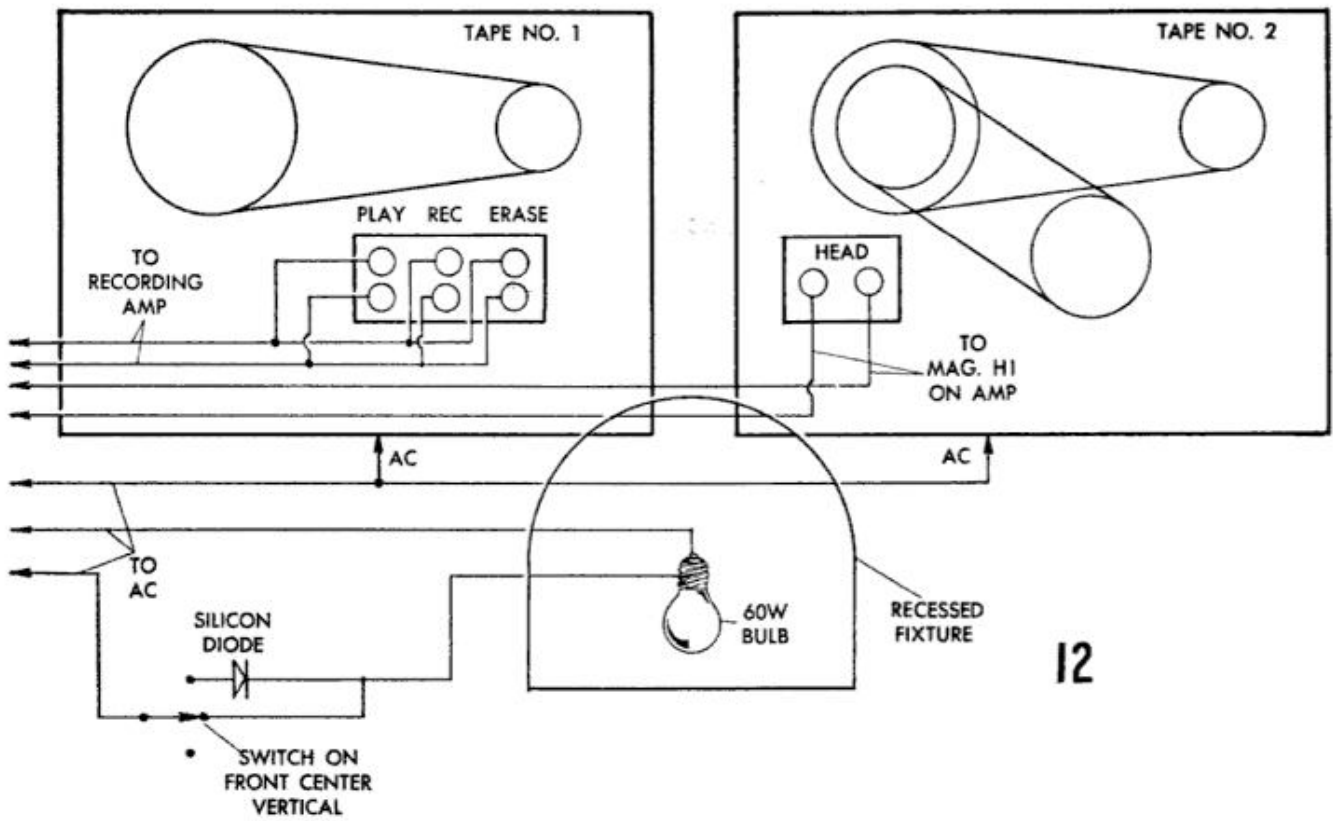

12

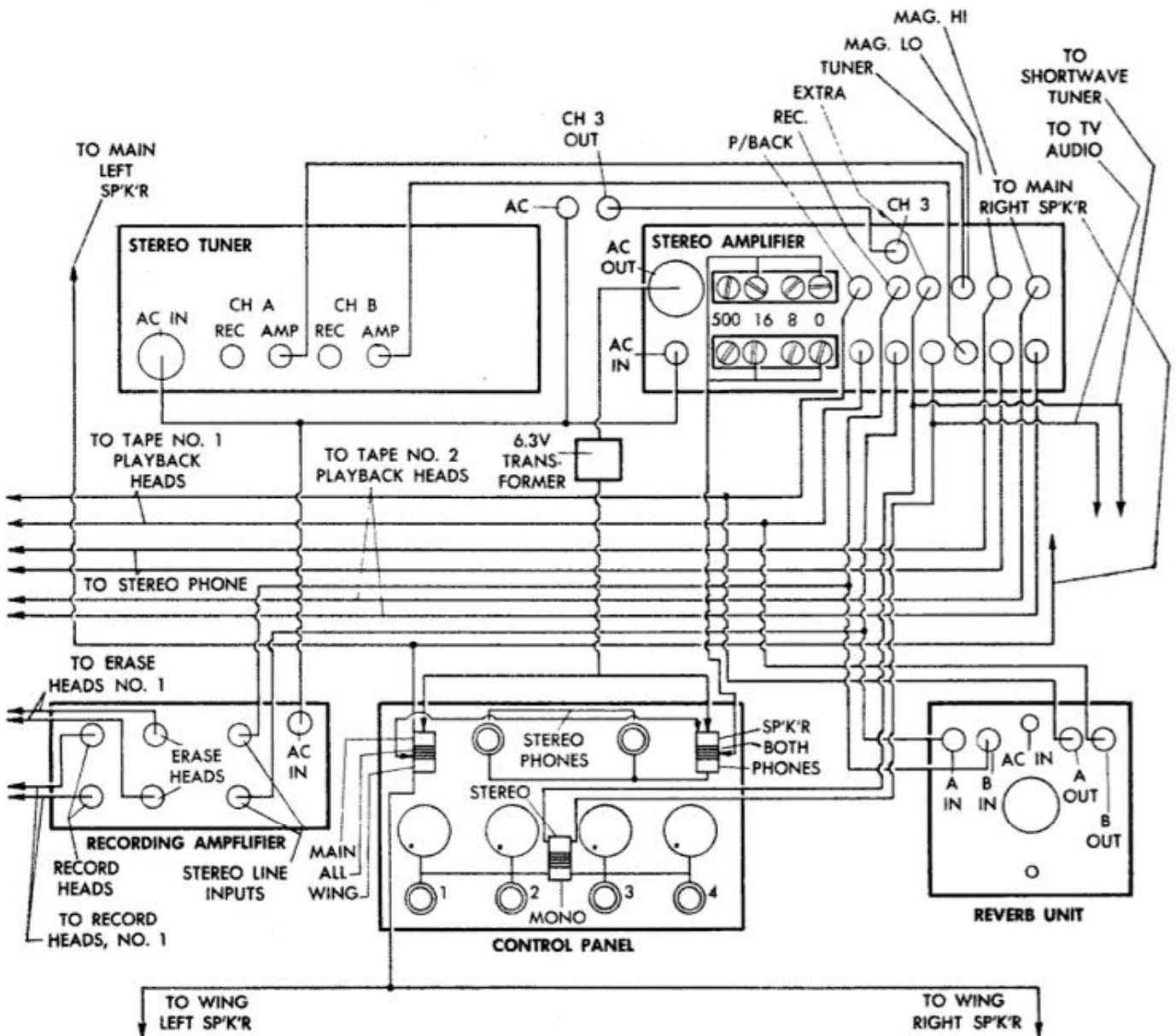

MATERIAL LIST

(All dimensions in inches)

No.	Dimension	
WALNUT PLYWOOD		
10	$\frac{3}{4}$ x 18 x 36	Tops and bottoms of cabinets—shelves
2	$\frac{3}{4}$ x 18 x 18	Sides—large cabinet
6	$\frac{3}{4}$ x 15 x 18	Sides—small cabinets
1	$\frac{3}{4}$ x 16 $\frac{1}{2}$ x 34 $\frac{1}{2}$	Drop front—large cabinet
3	$\frac{3}{4}$ x 13 $\frac{1}{2}$ x 34 $\frac{1}{2}$	Drop fronts—small cabinets
1	$\frac{1}{2}$ x 16 $\frac{3}{4}$ x 34 $\frac{1}{2}$	Front panel—large cabinet
1	$\frac{1}{2}$ x 13 $\frac{1}{2}$ x 34 $\frac{1}{2}$	Front panel—small cabinet

PERFORATED HARDBOARD

3	$\frac{1}{4}$ x 13 $\frac{1}{2}$ x 34 $\frac{1}{2}$	Back panels—small cabinets
1	$\frac{1}{4}$ x 16 $\frac{1}{2}$ x 34 $\frac{1}{2}$	Back panel—large cabinet

HIGH PRESSURE LAMINATE (COUNTER TOP)

3	$\frac{1}{16}$ x 13 $\frac{1}{2}$ x 34 $\frac{1}{2}$	Drop front—small cabinets
1	$\frac{1}{16}$ x 16 $\frac{1}{2}$ x 34 $\frac{1}{2}$	Drop front—large cabinet

ALUMINUM CHANNELS AND RELATED HARDWARE

4	$1\frac{1}{4}$ x $1\frac{1}{4}$ x 72	Aluminum U Channels—front, back legs
2	$1\frac{1}{4}$ x $1\frac{1}{4}$ x 72	Aluminum I channels—center legs
20	$\frac{1}{4}$ x 20 (long)	Spring nuts—for U channels
20	$\frac{1}{4}$ x 20 (short)	Spring-nuts—for I channels
6	$\frac{1}{4}$ x $1\frac{1}{4}$	Aluminum channel end caps
27'	$1\frac{1}{4}$	Aluminum closure strip
8	$1\frac{1}{4}$ x $1\frac{1}{4}$	Aluminum 90 deg. inside braces
32	$\frac{1}{4}$ x $1\frac{1}{4}$	Round-head machine screws—plated
8	$\frac{1}{4}$ x $\frac{5}{8}$	Flat-head machine screws—plated

HARDWARE (GENERAL)

8	10"	Plated lid supports
8	$\frac{1}{2}$ x $1\frac{3}{4}$ or $\frac{3}{8}$ x $1\frac{11}{16}$	Invisible hinges
8	$\frac{3}{8}$ x 7 $\frac{1}{16}$	Bullet catches
16	$\frac{3}{4}$ x 8	Oval head wood screws—per hardboard backs
16	Stop bead	washers for $\frac{3}{8}$ x 8 oval-head wood screws
40	$\frac{5}{8}$ x 6	Oval-head wood screws—hinges on cabinets, lid support brackets, shelves
16	1 x 6	Oval-head wood screws—hinges on edge of drop fronts
8	$\frac{5}{8}$ x 10	Round-head wood screws—lid support arms
20	1 x 6	F. H. wood screws—stops, front panels

MISCELLANEOUS

- 1 lb. Can plastic resin glue—(powder)
- $\frac{1}{2}$ to 1 gal. Danish oil finish
- 2 pts. Contact cement
- 12 1 x 8 Ft. rolls walnut edging tape
- Furniture wax
- 1 Can metal lacquer (clear)

16. HERE BACK OF CABINET is being fitted. Perforated hardboard panel is screw-fastened to blocks



panels by striking each one a sharp sidewise tap with a hammer. Overall sizes of the original cabinets and end dimensions are given in Figs. 8, 9 and 11.

Drop doors of the cabinets are faced on the back side with a white plastic laminate. The laminate is cut slightly oversize and attached with contact cement. After the cement has been allowed time to age somewhat, the overhanging edges of the laminate are trimmed flush with a special jig fitted to a router as in Fig. 6. As will be noted this provides an adjustment for trimming the laminate flush with the edge of the panel. After trimming the laminate, the exposed edges of the doors are veneer-taped to conceal the lumber core of the plywood. Edges of the shelves are also veneer-taped.

The drop doors fit with the outer face flush with the inner edge of the bevel when hinged, Fig. 10. Each is fitted with two knobs located as in Fig. 10. The screw of each knob is countersunk as in the sectional detail, Fig. 10, and the counterbore is filled and sanded flush before application of the laminate. The doors are hinged with two invisible hinges each, located and installed as in the detail, Fig. 11. Each door is provided with two lid, or door, supports and is held in the closed position by means of a bullet catch located as in Figs. 8 and 9. Notice in both Figs. 8 and 9 the location of the door-support screws and the slots in the cleats which allow the door supports to attain the full closed position without interference. Note also that in the small cabinet the cleats which back the control panels are set vertically, Fig. 9, while in the large cabinet, Fig. 8, the cleats are inclined at a slight angle. For the

(Continued on page 212)

17. FINE FINISH is obtained on walnut-faced plywood by using a prepared oil-finishing material





YOU LOVE THE FLAVOR...AND EVERYONE LOVES THE AROMA!

■ When you light up your pipe with HALF AND HALF, the people around you enjoy it almost as much as you do. That's because no other pipe tobacco has such a delightful aroma—and such a distinctive taste.

■ HALF AND HALF is a mixture of choice aromatic tobaccos... specially selected and blended for mild taste and friendly aroma. So, relax and light up—your pipe is welcome everywhere when you smoke HALF AND HALF.

■ Buy and enjoy famous HALF AND HALF in the pocket pouch or vacuum-packed humidor tin today.



CONFIDENTIAL!

(For married men only.)

**YOUR BETTER HALF
WILL LOVE THE AROMA
OF HALF AND HALF!**

A CARGO OF CONTENTMENT IN THE BOWL OF ANY PIPE!

©THE AMERICAN TOBACCO COMPANY

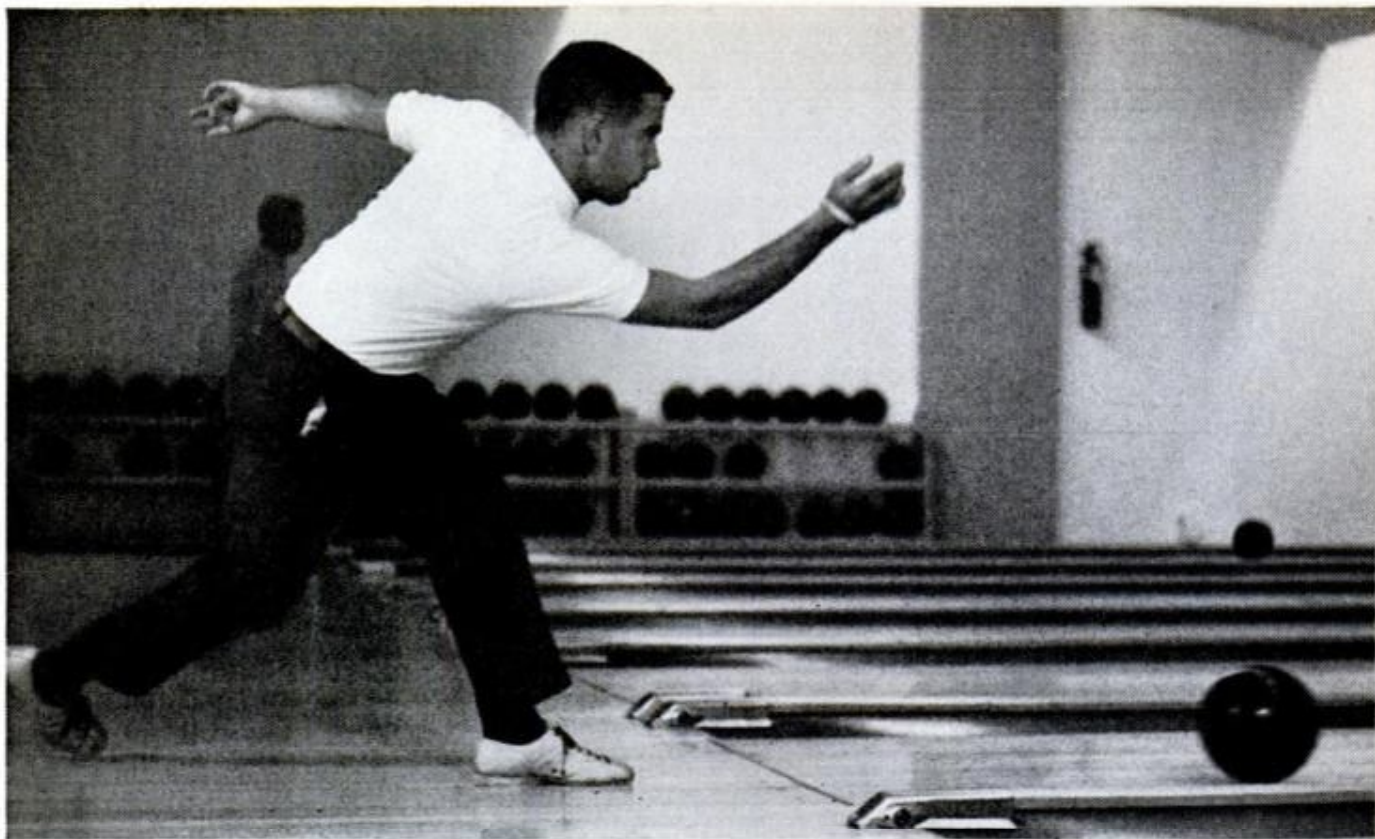

These five tough pictures were a snap



▲ Fast action in low light, captured by the KODAK RETINA Reflex III Camera at $f/1.9$ and $1/500$. No need for distracting flash. Imagine the dramatic black-and-white enlargements, the exciting slides you can have!

▶ Just the way you framed and focused it on the precision ground glass. Reflex viewfinder ends head-chopping parallax problems. Electric eye assures correct exposure even with tricky back lighting such as this.



▲ You're always ready for sudden action, because this camera's lens and shutter settings are coupled. Change the shutter speed, and lens setting adjusts automatically.

▶ Long-range telephoto lenses let you reach out to pull in distant views and action. You can take a side-line close-up from a grandstand seat.



▶ Photomicrograph of a flea made with KODAK RETINA Microscope Adapter Kit. Close-ups . . . telephotos . . . nature . . . action—the KODAK RETINA Reflex III Camera is your key to the fascinating world of 35mm photography.





with a KODAK RETINA Reflex III Camera

You can take pictures in light that puts other cameras to sleep. You can slice action up into 1/500 second. You're free of poses—you can catch people as active as they are.

You see exactly what you're taking: the lens projects an almost life-size image direct to the viewfinder. Focus, and you see your picture spring to life across the full-area ground glass—sharp and clear!

The KODAK RETINA Reflex III is a powerful and responsive camera, completely under your control. An electric-eye meter needle in the viewfinder signals when the

light changes enough to require a change in exposure. And you can correct exposure instantly, without lowering the camera from your eye. That's just one of a dozen ways this camera gets pictures lesser cameras couldn't take.

Handling a KODAK RETINA Reflex III—even on a "dry run"—is one of the most fascinating experiences in photography. Ask your Kodak dealer for a demonstration soon!

KODAK RETINA Reflex III Camera with f/1.9 lens, less than \$264. With f/2.8 lens, less than \$230.



Focus the entire scene, just as the lens sees it, in the ground-glass viewfinder. Or use centered split-image rangefinder to pinpoint subject in dim light. Meter needle in lower-left corner lets you keep constant check on the exposure.

Interchangeable lenses from a wide-angle 28mm to a far-reaching 200mm give you complete command of the field and perspective of your pictures. Lenses change in seconds.



Prices subject to change without notice.

EASTMAN KODAK COMPANY, Rochester 4, N. Y.

Enjoy Walt Disney's "Wonderful World of Color" Sunday evenings, NBC-TV

Kodak
TRADE MARK

CLINIC FOR HOMEOWNERS

Packaging Foods

Q—I recently purchased a home freezer and I'd like to have you tell me what are the best ways to package foods for freezing. What containers are best for the purpose? How does one pack the various containers in the freezer compartment? I've been told that glass containers, such as Mason jars, can be used. Is this true?

—L.S., Ga.

A—If you bought the freezer new, then most, if not all, the information you need on packaging foods came with it, or should have, as a service of the manufacturer. Space does not permit a complete outline of all the approved methods of preparing foods for freezing but in general the first essential is that all wrappings and containers be scrupulously clean and they must be as near moisture and vaporproof as possible, also they must be easy to handle and of a material that can be sealed tightly. Ready-made containers are available in a large range of sizes and types. We do not recommend use of glass containers, although it is true that glass jars of various types and sizes are used. Metal containers are sometimes recommended for preserving colors of certain fruits and vegetables. Plastic bags and foils, generally of aluminum, are recommended widely for wrapping vegetables, meats, and any other item which is of irregular shape. We suggest that you contact the dealer from whom you purchased the freezer, or the manufacturer, for informative booklets on packaging which are available free or for a nominal charge.

Putty Hardens

Q—What does one do to keep left-over putty from hardening? I think I've tried everything, or have I? But still the stuff hardens in whatever I put it in. Is there something I haven't tried?—W.R., Mass.

A—Possibly. When you purchase putty, that is, ordinary glazing putty, take it out of whatever container it came in and after you have used a portion of it, wrap the remainder in a metal foil such as that used in packaging foods for freezing. If you are careful to wrap the putty in the container in such a way as to exclude the air it will keep almost indefinitely. Or, place the unused portion in a plastic bag (the kind that is sealed at the seams, not sewed) and then seal the open end of the bag, the putty also will keep for long

periods of time. Add a little linseed oil and work the putty before storing.

Extra Early Garden

Q—I've heard that if you plant garden seeds in a shallow trench late in the fall and then cover with straw you can have fresh vegetables as much as three weeks earlier than usual. Has this sort of thing ever been done?—H.K., Ky.

A—Of course. Nature does it every season, with certain modifications. Yes, it has also been done by gardeners experimentally, but we wouldn't go so far as to say that you'll harvest three weeks earlier than normally. Perhaps one week to ten days earlier would be possible, but it should be remembered that usually it is the season that governs; not so much the method or precise time of sowing the seed. But there's no reason you can't try out the stunt, and have fun doing it. Just sow the seeds in much the regular way, covering with pulverized soil as you would in spring sowing. Then cover with straw, or any loose, fairly fine compost, to a depth of 6 to 10 in. (It will settle to half this thickness) and leave until the temperature reaches say 60 or 70 degrees come spring. Then remove the covering from the row only; do not remove it entirely as it can be utilized as a mulch.

Soundproofing

Q—In our first-floor apartment we always hear the lengthy piano practice of the growing family upstairs. It becomes pretty trying at times. Is there any inexpensive way of soundproofing the ceiling?—P.L., New York

A—Unfortunately not, as complete soundproofing would be difficult to carry out in a building already constructed. However, there is acoustical ceiling tile that will reduce sounds from above to a level below the objectionable, assuming, of course, that the tiles are properly installed and that the building is of standard construction. Most acoustical tile can be installed simply by applying a special adhesive to the plastered ceiling and pressing each individual tile into contact.

As a service to Popular Mechanics readers in solving the hundreds of problems pertaining to a home—inside or out—you are invited to present your problems to The Clinic Editor for his helpful advice. Address your questions to The Clinic Editor, Popular Mechanics Magazine, 575 Lexington Ave., New York 22, N.Y.

For giving or getting... Quality **DISSTON** tools for Christmas



Buy now for Christmas and save. Your dealer has all these Disston gift tools at special, Christmas money-saving prices. **1.** All-Purpose Kitchen Saw . . . \$1.80. **2.** Countryside Hand-saw . . . \$4.30. **3.** D-100 Handsaw . . . \$12.98. **4.** Pocket-Handbag 6-foot Steel Rule . . . \$1.19. **5.** DAGGER Sabre Saw with carrying Case and 9 Blades . . . \$54.50. **6.** DIRK 1/4-inch Power Drill . . . \$26.95. **7.** DRAGON Shrub and Hedge Trimmer with 62-foot Cord . . . \$44.50. **8.** DISCUS 6 1/2-inch Circular Saw with Carrying Case and Blade . . . \$54.50.

See these DISSTON CHRISTMAS SPECIALS at your local hardware, building supply or department store. Disston—Master Toolmaker since 1840.

Disston Division, H. K. Porter Company, Porter Building, Pittsburgh 19, Pa.

PORTER

DISSTON DIVISION
H. K. PORTER COMPANY, INC.

OUTGRIPS 'EM ALL...

BIG



SMALL



IN TIGHT
PLACES

CHANNEL LOCK

Easy does it on every gripping job with a Channellock Plier in your hands. Powerful parallel-jaw grip . . . tremendous leverage . . . patented, smooth-working, can't-slip adjustments. Your choice of five jaw capacities: $\frac{1}{2}$, $\frac{7}{8}$, $1\frac{1}{2}$, 2 and $2\frac{1}{4}$ inches. *Be sure it's a genuine Channellock. Look for the trademark on the handle. Write for catalog showing complete line of pliers. Made Only By Champion DeArment Tool Company, Meadville, Penna.*

"Thinking Factories"

(Continued from page 92)

rescue him?" The analyst has done half of the job by framing an answerable question from the vague query. Often the answer shows itself once a person trained in scientific thinking has rephrased the question to make the goal clear.

In order to crank a solution from his desk computer or slide rule—once a solvable equation has been formed—the analyst has to take into account all of the factors that he has been observing first-hand during his field duty. Some are obvious, such as the speeds of search planes, whether they are available, the times and conditions when they can search effectively and the nature of their search equipment such as radar. Some factors are not so obvious, such as what fraction of the time the planes and search radars work and how much duplicate equipment is needed to cover failures. And then the analyst even has to include mathematical values for the way a plane turns when it reaches the end of a search leg and whether while turning it loses potential radar contact with the downed aviator. The analyst has to know how radar operators observe their screens and how they rest their eyes, and account for these seemingly minor human variants in recommending the best search plan.

Solving Spare-Parts Problems

The largest of the thinking factories is the RAND (Research and Development) Corporation of Santa Monica, Calif, which does thinking for the Air Force.

RAND's work, like OEG's, is often an examination of alternatives. However, the problems are usually longer range and the alternatives to choose from may be whether to destroy enemy cities, or aim at missile sites instead. Nearly 10 years ago, RAND developed some of the Strategic Air Command plans that are in use now.

They showed the Air Force how to overhaul its spare-parts purchasing program to save up to 40 percent of the \$1-billion annual outlay. RAND calculated the time when a particular weapon would be obsolete and the Air Force bought only enough spare parts to last to that point. Before RAND made its study, enormous inventories of spares had piled up only to be junked when weapons were replaced.

The Army's thinking factory also has studied spare-parts problems. The operations Research Office (ORO) of Johns Hopkins University showed the Army that it is better to replace damaged or worn

(Continued on page 208)

REPAIR SPORTS GEAR—OR FRAME PICTURES

With a Weldwood Fix
and Finishes shelf
in your workshop



REPAIR FISHING TACKLE. Bond metal to fiberglass on your favorite fly rod with Weldwood® Epoxy glue. Seal oil or gas lines on your outboard. Bond almost any material. Supports tons—waterproof.



MAKE PICTURE FRAMES easily and simply. Mount pictures on plywood, frame them and cover the edges with Weldwood Flexible Wood-Trim®. Use Presto-Set Glue for both picture and frame.



MOUNT YOUR SUMMER SNAPSHOTS with Weldwood Presto-Set® Glue. It's quick and clean. Dries fast, and won't stain. In bellows-action squeeze bottle with spreader top.

You can never tell when you'll have an hour or two to catch up on the projects you've planned. So be ready with the materials you'll need. Pick them up on your next shopping trip—a full selection of Weldwood finishing materials—Deep Finish Firzite and White Firzite® and Satinlac®. They're available at your local lumber yard and at paint and hardware stores.



Products of United States Plywood
55 West 44th Street, New York 36, N. Y.

WORKING REPLICA OF EDISON'S
ORIGINAL GRAMOPHONE



Gifts worth giving...

NEW SCIENCE SETS BY LIONEL

Learning becomes an exciting adventure as your youngster probes the mysteries and wonders of science. Lionel provides all the equipment he needs to transmit his voice over a beam of light... turn on a TV set with a flashlight... build a tape recorder that actually works! He can launch rockets... make weather forecasts... even manufacture plastic products! Hundreds of fascinating things to build and do! Hours of fun for years to come! These new Lionel Science Sets are at your dealer's now! See them... *give* them!



FAMOUS INVENTORS SERIES. Build working replicas of Edison's Gramophone (left), Hooke's Microscope (above), Cartwright's Power Loom, Bell's Telephone, Gutenberg's Printing Press, Morse's Telegraph, Edison's Electric Light, Galileo's Telescope, Hero's Steam Turbine. Build them! They're authentic! They work! Under \$10.00 each.



WEATHER STATIONS. All the professional equipment needed for accurate weather forecasting. Electronic wind direction and wind speed indicators, aneroid barometer to measure atmospheric pressure, rain gauge, cloud charts, special equipment and computers to check humidity and THI. 3 sets—\$9.95 to \$29.95.



COMMUNICATIONS LABS. Build radio receivers, a transmitter, an intercom, a public address system, a tape recorder, a "phone" that transmits voices over a beam of light, a speaker device that lets a group of people carry on a telephone conversation simultaneously from anywhere in the room! 4 sets—\$9.95 to \$39.95.



ELECTRONICS LABS. Special sensing devices are used to build a burglar alarm, a rain detector, to turn on a TV set with a flashlight, or to wire an air conditioner so that it goes on automatically when the temperature rises! Hundreds of safe, easy-to-perform experiments with electrical circuitry! 4 sets—\$9.95 to \$25.00.



MICROCRAFT LABS. Finest, most complete microscope sets made! Five-turret metal microscope magnifies up to 750 times! Binocular eyepiece attachment, projector for group viewing, dissecting kit, slides, electron film strip, shrimp hatchery, specimens, special electronic stage, and much more! 8 sets—\$5.95 to \$39.95.



CHEMCRRAFT LABS. Over 1,000 exciting experiments in chemistry and atomic energy! Launch rockets! Make a pen that writes with invisible ink! There's a power agitator for mixing and blending, a centrifuge for separating solids and liquids, a balance so precise it can weigh a feather! Much, much more! 7 sets—\$2.95 to \$39.95.

SEE THE ENTIRE LINE IN THE NEW LIONEL CATALOGUE...AT YOUR DEALER'S NOW!

jeeps than to try to keep hundreds of parts stocked in supply lines that often are very long and may be subject to interruption by an enemy. Until then, the Army tried to make major overhauls in the field—an undertaking that ORO proved was more costly than simply getting new jeeps.

Last year, the Army reorganized its thinking factory to allow it to grow larger and handle longer-range problems. A nonprofit Research Analysis Corporation (RAC) was built around the former ORO. Defense Department limited-warfare expert Frank A. Parker, Jr., was brought in as president. He replaced the generally acknowledged "Grand Old Man" of military operations research—stubby, bouncy, dynamic Ellis A. Johnson. It was Dr. Johnson who first took ORO analysts to Korea in 1950. There they got themselves bombed, ambushed by guerrillas and shot down in planes. But they always managed to get the first-hand information that they needed for their studies.

ORO analysts saw the Army dropping leaflets that urged the North Koreans to surrender so they could live in a democracy and vote. General Walton Walker's interpreter, Jimmy Kim, told an opsearcher, "This is for the birds; the Army can't get those guys to come over with that line."

Free Rice Beats Free Vote

What kind of a line *would* work? Analysts began interrogating prisoners in great detail and soon they had the picture of a hungry man who wanted the rice that he knew the Americans had, but who was afraid to surrender because his officers had told him that the Americans would shoot him on sight. ORO learned that North Korean soldiers had never heard of "democracy" or "vote."

The analysts went to Bell Telephone Laboratories' Dr. William Shockley, who had won a Nobel Prize for development of transistors, and tossed him an idea. Shockley was in Korea with the Weapons System Evaluation Group, a thinking factory working on the Defense Department level. With him was Gen. James Gavin.

They got on a telephone and managed to talk themselves into a connection with Bell Labs in New Jersey. "Build us a loud-speaker that will operate on a C-54 at 10,000 feet but can be heard clearly on the ground," they shouted over the transoceanic circuit. "And now while we've got this line, connect us to Laurie Norstad down in Washington."

Five days later, the super bull-horn arrived in Korea on a plane hastily arranged

by Gen. Lauris Norstad. Tape-recorded messages offering rice and safe conduct, blared down on North Koreans who certainly could listen. Within a few months, at least 20,000 North Korean soldiers carrying illustrated safe conduct leaflets designed by ORO came over to the United Nations.

To find out what weapons were effective against tanks—rather than what the troops just *thought* were bringing results—opsearchers pierced deep into enemy territory to examine and photograph every damaged tank that they could find. Often they followed tank battles so closely that they were able to get pictures of tanks exploding from direct hits. The study showed that over 40 percent of the tanks were knocked out by Air Force planes, mostly using napalm; nearly 40 percent were knocked out by U.S. tanks; most of the remainder had suffered mechanical failure or had simply run out of fuel; almost none were victims of the highly touted bazooka.

Thinkers Hit the Field

Opsearchers went on to prove that the 2.36 bazooka was purely a suicide weapon. This study spurred production and delivery of the somewhat better 3.5 bazooka.

Opsearchers' studies led to the concept of Special Forces teams to train native troops. While America's attention was still riveted to Korea, and Indochina had not yet become Vietnam, Laos and Cambodia, ORO was recommending foreign-language training for Special Forces.

Keeping ORO—now RAC—up to date on Southeast Asia are analysts who bring back data from trips that they can discuss publicly only as "a vacation in Canada," or "a post-graduate course out West." From time to time, other opsearchers come back from "vacations in Florida" prepared to brief the Army on the alternatives attached to possible actions in Berlin.

Thinking factories do not limit their work to grand strategy, nor even to military operations. The classic example of O-R at the individual soldier's level is one that is typical of O-R performed for private business. An opsearcher, once assigned to evaluate field exercises, noticed a long line of soldiers waiting to wash their mess kits after eating. He also noticed that there were two tubs for washing and two for rinsing.

Following a hunch, the analyst checked the operations with a stop-watch. As he had guessed, the washing operation took three times as long as the rinsing operation. He

(Continued on page 210)



Pontiac Motor Division - General Motors Corporation

*optional at extra cost **up to 166 bhp at extra cost

I'm sure it's a lovely car, Destry, but in the bedroom . . . ?

Some cars have personality. They're the kind you hate to leave out in the rain (and not just because you're too lazy to start polishing all over again). The kind that bring back a long-disremembered sensation: That excitement you felt when you bought your first car. The new Le Mans is like that.

It isn't just the way it looks; there are other cars almost as good-looking as the '63 Tempest Le Mans. It isn't just the bucket-type seats or the floor shift or the extra-cost-option tachometer; other cars have pretty reasonable versions of this pizzazz.

It's when the thing is turned on and set in motion that the new Le Mans starts to worm its way into your affections,

develops that personality we were speaking about.

Some of it comes from the way our new 326 cu. in. V-8 rouses its 260 bhp and makes tracks (our 115 hp 4** with gentle thirst and the manners of an 8 is still standard equipment). Still more of it comes from the way the new rear suspension handles the handling. You point it, it goes that way, and no shilly-shallying.*

The quieter, more positive shifting automatic, the self-adjusting brakes, the 20-gallon gas tank (up from 17), the beefier differential unit, they're all nice. But it's the personality we like best about our new Le Mans.*

Pontiac Tempest

... the Newest **FREE**
Service to Car Owners...

Instant tests

...for **BAD** brakes

...for **BAD** balance

...for **BAD** steering

NEW BEAR SAFE-WAY SYSTEM OF BRAKE SERVICE

IF YOU CAN'T STOP YOUR
CAR, DON'T START IT!



includes free instant brake test that can save you a costly accident; if brakes are found dangerous, the Bear System assures you of new brake safety with economy!

Vibration wears the life
out of tires and
vital steering parts!

New Bear-Matic
balancer includes
a VIBRATION TEST
that SHOWS YOU IN-
STANTLY if wheel
balance is needed.



It's 3-to-1 your
car suffers from
TIRE SCUFF... this
INSTANT TEST IS FREE.
With the Bear Drive-Over
Test and Tire Waste Fore-
caster, your Bear Service-
man can show you in sec-
onds just how much tire
scuff is costing in wasted
tire mileage.

Only $\frac{1}{8}$ inch
MALADJUSTMENT can
Scuff away 50% tire life



Look for the sign of the
BEAR[®]
the sign of safety service

BEAR SCHOOL AND NEW BUSINESS
OPPORTUNITIES OPEN TO
MECHANICALLY MINDED MEN.

Write your name and address below and mail to
Bear Mfg. Co., Dept. P-10, Rock Island, Illinois

© 1962 431

suggested using three of the four tubs for washing and just one for rinsing. From that time on, there were no more long lines.

This is the type of O.R. that analysts very often perform for private business. Much of it involves "queuing theory" or the theory of waiting lines to locate check-out points in new supermarkets and to assign toll-booth operators at bridges and tunnels.

One private thinking factory, Operations Research, Inc., used queuing theory as a tool to show an Eastern railroad that it will never need to double-track its main line. The waiting (queuing) time on sidings for the longest trains that the line will ever need to run—even considering maximum prosperity—was calculated. ORI showed railroad officials that double schedules could be met with the single-track.

To make sure that he knew what he was talking about, ORI vice president Harold O. Davidson first followed some good op-searcher practice. He and a team of scientists donned coveralls and hard hats and climbed loading ramps, walked miles and miles of track, rode hand cars and worked in the yards to learn the operations.

Almost every operation that repeats itself is fair game for O-R. Forest fires, for example, repeat themselves seasonally. (It is not necessarily the same fire in the same place, but there are repeating similarities among most fires.)

The U.S. Forest Service recently adopted O-R to study fire fighting operations in California where the annual toll runs \$40 million. O-R is showing where a certain piece of equipment will buy more fire fighting than will other equipment.

Public health is a field where O-R is coming into its own and some thinking factories are turning in this direction. Repeating outbreaks of a disease are epidemics and O-R techniques can alert physicians to epidemics when only a few cases have actually appeared. Opsearchers at the U.S. Public Health Service's communicable-disease center epidemiology branch spotted the 1957 Asian flu epidemic more than six months before it got a solid footing in the U.S. The Public Health Service was able to warn localities, route vaccine shipments and help schedule hospital staffing on the basis of reports from its small internal operations research group.

What about the fear that thinking factories will replace human judgment?

Says one opsearcher:

"We don't make decisions, and computers can't make decisions, but we and our computers can certainly *help* executives and commanders make their own decisions faster and better." ★ ★ ★



It pays to keep your Chevy the Chevy-est

WITH GENUINE GM CHEVROLET REPLACEMENT PARTS

Naturally you care what parts go into your Chevrolet—because your Chevy does! Whether your pride and joy is a new Chevrolet or an older vintage model you're keeping in mint condition, the important thing is to use only *genuine* GM Chevrolet replacement parts. That way you're sure of maintaining the dependability that makes a well-cared-for Chevrolet such a pleasure to drive. The reason, of course, is that genuine GM Chevrolet parts are built *especially* for Chevrolets to fit right (for easy, fast installation) and work right for a long time to come. They're available at your Chevrolet dealer's and at leading independent garages and service stations. . . . CHEVROLET DIVISION OF GENERAL MOTORS, DETROIT 2, MICHIGAN.



Test your automotive I.Q!

QUICK QUIZ BY QUAKER STATE

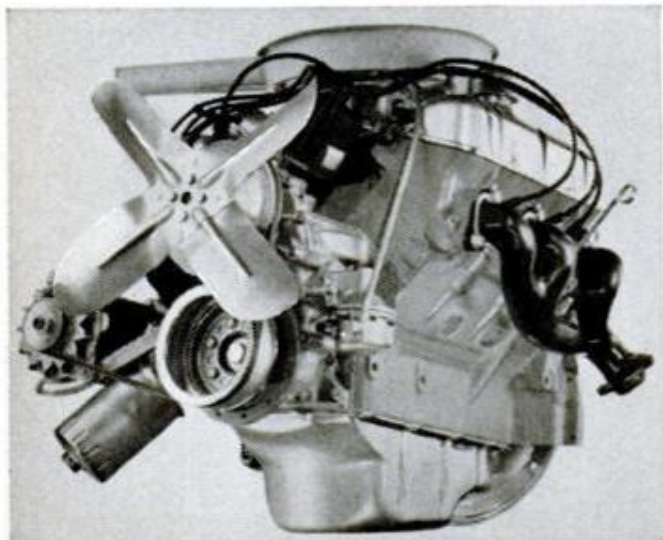

1. What is significant about this motor?



2. What does this symbol stand for?

This is the new V-6 engine developed by Buick. The life preserver at bottom stands for Quaker State Motor Oil—because it is the best engine life preserver. Made from 100% pure Pennsylvania Grade Crude Oil, Quaker State keeps your car on the road, out of the repair shop. Insist on Quaker State—the best engine life preserver.



QUAKER STATE OIL REFINING CORP., OIL CITY, PA.

Add-On Entertainment Center

(Continued from page 198)

sake of appearance and for the practical purpose of heat dissipation in those cabinets housing electronic equipment, the backs of all cabinets were made from 1/4-in. perforated hardboard. Notice that the hardboard panels are installed with a center support, Figs. 10, 11 and 16, but that blocks instead of cleats are used at the ends as a screw base. The backs are then covered with grille cloth, rubber-cemented in place.

Home recordists have the problem of space or work area for the splicing, mending and editing of tape. This is taken care of by the smooth laminate-surfaced areas of the drop doors. Likewise, there's always the question of where to put the album jackets when listening to the phono. This problem has been solved by the provision of a unique pull-out drop shelf, or easel, which fits under the phonograph shelf, Figs. 14 and 15. It's detailed in Fig. 7 and shown in relative position in Fig. 10. It consists of a pair of grooved cleats screwed edgewise to the underside of the phono shelf. These grooved cleats serve as a slide for a hinged, divided shelf of 1/4-in. hardboard, cut and hinged at the point indicated in Fig. 7. In use the whole thing is pulled out to the stops. At this point the hinged portion drops to form an easel having a lip at its lower edge, Figs. 7 and 10, which prevents records, jackets and any other small objects from falling to the floor. Lift the easel to the horizontal position and the whole thing slides back under the phono shelf, a neat and satisfactory solution to a rather troublesome problem.

Finishing

The original cabinets, as noted in Fig. 13, were made from lumber-core plywood panels walnut-faced with ribbon-stripe veneers. After a careful sanding, with special attention to the edges which were only slightly and uniformly rounded, all exposed surfaces were coated with a prepared oil finish, Fig. 17. This was applied in accordance with instructions on the container and produced a most attractive finish on walnut.

Should you use other woods, such as curly-birch or rift-sawn oak-faced plywoods, you can obtain most attractive effects by judicious use of the many stains available for toning and coloring these fine cabinet woods. Run tests on waste pieces of the same wood until you are certain that the stain will produce the color and tone desired.

(Continued on page 214)

NEW KIND OF POWER SAW

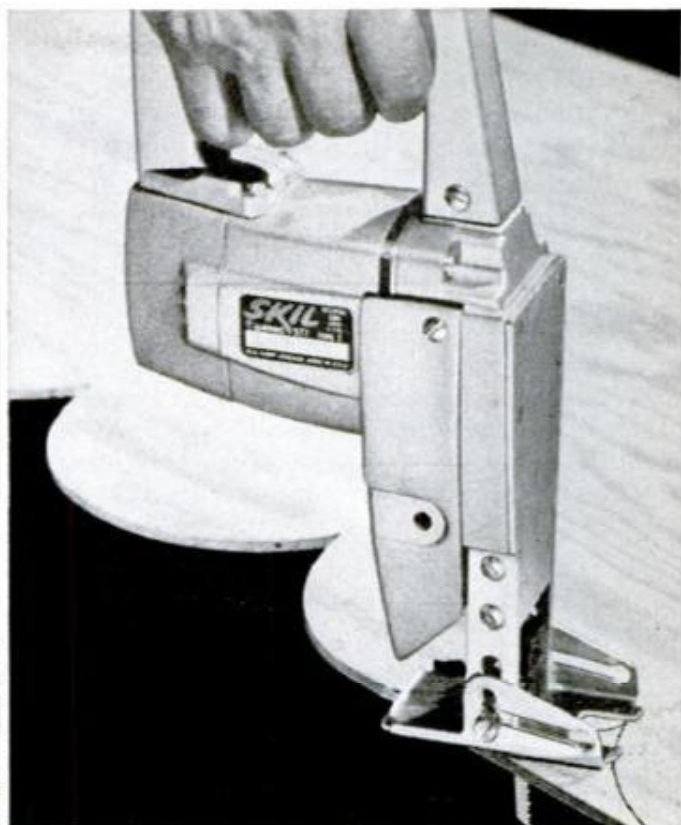
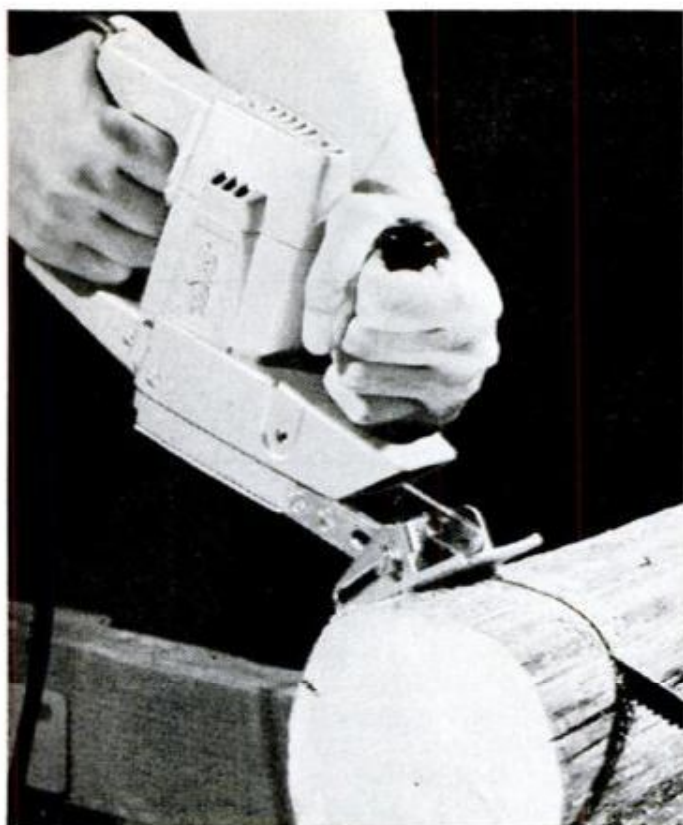

Skil Recipro Saw makes any cut from 6" fence posts to fancy patterns!

The Skil Model 577 Recipro Saw is the *first* portable power saw with almost unlimited cutting capacity! It'll cut thin sheeting or thick wooden posts . . . or steel pipe, sheet metal, aluminum, plaster, wall board, plastic laminates, you name it!

It's a coping saw, hacksaw, scroll saw, jig saw, crosscut saw and rip saw that'll make you twice the craftsman you ever thought you were! You can buy it at better hardware and lumber dealers everywhere. Priced under \$50 (slightly higher in Canada).



Bevels, Miters



Cuts in Walls, Floors



Cuts Metals



FREE OFFER! Metal utility case and 8 blades if you buy the Model 577 now. Hurry! Limited time offer at most dealers.

SKIL
POWER TOOLS

WATCH PRO FOOTBALL HIGHLIGHTS SPONSORED BY SKIL ON NBC-TV, EVERY SATURDAY AFTERNOON, SEPT. 22—DEC. 22

Looking now at the equipment installed in the dual unit, Fig. 1, you'll see that the cabinet can be adapted to any hi-fi equipment you now own. You can mount your equipment in one of two ways. If there's an overhang, or lip, around the chassis you cut the mounting hole only slightly larger than the chassis size less the lip. This permits you to drop the chassis in place and attach with screws through the lip. If this is not possible, then remove the dress panel, take off the knobs and touch the ends of the control shafts with oil paint. Then imprint the inside surface of the wooden panel by pressing the ends of the control shafts against it lightly. This will spot the 1/2-in. holes for the shafts. Use extended-shank knobs when reassembling the units. Another way to do this is to use the dress panel as a drilling template.

Wiring

Once you have the equipment mounted the next step is the wiring. For this use the shielded hi-fi cable now available in colors, which greatly simplifies the problem of determining where each lead comes from and where it is to be terminated. Similarly, the loudspeaker connections are made with miniature zip cord which is tinted red for left, blue for right. This cord also has one lead tinned, the other bared copper. This helps in eliminating phasing tests for the loudspeakers. By leading wiring through the openings in the center legs and cabinets the "spaghetti" is easily kept within bounds. The wiring diagram, Fig. 12, shows how the complex of source sounds is wired into the minimum input jacks of the Scott stereo amplifier used in this installation.

Control Panel

The only device in the setup which is non-standard is the control panel. This actually is a composite of two separate devices with two separate functions. First, it's a Switchcraft amplified mixer. It contains four level controls and four input jacks. You simply remove the mixer from its cabinet and rewire it to permit plugging in four microphone or other magnetic sound pickups at the front panel. You can set the levels individually and use as four mono inputs or two stereo inputs. The output connects to the auxiliary input on the amplifier. These inputs are also used with a Y-connector for the short-wave tuner on one channel and the TV audio on the other. Being a high-level input no hum results from the extra wiring connected to the channel which is not in use.

Switching of the output on the control panel is provided by two Switchcraft Lev-R-Lite switches. These are three-position switches with toggles that light up in three colors, depending on the switch position. Six-volt current for the bulbs is obtained through a filament transformer plugged into the switched receptacle on the amplifier. This also provides "on" indication when the amplifier is switched to the on position. The audio input from the amplifier is first led to one of these switches which chooses either phones, speakers, or both. In the phones position the audio is applied to the stereo earphone jacks at the front panel. In both it goes to the second switch as well as the phone jacks. In the speaker position the audio is applied only to the second switch. The second switch selects either main, thus transmitting the audio to the uppermost jacks on the verticals for the main speakers, or wing for the lower jacks, feeding only the remote speakers, or both, to all speaker jacks.

Other minor installations provide the operator with additional conveniences. A simple a.c. accessory outlet on the front panel permits use of a work light or a demagnetizer. The silicon-controlled rectifier is mounted with a recessed phono lamp to provide a half-bright position. An a.c. outlet and a phono jack in the rear center vertical permits use of a reverberating loudspeaker to fill a derived third channel.

Using the System

With the two tape decks you can copy tapes, edit without a splicer simply by playing the unedited tape into the second machine. Just start, stop and rewind the second machine to make a corrected and edited tape. For home recordings, set up the microphones and make the voice recording first. You can listen to the recording over the phones to monitor it as the deck is a three-head type. Then using either the phonograph or the other tape deck you can dub in musical backgrounds or other sound effects as desired.

When you get around to editing tape, use the system practiced in most recording studios. You switch to fast forward and to rewind you cue the tape. In this process the sounds emanating from the speakers are anything but pleasant. However, you just plug in the phones and switch to phones only. Then no one hears the sounds but you. Others can listen to TV while you do your work. Often when a good FM program parallels a desired TV program, you can tape the FM and watch the TV at the same time! ★★★



When
a
cigarette
means
a lot...

you get Lots More from L&M

more body in the blend... there's a special rich-flavor leaf — and more of it — among L&M's choice tobaccos.

more flavor in the smoke... every puff is heartier, for L&M has more longer-aged, extra-cured leaf than even some unfiltered cigarettes.

more taste through the filter... L&M's filter is the modern filter — *all white* inside and outside — so only pure white touches your lips.

• **It's the rich-flavor leaf that does it!**



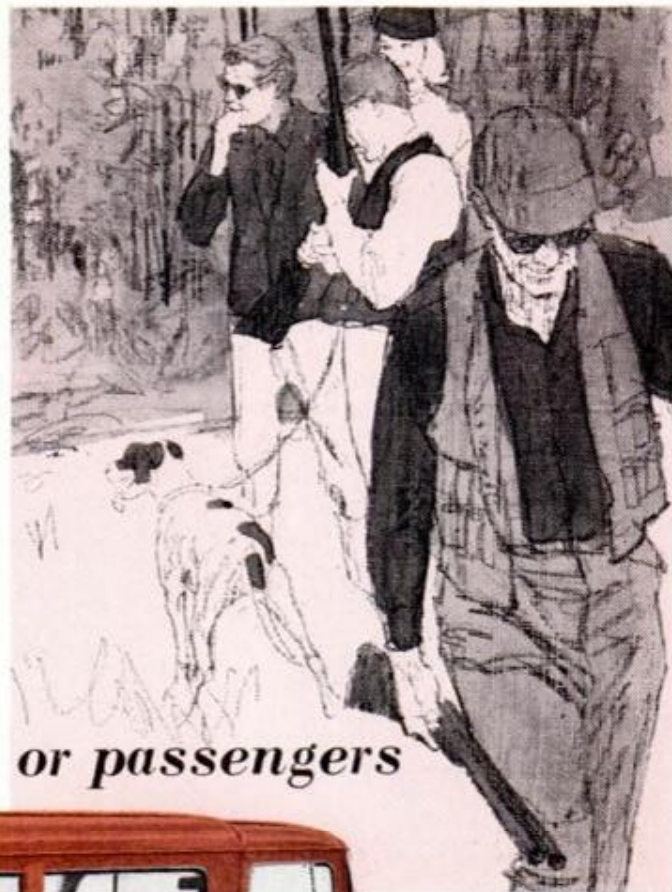
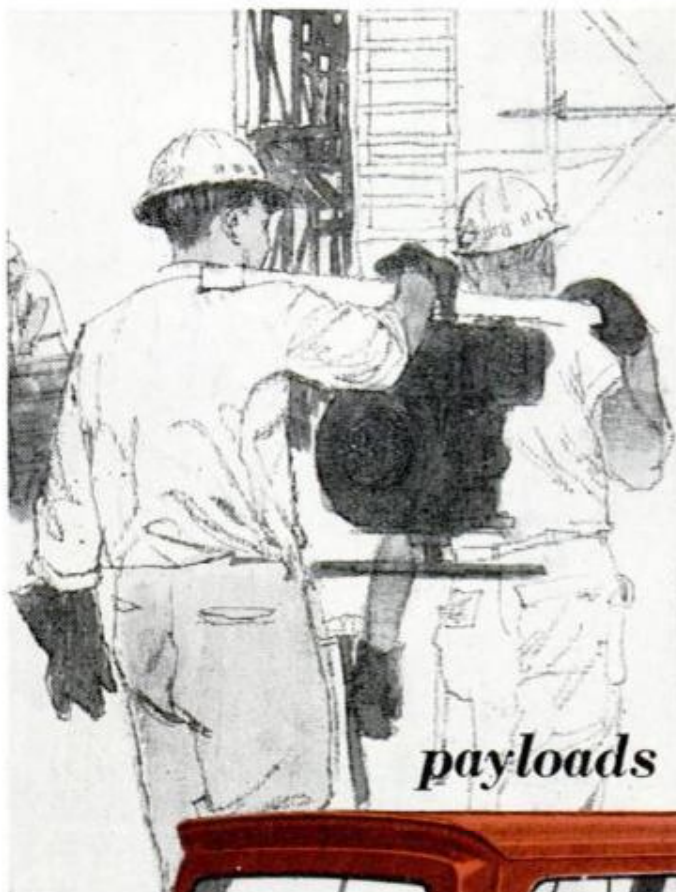

payloads or passengers



... HANDLE BOTH WITH FAMILY-CAR DRIVING EASE
in a GMC Suburban with Power Steering!

The versatile GMC Suburban Wagon with power steering is a multi-duty vehicle for the businessman who's a sportsman or family man! The Suburban with power steering lets you haul work loads with as much as 83% less steering effort! You can devote *more* energy and time to business. The Suburban's power steering makes leisure-time driving—and parking—as easy and enjoyable as if you were handling a passenger car! Get in touch with your GMC dealer when you're considering the purchase of a business-and-pleasure vehicle. Then take a *lighter* turn at the wheel of a GMC Suburban with power steering. GMC Truck Power Steering is a product of Saginaw Steering Gear Division, General Motors Corporation, Saginaw, Michigan.

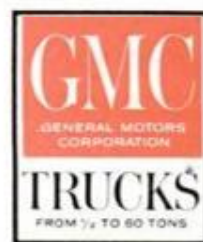



Driverless Tractor Goes to Work at Steel Mill

Believed to be the first remote-controlled tractor used for construction work, a 41-ton crawler tractor shovel was put to work removing slag at a steel mill. It was operated by a radio-control panel.

Called the Spook, the Allis-Chalmers creation is also expected to have applications for military and civil-defense use, fire-fighting, handling radioactive materials and other dangerous operations.

Men on Moon May Get Water and Air from Rocks

"Wringing out" rocks to get water and oxygen may be the answer to supporting life for tomorrow's men on the moon.

Earth rocks (believed to be similar to lunar rocks) are subjected to intense heat in a solar furnace. The sun is simulated by an arc light; its beam is gathered by a

large, curved mirror and focused on a spot that reaches 10,000 degrees F.

The rock literally boils away and yields water, oxygen, other valuable gasses and a glasslike material that may be used for construction purposes, say scientists at Aerojet General Corp., Azusa, Calif.

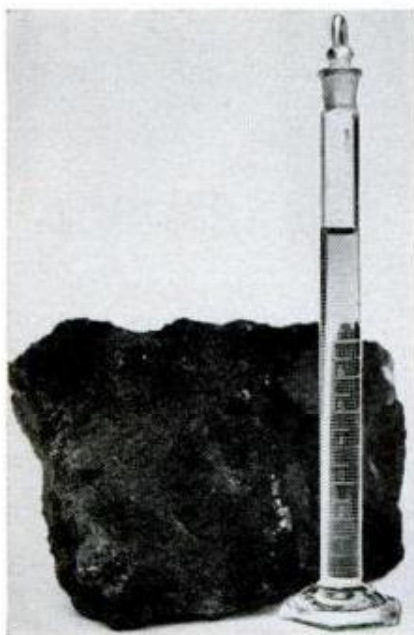

Unknown Menace:

(Continued from page 129)

Only during the fiery re-entry would germs perish — and then only those at the nose of the space ship (and if the ship bounce-skips back into the atmosphere, the germs are home free).

Dr. Phillips takes a different view toward what these space germs could do to us. He agrees with Dr. Lederberg that it is highly unlikely that germs from other planets could produce disease in earth people. That's because germs are highly specialized as to what they live on.

It's true that bacteria can infect every living thing on earth, and viruses can live in every kind of living cell. But it takes exceptional germs—such as those producing parrot fever and anthrax—to live in both man and animal. And not one of the germs that infects plants can infect man.

But, Dr. Phillips points out, it isn't always the murderer that poses the greatest threat. A life form that outeats, rather than outbites, can be even more dangerous. He refers to Darwin and the constant struggle for survival of the fittest. "The perilous knife-edge balance maintained by such competing forms is never more evident than when a new form is suddenly introduced," he says.

A germ from outer space that competes

with earth bacteria in the soil for free nitrogen, as an example, could destroy our food crops and just as surely kill us as, say, some creature from Mars. Dr. Phillips points to the Japanese beetle which somehow got into the United States and destroyed fruit crops. And the lions in Africa have never threatened to overrun their continent as have the rabbits in Australia. Not one rabbit has bitten a sheep, yet rabbits have just as surely killed herds of sheep by devouring whole fields of grass.

In the U.S., according to the Department of Agriculture, plant diseases destroy \$3-billion worth of crops a year. There are plenty of examples in the past where a new disease, by wiping out a crop, threatened human lives. In 1845 and 1846 almost all of Ireland's potato crop was wiped out, and over the next 15 years a million Irish died from starvation or from diseases brought on by malnutrition. Blight destroyed a third of Germany's potato crop in 1917 and was one reason for its defeat in World War I.

While germs that cause plant diseases can't infect us, they can kill us indirectly. Take ergot, caused by a fungus that infects cereal grains. In ergot is a powerful nervous-system poison that can cause gangrene, convulsions and death. In Europe in the

(Continued on page 220)



CRESCENT SNIPS

GIVE YOU A KEENER CUTTING EDGE

You can tell it's a CRESCENT snip the way it bites decisively into the toughest metal . . . or cuts cleanly around the tightest corners.

CRESCENT snips are designed from the start to help you do a faster, better job in cutting sheet metal, wire screen, linoleum, canvas, cardboard, plastics, etc. Blades are precision ground by machine to a keen cutting edge . . . then electronically hardened for long lasting service. They're shaped exactly for the job . . . with leverage and balance designed-in to make your work easier.

You can find a CRESCENT snip in any size or pattern you need. Look for the special display of quality CRESCENT snips at leading hardware stores.

Next time you buy hand tools, buy the best . . . buy CRESCENT!

CRESCENT 

CRESCENT TOOL CO., JAMESTOWN, N. Y.

WIDEN YOUR FUN HORIZONS

... GO

HARLEY-DAVIDSON IN

'63!



Go see your dealer now for a look at the spanking new Harley-Davidson line. You'll find a set of wheels to take you *wherever* you want to go, to wonderfully widen your fun horizons! Now at your dealer . . . new, free full-color literature . . . easy-pay terms . . . help in getting insurance . . . and the great Harley-Davidson get-up-and-go line for '63 . . . DUO-GLIDE, SPORTSTER H, SPORTSTER CH, SPRINT, SPRINT H, PACER, SCAT, TOPPER H. See the Yellow Pages under "Motorcycles" and "Scooters" for the name of your Harley-Davidson dealer.

HARLEY-DAVIDSON MOTOR CO.
Milwaukee 1, Wisconsin



what a
SNOW THROWIN'
family...

MOTO-MOWER SNOW THROWERS

20" BIG DAD — I'm the heavyweight of the family, because I eat more . . . up to 20" of even packed, crusted snow. I chew it up and spit over 18,000 cubic feet per hour right to the spot. See my chute? It revolves 90° left or right with a touch of that big fist-grip control. My big 4½ HP engine is winterized . . . completely shrouded . . . with a float feed carburetor that won't freeze up. And my deep tread tires really grrrrriipp. I'm big with the boys at the parking lot too.

18" BIG SON — Don't listen to him. I've got almost everything he's got. I'm self propelled; my chute does the same 180° twist; I'm shrouded; and you control me easily from the handle. I haven't got his big mouth; but I've got 18" of tough teeth . . . good for over 14,000 cubic feet of snow per hour.

15" SMALL SON
I haven't got my dad's mouth or my brother's twist, but I do my share...and with your guidance . . . yours too!



Look the whole family over at your Moto-Mower Dealer today.



MOTO-MOWER, INC.
Richmond, Indiana
A Subsidiary of the DC Dura Corporation

Middle Ages, thousands of people died in epidemics spread by ergot-infected rye.

Mars' lowly plants could well harbor such germs that could destroy our crops and poison our food.

According to President Kennedy's timetable, we'll put a man on the moon by 1970. We won't send a man to Mars, or even Venus, and bring him back for about 20 years, according to plans of the National Aeronautics and Space Administration.

NASA scientists have just begun to think about what to do about space germs. And they rely heavily on Dr. Phillips. For the past few years he's served through an inter-governmental agency agreement as an advisor to NASA on "exobiological safety."

Dr. Phillips's ideas for controlling space germs stems from BW research — kill or contain. Here, step by step, is how we will prevent any invasion of the earth by other-world microbes, yet still be able to study bits of these other worlds in our laboratories.

These principles are set forth in a newly issued NASA-Ft. Detrick movie called "Exobiological Safety." The film has had limited showing, and this is the first time these plans have been presented in a national magazine.

The space ship has just landed on the moon. The astronaut opens a door and steps into the combination air-and-germ lock. He closes the door. Sterilizing gas hisses into the lock and soon completely fills it to prevent contamination of the moon by any earth germs.

The astronaut's air-tight space suit protects him from the gas. His breath is passed through a special filter to trap earth germs before being exhaled.

The astronaut opens the outer door and steps down the ladder onto the soft lunar dust.

On the moon, with the earth looming large and bright above the horizon, the astronaut carries out the duties he has been trained for years to perform. Among these is the gathering of samples of lunar dust and rocks. Here could be the priceless evidence of life beyond earth.

The astronaut seals the lunar samples into a germ-tight container. He returns to the ship, and climbs up the space ship's ladder, opens the outer door and steps into the air/germ-lock. He closes the outer door. Sterilizing gas again floods the chamber, killing any microscopic forms that may have clung to his space shoes, suit or the container in his hand.

After a while, the gas is pumped out and the inner door to the space cabin opens.

(Continued on page 222)

So you want to buy a saw

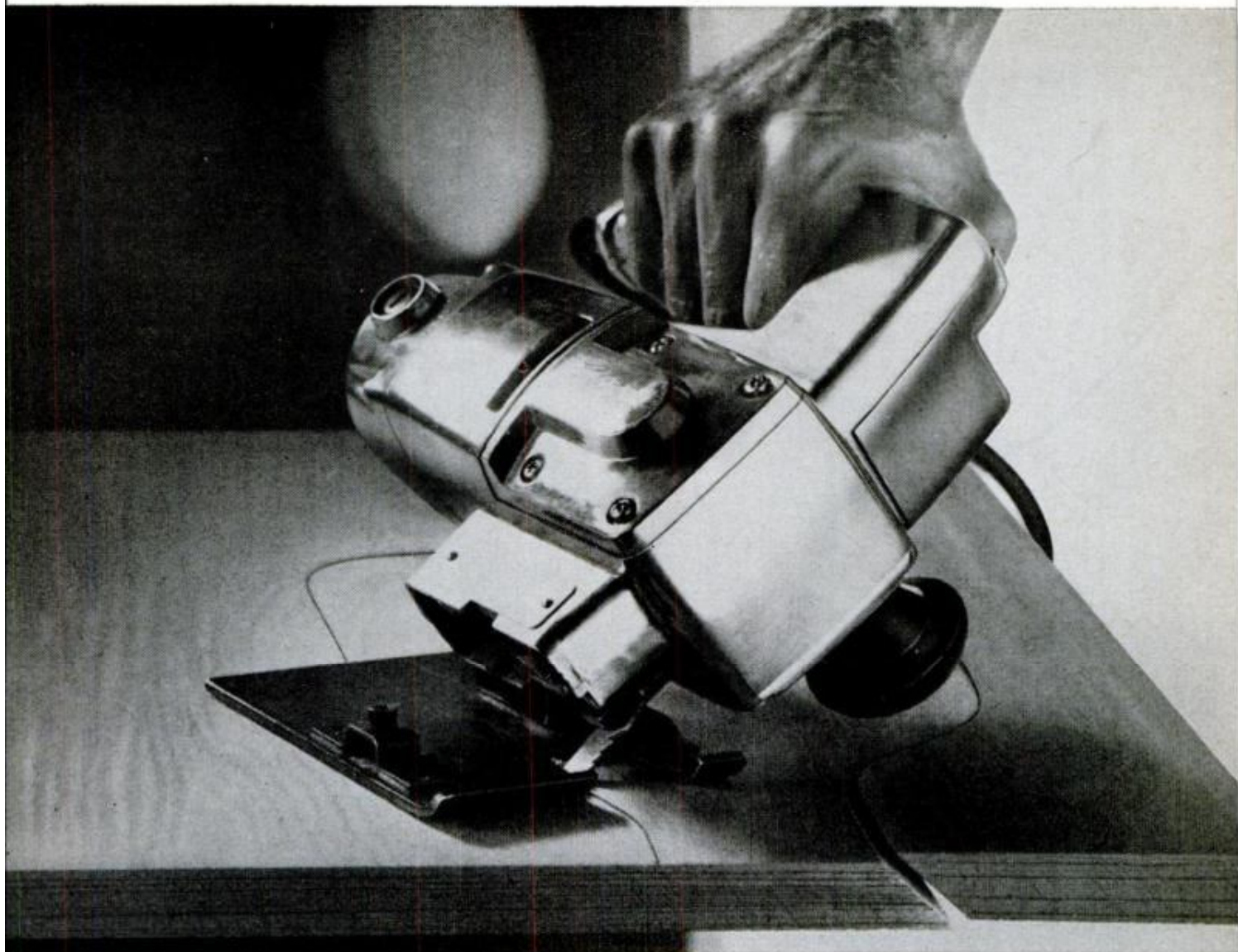

Meet the new Porter-Cable Bayonet Saw —fastest-cutting saw of its type



SPECIAL INTRODUCTORY PRICE

Model 300 Bayonet Saw
cuts 2½" wood, ½" aluminum, ¼" steel at
4000 spm. Blade stroke
—½", weight only 5 lb.

\$44.95

This Model 300 Saw cuts almost anything! Ferrous and non-ferrous metals—all woods—laminates and compositions—plastics. The reason: preferred orbital blade action powered by a failure-proof, 2.5 amp motor that's *guaranteed for two years*.

You'll handle a wide range of jobs with this saw—rips, cross cuts, angle cuts, plunge cuts—everything from inside curve cutting *without a starting hole* to big capacity straight line work. It's a honey of a value, see a demonstration today.

Your Porter-Cable dealer is listed under TOOLS, ELECTRIC in the Yellow Pages. For FREE folder write: BAYONET SAW, Rockwell Manufacturing Company, 502L N. Lexington Ave., Pittsburgh 8, Pa.

Rockwell
MANUFACTURING COMPANY





measure up with Measure Mates ...two new tape rules by **LUFKIN**

EAGAN, MICHIGAN



"MISS STATISTIC"

Just the thing for weight and waist watchers—this handy 6-foot tape rule has a calorie-counting table on the back. Ideal for 101 measuring jobs around the house. Why not get 2 or 3. Only 79¢



"MR. MEASURE"

Makes the man of the house a real craftsman. 10 feet long, but easy to carry as a cigarette lighter. Get one for tool box, tackle box, golf bag. Perfect gift for the man who measures up! Only \$1.29

Ask for them at your favorite store

The astronaut buckles himself down in his seat, and the ship blasts off for earth.

Back home, the container is placed in a Ft. Detrick-like germ-proof chamber and opened. The samples of rock and dust are chemically analyzed, dropped into "germ food" cultures, and injected into animals—all under the safety of the proven BW methods.

As for the space ship, some germs that might have clung to it were killed during re-entry. As soon as the ship touches the landing area—probably in Texas or Arizona—it is enclosed in a shroud (such as that used to sterilize it before it left earth) and sterilized.

In the precious moments before the ship is sterilized, experts agree, some space germ spores might float into the air, just as they might during the slow descent to earth. This is one problem that still has to be solved. It may never be resolved.

As we said, while it's still doubtful that there is any life on the moon, we're more sure of life on Mars. So we'll have to be even more careful there. Thanks to what we've learned in BW research, life on earth should be spared the agonies of any invasion from outer space that we brought back ourselves.

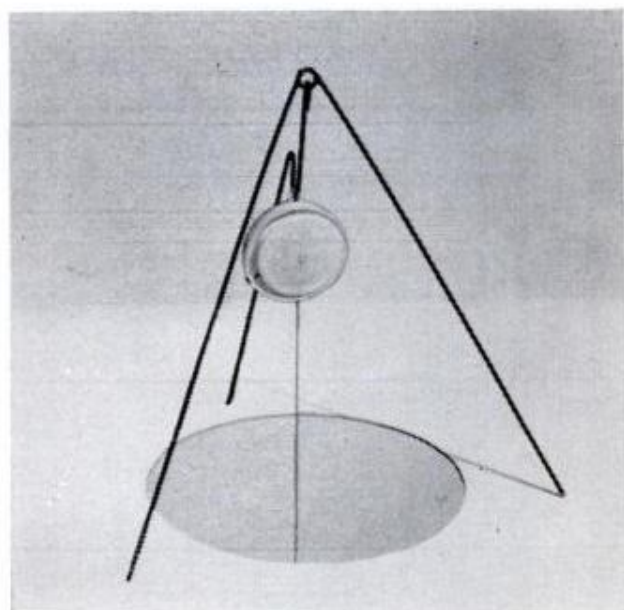

Automatic Under-Ice Fisher

Fish are automatically hooked and held by a new ice fisher when the bait is taken. A tug on the line sets the hook and a spring keeps the line tight on the fish. The unit is set by pulling out the line to the desired depth and pressing a button to engage the trigger mechanism.

It costs about \$1.50 and is made by Ritchie Mfg. Co., P.O. Box 711, 3194 E. Bdwy., North Little Rock, Ark.

ENJOY THE FUN OF
Big Scale Model Building
 This "T" is so BIG . . . it's a grand
 two-man project! 16³/₄ Inches Long

Deluxe Kit
\$10⁹⁸

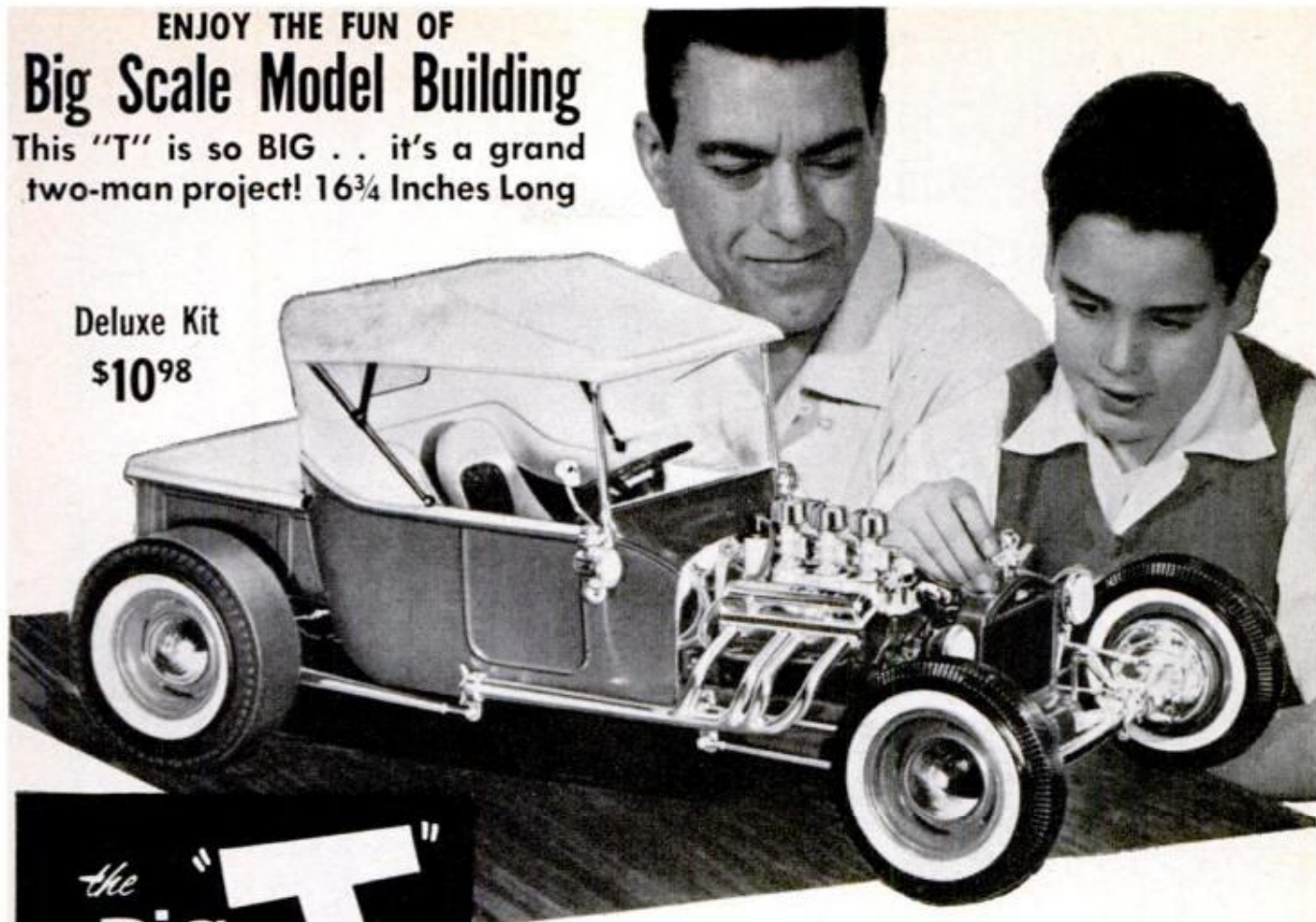

the **"T"**
Big
by **MONOGRAM**

Ford Custom "T" Street/Show Pick-Up

AUTHENTIC 1½ INCH SCALE ALL-PLASTIC MODEL
Steer It! Motorize It! Extra Custom and Show Parts



Extra Parts for Interior Variety. This interior has center console, Corvette shift lever, telephone, radio, TV, Stewart-Warner instruments, overhanging clutch and brake pedals, custom carpet and simulated Naugahyde sides.



Choice of Radiator Shells and Grill. Make your Big "T" with chopped '24 or '32 Ford shell and with Ford radiator or custom grill. Two shells, radiator and grill included in kit.

For home shop or kitchen table assembly—the Big "T" is magnificent fun. Big 1½ inch scale and amazing detail provide model building enjoyment in an entirely new dimension. This Monogram Street and Show Pick-Up model is built around the prized '24 Ford Roadster body and is customized with parts scaled from ten other cars and loads of special custom goodies. One-eighth real car size.

You make the Big "T" in the best customizing tradition—as you like it best—with choice of interiors and

front end. There's a custom 283 Chevrolet engine with three carburetors and all the trimmings, soft pliable and realistic tires and slicks, bucket seats, tools, trophy and "show" accessories. Model steers like a real car and can be motorized for electrical operation with \$1.49 power kit.

Big deluxe kit contains 203 precision-molded parts in 5 colors of plastic. 97 of the parts are in gleaming chrome plate. No painting required. 24-page assembly guide with 108 pictures makes assembly easy.

Get the Big "T" at Hobby Shops and Other Stores

For the time of your life and a beautiful show piece, get the Big "T" kit at hobby shops and other stores in your neighborhood. Watch for the Monogram display with the Big "T" in a "show setting." Don't accept a copy or substitute. Ask for it by name—the Big "T" by Monogram.

Monogram Models, Inc.
 Morton Grove, Ill.



Now you can repair messy joints around tubs, sinks, and tiles with fingertip ease!



better
buy

DAP

KWIK-SEAL



Get this new booklet filled with "Before You Paint" fix-up tips that save you time and money. Send 10¢, to cover handling, to:

DAP inc., Dept. 15 • Dayton 31, Ohio

BUILD...this famous engine

THE VISIBLE V-8

...it's a handsome

showpiece...and

it really

works

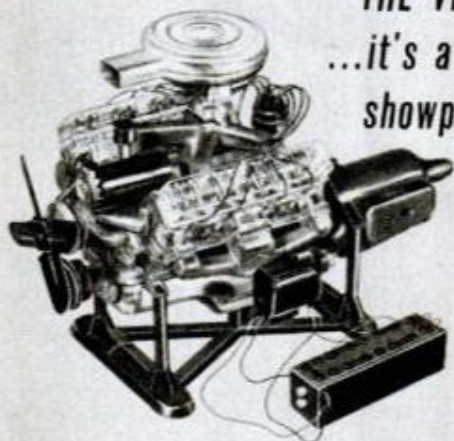

1/4 size scale model of the famous internal combustion engine that does everything but burn oil! Watch the valves open and close, the pistons moving in perfect timing, the spark plugs firing. It's a complete education in engines. Manual and easy-to-follow instruction book included. \$10.95

RENWAL

FREE

Write for copy of "Getting a Jump on the Future with a Renwal Hobby"

NAME _____
ADDRESS _____
CITY _____ TOWN _____ STATE _____

SEND TO: RENWAL, MINEOLA, N.Y. DEPT. PM-3

CRISIS! How Can We Store Human Knowledge

(Continued from page 110)

slant. NCR hopes to develop modules that will enable smaller companies to begin to mechanize their IR problems before they become completely out of control. Such modules might be simply micro-image viewers to begin with. Such a viewer might also have a means for making prints. Storage would be accomplished by a simple three by five manual card file.

A good many thoughtful Americans are wondering whether or not we still have the prerogative of proceeding slowly in the area of data storage and retrieval. Allen Kent, associate director of the Center for Documentation and Communication at Western Reserve University, said recently, "The Soviet Union has mounted a massive effort to 'brainpick' the world's recorded literature in order to assure a more effective scientific and technical effort on their part. We, too, must go in this direction, and our 'brainpicking' efforts have been desultory."

That's why the micro-image process may turn out to be a vitally important discovery. It seems almost incongruous to suggest it, but it's possible that the cold war might be won in a filing case. ★ ★ ★

Frozen Bands Ring Saturn

Saturn's rings are coated with frost crystals, reports Dr. V. I. Moroz, State Astronomical Institute, Moscow. They consist of chunks of cosmic material ranging from four inches to three feet in diameter.

The frosty bands were discovered by using a 50-inch reflecting telescope and an infrared spectrometer. Previous studies in the U. S. have indicated the possibility of frost, and Dr. Moroz' report confirms it.

Moon Ice May Furnish Water

Frozen lakes locked in dark moon craters may be the source of water for the first astronauts who land there. At the lunar poles, the sun barely rises above the horizon which keeps the crater temperatures very low. Under these conditions, it would take billions of years to evaporate a thimbleful of water.

"The presence of ice on the moon would make it possible to substitute important scientific instruments for water supplies on lunar spacecraft," said Dr. V. D. Davydov, State Astronomical Institute, Moscow.

Free!

DREAM SHOP

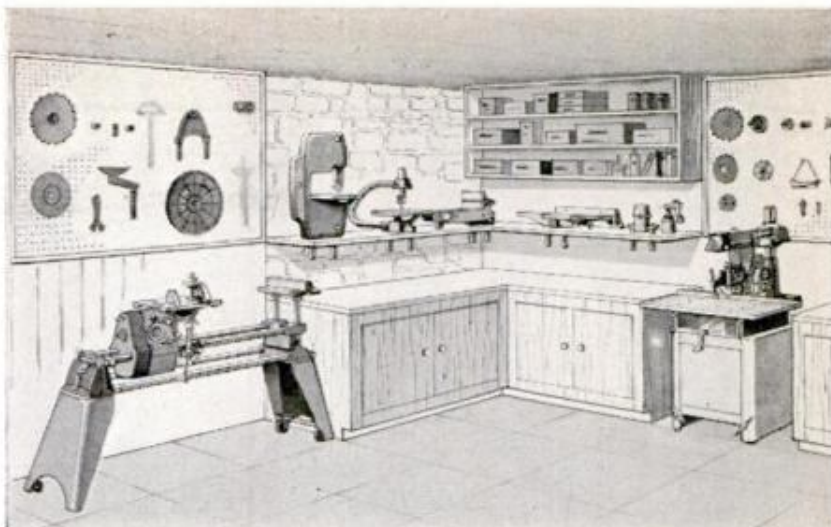

Put yourself in this magnificent Magna Dream Shop. It's complete in every detail: offers every power tool facility for home and hobby crafting and repair. SHOPSMTIH is a saw, horizontal drill, vertical drill press, lathe and sander. SAWSMITH Radial Arm Shop provides the ultimate in sawing versatility.

Also included are: Magna Bandsaw, Jig Saw, Sander, Jointer, Compressor Sprayer and a complete set of accessories . . . all manufactured by Magna American, builders of America's First Family of Power Tools.

Ask for free book, "Practical Power Tool Projects" and details of Free Dream Shop Contest at better power tool dealers and Montgomery Ward.

MAGNA AMERICAN CORPORATION

Interstate 75 Evendale, Cincinnati 15, Ohio

Constantine's Catalog & Manual for WOODWORKERS

ALL-NEW! 1963 Edition. More than a catalog—a manual too! 130 pages—exciting new items! Since 1812, world's most complete source for rare imported & domestic woods at rock-bottom prices. Inlays, bandings, carvings, hard-to-find hardware, inlaid wood picture kits, new brass hardware, etc. Plus tools, plans, projects. Enclose 25c for postage and mailing. Write for Catalog and Manual now.

ALBERT CONSTANTINE AND SON, INC.

2050 Eastchester Rd., Dept. S-5, New York 61, N. Y.



GEARS

In Stock — Immediate Delivery

Gears, speed reducers, sprockets, thrust bearings, flexible couplings, pulleys, etc. A complete line is carried in our Chicago stock. Can also quote on special gears of any kind. Send in your blueprints and inquiries.

Send for Complete Catalog No. 10
CHICAGO GEAR WORKS
440-50 N. Oakley Blvd., CHICAGO 12, ILL.



EMERSON ELECTRIC

PORTABLE WELDER High Capacity . . . Low Price

Ideal for farm, home workshop. Cuts, brazes, solders, welds. One man can carry . . . only 68 lbs. 9 welding heats up to 180 amps . . . 3/32" to 3/16" rod sizes. Write today for prices and receive **FREE WELDING SELECTOR GUIDE** . . . gives working data you need in seconds!

DEPT. PM-11



EMERSON ELECTRIC of St. Louis
B100 Florissant • St. Louis 36, Mo.

The hand-held
**2-WAY
RADIO**
that outperforms
'em all...



Anyone can operate—no license required—priced from \$109.50!

In the field or on the job . . . Viking "Personal Messengers" are delivering outstanding performance! Viking "Messengers" are available in compact hand-held units or maximum legal power Citizen's Band transceivers. Used by thousands of businessmen, salesmen and construction crews. Send today for full details.

FREE! SEND FOR COLOR BROCHURE

Please rush "Messenger" details to:

NAME _____

ADDRESS _____

CITY _____ STATE _____



Viking Messengers

E. F. JOHNSON CO.

1401-10 Av. SW, Waseca, Minn.



Spots Fishing Spots

If you know the water temperatures, you'll know where various fish—who like their particular degrees of warmth—are likely to be. That's the principle behind the \$29.95 Thermo-Fishometer. You drop the probe in the water to find depth and temperature. Bright Radio Lab, Mineola, N. Y.

A Star Is Born—Less Often

Men who look to the stars in years to come will have a less brilliant array to study than we have today. That's the conclusion of Dr. Maarten Schmidt, astronomer of Mt. Wilson and Palomar Observatories.

He found that small stars in the Milky Way galaxy—the shroud of billions of stars in which floats Earth and other planets of the solar system—are being formed at a lower rate than they previously have been.

After studying the amounts of metals in the atmospheres of 56 small stars within a few hundred light years of the solar system, Dr. Schmidt determined some did not contain the amounts of metal they should have to be considered young.

The higher the metal content, the younger the star, because the interstellar material from which stars are formed is becoming increasingly contaminated with metals.

1963 SAAB . . . built so well



SAAB STANDARD EXTRAS place complete comfort and convenience within easy reach of its driver. At no extra cost, SAAB provides: electric clock, temperature and fuel gauges, ammeter, on easy-to-read instrument panel; heater and defroster to warm or cool car interior as required and keep all windows fog-free; dual padded sun visors; cold start control, ventilator shades, and carburetor preheater for instant starts in any weather; windshield washers, lockable glove compartment; safety belt fittings; factory undercoating—all *standard* equipment!

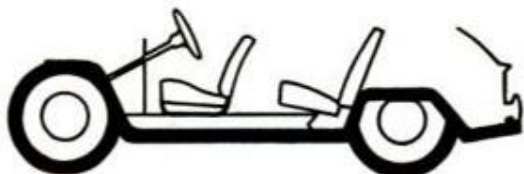

SAAB RIDING COMFORT is based on front wheel drive, which eliminates driveshaft, makes all floor space flat and usable, permits quick conversion of SAAB interior to a bedroom big enough for two. Front wheel drive, combined with carefully calculated understeering, low center of gravity, and advanced suspension design, provides swayless directional stability for relaxed driving. Sure-footed front wheel traction pulls the rest of the car firmly and easily around sharp curves and corners, through mud, ice, and snow.

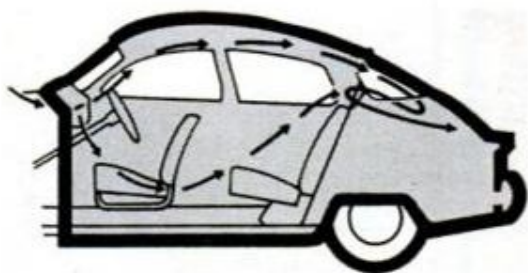

SAAB HEATING AND VENTILATION provides draft-free, year-round comfort. Fresh air is circulated and discharged through ducts below the rear window and vents behind the side windows. Removable ventilation lids help keep engine compartment and car interior cool in summer, warm in winter. New ultra-efficient hot water heating system eliminates hot spots and danger of exhaust fumes . . . provides even heat to front and back seats. Strategically-positioned air jet holes keep front and side windows clear and defrosted for fog-free vision—always.

that it has a 24,000-mile/24-month written warranty*

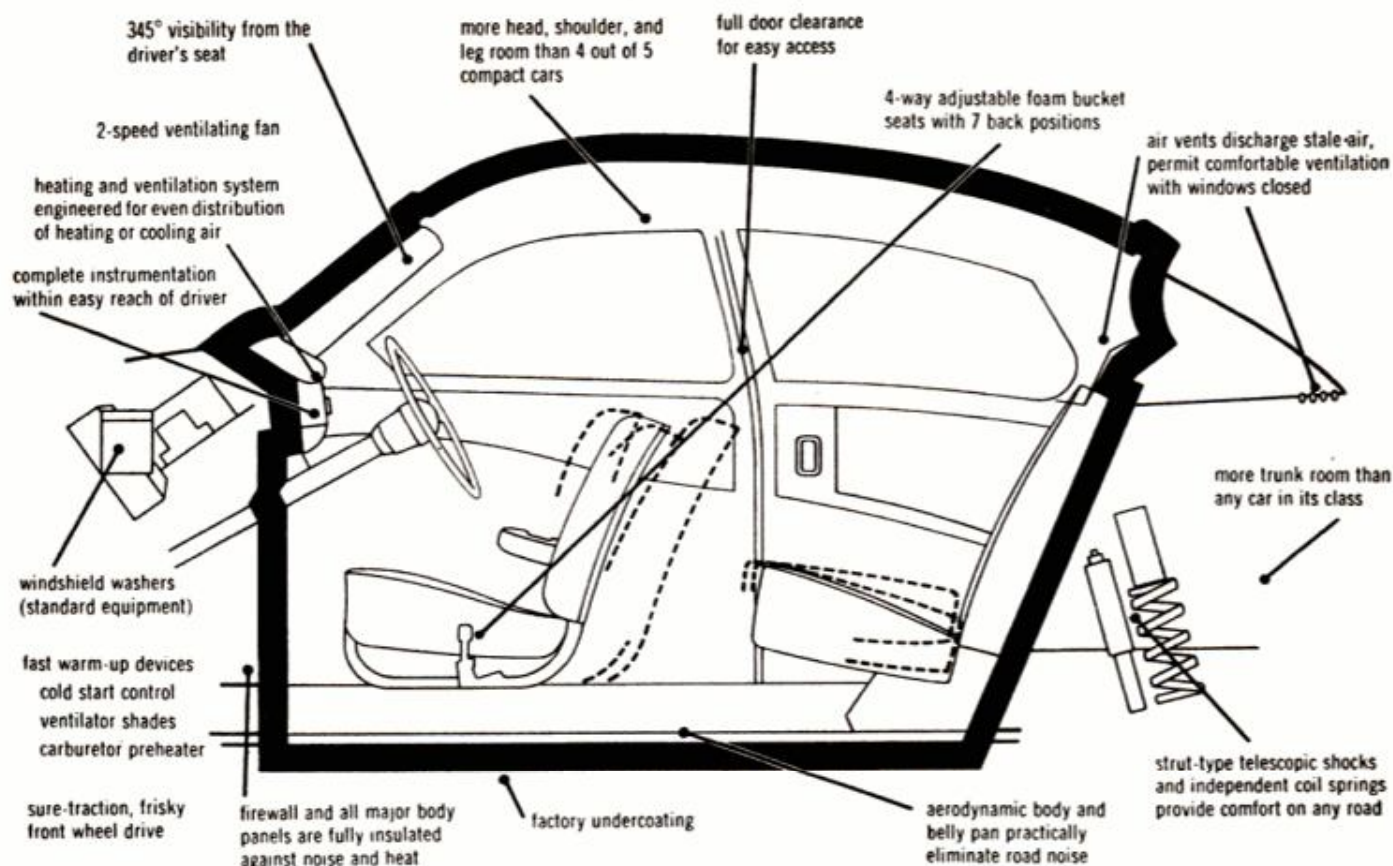

Take a critical look at SAAB comfort and convenience

Aircraft reliability and performance standards are blended with an entirely new approach to over-all automotive design in the Swedish SAAB 96. This car was built to be better and more comfortable, not different . . . by one of Europe's leading aircraft manufacturers

. . . for those who enjoy mechanical excellence, technical uniqueness, and extraordinary craftsmanship.

A critical look at *all* the facts and specifications will prove that SAAB is unquestionably one of the world's best engineered cars.

*Engine, transmission (3- or 4-speed gear box available), and differential have a written warranty for 2 years or 24,000 miles.



\$1895 P.O.E. (little enough for one of the world's best engineered cars)

Arrange a test drive at your nearest SAAB dealer. Or write for more information—and the SAAB North American Road Atlas, a 64-page comprehensive travel guide valued at \$1.00, but yours for only 25¢ to cover postage and handling. SAAB Motors, Inc., Dept. 511, 405 Park Avenue, New York, New York.



SAAB MOTORS, INC. — NEW YORK • NEW HAVEN • JACKSONVILLE • ST. LOUIS

Dr. Grabow Continentials



The Dr. Grabow
Symbol of
Quality

World's Finest
Imported Briar

Startfire ... \$ 3.95

Viscount ... \$ 5.00

Eldorado ... \$10.00

Pipes shown available
in all three price ranges.

Dr. Grabow Pipes
need no breaking in.
They are mechanically
pre-smoked and ready for
you to enjoy the most in rich,
sweet, cool, satisfying smoking.

Write for free booklet
Dr. Grabow Pre-Smoked Pipes • Greensboro, N. C.

Ford's Mustang

(Continued from page 94)

wheels. In effect, the engine was kept in the same position relative to wheels as in the Cardinal, but simply moved back to the rear axle. Transmission has four forward speeds.

There are several innovations in Mustang's design that will interest the racing world. First of all, driver and passenger seats are fixed parts of the frame structure itself enabling engineers to design the chassis for a permanent load distribution between the front and rear. Different-sized drivers are accommodated by moving steering wheel and pedals forward or aft.

Cooling chores are split between two small radiators on either side of body to which air is ducted. Electrically driven fans pull air through the radiators at slow car speeds when airstream is insufficient. Thus at high (racing) speeds, there is no power drain, as ram airflow is sufficient.

Suspension is by tubular A-arms connected to spindles via ball joints. Car weight is supported by coil-springs combined with adjustable telescopic shock absorber units. Brakes are spot disc at front, drum in rear.

Although the prototype has been fitted with built-in roll bars and a plexiglass competition windscreen, Ford designers have provided for a conventional windshield and roadster top.

According to Ford executives, there are no plans to mass produce Mustang at present. The car's future depends on public reaction. ★ ★ ★

EVERLITE* World's THRIFTIEST Light Plants

(Item 869-10T)

NEW TRANSISTOR ALTERNATOR REPLACES GENERATOR



*Trade-Mark Registered

Now a Service Free Light Plant built with a transistorized alternator. Offers 30% greater efficiency—more power for less fuel. Terrific service life—no brushes to arc and burn. No more commutator to wear, no collector ring trouble. And best of all it costs no more to "go modern with Ever-lite." Thrifty 1000 watt, 115v. AC plant powered by a rugged easy starting 4 cycle engine—leader priced. Model 869-10T. Wt. 65 lbs. as illustrated **\$179.50**

fob factory

All sizes available—can finance. Write for catalog. Special models for public utilities—Approved for Civil Defense. Write.

STANDARD DIAL PHONES

Western Electric late model dial phones same as used by all telephone companies. Ideal as extensions on any system. Easy to connect. Several may be connected on one line. Easily modified for private inter-com system. Cost \$40.00 new—guaranteed excellent condition.

ITEM 855 NC, Wt. 8 lbs. **\$6.95**



HEATING AND VENTILATING FAN

(Item 10) Easily installed in furnace pipes. Forces even heat to all rooms. Over range removes kitchen smoke and odors. Powerful, continuous duty motor, 110-120 v. AC. Mount in wall or ceiling to ventilate any area. Quiet, super-efficient fan moves huge volume of air, (400 to 600 CFM).

8" Pipe, wt. 5 lb. **\$6.85**
9" Pipe, wt. 6 lb. **\$7.85**
10" Pipe, wt. 7 lb. **\$8.85**
12" Pipe, wt. 8 lb. **\$9.85**



HEAVY DUTY FAN. Semi-enclosed motor, suitable for spray booths, restaurant exhausts, poultry houses, etc.

10" Fan, wt. 8 lbs. (Item 10E) **\$11.95**
12" Fan, wt. 10 lbs. (Item 10D) **\$12.95**

Send 10c for 100 page Catalog FREE with order. Prices f.o.b. factory—send check or MO.

MASTER MECHANIC MFG. CO., Dept. A-112, Burlington, Wis.

Southern Customers write Dept. A-112, Box 65, Sarasota, Florida

New Weapon for Fly Control

Cygon dimethoate 4E, or Cygon for short, is killing flies on farms and around dairies throughout the country. The new compound overcomes one of the major problems of fly control: It kills flies which have developed an immunity to widely used products such as DDT.

One spraying of the insecticide marketed by the American Cyanamid Co. remains deadly to flies for up to eight weeks or longer. It is also effective against insects attacking ornamental plants and seedling fruit trees; such plants are prey of about 20 common insects such as lace bugs, aphids and mites.

An unusual quality of Cygon, when applied to plants, is that it kills by both residual contact and systemic action. It becomes a temporary part of the plant and provides a protective covering to leaves and stems.

At present the compound is available only for use outside the house.

How to take clutter out of children's rooms

Get new Presto Peg-Board by Masonite. Quarter-inch heavy-duty hardboard panels, with hang-up fixtures, create convenient storage space. Everything finds a place...everything's easy to find.

Presto is attractive, too. Factory-finished in handsome "tracery" design. No further finishing required.

Let Presto Peg-Board transform children's rooms (and utility rooms, kitchens and garages) into neat, well-organized areas. We have free literature to show you how. Send for it today.



MASONITE

shows the way!

Masonite and Peg-Board are registered trademarks of Masonite Corporation.

Masonite Corporation, Dept. PM-11, Box 777, Chicago 90, Illinois
Send me free literature on Presto Peg-Board.

Name _____

Address _____

City _____ Zone _____

County _____ State _____

DRAINS cellars, cisterns, wash tubs; **\$7.95**
IRRIGATES - CIRCULATES - SPRAYS



1,001 uses. Stainless shaft. Won't rust or clog! Use 1/8 HP motor or larger... 3/4 HP for up to 2,400 GPH; 450 GPH 80' high; or 1800 GPH from 25' well. 1" inlet; 3/4" outlet. Coupling included free. **\$7.95.**
HEAVY DUTY BALL-BEARING PUMP. Up to 5,200 GPH; or 3,000 GPH from 25' well. 1 1/4" inlet; 1" outlet. **\$12.95**
Postpaid if cash with order. **MONEY BACK GUARANTEE**

Centrifugal and Gear Pumps in All Sizes

LABAWCO PUMPS, Belle Mead 7, New Jersey

NEW MAGIC RADIO WALKIE TALKIE!



TALK THRU ANY RADIO TO ANYONE—ANYWHERE.

Sends your voice to any car or house radio. Works up to 1-2 miles from car to car or 1-5 or more blocks house to house depending on local conditions. Just Push Button to Talk—No Complicated Hookups or Wires—Anyone can use it. Transistor powered by flashlight batteries. No License or Permits Needed. Guaranteed to Work, 1 yr. Service Guarantee. Should Last for Years!

SEND ONLY \$3.00 (cash, ck, mo) and pay postage or send \$12.99 for postpaid delivery. Ready to operate, with clear instructions. Order your Radio-Talkie today—Now! **WESTERN RADIO, Dept. TPM-11, Kearney, Nebr.**

Send 25c for a complete illustrated catalog to:

PROTO TOOLS
PROFESSIONAL QUALITY TOOLS

2202 Santa Fe Avenue, Los Angeles 54, California



AUTOMATIC SAW SHARPENERS FOR CIRCULAR, RIP & CROSS CUT SAWS — MANY OTHER MODELS

Low In Cost — Simple To Operate — Versatile — Grind To Precision Accuracy And Gum In One Automatic Operation Guaranteed By World's Largest Mfr.

Since 1881

HANCHETT MFG. CO., BIG RAPIDS, MICH.

from Scott . . .
FREE STEREO KIT CATALOG

Have fun . . . save money . . . build the best! Now world-famous Scott stereo components come in easy-to-build kit form. You can build an FM Multiplex tuner, your choice of an 80 watt or 48 watt stereo amplifier, a preamp, power amplifier, and a speaker. Write for complete details.



SCOTT® Dept. 525-11

H. H. Scott, Inc. 111 Powdermill Road, Maynard, Mass.

Rush me your new Kit Guide, 20 page "Guide to Custom Stereo" and your Free FM Stereo Demonstration Record.

Name _____

Address _____

City _____ State _____

Export: Morhan Exporting Corp., 458 Broadway, N.Y.C.
Canada: Atlas Radio Corp., 50 Wingold Ave., Toronto

NOVEMBER 1962

229



Flecto Varathane Outlasts Varnish 2 to 1

Flecto Varathane is a remarkable new clear plastic finish

that dries dust-free in minutes, and lasts *twice* as long as varnish.

Flows right on *any* kind of wood, inside or out. Needs no sealer. Put it on siding, floors, kitchen cabinets, furniture, even boats. Comes in glossy or satin finish, regular can or easy-to-use aerosol container for quick touch-ups.

Note to users: Clean brush and equipment with mineral spirits. First coat covers 500 sq. ft. per gallon. Second coat covers 600-800 sq. ft.

If your nearby paint, hardware or building supply dealer doesn't carry it yet — or for free brochure — contact . . .

The Flecto Company, Dept. P. M., Box 84, Berkeley 2, Calif.
Flecto Coatings, Ltd., 8850 Selkirk, Vancouver, B. C.



Men who know
PAINTERS' CUTLERY
say the **BEST** are
Red Devil Tools.



GENUINE ALNICO MAGNETS

AMAZING, PERMANENT, NON-ELECTRIC, HIGHLY PRACTICAL. Conduct interesting experiments. Hundreds of uses. Retrieve valuable steel items such as guns, tackle from fresh or salt water; tools from tanks & drains. **GUARANTEED.** Try any magnet one week. Money back if you are not well-pleased.

M-90 (Wt. 5 oz.) Has pull of 15 lbs. on steel block \$ 3.50
M-500 (Wt. 13 oz.) Has pull of 50 lbs. on steel block \$ 5.00
M-575 (Wt. 18 oz.) Has pull of 75 lbs. on steel block \$ 7.00
M-625 (Wt. 70 oz.) Has pull of 125 lbs. on steel block \$10.00
M-710 (Wt. 53 oz.) Has pull of 225 lbs. on steel block \$18.00
M-44 Rod Magnets for Electric Guitars 3/4" Dia. x 1 1/4" 12 for \$ 4.00
M-47 Hot Pad Magnets. 10 for \$1.00 \$ 1.00
M-35 Science Experimenter Kit of 8 magnets \$ 2.00

Send M.O. or check. We pay postage. Sorry no C.O.D.'s.

MIAMI MAGNET COMPANY, 3240 N.W. 27th Ave., Miami 42, Fla.

KING MIDGET FOR 1963

"World's Most Exciting
Lowest Priced Car"



Drive it for 75c a week. Rider Agents Wanted. Send 25c for 32 page book, full details, dealer price. Or send \$1 (refunded first order) for this plus Service and Repair Manual and 16 5x7 photos of car and factory.

MIDGET MOTORS CORP., Athens 1, Ohio



Solves Repair Problems

Durham's fills cracks and holes in plaster, wood and tile. Won't shrink or fall out. Economical, easy to use. Big 4-lb. can, only \$1.40 at lumber, paint and hardware dealers, or shipped direct postpaid in U. S. for \$1.75. Money-back guarantee. Order now. Donald Durham Co., Box 804-T, Des Moines, Iowa.

COMPLETE ADDRESSES of manufacturers, inventors, and sources of information for items mentioned in the editorial pages of this issue are listed in the free WHERE-TO-FIND-IT list. Send self-addressed, stamped envelope to

SERVICE BUREAU
740 Rush St., Chicago 11, Illinois



**LINCOLN
WELDERS**

PORTABLE POWER PLANT AND WELDER COMBINED!

Sells for price of power generator alone—only **\$680⁰⁰***

New Lincoln "WELDPower 225" combines 225-amp welder with 5000-watt power generator. Be prepared for power shortage. Have power for field jobs. WELDPower supplies power for lights, tools, machinery, farm equipment, home appliances. Pays for itself in daily use as a welder . . . welds, cuts, heats, brazes, solders, hardsurfaces. Dozens of uses including thawing frozen pipes. Get the facts from your Lincoln dealer today listed under Welders, Arc, in the telephone yellow pages. The Lincoln Electric Company, Dept. 4742, Cleveland 17, Ohio.

*Including all accessories you need to weld. Undercarriage extra. \$20 higher in 11 Western States.

The World's Largest Manufacturer of Arc Welding Equipment and Electrodes



NEW LOW PRICES
ON LINCOLN
180 and 225-AMP
SHOP WELDERS

AC-180-S — \$125
AC-225-S — \$140

Sun Just Shadow of Former Self

When it was forming, the sun had a radius several hundred times the present distance between it and the earth. It consisted of gas atoms, either in molecular form or condensed on interstellar grains.

When this "protosun," as it is called, shrank so that its radius was 100 times the distance from the earth to the sun, it became unstable. The instability lasted until after the protosun had shrunk to a radius of about the orbit of Mercury.

This early history of the sun's birth and development was drawn from a study by NASA's Institute for Space Studies.

Underwater Rodeo

Scientists plan to place electronic saddles on whales and let the huge mammals carry the tiny transmitters down beneath the surface and send back signals.

Because whales can dive much deeper than submarines, the data they send back will be valuable to studies of antisubmarine warfare research.

The miniaturized electronic gear will be planted on the backs of surfaced whales from small aircraft. Then scientists on a floating laboratory will follow the whale's course and record the electronic feedback. Whales can dive 1000 feet or more.

IMAGINE A GLASS AUTOMOBILE

You may be driving one before long. And they're already making sheet glass that bends and snaps back like spring steel. You can throw some glass at rocks and break the rock. All this and much more about the amazing world of glass in

DECEMBER
POPULAR MECHANICS

NOVEMBER 1962

A Revolution in Living!



LEISURAMA

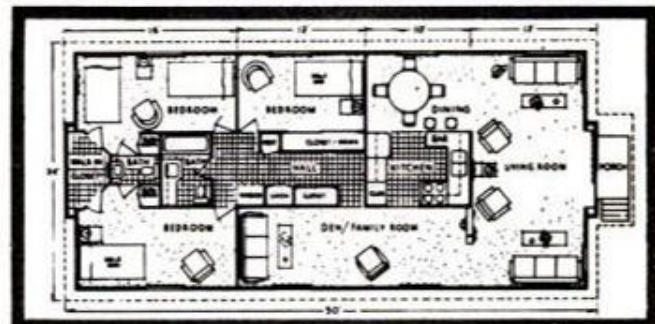

Now, for the first time, you can enjoy all the modern conveniences of a full size, fully equipped permanent or vacation home that features

- 1125 sq. ft. living area, wealth of closets and storage
- a houseful of decorator-selected furniture, accessories, brand-name appliances
- top-quality, engineered components and carefree aluminum exterior
- Underwriter approved 110V and 220V wiring, fully plumbed and insulated
- travels anywhere as a single 10-wide unit, easily expands in four hours to full 50 x 24-wide home
- costs far less than smaller unfurnished conventional house

Send the coupon for free color literature

Magnolia Mobile Homes

P. O. Box 230 Vicksburg, Miss.



Please send literature on Magnolia Mobile Homes to:

Name _____

Address _____

City _____ State _____

PM1162

231



LUIS CARDENAS lays hoops on still-wet plastic sheet in pleasing arrangement



PLASTIC PANELS, shown here as room dividers, are also used as windows, doors or walls. Unless so ordered, no two panels are alike

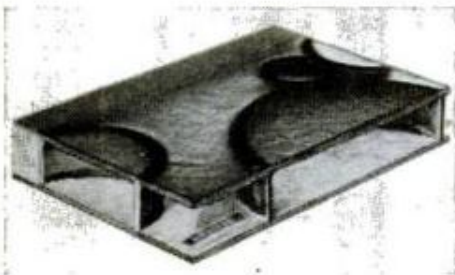

HOLLOW CORE gives panels insulating qualities, plastic gives translucence

Imbeds Designs in Decorative Plastic Panels

Using a process that took six years to develop, Luis Cardenas, a South American art student now operating his own business in Seattle, Wash., makes custom panels by fusing a variety of materials into plastic sheets.

Leaves, butterflies, grasses, hoops, sea shells and champagne glasses are imbedded in the resin-reinforced glass fiber while it is still wet. When it dries, the new shapes are an integral, and artistic, part of the panels' design and structure.

SEA SHELLS imbedded in plastic sheet make unusual wall decoration for bar



UNLIKE PANELS, such wall decorations use only one plastic sheet. Shells arranged on wet sheet become fused permanently when dry

10,000 Things Electronic To Enjoy—10,000 Ways to Save in Famous **RADIO SHACK CORPORATION'S**

Brand New 1963 Electronics Catalog

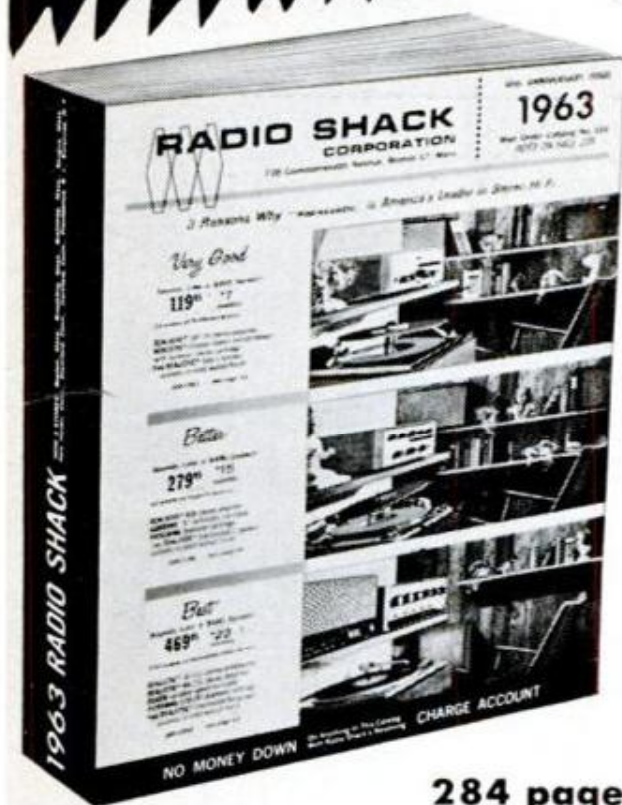

FREE

for You & 2 Friends Mail Card Today

The Radio Shack Story

Radio Shack Corporation of Boston, Massachusetts is one of America's big 3 distributors of things electronic to the general public, industry, craftsmen and hobbyists. We offer a complete selection of precision built products by mail, through stores, and direct to manufacturers. Our exclusive REALISTIC® line of electronic products is famous nationwide for its high quality, dependable service and fine values. Our selection of national brand products is the largest in the country.

Radio Shack Corporation has been serving the nation since 1923—from the very beginning of the electronic age. This year over 2,000,000 people—music devotees, ham operators, amateurs and professionals—will shop from our catalog because they get the most value for every penny they spend on their favorite products . . . they will buy on the easiest terms, cash or credit . . . they are assured by our guarantee of getting the most satisfaction on every purchase. Radio Shack Corporation invites you and your friends to get your share of these savings and satisfaction by mailing the card opposite for your FREE catalog.

**284 pages
over 10,000 items**

Partial List of Products in our New 1963 Catalog

- Amateur Radio
- Antennas
- Batteries
- Books
- Capacitors
- Controls
- Hi Fi
- Microphones
- Needles
- Phonographs
- Public Address
- Radios
- Resistors
- Tape Recorders
- Test Equipment
- Tools
- Transformers
- Transistors
- Tubes
- Wire

NO MONEY DOWN CREDIT TERMS
Take up to 2 Years to Pay

RADIO SHACK CORPORATION

BOSTON, MASSACHUSETTS
America's Electronic Headquarters

RADIO SHACK CORPORATION Dept. 62L3C

730 Commonwealth Ave., Boston 17, Mass.

Without obligation send me Free and Postpaid, your New Electronics Catalog plus every new issue for one full year.

Your name _____

Address _____

City, State _____

Name of a friend _____

62L3D

Address _____

City, State _____

Name of a friend _____

62L3E

Address _____

City, State _____

SNOW SLOW YOU DOWN?

GRAVELY
Blows Away
Snow Delay
FAST!



Throw away your shovel! Blow away snow problems with Gravelly's Snowblower. Clears a 26" swath—blows snow up to 30' to either side through adjustable chute. All-gear drive—powered directly by Gravelly's 6.6-HP engine.

See how the Gravelly Tractor and its 31 tools make all your tough jobs easy. For free copy of booklet, "Power vs. Drudgery," write now. Finance plan available.



GRAVELY TRACTORS

DIVISION STUDEBAKER CORPORATION
P. O. BOX 601-L DUNBAR, W. VA.

Too darn practical?

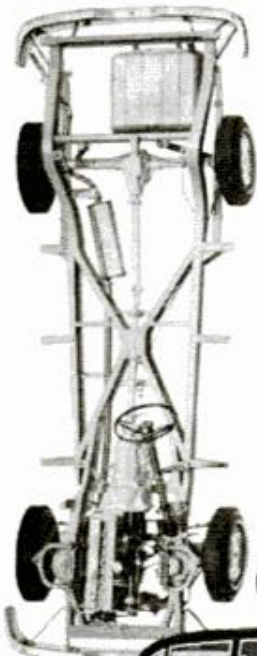

Certainly not! How can a car be too practical about safety? Or comfort? Or interior space? The CHECKER seats 8 adults... 6 in easy-chair luxury, 2 on neat auxiliary seats. That's practical transportation.

The timeless CHECKER is economical to operate, sneers at maintenance bills and is built to last for years and years and years.

Sound interesting? It is. Write for brochure.



Checker Motors Corp.
Dept. PM-2
Kalamazoo, Michigan

40th anniversary
CHECKER



CHECKER Marathon and Superba series... 4 door sedans and 4 door station wagons. Power and automatic equipment available.

FOR TOP VALUE... INSIST ON



Folding Wood
RULES



Steel White
TAPES
with belt holsters
6 ft. to 100 ft.



Evans RULE CO. 400 Trumbull Street, Elizabeth, N. J.



Print Your Own

Cards, Stationery, Advertising, Circulars, labels, photo and movie titles, church work, tags, etc. Save money. Sold direct from factory only. Raised printing like engraving, too.

Own a Printing Business

Print for Others, Good Profit. Have home shop. Junior press \$15; Senior \$35 up. We supply everything. Easy rules. Pays for itself in short time. Write now for free details.

KELSEY PRESSES, Z-37 Meriden, Conn.

**Fill Flaws
In Plywood**

Handles like putty. Hardens like wood.

PLASTIC WOOD

The *Genuine*—Accept No Substitute.



"Caught you doing a little cabinet making again, eh, Olson?"

POPULAR MECHANICS

COMPANY
MAKES ALL
DELIVERIES
for you!

EARN TO \$7,500.00

AND MORE EACH YEAR



NO
INVESTMENT
in Samples

SAVE CUSTOMERS 20% to 40%
on their clothing purchases. Every family needs clothing . . . you just show and take orders for the world's largest and oldest company, since 1916, selling clothing directly to the home. You make money from the first hour, plus cash bonuses, free clothing, special gifts . . . plus **SECURITY**. Mail Coupon Now!

NO EXPERIENCE NEEDED.
Choose full time or spare time. Nationally advertised in leading magazines and on TV.



... STYLE GUIDE FOR YOU — MAIL COUPON



Minnesota Woolen

Fashion Wagon



HUGH DOWNS
suggests you mail
this coupon today !!

DULUTH 2, MINNESOTA

MINNESOTA WOOLEN CO.,
DULUTH 2, MINNESOTA Dept. PM-112

I'm interested! Rush **FREE** details:

Full Time Spare Time (check one)

Name _____ Age _____

Address _____

City _____

County _____ State _____

Tel. No. _____ Do you have car? _____

Do we measure up to the Russians in space? When a space craft is ready for a shot at the moon, will our computers be ready to send it there? Read in December PM the startling facts about the measurement war we are fighting.

FREE

"HOW-TO" HANDBOOK ON GLUING



NEW 12-page Elmer's Wood-Gluing handbook gives you details on gluing for heavy construction, home improvements, cabinets and furniture, models and toys, sports equipment. Contains hints, tips, and shortcuts. Includes drawings, as well. Tells you what glue to use indoors and out. Send stamped, self-addressed envelope for your free copy. Elmer, The Borden Company, Dept. PM-112, 350 Madison Ave., New York 17, N. Y. (Available in Canada.)

NOVEMBER 1962

SAVE on DESK LAMPS
for HOME • SHOP
STUDENT

Now a drafting light or desk light at a price anyone can afford. Newly adapted from a Swedish design . . . ideal for drafting table, office desk, etc. Precision made and balanced. Reflector will swing to light desk or table up to 6 ft. long x 3 ft. wide. Extension arms are fully universal with surgical steel springs for counterbalance with finger-tip movement. Finished in baked enamel. In K-D kit to save shipping cost . . . takes but a few minutes to assemble.

No. ID-118 — MECH LYTE — Gives concentrated light for work bench, shop, etc. Gray finish only . . . \$9.95

No. ID-118B — COOL LYTE — Insulated lamp hood reduces heat. Ideal for draftsman, artist, etc. Colors: gray, brown or black (specify) . . . \$10.95

No. ID-MAG 1 — ILLUMINATED MAGNIFIER Has 5" dia. lens. Power of 3 diopters. 13" focal length. For stamp or coin collectors, etc. . . . \$28.95

85 TO 1 GEAR BOX

Drives through a 6-gear train that rotates on self-lubricating, high speed roller bearings. Has 180° offset drive. Take-off shafts are 1-1/4" and 3/8" diam. Overall size: 6" x 4" x 2 1/2". **12.95**



Only **9.95**
MECH LYTE

SURGICAL STEEL
COUNTERBALANCE
SPRINGS

PRECISION
STEEL ARMS
FULLY
UNIVERSAL

MAGNIFIER



Will pay out, hold or reel in 4500 ft. of 3/32" steel cable. Drum is gear driven and operated by a hand crank. Can be turned at 1 to 1 or 8 to 3 ratio. Overall size: 29" x 13-1/2" x 13".

HIS CATALOG!
260 PAGES OF BARGAINS
Includes: Hand & Power Tools, Sports & Outdoor Equip., Electric Motors & Generators, New and Used Hydraulic Equip. of all types

HER CATALOG!
64 PAGES OF GIFTS
Featuring Gift and Decor items from 'round the World. Primitive carvings from Africa, brassware from India, art objects from Italy, fantasies and furniture from the Orient PLUS budget priced gift items from the U.S.

SEND ONLY 50¢ AND GET BOTH CATALOGS!
to cover the cost of handling and mailing the catalogs! TO ORDER: Send check or M.O. 1/2 dep. with C.O.D.'s. All items sent freight or postage collect.

palleys

2263 E. VERNON AVE., Dept. PM-112
LOS ANGELES 58, CALIFORNIA

Home Craftsmen! Here's Your NEW MONEY SAVING CATALOG



FINE DOMESTIC AND RARE IMPORTED **WOOD**

Veneers, Plywoods, Mouldings, Kits, Ornaments, Lamp Parts, Mosaic Tile, Upholstery Materials, Hardware. Over 1,500 Essential Items ... 132 Pages ... Full Color

Send for this complete new wood buying guide and project book. Your complete source of finest kiln-dried domestic and rare imported woods, beautiful wood inlays, colorful bandings, furniture legs, matched plywoods, glue injector, embossed mouldings, carved ornaments, newest woodworking tools, "hard-to-find" cabinet hardware and fittings ... more than 1,500 items! New project ideas. Send 25¢ for postage, handling.

CRAFTSMAN WOOD SERVICE CO.
2729 South Mary Street
Dept. A-11, Chicago 8, Illinois

Big Discounts
on Famous Stanley
Power Tools, Drills,
Router, Many Others

**MAIL
COUPON
NOW!**

Craftsman Wood Service Co., Dept. A-11,
2729 South Mary Street, Chicago 8, Illinois
Rush new Craftsman Wood Catalog. 25¢ enclosed.

NAME _____
ADDRESS _____
CITY _____ ZONE _____ STATE _____

FREE PLAN How to Start Your Own Business



Start a steady repeat CASH business in your basement or garage. Earn \$3 to \$6 an hour in your sparetime! Excellent profits in saw sharpening business! Automatic Foley Saw Filer, easy to operate, files combination saws, hand, band, and circular saws. No experience needed. H. C. Delbert wrote us: "Since I got my Foley Filer 5 years ago, I have averaged 4½ saws each day since I started." Every saw you sharpen brings you more customers. "I rented a two-car garage and have all the work I can do," writes Charles H. Smith.

FREE BOOK Shows How to Start

Fact filled booklet tells you how to start a sparetime business immediately; how to get new business, how to advertise. Rush coupon now; get "Money Making Facts" and details on Easy Payment Plan. No Salesman will call.

Send Coupon for FREE BOOK Money Making Facts

FOLEY MANUFACTURING CO.
1116-2 Foley Bldg. Minneapolis 18, Minn.

Send FREE BOOK—"Money Making Facts",
and Time Payment Plan.

Name _____

Address _____



Chemical Makes Flies Sterile

When flies cross any surface treated with a new chemical, Apholate, they give up any chances of having young. The chemical makes them sterile; the flies live but their eggs do not hatch.

Such a chemical sterilizer is a necessary weapon against the fly, for during the past few years, several super-resistant strains of houseflies have developed. Some can walk unaffected over surfaces painted with 100 percent DDT.

Develop Perennial Wheat

Perennial wheat which produces crops for several seasons has been released to commercial seed companies. The wheat, a cross between ordinary wheat and one of its distant relatives called wheatgrass, was developed by agronomist C. A. Suneson, at the University of California.

The wheat is largely disease resistant and yields about as much as conventional varieties. Its commercial possibilities for food will probably not be exploited because of the wheat reserve in the U. S.

The wheat has been released to seed companies with research facilities to determine its potential usefulness as a grain crop, grass crop or in conservation and wildlife programs.

IDEAL CHRISTMAS GIFT FOR ANY MAN



LOW COST **WELDER**

WELD - BRAZE - SOLDER - CUT

NO OTHER WELDER AT THIS PRICE INCLUDES THIS COMPLETE EQUIPMENT—FULL FACE SHIELD, HEAVY CABINET, GROUND CLAMP, HEAVY WELDING CABLES PLUS twin carbon arc torch, welding rod holder, carbons, welding and brazing rods, flux, solder, instruction book. Make and repair auto bodies, parts, fenders, trailers, boats, metal furniture, fixtures, ornamental iron, farm equipment, garden tools, bicycles, toys, etc. Operates on any properly wired 115 V. line. **TEN-DAY FREE TRIAL. FULL ONE-YEAR GUARANTEE.** More than 250,000 in use in homes, garages, farms, shops, factories. Now ANYONE can weld, braze, solder, cut, heat metal without experience. Does 1001 jobs on all metals. Save and earn money.

SEND ONLY \$2.00

Pay postman \$12.95 plus C.O.D. charges. Practical lifetime gift for hobbyist, mechanic, auto restyler, hot rodder, homeowner. Order today on **10 DAY MONEY-BACK GUARANTEE.**

FOUR WAY WELDER CO. 1810 S. FEDERAL ST.
Dept. W2-M, Chicago 16, Ill.

GUNK® removes grease -- scourfully! cleans -- degreases -- freshens



- power mowers • engines
- cement floors • kitchen walls • ovens • exhaust ducts
- paint brushes • furnace filters • barbecue grills
- implements • machinery

AT AUTO SUPPLY, FARM & HARDWARE STORES!

GUNK CHICAGO CO., River Forest, Illinois
Serving the Midwest and Southwest
RADIATOR SPECIALTY CO., Charlotte, N.C.
Serving the East, Southeast and far West

DREMEL MOTO-SHOP

Complete All-Family Power Work Shop

Dremel Moto-Shop is the first real multi-purpose workshop designed for the whole family. In one compact, portable unit you have a jig saw, disc sander, buffing wheel, bench grinder, and a flexible shaft machine. 5 power tools in 1 unit that do 1,001 jobs. For the kids it provides hours of constructive, creative recreation. It's invaluable to Dad, and even Mom, for hobby work and home maintenance. Moto-Shop is not a toy, but a professional-quality power tool with a ball bearing rotary motor. It's super-safe; cuts 1 3/4" wood, metal, plastics, etc.; sets up anywhere, can be carried from room to room. Outperforms heavier, more expensive jig saws. See your power tool or hobby dealer today.

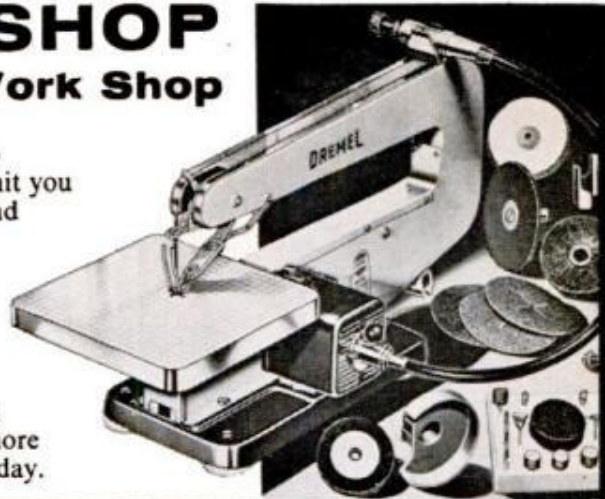

JIG SAW



DISC SANDER



BUFFING WHEEL



BENCH GRINDER



FLEXIBLE SHAFT

FREE! Moto-Shop Catalog. Write Today!
Dremel Mfg. Co., Dept. 112-L, Racine, Wisconsin

Model 571 (jig saw with disc sander)... **\$33.95**
Model 572 (all attachments shown)... **\$49.95**

158

BUY FACTORY DIRECT!

WREN by **BIRD** engineering \$99.95

Send 25c for brochure



\$10.00 Down
\$5.00 a Month
Complete with
Clinton 2 1/2 H.P.
engine, ready to run!

Bird Engineering, 206 S. 19, Dept. PM-WN Omaha, Nebr.

POOL TABLE PLANS with extra two-face top for table tennis and model railroad. Featured earlier this year in Popular Mechanics. Blueprints B1209 and building instructions, \$3.50. Popular Mechanics Service Bureau, 740 Rush St., Chicago 11, Ill.

CASTER LOOSE?

fix it quick with 

PLASTIC WOOD

Handles like putty-hardens like wood!

NOW! A REAL 6/12 VOLT BATTERY BOOSTER

Now you can own a genuine **SCHAUER** 6&12 volt battery booster at a low, low price! The Model H612 is positively not just a battery "warmer", as are so many "economy" models on the market! It delivers a full 1 1/4 amps of power at BOTH voltages, that will charge car, boat, motorcycle and lawnmower batteries. Has full-wave Selenium rectifiers... automatic circuit breaker... 6 or 12 volt selector switch... rugged steel case with handsome red finish. Money-back guarantee. Buy yours now. If your dealer can't supply, send check or money order.

Automotive Division
SCHAUER MANUFACTURING CORP.
4532 Alpine Avenue, Cincinnati 42, Ohio

ONLY \$9.95

Postpaid Model H612



Get more
GETUPANDGO
from every engine with
GUMOUT



\$1,000 CONTEST

Send picture and description of unusual use for Molly anchors and tell why you used Molly anchors. Judging will be based on skill in describing your preference for Molly anchors. Win one or more of 68 prizes. 1st prize, Molly anchors. \$500. Contest closes July 31, 1963. Write Molly Corp., Box 132, Reading, Pa., for entry blank and contest rules. Subject to all governmental regulations.

HANG FIXTURES SECURELY!



MOOLY SCREW ANCHORS

BETTER THAN NAILS & SCREWS—Molly anchors let you put fixtures where you want, not just where studs are. Spider backing reinforces area in which used. Won't pull through. **BETTER THAN TOGGLE BOLTS**—Easy to install, need much smaller hole, fixtures can be removed and replaced in same anchor! Money-back guarantee. Ask your hardware supplier for genuine Molly screw anchors... the name is stamped on the cap.

FASTEN FIXTURES TO HOLLOW DOORS WITH MOLLY JACK NUT ANCHORS

Jack Nut screw anchors need only 1/8" expansion space, grip any material 0" to 3/8" thick. Perfect for use in thin materials where nails and screws won't hold.



SEND \$1.00 FOR SAMPLE BOX OF 12

MOOLY CORP. BOX 1139-H, READING, PA.

Enclosed is \$..... for sample box of (check):

- Molly screw anchors Jack Nut anchors
 Send entry blank & contest rules

NAME

ADDRESS

CITY

ZONE

STATE

screens, upholstery, carpets...

hundreds of other uses.

You name 'em!



Swingline 101 Staple Gun

Staples practically anything. Exclusive push-button loading and built-in staple extractor. At your stationery, department or hardware store.

only **4⁹⁵**

FREE! New 8-page

SEND FOR YOURS TODAY!

"TIPS FOR TACKING" Booklet

... shows you how to save time, money and effort — with a SWINGLINE AUTOMATIC STAPLE GUN



Swingline INC.

32-00 Skillman Ave., Long Island City 1, New York

FREE EICO® CATALOG



Build your own stereo and mono hi-fi, radios, walkie-talkies, ham gear, test instruments—save 50% with famous EICO kits. No technical knowledge needed. Simple, step-by-step "Beginner-Tested" pictorial instructions guide you all the way. Choose from 108 beautiful kits. Mail coupon now!

EICO Electronic Instrument Co., Inc.
3300 Northern Blvd., L.I.C. 1, N. Y.

PM-11

Please send free catalog and name of local dealer.

Name

Address

City.....Zone.....State.....



Best Remover FOR Refinishing Furniture

Low-viscosity Klean-Strip is a free-flowing remover that peels off all furniture finishes without making a gummy mess.

Old finish stays wet and workable, can be wiped off easily. Leaves surface dry, clean, ready for new finish. Non-flammable, safe.

KLEAN-STRIP PAINT REMOVER

THE KLEAN-STRIP CO., INC.

MEMPHIS 6, TENN.—WINNIPEG, MAN.



Letters With Your Picture

Favorite snapshots of you or members of your family can now accompany your letters—and at little cost.

A rubber stamp, made from a snapshot for \$7.95, can be used to leave your personal mark on stationery, business cards, matchbooks and the like. The stamp is made by Augustine Co., Marshalltown, Iowa.



Memo Pad Holds Phone

Mounted on a wall next to the telephone, a convenient new memo pad has a bracket on which the phone can be hung if you're called away for a short time. A pencil is held magnetically above the note pad.

The unit is sold for \$4 (postpaid) by Panda Products, 1200 Niagara, Buffalo 13, N. Y. Color choices are black or ivory, and refills for the three by five-inch note pad are available.



Still a Man's Smoke!

Kirsten

POCKET SIZE, LIGHTWEIGHT

COMPANION \$3.95
POST PAID

WITH PATENTED
"RADIATOR" STEM
FOR CLEAN, COOL,
SAFER SMOKING



Kirsten
PIPE COMPANY

Write for catalog—Dept. C1, Seattle 7, Wash.

UNUSUAL TOOLS BY MAIL



DRILL GRINDER

Sharpens round Shank drills like new with hand or power grinders. \$2.95 ppd.



EASY SAW FILER

No. 11 Gives correct height, depth, pitch, bevel to any 6" to 10" hand or circular saw with no side pull. Includes 8" file. \$9.95 ppd.



No. 44 CORNER CLAMP & MITER BOX COMBINED

Adjustable to any angle. Accurate cuts with any handsaw from 0° to 180°. Full 3" capacity. Sides exposed for nailing and gluing. \$2.75. No. 33 corner clamp, only \$1.75 ppd.

SAW SET

automatically sets teeth at 10° or more \$2.95 ppd.



WRITE FOR FREE CATALOG

A. D. McBURNEY, 5908 Hollywood Blvd., Hollywood 28, Cal. Dept. A112

Winter Days are not dog days, but now Fido can have his own basement apartment with private entrance. The December issue of Popular Mechanics shows you how to suspend a doghouse from basement joists so that Fido can enter and leave by the basement window.

AUTOMATIC

MAKES NEW PROFITS

RETOOTHER

for HAND SAWS

Cuts new teeth in 50 seconds—any size 4 to 16 points. Old teeth fall off as chips. Easy to operate. A per-foot job.

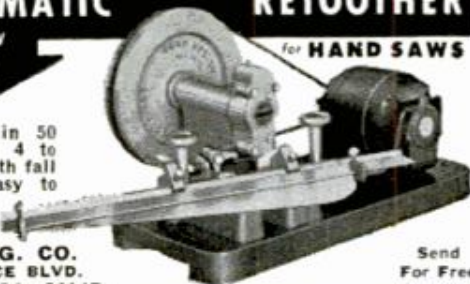

BURR MFG. CO.
8933-J VENICE BLVD.
LOS ANGELES 34, CALIF.

Send For Free Literature

ECONOMY POWERFUL!
TRACTOR

Thousands in Use!

Since 1946

UNEQUALLED LOW PRICE! TERRIFIC VALUE!

America's finest tractor. Ruggedly built. Easy to operate. 790 lbs. Borg-Warner clutch, trans. and diff. 140 to 1 reduction. 40% more drawbar pull than ordinary tractors. 9 H.P. engine. 20 quick change implements. HOOD-FENDERS.

Write for Catalog.

Engineering Products Co.
1005 K-11 Anoka Avenue
Waukesha, Wisconsin



NOVEMBER 1962

WAR SURPLUS AND OTHER BARGAINS SAVE UP TO 90%



DELUXE ELECTRIC STORAGE BATTERY WINCH

Handles 250' of 1/4" cable. Operates on 6 and 12 V. battery. 160:1 gear reduction. Lift cap. 2500 lbs. Heavy-duty mounting base with outrigger bearing and spool support. Rugged construction. Heavy-duty. Dim. 22" L. x 9" W x 8" H. For jeeps, trailers, boats, trucks, campers. Shpg. wt. 80 lbs. Approx. GOVT. COST \$490. NEW. Model E-D. \$72.50

MODEL E Same as above but without heavy-duty base and outrigger support. Spool cap. 70', 1/4" cable. NEW. \$52.50



BUILD YOUR OWN ARC WELDER, LIGHT PLANT OR BATTERY CHARGER \$39.50

Kit incl. 1 Navy NEA-5 Gen. combination AC-DC type. AC 115 V. DC 24 V.. 200-300 Amps. 2 complete generators in 1, yet no larger than reg. gen. Ideal for home, shop and farm lighting plants. Delivers 1200 Watts AC, DC side for charging batteries, welding and operating war surplus motors. Also in kit: 1 DC Voltage Reg., Reverse Current Relay, 1 Voltmeter, Rheostat, Electrode Holder, Toggle Switch, Welder's Shield, Wiring Diagram for kit. Wt. under 100 lbs. Approx. GOVT. COST \$650. Kit—\$39.50. Navy NEA-5 Gen. as above, purchased separately, \$23.50



DELCO DC GENERATOR — 12V. 50 Amp. at 2800 RPM. Pedestal mounting. Rugged, ball-bearing construction. 3/4" shaft with key and keyway. Shpg. Wt. 55 lbs. Great for trucks, busses, boats, for battery charging or wherever heavy amperage is required. Approx. GOVT. Cost \$97. NEW \$17.95



BIG NEW 1963 CATALOG!

Send 25c in coin for amazing new catalog with 1000's of surplus bargains in hydraulics, electrical, precision tools, marine items, automotive, etc. for hobbyists or industrial. Or order from this ad and receive a free copy. All prices F.O.B. Culver City, Calif. 50¢ dep. for C.O.D. Send check, cash or money order. Order today!

AIRBORNE SALES CO. INC. DEPT. PM1162

8501 Stellar Drive • Culver City, California



NO TOOL SET IS COMPLETE WITHOUT X-ACTO

X-Acto precision knives are used by skilled craftsmen on the job. They—and you, too, will—count on X-Acto's extra sharpness and perfect balance for accuracy and safety. For doing professional jobs, complete your tool set with X-Acto. X-Acto No. 82 Knife Chest contains three X-Acto knives with nine extra assorted blades in a fitted, natural-finish wood chest... \$4.50. See your X-Acto dealer, or write:

X-Acto, Inc.,
48-41 Van Dam St., Dept. R-8, Long Island City 1, N.Y.
ASK FOR X-ACTO'S NEW XMAS CATALOG OF DISTINCTIVE HOLIDAY GIFTS



HOW-TO DRIVE BRADS WITHOUT BANGING YOUR FINGERS



No 

YES

Pick up this handy tool from your local hardware, paint or building supply store. If not in stock, mail \$2.69 and we will send tool postage paid.

Hyde No. C22 Brad Driver drives and sets small finishing nails 1" long and smaller, 16 to 19 gauge. Special magnet in barrel lifts brad for driving and setting in wood. Dozens of uses for woodwork, miniatures, antiques, models, etc.

WRITE FOR FREE CATALOG

HYDE TOOLS

SINCE 1875

SOUTHBRIDGE, MASS., U.S.A.

BUILD THE FINEST TV KIT

On Easy "Pay as You Wire" Plan

Only \$15 for the Starting Package

The "PROFESSIONAL" Series TV KITS: Easy to assemble. No technical knowledge required. An ideal "Learning" Kit with a Complete Course of Study is available.

Over 50,000 satisfied users!



Also available: WIRED CHASSIS for custom installations

LEARN ELECTRONICS this interesting way

Complete a Kit—and get the finest TV performance, even in fringe areas. Has Hi-Fi Sound and latest professional quality features. 19", 23", or 27" picture tubes. Prices: from \$119 to \$199, on Easy-Pay plan.

Beautiful Cabinets available. See how EASY it's to assemble a Transvision Kit. Send \$2.00 for Assembly Manual

TRANSVISION

Grey Oaks Ave. Yonkers, N.Y.

TRANSVISION Electronics, Inc., Grey Oaks Ave., Yonkers, N.Y., Dept. PM-11

Send complete 12-page Catalog on TV Kits. Enclosed is \$15 for Starting Package. I understand that I can buy packages one at a time.

Name _____

Address _____

City _____ Zone _____ State _____

AMAZING SNOW THROWER PANZER



"Amazes me as well as my friends!"
—E. L. Mehler, St. Louis

Makes clearing snow fun instead of work. Cuts 36" path. Throws snow any direction. Rugged, maneuverable. Trouble-free Glide-Matic drive. 40" snow blade and 23 attachments for 1001 lawn and garden uses.

Ask your dealer or write for brochure
PANZER PRODUCTS, INC.
P. O. Box 1068
Waynesboro, Va.

ELECTRIC WELD - BRAZE & CUT

REPAIR MOST EVERYTHING MADE OF METAL

Home Appliances. Auto parts. Make and repair lawn chairs, tables, ornamental iron work, gates, wagons, etc. Solder, heat, bend, and straighten, with terrific heat from arc torch. Cut and weld up to 1/4" steel plate. A million uses for Home, auto, farm, inventors, factories, etc. Works from any home 110 volt plug-in. Complete with dark welder's mask, arc torch, supply of carbon steel welding and brazing rods and complete Welding Instruction Book. 1 year guarantee.



SEND ONLY \$3 (cash, ck. mo.) and pay postman \$11.95 plus we will send postpaid. COD postage on arrival or send \$14.95 and relatives. Friends. Order now. Available only from:

MIDWAY WELDER, Dept. DPM-11, Kearney, Neb.

You'll have the best outdoor Christmas display in your neighborhood if you follow the simple plans in the December Popular Mechanics. What makes them easy is "Project-A-Plan," a brand new method of full scale tracing for PM readers.

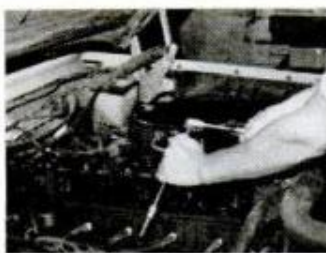

Save Time . . .
MAG-SERTS
. . . Don't swear

5 powerful magnets, sizes 3/8, 7/16, 1/2, 9/16, and 3/4, insert magnet in socket. Positively guaranteed to hold nut, washer or bolt in socket at any angle. If you can reach it with your socket extension, take it out, or screw it in. Practical, fool-proof. Set only \$1.98 postage paid. Retail salesmen wanted.

Mag-Sert, Box 301, Harrington, Wash.

FOUL WEATHER DRIVING SAFETY



RITE-OFF removes all dirt, oil and road film from windshields. One application is good for hundreds of safe driving miles. **FOG OFF** keeps inside of windshields fog free.

Regular \$2.95 Value
SEND TODAY ONLY \$1.99 POSTPAID

SCHRADER CHEMICAL CO.
(Since 1915)
P. O. BOX 426, ANTIOCH, CALIFORNIA

SURPLUS SALE

GOVT. SURPLUS
EXCESS INVENTORY
BANKRUPT STOCK



GOV'T AIR COMPRESSOR

• **Item #453.** Expensive Gov't. Compressor. G.E. motor 115-v, 60-c. Built-in air filter, relief valve, etc. Very compact and efficient.
• For paint spraying, insecticides, air brush, etc. A "Super Buy" Wt. 55 lbs. Gov't. cost over \$250. **SALE... \$19.97**
• Many other bargains in Air Compressors, Tanks.



AC-DC ELECTRIC GENERATOR

• **Item #675.** New Gov't. unit. Generates 115-v (800 cycle) AC (1200-w) and 30-v up to 200 amps DC
• Use for 115-v AC lights or stove or for DC 200-amp welder. Size 14"x8"x6"
Wt. 55 lbs. Cost over \$250. **SALE... \$15.85**



GENERATOR—3000W—115V

• **Item #633.** D.C. ball bearing compound-wound Delco unit, 1" dia. shaft, 2800 RPM. Ideal for portable tools, light, boats, etc. Will run any 115-v 2DC-AC tool. 100 lbs. Gov't. cost over \$175. **SALE... \$54.75**
Many other Surplus Power Plants and Generators.



115-V A-C GENERATORS

• Many other Surplus Plants.
• **Item #626.** Brand new 3-wire heavy duty 1,200 rpm 115-v 60-c 3000-4000-w ball bearing generator. Wt. 260 lbs. Gov't. cost over \$600. **SALE... \$139.50**

HYDRAULIC SURPLUS BARGAINS

• Great savings. Build loaders, diggers, presses, etc. Brand new equipment.
• \$95 Pump, 1000 lb., 12 gpm... **\$33.95**
• 12-v Battery Hyd. Pump, 12.5 gpm... **18.49**
• Hand Hyd. Pump System & Reservoir... **29.50**
• \$69 Hyd. Cyl. 2 1/2"x16"... **19.95**
• Hyd. 2-way 1000-lb. Valve... **18.00**

DIAL TELEPHONE

• **Item #716.** Std. phone, same used on all phone systems. Use as extension to main phone and on private systems. Directions furnished. Wt. 8 lbs. Cost \$25. **SALE... \$7.95**



AIR COMPRESSOR EQUIPMENT

• Make your own outfit. For painting, tires, shop use, etc. Save to 60%.
• Compressor, **\$21.50**. Gov't. Tank, **\$10.95**. Gauge, **\$1.75**. Paint Gun, **\$10.50**. Auto switch, **\$4.75**. Air Regulator, **\$3.95**.

STORAGE BATTERY WINCHES—HOISTS

• **Item #311.** 12-v Gov't. reversible, 1/2" I bearing 2000-lb. capacity winch. Holds 40' 1/4" cable. For trucks, docks, boats, etc. 55 lbs. Cost over \$250. **SALE... \$49.95**
Many other types battery winches—hoists.



SPECIAL OF THE MONTH!

AUTOMATIC STEPPING SWITCH

• **Item #732.** Expensive rotary stepping switch. Type used dial telephone exchanges, satellites, etc. Impulse magnet moves wiper contacts over 25 separate pairs of contacts.
• Wonderful for inter-com, private phone system, remote control, tele-metering, etc. Operates on low voltage D.C. Instructions and diagrams free. A four-star buy! 4 lbs. Cost Gov't \$35. **SALE... \$4.91**



HEALTH CHAIR MASSAGE MOTOR

• **Item #1019.** Brand new unit. Same used on expensive contour health chairs. Make vibrating chair. Useful for insomnia, aches, pains, sore muscles, etc.
• Consists of 115-v Ac motor with double eccentric weight, etc. Easy attachment to chair. Wt. 6 lbs. Size 7"x2"x4". List **\$16.95**. **SALE... \$8.99**



FOLDING WIRE REEL

• **Item #735.** Army units. Use for stringing or rolling up power wire, barb wire, etc. Compact, easy to use. Makes neat factory type coils. Fits any size coil.
• Useful for construction companies, farmers, electricians, etc. Wt. 39 lbs. Gov't. cost \$36.50. **SALE... \$9.91**



EXAMPLE BARGAINS IN 1962 CATALOG

• \$175 Gov't 12-Line Tel. Sw. Board... **\$13.29**
• \$90 Two Station Phone Inter-Com... **22.95**
• \$85 Fire-Burglar Alarm System... **12.95**
• \$16 AC-Volt meter 250-v... **7.95**
• \$52 Cathode Ray Exp. 5" Tube... **4.91**
• \$75 1 1/2" Bronze Water Pump... **19.95**
• \$40 Transformer 115 to 230 Volts—1KW... **15.61**

• Wonderful buys Surveyors Instruments—WRITE!

All Items This Ad **FREE** Send For Big New 1962 CATALOG

SURPLUS CENTER

Dept. 813, LINCOLN, NEBR.

PROTECTS TOOLS, SORTS THEM NEATLY

HUOT TOOL CHEST

Keeps tools organized. 4 sliding drawers, rugged steel Professional Style cabinet—blue or red—26" x 12 1/4" x 12 1/4". Write for FREE BULLETIN on this and 15 other models.



HUOT MFG. CO. 605 N. WHEELER ST., ST. PAUL 4, MINNESOTA MODEL 107

ONE-MAN SAWMILL LOW \$50.00 AS... DOWN

Take BELSAW Portable Sawmill right to the trees—turn out valuable lumber for home and farm—sell to local yards—make up to \$50 a day custom sawing for neighbors. BELSAW lasts a lifetime. No crew needed. Power with tractor or auto engine. Beginners get excellent results. Send today for FREE BOOK.



BELSAW MACHINERY CO
3453 Field Bldg. • Kansas City 11, Missouri

Don't read this UNLESS...

... you want a profitable hobby, a rewarding sideline, or your own full-time business. Perhaps you have seen Ornamental Concrete Items and wondered how they are made. You can make them, and in a professional manner. All you need is Molds and Knowledge. We'll sell you BOTH and you'll know what you are doing even before you start. We manufacture and sell on a direct basis the industry's best molds. Durable, Dependable, High Quality, and of Aluminum. 96-pg. "How To Turn Concrete Into Gold" includes 29 pgs. of priceless instructions for professional results. Describes and Prices over 300 molds for Bird Baths, Benches and Tables, Flower Urns, Statues, Animals, Religious Items, and many more from 2" to 68" high. It gives the full story. Order yours TODAY—Rushed to you by First Class Mail. It's only \$2.00.



No. 225 Hen Mold makes 15" High Concrete Hens. Price of Mold only \$40.00. No. 225 Chick, 6 1/2" high. Price of Mold only \$10.50. Over 300 other molds to select from.

HOW TO TURN CONCRETE INTO GOLD SEND \$2

Manufacture And Sell Your Own Ornamental Concrete Items OVER 300 DIFFERENT DESIGNS

Concrete Machinery Co., Inc.
839 Lenoir Road, N. W. • Hickory 2, N. C.

New Model 161 UTILITY TESTER® FOR REPAIRING ALL ELECTRICAL APPLIANCES MOTORS·AUTOMOBILES·TV TUBES

As an electrical trouble shooter the Model 161

- Will test Toasters, Irons, Broilers, Heating Pads, Clocks, Fans, Vacuum Cleaners, Refrigerators, Lamps, Fluorescents, Switches, Thermostats, etc.
- Will test all TV tubes (including picture tubes) for open filaments and burned out tubes.
- Measures A.C. and D.C. Voltages, (both 110 Volt and 220 Volt lines).
- Will measure current consumption (amperes) while the appliance under test is in operation.
- Incorporates a sensitive direct-reading resistance range which will measure all resistances commonly used in electrical appliances, motors, etc.

As an Automotive Tester the Model 161 will test:

- Both 6 Volt and 12 Volt Storage Batteries • Generators
- Starters • Distributors • Ignition Coils • Regulators • Relays
- Circuit Breakers • Cigarette Lighters • Stop Lights • Condensers • Directional Signal Systems • All Lamps and Bulbs
- Fuses • Heating Systems • Horns • Also will locate poor grounds, breaks in wiring, poor connections, etc. **\$22.50**

Model 161 comes complete including 56-page book... Only **SEND NO MONEY WITH ORDER—PAY POSTMAN NOTHING ON DELIVERY**

Try it for 10 days before you buy. If completely satisfied then send \$5.00 and pay the balance at the rate of \$5.00 per month until the total price of \$22.50 (plus small P.P. and budget charge) is paid. If not completely satisfied, return to us, no explanation necessary.

ACCURATE INSTRUMENT CO., INC.
Dept. B-223, 911 Faile St., New York 59, N. Y.
Please rush Model 161. I will pay on terms specified. Otherwise I will return tester.

Name _____
Address _____
City _____ Zone _____ State _____

All prices net, F.O.B., N.Y.C.

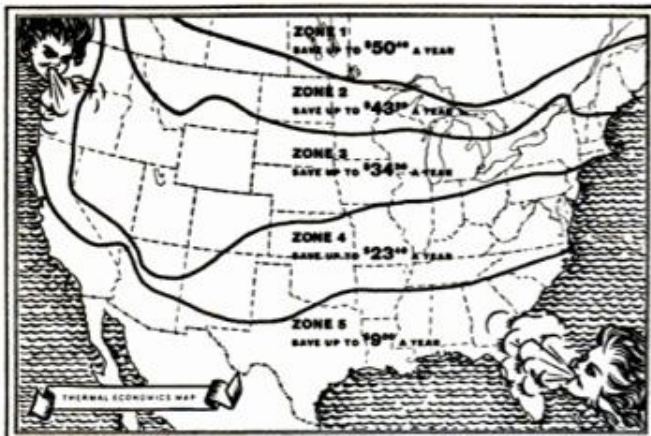

FIND YOUR WEATHER ZONE

See how much you can save on your heat bill this winter by bringing attic insulation up to the 4-inch level with Zonolite

Seven out of ten home owners pay heat bills that are way too high, because they don't have enough attic insulation. With four solid inches of attic insulation you can enjoy substantial savings (see map) every year. You just pour Zonolite, level it and leave it. Bring your attic insulation up to the four inch level now. Get Zonolite this weekend at your lumber or building supply dealer.

ZONOLITE

ZONOLITE COMPANY, 135 S. LA SALLE STREET, CHICAGO 3, ILLINOIS

Magna-Lite

Magnetic Base
SHOP LIGHT

puts the light
where it's needed!

45 lb. pull permanent Alnico V magnet base holds the light on machines, pipes, under car hood — on any ferrous metal surface. Ball-swivel allows full adjustment of light.

Complete with 5" spun aluminum spot-type reflector, 8' oil resistant GE cord. **\$6⁹⁵**

Each, Postpaid
Send Check or Money Order to
DeMambo Laboratories Mayville, N. Y.



PLANER • MOLDER • SAW!



Now you can use this ONE power-feed shop to turn rough lumber into moldings, trim, flooring, furniture... ALL popular patterns. RIP... PLANE... MOLD... separately or all at once with a one HP motor. Use 3 to 5 HP for high speed output. Low Cost... You can own this power tool for only \$30.00 down payment.

Send postcard today for complete facts.
BELSAW POWER TOOLS, 903 Field Bldg., Kansas City 11, Missouri



You have a use for

SPRAY PAINT

In Ready-to-Use Aerosol

IF YOU PRIZE IT... KRYLON-IZE IT!

FREE AMAZING NEW BOOK "HOW TO ANSWER ADS"



Never before have you seen anything like this. Tells you in simple language the correct way to answer ads. Gets you quicker replies—better results, and greater satisfaction. Will save you time and money and it's ABSOLUTELY FREE. No obligation whatever. Every reader of advertising should have this booklet. Send a postcard for your copy NOW. F. W. JOHNSON, Popular Mechanics Magazine, 740 Rush St., Chicago 11, Ill.

SHOOTS A STAPLE WHEREVER YOU'D DRIVE A NAIL!

ALL-PURPOSE
STAPLE
GUN



ARROW FASTENER COMPANY, INC. 1 Junius St. • Brooklyn 12, N. Y.

Works in seconds!



Loosens Rusted Bolts nuts, screws, "frozen" parts!

LIQUID WRENCH

SUPER-PENETRANT

The super-penetrating rust solvent that quickly loosens rust and corrosion.

AT ALL HARDWARE AND AUTO STORES

RADIATOR SPECIALTY COMPANY CHARLOTTE, N. C.



A FINE CHRISTMAS GIFT FOR YEAR 'ROUND ENJOYMENT



WELD FOR PLEASURE OR PROFIT TRINDL INDUSTRIAL ARC WELDER

Own a Trindl 125 Amp Industrial Welder at less than smaller machines. Welds metals to 1/2" thick. Operates off properly wired 110 or 220 volt line. 16 heat stages from 20 to 125 amps. Make, repair anything of metal in the home, garage, farm or shop. No experience or training needed. Full "do-it-yourself" instructions. Guaranteed 12 months in continuous operation. Complete only \$98.50 FOB or write for details on 125A and other Heavy Duty Trindl Welders. Dealer Inquiries Invited.

Trindl Products, Ltd., Dept. T2-M 1807 S. Clark St., Chicago 16, Ill.



EASY TERMS
\$98.50 FOB

FREE
Write for
Details and
Easy Pay Plan

More Gravity May Shrink Man

Research on mice indicates that if and when man moves to a larger planet, the increase in gravity may reduce his size.

Tests at the State University of Iowa show that, while man might actually weigh more because of the added gravity, his waistline would shrink and his children's growth would be stunted.

The mice were placed in cages that spun continuously at high speeds, producing gravitational forces from four to seven times normal. They adjusted to this life easily, some of them living their entire lifespan, from birth to old age, within the cages.

Predict Pocket-Size Computer

Businessmen may soon be able to carry computers around in their pockets to make lightning-fast calculations while away from their desks or offices.

The prediction is based on the recent development of a portable computer the size of a small suitcase, 18 by 12 by 20 inches, which can make calculations previously available only on giant computers.

Called SkeduFlo, the suitcase-size machine was introduced at a recent engineering convention by Dr. John W. Mauchly, co-inventer of Univac, the first commercial electronic computer.

PROJECT-A-PLAN FOR CHRISTMAS

And dress up your house with one of five Christmas costumes in as many different themes. What makes it easy is PM's Project-A-Plan system that shows the pattern right on the panelboard for full scale tracing. Look for all of this in

DECEMBER POPULAR MECHANICS

NOVEMBER 1962



Starrett TOOLS

the perfect gift

CRAFTSMEN
for MECHANICS
HOBBYISTS

The man or boy who loves fine tools always welcomes STARRETT tools. Choose the perfect gift for handyman, mechanic, skilled craftsman or hobbyist from more than 3000 STARRETT items — at hardware tool stores or industrial distributors.



STARRETT TOOL CHESTS
Mechanics' tool chests in wood or metal — available with or without Starrett tools.



STARRETT MICROMETER
No. 436 0-1"



STARRETT COMBINATION SQUARE
No. 11 12" blade



**STARRETT DIAL INDICATOR
POCKET GAGE**
No. 1010 Range 0- $\frac{1}{8}$ "



STARRETT TOOLMAKERS' HAMMER
No. 815
with magnifying glass

3,000 GIFT IDEAS Ask your Starrett distributor to show you the many gift-worthy items in the complete line of Starrett tools — or write for free Catalog No. 27. Use the coupon.

STARRETT TOOLS are carried by leading Industrial Supply Distributors and Hardware Tool Stores.

THE L. S. STARRETT COMPANY
Dept. AP, Athol, Massachusetts

Please send my free copy of Catalog No. 27 describing over 3,000 Starrett tools for professional and amateur craftsmen.

Name.....

Occupation.....

Address.....

City.....Zone....State.....





SPOTLIGHT ON THE **ALFA ROMEO 2600**

By Jim Whipple

IN A DAY when the roads are clogged with pseudo sports cars—sheep in wolves' clothing if you will, gussied up with fake wheel-spinners and imitation bucket seats done in imitation leather—it is indeed refreshing to drive a real one.

For indeed, Alfa Romeo's 2600 Sprint turns out to be an Italian wolf in sheep's clothing—the genuine article wrapped up in a neat, but not gaudy, package. At first glance, it looks like a well-finished economy car about the size of a Corvair Monza.

But appearances can be deceiving. Stand on the throttle for just 30 seconds and you'll put 11 out of 12 make-believe sports cars in your rear view mirror while the neat, white pointer on your speedometer dial comes to rest just below 130-mph.

To put the 12th car behind you, just wait for a narrow, winding, blacktop road and

you'll find yourself walking away from him with at least a 20-mph advantage.

Only the Corvette, and others of its breed, can lose you and they'll do it only by virtue of more powerful engines. The Alfa 2600 is a true sports car and handles as such a vehicle should. We didn't believe that it could be a full-fledged sports car at first, because it seemed too roomy and lavishly appointed. To top it all, who ever heard of a sports car with power windows?

It just doesn't seem natural for a car as comfortable as the Alfa 2600 to handle as well as it does. The interior is cloth upholstered with carpeting on the floor. Front seats are almost like armchairs taken from someone's living room. The foam padding, however, is properly firm and the seat backs are adjustable so that drivers of almost any size find a fatigue-free position.

PLAIN JANE look is a fooler in the sleek 2600 coupé. Its flat hood hides three carbs, 145 horses





**WHO
SAYS
YOU
CAN'T
WIN
'EM
ALL
?**

JULY 4: USAC PIKES PEAK AUTO HILL

- Sports cars 0.2000 cc CLIMB**
 1st—Ak Miller
Sports cars above 2000 cc
 1st—Bob Donner
Stock Cars Division
 1st—Curtis Turner
 3rd—Parnelli Jones
 5th—Gayle Warren
 7th—Bob Betts

**JULY 4: GRAND NATIONAL NASCAR
FIRECRACKER 250**

- 1st—Fireball Roberts 4th—Jack Smith
 2nd—Junior Johnson 5th—Jim Pardue
 3rd—Marvin Panch 6th—Larry Frank

**JUNE 10: A. H. R. A. CHAMPIONSHIP &
NATIONAL RECORD DRAG MEET**

- | | |
|--------------------|-------------------|
| Top Gas Eliminator | Middle Eliminator |
| Top Time Fuel | Little Eliminator |
| Top Time Gas | Street Eliminator |
| Low E. T. Gas | |

JUNE 10: ATLANTA 500*

- 1st—Fred Lorenzen
 2nd—Banjo Matthews
 3rd—Bobby Johns
 4th—Fireball Roberts
 5th—Troy Ruttman
 6th—Paul Goldsmith
 8th—Marvin Panch
 9th—Junior Johnson
 10th—Jim Paschal
 *Race halted by rain after 327 miles.

MAY 30: INDIANAPOLIS 500

- 1st—Rodger Ward, 140.293 mph. new record
 2nd—Len Sutton
 3rd—Eddie Sachs

MAY 27: CHARLOTTE WORLD 600

- 1st—Nelson Stacy, 125.552 mph. new world's record
 2nd—Joe Weatherly
 3rd—Fred Lorenzen

MAY 12: DARLINGTON REBEL 300

- 1st—Nelson Stacy
 2nd—Marvin Panch
 3rd—Fred Lorenzen
 4th—Jack Smith (John Allen)
 5th—Cotton Owens
 6th—Larry Frank
 8th—Bobby Johns
 10th—Jim Pardue

FEB. 3—FEB. 25: DAYTONA SPEED WEEKS

- Daytona 500
 1st—Fireball Roberts, 152.529 mph. new world's record
 Daytona Continental
 1st—Dan Gurney
 250 Mile Modified National Championship
 1st—Lee Roy Yarbrough, 146.723 mph
 First 100 Mile Stock Race
 1st—Fireball Roberts, 156.999 mph. new world's record
 Second 100 Mile Stock Race
 1st—Joe Weatherly

Give your car the checkered flag. Install a set of Autolite Power Tip spark plugs. They actually clean themselves while you drive.

SPARK PLUGS • BATTERIES • SERVICE PARTS
 **AUTOLITE**
 THE NAME TO REMEMBER WHEN YOU CARE FOR YOUR CAR

STOP WATER DAMAGE...



Wood
Plywood
Shingles
Asbestos siding
Concrete blocks
Concrete
Mortar
Stucco
Linoleum
Plaster
Brick
Paint
Wallboard
Tile
Canvas
Leather
Fabrics

Prevents warping, swelling, mildew, mold, water stains, seepage, dampness, rot.

Keeps moisture out 5 years and longer.

Use on all woodworking jobs, boats, patio furniture, planter boxes, shutters, screen doors, window sash, shingle roofs. Stops seepage in basement walls, concrete silos, foundations. Waterproofs canvas, tarps, tents, awnings, leather boots, shoes, outdoor clothing. Won't harden or crack leather or fabrics. Perfect underseal for oil base or alkyd paints. Deep penetrating, colorless. Apply by brush, spray or roller. At paint or hardware stores or order direct. 16 oz. spray can \$1.89, Qt. \$1.75, Gal. \$5.35, 5 Gal. \$25.25, ppd., tax incl. Send check or money order to E. A. Thompson Co 1355 Market St., San Francisco 3, Calif. No COD's please. (Since 1929.) Dealer and jobber inquiries invited.

**FREE
FOR
'63**

LAFAYETTE RADIO ELECTRONICS

1963 CATALOG
NO. 630

388 GIANT SIZE PAGES

The Largest Catalog in
our 42-Year History

It's New—It's Big—
It's Better Than Ever

It's from the "World's Hi-Fi
& Electronic Shopping Center"

Here it is—the exciting, all-new 1963 Lafayette Catalog. 388 giant sized pages—everything in hi-fi and electronics for the audiophile, technician, hobbyist, student, engineer and serviceman. Thousands of items at lowest prices.

Now—buy the Easy Way with Easy-Pay.
No money down . . . up to 24 months to pay.

LAFAYETTE LOCATIONS

SYOSSET • JAMAICA • NEW YORK CITY • BRONX • SCARSDALE
NEWARK • PLAINFIELD • PARAMUS • BOSTON

MAIL THE COUPON FOR YOUR FREE CATALOG

Lafayette Radio, Dept. LK-2
P.O. Box 10, Syosset, L. I., N. Y.

Rush My FREE 388 Page 1963 Lafayette Catalog

Name _____

Address _____

City _____

Zone _____

State _____

The rear seat is a bench type with a center arm rest that folds down. It will hold two adults if their legs aren't too long, or three children if they aren't big ones. Headroom is good both front and rear, thanks to a longer roof-line or greenhouse that gives the coupe a side view much like a sedan's.

Driver vision is excellent through the steeply sloped, moderately wrapped windshield, and down over the short hood. Windshield wiper action is good, and after you interpret the mysterious Italian "directions" on the heating and ventilating control knobs, you can get excellent demisting or defrosting. In fact, there's even an effective demisting setup for the rear window.

All this comfort was built into the car for a good reason: the Alfa is a real road car in which you'd find a 600-mile day's drive a lot less tiring than in most conventional non-sports cars.

For one thing, noise level is low. Although the 145-horsepower, six-cylinder engine is a high-performance job with dual overhead camshafts, it is not at all noisy.

We found cruising at 100 m.p.h. or so would be practical if highway conditions permitted it. Engine vibration is not noticeable thanks to excellent workmanship, seven main bearings, and well-designed rubber mountings.

Having recently "discovered" the four-speed floor shift, some Americans may be baffled by the Alfa's five-speed, synchromesh transmission. The car has a rear axle ratio of 4.13 to 1 and a short-stroke engine (3.27x2.85) of only 150 cubic inches. In a 2700-lb. car, this means that five gears are needed to provide pulling power at 5 m.p.h. on a snow-clogged driveway, or up to a comfortable 120 m.p.h. on the flat straights. In third, for example, you can idle through traffic at 10 m.p.h. or blast up to 65 m.p.h. The traditional 0-60 acceleration takes but 10 seconds, and you can reach 100 in 23.5. Fifth gear is an overdrive (0.79 to 1) which permits you to ghost along the turnpikes at 70, ticking off better than 25 miles for each gallon of fuel you burn.

Alfa's brakes match the stopping to the going with caliper discs up front and drums on the solid rear axle. A heavy pedal foot isn't necessary, either.

Ride is firm, and thus free from swaying or pitching, yet there's never harsh, objectionable jiggling on rough surfaces.

At just under \$6000 complete, the Alfa 2600 Sprint is not everybody's budget cupcake. But for anyone who's about to spend that kind of money for a "sporty" U. S. bucket seater, the 2600 will give him all the comfort of the former plus race-bred abilities that the other one can't touch.

"SEE **Black & Decker**[®] - FIRST!"

It makes a lot of sense. Getting to be No. 1 in the power tool business just didn't "happen." When you buy Black & Decker—for Christmas or any time—you get more value for your money.

Did you know that Black & Decker makes hundreds of *different* types and models of power tools for every use and user? Both electric and air — portable and stationary?

You can buy a superb ¼" Drill for well under \$16.00. Or a 1¼" Magnetic brute that weighs over 108 pounds—over 50 drills in all.

Are you looking for the best Radial Arm Saw on the market? Stop looking. The Black & Decker DeWalt Power Shop sets the pace for performance, power—and *pleasure*.

There's a tiny Black & Decker Master Power Grinder that's only *half* the length of an ordinary pencil—powered by air! Or a huge Super Hammer that crushes concrete walls like egg shells. Or Saws that cut under water.

Black & Decker is No. 1 in power tools for both home and industry.

That's important to *you*—because Black & Decker puts *know-how* into its tools that nobody else can touch. Testing metals for a Sabre Saw that can cut a house in half, for example, pays off in better performance for a Jig Saw you'd use to cut a valance at home.

What's more, there's a *quality guarantee* behind every Black & Decker tool. But should any tool ever need repair, you can count on factory trained men at over 100 conveniently located Service Branches and Stations to do the job right.

Yes, it makes sense to see Black & Decker—*first*. That means you get the widest choice—the finest features—the fullest value—and the surest satisfaction in power tools.

On the next pages are a few excellent suggestions. Go ahead and browse! And then see your Black & Decker, DeWalt, and Master Power Dealers. You'll find them by looking in the Yellow Pages under "Tools — Electric" and "Tools — Pneumatic." And—Merry Christmas!





BIGGEST SAW VALUE—saw for saw, dollar for dollar. This 6½" Utility Saw weighs 10½ pounds and every ounce is muscle. You get the power, rugged construction, handling ease and job accuracy that has made the name Black & Decker famous the world over—plus all the modern safety and operating features. Get or give a *real* saw: Black & Decker! \$49.95 and up.

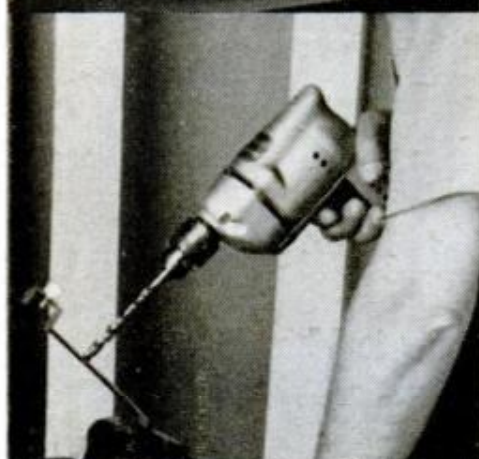

¾" DRILL—LOW PRICE TAG! This is no "warmed over" ¼" drill. It's a ¾" drill clear through with true double-reduction gears for extra power, terrific stamina. Drills up to ¾" holes in steel; ¾" in wood; ½" in masonry; 1½" Hole Saws. B&D's ¾" Utility Drill is a totally superior tool in its price range. Costs only \$26.95. Thirty-one other drills from \$16.00.

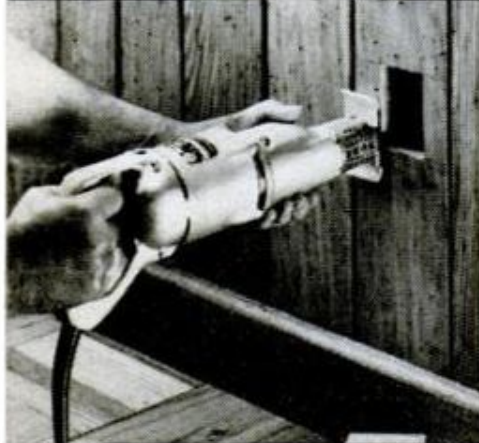

CUT OUT ANY POCKET—in any corner in any material with this super-powered Black & Decker Sabre Saw. Cut wood, plaster, metal pipe and sheet. Cut easy. Cut fast. Cut up, down, sideways—the blade spindle turns 90° to 180°. Long 1" stroke. Rock'n'lock shoe. Safeguard blade guide for up-front control. It's a brute for work on any job. See it soon.



TOP TORQUE IN SIX SECONDS! Black & Decker's Heavy-Duty Electric Impact Wrench (½" bolt capacity) packs more power and performance per pound than anything in its class. Drives home—or removes—nuts, bolts, cap screws or lag screws pronto. Get a free demonstration—or facts about electric and air impact tools. Call your Black & Decker jobber.

**DEWALT
15
POWER
TOOLS
IN ONE!**



1. Radial Power Saw



2. Saber Saw



3. Jointer



4. Drum Sander



5. Shaper



6. Surfacer



7. Disc Sander



8. Router



9. Horizontal Drill

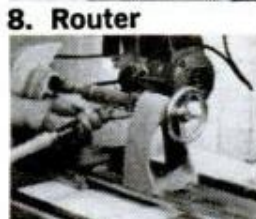

10. 12" Lathe



11. Dado Saw



12. Tilt Arbor Saw

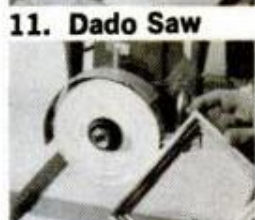

13. Buffer-Polisher



14. Metal Cutter

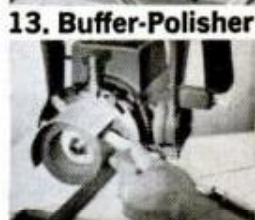

15. Grinder

"HOW TO CHOOSE AND USE POWER TOOLS," a highly practical, informative 180-page book for only 25c. Write to: The Black & Decker Mfg. Co., Dept. D-112, Towson 4, Md. In Canada: Brockville, Ont.

You name it—



Build a hutch cabinet . . . hobby room . . . or complete house.

THE NEW DEWALT POWER SHOP PUTS WOODWORKING MAGIC AT YOUR FINGERTIPS!

No other radial saw on the market performs like a DeWalt—for operating ease, accuracy of cuts, unlimited flexibility, professional results. And this new DeWalt is a *beauty!* New styling. New up-front controls. New features. Why, you can save hundreds of dollars in power tools, repair bills, modernization costs with a DeWalt.

Minute-magic changeovers give you 15 power tools in *one*. For example, check the numbers

on that hutch above against the pictures of the DeWalt in *action* on the left. DeWalt does everything—sawing, sizing, boring, jointing, da-doing, shaping, sanding, curve work, routing, grinding, buffing, turning, surfacing, polishing—and *more*.

Ask your dealer for a demonstration. Or write for an eye-opening 16-page booklet—free—to: DeWalt, Inc., Dept. BH-361, Lancaster, Pennsylvania.



Black & Decker® has it!

Tastes great because the tobaccos are!

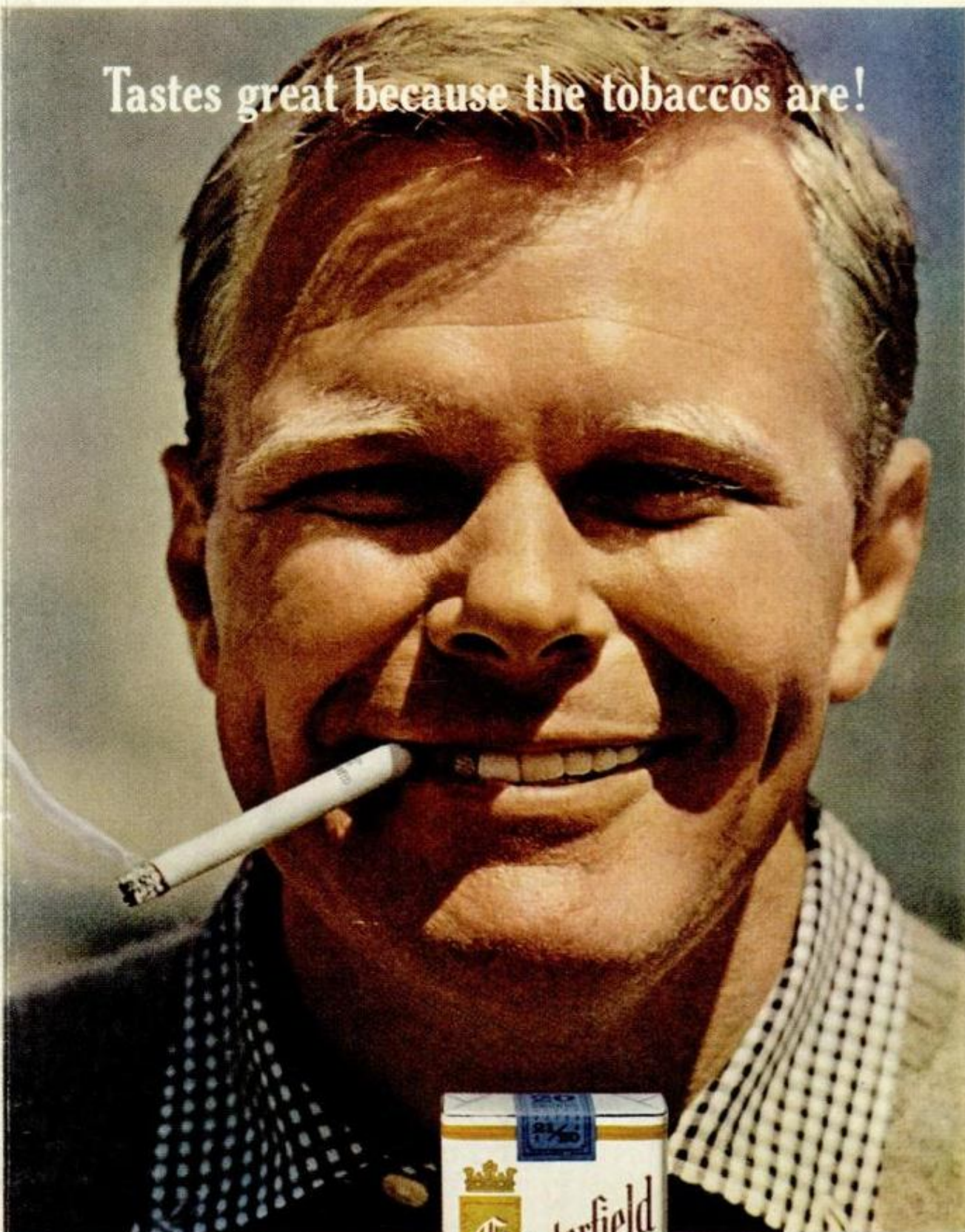

**21 GREAT TOBACCOS MAKE
20 WONDERFUL SMOKES!**

Vintage tobaccos grown, aged, and blended mild... made to taste even milder through the longer length of Chesterfield King.

CHESTERFIELD KING

TOBACCOS TOO MILD TO FILTER. PLEASURE TOO GOOD TO MISS



FOR A
GENTLER,
SMOOTHER
TASTE

ORDINARY CIGARETTES

ENJOY THE
LONGER
LENGTH OF
CHESTERFIELD
KING

CHESTERFIELD KING

The smoke of a Chesterfield King mellows and softens as it flows through longer length... becomes smooth and gentle to your taste.