

How Valid Are Those IQ Tests?

POPULAR MECHANICS

OCT. 1962
35 CENTS

THE '63 CARS! <sup>H.M. 1-2-2
6203</sup> Longer and Livelier:
How Much Better?

Buick Riviera

Plymouth

Ford Fairlane



Five Ways to Bend Wood

Build an Electric Accordion-Organ

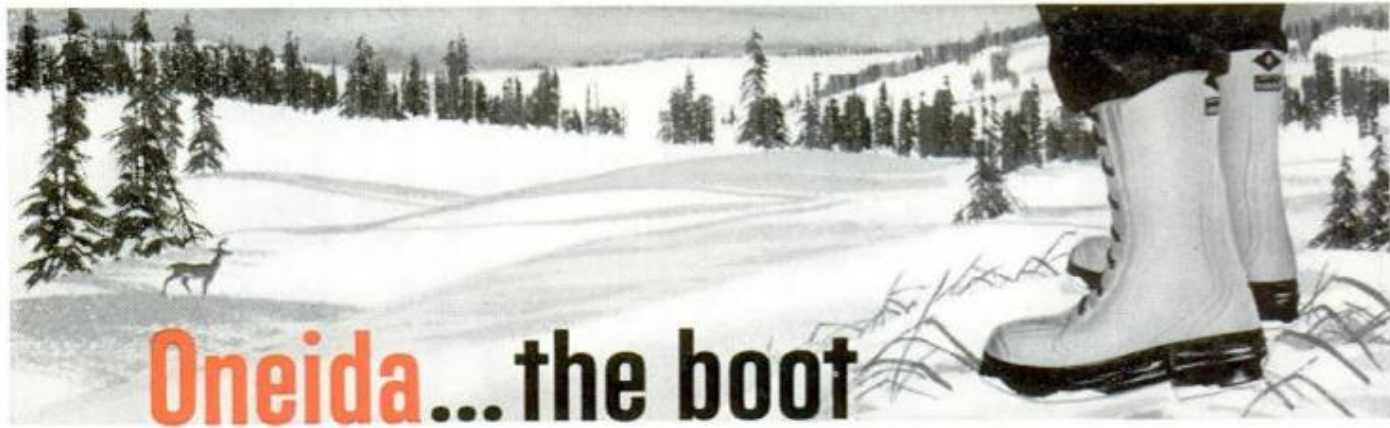

Oneida...the boot

with all 8 field proven features



1. Self Cleaning Gusset. Prevents trapping of dirt and moisture. Opens wide for easy cleaning.

2. Rust-Proof Eyelets. Tough non-corrosive aluminum eyelets securely anchored for snug lacing.

3. Thermo-Ply Insulation. Shuts out cold, won't absorb moisture even if snagged. This famous sealed unicellular insulation wraps the entire foot in protective warmth. Lets you hunt the coldest day in comfort.

4. Heavy Net Lining. Top quality net lining

wears and wears, never loosens.

5. Cushion Insole. Full-length cushion insole absorbs shock, gives all-day walking comfort.

6. Rigid Steel Plate. Gives extra support, protection at arch for all-day walking comfort.

7. Cleated Sole and Heel. Husky sharp-edged cleats give better traction, safer footing, longer wear.

8. Felt Mid-Sole. Thick felt mid-sole insulates against frozen ground, provides maximum foot comfort.

New! Hunting Guide Book. Packed with useful information to help you get more hunting enjoyment. Get your copy now at your Red Ball Footwear dealers or write: Ball-Band, Mishawaka, Ind. Enclose 10¢ to cover handling, mailing.



Red Ball Oneida
for sportsmen

by Ball-Band, Mishawaka, Indiana

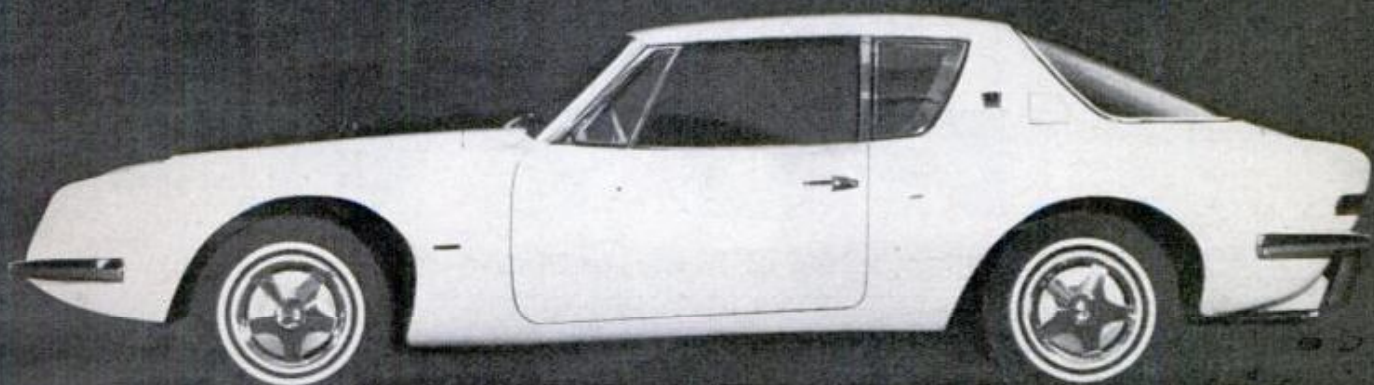

Studebaker's dramatic new Avanti comes equipped with silvery-plated Champions

Twice as many of the world's car manufacturers, including Studebaker, specify Champion spark plugs because Champions have no equal for quality and performance. Why settle for less in your car?



CHAMPION

Two simple exercises that can add years to your life



PUSH

This evening, while at home, get into your car and push the brake pedal. Have someone in your family make sure both your stop lights are working. If one is out, replace it tomorrow. You'll make it easier for the other driver—safer for yourself.



PULL

Then pull the light switch. Make sure all your headlamps (don't forget the upper beam) and your rear lights are working. And while you're at it, check your turn signals. These Push-Pull exercises will do you good—especially if you find a burnout. It's very possible you will—because one out of every six cars needs a new bulb.

When you find a burnout, replace it with a dependable General Electric lamp, the brand most people prefer.

Miniature Lamp Dept., Nela Park, Cleveland 12, O.



Progress Is Our Most Important Product

GENERAL  ELECTRIC

KEEP YOUR SHOP OPEN AFTER STORES CLOSE

Stock your workshop
with a Weldwood
Fix and Finishes Shelf



TACKLE TOUGH CHAIR REPAIRS with Weldwood Plastic Resin Glue. Makes joints stronger than the wood itself. Combines great water resistance with high strength for permanent load-bearing bonds.

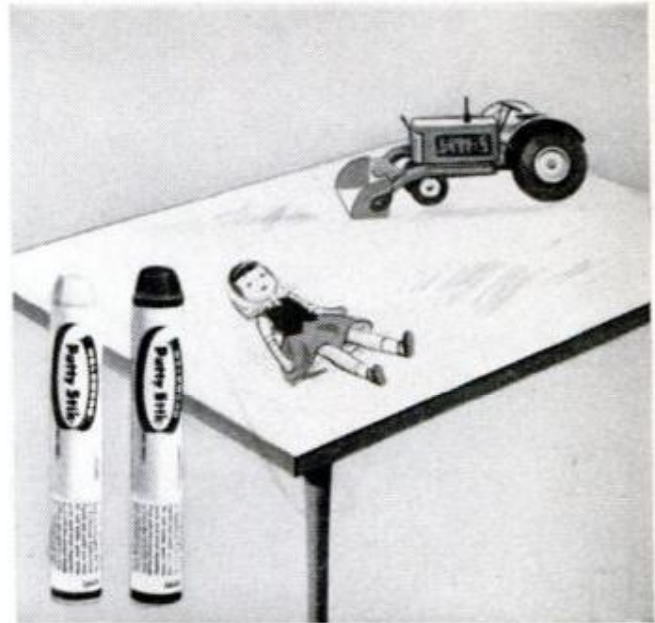

ERASE SCRATCHES AND MARS with Weldwood Putty Sticks®. Fill nail holes or repair any minor imperfections in finished paneling or furniture. Available in a wide variety of colors.



REVITALIZE FINISHES. Remove all wax, sand lightly, wipe on Weldwood Deep Finish Firzite®. Presto! On new work, use it for an effortless low luster Danish-type finish with a hand-rubbed effect.

How many times have you put off jobs because you've been out of a material—and the stores are closed? It's irritating and time wasting. Make full use of your time this Fall and Winter. Be ready to work when you have the time and the inclination. Stock up on the products featured here (especially Deep Finish Firzite, which you'll need also as a sealer for perfect paint jobs). You'll find them at your local lumber dealer's, at paint and hardware stores. Get them now!



Products of United States Plywood

POPULAR MECHANICS®

OCTOBER 1962
VOL. 118 NO. 4

INTERNATIONAL EDITIONS • SPANISH: Mexico-Caribbean, Southern Hemisphere • FRENCH

Features of Special Interest

The Longer Livelier '63s	87
Tom Thumb Plants	104
Does Anyone Know What IQ Means?	113
Tips on Decoys	122
They've Tamed the Power of Volcanoes	126
PM Shopping Guide: Dishwashers	130
Tractor Jack Stamped!	140

For the Craftsman

Convert Your Accordion Into An Organ	142
Home-Made Movie Fun With a Zoetrope	150
Play-Furniture From Sweden	152
Halloween Capers	158
Winter Store Your Mower	163
When Your Car Quits	178
Fix-It File: Electric Blender	182
Decoy Tote Coat	185
Prepare Your Outboard NOW	186
Put a Bend in Wood	192
Shoulder-Hung Shop Vacuum	199
Stereo Preamp for Magnetic Pickups	204

Address communications to: 575 Lexington Ave., New York 22, N. Y. **SUBSCRIPTION SERVICE:** Mail all subscription orders, changes of address, correspondence concerning subscriptions, and Postmaster notices of undelivered copies to Popular Mechanics, 250 West 55th St., New York 19, N. Y.

Published by Popular Mechanics Company, RICHARD E. BERLIN, *President*

DON DINWIDDIE
Editor

RICHARD E. DEEMS
Executive Vice-President

JOSEPH R. BUELL, JR.
Publisher

Executive Editor: RICHARD F. DEMPEWOLFF

Managing Editor: JOHN A. LINKLETTER

Assistant Managing Editor: WAYNE C. LECKEY

Midwest Editor: CLIFFORD B. HICKS
740 N. Rush St., Chicago 11, Ill.

Western Editor: THOMAS E. STIMSON
Suite 1003, 3460 Wilshire Blvd., Los Angeles 5, Calif.

Art Director: HENRY M. NEHRBASS

Automotive Editor: JAMES R. WHIPPLE

Associate Editors: KEVIN V. BROWN, W. CLYDE LAMMEY,
ALFRED W. LEES, ARTHUR MIKESSELL

Electronics Editor: BYRON G. WELS

Assistant Editors: STUART JAMES, JOHN P. MCNEEL,
ED NELSON, JOHN L. SCHERER

Art Editor: MURRAY COOPER

Assistant Art Director: LEO WEEKS

Chief Photographer: FRANK P. FRITZ

Editorial Assistant: JOHANNA L. PUGNI

International Editor: HEINZ P. SCHLICHTING
Ritterstrasse 26, Karlsruhe/Bd., Germany

Advertising Director: L. PARK BENJAMIN

If you wish additional sources of information for the articles in this issue, or if you wish the name and address of the manufacturer of a particular product shown here, write to Bureau of Information, Popular Mechanics, 575 Lexington Ave., New York 22, N.Y. Ask for the free "Where-to-Find-It-List" for this issue.



**Tricky
Decoys page 122**

DANISH • SWEDISH • GERMAN • PORTUGUESE • DUTCH

Departments

Over the Editor's Desk - - - -	10
Science Overseas - - - -	14
Tune In on the Inventors - - -	16
Science Bulletins - - - -	22
Items From All Outdoors - - -	24
Sidelights on Aviation - - - -	26
Pentagon Sidelights - - - -	34
Worth Writing For - - - -	44
Detroit Listening Post - - - -	78
What's New for Your Home - - -	136
Solving Home Problems - - - -	148
Clinic for Homemakers - - - -	210
Shopping for Tools - - - -	248
On the Market - - - -	256



**Tractor
Jockeys
page 140**



**Zoetrope
Movie
page 150**

Next Month . . .

TORTURED TOYS are what you get when **25 kids move in on a roomful of the toy industry's hottest ideas** for Christmas, 1962. That's what became of 145 entries in PM's toy contest. When the kids and the judges were through, we knew which toys held most appeal, which were built to last, and a few other things. Find the results in November PM, plus 10 Christmas projects, plans for a basement shooting range, features about antique airplane buffs, "thinking factories" and "How Can We Store Human Knowledge?"

NOTE OUR NEW ADDRESS!

ADVERTISING OFFICES—New York: 575 Lexington Ave., MUrray Hill 8-8500; Chicago: 740 N. Rush St., WHitehall 4-0100; Detroit: General Motors Bldg., TRinity 5-8711; Cleveland: Hanna Bldg., 1422 Euclid Ave., PRospect 1-0456; Los Angeles: 3460 Wilshire Blvd., DUmkirk 2-8458; San Francisco: 111 Sutter St., YUKon 2-0823.



**Bending Wood
page 192**

Published monthly by Popular Mechanics Company, 575 Lexington Ave., New York 22, N. Y. Richard E. Berlin, President; Richard E. Deems, Executive Vice-President; Fred Lewis, Vice-President and General Manager; John R. Miller, Vice-President; Joseph R. Buell, Jr., Vice-President; G. O. Markuson, Treasurer; R. F. McCauley, Secretary. Single copy in the United States and Canada, 35 cents. Subscription prices: United States and Possessions, \$4.00 for one year; \$7.00 for two years; \$9.00 for three years. Canada, add \$0.50 for each year. Pan-American Postal Union countries, add \$1.00 for each year. All other countries, add \$2.00 for each year. If you plan to move, notify us at least 30 days in advance so you will not miss an issue. Give both your old and new addresses. Second-class postage paid at New York, N. Y., and at additional mailing offices. Authorized as second class mail by the Post Office Department, Ottawa, and for payment of postage in cash. Registered as Second Class Matter at the Post Office at Mexico, D.F., Mexico, June 20, 1950. © 1962 by Popular Mechanics Company. All rights reserved. Printed in the United States of America.



**Razor Blade Radio
page 203**

This One



1N40-BHY-DT75

THESE 1963 MERCURY OUTBOARDS ARE NEW

... to everyone except our engineers (who have spent years crafting these precision engines), our test drivers (who have proved them out over a million miles at Lake X, Florida), and our factory-trained dealers (who are anxious to show you how the '63 Mercs can give you more RUN for your money). See your Mercury dealer soon. He's listed in the Yellow Pages.

The finer facts for outboard buffs: New weedless water pickup/anticorrosion trim tab for salt-water protection/fixed-jet carburetion/Jet-Prop exhaust/low-level water pump for easier service/Power-Dome combustion chambers/balanced manifold system/heavy-duty alternators/long and short shaft for 15" or 20" transoms available on all models/die-cast, one-piece lower unit housings/single-lever control of throttle, forward, neutral, and reverse/complete selection of props for any power need.



©1962, Kiekhaefer Corporation, Fond du Lac, Wisconsin

A subsidiary of BRUNSWICK CORPORATION

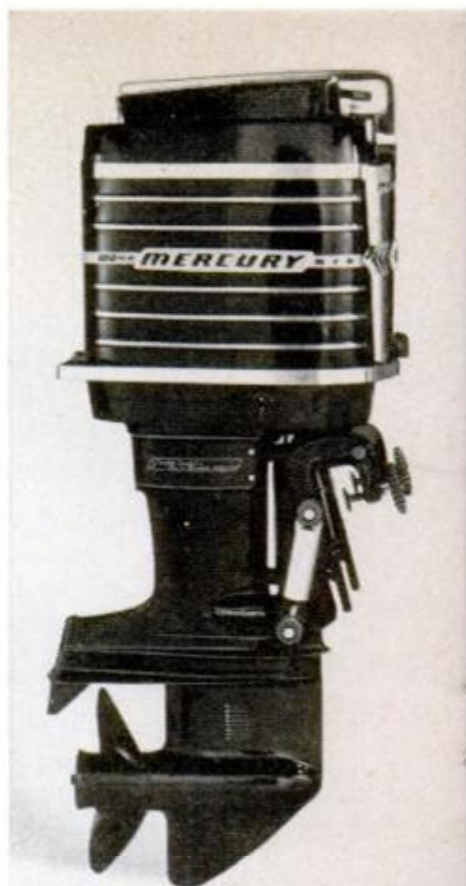

NEW MERC 1000: 6 CYLINDERS, 100 HP

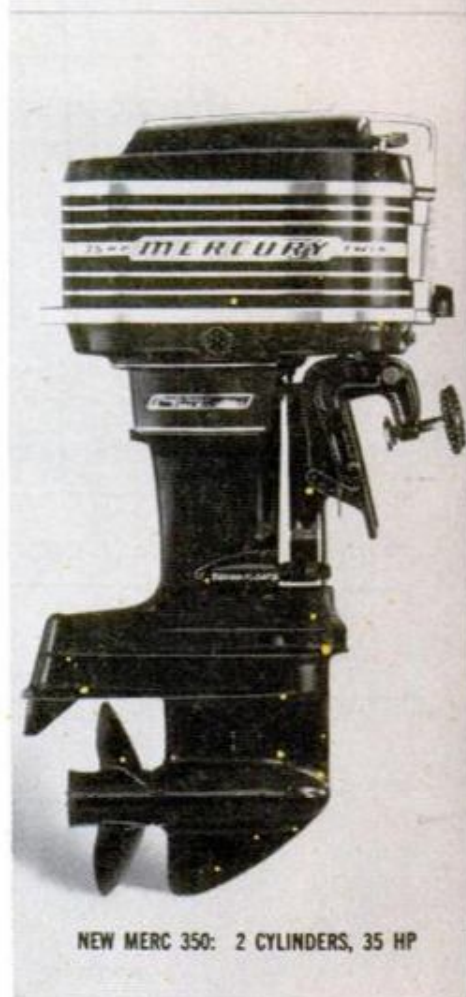

NEW MERC 350: 2 CYLINDERS, 35 HP

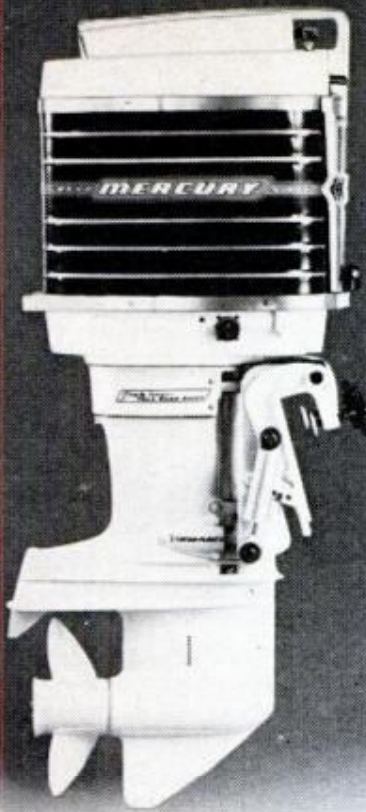

NEW MERC 850: 6 CYLINDERS, 85 HP

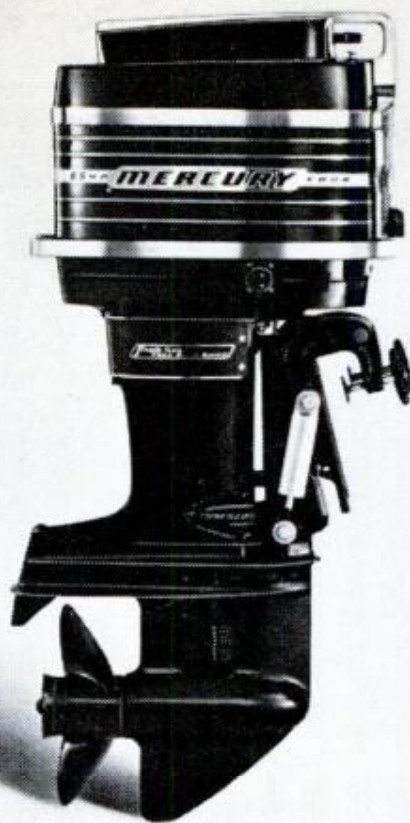

NEW MERC 650: 4 CYLINDERS, 65 HP

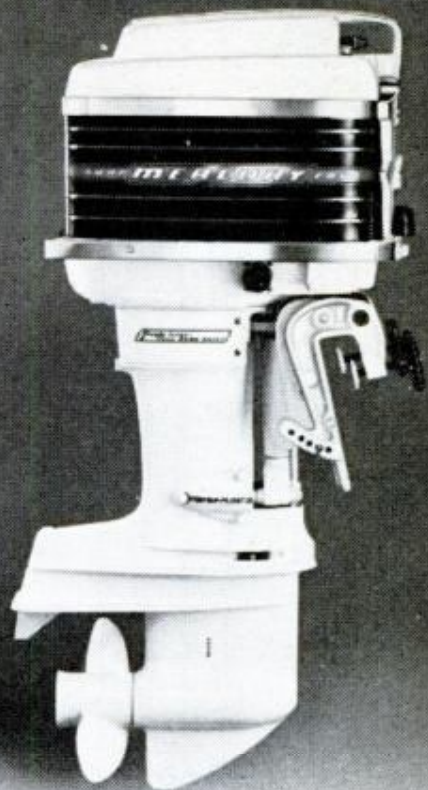

NEW MERC 500: 4 CYLINDERS, 50 HP

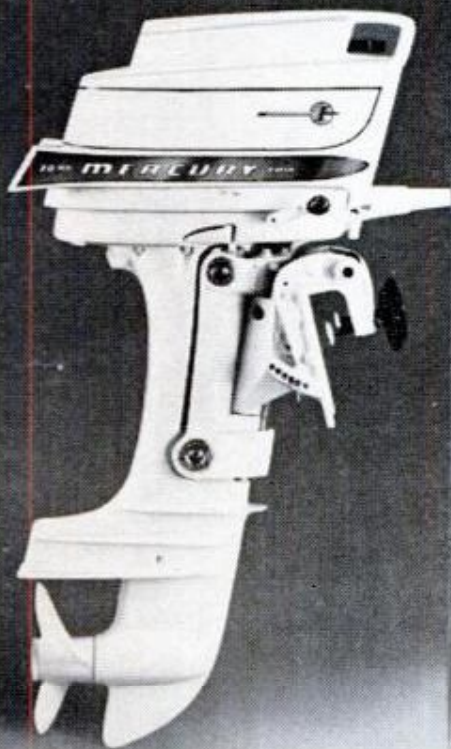

NEW MERC 200: 2 CYLINDERS, 20 HP

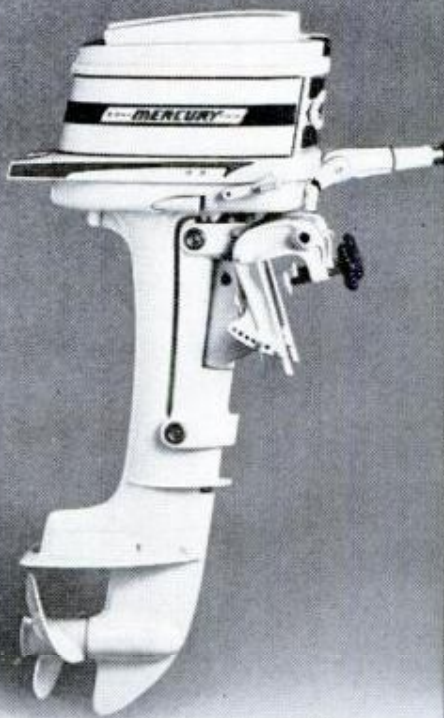

NEW MERC 110: 2 CYLINDERS, 9.8 HP



NEW MERC 60: 2 CYLINDERS, 6 HP



WHY TOY AROUND

WHEN YOU CAN ENJOY

THE ECONOMY OF

"NEW" ENGINE PERFORMANCE WITH

KENDALL QUALITY

MOTOR OILS REFINED FROM THE CHOICEST

100% PENNSYLVANIA CRUDE OIL



KENDALL REFINING COMPANY • BRADFORD, PENNA.
Lubrication Specialists since 1881

Yeast Yields Secrets

LONG known by homemakers as a vital ingredient in bread, yeast has risen to an important role in scientific research.

Although yeast is one of the lowliest forms of plant life, the cells are similar to human cells, having a nucleus, genes, cytoplasm and outer membrane. In addition, Dr. Carl C. Lindegren of Southern Illinois University, has discovered that yeast cells are male and female. Either the male or female cell can produce offspring by budding, or they can be mated to produce hybrids.

With some 20,000 species of yeast, the possibilities of making different strains are incalculable. One billion cells are "born" every hour, and many generations can be studied in a single day.

Using an electron microscope, the yeast cells can be magnified 30,000 times. Other sensitive instruments can manipulate them like golf balls so that what goes on inside the cells can be studied to learn how they react to radiation and other factors which affect human well being.

How do these revelations about the private life of yeast cells concern humans? First of all, budding yeast cells inherit certain traits from their parents through genes in precise ratios, just as humans inherit color of hair or eyes. Certain diseases, such as diabetes and afflictions like color blindness in humans will recur in a family. This is one reason why yeast is important in the study of human heredity.

Yeast is also being used to determine the long-range hereditary effects that radiation will have on human cells. In his laboratory at SIU, Dr. Lindegren can irradiate a cluster of cells and tell how many generations it will take for the effect of alpha rays, beta rays, gamma rays, x-rays, or ultraviolet rays to prove fatal. It's also been discovered that a tiny mechanism called the centriole inside the cell is the vulnerable target which radiation hits in order to destroy the cell. Such findings are valuable in measuring the hereditary effects on a human population of radioactive fallout from atomic bomb tests and cosmic rays.

The cause of cancer may even be revealed by further study of yeast cells. Basic investigations have shown that yeast cells can be made to act in the same way as cancer cells for research purposes, and that extremes of temperature may have a big influence on the spread of cancer.

Dr. Lindegren receives \$40,000 a year from cancer societies and the U. S. Public Health Service to pursue the cause of cancer, and yeast will be the medium used.

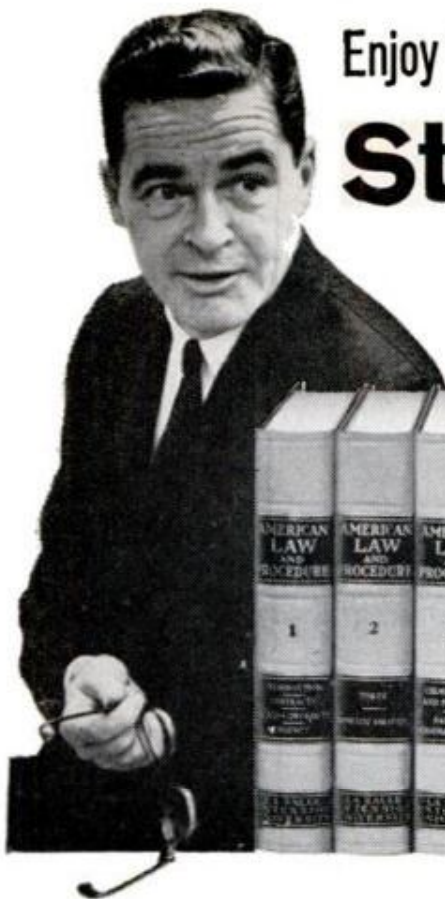

Enjoy the rewards offered Law-trained men in business

Study LAW at home

EARN AN LL.B. DEGREE FROM LA SALLE

Receive this famous
14-volume Law library
with your training

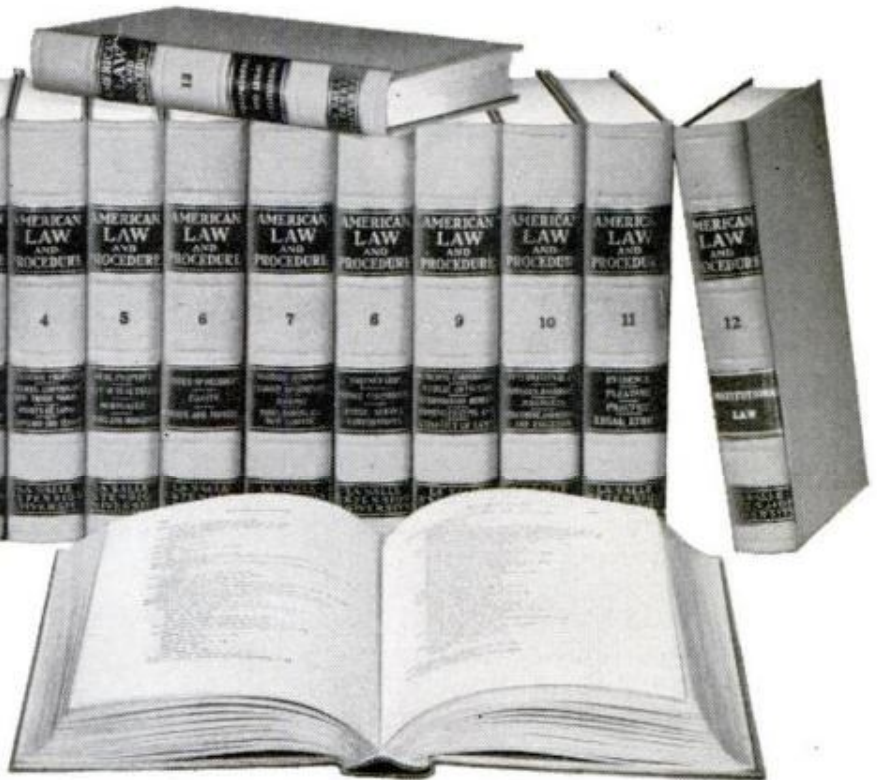

WHATEVER your present position, whatever your previous schooling, you can multiply your opportunities for rapid promotion, big income and prestige through LaSalle Law Training at home.

A knowledge of Law is regarded today as indispensable in every business activity. The greatly increased role of government in business, the many new problems of Law involving taxes, insurance, contracts, liability, employment—and much more—all require the legally-trained executive who can make day-to-day decisions effectively. That is why leading corporations seek out such men for key positions and reward them with top salaries.

Study in your spare time

Men and women in accounting, banking, sales, credit, real estate, traffic, insurance, government and the armed services have profited from LaSalle law training.

You can master Law easily and enjoyably in your own home under the supervision of LaSalle's distinguished faculty of lawyer-instructors. You work with actual legal cases, acquiring real experience. Upon completion of your training, you are awarded a Bachelor of Laws degree if qualified. *The famed LaSalle law library of 14 volumes is given to you as part of your course.*

The cost is remarkably low

For 54 years LaSalle has been an acknowledged leader in business training, with more than 1,000,000 students. Why be stalled in a dead-end job when a knowledge of Law will make you worth so much more money? Send for the free booklet "Law Training for Leadership" and see how LaSalle can help you move up rapidly in your career. You will be surprised by the low cost. Mail coupon to LaSalle, 417 So. Dearborn Street, Chicago 5, Ill.

This valuable booklet

LAW

TRAINING FOR LEADERSHIP

Free

to men who want to get ahead

It describes in detail today's opportunities for the Law-trained man and contains the full story of the La Salle home study program. For free copy, send the coupon today.



LA SALLE EXTENSION UNIVERSITY

An Approved Correspondence Institution

417 South Dearborn St., Dept. 10-090, Chicago 5, Ill.

Please mail me, free of cost or obligation, your illustrated booklet "Law Training for Leadership."

Name Age

Address County

City & Zone State

215

Over the editor's desk

Holes for Bike Parkers

Glad to see you imported an old European bike parker (p. 137, July PM). Having experienced the ever water-filled parkers while a youngster, I am surprised to see no PM solution to this. Why not add one or two drain holes in the bottom?

Owensboro, Ky. LEENDERT KERSTEN

Fine idea. Now where did we put those carbide-tipped drills?

Call the Plumber?

Our May article, *Be Ready to Save a Life*, prompted Reader Joseph Contrino to ask whether a plumber's plunger would also help in performing the emergency life-saving method described. An expert in the technique, Dr. W. B. Kouwenhoven of Johns Hopkins Hospital, says no. Such a device would press on the ribs and cause considerable damage. Dr. Kouwenhoven also goes on to amend an incorrect impression he says might be gained from one of our photos. Pressure, he says, should be applied to the breast bone (not the xiphoid) by placing the heel of the hand on the lower third of the breast bone just above the xiphoid. No pressure should be applied to the ribs with the fingers. The fingers of the lower hand should be parallel to the ribs.

Life Saver

[The following letter was received by the READER'S DIGEST. It refers to an article which originally appeared in our January issue, and was reprinted with POPULAR MECHANIC'S permission in the May issue of the Digest].

The first situation you described in your May article, *How Quick-Witted Are You?*, involved a car stalled on a railroad track. I didn't realize it at the time but this stuck with me, as I was to find out on May 18, 1962.

That afternoon I was driving our '55 Pontiac on the Dixie Highway in Bridgeport, Michigan when I noticed flashers on the railroad crossing. I stepped on the brake and the car stalled halfway across the track. The first thought that came to mind was your answer involving the stalled car. I at once got out of the car and got my two small children out of the back seat. And none too soon because I hadn't gotten too

far away from the car when the train hit it.

I honestly believe your article saved my life and my children from serious injury if not from death.

Burt, Mich.

KATHERINE BENNETT

Free Clock

After two years of part time work as a hobby, I completed this clock from your December 1959 issue plans. It keeps remarkable time and is not too noisy.



The case is of walnut fence board, the works frame of oak, the kickboard from a horse barn, and the gears of walnut, birch, hickory, and maple and oak. The cash outlay was nothing and I made all parts with a pocket knife, files and a coping saw.

Griffith, Indiana

JOHN P. SHULTZ

Wants a Wing Dingy

The *Wing Dingy* (June PM) is the answer to my prayer if I could learn to fly it at my advanced age (1903) and if it is priced within my means. Summers we are here in East Penobscott Bay and winters

(Continued on page 12)

Good News for the Man Who Needs
a Better Job or Is Ambitious
for a Business of His Own

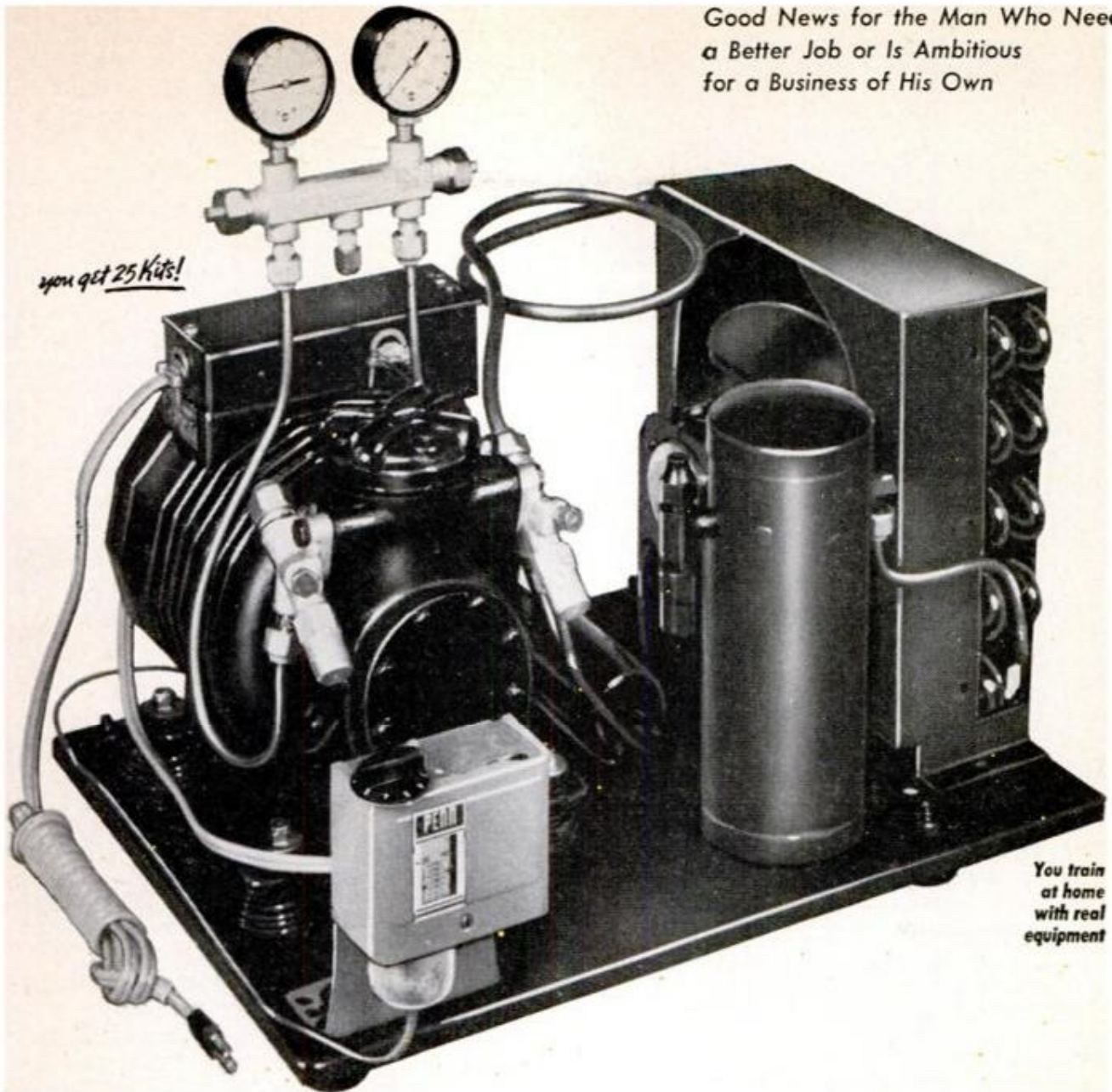

you get 25 Kits!

You train
at home
with real
equipment

Learn REFRIGERATION and AIR CONDITIONING

Thousands of men have found a short-cut to a good job, big money and security—even a business of their own—in the Air Conditioning and Refrigeration field.

This short-cut method is available to you as well. The only investment you make is a few hours of your time each evening and a few dollars of your income each month. And when you're ready for your big-pay job in Air Conditioning and Refrigeration—as a technician or mechanic—you switch over.

You'll find the key to a better future in the condensing unit above. It's the heart of the exclusive CTI Home Training Method. CTI sends you illustrated lessons which supply the knowledge and know-how. However, during your training, CTI also sends you 25 kits of parts and tools to build the condensing unit. With it you work on 20 practical projects. You develop your skill in trouble-shooting, using tools, making repairs and servicing. You learn by practicing!

Many CTI students earn money in spare time as they train. This extra income helps meet tuition payments, buys extra equipment.

Yes, CTI Home training has many parts. We'd like to tell you all about it—and the marvelous opportunities that are waiting. (Did you know that each year the Air Conditioning and Refrigeration industry needs 20,000 more newly-trained men?)

This information is free. You can have it just by filling out and mailing the coupon. Act today! — *Commercial Trades Institute* (a Non-Profit Organization), Chicago 26, Ill.

COMMERCIAL TRADES INSTITUTE
1400 GREENLEAF AVE. • CHICAGO 26, ILL.

Dept. R-132

Mail me your three free booklets: *Success in Air Conditioning & Refrigeration*; *Proof from Graduates*; and *Lesson Samples*. No obligation.

Name _____ Age _____

Address _____

City _____ Zone _____ State _____



Accredited by National Home Study Council

Skilled Machinists

Prefer
South
Bend

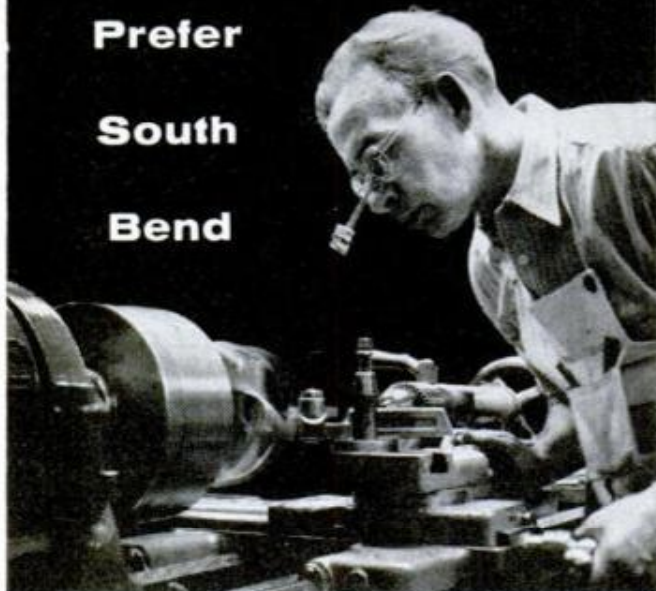

Photo from Learcal Division, Lear, Inc., Los Angeles

The day of the precise craftsman is not past. You should see how some of the nations finest workmen go about doing their jobs with painstaking accuracy.

Such accuracy is absolutely vital in the manufacture of many of the precision components that make this "Space Age" possible.

To get the accuracy and fine finish so necessary on precision parts, skilled machinists choose South Bend 16" Lathes.

- Dependable—Trouble-Free
- Spindle bearings designed specifically for precision work.
- Quiet running—No Vibration—No Gear Marks—Delivers parts with extremely fine finish.

Prices of South Bend 16" Lathes start at \$2591 f.o.b. factory

Write for catalog of South Bend Lathes, Milling Machines, Shapers, Drill Presses and Pedestal Grinders

SOUTH BEND



LATHE

SOUTH BEND 22, INDIANA
BUILDING BETTER TOOLS
SINCE 1906

we are in one of the Out Islands of the Bahamas where a nasty chop prevails, making it unpleasant even in our 16 foot Boston Whaler. Keep me posted on the Wing Dingy's progress.

Deer Isle, Maine

E. G. WALTON

That we will. The possibilities of this unusual boat-aircraft are too fascinating to ignore.

Multiprop GEM

Couple of years ago, I saw a toy ground effect machine in a magazine. I experimented on about 25 models and ended up with a 6 x 6 x 9-inch one which worked well. Then I built this man-size one, 6 x 6 x 9 feet, and have flown it.

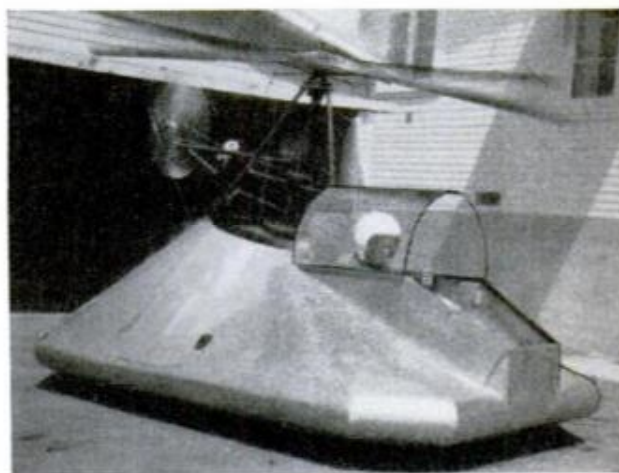

The machine begins to rise when the 72 hp. 2-cycle, 4-cylinder engine turns over 2,000 r.p.m. There's a four-bladed 29-inch prop on the engine to blow air under the body, a 4 foot overhead prop which tilts by stick for propulsion and a 22-inch variable pitch prop at the back, foot-controlled, for turning.

Lakeside, Calif.

A. G. KLEIN

Quite a craft, reader Klein. Let us know when you have her developed to the point where she'll go cross country, over the fences and above the cows. That would be a real breakthrough in GEM machine design.

Don't Do It

Somewhere in the confusion of moving our offices recently, we pulled a boo-boo. The method of cleaning drain pipes described on page 133 of our June issue works, but because of the danger of possible back siphonage of sewage it should not be used and is not permitted by most plumbing codes. Apologies to all.

The Editors

POPULAR MECHANICS



**A GOODYEAR
XTRA-GRIP
TRUCK TIRE
WAS HERE!**

Was here is right. Goodyear Xtra-Grip pulls through the mud and snow that leave ordinary truck tires slipping and spinning. That's because the Hi-Miler Xtra-Grip truck tire delivers up to **35% MORE TRACTION** than conventional tires. Truly, this is a safety-first tire. On rain-slick streets or back roads—in ice, snow, slush, mud—there are rugged, deep-biting lugs—more grip-

ping edges—to get you going, and stop you safely.

Xtra-Grip tires give you extra *mileage*, too. Up to **40% MORE MILEAGE** than the regulars, because they put more rubber on the road—rubber made of special extra-tough compounds. So for more traction—more mileage—get Xtra-Grip. Today. See your Goodyear Dealer or Goodyear Service Store. Goodyear, Akron 16, Ohio.

ANOTHER REASON WHY: MORE TONS ARE HAULED ON GOODYEAR TRUCK TIRES THAN ON ANY OTHER KIND

GOODYEAR

Hi-Miler—T.M. The Goodyear Tire & Rubber Company, Akron, Ohio

OCTOBER 1962

13

Science overseas

By William Kreh

Here's a jet-age mousetrap. Hordes of field mice around an airfield near Brunswick, Germany had plagued neighboring farmers for years. But soon after four French-built Alouette jet helicopters were stationed at the small field, the mice died by the score. Scientists gave the puzzled but pleased residents the answer: The jet's engine noise is of an unusually high frequency that is fatal to the rodents.



Pegase, Rhapsodie and Azur will soon be joining Peggy in France. It may sound exotic, but it's strictly scientific. Peggy is the name given to a small-scale reactor already in operation at the nuclear studies center being built by the French Atomic Energy Commission at Cadarache, near Aix-en-Provence. Pegase next year will start testing fuels for the industrial reactors of Electricite de France. Rhapsodie, a rapid neutron breeder will be ready for use in 1964. Azur, prototype of a reactor for submarines, goes into action late this year. Also being built and equipped at Cadarache are laboratories for research in irradiated fuel, purification of plutonium, studies in enriched uranium and beryllium, and experiments on hot glucine. The center is due to be completed by 1965.



A super-sensitive camera with an automatic focusing device has been developed in Britain for taking close-ups of the human eye. Held like a pistol, the camera throws out two D-shaped beams of light. To focus, the camera is moved toward the subject until the two D's form a circle. A trigger operates the shutter and fires an electronic flash. The camera is said to have many medical, scientific and industrial applications where rapid records are needed.



What was probably the first skyscraper city of the Americas is being unearthed in the Mexican province of Chihuahua. Archaeologists have uncovered about 40 acres of a city they estimate dates back to about 1200 A.D. Included in the ruins is a five-story apartment building.

You're shivering all the time and don't know it. And that, according to a Viennese scientist, may be the cause of regulated body temperatures in warm-blooded animals. The rhythmic, uninterrupted microvibrations impulsing through muscles at 7 to 13 times a second go on from birth to death, the scientist said. He found them in all warm-blooded organisms. Because of this, he believes they are the mechanism which maintains precise body temperature in warm-blooded animals.



Three Japanese firms are developing a communications satellite which they hope to put into orbit in time for world-wide telecasts of the 1964 Olympic Games in Tokyo.



Accurate measurement of blood pressure in the brain is possible with a new highly sensitive instrument developed by a Turkish scientist at the Istanbul Medical Academy. It is expected to be valuable in work involving brain tumors, vein blockages and hemorrhages.



A British scientist who is fond of bees has come up with a device for harmlessly extracting their sting venom. Used for research in the treatment of rheumatism, the venom was formerly obtained by wholesale crushing of the bees. The new device gives bees a mild electric shock which makes them eject their venom into thin silicone sheets from which they can withdraw the barbed stinger without harm. A normal sting tears the stinger and kills the bee. The venom crystalizes on the sheet in tiny globules. One gram of venom requires nearly 10,000 bee stings.



A tiny island in a Southeast African lake is receiving the attention of world scientists. It has been found to have a natural background radiation 30 times above normal. Natives of the 120-acre flatland—exposed to high dosages of radiation for generations—are being studied for noticeable effects. The high radiation is caused by unequal weathering of rocks, which has exposed radioactive minerals, subjecting the area to intense radiation.



An anchor light that is visible for half a mile and which switches itself on at dusk and off again at dawn has been developed by a firm in Great Britain.

GET READY FOR THE SPACE and SCIENCE ERA! SEE SATELLITES, MOON ROCKETS CLOSE-UP



AMAZING SCIENCE BUYS

for FUN, STUDY or PROFIT



See the Stars, Moon, Planets Close Up!

3" ASTRONOMICAL REFLECTING TELESCOPE



60 TO 180 POWER!
Famous Mt. Palomar Type!
An Unusual Buy!

See the Rings of Saturn, the fascinating planet Mars, huge craters on the Moon. Equatorial Mount with lock on both axes. Aluminized and overcoated 3" diameter high-speed f/10 mirror. Telescope comes equipped with a 60X eyepiece and a mounted Barlow Lens. Optical Finder Telescope included. Hardwood, portable tripod. FREE with Scope: Valuable STAR CHART plus 272-page "HAND-BOOK OF HEAVENS" plus "HOW TO USE YOUR TELESCOPE" BOOK.

Stock No. 85,050-H \$29.95 Postpaid
4 1/4" REFLECTING TELESCOPE—Up to 255 Power.
Stock No. 85,105-H \$79.50 F.O.B., Barrington, N.J.

BUILD A SOLAR ENERGY FURNACE



A fascinating new field. Build your own Solar Furnace for experimentation—many practical uses. Easy! Inexpensive! Use scrapwood! We furnish instructions. This sun powered furnace will generate terrific heat—2000° to 3000°. Fuses enamel to metal. Sets paper aflame in seconds. Use our Fresnel Lens—14" diameter . . . f.l. 14".

Stock No. 70,130-H Fresnel Lens \$6.00 Postpaid
11" Sq. Fresnel Lens F.L. 19".
Stock No. 70,533-H \$4.75 Postpaid

SPELLBINDING EXPERIMENTS with SILICON SOLAR CELL AND SUN BATTERY!



Experience endless fascination in converting sunlight into electricity to power small motors, amplifiers, etc. (See July '61 Popular Science article—"The Boat That Runs on Sunlight" for latest techniques). Plastic case 1 1/8" x 1 1/8" x 3/16". Produces .3 to .45 volts—10-16 milliamps. 24-page Handbook gives full data on 12 pat experiments.

Stock No. 60,216-H \$2.25 Postpaid
Selenium PhotoCell. Lower power, lower price than Silicon Cell.
Stock No. 30,411-H \$1.50 Postpaid
Solar Cell and PhotoCell Handbook. Fascinating 112-page Handbook on Silicon-Cell and Selenium projects, demonstrations, etc. Explains photo-voltaic theory, performance. Gives infrared and ultra-violet applications. Paperbound, 6"x9".
Stock No. 9230-H \$2.00 Postpaid

MINIATURE WATER PUMP



Wonderful for experiments, miniature waterfalls, fountains. Christmas gardens, HO gage railroad backdrops, hobbyists, labs, schools. Pumps continuous flow of water etc. Tiny (2 5/8" x 1 3/4") electric motor and pump ideal for hobbyists, labs, schools. Pumps continuous flow of water at rate of one pint per minute at a 12" head. With 2 D Batteries in series will pump to 24" high. Works in either direction. Stock No. 50,345-H \$2.25 Postpaid

SCIENCE TREASURE CHESTS



Extra-powerful magnets, polarizing filters, compass, one-way-mirror film, prism, diffraction grating, and lots of other items for hundreds of thrilling experiments, plus a Ten-Lens Kit for making telescopes, microscopes, etc. Full instructions included.

Stock No. 70,342-H \$5.00 Postpaid
Science Treasure Chest DeLuxe—Everything in Chest above plus exciting additional items for more advanced experiments including crystal-growing kit, electric motor, molecular models set, first-surface mirrors, and lots more.
Stock No. 70,343-H \$10.00 Postpaid

OPAQUE PROJECTOR



Projects illustrations up to 3" by 3 1/2" and enlarges them to 35" x 30" if screen is 6 1/2 ft. from projector; larger pictures if screen is further away. No film or negatives needed. Projects charts, diagrams, pictures, photos, lettering in full color or black-and-white. Operates on 115 volt, A.C. current. 6-ft. extension cord and plug included. Operates on 60 watt bulb, not included.

Size 12" x 8" x 4 1/2" wide. Weight 1 lb., 2 oz. Plastic case with built-in handle.
Stock No. 70,199-H \$7.95 Postpaid

ORDER BY STOCK NUMBER. SEND CHECK OR MONEY ORDER. SATISFACTION GUARANTEED.
EDMUND SCIENTIFIC CO., BARRINGTON, N. J.

'FISH' WITH A MAGNET

Go Treasure Hunting On The Bottom

Great idea! Fascinating fun and sometimes tremendously profitable! Tie a line to our 5-lb. Magnet—drop it overboard in bay, river, lake or ocean. Troll it along the bottom—your "treasure" haul can be out board motors, anchors, fishing tackle, all kinds of metal valuables. 5-lb. Magnet is war surplus—Alnico V Type—Gov't. Cost—\$50. Lifts over 125 lbs. on land—much greater weights under water. Order now and try this new sport.
Stock No. 70,571-H 5 lb. Magnet. . . . \$12.50 Postpaid



USE THIS AIR FORCE BUBBLE SEXTANT

ANYWHERE—Land or Sea
ANYTIME—Night or Day



Lighted bubble makes "any-time, anywhere use" possible. Employ as straight sextant to measure elevations referenced to bubble or horizon; or measure elevations with self-contained clock-driven mechanism that shows degrees and minutes of elevation averaged through a two minute sighting on a dial counter. Besides bubble, and swinging prism (for use with natural horizon), sextant contains astigmatizing lens, 4 sun shades, adjustable focus, rubber-padded eye-piece. Extras: suspension hook, spare bulbs, rheostat-controlled battery case. Measures 120 degree angle from -10 degrees to +110 degrees. Vernier drum reads to 2 minutes, may be interpolated to 1 minute. In late use by U.S.A.A.F.

Stock No. 70,574-H Used good condition. . . . \$32.50 Postpaid

LARGE SIZE OPAQUE PROJECTOR

Ideal for photographers, this low-cost unit projects 3 1/2 ft. sq. image at 6 ft.—7 1/2" ft. sq. image at 12 ft. Projects photos, drawings, sketches, clippings, any opaque copy up to 6" x 6"—larger pieces in sections. Lenses are 2 plano-convex, 3 1/2" dia. mounted in 5 1/4" barrel. Projector is 11 1/2" high, 13 1/4" wide, 9" front to back, pressed steel in black wrinkle finish, bakelite handle. Uses two 200 watt bulbs—not included. Complete with side platform to hold illustrations, 6 ft. elec. cord, heat resist. plate glass mirror.



Stock No. 80,066-H \$42.00 Postpaid

WAR SURPLUS AMERICAN-MADE 7x50 BINOCULARS

Big savings! Brand new! Crystal clear viewing—7 power. Every optical element is coated. An excellent night glass—the size recommended for satellite viewing. Individual eye focus. Exit pupil 7mm. Approx. field at 1,000 yds. is 376 ft. Carrying case included. American 7 x 50's normally cost \$274.50. Our war surplus price saves you real money.



Stock No. 1544-H . . . Only \$74.80 Postpaid (Tax included)
6 x 30 Binoculars—similar to above and a terrific bargain.
Stock No. 963-H . \$33.00 Postpaid (Tax inc.)

NEW! CIRCULAR SLIDE RULE!

Pocket Size—Fast—Easy to Use!



Multiplies, divides, figures fractions, percentages, squares, cubes, roots, proportions, circumferences, areas, prices, fuel consumption. Faster, easier to learn and use. Directions included.

Stock No. 30,336-H \$4.95 Postpaid

WOODEN SOLID PUZZLES

12 Different puzzles that will stimulate your ability to think and reason. Here is a fascinating assortment of wood puzzles that will provide hours of pleasure. Twelve different puzzles, animals and geometric forms to take apart and reassemble, give a chance for all the family, young or old, to test skill, patience, and best of all to stimulate ability to think and reason while having lots of fun. Order yours now.



Stock No. 70,205-H \$3.00 Postpaid

Order by Stock No.—Send Check or M.O.—Money-Back Guarantee
EDMUND SCIENTIFIC CO., Barrington, New Jersey

MAIL COUPON FOR FREE CATALOG "H"

160 Pages! Over 1000 Bargains!
EDMUND SCIENTIFIC CO., Barrington, N. J.
Please rush Free Giant Catalog "H"
Name
Address
City..... Zone..... State.....



Tune in on the inventors

by J. L. Pugni

Instruments inside satellites can be suspended away from the vibration and heat of the satellite shell with a method developed by Fred Esch of Silver Spring, Md. The structure on which the instruments are mounted is held in place with a nylon lacing under tension. Patent number is 3,043,644.

☆☆☆

For tenting out Indian style, how would you go for a build-it-yourself portable tepee? It's easily assembled and disassembled—and you can even build a fire inside. For his contribution to outdoor living, James S. Des Rosier of Butte, Mont., won patent No. 3,042,052.

☆☆☆

Look no hand sprinkling with a spray iron developed by Harold S. Foster and Alfred G. Swenson of Ontario, Calif. A button controls the kind of ironing—steam, spray or dry—and a dial controls temperature.

The iron is patented under Nos. 3,041,756 and 3,041,757.

☆☆☆

More plaster can be added to an already dry plaster of paris cast, and the new plaster will adhere well when mixed according to a "recipe" developed by Leo Brickman of Metuchen, N. J., and Martin Edenbaum of New Brunswick, N. J. Their patent, No. 3,043,298, covers the addition of hydroxy propyl methyl cellulose in the plaster of paris.

☆☆☆

A process for protecting the chlorophyll (green coloring matter) while green vegetables are being cooked won patent No. 3,044,882 for James P. Sweeney and Margaret E. Martin of Silver Spring, Md. They add a citrate-phosphate buffer to keep the cooking water neutral.

☆☆☆

Using a mirror and a music box, you can trick a bird into singing, according to Michael Marder, New York, who received patent No. 3,041,911, for his idea. The music box is activated when the bird perches on a support.

Copies of the original patents may be ordered for 25 cents each from the Commissioner of Patents, Dept. of Commerce, Washington 25, D. C.



MONTGOMERY WARD



INDOOR COMFORT FOR OUTDOOR MEN

Insulated, waterproof 4-season boots

with **NEOPRENE SOLES**

Here's a leather boot that's hard to beat! Insulated with polyurethane plus full linings of grain leather. Inside sealed seams waterproofed with pure rubber compound. Patented* gusset. Ward's 4-Season Boots take plenty of rugged wear, thanks to Du Pont Neoprene soles that stay flexible in coldest weather, resist oil, grease, gasoline and chemicals...take toughest jobs in stride.

Ask for No. 7157: Vintage Brown in 7-11, 12 D; 6-11, 12 E. Retail price \$24.99.

Catalog price \$23.99 plus postage.

Order from your nearest catalog office or mail-order house.

*U. S. Pat. No. 2,029,532

DU PONT
REG. U. S. PAT. OFF.

Better Things for Better Living . . . through Chemistry

Lighted lamps and burning ambitions. The two go together. And with them, in more than 100,000 cases, go the famous texts of International Correspondence Schools. The men who receive them are studying to be tomorrow's foremen, supervisors, department heads and office managers. Find out from I.C.S. how you can join them. Mark and mail the post card (or coupon). You'll receive a personal Success Kit containing three valuable booklets. All are yours to keep —FREE. They bring full information on how you can become one of tomorrow's leaders. But don't put it off. Mail post card (or coupon) this very minute!

INTERNATIONAL CORRESPONDENCE SCHOOLS

Dean's Office, Box K6419K, Scranton 15, Pa.

(In Hawaii: P.O. Box 418, Honolulu. In Canada: I.C.S. Canadian, Ltd., Montreal)

Please rush me my FREE Success Kit containing 3 valuable booklets.

Name _____ Age _____

Street _____

City _____ Zone _____ State _____

Field of interest _____

Employed by _____

Working hours _____ A.M. to _____ P.M.

Tomorrow's leaders are busy tonight

More than 7,000,000 students have enrolled with I. C. S.

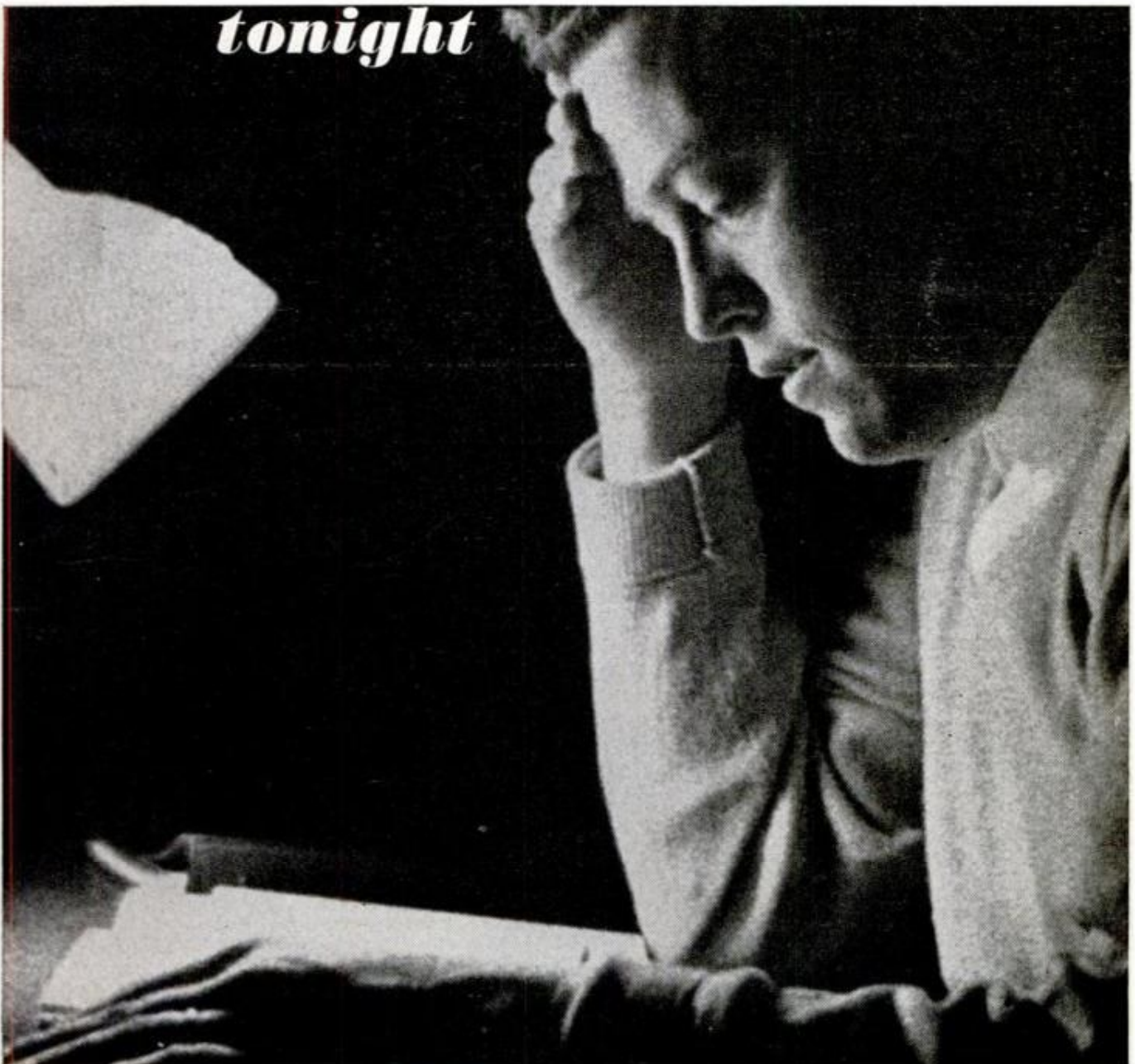

DRAFTSMEN



ARE NEEDED!

LEARN AT HOME IN YOUR SPARE TIME

Check the want ads in any newspaper. See the big-pay opportunities open to you as a draftsman. What's more, you can learn this well-paid, prestige profession at home—quickly, easily! No special talent needed! Get complete, step-by-step Chicago Tech

lessons in the mail, spend a few pleasant hours studying each week. In a short time you'll be a well-trained draftsman, ready to take your pick of many good jobs. Decide now to get ahead. Mail coupon today!

SEND FOR FREE TRIAL LESSON TODAY!

Get FREE TRIAL LESSON plus information about C.T.C. practical training. Learn what successful Chicago Tech graduates say about high pay and opportunities in drafting. No charge, or obligation. It's yours free.

Est. 1904 • Accredited National Home Study Council

CHICAGO TECHNICAL COLLEGE

N-200 Tech. Bldg., 2000 So. Michigan Ave.
Chicago 16, Illinois

Mail me FREE Lesson with information about big opportunities in DRAFTING.

Name _____ Age _____
Address _____
City _____ Zone _____ State _____

"\$7,108⁵⁰ NEW!"

FIRST YEAR Cleaning- Repairing RADIATORS."



—Hank Konter, Newcastle, Wyo.

Make \$6,000-\$9,000 a year servicing auto-truck-tractor radiators with Inland's new 1-Piece Radiator Shop. Easy to do entire job — TEST, CLEAN and REPAIR radiators. Only 11' 7" long. Inland, world's largest radiator equipment manufacturer, trains you free. Small down payment starts you. Easy-pay plan lets you pay from profits. Proved merchandising assures volume. Profitable department for garage or service station. Many set up Radiator Shop in garage at home, make good money working evenings. Write,

INLAND MFG. CO., Dept. PM-10, 1108 Jackson St., Omaha 2, Nebr.

TURN 58c INTO \$6.00 CASH PROFIT AT HOME IN SPARE TIME—METALIZING

Now you can invest 58c in material and get back \$6.95 and make \$6.00 for your time in this fascinating home business. Hundreds make good extra money in sideline work. So Easy—so much Fun! "Eternalize" baby shoes, other keepsakes. Big market everywhere. No face-to-face selling. Write for facts FREE, plus financing plan. No obligation. No salesman will call. WARNER ELECTRIC, 1512 Jarvis, Dept. M2L Chicago 26, Ill.

PROTECT YOUR INVENTION!

In a new book, YOU OUGHT TO PATENT THAT, the patent and inventions columnist for the *New York Times* guides you through every step in the process of obtaining a patent. In plain language, Stacy V. Jones tells what you should know about patent attorneys, how to research similar patents, and what you will gain from your patent. With a section on Practical Hints for Independent Inventors. \$4.00, now at your bookstore, or order from DIAL PRESS, Dept. PJ-86, 461 Park Ave. So., New York 16, N. Y.



WANT MORE MONEY? GET INTO PHOTOGRAPHY

Coast-to-coast, high-paying jobs in photography are waiting for people with the "know-how" to fill them. You can quickly, easily qualify at home with the world-famous NYI Learn-by-Doing Method. Write today for free catalog. Also resident training in N. Y. Our 53rd Year. Approved for Veterans.

NEW YORK INSTITUTE OF PHOTOGRAPHY
Dept. 49 10 West 33 St. New York 1, N. Y.

INVESTIGATE ACCIDENTS

Train quickly in your own home for repeat income in the exciting, secure Claim Investigation and Claim Adjusting field. Our students and graduates are already earning \$4, \$5, \$6 an hour extra SPARE TIME — and up to \$10,000 a year Full Time. You need NO prior experience or higher education. Your age does NOT matter.

HERE IS YOUR CHANCE FOR ACTION AND REAL JOB SECURITY

As a trained Claim Investigator you will (1) INVESTIGATE FACTS and (2) DISTRIBUTE MONEY as the representative of wealthy organizations.

No other business offers you greater opportunities for success and security. Here's why: The huge, rapidly expanding Claim Investigation and Adjusting Profession right now distributes more money than any other service industry. And it's growing fast. Over 200 MILLION ACCIDENTS must be investigated this year for Insurance Companies, Airlines, Railroads, Steamship Lines, and Government Offices.

MAIL NOW for FREE BOOK ➔

SEND TODAY for Big, FREE, Illustrated Catalog. Learn the exciting facts about Universal Schools' low cost training. No obligation. No salesman will call. GI APPROVED.



UNIVERSAL SCHOOLS
6801 Hillcrest Ave.
Dept. PM-10, Dallas 5, Texas

Please rush me your FREE book on Claim Investigation. This does not obligate me and no salesman will call.

Name _____ Age _____
Address _____
City _____ Zone _____ State _____

Approved by Government for Korean Veterans

Profits That Lie Hidden in America's Mountain of Broken Electrical Appliances

By J. M. Smith President, National Radio Institute



And I mean profits for you — no matter who you are, where you live, or what you are doing now. Do you realize that there are over 400 million electrical appliances in the homes of America today? So it's no wonder that men who know how to service them properly are making \$3 to \$5 an hour — in spare time or full time! I'd like to send you a Free Book telling how you can quickly and easily get into this profitable field.

THE COMING OF THE AUTO created a multi-million dollar service industry, the auto repair business. Now the same thing is happening in the electrical appliance field. But with this important difference: anybody with a few simple tools can get started in appliance repair work. No big investment or expensive equipment is needed.

The appliance repair business is booming — because the sale of appliances is booming. One thing naturally follows the other. In addition to the 400,000,000 appliances already sold, this year alone will see sales of 76 million new appliances. For example, 4,750,000 new coffee makers, almost 2,000,000 new room air conditioners, 1,425,000 new clothes dryers. A nice steady income awaits the man who can service appliances like these. And I want to tell you why that man can be you — even if you don't know a volt from an ampere now.

A Few Examples of What I Mean

Now here's a report from Earl Reid, of Thompson, Ohio: "In one month I took in approximately \$648 of which \$510 was clear. I work only part time." And, to take a big jump out to California, here's one from

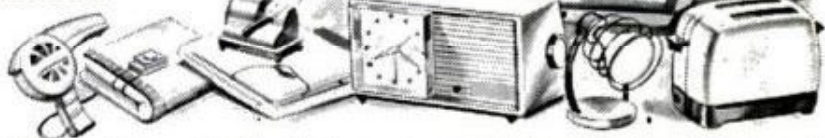

J. G. Stinson, of Long Beach: "I have opened up a small repair shop. At present I am operating the shop on a spare time basis — but the way business is growing it will be a very short time before I will devote my full time to it."

Don't worry about how little you may now know about repair work. What John D. Pettis, of Bradley, Illinois wrote to me is this: "I had practically no knowledge of any kind of repair work. Now I am busy almost all my spare time and my day off — and have more and more repair work coming in all along. I have my shop in my basement."

We Tell You Everything You Need to Know

If you'd like to get started in this fascinating, profitable, rapidly growing field — let us give you the home training you need. Here's an excellent opportunity to build up "a business of your own" without big investment — open up an appliance repair shop, become independent. Or you may prefer to keep your present job, turn your spare time into extra money.

You can handle this work anywhere — in a corner of your basement or garage, even

on your kitchen table. No technical experience, or higher education is necessary. We'll train you at home, in your spare time, using methods proven successful for over 45 years. We start from scratch — tell you in plain English, and show you in clear pictures — everything you need to know. And, you will be glad to know, your training will cost you less than 20¢ a day.

FREE BOOK and Sample Lesson

I think that our 24-page Free Book will open your eyes to a whole world of new opportunities and how you can "cash in" on America's "Electrical Appliance Boom."

I'll also send you a Free Sample Lesson. It shows how simple and clearly illustrated our instruction is — how it can quickly prepare you for a profitable future in this big field. Just mail coupon, letter, or postcard to me: Mr. J. M. Smith, President, National Radio Institute, Dept. AK2, Washington 16, D.C. (No obligation, of course — and no salesman will call on you.)

EARN WHILE YOU LEARN with this APPLIANCE TESTER

— Yours at No Extra Charge



Your NRI Course comes complete with all the parts to assemble a sturdy, portable Appliance Tester that helps you earn while you learn. Easy-to-follow manual tells how to assemble and use the Tester right away. Locate faulty cords, short circuits, poor connections, etc. in a jiffy; find defects in house wiring, measure electricity used by appliances; many other uses.

With this Tester you save time and make money by doing jobs quicker, making sure appliances operate correctly after repairs.

MAIL THIS FOR FREE BOOK and SAMPLE LESSON

Mr. J. M. Smith, President
NATIONAL RADIO INSTITUTE
Dept. AK2, Washington 16, D.C.

Tell me how I can "cash in" on the "Electrical Appliance Boom." Send me your illustrated FREE BOOK that outlines the whole NRI Course, tells what opportunities are open to me, answers my questions, describes success of other students, and much more. Also send me the FREE SAMPLE LESSON so I can see how clear and easy your instructions are. I am particularly interested in:

- Spare Time Earnings Business of My Own Better Job
I understand there is no obligation on my part; and no salesman will call on me.

Name.....

Address.....

City..... Zone..... State.....

Accredited Member National Home Study Council

High School "GRADS"

You don't need college to have a fascinating job, a bright future, big pay and advancement.

Those who don't know the facts say that only the college trained men get the good jobs in industry. Wrong! But it is true that the average high school graduate gets only the poorest kind of job—unless he has additional training in a specialized field.

For these men the biggest and fastest growing field open today is Electronics—all branches. Jobs are looking for men. You can train in as short a time as 35 weeks in the Electronic Labs of Coyne in Chicago, the Electronics Center of the Country. Low cost room and board; part time work, arranged for by Coyne's Employment Department, often covers living expenses; and most of your tuition can be paid *after you graduate*.

Like the great universities, Coyne School is an educational institution *not for profit*. A Coyne diploma gives you high standing with employers. Coyne graduates hold top jobs in Electronics all over the world.

Send your name for the Free Book, "Your Opportunities in Electronics." Read about the exciting job opportunities open to the Coyne Trained Man, the security, the future, the big pay and advancement offered by Electronics. See how little it costs to get the training you need. Then make your own decision. No salesman will bother you at your home. But, don't put off what may be a great future for you. Send your name today. A postal card will do. All information is free.

Coyne Electrical School, Chicago 7, Ill., Dept. 72-S

Coyne Electrical School, Dept. 72-S
1501 W. Congress Pkwy., Chicago 7, Illinois
 Please send Free Book "Your Opportunities in Electronics."
 I am under no obligation—no salesman will call at my home.

Name

Address

City RR No. or Zone State

GARDENCRETE CENTER



A New Business Opportunity for Men of Modest Capital

Gardencrete Center denotes a new wayside industry, covering the making and selling of decorative masonry. It sparks latent possibilities into practical opportunities. Opens up new horizons for a business potentially huge but long neglected. It is a low-investment franchise operation, with exclusive privileges in protected territories. A timely business with fascination, interest, and opportunity for expansion. Markets are broad; profit possibilities are generous. Practically every home owner is a prospective customer. No experience or special building required. We supply complete equipment, as well as manuals covering manufacturing and selling. Thousands of good territories are available, but those who act quickly get the choice of the select.

- Bird Baths
- Lawn Seats
- Flagstones
- Screen Blocks
- Flower Boxes
- Vases & Urns
- Brick & Stone for building
- Planters
- Walks
- Patios
- Etc.

Write at once for prospectus "The Gardencrete Center Idea".



COLORCRETE INDUSTRIES
 726 Ottawa Avenue
 HOLLAND, MICHIGAN



Science bulletins

The world didn't start with a bang! Nor will it end with a whimper. It just started rolling, and it will keep on rolling along, says astronomer Gerald Hawkins of Boston University.

Dr. Hawkins theorizes that the universe is static. It had no beginning, has no foreseeable end and—as opposed to other theories—it is *not* expanding. What it is doing is using up the old, decaying parts of stars and galaxies to form new stars and galaxies.

There is another "bang!" theory which says a primitive atom exploded and the universe is only its expanding bits of matter which, someday will be dead, isolated bits.

There is also a "steady state" theory which starts with an explosion but says matter is continually being created, rather than, as Dr. Hawkins says, being used and reused.

Feeling sluggish? You may be getting too many of the wrong kind of air ions.

Dr. Allan H. Frey has concluded experiments which show the electric charge in air has an effect on people who are in stress situations. People such as a pilot or astronaut, for example. Positive air ions, such as those produced by fluorescent lights, increase people's activity and ability; negative air ions, such as those used to heal wounds and infections, decrease capabilities and productivity.

If you've ever welded something, you can appreciate what a tiny, new micro-welder developed by Aerojet Co., can do. It is for use in outer space.

It will make a reliable weld in the time it takes to dot an "i" writing a letter. But—the dot of the "i" will be 30 times bigger than the size of the weld.

Scourge of the old, old West? Two paleobotanists from the University of Oregon have found the first fossil crocodile discovered west of the Rockies. They chipped it from rock 45 to 60 million years old.

The rock croc was about eight feet long.

James Biery

WHAT ALL AUTO MECHANICS WANT TO KNOW

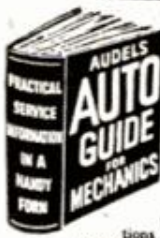

This Big Practical Book gives full information, with working diagrams, covering the principles, construction, ignition, service and repair of modern cars, trucks and buses.

Air Conditioners, Hydramatic & Fluid Drives Fully Explained.

A complete guide of 1132 Pages, with over 1000 Illustrations showing inside views of working parts, with instructions for service jobs. Completely up-to-the-minute! Priced at only \$6.

CIRCLE No. 1 IN COUPON

HOW TO FIX HOME APPLIANCES

REFRIGERATORS WASHERS TOASTERS DRYERS IRONERS RANGES VACUUMS FREEZERS

Handy other GAS AND ELECTRIC APPLIANCES Handy Reference for Electric & Gas Servicemen, Mechanics, Dealers and Homeowners. Explains clearly and simply how to locate troubles, how to test, reassemble and connect. Wiring diagrams. 1000 Facts. Easy to read. Answers ALL your questions. 864 Pages. Illustrated. Only \$6.

CIRCLE No. 2 IN COUPON



TV TELLS HOW TO ANSWER RADIO RADIO T.V. QUESTIONS SERVICE LIBRARY

HERE IS LATE INFORMATION IN HANDY FORM FOR RADIO AND TELEVISION REPAIRMEN, SERVICEMEN AND STUDENTS

TWO COMPLETE VOLUMES - 1568 Pages - 1085 Illustrations and Diagrams. 1001 Important Facts and Figures on Modern T.V. Radio, Electronic Devices. INCLUDES TRANSISTORS & Transistors Circuits, Rectifiers, Record Changers, P.A. Systems, Phonograph Pick-ups, F.M., Auto Radio, Short Wave.

Basic principles, Construction, Installation, Operation, Troubleshooting. How to get Sharp, Clear T.V. Pictures. Install Aerials. How to Test. Explains COLOR SYSTEMS, Methods of Conversion, Terms, etc. Includes Ultra High Frequency. Quick ready reference or use as a home study course. Only \$8 for BOTH volumes.

CIRCLE No. 3 IN COUPON

OUTBOARD MOTOR & BOATING GUIDE

Brand New Title! An essential tool for every outboard boating operator. Provides all information to maintain, adjust and repair all types of outboard motors. Covers: operating, starting, control, motor construction, power head and lower unit, cooling, carburetors, fuel, ignition systems, electrical system, etc. Also deals with trouble shooting, repairs and spare parts needed on board. Gives exploded views of the various parts assemblies, with relative position of each component. Profusely illustrated. 400 Pages only \$4.

CIRCLE No. 49 IN COUPON

PLUMBERS AND STEAMFITTERS GUIDES

Practical Trade Assistant & Reference Set. Explains in plain language and by clear illustrations, diagrams, charts, graphs and pictures the principles of modern plumbing practice including Pipe Fitting and Air Conditioning. 4 Vols. - 2624 Pages - 3642 Diagrams & Illustrations. Only \$9 for the complete set of 4 vols. Sold individually \$2.50 each.

CIRCLE No. 6 IN COUPON

7-DAY FREE EXAMINATION

SEND NO MONEY - Pay the postman nothing! We are glad to send you any of the Audel Guides for absolutely FREE examination in your own home. We take all the risks and leave all the decisions up to YOU. There is no obligation! If you decide to keep the books of your choice you may pay for them under our astounding easy-pay plan of only \$2 a month.

HERE IS ALL YOU DO

IT'S EASY TO ORDER: In the No-Risk Mail Order Coupon at the right just draw a circle around the number of Audel Guides you want us to send you for FREE EXAMINATION. We will send them to you at once to help you build a brighter future by increasing your SKILL. If for any reason at all you are not COMPLETELY satisfied, return the books to us, and that will end the matter! NO STRINGS OR CATCHES TO THIS OFFER.

THEO. AUDEL & CO.
49 West 23rd Street, New York 10, N. Y.

GAS ENGINE MANUAL

Just off the press! A helpful, practical guide for mechanics, students and homeowners. Maintenance and repairs of modern gas engines of all types and sizes used in almost every field, from motor transportation, to appliances around the home. Includes marine and aircraft engines.



FOR THE EXPERT OR THE DO-IT-YOURSELFER

THE FIRST PART explains the operating principles of various types of gas engines, and the function of engine parts and accessories: carburetors, fuel injection methods, cooling and lubrication systems, etc. THE SECOND PART covers trouble-shooting, modern service operations and engine tune-up procedures. Ignition system items are fully listed and illustrated. 468 pages. Only \$4.

CIRCLE No. 48 IN COUPON

PAINTING AND DECORATING MANUAL

NEW TITLE gives the practical know-how you have been looking for. Concise and late information on the many phases of home painting and decorating. Complete from A to Z. INSIDE TRADE INFORMATION!

Outside and inside work, how to mix paints, preparation of surfaces, paper-hanging, wood finishes, tools and their proper use, synthetic sprays: where and how to use them, the brush care, spray painting, scaffolds, rigging, costs, estimating, better methods and a dictionary of trade terms. Over 585 Pages. Fully illustrated. Only \$4.

CIRCLE No. 7 IN COUPON

MASONS & BUILDERS GUIDES

A PRACTICAL ILLUSTRATED 4 VOL. SET - Explaining in clear, simple language and profuse illustration, principles, advances, short cuts, trade secrets, based on modern practice - including how to figure and calculate various jobs. Vol. 1 - Brick work, bricklaying, bonding, designs. Vol. 2 - Brick foundations, arches, tile setting, estimating. Vol. 3 - Concrete mixing, placing forms, reinforced stucco. Vol. 4 - Plastering, stone masonry, steel construction, blueprints. 4 Vols. 1440 Pages. 2067 Illustrations. Complete Set only \$9.

CIRCLE No. 26 IN COUPON Sold individually \$2.50 each

MATHEMATICS MADE EASY

A COMPLETE HOME STUDY COURSE - Starting with the first principles of arithmetic, advancing step by step through the various stages of mathematics, including the rules and calculations for mechanical and electrical problems. New EASY correct methods. Includes plane and solid geometry, trigonometry, algebra, calculus, etc. Practical tests, reference tables and data. How to use slide rule. 672 Pages. 550 Illustrations. Priced at only \$4

CIRCLE No. 11 IN COUPON

NEW MACHINISTS AND TOOLMAKERS HANDBOOK

MODERN MACHINE SHOP PRACTICE - For every Machinist, Toolmaker, Draftsman or Student. Tells how to set up and operate lathes, s.w. and milling machines, shapers, drill presses and all other machine tools. A COMPLETE INSTRUCTOR AND REFERENCE BOOK 1250 Pages. Fully Illustrated. Priced at only \$6.

CIRCLE No. 12 IN COUPON

ELECTRIC MOTORS

THIS GUIDE covers the construction, book-keeping, control, maintenance and trouble shooting of all types of motors. Includes armature winding. Explains entire subject in great detail in simple language. Over 1056 Pages of information. 617 Diagrams. All types of motors fully illustrated and indexed for ready reference. Priced at only \$5.

CIRCLE No. 27 IN COUPON

REFRIGERATION & AIR CONDITIONING

FOUR BOOKS IN ONE - basic principles, servicing, operation, repair of: 1. Household Refrigeration. 2. Special Refrigeration Units. 3. Commercial & Industrial Refrigeration. 4. Air Conditioning Systems. A GOLD MINE of essential information. Completely up-to-date. 1360 Pages. Fully Illustrated and Indexed. Priced at only \$6. CIRCLE No. 14 IN COUPON

CARPENTERS AND BUILDERS GUIDES



PRACTICAL STOREHOUSE OF MODERN CONSTRUCTION INFORMATION (4 vol. set) for carpenters and all woodworkers. Explains in easy language and by profuse illustration principles, advances, short cuts, trade secrets, all based on the NEWEST information. Vol. 1 - Tools, steel square, saw filing, joinery, furniture, etc.; Vol. 2 - Builders' mathematics, drawing plans, specifications, estimates, etc.; Vol. 3 - House and roof framing, laying out, foundations, etc.; Vol. 4 - Doors, windows, stair building, millwork, painting, etc. 4 vols. 1904 Pages. 3700 Illustrations. Whole set only \$9. CIRCLE No. 8 IN COUPON

PRACTICAL ELECTRICITY

A COMPLETE HANDBOOK - Quick, simplified, ready reference. Complete instruction and practical information on the rules and laws of electricity - Maintenance of Machinery - A.C. and D.C. Motors - Armatures - Wiring Diagrams - House Lighting - Power Wiring - Motors - Batteries - Transformers - etc. Simple to understand. 1052 Pages. 2660 Illustrations. Priced at \$5. CIRCLE No. 4 IN COUPON

DIESEL

ALL THERE IS TO KNOW ABOUT MODERN DIESEL ENGINES - Basic principles, starting valves, timing, fuel pumps, fuel injection compressor, air compressors, pistons, cylinders, lubrication, cooling systems, etc. Answers on operation, calculations. 640 Pages. Fully Illustrated. Priced \$4

CIRCLE No. 9 IN COUPON

THE NEW ELECTRIC LIBRARY

A COMPLETE ENCYCLOPEDIA explaining in the simplest terms the fundamental principles, rules and applications of applied electricity.

A COMPLETE COLLEGE EDUCATION! Fully illustrated with diagrams and sketches, calculations and tables for ready reference. Questions and answers. Trial tests for practice study and review. All based on the most modern theory.

- Vol. 1 - Principles and rules of electricity, magnetism, armatures, repairs. No. 15
 - Vol. 2 - Dynamos, DC Motors, construction, installation, maintenance, etc. No. 16
 - Vol. 3 - Testing instruments and tests, storage battery constr. and repairs. No. 17
 - Vol. 4 - Alternating current, power factor, alternators, transformers. No. 18
 - Vol. 5 - A.C. Motors, windings, maintenance, converters, switches, fuses, etc. No. 19
 - Vol. 6 - Relays, condensers, regulators, rectifiers, meters, switchboards, etc. No. 20
 - Vol. 7 - Wiring, house light and power, circuits, high tension, plans, code, etc. No. 21
 - Vol. 8 - Railways, signals, elevators, ignition, etc. No. 22
 - Vol. 9 - Radio, telephone, telegraph, television, motion pictures. No. 23
 - Vol. 10 - Refrigeration, illumination, welding, x-ray, electrical appliances. Index. No. 24
- 6,000 fully illustrated pages. Priced at only \$22.50 for the ENTIRE SET. Also sold individually for \$2.50 each.

ADDITIONAL IMPORTANT TITLES

The following Audel Guides are all the best in their fields, written in clear simple fashion, all lavishly illustrated. Circle the numbers wanted in the MAIL ORDER COUPON below. All books are sent for FREE EXAMINATION.

- No. 5 TRUCK & TRACTOR GUIDE. 1376 Pages \$5.00
- No. 10 WELDERS GUIDE. 608 Pages 4.00
- No. 13 WIRING DIAGRAMS (Light & Power). 304 Pages 2.50
- No. 25 BLUEPRINT READING. 448 Pages 3.00
- No. 28 OIL BURNERS. 416 Pages 3.00
- No. 29 SHEET METAL PATTERN LAYOUTS. 1152 Pages 7.50
- No. 30 SHEET METAL HANDY BOOK. 448 Pages 3.00
- No. 31 MECHANICAL DRAWING GUIDE. 192 Pages 2.50
- No. 32 MECHANICAL DRAWING & DESIGN. 410 Pages 3.00
- No. 34 ELECTRICIANS EXAMINATIONS. 272 Pages 2.50
- No. 35 ELECTRIC POWER CALCULATIONS. Page 480 3.00
- No. 36 ELECTRIC DICTIONARY. 9000 Terms 3.50
- No. 37 POWER PLANT ENGINEERS GUIDE. 1568 Pages 6.00
- No. 38 ENGINEERS AND FIREMANS EXAMS. 544 Pages 3.50
- No. 39 OPERATING ENGINEERS LIBRARY. 3 Book Set 14.00
- No. 40 PUMPS, HYDRAULICS AND AIR COMPRESSORS 6.00
- No. 41 HOUSE HEATING GUIDE. 966 Pages 5.00
- No. 42 MILLWRIGHTS & MECHANICS GUIDE. 1248 Pages 6.00
- No. 43 DO-IT-YOURSELF ENCYCLOPEDIA. 2 Book Set 8.95
- No. 44 NEW MECHANICAL DICTIONARY. 712 Pages 6.95
- No. 45 MAGIC OF LANDSCAPING. 128 Pages 1.49
- No. 46 WATER SUPPLY & SEWAGE DISPOSAL 436 Pages 4.00
- No. 47 GUIDE TO CREATIVE PHOTOGRAPHY. 400 Pages 3.95

MAIL THIS NO-RISK COUPON TODAY!

THEO. AUDEL & CO. - Self Improvement Publishers Since 1879 - P-10
49 W. 23rd Street, New York 10, N. Y.

Please mail me for 7 days' FREE EXAMINATION the books I have circled at right. I agree to mail \$2 in 7 days on each book or set ordered, and to further mail \$2 a month on each book or set ordered until I have paid the purchase price, plus shipping costs. If I am not completely satisfied with my Audel Guides I may return them.

NAME _____

ADDRESS _____

CITY _____ STATE _____

EMPLOYED BY _____

SAVE SHIPPING COSTS! Check here if you enclose complete payment with order. We pay postage charges. You have same return privilege.

1	2	3	4	5
6	7	8	9	10
11	12	13	14	15
16	17	18	19	20
21	22	23	24	25
26	27	28	29	30
31	32	34	35	36
37	38	39	40	41
42	43	44	45	46
47	48	49		



Pays Up to \$8 an Hour. No Selling

Compare THIS Job to the One You Have NOW

Then, if you'd like to switch, I'll Show You How to DO It

Let me show you how to get into one of the fastest-growing professions in America—Auto Claim Investigating & Adjusting. Here's why insurance companies are glad to pay top prices to men in this particular field:

This year more than 25 million accident claims will have to be settled, and every year the number increases! No wonder insurance firms are glad to pay big sums for experienced men; provide such extras as a car, private office and secretary, free insurance, pensions, ent. expenses, other benefits. Even with only an average education you can go far in this exciting new field. We can teach you all the basic facts you need right at home to get started in your spare time. Just 3 or 4 months pleasant study reading case histories, learning procedures. You can set up your own office or work for a company. No need to change present location. No tedious office hours. We even supply FREE employment help! It costs nothing to find out all about this fascinating new profession for men from 20 to 60. Write to Liberty School of Claim Investigating, Dept. 910, Libertyville, Illinois. (Liberty School of Claim Investigating is Approved as a Private Business School by the State of Illinois).

— SIMPLY MAIL THIS COUPON NOW! —

**Eric P. McNair, President, Dept. 910
LIBERTY SCHOOL OF CLAIM INVESTIGATING
1139 W. Park, Libertyville, Illinois**

Show me how I can quickly become an Automobile Claim Investigator & Adjuster, and explain the many important social and financial benefits I can gain by switching into this exciting new profession now.

My Name

Address

City Zone State

JEEP OWNERS

**RE-POWER NOW WITH A V-8 OR 6 CYL. ENGINE — USE
FORD—CHEV.—MERCURY—GMC—PONT—STUDE—DODGE OR PLYMOUTH**
In Jeeps, Jeepsters, Sta-Wgn, trucks, Kaiser & H. J. cars.
Conversion Kits \$45.35 to \$56.90. Want fast action? Give us full information, send \$15.00 Dep. and we will ship correct kit. Bal. COD. Send full amount for prepaid shipment. Wire, phone or write today. Details FREE.

HOOSIER MACHINE PRODUCTS CO.
312 S. E. 6th St. Phone CR 6-3442 Pendleton, Oregon



STOP FRONT DRIVE DRAG AND WEAR ON 4-WHEEL-DRIVES!

Free-wheeling 2-wheel drive with Warn Hubs means big savings in gear, engine, tire wear, gas—plus more pep, performance, power in high, and easier steering. Rugged, dependable, proven, with over 400,000 in use. Iron-clad guarantee. Choose Lock-O-Matics that change drive as you shift, or manual Locking Hubs. Models for all 4-w. ds. at dealers, or write for literature.

WARN MFG. CO. Riverton Box 6064-A
Seattle 88, Wash.

Items from all outdoors

Goodies for fall sports department: One star of the recent fishing-tackle show is Du Pont's brand new monofilament fishing line that contains a daylight fluorescent additive, making the line easily visible any time it's light enough to see around you. Basing the new line on their Stren monofilament, they produced a line no different in physical qualities, but which emits a soft blue glow. When seen underwater and from below, as a fish sees it, however, the blue fluorescence loses itself against the light sky. Tests so far show no reaction on the part of the fish—they don't mind the color.

They're planning to call it New Stren Round Fluorescent Monofilament. It'll be in the stores this fall in sizes from 2 to 30 pounds.

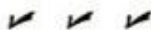

Getting your shotgun or rifle ready for hunting season? It doesn't really help your aim to have it looking good, but it'll pass the time until the season opens, and will make the gun last lots longer. There's a new gunstock refinishing kit on the market that makes it easy. It's a set of four small bottles—wet sanding fluid, primer-dewaxer, wipe-on finishing fluid, and liquid wax. The set makes refinishing pretty simple, and produces a fast, good-looking finish. It's called the Master Gun Stock Refinishing Kit, and is sold by the Thompson Company, 509 South Gilbert, Iowa City, Iowa.



Having trouble keeping your coffee warm all day, even in a vacuum bottle? Found a new gadget for that, too. It's an insulated container that's designed to hold your pint vacuum bottle. It not only adds a good quarter-inch of extra foam insulation, but also provides a nice, soft pad around the bottle for extra protection. It comes with a built-in hanging bracket and a matching holder that lets you hang the jug almost anywhere you can drive a screw—inside the car, boat, duck blind, on walls, or even on your belt. And they give you two attachment brackets so you can rig two spots for it; a third if you'll ask for it. The container fits all standard pint vacuum bottles and costs \$3.98 from Insulated Thermo-Tainer Co., Maquoketa, Iowa.

Dick Kiepatnik

POPULAR MECHANICS

Free

SEND TODAY FOR
YOUR MONEY-SAVING
464-PAGE

ALLIED

1963 CATALOG

mail
now

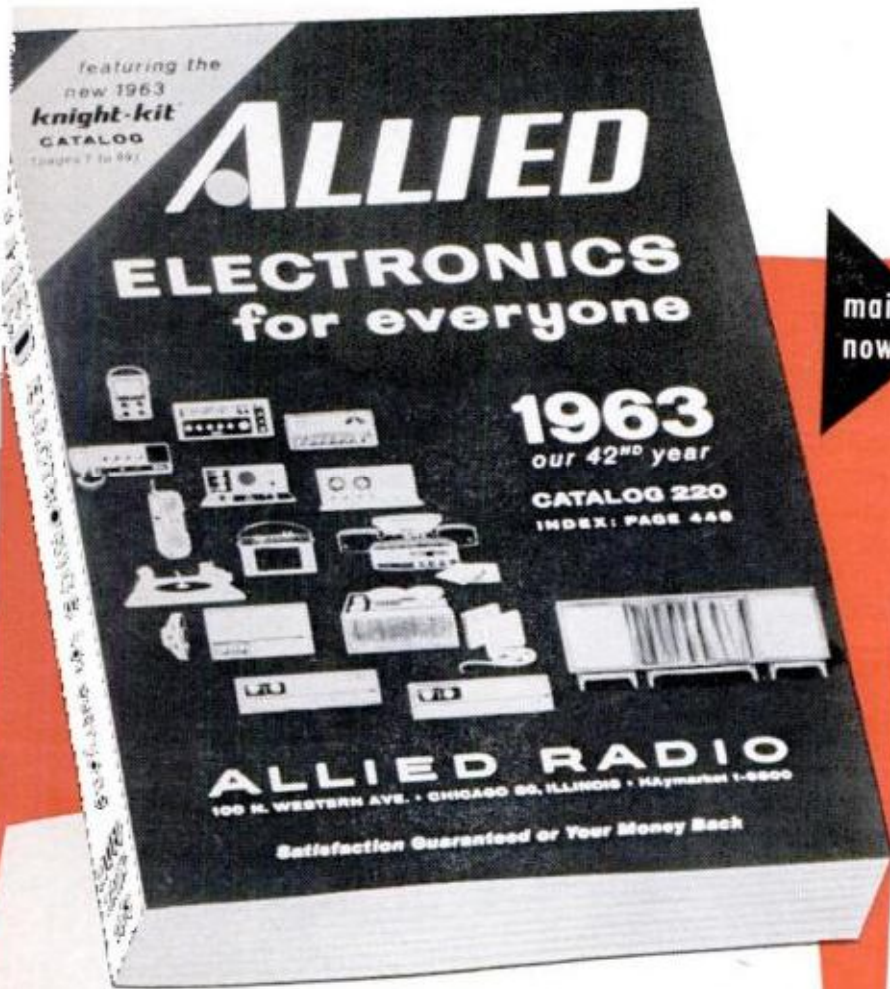

mail
now

FREE CLIP COUPON AND MAIL TODAY

ALLIED RADIO, Dept. 22-31-K
100 N. Western Ave., Chicago 80, Ill.

Send Free 464-Page 1963 Allied Catalog

Name _____
PLEASE PRINT

Address _____

City _____ Zone _____

State _____

FREE CLIP COUPON AND MAIL TODAY

ALLIED RADIO, Dept. 22-30-K
100 N. Western Ave., Chicago 80, Ill.

Send Free 464-Page 1963 Allied Catalog

Name _____
PLEASE PRINT

Address _____

City _____ Zone _____

State _____

FREE CLIP COUPON AND MAIL TODAY

ALLIED RADIO, Dept. 22-29-K
100 N. Western Ave., Chicago 80, Ill.

Send Free 464-Page 1963 Allied Catalog

Name _____
PLEASE PRINT

Address _____

City _____ Zone _____

State _____

SEND FOR IT NOW!

WORLD'S LARGEST ELECTRONICS CATALOG

BIGGEST SELECTION • BIGGEST SAVINGS

- Everything in Stereo Hi-Fi
 - New All-Transistor Stereo
 - Knight® Super-Value Hi-Fi
 - Tape Recorders & Tape
 - Phonographs & Records
 - Transistor & FM-AM Radios
 - World's Largest Selection of Parts, Tubes, Transistors, Books
 - 2-Way CB Radios
 - Shortwave Radios
 - Ham Station Equipment
 - PA Systems, Intercoms
 - Test & Lab Instruments
 - Tools & Hardware
- FAMOUS BUILD-YOUR-OWN **knight-kits**®

NO MONEY DOWN: Now! More Buying Power with your Allied Credit Fund Plan!

satisfaction guaranteed or your money back

SEND
COUPON

For your FREE 1963 ALLIED Catalog, fill in coupon at right, clip and mail today.

FREE

mail
now

Dr. Grabow Continentials



The Dr. Grabow
Symbol of
Quality

World's Finest
Imported Briar

Starfire ... \$ 3.95

Viscount ... \$ 5.00

Eldorado ... \$10.00

Pipes shown available
in all three price ranges.

Dr. Grabow Pipes
need no breaking in.
They are mechanically
pre-smoked and ready for
you to enjoy the most in rich,
sweet, cool, satisfying smoking.

Write for free booklet
Dr. Grabow Pre-Smoked Pipes • Greensboro, N. C.

You can shoot your rifle right inside the house if you follow all the directions in November PM describing—with plans—the soundproof gunbox and bullet-soaking backstop for a complete indoor range.



**NEW HI-FI
PERFORMANCE**

The Exciting NEW
MODEL 422 BENJAMIN
CO₂ 10-SHOT SEMI-AUTOMATIC
.22 PELLET PISTOL

\$24.00
Ask Dealer for Demonstration

AT LAST—an Amazing New Handgun that Incorporates the Characteristics Wanted for Serious Training, Plinking and Match Competition—Indoors and Outdoors—at **LOWEST SHOOTING COSTS!** Handsome, Dynamic, Mechanically Reliable, MODEL 422 combines Traditional BENJAMIN PEAK POWER and ACCURACY with Incredible Firing Speed—Smooth JAM-PROOF ACTION (no ramrod for cleaning pistol bore required)

WITH EXTRA MARGIN

BENJAMIN'S Unique DOUBLE SAFETIES

Press Trigger Safety "OFF"

Release Hammer Safety as Illustrated.



KEEPS SHOOTING & SHOOTING & SHOOTING & SHOOTING AS FAST AS YOU CAN SQUEEZE THE TRIGGER!

FREE Write today! Complete Catalog Benjamin Rifles & Pistols—Single Shot & Repeaters—BB or 177 or 22. Also, Special Offer on Hunting Knives.

Use Benjamin H-C Pellets in Model 422 for Accurate, Jam-Free Shooting.

BENJAMIN AIR RIFLE CO. 896 MARION ST., ST. LOUIS 4, MO.

Sidelights on aviation

THE BLUE ANGELS, the Navy's performing acrobatic team, break just about every rule of good jet piloting to fly some of the most precise formations in aviation.

Wing tip to wing tip, the four-man team does loops, rolls and all the other usual maneuvers, plus some highly unusual maneuvers in their supersonic F11Fs.

They pull more than six Gs at times, yet they scorn pressure suits and flight boots. They sit low in the cockpit, all cramped up with their knees in their faces and their feet in low-cut street shoes. And they fly with full nose-down trim.

This last would tear the arm off a pilot who wasn't used to it, but the *Angels* explain that forcing themselves to keep full back pressure on the stick to keep the nose up gives them a better feel of the plane for the high-precision touch they need. Over the years they've developed an extra bulge on their forearms to compensate.

For the rest, they say the heavy boots and pressure suits would only interfere with the delicate control they must keep over the planes, and the cramped position—using their legs, arms and even chin as one unit to nudge the stick ever so slightly this way and that—also helps overcome blackout on the high-G maneuvers.

The *Blue Angels* put on their amazing shows nearly 100 times a year throughout the country.



Military aircraft may finally get uniform designations.

Now, the Navy's F4H is the Air Force's F-110, yet they're identical aircraft. So are the Air Force's C-130 and the Navy's GV-1. These traditional designations just grew. The Air Force likes to name all its plane in the order they are made. The Navy likes to group them according to manufacturer.

It came to a head when Congressmen complained that they got confused when two witnesses talked about the same plane using two different designations.

Henceforth, the Department of Defense has ordered that planes will be identified by a letter designating basic mission (such as F for fighter), preceded, if necessary, by modified mission symbol (RF for reconnaissance fighter) and a model number.

Kevin V. Brown

POPULAR MECHANICS

RCA training at home can be the smartest investment you ever made

Look what you get in the Course in Radio and Electronic Fundamentals

40 Fascinating THEORY LESSONS



Containing all the basic principles of radio and electronics in easy-to-understand form.

40 EXPERIMENT LESSONS



Each containing absorbing, practical experiments bound together in 20 books.

40 SERVICE PRACTICES



Full of practical, time-saving and money-saving servicing tips, bound into 20 books.

PLUS ALL THIS AT NO EXTRA COST...

15 KITS

to build a Multimeter, AM Receiver and Signal Generator. Kits contain new parts for experiments, integrated so as to demonstrate what you learn in the lessons and to help you develop technical skills. Each kit is fun to put together!

MULTIMETER



A sensitive precision measuring instrument you *build* and *use* on the job. Big 4½" meter with 50 micro-amp meter movement. 20,000 ohms-per-volt sensitivity d-c, 6,667 a-c.

AM RECEIVER



Have the satisfaction of building your own radio receiver with this high-quality 6-tube superheterodyne set. Big 5" speaker, fine tone!

SIGNAL GENERATOR



A "must" for aligning and trouble-shooting receivers. Build it for your own use. 170 KC to 50 MC fundamental frequencies for all radio and TV work.

Also, comprehensive, fully-integrated home study courses in • *Television Servicing* • *Color Television* • *Automation Electronics* • *Transistors* • *Communications Electronics* • *Computer Programming* • *Electronic Drafting*. Stake out your future in electronics

with any one of this wide variety of courses. Practical work with the very first lesson! Pay-only-as-you-learn! No long-term contracts to sign! No monthly installments required. Pay only for one study group at a time, if and when you order it!

SEND FOR FREE HOME STUDY CATALOG TODAY!

RESIDENT SCHOOL COURSES in Los Angeles and New York City offer comprehensive training in Television and Electronics. Day and Evening classes. Free Placement Service. Catalog free on request.

RCA INSTITUTES, INC.
A Service of Radio Corporation of America • 350 W. 4th St., New York 14, N. Y. • 610 S. Main St., Los Angeles 14, Calif.



RCA INSTITUTES, INC. Home Study School, Dept. PM-02
A Service of Radio Corporation of America
350 West Fourth Street, New York 14, N. Y.

Without obligation, rush me the FREE 64-page illustrated booklet "Your Career in Electronics" describing your electronic home study training program. No salesman will call.

Name.....

Address.....

City..... Zone..... State.....

Veterans: Enter discharge date.....

CANADIANS—Take advantage of these same RCA courses at no additional cost. No postage, no customs, no delay. Send coupon to: RCA Victor Company, Ltd., 5581 Royalmount Ave., Montreal 9, Quebec.



The Most Trusted Name in Electronics

Imported Labor

A utility car from Japan, the Nissan Patrol, has a 125-horsepower, six-cylinder engine — unusually powerful for a four-wheel-drive vehicle. Long-leaf springs, double-acting shock absorbers and torsion bar-type stabilizers are designed to give a more comfortable ride than normally found in a vehicle of this type. Three power take-off points, roll-up windows make the Patrol a versatile worker. Price: \$2695 with full soft top. Write Nissan, Gardena, Calif.



One-Man Power Station

One man can pack a new 37-pound, 250-watt thermoelectric generator developed to power surveillance radar, communications equipment and other Marine gear.

Converting gas to electricity, it has no basic moving parts and is started simply by igniting the fuel.

Quiet, it powered a TV set in a demonstration without undue sound interference. The generator is a development of Minnesota Mining and Manufacturing Co.

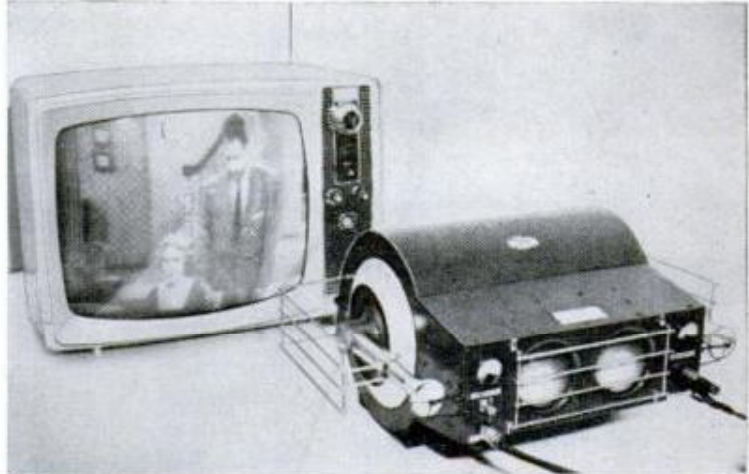

NEW!

**ACTUAL SIZE
Only 4 1/4" x 2 1/2"**

a perfect answer to "warning-light confusion"
STEWART-WARNER'S "TWO-IN-ONE" GAUGE CLUSTER!

With Stewart-Warner's new smartly styled "Two-In-One" Gauge Cluster you can see trouble before it happens. Contained in a single, compact, completely enclosed unit the Cluster has a gauge that registers exact oil pressure—and an ammeter that shows precise current flow. Fully illuminated. Attractive streamlined case blends with any car dash—mounts easily. See your dealer or write:

Symbol of Excellence
SW
INSTRUMENT DIVISION
STEWART-WARNER CORPORATION

Dept. C-102, 1840 Diversey Pkwy., Chicago 14, Ill.



Earn **HIGH WAGES** as a **HEAVY EQUIPMENT OPERATOR**



**FIELD-TRAIN
AT NATIONAL ON
DIESEL-ENGINE MACHINES**
Learn Operation,
Maintenance and
Safety

RUGGED OUTDOOR MEN

up to 56 years old can qualify!

**NO PREVIOUS
EXPERIENCE NECESSARY**
No Special Education Needed



High wages and security NOW and in the years to come are yours as a trained heavy equipment operator. Your chance is TODAY . . . your opportunity is HERE, if YOU will but take advantage of it! The world's fast-growing multi-billion dollar construction industry needs men NOW for work in this country and overseas — you can be one of them!

As a heavy equipment operator you will "move the earth" on aerospace projects, highway building, and industrial construction. Learn HOW at National, the original school of heavy equipment operation, through actual field training on the same kind of diesel-engined bulldozers, rubber-tired scrapers, motor-graders, and cranes now in use by the industry.

National School is NOT a correspondence school . . . if your application is accepted, you will field-train on its huge proving ground in the beautiful Piedmont area of North Carolina. Full training courses, VA approved, payment plans available. AND, National maintains its own Job Advisory and Counselling Department with a full-time Director for the exclusive use of its graduates!

Make up your mind NOW that you are interested in high wages and security and mail the coupon TODAY for FREE illustrated school catalog . . . you are not obligated in any way.

Even if you are presently taking a "course" in heavy equipment operation, write for our free catalog (there is no obligation), and compare the "training" you are receiving with ours.

MAIL TODAY
For **FREE** Illustrated School
Catalog and complete information

NATIONAL SCHOOL OF HEAVY EQUIPMENT OPERATION
Dept. D-33
P. O. Drawer 1686, Charlotte, N. C.

Please send one FREE illustrated school catalog and complete information about how I can become a Heavy Equipment Operator. I understand there's no obligation.

Name _____ Age _____
Address _____
City _____ Zone _____ State _____

**MY SPARE TIME HOBBY
MAKES ME
\$5⁰⁰ an hour
CASH PROFIT**

— Grover Squires

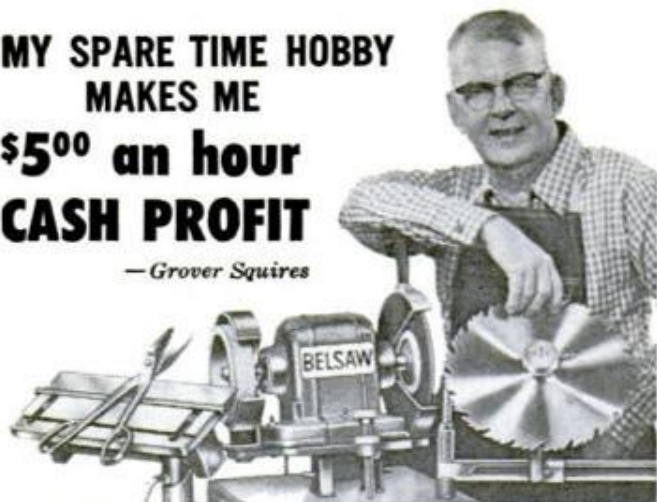

START YOUR OWN SPARE TIME BUSINESS
You can turn your spare time into Big Cash Profits with your own **COMPLETE SHARPENING SHOP . . .** Grind saws, knives, scissors, skates, lawn mower blades . . . all cutting edges. Your Own Cash Business with no inventory . . . right at home . . . no experience needed.

FREE BOOK tells how you can start your own spare time business while you are still working at your regular job. Low Cost — time payments only \$15.00 a month. Send coupon today.



BELSAW SHARP-ALL CO., 713 Field Bldg., Kansas City 11, Mo.
Send Free Book "LIFETIME SECURITY". No obligation.

Name _____
Address _____
City _____ State _____

Get ahead faster in AUTO MECHANICS

Don't get caught in a layoff! Get into Auto Mechanics. Earn big pay or go in business. Over 100,000 mechanics and 25,000 shops are needed. **Learn by practicing.** Easy CTI course includes 30 Job Experience Projects. Tools, Tune-Up Kit and Volt-Ampere Tester sent. **Earn as you train.** Diesel or Body-Fender instruction provided. CTI is a non-profit organization. Course is accredited by National Home Study Council. **Mail coupon for 3 free booklets.**

COMMERCIAL TRADES INSTITUTE Dept. A-289
1400 GREENLEAF AVE. • CHICAGO 26, ILLINOIS

Name _____ Age _____
Address _____
City _____ Zone _____ State _____

**BE A
REAL
ESTATE
BROKER**



PAYS BIG! SEND FOR FREE, BIG, ILLUSTRATED CATALOG NOW! Graduates report making substantial incomes. Start and run your own business quickly. Men, women of all ages, learn easily. Course covers Sales, Property Management, Appraising, Loans, Mortgages, and related subjects. **STUDY AT HOME** or in classrooms in leading cities. Diploma awarded. Write TODAY for free book! No obligation.

Approved for World War II and Korean Veterans
WEAVER SCHOOL OF REAL ESTATE (Est. 1936)
3523H Broadway, Kansas City 11, Mo.



engineering degree in 27 months

Industry demands graduates. Enjoy higher income . . . advancement. Major corporations regularly interview and employ seniors. *Bachelor of Science Degree in 27 Months* in Electrical, Mechanical, Aeronautical, Chemical, Civil Engineering. IN 36 MONTHS a B.S. Degree in Business Administration (General Business, Accounting, Motor Transport Administration majors). Small classes. More professional class hours. Well-equipped labs. Campus. New dorms. *Low costs.* Founded 1884. Enter January, March, June, September. Write J. E. McCarthy for Catalog and "Your Career in Engineering and Commerce" Book. Learn more and you'll earn more.



TRI-STATE COLLEGE

4102 College Avenue • Angola, Indiana

29 YEARS IN BUSINESS AT THE SAME ADDRESS.

NOWHERE CAN SUCH QUALITY BE FOUND AT SUCH LOW PRICE!

We Bought Tires by the Truck Loads— TO SAVE YOU MONEY



OUR ENTIRE STOCK OF GOOD USED PASSENGER TIRES ARE ALL FULL 4 PLY

850x14	\$4.75	670x15	\$4.75	700x17	\$9.05	900x20	\$16.95
600x16(6)	7.55	710x15	4.75	750x17	10.75	1000x20	17.95
650x16(6)	8.55	760x15	5.55	650x13	4.75	1100x20	16.95
750x14	4.75	800x15	5.55	700x20	10.55	1000x22	18.95
800x14	4.75	820x15	5.55	750x20	12.25	1100x22	18.95
700x15(6)	9.75	640x15	4.75	825x20	17.85	Whites	\$1.00 EX.

SNOW TIRES \$6.82 AND \$5.00 SIZE ANY BLACK WALL PASS.

Thousands of tires shipped all over the U.S.A. All tires shipped F.O.B. Phila. Send Check or M.O. with this ad. Dept. 5. No C.O.D. **STANDARD TIRE CO.**, 834 North Broad Street, Philadelphia 30, Pa.



EARN a SMALL FORTUNE IN YOUR SPARE TIME . . .

GUARANTEED 5 YEARS Make \$100, \$250, \$500 and MORE introducing amazing 5-Year Guaranteed light bulbs . . . to homes and businesses in your area. Show it and the sale is made! Earn over 100% profit on each sale! Rush your name, address now for special FREE Starting Offer and money making details. Write **SUNMASTER ELECTRIC PRODUCTS, INC.** (In Canada, 675 King St. W., Toronto, Ont.) Dept. PM-102, 366 Fifth Avenue - New York 1, New York



make your own Gems 36⁵⁰ F.O.B.

The Gem Maker comes complete with all necessary equipment, including a super-charged diamond blade for sawing, and all the wheels for grinding, shaping and polishing; also complete instructions. The complete equipment as shown, less motor and belt for only \$36.50. F.O.B., Burlington, Wisconsin. Write today for information and literature.

B & I MANUFACTURING CO.
Dept. P, Burlington, Wis.

EARN MORE be a TAX CONSULTANT

Our students earn lucrative fees in 3 month busy tax season preparing income tax returns in spare time—and operate profitable Business Tax Service yielding steady monthly fees of \$10-\$50 per client, year 'round. Enjoy professional standing in dignified full or part time home-office business. No experience necessary. We train you at home and help you start. Write today for free literature. No agent will call. State Approved Course.

UNION INSTITUTE, Lakewood, R20, New Jersey



100% PROTECTION!

Discharges tear gas to instantly stop, stun and incapacitate the most vicious man or beast. Effective substitute for firearms; leaves no permanent injury. No selling experience needed. Handle as profitable sideline, soon you'll sell it full time. Start now. 5 easy sales net \$25.00 a day up. Send \$5.95 for demonstration kit of Automatic Tear Gas Pencil, 10 Demonstration Blanks and 3 Tear Gas Cartridges. **NOT SOLD TO MINORS.** State age with order.

HAGEN SUPPLY CORP.: Dept. PM102, St. Paul 1, Minn.

BIG PROFITS, SELLS EASY TO GAS STATIONS, NIGHT WORKERS, MOTORISTS, NURSES, STORES, BANKS, HOMES



MANUFACTURING



ADMINISTRATIVE



PROFESSIONAL

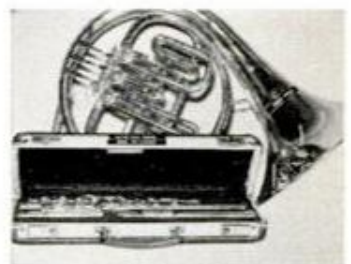

MUNICIPAL



PERSONAL

RAISED LETTER LABELS

MADE ON THE SPOT

If it can be mistaken, mislaid, misfiled, misused, misanything — label it with Dymo. See for yourself how easily you can make handsome, raised-letter labels for 1001 applications.

Embossed labels take seconds to make, cost pennies, stick permanently to almost any surface. Vinyl tape in 10 colors, five striped tapes, six metal

tapes. Five Dymo Tapewriter models, from \$24.95.

Send the coupon for a free booklet, "1001 Applications" for manufacturing, administrative, inventory, personalizing, professional, electrical, municipal, schools, electronics, and many more — along with a name badge personalized with your name.

Embossed letters provide maximum permanent legibility, quality appearance.



Prices slightly higher in Canada



WRITE FOR FREE BOOKLET "1001 APPLICATIONS" AND YOUR SAMPLE NAME BADGE

Dymo Industries, Inc., Department PM -10
P.O. Box 1030, Berkeley 1, California

Please send me free booklet "1001 Applications" and my name badge as follows.

Name _____ (PLEASE PRINT)
 Title: _____ Firm _____
 Product or Service _____ Tel. _____
 Address _____
 City _____ Zone _____ State _____

INDUSTRIAL OR TOOL ENGINEERING

BACHELOR DEGREE IN 31 MONTHS

HOME STUDY OR RESIDENT

DRAFTING ALL BRANCHES

TOOL & DIE DESIGNING & MAKING

AIR CONDITIONING HEATING & REFRIGERATION

AUTO MECHANICS

WRITE TODAY FOR FULL INFORMATION

ALLIED INSTITUTE OF TECHNOLOGY
1338-42 South Michigan Ave., Dept. PM-102, Chicago 5, Ill.

Send me without obligation information on your courses:
 Drafting—All Branches Air Conditioning & Refrigeration RESIDENT
 Tool & Die Designing Auto Mechanics
 Tool & Die Making Industrial Engineering HOME STUDY

Name..... Age.....
 Address,
 City..... County..... State.....

Allied Engineering graduates are earning top money in industry and the national space program.

Engineers are always in demand! Start training now in short courses at home or at the Allied Institute, and earn your degree in 31 months.

Shorter courses available in Drafting, Tool & Die Making & Design, and Auto Mechanics. Air Conditioning Service-man's course in as short as 24 weeks.

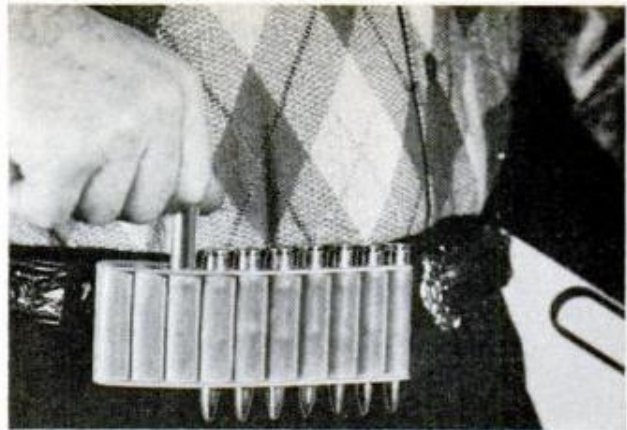

Expandable Cartridge Pack

Rubber holders of a new cartridge pack expand independently to hold a variety of cartridge calibers.

Made of flexible molded rubber formulated to work in temperatures from -65 to 240 degrees F., the pack holds the cartridges securely in "O" rings, yet releases them easily when needed. Each passage is open at both ends so moisture will not accumulate.

Two models are available, holding cartridges from 220 Swift up to 458 Winchester. The Sure Grip Cartridge Packs, which come in red, brown or black, are made by Mershon Co., 1230 S. Grand Ave., Los Angeles, Calif., and retail at \$3 each.

SAMURAI SUICIDE WARRIORS KARATE! JUDO BOXING! MUSCLEBUILDING! YOGA! STRONGMAN STUNTS! STRENGTH & ENDURANCE! HANDBALANCING! ETC.



YOU GET ALL THESE COURSES! *20 illus. FOR ONLY 35¢
 *Secret KARATE blows *SAVATE foot fighting
 *Secret NERVE CENTER and ANATOMY charts
 *20 lethal JUDO throws *20 terrific STRONGMAN STUNTS *Complete MUSCLE-BUILDING course *Ancient YOGA secrets *HANDBALANCING stunts *Complete BOXING course, Secrets of ENDURANCE *WRESTLING holds *WEIGHTLIFTING *Giant wall charts, All picture packed. No C.O.D. Canadian 50¢.

K-MAN Huge KARATE PRACTICE DUMMY Life like! Shows attack points, nerve centers, weak spots, 15¢ with 35¢ order only, Total 50¢. Plus FREE 16 Page Book

OXFORD STUDIO, 44A8 Bromfield St., Boston 8, Mass.
 NAME (print) 35c Program
 Address,
 City..... State..... 50c with K-man

Print Your Own



Cards, Stationery, Advertising, Circulars, labels, photo and movie titles, church work, tags, etc. Save money. Sold direct from factory only. Raised printing like engraving, too.

Own a Printing Business

Print for Others, Good Profit. Have home shop. Junior press \$15; Senior \$35 up. We supply everything. Easy rules. Pays for itself in short time. Write now for free details. **KELSEY PRESSES, Z-37 Meriden, Conn.**

5 BAR GENERATOR \$4.95!

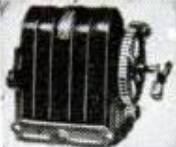

Telephone type generator with 90 volt output. Will ring standard telephone bell. Good experimental item. Write for free list. Shipments FOB Simpson, Pa.

TELEPHONE ENGINEERING CO.
Dept. 10B2 — Simpson, Penna.

PROFIT IN YOUR SPARE TIME



SMALL ENGINE REPAIR PAYS BIG!
 Outboard • Powermower • Chain Saw • Tractor
MAKE EXTRA MONEY — or fix your own engines and SAVE! Illustrated, easy-to-learn Home Study Course qualifies you as expert. Free information. Write today!

LINCOLN TECHNICAL INSTITUTE
SUITE 10-E, 472 MARKET STREET, NEWARK 5, N. J.

A QUICK & EASY WAY TO LEARN HOW TO REMEMBER NAMES

This proven name-memory course makes it easy for you to use the four natural laws of memory and the exclusive right-hand name-memory method. Tells how experts remember the names of groups of people. Tells how YOU can remember a person's name the next time you meet him, even months later. Course includes a 20-page illustrated booklet, personal memory test, five pocket memory reminder folders, and complete instructions... all for \$1 postpaid. Send check, money order, or stamps.

Human Relations Consultants - Box 10583-P - Houston 18, Texas

BUY WHOLESALE

FREE NAME BRANDS CATALOG WITH CONFIDENTIAL PRICE LIST

Your own high profit business full or part time. More than 2000 items: power tools, sporting goods, jewelry, cameras, hi-fi, appliances, housewares, hardware, almost everything! Orders shipped same day. Send for your Free catalog today.

H.B. DAVIS CORP. Dept. PM 10
 145 West 15th Street, New York 11, N. Y.



How Long Has it Been

...since you have had **a raise?**... **a promotion?**
...or any indication of a **richer future?**

Would you like a 32 page booklet (without cost) that will show you how to get continuous raises without long waits?

It has brought a new way of life to both men and women. It describes the Duraclean way to independence and higher income.

It tells you how our dealers, while continuing present job, earn up to \$9 and more hourly profit as their customer list grows... then switch to full time, lining up jobs for their servicemen. They gradually add more equipment, more men, and more profit.

It tells how they have eliminated job insecurity, income limits, dictates of a boss, lay-offs, and the monotony of office and plant routine; how now, instead, they enjoy security, freedom of action, ownership prestige, a fuller life and automatic income increases.

Territories for new dealerships get fewer every day as open areas rapidly fill up in this cooperative organization. This is a high profit, lifetime business with unlimited opportunity that has grown to a worldwide service. The coupon will bring you the full details by mail with no obligation.

No Experience, No Shop Needed

Owning your own business is easier and much simpler than you were likely thought... when you have the training and the constant aid of a firm that is deeply interested in YOUR success.

You need no previous experience. The business is easy to learn... easy to start... so easy to service that women do it. Dealers operate from home, office or shop. If you can invest a few hundred dollars, we will finance the biggest part of your business.

Each dealer has a personal relationship with our staff. We hold dealer area meetings, training schools, and dealer conventions. We all work together... exchange ideas and swap experiences.

\$9 hourly plus \$6 on Servicemen

The national price guide gives you a gross hourly profit of \$6 on EACH serviceman working for you... \$9 on your own service. One job a day brings a good income. Then, your business grows from recom-

mendations and repeat orders.

You not only steadily increase income... your dealership value grows. G. F. Munroe, after 12 months, sold his Texas dealership for 10 times his cost. Jerry Humbird operated 4 months and sold for \$1,325 above his cost. Jack Braniff started 3 dealerships and sold each at a profit. Leo Lubel, after 30 months, sold for \$8,308 above cost. We help dealers sell, if they wish to.

An experienced Duraclean dealer will train and assist you... reveal his proven ways to build customers. In a few days, your business is established with a growing income.

Customers Come Readily

The phenomenal growth of Duraclean service was due to the safer, quick-dry absorption process of cleaning, reviving, and protecting carpets and upholstery right on the premises. Housewives, hotels, theaters, clubs, motels, institutions appreciate having furnishings cleaned with a new consideration for life and beauty.

Customers tell friends how Duraclean eliminates soaking, harsh soaps and rough machine scrubbing... how mild, quick-action, foam lightly applied, cleans better, revives colors, enlivens fibers, makes fabrics brighter. Customers are your best salesmen.

You may write to one of our dealers, if you like.

You Have 6 Services

DURACLEAN brightens, cleans & revives upholstery.

carpets and rugs with a new SAFETY and convenience.

SPOTCRAFT safely removes spots and stains.

DURASHIELD retards soil and stains... keeps

fabrics fresh and bright months longer.

DURAPROOF kills and repels moths and carpet

beetles. You give a 6 year Warranty.

DURAGUARD flameproofs; avoids fire starts.

TUFTCRAFT repairs moth damage, cigarette

burns... often saves the furniture or carpet.



While
Still Employed,
You can Start
and **OWN**
a Growing
Business



Worldwide
Service

An Exploding Market

Government figures show service businesses growing faster than industries and stores... \$750 million yearly potential just in rug and furniture cleaning. You have 5 other services.

You will have pre-tested yellow-page and newspaper ads, commercials, store display cards, sales aids and mailings. You are backed by national ads, Parents' Magazine Seal, McCall's "Use Test" approval, American Research & Testing Laboratories, furniture and carpet manufacturers' endorsements.

Upholsterers, decorators, furniture, carpet, and department stores refer jobs to you from their customers. Car dealers take orders; have used cars Duracleaned.

We prefer you have no cleaning experience... not have to "unlearn" old scrub methods. We and an experienced dealer show you all you need to know to build your business.

Small Investment

A few hundred dollars establishes your business... you can pay rest from sales. We supply electric equipment and enough materials to return your TOTAL investment.

A Duraclean dealer must be reliable, honest, energetic, and willing to work. If you can meet these qualifications and can make the small initial investment, we'll be glad to hear from you and mail you complete facts.

But, whatever you do, mail the coupon today... now before you forget it, before someone else gets the dealership for your area. There is no obligation to find out.

It has been said, "Opportunity knocks but once at every man's door." This may be that one opportunity in your life.

Find Out!

With no obligation, we'll mail you a 36 page booklet explaining these 6 vitally needed services... how and why your business grows... how we help finance you.

Then decide if this sound business fulfills your dream of progress and independence. Your location could be taken tomorrow... so mail the coupon today—NOW!

What Dealers Say

L. Falls: "I cleaned 1900 sq. ft. of carpet in one day and made \$135."

L. Broersma: "Have now completed 5 years with Duraclean. We have never had one complaint."

George Byers: "For State University my total billing was \$2,416. Total expenses \$814."

Ed Kramsky: "In 2 years, I now have two assistants, a nice home and real security for my family."

Leon H. Babbitt: "I average about \$400 monthly part time. I'm starting full time."

John Jaffe: "There's a huge demand for good carpet and upholstery cleaning. If you tell enough people about Duraclean you have to make good."

W. C. Smith: "Earned \$650 one week. Our volume keeps getting bigger all the time."

Gerald Weirrauch: "Three persons called me... saw Duraclean advertised in magazines."

Earl Davis: "Our sales increased \$17,660.00 this year."

A service man for Dealer C. Weed: "The furniture was filthy black. When through, I was amazed at how clean it looked."

V. Nebendahl: "I've closed every sale where I used the new slide projector to date."

N. Josseland: "Have made as high as \$200 in one day. Largest earnings for a single week... \$750."

Mail this coupon TODAY
It may put you in business

DURACLEAN CO., 2-160 Duraclean Bldg., Deerfield, Ill.

With no obligation, mail letter with 36 page booklet fully explaining how I can increase my income and my family security with a Duraclean dealership.

Name.....

Address.....

City..... State.....

Pentagon sidelights

By William R. Kreh

A squeeze gauge has been devised and put to use at Fort Jackson, S. C., to help show new soldiers the importance of squeezing rather than pulling a trigger. The unit, which hooks onto a rifle, consists basically of a glass tube filled with pink water. As the rifle trigger is squeezed, the fluid is forced into the vertical tube, clearly marked to show the degree of pressure applied. Should the soldier jerk the trigger, the fluid spurts out the tube's open top. The gauge is being used by trainees in dry-firing practice before going out on the target range.

An electronic bloodhound, so sensitive it can detect alcohol in a man's saliva from a bottle of beer he drank the day before, has been developed by Air Force scientists. Called a gas chromatograph, it may be used to sniff out possible signs of life on Mars.

A new type of green paint has been developed by Army engineers to use in camouflaging its missiles. Although dark in color, the paint nevertheless reflects a high percentage of the sun's heat and keeps the delicate instruments inside the missile cool. Formerly, the missiles had to be painted white to reflect the sun's rays and protect their innards from solar radiation.

Flight box lunches offer the Navy more than food. Down at Jacksonville, Fla., they're using the discarded cardboard boxes as instrument hoods, used to simulate flying by instruments only by blocking from a pilot's view all outside conditions without hiding the aircraft instruments. With a couple of snips of the scissors and a few creases, one of the boxes can be shaped to fit under the visor of a flight helmet. Besides being simple, it's safe too, since it can be removed in an instant should an emergency arise.

Snapping shrimp, barnacles, and other sea creatures are appearing on television every day down in Florida and their No. 1 fans are Navy scientists.

The Office of Naval Research recently

installed a television camera and hydrophones on the ocean floor in the Florida Straits, connected by cable to a laboratory in the Bahamas where scientists study the marine life and the noises they make. Reason? Many of them make noises which, when heard on sonar, sound like a submarine engine. By watching and listening to them, the Navy hopes to be able to train its sonar operators to tell the difference between their noises from those of a real engine.

Along the same lines, the Navy has recently taken security off a tape recording of a "conversation" between three killer whales recorded in Puget Sound. The tape is being used to train sonar operators, since the noises sound amazingly like those made by the sonar echo off a submarine hull. As a sidelight, the Navy said only one whale "talked" at a time, the others waiting politely until he finished before "answering."

A super flash-bulb unit is being tested by the Army for use in night photography from the air. The electronic unit can illuminate an area of 750 square feet from an altitude of 1000 feet. The 165-pound unit is mounted in a 16-inch reflector which is carried under the wing of one of the Army's light aircraft. The new unit has several advantages over the style now used for night aerial photography—it's safe to handle (present bulbs are explosive), it can be used thousands of times without replacement, and since the duration of its flash is so short (1/10,000 of a second) it virtually eliminates any image motion on the film.

A compact "space kitchen" for feeding three men on a two-week space flight has been developed by the Air Force. The tiny, lightweight galaxy galley consists of an electric oven, water system, water heater and small refrigerator. The Air Force says the compact feeding console "is configured to resemble the eating facilities with which the astronaut is acquainted in his everyday living, thus maintaining a high interest level in eating."

A tick-pulling gadget that measures how much force it takes to pull one of the insects from a rabbit's ear has been built by the Navy. It was part of a search for an ointment or drug that will cause ticks to remove themselves from a man's body. They haven't found such a substance yet, but they're still looking. Meanwhile, they say kerosene and camphorated phenol are the most effective substances of all they've studied. Holding a lighted cigarette close to the tick's rump will also work wonders, we've found.

Spot Car Troubles **FAST!**

IN ANY PART OF ANY CAR

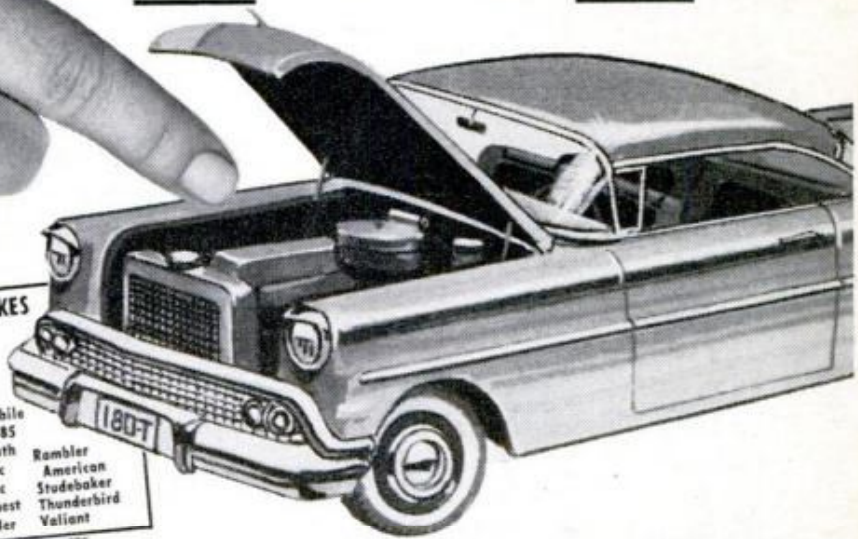

FIX ANY PART

Ignition	Automatic
Generator and	Transmissions
Regulators	Overdrive
Alternators	Suspensions
Starting Motors	Differentials
Carburetors	Brakes
Fuel Pumps	Steering
Engines	Dash Gauges
	Starter Switches

COVERS ALL THESE MAKES 1955 thru 1962

Buick	De Soto	Mercury
Buick Special	Dodge	Metzger
Cadillac	Edsel	Nash
Chevrolet	Fairlane	Oldsmobile
Chevy II	Falcon	Olds F-85
Chrysler	Ford	Plymouth
Comet	Imperial	Pontiac
Continental	Jeep	Rambler
Corvair	Lancer	American
Corvette	Lark	Studebaker
Dart	Lincoln	Thunderbird
		Valiant

..and FIX 'EM QUICK this easy way!

Automobile Factory Experts Show You Step-by-Step How to Service or Repair Almost Every Car Built Since 1955

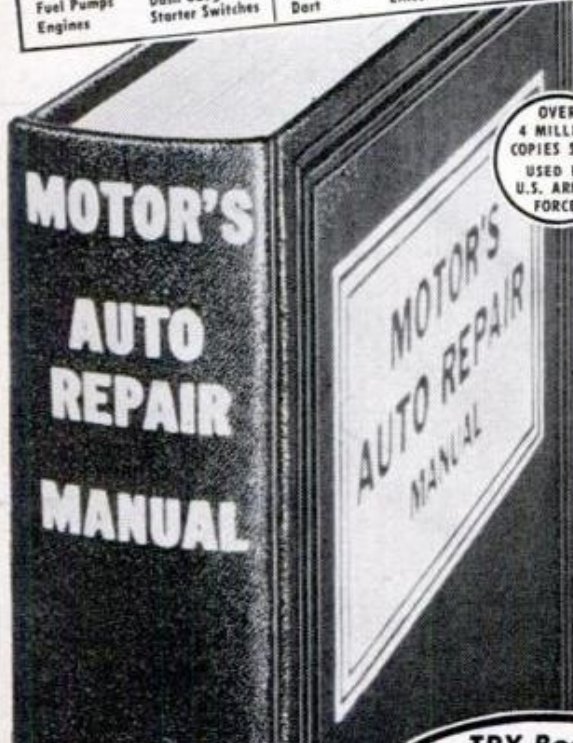

OVER 4 MILLION COPIES SOLD USED BY U.S. ARMED FORCES

WHY knock yourself out...wasting time, money, effort, trying to fix a car? Now, with the new MOTOR's Auto Repair Manual, you can breeze through tough repair jobs like an expert. Whether simple adjustment or complete overhaul - look it up in the handy index... then follow clear, illustrated, step-by-step instructions. You'll be amazed how easy it is!

Over 2800 Pictures! Everything You Need to Know Right at Your Fingertips!
It's like having auto factory experts at your side, showing you exactly what to do. You get the meat of 176 Official Factory Manuals... by the men who built the cars - boiled down into one big picture-packed book.

NEW, REVISED, ENLARGED edition covers 2,219 American made models, 1955 through 1962, including all new compacts. Over 1,100 double-size pages... 2850 pictures... more than 30,000 repair specifications... 195 "Quick-Check" charts... over 225,000 service and special repair facts... tune-up data for 36 foreign car makes... Trouble-Shooting section helps you

spot cause of 2,300 car troubles fast. So clear, complete, you CAN'T go wrong, even if you're a beginner. And if you're a top-notch mechanic you'll find short-cuts that will save you time, money, wear and tear.

Over 4 MILLION Copies Sold!
MOTOR's Auto Repair Manual is used by the Armed Forces, in schools, brings letters like these:
"MOTOR's has saved us a lot of time and money - cannot do without it."
-H. Hartman, Baltimore. "Since using MOTOR's I can overhaul any car. It's a book I can't be without."
-W. Harold, Julesburg, Colorado.

SEND NO MONEY
Use Manual FREE for 10 Days
We're so convinced MOTOR's Manual must save you time, energy, and money that we send you the new 1962 edition to use FREE for 10 days. If it doesn't pay for itself on the very first job, return it and owe nothing. You don't risk a penny. Rush coupon today to MOTOR Book Dept., Desk 210, 250 West 55th St., New York 19, N. Y. (Schools, Bookstores; Write for Discounts.)

TRY Book FREE For 10 DAYS

Beginner Raves About Book...
"Never knew anything about repairing cars until I got this wonderful book. Has paid for itself time and time again."
-P. Pempfer, Wis.

... So Does Expert
"Have been a mechanic for 25 years. MOTOR's Manual still takes me out of the tight spots. And it's simple enough to be understood by average person."
-V. Lauria, Nev.

Same FREE 10-Day Trial on MOTOR's New TRUCK REPAIR MANUAL
Covers 98% of all trucks, 1952 thru 1962, including Chev. Ford & International "Midgets." Over 2,000 illustrations: 300,000 facts. Covers all types of gasoline truck engines, as well as GM, International, Mack and Cummins Diesels. Over 800 big pages. For FREE Trial, check proper box in coupon.

MAIL NOW FOR 10-DAY FREE TRIAL (ATTACH TO POSTCARD FOR FASTER ACTION)

MOTOR BOOK DEPT.
Desk 210, 250 W. 55th St., New York 19, N. Y.

Rush to me at once MOTOR's New AUTO REPAIR MANUAL. If O.K., I will remit \$2 in 10 days, \$2 monthly for 2 months and a final payment of \$2.95 (plus 45¢ delivery charges and sales tax) one month after that. Otherwise I will return the book postpaid in 10 days.

Print Name..... Age.....

Address.....

City..... Zone... State.....

Also send me for 10 days Free Trial MOTOR's New TRUCK REPAIR MANUAL. If O.K., I will remit \$10.00 plus delivery charge and sales tax in 10 days. Otherwise I will return book postpaid in 10 days.

Check box and SAVE 45¢ delivery charge by enclosing WITH coupon in envelope entire payment of \$8.95 for Auto Repair Manual (or \$10 for Truck Repair Manual) plus sales tax. Same return-refund privilege.

Earned \$2,000 While Training!



Says **ROBERT N. MILLER, Oakland, N. J.**
 "I became a locksmith when a back injury forced me to give up my job as a truck driver. Now I own a successful mobile locksmithing shop."

Be a LOCKSMITH



Add 50%-100% to YOUR INCOME with easy spare time earnings. Cash in on nationwide shortage... in good times and bad. Quickly step into a big-pay opportunity job—high profit shop of your own.

Earn Extra Money RIGHT AWAY! All Special Tools, Supplies Furnished FREE.

Age, education, minor physical handicaps don't matter in this growing trade. You can quickly qualify as a skilled locksmith. Study at home as little as one hour a week. Gain practical experience through well-illustrated lessons. Do real jobs on car locks, house locks, padlocks and safe locks, under guidance of experts.

FREE Illustrated Book

For a future as your own boss or in a high-pay job, send for FREE book and sample lesson pages. Only school of its kind. Lic. State of N. J. Acc'd National Home Study Council. Vet. App'd. Locksmithing Institute (Div. of Tech. Home Study Schools). Dept. 110-2, Little Falls, N. J.

306

pieces of equipment—locks, Picks, Tools & Parts

FREE

for use with course.

MAIL COUPON NOW!

Please send, without obligation, FREE Book, "Big Money in Locksmithing," and Sample Lesson Pages. No Salesman will call.

LOCKSMITHING INSTITUTE
 Dept. 110-2
 Little Falls, New Jersey

Name _____
 (Print here)

Address _____

City _____ Zone _____ State _____

Check if Veteran

HOW TO ENJOY PIPE SMOKING

SEND FOR NEW

FREE
 PIPE SMOKER'S
 ANNUAL



Learn how to judge fine pipes, — How to break in a pipe, — How to keep a pipe sweet, etc. Big, colorful fact-filled International Pipe Annual lets you in on the secrets. Packed with photos, drawings, diagrams. Big round-up of Briar, Meerschaum and Calabash pipes from England, Belgium, France, Holland, Italy and U.S.A. all with detailed specifications and lowest prices. Every conceivable shape. Limited Edition.

WRITE FOR YOUR FREE COPY TO . . .

WALLY FRANK Ltd. DEPT. X165
 132 CHURCH ST., NEW YORK 7, N. Y.



Quick Cold Pack

Activated simply by a squeeze, a portable cold pack produces a chemical reaction resulting in a temperature of 20 degrees F.

Measuring six by nine inches, the pack is flexible and can be molded to fit any part of the body. It's a ready source of cold in situations where ice may not be available, as on an athletic field. Effectiveness is not lost even after two years of storage. Manufactured by International Latex Corp., the cold pack sells for \$1.25.



get into operating or repairing
EARTH MOVING EQUIPMENT

Men needed now for good paying jobs in booming road and construction work. Learn operating or repair-rebuilding of heavy road machinery, cranes, bulldozers, earth carriers, etc. Actual "on the job" training. 5 to 13 1/2 week courses. Classes start every Monday. Reserve your space now. Complete catalog and reservation facts FREE. Approved for veterans. Write

Greer TECHNICAL INSTITUTE
 Attn.: P. L. Hutch, Box 368, Braidwood, Ill.



Make Money with Your Telephone

NEW HOME BUSINESS. Men, women — no experience needed. No selling! Choose your own hours, full or spare time. We show you everything—tell you who to call, what to say, how to make money without ever leaving your telephone. **Free Copy,** "How to Make Big Profits by Phone," full details, write **TELEPHONE INSTITUTE, Dept. H17A**
 1038 S. La Brea - Los Angeles 19, California

Would You Like to Make **\$1,000 A MONTH?**



That's what Stanley Hyman made selling the amazing new Presto Fire Extinguisher! Many others "cleaning up"—so can you! Amazing tiny new extinguisher ends fires fast at 2 seconds. **Guaranteed for 20 years!** Sells for only \$4.95. Write for Free sales kit.



Merlite Industries, Inc., Presto Div.,
 114 E. 32nd St., Dept. P-15Z, New York 16, N. Y.

LAW FREE BOOK THE LAW TRAINED MAN

Write today for a FREE copy of illustrated law book, "THE LAW-TRAINED MAN," which shows how to earn the professional Bachelor of Laws (LL.B.) degree through home study of the famous Blackstone Law Course. All necessary books and lessons provided. Moderate cost; convenient monthly terms. Write for FREE law training book today.

Blackstone School of Law, 307 N. Michigan Ave.
 Founded 1890 Dept. 57, Chicago 1, Illinois



Police Play Roulette

Tiny roulette wheels send Edina, Minn., patrol cars on their rounds—by chance.

Edina's four squads patrol four zones. Each zone is subdivided into sections, corresponding to numbers on the wheels. Sections of higher crime rates are given more space on the wheels. When a squad calls in, its wheel is spun and it is sent to the "winning" section. By avoiding set patterns of patrol, the roulette-playing police take the house odds against the criminal element.

A chance to make extra money at home.

Be your own watchmaker! You can replace round waterproof crystals in 60 seconds! Special Offer:

The easy to operate SUC Rocket Watch Crystal Remover and Inserter tool with special base... plus 144 SUC AW Round crystals... complete size range... A \$37.95 value.

YOURS FOR ONLY \$27.95

Standard Unbreakable Watch Crystals, 123 E. 144 St., N.Y. 51, N.Y.



BUY FACTORY DIRECT!

WREN by **BIRD** engineering \$99.95

Send 25c for brochure



\$10.00 Down
\$5.00 a Month
Complete with
Clinton 2 1/2 H.P.
engine, ready to run!

Bird Engineering, 206 S. 19. Dept. PM-WJ Omaha, Nebr.

9 OUT OF 10 BUY NEW

SLEEPING COMFORT



Sells Electro-Warmth for you with generous profit. Averaging 9 buyers out of 10 triers on Guarantee Sales Plan. Much needed appliance used year around. Completely automatic and patented. Unusual opportunity to get in on the ground floor in your area. Write factory NOW for free information.

PATENTED PRODUCTS CORP.
Dept. PM-102 Danville, Ohio

INVENTORS NEEDED AT ONCE

If you have an invention you wish to sell outright or license on royalty, write us at once. We are seeking inventions of household items, games, toys, sports items, tools, and mechanical and technical devices. Patented or unpatented. For further information and free brochure outlining manufacturers' requirements, royalty rates, send your name and address (no drawings, please) to us by letter or on postcard at once.

KESSLER CORPORATION, Dept. D-510, Fremont, Ohio

WILL AUTOMATION MOVE YOU OUT OR UP?

Employers everywhere are turning to Automation in their offices and plants to cut costs and improve products and services. As a result, they are keeping their eye on men who are qualified or are training to operate, maintain and supervise electronic equipment. Designers, builders and installers of Automation equipment have a fast growing need for trained men, too. So does the government, in its military and civilian activities.

Automation is "Taking Over"

As the fast moving trend to Automation moves through offices, plants and service businesses of all kinds, hundreds of thousands of men who lack specific skills are losing out, joining ranks of unemployed or forced to take dull, low pay, no future jobs. At the same time, Automation has moved other thousands of men up to interesting, bright-future, high salaried positions. Is your job threatened by Automation? Are you thinking of switching to another field? Could you qualify for promotions if you knew Automation?

Threat or Opportunity—It's Up To You

Mail coupon below for answers to these and other questions and information about NRI training in Electronic principles, practices, maintenance. *NRI—oldest and largest school of its kind—trains you at home in spare time.* No previous experience or special educational requirements. Training includes custom equipment to make learning faster, easier. Convenient monthly payments, special trial enrollment plan. Don't be an Automation casualty. Mail coupon NOW. NRI, Washington 16, D. C.

MAIL COUPON NOW

NRI TRAINING 2KAA
Washington 16, D. C.

Please send me your free 64-Page Catalog about Automation/Electronics Training. (No salesman will call. Please Print.)

Name.....Age.....

Address.....

City.....Zone.....State.....

Accredited Member National Home Study Council

from Scott . . .
FREE STEREO
 KIT CATALOG

Have fun . . . save money . . . build the best!
 Now world-famous Scott stereo components
 come in easy-to-build kit form. You can build
 an FM Multiplex tuner, your choice of an 80
 watt or 48 watt stereo amplifier, a preamp,
 power amplifier, and a speaker. Write for
 complete details.



SCOTT Dept. 525-10

H. H. Scott, Inc. 111 Powdermill Road, Maynard, Mass.

Rush me your new Kit Guide, 20 page "Guide to Custom Stereo" and your Free FM Stereo Demonstration Record.

Name _____

Address _____

City _____ State _____

Export: Morhan Exporting Corp., 458 Broadway, N.Y.C.

Canada: Atlas Radio Corp., 50 Wingold Ave., Toronto



Tire Sculptor

Every time Arthur Gill cuts a tread pattern in a prototype tire at an English tire works, he saves his firm some \$2000—the cost of making a mold and experimental tire from a new design.

He takes a few days on a small tire, six weeks on an earthmover type, and recently whacked out a new race tire in 3000 cuts.

AVIATION CAREER

SPECIALIZED EDUCATION / PROFESSIONAL TRAINING . . . only 16 months to 2 years

Top-pay prestige positions, bright future in aviation. Job opportunities waiting for you as soon as you're ready. Airframe and Powerplant Technician, Aeronautical Engineering degree course, Business or Executive, Pilot. Classes in Miami.

SEND FOR FREE 80-PAGE BOOK

Embry-Riddle Aeronautical Institute
 Miami, Florida (Founded 1926)

Name

Address

City Zone State

3-PM-102

LEARN MORE . . . LEARN FASTER AT HOME
 EARN HIGH SCHOOL DIPLOMA

UNIQUE NEW WAY Now, from the Encyclopaedia Britannica family comes a new kind of education at home. Exclusive "teaching machine" courses, fresh new material interestingly presented, personal tutor service. You receive a sound education, faster. Take individual subjects or up to 4 year courses. Earn meaningful diploma in months, many do. Unlike ordinary home study schools. Moderate tuition, terms. Write for catalog. No salesman will bother you with calls.

Britannica Academy For Adults — Dept. PM-102
 14 E. Jackson Blvd. Chicago 4, Ill.

ARE YOU MOVING?

SIX WEEKS IS REQUIRED to change your magazine address.

A new regulation of the Post Office effective January 10, 1962 requires that you pay the extra postage if copies of POPULAR MECHANICS are forwarded to you at your new address. Copies will not be forwarded free and we cannot replace lost copies. To insure delivery at your new address please notify us at least six weeks in advance of your moving. Send us your old and new address and if possible the address label from your last issue . . . include your postal zone number. Thank you.

Write to:

POPULAR MECHANICS
 Subscription Dept.
 250 West 55th St., New York 19, New York

LEARN TO MOUNT BIRDS



ANIMALS, FISH, PETS

Be a Taxidermist. Save your hunting TROPHIES. Have a fine home-museum. Hunters, save and MOUNT your beautiful DUCKS, QUAIL, DEER, TAM skins and FURS. Great Fun, Spare-time PROFITS.
FREE BOOK Tells ALL about it. 100 fine wild-game pictures. 48 pages. Send TODAY, don't delay. Get this WONDERFUL FREE BOOK, MEN AND BOYS. Learn Taxidermy. Double your hunting pleasure. Rush letter or POSTAL today. STATE AGE. N.W. SCHOOL OF TAXIDERMY, Dept. 2510 Omaha, Neb.

\$1600 RETIREMENT HOME

CONCRETE BLOCK

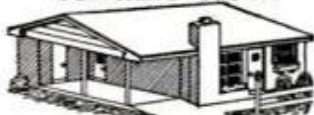

Build your own 24'x40' Ranch Home complete for \$1600. Liv. Room, Kit., two bedrooms, bath, Fireplace, slab or basement, carport or garage. Blueprints, instructions, and material list \$3.00 ppd. Money back guarantee. Other plans - \$600 and \$1000 Cottages, \$1200 Garage Apt., \$1900 and \$3000 Duplexes, \$2500, \$3800 and \$5400 4 Bed Rm. 2 Bath family room Ranch Home. Illustrated Folder, "How To Build Your Own Block Home", plus Plan Folder 10c.

QUALITY PLANS SINCE 1953

BAILEY BUILDERS, 70-B Flag Rd., Little Rock, Arkansas

INSTALL BURGLAR ALARM SYSTEMS... BIG PROFIT HOME BUSINESS

PROFITS!

Typical outright store installation
 CHARGE . . . \$90.00
 COST . . . \$14.00
 PROFIT \$76.00

Plus bell and box profits. Plus \$6,000 to \$12,000 per year by servicing contract installations.

Start spare time. No mechanical experience or costly equipment. Expert shows beginners way to big profits installing in stores, homes. Big demand. Write for FREE PLAN now. NASA, 11071 Massachusetts, Dept. D25A Los Angeles 25, Calif.

FREE GUIDE Reveals 200 Ways to Make Extra Money

YOU can turn your spare hours into cash (\$25 to \$100 a week) by selling products and services to friends and others. Famous *Salesman's Opportunity Magazine* shows you how. Contains hints, plans, hundreds of offers. No matter what your age, experience or occupation—write TODAY for next 5 issues—absolutely FREE. Send no money just name. OPPORTUNITY, 850 N. Dearborn, Dept 548, Chicago 10, Ill.

MAKE YOUR PHONES PORTABLE!

STANDARD 4 PRONG PLUG \$1.50 ea. STANDARD WALL JACK \$1.80 ea.
 EXTENSION CORD \$4.95 complete
 All wired, ready for use. Length to your order up to 20 feet.

DO IT YOURSELF with our simple instructions! Small screw-driver only tool needed.
 SPECIAL! SURPLUS EXTENSION DIAL PHONES \$9.95 fob/ NYC
 GEORGE'S Dept. PM
 1334 6th Ave. New York 19, N.Y.
 Add 25c on orders under \$3. Send for brochure antique and ultramodern phones.

Shrinks Hemorrhoids New Way Without Surgery Stops Itch - Relieves Pain

For the first time science has found a new healing substance with the astonishing ability to shrink hemorrhoids and to relieve pain - without surgery.

In case after case, while gently relieving pain, actual reduction (shrinkage) took place. Most amazing of all - results were so thorough that sufferers made astonishing statements like "Piles have ceased to be a problem!"

The secret is a new healing substance (Bio-Dyne®)—discovery of a world-famous research institute.

This substance is now available in suppository or ointment form under the name Preparation H®. Ask for it at all drug counters.

OCTOBER 1962

94.6% OF BAILEY GRADUATES ARE EMPLOYED AT TOP PAY IN THE FIELDS WHICH THEY WERE TRAINED!



DIESEL-AUTO MECHANICS DESPERATELY NEEDED!

We have a far greater demand for our students than we can fill! We can show you an actual waiting list of leading companies throughout the world who have tried Bailey graduates - found them outstanding, and are coming back for more! Bailey Graduates are Successful . . . RECEIVE BIG PAY - HAVE SECURE FUTURE!

The Famous Bailey Course prepares you for BOTH Diesel and Gasoline Mechanics. This is a must—due to the advent of using Diesel principles, such as 'Fuel Injection' on passenger cars . . . use of gasoline engines for starting Diesel engines, etc. You learn all this at Bailey in the amount of time ordinarily required to learn just one of these subjects, ALL FOR THE PRICE OF ONE.

Don't be satisfied with a 'futureless', one-type job - learn how you can make big money now! Write today for Free Booklet that takes you on a step-by-step camera tour through our spacious, modern shops - See Bailey students in action as they Learn-by-doing with the Famous Bailey Method of training!

We provide you with housing and part time jobs while in school, plus nation-wide placement service for graduates.

BAILEY Technical SCHOOLS

1634 S. GRAND ST. LOUIS 4, MO.

MAIL TODAY!

Please mail immediately this free booklet without obligation.

FREE BOOKLET



Name.....
 Address.....
 City..... State.....
 APPROVED FOR VETERAN...NON-VETERAN

**EARN \$125
A WEEK AND UP**

**BE AN AUTO DIESEL
EXPERT—LEARN
A TRADE YOU LIKE**

You learn fast in our shops because you learn with tools on real equipment. Students short of money may earn most of their expenses by doing part-time work. Experienced instructors explain WHY and show you HOW, then you DO IT YOURSELF. Many of our graduates earn \$125 a week and up. Approved for veterans. Day and evening classes. Free bulletin-write today.

MAIL THIS COUPON TODAY!

NASHVILLE AUTO-DIESEL COLLEGE
226 7th Ave., No., Dept. 86, Nashville, Tenn.
Please send without obligation free catalog.

NAME _____
(please print or write plainly)

ADDRESS _____

CITY _____ STATE _____



Tattles on Rough Handlers

Rough handling of containers in transit can be detected with a spring-operated detector mounted inside the package. Rough treatment trips the indicator, showing that the goods may have suffered damage that would not otherwise be seen.

It's made by General Dynamics Electronics, P.O. Box 127, San Diego, Calif.

**Make
\$20 to \$30 a Week
EXTRA MONEY!**

With the high prices of food, clothing and everything else, just think what you could do with extra money every week! Turn your spare time into CASH—sharpening saws with a Foley Automatic Saw Filer pays from \$3 to \$6 an hour. Start in your basement or garage—no experience necessary. "The first saw I sharpened with my Foley Filer came out 100%"—writes Clarence E. Parsons. No canvassing—"I advertised in our local paper and got in 93 saws—says M. L. Thompson. With a new model 200 Foley you can file all hand saws, also band and both combination and crosscut circular saws.



**FREE BOOK
Shows How to Start**

It explains how you can get business from home owners, farmers, carpenters, schools, factories, etc. "I get work from 20 and 30 miles away"—says Charles H. Smith. Free Book, "Money Making Facts," tells how to start. Time Payment Plan. Send coupon today—no salesman will call.

Send Coupon for **FREE BOOK**

FOLEY MFG. CO.
1016-2 Foley Bldg., Minneapolis 18, Minn.

Send **FREE BOOK**—"Money Making Facts," and Time Payment Plan.

Name _____

Address _____



Shield Stops Sun Glare

Reflected sun glare from a car's hood or dash is stopped with a magnetized sun shield. The adjustable-angle shield attaches on the dash or molding. Price \$2; J.T.B. Industries, Box 1105, Wyandotte, Mich.

Not everyone does as well, but T. N. CODY, who started a business of his own, reports...

For 12 months I've averaged **\$800** PER MONTH INCOME



—most of it clear profit for me!

Many men have discovered how to be independent, to be free of layoffs and bosses. C. G. Naples grossed more than \$200 his first week. A father-son combination grossed \$44,000 their second year. H. Lemon says, "I netted \$133 in one 8-hour day."

How much you earn depends largely on you, but we help you to start and work with you for your success. You need no special skill, no large investment. Start part time if you wish. Hire helpers as needed.

NO SHOP NECESSARY • Our PORTABLE ELECTRIC DETERGER shampoos rugs, carpets right on customer's floor. Wonderful results bring you repeat business, large fees. So efficient and safe, it is used by largest hotels and railroads.

OURS IS NOT A LEASE ARRANGEMENT • You are free to operate in an independent manner. You sign no contract. You own the detergent outright and are always your own boss... and every dollar you take in is yours to keep. You pay no fees, or dues, or royalties to anyone. And you take no risk. Your detergent is fully guaranteed and enough supplies come with it to return far more than your investment. Many earn the cost of the detergent in a week or two. It costs nothing to get the details... write TODAY.



MAIL COUPON TODAY FOR FREE BOOK

VON SCHRADER MFG. CO.
N10 "R" Pl., Racine, Wis.

Without obligation send me FREE booklet about your RUG DETERGER and tell me how I can start my own permanent, profitable business.

Name _____

Address _____

City _____ Zone _____ State _____

New Model 161 UTILITY TESTER®
FOR REPAIRING ALL ELECTRICAL APPLIANCES
MOTORS • AUTOMOBILES • TV TUBES

As an electrical trouble shooter the Model 161

- Will test Toasters, Irons, Broilers, Heating Pads, Clocks, Fans, Vacuum Cleaners, Refrigerators, Lamps, Fluorescents, Switches, Thermostats, etc.



- Will test all TV tubes (including picture tubes) for open filaments and burned out tubes.
- Measures A.C. and D.C. Voltages, (both 110 Volt and 220 Volt lines).
- Will measure current consumption (amperes) while the appliance under test is in operation.
- Incorporates a sensitive direct-reading resistance range which will measure all resistances commonly used in electrical appliances, motors, etc.

As an Automotive Tester the Model 161 will test:

- Both 6 Volt and 12 Volt Storage Batteries • Generators
- Starters • Distributors • Ignition Coils • Regulators • Relays
- Circuit Breakers • Cigarette Lighters • Stop Lights • Condensers • Directional Signal Systems • All Lamps and Bulbs
- Fuses • Heating Systems • Horns • Also will locate poor grounds, breaks in wiring, poor connections, etc.

Model 161 comes complete including 56-page book... Only

\$22.50

SEND NO MONEY WITH ORDER—
PAY POSTMAN NOTHING ON DELIVERY

Try it for 10 days before you buy. If completely satisfied then send \$5.00 and pay the balance at the rate of \$5.00 per month until the total price of \$22.50 (plus small P.P. and budget charge) is paid. If not completely satisfied, return to us, no explanation necessary.

ACCURATE INSTRUMENT CO., INC.
Dept. B-228, 911 Falls St., New York 39, N.Y.
Please rush Model 161. I will pay on terms specified. Otherwise I will return tester.

Name _____
Address _____
City _____ Zone _____ State _____
All prices net, F.O.B., N.Y.C.

ACCORDION PRICES SMASHED!



SAVE UP TO 1/2

Buy Direct at BIGGEST IMPORTER-TO-YOU DISCOUNTS!

Save more than you have ever dreamed possible... up to 50% off retail prices for comparable accordions. Pay no teacher or salesman commissions.

EASY TERMS! For just a small (or any old instrument in trade)... and pennies a day... you can own a new 1962 model famous accordion!

World's Largest Accordion Dealer offers biggest selection! Choose from over 35 models for students and professionals, standard or electronic... newest features. Amazingly high trade-in allowance on ANY used musical instrument. FREE HOME TRIAL. No Risk Offer—Satisfaction guaranteed or Money Back! FREE BONUS GIFTS. Mail coupon today for FREE Color Catalogs and Importer-to-You Discounts.

ACCORDION CORPORATION OF AMERICA
2003 West Chicago Ave., Dept. R-102, Chicago 22, Illinois

FREE Color Catalog Rush Coupon

Accordion Corporation of America, Dept. R-102
2003 West Chicago Avenue, Chicago 22, Illinois
Rush FREE Color Catalog, Accordion Selection Guide, and the Importer-to-You Discounts.

NAME _____
ADDRESS _____
CITY _____ STATE _____
() I have an accordion to trade.

**ENGINEERING
SCIENCE
MATH**

**B.S. DEGREE
IN 36 MOS.**



U.S. NEEDS 50,000 NEW ENGINEERS EVERY YEAR

EARN ACCREDITED B.S. DEGREE in Science or Engineering in 36 months — year-round program optional. 27-month engineering diploma also available. *Classes start January, March, June, September.* **QUALITY EDUCATION.** Graduates employed throughout U.S. and foreign countries. Government approved for veteran training. Students from 50 states, 40 countries. 20 buildings; dorms, gym, Campus. New library and laboratories. Employment help provided. **SAVE TIME AND MONEY.**

Write for catalog and complete information.

INDIANA TECHNICAL COLLEGE

1612 E. Washington Boulevard, Fort Wayne 2, Indiana

Please send free information on accredited B.S. Degree programs in Engineering and Science as checked:

- | | |
|---------------------------------------------------|----------------------------------------------------|
| <input type="checkbox"/> Aeronautical Engineering | <input type="checkbox"/> Mechanical Engineering |
| <input type="checkbox"/> Chemical Engineering | <input type="checkbox"/> Metallurgical Engineering |
| <input type="checkbox"/> Civil Engineering | <input type="checkbox"/> Physics |
| <input type="checkbox"/> Electrical Engineering | <input type="checkbox"/> Chemistry |
| <input type="checkbox"/> Electronic Engineering | <input type="checkbox"/> Mathematics |

Name _____

Address _____

City _____ State _____



You can make money in

**WATCH
REPAIR**

Learn at home the low cost Sweazey Way

Watch repairing pays up to \$6 an hour, part time watch makers report on survey. Unique and modern Sweazey home study System starts you making repairs right away on Swiss and American watches. Professionally prepared training. No previous experience needed. Special tools provided for practice. Tuition only \$5 a month. Diploma Awarded. Free sample lesson and opportunity book give all facts. Write today. No obligation.

CHICAGO SCHOOL OF WATCHMAKING

2330 N. Milwaukee Avenue, Dept. 1102, Chicago 47, Illinois

FREE BOOK and SAMPLE LESSON

CHICAGO SCHOOL OF WATCHMAKING
2330 N. Milwaukee Ave., Dept. 1102, Chicago 47, Illinois
Please rush **FREE BOOK** and Sample Home Study Lesson.

Name _____ Age _____

Address _____

City _____ Zone _____ State _____

**CHOOSE A
POCKET-SIZE**

Kirsten
"COMPANION"
PATENTED "RADIATOR" STEM MEANS
Cool Smoking!

\$3⁹⁵
POSTPAID

**WEIGHS ONLY
1 OUNCE!**

WRITE FOR FREE CATALOG
other pipes 5.00-7.50-10.00

Write to: **Kirsten** PIPE CO. Seattle 7, Wash. Dept. C

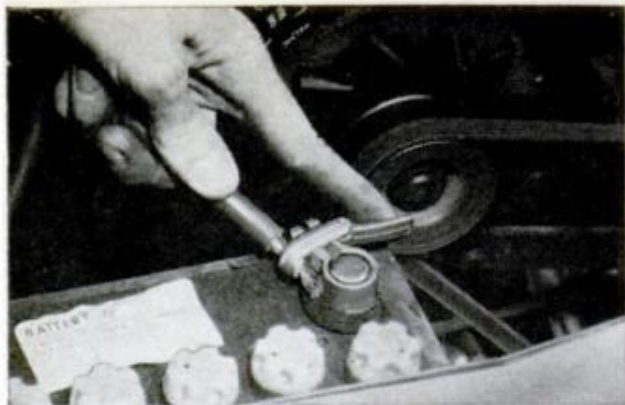

Quick Battery Clamp

A new battery terminal clamp allows an instant contact or disconnect without the use of tools. With a single motion, a simple lever action simultaneously grips the lead and the battery post.

As a safety device, the Hima clip enables the ignition circuit to be broken instantly in case of such emergencies as fire or a jammed horn button. It can also be used on boats where battery removal is necessary to prevent theft, and as an aid in very cold climates where batteries are brought indoors as protection against subzero temperatures. Six-volt models are available now, with 12-volt clamps to be sold soon. Price for a set of two: \$2 ppd. from Maier Import, 1408 Comanche Dr., Rockford, Ill.

GUITARS **Big Discounts**
WHOLESALE-TO-YOU!

BUY DIRECT! **SAVE! BIG DISCOUNTS!** Nationally advertised guitars. Over 100 models, all styles, for students and professionals. Low as \$19.95! **DIRECT** from Wholesaler-to-You. Easy Terms, low as \$5.00 down! **FREE** Home Study Course and Bonus Gifts! Discounts on banjos, mandolins, ukes. Satisfaction or money back. Free Color Catalogs, low discount prices. Write: **GUITAR WORLD, Dept. R-102** 2003 W. Chicago Ave., Chicago 22, Illinois

5-Day FREE Trial

**JOIN ME IN BUSINESS—
FULL OR PART-TIME**

I'll set you up free in a business of your own without any investment on your part. Get free "Portable Shoe Store" with demonstrators that get orders for you in 1 minute. Cash bonuses, life/hospitalization insurance, retirement bonds, free shoes to producers. Earn to \$10 a pair. Full or part-time. Write: Cabell Brand, Ortho-Vent Shoe Co., 11210 Brand Rd., Salem, Va.

**HIGH SENSITIVITY
NOISE DETECTOR**

AUTO MECHANICS, PLANT ENGINEERS, LOCKSMITHS, REFRIGERATION MEN. Electronic probe and powerful transistorized amplifier, will pick up the slightest sound or vibration such as defective bearings, engine noises or fluid flow. Data sheet available—write or send check or money order (No COD'S) to:

MAFCO DEPT. A, P.O. BOX 484
WEST COVINA, CALIF.
(Postage paid on shipments in USA)

VIBRA-TRACER
ONLY \$49⁰⁰
COMPLETE

MEN!! HEAVY EQUIPMENT

EARN UP TO \$4.50 PER HOUR!

Learn to operate Bulldozers, Motor Scrapers, Loaders, Graders, Shovel, Drag Line, others. Training includes **ACTUAL EXPERIENCE** on heavy equipment at our field training center. Free employment guidance. Write Today!

TRAINING SERVICES
120-P City Line Center Philadelphia 51, Penna.

WHY ARTISTS DON'T WORRY ABOUT JOB SECURITY

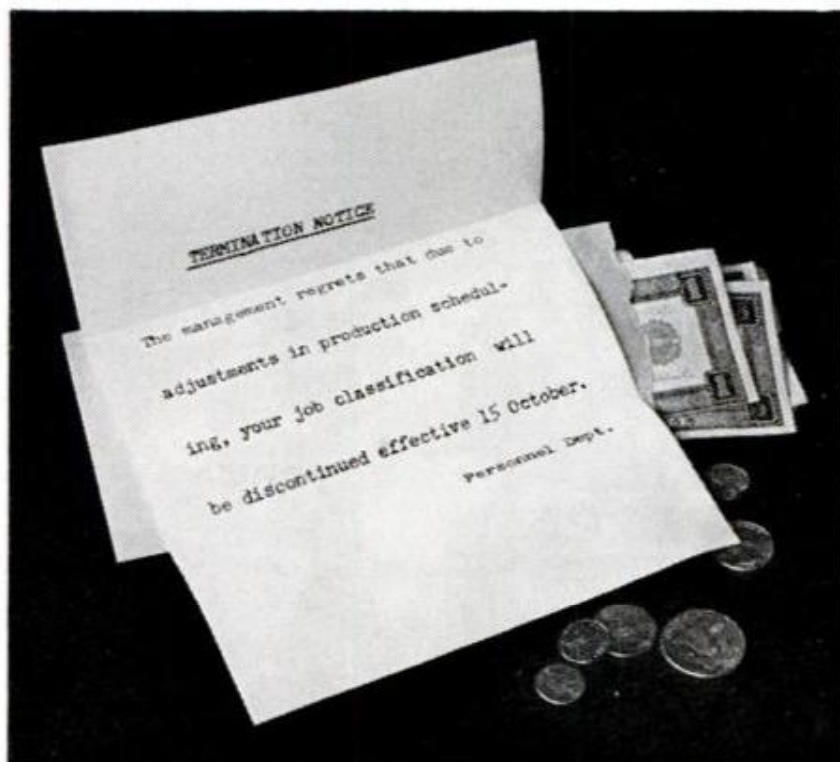

Once a commercial artist is trained, his future is secure. Nobody can take away his career because nobody can take away his talent. And the demand for artists increases every year. You may have natural art talent (and not even know it) that could make you "job secure" for life. Find out by taking the free Art Talent Test offered by America's leading home study art school.

If you like to draw—even if you like to doodle—you may have natural art talent worth training. Millions of drawings and paintings must be made each year for advertising, television, cartooning, and illustrating. Mail this coupon and you will receive a simple Art Talent Test from the art school that has started thousands of working artists on a secure future in commercial art. No cost. No obligation.

And if you haven't got natural art talent worth training, we'll tell you so.

ART INSTRUCTION SCHOOLS Studio 10132

500 So. 4th St., Minneapolis 15, Minn.

Please send me your Art Talent Test without cost or obligation. (PLEASE PRINT)

Name _____
Occupation _____ Age _____
Address _____ Apt. _____
City _____ Zone _____
County _____ State _____



Accredited by Accrediting Commission of National Home Study Council, a nationally recognized accrediting agency as defined by U.S. Office of Education under the Public Laws 82-550, 85-564.

LEARN PLASTICS



COMPLETE LOW COST SHOP METHOD HOME TRAINING NOW AVAILABLE

Get in on Big Money opportunities in Plastic molding, casting, forming, carving, etc. Earn as you learn with Interstate's professionally prepared course. All plastic materials furnished.

WRITE FOR
FREE
BOOKLET

INTERSTATE TRAINING SERVICE
DEPT. C-3, PORTLAND 12, OREGON

\$47,983.06 ORDERS FROM 12 WORD CLASSIFIED AD.

Amazing—Startling—but TRUE. Terrific story sent free. Request must be made on business letterhead. F. W. Johnson, Classified Adv. Manager, 740 Rush St., Chicago 11, Ill.

ALL FAMOUS BRANDS! **FARM TRUCK AUTO** **AT LESS THAN WHOLESALE**

TIRES! SAVINGS NEVER LESS THAN 50% up to 70% OFF REG. PRICE!

HEADQUARTERS for ALL SPORT CAR TIRE SIZES
FREE • SEND FOR YOUR FREE CATALOG • FREE!

RELIABLE TIRE DIST., 730 Morgan Blvd., Camden 4, N. J.

More Comfort Wearing FALSE TEETH

Here is a pleasant way to overcome loose plate discomfort. FASTEETH, an improved powder, sprinkled on upper and lower plates holds them firmer so that they feel more comfortable. No gummy, gooey, pasty taste or feeling. It's alkaline (non-acid). Does not sour. Checks "plate odor" (denture breath). Get FASTEETH today at any drug counter.

OCTOBER 1962

FREE GIANT NEW 1963 CATALOG

HI-FI & STEREO COMPONENTS AND SYSTEMS

SAVE UP TO 50% ON B-A SELECTED KITS

TOP VALUES IN POWER & HAND TOOLS

30 PAGES OF BARGAINS NOT IN ANY OTHER CATALOG

BURSTEIN-APPLEBEE CO.

Dept. PM, 1012 McGee St., Kansas City 6, Mo.

Rush me FREE 1963 B-A Catalog.

Name _____

Address _____

City _____ State _____

SEND FOR IT TODAY

FREE

POPULAR SHOPPING



Save money on heating, repainting and repairing your home by using aluminum siding. The Bridgeport Brass Company of Bridgeport, Conn., offers a free, 8-page pamphlet, "26 Straight



BE YOUR OWN MUSIC TEACHER ANY INSTRUMENT

even if you don't know a single note now!

Now it's EASY to learn ANY instrument. No boring exercise. Even if you don't know a single note now you can play delightful pieces—from your FIRST lesson! BY NOTE. Make amazing progress. No special "talent" needed. Learn at home in spare time, without a teacher. Low cost! Soon you can play popular music, hymns, classical and any other music. Over 1,000,000 students, all over the world. FREE BOOK. Send this ad with your name and address filled in below today, to: U. S. SCHOOL OF MUSIC, Studio 3010, PORT WASHINGTON, N. Y.



(No obligation, no salesman will call. Chartered by N.Y. State Education Dept.



Name

Address

City..... Zone.... State.....

Answers on Aluminum Siding," in which various types, qualities, and applications are discussed, with particular emphasis on the durability, beauty and minimum-maintenance advantages of this building material. **Space-minded?** Aero Publishers, Inc., has just come out with a free, 28-page "Aviation & Space Book Catalog" which describes and illustrates available and forthcoming books on such subjects as aircraft history, military aviation, flight training and piloting, rockets and missiles, air racing and model aircraft. A brief resumé, the cost, author, publisher and date available are given on each book. Write to

Aero Publishers, 2162 Sunset Blvd., Los Angeles 26, Calif.

"Photography Without Fear" is a 24-page booklet which offers the camera buff humorous, well-written and concise tips on the selection of subject matter, choosing backgrounds and contrasts how to snap a picture that really tells the story of the moment, and which film and flash equipment to use. Syverson, the cartoonist, has illustrated the booklet, which is now available for 25 cents from Agfa, Inc., 516 West 34th St., New York 1, N. Y.

Use common scents—animal scents, that is, for animal training, hunting, trapping and fishing. The Pacific Coast Scent Co., Garden Grove 1, Calif., specializes in making scents for the sporting reader. Their 23-page booklet, "National Scents," gives tips on how to break dogs from running desirable game to keeping deer away from orchards and crops. The basic idea is to minimize the human odor, using these scents as lures. They even have a scent to housebreak your dog. Price: 25 cents.



FREE! AIRMAILS
Fabulous collection of all-different genuine foreign Airmail Stamps from remote corners of the world — Africa, Europe, Exotic Orient, everywhere! World's Largest Airmail, Flying Doctor, Bomber, \$2.00 Helicopter, many others. PLUS Collection of thrilling Space-Age stamps — Sputniks, Jets, fantastic Moon Rocket stamps. Both of these remarkable collections — containing stamps worth up to 25c each! — for only 10c to cover mailing costs. Extra: Other sensational stamps for your free examination, plus Big Bargain Catalog. Rush 10c today to: Jamestown Stamp Co. Dept. F102PM Jamestown, N. Y.



FOR BIG OR TALL MEN ONLY!

We specialize in Large Sizes Only! Sizes 10 to 16; Widths AAA to EEE. Dress, sport, casual, golf shoes, insulated boots, socks, slippers, jackets. Also dress and sport shirts with bodies cut full 4" longer than usual. Slacks, raincoats and sweaters, too! Sold by mail only; Satisfaction Guaranteed! Write for FREE Style Book today! King-Size, Inc., 6232 Forest St., Brockton, Mass.

Operate Your Own... IMPORT-EXPORT Business at Home



Revolvers \$6.
Beautiful Wrist Watches \$2.63
Complete Export-Import mail order course tells you how to start your own profitable business and operate it from your home. Full details include overseas supply sources for wonderful low cost values that appeal to everyone. Send no money, write for full information today to GLOBAL EXPORT-IMPORT MAIL ORDER CO., Dept. M, Box 9584, Northside Station, Jackson 6, Miss.

DC Welder — AC Power combination gives you 3 units in 1. • 200 amp. DC welder • 2 KW AC power runs tools, lights, etc. while you weld • 5 KW AC full time power is invaluable in an emergency. Runs furnaces, brooders, shop equipment. Ask for data sheet A-279-J. Model GW-2225-S



You can Make Big Money arc welding!

Model TLG-182-S complete with accessories \$135
AC "TROJAN" SHOP WELDER fabricates parts, ornamental railings, furniture, etc. 180 amp. capacity. Ideal for repairs, hardsurfacing tools, brazing, soldering, cutting and burning holes. Has 18 current control steps. Meets REA requirements. Used by repair, sheet metal, hobby, plumbing, heating shops, garages. Ask for data sheet A-521-F.

HOBART BROTHERS CO., Box M-102, Troy, Ohio, U.S.A., Phone 332-1223



**MANUFACTURE this BEAUTIFUL
OUTDOOR FIREPLACE
in YOUR OWN BACKYARD**

\$4.00 worth of sand and cement produces this attractive fireplace. Sells on sight from \$60 to \$80. Easy to start your own profitable business in your backyard. No experience necessary. Big profits. Exclusive manufacturing territories. Write immediately for full details. General machines sold to U.S. Government. Dealer inquiries invited.

GENERAL ENGINES CO., INC. Dept. MF-102 Rt. 130
Thorofare, N. J.

75 POWER TELESCOPE \$3.98
25X-45X-75X

NEW 3 in one telescopes, 3 variable 25X-45X-75X magnification. Brass bound, 25 power for ultra bright images 45 & 75 power for long range. Guaranteed to bring distant stars, moons, objects, sports 75 times closer.

Most powerful scope sold anywhere near this amazing low price. American made, 5 sections. Opens 36", closes 1 ft.; contains 4 ground & polished lenses. Can also be used as powerful pound microscope. Mass production enables us to offer telescope complete at \$3.98 postpaid. Money back guarantee.

CRITERION CO., Dept. PMB-5, 331 Church St., Hartford, Conn.



**Given to men who want to get into
CRIME DETECTION
FINGER PRINT IDENTIFICATION**

Train at home, spare time. Join hundreds of I.A.S. graduates now employed by police and identification bureaus in every state. Learn finger print identification, crime investigation, firearms identification, police photography, other subjects vital to qualifying for good paying, secure, interesting jobs. "Blue Book of Crime" and details Free. Must state age.

Institute of Applied Science, Dept. 1357
A Correspondence School Founded in 1916
1920 Sunnyside Ave., Chicago 40, Ill.



Clock Plans & Movements

Build this beautiful grandmother clock from kit which includes plans, 110V movement and dial,—only \$9.95, Fed. Tax included.

Send 10c for 24-page booklet describing other plans, movements, dials and moldings.

CRAFT PRODUCTS, ELMHURST 1, ILL.

BIG Throwing Knife \$1.00
Special



PIERCES METAL

Specially weighted & balanced point zeroes right into bull's eye with a wallop! Positive accuracy! Deep penetration! Easy throwing! Hard hitting! Excellent for hunting game, self-defense, fun. Cutlery steel, double edge. Big 10" long. Leather handle. You must be delighted or your money back. Price Postpaid \$1.00. DeLuxe Chrome Finish Model for Exhibition Purposes \$2.50. Leather Sheath 50c. Professional Knife Throwing Book 25c.

JOHNSON SMITH & CO., Dept. 157, Detroit 7, Mich.

COMPLETE ADDRESSES of manufacturers, inventors, and sources of information for items mentioned in the editorial pages of this issue are listed in the free **WHERE-TO-FIND-IT** list. Send self-addressed, stamped envelope to

SERVICE BUREAU
740 Rush St., Chicago 11, Illinois

**Learn Electronics
Radio-Television
by Practicing at Home
in Your Spare Time**

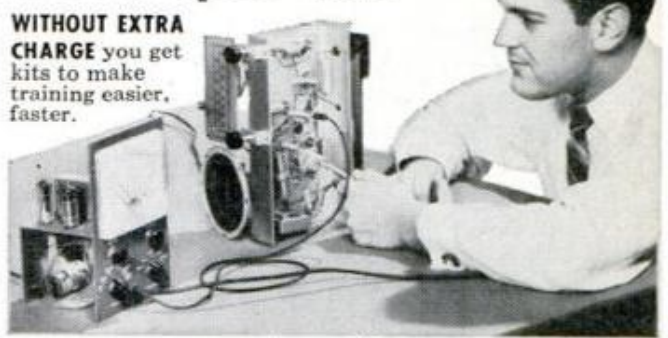

WITHOUT EXTRA CHARGE you get kits to make training easier, faster.

**Fast Growth Offers Prestige
High Pay—Bright Future**

Above average jobs with bright futures await men with Electronics training . . . jobs for which YOU could qualify through NRI. Train right at home in spare time, while you hold your present job. Earn high pay in jobs with TV and Radio Stations, industrial plants, or in a profitable business of your own.

Train with the Leader

NRI TRAINED THESE MEN

Own Business: I could hardly make ends meet. Now I have my own service business.

J. HILLENBRAND, Bklyn., N. Y.

Broadcasting. "I am now chief engineer of Station WARA. NRI was the foundation."

R. ARNOLD, Attleboro, Mass.

Industrial. "Four months after starting your course I went to work at Raytheon.

Now I am an engineering assistant in Microwave Power Tube Research." **L. J. BLOOM,** Newton Centre, Mass.

For 45 years NRI has featured the best Radio-TV Electronics training for beginners—for men without high school diplomas or previous experience. NRI is the oldest and largest home-study Radio-TV Electronics school. NRI "learn-by-doing" training is supplied at low cost. It's the easy way to get into the field of Electronics.

Start Soon to Earn More

Soon after enrolling, NRI shows you how to earn extra money in your spare time repairing sets. Many start a profitable business this way. Others get good paying jobs within a year. Take the first step to a new career NOW. Mail coupon for descriptive catalog. National Radio Institute, Washington 16, D.C.

64 PAGE CATALOG FREE



MAIL THIS COUPON NOW

NATIONAL RADIO INSTITUTE, Washington 16, D.C. 2KA
Send me full information without cost or obligation. No salesman will call. (Please print)

Name.....Age.....

Address.....

City.....Zone.....State.....

Accredited Member National Home Study Council

worth
writing
for...

Gem or mineral? Within half an hour, without previous knowledge of mineralogy or chemistry, according to the publishers, you will be able to tell the difference and name the type. "Mineral Sort," by geologist Joseph Forrester, is a pocket computer which lets you identify over 180 minerals on the basis of physical characteristics alone—with the aid of chemical tests. An instruction booklet gives a simple explanation of each category as it is indexed and described in text. In boxed-carded form, "Mineral Sort" is abundantly illustrated.



More Fiery than a Fine Diamond!

Yes, KENYA JEWELS are more dazzling, more fiery than diamonds, and they look amazingly like fine white diamonds. Superbly beautiful! Sparkling white! The Kenya is truly a miracle of modern science!

LOW COST—AMAZINGLY LOW COST! Actually only a small fraction of the cost of a diamond. Stylish, sparkling men's and ladies' rings. And very easy payments, if you wish—as little as \$6 down.

Write for Free Booklet

Send no money. Just write today for the FREE Booklet that tells you all about these dazzling, white man-made jewels, and shows you a wide selection of stylish rings.

KENYA GEM, Dept. 548, Phila. 22, Pa.

Available from The Sort-Card Company, Box 901, Boulder, Colorado, for \$5.00.

Boat plans for the new "Sea Surrey," a build-it-yourself pontoon family craft, are now offered at no cost by the Dow Chemical Co., Box 448, Midland, Mich. This twin-hulled, 8 x 20-ft. boat floats on plastic foam, can seat 8 to 10 persons, weighs 1,100 pounds and has been tested on Long Island Sound and Michigan inland lakes. Cost of materials is estimated at \$400, and 5 to 40 horsepower outboard motors power it along for family fishing, swimming or leisurely short hop water travel. Makes a good winter project.

Chemists will be interested in a new, four-color CHEM wall "Atomic Orbital Chart," which shows the distribution, spatial arrangement and energy levels of electrons in atoms of all elements from 1 to 118. Of heavy enamel paper, measuring 36 inches wide by 45 inches in height, the chart can be mounted easily in lab or office. Grease pencil markings wipe off—an advantage for teaching. It's available for \$8.50 from the Central Scientific Company, 1700

Irving Park Road, Chicago 13, Ill., under catalog No. 12045.

The Scientific Life is the title given to Theodore Berland's new book, published by Coward-McCann, Inc., 210 Madison Ave., New York 16, N. Y. First-hand interviews have resulted in candid studies of nine leading American scientists—Willard Libby, James Van Allen, Philip Hauser—among them. What views do these "New Men" who are determining the future have on politics, religion, the world today? Berland, former science writer for the Michael Reese Hospital in Chicago and freelance writer for Popular Mechanics has found these men to have fascinating answers. Price of the 308-page book: \$5.75.

Telephone travel plans into Montgomery Ward and have your reservations and routings set up for you within 12 hours! Through "Travel Catalog," 67 illustrated pages listing 775 trips and tours, you can choose a trip to suit your need, from a 3-day weekend in New Orleans to a 40-day round the world vacation. The catalog is free upon request from the Public Relations Dept., Montgomery Ward, 619 W. Chicago Ave., Chicago 7, Ill.



FAMILY ARMS

genuinely emblazoned from old records filed under 100,000 British & European surnames. In relief and full colour on immaculate

OAK WALL SHIELDS for mural decoration.

7" x 6"—\$ 7.00
12" x 10"—\$20.00

postpaid. Your check is returned if the Arms cannot be traced. School, Ship, Regimental Shields, Trade Marks, etc., similarly reproduced. Write Britain direct.

YORK INSIGNIA LTD., York, England

MEN! WE FIT
W-I-D-E
F-E-E-T!

E to EEEEE Only
Sizes 5 to 13

Men only. Casual, dress, work shoes that really fit. Top quality, popular prices. Money Back Guarantee.



Not sold in stores

Write Today for FREE CATALOG
HITCHCOCK SHOES, Hingham 28-H, Mass.

LICKITY LOG SPLITTER

Ends Wood
Splitting Drudgery



Dealer
Inquiries
Invited

Smooth 18 ton hydraulic power splits big profits for you from the toughest woods, including American Elm. 7 HP trailer unit squats under own power to receive large logs without "dead" lift. Has 2 speeds, auto-shift and auto-stroke. 26" ram travel splits up to 34" lengths, any diameter—or, with extended frame and adjustable wedge, splits up to 52" lengths, any diameter. Write for details.

THE WACO AIRCRAFT CO., Dept. D, Troy, Ohio

FOR EVERY ROPE USE ... choose VYNAC

The new synthetic that handles like fine cotton rope. VYNAC won't rot or mildew. Not affected by water, salt water, sun, oil or acid.

Use VYNAC for farm, industry, construction, boating, camping, mountaineering.

BUY DIRECT and SAVE 3-PLY

Diam.	Breaking Strength	Price/ft.
1/4"	902 lbs.	5¢
3/8"	2,024 lbs.	9¢
7/16"	2,882 lbs.	13¢

Other 3-ply sizes, and braid, available.

C.O.D. . . . or send check or M.O., and we pay shipping cost.

Write—on your letterhead—for 6" sample, literature.

SALTARE INDUSTRIES

3354 N. Crawford Ave. • Chicago 41, Ill.



BARBELLS

140-Pound, CHROME DELUXE Barbell-Dumbbell set only \$19.80. This is our feature set and is the finest ever manufactured.

Training with adjustable weight is the BEST way to keep fit: the ONLY way to develop great strength and a perfect body. As the oldest and best equipped barbell company, BUR gives value and prices no one can equal.

SEND FOR FREE CATALOG

BUR BARBELL CO.
Lyndhurst 9, New Jersey

100 POUND SET \$12.80
Extra Plates Only 12c Pound

Shop PM Ads for Exciting Direct-Mail Offers

SAVE 1/2 ON FINE ITALIAN CHORD ORGANS

BUY DIRECT
FROM IMPORTER!
BIG DISCOUNTS!

**5 DAY FREE
HOME TRIAL**



PLAY AT SIGHT! NO LESSONS NEEDED!

Now everyone can play and enjoy this new musical sensation. Buy direct from importer . . . **SAVE up to 1/2 off mfr's list prices.** Hand-crafted in Italy . . . finest Swedish Steel Reeds, plus many other exclusive features. Has famous easy-play DA-MAR Music System. **E-Z Terms**—Small down payment. Free Bonus Gifts. 24 models including piano-keyboard models. Money back guarantee. Rush coupon for FREE Color Catalogs and Low Discount Prices.

PHILHARMONIC ORGAN CORPORATION • DEPT. R-102
2003 West Chicago Avenue, Chicago 22, Ill.

Rush Color Catalogs and Lowest Discount Prices.

Name _____
Address _____
City _____ Zone _____ State _____

OCTOBER 1962

IMPORT PAYS BIG!



GIGANTIC U. S. BOOM OFFERS BIG PROFIT OPPORTUNITY

Import Boom is bringing success to hundreds. You can get into this profit bonanza. I'll show you how to get bargains that "sell themselves." I'll show you simple, proved, big profit methods.

NEW HOME IMPORT BUSINESS

Get Imports at trifling cost abroad. Sell to friends, stores, mail order. Imagine *huge profit* on watch for only \$2.87—radio, \$3.02—recorder, Derringer. Mellinger shows how you order *direct*—how to make profit in advance—starts you full or spare time without capital or experience.

10,000 Products to Choose from

Mellinger's 53 foreign agents discover bargains for you. 10,000 imports are evaluated yearly in Mellinger's Home-Office of 22 specialists. The most profitable are granted Mellinger's Seal of Approval and reported to you.

YOU KEEP ALL THE PROFITS . . .

You deal direct with overseas sources. Mellinger shows you how you get FREE samples, how to get in on the beginning of the import boom that can pay you dividends for years. Rush coupon for FREE BOOK "How to Import & Export." No salesman will call. Airmail reaches us overnight.

Beginners following this plan report

"On my very first transaction I made \$904.00 for just 4 days work . . . My wife and I started this business together . . ." D.M.C. "With an initial investment of less than \$100, I have grossed a profit in the neighborhood of \$12,000 . . ." D.L.S. "I was stumbling along on a time card job without much future. Now I can enjoy the freedom and security of a business of my own . . ." W.J.J. Many beginners start this way with little capital.

MELLINGER CO.
Dept. D25A,
1554 S. Sepulveda Blvd.,
Los Angeles 25, California



Plan shows where you get buys like these for big profit U. S. sales. Prices shown are direct from suppliers abroad.
DO NOT ORDER FROM US



RUSH COUPON for FREE Details and FREE BOOK!

Send for FREE BOOK!

MELLINGER CO., Dept. D25A
1554 S. Sepulveda Blvd., Los Angeles 25, Calif.

Show me how the big Import Boom can give me my own Home-Import Business. Rush FREE Book and details without obligation.

Name _____
Address _____
City & Zone _____ State _____

LEARN UPHOLSTERY

in your spare time
run your own
business
AT HOME



FREE BOOK
with
sample
lessons

**With Course
You Make**

**SLIPPER
CHAIR**

**CLUB
CHAIR**

OTTOMAN

**PLUS
SLIP COVERS
Yours to Keep
or Sell**

BE YOUR OWN BOSS

Earn more from the start in spare time. STOP worrying about layoffs, enjoy a steady growing income and independence for life in the booming field of Custom Furniture Upholstery. Right off, you start upholstering with the tools, complete frames, fabrics and materials, included FREE with N. Y. State-approved UTS Home Study Course. You learn skilled professional custom upholstery, reupholstery, furniture finishing, repairs, how to make valuable custom slip covers, cushions and draperies EARN WHILE YOU LEARN, in your spare time AT HOME . . . the UTS easy way.

FREE ILLUSTRATED BOOK—FREE SAMPLE LESSON
Get ready for well-paid job and big profits, from steady work, as your own boss, running your own business. Training in N.Y. School also available. Mail coupon NOW for FREE BOOK!
VET APPV'D. ACCREDITED BY N.H.S.C.

UPHOLSTERY TRADES SCHOOL
TR-310, 721 B'way, N. Y. 3, N. Y.

Please send me FREE book, "Your New Way to a Successful Career," and FREE sample lesson. No obligation—no salesman will call.
 Home Study Training in N. Y. School

Name (Please Print Plainly)
Address
City Zone State
 Check if Korean Veteran



Paper Clipper's Tool

Clippings can be cut from the center of a page with a compact clipping tool without the need of cutting in from an edge. Pages under the one being clipped are not damaged either.

The trick is in the clipping blade with a special piercing point. The page is raised, the point of the tool inserted, then the page is lowered and the tool pushed all around the article.

Made of gray and white plastic, Clipit is priced at 98 cents. It's made by Clipit, Janesville, Wis.

ENGINEERING



AMERICAN INDUSTRY NEEDS TRAINED ENGINEERS NOW

BACHELOR OF SCIENCE DEGREE, 30 MONTHS

SAVE 2 YEARS' TIME

B.S. Degree Courses:

- Electronic Engineering
- Mechanical Engineering
- Electrical Engineering
- Civil Engineering
- Architecture

Diploma Courses:

- Radio-Television Plus Color TECHNICIAN
- Architectural Drafting
- Electronic Technician
- Mechanical Drafting
- Structural Drafting

APPROVED FOR VETERANS

Send for FREE Information

HEALD Engineering College
Van Ness at Post, Dept. PM San Francisco, California

NAME _____
STREET _____
CITY _____ STATE _____

EXCLUSIVE DOUBLE-BEARING HEAVY DUTY PUMPS

IRRIGATE • DRAIN • CIRCULATE • SPRAY

Use 1/4 HP motor or larger . . . 1 HP for up to 5,200 GPH; 1,000 GPH 60' high; or 3,000 GPH from 25' well. 1 1/4" inlet; 1" outlet. Stainless shaft.

TYPE X—2 oil-less bronze bearings. \$10.95
Won't rust

TYPE XB—Ball bearing model. \$12.95
Best for belt drives.

Postpaid if cash with order.
Don't delay—send for yours today!
MONEY BACK GUARANTEE
Centrifugal and Gear Pumps in All Sizes
LABAWCO PUMPS, Belle Mead 2, N. J.

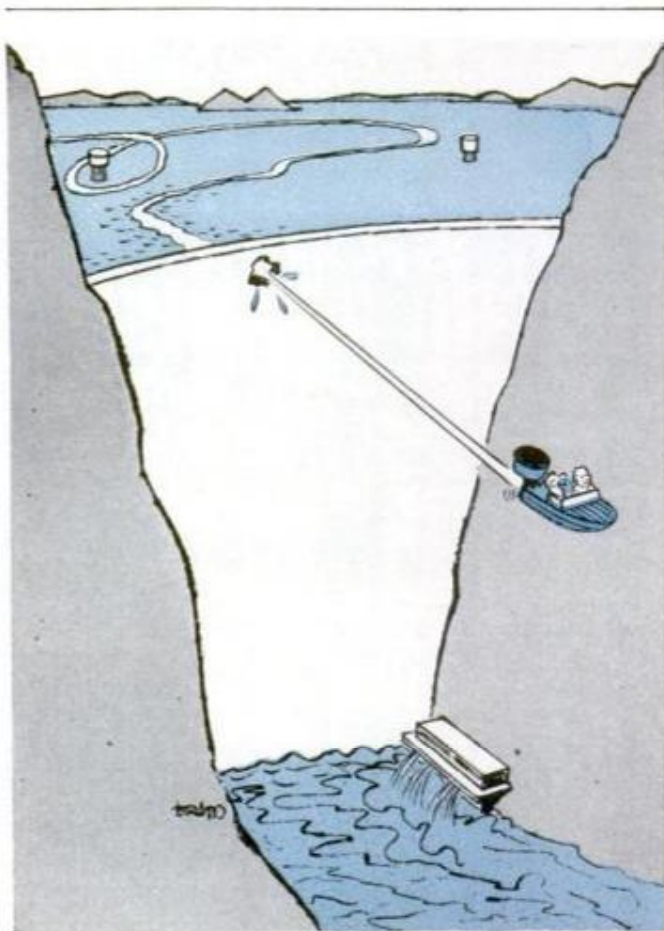
"Talk about power!"

POPULAR MECHANICS

Magic Mail Plan-Make up to \$5 an Hour!



Get **ORDERS** and **CASH** from your mailman—do work in **SPARE TIME** at home—or expand into **FULL TIME** business. Send coupon for Free facts about the newest and most fascinating of all home operated businesses. For the first time a simplified machine brings the fabulous profits of **Plastic Sealing** and **Plastic Laminating** within the reach of the small operator. Anyone can learn to operate the machine with a few minutes practice—then with our **Magic Mail Plan** can get mail orders pouring in daily with cash in every envelope. **No canvassing—no selling.** We even

Get into PLASTIC LAMINATING at home

WE'LL EVEN HELP FINANCE YOU supply the circulars you mail to bring back cash and orders, financing help, too. Rush name. We'll send you **FREE** and postpaid, pictures, prices, details, finance plan, all the facts you need. Mail coupon or send name on postcard. No charge. Warner Electric Co., 1512 Jarvis Av., Dept. L-2-L, Chicago 26, Ill.

THIS MAN . . .

is taking out of the machine a Plastic Sealing Job—ordered by mail—only 11¢ in material cost brings back \$2.58 in cash by mail. Capacity of machine: **\$25.00 profit per hour of operation.**

Make Thousands of Beautiful Art Creations

COSTUME JEWELRY • CIGARETTE BOXES TRAYS • CANDLESTICKS • COASTERS LAMP BASES • BOOK ENDS...ALL IN SPARKLING COLORED PLASTIC



WARNER ELECTRIC CO., 1512 Jarvis Av. Dept. L-2-L, Chicago 26, Ill.

At no cost to me, please rush full details and financing plan, postage prepaid. No obligation.

Name _____
 Address _____
 City _____ Zone _____ State _____

ELECTRIFY PLAYER PIANOS PUMP ORGANS

YOU CAN QUICKLY END TIRESOME FOOT-PUMPING With a Compact Low-Cost Lee Silent Suction Unit



EASY TO INSTALL
 FULLY GUARANTEED
 1000'S IN USE
 write to
LEE MUSIC MFG. CO.
 Box 595, Tujunga, Calif.



6-IN-1 ONLY MACHINE OF ITS KIND! UNIMAT

Compact workshop for all metal, plastic, wood. Precision lathe, milling machine, drill press, surface grinder, polishing/grinding machine, portable drill. Complete basic unit, \$139.50 **WRITE FOR FREE CATALOG.** **AMERICAN EDELSTAAL, INC., DEPT. GK, 350 BROADWAY, N.Y. 13, N.Y.**

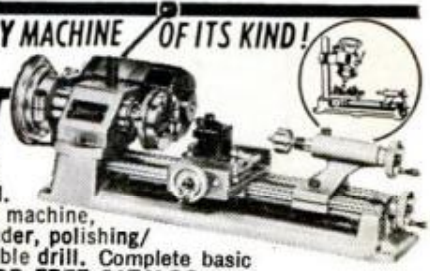

MEN...Get that Job! OPERATING HEAVY EQUIPMENT

Thousands of additional men will be needed to operate the Heavy Construction Equipment that will be used to build the new Roads, Bridges, Dams, Industrial Parks, Subdivisions, Irrigation Systems, Pipe Lines, Missile Sites, Shopping Centers, Home Sites, Airfields in a rapidly growing America!

Complete practical training on OUR modern machines, at either of OUR Florida or California Resident Training Centers, gives you the background you need to get that job you want as a **HEAVY EQUIPMENT OPERATOR** with the help of our **NATIONALLY RECOGNIZED PLACEMENT SERVICE.**

MAIL THIS COUPON FOR COMPLETE INFORMATION



LEARN TO OPERATE

- BULLDOZERS
- SCRAPERS
- GRADERS
- BACK HOES
- POWER SHOVELS
- CLAM SHELLS
- DRAG LINES

CONTRACTORS

Write to our Placement Department for information about our trained operators. Men who spend their own money and time to learn to operate and maintain equipment, make your best operators.

ASSOCIATED HEAVY EQUIPMENT SCHOOLS, INC.
 38-638 LITTLE RIVER STATION, MIAMI, FLORIDA

Please send full details immediately on your program of training for operators of Heavy Equipment.

Name _____ Age _____
 Street _____
 City _____ County _____ State _____
 Phone Number _____ Time Usually Home _____

INSURANCE—A VAST AND GROWING BUSINESS

**Expanding employment opportunities in claim adjusting and sales.
A multi-billion-dollar business employing about one million people.**

by B. Richard

The number of people employed by insurance companies increased by 50 percent from 1948 to 1958.

Although this rate of increase is expected to level off, there will continue to be literally thousands of new job openings each year because of the many factors that influence individuals and companies to purchase increasing amounts of insurance.

Our growing population; industry's continued emphasis on group pension, health and life insurance plans; the increasing trend on the part of parents in purchasing insurance as a means of providing college educations for their children; advances in medicine have made insurance available to those who had in the past been turned down as poor risks; industrial growth will necessitate more property and casualty insurance as new plants are constructed and new machinery purchased; and the amount of automobile insurance will continue to increase with greater car ownership—these are just a few of the many factors which are contributing to the even greater growth of the vast insurance business.

In addition to the many opportunities brought about by growth in insurance, workers in this field have a unique advantage in that the need for insurance is just as great in periods of economic decline as it is during normal times. Individuals and businesses tend to retain insurance even when business is not at its best. This means that insurance workers have more assurance of regular employment as compared to workers in some other fields.

Clerical workers and agents make up the largest percentage of all workers employed in insurance. Other workers have jobs which are unique in insurance. Actuaries, for example, are mathematicians, usually with a college degree, who determine what rates insurance companies should charge for particular types of in-

surance in order to maintain the financial soundness of the company. Underwriters decide whether to accept or reject insurance risks and select the appropriate premium rates. Claim adjusters investigate the facts surrounding each accident that has resulted in a claim against the company to determine the extent of the loss and who might be at fault.

Because a college degree is not necessarily a prerequisite for an insurance agent or a claim adjuster and because earning potential and job opportunities are great, let's take a closer look at what is involved with these two job classifications.

Insurance Agents

There are two types of insurance agents: those selling life insurance and those selling property and casualty insurance.

Life insurance agents must sell prospective customers on the idea of financial protection in the event of death. Because the agent is not selling a product or property that his customer can actually see, he must be adept at explaining the benefits, costs and types of insurance policies available.

Life insurance agents spend most of their time meeting people in their homes or places of business to explain and sell different types of life insurance. They must have the ability to communicate with and influence all types of people to make buying decisions.

After their initial training period, agents operate with a great deal of independence. Their incomes are in the form of commissions which represent a percentage of the premiums paid by those who have purchased insurance policies.

As owners make premium payments to keep their policies in effect, agents receive a percentage of each payment as their commission. After an agent has sold a number of policies, these renewal commissions add up to provide him with a

(Continued to page 54)

FREE FOR '63

LAFAYETTE RADIO ELECTRONICS

1963 CATALOG No. 630

It's New — It's Big —
It's Better Than Ever
It's From the

"World's Hi-Fi & Electronics Shopping Center"



**388
GIANT
SIZED
PAGES**



Here it is . . . the exciting, all-new 1963 Lafayette Catalog. 388 giant-sized pages (the largest in our 42-year history) . . . thousands of different items for the audiophile, experimenter, technician, hobbyist, engineer, student, serviceman . . . fully illustrated . . . hundreds of different manufacturers. It's the "World's Hi-Fi and Electronics Shopping Center" right in a catalog.

CHECK THESE OUTSTANDING LAFAYETTE BENEFITS

- ▶ **SATISFACTION GUARANTEED OR MONEY REFUNDED.** Lafayette's 30-day Free Home Trial lets you try-what-you-buy at home. If you're not completely satisfied, the full purchase price will be refunded.
- ▶ **LARGEST STOCK SELECTION.** If it's in Electronics or Hi-Fi it's in the Lafayette catalog — Citizens Band; Tape Recorders; Ham and Amateur Equipment; Test Instruments; P.A. Equipment; Radio & TV Tubes, Parts, Antennas; and much more.
- ▶ **EXCLUSIVE LAFAYETTE KITS.** Easy-to-assemble kits designed by Lafayette engineers for at-home construction. Dollar for dollar the best value for your money today.
- ▶ **SPECIAL HI-FI SYSTEM PRICES.** Select a hi-fi music system and get Lafayette's special money-saving price.
- ▶ **24 HOUR SERVICE.** Most orders fully processed within 24 hours after receipt.
- ▶ **LOWEST PRICES.** You always save more with Lafayette's low, low prices.
- ▶ **3-IN-1 EASY PAY PLAN.** Choose the plan that suits you best.

No Money Down, Up to 24 Months to Pay

LAFAYETTE'S NEW MAIL ORDER & SALES CENTER
111 JERICHO TURNPIKE, SYOSSET, L. I., N. Y.

OTHER LOCATIONS

JAMAICA, NEW YORK	NEWARK, NEW JERSEY
NEW YORK, NEW YORK	PLAINFIELD, NEW JERSEY
BRONX, NEW YORK	PARAMUS, NEW JERSEY
SCARSDALE, NEW YORK	BOSTON, MASS.
OPENING FALL 1962 — NATICK, MASS.	

FREE!
LAFAYETTE RADIO ELECTRONICS
DEPT. LJ2-2 P. O. Box 10
Syosset, L. I., N. Y.
Rush my **FREE** Giant Size, 388 Page
1963 Lafayette Catalog

Name _____
Address _____
City _____ Zone _____ State _____

CAREER TRAINING

JET / GAS TURBINE MECHANICS

Learn how you can cash in on the fabulous future for gas turbines—the engine that's revolutionizing air travel and now in miniature form is starting to power autos, trucks, tractors, boats. If you're mechanically inclined, here's the career opportunity with unlimited possibilities.

MARINE

AIRCRAFT • AUTOMOTIVE

MAIL
COUPON
NOW

Find out how Jetma—the nation's oldest training school for jet/gas turbine mechanics—can train you in your spare time at home for only a few dollars a week.



JETMA TECHNICAL INSTITUTE, Dept. PM 102
103 So. Airport Blvd.,
South San Francisco, Cal.

Please rush free bulletin on gas-turbine course.

Name _____

Address _____ Phone _____

City _____ Zone _____ State _____

FREE **EICO** CATALOG



Build your own stereo and mono hi-fi, radios, walkie-talkies, ham gear, test instruments—save 50% with famous EICO kits. No technical knowledge needed. Simple, step-by-step "Beginner-Tested" pictorial instructions guide you all the way. Choose from 108 beautiful kits. Mail coupon now!

EICO Electronic Instrument Co., Inc. PM-10
3300 Northern Blvd., L.I.C. 1, N. Y.
Please send free catalog and name of local dealer.

Name _____

Address _____

City _____ Zone _____ State _____



**DISCOUNTS to
40% BY MAIL
NEW CATALOG READY!**

More than 1000 famous U.S. products for home workshop, garden, boat . . . plus paint and painting supplies — all at great savings — in our new, expanded catalog! 80 fully illustrated pages. Each item guaranteed. Send only 25¢ for your copy.

GATES GENERAL CORPORATION
P.O. BOX 355PM FARMINGTON, CONNECTICUT

substantial income even though he may not sell large amounts of new insurance or even though his work may be interrupted by illness or some other cause.

After four or five years, agents can earn from \$5,000 to \$10,000 a year and earnings are considerably higher for the most successful agents. Beginning agents are usually financed under company plans for periods up to three years until their commissions are substantial enough so that additional income is not necessary.

Property and casualty insurance agents sell insurance against property loss or damage. Many of their customers are businessmen who represent manufacturing concerns, and property and casualty agents must be familiar with production processes, the kinds of losses that can occur in industry, and safety measures that can be used in manufacturing plants to reduce losses.

Most property and casualty agents represent more than one insurance company. They are independent agents who sell a policy from whichever company has the best plan for the customer's needs.

Their earnings are in the form of commissions from sales. The same commission rate paid for new sales applies to renewals. Renewal payments are usually due every three or five years on many property and casualty policies. Because of this agents continue to receive commissions even if work is interrupted by illness or other causes.

Both life and property and casualty agents must be licensed in the states in which they sell insurance. Most states require an agent to pass a written examination covering the insurance laws of the state and insurance fundamentals.

Applicants for jobs as insurance agents can write the main offices of insurance companies or apply to insurance agencies in their own communities. Personal interviews and tests are used by most companies to determine an applicant's aptitude for selling insurance.

Claim Adjusters

Claim adjusters make a vital contribution to any insurance company because they investigate losses to discover the facts and settle all resulting claims. Briefly, it is their job to determine the extent of loss, decide who is at fault, and adjust each claim by making payment or by collecting facts that show that no payment need be made.

Claim adjusting carries with it great responsibilities, and training or prior experience in the insurance field is essential. A college degree, however, is not a neces-

NEW RUBBER STAMP BUSINESS PAYS BEGINNERS UP TO \$9.20 AN HR.

**START AT HOME
IN SPARE TIME**
with Table Top Machine!

We Help Finance You

The multi-million dollar Rubber Stamp business—once controlled by a few big companies—is now being taken over by small operators—one in each community throughout the United States. Men and Women who have this inexpensive machine can turn out huge quantities of Rubber Stamps with special wording that buyers once were forced to buy from big cities. Material costing only 27c makes a stamp that sells for \$1.80. The machine that does the work is simple and easy to operate and it turns out as many as six Rubber Stamps at a time, each with different wording such as names, addresses, notices, stock numbers, prices and other "copy" needed by offices, factories and individuals. Working full capacity, it can earn as much as **\$9.20 an hour for the operator!** Now you can get into the big-pay business yourself, with your own home as headquarters. You don't need experience. We supply everything, including complete instructions and eight ways to get business coming in fast. **We even help finance your start.** Start making up to \$9.20 an hour from the very beginning. Cash in on the profitable Rubber Stamp business in your community, right away. We'll mail full particulars **FREE** and no salesman will call. Be first in your locality. Rush coupon today or send your name on postcard to:

RUBBER STAMP DIV., Dept. R-2-L
1512 JARVIS AVENUE • CHICAGO 26, ILLINOIS



RUBBER STAMP DIV.
1512 Jarvis Ave., Dept. R-2-L
Chicago 26, Illinois

FREE!

Please rush full particulars about your financing plan and the little machine that can get me started in the profitable Rubber Stamp business at home in spare time. Everything you send me is **FREE** and no salesman will call.

NAME _____

ADDRESS _____

CITY _____ ZONE _____ STATE _____

Information not listed on articles in this issue often is given in the WHERE-TO-FIND-IT list, available at no cost from the SERVICE BUREAU, POPULAR MECHANICS, 740 Rush St., Chicago 11, Ill.

High School Course at Home

Many Finish in 2 Years

Go as rapidly as your time and abilities permit. Course equivalent to resident school work—prepares for college entrance exams. Standard H. S. texts supplied. Diploma. Credit for H. S. subjects already completed. Single subjects if desired. High school education is very important for advancement in business and industry and socially. Don't be handicapped all your life. Be a High School graduate. Start your training now. Free Bulletin on request. No obligation.
American School, Dept. H745, Drexel at 58th, Chicago 37

A PERFECT HOLIDAY GIFT IDEA

(Rocket Viewer can be worn with glasses. Keeps both hands free.)

A precision stereoscopic magnifier complete with 3 interchangeable lense strengths. Ideal for: Hobbyists, Doctors, Chemists, Artists, Dentists, Machinists, etc. Standard Unbreakable Watch Crystals, 123 E. 144 St., N.Y. 51, N.Y.

\$12.50



LEARN MEAT CUTTING AT NATIONAL Pay After Graduation

The steady dependable trade of Meat Cutting taught easily in 8 short weeks. **YOU LEARN BY DOING** under actual meat market conditions in big modern school at Toledo.

For beginners or men with experience. Get a profitable store of your own. Remember, **PEOPLE MUST EAT!** Big pay jobs. Free employment help. Thousands of successful graduates.

Buying, cutting, percentage, pricing, advertising, selling, etc. A complete retail meat education. National School established 39 years. Get National training now. Pay your tuition in easy monthly payments after you graduate. Send coupon for **FREE** 40 page school catalog — **TODAY** G.I. approved.

National School of Meat Cutting, Inc., Dept. 50-K, Toledo 4, Ohio

Send me your **FREE** school catalog on National Training at Toledo in Meat Cutting, Meat Merchandising and Self-Service Meats. No obligation. No salesman will call.

Name _____ Age _____

Address _____

City _____ State _____

Approved for Veterans



THIS VALUABLE
BOOK GIVEN

Free

TO PEOPLE WHO
WANT TO EARN
MONEY IN AN

Accounting Career

LaSalle will train you in your spare time

The demand for trained Accountants far exceeds the supply. Salaries are at an all-time high. Accountancy-trained men move up to big positions in business. LaSalle's distinguished faculty prepares you at home, in your spare time—at remarkably low cost. You work with actual Accounting problems, acquire real experience. Thorough, practical, enjoyable—and quick in results. Many students report up to 56% pay increases even before completing training. Mail coupon for free book and sample lesson.

LASALLE EXTENSION UNIVERSITY

An Accredited Correspondence Institution

417 S. Dearborn, Dept. 10-099, Chicago 5, Ill.

Please send free book "Opportunities in Accounting" and interesting sample lesson.

Name..... Age.....

Address.....

City..... Zone.....

County..... State.....

104

BUILD, FLY ONE-MAN COPTER



Fun to build, inexpensive, easy to fly. Factory kits available. Order 3-view drawings, specs, photo of Gyro-Copter \$2 or motorless Gyro-Glider \$1. Send coupon today.

Send
\$1
or
\$2

BENSEN AIRCRAFT CORP., Dept. PM-102
Raleigh-Durham Airport, Raleigh, N.C.

NAME
ADDRESS

If You Want to Make up to \$1,000 a Month

Mail this Certificate NOW with name and address

Get FREE Details of Amazing Light Bulb with
No-Time-Limit Free Replacement Guarantee

Tear out this certificate, mail with name, address to learn how you can make up to \$50 and more in a day, spare or full time, introducing sensational longer-burning Merlite Light Bulbs in your area. Simply say . . . "Once you buy Merlite Bulbs, you never again have to buy light bulbs." Friends, neighbors, others order 12 to 24 and more at a time on astounding Free Replacement Guarantee without time limit! FREE SALES KIT! Everything you need to start making good money first day. Rush your name and address with this Certificate—TODAY!

MERLITE INDUSTRIES, Bulb Div., 114 E. 32nd., N.Y. 16, Dept. C-152
In Canada: Mopa Co., Ltd., 371 Dowd St., Montreal 1, P. Q.

sity and private correspondence schools offer training courses that are short and yet intensive enough to do a thorough training job. This makes it possible to undertake this type of training without interrupting present employment.

Trained men can work as staff adjusters with an insurance company and in other industries. For example, trained investigators are needed by trucking companies, railroads, steamship lines and government offices. Experienced adjusters can also work independently by representing companies that need accident claims settled. Such work is usually done on an hourly fee basis and hundreds of spare-time and full-time investigators and adjusters are at work in all parts of the country.

A unique advantage to this type of work is the great variety of challenges that it offers.

Millions of claims are handled each month in this country in accident, health and workmen's compensation claims. This presents a huge field for those who might be interested in the medical aspects of investigation.

For those interested in police-type work, thousands of thefts, robberies, burglaries and embezzlement losses must be investigated.

Investigators with mechanical ability can specialize in automobile and aircraft adjusting.

These are a few examples to show that claim adjusters can enter into the type of investigation best fitted to individual likes and abilities.

Claim adjusting is a field in which those involved provide a professional service that is needed and respected. It is a human-interest business offering opportunity for either full-time or part-time employment.

For details on employment and training opportunities in other fields, send for your SKILLS for AMERICA Booklet. Write Popular Mechanics, Dept. SFA, 740 Rush Street, Chicago, Illinois.

HELP

or

INFORMATION?

Do you need help or information for any repair or remodeling Idea Projects you are undertaking? A complete list of Lumber Dealers who are cooperating with Popular Mechanics to bring you information and quality products is available. To obtain this list of the dealer nearest you, write:

SERVICE BUREAU, POPULAR MECHANICS
740 Rush Street Chicago 11, Illinois

IDEA PROJECT

MINIMUM MAINTENANCE
FOR MAXIMUM LIVING
POPULAR MECHANICS

CENTER

Sworn statement from CHAS. LEMMING reads:

**"After starting
my own business**

Not everyone does as well...
Mr. Lemming owns two machines

**I'VE
AVERAGED**

\$100 A DAY

—most of it clear profit!"

• In city of less than 50,000, Mr. Lemming started his own business after filling in coupon like one below. He averaged \$100 a day during first year, some days \$200. F. E. Doran grossed \$1050 in a single month. Geo. Held grossed \$300 in one week.

How much you earn depends largely on you. You need no special skill, no large investment. Start spare time until full time justified. Hire helpers as needed.

NO SHOP NECESSARY • You clean upholstered furniture with efficient **PORTABLE ELECTRIC DETERGER** on customers' premises—homes, hotels, motels, etc. Auto upholstery, too. No hauling; operate from your home. Watch business grow as customers tell friends. Supplies cost little; what you take in is mostly profit. If you want to be independent—free from layoffs, bosses—start this profitable year-'round business of your own. We will help you to start and work with you for your success.



OURS IS NOT A LEASE ARRANGEMENT • You are free to operate in an independent manner. You sign no contract. You own the detergent outright and are always *your own boss*... and every dollar you take in is *yours* to keep. You pay no fees, or dues, or royalties to anyone. And *you* take no risk. Your detergent is fully guaranteed and enough supplies come with it to return far more than your investment. Many earn the cost of the detergent in a week or two. It costs nothing to get the details... write **TODAY**.

**MAIL COUPON TODAY
FOR FREE BOOK**

VON SCHRADER MFG. CO.
N10 "D" Pl., Racine, Wis.

Without obligation rush your **FREE** booklet about how I can start *my own* permanent, profitable electric Upholstery Cleaning business.

Name _____

Address _____

City _____

Zone _____ State _____

**NOW! EARN BIG MONEY IN
CARTOONING AND COMMERCIAL ART**

Now you can enter this highly-paid field quickly and easily. Learn in your own home, in spare time. No previous training or art ability required. Own your own business—urgent demand for artists everywhere! Earn 100% profit on all drawings—we show you how!

Send for your **FREE** Catalog today!

Continental Schools, Inc. Dept. E-160



4201 S. BROADWAY, LOS ANGELES 37, CALIF.

GET INTO ELECTRONICS

V.T.I. training leads to success as technicians, field engineers, specialists in communications, guided missiles, computers, radar, automation. Basic and advanced courses. Electronic Engineering Technology, an ECPD accredited Technical Institute curriculum. Assoc. degree in 29 mos. B.S. obtainable. G.I. approved. Start Feb., Sept. Dorms, campus. H.S. graduate or equivalent. Catalog.

VALPARAISO TECHNICAL INSTITUTE
DEPT. D VALPARAISO, INDIANA

Send for your free **WHERE-TO-FIND-IT** list giving sources of supply or further information on articles in this issue.

NO JOB WORRIES

PLASTEX INDUSTRY needs manufacturers on small scale for big production of Lamps, Clock Stands, Art Goods, Novelties in Plastic Marble imitation. No Experience necessary. 1/2¢ material makes regular 10¢ store sellers. Moulds furnished for fast production. Small investment brings good profit. Big wholesale orders now being placed. Ambitious men have chance for real prosperity and job security. Our **NEW FREE** booklet will interest and benefit you.

PLASTEX INDUSTRIES, Dept. A
3400 Third Ave. New York 56, N. Y.

Too darn practical?

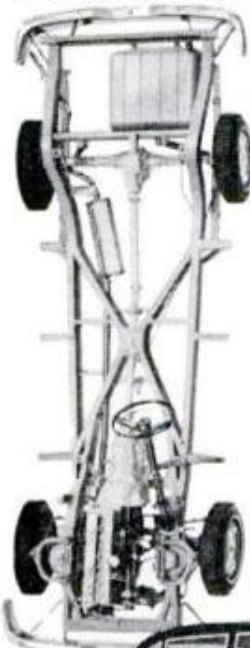

Certainly not! How can a car be too practical about safety? Or comfort? Or interior space? The **CHECKER** seats 8 adults... 6 in easy-chair luxury, 2 on neat auxiliary seats. That's practical transportation.

The timeless **CHECKER** is economical to operate, snarls at maintenance bills and is built to last for years and years and years.

Sound interesting? It is. Write for brochure.



Checker Motors Corp.
Dept. PM-1
Kalamazoo, Michigan

**40th anniversary
CHECKER**



CHECKER Marathon and Superba series... 4 door sedans and 4 door station wagons. Power and automatic equipment available.



"There's a man worth watching!"

"Keep your eye on Jim, there, and give him every chance. He's taking a course with International Correspondence Schools, and we want to help him all we can. We need more men like that. There's nothing like spare-time study to help a man get ahead."

Is your employer watching you? Has he sized you up as worth promoting, or will he pass you by because you aren't trained to handle bigger work?

To earn more, you've got to learn more. And to learn more, you've got to study in that hour after dinner most men waste. Here, I.C.S. can help.

I.C.S. is the oldest, largest school of its kind. More than 7,000,000 men and women have enrolled with I.C.S. It's the proven way to prepare for the job you want, in the field you like best. Make us prove it—now!

Mail coupon for 3 valuable booklets — FREE!

INTERNATIONAL CORRESPONDENCE SCHOOLS



Box U1419K, Scranton 15, Pa.

(In Canada: I.C.S. Canadian, Ltd., Montreal. In Hawaii, P. O. Box 418, Honolulu)

Without cost or obligation, send me "How to Succeed," the opportunity booklet for the field I've checked, and a sample study lesson.

- | | |
|---------------------------------------------------------|-----------------------------------------------|
| <input type="checkbox"/> Architecture & Building Trades | <input type="checkbox"/> Eng'r'g Drawing |
| <input type="checkbox"/> Automobiles | <input type="checkbox"/> High School |
| <input type="checkbox"/> Art | <input type="checkbox"/> Interior Decorating |
| <input type="checkbox"/> Business | <input type="checkbox"/> Math & Physics |
| <input type="checkbox"/> Chemical Eng'r'g | <input type="checkbox"/> Mechanical Eng'r'g |
| <input type="checkbox"/> Civil Eng'r'g | <input type="checkbox"/> Professional Eng'r'g |
| <input type="checkbox"/> Electrical Eng'r'g | <input type="checkbox"/> Shop Practice |
| <input type="checkbox"/> Electronics-TV-Radio | <input type="checkbox"/> Textiles |
| | <input type="checkbox"/> Other _____ |

Name _____

Age _____ Home Address _____

City _____ Zone _____ State _____

Working hrs. _____ Employed by _____

Special low rates to members of U. S. Armed Forces

FREE OUTFIT STARTS YOU IN BIG MONEY SHOE BUSINESS!



Run your own profitable 'shoe store' business from home! Represent fast growing million dollar firm in spare or full time. We give you—FREE—complete Starting Outfit that makes you \$217.00 EXTRA each month for just 2 easy orders a day. You feature 195 fast-selling dress, sport, work shoe styles for men and women. Air-cushion shoes, many other special features! Sizes 2½-15—widths AAAA to EEEE. Draw on 200,000 pair stock. Also horsehide jackets. Start now selling to friends, folks where you work. Rush postcard for FREE Outfit!

MASON SHOE, Dept. H-557, CHIPPEWA FALLS, WIS.

Learn PACKAGING! — Make to 2500% Profits at Home. WITHOUT SELLING!

Package products at home for nation-wide sales force. You package bulk items in your own home. We do your selling coast-to-coast. FREE "No Selling Plan" reveals thousands full, spare time big profit opportunities for beginners in self-service packaging, contract packaging, gift wrapping. We guide you step by step. Everything furnished. Write today for FREE "10-STEP PACKAGING PROFIT PLAN", and full details. No salesman will call.

HOME PACKAGING CO., Dept. A-252, 807 Sunset Blvd. Los Angeles 12, Calif.

MAKE BIG MONEY—ALL PROFIT—AT HOME

INVISIBLE MENDING

Pays up to \$10 in an Hour!

Make moth holes, cigarette burns, tears, rips, disappear from all fabrics. Little-known craft pays extra spare-time profits at home. Write today for exciting details FREE!

FABRICON, 1555 Howard St. DEPT. 3210, CHICAGO 26, ILLINOIS



HYDRAULIC JACK REPAIRS



Earn While You Learn at Home

Millions of jacks in gas and auto-service stations, truckers, body-shops, riggers, factories, farms need servicing. We show you HOW — easy step by step directions — what tools to use. EARN UP TO \$5 an hour, in spare time, in your own basement or garage. Start your own business NOW.

Write for folder PM10 and free bonus offer.

INSTITUTE OF HYDRAULIC JACK REPAIR

P. O. BOX 50 • BLOOMFIELD, N. J.

A Correspondence School Licensed by N. J. Bd. of Ed.

REAL ESTATE BE A BROKER

PAYS BIG! SEND FOR FREE, BIG, ILLUSTRATED CATALOG NOW! Graduates report making substantial incomes. Start and run your own business quickly. Men, women of all ages, learn easily. Course covers Sales, Property Management, Appraising, Loans, Mortgages, and related subjects. STUDY AT HOME or in classrooms in leading cities. Diploma awarded. Write TODAY for free booklet! No obligation. Approved for World War II and Korean Veterans

WEAVER SCHOOL OF REAL ESTATE (Est. 1936) 3521P Broadway Kansas City, Mo.



RUPTURED

BE FREE FROM TRUSS SLAVERY

Surely you want to THROW AWAY TRUSSES FOREVER, be rid of Rupture Worries. Then Why Do you put up with wearing a griping, chafing and unsanitary truss the balance of your life? If you do, it will NOT be through necessity but through choice on your part.

Now there is a new modern Non-Surgical treatment that is designed to permanently correct rupture. These Non-Surgical treatments are so dependable, that a Life-time Certificate of Assurance is given. Write today for our new FREE BOOK that gives facts that may save you painful, expensive surgery. Tells HOW and explains WHY NON-SURGICAL Methods of Treating Rupture are so successful today. No obligation.

Excelsior Medical Clinic Dept. H6125, Excelsior Springs, Mo.

POPULAR MECHANICS



CLASSIFIED ADVERTISEMENTS



Advertisements in this section \$1.35 per word, each insertion, minimum 10 words, payable in advance.

To be inserted under proper classification, copy must be in our office the

18th of the second month preceding date of issue

F. W. Johnson, Manager, Classified Advertising

Popular Mechanics, Classified Adv. Dept., 740 Rush St., Chicago 11, Illinois

YOU'LL PROFIT

By reading and answering the classified ads in this section. Hundreds of opportunities for you to make and save money

AUTOMOBILES, MIDGET CARS

V-BELT Variable transmission 1:4 to 4:1 Go-carts, tote-goats, motor-bikes, power tools. Plans and instructions \$1. Thomas Transmission Co., Box 1131P, Marysville, California.

GO-KARTS \$29.95 Full price less motor. Details 10¢. Sportsmobile, 905 N. Broad, Philadelphia 23, Penna.

AUTOMOBILE Literature, antique, modern; catalogs, photos, manuals. Monthly bulletin. Non-profit organization. Free information. Enthusiasts, Box 451B, Mount Clemens, Mich.

AUTO SUPPLIES AND EQUIPMENT

JEEP Parts! For military and civilian. At great savings. Largest inventory. Catalog for owners and dealers. Inquiries invited. American Auto Parts Co., 1830-PM Locust, Kansas City, Mo.

NEW And used parts at savings. Complete guaranteed parts service for all models cars and trucks. Largest in the West. Jeep and army parts specialists. Newest type shifting hubs for all jeep and all military and latest production front end drive vehicles. \$27.50 and up. Also, foreign car parts. Write, Pioneer Auto and Truck Parts Co., 734 W. 13th Avenue, Denver 17, Colo.

PARTS, Model "A." List 25¢. (Refundable) Matco, Box 135, San Pedro, Calif.

1909-1934 FORD Parts illustrated catalogs 75¢. Mark Auto, Layton, N. J.

RING-Valve job while driving, \$6.00 postpaid. Guaranteed! Nothing like it! Used by mechanics! Motaloy, Grantham, Penna.

ELECTRONIC Spark intensifier changes ignition spark to fireball. Patent pending. Amazing! Simple installation! Increases efficiency and point life. \$10.95 postpaid. State car voltage, compression. Raybin, 10908 Crenshaw, Inglewood, Calif.

CRANKSHAFT Grinder, hand operated. Makes bearings fit without taking engine apart. \$5.00. Literature, L. D. McGee, 719 Cascade, Wenatchee, Wash.

AUTO Testing equipment. 1963 Line available now. Free catalog. Power Lights, Tachometers, etc. Arco, Box 148, Desplaines, Ill.

AUTO Shop welding repair training in world's largest non-profit welding school. Low tuition. Free booklet. Hobart Welders, Box M-1021, Troy, Ohio.

CRAZY Customizing! Newest craze! Free information. Sample 25¢. Craft, 3008-M Montrose, Chicago 18.

SURLUSTER Wax and polish, used by more car dealers than any other product of its kind. Now available to public. Kit includes polish, wax, chrome cleaner. Unconditionally Guaranteed. Postage prepaid. Send \$2.95 to R. D. Dowd, 1111 W. Laurel, San Diego 1, California.

SAVE Up to 50% on auto parts, accessories! Get new 356-page illustrated catalog, just out. Over 100,000 items to renew, rebuild, renovate all makes, models domestic, foreign cars, trucks, sports cars, from 1920 to 1962's; '28 to '31 Model A! Latest Hollywood accessories, custom and hi-speed equipment. Rush 25¢ for postage, handling—refundable on first order. Whitney, 1919 PM-10 Archer, Chicago 16.

BATTERY Chargers. Home type. Electrotone's famous line. Wholesale prices. Same day delivery. Free catalog. Doron Enterprises, Inc. Box 7214, Chicago 80, Ill.

FORD T and A parts? Try best source old model parts, all makes. Pistons, gaskets, gears, valves, waterpumps, etc. "World's Largest Antique Auto Parts Corporation," Milwaukee 4, Wisconsin.

HYDRAULIC Jack repair parts. "Sava-Jack" genuine metal replacement parts; "Econo-Park" bulk items; Jackmaster repair kits; catalog 25¢ in coin. Hydraulic Jack Packing & Tool Co., P.O. Box 50, Bloomfield, N. J.

TRANSFIRE Transistor electronic ignition. Points, plugs last longer. Top performance, economy. Kits from \$34.95. Parts, Literature, Palmer Electronics, P27M, Carlisle, Mass.

OIL Filter refills, 10¢. Free particulars. E. L. G. Enterprises, Box 1655, Glendale, California.

DIRTY, Greasy hands? Use disposable gloves! Ten for \$1.00. Hansen, 512 Gayley, Los Angeles 24, California.

REPAIR Dents and rusted areas with plastic putty. Free instructions. Quart \$3.85, check or M.O. Dealer inquiries invited. Handy Plastics, Shrewsbury, Mass.

FORD Parts 1928-1953. Largest stock new Ford parts for the restorer. Send \$1.00 for catalog 1928-1948. Specialized Auto Parts, 301 Adams, Houston 11, Tex.

AMAZING "Jiffiwash" detergent now available for home auto washing. Not sold in stores. Air dries without streaks. Does not harm wax. Send for 6 month supply \$1.00. "Jiffiwash" 121 16th Avenue, San Francisco, California.

IMMEDIATE Delivery on foreign car parts. For complete catalog send name, address, and 25¢ to Tibur Imports, Dept. PM, P.O. Box 6194, Chicago 80, Ill.

SPORTSCAR Owners. Everything for sportscars \$25. James Auto Specialties, 3818 Magnolia, Burbank 10, California.

FREE Trial! "Ring-valve job" while driving. If satisfied owe \$3. Otherwise nothing. Motor, 5 Lander St., Pittsburgh 20, Penna.

JEEP Owners — V8 conversions. Read Jeep Owners ad, page 24.

CROSLY And foreign car parts. Discount club, Box 7B, Elmont, N. Y.

BONDED Brake shoes, guaranteed. State year, make. \$5.00 per axle. Include used shoes, or \$3.00 deposit, refunded. Lee, 65 Koenig, Tonawanda, N. Y.

AUTO TRAILERS

BUILD Camping travel trailers. Illustrated circulars 20¢. Kamcraft, Box 1153, Milwaukee 1, Wis.

PICKUP Campers. Pre-cut Kits. Blueprints. Supplies. Literature 10¢. Comstock Trailers, Parsons, Kansas.

MOTORCYCLES, BICYCLES, MOTORSCOOTERS AND SUPPLIES

BIG Discounts kart, mini-bike, scooter name brand engines, clutches, frames, wheels, tires, brakes, etc. Catalog 25¢ Universal, 3551 West 25, Chicago 23.

BUY Factory direct Wren motor scooter for only \$99.95 with Clinton 2 1/2 H.P. engine. Only \$10 down and \$5 a month. Send 25¢ for colored brochures to: Bird Engineering, 206 S. 19, Dept. PMC, Omaha, Nebr.

MOTORIZE Your bicycle. Plans \$1.00. Kits \$69.95: Go-Byk, Fergus Falls, Minnesota.

GO Cart \$10, Cushman \$15, less engines. Engines \$2 up. Servicecycle \$25, motorbike motor \$15. (Mailorder only). Send 25¢ (35¢ for First Class Mailing) for 32-page Directory-Catalogue Number 109, listing these and hundreds of other bargains in go-carts, motorscooters, homebuilders plans, parts, etc. Midget Motors Directory, Athens, Ohio.

HARLEY-Davidsons — Used bargains. New, used parts, accessories, all models. Bulletin 25¢. Knuth's (Factory Dealer), 1753 Muskego, Milwaukee, Wis.

RECONDITIONED Motorcycle motors. Large stock Indian Cushman Vespa Mustang NSU parts. Indian Motorcycle Sales, Kansas City 27, Missouri.

AVIATION

AMPHIBIAN—Airplane homebuilt, two passenger. Blueprints available. Literature \$2.00. Volmer Aircraft, Dept. 2, 104 East Providencia, Burbank, Calif.

PROPELLERS, Plans, supplies for airboats, snowplanes, 125 h.p. Lycoming engines. Prompt delivery. Catalog 25¢. Banks-Maxwell Propeller Co., Box 3301E, Ft. Worth 5, Texas.

LIGHTPLANE Blueprints. Manuals. Illustrated circulars 25¢. Kam-Craft, Box 1153, Milwaukee 1, Wis.

AUTOGYRO Blades for gyrocopters. Solid aircraft spruce. Terrific! Vancraft, 7246 North Mohawk, Portland 3, Oregon.

SURPLUS Airplanes \$159, helicopters, McCullough Drone engines \$63, components, wheels, etc., all sold at giveaway prices direct to you by U. S. Gov't. Complete details only \$1.00. Surplus Trader, Box 8M3, Thomasville, Penna.

HOMEBUILT Helicopter handbook \$1.00. Directory \$1.00. Urshanair, Box 250, Santee, California.

BATTERIES, GENERATORS

HEARING Aid batteries. Wholesale price list. Write: "Hearing," Box 1020, Harrisonburg, Virginia.

REBUILD Batteries! Complete manual \$3.00. Chrysler Corp. Alternator Guide \$3.00. C. O. D. accepted. Bayer Publications, 938 Betty Avenue, Neenah, Wisconsin.

ELECTRICAL SUPPLIES

GARAGE Door operator kits—Edwards KR-50 kit. Available with or without remote car control. Prices from \$59.95. Edward T. Fink Co., Inc., 284 Nepperhan Ave., Yonkers, N. Y., Dept. PM.

LAMP, Appliance, range parts. Wholesale distributors catalogue 25¢. SECO, 112 South 20th Street, Birmingham 3, Alabama.

LAMP, Electrical parts, wholesale. Thousands of items for repairing, converting. Catalog 35¢. Brown Lamp, Box 305, Clayton 5, Missouri.

LAMP Parts. Catalog, prices, wiring instructions, 50¢. Refunded first order. Gyro, 5208P N.W. 35 Ave., Miami 42, Fla.

WELDING, SOLDERING, PLATING

ARC Welder manual only 50¢. Regular \$1.00 value. Tells how to weld every job. Emerson Electric, 8100 Florissant, Dept. PM-10, St. Louis, Missouri.

CHROME Plating equipment, supplies. All other finishes. Home workshop and production sizes. Send \$1.00 (refundable) for formulas, operating data, equipment guide and catalog. HBS Equipment Division L50, 3445 Union Pacific Avenue, Los Angeles 23, Calif.

WELDERS, 110/220. \$39.50. Morris, 1070 Inner Drive, Schenectady 3, New York.

ACETYLENE Outfits, new \$59.50; used \$40.00. Arcwelders \$69.50. Eagle Welding, Dept. PM, 5085 Broadway, Chicago 40, Ill.

FREE Catalog, welders, kits. Build 350-ampere welder using aircraft generator, plans 25¢. Dunbar, Minneapolis 8, Minn.

WELD, Solder, cut, braze. $\frac{1}{8}$ " welder complete \$9.95. Flame-torch \$3.95. Postage 50¢. 75 ampere $\frac{1}{2}$ " transformer welder \$29.95 complete. F.O.B. Essay Mfg. Co., Dept. C, Quincy 69, Mass.

SURVEYING INSTRUMENTS

NEW And guaranteed factory rebuilt transits and levels, sale or rent, with purchase option. We will repair, trade or buy old instruments. Write for list M112. Warren-Knight Co. (Manufacturers of Surveying Instruments), 136 N. 12th St., Philadelphia 7, Penna.

MACHINERY, TOOLS, SUPPLIES

PLUMBERS And handymen. Amazing new tool makes it easy to solder copper fittings to lead pipe. Send for information. Fisher Cutter Co., 4621 Lafayette Esp., Fort Wayne, Indiana.

40 NEW Machinist tools. Campbell Tools, 1424 Barclay, Springfield, Ohio.

RADIUS Cutter. Beats all competition. Responsible franchises available. Shaw, Box 1144, Palo Alto, Calif.

MAKE Own light duty lathe grinder. Low cost. High quality. Drawings \$5.00 or request folder. Kimbrough, 304 Oriole Dr., Chattanooga 11, Tenn.

SHARPENING Equipment, circular saws. Low cost. Builders Supply, Carrollton, Ill.

ENGINES, MOTORS, DYNAMOS

REWIND Motors yourself. Complete instructions, \$1.00. Lewis Manufacturing, Howell, Michigan.

WINDING Data. 275 motors, single and three phase \$1.10. Data Company, 512 Kensington, Kansas City 24, Mo.

DIESEL Injector parts and fuel pumps wanted, GM51-53-71-110. Bares, 2093 East 19 Street, Cleveland 15, Ohio.

OPERATE 3-Phase motors from single phase. Plans \$1.00. Donald Howell, Barnesville, Ohio.

REWIND Motors yourself. Free details. Modern, Box 8715, Kansas City 14, Mo.

STEAM Engines! For boats, cars. Free literature. Reliable Steam Engine Co., 34403 Joel Street, New Baltimore, Michigan.

GOVERNMENT SURPLUS

WAR Surplus bargains! New government releases arrive constantly. Save up to 80%. Blankets, boots, cots, tents, wearing apparel, etc. Send for free war surplus catalog. Sioux Falls Surplus Store, Sioux Falls, South Dakota.

JEEPS \$278. Airplanes \$159, boats \$7.88, generators \$2.68, typewriters \$8.79 are typical government surplus sale prices. Buy 10,001 items wholesale, direct. Full details, 627 locations and procedure only \$1.00. Surplus, Box 177-C30, Abbottstown, Penna.

U.S. Government surplus—Jeeps, \$264.00, radios, \$2.53, guns, typewriters, cameras, tools, thousands of items. Fabulously low surplus prices. Complete information sent immediately. Send \$1.00 to—Surplus, P.O. Box 50512, Dept. E, New Orleans 50, Louisiana.

BUY Surplus direct from government. Complete guide—50¢. Satisfaction guaranteed. Janecek, 373 East 155th Street, New York 55-PM, N. Y.

JEeps \$223.83. Typewriters \$4.15. Boats \$6.18. Radios \$2.65. Televisions, guns, recorders. Typical surplus prices. Free exciting details. N. Y. Enterprises, Box 402-X3, Jamaica 30, New York.

PAINT Sprayers. Stainless steel tanks. Bargains. Free folder. Imasco, 1829 S. State, Chicago 16, Ill.

GOV'T Surplus. How and where to buy in your area. Send \$1.00. Surplus Information, PM, Headquarters Building, Washington 6, D. C.

JEeps, Boats, airplanes, helicopters, walkie-talkies, radar, tents, typewriters, tires, tools, cameras. Individuals can buy now direct from government. "U.S. Depot Directory & Procedure" \$1.00. Brody, Box 425-PM, Nanuet, N. Y.

GOVERNMENT Surplus. Walkie talkies, jeeps, boats, guns. Locations and procedures 50¢. Why pay more? Satisfaction guaranteed. Delta, Box 227, El Paso, Texas.

JEeps \$111.68, airplanes \$75.20, boats \$6.18; many others direct from U.S. Government. For complete "Directory" send \$1.00 to Quality Surplus, Box 22163R10, Indianapolis, Indiana.

ATHLETIC EQUIPMENT, BODY BUILDING COURSES

FREE Brochure! Lightest easiest exercise ever invented. Circularizer, 2515 Euclid, Santa Monica, California.

MUSCULAR Development. "Physical Conditioning Booklet" contains reasons for exercise and 51 exercises. Send 40¢ to: Thomas Garber, 104 Ashley Street, Korn Krest, Wilkes-Barre, Penna.

PHYSICAL Perfection. Reducing, gaining, muscles, longevity. Mail 25¢ for all 4 courses. Big deal \$3.00. Guaranteed. Personal supervision. Agents wanted. Sid's System, (PM-L62) 8421-C. Evergreen, Southgate, California.

UNUSUAL Exercises strictly for women \$1.00. Professional, Box 24, Pedro, Ohio.

DEADLY "Kungfu Karate" fighting. Break bricks within 100 days—\$5.00. Oriental Book Sales, P.O. Box 1183, Oakland 4, Calif. Free information.

DEVELOP Powerful arms, chest, shoulders, legs! Complete course, \$1.00. Keystone, Box 206, Pottsville, Pennsylvania.

"**GIANT** Arms." Dr. Young's, D.C. revolutionary discovery. \$2. Satisfaction or refund. Gaucho, Box 9309-S7, Chicago 90.

BAR-BELLS, Courses, equipment. Catalogue 10¢. Good Barbell, B-1495, Hendersonville, N. Car.

BOATS, OUTBOARD MOTORS

INCREASE Outboard speeds 20-30%. Same boat, motor. No cost. Results guaranteed. \$1.00. Boats, Box 21-M, Cambridge, Maryland.

FULL Size, cut-to-shape boat patterns, blueprints, 7 $\frac{1}{2}$ -38 feet. Big new illustrated "Build a Boat" catalog of 64 designs, including catamarans, cruisers, runabouts, skiffs, outboard boats, sailing, racing, houseboats, 50¢. "How to Build a Boat" booklet, \$2.50. Cleveland Boat Blueprint Co., Box 1651, Cleveland, Ohio.

NEW, Used, rebuilt marine motors. Marine conversions, fittings. Free catalog. Stokes Marine Supply, Dept. 24, Coldwater, Michigan.

MARINE Conversions. Ford, Chevrolet, Jeep engines. Catalog 25¢. Lehman Manufacturing Company, 800 Elizabeth Avenue, Linden 4, N. J.

FIBERGLAS Your old wooden boat. Make it waterproof. Repaint over fiberglass, wood, or metal with new Poly-Aqua Epoxy paint. Free literature. Ajax Plastic Co., Dept. 6, P.O. Box 1323, Ft. Worth, Texas.

MARINE Conversions and gears for all popular automotive engines. Send 25¢ coin for complete catalogue. Barr Marine, 2706A Castor Ave., Philadelphia, Penna.

BOAT Plans, frame kits, full-size patterns prepared specially for amateurs. Send 50¢ for new 80-page catalog illustrating over 40 build-it-yourself power boats from 7' to 28'. Glen Designs, 9152 Rosecrans, Bellflower, Calif.

BUILD Your own boat from our large-scale blueprints. Books of plans give how-to-build help. Hundreds of professional designs—motor, sail or auxiliary—for amateur builders. Free catalog. MoToR Boat-Ing, 959 Eighth Ave., Dept. RS, New York 19, N. Y.

SAIL Fin kit \$67.50 complete. 11'6" sail boat. Free literature. Box 78, Brecksville, Ohio.

CONVERT Any electric bilge pump to automatic. Kit \$6.95. KG Marine, Box 107, Arlington, New Jersey.

BUILD Your own boat trailer. Easily assembled from our trailer kits, 6 sizes, 350= to 1800= capacities. Professionally designed and manufactured. Buy direct from factory. You assemble at big savings. Free literature. James E. Dandy Mfg. Co., Portsmouth, Ohio.

STOP Paying ridiculous prices for your boat's interior. Finest, latest style plastics, foam rubber, tools. Send for free brochure. La Scala Textile, Box 1490, Albany, New York.

FIBERGLASS Cloth, matt, polyester and epoxy resins. Lowest prices. Seifert's, Box 1206-M, Green Bay, Wis.

CANOE Kits and plans. Model and size for every canoeing need. Also boat plans and patterns. Schneider Boats, Dept. 47, 3133 Lisbon, Milwaukee 8, Wis.

10' KAYAK Kit \$19.50 complete. Free literature. Box 78, Brecksville, Ohio.

MAKE Your dream of owning a boat a reality. Build one now! The 20th Anniversary boat kit catalog by Custom Craft offers the means of selecting a style best suited to you. Pram to cruiser, sailing dinghy to dragster—each engineered by the originator of kit boats to be the best value a boat builder can buy. Financing available. Send 50¢ for 1963 catalog to Custom Craft, Buffalo 7N, New York.

I want to send you proof of the wonderful pulling power of Popular Mechanics classified pages. What's your proposition? Write me today. Include literature if possible. F. W. Johnson, Manager Classified Advertising, Popular Mechanics Magazine, 740-G Rush St., Chicago 11, Ill.

SPORTING GOODS, GUNS, FISHING, SKIN DIVING, ARCHERY

ARCHERY Headquarters. All phases: Bows, arrows, raw materials, tools, books (some autographed). Rush orders, no waiting. Howard Hill's newest catalog. Send 50¢ (coin only). Receive also free illustrated archery catalog. Shoshone Archery, 10115 San Luis, South Gate, California.

MOLDS—For casting your own fishing sinkers. Free illustrated booklet. Reading Instrument Co., Box PM78, Reading, Penna.

CARRY & Set 6 duck decoys as easily as one, tangle proof. \$4.95. Automatic, 544 Jefferson Ct., Detroit 7, Mich.

154 PAGE Catalog—A real dream book for fishermen. It's free. Netcraft Company, Dept. B-10, Toledo 13, Ohio.

FLASH! Klein's \$1.00. Big all-new, all-sports bargain catalog has been price cut to 25¢. Order today! Klein's, Dept. PM, 227 West Washington St., Chicago 6, Illinois.

FREE—Wholesale catalog. Beads. Spinners. Lure parts. Sinker molds. Jigs. Reels. FinnySports (ME), Toledo 14, Ohio.

BIG Money raising crickets and 12 inch African fishworms. Free literature. Carter Ranch, Plains, Georgia.

MOLDS For fisherman's sinkers, jigs, squids, casting and spinning lures. Free catalog. Sweet's Molds, Tonawanda 1, New York.

EXPERT Trophy plate engraving 5¢ per character. Plastic name badges \$1.00. Literature free. Gull Stamping Company, Dept. 20, Richland, Michigan.

FISH Better. Eliminate bait. Self-propelled fish lure. \$2.98. Emm-Ess Company, 15 West Price, Linden, New Jersey.

10,000 GUN Bargains! Modern-antique guns, accessories. Giant 128 P. Bargain catalog \$1.00. Agramonte's, Yonkers, N. Y.

CAMPING EQUIPMENT AND TENTS

KEEP Warm. Send 10¢ for handbook catalog of down clothing and lightweight camping equipment. Gerry, Dept. 245, Boulder, Colorado.

CAMPING Equipment, tents, world's largest selection. Send 25¢ for new giant catalogue-handbook-camp site directory (print name-address). Morsan Tents, 10-21R 50th Ave., Long Island City 1, New York.

BINOCULARS, TELESCOPES, MICROSCOPES, MAGNIFIERS

BUILD Your own reflector telescopes. Complete kits: mirrors, eyepieces, tripods, all other accessories. Request free illustrated literature. Criterion Manufacturing, Dept. KPM-93; Hartford, Connecticut.

SCIENCE Bargains! Lenses, telescopes, binoculars, microscopes, kits, parts, war surplus. Send \$1.00 for beginner's 10-lens kit with instruction booklet. Order Stock 2-CH. Request free 144-page Catalog CH. Edmund Scientific Co., Barrington, New Jersey.

BARGAINS! Zoom binoculars! Riflescopes! Telescopes! Microscopes! Free catalog. Adventure Company, Box 2133, San Diego 12, California.

DYNASCOPE. Amazing world-famous reflector telescope. Request free brochure. Criterion, Dept. DP-96; Hartford, Connecticut.

TAXIDERMY

NOW. Learn at home to mount birds, animals, fish; tan skins. Low fee. Tremendous hobby. Over 400,000 students. Write for free book! Northwest Schools, Dept. 2570, Omaha 2, Nebr.

EARTHWORMS, CRICKETS, FROGS

BIG Money raising fishworms and crickets. We teach you how to raise and where to sell. Free literature. Medium redworms. 3000, \$5.95; 10,000, \$16.95. Carter Redworms, Plains, Georgia.

HYBRID Redworms. Live delivery guaranteed. 1000—\$4.00, 5000—\$16.50. Bedrun 2500—\$4.95, 5000—\$8.95, 10,000—\$16.85. Postpaid. Free literature. Hall Farm, Hilton, Georgia.

MEN!—Women! Make money raising bait at home for us! We buy your crop! Details free. Red Wigglers, Warsaw 45, Indiana.

EARN Money raising fishworms for us! Exciting details free! Oakhaven—56, Cedar Hill, Texas.

HYBRID Redworms 1000/\$3.00; 2000/\$5.00; 5000/\$8.00; 10,000/\$14.00; Postpaid with raising instructions. Live delivery guaranteed. Brazos Bait Farm, 60 Lincoln, Waco, Texas.

FREE Literature. Earthworms, books. Denton Enterprises, Box 348, Hattiesburg, Mississippi.

BROWNOSE Breeders: 5,000, \$17.50; 1,000, \$4.00 postpaid. Free instruction book. Three Oaks Ranch, Dresden, Tenn.

YOUNG Jumbo frogs and giant breeders. Stock your lakes and ponds. Nu-Tex Frog Farm, P.O. Box 4029, Corpus Christi, Texas.

PLANTS, SEEDS, BULBS, NURSERY SUPPLIES

GROW Mings! Seeds instructions. 35¢. U.S. only. "Specialties," 1439-X Sabraton Ave., Morgantown, W. Va.

GINSENG Bringing \$14 pound. Have seeds, plants, Goldenseal. Full information. K. Collins, Viola, Iowa.

PETS—DOGS, BIRDS, HAMSTERS, ETC.

PETS. Hamsters, mice, rabbits, squirrels, chipmunks, guinea pigs, skunks, raccoons. Picture catalog twenty-five cents. Moore's Hamster Ranch, Shepherdstown 25, West Virginia.

HAMSTERS. Ideal pets. \$2.95 pair. Booklet 10¢. Jer-Pre's Hamstery, 1447 Apple, Muskegon, Michigan.

HAWKS. Reptiles, raccoons, skunks, squirrels. Catalogue 25¢. Trails End Zoo, St. Stephen, S. C.

MAKE Money raising chinchillas, mink, rabbits, cavies for us. Free catalog. Keeney Brothers, New Freedom 2, Penna.

RABBITS—FUR BEARING ANIMALS

RAISE Profitable guinea pigs. Champion stock \$4.50 pair, trio \$5.50. Live delivery guaranteed. Book 50¢. Diamond J Rabbitry, Colborne, Ontario, Canada.

MINK Raising information free. Complete. Lake Superior Mink Farm, Superior, E.E.1, Wisconsin.

RAISE Rabbits successfully by knowing facts. 48 page book. 38 illustrations describing 25 breeds. Housing. Breeding. Feeding. Markets and Marketing. Bulletin etc. 25 cents. American Rabbit Association, 36 ARBA Building, Pittsburgh, Penna.

EARN \$10,000 Yearly raising Angora rabbit wool for us. Information 25¢ coin. American Angora Company, Malta 12, Montana.

RAISE Rabbits on \$500 month plan. Free details. White's Rabbitry, Mt. Vernon, Ohio.

RAISE Fur rabbits. Good profits. Fur house, S. 202 Howard Street, Spokane 4, Washington.

FARMS, FARM LANDS, REAL ESTATE

FLORIDA Campsites—deep in the heart of the great Ocala National Forest. Abundance of game, best fishing. Warranty deed. Unrestricted—pitch tent, park trailer, build lodge. Free maps and photos. Howard Vernor, DeLand, Florida, AD60088(Q-O).

\$5 MONTHLY Buys 5 acres—near clear-water lake. Price \$125. Excellent fishing, good cabin sites. Free list. Box 425-P, Carthage, Mo.

CANADIAN Vacation lands: Full price \$385.00, 40 acres, \$10 month. Suitable cottage sites, hunting, fishing, investment. Free information. Land Corporation, 3768-C Bathurst, Downsview, Ontario, Canada.

MONTANA—Fishing, hunting, cabin sites and campsites on beautiful Kootenai River in Montana Rockies. \$595 at \$10 down and \$10 a month. Mountain Empire Company, Box 203-P, Libby, Montana.

BAHAMA Island sunswept homesites (125'x80'). Sandy beach, fishing, water sports. \$895. No taxes. \$10 month. Suitable investment, vacationing, retirement. Free information. Bahama Estates, 3768-F Bathurst, Downsview, Ontario, Canada.

CAROLINA Coast—\$5 down. \$5 monthly. buys large homesite, 70x150. in beautiful Boiling Spring Lakes. Satisfaction guaranteed. 16,000 acres. 50 freshwater lakes. Excellent fishing, hunting. Free literature. Boiling Spring Lakes, Southport 1-C, North Carolina.

UNDER \$13 An acre! A terrific bargain for land alone, but picturesque 318 acres has 5-room 3-bedroom house and poultry house, too! Borders all-weather county road, in fine hunting area, 1½ miles pretty Ozark sports stream, 2½ village. Few acres tillable, all now in pasture and meadow, suitable for dairy, beef, hogs. 5 springs, creek, barb wire, estimated \$1,000 worth marketable timber. Non-resident owner offers bargain without equal at only \$3,900! Less than half down, immediate possession. New free illustrated fall-winter catalog, bargains coast to coast! United Farm Agency, 2825-PM Main St., Kansas City 41, Mo.

STROUT Big free catalog. 148 pages chock-full of values. Write for your copy. Strout Realty, 7-CJ S. Dearborn, Chicago 3, Ill.

CENTRAL Florida lots lake and citrus region, near Orange City. Total price \$90.00 each, \$2.50 down and monthly. Free literature. Casper Corporation, 3970 N.W. 177th, Carol City, Miami, Florida.

FLORIDA Highway frontage 55x115 only 4 miles from Suwannee River. \$499 total \$10 monthly. High, wooded. Hurr! Gilchrist, P.O. Box 163-W, Miami 37, Florida.

FLORIDA. Big, beautifully wooded tracts on prominent highway in famous Green Hills pleasure resort area 28 miles north Panama City. Also choice ¼-acre lakeside homesites. \$10 monthly. Free maps, photos. Owen Wood, Fountain 15, Florida. AD62005(K) (0)

PROFITABLE OCCUPATIONS

BARGAINS! Buy wholesale! Save money! Free catalog! Norris, 273-K Merrick Road, Lynbrook, N. Y.

INVESTIGATE Accidents Earn \$750 to \$1,000 monthly. Men urgently needed. Car furnished. Business expenses paid. No selling. No college education necessary. Pick own job location. Investigate full time. Or earn \$6 1/4 hour spare time. Write for free literature. No obligation. Universal, CPM-10, 6801 Hillcrest, Dallas 5, Texas.

\$2.00 WEEKLY Selling books by mail. Box 51-PA, Des Plaines, Illinois.

AUCTIONEERING—Home study course. Diploma granted. Auction School, Ft. Smith, Ark.

VENDING Machines. No selling. Operate a route of coin machines and earn amazing profits. 32-page catalogue free. Parkway Machine Corporation, Dept. #25, 715 Ensor Street, Baltimore 2, Maryland.

BAKE New greaseless doughnuts in kitchen. Sell stores. Free recipes. Michael, 3605 South 15th, Minneapolis 7, Minn.

BIG Money raising fishworms and crickets. Free literature. Carter Wormery, Plains, Georgia.

BECOME Independent with your own franchise business. Thousands earning handsome incomes. Request interesting facts today. National Franchise Reports, PM-528, 333 North Michigan, Chicago 1.

EARN \$240.00 A month at home, spare time, doing only two \$5.00 invisible mending jobs a day. Big money paid for service that makes cuts, tears disappear from fabrics. Steady demand. Details free. Fabricon, 1586 Howard, Chicago 26, Ill.

EARN Money raising fishworms for us! Write: Oakhaven—58, Cedar Hill, Texas.

SHARPEN Scissors, pinkers, clippers. Inexpensive machines, supplies. Blackhawks, Sheldahl, Iowa.

FREE Report: "609 Unusual, Successful Businesses." Box 1001-PT, Evanston, Ill.

INVESTIGATE Auto accidents. Earn up to \$750 monthly. Investigators needed in every state. No selling required. Car furnished; expenses paid. Or start a business of your own. Associate with interesting, important people. We train you at home. You hold present job until ready to switch. Get free information. No obligation. Write Liberty School, Dept. C-94, 1139 West Park, Libertyville, Illinois.

CHROME Plating. Instructions, equipment and supplies. Platers' Supply, P.O. Box 565, Lugo Station, Los Angeles, Calif.

AMAZING Profits in worms. Free informative letter. Hillaire, Northville, Mich.

PIANO Tuning quickly learned with home study course. Diploma granted. American Tuning School, Gilroy, Calif.

"RADIO Announcing; how to get started" \$2. Box 1665, Daytona Beach, Florida.

WHOLESALE Magazine subscriptions. Highest commissions. Bonus! Qualified Agencies, 451XA Kingston, Brooklyn 25, New York.

BIG Money collecting delinquent accounts, perfect for retired, handicapped people, full or part time, everything provided 50% commission, easy with our instructions. Business Protection, Box 298, Marion, Ohio.

MOLDS For concrete bird baths, benches, flower urns, animals, statuary items, etc. Buy durable aluminum molds direct from top manufacturer. 96-page manual complete instructions, product illustrations, mold prices, \$2.00. CMC, Inc., Drawer 99, Hickory 12, N. C.

BOOKS, PERIODICALS, PICTURES, POSTCARDS

FREE Catalog. Civil-Service. Self-help books. Bagley's, 158-18 Riverside Drive, New York 32.

THREE Books worth 30¢ to \$2.50 postpaid 25¢. Inquiries desired. Lund's Books, 2773 E. 79, Cleveland 4, Ohio.

A Governor who read "Segregation, Integration and Our Constitution" says every citizen in America should read it. \$1.00 postpaid. W. D. Avra, 1018 Preston Avenue, Houston 2, Texas.

NATIONAL Geographic magazines, 1888-1960, any issue. Periodical Service, Box 465-PM, Wilmington, Delaware.

BOOKS Located! You name it—we find it. Book Mark, 89A Macomb, Mt. Clemens, Mich.

FREE Catalog. Self-help books. Write Wilshire, 8721 Sunset, Los Angeles 69P.

BOOKHUNTERS! Scarce, miscellaneous books supplied! Atlantic Book Service, Cedar Street, Charlestown 29, Mass.

SURVIVAL Manual. Necessity for outdoorsmen. Illustrated. May save your life. \$2.00. Nugget, Box 462-P, Tucson, Ariz.

BRITISH Book bargains—Any subject. Catalogues free. Transatbooks, Wantagh, N. Y.

BOOKFINDERS! All subjects. Send wants! Jaher Book Service, 183 Hazelwood Drive, Westbury, N. Y.

PROPHET Elijah coming before Christ. Wonderful book free. E. Megiddo Mission, Rochester 19, N. Y.

SAVE To 84% on books, records. Free catalogue. Discount Reader's Service, MI-5435 Upland Way, Philadelphia 31.

GAMES, TOYS, NOVELTIES

GET Your novelties, tricks, gags wholesale. Sell friends. Big catalog, 50 gag samples 25¢. Dohn-SF-Marks, Broadview, Illinois.

EASY To follow plan for convertible sledding or ski slope playhouse, for yard. See picture in skiing magazine. \$2.00. Write Skiddle Slope c/o Bucher's Yodeling School, 2265 West Ford Pl., Denver 23, Colorado.

CHESS Introducing postal chess. Information, equipment, literature; play a professional. Write "E1" Cowan, Driggs, Idaho.

MAGIC TRICKS, PUZZLES, JOKER NOVELTIES

SMOKE Bombs 25¢, 7 for \$1.00. Terrific! 6703-N Eleventh, Philadelphia 26.

WORLD'S Finest professional magic. Joker novelties. Giant illustrated catalog 10¢. Top Hat, Evanston 12, Illinois.

500 TRICKS. New 1962 edition, famous Douglas catalog of magicians' tricks and supplies now available just 10¢. Fastest service. Douglas Magiland, Dept. 61, Dallas, Texas.

WORLD'S Finest magic catalog, \$2.50 (\$2.00 magic included free). 3000 tricks, pocket, stage (408 pages), Kanter's, M-200 South 13th, Philadelphia 7.

VENTRILLO Voice thrower 25¢. Ventriloquist's puppet 75¢. Box 971-PM, Philadelphia 5.

CATALOG. Free tricks, 25¢. (1,500,399 tricks, jokes, novelties.) Magico, 7408-P, San Antonio 7, Texas.

PROFESSIONAL Catalog, 175 pages, 25¢. Williams, 900 Plymouth, Ellwood City, Penna.

FLAME Thrower! 36" flashes at fingertips! \$1.00. Harmless! Ariane, Philadelphia 44.

GIANT Surprise catalog! 1000 tricks, jokes, professional magic! 160 pages thick! World famous! 10¢. House of 1000 Mysteries, Dept. PM10C-62, Trumbull, Conn.

ANTIQUES, RELICS, INDIAN GOODS, CURIOS

3 WAR Arrowheads, scalping knife, thunderbird \$4.00. List Arrowhead, Glenwood, Arkansas.

6 ARROWHEADS. Archaic knife, scraper. \$2.00. Smith, 841 N. Tacoma, Indianapolis 1, Indiana.

ISHKABILE! Have fun, make money collecting and selling antique relics of all sorts, and guns. Send 35¢ for large listing circular. Wooden Indian, Wenona, Illinois.

SELLING 20,000 Ancient arrowheads, spearheads, etc. List free. Lear's, Glenwood, Arkansas.

COINS, TOKENS, CURRENCY

UNCIRCULATED 1935 Silver penny express commemorative medal \$1.00. Coin lists free. Sayers, 1000 Unaka, Johnson City, Tennessee.

5 INDIAN Cents \$1.00: 6 Liberty nickels \$1.00. Doktor, P.O., Box 35151, Los Angeles 35, Calif.

FREE List. Coin accessories. Althor, 2301 Benson Ave., Brooklyn, N. Y.

TWENTY-Four page 1963 retail price list of USA and Canadian coins 10¢. Our selling prices on thousands of coins and coin collectors' supplies. Bryson Incorporated, 612A White, Toledo 5, Ohio.

SAVE Your slick nickels where date is worn off. Order a bottle of Coin Date. It will bring the date out on Buffalo, V. Shield nickels. It's easy to use. Satisfaction guaranteed. \$1.00 postpaid. Box 276-F, Mooresville, N.C. Carolina.

BARGAIN Pricelist, coins, supplies, 10¢ (refundable) Ron Farley, Metamora, Illinois.

TEN Different Indian cents \$2.50. Two different large cents \$2.50. With lists. Hutchinson's, Box 6256, Philadelphia, Penna.

12 DIFFERENT Lincolns before 1921 \$1.00. 24 before 1931 \$1.50. Gene Carlton, Chandler, Okla.

LINCOLN Cents, 1941 thru 1961, in folder, \$2.95. O'Malley, Box 592, West Covina, Calif.

FREE Coin supplies! Giant coin list 10¢ (refundable). Economy Sales, Mansfield, Massachusetts.

LARGEST Coin magazine, 288 pages, 50¢. Scrapbook, 7320-J Milwaukee, Chicago 31.

NUMISMATICS Largest newspaper. Semi-monthly. Sample 25¢. \$2.00 yearly. Numismatic News, Box 452, Iola, Wis.

RARE 1878 CC mint dollar uncirculated \$5.00. 100pg. catalogue 50¢. Shultz, Salt Lake City 10, Utah.

BARGAIN List! U. S. coins, accessories. Stamp please. Hugh's, Hickory, N. C.

40 PAGE illustrated United States and Canadian coin list 10¢. Stoney, 260 Washington, Boston 6, Mass.

COIN Collector's magazine. On your newsstand or direct. Sample 35¢. \$3.00 yearly. Coins Magazine, Box 274, Iola, Wis.

WORLD'S Greatest coin magazine and wooden nickel 10¢. Lawrences, Anamosa, Iowa.

GIANT Illustrated catalog listing hundreds of bargains in coins and supplies, only 25¢. Ben's Coin Company, 31 North Clark, Chicago 2.

STARTER Collections, 15 Indian cents, \$3.50. 12 Liberty nickels \$3.50. 18 Barber dimes, \$7.50. 15 Barber quarters, \$10.00. 15 Barber halves, \$20.00. Postpaid. All different. Folders, Good, Herman Prager, 470 27th Avenue, San Francisco, Calif.

COINS Wanted. Get extra cash for your Christmas shopping. Buying list 10¢. Dean-Lawrence, Box 309, Monticello, N. Y.

OVER 50 years old: Indian penny, 30¢; Liberty nickel, 30¢; Barber dime, 35¢; Barber quarter, 60¢; Barber half, 80¢; Silver dollar, \$1.50. Dates of our choice. Crystal Coin, Greenwood, Massachusetts.

82-PAGE illustrated foreign coin list 25¢. Jolie, Roslyn Heights, New York.

NORWEGIAN Animal set, seven pieces brilliant uncirculated dollar with coin approvals. Molzan, Box 275, Alameda, Calif.

RARE! Double strike mint mark. 1961-D over horizontal D cent. Uncirculated only \$8. Increase potential fabulous. Guaranteed! Kasproski, Box 92, Rt. 2, St. Clairsville, Ohio.

25 BEAUTIFUL Coins from 25 countries. Mostly uncirculated. Terrific assortment. \$1.00. Hindley, Box 708, Aurora, Illinois.

25¢ BRINGS Lincoln buying-selling list. Refunded with \$5.00 purchase. Investment details. Free cent (scarce). Kenwood Coins, 6513 Langdale Road, Baltimore 6, Maryland.

LINCOLNS For sale 50¢ each: 1913-D, 1916-S, 1921-S, 1924-S, 1932-PD, 1933. John Gardner, Box 408, Colorado Springs, Colorado.

BUY, Sell, trade, coins, books. Buying 50¢, \$1.00. Selling \$1.75. Oddity \$1.60. Japanese \$2.25. Spadone, Vincentown, New Jersey.

COINS Wanted. Absolutely highest prices paid. Illustrated "Rare Coin Guide" catalog 25¢ coin. Norris, Box 921-B, Salt Lake City 10, Utah.

BEAUTIFUL Uncirculated Roosevelt dime set in book-shelf album \$39.75. World coin sets—Cyprus, Kuwait, Madagascar, Mauritius, Pakistan, Siam, Uruguay, each \$1.95. World coin book \$4.25. Red guide-book \$1.75. Premium bluebook \$1.00. Bebe's, 4514 North 30th, Omaha 11, Nebraska.

TRUNKFUL 25,000 Indian-Lincoln cents mixed (from the 1920's & older). Will pack "grab-bag" style. 800 mixed \$50.00. Sample bag of 22—\$2.00. Mrs. Fisher, Box 5490, Sherman Oaks 21, Calif.

OLD Coins wanted. Catalog 25¢. Lacheen, Box 1355, Philadelphia, Penna.

AUTHENTIC Conn. continental currency 1776 \$1.00. Arcadian Fluck, Van Etten, N. Y.

MAJOR Variety-Oddity Coin Guide. 200 photos 50 pages \$1.60 copy. 231 North 18th St., East Orange, N. J.

ANY Five Jeffersons except 38-SD, 39-SD, 50-D \$1.00. Trayce, 25 Quinlan, Staten Island 14, New York.

RARE 1899 Philadelphia silver dollar, uncirculated, \$5.00. Butts, Torrington, Wyoming.

TOPS! Fascinating coin collection from Camerons, Formosa, Vatican, etc., and foreign banknote. Catalog price over \$1.50! Only 10¢ with exciting coin approvals! Littleton Coin Company, Littleton T1, New Hampshire.

FREE Gold! Blackhills gold ore, sawed specimen, 4 square inches. You can see the gold. \$1.00 plus postage. Lyman J. Carr, Onida, South Dakota.

SILVER Dollar with bargain list \$1.50 ppd. Nelson, 346-M, Rye, N. Y.

FREE Bargain coin lists. The RJR Company, Astoria 1, Oregon.

WONDERFUL Bargain! 32 different foreign coins, older and larger pieces included. \$1.00. Catalog free. Szego, Box 427, Oakdale, N. Y.

BARBER Dimes, 8 different \$1.95. Liberty seated dime \$1.50. 3¢ nickel \$1.00. Modern Coin Shop, 109 West Grace, Richmond 19, Virginia.

INDIANS, Lincoln, Liberty nickels. List free. Coins wanted, stamp please. Evans, Box 9912p, Atlanta 19, Ga.

THREE Genuine confederate bills—not reproductions! \$3.95. Illustrated catalog. \$1.00. Bobbies Hobbies, Quincy 4, Illinois.

LINCOLNS: 40 different 1909-1940 plus 1960D small date \$1.95. 25 different "S" including rare 1955S \$1.50. Harris, Box 9011B, San Francisco 29, California.

STAMP COLLECTING

WOW! 110 all different Germany 10¢! Zeppelins, semi-postals, airmails, high values, etc. Giant catalog, bargain lists included with beautiful approvals. Jamestown Stamp, Dept. A102 PM, Jamestown, N. Y.

FREE! North America plus 87 foreign flag stamps. Big valuable collection of all-different, genuine stamps from Greenland (North Pole), St. Pierre, Newfoundland, Canada—picturing Eskimos, Indians, scarce 1867 Confederation, Northern Territories, Nova Scotia, United Nations. U.S.—Ancient 19th Century: first ship & plane; rare whooping crane; pony express; etc. Also, complete set Colonial & Civil War commemoratives. Plus colorful flag stamps of 87 foreign countries. Extra! Big bargain catalog. Approvals. Send 10¢ for mailing. Kenmore, Milford EF-385, New Hampshire.

FREE 10 different U.S. Army, Navy stamps. 10¢ Handling. Loral Stamps, Box 11, New York 67, N. Y.

100 FOREIGN 10¢. Approvals. Batterson, Apt. 38, 642 N. Waddell, Freeport, Illinois.

90,000 STAMPS sale! Bargain lot: sets, packets, rare stamps \$1.00. Giant assortment \$5.00. High value packet \$3.00. Persile, 436 N. Y. Ave., Brooklyn 25, N. Y.

SURPRISE Collection! Exotic mint British colonials, absolutely free with approvals. Viking, Great Neck 8, N. Y.

200 DIFFERENT Worldwide, commemoratives, pictorials, etc., 25¢. Delorme, 954M Chatham East, Windsor, Ontario, Canada.

200 DIFFERENT U.S. stamps \$1.00. Approvals included. Shelron, P.O. Box 187-KP, Hempstead, L. I., N. Y.

TEENAGE Stamp magazine, \$1.00 yearly. American Stamp Collector, Saint Francisville, Louisiana.

FREE Stamps to buyers of worldwide approvals. Sets and singles. Handy Stamps, 460 Handy, Orange, California.

50 DIFFERENT, U.S., topicals, others 10¢ with approvals. Carpenter, Box 310, Claremont, Calif.

100 WORLDWIDE Collection, dime. Felco, PO Box 532, Santa Rosa, Calif.

PHILIPPINES. 20 commemoratives 10¢. Approvals. Rofa, Box 648, Orange, California.

"EUROPAS", 25 different \$2.00. Including sets, catalogue. Langheinrich, Munchen 23, Germany.

TOPICALS. Beautiful stamps, 25 different, only 10¢, approvals. Stamac, 108 Park Place East, North Charleston, S. C.

EXCITING One-time offer! 1,700 genuine stamps representing \$50.00 catalogue for \$1.00. Fine collections from France, Hungary, Czechoslovakia, Belgium, Germany, British Empire. Also a full quarter pound stamp mixture on paper—Men in Space cpl. issues, Oceania, general collection, Ghana's first stamps, etc. Possible only because it is a one-time "get-acquainted" offer. Other fine stamps for your inspection will also be enclosed. Adults only. Frasek Co., PM, White Plains, N. Y.

50 DIFFERENT British Colonies 10¢. Approvals. Viertel, 965 Heyl, Columbus 6, Ohio.

FOREIGN 400 Different only \$1.00. Ukastamps, Box 124, Hertogenbosch, Holland.

OLD United Nations (retail 50¢) free. Approvals. Teddie, Crystal Beach, Florida.

WHEN Buying our foreign approvals we give Scotts albums, catalogues, packets free with purchases. Truvalve Stamps, Box 2098M, Santa Ana, Calif.

500 FINE Mixed U.S. 15¢. Wright, Box 753M, Hagerstown, Md.

Buy Your U.S. stamps at 10% less than most other places. Catalogue 20¢. New-Way Stamp, Lawrence, Mass.

TREASURE Hunt. Foreign pictorials. Sort and save. Premiums. H. L. Otheim, Crosby, N. Dak.

ASTRONAUTS. Three sets 10¢. Approvals. Robbins, 487 Shiloh Dr., Dayton 15, Ohio.

EXTRAORDINARY Collection: 175 different, worldwide, catalog over \$11.00, 25¢ with unique, global approvals 1/2¢ up. Stamp Studio, Box 171M, New York 24, N. Y.

FREE! Giant bargain catalog. New edition listing thousands of bargains including U.S. and B.N.A. stamps, packets, mixtures, albums accessories and supplies; sent with beautiful approvals. Jamestown Stamp, Dept. E102PM, Jamestown, N. Y.

FREE! 25 Egypt, 10¢ handling. Approvals. Bellet, Mapledale, Hazel Park, Michigan.

U.S. Stamps. Giant discount catalog 25¢. Raymax, 37-VZ Maiden Lane, NYC 38.

GERMANY: 104 Old and new different stamps with complete airmail set. 10¢ approvals included. Boger, Box 152, North Wales, Penna.

FREE! Congo triangle set! Boy Scout beauty! 25 others. Approvals. Cambridge, Box 411, Cambridge, Ohio.

FALL Special 1000 worldwide stamps \$1.00. 3500 \$3.00. No approvals follow. Harrison's Stamps, 1435 First Ave., Oakland 6, Calif.

1948 U.S. Mint plate blocks. 5 for \$1.00. Wetterhahn, Box 43074, Los Angeles 43, Calif.

EXCHANGE. Send 100-200 different stamps with 20¢. Receive different. Patterson, Lancaster 10, New York.

50. LATIN. British, Orient: 10¢. Approvals. Thiese, 9320-B San Juan, South Gate, California.

WRITE For list. British Colonial, foreign lots. Thomas Drew, Box 325A, Deep River, Ontario, Canada.

FREE—50 different stamps, with approvals. Fahsing, Dept. PM, Atascadero, California.

333 DIFFERENT Triangles, sports, topicals etc. Worth \$8. Only 25¢. Approvals. Jayto Stamps, Box 246B, East Syracuse, New York.

300 DIFFERENT. Includes pictorials. 25¢. Knopp, Box 1381, Bristol, Conn.

GIANT Stamp collection including: astronauts, satellites, moonrockets, Boy Scout issue, complete UN set, recent Olympic and sport issues from many countries, etc.; Plus big stamp dictionary and approvals. Everything 10¢! Stampex, Box 47-LM, White Plains, N. Y.

FIRST Day cover approvals! Included free, valuable airmail cover. Myers, Coopersburg, Penna.

FREE—25 large beauties with request for approvals. Al Gray, 506-15th St., Moline, Illinois.

FREE! Antique autos! Complete! 10¢ handling. Approvals included. W. Shaver, 3075 Vamana, Pomona, California.

25 DIFFERENT U. S. commemoratives, 1893 up, 10¢ approvals. K & B Stamp Co., Box 70, Brooklyn 23, N. Y.

50 DIFFERENT Central and South America, 10¢ with worldwide approvals. Cole, Box 223-A, Buffalo 21, N. Y.

21,000 ALL Different, only pennies a day using our systematic payment plan. Details free. Sjoquist, 1435 Cherrydale, San Jose 25, California.

FREE Mint Africa set with approvals. Lithor, Box 51, Canoga Park, Calif.

FREE Sample. Interesting, informative, illustrated. National Stamp News, Anderson, South Carolina.

OVER \$20.00 Catalog value for just \$1.00. 1000 different worldwide. Approvals included to adults only. Universal, Box 6, Kenosha 5, Wisconsin.

200 STAMPS. 25¢ With approvals. Smith, 508A Brooks, College Station, Texas.

FREE! 222 worldwide. 10¢ handling. Penny approvals. Jung, 1601 North Stanley, Los Angeles 46.

U.S. Mint specials! Flag set, complete \$1.00; 1¢, 2¢, 3¢ famous Americans (21 different), \$1.00. Free list. Brooks, 2323 Avenue X, Brooklyn 35, New York.

TWO \$5.00 United States stamps, 20 others 10¢ with United States approvals. Irwin, Box 1105, Brooklyn 30, New York.

80 DIFF. U. S. stamps includes 19th Century commemorative. High values. Plus 1943 flag stamp of occupied nations. All for only 25¢. Approvals included. Willett Co., Box 338-C, Yorktown Heights, N. Y.

UNITED Nations 15th anniversary sheet with first day cancel, as commemorated by Russia. Free! While they last, with approvals. Philatelics. R-J, New Paltz, N. Y.

PENNY Approvals. Thousands. Bargains for pennies. Gifts with purchases. Penny Stamps, Orange, California.

INTRODUCING Our better United States approvals we offer 15 United States stamps including Columbian, Bi-Centennials, famous American, airs, others: only 10¢. Ocean Stamps, Box 64-PM, Brooklyn 29, New York.

UNITED States commemorative collection containing 33 different—10¢. Approvals. White, 516-A Avenue L, Brooklyn 30, New York.

AMAZING OFFER! 200 United States stamps — including commemoratives, airmails, high denominations to \$1.00. Only 10¢ to approval applicants! Illustrated bargain lists free. Mystic Stamp Co., Dept. 80, Camden, New York.

100 OLD United States between 1861 and 1935. \$1.00. Roush Stamps, 51 Chestnut, Mansfield, Ohio.

FREE Monaco nudes. Approvals. Stamp Ranch, 902 Addison, Chicago 13, Ill.

60 DIFFERENT U. S. (30 commemoratives) 25¢. No approvals. Seidenberg, Appleton, Wisconsin.

225 STAMPS For only 10¢! This mammoth value includes airmails, pictorials; stamps from strange countries cataloging up to 25¢ each! Also approvals. Mystic Stamp Company, Camden 80, New York.

FREE 50 Worldwide, mailed with inexpensive approvals. University Stamps, P.O. Box 44-592, Miami 44, Florida.

215 DIFFERENT Worldwide 25¢. Flume, Korea, Laos, Russia, Transvaal, Approvals. Bobb's, Box 3045, Saint Louis 30, Missouri.

MILLION Foreign stamps! 2¢ each! Send for thrilling, giant approvals! ABC Stamps, Box 6000-MB, San Francisco 1, Calif.

14,000 DIFFERENT! Amazing new plan builds your collection systematically, country by country. Only 50¢ weekly. Free details. L. G. Ware, Monroe 75, Conn.

ZOWIE! U.S. commemorative collection free. 33 different, plus gift, approvals, 10¢ handling. Russell Stamps, Jamestown 5, Rhode Island.

FREE—When you buy our foreign approvals, you receive absolutely free stamps equaling your purchases. Coast, 1609 S. Park, Santa Ana, California.

1000 DIFFERENT, \$1.00 With approvals. Louis Golden, 6721 Eastwood, Philadelphia 49, Penna.

SELL Your surplus good grade stamps. Write, describing fully what you have. Vanroy Shirk, Lebanon, Pennsylvania.

APPROVAL Applicants special. 1025 different stamps \$1.00. Klondike, Harrisburg, Illinois.

FREE, 50 Worldwide with request for approvals. Hackman, 6649 Odessa Ave., Van Nuys, California.

PHILATELIC Spectacular, 21 complete sets 25¢. Mint and used including commemoratives, pictorials, topicals. Approvals accompany. Abbot Stamp Company, Box 245F, Jamaica 31, New York.

2 MINIATURE Sheets. Latest New Zealand Health plus cover 1 dollar. Christmas stamp plus cover 50 cents. Order airmail. Marc Roberts, Riversides, Culverden, New Zealand.

TEN Different nudes on stamps. Only two dimes. Twenty-eight different. \$1.00. Approvals. Stamp Farm, MN-49, Oxford, Wisconsin.

ALL Mint pot luck packets \$1.00! No approvals. Ross, 1127 Nichols, Stratford, Conn.

2,000 DIFFERENT, \$3.95. 3000 different, \$6.95. No approvals. Holtzman, 95P Terrace, Levittown, Penna.

FREE Mint set, with approvals. Alton Cox, Box 1563, Charlotte 1, N. C.

ICELAND, 50 Different, \$1.00. Introductory bargain! Evenden, Box 5001, Eugene, Oregon.

100 DIFFERENT U.S. commemorative plus 6—8¢. Champions \$1.00. 75 different U.S. revenues \$1.00. Flamingo Stamps, 1099 NW 3rd Avenue, Miami 36, Florida.

U.S. Commemoratives: 166 different \$1; 230 different \$2. Moseley, 6 Hanley Downs, St. Louis 17, Missouri.

UNITED STATES Mint well centered. Famous Americans complete \$7.50. Flags 90¢. 1948 complete \$1.50. Tipex 50¢. SPA 25¢. Cipex 25¢. Fipex 55¢. List 10¢. Le-Breque, 132 Columbia Blvd., Waterbury 10, Conn.

U.S. Mission mixture. Guaranteed un-picked. 2 lbs., \$4.00; 5 lbs., \$8.50. Skytop, Box 1022PM, Binghamton, N. Y.

FREE Wonderful Vatican souvenir with approvals. Beverini, Manno 2/12, Gesestri, Italy.

U.S. Want list specialist. Approvals. Catalog 10¢. Bogle, Avondale, Mo.

U.S. Bargain, 50 different 10¢, with beautiful worldwide approvals. Stamps, Kennebunk, Maine.

FREE Fifty foreigners, approvals. Bob's Stamp House, RFD #1, Manchester, New Hampshire.

PRECANCELS Wanted! Will trade 5 commemoratives for each precancel kept. Koehler, 1718 South Heights, Youngstown, Ohio.

SOUVENIR Sheets Czechoslovakia 1937 plus Japan 1947, 10¢ with approvals. Kingman, 30 Empire, Yonkers 4, N. Y.

6 COMPLETE Foreign sets 25¢. Approvals. Monahan, Box 352, Wahiawa, Hawaii.

10 DIFFERENT Canal Zone 25¢. Approvals! Merkel, 30 Grandview, South Hadley Falls, Mass.

UN New regulars complete, \$30. USA-UN approvals. Bill Erwin, RFD-1, Marysville, Ohio.

U.S.-Foreign price lists free. Request foreign approvals. Somith, Box 83-PM (Rugby), Brooklyn 3, N. Y.

UNCOMMON Old U.S., defective. Bargain prices. K. Swartz, Malden Bridge, New York.

U.S.-Canada price list free. Scarlet, 116 Nassau Street, New York City.

START Approval business. Details 10¢. Steele, Box 553-PT, Pacific Grove, Calif.

GLORIOUS Bathing beauty. Miss Universe stamp. Nine sparkling colors. "Phootnotes" subscription. Free! While they last, with approvals. Philatelics, RM, New Paltz, New York.

100 DIFFERENT Far East, \$1.00. Chingwah, Box 77583, Los Angeles 7, Calif.

FREE Gifts: Penny approval purchases. Ross, Box 341, Yonkers, New York.

"POPE" Triangle! Multicolored butterflies diamond! 50 others. 10¢. Approvals. C & R, 522 Hicksville, New York.

100 DIFFERENT United States commemoratives \$1.00. No approvals. Roger Whitten, R #2, Sturgis, Mich.

25 COLUMBIA 20¢. Approvals included. Reed, Box 980, Chicago 90, Illinois.

MAYFLOWER Stamp album 10¢. 407 illustrations, 64 pages. Approvals accompanying. Niagara Stamps, St. Catharines 701, Ontario.

WILL Rogers air! Helicopter triangle! Plus Monte Carlo dove triangle! Stamp printed in solid gold! New York Empire State Bldg. airmail, lovely Congo orchids in full color, etc. 10¢ with approvals. Sunny Stamps, Apopka 24, Florida.

AMERICAN Historical collection! Enormous George Washington beauty, F. D. Roosevelt diamond, giant Abe Lincoln U.S.A. flag commemorative, plus midget soldier, Latin orchid issue, old IFNI overprint, etc. 10¢ with approvals. Roseland Stamps, Spring Lake 2A, Mich.

HOLY Stamp depicting Christ and cross! Plus triangle discus thrower, enormous multi-colored Balkans Diamond issue, wonderful map collection from Timor, Macao and Angola, Extra! Brilliant flag set, etc. only 10¢ with approvals. Capital Stamp Co., Ferrysburg 2C, Michigan.

PHILATELIC Jungle 10¢. Fifteen zoological specimens. Approvals included. Free watermark detector. Crown Stamps, Virgil 301, Ontario.

105 DIVERSIFIED British Empire 10¢. Approvals included. Linstamps, St. Catharine 401, Ontario.

SMASHING Collection free. Includes triangles, early United States, rockets, sports, British Colonies, high value pictorials, etc. Complete collection plus big, illustrated magazine, all free. Send 10¢ for postage. Gray Stamp Co., Dept. PM, Toronto, Canada.

FOOTBALL. Latest gigantic bicolored Hungary commemoratives. Free with approvals. William Deems, 226a Race, Ravenswood, West Virginia.

AFRICA Independent nations. Fascinating collection butterflies, flowers, masks, birds, fish, triangles only 25¢. Approvals. Berchtold, Troy, Ohio.

FREE Togo UN set with approvals, Stuart Stamps, 23450 Sussex, Oak Park 37, Michigan.

200 DIFFERENT U.S. including airs, dues, older issues and over 100 commemoratives \$1.00 with approvals. Winchester Stamps, 45 Winchester Rd., Mansfield, Ohio.

1¢, 2¢ APPROVALS. Write: A. Jones, Box 88, Haddon Heights, New Jersey.

EXOTIC Orchids. Long complete mint set, 10¢ with exciting approvals. Stamp Imports, Peterborough, Canada.

INEXPENSIVE Approvals 2¢ up. Worldwide bargains. Carling, 1062-A, Howard City, Michigan.

300 DIFFERENT United States commemoratives \$3.00. Knott, 3915 Trier Road, Fort Wayne, Indiana.

3¢ COMMEMORATIVE Plates. Baker's dozen for \$2.00. Deluxe price list free with order. Colby's, 505 Fifth Ave., New York 17.

FREE! "Mystery" stamp packet. Approvals. Premiums. Dancer, 75-P37, Mansfield, Ohio.

LOOK! 200 different U.S. commemoratives! \$5.00 value! Special \$2.00! Ewing, 2133 Lunt, Chicago 45.

FREE Stamp wallet with approvals. Wide selection collections by countries. Clark, Box 28-C, Wilmette, Illinois.

12 DIFFERENT Triangles 10¢. Pictures Stamps, Box 46193, Hollywood 46, California.

SPAIN'S "Goya Nude" 25¢. Approvals. Royal Stamp Company, Tamaqua, Penna.

COLORFUL Triangle collection just 10¢ with approvals. Valley's, Box 414PM, Spring Valley, California.

OLD U.S. covers, 3 free with 30 foreign covers \$1.00. Box 7363, Columbus 9, Ohio.

STAMP Collecting outfit, includes, packet worldwide stamps, package hinges, watermark detector, millimeter gauge. Everything 10¢ with approvals. Loraine Brown, Marion, Michigan.

50 FREE With U.S. approvals. Rayworth, 321 South Cicero, Chicago 44.

EXTRAORDINARY! Free! 20 different Finland to those requesting approvals. Rossonberg, Box 1303, Chicago 90, Ill.

OLD Hawaii stamp free. W-B Stamp Co., Wilkes-Barre, Penna.

8 DIFFERENT U.S. airmails free! Approvals accompany. Dee, Box 1507, Ormond, Beach, Fla.

FREE 100 Different worldwide plus 1¢ approvals. Wildes Stamp Co., Cape Porpoise, Maine.

50 DIFFERENT Latin America 10¢ with approvals. Quynn's, Scotland 2, Penna.

LARGE Discount. All stamp albums. Free catalogs and information. Norwick, 341 West 44th Street, New York 36, N. Y.

SELL Stamps to our readers. Your ad in this space will be read by thousands of stamp buyers. I'll prove that to you. Write now for Folder "S." F. W. Johnson, Classified Advertising Manager, Popular Mechanics, 740-ST Rush St., Chicago 11, Ill.

HOBBIES AND COLLECTIONS

OLD Blue prints of Minneapolis-St. Paul street car system trackage power houses \$1.00 postpaid. Also photos, books. Norman, 3601 1st Ave. So., Minneapolis 8, Minn.

WANTED. Cigarette, tobacco cards. Write: Charles Bray, East Bangor, Penna.

INTRODUCTORY: Free 20 Military Emblems, Service stripes and catalog; send 25¢ postage, handling. Insignias, Box 71-M, Rockaway 94, N. Y.

AMAZING Introductory offer. Collect regulation medals with ribbons: Five different French, \$3.00; Four British, \$3.00; Five German, \$3.00. Catalog 25¢ (refundable). Insignias, Box 71-M, Rockaway 94, New York.

AMERICAN Newspaper, complete, original, dated before 1860, \$1.50. 25¢ stamps brings catalogue. D. R. Spaight, Book-seller, Tall Timbers 1, Maryland.

PRECIOUS STONES, MINERALS

GET Free catalog no serious rockhound, gem cutter, jewelry maker, hobbyist or craftsman can be without. Full of bargains, exclusive items, low prices from largest suppliers and authorities in the field. Free new catalog just off the press, yours for the asking! Write Grieger's, Dept. C-12, 1633 E. Walnut, Pasadena, California.

20 POLISHED gem stones \$1.00. Eberles, 2727 West Slauson, Los Angeles 43, Calif.

HOW And where to pan gold. All you need to know. Illustrated. 18 maps. \$2.00. Nugget, Box 462-P, Tucson, Ariz.

SEMI-Precious uncut gems. Ten different for \$1.00. Request list 28. Prospectors Shop, 201 San Francisco, Santa Fe, New Mexico.

EARTH Science Rockhound's National Magazine. Subscription \$2.50. Sample 35¢. Box 1357-PM, Chicago 90, Ill.

PHOTOGRAPHY, CAMERAS, PHOTO SUPPLIES

PHOTOGRAPHY For pleasure or profit. Learn at home. Practical basic training. Long established school. Free booklet. American School of Photography, 835 Diversey Parkway, Dept. 345C, Chicago 14, Illinois.

FREE! Send now for circular of new and used photographic bargains. Dept. 1-H-10. Central Camera Company, 230 So. Wabash Ave., Chicago, Illinois.

PHOTO FINISHING

KODACOLOR Films developed and printed, plus new roll, 12 exposures, only \$2.95. MBG Photo, Box 537, Toledo 1, Ohio.

COLOR Movie fans! Low cost—high quality processing our specialty, 8mm. just \$1 (or \$3 with fresh film). Mailed back next day. Craftsmanship guaranteed. Send exposed reel or request free mailers and price list of complete photo-finishing services. Direct Mail Photo, Box 8352-PM, Pittsburgh 18, Penna.

2 BLACK And white prints from each picture on roll. 8 exposures 45¢; 12 exposures 60¢. Forty-two years of satisfied customers. Quick service. Lens Photos, Dept. J-4, Janesville, Wis.

A FREE Kodak roll returned with each black and white or Kodacolor developed and printed, fast service, lowest prices, guaranteed quality send for free mailers. Economy Photo Service, Dept. P. M., Box 1111, Albany 1, N. Y.

FAST, Hi-quality finishing. Kodacolor rolls: eight jumbo prints \$1.98. Twelve \$2.49. Twenty \$3.49. Reprints 15¢. Also low B&W prices. Custom Quality Studio, Box 4838, Chicago 80.

EKTACHROME-Ansochrome 35mm. 20 exp. 620, 120, 127, developed, mounted, \$1.00. Exceptional low prices on Kodacolor films. Prompt service. Complete price list-free mailers. Write Trycolor, P.O. Box 123, So. Windsor, Conn.

MOTION PICTURES AND SOUND EQUIPMENT

8MM. Valentino, Fairbanks, Keaton, others. 16mm. sound features, shorts, silent classics. Large assortment. Entertainment Films Co., 236 W. 55th, New York City.

16MM. Films—projector parts. Gordon, 28-53 Steinway Street, Long Island City, N. Y.

5,000 8-16 M.M. Movie films. Free catalogues. International, Greenvale, N. Y.

MOVIE Camera film: 8mm. roll \$1.50. 16mm. 100' \$3.00. Free processing. Better Films, 742 New Lots, Brooklyn, N. Y.

MOVIE Film! Free catalog! ESO-R. 47th Holly, Kansas City 12, Missouri.

LADY Wrestling. Movies, photos. Free list. Peerless, Box 171-M, New York 13, N. Y.

15 PAGES, 16MM sound film bargains. Gaines, 13735-PM Victory, Van Nuys, Calif.

BARGAINS 16MM. sound features \$16.00. Bedner, 5300 So. Talman, Chicago.

PRESSBOOKS, Posters, stills, 8mm. 16mm. 35mm. Free information. Leonard Malik, 1200 El Camino, North Sacramento, California.

16MM. Sound, projectors, films. Sale, rental, exchange. Stereo Tapes. Rental and sale. Visit store or write for catalog. National Cinema, 71 Dey St., New York City.

USED-New movies. Free bulletin. Lee Movies, Box 4752, Chicago 80.

FREE Catalog! Save on 8/8mm.-16mm. film and supplies. Superior, 448 N. Wells, Chicago 10.

COLOR SLIDES

YELLOWSTONE Or flowers. Twenty 35mm (unmounted color transparencies) \$1.00. Eddings, 8-PM Roberts, Corning, N. Y.

LINCOLN Lore in color slides. Kentucky, Indiana, Illinois, Washington, others. Sample slide, 35¢. Catalogue for stamp. Willems, Box 1515-A, Chicago 90.

8MM., 16MM. Movie subjects. Silent sound. New, used. 2"x2" color slides. Biggest selection anywhere! Free each month, big 24-page newspaper-size catalog. Blackhawk Films, Davenport 14, Iowa.

TRANSPARENCIES Wanted. Up to \$500.00 each. For information write American Color, P.O. Box 46372, Hollywood 46, Calif.

MUSIC & MUSICAL INSTRUMENTS

USED: Electric guitars, amplifiers, bargains. Write: Hills, 1215 War Memorial, Peoria, Illinois.

SONGWRITERS Handbook—only \$1.00. Valuable information. Songwriters Service, 1619-D Broadway, New York 19.

POEMS Wanted for musical setting and recording by America's largest song studio. Send poems. Free examination. Five Star Music Masters, 630 Beacon Building, Boston.

SONGPOEMS Wanted for musical setting. Free examination. Get "The Nashville Sound" in your songs and records. Send poems: Music City Songcrafters, 6145-N, Acklen Station, Nashville, Tenn.

ELECTRIC Guitars, amplifiers, wholesale. Free catalog. Carvin, PMM, Covina, Calif.

POEMS Wanted for musical setting and recording. Send poems. Free examination. Crown Music Company, 49-C West 32 Street, New York 1.

GUITAR Making books, plans, imported woods, tools. List 10¢. Satinwood, 510 East 11th Street, New York 9, N. Y.

SONGS Wanted. Pays royalties. Enclose postage. Olenik Records, Mount Morris, Michigan.

ACCORDION-O-RAMA, 874 Broadway, New York 3, N. Y. Tremendous discounts. Top brands. Free brochure.

SEND Songpoems. Needed immediately for songs and recordings. Free professional appraisal. TV-Soundcrafts, Box 550-G, Radio City, New York 19, N. Y.

SONGPOEMS Wanted! Collaborate with professional songwriters on equal basis. Share royalties. Songwriters Contact Co., 1619-D Broadway, New York 19.

TRANPOSE Easily. New plastic musical slide rule—only \$1.00. "Transpos-A-Chord," Box 189PM, Hollywood 28, California.

SONGPOEMS Needed immediately. Nashville Music Institute, Box 532-M, Nashville, Tennessee.

ACCORDIONS, Piano, chromatics, button-type, concertinas. Wholesale catalogues free. Italian Accordion Mfg. Co., 7600-C Cottage Grove, Chicago 19, Illinois.

ACCORDION Exchange plan. Catalog terms. Accordion Import Center, 7120 Galli Dr., San Jose 29, Calif.

POEMS Wanted. Surprising offer. Free recordings. Successful Songs, 6 North, Danbury, Conn., Phone 748-6603.

GUITARS. Big discounts! Wholesaler-to-you. Famous makes. Free home trial. Easy terms. Free catalog. Guitar World, Dept. 102-R, 2003 W. Chicago, Chicago 22.

ACCORDIONS. Save ½. Famous makes. Free home trial. Easy terms. Trades accepted. Free catalog. Accordion Corporation, Dept. 102-R, 2003 Chicago, Chicago 22.

SWISS Music boxes, movements. Mechanical, electrical. Tunes to order. Spielman, 131 West 42nd, New York 36.

VIOLINMAKERS, Repairers. Fine tone woods and supplies. Also headquarters for violins, guitars (regular and electric) cellos. Send for wholesale price lists. International Violin Co., 414-MPM E. Baltimore Street, Baltimore 2, Maryland.

MUSICAL Merchandise catalog \$3.00. Retail only. Refunded on your order. Postage and freight paid. From organs to flutes. Dahlstrom Piano & Supply, Thief River Falls—P, Minnesota.

GUITAR Self-instruction books, all chords, melodies. Special \$1.00. Guitar Co., Box 950, Chicago 90.

RADIO, TELEVISION AND ELECTRONICS

RADIO Course only \$14.95. Includes all tubes, parts, tools, instructions. Write for full information. Progressive "Edu-Kits" Inc., Dept. 576B, Hewlett, N. Y.

KITS: One tube shortwave or broadcast band \$3.50; crystal radio 75¢. Alliance, 2059 60th, Brooklyn 4, N. Y.

QUALITY Recording tapes. 1800' Mylar \$2.00 postpaid. Towers, Lafayette Hill, Penna.

TELEVISION Tuners rebuilt. Western Tuners, 4130 El Cajon Blvd., San Diego 5, Calif.

SAVE 30% Up! Blank-stereo recorded tape-recorders, Norelco speakers. Saxitone, 1776 Columbia Road, Washington 9, D. C.

SAVE 50 To 100%. Portable transistor tape recorders, FM, stereo, radios. Wingfield Company, Inc. P.O. Box 2404, Memphis 2, Tennessee.

TRANSISTOR Radios repaired: Japanese specialization; extremely low rates. Work guaranteed. Mail radios: Orange Electrical Co., 1514 So. Van Ness, Santa Ana, Calif.

"LISTEN-In-Coil" picks up any telephone conversation in vicinity. No connection to telephone necessary. Easily concealed. \$2.98 complete. Acoustical Research, 512P East 80, NYC 21.

FREEZER Alarm. Prevent your frozen food from spoiling. Send one dollar for complete instructions to: Freezer Alarm, P.O. Box 9153, Union Park, Florida.

INTERCOMS, Two station, 3 transistor, battery, 60' wire. Office, plant, home, hear baby. \$25. Guaranteed. Trader Jim, 6715 E. 25, Tulsa.

GOVERNMENT Surplus radios, parts. Picture catalog 10¢. Meshna, Malden 48, Mass.

FIX Your own TV. Save 80%! Send for free illustrated chart showing how! We'll include giant electronics catalog. Zalytron, 220-M West 42 St., New York City.

TAPE Recorders hi-fi components. Sleep learning equipment, tapes. Unusual values. Free catalog. Dresser. 1523M Jericho Tpke, New Hyde Park, N. Y.

SAVE Dollars on radio, TV-tubes, parts at less than manufacturer's cost. 100% guaranteed! No rebrands, pulls. Request bargain bulletin. United Radio, 1000-M, Newark, N. J.

EXPORT — IMPORT

FREE Imports from overseas. Details 10¢. Imports, 828 Fullerton, Chicago 14, Illinois.

WE Handle butterflies, beer steins, wood carvings. Gonzales, 3100 Gaston, Dallas 26, Texas.

JAPAN: Direct mail-order 26 page catalogue: dolls, novelties, business information, manufacturers' names, addresses, \$1.00; Japan's Trade Directory, 3000 companies, \$3.00. Send cash. Clarence Yamagata, 814 Toginbiru, Marunouchi, Tokyo.

BUSINESS OPPORTUNITIES

INCREASE Your profit \$5,000 to \$10,000 yearly. Famous free paint offer has established "State Paints" as one of the fastest growing paint companies. Exclusive distributors and dealer franchises still available in many areas east of Rocky Mts. Also available to established businesses who wish to invest in a paint department for as little as \$1500. Inventory turns over from 8 to 10 times yearly and returns up to 200% on investment. Write: State Paint Mfg. Co., 4610 W. Buffalo, Tampa, Florida.

BECOME Tax consultant. Graduates earn \$1,000-\$3,000 every tax season preparing returns evenings. State approved. Union Institute, Lakewood R-2, N. J.

START Your own business on credit. Your own boss. 1199 dealers sold \$5,000 to \$25,500 in 1961. We supply stocks, equipment on credit. 200 home necessities. Sales experience unnecessary. Pleasant, profitable business backed by world-wide industry. Write Rawleigh, Dept. J-U-PPM, Freeport, Ill.

MAKE Extra money. Big steady earnings, repeat business. Sell advertising book matches, full or part time. New 1962 line. Show glamour girls, colorama, tenoramas; dozens more. All sizes. Free master outfit, sales helps, leads, no experience necessary, no investment. Write today. Superior Match, Dept. MX-1062, 7530 Greenwood, Chicago 19, Ill.

BIG Money—Operate your own fix-it shop. Service all household appliances; irons, fans, refrigerators, automatic washer-dryers, etc. Do house wiring, commercial wiring. Rewind motors of all sizes. Sharpen mowers, skates, saws. Buy needed spare parts wholesale. Free book. Christy Trades School, A-3003 3214 W. Lawrence, Chicago 25.

DOLLS! Dolls! Dolls! We teach you to make, repair, dress and sell. Study at home. Earn while learning. Free booklet. Doll Hospital School, Studio MC-102, 11826 San Vicente Blvd., Los Angeles 49, Calif.

MAIL-ORDER Home business. Get free copy. "Make Money in Mail Order." Mallico, 1554 S. Sepulveda, Dept. D70A, Los Angeles 25.

EXPORT-Import opportunity, profitable, world-wide, mail-order business from home, without capital; or travel abroad. Established world trader ships instructions for no-risk examination. Experience unnecessary. Free details. Mellinger, D70A, Los Angeles 25.

LEARN Landscaping and the growing of plants. Start a profitable business part or full time. Free information without obligation. National Landscape Institute, Dept. MC 102, 11826 San Vicente Blvd., Los Angeles 49, Calif.

ASSEMBLE Artificial lures at home for stores. Materials supplied free. Profitable! Write: Lures, Ft. Walton Beach 11, Fla.

BIG Profits. Hand crafted jewelry business. Free details. LPS, 1736 Argon, Mesa, Arizona.

"**MAKE** Big Profits by Mail." Write: American Distributors, Box 409-P, Niles, Michigan.

EARN Minimum \$40.00 hour. Learn water weed control by correspondence. Aquatic Weed Control Institute, Tishomingo, Okla.

LARGE Profits manufacturing, selling own brands. Andrews, East 3823 Liberty, Spokane 27, Wash.

MAILORDER. Year round baby market. Everything supplied. Orders dropshipped. Low cost beginners plan. Barr, 24 Phyllis, West Orange 1, New Jersey.

PLASTERCRAFT. Sample kit, catalog \$1.00. Eureka, 2717 N.W. 10th, Oklahoma City, Oklahoma.

AMAZING Profits in worms. Free informative letter. Hillaire, Northville, Mich.

\$50 PER Day. New process wall washing. Details free. Box 5406, Minneapolis 8, Minn.

FREE Catalog. Self improvement books. BID, 2630 Midvale, Los Angeles 64, California.

ESCAPE Jobs forever! Unusual Books show how. 2325A Bonair, Montreal 35, Canada.

INTERNATIONAL Mailorder business made easy. Complete setup service, not just instructions. Hermes, 152 West 42, New York City 36.

GOLD, Silver, platinum; refining, testing, make alloys, solders, etc. Learn wonderful business. Frank J. Herman, Metallurgist, 1529 Liberty Street, Los Angeles 26, Calif.

MAILORDER To motels, churches, institutions. Individual setup. Not just instructions. Hermes Advertising, 152 West 42, New York City 36.

FREE "Franchise Profit Letter" tells how unique NFR service is helping thousands seeking profitable businesses. Write today. National Franchise Reports, W-528, 333 North Michigan, Chicago 1.

START A business spare or full time immediately repairing small electrical appliances. Free literature. M & L Appliance Parts, Dept. A, 1507 W. 69th St., Chicago 36, Illinois.

BUSINESSES, Resorts, motels, investment property, ranches. Our special service dept. at your disposal. No obligation. World's largest. 62 years service. Strout Realty, 7-MB S. Dearborn, Chicago 3, Ill.

EARN \$10,000 Selling books by mail. Box 51-BY, Des Plaines, Ill.

OPERATE Mailorder bookshop. Free details. Ballard, 1834 Edgeland, Louisville 4, Ky.

MAKE Money making leathersgoods. 1148 ideas. Free information. Tandy Leather Co., Box 791-Q3, Fort Worth, Texas.

IMMEDIATE Profits with no capital or experience. Take orders for all magazine subscriptions. Friends and neighbors are your prospects. Write now for complete, free kit. McGregor Magazine Agency, Dept. CB2, Mount Morris, Illinois.

HOW And where to obtain capital. Reliable Service, Rome City, Ind.

SELL Champion, AC, Autolite spark plugs. Reconditioned, electroplated, guaranteed 10,000 miles, 100% profit. Free sample. Lee Plugs, 1608-A Roberts, Houston 3, Texas.

VENDING Machines. No selling. Operate a route of coin machines and earn amazing profits. 32-page catalogue free. Parkway Machine Corporation, Dept. #27, 715 Ensor Street, Baltimore 2, Maryland.

BIG Money raising fishworms and crickets. Free literature. Carter Farms, Plains, Georgia.

TO \$100.00 Weekly. Sparetime, home operated mailorder business. Successful beginner's plan. Everything supplied. Lynn, 10420-M National, Los Angeles 34.

PIANO Tuning learned quickly at home. Tremendous field! Musical knowledge unnecessary. Information free. Empire School of Piano Tuning, Champaign, Ill. (Founded 1935).

OPERATE Profitable mail order business. Write Walter Service, 4159A East 112th, Cleveland 5, Ohio.

BAKE New greaseless doughnuts in kitchen. Sell stores. Free recipes. Montgomery, 3605 South 15th, Minneapolis 7, Minnesota.

MAKE \$46 From square foot plywood; jigsaw necessary. Free details. Woodart, Bridgewater, Mass.

\$400.00 MONTHLY Raising giant fishworms. Soilless method. Charlie Morgan, Bushnell, Florida.

PLASTERCRAFT Molds, liquid rubber, plasters, flocks, candle supplies. Catalog and manual free. Blue Rapids Supply, Blue Rapids, Kansas.

WORLD'S Largest wholesale supply. Buy from 679 American, European, Japanese wholesalers. Tailormade suits from Hongkong. 123 dropship catalogs. Rock-bottom prices. Free details. International Buyers, 216-MM Jackson, Chicago 6, Ill.

MANUFACTURE Polishes, cleaners, cosmetics, anything. Literature, stamp. Neiko, 3462 Merchandise Mart, Chicago 54.

11,000 NEW Prospects daily. Baby record books, shoes, albums. Sell mailorder. Use our literature. Write: No-Co-Ro, Capitola, Calif.

OPERATE Home mailorder business. Vosacek Printing, 4444AI Ute, San Diego, 17, Calif.

COLORGLAZED Concrete pottery made without molds. Patented method. Cemetery products, novelties, tiles. Basement leak-sealing. Money-making projects. Booklet, details free. Men only. National Potteries Company, Grand Rapids, Minnesota.

WANT To make big money at home? \$10.00 profit in an hour possible with invisible mending. Make tears, holes disappear from clothing, fabrics. Steady year-round demand from cleaners, laundries, homes. Details free. Fabricon, 1585 Howard, Chicago 26, Ill.

EARN Money raising fishworms for us! Write: Oakhaven—38, Cedar Hill, Texas.

LEARN Sewing machine repairing. To \$125 weekly. Sparetime. Supplies. Add to present business. Write today! Taylor Service, Box 484, Cupertino, Calif.

MAKE Money from old tires. Operators clearing \$400 weekly. Equipment costs \$800. Get facts. S & S Patents, Inc., 3511 N. Lincoln, Chicago 13.

VENDING Machine catalog. Rakes, 609P Spring Garden, Philadelphia 23, Penna.

BRONZE Baby shoes. Genuine electroplating process. Equipment, mountings, instructions. Send \$1.00 for valuable book "Your Guide To Success" bronzing baby shoes, plus complete catalog. Hollywood Bronze Supply, Dept. B60, 3445 Union Pacific Avenue, Los Angeles 23, California.

RAISE Rabbits on \$500 month plan. Free details. White's Rabbitry, Mt. Vernon, Ohio.

\$200.00 MONTHLY. Spare time. With tablesaw, bandsaw or jigsaw. Write. Holiday House, A3800 Harney, Vancouver, Washington.

SHARPEN Saws and lawnmowers the profitable way. Send for free literature. Max Manufacturing Company, 138 Stockton Avenue, San Jose 26, California.

SIMPLE. Pleasant mailorder can net \$12,000 year. Write: Rutward, 2010 Bryant, Columbia Station, Ohio.

\$34.70 TWO Hours manufacturing concrete products. No selling. Castings #3, Box 1721, Rapid City, South Dakota.

LAUNCH Profitable mailorder business. Write: Kozar, 159 Belleville, Belleville, N. J.

GARDEN Golf. Start amusement center. Invest now. Brockway, Box 3762, Portland 8, Oregon.

EVERYBODY Likes fine candy and popcorn specialties. Make professionally home. (Our 50th year.) Ragsdale Candies, B107 East Orange, New Jersey.

PROFITABLE Mailorder business! Write: Vikari, 468-P Third Avenue, Salt Lake City 3, Utah.

WORK At home packaging merchandise. Very profitable. No selling. Everything supplied. Details free. D'Amico, 209 W. Jackson, Chicago 6.

MANUFACTURE Products—400% profit. Sell mailorder. Catalogue free. "International," 6347 Farnell, Chicago 21, Illinois.

AVOID Trouble. Order latest mailorder business "Legal Guide." Explains all about licenses, taxes, etc. \$2.00. Neil H. Tasker, Shamokin, Pennsylvania.

EARN \$100.00 Weekly. Unusual home business. Fourteen magic methods. Derco, Box 494-B, Muncie, Indiana.

SELL Books by mail. 400% profit. Royal, Box 450-X, Cleveland 27, Ohio.

MOLDING Rubber. Free information. Chaney's, 5415-A San Jose Blvd., Jacksonville 7, Fla.

FREE Necklace kit offered by Modern Craft under Home Craftsmen.

STOP Throwing away boxtops! They're worth money! Some, 25¢! Inquire: Box-tops-MB, Cedar Hill, Texas.

FREE Book: "609 Unusual, Successful Businesses," Box 1001-PX, Evanston, Illinois.

\$100.00 WEEKLY. Sparetime home mail order business. Successful beginners plan. L&D, 109 W. 42nd, New York City 36.

LOVE Pays. Bronze baby shoes. Free booklet. Box 5036A, Inglewood, California.

BUY Direct from factories. Appliances, cameras, watches! Free details! Cam Co., 436 P.M. Bloomfield Ave., Verona, N. J.

COPUBLISH Mail Sale Advertiser, leading mail order paper. Details, latest copy, dime. Vanroy Shirk, Lebanon, Penna.

LEARN To sharpen, repair, and service lawn mowers, also straighten crank shafts intact. Wirt's, 2419 Gnahn, Burlington, Iowa.

OPERATE Own collection agency. Spare time extra cash: Satellites, Box 172PM Manhattanville Station, New York 27, N. Y.

EXPORT-Import trade course teaches you how to establish profitable mail order import business from your home. Free details. Write today. Global Export-Import Co., Box 9584, Northside Station, Jackson 6, Miss.

HONEST Help for home mailorder. \$1000 monthly possible. Write: Murray's, Litchfield, Maine.

SIMPLE, Easy business of your own. No selling. Test it free! Details will amaze you! Kahm Co., 2008 Bryant South, Minneapolis 5, Minnesota.

LEARN Professional TV servicing in one week! Fabulous new simplified system. No big expense. No studying. No tools or equipment. Spare, full time. Own your own big profit business! Save! Amazing but true! Free! Write TV Systems, Dept. NA, 1038 So. La Brea, Los Angeles 19.

MAKE Telephone surveys spare time! Free home-business details. No selling, choose your own hours. Telephone Institute, Dept. NA, 1038 So. La Brea, Los Angeles 19.

CANDLE Making, decorating supplies, tools, equipment, instruction. Also full line of cake decorating, candy making items. Largest selection. Lowest prices. Send 25¢ today for big new catalog, applied to first order. General Supplies, Dept. G-249, Fallbrook, Calif.

OPERATE Profitable home mail-order business. Sparetime. Get lifetime repeat orders. Write Wayne's Service, 3016-J Channing, Washington 18, D. C.

MADE \$10,000.00 Typing at home. Guaranteed prof. Amazing information 15¢. Lenore Felgen, 30A Washington, Oak Park, Ill. Dept. PM.

MAIL Order Magazine free plus unusual mail order offer. Egyptian, Box 168, Anna, Illinois.

OPERATE Profitable mimeographing business. Write. Mimeographing Dollars, 1012-M Center Street, Evanston, Wyo.

MAIL Order beginners. Start small, grow big. Send for interesting literature. Roy Thacker, 220 S. Mission Ridge Dr., Rossville, Ga.

"MAIL Sales Digest": Quarterly mail-order ideas, plans. Year \$1.00. Sample 35¢. Eisenberg, 7807-PM 166th, Flushing 66, New York.

OPERATE Profitable "inexpensive" mailorder business! Write! Liberty, 210-PM02 Fifth Ave., New York 10, N. Y.

CASH From sawdust, tin-cans, newspapers. Over 200 methods. Instructions \$1.00. Charles Company, 42-AR, Norwood, Ohio.

YOUR Own mail order business. New guide tells how to start, what to sell, where to sell. Step-by-step instructions. \$2.00 ppd. VanJohn, Box 414, Waynesboro, Penna.

EARN \$200 weekly selling books by mail. Enterprises, Box 181-P, United, Penna.

"SELLING By mail with catalogues" manual puts you squarely, completely into the mail order picture. Copy \$2.00. Trousdale, Box 94, Charleston, Mo.

FREE Mail order plans. Linco, 5117 East 22nd, Tulsa 14, Okla.

AMAZING New home plastics business! Up to \$10.00 hour if you qualify. Pleasant, easy. No selling. Secrets revealed in free plan. NPC, Box 23321-P, Los Angeles 23.

2500 RECENT Cash buyers. Trial 264 names, \$1.00. Entire list, \$3.00. Neil H. Tasker, Shamokin, Pennsylvania.

SUCCEED With America's fastest growing company. Reedco, 7907 Blackshear, Dayton 24, Ohio.

\$10.00 IN An hour spare time at home possible with amazing "Magic Wonder Method" invisible reweaving. Details free. IRI, Dept. P-1, 8411 La Mesa Blvd., La Mesa, Calif.

REPAIR Door closers. Used on store doors, schools, homes, offices, factories. Lifetime trade. At home, or full time business. Big demand. Big profit. Details free. Eagle Company, 1906 Taylor, Columbia, South Carolina.

BECOME Notary Public. Easily accomplished. Enjoy extra income, prestige. Free details. Stationers Exchange, Box PM-542, Cleburne, Texas.

PACKAGE At home for profit! We supply everything. No selling. Free home business details. HPC 2212BA, Jesse Street, Los Angeles 23.

INVESTIGATE New mail order drop shipment plan. OPCO, 13389 23rd Place, Golden, Colorado.

UNBELIEVABLE? Enter concrete drain tile business on profitable, competitive basis for less than \$500. Durable Marvel. Best and still lowest-priced of drain tile machines. Pays for itself with two weeks production. Data and industry's most thorough info on making concrete drain tile 25¢. Concrete Machinery Company, Inc., Drawer 99, Hickory 12, N. C.

MAILORDER Catalogs. No inventory required. Full profits. Operate from home. Send 25¢ for 32-page sample catalog featuring 150 unusual fast-moving products and complete details. Satisfaction guaranteed. Gaylords, North Adams 6, Mass.

EARN \$12,000 in 7 months with a freezer-fresh "Dairy Bar on Wheels," most complete soft ice cream mobile unit available. No franchise, no royalties. Also available, oven-fresh pizza-refreshment units and assorted food-drink vehicles. Distributors needed. Dept. PM, Tri Metal Works, Riverton, N. J.

MONEYMAKING OPPORTUNITIES

MAKING Beautiful plastic products, per our easy instructions, your greatest money-making opportunity. Write for prof. Plasticon Company, Box 105, Grove City, Penna.

HOME Mailorder "manufacturing." Everything supplied. Clenso Products, 184 Oakview, Winnipeg 15, Manitoba.

DOES Well-paying research interest you? Or operating telephone answering service? Write: Murray's, Litchfield, Maine.

FREE Necklace kit offered by Modern Craft under Home Craftsmen.

FABULOUS Profits raising earthworms. Picture folder free. Excello, Kosciusko 6, Mississippi.

HOW To win prize sweepstakes, drawings, contests. Lesson 50¢. Winner, Box 304, Columbia City, Indiana.

EARN \$240.00 a month at home, spare time, doing only two \$5.00 invisible mending jobs a day. Big money paid for service that makes cuts, tears disappear from fabrics. Steady demand. Details free. Fabricon, 1532 Howard, Chicago 26, Illinois.

EARN Money evenings, copying and duplicating comic cartoons for advertisers. Adservice, Argyle 1, Wisconsin.

MAKE Plastic novelties for extra income. Low cost home training now available. Write for free booklet. Interstate Training Service, Dept. D-3, Portland 12, Oregon.

BAKE New greaseless doughnuts in kitchen. Sell stores. Free recipes. Melvin, 3605 South 15th, Minneapolis 7, Minn.

CIGARETTES—Make 20 plain or filter-tip for 9¢. Facts free. Moberly, Box 4012, Owensboro, Kentucky.

MINK Raising information free. Complete. Lake Superior Mink Farm, Superior, EE1, Wisconsin.

VENDING Machines. No selling. Operate a route of coin machines and earn amazing profits. 32-page catalogue free. Parkway Machine Corporation, Dept. #26, 715 Ensor Street, Baltimore 2, Maryland.

EARN Money raising fishworms for us! Write: Oakhaven—59, Cedar Hill, Texas.

YOUR Own, easy-to-start, home mail-order business, sparetime. Fascinating; profitable! Information free. Alfano, 19-PM Pine, Closter, N. J.

BIG Money raising fishworms and crickets. Free literature. Carter Hatchery, Plains, Georgia.

AMAZING Successes through franchises! Become exclusive franchise holder your territory. Information rushed. National Franchise Reports, MP-528, 333 North Michigan, Chicago 1.

LEARN The secrets of repairing junk batteries, generators, starters, profitable, easy, at home. Free particulars. Batterymen, 3465 Forrest, Santa Clara, Calif.

CASH For box tops and labels. For information write: Sunrise Enterprises, 709 Jefferson Ave., Falls Church, Virginia.

ELECTRIC Blankets easily repaired. Free information. Electric Blanket, Hubbard, Texas.

SEASHELLS, Shellcraft and jewelry supplies. Wholesale catalog 25¢, refunded on first order. Our 28th year. Florida Supply House, Box 847M, Bradenton, Florida.

START Good pay business at home in spare time. No experience needed to operate little table-top machine for bronzing baby shoes. Make \$6.00 profit on every pair. Full particulars free. Send postcard to Warner, 1512 Jarvis, Room CM-2-L, Chicago 26, Illinois.

EASY To start rubber stamp business at home in spare time. Make up to \$9.80 an hour without experience. Facts free. Write Roberts, 1512 Jarvis, Room CR-2-L, Chicago 26.

MEN—Women! Start money-making plastic laminating business at home in spare time. Material that costs 11¢ brings back \$2.58. No canvassing or selling but mail orders bring in \$20 a day. Write for full particulars free. Rush name on postcard to Warner, Room CL-2-L, 1512 Jarvis, Chicago 26, Ill.

THE CRUCIFIXION: cast in marblerock—finished in gold. Weight ¼ lb. Height 5½". Retail \$2.00 each. Wholesale \$7.00 doz., ppd. Sample \$1.00. Hall Gift Products, 119 S. Calverton Road, Baltimore 23, Maryland.

EARN \$10. daily, spare time. Free particulars. Write Springer, 5031-X First, N.W., Washington 11, D.C.

LEARN Window trimming at home. Free information. Write Window Trimming, Box 557, Whittier, Calif.

MAKE Money spare time or full time. I'll send you valuable kit of full-size famous Blair home products for free trial. Show friends, neighbors, take easy orders. Make big profits. Write Blair, Dept. 31FT, Lynchburg, Va.

HUSBANDS And housewives wanted! Big money. Spare or full time cake decorating and candy making. Turn your kitchen into a gold mine. No age, education limits. Complete instruction. Learn and earn at home. Write for free facts. Candy and Cake Dept. D-429, Fallbrook, Calif.

\$50,000 POSSIBLE In mail order. Details free. Harte, Decatur, Mich.

MANUFACTURE Brikerete. Used equipment. Must sell. Grasso, Erikrete, Rome, N. Y.

MONEYMAKING Opportunities galore! Details free. Berthold's, 739-PM Sylvania Avenue, Toledo 12, Ohio.

OUTSTANDING Profit possibilities at home. Experience unnecessary. No canvassing. Few hours weekly. Start on \$5 monthly. Free information. The Den, Box 3003, Long Island City 3, New York.

CO-PUBLISHERS Wanted. Details and sample magazines 25¢. Unified Publications, P.O. Box 3030-J, Tampa 1, Florida.

RENT Imported gifts. Take orders. Tainter's, Box 346P, Auburn, Maine.

PARTY Plan operators! Double your profits. Sell imported quality gift line. Rettlyn, Box 541, Monterey Park, Calif.

MAKE \$5,000 Yearly sparetime raising mink, chinchillas, nutria, etc. Free booklet reveals proved plans. Write: Furs, 588 Mt. Pleasant Road, Toronto 1, Canada.

LEARN Jewelry making at home. Inexpensive art metalcraft course teaches how to make all types cuff links, earrings, tableware, etc. of silver, gold, copper. Send postcard for free booklet. Interstate Training Service, Dept. L-3, Portland 12, Oregon.

RESEARCH Interviewing. Sparetime employment. No age limit. Proven Techniques, \$1.00. Box 7462, Dallas, Texas.

BECOME A notary public! Win extra income, prestige, business contacts. Details free. Stationers Exchange, Box 552-P, Kermit, Texas.

MAILERS' Opportunity mart. Starting kit. dime. Terrific. Brown, 184-P McClellan, New York 56.

WE Purchase items you make at home for us. Enclose stamp for details. Wolfe Specialties, Box 171, Center Line, Michigan.

\$2.50 STARTS Profitable lifetime business selling new liquid glass auto polish. Details, Stark, 14321 Wentworth, Chicago 27.

\$30 FROM Small strip balsawood. Free details. Woodcraft, Bradford, Maine.

CONCRETE Bird baths, animals, etc. Want to make them? We have the molds. Instructions and prices \$2.00. CMC, Drawer M99, Hickory 12, N. C.

IT'S True. Invest in a business without money. The U.S. Government library now contains copies of the phenomenal "Start Your Own Business Annual" (1962). Contains information and true facts about 700 top opportunities. Show you how to make money with or without investment. Full or part time. If you're really looking for extra income invest \$2 and send today. Annual Publication, Box 26-PM, New York City 8.

SCIENCE & CHEMISTRY

ROCKET Amateur supplies. Chemicals, engines, instruments. Big new catalog 25¢. Central Rocket Co., Waupaca, Wis.

CHEMICALS And apparatus for industrial, analytical, and private laboratories. Catalog 35¢. Dept. M-50. Biological Supply Co., 1176 Mt. Hope Ave., Rochester 20, N. Y.

ILLUSTRATED Catalog: Chemistry, mineralogy, biology 25¢. Tracey Laboratories, Evanston, Illinois.

UNUSUAL Chemistry books, courses, kits! Rare chemicals, cheap! Catalog 25¢. NSC, Box 11133, Palo Alto, Calif.

USEFUL Laboratory instrument, with bigger catalogue, 25¢. Hagenow Laboratories, Manitowoc, Wisconsin.

FUTURE System of Mathematics. Guaranteed, \$1.00. Knowledge, 2900-9th Street, Rock Island 17, Illinois.

FREE. Send for experimenter's dream catalog. Christmas shoppers: Visit our wonderful science store. Frey Scientific, 273 Orange, Mansfield 2, Ohio.

AMAZING New book of science experiments, formulas, and catalogue of laboratory supplies. Only 35¢. National Scientific Co., 13 S. Park Avenue, Dept. PM-10, Lombard, Illinois.

CHEMICALS In small quantities, apparatus, biologicals. Catalog 25¢. Winn Chemicals, 124 West 23rd, New York 11, N. Y.

SUN Battery, converts sunlight directly into 1/2 volt at 5 MA. Instructions for powering radios, making light meters, etc., included. Bargain priced \$1.00 each, 5 for \$4.00 postpaid. Custom 10 Service, 5071 Pico Blvd., Los Angeles 19, Calif.

FORMULAS, PLANS, ETC.

FORMULAS—All kinds. Amazing big catalog. 10¢. Kemixal, Park Ridge, Ill.

LATE, Modern manufacturing formulas. List free. Moon Chemical, Martville, New York.

FORTUNES In formulas! Information free. Thrifty, Box 814-D, Macon, Georgia.

FRENCH Fries 1847 formula \$1.00. Francois, 4311-A Lotus, New Orleans 22, La.

UNUSUAL Formulas, home businesses. Write Southland, 401-C E. Jackson, Orlando, Florida.

FORMULAS For latest money-making discoveries. New! Good! Valuable literature free! Miller, Chemist, 1517-D, Tampa, Florida.

PLASTICS

NEW! Low priced plastic laminating machine. Details. Burr, 7645 Oakland, Kalamazoo, Michigan.

EMBEDDING, Casting secrets free. Sample, 25¢. Crystal, 4350-B N. Whipple, Chicago 18.

LIFE Lasting fiberglass signs 3¢ square inch up. Boettger, 961, Dorothy, N. J.

BOXES, Plastic. 200 sizes. Free list. Althor, 170 Bay 23 Street, Brooklyn, N. Y.

NEW Liquid casting plastic, clear, colors. Embed real flowers, butterflies, photos, coins. Send 25¢ for two handbooks, "How to Cast Liquid Plastics" and "How to Make Extra Money at Home." Castolite, Dept. L-101, Woodstock, Illinois.

FIBERGLASS Handbooklet. Instructions, repair, \$1.00. Urshanair, Box 250, Santee, California.

AGENTS WANTED

MAKE \$50.00 Selling 25 boxes of our personalized Christmas cards. 49 exclusive designs. Free album. No obligation. Write Elmcraft, Dept. EC-15, 5930 So. Western, Chicago 36, Ill.

RUN A spare-time greeting card and gift shop at home. Show friends samples of our new 1962 Christmas and all-occasion greeting cards and gifts. Take their orders and earn to 100% profit. No experience necessary. Costs nothing to try. Write today for samples on approval. Regal Greetings, Dept. 7, Ferndale, Mich.

YOUR Own business—Used suits \$1.50; overcoats 65¢; mackinaws 35¢; shoes 12 1/2¢; ladies' coats 30¢; dresses 15¢. Enormous profits. Catalog free. Nathan Portnoy Associates, 2109-AA Roosevelt Road, Chicago 8, Ill.

PRINTING, Advertising salesmen—Excellent moneymaking sideline selling decicomania name plates, small quantities. Automobile initials, sign letters. Free samples. Balco, XL, Boston 19, Mass.

FREE Sample. Beautiful curios! Sell on sight! Apartado 9036, Mexico City.

WILL You test new items in your home? Surprisingly big pay. Latest conveniences for home, car. Send no money. Just your name. Kristee 126, Akron, Ohio.

MAKE Most extra cash with world's biggest line Christmas cards, wrappings, gifts. Introduce friends, neighbors to 150 Christmas, everyday box assortments, 600 big money-making novelties. Pocket up to 50% profit plus liberal bonus. Free giant color catalog; samples on approval. Arrow Greetings, 513 Fourth Ave., S., Dept. 83-V, Minneapolis, Minn.

AUTOMATIC Money. Demonstrating fire extinguishers. Details free. Out-O-Matic, 1737C East 31st, Denver 5, Colo.

BIG Money. Sensational new plan taking orders on trial basis for guaranteed hosiery. Write Lee Co., P.O. Box 486, Arlington Heights, Illinois.

TERRIFIC Seller. Genuine oil portraits. Just take orders. 4 sales pay \$100.00 to \$150.00 profits. Beautiful sample makes easy sales. Amazing offer free. Nichols, Box 1054, Coral Gables 34, Fla.

SELL Beautiful unusual foreign art to stores. Big income. Free information. Fruitland Traders, Fruitland, Maryland.

EARN Up to 50% profit. Tremendous profits with beautiful gifts and novelty items. For details and free color catalog, write Royal of America, Dept. 77, Providence, R. I.

SELL Bibles. Write for sample. Lee, Box 174, Romoland, California.

HUGE Profits selling color slides. Samples and details \$1.00. Berman, 2529 Wyandotte Avenue, Oroville, California.

REAL Diamond rings. Nationally advertised. Sell direct. Make big middleman's profit. No investment. Experience unnecessary. Free catalog, details. Gleamlight, 111-B11 North Columbus, Mount Vernon, N. Y.

MAKE Money selling ties, Tiekerchief sets, readyknots. Free catalog. Phillips Neckwear, 22 West 22nd, New York.

WHOLESALE Catalogue! Appliances, cameras, watches. Associated Distributors, Box 1481-D, Denver 1, Colo.

BIBLES. Make \$120 week giving Webster's Dictionary free with Bible. Sale of first order guaranteed. Write today. Bible Publishers Exchange, Rolla, Missouri.

BE The Popular Mechanics representative in your neighborhood and earn big profits in your spare time. Write Popular Mechanics, Room 10-A, 250 West 55th St., New York 19, N. Y.

CHRISTMAS Cards. Earn bigger commissions with this exceptional line. Price range: \$4.75 to \$14.25 for 25 cards, with customer's name imprinted. Album contains 85 personal and business designs that are "different." Inexperienced salespeople can earn up to \$600 and more this season, even in spare time. Experienced Christmas card salespeople can earn up to \$1,800 from now 'til Christmas. Sales kit includes expensive sample album and easy selling instructions. If you want really big commissions from this higher-priced line, send for kit now! Write Process Corp. (our 41st year), Dept. Y-3, 3450 S. 54th Ave., Chicago 50, Illinois.

BUSINESS Kit free! Postcard shoe you in business! Complete line 230 shoe styles, jackets! New discoveries pay big commissions. No investment. Send for free kit. Mason, Chippewa Falls K-437, Wisconsin.

AGENTS—300% Profit selling GENUINE gold window letters; stores and offices. Free samples. Metallic Sign Letter Co., 1217-D West Newport, Chicago.

SELL Deluxe name imprinted Christmas cards. Make fast 40% commission taking easy orders from beautiful albums displaying actual name imprinted sample Christmas Cards. Friends, business and professional people who want the best all excellent prospects. Retail prices range from \$4.50 for 25 cards to \$63.50 for 100 cards. No matter what your circumstance, you can add to your income tremendously with this exceptional line. Over 250 name imprinted Christmas cards available. Expensive album loaned free to serious, responsible men and women who want to build a lucrative, repeat business of their own. Write Hedenkamp, 361 Broadway, Dept. PM-82, New York.

EARN Up to \$50.00 daily or more. List delinquent accounts. Top commissions. National Credit Co., 304B Pickwick Bldg., Kansas City 6, Mo.

\$100.00 1ST Week. \$200.00 2nd week to millionaire possible. 2 men 1 woman did it. All started part time with \$1.95 investment. Groveland Sales Agency, Holly, Michigan.

BIG Profits. Stamp social security plates, key protectors. Sample 50¢. Catalog free. General Products, 11 No. Pearl St., Albany 7, N. Y.

MEN-Women sell most unique patented infants' and children's gift item ever devised. Nationally advertised magazines and TV. Earn big money fast! Send for free information. Dream-Lite Co., Dept. P190, 55 Catherine Street, Dayton 2, Ohio.

BUY IT WHOLESALE

WHOLESALE Bargains catalog. Terrific sales. Baldwin's, Box 257P, Norristown, Penna.

FREE Catalog. Largest wholesale supply source in the U.S. We're in business to save you money on anything you buy—for self or resale. Write Associated Wholesalers, Box 108-DD, Lincoln 1, Nebraska, for catalog and money-saving details.

TERRIFIC Sale. Hundreds of bargains. Appliances, cameras, jewelry, many other gifts. Catalog 25¢. Trading Unlimited, 12, Ginger Dr., Milledgeville, Ga.

2,000 PAGES Wholesale catalogs! Write: Mosaser, Box 47-B, Newark, Ohio.

100,000 PRODUCTS Wholesale! Terrific bargains! Wholesalers, 1265-MR Broadway, New York 1, N. Y.

350,000 ITEMS Below wholesale! Many free! Goldmine, Planetarium Station, New York City 24.

GARDEN Rotary tiller and tractor combination. Universal Mfg. Co., 324 West Tenth, Indianapolis 2, Indiana.

BUY Direct from factories! Appliances, cameras, watches! Free details! Cam Company, 436PA Bloomfield Ave., Verona, N.J.

WORLD'S Largest wholesale supply. Buy from 679 American, European, Japanese wholesalers. Tailormade suits from Hongkong. 123 dropship catalogs. Rockbottom prices. Free details. International Buyers, 216-M Jackson, Chicago 6, Illinois.

NEW Deluxe below wholesale catalog. Automobile catalog and others. Furniture, clothing, housewares, appliances, refrigerators, freezers, washers, dryers, television, radios, luggage, binoculars, hi-fi, stereo, phonographs, recorders, cameras, projectors, musical instruments, sporting goods, toys, tools, typewriters, watches, jewelry. Huge discounts on thousands of name brand items. For free specimen list of actual factory prices—postcard: Selbyco, Decatur 15, Illinois.

FREE! Name brands catalog! Your own high profit business. Sell name brands, full or part time. No inventory, no investment. More than 2,000 name brand items; lowest wholesale prices. Watches, jewelry, cameras, hi-fi, stereo radios-phonos, appliances, housewares, hardware, power tools, luggage, musical instruments, garden equipment, sporting goods, toys, many others. 8 floors of name brands. Million dollar inventory. Orders shipped complete in 24 hours! Send for free, beautifully illustrated catalog now! Separate wholesale price list. H. B. Davis Corp., Dept. PM, 143 W. 15 St., New York 11, N. Y.

USED And new watches \$2 up. Free list. Southern Watches, 5-PM So. Wabash, Chicago 3.

ELECTRIC Guitars, amplifiers, wholesale. Free catalog. Carvin PMW, Covina, Calif.

WHOLESALE Offers! Importing! Dropshipping. Business opportunities! Directories! Folios! Write: Importico, Enka, North Carolina.

FREE Wholesale catalog! Bargains galore! Jiffy Sales, R-2, Rhineland, Wis.

DISCOUNTS To 75%. Nationally advertised appliances, watches, jewelry, power tools, silverware, kitchenwares, luggage, photographic equipment, radios, televisions, perfumes, typewriters, phonographs, clocks, cookware, musical instruments, sporting goods, etc. Over 3000 items. Catalog \$5.00 or free details. R. Aumueller, 309 Cedar Ave., Long Branch, N. J.

FREE Catalog! Amazing bargains! Diro, 1016 West Main, Lebanon, Tennessee.

TOOL Catalog. Send 25¢. Silvo Hardware, 107-PM Walnut, Phila. 6, Penna.

BALL Pens. Leatherette photo cases. Social Security plates. Rain bonnets. Bonomo, 54 Jefferson St., Brooklyn 6, N. Y.

SALESMEN-DISTRIBUTORS

SENSATIONAL New longer-burning light bulb. Amazing free replacement guarantee—never again buy light bulbs. No competition. Multi-million dollar market yours alone. Make small fortune even spare time. Incredibly quick sales. Free sales kit. Merlite (Bulb Div.), 114 E. 32nd, Dept. C-74Z, New York 16.

MANUFACTURER Of automatic greaser, lawn spiker and duck decoy kit, wants salesmen, distributors. Automatic, 544 Jefferson Ct., Detroit 7, Mich.

GET New shirt outfit free! \$90 weekly on 5 average orders a day. Famous quality made-to-measure dress and sport shirts at \$4.50 up, sell to all men. No experience needed. Full or part time. Write: Packard Shirt Co., Dept. 617, Terre Haute, Indiana.

MAKE Extra money. Big steady earnings, repeat business. Sell advertising book matches, full or part time. New 1962 line. Show glamour girls, colorama, tenorama; dozens more. All sizes. Free master outfit, sales helps, leads, no experience necessary, no investment. Write today. Superior Match, Dept. M-1062, 7530 Greenwood, Chicago 19, Ill.

HIGH Commission and bonus. Earn \$100 to \$300 weekly. 30 year old company has openings. List delinquent accounts for collection. Experience not necessary. Permanent. Write Merchants Protective Agency, Dept. PM-10, 1015W Walnut, Kansas City, Mo.

MAKE Big money taking orders for Stark dwarf fruit trees. Everybody can now grow giant size apples, peaches, pears in their yards. Also shade trees, shrubs, vines, roses, etc. Outfit free. Stark Bro's, Desk 30103, Louisiana, Missouri.

EARN Big commission full or part time. Build profitable business of your own selling America's largest line low priced business printing and advertising specialties. 360 page catalog samples hundreds of items used daily by business people. Imprinted ball pens low as \$7.95 for 100. Big line low priced union label political printing included. Free sales kit. National Press, Dept. 8, North Chicago, Illinois.

IF You're interested in making money in selling, see the hundreds of exceptional opportunities in Salesmen's Opportunity Magazine. Send name for your copy, absolutely free. Tell us what you're selling now. Opportunity, 848 N. Dearborn, Dept. 17, Chicago 10, Illinois.

SWEDISH Products. Steady repeat items. High earnings. Write immediately to Lindstroms, 48 Boylston, Cambridge, Mass.

HAND-MADE Genuine leather billfolds. Assorted designs; \$11.00 dz. \$120.00 gross. Write for free pamphlet. Southeastern Leather Co., P. O. Box 573, La Grange, N. C.

EARN To \$3000 by Christmas. Sell "Sno-Thaw" (Chemical de-icer). Sells in large quantities. Every business a prospect. No investment. Liberal weekly commissions. Full or part time. Distributors wanted. Sno-Thaw, Box 8505 Nashville 11, Tennessee.

\$1,000.00 A Month for making dramatic 3-second demonstration of amazing lightweight Presto fire extinguisher. New chemical used by Airforce snuffs out fires instantly. Only \$4.95. Terrific commissions. Millions want it. Free kit. Merlite, 114 E. 32nd, Dept. P-66Z, New York 16.

MAKE Extra money selling advertising matchbooks. Free catalog and sales outfit. Matchcorp, Dept. PM-102, Chicago 32.

TERRIFIC Bathroom dispenser. Write. Nuva, 2327 Pine, Long Beach, Calif.

SELL Prestige credit collection system. Top commissions plus expense allowance! No investment. Write to Master System, Dept. 10, Box 52, Appleton, Wisconsin.

RESTAURANTS Need our intangibles. Resume, references, please. Kohr, Box 111-J, Clearwater, Fla.

SELL New inexpensive mailing machine to offices. Excellent commissions. OPO, 13389 23rd Place, Golden, Colorado.

CHOICE Distributorships available. Revolutionary, nationally advertised, patented Aqua Pen. Fills with water—writes with genuine ink! Lifetime service guarantee. No risk plan. Guaranteed money making proposition. Rohill Company, 1133 Broadway, New York 10, N. Y.

EMPLOYMENT INFORMATION

CALIFORNIA. Jobs, business opportunities. Leading newspaper classified sections. Reveals amazing opportunities and jobs. Save transportation. Free details. Austin Trousdale, 14 East Lake, Watsonville, Calif.

TREMENDOUS Opportunities U.S.A., overseas. Choose jobs, locations, transportation. Free details. International Occupations, International Airport, Box 100C-9, Jamaica 30, New York.

WORK For the U.S. Government. Send \$1.00 for next five monthly issues containing announcements of Federal job examinations. Good pay plus fringe benefits. Civil Service Reporter, 330 Newbury Street, Boston 15, Massachusetts.

MIAMI, Florida. Job listings, housing information, current events, \$1.00. Preco, Box 62-56, Miami 62, Florida.

MERCHANT Marine. Men and women Top wages. Travel. Information. Captain Box 501-P, Reading, Massachusetts.

FOREIGN Employment. Construction, other work projects. Good paying overseas jobs with extras, travel expenses. Write only: Foreign Service Bureau, Dept. PM, Bradenton Beach, Florida.

FOREIGN Employment information. Europe, Africa, Asia, South America. Free transportation. Up to \$1600.00 monthly. Sensational opportunities. Construction workers, clerks, truck drivers—every occupation. Complete information, application form, sent immediately by return mail. Satisfaction guaranteed. Only \$2.00 (\$2.25 airmail) (C.O.D.'s accepted) to: Jobs, P.O. Box 50512, Dept. E, New Orleans 50, Louisiana.

WEST Coast boom! Government employment opportunities. All occupations. Current list \$3.00 airmail. Satisfaction guaranteed. Careers, 3534 N. Meridian, Fresno 3, Calif.

JAPAN! Exotic Orient. Many hi-paying jobs available. Complete, detailed reports \$2.00. Japan Reports, Box 2202-C, Newport Beach, California.

DIRECTORY Reports. Construction, aviation, shipping, oilfields, government, manufacturing, trucking, etc. Foreign-stateside. Helpful information plus job-getting tips on preparing application letters. Unconditional money-back guarantee of satisfaction. Act today. Only \$3.00. \$3.25 airmail. (C.O.D.'s accepted). Research Services, Meramec Building, St. Louis 5-PM, Missouri.

SPECIAL SERVICES

SCIENCE Baffling? Test yourself: Define Cryogenics; Explain Lasers. Get both right? Scientist answers your science questions, engineering problems. Free details. Science Forum, 35 Oakcliff Rd., Newtonville 60, Massachusetts.

INFORMATION Concerning any matter. Folborg Research Agency, Wyckoff Heights, Brooklyn 37, New York.

COMPLETE Spectrographic analysis of ore or mineral samples by modern, best equipped west coast institution. Send sample with \$10.00 money order to Hornkohl Laboratories, Inc., 714 Truxtun Avenue, Bakersfield, California.

INFORMATION On anything. Ferguson Research Specialists, 59 Lent Ave., Hempstead, N. Y.

RESEARCH Service. Any subject! Product information. Jake Barraco, 478 Gardner, South Beloit, Illinois.

EDUCATIONAL AND INSTRUCTION

LEARN Fascinating, profitable invisible reweaving at home. \$10.00 earnings in an hour possible making tears, holes disappear from clothing, fabrics. Steady demand from cleaners, laundries, homes. Details free. Fabricon, 1534 Howard, Chicago 26, Illinois.

GUARANTEED America's finest and most complete line of slide rules. Wholesale prices. You save 30 to 50%. Post card brings our catalog. Lewis M. Crawford & Sons, Joanna, South Carolina.

ENGINEERING And Art degrees earned through home study. Electronics, Mechanical, Liberal Arts. When writing specify course desired. Pacific International College of Arts & Sciences, primarily a correspondence school. Resident classes also available. 5719-B Santa Monica Blvd., Hollywood 36, California.

PENMANSHIP Corrector. Improve poor penmanship quickly. Details free. Ozment, Box 665-34, St. Louis 88, Mo.

INVESTIGATOR'S Course. Credentials, diploma. Free information. Southwestern Institute Criminology, Box 201, Geronimo, Oklahoma.

SPEAK, Sing with power. Self-training records. Canfield, 2018-A Fifth Avenue South, Minneapolis 4, Minnesota.

DENTAL Technician's home study student's kits. Instruments, plastic, etc. Illustrated instructions. Write for free lesson. Grant Laboratory, Haas Bldg., Los Angeles 14, Calif.

PHYSICAL, Culture and massage pays big profits. Learn at home. Free catalog. Write National Institute, Dept. A-1, 874 N. Wabash, Chicago 11, Ill.

MASTER Secrets of the ages. Key to success. Dynamic formula! Free literature. Leavitt Science, Clinton, Illinois.

FREE Literature, self-help books, sleep learning. Fletcher, 2407-PM Catherine, Dallas 11, Texas.

GET A British degree. Divinity, Philosophy, Radionics, Biochemistry. 35 courses. Prospectus free. Brantridge Forest School, "Lodge", Brantridge, Balcombe, Sussex, England.

INVESTIGATOR Training. Free booklet covering approved home-study plan. Write National Detective Academy, 12812 Hazel Ave., Garden Grove, Calif.

AIRLINE Careers. Adventure! Prestige! Promotion! Four-week course. Free placement service with 35 airlines. G. I. approved. Free catalog B. McConnell Airline School, 1030 Nicollet, Minneapolis, Minnesota.

BE A Real Estate Broker. Insure security for yourself and your family. Study at home. Prepare for state examination. GI approved. Write for free book today. Weaver School of Real Estate, 3519P Broadway, Kansas City, Missouri.

SWEDISH Massage. Foot technique. Post graduate. Home study. Residential. Diploma. Dr. Swanson's Illinois Licensed School, 3809-PL Alta Vista, Chicago 13.

USED Correspondence courses and books sold and rented. Money back guarantee. Catalog free. (Courses bought.) Lee Mountain, Pisgah, Alabama.

HIGH School diploma at home. Licensed teachers. Approved materials. Southern States Academy, Station E-16, Atlanta, Ga.

WOODWORKING And cabinetmaking course for beginning and advanced home craftsmen. Only complete low-cost home training program available. Write for free booklet. Interstate Training Service, Dept. G-3, Portland 12, Ore.

BOOKKEEPERS. Operate your own "Dollar-A-Week" system. Ellis, Box 200, Cedar Grove, North Carolina.

LEARN Asleep or awake! Records, tapes, equipment! Free catalog! Drawer PM-697, Ruidoso, New Mexico.

MEN Wanted. Earn \$125 a week and up. Master a trade with a future. Learn auto diesel mechanics in our shops. You learn with tools on real equipment. Earn while you learn. Many of our graduates earn \$125 a week and up. Write for free bulletin: Dept. 256, Auto Diesel College, Nashville 3, Tenn.

FINGERPRINTING And identification taught at home. Diploma. Details free. Alabama School of Fingerprinting, Fairfield, Alabama.

LEARN Auctioneering. Free catalog. Missouri Auction School, 1330 Linwood, Kansas City 9-X3, Mo.

LEARN Ventriloquism. Amazing-entertaining! Easy! Details free. B. Davis, B-38, Safety Harbor, Florida.

LEARN While asleep with your recorder, phono. Details, catalog free. Sleep-Learning, Box 24-PX, Olympia, Wash.

PROFESSIONAL Investigator. Home study. Lapel pin, certificate, future. Box 41197-P, Los Angeles 41, California.

OPERATE Collection agency. Little gold mine. Franklin Credit, Roanoke, Virginia.

LEARN Real Estate business fast. Economical homestudy. Literature free. Howard Schools, Box 8394-A, Kansas City 5, Missouri.

PIANO Tuning pays. Learned easily at home. GI approved. 59th year. Free booklet. Niles Bryant School, Dept. P, 3731 Stockton, Sacramento 20, Calif.

LEARN Profitable art. Make cement lawn ornaments, plaster craft. Catalogue, instructions, sample free. Wooley, 1915A North Peoria, Ill.

USED Courses! Books! List 10¢. Smith's, 124 Marlborough, Salem, Mass.

OPERATE Bookkeeping service. Personal coaching. Whiteley, 1645 Warwick, Warwick, Rhode Island.

MASTER Watch making at home. Free sample lesson. Chicago School, 2328-YK Milwaukee, Chicago 47.

ACCOUNTING. Prepare at home in spare time for high paying positions. Personal coaching. Learn-to-do-it problem method. Low cost. Write for free copy, "Accounting Opportunities." No obligation. Accounting Workshop, Post Office Box 8423, South Charleston 3, West Virginia.

PIANO Tuning pays. Big money in spare time. Learn at home. No musical knowledge necessary. Phonograph, records, tools and instructions furnished. Electronic tuning also taught. Free catalog. Capital Tuning School, 3160 S.W. 16th Court, Ft. Lauderdale, Fla.

CORRECT Your penmanship and learn shaded writing with—now ready—amazing new penmanship book. Details free. T. Tevis, Chillicothe, Mo.

OPPORTUNITY To improve your position. Know-how books will show you. Details free. Stephen Sidella, Pottsville, Penna.

SELF-Help course. Unusual books. Free list. Stenseth, Box 246P, Hialeah, Florida.

GOOD Paying jobs open! Operate, repair heavy earth moving equipment! Learn "on the job" operating latest cranes, bulldozers, earth carriers! V.A. approved. Free catalog. Write L.P. Hutch, Greer Technical Institute, Braidwood, Illinois.

INVESTIGATORS Trained, men-women. Fascinating, profitable profession, spare time study. Big pay. Details to open own agency any state. Free booklet. Investigator, Box 490PM, Times Square Station, New York 36, N. Y.

AUTOMATION Worries? Electronic, mechanical drafting pays \$175.00 weekly. Send \$2.00 first lesson, complete home study course \$25.00. Prior Inc., 23-09 169 St., Whitestone 57, New York.

INSURE Your fun! Dance confidently! \$1.00 sample lesson. John Paxton, Box 532, New Bedford, Mass.

WIN: Big money, success, school honors! Pass tests. Solve problems. Increase effective intelligence. Gain super-learning power. Unique book. Write: Guide, Box 362-PS1, Yorktown Heights, New York.

FINISH High School at home. Better jobs, more pay for high school graduates. Get your diploma thru simplified home study course. Personal attention. Write for free book, read about our "Guarantee of Success." Wayne School, Dept. 10-556, 417 S. Dearborn, Chicago 5, Illinois.

WRITERS Wanted for magazines, television, newspapers, motion pictures. Easy to learn home-study course shows you how to write and sell stories. Free!—revealing book. Lesson, writers magazine, and aptitude test. Write: Palmer Institute, 810-NA Dodsworth, Covina, Calif.

GAME Warden, Government hunter, Forestry, Park and Wildlife Services announce job openings regularly. Enjoy outdoor work, good pay, real security. Complete information free! Write North American School of Conservation, Dept. 17A 810 Dodsworth, Covina, Calif.

LEARN Civil and criminal investigation at home. Earn steady, good pay. State age. Institute Applied Science, 1920 Sunnyside, Department 167, Chicago 40, Illinois.

COMPLETE Your high school at home in spare time with 65-year-old school. Texts furnished. No classes. Diploma. Information booklet free. American School, Dept. X745, Drexel at 58th, Chicago 37, Illinois.

"HOW To Train Horses." A book everyone who likes horses or ponies should have. Free. No obligation. Simply address Beery School, Dept. 11010, Pleasant Hill, Ohio.

DRAFTING Pays big money. Leads to position in automotive, aeronautical, construction, mechanical fields. Learn at home in spare time. All equipment supplied. Pay later plan. Free book. Christy Trades School, D-6403, 3214 Lawrence, Chicago 25, Ill.

NEW Self-teaching course in memory helps you achieve greater success in business and social world. Free booklet. Memory Studies, 835 Diversey Parkway, Dept. 3437, Chicago 14.

SIGN Painting. Simplified, quick, easy. Learn home. Ramey, 19-P South Martin, Waukegan, Ill.

WANT A diesel job? Higher pay? Advancement? We can help you qualify! Complete diesel, tractor and heavy equipment and Cummins Diesel Engine Shop-method home-training courses available. Write today. Interstate Training Service, Dept. B-3, Portland 12, Ore.

COLLECTIONS—Bad accounts. Complete instructions \$1.00. Patterns for Success Institute, Box 1133, Boston 3, Mass.

BOOKS. Practical help for trades, skills, professions. Ramey, 19-B South Martin, Waukegan, Ill.

EXPERIENCE Ecstatic illumination. New mental-exercise for startling psychic development airmailed \$3. Money-back guarantee. Leroy Morgan, 3405 30 S.W., Seattle 6, Wash.

LEARN Automatic heating repair and installation. For free sample lesson write ETI-B, 608 S. Dearborn, Chicago 5.

OPPORTUNITIES Unlimited for big pay, security in earthmoving. Complete home study course now available. Diploma, employment assistance to graduates. Free opportunity folder. Canaveral Institute, Box 901B, Cocoa Beach, Florida.

SECRET Investigations. Experience unnecessary. Investigators particulars free. George Wagner, M125 West 86th, New York City 24.

USED Correspondence courses, books. Satisfaction guaranteed. Catalog 10¢ refundable. Courses bought. Bayles, 78-B Courtright, Wilkes Barre, Penna.

FCC License in 6 weeks. First class radio telephone results guaranteed. Elkins Radio School, 2603D Inwood, Dallas, Tex.

PLAYS, STORIES, MANUSCRIPTS

PUBLISH Your book! Join our successful authors: publicity advertising promotion, beautiful books. All subjects invited. Send for free appraisal and detailed booklet. Carlton Press, Dept. PMJ, 84 Fifth Avenue, New York City 11.

WRITERS Send your books, articles, stories, plays for free evaluation, screening and sale. Write today! Literary Agent Mead, 915 Broadway, New York City 10.

WANT Your book published? Learn how we publish, advertise, promote, distribute. Many successes. Free booklet PM. Vantage, 120 West 31, New York City. Or 6253 Hollywood Blvd., Hollywood 28, Calif.

AMAZING New way to get your book published now! Maximum prestige! Free details. Author's Bureau, 145 Lexington Avenue, Providence 7, R. I.

ADVERTISING AGENCIES, ADV. SERVICE, MAILING LISTS

FREE! Red-hot book — "More Profit From Your Advertising." Lists best mail-order magazines, newspapers. Adservice, 516B Cornelia, Chicago 13.

ADVERTISING Ratebook leading newspapers, magazines, free. Chicago Advertising Agency, 28-E Jackson, Chicago 4.

MAILING Lists most all kinds 1000 \$5.00. Free folder. Your circulars mailed \$4.00 1000. Dixie Mailers, King, N. C.

AMAZING New Book—"Profits From Classified Advertising." Tells how and what to advertise. Be sure to read this book before you invest one cent in advertising. Write for your copy now. F. W. Johnson, Classified Advertising Manager, Popular Mechanics, 740-PR Rush St., Chicago 11, Illinois.

ADVERTISE: 24 words, 50 Canadian newspapers, \$5.50. Lists free. Advertising Bureau, 10511-C Springfield, Chicago 55.

TYPEWRITERS, DUPLICATORS, OFFICE DEVICES

MIMEOGRAPH Duplicator and addressing set with complete supplies. Multi-purpose. Up to 35 words. Best results guaranteed. Flex-Add, 106 Galloping Hill, Roselle Park, N. J.

DUPLICATORS, New and used. Holz, 5572 South 3rd, Milwaukee 7, Wis.

RECONDITIONED Typewriters, mimeograph, printing presses \$25.00 up. Write Dixiegraph, King, N. C.

RUBBER STAMPS AND OFFICE SUPPLIES

POCKET 3 Lines \$1.00. Guaranteed. Catalog free. W. J. Specialty, 8464 Manhattan, Detroit 11, Michigan.

FREE CATALOG: Rubber stamps, printing, labels; Business cards, \$3.50. Martin, 1425 Major, Jefferson City, Missouri.

THREE-Line pocket rubber stamp, self-inking, plastic case, \$1.00. L. Watson, P.O. Box 162, St. Charles, Illinois.

STAMP Makers' supplies. Lowest prices. O'Brien's, 421 Jackson, Toledo 4, Ohio.

QUALITY Rubber stamps! All kinds. Low prices! 3 lines, \$1.00. 1000 address labels, \$1.00. Prompt service. Johnson, 443-pm, MacDonough, Brooklyn 33, N. Y.

FREE 32 Page rubber stamp catalog. Youngers Stamp Shop, Princeton, Iowa.

3 LINES \$1.00. Wholesale brochure-gift free. Printers, Big Moose, New York.

FREE Ink pad with name-address rubber stamp \$1.00. Full size. Rubber Stamps, Box 91, Akron 9, Ohio.

CARTOONING, COMMERCIAL ART, SHOWCARD & SIGN PAINTING, TATTOOING

PAINT Signs! Letter patterns, hundred selections. Paulow Signs, Crystal Falls, Michigan.

YOU Can entertain with chalk talks. Catalog 10¢. Baida the Cartoonist, Oshkosh, Wis.

LEARN Sign painting at home. Free talent test. Ben Kerns, Box 812-PM, Greenville, S.C.

LEARN Sign painting with fascinating system. Straley, 410 S. Western, Springfield, Ohio.

LEARN Profitable magazine cartooning. Free details. Hartman, Box 3097, Lincoln 10, Nebraska.

PAINT Artistic showcard-signs by new number method. Free Strok-O-Graph and details. Idea clipbook \$1. Midwest School of Art, 103 East Main, Fort Wayne, Indiana.

ART Learn at home. Earn big money. Learn commercial art, cartooning, lettering, figure drawing, painting, TV art, in part time. All for 20¢ a day. Send for free 36-page book. No obligation. Washington School of Art, Studio 1410X, Port Washington, N. Y. Tear this out as reminder.

LEARN Profitable, fascinating tattooing. Illustrated information \$1. Zeis, 728-C Leslie, Rockford, Illinois.

"HOW To Make Money with Simple Cartoons." A book everyone who likes to draw should have. It is free; no obligation. Simply address Cartoonists' Exchange, Dept. 510, Pleasant Hill, Ohio.

CARTOONERAMA Teaches you cartooning in a new 24 lesson course. Free brochure. CFA, Box 263-F1, Branford, Conn.

SIGN Painting—for profit. Free information. Kaufman Sign Company, Centertown, Missouri.

PRINTING OUTFITS AND SUPPLIES

PRINTING Presses, type, supplies. Lists 4¢. Turnbaugh Service, Mechanicsburg, Penna.

TYPE Cases. Manufacturer. Catalog. King McKay Company, 23179 Telegraph, Southfield, Michigan.

MAKE Your own self-molding rubber stamps and printing cuts. Plexirubber, Argyle 1, Wisconsin.

NEW 1962-63 Illustrated printing equipment and supply catalog. This 9"x12", 336-page book is the most complete catalog of the century. Contains everything used in the graphic arts industry including thousands of offset, letterpress, bindery, rubber plate and stamp, composing room, silk screen, art and engraving supplies and equipment. Includes paper cutters, folding machines, printing and proof presses, padding presses and many more. Send \$2.00 to cover mailing. Refund with first order. Also available is our latest 184 page type catalog—add \$1.00. American Printing Equipment & Supply Co., Dept. PM 42-25 Ninth Street, Long Island City 1, N. Y.

RUBBER Stamp presses, hydraulic operated, electrically heated. Sizes 5"x8", 8"x12", 10"x15". Starting outfits, supplies. Printing presses. Custom Manufacturing, 1464-P East Commercial, Springfield, Missouri.

DO Your own printing. Save money. Simple rules. We supply everything. Print for others; good profit. Raised printing like engraving too. Have home shop. Details free. Kelsey Presses, V-11, Meriden, Connecticut.

RUBBER Stamp outfits, supplies. Kiewit, 2025 Barnev Road, Kalamazoo, Mich.

SILK Screen dry photo stencils. Photo, art service. Boettger, 960, Dorothy, N. J.

FREE Rubber stamp press. Postpaid stamp materials. Duckman, Avoca, Ark.

PRINTING, MULTIGRAPHING, MIMEOGRAPHING, GUMMED LABELS

PERSONALIZED Stationery. A delight to use. The perfect gift for any occasion. Beautifully printed in distinctive modern type on fine quality white bond with envelopes to match. Sheets are executive size, 7 1/4" x 10 1/2". Be sure to state clearly name and address desired. 100 sheets, 50 envelopes sent postpaid, \$2.95. Lakeside Press, Box 547, Whitmore Lake, Michigan.

ADVERTISING Flyers, 1000—\$7.80. Details. Rich, 67 Cheyenne, Springfield, Mass.

WHOLESALE Printing; Office supplies; want proof? Pacific, P.O. Box 6215, Long Beach 6, California.

250—8 1/2"x11 HAMMERMILL Letterheads \$2.50. 250 envelopes \$2.50. Samples. Patton, Box 248J, South Haven, Mich.

BUSINESS Cards \$3.50 thousand. Prepaid. Samples. Juanita, Route 3, Lincoln, N. C.

1000 BUSINESS Cards, raised letters. \$3.75 postpaid. Samples. Routh, PM-10, 3910 Kipling, Greensboro, N. C.

FREE Samples. Business cards, letterheads, labels. Greszczuk, Box 3788-M, New York 17.

BUSINESS Cards, \$3.75 thousand. Prepaid. Guaranteed. Mauney's, 1103 Fern Street N.W., PM10, Washington 12, D. C.

FREE Catalogs. All kinds of printed business forms and salesbooks. Box 1, Bronx 72, N. Y.

1000 NAME-Address labels 75¢. Hallows, 14 Drexel Drive, Cahokia, Illinois.

GUARANTEED Quality printing, discount prices. Latest inventory catalog 10¢. Hollywood Press, 6206 W. Lincoln, Milwaukee 19, Wisconsin.

FREE Catalog quality line of printing. Low prices. E. Owens, 24555 Mary St., Taylor, Mich.

LOW Priced business or personalized stationery. Free samples. Debblor Printing, 1309-F North 38th Street, Milwaukee 8, Wis.

1000 NAME. Address labels plus rubber pocket stamp \$1.85. Nemitz, Box 1088, Milwaukee, Wisconsin.

QUALITY Offset printing. Special business stationery offer. Okay Print, Martins Ferry, Ohio.

100 EACH 8 1/2"x5 1/2" Letterheads, 6 3/4 envelopes \$2.00. Catalog. Steinbergen, Box 2354A, New York City 8.

250 8 1/2"x11 MODERN Designed Hammermill letterheads \$2.95. Envelopes same. Samples! Davis's, 7609 Spruce Road, Baltimore 22, Maryland.

POSTPAID Printing. Free catalog, samples. 10% deductible first order. Burgan Press, 1160 Namdac Ave., Bay Shore, N. Y.

LABELS, Blank. Self-adhesive. Stock sizes. Free list. Althor, 2301 Benson Ave., Brooklyn, N. Y.

WHOLESALE Business forms, \$2.95 thousand. Samples. Post-Age Industries, Brazil, Indiana.

SAVE On mimeographing. Samples. Fuesing's, 6522 West Center, Milwaukee 10, Wisconsin.

PERSONALIZED Correspondence cards, white or colored, neatly printed, 100 \$1.25; 1000 business cards \$3.95, postpaid. May Printers, Box 1703, Gary, Indiana.

OFFSET, Letters, booklets, statements. Free estimates. Powell, 2917 W. Kiowa, Colorado Springs, Colorado.

PRINTED Scotch tape. Free price sheet. Kavanagh, 607 Knickerbocker Ave., Brooklyn 21, N. Y.

MIMEOGRAPHING, Offset printing. Free samples. Pennway, Drawer 1340, Scranton, Penna.

OVERNITE Offset printing 1000 8½" x 11"—\$6.50. Postage extra. Evergreen, 9420 Trumbull, Chicago 42.

AMAZING Business printing values. Samples. Print Shop, Box 576, Greenville, R. I.

FREE Catalogs postpaid printing. Rubber stamps. DM Press, Sebastopol, Calif.

OFFSET Printing. 100 8½" x 11 \$2.49. Additional 100's 43¢—add shipping. Parks, 1879 Dover, Wantagh, New York.

ADS Running under this heading sell printing. Ask me for proof. I'll gladly send you amazing facts. Ask for Folder "P." F. W. Johnson, Popular Mechanics, 740-P Rush St., Chicago 11, Ill.

FOR INVENTORS

INVENTORS: Save time and money. Prepare and file your own patent application. Our complete "Patent Kit" makes it easy. Includes detailed instructions and all necessary material. Only \$12.95. Money back guarantee. Don't delay. Send check or money order today to National Inventors Service, Box 88, Benjamin Franklin Station, Washington, D. C.

INVENTORS—If you have an invention for sale, patented or unpatented, write for free brochure outlining manufacturer's requirements, royalty rates. Kessler Corporation, C-510-FI, Fremont, Ohio.

SAVE High fees! Less than 50¢ protects your unpatented invention. Write: "Protection": 4105 Metropolitan, Dallas 10, Texas.

MANUAL For inventors. All necessary information to help you make money with your ideas and inventions. Developing, promoting, advertising, patents, market surveys, etc. Send for manual, \$2. Product Promotion Development—2, Little Building, Boston 16, Mass.

PATENT Searches—48 hour airmail service, \$6.00, including nearest patent copies. More than 200 registered patent attorneys have used my service. For free invention protection forms and sample patent application, write Miss Ann Hastings, P. O. Box 176, Washington 4, D. C.

QUALITY Patent searches, \$6.00. Complete Patent Office report forwarded. Free "Protection Certificate." American Patent Search Co., 422 Washington Bldg., Washington 5, D. C.

PATENT Searches, including copies of related U.S. Patents, \$6.00. Inventors, attorneys, manufacturers use my "Worldwide" airmail service. "Invention Record" form and "Information Every Inventor Needs," sent free! Miss Hayward, 1029 Vermont Ave. NW, Washington 5, D. C.

PROFESSIONAL Searches of the Patent Office. Dependable—reliable \$6.00 including airmail report and related patents. For free protection forms and "Patent Information" write Trans-World Patent Service, 500 Walker Building, Washington 5, D. C.

SAVE High fees! Prepare your patent application yourself! New "do-it-yourself" patent kit now makes it easy. Free "Registration Form." Miss Blaine, 306 Carry Building, Washington 5, D. C.

PATENT Searches, professional patent development of inventions by licensed professional patent engineer and U.S. Patent Office former examiner with staff of engineering specialists in all fields of inventions. Expert searches performed in the U.S. Patent Office. Your inventions and ideas engineered for maximum patent protection and greatest commercial value. Inventions developed by us negotiated for cash or royalties with our nationwide contacts. Send for free protection "Invention Certificates" and further interesting, valuable patent information. George Spector, Licensed Professional Patent Engineer, U.S. Patent Office Former Examiner, Woolworth Building, New York.

PATENT Searches including full, airmail report and closest patent copies, \$6.00. Quality searches, expertly administered. Free protection forms and "Patent Information." Write Professional Patent Office Search Bureau, 709 Albee Building, Washington 5, D. C.

PATENTS Skillfully prepared for maximum commercial value, with useful product development. High record of success in proving and claiming patentability. Valuable market service. Patent prepared for a fee as low as \$200.00. Send for self-protecting record of invention forms free. Patent search with valuable engineering report \$10.00. Foreign patents filed at low cost. Thirty years established. Joseph O'Brien, Patent and Development Engineer, 132 Nassau St., New York 38, N. Y.

PATENT Searches, prompt complete \$6.00. Patent office copies of related patents airmailed. For free "Protection Forms" and "Patent Information" write to Anne Hamilton, 711 14th Street N. W., Suite 507, Washington 5, D. C.

PATENT Searches, \$6.00, including official patent office copies of related U. S. patents. Certified, airmailed! For free "Invention Record" and "Patent Information," write: United States Inventors Service Company, 1311 "G" Street NW, Washington 5, D. C.

PROFESSIONAL Patent searches, \$6.00, including official copies of related U.S. patents. Prompt, dependable airmail service! For free "Invention Record Folio" and "Information Every Inventor Should Have," write: Congress Invention Institute, 210 McKim Building, Washington 5, D. C.

U.S. Patent office searches—\$5.00. Free invention record. Patents engineered. Patent Office Searchers, 233 Broadway, Room 3615, New York.

PATENT Searches, including copies of nearest patents, \$6.00. Reports airmailed within 48 hours. More than 200 registered patent attorneys have used my service. For free invention protection forms, write Miss Ann Hastings, P. O. Box 176, Washington 4, D. C.

WE Have the markets if you have the ideas. Harvey Engineers, Cambridge 1 Maryland.

INVENTORS: Test the commercial value of your patented or unpatented inventions, quickly and inexpensively. Write for free information. Institute of American Inventors, Dept. 40-B, 635-F St., N.W., Washington 4, D. C.

INVENTORS. Write for free literature "Your Inventions Are Our Business." Inventors & Manufacturers Service, 3852 First Ave., San Diego 3, Calif.

PATENTS Professionally prepared for maximum commercial value. Patent searches including report \$6. Valuable market service. Cash or royalty sales. 10 years dependable service. For free self-protective Record of Invention forms write: H. Lawrence Blasius, 19 Park Row, New York 38, N. Y.

INVENTORS! Searches of the patent office \$6.00 including airmail report, related copies. Free protection forms, "Patent Information." Washington Patent Office Search Bureau, 1426 G Street, N.W., Washington 5, D. C.

INVENTIONS WANTED

INVENTIONS Needed immediately for manufacturers. For additional information write Kessler Corporation, C-510-IW, Fremont, Ohio.

WE Develop, promote and protect your product or ideas. Write for information. Product Promotion Development—2, Little Building, Boston 16, Mass.

INVENTIONS And ideas wanted for manufacturers. Information =1210 free. Riddle Engineering, 2661 Northwood, Toledo 6, Ohio.

INVENTIONS Sold, licensed. Cash-royalty basis. Inventions International, Box, 560 Wall Street, New York 5, N. Y.

NATIONAL Mailorder catalog needs quality products. Galleon, 27 School, Boston 8, Massachusetts.

INDUSTRY Needs inventions immediately. Inventions for Industry, organized to discover and assist new inventors. Write Delmar Mason, Chairman Investigating Committee, 3021 Monroe Street, Toledo, Ohio, for details.

INVENTORS! Consider our offer first before selling or licensing your invention on a cash or royalty basis. Patented. Unpatented. Write Wall Street Invention Brokerage, 79 Wall Street, New York 5, New York.

INVENTION Engineers have manufacturers waiting for patented, unpatented inventions. Inventors Creative Service, 354 South Spring, Los Angeles 13, Calif.

INVENTIONS Wanted. Patented: unpatented. Tremendous manufacturers lists. Global Marketing Service, 2420 77th, Oakland 5, California.

INVENTORS: Hundreds of manufacturers have requested our assistance in locating marketable new products. Complete information free. Institute of American Inventors, Dept. 40-D, 635-F St. N.W., Washington 4, D. C.

ARE You interested in offers from reliable manufacturers for your invention? Patented, unpatented. Harvey Engineers, Cambridge, Maryland.

INVENTORS! Outright cash sale or royalties for your inventions. Patented. Unpatented. Constant demand from our client manufacturers. Write: United States Invention Brokerage, 78 Wall Street, New York 5, N. Y.

INVENTORS Needing help with any problem, financial, development, securing manufacturer, obtaining patent. Write the organization that delivers action and results—not promises. Pioneer Invention Institute, 150 Broadway, New York 38, N. Y.

INVENTORS! Sell your invention for cash or royalties! Our manufacturers constantly seeking new items. Patented. Unpatented. For free information write Gilbert Adams, Patent Broker, 80 Wall Street, Financial District, New York, N. Y.

INVENTIONS Promoted-for cash-royalty sales with manufacturer contacts. George Spector, Licensed Invention Engineer, Woolworth Building, New York.

SELL Your invention for cash. No commissions. Milburn, Burlington, Kentucky.

CASH Or Royalties for inventions! Consider our offer first before licensing or selling your patented or unpatented invention. Write Aladdin Industries, 80 Wall St., New York 5, N. Y.

MODELS—SHIPS, TRAINS, PLANES, ETC.

STEAM Engines, tractors, boilers, castings, prints. Catalog \$1.00. Tiny Power, Junction City, Oregon.

MODEL Hobbyists! Send 10¢ for catalog. Our 70 powered model plane and boat kits, many radio-control operated, also accessories. Sterling-M, 501 Wister, Philadelphia 44, Penna.

SHIP Models. Kits, fittings, plans, books, tools, engines, motors. Big illustrated catalog 50¢. James Bliss & Co., Dept. SM, 342 Atlantic Avenue, Boston 10, Massachusetts.

SHIP Model kits and fittings: clippers, frigates, etc. Catalog paint-tool list, book list, 35¢. Model Shipways, Box 85, Bogota, N. J.

SHIP And yacht model fittings; blueprints. Send 40¢ for illustrated catalog listing hundreds of items. A. J. Fisher, Inc., 1002-1 Etowah Ave., Royal Oak, Mich.

"POWER Drives Handbook"—36 pages illustrating many types motor drives for model autos, boats, displays, turntables, etc. Mail 25 cents cash, returnable first order \$3.00 or more. Wilson's of Cleveland, Dept. PM, P.O. Box 8995, Ft. Lauderdale, Fla.

"WHITE Heat V" radio-controlled model hydroplane featured June 1962 Popular Mechanics. Full size plans, patterns, accessories and engine available. Literature for stamped addressed envelope. Octura Models, 8144-P No. Milwaukee Ave., Niles 48, Illinois.

FREE Plan for miniature steam engine included in new illustrated comprehensive Model Engineering supplies catalog; largest selection model gasoline, steam-engine casting kits; 1962 catalog 35¢. Octura Models, 8144 Milwaukee Ave., Niles 48, Ill. Dept. PM.

FREE Price list. Stuart Products, etc. Steam, gasoline engines, Corliss, tractor, locomotive. Complete 100-page catalog \$1.00. Cole's Models, Ventura, Calif.

MODEL Steam engines, ready to run. Catalogue 25¢. Gun Shop, Baker, Oregon.

LIVE Steam engine castings kits; marine, walking beam, mill engines, boilers, from \$7.45. Some machined, finished. Illustrated catalog \$1.00. H.P.K. Models, P.O. Box 34, Centuk Station, Yonkers, N. Y.

ORIGINAL Cleveland model airplane plans, printwood, kits selling out fast! Rush 25¢ for catalog, 500 designs. Cleveland-Peerless Antiques, 4502-M10 Lorain, Cleveland 2, Ohio.

LIONEL Trains. Big discounts bulletin 10¢. Catalog 25¢. Mack-Bros., 2043P, Chicago Ave., Chicago 22.

LIVE Steam powered backyard railroads! All sizes. Complete "bolt-together-kits," and rough castings. Excellent drawings. 100 page catalog \$1.00. Little Engines, Lomita, Calif.

LIONEL Train catalog, 25¢. 96 page. Trains-kits. Catalog \$1.00. Returnable with purchase. Free discount price sheet. Hobbies, 2609 North, Chicago 47.

MANUFACTURING

MODELS — Small lot manufacturing. Metals, plastics, etc. Milburn, Burlington, Kentucky.

HOME CRAFTSMEN

GRANDFATHER Clock movements, case plans, kits. Catalog 25¢. Mason-Sullivan, Osterville 7, Mass.

FREE "Do-It-Yourself" leathercraft catalog. Tandy Leather Company, Box 791-A46, Fort Worth, Texas.

PICTURE Frame moulding, squares and lumber. Kiln dried walnut, cherry, silver maple. Midland Lumber Company, Box 262, Savannah, Mo.

SKIL-CRAFTS New 62-63 catalog. Largest and finest selection of leathercraft, artist, hobbycraft supplies in the world. Free gift with first order. Send 50¢. Refundable with first order. Skil-Crafts, Box 167-P, Joplin, Missouri.

FREE! Leathercraft catalog. Hundreds of new items. Write MacPherson Bros. Leather Company, Dept. E. 730 Mission St., San Francisco 3, Calif.

SAVE. Raw picture frame moulding from manufacturer. Ash, poplar, walnut, cherry, mahogany, all styles. Bauerle Cabinet Wks. Inc., Hammond, La.

FREE Necklace kit with new jewelry supply catalog, 25¢. Designs, kits, instructions. Big profits! Easy to make and sell! Modern Craft, Box 11088-R30, Saint Petersburg 33, Florida.

CATTLE Horn kits. Make your own western wall decorations. \$2.50 to \$10. Texas Trophy, Box 506, La Porte, Texas.

FOUNDRYETTE. 2400°F., 1½ to 48 lb. capacity. Descriptive circular; send 10¢ for postage. Kansas City Specialties Co., Dept. P-10, Marysville, Kans.

PLANS For pool table with extra two-face top for table tennis and model railroad. Blueprints B1209 and building instructions \$3.50. Popular Mechanics Service Bureau, 740-M Rush St., Chicago 11, Illinois.

STAINLESS Steel, Aluminum, Copper, cut to size. Perforated, expanded, for grilles, radiator covers. Tell us size, thickness, how used. We will make recommendation and advise price. Metallic Operations, Inc., Warsaw, N. Y.

101 PATTERNS Of smart gifts, novelties, shelves, action windmills plus "Make Money Jig Sawing." \$1.00. Mastercraft, 105M 7041 Olcott, Chicago 31.

WOODWORKERS—Home workshop catalog 132 pages. Save on fine woods, hardware, power tools, 25¢. Craftsman, 2719 S. Mary, Chicago 8, Ill.

CORNER Joints. Made easy and perfect. Table saw kit \$3.25. Radial \$5.95. Toni Mfg. Co., 445 Catherine St., Fort Lee, N. J.

FREE. New catalog, 2447 plans, patterns. World's greatest selection things to do, make. Fun, Profit, Craftplans, 18250-A, Harwood, Homewood, Ill.

ENEERS. 1/28" Thick. Send \$1.50 for two square feet each of cherry, mahogany, maple, oak and walnut. Catalog of wood-working supplies 10¢. Barap Specialties, P.O. Box 2044, Dept. P-18, Chicago 9.

"**MAKE** Leisure a Pleasure." If you are looking for a truly rewarding pastime; turn your mind to a creative hobby. For suggestions in the hobby field see our fascinating catalog which is filled with hundreds of interesting projects for the family, modeller and handyman. Enclose 25¢ to defray mailing and handling costs. Renown Enterprises, 521 Rocket St., Rochester 9, N. Y.

UNUSUAL Projects: wood, sheet metal, welding, outdoor Christmas decorations. Catalog free. Smithcraft, Box 25, Latham, N. Y.

WATCHES, OLD GOLD, JEWELRY

FREE Necklace kit offered by Modern Craft under Home Craftsmen.

WATCH And clock repairing books. Free catalog. North American, 2320-AX Milwaukee, Chicago 47, Illinois.

HIGHEST Cash for gold, teeth, jewelry, rings, diamonds, watches, silver, platinum. Mail articles today. Free gift with information. Chicago Gold & Precious Metals, 6 E. Monroe, Dept. 4458, Chicago 3.

TOBACCO, SMOKERS' SUPPLIES

PIPE Smokers! Finest quality tobaccos. Expertly blended. Four different blends, only \$1.00. Amar Blends, Box 127, Wantagh, N. Y.

DO IT YOURSELF

OPERATE Own investigation agency. Make extra cash. Satellites, Box 172PM, Manhattanville Station, New York 27, N. Y.

SAVES Haircuts! Sideburn tapering attachment (Gillette razors) \$2; Nuglits, Escondido 26, Calif.

CONCRETE Drain tile. Want to make them? We have the machine. Thorough data 25¢. Concrete Machinery, Drawer 99, Hickory 12, N. C.

EPOXY Fix 'N Patch repair kit plus free 59¢ Plastic Aluminum, \$1 postpaid. Specialty Plastics, Baltimore 15, Md.

INSTANT Laminating; photos, cards. Self-adhesive plastic. Sample, details. Hughes Company, PM, Middletown, Conn.

TERMITES? U-Do-It! Inexpensive! Arab, Box 55585, Indianapolis, Indiana.

EXERCISE At home on build-it-yourself physical fitness equipment, including bicycle exerciser, rowing machine, belt massager, and abdominal board. Send \$2.50 for blueprints B1208 and instructions. Popular Mechanics Service Bureau, 740-K Rush St., Chicago 11, Illinois.

FREE Check-list covering more than 500 classifications of projects, plans, instructions, service and repair information detailed in Popular Mechanics famous series of instructional booklets, books, patterns, and blueprints. List covers an extremely wide variety of do-it-yourself data on home remodeling, repair and improvement, hobbies, crafts, boating, games, lawn and garden, and hundreds of others. For your free copy of this helpful list, write: Service Bureau, Popular Mechanics, 575 Lexington Ave., New York 22, New York.

OF INTEREST TO WOMEN

KILL The hair root! With the famous Mahler Hair Removal Epilator, you can destroy unwanted hair permanently in the privacy of your own home. Send 10¢ for "New Radiant Beauty" booklet to Mahler's Inc., Dept. 252P, Providence 15, Rhode Island.

GIFTS For Mother, baby. Free illustrated catalog. Kenna, 2200 Hamilton, No. Merrick, N. Y.

\$25.00 **WEEKLY** Making jewelry, flowers, artfoam. Catalog 10¢. Plocraft, Farrell 34, Penna.

LEARN Expert cake decorating, candy making. Free details on home instruction method. Candy & Cake, Dept. D-430, Fallbrook, California.

HOSIERY Case \$1.00. L. A. Barrette, Box 41, East Meadow, N. Y.

MAKE Gorgeous original candles for all holidays and special occasions. Learn expert candle decorating, candlemaking, use of professional molds. Free details on home instruction method. Candle Institute, Dept. X-800, Fallbrook, California.

FREE Catalog. Spanking new gifts for Christmas. Murrey's, Litchfield, Maine.

SELL Fine fabrics. Get yours wholesale. Box 863, Norwalk, Conn.

WOMEN! Make big money at home. \$10.00 profit in an hour possible with invisible mending. Make holes, tears disappear from clothing, fabrics. Steady year-round demand from cleaners, laundries, homes. Details free. Fabricon, 1533 Howard, Chicago 26, Illinois.

PERSONAL

BORROW \$100 to \$1000 by mail. Quick, easy, private. No co-signers. Repay in 24 small monthly payments. For the amount you want write today to Dial Finance Co., 410 Kilpatrick Bldg., Dept. K-1, Omaha 2, Nebraska.

MAGIC Of Mexico. A "must" pamphlet for your first trip south. \$1.00. Trader May, Rt. 1, Box 3488, Ridgecrest, Calif.

SPEAK Instant Spanish. Free details. Trader May, Rt. 1, Box 3488, Ridgecrest, Calif.

YOUR Name imprinted 24K gold on 5 ball pens. Each writes different color. Guaranteed. Send \$1.50: The Hines Co., Cicero, N. Y.

LARAMIE, Wyoming. Confidential address. \$3.00 month. Write: Cepr, 104 Hodgeman.

BIBLE Questions answered. Stamped envelope. Bylon, 17167 Bentler, Detroit 19, Michigan.

LOANS By mail, \$100-\$600. Anywhere. Confidential. Write Union Finance, Dept. PM, 323 E. Camelback, Phoenix, Arizona.

LOANS By Air Mail, \$100-\$600. Anywhere. Confidential. Easy payments. Write Security Finance Co., 898 Van Ness Ave., Dept. PM, San Francisco 9, Calif.

DEVELOP Mind power, personality while asleep. Details free. Research Association, Box 24-N, Olympia, Washington.

NEW! Borrow \$1000. Anywhere. Increased loan limit. Air mail service. Postal Finance, 374 New Brotherhood Building, Dept. 17-D, Kansas City, Kans.

INVESTIGATORS. Free brochure, latest subminiature electronic listening devices. 11500-P NW 7th Ave., Miami 50, Florida.

STAMMERING. Corrected myself. Could help you. Dipple, 103 Church, Detroit 3.

REMAILING SERVICE

PHILIPPINES Reairmails \$1.00. Native card, message copied, airmail \$1.00. Exotic novelty gift \$2.00. Prudencio Abad, 217 Cu-Unjieng Building, Box 2239, Manila.

CONFIDENTIAL Remailing. 25¢ each, \$3.00 monthly. Alucard, 10203P 24 SW, Seattle 66, Wash.

RELIABLE Receiving-remailing, \$3.00 monthly. URS, Box 53, Wilmington, California.

SECRET Mail address. \$3.00 monthly. Seneath, Box 246P, Hialeah, Florida.

CONFIDENTIAL Address. Monthly \$3. Remails 25¢. Other services. Inquire. Bagley's, 158-18 Riverside Drive, New York 32.

REMAIS 25¢. Confidential, Khan, Room 304-8914 Hudson Street, Vancouver 14, Canada.

SWITZERLAND Reairmails \$1. E. Guillot, Mousquines 23, Lausanne, Switzerland.

NATION'S Capital. Remails 25¢. Monthly \$3.00. Mallon, Box 166, Washington 4, D. C.

NIAGARA FALLS—Europe. Complete remailing service. Details. Box 974, Adelaide P.O., Toronto, Canada.

SECRET Address. 25-\$3.00. Professionals. Degraff, Box 14-156M, San Diego, California.

CONFIDENTIAL Remailing 25¢. \$3 monthly. SCC, Box 891, Albany 7, New York.

CONFIDENTIAL Southern remailings. 25¢ each, \$3.00 monthly. Dixie, Box 9781-M, Atlanta 19, Georgia.

CONFIDENTIAL Mail address. Merchandise Bureau, 1105 Mayor Building, Montreal, Quebec.

LOS Angeles, Hollywood, San Fernando Valley 25¢ single, \$3.00 monthly. Confidential. 10437 Lanark, Sun Valley 3, Calif.

CONFIDENTIAL New York City mailing, receiving, forwarding address. Business personal mail \$3.00 month. Remails 25¢. Details free. Birnhan, 152 West 42, New York City 36.

RENO, Nevada, confidential remails, 25¢. Monthly \$3.00. Garakontie, Box 2876-A.

CHICAGO Address \$3.00 month. Details. Continental, 64 E. VanBuren, Chicago 5.

PALM Beaches remailing 25¢. Evco, 1630 44th St., West Palm Beach, Florida.

SECRET Mail address. \$3 month. Hedgpath, Box 830, Alhambra 23, California.

NATION'S Capitol. Remails 25¢. Monthly \$3.00. Mallon, Box 7166, Washington 4, D. C.

LETTERS Retailed 25¢. Six 50¢. Permanent address, anniversary, other services. Morris, 1613 Bradley, High Point, N. C.

HAWAII Secret address. Receiving-forwarding 25¢, \$3.00 monthly. Postcards. Coe, Box 984, Kailua, Hawaii.

MOSCOW Remails 50¢ each. D. A. Durocher, P.O.B. 2292, Station A, Cumberland, Maryland.

TREASURE FINDERS

FINEST Transistor, coin, metal locators \$34.95 up. IGWTP, Williamsburg, New Mexico.

FUN & Profit finding buried treasure, relics with transistor M-Scope. Known worldwide for super-sensitivity, dependability. Guaranteed. Easy terms. Send for free literature, fascinating user experiences. Fisher Research, Dept. AZ, Palo Alto, Calif.

TREASURE Hunters guide! Treasure signs, Indian symbols. \$1.00 postpaid. R. O. Morgan, Box 344, Inyokern, Calif.

NEW Coin locator! Free literature. Howe, 811-C Kansas, Atchison, Kansas.

TREASURE, Gold, silver, relics. Find them with new Detectron instruments. Free information. Raytron, Box 715, North Hollywood, California.

TREASURE. Find gold, silver, relics with super, powerful, Detectron locators. Free information. Detectron, Dept. PM-10, San Gabriel, California.

METAL Locator kits and assembled models from \$39.90. Terms. Transistorized and underwater models available. Free catalog. Electronic Applications, Dept. M, Box 8, Arlington 10, Virginia.

GOLD, Silver, coins, Civil War relics, treasures. Choice 5 locators. Established 1933. Free literature. Write The Goldak Company, 1541 W. Glenoaks Blvd., Glendale 1, California.

TRANSISTORIZED Treasure finder locates deep buried, sunken treasures. Easily, inexpensively built without previous electronic experience. Step by step illustrated plans, details, \$2.00. Dee Designs, Box 7263-A, Houston 8, Texas.

WANTED—MISCELLANEOUS

STAMP Collections, accumulations. Eagle Stamp Co., 2221 Romine, Pittsburgh 26, Penna.

QUICKSILVER, Platinum, silver, gold. Ores analyzed. Wholesale Terminal, Norwood, Mass.

FOR SALE—MISCELLANEOUS

AMAZING Moist-Trol valve stops toilet tank sweating. Install yourself. \$7.95 postpaid. (Chrome \$9.95) Dept. A, Raymond, Owatonna, Minnesota.

HEARING Aids. Equal to units selling for \$150.00. 10 day money back trial. Check or money-order \$24.50. Wolch, 44-59 Kissena Blvd., Flushing 55, N. Y.

AMAZING New pen! Fill with water, write with ink. Fully guaranteed. \$2.98 postpaid. E. C. Berg, Napa St. Station, Spokane, Wash.

FREE Money-saving catalog. Surplus and newly manufactured equipment and tools for workshop, home, boats, farm, factory. Write: Groban, 1139 So. Wabash, Chicago 5, Ill.

HEARING Aid batteries wholesale. Free list. Habs, Box 51, York, Penna.

MISCELLANEOUS

LET Us tell you how to turn the reading habits of your friends into profit for you. \$10.00, \$25.00 or \$50.00 can easily and quickly be made under our Popular Mechanics subscription plan. No experience needed. Write Popular Mechanics, Room 10-M, 250 West 55th St., New York 19, N. Y.

PHOTO Copy your receipts, valuable papers, etc. 8½x11", 3 for \$1.00. Mom-mouth Blueprint, Rd. #2, Box 180, Farmingdale, N. J.

"HOW To Sell Your Own Home." Booklet guides you in preparations, showing, getting buyers, negotiating. Eliminates mystery of transaction. \$1.00. HOMESALE, Box 136, Deerfield 5, Illinois.

BURGLAR Alarm devices. Complete line. Catalog \$1.00. Full details. Sootin's, 321 Northwest Third Avenue, Miami, Florida.

VX-6 Eliminates battery trouble. Guaranteed. For cars, boats, tractors, etc. \$2.98 postpaid. World's first self-propelled fishing lure. Climbs and dives by its own power. Complete with propellant fuel. \$2.98 postpaid. Sidney Roscher, Box 223, Jericho, N. Y.

EARN Money raising fishworms for us! Write: Oakhaven-60, Cedar Hill, Texas.

CIGARETTES—Make 20 plain or filter-tips for 9¢. Facts free. Moberly, Box 785, Owensboro, Kentucky.

SEND Us wool for blankets. Write Eldorado Woolens, Eldorado, Texas.

WANT Your name with 1000 mailers? 25¢ lists your name year with our mailings every month. Dixie Mailers, King, N. C.

BOOKS On antiques and their prices. Free circular! P. Warman Publishers, Uniontown, Penna.

SUPER Memory overnight! Success guaranteed! Bijou, Box 1727-M, Hollywood 28, California.

OUTHOUSES, Septic tanks, cesspools, clogged drains, filter beds, restored to newness by miracle crystal pellets. New discovery. Do-it-yourself. Easy-to-follow instructions. Free literature and testimonial letters. Electric Sewer Cleaning Co., Boston 34, Mass.

AT Last! Hearing aids only \$28.95. Free trial, terms. Write Cary-B Sales, Inverness, Fla. Salesmen wanted.

KEEP Your mail box loaded. Get listed 10¢. Frankland Enterprises, P.O. Box 112, Chicago 17, Ill.

"STAMMER, Stutter, No More." (Dr. Young.) Write: Gaucho, Box 9309-ST, Chicago 90.

MARRIAGE Certificate. Suitable for framing, in two colors, 8x10"—\$1.00. Harvey's, Box 1402-C, Englewood, Colo.

UNUSUAL Gifts whole family. Free catalogue. Jordan's, 743 South Dorrance St., Philadelphia 46, Pa.

EARLY American Maine products available. Write for circular: Pine Cone-Tassel Shop, Litchfield, Maine.

BEAUTIFUL Oil paintings at reasonable prices. Free catalog. Rhody Yule, RR 5, Faribault, Minnesota.

FREE Wholesale catalog! 100,000 products. Tremendous discounts! Taylor Distributors, Newton 2, New Jersey.

YOUR Family Coat of Arms researched, made. Write: Roy Hicks, Alpharetta 1, Ga.

FREE Bargain catalog. Auto owners, businessmen, hobbyists. Herbert Jamison, 6912 RSM, APO 742, Box 193, New York, New York.

TROPHIES—Awards, 25% discount. Catalog 30¢. Architectural Bronze, Skokie, Illinois.

RECEIVE Worldwide mails. Lifetime 25¢. Bagby, Box 144-E, Coos Bay, Oregon.

MAGNIFIER Flashlight. Ideal for students, lab., shop workers. Magnifies 10 times. Coated lens. Precision made. Battery operated. \$2.98 postpaid. Paul Adams, 1315 Warren, St. Louis 6, Mo.

BUSY People shop by mail. Catalog name brand items. Send 50 cents refundable with first order. G. L. Richardson, 56 Pleasant St., So. Eliot, Maine.

AUSTRALIAN Novelties from kangaroo skin, cuddly Koala bears, lambswool rugs, boomerangs. Samples and catalogue \$3.00. U.S. manufacturers represented in Australia. Details to Pendle Products, P.O. Pendle Hill South, Sydney, N.S.W.

FREE Publication your poem in new poetry volume. Details free. Poetry Press, Ionia 8, Mo.

POPULAR Mechanics readers. Library files protect your copies. Each set holds one year. Complete with date labels. 50¢ per set postpaid. Walter Ashe Radio, 1125 Pine, St. Louis 1, Missouri.

PROBLEMS You can solve through mail. Hard-to-find items located and mailed, new or used. Unwanted surplus sold. Information furnished. Teddy Race, Box 364, New York 28, N. Y.

RECEIVE Offers, opportunities, catalogs, samples, 10¢. Alpoen-IPM, 1652 Dounton, Philadelphia 40, Penna.

CRYST-L-CRAZE Paint for beautiful amazing crystallizing effects. Sample 10¢. Metal tooling catalog 10¢. Groundmaster, Boulder, Colorado.

FREE! Exciting new catalog—Western wear, saddles, riding accessories. Western Saddlery, Box 1864-V4, Fort Worth, Tex.

UNLUCKY? Your solid silver lucky "Leprechaun" airmailed overnight with free history. Only \$2.50. Silvercraft, 10 Albert Walk, Bray, Ireland.

FASCINATING Sellout offers: pictures. Novelties. Stamps. Giant sample assortment 30¢. Books 11 different 4¢. Persil, 436 N. Y. Ave., Brooklyn 25, N. Y.

WE'VE MOVED!

Our NEW Address is

**575 Lexington Ave.,
New York 22, N.Y.**

We're excited about our move!

For generations, PM's readers have been vitally interested in the latest developments of science, in new industrial processes, in fascinating new home products, in new shop techniques, in dozens of new ways to use leisure time profitably and enjoyably!

And these are the very interests that are expanding most rapidly today.

In order to serve you better, in order to expand our coverage of these fields, we're moving to brand-new quarters. We'll have new automotive and electronic test equipment, a bigger shop, finer facilities for testing new products.

We're making the move to develop an even bigger and better magazine during the exciting years ahead!



INSURED SAVINGS

This new higher rate is far above the national average.
■ Each account insured to \$10,000 by the American Savings Insurance Company of Jackson, Mississippi. ■ State Government Supervision. ■ Employees bonded to \$500,000. ■ Share the wealth of the prosperous, new South-land. ■ Dividends paid two times a year. ■ Savings postmarked by the 20th earn from the first of the month. ■ Air mail postage pre-paid both ways. ■ Fast, gracious service. ■ Free gifts to new savers.

FIRST SECURITY SAVINGS AND LOAN ASSOCIATION

First Security Savings and Loan Association
131 North Lamar Avenue, Jackson, Mississippi

Please open my 5% Savings Account at First Security Savings. I enclose the amount of \$ _____ for a Joint Account Individual
 Send free "The Mississippi Story"

Name _____

Address _____

City _____ Zone _____ State _____

CHECK YOUR GIFT

6-piece manicure set in leatherette kit  \$250

Travel clock with luminous dial, leatherette case  \$500

52 piece famous "International" Stainless Steel dinner setting  \$1500

5 1/4% plus choice of gifts \$5000

CHECK YOUR GIFT

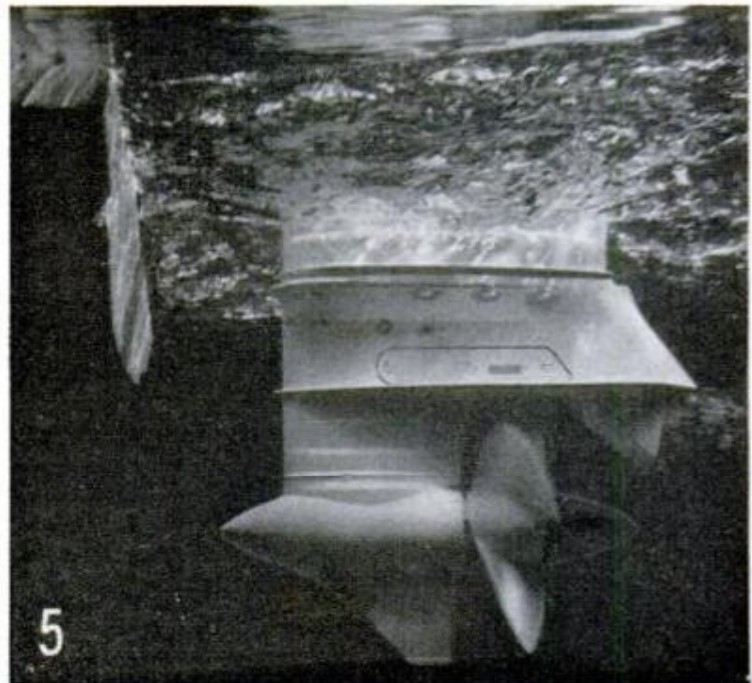
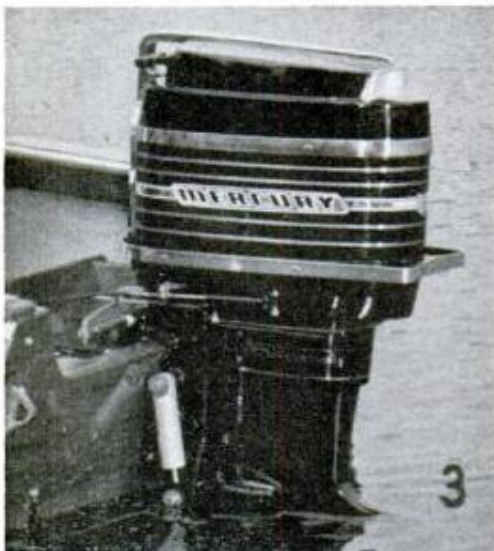

OUTBOARDS FOR '63

1. **EXTRA MUSCLE** for Royal Scott brings it up to 45 hp. (shown), as Scott concentrates on detail improvements. New addition: 9.5-hp. motor for high-style fishing boat
2. **ENGINEERING REFINEMENTS**, rather than new power ratings, are offered by Johnson in the firm's existing line of 75, 40, 28, 18 (shown), 10, 5½ and 3-hp. Sea Horses
3. **STRESSING LIGHT WEIGHT** and compactness of its expanded line for 1963, Mercury adds new 20, 35 and 65-hp. (shown) ratings while dropping 25 and 45-hp. models
4. **COLOR OPTION** (gray or blue) is offered by Evinrude on push-button gearshift motors, new in '62. Same range of motors is maintained for coming year; shown is 40-hp.
5. **STREAMLINED** unit on 60-hp. models is retained unchanged by Gale. Most emphasis is being placed on low cost and dependability as Gale makes no major changes

THE ONE AND ONLY *knight-kit*® "SPAN MASTER!"®



WORLD-WIDE 4-BAND SHORT WAVE RECEIVER KIT

ONLY
\$25⁹⁵

NO MONEY DOWN

only \$5 per month on
Allied's Credit Fund Plan

You can hear *everything* on the fun-to-build "Span Master"—far and away the leader in its class for radio coverage, sensitive performance and value. Continuous tuning from 540 kc to 30 mc lets you hear ships, planes, direct broadcasts from Moscow, Berlin, Rome, London, Paris; tunes the 160, 80, 40, 20, 15 and 10-meter Ham bands—plus powerful local AM reception and dozens of other exciting broadcast services.

Bandspread dial and fine regeneration make tuning an easy pleasure. Has headphone terminals and speaker cut-out switch for private listening. Super-sensitive circuit. Easy to assemble from step-by-step instruction manual—includes list of foreign stations and international Morse code. Pyroxylin-covered cabinet with perforated white baffle and satin-chrome control panel. Complete with all parts, tubes, wire and solder. Size, 6¼ x 14 x 6¾". For 110-125 v., 60 cycle AC. Shpg. wt., 8 lbs.

83 YX 258BV. "Span Master" Kit, only **\$25.95**

83 Y 025. Outdoor Antenna Kit..... **\$1.03**

83 Y 027. Dual Headset..... **\$2.08**

Satisfaction guaranteed or your money back!



manufactured by

KNIGHT ELECTRONICS CORP.

A DIVISION OF

ALLIED RADIO

OCTOBER 1962

**GREAT TO BUILD!
GREAT TO OWN!**
packed with endless
listening thrills



Tune world capitals direct



Hear ships at sea



Hear planes in flight



Tune all your favorite local AM programs

- Tunes Shortwave and Broadcast Bands continuously from 540 kc to 30 mc
- Bandspread Control for easy, enjoyable shortwave tuning
- Sensitive Regenerative Circuit for world-wide radio reception
- Built-in Speaker plus headphone terminals for privacy listening
- Transformer Powered for maximum circuit performance

ORDER TODAY

ALLIED RADIO

100 N. Western Ave., Chicago 80, Ill.

Ship me the following:

"Span Master"® 4-Band Receiver Kit 83 YX 258BV

Antenna Kit 83 Y 025. Dual Headset Kit 83 Y 027

Ship No Money Down on Allied's Credit Fund Plan

New Credit Customers Only: Send name and address present employer, how long employed, position, monthly salary; rent or own home, how long at present address; give age (21 minimum for credit account).

\$_____ enclosed (check) (money order)

Name _____
PLEASE PRINT

Address _____

City _____ Zone _____ State _____



By Jim Whipple



Let's Look at the Record of 1962 Versus 1961— How 30 Cars Sold and Some Reasons Why

How do the various makes of cars line up just before the starting gun of the 1963 sales race? Remember that October is the end of the Automotive Year. By November 1st, 95 percent of the 1963 models will be in the showrooms and the sales race of 1962 will officially be over.

The only real measure of success in automobiles, as in any other business, is sales. Not the number of cars a manufacturer was able to stamp out, but how many his dealers actually sold. As we go to press comparable sales results are available for all makes during the first six calendar months.

In the big picture, all five major companies showed gains in '62, which followed a year of mild recession.

However, discounting the general buying upswing, some cars gained a lot more than others, while some actually lost ground. In an uptrend the losses are even more conspicuous and should be weighed more heavily.

Among the compacts, for example, standpat *Falcon* dropped 52,000, while *Rambler Classic* rose 56,000. Much of the buying uptrend in the compact field was soaked up by two cars, Ford's *Fairlane* and *Chevy II*, brand new cars accounting for over 333,000 sales

It appears that *Fairlane's* 173,000 sales

came at the expense of its big and little brothers *Falcon* and *Galaxie* which lost over 100,000 between them; cousin *Comet* dropped 22,000.

Launching a new compact resulted in a happy uptrend for *Chevrolet*. *Big Chevys* rose some 17 percent in sales while *Chevy II* sold nearly 175,000 units from the same salesrooms. Meanwhile *Corvair* stood about "as is," losing some compact sedan and wagon prospects to *Chevy II*, but picking up more and more lovers of the sporty *Monza* coupes and convertibles.

Buick Special racked up the success story in the compact field however, nearly doubling its sales compared to '61s' first six months, thanks to the lower-priced V6 and the top of the line *Skylark*.

Among the low-priced three *Chevrolet* surged ahead of *Ford Galaxie* to nearly double the number of *Biscaynes*, *Belairs* and *Impalas* sold compared to *Galaxies* and *Galaxie 500s*'. Even adding *Fairlane's* 173,000 to balance out *Biscayne* in a price comparison and adding *T-Bird's* 37,000 to balance *Corvette*, *Chevrolet* would still be over 200,000 units ahead.

In the medium-priced cars *Pontiac* scored a 50 percent increase as the entire group moved upwards in tune with, but not ahead of, the industry's increased pace.

Imperial gained about 25 percent in a field heavily dominated by *Cadillac*.

SEE HOW THEY RAN—Comparative Sales for First Six Months

MAKE OF CAR	1961	1962	CHANGE	MAKE OF CAR	1961	1962	CHANGE
Compacts				Big Four			
Buick Special	40,254	79,534	+ 39,280	Chevrolet*	624,823	753,554	+ 128,731
Chevy II	-----	169,678	-----	Ford Galaxie	373,692	348,916	- 24,776
Comet	90,059	73,049	+ 17,010	Plymouth	91,689	83,017	- 8,672
Corvair	165,032	158,301	- 6,731	Dodge	82,079	74,421	- 7,658
Falcon	239,264	187,117	- 52,157	Medium-Priced			
Fairlane	-----	173,694	-----	Buick	99,028	122,387	+ 23,359
Meteor	-----	39,335	-----	Chrysler	46,971	61,088	+ 14,117
Olds F-85	34,358	46,195	+ 11,837	Mercury	59,354	50,672	- 8,682
Rambler American	77,420	74,012	- 3,408	Oldsmobile	120,472	168,000	+ 47,528
Rambler Classic	140,829	197,145	+ 56,316	Pontiac	128,264	191,141	+ 62,877
Rambler Ambassador	14,317	17,062	+ 2,745	Luxury			
Studebaker Lark	42,811	47,459	+ 4,648	Cadillac	72,791	75,338	+ 2,547
Tempest	52,538	73,122	+ 20,584	Imperial	5,218	6,609	+ 1,391
Valiant	57,572	53,530	- 4,042	Lincoln Continental	15,276	14,779	- 497
Dodge Lancer	31,985	29,030	- 2,955	Sports Coupes			
Volkswagen	89,559	108,462	+ 18,503	Thunderbird	43,424	37,248	- 6,176
				Studebaker Hawk	2,577	5,471	+ 2,894

* Includes Corvette

metal in paste form
made with aluminum powders
from *ALCOA*

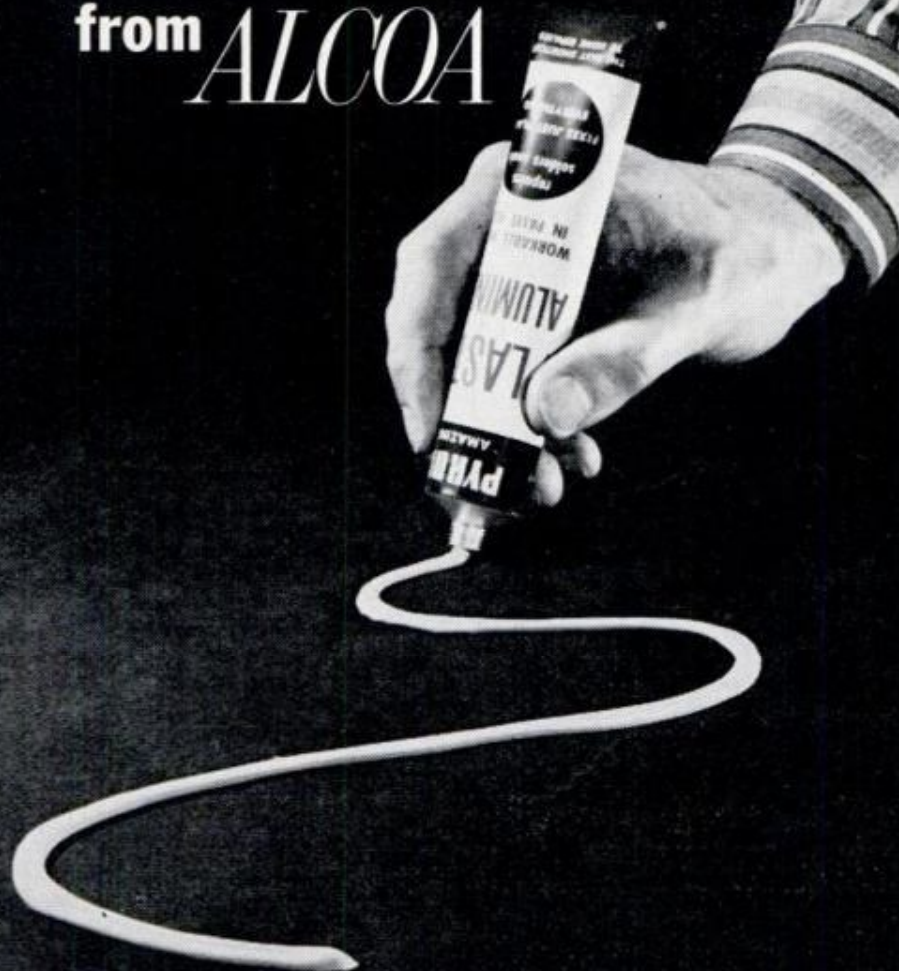

Cut repair bills with Pyroil Plastic Aluminum

Think of the things you can fix yourself with Pyroil Plastic Aluminum. Users tell us it seals joints in gutters and downspouts; fills auto body cracks; stops leaks; mends pots and pans; repairs window screens. The list is a long one.

Workable metal in paste form, a good aluminum putty like Pyroil Aluminum is made with Alcoa® Powders. Apply it cold. It dries quickly to solid metal, withstands high heat—adheres to

metal, wood, concrete, glass—even hard plastics.

Once applied, Pyroil Plastic Aluminum can be filed, sanded, drilled and threaded. (Talk about versatility!) Your dealer stocks it or can get it for you. See him today.

Alcoa does not make aluminum putties, but Alcoa Aluminum Powders are used in all the best brands. Cold solders are easy to use, require no tools, heat or flame. Send the coupon today.



Entertainment at Its Best
ALCOA PREMIERE Presented by Fred Astaire
Thursday Evenings, ABC-TV

Aluminum Company of America
1743-K Alcoa Building, Pittsburgh 19, Pa.

Please send more information on cold solders made with Alcoa Aluminum Powders.

Name _____

Address _____

City _____ Zone _____ State _____

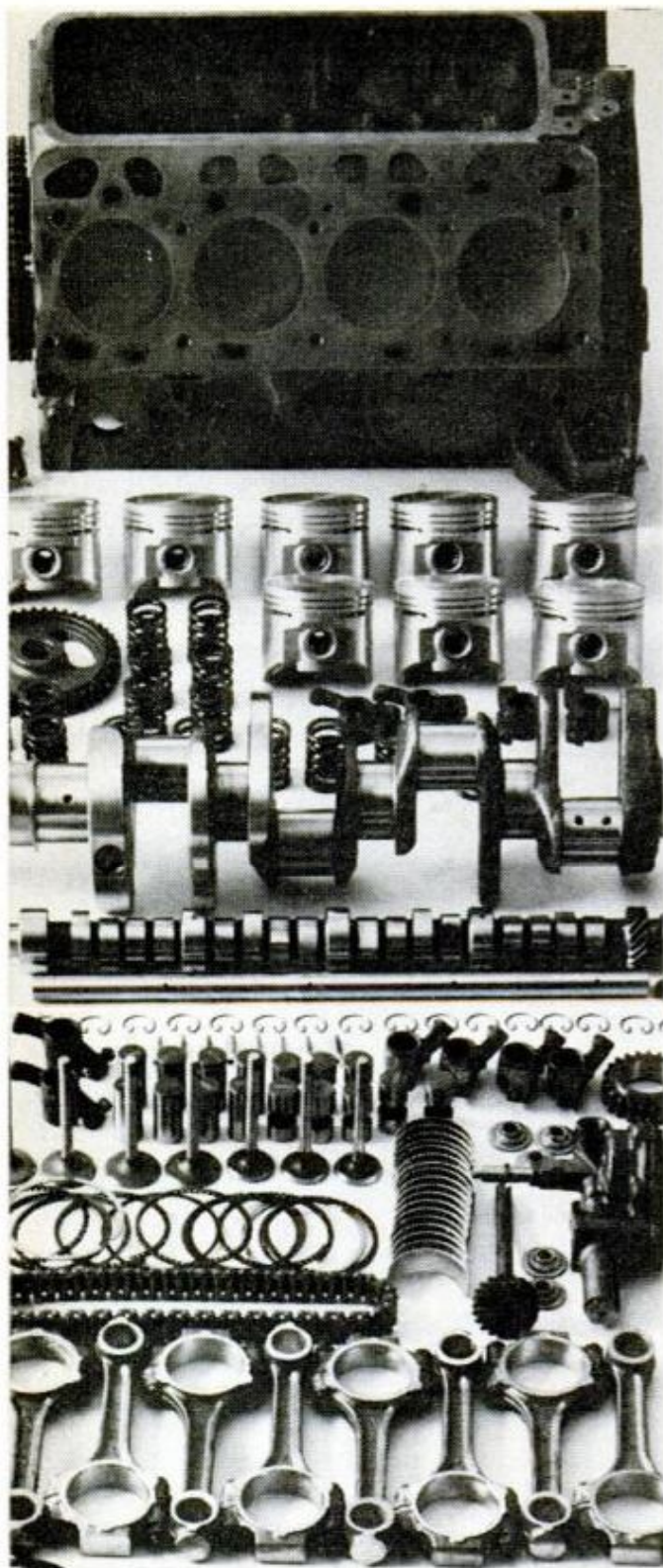

**all this
depends
on
this**

A Fram "Wear-Guard" oil filter traps up to 40% more of the dirt and grit that can grind away at moving parts and cause engine damage. Protect your car's engine. Ask for a fresh Fram "Wear-Guard" filter when you change oil.

FRAM
Wear-Guard Filter



Radioactive Reindeer

Strontium-90, a radioactive-fallout product of nuclear explosions, has been found to be highly concentrated in Alaskan caribou, according to Dr. Arthur R. Schulert, biochemist, Vanderbilt University. A native North American reindeer, the caribou is a staple in the diet of Eskimos and has been found to carry 10 to 20 times the level of strontium-90 in domestic cattle.

Dr. Schulert's findings may have some bearing on fallout dangers to humans, animals and plants from a proposed nuclear explosion, Project Chariot on the northwest coast of Alaska, which is intended to excavate a harbor.

The Atomic Energy Commission is now conducting studies to determine if the fallout dangers would pose a potential threat to the entire northern Alaskan food chain of plants, animals and man.

Exercise Lowers Cholesterol

President Kennedy's physical-fitness program has resulted in cholesterol reduction in a group of men subjected to strength exercises. Cholesterol is a waxy fat in the blood stream which may cause coronary heart problems.

The study was undertaken on 42 middle-aged white-collar workers whose average cholesterol levels were above normal. The group met Monday through Friday during the noon hour and began with a small work load which gradually built in intensity.

According to Dr. Lawrence A. Golding, physiologist at Kent State University, the average drop of the cholesterol level in the group was from 261 to 195, with individuals going from nearly 300 to about 150. In addition, the group's physical endurance and strength was greatly increased.

Man and Animal Astronauts

The two-man Gemini space capsule may be sent into orbit containing a man *and* an animal. Biological space experiments, such as deep brain probes or implanted blood sensors, could be tried on the animal. The man could verify the reactions of the animal. In this way, the effect of confinement, weightlessness and immobility for long periods would be studied, according to Brigadier General Charles H. Roadman, National Aeronautics and Space Administration.

For man's welfare, the problems in the health sciences will significantly outweigh the problems brought about by the physical and political sciences, says Dr. Roadman.

(Advertisement)

A number of one-man mail order enterprises are paying their owners an income of \$40,000 to \$50,000.

SPECIAL OPPORTUNITIES

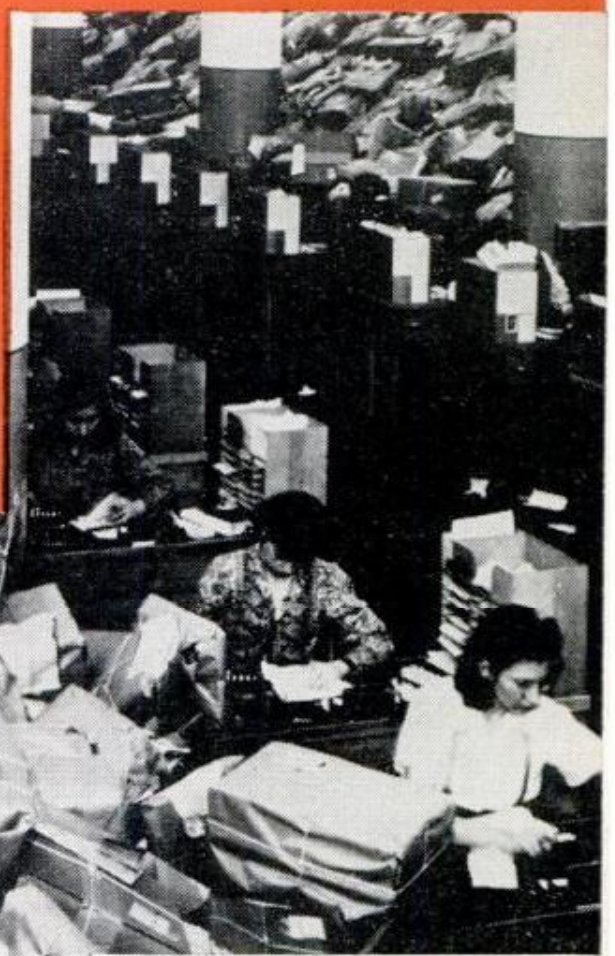

Mail order is big business. Annual catalog sales volume of Sears, Roebuck and Co. is over 700 million dollars!

HOW TO START

Your Own Mail Order Business

You can make a fortune by mail. New firms will set you up in a fabulous mail order business of your own! They'll make up your catalogs, prepare your advertising, supply mailing lists and even ship your products for you!

By Robert Stephenson

When Anthony Sambati injured his back and was laid off from work he never dreamed it would be a blessing in disguise. Bedridden for weeks, he decided to start a small mail order business. This was something he could run right from his own home and required very little capital to begin. In fact, Sambati started with less than \$85.00.

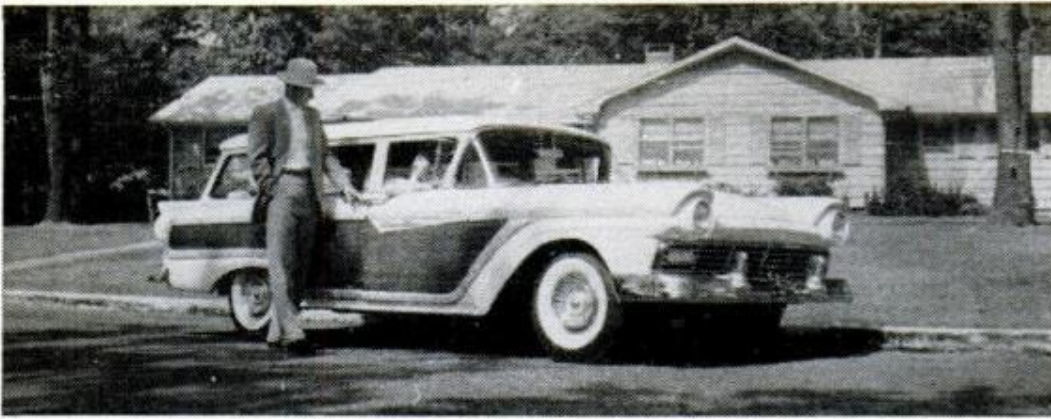

After a short time in mail order, Sambati soon had a beautiful home with all the luxuries of a successful businessman.

He figured that a small mail order business might provide a temporary income to support his family until he got back on his feet. His first step was to obtain a franchise from a large wholesale mail order firm which supplied him with all the necessary catalogs and mailing literature. It wasn't long until his spare-time venture blossomed into a booming enterprise. Drawing a small salary and pouring the rest of the profits back into the business, he soon had others working for him! Today he owns a large retail store, his own warehouse and a beautiful home with all the luxuries of a successful businessman.

Sambati's story is typical of a number of men and women who began a small mail order business with absolutely no previous experience, and made a huge success of it. These 'little' people are quietly pocketing big profits every day—many content to keep the business small . . . spending an hour or two each day in the privacy of their own home. No bosses, time clocks or small pay envelopes. No door to door selling, in fact, you never even meet your customers face to face.

Yes, a small one-man mail order business is ideal for anyone wanting a chance to gain financial security and independence. Yet thousands try mail order each year and fail, simply because they don't learn the few simple secrets of success early in the game.

Take the case of Bud Sheer who had been working for a theatre in a small New Jersey town. With only a few hours spare-time to spend each morning, he tried mail order to supplement his regular income. Like many beginners in this field, Sheer was faced with the problem of finding good mail order items which would have a high mark-up and repeat sales potential. But the biggest obstacle was the expense of printing a catalog.

Then he heard about the A. J. Statile Co. of Hillsdale, New Jersey — an organization set up to aid the small mail order beginner.

He wrote to A. J. Statile Co. for full information, sent in his application for a franchise and within a short time the cash began rolling in. Today Bud Sheer *owns* the theatre he once worked for. Sheer attributes his success in mail order to the A. J. Statile Co. Actually, the theatre he owns has become a side investment.

He still uses the beautiful 300 page mail order catalogs supplied by A. J. Statile Co.

How does the Statile Co. help the beginner get a sound start in mail order? Very simply. Just as Henry Ford made automobiles within the reach of the general public—by mass production and large volume.

Let's take a few specific examples:

(1) All franchised dealers of A. J. Statile are offered ready to mail catalogs and sales literature. Each mailing piece has the dealer's name and address printed right on it. By printing millions of catalogs, Statile is able to offer these at a fraction of their regular cost. The artwork and layout costs for these catalogs would run into thousands of dollars for the beginner if he were starting from 'scratch'.

(2) Since all mailing material and catalogs contain your name and address, all orders come directly to you. Yet you don't have to invest one penny in inventory. All merchandise is stocked for you. In fact Statile has over \$3 million dollars worth of mail order merchandise at your disposal.

(3) All packaging and shipping is done for you. You simply send a shipping label to Statile together with the wholesale cost of the items, and the merchandise is shipped directly to your customers under your own shipping label.

(4) A consultation service is provided to answer any questions you may have. You receive a secret list of over 100 national magazines which run free ads. You'll be shown how to obtain free publicity on your own mail order items. In addition, you obtain trade names and addresses of over 150 other mail order wholesalers who drop-ship top mail order items for you. You'll also be given all the government laws and regulations pertaining to a home operated mail order business. These laws are a 'must' for all beginners.

All this valuable information is covered in the Statile Mail Order Survey which every new franchised dealer receives from Statile before they begin. Formerly sold for \$25.00, this survey has become the 'bible' of the trade. Mr. J. M. of Baltimore, Md., writes, "To tell the truth, all the information in regard to obtaining free ads is alone worth the \$25.00 I paid you . . ." J. D. of Kalamazoo, Mich.,

states, "Just a personal note to say I am most satisfied with my \$25.00 investment. Your sales plan is simple and well organized . . ." These are only a few of the many testimonials received praising the Statile Mail Order Survey.

(5) The catalogs and mailing literature offered by Statile Co. cover every conceivable mail order item. You select the field you are interested in . . . **BABY ITEMS, TOYS, APPLIANCES, VITAMINS, BOOKLETS AND**



The thrill of receiving money in your morning mail is one you'll never tire of.

MAIL ORDER COURSES, you name it, Statile has the catalog or mailing piece. Select your market, order your mailing literature and you're in business.

(6) You'll be told how to compile your own mailing lists—and this is the most important part of your business. Many a beginner has fallen by the wayside simply because he mails his catalogs to a poor list of names. Suppose, for example, you offered a beautiful scale model of a 40' Chris-Craft cabin cruiser by mail. You would probably make your mailings to boating enthusiasts and the chances are that nine times out of ten your mailings would show a loss instead of a profit. How would Statile help you solve this particular mailing list problem? He would show you where to get the names and addresses of *actual owners* of 40 foot Chris-Craft cabin cruisers! Surely every owner would like to have a scale model of his own boat. Strange as it may seem, such a mailing list is available to anyone. The secret is where to find it. This is just one example of how an experienced mail order expert giving you personal advice, may mean the difference between success and failure!

This same method of obtaining selective specialized mailing lists may be applied to practically any market . . . selling baby items to new mothers, selling toys to young children, etc., etc.

So much for starting your own mail order business. Now, a word of caution. **OBTAIN YOUR MAIL ORDER FRANCHISE FROM A**

REPUTABLE MAIL ORDER FIRM. Unfortunately, during the past few years a number of ads have appeared in newspapers and magazines offering to start people in mail order. The ads are grossly misleading. Many imply that you can become a millionaire over night if you use their catalogs. Beware! Particularly if they operate their own mail order business direct to the consumer. These firms compete with their own franchised dealers! They could just as well mail all the catalogs themselves. They don't need you.

Other shady firms fail to drop-ship your orders promptly, thereby losing customers for you. In mail order, prompt shipment is an absolute requirement for a successful operation.

Deal only with firms whose business is preparing catalogs and shipping merchandise. They operate on a strict wholesale basis for franchised dealers exclusively. Such a firm is the A. J. Statile Co. Letters from successful franchised mail order dealers speak for themselves. A woman from Milwaukee writes, "It has been better than my expectations." A gentleman from California states "we are quite pleased with the response we are receiving." Another man from Wisconsin writes, "To say the least, I am more than satisfied."

Yes, a small mail order business offers you an opportunity to earn a second income, or—if you work at it in earnest, a chance to strike it rich. The young housewife in St. Louis may be content to make an extra \$20.00 a week . . . the office worker in Los Angeles may be aiming for \$150.00 weekly full time business . . . and the ambitious schoolteacher in Newark may reach \$20,000.00 a year. What is your objective? Set your own goal, pick your own hours, and the sky is the limit.

Even a government report stated that a number of the most successful one-man mail order enterprises make as high as \$40,000 to



Big firms will carry all stock for you. They ship orders direct to your customers using your own shipping labels.

(Advertisement)

Your Own Catalogs of Top Mail Order Items!



• NAME BRAND GIFTS, BABY ITEMS

• CATALOGS OF TOYS, MERCHANDISE

• CORRESPONDENCE COURSES

A. J. Statile Co. will prepare your catalogs, write your sales letters, supply mailing lists and even ship merchandise for you, using your own shipping labels!

\$50,000 a year! But frankly, this is the exception rather than the rule. Most mail order operators are content to earn a comfortable living doing little physical work, but enjoying their work thoroughly! We don't say you'll be a mail order millionaire or another Sears & Roebuck, but if you're looking for a business of your own with financial security, the answer is mail order. If you've already tried mail order with little or no success, don't give up! Try to analyze what went wrong. Success comes only to those who keep trying and learn from their own mistakes. Again we emphasize, deal only with a reputable firm.

The A. J. Statile Co. has been in business for over twelve years.

They gladly furnish bank or trade references upon request. They are probably one of the largest mail order wholesalers in the country. Whether it be toys, gifts, vitamins or appliances—they've got it ready to ship under your label **WITHIN 24 HOURS!**

Firmly convinced that no other business offers the tremendous opportunities of mail order, A. J. Statile, president of the firm, is an outspoken advocate of the man or woman who wants to start in business for himself. As Statile puts it, "by all means, start your own business and start **NOW!** If you want a chance at security and financial independence make your choice mail order. There's nothing like it. Absolutely nothing!"

FOR FREE DETAILS

Mail coupon below — no obligation

A. J. Statile Co., Dept. 43 • Statile Building • Hillsdale 43, N. J.

Dear Mr. Statile:

Please send me complete **FREE** details telling me how I may obtain a franchised mail order dealership with your firm. I understand I am under no obligation and no salesman will call on me.

NAME..... AGE..... SEX.....

ADDRESS

CITY..... ZONE..... STATE.....

PREVIOUS EXPERIENCE, IF ANY.....

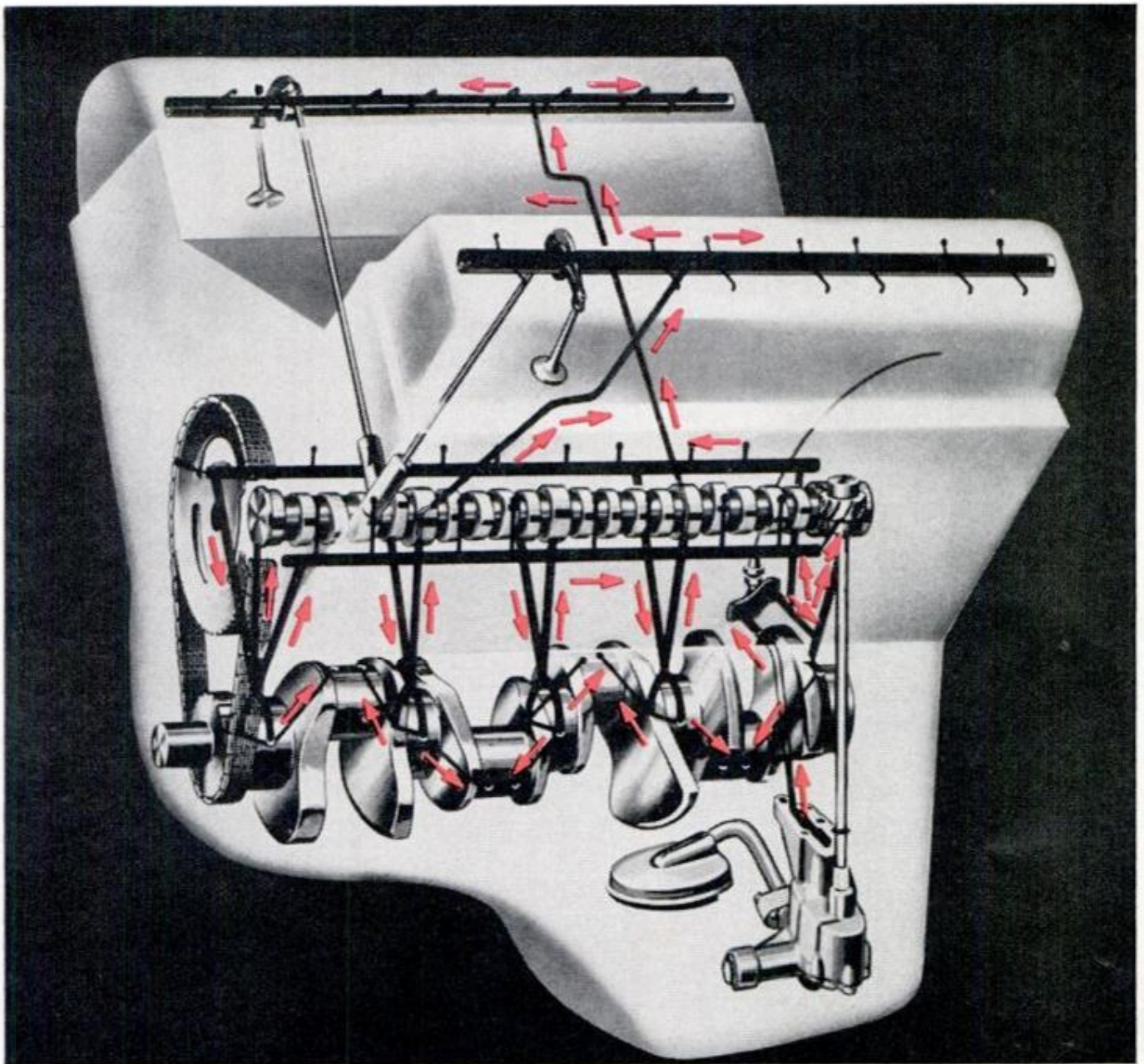

Cut Engine Wear

with the oil filter

that is engineered for your car

As you are well aware, different engines have different oil filter requirements. For this reason, it is important that you use the oil filter that is engineered for your car. Surest way is to specify AC. That's because AC makes oil filters that are tailored to the specific needs of each car on the road. They are carefully engineered to remove dirt and grime from the oil in your engine and to prevent harmful contaminant build-up. See your AC dealer and get the one filter that is specifically engineered for your car.

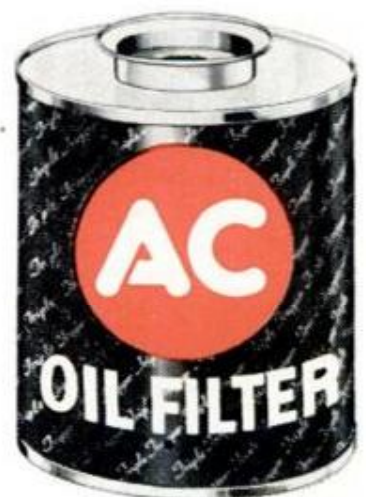

AC SPARK PLUG  THE ELECTRONICS DIVISION OF GENERAL MOTORS

OCTOBER 1962

84A

Материал, защищенный авторским правом

LOOK WHAT'S NEW IN '63 FORD TRUCKS!

NEW FRESH-STYLED PICKUPS— BUILT LIKE THE BIG ONES!

In axles, springs, frame, '63 Ford pickups have the same kind of durable design as big trucks. And you'll find new styling and a new feel at the wheel . . . new easier steering, new smoother shifting, new comfort!



New models! New engines! New reliability features throughout the most complete line ever offered by FORD

NEW! V6 and V8 Cummins Diesels cut engine weight 1000 pounds!

Up to 1000 pounds lighter than other Vee and in-line Diesels, new Cummins engines can add 50,000 ton-miles a year to a highway tractor's earnings. Compact and easy to service, the 588-cu. in. V6 develops 200 horsepower . . . the 785-cu. in. V8 produces 265 horsepower.

NEW! 8-door option for Ford's Econoline Van!

Now you can unload America's most popular Van from the street or curb, front or rear! Econoline saves loading time . . . saves on price, gas, tires and upkeep, too!



NEW! Transistorized ignition saves 3 out of 4 ignition tune-ups!

Electronic breakthrough—Perma-Tuned ignition! Transistors relieve points of heavy current, keep plug voltage high. Points and plugs last far longer; starting is easier; performance is better. No condenser to fail. Optional on Super Duty V-8's.

NEW! City-size Ford Diesels —4-cylinder, 6-cylinder!

New 330-cu. in. Diesels for tilts and 89" BBC models! New 220-cu. in. Diesels for parcel delivery units! In typical city operation, they can give twice the fuel economy of comparable gas engines!



NEW! Low gear synchronized for easier downshifting!

Only from Ford! Standard 3-speed transmissions in '63 Ford pickups and Econolines are synchronized in all forward gears. You can downshift to low while moving without gear clash. Helps maintain momentum, cuts chance of stalling in heavy going. Reduced stress extends gear life, too!

NEW! Over 30 major reliability advances!

New durability in big and small components. Added corrosion resistance in bodies! New weather-sealed electric connections! Lifetime lubricated speedometer cables! All to give you more trouble-free trucks—at Ford Dealers' now!

NEW 89" BBC LINE CUTS LENGTH, ADDS MANEUVERABILITY!

Priced between conventionals and tilts, new short "N" models range from 11,000-lb. GVW to big 76,800-lb. GCW. Both single- and tandem-axle series offer wide choice of Diesel as well as gaso-line engines.



PRODUCTS OF  MOTOR COMPANY

FORD TRUCKS

**For
Outstanding
Reliability &
Durability**

Get Lucky

the taste to start with...the taste to stay with

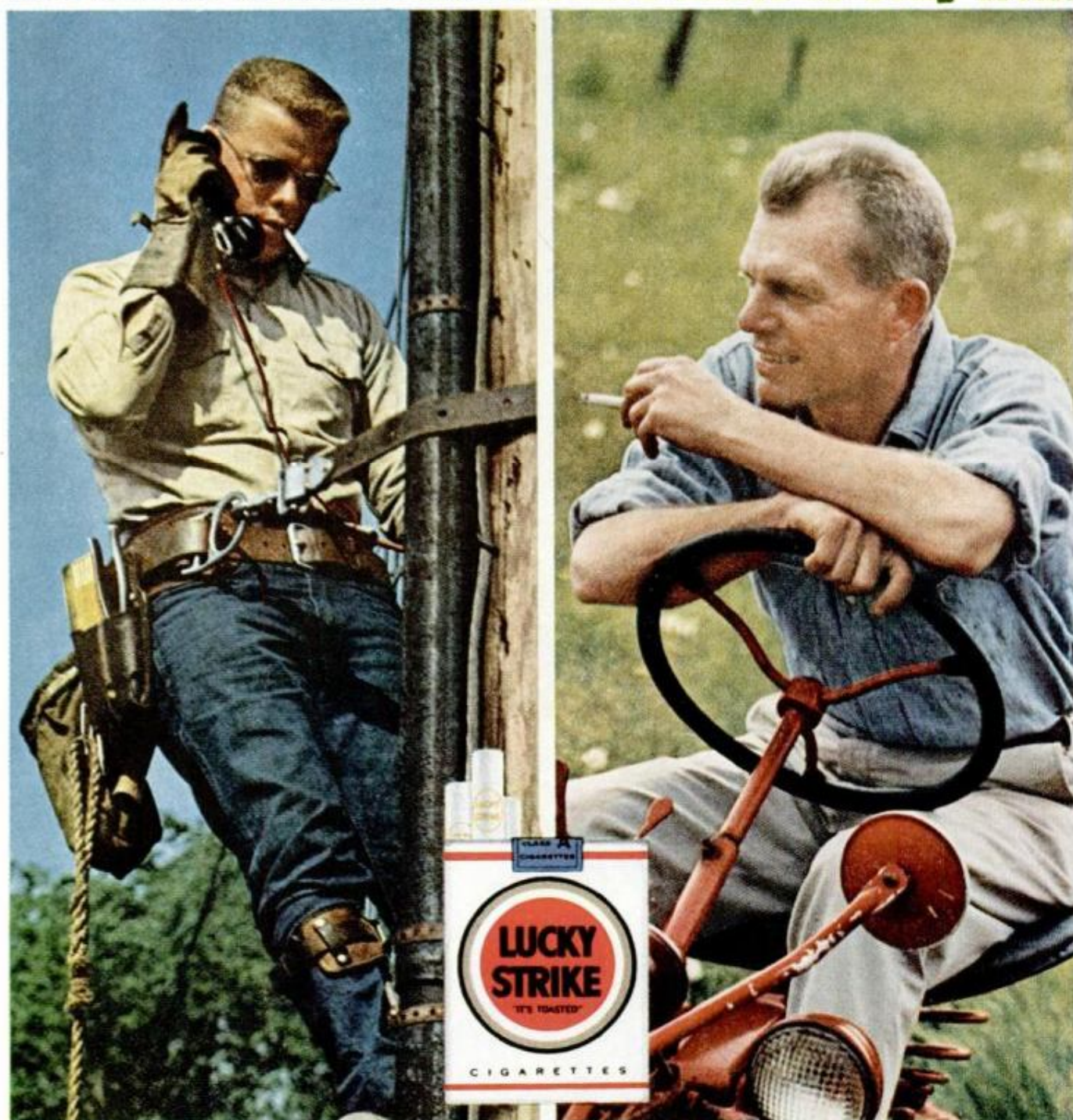

The taste of a Lucky spoils you for other cigarettes. This famous taste is the best reason to start with Luckies...the big reason why Lucky smokers stay Lucky smokers. How about you? Get the taste you'll stay with. **Get the fine-tobacco taste of Lucky Strike.**

© A. T. Co.

Product of *The American Tobacco Company* — "Tobacco is our middle name"

Buick Riviera

**POPULAR
MECHANICS**

OCTOBER

1962



BUICK'S RIVIERA packs a 340-horsepower wallop, has a 117-inch wheelbase frame under its razor-edge body

The Longer, Livelier '63s

What They'll Be Like to Live With

By Jim Whipple

AT FIRST GLANCE it might seem that the motto of those who styled the 1963 cars was "let's not be too different."

Almost everywhere you look, there's a T-Bird style roof, perched on a comfortably rounded-off rectangular body that spells GM styling.

But a second, closer look reveals the beginning of two striking new styling trends.

One trend substitutes creases for chrome to achieve a crisp silhouette reminiscent of the Rolls-Royce razor-edge school. You'll see it on Buick's Riviera, in the roof and rear quarter panels of the new Chryslers,

and on Dodge's compact Dart (which used to be called the Lancer).

Frankly, we think that razor-edge body lines might, in a year or so, sweep the industry as completely as the late, unlamented fin and wrap around windshield, both of which have finally been laid to rest in '63.

The sharp-edged bodies make more styling sense because they appear functional; the creases come where you have to fold the metal anyway. And after all, what did fins ever do except provide a breeding ground for monster tail lamps?

The second interesting trend, still in the

CORVETTE STING RAY, a true sports car, has marine-life look to new fiberglass body, plus "swing" rear axles



Material, designed by the author's firm



DODGE DART and Valiant looked alike, were sized alike in 1962. For '63 (above) they share slant Six engines, windshield, suspensions and drivelines but have different bodies. Valiant's wheelbase is 106, Dart's 111 inches

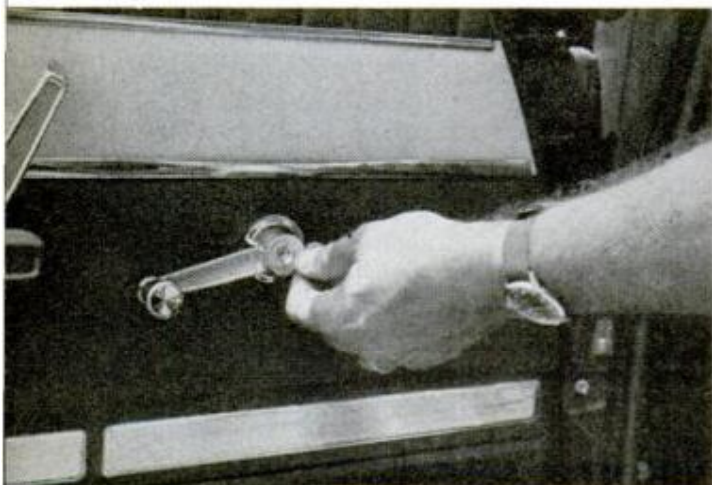

WINDOW CRANKS on Dart, Dodge, Plymouth and Valiant have screws that lock in nylon threads

early stages of gestation as it appears only on two advance-look cars, might be called marine life aerodynamics. It is embodied in the fish-like curvature of Studebaker's Avanti and the new Corvette Coupe.

Most of you have already seen the Avanti, and after you've had a chance to drive it, you'll probably agree that it's a T-Bird with some real hair on its chest. Although it lays no claim to being a full-fledged sports car, among American cars in production trim, its roadability is second only to Corvette's. But for those seeking really capable competition machinery, 1963 may well be remembered as the year of the Sting Ray. That's the fishy title Chevrolet has hung on its startling, new swing-axle Corvette. And in this car, you'll see the most exciting mechanical developments of the year—a year when most engineering departments have been busily refining previous mechanical breakthroughs. More on this car—and this point—later.

As styles, both the razor-edge and the marine life looks are the exceptions for 1963. Most models lean to the conservative, and many have even abandoned the sculptured side panels that provided some wel-

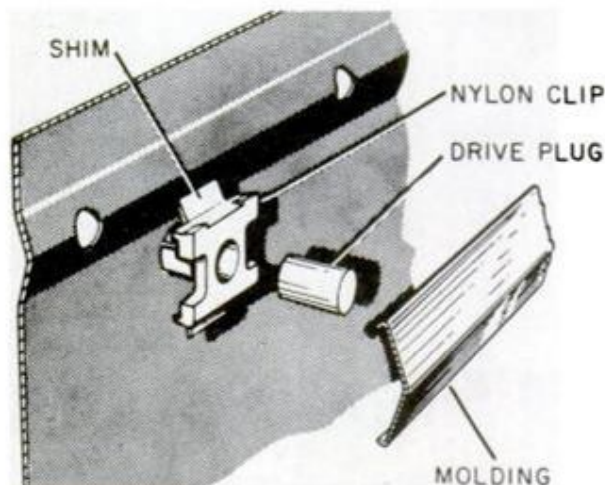

RUSTPROOF, rattleproof nylon clips replace wire in fastening trim moldings on all '63 Chrysler cars

come individuality on '61 and '62 models. Instead, the bread-and-butter models of the '63s use broader, flatter expanses of side paneling.

There's a plus to this approach which stems from its simplicity. On some cars, such as Pontiac's Grand Prix, the smooth flanks lend a touch of elegance. Then, too, the plainer panels should be easier, perhaps even cheaper, to bump out at the body shops.

With a few notable exceptions, the major mechanical news for 1963 involves improvements made in the radical innovations of yesterday. A case in point is the 1963 version of the Pontiac Tempest's independent transaxle rear suspension. The new version is no different in concept, not too changed in form, but at least 100 per cent improved in behavior.

Compliant Suspension

As another example, Ford has switched from a mechanical link plus rubber bumper to a simpler and equally satisfactory spool-type rubber bushing at the front end of its rear leaf spring. This should provide improved compliance or "give" where it is



RAZOR-EDGED styling on roof and rear quarters of '63 Dart, right, contrasts with rounded lines of Valiant, left. Dart is longer overall by seven inches which makes for a bit more legroom and also more trunk space



CONVERTIBLES are available for the first time on all Chrysler Corporation compacts. Above is Dart's on 111-inch wheelbase with choice of manual or automatic top. Front seat may be either three-place bench or buckets

needed for a more comfortable ride.

By a process of evolution, Ford has also come up with a new manual transmission—standard on all Galaxies and Fairlane V8s—which is the first three-speed transmission with synchromesh on all forward speeds in the U. S. auto industry. It will be a pleasure for Americans to slip soundlessly into low after half a century of gear-grating downshifts.

Alternators also come into their own in '63. After weathering their growing pains on Chrysler cars (and credit is due the pioneers), these battery savers will appear on all GM cars except Corvair, all Studebakers and Lincoln Continentals. Ford, Mercury and the Ramblers are sticking to conventional DC generators at this writing.

Long Time No Lube

By the end of the 1963 model year we should know whether the widely promoted "self-maintenance" features of the new cars have really been a boon or a bust. There's no doubt that the trend toward long, interval lubrication is snowballing, as Chevrolet, currently selling three out of every ten automobiles, joins Ford,

Chrysler and other GM divisions in eliminating the 1000-mile lube stop.

A greater use of galvanized body panels and more dipping in primers in '63 should also help to reduce the rusty lacework time has been weaving into aging body parts in previous years.

The Prodigals' Return?

The only totally new engine for '63 is the big Chevrolet's 230-cubic-inch inline Six, of which more later. For the rest of the '63s the much talked about reopening of the horsepower race is more publicity than reality, at least on bread and butter models.

The climb in engine displacements beyond the 400-cubic-inch mark is by way of extra cost (and probably limited production) options rather than basic engines.

Such policies create the image of power for the maker's product without forcing the customer into buying it.

Thus, happily, manufacturers are not repeating the mistakes of the early 1950s when buyers were forced into a rigid choice between an underpowered Six (if the maker optioned one at all) or an over-carbureted V-8 which required dual ex-



PONTIAC'S TEMPEST LeMans convertible, above, has new grille and sheet metal on unchanged body shell

NO LONGER will Tempests do the Twist when cornered too hard, thanks to completely revised independent rear suspension, right, which has new geometry that controls rear wheel "steering" tendencies

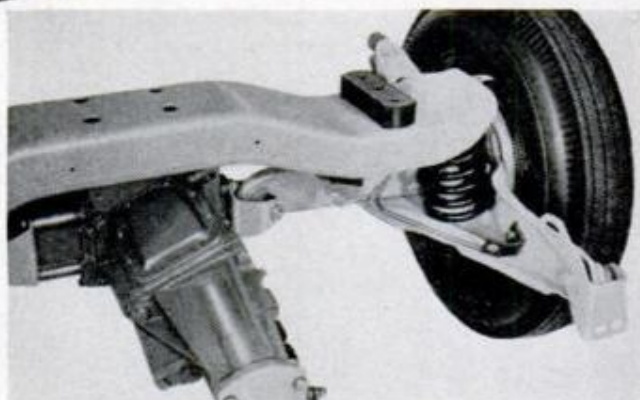

hausts and gobbled up lots of premium fuel. In '63, you can order every car that has a "hot one" (such as Pontiac's Bonneville) with a "cool," regular-gas, two-barrel-carburetor engine.

It would be foolish to deny that in the U.S., styling helps sell cars to men just as fashion sells clothes to women. After all, isn't auto styling about 9/10ths personal preference and 1/10th aerodynamics?

But what keeps you happy with your car after the honeymoon is design, the concept of space relationships inside and outside

the car. It is design, the total sum of all the parts, that determines how straight and comfortably you may sit, how much or how little you must stoop to enter, how easy it is to reach the controls—in short, how pleasant your car is to live with.

In the area of livability, the '63 models continue the encouraging swing back to more sensible interiors. Driver vision has been improved, even though windshield glass areas have been reduced. This is particularly true of Studebaker's Lark and the senior GM lines.



BUICK SPECIAL has rear quarter panels (left) that extend four inches beyond actual end of car to add unusable length. Skylark sport coupe is shown below

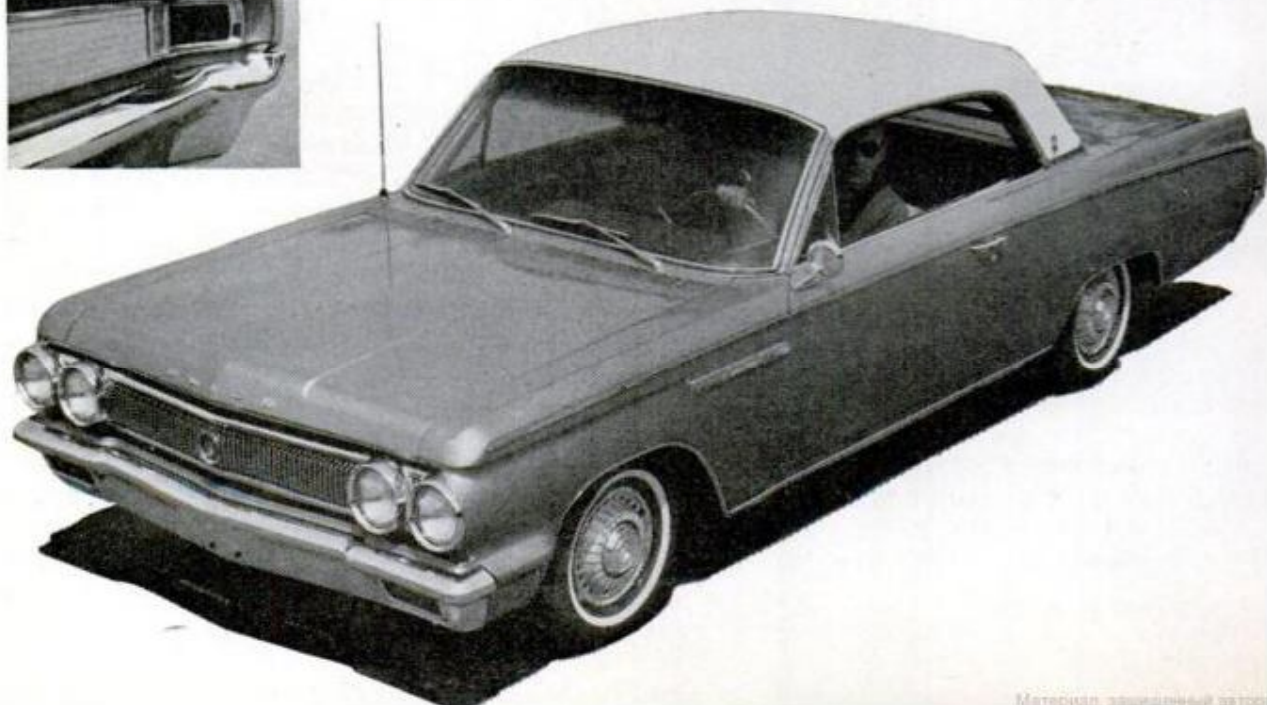



COMET, like its companion compact Falcon, gets a convertible for '63. On 114-inch wheelbase, it will have power operated top, bucket-type front seats and a choice of the 85 or 101-horsepower six-cylinder engines



OLDS F-85 (above) has same inner body-frame structure and greenhouse as '62 model, but fenders, doors, panels are new. Instrument cluster for Chevy II NovaSS (below) has temperature, oil pressure, amp gauges

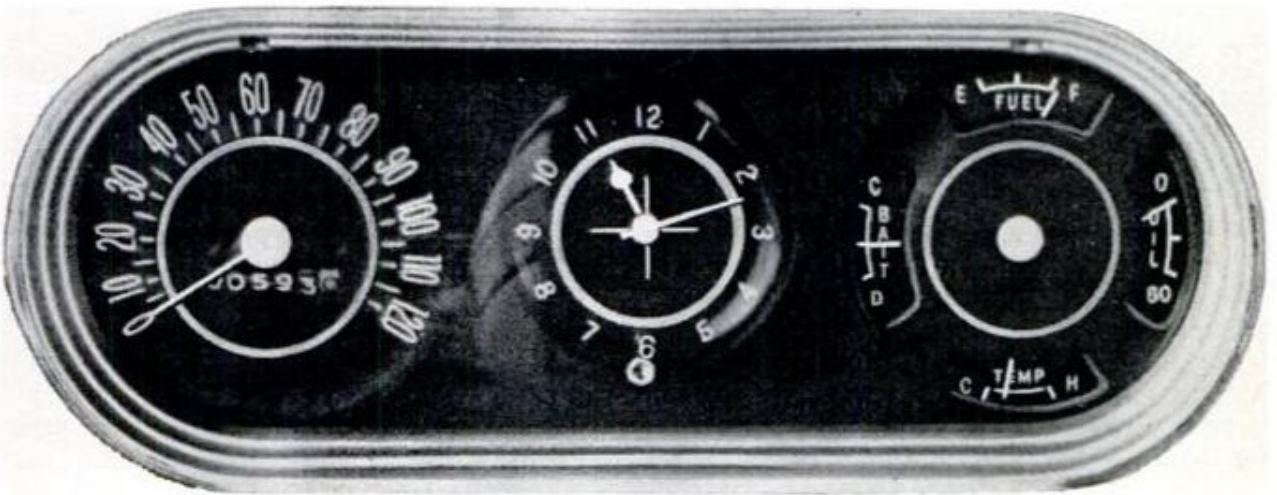

We second this happy move away from the giant solariums of a few years ago where driver and passenger perspired helplessly while squinting through distorted corner sections.

Wherever body shells have been completely redesigned, as on the '63 Valiant, Dart and Rambler, door openings have been made larger and cleaner, with no more doglegging at the corners and fewer slanting center pillars.

In general, the '63s have stretched a bit, with increases in over-all length (see page 102) ranging from fractions of an inch up to six or seven inches. Unfortunately, these increases do not seem in all cases to

have been translated into extra legroom.

Several transmission tunnels have been reduced due to relocating the engine farther forward, as on the new Olds and Cadillac. In some quarters, this move is considered a mixed blessing, because of the potentially adverse effects on handling.

One truly welcome feature reappearing on several '63's are honest-Injun gauges for oil pressure, generator charge and temperature, in place of the idiot lights which tell you you're in trouble only after you have already arrived there. To date, these gauges show up on only a few 63s, such as some of the Chevy II and Mercury lines, but we can hope that they constitute the



LARK'S ingenious sliding roof is standard on all station wagons; they call it Wagonaire. Panel slides rearward to meet back glass



FOUR-DOOR Larks are on 113-inch wheel base, are very easy to enter



METEOR takes to the air, but two-way stretch of its "compliance" front suspension helps soak up shock

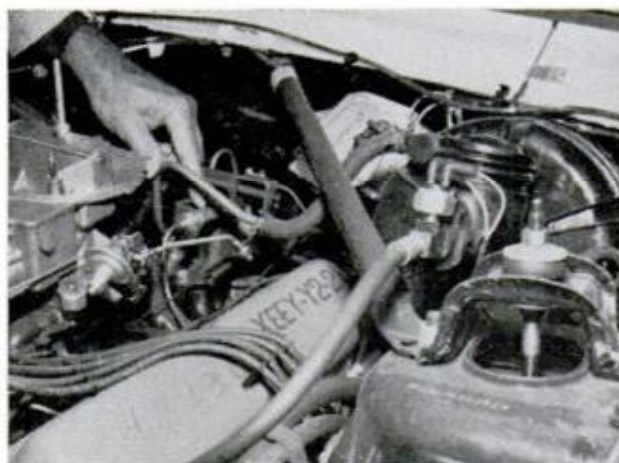

PISTON, on Meteor V8, senses pressure rise as power steering is used, opens throttle to prevent stall

start of a long-awaited counter-trend.

Within the over-all framework of change that makes up the 1963 automotive scene, there are two cross-currents worth special mention.

Boom in Buckets

The first is the battle of the bucket seats, manifested by a seemingly inexhaustible flood of two-door, divided front-seat coupes and convertibles appearing in almost every line. These cars now range from gussied-up two-door sedans like Falcon's Futura, to genuine special body jobs like the Avanti and Buick Riviera.

It all started, of course, with the four-passenger Thunderbird introduced in 1958. After letting T-Bird corner the "personal car" market for four years, the competition has come alive with a vengeance.

With the entry of Riviera and Avanti, as well as Pontiac's sleek Grand Prix, the elegant Olds Starfire and Studebaker's restyled Hawk, a real effort will be made to

take some of the play from the 'Bird, which sold over 37,000 cars in the first six months of 1962.

The second big trend running through the industry for 1963 is a reshuffling of car names, prices and sizes that we'll call, for lack of a better term, the size shakeout.

For the past three model years, the industry has been tossing trial balloons at the American car buyer in an effort to determine "how small is compact?" or, in other terms, what sizes of automobiles and what performance levels could be sold and in which price categories.

Size Realignment

After this feeling of the public's pulse, the industry has come up with a series of size changes for '63 that add up to a market realignment based on the truism that most people expect to pay more money for a bigger car. Or (if you flip the coin), that smaller cars should cost less money. Now, the lowest-priced cars will generally be, as



RAMBLERS have completely new unit bodies for '63. Shown above is Classic four-door. Although wheelbase has been upped from 108 to 112, over-all length has been reduced by over an inch. Windows are curved



STATION WAGONS have all-new bodies too, but there's still a trace of the dipped roofline that's been a Rambler wagon trademark since 1955. The three-seat model, above, continues to use a swing-out rear door

in the past, the smallest. And all "Big Three" cars are again full-sized.

That's the general picture. Now, we'll switch from wide angle to close-up lens and see how the engineering and design changes have affected each car.

Valiant, and its Chrysler Corporation stablemate, Dodge Dart, are the most changed cars in the lower-priced group of compacts. Neither resembles the other or its 1962 predecessor.

The only sheet metal they share are some inner structural parts, the windshield and cowl area and the station wagon bodies. Only body parts retained from the '62s are the floor pans and body sills that form the frame areas in the unit construction bodies.

Valiant looks so different that you'd think it's road behavior would be quite a fresh experience. Actually, it is little changed, primarily because Valiant uses the same mechanical components as in '62. These include the torsion bar suspension at front, leaf springs in the rear and

a choice of 101 or 145-horsepower engines. Wheelbase is 106, down half an inch, while over-all length has gone up two inches from 184 to 186.

Weight change is slight, so that performance of the standard 101-horsepower engine is about on a par with Falcon's premium 101-horsepower engine. But Valiant's extra-cost, 145-horsepower slant Six should out-perform all of the smaller compacts except Chevy II and Rambler by a wide margin.

Both the Valiant sedan and station wagon are more rigid structurally. We drive-compared these cars against a like-new '62 Valiant and found that the slight body shake encountered on rough roads in the '62 model was absent from both of the '63s.

Seating position and the new windshield has improved forward vision and the '63 wipers now work in parallel, overlapping their strokes to clean a center area that was a dangerous blind spot on earlier models.



PLYMOUTH gets new rooflines, bulkier looking body that's three inches longer.

1962

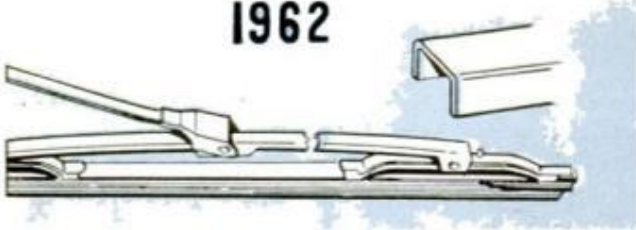

1963

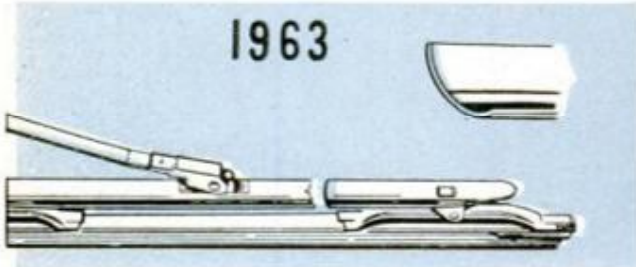

AIRFOIL shape of wiper blade bar on Chrysler Corporation cars presses it to windshield at high speeds

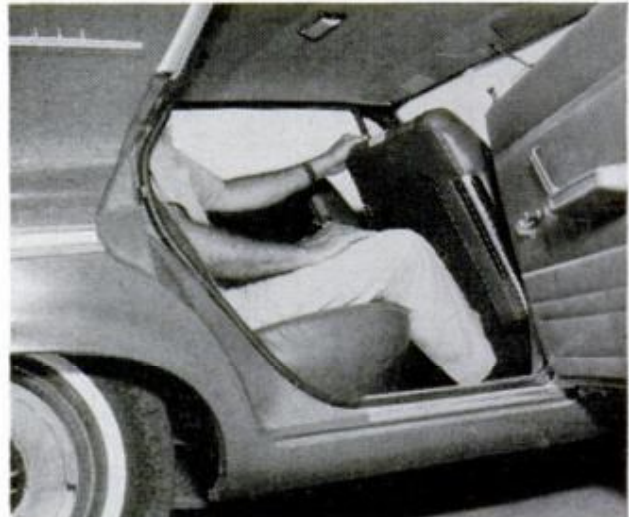

LEGGROOM in Plymouth's back seat is as good as Ford's or Chevrolet's despite shorter wheelbase

The three-speed automatic transmission is still controlled by a set of pushbuttons on the left of the instruments, leaving Valiant and Dart the only cars in the compact field to have pushbutton control (Rambler returns to steering column lever control for '63). Valiant's parking lock lever combined with the automatic transmission control setup has been retained, but the foot-operated parking brake has been replaced by a cane-type pull handle under the panel. Plymouth engineers felt that a hand brake was more convenient for manual transmission operation as you synchronize the release of that type of parking brake when the clutch is engaged for up-hill starts.

Valiant's station wagon is cleaner with more cargo space between the rear seat and the enlarged tailgate opening. A new convertible is available with bucket seats in the Signet series as a four-passenger car, or with a bench-type, conventional front seat for five-passenger capacity in V-200 series. Either model comes with manual, spring-counterbalanced top or with automatically-operated top.

Dodge Dart, successor to the Lancer,

shares engines, transmissions, suspension and drive train with Valiant, but has a five-inch longer wheelbase (111 vs. 106) and a ten-inch increase in over-all length (196 vs. 186). It's also seven inches longer than the '62 Lancer. This extra length has given the car a slightly smoother ride, an inch and a half greater legroom in the rear seat and 5.4 cubic feet of added trunk space.

Like Valiant, Dart has an 18-gallon fuel tank, up four gallons from last year's tank capacity. Unfortunately, both cars still use the same horizontally pitched fuel filler pipe in the left rear quarter panel that has meant spilled gasoline for the past several years for Lancer and Valiant owners. This is the price paid for locating the spare tire under the flat luggage compartment floor—a design that does help to produce a larger, more useful trunk.

Custom Fit Your Seating

On its bucket-seated convertible and GT hardtop, Dart has front seats that adjust on their bases. By loosening bolts you can raise or lower, tilt forward or backwards, as well as move seat fore and aft on its tracks. The new Dart also shares with



CHEVROLET has smooth new sheet metal over unchanged body shell and flaring fin low on body that's much like '61-'62 Cadillac's. Four-door hardtop has a brand new roof that's slimmer. Entire car has a hint of the razor-edged styling seen on Buick Riviera

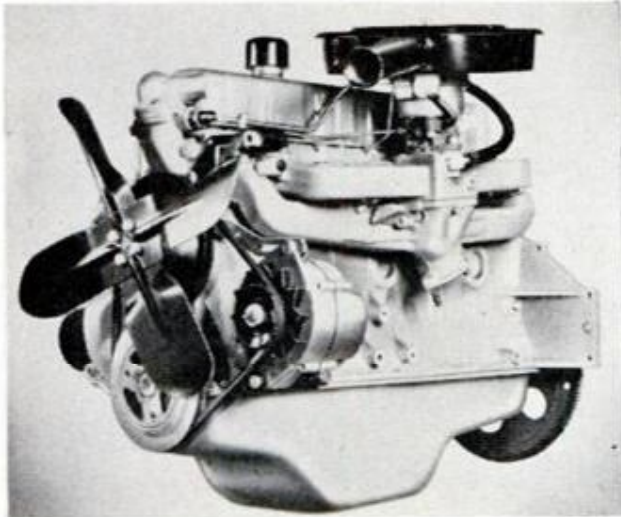

NEW SIX for '63 Chevrolet has seven main bearings, short stroke (3.25 in.), is 150-lbs. lighter than '62 Six

Valiant such practical improvements as rustproof nylon clips that fasten 80 percent of the exterior trim and nylon-threaded center-screw fastenings for all window cranks; these strengthen the attachment and can be removed by common Allen-type insert wrenches.

Instead of pushbuttons and vacuum servos to control air flow dampers, the new Dart uses three simple push-pull knobs to control the heating. Direct, ram-air ventilation for summer cooling is through hinged doors below the instrument panel; these replace the remote control dampers on the 1962 Lancer.

Rambler. After seven years of styling and restyling—fins came and fins went—Rambler has come up with an all-new body for its Classic (108-inch wheelbase) sedans and station wagons.

This car was designed and put into production while George Romney, the apostle of "bigger on the inside, smaller on the outside," was still heading American Motors, and is a perfect reflection of his philosophy. It is 1.2 inches shorter, 1.1 inches narrower and 2.9 inches lower, yet has lost only fractions of an inch here and

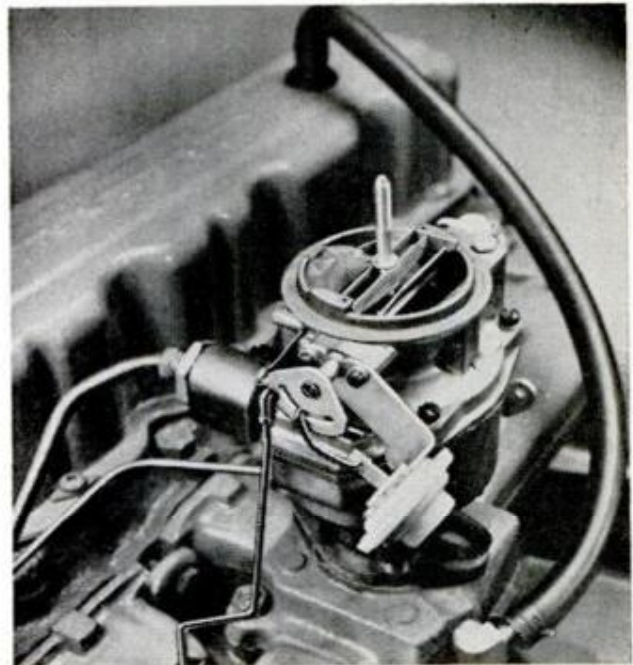

CARBURETOR on the new Chevrolet Six has automatic choke with heat-sensing unit next to exhaust

there from an interior that's noticeably larger than that of the average compact.

Wheelbase has been increased from 108 to 112 inches, which has enabled the designers to make a useful enlargement of the rear door opening to aid entry and exit.

Under-the-hood changes are few. The basic engine is the 127-horsepower overhead valve Six, while Ambassador models (they have more side trim strips, fancier interiors) are powered by the 250-horsepower V8 used in the past. Three-speed manual, overdrive and three-speed automatic transmissions are available with either engine.

A new and more readable instrument cluster is no longer flanked by pushbuttons on automatic transmission models, as the control has been returned to the steering column. There's no E-stick transmission available for the Classic yet; it remains an exclusive option for the Rambler American.

Suspension is coil spring all around as in the past, with ball joints in front (new in '62) and torque tube at the rear.

Rambler's American substitutes vertical for horizontal grille bars.

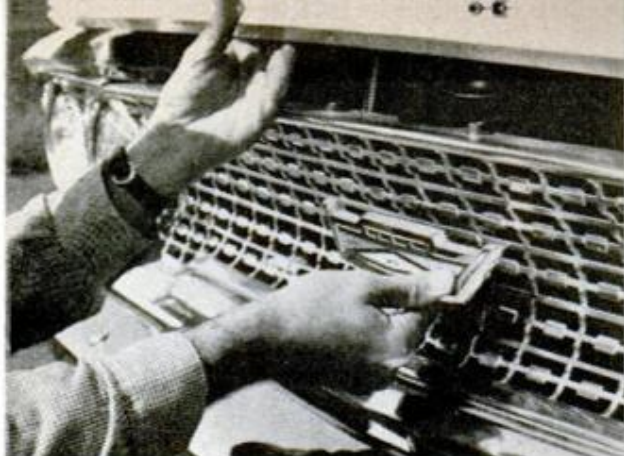

FORD'S new patterned grille has useful ornament that wins title of 1963's most accessible hood latch



GIANT tail lamp on '63 Fords outshines editor's size 7½ head (no trick shot), should give ample warning



DODGE'S whale-toothed grille swallows human hand in search of a relatively inaccessible hood latch



NEW STERN and rear window on six-inch longer '63 Dodge makes for neater, more conventional styling

Lark. Bob-tailed rear deck and broad grille for 1963 remind you of the '62 model, though a trim strip has been added to the deck and the grille's texture has been changed.

Above the hood and side panels, however, every piece of glass and metal has been changed. The roof is much flatter, all door posts and window frames have been slimmed and Studebaker has wound up with a car that's both easier to look out of and easier to look at from the outside.

Studebaker engineers have added a new water pump on Sixes and V8s, and a dual master cylinder braking system with separate hydraulic lines leading to front and rear brakes. A new aluminum housing removes 40 pounds from the Six's automatic transmission. All brakes are now self-adjusting, and as an option, you may have Avanti's power-assisted disk front and finned-drum rear brakes on any Lark Six or V8 model of the '63 line.

Airy Wagon

Lark has also switched to alternators across the board. On all station wagon models, Lark has come up with a refreshing innovation called Wagonaire. It consists

of a sliding roof panel that leaves the entire rear compartment third seat area open. Surprisingly enough, it's standard at no extra cost.

Chevy II, an all-new car in '62 gets a new radiator grille as its only significant appearance change. There's a new model hardtop called the Nova SS, with bucket seats and a floor stick control for Power Glide automatic transmission. Engineering changes include adoption of self-adjusting brakes and Delcotron alternators as standard equipment. The instrument cluster is changed to include space for a clock and, on the Nova SS models, a full set of gauges replace the idiot lights for alternator charge, coolant, temperature and oil pressure. Praise be, indeed, but why exclude buyers of sedans and station wagons who need and desire full instrumentation just as much as the sporty types who buy the bucket seat hardtop or the convertible?

Corvair. You may have difficulty spotting a '63 Corvair, which has changed only the front panel trim strip and tail lamps. Corvairs will have self-adjusting brakes. But as of introduction time, they will go with conventional generators, instead of alternators.



PONTIAC'S sleek Grand Prix shows how beauty grows when trim goes. Note over-under lamps

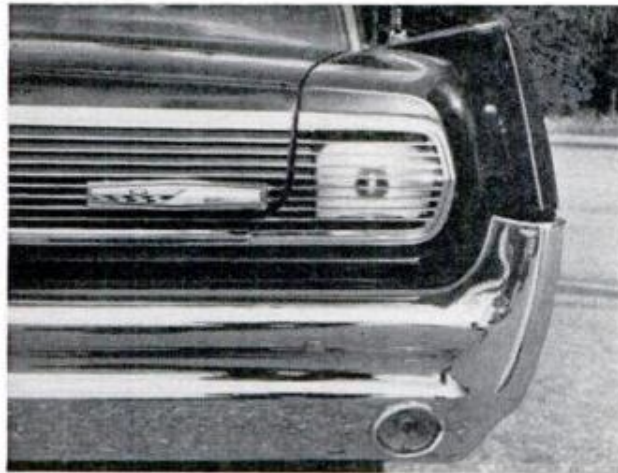

PEEK-A-BOO tail lamps on Grand Prix Pontiac are hidden behind extension of die cast trim bars on the rear of trunk. Other Pontiacs have more conventional, exposed tail lamps. All models share same bumpers

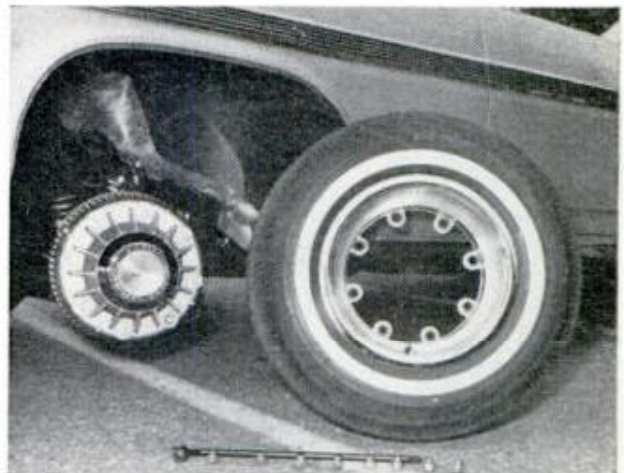

ALUMINUM hub and drum unit is optional on Pontiacs for '63. Wheel rim has eight steel tabs that fit over studs in face of drum. This feature makes for lighter wheels and cooler brakes less prone to fade



OLDSMOBILE Super 88 shown above, has plainer panels with a minimum of sculpture. Roof of four-door hardtop is new for '63. Starfire two-door hardtop, below, has unique concave-curved backlight

SPEEDOMETER drive cable on Oldsmobile runs in kink-free curve from instruments through left front spindle. It attaches to dust cap on hub, thus eliminating former complicated gearing and cable routing

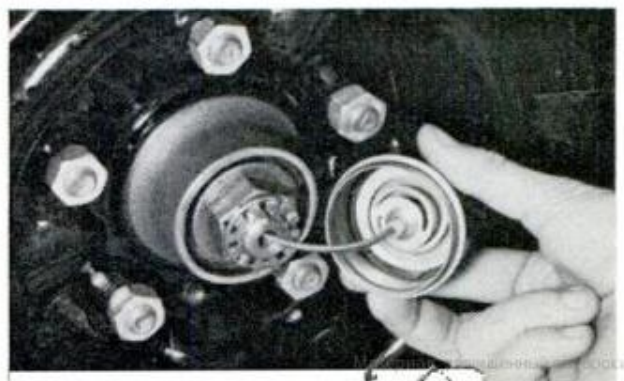
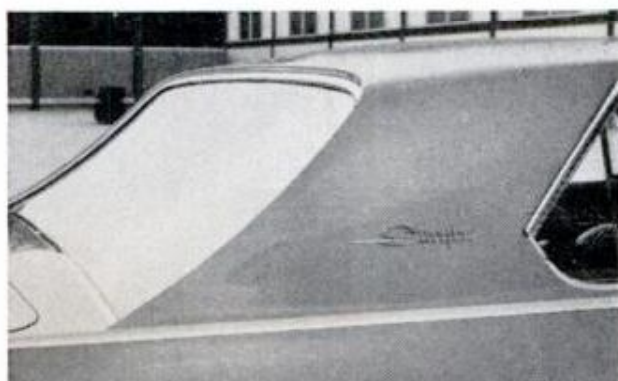



BUICK WILDCAT has grille and rear deck treatment distinct from other series. Turning lamp ahead of front wheel is new, is visible from the side

← **TILTING** steering wheel is optional on Buicks, Pontiacs and Oldsmobiles. Left hand at lever unlocks it



All popular options such as the four-speed manual transmission and the Turbo-charged 150-horsepower engine are continued. The Lakewood station wagon has been dropped, perhaps because it offered about half of the space available in a Chevy II.

Tempest, F-85 and Buick Special. Among the intermediate compacts, the most notable changes are the new exterior sheet metal on Tempest, F-85 and Buick Special.

Wheelbase and body shells remain at 112 inches on all three. Extending the sheet metal, primarily in the rear quarter panels beyond the rear of the trunk to fit extensions of the bumper gives a "false rear" increase in overall length of 3.7 inches on the Buick Special, 4.2 inches on the F-85.

By eliminating the sculptured gooves in body side panels, designers have made the cars look bigger—wider as well as longer. Actually, width is up 1.8 inches on the F-85 as a result of a flared rear quarter panel, while Tempest width is up two inches.

Tempest's length has been increased a full five inches—to 194.3 inches. However, three inches of this increase show up in additional and useful luggage space.

← **MERCURY**, on the other hand, offers option of same swing-away steering column seen on '62 Thunderbird

MOST NOTICEABLE new feature of Mercury is the reverse slope rear window, formerly on Lincolns

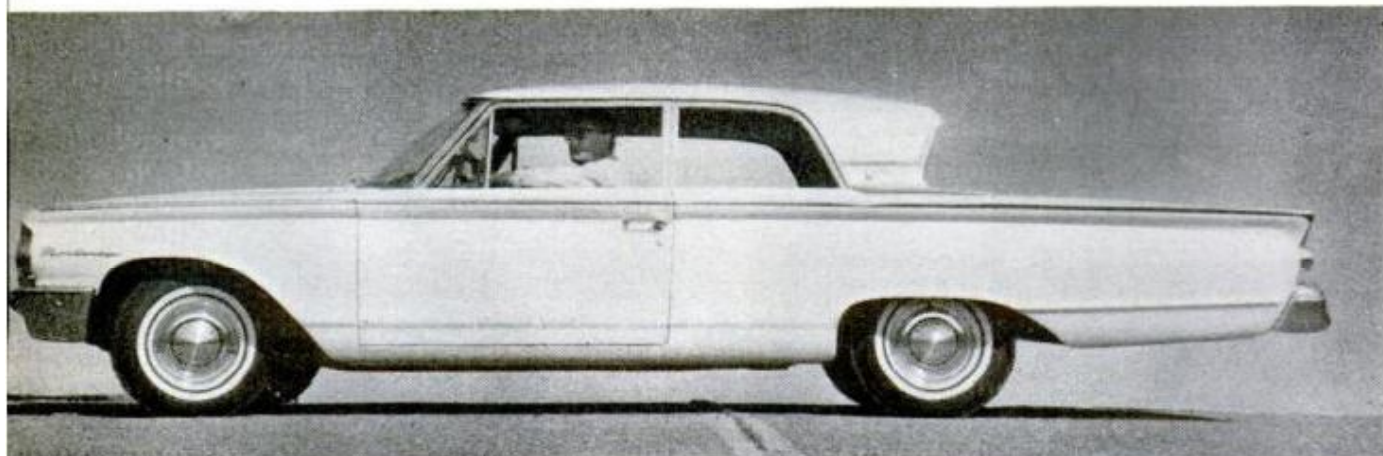
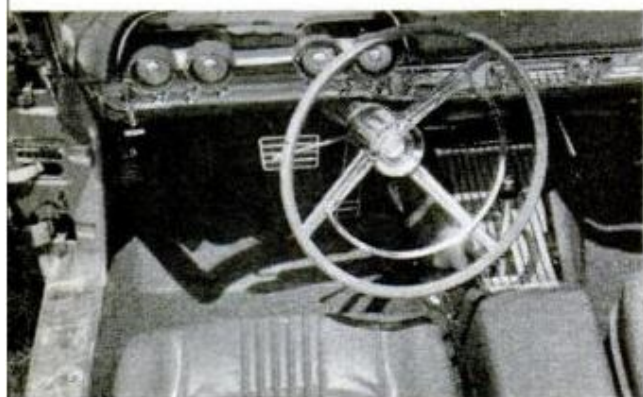



CHRYSLER 300 has an impressive new grille with the familiar crossed bars. Newport's grille is plain mesh

Weight has not increased appreciably, say engineers at Buick, Pontiac and Olds, as the extension of a few inches in overhang involves a relatively thin band of sheet steel. The whole stretchout of the B.O.P. compacts is somewhat like letting out the hem in your daughter's dresses as she mushrooms between sixth and seventh grades. And just as in certain growth periods in little girls, Tempest, Special and F-85 are beginning to lose that cute look which was a result of their small size.

Inside these three B.O.P. compacts, the passenger package size is exactly the same, and in some dimensions smaller than the Chevy II. Perhaps the most important practical result of the restyling, other than Tempest's larger trunk, are some really effective, full-depth bumpers for both Special and F-85.

Mechanically, F-85 and Special are little changed. They share new self-adjusting brakes, better insulated suspension bushings, and Delcotron alternators.

No More Stormy Walking

Tempest has undergone some interesting mechanical changes in its rear suspension.

An entirely new set of control arms are used. One is fastened to the differential for lateral location of the wheel; the other is pivoted on the body-frame sill for fore-and-aft location. Coupled with an inch increase in tread, the altered geometry of this new setup (coil springs are the same) has cancelled out the rear-wheel steering effect that had '61 and '62 Tempests living up to their names with some pretty stormy behavior on rough roads or when cornered hard. Now the rear end no longer "walks out" from under, creating a nasty oversteer condition. For '63, the Tempest's handling is predictable and pleasant.

The slanted, 195-cubic-inch, four-cylinder engine remains the standard powerplant for Tempest. For an optional V8, though, Pontiac has switched from the 215-cubic-inch aluminum V8, used on Buick

CRISP, uncluttered lines on this Chrysler New Yorker four-door hardtop are typical of the new Rolls-Royce-reminiscent, razor-edge styling. Only the windshield and inner body parts remain unchanged from 1962





BUICK'S RIVIERA is another '63 model displaying unadorned, razor-sharp lines. Riviera comes only as a pillarless two-door model, has bucket seats, center console and options some real leather upholstery

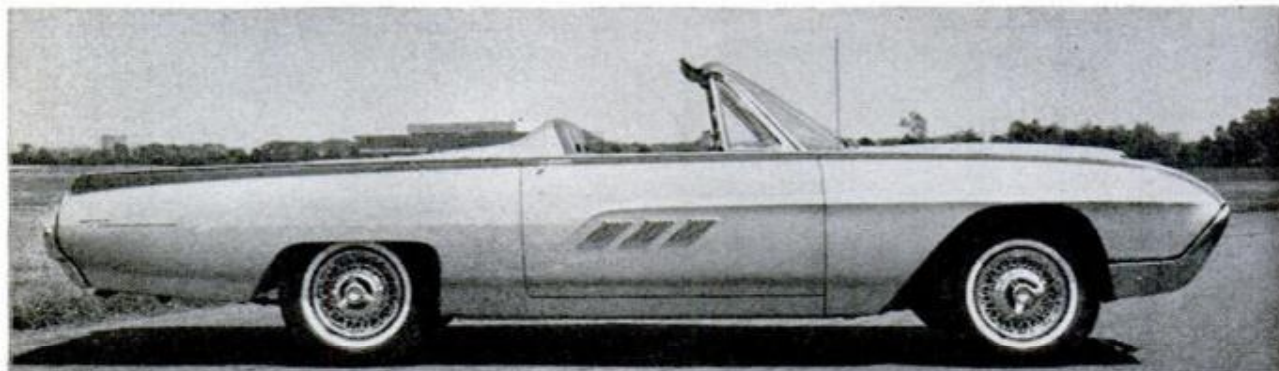

THUNDERBIRD, in contrast to Riviera, with which it will compete, sticks to rounder contours and its torpedo-like styling. Crease in front fender and dummy vent louvers on door are notable '63 styling changes

Specials, to a 326-cubic-inch version of Pontiac's big, cast-iron V8.

This engine was created by reducing the bore of the big engine from 4.06 to 3.75 inches. Its horsepower is rated at 264. Now that's a lot of muscle to put in a car weighing in the neighborhood of 3000 pounds, especially when it means 150 pounds more weight on the front wheels than in the already nose-heavy four-cylinder Tempest.

PM test-drove the V8 and found it to have a good deal more understeer than desirable. We recommend power steering as a must on this car.

Ford's Fairlane and Mercury's Meteor retain their 1962 unit bodies with wheelbases of 115.5 and 116.5 respectively. Added to both lines are four-door station wagons and two-door pillarless hardtops. The hardtops have more steeply sloped windshields and shorter greenhouse areas. Both Fairlane 500 and Meteor hardtops are available with conventional bench type or bucket type front seats. The buckets go with a fancy interior package called Sports Coupe on the Fairlane and S-33 on Meteor. Station wagons are available in Squire trim, that is, with imitation wood paneling on their sides.

Standard engine on both cars is Ford's 170-cubic-inch 101 horsepower Six. Although efficiently designed with minimum weight for their size, both Fairlane and Me-

teor need more power than the 156 foot-pounds of torque provided by the Six. But it does have hydraulic valve lifters for '63 to make it quieter.

As optional engines, both cars have the 221- and 260-cubic-inch light cast-iron V8s introduced in '62. Their horsepower and torque ratings are 145 horsepower and 216 foot-pounds for the smaller and 164 horsepower and 258 foot-pounds for the larger.

Full Synchro Transmission

Both V8s on either Fairlane or Meteor come with Ford's new, fully synchronized three-speed manual transmission which should be more attractive to many than the two-speed-and-torque-converter automatic. The smaller V8 with overdrive teams with the all-synchro transmission to make a very flexible power package. Like the other cars in the group, Fairlane and Meteor have self-adjusting brakes. With overall lengths of 197 inches for Fairlane and 202 for Meteor, they are the largest of the intermediates and have a bit more interior space than Tempest, F-85 or Special.

Comet, by virtue of its 114-inch wheelbase and 194.8-inch overall length, falls in the intermediate compact group. Mechanically, though, it is virtually identical to Falcon, one of the smaller of the compacts.

Biggest of Comet's 1963 changes is the



BONAFIDE BOMB is Corvette Sting Ray, above in its convertible version. Entire fiberglass body is new

DUAL HEADLAMPS set in pivoted body sections, may be closed (above) or opened (right) electrically



FASTBACK contours of the Sting Ray coupe, below, will be view that other motorists will see most of

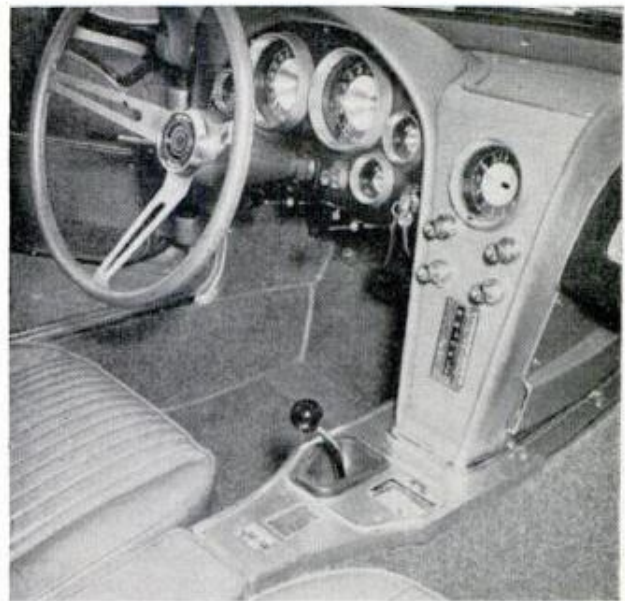

CORVETTE'S cockpit, right, is snug but comfortable. Rear wheels, below, move up and down independently as axles attach to frame-mounted differential via universals. Single leaf spring supports rear of car

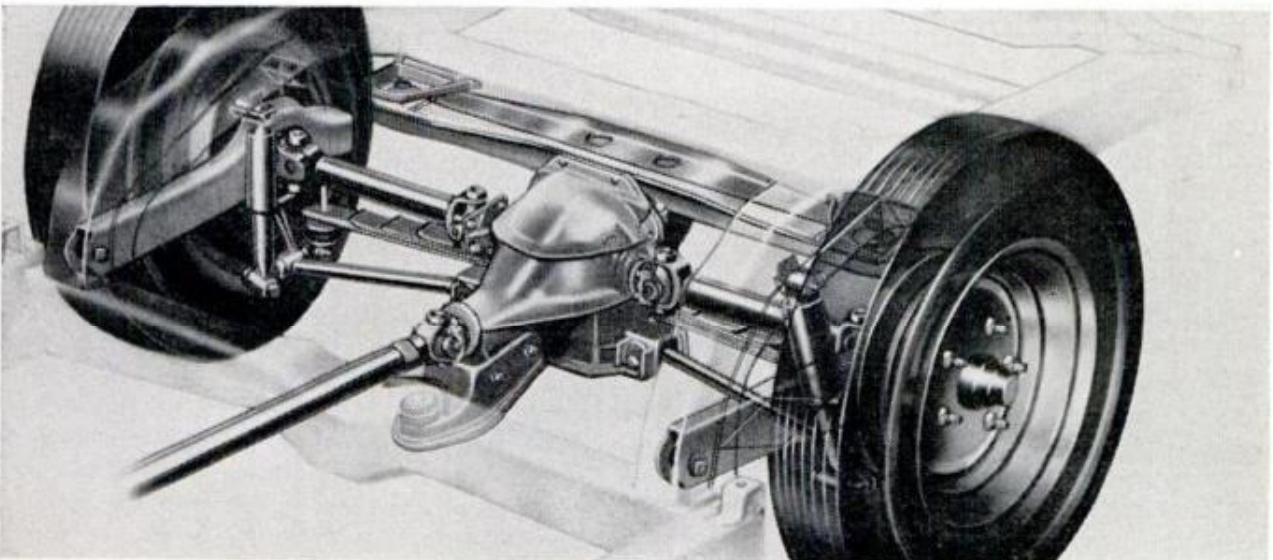

Sizing Up the '63s

MAKE of Car	WHEELBASE			OVERALL LENGTH			OVERALL WIDTH			HORSEPOWER RANGE	
	'62	'63	Chg.	'62	'63	Chg.	'62	'63	Chg.	'62	'63
BUICK Special	112	112.1	+ .1	188.4	192.1	+3.7	71.3	70.2	-1.1	V6 135, V8 155	V6 135, V8 155
LeSabre, Invicta	123	123	—	214.1	215.7	+1.6	78	78	—	V8 280-325	V8 280-340
Electra 225	126	126	—	220.1	221.7	+1.6	—	—	—	V8 325	V8 325
Riviera	—	117	—	—	208	—	—	76.6	—	—	V8 340
CADILLAC 62	129.5	129.5	—	222	223	—	79.9	79.7	-.2	V8 325	V8 325
Fleetwood	129.5	129.5	—	222	223	—	79.9	79.7	-.2	V8 325	V8 325
Series 75	149.5	129.5	—	242.3	243.3	+1	80.6	79.9	-.7	V8 325	V8 325
CHEVROLET	119	119	—	209.6	210.4	+ .6	79	79.4	+ .4	Six 135, V8 170	Six 140, V8 195
CHEVY II	110	110	—	183	183	—	70.8	70.8	—	Four 90, Six 120	Four 90, Six 120
CORVAIR	108	108	—	180	180	—	67	67	—	Six 80-102-150	Six 80-102-150
CORVETTE	102	98	-4	176.7	175.3	-1.4	70.4	69.6	-.8	V8 250-325(†)	V8 250-360(†)
CHRYSLER											
Newport, 300	122	122	—	214.9	215.3	+ .4	79.4	79	-.4	V8 265-305	V8 265-305
New Yorker	126	122	-4	219.3	215.5	-3.8	79.4	79	-.4	V8 340	V8 340
DODGE	116	119	+3	202	208.2	+6.2	76.5	76.5	—	Six 145, V8 230	Six 145, V8
DODGE DART	106.5	111	+4.5	188.8	195.9	+7.1	72.3	68.7	-3.6	Six 101-145	Six 101-145
FALCON	109.5	109.5	—	181.1	181.1	—	70.6	70.1	—	Six 85-101	Six 85-101
FORD Fairlane	115.5	115.5	—	197.6	197.6	—	71.3	71.3	—	Six 101, V8 145	Six 101, V8 145
Galaxie	119	119	—	209.3	209.9	+ .6	79.2	79.9	+ .7	Six 135, V8 175	Six 135, V8 164
IMPERIAL	129	129	—	227.1	227.8	+ .7	81.7	—	—	V8 340	V8 340
LINCOLN											
CONTINENTAL	123	123	—	213	213	—	78.6	78.6	—	V8 300	V8 320
MERCURY Comet	114	114	—	194.8	194.8	—	70.4	70.4	—	Six 85-101	Six 85-101
Meteor	116.5	116.5	—	203.8	203.8	—	71.3	71.3	—	Six 101, V8 145	Six 101, V8 145
Monterey	120	120	—	215.5	215	-.5	79.5	—	—	Six 135, V8 170	V8 250-385(†)
OLDSMOBILE F-85	112	112	—	188.2	192.2	+4	71.6	73.4	+1.8	V8 155-215(†)	V8 155-215(†)
88, Super 88,											
Starfire	123	123	—	213.9	214.4	+ .5	77.9	78.0	+ .1	V8 280-330	V8 280-330
98	126	126	—	220	221.5	+1.5	77.9	78.0	+ .1	V8 330	V8 330
PLYMOUTH	116	116	—	202	205	+3	75.4	75.6	+ .2	Six 145, V8 230	Six 145, V8 NA
PONTIAC Tempest	112	112	—	189.3	194.3	+5	72.2	74.2	+2	Four 110, V8 185	Four 110, V8 260
Catalina	120	120	—	211.6	212.1	+ .5	78.6	78.7	+ .1	V8 215	V8 NA
Bonneville	123	123	—	218.6	219.1	+ .5	78.6	78.7	+ .1	V8 235	V8 NA
RAMBLER American	100	100	—	173.1	173.1	—	70	70	—	Six 90-125	Six 90-125
Classic,											
Ambassador	108	112	+4	190	188.8	-1.2	72.4	71.3	-1.1	Six 127, V8 250	Six 127, V8 250
STUDEBAKER Lark*	109	109	—	188	188	—	71.25	71.25	—	Six 112, V8 180	Six 112, V8 NA
Hawk	113	113	—	—	—	—	—	—	—	—	—
Avanti	120.5	120.5	—	204	204	—	71.3	71.3	—	V8 210	V8 NA
THUNDERBIRD	—	109	—	NA	—	—	NA	—	—	—	V8 NA
THUNDERBIRD	113.2	113.2	—	205	205	—	76	76.5	+ .5	V8 300	V8 340
VALIANT	106.5	106	-5	184.2	186.2	+2	67	68.8	+1.8	Six 101-145	Six 101-145

NA NOT available at presstime.

*Lark includes 108" wheelbase for two door models, 113" for wagons and four-door models.

(†)Horsepower given is for standard engines unless noted (†) in which case figures are for lowest and highest ratings.

addition of a convertible with power top that's available with bench or bucket-type individual front seats.

Powerplants for Comets are 85 or 101-horsepower versions of Ford's junior Six which began its career with Falcon and is also found on Fairlane and Meteor. This faithful engine now has hydraulic tappets and positive crankcase ventilation. An interesting option for the sporting driver is a four-speed floor shift fully synchronized transmission that's optional on any Comet model at extra cost.

Ford, Chevrolet, Plymouth, Dodge. All-new exterior sheet metal over unchanged

body shells is almost the rule among these four cars of the high volume, full-size field.

Ford, Chevrolet and Plymouth are unchanged in wheelbases at 119, 119 and 116. Dodge, however, was upped from 116 to 119 inches. As a result, Dodge picks up a couple of useful extra inches of rear seat legroom and, by virtue of a six-inch increase in overall length (202 to 208 inches) gains an additional 10 percent of trunk capacity. This body change was made by adding to the rear floor-frame structure and to the quarter panels. In spite of the size increase, weight increases only 45 pounds.

(Continued on page 238)

Texas Thumper Locates Oil

Dropping a heavy weight on the ground is a safer, less expensive and quieter way than dynamiting to find oil, reports the Humble Oil Co. of Houston, Tex.

"Thumping" costs less than half the expense of blasting; it's done with a 6000-pound steel plate suspended from an arched frame over the back of a truck. The slab is raised nine feet and dropped with a thump every few truck lengths along a line.

Seismic technicians lay out 96 geophones in star patterns at the ends of this line. An instrument truck receives the reflected impulses and tape records them for a geologic profile of the area.

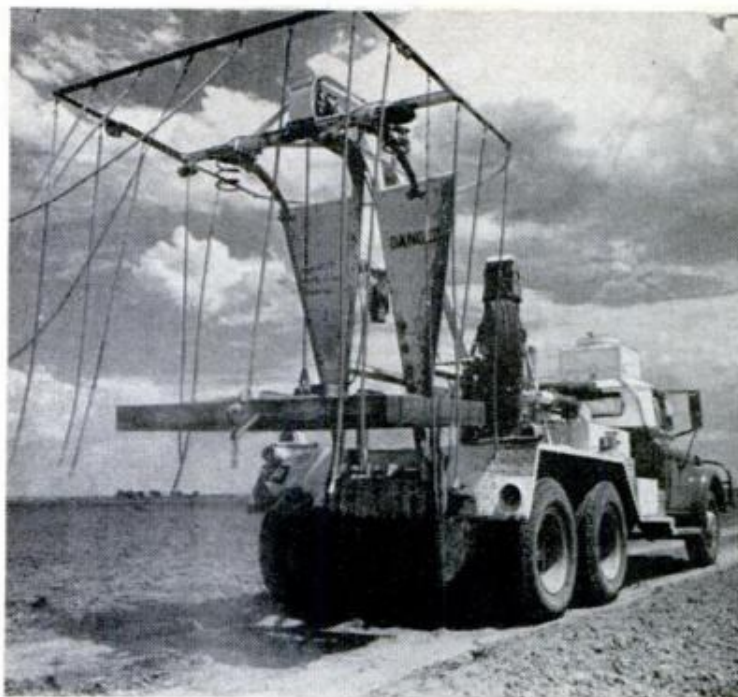

Wash 'n' No Wear For Rocker Panels

Chevy II's engineers designed the new car's cowl ventilation system to flush road salt and other corrosive agents out of the rocker sills.

Water enters the vent during rain or washings and flows through the sills and out drain holes at the rear. With the car moving, enough air flows from the vent through the sills to dry them out.

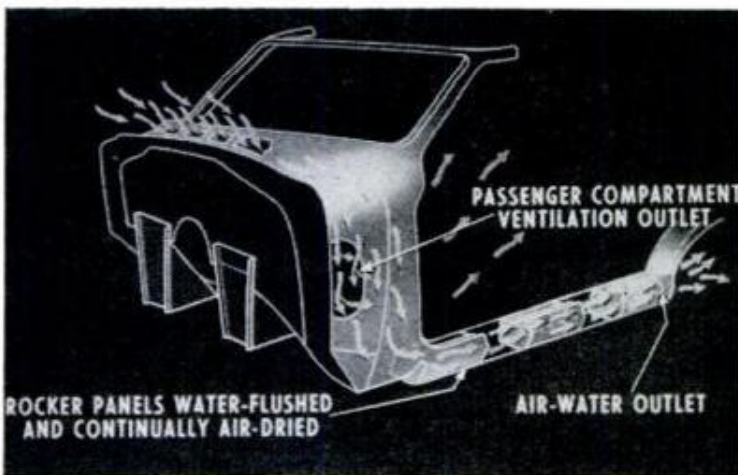

Closed-Circuit TV Looks into Microscope

Coupling a closed-circuit television system with a microscope enables Avery Ugent, 14, of South Miami, Fla., to enlarge a microscopic display to television-screen size. A drop of water, filled with one-celled life, can be viewed at one time by all 32 students in Avery's science class.

Reversing the polarity of the TV camera makes the black areas white, and the white black. This provides a negative display, which, coupled with the use of the contrast control on the monitor, brings out the organisms more clearly. The feeding, reproducing and motion can be clearly seen.

A turret lens on the microscope permits several magnifications to be used.

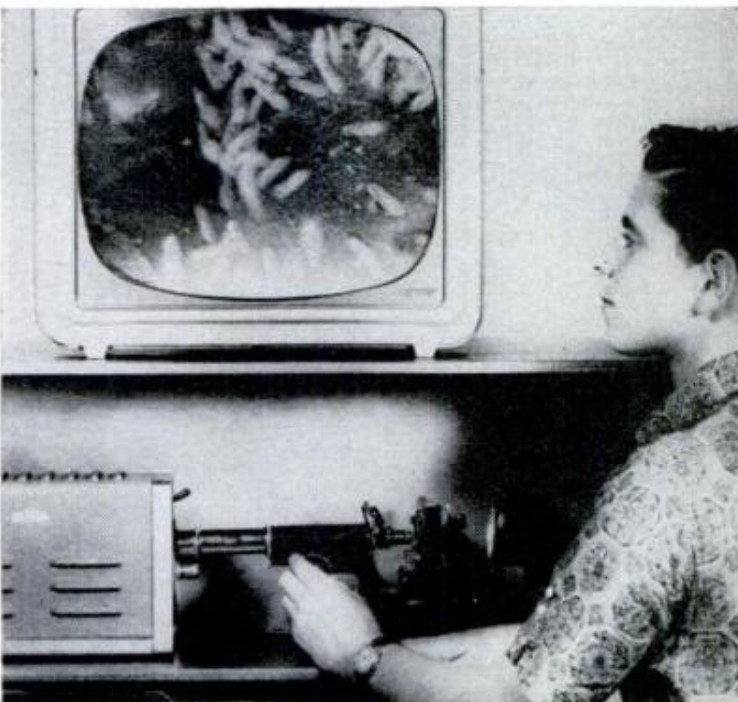

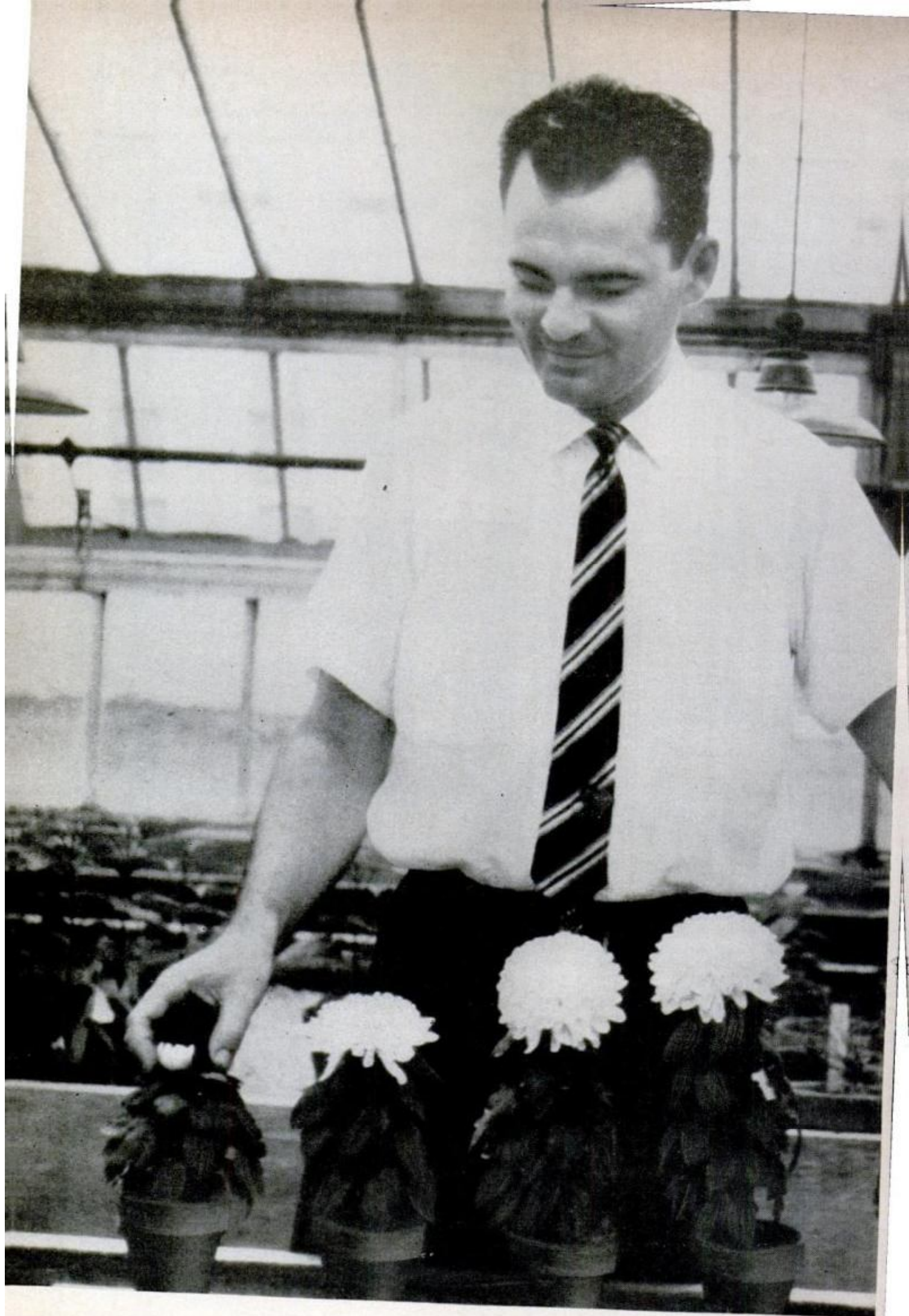



Try your own experiments with these strange growth-regulating chemicals. You can develop

Tom Thumb Plants . . . Full-Size Blooms

By James N. Miller

HOW TALL do you like your flowers? When do you want them to bloom? Surprisingly enough, you'll soon be able to make nature deliver your answers to both of these questions!

Four remarkable new chemicals are making their way from the fields of experimental agriculture to the plots of the home gardener to help you tailor-make your plants. They will, for example, allow you to grow short-stemmed flowers with full-size blooms. One of the chemicals also will help you get May flowers to bloom in January, if that is when you wish blossoms.

These chemicals are called Phosfon, CCC, Amo-1618 and cardavan. All told, they can dwarf more than 50 different varieties of potted and garden plants. In addition, Phosfon has proven capable of getting azaleas to bud when government scientists desire them to, and, further, it has initiated blooming of camellias, rhododendrons and other woody shrubs. These experiments point to the time when you will be able to order not only how, but when, your garden will grow.

The first of these four growth retardants to reach the market is Phosfon. It is manufactured by the Virginia-Carolina Chemical Corp., and like the others, it was developed through work at the research stations of the Department of Agriculture. It is available in three formulations today; two are for commercial use; the other, a one percent powder for home gardeners, is sold for about a dollar in 1½ ounce packages which contain enough of the chemical to treat, for example, 30 mum plants for height control. "When added to the soil at potting time, or applied as a drench during forcing, Phosfon reduces the height of the upper stem without serious effect on time of flowering or

TRY THESE



ADD POWDER to potting soil for dwarfing mums. Place four-week-old plants in pots containing mixture

flower number and quality," say researchers at the government's Beltsville, Md., experimental station. They've used it successfully on chrysanthemums, Easter lily and poinsettia plants, on holly, petunia, marigold, red maple, salvia and coleus, among other plants. Growers may have to modify the Beltsville techniques, due to the fact that the effect of the chemical may vary according to the section of the country, soil mixture, forcing procedure and plant variety. Here's how Phosfon was used in a couple of instances at the experimental station:

Potted lilies—Powder was added to the potting soil at rates of 1 to 1½ ounces of 10 per cent Phosfon (the commercial formulation) per cubic feet of soil. A Phosfon drench, applied during forcing, when plants were 5 to 7 inches high, proved to be as effective as the powder when used in potting soil. The solution contained 5 ounces of the 10 percent powder in 4 gallons of water; it was applied at the rate of one cup per six-inch pot.

Chrysanthemums—Dr. Marc Cathey, Beltsville horticulturalist, reports success in dipping clay pots in a very dilute solu-



DRENCH four-week-old mum during forcing process with Phosfon solution. Use one cup per six-inch pot

tion. Dipping takes a few seconds; the porous clay absorbs enough Phosfon in 5 seconds to produce an attractive, easy-to-handle, compact mum plant. Peat pots may be used also; they require a few seconds longer soaking but the pot can be planted right into the soil and roots will grow through as the peat disintegrates.

Treated plants have stronger stems, resist breaking due to bloom load and do not sprawl as do untreated plants. The compact growth of cushion and button types of mums are further enhanced by treatment with Phosfon.

The chemical, says its manufacturer, "does not produce phototoxicity or affect the size or quality of blooms when used at the recommended rate. Some varieties show a slight delay in blooming."

Manufacturer's direction for the home gardener illustrate the simplicity of normal use. "Remove one quart of soil (a hole five inches across and three inches deep will give a quart) from the location where the rooted chrysanthemum is to be planted. Place soil in container. Sprinkle one-half level teaspoon of Phosfon over the soil and mix it uniformly. Replace soil in the hole

FOUR METHODS YOURSELF



DIP clay pot containing young mum plant for a few seconds into a dilute solution of Phosfon retardant



DUNK a peat pot containing plant of type you want for a few seconds. You'll have to experiment

and plant rooted cutting in the center of the treated areas. Follow your normal schedule of watering, fertilizing and plant care." The manufacturer could not add, "And stand back!" of course, but he might almost have said, "Lean forward!" to watch the unusual and truncated growth.

Chemicals used as braking tools to hold back the stem growth of a plant and hold it at a desired height have looked promising since 1949 when researchers at Beltsville applied nicotinium compounds to the stems of the Black Valentine snap bean. While the yield of beans was not affected, the stem length was cut in half.

Early Experiments

Research had started in the 1930s, but plants dwarfed then had low yields of grain, fruit and flowers. In 1950, with interest in dwarfing reviving, Beltsville scientists reported that an ammonium compound, Amo-1618, shortened plant height by fully two-thirds. When applied to the soil, it dwarfs mums.

Although poinsettias scarcely responded to Amo-1618, a single change in the compound has recently produced a new but

unstable chemical, cardavan, that can dwarf a tall-growing poinsettia variety down to half or a fourth of its normal height. At the moment, Amo-1618 and cardavan are said to be too expensive for regular commercial use; furthermore, they have not been authorized by the USDA for registration and availability to commercial growers. However, CCC, the fourth member of the new group of retardants is expected to be used, eventually, as freely as Phosfon.

Atomic Substitution

Less than three years old, CCC was announced in November, 1959, by Dr. N. E. Tolbert, biochemistry professor at Michigan State University. He found that as much as 30 percent of the total soluble phosphorus in a plant root, and sometimes in the leaves, was present in the form of phosphorylcholine. In an effort to block action of this compound in the plant, Dr. Tolbert altered it chemically by substituting a chlorine atom for the OH group of choline.

This new chemical, one atom different from the naturally occurring one, was chlorocholine chloride, now known as CCC.



CHEMICALS react this way in summer: Plant, left, untreated; then plants treated by Amo-1618, Phosfon, CCC

UNDERWAY: TAILOR-MADE PLANTS

When it was fed to wheat seedlings, the chemical surprisingly altered their growth. Today CCC is used by one of Dr. Tolbert's research associates, Richard Lindstrom, for growing poinsettias that have brighter and more decorative red and white "flowers" than normal. While normal plants are as much as six-feet tall, and sprawling, Lindstrom's CCC-treated poinsettias are only about 24 inches in height and are compact. Furthermore the bracts, as the blooms are called, are of normal size.

Four Chemicals

In the current Beltsville studies, these four chemicals—Phosfon, CCC, Amo-1618 and cardavan—are being used in tests on 22 kinds of woody plants and 17 kinds of foliage plants, shrubs and trees. Also, other potential retarders made from phosphonium, ammonium carbonate and choline compounds are being tested. Thanks to the new chemical tools which will emerge from this research, florists are assured of handling many attractive flower varieties

that normally grow too tall for satisfactory potted plant use.

Tailor-made plants are another fascinating possibility in the offing, according to the Beltsville researchers. Scientists are intrigued by the fact that the short and stocky plant growth obtained from treatments with CCC is just the opposite from the tall and elongated growth obtained by treatment with gibberelic acid, a type of plant growth stimulator which made the headlines a few years ago. The actions of the two types of chemicals are mutually antagonistic. It is quite possible that accurate control over plant growth might be obtained by teaming the two types of regulators. It might be possible to make a stem and flower within centimeters of the size you want!

Improved Vegetables

Vegetable crops also are being improved by use of dwarfing chemicals. For instance, Amo-1618 is helping breed new soybean varieties at Beltsville. In winter green-

Winter



ALL reduce about the same in winter. Plant, left, untreated. Amo-1618, Phosfon, CCC. Effect is being tested

houses, soybean plants normally tend to develop over-active, thin-stem growth. This condition hampers the geneticist who would like, and could use, more compact plants for easier tending and tailoring. Amo-16-18 helps here. It is being used, specifically, to develop experimental plants less than half of normal height, but completely normal in other characteristics. Similar experiments with other crop plants will be tried soon.

The immediate outlook in this new field of agricultural science depends to a great extent on what researchers turn up about plant physiology. Little is known about how and why the growth-curtailling chemicals operate in plants as they do. When they acquire such knowledge, plant "inventors" will be able to avoid much of the slow trial-and-error testing now required in developing useful treatments.

Then, in all probability, we will be able to add chemicals to the soil about our flowers and plants and sit back to watch the wonderful and helpful results—flowers and plants the size we can best use growing at the time most desirable for us to use or enjoy them! ★★★

HOME GARDNER'S first step: Adding 1½ teaspoons of Phosfon to soil to dwarf a potted mum cutting



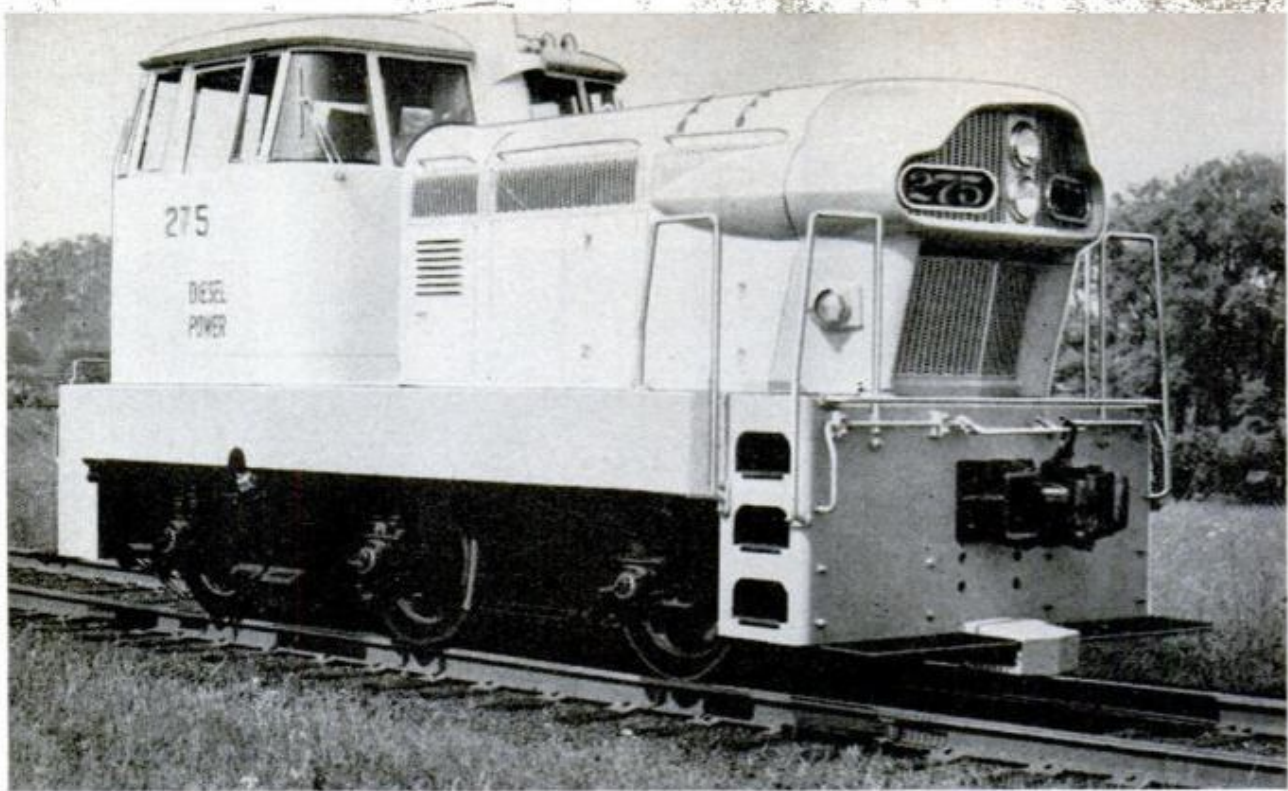

"Kit" Locomotive Is a Do-It-Yourself Project

Building from a variety of components, the user of a new do-it-yourself locomotive can tailor the machine to the size, power and track gauge he requires. Parts supplied by General Motors Diesel, Ltd., of London,

Ontario, will produce two basic locomotive types: A double-engine two-truck model and a single-engine unit with three axles. Engines available are a 275-horsepower V8 and a 400-horsepower V12.



Portable Photocopy Machine

For traveling executives or others who need to make quick copies of reports while in the field, a copy machine has been built into an attache case.

The machine can accept any original up to nine inches wide. Cut-sheet negative and positive papers are stored in the top of the case. The unit can be used in either artificial or daylight conditions; it has an 8-watt, 12-inch green fluorescent lamp, rheostat-controlled, to compensate for varying shadings of the original. The 12½-pound unit is sold at \$149.50 by Anken Chemical & Film Corp., Newton, N.J.



Wide-Screen Microscope

Specimens under the lens of a new reflecting microscope can be viewed by several persons at a time in the large illuminated screen of the instrument.

The new battery-operated 'scope magnifies 50 to 100 times, and its projected picture on the viewing screen can be seen as far as 10 feet away. Brightly illuminated, the screen permits photographs to be made.

Recommended by the manufacturer for use by students, teachers, professional and amateur researchers, it is available for \$8.99 from Superior Products (Import Div.), 34 East 12th St., New York 3, N. Y.



Indoor Heat for Outdoor Pools and Patios

On cool summer days and nights, a gas-fired radiant heater can warm up a 20-foot outdoor area. Portable, it can be rolled about, or it can be installed permanently.

Operated with either LP or natural gas,

the heater has a safety shutoff. It is 8 feet high with a 34-inch reflector. The portable unit is \$199.50. It is sold by Mountaineer Products, 5143 W. Diversey Ave., Chicago 39, Ill.

Look and Listen

Avid sports fans who carry a radio to the game can now look and listen at the same time with a combination of radio and field glasses.

The tuning range of the four-transistor radio is a full 535-1605 KC and the antenna is collapsible. It's equipped with a built-in speaker, earphone and battery.

The 7 by 50-mm. field glasses feature coated lenses and center focusing.

The unit costs \$37.50 from Al Monte, 1254 W. Jefferson Blvd., Los Angeles 7.

QUOTE

"A mediocre student is never going to hurt anybody as a mathematician, because he's not going to be one. He's just going to work at it and eventually fail. . . . But a mediocre student in some institutions can become a high-school teacher and then can continue to do damage the rest of his life."

MR. STERLING M. McMURRIN
U.S. Commissioner of Education



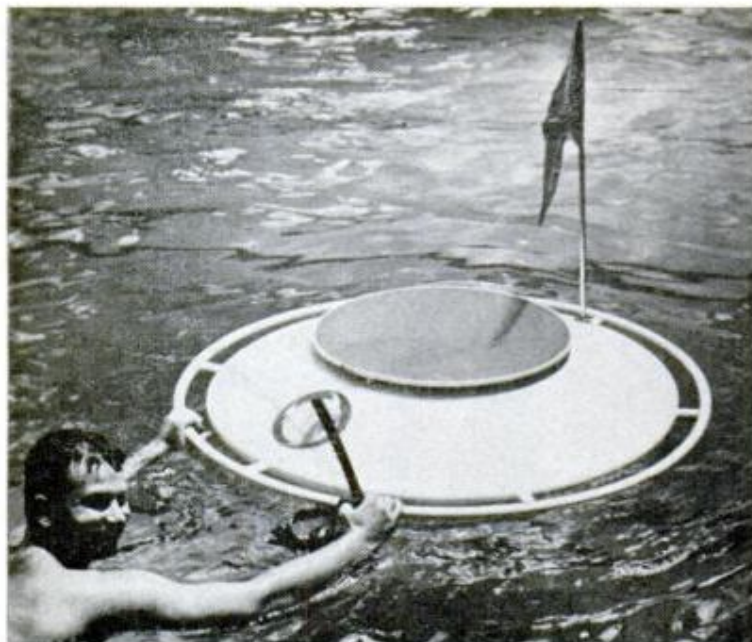

SAUCER, driven in water by propeller, travels over land on special trailer. It's by Leslie Perhacs, U. of Calif.



SAFETY BENCH slides easily on sled-type runner base when hit by players. It was designed by G. W. Clapp, Jr., Auburn, U.



SURFBOARD for snow is operated the same way as a surfboard in water. It won an award for Steve Nelson, U. of California

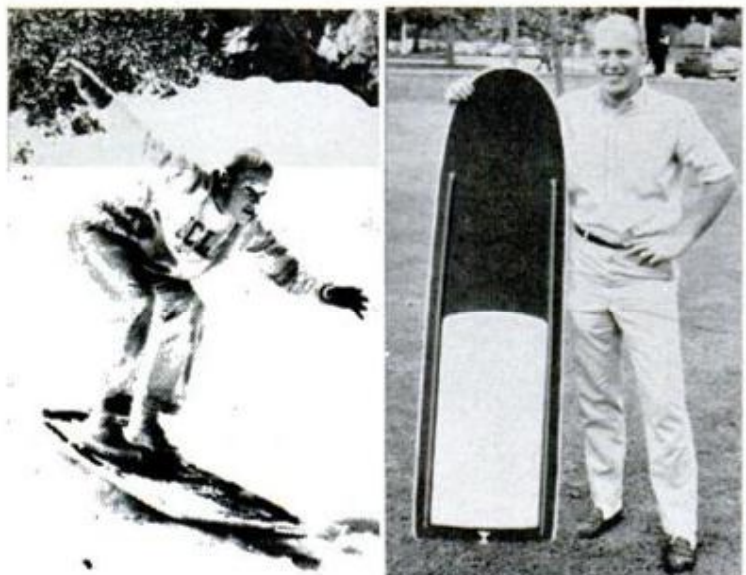

Aluminum Designs Shape Products of Tomorrow

Skin divers can travel farther, football players can hit benches without injury and there's a new snow sport—all as a result of designs by students in the Alcoa Student Design Merit Awards program for 1962.

Water Saucer is a battery-powered sea sled which transports up to four skin divers and serves as their operating base. The sled, based on the disk-shaped Mexican guitar fish, gives divers great range to reach unexplored areas and safe transport back for the exhausted.

Safety Bench

A safety bench for football players replaces conventional massive wooden benches and helps eliminate injuries to players who are pushed out of bounds. The unit is lightweight, slides easily when hit, and is padded on lateral surfaces and on the corners. It supports several husky players and provides a comfortable arm rest.

Sno-Surfer is a jaunty application of surfboarding to snowy slopes. It's lightweight, resistant to snow sticking and needs no waxing. An abrasive tread area stabilizes the erect rider, who stands near the rear, guiding the surfer by weight movement.

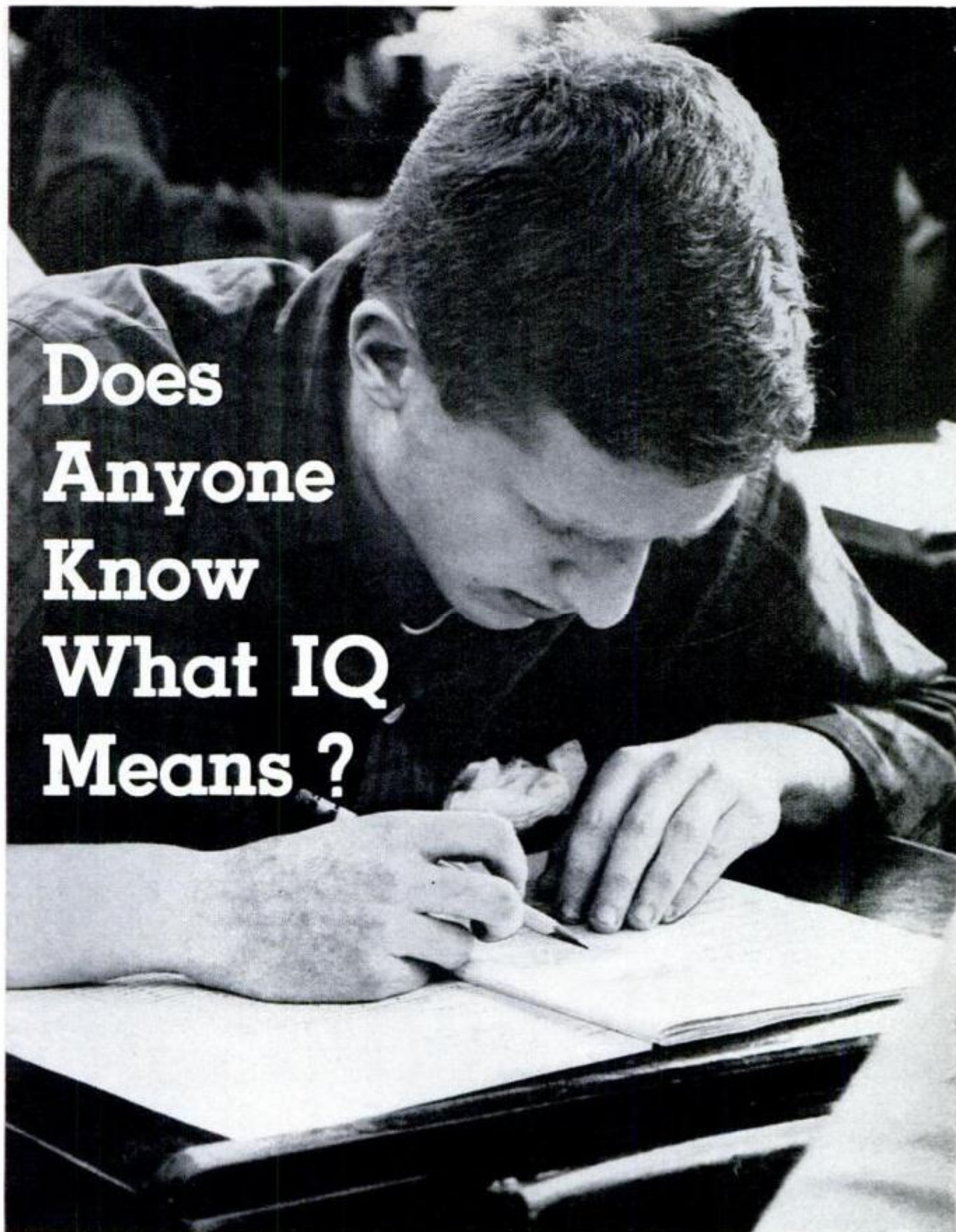

Does Anyone Know What IQ Means ?

By Theodore Berland

Your child's advancement in school, your promotion in your work—both may depend upon IQ test scores. How scientific are these tests? Can you improve your IQ? Should teachers disclose IQ scores to parents? This year an estimated 10 million American school children will take tests designed to measure their intelligence. At the same time, some seven million adults—more than half of the people in the



PRESCHOOL YOUNGSTERS can be tested for intelligence by their responses to questions and instructions

U.S. looking for jobs—will take similar tests in personnel offices across the continent.

Today, Americans are in the "brain numbers" game as never before. For children, scores on IQ tests (often called "mental ability," "aptitude," "mental alertness" tests) can mean demotion or special instruction leading to a skip in grades. For many adults, a magic IQ number can mean the difference between getting or not getting a job.

It's small wonder, then, that IQs are talked about wherever young parents and wage earners meet. Still, most people have a poor understanding of what IQ scores mean or even of what IQ tests measure. They don't realize that intelligence tests measure more than one thing, that they are not infallible, that they can't guarantee success or failure in life, that intelligence can change during a lifetime, or that a person can work to improve his IQ.

Before you can understand what intelligence test scores mean, you first have to know what intelligence is and how it is measured.

A New York designer of intelligence tests, Dr. David Wechsler, defines intelligence as a person's ability "to act purpose-

fully, to think rationally and to deal effectively with his environment.

Another test designer, Dr. Thelma Gwinn Thurstone of the University of North Carolina, says that "intelligence is not one thing, but a combination of several different abilities tied up in a package that is labeled intelligence." In its broadest meaning, she adds, intelligence is a person's ability to adjust to the problems of life.

Tests to measure intelligence date back to 1904, when Paris schools used one designed by Dr. Alfred Binet, a French physician, to weed out dull pupils. Dr. Binet's test came to the U.S. in 1910 and was revised several times, particularly by psychologists at Stanford University.

In general, the Stanford-Binet test assesses intelligence by measuring a person's ability with words, ability with numbers, ability to reason and his memory. It does this by a series of mental hurdles. You answer the first questions easily, then begin to fail more and more items as you go on to "higher" intellectual hurdles. Finally you come to hurdles just too "high."

Each of these hurdles, in effect, is a mental age. A preschool child, if he is of average intelligence, should do the items on the first hurdles easily: Point to the toy for "drinking out of," point to the doll's hair, name a key and a chair, repeat numbers 4 through 7, etc. But he may have more trouble with the items on the next hurdle: Matching circles and squares or answering "Why do we have houses?"

This is how the Stanford-Binet renders a "mental age" score. This mental age is then divided by the child's chronological age and multiplied by 100 to give Intelligence Quotient or IQ. For example, a six-year-old with a mental age of eight would have an IQ of 133 ($8 \div 6 = 1.33$; $1.33 \times 100 = 133$). This is one of the few intelligence tests that produce IQ scores directly.

Such general intelligence tests are widely used and very reliable, but they have to be given to one person at a time by a clinical or school psychologist. During World War I, psychologists designed pencil-and-paper IQ tests for the Army that could be used to screen large groups of recruits. So, instead of a psychologist asking for word definitions, a printed form would ask: "Gun is to shoot as knife is to (fly, glove, meat, hurt, cut)." Or: "Distance means the same as (seldom, far, old, dark, space)."

General intelligence tests had another limitation—they told nothing about the specific parts of intelligence. So, in 1938 the late Dr. Louis L. Thurstone sorted

Nonverbal Test Is Made Up of Pictures

A nonverbal test of the type devised by Science Research Associates helps measure the intelligence of those who don't handle language well—such as new immigrants. Try it. Mark an X in the box of the most different picture in each row. Note in the sample that four pictures show meat and one shows fish. Therefore, the fish picture is most different.

SAMPLE

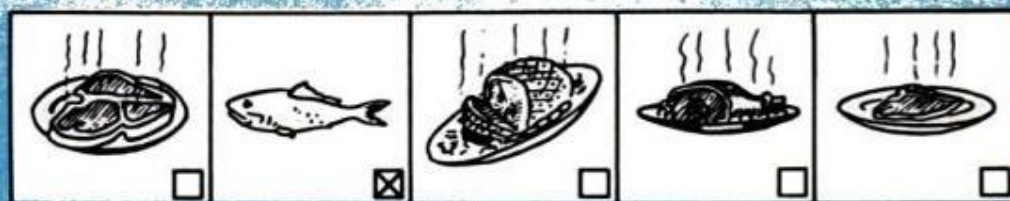

1

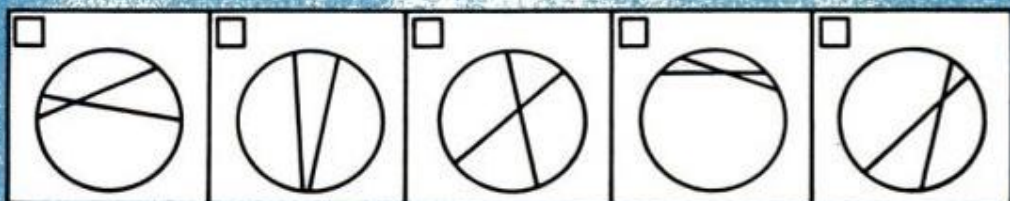

2

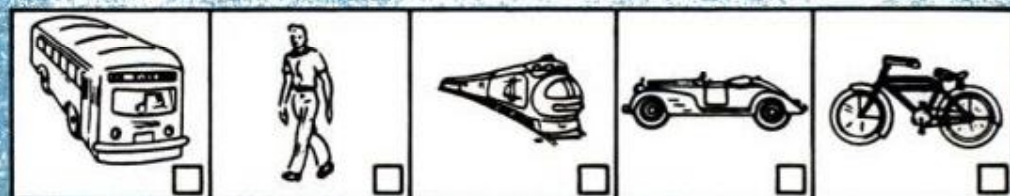

3

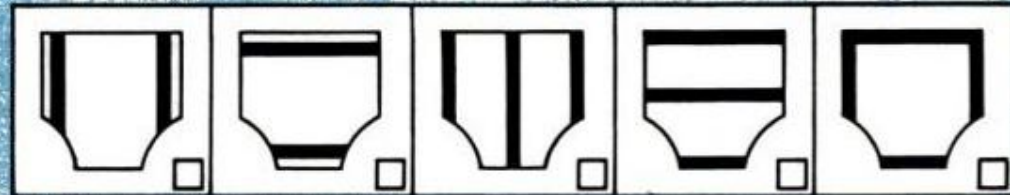

4



5

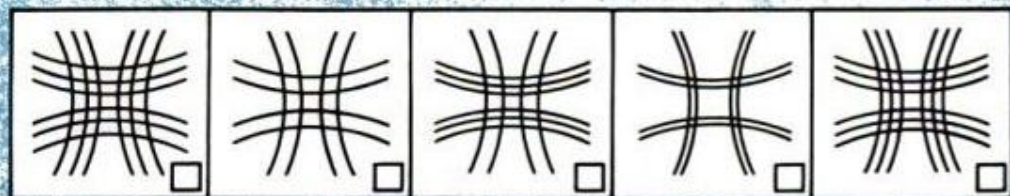

6

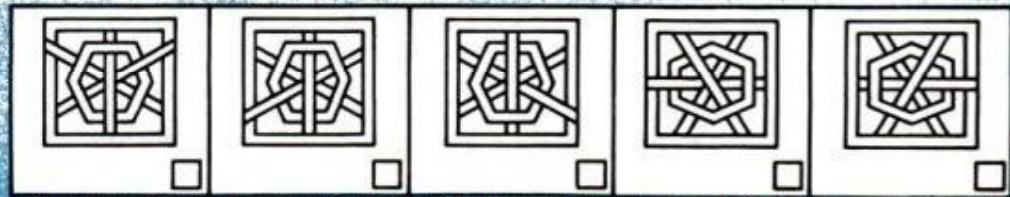

Answers on page 117

out seven factors of intelligence after testing hundreds of University of Chicago students, high-school students, and grade-school pupils. He called these the "primary mental abilities:"

Space, ability to visualize objects; *Number*, ability to do simple arithmetic; *Verbal comprehension*, ability to understand words; *Word fluency*, ability to use words; *Memory*, ability to memorize; *Perception*, ability to quickly recognize similarities and differences between objects; and *Reasoning*, ability to find the underlying principle.

With his wife, Thelma, Dr. Thurstone devised tests to measure these abilities. Today there are a host of similar tests. The scores of these ability tests are converted to percentiles that can be arranged to form a "mental profile."

Each ability score tells its own story. For instance, a high Verbal Meaning score—above 75 percentile—means a person well understands ideas as expressed in words and could be a successful secretary, teacher, editor, or librarian. A high Space score indicates probable success as a designer, machinist, or pilot. High Reason-

ing scores indicate probable success in science and mathematics.

High scores on both Verbal Meaning and Reasoning indicate "scholastic aptitude"—whether or not a student has what it takes to go further in school.

And, by adding up the individual scores and weighting Reasoning and Number, a total percentile score is derived. This can then be converted to an IQ score.

The major purpose of intelligence tests hasn't changed since they were invented at the beginning of the century. Primarily, IQ tests are for schools—to help teachers sort out the good, average, and poor students. A good teacher could do this by herself, but it would take her several months. A test can do it for her in an hour. Also the teacher would tend to compare each child with his classmates, or with previous pupils. She couldn't compare each pupil with the millions of others his age in this country, as mass IQ tests can.

Whether schools should disclose their children's IQs to parents is a highly controversial point these days. On one side are such authorities as Prof. James B. Bonder, of State Teachers College, West

Try These Sample Tests for Four

SPACE

In the row of figures below, mark an X in the box of **every** figure which is **like** the first figure. Do **not** mark the figures which are made backward.

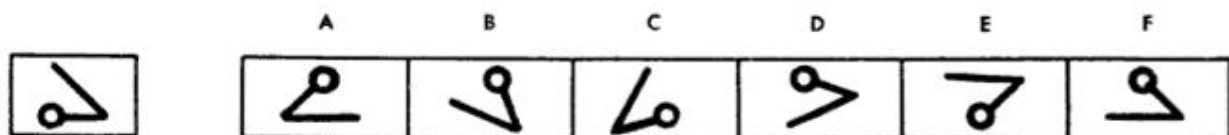

You should have marked an X in A and in E.

In the two rows below, mark an X in the box of **every** figure which is **like** the first figure in that row. Answers are on the facing page.

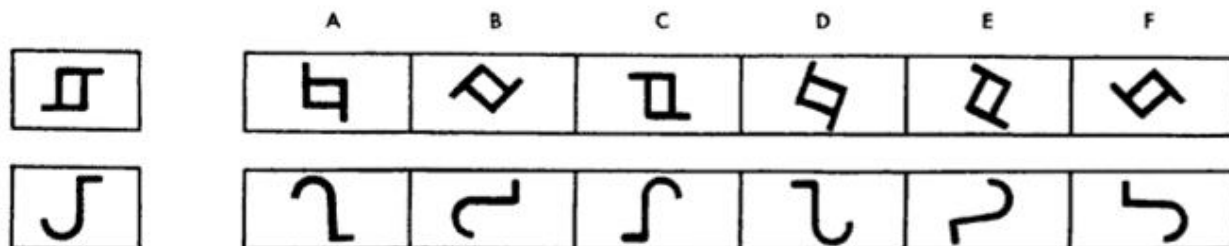

NUMBER

At right are three columns of numbers which have been added. Add the numbers for yourself to see if the answers are correct. Mark each one right or wrong.

A	B	C
17	35	63
84	28	17
29	61	89
—	—	—
140	124	169

MACHINES have been designed that can test mental abilities. The one shown at the right tests reasoning

Chester, Pa., who says: "I believe school staffs should tell you your child's IQ. For them not to tell you is about as sensible as testing your child's eyes and then not letting you know whether or not he needs glasses."

Others, such as Dr. John A. R. Wilson, director of student teaching for the University of California at Santa Barbara, don't agree. There are psychological hazards, he warns. Parents can make a child with a high IQ cocky and push him too hard. A dull child's parents might let him drop out of school without even trying. "Children," says Dr. Wilson, "will have a better chance to become their best selves if parents generally don't know the score."

A Michigan mother who learned of her grade school son's 140 IQ used this score as a form of blackmail. "Well," she told the boy, "now that we know you're smart, I'd better see perfect grades on your report card." Unless the somewhat lazy boy brought home straight As, he didn't get



of the Primary Mental Abilities

VERBAL

In each of the following problems, mark an X beside the word that means the same as the first word.

1. INSIDIOUS A. Treacherous B. Slovenly C. Capricious D. Elemental
2. BENIGN A. Naive B. Kindly C. Effeminate D. Prosperous
3. STRINGENT A. Calm B. Tight C. Desperate D. Strict

REASONING

Add the next letter in each of the following series:

1. a x b y a x b y a x b —
2. a b m c d m e f m g h m —
3. r s r t r u r v r w r x r —
4. a b c d a b c e a b c f a b c —

ANSWERS

Nonverbal test: 1. Second from left (the only circle with inner lines not crossing); 2. Second from left (the only picture showing a human); 3. Fifth from left (the only figure in which all solid lines are on outside edges); 4. Second from left (the only person not playing); 5. Third from left (the only figure with an unequal number of lines vertically and horizontally); and 6. First from left (the only figure in which two crossbars of the central design are on top of the surrounding frame).

Space test: In the first row, you should have marked A, D and F.
In the second row, you should have marked C and F.

Number test: A. Wrong; B. Right; C. Right.

Verbal test: 1. A; 2. B; 3. D

Reasoning test: 1. y; 2. i; 3. y; 4. g.

The last four problems are from the Primary Mental Abilities test prepared by Science Research Associates

Distribution of Intelligence in a Normal Population

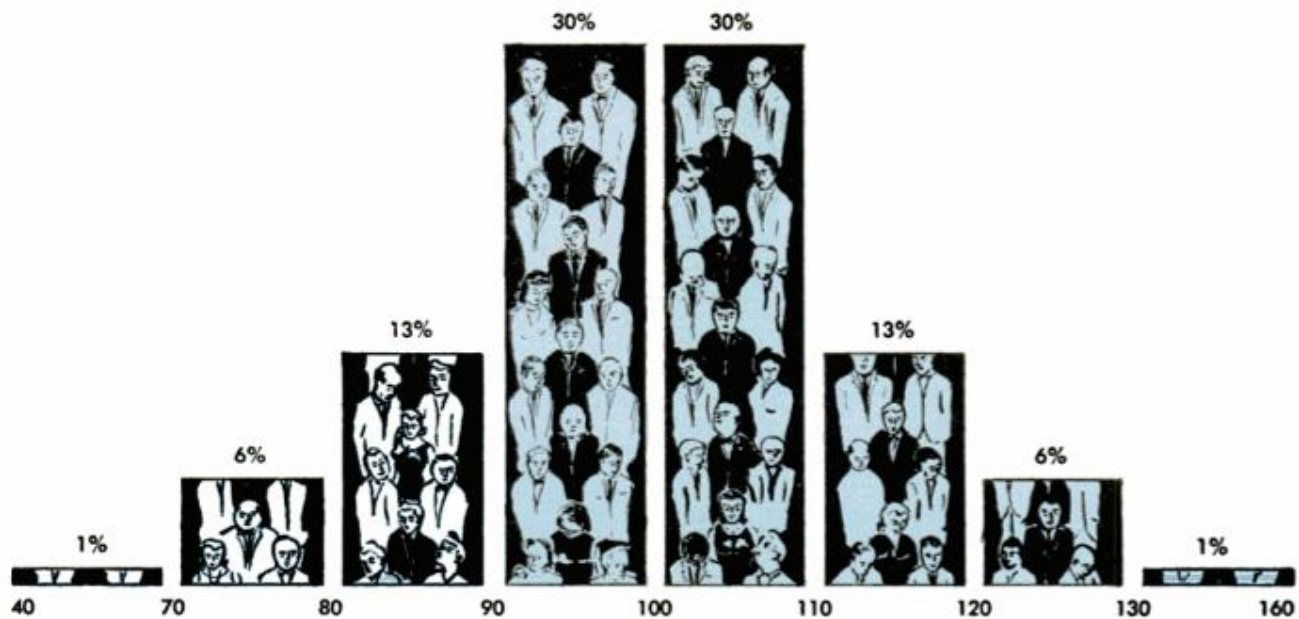

SIXTY PERCENT of the people in a normal population group are within the 90 to 110 IQ range. The remaining 40 percent are distributed equally on each side of the 100 mark in the manner shown in this drawing

the bicycle or whatever else she had promised him.

This is how parents, armed with an IQ score, can put undue pressures on their children.

Test devisers shudder at still another specter of disclosed IQ scores: Fathers and mothers competing with other parents on the basis of their children's IQs—over poker or bridge tables, at the back fence, on the golf course.

"A test score by itself means very little," says Dr. Henry Chauncey, president of Educational Testing Service, Princeton, N.J. "It takes meaning only in relation to all other information about an individual. The wise and sensible user, therefore, does not make decisions on the basis of test scores alone. On the other hand, the kind of information provided by good tests cannot be ignored by conscientious educators seeking all possible information about students before making important decisions."

As an example of the kinds of pressures placed on school systems to reveal pupils' IQs, New York State schools now, *by rule*, have been forced to make some test records available to parents, but not IQ scores. This ruling followed a report by a committee from Columbia University's Teachers College that pointed out that a little knowledge is a dangerous thing and that IQs are merely numbers, without expert interpretation.

Unfortunately, there are many teachers who don't know how to use IQ scores

properly, either, says Dr. William Buel of Science Research Associates, Chicago. (SRA is a major publisher of intelligence tests.)

In the first place, he says, the absolute numbers mean little by themselves. The difference between an IQ of 125 and one of 126 is no difference at all. "We can't even tell the difference between IQs of, say, 170 and 180," he says. "It may mean one question on the test. All we know is that one is a notch higher than the other. Both are in the highly superior range."

Also, he points out, the differences at each end of the scale are different. This is because quotients are derived by mathematical division. You can demonstrate this to yourself by looking at IQs of 80 and 85 versus IQs of 120 and 125. First, divide 85 by 80; then, 125 and 120. In the first case, the result is 1.0625; in the second it is 1.0416. So IQs of 80 and 85 are further apart than those of 120 and 125.

For another thing, says Dr. Frederic Weinfeld, also of SRA, IQ scores shouldn't be looked at as numbers, but as to where they fit in bands. IQ scores have a built-in error of 10 points in 65 percent of tests taken. The roughest Stanford-Binet bands, for instance, are these: 60-87 poor; 88-112, average; 113 to 140, good.

People with IQ scores below 60 are mentally retarded; those above 140 are mentally superior. (Einstein, who never took an intelligence test, was estimated to have had an IQ of 207.)

Another danger in interpreting IQs lies

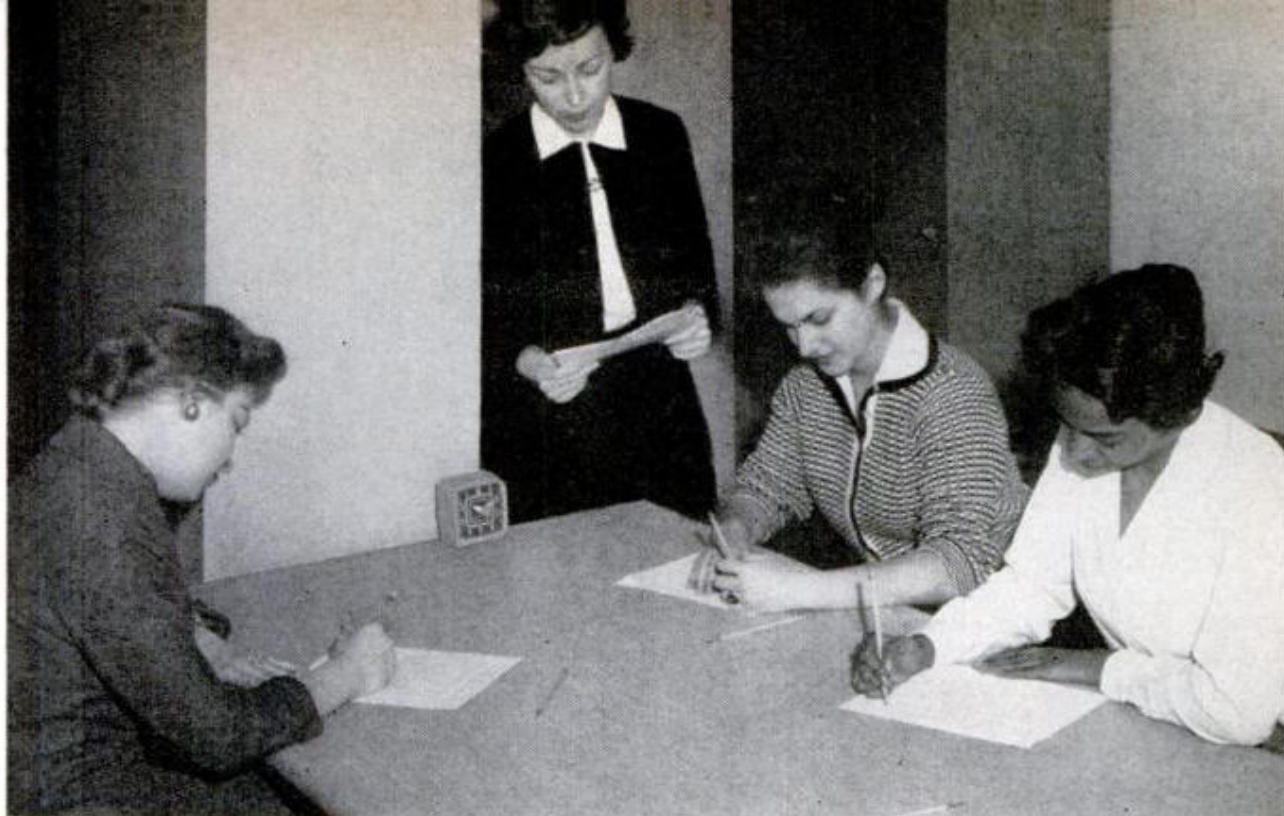

LOOKING FOR JOBS, some seven million adults will take intelligence tests this year in the U.S. Some firms have reported a high correlation between test performance and later job performance—and promotions

in treating them as measures of capacity. Intelligence tests can only give you a score that tells how good you did on them. They cannot tell you what your capacities are; capacities can only be inferred.

Likewise, an IQ can not accurately predict how well you will succeed in life. They can generally tell whether a student should go to college and generally predict how well he'll do once he gets there.

A person with a 120-130 IQ is considered "good college material." But what about the school he intends to attend? Students at Massachusetts and California Institutes of Technology, for instance, have mean IQs of 145; students at the average college have 110-120 IQs; students at teachers' colleges average 100 IQs.

Success at college also depends on other things, like personality, that IQ tests don't measure. There are no points in intelligence tests for creativity or for motivation. A highly-motivated boy with an IQ of 100 could still become an engineer, if he went to a second-rate college and worked hard. The roster of Ph.D. degree holders in the U.S. includes people with 86 IQs.

"Good modern tests can measure reasonably well what a person *knows*, less well what *interests* he has, and only poorly what he *is* and *may become*," says Dr. Chauncey.

What's true with Ph.D. degrees is also true about success in specific jobs. Yet industry more and more relies on intelligence tests to screen job applicants. And check-back studies indicate that the tests

are doing what they're supposed to do.

About 80 percent of our larger companies use intelligence tests today. There are few major corporations in the U.S. which don't use these tests in some job screening, says Mr. Jean Maier, director of industrial test research at SRA. Usually the IQ is reserved for office job applicants and for executives. Few companies give all prospective employees IQ tests.

Most personnel offices use tests you can take in 15 or 20 minutes. These aren't full-scale intelligence tests, but are designed to measure only specific key parts of intelligence—verbal ability and reasoning, usually.

Two companies, Proctor and Gamble and Lockheed Aircraft, pioneered in employee testing programs as early as the 1930s. Sears Roebuck and Co. was a late-comer, but today has probably the most extensive employee testing program in the country.

Companies don't like to reveal how well their IQ tests do in screening applicants, because it gives away an advantage they have over competing companies. Five years ago, for instance, a leading electronics firm realized that it was spending \$10,000 to train each computer salesman—and many trainees never made the grade. Now, with a simple pencil-and-paper test which costs less than a dollar, applicants who don't make a minimum score can be quickly eliminated.

Without revealing any company names,

(Continued to page 232)

Floating Military Truck Goes Anywhere

Now under development for the armed forces, a 1500-pound truck can travel over any terrain, even water, without extra gear.

The water-tight aluminum hull and rear-drive 55-horsepower engine can carry four men and their equipment across rivers or up to 75 miles per hour on a straight-away.

Made by the Fletcher Aviation Co. of El Monte, Calif., the *Flair* is light enough to be airlifted seven at a time by large cargo planes or one at a time by helicopter, and rugged enough to be used in rough terrain.



Telescoping Hangar Saves Shipboard Space

Conceived for use aboard cramped ocean vessels, a hangar that retracts permits a helicopter to land on its small heliport, then extends to cover it up.

Produced in Canada for the Canadian Marine Service, the telescopic hangar measures less than 10 feet retracted and more than 48 feet when extended.

The first of these hangars was installed aboard an ice breaker, the CMS *Wolfe*, and several more have been installed since. Apart from space saving, the hangars protect the helicopters from the corrosive effects of salt spray and sea air.

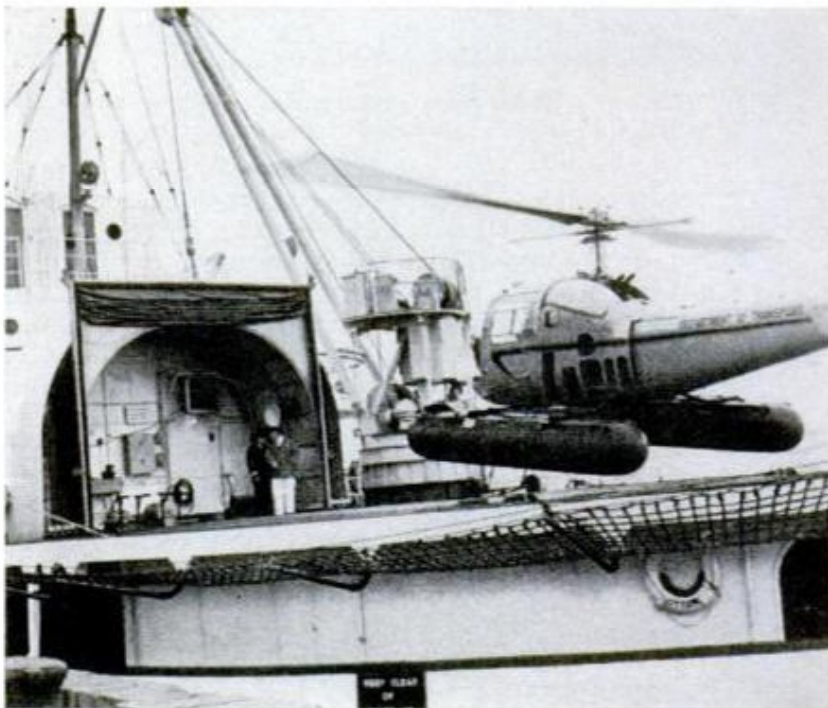

Balloon-Borne Cable Connects Two Islands

Japanese engineers, faced with the problem of connecting two transmission towers—located on islands separated by a one-mile strait too turbulent for boats—solved the dilemma by using balloons. Steep inclines made helicopter approach impossible.

One hundred balloons were used to suspend a messenger wire of 9 mm. (2/5 inch) diameter to make the initial connection. It was then replaced with 15 mm., 20 mm. and, 35 mm. wire and finally with the 35.2 mm. (1 2/5 inch) permanent power cable.



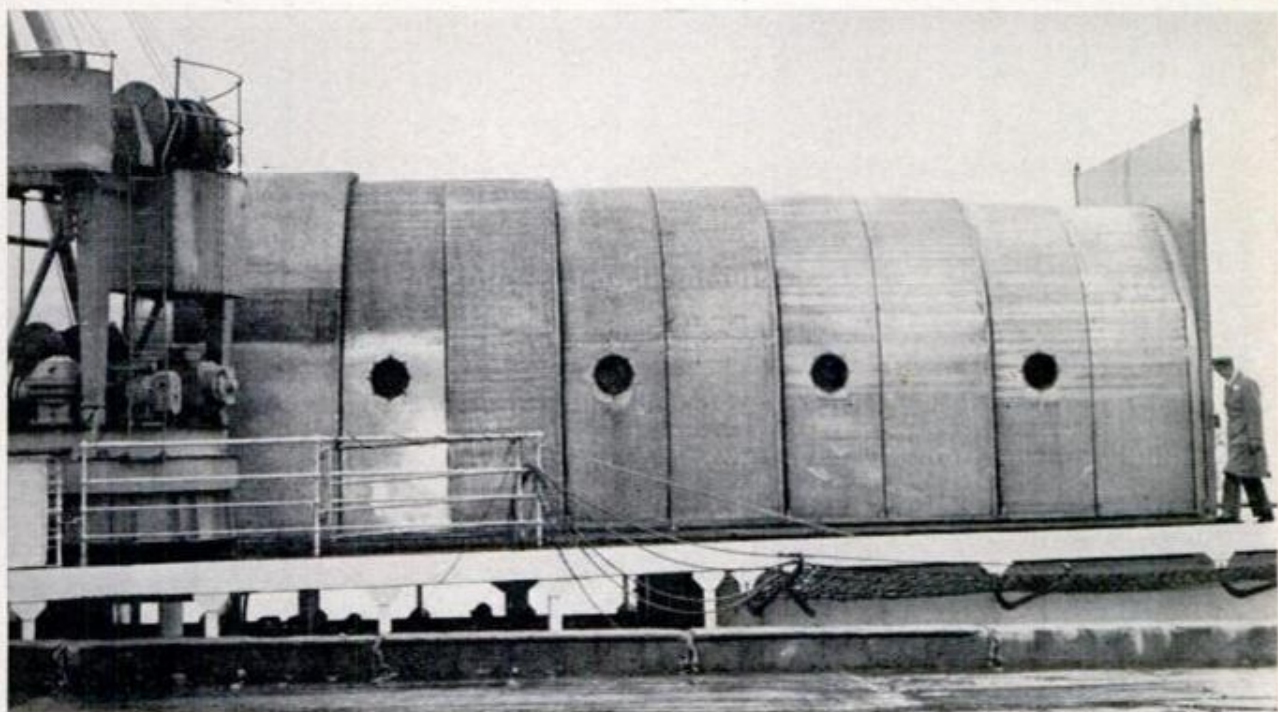

There's more to luring ducks into gun range than simply setting out some decoys. If they spot your spread for a phoney—and ducks are smarter than most hunters think—you're in for a quiet day. But attention to some small details, taking advantage of wind, water, weather, cover and the lay of the land, can change an ordinary bunch of decoys into an inviting spread that'll pull ducks in for you consistently. . . .

By William W. Hunter

1. The Split-Spread Trick

When shooting over moving water, you can bring decoying ducks in right where you want them by splitting your decoys into two groups with a space between them. The newcomers will usually drop into the open space, right in front of your blind.

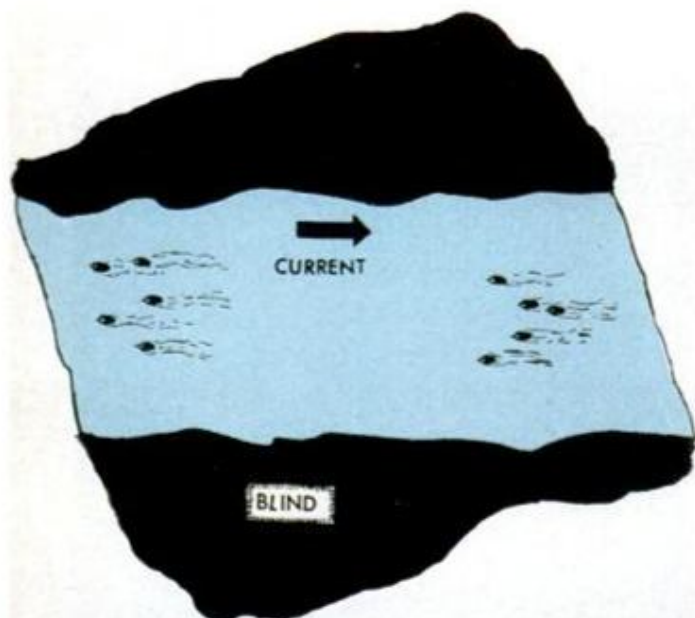

Tips on Decoys



2. The Extra Wing Gambit



Real ducks don't always look like stiff, painted decoys—they stretch and ruffle their feathers like chickens. Save the wings from a few ducks and attach them to some of your decoys with rubber bands as shown; they simulate a resting duck stretching his wings and will help give your spread some realism.

3. The Fall-in-Line Trick

Ducks follow each other like sheep sometimes. A line of decoys set up to look like a flock of newcomers joining the main flock will not only allay the fears of wary flights, but will make your spread easier for low-flying ducks to see.

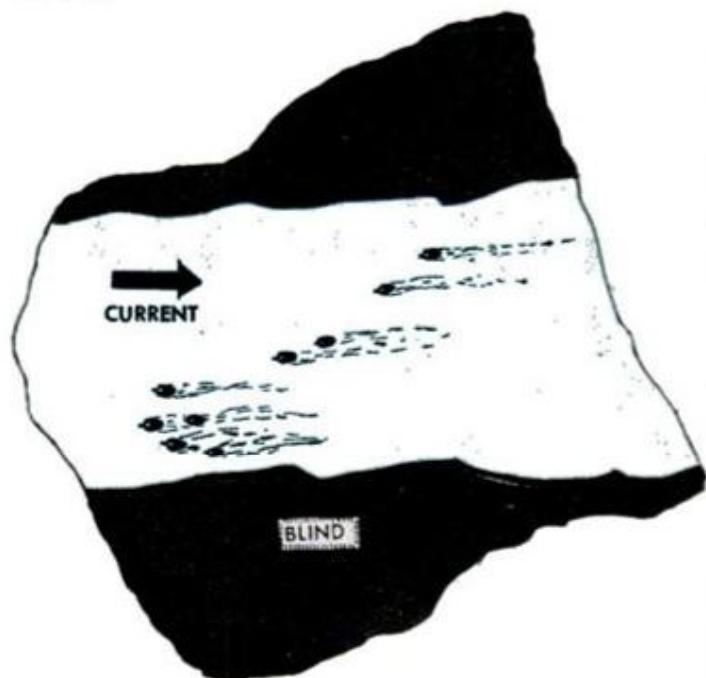



4. The Rippling Decoy Ploy

Nothing looks phonier than a spread of motionless decoys on glassy-smooth water. Anything you can do to add some motion will make the decoys look more lifelike. One good trick, on moving water, is to set up rocks upstream from your decoys to make an eddy in the current. It'll provide the blocks with constant motion.

5. Hiding in the Wind

Since ducks almost invariably land into the wind, and keep their eyes on their landing spot during their approach run, you can hide best downwind from your decoys. The approaching ducks' view will slide over the blind to focus on the spread. Also, when you stand to shoot, the ducks must then fly upwind to escape.

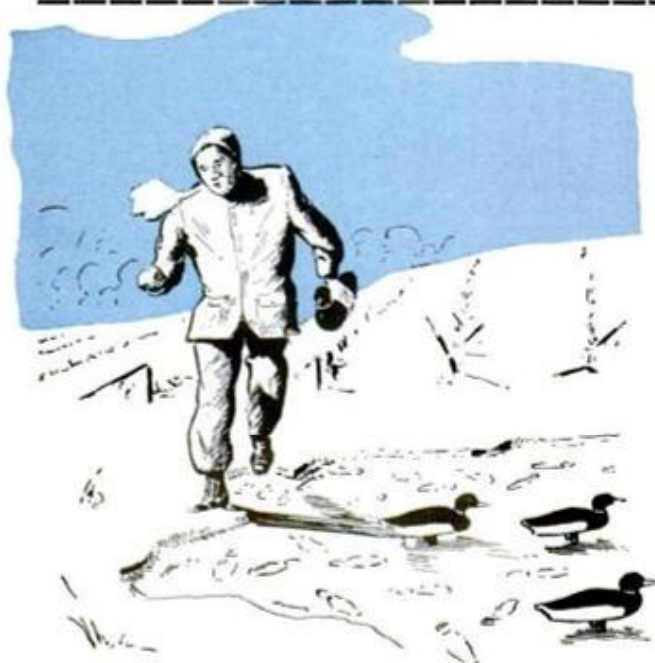

6. The Fake Snow Sign

Smart ducks, looking over decoys set out in fresh snow in a field, look for signs of their feeding. You can simulate this by stamping down the snow in the area around your decoys until the area looks like a popular feeding spot. Be careful, though, not to leave telltale muddy footprints—just pack down the snow.

7. Three Field-Shooting Tricks

Remember, when shooting over a dry-land spread: Always face the decoys into the wind, just as on water. Never place one decoy in line behind another—the real ducks always feed on their own path but parallel to the others. Always tip the decoys' chests upward a bit to make the spread more easily visible from above.

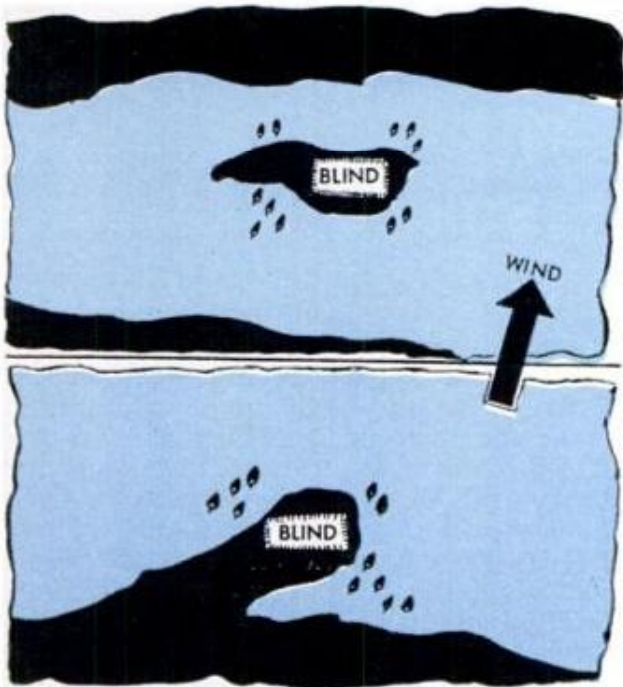

8. The Ideal Blind Location

Have as much visible water around your blind as possible—a small island or point of land is perfect. Spot your decoys in small groups like contented ducks. Pick a spot with a minimum of cover, and use a minimum of natural cover for your blind. Ducks are less suspicious when few hiding places show.

9. The High-Ground Trick

Smart ducks like to feed on high ground so they can spot approaching danger. A flight of ducks won't join your decoys if they think they're feed-

ing in a dangerous low spot. If visibility permits, place your blind in that low ground—tall cover will look more natural in the low spots.



They've Tamed the Power of Volcanoes

By
**Floyd
McCracken**

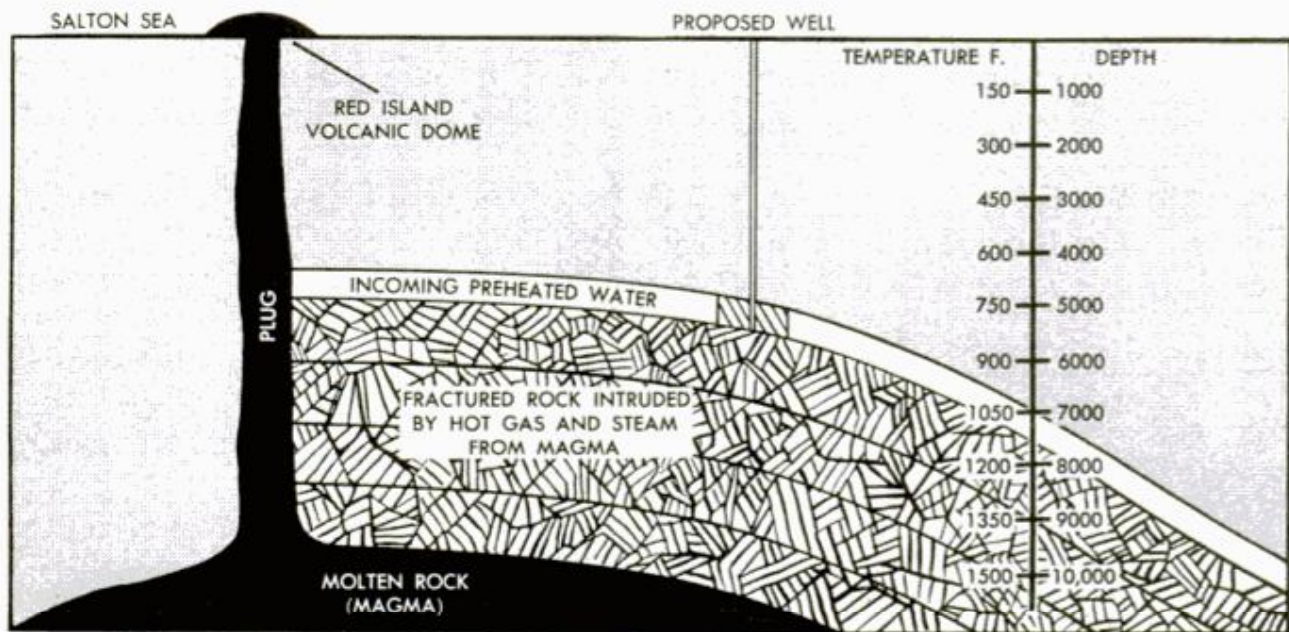

PROFILE of earth under Salton Sea shows how area functions as automatic boiler when well penetrates it

THE WILDCATTERS who departed California's Imperial Valley in disgust in 1957 after their drills struck steam instead of oil left behind a rich discovery—of heat, hot water and minerals—that today promises to be a new source of electrical energy and a chemical industry for the region.

What they didn't know, but what geologists have since learned, is that the area under the Valley's Salton Sea holds a store of hot water. The water is held under great pressure in fragmented rocks; either it was entrapped by an ancient earth movement or it has been squeezed from the rocks by pressure and heat.

Texas oilman Joseph I. O'Neill, Jr. is putting down 10 wells to test the heat-producing potential of the area's 14,000 acres.

The heat is a residue from five extinct volcanoes whose vents were plugged by cooling obsidian. This rock gleams in two black domes that rise 100 feet above the Valley floor. Two earth faults are believed responsible for the drill-exposed rocks being hot. San Andreas Fault runs north-south along the eastern side of Salton Sea. It has been responsible for California's major earthquakes. Obsidian Fault branches from San Andreas and courses southwestward between the obsidian domes and the well sites. Slippages along these cleavages have fragmented Earth's mantle, permitting volcanic heat to rise within reach of rotary drills. A thick blanket of alluvium

effectively prevents the heat from escaping.

This phenomenon is unique in the engineer's experience with magmatic heat. Other areas are producing usable steam from the magma, but they are tapping steam-filled crevasses reaching deep into the earth. Such crevasses exist in California (at the Geysers, north of San Francisco), New Zealand, and in Italy where magmatic steam produces usable energy.

The drillers for heat energy have bypassed the wildcatters' well, although they are drilling near it. Of the two steam wells drilled so far, the second, at a depth of 5230 feet, has temperatures of 715 degrees. Well-head flow conditions give a per-square-inch pressure of 200 pounds, a heat recording of 400 degrees. Engineers estimate that this will produce 10,000 kilowatts which, with minerals produced, will add up to an annual value of some \$600,000.

Steam from this well, if condensed, would produce 400,000 gallons of pure water.

Since the well's output is 32 percent mineral by weight, the water is run into a flash vessel that functions much like a conventional boiler. Steam flashing to the top is used in a turbine; mineral-laden brine drains away at the bottom. When operating properly the system produces virtually pure steam.

The developers regard their property as a boiler with an inexhaustible fuel supply, a boiler that has its own fireman.

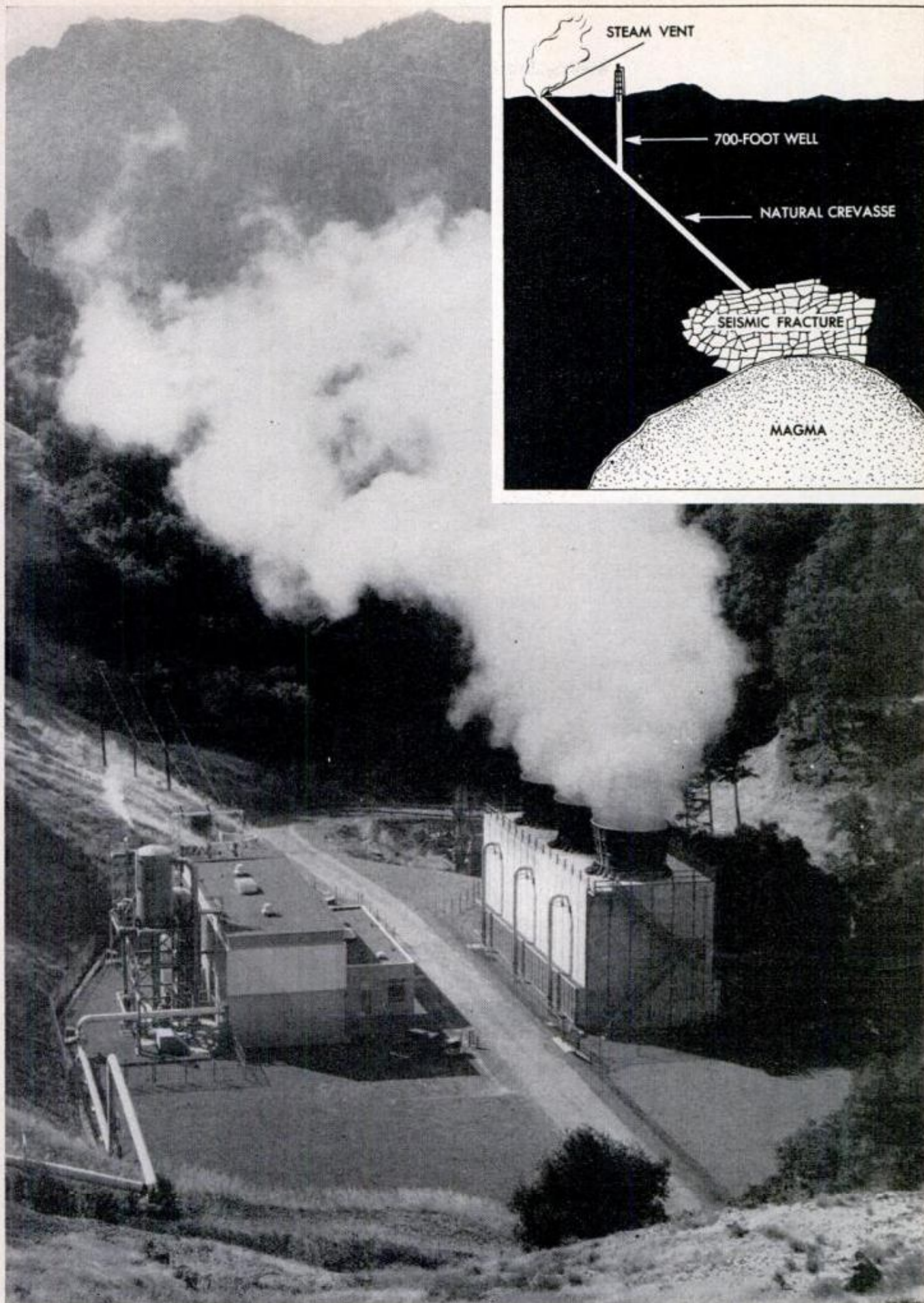
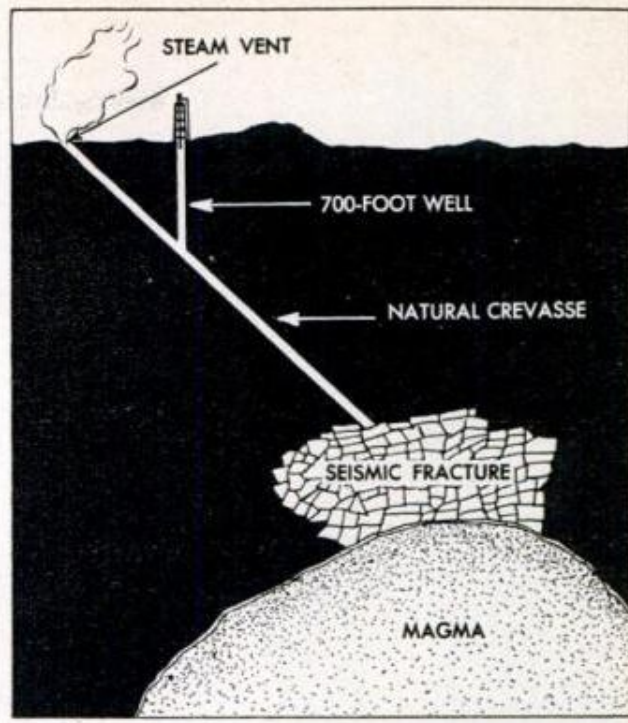

ENERGY at the Geysers geothermal steam plant north of San Francisco is tapped in a more conventional way than it is tapped at the Salton Sea. Here, as in other magma heat areas around, the engineers tapped steam-filled crevasses that reach far into the earth. This plant will produce 25,000 kilowatts of energy



Quick Picture Brooches

Camera and "darkroom" are mounted on a single tripod in a new street-side photographer's rig that produces pictures in brooches that can be pinned to clothing.

Sensitized picture blanks are fed by cartridge into the camera, exposed and then developed in a process that uses chemicals in rubber squeeze containers. Priced at \$89, the camera is sold by PDQ Camera Co., 1546 W. Cortez St., Chicago 22, Ill.



Bowler or Fortune Teller?

Even though they look as fragile as fortune teller's crystals, transparent acrylic resin bowling balls can roll down an alley at 60 miles per hour (or faster) and scatter rock-maple pins along with the best of them.

The ball, tested and accepted by the American Bowling Congress, is a product of the Wondercraft Company of York, Pa. It's made of DuPont Lucite.

Disappearing Act: Controls Vanish at 40,000 Feet

Condensation trails, unwanted by-products of high-altitude flight which betray the presence of an aircraft when the aircraft itself can't be seen, may disappear.

Scientists at the Air Force Cambridge Research Laboratories developed a chemi-

cal method to prevent ice crystals, formed in the engine exhaust, from becoming large enough to scatter light visible from the ground. The upper of the two pictures below shows normal contrails and the other shows them cut off on one side.



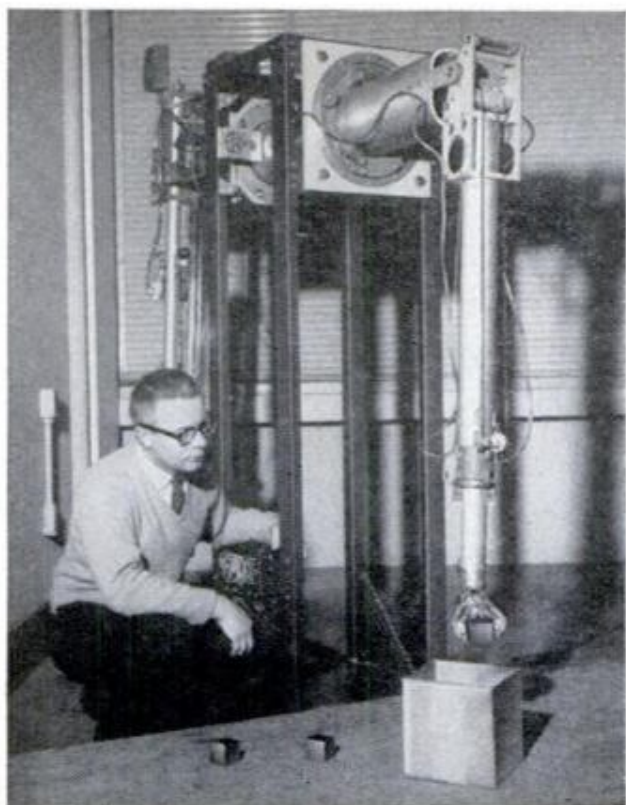

Hand Has a Brain

There is a mechanical hand groping around at Massachusetts Institute of Technology that works with wooden blocks much the way a child does. The hand, equipped with 30 sensing devices and equipped with an artificial intelligence (in the form of a program in an electronic computer), explores its environment, locates a block, determines its size, picks it up, puts in a box. Should the hand run into an obstacle, it picks its way around it.



Siphoning Simplified

You can remove liquids from cans and tanks without risking a mouthful of high octane with a new plastic handler that sucks up half a gallon at a time, then squirts it out on demand. The accordion-folded plastic body does the job for handling fuels or other chemicals, or even watering plants.

Made by Diamond F Sales, 921 Sherman St., Akron 11, Ohio, The Gasser sells for \$1.98.

Built-In Metal Spare Keeps Car Rolling

Bolted to the center of automobile wheel wells, cast-aluminum inserts will hold a deflated tire two inches from the rim in case of a blowout or puncture. The rail's own rubber tread grips the inside of the tire to maintain traction, yet flexes with the tire

allowing the car to be driven to the nearest service station. The car can travel several miles under full control.

The manufacturer of the rail insert is Posi-Trac Rail, Inc., 711 Taft, Houston 19, Tex.

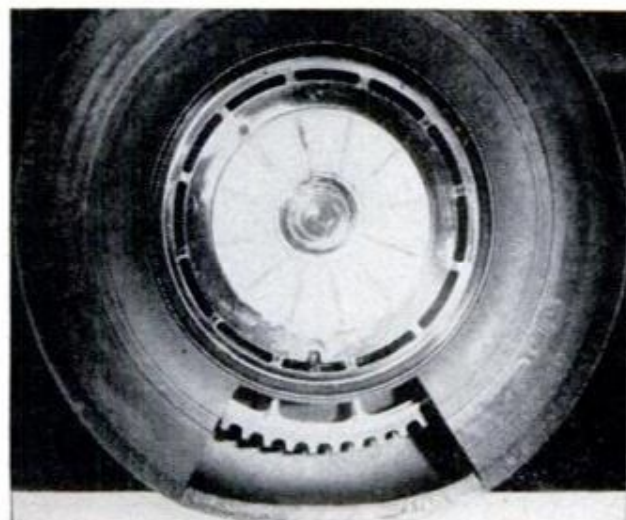

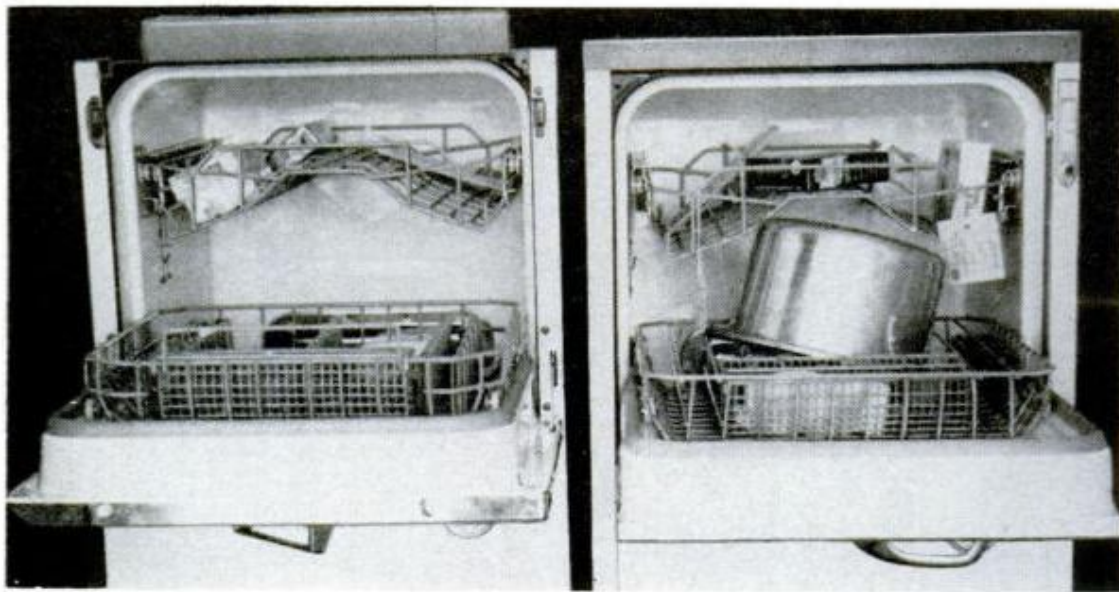

COOKING POT, too large to fit in dishwasher at left, fits in similar model from same maker. Best way to solve this dilemma, when inch might make difference, is to bring pot to store

THERE ARE two major factors in buying a dishwasher, things to know before shopping and things to look for while shopping.

Things to know:

How much space? Some kitchens are too small for some models. Check yours against the available models.

Water pressure. Dishwashers operate on water pressures from 15 to 150 pounds, but it must be *steady* pressure. Fluctuations seriously affect operation.

Clear drains. When dishwashers start pumping, they dump their water in a hurry. Drains must flow fast.

Hot water. All units require 140-

degree water or better, up to 12 gallons per cycle. Best check: If you have a clothes washer, and it works, the water is hot enough.

Wiring. All types use 110-volt, 60-cycle current, but they draw plenty at times. You should have a 15-amp. branch circuit just for the dishwasher, or plan its use for times when your other appliances are not operating.

Additional factors include whether portable dishwashers will roll through doorways, piping for built-in models and distance of electric sockets.

The physical factors of your own

LOADING RACKS change design constantly. Old type (left) dictates which dish will go where. New random type (right) is more flexible, allows almost any dish to be placed anywhere

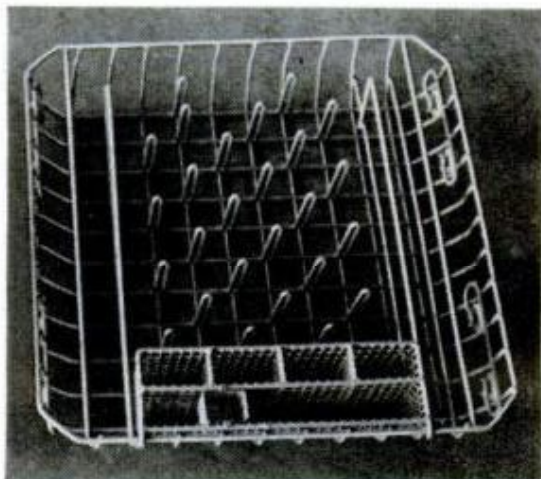
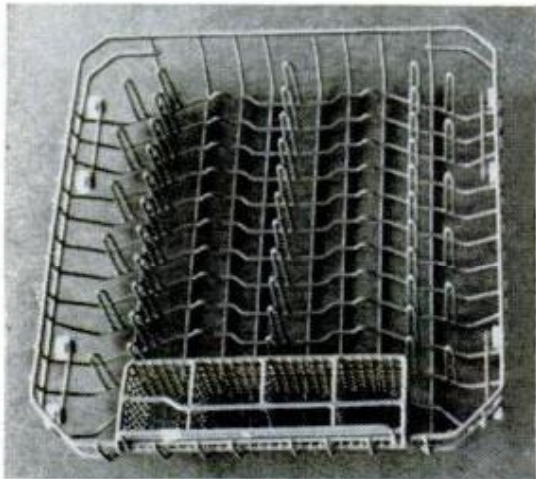



FRONT LOADER allows user to work all around with less stooping, but needs space to front



TOP LOADER requires less floor space, but is harder to load. User must bend to load

kitchen can help you decide which type of dishwasher is best: Portables that can be rolled away and stored; built-ins that are installed inside existing cabinetry; free-standing types that are installed like ranges or clothes washers; or sink-combinations that are included in a complete sink-and-cabinet unit. The advantages and disadvantages of each type are given in the chart on page 133.

Things to look for while shopping:

Loading design. This is the most important use factor. Although front-loaders are becoming more common, both front-loaders and top-loaders have advantages and disadvantages. These are also given in the chart.

Capacity. This is probably the most ballyhooed advertising factor, and the most over-rated. Capacity claims are mere yardsticks of dishwasher size, not dishwasher quality, and many have been known to be exaggerated by 20 percent anyway. Standard claims of from 8 to 12 place settings are possible, but just loading 12 settings is difficult and the wash job is not as good as with a smaller load. Also, these ratings do not include pots, pans and serving dishes.

You can figure your needs by piling a full day's dishes and utensils on the table and counting them. The standard setting per meal is five

pieces of china, a glass, and five pieces of silver. Figure how many settings your family generates in a day, add pots and pans normally used, and you'll come close to the capacity your dishwasher needs.

One tip: Take along your wife's favorite large saucepan or pot when looking over new machines. See if it fits in the one you want. Some don't.

In the end, you'll do better by thinking "How many loads?" rather than "How much per load?"

Racks. More important than capacity is the ease and flexibility of loading arrangements on the racks. There is no current standard, in fact

SECOND ROTOR ARM cuts clearance, capacity. Here it barely clears huge cooking utensil

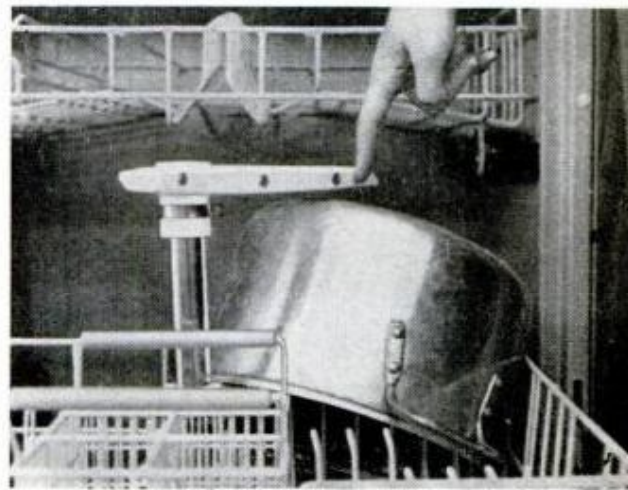

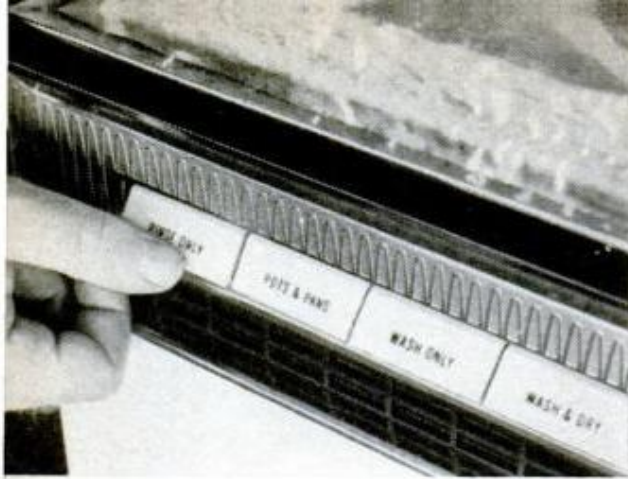

'RINSE ONLY' cycle allows dishes to be held over for full day, from breakfast to dinner

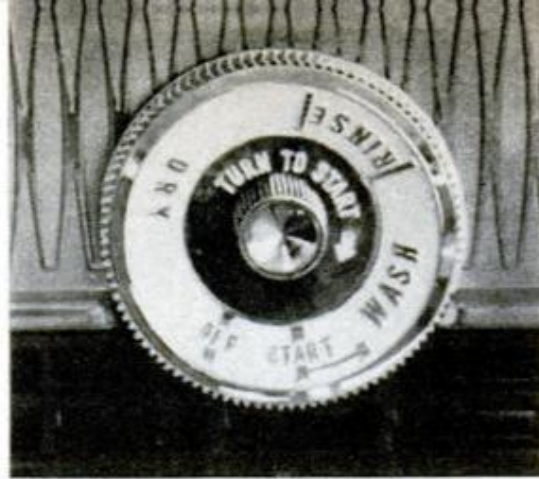

SIMPLE CONTROL is all that's really needed. Easy to read, large enough to operate simply

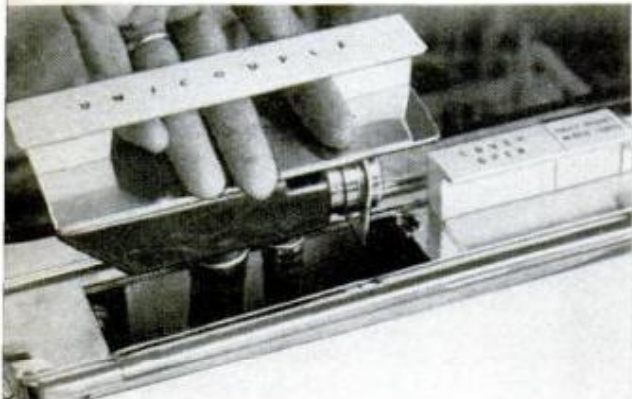

HOSE STORAGE is easy in this model, includes sturdy grip for easier handling and hookup

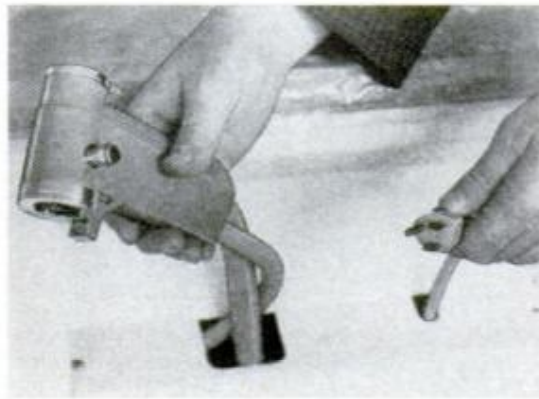

HOSES AND CORDS both need storage compartments. Straightforward design is good

some plants change their racks annually. The latest, one which other manufacturers are frantically copying, is the "random rack" which consists of a series of pegs only—no slots, cup hangers, etc.—allowing any item to be placed anywhere.

The racks are usually plastic-coated steel wire. Nearly all have the same plastic material, but the heavier the wire underneath, the stronger and longer-wearing it will be.

Controls. All that's really necessary is a control that is easy to read, that shows where in its cycle the machine is, and that allows the user to skip cycles or to repeat them by just adjusting the control. Anything more complex is gingerbread.

In almost every case, the difference in controls is the difference in price between the high and low-price models.

Special settings such as "Fine China and Crystal" or "Pots and Pans" are mere variations on the normal cycle. Worthwhile special cycles are "Rinse Only" and "Short Cycle." The first is good when a few dishes must be carried over until there is a full load. The rinse keeps

food from caking on the dishes. The short cycle is handy for large batches of slightly soiled dishes.

Washing action. There are three main mechanical designs for washing dishes, the impeller, the rotor arm and the spin-tube.

The impeller is probably most used now. This is a powerfully driven propeller mounted in the bottom of the tub, which operates in a pool of water throwing it against the dishes.

Most newly designed machines are using the rotor arm. This is a revolving fixture with jets on its upper surface through which water is both pumped and thrown at the dishes.

Least-used is the spin-tube, a cylinder that spins about its long axis spraying water through jets along its sides.

Machine washing requires only that hot water with detergent reach the dishes with enough velocity to have a scrubbing action. All three designs do it, although the rotor arm gets closest to the dishes, so probably is the best design.

Extras. Most accessories are decorative—and expensive. A worthwhile extra is a maple chopping-block top,



CYCLE DIAL on this automatic is in awkward position near floor, where it's hard to read



FILTER SCREEN should be easy to get to, remove or replace. Good ones last much longer

ADVANTAGES

PORTABLES: No installation. Can be moved from house to house. Trade-ins simplified. Low first cost. Service accessibility usually better. Has same capacity.

BUILT-IN: Out of way. Quiet when installed properly. Always ready to use. Adds to house value. Can be purchased with FHA loan when part of kitchen remodeling. Has low first cost when purchased with house.

FREE-STANDING: Installed like any appliance. Moves to another house relatively easily. Trading and changing simple. Shares most advantages of built-ins.

SINK-COMBINATION: Fits same 48-in. space as normal sink. Preplumbed, prewired for simple installation. Is the only answer when space is really tight.

TOP-LOADING DESIGN: Smallest floor-space requirement. Easy to see into. Simple construction.

FRONT-LOAD DESIGN: Easiest to load. Uses full capacity. Permits top to be used as table.

WATER TEMPERATURE BOOSTER DESIGN: Maintains necessary water temperature where water heater is inadequate.

GAS-FIRED WASHERS: Heats own water. High heat eliminates separate dryer devices. Unit is fast, works at 180 degrees.

DISADVANTAGES

Noise level usually higher. In the way in busy kitchen. Requires "plugging and unplugging" at each use. Ties up sink while working. Seems to vibrate more.

Usually higher in cost, and must be installed, at further cost. Service access not always simple. Won't fit all kitchens. Not for renters. Trade-ins restricted to brands that will fit "hole."

Is a pretty big package for many kitchens. More expensive than most portables, many built-ins. Not offered by all brands.

High cost. Does not allow all sink styles. Only offered by two brands.

Hardest to load. Requires much bending. Requires space overhead. Capacity slightly cut in upper rack. Top cannot be left in use as table space or work area.

Has more hardware. Requires space to front, nearly doubling floor-space needs. Not easy to see into.

Draws more current. Slows cycle if much heating is necessary.

Comes only as built-in. Require gas piping as well as water, electricity. Is "new" to the market.

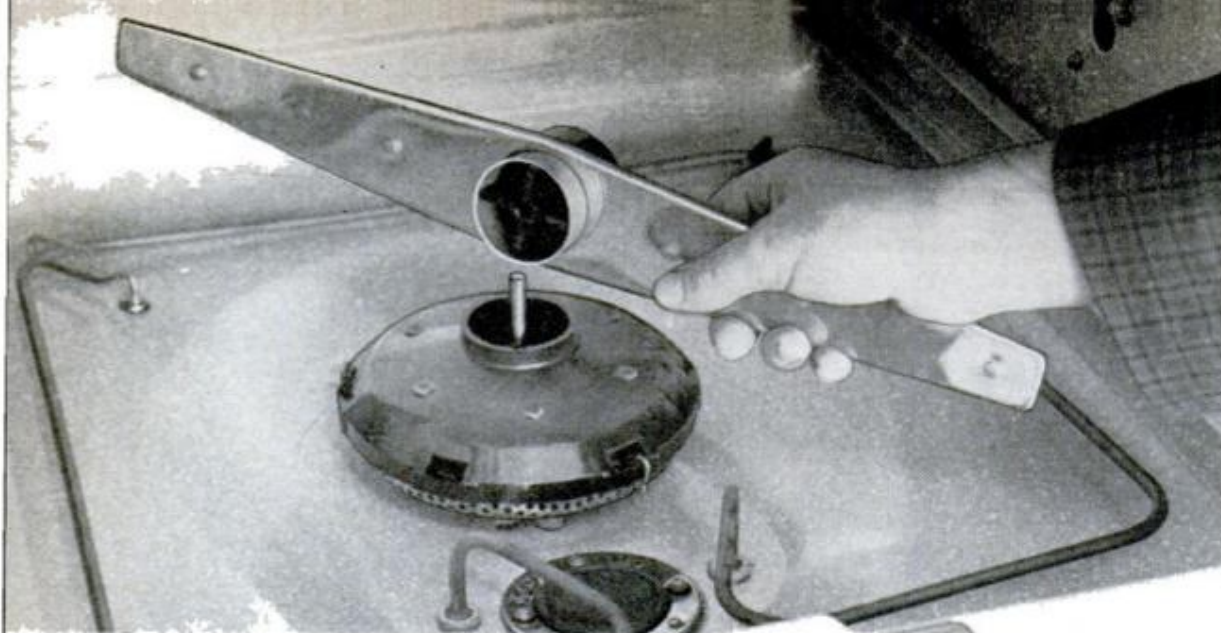

ROTOR ARM should lift out easily for occasional cleaning. Main rotor here is on direct drive. If machine has second rotor (page 131), top rotor is usually operated by water pressure only

which turns the dishwasher top into a usable work surface.

Some machines offer automatic rinse and detergent dispensers, but not all work well.

Some machines have rather special features, such as an electric unit that heats its own water and the gas-fired unit that needs no dryer. Both are covered in the chart.

The dealer is important in purchasing a dishwasher, and should be judged on his service ability as well as his price. Most dishwashers are sold on a year's parts and service warranty, and offer less trouble than the average clothes washer. Users, however, are less familiar with dishwashers, creating service problems.

Dealers who offer free home trials—and some do, because dishwashers are “low saturation” items, meaning relatively few people own one yet so they get special treatment—claim they sell nine out of ten they place in homes. If you can find such a dealer, it's probably the best way to buy. Such dealers don't offer the best discount price, but they do offer something else—the chance to change your mind.

Dishwashers are priced about like clothes washers, retailing from \$175 up. And what do you get for your money? Convenience—a task done mechanically that hardly anyone enjoys doing by hand. And time—time to spend doing other things.

For the mother of several children, for the working wife, for the family who entertains a lot, the purchase may make sense. ★ ★ ★



SINK CONNECTOR works easily on this model with large thumb latch (top). Side button on same connector (bottom) operates bypass to get water from faucet while dishwasher is in operation

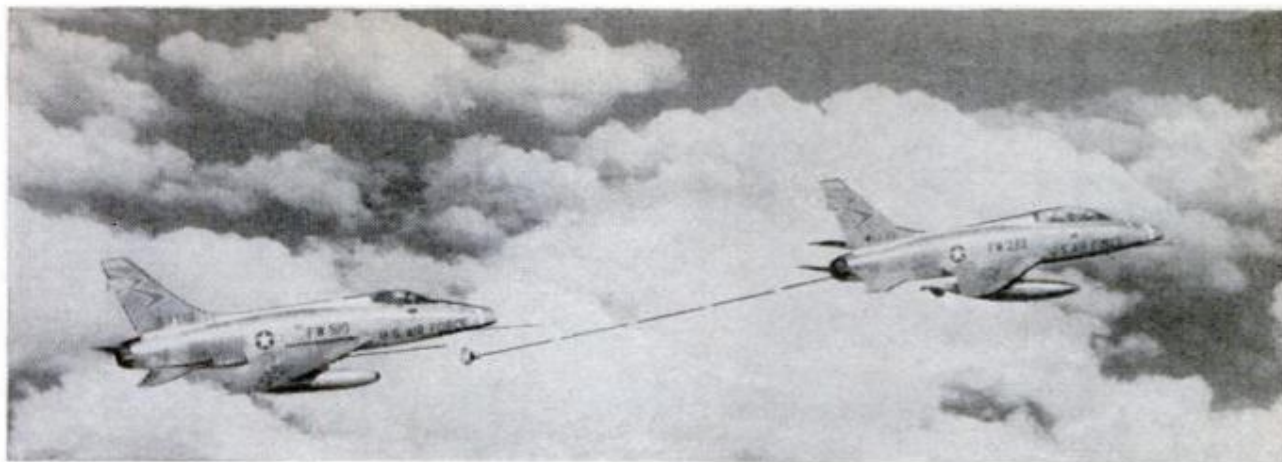

Fighter Feeds Fighter in New Midair Refueling Technique

Because of the high rate of fuel consumption of jet fighters, extended missions require wing tanks or midair refueling or both. Aerial tankers, usually four-engine cargo planes, have usually performed these missions. Now, to speed up the process,

F-100 *Super Sabres* have been outfitted with refueling equipment for other F-100s at the Misawa Air Force Base in Japan. Two tanks slung beneath the fuselage carry the 57-foot hose and 900 gallons of fuel. Connecting speed is around 300 knots.

Portable Planetarium

Small enough to be wheeled around on a cart, a planetarium can be used in projection domes 16 feet in diameter.

The planetarium projects planets, the moon and sun, galaxies, morning and evening glow, even satellites. It projects 2500 stars down to the fifth magnitude.

It is sold by Wyle Laboratories, 128 Maryland St., El Segundo, Calif., for \$7500 with a 16-foot fibreglas dome.

Back-Seat Platform

Sedans can do some station-wagon chores with an Auto Platform—two pieces of hardboard with adjustable steel legs that convert rear-seat areas to a flat space for light hauling or a sleeping and play area for small children. The maker says the platform will support up to 600 pounds, yet attaches without screws or tools. Approved Products Co. prices it at \$7.95, f.o.b. 1625 South 6th Street, Milwaukee 4, Wis.





FIRE STARTER IN PAPER CUP is made of paraffin and dry wood shavings. It burns for 10 minutes, igniting barbecues, campfires, fireplaces. Box of 50, \$2; Fire Starters, Dept. 90, P.O. Box 711, Tacoma 1, Wash.

WHAT'S NEW FOR Your Home

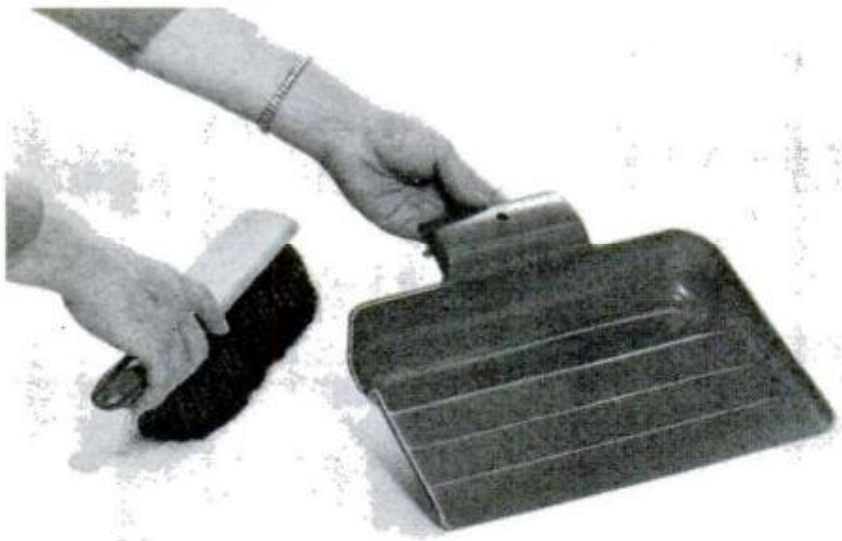

MOLDED PLASTIC DUSTPAN has a deep-trough well with pouring spout for easy emptying and grooves to catch and hold dirt. Several nest together to save storage space. Fox Specialty Co., Lowell, Mass.

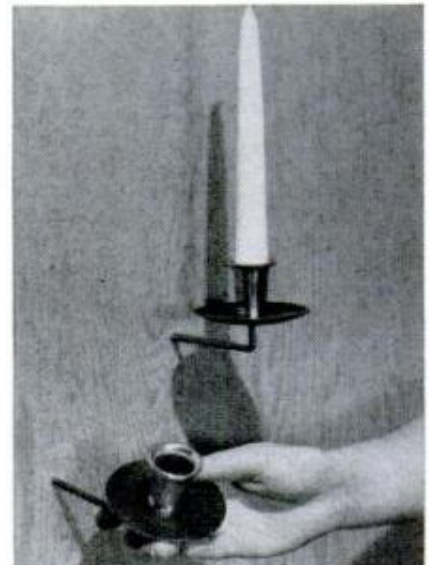

SCREW-IN CANDLE HOLDERS create wall sconces. Price: 85 cents; Beagle Mfg. Co., 91 Beacon Pl., Pasadena

HOME THERMOSTAT-CONTROL UNIT has barometer, thermometer, humidity indicator and warning light to indicate when furnace air filter needs changing. It's sold by Sears, Roebuck and Co., and costs \$30

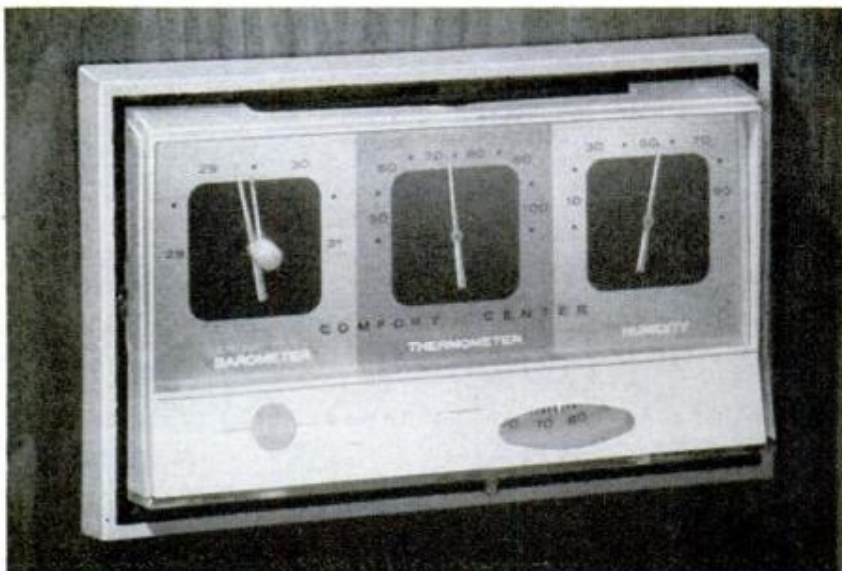

MAIL SCALE weighs up to four ounces. Costs \$1.50; Triner Scale & Mfg. Co., 2714 W. 21st St., Chicago

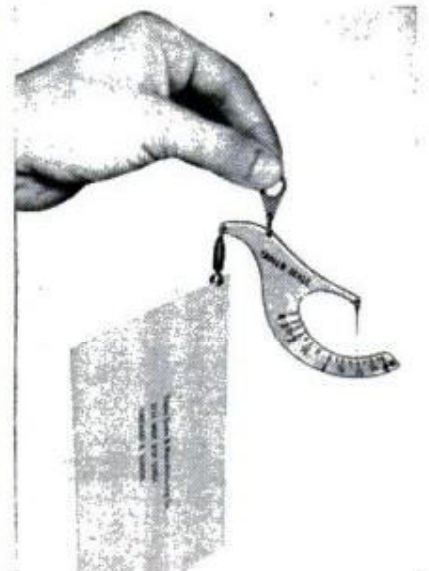



ONE OPENER for all jars, bottles, cans. Costs \$1; from Geo. F. Maier, 1408 Comanche Dr., Rockford, Ill.



HANDY PHONE AID has memo pad, pen index, ashtray. Costs \$4; sold by Omar's, Dr. 756, Indio, Calif.

PLASTIC SOLE fits on iron, prevents shining, sticking, burning. Costs \$4; Tri-Point, Albertson, Long Island



OCTOBER 1962



DISHWASHER-SINK-CABINET COMBINATION can be installed with minimum remodeling in space left by old sink. It's made by Kitchen Aid Home Dishwasher Div., Hobart Mfg. Co., Troy, Ohio, in several models

SILVER SPRAY-CLEANER PREVENTS TARNISH for months, and cleans flatware and jewelry without scratching or abrading. A 7-ounce can costs \$2.49; Minnesota Mining Co., 900 Fauquier St., St. Paul 6, Minn.



137

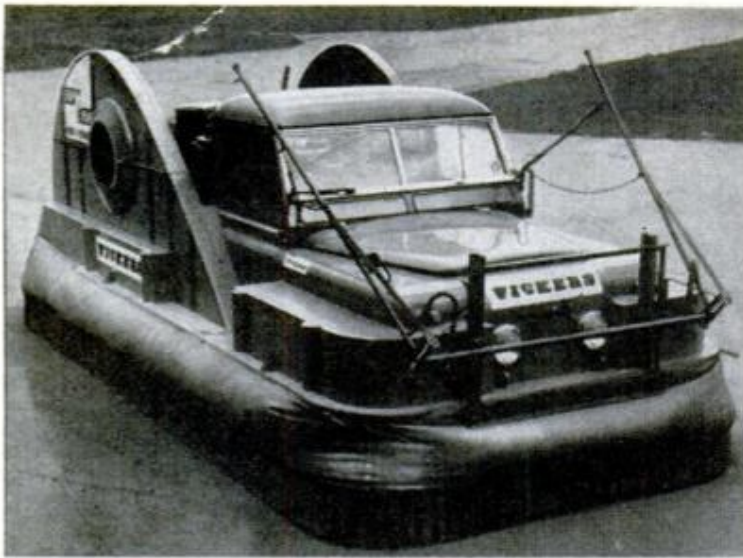

Truck Made Into Air Car

Converted from a utility vehicle, an English ground-effect machine never actually leaves the ground but is able to drive over boggy terrain with ease.

Called the Vickers Air Cushion VA-3, it consists of a standard utility vehicle, the Land Rover, and an air-pressure system that produces 40-pounds-per-square-foot pressure underneath the vehicle.

It was demonstrated recently at the Vickers factory in Swindon, England. Several other British air-cushion machines have been built in recent years.



Predicts Life Span

How long will you live?

A machine developed by the National Institute of Mental Health may be able to predict future physiological changes — disease and even death.

The electronic Psychomet uses a series of 10 lights and 10 keys to test a subject's motor activity and associative-activity speed. The lights go on in a preset pattern and the patient responds by operating the keys.

Recorded data is analyzed to foretell physiological changes. The machine was originally designed to study air-traffic controllers.



Transfer Color Murals

Color murals, painted by well-known artists, can be transferred to any painted surface with a do-it-yourself application.

The preprinted mural, on a sheet of specially treated paper, is taped against the wall, then rubbed with a special stylus to transfer it in full color to the wall.

Once applied and allowed to harden for a few weeks, the mural is washable but can be removed without marring the wall. More than 50 designs are available, including landscapes, city views, and abstracts. Some can be cut apart and spaced around a room. The size range is from three feet square to four by twelve feet. They are priced from \$5 to \$45.

The manufacturer is Art Transfer Co., Merchandise Mart, Chicago 54, Ill.

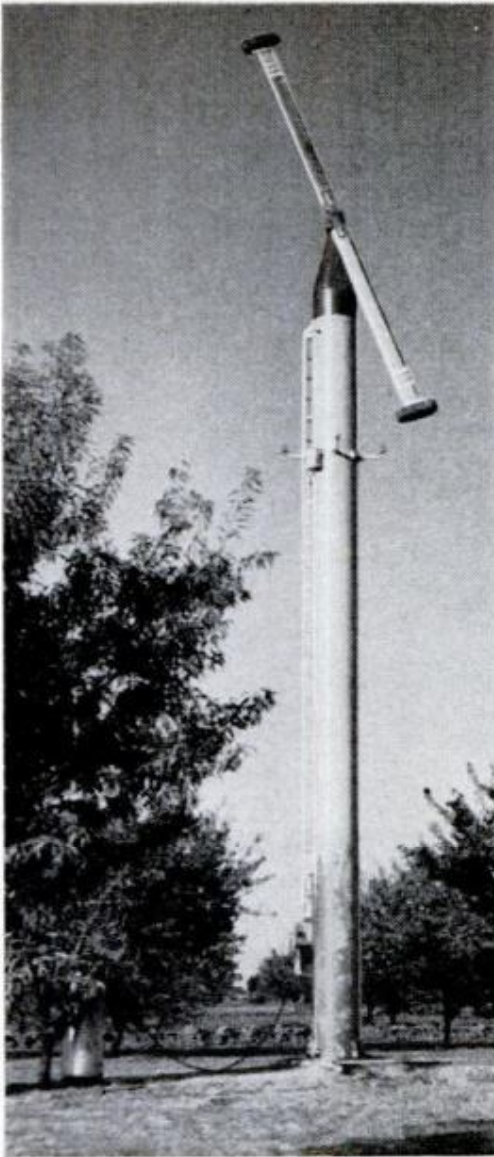

Anti-Freeze Breeze

Frost damage to crops can be prevented by a heat-and-wind machine that provides protection for up to 40 acres.

The 25-foot propeller atop the tower is powered by two ram-jet engines which produce 70 pounds of thrust to rotate the blade at 550 revolutions per minute. The machine is made by Hipp Welding Inc., PO Box 28, Palo Alto, Calif.

Pen Holds Own Paper

Pen and paper are combined in one small package by a new ball-point that carries its own supply of paper.

A small roll of note paper inside the pen can be pulled out like a window shade when needed. A fresh paper supply is installed by unscrewing the end and inserting a new roll. The pen costs \$4.95 and is available from J. A. Bennett & Co., Osgood, Ind.

OCTOBER 1962

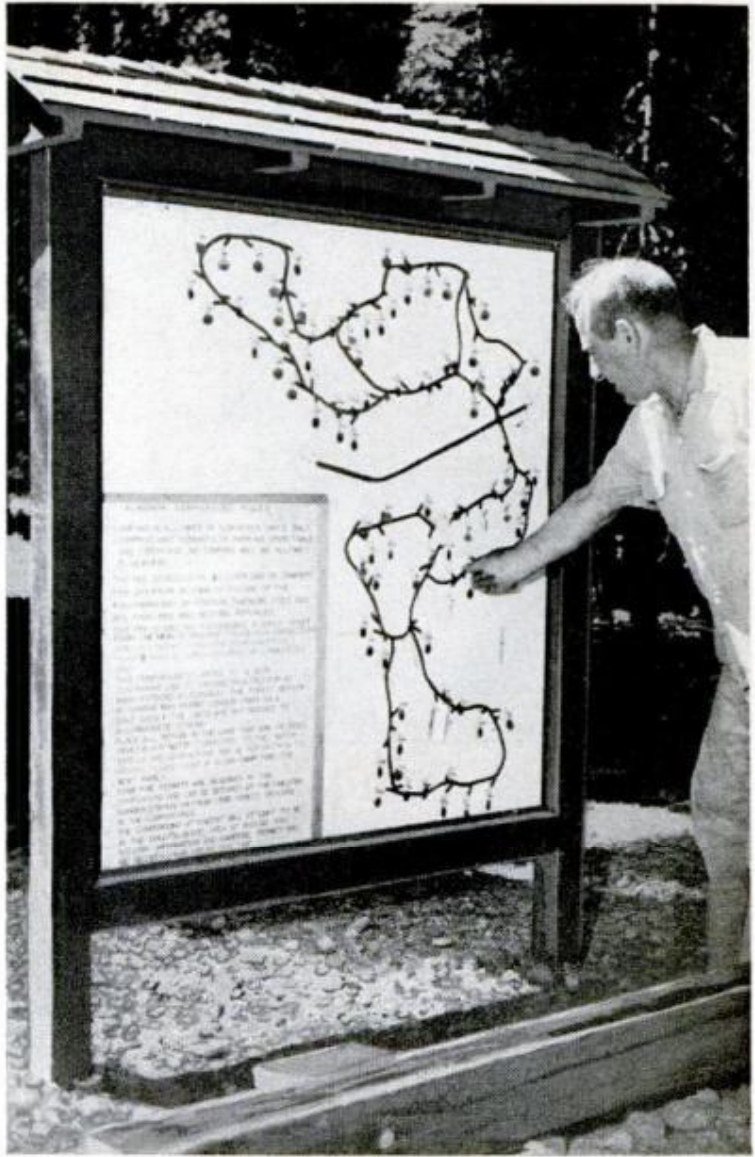

Campers Serve Selves to Camp Sites

Solving the problem of selecting and assigning public camp sites in one easy stroke, the California Forest Service has installed self-service camp-site selectors in three campgrounds.

The arriving camper gets a picture of the entire grounds and finds the rules at the same time on the big signboard. He removes a marker to reserve the site he wants. The marker matches a tag posted at the site. Campers even use the board to leave messages for others. The system works 24 hours a day, and has freed rangers for other duties.



139



TRACTOR CLOWNS, like clowns at any stampede, amuse crowds between events. In this case, he's doing a "Look, Ma! No hands!" routine on baby tractor

By
Rafe Gibbs

Tractorjack Stampede!

NO ONE HAD EVER held a competition for tractors before, but the Chamber of Commerce of Moscow, Idaho, thought someone should.

So the First Annual Tractorjack Stampede was organized with resounding success. There were so many entrants that the committee had to stop taking them.

The contestants were judged in seven

events, with only the top three competing in the seventh, a steeplechase.

The first six events included cross-steering on a combined pull; racing over a marked course, grabbing a numbered pig from a pen and carrying it back to the starting point; a trailer pull over a hilly course; boulder bulldozing; log lifting; and balancing on a log.

BOULDER BULLDOZING consists of rolling three huge boulders down marked course without scraping up too much dirt. Event was won by Idaho lumberjack



LOG LIFTING event requires tractorjacks to hoist large log with small clamshell attachment and put it back between stakes without ever touching the stakes

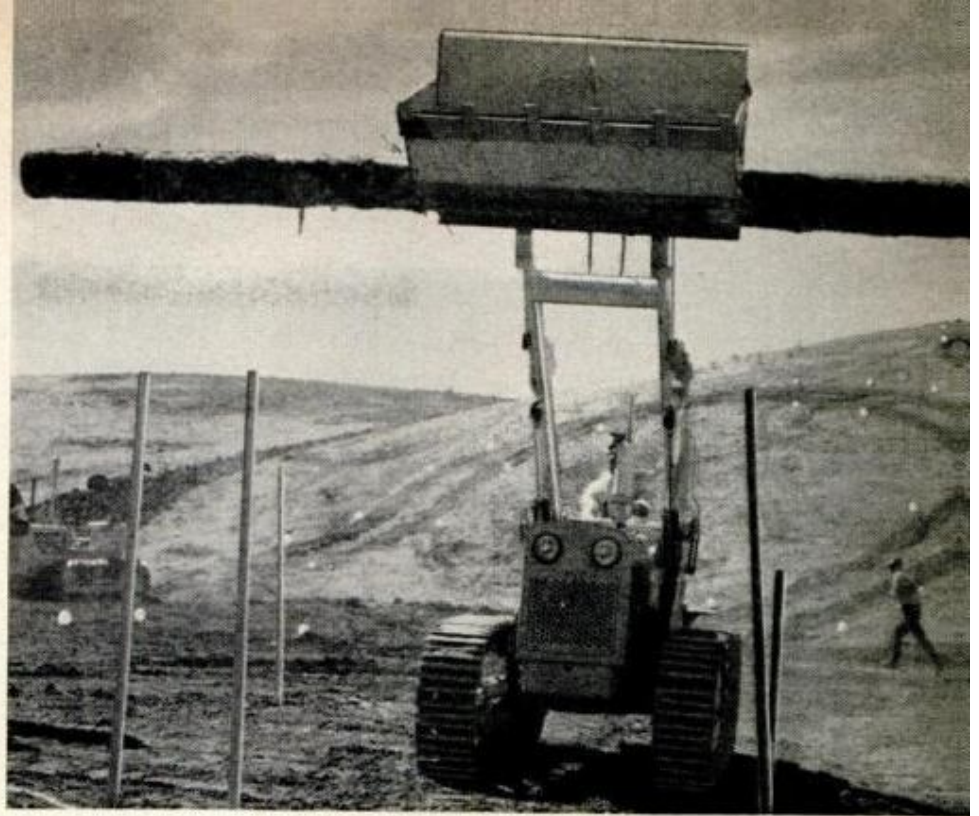

TRACTOR BALANCING on log was won, not surprisingly, by another woodsman. Contestants drive onto log and balance tractor, front and rear ends in air

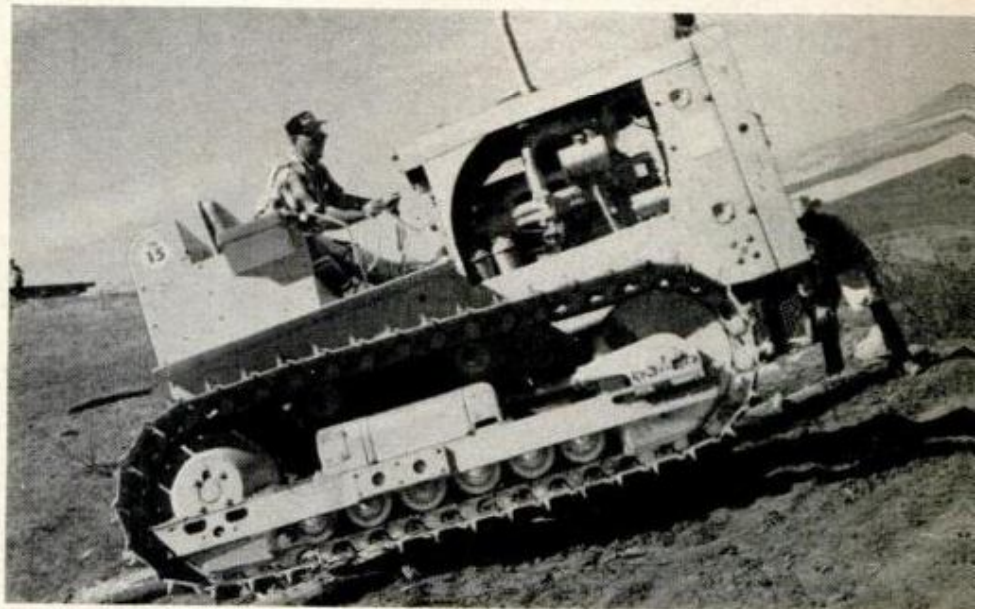

TRAILER PULL was on winding course marked by balloons. If balloon broke, it cost points



CONVERT YOUR ACCORDION INTO

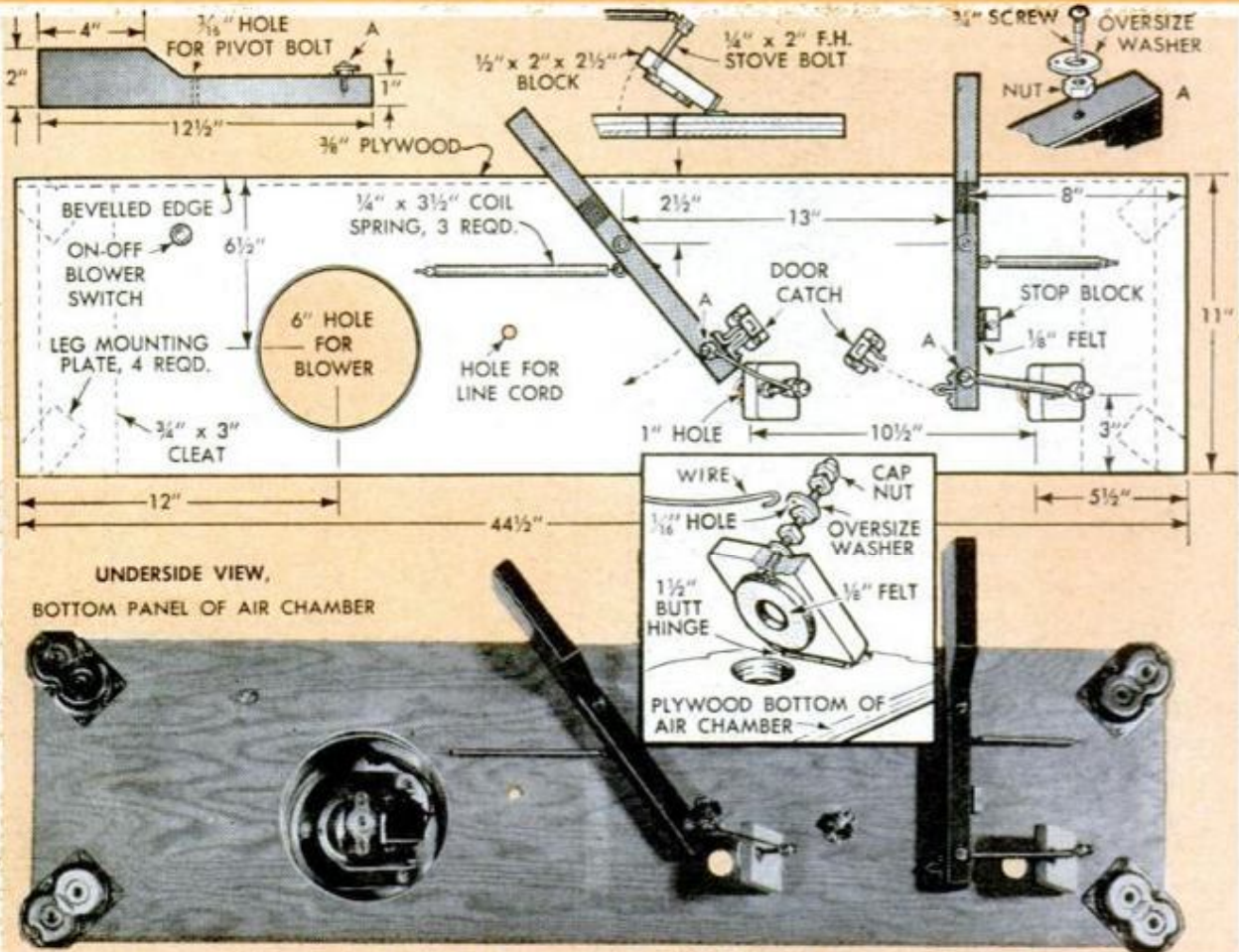

LOOKING UP underneath you see blower, volume-control arrangement, and plates to attach legs

BASS AND TREBLE ASSEMBLIES project from front panel so keyboards will be level and in alignment. View shows assemblies before adding grilles. Opposite page shows how grilles add to appearance



AN ORGAN



By G. W. Stamm

YOU, YOUR FAMILY, and your friends will all be fascinated with this portable chord organ that can be made easily from an accordion, substituting a silent electric blower for the bellows. Being small and lightweight, it can be carried by one person and easily transported in a car. You can connect it to a long extension cord and have music at your garden barbecue.

Selecting the Accordion

You may have an old accordion or you may want to buy one secondhand for the purpose. No alterations are made that will

prevent changing the instrument back to its original purpose should you desire to do so. Accordions come in a number of sizes and with 12, 48, 80, 120, and 140 bass keys. One having only 12 bass keys is too small. For best performance use a 120 or 140-bass with 41 treble keys and a keyboard not less than 18½ in. long.

Case Construction

As it serves as the air compression chamber the case must be airtight. It can be built of ¾-in. hardwood-faced plywood if you wish to finish it with stain and varnish,

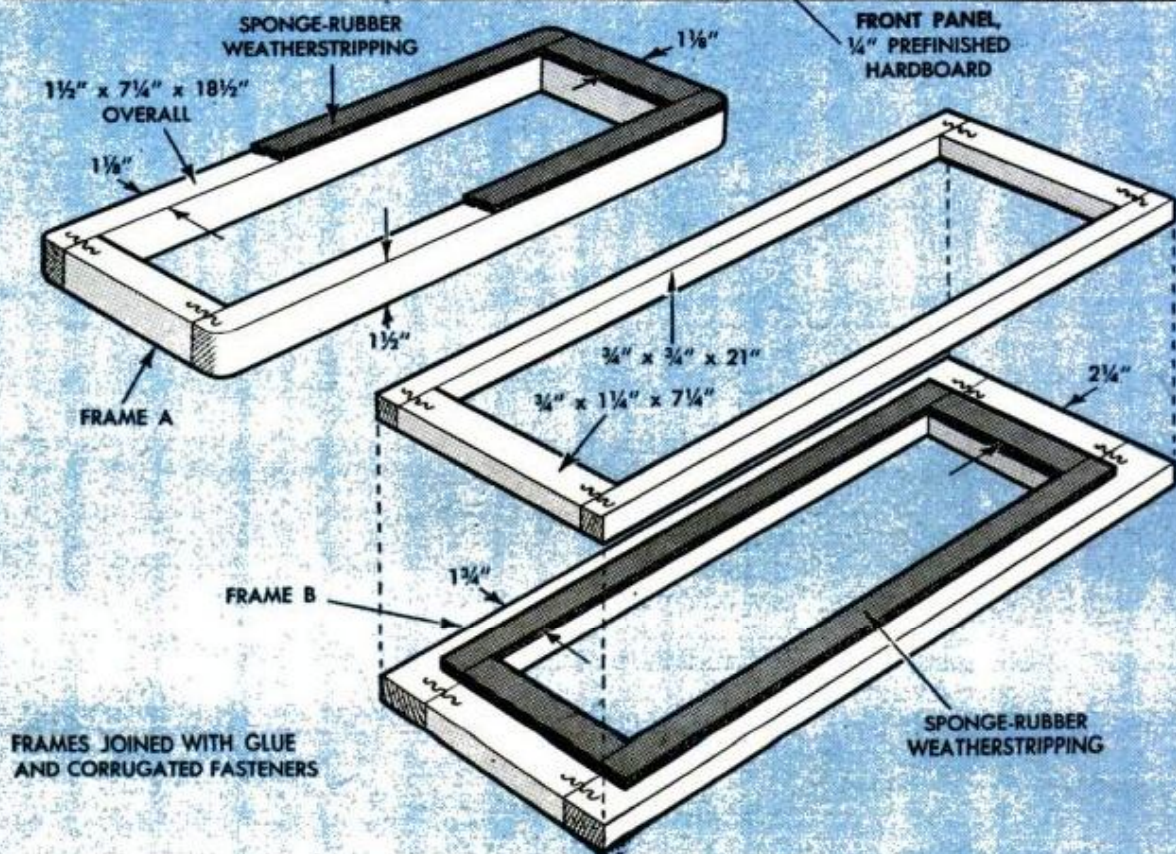
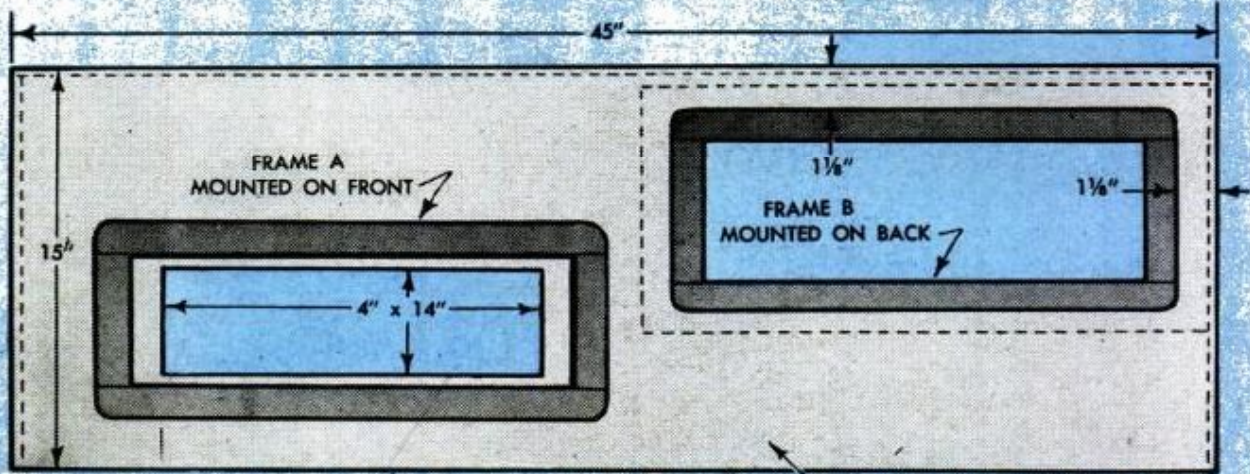
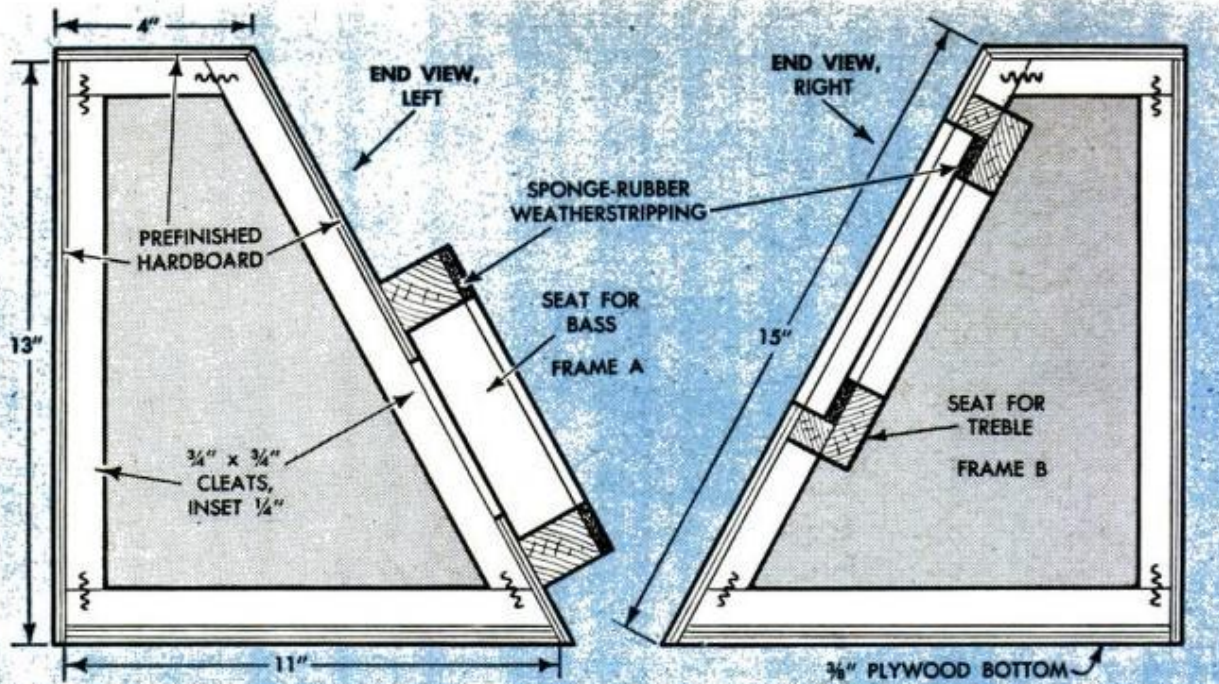

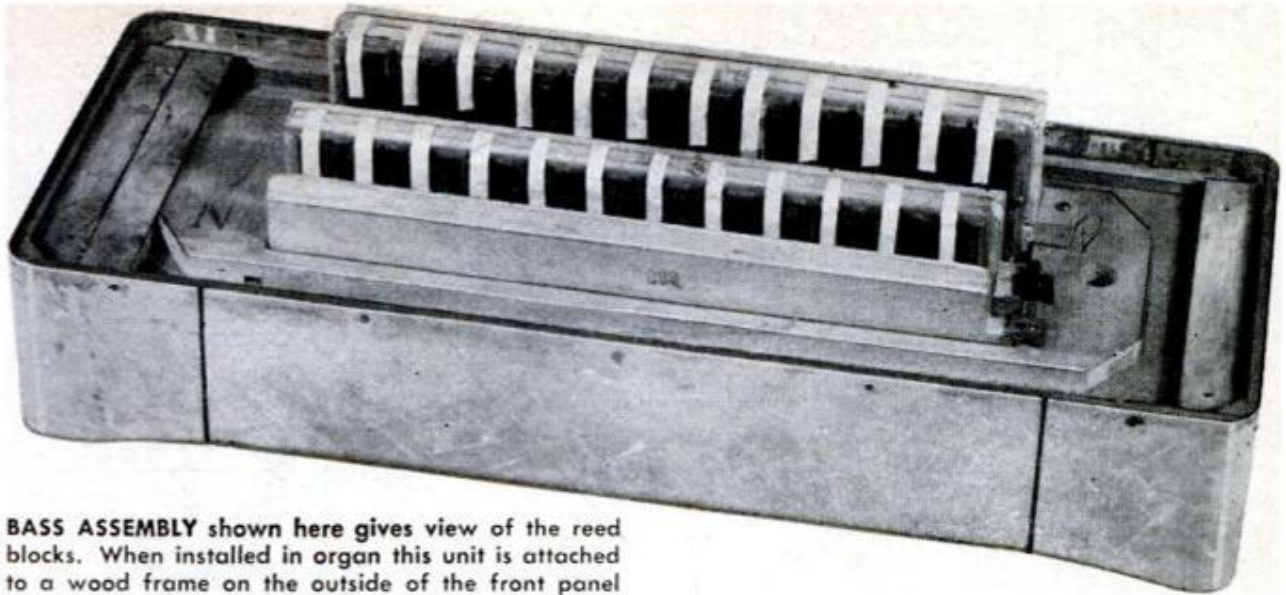

BASS ASSEMBLY shown here gives view of the reed blocks. When installed in organ this unit is attached to a wood frame on the outside of the front panel

or from 1/4-in. plywood to which plastic laminate is cemented, after the case has been completed. The original case was made of 1/4-in. Marlite, a prefinished, wood-grained wall paneling.

Case dimensions to house the bass and treble assemblies of your accordion may vary a little from those given here, which are for a 120-bass Hohner having a 7 1/4 by 18 1/2-in. body—about as large as 120-bass models are made. For a larger instrument than this you increase the size of the case to suit. For a smaller one, use the case size given here but place the keyboards farther away from the ends.

The angle and width of the front panel, and the width of the top often differ slightly from those shown here because angles at which treble keyboards of accordions join the bodies vary from 60 to 65 deg. To determine the angle for your front panel hold the treble keyboard perfectly level so you can measure the angle of the housing where it will be joined to the panel. After having determined the angle and widths of front

(Continued to page 228)

TREBLE ASSEMBLY showing how strips of adhesive tape are used to seal apertures of the suction reeds which are not used but will allow air to escape

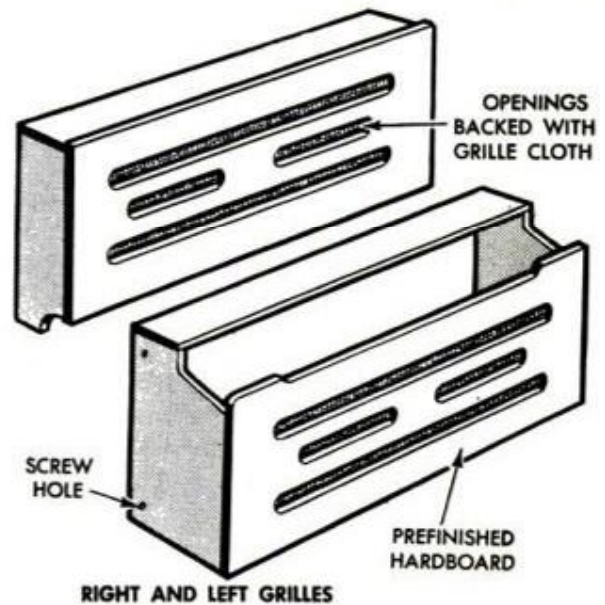
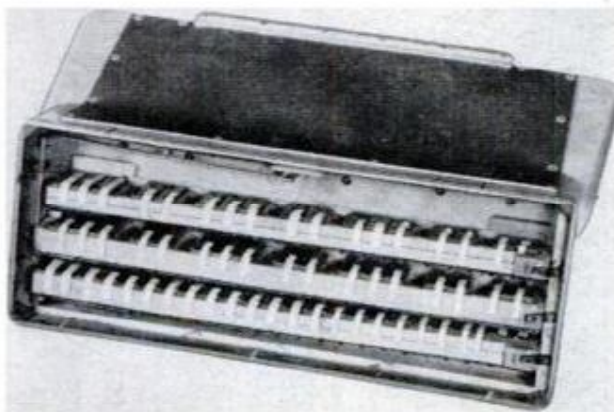

RIGHT AND LEFT GRILLES

GRILLES that cover part of the projecting accordion assemblies were made of prefinished hardboard wall paneling to match the case. Slotted openings which are backed with grille cloth, are neatly cut by first boring holes at the ends of the slots, then sawing from hole to hole with a jig or coping saw

SILENT BLOWER especially designed for organ use draws in air through hole in bottom of the case and provides plenty of air pressure for maximum volume

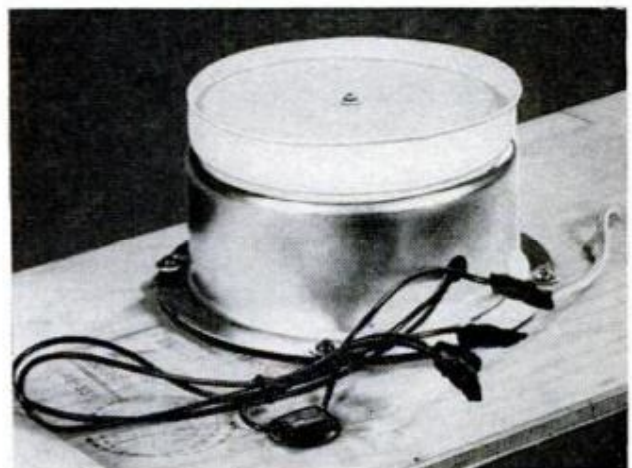

DART BASEBALL

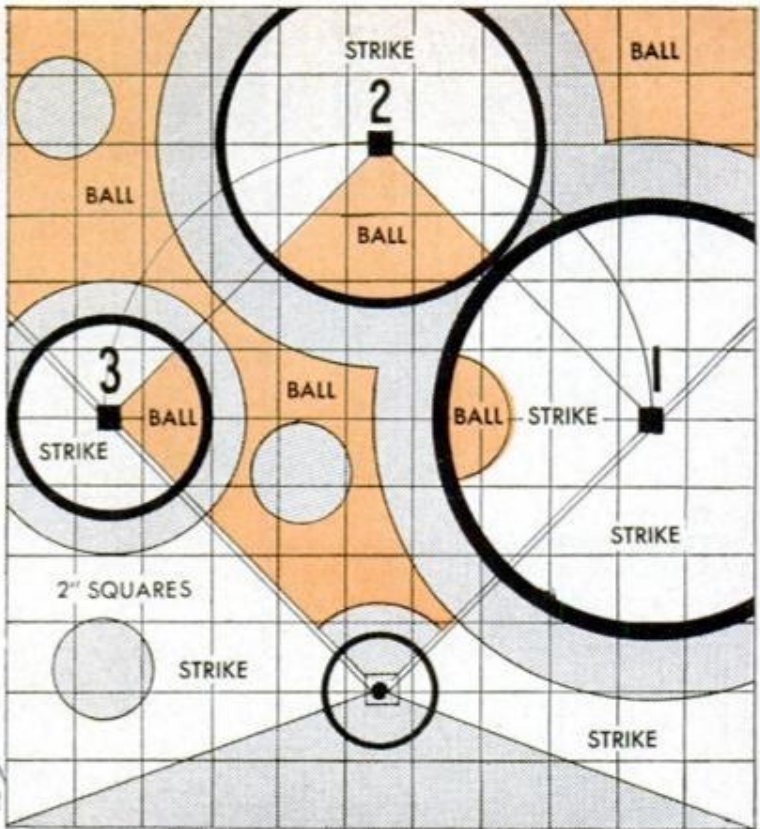

Here's a game that's sure to make a big hit with baseball fans of all ages. Make the playing board from wallboard, painting in the markings as indicated, and mark a throwing line on the floor 10 ft. from the board. Designed for an even number of players, each "team" throws until three outs are made, and the normal rules of baseball apply. Scoring is as follows:

1. Black areas count as base hits, the number depending on the base (1 for 1st,

2 for 2nd, 3 for 3rd, etc.).

2. Gray areas count as outs.

3. Colored areas count as balls.

4. White areas count as strikes.

5. Darts landing between the double lines running from home plate through first base and from home plate through third base count as foul balls.

6. When dart hits on the line, ruling is always to the player's advantage.

—David Eddy

Longer Reach

You can do more accurate work near the top and bottom of your drawing board if the T-square edge is extended so as to provide full support for the square in all positions. Use a 1-in. strip of wood the thickness of the board and extend it about 4 in. beyond the top and bottom of the board. If you attach it with angle irons, the strip can be taken off simply by removing four screws. Wax the edge of the strip to provide a smooth surface for sliding the T-square.

—Richard Hanscom

Twisting crepe paper to make party decorations is a time-consuming job if done by hand. Next time, do it the easy way. Tie the strip of crepe paper to a hooked wire and chuck the other end of the wire in a hand drill. A few turns of the drill and the crepe paper is twisted, ready to pin in place.—R. M. Woodbury

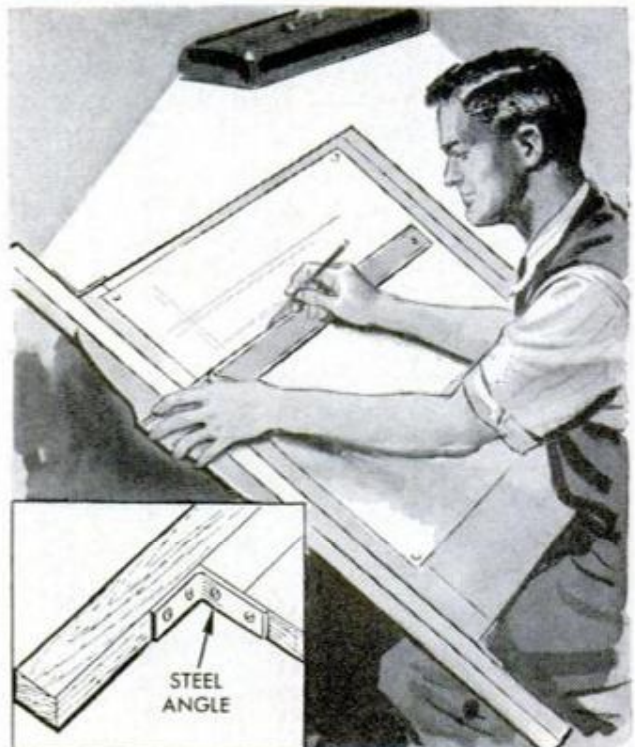

Substitute Cord Clip

A lost clip that keeps a hearing-aid cord from getting in the way or catching on things, can be replaced with a necktie clip. Fasten the cord as shown or run it through the open part between the pivot and teeth before putting the clip on the lapel. Or, you can completely eliminate a clip and conceal more of the cord by providing a buttonhole under the lapel, making it large enough to permit passage of the ear mike.

Squeaky floors usually result from minute rubbing movement between top and subfloor, although either floor may be rubbing on the nails holding it. To cure, drive spirally-fluted floor nails through both floors where squeaking occurs. Set nail heads just below surface, fill holes with wood putty, and sand flush. Flat-head wood screws driven in counterbored holes also do the job. Holes are filled with boat plugs of the same wood as floor to conceal screws.

Concave Mortar Joints

This lightweight jointer for concrete-block and brick work assures concave joints that are smooth, without irregularities often caused by short tools. It consists of a 24-in. length of electrical conduit of a diameter to suit the joint width. Bend one end smoothly at an angle and weld on a metal handle so the tool balances in your hand. Wash the tool clean after each joint is struck.—*Richard Huhta*

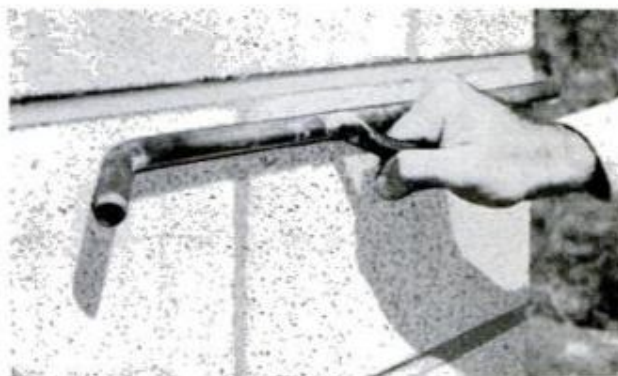

Tilting Cap Stops Downdraft in Pipe Flue

Annoying downdrafts in a pipe flue that were previously impossible to stop by many devices tried, ended when this automatic tilting cap was used. A slight wind tilts the pivoted cap, lowering it over one side of the flue to shield it, but leaving the

other side open and actually increasing the draft. The side of the cone slopes at 45 deg. to its base which is twice the diameter of the flue and comes 1 in. above it. Construction details are shown in the drawing below.—*Robert Micals*

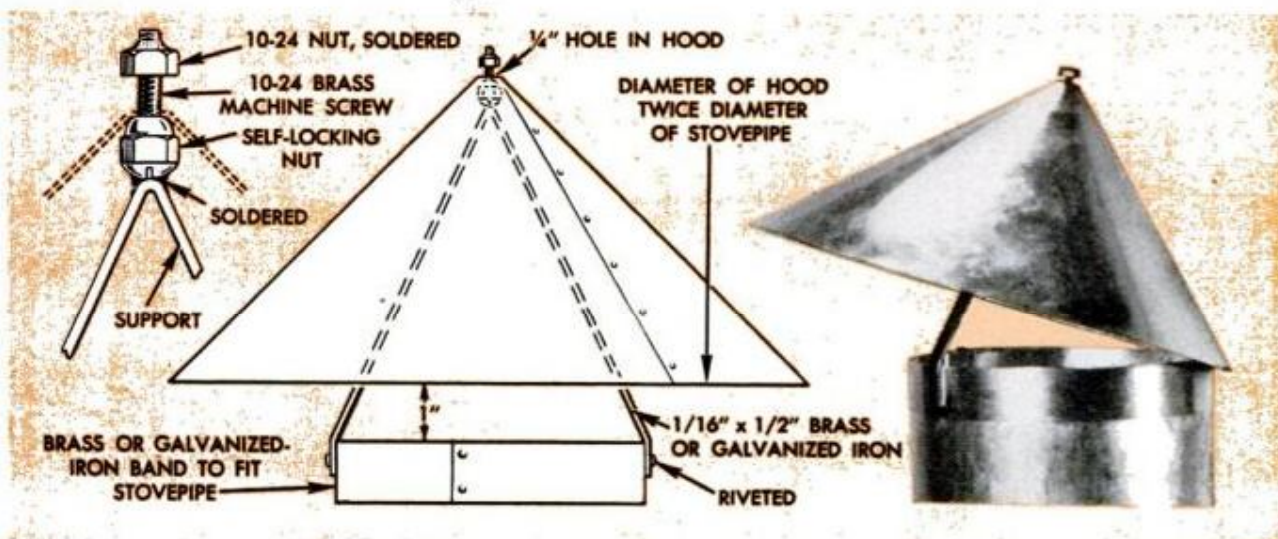

Solving

HOME PROBLEMS



SAVE STEPS when installing asphalt or vinyl tile on a cold floor. Instead of warming tiles in oven to make them pliable, plug in an electric skillet where you're working and set the temperature control to "warm"

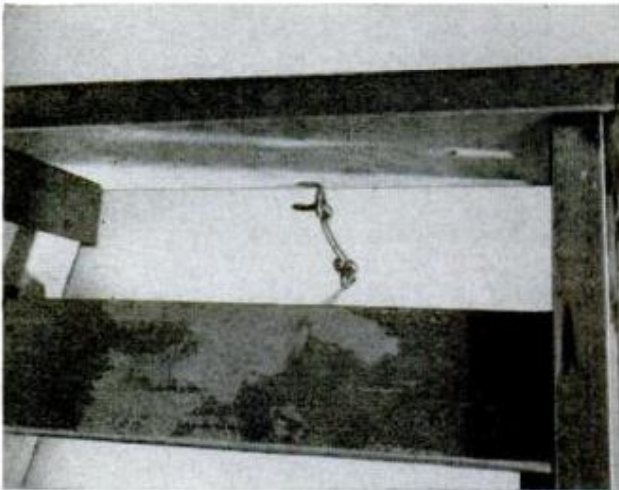
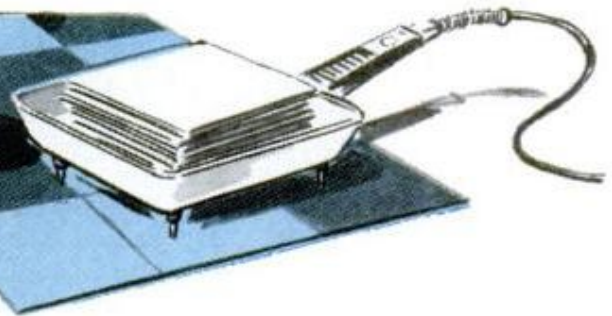

STEPLADDER takes up a lot of floor space when you store it in a leaning position. To hold it flat against the wall, install a screen-door hook on the wall and a screw eye on the underside of the top step

WOOD PUTTY may be tinted to match almost any color work by mixing in small amounts of scrapings from colored blackboard chalk before adding water. Mix it well, or the result will be a marbled effect

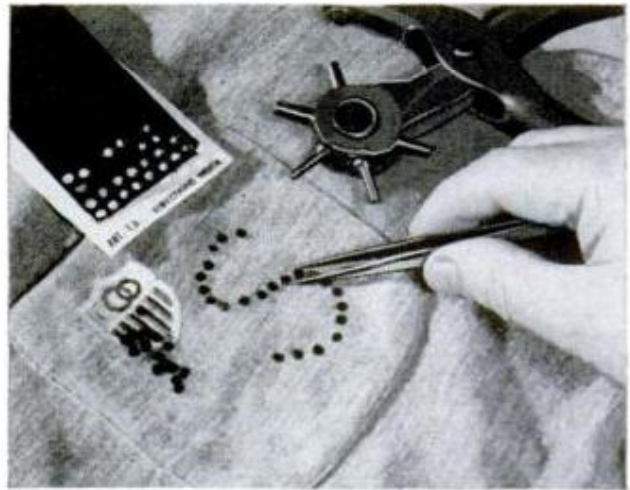

ANYONE CAN MONOGRAM shirts, sweaters or blouses by using press-on mending cloth. One novel method is to perforate the cloth with a punch and lay out a dotted initial with the punched-out disks of cloth

EMERGENCY REPAIR for leaky ball float in closet tank permits continued operation until float can be replaced. Empty float, then enclose it in a plastic bag extending up stem and tie end of bag tightly

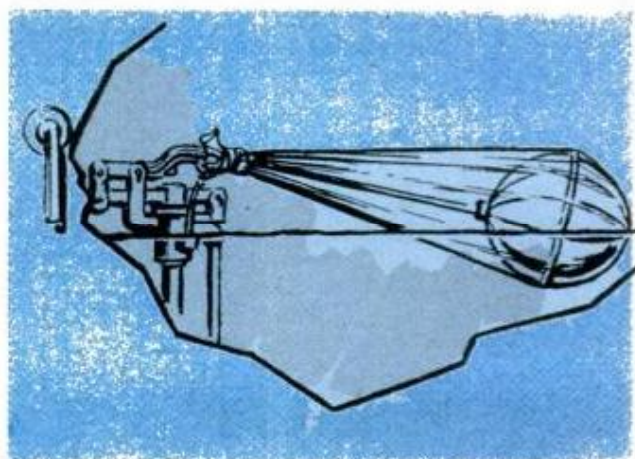

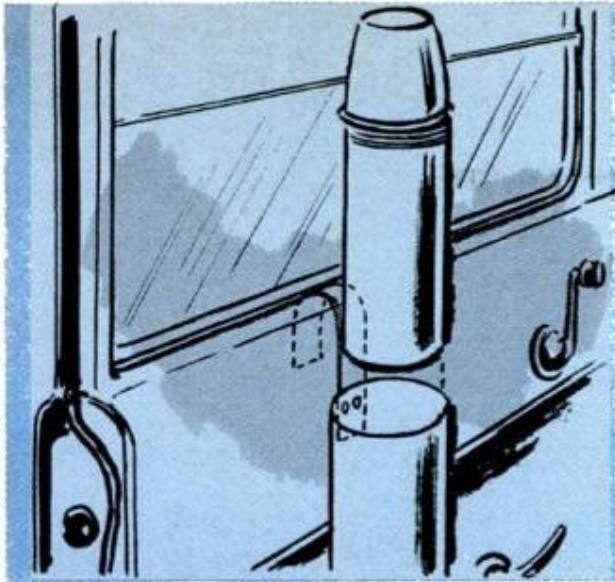

VACUUM-BOTTLE HOLDER which hangs from the inside of the car door can be made by riveting a strip of light metal to a tin can slightly larger in diameter than the bottle. Bend the end of strip to form a hook



UPHOLSTERY COVERS are often difficult to slip back over foam cushions once you have removed them for cleaning. You'll find that dusting the cushions with talcum powder will make them slide in easier



ENLARGED BUTTONHOLE which allows the button to slip out is an annoyance. To repair it, mount a piece of press-on mending tape on the reverse side and make a slit in the tape with a knife or razor blade

EASY WAY TO REMOVE jelly glass from boiling water is to slip a dipper under it and insert a wooden spoon in the top. Use dipper to lift glass out and invert it over the sink to drain, holding with spoon



OCTOBER 1962

TO DISCOVER whether the moisture in your basement is condensation or seepage, tape a small mirror over a moist zone. If condensation is the problem, the mirror will soon be covered evenly with condensate

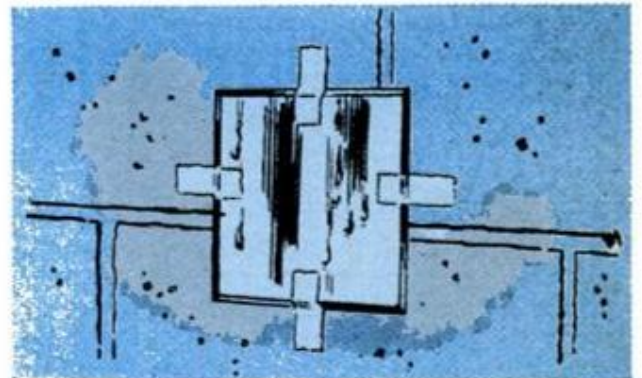

WANT AN EXTRA SHELF in your basement without all the bother of installing masonry anchors? For the extra one, make up a pair of U-shaped hangers from 1x2 stock, nail these to the joists to support the shelf



149

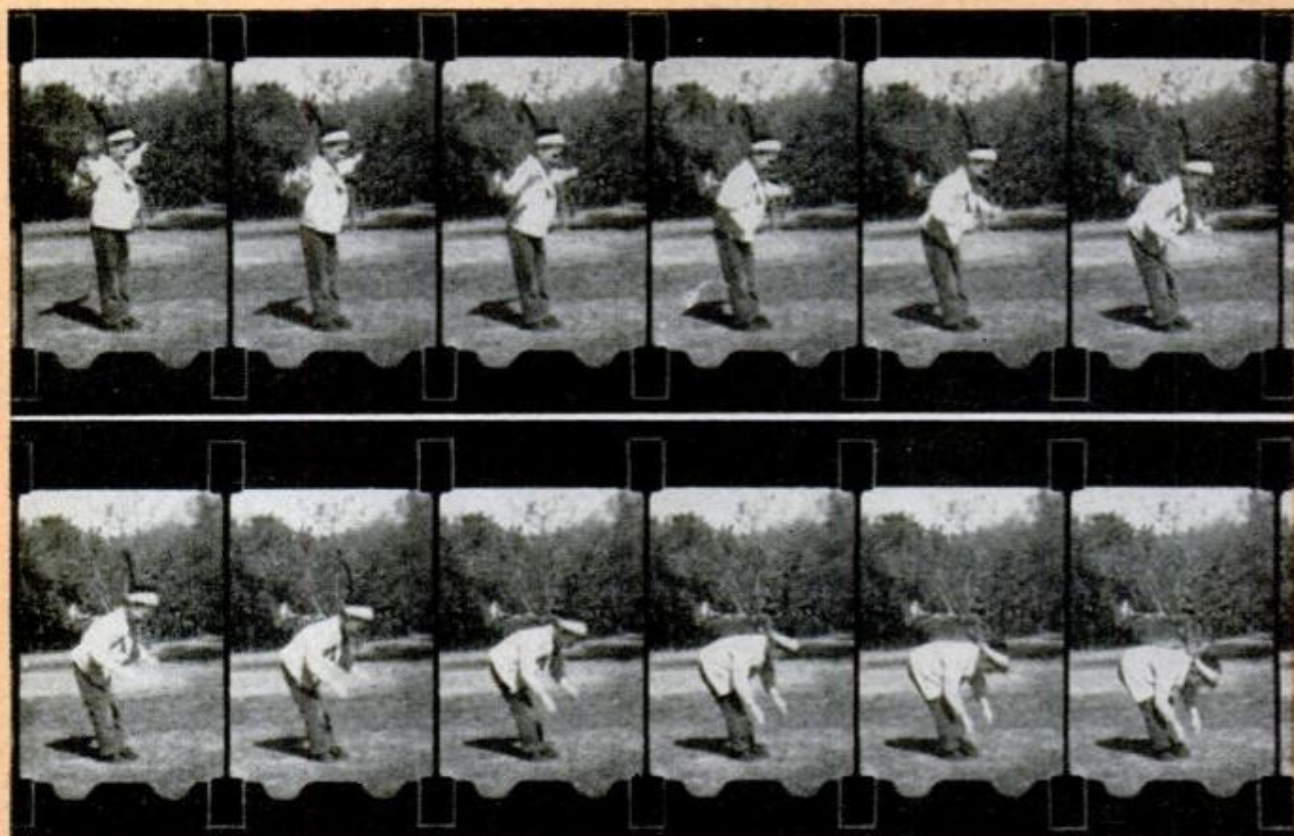

SEQUENCE of about 18 frames gives approximately one full second of action. Can be viewed anywhere

HOME-MOVIE FUN WITH A ZOETROPE

By Louis Hochman

THE OLD-FASHIONED zoetrope which was a forerunner of modern motion pictures, can be updated to provide hours of entertainment for young and old by adapting it to your home-movie activities. Originally, a band of drawings made in the form of an animated cartoon strip was placed inside a drum and below a series of slots, or windows. By spinning the drum, the drawings would come to life in animat-

ed action when viewed through the revolving slots. For home-movie fun, you simply shoot special film strips of your friends and family to take the place of the cartoon strip. What's more, you can view these animated strips anywhere without need of projector, screen or darkened room.

The zoetrope shown was made of cardboard wrapped around a plywood disk and fitted with a short dowel handle as detailed.

SLOTS CUT in cardboard strip give the picture strip its animation when the zoetrope is turned by hand

SLOTTED CARDBOARD STRIP is glued to plywood disk with ends meeting in butt joint. Joint is taped

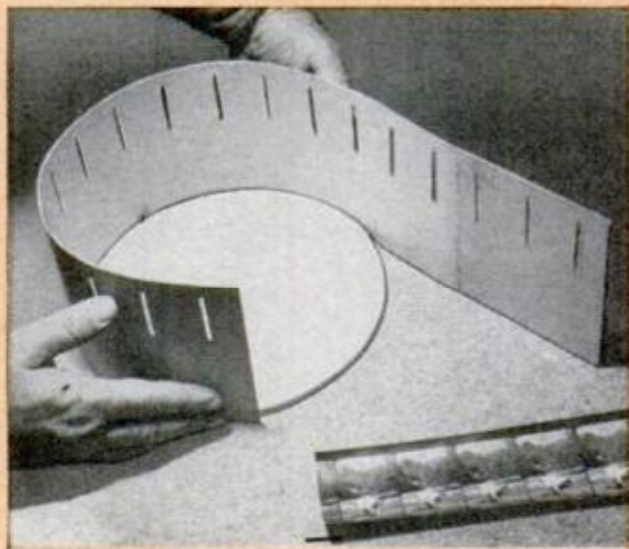
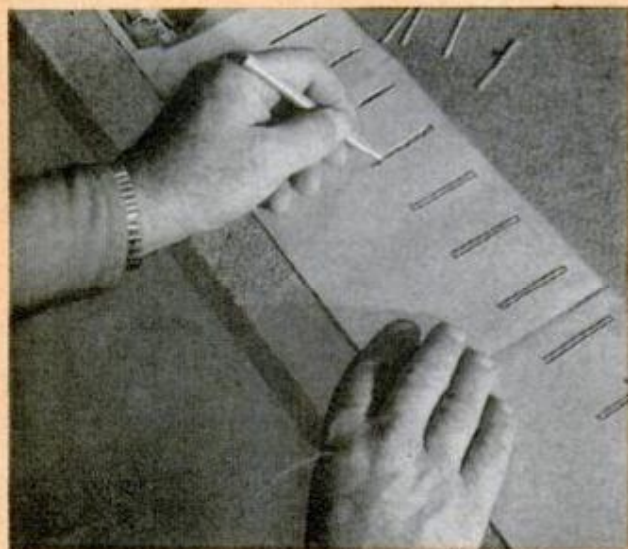

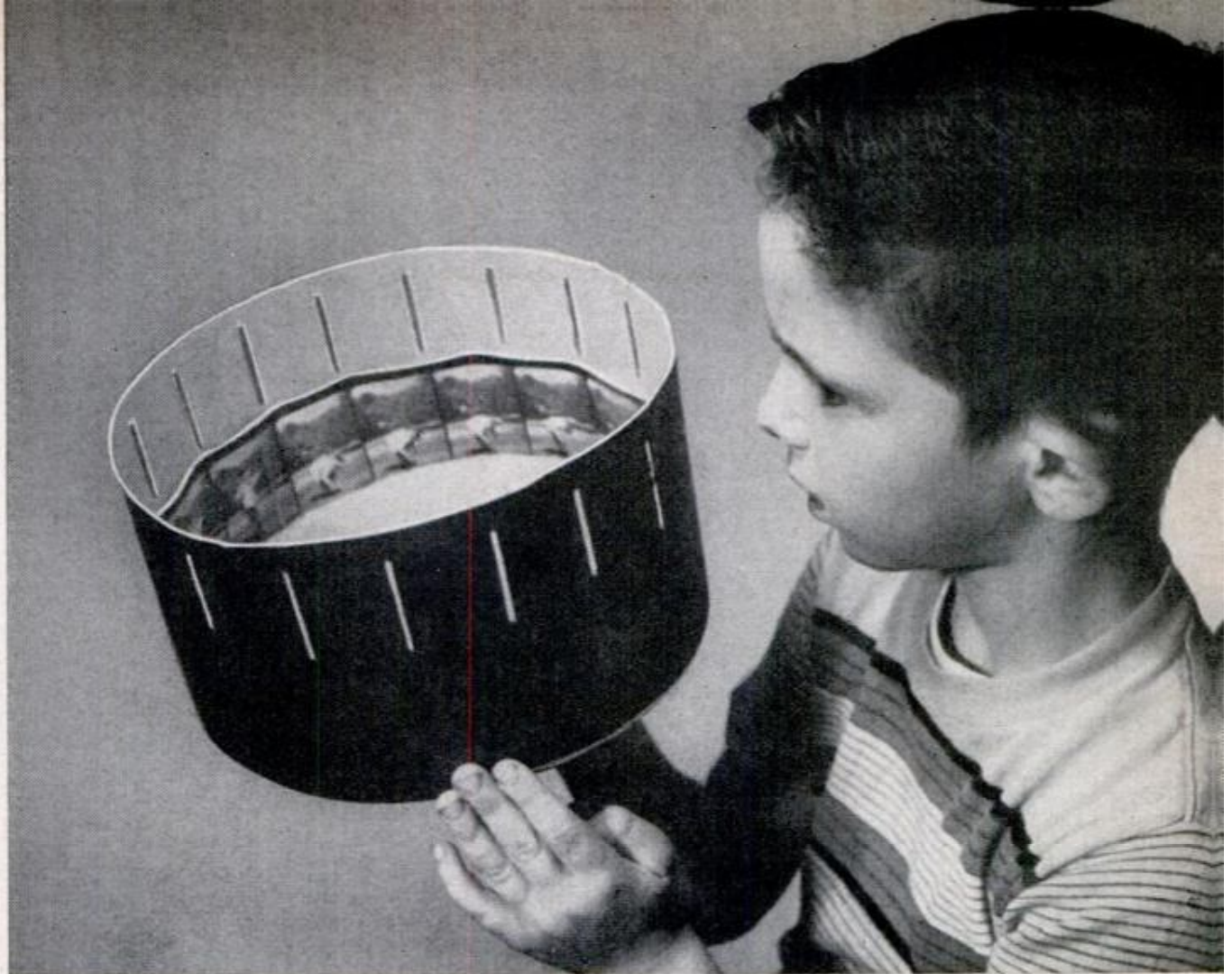

HERE'S HOW zoetrope is operated. Look through slots and rotate unit slowly to get animated picture

It was designed to hold an 18-frame picture strip, or band, which at 16 frames per second, covers a little better than a full second of action. First cut an 8 $\frac{3}{4}$ -in.-dia. circle of $\frac{1}{4}$ -in. plywood and drill a $\frac{1}{8}$ -in. hole through its center. Next, cut a strip of heavy cardboard 27 $\frac{1}{2}$ in. long by 5 in. wide, taping shorter lengths of cardboard to-

(Continued to page 218)

PICTURE STRIP is placed inside and held in position with pressure disk to fit and pressed in place

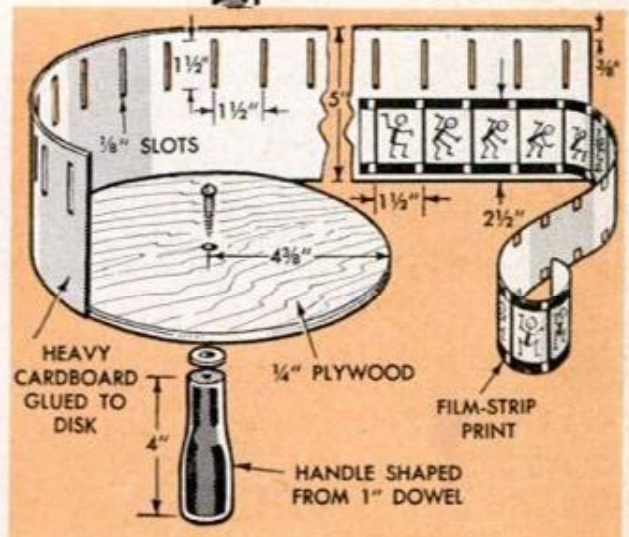
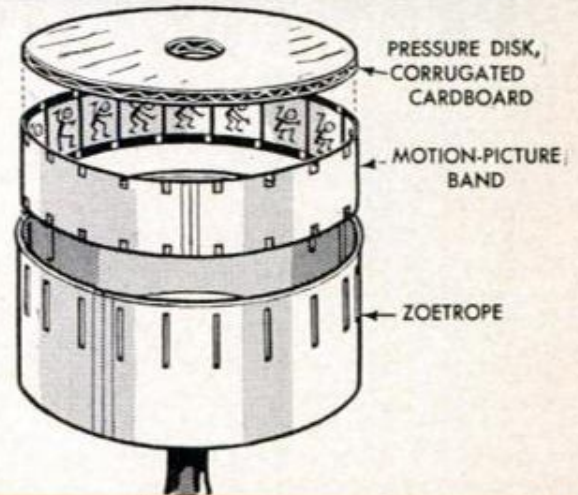
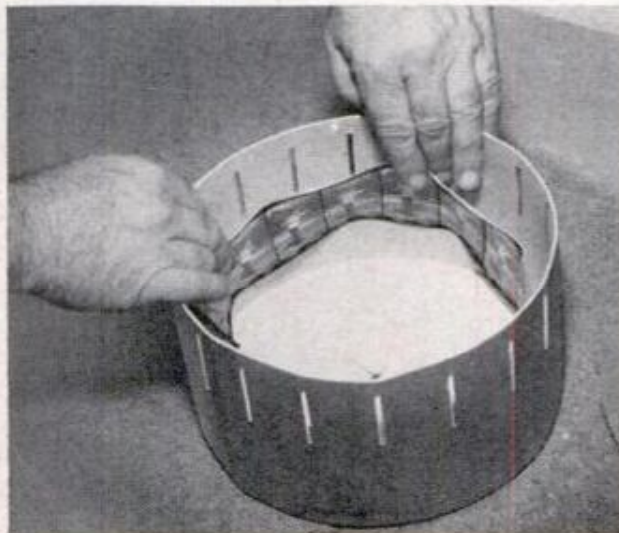

Here are four more pieces of functional play furniture in simplified modern Swedish design which you can build

PART II—Conclusion

Combination Blackboard Cabinet, Toy Bin and Table

TELESCOPING together to occupy minimum space, the assembly of play furniture pictured on this page consists of three separate pieces. There is a simple cabinet having two sliding blackboard doors and shelf storage space, a metal-leg table, and a toy bin on casters. Tots can either stand up to draw on the blackboards, or they can sit on the table which is only 17 in. high and provides plenty of space for two to sit side by side. Then they have separate but adjoining blackboards, which is conducive to learning to share and cooperate.

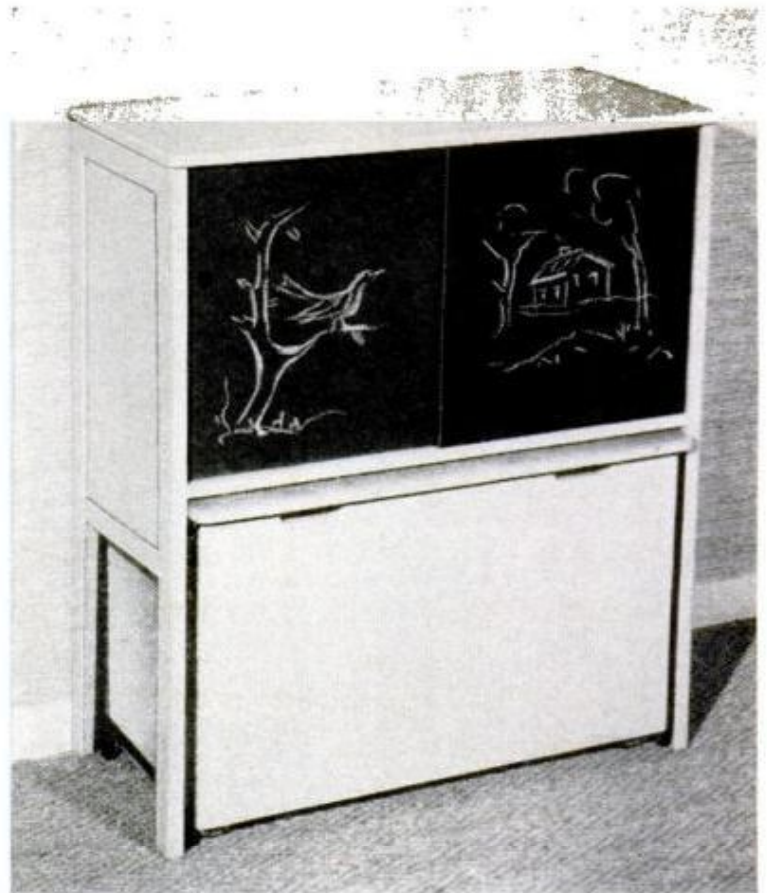

PLAY-FURNITURE FROM SWEDEN

Constructional details of these pieces are given in the drawing on the facing page. Ends of the cabinet consist of white-pine frames grooved to take hardboard panels. The side members of the frames extend to form legs. Although a panel thickness of $\frac{1}{4}$ in. is given in the drawing, you can use $\frac{1}{8}$ -in. tempered hardboard. The grooves can be cut with either a dado head on your circular saw or with the saw itself, but the dado head will assure uniformity in the width of all grooves. You can stop the grooves in the leg members at the position of the lower crosspieces, finishing the grooves by hand with a chisel, or you can run the grooves the full length of the leg members and fill the lower portions with strips of contrasting wood. The crosspieces have tongues that fit the grooves in the leg members. The cabinet ends are assembled with waterproof glue and are clamped overnight, after checking for squareness. Joints may be reinforced with dowels also if you wish.



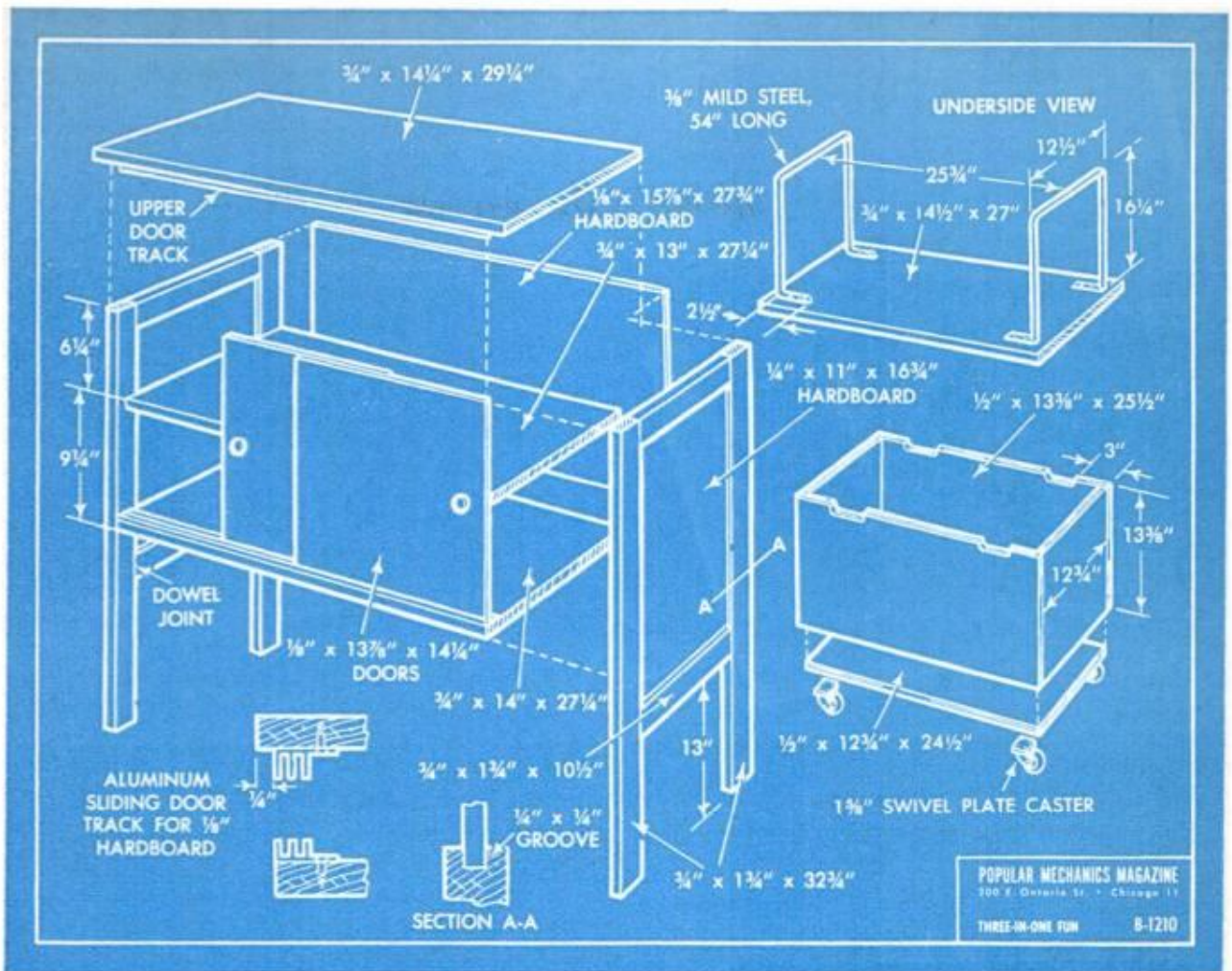

Pieces of stock are built up to the proper widths for the top, bottom, shelf, and back by doweling and edge-gluing. The 1/8-in. blackboards (painted hardboard) are fitted in aluminum tracks attached to the top and bottom. After assembling the ends, bottom, and shelf, you attach the back and top.

Using glue and 8 or 10d. finishing nails at joints will provide sufficient strength for ordinary service, but increased holding power is obtained by using flat-head wood screws in counterbored holes, concealed with boat plugs or screw-hole buttons.

Ends and sides of the bin fit over the

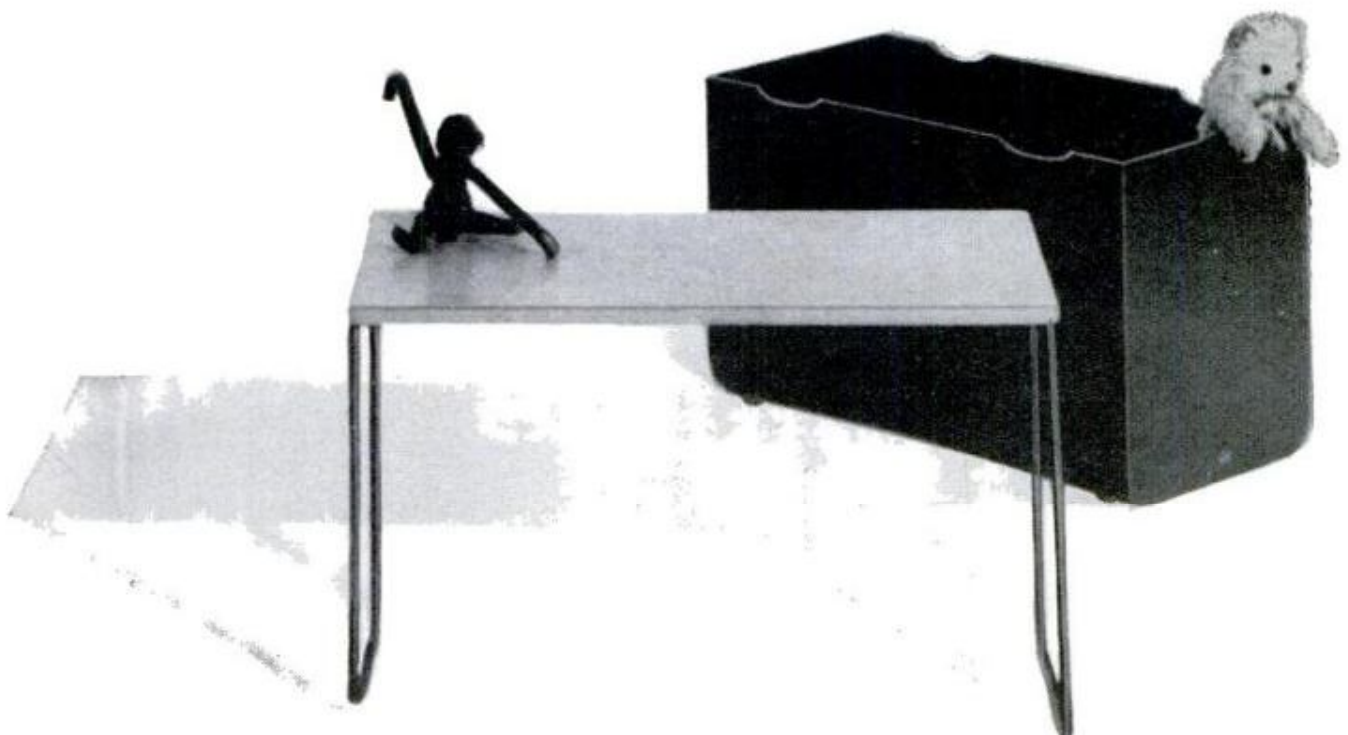



PONY HEADS with dowel "ears" for handholds lend realism to teeter board that pivots 9 in. above floor

bottom and may be joined in the same way as the corresponding edges of the Horse Cart shown in Part I. Rubber or plastic casters do not leave any traces of rust on carpeting during humid weather as steel casters do. Notches at the top edges of both sides serve as hand grips to pull the bin out from under the cabinet.

Like other pieces of this type of furni-

ture, edges should be "softened" by sanding as explained in Part I. Cabinet and table top are oil-finished but the bin and table legs are finished with a nontoxic enamel of a color that matches or complements the color scheme of the room.

Teeter Board

Tots just love to go for a pony ride on this teeter that daddy can make in an evening or two. Flat-head wood screws for assembling give the required holding power. The screw holes that show may be counterbored slightly so you can hide screw heads as already described. There's practically no risk of injury from splinters if you sand the wood surfaces and carefully round edges and sharp corners before applying the oil finish. For small tots, two screws that serve as a pivot assure sufficient strength. For a stronger pivot use a carriage bolt that passes entirely through the cleat—or, you can use two cleats spaced to accommodate the bolt between them.

Rocker Boat

Sides, seats and ends of the Rocker Boat are made of $\frac{3}{4}$ -in. white pine, but the bottom is a piece of $\frac{1}{4}$ -in. plywood or $\frac{1}{8}$ -in. tempered hardboard. The bottom is attached to the sides and to cleats on the ends

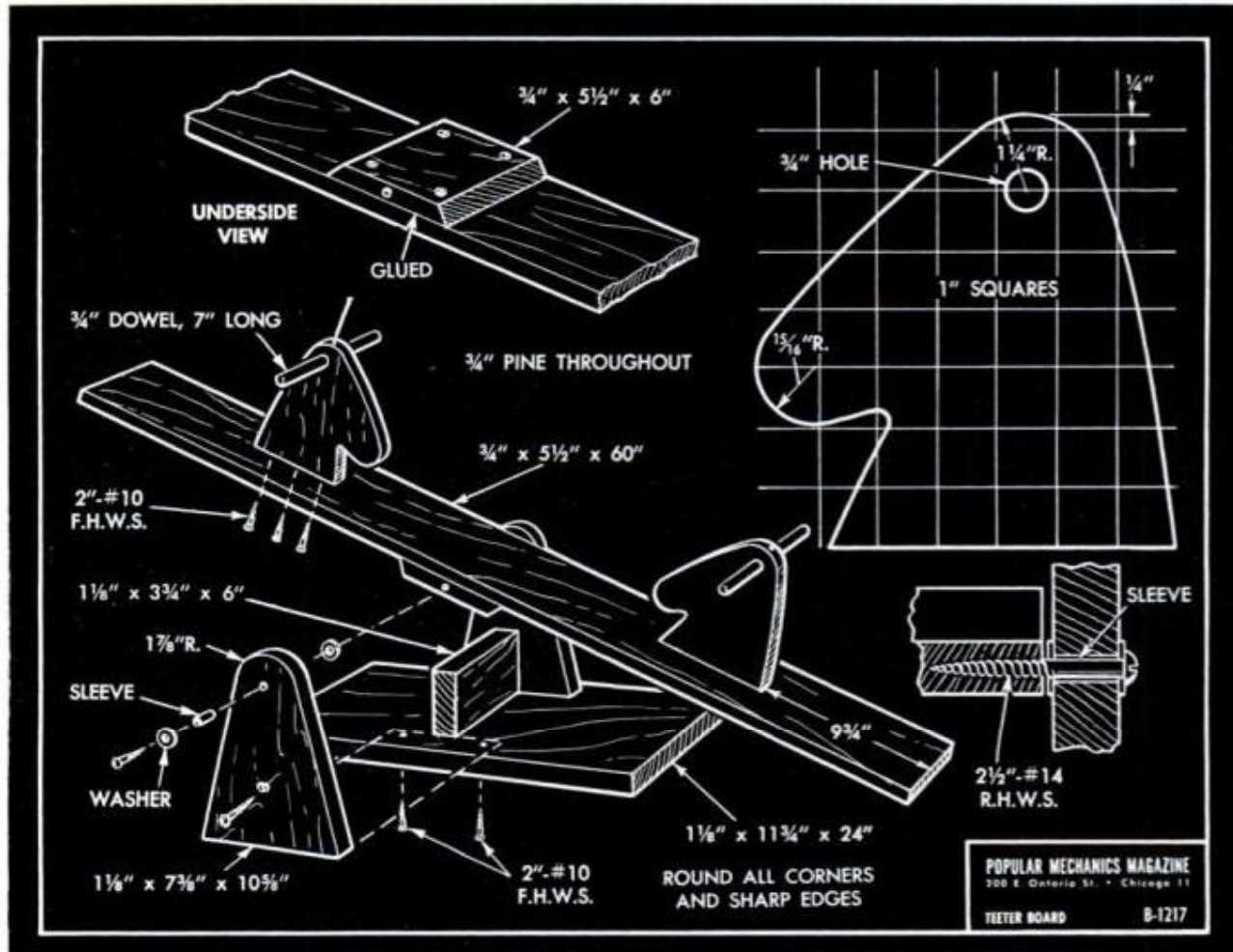

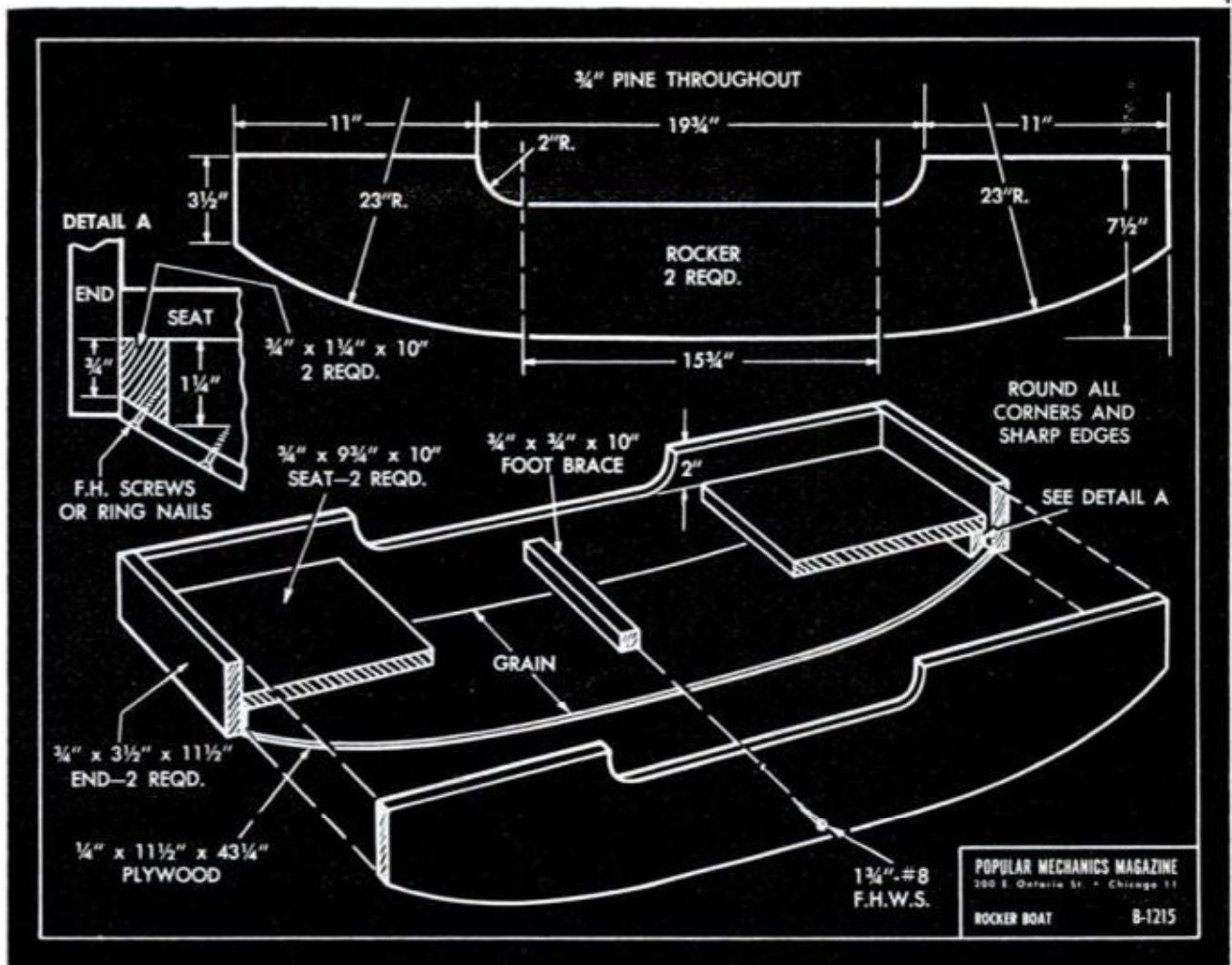

with flat-head screws or ring nails. All constructional details are shown in the drawing. As the width is only 11½ in., the riders can hold onto both sides for support. An alternate handhold may consist of a U-shaped metal rod, inverted and attached to the sides with two screws at each end of the rod.

Table House

Whether it's a circus arena, rodeo, a bandstand, theater stage, or an Eskimo igloo, an imaginative youngster can form almost anything with this Table House and attached folding screens. The table ends and the screens are framed panels of identical size. The frames are mitered at corners and are grooved to take hardboard panels which then are covered with self-adhering sheet plastic of various bright colors. The table top is ½-in. plywood to make it lightweight. Rigidity is obtained by gluing and nailing cleats along the edges. Then the table ends are screwed to the top. Note that the oval-head wood screws which are used to fasten the ends to the top are fitted with bright cup washers. For extra strength chair braces are used as shown in the drawing. Flat steel links at the corners of the screens form hinges. The screws holding them are left a little loose, which

ROCKER BOAT for tiny tots has action with safety, is simple to build, has plywood or hardboard bottom



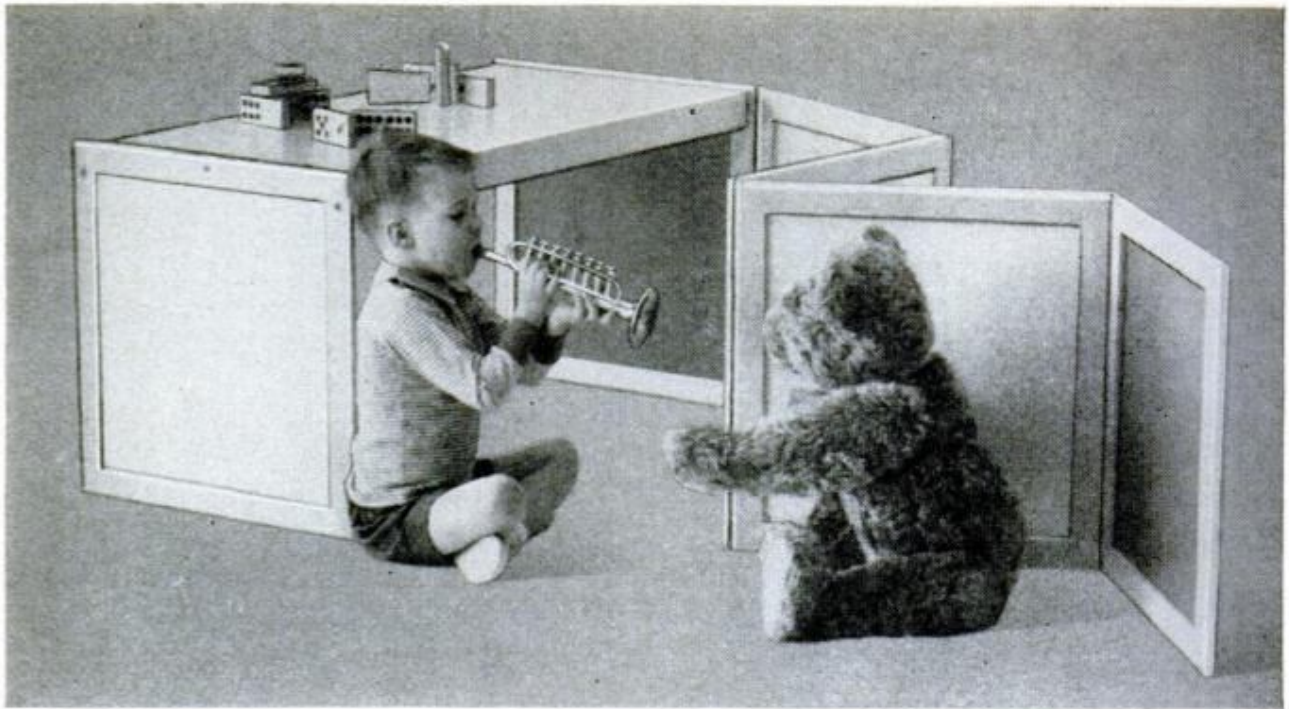
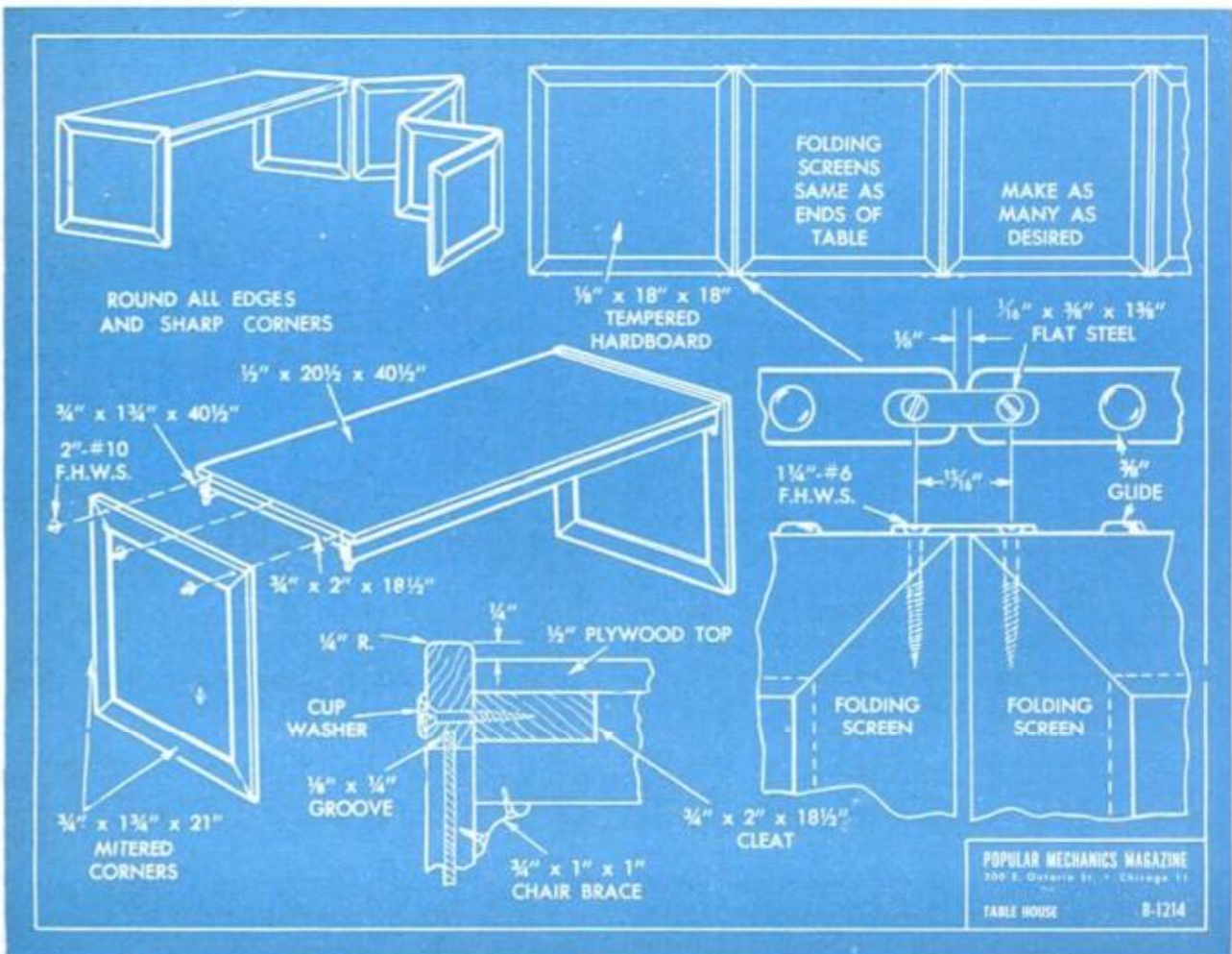

TABLE HOUSE with colored screens makes almost anything from circus arena with performing bear to an igloo

permits moving the screens at any angle or folding them together when not in use. Plastic furniture glides on the bottom edges of the screens and table will prevent the hinges from scratching wood or tile floors. Finish the exposed wood parts natural. ★ ★ ★

PLANS AVAILABLE

Large 17 x 22-in. blueprints detailing construction of each of these nine pieces are available at 50 cents each. Simply address Blueprint Department, Popular Mechanics Magazine, 200 East Ontario Street, Chicago 11, giving the plan number of each blueprint desired.



Nerves of Steel? Coordinate With This Electric Tester

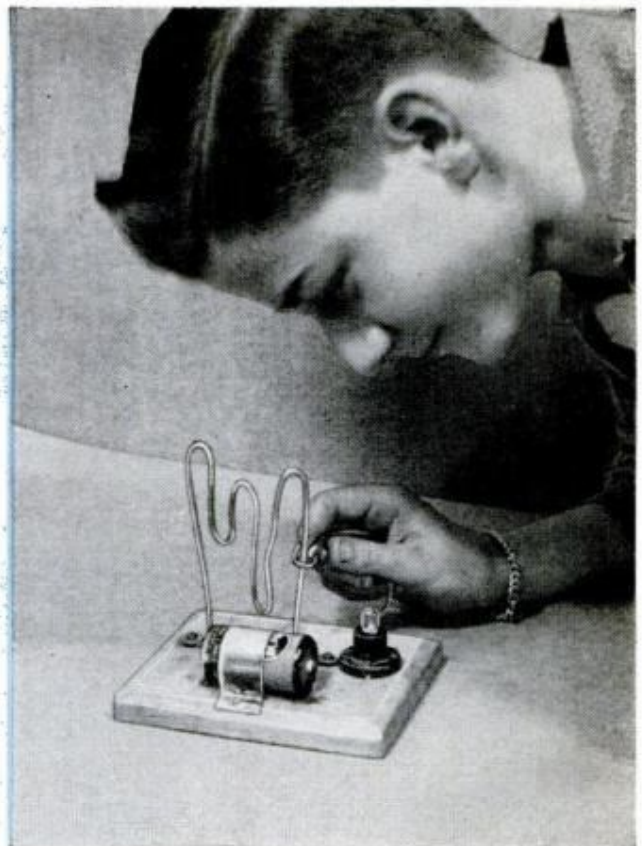
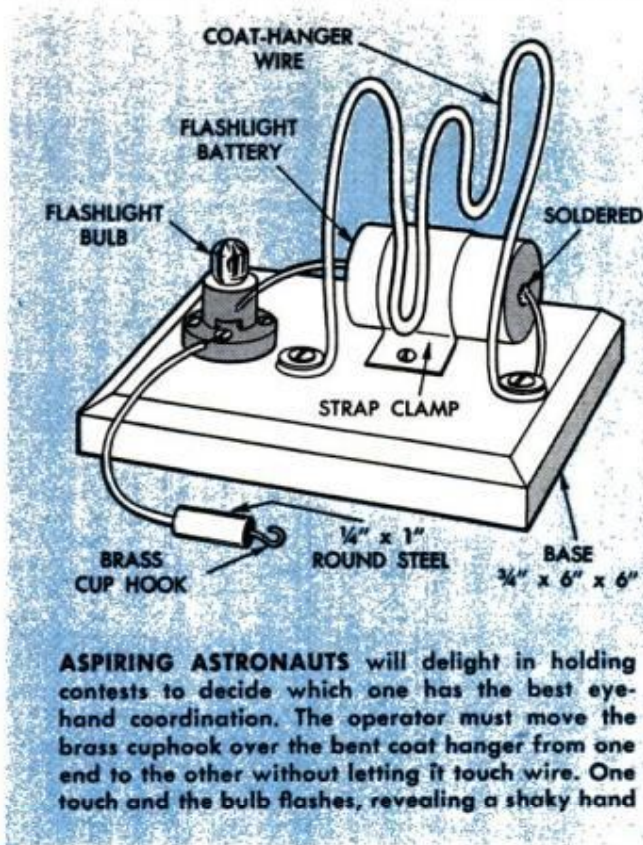

Hammer-Head Shoe Protects Surface

Common practice in pulling nails from molding or other finished stock you plan to reuse is to protect the surface of the work from dents with a wood block placed under the hammer head. However, if you have a lot of nails to pull, it will pay you to pad the hammer head with a slip-on, non-marring shoe of soft, heavy leather. The job will go twice as fast without having to bother with a block. Simply make a pattern to fit your hammer, following the general outline pictured at the right, and cut the protective shoe from an old leather pocket-book, camera case or shoe.

—Arthur R. Tanner, Jr.

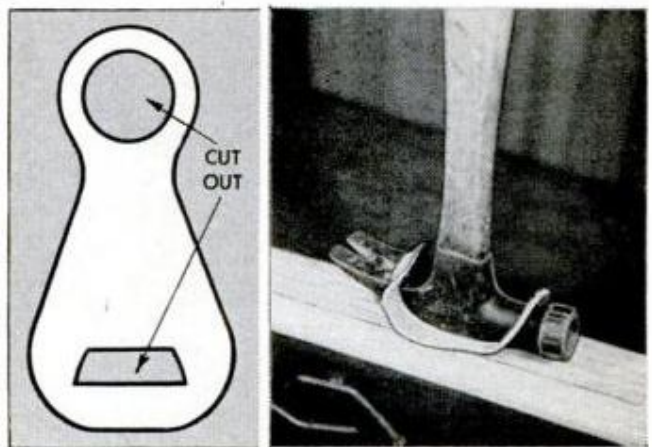

Leveling Phono Turntable

A level turntable is a must when playing hi-fi and stereo records and a convenient way for holding a level for checking it is to cement a button level to the top of a standard plastic cone center which is sold in music stores for centering 45-r.p.m. records. When pressed down over the turntable spindle, the cone-supported level will permit you to level the table dynamically while it is rotating. In playing 45s, of course, you can leave the center, level and all, right on the spindle where it will always be handy and won't be misplaced.

—Art Trauffer

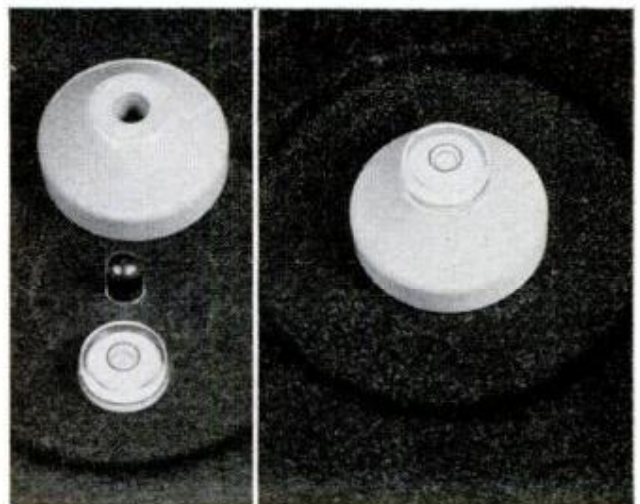

HALLOWEEN CAPERS

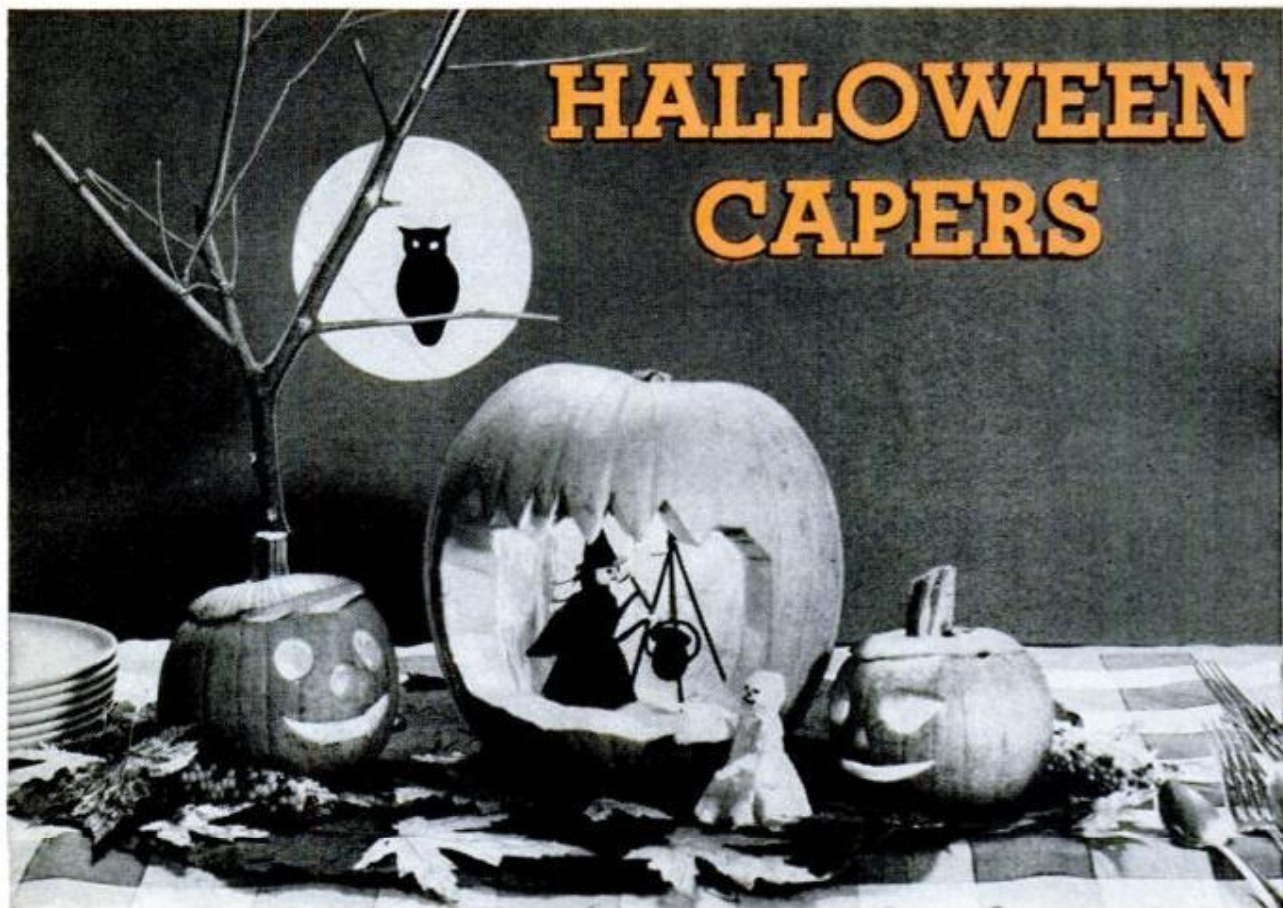

1. WITCH'S DEN is an appropriate table decoration that helps stimulate the atmosphere of fun and gaiety

By Willard and Elma Waltner

NEW LOOKS AND ANIMATION in jack-o-lanterns for table, window and porch displays can lend a touch of distinction to your Halloween party this year. Or, you may just want to please the kiddies with something different. New, decorative

effects are the Witch's Den, a table-top display, the all-vegetable face of Personality Pete, and the deep-etched features of Jolly Farmer Brown. Animation is furnished by Jack the Winker. For illumination, 7-watt night lamps in outdoor Christmas-tree



4. ONION EYEBALLS with raisin inserts for pupils are pierced with toothpicks which are pressed into lower eye sockets. Teeth are white beans



5. PINNED-ON EARS are sections of green pepper which are fastened to sides of the head with toothpicks. Latter are easily inserted in holes punched with darning needle



6. CROOKED CARROT NOSE lends a touch of humor to "Personality Pete." End of carrot is trimmed to fit snugly into a hole punched in wall with apple corer



2. CREPE-PAPER DRESS hides witch's framework of pipe cleaners. Tripod also consists of pipe cleaners wrapped with crepe paper. Here is a wooden bead

sockets are handy to use. The sockets can be passed through holes cut in pumpkin walls with an apple corer.

The Witch's Den, Fig. 1, makes an arresting decoration on a buffet table. A big pumpkin is needed for this. The jagged cavern opening shows the witch stirring her brew in the cauldron. The long, crepe-paper skirt conceals her skeleton and three legs made from pipe-stem cleaners as shown in Fig. 2. A wooden bead forms the head. The tripod is made either from tiny twigs or from pipe cleaners wrapped with crepe paper, and are lashed together at the top. The kettle is crepe paper shaped on a wooden bead. You can also make a ghost, using a similar skeleton and a cotton-wad

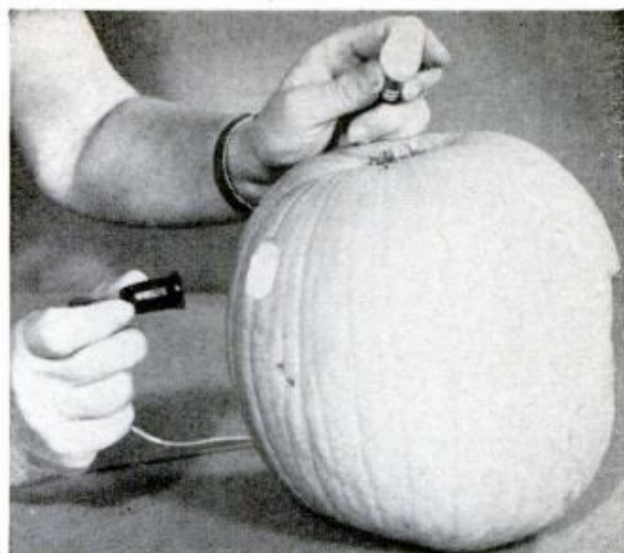

3. CHRISTMAS-LIGHT SOCKET is pushed into a hole punched through the pumpkin wall with an apple corer. Small night light screws into socket from inside

PUMPKIN CARVING PATTERNS



8. WAILING GOBLINS are some of the unusual effects you can produce by distorting mouth and eyes



7. BUTTERNUT SQUASH provides a tam or toupee. Bottom is trimmed to fit on head. Hole that fits on pumpkin stem holds squash firmly. Completed job is shown at the right





9. OUTLINING FEATURES with a wax crayon or with quick-drying ink is first step for "sculpturing." Use big pumpkin having wall no less than 1 in. thick



10. FACE CONTOURS are carved in bold relief. The skin of the pumpkin is removed from the entire face area which is best done as you proceed with carving

head. Robe it in white cleansing tissue, draping it over the head and tying around the neck. Paint on the features. The cavern has a small light just under its ceiling and near the back. Fig. 3 shows the lamp socket that is inserted through a hole in the back wall. It is nestled in the hole.

Flanking the Witch's Den are two small, grinning urchins, also lighted. The bare "tree" is a small branch that can be set in a plaster-of-paris base. The large harvest moon with the silhouetted owl is glued to the rear part of the tree. The assembly then is arranged on a piece of crumpled brown crepe paper on which autumn leaves and colored popcorn are scattered.

Personality Pete, Figs. 4 to 7, has distin-

guishing features to give character—pearly teeth of white beans, a carrot nose, onion eyeballs with raisin pupils, green peppers for ears, and an acorn-squash hat. If you want some highly accentuated features follow the patterns in Fig. 8.

Jolly Farmer Brown, Figs. 9 to 12, challenges your skill at sculpturing pumpkins. For this caricature you need a large pumpkin with a wall not less than 1 in. thick. After sketching the features with a crayon or felt-tipped, quick-drying ink dispenser, you carve the features rather deeply as you would when whittling wood or carving soap, in order to get a good three-dimensional effect. Peel off all of the outer hard skin for the face after outlining it. A thick-

13. JACK THE WINKER, shown completed at the left, is set on a window sill and contributes to the fun of the occasion by incessant winking at passers-by

14. WINKING EYE has 10-watt lamp in standard-size socket fitted into the side of small tin can. End of can is pressed into "flesh" surrounding eye slit





11. ACCENTUATE the sharply carved features more with water colors or tempera, which will adhere to the "flesh" after setting the pumpkin aside to dry

walled pumpkin gives you plenty of leeway in sculpturing. When finished, set the pumpkin aside to dry until there are no more drops of water on the surface. Then you can apply water colors or tempera to accentuate the features. Finish the job by adding a straw hat and corn-cob pipe, and of course include a lamp.

Jack the Winker, Figs. 13 to 15, will intrigue everybody as he sits in the window and winks at passers-by. One of his eyes is round, the other is a narrow slanting slit. Inside there are two lamps. One lights up the nonwinking eye continuously. The other is a round 10-watt lamp installed through the side of a small can as in Fig. 14. The edge of the can is pushed into the flesh of the pumpkin inside of the head so it comes behind the winking eye. The light of the first lamp cannot be seen through the winking one, which intensifies the winking effect.

A 60-watt Christmas-light flasher of the

15. DROP-IN FLASHER such as used for Christmas-tree lights, is placed in the socket after which the plug of the cord for the winking eye is screwed in snugly

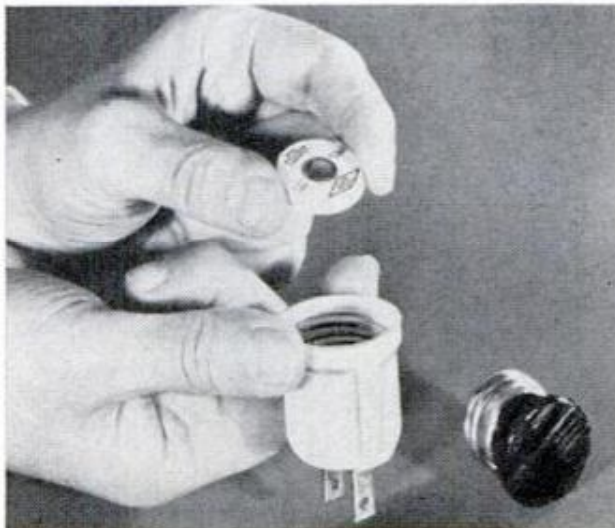

12. STRAW HAT AND PIPE are the finishing touches on the caricature of Jolly Farmer Brown that make him just as colorful in daytime as he is at night

drop-in type is placed in a standard lamp socket to which the winking-eye line is plugged. Fig. 15 shows the flasher, socket and plug. The latter screws down on the flasher unit firmly. Winking starts when the flasher warms up.

Fig. 16 shows "skin carving" of a pumpkin. Instead of cutting entirely through the wall to form features, you make outline cuts about $\frac{1}{8}$ in. deep and then strip off the outer skin between the cuts. When illuminated, the features then will show up distinctly. Also, they are illuminated more uniformly than features consisting of open holes cut entirely through the wall. ★★★

16. "SKIN CARVING" consists of outlining features with shallow cuts to permit peeling off skin between them; results in uniform illumination of features





KEEP THESE IN MIND

Rodent Guard

You can prevent rats and other rodents from slipping in through the ventilating tiles in the foundations of outbuildings by simply inserting eavestrough strainers in the tiles. These strainers are made of heavy wire and come in various sizes. Select a size that fits snugly in the tile, and it will provide an effective barrier to rats and even mice.—*G. E. Hendrickson*

When repairing cracks in plastered walls, do you find that the patching plaster begins to harden before you finish? Next time, mix your patching plaster with full-strength white vinegar instead of water and it will extend the drying time.

—*R. N. Bauman*

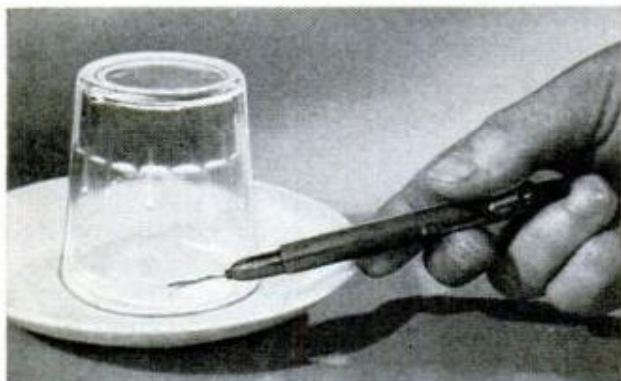

Weather Eye

In less than a minute you can make a barometer which will forecast the weather a day in advance. Pour about 2 oz. of mineral oil (crankcase oil) into a small drinking glass, cover the glass with a saucer and invert the two. Then, using a grease pencil, mark the present oil level on the glass. An increase in atmospheric pressure, indicating fair weather, will tend to force the oil in the glass to a level above the mark.

—*Ken Murray*

Jig for Centering Turning Squares

That diagonal corner-to-corner kerfing of square stock for centering and engaging the spurs of the live center on your wood lathe can be done with a handsaw, but here's a better way. Make a sliding jig to ride along the ripping fence of your table

saw from a 6 or 8-in. length of 2 x 4, cutting a 90-degree included-angle notch in one edge. This notch should be just deep enough to take the square standing vertically as pictured. Center the blade on the corner. Make two cuts. —*W. E. Powers*

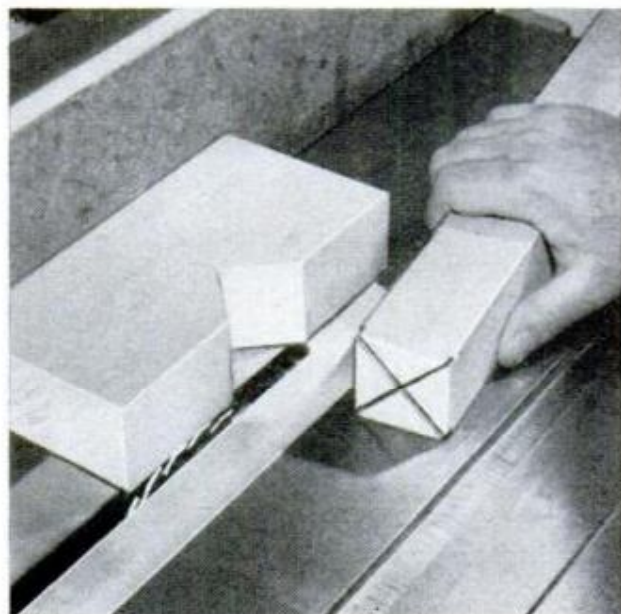
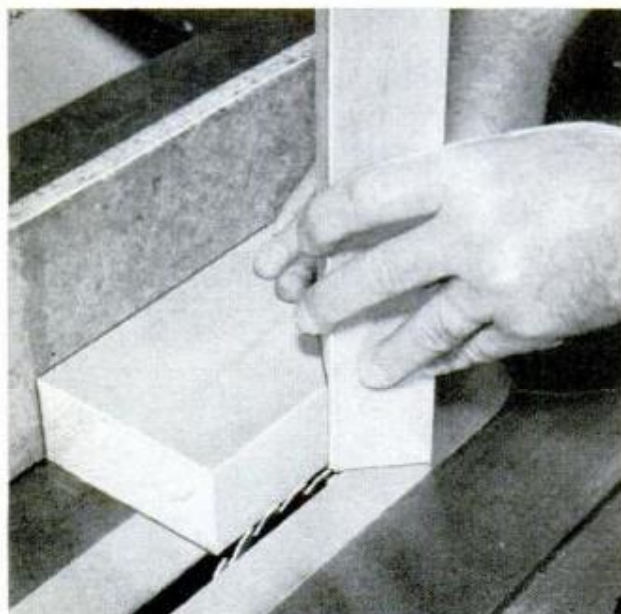

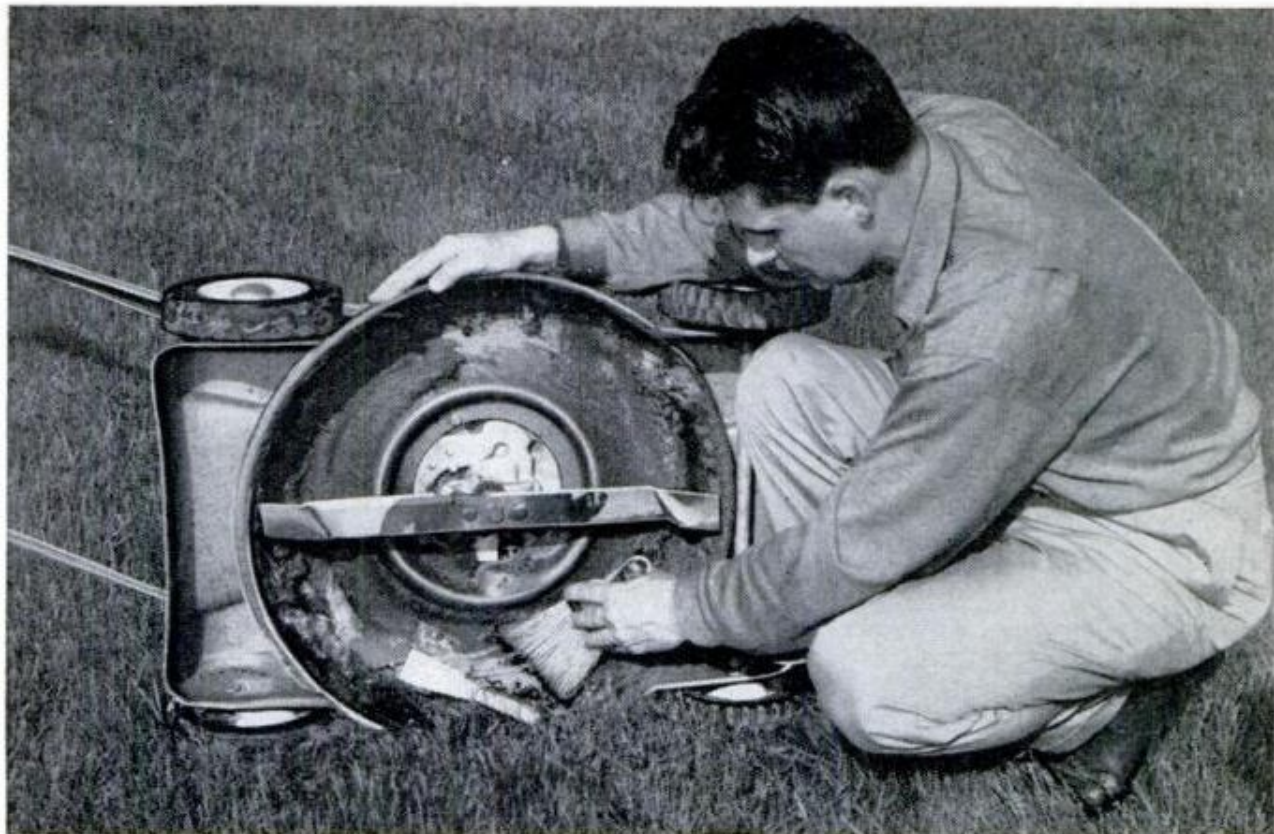

USE PUTTY KNIFE, wire brush, a whisk broom to remove all caked grass cuttings. Wash away loose material

Winter-Store Your Mower

THE GRASS has given its last spurt of green growth, there's a chill in the air, and yesterday you imagined (though you couldn't be sure) that you saw the first few snowflakes.

Now's the time to put away that power mower. The big temptation is to shove it into the garage and forget it until next

spring. There are storm windows to put up and garden plants to bed down for the winter. After all, you won't be pushing the mower around the lawn any more this year.

But if you neglect your mower now, you'll regret it, come spring. When you wheel it out for the first go-around, it will be in no better shape—and may be in much

DRAIN CRANKCASE, right, while engine is still warm after burning all fuel. Refill case with No. 20 oil

REMOVE SPARK PLUG, force a good ounce of No. 20 oil into cylinder. Crank engine slowly to distribute oil

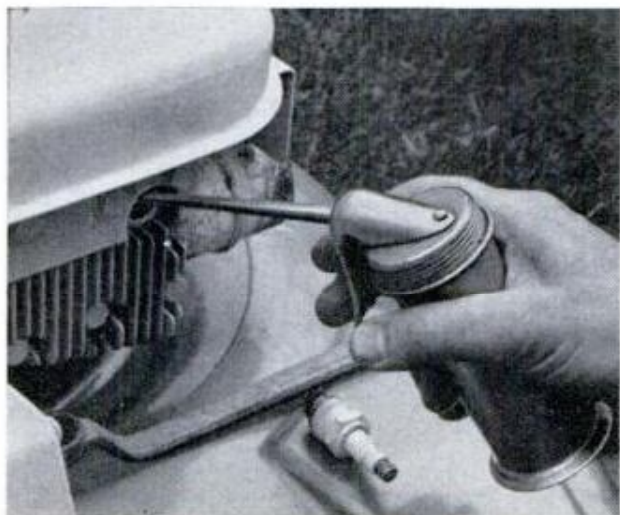

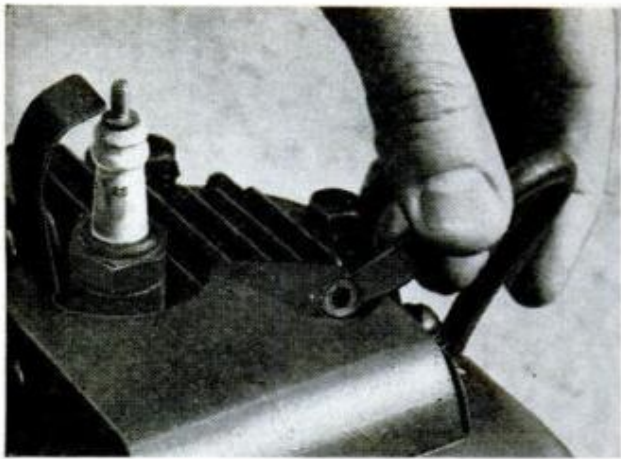

REMOVE CABLE from the spark plug and clean the terminal with fine steel wool. Clean the threads and terminal seat on plug. Leave cable disconnected

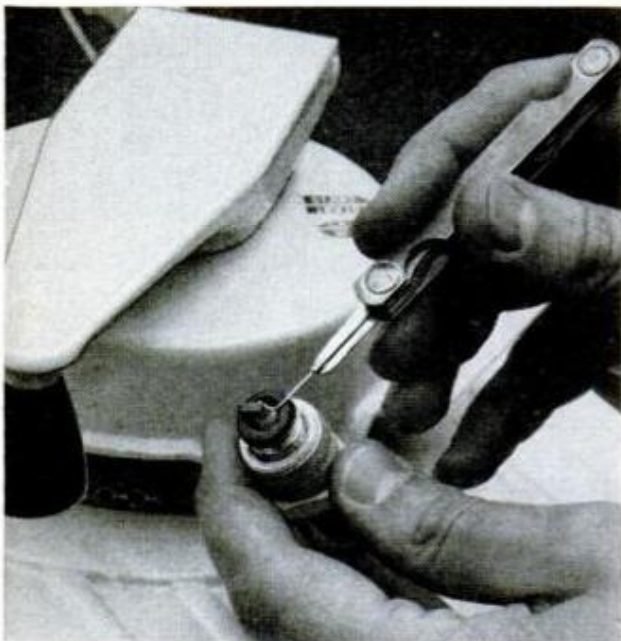

INSPECT THE PLUG electrodes, clean thoroughly and check gap. Make sure gap is in accordance with manufacturer's instructions. Replace plug finger-tight

AIR CLEANERS on newer mowers have foamed-plastic inserts which are cleaned to remove dirt and gummy deposits. Follow manufacturer's cleaning instructions

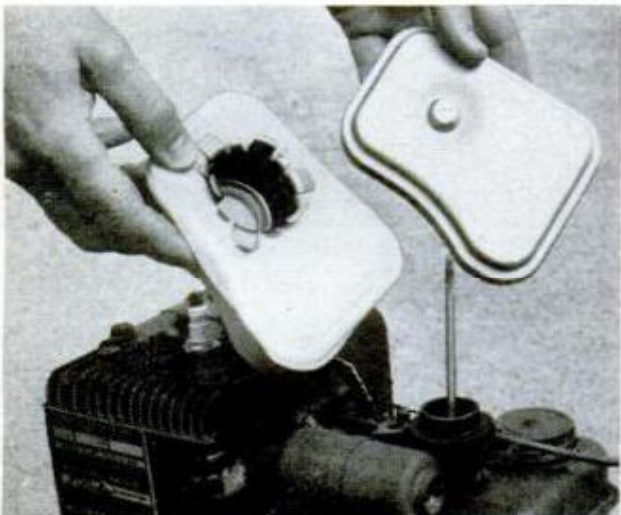

164

worse shape—than when you put it away. In fact, improper storage can ruin a mower.

On these pages are the 12 basic steps in preparing a mower for storage. The mower shown here is a typical rotary, probably the most common of all power mowers. The tips given here apply generally to all:

- If you have a four-cycle reel-type mower, give the engine the basic cleaning and storage treatment shown here. In addition, thoroughly clean both the bed knife and the reel blades (it's also a good idea to sharpen them, or have them sharpened, at the same time) and readjust them. Run a film of oil along both sides of all blades, and lightly oil all moving parts.

- If you have a two-cycle rotary, follow all the steps shown here except, of course, you won't refill the crankcase with oil as the lubricant is mixed with the fuel.

- If you have an electric mower, follow the blade and housing clean-up procedures shown here. In addition, check the cord for worn or frayed spots, and check the condition of the socket on the mower, and the socket and plug on the cord.

The biggest source of damage to a gasoline-powered mower, improperly stored, is fuel—gasoline remaining in the carburetor, fuel filter, fuel lines and tank. Left for months in the engine, gasoline will form gummy deposits on all of these parts. Such deposits not only may make the mower difficult or even impossible to start when you wheel it out in the spring, but may so foul the flow of fuel that the entire engine may have to be torn down and cleaned.

It's essential, therefore, that the first step in mower layup—a step not shown in the photos—is draining the fuel tank completely and then operating the engine until it coughs its last gasp from exhaustion of the fuel. This not only cleans the tank, but the fuel line and carburetor. ★ ★ ★

ON OLDER MOWERS service the air cleaner as directed in your owner's manual. Do a thorough job as air cleaner servicing is a factor in long engine life



POPULAR MECHANICS



WHEN REMOVING cutter bar, be sure to keep parts in order. Mowers differ in this assembly. Examine each part closely. Replace unduly worn or damaged parts

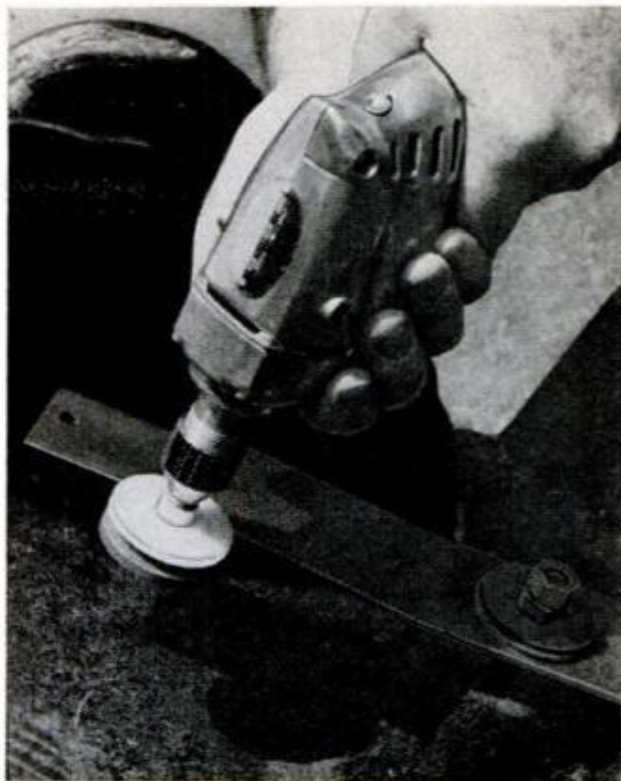

SHARPEN BLADE so mower is ready to go come spring. Don't grind off more metal than necessary to obtain a good cutting edge. Sharpener shown does good job

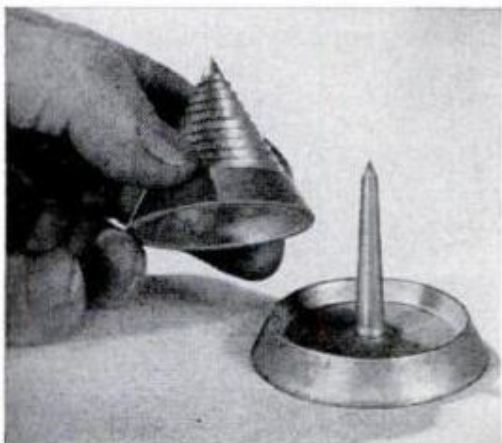

AFTER SHARPENING always balance blade. Take it to a mower service shop where it can be checked on a balancer like that pictured at left. Or, do the job yourself by clamping a strip of sheet metal in a vise with edge up. Lay blade across edge and center hole on the edge. File off metal at the heavy end until blade balances perfectly. Oil blade, then replace

FUEL FILTERS on mowers are of different types but yours may have one like this. Go easy on screw when you take it apart for cleaning. Follow instructions

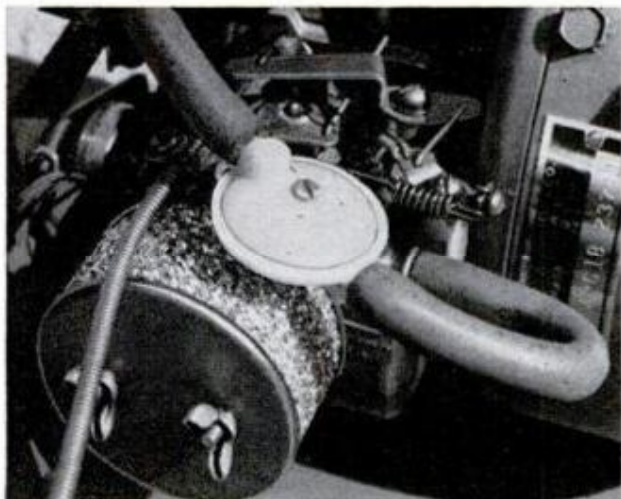

STORE MOWER in a clean corner of garage or basement where it will be dry and, nothing will fall on it. Cover it with a sheet of plastic which extends to floor





Treat Wood Before Calking

You may avoid costly repairs later if you spray the cracks and openings between siding boards with wood preserver and termite repellent before calking. Such cracks often have been exposed to the weather for years, and it's possible that dry rot has already set in. If so, such precautionary spraying will prevent it from spreading.

A small insecticide sprayer is perfect for applying the preservative. Use a Penta solution thin enough for spray application. If you reduce it yourself from the concentrate, be sure that you use the thinner recommended in the instructions to assure that calking will adhere. Hold the sprayer close to the surface to be treated and apply the preservative generously. Then wipe off any overspray and allow the surface to dry thoroughly before calking the crevice. Follow procedure when calking, making sure you apply a uniform bead of calking material.—*Ken Murray*



Tip for Myopic Skindivers

Prescription-ground diving goggles and masks are too expensive for most skin or scuba divers who wear glasses. A far simpler and more economical solution is to remove the bows from a spare pair of glasses and wedge them into your diving mask. If the mask is too large for the glasses to fit snugly, use safety pins and water-resistant tape to secure them. In any case, make sure they are fastened securely.—*Michael Lamm*

Giant Vacuum Gathers Autumn Leaves

Clarence Bailey, greenskeeper at the Mill Creek Golf Club, Youngstown, Ohio, came up with an unusual solution to the problem of keeping the links free of leaves. He mounted an old blower unit on the front end of a truck and ran heating ducts from this to a wire-mesh cage on the truck body. The blower is driven by power takeoff. Men with hand rakes windrow leaves under intake duct and they are blown back into cage

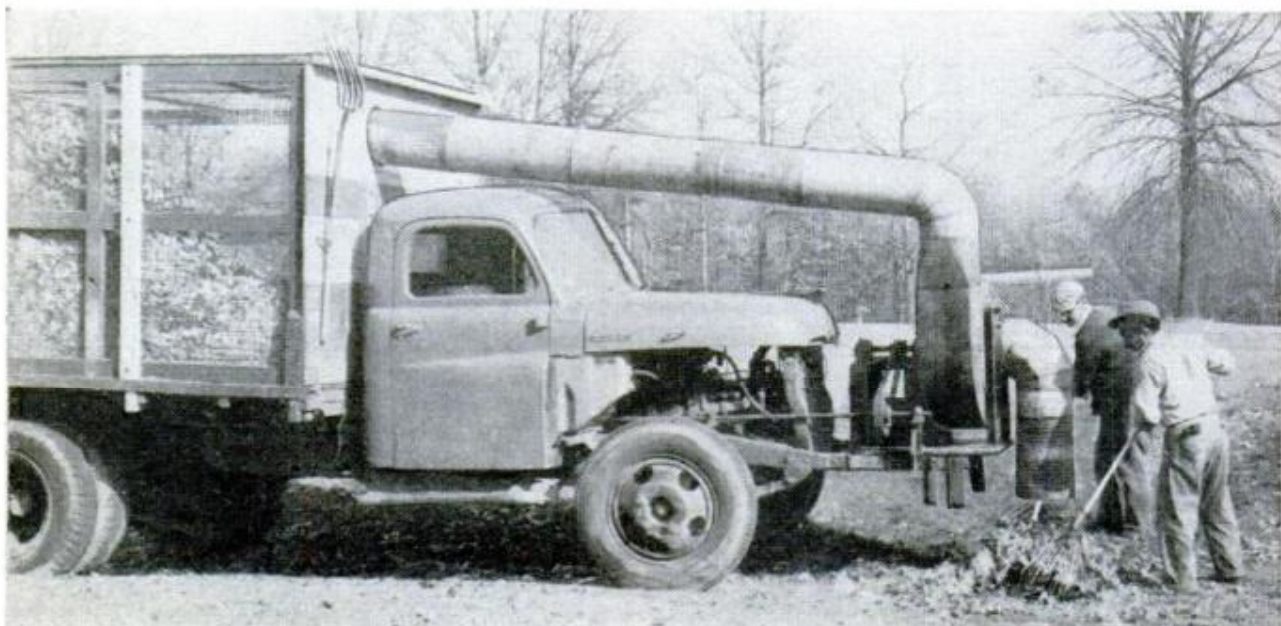

FLOODLAMP

With Barn Doors

FINE VARIATIONS of lighting for better pictures are possible with this controllable floodlamp which is easy and inexpensive to make. Two sheet-metal vanes permit delicate control of background lighting, a diffusing screen softens too brilliant light, and a pan head permits quick beaming of light where wanted, also locking the lamp in position.

The framework that holds the vanes and diffusion screen attaches to a steel plate which mounts on the pan head. The heart of the unit is an RFL-2 sealed-reflector floodlamp. This turns into a porcelain surface-type socket fastened to a wooden block held on the steel plate with screws. Tape the exposed terminals to prevent shocks or shorts and fit a through switch in the cord so the lamp can be turned on and off conveniently.

Drill and tap the plate for the screw of the pan head. Bend the forward end at right angles, then drill and tap it to take the threaded end of a 5/16-in. steel rod to which you braze the U-shaped vane holder. File a round-bottom notch across the rod to fit the vane holder and to provide good contact for silver soldering or brazing. This can be done with a gas (propane) torch and is just as easy as soft soldering, but provides a great deal more strength. Bend an offset in the rod to clear the lamp.

Make the vanes of 26-ga. sheet steel or aluminum. Round the corners, file off the

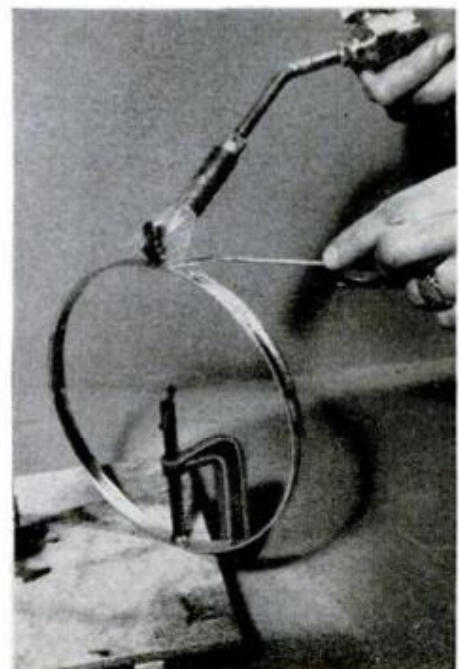
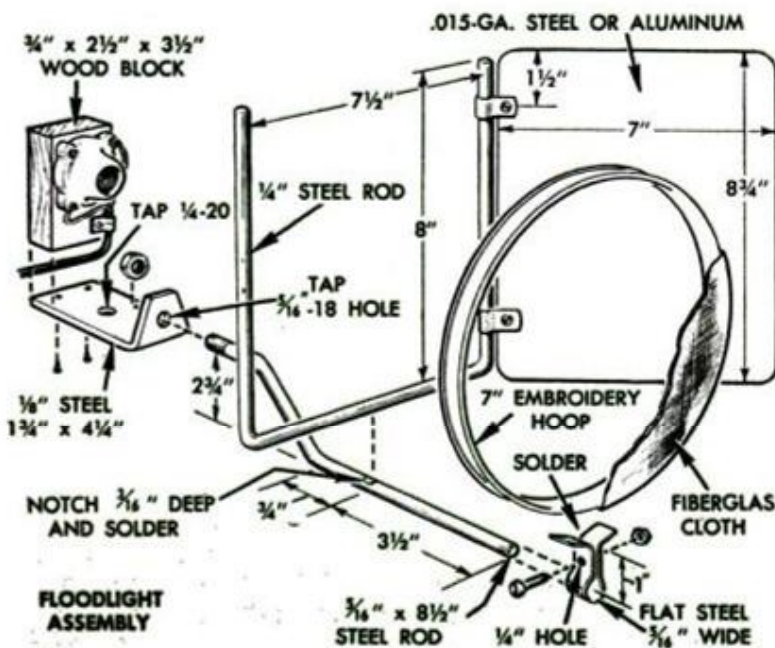
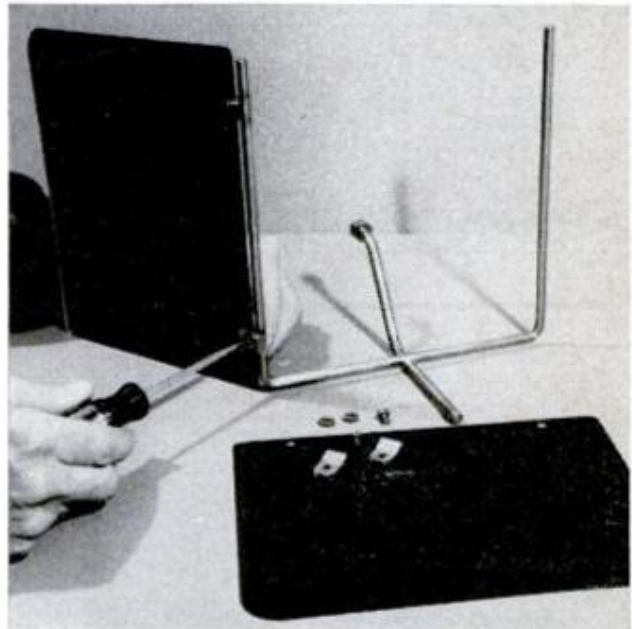



READY FOR USE, swinging vanes control background lighting and diffuser softens too brilliant light

sharp burrs, and paint the surface toward the light a matte black. Next, form the hinges from a piece of sheet steel about .010 in. thick (No. 30 ga.). These should be a friction fit on the holder so that the vanes will stay put in any position. Machine screws and nuts holding the hinges on the doors are turned to tighten or loosen the fit on the rod supports.

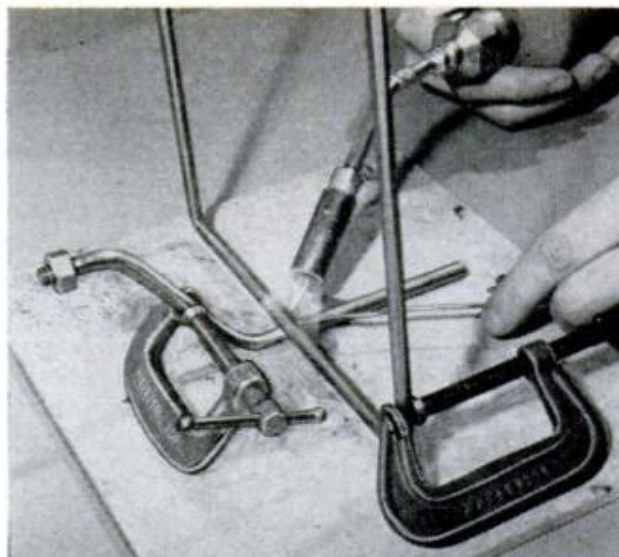

BRAZING VANE HOLDER to support rod after filing notch in latter and applying C-clamps to hold pieces

The diffusing screen consists of a 7-in. embroidery hoop and a piece of fibreglas cloth. Make the bracket from sheet steel about .040 in. thick (No. 18 ga.), forming it for a friction fit on the rod and making it adjustable for tightness with a machine screw and nut. Solder or braze the bracket to the embroidery ring as in the photo to complete the job.—*Martin D. Koehler*

FOR CAMERA BUGS



Tape Always at Hand

Several strips of masking tape stuck to the inside of your camera carrying case, will be instantly accessible for sealing opened cartons in which you have put exposed roll film. When so protected it is impossible for rolls of exposed film to slip out of the cartons if contents of the case are shuffled about, and possibly becoming lightstruck along the edges.—*O. A. Nelson*

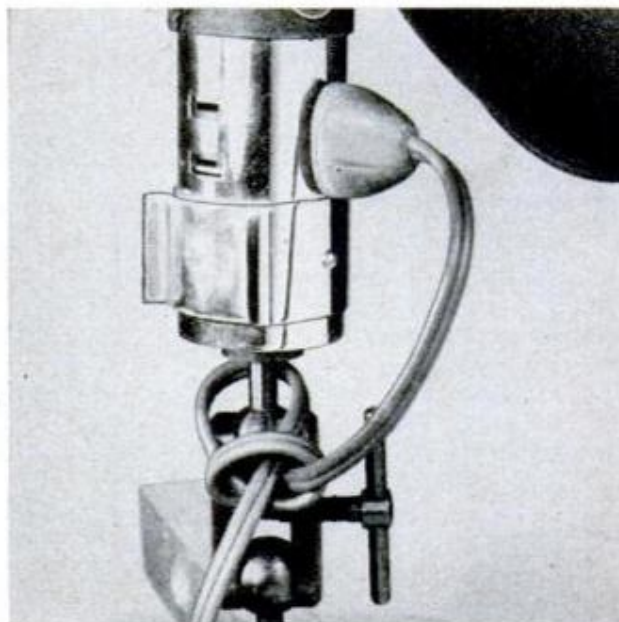

Keeping in Contact

When cords to extension flash units are subjected to strains and tugs, connections may be loosened just enough to prevent the bulbs from firing. To avoid this trouble simply tie the cords around the base of the flash-bulb holders as shown so that the cord movement will not be transmitted to the plugs. Any tug on the cord will be on the knot.—*Bill Toman*

NEW FOR SHUTTERBUGS NEW

1. REVERSIBLE UMBRELLA REFLECTOR provides a good diffused source of illumination when used with a primary light source, such as flash, sunlight or speedlight. The umbrella is reversible: One side is white nylon and the other aluminized Mylar. Collapsed length is 22 in. Model No. 36, \$39.95. Photo Lectronic Research, 141 W. 42 St., New York 36, N.Y.

2. AUTOSET 35-MM. CAMERA features automatic exposure control over wide range of shutter speeds and lens openings. Indicator signals if film has been advanced after previous exposure. For flash exposures, you dial guide number, setting it opposite distance setting. Camera includes coupled view and range finder. Less than \$90. Ansco, Binghamton, N.Y.

3. ROLL-FILM WASHER washes film rapidly, forcing the hypo to rise over top of tank. Two jet openings at the base swirl the water as it is forced up and over the top. Washer holds two 120 or 620 reels, or four 35-mm. reels. Pressure is controlled from the water faucet. Priced at \$19.95 from Standard Photo Supply Co., 43 E. Chicago Ave., Chicago 11, Ill.

4. ZOOM 8 REFLEX MOVIE CAMERA is capable of focusing from four feet to infinity for all focal lengths. New shutter-governor provides quiet running and stopping. Retaining all important features of previous model, camera includes push-button zooming, through-the-lens viewing and automatic electric eye. Less than \$215. Eastman Kodak Co., Rochester 4, N.Y.

5. MATCHBOX-SIZE BC flash unit fits accessory shoe of any camera. The holder uses AG flashbulbs and a 1½-in. dia. silvered aluminum reflector—weighs only 1¼ oz. An ejector button assures easy removal of bulb. Flash unit is priced at \$4.95; top-grain leather case, \$1.75. Distributed by Kling Photo Corp., 257 Park Ave. South, New York 10, N.Y.

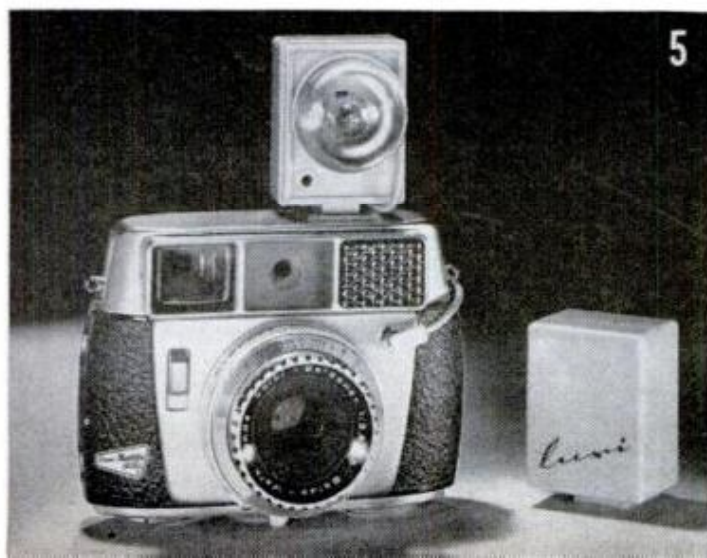



When Your Car Quits ...

miles from professional help what you can do in improvising an emergency repair determines whether you walk home—or ride

By Paul Weissler

WHEN YOUR CAR stops on the road rather suddenly—and this can happen half a county away from help—it's usually some simple thing or something that's been developing without giving any warning. Locating the trouble is only half the problem; the other half is to devise some means of making an emergency on-the-spot repair that'll get you back to the main highway, to the nearest gas station, or maybe all the way home.

Confronted with such an emergency a good Saturday mechanic would think of several possibilities before he even got out of the car. For example, a jerky, sputtering stop would remind him that he hadn't filled the tank at the last gas station. But he'd also remember that on most cars the fuel tank is so shaped that there's still eight to ten miles of going left in it after the engine sputters out. So, he would drain

what's left of the gas from the tank, pour in about the same amount of water (or the winter fill of water and antifreeze) from the radiator, pour the precious mite of drained fuel back into the tank—it will remain on top of the water—and take off for the nearest gas station, or as near as he can get before the engine conks out again. Whether he makes it to the station or not, he must remember to drain the water from the fuel tank before adding fresh gas. No harm will be done, that is, if Saturday mechanic doesn't forget to drain the water. Otherwise there's trouble.

But that's only one example of what can happen. Here are several case histories of unexpected car failures that have stopped Saturday mechanics and others far from help, and what they did to get going again. Some are old tricks, well known to older-generation auto mechanics, but remember-

FUEL TANKS of most modern cars will contain six to ten miles of going after the engine sputters to a stop. Drain gas, add water and then replace



WRAPPING BURNED POINTS with foil usually will get you to nearest station and necessary replacements

IN AN EMERGENCY driver made do with a broken fan belt joined with shoelaces. Crude, but it worked

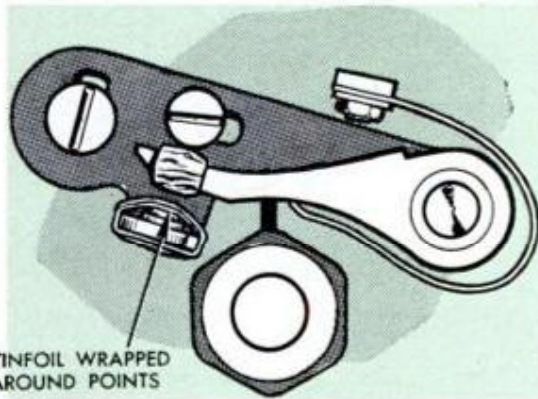

TINFOIL WRAPPED AROUND POINTS

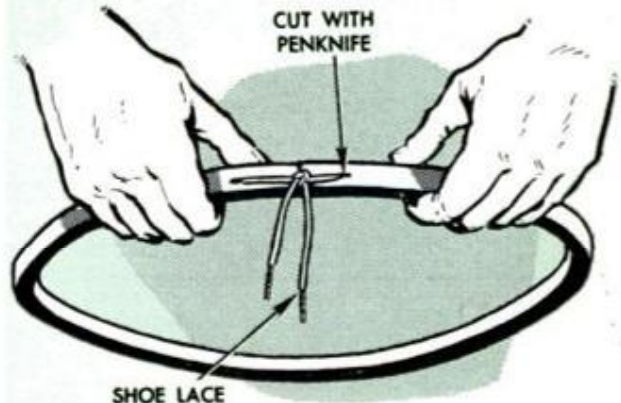

SHOE LACE

A HUNTER, miles from anywhere, discovered a parted ground strap. Detail below shows how he improvised

ONE DRIVER repaired a leaking upper hose with tail-pipe section and tape. He made it all the way home

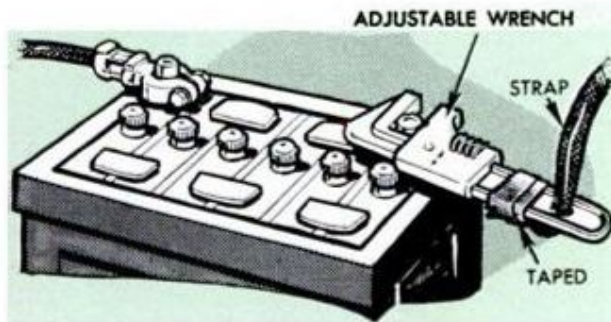

ADJUSTABLE WRENCH

STRAP

TAPED

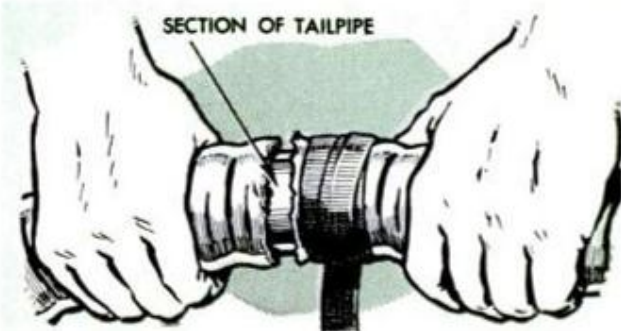

SECTION OF TAILPIPE

IN THIS CASE a baby-food jar served as a fuel filter bowl and saved a picnic. Any small jar also might do

THIS DRIVER found coil lead loose and carbon-brush assembly missing. Repair—ball-point pen spring



BABY-FOOD JAR



SPRING FROM BALL-POINT PEN

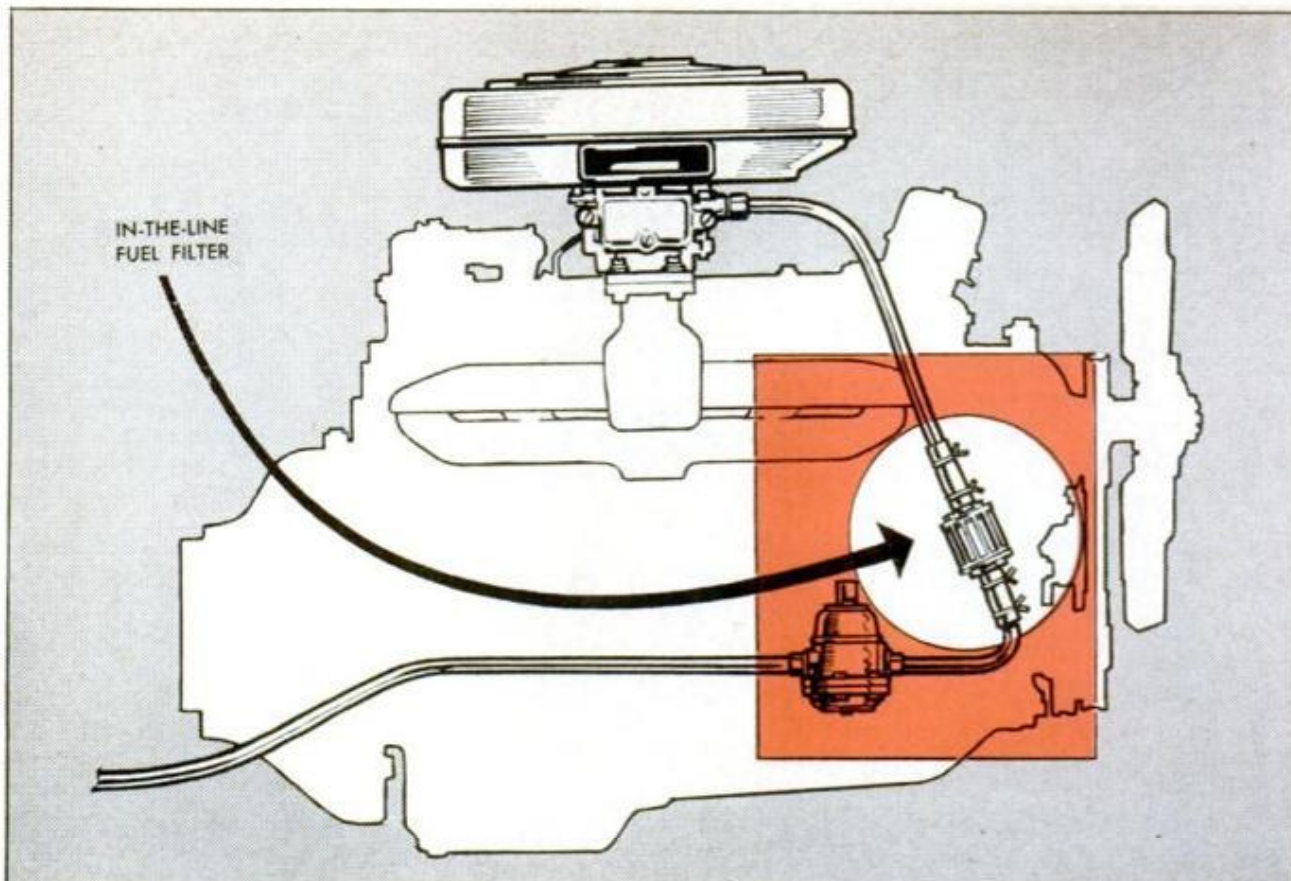

IN-THE-LINE FILTER protects fuel system, keeps carb clean. Install according to manufacturer's instructions

ing them may well save you a long walk.

Burned breaker points stopped a car nearly 20 miles from a source of standard replacements. What to do about it?—with nothing seemingly at hand to do with. But the driver was more than ordinarily resourceful. Searching the car he found a package of chewing gum in the back of the glove compartment. He stripped the foil wrapping from a couple of sticks of gum, folded it tightly and wrapped a piece about each point, being careful not to ground the

WHEN FUSE fails, wrapping it in foil and replacing can get you home or within reach of a replacement

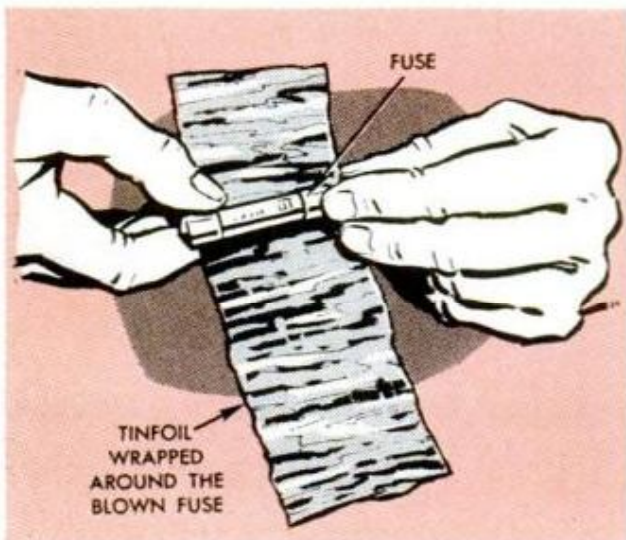

moveable contact point. These improved "points" took him nearly half of the way to help, before the foil burned through and left him stalled again. He disassembled the distributor and repeated the performance and with this second set of foil points he made it to within walking distance of a gas station.

Another driver was stalled by a broken fan belt on a little used rural road. He was about to give up and start the long walk back when he thought of his shoelaces. Why not use one as belt lacing? To think was to act, for it was getting late in the day. He cut a small slit about an inch from each end of the broken belt and drew the ends together with the shoe lace. But this lace, being worn, let go after only a few miles. He relaced the belt with the second shoelace, the last one, of course. This one, being less worn than the first, held until he made a gas station. Of course, his car was equipped with manual steering. The laced belt would not have held under the additional load of a power-steering unit.

A hunter, driving a one-track trail to a remote lodge, was stalled by a ground strap corroded so badly by battery acid that it let go. He discovered the defective strap when he attempted to start the station wagon for the return trip. It took a while for him to contrive a way out of such

(Continued to page 214)

SHOP SHORT CUTS

Nonslip Grip

Occasionally, when cutting a dowel on the jigsaw, the blade will grab suddenly and break. To prevent this, stretch a length of friction tape over the table, adhesive side up, with one edge just clearing the blade. Twist the ends of the tape so you can stick the adhesive side to the table flanges as pictured. Then just roll the dowel into the blade slowly, holding it firmly until the blade cuts through.—*G. E. Hendrickson*

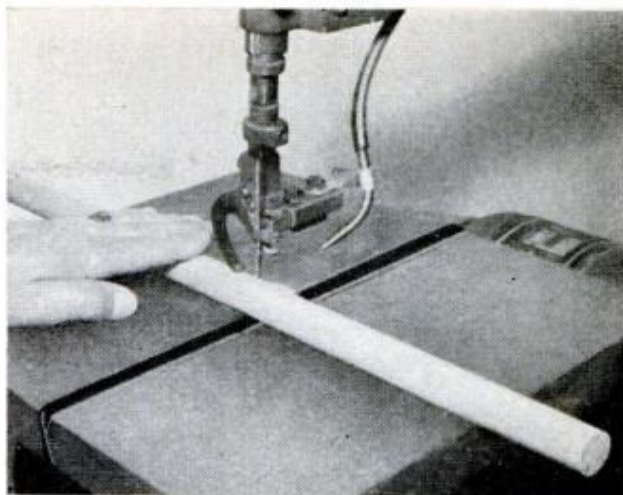

Made to Measure

You need a straight cylindrical turning in wood, no dips or bulges in it from end to end. Free hand, this is no simple trick on a wood lathe. There's a faster, easier way: Caliper two grooves, one near each end of the work, to the diameter required. Then measure from the back edge of the tool rest to the bottom of each groove. Set the rest so the measurements are equal. Drill and clamp two short strips of hardwood to the gouge with stove bolts and wing nuts as pictured. Now you're set to use the back edge of the tool rest as a guide.—*H. Hanscom*

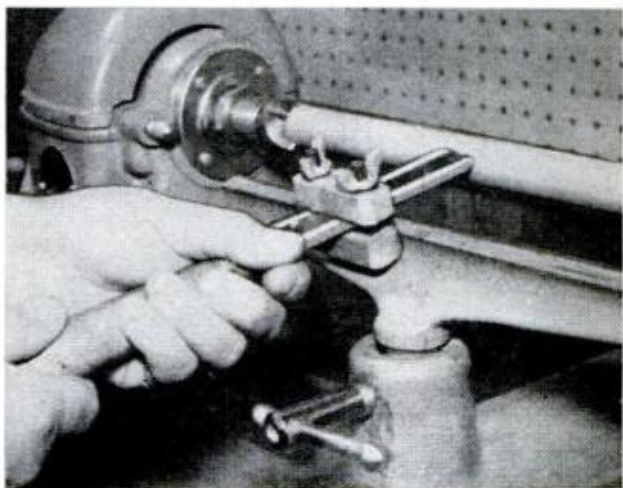

Drill Spotter

Starting a drill bit on round or tubular stock can be done quite accurately simply by spotting the hole with an X-mark on a strip of tape pressed firmly onto the surface as pictured. The tape holds the drill, keeps it centered until the point bites in. This kink will serve only for starting small drills, $\frac{1}{8}$ in. or less. If you need a larger hole, go through first with a pilot drill, using a $\frac{1}{16}$ or $\frac{3}{32}$ -in. drill bit. Then strip off the tape and go through with a drill bit of the required diameter. Use very light pressure when drilling.

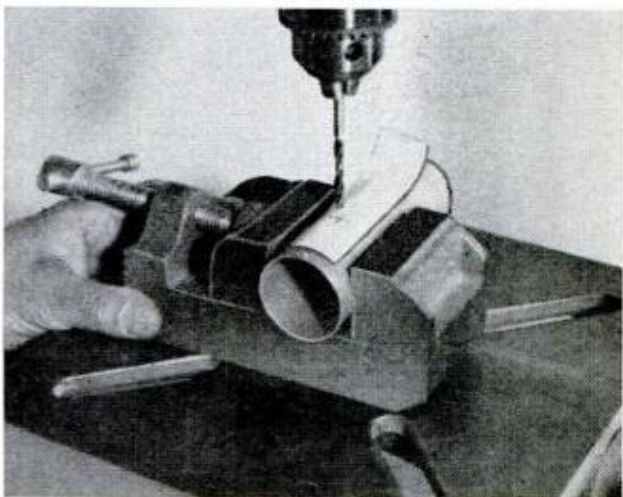

Step Table

Most of you radial-saw owners will find this kink useful and timesaving when using the tool for several operations that differ but follow in sequence. Place a piece of $\frac{1}{4}$ or $\frac{3}{8}$ -in. plywood in front of the fence with one edge against the fence. Mark around the edges of the original table and cut the plywood to this size. Attach to the table with several screws. Now, when you need to adjust the blade from a 90-degree cut to a miter cut, just push the carriage back past the fence. Since the rear surface is lower, you can swing the blade into any angle position without having to raise the arm. You'll find this a real convenience.

—*Arthur Shults*

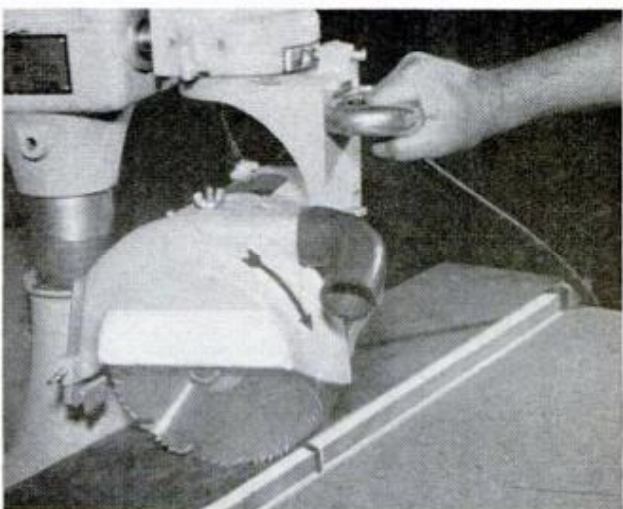

ELECTRIC BLENDER

Household

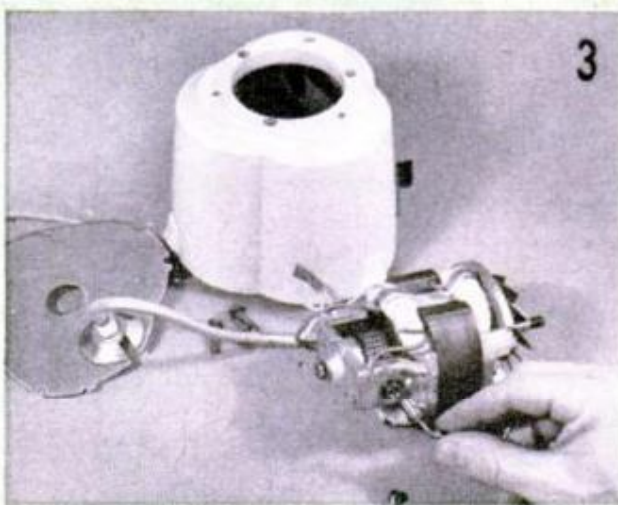
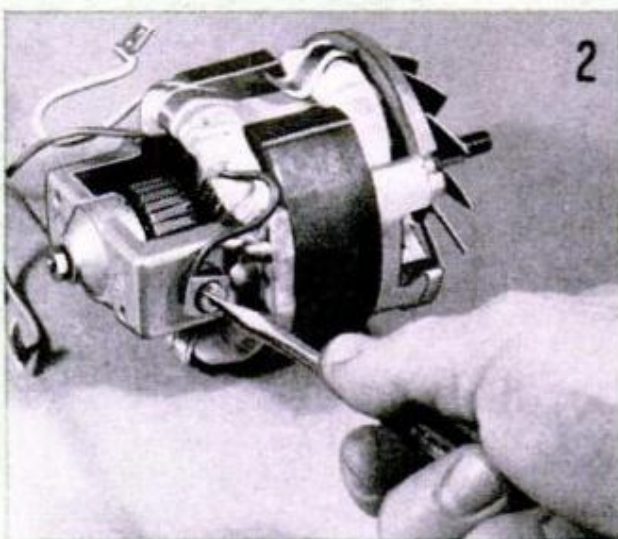
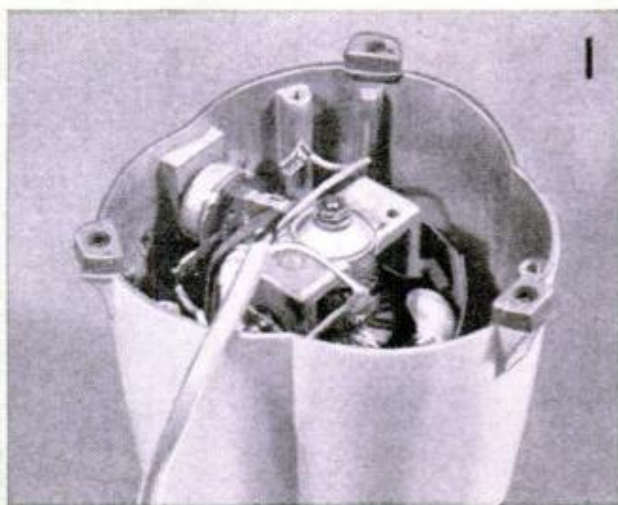

ONE THING to keep always in mind in connection with routine operation of your food blender is to be careful about what you put in it. It will grind and blend almost anything edible to a pulpy, appetizing mass but a peach or prune pit or a gravel particle that goes in with a few lettuce leaves—well, a blender just isn't built for crushing pits or stones! Other than that you haven't much to worry about in its operation, unless you drop it, or you have had it a long time.

Cords usually go first, but not always. When something goes wrong—the unit doesn't operate properly or won't run at all—the experienced appliance serviceman generally thinks first of the power cord and the motor brushes. That's your cue in fix-it-yourself. If there's reason to suspect the cord, go over it inch by inch, looking for breaks, a cracked plug or a wire loose, either at the plug or the other end of the cord at the terminals. If you see anything wrong with the cord, or if it looks like it might go bad, replace it.

With the cord examined and passed, the motor brushes are next. To get at them you have to take things apart. When you turn the unit over and remove the bottom plate you'll see something like that pictured in Fig. 1. Likely you'll have to take the motor out to reach the brush retaining screws, Fig. 2. Remember when you turn out screws, easy does it. And don't let the brushes pop out when the retainer is loosened; they're spring-loaded, you know. If the brushes are still good—

Appliance Fix-It File

not badly worn, cracked or chipped—make sure that you put them back just as they came out. Don't turn them over or interchange them, Fig. 3. This is important as in use the ends of the brushes have worn to an almost perfect seat on the commutator. If you turn them over or interchange them, you'll get an imperfect contact and a stream of sparks from each brush when the motor is running. This can cause rapid wear of brushes.

Anytime you have the unit apart so that the motor can be seen, examine the commutator. If the brush track appears reasonably clean and a uniform color, just wipe with a dry cloth and let well enough alone. But if it appears blackened and slightly pitted, then it's permissible to clean it with a piece of fine sandpaper as in Fig. 5. Don't use emery cloth or any similar abrasive as just one grain of these abrasives can cut out an armature bearing in no time.

Often in servicing it may be advisable to test the resistance in the switch. This is done as in Fig. 4, by applying the common lead to the power terminal and the ohm lead to the high and low-speed terminals in turn (most blenders have a two-speed switch). The ohmmeter will register the amount of resistance in the switch. If this seems high, the switch should be replaced.

The three or four-blade cutter in your blender must be quite sharp to do a good job of blending. Touch up the blades on an oilstone as in Fig. 6, being careful to get a uniform bevel on each blade.

—John Pennington

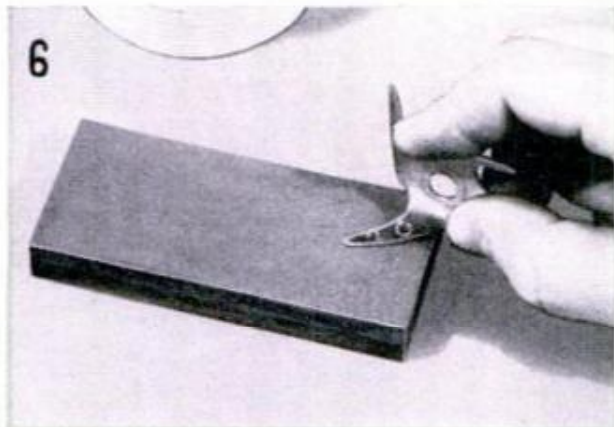
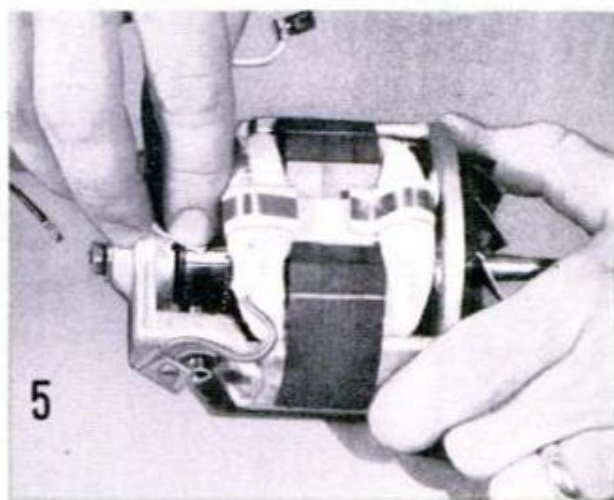

FARM TIMESAVERS

Sack Trap

When spreading dry fertilizers in an open field the empty sacks often become a problem, especially on a windy day. With no stone or other weight handy, the empties may be blown into the next county. One farmer, after covering most of a neighbor's field gathering wind-blown fertilizer sacks, carried a three-tined pitchfork. As the sacks are emptied into the spreader he stacks the empties and drives the fork tines through the stack as pictured.

—G. E. Hendrickson

Household iodine is always a good substitute for penetrating oil when you have need to loosen a rusted nut or capscrew without danger of twisting off the head of the screw or the bolt.—Charles V. Mathis

Made to Measure

Holding a bushel basket or other container under a grain chute from an overhead bin while you measure a given quantity is a three-handed job—one to operate the shutoff slide and two to hold the basket. One farmer, having frequent need to do this kind of thing, drilled a 1-in. hole through opposite sides of the chute, the holes just below the slide. Then he cut a $\frac{3}{4}$ -in. dowel to a length that would permit sliding the handles of the basket over the ends and passed it through the holes, the ends projecting about equally. With this arrangement the basket is placed in position directly under the chute and is held while a given quantity of grain is measured into it.

Open Door

Instead of propping the trap door into the hay loft open with a short strip which is likely to be misplaced and unavailable when needed, a hinged prop, or stop, was made and attached directly to the underside of the door. The stop roughly triangular in shape, was cut from a 2 x 6 and positioned so that when the door is raised, the stop is pushed slightly past the 90-degree position and the door lowered so that the stop bears on the frame.

Solder filings mixed with paste flux often make it possible to solder small parts which are difficult or impossible to clamp together or that are of such a shape that they will move out of place when touched with wire solder or the tip of the gun. Spread the paste-filings mix on the joining members and solder with torch flame.—Paul D. Brey



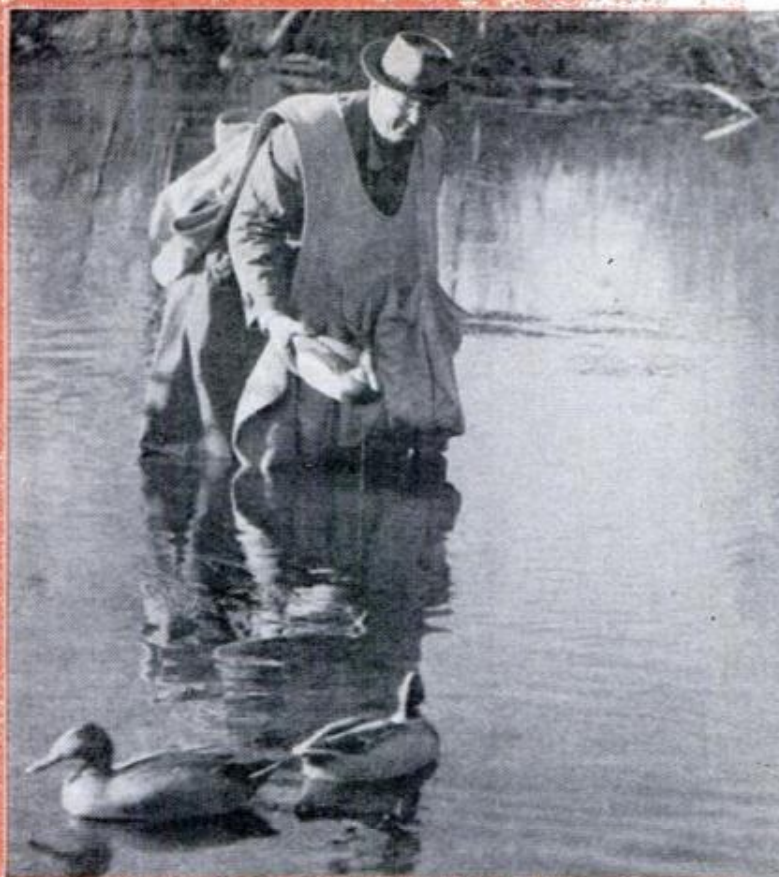

DECOY TOTE COAT

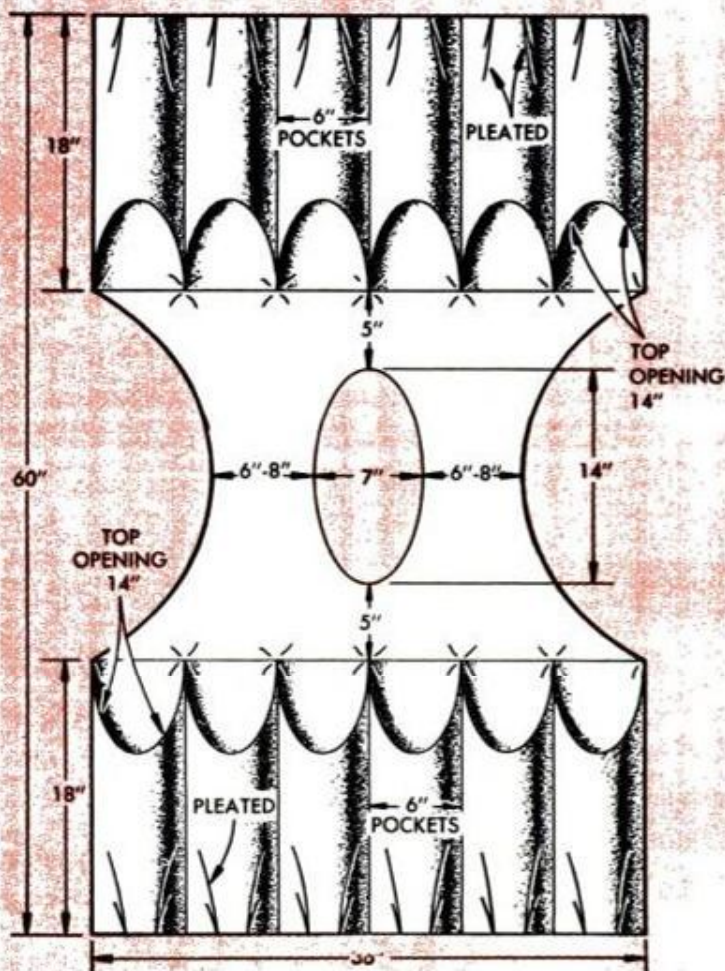
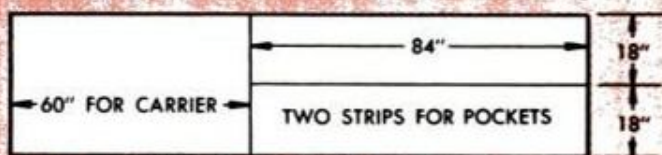

IF YOU'VE EVER missed that perfect jump shot at puddle ducks because of the sack of decoys on your back, you'll go for this canvas tote. Just load your rack of twelve decoys, one to each pocket, drop the thing over your head and shake it down a little to distribute the load comfortably. You've still got both arms free to put a scatter-gun on any duck that gets up unexpectedly from a small backwater or spring hole while you're on the way to the blind or when you're shooting a river or ditch from the banks.

And when you finally do get to the blind, drop off the rack of decoys, lift the tote over your head, fold it and you've got a reasonably comfortable cushion to sit on for the long wait. The tote requires about 4½ yards of medium-weight canvas. Cut it into three strips as in the upper detail, then cut an oval opening in the carrier piece and cut to the shape indicated in the lower detail to fit over your shoulders. Hem the edges and sew on the pockets, six at each end. Note that each pocket is pleated at the bottom and has a 14-in. opening at the top. Bar-tack each pocket at top and bottom corners so they'll take rough useage without tearing.—William W. Hunter

Prepare Your Outboard NOW for Next Season

Tips on outboard layup,
plus plans for PM's
Motor Minder stand

By Arthur Mikesell



CLOSE YOUR EYES and try to picture that first launching early next spring. Winter's chill may still be strong in the air, but the sun speaks of warmer days to come and you feel a familiar urge to be out on the water. Your boat rocks quietly at the dock, small waves gently lapping against the hull, and you're ready to go. What happens next? That depends on what you do *right now*.

The best way to insure trouble-free boating next year is to spend an hour or so going over your motor before you hang it up to hibernate for the winter. Routine end-of-season maintenance may save you from the necessity of a major overhaul later on.

Any fuel remaining in the motor during storage will form harmful deposits in the fuel system. The easiest way of emptying the fuel system is to disconnect the line to the fuel tank while the motor is running and let it run until all fuel is exhausted. Since the cooling system should be flushed with clean water, you can combine these operations by letting the motor run in a clean garbage can filled with water until the fuel in the line is exhausted.

Water left in the powerhead and water pump is an invitation to rust. More important, if you store your motor in an unheated shed or garage, water in the cooling system may freeze and cause serious damage. When you have clamped the motor upright on its storage rack, close the throttle all the way and either pull the starter or rotate the flywheel by hand to expel water from the cooling system.

After emptying the fuel and cooling systems, you can go to work on the powerhead. Remove the shroud and wipe all accessible parts with solvent. Gasoline is fine for this job, since it leaves an oily film which will prevent rust. However, be sure to take all the normal precautions against fire—plenty

TOUCH UP SCRATCHES on the shroud, lower unit and fuel tank with matching paint from a spray can. Be sure to mask adjacent manufacturer's emblems etc.



OCTOBER 1962

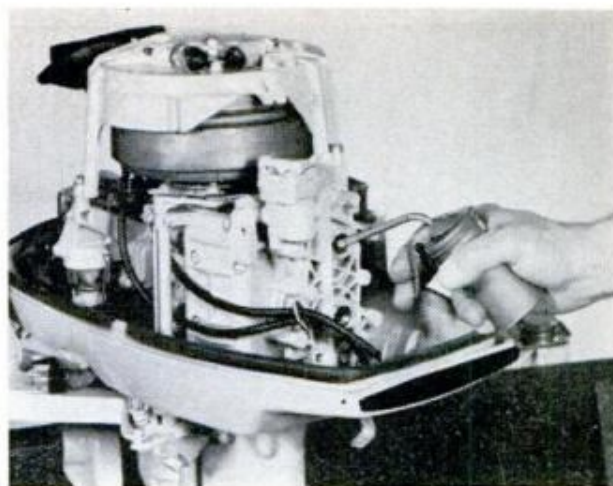

SQUIRT SEVERAL DROPS of #10 oil into each cylinder while you have the spark plugs out, then rotate flywheel to distribute it evenly over internal surfaces

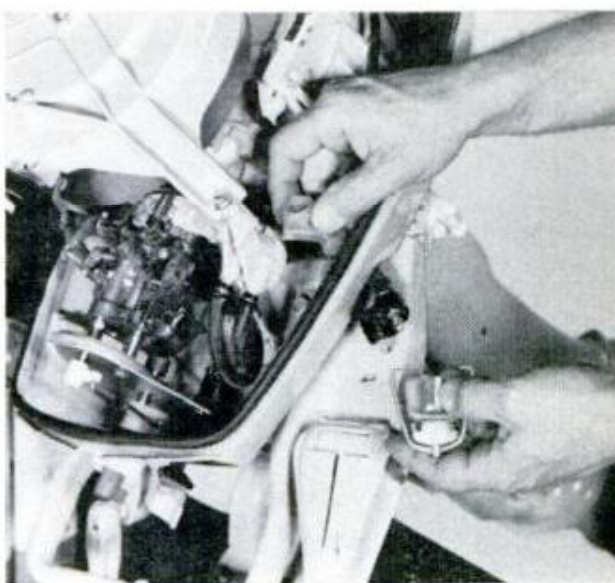

REMOVE AND CLEAN sediment bowl and filter. When replacing assembly on carburetor, make sure that the gasket fits snugly and check carefully for leaks

SILICONE SPRAY lubricant discourages corrosion and protects the rubber cover gasket. Cover all exposed surfaces of the powerhead with a light even coating



187

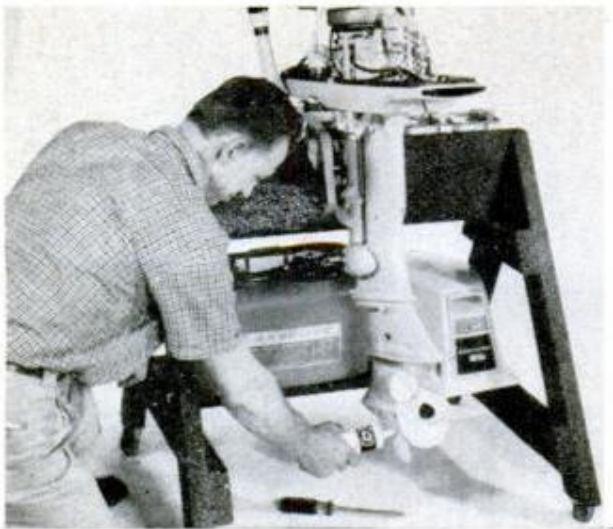

DRAIN LOWER UNIT and refill with fresh gear lubricant. Grease must be forced into gear housing until it shows at vent hole, indicating cavity is filled



PROPELLER SHAFT may be coated with hardened grease. Remove this with steel wool and apply a new coat of water-resistant grease before replacing prop

of ventilation, no smoking and burn any rags used. While wiping, check all linkage points for bent levers, loose-fitting joints and corrosion, especially on sliding parts. Make any adjustments necessary, and if you find a damaged part, tag it for replacement. Remove rust with emery or crocus cloth, and grease all linkage points with the proper lubricant.

Next, remove the spark plugs and check them for wear. If electrodes are only slightly worn and plugs show brown to grayish-

(Continued to page 212)

PM'S MOTOR MINDER

Here's a combination storage stand, workbench and carrying cart that you can build in an evening. Designed by Kenneth G. Hawkins, it not only provides a handy rack for storing your outboard in the proper upright position, but also has shelf space for the fuel tank, battery, and common maintenance equipment. You can vary the dimensions to suit your motor.

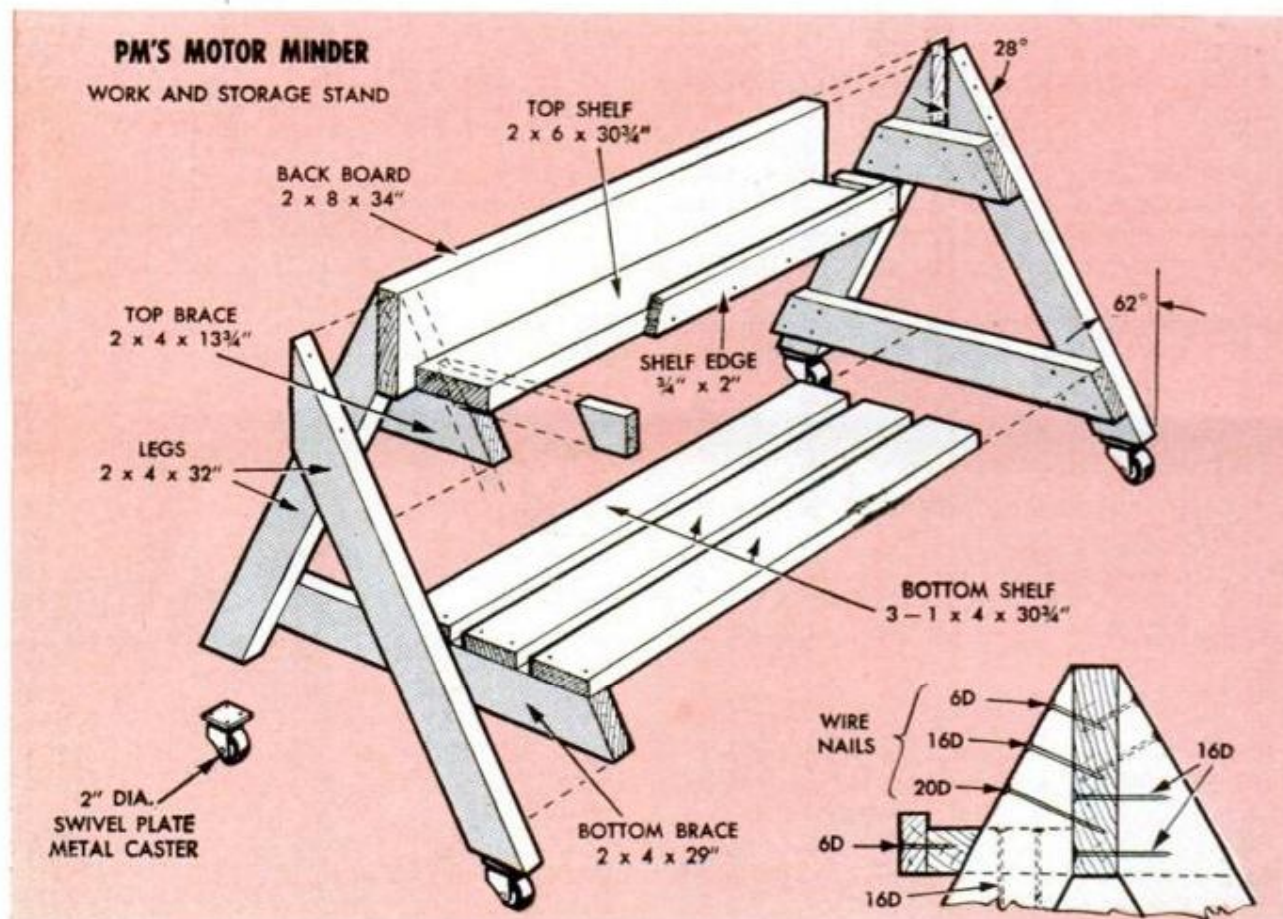

SHOP SHORT CUTS

Saw-Blade Sheath

Storing or transporting a circular saw blade without suitable protection over the teeth always involves the risk of cutting yourself and also of dulling the teeth. A simple solution is to slip the blade into a discarded phonograph-record jacket. In case you don't have one, make one from a suitable piece of cardboard folded and sealed along two free edges by using some 1-in. masking tape.—*John Mihalick*

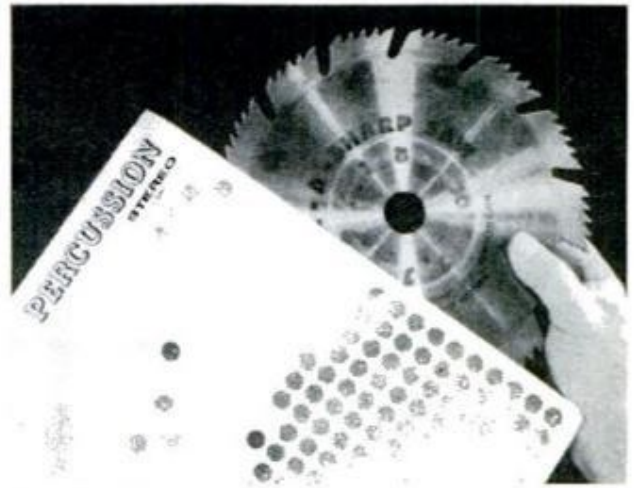

Tap Cuts Oversize

Next time you have to thread a hole that is a little too large for the tap you have, or to slightly enlarge a tapped hole of the same thread size, use this effective method. Push a short length of drill rod of the right size in one of the flutes when starting the tap and leave the rod there until you have run through the work. Numbered twist drills can be used and provide a wide range of sizes. A drill is inserted so only the shank end makes contact between the tap and work.—*H. J. Gerber*

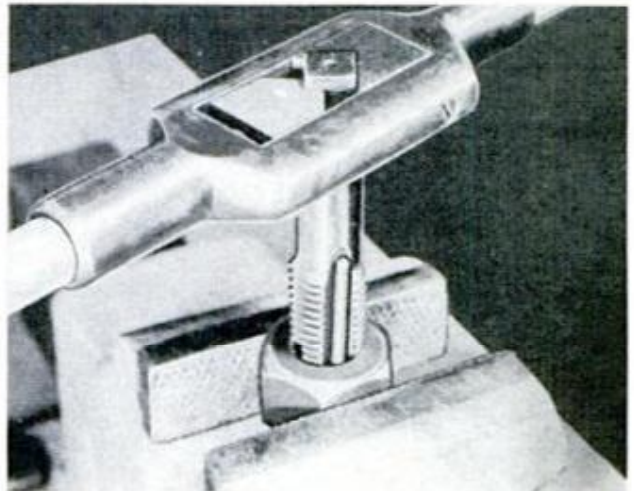

Storing Saber Saws

A good way to store your saber saw where it will be accessible instantly, yet fully protected against damage, is to set it upright on a narrow shelf with the blade projecting downward through a 1/2-in. hole. The shelf should be narrow to avoid piling it with other items. Since a bent blade may result from laying the saw against other tools on a benchtop, it's a good idea to bore another hole at the rear of the bench to accommodate the saw temporarily between moments of using it.—*William B. Eagan*

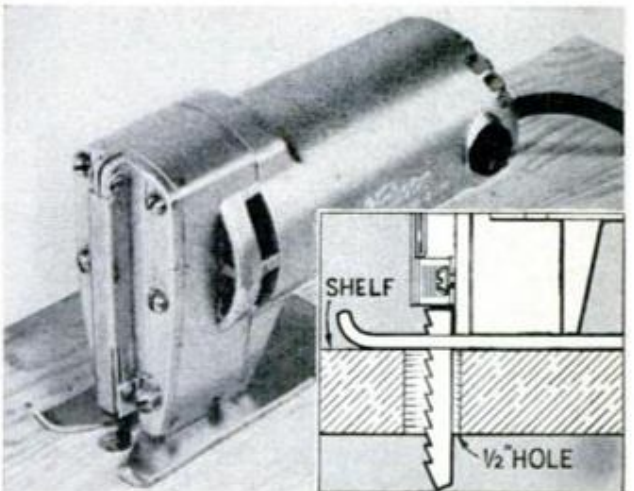

Handy "Deburring" Tool

Removal of sharp burrs from the edges of sheared plastic or aluminum sheets can be done with speed and ease by using the little tool shown here. It is made from 1/8 by 3/4 or 1-in. flat steel. One end is bent at right angles and the other is doubled for a comfortable grip. A V-notch is filed or ground in the bent end. Sides of the notch are dressed to a slight angle, forming sharp edges on the inside so that the tool will cut as it is pulled. It should be held upward at an angle in order to prevent cutting your fingers while drawing it over the burred edges.—*Bernard W. Draper*

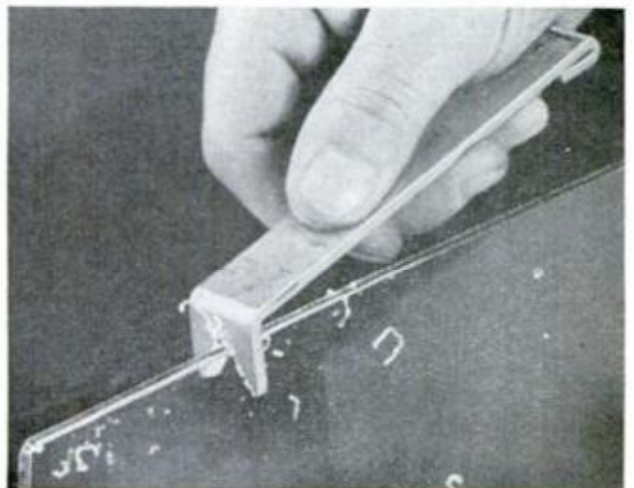

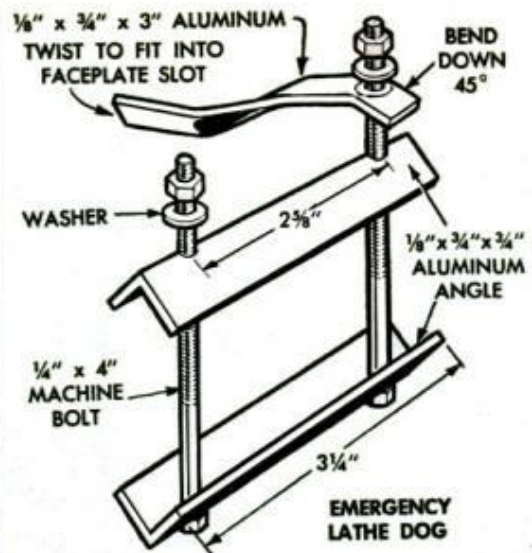
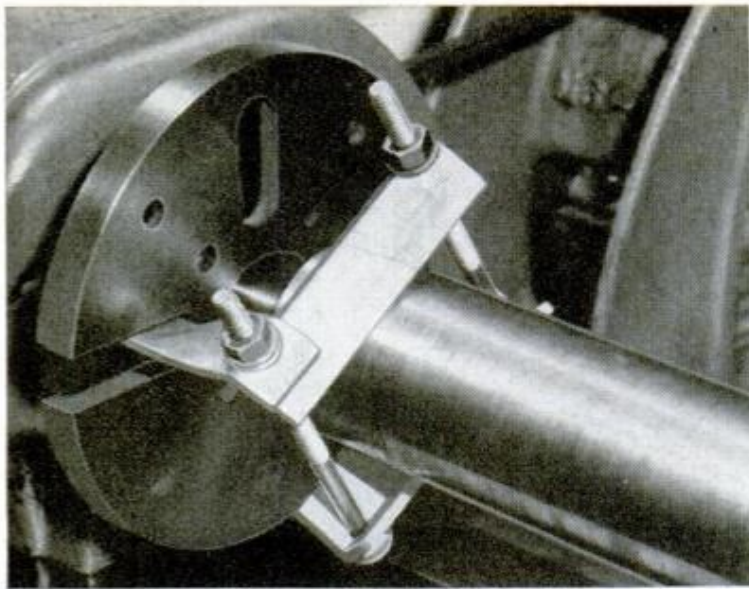

Emergency Lathe Dog for Large-Diameter Work

You have a small metal-turning lathe and a comparatively large-diameter workpiece to turn down between centers. The regular dog won't take the work. So, what do you do? You make an emergency dog from two short pieces of aluminum angle, two $\frac{1}{4}$ -in. machine bolts and a flat piece of aluminum about 3 in. long to serve as the tail. The photo at the left shows such an improvised dog in use; the detail at the right shows how it's made. Of course, you don't have to

follow the dimensions exactly. Your workpiece may be even larger than that pictured and you make the dog to suit. To drill aluminum angle on the corner as is required, file a flat at the point where the hole is to be drilled, spot it, and then go through with a small pilot drill first. Then you can get the larger drill started easily. Twist the flat piece so that the free end drops into the faceplate slot as pictured. Keep your fingers clear of the dog!—*Manly Banister*

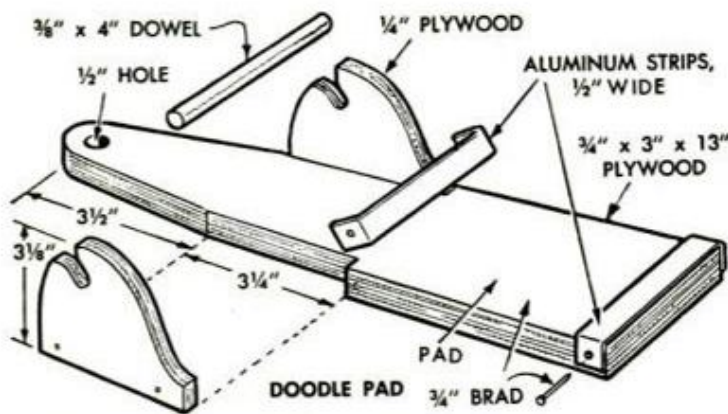

Shop Doodle Pad

Things to remember, shop supplies to be purchased, one-minute sketches of projects in process or the planing stage, can be penciled on this doodle pad for ready reference. After you've purchased the adding-machine roll which is used as the paper supply, making the rest of the pad is a simple one-evening project. Plywood serves as a base and it's made so that the complete pad can hang on the wall or sit firmly on a bench. Note that both sides of the base are notched for supports, or bearings, which carry the paper roll. Aluminum strips, one serving as a paper hold-down and providing an edge for tearing off, the other as a guide to align the paper strip as it comes off the roll are bradded to the base. Nothing is critical about dimensions or fit of the parts and the sweep of the curves can be anything that suits your fancy. The pad also comes in handy for jotting down the week's grocery list. Hang it on the kitchen wall.

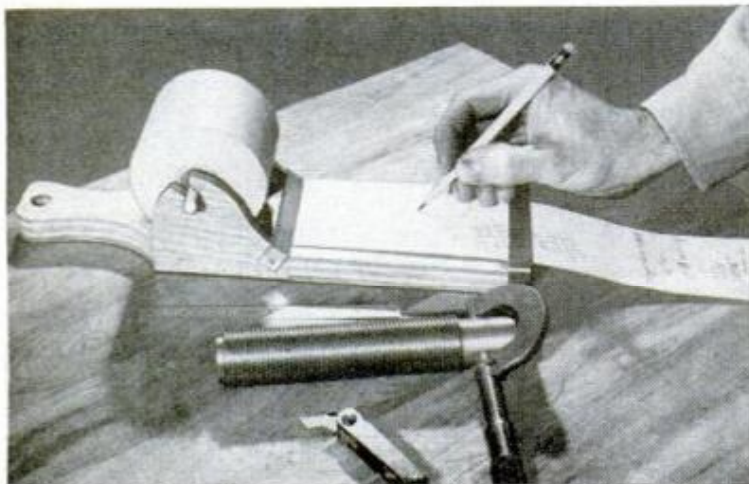

FARM TIMESAVERS

Up the Ramp

This portable hog waterer has a swing-up ramp made nonslip in any weather by lengths of steel angle inverted as pictured. The ramp is held in the up position by means of a chain. The water trough is supported on a welded-steel framework alongside the supply tank and is fed by a float-controlled valve. This arrangement makes for fast, easy transport to and from the lot when the tank is empty, also for tractor transport from one location to another to prevent the formation of mudholes around the waterer.—*Paul D. Andre*

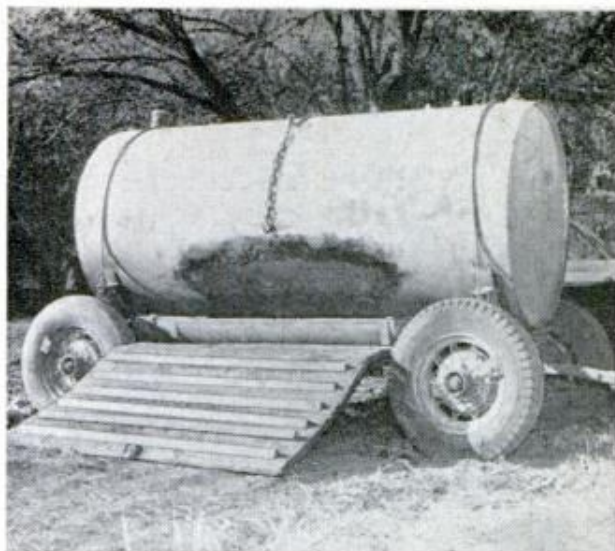

Spring Support

There's no chance of the hydraulic hose connecting the tractor with the lift cylinder being damaged or pulled loose when it's carried on this support which is a heavy coil spring from an old cultivator, one end being bolted to the trailer drawbar as pictured. A steel ring is welded to the top end of the spring and the hose passed through it. Spring will return to original position if struck or pushed sidewise.

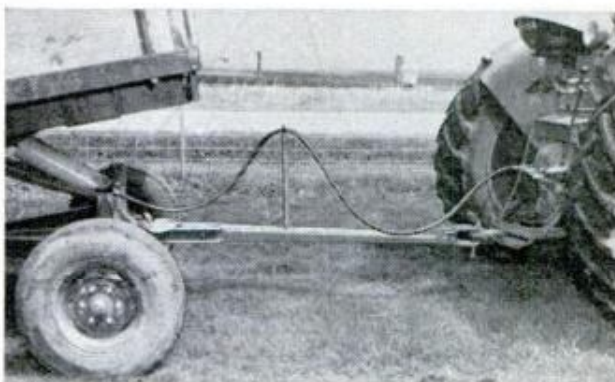

Washtub Hopper

An ordinary washtub forms the hopper for this homemade small-grain elevator. Note that the tub is cut away on one side to permit the lower end of the elevator to drop into the opening. The cut sides of the tub are bent outward and nailed or screwed to the wood sides of the elevator chute to form a grain-tight joint on both sides. The tub is just the right size to catch a scoopful of grain without spilling and the elevator flights pick up the grain without scattering it about. If the tub is required to support all or nearly all the weight of a fairly long elevator chute, it may be necessary to reinforce the bottom with a disk cut from flat steel.—*Wayne Floyd*

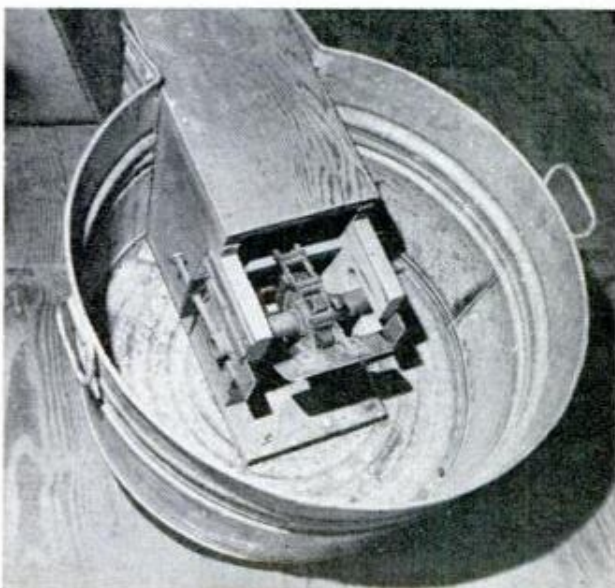

Feedlot Cafeteria

By mounting hog feeders on angle-steel frames, or stands, one livestock feeder found that cattle soon learn to raise the tilting lids of the hoppers and reach the feed or concentrate. The feeders hold several days' supply, saving time and preventing waste. The angle-steel frames are joined by welding stretchers and braces to angle steel legs. For easy tractor transport from one location to another, the legs might be fitted with channel-steel runners.—*A. M. Wettach*

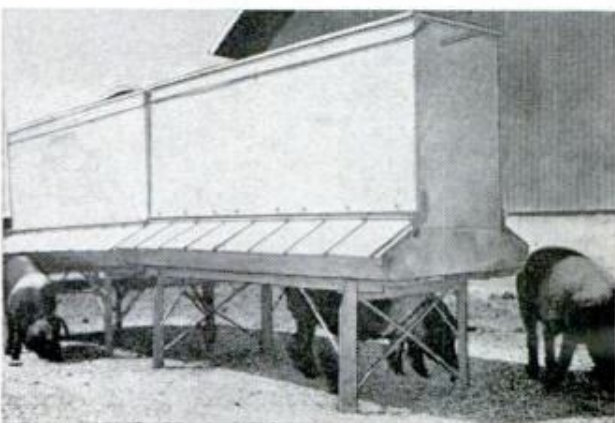

PUT A BEND IN WOOD

Simple procedures that enable craftsmen to make almost any desired bend in bendable woods

By Manly Banister



1. APPLYING HEAT with electric iron will cause $\frac{1}{4}$ -in. plywood to take a moderate bend. Fasten as you go

OFTEN YOU as a craftsman have admired a fine example of bent woodwork and said to yourself, "if I could only do that. . ." You can. Just look at the two photos below which picture examples of wood bending done with simple, inexpensive equipment that can be assembled by any craftsman. You probably already have some of the necessary equipment such as the household iron, shown in use in bending plywood in Fig. 1, or the radial saw and bandsaw used in kerfing, Figs. 7, 8 and 9.

2. SOLID WOOD can be bent by kerfing, steaming, boiling or with cauls. Bending by kerfing is well known to old-time carpenters, also cabinetmakers

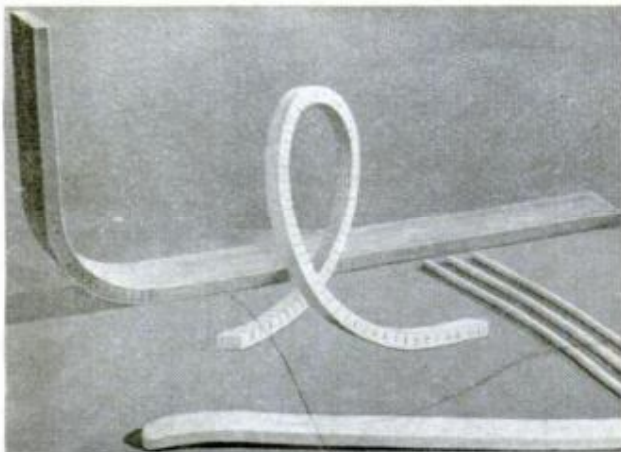

But for kerf bending you don't even need these power tools. Kerfing can be done with a backsaw, using a guide to make sure all the cuts are square across the stock and are made to a uniform depth.

Some kinds of wood bend more readily than others. For example, hickory which has been properly prepared by heating, soaking or steaming, will bend almost back on itself without splintering or breaking. Ash, properly prepared, will bend quite easily. This also is quite generally true of

3. AN EXAMPLE OF WOOD BENDING by lamination of layers of thin stock joined layer by layer with glue. Piece will hold bend even though left freestanding



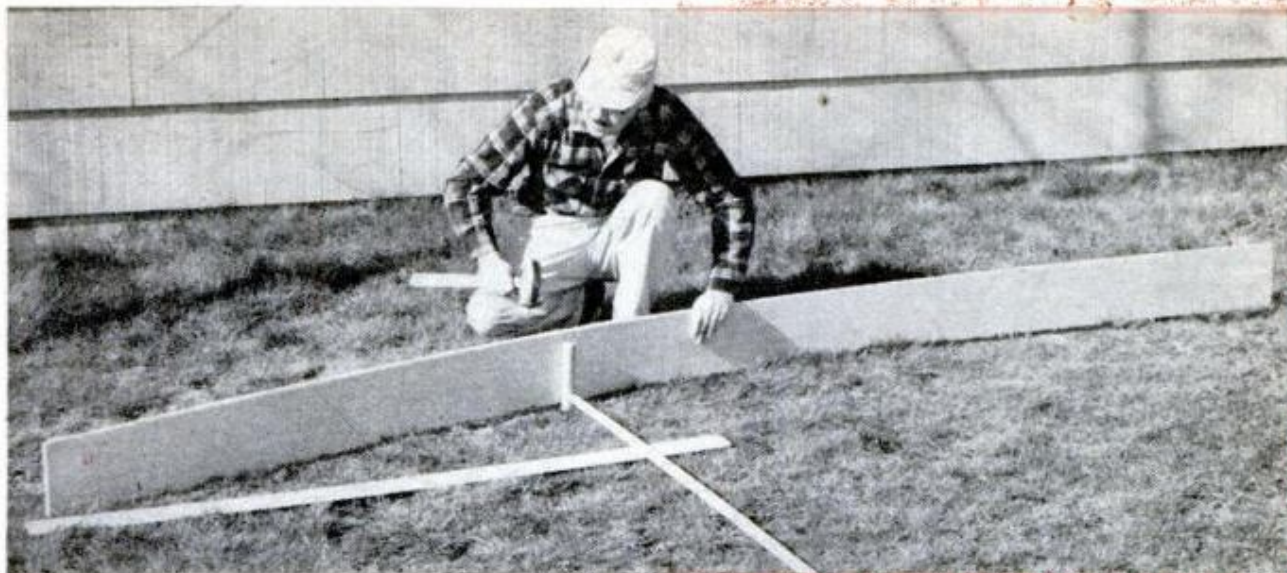

4. LONG STRIPS and even wide boards can be bent by soaking or heating part to be bent and staking on any level area in the yard until dry. Degree of bend should be over that required to allow for spring-back

the domestic oaks. On the other hand, the more dense, fine-grained woods such as birch and maple are more difficult to bend in the solid. If you build up to a required thickness by gluing and laminating thin strips of these woods, then bending is easily done by clamping the strips between shaped cauls, as in the various methods of caul bending, Fig. 18. You can put a sweeping bend in a long strip or board simply by soaking the piece and staking out in the yard as in Fig. 4.

Old-time carpenters and interior trimmers were familiar with the method of kerf bending, Fig. 5. The trick in obtaining the degree of curvature desired is in the spacing, number and depth of the kerfs. As you can see in Fig. 5, detail B, the curvature can be varied by spacing of the kerfs. And the bend can be easily held by applying glue in the kerfs before bending as in detail C, Fig. 5. To determine the space between kerfs you work from the known radius. The bend you plan to make is an arc of a circle. First, determine the circumference of the circle. Then divide 360 by the number of degrees that will be included in the bend (arc). As an example, for a right-angle bend divide 360 by 90. The answer, of course, is 4. Divide the length of the circumference by 4 and the answer will be the length of the curve you desire. Mark this distance, or length, on the work where the curve is to be and make the first kerf at one end of the portion that is to be curved. Then clamp the board to a table or bench as in A, Fig. 5, also Fig. 6. Raise the end opposite the kerf until the edges of the kerf meet. Then measure the distance from the lower edge of the board (a second kerf is shown in detail A at this point) to the bench top and you've got the spacing of the kerfs for that particular job.

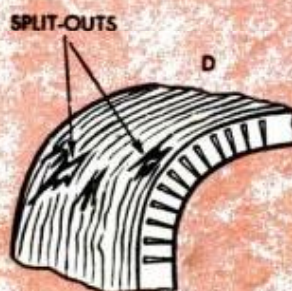
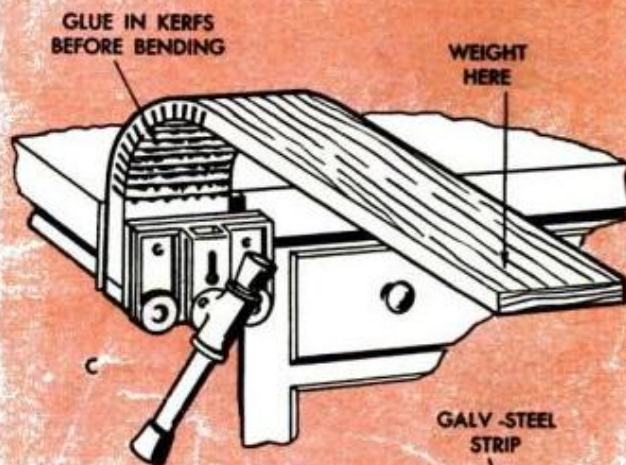
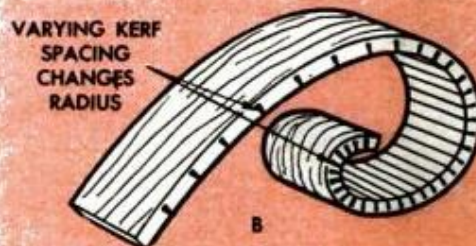
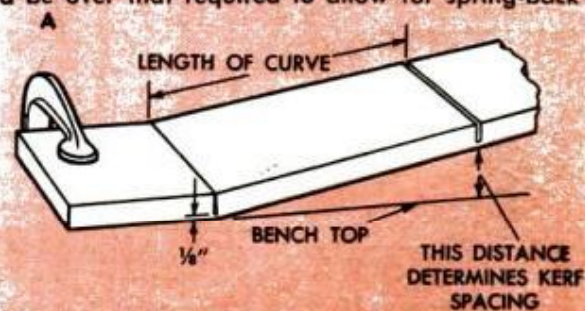

5 KERF BENDING



6. METHOD OF MEASURING spacing of kerfs. Raise stock until kerf at left closes. Then measure as shown

7. KERFING is easily done with a bandsaw. Note guide is set at slight angle so stock will clear frame

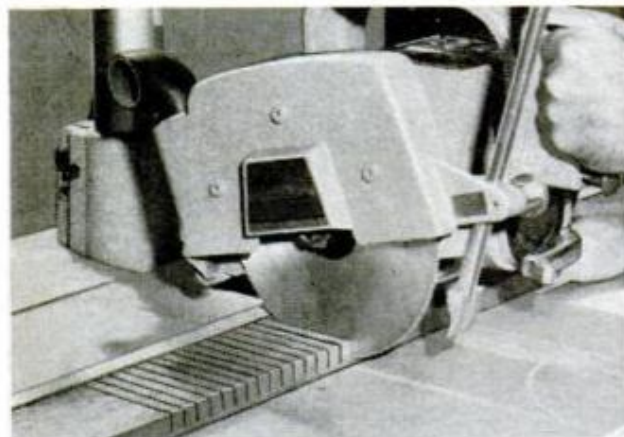
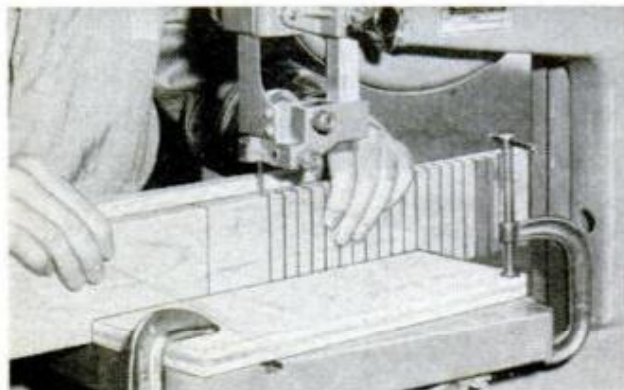

8. KERFING also is easily and quickly done with a radial saw. Here spaced kerfs are cut square across

9. KERFING STOCK at an angle results in an advancing spiral bend like in center of photo, Fig. 2

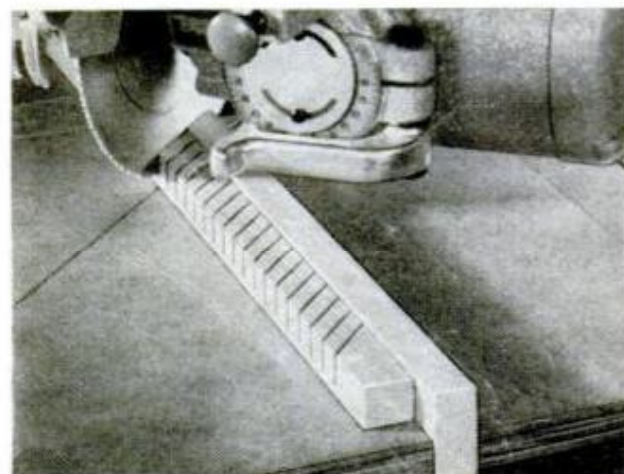

Kerfing at an angle with the center line of the work, Fig. 9, will give you an advancing spiral form of the type shown at the center of the photo, Fig. 2. In making a right-angle bend, or when making a fairly sharp bend past a right angle, you may have trouble with split-outs on the convex face, Fig. 5, detail D. This usually can be overcome by strapping with a strip of galvanized steel as in Fig. 5 detail E, also detail B, Fig. 18. The metal strap must extend the full length of the work and be clamped at the ends before the bend is made. As the work shortens in bending, the strap will be drawn very tight. This will prevent any split-outs by forcing the surface fibers to take the bend. After the work has thoroughly dried and the fibers have taken a set, split-outs are unlikely.

Plywood, $\frac{1}{4}$ in. and less in thickness, can be made to take a bend quite easily by alternately sponging and ironing a small area as in Fig. 1. The material is nailed or screwed in place as you go. Apply pressure and keep the iron moving so that its heat is distributed as uniformly as possible over the sponged area.

Short strips of any of the bendable woods, also sections of long strips such as boat chines, can be bent by steaming as in Fig. 11 and in Fig. 12, details A and B. Anything you can devise from materials at hand which will partially confine the steam will serve the purpose. Fig. 11 and detail A, Fig. 12 suggest methods of steaming small pieces. Although necessarily rather crude, both methods are, nevertheless, effective. Note that in both units steam is generated in a separate container, or "boiler," and piped to the steam box. A length of box gutter or a length of square downspout is excellent for steaming long pieces. If a gutter is used it should be covered with a straight board or sheet metal and the ends closed with slip-type fittings. A long wooden box, detail A, Fig. 12, is quite as effective as it can be made any practical length. These units should never be made steam-tight as this will serve no useful purpose.

Another simpler method of steaming small strips is shown in detail B, Fig. 12. Anything that will hold water, or that can be made to hold water, will do—a length of pipe capped at one end as shown, tubing closed at one end, or even a three or four inch vent pipe sealed at the joints and capped. Still another method is detailed at C in Fig. 12. Here the stock is subjected to boiling water for twenty minutes to a half hour. Use a 55-gal. drum for long pieces, an ordinary wash boiler for short strips.

While boiling or steaming, especially in a wash boiler, the process should be closely watched. Don't permit the container to boil

dry as the work may be ruined. Softer woods will be ready to bend after about thirty minutes of steaming or boiling. Harder woods may require up to an hour or more. Steaming affects the natural color of most bendable woods very little but boiling tends to darken some woods more or less permanently. Small pieces of most of the bendable woods can be bent satisfactorily if merely soaked overnight in a wash boiler or any watertight container. In any case once the soaked, boiled or steamed wood is removed from the steam box or other container it should be bent to the desired shape immediately. That means that the cauls, patterns, clamps, metal straps and any other equipment to be used must be at hand so there will be no loss of time getting the prepared pieces bent and clamped in position. Once in place give the bent pieces plenty of time to dry thoroughly as otherwise there will be excessive spring-back, or straightening of the bend when you remove the clamps. Remember that there always will be a certain amount of spring-back even though the work is thoroughly dry. Any cauls or bending forms should always be made with this allowance, about three to five degrees.

Caul bending, Figs. 15 through 18, provides a means of bending either thin solid stock, the toboggan slats in Fig. 17 being one example, and the bending of panels or strips laminated from several thicknesses

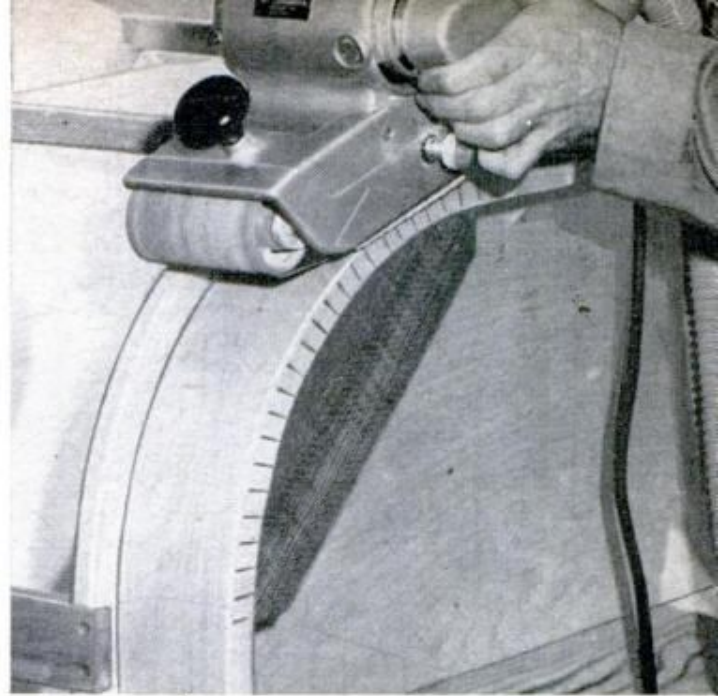
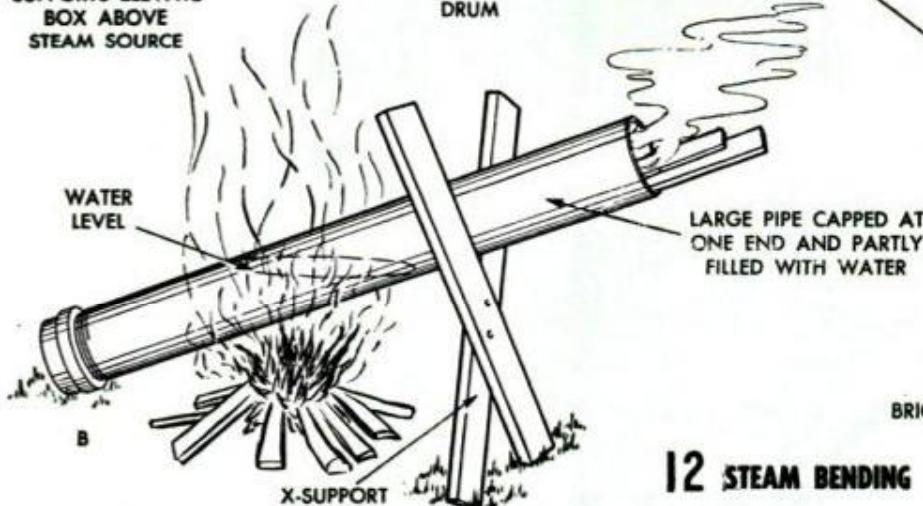

10. AFTER BENDING tension, or face, side of stock is finished by sanding. Be careful not to cut through

11. SIMPLE SETUP for steaming short strips of solid stock. Steam source is 1-gal. can serving as "boiler"

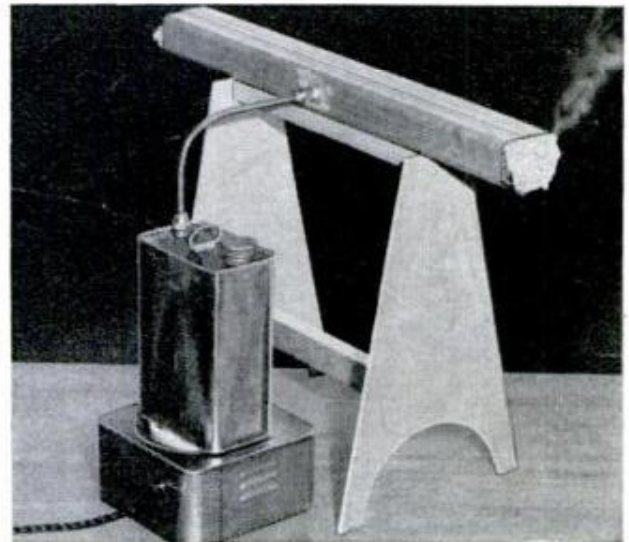

12 STEAM BENDING

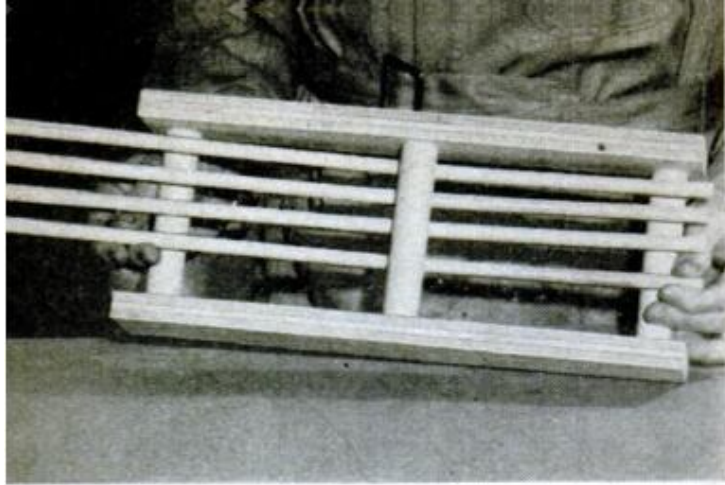

13. OLD METHOD of bending chair slats (or splats) and rounds. Stock to be bent is steamed or soaked

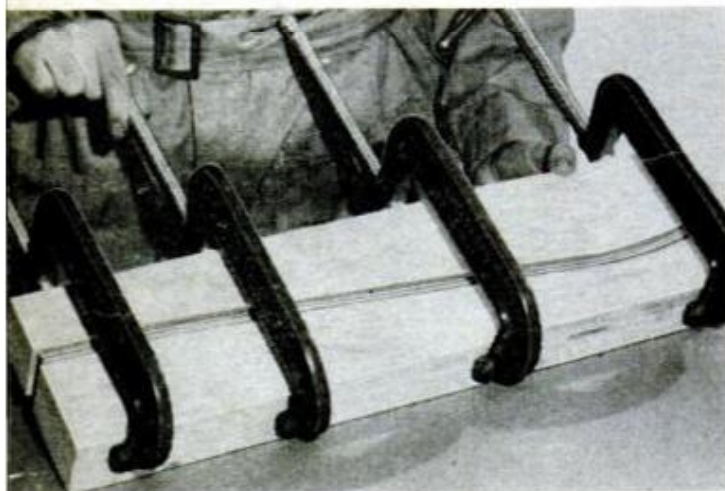
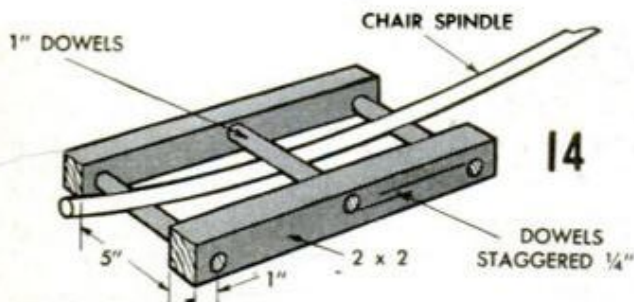

15. BENDING LAMINATED stock is best done with cauls built up from several thicknesses of plywood

16. CAUL BENDING of a panel, the laminations being joined with glue. When dry, panel will hold bend

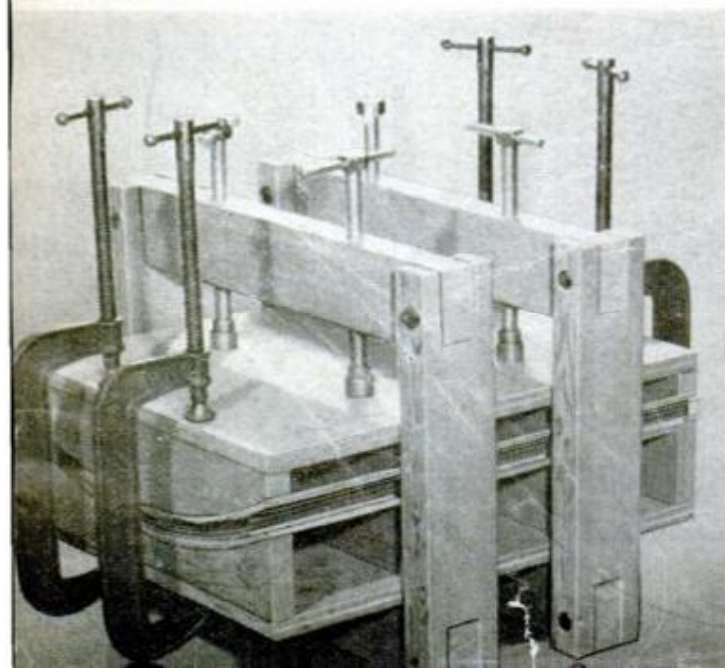

of thin material, Figs. 15, 16 and 18. Detail A, Fig. 18 is a common, workable method of bending a laminate, which consists of several thicknesses of thin stock (veneers in regular thicknesses can be used) glued together and clamped to the form as indicated. Detail B, Fig. 18 shows the method of making toboggan slats and similar bent parts, also pictured in Fig. 17. A reverse-curve bend can be cauled as in Fig. 18.

Material can be made to take an edgewise bend by first bandsawing a kerf on the center line as in Fig. 18, detail D, and then steaming and bending around a form. After the piece has dried on the form, the kerf can be opened and glue applied and the work clamped until dry. Details E and G show built-up cauls for laminating small panels, both convex and concave forms. When laminating stock in this manner, apply glue to the laminations and then drive a brad near each end as in detail F. This will prevent the laminations from shifting when the cauls are clamped together.

An old method of setting a bend in chair rounds (an example is the bend in the back rounds of the Boston rocker) is pictured in Fig. 13 and detailed in Fig. 14. Thin, flat stock also can be bent in this form, Fig. 14. When flat stock is bent in such a form, or bending jig, 1 x 2s with one face slightly rounded are usually substituted for the round dowels. Pieces so shaped give a more uniform bend in flat stock.

Domestic woods which can be made to take a bend quite easily by the methods outlined include ash, hickory, elm, birch, maple, red gum, oak and beech. Of these only ash, hickory and elm will take the more extreme bends. Only straight-grained stock in any of these woods is suitable for bending. Only the fir plywoods can be bent moderately by use of heat. ★ ★ ★

17. FORM BENDING, a method commonly used to produce toboggan slats requiring extreme bends

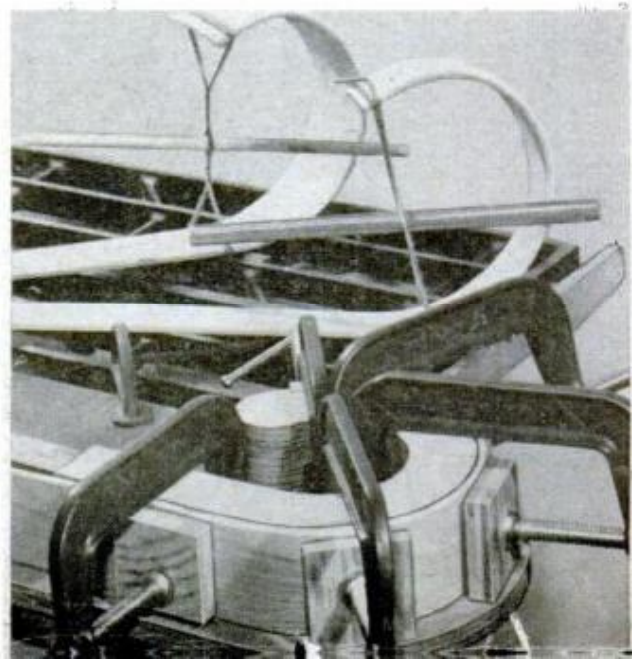

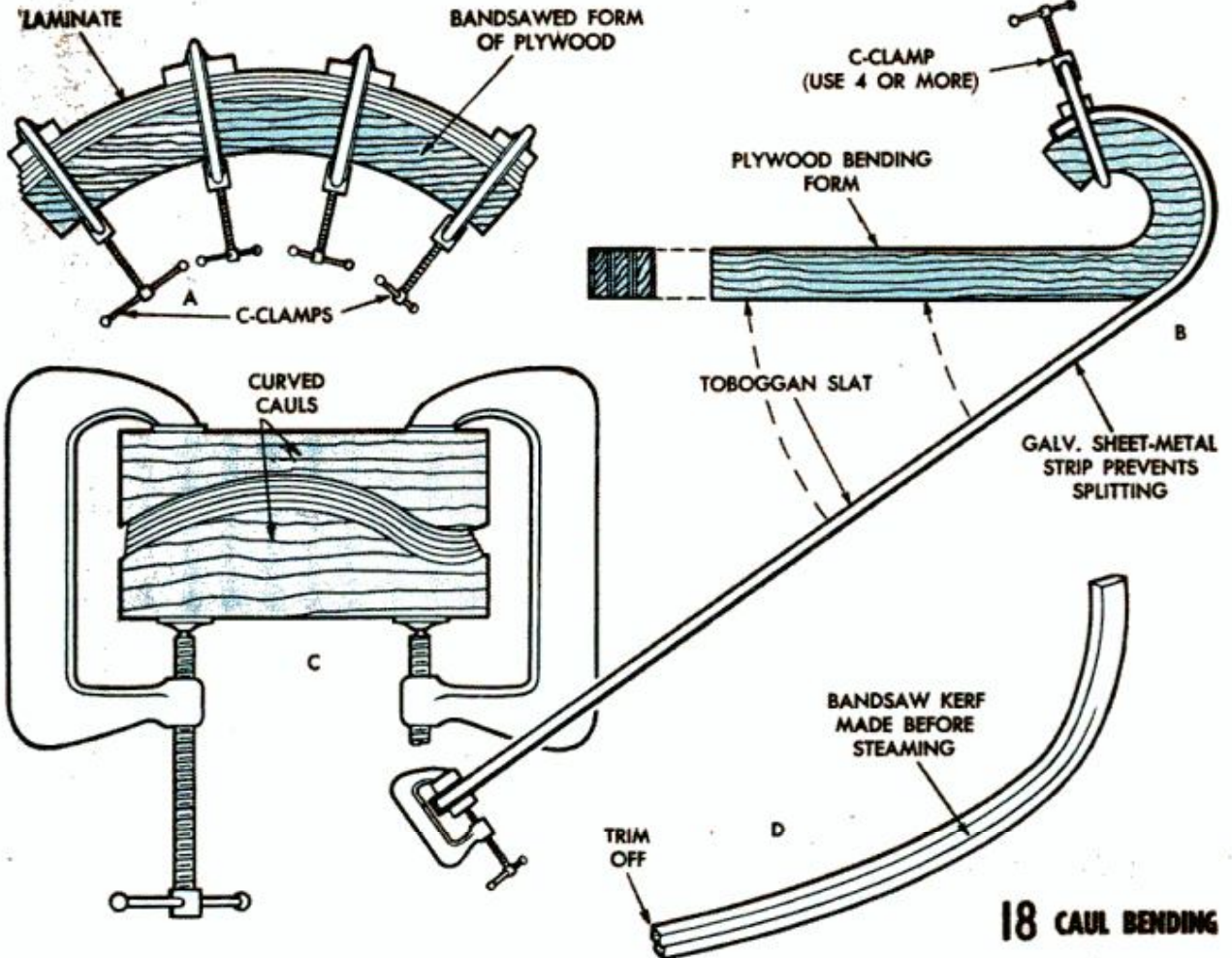

18 CAUL BENDING

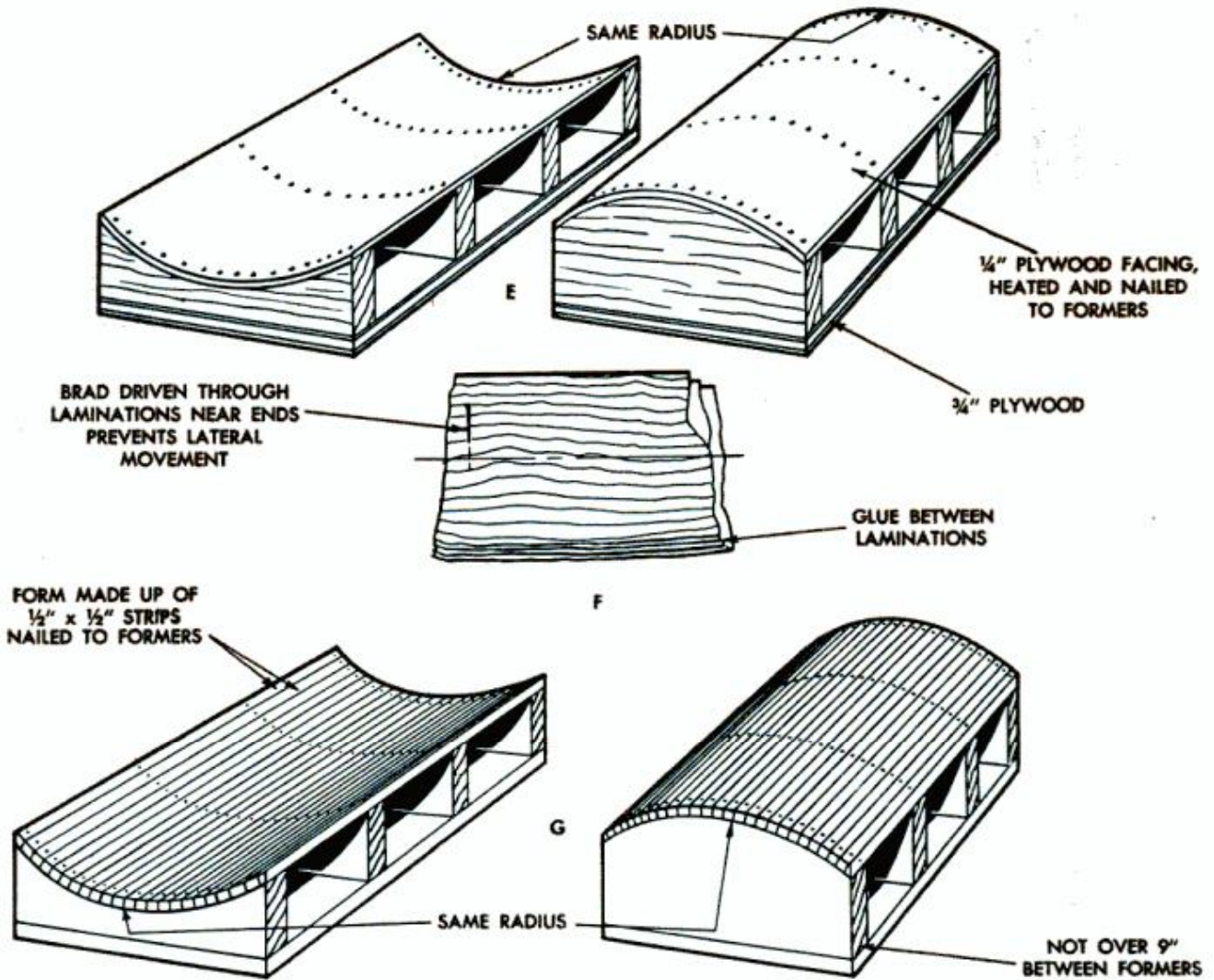

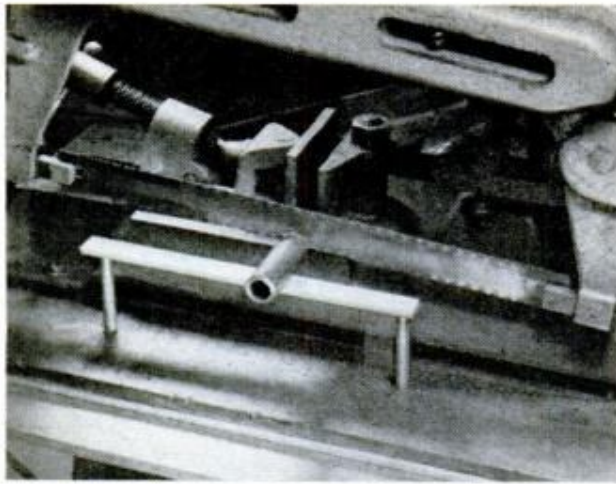

SHOP SHORT CUTS

Hacksaw Work Support

When a short length of rod, tube or bar being cut off on a power hacksaw tilts down without separating, you can prevent cutting into the upturned end with a simple work support. It consists of a steel bar, supported at its ends by two pieces of tubing so the top of the bar will come level with the work-supporting surface of the saw. Long nails pass through holes in the ends of the bar, through the tubes and into the wooden saw table—*Walter E. Burton*

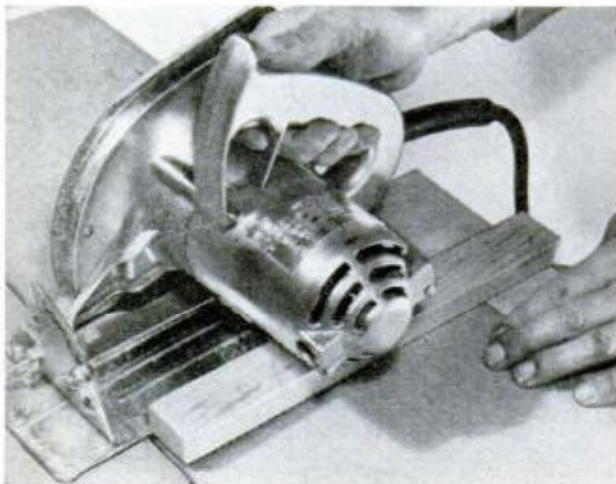

T-Square Saw Guide

When you are making duplicate angle cuts with a portable electric saw, such as on stair stringers, or when cutting off duplicate pieces, the guide shown assures accuracy. It consists of two wooden strips nailed together firmly at the desired angle. The one shown is a T-square for making right-angle cuts. The bed of the saw is run along the edge of the guide while holding the head firmly against the edge of the stock being cut. Part of the head on saw side projects only the distance from edge of the bed to blade.—*Jackson Hand*

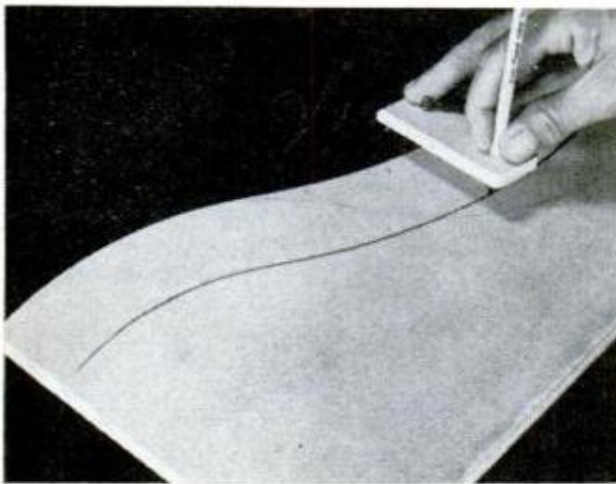

Parallel Curves

This marking gauge enables you to duplicate accurately either regular or irregular curved edges. It's just a short piece of wood with a pencil hole drilled at one end and a nail driven through the other end. The nail rides against the edge of the stock being marked. The pencil should fit the hole snugly and should be pointed on a pencil sharpener. An advantage of this arrangement is that the nail, unlike a regular marking gauge, gets into tight corners and radii—*R. J. DeCristoforo*

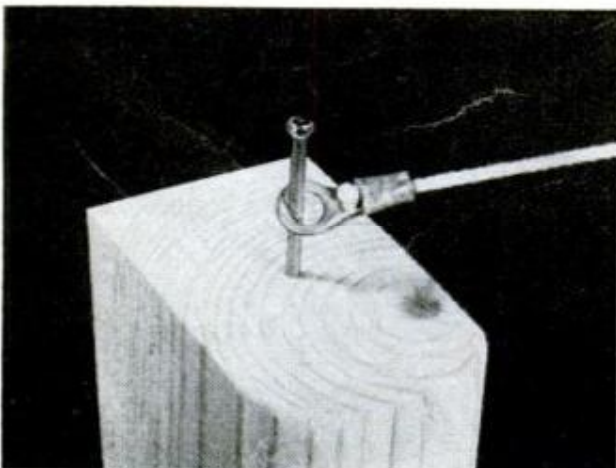

Chalk-Line Terminal

Cords that are used for measuring or for laying out flagstone terraces, sidewalk forms, and similar purposes, can be improved both in their utility and in their appearance by providing the ends with wire terminals. The best kind for this purpose are those that grip small insulated wires firmly, and therefore can be clinched on chalk lines and cords of similar thickness. They will keep the ends of the cords from fraying. The eyes of the terminals should be large enough so that they can be slipped over the heads of 8d. nails.



CARRIED WITH EASE, this little vacuum cleaner quickly removes all traces of sawdust from woodworking tools

Shoulder-Hung SHOP VACUUM

By Harold P. Strand

SHOP SAWDUST, shavings and dirt are disposed of quickly with this handy, shoulder-hung vacuum cleaner, which has considerably more power than the average small, portable cleaner and also serves as a blower to dislodge dirt that you can't pick up with the vacuum. Although a number of old vacuum cleaners can be converted to serve this purpose, one make that is particularly easy to convert is an upright Universal which was very popular a few years ago. Information that follows pertains to this make.

Examine the accompanying illustrations carefully so that you'll recognize the make and model easily when shopping around.



QUICK CONNECTION of the hose to outlet port of the unit before using it as blower to clean out crevices

BLOWING AWAY dust and chips from motor with blast where the dirt cannot be dislodged by suction

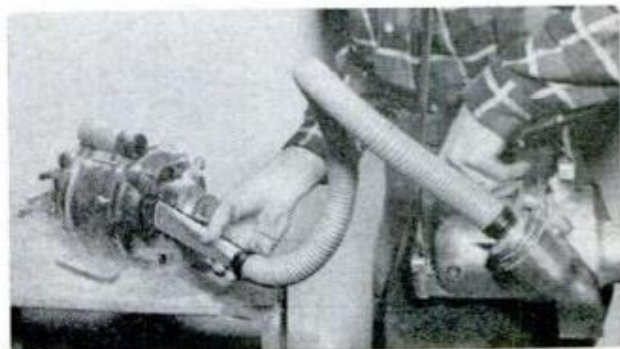

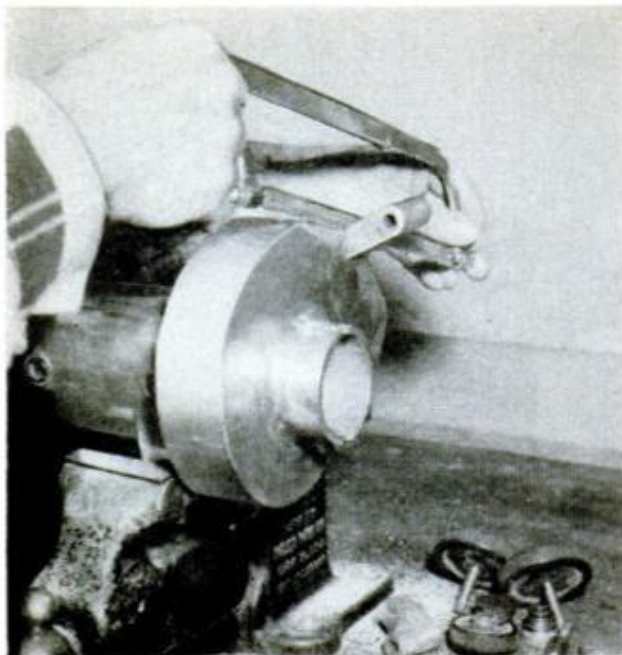

WHEEL SUPPORTS are first cut off with a hacksaw after which stubs are filed flush with housing surface

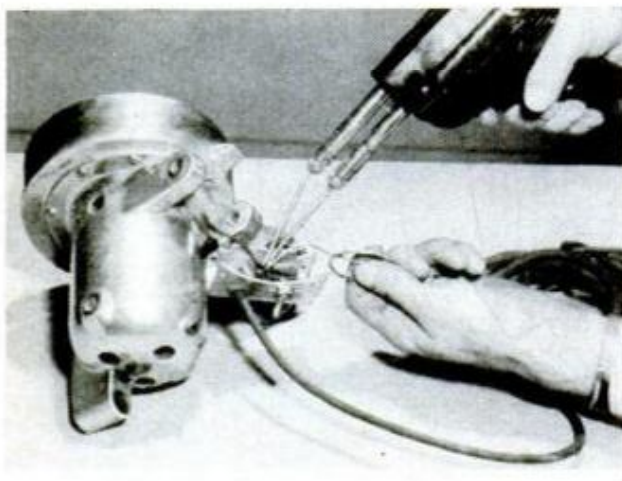

ELECTRICAL CONNECTIONS between motor leads, cord and switch are soldered before closing the box

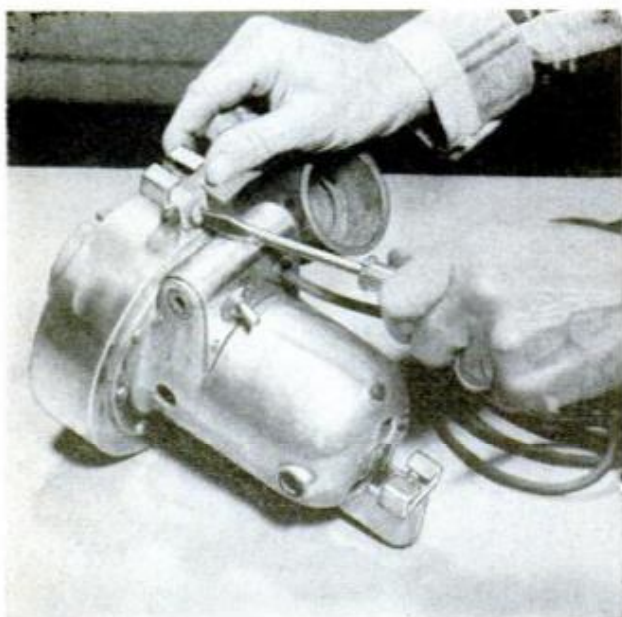

STRAP-SUPPORT BRACKETS with straps riveted to them are attached with screws. Unit is ready for use

It has two wheels on the fan housing, a caster at the rear, and two supports on top to which the handle is attached. The adapter fittings on the bag and on the front or intake hood fit either intake or outlet port, permitting a quick change from suction to blower.

The following minor changes are to be made: (1) Remove the wheels and the caster; also the wheel supports but not the caster support. (2) Make a terminal and switch box to fit over the handle supports. (3) Make a smaller dust bag as shown in upper drawing details. (4) Provide a strap held by two brackets. (5) Fit a length of plastic-covered, vacuum-cleaner hose to the old dust-bag adapter ring and to a nozzle that you make of sheet metal.

After removing the handle, wheels and caster, saw off the front-wheel supports and file down the stubs smooth while the housing is held securely between brass or copper pads in a vise. Form the terminal and switch box from a piece of sheet aluminum to fit snugly over the handle supports and against the housing. Drill two holes in the box, one for a toggle switch and one for a rubber grommet to protect the electric cord. The box is attached to the supports with machine screws driven into tapped holes.

Making the Dust Bag

An old dust bag in good condition can be cut off to shorter length or you can make a new bag by sewing together two pieces of closely-woven black drill cloth or cotton gabardine. Hem a cord in at the large opening to hold the spring clip in place. The small opening should fit snugly over the adapter end of the front hood after cutting off the unwanted portion. Slip the retained portion through the hole when the bag is turned inside out. Then wrap a few turns of cord tightly over the cloth just behind the shoulder of the adapter, tying the ends, and then reverse the bag.

One of the two strap-support brackets is attached to the original handle stop, and the other is held by a bolt passed through the original caster support. The strap can be a man's leather belt cut to convenient length. The ends are slipped through the brackets and riveted.

The hose may be a portion of a discarded one. Drawing details show how it is provided with fittings for attachment to the old bag adapter. Some black plastic tape can be wrapped over the end to help hold it and make a neat joint. The nozzle should fit snugly inside the other end of the hose. In addition to the nozzle you can make other fitting as shown in the lower right detail of the drawing.

AFTER TYING, PULL BAG OVER ADAPTER IN THIS DIRECTION

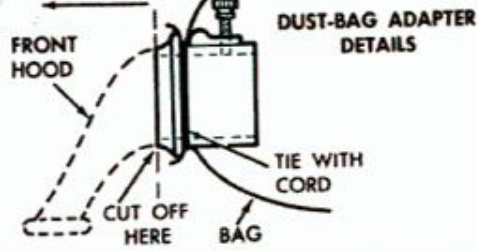

TIE OVER NECK OF ADAPTER HERE

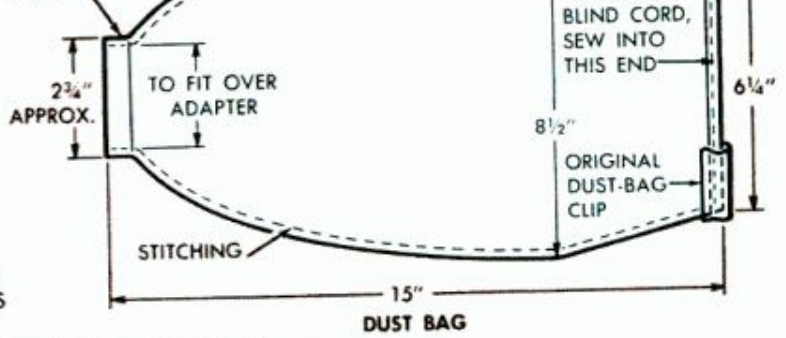

CUT AND SHAPE TO FIT SUPPORTS

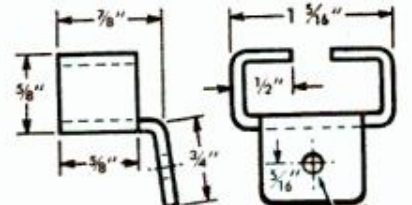
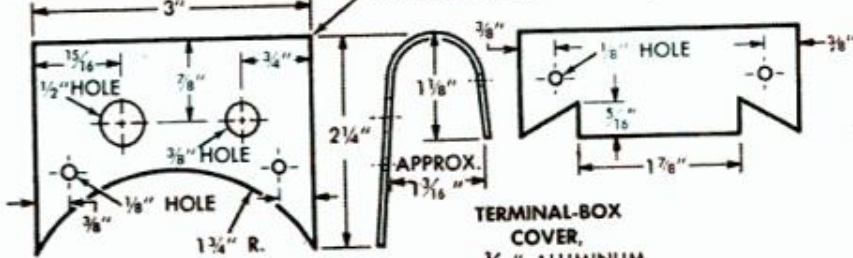

STRAP-SUPPORT BRACKET, FRONT
3/32" ALUMINUM
NO. 11 DRILL

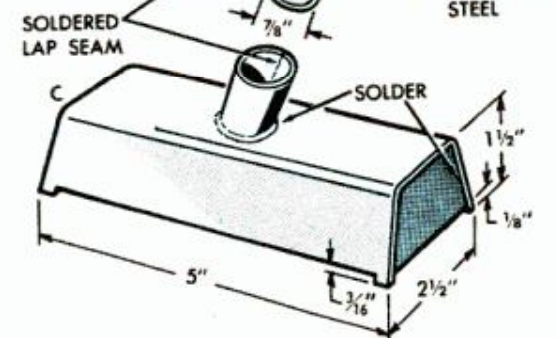
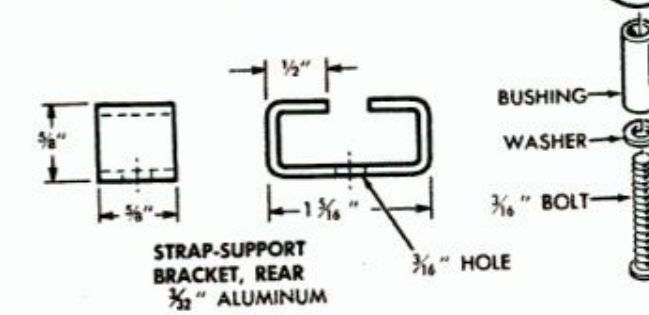
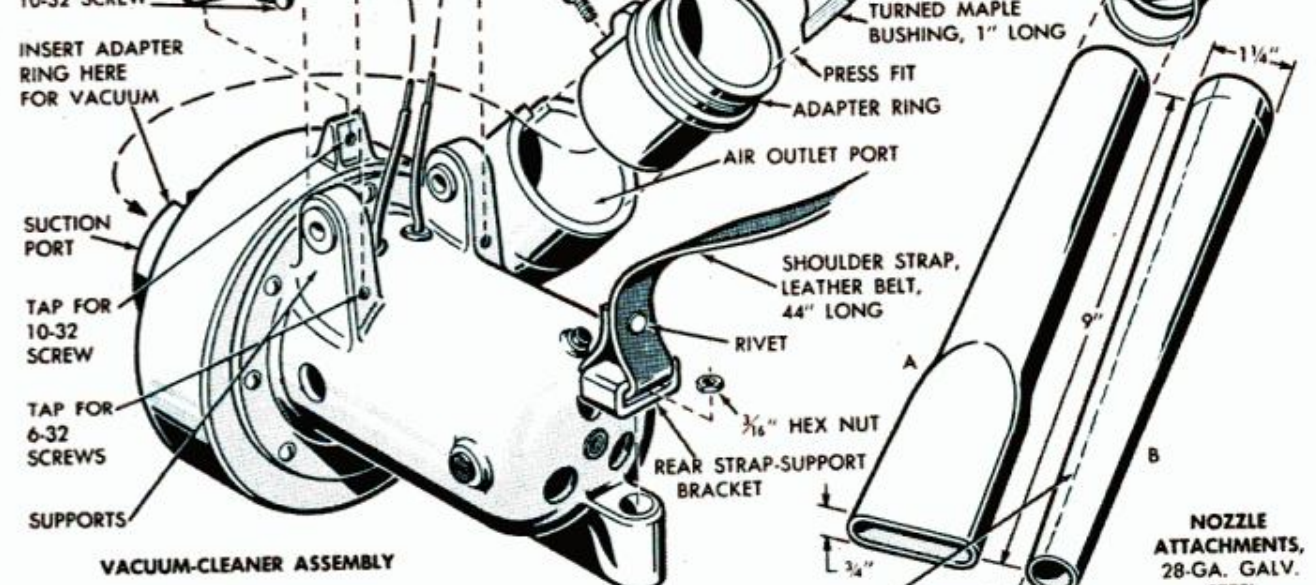
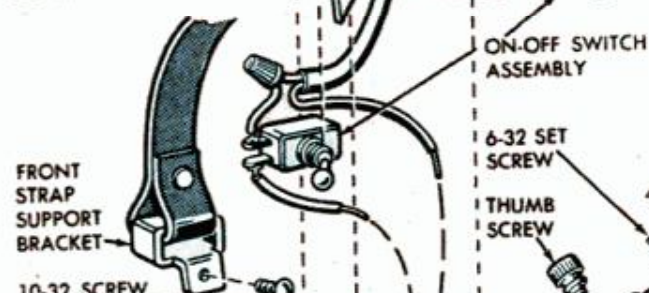

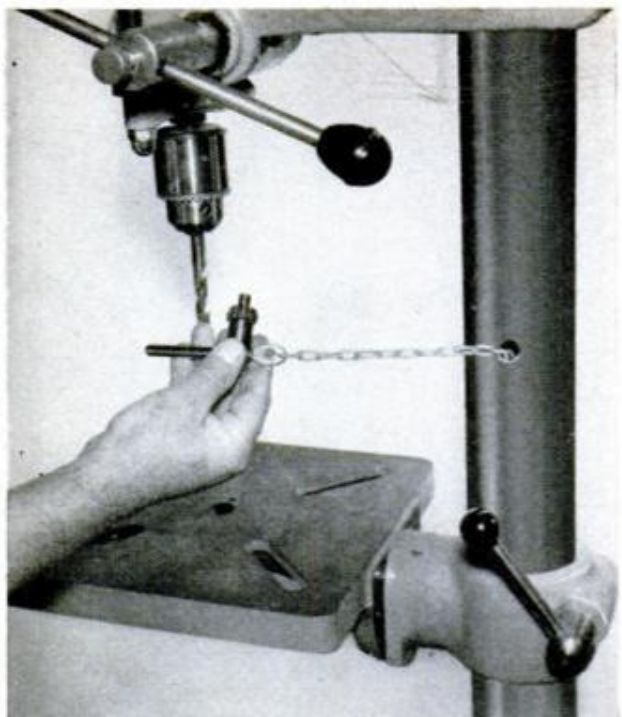

Wrench Tether

Put that chuck wrench on a ball and chain and you'll always have it within easy reach. What you do is drill a hole through the drill-press column large enough to take a small link chain. Drill this hole at a point about 2 in. below the lower end of the chuck when it's in the retracted, or up, position. This will permit raising the machine table as high as necessary to reach any small part to be drilled without interference from the chain. Attach one end of the chain to a 10 or 12-oz. weight, drop the free end of the chain into the column and fish it through the hole. Then drill a small hole through the flat on the end of the wrench handle and attach the end link to the wrench. From that point on your chuck wrench is always at hand.—*Floyd L. Fisher*

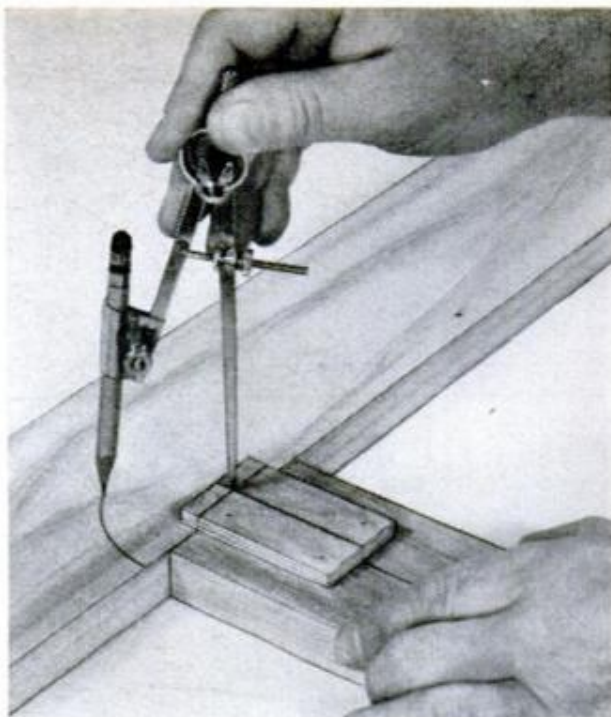

Compass Point

Scribing a 180-degree arc from the edge of the stock just isn't done without this jig, which enables you to set the point of the scriber precisely on the edge of the material. It comes in handy when you're laying off a scalloped edge or any similar job requiring the scribing of 180-degree arcs from the edge. Just cut a short length of stock of the same thickness as the material on which the arc is to be scribed. Then tack a short piece of 1/4-in. plywood near one end, the end of the plywood piece overhanging 1/4 to 3/8 in. Scribe a center line on the plywood piece and another line perpendicular to it and flush with the edge of the thicker piece. Then just butt the jig against the stock, set the compass point on the intersection of the lines.—*William B. Eagan*

COMING UP NEXT . . .

CHRISTMAS TOYS AND GIFTS. It's that time again. Santa has allotted PM 14 pages of nifty toys and gifts which he had a hand in designing but no time to build in his workshop. The selection—especially good this year—is presented in November so you'll have plenty of time to make one or all.

TEACHING MACHINE. Teachers and instructors who have examined this unit have called it the most practical teacher's aid they have ever seen. It's simple in construction and can be built by the dozen in the school shop. Look for it in the November PM.

INDOOR SHOOTING. All about setting up for indoor shooting with BB guns, CO₂ and air guns, .22s, and even big-bore weapons. How to set up an indoor range, build bullet stops and a special bullet trap. A PM sports feature for November.

LATHE-DRIVEN BELT SANDER. Why not stop wishing for a belt sander and build one that mounts on your wood lathe? PM's shop feature for November details just such a unit. All you need are a 4-in. sanding belt, two hardwood rollers, a few pieces of plywood, eyebolts and corner irons.

RADIO TV HI-FI

ELECTRONICS

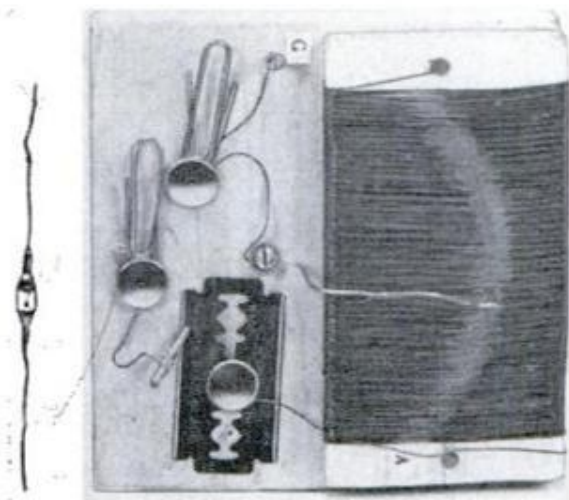

GERMANIUM DIODE, such as 1N34, shown at left, can substitute for razor blade to increase range

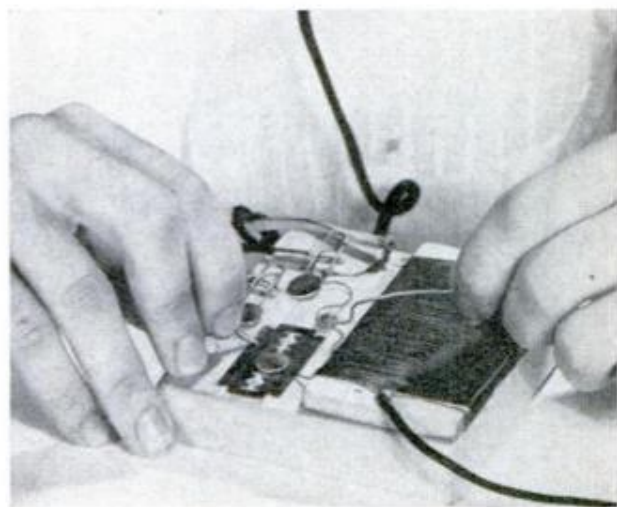

PROBE WITH PENCIL LEAD then adjust tuning arm for maximum volume. Result? Free radio—no batteries

RAZOR-BLADE RADIO

DURING WORLD WAR II, entertainment-hungry soldiers found that discarded razor blades could help them get around the shortage of personal radios.

Once they discovered that the quenched type of blade made a good detector, the rest of the construction was easy.

You can duplicate this bit of war-time ingenuity very easily. The result is a radio receiver that requires no electricity, and will pull in the local stations.

Use No. 26 or 30 magnet wire, wind a coil on a block of wood four inches long and two inches wide by a quarter-inch thick. Wind the turns as closely as possible. Scrape the

enamel from the ends of the coil and attach to the nails on the wood base. Scrape the enamel to form an arc as shown below. The probe is graphite from a lead pencil, and the antenna should be at least 50 feet long.

Move pencil lead around until a station is heard and then move the wiper arm across the coil till it is loudest. Use high impedance magnetic earphones. While reception will vary greatly with location, our set pulled in two stations from a distance of about six miles with the razor blade. Substituting the diode resulted in two additional stations and increased range to the extent of three more miles.—Joe Tartas

MOUNT THE COIL on four-inch square board; use nails for contacts. No soldering required. Razor-blade radio is a one-evening project. During World War II, the GIs used bayonets buried to the hilt in moist earth for a ground connection. You can use a water pipe for a connection

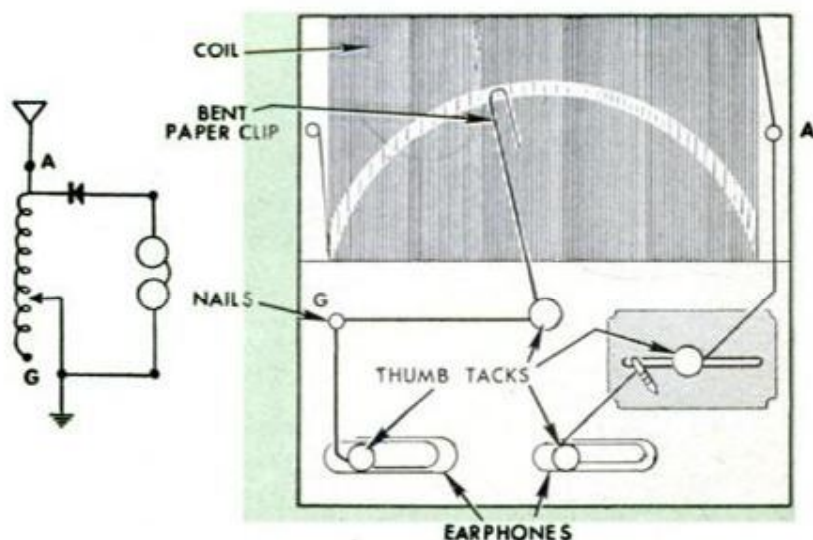

X256 M

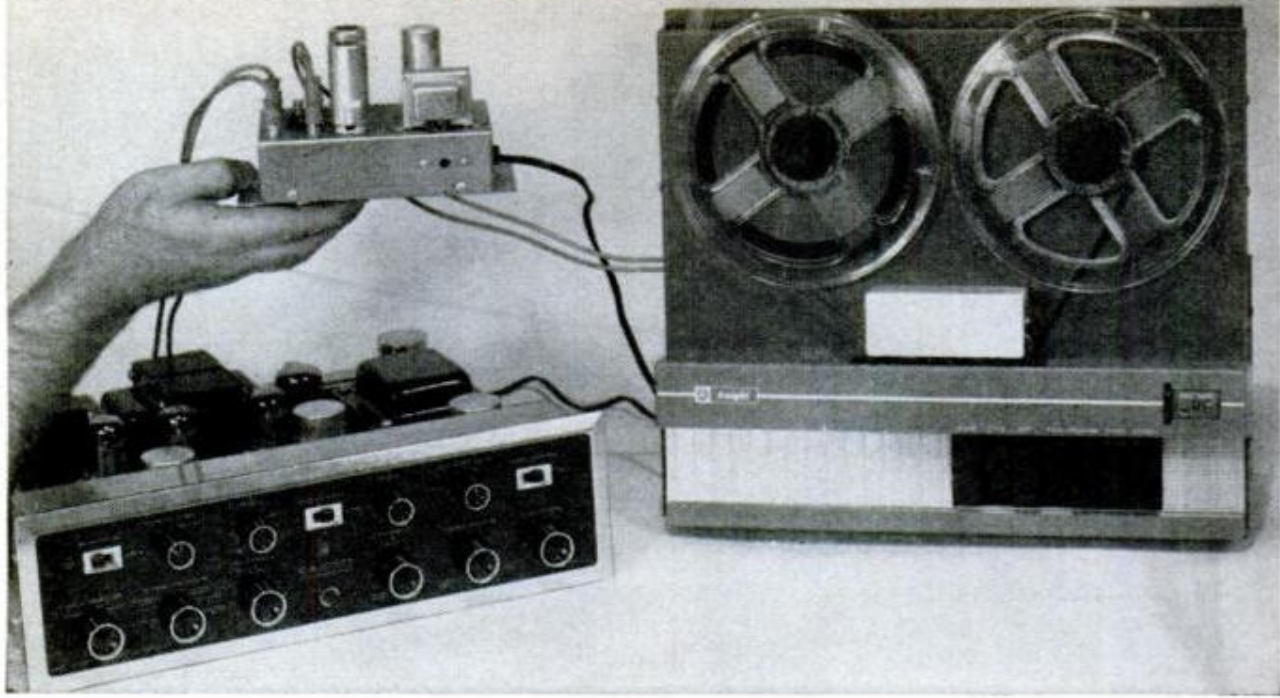

Stereo Preamp for Magnetic Pickups

IF YOUR phonograph provides you with almost as much scratchiness as it does music, it could very well be that you have a crystal or a ceramic pickup. The pickup translates the information in the record grooves to electrical impulses, and crystal or ceramic pickups provide an output of about three to five volts. On the other hand, a magnetic pickup will provide an output measured in millivolts, so less surface noise of the record is picked up.

While using a magnetic pickup thus results in less scratch, the voltage must be preamplified before you feed it to the amp-

lifier. The unit described here will give that extra boost to various magnetic playback devices, such as phonos, tape or microphones.

In constructing the unit, lay out the chassis and punch all holes. Mount the major components and proceed with the wiring. Use terminal strips where required to avoid crowding at lugs. When the unit is completely wired, insert the tubes and add decals to identify the various switch positions and sockets. We are now ready to test.

To test the setup, plug the magnetic sound source (we used a tape deck) into

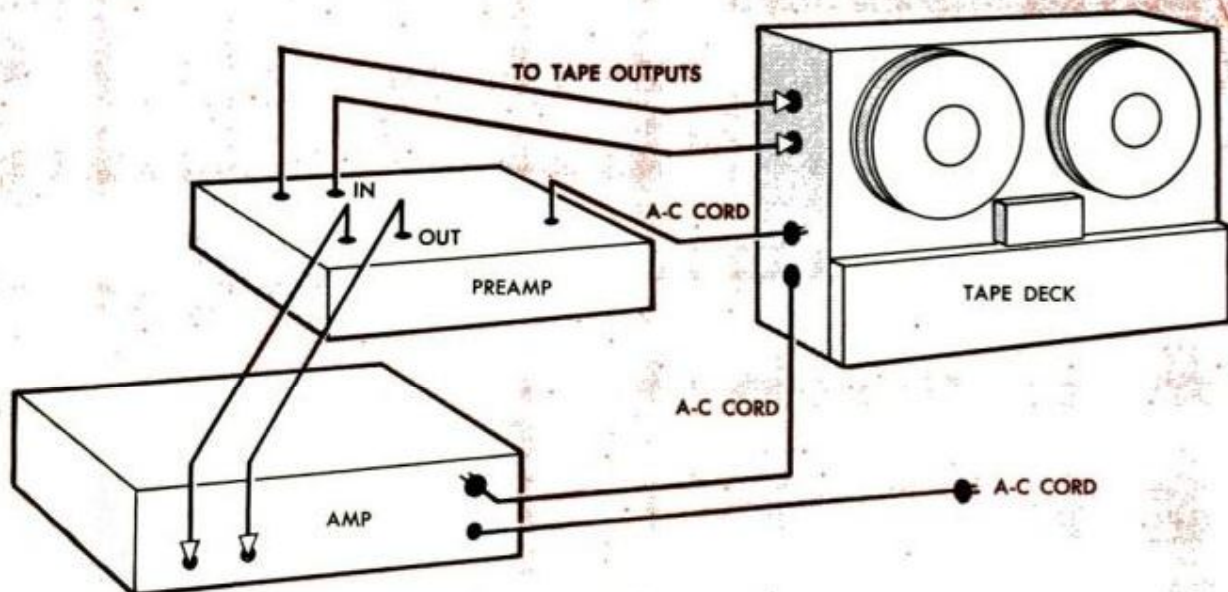

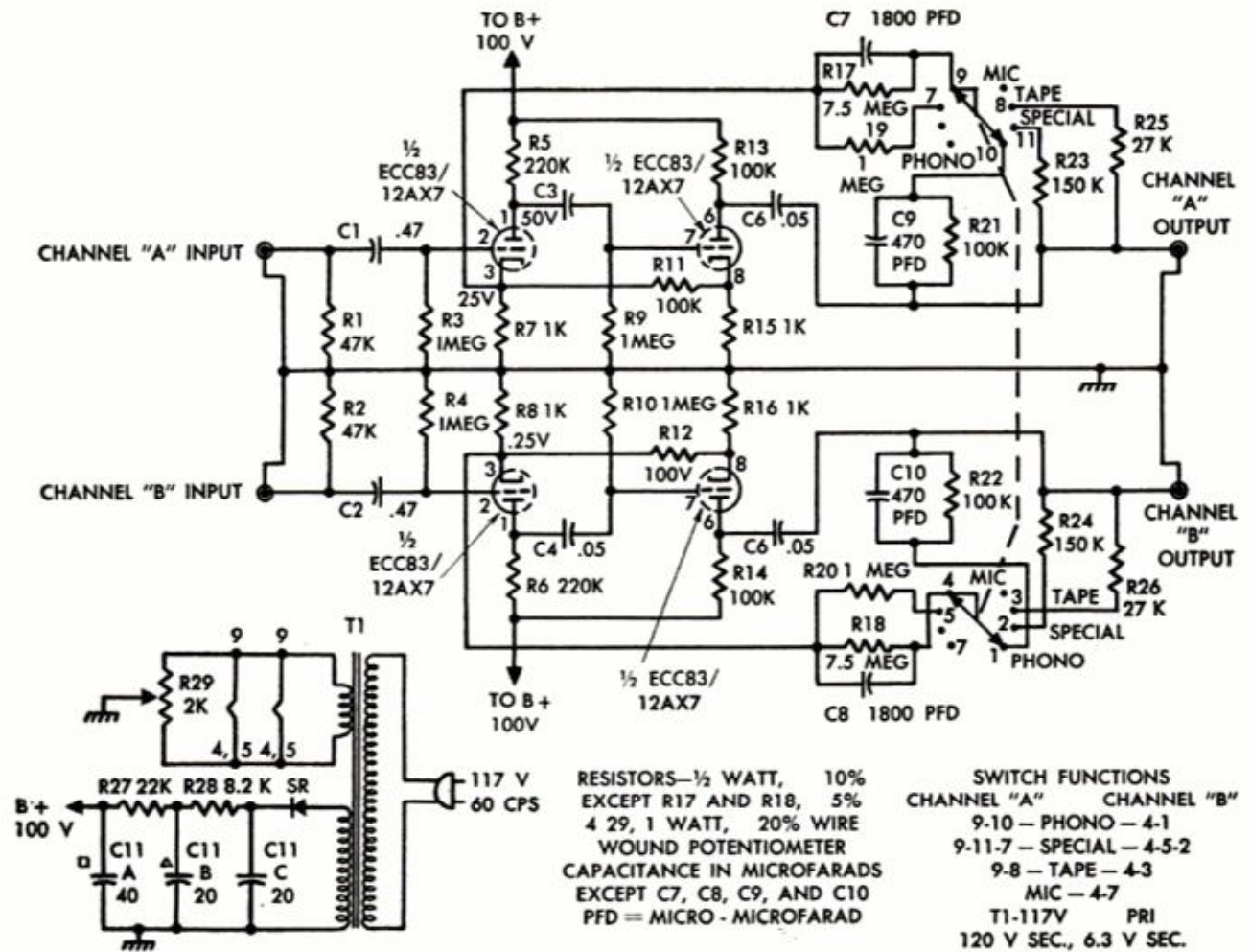

the input jacks on the preamp. Connect the output jacks to a basic amplifier. Connect the a.c. line from the preamp to a switched outlet on the tape deck. In this way, the preamp will be on only when the tape deck is on. The a.c. line from the tape deck can be plugged into a switched outlet on the basic amplifier.

Start the sound source working. If you use a tape deck, put a tape on. If you use a phono, put a record on. Turn on the amplifier and the sound source. This will automatically turn on the preamp. The result should be nearly scratch-free, high fidelity sound. The small preamp can easily be mounted behind a panel.—*Otto Fried*

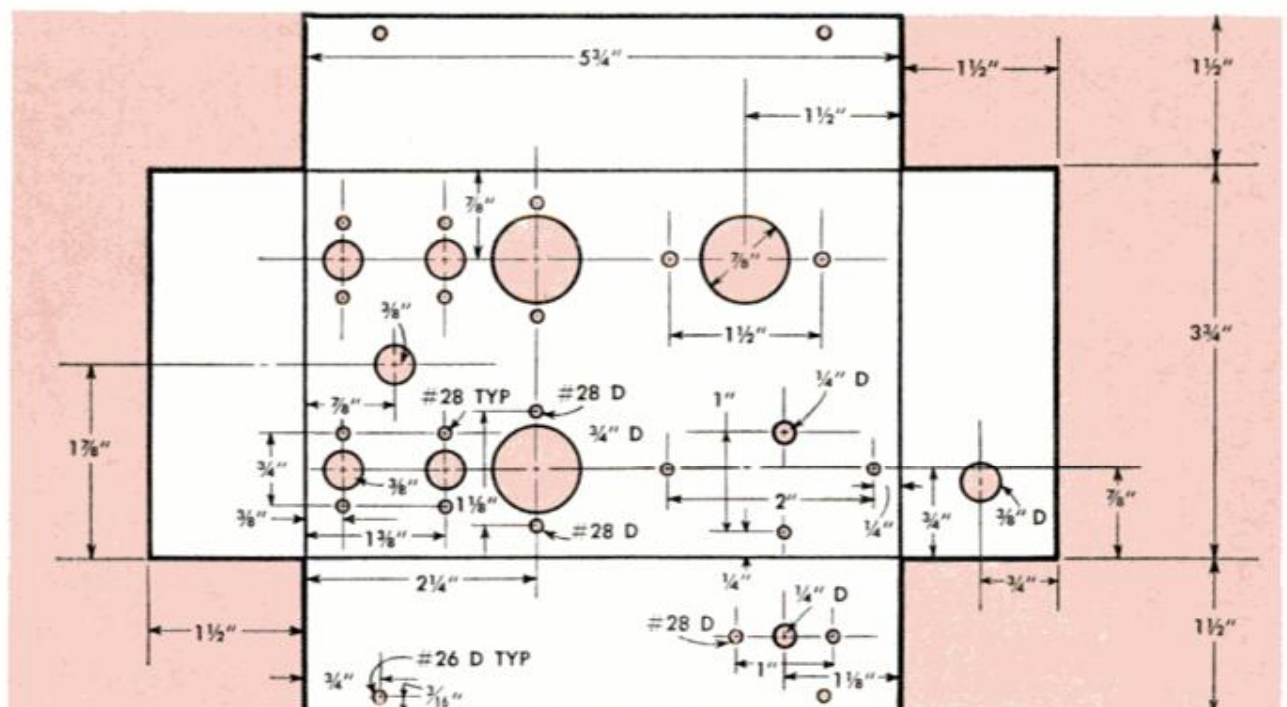

Electronically New...

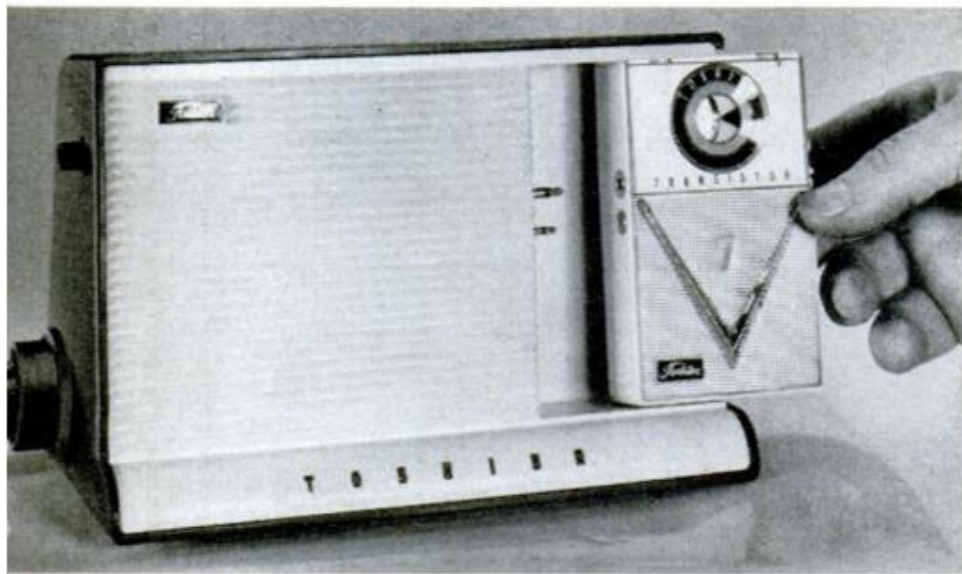

TWO-WAY RADIO doubles service. Shirt pocket model plays by itself, or can be plugged into a table adaptor which improves sound with larger speaker, saves batteries. A.C. battery saver is also available. \$34.95 for radio \$19.95, speaker cabinet. Transistor World, 52 Broadway, N.Y.

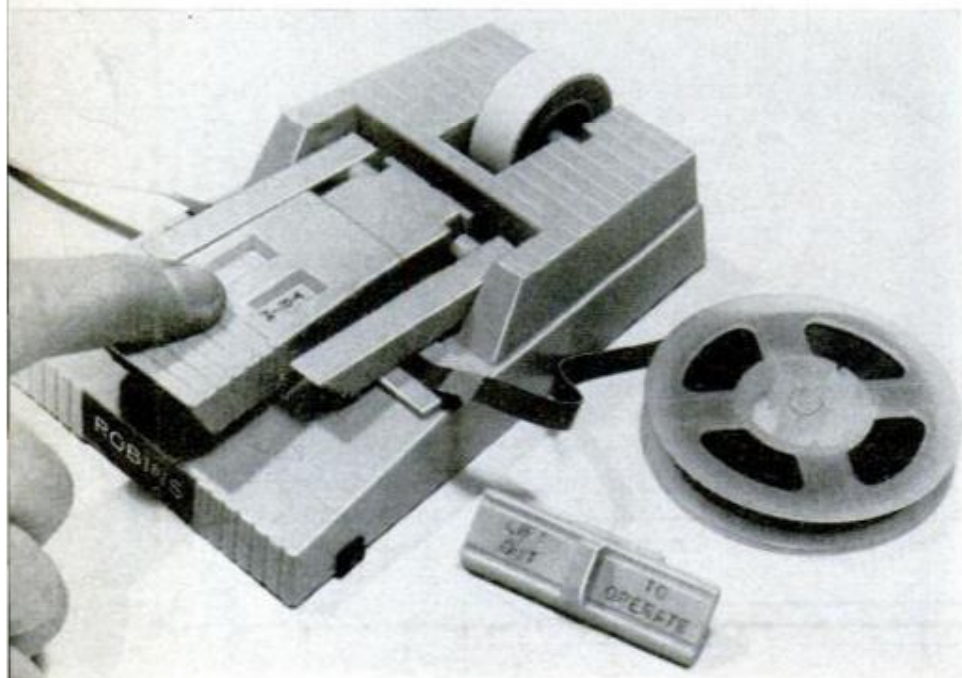

AUDIO TAPE SPLICER has many new features. Permits one holding arm to be raised while a tape is cut, windows indicate cut and trim positions. After cutting tape, unit trims slight waist to prevent cement ooze. Model Stereo 4 Deluxe, \$11.50, Robins Industries, Flushing, N.Y.

TAPE STORAGE CHEST keeps reels in order. Heavy cardboard case holds 12 plastic cans. Index on front permits easy selection. \$4.95 Lafayette Radio, Syosset, N.Y.

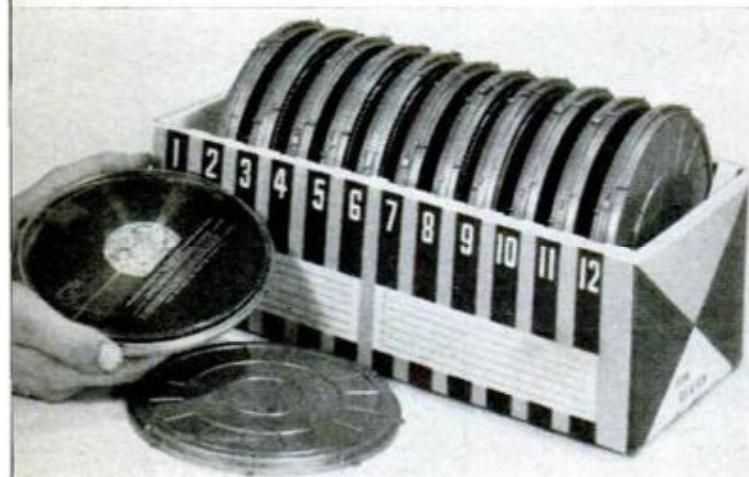

TWIN-BULB FLASHLIGHT has rechargeable battery, lasts up to five hours per charge. Dynatron, \$4.95, charger \$1.95. Polks, 314 Fifth Ave. N. Y. 1.

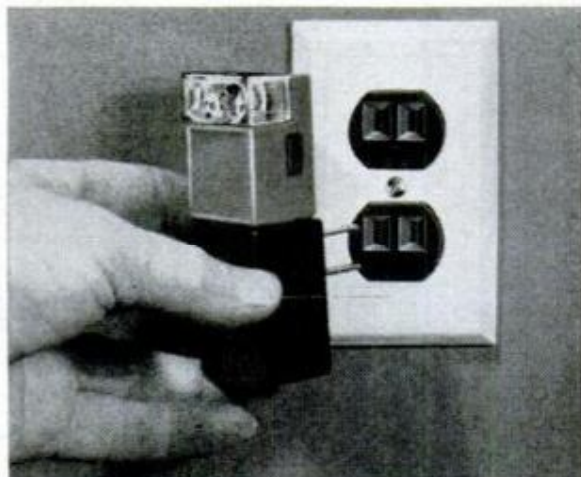

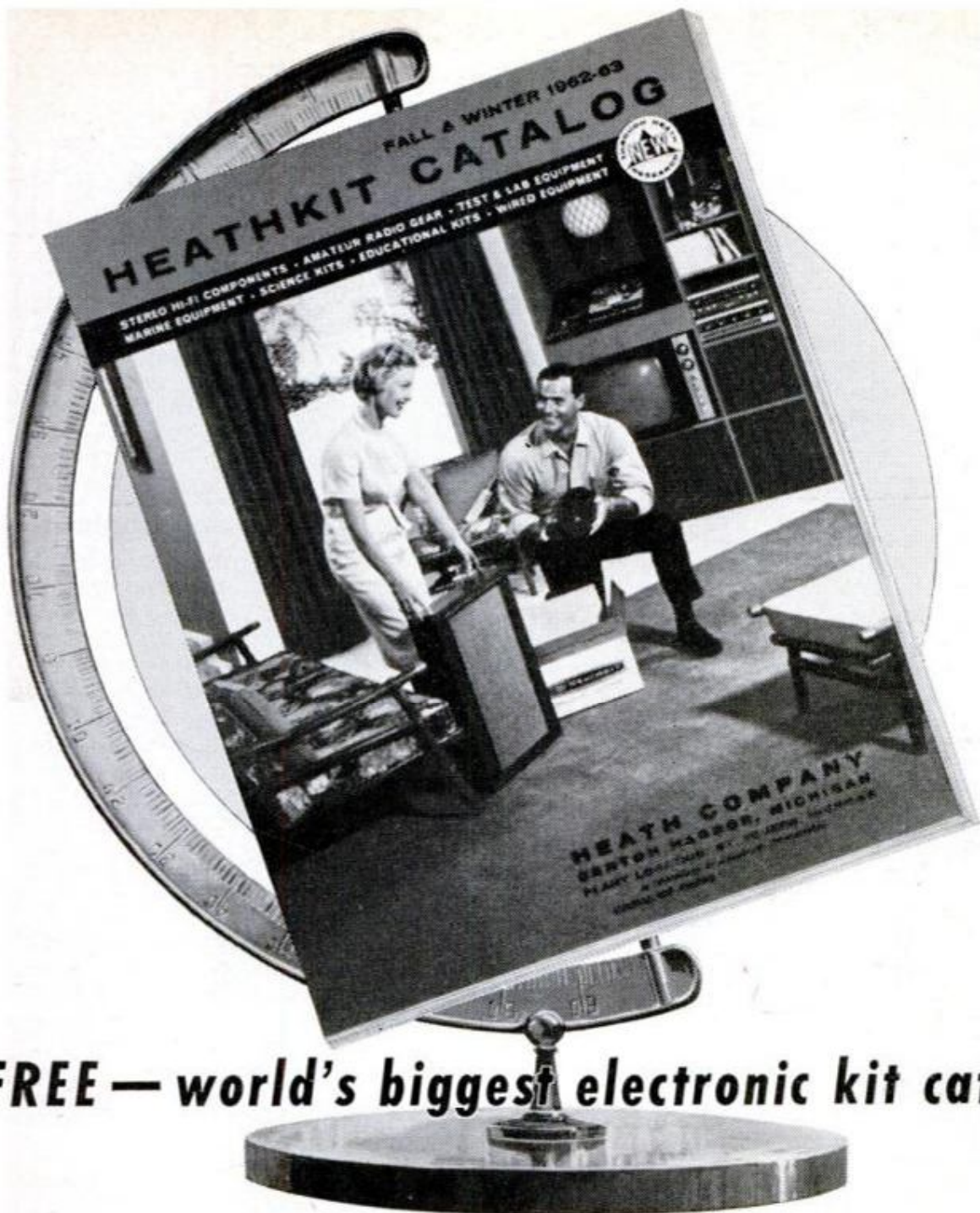

FREE — world's biggest electronic kit catalog

Fastest growing hobby of the space age — Heathkits!

Explore this most rewarding of "do-it-yourself" ideas. Heath combines fine components and latest engineering techniques with complete check-by-step instructions to provide quality electronic kits with guaranteed performance specifications. Choose stereo/hi-fi, marine gear, ham radio, test & lab instruments, educational courses, home, hobby & auto items. It's fun, it's easy, and you save up to 50% . . . by buying direct and by assembling your own Heathkit.



- Please send my FREE copy of the 100 page 1963 Heathkit catalog describing over 250 electronic kits.

Name _____

Address _____

City _____ Zone _____ State _____

HEATH COMPANY
Benton Harbor 17, Michigan

CLINIC FOR HOMEOWNERS

Hiding Basement Columns

Q—I'm planning to finish our basement this winter and want to do a good job since the project will involve quite a bit of money. My problem is the round metal columns which support the center beam. No matter how much money we spend on paneling, floor tile, etc., the room will still look like a basement with those columns running down the middle. I am considering replacing them with wooden columns and staining these to match the paneling. Would this be practical?

—B.T., Conn.

A—A much simpler solution would be boxing in the metal posts. Make a nailing base by cutting two short lengths of 2 x 4 stock to the inside measurement of the proposed wooden column, add a semi-circular cut in the edge of each to fit around the post, and bolt these two pieces around the column.

Does Glass Insulate?

Q—A friend of mine from work told me that there is a big difference between the insulating properties of single and double-strength glass. He says that double-strength glass is far more efficient in stopping heat loss. I find this hard to believe, since we have double-strength glass in all our windows and they seem to admit a lot of cold during the winter. Is he right?—J.F., Mich.

A—The resistance of a pane of glass to the passage of heat is due not so much to the glass itself as to the air film on both sides. There is almost no difference in heat transmission between single and double-strength glass. Scientists have measured the surface temperature on each side of a pane of glass while raising the air temperature on one side 100 deg. above that of the other. With this 100-deg. variation, there was only a 2-deg. difference between the actual temperature of the two surfaces. Because of its sectional density, glass is not generally regarded as an insulating material.

Bugs in Wet Paint

Q—I painted our house this fall and ran into some trouble with insects getting stuck in the fresh paint. Is there any way to avoid this problem?—S.M., Ill.

A—Some painters mix a little insect repellent into the paint, and we under-

stand that this works quite well. However, we have some reservations about this procedure since it's possible that ingredients in some repellents might affect the durability drying time or color of the paint.

Try to schedule your painting during periods of settled weather. The drying conditions are usually ideal then and insects aren't as likely to be a problem, especially during the morning hours. With the right drying conditions, the paint should set enough so that it won't trap insects after an hour or so.

Ice Dams and Leaky Roofs

Q—Our one-year-old ranch-type home has a low-pitched roof, and last winter the ceiling plaster was severely damaged by water which apparently leaked through the roof just above the eaves. Upon checking the attic, I found that water was dripping from the roof boards near the lower ends of the rafters. Since the roof is new, I'm at a loss to figure out where the water comes from. Can you help me?—A.C., N.Y.

A—There is an outside chance that this is a condensation problem, but judging from your description, we think it more likely that an ice dam forms on the roof just above the eaves. On clear days, snow on the roof is melted by the sun and heat loss through the attic. However, snow on that portion of the roof which projects beyond the walls of the house is less likely to melt since it isn't subjected to heat escaping from the interior of the house. This causes the formation of an ice dam which traps water running down from the melting snow higher up the roof. As you have observed, water trapped in this way seeps under the shingles and through the roof boards, often causing extensive damage.

Probably the simplest solution to your problem is to install electric heating cables along the eaves. Heat from these lead-covered cables (which are designed for just this purpose) will melt the snow that normally collects here and prevent the formation of a dam.

As a service to Popular Mechanics readers in solving the hundreds of problems pertaining to a home—inside or out—you are invited to present your problems to The Clinic Editor for his helpful advice. Address your questions to The Clinic Editor, Popular Mechanics Magazine, 575 Lexington Ave., New York 22, N.Y.

NEW KIND OF POWER SAW

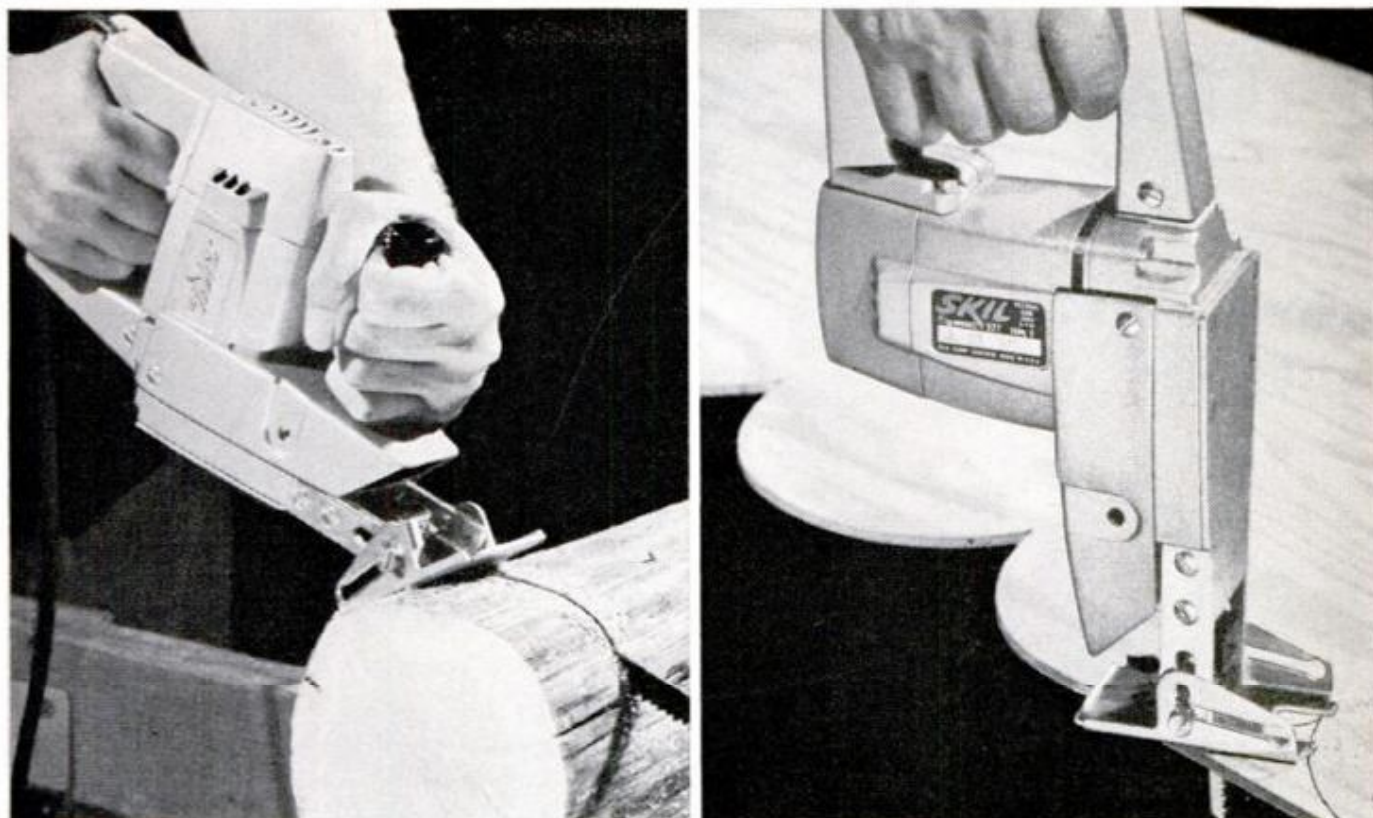

Skil Recipro Saw makes any cut from 6" fence posts to fancy patterns!

The Skil Model 577 Recipro Saw is the *first* portable power saw with almost unlimited cutting capacity! It'll cut thin sheeting or thick wooden posts . . . or steel pipe, sheet metal, aluminum, plaster, wall board, plastic laminates, you name it!

It's a coping saw, hacksaw, scroll saw, jig saw, crosscut saw and rip saw that'll make you twice the craftsman you ever thought you were! You can buy it at better hardware and lumber dealers everywhere. Priced under \$50 (slightly higher in Canada).



Bevels, Miters



Cuts in Walls, Floors



Cuts Metals



FREE OFFER! Metal utility case and 8 blades if you buy the Model 577 now. Hurry! Limited time offer at most dealers.

SKIL
POWER TOOLS

WATCH PRO FOOTBALL HIGHLIGHTS SPONSORED BY SKIL ON NBC-TV, EVERY SATURDAY AFTERNOON, SEPT. 22—DEC. 22

OCTOBER 1962

211

**Rugged Design...
Easy-to-Handle Balance**

RIGGID®

**HEAVY DUTY
PIPE CUTTERS**

**give faster,
straighter
cuts**

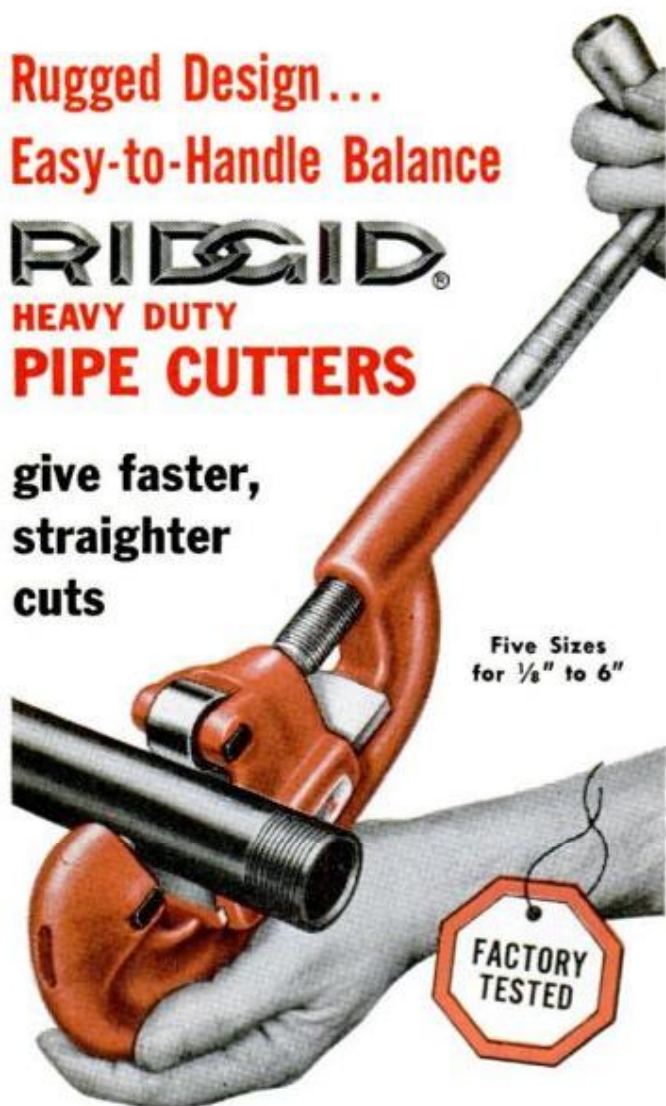

Pick up a **RIGGID** Heavy-Duty Pipe Cutter, and you'll instantly know why it makes pipe and conduit cutting far easier. Perfectly balanced . . . gives you a feel of confidence no other cutter can match. See the extra-long shank that protects handle threads . . . assures easy pressure application. Feel the large, smooth handle that gives you a comfortable, powerful grip. Try it, and you'll find a built-in cushion to keep the cutter wheel "on track" through hard or uneven spots. Rugged frame, guaranteed not to break or warp, stays straight for clean cuts every time.

**You'll Want a
RIGGID 4-Wheel
Pipe Cutter for Work
in Tight Places!**



Be sure to see these **RIGGID** Cutters at your Dealer's. For your convenience he carries a complete stock of **RIGGID** Work-Saver Pipe Tools.

RIGGID®

The Ridge Tool Co. • Elyria, Ohio, U.S.A.

Prepare Your Outboard NOW

(Continued from page 188)

tan deposits, they can be cleaned and re-gapped. Seriously pitted or burned plugs should be replaced. While you have the spark plugs out, squirt several drops of #10 oil into each cylinder and also into the carburetor through the air silencer. Then rotate the flywheel to distribute this oil evenly over internal surfaces.

If your motor performed poorly toward the end of the season, and both plugs and carburetor adjustment check out A-OK, this would be a good time to take it in to your dealer for a thorough examination. With the special equipment in his shop, he is better able to diagnose internal wear or damage.

To complete servicing the powerhead, remove and clean the sediment bowl and filter element. When replacing the assembly on the carburetor, make sure that the gasket is properly seated. Before replacing the shroud, spray the powerhead and cover gasket with silicone spray lubricant.

Servicing Lower Unit

Moving down to the lower unit, remove the propeller and dress down any small nicks or burrs with a metal file. If the blades are even slightly bent, better take it to a professional for repair since a special prop block is required for this job. Clean off any hardened grease from the shaft to prevent the propeller from freezing to it and apply new waterproof grease. When remounting the propeller, check the shear pin for wear and replace it if necessary. Finally, drain the lower unit and refill with fresh gear lubricant.

Even though it's no longer perched atop the powerhead, the fuel tank is still an important part of your motor. At the end of the season, drain out old fuel and rinse the tank thoroughly with alcohol or lacquer thinner. Either of these is highly inflammable, so be sure to remember the fire precautions mentioned above. Check for worn fittings. Examine the gasket in the cap, and if you find that it's compacted, replace it.

If your motor has an electric starter, check the battery, clean the terminals and put it on trickle charge for the winter. Most people don't have chargers, however, and if you belong in this group, ask your dealer about storing your battery for you.

Scratches in the finish of your motor or fuel tank make the equipment look old before its time and encourage rust. Feather out deep scratches with fine sandpaper, then mask nearby emblems, etc., and touch up with matching paint.

Store your motor in an upright position in a dry well-ventilated room. ★ ★ ★



BEAUTIFUL MARLITE PANELING

wash-and-wear walls you can install yourself

You can finish a room with Marlite this weekend—and eliminate redecorating for good! Marlite's melamine plastic finish is *baked on*, so it's smooth and durable as the surface of a refrigerator. It takes abuse that would spoil other finishes, then wipes clean with a damp cloth. And Marlite's simple to install in new rooms or old. Choose from a handsome array of Trendwood® reproductions, beautiful patterns and decorator colors—in large sheets or easy-to-handle Plank and Block. See your building materials dealer.



Tongued-and-grooved Marlite Random Plank (16" x 8" x 1/4") goes up fast over furring strips or solid backing with no waste, muss or fuss.

Marlite®
plastic-finished paneling

Marlite Division of Masonite Corporation
Dept 1042, Dover, Ohio

Please send full-color building and remodeling folder on Marlite Paneling.

Name _____

Address _____

City _____ Zone _____ State _____



ANOTHER QUALITY PRODUCT OF MASONITE® RESEARCH

When Your Car Quits . . .

(Continued from page 180)

a dilemma. Here's what he finally did: In the wagon's tool kit he'd always carried an adjustable wrench—some call them monkey wrenches—and after a search he located tape left over from package wrappings. The wrench was tightened on the battery post and the end of that part of the ground strap still hooked to ground was forced through the hang-up hole in the wrench handle. Then the free end of the strap was taped tightly to the wrench handle as in one of the illustrations on page 171. This improvisation, crude as it necessarily was, held for the trip out.

But a family searching for a more secluded picnic spot had their car conk out just before they arrived. This not only spoiled the picnic; it posed a real problem, for something had, of all things! broken the fuel filter bowl. Probably a stone thrown by a tire, but this is such a rare occurrence that the driver discovered it only after he had checked out all the other more logical possibilities. And, believe it or not, he found the repair part in the picnic lunch! The emptied baby-food jar didn't fit very well (see detail on page 171) but the picnic went off, belatedly, and the improvised filter bowl served the purpose until it could be replaced with a standard part. In another similar instance, with an upside-down filter bowl, a small glass tumbler was made to serve in an emergency. The tumbler was lashed in place with light cord. Some small marmalade jars might also be used for the same purpose in an emergency.

When the upper radiator hose let go one ranchman figured that was it. He'd been repairing a pump on one of the remote sections of the ranch and he'd started walking out when he remembered the tool kit in the pickup. Among the tools he had used was a hacksaw. It was then he recalled that he had just installed a new tail pipe on the pickup truck. Putting these two thoughts together he hurried back to the stalled pickup, grabbed the hacksaw and cut a short section from the end of the new tail pipe. Then he removed the hose, severed it completely at the break and pressed the cut ends over the section of tail pipe, using the pipe-joint compound he had in the tool kit to form a seal. The cut ends were then taped over the section of tail pipe and the whole thing replaced. Then the radiator was topped out with water from the well and the rancher made it home and also to town the next morning for a new hose.

(Continued to page 216)



with Master

LAMINATED

Padlocks

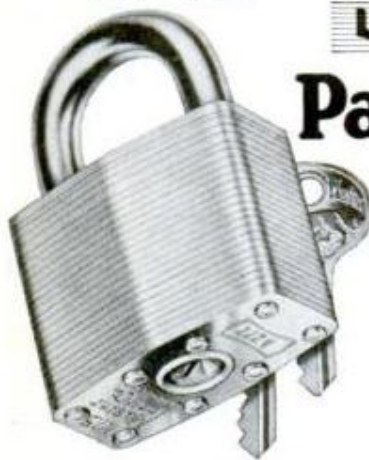

Layer on layer of solid steel for the powerful laminated protection that gives you peace of mind.

25¢ to \$4.00, in a variety of sizes, at locksmiths and hardware stores everywhere.



TOOL CHESTS



GARAGES

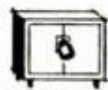

CABINETS



SHEDS



FREEZERS



FUEL TANKS

Master Padlocks

ALWAYS ON GUARD



DAY AND NIGHT

MASTER LOCK CO., Milwaukee 45, Wis.

World's Largest Padlock Manufacturers

WIDEN
YOUR
FUN
HORIZONS

... GO

HARLEY-DAVIDSON IN

'63!



Go see your dealer now for a look at the spanking new Harley-Davidson line. You'll find a set of wheels to take you *wherever* you want to go, to wonderfully widen your fun horizons! Now at your dealer . . . new, free full-color literature . . . easy-pay terms . . . help in getting insurance . . . and the great Harley-Davidson get-up-and-go line for '63 . . . DUO-GLIDE, SPORTSTER H, SPORTSTER CH, SPRINT, SPRINT H, PACER, SCAT, TOPPER H. See the Yellow Pages under "Motorcycles" and "Scooters" for the name of your Harley-Davidson dealer.

HARLEY-DAVIDSON MOTOR CO.
Milwaukee 1, Wisconsin

Another motorist coasted to a stop on a back road. Checking, he found that the coil lead to the distributor tower was hanging loose. He tried to push the lead back in place but something seemed to be wrong. Removing the tower he found that the carbon-brush assembly had popped out. He bent the rotor spring contact up and again pushed the lead in place. But still the coil wouldn't put out sufficient voltage for a spark to jump the gap between the coil lead and the rotor. That stopped him—for a moment. There seemed nothing at hand, in the car or in his pockets, with which to make an emergency repair. Then the driver thought of the spring in his ball-point pen. Quickly he removed the spring, inserted it into the cap tower, pushed the coil lead back in place and taped it. It worked.

Then there's the fellow who discovered that a fuse had failed, apparently from fatigue—it does happen—with no replacement at hand. His solution was to wrap the dead fuse with foil from a cigarette pack, taking the chance there was no short in the electrical system. In this case he was right, and was on his way in minutes.

None of these instances is intended to outline a recommended procedure or practice. They are simply emergency roadside repairs, utilizing whatever happened to be

at hand which would serve the purpose until a standard replacement could be obtained. Some drivers carry a repair kit of standard parts for emergency repairs. One driver a long way between stations was stopped by a hole chafed in the fuel line. He bent the line away from the point of contact, cut a 4-in. section from it and installed the in-the-line filter he'd been carrying in his kit, intending to install it at the first opportunity. The emergency provided him with the opportunity. ★ ★ ★

QUOTE: Dirty Headache

"Since the majority of our ICBM launchers are being built in underground emplacements to protect the missiles against attack, the earth-moving phases of the construction program are staggering in themselves. For example, in building the sites now programmed—for Atlas, Titan and Minuteman—more than 37.5 million cubic yards of dirt will be moved.

This is a job equivalent to digging an irrigation ditch 10 feet deep from Lubbock [Tex.] to Detroit [Mich.]—and back again."

LT. GEN. HOWELL M. ESTES, JR.
Deputy Commander (AFSC)
for Aerospace Systems



Now! The oil that protects you if you forget to change

Lots of people do forget to change motor oil on time. In case you *might* forget, drive with Pennzoil Z-7 . . . the oil with *protection reserve*.

Regardless of price, you can't buy a finer, longer lasting motor oil. Pennzoil is 100% pure Pennsylvania crude, refined by an exclusive process, making it the world's *richest* motor oil. Z-7 makes it so *complete* you never need buy expensive extra additives. Result: *protection reserve*. Cars perform better, engines live longer.

Insist on Pennzoil. For your nearest dealer, write Pennzoil, Oil City 61, Pa.

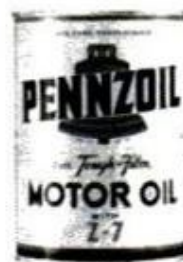

When to Change Oil

Every 60 days under normal driving conditions.

Every 30 days under severe stop-and-go or cold-weather conditions.

It is cheaper to change your oil than your engine!

PENNZOIL Z-7 — World's richest, most complete motor oil . . . now with protection reserve

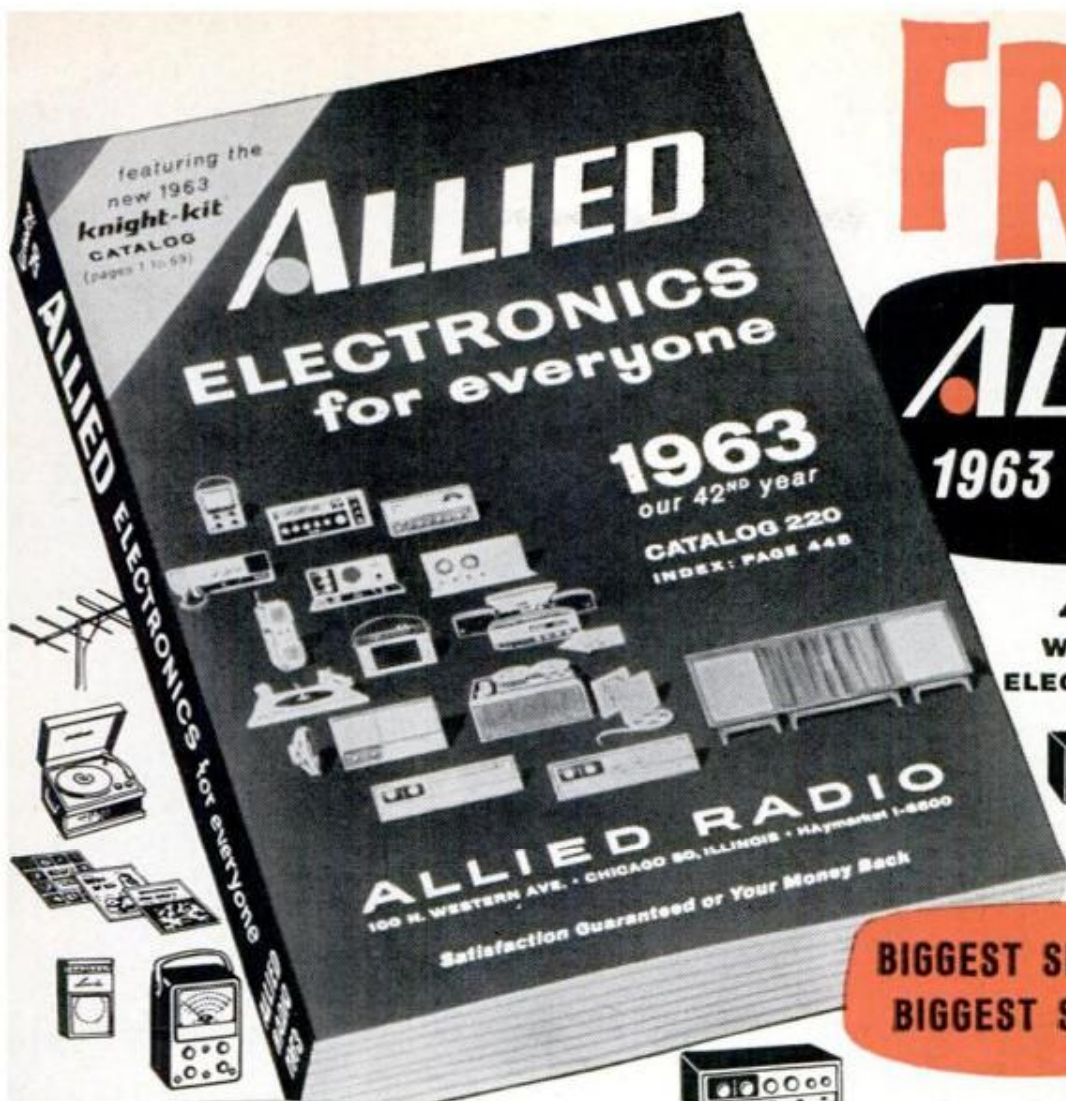

FREE

ALLIED 1963 CATALOG

**464 PAGES
WORLD'S LARGEST
ELECTRONICS CATALOG**

**BIGGEST SELECTION
BIGGEST SAVINGS!**

see what's new in
STEREO HI-FI

top buys in
TAPE RECORDING

latest values in
**CITIZENS BAND &
SHORTWAVE RADIOS**

exciting build-your-own
knight-kits

NO MONEY DOWN: Now! Get More
Buying Power with your
Allied Credit Fund Plan!

Satisfaction guaranteed or your money back

ALLIED RADIO
The World's Largest Electronic Supply House

SAVE MOST ON:

- Everything in Stereo Hi-Fi
- New All-Transistor Stereo
- KNIGHT® Super-Value Hi-Fi
- Tape Recorders & Tape
- Citizens Band 2-Way Radios
- Transistor & FM-AM Radios
- Phonographs & Records
- Ham Station Equipment
- PA Systems, Intercoms
- Latest Test & Lab Instruments
- TV Tubes, Antennas, Accessories
- Parts, Tubes, Transistors, Books, Tools

ALLIED EXCLUSIVES:

See special products
and values available
only from Allied—plus
all the famous makes!

FREE

SEND FOR YOUR COPY TODAY!

ALLIED RADIO, Dept. 22-28-K
100 N. Western Ave., Chicago 80, Ill.

Send FREE 1963 ALLIED Catalog

Name _____
PLEASE PRINT

Address _____

City _____ Zone _____ State _____

Fun With a Zoetrope

(Continued from page 151)

gether, if necessary, to achieve the desired length. The grain of the cardboard should run crosswise so that it will curve naturally. Slots of $\frac{1}{4} \times 1\frac{1}{2}$ in. are then cut into this cardboard strip as shown, starting them $\frac{3}{8}$ in. in from the top border and spacing them $1\frac{1}{2}$ in. apart. To avoid having a slot come at the very edge where the ends of the strip butt-join, the first slot should be made $\frac{3}{4}$ in. in from the leading end.

When finished, this slotted strip is curved around the plywood circle and attached with either gummed tape or small tacks. Add the handle by fastening it loosely with a round headed screw so the drum will spin freely without wobbling. Finish by painting the outside of the drum a dull black to kill light reflections when viewing through the slots.

An ideal way to make animation strips for this zoetrope is to shoot them with a 16-mm. movie camera turned sideways to produce a vertical instead of the usual horizontal picture. Since only short bits of action will be photographed, you can use short lengths of inexpensive, surplus black and white negative film and in the dark-room, cut off the short exposed portions and develop them by hand in a tray or tank.

Here a simple method of holding the film is to wrap it around a 4x5 cut-film hanger. A wire frame also can be used for this purpose.

Requires Positive Prints

The resultant 16-mm. negative strip is then placed in the enlarger and blown up to produce positive prints in strip form which contain frames that measure $1\frac{1}{2}$ in. across their narrow widths. A little over 6 frames can be enlarged on a $2\frac{1}{2} \times 10$ -in. strip of bromide paper. Use semimatte paper, preferably, but if glossy is used, do not ferrotype it because ferrotyping tends to stretch the paper to a slightly larger size and this will seriously affect the fit of the movie strip.

After enlarging the first six frames, advance the film in the enlarger and blow up the next six frames. Repeat this procedure a third time to complete the required sequence. The three resultant strip blow-ups are then developed and printed and finally joined together, end to end, to produce a continuous strip which is subsequently formed into a circle and joined again with cellophane tape to form the completed animation band. This band should fit snugly into the drum of the zoetrope. If necessary, it can be anchored in place with a corrugat-

(Continued to page 220)

CRESCENT SNIPS



5 ways better

Sheet metal, wire screen, linoleum, cardboard, canvas, plastics, etc., cut faster and easier with CRESCENT snips. Here are five reasons why:

- 1** Shaped perfectly to fit the job at hand. Leverage, balance, and comfort are designed-in.
- 2** Forged from a special grade alloy steel, selected for its hardness and durability.
- 3** Blades are precision-ground by machine to a keener edge for cleaner cutting.
- 4** Selective electronic hardening keeps the cutting edge sharper, longer.

- 5** The name CRESCENT on the handle is your guarantee of quality . . . backed by more than half a century of fine craftsmanship in the manufacture of better hand tools.

Look for the special display of quality CRESCENT snips at leading hardware stores. Next time you buy hand tools, buy the best . . . buy CRESCENT!

CRESCENT 
CRESCENT TOOL CO., JAMESTOWN, N. Y.

CRAMPED, OLD-FASHIONED MESS...?



Organize your garage with
PRESTO PEG-BOARD

New Presto Peg-Board by Masonite makes it easy work to transform children's rooms, garages, utility rooms into neat, well-organized areas. No need to paint Presto Peg-Board. It comes to you all prefinished in an eye-pleasing pattern.

More good news: this strong, heavy-duty Presto Peg-Board is priced so low it will amaze you. Why not start from the plans we'll send you? Just fill in the coupon.

 **MASONITE** *shows the way!*

Masonite and Presto Peg-Board are registered trademarks of Masonite Corp.



Masonite Corporation, Dept. PM-10, Box 777, Chicago 90, Illinois
Send me plans booklet and literature for Presto Peg-Board.

Name _____

Address _____

City _____ Zone _____

County _____ State _____

SO YOU WANT TO BUY A SAW

Don't miss this saw spectacular! Spend a few minutes with the next five pages . . . compare prices, sizes, capacities. Read about big savings and special offers you can get.

For FREE Folder on any or all of the great Rockwell saws featured, write:

Rockwell

MANUFACTURING COMPANY

Dept. 502K, Pittsburgh 8, Pa.



ed cardboard disk cut to fit snugly into the drum and clamp the picture band in place around its bottom edge. A 1½-in. hole, cut in the center of this pressure disk will let it clear the pivot crew and provide a finger grip for its removal.

To view the movie strip in action, hold the zoetrope under a light, look through the slots and give the drum a spin. The picture frames seen through the slots will miraculously come to life. Viewing can be done by several people at the same time, each viewing from different positions around the drum. If desired, the handle of the zoetrope can be eliminated and by means of a larger hole drilled through the plywood disk, the drum can be set on the turntable of a record player for continuous, automatic spinning.

The best type of activities to film for zoetrope viewing are short, snappy actions that repeat themselves by coming back to their original starting points as in calisthenics, rope jumping, lollipop and ice-cream licking, swinging, tree chopping, etc. It is best to set the camera on a firm tripod and avoid actions that require panning, though this is by no means a firm rule. One interesting stunt is to focus on a low diving board and have your subject run into the frame and dive off the board. On the zoetrope, you will see an endless procession of divers running out and leaping into the water—all the same person. Try this same stunt with a person simply running in and out of the frame. The results will be that of a long line of runners running around the inside of the drum. With a little imaginative experimenting, many novel and amusing effects can be achieved. ★ ★ ★

U. S. May Import Insects

Ever vigilant against the invasion of harmful foreign insects, the U. S. government, however, is seriously pondering admitting the flea beetle, a native of Argentina.

Something is needed to control the growth of alligatorweed, a choking pest of southern waterways. The flea beetle has an excellent record as a weed controller in Argentina; also, it is not known to feed on any plant other than alligatorweed and its one close relative, which is not found in this country.

Agriculture Department entomologist George Vogt investigated the record of the beetle's performance. It was good in South America. But, things being what they are, Vogt says, at least two years of work will be needed before any weed-destroying insects can be introduced into the U. S.

So you want to buy a BAYONET SAW



Reg. \$54.95

\$44.95

Special
Introductory Price

SPECIFICATIONS

(Model 300 Bayonet Saw)

Blade Stroke	9/16"
Cutting Capacity Wood	2 1/2"
	Aluminum	5/8"
	Steel	3/16"
Motor	2.5 amps
Speed	4000 spm
Net Weight	5 lbs.
Length	7 1/4"

*Here's a new PORTER-CABLE saw that's unequalled in sawing flexibility . . . actually the fastest cutting saw of its type. It has preferred orbital blade action and is powered by a failure-proof motor guaranteed for two years! And it cuts almost anything—ferrous and non-ferrous metals, all woods, compositions and plastics. You'll do everything from inside curve cutting *without a starting hole* to big capacity straight line cutting jobs. All in all, a honey of a value.*

Own it today. See your PORTER-CABLE dealer.

Rockwell

MANUFACTURING COMPANY

Dept. 502K, Pittsburgh 8, Pa.





you're **IN**

with foreman
appearance
at apprentice prices

CARWOOD TAILORED MATCHED SETS

On the job as in everything you do and every place you go, your appearance helps you get ahead. Carwood Tailored matching shirts and pants are sportswear styled—with workwear stamina. Army twills and random cords; Sanforized, vat-dyed, wash-and-wear, easy to launder. Tan, Silver, Medium Grey, Spruce Green, Loden and Air Force Blue.

For name of dealer nearest you, write to

CARWOOD MFG. CO.
division of Chadbourn Gotham, Inc.,
WINDER, GEORGIA

STOP WATER DAMAGE...



Wood
Plywood
Shingles
Asbestos siding
Concrete blocks
Concrete
Mortar
Stucco
Linoleum
Plaster
Brick
Paint
Wallboard
Tile
Canvas
Leather
Fabrics

**Prevents warping, swelling, mildew, mold,
water stains, seepage, dampness, rot.**

Keeps moisture out 5 years and longer.

Use on all woodworking jobs, boats, patio furniture, planter boxes, shutters, screen doors, window sash, shingle roofs. Stops seepage in basement walls, concrete silos, foundations. Waterproofs canvas, tarps, tents, awnings, leather boots, shoes, outdoor clothing. Won't harden or crack leather or fabrics. Perfect underseal for oil base or alkyd paints. Deep penetrating, colorless. Apply by brush, spray or roller. At paint or hardware stores or order direct. 16 oz. spray can \$1.89, Qt. \$1.75, Gal. \$5.35, 5 Gal. \$25.25, ppd., tax incl. Send check or money order to **E. A. Thompson Co** 1355 Market St., San Francisco 3, Calif. No COD's please. (Since 1929.) Dealer and jobber inquiries invited.

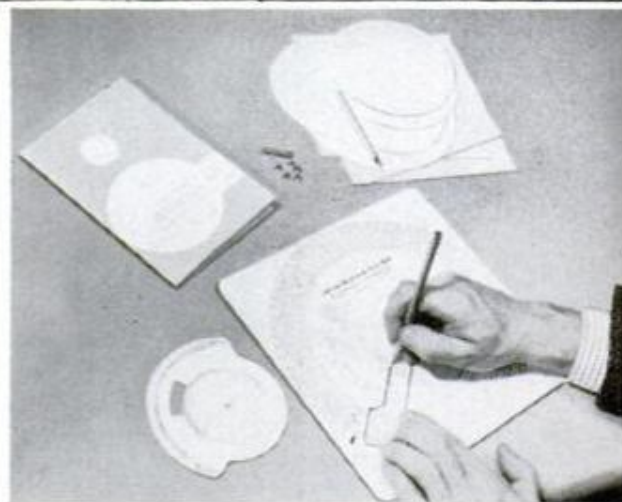

Slide Rules From Kits

Special-purpose slide rules can be constructed from kits by an individual for doing recurring calculations connected with his work. The scales are calibrated with the actual values they are to represent so that calculating decimal point placement is not necessary—the rule is read by aligning the values with each other and reading the answer.

The complete kit, including parts for making three basic slide rule blanks and instructions, costs \$8.50. Made by Dyna-Slide Co., 600 S. Michigan Ave., Chicago 5.

So you want to buy a PORTABLE SAW



Reg. \$59.95

only **\$49.95**

SPECIFICATIONS

(Model 170 Portable Saw)

Blade diameter	7"
Depth of Cut, 90°	2½"
Depth of Cut, 45°	2"
Motor	10 amps
Idle Speed	4500 rpm
Net Weight	9¾ lbs.
Length	11½"

This PORTER-CABLE saw is the fastest-cutting 7" saw made . . . and it's yours now at a big \$10.00 savings. It whizzes through stock a full 2½" thick. You'll find it powerful, superbly balanced, safe and convenient for all types of cutting. And you'll like these Porter-Cable quality features: Kick-Proof Clutch, Built-in Blade Lock, Trigger Switch with Lock Button, Telescoping Guard, Single Line of Cut and Wide Wrap-around Base. Why wait?

Own it today. See your PORTER-CABLE dealer.

Rockwell
MANUFACTURING COMPANY
Dept. 502K, Pittsburgh 8, Pa.





This point lets you bore holes up to 1½" with small electric drill

It's hollow ground to bore cleaner, faster at any angle

NOW YOU CAN increase the boring range of your small electric drill or drill press. New Irwin Speedbor "88" bits bore faster, cleaner holes up to 1½" in any wood. ¼" shank chucks perfectly. No wobble, no run-out. Sharp cutting edges on Irwin exclusive hollow ground point start holes faster, permit spade-type cutters to bore up to 5 times faster. All Irwin Speedbor "88" wood bits are forged from single bar of special bit steel, tempered full length and machine-sharpened for extra accuracy, longest life. 17 sizes, ¼" to 1½". Buy individually or in sets from your Irwin hardware or building supply dealer.

Only 75¢ each, sizes ¼" to 1"

Only \$1.25 each, sizes 1½" to 1½"

IRWIN SPEEDBOR "88" WOOD BITS
at Wilmington, Ohio, since 1885

MIGHTY GRIP

12" or 15" CHAIN WRENCH

DIAMALLOY

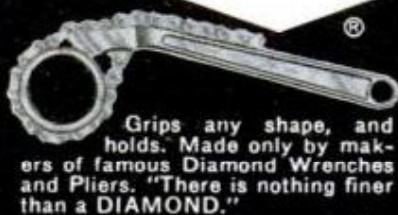

Grips any shape, and holds. Made only by makers of famous Diamond Wrenches and Pliers. "There is nothing finer than a DIAMOND."

Write for Free Tool Catalog

DIAMOND TOOL and Horseshoe Co.

DULUTH, MINNESOTA EST. 1908 TORONTO, ONTARIO



Optical Radar for Satellite

Radar practical for use in orbiting satellites to detect distant objects has been developed experimentally by Hughes Aircraft Co. It uses light from a laser transmitter housed atop a telescope. The laser light pulses out to a target, is reflected back and collected by mirror in the scope. Associated electronic equipment processes the signal to provide data about the distance and angle.

The experimental model operates at two miles in sunlight and seven miles at night.

Magna-Lite Magnetic Base SHOP LIGHT

puts the light where it's needed!



45 lb. pull permanent Alnico V magnet base holds the light on machines, pipes, under car hood — on any ferrous metal surface. Ball-swivel allows full adjustment of light.

Complete with 5" spun aluminum spot-type reflector, 8' oil resistant GE cord. **\$6.95**

Each, Postpaid
Send Check or Money Order to
DeMambo Laboratories Mayville, N. Y.

So you want to buy a **COMPACT SAW**



\$79⁹⁹

Includes built-in motor

(suggested retail)

SPECIFICATIONS

(Model 34-200 COMPACTOOL
Circular Saw)

Blade diameter 7¹/₄"
Diameter of Arbor 1¹/₂"
Depth of Cut, 90° 1¹¹/₁₆"
Depth of Cut, 45° 1³/₄"
Speed 3450 rpm
Rip capacity with extension
wings . center of 20¹/₂" board

Overall dimensions: Depth 17"
Width 13" Height 17¹/₂"

The COMPACTOOL saw gives you "big tool" accuracy, versatility—goes anywhere. If you're itching to do projects your portable can't handle—but feel you can't afford to step up to a heavier, stationary saw—this is for you! Lightweight, easy to take to the job—easy to store away. And you'll like the smooth, quiet power the revolutionary, built-in motor delivers. A demonstration can be mighty convincing. (There's also a COMPACTOOL Joints and Drill Press.)

Own it today. See your COMPACTOOL dealer

Rockwell

MANUFACTURING COMPANY
Dept. 502K, Pittsburgh 8, Pa.





YOU LOVE THE FLAVOR...AND EVERYONE LOVES THE AROMA!

■ When you light up your pipe with HALF AND HALF, the people around you enjoy it almost as much as you do. That's because no other pipe tobacco has such a delightful aroma—and such a distinctive taste.

■ HALF AND HALF is a mixture of choice aromatic tobaccos... specially selected and blended for mild taste and friendly aroma. So, relax and light up—your pipe is welcome everywhere when you smoke HALF AND HALF.

■ Buy and enjoy famous HALF AND HALF in the pocket pouch or vacuum-packed humidor tin today.



CONFIDENTIAL!

(For married men only.)

**YOUR BETTER HALF
WILL LOVE THE AROMA
OF HALF AND HALF!**

A CARGO OF CONTENTMENT IN THE BOWL OF ANY PIPE!

©THE AMERICAN TOBACCO COMPANY

So you want to buy a **BENCH SAW**

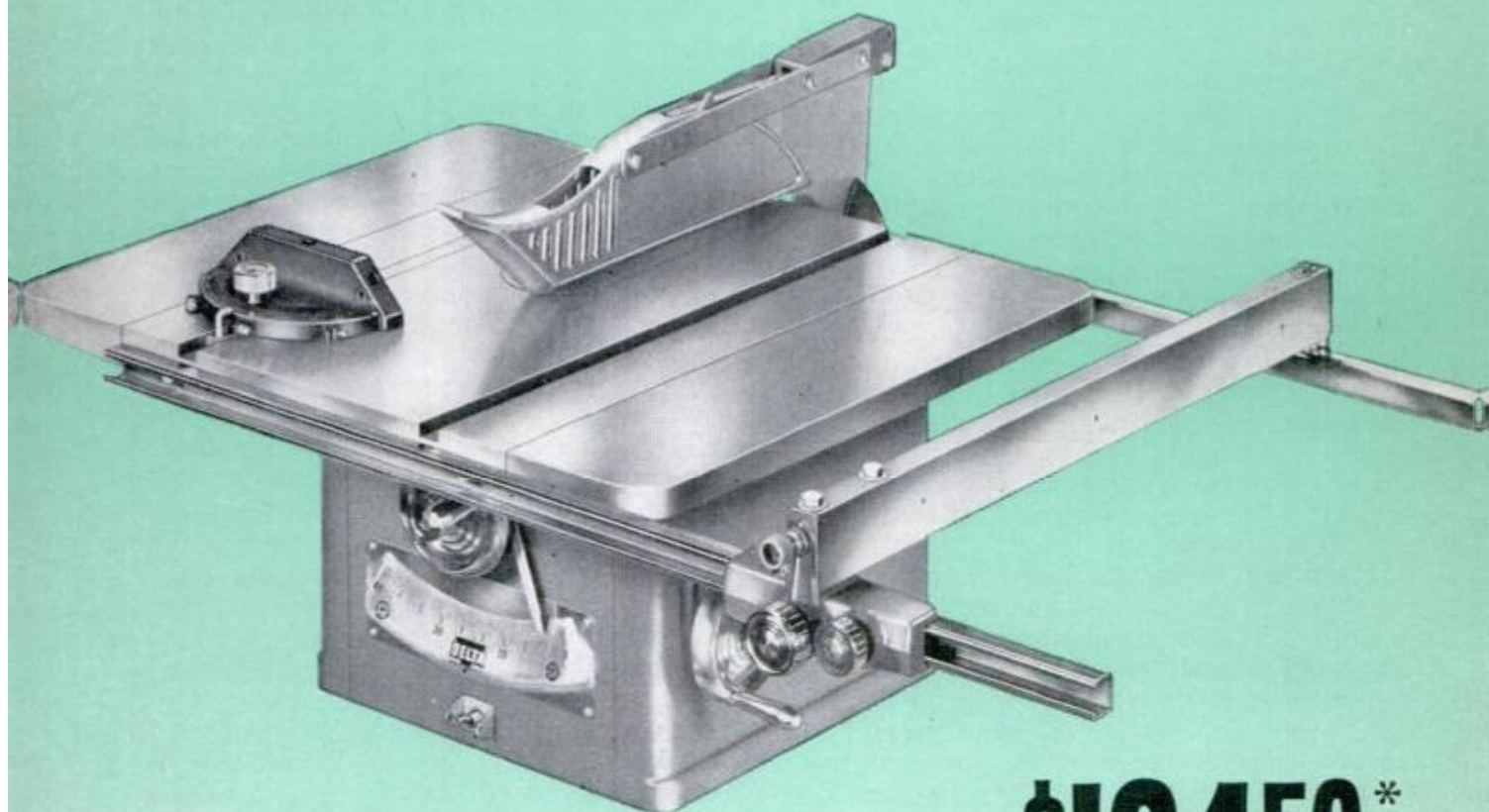

\$10450*

(guard and wings optional extras)

SPECIFICATIONS

(Model 34-600 Delta 9" Saw)

Blade diameter 9"
Diameter of Arbor 5/8"
Depth of Cut, 90° 2 3/4"
Depth of Cut, 45° 2"
Speed with 3450 rpm
motor 3800 rpm
Rip capacity with extension
wings . . . center of 48" panel
Overall dimensions: Depth 36"
Width 37 1/2" Height 17 1/2"

Buy the famous DELTA 9" Tilting Arbor Saw—get the stand FREE. If you act now, you'll get a sturdy steel stand (a \$22.00 value) as a bonus for choosing a tool that's really "loaded." It has the power, precision and capacity to satisfy the most exacting users. It's the saw with truly industrial quality and performance at a home workshop price. The offer is limited—take advantage of it!

Own it today. See your DELTA dealer.

*Slightly higher in the West.

Rockwell
MANUFACTURING COMPANY
Dept. 502K, Pittsburgh 8, Pa.



Convert Your Accordion

(Continued from page 145)

and top, you can make the end frames and cut the plywood for the case. However, before assembling the case you complete the front and bottom panels.

Front-Panel Details

The bass assembly of the accordion is to be mounted at the left end of the front panel to wood frame A, which is attached to the outside of the panel. The treble assembly is mounted at the right on frame B which is attached to the inside of the panel. For measurements to make the frames, which may vary from those given, remove the bellows of the accordion by pulling out the holding pins. After making frame A, screw it temporarily to the front panel so its left edge is $1\frac{5}{8}$ in. from the left end of the panel, and its lower edge $\frac{3}{4}$ in. from the bottom. Then mark and cut an opening that will accommodate the reed blocks of the bass assembly with sufficient clearance; a 4 x 14-in opening was ample in the original. After preparing the accordion parts as will be explained later, you screw the bass assembly temporarily to frame A.

Holes for screws to hold accordion assemblies to the frames are drilled so the screws will fit the holes snugly. In the final assembly you use metal washers faced with felt or leather under the heads of the screws to prevent air leakage. If you cannot find suitable places for screws, you can use small metal angles attached to the outside of the frames. The angles can be concealed later with strips of wood. The accordion parts should fit snugly on sponge-rubber strips glued to the frames. When making the final assembly fill holes that were occasioned by the removal of parts, with non-drying putty which does not shrink and is easy to remove.

Next, you determine the approximate location of the treble assembly so that the left end of its valve-and-reed housing will not be closer than $1\frac{3}{4}$ in. to the bass assembly, which provides clearance for the side extension of the treble keyboard. Also locate the assembly so that the treble keys will line up with the bass keys. Then cut an opening in the panel through which the reed blocks will pass; a $7\frac{1}{4}$ x $18\frac{1}{2}$ -in. opening was ample in the original.

Now place the treble assembly flat on the panel with the reed blocks projecting through the opening and the keys in alignment with the bass keys. Mark the outline of the housing on the panel and enlarge the hole to this size. After screwing frame B to the back of the front panel to line up with the opening, without letting any of the screws project through the panel, screw the

treble assembly in place temporarily. As frames A and B have only been screwed on, you still can alter their positions for good alignment. When locations have been established, remove the accordion parts and then glue and screw frames A and B in place permanently.

Assembling the Case

You now proceed to assemble all parts of the case except the bottom, which is done last. Wood strips are used at all joints for strength and airtightness. The strips are coated with glue and flat-head screws are driven through the panels into the strips. The bottom is prepared by boring the required holes, attaching the cleats that serve to reinforce the legs, installing the blower, switch and wiring, adding the volume controls, and the leg-mounting plates as shown on page 142. Seal all cracks, even those around the electric cord and switch, using putty or caulking compound. Use a silent electric blower such as No. XP-700 made by the Magnus Organ Co., 100 Naylor Ave., Livingston, N. J.

As you will see from the underside view of the bottom panel, page 142, there are two knee-operated volume controls. Volume is reduced by letting air escape. This does not result in an instantaneous reduction of sound, but involves a slight time lag, and the sound reduction is gradual. The levers connect to hinged blocks faced with felt or leather to tightly close the air-escape holes for increased volume. Cabinet-door catches are used to keep the levers in the loud position when variations of volume are not desired. After the case has been assembled, you can cement on the $\frac{1}{8}$ -in. covering material and then install the accordion parts permanently.

Preparing Accordion Parts for Organ Use

To dismantle an accordion, remove the straps, grille, and all external metal fittings. Remove the reed blocks after marking them with pencil lightly so they can be returned to their places. Each note of an accordion has two reeds, one that sounds when the bellows is being inflated, and another that sounds when it is being deflated. A leather flap for each reed (except those of high notes) prevents air leakage through the reed when its companion reed is in use. When an accordion is used in its normal way, the flaps fall on their seats as soon as air pressure is applied. However, in the accordio-organ half of the flaps hang downward and will eventually fail to function, thus causing air leakage. To prevent this failure use narrow strips of adhesive tape to hold the lower flaps over their

(Continued to page 230)

So you want to buy a RADIAL SAW

\$259⁰⁰

(stand extra)

Meet the DELTA Super 990 9" Radial Saw — a versatile one-tool workshop. Rip, cross cut, miter, bevel, dado, shape, drill, sand . . . you name it, this workshop workhorse does it! You get horsepower that backs up cutting power. And you get useful features like the new built-in brake, exclusive "Turret Arm" action, Micro-Set Stops and new double-shaft motor. These are some of the reasons you get more for your money with the Super 990. Ready for a Radial?

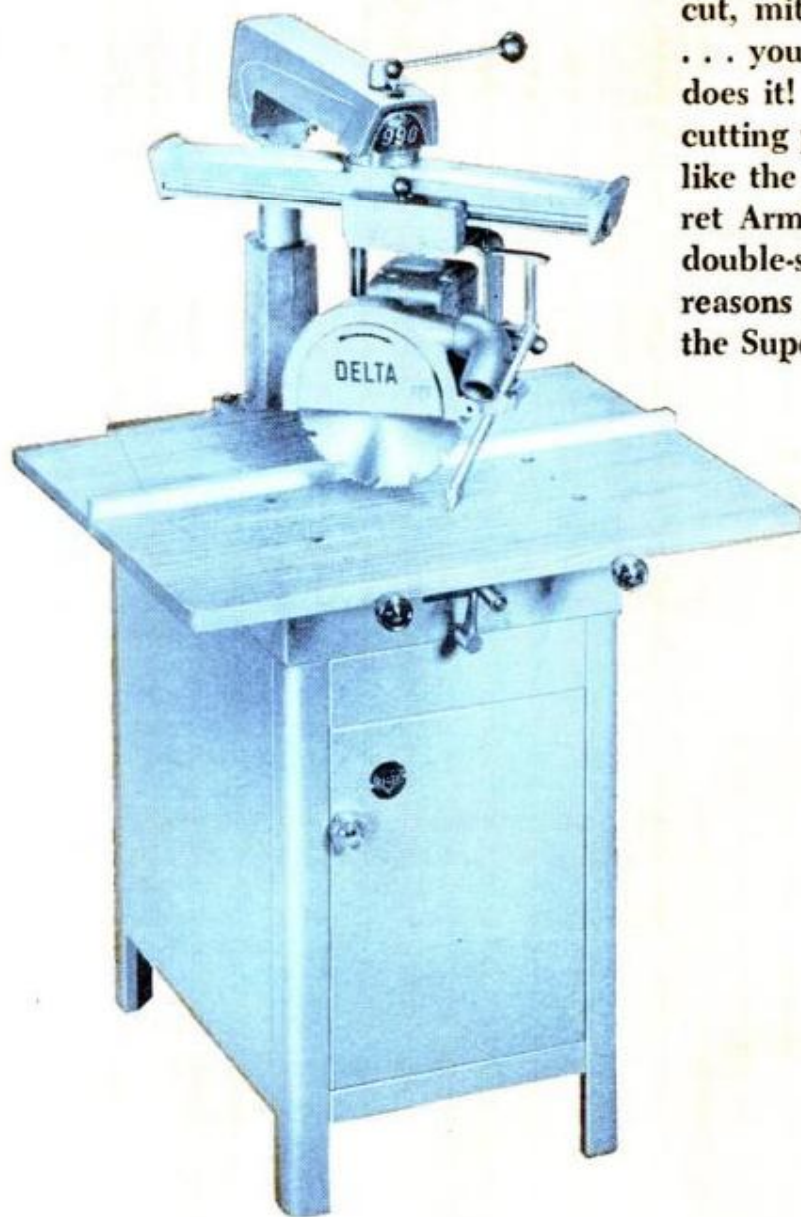

SPECIFICATIONS

(Super 990 Radial Saw)

Blade diameter 9"

Diameter of arbor 5/8"
(rear shaft) 3/8"

Depth of Cut, 90° 2 1/2"

Depth of Cut, 45° 1 7/8"

Speed (full load) 3450 rpm

Rip Capacity
center of 48" panel

Overall dimensions: Depth 27"
Width 32" Height 55"

Own it today. See your DELTA dealer.

Rockwell

MANUFACTURING COMPANY

Dept. 502K, Pittsburgh 8, Pa.



SNOW SLOW YOU DOWN?

GRAVELY
Blows Away
Snow Delay
FAST!



Throw away your shovel! Blow away snow problems with Gravelly's Snowblower. Clears a 26" swath—blows snow up to 30' to either side through adjustable chute. All-gear drive—powered directly by Gravelly's 6.6-HP engine.

See how the Gravelly Tractor and its 31 tools make all your tough jobs easy. For free copy of booklet, "Power vs. Drudgery," write now. Finance plan available.



GRAVELY TRACTORS

DIVISION STUDEBAKER CORPORATION
P. O. BOX 601-K DUNBAR, W. VA.

Paint jobs last
longer when you seal
cracks and leaks
before you paint!



better
buy **DAP**
CAULKING



Get this new booklet filled with "Before You Paint" fix-up tips that save you time and money. Send 10¢, to cover handling, to:

DAP inc., Dept. 14 • Dayton 31, Ohio

openings. If your blower draws air out of the case instead of compressing air into it, you fasten the tape over the exposed upper reeds to prevent escape of air.

Test the reeds by sucking at each hole in the reed block, or by blowing if the blower is the decompression type. Foreign matter on reeds may prevent them from vibrating, but this often can be cured by cleaning them carefully with benzine. If a reed is mutilated or is out of tune, invert the metal frame so that the companion reed is brought into use.

Adding the Legs and Grilles

Keyboard height should be from 27 to 28 in. above floor level. You can purchase tapered brass or wood legs 22 in. long that screw into steel plates which are attached to the underside of the case. Two grilles, page 145, which are made to fit over the exposed parts of the accordion assemblies, will greatly improve the appearance of your accordio-organ. These can be made from prefinished hardboard to match the case. Small, flat-head screws and glue are used to hold the parts together. ★ ★ ★

QUOTE: Universal Revolution?

"To our descendants, our era will appear above all as the era when man's life expectation . . . has increased two or three times in the span of a few generations, an era when the amount of energy available for the average individual to satisfy his wants and his desires has grown tenfold if not a hundredfold. In this era, man has penetrated the atom, and released the awesome energies of its nucleus; he has first left his planet to surge into space. This revolution in human existence unfolds before our eyes, not as a part of the conflict between the two camps into which the Western world is divided, but, in essence, through their common efforts. Our era may appear, to a myopic mind aware only of the bitter conflict raging between the ideas extrapolated from mankind's obsolescent experience, as an era of alienation in which mankind has become separated as never before into two irreconcilable camps; but to the future generations it will appear as an era of the beginning worldwide cooperation of mankind. Never before have so many outstanding men of all nations devoted themselves to parallel or concerted activities based on commonly acknowledged truths, and dedicated to the common aim of better understanding and more effective mastery of nature."

DR. EUGENE RABINOWITCH, Editor,
Bulletin of the Atomic Scientists

POPULAR MECHANICS

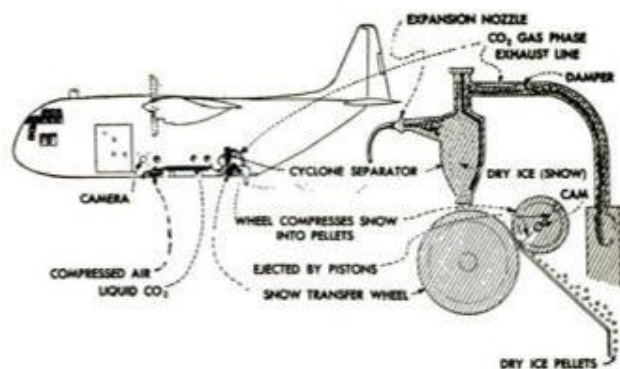

Air Force Cuts Holes in Clouds for Landing Through Overcasts

Holes more than three miles wide have been created in clouds by Air Force scientists in tests using a new machine that makes dry-ice pellets as needed.

The purpose is to give cargo and transport pilots an economical way to seed clouds whenever and wherever necessary. Previous methods, which involved carrying dry ice aloft, were cumbersome.

The new machine makes ice pellets by passing liquid CO_2 through an expansion nozzle, compacting the resulting dry-ice snow and then forming it into pellets.

An added bonus to the system is that the tank of CO_2 can easily be connected to the aircraft's existing, fire-fighting system, virtually eliminating the danger of unextinguishable aircraft fire.



Latakia?

IT'S JUST ONE OF THE
FIVE FINE TOBACCOS IN REVELATION

Latakia adds a touch of exotic aroma. Just a touch. Each of the *other* four adds something special too. Bring them all together with the Revelation recipe and something rare happens. Try it soon.



Kentucky Burley—dark flakes, slow burning
Virginia Bright—bright leaves, even burning.
Old Belt Bright—slightly darker, good body
Latakia—deeper brown, extra mild
Perique—very dark, wonderful aroma

REVELATION

MILD SMOKING MIXTURE

THE POCKET SIZE MACHINE SHOP Dremel MOTO-TOOL

In your workshop, on your job — it's the handiest tool you'll ever own! Moto-Tool is ideal for precision grinding, polishing, carving, drilling, engraving, deburring, sharpening — does fine detail work with pin-point accuracy. It eliminates time-consuming hand work, gives the finished job a professional look. Moto-Tool weighs only 13 oz. — fits your hand like it belongs there. Fastest, most powerful tool of its kind — develops 27,000 rpm! Widely used by tool and die makers, model builders, craftsmen, lab technicians, repairmen, gunsmiths, schools.

See your dealer or write for free catalog.



No. 1 Moto-Tool
— Weighs 6 oz.
Produces 25,000
R.P.M.\$16.95
**No. 1 Moto-Tool
Kit** — with 34 as-
sorted accessories
in steel case
\$25.50
No. 2 Moto-Tool
— Weighs 13 oz.
Produces 27,000
R.P.M.\$19.95
**No. 2 Moto-Tool
Kit** — with 23 as-
sorted accessories
in steel case
\$29.95

DREMEL MFG. CO.
Dept. 112K, Racine Wis.
Quality Power Tools Since 1934

HEAVY DUTY NO. 3 MOTO-TOOL

New high torque motor designed for industrial use. Same features as No. 2 plus 50% increase in power. Weighs 18 oz. No. 3 Moto-Tool — with 1/8" and 3/32" collets and finger grip in steel case.....\$29.95

For Perfect Painting

DO IT YOURSELF!



"Pressure Maid"

**PORTABLE PAINT
SPRAYER**

Complete — ready to spray — with gun, hose, compressor, and motor. Gives you the features and performance of more costly units... fast, easy professional results every time. Also useful for inflating toys and tires, all-purpose spraying, etc. Displaces 4.7 CFM... delivers over 2.2 CFM at 40 psi.

Write for Catalog

The Campbell-Hausfeld Co.
1046-V Railroad Ave., Harrison, Ohio



CAMPBELL-HAUSFELD

Know What IQ Means?

(Continued from page 119)

here are some examples of how good the quick IQ tests are at screening new applicants for jobs.

One company tested all applicants for sales jobs, then went back five years later to see how many had been promoted. All who had made the top score had; 77 percent of those who ranked second had; 70 percent of the third rank; 58 percent of the fourth; and so on. Only 13 percent of the third, lowest ranks, and none of the second lowest had been promoted.

Another company similarly checked back on its division managers. A hundred percent of the top rankers had been promoted; only 15 percent of the seventh rankers were; and those in between were promoted proportionally.

Another study, of managers of a chain of small retail stores, showed that both sales ability and sales volume (in dollars and cents) correlated highly with IQ scores.

Still another test found that higher scoring bank tellers worked with greater accuracy and efficiency, even under pressure.

How to Improve Your IQ

Job seekers traveling from personnel office to personnel office take so many IQ tests that they soon become proficient at them. That's one way, says SRA's Dr. Weinfeld, that IQ scores can be made to vary. The same applies to school children. In areas such as New York suburbs, where pupils are apt to be "over-tested," IQ scores generally are higher than in, say, Nebraska, where children may be "under-tested," he says.

There are other ways IQ scores can be raised. You can "cram" for them. The best thing to study, say the experts, are words. The core of any intelligence test is its vocabulary unit. In fact, as stated earlier, short-cut IQ tests rely heavily on word sense. That's because psychologists feel that, since words represent ideas, how adept you are with them indicates how well you grasp ideas.

Intelligence test designers make no bones about telling parents how they can work to improve their children's—or their own—IQs. Of course, we are all born with an upper limit to our potential intelligence which is, unfortunately, determined by heredity. There's nothing we can do about changing our genetic makeup. But we can, says Dr. Buel, make the most of what we have. "No one is at the upper limit of his

(Continued to page 234)

FOR TOP VALUE... INSIST ON



Folding Wood
RULES



Steel White
TAPES
with belt holsters
6 ft. to 100 ft.



Evans RULE CO. 400 Trumbull Street, Elizabeth, N. J.

Works
in
seconds!



Loosens Rusted Bolts
nuts, screws, "frozen" parts!

**LIQUID
WRENCH**
SUPER-PENETRANT

The super-penetrating rust solvent that quickly loosens rust and corrosion.

AT ALL HARDWARE
AND AUTO STORES

RADIATOR SPECIALTY COMPANY
CHARLOTTE, N. C.



HOW-TO Remove Wallpaper

You can remove your wallpaper fast and efficiently with the Hyde E599 All-Electric Wallpaper Steamer. Automatic features include shut-off valve on pan, steam pressure control and low water shut-off. Operates off 110-120 volt AC on 15 amp. fuse. Rent from your local paint, hardware and lumberyard dealer, or write Hyde with name of your dealer.



WRITE FOR
FREE
CATALOG



HYDE TOOLS

SINCE 1875

SOUTHBRIDGE, MASS., U. S. A.

Weller[®] Heavy Duty Soldering Kit

Features a professional 275-watt Weller gun that makes soldering a cinch. Pull the trigger—tip heats instantly and twin spotlights illuminate work. Includes: Soldering tip. Cutting tip that cuts plastic materials and tile. Smoothing tip that heat-seals thermoplastics. Tip wrench. Solder. Instructions. Plus break-proof plastic carrying case that can be used as a lunch, tool or fishing tackle box. Available wherever quality tools are sold. Model 8250AK. **\$14⁹⁵**



*For quick, easy soldering
and scores of household repairs*

WELLER ELECTRIC CORP. EASTON, PA.



DUCO[®] CEMENT
DOES IT BETTER
faster, neater! Mends
china, leather, wood,
paper, glass, metal.

FIX IT
FOR KEEPS



Better Things for Better Living ... through Chemistry

NOW! A REAL 6/12 VOLT
BATTERY BOOSTER

Now you can own a genuine SCHAUER 6&12 volt battery booster at a low, low price! The Model H612 is positively not just a battery "warmer", as are so many "economy" models on the market! It delivers a full 1 1/4 amps of power at BOTH voltages, that will charge car, boat, motorcycle and lawnmower batteries. Has full-wave Selenium rectifiers... automatic circuit breaker... 6 or 12 volt selector switch... rugged steel case with handsome red finish. Money-back guarantee. Buy yours now. If your dealer can't supply, send check or money order.

Automotive Division
SCHAUER MANUFACTURING CORP.
 4532 Alpine Avenue, Cincinnati 42, Ohio

ONLY
\$9.95

Postpaid
 Model H612



intelligence," he says, "we can all extend and push ourselves upward."

How? Well, if you're an adult, you can leave that television set alone and spend evenings with challenging, mind-stretching mental work; study, read, take advanced courses; don't always do what comes easiest; rather, grasp for what is difficult.

"It's a poor analogy, I know, but you should think of exercising your brain like a muscle with informative and conceptual pushups," Dr. Buel says.

As for your children, says Dr. Thelma Thurstone, answer their questions; use good English when you do, not baby talk; listen to their stories; teach them nursery rhymes; help them to solve problems, word games, and riddles; take them to see new places and things; give them tasks and responsibilities around the house; and provide them with challenging toys and playthings they can work with, not just wind up.

Home Atmosphere Important

By giving them a proper home atmosphere, says Dr. Buel, you can raise your child's IQ by 15 to 20 points. This could mean the difference between going or not going to college later, between getting or not getting that job 20 years from now.

In England, psychologist P. E. Vernon showed that he could raise grade school pupils' IQs an average of 11 points with just a few hours' coaching.

In Iowa, 652 preschool children from middle income homes, where the fathers were high-school graduates or better, had an average IQ of 117. Sent to a nursery school which emphasized the intellectual, many raised their IQs seven points the first year, four the second, and two the third—for a grand total of 13 points.

A Midwestern parent coached her child with vocabulary and arithmetic material and raised his IQ score by 19 points.

We mentioned earlier that children in New York are liable to score higher on IQ tests than children in Nebraska. There are other differences between people in general. In 1956 a Columbia University psychologist, Dr. John B. Moner, surveyed intelligence in the U.S. by giving tests to a random sample of 1500 people in 228 cities, towns, and counties.

Briefly, he found that those with the highest intelligence were better educated, higher skilled, white (see additional information below) middle class, urban adults. Age, he found, also makes a difference: Intelligence rises until about 25 years of age; it stays at this plateau until about 55 years; then it creeps down.

(Continued to page 236)

ADDS BEAUTY TO ALL WOOD FINISHES

PRIMES - SEALS - CONDITIONS

Best start for a better finish! Dries fast, seals thirsty wood tack-free in minutes. Sands without gumming. Insures lightest possible natural wood finish; increases coverage and lustre of top coats. At Paint, Hardware, Lumber Stores. Pierce & Stevens Chemical Corp., Buffalo 3, N. Y.

In Canada: Pierce & Stevens Canada, Ltd., Fort Erie, Ont.

Made by the makers of famous **FABULON**

PRYME

FIRST-COATER and LIGHTENER

POOL TABLE PLANS with extra two-face top for table tennis and model railroad. Featured earlier this year in Popular Mechanics. Blueprints B1209 and building instructions, \$3.50. Popular Mechanics Service Bureau, 740 Rush St., Chicago 11, Ill.

ENDS WRONG TURNS FROM BOTH
ABSENT-MINDEDNESS AND
ABSENT ROAD SIGNS



THE ORIGINAL
HULL AUTO COMPASS

\$5.95 to \$7.50. At your
dealer's, write for lit.



HULL MFG. CO., Box 246-D-10 Warren, O.



Model #1776

The
Minuteman

EMERGENCY TOOL KIT

Exclusive!

for

**AUTO
BOAT
TRUCK
TRACTOR
KART
MOWERS**

Ten piece socket set of hot forged steel heavily chrome plated. Includes spark plug wrench. Heavy duty battery jumper cables. Regular and Phillips screwdrivers. Eight inch adjustable wrench. All purpose plier. Fuse kit. Two flares in separate pak. All tools in special eazy-pik liner. A kit you will be proud to own.

Special low prices
at volume outlets now.

Schiller Park, Illinois

Fleet TOOLS

VERSATILITY PLUS...

2½X to 8X instantly with the

WEAVER SCOPE

V8



\$79⁵⁰ for the versatile V8 complete
with Weaver-Adjustable Mount

Here's the all-purpose scope that offers a clear, sharp image at any power. A one-third turn of the eyepiece gives full power change from 2½X to 8X instantly. Constantly-centered reticle and precision adjustments make accurate shooting fast and easy. See the Model V8 at your dealer.

© 1962 W. R. WEAVER COMPANY

FREE 36-page full-color catalog

Name _____

Address _____

City _____ Zone _____ State _____

W. R. WEAVER COMPANY
Department 91 El Paso, Texas

THE WORLD'S MOST USED, MOST PROVED SCOPES

1963 SAAB ... built so well



SAAB FRONT WHEEL DRIVE transmits engine torque directly to front wheels to pull the car firmly along narrow winding roads, around corners, and over icy, wet, or muddy stretches. Self-centering action of front wheel drive and calculated understeering ensures immediate recovery from skids, makes SAAB safer to drive in any weather and on any road. Bonus: Since SAAB transmission and differential are up front, you need no driveshaft to the rear wheels. You get more floorspace and trunk room.

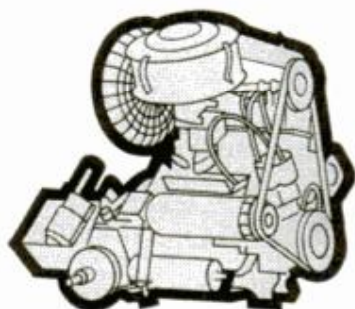

SAAB TWO-CYCLE ENGINE, an economical, quiet three-cylinder, two-stroke valveless unit, employs Schnürle principle of charging through the crankcase. With every stroke a power stroke, it is comparable to a conventional "6" in pickup, hill climbing acceleration, fast cruising speeds—and offers fuel economy ranging from 30 to 35 miles per gallon. Engine dependability has been proved—in competitive victories and by the many SAABs which have provided low-maintenance performance past the 100,000-mile mark.



SAAB RALLY VICTORIES are the ultimate proof of performance, and Monte Carlo 1962 was no exception. Here again, SAAB won by outrunning and outperforming more powerful cars. Reasons: gas turbine-like efficiency at high speeds, road-hugging traction for fast swayproof turns, low steering factor ($2\frac{1}{4}$ turns lock-to-lock) for maximum responsiveness. This unique combination of characteristics makes SAAB ultraroadable in any driving situation . . . turnpike, traffic, competition, back road, even parking.

IQs in general, says Dr. Weinfeld, seem to be increasing slowly over the years. There are also seasonal shifts, easily explained: IQs of schoolchildren are higher in the spring than they are in the fall. This is because children who take IQ tests in the spring have a semester and a half of mental limbering up behind them; fall test takers are still rusty after the summer vacation.

There is also, SRA finds, a difference between sexes. Girls do better than boys on Verbal Meaning, Word Fluency, and (sometimes) Reasoning. Boys do better on Space and Numbers.

Because environment has a tremendous influence on IQ, psychologists have been perfecting what they call "nonverbal" tests. SRA's "nonverbal" test was used dramatically in a New York public school attended by Negro and Puerto Rican pupils. Most of these culturally deprived slum children had never been exposed to many good books, much stimulating conversation, or interesting toys. Their average IQ had been measured at 82. The new tests showed that about half the pupils actually were college material!

This New York experience was the springboard for a "Higher Horizon" program launched across the country in big-city schools to discover hidden "brains."

The "nonverbal" tests use geometric forms and pictures to test reasoning, mental alertness, and perception. All the test taker has to do is find the one of a series of four somewhat similar pictures that, for some reason, is different.

"Nonverbal" tests are still new and have a lot of "bugs" that have to be ironed out. But the same is still true of the older IQ tests. While they are constantly altered and changed to make them better, they still have their shortcomings. And the people who use them—teachers, personnel managers, etc.—have to learn to use them properly. But despite all the obvious drawbacks, IQ tests are still the quickest, surest way to get a general idea of how smart anyone is. ★★★

● Russian scientists have discovered that ice-locked harbors can be opened by spreading coal dust. The dark dust readily absorbs the heat from sunlight, which melts the ice underneath.



● The mudskipper is a fish whose behavior resembles that of a frog. It hops about on tropical mud flats and mangrove swamps catching insects. The froglike fish can remain out of water for long periods of time, but returns at intervals to moisten its gills.

that it has a 24,000-mile/24-month written warranty*

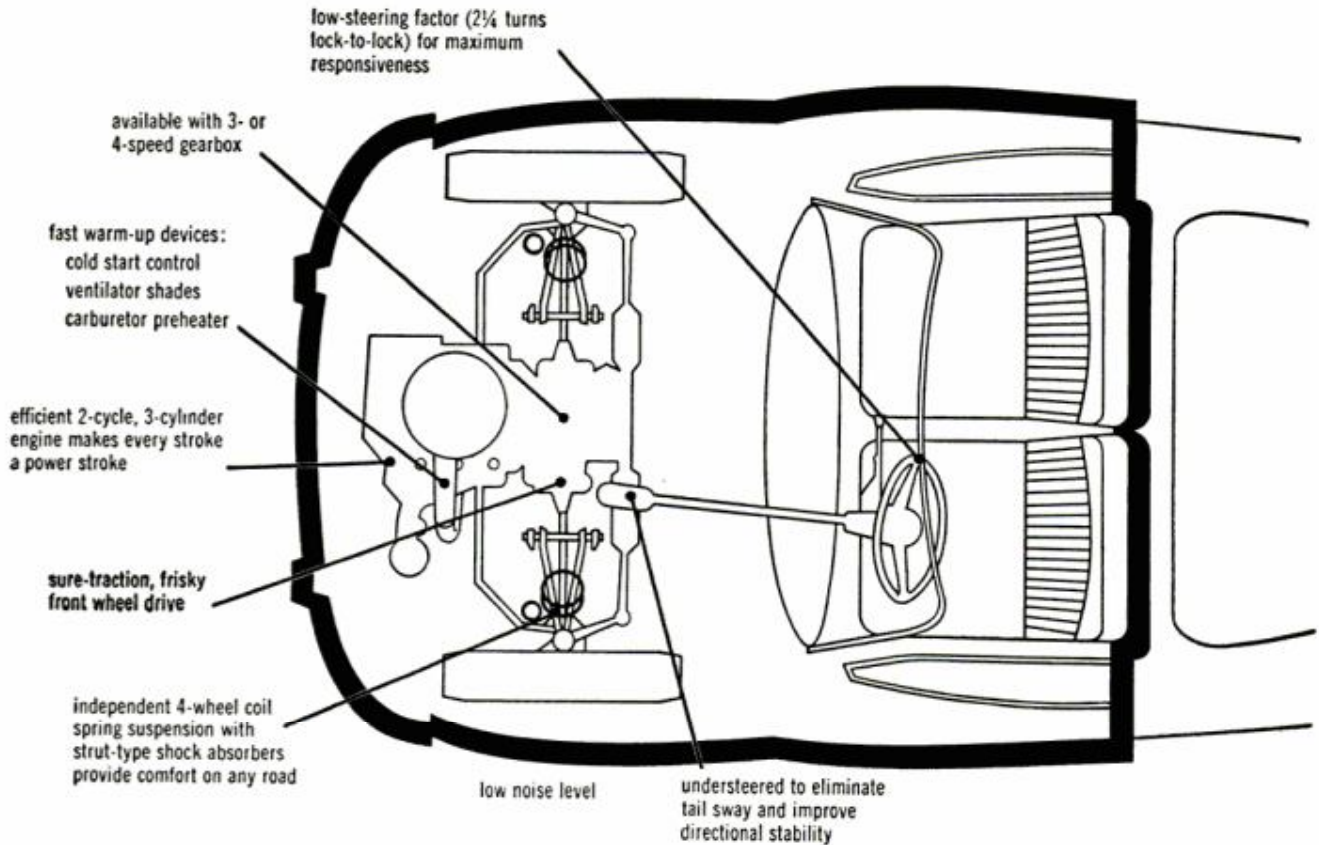

Take a critical look at SAAB performance

Aircraft reliability and performance standards are blended with an entirely new approach to over-all automotive design in the Swedish SAAB 96. This car was built to be better, not different . . . built by one of Europe's leading aircraft manufacturers . . . built for those who

enjoy mechanical excellence, technical uniqueness, and extraordinary craftsmanship.

A critical look at all the facts and specifications will prove that the new SAAB 96 is unquestionably one of the world's best engineered cars.

*Engine, transmission and differential have a written warranty for 2 years or 24,000 miles.



\$1895 P.O.E. (little enough for one of the world's best engineered cars)

Arrange a test drive at your nearest SAAB dealer. Or write for more information—and the SAAB North American Road Atlas, a 64-page comprehensive travel guide valued at \$1.00, but yours for only 25¢ to cover postage and handling. SAAB Motors, Inc., Dept. 510, 405 Park Avenue, New York, New York.



SAAB MOTORS, INC. — NEW YORK • NEW HAVEN • JACKSONVILLE • ST. LOUIS

OCTOBER 1962

237

THE EASIEST WAY IN THE WORLD TO DRIVE AND REMOVE SCREWS

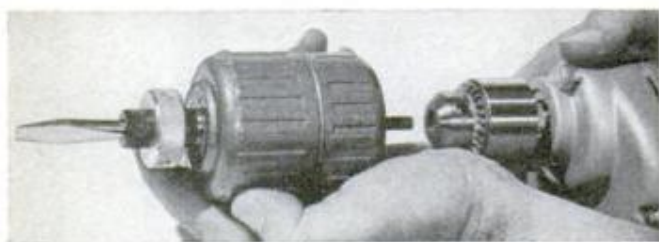

1. After drilling pilot holes simply attach a Versamatic to electric drill. Fits any make.

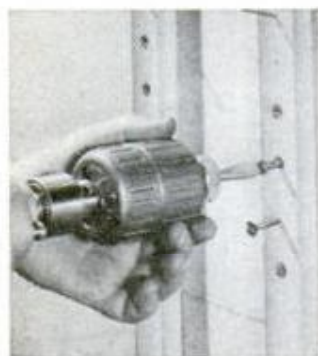

2. Place screw in hole; drive it easily with slight forward pressure . . . hold housing in fingertips.

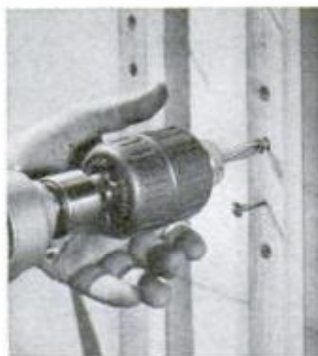

3. Your fingers act as a clutch . . . starting, stopping action instantly. Simple and safe . . . no blisters.

Versamatic puts your power drill into low gear . . .

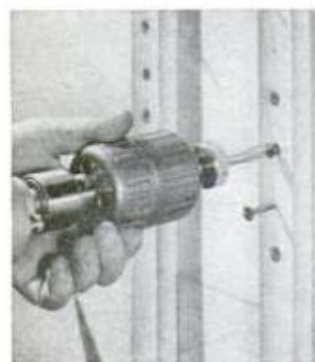

4. Versamatic runs in reverse for removing screws. You won't believe how easy it is until you try it.

by means of 7 to 1
speed reduction.
Gives your drill 7
times more power.

Supreme Versamatic

MADE BY THE MAKERS OF
SUPREME BRAND CHUCKS
SUPREME PRODUCTS
CORPORATION
2222 S. CALUMET, CHICAGO

Sold by leading tool dealers...\$14.95 list

Also . . . ask to see the Supreme **Versamate** . . .
the non-reversing speed reducer . . . just \$9.95

The Longer, Livelier '63s

(Continued from page 102)

Although there was no wheelbase increase on Plymouth, it gained three inches in overall length.

Mechanically, the biggest single change in this group is Chevrolet's all new six-cylinder engine, which displaces 230 cubic inches and develops 140 horsepower at 4400 rpm. Although only six cubic inches smaller in displacement and rated at only five-horsepower less, the new Six is two inches lower and 2.6 inches shorter. It weighs approximately 500 pounds, about 150 pounds less than the engine it replaces.

A short stroke (3.25 inches) and crankshaft with seven main bearings make the new engine smoother and quieter, we found after a test run. Performance is slightly improved due to the reduced weight.

Chevrolet's basic 283-cubic-inch V8 has been increased from 170 to 195 horsepower by raising the compression ratio to 9.25 to 1 and changing the valve timing. This means that owners will have to pay for their power boost in the form of premium gasoline, which the increase in ratio demands. Premium V8s for Chevy are the 327-cubic-inch job at 250 or 300 horsepower and the whole hog job, a 409-cubic-incher with 400 and 425-horsepower ratings for single and dual four-barrel carburetor set-ups, respectively.

Although Chevrolet's external sheet metal and trim are new for '63, the functional change that will be noticed by driver or passengers is a welcome redesign of the windshield and its corner posts. These have been straightened to improve vision and remove the dogleg in the door opening.

Ford Galaxie's external changes are below the window line, which results in a "different sameness" in appearance and no alteration of the passenger compartment. Most notable change is the increase in size of the tail lamps — they're big as wash basins.

Ford's basic 292-cubic-inch Galaxie V8 has been replaced by the new, lighter 260-cubic-inch V8 introduced as a premium engine of 164 horsepower on the Fairlane during the '62 model year. Other Ford V8s are 352, 390 and 406-cubic-inch jobs of 220, 300 and up to 405 horsepower on the performance specials.

On all engines but the 406, standard transmission is Ford's new all-synchromesh job of three forward speeds. This is a first for U.S. built cars and putting it on at no visible extra cost was an admission by a

(Continued on page 240)



Now...
 bucket
 seats
 in the
Scout!

Yes, bucket seat comfort in the SCOUT by INTERNATIONAL, along with easy-access 2-passenger rear seat. This "4-person" roominess is the latest in a long list of SCOUT surprises . . . features that make it the most complete action vehicle you can buy today!

The compact SCOUT goes almost anywhere . . . on the road or off. Its rugged truck-built frame has plenty of ground clearance. 4-cyl. 93 hp. COMANCHE® engine supplies hustle when you want it, muscle when you need it. All-wheel-drive traction keeps the SCOUT rolling up hills, through woods, over trails.

It's a real fun-driving vehicle, especially for hunting, fishing or camping. Load all your equipment in the 78½ cu. ft. of space fully-enclosed by TRAVEL-TOP. Six steel or vinyl-coated tops to choose from. And use your SCOUT with trailer-hitch, winch, 3-point rear-mounted hitch, snow plow. Find out more about it—mail coupon now.

THE *Scout*® by INTERNATIONAL® **IH**®

OCTOBER 1962



Please send me full-color literature with complete information on the SCOUT.

International Harvester Company
 Department PM, P. O. Box 7333
 Chicago 80, Illinois

Name.....

Address.....

City..... State.....

screens, upholstery, carpets...

hundreds of other uses.

You name 'em!



Swingline 101 Staple Gun

Staples practically anything. Exclusive push-button loading and built-in staple extractor. At your stationery, department or hardware store.

only **4⁹⁵**

FREE! New 8-page

SEND FOR YOURS TODAY! "TIPS FOR TACKING" Booklet . . . shows you how to save time, money and effort — with a SWINGLINE AUTOMATIC STAPLE GUN



Swingline INC.

32-00 Skillman Ave., Long Island City 1, New York

CAR-REST



NOW YOU CAN RELAX OR NAP WHILE TRAVELING. CAR-REST

is a new, patented head rest that does not require clamping to the top of the seat. A chrome plated brace rod down the rear of the seat back supports it—no bolts or other permanent attachments are required.

Installed in seconds, easily removed when not in use.

Fits all makes and models. Does not interfere with tipping seat forward.

Plastic foam pad is fabric covered, removable for cleaning. Comes in plain colors: beige, turquoise or cocoa brown. Also in plaids: blue and green, or tan and gold. Please specify color when ordering. Price—\$6.50 postpaid. Send check or money order to

MILLS MANUFACTURING CO. 2725 Bailey St., Dearborn Mich.

DYNAMIC INDUSTRIAL TYPE TRANSFORMER WELDER

WELD-CUT-BRAZE-SOLDER-HEAT IRON-STEEL-BRONZE-BRASS ALUMINUM AND OTHER METALS

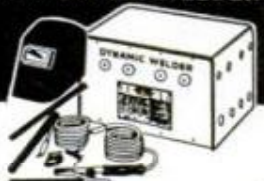

Professional Electric Arc Welder. Ideal for Home, Shop, Farm or Industrial use. The handiest tool in your workshop. Weld, Braze, Solder, Cut, Bend all metals. Do expert work on your first job. Build or repair Boats, Trailers, Auto Bodies, parts, fenders, metal and ornamental iron furniture, fixtures, farm equipment, garden tools, bicycles, toys, etc. Operates on any properly wired 110 V. A.C. line. Complete with helmet, arc torch, electrode holders, flux, rods, cables, instruction book. FULL YEAR GUARANTEE. 10 day money back trial. ONLY \$38.50 f.o.b.

Only \$38.50 f.o.b. Send only \$6.00 check or m.o. Pay postman balance plus charges. EASY PAY PLAN. Low down payment. Pay as you weld.

DYNAMIC WELDER CO. 1808 SOUTH FEDERAL STREET Dept. D2-K, CHICAGO 16, ILL.

major manufacturer that stickshifts are here to stay.

Galaxie has incorporated a crank mounting on the lower control arm of the front suspension which permits the wheel to give slightly. It provides compliance (rearward as well as upward wheel travel) in reaction to bump shock. The same effect is achieved at the rear wheels by a squeezable rubber bushing at the front eyes of the rear springs.

The swivel steering post, introduced on the '62 T-Bird as an option will appear as an option on '63 Ford Galaxies. This is the jointed steering column that swings horizontally to the right for about seven inches.

Pontiac, Olds, Buick, Mercury Monterey and Chrysler. Among these five medium-priced cars, size increases are measured in fractions of inches for '63. Few owners complained in recent years that these cars were too small, so there has been no need for a stretchout.

All three GM medium-priced cars have been restyled with flat side panels giving an almost unbroken sweep of convex curved paneling from headlamp to tail lamp. This does make the cars look longer.

Concave Backlights

All three GM mediums have new windshields with straightline corner posts. Pontiac's Grand Prix and Oldsmobile's Starfire sports coupes share a common two-door hardtop roof with a unique backlight glass running flat from side to side yet concave in profile from top to bottom.

The small quarter window that formerly filled the space between the rear door frame and the backlight glass has disappeared to be replaced by a "blind" metal panel on both sedans and hardtops alike among all cars in this group except the Buick Electra, which still offers a "six-window" sedan.

The blind quarter may be stylish, but it does block some of the driver's backup parking vision.

Chrysler has reduced the size of its front compartment floor tunnels by eliminating the driveshaft parking brake. By moving the engine forward, Oldsmobile has cut the front tunnel in half and reduced the base width of the rear seat tunnel by four inches.

Adjustable Steering Wheel

As an option available with power steering only, Olds has a Tilt-Away steering wheel. It is mounted on a universal joint at the hub so it may be moved vertically through a seven-position arc by the release of a lever. By permitting a change in driving position, this might reduce fatigue on long trips. The tilting wheel option is also available on Pontiac, Buick and Buick

(Continued on page 242)

WOODS CONSTANTINE'S

Whether you work with wood for fun or profit, you're sure to find *everything* you need in the World's most Complete Source for rare, imported and domestic woods, in veneer, lumber and plywood... inlays, pre-cut picture kits, furniture hardware, finishing and upholstery supplies, tools, BIG ALL-NEW CATALOG and MANUAL. 132 value-packed pages, many in full color, of exciting new items. Over 2,000 in all. Send 25c for Big Catalog and Manual today... NOW! **ALBERT CONSTANTINE & SON, Inc.** 2050 Eastchester Rd., Dept. P-5, New York 61, N.Y.

NEW MAGIC RADIO WALKIE TALKIE!



TALK TO ANYONE ANYWHERE BY RADIO! Sends your voice to any car or house radio. Works up to 1-2 miles from car to car or 1-3 or more blocks house to house depending on local conditions. Just Push Button to Talk—No Complicated Hookups or Wires—Anyone can use it. Transistor powered by flashlight batteries. No License or Permits Needed. Guaranteed to Work. 1 yr. Service Guarantee. Should Last for Years!
SEND ONLY \$3.00 (cash, ck, mo) and pay postman \$9.95 C.O.D. postage or send \$12.99 for postpaid delivery. Ready to operate, with clear instructions. Order your Radio-Talkie today—Now! **WESTERN RADIO, Dept. TPM-10, Kearney, Nebr.**

DRAINS cellars, cisterns, wash tubs; \$7.95 IRRIGATES - CIRCULATES - SPRAYS



1,001 uses. Stainless shaft. Won't rust or clog! Use 1/6 HP motor or larger... 3/4 HP for up to 2,400 GPH; 450 GPH 80' high; or 1800 GPH from 25' well. 1" inlet; 3/4" outlet. Coupling included free. \$7.95.
HEAVY DUTY BALL-BEARING PUMP. Up to 5,200 GPH; or 3,000 GPH from 25' well. 1 1/4" inlet; 1" outlet. \$12.95 Postpaid if cash with order. **MONEY BACK GUARANTEE**

Centrifugal and Gear Pumps in All Sizes

LABAWCO PUMPS, Belle Mead 7, New Jersey

Gremlins warm your parked car.

The tricky new robot that starts the engine of a parked car, and shuts it off when the block reaches 125° F., is described in November PM. It's theft-proof, too.

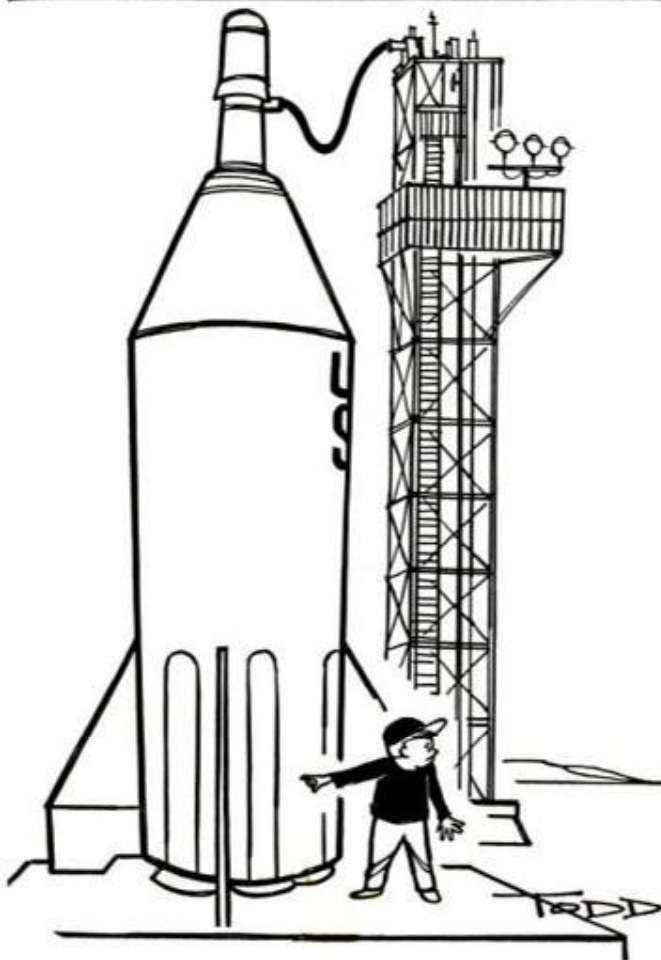

PROTECT AGAINST IMPROPER VOLTAGE THAT CAN SERIOUSLY DAMAGE YOUR CAR

Install a New

HOLLEY PEP[®] VOLTAGE REGULATOR

FOR ALL
U.S. CARS,
TRUCKS—
6-V OR 12-V



IF YOUR CAR'S voltage regulator is defective, it will pay you to replace it now with a new Holley PEP Voltage Regulator, and avoid costly damage to the battery and other electrical components. Holley PEP Voltage Regulators are designed for *Preferred Electrical Performance*, backed by Holley's long reputation for quality. They are fully temperature compensated, individually calibrated and tested for performance and accuracy. There's a Holley PEP Voltage Regulator to fit your car or truck!

®Registered Trademark

HOLLEY
Carburetor Co.

C-10

11955 E. Nine Mile Road • Warren, Michigan

DISSTON



EASY CUT!

You never saw a saw saw like a Disston saw saws

Here's a saw that's built to meet the demanding specifications of professional carpenters. Put its tough steel blade to the test. You'll never see an easier cut, because nobody tempers, smiths and grinds metal like Disston. Grip a Disston. Note how good the perfect balance feels—the result of more than 120 years of crafting *the saws most carpenters use*. Disston—Master Toolmaker since 1840.



THIS IS THE DISSTON D-23—a lightweight, straight-back handsaw. Weather-proofed handle. Available in 16", 20", 24", 26" lengths; 5½ to 12 points. Suggested retail price: \$9.75. Ask your Dad about Disston saws.

Disston also manufactures a full line of circular and sabre saws.

Disston Division, H. K. Porter Company, Inc., Porter Building, Pittsburgh 19, Pa.

PORTER

DISSTON DIVISION

H. K. PORTER COMPANY, INC.

Riviera. Add in the Mercury Monterey swing-away wheel and it looks as if there will never be a dull moment in the driver's seat next year.

Pontiac engineers have improved foundry techniques on the 389-cubic-inch V8 that's standard on all models. As a result, both cylinder heads and block casting are lighter. Heads have been redesigned to increase power output.

Pontiac's much-heralded wide track has been made 1.5 inches wider at the rear and rear suspension control arms have been changed and given new rubber bushings for a softer ride. Up front the steel control arm bushing has been replaced with rubber; this softens the action and eliminates lubrication points. Brakes are self-adjusting and Delcotron alternators are standard.

Pontiac retains a two-barrel, low-compression ratio (8.6 to 1) version of its engine teamed with either manual or Hydra-Matic transmissions for those who appreciate the economy of regular grade fuels. It puts out over 200 horsepower (the exact rating will be announced later) which is plenty for family style touring, even in 3900-pound Pontiacs.

More Trouble-Free Speedometers

Olds has come up with an innovation that may spread throughout the industry. The speedometer is driven by direct cable connection with the left front wheel via a hollow spindle. Coupling between drive cable and wheel is made at a nylon block embedded in the bearing dust cap. The advantage is a smooth kink-free cable route and elimination of various sets of speedometer drive gears needed to match different rear axle ratios. With the new system, only two gearsets in the head (behind the panel) are required, one for each tire size.

Changes in the three regular series of Buicks are minor—a switch to Delcotron alternator, lifetime greasing of front suspension upper arm pivots, lighter weight rear axle and positive (vacuum valve controlled) crankcase ventilation system.

Chrysler's big story is in the transformation in styling made by the new exterior sheet metal and new roofs.

All traces of the old Forward Look are gone, including the rear fenders that looked amputated in 1962 when the fins were "left off." The only external item on the car that's unchanged is the windshield glass and its corner posts.

A new instrument panel with a full set of round-dial, readable gauges has made a big improvement. With the move from transmission-mounted parking brake to

(Continued on page 244)

POPULAR MECHANICS

PLANER • MOLDER • SAW!



Now you can use this ONE power-feed shop to turn rough lumber into moldings, trim, flooring, furniture... ALL popular patterns. RIP... PLANE... MOLD... separately or all at once with a one HP motor. Use 3 to 5 HP for high speed output. Low Cost... You can own this power tool for only \$30.00 down payment.

Send postcard today for complete facts.
BELSAW POWER TOOLS, 903 Field Bldg., Kansas City 11, Missouri

UNUSUAL TOOLS BY MAIL



DRILL GRINDER

Sharpens round shank drills like new with hand or power grinders. \$2.95 p.p.d.



EASY SAW FILER

No. 11 Gives correct height, depth, pitch, bevel to any 6" to 10" hand or circular saw with no side pull. Includes 8" file. \$9.95 p.p.d.



NO. 44 CORNER CLAMP & MITER BOX COMBINED

Adjustable to any angle. Accurate cuts with any handsaw from 0° to 180°. Full 3" capacity. Sides exposed for nailing and gluing. \$2.75. No. 33 corner clamp, only, \$1.75 p.p.d.

SAW SET

automatically sets teeth at 10° or more \$2.95 p.p.d.



WRITE FOR FREE CATALOG

A. D. McBURNEY, 5908. Hollywood Blvd., Hollywood 28, Cal. Dept. A102



Flecto Varathane Outlasts Varnish 2 to 1

Flecto Varathane is a remarkable new clear plastic finish

that dries dust-free in minutes, and lasts *twice* as long as varnish.

Flows right on *any* kind of wood, inside or out. Needs no sealer. Put it on siding, floors, kitchen cabinets, furniture, even boats. Comes in glossy or satin finish, regular can or easy-to-use aerosol container for quick touch-ups.

Note to users: Clean brush and equipment with mineral spirits. First coat covers 500 sq. ft. per gallon. Second coat covers 600-800 sq. ft.

If your nearby paint, hardware or building supply dealer doesn't carry it yet - or for free brochure - contact...

The Flecto Company, Dept. P. M., Box 84, Berkeley 2, Calif.
Flecto Coatings, Ltd., 8850 Selkirk, Vancouver, B. C.

SPECIAL OFFER FOR OCTOBER



T-50 ALL PURPOSE STAPLE GUN

SHOOTS
A STAPLE WHEREVER
YOU'D DRIVE A NAIL!

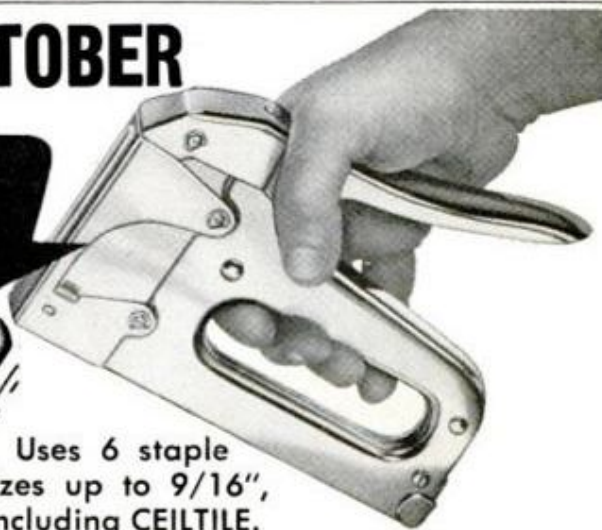

Uses 6 staple sizes up to 9/16", including CEILTILE.

1001 HANDY USES for this heavy duty ARROW Automatic Nailing Tool in and around the house! Saves time and labor applying insulation, ceiling tile, screen, weatherstripping, etc.

COMBINED Retail Value: \$13.50
BOTH only \$12.50 (Reg. Price of Gun)



FREE!
\$1.00
STAPLE LIFTER
with purchase of
T-50 Staple Gun

ARROW FASTENER CO., INC. Brooklyn 12, N. Y.

Available at HARDWARE, LUMBER, BUILDING SUPPLY & STATIONERY STORES EVERYWHERE.

EVERLITE* World's THRIFTIEST Light Plants

(Item 869-10T)

NEW TRANSISTOR ALTERNATOR REPLACES GENERATOR



Now a Service Free Light Plant built with a transistorized alternator. Offers 30% greater efficiency—more power for less fuel. Terrific service life—no brushes to arc and burn. No more commutator to wear, no collector ring trouble. And best of all it costs no more to "go modern with Everlite." Thrifty 1000 watt, 115v. AC plant powered by a rugged easy starting 4 cycle engine—leader priced. Model 869-10T. Wt. 65 lbs. as illustrated **\$179.50** fob factory

*Trade-Mark Registered

All sizes available—can finance. Write for catalog. Special models for public utilities—Approved for Civil Defense. Write.

STANDARD DIAL PHONES

Western Electric late model dial phones same as used by all telephone companies. Ideal as extensions on any system. Easy to connect. Several may be connected on one line. Easily modified for private inter-com system. Cost \$40.00 new—guaranteed excellent condition.



ITEM 855 NC, Wt. 8 lbs. **\$6.95**

HEATING AND VENTILATING FAN

(Item 10) Easily installed in furnace pipes. Forces even heat to all rooms. Over range removes kitchen smoke and odors. Powerful, continuous duty motor, 110-120 v. AC. Mount in wall or ceiling to ventilate any area. Quiet, super-efficient fan moves huge volume of air. (400 to 600 CFM).

8" Pipe, wt. 5 lb. **\$6.85**
 9" Pipe, wt. 6 lb. **\$7.85**
 10" Pipe, wt. 7 lb. **\$8.85**
 12" Pipe, wt. 8 lb. **\$9.85**



HEAVY DUTY FAN. Semi-enclosed motor, suitable for spray booths, restaurant exhausts, poultry houses, etc.
 10" Fan, wt. 8 lbs. (Item 10E) **\$11.95**
 12" Fan, wt. 10 lbs. (Item 10D) **\$12.95**

Send 10c for 100 page Catalog FREE with order. Prices f.o.b. factory—send check or M.O.

MASTER MECHANIC MFG. CO., Dept. A-102, Burlington, Wis.

Southern Customers write Dept. A-102, Box 65, Sarasota, Florida

FREE FLORIDA FISHING GUIDE

A gold mine of information for anglers and travelers. Huge color wall map unlocks secrets of world's most fabulous fishing! Perfect for display in home or office.

Tells *how* and *where* to catch the big ones. Includes giant road map pinpointing every major attraction, scenic spot, historical monument. Free—while supply lasts.

ACT NOW. Send for it TODAY!

FLORIDA FISHING & ROAD GUIDE

557 N.E. 81st St. 5 VE-5
 Miami 38, Florida

OK—please rush my FREE Fishing & Road Guide

NAME.....

ADDRESS.....

CITY.....ZONE.....STATE.....

AD 58022 (Q12)

CC 416 A

cable operation of rear brake shoes, Chrysler has added a parking lock to the automatic transmission controls.

Standard transmission on Newport is a three-speed floor shift. Chrysler claims that their new body structures are more rigid and durable. After a short road test PM is inclined to agree that almost all traces of body shake on rough roads are gone.

Among the Bucket Seat Specials, Studebaker's Hawk and Avanti, Thunderbird, Buick Riviera and Corvette, the last two are the big news items (PM tested the Avanti in the August 1962 issue, p. 74).

Underneath its sleek and exciting body shell the Riviera carries pretty much standard Buick hardware. True, overall length is seven inches shorter and the frame is six inches shorter in wheelbase than the LeSabre and Invicta, but the frame is still a wasp-waisted X-member structure that's typically Buick. The front and rear tread are two inches narrower than on the conventional Buicks.

The Riviera—How Sporty?

Weight is distributed 53 percent front and 47 percent rear. This balance gives rather good handling considering that the car is neither intended for nor billed as a sports racing machine. Steering is available only with power assist, but the 3.5 turns lock to lock makes the Riviera exceptionally responsive.

After a short road test, we decided that with much firmer shock absorbers and perhaps a stiffer front anti-roll bar, it would make a very creditable sports touring car. Sporty types will be very comfortable but not happy in the Riviera in that there is no four-speed (or even three-speed) manual transmission to play games with.

Stick shift or no, the Riviera has straight-away performance aplenty with a 425-cubic-inch engine rated at 340 horsepower. An informal check showed acceleration to 60 from standstill in the area of 7.5 seconds. That's for a loaded car with air conditioning.

Underslung Corvette

Real sports will rejoice when they take their first spin behind the wheel of the '63 Corvette, literally all-new with the exception of the engine and transmission. And even the engine has a redesigned fuel injection system.

An entirely new box section frame gets all weight as near to the road as possible; this includes the passengers, as the car sits only 49 inches high. Yet the modified buckets are comfortable and there's headroom

(Continued on page 246)

END NUT and BOLT HANGOVERS

DOT Teenuts

Can't Slip . . . Steel Threads in Wood
Flush-Mounted . . . Strong . . . Versatile!
The **One** Nut That Makes Sense!



Ideal for permanent work or where easy "knock-down" feature is wanted. Available to fit standard thread bolt sizes: 6-32, 8-32, 10-24, 10-32, 1/4-20, 5/16-18, 3/8-16. Available at

hardware dealers. If not, send \$1 for special mail order package and name of nearest distributor. Specify size.

COLUMBIA FASTENER COMPANY
3229 South Ashland Ave. • Dept. PM • Chicago 8, Illinois

Hook your sander to a lathe, and enjoy dustless sanding with a vacuum cleaner attachment. The way to make this belt-sanding rig can be found in November PM.

KROIL LOOSENS RUSTY FROZEN PARTS

creeps in



Frozen bolts, pipe threads, bearings, etc., yield to Kroil, the chemical lubricant that creeps into millionth inch spaces, dissolves rust and dried grease. Harmless to metal or skin — used by 25,000 shops for 20 years. Now available in half-pint spout cans, 65c at your dealer.

KAND

LABORATORIES, Nashville 11, Tennessee

Now there's a plastic wood filler that fills holes easier and sands smooth faster!



better buy **DURATITE®**
WOOD DOUGH

Molds like dough,
hardens into wood

Write for free Wood Dough folder

DURATITE Division 12, DAP inc., Dayton 31, Ohio

Build a
**BANK
ACCOUNT**
with
Workshop
Savings

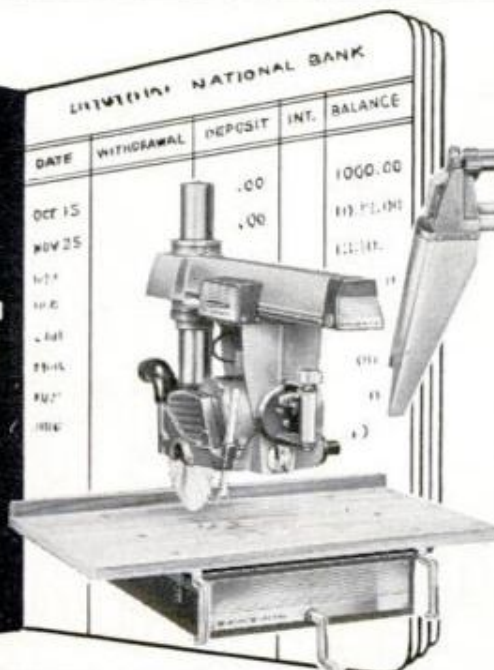

SHOPSMITH

Complete multi-purpose power shop: saw, lathe, horizontal drill, vertical drill press and sander . . . all in one!

SAWSMITH

World's most versatile radial arm shop. Performs 14 basic wood and metalworking jobs.

Either SHOPSMITH or SAWSMITH costs about 1/3 the price you'd pay for single purpose tools to do the same operations . . . less than the labor charge on a single home improvement job! Work with professional

skill and accuracy to build beautiful furniture, panel rooms, enclose porches, install efficient "built-ins." Live better today . . . bank more for tomorrow. Enjoy saving with SHOPSMITH or SAWSMITH!



Ask about **DREAM SHOP Contest**
AMERICAN CORPORATION

Interstate 75—Evendale, Cincinnati 15, Ohio

GET FREE BOOK—
"Practical Power Tool Projects"
at better power tool dealers
and Montgomery Ward.

NOW! FAMOUS SAVAGE MODEL 110 ACTIONS



You can custom build a rifle to your own specifications with the Savage One-Ten, America's finest bolt action.

No conversion needed—you can make your own brand-new sporter, bench rest or varmint rifle.

First completely new bolt action in years, the One-Ten is the only American-made rifle available as an action in both right and left-hand models. Precision head-spacing, double front locking lugs, top tang safety and other unique features. Calibers .243, .270, .308 and .30-06. Parts and service always readily obtainable.

One-Ten barreled actions are available through your sporting arms dealer. Right-hand, \$84.00; left-hand, \$88.50. For actions only, see your gunsmith or write Savage Arms, Westfield 130, Massachusetts.

model 110 actions by
Savage 

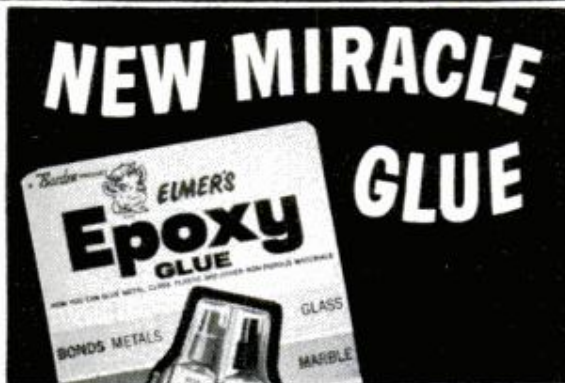

for metals, glass, china, tile, most plastics, other non-porous materials
It's Elmer's new Epoxy glue—the new wonder-glue—the “stickingest” glue made especially for non-porous surfaces. The molecules of the Epoxy bond with those of the surface to be repaired. Dries clear, strong, and waterproof. Send stamped, self-addressed envelope for your FREE copy of ELMER'S WOOD-GLUING HANDBOOK. Elmer, The Borden Company, Dept. PM-102, 350 Madison Avenue, New York 17, New York. (Available in Canada.)

in the coupe for over six-footers.

The car is so low that the driveshaft actually passes *above* two of the frame members on its way back to the chassis mounted differential. Drive is by double U-jointed swing axles to independently suspended rear wheels which are linked to the chassis by fore-and-aft torque arms. The wheels are also positioned laterally by the axles in combination with pivoted cross links acting together as a parallelogram, with unequal length arms which hold the wheels at a constant angle relative to the body. This suspension controls “rear axle steering” effects to the driver's advantage.

Corvette Test Run

Rear springing is by a single transverse leaf spring linked to the torque arms. We found out in a brief but memorable test run that if the '63 Corvette tends to drift out when cornering at really high speeds you need only downshift and dump more power to the rear wheels and the car will bore its way tighter in the direction that you want it to go. Also contributing to the car's ease of control is a weight distribution with rear bias. Corvette's front suspension is adapted from 1962-3 Chevrolet parts so located as to complement the unique rear suspension.

An interesting steering system involves dual mounting points on pitman arm and idler arm for the relay and tie rod assembly, so that you can “quicken” the stock steering from an overall ratio of 19.6 to 1 down to 17.0 to 1 by moving two bolts. The steering also has another first for modern U.S. production cars — a steering damper or shock absorber between the frame and tie rods. The steering wheel, incidentally, is adjustable on a splined shaft through a three-inch travel in or out to suit driver size and preference.

Lincoln Continental, the only one of the three luxury cars to be dealt with in this issue of PM, has incurred a number of changes for '63. The grille pattern is new, and the rear deck lid has been redesigned to add 1.3 cubic feet of space. Under the hood a new four-barrel carburetor mounts the primary barrels directly over the intake manifold so that 90 percent of the time the carburetor acts as if it were a simple two-barrel model. The booster barrels don't cut in until you top 75 miles per hour. A 40-amp alternator has replaced the generator and aluminum front brake drums have been added to increase fade resistance. ★★★

● One million earthquakes may occur in a single year. Though some cause great damage and loss of life, most are harmless.

Weld. Cable No. 1, 100' \$19.00, 50' \$9.95
Arc Stabilizer for R-1, P-1 or G-1
 G-1, 160-250A gen. \$12.95, R-1 300 Amp \$16.50, Throttle Solenoid \$7.95

Accessories Kit For Arc Welder for above generators has helmet, gloves, elect. holder, volt reg. rheostat, voltmeter, Gr. Clamp, switch, 30' cable & G-1 gen. 160-250 Amp. . . . \$29.50
 R-1 300 Amp. Gen. with accessories kit plus reactor coil \$44.50

AC DC gen. G.E. rated 1250 watts AC, 200 Amp. DC, plus Accessories kit \$38.50

24-12V DC MOTORS
 (+15% p.p.) *Reversible

H.P.	Amp.	RPM	Price
1/4	8.4	2500	\$4.95
1/8	6.5	2500	\$4.50

Delco 1/4 8 amp 2500 \$5.50
 Dumore 1/8 AC DC w/34:1 red. \$4.95
 Pesco 3-HP, 250A 2300 \$7.95 with 10:1 gear reduction \$12.95

400 GPH pump with Motor, 1/4 HP 24-12VDC. For hydraulic, fuel or water (specify) . . . \$7.95

HYDRAULIC SNOW PLOW LIFT KIT
 Consists of 1 Stratopower hyd. pump, .450 cu. in. 1400PSI, drive from engine or power take off, 1 DA cyl. 1 1/2" bore X 8 1/2" stroke, control valve, tank, filter, hose & fittings \$43.50

NEW HYDRAULIC CYLINDERS
 Hvy Duty 2000 P.S.I. Air-oil
 FOB KC under 20 lbs. add 15% PP

Bore	Stroke	D. Shaft	Long	Double Action	Price
1"	1 1/2"	1/2"	6 1/2"	1 1/2 lbs.	\$ 2.75
1 1/8"	2 3/4"	1/2"	9"	2 lbs.	\$ 2.95
1 3/8"	3 3/4"	3/8"	13"	5 lbs.	\$ 3.50
1 1/2"	24 1/2"	3/8"	34"	6 lbs.	\$ 8.95
1 1/2"	4 1/2"	1 1/8"	10"	3 1/2 lbs.	\$ 2.95
1 5/8"	2 5/8"	1"	38"	11 lbs.	\$10.95
1 3/4"	8 1/2"	3/4"	13"	8 lbs.	\$ 6.95
2"	6 1/2"	9/16"	17 1/2"	6 1/2 lbs.	\$ 6.75
2 1/8"	15 1/2"	1 1/4"	30"	11 lbs.	\$14.50
2 3/8"	13"	1 1/4"	33"	16 1/4 lbs.	\$16.75
3"	10 1/4"	1 1/2"	19"	15 lbs.	\$12.95
3 1/4"	10 1/2"	2 1/8"	23"	29 lbs.	\$14.50
3 1/2"	9"	1"	21"	12 1/2 lbs.	\$12.95
3 3/8"	10"	1 1/4"	27"	22 lbs.	\$15.50
4 1/2"	10 3/4"	1 3/8"	23"	15 lbs.	\$21.50
4 7/8"	8"	2"	22"	35 lbs.	\$22.50

***HYDRAULIC PUMP BARGAINS 1500 PSI.**

GPH	RPM	gear type	Price
*Pesco 400	447	4500	\$9.95
*Pesco 165	172	1250	\$6.75
Hand Pump 1.5 cu. in. p. stroke			\$6.75
Vickers P. Disp. 375	.410	3750	\$17.50

Bendix Vacuum Air pump 17C.F.M. 24" HG Press 20" HG suction. New \$9.95

New open center 4 way control valve #10060 with adj relief for 1 to 4 D.A. cyl. 3/8" ports \$12.95. New Hyd. Solenoid control valves 3 way 12-24 VDC 1500 PSI \$6.95 per pair.

24-12V. D.C. Electric Hydraulic Lift Kit.
 Ideal for operating light blades, plows, etc. for lifting, turning, push & pull. Has 24-12V. D.C. reversible motor, reversible electric pump, 1000PSI, 1 D.A. cylinder 2 3/8" bore x 13" stroke, 1" shaft, oil reservoir, reversing switch, Max. lift cap. 900 lbs. 3 Way solenoid control valve, hose & fittings. Size 15" x 10" x 10". Wt. 40 lbs. complete ready to operate, \$104.50 value. Price \$44.50.

***New Hyd Accumulators 3000 PSI.**

50 cu. in. 11" L x 3 1/2" D	6 lbs.	\$ 8.95
100 cu. in. 21" L x 3 3/4" D	15 lbs.	12.95
200 cu. in. 36" L x 3 1/2" D	15 lbs.	14.50

*Sliding piston type Bendix.

NEW HYDRAULIC SYSTEM KIT
 #400 K heavy duty Power driven, rated 16,000 lbs. lift. Consists of 2 D.A. hyd Cylinders 3 1/2" bore x 21 5/8" stroke ea. rated 8000 lbs. ea. with 1000 PSI, 1 four way hyd control valve with relief, 1 Vickers .410 cu. in. hyd pump 375 GPH 1000-1500 PSI 3750 RPM, filter, hose & fittings. Value \$169.95. Kit Price \$79.95

GENERAL SALVAGE CO Check or M.O.
 2922 E. 27 St., Dept. 110, Kansas City 27, Mo.

BUY GREAT NECK HAND TOOLS
 . . . for long-lasting performance

Precision Balanced NAIL HAMMER



One-piece, forged steel, rubber-cushioned, no-slip grip

GREAT NECK SAW MFRS., Inc.
 MINEOLA, N. Y. — SEE YOUR LOCAL STORE

RETARDED CHILDREN CAN BE HELPED



SUPPORT YOUR LOCAL ASSOCIATION FOR RETARDED CHILDREN

REPAIRING OR REMODELING? All the subjects in Popular Mechanics books, booklets, plans and patterns are listed in our free Service File. Write Service Bureau, Popular Mechanics, 740 Rush St., Chicago 11, Ill.

BETTER than PUTTY!

RUTLAND Glazing Compound remains semiplastic underneath. Insures easy removal of broken glass plus protection against shock. Will not sag, crack or pull away.



other quality
RUTLAND PRODUCTS
 Caulking Compound
 KEX Spackling
 Patching Plaster
 Concrete Patcher



RUTLAND FIRE CLAY CO. Rutland, Vt.

Ask For —

CHANNEL LOCK

THE HANDIEST PLIERS OF THEM ALL

When It Needs Oiling IT NEEDS 3-IN-ONE® OIL

All-purpose 3-IN-ONE OIL cleans, oils, prevents rust. A superfine oil that doesn't gum up like heavier oils. 3-IN-ONE is 'oil-right.'

NEW CATALOG

WOOD

Everything for the Craftsman
 Over 1,500 Items
 Finest Domestic and Imported Woods . . .
 Kits . . . Ornaments . . . Tools . . . Special Hardware . . . Tile, LOW MONEY-SAVING PRICES
 Stanley Power Tools — Big Discounts!

Workshop Supplies, Equipment
 Send for Craftsman's NEW 132-page catalog . . . get big discount prices on Stanley Power tools! Finest kiln-dried domestic and imported woods, wood and metal legs, ornaments. Over 1,500 items! Big values on tools, craftsman hardware, Mosaic Tile, upholstery supplies, lamp parts. **Glue Injector**. Send 25c to help pay postage and handling.
Craftsman Wood Service, Dept. A10
 2729 S. Mary St., Chicago 8, Ill.

MAIL COUPON NOW!

CRAFTSMAN WOOD SERVICE CO., Dept. A-10
 2729 South Mary Street, Chicago 8, Illinois
 Enclose find 25c. Rush new CRAFTSMAN Wood Catalog.

NAME _____
 ADDRESS _____
 CITY _____ ZONE _____ STATE _____

Shopping for tools

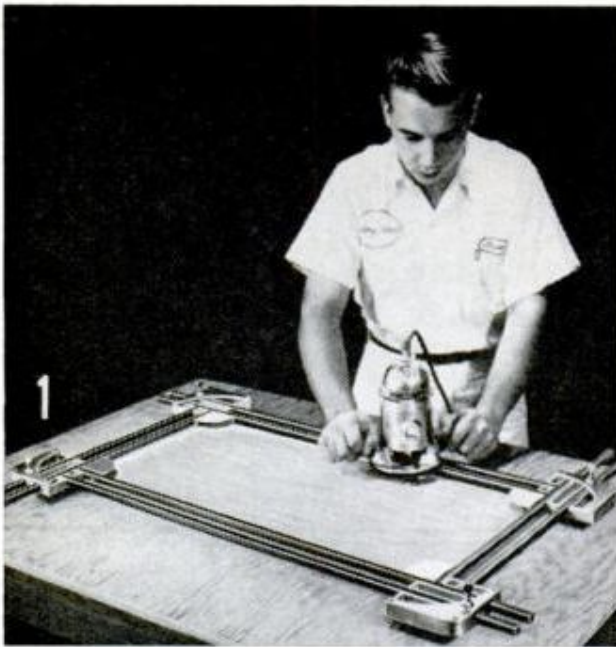

1. ROUTER TEMPLATE, or jig, simplifies routing of ornamental designs on doors, drawer fronts and panels of radio and TV cabinets, hi-fi consoles, break-fronts and other furniture requiring ornamentation. It's precision built, having a frame of steel tubing, aluminum fittings. Adjusts from 3½ x 3½ to 24 x 36 in. Wing Cabinet Co., 805 Farmer Ave., Tempe, Ariz.

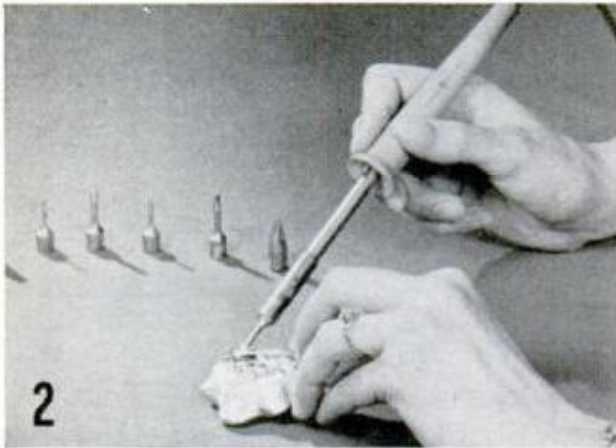

2. PEN-SIZE SOLDERING IRON features 20 different tips for its 40-watt heater assembly. Developed primarily for electronic equipment manufacturers, this iron with its interchangeable tips is now available for use by radio and TV servicemen for the intricate soldering jobs necessary in repair of electronic units. General Electric Co., Schenectady 5, N. Y.

3. WINCH-HOIST COMBINATION weighs only 6½ lb., will lift, pull, lower and skid loads up to 2000 lb. Has full circle ratchet with a safety pawl of positive action. Comes equipped with 16 ft. of aircraft-quality cable having forged steel hooks. Full 16-ft. lift. Moving parts turn in nylon bearings. Price \$29.95. Comet Industries, 801 Elm Place, Richmond, Ind.

4. HEAVY-DUTY TACKER handles 12 sizes of staples without adjustment. Takes staples in a size range from 11/64 to 9/16 in. and made of such materials as flat-steel wire, phosphor bronze, tinned copper and cement-coated steel. Tacks anything tackable from ceiling tiles to upholstery coverings. Made by Markwell Mfg. Co., 424 W. 33rd St., New York 1, N. Y.

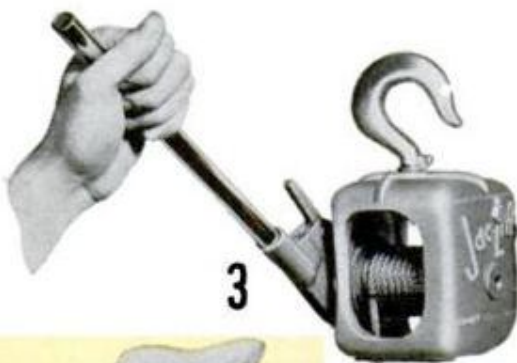

5. ELECTRIC WINCH operates from any 12-volt battery, has a lift capacity of 2500 lb. The unit is 22 in. long, 9 in. wide, 8 in. high and weighs only 66 lb. Has heavy duty mounting base with an outboard bearing for spool, or winding drum. Gear reduction is 160 to 1. Handles 250 ft. of ¼-in. cable. Priced at \$69.50. Airborne Sales, 8501 Stellar Drive, Culver City, Calif.

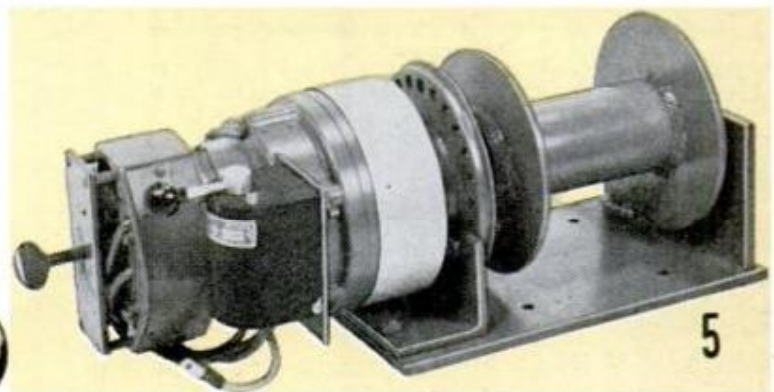

ELECTRIC WELD - BRAZE & CUT

REPAIR MOST EVERYTHING MADE OF METAL

Home Appliances. Auto parts. Make and repair lawn chairs, tables, ornamental iron work, gates, wagons, etc. Solder, heat, bend, and straighten, with terrific heat from arc torch. Cut and weld up to 1/4" steel plate. A million uses for Home, auto, farm, inventors, factories, etc. Works from any home 110 volt plug-in. Complete with dark welder's mask, arc torch, supply of carbon steel welding and brazing rods and complete Welding Instruction Book. 1 year guarantee.

SEND ONLY \$3 (cash, ck. mo.) and pay postman \$11.95 plus COD postage on arrival or send \$14.95 and we will send postpaid. Ideal gift for mechanically minded, relatives, friends. Order now. Available only from:

MIDWAY WELDER, Dept. DPM-10, Kearney, Neb.



New ALVA ALLEN Power Punch Press HANDBOOK Catalog

100 pages. Shows 1 to 25 Ton Capacity Punch Presses in hundreds of different model combinations. Full of general detail information on Punch Presses. Gives information on accessories as—Feeds, Punch Units, etc. Most complete Punch Press and Accessories Handbook Catalog. \$1.00 postpaid. Alva Allen Industries, Dept PM, Clinton, Mo.

Fifteen Christmas gifts you can make yourself, include everything from tape and stamp dispensers for mom and hammered fruit bowls for Aunt Hattie, to a self-storing doll-house and a king's castle for the kids. Watch for these ideas, complete with working plans, in November PM.



GUNK® removes grease -- scourfully!
cleans -- degreases -- freshens



- power mowers • engines
- cement floors • kitchen walls • ovens • exhaust ducts
- paint brushes • furnace filters • barbecue grills
- implements • machinery

AT AUTO SUPPLY, FARM & HARDWARE STORES!

GUNK CHICAGO CO., River Forest, Illinois
serving the Midwest and Southwest
RADIATOR SPECIALTY CO., Charlotte, N.C.
serving the East, Southeast and far West

Starrett

SATIN CHROME MICROMETERS

with FRICTION THIMBLE*
AND NEW EASY READING
STAGGERED GRADUATIONS



FRICTION THIMBLE — an improved friction stop mechanism built right into the thimble for easy, one-hand operation. Insures uniform contact pressure. You get the same sure accuracy in every measurement. *A standard feature on Starrett micrometers since 1936. Also available with Ratchet Stop or Plain Thimble.

NEW SLEEVE DESIGN — with staggered lines for more precise, easy readability. SATIN-CHROME finish plus crisp, black figures and straight-line graduations make reading easy in any light.

OTHER BIG FEATURES — knurled, non-distorting uniform-pressure ring-type locknut; lapped high-micro finish on anvil and spindle; hardened and ground threads on one-piece spindle, tapered frame.

Ask your Industrial Supply Distributor or Tool Dealer to demonstrate these and many other precision features . . . or write for Catalog No. 27. Please use the coupon.

STARRETT TOOLS are carried by
leading Industrial Supply Distributors
and Hardware Tool Stores.

THE L. S. STARRETT COMPANY
Dept. AP, Athol, Massachusetts, U. S. A.

Please send my free copy of Starrett Catalog No. 27 describing Starrett SATIN-CHROME Micrometers and over 3000 other fine precision tools.

Name _____

Occupation _____

Address _____

City _____ Zone _____ State _____

faster
snow
removal
at
less cost
with

Less time per snow plow job, more jobs per day with a dependable, quick-acting Monarch Control. Instant up-and-down action from the cab with a flick of the wrist... automatically! Quickly installed. Don't delay — see your dealer today. Free folder on request.



MONARCH

POWER HYDRAULIC CONTROLS



HY-LO JACK
Fan Belt Driven



DYNA-MIGHT
Battery Operated

MONARCH ROAD MACHINERY COMPANY

1363 Michigan St., N.E., Grand Rapids 3, Mich., USA

WAR SURPLUS AND OTHER BARGAINS SAVE UP TO 90%



HYDRAULIC PUMP & MOUNTING BASE

Pump has built-in pressure relief in head, positive displacement piston-type. Rated 1400 PSI @ 2 gal. per min. Continuous duty @ 1500 RPM. Rotates in either direction without adjustment. Base mounts directly to front flange of pump, has a 3/4" shaft with keyway bronze bushing and snap ring for either direct or pulley drive. Inlet & outlet size 3/4" pipe. Great for hydraulic presses, loaders, steering, etc. 9 3/4" long x 6" wide. Shpg. Wt. 12 lbs. Like new. Approx. GOVT. COST \$195. Terrific value. **\$17.95.**

AIR COOLED WELDING KIT — Contains Famous P-2 generator (200 amps/30 V.D.C.) with built in fan. Also in kit — D.C. Voltmeter, Control Rheostat, Switch, 300 amp. Electrode holder, welder's gloves, adjustable welder's helmet, 30 ft. rubber covered welding cable and wiring diagram. All units guaranteed pre-tested prior to shipment. A terrific value. All units guaranteed pre-tested. Shpg. wt. 75 lbs. Approx. GOVT. COST \$475. Most items new — all perfect. **\$47.50.**



DC JET GENERATOR ARC WELDING KIT Complete with GE Type CM-77 Generator (30 volts D.C., 400 Amp., 3000 RPM up; ampere rating is for continuous duty, intermittent amperage is 500 to 600 amps.), also 2 rheostats, 1 voltage reg., 1 voltmeter, 1 electrode holder, 1 welder's mask, 1 toggle switch, 10 lb. vacuum packed 1/8 in. welding rods, pair welder's gloves & spline coupling. All units guaranteed pre-tested. Wt. 110 lbs. Approx. GOVT. COST \$700. All items, now only **\$64.50.**

*G.E. Generator noted above can be purchased separately. Makes deluxe heavy-duty welder comparable to the finest commercial welders available. Wt. 90 lbs. Approx. GOVT. COST \$600. Gen. alone — **\$49.50.**



BIG NEW 1963 CATALOG!

Send 25c in coin for amazing new catalog with 1000's of surplus bargains in hydraulics, electrical, precision tools, marine items, automotive, etc. for hobbyists or industrial. Or order from this ad and receive a free copy. All prices F.O.B. Culver City, Calif. 50% dep. for C.O.D. Send check, cash or money order. Order today!

AIRBORNE SALES CO. INC. DEPT. PM1062

8501 Stellar Drive • Culver City, California

Explosion Creates Diamonds

Synthetic diamond particles have been created by subjecting artificially produced graphite to explosive shock at the Poulter Labs of Stanford Research Institute.

Graphite is composed of sheets of atoms arranged in one of two patterns. The less common form is similar in structure to the diamond, except that in the diamond the sheets are puckered and closer together. The explosive force puckers and compresses the graphite to form diamond.

The experiment was performed by placing an explosive charge atop an unrestrained graphite specimen over a container of water. Following the explosion, small diamonds were recovered from the water.

Current methods of diamond synthesis require high capital investment, but the explosion method is limited only by the noise which can be muffled. Commercial value of the explosion method is not presently apparent, technicians say.



"Does anybody know I'm here?"

"Does anybody care?"

These are questions GI's all over the world are asking themselves. For many, the only evidence they see that Main Street, U.S.A., does care is their nearby USO. The USO offers GI's its vital measure of home when and where it's needed most.

But, with our military buildup, the USO hasn't been able to keep pace. More USO's are needed for the relaxation and spiritual uplift so urgently required by our sons in service.

Let every GI know that you care, so that he'll never have to wonder, "Does anybody know I'm here?" Support the USO through your Community Chest or United Fund.



Published as a public service in cooperation with The Advertising Council.

STANLEY

Better Your Home On Your Own!

and *SAVE*

NEW 7" POWER SAW

H271



H37

FINISHING SANDER



H15

1/4 H. P. ROUTER



BASIC ROUTER BIT KIT

H248



STANLEY FALL FAVORITES

NEW 7" POWER SAW is ideal for both the amateur's home workshop projects and the professional's light construction work. Stanley "Motor Saver" drive and many other quality features make this a real value at **\$44.50**.

1/4" H.P. ROUTER is in a class by itself for fast, clean cutting. Will do 90% of your woodworking jobs. \$47.50 value. Special **\$39.95**.

ROUTER BIT KIT contains basic assortment needed by every router owner. Straight, round-

ing over and grooving bits plus Silicon Carbide Hone. \$13.00 value. Only **\$9.95**.

FINISHING SANDER for "professional" quality sanding and finishing of table tops, chairs, cabinets and other home projects. \$34.95 value. Special **\$29.95**.

STANLEY POWER TOOLS

STANLEY®

Division of The Stanley Works
NEW BRITAIN, CONNECTICUT

MEN PAST 40

Afflicted With Bladder Trouble, Pains in Back, Hips, Legs, Nervousness, Tiredness.

If you are a victim of these symptoms, your trouble may be due to Glandular Inflammation. A constitutional Disease that requires special types of medical treatment. Neglect of such Inflammation causes men to grow old prematurely and often leads to Incurable conditions.

Most men, if treatment is taken in time, can be successfully NON-SURGICALLY treated for Glandular Inflammation. If the condition is aggravated by lack of treatment, surgery may be the only chance.

NON-SURGICAL TREATMENTS

The NON-SURGICAL New Type treatments used at the Excelsior Medical Clinic are the result of discoveries in recent years of new techniques and drugs, plus over 20 years research by scientific technologists and doctors.

Men from all walks of life and from over 1,000 communities have been successfully treated here at Excelsior Springs. They found soothing and comforting relief and new health in life.

EXAMINATION AT LOW COST

When you arrive, our Doctors, who have years of experience in this field, make a complete examination. You then decide if you will take the treatments needed, which are so mild, hospitalization is not needed—a considerable saving in expense.

RECTAL-COLON DISORDERS

Are often associated with Glandular Inflammation. We can treat these disorders at the same time we treat Glandular Inflammation.

REDUCIBLE HERNIA

Is also amenable to a mild Non-Surgical treatment that we have developed. Full details of this treatment given in our Free Book.

Write For FREE BOOK

The Excelsior Medical Clinic has published a New FREE Book that deals with diseases peculiar to men. It could prove of utmost importance to your future life. Write today. No obligation.



EXCELSIOR
MEDICAL CLINIC
Dept. B6151
Excelsior Springs, Mo.

Gentlemen: Kindly send me at once, your New FREE Book. I am interested in full information. (Please Check Box)

Glandular
Inflammation

Hernia
 Rectal-Colon

Name.....

Address.....

City..... State.....

Peanut Butter From Sawdust Flour!

SOON YOU MAY BE sprinkling peanut butter on a slice of bread or munching a cookie that's made from sawdust flour, which is totally lacking in calories.

Cellulose, an organic compound constituting the structural stuff of wood and grasses, has been put into edible form which can be readily digested by man. In its natural state, cellulose is fibrous and resists man's earnest efforts to digest it. Termites have been eating and digesting it for years, since they are equipped with special bacteria in their intestines which help decompose it. Man, however, not equipped with similarly talented bacteria, gets only a small amount of cellulose in vegetables which is not digested, but acts as roughage. Cellulose is noncaloric and provides no nourishment. Inside the body, it takes up space, but since it is not digested, it cannot add weight to the eater.

Two Forms Developed

Two forms of digestible, nonfibrous cellulose have been developed as a result of applied research in the fields of high polymer chemistry by American Viscose scientists. Avicel, a highly purified form of cellulose, is dependent upon colloidal phenomenon for its unique properties.

In its dry form, Avicel is a snow-white, free-flowing edible flour that resembles sawdust. In this form, it is capable of absorbing fats and oils which means that such syrupy and oil-based foods as cheese, peanut butter, molasses and honey can be converted into free-flowing forms. For example, Avicel can be used to make a dry free-flowing peanut butter that can be sprinkled on bread. The white powder can also be used in the preparation of such calorie-controlled baked goods as pastries, cookies, and breads; it can be added to meat products; or it can be used in making candy and confections. This same absorptive property permits Avicel to be used as a carrier for active constituents in the pharmaceutical and cosmetic fields.

A gel can be prepared by dispersing the powdered Avicel in water. It is smooth, odorless, tasteless, easily spreadable and noncaloric. Because of gel-like properties—stability, body, bulk, opacity, texture and palatability—Avicel is an effective ingredient in the preparation and calorie control of dressings, puddings, custards, spreads, aerosol-whipped toppings and frozen desserts. ★★★

SURPLUS SALE

GOVT. SURPLUS
EXCESS INVENTORY
BANKRUPT STOCK

HYDRAULIC SURPLUS BARGAINS

- Great savings. Build loaders, diggers, presses, etc. Brand new equipment.
- \$95 Pump, 1000 lb., 12 gpm. . . . \$33.95
- 12-v Battery Hyd. Pump. . . . 18.49
- Hand Hyd. Pump System & reservoir 29.50
- \$69 Hyd. Cyl. 2 1/2"x10". . . . 19.95
- Hyd. 2-way 1000-lb. Valve. . . . 18.00

DIAL TELEPHONE

- Item #716. Std. phone, same used on all phone systems. Use as extension to main phone and on private systems. Directions furnished. Wt. 8 lbs. Cost \$25. SALE \$7.95

AIR COMPRESSOR EQUIPMENT

- Make your own outfit. For painting, tires, shop use, etc. Save to 60%.
- Compressor, \$21.50. Govt. Tank, \$10.95. Gauge, \$1.75. Paint Gun, \$11.50. Auto switch, \$4.75. Air Regulator, \$3.95.

FARMERS-CONTRACTORS PUMPS-PIPE

- Item #204. Self priming Timken bearings, 1 1/2" size, use for irrigation, swimming pools, boats, cellar drains, etc. Wt. 32 lbs. Gov't cost, \$80.50. SALE \$19.49
- Plastic pipe 3/4" 71c, 1" 121c, 1 1/4" 171c, 1 1/2" 21c per foot.

12-V BATTERY ELECTRIC CAR MOTOR

- Item #564. Powerful gear motor. Hi torque. Build boy's car, golf-cart, winch elevators, etc. Runs on 12-v battery. Reversible. Gear ratio 24 to 1. 100-150 rpm. Ball bearings. Shaft 1 1/16" diam. Size 17"x6". Wt. 36 lbs. Govt. cost \$295. SALE \$18.95
- Reversing switch for above motor, \$3.95

STORAGE BATTERY WINCHES-HOISTS

- Item #311. 12-v Govt. reversible, ball bearing 2000-lb. capacity winch. Holds 40' 3/4" cable. For trucks, docks, boats, etc. 55 lbs. Cost over \$250. SALE \$49.95
- Many other types battery winches-hoists.

HYDRAULIC SPEED REDUCER

- Item #1311. 1 h.p. transmission. Variable 0 to 350 rpm. Instantly reversible. Ideal for lathes, midget cars, etc. Roller bearings. Complete except motor. Use your own single or 3 phase motor. Equipped with pulley. Easy to mount motor. Size 21"x9"x20". Wt. 200 lbs. Govt. cost over \$900. SALE \$79.50

ARMY CAPSTAN WINCH

- Item #325. Just rec'd Govt. award. New Army worm gear capstan winches. Designed for front end mtg. on trucks & jeeps. Ideal for boats. Has input shaft which can be driven thru flexible coupling to fan pulley shaft. Also easily adapts to 12-v battery motor drive. Size 14"x12"x9". Wt. 39 lbs. Govt. cost over \$100. SALE \$33.95

GOV'T. SURPLUS A-C POWER PLANTS

- Wonderful buys in fine Govt. plants and generators. Save 40% to 70%.
- 1000-w 115-v 60-c \$172.50
- 2500-w 115-v 60-c 269.50
- 3500-w 115-v 230-v 329.50
- 3000-w 115-v 230-v 429.00
- 3000-w AC generator 139.50

GOV'T AIR COMPRESSOR

- Item #453. Expensive Gov't. Compressor, G.E. motor 115-v, 60-c. Built-in air filter, relief valve, etc. Very compact and efficient.
- For paint spraying, insecticides, air brush, etc. A "Super Buy." Wt. 55 lbs. Gov't. cost over \$250. SALE \$19.97
- Many other bargains in Air Compressors, Tanks.

GENERATOR-3000W-115V

- Item #633. D.C. ball bearing compound-wound Delco unit. 1" dia. shaft. 2800 RPM. Ideal for portable tools, light, boats, etc. Will run any 115-v 2DC-AC tool. 100 lbs. Govt. cost \$250. SALE \$54.75
- over \$175. SALE Many other Surplus Power Plants and Generators.

SPECIAL OF THE MONTH!

PORTABLE GOV'T. SPRAY TANK

- Item #1810. Gov't. surplus pressure spray tank useful for spraying weeds, fertilizer, pesticide, etc. Fine unit for home owner, farmer, dairy, nursery, etc. Consists of 5-gal. tank with capillary feed tube, 60-lb. gauge, filter valve, liquid port, spray hose, nozzle, valves, etc. Pressurize at filling station. Size 26" high, 10" diam. Wt. 18 lbs. Cost Gov't. over \$38. SALE \$11.79

POOL WATER FILTER

- Item #2019. Provides filtered water for small home swimming pools, for business, industry, etc. Consists of multi-section filter in steel tank with clamp-on cover. Filter pads and plates are easily removable for cleaning. Provides up to 420 g.p.h. of filtered water. Complete with valves, etc. Inlet outlet fit garden hose threads. Data furnished. Size 14 1/2" high, 19" diam. Wt. 18 lbs. Cost Gov't. over \$95. SALE \$19.71

GOV'T. CABLE AND WIRE

- Save 75% on multi-pair cable, copper wire, power cords, etc. For intercom, private telephone system.
- Item #757. 6-pr. #22 gauge copper-weld color coded, insulated cable. Use aerial or buried. Only 7c per ft.
- Item #759. 11-pr. #22 gauge copper color coded rubber insulated cable. Only 9 1/2c per ft.
- Item #760. 1-pr. #14 gauge copper rubber insulated electric wire. Use for conduit wiring, outside lights, etc. 330-ft. per reel. Full reel, \$29. Per ft. 1c.

*Wonderful buys Surveyors Instruments-WRITE!

All Items This Ad **FREE** Send For
FOB LINCOLN Big New
1962 CATALOG
SURPLUS CENTER
Dept. 812, LINCOLN, NEBR.

HANDIEST SAW YOU EVER HELD!

Cuts Wood -- Metal -- Plastic -- up to 4 1/4" thickness with Finger-Tip Control



Just \$14.75 including 6 assorted blades, lubricant and wrench (postage prepaid if cash with order). Wt. 2 1/2 lbs. GRIP-TORC Saw gives YOU control of the blade because of its right angle pivoting on electric drill. Compact 6 1/4" length gets at hard-to-reach places . . . cuts squares, circles, bevels, and close to wall or floor. Reversible blade for right or left hand use, with push or pull movement. Provides unexcelled cutting speeds. Unconditionally guaranteed. In Cal. add 4% tax.

GRIP TORC

tools 17480 SHELburnE WAY LOS GATOS, CALIFORNIA

F.O.B. Los Gatos (postage prepaid if cash with order). Wt. 2 1/2 lbs.

Constructive and Profitable . . .

. . . and enjoyable. Manufacture and sell ornamental concrete items in your spare time. Warning, it could become a rewarding, full-time business. It has for many, many others, why not you? We manufacture and sell on a direct basis the industry's best molds. Durable, Dependable, High Quality, and of Aluminum. 96-pg. "How To Turn Concrete Into Gold" includes 29 pgs. of priceless instructions for professional results. Describes and Prices over 300 molds for Bird Baths, Benches and Tables, Flower Urns, Statues, Animals, Religious Items, and many more from 2" to 68" high. It gives the full story. Order yours TODAY -- Rushed to you by First Class Mail. It's only \$2.00.



See Horse Bird Bath One of over 300 different Ornamental Concrete Items you can make in CMC Molds.

Manufacture And Sell Your Own
Ornamental Concrete Items
OVER 300 DIFFERENT DESIGNS

Concrete Machinery Co., Inc.
839 Lenoir Road, N. W. • Hickory 2, N. C.

HOW TO TURN CONCRETE INTO GOLD
SEND \$2

FREE PLAN tells how to start your own business FILING SAWS

Here is a steady repeat CASH business you can start in your own basement or garage in your spare time and make up to \$3 or \$6 an hour. You can file hand, band and both combination and cross-cut circular saws on the Foley Saw Filer. No eyestrain--no experience needed. "The first saw I sharpened with my Foley Filer came out 100%"--writes Clarence E. Parsons.



Every saw you sharpen with the Foley Saw Filer brings you more customers. "I rented a two-car garage and have all the work I can do!"--Charles H. Smith.

FREE BOOK Shows How to Start

Foley Price Guide gives saw sharpening charges. Send coupon today. No salesman will call.

Send Coupon for FREE BOOK

FOLEY MFG. CO.
1043-2 Foley Bldg., Minneapolis 18, Minnesota.
Send FREE BOOK--"Money Making Facts," and Time Payment Plan.

Name _____
Address _____



WORLD'S MOST AMAZING CATALOG — 260 PAGES of BARGAINS

Here are items of every description — at lower than wholesale prices. Products include Hand & Power Tools, Sports Equipment, Outdoor Equip., Hobby Kits & Gadgets, Electric Motors and Generators, PLUS World's largest on the shelf stock of New & Used Hydraulic Cylinders, Pumps, Motors.

Only 50c TO COVER HANDLING & MAILING

Your 50c will be refunded with your first order of \$1.00 or more.

2000 PSI HVY. DUTY HYDRAULIC CYLINDERS

Engineered for earth moving equipment, tail gates, presses, agricultural equip., lift assemblies, backhoes, front loaders, etc.

SAVE UP TO 82%

Part No.	Bore	Stroke	Length	Shaft Dia.	Price ea.
H-70A	2-1/2"	8-3/8"	18-3/4"	1-1/2"	\$11.88
H-70E	2-1/2"	30"	40-1/2"	1-1/2"	28.88
H-70L	3-1/2"	43 1/2"	55-1/8"	1-3/4"	53.88

U.S. SIGNAL CORPS FIELD PHONE

A two-way ringing telephone system built for rugged in-the-field use... UP TO 5 MILES! Operates on two standard flashlight batteries. Generator has built-in ringing crank. Up to 10 phones can be hooked together. Ideal on farm, rifle range, etc.

3250 PAIR 1795 EA

2500 LB. LIFT WINCH HOIST

Ideal for garages, shops, on boats, jeeps, trucks, etc. Has a 24 to 1 ratio through a worm gear drive, a free-spool, pull-out clutch and a three-speed crank. Comes with 18 ft. of 3/16" steel cable. Lifts up to 2500 lbs.

3795

MOUNT FRAME for Hoist \$5.00

115 VOLT INVERTER ONLY 798

Cat. No. EA-MG-2500A

JUST RELEASED!

Cont. duty, 2500 volt amp, single phase. Input, 28V., D.C., 160 A. Output 115V., A.C., 21.6 amps, 400 cycles. With circuit breakers, voltage reg., transformer, etc.

TO ORDER — Send your Check or Money Order. Enclose 50% deposit with all C.O.D.'s. All items sent freight or postage collect.

palley's 2263 E. VERNON AVE., Dept. PM-110
LOS ANGELES 58, CALIFORNIA

SERVICE FILE — FREE listing of books, booklets, blueprints, patterns and plan sheets by subject. Write Service Bureau, Popular Mechanics, 740 Rush St., Chicago 11, Ill.

Briggs & Stratton — Clinton New Gas Engine Sale

Never before and perhaps never again—this offer of brand new genuine Clinton and Briggs & Stratton engines including 1 yr. factory warranty at less than cost. Perfect power for go-carts, scooters, tractors, mowers, generators, pumps, sprayers, etc. We bailed out 3 big factories who needed cash and the savings are yours while quantities last. Act fast.



Clinton 2 1/2 hp, MdI. A-400—Re-coil starter Std. 3/8 shaft w. keyway—ready to go. Reg. price \$49.50 Special (item 1002)

\$29.95

2 for \$57.50
6 for \$150.00



Briggs & Stratton 2 hp, MdI. 60101 Rope start, std. 3/8 shaft w. keyway. Sturdy 4 cycle power. Regular price \$49.80 Special (item 106a)

\$29.75

2 for \$57.40
6 for \$149.50

\$67.50

5 3/4 hp.

Briggs & Stratton



Briggs & Stratton 5 3/4 hp, MdI. 143302. Re-coil start. Std. 1" shaft w. keyway, aut. choke & throttle control—a rugged big engine ready to tackle any job. Regular price . . . \$92.60 Special (item 1059) . . . **\$67.50**

2 for \$130.00 6 for \$350.00



Insects Are Studied by X Ray

Dr. Ronald Stark is getting the goods on insects that destroy wood. The University of California entomologist studies pieces of Ponderosa pine and other wood with an X-ray machine to learn insect habits. Above, right, is a borer at work in a chunk of pine. He plans to develop a portable machine for use in forests.

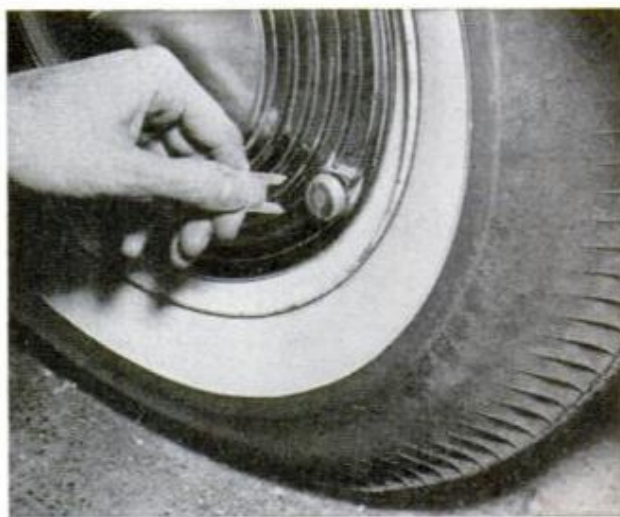

Hub Cap Lock-Up

Have you ever had your car's wheel covers stolen, then seen a similar set turn up as a "custom" touch on a car of another make? Safety hub-cap locks are designed to put a stop to that and keep wheel covers on the cars they belong to.

The lightweight, polished, rustproof locks screw on to tire valve stems, then lock with a special key to prevent theft or tampering with tire valves. A set of four locks and two keys can be had for \$1.49 from Safety Plug Lock Corp., 1270 Broadway, New York 1, N. Y.

Better Your Home On Your Own!

and SAVE



STANLEY FALL FAVORITES

Here are quality tools to help you breeze through those Fall fix-up jobs. See your nearby Stanley retailer. NOW, while he is offering many of these tools at special prices. And send for our free booklet #T2 that lists books and plans available and the tools you'll want to make short work of your Fall projects. Stanley Tools, Division of The Stanley Works, 6210 Elm Street, New Britain, Connecticut.

1. New "Steelmaster" Hammer with FREE Self-Centering Nail Set. OST1½, Special \$5.25.
2. Set of 4 Chemical Spray Tools with FREE handy spray handle. CT4, Special \$4.49.
3. "Life Guard Yellow" 10-Ft. Pocket Rule, ¼" Blade. MYT10, \$1.29.
4. "Yankee-Handyman" Push Drill. 46Y, \$4.25.
5. Set of 5 "Stanley-Handyman" Screw Drivers with FREE metal rack. 3005, Special \$2.99.
6. "Surform" File with Metal Cutting Blade and FREE Wood Cutting Blade. S295, Special \$2.79.
7. "Life Guard Yellow" 6 Ft. Folding Rule. 6LG, Special \$1.79.
8. New "Stanley-Handyman" Trimming Plane. H101, 99¢.
9. New "Stanley-Handyman" Block Plane. H102, \$1.69.
10. New "Stanley-Handyman" Bench Plane with FREE extra cutter. H104, \$4.49.
11. "Stanley-Handyman" Mitre Box. H114, \$6.00.

STANLEY

THE TOOL BOX OF THE WORLD

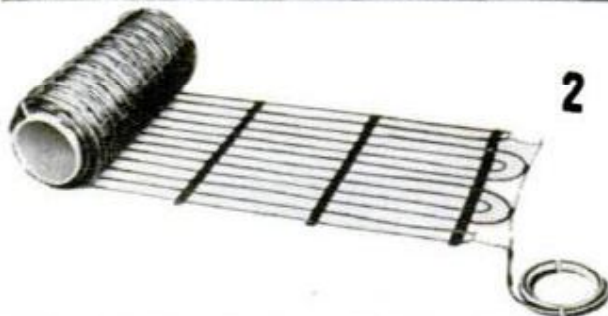
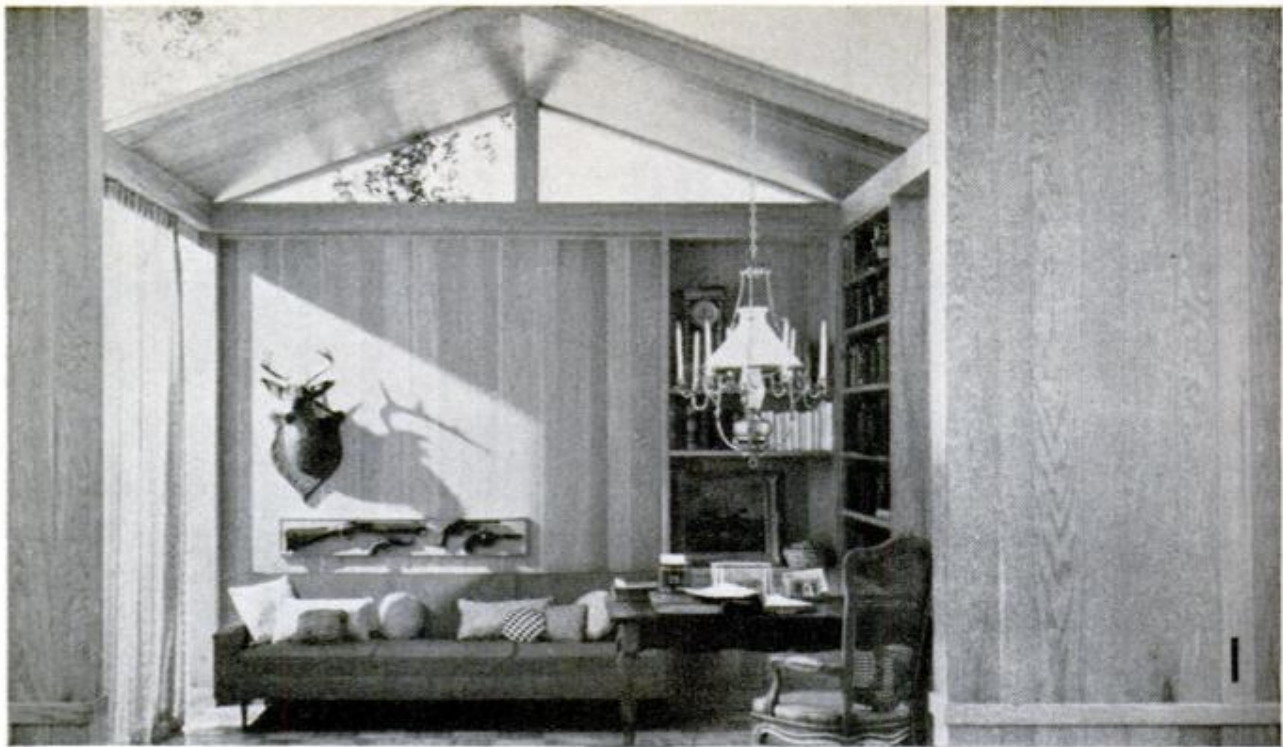

2

On the market



3



4



5

1. PREFINISHED HARDWOOD PANELING 7/16 in. thick eliminates need for backing or furring strips which saves cost of labor and materials. Called Craft-wall, it is sold in walnut, elm, oak, cherry, mahogany, birch, maple and four additional color tones. Weyerhaeuser Co., Wood Products Div., Tacoma, Wash.

2. ELECTRIC SNOW MATS embedded in blacktop driveways, parking areas, walks, etc., keep them free of snow and ice. They are 18 in. wide and operate on 230-240 volts, a.c. Priced at \$17.75 for 5-ft. length, \$21.75 for 10-ft., \$39.95 for 20-ft. and \$59.95 for 40-ft. Made by Smith-Gates Corp., Farmington, Conn.

3. MOLDED FOAM-PLASTIC CEILING TILES have attractive diamond-patterned squares and a lap edge. Easy to handle, they can be cut with standard tools and stapled, nailed or glued in place. Available in two-foot squares, in thicknesses ranging from one to eight inches. United Progress Co., Albany, N. Y.

4. LOUVERED PINE-DOOR CABINET is something new in home fixtures. Designed for bathrooms with large vanity mirrors, it is equally appealing in kitchens and recreation rooms. Enameled steel body has adjustable glass shelves and magnetic door catch. The F. H. Lawson Co., Dept. VPW, Cincinnati 4, Ohio

5. BOTTLED PRESSURE sprays liquids and chemicals such as insecticides, germicides, foams, paint and a variety of petroleum and water base chemicals. Pressurized aerosol can is refillable. Safety valves protect against excess pressure. Sells for \$19.95. Made by Aero-Dyne Corp., Box 247, Emmetsburg, Ia.

KING MIDGET FOR 1963

"World's Most Exciting
Lowest Priced Car"

Drive it for 75c a week. Rider Agents Wanted. Send 25c for 32 page book, full details, dealer price. Or send \$1 (refunded first order) for this plus Service and Repair Manual and 16 5x7 photos of car and factory.



MIDGET MOTORS CORP., Athens 1, Ohio

Entertainment center grows as needed when you add the proper modules described in the November issue of Popular Mechanics. Standard boxes, aluminum framing and shelves are designed to hold any type of hi-fi equipment available. Don't miss this.

The 'All-Purpose' Oil For Home Workshops

Cleans • Lubricates • Prevents Rust

3-IN-ONE® OIL

REGULAR—OIL SPRAY—ELECTRIC MOTOR

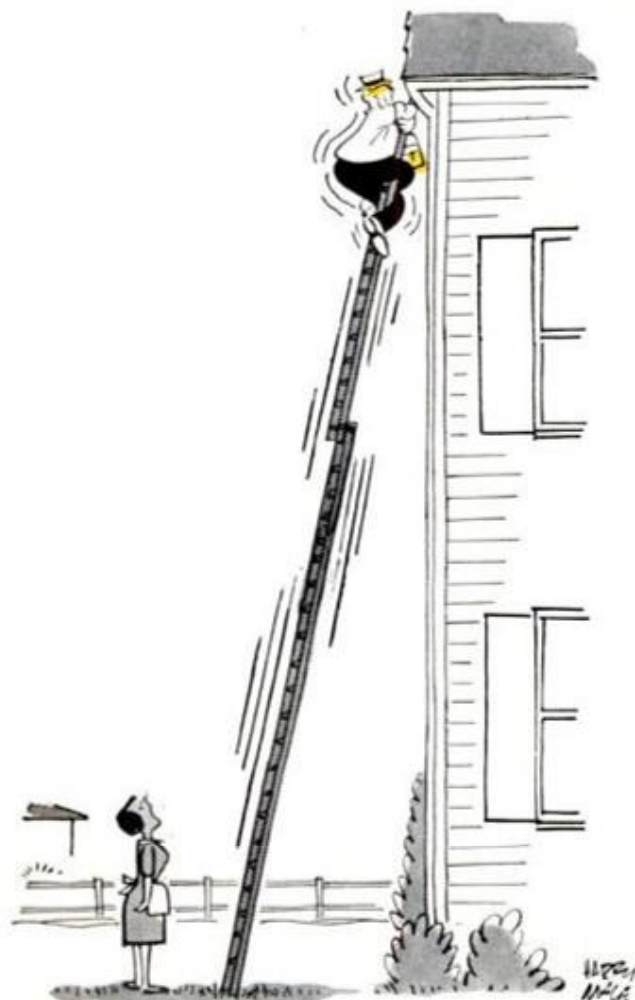

"When are you going to start painting?"

OCTOBER 1962

WISS SNIPS CUT BEST

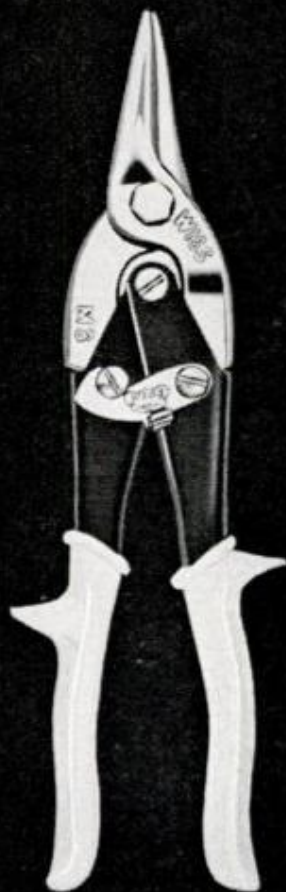

STRAIGHT OR CIRCULAR—CUT WITH HALF THE EFFORT!

The amazing compound action of Wiss Metal-Master Snips allows you to cut with half the effort required by conventional snips. They are preferred by many for their compact size and versatile cutting. The M-3R illustrated cuts straight, also shallow arcs. For more intricate cutting and scrollwork, model M-1R cuts to the left, M-2R to the right. At hardware and tool stores.

J. WISS & SONS CO., NEWARK 7, N. J.

World's Largest Manufacturer of Shears, Scissors, Pinking Shears, Skalloping Shears, Metal Cutting Snips and Garden Shears

BUY DIRECT FROM OUR FACTORY

SAVE 80%

ON THIS AMAZING **AMCO**
8" TILT ARBOR
POWER SAW

RUGGED ... HEAVY DUTY ... PROFESSIONAL QUALITY ... LIFETIME ENGINEERED

GUARANTEED TO DO THE
WORK OF \$50 BENCH SAWS

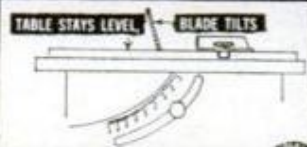
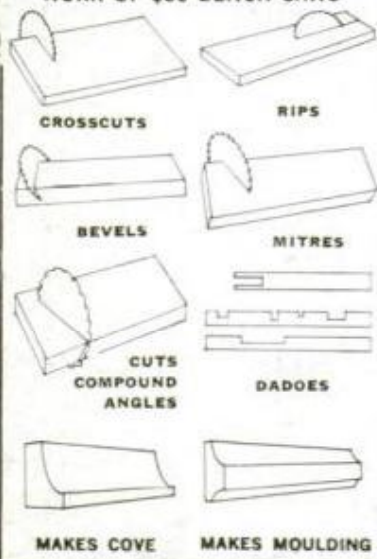

TAKE THE WORK
OUT OF WOODWORK
... AND ONLY ...

\$995

Wt. 25 lbs.
Exp. Coll.

UNCONDITIONAL
10 YEAR
GUARANTEE

Complete as shown, less blade, rip fence. Incl. precision miter gauge, ground cast iron table. If desired, RIP FENCE for easier work alignment, \$3.50 additional.

REVOLUTIONARY NEW PATENTS ... NEW DESIGN

REVOLUTIONARY PATENTS DECREASE COSTS, INCREASE EFFICIENCY. Top quality full scale power tools of heavy duty 100% cast iron and steel. Streamlined design features such as perforations on table tops reduce weight, cut material costs, cut polishing and grinding time—reduce production costs. Special patents provide added efficiency, accuracy, savings. Nothing left out but expensive gingerbread. Parts made, assembled, tested and packed in our own factories, shipped direct to you. No retail store handling or profits to add to your cost.

TABLE STAYS LEVEL, BLADE TILTS

Patented motor mount takes any standard 1/4 to 1/2 h.p. motor ... keeps belt tight, assures perfect alignment at any angle, transmits full power. Table stays level—blade tilts, locks securely at any angle to 50°, raises, lowers 0" - 2 1/4". Patented tilt mechanism has accurate etched scale. Takes standard blade, saw insert removes easily for insertion of any STANDARD dadoe heads, cutters, etc. Accessories, table extensions, when wanted, at factory prices.

CLIP AND MAIL
THIS MONEY SAVING
COUPON TODAY!

BUILD
ALL
THESE

INDOOR
FURNITURE

OUTDOOR
FURNITURE

SHELVES
& CLOSETS

CHILDREN'S
TOYS

ALL HOME
IMPROVEMENTS

AND SAVE
AS YOU
SAW

American Machine & Tool Co. Dept. PM-102 Royersford, Pa.

- Send 8" Tilt Arbor Power Saw at \$9.95
- Incl. Rip Fence at \$3.50 (both for 13.45)
- Payment in full enclosed \$..... or
- \$3 dep. enclosed, balance C.O.D. I MUST BE FULLY SATISFIED OR WILL RETURN WITHIN 10 DAYS FOR FULL REFUND, no questions asked.
- Please send free catalog of America's greatest power tool values.

NAME _____

ADDRESS _____

CITY _____ ZONE _____ STATE _____

(Please print)

NO RISK TO YOU

Also ideal for boy scout troops, clubs and other groups. Share one with your neighbor.

10 DAY
MONEY BACK
GUARANTEE

You must be completely satisfied or return 8" power saw for full refund. Fair enough?

SEND FOR YOURS
TODAY!

AMERICAN MACHINE & TOOL COMPANY
DEPT. PM-102, ROYERSFORD, PA.

RUGGED, VERSATILE
PERFORMANCE PROVED
BY MORE THAN
500,000 USERS! !

Send for our FREE catalog of America's greatest power tool values.

from raincoats



... to motorboats



... chinaware



... to dining chair



MENDS EVERYTHING* BUT A BROKEN HEART and the crack of dawn

* well, just about everything



Don't let "fix-it" problems go unsolved. DURO-PLASTIC has the answer for you in a tube — ready-mixed, ready to use. Just apply and let dry! 1,001 home, auto, boat, shop and farm repairs made easy! Get one of each from your favorite hardware, department, automotive, paint or variety store — in \$1.00 to 59¢ sizes.

OTHER KITS FOR THE HANDYMAN

- PLASTIC MENDER • E-POX-E CEMENT and FILLER • HANDY PATCH • HOUSEHOLD CEMENT
- LIQUID METALLIC SOLDER • MUFFLER and TAILPIPE FIX-IT KIT • MATCHWOOD FILLER
- RUST REMOVER • WEATHERSTRIP and TRIM CEMENT • WINDSHIELD and WINDOW SEALER
- PLASTIC for PORCELAIN REPAIR • PLASTIC LOCK WASHER • DARN FABRIC MENDER

THE WOODHILL CHEMICAL CORPORATION

CLEVELAND 14, OHIO

TORONTO, ONTARIO, CANADA

The Nation's Only "Mother-in-Law Approved" Fix-it Products



When
a
cigarette
means
a lot...

you get Lots More from L&M

more body in the blend... there's a special rich-flavor leaf — and more of it — among L&M's choice tobaccos.

more flavor in the smoke... every puff is heartier, for L&M has more longer-aged, extra-cured leaf than even some unfiltered cigarettes.

more taste through the filter... for full pleasure. And with L&M's modern filter — the Miracle Tip — only pure white touches your lips.



It's the rich-flavor leaf that does it!