

Buick V6 and Ford: Owners' Reports

POPULAR MECHANICS

MAY 1962
35 CENTS



**Paint Peeling?
Here's the Answer!**

Fishing's Deadliest Dozen Lures

Dark Secrets of Industry's Spies

**IS THE INDY RACE
IN A RUT?**



Built-in comfort and good looks. Service oxfords with oil-resisting neoprene soles, with cushion insole or new Airweight models. All widths.



Dry-soft, triple-tanned shoes and logger boots. Crafted from rugged shell horsehide with sweatproof leather insoles and triple-ribbed steel shanks.

For down-to-earth comfort, you just can't beat Wolverine's tough horsehide and pigskin leathers. They're tanned in our secret half-century-old process, and tanned not once but triple tanned to a softness that stays soft, even dries soft. Get this comfort and get long wear that saves you money in the long run. Buy work shoes, caps and gloves by Wolverine.

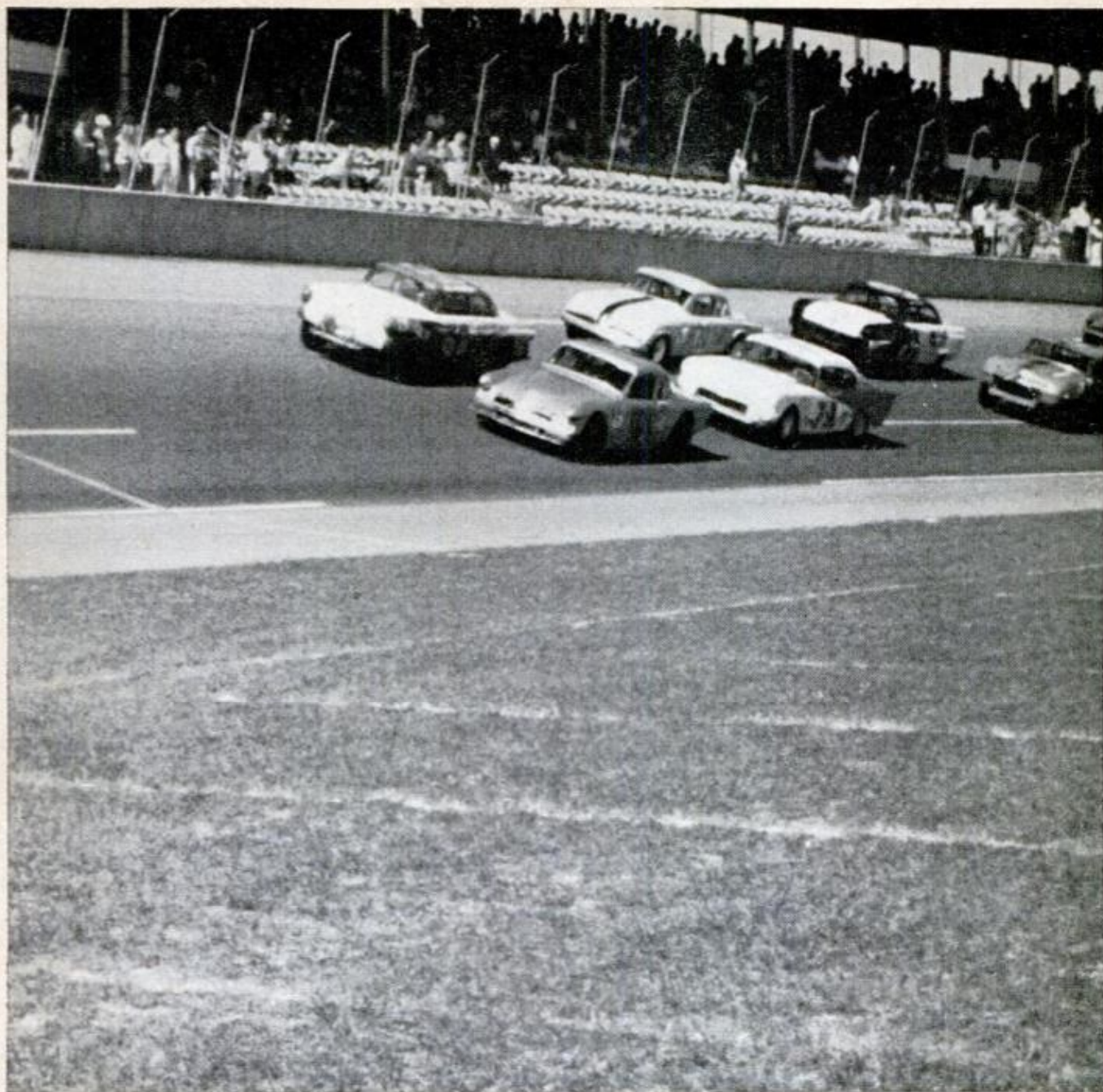
WORKINGMAN'S LEATHERS BY WOLVERINE



Colorful brushed pigskin caps for work and sport. Specially treated to resist soil, spots and water. Even dry soft. Just brush clean; look like new again!



WOLVERINE SHOE & TANNING CORP., ROCKFORD, MICH.



FIREBALL, DAN, LEE ROY, AND AUTOLITE MAKE SHAMBLES OF DAYTONA SPEED WEEKS

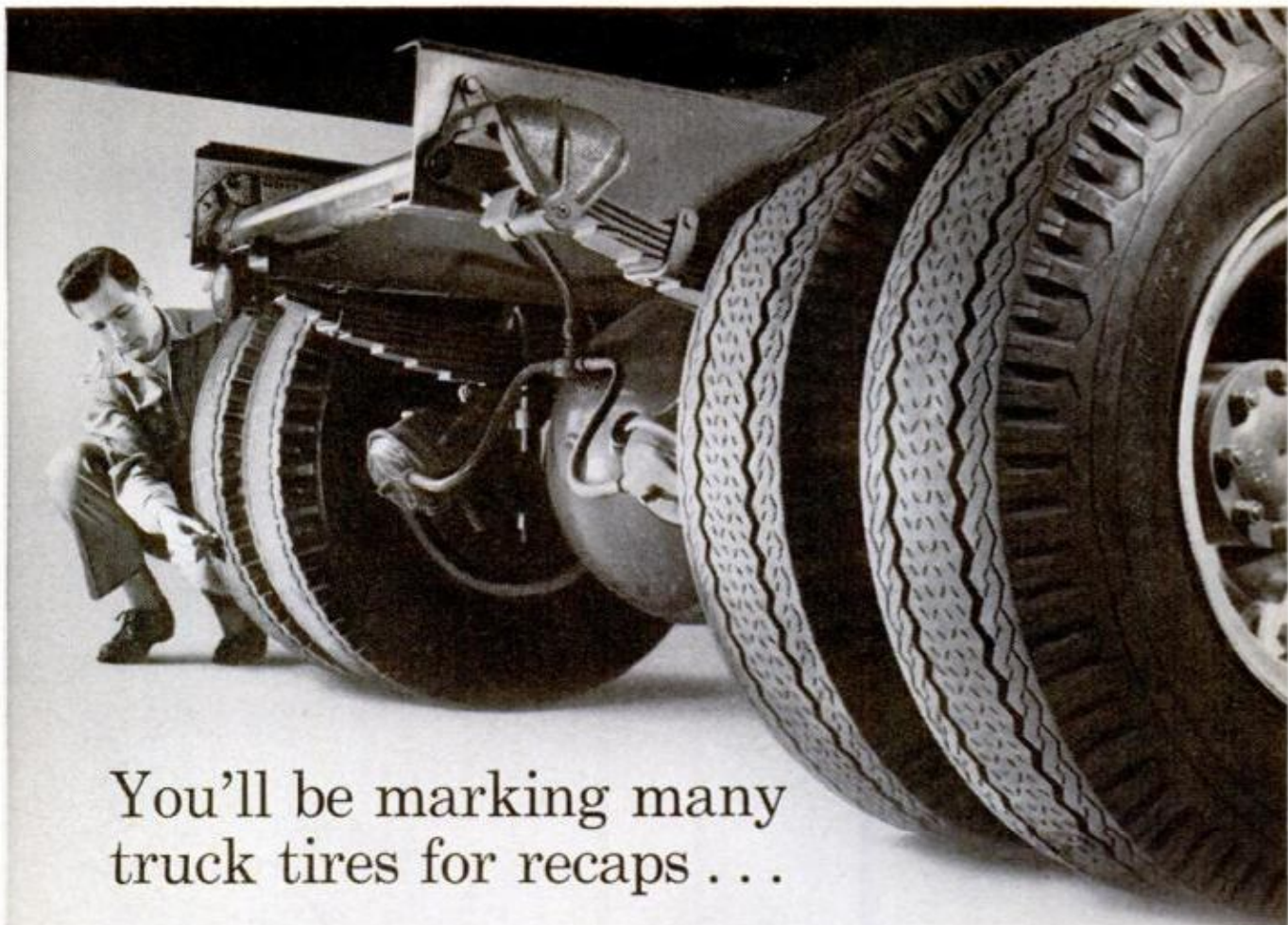
Fireball Roberts runs the fastest 500 miles ever driven over a closed course to win the Daytona 500 Grand National Race. His record speed: 152.529 mph. His prize: \$24,000. His spark plugs? Autolite. Dan Gurney wheels a Lotus 19 over the twisting 3.8-mile Daytona sports car track, wins the Continental 3-hour Grand Touring and Sports Car Race. His speed? 104.101 mph. His prize: \$7,500. His spark plugs? Autolite. Lee Roy

Yarbrough tools a modified '56 Ford to first place in the 250-mile National Championship Modified and Sportsman Stock Car Race. His record speed: 146.723 mph. His prize: \$4,800. His spark plugs? Autolite. Every single big race at the 1962 Daytona Speed Weeks fell to Autolite spark plugs. Like a little extra power in your car? Give Autolite spark plugs a try next time. You'll be traveling in rather distinguished company.

This One



2YWF-QSK-HU20



You'll be marking many truck tires for recaps . . .

while your **Firestone**
TRANSPORT-100's
 are still marking up records!

"INCREASES MILEAGE 50% . . . AND MORE. GREATER STOP-AND-GO TRACTION POWER!" That's the verdict of independent fleet operators who drove—and kept tabs on the Firestone Transport-100. Millions of grueling miles throughout the country proved these two good reasons for its cost-saving durability: (1) The Transport-100's broad-center rib all but eliminates squirming and scuffing to greatly increase mileage over any previous Firestone regular-skid highway tire. (2) The bladed design with over 1,000 deep traction slots and deep wide grooves give extra traction on wet, slick pavement and in snow. And you get increased mileage and traction at no increase in price! Order Transport-100's in nylon or Tyrex[®] rayon cord, tubeless or tubed, at your Firestone Dealer or Store. *Always Specify **Firestone** —Your Symbol of Quality and Service—on Tires for New Trucks and Trailers*

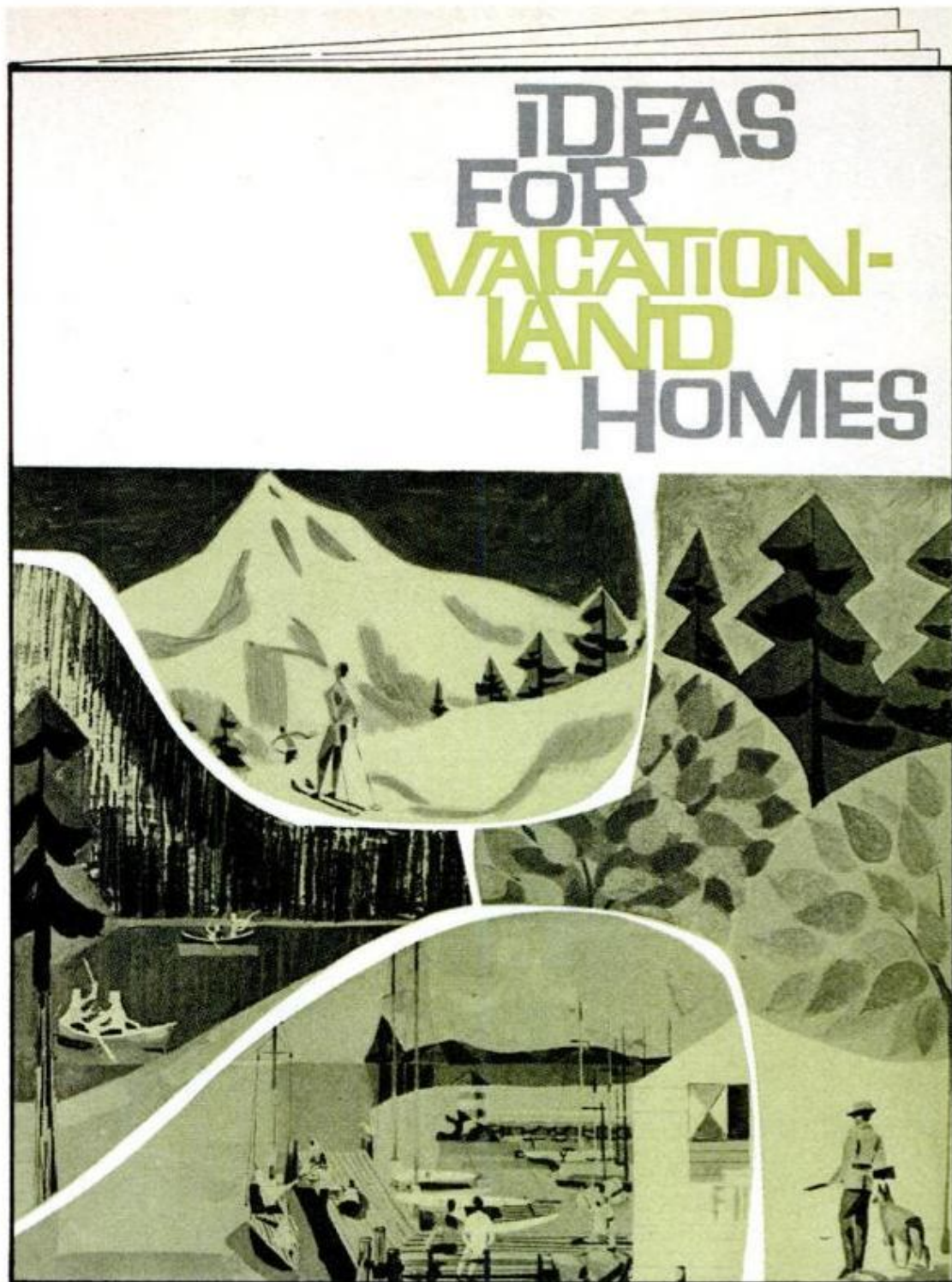
MEMBER  AMERICAN TRUCKING INDUSTRY

Copyright 1962, The Firestone Tire & Rubber Company

© T. M. of Tyrex, Inc.

Transport © T. M. Firestone

ALWAYS SPECIFY QUALITY GRADED LUMBER FROM
 ■ WESTERN PINE ASSOCIATION MEMBER MILLS ■



IDEAS FOR VACATION- LAND HOMES

Get This FREE Booklet . . . available now at your building supply dealer's. Here are 10 exciting "second homes" designed by leading architects for your family's complete enjoyment of shore or mountains. Designs are fully illustrated, with floor plans. Complete building plans are available for each home shown. If your dealer is unable to supply you with this booklet, send 10c to Western Pine Association, Dept. M-8, Yeon Building, Portland 4, Oregon. **Western Pine Region Solid Lumber** will give you enduring enjoyment of your vacation home. These remarkable woods provide beauty that fits into nature's mood. They offer strength, durability and easy working qualities in ideal combination.

WHITE

LOGEPOLE PINE ■ SUGAR PINE ■ LARCH ■ WHITE FIR ■ RED CEDAR ■



POPULAR MECHANICS®

MAY 1962
VOL. 117 NO. 5

INTERNATIONAL EDITIONS • SPANISH: Mexico-Caribbean, Southern Hemisphere • FRENCH •

Features of Special Interest

We Fought the Red Guerrillas - - - - -	67
Owners Report on the Buick Special V6 - - - - -	74
Owners Report on Ford's Fairlane - - - - -	79
Fishing's Deadly Dozen - - - - -	83
Is the Indy Race in a Rut? - - - - -	88
Be Ready to Save a Life - - - - -	94
Foresters Bicycle Up Tree Trunks - - - - -	100
They Spy for Industry - - - - -	102
Mother Nature—Secret Partner in Defense - - - - -	108
PM Shopping Guide: Sleeping Bags - - - - -	114

For the Craftsman

How to Build Your Own Table-Top Road Track - - -	124
Control and Prevention of Termites - - - - -	128
Appliance Fix-It File: Floor Polisher - - - - -	134
When Paint Peels - - - - -	136
Start Your Vacation Home at Home—Conclusion - -	142
Portable Electronic Enlarger - - - - -	150
Ignition's the Word for Go - - - - -	158
Decorative Dado Cutting - - - - -	164
"Silent" Phono for Youngsters - - - - -	167
Keep Up With TV on Your Radio - - - - -	168

Address communications to: 200 E. Ontario St., Chicago 11, Illinois. **SUBSCRIPTION SERVICE:** Mail all subscription orders, changes of address, correspondence concerning subscriptions, and Postmaster notices of undeliverable copies to Popular Mechanics, 250 West 55th St., New York 19, N. Y.

Published by Popular Mechanics Company, RICHARD E. BERLIN, *President*

CLIFFORD B. HICKS
Editor

RICHARD E. DEEMS
Executive Vice-President

JOSEPH R. BUELL, JR.
Publisher

Managing Editor: DON DINWIDDIE
Assistant Managing Editor: JOHN A. LINKLETTER
Shop and Crafts Editor: WAYNE C. LECKEY

Eastern Editor: RICHARD F. DEMPEWOLFF
959 Eighth Ave., New York 19, N. Y.

Western Editor: THOMAS E. STIMSON, JR.
Suite 1003, 3460 Wilshire Blvd., Los Angeles 5, Calif.

Art Director: HENRY M. NEHRBASS
Automotive Editor: JAMES R. WHIPPLE

Associate Editors: W. CLYDE LAMMEY, WALLACE MYERS
Electronics Editor: BYRON G. WELS

Assistant Editors: JAMES BIERY, KEVIN V. BROWN
ROBERT L. HERING, R. B. KIRKPATRICK
ARTHUR MIKESELL, BIL TOMAN, RICHARD WILLIFORD

Assistant Art Director: LEO R. WEEKS
Art Editor: RICHARD A. POTTS

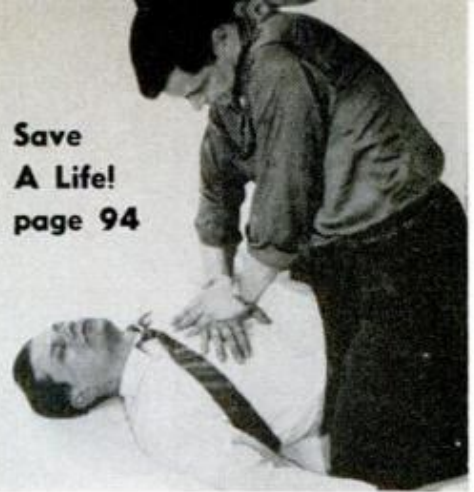
Chief Photographer: FRANK P. FRITZ
International Editor: HEINZ P. SCHLICHTING
Ritterstrasse 26, Karlsruhe/Bd., Germany

Advertising Manager: FRANK R. DUPUY
959 Eighth Ave., New York 19, N. Y.

Advertising Production: DOROTHY M. WINER
Director, Bureau of Information: ALLAN CARPENTER

If you wish additional sources of information for the articles in this issue, or if you wish the name and address of the manufacturer of a particular product shown here, write to Bureau of Information, Popular Mechanics, 200 E. Ontario St., Chicago 11, Ill. Ask for the free "Where-to-Find-It-List" for this issue.

Save
A Life!
page 94



DANISH • SWEDISH • GERMAN • PORTUGUESE • DUTCH

Departments

Tune In on the Inventors - - - -	10
Over the Editor's Desk - - - -	12
Pentagon Sidelights - - - -	16
Sidelights on Aviation - - - -	20
Science Overseas - - - -	22
Science Bulletins - - - -	26
Worth Writing For - - - -	38
Spotlight on the Turbocharged Corvaire and Olds F-85 - - -	60
Items From All Outdoors - - -	66
Detroit Listening Post - - - -	73
What's New for Your Home - - -	122
Solving Home Problems - - - -	156
Clinic for Homemakers - - - -	172
On the Market - - - -	210
Shopping for Tools - - - -	214

Next Month . . .

A boat that flies, simple swimming pool filtration techniques, a combination arc-spot welder, a radio-controlled model racing hydroplane that could challenge the champions—they will all be waiting for you in the June PM. So will the owners' million-mile report on the new Valiant, tips on taking the backaches out of backpacking, a shopping guide for air conditioners and an easily-built projector-enlarger.

ADVERTISING OFFICES—Chicago: 200 E. Ontario St., Whitehall 4-0100; New York: 959 Eighth Ave., Columbus 5-7300; Detroit: General Motors Bldg., TRinity 5-8711; Cleveland: Hanna Bldg., 1422 Euclid Ave., PProspect 1-0456; Los Angeles: 3460 Wilshire Blvd., DUnkirk 2-8458; San Francisco: 111 Sutter St., YUkon 2-0823.

Published monthly by Popular Mechanics Company, 200 E. Ontario St., Chicago 11, Ill. Richard E. Berlin, President; Richard E. Deems, Executive Vice-President; Fred Lewis, Vice-President and General Manager; John R. Miller, Vice-President; Joseph R. Buell, Jr., Vice-President; G. O. Markuson, Treasurer; R. F. McCauley, Secretary. Single copy in the United States and Canada, 35 cents. Subscription prices: United States and Possessions, \$4.00 for one year; \$7.00 for two years; \$9.00 for three years. Canada, add \$0.50 for each year. Pan-American Postal Union countries, add \$1.00 for each year. All other countries, add \$2.00 for each year. If you plan to move, notify us at least 30 days in advance so you will not miss an issue. Give both your old and new addresses. Second-class postage paid at Chicago, Illinois, and at additional mailing offices. Authorized as second class mail by the Post Office Department, Ottawa, and for payment of postage in cash. Registered as Second Class Matter at the Post Office at Mexico, D.F., Mexico, June 20, 1950. © 1952 by Popular Mechanics Company. All rights reserved. Printed in the United States of America.

Defense
Partner
page 108

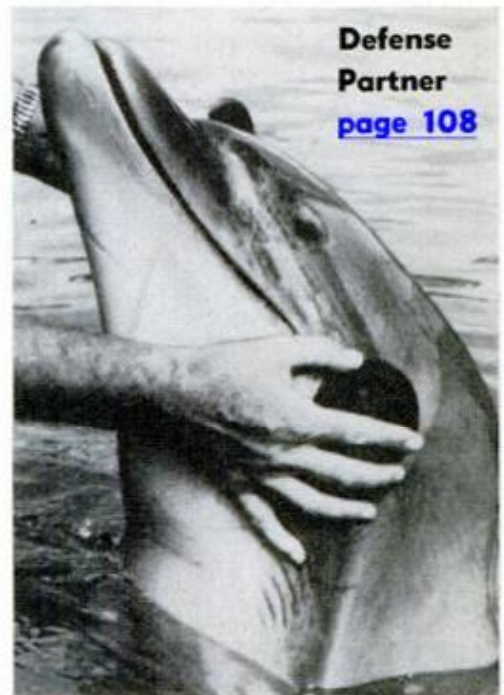


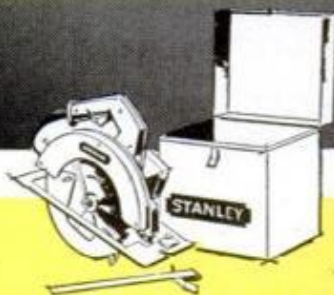
Table
Racing
Setups
page 124



Fancy
Dadoes
page 164



NOW...2 GREAT OFFERS FROM **STANLEY**



MODEL
H-273

7" Heavy-Duty Builders Saw

with Free Carrying Case, Ripping Guide. Spring steel beam absorbs shocks, if saw is dropped. Ball bearing construction. "Motor Saver" drive. Large, rear position depth and bevel control knobs. Complete saw kit (\$81.95) at cost of saw alone!

\$69⁹⁵

SEE 'EM AT YOUR HARDWARE STORE or LUMBER YARD



MODEL
H-264

7/8 H.P. Router with 3 Free Bits and Router Use Manual. Full ball bearing. Spotlight throws bright beam on working area. Precision micro-depth adjustment. Recessed safety switch. \$76.50 total value for only . . .

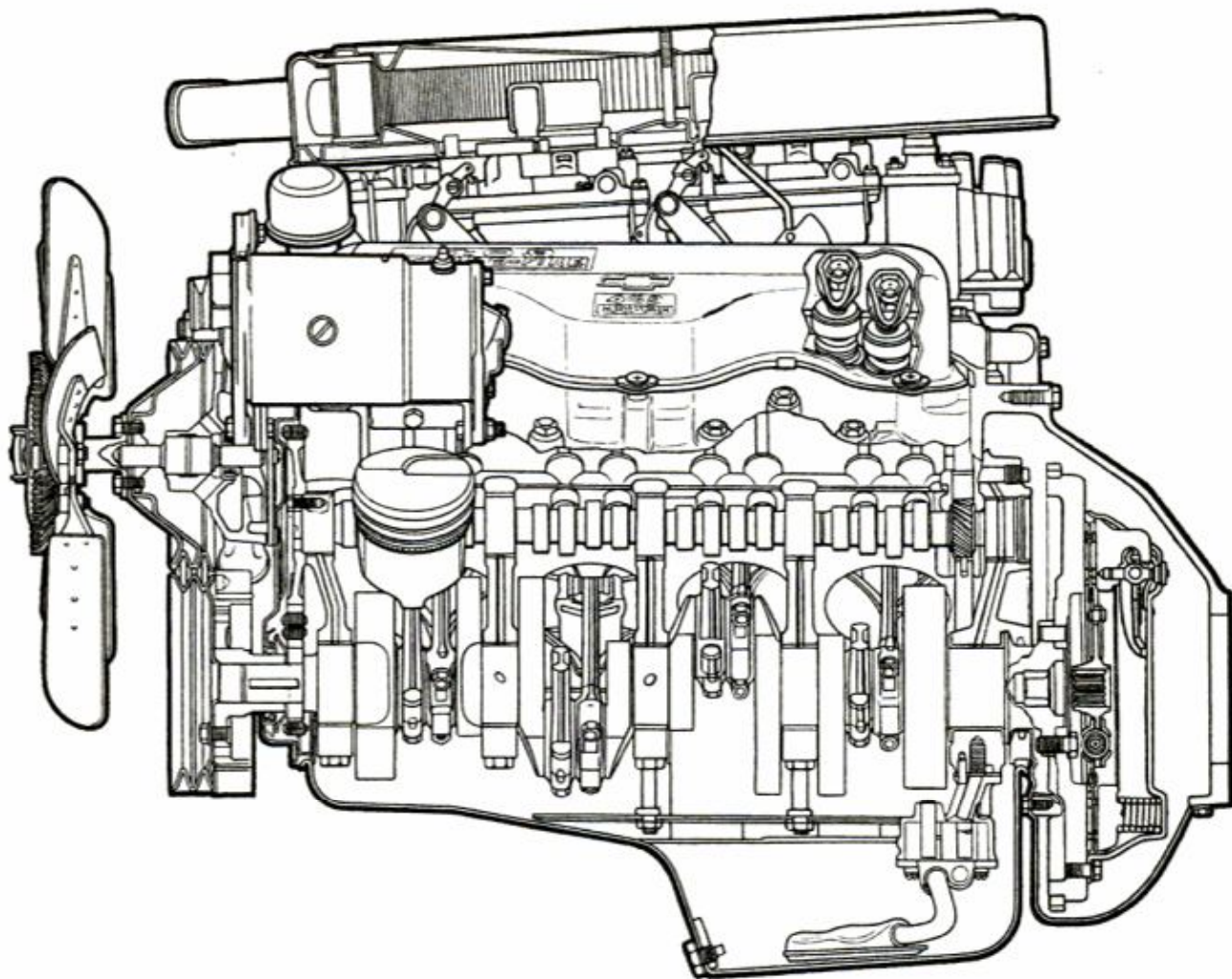
\$69⁹⁵


STANLEY

STANLEY POWER TOOLS

DIVISION OF THE STANLEY WORKS
625 MYRTLE STREET, NEW BRITAIN, CONNECTICUT

POPULAR MECHANICS



JOB <i>Chevy 409 V8</i>	REMARKS <i>Son of a gun!</i>
BORE 4.3125	<p>Amazing! This engine, available as an extra-cost option, turns a perfectly normal Chevrolet into something else altogether. It's available as shown with two aluminum four-barrels and a special cam or in a slightly tamer version with one four-barrel and a mere 380 horsepower. If performance is your meat, this engine'll give you just about all the protein a feller could use. Check the chart!</p>
STROKE 3.50	
GROSS HORSEPOWER 409 @ 6000	
GROSS TORQUE (LB. FT.) 420 @ 4000	
COMPRESSION RATIO 11 to 1	
DISPLACEMENT (CU. IN.) 409	
	CHEVROLET DIVISION OF GENERAL MOTORS, DETROIT 2, MICHIGAN



CLEAN CARBURETORS RIGHT ON-THE-ENGINE

Low cost **CARBURETOR CLEAN-OUT KIT** boosts engine performance—stops gasoline waste

Stop engine stalling, hard starts, rough idling and gas waste caused by a dirty carburetor. Now you can clean carburetors the professional way and at the lowest cost with GUMOUT and the easy-to-use CLEAN-OUT KIT. Simply hook up the kit, turn on the engine and GUMOUT goes to work. It takes just a few minutes. Clean your carburetor

three or four times a year this modern way, and you'll save many dollars in repair and operating costs.

There's nothing like GUMOUT for quick results!

The CLEAN-OUT KIT will give you many years of service. Use it with GUMOUT, the carburetor cleaner that gives instant results.



GUMOUT

in the pint can is used with the CLEAN-OUT KIT. GUMOUT also gives excellent results added to the gas tank.

\$1.69

CARBURETOR CLEAN-OUT KIT

Packed in a re-usable slide-on blister package. Fits all American made cars, trucks, tractors. Easy-to-follow directions come with the kit.

\$2.49



Buy GUMOUT and the CLEAN-OUT KIT from your favorite auto supply store or write:

GUMOUT DIVISION, PENNSYLVANIA REFINING COMPANY
Cleveland 4, Ohio

Cast your ballot for a successful future!

249 I.C.S. COURSES



I.C.S. is the oldest, largest school of its kind. Over 249 courses for men and women. High school, business, secretarial, interior decorating, engineering. One for you. Direct, job-related. Bedrock facts and theory plus practical applica-

tion. You learn from experts. Diploma to graduates.

Clip and mail the coupon now. You'll receive, absolutely FREE, 3 valuable booklets that have helped thousands. But don't delay. Cast your "ballot" for future success!



ACCOUNTING

Accounting
Auditing
Cost Accounting
General Accounting
Junior Accounting
Practical Accounting
Public Accounting

ADVERTISING

Advertising
Magazine & Newspaper
Advertising

ARCHITECTURE AND BUILDING CONSTRUCTION

Architectural Drawing & Designing
Architectural Interiors
Architecture
Building Contractor
Building Contractor with Drawing
Building Estimator
Building Maintenance
Carpenter-Building
Carpentry & Millwork
House Planning
Lumber Dealer
Mason
Painting Contractor
Reading Arch. Blueprints
Reading Struct. Blueprints

ART

Advertising Layout & Illustration
Amateur Artist
Commercial Art
Commercial Cartooning
Fashion Illustrating
Figure Drawing & Painting
Magazine Illustrating
Show Card & Sign Prod'n
Show Card Writing
Sign Painting & Designing
Sketching & Painting

AUTOMOTIVE

Auto Engine Tune-up
Automobile
Automobile Body Rebuilding and Refinishing
Automobile Electrical Technician
Automobile Technician
Diesel Engines

Diesel-Gas Motor Vehicle Engines
Gas Engines
Internal Combustion Engines

AVIATION

Aero-Engineering Technology
Aircraft & Engine Mechanic
Aircraft Mechanic
Aviation Engine Mechanic

BUSINESS

Business Administration
Business Correspondence
Business Law
Business Management & Marketing
Business Management & Production
Business Psychology
Canadian Business Management
Clerk-Typist
Commercial
Condensed Business Practice
Federal Tax Course
Managing a Small Business
Marketing
Office Administrative Engineering
Office Management
Professional Secretary
Programming for Digital Computers
Purchasing Agent
Retail Business Management
Shorthand
Stenographic
Typewriting

CHEMICAL

Analytical Chemistry
Chemical Engineering
Chemical Engineering Unit Operation
Chemical Laboratory Technician
Elements of Nuclear Energy
General Chemistry
Industrial Analytical Chemistry
Industrial Chemistry
Professional Engineer—Chemical

PULP AND PAPER

Paper Making
Pulp & Paper Engineering

Pulp & Paper Making
Pulp Making

CIVIL ENGINEERING

Bridge & Building Foreman
Civil Engineering
Construction Engineering
Highway Engineering
Mine Surveying & Mapping
Principles of Mapping
Principles of Surveying
Professional Engineer—Civil
Railroad Engineering
Roadmaster
Sanitary Engineering
Section Foreman
Sewage Plant Operator
Structural Engineering
Surveying and Mapping
Water Works Operator

DRAFTING

Aircraft Drafting
Architectural Drafting
Drafting & Machine Design
Electrical Drafting
Electrical Engineer Drafting
Electronic Drafting
Industrial Piping Drafting
Junior Mechanical Drafting
Mechanical Drafting
Sheet Metal Drafting
Structural Drafting

ELECTRICAL

Elec. Appliance Servicing
Electrical Contractor
Electrical Eng'g (Power Plant option—Electronic option)
Electrical Engineering Tech.
Electrical Instrument Tech.
Electric Motor Repairman
Illumination Eng'g Tech.
Industrial Electrical Techn.
Power-House Engineering
Power Line Design and Construction
Practical Electrician
Practical Lineman
Professional Engineer—Electrical
Reading Electrical Blueprints

HIGH SCHOOL

Good English
High School Business
High School College Prep (Arts)

High School College Prep (Engineering & Science)
High School General
High School Mathematics
High School Secretarial
Modern Letter Writing
Short Story Writing

LEADERSHIP

Industrial Foremanship
Industrial Supervision
Personnel-Labor Relations
Supervision

MATHEMATICS

Mathematics and Mechanics for Engineers
Mathematics and Physics for Engineers
Mathematics and Physics for Technicians

MECHANICAL

Industrial Engineering
Industrial Instrumentation
Junior Mechanical Engineering
Mechanical Engineering
Professional Engineer—Mechanical
Quality Control
Introductory Technical Writing

PETROLEUM

Natural Gas Production & Transmission
Oil Field Technology
Petroleum Production
Petroleum Prod'n Eng'g
Petroleum Refinery Operator
Petroleum Refining
Petroleum Technology

PLASTICS

Plastics Technician

PLUMBING, HEATING, AIR CONDITIONING

Air Conditioning
Air Conditioning with Draw'g
Air Conditioning Maintenance
Domestic Heating with Oil & Gas
Domestic Refrigeration
Heating
Heating & Air Conditioning with Drawing

Heating, Drawing & Estimat'g
Plumbing
Plumbing, Drawing & Estimating
Plumbing & Heating
Plumbing & Steamfitting
Practical Plumbing
Refrigeration
Refrigeration & Air Conditioning
Steamfitting

RAILROAD

Air Brake Equipment
Car Inspector & Air Brake Diesel Electrician
Diesel Engineer & Fireman
Diesel Locomotive
Diesel Machinist
Railroad Administration
Railroad Car Repairer

SALESMANSHIP

Creative Salesmanship
Real Estate Salesmanship
Retail Merchandising
Retail Selling
Sales Management
Salesmanship & Sales Management

SHOP PRACTICE

Boilermaking
Electric Welding
Foundry Practice
Gas and Electric Welding
Gas Welding
Heat Treatment of Metals
Industrial Metallurgy
Machine Shop Inspection
Machine Shop Practice
Machine Shop Practice & Toolmaking
Metallurgical Engineering Technology
Physical Quality Control of Metals
Practical Millwrighting
Reading Shop Blueprints
Resistance Welding Technology
Rigging
Safety Engin'g Technology
Sheet Metal Worker
Tool Design
Tool Engineering Technology

Toolmaking
Welding Engineering Technology

STEAM AND DIESEL POWER

Combustion Engineering
Power Plant Engineering
Stationary Building Eng'g
Stationary Diesel Eng'g
Stationary Diesel-Electric Engineering
Stationary Fireman
Stationary Steam Eng'g
Steam Engine Operation

TEXTILES

Carding and Spinning
Carding
Cotton Manufacturing
Cotton Warping & Weaving
Dyeing & Finishing
Hosiery and Circular Knitting
Loom Fixing
Spinning
Synthetic Fabri. Manufacturing
Synthetic Throwing, Warping & Weaving
Textile Designing
Textile Engineering
Textile Mill Supervisor
Woolen Manufacturing
Worsted Manufacturing

TRAFFIC

Motor Traffic Management
Railroad Rate Clerk
Traffic Management

TV-RADIO-ELECTRONICS

Gen'l Electronics Technician
Industrial Electronics
Practical Radio-TV Eng'g
Radio Operating
Radio Servicing
Radio Servicing with Practical Training
Radio & TV Servicing
Radio & TV Servicing with Practical Training
Servicing Electr'n'c Devices
Servicing Sound Equip't
Practical Telephony
Telephony and Radio Communications
TV Receiver Servicing
TV Technician

For Real Job Security—Get an I. C. S. Diploma! I. C. S., Scranton 15, Penna.

Accredited Member,
National Home Study Council

INTERNATIONAL CORRESPONDENCE SCHOOLS



BOX F0419E, SCRANTON 15, PENNA.

In Hawaii reply P.O. Box 418, Honolulu

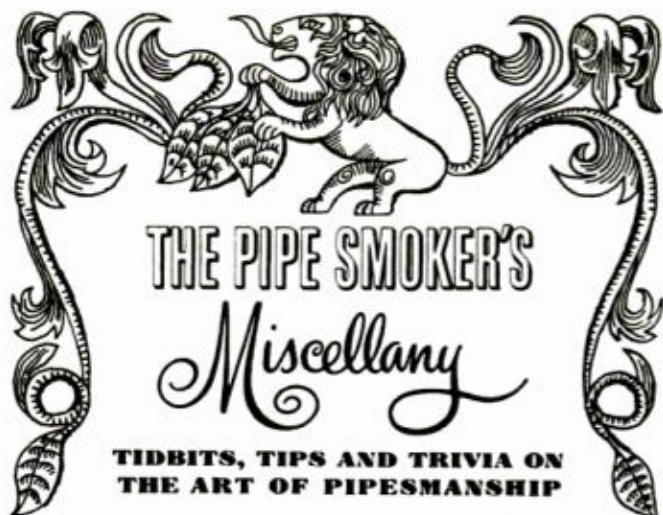
Without cost or obligation, send me "HOW to SUCCEED," the opportunity booklet about the field I have indicated below, and a sample lesson

Name of the course in which you are interested _____

Your Name _____ Age _____ Home Address _____

City _____ Zone _____ State _____ Working Hours _____ A.M. to _____ P.M.

Occupation _____ Canadian residents send coupon to International Correspondence Schools, Canadian, Ltd., Montreal, Canada. . . . Special low monthly tuition rates to members of the U. S. Armed Forces.



HOW TO KEEP YOUR HEEL DRY

You can discourage (or, hopefully, prevent entirely) a soggy heel from developing in the bowl of your pipe by always following these two procedures of pipesmanship:



1 After every pipeful you smoke, empty out *all* ashes—and *all* unsmoked tobacco, too. Leave a respectable cake, of course.

2 After every pipe-cleaning, leave the stem out of the shank overnight to give both an airing. If you like, you can leave a clean pipe-cleaner in the shank to dry bottom of the bowl and shank out thoroughly.

THE PIPE TOBACCO THAT STAYS LIT



Bond Street Pipe Tobacco keeps burning because of its old English cut—a combination of flakes for even-burning and cubes for slower-burning. You'll like its aroma of fine imported and domestic tobaccos, too.

That man is twice-blessed who has a young wife and an old pipe



BOND STREET
A product of Philip Morris Inc.

Tune in on the inventors

Ambitious patentee of the month is Dr. Bernard Vonnegut of North Scituate, Mass., who won patent No. 3,019,989 for a method of controlling electrical disturbances in the atmosphere by modifying the existing space charge. Dr. Vonnegut's invention would decrease—or increase—the electrical-storm activity in an area by introducing into the atmosphere a mass of particles with a negative or positive electrical charge. To produce significant results, the particles would have to be introduced at a rate of one to 20 microamperes per square mile and over an area of at least a thousand square miles. His patent rights are assigned to Arthur D. Little, Inc., of Cambridge, Mass.

Pistachio nut lovers will applaud the awarding of patent No. 3,002,807 to Felix Bloch of Oakland, Calif. His patent is for a process to split the shells of pistachio nuts. (For nonpistachio fans, the tough, slippery little shells are very hard to open unless they're split part way first.) Mr. Bloch's process causes the desired splitting by placing the nuts in a container of water—salted water for salted pistachios—and subjecting it to high pressures, up to around 150 pounds per square inch. The nuts are held at that pressure for five minutes to three hours, depending on the time needed to crack the batch being processed. After splitting, the nuts are drained, then dried in a current of warm air. The patent rights were assigned to the U. S. Government, though no mention was made of their plans on what to do with all those split pistachio nuts. Space food?

Golf shoes can go indoors safely with a flexible sport-shoe sole which won patent No. 3,020,654 for Donald McCann of Tiverton, R.I. The indoor sole fits over the spikes and is held in place by small magnets.

Sun tan in two minutes is the purpose of the invention which won patent No. 3,009,055 for Michael Franzese of New York City. The lamp uses several reflectors and sun lamps to concentrate its beams at a range of only 18 inches.

Copies of the original patents may be ordered for 25 cents each from the Commissioner of Patents, Dept. of Commerce, Washington 25, D. C.

Important News for the man who needs a **GOOD JOB, MORE MONEY AND GREATER SECURITY**

You train
at home
with real
equipment

1. Air Conditioning and Refrigeration offers better opportunities in a growing uncrowded field
2. CTI provides proven Home Training which lets you learn by practicing with real equipment

Why worry about a poor-pay or unsteady job when the blessings of a big-money career in Air Conditioning and Refrigeration are within your reach? This fast-growing industry needs 20,000 newly-trained mechanics each year. It is pleading for skilled men who can install the 8 million air conditioners, refrigerators and freezers that are produced annually . . . and service the 150 million units already in use. Send for complete information on how you can qualify for a full-time, top-pay job in a dynamic, uncrowded field!

CTI Home Training Is Easy—Fast—Proven

CTI Home Training is prepared so that even a man of limited education, who has been out of school for years, can understand it. The lessons are written in simple English, and many illustrations are used to explain operating principles. Training kits of parts and tools are provided so that the student can develop his skill and acquire practical experience. CTI instructors are efficient and courteous. The student gets personalized training as well as extra help if he needs it.

Why Many Students Earn Cash as They Train



A CTI student spends a considerable part of his time training with kits we send. The 20 field-type projects provide him with experience. Due to the practical nature of this exclusive training, many students soon do repair work in spare time for profit. They make calls on their own, or develop servicing arrangements with local distributors and contractors. Their earnings often pay the cost of tuition before graduation.

How to Start a Business of Your Own

Once a student begins to do part-time servicing, he actually puts himself in his own business. Some students make contracts with owners of food stores, restaurants, and air conditioned buildings to handle servicing on a monthly fee basis. An impressive number of CTI students follow this success pattern—have a prosperous business under way by the time they graduate. Air Conditioning and Refrigeration is well suited for starting out on a modest basis, with very little capital, and then expanding as service calls increase.



Letters Prove Value of CTI Training

We want to send you a fascinating booklet called *Proof from Graduates*. In their own words, men who have earned diplomas record their successes. Better jobs, higher pay, self-employment, confidence—these are a few of the rewards of a sound training program carried to fulfillment. We'll rush this testimonials booklet, along with other factual information, as soon as we hear from you.



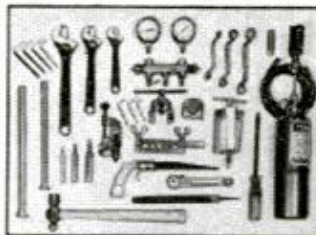
COMMERCIAL TRADES INSTITUTE
A Non-Profit Organization • Accredited by National Home Study Council



YOU BUILD THIS
1/4 H. P. HEAVY DUTY
CONDENSING UNIT!

you get 25 kits!

Only CTI sends parts to build a refrigerating unit. You get 25 kits, which also include mechanic's tools. During this practical phase of your training, you complete 20 job projects similar to what you will encounter in the field. If you wish, you may build your condenser into an air conditioner, freezer, refrigerator or milk cooler. The advantages of CTI Home Training are clear: You learn the interesting way—by practicing. You develop your skill, acquire experience, gain confidence.



Opportunities Are Great for a Fresh Start

Whether you are a young man looking for a field with bright prospects, or a mature person who is stuck in a job with no future, you will find the breaks you need in Air Conditioning and Refrigeration. During the past 12 years, the production of air conditioners increased by 400%—a growth matched by just one other industry! Despite this growth, the industry is said to be in its infancy, because only 8% of all American homes are air conditioned. Auto air conditioning is big business, too—Nearly 600,000 units installed annually!

If you are looking for a fresh start in life, consider Air Conditioning and Refrigeration. No industry is growing faster. The pay scale, working conditions, and the 20,000 new jobs that open each year are unique attractions indeed. Send for free information at once.

COMMERCIAL TRADES INSTITUTE

1400 GREENLEAF AVENUE DEPT. R-87
CHICAGO 26, ILLINOIS

Please send me your three free booklets: *Success in Air Conditioning and Refrigeration*, *Proof from Graduates*, and *Lesson Samples*. No obligation.

Name _____ Age _____

Address _____

City _____ Zone _____ State _____



Over the editor's desk

J-Bolt Just Right

Give Joseph Federico my sincere thanks for his very good drill press "quick clamp" (page 191, Jan. PM). Right off I went to the shop and made the J-bolts and two clamps which are all done except for the wing nuts.

I've tried many times to work out something like that, mostly with a loop of wire which worked sometimes but was unhandy. The J-bolt is the answer and now I wonder why it had not occurred to me.

Weston, W. Va.

KARL L. HOSKINS

And we'll bet Joe Federico would feel the same way about some of the shop short cuts you've worked out, Karl. We're considering a short feature in each issue entitled "My Favorite Shop Short Cut." Do you experienced workshoppers have some ideas?

Neighborhood Pipe



Made this cement mixer from your Aug. '60 PM plans, using a drum I found in a service station and 1/2-inch pipe in place of angle iron. I found most of the pipe around the neighborhood. I also added two rubber-tired wheels for easier handling. Cost me \$5.50.

Milwaukee, Wis.

LYNDON W. TAYLOR

A Real Gasser

If I am 10 miles from the nearest gas station and I have only enough gas for five miles, is it best to speed up to the speed limit or go very slow? Which would get me the farthest?

Fresno, Calif.

PETER COLETT

Unless your car is an unusual one, you'll do better running between 30 and 40 m.p.h. in high gear, with a very steady, but feather foot on the gas pedal, and a prayer on the lips.

They Came Out Fighting

Referring to your *Bitter Battle of the Waterways* (Mar. PM), it's hard to choose sides. I think it very ignorant and nasty of some jerk to "buzz" a fisherman and very rude of some fishermen to get in the way of a water skier's towline. When going to or coming from their fishing spots, fishermen are as dangerous as those "careful" drivers who drive 10 m.p.h. on 65 m.p.h. expressways . . .

Livonia, Mich.

H. L. HANKS

. . . It should be legal for fishermen to carry a light-gauge shotgun to use on all speed demons, and illegal for speedboats on certain waters or within 150 yards of a fishing boat. The river that runs by my house is hardly wide enough for all the fools that race and play "chicken" and those silly games that usually get someone hurt or drowned. I would rather sit on the banks and fish than be a wet "cool cat."

Reedley, Calif.

S. SCOTT

I do a good bit of fishing so I know how Mr. Hartman feels, but I think that people who like to ski should be permitted to do so on any lake that can be fished. Out of common courtesy I think the skiers should keep well clear of the fishermen . . .

Lafayette, La.

PAT ADERMAN

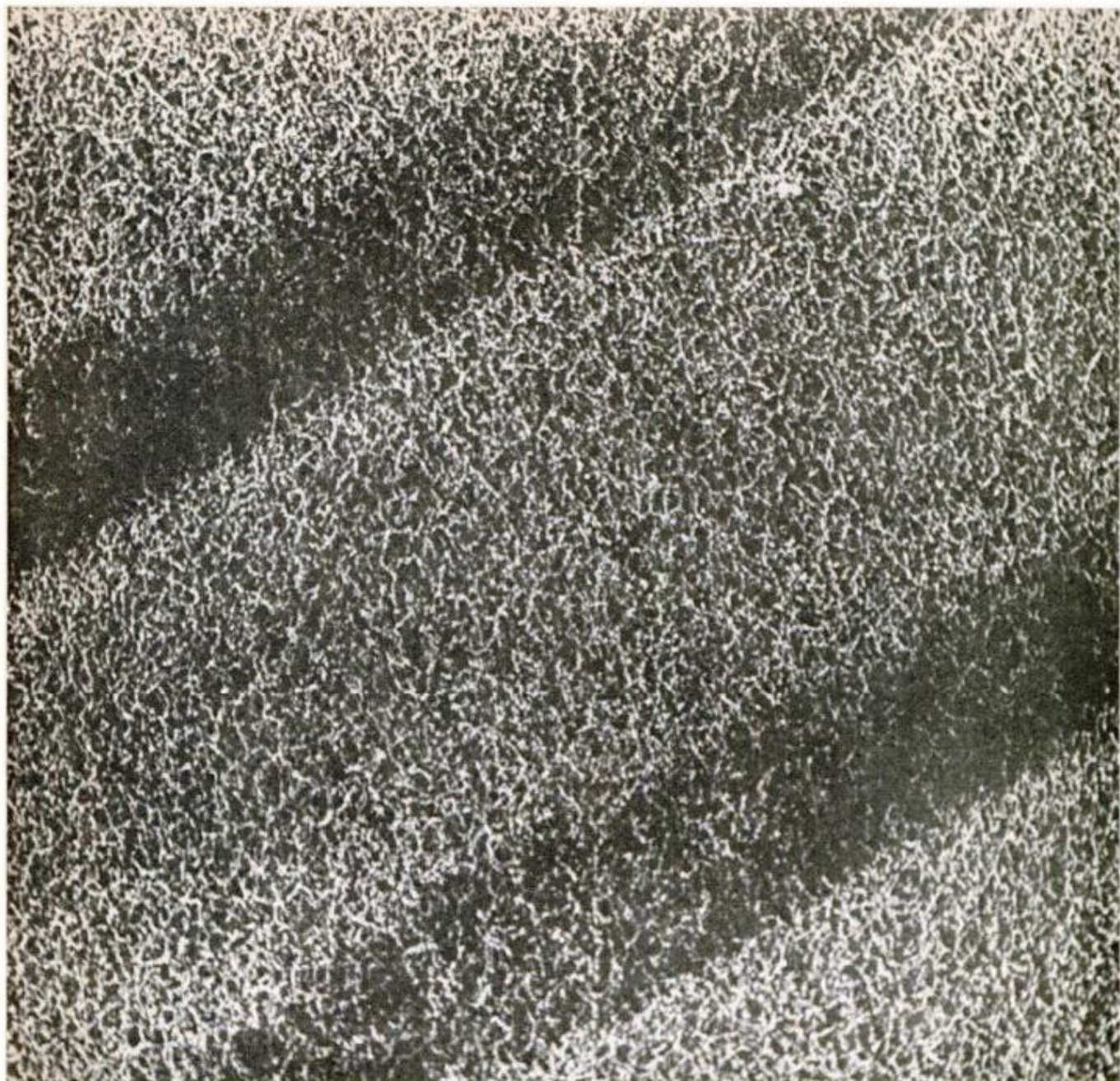
. . . Fishermen should have the rights to the water until 10 a.m., then let the speedboats have it to 4 p.m., then let the fishermen take it back again . . .

Poolsville, Md.

STEWART E. WEBB, JR.

. . . Speedboat operators have their rights and so do fishermen, but I think scuba and skindivers do, also. While diving I have almost been hit by both any number of times, even though a diving flag was clearly displayed in the immediate vicinity. I have had an anchor from a fisherman's boat dropped within five feet of me, and a

(Continued to page 14)



X-ray of a tire with a built-in barricade of steel

And it's a bonus you get in most Goodyear off-the-road tires.

What you see above are the short lengths of steel wire we mix into our undertreads. They form a rugged barricade against sharp rocks, cutting shale and other tire killers.

How much wire? Over 6 million pieces, on the average. Fully 19 pounds' worth! And it does more than

just short-stop punctures. It reduces bruise breaks — retards cuts and cut growth — guards against separation by “zippering” the tread to the body.

How much extra do you pay for all this? In most Goodyear off-the-road tires it costs you nothing. It's a bonus! See your Goodyear Dealer or Goodyear Service Store for your bonus, today! Goodyear, Akron 16, Ohio.

ANOTHER REASON WHY: MORE TONS ARE HAULED ON GOODYEAR TRUCK TIRES THAN ON ANY OTHER KIND

GOODYEAR

FREE

1962 VACATION GUIDE TO NEW YORK STATE



- 196 pages of vacation information . . . 140 full-color photos
- Describes hundreds of exciting vacation attractions and communities
- Tells how to get to each by car, train, plane and bus
- Lists 150 public golf courses
- New sections on boating, camping, state parks and touring
- Locates forts, battlefields and other historical sites
- Lists attractions for children

YOU'LL FIND A WORLD OF FUN IN NEW YORK STATE

New York State Department of Commerce
Dept. PM-11, P.O. Box 1350, Albany 1, N. Y.

Please send me the free 1962 "New York State
Vacationlands" guide.

Name _____

Address _____

City _____

Zone _____ State _____

speedboat and skier use my flag as a divider. Both types of boat operators should either be required to have a license as motor vehicle operators do and know the waterways rules, or else use their boats for display ornaments on their property . . .
Stratford, Conn. R. A. BENSON

. . . Keep the power boat jockeys where they are now. Each lake can be evaluated as to size and, more important, fishing quality. Poor fishing lakes and rivers can be let open to these skippers and good fishing lakes and rivers should be limited not in speed but in horsepower of the motors. Skiers should be kept off lakes where fishing is good and motors should be kept below 10 horsepower . . .

Houghton, Michigan KARL H. LAANINEN

. . . If the sadly-neglected waterways law enforcement would leave a fair area for fishermen I would not object to big motors on any water, but when one of them comes into an area designated for fishing, I feel like starting a new revolution . . .

Columbus, Ohio C. E. BURWELL

. . . I can remember when I could go out with my dad and have a ball catching nice-sized fish. In the last four years, it hasn't been safe to get a boat on the water on Saturday or Sunday unless it had a 35-horse outboard and mirrors all around so you could try to out-maneuver those high-speed dimbulbs.

Since their boats cost five times as much as the average fishing boat, most seem to think they own all the lake. The little fishing room in the lakes where they have taken over is around weed beds and stumps. Even then they resent the fact their targets have gone into a fairly safe place, so they come in as far as they can—and find out how much they are missing . . .

Aurora, Col. ROLLAND G. KELSON

And so the battle rages, with worthwhile points being scored by all sides—and there certainly are more than two sides to the question of waterway rights. Letters are still pouring in and we'll have to wait for a later issue to bring you the final box score—the number of fishermen and boaters who came out fighting, along with the swimmers, scuba divers and fence sitters.

Not to mention sailboat owners who, up to now, have been remarkably silent on the subject.

The Editors

POPULAR MECHANICS



CUT OUT AND "TACH UP" IN A NEW TEMPEST LE MANS

Tempest's frisky LeMans (convertible or coupe) can please you in as many ways as there are roads. No wonder; under the hood lurks a four-cylinder engine that runs around acting like a V-8. A four whose hottest version (optional at extra cost) develops more horsepower and more torque than any other production four in the everlovin' world.

Tell you what you do, just for kicks: hook that 166-hp plant up to Tempest's 4-speed stick (optional at extra cost). Run through a quartet of quick, positive shifts, and see how you like it. We have a good idea it'll set you thinking about the rear axle you'd like in your new LeMans. You've got five to pick from: 3.08:1, 3.31:1, 3.55:1, 3.73:1, 3.90:1, all available at no extra cost.

Of course, any engine/transmission pairing you like delivers a whopping big serving of Pontiac punch. (If you're after the lazy life, you couldn't do better than Tempest's automatic—an extra-cost option.)

One thing, though: you'll have to install your own tachometer to measure Tempest's fast-winding four. Go right ahead. But tach or no, Tempest's going to make you happy. We'd bet on it.

TOTAL TORQUE MULTIPLICATION* WITH TEMPEST POWER TEAMS

TRANSMISSION GEAR RATIOS	REAR AXLE RATIO CHOICES				
	3.08:1	3.31:1	3.55:1	3.73:1†	3.90:1†
3-SPEED MANUAL					
1st—2.94:1	N.A.	9.73:1	10.44:1	10.97:1	11.47:1
2nd—1.68:1	N.A.	5.56:1	5.96:1	6.27:1	6.55:1
3rd—1.00:1	N.A.	3.31:1	3.55:1	3.73:1	3.90:1
Reverse—3.32:1	N.A.	10.99:1	11.79:1	12.38:1	12.95:1
4-SPEED MANUAL					
1st—3.65:1	11.24:1	12.08:1	12.96:1	13.61:1	14.24:1
2nd—2.35:1	7.24:1	7.78:1	8.34:1	8.77:1	9.17:1
3rd—1.44:1	4.44:1	4.77:1	5.11:1	5.37:1	5.62:1
4th—1.00:1	3.08:1	3.31:1	3.55:1	3.73:1	3.90:1
Reverse—3.66:1	11.27:1	12.11:1	12.99:1	13.65:1	14.27:1
TEMPESTORQUE AUTOMATIC					
Low (Plus Converter) 3.64:1	11.21:1	12.05:1	12.92:1	13.58:1	14.20:1
Low (Gears Only) 1.82:1	5.61:1	6.02:1	6.46:1	6.79:1	7.10:1
Drive—1.00:1	3.08:1	3.31:1	3.55:1	3.73:1	3.90:1
Reverse—1.82:1	5.61:1	6.02:1	6.46:1	6.79:1	7.10:1

*The higher the total torque multiplication figure the faster the engine will be turning at a given road speed and the livelier the performance.
†Must be special-ordered.

PONTIAC MOTOR DIVISION • GENERAL MOTORS CORP.

TEMPEST BY PONTIAC

Pentagon sidelights

By William R. Kreh

Floating targets. The Coast Guard has started filling some of its buoys with plastic foam to keep them from being sunk by sharpshooters.

It seems the buoys in some of the inland rivers exert a fatal fascination as targets. An ordinary buoy, punctured near the water line, will soon sink and be lost forever. A plastic-filled buoy will become waterlogged and sink eventually, but it takes quite a few days to go down. The Coast Guard can often catch it before it has time to sink and it can be repaired and refilled. Now the Coast Guard is wishing someone would invent a way to bulletproof a light. The floating navigation beacons make good targets too.

Plastic scalpels? The Army's medical-equipment development laboratory is working on a whole new line of surgical instruments made of plastic. The instruments, ranging from retractors to scalpels and scissors, are designed for use in case a national emergency should cause critical shortages of the various metals now used to make the surgeon's tools.

A foxhole umbrella to protect soldiers from falling debris and shrapnel is being developed by Army engineers. It will be about four feet wide, weigh about four pounds and be made of some high-strength, resilient material such as nylon or glass fiber.

The Air Force is equipping its planes with a new special tool for pilots to use should they have to smash their way out of a jammed cockpit canopy. The small tool has one blunt end for shattering the Plexiglas canopy. At the other end is a razor-sharp edge for cutting away stubborn pieces.

There's good news for people who are sensitive to paint odors. An experimental, water-thinned paint, developed by the Navy for use in nuclear submarines, is almost free of odor. The Navy says the semi-gloss paint is resistant to dirt, easy to clean and dries in 20 minutes.

History's longest garbage collection will be made when two nuclear reactors go into operation in Antarctica. An international treaty bans the dumping of radioactive wastes on the cold continent, so twice a year a Navy ship will have to go there to pick up the reactors' waste and haul it back to the U.S. for burial in special underground nuclear "cemeteries" or dump them at sea in shielded containers. The garbage route will be 24,000 miles round-trip.

Salty sound. The Naval Ordnance Laboratory has completed a year-long project of making the first comprehensive high-precision measurements of the speed of sound in sea water. Sea water from the Bermuda-Key West area, where the ocean is about the saltiest, was divided into eight samples which were diluted to varying degrees with distilled water to represent the entire range of sea water in all the oceans of the world. Each sample was put in a special five-inch tube called a velocimeter. A crystal at each end measured the speed of sound through each.

All quiet on the Western front. Army ordnance experts are stepping up research to find a device that could be used on present infantry weapons that would make them noiseless, smokeless and flameless. A number of commercial silencers and smokeless powders have been tested, but none has been effective enough in preventing a potential enemy from finding the shooter. The Army needs such a device for its special forces, troops designed to operate behind enemy lines.

Volleyballs are helping the Navy test new explosives. Scientists at the Naval Ordnance Laboratory have found that the hollow and flexible playthings make good molds in which powdered explosives can be compressed into solid spherical charges of even density. They attach a rubber neck to the ball, pour in the powdered explosive. Then they pump all the air out of it, seal it, and put the ball into a water press to compress it until a solid charge is formed that has the desired density.

"Floatable" uniform material, which will keep men who are swept overboard from drowning has been designed by the Navy. It's made of a substance called polyvinyl chloride, a rubberlike material of nonconnecting cells which won't act as a sponge in water. While not intended to replace life jackets, it won't absorb water if a man falls overboard and will help keep him buoyant until he can be rescued. ★ ★ ★

If reply card
has been detached,
mail this coupon

LaSalle, Dept. 95-102
417 So. Dearborn,
Chicago 5, Ill.

Please send me, free of cost or
obligation, your illustrated book
"Opportunities in Accounting"
and also your sample lesson.

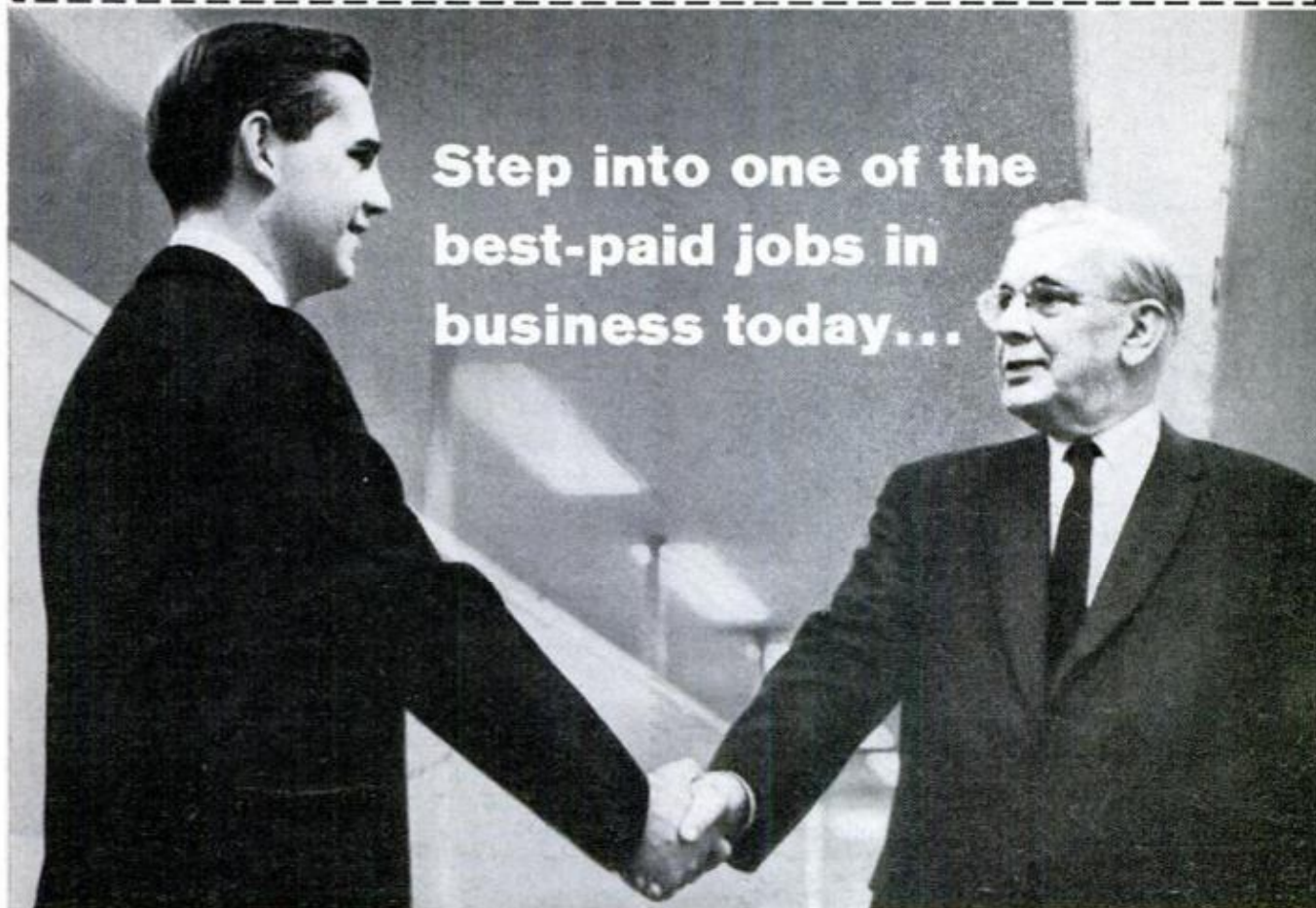
NameAge

Address

CityZone

CountyState

102



Step into one of the
best-paid jobs in
business today...

Be an ACCOUNTANT

Train in your spare time with LaSalle

LaSalle graduates report up to 56% increased pay the first year

THE demand for trained Accountants exceeds the supply. Salaries keep going higher, promotions are rapid. Many accountancy-trained men are being moved up to important management positions. Why remain in a dull job with insufficient pay when you can reap such big rewards in money and prestige?

You can take LaSalle Accounting training at home, in your spare hours, without any previous bookkeeping experience. LaSalle's distinguished faculty starts you at the beginning; explains every basic Accounting principle and method; gives you actual Accounting problems with your lessons, then corrects and grades your work; shows you exactly how accountants on the job handle these problems. Your training is complete, practical, and enjoyable. You are thoroughly prepared for every Accounting task you will be expected to handle in the business world.

Your career could not be in more experienced hands. For 53 years, LaSalle has been a world leader in business training, with over 1,500,000 students. More than 5,300 of today's CPA's are LaSalle alumni. A LaSalle diploma in Accounting is a credential respected by America's biggest companies.

Mail Attached Air-Mail Card

for Free Book and Sample Lesson

If you are truly seeking a more rewarding job, with higher pay, a solid position in the business world, and all the good things that come with success, you owe it to yourself to read LaSalle's famous book "Opportunities in Accounting". With it you will receive a free sample lesson in Accounting which will demonstrate how LaSalle makes home study easy, interesting and practical. Mail attached card today.

LA SALLE EXTENSION UNIVERSITY

An Accredited Correspondence Institution Chicago 5, Ill.

FOR FATHER-SON FUN!

HONDA TRAIL "50"

The Trail Machine That Needs No Trail!



**HUNTING
FISHING
EXPLORING
CAMPING
PICNICS**

ONLY \$275
plus destination and setup charge

You who yearn for adventure, the thrill of discovering new things and new places, will find the answer with a HONDA Trail "50". Wherever you want to go—desert or mountain country, over rocks, logs, through underbrush, up 45 degree slopes with a full load—the incredible Trail "50" will take you there and bring you back!

The Trail "50" is virtually indestructible and maintenance-free, yet built with the precision of a fine watch. So compact it'll fit a car bumper, station wagon, small boat—and almost any budget!

And just look at some of the Trail "50's" exclusive features! Weighs only 121 lbs. Performance-packed low gear ratio of 82 to 1. Speeds to 30 m.p.h., with a quick-change sprocket for 45 m.p.h. touring. Powered by HONDA'S famous 50 cc 4-cycle O.H.V. engine.

So head for the hills... but not until you've seen and tried the HONDA Trail "50"!

For name of nearest dealer, phone Western Union by number and ask for OPERATOR 25.

HONDA

World's Largest Motorcycle Manufacturer

4077 WEST PICO BLVD., LOS ANGELES 19, CALIF.

AMERICAN HONDA MOTOR CO., INC., Dept. PM 62-5
4077 West Pico Blvd., Los Angeles 19, Calif.

Please send free literature on HONDA TRAIL "50" to:

NAME _____

STREET _____

CITY _____ ZONE _____ STATE _____

- Include information on the complete Honda "50" line.
 Include information on Honda motorcycle line (9 models 125 to 305cc) and new 125cc Honda Scooter.
 I am interested in dealer franchise information.

Sidelights on aviation

In the wake of Popular Mechanics' feature on World War II combat aircraft that are still flying (PM, March, 1962), reports reached us on several others. One of the most unusual concerned a whole air force that is made up entirely of WW II fighters.

The Confederate Air Force—which, if it had been around, might have won the war in the 1860s—is, in the 1960s, a relatively peaceful organization headquartered at Mercedes, Tex. Duly chartered by the state of Texas, the CAF consists of more than 60 former military pilots who fly everything from a P-38 to an F8F.

All of the pilots are colonels—"so nobody can pull rank." All have been given security checks, not to test their loyalty, but to screen out damyankees. Their ultimate purpose is not to overthrow the federal government, but at least to get them to turn the capitol building around so it faces South.

According to their commanding officer, Col. Jethro E. Culpepper (who may or may not exist), the CAF currently has 10 fighters in its inventory which do exist, including the P-38 *Lightning*, P-40 *Warhawk*, P-51 *Mustang*, F4U *Corsair*, F4F *Wildcat*, F6F *Hellcat* and F8F *Bearcat*. The planes are shown and flown at air shows.

The CAF pilots hope to get at least one model of each fighter plane that saw combat in World War II and put it back in flying condition. Sentimentalists, they would like to see that at least one representative of each of these great war birds survives and flies.

One of their problems is getting pilot handbooks and maintenance manuals for all of them, and they would appreciate hearing from anyone who might have some stashed away—even a damyankee.

Icarus tried it 3000 years ago, but his wax wings melted in the sun. Now man may have at it again—that is, try to fly just like birds. An Englishman has offered £5000 (\$14,000) to anyone who can design an aircraft that can take off and fly using only the power of the pilot's muscles.

The specific conditions are that it stay 10 feet off the ground at all times and fly a figure-8 pattern around points a half mile apart. Several British teams are now at work on the project.

Kevin V. Brown

POPULAR MECHANICS

(F)
ROYAL AERONAUTICAL SOCIETY
4 HAMILTON PLACE, LONDON W.1, England

BE THE MAN IN DEMAND

Train at home for a high-paying job
in one of these 4 major fields



N.T.S. TRAINED
TECHNICIANS ARE
HIGHER PAID ...
MORE RESPECTED ...
CONFIDENT
OF SUCCESS

START NOW in one of these "Big 4" Industries, and be among the most sought after technicians in America. As an N.T.S. Trained Technician you can enjoy higher pay, rapid promotion, lifelong security.

N.T.S. TRAINS YOU RIGHT, FAST AND EASY!

Incomplete, "short-cut" training limits your earning power, even disqualifies you for top-pay jobs. N.T.S. gives you everything in *All Phases* ... to qualify you for any job in your field ... for greater profits the year round.

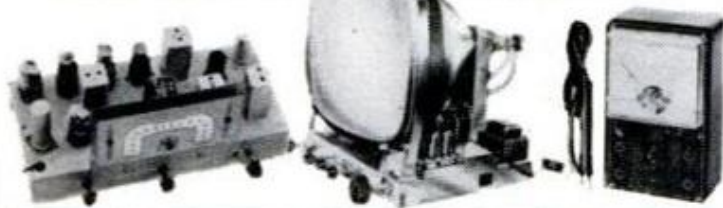
BETTER, MORE COMPLETE, LOWER COST TRAINING

N.T.S. Home Training is proved and tested in N.T.S. Resident School Shops and Laboratories — the oldest, largest school of its kind in the world. You learn *all phases*, and receive everything you need — Lessons, Manuals, Diagrams, big professional Kits with parts, tools, instruments for experimental, repair, service, troubleshooting projects. Yet N.T.S. Training costs less; only 1 Low Tuition. Other schools make several courses from the material in each of our Master Courses.

ELECTRONICS TELEVISION AND RADIO

YOU ARE NEEDED in All Phases of ELECTRONICS TELEVISION- RADIO ... Servicing, Communications, Broadcasting, Manufacturing, Automation, Radar and Micro Waves, Missile and Rocket Projects, plus all the other high-pay branches of this vigorous Industry. N.T.S. Shop-Tested Home Training gives you ONE MASTER COURSE... at ONE LOW TUITION...

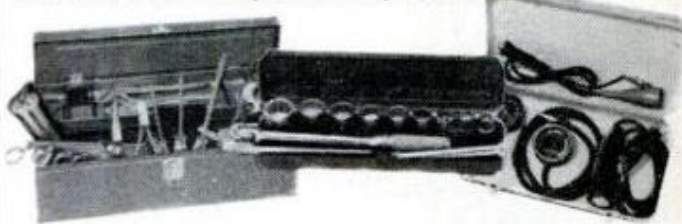
INCLUDES RADIO SET, TV SET, MULTITESTER.



AUTO MECHANICS AND DIESEL

TAKE YOUR CHOICE ... be a successful all-around mechanic in cars, trucks and heavy-engines. Or specialize in your favorite field ... Tune-Up, Automatic Transmissions, Farm Mechanics, Trucks and Buses, Stationary Installations, Foreign Cars, or get into Auto Air Conditioning, Engine Rebuilding, Diesel, and other high-pay fields, or go into business for yourself.

INCLUDES SOCKET SET, ANALYZER, TOOLS.



AIR CONDITIONING REFRIGERATION ELECTRICAL APPLIANCES

FUTURE BRIGHT FOR TRAINED MASTER TECHNICIANS ... over 30,000 new Technicians must be trained annually. You are needed to help service and repair the 50 million air conditioners, refrigerators and electrical appliances that will need fixing this year alone. You can go places in your own business or with a manufacturer, dealer, distributor or department store. With All-Phase training, your earning power is unlimited!

INCLUDES TESTER, GAUGES, TOOLS.



HOME APPLIANCE TECHNICIAN'S COURSE

MILLIONS OF HOME APPLIANCES NEED FIXING ... Every home is your market for Full-Time career or spare-time "Second Income." All you need is a workbench, spare time and N.T.S. Home Training. Costs less than \$1.50 per week. Repair any home appliance—from toasters, electric irons to washing machines and even room air conditioners — right in your own workshop. Or take a high-pay job with appliance manufacturer or large service company.

INCLUDES TOOLS, PROFESSIONAL TESTER, SOLDERING SET.



NATIONAL TECHNICAL SCHOOLS
WORLD-WIDE TRAINING SINCE 1908
4000 S. FIGUEROA ST., LOS ANGELES 37, CALIF., U. S. A.

Accredited
Member
National Home
Study Council

NATIONAL TECHNICAL SCHOOLS
WORLD-WIDE TRAINING SINCE 1908

National Technical Schools, Dept. B-52
4000 S. Figueroa St., Los Angeles 37, Calif.

Please rush FREE Book and Actual Lesson checked below.
No obligation. No salesman will call.

- Electronics — TV — Radio
 Auto-Mechanics & Diesel
 Air Conditioning, Refrigeration & Electrical Appliances
 Home Appliance Technicians Course

Name _____ Age _____

Address _____

City _____ Zone _____ State _____

Check here if interested ONLY in Resident Training at L.A.

RESIDENT TRAINING AT LOS ANGELES

If you wish to take your training in our famous Resident School in Los Angeles — the oldest and largest school of its kind in the world — check special box in coupon.

SEND FOR
FREE BOOK
(fully illustrated) and
ACTUAL LESSON



NO OBLIGATION
NO SALESMAN
WILL CALL

**CHECK
ONE**

Science overseas

By William Kreh

American willow trees are keeping a Russian river within its banks.

The Amu Darya, which flows from the Pamir plateau across desert sand to the Aral Sea, continually washed away its right bank and overflowed into farm lands in Soviet Uzbekistan. It was too expensive to build concrete embankments and metal pilings, so willow plantings from the U.S. were brought over. The Russians report they've grown into dense groves that anchor the sand and keep the river in bounds.

Gravity apparently has a bearing on how fast things grow. Experiments by a British doctor show that rats whirled in a centrifuge to produce about three times the force of gravity have a slower growth rate than rats subjected only to conditions of normal gravity.

India's first full-fledged center for rocket research is being built at the Birla Institute of Technology in Ranchi. The center, designed to undertake fundamental research in rocketry, is expected to send up a two-stage rocket this year.

Workmen with bulldozers are uncovering more relics of ancient Greece than are archaeologists, or so it seems. Latest find was under a downtown Athens street where workmen, cutting a trench to lay water pipe, dug into a large cemetery of the fifth century B.C. and uncovered some valuable ancient pottery.

Other recent finds include a tomb from the third century B.C., uncovered by road repairers on a major highway and a number of large chamber tombs dating from the fourth century A.D., unearthed by workmen digging the foundations for a new building at Salonika University.

The Mounties, and other agencies of the Canadian government, are abandoning the old cowhide-and-wood snowshoes with which they tracked down many a man.

New shoes made of a frame of magnesium alloy strung with nylon-covered aircraft cable will cost three times as much as the old-fashioned kind, but will wear ten times as long.

Civilization, apparently, is not entirely responsible for the disease of cancer. So says Dr. W. S. Swinton, a paleontologist who heads the Royal Ontario Museum's Life Sciences Division in Canada. He tells of finding a clear-cut case of bone cancer in the skeleton of a dinosaur, an animal that became extinct more than 60 million years before man first appeared on Earth.

Argentine meteorologists will use Japanese rockets to gain weather information. Other countries—Canada, Burma, Australia, Spain, Brazil, Formosa and surprisingly, the U.S.—have shown interest in the Japanese Kappa rocket, developed by scientists and students of the Tokyo Institute of Technology and the Prince Motor Company.

The solid-fuel rocket has a near 100-percent successful firing record and proved invaluable in Japanese weather research.

The eyes of the Greenland shark light up when a meal is on the way.

Dr. Bjern Berland of the Norwegian Directorate of Fisheries reports that the heavy-eating, though slow-moving, shark forms a strange partnership with a tiny shell fish, the copepod. This minute, yellowish-white creature fastens itself with tiny suction cups to the cornea of the shark's eyes. Apparently they prove a strong attraction for fish. The fish are lured to them, allowing the lazy shark to lie still and gulp mouthfuls of food.

Whale hunters claim the copepods attract fish with a strange underwater light. Dr. Berland couldn't find that they gave off visible light, but thinks they might send out a type of light people can't detect.

Australian scientists believe research on a development known as a plasma torch may help harness the energy of hydrogen bombs for peaceful purposes. The torch produces temperatures higher than the sun, vaporizing all known materials. Using it to understand behavior of matter at high temperatures, the scientists hope to gain clues so they can control thermonuclear reactions.

The problem of fitting a large pin in a small hole was solved economically at an English steelworks through use of liquid nitrogen.

Eight steel pins, each more than two feet across, were just a fraction too big for their corresponding holes in four 100-ton ladles. Immersed for about 52 minutes in a tank containing more than 1200 gallons of nitrogen, each pin shrank about 4/100 of an inch and fit perfectly. ★ ★ ★

GET READY FOR THE SPACE and SCIENCE ERA! SEE SATELLITES, MOON ROCKETS CLOSE-UP



AMAZING SCIENCE BUYS

for FUN, STUDY or PROFIT



See the Stars, Moon, Planets Close Up!

3" ASTRONOMICAL REFLECTING TELESCOPE

60 TO 180 POWER!
Famous Mt. Palomar Type!
An Unusual Buy!



See the Rings of Saturn, the fascinating planet Mars, huge craters on the Moon. Equatorial Mount with lock on both axes. Aluminumized and overcoated 3" diameter high-speed f. 10 mirror. Telescope comes equipped with a 60X eyepiece and a mounted Barlow Lens. Optical Finder Telescope included. Hardwood, portable tripod. FREE with Scope: Valuable STAR CHART plus 272-page "HAND-BOOK OF HEAVENS" plus "HOW TO USE YOUR TELESCOPE" BOOK.

Stock No. 85,050-H \$29.95 Postpaid

4 1/4" REFLECTING TELESCOPE—Up to 255 Power.

Stock No. 85,105-H \$79.50 F.O.B., Barrington, N.J.

WHIRLING WONDERS

WONDERFUL WORLD OF WHIRLING WHEELS



Here's a new adventure in optical impressions—created by the magical effect of these fascinating, rotating discs. In addition to weird shapes and fantastic "after images" this kit demonstrates "stop motion" stroboscopic principles—"off center" focus and even hypnotism. Kit includes 13 discs, approx. 5" dia. battery holder, rheostat, small motor mounted on bracket, bulb, socket, plug and complete booklet of instructions and experimental use.

Stock No. 70,414-H \$9.95 Postpaid

SPECIAL PURCHASE—SAVE \$7 ON THIS

PROFESSIONAL MECHANICAL DRAWING SET



Made to Sell for \$19.95—OUR PRICE ONLY \$12.95. Precision-made for professionals, yet priced within low-budget range. We bought all available stock from one of West Germany's famous instrument makers to bring you this super bargain. Every instrument real chromium on brass—not brass nickel. Wonderful gift for anyone in need of drawing equipment. Set includes: 6" detail divider with pen, pencil and extension; 6" bow divider with center wheel; low pencils with center wheel; and bow pen, all precision type; 4 1/2" drop compass with pencil and pen attachment; spare parts box; screwdriver for adjusting extra lead box; polishing cloth. All metal parts rust free. Two-flap velvet lined case.

Stock No. 70,440-H \$12.95 Postpaid

WOODEN SOLID PUZZLES



12 Different puzzles that will stimulate your ability to think and reason. Here is a fascinating assortment of wood puzzles that will provide hours of pleasure. Twelve different puzzles, animals and geometric forms to take apart and reassemble, give a chance for all the family, young or old, to test skill, patience, and, best of all to stimulate ability to think and reason while having lots of fun. Order yours now.

Stock No. 70,205-H \$3.00 Postpaid

MINIATURE WATER PUMP



Wonderful for experiments, miniature waterfalls, fountains, Christmas gardens, HO gage railroad backdrops, hobbyists, labs, schools. Pumps continuous flow of water etc. Tiny (2 5/8" x 1 3/4") electric motor and pump ideal for hobbyists, labs, schools. Pumps continuous flow of water at rate of one pint per minute at a 12" head. With 2 D Batteries in series will pump to 24" high. Works in either direction. Stock No. 50,345-H \$2.25 Postpaid

BUILD A SOLAR ENERGY FURNACE



A fascinating new field. Build your own Solar Furnace for experimentation—many practical uses. Easy! Inexpensive! Use scrapwood! We furnish instructions. This sun powered furnace will generate terrific heat—2000° to 3000°. Fuses enamel to metal. Sets paper aflame in seconds. Use our Fresnel Lens—14" diameter . . . f. l. 14". Stock No. 70,130-H Fresnel Lens \$6.00 Pstpd. 11" Sq. Fresnel Lens F.L. 19". Stock No. 70,533-H \$4.75 Pstpd.

OPAQUE PROJECTOR



Projects illustrations up to 3" by 3 1/2" and enlarges them to 35" x 30" if screen is 6 1/2 ft. from projector; larger pictures if screen is further away. No film or negatives needed. Projects charts, diagrams, pictures, photos, lettering in full color or black-and-white. Operates on 115 volt, A.C. current. 6-ft. extension cord and plug included. Operates on 60 watt bulb, not included.

Size 12" x 8" x 4 1/2" included. Weight 1 lb., 2 oz. Plastic case with built-in handle. Stock No. 70,199-H \$7.95 Postpaid

ORDER BY STOCK NUMBER. SEND CHECK OR MONEY ORDER. SATISFACTION GUARANTEED.
EDMUND SCIENTIFIC CO., BARRINGTON, N. J.

'FISH' WITH A MAGNET

Go Treasure Hunting On The Bottom

Great idea! Fascinating fun and sometimes tremendously profitable! Tie a line to our 5-lb. Magnet—drop it overboard in bay, river, lake or ocean. Troll it along the bottom—your "treasure" haul can be out board motors, anchors, fishing tackle, all kinds of metal valuables. 5-lb. Magnet is war surplus—Alnico V Type—a terrific bargain. Lifts over 125 lbs. on land—much greater weights under water. Order now and try this new sport. Stock No. 70,183-H. 5-lb. Magnet. . . . \$9.95 Postpaid



NEW EDMUND STAR FINDER



With this precision made metal instrument, any observer can quickly locate and identify any charted visible star. The view is erect, same size, same brightness.

Overall size is 8" x 4" wide x 7 1/4" deep. It is designed for use on any photo tripod or simple mount. (Suggestions for mounting are included). Full directions included.

Stock No. 70,501-H \$9.00 Postpaid

LARGE SIZE OPAQUE PROJECTOR

Ideal for photographers, this low-cost unit projects 3 1/2 ft. sq. image at 6 ft.—7 1/2" ft. sq. image at 12 ft. Projects photos, drawings, sketches, clippings, any opaque copy up to 6" x 6" —larger pieces in sections. Lenses are 2 plano-convex, 3 1/2" dia. mounted in 5 1/4" barrel. Projector is 11 1/2" high, 13 1/4" wide, 9" front to back, pressed steel in black wrinkle finish, bakelite handle. Uses two 200 watt bulbs—not included. Complete with side platform to hold illustrations, 6 ft. elec. cord, heat resist. plate glass mirror.



Stock No. 80,066-H \$42.00 Postpaid

Remove Your Retaining Rings—Disassemble Lenses, Cameras, etc.



ADJUSTABLE SPANNER WRENCH

Made for U.S. Air Force—available at a fraction of Government cost. A top grade, versatile tool that every instrument and camera repair man or just plain tinkerer should own. Adjustable for 1/2" to 12" diameter retaining rings. Complete with six different pairs of points to fit all types of slots and holes. 3", 6", and 12" main bars. All steel and nicely plated. The finest tool we have ever come across for this type of retaining ring work AND a real bargain at our low price. Stock No. 70,355-H \$12.50 Postpaid

WAR SURPLUS AMERICAN-MADE 7x50 BINOCULARS

Big savings! Brand new! Crystal clear viewing—7 power. Every optical element is coated. An excellent night glass—the size recommended for satellite viewing. Individual eye focus. Exit pupil 7mm. Approx. field at 1,000 yds. is 376 ft. Carrying case included. American 7 x 50's normally cost \$274.50. Our war surplus price saves you real money. Stock No. 1544-H Only \$74.80 Pstpd. (Tax included)



6 x 30 Binoculars—similar to above and a terrific bargain. Stock No. 963-H . . . \$33.00 Pstpd. (Tax inc.)

NEW! CIRCULAR SLIDE RULE!

Pocket Size—Fast—Easy to Use!



Multiples, divides, figures fractions, percentages, squares, cubes, roots, proportions, circumferences, areas, prices, fuel consumption. Faster, easier to learn and use. Directions included. Stock No. 30,336-H \$4.95 Postpaid

VISIT AND SEE THE FAMOUS EDMUND RAINBOW SHOWPLACE

SEATTLE WORLD'S FAIR

April 21 to Oct. 21

Order by Stock No.—Send Check or M.O.—Money-Back Guarantee
EDMUND SCIENTIFIC CO., Barrington, New Jersey

MAIL COUPON FOR FREE CATALOG "H"

160 Pages! Over 1000 Bargains!

EDMUND SCIENTIFIC CO., Barrington, N. J.

Please rush Free Giant Catalog "H"

Name

Address

City..... Zone..... State.....



FREE!

TRIAL LESSON



Trial lesson in DRAFTING



LEARN AT HOME IN SPARE TIME

Check the want ads in any newspaper — SEE the big-pay opportunities open to you as a draftsman. What's more, you can learn this well-paid, prestige profession at home — quickly, easily! No special talent needed! Get complete, step-by-step Chicago Tech lessons in the mail, spend a few pleasant hours studying each week. In a short time you'll be a well-trained draftsman, ready to take your pick of many good jobs. Act now!

FREE INFORMATION—MAIL COUPON TODAY!

Get FREE TRIAL LESSON plus information about C.T.C. practical training. Learn what successful Chicago Tech graduates say about high pay and opportunities in drafting. No charge, no obligation.

Est. 1904 Accredited National Home Study Council

CHICAGO TECHNICAL COLLEGE

E-200 Tech. Bldg., 2000 So. Michigan Ave.
Chicago 16, Illinois

Mail me FREE Lesson with information about big opportunities in DRAFTING.

Name _____ Age _____

Address _____

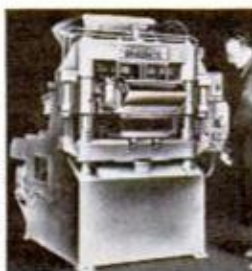
City _____ Zone _____ State _____

811

WANT TO BE A LOCAL BRIKCRETE* MANUFACTURER?

*Guaranteed to Contain No Clay

High income can be earned operating a Brikcrete plant, because Brikcrete — world's most modern masonry — gives more value for less cost to building owners without sacrifice of profits. Huge savings by local production makes possible low prices and high income potentials.



Choice Territories Open

Broad markets are waiting because Brikcrete is popular for every type of residential, commercial and industrial construction. Ultra modern in design, size, proportion. Cost less than lumber. Wide color range. Combines all the features that make for large consumer acceptance. More local plants are needed. Exclusive privileges in franchise-protected territories. Mark-up averages 100% on basic cost. Machine available on long-term payments. Write for Brikcrete Book No. 2 and tentative reservation of territory.

Brikcrete Associates, Inc., 402 W. 25th, Holland, Mich.

MY SPARE TIME HOBBY MAKES ME

\$5⁰⁰ an hour CASH PROFIT

—Grover Squires



START YOUR OWN SPARE TIME BUSINESS

You can turn your spare time into Big Cash Profits with your own COMPLETE SHARPENING SHOP... Grind saws, knives, scissors, skates, lawn mower blades... all cutting edges. Your Own Cash Business with no inventory right at home... no experience needed. FREE BOOK tells how you can start your own spare time business while you are still working at your regular job. Low Cost—time payments only \$15.00 a month. Send postcard today.

BELSAW SHARP-ALL CO., 712 Field Bldg., Kansas City 11, Mo.

GOVERNMENT OIL LEASES LOW AS \$1 PER ACRE

You do no drilling, pay no taxes, may realize a king-size profit without ever leaving home. Write for free map and literature.

AMERICAN OIL SCOUTS, Dept. PM
619 Cascade Bldg. Portland 4, Oregon



Repair any watch

... SWISS OR AMERICAN

Unique, modern Sweazey System starts you making repairs right away. Develops skill step by step at home in spare time. Tuition \$5 monthly. Diploma awarded. Free sample lesson. No obligation.

CHICAGO SCHOOL OF WATCHMAKING
2330 Milwaukee, Dept. 152, Chicago 47, Ill.

REAL ESTATE BE A BROKER

PAYS BIG! SEND FOR FREE, BIG, ILLUSTRATED CATALOG NOW! Graduates report making substantial incomes. Start and run your own business quickly. Men, women of all ages, learn easily. Course covers Sales, Property Management, Appraising, Loans, Mortgages, and related subjects. STUDY AT HOME or in classrooms in leading cities. Diploma awarded. Write TODAY for free booklet! No obligation. Approved for World War II and Korean Veterans



WEAVER SCHOOL OF REAL ESTATE (Est. 1936)
3521P Broadway Kansas City, Mo.



GLASS Slicing Tool & Diamond CUTTER

22" Long \$3.95
42" Long \$4.95
Extra Diamond Cutter \$1.98

Now anyone can cut glass easily, accurately. Just run cutter down slotted guide board. Glass slices itself or separates at a slight bend of the spring steel base. Wide or narrow cuts, thick or thin glass. Complete with diamond cutter.

Randolph-Page, Inc., 175 5th Ave., N.Y. 10, N.Y.

RUPTURED

BE FREE FROM TRUSS SLAVERY

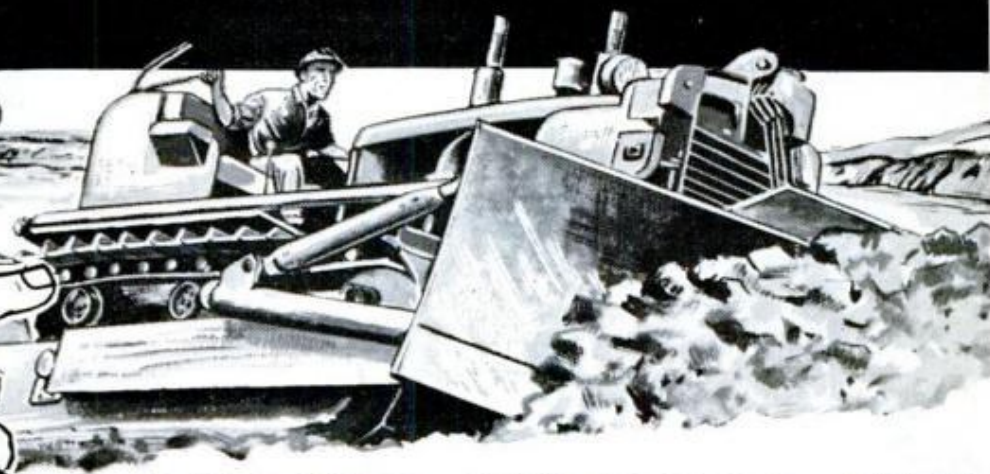
Surely you want to THROW AWAY TRUSSES FOREVER, be rid of Rupture Worries. Then Why Do you put up with wearing a griping, chafing and unsanitary truss the balance of your life? If you do, it will NOT be through necessity but through choice on your part.

Now there is a new modern Non-Surgical treatment that is designed to permanently correct rupture. These Non-Surgical treatments are so dependable, that a Lifetime Certificate of Assurance is given. Write today for our new FREE BOOK that gives facts that may save you painful, expensive surgery. Tells HOW and explains WHY NON-SURGICAL Methods of Treating Rupture are so successful today. No obligation.

Excelsior Medical Clinic
Dept. H6125, Excelsior Springs, Mo.



Earn **HIGH WAGES** as a **HEAVY EQUIPMENT OPERATOR**



**FIELD-TRAIN
AT NATIONAL ON
DIESEL-ENGINE MACHINES**

Learn Operation,
Maintenance and
Safety

RUGGED OUTDOOR MEN

up to 56 years old can qualify!

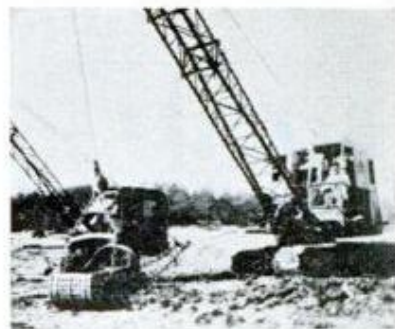
**NO PREVIOUS
EXPERIENCE NECESSARY
No Special Education Needed**

High wages and security NOW and in the years to come are yours as a trained heavy equipment operator. Your chance is TODAY... your opportunity is HERE, if YOU will but take advantage of it! The world's fast-growing multi-billion dollar construction industry needs men NOW for work in this country and overseas — you can be one of them!

As a heavy equipment operator you will "move the earth" on aerospace projects, highway building, and industrial construction. Learn HOW at National, the original school of heavy equipment operation, through actual field training on the same kind of diesel-engined bulldozers, rubber-tired scrapers, motor-graders, and cranes now in use by the industry.

National School is NOT a correspondence school... if your application is accepted, you will field-train on its huge proving ground in the beautiful Piedmont area of North Carolina. Full training courses, VA approved, payment plans available. AND, National maintains its own Job Advisory and Counselling Department with a full-time Director for the exclusive use of its graduates!

Make up your mind NOW that you are interested in high wages and security and mail the coupon TODAY for FREE illustrated school catalog... you are not obligated in any way.



Even if you are presently taking a "course" in heavy equipment operation, write for our free catalog (there is no obligation), and compare the "training" you are receiving with ours.

MAIL TODAY
For FREE Illustrated School
Catalog and complete information

NATIONAL SCHOOL OF HEAVY EQUIPMENT OPERATION
Dept. D-28
P. O. Drawer 1686, Charlotte, N. C.

Please send one FREE illustrated school catalog and complete information about how I can become a Heavy Equipment Operator. I understand there's no obligation.

Name _____ Age _____

Address _____

City _____ Zone _____ State _____

**ENGINEERING
SCIENCE
MATH**

**DEGREE IN
27 or 36 MOS.**



B.S. degree — 36 mos. • B.E. degree — 27 mos.

ACCELERATED YEAR-ROUND PROGRAM prepares for early employment in fields of SCIENCE AND ENGINEERING. Regular 4-year program for B.S. Degree completed in 36 months, special engineering degree program in 27. Classes start—June, July, Sept., Jan., March. QUALITY EDUCATION. Graduates employed from coast to coast. Government approved for veteran training. Students from 50 states, 40 countries. 20 buildings; dorms, gym. Campus. SAVE TIME AND MONEY. EARN BOARD while studying. Write for catalog and complete information.

INDIANA TECHNICAL COLLEGE

552 E. Washington Boulevard, Fort Wayne 2, Indiana

Please send me free information on Bachelor's Degree Programs in Engineering and Science as checked below:

- | | |
|---|--|
| <input type="checkbox"/> Aeronautical Engineering | <input type="checkbox"/> Mechanical Engineering |
| <input type="checkbox"/> Chemical Engineering | <input type="checkbox"/> Metallurgical Engineering |
| <input type="checkbox"/> Civil Engineering | <input type="checkbox"/> Physics |
| <input type="checkbox"/> Electrical Engineering | <input type="checkbox"/> Chemistry |
| <input type="checkbox"/> Electronic Engineering | <input type="checkbox"/> Mathematics |

Name.....

Address.....



LIVE SEA HORSES

LIVE SEA HORSES. Order one mated pair of Dwarf species Living Sea Horses, sent air mail from Florida for \$3.50 postage paid. We include food and instructions free. Father bears the young alive! Easy to keep in a goldfish bowl. Hardy, educational, fun for the entire family. We guarantee Live Delivery. Order 3 mated Pair for \$6.98
FLORIDA SEA HORSE CO. DEPT. P
 Box 5095, Miami 1, Fla.

**NEW! TEN POWER
TELESCOPE**



THE BALSCOPE TEN

at only **\$9.95**

■ For the first time, due to a manufacturing breakthrough... a *quality* telescope for only \$9.95! Ideal instrument for all kinds of nature study, for vacations, for all outdoors. No clumsy draw tube—focus with a single turn of the eyepiece. Only 10¼" long, and weighs just 9 ounces. Belt holster accessory at 98¢. See it at optical, photographic and sporting goods dealers. Made to American standards of quality by America's most respected optical craftsmen, Bausch & Lomb Incorporated, Rochester 2, N. Y.

BAUSCH & LOMB



**Science
bulletins**

Bugs? Yes, bugs! These bugs (a hush-hush variety of bacteria) are providing electricity to power a radio signal over a range of 15 miles. They feed on sugar in a test tube of sea water to make a secret "biochemical fuel cell" which the U. S. Navy is finding uses for.

The cell, developed by General Scientific Corp., generates current in the same manner bacteria do in the ocean. Its use is predicted for generating electricity in such places as the Black Sea, the Mediterranean, the swamps of Florida and the Bahamas.

Thousands of new chemicals will be made within the next few years using extremely high temperatures produced, perhaps, by the electric arc.

Dr. John L. Margrave, chemist at the University of Wisconsin, says the exact number is difficult to forecast. He notes, however, that chemists have made more than a million compounds from only five or six elements. Today's high-temperature chemists, he said, have available more than 100 elements and a temperature range of 100,000 degrees to work with.

Some 2000 balloons circling Earth will be used to survey formation of weather. Satellites of satellites, they will pass information to permanent orbiting satellites for telemetry to Earth.

The balloons, flying at 20,000 to 100,000 feet will shatter if hit by an aircraft. They will remain in orbit for 60 days, primarily to note temperatures for transmission to the big weather satellites.

Department of undue modesty.

The National Aeronautics and Space Administration's Space Activities Summary for February reports, under the heading, "Mercury Atlas VI" (Glenn's orbital flight)

Major Objective: Orbit and recovery of manned spacecraft.

"Major Results: Orbit achieved and capsule recovered."

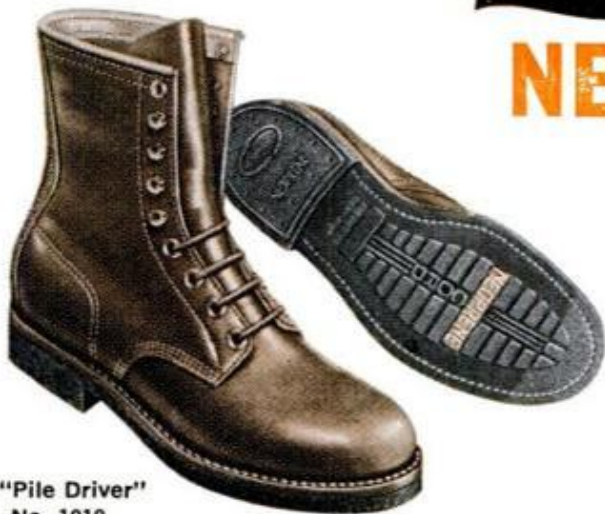
James Biery

POPULAR MECHANICS

LOOKING FOR LONG WEAR IN SERVICE BOOTS?

TRY **ACME BOOTS** WITH

NEOPRENE SOLES!



"Pile Driver"
No. 1018

HAWKEYE service boots by ACME are every bit as rugged as they look—sturdy leather uppers, safety toes and tempered steel shanks, solid leather mid-soles, tough functional nylon stitching, and extra-long-wearing soles and heels of durable Du Pont Neoprene. The Neoprene soles and heels resist oil, grease, chemicals, and cold weather cracking... and their resilience helps reduce fatigue on the job or in the field. That's why performance-proved Neoprene is used in ACME and other fine work, sport, and safety shoes. Write Dept. PM-5-NS, Wilmington 98, Del.



Better Things for Better Living... through Chemistry

Ask for Neoprene soles the next time you buy service shoes!

"\$7,108⁵⁰ First Year
SERVICING RADIATORS!"

— Hank Konter, Newcastle, Wyo.
Make good money servicing auto-truck-tractor radiators with new Inland 1-Piece Radiator Shop. Easy to test-clean-repair radiators. Inland, world's largest radiator equip. mfr., trains you free. Small down payment starts you. Easy-pay plan lets you pay from profits. Proved merchandising assures volume. Profitable dept. for garage or service station. **WRITE for Free Book.** INLAND MFG. CO., Dept. PM51108 Jackson St., Omaha 2, Nebr.



NEW!

JEEP OWNERS

RE-POWER NOW WITH A V-8 OR 6 CYL. ENGINE — USE FORD—CHEV.—MERCURY—GMC—PONT—STUDE—DODGE OR PLYMOUTH In Jeeps, Jeepsters, Sta-Wags, trucks, Kaiser & H. J. cars. Conversion Kits \$45.35 to \$56.90. Want fast action? Give us full information, send \$15.00 Dep. and we will ship correct kit. Bal. COD. Send full amount for prepaid shipment. Wire, phone or write today. Details FREE.

HOOSIER MACHINE PRODUCTS CO.
312 S. E. 6th St. Phone CR 6-3442 Pendleton, Oregon



STOP FRONT DRIVE DRAG AND WEAR ON 4-WHEEL-DRIVES!

WARN HUBS

Free-wheeling 2-wheel drive with Warn Hubs means big savings in gear, engine, tire wear, gas—plus more pep, performance, power in high, and easier steering. Rugged, dependable, proven, with over 400,000 in use. Iron-clad guarantee. Choose Lock-O-Matics that change drive as you shift, or manual Locking Hubs. Models for all 4-w. ds. at dealers, or write for literature.

WARN MFG. CO. Riverton Box 6064-A Seattle 88, Wash.

... TURN CONCRETE INTO GOLD!

MAKE UP TO \$75 A DAY IN YOUR OWN BUSINESS

If you want to have your own business — to start a business on your own — here's your big opportunity! New high speed, low cost General block machine produces up to 1,000 concrete blocks a day. Sell all you make to builders, supply houses, and others for homes, factories, buildings, garages. Cash in on the building boom! You can make profits of 100% to 150% — up to \$75. a day! General block machine equipped with 1/2 h.p. electric motor — or can be supplied with gasoline engine — works anywhere, in little space, indoors or out. Operates from ordinary house light socket. Simple, foolproof 3 step operation — so easy a child can do it. Makes superior 3 core blocks any size from 4" to 12" Also makes chimney, sash, corner and other types. Blocks meet any building code anywhere in the country. Materials — sand, water, cement, available anywhere. Simple illustrated operating instructions and mixing formulas for cement and cinder blocks supplied with each machine. Write for FREE folder with full information.

MOTOR DRIVEN

R. L. T. of New York City reports: "MY GENERAL BLOCK MACHINE PAID FOR ITSELF IN FIRST 2 WEEKS!"
Hundreds now in use the world over!
Write for FREE details today!

EXTRA

Amazing illustrated book gives floor plans for 6 sensational concrete block bungalows. Tells how to lay blocks, lay out building lines, mix concrete, build steps, porch and concrete floors all at great savings. Written by experts. Can save many times the cost of the machine! Get it now! No strings attached. Send \$1.

BOOK SENT FREE IF YOU BUY MACHINE.
\$1 REFUNDED IF YOU BUY LATER.

GENERAL ENGINES CO.
DEPT. PB-52, ROUTE 130, THOROFARE, N. J.



AUDELS GUIDES

No. 1	AUTOMOBILE MECHANICS GUIDE. 1132 Pages	\$ 6.00
No. 2	HOME APPLIANCE SERVICE GUIDE. 864 Pages	6.00
No. 3	TV & RADIO SERVICE LIBRARY. 2 Book Set	8.00
No. 4	HANDY BOOK OF ELECTRICITY. 1052 Pages	5.00
No. 6	PLUMBERS & STEAMFITTERS GUIDES. 4 Book Set	9.00
No. 7	PAINTING & DECORATING MANUAL. 585 Pages	4.00
No. 8	CARPENTERS & BUILDERS GUIDES. 4 Book Set	9.00
No. 10	WELDERS GUIDE. 608 Pages	4.00
No. 11	MATHEMATICS MADE EASY. 672 Pages	4.00
No. 12	MACHINISTS & TOOLMAKERS HANDBOOK. 1250 Pages	6.00
No. 14	REFRIGERATION & AIR CONDITIONING. 1360 Pages	6.00
No. 15	ELECTRIC LIBRARY. 10 Volume Set	22.50
No. 26	MASONS & BUILDERS GUIDES. 4 Book Set	8.00
No. 27	ELECTRIC MOTOR GUIDE. 1056 Pages	5.00
No. 29	SHEET METAL PATTERN LAYOUTS. 1152 Pages	7.50
No. 43	DO-IT-YOURSELF ENCYCLOPEDIA. 2 Book Set	8.95
No. 44	NEW MECHANICAL DICTIONARY. 712 Pages	6.95
No. 46	WATER SUPPLY AND SEWAGE. 436 Pages	4.00
No. 47	PRACTICAL CREATIVE PHOTOGRAPHY. 416 Pages	3.95
No. 48	GAS ENGINE MANUAL. 480 Pages	4.00
No. 49	OUTBOARD MOTORS & BOATING GUIDE. 400 Pages	4.00

7-DAY FREE EXAMINATION SEND NO MONEY—Pay the postman nothing! We'll send you any of the Audel Guides for FREE examination. If you decide to keep the books you pay for them under our easy-pay plan of only \$2 a month.

HERE IS ALL YOU DO IT'S EASY TO ORDER: In the No-Risk Mail Order Coupon below draw a circle around the number of Guides you want. We will send them to you at once. If you are not completely satisfied, return the books to us.

MAIL THIS COUPON TODAY!

THEO. AUDEL & CO. — Self Improvement Publishers Since 1879
49 W. 23rd Street, New York 10, N. Y. P5

Please mail me for 7 days' FREE EXAMINATION the books I have circled below. I agree to mail \$2 in 7 days on each book or set ordered, and to further mail \$2 a month on each book or set ordered until I have paid the purchase price, plus shipping costs. If I am not completely satisfied with my Audel Guides I may return them.

NAME _____
ADDRESS _____
EMPLOYED BY _____

1	2	3	4	6	7	8	10	11	12	14	<input type="checkbox"/>	Check Here for Free Complete Catalog
15	25	26	27	29	43	44	46	47	48	49	<input type="checkbox"/>	SAVE SHIPPING COSTS! Check here if you enclose complete payment with order. We pay postage charges. You have same return privilege.

EARN MORE - LEARN AUTO DIESEL MECHANICS

- OR TRAIN WITH OTHER GREER DIPLOMA COURSES
- | | |
|---|--|
| <input type="checkbox"/> AUTO MECHANICS | <input type="checkbox"/> REFRIGERATION |
| <input type="checkbox"/> DIESEL MECHANICS | <input type="checkbox"/> AIR CONDITIONING |
| <input type="checkbox"/> BODY & FENDER REPAIR | <input type="checkbox"/> MACHINIST-TOOL & DIE |
| <input type="checkbox"/> GAS, ARC WELDING | <input type="checkbox"/> AUTOMATIC TRANSMISSIONS |
| <input type="checkbox"/> HELIARC WELDING | <input type="checkbox"/> MOTOR TUNE-UP |
| <input type="checkbox"/> DRAFTING | |
- Civ. or G.I.

Skilled men are needed in every part of the country. Earn top pay in established shops or start your own business. Greer's expert instruction and actual shop training teaches you how. You learn by doing—quick, easy courses using the latest tools and equipment. Day, evening and part time instructions available.

Job placement aid and convenient living accommodations are yours while training. Contact GREER'S FREE JOB PLACEMENT SERVICE when you enroll if you wish part time or full time employment assistance.

- TECHNICIAN COURSES**
- DIESEL AUTOMOTIVE TECHNICIAN—21 MONTHS
 - REFRIGERATION & AIR COND. TECHNICIAN—17 MONTHS
 - WELDING TECHNICIAN—14 MONTHS

Please rush me free literature on the trade indicated at no obligation.

NAME _____ AGE _____
STREET _____
TOWN _____ ZONE _____ STATE _____

Established 1902
GREER SHOP TRAINING
Box E, 2236 S. Michigan Ave, Chicago 16, Ill.

engineering degree in 27 months

Industry demands graduates. Enjoy higher income . . . advancement. Major corporations regularly interview and employ seniors. Bachelor of Science Degree in 27 Months in Electrical, Mechanical, Aeronautical, Chemical, Civil Engineering. IN 36 MONTHS a B.S. Degree in Business Administration (General Business, Accounting, Motor Transport Administration majors). Small classes. More professional class hours. Well-equipped labs. Campus. New dorms. Low costs. Founded 1884. Enter June, September, January, March. Write J. E. McCarthy for Catalog and "Your Career in Engineering and Commerce" Book. Learn more and you'll earn more.



PROFITS IN PLASTICS

Manufacture beautiful lightweight vases, patio tiles, wall panels, artistic grill dividers, etc. with our latest technical manuals. Sparkling, hi-glazed finishes. Amazingly fast, easy production of quality products. Exclusive, machineless processes create modern, money-making opportunity. Basic Manual \$3.25—Master Set \$8.50. Free information.

PLASTICON COMPANY
North Street, Box 105, Grove City, Pennsylvania

LEARN MEAT CUTTING

Train quickly in 8 short weeks at Toledo for a bright future with security in the vital meat business. Big pay, full-time jobs — HAVE A PROFITABLE MARKET OF YOUR OWN! Pay after graduation. Diploma given. Job help. Thousands of successful graduates. Our 39th year! Send NOW for FREE catalog. No obligation. GI approved.

NATIONAL SCHOOL OF MEAT CUTTING, Dept. 50-E, Toledo 4, Ohio

Would You Like to Make \$1,000 A MONTH?

That's what Stanley Hyman made selling the amazing new Presto Fire Extinguisher! Many others "cleaning up"—so can you! Amazing tiny new extinguisher ends fires fast at 2 seconds. Guaranteed for 20 years! Sells for only \$4.95. Write for Free sales kit.

Merlite Industries, Inc., Presto Div.,
114 E. 32nd St., Dept. P-157, New York 16, N. Y.

Shrinks Hemorrhoids New Way Without Surgery Stops Itch - Relieves Pain

For the first time science has found a new healing substance with the astonishing ability to shrink hemorrhoids and to relieve pain — without surgery.

In case after case, while gently relieving pain, actual reduction (shrinkage) took place. Most amazing of all — results were so thorough that sufferers made astonishing statements like "Piles have ceased to be a problem!"

The secret is a new healing substance (Bio-Dyne®)—discovery of a world-famous research institute.

This substance is now available in suppository or ointment form under the name Preparation H®. Ask for it at all drug counters.

SENSATIONAL OFFER TO POPULAR MECHANICS' READERS

**SAVE
MORE
THAN
EVER**

2 COMPLETE 1962 MODEL FISHING OUTFITS 279 pcs

PFLUEGER, MUSTAD, DUPONT

SMOOTH POWERFUL DIRECT DRIVE
LEVEL WIND CASTING REEL

FREE! If you order NOW!
LEAKPROOF FLOATING
TACKLE BOX

POWER ACTION
GLASS RODS
STRONGER
THAN STEEL
OR BAMBOO

LIVE BAIT BOX

FOLD-A-WAY
FLOATING
TROUT NET

PRE-WOUND
ON REEL

FISH KNIFE
with SHEATH

FAMOUS
JIGS and FLIES

28 Pcs.
POPPING
LURE SET

SAFETY
STAR DRAG
Found only
on best reels

DETACHABLE
HANDLE
FULL CORK
GRIP

COMPARE!
with EXPENSIVE SETS

\$12.95
NEW
LOW
PRICE

**BOTH SETS
FOR THE PRICE OF A
REEL ALONE**

NEW! AUTOMATIC
SUPER "88" REEL

- SMOOTH POWERFUL LIGHTNING FAST FINGERTIP CONTROL
- PUSH BUTTON CASTING ANTI-REVERSE—NO BACKLASH

19 FAMOUS
CRAFTY
LURES

COMPLETE! Nothing else to BUY!

NEWEST! EASIEST WAY TO CATCH FISH!

SELECTED FOR YOU BY EXPERTS. This choice fish-getting tackle, used by experts; contains nationally famous brands. Each item carefully chosen—everything you need for all types of fishing. Deadly lures that are all time favorites. Whether you're a veteran angler or an occasional fisherman, you can be proud of this precision-built kit. Nothing else to buy—you can go fishing at once. Compare! You will not find a bargain like this anywhere.

LOOK! YOU GET EVERYTHING SHOWN. Super "88"—Automatic Spin Cast Reel with line. Comet X3C Bait Casting Reel—5 ft. (2 pc.) Spin Cast Rod—4 ft. Bait Cast Rod, Live Bait Box, Fish Knife and Sheath, 19 Famous Lures, Tackle Box and Removable Tray, Cable Leader, Clincher Sinkers, Assorted Hooks, Snelled Hooks, Fold-Away Trout Net, Stringer, Hook Remover, Hook Guards, Bobbers, Split Shot, Snaps and Swivels, Practice Plug. 28 pc. Popper Lure Set and Complete Instructions.

FREE! "Experts Guide" Over 200 best lakes and streams selected from more than 10,000 FAMOUS FISHING SPOTS IN AMERICA.

NIRESK DISCOUNT SALES Div. of NIRESK IND. • CHICAGO 47

MONEY BACK GUARANTEE!

NIRESK DISCOUNT SALES • Chicago 47, Ill. • Dept. FE-19

ORDER TODAY! We're so sure that you will be pleased that we make this daring offer. If you're not 100% pleased we'll refund your full purchase price promptly. **YOU KEEP FREE TACKLE BOX REGARDLESS!**

Please rush _____ 279 pcs. 2 Complete Fishing Sets

NAME _____

ADDRESS _____

CITY _____ ZONE _____ STATE _____

- I enclose \$12.95 plus \$1.00 for postage & handling
 Ship C.O.D. I will pay C.O.D. charges and postage.

CASH FOR YOU-



Electric APPLIANCES

Learn at Home • \$3 to \$5 an Hour
Spare Time, Full Time • Be Your Own Boss

FREE BOOK tells about profitable business you can run — right at home. Repair Electric Appliances, using simple tools. Pays \$3-\$5 an hour!

CASH IN ON THIS BIG BOOM 400 MILLION Appliances are in American homes right now. People need them fixed. You make good money doing it. In your basement, garage, even your kitchen.

QUICK WAY TO GET STARTED For less than 20¢ a day our

easy, pictured instruction — backed by 45 years of success in home-training — prepares you for top earnings. Earl Reid of Thompson, Ohio says: "Made \$510 in one month spare time." At no extra charge you get Appliance Tester, too. Finds trouble-spots, checks your work.

Get your **FREE** Book and **FREE** Sample Lesson! Mail coupon below, letter or postcard, now.

NATIONAL RADIO INSTITUTE, Appliance Div.
Dept. AE2, Washington 16, D. C.

Send **Free** Book, **Free** Appliance Repair Course Lesson. Am interested in:

- Spare Time Earnings My Own Business
 Better Job

Name.....

Address.....

City..... Zone..... State.....

Accredited Member National Home Study Council



New Catalog of 2900 Novelties

Send 10c for amazing catalog of novelties, live animals, scientific supplies, hobbies, funmakers, planes & boats, looms, magic tricks, joke articles, unusual seeds, gadget timesavers, cameras, optical goods, projectors, movies, lucky jewelry, religious novelties, disguises, musical instruments, stamps, coins, puzzles, fortune tellers, radios, auto & bike accessories, telescopes, magnifiers, compasses, banks, smokers' gadgets, artists' supplies, printing sets, engines, motors, shockers, knives, billfolds, guns, rifles, sports, books, games, plants etc. Send 10c.

JOHNSON SMITH COMPANY Dept. 565 Detroit 7, Mich.

BE A BUILDING BEAUTIFIER



A LOW-INVESTMENT, HIGH-INCOME OPPORTUNITY

Turning dirty drabness into clean, gleaming newness is the purpose of Colorcrete. When stucco, concrete, or other masonry becomes shabby and time-worn — whether it's a home or almost any kind of commercial or public building — there's a job awaiting the local Colorcretor. In the briefest of time, old surfaces are transformed into walls of colorful beauty that outlasts the years — at small cost to the owner and good profit to the Colorcretor. Write for the Colorcrete Opportunity Book.

COLORCRETE INDUSTRIES, INC.
570 Ottawa Avenue, Holland, Mich.



New Table Top Invention Puts You In...

PROFITABLE RUBBER STAMP BUSINESS

Home Operators now make **\$9.20 AN HOUR** in Business once monopolized by a few big companies

Special rubber stamps bring high prices—cost only pennies to make on new, low-cost table top machine. Take 27 cents worth of material, make perfect stamps, the kind businesses and offices now buy by the dozen at \$1.80 each. Make up to \$9.20 an hour. Start in spare time in your own home. Run machine on kitchen table using ordinary electrical outlet. Make any kind of stamp. We'll send you free information without obligation about this established, highly profitable business. **We'll even help finance your start.** For free information send name and address today on a postcard to: **Rubber Stamp Div., 1512 Jarvis Ave., Dept. R-2-E, Chicago 26**



ELECTRIFY PLAYER PIANOS PUMP ORGANS

YOU CAN QUICKLY END TIRESOME FOOT-PUMPING
With a Compact Low-Cost Lee Silent Suction Unit



EASY TO INSTALL
FULLY GUARANTEED
1000'S IN USE

write to
LEE MUSIC MFG. CO.
Box 595, Tujunga, Calif.



LAW FREE BOOK THE LAW TRAINED MAN

Write today for a **FREE** copy of illustrated law book, "THE LAW-TRAINED MAN," which shows how to earn the professional Bachelor of Laws (LL.B.) degree through home study of the famous Blackstone Law Course. All necessary books and lessons provided. Moderate cost; convenient monthly terms. Write for **FREE** law training book today.

Blackstone School of Law, 307 N. Michigan Ave.
Founded 1890 Dept. 55, Chicago 1, Illinois

get into operating or repairing EARTH MOVING EQUIPMENT

Men needed now for good paying jobs in booming road and construction work. Learn operating or repair-rebuilding of heavy road machinery, cranes, bulldozers, earth carriers, etc. Actual "on the job" training, 5 to 13½ week courses. Classes start every Monday. Reserve your space now. Complete catalog and reservation facts **FREE.** Approved for veterans. Write

Greer TECHNICAL INSTITUTE
Attn.: P. E. Hutch, Box 368, Braidwood, Ill.

LEARN TO BE A DENTAL MECHANIC

SECURITY • PRESTIGE • GOOD PAY
Learn at home, in your spare time, to make Crowns, Plates, Bridgework, etc. Dental Mechanics are employed by Dentists, Dental Laboratories or open your own shop, full or spare time. **FULL EQUIPMENT OF TOOLS AND MATERIALS INCLUDED WITH COURSE.** Low tuition. Easy Terms. Write for **FREE** BOOK about this money-making profession that's not affected by automation.

McCARRIE SCHOOL OF MECHANICAL DENTISTRY
127 So. 13th St., Dept. 59, Philadelphia 7, Pa.

NO JOB WORRIES

PLASTEX INDUSTRY needs manufacturers on small scale for big production of Lamps, Clock Stands, Art Goods, Novelties in Plastic Marble imitation. No Experience necessary. **1/2¢** material makes regular 10¢ store sellers. Moulds furnished for fast production. Small investment brings good profit. Big wholesale orders now being placed. Ambitious men have chance for real prosperity and job security. Our **NEW FREE** booklet will interest and benefit you.

PLASTEX INDUSTRIES, Dept. A
3400 Third Ave. New York 56, N. Y.



POPULAR MECHANICS

**FLASH
NEWS!**

AUTO REPAIR Bulletin

**EXTRA!
★★★★★**

Published by the Automotive Experts of MOTOR's Manual

AMAZING FREE OFFER PROVES YOU CAN FIX ANY PART OF ANY CAR!

OVER 4
MILLION COPIES
ALREADY SOLD!



**MOTOR'S Manual Shows Green Beginner and Skilled Mechanic
Alike How To Do ANY Job Quick, Easy, Right the First Time!**

USE FAMOUS MOTOR'S Manual for ten days at our expense. See how its giant "Trouble-Shooter" section pinpoints 2300 car troubles right away. Then see how it shows you *where* to start, *what* tools to use, *how* to use them.

If MOTOR'S Manual doesn't make even the toughest jobs A-B-C Easy - if it doesn't pay for itself the first 2 times you use it - simply return it and pay *absolutely nothing*. That's how confident we are that **THIS Manual really works!** Beginners turn into skilled mechanics,

experts get many valuable time and money-saving tips. Crystal-clear directions and 2,850 big photos, diagrams, charts, etc. You **CAN'T** go wrong!

**The "Meat" of 176 Official
Shop Manuals**

You get a wealth of "Know-How" from 176 Official Shop Manuals and hundreds of Factory Bulletins, boiled down into one giant easy-to-use book. No more guesswork. You use same procedures as "pros" to do every job quick, easy, right the first time.

**Look At All
You Get:**

Over **ELEVEN HUNDRED** giant pages. 2,850 "this-is-how" pictures. 195 Quick-Check charts. 30,000 essential repair specs. Over 225,000 service and repair facts. **PLUS** adjustment tables, measurements and clearances, overhauling and replacement facts, **tune-up data for 40 foreign cars**, much more! Covers 2,219 popular make models since 1955 - including all new 1962 cars!

DO ANY CAR REPAIR JOB...



QUICK, EASY, RIGHT the first time!

Everything from tune-ups to transmission overhauls

Using new, revised MOTOR'S Manual is like having factory experts themselves standing right beside you, guiding your hands through every job. You get big illustrated sections covering every one of 35 car makes - plus detailed chapters on transmis-

sions, rear ends, alternators, generators and regulators, fuel pumps, ignition systems, overdrives, automatic transmissions, engines, brakes, valves, rings, water pumps, distributors, dash gauges, power steering, power brakes, starting motors, etc.

"Inquiring Photographer"

**Q. What Do You Like About
MOTOR's Manual?**



HAS PAID FOR ITSELF TIME AND AGAIN. "It sure doesn't take schooling to read it. It's easy to see pictures of every part. Has paid for itself time and again."

—Paul Pemper, Wisconsin

SO COMPLETE AND EASY TO UNDERSTAND. "So complete, so easy to understand - I have done jobs with Manual that I would not have attempted without it."

—C. L. Vanerstrom, Michigan



AMAZED SELF AND FRIENDS. "I amazed myself and my friends, too. I now do auto repair jobs that stumped me before."

—Michael Baliczky, New Jersey

PAID FOR ITSELF ON FIRST 2 JOBS. "MOTOR's Manual paid for itself on the first 2 jobs and saved me valuable time by eliminating guesswork."

—W. Schrop, Ohio



Used by
U.S. Army & Navy
and Thousands of
Service Stations
and Repair
Shops

**USE MANUAL FREE
FOR 10 DAYS**

**FIX ANY PART OF ANY OF THESE MAKES
1955-1962—including all new compacts!**

Buick
Buick
Special
Cadillac
Chevrolet
Chevy II
Chrysler
Comet
Continental
Corvair
Corvette
Dart
De Soto

Dodge
Edsel
Falcon
Ford
Fairlane
Imperial
Jeep
Lancer
Lark
Lincoln
Mercury
Meteor
Nash

Oldsmobile
Olds F-85
Plymouth
Pontiac
Pontiac
Tempest
Rambler
Rambler
American
Studebaker
Thunderbird
Valiant

FREE 10-DAY TRIAL OFFER

Just mail the coupon below. We'll rush Manual to your home or shop. Use it **FREE** for ten days! See if it doesn't help you whiz through even the toughest jobs. If Manual doesn't pay for itself in the first ten days, return it and pay nothing, owe nothing. So mail the No-Risk coupon **AT ONCE** to: **MOTOR Book Dept., Desk 215, 250 West 55th Street, New York 19, New York.** (SCHOOLS, BOOKSTORES: Write for discounts.)

**MAIL COUPON NOW FOR 10-DAY FREE TRIAL
(Attach to Postcard for Fast Action)**

**MOTOR BOOK DEPT., Desk 215,
250 W. 55th St., New York 19, N. Y.**

Rush to me at once the book(s) I have checked below:

MOTOR's New AUTO REPAIR MANUAL. If O.K., I will remit \$2 in 10 days, \$2 monthly for 2 months and a final payment of \$2.95 (plus 45¢ delivery charges and sales tax) one month after that. Otherwise I will return the book postpaid in 10 days.

MOTOR's New TRUCK REPAIR MANUAL. If O.K., I will remit \$3 in 10 days, \$3 a month later, then \$2 monthly for 2 months, plus 45¢ delivery charges and sales tax with final payment. Otherwise I will return book postpaid in 10 days.

Name.....Age.....
(Please Print)

Address.....

City.....Zone.....State.....

Check box and save 45¢ shipping charge by enclosing **WITH** coupon entire payment of \$8.95 for Auto Manual or \$10 for Truck Manual plus sales tax. Same 10-day return-refund privilege.

Same FREE Offer on MOTOR's New TRUCK REPAIR MANUAL



Covers 98% of all trucks, 1952-1962, including all new "Midgets." Over 2,000 illustrations; 300,000 facts. Easy to use. Covers all gasoline engines, plus Cummins, Mack, GM & Int'l Diesels, 822 pages. For 10-day FREE Trial, check box in coupon.

ENGINEERING



Heald's Micro-wave and Radar Laboratory Equipment.

AMERICAN INDUSTRY NEEDS TRAINED ENGINEERS NOW
BACHELOR OF SCIENCE DEGREE, 30 MONTHS

SAVE 2 YEARS' TIME

B.S. Degree Courses:

- | | |
|---|---|
| <input type="checkbox"/> Electronic Engineering | <input type="checkbox"/> Mechanical Engineering |
| <input type="checkbox"/> Electrical Engineering | <input type="checkbox"/> Civil Engineering |
| <input type="checkbox"/> Electronic Engineering | <input type="checkbox"/> Architecture |

Diploma Courses:

- | | |
|--|---|
| <input type="checkbox"/> Radio-Television Plus Color | <input type="checkbox"/> Architectural Drafting |
| <input type="checkbox"/> TECHNICIAN | <input type="checkbox"/> Mechanical Drafting |
| <input type="checkbox"/> Electronic Technician | <input type="checkbox"/> Structural Drafting |

APPROVED FOR VETERANS

Send for **FREE** Information

ENROLL NOW FOR NEW TERM

HEALD Engineering College

Van Ness at Post, Dept. PM San Francisco, California

NAME _____
 STREET _____
 CITY _____ STATE _____

Be a LOCKSMITH

Want BIG PAY—Your Own Business?



You can quickly step into a well-paid job or start a big-profit business of your own. Shortage of locksmiths means opportunities everywhere, spare-time or full-time in good times or bad.

EARN EXTRA MONEY FROM THE START

All Special Tools, Supplies Furnished Free
 Age, education, minor physical handicaps don't matter in this growing, steady-income trade. You learn fast at home—gain practical experience through well-illustrated lessons. You do real jobs under the personal guidance of experts.

ILLUSTRATED BOOK—FREE

For a future as your own boss, or in a big pay job, send for **FREE** illustrated book today. No salesman will call. Only school of its kind, Lic. State of N.J.; Accredited Nat'l Home Study Council. **Vet. Approved.**

MAIL COUPON NOW

LOCKSMITHING INSTITUTE
 (Div. Tech. Home Study Sch.)
 Dept. 105-2, Little Falls, New Jersey

Name _____
 Address _____
 City _____ Zone _____ State _____

306
 pieces of professional equipment
FREE
 for use with course.

Please send without obligation **FREE** Illustrated Book and sample lesson pages.

\$6.44 AN HOUR IN YOUR OWN BUSINESS

STEP INTO THIS BOOMING \$19 BILLION A YEAR INDUSTRY



Hundreds of accidents and losses will happen this year in *your* community.

We'll show you how to investigate and adjust these losses for insurance companies, railroads, government offices. You buy **NO** tools or equipment. You do **NO** selling. You need **NO** prior experience or higher education. And you can operate out of your own home. *Right*

now independent Accident Investigators average \$6.44 an hour. We'll train you quickly to do the same. Start part-time if now employed. Fill the need for an Accident Investigation specialist in your area. Colorful booklet explains everything. Absolutely no obligation on your part. No salesman will call. Write **TODAY** for **FREE** Booklet.

UNIVERSAL SCHOOLS, P.M.-5, 6801 Hillcrest, Dallas 5, Texas



Play Right Away!

ANY INSTRUMENT

New it's **EASY** to learn **ANY INSTRUMENT**—even if you don't know a single note now. No boring exercises. You start playing delightful little *pièces* **RIGHT AWAY**—from very first lesson! Property—by note. Simple as A-B-C. You can make amazing progress—at home, in spare time without teacher. Only few cents per lesson. 1,000,000 students all over the world. (Est. 1898—Chartered by N.Y. State Education Dept.)

FREE BOOK Shows how easily you can learn music. Write for it. No obligation. No salesman will call. **U. S. SCHOOL OF MUSIC, Studio 305, Port Washington, New York.**



ACCORDIONS UP TO 1/2 OFF

Save up to 1/2 off retail prices of comparable accordions

- **5-DAY FREE TRIAL**
- Buy **DIRECT** from world's Largest Exclusive Dealer! Compare our Importer-to-You prices!
- See how you save! Over 30 models—finest genuine Italian makes! New, easier terms! 5-Day Free Home Playing Trial with satisfaction
- **100% assured.** Bonus Gifts Free. Rush name and address for **FREE** Color Catalogs and direct Importer-to-You prices—**FREE**. Write **TODAY!**
- **Accordions Corporation of America**
- 2003 W. Chicago Av., Dept. R-52 Chicago 22

PROFIT IN YOUR SPARE TIME

SMALL ENGINE REPAIR PAYS BIG!

Outboard • Powermower • Chain Saw • Tractor

MAKE EXTRA MONEY — or fix your own engines and **SAVE!** Illustrated, easy-to-learn Home Study Course qualifies you as expert. Free information. Write today!



LINCOLN TECHNICAL INSTITUTE
 SUITE 5-E, 472 MARKET STREET, NEWARK 5, N. J.

KILLS USING NO CHEMICALS, GASES, ETC.

- MOSQUITOES • MOTHS, MILLERS
- FLIES, GNATS • FISH FLIES, ETC.

OVER 1/4 ACRE HANGS ANYWHERE

No insect recovery. Guaranteed. Beautiful outdoor lighting. Plug into any 110 volt socket.

NO AREA CONTAMINATION
 Safe, beautiful. Com. etc with fly attractor. Dead insect catcher. Cord. Directions. Etc. Low cost. **SING SING BUG CHAIR, INC.**
 Box P3708, Oak Park 37, Mich.



earn as TAX EXPERT

\$15 HOUR

Our students earn as much as \$3,000 in 3 short months preparing income tax returns in spare time —also operate lucrative Business Tax Service yielding steady monthly fees of \$10-\$50 per client, year round. Enjoy professional standing in dignified home office business. No experience necessary. We train you at home and help you start. Write today for free literature. No agent will call. Approved by N. J. Dept. of Education.

UNION INSTITUTE, Dept. I-20, Lakewood, N.J.

SOURCES of further information on articles are listed in our free **WHERE-TO-FIND-IT** list.

For your copy just write to the

SERVICE BUREAU
POPULAR MECHANICS
 200 E. Ontario Street
 Chicago 11, Illinois.



POPULAR MECHANICS

95% PROFITS YEAR 'ROUND

Be your own boss, Operate a SIMPLEX lawn-mower sharpening service in your community. One compact machine grinds all mowers, sharpens cutlery. Low investment, 95% profit. Pays for itself in average month.

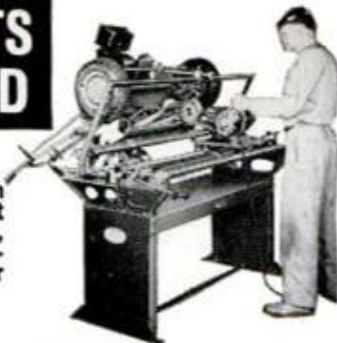
SIMPLEX

—4 Machines in One!
Reel Grinder—sharpens any mower reel in or out of mower.
Bed Knife Grinder—grinds with either round or cup wheel.

Rotary Blade Grinder—hollow grinds any rotary mower blade.
Cutlery Knife Grinder—sharpens cutlery, tools, scissors.

Send for free, money-making details!

The FATE-ROOT-HEATH Company • Dept. PM-5, Plymouth, Ohio



ROCK HOUNDS THUMLER'S TUMBLER

- Imparts gem-like polish to 3 to 10 lb. rocks.
- Simple—guaranteed—no better at any price.
- If your dealer can't supply, order direct \$18.95 postpaid. (Set of 2 grits, 1 polish, \$1.20 additional.)



TRU-SQUARE METAL PRODUCTS, INC.

(CHECK OR MONEY ORDER ONLY)
 P.O. BOX 375, AUBURN, WASH.



Transistor Radio with Battery \$3.02



17-Jewel Watch \$2.87



Derringer Pistol \$5.74

HOME-IMPORT BUSINESS—Make Big Profits

New Drop Ship Plan offers you first day profits! Deal direct with overseas sources at prices shown. Dazzling bargains with no investment. Full or spare time. Write for FREE BOOK today to . . .

MELLINGER, 1554 S. Sepulveda, Dept. D255 Los Angeles 25

GET INTO ELECTRONICS

V.T.I. training leads to success as technicians, field engineers, specialists in communications, guided missiles, computers, radar, automation. Basic and advanced courses. Electronic Engineering Technology an ECPD accredited Technical Institute curriculum. Assoc. degree in 29 mos. B.S. obtainable. G.I. approved. Start Sept., Feb. Dorms, campus. H.S. graduate or equivalent. Catalog.

VALPARAISO TECHNICAL INSTITUTE
 DEPT. D VALPARAISO, INDIANA

How would you like to **MAKE \$26⁵² in 3 HOURS?**



That's what M. R. Stanley of Calif. did with amazing MERLITE FIRE ALARM!
 You can make big money, spare or full time, up to \$1,000 in a month, introducing sensational new automatic Fire Alarm. No installation, hangs on wall like picture. When fire starts, Alarm "howls," can be heard 1/5 mile! Astounding "lighted match" demonstration sells alarms fast. **FREE SALES KIT!** Rush name, address for big Sales Kit with everything you need to make big money first day. All FREE. No obligation. Write: MERLITE, Dept. F-15T, Alarm Div., 114 E. 32nd, N.Y. 16, N.Y.



Worry of FALSE TEETH Slipping or Irritating?

Don't be embarrassed by loose false teeth slipping, dropping or wobbling when you eat, talk or laugh. Just sprinkle a little FASTEETH on your plates. This pleasant powder gives a remarkable sense of added comfort and security by holding plates more firmly. No gummy, gooey, pasty taste or feeling. It's **alkaline** (non-acid). Get FASTEETH at drug counters everywhere.

MAY 1962

94.6% OF BAILEY GRADUATES ARE EMPLOYED AT TOP PAY IN THE FIELDS WHICH THEY WERE TRAINED!



DIESEL-AUTO MECHANICS DESPERATELY NEEDED!

We have a far greater demand for our students than we can fill!

We can show you an actual waiting list of leading companies throughout the world who have tried Bailey graduates — found them outstanding, and are coming back for more!

Bailey Graduates are Successful . . . RECEIVE BIG PAY — HAVE SECURE FUTURE!

The Famous Bailey Course prepares you for BOTH Diesel and Gasoline Mechanics.

This is a must—due to the advent of using Diesel principles, such as 'Fuel Injection' on passenger cars . . . use of gasoline engines for starting Diesel engines, etc. You learn all this at Bailey in the amount of time ordinarily required to learn just one of these subjects, **ALL FOR THE PRICE OF ONE.**

Don't be satisfied with a 'futureless', one-type job — learn how you can make big money now!

Write today for Free Booklet that takes you on a step-by-step camera tour through our spacious, modern shops — See Bailey students in action as they Learn-by-doing with the Famous Bailey Method of training!

We provide you with housing and part time jobs while in school, plus nationwide placement service for graduates.

BAILEY Technical SCHOOLS

1634 S. GRAND ST. LOUIS 4, MO.

MAIL TODAY!

Please mail immediately this free booklet without obligation.

FREE BOOKLET



Name.....

Address.....

City..... State.....

APPROVED FOR VETERAN . . . NON-VETERAN

OWN a BUSINESS

Make \$200 Weekly As Your Own Boss



Get in on the ground floor of a booming \$750-million-a-year industry. Fill the need in your area for safe, effective in-the-home cleaning of carpets and furniture. Every homeowner and business is a customer. We'll train and establish you in your own lifetime business. Start part time, full time or hire crews for servicing. You'll be trained by a nearby dealer, get complete instructions and can attend free training school, if you wish. You'll use the famous Duraclean absorption process which cleans without harmful scrubbing or soaking. It's backed by McCall's and Parent's seals. Just 2 jobs a day means a gross of more than \$200 a week. No shop needed.

WE HELP YOU GROW Duraclean backs you with an assistance program designed to help you build business, make money fast. You receive counseling from experts at Duraclean Hq. You're backed by national advertising in Parents', McCall's, American Home and other famous magazines. Free 36 page book tells all. Send coupon today.

FUTURE SECURITY COUPON

DURACLEAN, DEPT. 2-165, Deerfield, Illinois

Rush details on Duraclean

Name

Address

City

State

EARN HIGH SCHOOL DIPLOMA AT HOME AT YOUR OWN SPEED

a program of **ENCYCLOPAEDIA BRITANNICA FILMS**

Learn fast! Earn more! Enter college, professional or technical schools. Take individual courses or full 4 year schooling for high school diploma. Work at home at your own speed under qualified teachers offering personalized instruction. Moderate tuition includes all textbooks. *Please send me latest school catalog.*

ACADEMY FOR ADULTS

a division of Encyclopaedia Britannica Films, Inc.
30 W. Washington, Dept. PM-5, Chicago 2, Ill.

NAME

ADDRESS

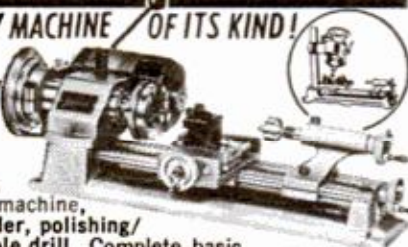
CITY

STATE

6-IN-1 ONLY MACHINE OF ITS KIND! UNIMAT

Compact workshop for all metal, plastic, wood. Precision lathe, milling machine, drill press, surface grinder, polishing/grinding machine, portable drill. Complete basic unit, \$129.50. **WRITE FOR FREE CATALOG.**

AMERICAN EDELSTAAL, INC., DEPT. GE 350 BROADWAY, N.Y. 13, N.Y.



NEW 1962 HOMEBUILDER'S CATALOG \$2

Catalog is full of drawings, photos, descriptive literature and ideas on our complete line of autogyros, airboats, helicopters, snow sleds, ground effect machine, engines, propellers and numerous other items. All products are available as plans, kits, or factory finished items.

CATALOG \$2.00

MILLER ENGINEERING & SALES COMPANY
BOX 6, DEPT. PM, SHAWNEE, OKLAHOMA

PROFIT OR PAYCHECK?

Now, be your own boss in your own business. Nationally advertised Muntz TV with a proved, successful program gives you an exclusive, big city market and a quality, value-priced, fast selling complete line of television—Consoles, Combinations, Table Models, Portables plus Stereo Units. You and only you sell Muntz TV in your exclusive big city retail trading area. You're backed all the way with location, sales helps, promotions—everything you need to succeed. If you have \$8,000 to \$15,000 for your own area or are willing to re-locate, write to: **Jack Simberg, Vice-President**

Muntz TV inc.



1040 Noel Avenue • Wheeling, Illinois



DAN LURIE
World's Most
Famous
Body-
Builder,
TV Strongman

**A BODY LIKE MINE
IN SHORT TIME with famous
DAN LURIE BARBELLS!**

SEND FOR NEW GIANT CATALOG

Factory Prices Cast Iron Steel **\$9.48**

50 lb. Set... \$3.48... \$10.48

100 lb. Set... \$13.98... \$18.98

150 lb. Set... \$23.48... \$27.48

Extra Wts... 160 lb. \$38.48... \$42.48

Plus Free MONEY BACK GUARANTEE—Send

50% in check or money order F.O.B. Plant

Brooklyn, New York. Balance C.O.D.

DAN LURIE BARBELL CO. 1661-MS Utica Ave., Dept. 259E, Brooklyn 34, N.Y.

Give the radio-control model fans both barrels of fun. That's what PM does in the June issue, with authoritative articles on the latest trends in R/C model airplane controls plus plans for a championship R/C model racing hydroplane.

STOP SUN REFLECTIONS from HOOD, DASH, etc.

Adjustable CAR VISOR with Super-Grip Magnet

\$2.00 each MOVE IT where you NEED IT
POSTPAID



Send Check or Money Order to

P. O. BOX 1105

J. T. B. INDUSTRIES WYANDOTTE, MICH.

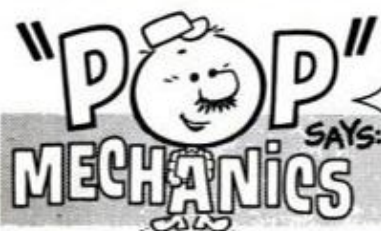


Solar Cell Kits

Educational electronic kits employing solar cells help students in the 10-to-18 age group learn basic electronic principles. The possibilities range from simple experiments to projects as complex as transistor-diode circuitry, transmitters, and receivers.

The kits enable the students to perform up to 100 electronic experiments. The solar cells furnish power from sunlight, electric light, or radiant energy.

The kits range in price from \$7.95 to \$39.95, complete with instruction manuals, and are made by International Rectifier Corp., El Segundo, Calif.



"Astronomers point out that the universe is expanding away from Earth. Can you blame it?"



Excitement! Security! Good Pay! CRIME DETECTION

LEARN AT HOME IN SPARE TIME—START NOW!

Crime everywhere is on the rise! Learn now, in your own home, the profitable profession that enables you to track down criminals and bring them to justice! Hundreds of Identification Bureaus employ I. A. S. graduates . . . trained in finger printing, police photography, handwriting identification, firearms and investigation. Our 44th year! FREE "Blue Book of Crime" . . . packed with crime facts and the full story of famous I. A. S. training. State exact age. No salesman will call. Rush Coupon! A Correspondence School Founded in 1916.

FREE
Blue Book
of Crime
MAIL
COUPON

INSTITUTE OF APPLIED SCIENCE, Dept. 1355
1920 Sunnyside Avenue, Chicago 40, Ill.
Rush Blue Book of Crime . . . FREE!

NAME _____ Age _____
ADDRESS _____
TOWN _____ STATE _____

Get the Big Dividend!
Save by Mail! Earn More!
FREE GIFTS!

CITY SAVINGS ASSOCIATION
SINCE 1908
Current Rate **4%**
Per Annum
Money in by the 15th
earns from the 1st

Free with
\$3,500 Account
POLAROID ELECTRIC-EYE CAMERA
The new, fully-automatic J66 Model.



Free with
\$1,000 Account
PHILCO SLIM-LINE CLOCK RADIO
New 1962 Model. UL approved. AC only.



Free with
\$250 Account
DEBUTANTE 2-in-1 HAIR DRYER
Home hair dryer with vanity compartment.



54 Years • 1908-1962
CITY SAVINGS ASSOCIATION
1656 W. Chicago Avenue, Chicago, Ill.
ASSETS OVER \$22,000,000.00

BIG PROFITS FROM FIREPLACE WOOD

Lickity log splitter eliminates the drudgery of splitting logs up to 48" lengths, any diameter. Does splitting with 18 ton hydraulic power. It's fun to operate. Highly profitable for FIREWOOD MERCHANTS, Farmers, Estate Owners, Country Clubs, Parks, Cities. Write for complete details without obligation to:

WACO AIRCRAFT CO., Dept. D, TROY, OHIO

ELECTRONICS

Train in the new shop-labs of the world famous **COYNE ELECTRICAL SCHOOL** on a quarter of a million dollars worth of equipment. Est. 1899—Non-Profit Institute. Courses: Electronics • Electricity • TV-Radio.

Use this coupon to get our free book
"GUIDE TO CAREERS"

COYNE ELECTRICAL SCHOOL Educ. Serv. Dept. 52-S
1501 W. Congress Parkway, Chicago 7, Ill.

NAME _____
ADDRESS _____
CITY _____ STATE _____

Unlike most other schools, we do not employ salesmen.

WANTED!

**Mechanically Inclined
Men to Qualify for
BIG PAY JOBS
AND SPECIAL FACTORY
TRAINING IN DIESEL**



"We need qualified repairmen, operators, mechanics NOW!", say Diesel Manufacturers, Highway Builders, Truck Line Operators in every corner of America. Can you qualify for these High Pay Jobs? We can help you! Interstate's General Course and Cummins-approved Diesel home-training courses are internationally recognized. Advisory placement service for trainees. Don't wait. Men are needed NOW!

Get the Facts Today!

WRITE INTERSTATE TRAINING SERVICE

Dept. A-3, Portland 12, Oregon

Rush information on I.T.S. Diesel Courses, Special Factory Training and Diesel Job Opportunities.

Name _____ Age _____

Address _____

City _____ Zone _____ State _____

LEARN UPHOLSTERY
in your spare time
run your own
business AT HOME

FREE BOOK SAMPLE LESSON

WITH COURSE YOU MAKE
SLIPPER CHAIR
CLUB CHAIR
OTTOMAN
PLUS SLIP COVERS

BE YOUR OWN BOSS

Earn more from the start in spare-time while learning at home. STOP worrying about lay-offs, enjoy steady income, independence for life in the booming field of Custom Furniture Upholstery.

EARN WHILE YOU LEARN . . . the easy UTS way.

Right off you start with tools, complete frames, fabrics, materials. ALL FREE with your practical, N. Y. State-approved UTS Home Study Course. You learn skilled professional upholstery, re-upholstery, furniture finishing, repairs; to make slip covers, window cornices, cushions, draperies.

Send for **BIG FREE Illustrated Book, Sample Lesson AT HOME** prepare for well-paid job, steady work and big profits as your own boss. Also training in N.Y. School. VET. APPROVED. Accredited by N.H.S.C.

MAIL COUPON TODAY. No obligation.

UPHOLSTERY TRADES SCHOOL
Dept. TE-310, 721 Broadway, N. Y. 3, N. Y.

Please send me **FREE** book, "Your Future in Custom Upholstery," and **FREE** Sample Lesson. No obligation—no salesman will call.

Home study Training in N.Y. School

Name _____
Address _____
City _____ Zone _____ State _____

Check if Korean Veteran

NEW HI-FI PERFORMANCE

The Exciting **NEW MODEL 422 BENJAMIN CO. 10-SHOT SEMI-AUTOMATIC .22 PELLET PISTOL**

\$24.00

Ask Dealer for Demonstration

EFFICIENT—SAFE—DEPENDABLE—CONVENIENT
Famous BENJAMIN Quality

AT LAST—an Amazing New Handgun that incorporates the Characteristics Wanted for Serious Training, Plinking and Match Competition—Indoors and Outdoors—at LOWEST SHOOTING COSTS! Handsome, Dynamic, Mechanically Reliable, MODEL 422 combines Traditional BENJAMIN PEAK POWER and ACCURACY with Incredible Firing Speed—Smooth JAM-PROOF ACTION (no ramrod for cleaning pistol bore required)

WITH EXTRA MARGIN—BENJAMIN'S Unique DOUBLE SAFETIES

Press Trigger Safety "OFF"

Release Hammer Safety as illustrated.

KEEPS SHOOTING & SHOOTING & SHOOTING & SHOOTING AS FAST AS YOU CAN SQUEEZE THE TRIGGER!

FREE Write today! Complete Catalog Benjamin Rifles & Pistols—Single Shot & Repeaters—BB or 177 or 22. Also, Special Offer on Hunting Knives.

Use Benjamin H-C Pellets in Model 422 for Accurate, Jam-Free Shooting.

BENJAMIN AIR RIFLE CO., 896 MARION ST., ST. LOUIS 4, MO.

ARE YOU MOVING?

SIX WEEKS IS REQUIRED to change your magazine address.

A new regulation of the Post Office effective January 10, 1962 requires that you pay the **extra postage** if copies of **POPULAR MECHANICS** are forwarded to you at your new address. Copies will not be forwarded free and we cannot replace lost copies. To insure delivery at your new address please notify us at least six weeks in advance of your moving. Send us your old and new address and if possible the address label from your last issue . . . include your postal zone number. Thank you.

Write to:

POPULAR MECHANICS
Subscription Dept.
250 West 55th St., New York 19, New York

SAVE MONEY! MAKE MONEY!
WITH PORTABLE CEMENT MIXER!

It's easy, fast, fun to do your own work with the MIXAL Mixer. Build barbecues, patios, sidewalks for yourself, for others! Mixes 3' x 8' sidewalk every hour! Uses any 1/4 HP motor. Thousands used by contractors! Try it on **MONEYBACK GUARANTEE!** Send for **FREE HOW-TO-DO-IT CEMENT MIXING BOOKLET**. Dept. PM-5.

\$29.95 pp without motor (add \$3 W. of Rockies)

KOL, INC., 2323 Ellis Ave., St. Paul, Minn.



"Homer built it last winter in our furnace room."

Материал, защищенный авторскими правами

Magic Mail Plan—Make up to \$5 an Hour!



THIS MAN...

... is taking out of the machine a Plastic Sealing Job—ordered by mail—only 11¢ in material cost brings back \$2.58 in cash by mail. Capacity of machine: **\$25.00 profit per hour of operation.**

Get **ORDERS** and **CASH** from your mailman—do work in **SPARE TIME** at home—or expand into **FULL TIME** business. Send coupon for Free facts about the newest and most fascinating of all home operated businesses. For the first time a simplified machine brings the fabulous profits of **Plastic Sealing and Plastic Laminating** within the reach of the small operator. Anyone can learn to operate the machine with a few minutes practice—then with our **Magic Mail Plan** can get mail orders pouring in daily with cash in every envelope. **No canvassing—no selling.** We even

Get into PLASTIC LAMINATING at home

WE'LL EVEN HELP FINANCE YOU

supply the circulars you mail to bring back cash and orders, financing help, too. Rush name. We'll send you **FREE** and postpaid, pictures, prices, details, finance plan, all the facts you need. Mail coupon or send name on postcard. No charge. Warner Electric Co., 1512 Jarvis Av., Dept. L-2-E, Chicago 26, Ill.

Make Thousands of Beautiful Art Creations

COSTUME JEWELRY • CIGARETTE BOXES TRAYS • CANDLESTICKS • COASTERS LAMP BASES • BOOK ENDS... ALL IN SPARKLING COLORED PLASTIC



WARNER ELECTRIC CO., 1512 Jarvis Av. Dept. L-2-E, Chicago 26, Ill.

At no cost to me, please rush full details and financing plan, postage prepaid. No obligation.

Name.....

Address.....

City.....Zone.....State.....

HELP WANTED—SPARE TIME

SENSATIONAL NEW LONGER-BURNING LIGHT BULB. Amazing Free Replacement Guarantee—never again buy light bulbs. No competition. Multi-million dollar market yours alone. Make small fortune even spare time. Incredibly quick sales. Free sales kit. **MERLITE (Bulb Div.), 114 E. 32nd, Dept. C-15T New York 16, N.Y.**

In Canada: Mopa Co., Ltd., 371 Dowd St., Montreal 1, P.Q.

The big blowup is what you'll get with PM's simple opaque projector. Plans shown in the June issue. Ideal for enlarging craft designs. And it's not done with mirrors.

ALLIED'S LOW-COST ELECTRONICS LIBRARY



4 BOOKS \$1
Electronics Data Handbook—formulas, data standards, tables, charts. 35¢
Radio Circuit Handbook—basic circuits & practical applications. 25¢
Radio Builder's Handbook—for the beginner, experimenter & builder. 25¢
Dictionary of Electronic Terms—over 4,000 electronic terms defined 35¢

ORDER No. 37 K 399AD ALL 4 BOOKS for only

\$1.00

order from **ALLIED RADIO**
 100 N. Western Ave., Chicago 80, Ill.

NEW INFRA-RED REFRIGERATOR DEFROSTER

Defrost Refrigerators, Freezers in minutes...!

Now! An easier life for every wife! New Infra-Red Defroster works so fast that food never has a chance to thaw! Simply place this compact unit in the freezing chamber, plug into nearest outlet, and safe infra-red heat rays do the work. In minutes the refrigerator or freezer is ready to keep foods and beverages ice cold. No more messy pans of hot water to carry and spill.

UL approved cord and plug 110-120 V. AC/DC. Order today.

Send Check or Money Order. No C.O.D.'s. Money back in 10 days if not satisfied. 1-year factory guarantee.



Durable aluminum only

\$6.95 Postpaid

MYSTIC HOUSE

DEPT. PM5 • 60 East 42nd Street, New York 17, N.Y.

BARBELLS

140-Pound, CHROME DELUXE Barbell-Dumbbell set only \$19.80.
 This is our feature set and is the finest ever manufactured.

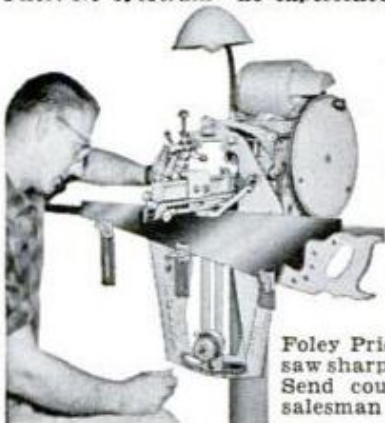
Training with adjustable weight is the **BEST** way to keep fit; the **ONLY** way to develop great strength and a perfect body. As the oldest and best equipped barbell company, BUR gives value and prices no one can equal.

SEND FOR FREE CATALOG
BUR BARBELL CO.
 Lyndhurst 9, New Jersey

100 POUND SET \$12.80
 Extra Plates Only 12c Pound

FREE PLAN tells how to start your own business FILING SAWS

Here is a steady repeat CASH business you can start in your own basement or garage in your spare time and make up to \$3 or \$6 an hour. You can file hand, band and both combination and cross-cut circular saws on the Foley Saw Filer. No eyestrain—no experience needed. "The first saw I sharpened with my Foley Filer came out 100%,"—writes Clarence E. Parsons.



Every saw you sharpen with the Foley Saw Filer brings you more customers. "I rented a two-car garage and have all the work I can do!"—Charles H. Smith.

FREE BOOK Shows How to Start

Foley Price Guide gives saw sharpening charges. Send coupon today. No salesman will call.

Send Coupon for **FREE BOOK**

FOLEY MFG. CO.
 516-2 Foley Bldg., Minneapolis 18, Minnesota.
 Send **FREE BOOK**—"Money Making Facts," and Time Payment Plan.

Name.....

Address.....



POPULAR SHOPPING

worth
writing
for ...

GREENE ATTACHMENT

Converts
your 1/4"
electric
drill to a

POWER HACKSAW

Over 240,000 sold! Zips through steel (even bolts), wood, plastic — anything that can be sawed—10 times faster than by hand! Uses regular hacksaw blades, any length—no pre-drilling. Offer includes blade, wrench and directions. Full year's guarantee; money back if not as advertised. We ship fast.

Dealers: Write for quantity prices!



Only
\$9.95
postpaid

H. R. GREENE & SONS
3800 Lincolnway West
South Bend, Indiana

THE FLYING JODHPUR

Nothing like it. Benchmade!... Comfortable, glove-soft long-wearing leather and fully lined. Black.. Brown.. Tan. Sizes 5 to 13. \$3 more for sizes 13 1/2 to 15. \$2 C.O.D. deposit.



1995 PPD #5006

Sold only by mail
Fully guaranteed

Write
for Free
Folder.

NAVARRO BROS.

DEPT. IVI • 304 SAN FRANCISCO AVE. • EL PASO, TEXAS

How to find a summer job is a problem faced primarily by teachers and students, but anyone seeking summer-season work will find some helpful tips in a 25-cent pamphlet published by the National Directory Service, Box 32065, Cincinnati 32, Ohio. "How To Find A Summer Job—For Teachers" discusses possibilities of summer employment, types of jobs available (camps, parks, resorts and others), and how to make application.

A darkroom does not have to cost a small fortune. "How To Start

A Darkroom On A Budget," a booklet available free of charge from Spiratone, Inc., 135-06 Norther Blvd., Flushing 54, N. Y., tells how a complete enlarging darkroom can be equipped with basic, but good quality essentials for about \$50. It also includes tips on how to make darkroom work more convenient and fun.

Do-it-yourself for youngsters (and Dad) is treated in a wood-and-metal-working handbook printed especially for young and beginning home craftsmen. It contains basic, step-by-step construction instruction, starting with the measuring and marking of a board and takes the reader up to finishing surfaces of completed projects. The book, "Arco Workshop Companion," contains 218 pages, has 322 illustrations, and holds a basic list of necessary tools and their average prices. It also has sections on the properties of metals and types of wood used in workshops. Published by Arco Publishing Co., Inc., Dept. PM, 480 Lexington Ave., New York 17, N. Y.

Water travel—a new vacation adventure. "America's Waterways" offers 16 pages of sources for charts, maps and guides of major water routes and nearby recreation spots, from coasts inland to the Mississippi. Free from Mobil Oil Co., Marine Retail Dept., 150 East 42nd St., N. Y. 17.

Garden pests might not plague your gardening efforts if you follow expert tips on insect recognition and control (including mixing and applying dusts and sprays) in the 48-page booklet, "Insects and Diseases of Vegetables in the Home Garden." Available for 25 cents from the Superintendent of Documents, U. S. Gov't Printing Office, Washington 25, D. C.



Finest Imported PIMA COTTON BROADCLOTH SHIRTS

Direct from Hong Kong

Pure white Sanforized and Mercerized. Permanent collar stays, long or short sleeves, spread or snap-tab collar styles. Order direct: give collar size 14 1/2 to 17 and sleeve length 32 to 35. Guaranteed satisfaction or money back. Postage prepaid. Reg. \$5.95 values.

LIMITED SUPPLY **\$3.89**

No C.O.D. — 3 for \$11

TRANS-OCEANIC AGENCIES
141 Battery St. San Francisco 11, Calif.

HOW TO ATTRACT MONEY

Learn how to use your subconscious mind and become rich. This book has helped many thousands on the Road to Riches.

You have a right to be rich. Send for book today and enclose \$1.15.

DR. JOSEPH MURPHY

501 N. Alfred Street
Los Angeles 48, Calif.

EARN BIG MONEY WELDING - REPAIRING - FABRICATING METAL WITH A HOBART*

★ AC TRANSFORMER WELDER

★ DC WELDER

★ DC WELDER / AC POWER UNIT



180 amp. AC "TROJAN" delivers top results in garages, sheet metal, hobby, plumbing and heating shops. It welds, brazes, cuts, solders, burns holes. Accessories included. Ask for data sheet A-520-G.

Model TIG-182-5



200 amp. DC "HUSKY BOY" can handle repair, construction, heating, piping installations. Slip it on a pickup truck for big profit emergency jobs. Has rugged 2 cylinder air-cooled engine. Ask for data sheet A-202-I.

Model GW-223-5



200 amp. DC "POWER/WELD" runs lights, tools, pumps, sprays plus welding. Invaluable as an emergency power source for furnaces, brooders, etc. 2 cylinder air-cooled engine. Ask for data sheet A-279-J.

Model GW-2235-5

HOBART BROTHERS COMPANY, BOX M-52, TROY, OHIO, U.S.A., Phone FE 2-1223

LEARN TO EARN



HIGH WAGES
AS A HEAVY EQUIPMENT
OPERATOR OR MECHANIC

- WORLD'S ONLY CONTRACTOR OWNED AND OPERATED SCHOOL
 - MODERN EQUIPMENT, HIGHLY QUALIFIED INSTRUCTORS
 - V.A. APPROVED FOR GI TRAINING

Learn to operate bulldozers, draglines, cranes, back hoes, scrapers and motor graders ON ACTUAL CONSTRUCTION PROJECTS!

Learn by doing . . . no impractical correspondence courses.

WESTERN SCHOOL OF HEAVY EQUIPMENT OPERATION

WRITE TODAY FOR FREE SCHOOL CATALOG

DEPT. B-19, BOX 510
WEISER, IDAHO
PHONE 549-1112



Member American Road Builders Association
Associate Member Associated General Contractors

LITTLE PUMP DOES 1000 BIG JOBS



QUICKLY DRAINS CELLARS AND POOLS
FILLS TANKS • IRRIGATES • SPRAYS

Pumps up to 5000 GPH. Up to 60 ft. head. Threaded. 1 1/4" intake. 1" discharge. Rust-free aluminum castings. Superior design. Top quality. Fits any motor. Satisfaction guaranteed or money refunded. Send check or M.O. \$1 deposit on C.O.D.'s. Flexible drive coupling \$1 extra.

895 ppd.

Heavy Duty Ball Bearing Model . . . \$12.95 ppd.

AMERICAN MACHINE & TOOL CO., INC.

Dept. PM-52, Royersford, Pa.

Shop PM Ads for Exciting
Direct-Mail Offers

SONG IDEAS WANTED



Songwriters, with publisher contacts, want song ideas. **SHARE ROYALTIES.**

NO FEES. Send poems:

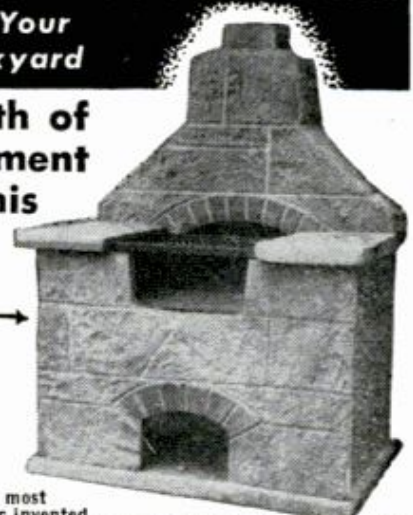
SONGWRITERS' ASSOCIATES

Studio 24, 1650 Broadway, New York 19, N. Y.

MANUFACTURE THIS BEAUTIFUL CONCRETE OUTDOOR FIREPLACE

Right In Your Own Backyard

\$4.00 Worth of Sand & Cement produces this Attractive Fireplace.



Sells on Sight from \$60. to \$80. Easy to start your own Profitable Business.

The General Fireplace Molds and Process are the most amazing and foolproof ever invented. Simple to operate. Two men can produce five fireplaces a day.

BIG DEMAND!!

Sell all you produce to Department Stores, Homeowners, Parks, Nurseries and Picnic Groves. Fireplaces sell on sight. No experience necessary. We supply full operating instructions and equipment plus the know-how that spells **BIG PROFITS.** This is an outstanding opportunity for men of vision and small capital to get into a busy rich paying field. Don't delay, be the only exclusive manufacturer in your own home town. Mail coupon at once for full details as to how you can reserve your territory. **Molds sold only on exclusive franchise.**

GENERAL ENGINES CO., Inc., Dept. MF-52
ROUTE 130, THOROFARE, N. J.

Mr. Tor of Philadelphia writes: Sold 250 in first 4 months. Selling to Sears Roebuck, John Wanamaker, and Gimbel Bros. in Philadelphia area.

Name

Address

City Zone

State

TEAR OUT THIS AD... and Mail with Name and Address NOW!

SPARE TIME HELP WANTED

UP TO \$1,000 MONTHLY introducing amazing new invention. Seals puncture, re-inflates tire in 2 minutes without changing wheel. Fleets order dozen or more, every motorist needs. Millions already sold. **Sales Guaranteed. FREE details. National Dynamics, 222 East 23rd, Dept. 10JK, New York 10, N. Y.**



LEARN ELECTRONICS AT HOME
FOR A BETTER JOB WITH BETTER PAY

Choose from these courses: 1. Radio and Electronic Fundamentals 2. TV Servicing 3. Color TV 4. Communications Electronics 5. Automation Electronics 6. Computer Programming 7. Transistors

RCA Institutes offers you the finest training-at-home program in electronics. Practical application begins with your first lesson. All equipment furnished is of prime quality . . . to keep and use on the job. Pay only as you learn. Courses for beginners and advanced students. Approved for Veterans.



RCA INSTITUTES, INC.

A Service of Radio Corporation of America

The Most Trusted Name in Electronics

CANADIANS—Take advantage of these same RCA courses at no additional cost. No postage, no customs, no delay. Send coupon to: RCA Victor Company, Ltd., 5581 Royalmount Ave., Montreal 9, Quebec.

RCA INSTITUTES, INC. Home Study School, Dept. PM 52, 350 West Fourth Street, N. Y. 14, N. Y.

Rush me the FREE 64-page illustrated booklet "Your Career in Electronics" describing your electronic home study training program. No salesman will call.

Name..... Age.....

Address

City..... Zone..... State.....

A FULL ACRE of Your Own in SUNNY NEW MEXICO



The sunniest, healthiest state in all of America is New Mexico with its 360 days of sunshine per year and with its balmy, dry climate. And nowhere in our land do people lead longer, more pleasure-filled lives than in the Albuquerque region, described by Encyclopaedia Britannica as a "health resort."

Thirty-nine miles from booming Albuquerque (the city has grown by 800% since 1930) is the lovely VALLEY OF THE ESTANCIA RANCHETTES. Lying directly on famous Route 66, this Valley is destined to become a suburb of Albuquerque. Right now an acre in the VALLEY OF THE ESTANCIA RANCHETTES may be purchased for \$395, \$10 down and \$10 monthly. Write for FREE color brochure. No salesman will call.

Valley of the Estancia Ranchettes, Dept. N-53B

2316 Central S.E.
Albuquerque, N. M.

Please send me your FREE portfolio in full color including maps and story.

Name _____
Address _____
City _____ Zone _____ State _____

Draw CARTOONS



...for a wonderful pastime or excellent earnings. Master cartooning at home in a few short weeks without waste of time or effort through the Famous System of Manual Training.

*U.S. Pat. Applied For. Exciting Kit Included... Start earning money at once. FREE CATALOG. Send coupon below.

Continental Schools, Inc.

4201 S. BROADWAY, LOS ANGELES 37, CALIF. DEPT. E-150

Continental Schools, Inc., Dept. E-150
4201 S. Broadway, Los Angeles 37, Calif.

Please rush me your Free Catalog and other information by return mail. No charge or obligation, no salesman will call.

Name _____ Age _____
Address _____
City _____ Zone _____ State _____



SEND COUPON
FOR
FREE BOOK

SAMURAI SUICIDE WARRIORS KARATE!

JUDO BOXING! MUSCLEBUILDING! YOGA!

STRONGMAN STUNTS! STRENGTH & ENDURANCE! HANDBALANCING! ETC.



YOU GET ALL THESE COURSES! *20 illus- FOR ONLY
strated KARATE blows *SAVATE foot fighting
*Secret NERVE CENTER and ANATOMY charts
*20 lethal JUDO throws *20 terrific STRONG-
MAN STUNTS *Complete MUSCLE-BUILDING
course *Ancient YOGA secrets *HANDBALANC-
ING stunts *Complete BOXING course. Secrets
of ENDURANCE *All picture packed. Super
wall charts, (surplus 1961 printing). No
C.O.D.'s. Canadian orders 50c.
K-MAN KARATE PRACTICE DUMMY. 15c
Life like! Shows attack points.
15c with 35c order only. Total 50c
Oxford Studio, 44V Bromfield, Boston, Mass.

35c
You get the lot!

POPULAR MECHANICS

The Issue You NEED Is Always AT YOUR FINGERTIPS



When You Use Popular Mechanic's FILE BOXES

OH SO HANDY! Each box holds a full volume of Popular Mechanics—6 big issues. Keeps all your back copies in order, and any issue you want is instantly available.

ATTRACTIVE—Blue, grained, washable cover looks and feels like leather. Embossed gold lettering makes your storage boxes suitable for the finest libraries.

ECONOMICAL—Set of two handsome, sturdy Popular Mechanics file boxes only \$1.00—six sets for \$5.00. One set holds and protects and organizes a full year, 12 big issues, of the magazine everybody wants to save for constant reference.

CLIP THE COUPON TODAY and send in your order.

Service Bureau, Popular Mechanics
Department FB, 200 E. Ontario, Chicago 11, Ill.

Please send me sets of storage boxes for Popular Mechanics, @ \$1.00 per set, six sets for \$5.00, for which I enclose \$.....

Name.....
Street.....
City..... Zone..... State.....

EARN EXTRA MON

With Amazing "HEXE"
AUTOMATIC NEEDLE THREADER

HEXE—World's
Most Perfect
Needle Threader
SATISFACTION
GUARANTEED

The Outstanding Demonstration
Seller that threads all size needles
with the simple press of a button.

MAKE UP TO \$8.50 PER HOUR

by simply showing people how
this unique and useful device
operates. Call on homes, stores,
factories, taverns. Wonderful
for gifts, fund raising, or home
parties. Men as well as women
will be fascinated by this
mechanical wonder. SELLS IT-
SELF wherever there are peo-
ple for only \$1.00. Our Proven
Sales Plan shows you how.

Free needles and thread, to-
gether with Guaranteed Sales
Plan, come with all initial or-
ders. Order at these low prices:

Two demonstrator samples—\$1.00
1 Dozen \$4.75 Your profit—\$7.25
3 Dozen \$13.00 Your profit—\$23.00
1 Gross \$40.00 Your profit—\$104.00

Save Shipping Cost—We pay all transportation charges when
full payment is included with order. (C.O.D. orders must in-
clude 25% deposit.) Satisfaction Guaranteed. ACT TODAY!

NORTHERN IMPORTERS

Dept. PM-52, 2453 Morse Ave. Chicago 45, Ill.

NEW PACKAGING BUSINESS

PAYS UP TO 2500% PROFITS AT HOME
NO SELLING!! YOU SUPPLY NATIONWIDE SALES FORCE
An amazing new kind of Home Business. Package bulk
products for self service salesmen, Coast-to-Coast. FREE
NO SELLING PLAN reveals thousands full, spare time big
profit opportunities for beginners. We guide you step-by-step.
Everything furnished. Write today for FREE "10 Step
Packaging Profit Plan" and full details.

HOME PACKAGING CO. — Dept. R-258
2212 E. Jesse Street Los Angeles 23, California

BUILD YOUR OWN AIR CONDITIONERS

From Junked Refrigerators for a Few Dollars
INSTRUCTION BOOKS SHOW YOU HOW 75c Each
"HOW TO BUILD a Low Cost Air Conditioner"
"HOW TO BUILD an Automobile Air Conditioner"
"HOW TO BUILD a Low Cost Home Freezer"
"HOW TO BUILD an Electrostatic Precipitator"
"HOW TO BUILD a Low Cost Dehumidifier"
Complete "Install-It-Yourself" Air Conditioner
kits for home and automobile, 2 Ton capacity,
Brand New Parts—\$92.00 and up.

SPECIAL OFFER
2 Books — \$1.00
3 Books — \$1.50
or all 5 for \$2.00

FREE!
Instructions
and Literature
on kits

KOOL ENGINEERING CO., Dept. M-5, 1318 N. Clybourn, Chicago 10, Ill.

ORGANIZE! SORT OUT! FILE AND STORE 1001 ITEMS!

40 File Compartments



IN THIS PLASTIC TRAY for
MECHANICS! DESK! HOME! HOBBY!
Individual bins are two inches
long and corner rounded to protect
delicate parts. Use at home, office,
desk or shop. Stack in drawers or
make parts cabinets with simple
sides. Stamp, Coin collectors . . .
Mechanics . . . Please note:
• Stamps • Drills • Hooks
• Coins • Jewelry • Herbs
• Screws • Minerals • Buttons
• Nails • Gems • Paints

Dept. M51
176 Federal St.
Boston 10, Mass.

\$1.00 ppd.
(5 for \$4)

STAMP COLLECTORS!!!

ASTRONAUT SHEPARD



Complete mint postage set,
commemorating our first
American Astronaut Alan B.
Shepard & the Mercury capsule, given FREE to ADULTS
to introduce our bargain approvals.

STAMPEX CO., BOX 47-HM, WHITE PLAINS, N.Y.

"MADE \$1200 ON ONE JOB"

Some make more, some less...

We help you start Your
Own All-Year Business

Make BIG Money! With
our easily operated,
highly efficient wall
washer, G. H. Jones
made \$1200 on one
school job. E. L. Goss
took in more than
\$10,000 in one year.



E. C. Taber wrote, "I made \$400 gross in
two weeks." And no wonder...this machine
washes walls 6 times faster and better than
by hand—with no mess...no drop cloths.

Your Money-Making Opportunity • We
want more men to go into this profitable
business for themselves and enjoy inde-
pendence—freedom from layoffs and
bosses. Customers everywhere—homes,
offices, schools, churches, hotels, etc. How
much you earn depends largely on you.
What you take in is mostly profit. No need
to rent shop or office; operate from home.
Start spare time until full time is justified.

Lose No Time — Send Coupon Today for All the Facts

FREE BOOK! MAIL COUPON TODAY!

VON SCHRADER MFG. CO.
510 "W" Pl., Racine, Wisconsin

Send at once (no obligation) your FREE booklet
containing information about your WALL WASH-
ING MACHINE and how I can start my own
permanent, profitable business.

Name _____

Address _____

City _____ Zone _____ State _____



THE INTERNATIONAL
ELECTRONICS UNIVERSITY
OF PARIS

72, rue Ampère, PARIS-17°

wishes to give notice of a new series of correspon-
dence courses in the English language. These courses
are available to anyone having an elementary edu-
cation with an interest in electronics.

After 12 months of successful study the applicant
will obtain a certificate in RADIO-ELECTRONICS
from the University and will be capable of continuing
to the level of RADIO-TECHNICIAN or
ELECTRONICS ENGINEER.



HOW MUCH MORE MONEY DO YOU NEED RIGHT NOW?

How much will you need next year? Two, three, five years from now? Will you still be skimping along, "sweating it out" from one paycheck to the next? Or will you be moving up steadily, earning "boom-time" pay?

To earn more, you've got to be worth more. This is true today as never before. That's why, for men sincerely interested in getting ahead, I. C. S. is the answer to a prayer! For here's the proven way to acquire the skills demanded in any of today's most rewarding job opportunities.

No commuting. No time away from your job. Just practical, step-by-step instruction, presented in a way that enables you to master any subject as fast as time and ability permit. Does it work? I. C. S. has more graduates in supervisory and managerial positions than any other school! Isn't it worth the few cents for a stamp to find out what I. C. S. can do for you?

Mail coupon for 3 valuable booklets — FREE!

INTERNATIONAL CORRESPONDENCE SCHOOLS



Box U2419E, Scranton 15, Pa.

(In Canada: I. C. S. Canadian, Ltd., Montreal. In Hawaii, P. O. Box 418, Honolulu)

Without cost or obligation, send me "How to Succeed," the opportunity booklet for the field I've checked, and a sample study lesson.

- | | |
|---|---|
| <input type="checkbox"/> Architecture & Building Trades | <input type="checkbox"/> Eng'r'g Drawing |
| <input type="checkbox"/> Automobiles | <input type="checkbox"/> High School |
| <input type="checkbox"/> Art | <input type="checkbox"/> Interior Decorating |
| <input type="checkbox"/> Business | <input type="checkbox"/> Math & Physics |
| <input type="checkbox"/> Chemical Eng'r'g | <input type="checkbox"/> Mechanical Eng'r'g |
| <input type="checkbox"/> Civil Eng'r'g | <input type="checkbox"/> Professional Eng'r'g |
| <input type="checkbox"/> Electrical Eng'r'g | <input type="checkbox"/> Shop Practice |
| <input type="checkbox"/> Electronics-TV-Radio | <input type="checkbox"/> Textiles |
| | <input type="checkbox"/> Other _____ |

Name _____

Age _____ Home Address _____

City _____ Zone _____ State _____

Working hrs. _____ Employed by _____

Special low rates to members of U. S. Armed Forces

is is for You...IF...

If you want a profitable hobby, a rewarding career or your own full-time business. Perhaps you've seen Ornamental Concrete Items and wondered how they are made. You can make them, and in a professional manner. All you need is Molds and Knowledge. We'll sell you BOTH and you'll know what you are doing even before you start.

We manufacture and sell on a direct basis the industry's best molds. Durable, Dependable, High Quality, and of Aluminum, 96-pg. "How To Turn Concrete Into Gold" includes 29 pgs. of priceless instructions for professional results. Describes and Prices over 300 molds for Bird Baths, Benches and Tables, Flower Urns, Statues, Animals, Religious Items, and many more from 2" to 68" high. It gives the full story. Order yours TODAY—Rushed to you by First Class Mail. It's only \$2.00.



No. 447 Grecian Jr. Mold makes concrete item 9 1/2" high. Price of Mold only \$30.00 AND, there are over 300 others to select from.



Manufacture And Sell Your Own Ornamental Concrete Items OVER 300 DIFFERENT DESIGNS

Concrete Machinery Co., Inc. 839 Lenoir Road, N. W. • Hickory 2, N. C.

EXCLUSIVE DOUBLE-BEARING HEAVY DUTY PUMPS

IRRIGATE • DRAIN • CIRCULATE • SPRAY

Use 1/4 HP motor or larger . . . 1 HP for up to 5,200 GPH; 1,000 GPH 60' high; or 3,000 GPH from 25' well. 1 1/2" inlet; 1" outlet, stainless shaft.

TYPE X-2 oil-less bronze bearings. \$10.95

TYPE XB—Ball bearing model. \$12.95

Best for belt drives. . . .
Postpaid if cash with order.
Don't delay—send for yours today!

MONEY BACK GUARANTEE
Centrifugal and Gear Pumps in All Sizes
LABAWG PUMPS, Belle Mead 2, N. J.



MAKE MONEY! REPAIR HYDRAULIC JACKS



Earn While You Learn At Home

Make up to \$5 an hour, full or part-time, in the competition-free field of Hydraulic Jack Repair. Millions of jacks in auto service stations, truckers, body shops, riggers, farms, need servicing. We show you NOW. Easy step-by-step directions.

Write for Folder PM-5 and Free Bonus Offer

Institute of Hydraulic Jack Repair

P. O. BOX 50 • BLOOMFIELD, N. J.

A Correspondence School Licensed by N.J. Bd. of Ed.

Turtleback boat port, a simple solution to carrying your boat's shelter with you. Watch for it in the June Popular Mechanics.

make your own **Gems** 36⁵⁰ FOR

The Gem Maker comes complete with all necessary equipment, including a super-charged diamond blade for sawing, and all the wheels for grinding, shaping and polishing; also complete instructions. The complete equipment as shown, less motor and belt for only \$36.50, f.o.b., Burlington, Wisconsin. Write today for information and literature.

B&I MANUFACTURING CO.
Dept. P, Burlington, Wis.

MEN PAST 40

Afflicted With Bladder Trouble, Pains in Back, Hips, Legs, Nervousness, Tiredness.

If you have these troubles, particularly bladder trouble, then your condition may be traced to Glandular Inflammation . . . a constitutional disease. Neglect of this condition often leads to premature old age and sometimes incurable conditions.

The Excelsior Medical Clinic has a New Free Book that tells how thousands of men have been successfully treated here at Excelsior Springs for Glandular Inflammation by **NON-SURGICAL Methods**. They found soothing relief and a new outlook in the future of life.

This Free Book may prove of utmost importance in your life. Write Today. There is no obligation.

Excelsior Medical Clinic, Dept. B6129, Excelsior Spgs., Mo.

POPULAR MECHANICS



CLASSIFIED ADVERTISEMENTS



Advertisements in this section \$1.35 per word, each insertion, minimum 10 words, payable in advance. To be inserted under proper classification, copy must be in our office the 18th of the second month preceding date of issue
F. W. Johnson, Manager, Classified Advertising
Popular Mechanics, 200 East Ontario Street, Chicago 11, Illinois

YOU'LL PROFIT

By reading and answering the classified ads in this section. Hundreds of opportunities for you to make and save money

AUTOMOBILES, MIDGET CARS

WANTED — McGuffey Readers, Horatio Algiers, Tom Swift, Uncle Tom's Cabin, old automobile, motorcycle, airplane books, magazines. Describe, prices. Send for free catalog 200 automotive books. Floyd Clymer, Los Angeles 6, Calif.

FREE Literature. Famous Lil' 500 karts now available at factory-direct-to-you prices. Lowest cost of any nationally known kart. Complete line of power options. Lil' 500 also sells husky two-wheel scooter direct-to-you for less than \$100, including engine. Write: 500 Industries, Box M-688, Fremont, Nebraska.

HOTTSPARK: Starting mileage. Vartyper, offset, IBM, barbells. Eg. Elmsford, N. Y.

BUILD The electric sidewalk car cover featured February 1961 Popular Mechanics and 1962 Shop Projects. Order exact gear motor used. \$15.00 each. Information available. J-R Engineering, Box 343, Wausau, Wisconsin.

CATALOGS. Photos, manuals; monthly hobby bulletin. Free information. Auto Enthusiasts, Box 451B, Mt. Clemens, Mich.

CARS On postage stamps. Exciting collection of 50 different only \$1.00. Stampfun, Matteson 12, Ill.

AUTO SUPPLIES AND EQUIPMENT

AUTO Shop welding repair training in world's largest non-profit welding school. Low tuition. Free booklet. Hobart Welders, Box M-521, Troy, Ohio.

JEEP Parts! For military and civilian. At great savings. Largest inventory. Catalog for owners and dealers. Inquiries invited. American Auto Parts Co., 1830-PM Locust, Kansas City, Mo.

LETTERED Jackets, emblems, blazers, auto accessories. Free catalog. National, 277 Passaic St., Newark, N. J.

JUST Out! New 324-page, illustrated catalog offering savings up to 50% on over 100,000 auto parts and accessories, everything to renew, rebuild, renovate '28-'31 Model "A" Fords. All makes (1920 to 1962 models) trucks, foreign and sports cars. Hollywood accessories, custom styling, hi-speed equipment. Send 25¢ for postage, packing—refundable on first order. Whitney, 1919 PM-5 Archer, Chicago 16, Ill.

JEEP Owners — V8 conversions. Read Jeep Owners ad, page 27.

RECLAIM Used motor oil. Easy instructions \$1.00. Hawkins, 3464 Ahern, Baldwin Park, Calif.

RARE Brass bulb horn. Free picture. Box 5406, Minneapolis 19, Minn.

DRIVE Like a pro! Learn from the experts. Order "Tomorrow's Drivers," the professional driver's manual. \$2.00 postpaid. Lyons & Carnahan, Dept. 1, 2500 Prairie Ave., Chicago 16, Ill.

15-MINUTE Emergency highway flares. Top quality. Easily ignited without matches in any weather. Burns bright red. Every vehicle should carry them. Box of 3, plus holders; instructions, \$1.75 prepaid west of Mississippi, \$2.00 east of Mississippi. Clearlite Products, Dept. M, 2137 Pacific Ave., San Francisco 15, Calif.

ONE Transistor ignition system. Complete instructions \$2.00. Frank Anderson, 16 Williams, Wrentham, Mass.

NEW And used parts at savings. Complete guaranteed parts service for all models cars and trucks. Largest in the West. Jeep and army parts specialists. Newest type shifting hubs for all jeep and all military and latest production front end drive vehicles. \$27.50 and up. Also, foreign car parts. Write: Pioneer Auto and Truck Parts Co., 734 W. 13th Avenue, Denver 17, Colo.

PARTS. Model "A." List 25¢. (Refundable) Matco, Box 135, San Pedro, Calif.

1909-1934 FORD Parts illustrated catalogs 75¢. Mark Auto, Layton, N. J.

RING-Valve job while driving, \$6.00 postpaid. Guaranteed! Nothing like it! Lasts 100,000 miles! Motaloy, Grantham, Penna.

A Powr-Grip valve grinder grips better. Free circular. Wood's Powr-Grip, Wolf Point, Montana.

JEEP Owners. Four Wheeler magazine. Road tests, V-8 conversions, back country trips, technical articles. \$4.50 year. Box 95P, Tarzana, California.

WILLYS Jeep tops, \$87.50. Mor-Nan, Box 141, Beverly, Mass.

AIR Conditioner for your car. Build it yourself for \$37.50. This is new. Not an evaporator, but real refrigerated air. Use in your car and sell them. Easy plans, \$1.00. Box 1196, Sioux City, Iowa.

AUTO TRAILERS

BUILD Camping travel trailers. Illustrated circulars 20¢. Kamcraft, Box 1153, Milwaukee 1, Wis.

BUILD Expanding eight foot trailer. Accommodates five. Literature 10¢. Frarmar Company, Wilmington, Mass.

VACATION Rentals. Brand new 15- and 16-ft. travel trailers. Sleeps 6 people. Hitch, insurance and hookup included. If you are going to Seattle World's Fair, Yellowstone, or anywhere in the Rocky Mtn. area, make arrangements to pick your trailer up in Denver. Write for full details. Mobile Trailer Leasing, Inc., 4101 W. Colfax, Ch. 4-7782, Denver 4, Colo.

MOTORCYCLES, BICYCLES, MOTORSCOOTERS AND SUPPLIES

HARLEY-Davidsons — Used bargains. New, used parts, accessories, all models. Bulletin 25¢. Knuth's (Factory Dealer), 1753 Muskego, Milwaukee, Wis.

GO Cart \$15. Doodlebug motorscooter \$10. Jawa \$15, less engines. Engines \$2.50 up. Vespa motorscooter \$30. Whizzer \$15. Indian Scout \$75. Johnson outboard \$10. Gyrocopter \$275. (Mailorder only). Send 25¢ (35¢ for First Class Mailing) for 32-page directory catalogue Number 107, listing these and hundreds of similar bargains. Midget Motor Directory, Athens, Ohio.

GO-Carts. Motorbikes. Parts. Tires. Wholesale catalog 10¢. Loren Products, Danville, Illinois.

BIKE Motorizer, V-belt drive \$79.95. Plans \$1.00. Go-Byk Industries, Fergus Falls, Minnesota.

RECONDITIONED Motorcycle motors. Large stock Indian Cushman Vespa Mustang NSU parts. Indian Motorcycle Sales, Kansas City 27, Missouri.

MOTORCYCLE Parts. New, used. List 25¢. Ballak, 811 N. 9th, St. Louis 1, Mo.

AVIATION

PROPELLERS. Plans, supplies for airboats, snowplanes. 125 h.p. Lycoming engines \$135.00. Prompt delivery. Catalog 25¢. Banks-Maxwell Propeller Co., Box 3301E, Ft. Worth 5, Texas.

GYROSCOPE Rotor blades, marine plywood or aircraft spruce \$29.95. Steel spars and other accessories available. Free brochure. Roto-Float Co., Box 451, Winston-Salem, N. C.

SMALL Helicopters theory and guide manual. Drawings. Construction data. \$2.00. Greater Plains Industries, Box 482A, O'Neill, Nebraska.

HOMEBUILT Helicopter handbook \$1.00. Directory \$1.00. Urshanair, Box 250, Santee, California.

SURPLUS Airplanes \$159, helicopters. McCullough Drone engines \$63, components, wheels, etc., all sold at giveaway prices direct to you by U. S. gov't. Complete details only \$1.00. Surplus Trader, Box 8M2, Thomasville, Penna.

HOT Air ballooning: Plans plus material in kit. Thrill as it soars in the air. \$1.00. Balloon, 2938 Maple Springs, Dallas, Texas.

AUTOGYRO Blades for gyrocopters. Solid aircraft spruce. Terrific! Vancraft, 7246 North Mohawk, Portland 3, Oregon.

BATTERIES, GENERATORS

BATTERY Repair kit: Revive old batteries. Rebuild new posts. Repair cracked cases. Look new again. Profitable, easy, at home. Kit includes, molds, material, complete instructions. \$9.95. Apex Engineering, 1127 Auzeais, San Jose, Calif.

REBUILD Batteries! Complete manual \$3.00. C.O.D. accepted. Bayer Publications, 938G Betty Avenue, Neenah, Wis.

BATTERY Bluebook \$1.00. Why pay more? Pal, 1105-5th, McKeesport, Penna.

ELECTRICAL SUPPLIES

WASHING Machine, dryer parts! Illustrated catalog, plus trouble diagnosis chart, 50¢, refundable first order. Jonsal Appliance Parts Company, Dept. PM5, 291 Atlantic Avenue, Massapequa Park, New York.

SELL And install replacement cords for electrical appliances. Irons, toasters, vacuum cleaners, lamps etc. Be Mr. Fixit in your territory. \$5.00 kit available. Kesco Co., 9520 W. Lorraine Place, Milwaukee 10, Wisconsin.

LAMP, Electrical parts, wholesale. Thousands of items for repairing, converting. Catalog 35¢. Brown Lamp, Box 305, Clayton 5, Missouri.

LAMPS—Parts handbook with instructions for wiring, 50¢ refunded first order. Gyro, 5208P N.W. 35th Ave., Miami 42, Florida.

APPLIANCE, Lamp, vacuum parts wholesale. Catalogue 25¢. Seco, 112 South 20th Street, Birmingham 3, Alabama.

WELDING, SOLDERING, PLATING

PLATING Equipment and supplies. Save 50% and more on new fiberglass tanks, DC power units. 50 amp, 6 volt DC power supply \$97.50; 100 amp, 6 volt \$145; other sizes from 5 amps to 250 amps. Easy terms. Mix your own solution and save. Send \$1 for newest formulas and operating data for all types of plating, equipment guide and catalog. HBS Equipment Division, Dept. L5, 3445 Union Pacific, Los Angeles 23, Calif.

ARC Welder manual. Only 50¢. Regular \$1.00 value. Tells how to weld every job. Emerson Electric, 8100 Florissant, Dept. PM-5, St. Louis, Missouri.

WELDERS, 110/220, \$39.50. Morris, 1070 Inner Drive, Schenectady 3, New York.

ACETYLENE Outfits \$59.50; arcwelders \$69.50. Eagle Welding, Dept. PM, 5085 Broadway, Chicago 40, Ill.

FREE Catalog, welders, kits. Build 350-ampere welder using aircraft generator, plans 25¢. Dunbar, Minneapolis 8, Minn.

MACHINERY, TOOLS, SUPPLIES

40 NEW Machinist, draftsmen tools. Campbell Tools, M-1, 1424 Barclay, Springfield, Ohio.

MARK Tools. Etch names permanently on your tools. Harmless to skin and clothes. Send \$1.00 postpaid to Help Enterprises, 890 S. Rosemead Blvd., Pasadena, Calif.

SHARPENING Equipment, circular saws. Low cost. Builders Supply, Carrollton, Illinois.

"RAM" Power tools below wholesale. R-44- Sabre Saw, cuts wood, metal, plastic, \$14.56; R-200- 40 piece 1/4" drill kit, \$14.60; R-500-3- heavy duty 1/2" drill, \$24.10; R-88-3- 7" Skill saw, \$24.30; R-600-Bench grinder, \$24.30; Order from: Starr Distributing Co., Box 24, Bradford, R. I.

MACHINE Tool dials. Replacement. Experimental. Special. M-D Dials, LeClaire, Iowa.

HORIZONTAL Medal cutting band saws. Write for circular. Olson Mfg. Co., Brule, Nebr.

ENGINES, MOTORS, DYNAMOS

DIESEL Injector parts and fuel pumps wanted. GM51-71-110. Bares, 2093 East 19 Street, Cleveland 15, Ohio.

REWIND Motors yourself. Complete instructions, \$1.00. Lewis Manufacturing, Howell, Michigan.

WINDING Data. 275 motors, single and three phase \$1.10. Data Company, 512 Kensington, Kansas City 24, Mo.

ELECTRIC Motor repairing simplified! Details free! Modern, Box 8715, Kansas City 14, Mo.

LAWNMOWER Parts. Wholesale catalog free to dealers, mechanics and repair shops. Ellwangers, 15 Canal, Port Jervis, New York.

LEARN Auto electricity at home. Instructions \$2.00. Waco, 3809 Kansas, Oakland 19, Calif.

WHOLESALE—Carbon brushes. Electric Motor Parts, Kings Highway, Mt. Ephraim, New Jersey. Free catalog.

REFRIGERATION, AIR CONDITIONING

INSTALL Your own air conditioning or heating system. All materials, tools, and instructions furnished. Send 25¢ for new catalog. Cushman Refrigeration, Fairfield Rd., Wauconda, Ill.

GOVERNMENT SURPLUS

JEEPS, Boats, airplanes, helicopters, walkie-talkies, radar, tents, typewriters, tires, tools, cameras. Individuals can buy now direct from government. "U.S. Depot Directory & Procedure" \$1.00. Brody, Box 425-PM, Nanuet, N. Y.

TENTS, Government surplus. Hexagonal, Pyramidal. Cost \$140. Our price \$39.50. \$225 paint spray unit, \$44.50. Free folder. Insc, 1829 S. State, Chicago, Ill.

GOV'T Surplus. How and where to buy in your area. Send \$1.00. Surplus Information, PM, Headquarters Building, Washington 6, D. C.

U.S. Government surplus—jeeps, \$264.00; radios, \$2.53; guns; typewriters; cameras; tools; thousands of items. Fabulously low surplus prices. Complete information sent immediately. Send \$1.00 to: Surplus, Box 512-E, New Orleans 12, Louisiana.

GOVERNMENT Surplus, radios, jeeps, walkie talkies, guns, etc. Buy direct. Locations & procedures, 50¢. Why pay more? Satisfaction guaranteed. Delta, Box 2262-M, Dallas 21, Texas.

GOVERNMENT Surplus clothing, etc. Pricelist 50¢. Medford Surplus, Medford, Wisconsin.

BOATS, OUTBOARD MOTORS

FREE. 32 page 4-color catalog of Klepper foldaway boats and tents custom built by Europe's foremost craftsmen since 1907. Sail, motor, paddle; Klepper boats are guaranteed unsinkable. Amazingly compact. Pack down to fit any car trunk. Carried like luggage. Smallest storage space. Snap-lock fittings speed assembly (16 minutes) without tools. Built-in air tubes; ideal family boat. Economical, no dockage, no trailer, lowest maintenance. Kleppers merited 4 world championships, won all international slalom awards, performed 2 Atlantic crossings. Many new models, kayaks to sloops. New tent section. For free catalog write to Hans Klepper, Dept. PM2; 820 Greenwich Street, New York City 14.

DISTINCTIVE Clothing and superior equipment for boating. Guaranteed outstanding value and quality. Dress right, be right while boating. Free catalog. Write: Captain Bill, 562 Mechanics Street, Longbranch, Washington.

BOAT Registrations plasticized. Made unsinkable, hangable. \$2.50. Plastics-1, Lockport, Illinois.

FREE Literature on how to stabilize your outboard motor. Eliminates pounding and cavitating. Jagiel Research, 3106 Algonquin, Toledo 6, Ohio.

FULL Size, cut-to-shape boat patterns, blueprints, 7 1/2-38 feet. Big new 88-page illustrated "Build a Boat" catalog of naval architect-designed catamarans, cruisers, runabouts, skiffs, outboard boats, sailing, racing, houseboats, 50¢. "How to Build a Boat" booklet, \$2.50. Cleveland Boat Blueprint Co., Box 1651, Cleveland, Ohio.

NEW. Used, rebuilt marine motors. Marine conversions, fittings. Free catalog. Stokes Marine Supply, Dept. 24, Coldwater, Michigan.

MARINE Conversions, Ford, Chevrolet, Jeep engines. Catalog 25¢. Lehman Manufacturing Company, 800 Elizabeth Avenue, Linden 4, N. J.

FIBERGLAS Your old wooden boat. Make it waterproof. Repaint over fiberglass, wood, or metal with new Poly-Aqua Epoxy paint. Free literature. Ajax Plastic Co., Dept. 6, P.O. Box 1323, Ft. Worth, Texas.

MARINE Conversions and gears for all popular automotive engines. Send 25¢ coin for complete catalogue. Barr Marine, 2706A Castor Ave., Philadelphia, Penna.

HOW To build floating docks from inertubes. Send \$1.00 for blueprint. Jagiel Research, 3106 Algonquin, Toledo 6, Ohio.

BOAT Plans, frame kits, full-size patterns prepared specially for amateurs. Send 50¢ for new 80-page catalog illustrating over 40 build-it-yourself power boats from 7' to 28'. Glen Designs, 9152 Rosecrans, Bellflower, Calif.

BOAT Docks, build yourself or for profit. Complete plans, specifications, instructions for six different models. Send \$1.00. National Floating Dock Co., 1717 Gent, Indianapolis 2, Ind.

KAYAKS—Complete kits only \$39.95. Catalogue 10¢. Klondike Kayaks, Box 63P, Corte Madera, California.

NEW! Patented chromed streamlined fender cleat. No prongs, snagging, tying. Takes up to 7/16 inch line. \$3.50, set of two, prepaid. Money back guarantee. Safety Boat Cleat Company, Box 456, Dept. A-5, Chicago 90, Illinois.

NEW Boat cover support that needs no installation. Write: Ipsen Marine, 1085 Des Plaines Avenue, Des Plaines, Illinois.

CANOE Kits, model and size for every canoeing need. Schneider Boats, Dept. 45, 3133 Lisbon, Milwaukee 8, Wis.

BUILD Your own boat trailer. Easily assembled from our trailer kits. 6 sizes. 350- to 1800- capacities. Professionally designed and manufactured. Buy direct from factory. You assemble at big savings. Free literature. James E. Dandy Mfg. Co., Portsmouth, Ohio.

BUILD Your own boat from our large-scale blueprints. Books of plans give how-to-build help. Hundreds of professional designs—motor, sail or auxiliary—for amateur builders. Free catalog. MoToR Boat-ing, 959 Eighth Ave., Dept. RS, New York 19, N. Y.

FIBERGLASS Boat covering. Free literature. Wholesale prices. Empire Fiberglass Products, Central Ave., Iion, N. Y.

BOAT-Motor combination \$199.95. 4 hp. outboard, 14' fiberglass canoe or fishing boat. Complete line boats, fiberglass materials, hardware, ski equipment distributor prices. Brochure 10¢. Queen City Canoes, 6100 Candlewood, Charlotte 9, N. C.

I Want to send you proof of the wonderful pulling power of Popular Mechanics classified pages. What's your proposition? Write me today. Include literature if possible. F. W. Johnson, Manager Classified Advertising, Popular Mechanics Magazine, 200 E. Ontario St., Chicago 11, Ill.

ATHLETIC EQUIPMENT, BODY BUILDING COURSES

PHYSICAL Perfection. Reducing, gaining, muscles, longevity. Mail 25¢ for all 4 courses, (Guaranteed) to Sids System, PM-2, 8421-C Evergreen, Southgate, California.

"GIANT Arms." Dr. Young's, D.C. revolutionary discovery. \$2. Satisfaction or refund. Gaucho, Box 9309-S7, Chicago 90.

OUTSTANDING Physical development! Any age. New guaranteed discovery uses only a rope! Strength, health, muscles. Gain—reduce. Free information. Roper-cie, 4834 Art, San Diego 15, California.

BARBELLS, Dumbbells, Courses, Booklet 10¢. Good Barbell Co., Siloam Springs, Arkansas.

POWERFUL Arms. No apparatus needed. Age no barrier. Send \$2.00. Progressive Health System, Box 2205, St. Louis 9, Mo.

BIG Muscles fast—gain up to 4" on arms, 10" on chest in just 7 weeks. Free details. Sinkram Body Builders, Dept. ME-2, Box 11, Brooklyn 36, N. Y.

BECOME Taller. New scientific method will add inches to your present height even after maturity. Visible results in weeks. Send for free information and trial offer. Height Increase Institute, Dept. PM-6, GPO Box 1902, New York 1, N. Y.

SPORTING GOODS, GUNS, FISHING, SKIN DIVING, ARCHERY

BRITISH Plat "bazookas." \$9.95. Century Arms, 54 Lake St., Albans, Vermont.

DEALERS Get my list for free delivery and 5% cash. Fred Ness, Red Wing, Minn.

GUN Replicas. \$3.95 prepaid. Exact copies. Used in movies, TV. Solid aluminum. Army 45, Fast draw, snub nose, Luger. Lytle Guns, Box 2146, Whittier, Calif.

1962 GREEN Catalog available now. Thousands of guns, accessories, relics, ammunition. 25¢. Retting, 11029 Washington, Culver City, California.

SINKER Molds for making your own sinkers. Free information. Fisk Molds, Box 63, Berrien Springs, Michigan.

DISTANCE Calculator tells boating, golfing, hunting distances. 50 yards to 10 miles. \$2.00 postpaid. Shang's, 223 Walter Court, Elgin 3, Illinois.

SKINDIVING Equipment. Wholesale catalog. Send \$1.00 to Midwest Skindiving Supply Co., 419 University Ave., St. Paul, Minnesota.

FREE Introductory offer! 5 hand tied flies 25¢. Postage, handling. Flies, Chappell, Nebraska.

AMAZING Discovery attracts more fish. Really works. Simple. Inexpensive. Send only \$1.00 for full details. Money back guarantee. ABC Sales, 4760A Goethe, St. Louis 16, Missouri.

FLATFISH Type plug; cemented and rebalanced solid color bodies 1 1/4" length. You add spots and No. 6 treble: 5 for \$2.00 ppd. L. L. Recks, 984 Bates Avenue, Reno, Nevada.

JAP Rifle altering to 30-06, \$6.00. Japshells, \$3.95. Catalog 10¢. T. P. Shop, West Branch 11, Mich.

MOLDS—For casting your own fishing sinkers. Free illustrated booklet. Reading Instrument Co., Box PM78, Reading, Penna.

FREE—Wholesale catalog. Beads. Spinners. Lure parts. Sinker molds. Jigs. Reels. Finnyports (ME). Toledo 14, Ohio.

BIG Money raising crickets and 12 inch African fishworms. Free literature. Carter Ranch, Plains, Georgia.

MOLDS For fisherman's sinkers, jigs, squids, casting and spinning lures. Free catalog. Sweet's Molds, Tonawanda 1, New York.

SPORTING Goods. Wholesale. Information. \$1.00 refundable. Berkshire Wholesale Sporting Goods, Six Lakes, Michigan.

KLEIN'S Famous 1962 all-sports bargain catalog is free to our customers. Others please send \$1.00 (refunded with first order). Money back guarantee. Klein's, Dept. PM, 227 West Washington, Chicago 6, Illinois.

"**LITTLE Ace**," world's smallest real Derringer, .22 caliber. \$12.95. Circular free. A-B Distributor, 4243-H North Harlem, Chicago 34, Illinois.

TAXIDERMY

BEAR Rugs (Black, Grizzly, Polar). Tiger. Hofmann-Taxidermy, 969 Gates, Brooklyn 21, N. Y.

CAMPING EQUIPMENT AND TENTS

PORTABLE Kitchen-pantry. Award winning design. Nothing else like it. Copyrighted plans, simple plywood construction \$1.00. Specify station wagon, sedan, boat. Literature 10¢. Campers Kitchen Co., Box 6062, San Antonio 9, Texas.

CAMPING Equipment, tents, world's largest selection. Send 25¢ for new giant catalogue-handbook-camp site directory (print name-address). Morsan Tents, 10-21R 50th Ave., Long Island City 1, New York.

PICKUP Campers. Pre-cut kits. Blueprints. Supplies. Literature 10¢. Comstock Trailers, Parsons, Kansas.

BINOCULARS, TELESCOPES, MICROSCOPES, MAGNIFIERS

BINOCULARS, Telescopes, microscopes and accessories. Profusely illustrated brochure. Wolbers, Portage, Mich.

TELESCOPES, Microscopes, Binoculars, \$1.49 to \$99.99. Free catalog! Quality Optics, 13571 Kentucky, Detroit 38, Mich.

DYNASCOPE. Amazing world-famous reflector telescope. Request free brochure. Criterion, Dept. DP-91, Hartford 1, Conn.

TELESCOPE Kits—Direct from manufacturer. Other optical hobby kits. Large selection. Free booklet. Esco Products, Oak Ridge, N. J.

AMAZING New Zoom binoculars! Telescopes! Microscopes! Riflescopes! Free catalog. Adventure Company, Box 2133, San Diego 12, California.

SCIENCE Bargains! Lenses, telescopes, binoculars, microscopes, kits, parts, war surplus. Send \$1.00 for beginner's 10-lens kit with instruction booklet. Order Stock 2-CH. Request free 144-page Catalog CH. Edmund Scientific Co., Barrington, New Jersey.

REFLECTING Telescope, 60X, completely assembled. Guaranteed observatory clearness. Free information. Skyscope, P.O. Box 55, Brooklyn 28, N. Y.

BUILD Your own reflector telescopes. Complete kits: mirrors, eyepieces, tripods, all other accessories. Request free illustrated literature. Criterion Manufacturing, Dept. KPM-88, Hartford 1, Conn.

EARTHWORMS, CRICKETS, FROGS

EARN Money raising fishworms for us! Exciting details free! Oakhaven—36, Cedar Hill, Texas.

BIG Money raising fishworms and crickets. We teach you how to raise and where to sell. Free literature. Medium redworms, 3000, \$5.95; 10,000, \$16.95. Carter Redworms, Plains, Georgia.

WORM Your way to wealth. Raising red worms is profitable. Information. Early-bird Worm Hatchery, 273, Moylan, Penna.

PROFIT With hybrid redworms, for compost, garden, fishing, pit-run, 2000—\$4.00. Breeders 1000—\$4.00 postpaid. With instructions. Copps Worm Farm, So. Barre 2, Mass.

FISHWORMS. Live delivery prepaid. 100,000 young worms \$150.00. Selected African giants, 5,000 for \$35.00. Literature free. Associated, 3620 N. Meridian, Oklahoma City 12, Okla.

LARGE African nightcrawlers! 100—\$2.00, 500—\$7.00, 1000—\$12.50, postpaid. (Dealers wanted). Ozark Worm Farm-J, Willow Springs, Missouri.

HYBRID Redworms 1000/\$3.00; 2000/\$5.00; 5000/\$8.00; 10,000/\$14.00; Postpaid with raising instructions. Live delivery guaranteed. Brazos Bait Farm, 60 Lincoln, Waco, Texas.

EARN Money raising bait at home for us. Guaranteed market! Red Wigglers, Warsaw 45, Indiana.

REDWORMS 1000—\$4.00; 5000—\$16.00. Medium 2500—\$4.95; 5000—\$8.95; 10,000—\$16.85. Postpaid. Guarantee count, live delivery. Free literature. Hall Farm, Hilton, Georgia.

PLANTS, SEEDS, BULBS, NURSERY SUPPLIES

GINSENG Bringing \$14 pound. Have seeds, plants. Goldenseal. Full information. K. Collins, Viola, Iowa.

COMPLETE Line of insect eating plants and supplies; unusual and atomic mutated seeds. Peter Pauls Nurseries, Bldg. 2, Canandaigua, New York.

GROW Mings! Instructions, seeds, 35¢ U.S. only. Specialties, 1439-X Sabraton Ave., Morgantown, W. Va.

ROOT Branches on the plant for individual bearing trees and shrubs in weeks. Information free. P. Robbins, Box 1673, Escondido, Calif.

GARDEN EQUIPMENT & SUPPLIES

LAWNMOWER Foot guard. Clips on rear. \$1.50 ppd. Box 453, East Point, Ga.

PETS—DOGS, BIRDS, HAMSTERS, ETC.

HAMSTERS. Ideal pets. \$2.95 pair. Booklet 10¢. Jer-Fre's Hamstery, 1447 Apple, Muskegon, Michigan.

TRAIN Dogs. Hobby; big pay. New. Easy. Using expert's shortcuts; secrets. Fully explained. \$1.00. Canine Center, 3232 West Central, Franklin 7, Wisconsin.

UNUSUAL Pets—Animals, birds, reptiles. Catalog 10¢. Ray Singleton, Interbay Station, Tampa, Florida.

BABY Raccoons, monkeys, skunks, snakes, lizards, turtles, birds. Catalogue 10¢. Thompson Zoo, Clewiston, Fla.

SKUNK Kittens, pen raised, deodorized. \$10.00. Ferrets \$6.00. June-July delivery. Ruby Fur Farm, New Sharon, Iowa.

PETS—Hamsters, mice, rabbits, squirrels, chipmunks, guinea pigs, skunks, raccoons. Pricelist dime. Picture catalog twenty five cents. Moore's Hamster Ranch, Shepherdstown 25, West Virginia.

HAWKS. Reptiles, raccoons, skunks, squirrels. Catalogue 25¢. Trails End Zoo, St. Stephen, S. C.

MAKE Money raising chinchillas, mink, rabbits, cavies for us. Free catalog. Keeney Brothers, New Freedom 2, Penna.

RABBITS—FUR BEARING ANIMALS

ATTENTION Nutria purchasers. Be associated with the only organization in North America which offers you a known pelt guarantee. Yes, here is your pelt market with guaranteed floor price on all pelts. For free book (on how to raise nutria) write to Canadian Nutria Limited, R.R. 2, Stouffville, Ontario, Canada.

RAISE Rabbits. Make money. Information and prices sent free. Write Johnson, 683, Kansas City, Missouri.

MINK Raising information free. Complete. Lake Superior Mink Farm, Superior, Eel, Wisconsin.

RAISE Rabbits successfully by knowing facts. 48 page book. 38 illustrations describing 25 breeds. Housing. Breeding. Feeding. Markets and Marketing. Bulletin etc. 25 cents. American Rabbit Association, 36 ARBA Building, Pittsburgh, Penna.

RAISE Rabbits. Details. Rabbit Enterprises, 548 River Road, Ludlow, Ky.

EARN \$10,000 Yearly raising Angora rabbit wool for us. Information 25¢ coin. American Angora Company, Malta 12, Montana.

RAISE Rabbits on \$500 month plan. Free details. White's Rabbitry, Mt. Vernon, Ohio.

FARMS, FARM LANDS, REAL ESTATE

TROUT And beef farm. Picturesque 160 acres on market now for little more than insured value of buildings alone! Ideal for raising rainbow trout, has fish hatchery building, large trout pool and 3 concrete runways fed by 8 everlasting springs. Sparkling spring creek reportedly can be dammed to form lake 1/2 mile long and several hundred-ft. wide. Rustic log home in good condition, has 5 rooms, 2 bedrooms, bath, 4-room 2-bedroom log tenant house. Small barn, poultry house. On good road in the beautiful Ozarks, 1 1/2 miles store and church. 40 tillable acres, 100 wooded, estimated \$4,000 to \$5,000 worth of marketable timber, pasture for 60 head, barb wire. The man of vision should snap this up in a hurry at \$16,000, only \$4,000 down! Immediate possession. New free illustrated Summer catalog, bargains coast to coast! United Farm Agency, 2825-PM Main St., Kansas City 41, Mo.

FLORIDA Land inspections. Continental Real Estate Investigations, 1060 East 24th St., Hialeah, Florida.

FLORIDA Campsites—deep in the heart of the great Ocala National Forest. Abundance of game, best fishing. Warranty deed. Unrestricted—pitch tent, park trailer, build lodge. Free maps and photos. Howard Vernor, DeLand, Florida, AD60088/Q-O.

CANADIAN Lands, seized and sold for taxes. Our 45th annual series of lists, just begun, describe many choice properties, situated from coast to coast, acquired by us through tax sale. Priced as low as five dollars per acre, guaranteed perfect title, small monthly payments, no mortgage. Beautifully situated hunting and fishing camps, where there is real sport; summer cottage sites, heavily wooded acreages. Now is the time to invest in Canada's minerals, forests and farms. Write today for free twenty page booklet with full explanation. Tax Sale Service, Room 411-D, 1173 Bay St., Toronto 5, Canada.

FLORIDA: 2 1/2 Acres, Gulf Coast area: 50 ft. elevation. \$795.00. \$15.00 down and month. Russell Hancock, Realtor, Brooksville, Florida.

OZARKIAN Contentment! Improved acreage \$15 monthly. Descriptions free. Armstrongs, Wappapello, Mo.

85 MONTHLY Buys 5 acres—near clearwater lake. Price \$125. Excellent fishing, good cabin sites. Free list. Box 425-P, Carthage, Mo.

FREE Strout catalog! Farms, homes, businesses, resorts, retirement properties. Over 3000 values coast to coast. 61 years service. World's largest! Write Strout Realty, 7-CJ S. Dearborn, Chicago 3, Ill.

CANADIAN Vacation lands: Full price \$385.00. 40 acres, \$10 month. Suitable cottage sites, hunting, fishing, investment. Free information. Land Corporation, 3768-C Bathurst, Downsview, Ontario, Canada.

FLORIDA — Big, beautifully wooded tracts on prominent highway in famous Green Hills pleasure resort area 28 miles north Panama City. Also choice 1/4-acre lakeside homesites. \$10 monthly. Free maps, photos, Owen Wood, Fountain 15, Florida. AD62005 (K) (O)

CENTRAL Florida lots, lake and citrus region, near Orange City. Total price \$99.00 each. \$2.50 down and monthly. Free literature. Casper Corporation, 3970 N.W. 177th, Carol City, Miami, Florida.

FARM MACHINERY AND SUPPLIES

3 H.P. Hoeing machine. No other like it. Uproots all weeds in row and between plants. Very simple. Very sturdy. Women operate easily. Also tills. Depth adjustable 0-6". Self propelled. Buy direct at discount. 30 day trial. One year warranty. Write Autohoe, West De Pere 22, Wis.

PROFITABLE OCCUPATIONS

INVESTIGATE Accidents. Earn \$750 to \$1,000 monthly. Men urgently needed. Car furnished. Business expenses paid. No selling. No college education necessary. Pick own job location. Investigate full time. Or earn \$6.44 hour spare time. Write for free literature. No obligation. Universal, CPM-5, 6801 Hillcrest, Dallas 5, Texas.

DISC Jockey work available. Learn Dee Jay techniques for high paying radio work. Send for free information. Robert Lyndon Studios, Dept. PM-2, Tarboro, N. C.

FREE Details! "211 Lucrative Business Ventures." Work home! Dilley, Box 3854, Milwaukee 5, Wis.

WHOLESALE Magazine subscriptions. Highest commissions. Bonus! Qualified Agencies, 451PA Kingston, Brooklyn 25, N. Y.

BIG Profit sharpening files. Details free. Box 5406, Minneapolis 8, Minn.

INVESTIGATE Auto accidents. Earn up to \$750 monthly. Investigators needed in every state. No selling required. Car furnished; expenses paid. Or start a business of your own. Associate with interesting, important people. We train you at home. You hold present job until ready to switch. Get free information. No obligation. Write Liberty School, Dept. C-94, 1139 West Park, Libertyville, Illinois.

BUY Below wholesale! Thousands of nationally advertised products. Drugs, clothing, housewares, cameras, jewelry, hardware, sporting goods, etc. Postcard brings price list showing actual factory cost. Buy-Rite, 310 Main, Bennington 1, Vermont.

AUCTIONEERING—Home study course. Diploma granted. Auction School, Ft. Smith, Ark.

VENDING Machines. No selling. Operate a route of coin machines and earn amazing profits. 32-page catalogue free. Parkway Machine Corporation, Dept. #25, 715 Ensor Street, Baltimore 2, Maryland.

BAKE New greaseless doughnuts in kitchen. Sell stores. Free recipes. Michael, 3605 South 15th, Minneapolis 7, Minn.

BIG Money raising fishworms and crickets. Free literature. Carter Wormery, Plains, Georgia.

BECOME Independent with your own franchise business. Thousands earning handsome incomes. Request interesting facts today. National Franchise Reports, PM-528, 333 North Michigan, Chicago 1.

HOME Mailorder business. Simple, enjoyable. Net \$15,000 year. Write: Mail-order, Box 512-E, New Orleans 1, La.

SAVE Those boxtops! They're worth money! Inquire: "Boxtops-MA," Cedar Hill, Texas.

EARN \$240.00 A month at home, spare time, doing only two \$5.00 invisible mending jobs a day. Big money paid for service that makes cuts, tears disappear from fabrics. Steady demand. Details free. Fabricon, 1586 Howard, Chicago 26, Ill.

EARN Money raising fishworms for us! Write: Oakhaven—58, Cedar Hill, Texas.

SHARPEN Scissors, pinkers, clippers. Inexpensive machines, supplies. Black-hawks, Sheldahl, Iowa.

FOR Real earning security learn to straighten crank shafts, sharpen, repair, and service lawn mowers. Wirt's, 1419 Gnahn, Burlington, Iowa.

FREE Report: "609 Unusual, Successful Businesses." Box 1001-PT, Evanston, Ill.

START A magazine subscription business. Earn generous commissions on Popular Mechanics, Good Housekeeping and all others. Best commissions, bonus, all materials sent free. No experience needed. Write Popular Mechanics, Room 5-P, 250 West 55th St., New York 19, N. Y.

BOOKS, PERIODICALS, PICTURES, POSTCARDS

HERE They are again! By Edgar Rice Burroughs "A Fighting Man of Mars"; "Moon Men"; "Monster Men." New editions illus. by Mahlon Blaine. Cloth \$2.75. Available May, 1962. Canaveral Press, Inc., 63 Fourth Ave., New York 3, N. Y.

BOOKFINDING Our specialty. Try us. Babcock, 412 Lulu, Wichita 11, Kansas.

COVERED Bridges books, pictures. Stamp please. Swanson Publications, Moline, Illinois.

FOR Discriminating readers. Books from windfall. Free brochure. Windfall Press, 1814-E Norwood Street, Chicago 26, Ill.

NEW ENGLAND Legends and lore, local history, genealogy. Catalogue 10¢. Box 4, Cambridge 40, Mass.

BOOKS Located! You name it—we find it. Book Mart, 51A Walnut, Mt. Clemens, Mich.

SAVE To 83% on books. Free catalogue. Discount Reader's Service, MD-5435 Upland Way, Philadelphia 31.

TRANVESTIA Magazine, other interesting books available. Free descriptive folder. Chevalier D'eon Publications, Box 36091P, Los Angeles 36, Calif.

FREE Catalog. Self-help books. Write Wilshire, 8721 Sunset, Los Angeles 46P.

NATIONAL Geographic magazines, 1888-1960, any issue. Periodical Service, Box 465-PM, Wilmington, Delaware.

BOOKHUNTERS! Scarce, miscellaneous books supplied! Atlantic Book Service, Cedar Street, Charlestown 29, Mass.

BRITISH Book bargains—Any subject. Catalogues free. Transatbooks, Wantagh, N. Y.

PROPHET Elijah coming before Christ. Wonderful book free. E. Megiddo Mission, Rochester 19, New York.

OUT-Of-print books at lowest prices! You name it, we find it! Fast service. No obligation. International Bookfinders, Box 3003-PM, Beverly Hills, Calif.

GAMES, TOYS, NOVELTIES

WOW The gals! Beautiful lapel tulip lights at your command. Battery, switch, concealed in pocket. \$2.00. Eskimo White, 520 East 20 Street, New York 9, N. Y.

MAGIC TRICKS, PUZZLES, JOKER NOVELTIES

84 PAGES, Completely illustrated catalogues, 25¢. Manhattan Magic, Box 334-P, New York City 11.

BE A Magician! Introductory catalog with free trick, only 35¢. Ireland, 109-F North Dearborn, Chicago 2.

WORLD'S Finest professional magic. Joker novelties. Giant illustrated catalog 10¢. Top Hat, Evanston 12, Illinois.

3000 TRICKS, Pocket, parlor, stage. World's finest magic catalog (408 pages), \$2.50. Kanter's, M-1311 Walnut, Philadelphia 7.

500 TRICKS, New 1962 edition, famous Douglas catalog of magicians tricks and supplies now available just 10¢. Fastest service. Douglas Magicland, Dept. 61, Dallas, Texas.

CATALOG, Free trick, 25¢. (1,500,399 tricks, jokes). Magico, Box 4373-P, San Antonio 7, Texas.

FUNNY Cards, 50 samples 25¢. Wholesale joke catalog. Dohn—RN—Marks, Broadview, Illinois.

MAGIC Tricks book \$1. Be party live-wire! Free catalogue. Mandel, 1200-PM Avenue H, Brooklyn 30, New York.

LOOK! 1000 World's best tricks, jokes, magic! Big 160 page professional magic catalog with free trick 10¢. House of 1000 Mysteries, Dept. PM5C-62, Trumbull, Conn.

Electric Matches! 4 for \$1.00. Pen Lite cell ignites remotely, instantly! Opperman, Lemoyne, Penna.

PROFESSIONAL Catalog, 175 pages, 25¢. Williams, 900 Plymouth, Ellwood City, Penna.

FLAME Thrower! 36" flashes at fingertips! \$1.00. Harmless! Arlane, Philadelphia 44.

INVISIBLE Ink—\$1.00 bottle. It's great! Box 63, Hillside, N. J.

VENTRILLO Voice thrower 25¢. Ventriloquist's puppet 75¢. Box 971-PM, Philadelphia 5.

SMOKE Bombs 25¢ 7 for \$1.00. Terrific! 6703-N Eleventh, Philadelphia 26.

ANTIQUES, RELICS, INDIAN GOODS, CURIOS

SELLING 20,000 Ancient arrowheads, spearheads, etc. List free. Lear's, Glenwood, Arkansas.

GENUINE Oregon obsidian arrowheads. Special 6 bird points \$2.00. Strobeck, 724B Willamette, Eugene, Oregon.

11 BUTTERFLIES \$1.00, 7 African, Comanche, Southwest artifacts \$2.00, 16 minerals \$1.00. Free lists. Tervo's, 14 Nassau, Garden City South, New York.

3 WAR Arrowheads, scalping knife, thunderbird \$4.00. List. Arrowhead, Glenwood, Arkansas.

AFRICAN Carving set \$1.00. Liliput, Box 7474, Mombasa, Kenya.

PETRIFIED Teeth from prehistoric animals. Excellent condition. \$1.00 each. R & D, 738 Hudson Ave., Sarasota, Fla.

COINS, TOKENS, CURRENCY

FREE Brochure describing Presidential art medals, a series of finely sculptured medals honoring each President. Kennedy medal selected by President for distribution on good will missions. Unmatched quality. Collection of appreciable value, historic and education interest. Send for free descriptive brochure. Presidential Art Medals, Inc., P. O. Box 187M, Englewood, Ohio.

SILVER Dollars! 1880-P and 1881-P uncirculated, \$2.50 each. Bargain list free! Stroud's Coins, Kinston, N. C.

FIVE Confederate Generals coins \$1.00. Middtown, Box 1656, Worcester 7, Mass.

\$20.00 GOLD. Very fine \$47.50; uncirculated \$56.50. Brilliant proof sets—1956, \$6.95; 1957, \$4.25; 1958, \$8.95; 1959, \$4.95; 1960, \$3.95; 1961, \$3.00; 1962, \$3.00. All seven \$32.35. Fifteen different Indian cents \$4.95. "Red"—Guidebook \$1.75. Bebee's, 4514 North 30th, Omaha 11, Neb.

PROOF Sets 1961, \$2.75. 1962, \$2.60. Tom Norman, Corinth, Miss.

\$18,000 FOR 1913 Liberty head nickel. Uncirculated dollars 1804-1839, 1893-S, 1895-P, 1903-O pay \$200.00-\$15,000.00. Certain dates—Lincoln cents before 1932, \$250.00; Flying eagle cents, \$950.00; Indian cents, \$1,750.00; Dimes before 1943, \$5,250.00; Quarters before 1924, \$5,250.00; Half dollars before 1929, \$7,500.00; 2¢ pieces, \$200.00; 3¢ pieces, \$200.00; half-dimes, \$3,250.00. Hundreds of others worth \$10.00-\$10,000.00. Canadian coins, 1921, 5¢ Silver, \$300.00. 1875 quarter, \$500.00. 1921, 50¢, \$2,000.00. Wanted 20¢ pieces, gold coins, paper money, etc. Our large illustrated guaranteed buying-selling catalogue, giving complete alcoin information. Send \$1.00. Purchase catalogue before sending coins. Worthycoin Corporation (K-508-C), Boston 8, Massachusetts.

LINCOLN Cents for sale: 15¢ each. 1909, 1914, 1917D, 1918D, 1918S, 1919D, 1919S, 1920D, 1920S, 1925S, 1926D, 1927D, 1928D, 1929D, 1929S, 1930D, 1930S, 1931, 1934D, 1935D, 1935S, 1936D, 1936S, 1937D, 1937S, 1938D, 1938S. Dennis, Box 3555, Toledo 8, Ohio.

50 DIFFERENT Coins from 25 countries \$1.89. Jolie, Roslyn Heights, N. Y.

U.S. Gold coins wanted. Paying double face for all denominations. Bob's, 1637 S. Michigan, South Bend, Indiana.

10 DIFFERENT Indian cents \$1.00. Lists. John Moody, Route 3, Bonnieville, Kentucky.

25% DISCOUNT! Coin supplies. List 10¢. Kaplan, Box 115, Hollis 23, N. Y.

1939-S JEFFERSON Nickel, 25¢ with coin approvals. California Company, Box 871, Oakland 4, California.

BUYING: All Lincoln pennies with mint marks before 1940! Thousands other common coins! Send 25¢ for buying list. Leecoins, 641—9th Street North, Wisconsin Rapids, Wisconsin.

CALIFORNIA Souvenir gold tokens, unc. One pc. \$1.00, two different \$1.75, three different \$2.50, four different \$3.25, five different \$4.00. Chambers Coins, Box 102-P, Fort Lavaca, Texas.

DESIRE Pull cash value for old coins? Without paying for gimmicks, misleading catalogues? Submit priced inventory or ship for offer. Antique Coin Exchange, Incorporated, 95 East Post Road, White Plains 2, N. Y.

96 BEAUTIFUL Replicas. Confederate bills plus 2 different Indian cents, plus catalog \$1. Hanson Coin Company, Box 5649M, Minneapolis 17, Minnesota.

INDIAN Cents, 6 different \$1.00. Evans, Box 9912, Atlanta 19, Ga.

BARBER Dimes: 12 different \$3.95, 20 different \$11.95, large cent \$1.75, 2c piece \$1.25, 3c piece 95c. Vacoin, Box 10, Richmond 1, Va.

LINCOLNS For sale 20c each: 1909, 1910, 1911, 1912, 1913, 1914, 1916-PD, 1917-PDS, 1918-PDS, 1919-PDS, 1920-PDS, 1926-D, 1927-PDS, 1928-PDS, 1930-DS, 1931, 1934-PD, 1938-DS, 1939-DS, 1943-PDS, 1954-PDS, 1955-S. All 43 \$7.00. John Gardner, Box 408, Colorado Springs, Colo.

BUYING Coins. Lists free. Alan, 2847 Forrester, Los Angeles 64, California.

PICKWICK Wants to buy your coins and stamps. Send \$1.00 for new combined illustrated buying prices refundable when we buy your material. See Pickwick before you sell for top prices. Pickwick, Box 34, Stamford 1, Conn.

GOLD Coins. For investment, safety, profit, pleasure. Available: gold coins of United States, England, Switzerland, France, Italy, Holland, Belgium, Russia, Mexico. Austrian coins are special bargains. Free: the full story. Parker, Importer, Box 13406, Houston, Texas.

LINCOLN Cents 24-S, 21-SD, 18-SD, 19-SD, 20-SD, 55-S, 54-SP, 34-D, 28-SD, 27-SD, 38-SD, 29-SD, 25-SD, 09 P, 30-SD, 31-P. Good to fine complete lot \$4.35. Rolls 1955-S Lincoln cents fine to A.U. \$7.00. Berry, Box 306, Westminster, Calif.

GOLD U.S. \$10.00 pieces. Bright. Any year 1880-1920. Bernstein Coin, 3324 Lawrence, Chicago 25.

INTRODUCTORY: Free confederate replica dime, foreign coin, coin and medal catalog; send 25c postage, handling. Collectors Club, Box 71-C, Rockaway 94, New York.

CANADIAN Coins skyrocketing! Just released 1962 catalogue-prices, illustrates thousands! 224 pages. \$2 includes Buying Book. Coin Publications, 1636 West Fourth, Vancouver 9, Canada.

MAILING List coin and supply. Box 276P, Mooresville, N. C.

U. S. Coin value guide, \$1.00. Refundable. Griffin's, 322 West State, Ithaca, New York.

HIGHEST Prices paid for United States coins. Send 25c for our buying lists. Wilmot's, 1067-A Bridge, Grand Rapids 4, Michigan.

GUARANTEED Profit on uncirculated bags cents. Carolina Coin Company, Box 1338, Charlotte, N. C.

COINS. Closeout prices. List 15c. Lee's, 525 Mt. Curve, St. Paul 16, Minn.

FREE Coin bulletin listing coins for sale at bargain prices. Send self-addressed, stamped envelope to: Ben's Coin Company, 31 North Clark, Chicago 2.

FREE Coin supplies! Giant coin list 10c (refundable). Economy Sales, Mansfield, Massachusetts.

COINS & supplies, Lincoln cents our specialty. Catalogue free. Hyles Sales, Box 9566, Dallas 14, Texas.

LARGEST Coin magazine, 288 pages, 50c. Scrapbook, 7320-J Milwaukee, Chicago 31.

NUMISMATICS Largest newspaper. Semi-monthly. Sample 25c. \$2.00 yearly. Numismatic News, Box 452, Iola, Wis.

RARE 1878 CC mint dollar uncirculated \$5.00, 100pg. catalogue 50c. Shultz, Salt Lake City 10, Utah.

BARGAIN List! U. S. coins, accessories. Stamp please. Hugh's, Hickory, N. C.

40 PAGE Illustrated United States and Canadian coin list 10c. Stoney, 260 Washington, Boston 8, Mass.

25 BEAUTIFUL Coins from 25 countries. Mostly uncirculated. Terrific assortment. \$1.00. Hindley, Box 708, Aurora, Illinois.

RARE Unc. 1899 Philadelphia silver dollar, \$5.00. Butts, Torrington, Wyo.

COIN Collector's magazine. On your newsstand or direct. Sample 35c. \$3.00 yearly. Coins Magazine, Box 274, Iola, Wis.

TWENTY-Four page 1962 retail price list of USA and Canadian coins 10c. Our selling prices on thousands of coins and coin collectors' supplies. Bryson Incorporated, 612A White, Toledo 5, Ohio.

SIX Different Indian cents with lists. Hutchinson's, Box 6256, Philadelphia, Penna.

COINS Bought. Illustrated catalog 25c. Hutchinson's, Box 6256, Philadelphia, Penna.

15 DIFFERENT Lincolns before 1921. \$1.00. Gene Carlton, Box 336, Chandler, Oklahoma.

LINCOLNS 40 Different 1909-1940 plus 1960D small date, \$1.95. 25 different "S," including rare 1955S \$1.50. Harris, Box 611P, Cupertino, California.

WORLD'S Greatest coin magazine and wooden nickel 10c. Lawrences, Anamosa, Iowa.

STAMP COLLECTING

CARS On stamps. Collection of 50 different only \$1.00. Stampfun, Matteson 14, Ill.

105 DIFF. U.S. only 25c. Approvals, inc. Shelton, P.O. Box 187-K, Hempstead, N. Y.

103 DIVERSIFIED British Commonwealth 10c. Approvals included. Crown Stamps, Virgil 601, Ontario.

327 WORLDWIDE Different 25c. Bargain approvals. Niagara Stamps, St. Catharines 201, Ontario.

FREE—Mint British Colonials from Maldives, Solomon Islands, Pahang, St. Christopher, Nevis, Sarawak, Cayman Islands, Gilbert Ellice. Free with approvals. Viking, Great Neck 8, N. Y.

DEALERS—Wholesale list. Postage 4c. Frank, 5031 Queensberry, Baltimore 15, Maryland.

WOW! 110 All different Germany 10c! Zeppelins, semi-postals, airmails, high values, etc. Giant catalog, bargain lists included with beautiful approvals. Jamestown Stamp, Dept. A52PM, Jamestown, N. Y.

25 LARGE American commemoratives 10c. Accompanying approvals. Free perforation gauge. Linstamps, St. Catharines 101, Ontario.

GAMBLER'S Packet, 25c, with approvals. Lee Kennedy, Box 9497, San Diego 9, Calif.

FREE! Shepard astronaut commemorative! 25 others different. Approvals. White, Box 485, Flemington, New Jersey.

FREE! 55 Different triangles, pictorials, others. Colorful, low-priced approvals. L. Baird, PM-4, Box 8128, Portland 7, Oregon.

U.N. Commemorative set 10c to approval applicants. Fine Stamp Co., Box 71-P, Detroit 24, Mich.

FREE—200 Worldwide with purchase of illustrated album, \$1.00. No approvals. Russell's, 736 Hillcrest, Frankfort, Ky.

FREE! Three different \$1.00 stamps. Craigs, 1183 Sherburne, St. Paul 4, Minn.

NO Gimmicks. No gadgets. No giveaways. Just attractive approvals at attractive prices. Sunny Stamps, Apopka 2B, Florida.

FANTASTIC Fish triangles! Valuable "Ben Franklin" on Canal Zone! Flaming bi-colored volcano triangle! Lovely Olympics triangle! Plus icy Greenland, weird wild beast issue and others. 10c with approvals. Roseland Stamps, Spring Lake 2, Michigan.

30 DIFFERENT Soviet stamps only 10c! See "behind the scenes" in mysterious Russia. View the Kremlin, satellites, atomic icebreaker, Russian jet plane. Tour Red Square, ancient forts, onion towers. Meet Red leaders. Only 10c with approvals. Offer open to adults only. Littleton Stamp Co., Littleton C1, New Hampshire.

TERRIFIC Stamp bargain! Israel, Iceland, San Marino, plus triangle set, plus Antigua, Borneo, Virgin, Scots, Congo, Russia, plus large stamp book. All four offers free. Send 10c for mailing cost. Empire Stamp Corporation, Dept. PM, Toronto, Canada.

82 DIFFERENT U.S. stamps 25c. Frazer, 1093 "D," Springfield, Oregon.

1847, FIRST USA variety! Goliath foreign beauty shows Ben Franklin in this outstanding issue! Plus Congo freedom stamp, unused 1/2 inch midget stamp freak, real cigar issue, icy Greenland, Free China Bomber airmail giant, etc. only 10c with approvals. Capital Stamp Co., Ferrysburg 2D, Mich.

115 UNUSUAL Stamps from 5 continents. Airmails, dead countries, pictorials, etc., value over \$2, all for 10c to introduce our superb service of U. S. & foreign approvals. Globus Stamp Co., New York 10, N. Y., Dept. 214.

OLD Scarce U.S. seconds on approvals. Slight imperfections, lowest prices. Hernefield, Clintonhill Sta., Newark 8, N. J.

200 MIXED U.S. including large Commemoratives, 10c. Monjar, Cincinnati 14, Ohio.

FREE! Antique autos! Complete! 10c handling. Approvals included. W. Shaver, 3075 Vamana, Pomona, California.

REAL Old U.S. seconds. Bargain prices. K. Swartz, Malden Bridge, New York.

50 ITALY Pictorials 25c with approvals. Bonner, 1517 Converse, Fayetteville, N. C.

U.S. Stamps. Giant discount catalog—25c. Rayman, 37-VZ Maiden Lane, New York City 38.

WORLDWIDE Mission mixture. Pound \$2.00. Over 1,000 foreign stamps \$1.00. Lange, Box 40, Hub Sta., New York 55.

100 DIFFERENT Norway—25c! World-wide approvals. Carling's, B-502, Howard City, Michigan.

FREE First day cover, approvals. Gall, Box 96, Coopersburg, Pa.

FREE—Scott's International, Master Global albums, catalogues when you buy foreign approvals. Bargain Stamps, 1746 Meridian, Miami Beach 39, Florida.

CANADA, 10 Large commemoratives, 10c with approvals. Salsman, 1404 Harrison, Fairfield, Calif.

BRITISH Colonies, foreign, U.S.A., commemoratives, airmails, pictorials, 10c with approvals. Stanley Zajac, 159 Emerson Ave., Toronto, Canada.

START Approval business. Details 10c. Steele, Box 553-PM, Pacific Grove, Calif.

BUYING U.S. covers; stampless, express, colonials, westerns. Bruce Gimelson, 7627 Germantown Avenue, Philadelphia 18, Penna.

EXCHANGE. Send 100-200 different stamps with 15c. Receive different. Paterson, Lancaster 10, New York.

TRADE Doubles for free stamps. Drolinger, 103 S.W. 14th Street, Deerfield, Florida.

100 DIFFERENT U.S. commemoratives 25c. Approvals, Gordon Davison, Henrikers, N. H.

SEND For better grade approvals. Reasonable prices. Free packet accompanies. Gilcraft, Box 313, Lorain, Ohio.

FREE! 29 Thrilling jet, astronaut, rocket, space airmails. Send 10c handling, 2c approvals included. ABC World, Box 6000-YA, San Francisco, California.

20 CZECHOSLOVAKIAN Commemoratives, 10c with approvals. Covey, 35 Bothwell, Palatine, Illinois.

303 DIFFERENT Stamps 25c plus free gift with our low priced approval. Try us. You will be satisfied. Trust Stamp Co., P.O. Box 132-B, Jamaica 35, N. Y.

200 DIFFERENT Stamps 10c approvals. Peterson, Box 31, St. Paul 2, Minnesota.

PROJECT Mercury plus 8 first day covers plus 88 page illustrated U. S. list. \$1. BR Brown, Williamsburg, Va.

SCREWBALL Fish in natural colors: Pan, the Goat Man; Egypt; Mothers' Day; Crawley Bugs set; Jets; Somaliland Flower Garden; French Model; U. S. Revolutionary War; Others free while purchasing approvals. Stamp Farm, MS-44, Oxford, Wis.

FREE Limited offer! 4 unusual Japanese, 11 other surprise stamps. Approvals. Postmark, Box 542-PM, Great Neck, N. Y.

AGENTS Wanted. Profit from sales. Information free. Zidek, Layton, N. J.

FREE Premiums: Penny approval purchases. Ross, Box 341, Yonkers, New York.

QUALITY Worldwide selections on approval. Want lists filled. Don's Stamps, 45 Sturdevant, Wilkes-Barre, Penna.

FREE! "Mystery" packet. Approvals. Premiums given. Dancer. 75-P33, Mansfield, Ohio.

ADULTS: 100 Canadian 10¢. Approvals. Daleti, Box 832, Moncton, New Brunswick.

MIDDLE Congo. Colorful mint set (8), Triangles, Topicals. 10¢. Approvals. Lang, Box 971, Brooklyn 1, N. Y.

MINT Pairs 28-50¢; 52-\$1.00; 10-25¢. 100 pipe cleaners 50¢. 19 Christmas seals 50¢. King, 330 Alexander, Kamloops, B.C., Canada.

COLLECTORS: Join the Worldwide Stamp Club. Trade with other collectors throughout the world. Details 10¢. Universal, Box 33117, Houston 33, Texas.

2,000 DIFFERENT, No China, \$4.00 approvals. Jacobsen, Crompond, N. Y.

ATOMIC Fallout laboratory. See fallout radiations. New complete science project. Kit \$3.95. Laboratory \$4.95. Florida Radiations Co. PM, Green Cove Springs, Fla.

1000 WORLDWIDE Stamps. 50¢. Approvals. Solar, 1616 Newcombe, Flint 6, Michigan.

COLLECTORS. 25¢ lists you with dealers. Stanley, Box 891, Albany 7, N. Y.

150 DIFFERENT U.S. commemoratives! Special \$1.00! Money saving list free! Ewing, 2133 Lunt, Chicago 45.

1¢ EACH Over face value mint United States commemoratives 1922 to date. Beautiful United States catalog 10¢ handling. Hillie, 51 Lake, Arlington 74, Mass.

CHEAPIES 1/4¢ To 1¢. Excellent foreign 1/3 catalogue. Tobysco, Gloveville, N. Y.

U.S.-Foreign pricelists free. Somith, Box 83-PM (Rugby), Brooklyn 3, N. Y.

BATHING Beauty, spacemen packet, approvals. 10¢. Nugget, 2408 Gillen, Racine, Wisconsin.

OVER \$20.00 Catalog value for just \$1.00. 1000 different worldwide. Approvals included to adults only. Universal, Box 6, Kenosha 5, Wisconsin.

MINT FN Complete 1937 Army-Navy set 50¢. Approvals. Taylor Box 91, Brooklyn 23, N. Y.

25 DIFFERENT U. S. commemoratives, 1893 up, 10¢ approvals. K & B Stamp Co., Box 70, Brooklyn 23, N. Y.

500 DIFFERENT. Includes pictorials. 35¢. Knopp, Box 1381, Bristol, Conn.

NEW Zealand. 25 beautiful 10¢ with world approvals. Terrace, Box 718, El Cerrito, Calif.

INDONESIA Set free. Approvals. Spangenberg, 4619 Gary Dr., Bristol, Penna.

50 DIFFERENT Central and South America. 10¢ with worldwide approvals. Cole, Box 223-A, Buffalo 21, N. Y.

21,000 ALL Different, only pennies a day using our systematic payment plan. Details free. Sjoquist, 1435 Cherrydale, San Jose 25, California.

50, LATIN. British, Orient: 10¢. Approvals. These, 9320-M San Juan, South Gate, California.

U.S. Fully illustrated catalog 10¢ deductible. Simmy's, 45 Bromfield, Boston 8, Massachusetts.

U.S. Approvals. Low prices. Eagle Stamps, Romine Ave., Pittsburgh 26, Penna.

FREE! 25 Different Portuguese; colorful, inexpensive approvals. Elkhart, Box 33, Elkhart, Indiana.

FREE Mint Africa set with approvals. Lithor, Pox 51, Canoga Park, Calif.

300 DIFFERENT Given free with approvals. Particulars. Windsor Stamps, P.O. Box 735, Santa Clara, California.

FREE 30 Large U. S. commemoratives with approvals. 10¢ handling. Jack Clancy, Box 2187, Portland 14, Oregon.

FREE Sample. Interesting, informative, illustrated. National Stamp News, Anderson, South Carolina.

FREE! 25 Egypt, 10¢ handling. Approvals. Bellet, Mapledale, Hazel Park, Michigan.

200 STAMPS. 25¢ With approvals. Smith, 508A Brooks, College Station, Texas.

FREE! 222 worldwide. 10¢ handling. Penny approvals. Jung, 1601 North Stanley, Los Angeles 46.

TERRIFIC Value. Eight complete mint sets 10¢ with approvals. Beatties, Box 4503, Fort Lauderdale, Florida.

U.S. Mint specials! Flag set, complete \$1.00; 1¢, 2¢, 3¢ famous Americans (21 different), \$1.00. Free list. Brooks, 2323 Avenue X, Brooklyn 35, New York.

TWO \$5.00 United States stamps, 20 others 10¢ with United States approvals. Irwin, Box 1105, Brooklyn 30, New York.

80 DIFF. U. S. stamps includes 19th Century commemorative. High values. Plus 1943 flag stamp of occupied nations. All for only 25¢. Approvals included. Willett Co., Box 338-C, Yorktown Heights, N. Y.

UNITED Nations 15th anniversary sheet with first day cancel, as commemorated by Russia. Free! While they last, with approvals, Philatelics, R-J, New Paltz, N. Y.

25 COLUMBIA 10¢. Approvals included. Reed, Box 980, Chicago 90, Illinois.

INTRODUCING Our better United States approvals we offer 15 United States stamps including Columbian, Bi-Centennials, famous American, airs, others; only 10¢. Ocean Stamps, Box 64-PM, Brooklyn 29, New York.

PENNY Approvals. Thousands. Bargains for pennies. Gifts with purchases. Penny Stamps, Orange, California.

GIANT Approvals, thousands different. 1¢ and 2¢ each. Wahl's Stamp Exchange, 7008P Farragut, Chicago 31, Ill.

UNITED States commemorative collection containing 33 different—10¢. Approvals. White, 516-A Avenue L, Brooklyn 30, New York.

SELL Your surplus good grade stamps. Write, describing fully what you have. Vanroy Shirk, Lebanon, Pennsylvania.

AMAZING OFFER! 200 United States stamps — including commemoratives, airmails, high denominations to \$1.00. Only 10¢ to approval applicants! Illustrated bargain lists free. Mystic Stamp Co., Dept. 80, Camden, New York.

100 OLD United States between 1861 and 1935. \$1.00. Roush Stamps, 51 Chestnut, Mansfield, Ohio.

FREE Monaco nudes. Approvals. Stamp Ranch, 902 Addison, Chicago 13, Ill.

PENNY Approvals! Regardless catalogue! Kloster, 4164—52nd St., San Diego 5, Calif.

60 DIFFERENT U. S. (30 commemoratives) 25¢. No approvals. Seidenberg, Appleton, Wisconsin.

225 STAMPS For only 10¢! This mammoth value includes airmails, pictorials; stamps from strange countries cataloging up to 25¢ each! Also approvals. Mystic Stamp Company, Camden 80, New York.

FREE 50 Worldwide, mailed with inexpensive approvals. University Stamps, P.O. Box 44-592, Miami 44, Florida.

FREE Mint set! Approvals accompany. Stampco, Box 737, Memphis 1, Tenn.

111 WORLDWIDE. Includes airs, midgets, triangles. 10¢. Approvals. Premiums. Faith, 20 1/2 Bushnell, Alhambra, Calif.

100 DIFFERENT United States commemoratives, 1/4¢ to 10¢ values—used \$1.00; Mint \$4.95. No approvals. Gil's, Box 12BA, Brooklyn 29, N. Y.

FREE Macao mint set, approvals. Coretta, G.P.O. Box 1546, New York 1.

215 DIFFERENT Worldwide 25¢. Fiume, Korea, Laos, Russia, Transvaal. Approvals. Bobb's, Box 3045, Saint Louis 30, Missouri.

FREE! World's largest! Strange, valuable 7"x14" beauty. Send 15¢ handling now! Norrisco, Milwaukee 7, Wis.

PENNY Approvals. 1,000 foreign stamps mounted in Scott order. No assorting! Bullot Approvals, 1359 Coney Is. Ave., Brooklyn 30, N. Y.

FREE—When you buy our foreign approvals, you receive absolutely free stamps equaling your purchases. Coast, 1609 S. Park, Santa Ana, California.

MINIATURE Collection Queen Elizabeth mint sets (Antigua, Caymans, Mauritius, Montserrat, Virgins, St. Kitts)! 21 lovely pictorials, only 25¢! Attractive approvals! Gannon Stamps, Box 931, Canton 1, Ohio.

UNIQUE Collection 51 all different world wide religious stamps 10¢! Includes cathedrals, shrines, temples, saints, plus religious dancers, nativity issues and scarce mint Goya Holy Family painting. Wonderful approvals. Darling Co., Ridgway 1, Penna.

MILLION Foreign stamps! 2¢ each! Send for thrilling, giant approvals! ABC Stamps, Box 6000-MB, San Francisco 1, Calif.

14,000 DIFFERENT! Amazing new plan builds your collection systematically, country by country. Only 50¢ weekly. Free details. L. G. Ware, Monroe 75, Conn.

FREE Surprise set with approvals. Way-out Peachtree, Box 9875, Atlanta 19, Ga.

SENSATIONAL Penny approvals! Pictorials, topicals, etc. Write today! Schmidt, Box 1128, Richmond, Calif.

SPRING Offer, 1000 worldwide stamps \$1.00, 3500, \$3.00. No approvals follow. Harrison's Stamps, 1435 First Ave., Oakland 6, Calif.

900,000 STAMPS Sellout! Bargain lot: packets, sets, rare stamps \$1. Giant sell-out assortment \$5. High value packet \$3. Persile, 436 N. Y. Ave., Brooklyn 25, N. Y.

PAPUA Free with 20 Netherlands at 10¢. Adanac, 6884 Briand, Montreal 20.

110 DIFFERENT World-wide stamps, 10¢. Bargain lists, special offers, sent with beautiful approvals. Galaxy Stamp, P.O. Box 641, Miami (Tamiami Station), Florida.

COMPLETE Vatican, Israel, United Nations. Pricelists. Zampino, 2055 West Tenth, Brooklyn 23.

HUNDREDS Of free commemoratives and bi-colored stamps to buyers from our 1/2¢, 1¢ and 2¢ approvals. Orana, Box 424, Tustin, California.

AFRICA Independent nations. Fascinating collection 11 sets 9 countries 36 stamps only 25¢. Approvals. Berchtold, Troy, Ohio.

MAKE \$5,000-\$10,000 year. Start a profitable approval business from your own collection. One dollar brings details. Universal, Box 33117, Houston 33, Texas.

HAWAII—Old stamp. Free. Approvals. W. B. Stamps, Wilkes Barre, Penna.

SELL Stamps to our readers. Your ad in this space will be read by thousands of stamp buyers. I'll prove that to you. Write now for Folder "S." F. W. Johnson, Classified Advertising Manager, Popular Mechanics, 200 E. Ontario St., Chicago 11, Ill.

HOBBIES AND COLLECTIONS

AMERICAN Newspaper, complete, original, dated before 1860, \$1.50. 25¢ stamps brings catalogue. D. R. Spaight, Book-seller, Tall Timbers 1, Maryland.

50 GORGEOUS Jungle butterflies \$2.00. Haas, Box 2466, New York 8.

CHESSE Players urgently needed! Enter international competition by correspondence. Players from many countries waiting opponents. International Chess Club, Box 1502, Manhattan Beach, California. Membership fee \$1.00.

COLLECTORS Matchbook covers. 100 different unused, \$1.00. Catalog 25¢. Album \$3.00. Charles Edelman, 1311-C East 84, Cleveland 3, Ohio.

EXCLUSIVE Matchbook covers. Famous Las Vegas casinos, Palm Springs, Hollywood nightclubs. Etc. 25 new assorted \$1.00. Exclusive Collectors, Box 21, Lytle Creek, California.

PRECIOUS STONES, MINERALS

ROCKHOUND—Gem cutters — jewelry makers. New free catalog just off the press! Biggest supplier to hobbyist and craftsman offers you tools, materials, equipment, introductory bargains and know-how. Free catalog. Write: Grieger's, Dept. C-11, 1633 E. Walnut, Pasadena, California.

FREE Bargain gem list. 1961 lapidary and silversmith tool catalog, 50¢. O'Brien's, 1116B Wilcox, Hollywood 38, Calif.

SEMI-Precious uncut gems. Ten different for \$1.00. Request list 28. Prospectors Shop, 201 San Francisco, Santa Fe, New Mexico.

EARTH Science. Rockhound's National Magazine. Subscription \$2.50. Sample 35¢. Box 1357-PM, Chicago 90, Ill.

PHOTOGRAPHY, CAMERAS, PHOTO SUPPLIES

FREE! Send now for catalog of new and used photographic bargains. Dept. 1-H-5, Central Camera Company, 230 So. Wabash Ave., Chicago, Illinois.

COST Plus Petri-Flex, other SLR. Lenses. Write: Cameras, Box 156PM, Englewood, Colo.

FREE Price-list up-to-date used cameras one of America's largest. New too at prices. Kodak film paper, Polaroid. Sterling-Howard, 559 East Tremont, New York City.

FREE Catalog. Cameras below wholesale. Gibson's, 188 King, East Aurora 1, N. Y.

PHOTO FINISHING

KODACOLOR Film 120-127-620, including processing and prints, \$2.95. MBG Photo, Box 537, Toledo 1, Ohio.

COLOR Movie fans! Low cost—high quality processing our specialty, 8mm. just \$1 (or \$3 with fresh film). Mailed back next day. Craftsmanship guaranteed. Send exposed reel or request free mailers and price list of complete photo-finishing services. Direct Mail Photo, Box 8832-PM, Pittsburgh 21, Penna.

A FREE Kodak roll returned with each black and white or Kodacolor developed and printed, fast service, lowest prices, guaranteed quality send for free mailers. Economy Photo Service, Dept. P. M., Box 1111, Albany 1, N. Y.

FAST, Hi-quality finishing. Kodacolor rolls: eight jumbo prints \$1.98. Twelve \$2.49. Twenty \$3.49. Reprints 15¢. Also low B&W prices. Custom Quality Studio, Box 4838, Chicago 80.

EKTACHROME-Anscochrome 35mm. 20 exp. 620, 120, 127, developed, mounted, \$1.00. Kodachrome 8mm. and 35mm., low prices, prompt service. Complete price list—free mailers. Write Trycolor, P.O. Box 123, So. Windsor, Conn.

FILMS Developed 49¢. Get-acquainted black-and-white offer. 8 to 12 exposures in jumbo size, 49¢ with this ad. Service 10 to 4. No limit. Bring in or mail. Add 1¢ sales tax. Dean Studios, Dept. A, 913 Walnut St., Des Moines, Iowa.

ROLL Developed, 8 jumbo prints 39¢; 12, 59¢. Reprints 5¢. Fast service. Free mailers. Willard's, Box 2554G, Cleveland, Ohio.

COLOR Portraits. Handpainted in oil from ordinary photographs. Economical. Satisfaction guaranteed. For immediate information, write: Trade Winds Company, P.O. Box 913, Baltimore 3, Md.

MOTION PICTURES AND SOUND EQUIPMENT

BARGAINS 16MM. sound films, list. Bedner, 5300 So. Talman, Chicago.

SAVE Money on B&W, color, 8mm., 16mm. film and supplies. Send 10¢ for bargain catalog. Superior, 448 N. Wells, Chicago 10

5,000 8-16 MM. Movie films. Free catalogues. International, Greenvale, N. Y.

MOVIE Camera film: 8mm. roll \$1.50. 16mm. 100' \$3.00. Free processing. Better Films, 742 New Lots, Brooklyn, N. Y.

MOVIE Film! Free catalog! ESO-R, 47th Holly, Kansas City 12, Missouri.

16MM. Sound, projectors, films. Sale, rental, exchange. Visit store or write for catalog. National Cinema, 71 Dey St., New York City.

LADY Wrestling. Movies, photos. Free list. Peerless, Box 171-M, New York 13, N. Y.

8MM. Valentino, Fairbanks, Keaton, others. 16mm. sound features, shorts, silent classics. Large assortment. Entertainment Films Co., 235 W. 55th, New York City.

8MM. Home movies. Free catalog. Midwest Enterprises, P.O. Box 2062, Milwaukee, Wisconsin.

8MM. 16MM. Movie subjects. Silent, sound. New, used. 2"x2" color slides. Biggest selection anywhere! Free each month, big 24-page newspaper-size catalog. Blackhawk Films, Davenport 14, Iowa.

HOUDINI 8mm 16mm. Film Classic, 1926 South Vermont, Los Angeles 7, Calif.

COLOR SLIDES

TRANSPARENCIES Wanted. Up to \$500.00 each. For information write American Color, P.O. Box 46372, Hollywood 46, Calif.

LINCOLN Story in 500 color slides: Hogdenville, Knob Creek, Gentryville, Rockport, New Salem, Springfield, Washington, Gettysburg, statues, memorials, etc. Sample slide 35¢. Catalogue free. Willems, Box 1515-A, Chicago 90.

MUSIC & MUSICAL INSTRUMENTS

PLAY guitar. Teach yourself, \$1.00. Ernie Ball Guitars, Box 308PM, Tarzana, Calif.

ACCORDIONS, Chord organs, guitars! Buy direct—save to 1/2. Famous makes. Free home trial. Easy terms. Trades. Free catalogs. Mention instrument. International Music Mart, Dept. R, 2003 Chicago Avenue, Chicago 22.

ELECTRIC Guitars, amplifiers, wholesale. Free catalog. Carvin, PMM, Covina, Calif.

LOW Quotes: Stereo tapes, components, recorders. HiFi, Roslyn 6, Penna.

ACCORDIANS, Piano, chromatics, butontype, concertinas. Wholesale catalogs free. Italian Accordion Mfg. Co., 7600-C Cottage Grove, Chicago 19, Illinois.

SONGPOEMS Wanted! Collaborate with professional songwriters on equal basis. Share royalties. Songwriters Contact Co., 1619-D Broadway, New York 19.

PIANO Tuning pays. Learn at home in 30 days. Diploma granted. American Tuning School, Gilroy, Calif.

"HOW To Write, How to Sell Songs," including a practical rhyming dictionary. Complete book—\$2.95 postpaid. Send check or money order to: Belmont Press, 200-A 23rd Ave. N., Nashville 5, Tenn.

SONGPOEMS And songs wanted! Mail to: Tin Pan Alley, Inc., Box 405, Radio City Station, New York 19, N. Y.

POEMS Wanted for musical setting and recording. Send poems. Free examination. Crown Music Company, 49-C West 32 Street, New York 1.

POEMS Needed immediately for new songs and records. Free examination and appraisal. Send poems: Songcrafters, Acklen Station, Nashville, Tenn.

GUITAR Making books, plans, imported woods, tools. List 10¢. Satinwood, 510 East 11th Street, New York 9, N. Y.

SONGS Wanted. Pays royalties. Enclose postage. Olenik Records, Mount Morris, Michigan.

POEMS Wanted for songs and records by America's original oldest and largest song studio. Established 20 years. Avoid imitators. We have helped many. We can help you with your songs. Send poems for free examination. Immediate consideration guaranteed. Five Star Music Masters, 620 Beacon Bldg., Boston.

ACCORDIONS All sizes. Free home trial. Color catalog. Save 1/2. Terms. Accordion Import Center, 7120 Galli Dr., San Jose 29, Calif.

PLAY Piano instantly. Newest method. Send \$1.00: Musical Adviser, 15 Almond Street, Gloversville, N. Y.

DOBRO Guitar parts available wholesale also. Original Guitars, Box 589, El Monte, Calif.

PLAY Rhythm spoons. \$1.00 postpaid. Millerlei Novelty, Box 6044, Station B, Evansville, Indiana.

ACCORDION-O-RAMA, 874 Broadway, New York 3, N. Y. Tremendous discounts. Top brands. Free brochure.

SONGS, Lyrics wanted. Royalties paid. Toni Associates, 406-F South 2nd, Alhambra, Calif.

RADIO, TELEVISION AND ELECTRONICS

SAVE 30% stereo music on tape. Free bargain catalog, blank tape, recorders. Norelco speakers. Saxitone, 1776 Columbia Road, Washington, D. C.

RADIO Course only \$14.95. Includes all tubes, parts, tools, instructions. Write for full information. Progressive Edu-Kits, Inc., Dept. 571B, Hewlett, N. Y.

ELECTRONIC Kits wired and tested. Tri Acce Electronics, East Pine St., Plais-tow, N. H.

SURPLUS TV and radio tubes. New and pretested used. 6SN7—50¢, 6BQ6—80¢. Free price list. Sales and Service, 2444 Woodstock Ave., Pittsburgh 18, Penna.

CONVERT Any television to sensitive, big-screen oscilloscope. Only minor changes necessary. Plans \$2.00. Relico, Box 10563, Houston 18, Texas.

SEE Color on your TV. Amazing device brings glorious thrilling color pictures. Free details. Gay-Dol Co., 937 Ludlow St., New Bedford, Mass.

RADIO And television parts below wholesale. Request free bulletin. Buckeye, Fairlawn Station, Box 5122, Akron, Ohio.

QUALITY! Recording tape. 73% discounts. Catalog. Tape, 2028 Garth, Los Angeles 34, California.

SPECIAL Offer. All tape recorders, \$10.00 above cost. Arkay Sales, 380-E Highland Ave., Somerville 44, Mass.

DON'T Buy hi-fi components, kits, tape, tape recorders until you get our low, low return mail quotes. "We guarantee not to be undersold." Wholesale catalog. Easy time payment plan. 10% down—up to 24 months to pay. Send 10¢ to: Hi-Fidelity Center, 220-M E. 23 St., New York 10, N. Y.

RECORDING Tape wholesale bargain list. West Pacific Distributing, 1301 N. W. Glisan, Portland, Oregon.

RECORDING Tapes. Lowest prices. Free literature. Towers, Box 3095, Philadelphia 50.

SILENCE Annoying TV commercials. Inexpensive method revealed for \$1.00. Norm's 1135 W. Arrow, Claremont, Calif.

LEARN While asleep with amazing "Electronic Educator" endless tape recorder. Details free. Research Association, Box 24-PX, Olympia, Wash.

RECORDERS, Hi-fi. Free wholesale catalogue. Carston, 125-Y East 88, N. Y. C. 28.

GOVERNMENT Surplus radios, parts. Picture catalog 10¢. Meshna, Malden 48, Mass.

FIX Your own TV. Save 80%! Send for free illustrated chart showing how! We'll include giant electronics catalog. Zalytron, 220-M West 42 St., New York City.

TAPE Recorders hi-fi components. Sleep learning equipment, tapes. Unusual values. Free catalog. Dressner, 1523M Jericho Tpke, New Hyde Park, N. Y.

SAVE Dollars on radio, TV-tubes, parts at less than manufacturer's cost. 100% guaranteed! No rebrands, pulls. Request bargain bulletin. United Radio, 1000-M, Newark, N. J.

BUSINESS OPPORTUNITIES

START Your own business on credit. U.S. only. Your own boss. 1344 dealers sold \$5,000 to \$25,500 in 1960. We supply stocks, equipment on credit. 200 home necessities. Sales experience unnecessary. Pleasant, profitable business backed by world-wide industry. Write Raveligh's, Dept. E-U-PPM, Freeport, Ill.

"MAILORDER Methods." Your own imprinted brochure, containing 72 luxury gifts, drop-shipped to your customers, while you operate from home! Details, sample, wholesale price list. "Methods," Lafayette Hill 64, Pennsylvania.

FORTUNES Made prospecting! Are you walking over money when hunting, fishing, or hiking? Learn how to locate, identify, sell, stake claims on valuable ore and minerals. New comprehensive approved correspondence course. Free revealing information! Modern Prospector, 1038 So. La Brea, Dept. HC175, Los Angeles, Calif.

LEARN Landscaping and the growing of plants. Start a profitable business part or full time. Free information without obligation. National Landscape Institute, Dept. MC-52, 11826 San Vicente Blvd., Los Angeles 49, Calif.

EXPORT-Import opportunity, profitable, world-wide, mail-order business from home, without capital; or travel abroad. Established world trader ships instructions for no-risk examination. Experience unnecessary. Free details. Mellinger, D705, Los Angeles 25.

SECRETS! Secrets! Mail order success revealed by internationally famous expert who discovered how to make home business fortunes. Beginners: Get free copy "How to Make Money in Mail Order." Disclosed free advertising, profitable products, everything! No obligation. Write Mailco, 1554 Sepulveda, Dept. D705, Los Angeles 25.

DOLLS! Dolls! Dolls! We teach you to make, repair, dress and sell. Study at home. Earn while learning. Free booklet. Doll Hospital School, Studio MC-52, 11826 San Vicente Blvd., Los Angeles 49, Calif.

NEW Swiss watches \$2.95. Illustrated bargain catalog free. Cosmos, New York 35. Dept. 815.

I Want a man who wants a business of his own. I will train you, supply the equipment, help finance you, start you rolling. This is not a risky get-rich-quick scheme. It is a legitimate business, a selected franchise, proved successful by hundreds throughout the country. Send name, address and phone number to Marion Wade, 2117 North Wayne, Dept. 624. Chicago 14, Ill.

MAKE Extra money. Big steady earnings, repeat business. Sell advertising book matches, full or part time. New 1962 line. Show glamour girls, colorama, tenor-rama; dozens more. All sizes. Free master outfit, sales helps, leads, no experience necessary, no investment. Write today. Superior Match, Dept. MX562, 7530 Greenwood, Chicago 19.

BUY From factories; thousands, nationally advertised brands. A & H Wholesale, 97-9 Pulaski St., Brooklyn 6, N. Y.

START Your own sharpening shop. Whether you have your own hobby or want a full or part time business or extra retirement income, you can easily start with Treco grinding equipment. Sharpen knives, saws, scissors, clippers, tools, skates, surgical instruments, etc. Make \$6.00 and more per hour. Grinding outfits \$34.95 up, factory to you. Manual furnished. Easy terms. Write Treco, N. Tonawanda 25, N. Y.

IMMEDIATE Profits with no capital or experience. Take orders for all magazine subscriptions. Friends and neighbors are your prospects. Write now for complete, free kit. McGregor Magazine Agency, Dept. CB2, Mount Morris, Illinois.

MAKE Telephone surveys spare time! Free home-business details. No selling, choose your own hours. Telephone Institute, Dept. HC175, 1038 So. La Brea, Los Angeles 19.

IDENTIFICATION Nameplate machines! Identification Systems Co., 246 5th Ave., New York 1, N. Y.

HOW And where to obtain capital. Reliable Service, Rome City, Ind.

10,000 PROFITABLE Formulas, recipes, trade secrets. Details free. Colen, 7731-M5 Yates, Chicago 49.

SUCCESSFUL Mailorder! Tested, proven, moneymaking opportunity. Free particulars. Mann, 266-D, Hillsdale, New Jersey.

BECOME Tax consultant. Graduates earn \$1,000-\$3,000 every tax season preparing returns evenings. State approved. Union Institute, Lakewood L-2, N. J.

BIG Money — Operate your own fix-it shop. Service all household appliances: irons, fans, refrigerators, automatic washer-dryers, etc. Do house wiring, commercial writing. Rewind motors of all sizes. Sharpen mowers, skates, saws. Buy needed spare parts wholesale. Free book. Christy Trades School, A-2503, 3214 W. Lawrence, Chicago 25.

WANTED—Cartoonists. Amateurs, professionals. Over 200 markets. Information free. Cartoon Markets-B5Pm, 11620 Lansdowne, Detroit 24, Michigan.

SOURCE List directory. For the needs of a nation. Price \$1.00. Buyers Service, 3702 Aurora, Indianapolis 27, Indiana.

ENJOY Advantages of prestige Toronto office without the expense. Inquiries invited. 173-G Eglinton East, Toronto, Canada.

PROFITABLE Beginner's mail-business opportunities. Details free. American Distributors, Box 409, Niles, Michigan.

MAILORDER To motels, churches, institutions. Individual setup. Not just instructions. Hermes Advertising, 152 West 42, New York City 36.

SENSATIONAL. No cost, mailorder opportunity for beginners, advanced. Edward Guerinot, 154 Masseth St., Rochester 6, N. Y.

OWN A paying mail order business. Personal attention to beginners. Kukitz, 369 Spruce St., Coplay, Penna.

NATURAL Molding rubber, extra thick. Free samples. W. Wooley, 2801-A Latrobe, Peoria, Illinois.

SIGNS, Sell restaurants, etc. Samples \$1.00. Box 9563, Dept. P5, Jackson, Miss.

PARTS Bins. Quart capacity. Unbreakable! Hundreds free. Details 25¢. Tommy Lynch, 2330 Springlake, Dallas 34, Texas.

\$80.00 A Pound for junk jewelry I pay you. Home business. No buying. No selling. D'Amico, 1506 W. Erie, Chicago 22.

OPERATE Profitable mail order business. Splendid opportunity. For details write: Triple R Company, P.O. Box 732, Longview, Wash.

SELL Automatic needle threaders, palm-looms, needles. Vidmar Sales, Freeburg, Illinois.

BUY Cosmetics direct from factory. Cosmetics, Box 285, Jennings, La.

\$7500 YEARLY Operating mailorder business. Free details. Request free catalog offer. Coats, Box 1247A5, Ontario, California.

EARN Money raising bait at home for us. Guaranteed market! Red Wigglers, Warsaw 20, Indiana.

SPECIALTY Manufacturing at home. Big profits. 50 products. Instructions, \$1.00. E. Bidding, 3912 Banks, Cincinnati 45, Ohio.

PROFITABLE Worthwhile food supplement dealerships available. A growing repeat business of your own. Ultra-Bio 515F, 5555 Wissahickon, Philadelphia 44, Penna.

PROFITABLE Dealer franchises available. \$5,000 investment covered by inventory will open Ceramic Tiles Supply Center, your town. Inland Lakes Imports, 6051-P So. Wentworth, Chicago 21.

PROFITABLE Catalog mailorder business. Vikari, 468-PM5 Third Avenue, Salt Lake City 3, Utah.

WILL Blanks. Three copies \$1.00; dozen \$2.00. Goodall Printing Service, 68 Joost, San Francisco 12.

OPERATE Profitable home mail-order business. Sparetime. Get lifetime repeat orders. Write Wayne's Service, 3016-J Channing, Washington 18, D. C.

PRINT Colorful signs, posters, advertising specialties—without expensive equipment! 800% profit. Particulars free. Rapid Screen-Print Service, Edwardsville, Ill.

NEW: Build waterfalls, fountains. Parts supplied. Priplata Fountains, Pasadena 3, Calif.

EVERYBODY Wants this. New, simple do-it-yourself business. Make two daily profit up to \$25.00 each. Business places need it. Attractive, sells on demonstration. Start small. Grow fast. Free information. Whirl-Adds, Box 761, Truth or Consequences 3, New Mexico.

FREE Business franchise protected. Have own office. Self-employed. Nationwide. Travelers message service. Non-competitive in United States and Canada. Details free. Pippin and Company, Box 87, Benham, Kentucky.

GOLF Franchise. Self service displays. Darco, Box 612A, Oak Lawn, Illinois.

MAKE Babies' shoes bronze/pearl-kote for money. 25-yr. old company offers kits, instructions, financing. Dept. PM-5, Box 5036, Inglewood, Calif.

MAILORDER Certificate worth \$1.00. Absolutely free. Neil H. Tasker, Shamokin, Pennsylvania.

ENJOY Independence and high income? Tired of working for others? Obtain a program for business planning! Guaranteed or money returned. \$5.00 complete. Information free. Business Advisors, P.O. Box 91, LaSalle Station, Niagara Falls, New York.

ATOMIC Fall-out laboratory. Sell: these new radiation kits and laboratories. Kits \$3.95. Laboratories \$4.95. 40% off order 3. Florida Radiations Co. PM, Green Cove Springs, Fla.

SUCCESSFUL Mail order business. Spare time or full time. Write to Daniel's, Box 267, Brookneal, Virginia.

HOW To make money by mail. Free literature. Miech Enterprises, Box 27D, Muskego, Wisconsin.

MAKE Extra money making and selling homemade candies. Details, recipes, \$1. Ellen Fuhrman, Box 7883, Orlando, Fla.

STRIKE It rich! Operate home mailing list business. Complete instructions and guidance only \$2.95 postpaid. Rush order to: Megargel, 10730 Dowry, Tampa, Fla.

OPERATE Profitable mail order business. Splendid opportunity. For details write Parade of Bargains, Inc., 271 Sterling, Buffalo 16, N. Y.

"MAILORDER Laws and Regulations." Explains licenses, taxes and legal preparations necessary before starting business. \$2.00. Neil H. Tasker, Shamokin, Penna.

MAKE Durable building plastic easily. Waterproof, fireproof, economical. Bays Laboratory, Cedaredge, Colorado.

MOLDING Rubber, plastic, shells, flow-ercraft. Free information. Chaney's, 5415 San Jose Blvd., Jacksonville 7, Fla.

PACKAGE At home for profit! We supply everything. No selling. Free home business details. HPC 2212BK Jesse Street, Los Angeles 23.

LEARN To sharpen, repair, and service lawn mowers, also straighten crank shafts intact. Wirt's, 2419 Gnahn, Burlington, Iowa.

BRONZE Baby shoes. Genuine electroplating process. Equipment, mountings, instructions. Send \$1.00 for valuable book "Your Guide To Success" bronzing baby shoes, plus complete catalog. Hollywood Bronze Supply, Dept. B60, 3445 Union Pacific Avenue, Los Angeles 23, California.

TOP Phonograph record manufacturer seeks qualified individuals to establish custom recording business under exclusive franchise. \$2300 investment required. Complete training, business formula, management guidance, sales promotion program provided. Century Records, Dept. PM, Box 308, Saugus, Calif.

\$50-\$100 WEEKLY With your camera. Information: Camera Artists, Rt. 1, Box 365, Grass Valley, California.

MAILORDER. America's most unique no cost beginner's plan. Armstrong's, 154-A Darrington S.W., Washington 24, D. C.

FREE Sample for magic beautiful green lawn growth. Free catalog showing how to make big money at home business. Sure-grow Company, 1019-6th North, Seattle, Wash.

HIGH Earnings cleaning, repairing, watches! Illustrated instructions. Kester, Deckerville, Michigan.

OPERATE Profitable home mailorder business. Details free. Alto Distributors, Box 253, Palo Alto, California.

TERRIFIC Profits! Sells itself! Golden brass social security card. 3-Color U.S. flags and eagle. Rush \$1.00 (agent's price) for your engraved Perma-Card. Print name, address and Social Security number. Free carrying case and complete sales kit. Perma-Card, P.O. Box 704-CA, North Miami Beach 62, Florida.

STOP Looking, start earning! Learn of opportunities to have your own franchised business. Write immediately for free information. National Franchise Reports, Dept. PB-528, 333 North Michigan, Chicago 1.

\$100.00 WEEKLY. Sparetime home mail order business. Successful beginners plan. L & D, 109 W. 42nd, New York City 36.

\$70.00 WEEKLY — Home, spare time. Simplified mail bookkeeping. Immediate income—easy. Auditax, 34741A, Los Angeles 34.

RAISE Rabbits on \$500 month plan. Free details. White's Rabbitry, Mt. Vernon, Ohio.

BUY Direct from factories. Appliances, cameras, watches! Free details! Cam Co., 436 P.M. Bloomfield Ave., Verona, N. J.

\$200.00 MONTHLY. Spare time. With tablesaw, bandsaw or jigsaw. Write. Holiday House, A3800 Harney, Vancouver, Washington.

SHARPEN Saws and lawnmowers the profitable way. Send for free literature. Max Manufacturing Company, 138 Stockton Avenue, San Jose 26, California.

FRANCHISES Make profits! Operate your own exclusive franchised business. Write today for free interesting details. National Franchise Reports, W-528, 333 North Michigan, Chicago 1.

SELL Champion, AC, Autolite spark plugs. Reconditioned, electroplated, guaranteed 10,000 miles. 100% profit. Free sample. Lee Plugs, 1608-A Roberts, Houston 3, Texas.

VENDING Machines. No selling. Operate a route of coin machines and earn amazing profits. 32-page catalogue free. Parkway Machine Corporation, Dept. #27, 715 Ensor Street, Baltimore 2, Maryland.

BUSINESSES, Resorts, motels, investment property, ranches. Our special service dept. at your disposal. No obligation. World's largest. 58 years' service. Strout Realty, 7-MB S. Dearborn, Chicago 3, Ill.

BIG Money raising fishworms and crickets. Free literature. Carter Farms, Plains Georgia

TO \$100.00 Weekly. Sparetime, home operated mailorder business. Successful beginner's plan. Everything supplied. Lynn, 10420-M National, Los Angeles 34.

PIANO Tuning learned quickly at home. Tremendous field! Musical knowledge unnecessary. Information free. Empire School of Piano Tuning, Champaign, Ill. (Founded 1935).

COPUBLISH Mail Sale Advertiser, leading mail order paper. Details, latest copy, dime. Vanroy Shirk, Lebanon, Penna.

OPERATE Profitable mail order business. Write Walter Service, 4159A East 112th, Cleveland 5, Ohio.

BAKE New greasiness doughnuts in kitchen. Sell stores. Free recipes. Montgomery, 3605 South 15th, Minneapolis 7, Minnesota.

MAKE \$46 From square foot plywood; jigsaw necessary. Free details. Woodart, Bridgewater, Mass.

\$400.00 MONTHLY Raising giant fishworms. Soilless method. Charlie Morgan, Bushnell, Florida.

SELL Books by mail. 400% profit. Royal, Box 368-X, Cleveland 27, Ohio.

PLASTERCRAFT Molds, liquid rubber, plasters, blocks, candle supplies. Catalog and manual free. Blue Rapids Supply, Blue Rapids, Kansas.

WORLD'S Largest wholesale supply. Buy from 679 American, European, Japanese wholesalers. Tailormade suits from Hongkong. 123 dropship catalogs. Rock-bottom prices. Free details. International Buyers, 216-MM Jackson, Chicago 6, Ill.

RE-CAST Junk batteries into new. Latest achievements. Battery Laboratories, Bayou LaBatre, Alabama.

11,000 NEW Prospects daily. Baby record books, shoes, albums. Sell mailorder. Use our literature. Write: No-Co-Ro, Capitola, Calif.

INTERNATIONAL Mailorder business made easy. Complete setup service, not just instructions. Hermes, 152 West 42, New York City 36.

OPERATE Home mailorder business. Vosacek Printing, 4444A Ute, San Diego, 17, Calif.

COLORGLAZED Concrete pottery made without molds. Patented method. Cemetery products, novelties, tiles. Basement leak-sealing. Money-making projects. Booklet, details free. Men only. National Potteries Company, Grand Rapids, Minnesota.

CANDIED Popcorn and potato chip equipment. Eakins, Box 933-A2, Springfield, Ohio.

MAKE Money making leathersgoods. 1148 ideas. Free information. Tandy Leather Co., Box 791-F2, Fort Worth, Texas.

WANT To make big money at home? \$10.00 profit in an hour possible with invisible mending. Make tears, holes disappear from clothing, fabrics. Steady year-round demand from cleaners, laundries, homes. Details free. Fabricon, 1585 Howard, Chicago 26, Ill.

LEARN Sewing machine repairing. To \$125 weekly. Sparetime. Supplies. Add to present business. Write today! Taylor Service, Box 484, Cupertino, Calif.

EARN Money raising fishworms for us! Write: Oakhaven—38, Cedar Hill, Texas.

MAKE Money from old tires. Operators clearing \$400 weekly. Equipment costs \$800. Get facts. S & S Patents, Inc., 3511 N. Lincoln, Chicago 13.

DRIED Mushrooms \$4.50 pound for large canning company. Receiving warehouse in United States. Growers wanted on contract, everything supplied. Dehydrated Products & Chemicals, No. 548, Calgary, Alberta, Canada.

GARDEN Golf. Start amusement center. Invest now. Brockway, Box 3762, Portland 8, Oregon.

AMAZING Profits in exterminating. Full time, part time. Free details. Baylab 21-M, Cambridge, Maryland.

NEW Imports. New American products. Largest selection. Wholesale only. Exclusive Reviews, 1186 Broadway, New York 1, N. Y.

PROFITABLE Mail order businesses directory, 25¢. Mail Dealers Headquarters, Box 64, Rego Park 74, N. Y.

JOIN Dollars unlimited club. Huge profits. Box 2766B, Kalamazoo, Mich.

VENDING Machine catalog. Rakes, 609P Spring Garden, Philadelphia 23, Penna.

MONEYMAKING OPPORTUNITIES

MAKE Money by mail, sparetime. Dawe, Dept. E, Box 1821, Philadelphia 5, Penna.

EARN Extra cash selling live fishworms from your own lawn. Sensational new "Worm Out" brings them up in broad daylight. No digging! Eight ounce package will produce hundreds. \$2.00 post-paid. Worm Out, 2715G Wymer, Boise, Idaho.

\$25.00 WEEKLY Making jewelry, flowers. Catalog 10¢. Flocraft, Farrell, Penna.

START A profitable subscription business in spare time! We need men and women (young and old) as representatives for all leading national magazines. Liberal commissions on all subscriptions. Supplies free. No experience needed. Send this ad with your name and address to: Popular Mechanics, Room 5-O, 250 W. 55th St., New York 10, N. Y.

AMAZING Profits in worms. Free information. Hillaire Wormery, Northville, Michigan.

PIANO Tuning learned at home quickly. Tremendous field! Be independent! Information free. Empire School, Dept. P, Champaign, Ill. (Founded 1935.)

"HOW You Can Make Money in Rentals." Landlord reveals trade secrets. Send \$2.00 for bargain booklet to: Money in Rentals, 675 North Hamilton, Pomona, California.

NOW! 1000 money making ideas for you. Write: Wallace & Company, Box 448, Newark 1, N. J.

IF You live in a resort area or famous locality, anywhere, contact Atlas, 122 Park Place, Schenectady 5, New York.

LEARN Auto selling. Free details. Wasc., Box 130, Scarborough, Ontario, Canada.

MAKE Over \$100 week with herbs. Grow inside-outside or gather wild. Free details. Whitlow, Dept. A-5, 726 Fairwood, Dallas 32, Texas.

MAIL Order is my business. I'll make it yours. Free information. Write to: Taylor Enterprises, 15 Agnes Drive, E. St. Louis, Ill.

EXECUTIVE-Style business. Tired of losing money in mail order? Like to be the big fellow who starts the little fellow in his own business? Free details. Business Promotional Service, 353 West Side, Dept. 3, Jersey City 5, N. J.

EARN Money evenings, copying and duplicating comic cartoons for advertisers. Adservice, Argyle 1, Wisconsin.

PRACTICAL Mail order. Start small. Moneymaker, 722-P5, East Silver Spring, Milwaukee 17, Wisconsin.

2,500 BIG-Mails \$1.00! Details free! Hamilton's, Box 1374, Las Cruces, New Mexico.

MAKE Plastic novelties for extra income. Low cost home training now available. Write for free booklet. Interstate Training Service, Dept. D-3, Portland 12, Oregon.

\$35-\$65 WEEKLY Assembling artificial lures at home for stores. Materials supplied free. Write: Lures, Box 1280, Fort Walton Beach, Fla.

BAKE New greasiness doughnuts in kitchen. Sell stores. Free recipes. Melvin, 3605 South 15th, Minneapolis 7, Minn.

FABULOUS Profits raising earthworms. Picture folder free. Exceilo, Kosciusko 6, Mississippi.

ATTENTION—Aluminum concrete yard ornament molds—donkey cart planters, beautiful bird baths, urns, etc. Prices slashed. Write for information. Knapp's, 4257 Josephine Street, Denver 16, Colorado.

CIGARETTES—Make 20 plain or filter tip for 9¢. Facts free. Moberly, Box 4012, Owensboro, Kentucky.

MINK Raising information free. Complete. Lake Superior Mink Farm, Superior, E.E. Wisconsin.

VENDING Machines. No selling. Operate a route of coin machines and earn amazing profits. 32-page catalogue free. Parkway Machine Corporation, Dept. #26, 715 Ensor Street, Baltimore 2, Maryland.

EARN Money raising fishworms for us! Write: Oakhaven—39, Cedar Hill, Texas.

YOUR Own, easy-to-start, home mailorder business, sparetime. Fascinating; profitable! Information free. Alfano, 19-PM Pine, Closter, N. J.

BIG Money raising fishworms and crickets. Free literature. Carter Hatchery, Plains, Georgia.

READ "Progressive Mailtrade," the magazine that tells how to make money by mail. Quarter brings sample and special offer. Progressive Mailtrade, Box 357, Sheboygan, Wisconsin.

AMAZING Successes through franchises! Become exclusive franchise holder your territory. Information rushed. National Franchise Reports, MP-528, 333 North Michigan, Chicago 1.

LEARN The secrets of repairing junk batteries, generators, starters, profitable, easy, at home. Free particulars. Batteryman, 3465 Forrest, Santa Clara, Calif.

MAILORDER Business learned easily. Write: Esasco, Box 323, Grand Rapids 1, Michigan.

PROFITABLE Mail-work, evenings. Literature 25¢ refundable. Interstate, 37-1 Besch, Albany 9, N. Y.

MEN—Women! Start money-making plastic laminating business at home in spare time. Material that costs 11¢ brings back \$2.58. No canvassing or selling but mail orders brings in \$20 a day. Write for full particulars free. Rush name on postcard to Warner, Room CL-2-D, 1512 Jarvis, Chicago 26, Ill.

FREE! Directory extraordinary money-making home businesses! Southern Specialty Supply, 1912-PM, Corpus Christi, Texas.

MAKE Up to \$200 a week or more. Set your own pace! Get paid top rates every day for each name on lists of past due accounts you send in to us for our firm to collect. General Finance Company, 304X Pickwick Bldg., Kansas City 6, Mo.

EASY To start rubber stamp business at home in spare time. Make up to \$9.80 an hour without experience. Facts free. Write Roberts, 1512 Jarvis, Room CR-2-D, Chicago 26.

SUGGESTIONS. 100 ways to make money through your plant suggestion plan. Booklet with sketches and examples, \$1.00. Suggestions, P.O. Box 2541, Mansfield, Ohio.

MAKE Money with your car. Quarter brings plans. Dennis, 954 W. 70th Place, Hialeah, Fla.

EXPORT — IMPORT

AMAZING Bargains! Thousands! Dropshipped from Europe, Asia. Directory \$1.00. McAvoy, 2851 North Ringgold, Philadelphia 32, Pennsylvania.

INFORMATION Foreign catalogs free. Baker Enterprises, 313 East Harrison, Sullivan, Illinois.

A Complete catalog of foreign products at discount prices. Send \$1.00. The Robinson Co., 15468 Hiway 80, El Cajon, Calif.

LEARN Importing! Get "Foreign Bargains" directory. \$1.00. L. J. Finn Company, 140 Virginia Park, Detroit 2, Mich.

RECEIVE—Hundreds foreign catalogs, samples without contacting exporters! Details. Importico-S, Enka, North Carolina.

NEWEST Products, fabulous bargains in direct importing. 475 worldwide firms, classified—\$1.00. Henderson, 2620 Rio Vista, Tampa 3, Florida

WATCHES! Airmailed from Switzerland. 152-page catalog 35¢. K-P Imports, 511 Glenwood, Buffalo 8, N. Y.

SCIENCE & CHEMISTRY

ROCKETS: New illustrated catalog 25¢. Single and multistage kits, cones, engines, launchers, trackers, technical information, etc. Fast service. Estes Industries, Penrose 7, Colorado.

CHEMICALS And apparatus for industrial, analytical, and private laboratories. Catalog 35¢. Dept. M-50. Biological Supply Co., 1176 Mt. Hope Ave., Rochester 20, N. Y.

232 PAGE Catalog \$2.00. Laboratory Materials, 7319 Vincennes, Chicago, Ill.

ILLUSTRATED Catalog: Chemistry, mineralogy, biology 25¢. Tracey Laboratories, Evanston, Illinois

UNUSUAL Chemistry books, courses, kits! Rare chemicals, cheap! Catalog 25¢. NSC, Box 11133, Palo Alto, Calif.

LABORATORY Conversion charts with bigger catalogue—25¢. Hagenow Laboratories, Manitowoc, Wisconsin.

AMAZING New book of science experiments, formulas, and catalogue of laboratory supplies. Only 35¢. National Scientific Co., 13 S. Park Avenue, Dept. PM-5, Lombard, Illinois.

SOLAR Motors, educational scientific. Will operate forever. \$1.75 each ppd. Delighted or money back. Tom, 174 Willow, East Brunswick, New Jersey.

ROCKETS Available now: Powerful new multistage model spacecraft! Bigger illustrated catalog 25¢. Kits, parachutes, cones, chemicals, instruments, engines, plans, etc. Central Rocket Company, Waupaca 9, Wis.

BUY Chemicals in small quantities. Complete line glassware and apparatus. Ship anywhere, promptly. Catalog 25¢. Camptown Chemical and Supply Co., 705 Lyons Ave., Irvington, N. J.

30,000 CHEMICALS In stock. Your order shipped today anywhere. Metropolitan Chemical, 21 W. 60 St., New York City 23.

FORMULAS, PLANS, ETC.

FORMULAS For latest money-making discoveries. New! Good! Valuable literature free! Miller, Chemist, 1517-D, Tampa, Florida

10,000 PROFITABLE Formulas, recipes, trade secrets. Details free. Colen, 7731-ME Yates, Chicago 49.

PROFESSIONAL Formula books. Information free. Directory Service, Box 964, Philadelphia 5.

FORMULAS—All kinds. Amazing big catalog, 10¢. Kemixal, Park Ridge, Ill.

LATE Modern manufacturing formulas. List free. Moon Chemical, Martville, New York

SELECT List of modern, useful formulae. List free. Box 161, Waco, Texas.

SECRET Chinese barbecue sauce recipe. Send \$1.00. Continental, P.O. Box 3321, Bakersfield, California.

RESILVERING Mirrors. Lookout Mirror, Copper Mirror. All \$1.00. Nelko, 3462-K Merchandise Mart, Chicago 54.

PLASTICS

PLEXIGLAS Hobbycraft sample free. Experimenters Supply Co., 1924 Columbia, Chicago 26.

NEW Liquid casting plastic, clear, colors. Embed real flowers, butterflies, photos, coins. Send 25¢ for two handbooks "How to Cast Liquid Plastics" and "How to Make Extra Money at Home." Castolite, Dept. E-101, Woodstock, Illinois.

PLASTIC Laminating 5¢ sq. inch. Bronze social security plates \$1.50. Sibmar's, 9042 Woodman, Pacoima, Calif.

FALSE Teeth broken? Send \$1.98 for new, improved, professional plastic repair kit. Free denture cleaner with prompt orders. Professional Plastic Products, Haas Bldg., Los Angeles 14, Calif.

PLASTIC Embedding and molding made easy with new instruction manual, \$1.00. Catalog 25¢. Castacraft Corp., Dept. M-562., P.O. Box 555, Palo Alto, Calif.

BOXES, Plastic. 200 sizes. Free list. Althor, 170 Bay 23 Street, Brooklyn, N. Y.

PROFITS! Vacuum form plastic! Easy! Box 1971, San Diego 12, Calif.

AGENTS WANTED

SHOW Your free sample. I give you amazing Leth'r-Test Footwear. Show on your feet to 10 people and 5 will buy on sight because of beauty, quality. You'll see! Only \$1.99 to \$4.99, none higher. Guaranteed for one whole year. Highest commissions. Perfect-World Co., Dept. 115, Cincinnati 12, Ohio.

ENGLISH Chamolis—low tannery prices. Good profits. Chantana, Lakeland, Florida.

FREE Sample. Beautiful curios! Sell on sight! Apartado 9036, Mexico City.

PRINTING. Advertising salesmen—Excellent moneymaking sideline selling decalcomania name plates, small quantities. Automobile initials, sign letters. Free samples. Raico, XL, Boston 19, Mass.

YOUR Own business—Used suits \$1.50; overcoats 65¢; mackinaws 35¢; shoes 12½¢; ladies' coats 30¢; dresses 15¢. Enormous profits. Catalog free. Nathan Portnoy Associates, 2109-AA Roosevelt Road, Chicago 8, Ill.

MAKE Up to \$50.00 a day soliciting delinquent accounts. Terrific commissions. Write today. National Credit, 304Y Pickwick Bldg., Kansas City 6, Mo.

BIG Profits. Stamp social security plates, key protectors. Sample 50¢. Catalog free. General Products, 11 No. Pearl St., Albany 7, N. Y.

\$20.00 FIRST Day introducing distinctive personalized doorplate assortment. Complete sales kit free. Reeves, Attleboro 7, Mass.

AUTOMOTIVE Wagon jobbers! New aerosol chemical! Dries ignition systems, penetrates, prevents rust, lubricates. Works like magic! No selling. We give you free samples for your customers, guaranteed to produce orders that repeat. Excellent profits. Details. Product Research, Blue Bell, Penna.

MAKE Most extra cash with world's biggest line everyday greeting card assortments, gifts. Introduce friends, neighbors, to over 150 assortments, 500 big money-makers. Pocket up to 100% profit plus big cash bonus. Free giant color catalog; samples on approval. Write Arrow Greetings, 513 Fourth Ave., S., Dept. 83-N, Minneapolis, Minn.

Sell Pin on nameplates. Sample \$1.00. Refundable. Farley, Box 924, Tampa 1, Florida.

AGENTS! 47 Moneymakers. Pay surprisingly well. For proof write Blaine's, Norway, Maine.

PROFITS Selling handmade tote bags. Sample \$2.75. A Loughren, Deckerville, Michigan.

YOUR Ad in this space will get some good agents for you. Yes, I'll prove it. Write for Folder "A" right now. F. W. Johnson, Classified Advertising Manager, Popular Mechanics Magazine, 200 E. Ontario St., Chicago 11, Ill.

OPEN cans, bottles, pull corks. For home, trailer, boat, bar, etc. Chrome plated. Guaranteed. \$2.49. D.T.A., 24575 Kelly, Suite 1, East Detroit, Mich.

\$25 WEEK Spare time. Beautiful unusual imported art. Easy sales. \$3 samples sent for \$1. Traders, Box 74, Fruitland, Maryland.

BUY IT WHOLESALE

NEW Deluxe below wholesale catalog. Automobile catalog and others. Furniture, clothing, housewares, appliances, refrigerators, freezers, washers, dryers, television, radios, luggage, binoculars, hi-fi, stereo, phonographs, recorders, cameras, projectors, musical instruments, sporting goods, toys, tools, typewriters, watches, jewelry. Huge discounts on thousands of name brand items. For free specimen list of actual factory prices—postcard: Selbyco, Decatur 15, Illinois.

WHOLESALE Bargains. Guaranteed. Special catalog \$1. Loeber, 224-AC Wyatt, Lincoln, Ill.

FREE! Name brands catalog! Your own high profit business. Sell name brands, full or part time. No inventory, no investment. More than 2,000 name brand items; lowest wholesale prices. Watches, jewelry, cameras, hi-fi, stereo radios-phonos, appliances, housewares, hardware, power tools, luggage, musical instruments, garden equipment, sporting goods, toys, many others. 8 floors of name brands. Million dollar inventory. Orders shipped complete in 24 hours! Send for free, beautifully illustrated catalog now! Separate wholesale price list. H. B. Davis Corp., Dept. PM, 145 W. 15 St., New York 11, N. Y.

BUY Below wholesale! Thousands of nationally advertised products. Drugs, clothing, housewares, cameras, jewelry, hardware, sporting goods, etc. Postcard brings price list showing actual factory cost. Buy-Rite, 310 Main, Bennington 2, Vermont.

WORLD'S Largest wholesale supply. Buy from 679 American, European, Japanese wholesalers. Tailormade suits from Hongkong, 123 dropship catalogs. Rockbottom prices. Free details. International Buyers, 316-M Jackson, Chicago 6, Illinois.

USED And new watches \$2 up. Free list. Southern Watches, 5-PM So. Wabash, Chicago 3

LARGEST Wholesale supply source in U.S.! 15 free catalogs. Furniture, clothing, appliances, housewares, automobiles and accessories, tools, sporting goods, hobby supplies, farm equipment, imports, new products, bargain merchandise. Free details. Associated, Box 108-DD, Lincoln 1, Nebr.

100% DISCOUNTS. Hundreds articles from Puerto Rico. Send \$1.00 for catalog (refundable). Mail Order Discount Co., KI-15A, Caparra Terrace, San Juan, Puerto Rico.

BULOVA. Benrus watches like new \$5.95 up. Hundreds of other bargains, 30 page illustrated catalog free. Cosmos, New York 35, Dept. 811.

AIR Conditioners, gas furnaces 40% discount. Name brand. Details 10¢. Egyptian, Box 168-15, Anna, Illinois.

EVERYDAY Necessities. Everything guaranteed. Free illustrated wholesale catalog. Bargain packed. Free offer. Southland Enterprises, Forest City, Fla.

BUY Wholesale. W. Cohen, 4841 North Albany St., Chicago 25, Ill.

FREE Wholesale catalog! Thousands of different products. A. Stogsdill, 3 Ivan Place, Alexandria, Virginia.

WHOLESALE Bargains. Name brands. Send postcard for catalog. Tod's Agency, Box 101, Mountainville, N. Y.

TREMENDOUS Savings! Hundreds necessities! 10¢ brings big illustrated wholesale catalog. Willnor Distributors, 22 Judson, New Haven 3, Conn.

1/2 MILLION Items wholesale. Buys at 10¢ on the dollar. Argee, Box 6211, Philadelphia, Penna.

HANDMADE Western boats. Free catalog. Sellers Co., 8830 Alameda, El Paso, Texas.

BELOW Wholesale! Wide selection tools, appliances, varieties. Details: Lantco, 718 Myrtle, Albany 8, New York.

THOUSANDS Of terrific bargains! Tremendous discounts! Write: United Wholesalers, 1265-M Broadway, New York 1, N. Y.

REAL Wholesale prices. General merchandise. Free catalog. Ateep, Box 66, Teaneck, New Jersey.

NEW Style ball point pens—1,000 for \$27.50. Trial order 100 for \$3.50, postpaid. Glow-ette, Box B, Ringgold, Georgia.

ELECTRIC Guitars, amplifiers, wholesale. Free catalog. Carvin PMW, Covina, Calif.

2,000 PAGES Wholesale catalogs! Write: Mosaser, Box 47-B, Newark, Ohio.

SALESMEN—DISTRIBUTORS

BIG Profits. Repeat sales. Selling corrosion inhibitors to service stations, auto dealers, stores. Prevents power wasting corrosion from forming on auto batteries, cables. Free details. Aldo Company, 4275—10th Ave. North., Lake Worth, Fla.

EARN Big commission full or part time. Build profitable business of your own selling America's largest line low priced business printing and advertising specialties. 360 page catalog samples hundreds of items used daily by business people. Imprinted ball pens low as \$7.95 for 100. Big line low priced union label political printing included. Free sales kit. National Press, Dept. 8, North Chicago, Illinois.

STOP Looking, start earning! Learn of opportunities to have your own franchised business. Write immediately for free information. National Franchise Reports, Dept. PT-528, 333 North Michigan, Chicago 1.

MAKE Up to \$50.00 a day soliciting delinquent accounts. Terrific commissions. Write today. General Finance, 304V Pickwick Bldg., Kansas City 6, Mo.

IF You're interested in making money in selling, see the hundreds of exceptional opportunities in Salesmen's Opportunity Magazine. Send name for your copy, absolutely free. Tell us what you're selling now. Opportunity, 848 N. Dearborn, Dept. 17, Chicago 10, Illinois.

MAKE Extra money selling advertising matchbooks. Free catalog and sales outfit. Matchcorp, Dept. PM-52, Chicago 32.

MAKE \$40 A day full or part time with the greatest new opportunity in America today. Beaver Shoes made of Everon. Look like leather, wear far longer. \$1.99-\$5.49 retail. Big commissions. Beaver Shoes, Dept. PM-562, Beaver Meadows, Penna.

MAKE Extra money. Big steady earnings, repeat business. Sell advertising book matches, full or part time. New 1963 line. Show glamour girls, colorama, tenorama; dozens more. All sizes. Free master outfit, sales helps, leads, no experience necessary, no investment. Write today. Superior Match, Dept. M562, 7530 Greenwood, Chicago 19.

HANDY Advance room reservation card for salesmen. 25 for \$1.00 postpaid. J-C Printers, 1129 East Front, Traverse City, Mich.

HIGH Commission and bonus. Earn \$100 to \$300 weekly. 30 year old company has openings. List delinquent accounts for collection. Experience not necessary. Permanent. Write Merchants Protective Agency, 1015Y Walnut, Kansas City, Mo.

CALENDARS, Novelties. Full or part time. Liberal commissions. Fleming, 6335-A Cottage Grove, Chicago 37.

SEAMLESS Nylons \$6.75 doz. Seams \$4.75. Lizmar Hosiery, 10409 St. Clair, Cleveland 8, Ohio.

SENSATIONAL New longer-burning light bulb. Amazing free replacement guarantee—never again buy light bulbs. No competition. Multi-million dollar market yours alone. Make small fortune even spare time. Incredibly quick sales. Free sales kit. Merlite (Bulb Div.), 114 E. 32nd, Dept. C-74T, New York 16.

\$1,000.00 A month for making dramatic 3-second demonstration of amazing light-weight Presto fire extinguisher. New chemical used by Airforce snuffs out fires instantly. Only \$4.95. Terrific commissions. Millions want it. Free kit. Merlite, 114 E. 32nd, Dept. P-66T, New York 16.

AMAZING Opportunity. Now low priced fire alarm protects homes, farms, offices, factories, etc. No wiring—hangs like picture. Pays up to \$1,100 a month. Free kit. Merlite (Alarm Div.), 114 E. 32nd St., Dept. F-66T, New York 16, N. Y.

BE A distributor with an exclusive territory. Investment as low as \$10. Every home, apartment, hotel, motel, hardware store, building material store, builder, lumber yard a prospect for our complete line of 1,000 fast moving building specialties priced from 69¢ to \$9.75. A proven moneymaker. Full or part time. Write for complete kit today. Huskee Products, 30 N. La Salle St., Chicago 2, Illinois.

AMAZING New invention. Prevents flooded basements. Proven seller. Ground floor opportunity. Exciting profits for hustlers. Franchises available. Big Jim Flood Control Systems, Inc., 3334 West 63rd St., Chicago 29, Ill.

SAFETY Glofuse—glows when it blows! New, patented, for homes, offices, factories. A tremendous rack deal for stores. Sell wherever electricity is used. Send \$1 for samples, sales suggestions, no-risk offer. Safety Plug Lock Corp., Dept. P5, 1270 Broadway, New York 1, N. Y.

WE Need agents to sell monuments, markers. Make 30%. Free details. Dobson Memorials, Fort Payne, Alabama.

AMAZING Invention. Stops auto thefts. Prevents fires. Secret button operates from driver's seat. Install 30 minutes. Salesmen coining money. Write Sampson Safety Switch Co., Clinton, N. C.

REPUTABLE Direct salesmen needed. Quality product. Sound program. Sundstrand Sales Company, 315-24th St., Rock Island, Illinois.

EMPLOYMENT INFORMATION

MERCHANT Marine jobs. Men and women. Top wages. Travel. Helimco, 234 Broadway, Pendleton 1, Indiana.

WORK In Sunny Arizona. Information and job listings, \$1.00. Thompson Enterprises, Box 6561, Phoenix 5, Ariz.

JOBS Galore. Big classifieds \$1.00. Gart, Box 18333, Dallas 18, Texas.

GOVERNMENT Jobs open! Now! Everywhere! Every occupation! Amazing new book tells how to get them and succeed! Good pay! Security! Retirement! Details free or will rush postpaid copy for \$2.00. C.O.D.s accepted. Wicks, Topping, Va.

DIRECTORY Reports. Construction, aviation, shipping, oilfields, government, manufacturing, trucking, etc. Foreign-stateside. Helpful information plus job-getting tips on preparing application letters. Unconditional money-back guarantee of satisfaction. Act today. Only \$2.00 (\$2.25 airmail). (C.O.D.'s accepted). Research Services, Meramec Building, St. Louis 5-PM, Missouri.

FOREIGN Employment information. Europe, Alaska, Africa, Asia, Canada. Travel, adventure. Up to \$1,600 monthly. Construction workers, truck drivers, clerks, teachers, professionals, etc. Sensational opportunities—most complete information, application form sent immediately by return mail. Send \$2.00 to: Jobs, Box 512-E, New Orleans 12, Louisiana.

MERCHANT Marine jobs. Men and women. Top wages. Travel. Captain, Box 501-P, Reading, Massachusetts.

FOREIGN Employment. Construction, other work projects. Good paying overseas jobs with extras, travel expenses. Write only: Foreign Service Bureau, Dept. PM, Bradenton Beach, Florida.

FLORIDA Booming! Classified job advertisements Miami or Fort Lauderdale 50¢ each. Cards, letters remailed, 25¢ each. Errands performed. Goldcoaster, Box 477, Ft. Lauderdale, Florida.

JOBS On ships. Age 18 to 55. Experience not required. National Seafaring, Box 71881-B, Los Angeles 1, California.

CIVIL Service jobs. How to get them, what to do. Circular. Ingills, P.O. Box 1602A, Chicago 90, Illinois.

TREMENDOUS Opportunities U.S.A., overseas. Choose your job, your location. Bonuses. Free transportation. Free details. International Occupations, International Airport, Box 100C-6, Jamaica 30, N. Y.

AUSTRALIA Is booming. Sydney classified ads \$2.50 airmail. Get the actual facts. From a Yank "downunder." G. Jones, P.O. Box 171, Crows Nest, Sydney, Australia.

U.S.A. And foreign jobs, up to \$1600.00 monthly. Construction, shipping, aviation, clerical, supervisory, etc. Skilled, unskilled. Free transportation. Unusual opportunities. Complete information plus worldwide reports. Only \$2.00 (\$2.50 airmail). Satisfaction guaranteed. International Opportunities, Dept. 26-A, 152 W. 42nd, Suite 536, New York 36, N. Y.

TOP Wages. Large number of construction companies with work in twelve foreign countries to choose from. For information send one dollar to Hugh Phillips, Rt. 3, Box 120, Carthage, North Carolina.

CHOICE Government jobs. Short cut information 25¢. Careers, 722-P5 East Silver Springs, Milwaukee 17, Wisconsin.

JOBS Unlimited. High pay in your own area. Complete list send \$1.00. Employment Information PM, Headquarters Building, Washington 6, D. C.

JOBS On ships and yachts traveling foreign countries. Davenport, GPO 1354, New York 1, N. Y.

IMMEDIATE Openings. Men. Women. Skilled. Unskilled. Excellent salary. United States, \$2. Foreign-Alaska, \$2. Employment Surveys, 2908-A Gawthorne, Oroville, California.

SPECIAL SERVICES

TRANSLATIONS. 9 Languages, 1½¢ word. Translations, P.O. Box 151, Cherry Hill, N. J.

RESEARCH Service. Any subject! Product information. Jake Barraco, 478 Gardner, South Beloit, Illinois.

INFORMATION On anything. Ferguson Research Specialists, 59 Lent Ave., Hempstead, N. Y.

EDUCATIONAL AND INSTRUCTION

LEARN Civil and criminal investigation at home. Earn steady, good pay. State age. Institute Applied Science, 1920 Sunnyside, Department 165, Chicago 40, Ill.

AIRLINE Careers. Adventure! Prestige! Promotion! Four-week course. Free placement service with 35 airlines. G. I. approved. Free catalog B. McConnell Airline School, 1030 Nicollet, Minneapolis, Minnesota.

FCC License in 6 weeks. First class radio telephone. Results guaranteed. Elkins Radio School, 2603D Inwood, Dallas, Texas.

FINISH High school at home. Better jobs, more pay for high school graduates. Get your diploma through simplified home study course. Personal attention. Write for free book, read about our "Guarantee of Success." Wayne School, Dept. 05-543, 417 S. Dearborn, Chicago 5, Illinois.

MASTER Watch making at home. Free sample lesson. Chicago School, 2328-YE Milwaukee, Chicago 47.

SPEAK. Sing with power. Self-training records. Canfield, 2018-A Fifth Avenue South, Minneapolis 4, Minnesota.

DRAFTING Pays big money. Leads to position in automotive, aeronautical, construction, mechanical fields. Learn at home in spare time. All equipment supplied. Pay later plan. Free book, Christy Trades School, D-5903, 3214 Lawrence, Chicago 25.

HIGH School at home in spare time with 65-year-old school. No classes. Standard high school texts supplied. Single subjects if desired. Credit for subjects already completed. Progress at own speed. Diploma awarded. Information booklet free—write today! American School, Dept. X545, Drexel at 58th, Chicago 37.

INVESTIGATE Accidents. Earn \$750 to \$1,000 monthly. More investigators urgently needed. Car furnished; business expenses paid. No college education necessary. No selling of any kind. Pick your own job locality. We train you at home spare time. You keep present job until ready to switch. Write for free book. No obligation. Universal Schools, CPM-51, 6801 Hillcrest, Dallas 5, Texas.

NEW Trade? Electronic, Mechanical Drafting pays \$150 week. Send \$2 first lesson, complete home study course \$25. Prior Inc., 23-09 169 St., Whitestone 57, New York.

TAKE Bachelor's and Master's Degree correspondence courses from leading universities! Directory of 6,000 courses—\$2.00. College Research, North Highlands 1, Calif.

WASHING Machine, dryer service instructions, easy to understand, plus illustrated parts catalog, \$3.00. Jonsal Appliance Parts Company, Dept. PM5E, Atlantic Avenue, Massapequa Park, New York.

I M P R O V E: Grammar, vocabulary. Write: English Comprehension, 585 Winthrop, Taunton, Mass.

GOOD Paying jobs open! Operate, repair heavy earth moving equipment! Learn "on the job" operating latest cranes, bulldozers, earth carriers! V. A. approved. Free catalog. Write, E. P. Hutch, Greer Technical Institute, Braidwood, Illinois.

BOOKKEEPERS. Operate your own profitable bookkeeping service. Whiteley, 1645 Warwick Avenue, Warwick, Rhode Island.

SUCCESS For you! Read "A Key to Success." \$1.00. Box 2025, Orcutt, Calif.

WORLD'S Most comprehensive correspondence school directory. Free details. Aureaw, Central Valley, New York.

USED Correspondence courses, books. Satisfaction guaranteed. Catalog 10¢ refundable. Courses bought. Bayles, 78-B Courtright, Wilkes Barre, Penna.

SPANISH As you like it. Unique Audio-visual method. Listen to eight different native voices. Ideal for young and old alike. \$6.95 money-back guarantee. Roscon Corporation, Box 2793, New York 17, N. Y.

POLICE Training. Investigator course. Credentials, diploma. Free information. Southwestern Institute Criminology, Box 200A, Geronimo, Oklahoma.

CLERICAL And Civil Service training. Complete homestudy course only \$5.00. Details \$1.00. Returnable. American Tech., P.O. Box 6241, Atlanta 8, Georgia.

LEARN Sewing machine repairs. Send \$1.00. Vast, Box 162, Bayonne, New Jersey.

ANNOUNCING: Self-study books and recordings. Jobs waiting for combo men. National Academy of Broadcasting, Washington 10, D. C.

HOLLYWOOD Correspondence School of Bartending. Information free. Box 492, Hollywood, Calif.

BE A Real Estate Broker. Insure security for yourself and your family. Study at home. Prepare for state examination. GI approved. Write for free book today. Weaver School of Real Estate, 3519P Broadway, Kansas City, Missouri.

OVER 75 Million watches in U.S. waiting repair. Urgent need for watchmakers. Get the facts. Write Kansas City School of Watchmaking, 1228PM Admiral Blvd., Kansas City 6, Missouri.

SWEDISH Massage. Foot technique. Post graduate. Home study. Residential. Diploma. Dr. Swanson's Illinois Licensed School, 3809-PL Alta Vista, Chicago 13.

LEARN Realistic oil painting by correspondence. Amateur and advanced. Walker School of Art, Box 486, Montrose 4, Colo.

BARGAINS! Used correspondence courses and instruction books bought, sold, exchanged. List 10¢. Smith's, 124 Marlborough, Salem, Mass.

ENGINEERING And Art degrees earned through home study. Electronics, Mechanical, Liberal Arts. When writing specify course desired. Pacific International College of Arts & Sciences, primarily a correspondence school. Resident classes also available. 5719-B Santa Monica Blvd., Hollywood 38, California.

USED Correspondence courses and books sold and rented. Money back guarantee. Catalog free. (Courses bought.) Lee Mountain, Pisgah, Alabama.

WOODWORKING And cabinetmaking course for beginning and advanced home craftsmen. Only complete low-cost home training program available. Write for free booklet. Interstate Training Service, Dept. G-3, Portland 12, Ore.

WANT A diesel job? Higher pay? Advancement? We can help you qualify! Complete diesel, tractor and heavy equipment and Cummins Diesel Engine Shop-method home-training courses available. Write today. Interstate Training Service, Dept. B-3, Portland 12, Ore.

HIGH School diploma at home. Licensed teachers. Approved materials. Southern States Academy, Station E-18, Atlanta, Ga.

BOOKKEEPERS. Operate your own "Dollar-A-Week" system. Ellis, Box 200, Cedar Grove, North Carolina.

LEARN Asleep or awake! Records, tapes, equipment! Free catalog! Drawer PM-697, Ruidoso, New Mexico.

MEN Wanted. Earn \$125 a week and up. Master a trade with a future. Learn auto diesel mechanics in our shops. You learn with tools on real equipment. Earn while you learn. Many of our graduates earn \$125 a week and up. Write for free bulletin: Dept. 256, Auto Diesel College, Nashville 3, Tenn.

PIANO Tuning pays. Learned easily at home. GI approved. 59th year. Free booklet. Niles Bryant School, Dept. P, 3731 Stockton, Sacramento 20, Calif.

SWEDISH Massage, physical culture and weight reduction pay big profits. Men and women. Learn at home. Diploma course. Free catalog. National Institute, Desk 4, 165 E. Ontario, Chicago 11, Illinois.

PENMANSHIP Corrector. Improve poor penmanship quickly. Details free. Ozment, Box 665-34, St. Louis 88, Mo.

FINGERPRINTING And identification taught at home. Diploma. Details free. Alabama School of Fingerprinting, Fairfield, Alabama.

LEARN Auctioneering. Free catalog. Missouri Auction School, 1330 Linwood, Kansas City 9-X3, Mo.

LEARN Ventriloquism. Amazing-entertaining! Easy! Details free. B. Davis, B-38, Safety Harbor, Florida.

SECRET Investigations. Experience unnecessary. Investigators particulars free. George Wagner, M125 West 86th, New York City 24.

LEARN While asleep with your recorder, phono. Details, catalog free. Sleep-Learning. Box 24-PX, Olympia, Wash.

PROFESSIONAL Investigator. Home study. Lapel pin, certificate, future. Box 41197-F, Los Angeles 41, California.

PIANO Tuning pays. Big money in spare time. Learn at home in 30 days. No musical knowledge necessary. Phonograph, records, tools and instructions furnished. Electronic tuning also taught. Free catalog. Capital Tuning School, 3160 S.W. 16th Court, Ft. Lauderdale, Fla.

INVESTIGATOR Training. Career for young and old, men and women. Write to: Phillips Secret Service, 1917-PM North Kenneth, Chicago 39, Illinois.

OPERATE Collection agency. Little gold mine. Franklin Credit, Roanoke, Virginia.

BOOKS. Free general catalog, 100 pages. Text, vocational, educational, instructional subjects. Millions of volumes, new and used. Bargain prices. Books bought. Est. 1902. Long's College Book Co., Dept. PM, Columbus 1, Ohio.

SLIDE-RULE. Home study. \$29.00. Patco, Marion, Texas.

LEARN Real Estate business fast. Economical homestudy. Literature free. Howard Schools, Box 8394-A, Kansas City 5, Missouri.

DENTAL Technicians. Simplified home study. Accredited A.C.S.C. certificate. Denshire School, Box #762, Boston 2, Mass.

PLAYS, STORIES, MANUSCRIPTS

WANT Your book published? Learn how we publish, advertise, promote, distribute. Many successes. Free booklet PM. Vantage, 120 West 31, New York City. Or 6253 Hollywood Blvd., Hollywood 28, Calif.

WRITERS: Sell your work. Free details. American Authors' Society, 40 Shirley Lane, Jamestown, N. Y.

FREE Details: "Selling Your Manuscripts." Beth Kramer, Authors' Agent, Tahlequah, Oklahoma.

ADVERTISING AGENCIES, ADV. SERVICE, MAILING LISTS

FREE! Red-hot book — "More Profit From Your Advertising." Lists best mail-order magazines, newspapers. Adservice, 516B Cornelia, Chicago 13.

YOUR Circulars, sales letters mailed. \$2.50 to \$4.50 1000. Mailing lists \$5.00 up. Many classifications. Free information. Occupant lists. Stephens Distributing Co., P.O. Box 1434, Atlanta 1, Ga.

ADVERTISE: 24 Words, 75 Canadian newspapers, \$5.50. Lists free. Advertising Bureau, 10511-C Springfield, Chicago 55.

ADVERTISING Ratebook leading newspapers, magazines, free. Chicago Advertising Agency, 28-E Jackson, Chicago 4.

MAILING Lists most all kinds 1000 \$5.00. Free folder. Your circulars mailed \$4.00 1000. Dixie Mailers, King, N. C.

NOW Ready: New, amazing Classified Advertising Record Book — prepared especially for recorded advertisers. Here is a book that tells you instantly whether or not your advertising in any publication is paying you real results. You can tell immediately how many inquiries each publication produced — how much cash received from every ad. Spaces are provided for the name and address of the publication, date of issue, space used, rate, cost of ad, key number, etc. You have a complete record of each publication right before your eyes. Plenty of space to keep accurate record of 28 separate publications. You can have a copy by sending only 10¢ to cover postage and handling. Send for your copy now. W. F. Johnson, Classified Adv. Mgr., Popular Mechanics Magazine, 204 E. Ontario Street, Chicago 11, Illinois.

AMAZING New Book — "Profits From Classified Advertising." Tells how and what to advertise. Be sure to read this book before you invest one cent in advertising. Write for your copy now. F. W. Johnson, Classified Advertising Manager, 202-210 East Ontario Street, Chicago 11, Illinois.

TYPEWRITERS, DUPLICATORS, OFFICE DEVICES

EASY, Automatic mimeograph. Unbeatable buys. Springer, 5031M First, Washington 11, D. C.

RECONDITIONED Typewriters, mimeograph, printing presses \$25.00 up. Write Dixigraph, King, N. C.

RUBBER STAMPS AND OFFICE SUPPLIES

NAME And address, indexed, cushioned. 3 lines \$1.00. Literature free. Sharrer, Parkhill, Pennsylvania.

FREE 32-page rubber stamp catalog. Stock stamps, pads, ink. Signature stamps \$3.50. Notary seals & embossers, business cards, labels. Youngers Stamp Shop, Princeton, Iowa.

SPECIAL — 3 lines 50¢. Signature \$2.50. Economy, 4719 Wisconsin, Milwaukee 8.

POROUS Rubber stamps. "Alive, breathing." No pad! Pencil end initials \$2.50. Stock, signature. Free circulars. Medalion, 356 E. Alondra, Gardena, California.

PLEASE Print, 15¢ word. Rubber Stamp Mfgs., Ned Collins, Cayuta, N. Y.

QUALITY Name-address pocket stamp, 75¢. Gottfried, 732 Sackman, Brooklyn 12, N. Y.

THREE Line pocket stamp 50¢. B. Meese, 42 "E," Keyser, W. Va.

FREE — Illustrated rubber stamp catalog. Low prices! Hildreth, 1047-A Inner, Schenectady 3, New York.

STAMP Makers' supplies. Lowest prices. O'Brien's, 421 Jackson, Toledo 4, Ohio.

3 LINES \$1.00. Extra lines 25¢. Cushioned mount, knob handle. One day service. Wallace, Box 146, Hanover, Penna.

CATALOG: Rubber stamps, daters, printing, business cards. Martin, 1425 Major, Jefferson City, Missouri.

POCKET, 3 lines \$1.00. Guaranteed. Specialty, 8464 Manhattan, Detroit 11, Michigan.

FACTORY Prices. Rubber stamp catalog 10¢. Adirondack Printers, Saranac Lake, New York.

CARTOONING, COMMERCIAL ART, SHOWCARD & SIGN PAINTING, TATTOOING

"HOW To Make Money with Simple Cartoons." A book everyone who likes to draw should have. It is free; no obligation. Simply address Cartoonists' Exchange, Dept. 95, Pleasant Hill, Ohio.

PAINT Signs! Using patterns! Trial alphabet \$1.00. Harwell, PM-562, Byrds-town, Tennessee.

COMPLETE Set sign lettering patterns \$3.00. Stamp brings details. Anderson Studio, 1420 Logan, Denver 3, Colorado.

PAINT In oils. Home study course anyone can complete successfully. Write The Hartley Course, PM562, Westport, Conn.

WANTED—Cartoonists. Amateurs, professionals. Over 200 markets. Information free. Cartoon Market-5PM, 11620 Lansdowne, Detroit 24, Michigan.

COMPLETE Lightning trick cartoon program \$1.00. Lee Cressman, Washington, N. J.

CARTOON Books, cards, jokes. Liberal assortment, \$1. Harris, Box 1567, Portland 7, Oregon.

ART—Learn at home. Earn big money. Learn commercial art, cartooning, lettering, figure drawing, painting, TV art, in spare time. All for 20¢ a day. Send for free 36-page book. No obligation. Washington School of Art, Studio 145X, Port Washington, N. Y. Tear this out as reminder.

TRUCK Lettering. Interesting, profitable. Details free. Martin, 314 Delatre, Woodstock, Ontario, Canada.

LEARN Profitable magazine cartooning. Free details. Hartman, Box 3097, Lincoln 10, Nebraska.

YOU Can entertain with chalk talks. Catalog 10¢. Balda the Cartoonist, Oshkosh, Wis.

LEARN Sign painting at home. Free talent test. Ben Kerns, Box 812-PM, Greenville, S.C.

LEARN Sign painting with fascinating system. Straley, 410 S. Western, Springfield, Ohio.

SIGN Painting—simplified, quick, easy. Learn home. Ramey, 19 So. Martin, Waukegan, Illinois.

SIGN Painting. Easy method. Ellis, 10533 121 Ave., Largo, Florida.

PRINTING, MULTIGRAPHING, MIMEOGRAPHING, GUMMED LABELS

1,000 NAME And address labels. \$1.00. Pocket rubber stamp with name and address. \$1.00. 5x2 name plate \$1.00. Parravano Products, Dept. PM, 4808 West Century, Inglewood, California.

50 NAME Iron-on cloth labels \$1.00. Bingham Gifts, 1015 Ringwood, Pompton Lakes, New Jersey. Free brochure.

FREE Catalog and samples, quality printing. S. D. Walker, 406 Ventura Ave., Orlando, Florida.

100 6¼ ENVELOPES, 100 5½x8½ letterheads printed, \$2.35. M. Fortney, Route 3, Dillsburg, Penna.

PRINTING, Business, personal. Send copy. Prices quoted free. Samples. Fred, Box 623, Independence, Missouri.

OFFSET—8½x11, 1000, \$6.50. F.O.B. Free samples, prices. Harrison Litho, 1708 Grant, Beloit, Wis.

1000 NAME, Address labels \$1.00. Rubber pocket stamp \$1.00. Labels, printing, business cards, rubber stamp, catalogs. Jordan's, 552 West O'Connor, Lima, Ohio.

QUALITY Duplicating; photocopies. Samples. National Duplicating, 340 Perry Drive N.W., Canton 8, Ohio.

FREE Samples. Personalized address labels. Stamponics, Box 611, Merrick, New York.

1000 EMBOSSED Business cards \$3.95 postpaid. Samples. Kraemer, Esperance, New York.

1000 BUSINESS Cards, raised letters. \$3.75 postpaid. Samples. Routh, PM-5, 2633 Randeman, Greensboro, N. C.

SALESBOOK, Snap-A-Part forms. Free catalog. Printed business forms. Eddi Rose Ptg., Box 1, Bronx 72, N. Y.

PERSONALIZED Stationery, wedding invitations, announcements, letterheads, envelopes, imprinted scratch pads. Details free. Tobin Printing, 1114 Marline, El Cajon, California.

MODERN, Professional business stationery. Low combination prices. Free cut service. Write Okayprint, Martins Ferry, Ohio.

1,000 GUMMED Name and address labels. Free plastic case. \$1.00. Sel Engraving, Box 153, Irvington 11, New Jersey.

QUALITY Business cards. Free samples and prices. Eaton Enterprises, 4446 S. Fairfield Ave., Dept. PM, Chicago 32, Ill.

TWO Color embossed business cards \$4.95—1,000. Advertising postcards \$9.95. Labels \$1.00. Stationery. Postpaid. Samples. Agents Inquire. Medallion, 356 East Alondra, Gardena, California.

250—8½x11 BOND Letterheads \$2.75. 250 envelopes \$2.75. Samples. Patton, Box 248D, South Haven, Mich.

SPECIAL! 250 8½ x 11 letterheads, \$2.25. 250 envelopes, \$2.75. 1000 business cards, \$3.50. Barney Barsketis, 6540 So. Western, Chicago 36.

OVERNITE Offset printing 1000 8½" x 11"—\$6.50. Postage extra. Evergreen, 9420 Trumbull, Chicago 42.

FREE Descriptive label literature. Name and address, stock, photographers, religious, record and comic labels. Youngers, Princeton, Iowa.

MIMEOGRAPHING, Offset printing. Free samples. Pennway, Drawer 1340, Scranton, Penna.

AMAZING Business printing values. Samples. Print Shop, Box 576, Greenville, R. I.

FREE Catalogs postpaid printing. Rubber stamps. DM Press, Sebastopol, Calif.

OFFSET, 8½x11, 16 lb. White, line copy! 1000, \$7.00; 5000, \$19.50; 10,000, \$35.00. F.O.B. Cash with order. Free samples, pricelists. Napco, 1744 Bath Avenue, Brooklyn 14.

FREE Printing catalog. Low postpaid prices. Musselman, Box 2766F, Kalamazoo, Mich.

ADS Running under this heading sell printing. Ask me for proof. I'll gladly send you amazing facts. Ask for Folder "P." F. W. Johnson, 200 E. Ontario St., Chicago 11, Ill.

PRINTING OUTFITS AND SUPPLIES

HARD Type for rubber stamp making, printing. Introductory offer 10 or 12 pt. 20th Century Medium caps or L.C. \$2.50. Free catalog. Barco Type, 232 Evergreen, Bensenville, Ill.

RUBBER Stamp presses, hydraulic operated, electrically heated. Sizes 5"x8", 8"x12", 10"x15". Starting outfits, supplies. Printing presses. Custom Manufacturing, 1464-P East Commercial, Springfield, Missouri.

NEW 1962-63 Illustrated printing equipment and supply catalog. This 9 x 12", 336 page book is the most complete catalog of the century. Contains everything used in the graphic arts industry including thousands of offset, letterpress, bindery, rubber plate and stamp, composing room, silk screen, art and engraving supplies and equipment. Includes paper cutters, folding machines, printing and proof presses, padding presses and many more. Send \$2.00 to cover mailing. Refund with first order. Also available is our latest 184 page type catalog—add \$1.00. American Printing Equipment & Supply Co., Dept. PM, 42-25 Ninth Street, Long Island City 1, N. Y.

MAKE Your own self-molding rubber stamps and printing cuts. Plexirubber. Argyle 1, Wisconsin.

DO Your own printing. Save money. Simple rules. We supply everything. Print for others; good profit. Raised printing like engraving too. Have home shop. Details free. Kelsey Presses, V-11, Meriden, Connecticut.

RUBBER Stamp outfits, supplies. Kiewiet, 2025 Barney Road, Kalamazoo, Mich.

PRINTING Presses, type, supplies. Lists 4¢. Turnbaugh Service, Mechanicsburg, Penna.

TYPE And supplies for printers and rubber stamp makers. Buy direct. Satisfaction guaranteed. Send \$1.00 for big 96 page catalog and free printers tweezers, deductible from first order. Acme Type, 633 Plymouth Court, Chicago 5, Ill.

FOR INVENTORS

INVENTORS Seeking cash or royalties for patented or unpatented inventions, write New Products Co., 734 15th Street, N.W., Washington 5, D. C.

PATENT Searches, prompt complete \$6.00. Patent office copies of related patents airmailed. For free "Protection Forms" and "Patent Information" write to Anne Hamilton, 711 14th Street N. W., Suite 507, Washington 5, D. C.

LEARN How to get free government assistance in marketing your idea! Patent Info Service, P.O. Box 1971, San Diego 12, Calif.

PATENT Searches, \$6.00, including official patent office copies of related U. S. patents. Certified, airmailed! For free "Invention Record" and "Patent Information," write: United States Inventors Service Company, 1311 "G" Street NW, Washington 5, D. C.

SAVE High fees! Prepare your patent application yourself! New "do-it-yourself" patent kit now makes it easy. Free "Registration Form." Miss Blaine, 306 Carry Building, Washington 5, D. C.

PATENT Searches, professional patent development of inventions by licensed professional patent engineer and U.S. Patent Office former examiner with staff of engineering specialists in all fields of inventions. Expert searches performed in the U.S. Patent Office. Your inventions and ideas engineered for maximum patent protection and greatest commercial value. Inventions developed by us negotiated for cash or royalties with our nationwide contacts. Send for free protection "Invention Certificates" and further interesting, valuable patent information. George Spector, Licensed Professional Patent Engineer, U.S. Patent Office Former Examiner, Woolworth Building, New York.

PATENT Searches, including copies of related U.S. Patents, \$6.00. Inventors, attorneys, manufacturers use my "Worldwide" airmail service. "Invention Record" form and "Information Every Inventor Needs," sent free! Miss Hayward, 1029 Vermont Ave. NW, Washington 5, D. C.

PROFESSIONAL Patent searches, \$6.00, including official copies of related U.S. patents. Prompt, dependable airmail service! For free "Invention Record Folio" and "Information Every Inventor Should Have," write: Congress Invention Institute, 210 McKim Building, Washington 5, D. C.

FAST Airmail service on all patent searches; \$6.00, including copies of related U.S. Patents! For free Record Form and vital information, write: Washington Inventors Service, 422 Washington Building, Washington 5, D. C.

PROFESSIONAL Searches of the Patent Office. Dependable—reliable \$6.00 including airmail report and related patents. For free protection forms and patent information write Trans-World Patent Service, 500 Walker Building, Washington 5, D. C.

PATENT Searches including full, airmail report and closest patent copies, \$6.00. Quality searches, expertly administered. Free protection forms and patent information. Write Professional Patent Office Search Bureau, 709 Albee Building, Washington 5, D. C.

PATENT Searches, including copies of nearest patents, \$6.00. Reports airmailed within 48 hours. More than 200 registered patent attorneys have used my service. For free invention protection forms, write Miss Ann Hastings, P. O. Box 176, Washington 4, D. C.

WE Have the markets if you have the ideas. Harvey Engineers, Cambridge 1 Maryland.

INVENTORS: Test the commercial value of your patented or unpatented inventions, quickly and inexpensively. Write for free information. Institute of American Inventors, Dept. 40-B, 635-F St., N.W., Washington 4, D. C.

INVENTORS! Searches of the Patent Office administered professionally. \$6.00 including airmailed comprehensive report and related patent copies. For free invention protection forms, dependable service, write Washington Patent Office Search Bureau, 1426 G Street N.W., Washington 5, D. C.

PATENTS Skillfully prepared for maximum commercial value, with useful product development. High record of success in proving and claiming patentability. Valuable market service. Patent prepared for a fee as low as \$200.00. Send for self-protecting record of invention forms free. Patent search with valuable engineering report \$15.00. Foreign patents filed at low cost. Thirty years established. Joseph O'Brien, Patent and Development Engineer, 132 Nassau St., New York 38, N. Y.

PATENTS Professionally prepared for maximum commercial value. Patent searches including report \$6.00. Patents prepared as low as \$195.00. Valuable market service with cash or royalty sales. 10 years dependable service. For free self-protecting Record of Invention forms write: H. Lawrence Blasius, Patent and Development Engineer, 19 Park Row, New York 38, N. Y.

U.S. Patent office searches—\$5.00. Free invention record. Patents engineered. Patent Office Searchers, 233 Broadway, Room 3615, New York.

INVENTORS: If you have an invention for sale, patented or unpatented, write for free brochure outlining manufacturers requirements, royalty rates. Kessler Corporation, C-55-FI, Fremont, Ohio.

INVENTORS: Save time and money. Prepare and file your own patent application. Our complete "patent kit" makes it easy. Includes detailed instructions and all necessary material. Only \$8.95. Money back guarantee. Don't delay. Send check or money order today to National Inventors Service, Box 88, Benjamin Franklin Station, Washington, D. C.

THE American Association of Inventors is your professional society. Membership entitles you to the help the association has given many inventors. Write. AAI, 3852 First Ave., San Diego 3, Calif.

I Sold my invention! Can I help you? Write: Metro, Box 151, Oak Park, Illinois.

WHY Do successful inventors prefer Universal Invention Sales, Marion, Ohio, to represent their inventions? What's the reason?

INVENTORS: We help you market or sell your invention. Details without obligation. Intl. Inventors' Congress, 105 W. Adams St., Chicago 2.

INVENTIONS WANTED

INVENTIONS Needed immediately for manufacturers. For additional information write Kessler Corporation, C-55-IW, Fremont, Ohio.

WE Develop, promote and protect your product or ideas. Write for information. Product Promotion Development-2, Little Building, Boston 16, Mass.

INVENTORS Seeking cash or royalties for patented or unpatented inventions, write New Products Co., 734 15th Street, N.W., Washington 5, D. C.

INVENTIONS Wanted. Patented; unpatented. Tremendous manufacturers lists. Global Marketing Service, 2420 77th, Oakland 5, California.

INVENTORS: Hundreds of manufacturers have requested our assistance in locating marketable new products. Complete information free. Institute of American Inventors, Dept. 40-D, 635-F St. N.W., Washington 4, D. C.

ARE You interested in offers from reliable manufacturers for your invention? Patented, unpatented. Harvey Engineers, Cambridge, Maryland.

INVENTORS! Outright cash sale or royalties for your inventions. Patented. Unpatented. Constant demand from our client manufacturers. Write: United States Invention Brokerage, 78 Wall Street, New York 5, N. Y.

INVENTORS! Consider our offer first before selling or licensing your invention on a cash or royalty basis. Patented. Unpatented. Write: Inventions on Demand, 79 Wall Street, New York 5, N. Y.

INVENTORS Needing help with any problem, financial, development, securing manufacturer, obtaining patent. Write the organization that delivers action and results—not promises. Pioneer Invention Institute, 150 Broadway, New York 38, N. Y.

INVENTORS! Sell your invention for cash or royalties! Our manufacturers constantly seeking new items. Patented. Unpatented. For free information write Gilbert Adams, Patent Broker, 80 Wall Street, Financial District, New York, N. Y.

INVENTIONS Promoted-for cash-royalty sales with manufacturer contacts. George Spector, Licensed Invention Engineer, Woolworth Building, New York.

SELL Your invention for cash. No commissions. Milburn, Burlington, Kentucky.

CASH Or Royalties for inventions! Consider our offer first before licensing or selling your patented or unpatented invention. Write Aladdin Industries, 80 Wall St., New York 5, N. Y.

PATENTS FOR SALE

MANUFACTURERS Sell specific nationally desired gadget. Klutch, Box 405, Alhambra, Calif.

MODELS—SHIPS, TRAINS, PLANES, ETC.

ROCKET Kit, complete solid fuel flying model plus new catalog; everything for rocketeers. Immediate shipment. \$1.00. Astrocraft, Box 45, Stevens Point, Wis.

MODEL Hobbyists! Send 10¢ for catalog. Our 70 powered model plane and boat kits, many radio-control operated, also accessories. Sterling-M, 501 Wister, Philadelphia 44, Penna.

LIONEL Trains. Big discounts bulletin 10¢. Catalog 25¢. Mack-Bros., 2043P, Chicago Ave., Chicago 22.

FREE Plan for miniature steam engine included in new illustrated comprehensive Model Engineering supplies catalog; largest selection model gasoline, steam-engine casting kits; 1962 catalog 35¢. Octura Models, 8148 Milwaukee Ave., Niles 48, Ill. Dept. FPM.

LIVE Steam powered backyard railroads! All sizes. Complete "bolt-together-kits," and rough castings. Excellent drawings. 100 page catalog \$1.00. Little Engines, Lomita, Calif.

HARD To get! Hundreds of sizes rods: round, hexagon, square, flat, special shapes, various metals. Thousands of accessories. Steam, gasoline, Corliss, traction, locomotive engines. Comprehensive 100-page catalog =18, \$1.00. Chas. Cole, Ventura, Calif.

CATALOG Of scale model airplane wheels and pilots 5¢. Williams Bros., Box 1254, Huntington Park, Calif.

ROCKETS! Five blueprints. Plus instrumentation, fuels, electronic firing, parachute systems. \$1.00. Amazing 2-stage Missile, \$1.50. 7 mile altitude. Officially designed by United States Altitude Champion. Both publications, \$2.00. Rocketry, Dept. D2, Box 4708, Washington 20, D. C.

LIVE Steam engine castings kits, boilers, variety. Model maker's lathe, low priced, compact, motorized. Illustrated catalog 35¢. HPK Models, P.O. Box 34, Centuck Station, Yonkers, N. Y.

ROCKET Amateur's guide. Designs, propellants, instrumentation, launching, data evaluation. Complete. \$1.00. 3-stage, 21-foot rocket. Parachute, instrumented, tested, approved. Detailed diagrams, instructions, \$4.00. Limited offer, both only \$4.00. Missile Development Center, Dept. A, Box 16032, Suitland, Maryland.

SHIP Models. Kits, fittings, plans, books, tools, engines, motors. Big illustrated catalog 50¢. James Bliss & Co., Dept. SM, 342 Atlantic Avenue, Boston 10, Massachusetts.

SHIP Model kits and fittings: clippers, frigates, etc. Catalog paint-tool list, book list, 35¢. Model Shipways, Box 85, Bogota, N. J.

SHIP And yacht model fittings: blueprints. Send 40¢ for illustrated catalog listing hundreds of items. A. J. Fisher, Inc., 1002-1 Etowah Ave., Royal Oak, Mich.

"POWER Drives Handbook"—36 pages illustrating many types motor drives for model autos, boats, displays, turntables, etc. Mail 25 cents cash, returnable first order \$3.00 or more. Wilson's of Cleveland, Dept. PM, P.O. Box 8995, Ft. Lauderdale, Fla.

ROCKETS: New illustrated catalog 25¢. Single and multistage kits, cones, engines, launchers, trackers, technical information, etc. Fast service. Estes Industries, Penrose 2, Colorado.

ENGINEERING SERVICES

INVENTION Development. Industrial research. Technical advice: machinery, electronics, chemistry. Specific inquiries invited. Todd Consulting Engineers, 424 West 119th, New York 27.

MANUFACTURING

FOR Inventors. Model building. Manufacturing. Research. William Parker, 32 Westminster, Worcester 5, Mass.

MODELS—Small lot manufacturing. Metals, plastics, etc. Milburn, Burlington, Kentucky.

HOME CRAFTSMEN

UNIQUE! "Logicalectric," the Binary puzzle: Fun for the whole family! Build easily with full plans, step-by-step instructions—\$2.00. Logica, Box 15063, San Diego 15, California.

KNOCKDOWN Cedar chests and lumber. Catalog 25¢. Bedford Lumber Company, Dept. A-3, Shelbyville, Tennessee.

FREE! Leathercraft catalog. Hundreds of new items. Write MacPherson Bros. Leather Company, Dept. E, 730 Mission St., San Francisco 3, Calif.

PICTURE Frame moulding, squares and lumber. Kiln dried walnut, cherry, silver maple. Midland Lumber Company, Box 262, Savannah, Mo.

SKIL-CRAFTS New 62-63 catalog. Largest and finest selection of leathercraft, artist, hobbycraft supplies in the world. Free gift with first order. Send 50¢. Refundable with first order. Skill-Crafts, Box 167-P, Joplin, Missouri.

FREE "Do-it-yourself" leathercraft catalog. Tandy Leather Company, Box 791-042, Fort Worth, Texas.

BUY Picture frame moldings at wholesale. All styles and widths. Necessary tools, too. Free deliveries in U.S.A. Write for pricelists. Chesapeake Picture Frame Company, 414-A East Baltimore St., Baltimore 2, Md.

101 **PATTERNS** Of smart gifts, novelties, shelves, action windmills plus "Make Money Jig Sawing." \$1.00. Mastercraft, 55M, 7041 Olcott, Chicago 31.

VENEERS, 1/28" Thick. Send \$1.50 for two square feet each of cherry, mahogany, maple, oak and walnut. Catalog of wood working supplies 10¢. Barap Specialties, P.O. Box 2044, Dept. P-16, Chicago 9.

2447 **PLANS**, Patterns, things to make, do. Fun. Profit. Illustrated catalog 10¢. Craftplans, 1322-A Wabash, Chicago 5.

STAINLESS Steel, aluminum, copper; cut to your size. Perforated, expanded stock for grilles, enclosures; corrosion resistant fittings. Tell us size, thickness, how used—we will make recommendation and advise price. Metallic Operation, Inc., Mail Order Division, Warsaw, New York.

DO IT YOURSELF

MAKE Hydrogen, inflate balloons. Make your own generator. Plans \$1.00. Box 1196, Sioux City, Iowa.

FALL-OUT Shelter equipment—Fresh air blowers, hand-operated, 100 CFM., \$21.95. Hoods for vent pipes \$8.95. Both non-rusting, cast aluminum. Fits standard 3" steel vent pipes. Money-back 10 day guarantee. Ppd. U.S.A. only. No c.o.d.'s. Free literature. Kloppenborg Fan Co., 211 Marquette, Davenport, Iowa.

RESILVER Mirrors; plate. Literature catalog 25¢. Mirrocraft, 18518 Winthrop, Detroit 35.

INSTANT Laminating, photos, cards. Self-adhesive plastic. Sample, details. Hughes Company, Middletown, Conn.

AIR Conditioners, home, automobile. See Kool Engineering ad Page 41.

MAKE Your next walk or patio look like flagstone, with Green's designing tool, \$2.50. Green-Way, 1516 Nero Street, Metairie, Louisiana.

WASHING Machine, dryer service instructions, easy to understand, plus illustrated parts catalog, \$3.00. Jonsal Appliance Parts Company, Dept. PM5D, 291 Atlantic Avenue, Massapequa Park, New York.

FREE Check-list covering more than 500 classifications of projects, plans, instructions, service and repair information detailed in Popular Mechanics famous series of instructional booklets, books, patterns, and blueprints. List covers an extremely wide variety of do-it-yourself data on home remodeling, repair and improvement, hobbies, crafts, boating, games, lawn and garden, and hundreds of others. For your free copy of this helpful list, write: Service Bureau, Popular Mechanics, Room 520, 200 East Ontario, Chicago 11, Ill.

WATCHES, OLD GOLD, JEWELRY

WATCHMAKERS' Tools, materials, supplies, watches. Catalog. Gales, Box 1000, Chicago 90, Ill.

17-JEWEL Watches, \$8.95. Details. Wilson, 2506 W. Lloyd, Pensacola, Florida.

WATCH And clock repairing books. Free catalog. North American, 2320-AS Milwaukee, Chicago 47, Illinois.

HIGHEST Cash for gold, teeth, jewelry, rings, diamonds, watches, silver, platinum. Mail articles today. Free gift with information. Chicago Gold & Precious Metals, 6 E. Monroe, Dept. 3958, Chicago 3.

FREE Watchmaking course! Wholesale catalogue, details, 25¢. Bengal's, Culver City, California.

FREE Price list gem stones, rings. Phillips Gem Co., Brady Lake, Ohio.

WATCHES—First quality Swiss, wholesale catalogs \$1.00. Refundable first order. Davidson Importing, 14 So. Mallory St., Phoebus, Va.

CASH Immediately for old gold, jewelry, gold teeth, watches, diamonds, silverware, spectacles, platinum, mercury. Free information. Rose Industries, Heyworth Building, Chicago 2.

OF INTEREST TO WOMEN

SELL Fine fabrics. Get yours wholesale. Box 863, Norwalk, Conn.

STOP Throwing away boxtops! They're worth money! Some, 25¢! Inquire: "Box-tops-M." Cedar Hill, Texas.

PERSONALIZED Home study. Doll Hospital School, Studio MC-52A, Los Angeles 49, Calif.

FREE! Gold ink pen with order for 1000 name and address labels. \$1.25 postpaid. Specialties, Dept.-PM, Ora, Indiana.

LEARN Professional candle making—decorating. Send for free facts on famous home study course, Candle Institute, Dept. X-684, Fallbrook, Calif.

LEARN Expert cake decorating, candy making. Free details on home instruction method. Candy & Cake, Dept. D-238, Fallbrook, Calif.

"I Eat as I Please and Control My Weight"—Bayer. \$3.00 c.o.d. accepted. Satisfaction guaranteed. Bayer Publications, A938 Betty Avenue, Neenah, Wis.

RAZORS, BLADES, SHARPENING

ELECTRIC Razor. German precision made for clean shaves. \$11.95 postpaid. No C.O.D.'s. Sarco Distributors, Box 141, Buffalo 5, N. Y.

FOR THE HOME

LADIES. Sell useful \$1.00 household utensils. Send 50¢ for sample: refundable if unsatisfactory. Nachtrieb, Loveland, Colorado.

MARVELOUS Jar opener. Copper finish. \$1.25 postpaid. Audvis-Tronics Co., Box 823, Clark, New Jersey.

PERSONAL

AMAZING! Frank! ESP deep character analysis from your photo and signature. \$5.00. Isis, Box 75628-M, Los Angeles 5, California.

BIBLE Questions answered. Stamped envelope. Bylon, 17167 Bentler, Detroit 19, Michigan.

LOANS By mail, \$100-\$600. Anywhere. Confidential. Write Union Finance, Dept. PM, 323 E. Camelback, Phoenix, Arizona.

LOANS By Air Mail, \$100-\$600. Anywhere. Confidential. Easy payments. Write Security Finance Co., 898 Van Ness Ave., Dept. PM, San Francisco 9, Calif.

NEW! Borrow \$800. Anywhere. Increased loan limit. Air mail service. Postal Finance, 374 New Brotherhood Building, Dept. 17-C, Kansas City, Kansas.

DEVELOP Mind power, personality while asleep. Details free. Research Association, Box 24-N, Olympia, Washington.

WILL Forms. Two \$1.00. Superior Products, Box 102-A, Van Wert, Ohio.

INVESTIGATORS. Free brochure latest subminiature electronic listening devices. Dept. 5P, 11500 NW 7th Ave., Miami 50, Fla.

MAIL Loans, \$100 to \$1,000. Private. Fast service. Reliable company. Write now for free information. World Finance Co., Dept. 42-H, 620 Symes Bldg., Denver 2, Colo.

BORROW \$100 To \$1,000 by mail. Quick, easy, private. No co-signers. Repay in 24 small monthly payments. For the amount you want write today to Dial Finance Co., 410 Kilpatrick Bldg., Dept. E-1, Omaha 2, Nebraska.

RECEIVE Big mail. Samples, catalogs, magazines. Get listed 25¢. Logan, (300-H), 8-288 Charles, Winnipeg 4, Man.

RESEARCH—Any subject in vast library. Questions answered \$1.00. Arthur Buczak, 243 N. Ogden, Buffalo, N. Y.

"MAKE Your Own Will!" Booklet, legal forms \$1. Crystal's 28-WPM2, Millburn, New Jersey.

STAMMERING. Corrected myself. Could help you. Dipple, 103 Church, Detroit 3.

"HOW To Wake Up Life-Changing Winning Ability" sent you free. Rush request: President, Box 1924-W, Louisville 1, Ky.

LIVE Well on \$58.00 monthly in Guadalajara. Valuable booklet tells all. Only \$2.00. Herbert Schulstadt, Guadalajara, Mexico.

WILLS. Two "will" forms with instructions. \$2.00. Dependable Form Co., P.O. Box 573, Birmingham 1, Alabama.

REMAILING SERVICE

YUKON Territory postcards, 4 for \$1.00. Write message and return to us for remailing. Monthly forwarding service \$3.00. Other remails, 25¢. Yarter, Box 177, Watson Lake, Yukon Territory, Canada.

SECRET Mail receiving-forwarding system. Hedgpath, Box 830, Alhambra 23, California.

LETTERS Remailed 25¢. Confidential. Robert Carter, Box 742, Los Angeles 53, Calif.

MILWAUKEE, Wis. Confidential, secret, remailing, forwarding service. 25¢, \$3.00 monthly. Paul's 2526-A, W. Greenfield.

LOS Angeles, Hollywood, San Fernando Valley 25¢ single, \$3.00 monthly. Confidential, 10437 Lanark, Sun Valley 3, Calif.

CONFIDENTIAL New York City mailing, receiving, forwarding address. Business personal mail \$3.00 month. Remails 25¢. Details free. Birnhan, 152 West 42, New York City 36.

MASSACHUSETTS Remailing 25¢ each. Business details. Write: Seabury Co., Box 133, Arlington 74, Mass.

REAIRMAIL, Panama Canal Zone, \$1.00. Lev'n, 2942, Cristobal, Canal Zone.

RENO Remails 25¢. Monthly \$3. Garakontie, Box 2876-A, Reno, Nevada.

SECRET Mailing address. Remail 30¢. Remail and answer forwarded \$1. Monthly rates. Free informations. Henry Labrie, 380 Elgin St., Room 7, Ottawa 4, Canada.

ST. LOUIS Remailing service. Write big. Red, Drawer 6, St. Louis 88, Mo.

TWO Secret addresses \$3.00 month. De Graff, Box 14156M, San Diego, Calif.

HAWAII Remails 25¢. Information free. Coe, Box 984, Kailua, Hawaii.

AUSTRALIA Reairmails \$1.00. Ling, Box 3114, G.P.O. Sydney.

REMAILS 25¢ monthly \$3.00. 1700 Las Vegas, Wichita Falls, Texas.

CONFIDENTIAL. Mail forwarded. 25¢. Consolidated Services, Box 1386, Roanoke, Va.

SAULT Ste Marie, Ontario, Canada remails. \$3.00 month. T. Cahill, Box 981.

NORDIC Reairmails \$1, postcards 50¢. Fransson, Backvagen, Bergs slussar, Sweden.

NEVADA, Confidential, receiving, forwarding. Free information. Box 145, Carson City, Nevada.

TRUSTWORTHY, Confidential, worldwide receiving and forwarding system. Reasonable rates. Write for complete information and special services, free. Kenneth Fischer, Box 1207, Newark 1, New Jersey.

AUSTRALIAN Reairmails \$1.00. Confidential. Thompson, Box 18, Surreyhills, Victoria, Australia.

ATLANTA 19, Ga. Letter 25¢, month \$2.00. Evans, 1171A Clearview Dr.

WASHINGTON, D. C., remails 25¢. \$3.00 monthly. N. Hamilton, 3149 Mt. Pleasant St., N.W.

TREASURE FINDERS

GOLD, Silver, coins, Civil War relics, treasures. Choice 5 locators. Established 1933. Free literature. Write The Goldak Company, 1541 W. Glenoaks Blvd., Glendale 1, California.

TREASURE Gold, silver, relics. Find them with new Detectron instruments. Free information. Raytech, Box 715, North Hollywood, California.

EXCITING Adventure locating hidden loot, treasure, relics, etc., with powerful, electronic M-scope locator. Lightweight. Guaranteed. From \$59.50. Easy terms. Send for free booklet, interesting customer reports. Fisher Research, Dept. AY, Palo Alto, Calif.

BUILD Amazingly sensitive transistorized treasure finder. Available partially wired. Inexpensive. Simple, illustrated plans, details. \$2.00. Deekits, Box 7263-A, Houston 8, Texas.

FIND Coins, treasure. "Metal Locating Kinks" 25¢. IGWTP, Williamsburg, New Mexico.

WANTED—MISCELLANEOUS

STAMP Collections, accumulations. Eagle Stamp Co., 2221 Romine, Pittsburgh 26, Penna.

QUICKSILVER. Platinum, silver, gold. Ores analyzed. Wholesale Terminal, Norwood, Mass.

PHOTOCOPY Work wanted. \$1.00 minimum charge. Severino F., 41 Vincent Street, Newark 5, New Jersey.

FOR SALE—MISCELLANEOUS

FREE Money-saving catalog. Surplus and newly manufactured equipment and tools for workshop, home, boats, farm, factory. Write: Groban, 1139 So. Wabash, Chicago 5, Ill.

HEARING Aid batteries wholesale. Free list. Habs, Box 51, York, Penna.

MOON Maps. Three different 40" x 50" photomaps in color, with descriptive table. Shows lunar rays, other surface features. Prepared (1961) by Government scientists. \$2.98 postpaid. T-A Associates, Box 273-P, Parkton, Maryland.

MISCELLANEOUS

EARN Money raising fishworms for us! Write: Oakhaven—60, Cedar Hill, Texas.

BOOKS On antiques and their prices. Free circular! P. Warman Publishers, Uniontown, Penna.

CIGARETTES—Make 20 plain or filter-top for 9¢. Facts free. Moberly, Box 785, Owensboro, Kentucky.

WANT Your name with 1000 mailers? 25¢ lists your name year with our mailings every month. Dixie Mailers, King, N. C.

100,000 PRODUCTS Wholesale—Free catalog! Send postcard: Econ-O-Mart, Whippany 15, New Jersey.

NEW Process. Words raise out; when you write. Details free. Stephen Sidella, Pottsville, Penna.

STAMMER, Stutter, no more. (Dr. Young.) Write: Gaucho, Box 9309-S7, Chicago 90.

EMBROIDERED Emblems. Send 20¢ for this full color catalog showing prices in quantities of from 1 to 1000 patches. Ken Nolan, Inc., Emblems Catalog, San Clemente, Calif.

TROPHIES Send 50¢ for this handsome giant catalog illustrating over 200 trophies ranging in price from \$3.00 to over \$200. We offer complete engraving service as well. Ken Nolan, Inc., Trophy Catalog, San Clemente, Calif.

HAVE Something to trade? List it free. Swap Sheet, Humnoko, Arkansas.

6" HEAVY Duty paint brush \$1.25. Brown's, 103 West George, Arcanum, Ohio.

FREE Trial hearing aids only \$29.95 up. Terms. Glasses, body, barrettes, tieclips, earrets. Write: CaryB Sales, Inverness, Fla.

PRICE Card holders for many types stores. Big profits. Write for circular. Perfection Devices, 637 E. 71st, Chicago 19, Illinois.

RECEIVE Mails—Offers from everywhere. Samples, catalogues, magazines bargains. Get listed 25¢. Rorick, Cincinnati 26, Ohio.

GRASSCLOTH Wallpaper. Remodeling? Use this elegant handmade textured wall covering for home or office. Send 25¢ for sample book. Buy direct from importer and save over 50%. \$4.50 per roll. Pacific Grasscloth Co., P.O. Box 2491, San Francisco, Calif.

SEND Us wool for blankets. Write El-Dorado Woolens, Eldorado, Texas.

AMERICAN'S Creed. Five color parchment, suitable framing, home or office. Sent postpaid 25¢ coin. Mayer, Box 6024, Tucson, Arizona.

REMAINS 25¢. Literature, souvenirs 30¢. Giant assortment including imported novelties 97¢. Persil, 436 N. Y. Ave., Brooklyn 25, N. Y.

6" HEEL Shoes! Photo catalog, \$1.00. Finecraft, Box 442-R, Hollywood 28, Calif.

FREE Catalog of beautiful gifts. Many personalized. Kenneth Martwick, 550 Agness Ave., Grants Pass, Oregon.

MUSICAL Cigarette lighters. Durable pocket size. Useful conversation piece. \$3.00 postpaid. Newmire, Box 777-A, Blacksburg, Virginia.

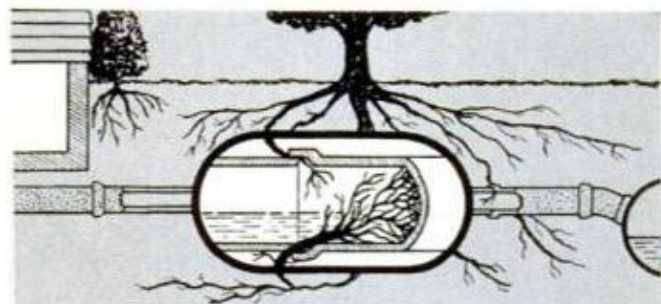
YOUR Name listed in 1962 Buyers Directory brings offers from everywhere. Your directory free. \$1.00 acknowledged. Wagner, 699 31st St., Downers Grove, Illinois.

MARRIAGE Certificate, \$1.00. Loswells, 152 West 42nd Street, New York 36.

PLEASURE, Power, prestige inventing. Sample ideas free. Dunham, 425 East Green, Pasadena, California.

ENGLISH And continental hotel labels. Colorful. Decorative. 25 different \$1.00. Brown, 51 Woodside House, Wimbledon, London, England.

HOME Fire alarm. Gives ear splitting signal when danger threatens. Flash light battery operated. Metal case 4"x7/8"x1 1/2". Easy installation. No wiring. \$2.95 postpaid. Amazing agents moneymaker. Sells like wildfire. Good profit. Illustrated circular free. Guardian, 1401 N. Wood, Sherman, Texas.



END SEWER-LINE ROOT MESS, SAVE ON COSTLY REPAIRS!

Roots are just naturally thirsty. They force their way through joints in your sewer line, eventually clog it. Toilets and sinks "back up", soon overflow. Now you can avoid costly digging or mechanical cleaning this easy, permanent way.



Pour one box of revolutionary Hercules R-D into toilet bowl. R-D kills and decomposes roots permanently, often overnight. To keep sewer lines root free, apply R-D twice a year. Safe to handle. Safe in septic tanks. Don't wait for trouble. Get R-D now from your plumbing or hardware dealer. It works, or your money back. Only \$3.95 for 2 lb. box. Send for literature.



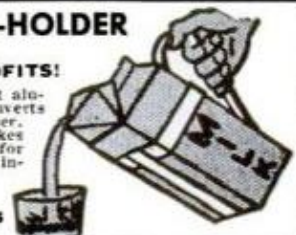
HERCULES CHEMICAL CO., INC.
416 Broadway, New York 13, N.Y.

ALUMINUM CARTON-HOLDER

BE FIRST TO CASH IN ON ZOOMING DEMAND—BIG PROFITS!

Ready market everywhere! Stay-bright aluminum, non-breakable, rust proof! Converts half-gallon container into pouring pitcher. Sells fast at only \$1.00 retail, makes 100% profit or more! Send \$1.00 today for postpaid demonstrator, complete sales information.

ALUMINUM CARTON HOLDER CO.
Dept. 4 P. O. Box 945
Cedar Rapids, Iowa



NEW PORCELAIN-ENAMELED BARBECUE

fun for everyone — for all occasions



Chrome grille, 21" x 10 1/2", adjusts to 3 cooking levels, lifts out for serving. Double unit has 2 separately adjustable grilles, 21" x 21" over-all. Removable charcoal pan has 2 cooking levels. Unit built-to-last, galvanized steel. Other units available.

Send TODAY for specs and name of dealer!

Send \$1 for **BIG FIREPLACE IDEA BOOK**
Over 200 pictures — fireplaces, barbecues galore!
Plans, designs, diagrams, "how-to" instructions.

The **Majestic** Co., Inc. 619 Erie Street, Huntington, Ind.

DO-IT-YOURSELF NEWS!

DAVOL RESP-R-AID MASK

T. M.

Filters Your Breathing Against
Dusts . . . Sprays . . . Pollens

Protects against common home workshop dust, non-toxic paint sprays, garden insecticides and allergy pollens.

Lightweight Resp-R-Aid has washable filter, foam cushioning, adjustable strap.

At Your Drug or Hardware Store
DAVOL RUBBER COMPANY

PROVIDENCE 2, R. I.



KILL TERMITES yourself

with Arab®

U-DO-IT

PROFESSIONAL TERMITE
PRODUCT FOR HOMEOWNERS

\$9.95 Treats Avg. 5-Room Home

Save as much as \$100 or more. Do the job yourself with this professional Chloro-

dane formulation (government tests still effective after 12 years). Easy to apply. Thousands of satisfied customers. 5 yr. chemical replacement **GUARANTEE** available. If your lumber dealer can't supply you, send for further information to **ARAB U-DO-IT**, 2707 Winthrop, Indianapolis 5, Ind.



EARN \$125 A WEEK AND UP

BE AN AUTO DIESEL EXPERT — LEARN A TRADE YOU LIKE

You learn fast in our shops because you learn with tools on real equipment. Students short of money may earn most of their expenses by doing part-time work. Experienced instructors explain WHY and show you HOW, then you DO IT YOURSELF. Many of our graduates earn \$125 a week and up. Approved for veterans. Day and evening classes. Free bulletin-write today.

MAIL THIS COUPON TODAY!

NASHVILLE AUTO-DIESEL COLLEGE

226 7th Ave., No., Dept. 86, Nashville, Tenn.
Please send without obligation free catalog.

NAME _____
(please print or write plainly)

ADDRESS _____

CITY _____ STATE _____

Rotary engine for your lawn mower?
It's being worked on right now. Read the exclusive report on two new tested rotary engine designs in the June Popular Mechanics.

FREE

FLORIDA BOOK!

Yes! This amazing new fact-filled digest is yours **FREE!** Discover the true inside story of Florida's fantastic growth and exciting opportunities for vacation . . . retirement . . . investment or year round living! Offer limited—so **ACT NOW!**

MAIL THIS COUPON TODAY!

TO: "Florida Book", 557 N.E. 81st St.,
Miami, Florida 5PZ-385

Name _____

Address _____ (PLEASE PRINT)

City _____ Zone _____ State _____



AD 58022 (Z-12) CC 381



OLDS F-85 JETFIRE gets a real boost from Turbosupercharging, which cuts 0-60 m.p.h. time to 8.5 seconds

ELECTRIC SPEEDOMETER told an amazing story about Corvair's turbocharged Monza: 107 m.p.h., and 0-60 in 11.6 seconds



SPOTLIGHT on the **Turbocharged** **OLDS F-85** and **CORVAIR**

By Jim Whipple

PM RECENTLY test drove a pair of turbosupercharged sport coupes: Corvair's Monza Spyder and Oldsmobile's F-85 Jetfire, both limited production jobs.

Addition of turbosuperchargers to the 145-cubic-inch displacement Corvair six and the F-85's 215-cubic-inch V8 jumped their horsepower from 80 to 150 on Corvair (a gain of 87 percent over the base engine) and from 155 to 215 on the F-85 (a gain of approximately 40 percent over the aluminum V8 in standard trim). Torque rating went up from 128 to 200 foot-pounds on Corvair, from 210 to 300 on the Olds F-85.

But curves on a graph can't convey the difference in performance. We hurtled down the track in the Corvair Spyder coupe with the fifth-wheel electric speedometer needle off the dial beyond the 100 mark at an estimated 107. Acceleration through the four-speed transmission was equally impressive—0 to 60 in 11.4 seconds compared to 16 or so for the stock job. In third gear we jumped from 50 to 70 in 6.2 seconds—a really fabulous increase over

the unsupercharged Corvair which eased through the same run in 17.1 seconds.

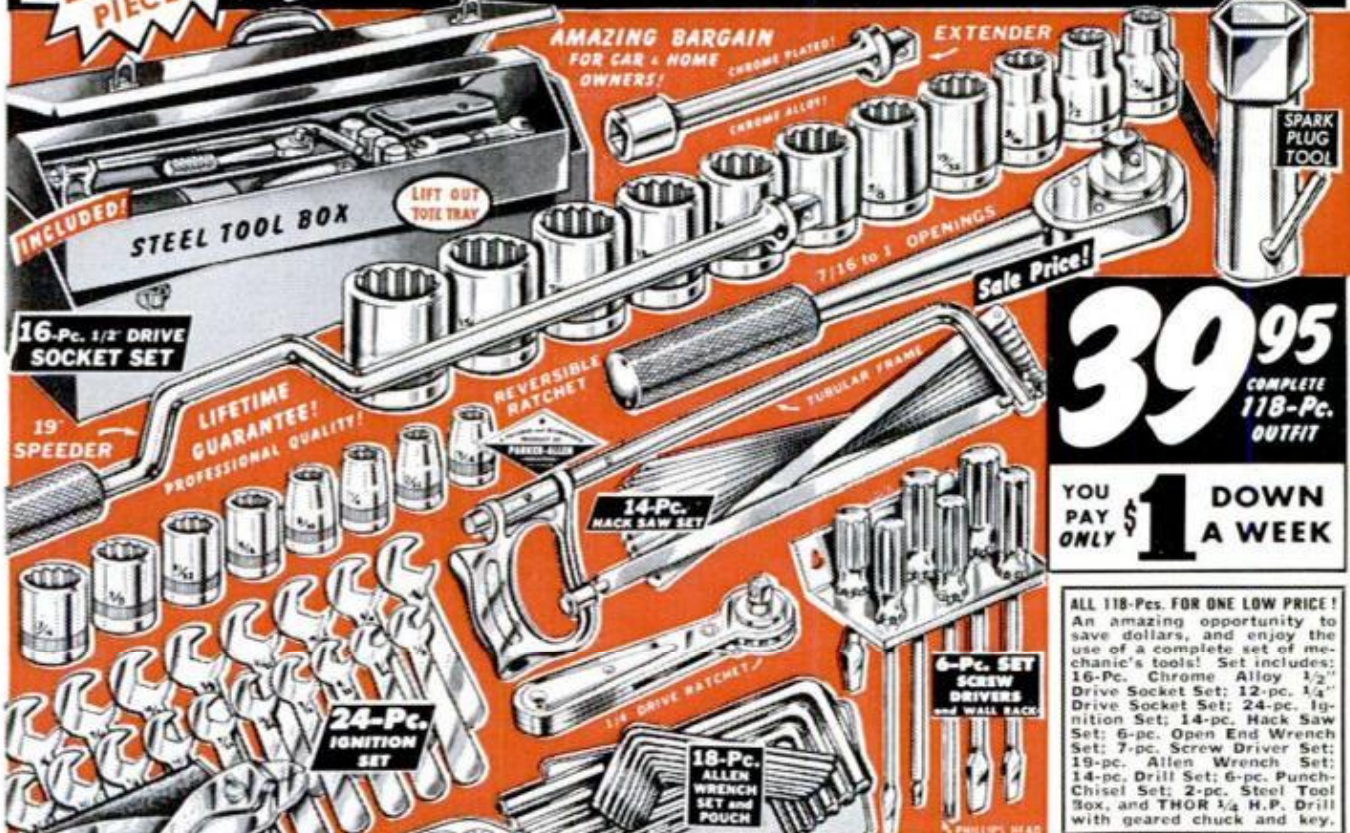
The Olds Jetfire coupe looked equally good. In it, we hacked off a 0-60 run in 8.5 seconds, a time just about on par with the big Olds Super 88. The 50-70 run was a quick 5.9-second affair. Top speed was estimated at 110 plus. In stock trim (155 hp.) the F-85 sedan took 12.5 seconds for the 0-60 and 8.7 for the 50-70 jump.

The source of these impressive power gains is the exhaust turbosupercharger—a device simple in basic principle but somewhat sophisticated in application.

The principle of supercharged induction has been known and used in the automotive industry for 40 years. In simplest terms it's a rotary pump, or blower if you will, that aids atmospheric pressure in charging the cylinder with air-fuel mixture. In an unsupercharged internal combustion engine, atmospheric pressure alone moves the vaporized fuel and air into the cylinders filling the space displaced by the

(Continued to page 62)

SALE!
118
PIECE SET INCLUDING **SOCKET WRENCH & TOOL SET**
THOR 1/4 H.P. POWER DRILL



39⁹⁵
 COMPLETE
 118-Pc.
 OUTFIT

YOU
 PAY
 ONLY **\$1**
 DOWN
 A WEEK

ALL 118-Pcs. FOR ONE LOW PRICE!
 An amazing opportunity to save dollars, and enjoy the use of a complete set of mechanic's tools! Set includes: 16-Pc. Chrome Alloy 1/2" Drive Socket Set; 12-pc. 1/4" Drive Socket Set; 24-pc. Ignition Set; 14-pc. Hack Saw Set; 6-pc. Open End Wrench Set; 7-pc. Screw Driver Set; 19-pc. Allen Wrench Set; 14-pc. Drill Set; 6-pc. Punch-Chisel Set; 2-pc. Steel Tool Box, and THOR 1/4 H.P. Drill with geared chuck and key.

INCLUDED FREE OF ANY EXTRA COST!

1/4 H.P. NATIONALY FAMOUS THOR POWER DRILL SET

WITH THE MOTOR THAT WON'T BURN OUT!

- 1/2" Capacity in Wood
- 1/4" Capacity in Steel

- AUTOMATIC TRIGGER RELEASE
- 2.5 Amp.



PRECISION MADE
GEARED CHUCK
 And GEARED CHUCK KEY

13 PC. DRILL SET INCLUDED

6-FT. 3-WIRE CORD

Klein's
 Sporting Goods

KLEIN'S—Dept. 120
 227 W. Washington St.
 Chicago 6, Illinois

YOURS FOR 30 DAYS FREE TRIAL!
MONEY BACK GUARANTEE—CASH OR CREDIT!
DON'T WAIT! ORDER BY MAIL TODAY!

I enclose \$1.00 Down Payment. Without obligation, please send me for 30 days FREE TRIAL the complete 118-piece Socket Wrench and Tool Set with FREE Thor 1/4 H.P. Power Drill. If I'm not 100% satisfied, I'll return the set—and you'll immediately refund my \$1.00. Otherwise, I'll send you only \$1.00 each week (billed monthly) until the low price of only \$39.95, plus a small charge for shipping and credit, is paid.

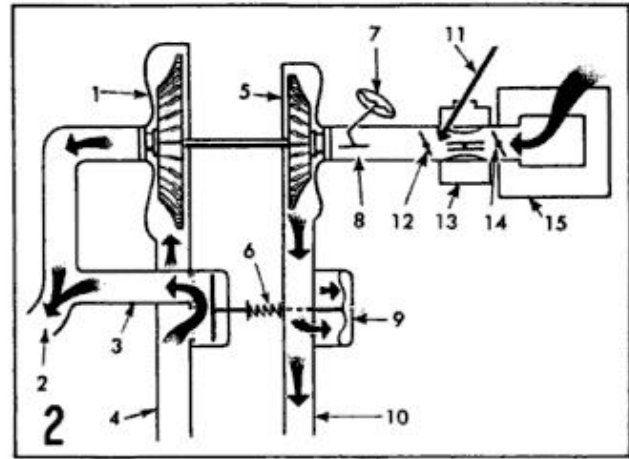
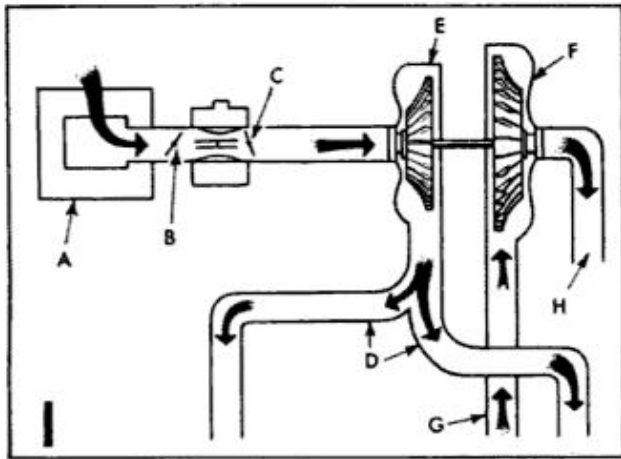
- Credit Order (Enclose Credit Information Requested at Right)
- Cash Order C.O.D. (10% deposit)

NAME

ADDRESS

CITY..... STATE.....

CREDIT CUSTOMERS: To speed your order, send name & address of your employer and name and address of 2 or more companies with whom you have (or have had) credit accounts. Also your age, occupation, no. of dependents, date present job began, and your weekly salary. THIS INFORMATION IS REQUIRED ONLY ON YOUR FIRST CREDIT ORDER. SAVE MORE! Send your check for \$39.95 and we pay shipping and handling charges. Same FREE TRIAL privilege with full refund guaranteed.



1. CORVAIR TURBOCHARGER system, above left, is fairly simple. Exhaust gases, G from cylinders, spin turbine F driving compressor E which draws air through cleaner A and carburetor B and C, compresses it and sends it on to cylinders through induction pipe D. **2. OLDS F-85'S TURBOCHARGER**, above right, is more complicated. Gases from manifold 4 rush to turn turbine 1 unless pressure of mixture in the intake manifold 10 acts on diaphragm in chamber 9 thus opening valve 6 permitting gases to escape through bypass 3 and limiting speed of turbine so that boost pressure remains at 5 lb. Compressor 5 draws mixture through air cleaner 15, carburetor and throttle 12, 13, 14 to injection pipe 11 which injects antiknock mixture when boost pressure raises to 1 lb. or above. Valve 8 controlled by diaphragm 7 limits mixture flow to engine in the event that antiknock fluid happens to be not flowing properly

piston as it moves downward on its intake stroke. As engines reached higher speeds it became evident to engineers that even though the intake valves were kept open before the start and after the completion of the intake stroke, the voided area or displacement was not being completely filled with air-fuel mixture. The amount of mixture an engine is able to draw into the space displaced by the piston is expressed in terms of a percentage of the whole, called "volumetric efficiency."

The more fuel mixture in the combustion chamber at the time of ignition, the greater the force exerted on the piston during the power stroke. Thus, greater volumetric efficiency spells increased torque and horsepower.

The supercharger boosts volumetric efficiency by forcing the fuel mixture in at greater-than-atmospheric pressure (14 lb. per square inch). For many years superchargers were driven from the engine's crankshaft by belts, gears or chains. These engine-driven superchargers boosted engine power but at the same time required considerable horsepower to drive them.

But prior to World War II aircraft engineers learned to harness the power of expanding exhaust gases to drive a turbine which was coupled to the supercharger compressor wheel. The results were higher speeds and altitudes for the bombers and fighters. Power drain imposed by the turbosupercharger was a fraction of that required by engine-driven supercharger.

However, Chevrolet and Olds engineers had to solve problems before going into production. As a supercharger increases

the density of fuel in the combustion chamber the rate of burning of the tightly packed mixture speeds up so that instead of a controlled burning and expansion of gases that drives the piston smoothly downward, a powerful instantaneous explosion occurs. This unwanted blast hammers at piston heads and sometimes breaks through them.

The same detonation takes place in any engine when fuel density is increased by raising the compression ratio, without proper control of detonation—the familiar knock or "ping."

The Corvair turbocharger controls the burning of fuel to avoid harmful detonation. Corvair does it by retarding the spark timing at the time when the boost pressure in the intake manifold raises. By a combined pressure and vacuum control, Corvair's distributor permits the spark plug to fire late, as the piston begins its downstroke, so the accelerated burning occurs as pressure is being reduced. Another factor is that Corvair's compression ratio is not raised beyond the stock 8 to 1.

Oldsmobile avoids the detonation problem, yet keeps the higher efficiency of 10.25 to 1 compression, by limiting the boost of its turbocharger to 5 lb. (versus Corvair's up to 10-lb. boost) by means of an exhaust by-pass valve operated by a pressure-sensing diaphragm. The Olds Jetfire engine also inhibits detonation by means of a jet in the carburetor that pumps antiknock fluid (methyl alcohol and water) into the mixture from a reservoir when boost climbs over one pound. This fill lasts from 750 miles (under full acceleration), to 8000 miles of normal driving. ★ ★ ★

It seems there's no end of uses for



made with aluminum powders from **ALCOA**

Atomized aluminum metal in putty form, DURO-PLASTIC Aluminum is a home repair kit in a tube. According to users, it seals, solders, repairs—adheres to virtually any surface. Made by Woodhill Chemical Co., Cleveland, Ohio, with Alcoa® Aluminum Powders, DURO-PLASTIC Aluminum is applied like paste, dries to a metal-like hardness in three hours. Users write that it fixes anything. Here's a sampling from their letters:

Household — "I've used DURO-PLASTIC Aluminum to rescue leaky utensils, solder toys, steady pot handles, hush plumbing leaks, tighten tool handles, you name it." — Los Angeles housewife.

Car Radiator — "DURO-PLASTIC Aluminum sealed my radiator after a fan belt went through it . . . saved a \$15-\$20 charge at a shop."—Pennsylvania motorist.

Fragile things — ". . . repaired antique vase with DURO-PLASTIC. It enabled me to outline skillfully, seal securely, enhance the beauty of the design."—El Paso aesthete.

Trailers — ". . . waterproofed the seams of our house trailer . . . very easy to apply . . . not a leak since."—Seattle trailer owner.

Art — "I dribble it on wire-sculpture figures for interesting effects. It provides creative activity for children, yet is challenging to adults."—Canadian hobbyist.

Gutters and Downspouts—"It quickly repairs gutters and downspouts, and solders gutter joints."—California apartment manager.

Plumbing — "Frequently I use DURO-PLASTIC to save customers' money. It's standard equipment on my service truck."—Knoxville master plumber.

Alcoa does not make aluminum putties, but Alcoa Aluminum Powders are used in all the best brands. Cold solders are easy to use; require no tools, heat or flame. They adhere to metal, wood, plastic, glass or concrete . . . are not affected by water, oil or gasoline . . . can be burnished to a high luster or even painted. Send coupon for more information.

Aluminum Company of America
1743-E Alcoa Building, Pittsburgh 19, Pa.

Please send more information on cold solders made with Alcoa Aluminum Powders.

Name _____

Address _____

City _____ Zone _____ State _____

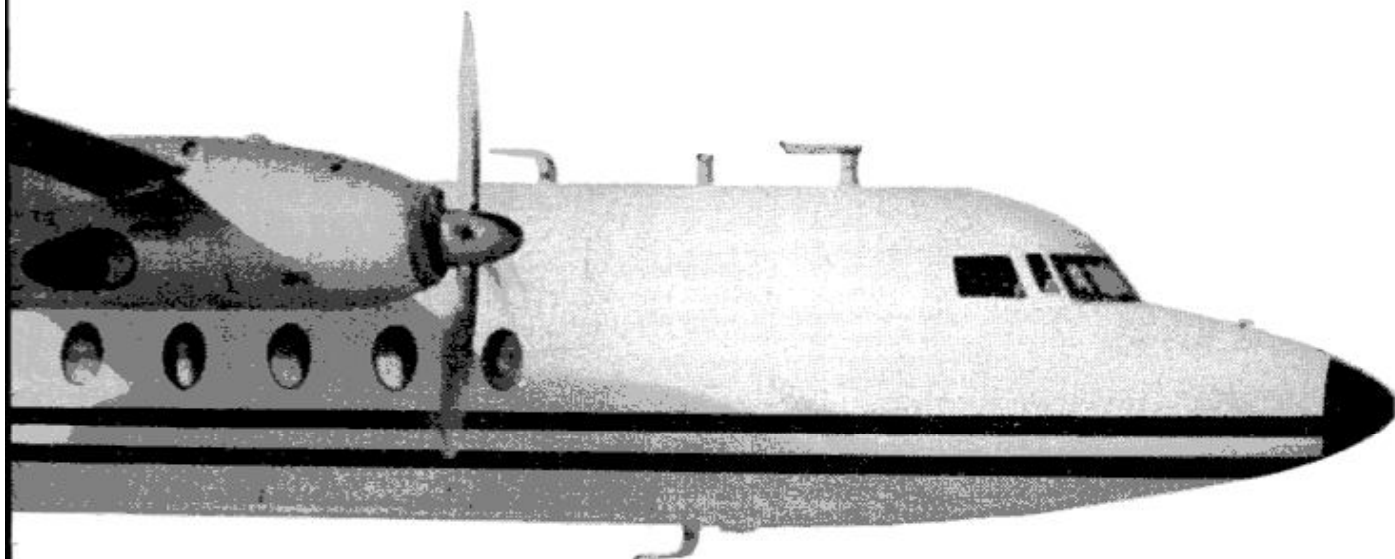
Entertainment at Its Best
ALCOA PREMIERE with Fred Astaire as Host
Tuesday Evenings, ABC-TV





Win your own private airliner and crew for 14 days - plus \$5,000

Enter the Champion Spark Plug Vacation-of-a-Lifetime contest!



Fly anywhere you want in North America! Take along your family and friends—up to 12 people in all! \$5,000 cash to spend as you like! We pay all taxes on this prize. Nothing to buy! Easy to enter!

Here's your opportunity of a lifetime to live like a king and travel like a maharajah for 14 glorious days!

The whole continent—from California to Maine, from Alaska to Mexico—can be your playground! A luxurious airliner and crew are yours. Fly anywhere you want, any time you like!

Take along your family and friends (up to 12 people) if you wish.

Spend the \$5,000 any way you want. Or, put it in the bank. You don't have to worry about the taxes. Champion pays them for you—just as it pays for the crew and all expenses of your airliner!

And there are 1,242 other prizes—new cars . . . color TV sets . . . movie cameras!

It's easy to win! You don't have to buy anything to enter. Just go to your favorite

service station, car dealer or garage. Ask for a free spark plug check and Champion entry blank. It gives you complete contest rules. (You just complete a jingle . . . and the blank gives you plenty of hints!)

Contest opens April 16—closes May 27. Winners will be notified about July 31. Trip can be taken any time during the next 12 months. Get your free spark plug check and entry blank *today!*



CHAMPION SPARK PLUG
COMPANY • TOLEDO 1, OHIO

Items from all outdoors

Any of you outdoor types interested in a two-year working vacation and a chance to do some real good for our overseas relations? Here's your chance. The Peace Corps is looking for six volunteers with some experience in commercial fishing and fisheries development. They'll join a mission to Togo, a small but attractive new nation on the south coast of West Africa.

The Togolese have a critical food shortage despite their liking for fish and their excellent potential fisheries. They have 40 miles of coastal beach, a large inland lake, and a great many ponds and reservoirs, but need help both in harvesting the fish that are already there and in managing their waters to improve the supply. Volunteers with practical knowledge of commercial methods along our coasts or in our southern fresh waters could do a lot of good. What's more, the experience in developing a fishery almost from scratch would be a big advantage to anyone studying or planning to study fisheries management or conservation.

The requirements are simple enough—you must be over 18, but there's no age limit; some Peace Corps workers are in their sixties. There's no need for a college degree, some practical experience would be more valuable. The language of Togo is French, and some knowledge of the language would be desirable, but they're prepared to provide language training as well as their usual two-to-four-month training program. Volunteers enjoy a deferment, though not a permanent exemption, from the draft, and service reserve commitments are suspended during the term of service. The Peace Corps pays for official travel, training, and other expenses, and handles the details: volunteers receive a living allowance (usually around \$150 a month in Africa), plus a separation allowance of \$75 for each month served, plus 2½ days per month vacation with a special vacation allowance. Most important, you get the satisfaction of helping a young nation learn to stand on its own feet.

Training for the Togo project starts this summer. If you're interested, write Mr. Harris Wofford, Special Assistant to the President, The White House, Washington, D.C. Tell him I sent you.

Dick Liebpatrick



**Pack the
shaver
that packs
its own power!**

- Runs on two flashlight batteries tucked into its case.
- World-famous rotary blade shaves, 'flip-top' cleaning.
- Easy to pack, pocket-slim.
- Case houses built-in mirror and quick-recoil cord.

**ANY PLACE
YOUR FACE CAN GO,
THE SPORTSMAN
CAN, TOO!**

- Ask your Norelco dealer about the whole line of rotary blade shavers.

NEW
Norelco[®]
SPORTSMAN

NORTH AMERICAN PHILIPS COMPANY, INC., 100 East 42nd Street, New York 17, New York.
Norelco is known as PiliShave in Canada and throughout the rest of the free world.



KEEP YOUR CHEVY the CHEVY-EST* with *Genuine* GM Chevrolet cooling system replacement parts

Say it's a vital cooling system part you need, such as a water pump. Or simply a radiator hose. The important thing is to make sure you get the same quality that was originally built into your Chevrolet part by part. That means *genuine* GM Chevrolet parts. They're engineered especially for your car, so you know they'll fit right the first time—an important advantage, whether you do the installation yourself or have it done. And they're durably built to Chevrolet's quality-controlled specifications to give you long trouble-free service. You'll find them available at your local Chevrolet dealer's or through leading independent garages and service stations. Ask for them by name.... Chevrolet Division of General Motors, Detroit 2, Michigan.



**Chevy-est: all Chevy with new-car reliability maintained part by part.*

You can light either end!



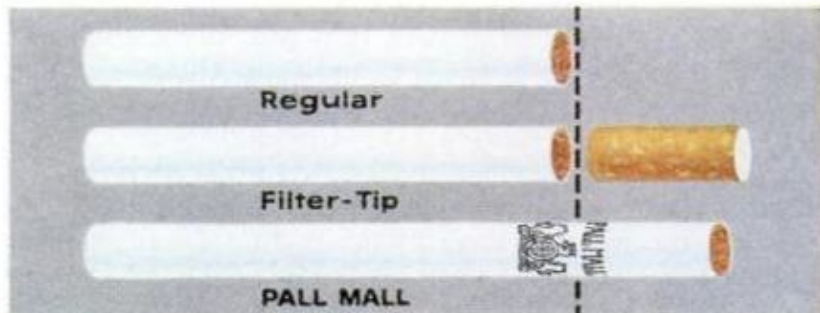
"Wherever particular people congregate"



Pall Mall's natural mildness is so good to your taste!

So smooth, so satisfying, so downright smokeable!

See how Pall Mall's famous length of fine tobacco travels and gentles the smoke naturally—makes it mild—but does not filter out that satisfying flavor. Never too strong. Never too weak. Always just right! Enjoy satisfying flavor...so friendly to your taste.



Compare all three! Smoke "traveled" through fine tobacco tastes best! See the difference! With Pall Mall, you get that famous length of the finest tobaccos money can buy. Pall Mall's famous length travels and gentles the smoke naturally...over, under, around and through Pall Mall's fine, mellow tobaccos. Makes it mild...but does not filter out that satisfying flavor!

Outstanding...
and they are Mild!



*Richard Dunlop
1115 Mayfair Road
Arlington Heights, Ill*

**POPULAR
MECHANICS**

MAY

1962

We Fought the Red Guerrillas

This is how the guerrilla war in Vietnam looked to us through the sights of an M-1 rifle.

There is always the jungle, choking the narrow valleys and sweeping in a tangle of irresistible growth over the jumbled mountains that back up against the borders of Laos and Cambodia. Down through the jungles from the railheads



By Sgt./Major Gregory Matteo
As told to Richard Dunlop





SERGEANT MATTEO (left) and another U.S. instructor show Vietnamese Rangers how to make raft from GI poncho shaped around crossed rifles or branches hacked from trees. Rafts are important in jungle

in North Vietnam move the Communist Viet Cong guerrillas like the monsoon rains trickling through a thatched roof. They slash at outlying villages, torturing and murdering, plundering and burning, and terrorizing the people into helping them. The Vietnamese army opposes them from garrison points. The soldiers fight bravely and effectively when they can come to grips with the enemy, but all too often they arrive hours late on the scene of the latest outrage. The guerrillas have vanished, taking with them food, clothing and often, at gunpoint, the pick of the village's youth. The youngsters make sturdy if unwilling beasts of burden, sometimes can be frightened into joining the guerrillas and are hostages to insure the village's begrudging support.

Usually the Viet Cong enemy sticks to the trails because, contrary to what journalists have written, they are afraid of the jungle. They are afraid of the pythons coiled in the trees, the poisonous snakes lurking underfoot, the fire ants with their fearful stings, and the terror of being lost. They are particularly afraid of the jungle at night because of the numerous tigers.

We found that government troops were equally afraid of the jungle and of the tigers. When our special forces team set up our base camp in a forward area and began

to give the Vietnamese Rangers "on-the-job" training in guerrilla warfare, we led them on forays through the jungle. We followed the classical guerrilla rule that you can get there faster and undetected if you ignore roads and trails and cut across even rough country following a compass. At first the stocky Rangers picked their way through the jungle with hardly as much confidence as Park Avenue dowagers at a beatnik bash. Gradually they grew accustomed to this method of operation, however, even though we did have a chilling encounter with a python and narrowly escaped casualties from poisonous snakes.

One day we were patrolling a stretch of jungle in Viet Cong territory when the advance screen of men howled in agony. I rushed forward. How could they forget the absolute necessity of stillness when probing the enemy-infested jungle? Suddenly I was overwhelmed by scores of fiendish stabbing bites that blazed with poison. I, too, screamed and danced in pain. We had stumbled on a tree full of fire-ant nests, and if the Viet Cong had arrived at that moment, we might have welcomed them, providing they had shot us at once and put us out of our misery.

When it came to night operations in the jungle, the Rangers remained fearful. A man quickly forgets he is stalking an



SPECIAL SERVICES officers demonstrate raft made from poncho. Since few Vietnamese fighting men can swim, they must learn how to build these rafts to cross frequent and turbulent streams with their equipment

enemy encampment when he hears the coughing snarl of a tiger hunting in the dark. Nevertheless, we American advisers, appreciating what an edge it would give the Rangers in the fighting if they could move freely through the jungle at night, insisted on night patrols.

We maintained that the tiger menace was over-rated even after our weapons NCO saw astounding proof of the strength and ferocity of the giant cats. Driving a jeep along a jungle road, he slowed behind a Vietnamese farmer herding a hulking water buffalo home from the rice paddies. As he jockeyed to pass, a huge tiger leaped from the jungle, its enormous claws outstretched, and struck the buffalo such a powerful blow that the beast fell to the ground with a broken leg. Turing its savage eyes on the sergeant, the tiger growled, then sprang out of sight as he raised his rifle to fire.

"It vanished on steel springs," the sergeant told us later. "The poor farmer was running for his life. I stopped him and said that if the tiger came back, I would shoot it. As I was arguing with him, there was a sickening roar and the tiger leaped into the road again. He seized the buffalo in his mouth and with three incredible tugs yanked the enormous struggling beast out of sight into the jungle. It happened so

fast that once again I could not even get a shot off."

This demonstration of power, speed and camouflage made us realize that both the Viet Cong enemy and the Vietnamese soldiers have reason to fear the striped cats. But we still insisted on operations at night. Tigers or no tigers, the Vietnamese and we were agreed that the Red marauders had to be stopped.

The bitter fighting in Vietnam has been going on for years. It became something personal to me in April, 1960. I had just returned from survival training in Utah to the Special Warfare Center at Fort Bragg, N. C., when Lt. Colonel Bill Ewald sent for me.

"We've got something hot going in Vietnam," he said. "We're going out, and I'd like to have you come with us."

Special Forces men are trained for action wherever we are needed the world over. We are double volunteers. First we volunteer for the paratroops. When we have qualified as paratroopers, we volunteer for intensive special forces training and the privilege of wearing the green beret of men ready to fight for freedom in enemy-held territory.

"Okay, sir," I said. "No sweat."

Colonel Ewald grinned with approval because I had served under him before.

A basic special forces team is made up of ten men and two officers. It includes two medics, who must be able to perform minor surgery, and two specialists each in light and heavy weapons, communications and demolitions. But each man is cross-trained, which means he is not only able to do his job expertly but can fill in for any of his buddies. On our team I was the medic, but I was ready to repair and fire captured enemy weapons, blow a bridge or send a radio message. The other men knew how to use my medical kit.

Each special warfare detachment must also know how to organize, train and direct a guerrilla force, which may be 100 times as big as it is. In special forces we not only get cross training but schooling ranging from underwater assaults and hand-to-hand combat to the languages and customs of the people in whose country we are going to operate. We undergo realistic training all over the world in preparation for the day we are infiltrated or jumped into the middle of the enemy.

Actually none of the three teams that boarded the Military Air Transport Service plane for southeast Asia were organized by the special forces book, because we had an unusual job to do. My own team, headed by Major Ray Call, included four officers and five noncoms. When we arrived, we learned our mission.

Bitter Lesson

Red invaders were terrorizing the countryside right up to the suburbs of Saigon. The Vietnamese army, trained in conventional warfare, had discovered a bitter maxim of antiguerrilla operations—that it takes 15 regular soldiers to hunt down and eliminate one guerrilla. Army casualties were running 2000 a month as government soldiers fought to eliminate some 25,000 Viet Cong. President Ngo Dinh Diem had urgently requested American help in training an aggressive force of Vietnamese Rangers who would know how to give the Reds a taste of the guerrilla warfare that they had started. We learned that this was our task.

Each team set up its base in forward areas where our forces, even as they trained, could protect sizeable stretches of country. Captain Jamie Hendrix, second in command of our team, gave a fitness test to the first 76 Vietnamese Rangers. None passed. To outfight the Viet Cong the Rangers would have to outmarch them, so we whirled the soldiers into a kaleidoscope of physical exercises, forced marches and jungle patrols to toughen them up. We led them on cross-country hikes through the jungle. They ran for miles to build their



VIETNAMESE RANGER practices guerrilla-fighting tactics taught him by troops of U.S. Special Forces

lungs. Push-ups, pull-ups and swimming lessons developed shoulders and arms.

Every morning we started in training at 4:30 and kept it up until 11:00 at night. We worked right through the traditional Vietnamese "siesta" which lasts from noon until at least two o'clock. When the men complained, we bluntly explained, "The Viet Cong doesn't take a siesta. We don't either."

Only two weeks after the first P.T., Captain Hendrix gave the Rangers a second test. Those that still remained, passed.

We were proud of the obstacle course we set up. Men climbed a 30-foot rope, pulled themselves hand over hand over ropes stretched parallel to the ground and dropped back to earth, rolling at the impact to prevent injury. They crawled under barbed wire while bullets zinged over their backs. They jumped a ditch of flaming gasoline, leaped against a stone wall taller than their heads and flipped themselves over it. Swinging over a muddy pit on a rope, they raced down a zigzag trench under overhead fire, climbed to a high platform to walk across narrow planks to another platform and wound up the course by throwing themselves against barbed wire, protecting their chests from the sharp prongs with their rifles so that men behind could step on their backs and pass the last obstacle in a hurry.

The Vietnamese were surprised when we



RANGER PATROL starts trek up into jungled mountains from rich valley where rice is grown in paddies. Rice of Vietnam is prize for which Communists are fighting and which Vietnamese are trying to protect

supposedly luxury-loving Americans ate the same food they did, slept on ponchos stretched out on the ground as they did, dug our own latrines, usually walked or, if we did ride, drove our own jeeps. Red propaganda had not prepared them for the hardy, independent sort of cusses we turned out to be. Any lingering doubts about Americans vanished when one day two of our officers drove a jeep onto a five-mile stretch of smooth beach near our camp. One tied a rappelling rope to the rear bumper and broke out a pair of water skis, which are virtually unknown in that part of Vietnam. Wading out into the water with the rope in his hand, he put on the skis. At a signal the other started the jeep down the beach. To the amazement of the Vietnamese the American in the water rose up on two skinny strips of wood and went streaking down the shore among the black, basalt rocks. Word spread rapidly from village to village about the American's exploit. Village elders sagely agreed that Special Forces men were more than a match for the Reds.

A few days later we reconnoitered an offshore island. As we were coming back in open power boats, Major Call winked

at Colonel Ewald, handed his wallet to the Vietnamese Ranger at the tiller and plunged fully dressed into the water. The Vietnamese stopped to pick him up.

"Hurry before the sharks get you," they cried.

"I'll swim ashore," said the major, ignoring their fears.

"How's the water?" asked the colonel.

Handing his wallet to the tillerman, he too dived overboard with the zest of a kid plunging into a swimming hole back home. When it got around how these two American officers ignored danger and stoutly swam ashore just for the fun of it, we noticed a definite change in the attitude of soldiers and villagers.

We knew that the Viet Cong regularly marches 40 miles to fall unexpected on an unprepared outpost. We toughened the Rangers to march 60 miles at a crack.

"Once you get on their trail, they won't be able to outrun you now," we pointed out grimly.

We taught the Rangers to work with helicopters, which could leapfrog units behind the fleeing enemy to put ambushes on his escape route. Even as we toughened the men, we built up their knowledge of



LT. COL. BILL EWALD, Sgt. Matteo's C.O., was shot at by Red sniper shortly after this picture was taken

guerrilla war by patrolling the country in which the Viet Cong was active. We clamped road blocks on trails frequented by the enemy. But the Rangers still did not show the dare-devil spirit that makes good guerrilla fighters.

"We've got to make these fellows more aggressive," Major Call said one day.

We dug a pit, 25 feet in diameter and six feet deep and sent one platoon into it. Then we told a second platoon to throw them out. It was the phoniest fight I've seen since I quit watching professional wrestling.

"Hey you guys," shouted Major Call. "The platoon that throws the other out can go to the beach and swim. The other goes over the obstacle course again."

The two platoons went after one another as if their lives depended on the result, which in a real way was true since no force can win a real fight if it doesn't have an aggressive spirit.

As we pushed out patrols farther into Viet Cong country, we freed more and more villages from the fear of Red attack. Now whenever the Rangers came through a town, the once-wary populace welcomed them. Admiring kids followed along, waving and calling to get our attention and then snapping off military salutes. When a jeep in which two Americans were riding

broke a tie-rod near the Cambodian border, they hiked down the trail until at last they came to a village.

The villagers told the soldiers that a bus came as far as the village and could take them to the nearest town where they could get a repair part for their jeep. The men sat down in front of a store and waited. Learning that the store actually contained iced soft drinks, they each thirstily downed a bottle before they saw the ring of kids eyeing them. Those Vietnamese kids are cute as buttons, and the Americans spent every piastre they had buying them pop.

Just as they finished, the most decrepit bus they'd ever seen arrived. Climbing up on top, they sat down on the cords of firewood stacked up there.

"Money? You have to pay to ride," said the bus driver. "Give me money."

The Americans explained in their halting Vietnamese that they had no money left. With a big grin one of the kids went into a thatched house and came out with the coins needed to pay their new friends' fares. The whole village waved farewell as the bus rattled away down the road.

Things like this helped a great deal to improve our relations with soldiers and civilians alike. The Vietnamese have been fed a lot of Red propaganda about the ugly

(Continued to page 200)



By Jim Whipple



Two-Seat T-Bird Lovers, Here Comes the Cougar. Detroit Is Heating Up the Cold War on Smog

Last week Ford sent up what seems to us an obvious trial balloon when it displayed its new show car, the "Cougar 406," at the International Automobile Show in New York.

This car, a wire-wheeled, Europe-cum-Dearborn-styled bomb on 102-inch wheelbase, is built around two bucket seats and Ford's hottest V8.

It fits the image of the old (1955-57) two-place **Thunderbird** the way Cinderella's foot slipped into the glass slipper. Ford's statement on the car, delivered by Division Manager Lee Iacocca, leaves plenty of room to read between the lines too. "Although we have no current plans for production . . . it's more down-to-earth than a dream car."

Dreams are undoubtedly involved however, on the part of a small but loyal band of "Mark I" **T-Bird** lovers who are still willing to pay half of original cost—sometimes more—for a sound specimen, the newest of which rolled off the line in September 1957.

Ford executives are aware of this trend, just as they are aware of the small but steady stream of **Corvettes** rolling off the assembly line as well as the profitable traffic in hot, two-seaters made in England, Italy, Germany and now even Sweden.

Now that Ford has plenty of high-speed hardware around (400-horsepower engines, four-speed transmissions, etc.) for the benefit of the company's stock-car racing friends, it wouldn't be difficult at all for the Company to develop a "**Corvette**" all its own. We can only hope that if and when Ford produces the "Cougar," or something like it, there will be a truly hot-handling sports-car version of it. Americans would love to watch Ford and Chevy products dicing on the sports-car tracks.

Speaking of sports cars—bonafide or otherwise—Studebaker is rustling up a Fiberglas two-seater in South Bend. It will be powered by Studebaker's biggest V8 (the 289-cubic-inch job) which, in turn, will be vitamin-enriched by means of a Paxton Products centrifugal supercharger.

Unlike the blower used on the **Golden Hawk** a few years back, this one will not have the variable-speed feature, but will depend on increase in crankshaft speed for manifold pressure buildup. Supercharging should do wonders for this power plant, which is rated at 210 horsepower on today's **GT Hawk**.

By bolting two of his superchargers on a 361-cubic-inch '62 **Plymouth**, Andy Granatelli, guiding genius of Paxton Products, hit 181 miles per hour hauling a stock sedan body.

We think the real sleeper on this new Stude sports car (wonder if they'll call it the Gran Turismo Lark?) will be its list price. It could be in the \$2800 range, and with close to 300 horsepower at the top r.p.m. of the blown engine it might make a lot of **Corvette** dealers look over their shoulder and wonder where the "green" went.

At any rate the "Studesports," will be a real break for Studebaker dealers, who are momentarily suffering from less-than-startling **Lark** sales.

There's good news this spring for America's smog-choked cities. A team of Chrysler Corporation engineers has devised a conversion kit of four items:

First, a modified carburetor with lean fuel jets, choke restriction and lean idle adjustment. These modifications combine to provide cleaner burning, less CO.

Second, a distributor modification that retards spark at idle which reduces hydrocarbon formation at idle and permits the throttle to remain slightly open during deceleration for more complete burning.

Third, a vacuum sensing valve between distributor and carburetor which provides maximum spark advance during deceleration to aid in complete burning of otherwise wasted fuel.

Fourth, a steel fan shroud fitted onto the radiator to provide better cooling at idle as the spark retarding of item No. 3 puts a greater load on the cooling system.

Chrysler is making 100 kits available to their competitors and independent laboratories for evaluation. ★ ★ ★



SPECIAL'S clean, simple lines, shown-off to advantage on PM's test convertible, won high owner approval

Owners Like Zip, Zing of Buick Special V6 But Find Gas Mileage Less Than Expected

Marginal and boldface comments by Jim Whipple, PM's Auto Editor

And, frankly we find it a fun car to drive →

Buick has been busy adding new Specials to the line-up: two coupes and two convertibles were added during the past year →

In fact it shares many common parts—pistons, rods, valves and water pump with the aluminum V8 →

PM CHOSE TO do an Owners Report on Buick's new Special after some 1100 miles of test driving in Michigan last summer. The economy and performance of the V6 engine, coupled with the roadability and ease of driving of the Special, made the car a natural candidate for a Report. Questionnaires were sent only to V6 owners.

Even though this Report comes soon after PM's previous Report on the '61 Buick Special V8 (PM, March 1961, p. 122), we felt that the unique new engine justified a return engagement. Except for the addition of the V6 engine and an inch or two more room in the rear seat of the sedan, no major mechanical changes were made in the car itself.

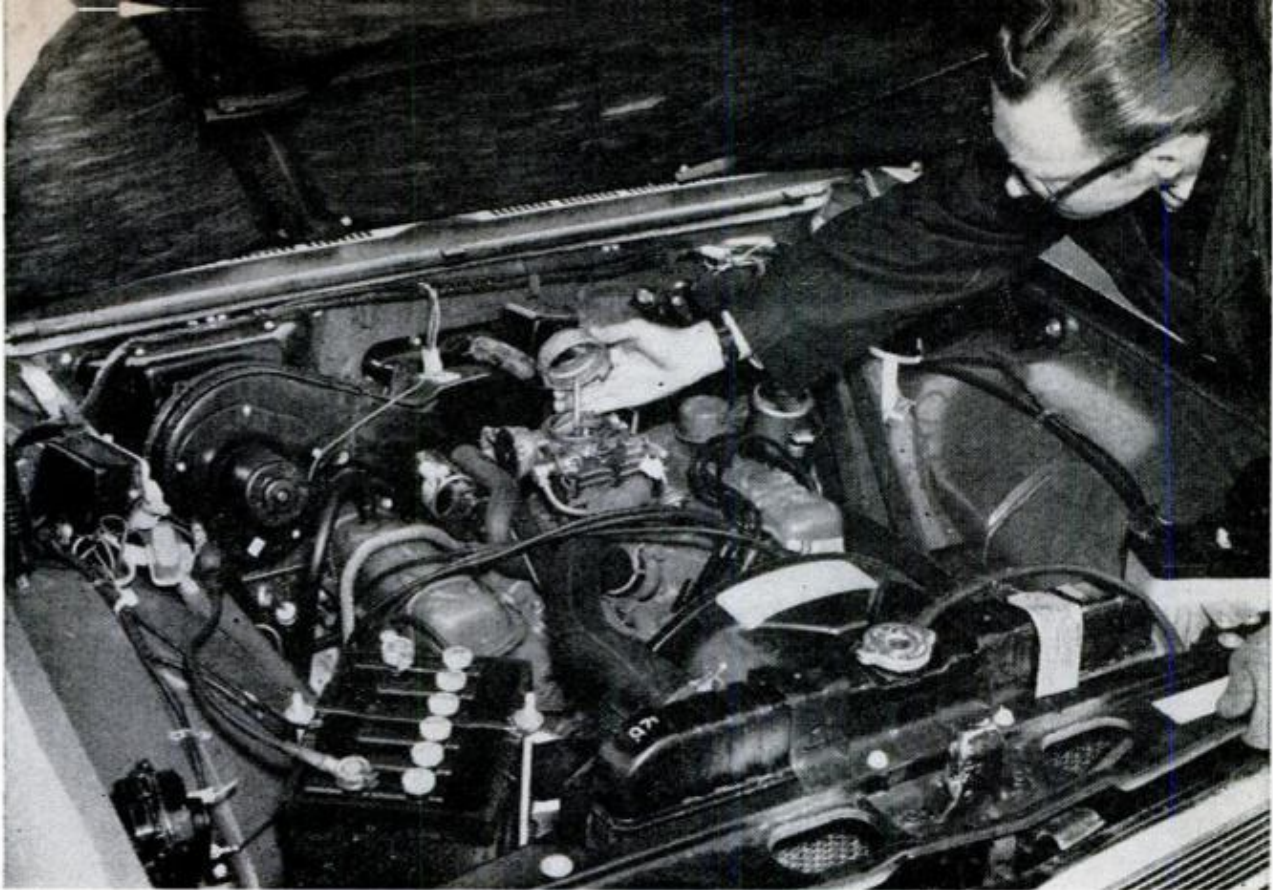
Although Buick's V6 is a mass-production "first" in the U. S. it is not an exotic power plant requiring kid-glove treatment. Its only technically unique characteristic is the firing order, which progresses in zig-zag fashion from one cylinder to its opposite number on the other bank of the engine's Vee. Cylinders also fire in uneven rotational sequence which

Buick V6 Owners LIKE . . .

Ease of driving, handling
Peppy performance
Stable, big-car ride

DISLIKE . . .

Less-than-expected mileage
Poor-quality paint jobs
Cramped entry and exit



UNIQUE, COMPACT V6 engine sits far back under Special's wide hood, but is accessible for servicing

BASED ON 1,151,106 OWNER-DRIVEN MILES



adds up to an inherent tendency for lateral shake at low speeds. Buick engineers have compensated for this so well that it can be felt only at low-speed idle or when the engine is improperly tuned.

In addition to a compact space-saving layout Special's V6 provides a solid gain in efficiency, with a rating of 202 foot pounds of torque (the measure of actual turning power at the flywheel) compared with 177, 180 and 190 for similar-sized (194, 196-cubic-inch) engines.

This showed up in the enthusiastic response of owners, some 43.5 percent of whom rated the V6's power and performance as a "best-liked" feature, contrasted with the previous report on the Special V8 in which only 23 percent of owners rated performance as a best-liked feature, third on the list.

Mechanically, the new V6 engine showed up very well, with only 5.6 percent of all owners reporting trouble. On last year's report, 10.8 percent of all owners reported troubles with the aluminum V8.

In spite of its pleasing pep and freedom from trouble early in its service life, the V6 drew owner criticism on several points.

Approximately 10 percent of both manual and automatic V6 owners complained of less-than-satisfactory fuel mileage.

- ← This crosswise shake engineers call "rocking couple" is moderate, and absorbed by rubber engine mounts under most conditions
- ← The extra power is free —until you use it—comes from better "breathing in" of fuel charge, not bigger cylinders
- ← This figures; the performance (220 ft. lbs. of torque for V8 vs. 202 for V6) was expected—and paid for—on the V8, but came as a pleasant bonus for V6 buyers
- ← Chief source of trouble on both engines has been the carburetor



These figures compare favorably with other compacts with smaller, less capable engines →

On many short trips in this zero-ish weather the choke never did get fully open →

Firmer shock absorbers and "quicker" steering action would make the Special a real touring sports car →

This "eight-cylinder feeling" is a common reaction of many who try Specials and have to be shown the V6 under the hood →

An additional 3.5 percent complained of fast, rough idling while 3.2 percent felt that the engine was too noisy.

Fuel mileage on PM's test V6, a convertible with automatic transmission, turned up the following figures:

- 26.9 miles per gallon at 30 m.p.h.
- 26.5 miles per gallon at 40 m.p.h.
- 24.2 miles per gallon at 50 m.p.h.
- 20.4 miles per gallon at 60 m.p.h.
- 17.4 miles per gallon at 70 m.p.h.

Over-all mileage, including turnpike, city-traffic and country-road driving, most of it with two passengers aboard, worked out to 16.7 miles per gallon. This driving was done in cold weather (-10° to $+20^{\circ}$ F.) and a lot of it through snow.

According to most owners, the V6 turns out to be a considerable success; 65.3 percent rated it "Excellent," 29.4 felt that it was "Good," while only 4.4 and 0.9 percent rated it "Fair" and "Poor" respectively. The "Poor" rating given the V6 (0.9 percent) is commendably lower than the 2.1 percent rating given to the 1961 Special V8.

Now let's see what the owners of new V6 Buick Specials think of their cars. . . . The following are the first five best-liked features in the order they were mentioned:

"My V6 coupe is the finest handling car I have ever owned."—Utah salesman.

"Like the ease of handling—combined with big-car ride and roominess."—New York lab technician.

"It's easy to handle in traffic and on the road."—Kentucky serviceman.

"I like the ease of handling with no power assists."—California highway engineer.

"I like the all-around performance; the engine is smooth and snappy for a six—sometimes feels more like a small eight."—Wisconsin state patrolman.

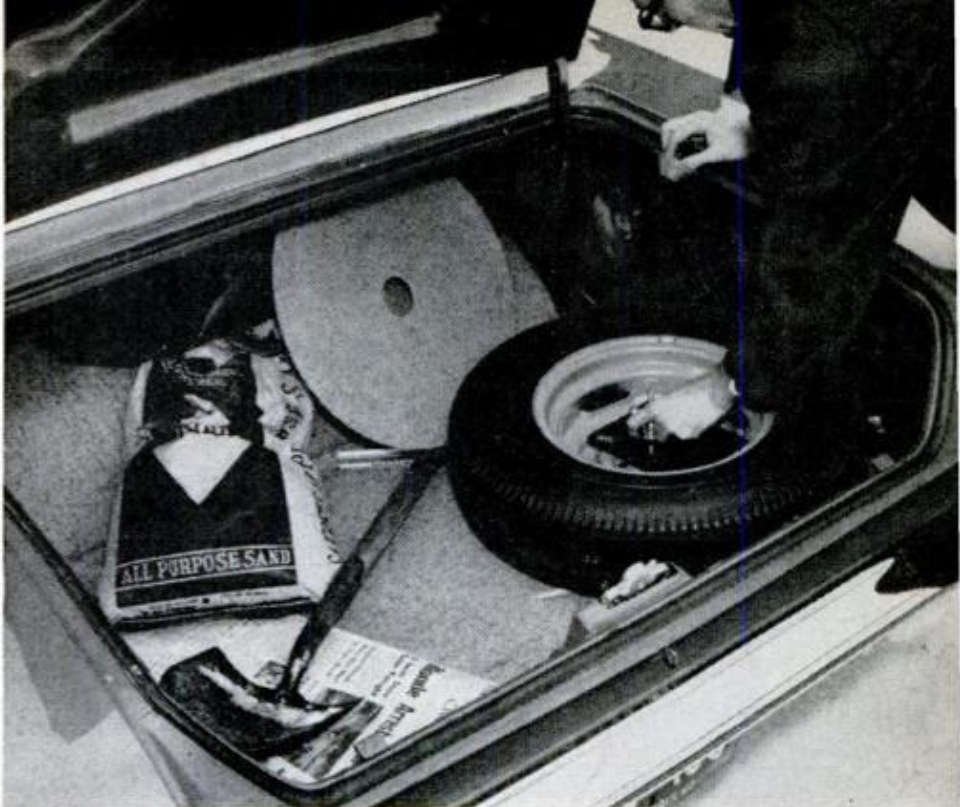
"It's got plenty of pep, even when pulling a 15-foot boat."—Texas businessman.

"When you want power you get it at once, especially ascending a hill or passing another car safely."—Pennsylvania supervisor.

◀ **REAR SEAT**, far left, of Buick Special convertible, like the coupe's, is comfortable, provides adequate, if not generous legroom for average-size adults

◀ **MOST OWNERS**, of all sizes, found Special's front seat, left, gave a comfortable driving position. Bucket seats, carpet were \$94 extra on PM's test car

PM, LIKE MANY owners, found traction poor on ice; used sand and shovel, right, more than once. Flat-mounted spare usurps space in otherwise roomy trunk



"It is neither underpowered nor overpowered."—Tennessee electrical engineer.

"The power and snappy pickup of this car is far above what I expected compared to my previous six-cylinder standard-shift 1960 Chevrolet. In short, I'm delighted."—Pennsylvania engineer.

"It rides better than my '59 Buick LeSabre."—Montana insurance agent/special deputy sheriff.

"I like its excellent ride—like that of a much heavier car."—Pennsylvania electrical engineer.

"It rides like a luxury car."—California machinist.

"It's by far the easiest riding, most comfortable of all cars I have owned (sedan)."—New York salesman.

"The over-all performance and roadability and the comfort of this car on the highway is amazing."—Indiana retiree.

"It is a very good road car. The seats are quite comfortable."—Maryland engineer.

"The coupe exhibits a fine compromise of performance, size, operating cost, and initial cost."—California designer.

"It's just the right sized car for my wife and me for two-thirds city travel, to market, etc., and an occasional trip."—New York engineer.

"The Buick Special has 'class.'"—Alabama librarian.

"The body lines are good."—Oklahoma retiree.

Unfortunately, we can always count on complaints; here's the first group of five, listed by frequency of mention:

"We don't seem to get the kind of mileage on the production car that you got (19.3-23.3) on your test, or that anyone else who tested it got."—Illinois purchasing agent.

"There's no crank on the front window vents and no ash tray in rear seat."—Alabama retiree.

"My father's V8 Special gets 22 m.p.g. I should get approximately 25 m.p.g., but get only 20 or less. While this isn't bad compared to other medium-size cars, it could be better."—Massachusetts chemist.

"Improve the vent on the gasoline tank; it's difficult to get a gas-station attendant to fill the tank."—New York salesman.

"A few spots were missed when the car was painted."—Maine banker.

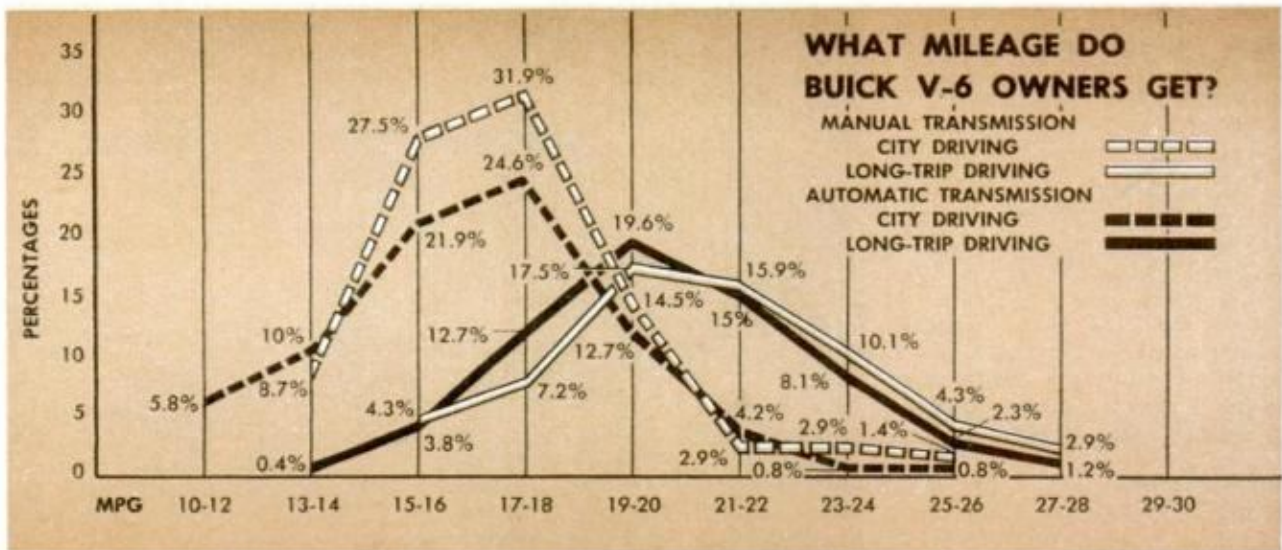
← **He's right; six out of ten Americans could live happily with a car of V6 Special's power-to-weight ratio**

← **Detroit's suspension engineers have really come into their own in the last 10 years. Now the small ones ride like big ones and the big ones ride like clouds**

← **We agree, but we'd still like to see that price a bit lower. The Special V6 could take a lot of play away from the Big Three compacts at the right price**

← **PM's previous test runs were made in mild summer weather with factory-tuned cars. Boy, were they ever well tuned!**

← **Some of this may be tune-up or carburetor maladjustment, but we'd be willing to bet that your right foot is heavier than your dad's!**



This is a penalty that you pay for a low-roofed car that makes space by dropping floor below door sills →

This is a design problem that should be remedied—and soon →

“The seat is too close to the steering wheel, and I bump my head when getting into the car.”—North Carolina laborer.

“There’s insufficient legroom, front and rear; it’s difficult to get into the driver’s seat.”—Connecticut management scientist.

“It’s too difficult to get in and out, especially of the rear seat.”—Ohio housewife.

“Although rattle-free, the doors are not a good fit.”—Georgia sales engineer.

“There is a gap all around the doors which is ¼ inch to ½ wide.”—Illinois instrumentmaker.

“The poor fit on doors allows cold air to enter.”—Pennsylvania foreman.

(Continued to page 204)

BUICK V6 OWNERS' RATINGS:

EXCELLENT 65.3% GOOD 29.4% FAIR 4.4% POOR 0.9%



Satisfied with automatic economy?	
About as expected.....	50.2%
Better	14.1
Not as good.....	35.7
Satisfied with manual economy?	
About as expected.....	47.0
Better	19.7
Not as good.....	33.3
Best-liked features	
Handling ease	61.1
Power, performance	43.5
Riding comfort	30.6
Size	24.7
Styling	23.5
Gas economy	18.2
Roomy interiors	12.6
Parking ease	10.9
Visibility	9.4
Most frequent complaints	
Poor gas mileage.....	9.1
Inferior paint job.....	6.2
Difficult entry/exit.....	4.4
Poor door fit.....	4.1
Poor workmanship.....	3.8
Fast, rough idle.....	3.5
Had mechanical trouble?	
No trouble	79.1
Some trouble	20.3
Considerable trouble	0.6
What was trouble?	
Manual gear shift.....	2.9
Carburetor	2.6

Best-liked exterior features	
Clean, smooth styling.....	18.3%
Paint finish	5.0
Sparse chrome	4.7
Front-end styling	4.4
Grille	3.8
Hood	3.2
Colors	2.1
Front fenders	2.1
Least-liked exterior features	
Bumpers	7.4
Trunk lock	5.9
Windshield	2.4
Protruding front fender points.....	2.1
Rear-end treatment	2.1
Best-liked interior features	
Dashboard	14.7
Upholstery	13.8
Comfortable seats	13.5
Legroom	5.6
Lowered transmission hump.....	2.9
Floor covering	2.9
Least-liked interior features	
Omission of small, "standard" items	23.8
Lack of headroom.....	7.7
Indicator lights	4.7
Considered another car in Special's price range?	
Chevrolet	19.3
Tempest	17.9
Olds F-85	15.2
Corvaire	12.5
Chevy II	10.8

Is Special only car in family?	
Yes, it is.....	60.5%
No, it isn't.....	39.5
Make of other car:	
Another Buick	10.8
Chevrolet	7.7
Other GM make.....	5.9
Ford	5.3
Other U.S. make.....	4.7
Foreign make	4.4
Plymouth	2.0
Decision to buy Special V6 based on:	
Size	67.6
Performance	57.5
Styling	44.7
Price	40.3
How is dealer service?	
Excellent	63.0
Average	31.8
Poor	5.2
Make of car traded in:	
Buick	23.8
Chevrolet	16.4
Other GM make.....	9.1
Ford	11.1
Other Ford Motor make.....	3.8
Plymouth	5.8
Other Chrysler Corp. make.....	6.1
Would buy another Special V6?	
Yes, would buy.....	85.3
No, would not buy.....	5.9
Undecided	8.8

BASED ON 1,161,525 OWNER-DRIVEN MILES



FAIRLANE STYLING makes a big hit with owners who like Thunderbird look, feel there's just enough chrome trim

Owners Find Ford's "In-Between" Fairlane Easy to Handle, Handsome, Sized Right

Marginal and boldface comments by Jim Whipple, PM's Auto Editor

FAIRLANE REPRESENTS a return to the two-car policy on the part of Ford Motor Company. Back in '57 and '58 Ford had a Custom series on a 116-inch wheelbase, with 202-inch over-all length; and a Fairlane, which was the "big" car with 118-inch wheelbase and 208-inch over-all length.

Today's Fairlane is the "little" car, with a 115.5-inch wheelbase on a 197-inch-long chassis, while its big brother, the Galaxie has a 119-inch wheelbase and stretches out to 209 inches.

A smaller version of the big Ford—the Fairlane of 1962—seems to have pleased a lot of repeat Ford owners who were waiting for a compromise package, bigger and more capable than the compact Falcon, yet smaller, more maneuverable and more economical than the Galaxie.

Fairlane's appeal to Ford and Falcon owners alike was

The '57-58 Custom was a very sensible size compromise. Ford dropped it in favor of the Fairlane-Galaxie of '59-61 when research indicated that people wanted a bigger "big" car

In effect they resurrected the '57-58 Custom-size category. Wonder what would have happened if they'd never dropped it?

LIKES

Maneuverability
Crisp, T-Bird styling
Practical, in-between size

DISLIKES

Disappointing mileage
"Bottoming" front end
Speedometer, shift troubles



MOST OWNERS of the new Fairlane like the driving position and feel that forward vision is good. They also appreciate the well-shaded instrument dials

It would be interesting to know what car these people would have chosen if Ford hadn't built Fairlane →

As we go to press Ford executives tell us the buying pattern has switched to 80 percent in favor of V8 engines—a wiser choice we think →

Ease-of-handling is partly a result of smaller size, partly due to nimble response to controls →

Fairlane's two-speed automatic is less efficient than three-speed automatics of some competitors; it puts engine and car at a disadvantage →

Our own choice of power teams would be V8 with overdrive, a combo that used to give over 20 m.p.g. on Ford V8s of 10 years ago →

Lower-than-expected mileage tipped us off to this production goof. It happens infrequently but owners with inexplicably poor mileage would do well to check out their axle ratios →

A totally new car purchased early in the year is like a play seen in its try-out run in New Haven—both have rough edges →

definitely indicated by the reports. Some 61.9 percent of all trades on new Fairlanes were either big Fords (46.2 percent) or Falcons (15.7 percent).

Equally evident is Fairlane's ability to win friends and favorably influence owners, 82.8 percent of whom declared that they would buy another Fairlane.

The majority of owners surveyed (67.4 percent) chose the six-cylinder, 101-horsepower engine in the deluxe "500" trim (69.4 percent). From their remarks it was clear that most owners were looking for economy in a well-finished, near "full-sized" package. This is reflected in the fact that 28.8 percent rated Fairlane's size as a best-liked feature.

One of the obvious advantages of Fairlane's near-to-compact size is maneuverability (ease of handling). This quality was rated as a "best-liked" item by nearly half of all owners responding (46.5 percent).

Figures (see fuel-mileage graph, page 81) show that Fairlane is reasonably economical. However the car did not live up to the mileage expectations of a number of owners (21.9 percent of manual transmission owners—40.8 percent of those having automatics). In passing it is worth noting that 70 percent of six-cylinder buyers chose manual transmissions, while 65 percent of V8 owners optioned automatic.

PM chose as its test car a V8 four-door with automatic transmission (before tabulating reports) on the premise that this new, small V8 would appeal to most owners as the compromise between performance and economy.

Unfortunately PM's car was equipped with an incorrect rear axle ratio (3.50 to 1 instead of 3.00 to 1). This meant that the engine was forced to run at a higher-than-efficient speed, thus using more fuel than necessary.

Results of constant-speed mileage tests as well as over-all mileage were accordingly disappointing and do not reflect the true potential of this engine-transmission combination.

19.5 miles per gallon at 30 m.p.h.

18.6 miles per gallon at 40 m.p.h.

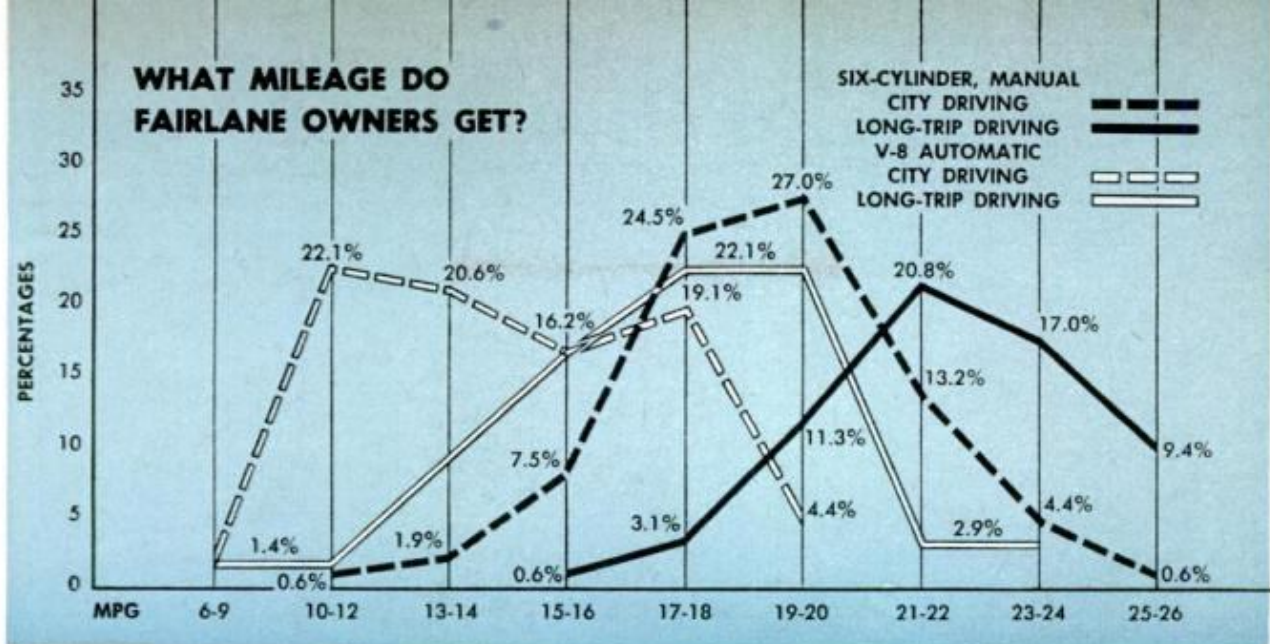
16.7 miles per gallon at 50 m.p.h.

15.2 miles per gallon at 60 m.p.h.

13.4 miles per gallon at 70 m.p.h.

Over-all mileage, including turnpike, country road and traffic was 15.9 miles per gallon.

As a brand-new car, it was expected that Fairlane would have some faults—and it did. However, it wound up with a fairly good over-all rating from owners, 58.4 percent of



whom rated it "Excellent" while 34.1 said that it was "Good." Less pleased were 6.6 percent who rated it "Fair." However, a creditably small number turned thumbs down (0.9 percent) and called it "Poor."

Now let's get to the owners' shakedown of the new Fairlane; here are the first five best-liked features in the order of frequency of mention.

"The car is easy to handle for city driving and parking."—Ohio insurance agent.

"Riding and handling are excellent for a light car."—California service manager.

"It's a bit light, but handles well. About the right power for weight and size."—New York salesman.

"Handles like a baby carriage when steering or parking."—New Jersey printer.

"I like the T-Bird roof styling."—New York parts manager.

"I believe it has the best looking body style that Ford ever put out."—Virginia electrician.

"The roof styling gives so much more headroom than some cars."—Kentucky carpenter.

"I like its size—between compact and big car."—Indiana letter carrier.

"It is small enough for my wife to handle and still is big enough to haul my four-man survey crew."—Wisconsin highway engineer.

"It's more economical than a larger car and roomier than smaller ones."—Kentucky mason.

"It has the advantage of a compact but handles like a regular-size car."—Georgia executive.

"I like the interior roominess yet absence of exterior bulkiness."—Pennsylvania sales manager.

"I like the economy (20 m.p.g. over-all) with family-size room. It should do 25 m.p.g. when broken in."—Wisconsin farmer.

"Driving from 350 to 500 miles per week on all types of rural roads, I find it comfortable with cost of operation low. It averages better than 20 miles per gallon (six-cylinder, manual shift)."—South Carolina housewife.

"I like the room—I am 6 feet 2½ inches and cannot drive a conventional Ford or Chevrolet."—Michigan engineer.

"It has roominess without sacrificing economy."—Texas salesman.

"It seats six adults comfortably."—Washington industrial engineer.

Wife of PM's Auto Editor rated Fairlane as easy to get around in as a pair of ballet slippers

The Six that PM checked out last fall was a bit "light" in vigorous crosswinds, but V8 felt about right in similar gales

Fairlane is styled to be pleasing, not exciting. It will not look desperately dated five years hence

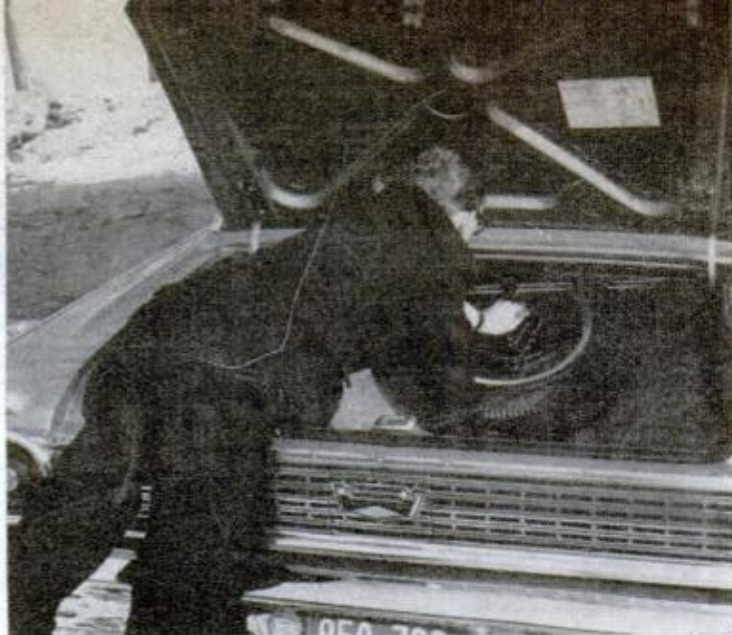
We'll go out on a limb and bet that in five years a majority of under-\$3000 cars will be Fairlane's size

She's getting the kind of economy Fairlane's intended to deliver, but we wonder who's watching the stove?

We think Fairlane was designed in reaction to owner complaints on lack of headroom in '57-'59 Fords



THERE WERE some complaints about the "step-down" floor, few on entry-exit problems



ROOMY TRUNK is a chore to load; cargo must be lifted over high rear panel. A real stretch is required to reach spare

Could be that he's got another rear axle with goofed-up ratio →

But, everything didn't come up rosy for all owners; here's a list of the first five complaints in their order of mention.

"The gas mileage leaves something to be desired for six-cylinder, straight shift, with manual choke."—Illinois radio technician.

"Indications are that mileage is going to be poor. My six-cylinder averages about 13 miles per gallon, less than my '57 Fairlane with 295-hp. motor."—Ohio tool and die maker.

"The V8 stick shift 145 over-all gets very poor gas mileage for such a small car. Normally on other cars, I get 3-4 miles per gallon better than average."—Maryland Defense Department analyst.

(Continued to page 194)

FAIRLANE OWNERS' RATINGS:

EXCELLENT
58.4%

GOOD
34.1%

FAIR
6.6%



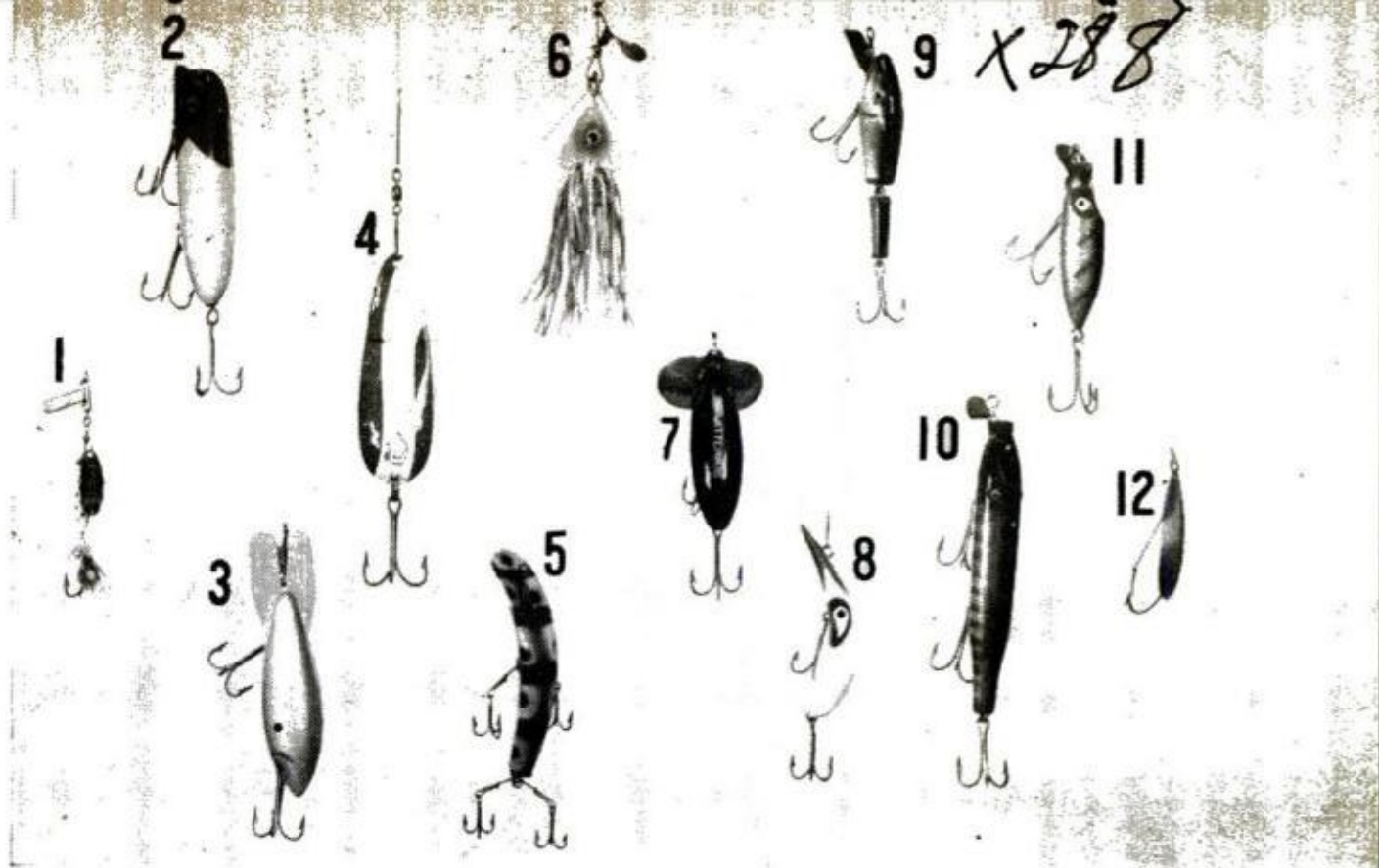
POOR
0.9%



Satisfied with automatic economy?	
About as expected.....	45.6%
Better	13.6
Not as good.....	40.8
Satisfied with manual economy?	
About as expected.....	53.4
Better	24.7
Not as good.....	21.9
Best-liked features	
Handling ease	46.5
Styling	37.1
Size	28.8
Gas economy	24.3
Roominess	22.3
Riding comfort	21.4
Power, performance	14.5
Easy to park.....	10.1
Most-frequent complaints	
Poor gas mileage.....	6.5
Weak front suspension.....	5.6
Slow, stiff manual shifting.....	5.5
Manual gear ratio requires too much shifting.....	5.0
Speedometer ailment	3.6
Rattles and squeaks.....	3.3
Trunk hard to unload.....	3.0
Had mechanical trouble?	
No trouble	69.1
Some trouble	27.9
Considerable trouble	3.0
What was trouble?	
Speedometer troubles	3.6
Carburetor troubles	3.0
Automatic transmission troubles.....	3.0

Best-liked exterior features	
Clean, uncluttered appearance.....	9.8%
Chrome trim	8.0
Large trunk	4.4
Paint finish	4.1
Colors	4.1
Roof line	3.6
Windshield wipers	3.0
Front-end treatment	2.1
Square, straight body lines.....	2.1
Least-liked exterior features	
13-inch wheels, tires.....	8.6
Grille	3.0
Rear-end treatment	2.7
Hood latch	1.5
Bumpers	1.5
Ribs on hood throw water.....	1.2
Best-liked interior features	
Upholstery	24.6
Comfortable seats	14.8
Dashboard, instrument panel.....	14.5
Headroom	4.4
Ash tray	3.6
Floor covering	3.2
Least-liked interior features	
Transmission hump	7.4
Recessed floor walls.....	5.9
Uncomfortable seats	5.3
Considered another car in Fairlane's price range?	39.2
Chevrolet	22.7
Ford	5.3
Plymouth	4.5
Dodge	3.8

Is Fairlane only car in family?	
Yes, it is.....	63.5%
No, it isn't.....	36.5
Make of other car:	
Another Ford	14.5
Other Ford Motor make.....	5.3
Chevrolet	7.4
Other GM make.....	4.7
Plymouth	2.4
Other Chrysler Corp. make.....	1.5
Other U. S. make.....	1.5
Foreign make	1.8
Decision to buy Fairlane based on:	
Size	68.2
Economy	61.7
Styling	53.4
Performance	39.5
How is dealer service?	
Excellent	58.2
Average	34.2
Poor	7.6
Make of car traded in:	
Ford	46.2
Other Ford Motor make.....	15.7
Chevrolet	8.3
Other GM make.....	7.4
Plymouth	5.6
Other Chrysler Corp. make.....	2.7
Other U. S. make.....	1.5
Foreign make	2.3
Would buy another Fairlane?	
Yes, would buy.....	82.8
No, would not buy.....	6.2
Undecided	11.0



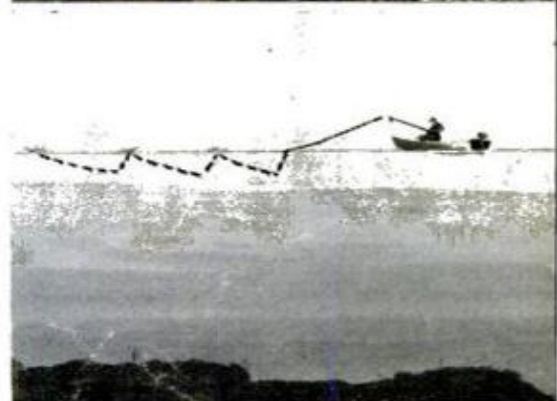
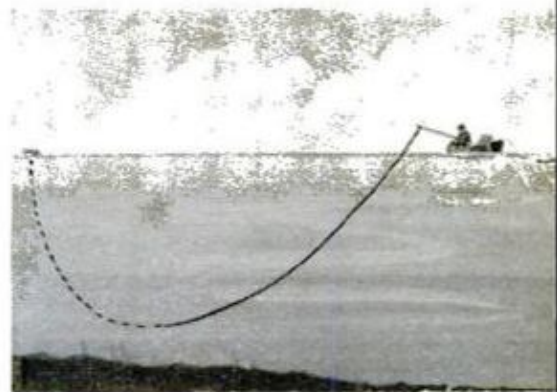
Fishing's Deadly Dozen

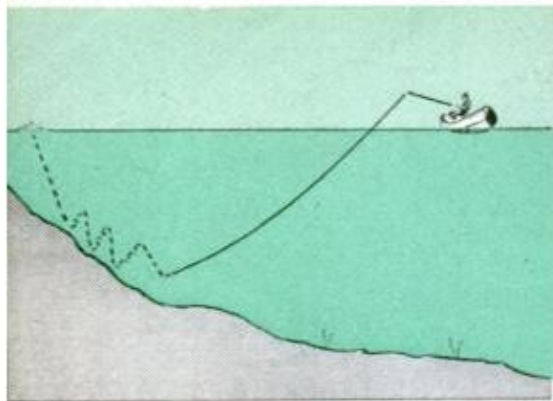
By Dick Kirkpatrick

FISHING LURES come and go, but a few—the great ones—go on forever. When PM polled a panel of experts for nominations for our list of all-time greats, they surprised us by agreeing on almost all the lures. But more important, almost all reported that most fishermen not only don't fish the lures right, but won't read the instructions in the box, either. Here's their list, in alphabetical order, with their tips for fishing them . . .

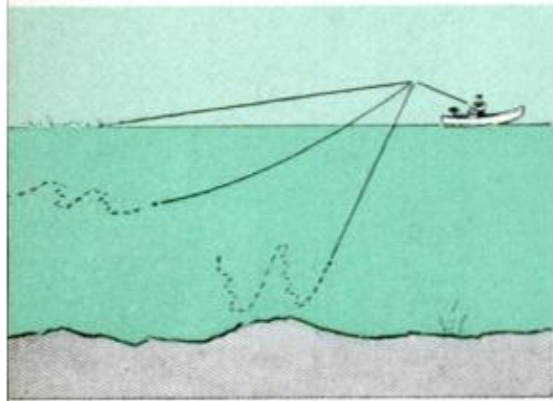
1. THE ABU REFLEX SPINNER is the newest lure on the list at five years old, and the only import. It comes from Sweden through the Garcia Corp. of New York City. The quarter-ounce model shown, with a chrome blade and white body with black spots, is the most popular. Seven other models come in 10 other combinations. The weedless-hook model shown is a good idea, since spinners are notorious snag-finders. The keel ahead of this lure isn't standard equipment, but helps avoid line twist, though later Abus have a new nontwist eye. Best tip: Fish the Abu just fast enough to keep the blade spinning, and use the "slow roll" method illustrated to cover all depths until you find the fish, then control depth with reeling speed.

2. THE BASS-ORENO is the oldest (60 years) and probably best-known of the PM team. It is now made by South Bend Tackle Co., of Chicago, in four sizes from $\frac{5}{8}$ to $\frac{1}{4}$ ounce and in seven finishes. But the original size and style shown—a $\frac{5}{8}$ -ounce bait-casting size with a red head and white body—is still considered best. Designed as a floating-diving wiggler for bass and northern pike, the lure is still at its best for those species, but has spread to all kinds of shallow-feeding game fish; it's even trolled in the Gulf Stream for big pelagic species. Best tip: By using a reel-pause retrieve, you can make the Bass-Oreno dive and bob near the surface to imitate a struggling, injured baitfish; the method is especially effective over submerged weeds.

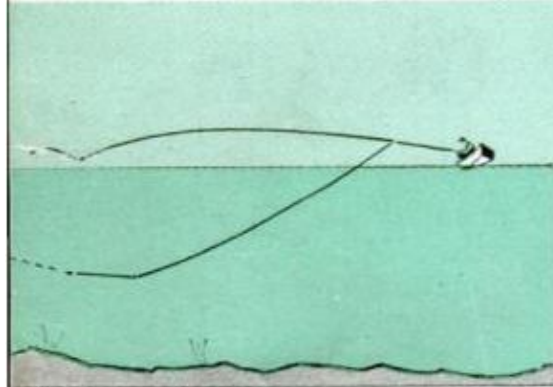




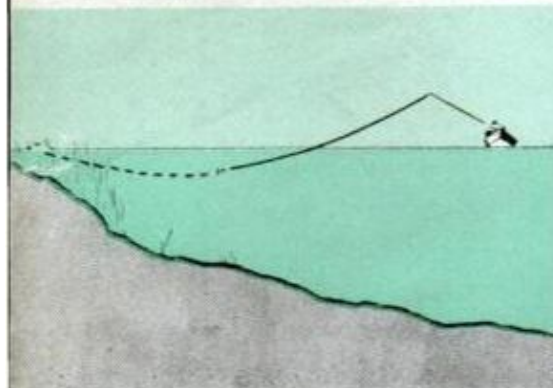
3. THE BOMBER, made by The Bomber Bait Co. of Gainesville, Texas, was designed for a specific type of fishing—bottom bouncing down the precipitous dropoffs in southern artificial lakes for smallmouth bass and walleyes. But it has become the hottest thing in deep fishing everywhere. The big $\frac{3}{4}$ -ounce silver-white shad model shown has been most popular, but the line offers five sizes in 33 finishes. All but the quarter-ounce spinning size are deep-diving floaters; they dive so sharply that you can reel them under your own boat. Best tip: Bounce the Bomber down slopes as illustrated with a reel-pause retrieve. The diving bill protects the hooks from snags.



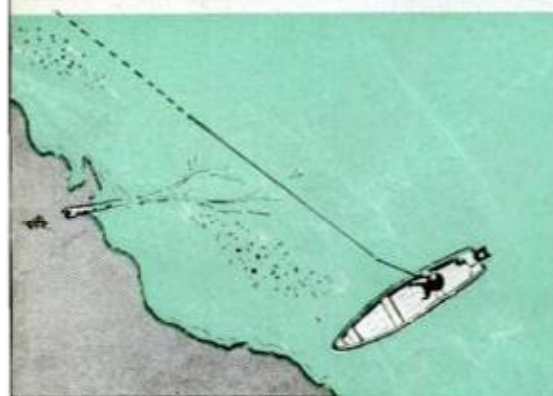
4. THE DARDEVLE, made by the Lou J. Eppinger Co., Dearborn, Mich., was the first metal spoon to be designed for casting as well as a fish-catching action, and is indisputably the most imitated lure in the business, but has a reputation for outfishing most spoons. Most popular model in its 50-year history is the familiar red-and-white one-ounce style with nickel plating on the inside, but there are 22 other sizes and styles in 35 finishes. Best trick is built right into the lure—it can be fished in a variety of ways to get different actions. Three good variations are illustrated; a fast skittering retrieve on the surface, a reel-and-pause retrieve, and a jigging action near the bottom.



5. THE FLATFISH, developed in 1933 by the Helin Tackle Company of Detroit, is perhaps the most unlikely looking of lures—but probably the biggest seller. Its wild wobbling action is unmatched anywhere; its tiny hooks on spreader bars make it a fine hooker. And almost everyone fishes it wrong. The Flatfish should **never** be fished with a snap between lure and line, and should **always** be fished with a weight about a foot ahead of the lure. It makes casting tricky—unless you learn to stop the cast and let the line straighten out as illustrated. We show the “U-20” model in a green frog finish; it’s probably the most popular, but there are 21 models in all, in 27 finishes.

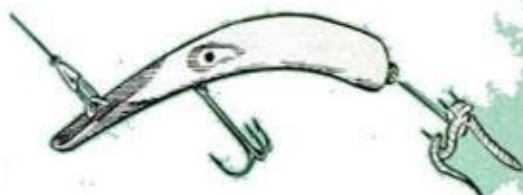


6. THE HAWAIIAN WIGGLER, made by the Fred Arbogast Co., of Akron, Ohio, was one of the first really weedless lures made to be fished right in the weeds for shallow-feeding bass and pike. The combination of spinner, wobbling body, and wiggling skirt has kept it popular—and effective—for around 30 years. The Number Two Wiggler, shown, isn’t the oldest, but is the most popular in this $\frac{5}{8}$ ounce size with a red and green body and black and white “hula skirt.” There are 10 other models, available in six finishes. Best trick: A second hook, trailing behind the main hook, for short-striking fish; the manufacturer now supplies a special add-on hook with each lure.



7. THE JITTERBUG, also made by the Arbogast Company, is a double-purpose surface lure. The Jitterbug is intended for a slow, steady crawling retrieve, but also works well as a surface popper. Most popular model with our experts is the $\frac{5}{8}$ -ounce black model shown; it’s also available in four other sizes in nine finishes. It’s been a top-selling surface lure for over 15 years; our experts agree it’s because it doesn’t require the poppers’ maddening wait after the cast, before the retrieve. Best trick: Fish it along weeds **parallel** to shore to keep it in productive water through the entire retrieve. Reel about three feet, pause for a few seconds, then reel again.

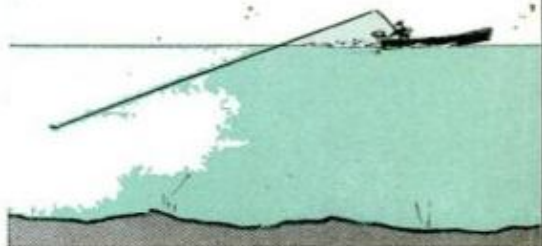
8. THE LAZY IKE, made by Lazy Ike Corp., of Fort Dodge, Iowa, was developed by the Kautzky Sporting Goods Co. in the early forties. It's a "sharp" wiggler with an unusual capacity for working at any speed, became quickly popular with Minnesota trollers, especially for walleye, and spread from there. Most popular size and finish has been the $\frac{3}{8}$ -ounce red and white model shown, but similar models come in seven sizes and 12 finishes, plus a good-looking new line of nine metallic finishes. Two good tips: **Always** fish the Lazy Ikes with a metal snap between the line and lure, and try a worm or a plastic imitation on the rear hook to encourage slow strikers.



9. THE L & S MIRROLURES, made by the L & S Bait Co., of Bradley, Ill., were the first to use the reflective qualities of metallic materials inside clear plastic, and have been very popular, especially in their jointed-minnow models like the half-ounce, black-white-and-silver scale model shown. Their excellent built-in action imitates a live minnow with surprising realism; the slow-sinking plug can be adapted to many retrieving speeds simply by bending the diving lip—forward for a shallow, fast wiggle; back for a slower, deeper action. With the bottom barb taken off both hooks, the lure can be made to crawl along the bottom like a feeding minnow.



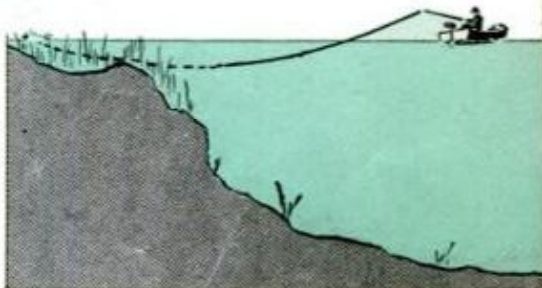
10. THE PIKIE MINNOW, made by The Creek Chub Bait Co., of Garrett, Indiana, is another old-timer; it was developed from a customer's suggestion fifty years ago. Its slow, wobbling action was designed for the big northern species—bass, pike, muskies and lake trout, and it holds the world record for largemouth bass and muskies. The $\frac{3}{4}$ -ounce straight-body floater, in the familiar "pikie" scale finish, leads the line, but the lure is also made in a dozen other sizes from $\frac{1}{8}$ ounce to 4 ounces, and 17 finishes. Best tip: One nationally-famous muskie fisherman gets his big ones by trolling a jointed Pikie Minnow as fast and deep as possible—at night!



11. THE RIVER RUNT, made by James Heddon's Sons, Dowagiac, Michigan, was developed from the Heddon Vamp Spook, the first plastic lure. Basically a sinking fast wobbler, it also comes in nine other styles, including floating and deep-diving models, from $\frac{1}{4}$ to $\frac{5}{8}$ ounce, in eight finishes. The $\frac{3}{8}$ -ounce Midget River Runt is the most popular size; red and white, yellow, and the perch scale (shown) the most popular finishes. Best tip: Mass-produced lures (of any brand) vary a bit from lure to lure in effective retrieving speed. Since the most violent wobble is most effective, Heddon recommends testing each lure's action to make sure you're retrieving at that speed.



12. THE SILVER MINNOW, made by Louis Johnson Company of Highland Park, Ill., was the source of the old story of the fisherman who made lures from his wife's teaspoons until she caught him at it and forced him to forge his own. The little spoon is probably the most weedless lure on the market, and the best hooker among guarded-hook models. The lure is made in six sizes, from $\frac{1}{24}$ ounce to $1\frac{1}{8}$ ounce, and in nine finishes. By far the most popular is the $\frac{1}{2}$ and $\frac{1}{4}$ -ounce silver-plated model. Best fished with a bass-sized pork rind strip, the Silver Minnow is becoming popular in the South with a four or six-inch plastic worm trailer, fished slow and deep.





Tiptoe Through the Oyster Shells

Farming oysters, which take up to five years to mature, is a delicate business. In transplanting and harvesting, a mechanical

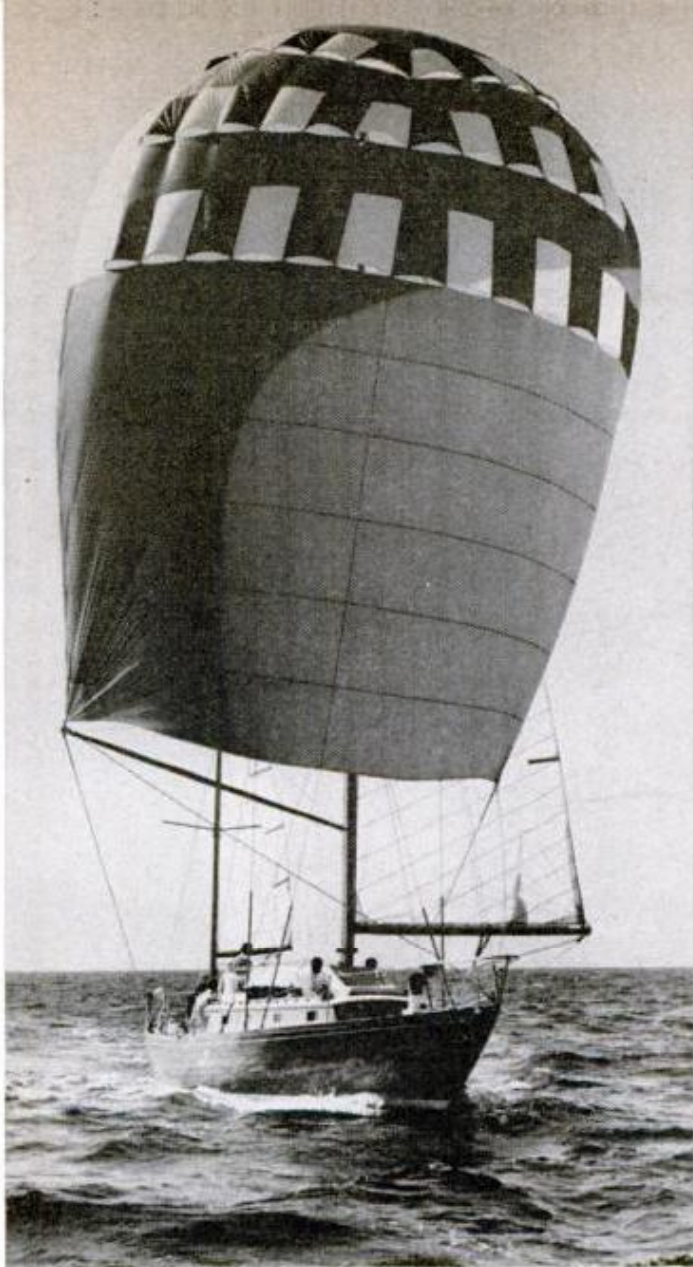
picker is pulled by a tractor which uses four-foot-high, soft tires that run over the oysters without crushing them.

Roof-Top Water Supply for Travelers

Built to ride on top of a car or station wagon, a Neoprene-coated nylon bag holds 14 gallons of water, enough for four per-

sons for a week. The water runs out by gravity from an attached hose. Price is \$14; Field Products Co., Mount Carmel, Ill.





High-Speed Racing Sail

Tremendous lift and driving power are built into a new Venturi spinnaker for racing sailboats, based on the new French Parachute Lemoigne (PM, March '62, page 114). Three rows of transverse slots across the top of the sail direct a downward air flow ahead of the sail. The flow reduces knockdown on a close reach, increasing the boat's speed. It's made by Ratsey & Laphorn, Inc., City Island, N. Y.



Batting Shirt

Worried about injuries to young baseball players, a Baton Rouge, La., mother has designed and patented a protective half-shirt for youngsters. The shirt, padded like a catcher's chest protector, withstands the fastest pitched balls but does not impair the batter's swing. The inventor is Mrs. M. J. Doughty.



Trigger for Arrows

Pistol grip for archers gives even beginners a smooth arrow release and a strong, steady pull. Made of durable plastic, the releasing assembly holds both bowstring and arrow securely; the arrow cannot be released unless the trigger is pulled. The hand-grip takes the pressure off the archer's fingers, and the trigger mechanism assures a consistent, true release on every shot. It's made by Brittain Products, Cuyahoga Falls, Ohio.

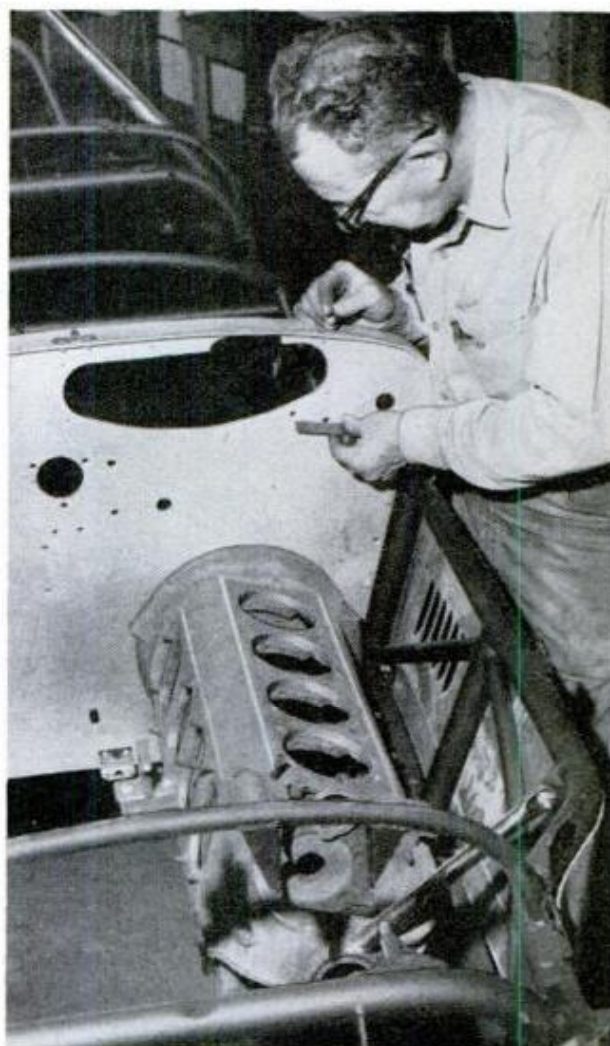
Is the Indy Race in a Rut?



The critics say the cars are too much alike, the rules need changing and that Indy is a proving ground that doesn't prove anything. Are these fair judgments?



FLIPPING INTO AIR during the race last year, Jack Turner was saved by seat belt-shoulder harness rig



ENGINE, gear box, drive shaft on typical Indy car are offset to left to help on track's left turns

← **STOCK CAR RACE?** In this flying start of last year's 500, cars look alike but differ. This year will see more variety, including (if they qualify) a gas turbine and rear-mounted Buick Special V8s

IS THE INDIANAPOLIS RACE overdue for a change? Some people who know the sport are saying so.

"Pure Dullsville," is the way one automotive expert described Indy. "It's a beer festival for low-IQ service station hangers on. The basic race has become as formalized as an 18th century minuet, and usually about as uninteresting. The formula: Take a group of carbon copy Meyer-Drake-engined cars, stuff them with fearless, well-coordinated boys, and let them go round in a circle until something goes wrong . . . the crowd loves blood."

The complaint that Indy race cars are too much alike is echoed by others in the sport. As a result, they feel that the "500" can no longer lay claim to being the proving ground for the motor industry it was

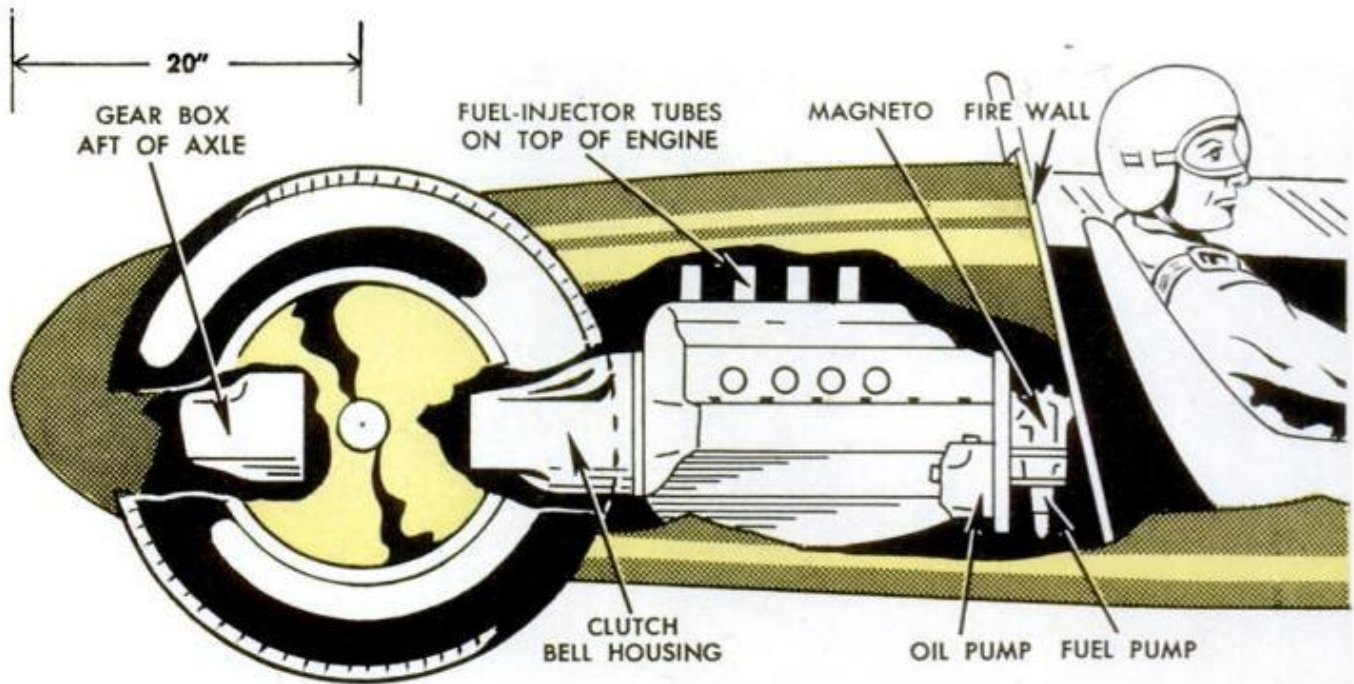
once reputed to be. Still others maintain that Indy never did do much proving—either of automotive innovations or driving skill.

Some race-car builders are grumbling because the rules haven't changed in six years. They think it's high time to call for smaller engines that would allow Indianapolis cars to compete in international Grand Prix racing events.

Recently, these complaints were tossed at Sam Hanks and he snorted at them. Sam is director of racing at the Indianapolis Motor Speedway and a former winner of the Memorial Day Race.

"Engine specifications will not be changed before the 1965 race, if then," he said firmly. "The present rules are very broad. Non-supercharged engines are limited to no

Two New Ones for the Brickyard



A Mickey Thompson Rebored Buick Special V8

more than 256.28 cubic inches of displacement, or 170.8 cubic inches if supercharged. Diesels are limited to 335.61 cubic inches. There is no limitation on the size of gas-turbine power plants.

"Sure, I know that an owner usually installs as powerful an engine as the rules allow, but he doesn't have to. If he sees an advantage in a smaller engine, he's free to use one!"

In recent years, few owners have. A notable exception was the unblown 167-cubic-inch Cooper-Climax power plant driven to a 9th place finish by Jack Brabham last year.

Have most of the cars entered been alike? Actually, no two have been identical twins, but the family resemblance of essential ingredients has been remarkable. One of the favorite basic combinations for several years has been a Meyer & Drake four-cylinder racing engine in a Watson or Kurtis chassis. Of course, by the time the owners and chief mechanics incorporated some of their pet ideas, each car began to assume some individual characteristics. Differences in gear ratios, bores and strokes, and various ways of powering fuel pumps testified to the tinkering creativity of the owners and mechanics.

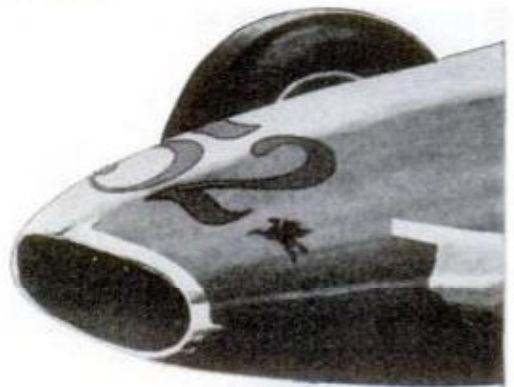
New Day Dawning at Indy

There are signs, though, that this year may bring an abrupt end to the general over-all similarity in cars, that—rules

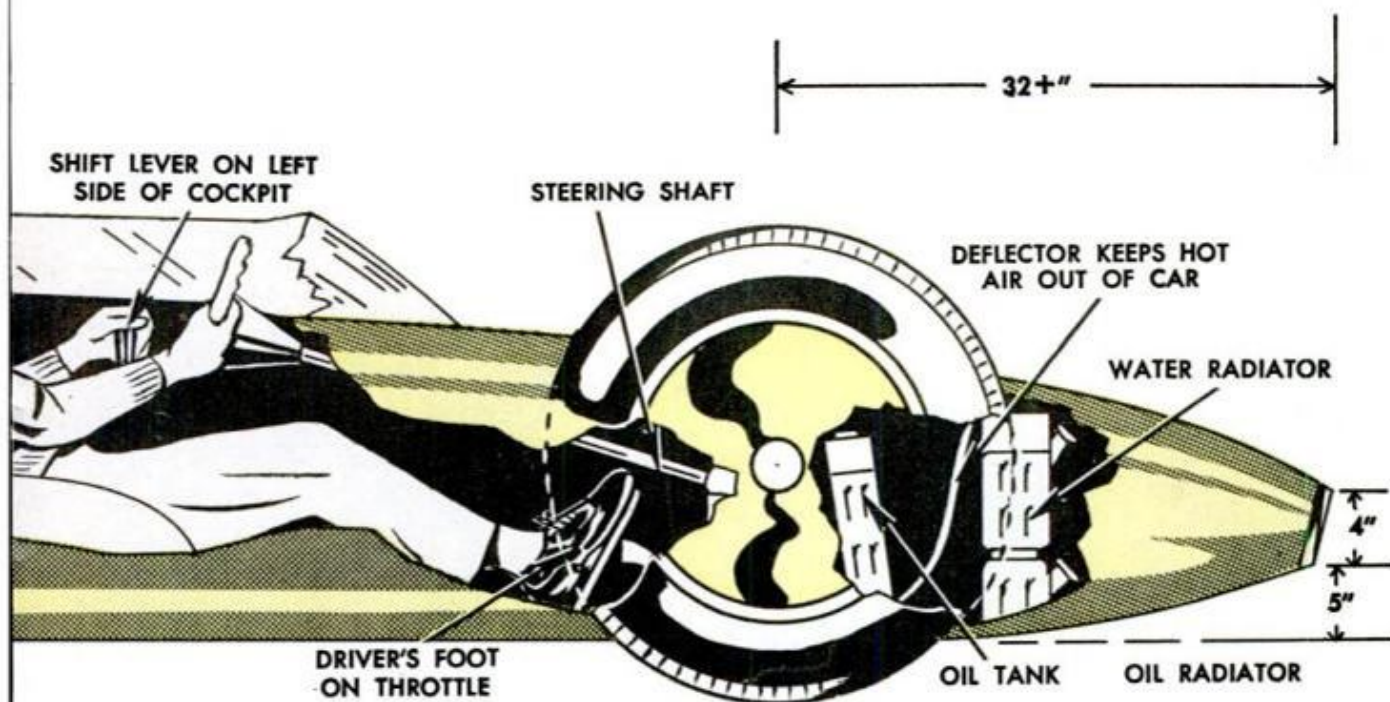
changes or no—the "stock car" accusation leveled at Indy may become passé.

A gas turbine car, others with Buick power plants, others with superchargers, some with engines mounted in the rear have all been built for this year's race. And—perhaps inspired by Brabham's experience last year—there's a distinct trend to lighter cars which give a better power-to-weight ratio. In the past, most owners have had their doubts about whether a light car would take high-speed punishment for 500 long miles and not break down. So they played it safe and their cars averaged 1600 lb. dry weight. Yet, with few exceptions, this year's flock of new

A Gas Turbine Entry From Jack Zink



This Year



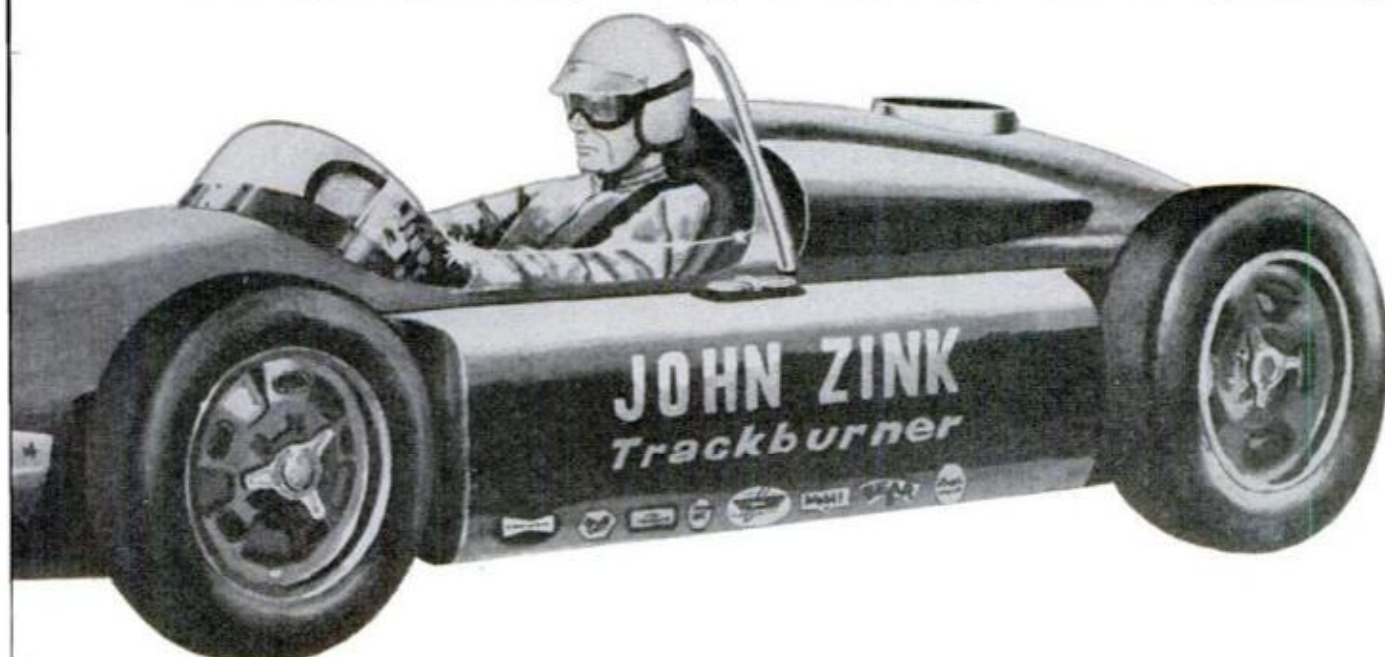
entries will weigh considerably less. Two builders are shooting for a dry weight of under 1100 lb.

One of these super-lightweight exponents is 33-year-old Mickey Thompson who has driven a car faster than any other human (406 m.p.h. one-way at Bonneville). Thompson will not drive in the race but he has built three new Indianapolis cars, one for himself and two for other owners. Except for the frame, coil springs, gears and shafts, each consists almost entirely of lightweight metals.

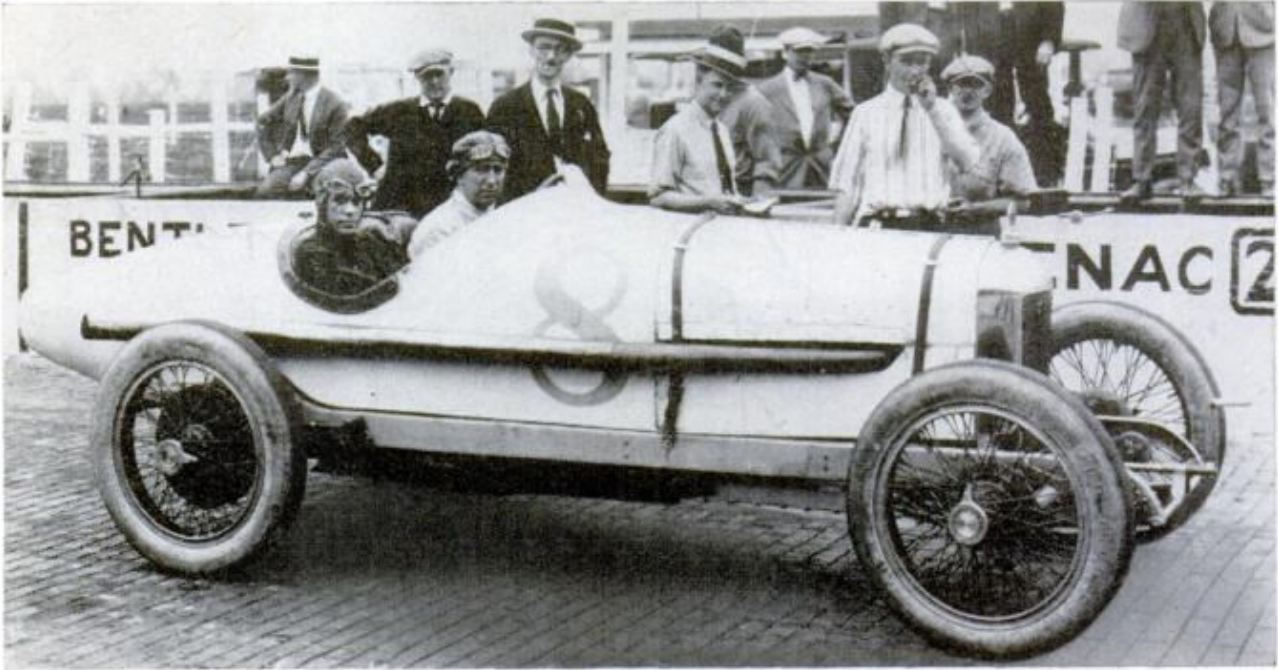
The Thompson cars are each powered by

a rear-mounted compact aluminum Buick Special V8, bored out and stroked to 256 cubic inches and developing 330 hp. at 7500 r.p.m., on alcohol plus a small fraction of nitromethane. (Advertised horsepower of best 215-cubic-inch stock version of this engine is 190 b.hp.). Aluminum fuel tanks are positioned on each side of the cockpit, at the center of balance, so that the car's handling characteristics remain the same when the tanks are full or almost empty.

Such engine parts as connecting rods, rocker arms and lifters are of forged aluminum. (Thompson has been experimenting



Four Significant



1922—The first four-wheel hydraulic brakes at Indianapolis were on this two-man car that won in 1922. Its average speed was 94 m.p.h.



1938

Team of these rear-engine, four-wheel-drive cars was beset by woes and the idea has not been tried since then

with forged aluminum crankshafts but will not use them this year.) Magnesium is used for the transmission and rear end cases and for the wheels. The cars have aluminum and magnesium skin panels. In his quest to get the weight down, Mickey is using titanium disks instead of steel for the spot brakes. The new brakes save four pounds per wheel.

The Thompson cars have a wheelbase of 96 inches, a tread of 52½ inches, and an over-all length of 135 inches. The top of the driver's shoulder is 25 inches from the ground. The driver and engine are offset 1½ inches to the left of the center line to get the weight over to the left, and the entire chassis can be moved to the left or right of center line in relation to the wheels.

Another all-out exponent of light weight

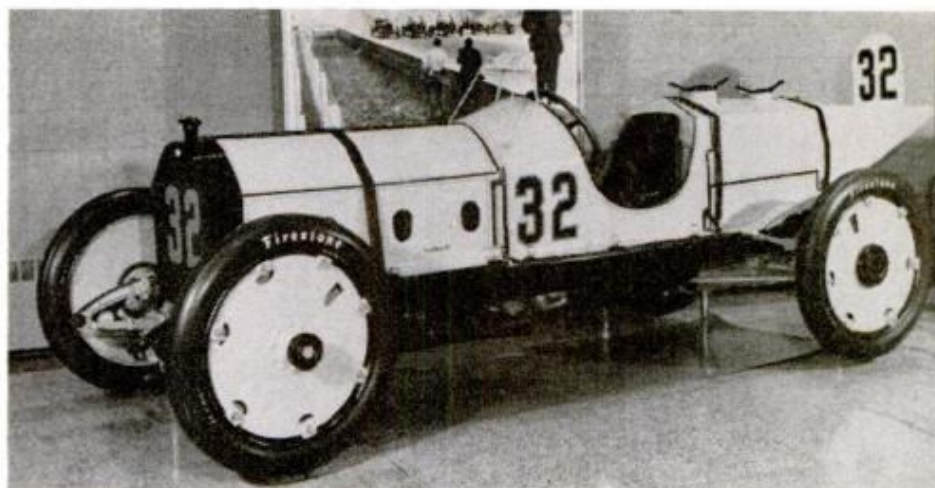
this year is Jack Zink, head of the famed John Zink racing team of Tulsa. His approach is radical, a car powered by a Boeing gas turbine, mounted behind the driver and geared to the rear wheels. The engine is 42 inches long and weighs only 335 lb., yet develops 350 hp. on low-grade fuel.

In the past, the big objection to a turbine as a racing power plant was its poor acceleration. In the Zink entry this is solved by ingenious engineering that allows the turbine to rotate at a constant 39,000 r.p.m. The driver's foot throttle is not connected to the fuel control; instead, it operates a "waste gate" that is installed just forward of the power stage of the turbine. When the driver presses the throttle he closes the waste gate, channeling the hot burner gases to the power turbine. When he releases the

Old-Timers

1911

First Indy winner was this Marmon with 447-cubic-inch engine. Its average speed was 74 m.p.h.



1925—This Duesenberg Special was the first winner to utilize balloon tires, in 1925. Its average race speed was 101 m.p.h.



throttle, the gate opens and the gases are exhausted into the air. This arrangement is supposed to allow maximum torque to be available at all times.

Arnold Maremount, Chicago muffler manufacturer, is readying a car powered by a modified Chevrolet V8 engine and equipped with special air-cooled drum brakes.

Ever since the 1941 race when neither car was ready at qualifying time, the Novi team has been one of the big threats at Indianapolis. Heavier and with almost twice the power of the other cars, the Novis have possibly been the fastest at the track but never won a race. Year after year, the team was dogged by mechanical failures or wrecks. The team no longer exists and the cars have been retired, but stemming di-

rectly from them are two new cars that are being readied for the race by the Paxton Products team. Each, as were the Novis, is powered by a supercharged V8 developing 500 or more hp. Each engine weighs some 700 lb. and is mounted seven inches to the left of the center line. The dry weight of each car is around 1800 lb., yet because of the enormous power, the power-to-weight ratio remains excellent.

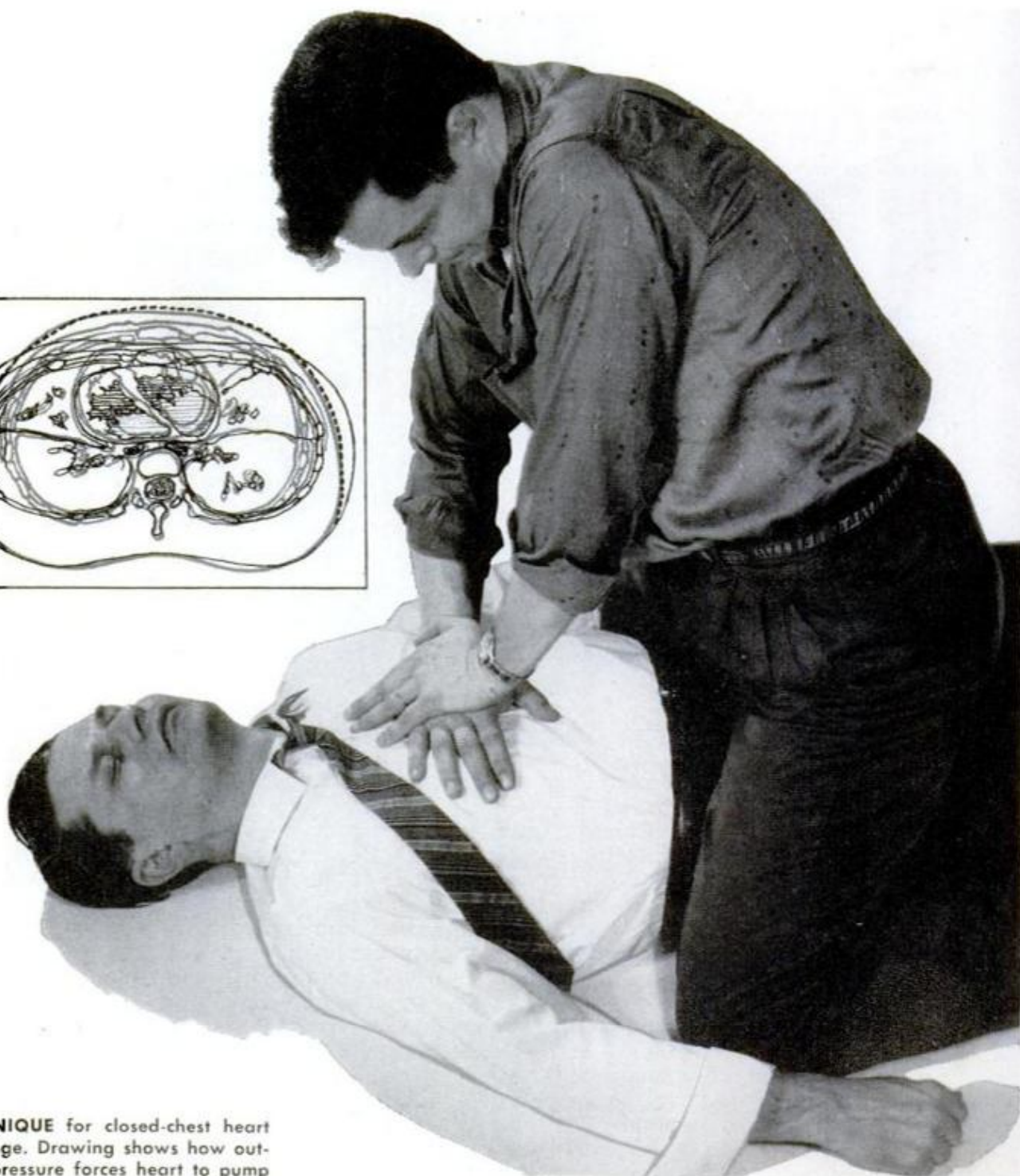
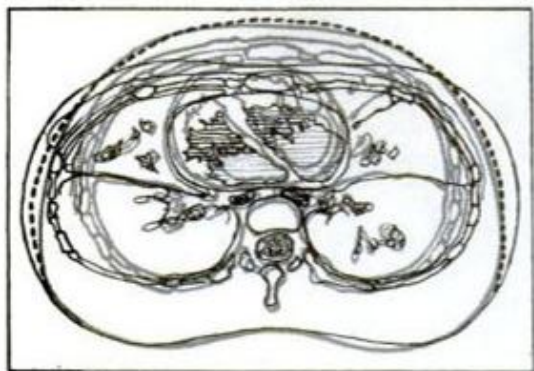
The mounting of the Thompson and Novi engines off center to the left follows one of the trends at Indy in recent years. Because it helps shift much of the car's weight to the left wheels, it permits higher speeds on the track's four left turns—one reason for new speed records in recent years.

This "left-handed" preoccupation at Indy
(Continued to page 182)

What can you do when someone collapses with a heart stoppage or asthma attack? You only have about four minutes after his heart stops before he'll be dead or injured beyond repair. There is an approved way to help him.

BE READY TO SAVE A LIFE

By Paul W. Kearney



TECHNIQUE for closed-chest heart massage. Drawing shows how outside pressure forces heart to pump

ON THE EVENING of November 20th last year, Capt. William E. Moberley, a USAF officer, read an article in a service publication on "external cardiac massage." At 3:15 next morning, he used his brand-new knowledge to save the life of his next-door neighbor.

Awakened by the screams of his neighbor's wife, the Captain rushed over to be told hysterically that the husband was dead. Prostrate on the bathroom floor, with no heartbeat, no respiration, and the gray-blue pallor of cyanosis already tinging his cheeks, he certainly looked gone.

The Captain, a Supply Officer at Hickam Air Force Base, Honolulu, recalled what he had read the night before. He instructed the distraught wife to phone for an ambulance; then he rolled the victim on his back on the floor and went to work. He placed his hands on the victim's breastbone. Then, using a firm, quick thrust, he pushed the unconscious man's chest down about an inch, and quickly released it. In a rapid cadence, the movement was repeated.

Moments dragged by and nothing happened. But through Moberley's mind raced the article's admonition: Don't quit until rigor mortis sets in." So he kept going. Then, almost imperceptibly, the still heart seem to stir. The faint beat persisted. So the rescuer kept on—for 45 minutes before an ambulance finally arrived to transport the patient to Leeward Hospital. With pulse and respiration re-established by the first-aid work, medical treatment kept him going even though he didn't regain consciousness for another 12 hours. The lucky man was discharged a week later and returned to his job. According to Dr. Howard Lilijestrand, hospital director, he owes his life to the intelligent action and physical stamina of a neighbor.

That is "closed chest heart massage" in action, newest thing in resuscitation and the first effective weapon that any layman can use in cases of heart standstill. In 10 months, the men of the Baltimore Fire Department's Ambulance Service have used it successfully in 14 out of 18 emergencies. These men are not even internes; they are only trained first-aiders.

The method is so logical that it holds significant life saving potential even in untrained hands. It was developed at Johns Hopkins Hospital through years of research and experiment, and was reported in the *Journal of the American Medical Association* in July, 1960, on the strength of 44 successes in 56 cases of heart arrest. This report observes: "The method of closed chest cardiac massage . . . is simple to apply; it is one that needs no complex equipment. Only the human hand is re-

quired. . . . Its real value lies in the fact that it can be used wherever the emergency arises . . . in or out of a hospital."

Here are the basic steps in the simple procedure:

1. Lay the patient on his back on a firm support, such as a floor or a table. A bed is too soft and should not be used.

2. *It is imperative to tilt the victim's head well back so his chin is pointed toward the ceiling.* This keeps the windpipe free from obstruction by the tongue, which may result if head sags forward. Lolling tongues can cause asphyxiation.

3. Straddle the victim and place your right hand on his breastbone, right at the junction point of the two lowest ribs. Then place your left hand directly on top of the right.

4. Press downward firmly to compress the victim's chest about an inch to an inch and a half.

5. Release pressure sharply after each thrust, and spread the fingers up off the chest to avoid rib injury.

6. Thrust and release should be repeated continuously at a cadence of about 60 to 80 thrusts per minute. This simulates the normal heartbeat closely enough to "crank the stalled engine" in many cases that may appear hopeless. Don't stop until: (a) help arrives, (b) the victim resumes breathing regularly, or (c) you are sure the subject is past saving.

The method described applies to adults. For children, one hand is enough, and half to three quarters of an inch compression should be sufficient.

What makes this system practical is the fact that the human heart is not entirely on the left side as popularly supposed. The greater part of it lies directly beneath the sternum, or breastbone. Hence, your simple hand pressure compresses the heart between sternum and backbone, forcing blood out of it and into the arteries. Releasing pressure allows the heart to expand and pull in more blood from the large veins. You are, in effect, working the heart manually.

7. Check occasionally to see if the victim's heart is actually working again under its own steam. You do this by taking his pulse. The best place for a layman to check a pulse is *not* in the wrist, but in the throat where the big carotid artery passes on either side of the windpipe near the collarbone.

8. Get the victim to a hospital as soon as possible, even if pulse and breathing have been restored. The patient is sorely in need of professional aid. In cardiac arrest cases, attempts to re-start the heart may result in fibrillation (a sort of helter-skelter heart

Rescue Breathing Saves a Life...





MOUTH-TO-MOUTH insufflation can be applied almost anywhere; here a fireman saves a life on the spot

flutter) which no layman can detect. Unless checked, it is fatal, and the only place to check it is in a well-equipped hospital emergency room. But external massage may well keep the victim alive until he gets there.

So much for procedure. Despite the simplicity of the method and its impressive record of success, medical men offer a number of stern warnings about using it.

First, if the external heart massage is not begun within about four minutes after the pulse has stopped, the chances are high that irreparable brain damage will be done by lack of oxygen.

Second, do not look for the impossible. Not infrequently, even hospital patients revived by it may die a day or so later from the same thing that caused the original heart stoppage.

The new technique is of proven value not only for cardiac cases or asthma attacks, but in drowning, electrical shock or lightning stroke, smoke or gas asphyxiation, overdose of drugs, or any other mishap which causes the heart to stop. A real bonus provided by the technique is that the chest pressure will force some ventilation of the lungs. This is a vital factor since, in cardiac arrest, breathing also stops and some form of artificial respiration must be applied.

All of which brings up another first-aid technique for the accident victim with a pulse but no respiration. Such a victim also is in dire need of air within the aforementioned four minutes. And the easiest,

Anyone can learn rescue breathing; remember these three steps



1

CLEAR the victim's throat with two fingers, using cloth if handy. If he's choking, pick him up by the waist, head down in a jackknife position, and hit a sharp blow between his shoulder blades to dislodge object



2

WITH VICTIM on his back, lift his chin until his jaw line points straight up to keep him from choking on his tongue. This may get breathing started, but if the tongue is blue or gray, begin mouth-to-mouth rescue breathing



3

COVER the victim's lips with your own to make an airtight seal; close his nose with one hand. Blow hard enough to make his chest expand (more gently for children) 12 to 20 times per minute, letting him exhale normally

Johnson & Johnson
New Brunswick, N.J.



MORE EFFICIENT and requiring less personal contact, resuscitation tubes greatly simplify rescue breathing

quickest, most efficient method of providing that air is by "rescue breathing"—blowing it out of your lungs into his.

After lying dormant for generations, the technique, actually the oldest effective resuscitation method known to man, was revived and perfected about four years ago by Dr. Peter Safar, chief anesthesiologist for the Baltimore City Hospitals. Again it was taught to Captain McMahon's crack ambulance personnel, who have put it on the map with scores of successful applications. The National Academy of Sciences has declared it to be the most practical method of artificial respiration for first aid in the field, and it has been adopted by the American Red Cross and countless other rescue agencies.

In the surge of publicity following these acknowledgments, practically everybody has read something about "mouth-to-mouth insufflation." Hundreds of rescues have been achieved with it by laymen who had no more practice than did the captain at Hickman Field with heart massage.

Although expired air from the lungs contains only about 16 percent oxygen—as against some 21 percent for inhaled air—even a briefly trained novice using "rescue breathing" can move 10 to 12 times as much air into a victim's lungs as can a trained first aider using the old pressure methods. And this air is at exactly the proper temperature and moisture content for instant use.

The major objective is to get the *maximum* volume of air *directly* into the lungs without any waste, and this involves several important points.

1. The victim's mouth and throat must be cleared of any foreign obstruction such as water, blood, or regurgitated matter, using the first two fingers of your hand. In the common family emergency of a child (or an

adult) choking on some solid object, don't waste time *patting* him on the back! Pick up a child with your arm around his abdomen; jack-knife him head down; and hit him a lusty wallop between the shoulder blades to dislodge the object. The adult victim should be folded double, head down. Then hit him a sharp blow on the back.

2. Once the victim's airway is cleared, it is again vital that the chin be kept straight up to keep him from "swallowing his tongue." This cannot be overemphasized.

3. If the victim starts breathing naturally after the obstruction is removed, this "chin up" position may be all that need be done. But, if his tongue is blue or gray, rather than pink, start rescue breathing immediately, *even if he is breathing on his own.*

4. Do not merely *breathe* into an adult victim's mouth. *Blow*—hard enough to make his chest expand.

5. Do not hold the victim's mouth wide open: you must take his lips *inside* of yours with an airtight seal. You should also close the victim's nose with one hand. With a baby, you take both its nose and mouth inside your lips.

6. Blow gently for children; for babies, use only *puffs* of air from your cheeks, not from your lungs.

If the idea of such close personal contact with a stranger is repellent, a handkerchief can be spread over his mouth without impairing the procedure. The fact is that a bloody, drooling or regurgitating accident victim can be a pretty repulsive sight. But, recently, several devices have been developed which do away with direct contact. They also make the method even more efficient. One is the Resuscitube, a simple tube, one end of which fits over the victim's mouth while the rescuer breathes into the other end.

Lacking such aids, however, most householders have lips, hands and lungs with which to save life in an emergency. And the modern methods are not only simple, but comparatively easy on both the rescuer and the victim. This is a far cry from days gone by when the prevailing resuscitation techniques were as tough on both parties as they were ineffectual.

The modern evolution of closed chest heart massage and rescue breathing have been Godsend to all concerned. On top of this is the hopeful fact that modern advances in resuscitation are making it more and more difficult for even medical men to decide just when a person is dead beyond recall. So many individuals, apparently "gone" by all the old rules of thumb, have been revived that informed opinion today agrees "no person is dead until we have done everything we know how to do to keep him alive." ★ ★ ★

Down to the Sea In a Tinkerer's Pram

Conspicuous among the vehicles of English students making their annual 50-mile run from London to the Brighton seashore this year was a motorized pram, or baby carriage.

It carried three students to the carnival procession along the Sussex seafront, making the trip from London in six hours.

The pram was powered by a 98-cubic-centimeter motorcycle engine mounted on one side.



Fixed-Wing STOL

Short-takeoff-and-landing (STOL) aircraft are usually variations of helicopters or autogyros, so a standard fixed-wing airplane that can land or take off from a helicopter pad is unique.

Made by Helio Aircraft Corp., the L-28 features a high wing and huge flaps that enable it to take off or land in as little as 44 yards, an area about the size of a tennis court. It can reach speeds of 160 m.p.h. or fly straight and level as slow as 30 m.p.h. Its ceiling is 22,500 feet and its range 850 miles.

The Air Force is studying the plane for use at missile sites.



Rugged Road Rider

Sportsmen can traverse rugged terrain and rocky mountain trails with a new motorcycle designed to make hard-to-reach trout streams and game trails accessible.

The vehicle weighs 178 pounds and is powered by a 165-cc. engine. It has a three-speed transmission and a large, 84-tooth sprocket on the rear wheel. Five-inch brakes, both front and rear, provide a necessary safety factor.

The motorcycle is 76 inches long, 30.5 inches wide and 40 inches high. The engine is rated at six horsepower at 4800 r.p.m.

Manufacturer of the machine is Harley-Davidson Motor Co., Milwaukee, Wis.



☛ Cows graze peacefully on South Uist, Scotland's rocket range. Before a rocket is fired, they are herded to safer pastures.



PEDALING UP on his bike goes a seed collector. Most are Maoris, men whose ancestors came from Tahiti



POLLINATING a selected tree bud artificially is another job for men of the Forest Research Institute

Foresters Bicycle Up Tree Trunks

EXPERT TREE CLIMBERS who gather seeds to stock New Zealand's man-controlled forests get to the top in a hurry. Sometimes they ride a bicycle, a Swiss invention that allows them to take seeds without damaging trunks. This is an important consideration, for it may take these climbers from New Zealand's Forest Research Institute a year to collect enough seeds from healthy trees to plant 25,000 additional acres.

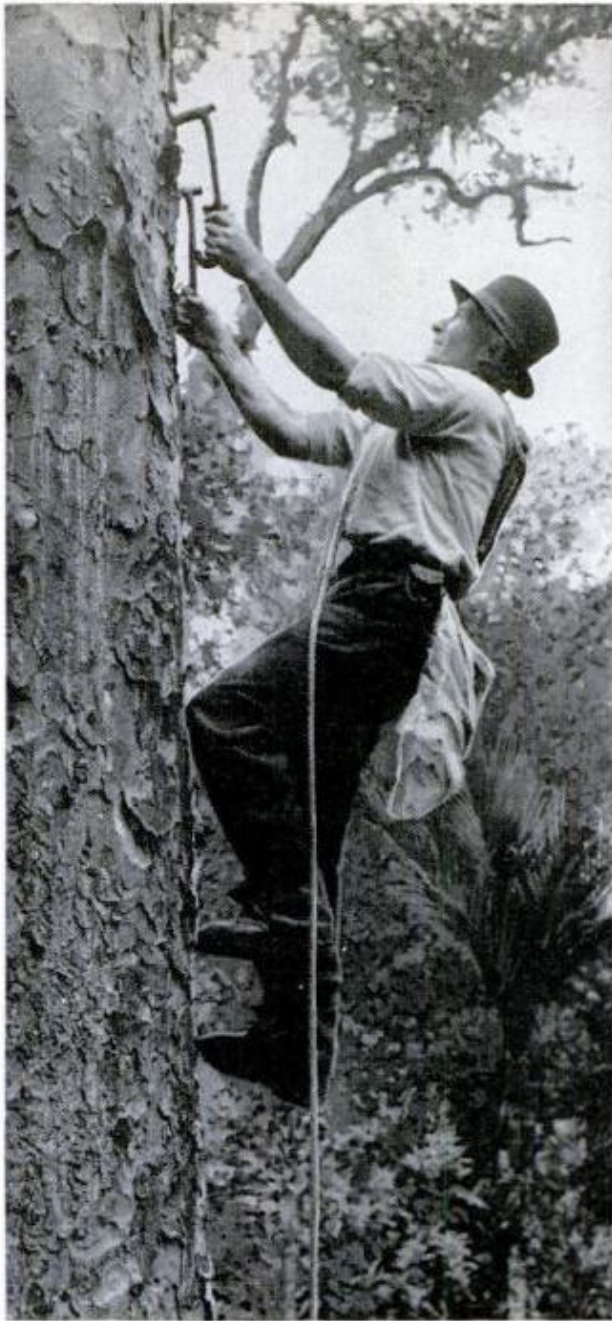
The Swiss bike consists of two metal hoops passed around the tree trunk. Each hoop carries a stirrup-type footplate strapped to the climber's foot. By pedaling the hoops up the trunk, he ascends quickly,

safely. He is protected by a special brace which links him to the trunk.

The method is far superior to the old style one of clawing up the tree by using climbing hammers and spike-tipped boots.

On trees too big for the bicycle, climbers use an aluminum extension ladder; it is lashed to the trunk progressively until the climber can enter lower branches to collect seeds. Its light weight does not harm trees.

Since seed is taken only from the best trees, and very few are suitable for breeding the high-quality stock, such tender care of trunks is an absolute necessity. One careful examination of a 20,000 acre plantation, for example, yielded only 15 trees to



OLD-STYLE CLIMBERS used claw hammers and spike-toed boots to get purchase, carried rope, collecting bag

NEW TECHNIQUES included using aluminum ladders on trunks too thick for bikes. All save wear and tear

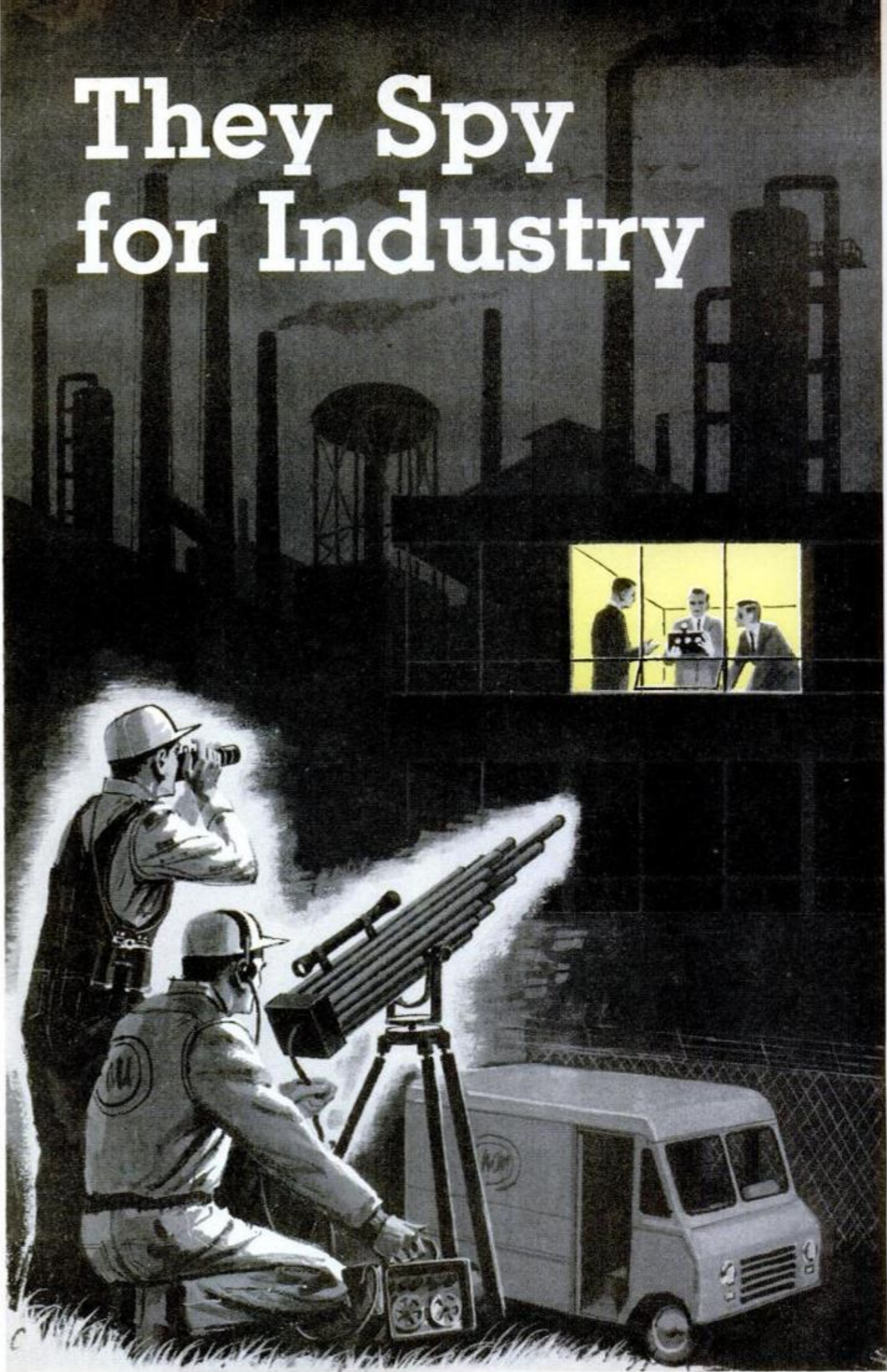
be potential breeding trees. That worked out to one tree per 1300 acres!

The Institute climbers collect many types of seed. Most common is *Pinus radiata*, better known to Americans as Monterey pine and now the principal exotic species grown in New Zealand. Such exotics, incidentally, often thrive better in New Zealand than in their native lands. For example, several imported origins of Douglas fir have shown superior growth to trees raised from hand-picked native seeds.

Sitka spruce from Oregon and California at three years show a growth rate more than double that of previously introduced races of the species.—*Albert E. Norman*



They Spy for Industry



Quarter-mile microphones, rapid-sequence cameras and ingenuity are tools of private eyes who search out industrial secrets, trap thieves

By Myron Brenton

IN THE MIDWEST, a leading paper manufacturer learns that both his office and home phones are being tapped. In the East, an electronics assembler sits at his factory workbench during the day, but at night prepares secret memos about the instruments he has been handling on the job. In the North, a group of light-fingered workers is suddenly fired from the small-appliance plant from which it has been stealing for years.

In every instance, "IE" has been at work.

The initials stand for "industrial espionage," a subject once discussed only in whispers. Now, however, it is coming out in the open, with more and more executives acknowledging it to be industry's deadliest weapon.

Does one firm want to pirate the manufacturing process of another? Does a clique of engineers from XYZ Corp. intend to steal the firm's latest research and go into business on its own? Are a company's high inventory losses the result of sloppy bookkeeping or light-fingered employees? Industrial spies can provide the answers.

Round-the-World "Tail"

The men who do the spying are often former FBI or OSS investigators—and a tenacious lot. They may trail the ranking executive of a firm as he makes a round-the-world business trip—and report the man's activities and contacts to his competitor. They have been known to buy the contents of executive wastepaper baskets, persuade unscrupulous cops to make wire taps, and bribe hotel bellboys for a quick look at certain incoming or outgoing telegrams—all for clients who find that stealing ideas and processes is easier than originating them.

In the secretive world of IE, a New Yorker named Ulmont Cumming declares that he is "the top industrial spy in the country." Ruddy-complexioned and balding, he looks less like a spy than a production worker or minor stockholder—which are, in fact, his favorite disguises. Unsuspecting plant officials have led him through their premises believing him to be

a writer, fire inspector or truck driver.

In a typical case, Cumming's client wanted to know the nature of a machine his competitor used. The assignment was complicated by the fact that the president of the rival firm personally interviewed everyone going through his plant.

Cumming decided not to risk such an interview. After familiarizing himself with the manufacturing process in question, he threw a pair of coveralls into a suitcase and flew to the competitor's city. Upon arriving, he rented a pick-up truck.

Early next morning, dressed like any factory worker, he drove up to the plant just as the night shift was breaking. Sauntering into the plant, he punched somebody else's time card, then nonchalantly looked for the crucial machine. He might have been any other employee going to his post. Nobody paid attention to him. Spotting the right piece of equipment, he shuffled around it a couple of times. Then he was back in his pickup truck, relying on his highly-developed memory to make a deft sketch of the machine. For Cumming, who travels 100,000 miles a year on such expeditions, another job was done.

Modern Mata Hari

Cumming admits that on some difficult assignments he has used his wife's able assistance. Once he was asked to find out what kind of device was being used to eliminate poisonous diesel truck fumes in an Oklahoma zinc mine. Cumming could find no plausible pretext for descending into that mine. So he instructed his wife in the intricacies of diesel engines, told her exactly what to look for, and sent her down in the guise of a magazine writer doing a piece on mining from a woman's point of view.

"She was so successful," Cumming recalls, "that the mine officials not only told her everything she wanted to know, they even tried to date her!"

The use of wives in industrial espionage is unusual. But IE itself is not. As far back as the 17th century, the British succeeded in making off with several secret German

INDUSTRIAL SPIES



SPY HEARS plan to take extra tools on job and keep them. Earlier, \$10,000-worth had been stolen

BURNS DETECTIVES then marked every tool with powder that would glow under beam of an ultraviolet light

pottery-glazing techniques. Only lately, though, with the tremendous growth of technology, has IE really come into its own. Today the cost of research and development can be staggering. Competition is becoming increasingly bitter with firms engaging in breakneck races to see who can be the first to market a new product. For some companies, survival largely depends on their ability to kidnap the competition's brain children.

Small wonder, then, that superspy Cumming reports that the demand for his services has increased 100 percent in the last ten years.

The High Cost of Espionage

Those services don't come cheaply. Many business spies will not work for less than \$200 per day. When one adds up management's cost of IE, plus its cost of guarding itself against espionage, plus the losses actually incurred through pilferage, larceny and security leaks (well over \$1 billion yearly), the amount is fantastic.

"The consumer is paying as much as a penny on every dollar because of management's need to protect itself against espionage, internal theft and fraud," according to S. O. Astor, president of Management Safeguards Inc., a New York firm that provides some of this protection.

IE is not limited to professional spies, however. A West Coast supermarket has been known to bribe a printer into letting it get an advance look at another market's weekly advertising, so it could adjust its

prices accordingly. An oil man has paid geologists from five competing companies several hundred dollars a month each to supply him with confidential lease-buying information. Many companies require their salesmen to come up with intelligence about the competition as well as orders. Conversely, some industrialist's wine and dine talkative salesmen from rival companies in order to elicit information. And it's by no means rare for a company to hire a top researcher away from the competition—keeping him on the payroll just long enough to pump him fully.

By and large, however, the career spy is the mainstay of industrial espionage. He has the know-how, tools and undercover agents to help him gather intelligence. Undercover men are planted inside an organization in the guise of porters, laborers, clerical help—even supervisory personnel.

Recently, a St. Louis manufacturer asked himself sadly why his Boston competitor could sell the same item in St. Louis more cheaply than his own firm could? He hired a spy, who placed an undercover man strategically inside the Boston plant. Within a month he knew how much the competition paid for its raw material packaging costs, freight charges—practically everything except what the company's executives were eating for dinner at night! Armed with this information, the St. Louis manufacturer whittled down his costs and met the competition.

Espionage inevitably gives rise to count-

CATCH A THIEF



DISHONEST EMPLOYEES next were kept under round-the-clock surveillance to make sure of trapping their ringleader



HE TOOK several thousand dollars' worth of tools home, was trapped, hands glowing, unloading

er-espionage. Several of the country's biggest and most respected detective agencies, while denying vehemently that they ever stoop to spying, freely admit that they protect their clients against others.

"Our undercover service provides management with extra sets of eyes and ears to detect pilferage by employees or collusion efforts by outsiders to steal," says W. Sherman Burns, president of the William J. Burns International Detective Agency, Inc. Catering to some 500 clients who are in need of those extra eyes and ears, Burns is doing a booming business—as are other firms involved in similar work.

Pinkerton's National Detective Agency Inc., which also does a lot of inside snooping for its clients, has discovered an ironic tendency among dishonest employees. Sometimes they have pilfered their companies for so long, they completely lose sight of the fact that they are doing anything wrong!

For years a wholesale grocery firm on the East Coast incurred extremely heavy inventory losses. Finally, with a shift in management, the company decided to act. Nobody but the top brass knew that the new elevator operator hired in the next few weeks was actually a Pinkerton undercover man.

This investigator found out that roughly 80 percent of the employees were regularly stuffing the company's packaged foods into their pockets at quitting time. This thievery was blatant, employees from the various departments actually exchanged

foods with each other. But when the firm began to crack down, it was the employees who became angry. They protested that the groceries they pilfered were actually a form of "fringe benefit."

Dishonesty within an organization can take many forms—including sabotage, as one large chemical plant has discovered. Its owners had second-string executives run the business. Eventually, the company's sales-service division found itself in bad trouble. Orders were mislaid, deliveries carelessly switched, customers antagonized and irretrievably lost. When the owners finally awakened to what was happening, it was almost too late. The firm worth \$5,000,000 on the going market two years before, had dropped to nearly half that value.

Double-Dealing Executives

An outside investigation was immediately started, including both undercover and surveillance techniques. Soon the owners of the faltering business had the dismaying solution to their problem. A nest of sales-services executives were deliberately and systematically downgrading the firm, trying to get the owners to sell out. Why? They were members of a syndicate that wanted to buy it—cheap.

Counter-espionage can be as tricky as a counter move in chess. It can also create situations bordering on the ridiculous. One company had as many as 35 undercover agents inside one plant, none of whom were known to each other. Unwittingly,

Stealing Secrets Deep In a Mine

they frequently wrote reports criticizing each other's conduct. Counterspies have been known to trail spies who were trailing the counterspy's client. Once, doing an IE job, private eyes tried to sneak into a plant at night—and were promptly arrested by guards working for their own agency.

Arrests and lawsuits are big hazards in IE. A businessman may be successful in obtaining a competitor's secret process. But that does not mean he won't be subject to massive legal retaliation. Typical is the multimillion-dollar patent infringement suit that one angry soap company leveled against another.

The soap industry isn't the only one which has experienced IE troubles. The oil industry seems to be studded with almost as many spies as derricks. In one instance, a switchboard operator for a major oil company sold confidential lease information to a curbstone broker who in turn sold the information to a third party. In a second case, the theft of some highly valuable geophysical maps from another of the majors brought to light that one of its employees was the silent partner of a small, competing oil company.

Paradise for Spies

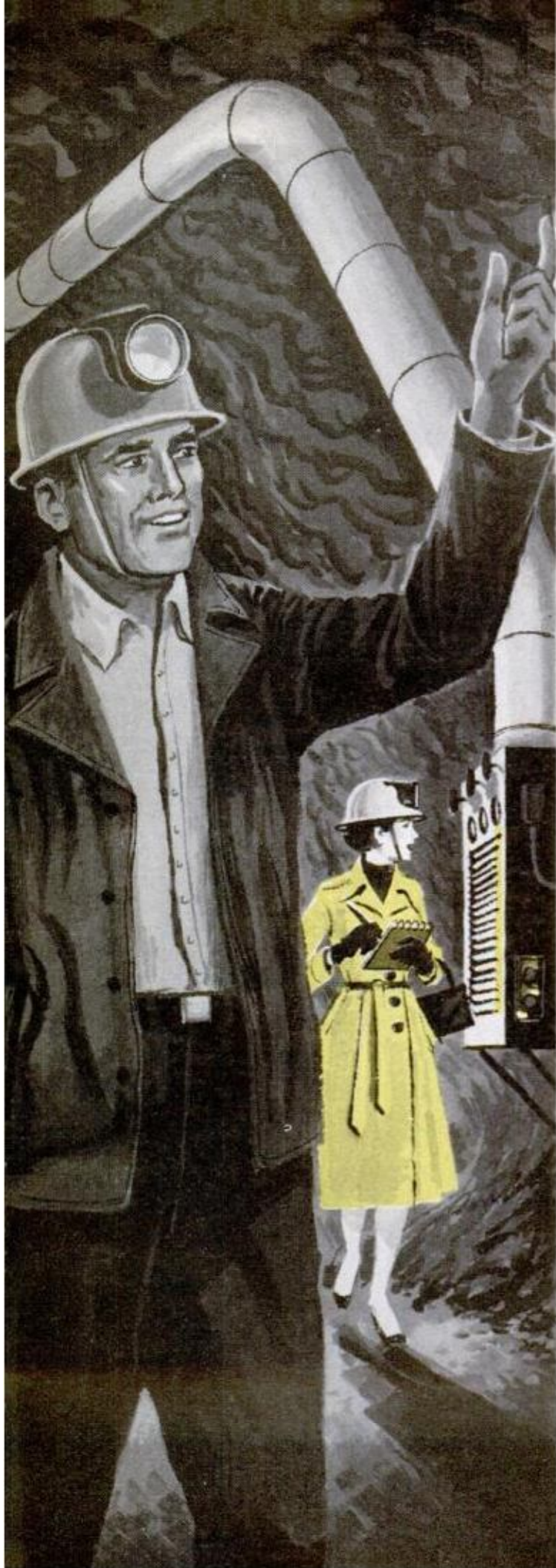
Detroit is a notoriously happy hunting ground for industrial spies, who today are scurrying to sell auto manufacturers details of their competitors' 1964 cars. The fashion industry is so plagued by piracy that one of its members has said, in print, "Ninety percent of the trade lives by swiping styles. Everybody knows it." Even the tots are affected by IE: Toy manufacturers report virulent espionage in their field.

Advanced electronic developments are not only subject to raiding, they are also used in the business of spying itself. The modern industrial spy can use a highly-directional parabolic microphone that picks up voices from as far away as a quarter of a mile. Or a six-foot directional gun mike with telescopic sighting lens, to pick up street level conversations from six floors above. He can bug a room by hiding a transistorized mike and transmitter inside the coverplate of an electrical outlet plug, or even inside a telephone receiver.

The wire-tapping of telephones for pri-

(Continued to page 192)

SUPERSPY Cumming sent wife, posing as writer, to get description of mine equipment. She succeeded



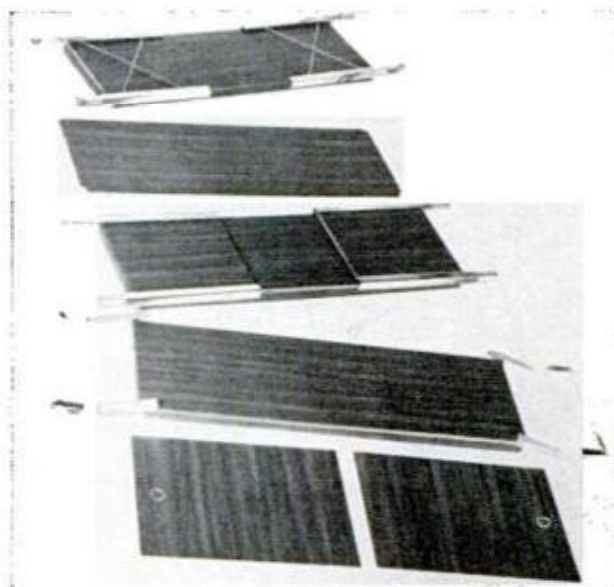


Store-able Storage Walls

Assembled in minutes, a new type of modular shelf kit can form anything from a simple bookcase to a complete custom storage wall. When disassembled, the components can be stored in a small space. The units are self-locking; no tools are needed for assembly.

The shelves and cabinets are made from walnut-grained vinyl bonded to 24-gauge steel. They come in two standard depths—9 inches and 14½ inches. The units are scratch resistant, liquid-and-stainproof and require no polishing. Verticals and fittings are brass plated.

The manufacturer is All-Luminum Products, 36th & Reed Sts., Philadelphia, Pa.



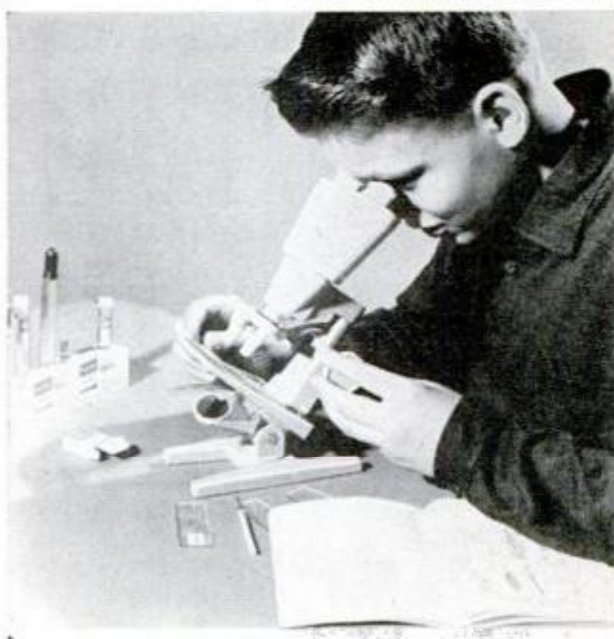
Zoom Microscope

Slides can be brought into focus under this microscope, then specimens magnified up to 1000 times by zooming in.

Zoom lenses work on the same principle as those on movie, television and still cameras. Changing relative positions of lens elements changes the effective length of the lens. The advantage with the microscope is that the entire width of a specimen on a slide may be viewed or a small portion of it may be magnified many times, all in perfect focus.

The microscope also swings around 180 degrees for viewing details of large objects, tilts up to 90 degrees and has plug-in lighting for above and below the stage.

Made by A. C. Gilbert Co. of New Haven, Conn., the all-metal microscope retails from \$12.98 to \$24.98.



MOTHER NATURE — Secret Partner In Defense

By William R. Kreh

A HOMING PIGEON is released from a field in a suburb of Philadelphia. Strapped to its back is a tiny radio transmitter with a 40-inch antenna. In a nearby laboratory two technicians listen to the bird's radio and carefully plot every movement in its 25-mile flight to its home loft in the city.

In a Virginia laboratory, two scientists watch a school of tropical fish glide back and forth in a special aquarium that's intricately wired to record the slightest change in an infinitesimal electrical current within it.

At a New England university, high-speed cameras and special recording equipment methodically detail every sight—and sound—of a hungry bat as it darts erratically, gobbling fruit flies and moths in mid-air.

Down in Florida, a four-foot shark is fitted with a "lie detector" while scientists tantalize him with a speared fish.

Out on the West Coast, a playful porpoise gracefully knives through the water. Tiny instruments fastened to its rubbery skin radio the mammal's heartbeat, respiration and temperature to physiologists outside its special windowed tank.

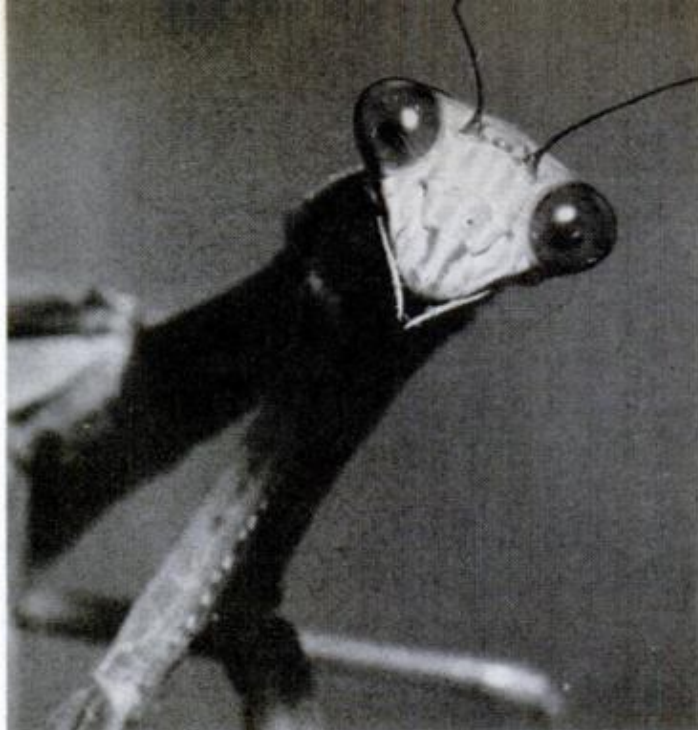
And in dozens of other U. S. laboratories, scientists are probing the innermost habits and mechanisms of countless other creatures—frogs, praying mantes, salmon, moths, honey bees, chicken hawks and even the lowly housefly.

Why this intense—and somewhat sudden—interest in the birds and the bees and the beasts and the bugs?

Because in these creatures' brains and instincts—in some respects far surpassing anything human—are mechanisms that, if duplicated by man, could result in some of the most amazing machines, or weapons, ever visualized.

Dr. Harvey E. Savely, director of life sciences in the Air Force's Office of Scientific Research, says:

"Our technology is faced with problems of increased complexity. In living things, problems of organized complexity have



N. E. Beck Jr. from National Audubon

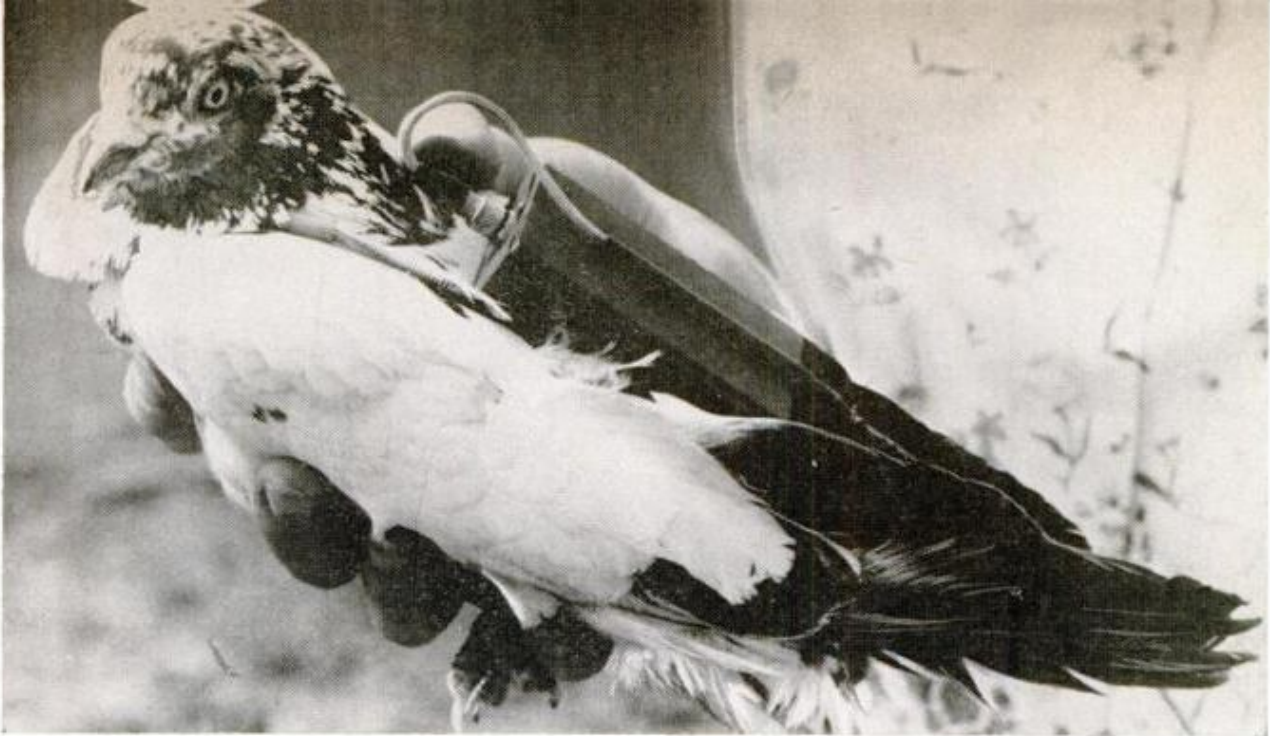
PRAYING MANTIS has computer-like brain that military men would like to adapt for military purposes



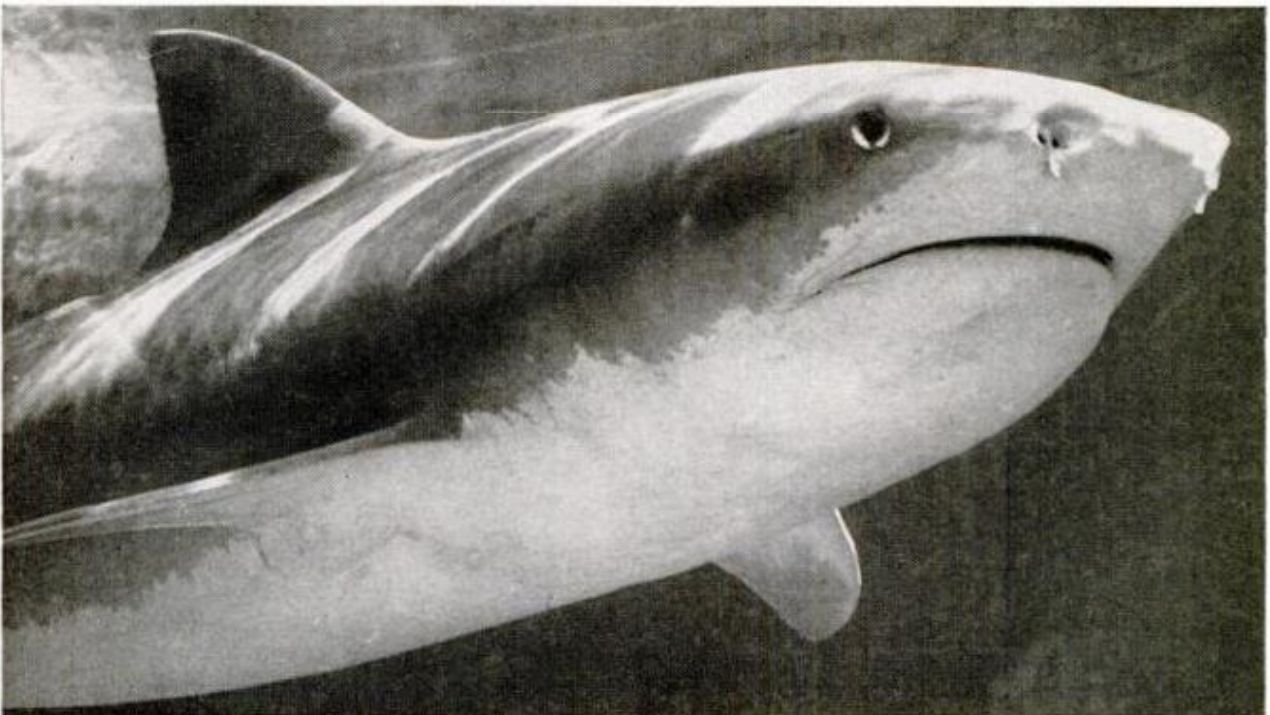
FABLED ALBATROSS has practical mechanism in its nostrils to distill sea water. Navy is interested

been solved with a success that invites our wonder and admiration. So we look to these inventions in nature for clues, as well as inspirations, for new classes of man-made machines with greatly increased capabilities."

Most of this study of biological mechanisms is being conducted by private firms and universities under contract with one or more of the armed forces. That's not surprising because some of nature's most primitive creatures possess intriguing talents that far surpass anything we now have in America's arsenal.



HOMING PIGEON, long admired for its uncanny homing instincts, is now being studied scientifically. Tiny radio transmitter strapped to its back sends back signals, tracing every move it makes during flight



DEADLY SHARK, once believed to locate its prey by smell such as blood, is now thought to pick up sounds or vibrations just like guided torpedo. Navy study hopes to find out how it's done, adapt it for weapons

Take the common salmon, for example. Here's a fish with a brain that weighs less than a nickel. Yet it can head for a target located a continent away, locate it, then turn around and journey back through oceans into estuaries and streams, finally reaching the original headwaters from where it started.

Wouldn't the skipper of a Navy submarine like to have a navigation system like that!

Research indicates the salmon has an astounding sense of smell which might enable it to isolate certain chemical factors

in the water and maybe follow these chemical trails to its desired destination.

But W. E. Johnson of the Fisheries Research Board of Canada has another theory. His experiments show that salmon must certainly chart their course by sun, moon and stars. Johnson studied the migration of salmon in a complex of almost land-locked lakes in north-central British Columbia. In this lake system, young salmon making their trip from home waters to the sea had to migrate southward, then westward, and finally northward to reach the sea.

Johnson said he and his colleagues caught young salmon at the start of their trip to the sea, put them in a large plastic tank and recorded the directions of their pointing.

He said the studies, correlated with migration time and distance, showed that the captive fish headed in the same migration directions as their free-swimming former companions. When first caught, the fish pointed south; later, just about the same time their ex-companions turned westward, the tank fish turned to the west. Finally, they pointed north on the hour the free swimmers veered north.

Turning the tank at varying angles did not disorient the swimming directions of his fish. Only by placing large mirrors at the top side of his open tank was he able to confuse the captive salmon. The mirrors gave the fish a distorted view of the sky, and their confusion indicated, Johnson said, that they were getting navigational help from the sky.

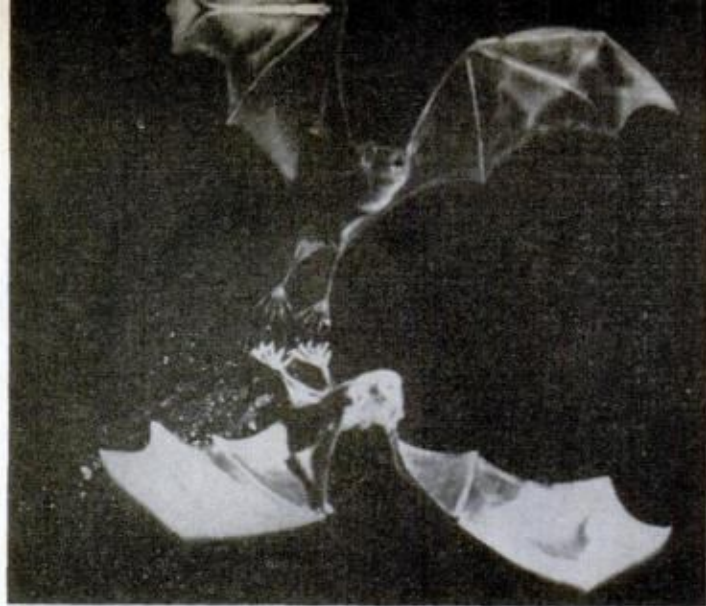
Ever watch a bat go after its prey? In midflight he can sense a distant moving target, calculate its trajectory perfectly and meet the target head on. Scientists know he does it with a type of sonar. A tiny larynx emits up to 200 beeps a second, inaudible to humans. These beeps hit his insect target and the bat's large ears detect the returning echoes. A brain the size of a pea computes the data and controls the hunter's speed and direction.

Can man with his electronic skill duplicate this mechanism and install it in a guided missile? It's hard to say, but the military is sponsoring a large-scale research project into bats at the Lincoln laboratory of the Massachusetts Institute of Technology.

One species of bat has particularly caught the Navy's interest. It's the *noctilio leporinus*, a type of bat that fishes. It swoops down low over the waters of a tropical lagoon and uses a special sonar to detect small fish under the water. Noctilio will suddenly dip its sharp claws under the surface and come up with a speared fish every time. This creature's secret might give the Navy a more effective way to detect submerged enemy submarines.

Research has disclosed that a shark—which one scientist described as “truly nature's guided torpedo”—may be steered to its prey by sounds or vibrations it picks up with a super-human detection system, not with an extraordinary sense of smell as previously thought. Under Navy contract, Dr. Warren Wisby of the University of Miami is using a special shark “lie detector” electrode to find how it's done.

The electrode is attached to the shark's heart while it is unconscious. Then the shark is put in a tank.



BAT RADAR enables it to send out signals, bounce them off fish underwater, pick up echoes and swoop down for kill. Navy could use sub-spotter like this

SCOUT BEE has remarkable communication system. Mid-air dance tells worker bees location of nectar far from hive. What are the signals, their meaning?

Treat Davidson from National Audubon

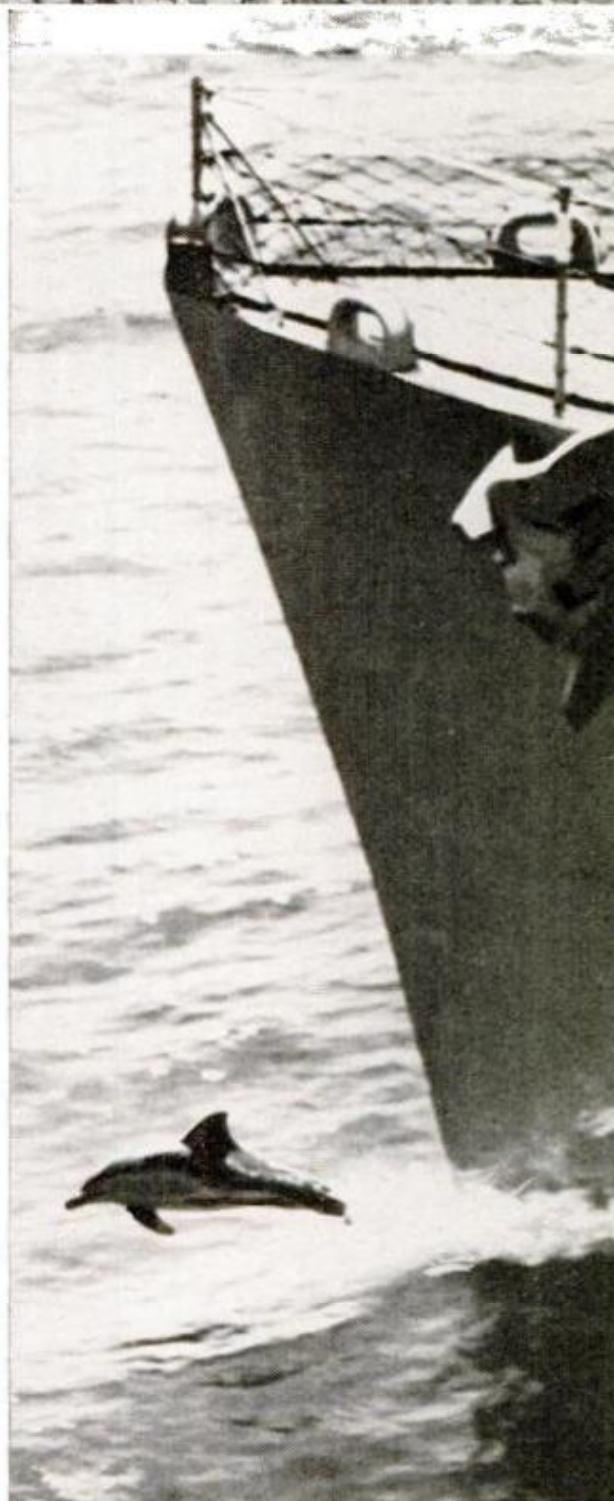




Gene Wolfshelmer from National Audubon

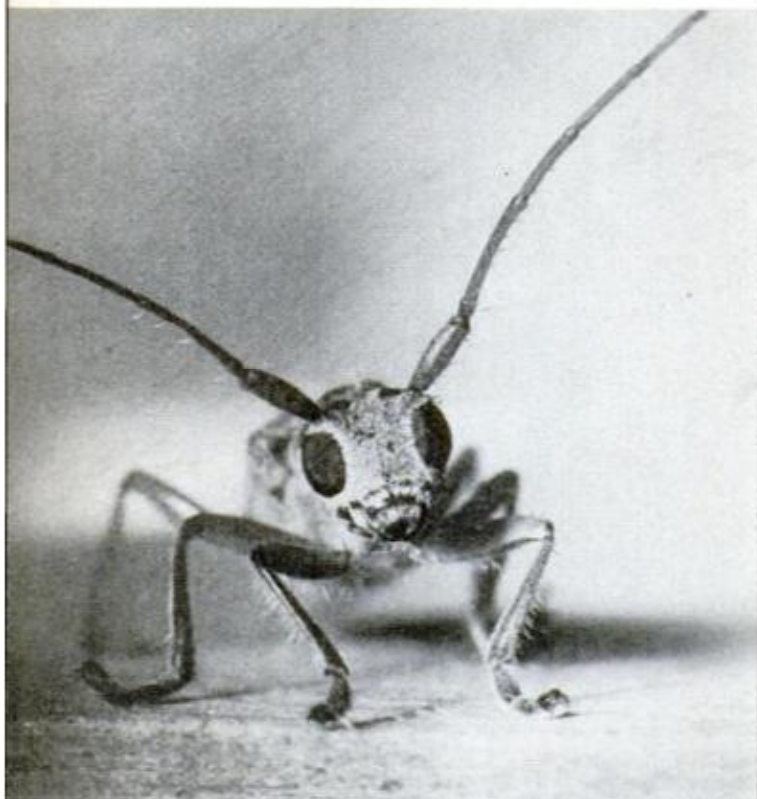
TROPICAL FISH swim in schools, change direction in unison. Who gives the signal? Is it electronic? How can they all know exact instant, direction?

PLAYFUL PORPOISES, who can swim unerringly in dark or outrace a ship, cooperate happily in tests. Suction cups cover eyes for blind-swimming studies





SPEEDY DOLPHIN is smeared with dyes that wash off in water. Its wake is photographed and studied



G. M. Bradt from National Audubon

BEETLE'S EYE has been copied by Air Force. Compound structure gives it extremely accurate data

PLACID FROG screens out trivia with eye and mind, concentrates on basic essentials of food and escape



"A low-frequency sound, similar to that of a struggling fish, is released in the water. At the same time the shark is given a mild electric shock. The lie detector shows that the shark's heart skips a beat," Dr. Wisby explained.

"We have trained these sharks to the point that after a while we can release the sound wave and the heart skips a beat without the electrical shock," he added. This proves the shark can detect the sound wave.

"We haven't yet been able to make these sharks react to a sound without first using the electric shock to train them," the doctor explained. "In other words, we haven't found the exact sounds that arouse them. Later we'll go out in the ocean and try to attract sharks with various low-frequency vibrations."

What are some of the other secrets of Mother Nature that scientists are trying to unlock?

- Honey bees have a phenomenal sense of navigation, a remarkable memory system, and a mysterious means of communication. A scout bee, for example, can find nectar far from its hive, return to the hive unerringly, and communicate by means of a special mid-air "dance" the location of the nectar to worker bees. He never leads them, always stays in the hive once he returns with the information.

- The praying mantis integrates all the information it receives on the position of a fly, strikes and captures its prey within $\frac{50}{1000}$ of a second.

- The albatross has an unusual mechanism in its nostrils which excretes the salt from the sea water the marine bird drinks.

- Tropical fish have an almost uncanny way of communicating with each other. How does one member of a school know the exact moment when the others are to turn, and in which direction, so that the movement of all is simultaneous? The fish may emit pulses of low voltage. Experiments show that some types of tropical fish are so sensitive to changes in their natural electrical field that they will respond to an electrostatic charge produced by waving a comb run through somebody's hair in front of an aquarium.

- The eye and mind of a frog are combined in a simple system that screens out all details except those that are needed to catch an insect on the wing or to escape an enemy. If scientists could build an electronic system that uses some of the principles found in the frog's mechanism it might be used to watch a radar screen at a major airport, detect any plane leaving its course, and flash instructions to the auto-

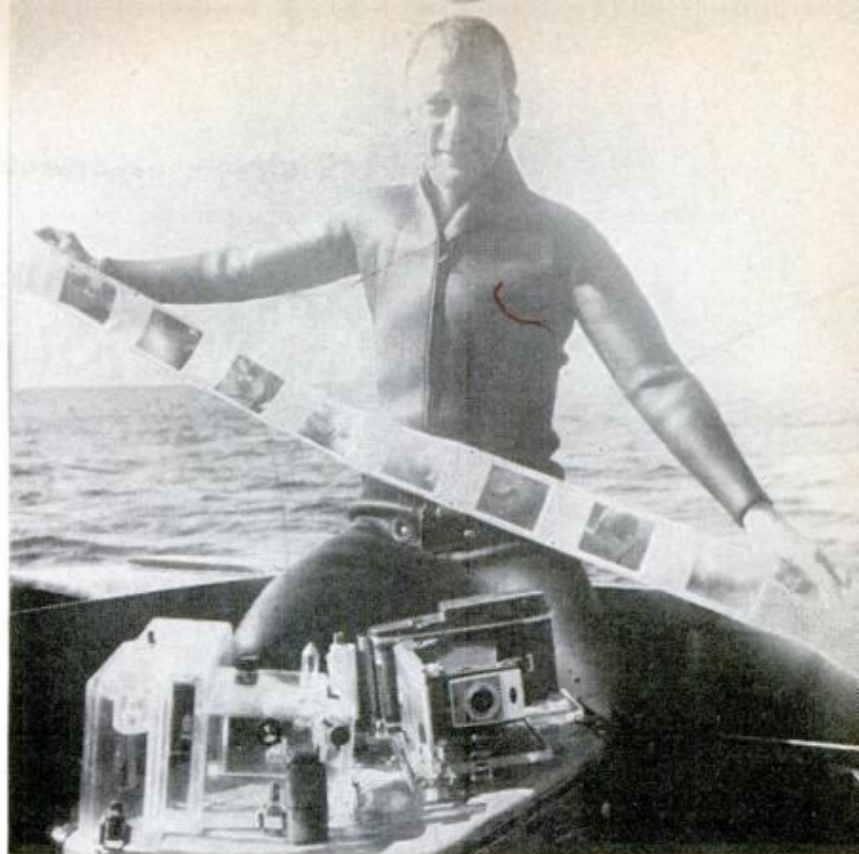
(Continued to page 188)

Underwater Housing For Polaroid Camera

Ten-second pictures can now be taken underwater — and seen immediately—with the aid of a pressureproof housing built to accommodate the Polaroid 4 x 5 camera.

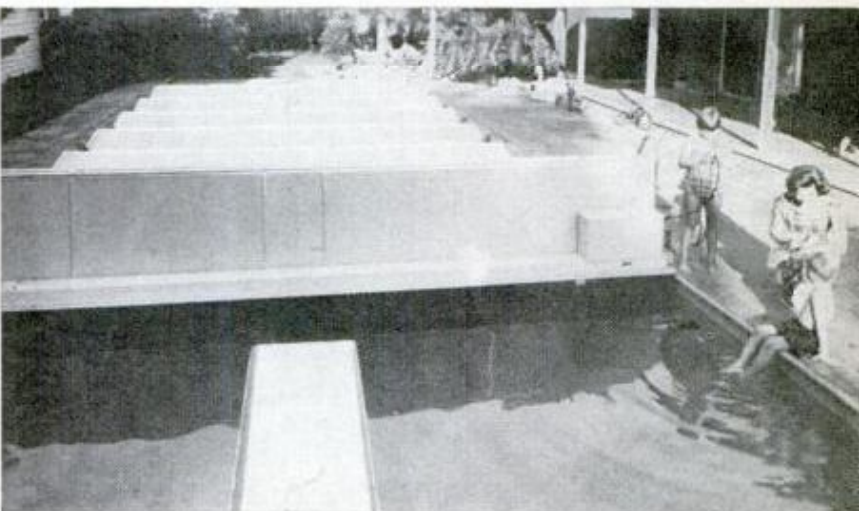
Eight pictures can be taken on one roll of film. The electric eye of the Model 850 camera automatically adjusts aperture and shutter speed, and Polaroid's high-speed film (ASA 3000) produces good pictures in the low-light conditions underwater.

Some uses for the underwater camera are salvage work, underwater inspection of docks and hulls, marine biology and hobby work. The advantage of the Polaroid is that if one picture is not good, it can be retaken.



Push-Button Pool Cover

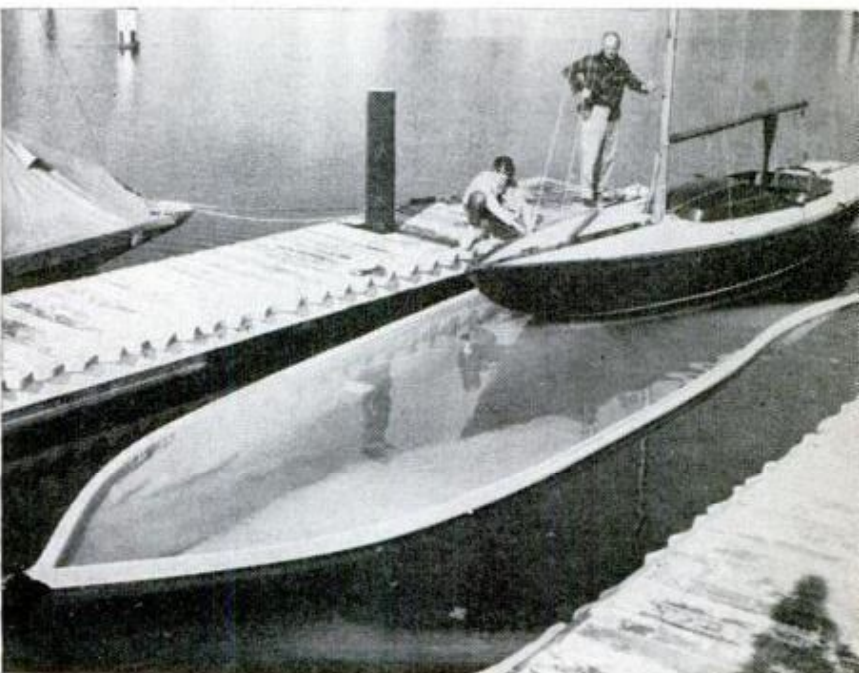
Self-propelled and self-storing, a new aluminum swimming-pool cover opens and closes in accordion folds, and forms a foolproof cover when in place. The cover opens and closes on a poolside track, powered by electric motors, and works something like a horizontal garage door. It cannot be opened again without the owner's key switch cord. The cover was invented and patented by engineer E. A. Bender of Bakersfield, Calif.



Chemical Bath Keeps Hull Clean

Marine growth comes off boat hulls the easy way with a method employing a plastic "bath" tank.

To clean the hull, the boat is moored over a plastic envelope with built-in flotation tubes around the edges. The envelope is closed behind the boat, and calcium hypochloride chlorinating tablets dropped into the water. The envelope, moored to the boat, rises, falls and swings with the boat; four ounces of the chemical will keep growth off a sealed 29-foot hull for a month. Prices start at \$150 for a tank that holds a 24-foot boat. The manufacturer is Boatbath, 1215 Westwood Blvd., Los Angeles 24, Calif.



PM Shopping Guide



OVERSIZE BAG gives six inches more length and width for big men and restless sleepers; shown above with regular size



SHELL FABRIC needs high thread count; lower sample is best

NO CAMPING TRIP is a success if you can't sleep comfortably. And the difference between sleeping snug and warm or spending the night cramped and miserable will be in your choice of sleeping bags. Here's how:

The major factors to consider in buying a sleeping bag are, in order of importance, filler and fabric, size and shape, construction, and accessories. By far the most important is the amount and type of insulating material that makes the bag work.

The oldest filler materials are eider duck and goose down — and all the advances of modern science have failed to equal them. Down is light, warm and durable—it will weigh half as much and take up only a third as much space as its nearest competitor.

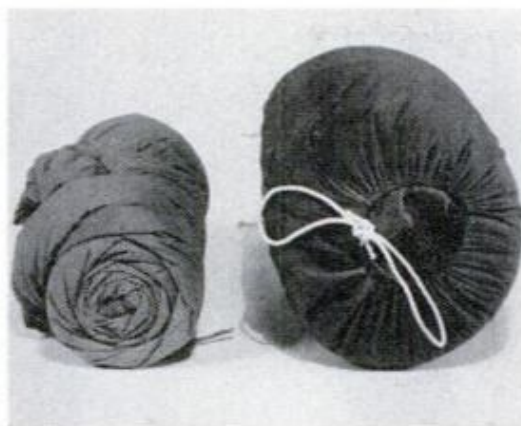
But there are drawbacks. Down is expensive (about twice the cost of synthetic fillers of equal insulating capacity), sometimes hard to find, subject to moth, rodent, and mildew damage, and slow drying. Also, some campers are allergic to feathers, and down is feathers.

A good substitute for expensive down is a batting made from specially-crimped *polyester* fiber designed for sleeping bags and insulated clothing. Another good synthetic is a similar filler made of *acetate* fiber, which has a slightly lower insulating quality and therefore a bag must be bigger and heavier, but the price makes it attractive.

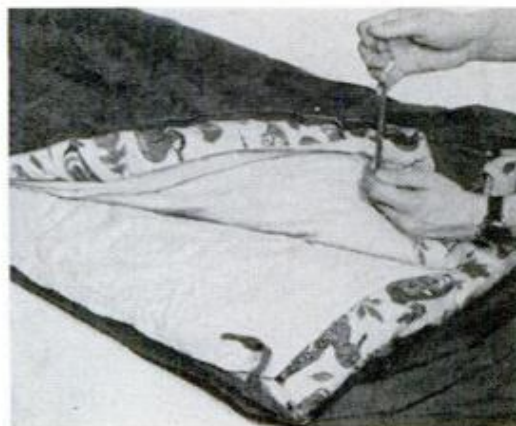
Both synthetic fibers are nonallergenic and not dusty, and are also moth-, rodent- and mildew-resistant,

By
Patrick K. Snook

Sleeping Bags



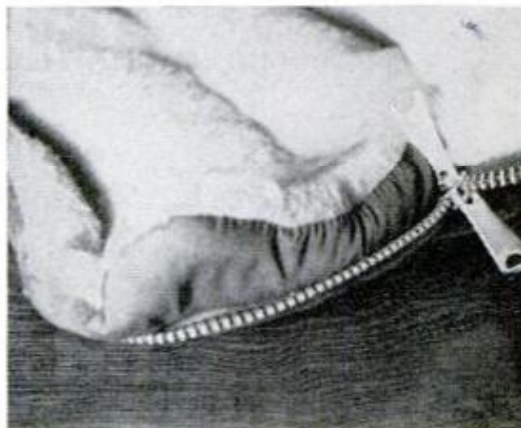
ROLLED SIZE of down bag, left, compared to synthetic-filled bag of equal comfort rating



FLANNEL LINING ties in with tapes; gives more warmth, wear; removes for cleaning, airing



COMPROMISE BAG has waterproof bottom, but top is only water-repellent for ventilation



HEAVY DOUBLE-TAB ZIPPER makes best closure; draft tab covers inside of zipper for warmth

and quick-drying. If you aren't worried about size and weight in packing, and don't need to be insulated below 10 degrees, they'll do the job at a great saving.

Some of the other fillers used are synthetic pile linings, clipped feather ends, clipped synthetic fiber ends, kapok, wool, cotton, and many other materials. While none of them equals the big three for insulating ability, all have a great price advantage. If you don't need the insulation, they're OK. Remember, too warm a bag is uncomfortable, too.

Rating Is by Temperature

Sleeping bags are rated for the lowest temperature at which they'll keep the *average* sleeper comfortable. That rating depends on the type and

amount of filler in the bag, and most good manufacturers list the rating of each bag. All of them must list the amount and type of filler on the Federal bedding label ("Do Not Remove This Tag"). By comparing the amount and type of filler against a rated bag, you can approximate the rating of any bag, and it's your best bet as a buyer's guide to comfort.

Consumer bags are rated from 50 to 10 degrees. Heavy-duty arctic models can take you down to 30 below, but they're expensive professional models. Buy the rating you'll need, and remember, if you like an extra blanket at home, get a bag rated a bit lower than you think you'll need.

The shell (outer) fabric should be tough, lightweight, and water repel-

PM Shopping Guide

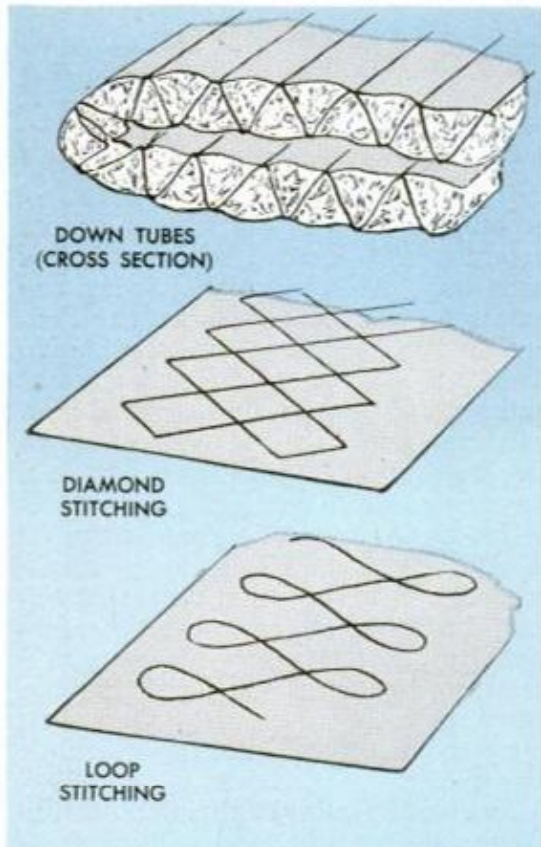


POLYESTER FIBER is good substitute for down; trade names vary, but tag will always list material as polyester filler after trade name



COMBINATIONS of synthetic fillers, often from cut ends, don't equal virgin filler for warmth but make a good budget bag for warmer camps

STITCHING PATTERNS insure distribution of filler. Overlapping V tubes are best for down; diamond and loop stitch for synthetics



lent—not waterproof. A **waterproof** bag will trap your body moisture inside, and you'll wake up wet and cold. If you're concerned about ground moisture, use a ground cloth or tarp, and don't attempt to sleep outside in the rain. Get a fabric with a high thread count—more threads per square inch—and get at least a percentage of synthetic material for durability. The shell material is also listed on the bedding label.

Pick Your Size

Size and style of your bag are up to you. The form-fitting "mummy" style bags are lightest and least bulky, but many campers don't like their zipped-in feeling. The square bag, or sleeping robe if it unzips clear around, will be more like your bed at home. Many robe-styles can be zipped together to make double bags, and the full-opening zipper makes them easy to air and clean.

The average adult bag will measure about 32 by 76 inches, *finish* size. If you're over 6 ft.-2 inches or more than 40 inches around the middle, or a restless sleeper, you'll like the over-size bag, around 40 by 82. You can get smaller-than-adult bags for kids, but if you buy good bags, they'll out-grow them before they wear them

Sleeping Bags



PURE GOOSE DOWN can't be equalled for warmth or light weight; despite fragile nature of individual feathers, they're quite durable



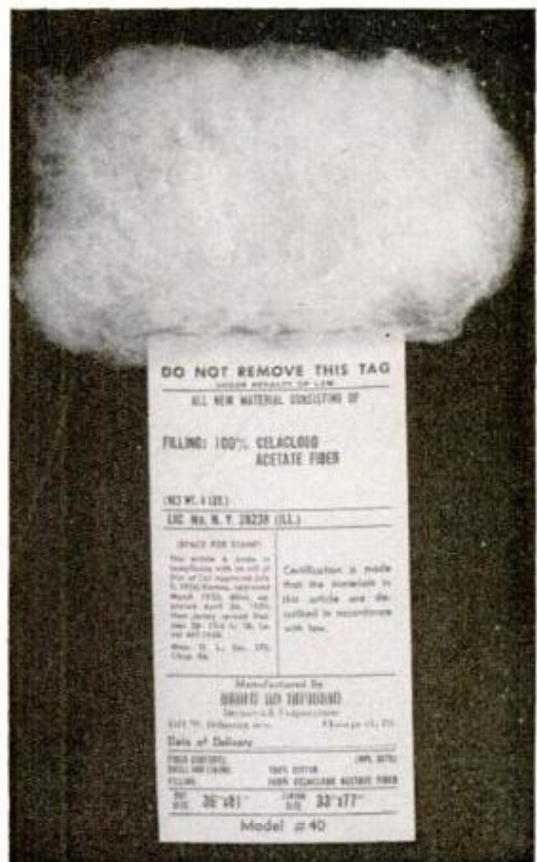
POOR SUBSTITUTE for down, clipped feather ends haven't the insulating quality or resiliency of the real thing. Watch the tag

out. Better go full size. If rolled size is important to your packing plans, remember that bags are rolled loosely on the shelves, and ask for a chance to roll it tight for comparison.

Construction Features

Construction features that mark a good sleeping bag are easy to spot. Look for a high-grade, heavy-duty zipper with pull tabs inside and out. Snaps don't make good closures. Look for a "draft tab" inside the zipper, to keep out cold air and keep the cold metal off your skin. Check for heavy thread and double stitching in the seams. Quilting pattern marks quality; look for V-tubes in a down bag, and a diamond or cross-stitch in synthetics. Loopstitching is less desirable, but less expensive. Look for a liner for extra warmth and wear, and for easy cleaning, and for cloth tie tabs to hold it. Head canopies aren't really much use, but the canopy makes a wrapper when rolled, and that's essential for long shell wear. An air-mattress pocket is good, but only if the bag is big enough so the inflated mattress won't crowd you. If you'll be camping out in very cold weather, a head-and-shoulder hood is a good idea. ★ ★ ★

CLOSE SECOND among synthetics is acetate fiber filler. "Do Not Remove This Tag" is for dealer; you can take it off of your bag





Electric Caddy Cart

Traveling 36 holes without recharging, a silent, battery-operated caddy cart follows the golfer's stride at any speed. Finger-tip guidance on its single handle provides easy handling up or downhill.

The unit has a 2.5-horsepower electric motor with six batteries. The 110-volt a.c. charger and timer clock are built into the battery box, and the unit disassembles to fit into a car trunk. The 12-volt power supply is enclosed, and the motor is sealed against dirt. The four-wheel trailing cart weighs 79 pounds.

The unit costs \$230. The manufacturer is Toro Mfg. Co., 2016 Snelling Ave., Minneapolis, Minn.



Made in Mexico By Mexicans

Believed to be the first commercial airplane to be built in Mexico by Mexicans, the LASA 60 was designed by Juan F. Azcarate who studied at the Guggenheim School of Aeronautics in New York City in 1927. Three decades passed before he could realize a dream.

With the cooperation of Lockheed Air Corp. of the U. S., which built the prototype, the LASA (for Lockheed-Azcarate, Sociedad Anonima) is a six-place monoplane built at the company plant at San Luis Potosi, Mexico. It has a six-cylinder engine and is capable of nearly 170 m.p.h.



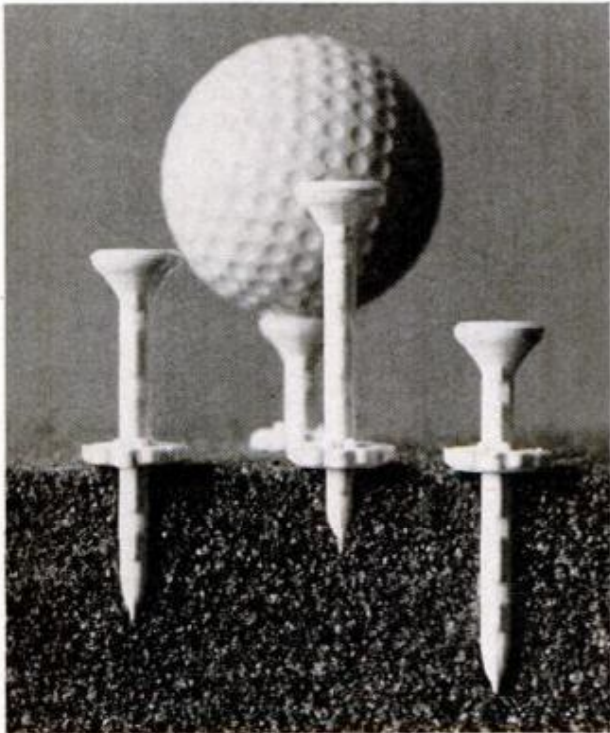
Go Anywhere Go-Buggy

Equipped with endless rubber tracks and either wheels or skis up front, a two-place amphibian can traverse swamps, snow, bogs or mountains. Designed for commercial cross-country travel for foresters, oil crews, road builders and others, the 9.5-horsepower vehicle could also be used by sportsmen.

The Polar 500 is eight feet long, three feet wide and weighs 660 pounds. It is made by the Polar Manufacturing Co. of Thief River Falls, Minn.

Four-Way Golf Tee

Adjustable to four heights, a new plastic golf tee helps set the ball at the best height for a golfer's swing every time. Moving the collar up or down determines the height; strong, but resilient plastic prevents marring of club heads. It's made by Cosom Corp., 6030 Wayzata Blvd., Minneapolis 16, Minn.



It's Light on the Feet

Solid squares of steel embedded in the ground produce light through the principle of electroluminescence. Light is created by the excitation of phosphors in an electrical field without bulbs, tubes, filaments or cathodes. The solid-state, lighted steel sidewalk is produced by Sylvania Electric Products, Inc.



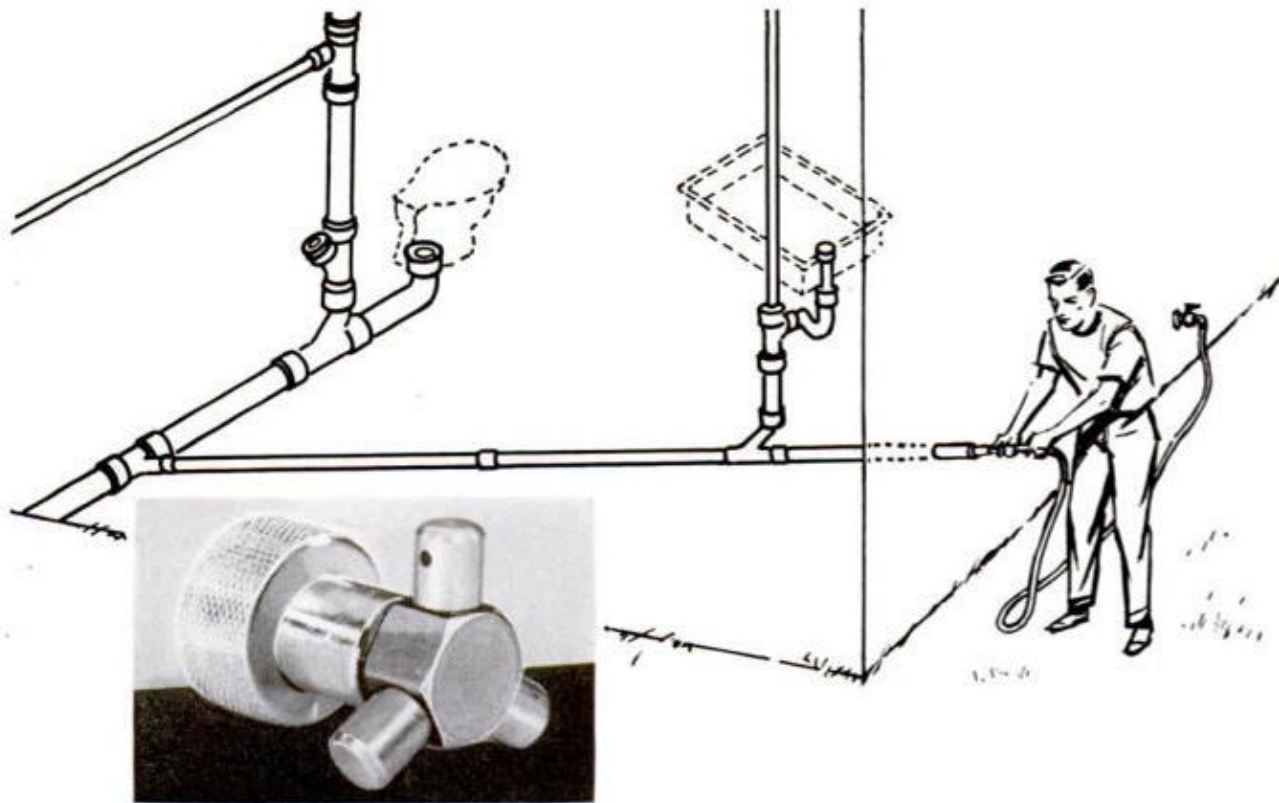
Outboard Motor Sailer

Half power cruiser and half cruising sloop, a new 17-foot outboard sailer has a hull designed for performance with either power.

The hull is an inverted bell shape in cross section, which provides keel area without undue drag, a dry ride even under 180 square feet of sail, and a walkaround deck without sacrificing cabin space.

The cabin sleeps three; the big cockpit rides six. Sails are roller reefing—they roll up like window shades. Other features include a self-bailing cockpit, telescoping centerboard and retractable rudder. "Picnic" sells for about \$2000 from General Boats Corp., 32 West 46th St., New York 36.





Three-Jet Nozzle on Garden Hose Flushes Clogged Pipes

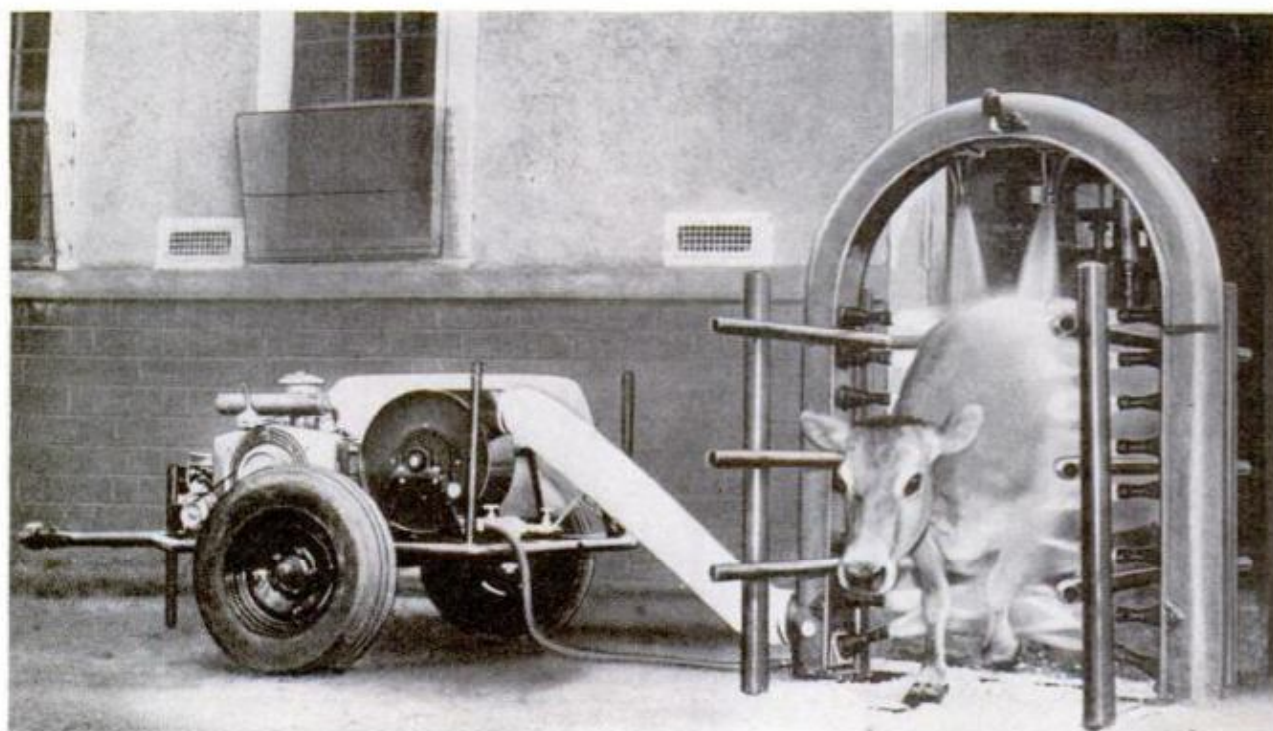
Sewer and drain pipes can be flushed out with a rotating nozzle that fits on a garden hose. The hose is inserted in the pipe until it reaches the obstruction, then the water

is turned on and the three-jet nozzle, rotating like a pinwheel, dislodges the obstruction. Price is \$4.95 from Normac Engineering Co., Box 2202, Torrance, Calif.

Spray Gate Gives Bossy a Quick De-Bugging

Both dairy and beef cattle can be chemically sprayed with a rig resembling the kind used in "speedy car wash" garages. A liquid mixture enters each of the 18

nozzles and blowers atomize it, forcing it out in a fine spray that covers the animal. It's made by Sprayfoil Corp., 222 W. 82nd St., Minneapolis 20, Minn.





Live Clay Pigeons for Army's Shooting Gallery

Since troops on maneuvers cannot use live ammunition, individual soldiers do not get the psychological satisfaction of knowing when they score hits.

A new hit-indicator system, consisting of an infrared flash lamp and antenna mounted on the helmet and corresponding

firing equipment in the M-14 rifle, will give off an appropriate signal when hits are scored, just as in a shooting gallery.

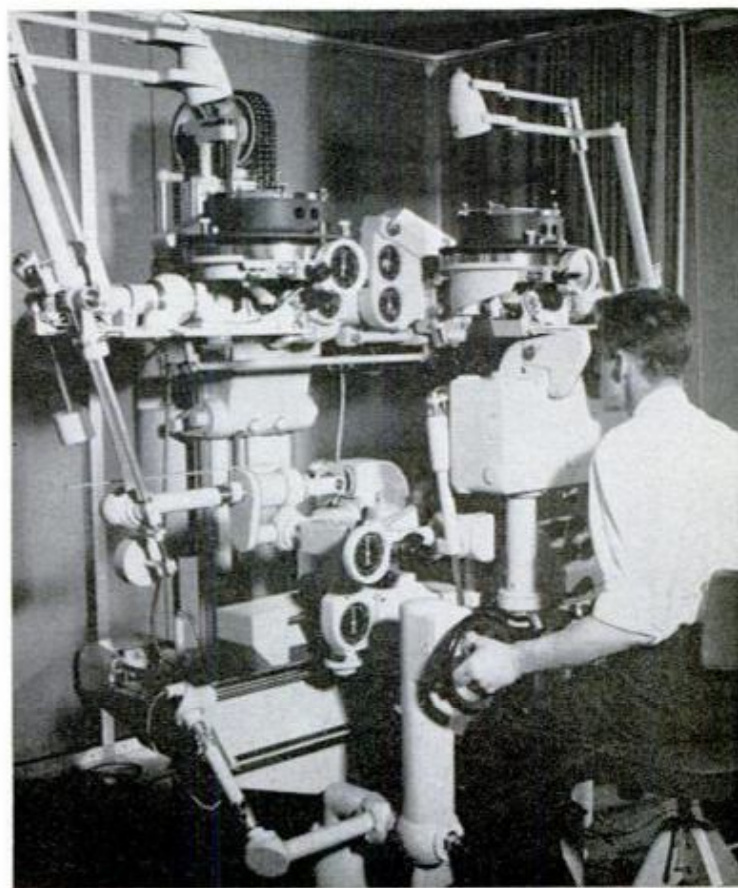
Under study by the Army, the equipment was developed by Aircraft Armaments, Inc. It has a range of up to 500 yards and may later be adapted for larger weapons.

Aerial Photos in 3-D

Because of a shortage of civil engineers, U. S. Forest Service people in Utah bought a German-made stereoplanigraph, a machine which projects 3-D images of photos taken from the air.

These aerial pictures are shot over areas where the forest service would like to build roads leading to inaccessible timber areas. By viewing the pictures in stereo, and leisurely, the forest service can make accurate determinations of the best routes without spending a lot of time in the field.

The original photos are made with a companion camera to the stereoplanigraph. Diapositives are made from the photos and inserted in the round grids above the operator's head. These transmit enlarged 3-D images onto the viewer. The machine also feeds to a computer information on the proposed road's grade, the amount of earth to be removed or filled and other data needed by road crews.



WHAT'S NEW FOR



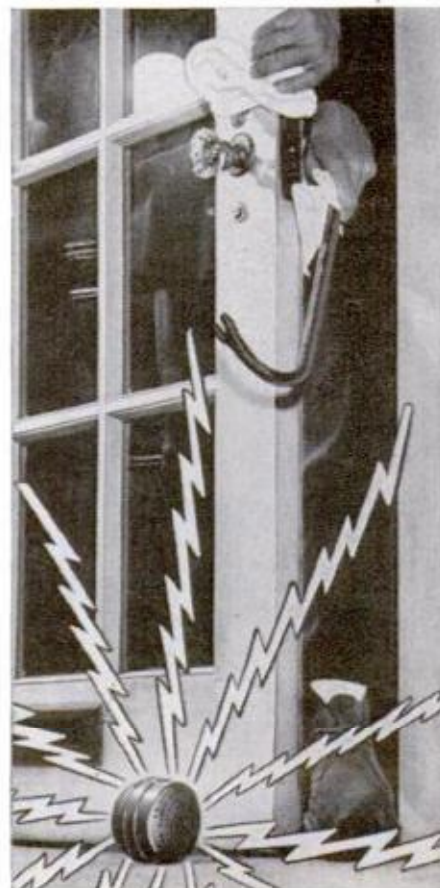
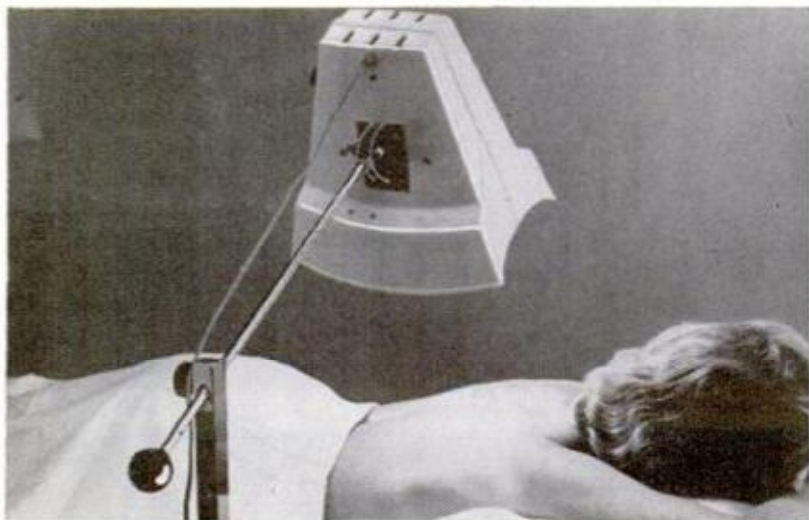
FLUFFY CARPETING goes on any floor without adhesives; tiles interlock. The plastic-based acrilan (in 20 colors) costs \$1 per nine-inch square from the Jaystron Corp., Box 1190, Akron 9, Ohio



CORDLESS HAND MIXER allows freedom from outlets. Rechargeable battery in handle furnishes ample power. Sunbeam Corp., Chicago 50, Ill.

BATTERY-OPERATED alarm, right, screams when bumped; a thread connecting several doors and windows may operate one alarm. Costs \$6.95 from Volz Enterprises, 602 Ferris St., Ypsilanti, Mich.

OSCILLATING BULB in infrared ultraviolet lamp heats a wide area; prevents focusing too much heat on one spot. Automatic timer sets for 1 to 60 minutes. Cuffman Co., Box 30, Malvern, Ark.

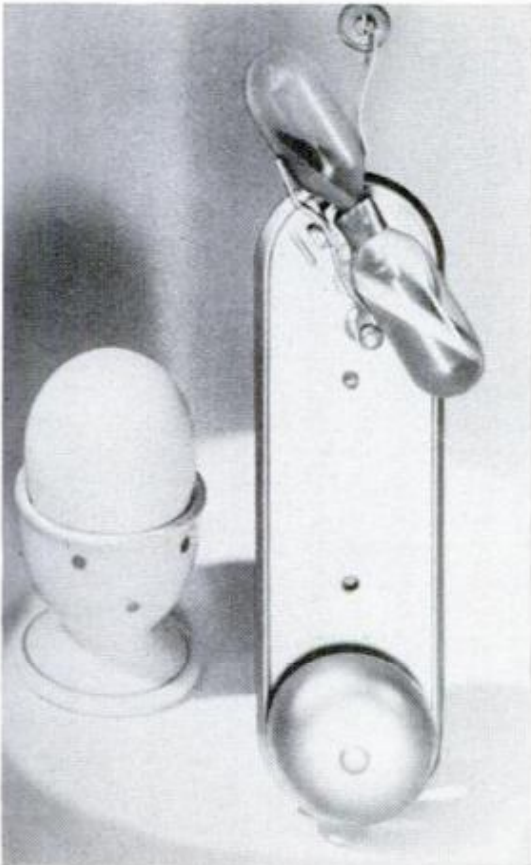




PORTABLE INFRARED HEATER provides heat in a few seconds regardless of surrounding air temperature. It can be hung on walls or ceilings; reflectors can be angled to direct heat. Available in 500 and 750-watt models for under \$40 from the Lau Blower Co., 3525 E. Washington St., Indianapolis 7, Ind.

BELL-RINGING HOURGLASS timer (for eggs or phone) strikes bell when eggs are ready. Attaches to wall or cabinet door. Costs \$1.25 from Hollis Co., 1133 Broadway, New York 10

TRANSISTORIZED STEREO PHONO and AM-shortwave radio plays through speaker or stereo earphones; runs on flashlight batteries. Portable unit costs \$79.95 from the Hoffman Electronics Corp., 3761 S. Hill St., Los Angeles 7





MINIATURE GRAND PRIX

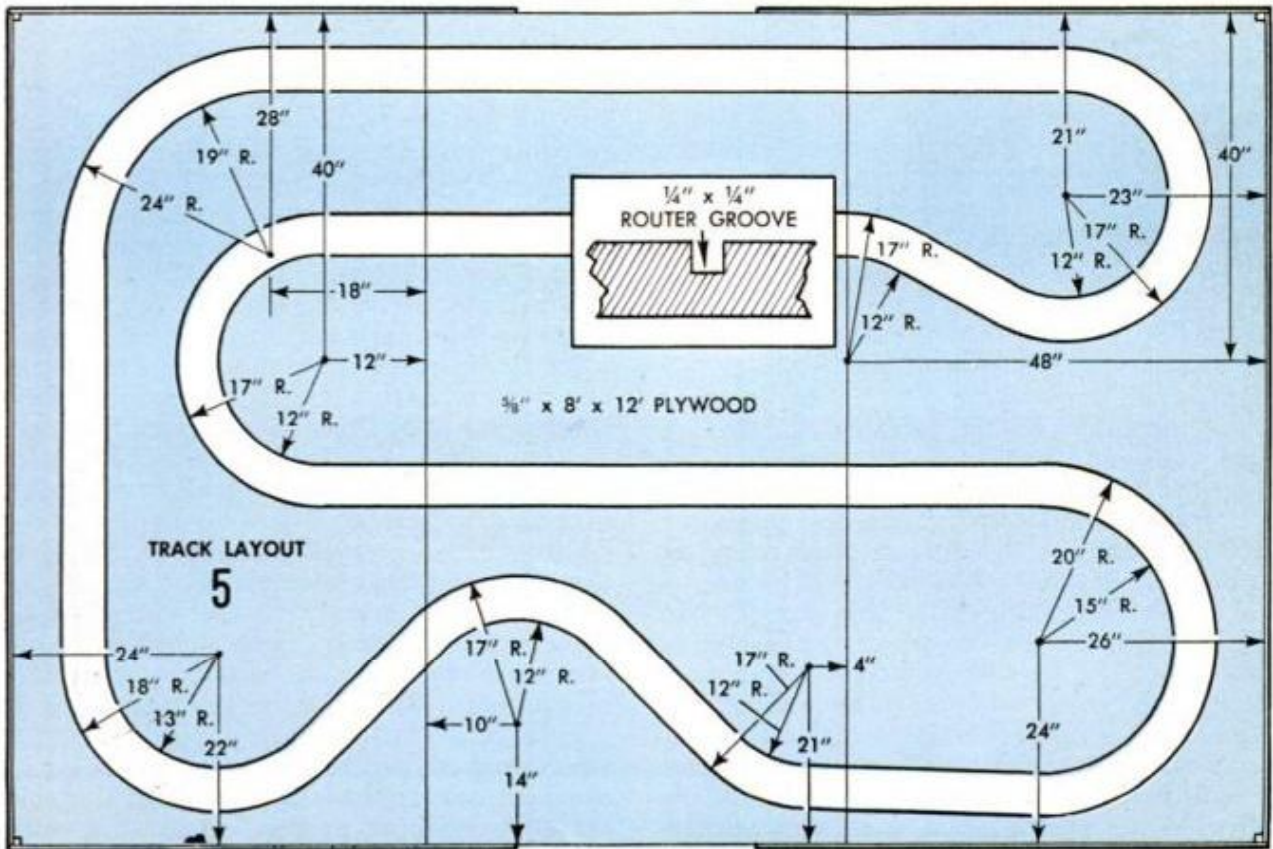
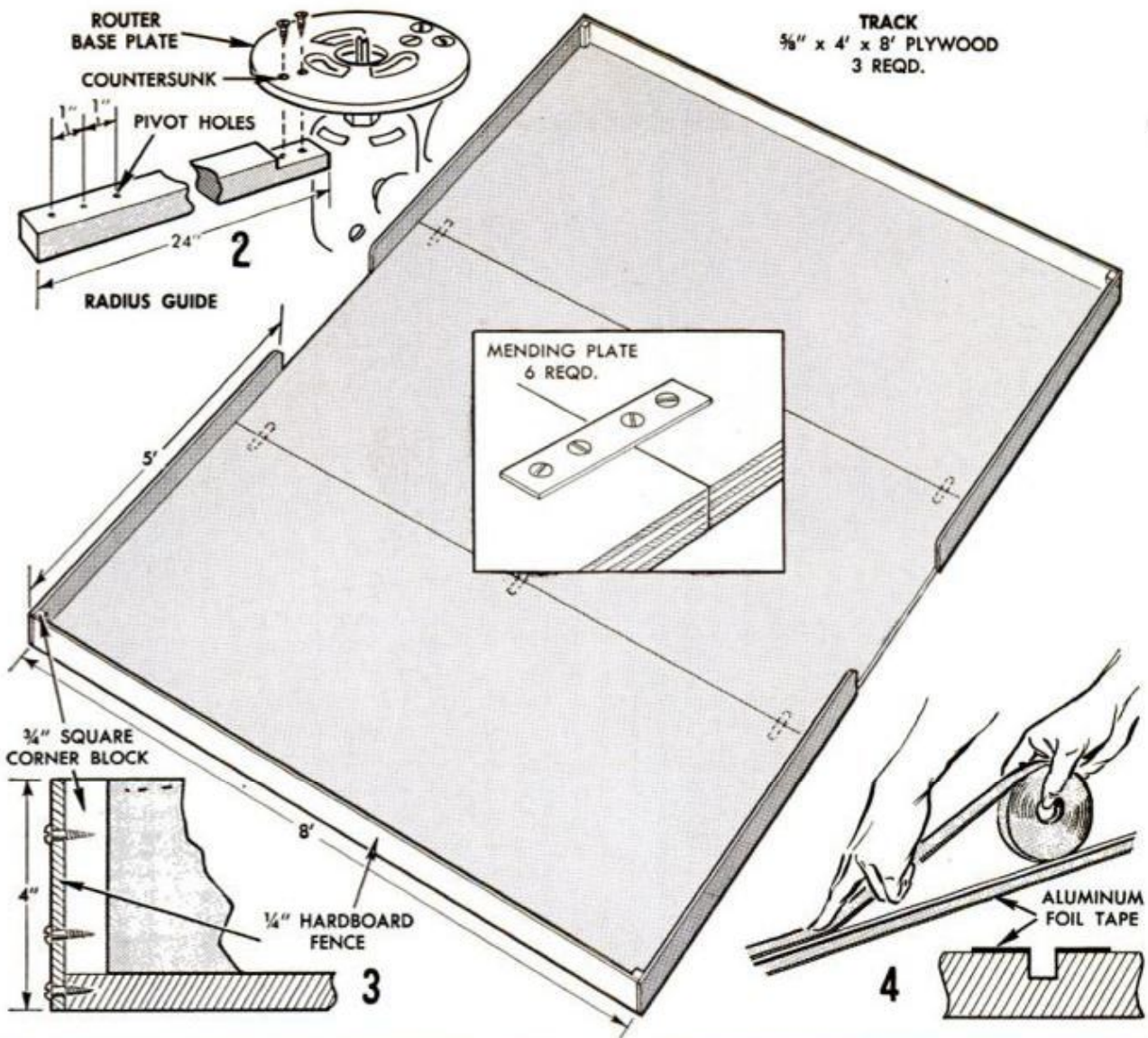
How to build your own table-top road track

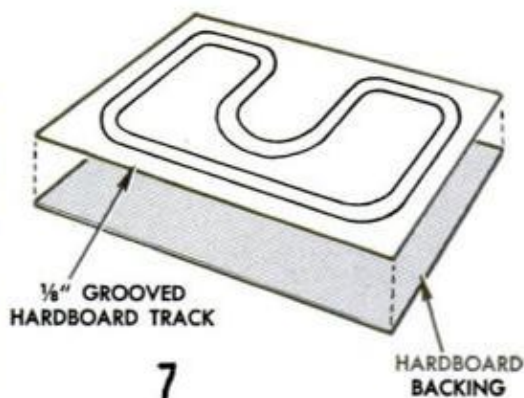
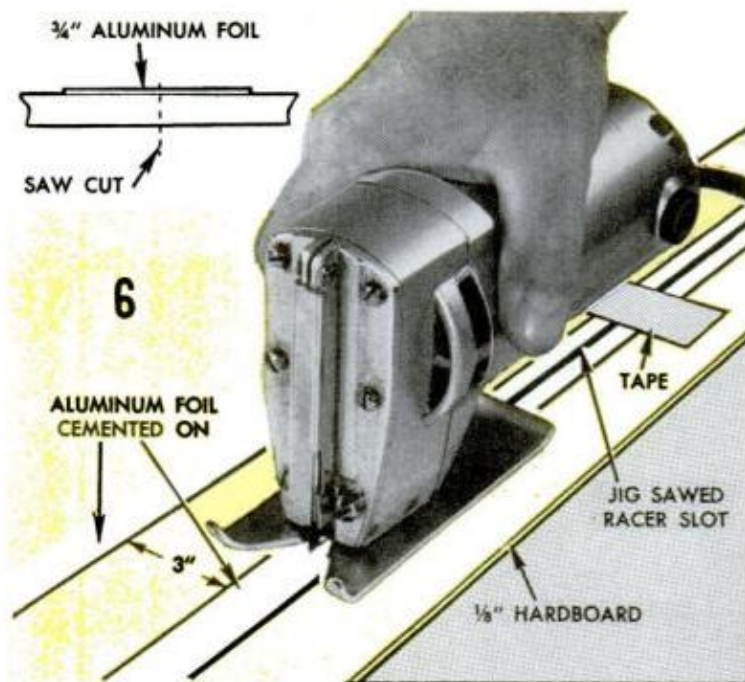


TABLE-TOP ROAD RACING is today's fastest-growing hobby, well on its way to outdistancing model railroading in popularity. Everyone seems to enjoy the thrill of whipping a tiny car through tight esses and around hairpin turns at tremendous scale speeds, and clubs devoted to this new sport are springing up all over the nation as reported in the December 1961 issue of *Popular Mechanics*.

As in model railroading, making your own custom road-track can be as much fun as racing the cars. You can make it as large and elaborate as you want, as hazardous and as scenic. The one big problem is the groove which guides each car. How to make it?

You have a choice of three methods: In one the groove is made with a portable electric router, in another it is formed with a saber saw and in a third the groove is cut





by hand with a special tool made for the purpose. In the latter two instances, you are limited to using hardboard as a roadway, and with the saber saw to making an HO-ga. track. The size of the groove is governed by the size of the car. If you are interested in HO-ga. scale, the groove need only be about $\frac{1}{8}$ in. wide. If you are interested in racing the larger scale models, say $\frac{1}{24}$ scale, the groove must be $\frac{1}{4}$ in. wide.

With a router, you can use either plywood or hardboard for a roadway, and of the three methods, a router does the best and most accurate job. Here the router is used like a beam compass in cutting the parallel grooves at the turns, Fig. 1, and guided along a straightedge to connect the turns with the straightaways. Fig. 2 shows how a radius guide strip is notched at the end and attached to the router by drilling two small holes in the base and countersinking for short, flat-headed wood screws. A row of holes for a nail pivot is made in the strip at 1-in. spacings (starting at a point 6 in. from the center of the router bit) to swing a minimum radius of 12 in.

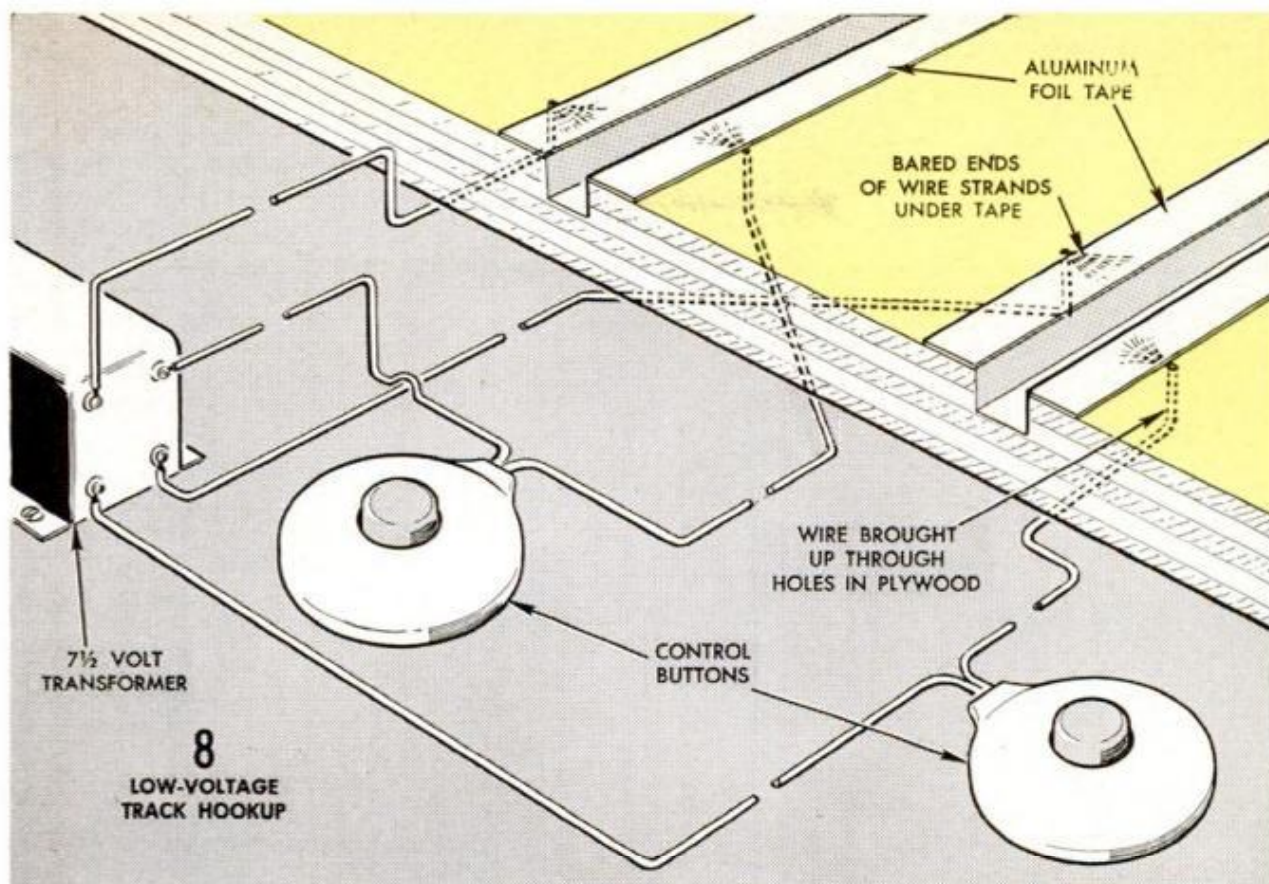
Over-all track size can be as large as space permits. The suggested two-lane layout shown in Fig. 5, measures 8 x 12 ft., being laid out on three 4 x 8-ft. sheets of fir plywood placed side by side and joined on the underside with common steel mending plates. Two long, table-high sawhorses are used to support a track of this size. Guard rails of 4-in. hardboard strips are erected at the turns, Fig. 3, to keep the cars from skidding and rolling off the table. Paint the whole table top green, then mark off a roadway about 8 in. wide and spray light gray.

Adhesive-backed, aluminum-foil tape applied along each side of each groove, provides power pick-up for the cars, Fig. 4.

The tape, which is about $\frac{1}{4}$ in. wide and easily applied around the turns of 12-in. radii without wrinkling, is joined by lapping the ends $\frac{1}{4}$ in. Use the bowl of a spoon to press the tape firmly in contact. Current from a 7 $\frac{1}{2}$ -volt twin-circuit transformer is supplied to the

tape contact ribbons by bringing the wiring up through holes drilled through the plywood directly under the tape. The bared ends of the wires are spread fan shape, pressed down flat, Fig. 8, and anchored with a spot of liquid solder before the tape is stuck down. Both the transformer and the remote-control hand throttle buttons (one for each car) can be purchased at hobby stores or you can make your own make-break control buttons from a couple of doorbell buttons. Adhesive-backed aluminum-foil tape can be purchased by the roll (180 ft.) from Mystik Adhesive Products, Inc., 2635 N. Kildare St., Chicago, Ill.

In following the saber-saw method, the saw cut itself forms the guided groove, and for this reason, the saw method is only applicable to making an HO-ga. track where only a tiny groove is required. Here $\frac{1}{8}$ -in. tempered hardboard works best for a roadway, and because of the small scale of the cars, a single 4 x 8-ft. sheet will let you lay out an extensive track of many hairpin turns. Where aluminum foil was applied after the grooves were made in the case of the router method, with the saw method the foil is applied first. But instead of tape, regular sheet aluminum foil is cut up in $\frac{3}{4}$ -in.-wide strips for the straightaways, on a radius for the turns and cemented to the hardboard with rubber cement. This, is done, of course, along $\frac{3}{4}$ -in. predrawn roadways 3 in. apart, the foil being joined as before by lapping the ends and wiring in the same manner. The saw cuts are made down the center of the foil roadways, Fig. 6, and to do this you will need to support the sheet on a couple of 2 x 4s to provide clearance for the saw blade. Keeping the severed pieces from shifting until such time as the whole panel can be glued to a second



supporting panel of hardboard, Fig. 7, is the tricky part. The best way to do this is to saw a short distance, stop and bridge the saw cut with tabs of masking tape. It is important, as you can see, that the saw cut does not close up at any point which would cause the car guide pin to bind in the groove. Perhaps no more than a two-lane track layout should be attempted with the saber-saw method as otherwise you will wind up with a jigsaw puzzle of so many

separate pieces it will be impossible to handle. With a two-car track, only three separate cutouts are involved.

Where you have neither a router nor a saber saw, you can buy a tool at hobby shops called a Track Maker. It's a handheld cutter which you push like a plane. Designed for use in hardboard only, the tool comes with a radius setting arm for accurately cutting the grooves at the turns.

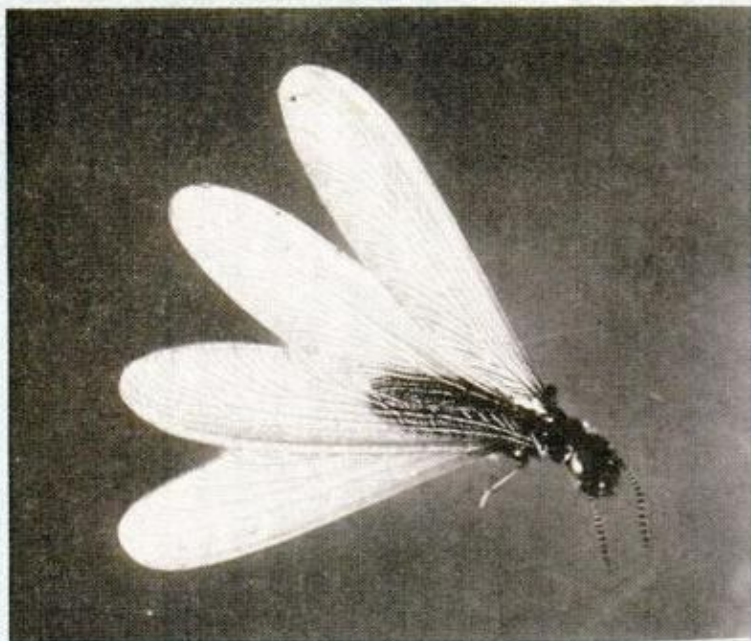
★ ★ ★

Calling All Rabbits

For several years some friends of mind had a lot of trouble with wild rabbits eating up their garden vegetables and flowers. The rabbits ate everything right down to the ground. After trying any number of deterrents, they bought twenty toy windmills of the type pictured and placed them at strategic points around the lawn and garden. Whether it is the spinning, the whirring sound or both, the rabbits since have been content to feed on the garden next door.—Robert A. Brown

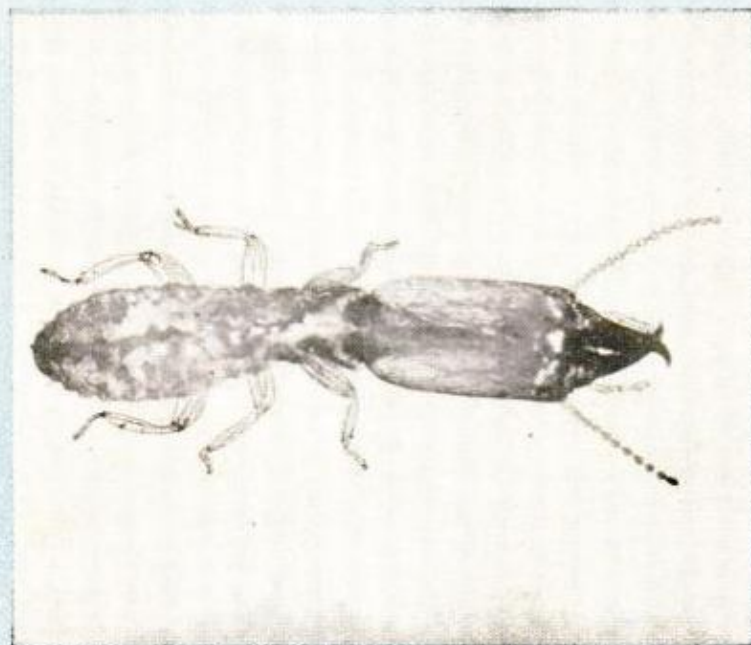
Before you toss out worn-out trousers save the pockets. Slipped over the hand when shining your shoes they make handy mitts for applying the polish or for buffing to a high shine.—Leo C. Schlitt, Jr.





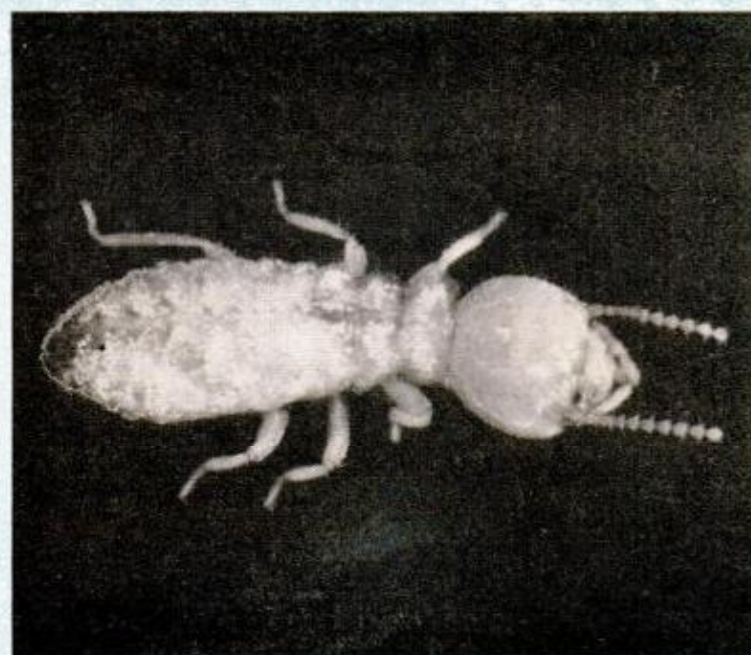
QUEEN

Subterranean termite colonies are highly organized societies with three well-defined castes, the king and queen, or reproductives, the soldiers and workers. When young kings and queens emerge, or swarm, from the subterranean colony they have wings like the individual pictured. After a short flight (distance may vary greatly) they settle, shed their wings, tunnel into the earth and start a new colony which may develop into a family of several thousand individuals in 5 to 10 years. New colonies do comparatively little damage during the first two or three years. Winged individual pictured is only about $\frac{1}{2}$ in. long



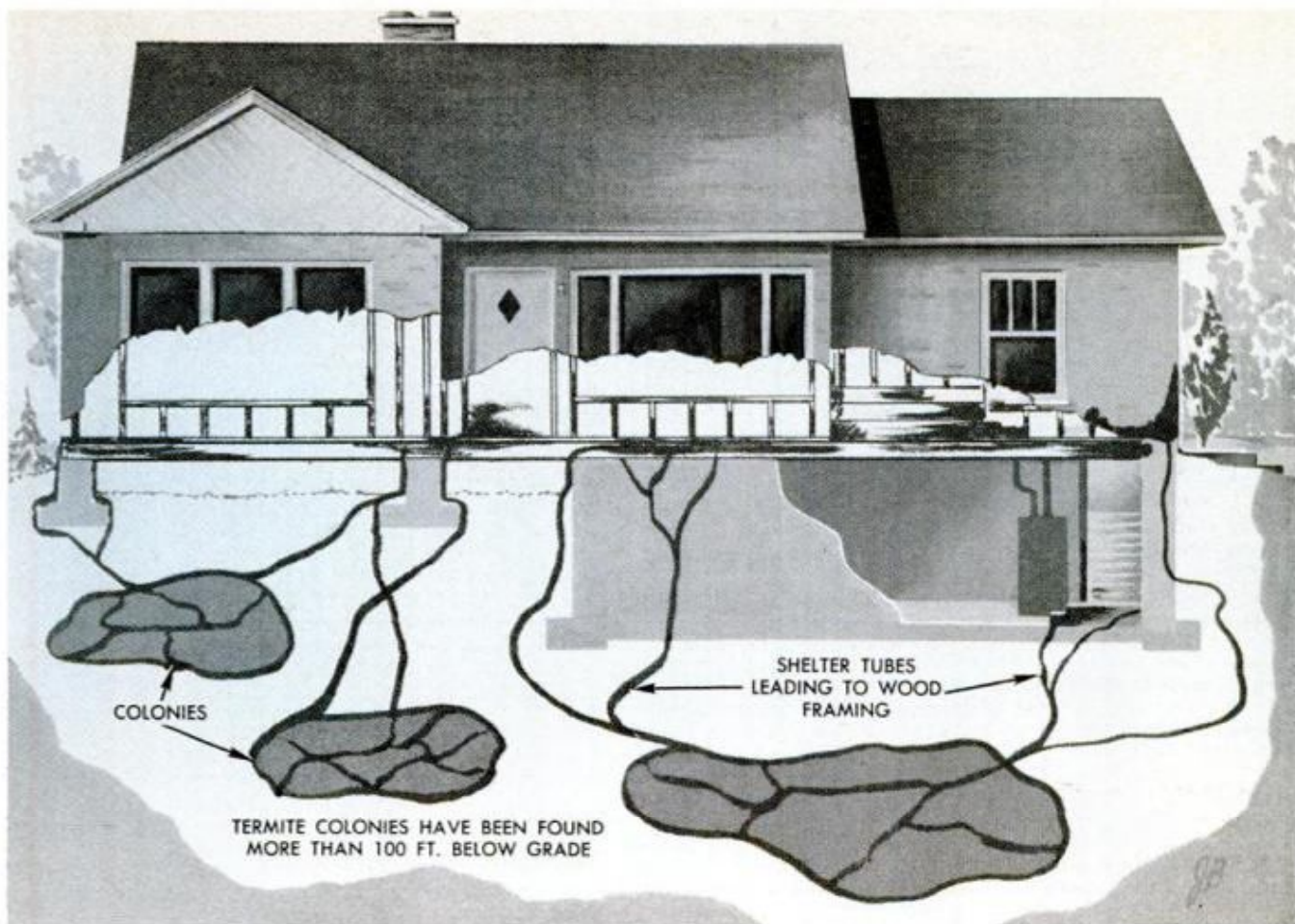
SOLDIER

This fellow looks every inch the soldier although he's less than a half inch long, life size. He does no work. His job is to guard the termitary, or nest, and the workers, protect both from natural enemies. He is far outnumbered by workers and because of this, does comparatively little damage during his whole lifetime. In general build he is much like the worker termite but his head is longer and he has a pair of powerful mandibles, or jaws. Open a shelter tube at some point and almost instantly soldiers will appear and remain on guard until workers have fully repaired the break



WORKER

After a new colony is established eggs laid by the queen hatch into nymphs which develop into adult soldiers and workers, the latter far outnumbering the former. Workers do the damage, their food being solely the softer portions of wood, usually summer wood. Given time workers can tunnel the entire length of a supporting beam or sill, or honey-comb a stud from sole to plate and never betray their presence. Floor joists, sheathing, other wooden members get the same treatment. But remember it usually takes years of work by a well established subterranean colony to damage a structure to the collapse point



SUBTERRANEAN TERMITES attack your home from below and this diagram illustrates how they go about it. There may be only one nest, or territory, from which long shelter tubes lead up to wood which is their food

SNEAK ATTACK!

Here's how to discover and destroy those house-wrecking termites, and ways to keep them from attacking and damaging your home

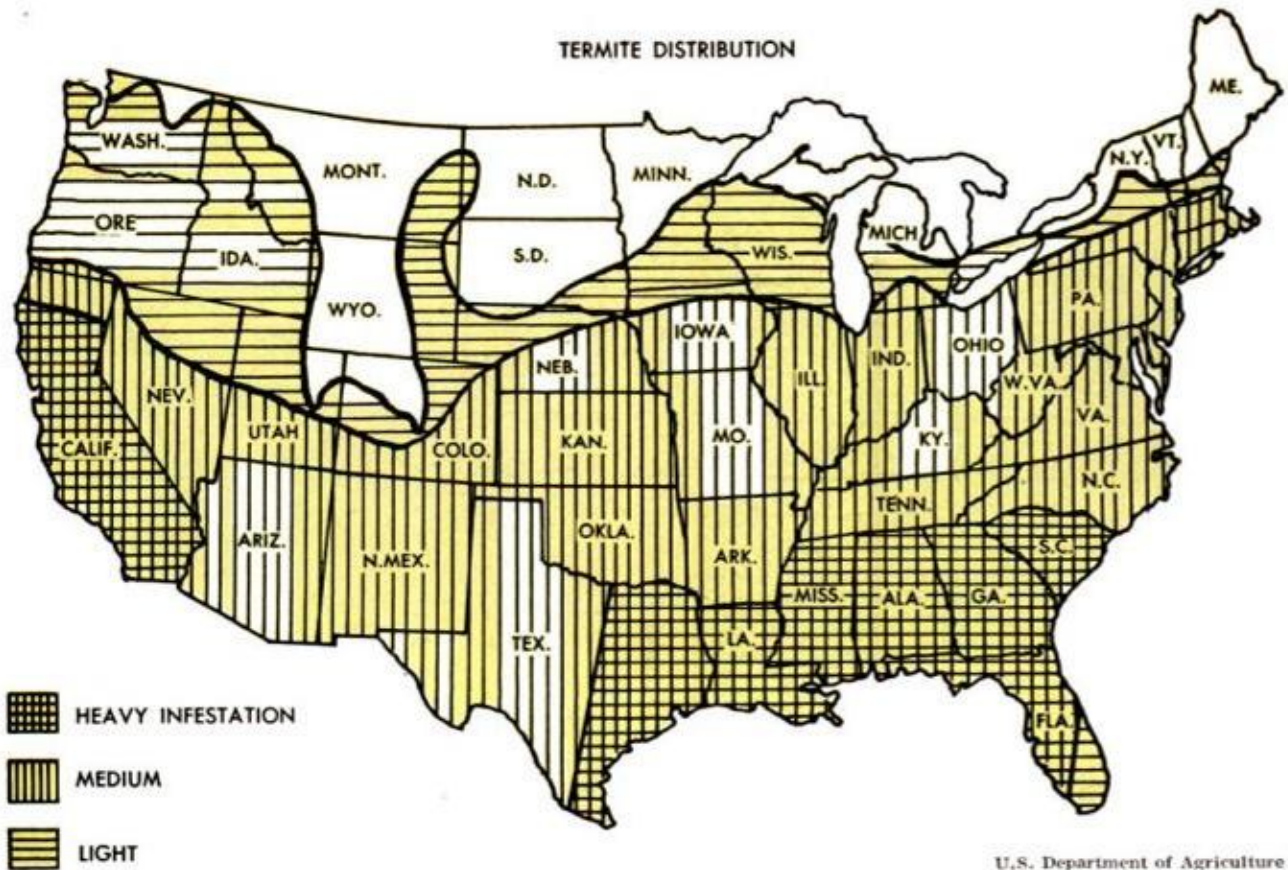
By Fred R. James

AS THE SHADED MAP on the following page shows graphically, termites have been found in nearly all states, some in climates and localities where they were never known before. Pioneer termite colonies now are spreading out to include ever widening areas of infestation. Unprotected seasoned wood of almost any kind is termite food, also most products made from wood. Termites are of two kinds, subterranean and nonsubterranean. The latter are far less widespread than the former and as a rule are much less damaging to wood structures.

Termites work slowly and that leaves time on your side. If you're a fairly close observer and know what signs to look for in and about the home, the chances are

better than good that you can discover and destroy any termites you may be unknowingly hosting before they can do any appreciable damage to the structural members of your home. Take a long, close look at the three characters pictured on the opposite page, especially the winged individual, so that you are sure to remember them clearly. The winged kings and queens (they look much alike) are the only ones you are ever likely to see either in the home or on the grade outside. Study the family cycle which is diagrammed on the following page. This progresses from eggs to nymphs to workers, soldiers, and winged reproductives, that is, kings and queens. These latter leave the original nest, emerge, sometimes in your basement but usually

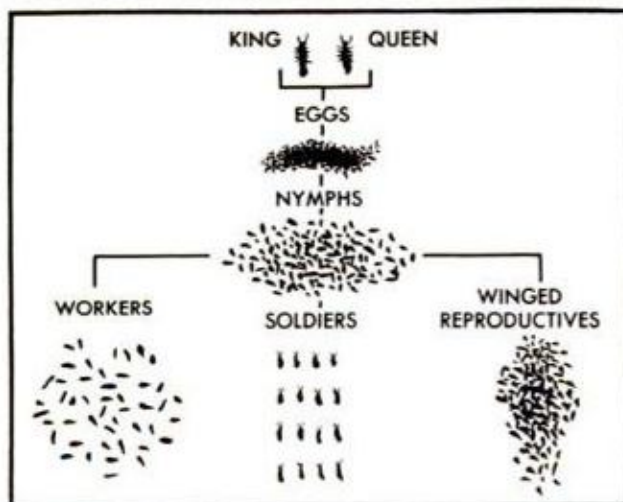
TERMITE DISTRIBUTION



- HEAVY INFESTATION
- MEDIUM
- LIGHT

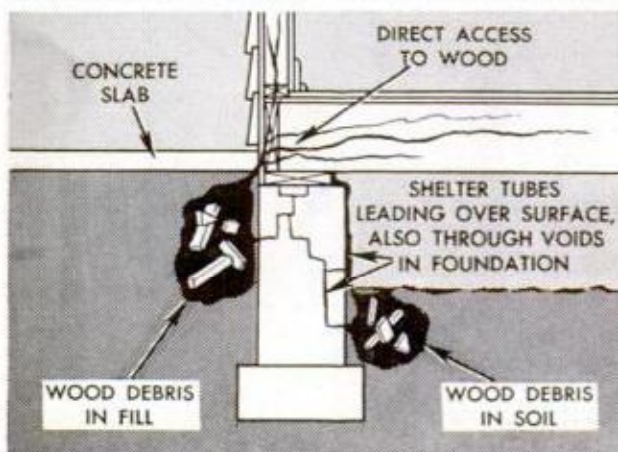
U.S. Department of Agriculture

MAP ABOVE shows present extent of termite distribution. Range is no doubt being extended year by year



DIAGRAMMED above is order of family descent of the subterranean termite. Workers do greatest damage

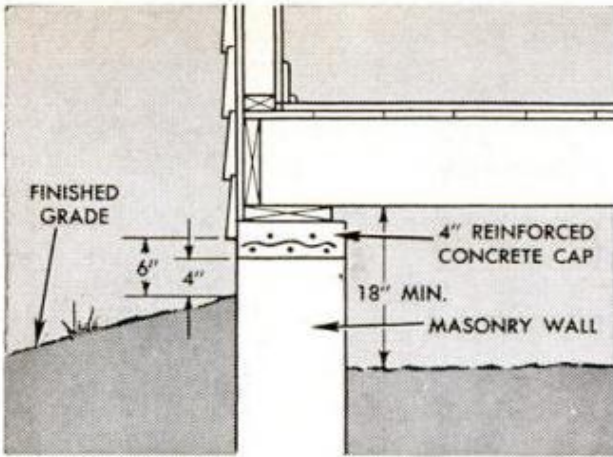
WOOD CUTTINGS buried below grade around new construction are invitation to new termite colonies



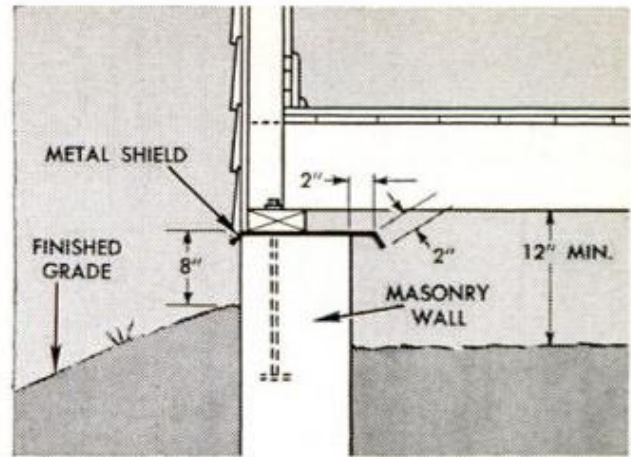
outside somewhere on the grade, swarm, and then take off to establish new colonies, generally in the immediate vicinity, but sometimes at a considerable distance, especially if carried by a strong wind.

Moving day in a termite colony can come at any time during warm weather, but generally takes place in the early spring. Termites reveal their presence only by the emergence above ground of the winged members of the colony and by shelter tubes which lead from the ground across open areas of foundations to the wooden members of a structure. Note the shelter tube pictured on page 132 leading from the basement floor to the joists. This has been purposely exaggerated, as is the drawing of the colonies and access tubes on the preceding page, but both do give an idea of the colony system of the common subterranean termite and how it functions. Termites actually require only one contact with the wood in a structure to work their way eventually throughout parts of the whole structure.

The workers tunnel up from the nest, or termitary, which may be 100 feet or more underground, through the earth, through voids in masonry foundations and build shelter tubes, or tunnels, as already noted, to reach wood sills, studs, sheathing and joists. Subterranean termites do not ordinarily work to the surface of wood frame members; they work entirely within the section. Thus small round holes on the sur-



CONCRETE CAP on a block foundation prevents termites from reaching sills, joists and other frame members through blocks or voids in the brick or concrete



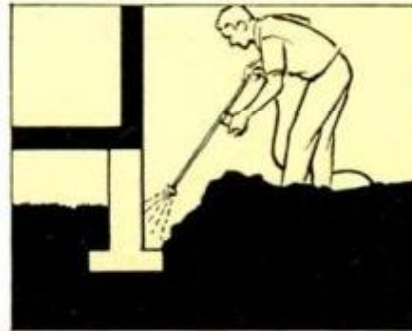
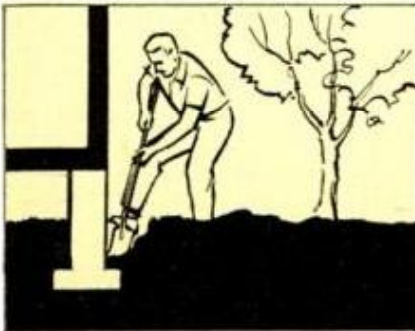
METAL SHIELDS are often used by builders as termite barriers. Properly installed these are quite effective in preventing termites from reaching wood members

Chemical soil treatment for home with crawl space

FIRST STEP in chemical soil treatment is to trench down to footing

APPLY SOLUTION at rate of about 1 gal. to 5 linear ft. of trench

FILL TRENCH and apply same amount of solution on top of fill

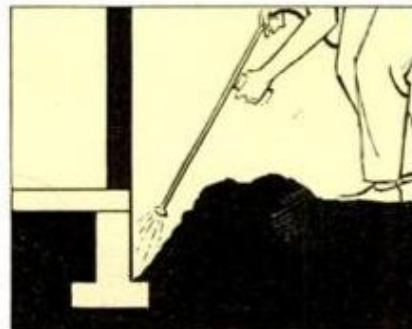


Chemical soil treatment for home on concrete slab

HOMES ON SLABS also require trenching to top of the footing

APPLY SOLUTION in about same proportions as for crawl space

GIVE SPECIAL attention to areas around soil pipes, water pipes



Chemical soil treatment for home with basement

IN BASEMENT force solution around soil and water pipes

TRENCH around basement wall should be dug to a depth of 30 in.

DRILL through basement floor and pour solution through holes



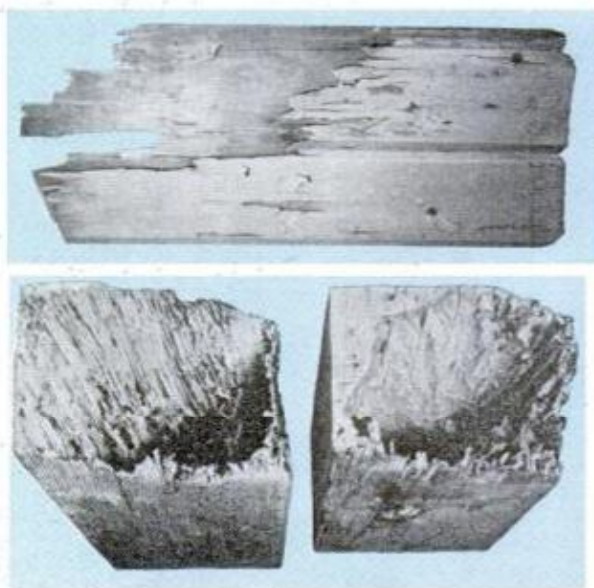


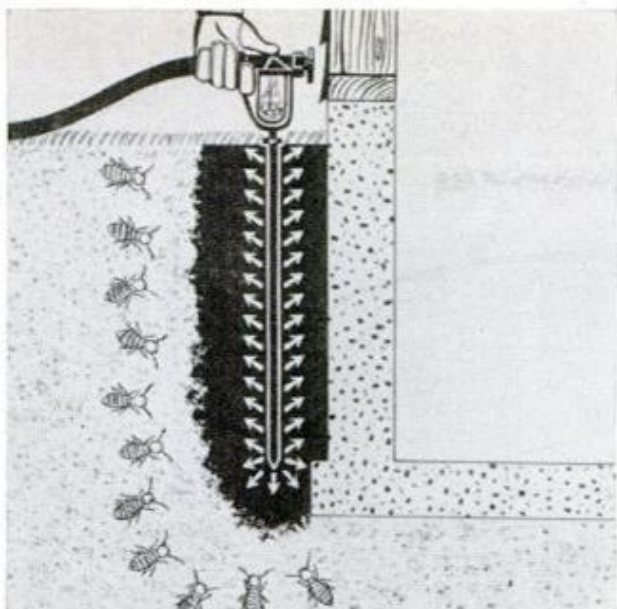
faces of joists, sills, or any other frame members of a structure, although they may appear to be suspect, are not normally the work of the subterranean termite. Note in the honeycombed framing members, as pictured below, that the centers of the lower two members have been almost entirely consumed, leaving only the four sides of the sections still intact. This is typical of the damage done by the subterranean termite. On the other hand, nonsubterranean termites work above grade, may attack any part of any wooden structure. They do not build tunnels from below-grade termitaries, but fly directly to and bore into seasoned wood, which can be anything—telephone and power-line poles, stacked lumber, building framing such as exposed rafters, outdoor and indoor furniture, even the books and bookcase in your library, or your piano, if you have one. At present the nonsubterranean termite is not found north of the Gulf States.

To locate a colony of subterranean termites look closely along the foundation, inside and out in either a crawl space or basement, for the telltale shelter tubes. These are mud-like structures a half inch or more in width, roughly semicircular in section and attached firmly to the surface of masonry. Evidence of the presence of termites is more likely to be found in locations where there is comparative darkness throughout the day and where the soil is always damp. Go over every inch of the foundation in a crawl space from the grade level to the sill and search closely along the foundation of a house built on a slab. If you discover even one shelter tube, you are host to a termite colony. Or, if you see winged swarms flying outside, clustered on a basement window or on the grade near the foundation on a warm spring day, it can only mean that these individuals either are leaving an established colony or are in the process of establishing a new colony.

Damaged wood and the extent of any damage usually can be checked with fair accuracy simply

SHELTER TUBES, left, built by termites to reach wooden members of structure can be inside or outside basement wall. Below, work of subterranean termites shows timbers hollowed out



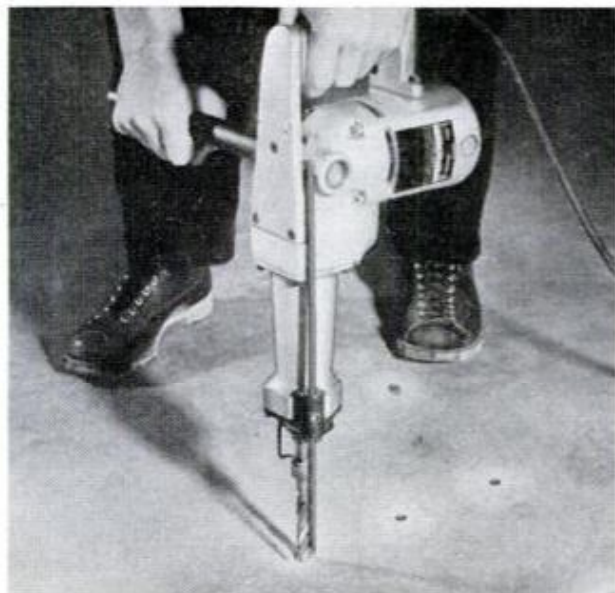


SOIL INJECTOR attaches to garden hose, forces chemical into soil along the foundation wall, as at right

by pressing the point of an awl or a sharp knife blade into the wood along sills, joists, beams and any other exposed framing members. Also, tapping these exposed members lightly with a hammer will disclose any hollowed-out sections. Do the same with any wooden stair or step stringers resting on low piers of wood or masonry near the grade level. In older homes the space under the front porch floor is often utilized for storage of fireplace wood, lumber, discarded screen frames and what have you. Here's the setup made to order for budding termite kings and queens to establish a new colony. Clear the rubbish out of such places and go over the exposed foundation wall closely.

Ordinary prevention and elimination
(Continued to page 180)

SLAB FLOORS can be treated during or after construction by drilling holes and pouring in the solution



MAY 1962



COMMON METHOD (below) is to trench along foundations in new homes and apply chemical solutions



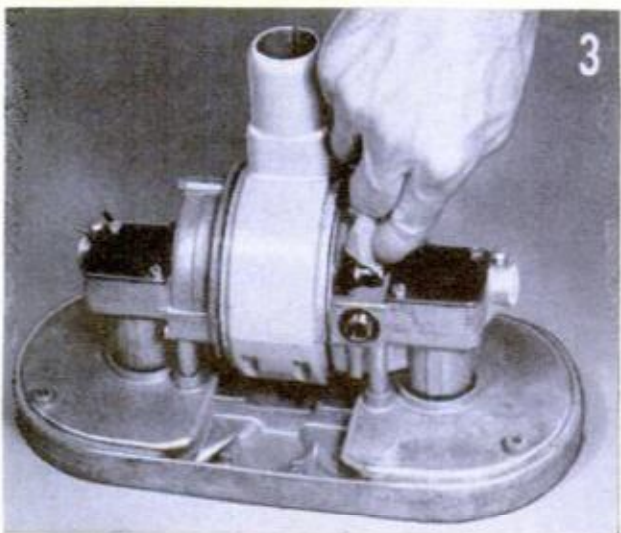
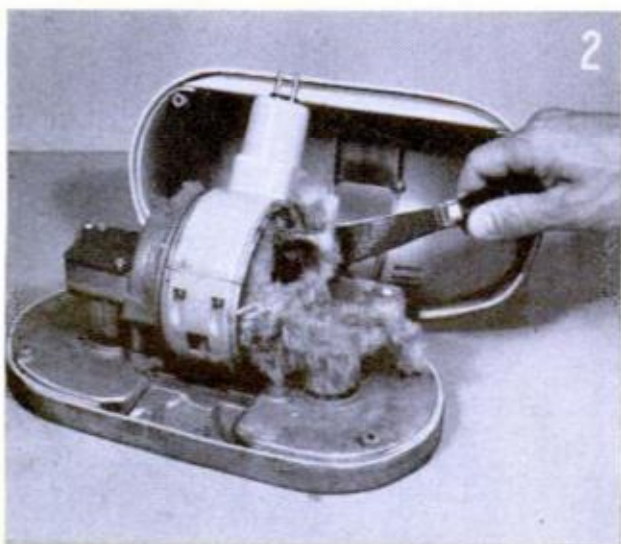
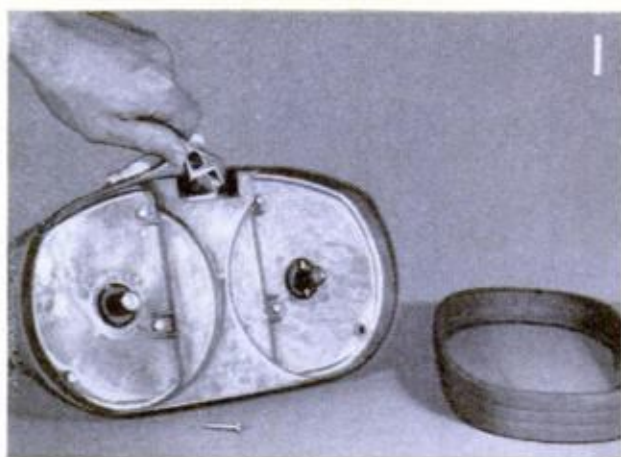
SOME BUILDERS apply solutions in trenches made for footings. Method is effective in absorptive soils



133

FLOOR POLISHER

Household



D ID YOU ever see a household electrical appliance of which it could be said that all parts were completely worn out, no longer serviceable? That would be a rare thing. Most of them are swapped or junked when motors, bearings and many other parts are still serviceable — with a little fixing. Parts that are especially vulnerable to wear go faster, of course, an example being motor brushes. Normal wear is often greatly accelerated by simple neglect and by unusual operating conditions.

There is always the tendency to leave well enough alone when things appear to be working and there are no unusual mechanical noises to attract attention. But take a look at the insides of the floor polisher in Fig. 2 and you'll see what usually happens after a time when you continue to polish what you thought were clean floors.

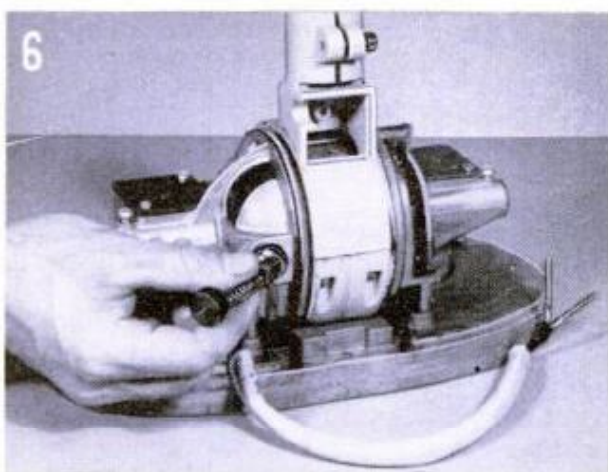
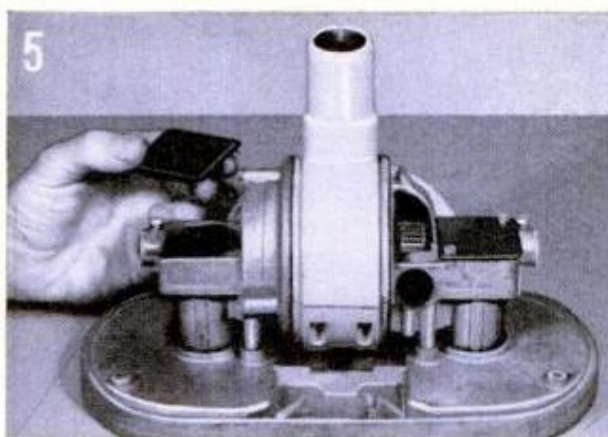
Here the accumulation of dust, lint and no telling what else has almost reached the point where it could conceivably provide a path for an electrical short. The lesson to be drawn from this exhibit is simply to clean up the floor polisher periodically and also give it the once-over to discover any parts that may be showing undue wear. When you dismantle a polisher, Fig. 4, be especially careful when removing the handle. Usually you loosen a clamp at the base, unplug the cord and slip the handle out of a socket. Then you remove the cover, or housing, by backing out several small screws having either slots or hex heads, Fig.

Appliance Fix-It File

1. As a rule you'll find the commutator, Fig. 3, in good condition, that is, it will be a uniform color. Usually it's best to just wipe it with a clean, soft cloth as you turn the armature by hand. If the commutator seems to be rough or slightly pitted, then it's permissible to clean it with very fine sandpaper.

It's always a good idea to remove the brushes, Fig. 6, and examine them for wear and chipping at the edges. Usually it's the rule to replace brushes worn shorter than $\frac{3}{8}$ in. or so. Never replace just one brush. Always replace both brushes, even though one may appear to be in good condition.

Floor polishers are pretty much the same in general design. The motor usually is mounted between two vertical shafts, or spindles that carry the brushes. These spindles are driven by bevel gears from the armature shaft. These gears run in oil or light grease contained in reservoirs. In older polishers it is a good idea to remove the covers of these reservoirs and check the oil level, or the amount of grease they contain, Fig. 5. The amount should conform to the manufacturer's specification but if you do not have this and added lubricant appears necessary, then it is best not to fill the reservoirs more than about two-thirds full; never full, as the lubricant will be forced out through the oil seals. After completing the routine checks, replace parts and reassemble in the reverse order. Be especially careful to draw all screws uniformly tight.—*John Pennington*





WHEN PAINT PEELS

THAT OLD DEMON MOISTURE is a natural enemy of paint and will produce results like this if given a chance

By E. R. Haan

IF YOU'VE DISCOVERED blistering or peeling paint on the outside of your house, then you can be sure that moisture is lurking somewhere in the background. Whether it's free water or water vapor, you'd better correct the condition before repainting or you'll be faced with the same problem next year (and every year thereafter until the wood finally rots).

When free water is permitted to run into crevices and permeate the wood, it loosens paint. Water vapor produced inside the house has the same effect. Moist inside air moves toward drier outside air with considerable pressure, and this vapor pressure increases as the temperature difference between the moist and dry air increases. If walls are not provided with a vapor barrier, this moisture will travel through plaster, insulation, sheathing, siding, porous brick masonry block and other materials until it reaches the exterior paint film, where the sun accelerates the loosening process.

Siding-to-casing joints: Most peeling caused by free water occurs on or around windows and doors because these contain so many joints which can develop leaks. Siding that fitted tightly against door or window trim when installed may shrink enough to break the paint film at the joint and admit water. If such cracks are too wide to be sealed with paint, use calking compound before repainting. Calking is especially important where casings are set in brick. Where shingles join a window dormer, Fig. 2, wood trim may overlap shingles and absorb water. Seal these joints with calking also.

Drip caps: Peeling paint at the top of a door or window may indicate omission or faulty installation of the drip cap, Fig. 3. The lower edge of the flashing should extend beyond the bottom of the cap, and the flashing bent down to cover the ends.

Casing joints: Where paint peels at the lower end of a door or window casing, there

may be leakage between the casing and the sill. When repainting or applying calking compound, make sure that the wood or other surface is absolutely dry to assure good adhesion. The exposed ends of sills, Fig. 4, should also be kept sealed with paint because water quickly soaks into unsealed end grain.

Window sash: Rain soon gets under putty or retaining strips holding glass in sash when the paint seal weathers thin or the paint overlap on the glass is destroyed. The paint should lap about $\frac{1}{8}$ in. on the glass, but many neat homeowners scrape off this lap with a razor blade, thus permitting water to enter. Pass this information on to your wife and it may save work next year.

Contact with concrete sills: When exterior woodwork is in contact with a concrete sill, porch floor or metal deck, water may be drawn up into the wood and cause the paint to peel. Keep such joints well sealed with calking compound, Fig. 5.

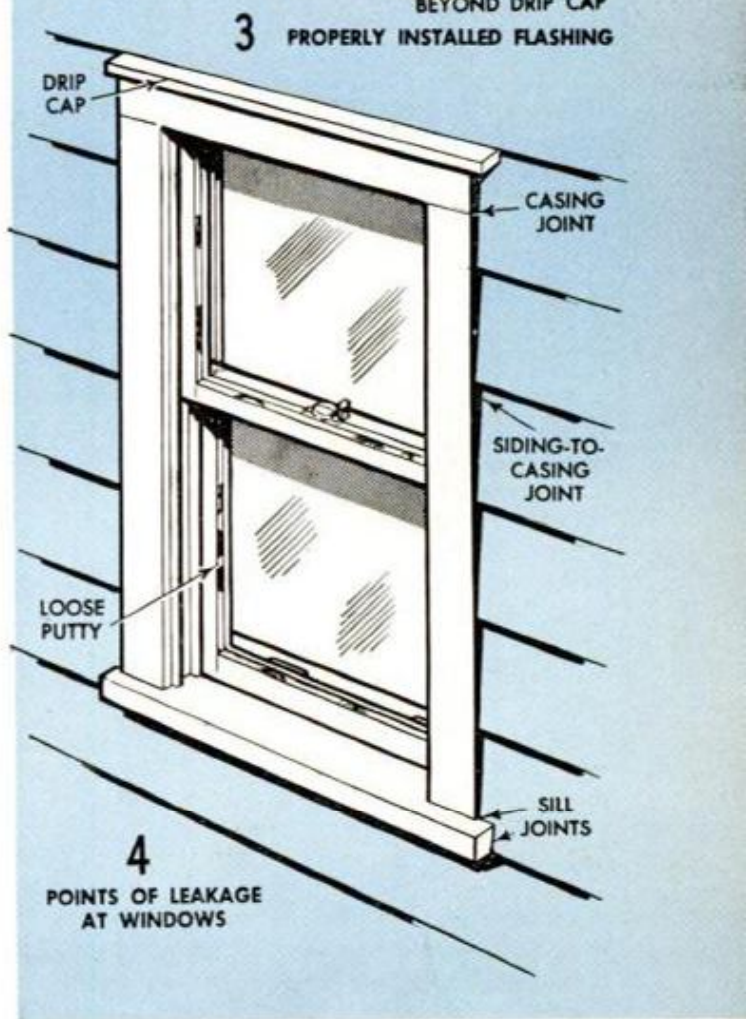
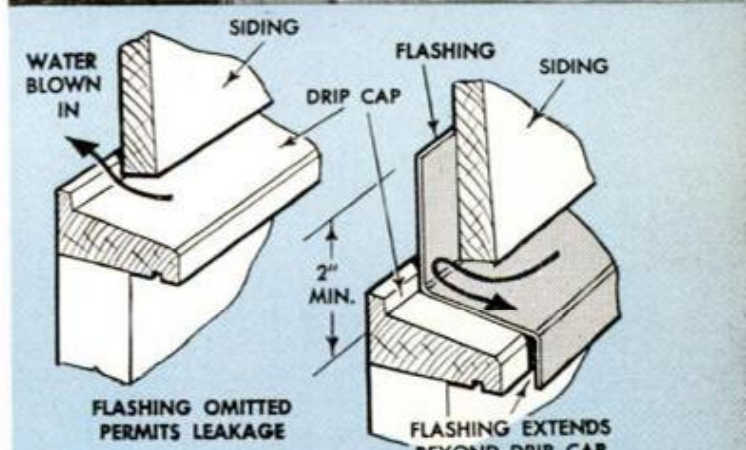
Wood combination doors: Since the top edges are often left unpainted and exposed to weather, wood combination doors are highly susceptible to water absorption. Also, water runs down the inner edges of the stile and gets into joints, causing them to loosen so that the door sags and drags on the sill. Therefore, you should keep such doors painted to prevent water absorption at the joints.

Siding joints: Leaks are likely to develop where the ends of siding are butted together. Press calking compound into big cracks with a putty knife, Fig. 6. Where siding butts against corner trim, seal in the same way as siding-to-casing joints. Siding which is mitered at outside corners instead of being butted to corner trim should be covered with metal corner caps, Fig. 7. Where corner trim is installed over siding or clapboard (a poor construction method), open spaces under the trim may be too large to fill with calking compound. In such cases, tamp oakum into the cavities, Fig. 8, then seal with calking.

Walls of vertical panel construction, common on today's ranch-type homes, often have cross battens because of the limitations of panel lengths. These battens should be provided with flashing, Fig. 9, because they cover horizontal joints which are susceptible to water infiltration.

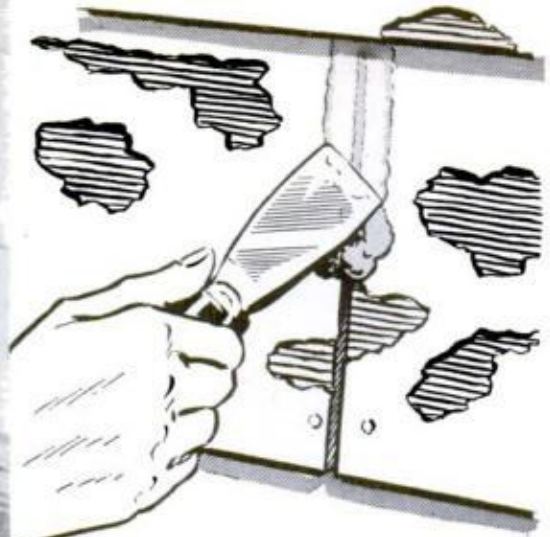
Siding in contact with earth: It is advisable to leave a 4 to 8-in. space between the lowest course of siding and the ground to prevent absorption of moisture. Dense foundation plantings and beds of tall plants set close to the wall will transmit considerable dampness, especially if watered often.

Joint between roof and wall: Flashing is highly important where a roof joins a





USE A CALKING GUN to seal joint between exterior woodwork and concrete porches or steps. The same treatment should be used to seal door and window casings set on stone or cement sills



6 SEALING OPEN JOINTS IN SIDING

BUTT JOINTS in siding will often open as lumber shrinks with age. Seal them with calking compound applied with putty knife

wall, Fig. 11. Often there isn't sufficient clearance to permit painting the ends of the siding, and sealing with calking compound is about the only practical solution. If necessary, install new flashing, interleaving it between siding and shingles. With a low-pitched roof, the flashing should extend as much as 12 to 18 in. up under the siding to prevent the entrance of water from accumulations of snow.

Gutters and downspouts: Check the condition of gutters and downspouts often, removing debris and repairing leaks, Fig. 10. If built-in gutters develop leaks which permit water to get into wood or brickwork the results can be disastrous, Fig. 13.

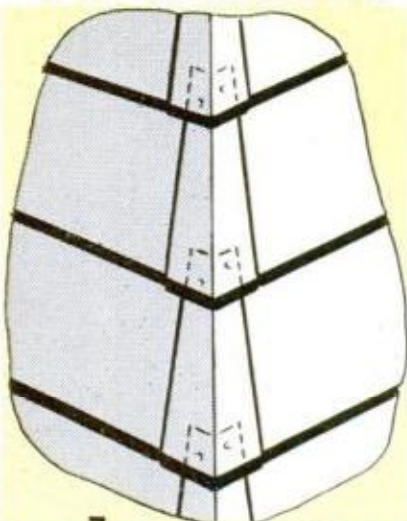
Clogged gutters may cause snow and ice to accumulate on the roof directly above them. This forms a dam, permitting water

to get between the shingles and find its way into the walls, Fig. 12.

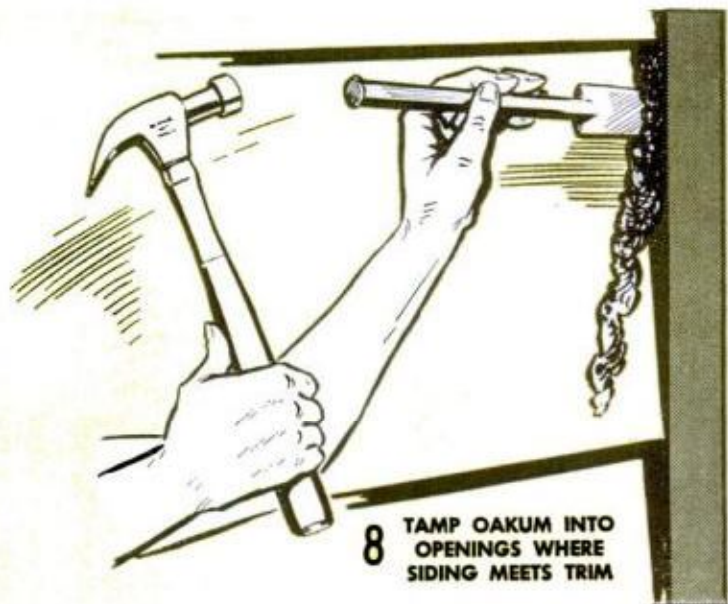
Leaking roofs: If chimney flashing is defective or there are leaks in the roof itself, water will seep inside and follow rafters down to the walls. On flat roofs the attachment of railing posts often provides an entrance for water.

Porch columns: When porch columns are in direct contact with a floor that is exposed to weather, they will often soak up water causing the paint to peel, Fig. 16. An improvised solution is to cut off a section of the column and replace it with a block equipped with adjustable feet, Fig. 15. Hollow columns should have vent holes at top and bottom to allow air to circulate and remove dampness.

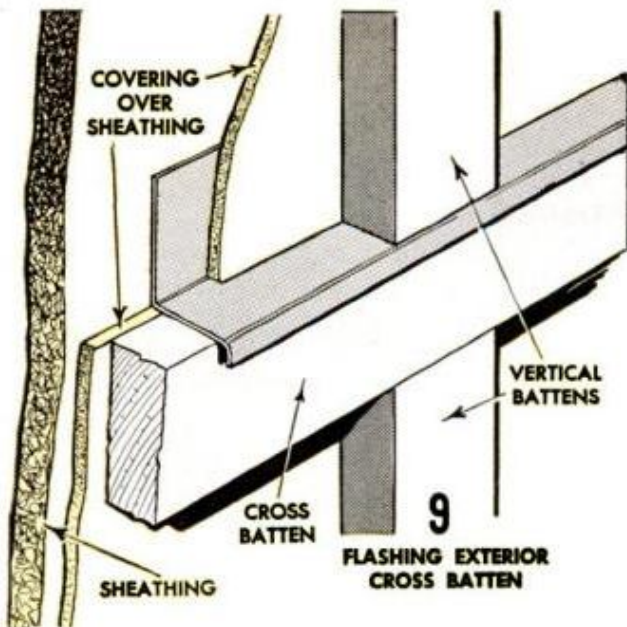
Vapor barriers: In modern house con-



7 METAL CORNER CAPS



8 TAMP OAKUM INTO OPENINGS WHERE SIDING MEETS TRIM

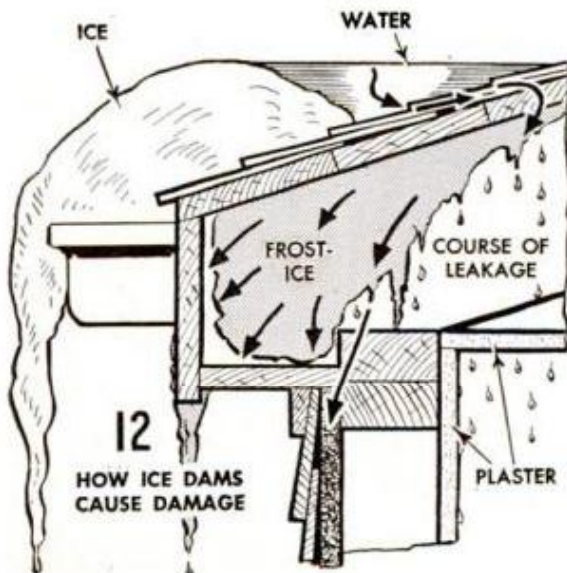


CROSS BATTENS on walls of vertical panel construction conceal horizontal panel joints. Such battens should be provided with flashing to protect these joints

struction, a continuous vapor barrier is used to prevent penetration of inner moisture through outside walls. Usually this barrier is one side of batt or blanket insulation placed to face the interior.

If you have an older home, there is a good chance that it doesn't have a vapor barrier, even though it may be insulated. To provide a vapor barrier as continuous as possible, paint all walls and ceilings with a paint that is impervious to water vapor. Exhaust fans located in the kitchen, laundry or bathroom will help to eliminate excessive moisture from the house.

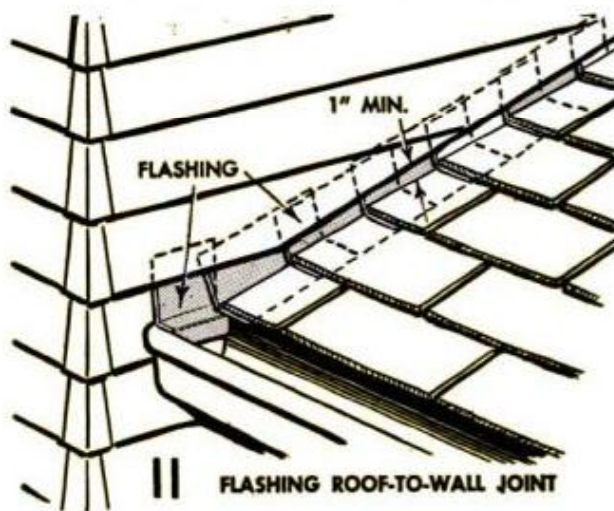
Wet foundation walls: If the foundation walls of your house are constantly wet, it means double trouble. This condition causes high humidity in the house, thus increasing the vapor problem. On top of that, the moisture will penetrate wood framing



MAY 1962



CLEAN OUT GUTTERS and downspouts periodically. After cleaning, check for leaks at joints and elsewhere so they can be repaired before becoming a problem

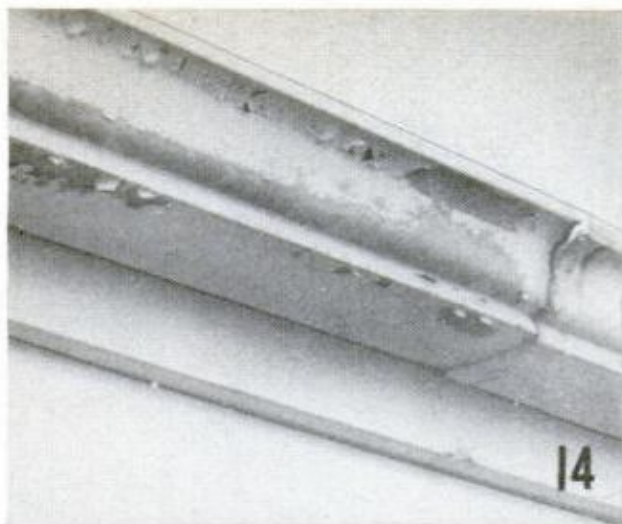


FLASHING AT ROOF-TO-WALL joints may have to extend 12 to 18 in. if the roof only has a slight pitch

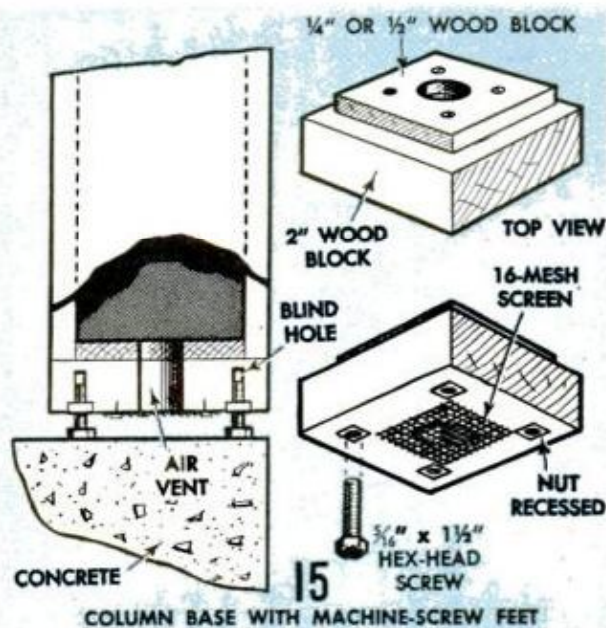
LEAKS IN BUILT-IN GUTTER on relatively new building can cause severe paint peeling and eventual wood rot



139



NO CAUSE FOR ALARM if the paint starts to peel on new galvanized gutters. Repaint after 6 to 12 months' weathering and the new coat is not likely to peel



PEELING AT BASE of porch column precedes decay. Prevent this by installing a new vented base block

WARNING SIGNS like the peeling paint on base of this column indicate corrective measures are required



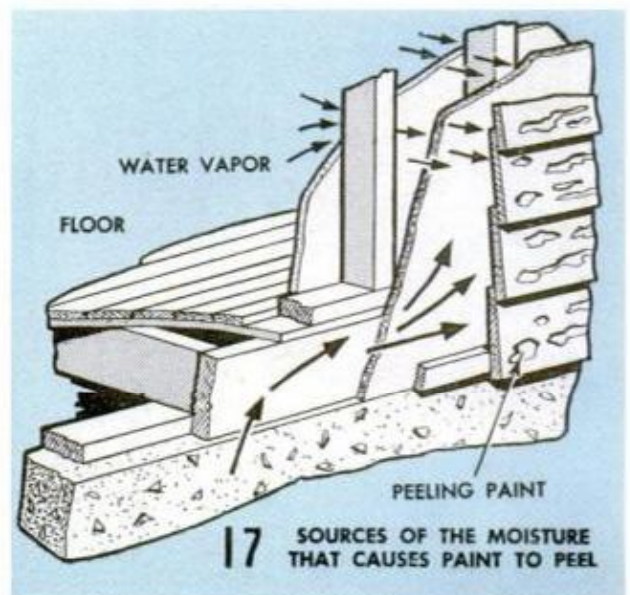
members and progress to exterior walls, Fig. 17. Waterproofing the inside surfaces of foundation walls won't stop the trouble. You'll have to waterproof the outside surfaces, and possibly even tile the foundation to drain away excess water.

Damp attic spaces: Excessive moisture in attic spaces is usually caused by poor ventilation. During cold weather the vapor will condense and freeze on roof boards. When the weather turns warm it will melt and run down the rafters to the side walls. The only remedy is to provide sufficient attic ventilation throughout the year.

Condensation on sash: During the winter, lack of storm sash often causes vapor to condense on window panes and run down over sills and sashes. Naturally, this moisture is likely to cause the paint to peel, and the only way to stop it is to install storm sash or double-glass sash.

Paint peeling on galvanized metal: If you've noticed paint peeling on relatively new galvanized gutters, Fig. 14, don't be alarmed. This often happens on new galvanized surfaces. Weathering for 6 to 12 months will lessen this tendency to peel, but after you find it necessary to paint new galvanized work immediately instead of letting it weather. In such cases, the following procedure will minimize peeling.

First, clean the work with rag moistened slightly with turpentine. Then brush on vinegar or acetic acid. (A phosphoric-acid solution of zinc phosphate or a phosphate-chromate solution, sold under brand names, is most satisfactory for this purpose but not always available.) Next, coat the metal with a special primer for galvanized surfaces. When this is dry, apply one or two finish coats, as required. On work that has already peeled, simply remove loose paint and repaint, as enough weathering probably has taken place to prevent further trouble. ★ ★ ★

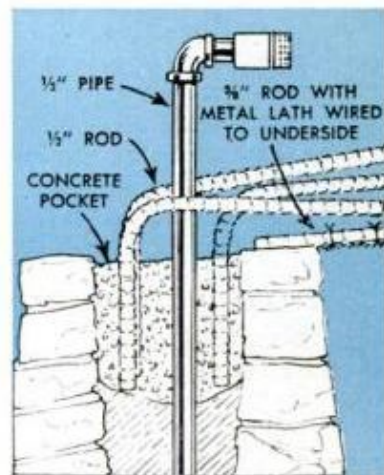




POOLSIDE GROTTTO

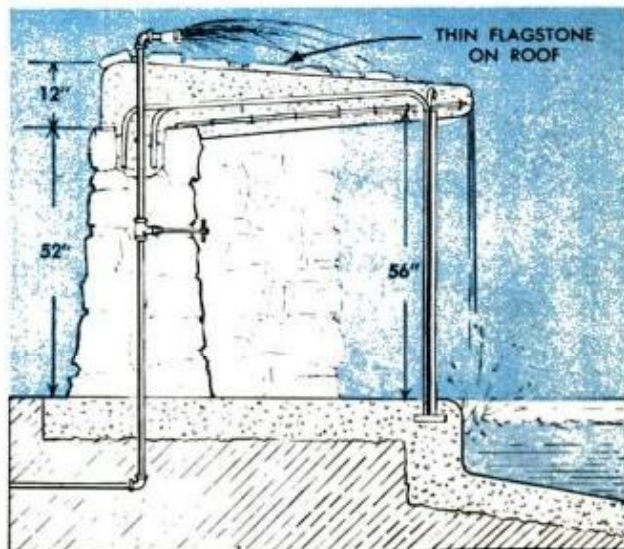
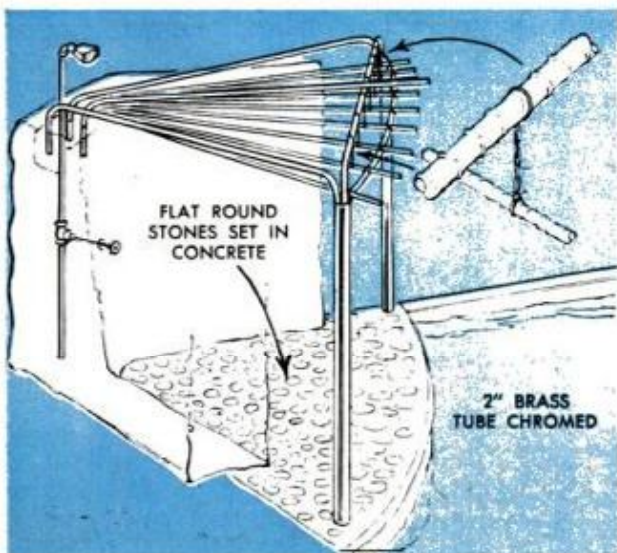
EVEN AT MOMENTS when you don't care to swim you can keep delightfully cool under this picturesque waterfall grotto. Designed by Mrs. Robert O'Donnell, the whole thing is of rugged natural-stone masonry combined with reinforced concrete and houses a statue of the Blessed Virgin behind a curtain of water. To build it, you first bring in the pipe, set up the standing part and install the nozzle and valve. Next, you pour the concrete floor, pressing small, flat stones in the surface. Follow by laying up the stone, leaving a pocket at the top into which you can pour concrete to anchor the bent ends of the reinforcing rods. Build a form for the roof, making sure the reinforcing rods are correctly spaced, fanwise, before pouring. Finally, bed flagstones in the roof before the concrete sets. The underside of the roof was plastered and tinted light green to match the pool.

—Hi Sibley



FAN OF REINFORCING RODS is hung with wire from support rods bent to rest in open ends of pipe posts

SECTIONAL VIEW of poured roof shows how slope permits spray to run off in curtain of water across front



START YOUR VACATION HOME *at Home*



BAT INSULATION in 8-ft. lengths is being installed between roof rafters. The flanges are stapled to the sides of rafters

CONCLUSION

BY NOW you could very well have the foundation in, the floor and wall sections (which you prefabricated at home) delivered to the site and be well on your way to completing your vacation home. In areas where the weather has not been a problem you may even have the basic unit under cover. In fact, you may be at a stage where you are about ready to insulate.

There are several things, however, that must be done first. The kitchen and bath partitions must be in, nailers for the interior wall covering installed and the plumbing and wiring completed. The bathroom is designed to take a standard 5-ft. tub which means that the distance between the walls of the room must be placed just a little over 5 ft. apart. You'll note in check-

ing the floor plan of the basic home that a plumbing wall for the sink and the bathroom fixtures is formed by erecting the 2-in. back-to-back wall sections 8 in. apart. It is recommended that both the wiring and the plumbing be installed by a professional tradesman to be sure that the installations follow local code requirements in the particular locality.

Nailers must be fitted between the studs of all partition walls, namely, the central roof-bearing wall, the kitchen wall and the bathroom wall. These nailers, as their name implies, provide a place in which to nail when fastening the interior wall covering. They are merely scraps of 2 x 4 cut to fit between the studs and centered on a line 8 ft. up from the floor. In nailing them in

METAL ROOF requires polyethylene membrane applied over insulation to prevent condensation on metal



ROOM PARTITIONS require nailers between studs, centered on line 8 ft. from floor, to back up paneling



place, you'll be able to drive through into the end of each block at one end, but at the other end you'll have to toenail.

Additional nailers must be fitted at the ceiling line of the two gable ends of the house. Here they are necessary to provide a nailing surface for both the furring strips which will eventually be applied to the rafters for fastening the ceiling tile and the soffit material on the underside of the roof overhang. You'll find it easier to install these gable nailers if it is done after the rake panels are in place and before the roof sheathing is applied. Short sections of 2 x 6 are cut to fit between the cross members of the rake panels and spiked to the top plate of the gable sections so that the 2 x 6 nailers overhang each side of the 2 x 4 plate an equal amount.

How thoroughly you insulate depends on whether you plan to use your vacation home strictly as a vacation home whereby you would occupy it during the warm months, or as a year-'round home. In the latter case, it will pay to insulate throughout—the walls, the floor and the ceiling. But where the home is to be occupied during the summer months only, you can limit the insulation to just the ceiling. Here you'll save both time and money, but it should be remembered that since it is impractical to add insulation to the walls at a later date, it may in the end prove to be false economy. In the case of the pilot home, the home was

insulated throughout since it was to be used as a year-'round home. While 8-ft. bats were used in the ceiling of the pilot home and roll-type in the walls, the latter could be used throughout. Available in 50 and 75-ft. rolls, it would permit single lengths to be applied to the ceiling from the front wall to the back wall by feeding it up over the roof-bearing wall before stapling it in place. In some cases it will be necessary to crowd the insulation into spaces less than the standard 16-in. spacing, particularly in the walls. In other instances it will be necessary to cut the roll insulation in narrow strips.

If you use a corrugated aluminum roof as on the pilot home, it will be necessary to add a polyethylene vapor barrier to prevent condensation of moisture on the metal. This was applied in 12-ft. widths directly over the blanket insulation and stapled to the edges of the rafters. Meeting edges of the plastic were rolled before stapling to assure an airtight seal at the seams, and the plastic was brought down the side walls 4 or 5 in. to permit stapling to the top plate. This additional plastic insulation is only neces-





VERTICAL-GROOVED HARDBOARD paneling was used in pilot home. Here first panel is started in corner



TO SPOT LOCATION of outlet box on back of paneling, chalk edges of box and press panel against it

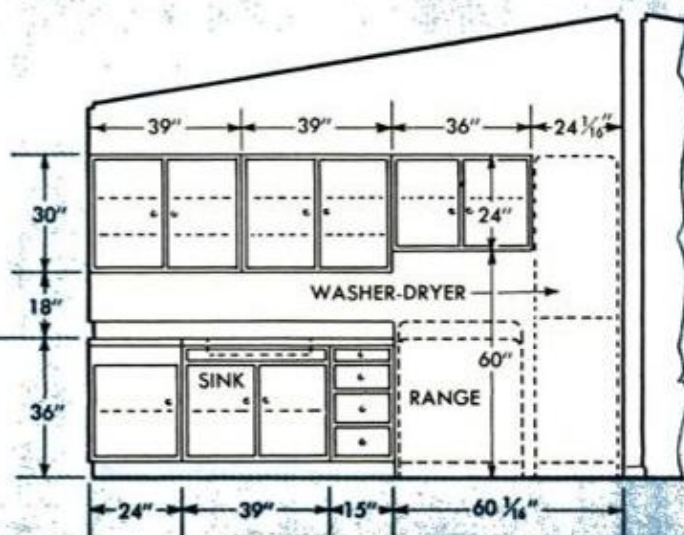
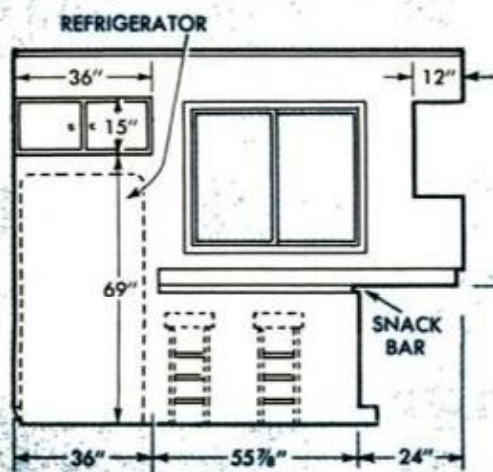
sary where an aluminum roof is used. Bat or roll insulation with a foil facing is usually sufficient for a conventional-type roof of wood and asphalt shingles.

This brings you to the interior wall paneling. There's a great variety of panel boards from which to choose, both plain and fancy, prefinished and unfinished. A textured, vertical-grooved hardboard, which comes primed and ready for final painting, was used in the pilot home. Standard 8-ft. lengths are used to cover the 8-ft. side walls. In the case of the gable-end walls and the room partitions, you have the option (in the case of some materials) of using 10-ft. panels. The longer panels eliminate a joint at the 8-ft. level which you will have in using 8-ft. material, and also the need for nailers on the partitions. However, if the material you select does not come in greater than 8 ft., the joint mentioned can be covered neatly with a stock molding.

The starting point of the first panel is unimportant, paneling can be started on any wall. It is important, however, where the first panel is positioned on the wall. As there is a doubled stud wherever wall sections butt, you must position the panel so that its edge centers on one or the other of the two studs and not center on the wall joint itself. In this way, the panel joint actually laps the wall joint. Whatever material you use, follow manufacturer's instructions for applying. A trick to remember in marking cutouts for switch and receptacle outlets is to rub chalk on the edges of the outlet boxes and press the panel against the chalked edges. This will transfer the outlines of the box to the back of the panel for a perfect fit. The nails supplied with some prefinished boards have heads which match the surface grain, others are supplied with special clips for concealed fastening.

Fiberboard accoustical tile was used to

KITCHEN WALLS



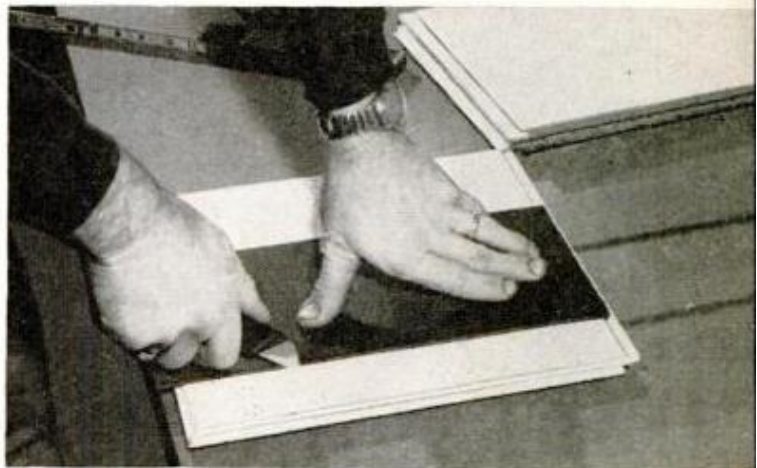


FURRING STRIPS nailed directly to edges of rafters and spaced 12 in. on centers, are required to provide stapling surface for 12-in. fiberboard tile

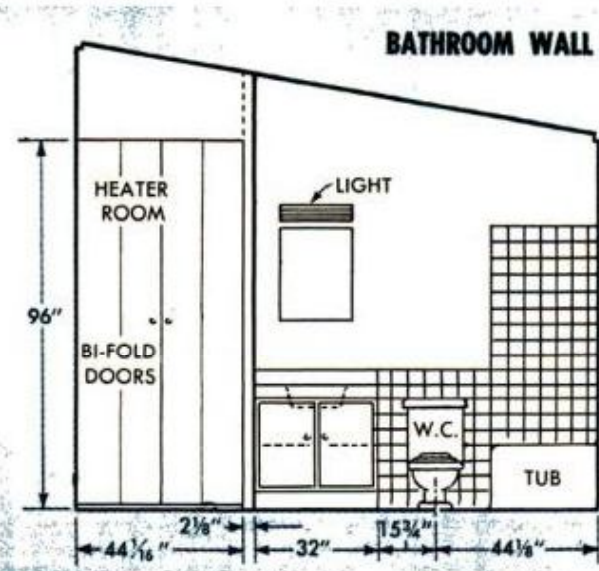
cover the ceiling of the pilot home. This first required the application of 1 x 3 furring strips crosswise of the rafters, the full length of the house. Spacing of the strips is important if you are to end up with border tile of the same width along opposite sides of the room. First apply the furring next to the side walls and the roof-bearing wall. Then center the next strip 10½ in. from the side walls, and do the same with a strip parallel to the bearing wall. From here you simply fill in with strips spaced 12 in. center to center. The joints of the tile were staggered rather than aligned, and to assure border tile of equal width along the gable ends of the rooms, half tile are used at the ends of every other row. This means that the starting tile in the



BORDER TILE at ends of every other row are cut in half when joints of tile are staggered. Initial starting tile in very corner measures 10 x 12 in.



ACCOUSTICAL TILE cuts easily with sharp knife, above. Below, electrical entrance cabinet is located in closet housing furnace and hot-water heater. See plan



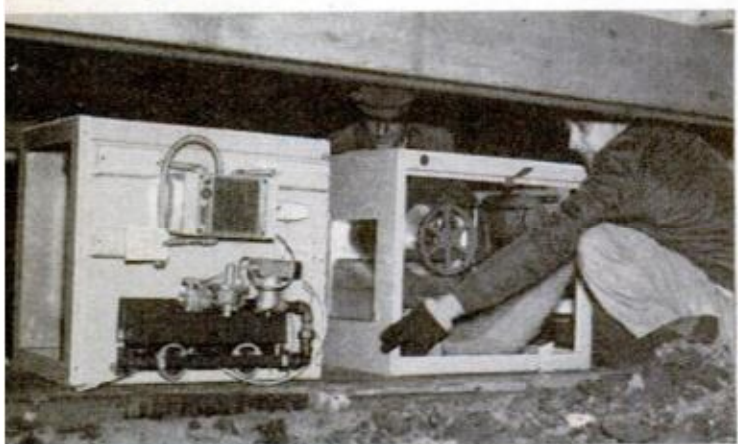


AT FAUCET END of tub, left, stud is shortened and a header installed to permit plumbing connections to tub

lower corner of the living room, for example, is cut so it measures 10 x 12 in. The next tile up the gable is a half tile, 6 x 12 in., followed by a full tile, then a half tile, and so on. Fiberboard tile cuts easily with a sharp knife, and goes on quickly with a staple gun. To assure straight rows, chalk lines should be struck on each furring strip and used in aligning each tile as it is applied rather than relying on the straightness of the tongue and groove of the tile.

COMPLETE PLANS

including a material list, are available for the PM Vacation Home. Each set contains 14 sheets which detail the basic home as well as the add-on units. Floor alternates are included for the builder who may wish to follow conventional joist construction rather than pre-fabricating sections. The cost of the plans is \$20.00 for one set, \$35.00 for four sets. Each additional set is \$5.00 when ordered with the initial set. Order from Plans Department, Popular Mechanics Magazine, 200 East Ontario Street, Chicago 11, Illinois.



Arrangement of the kitchen can be altered from that shown in the plans, insofar as the placement of the cabinets is concerned. Stock wall cabinets are available from mail-order houses in knockdown form and are priced at less than the cost of building them yourself.

As for heating, here again it depends on whether you plan to occupy your vacation home during cold weather. If not, installation of a portable, wall-type fireplace would help remove the first chill of fall evenings. Since the pilot home was to be occupied the year 'round, a compact gas-fired, forced-air furnace of 80,000 B.T.U. output in addition to the fireplace, was installed in the crawl space, centrally located in the basic unit.

Pine trim was used throughout in finishing off the doors, windows and baseboard, cove molding added to the ceiling tile and the entire floor of the basic unit was covered with asphalt tile. ★ ★ ★

GAS-FIRED FURNACE in pilot home was located in crawl space, left center. Packaged free-standing fireplace is shown being assembled on living-room wall



NEW FOR SHUTTERBUGS NEW

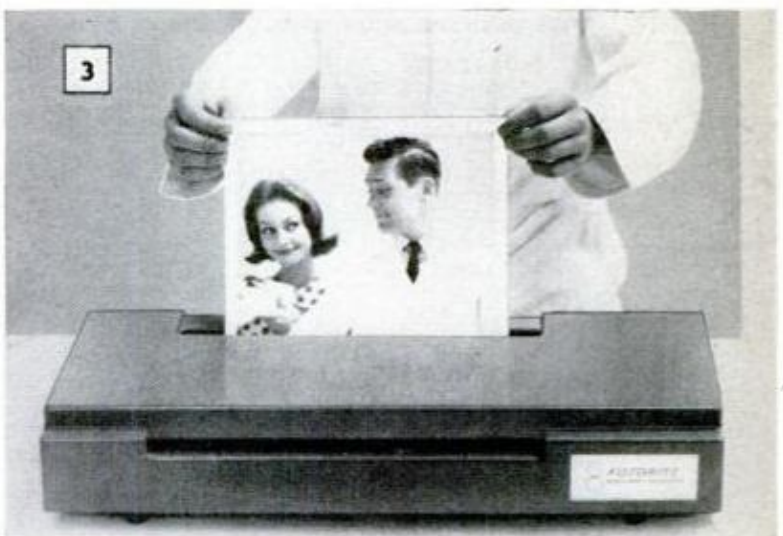
1. BROWNIE CAMERA features a built-in flash holder having a hinged lid. With the lid open, shutter is set automatically to the correct flash speed. With lid closed, it is ready for outdoor shooting. One knob advances film and sets shutter. Price is less than \$19. Eastman Kodak Co., Rochester 4, N. Y.



2. ANSCOMATIC PROJECTOR has complete remote control, including focusing, remote forward and reverse, and a light pointer. Auto-timing permits intervals from 5 to 60 seconds. There's even a convenient dimmer control for the 500-watt projection lamp. Priced at less than \$140. Ansco, Binghamton, N. Y.

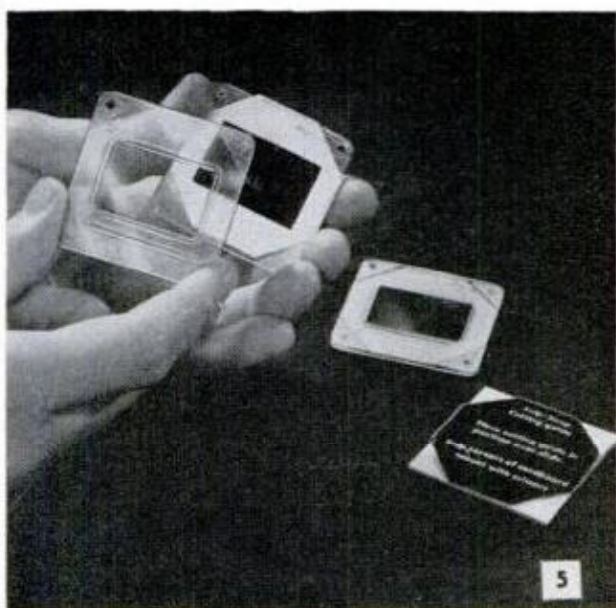


3. RAPID PRINT PROCESSOR produces semidry prints in quantity in seconds. You simply expose your negative on special photographic paper with your own contact printer or enlarger and slip it into processor. Fotorite, Inc., 6424 N. Western Ave., Chicago 45, Ill.

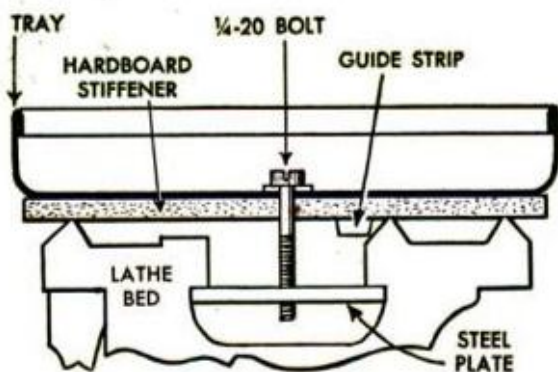


4. ELECTRONIC FLASH UNIT fits easily into pocket. Powered by eight inexpensive pen-light batteries, the set yields more than 125 flashes and eliminates recharging problems. Gun includes convenient on-off switch, ready light, and exposure scale. Less than \$40. Yashica, 5017 Queens Blvd., Woodside 77, N. Y.

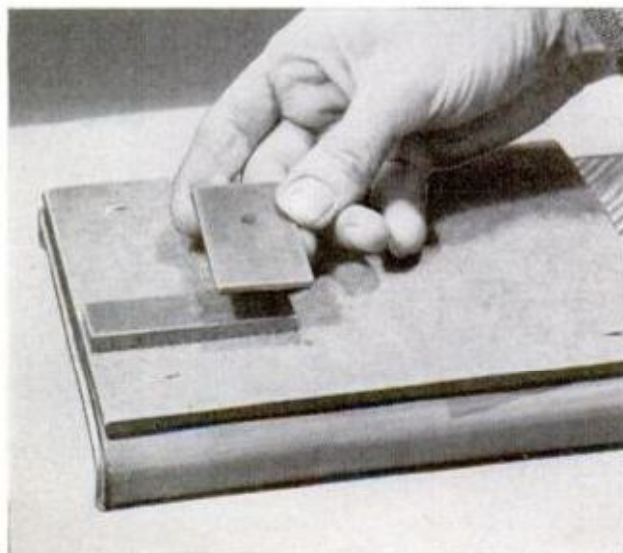
5. PLASTIC SLIDE MOUNTS protect films from finger prints and handling. With scissors, four corners of readymount are snipped off and slide inserted between two halves of plastic mount. Then the mount is snapped together. Box of 20 is \$1.69. Walco Molded Products, 1923 S. Allport St., Chicago 8, Ill.



LATHE TOOL TRAY



TRAY IS HELD in place by a clamping screw and steel plate, the latter of same size as tailstock plate



HERE'S A divided tray that clamps onto the bed ways of the lathe and allows you to reach the tools and holders you want without scooping up grease, cutting oil and metal chips along with them. Just slice off the side of a gallon can, leaving about an inch of wall and solder in dividers to take the tools and holders you need most often.

Roll the edges of the tray sides and ends, and reinforce the bottom with a piece of $\frac{1}{4}$ -in. hardboard cut slightly smaller than the over-all size of the tray. Then center a hole through the bottom of the tray and through the hardboard for a $\frac{1}{4}$ -in. screw or stove bolt of sufficient length to reach through the steel clamping plate. Cut the latter from $\frac{1}{4}$ or $\frac{1}{8}$ -in. flat steel to the same over-all size as the tailstock clamping plate, center-drill it and tap for the clamping screw. Notice also the hardwood guide strip screwed to the bottom of the tray and riding alongside the inside V-way of the lathe bed. This keeps the tray lined up with the bed, prevents it from sliding side-wise when you loosen the clamping screw.

Arrangement of the dividers pictured suited the owner of the original tray, but you'll want to install these to fit your own requirements. Usually you can cut dividers from what's left of the gallon can. Roll the edges over on themselves just as you did with the edges of the tray. This eliminates those raw metal edges that can cause a nasty cut.—Walter E. Burton

SHOP SHORT CUTS

Stop Right There

Some types of the more precise work require that countersinks in metal to run to exact depth, not only for neatness but for uniform seating of flat-headed screws. One way is to remove the depth gauge on your drill press and substitute a rod of the same diameter and of sufficient length to contact the machine table when the countersink reaches the desired depth. With this stop you can countersink any number of holes in the work with precise uniformity.

—H. J. Gerber

Soft Corners

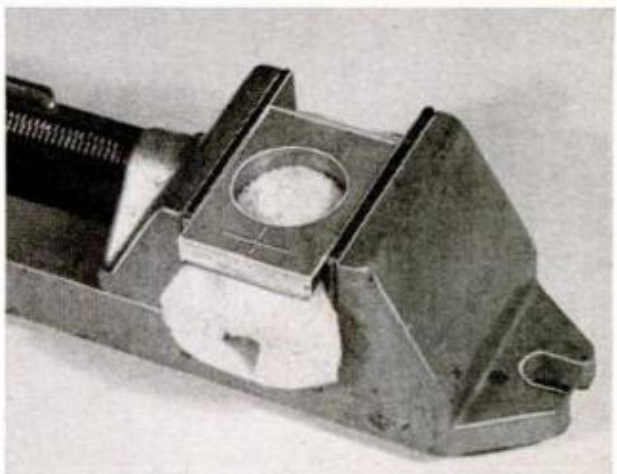
Soft corners on all exposed work are a mark of the craftsman, "soft" being his word describing a neatly rounded corner on finished stock. Of course, you can do this with a plane and sandpaper but a quicker way is to make a tool for the purpose from a beverage-can opener. All you do is hit the high portion of the curved end of the opener on the corner of the grinding wheel. Hold until the wheel just cuts through the metal, leaving a small, oval-shaped opening as in the lower view in the photo. The edge of this opening does the cutting and the deeper the grind the bigger the bite.—Jerry Thompson

Sponge It Up

When it's necessary to support thin workpieces in a drill vise, fold a small artificial sponge and place under the work as pictured. The folded sponge will support the piece at a point near the top of the vise jaws, making it much easier to position and adjust for drilling. For work not requiring extreme accuracy this method is much better and faster than blocking up under the workpiece in the conventional manner. Also, there's no problem in drilling through as the drill bit can cut into the sponge without damage.—H. Hanscom

Lap It Up

Although it wears out of true faster than a cast-iron plate, a lead lapping plate charges itself much more uniformly with the abrasives suitable for hand finishing of small hardened workpieces. Turn a cast-iron ring, fill with molten lead and face off both sides, making spaced concentric cuts in the lead about $\frac{1}{16}$ in. deep. Charge one side with a relatively coarse abrasive, the other with very fine. When the plate wears slightly out of true, face off in the lathe, cutting deep enough to get under the abrasive with the first cut.





ALL PARTS of enlarger, including lamphouse, pack into carrying case, or box, as in photo above. Below, you see electrical parts which remain in box in use



Portable Electronic Enlarger

It's a condenser-type that packs into a box which serves as a base and carrying case. Blows up 35-mm. film to 8 x 10s. Has built-in electronic timer and a precision exposure meter—all for just under \$30.00 worth of parts

By G. A. Wesenfeld

LAMPHOUSE, electronic parts and wiring of this midget enlarger all fit in a Bakelite box only 3 x 7½ x 8 in. as you see in the photos above. That alone makes it something extra-special for the photographer who gets about and has need for needle-sharp blowups that you get only with condenser-type illumination, and a built-in electronic meter. And if you're really out in the back country where the high line is something they still dream about, you can operate this enlarger off a 6 or 12-volt car battery. There are no tubes or transistors to burn out.

You don't buy such an enlarger ready-

made; you buy the plastic box, the electronics, switches and the like, and you make the lamphouse from a chrome-plated tail-pipe extension, the lamphouse and focusing brackets and the film carrier from a few pieces of clear plastic. Getting these parts assembled and wired and checked out electrically takes a little doing but once you get them put together and working, you're in business.

Construction: Begin by preparing the Bakelite case. Over on page 153 you see that it has a removable panel. Before cutting any openings or drilling holes be sure to check the part sizes closely. It sometimes

PARTS LIST

OPTICAL

- 1 50-mm. Enlarging lens, #30,181
- 2 Condensing lenses, #90,009
- 1 Ground glass, #30,434
- 1 Lamp, 6-volt midget, #1184
- 1 Lamp socket, #74

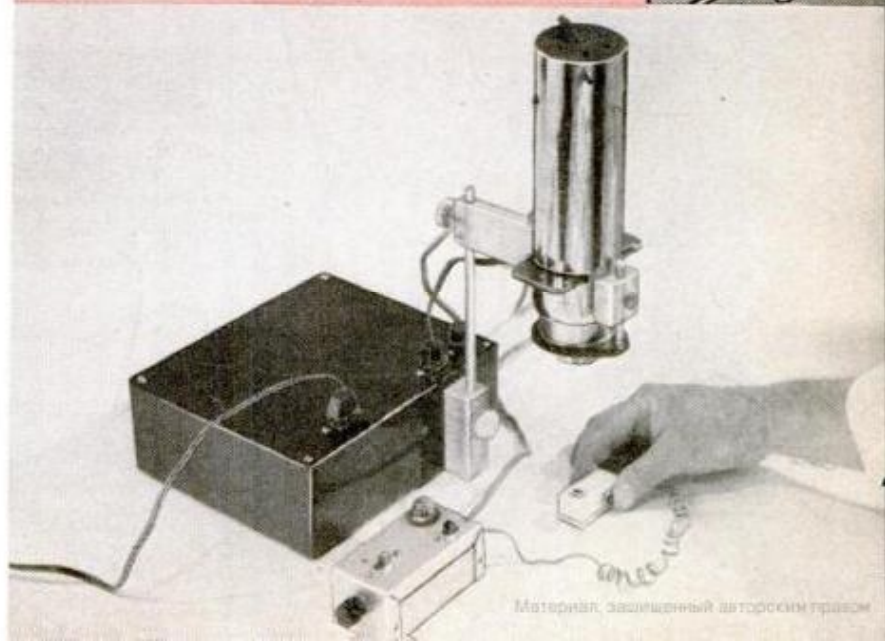
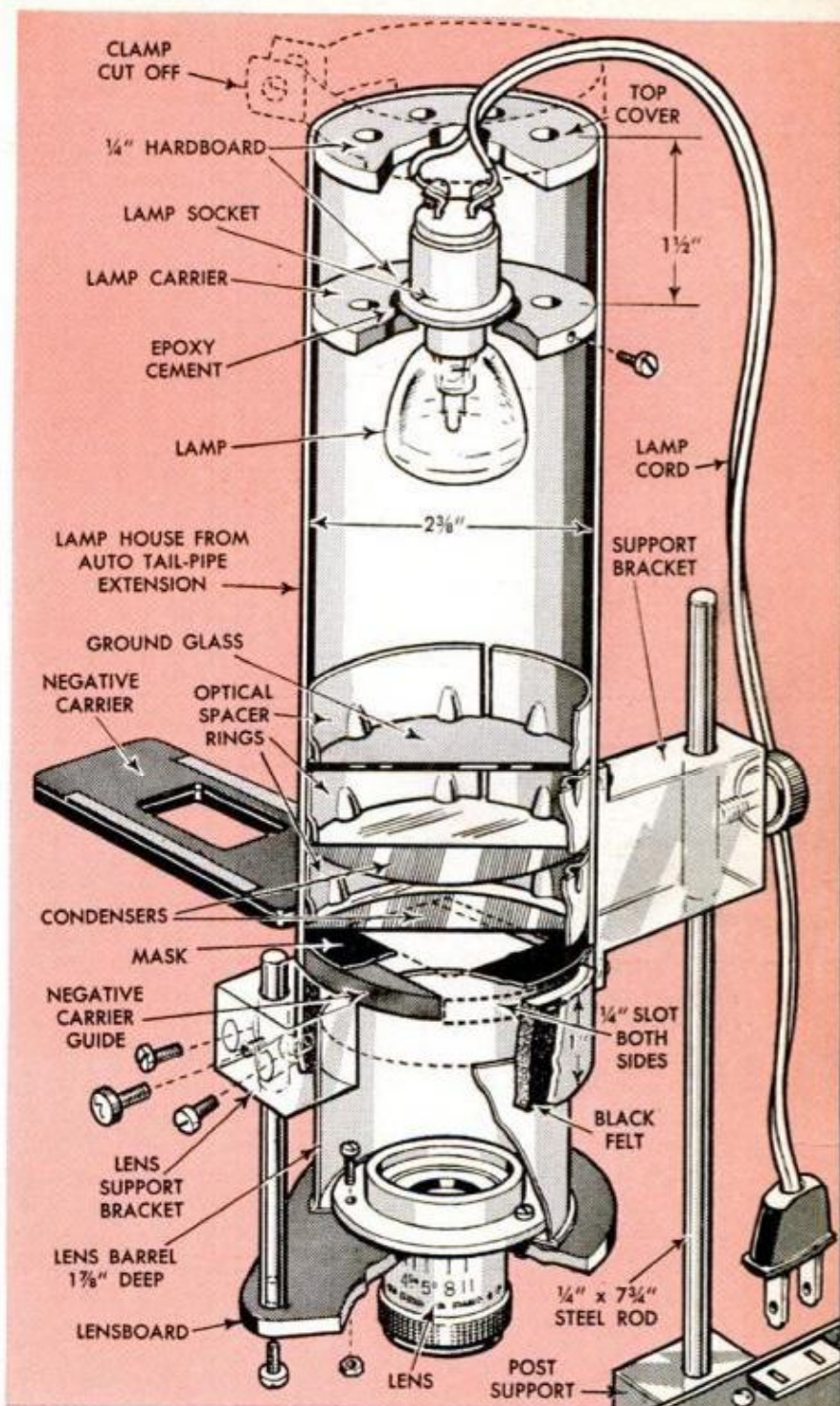
Above items available as a kit from American Science Center, 5700 Northwest Highway, Chicago, Ill., Price \$14.50.

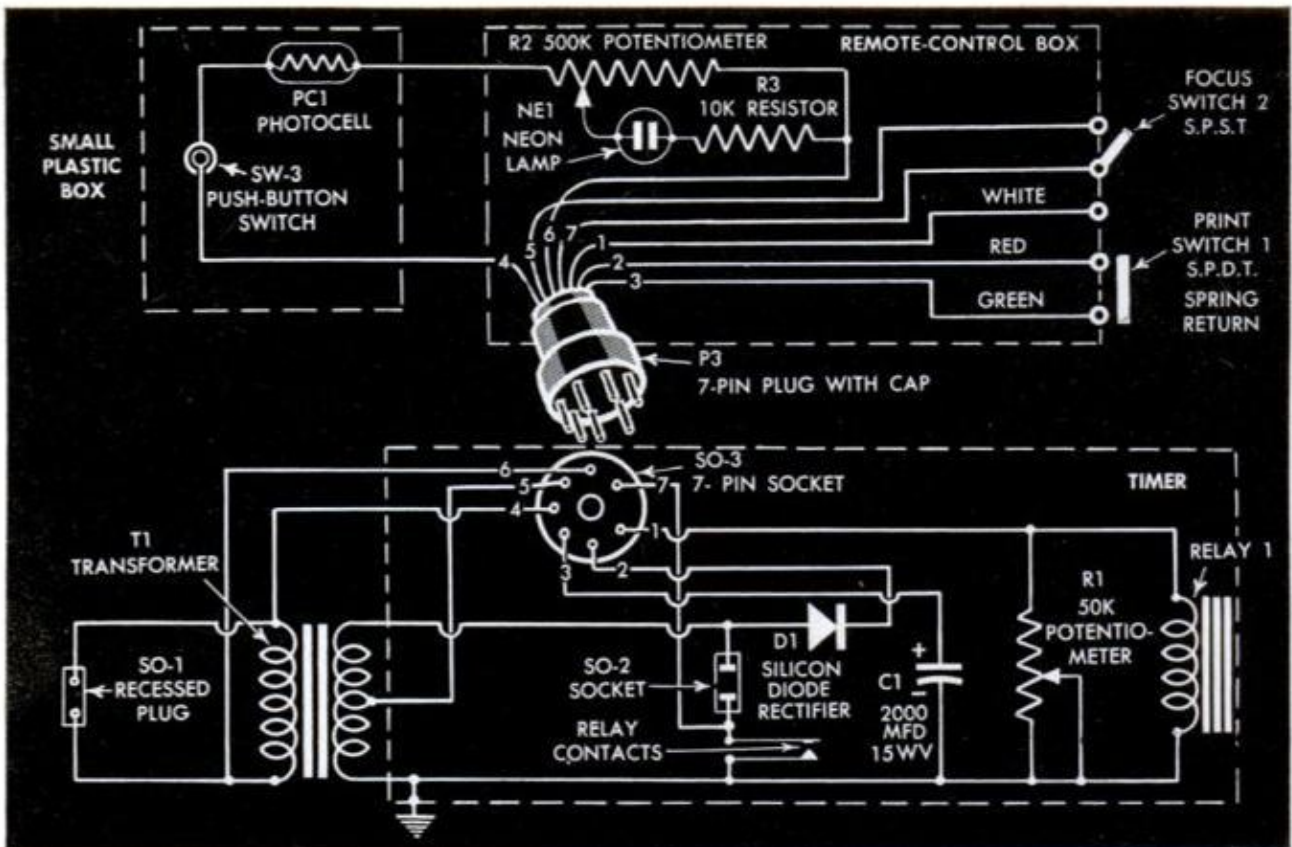
ELECTRONIC

- T1—Stancor, 12.6VCT-2A, P-8130, Lafayette TA-266
- D1—Silicon Diode, 150 MA, Lafayette RE-40
Holder for rectifier, Lafayette EL-183
- C1—2000 MFD/15WV—electrolytic Lafayette Z-805
- R1—50K ohm midget potentiometer, Mallory SU-35, Lafayette VC-394
- R2—500K meg., midget potentiometer, Mallory SU-54, Lafayette VC-39
- R3—10K ½-watt carbon resistor
- PL1—Pilot-lamp assembly, Allied Radio #78E686
- NE1—NE-51 neon lamp
- PC1—Polaris Maj-1 photocell, Lafayette MS-791
- SW-1—SPDT slide switch, Lafayette SW-15
- SW-2—SPST slide switch, Lafayette SW-14
- SW-3—Miniature push-button switch, MS-449, Lafayette
- SO-1—TV-type chassis mounted a.c. plug—recessed
- SO-2—Chassis-mounting a.c. socket, Allied Radio #40H830
- SO-3—7-pin tube socket
- P1—"Cheater" cord—TV type
- P2—a.c.—2-prong plug
- P3—Miniature "CP"-type plug with cap. Allied Radio #42H-652
- Relay—1 Potter & Brumfield relay, 2.5 MA, 10,000 ohms, Lafayette #RY-161

MATERIAL

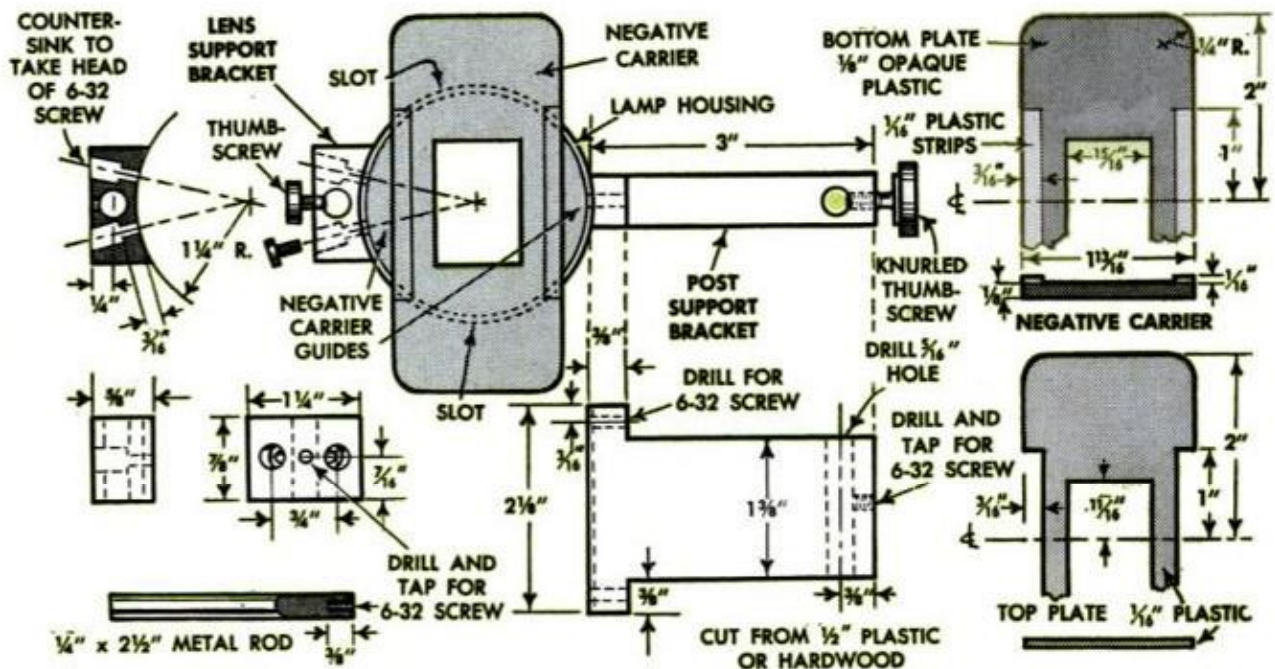
- 1—Bakelite case, Lafayette MS-844
- 1—Panel for case, Lafayette MS-845
- 1—Minibox, Bud CU-2102-A, Allied Radio, #80P344
- 1—8-conductor cable, 36 in. long Bel-den #8447 Allied Radio, #47T321 (use only seven)
- 1 pc. 28-ga. aluminum about 1 sq. ft.
- 1—Plastic block 1" x 1" x 2¾"
- 1—Plastic block ½" x 2½" x 3"
- 1—Plastic block ⅝" x ⅞" x 1¼"
- 1 pc. Opaque plastic ⅛" x 2" x 4"
- 1 pc. Opaque plastic ⅛" x 3" x 4"
- 1—Auto tail-pipe extension Sears or Wards
- 1—Steel or aluminum rod, ⅝" x 7¾"
- 1—Steel or aluminum rod, ¼" x 2½"

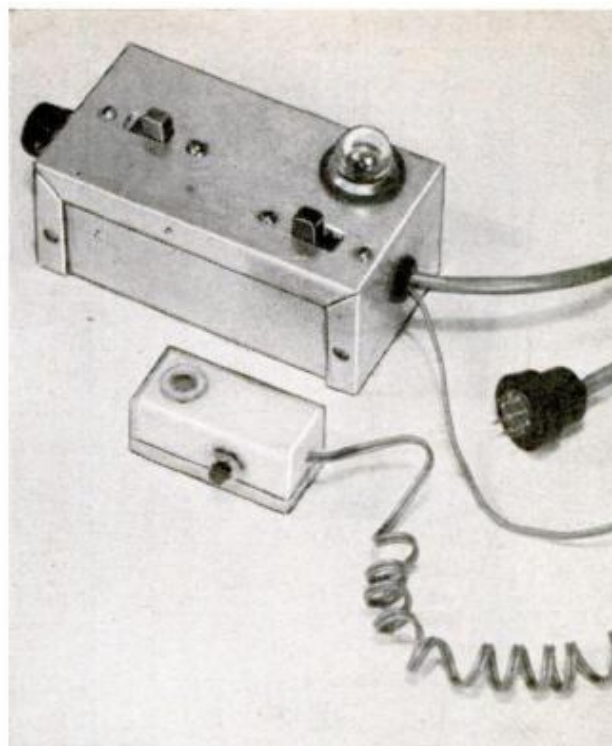
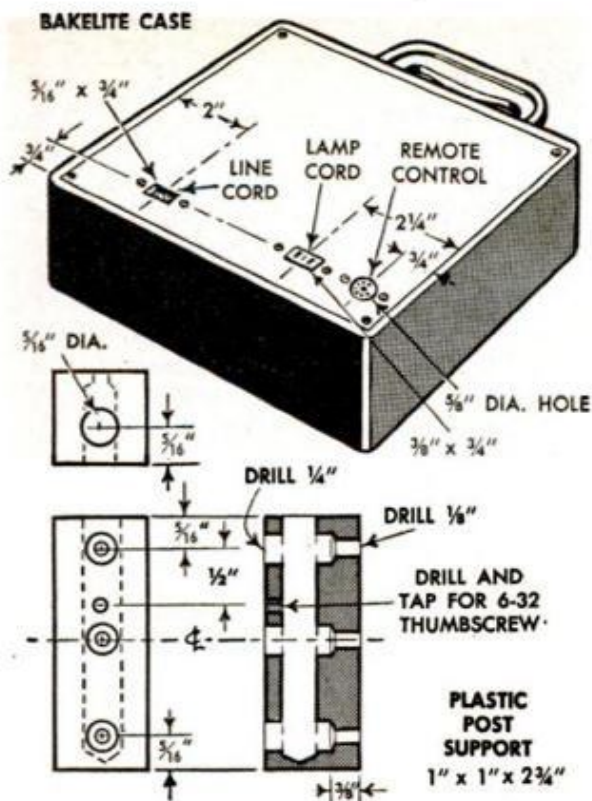




happens that the parts supplier furnishes items that are similar but not identical. You may have to make some changes due to possible variations. After the case is prepared, mount the transformer T1 and the timer housing. The details of the timer housing also are shown on page 153. Follow the wiring diagram on this page when assembling and wiring electrical parts. When all parts have been wired, either cable the longer wires together with cord or wrap them with electrician's plastic tape.

Next you prepare the control-box cover or lift-off portion, which is shown in the lower detail on page 153. The complete box, assembled and wired, is pictured in the photo on the same page, also on page 151. It's one of the readymades and requires no major alteration. Mount the parts and wire. The control box is connected to the main case by a 7-conductor cable. See the 7-pin plug in the wiring diagram. Before plugging this cable into the main unit, check all connections closely as these carry 115-v

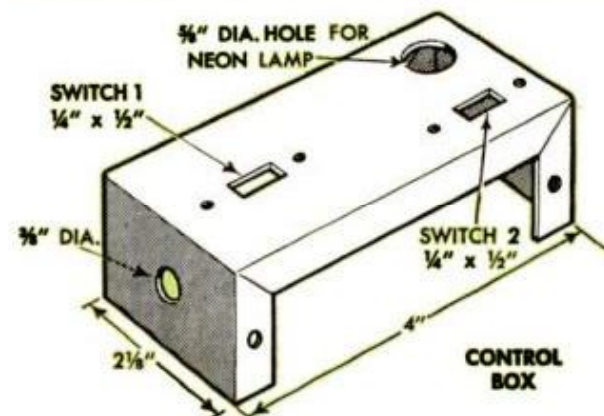
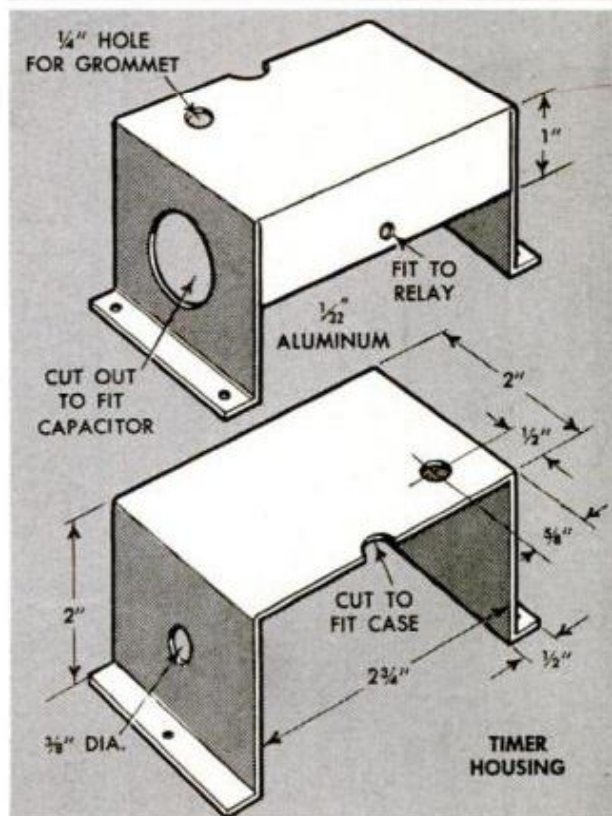


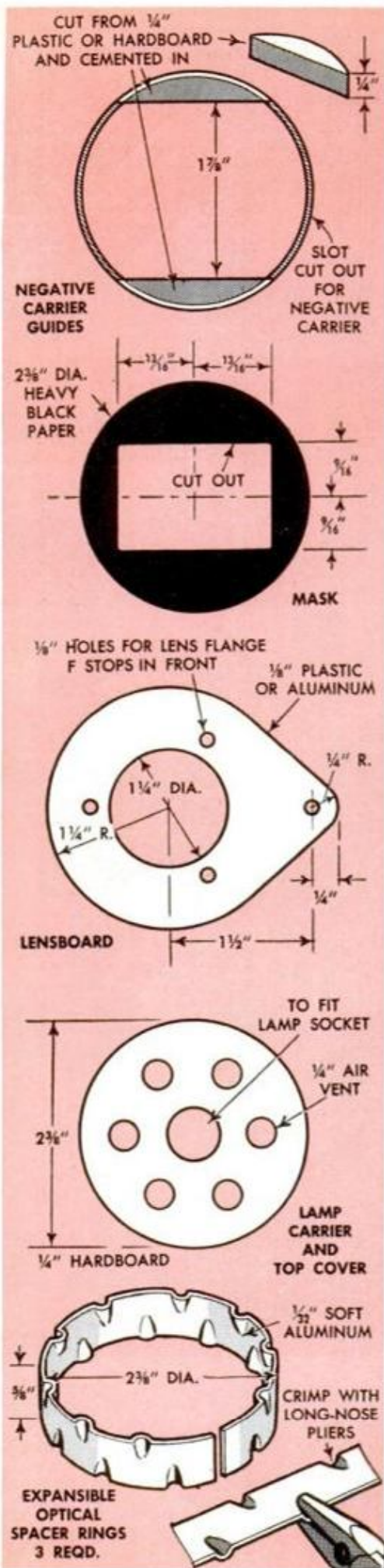


current. Also check the switch leads to the timer circuit.

The exposure probe: To mount the photocell in the plastic case you first solder the leads to the photocell. Paint the inside of the case with modelmakers' white plastic enamel, masking off the cell window with a 3/8-in. disk cut from plastic tape. After the paint has dried, position the photocell in place and build a temporary retaining ring around it with putty. Attach the plug to the other end of the lead and test it. When you are sure that the photocell is working properly, place a cardboard dike around the switch, sealing the joints with paraffin or lacquer. Now fill the case with epoxy encapsulating plastic, being careful not to get any in the switch well. Place the cover in place before the epoxy sets.

The enlarger: The housing is constructed from a chrome-plated tail-pipe extension and if you study the cutaway view on page 151, you will readily see how the lamp, condensing lens, carrier and enlarger lens are assembled in and on the plated tube. The lens barrel is cut from a developer can, lined with felt and the bottom is cut out, leaving a flange. The lens is attached by screws which pass through holes in the flanged bottom of the can and turn into tapped holes in the 1/8-in. lens board. The latter is dimensioned on page 154, the center detail. Note that the lower end of the lamphouse has a 1/8 x 8-in. strip of felt cemented in place to provide a sliding fit for the lens barrel. It also serves as a support for the negative-carrier guides.





The two upper details on page 154 show how to make the negative-carrier guide and the mask. The two lower details, page 154, show how to make the lamphouse cover and lamp carrier (the parts are duplicates) and also how to make the spacer rings which hold the condensing lenses in place. Mount the ground glass above the condensing lenses as in the cutaway view, page 151. The lamp carrier is held in place with a 6-32 machine screw as in the detail on page 151.

Using an f:4.5 enlarger lens you may need to trim down the length of the lens barrel to $1\frac{3}{4}$ in. from the lip to the end to allow sufficient movement for blowups to 8 x 10 in. Paint the barrel a matte black inside. If you wish to make prints smaller than $3\frac{1}{2}$ x 5 in., make up another barrel measuring $2\frac{1}{2}$ in. from lip to bottom.

Details at the bottom of page 152 dimension not only the negative carrier but also the lamphouse and lensboard brackets. These are made from clear plastic. The aluminum rod carrying the lens board is $\frac{1}{4}$ x $2\frac{1}{2}$ in. and is center-drilled and tapped for a 6-32 screw. The lamphouse supporting rod is $\frac{5}{16}$ x 8 in. and is attached to the back of the base with the plastic bracket.

Test procedure: After giving all the wiring a careful final check, plug the a.c. cord into an a.c. outlet and connect it to the socket on the case. Set R1 to about $\frac{1}{3}$ turn to the right. Set switches SW1 and SW2 to off. After several seconds, push switch SW1 to time. If all is working properly, the relay will pull in after five or six seconds. R1 controls the delay time. Switch SW2, focus, bypasses SW1 to turn on the enlarger for focusing. If everything's working to this point, check out the exposure meter in a room with dim lighting. Plug the photocell into the control box and turn R3 to the left. Next aim the photocell at a table lamp, press switch SW3 and turn R3, sensitivity, clockwise. At some point, the neon lamp should light.

Printing: Set the enlarger in position on its post. Place a good negative of normal contrast in the negative holder and insert into the enlarger. Set SW2 to focus and adjust the enlarger to print say, a $3\frac{1}{2}$ x 5 print. Set the diaphragm at f:6.3 and the timer at about 10 seconds. Make a print on normal contrast paper and develop the print according to the manufacturer's instructions. You will probably have to make four or five such tests, changing the timer setting until you get a correctly exposed print.

It is not necessary to set the exposure meter R2 for sensitivity. Place the photo probe on the easel so that the cell can measure the light from what you consider the most important area. In most cases, this will be a face. In any event, use a middle tone area for best results. Press switch SW3 and turn R3 counterclockwise to zero; then slowly turn clockwise until the neon lamp lights. The exposure meter is now set for that particular type of paper. Mark its position with India ink. Repeat the process for the normally used grades and types of paper. The meter is used as follows: Place the meter on the easel as in testing to read the desired area of the negative being printed. Close the lens diaphragm to f:11 and open it until the neon lamp lights. ★★ ★



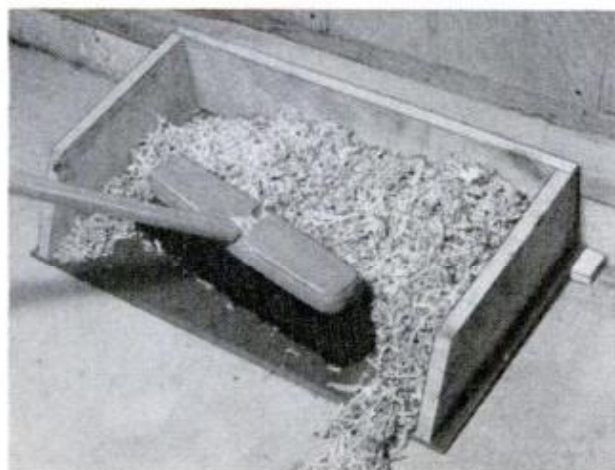
Picture This

Before you give up trying to figure a way to hang a picture on an inside brick wall with raked mortar joints—a fireplace wall, for example—try this: Make a small wedge of softwood, beveling two sides just enough so the block will drive tightly into the mortar-joint space between the bricks. Drive a small, round-headed screw at the center of the block.—*Frank N. Stephany*

A Sweeping Change

Jumbo-sized dustpan accepts sweepings in the workshop, basement or garage. It's made from three lengths of 1 x 6 stock and has a 1/4-in. hardboard bottom. Make it any size to suit your purpose. Bevel the front edge of the bottom to take dirt in a clean sweep. Tack a 1 x 2 strip to the bottom near the back to tilt the pan forward.

—*Jackson Hand*



Coming Up Next

POOL FILTERS. You want to know about pool filters. Okay. In June PM we're going all out to tell what a filter should do, how it works, what kinds and sizes to install. And, just for good measure, the article will include a do-it-yourself filter.

MODEL RACING BOAT. It's a radio-controlled, one-step, engine-driven hydroplane 42 in. long that really performs. We know for we've seen it, or something that was supposed to be it when it was going full out. Building plans and where to buy the hard-to-get items coming in June PM.

EMERGENCY FIRE ESCAPES. When you're caught above stairs in a bad fire it's a long ways down, even from a second-story window. Have you thought about an emergency ladder for your home? It's easy to make one that's always ready. We'll remind you in June PM.

3-WAY WELDER. This combination spot welder, arc welder, voltage booster plugs into the 115-v. line, was made at a materials cost of about \$15, give or take a little. Spot-welds ferrous metals 3/32 in. thick. How-to-build-it article comes next month.

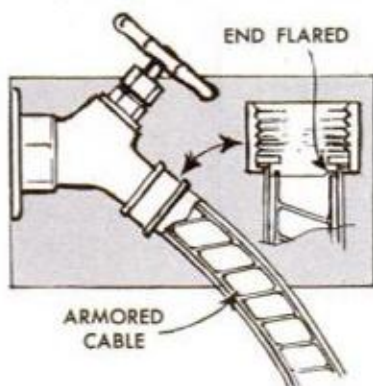
Solving HOME PROBLEMS



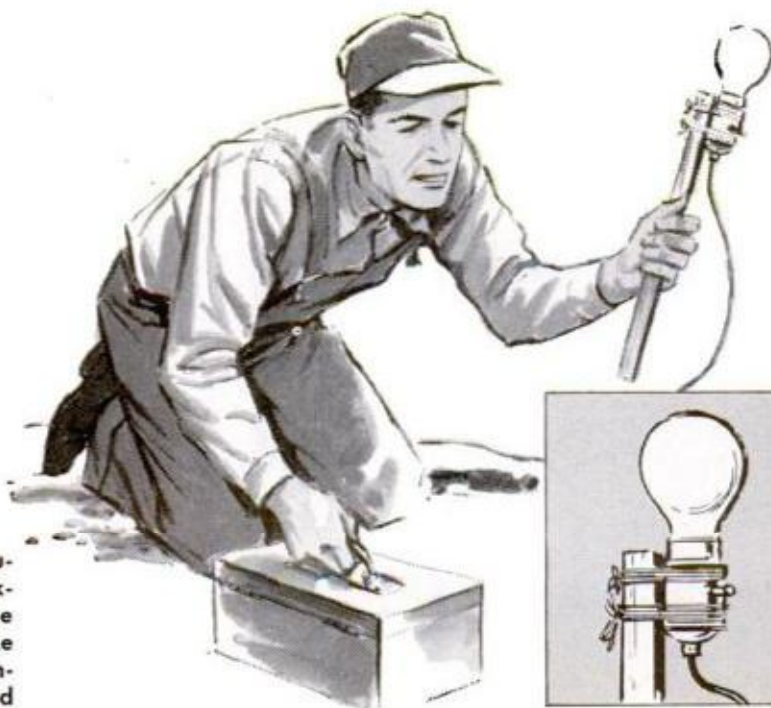
DUSTING PLANTS with insecticide on a windy day can be a hopeless task. However, if you drop an old lamp shade over each plant before dusting, you'll have a perfect windbreak for confining the spray



RIGID SLEEVE for attaching an extension handle to paint roller can be improvised from newspapers. Roll several layers to form a tube, slip handles into either end and secure by tying tightly with cord



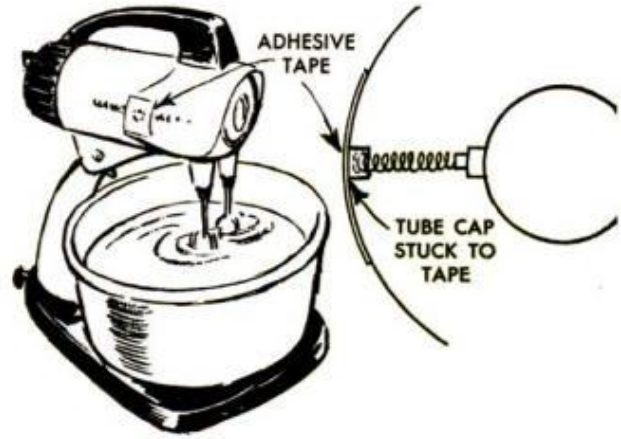
PLASTIC HOSE will sometimes collapse and bend at the hydrant coupling. This can be prevented by reinforcing it with a length of flexible armored cable (BX) from which the insulated wires have been removed



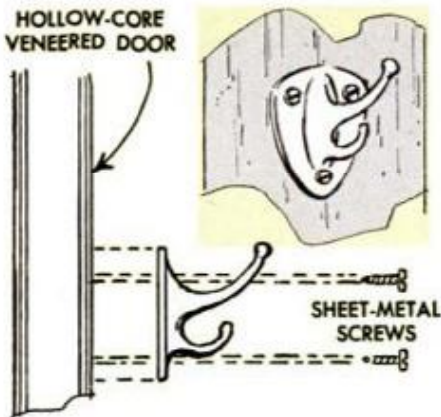
SHORT HANDLE for an improvised trouble light is especially handy when working in cramped conditions such as those encountered in crawl spaces. To make it, tie socket to a stick or dowel. Handle can be pointed to stick in ground



SURE-FIRE BAIT for mouse traps is made by mixing a little powdered skim milk with water to form a thick paste. Apply this paste to the bait holder with a knife and it will adhere to the metal when it dries



TEMPORARY REPLACEMENT for hard-rubber, brush-spring retainer on mixer can be made by taping the plastic cap from a small cosmetic tube over the spring



IF YOU ATTACH a robe hook to the thin facing on a hollow-core door, use sheet-metal screws. Having threads their full length, they'll hold where ordinary screws won't

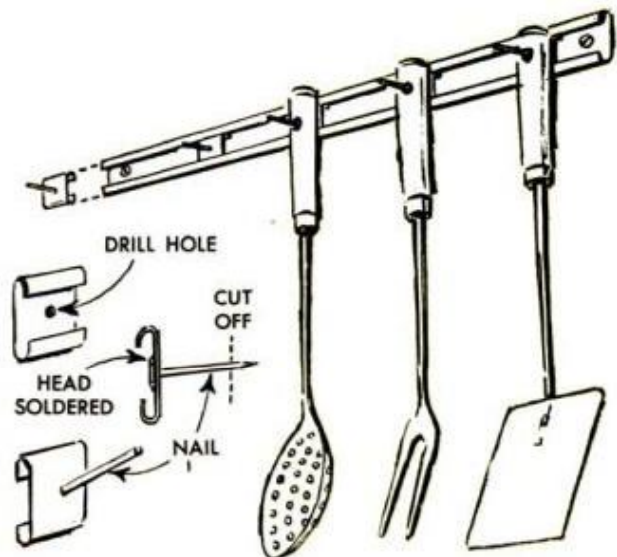


KILL ODORS from a vacuum-cleaner dust bag at the source. With the cleaner running, disconnect the hose and spray room deodorizer into the intake hole. Repeat as often as necessary

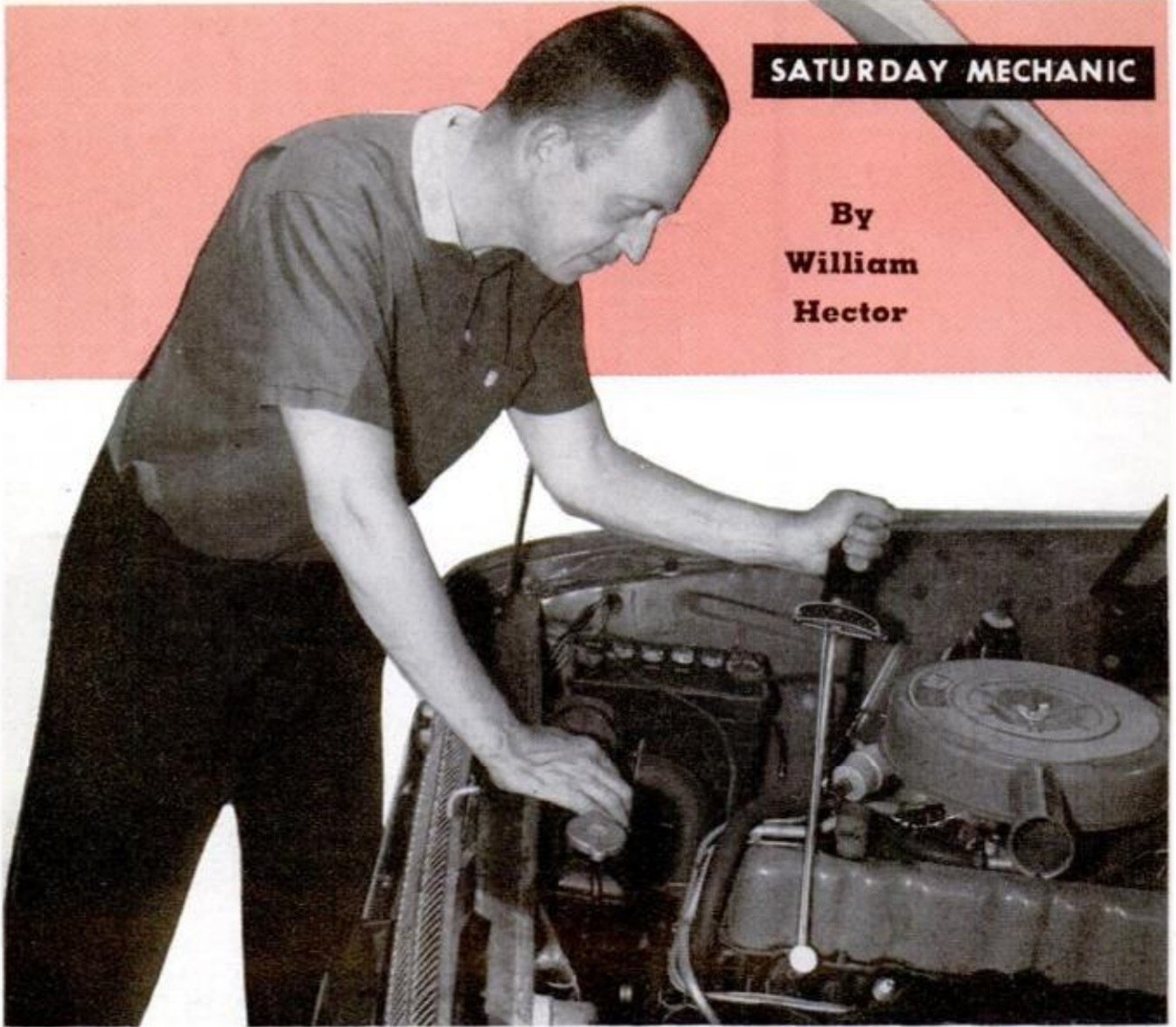
WALL HOLDER for vacuum-cleaner hose can be made from a discarded electrical wire spool. Mount the spool on the wall or inside the broom closet door and give it a coat of paint to match the closet



ADJUSTABLE RACK for holding kitchen utensils was originally a telescoping curtain rod. Make the sliding hooks by sawing the inner section into 1-in. lengths and soldering a nail to each as shown



**By
William
Hector**



1. WHEN TIGHTENING PLUGS it's best to use a torque wrench to make sure that plugs are tightened to specs

Ignition's the Word for Go

IN ANY ONE CYLINDER of your car a fuel-and-air mixture is ignited several thousand times per mile. That tiny, lively spark supplied by the ignition system at just the right time and of just the right intensity keeps your car rolling at a heavy-traffic crawl or expressway speeds. Rarely does the ignition system fail completely and leave you stranded miles from nowhere. But it does give warning of needed checks, adjust-

2. IF PLUGS appear other than normal, either you are using wrong heat range or ignition needs checking



NORMAL



LEAD FOULED



ELECTRODE WEAR



OIL FOULED



8. MECHANICS CLEAN plugs by sandblasting on a machine like that pictured. Unit does thorough job

blast them for quick results in special equipment, Fig. 8. If you have a paint compressor, a small sandblasting unit, Fig. 9, is available for \$6.50. It does an acceptable job and does not damage the plugs.

The threads of the plug should be cleaned with a wire brush to free them of any carbon deposits. Be careful not to injure the



9. SATURDAY MECHANICS can own this unit for about \$6.50. Utilizes air blast from small paint sprayer

electrodes or insulator. If the electrodes are in good shape, but require cleaning and regapping, first take a flat ignition file and file the center electrode square across, Fig. 6. Do the same to the outside electrode. This will remove any oxide deposits at the ends and produce an efficient conductive surface. Use a wire gap gauge, Fig. 7, setting the spacing to the manufacturer's specs. Do not use gapping pliers. They may produce hidden cracks in the porcelain due to stress on the center electrode. Dip a clean rag in solvent (carbon tet) and wipe the outside of the plugs. Now, replace all gaskets with new ones to assure a good seal.

If you are due for new plugs, you should know the heat range, thread size and thread length you require. Your driving habits may dictate a special heat range. If you foul plugs consistently with oil or carbon, the next higher heat range should be installed. If your plugs wear rapidly, or there is pinging or preignition because of

IGNITION SYSTEM

DISTRIBUTOR

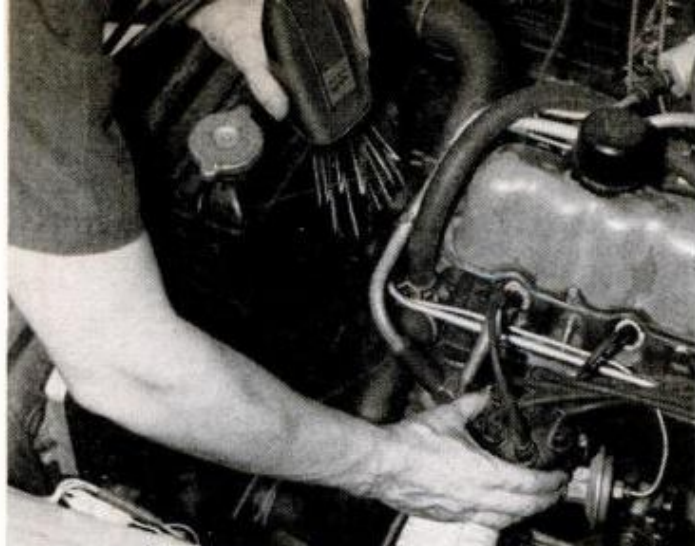
Initial Advance Crankshaft Degrees (BTC)	Breaker Arm Spring Tension (Ounces)		Contact Spacing	Dwell Contact at Idle Speed	
	Min.	Max.			
Conventional Drive	2°	10°	17-20	0.024-0.026	35°-38°
Fordomatic	4°	10°	17-20	0.024-0.026	35°-38°

VACUUM ADVANCE CHARACTERISTICS

144 Cu. In. Engine		
Distributor CODF-12127-A		
Standard Transmission		
Set test stand to 0° @ 1000 rpm and 0 inches of Mercury		
Distributor (rpm)	Advance (Degrees)	Vacuum (Inches of Mercury)
400	0	0.33
600	1/2-1 1/2	0.78
800	3 1/2-4 1/2	1.30
1400	10-11 1/4	3.45
1800	12 1/2-13 1/4	5.00
2000	12 1/4-14	5.35
Maximum Advance Limit		15 1/4°*
Distributor CODF-12127-B		
Automatic Transmission		
Set test stand to 0° @ 60° rpm and 0.48 inches of Mercury		
Distributor (rpm)	Advance (Degrees)	Vacuum (Inches of Mercury)
700	0	0.65
1000	1 1/4-2 1/4	1.27
1600	4 1/4-5 1/4	2.93
2000	5 1/4-7	3.94
Maximum Advance Limit		15 1/4°*
170 Cu. In. Engine		
Distributor CIDF-12127-B		
Standard Transmission		
Set test stand to 0° @ 45° rpm and 0 inches of Mercury		
Distributor (rpm)	Advance (Degrees)	Vacuum (Inches of Mercury)
700	1 1/2-2 1/2	0.43
1000	5 1/4-6 1/4	0.92
1300	7 1/2-8 1/4	1.50
1700	10-11 1/4	2.40
2000	11-12 1/4	3.00
Maximum Advance Limit		16 1/2°*

Ignition System Tests and Instruments Used

- Breaker arm spring tension (spring scale)
- Spark output (spark output meter or ignition analyzer)
- Coil resistance (voltmeter or ohmmeter)
- Distributor shorts or opens (ohmmeter)
- Condenser (substitute new condenser or condenser tester)
- Condition of point surfaces (voltmeter)
- Stationary ignition point ground (voltmeter)
- Battery side of coil (voltmeter)
- Dwell (electrical or mechanical dwell meter)
- Distributor resistance (voltmeter or ohmmeter)
- Variation in dwell time (electrical dwell meter only)
- Ignition timing (timing light)
- Worn cam test (electrical dwell meter)
- Centrifugal advance (timing light or distributor tester)
- Vacuum advance (timing light or distributor tester)



10. ADJUSTING IGNITION TIMING is the final check on the system. Electronic flash stops mark on the harmonic balancer in relation to a stationary pointer

excessive heat, go to a lower heat range. Your driving habits will determine proper selection of heat range, assuming all other conditions are normal. The installation of spark plugs requires attention to three details (1) air gap between the electrodes, (2) ignition wire cap making good contact with the plug, (3) tightening the plugs to the correct tension. Before installing plugs scrape out the ignition wire cap with a screwdriver, then crimp the cap with pliers just enough so it snaps on tightly. A little liquid graphite on the plug thread will prevent it from seizing. Now turn the plug in finger tight and using a socket wrench, give it a half turn. Then tighten to factory specs with a torque wrench, Fig. 1, usually about 28 to 30 foot-pounds on cast-iron blocks and 25 on aluminum.

A cardinal rule when working on a car is never to remove anything unless it's necessary. In the case of the distributor, Figs. 10 through 14, this is doubly important. If you must remove the unit, wipe off the area around the opening in the motor block first. Scratch a mark on the block and distributor for line-up of parts. Then remove the cap. Some caps are attached with spring clips, some with screw-down lugs. In either case use care to avoid breaking the cap. Make a visible mark on the distributor to show the position of the rotor. When the distributor is eventually replaced, the direction of the rotor must be exactly the same as when removed.

The distributor cap handles extremely high voltages, as high as 10,000 to 20,000 volts. The film of grease and dirt that collects in time in and on a distributor cap can detour high-tension current. That's why it's important to keep the cap reasonably clean. Dip a cloth in carbon tet, (other solvents may leave a residue) and wipe both the inside and outside of the cap. Then examine it closely for carbon tracks or any



TUNEUP KIT



DISTRIBUTOR ROTORS

Distributor CIDF-12127-C		
Automatic Transmission		
Set test standard to 0° @ 600 rpm and 0.27 inches of Mercury		
Distributor (rpm)	Advance (Degrees)	Vacuum (Inches of Mercury)
700	0	0.43
900	¼-1¼	0.76
1300	4½-5½	1.50
1700	7-8¼	2.40
2000	8½-9¼	3.00
Maximum Advance Limit		16½°

DISTRIBUTOR DIMENSIONS

Distributor Shaft	Inches
Diameter (at bushing)	0.4675-0.4680
End clearance (to gear)	0.028
Gear Location (from bottom of gear to bottom of mounting rib)	2.510-2.515

CONDENSER

Capacity Microfarads	Min. Leakage Megohms	Max. Series Resistance Ohms
0.21-0.25	5	1

COIL

Amperage Draw	
Engine Stopped	Engine Idling
4.5	2.5
Primary Resistance Ohms	Secondary Resistance Ohms
1.40-1.54 (75°F.)	8000-8800 (75°F.)

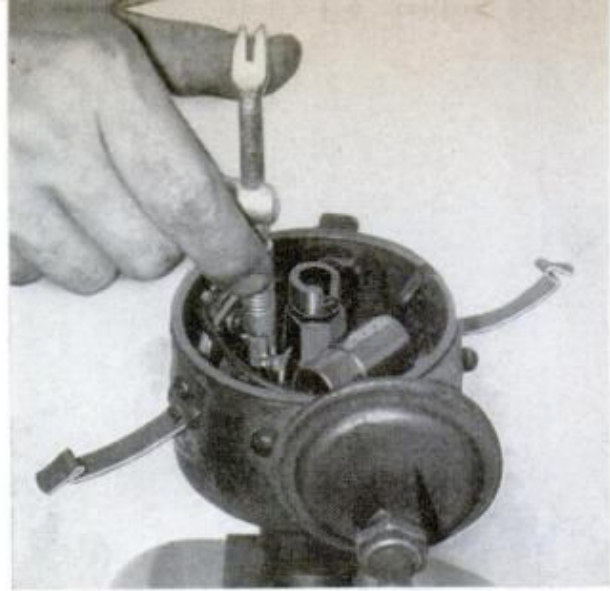
*Primary Ignition Circuit Resistor—1.30-1.40 (75°F.)

SPARK PLUGS

Commercial Equivalent	Size	Gap (Inches)	Torque (Ft.-Lbs.)
Champion No. F-14-Y	18 mm	0.032-0.036	15-20
Champion No. 870	18 mm	0.032-0.036	15-20



11. CLEAN DISTRIBUTOR towers with a brush made for the purpose or with sandpaper on dowel



12. ADJUSTING BREAKER-ARM spring tension is done with a special tool. Keeps points in alignment

Tools

Gap gauge
Ignition file
Air pump
Wrenches
Voltmeter
Tachometer
Dwell meter (electronic or mechanical)
Spring scale (adjustable tension)

Timing light
Spark-plug cleaner

Materials

Cleaning solvent
New points, condenser, rotor (kit)
High-temperature cam lubricant
Spark plugs



13. CORRECT POINT TENSION is necessary to prevent point bounce. Tension scale gives accurate check

14. INEXPENSIVE CAM-DWELL indicator of mechanical type permits cam adjustment in car or at the bench



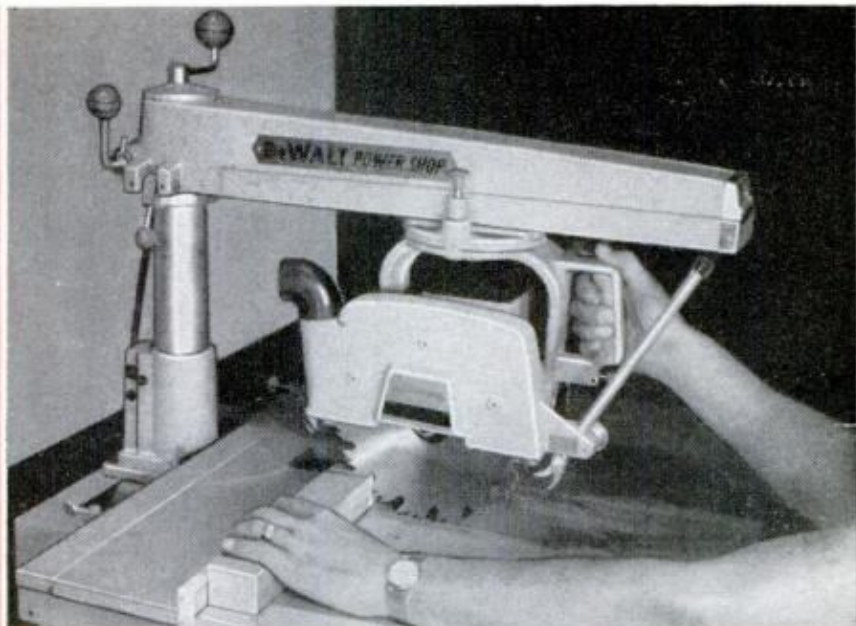
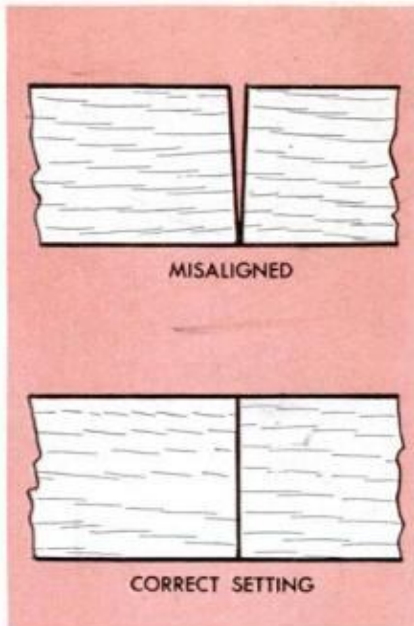
other evidence of cap-material breakdown. If there are carbon tracks, chips or cracks, better replace the cap. Otherwise pull out the wires, one by one, and clean the inside of the towers with the special wire brush made for the purpose, or a dowel with a strip of fine sandpaper wrapped around it as in Fig. 11. When replacing the old cap, do not pull all the wires out of it at one time. Place the new cap beside the old one and replace the wires one at a time. Finally, push the wires all the way down, the insulator caps following. In the future, recheck these wires every time you grease the car, or open the hood of the car. They do have a way of working loose.

Ignition wires should be kept clean. Use a cloth dampened with carbon tet. As in the distributor cap, high voltages are present. It is possible for more voltage to be travelling on the outside of the wire insulation than in the wire itself. If the wires have deteriorated from long exposure to heat they should, of course, be replaced.

There are various types of rotors but all are designed to transmit the high voltage from the ignition coil to the wires leading to the plugs. Be sure there is sufficient tension on the rotor spring to make good contact with the carbon button in the center of the cap. Clean and polish the rotor tip. Then replace, pressing down on the sides, not on the spring. Make sure the rotor is pressed all the way down to the shaft shoulder. Lower photo at the right of Fig. 10 pictures different types of rotors.

Distributor points may be cleaned with a point file, but this should never be done until the condition of the points makes dressing necessary. On the other hand if the points are badly burned, they should be replaced. Before removing anything, note closely the placement of the leads. Only loosen the terminal screws since the

(Continued to page 174)



Keep Your Power Saw in Line

With the tilt gauge set at its normal 90-degree position, here's a simple check you can run in about one minute to determine the accuracy of the miter-gauge setting on a table saw or the angle setting on a radial saw in making a square cut. Set the miter gauge, or the radial saw, to 90 degrees, place two short lengths of 1 x 4 stock, one on top of the other, and cut through both.

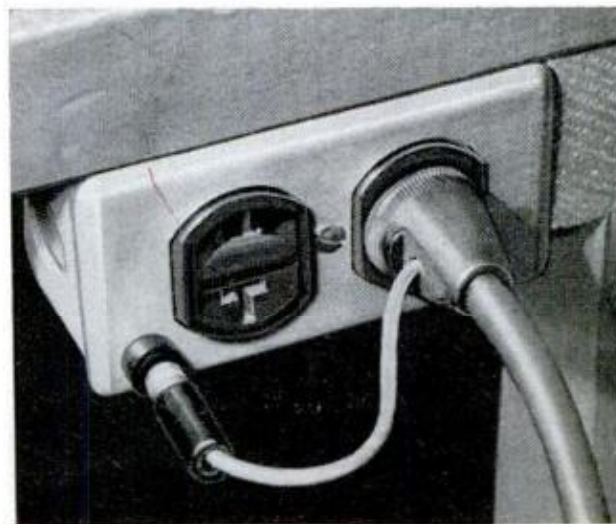
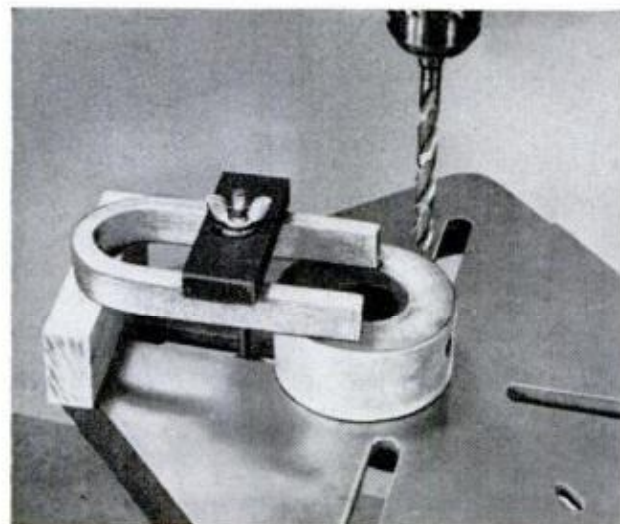
Then stand them on edge, swing one piece, still on edge, through 180 degrees and butt the cut ends together. If there's a V-shaped opening as in the upper detail, then you will need to reset your miter gauge, or the angle setting on your radial saw, until you get a true butt joint as in the lower detail. Use a hollow ground blade for greater accuracy.—*Eugene S. Weiss*

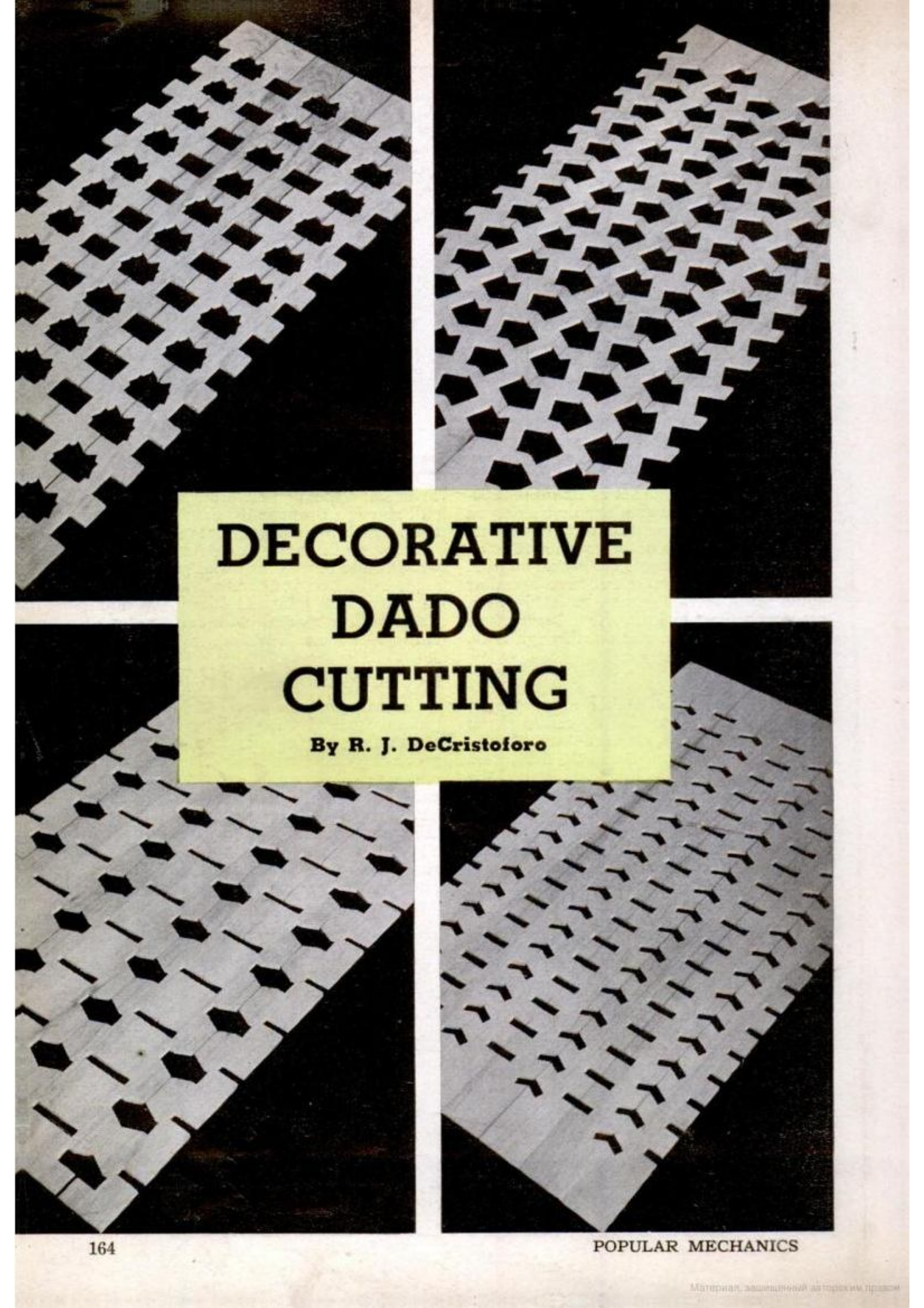
Slipproofing

The shape of a horseshoe magnet is an excellent substitute for a conventional strap clamp when you need to hold difficult-to-clamp workpieces on the drill-press table. To set up the clamp you'll need the magnet, a length of bar steel long enough to span the legs of the magnet, a bolt and wing nut and a block of hardwood approximately the same width as the height of the workpiece. You assemble these parts as pictured with the legs of the magnet bearing on the workpiece.—*H. Hanscom*

Grounded for Good

On older portable power tools having the ground (green) wire leading out the side of the plug, it's too easy to neglect proper grounding when the wire has to be put under a screwhead. However, if the wire can be quickly plugged in, it's another matter. Simply connect a phone-tip plug to the green wire of each tool cord and drill a hole in the metal cover of the receptacle box for a jack. When you use the tools, plug in the ground wire first, then the power-cord plug.—*Herbert Y. Moon*





DECORATIVE DADO CUTTING

By R. J. DeCristoforo

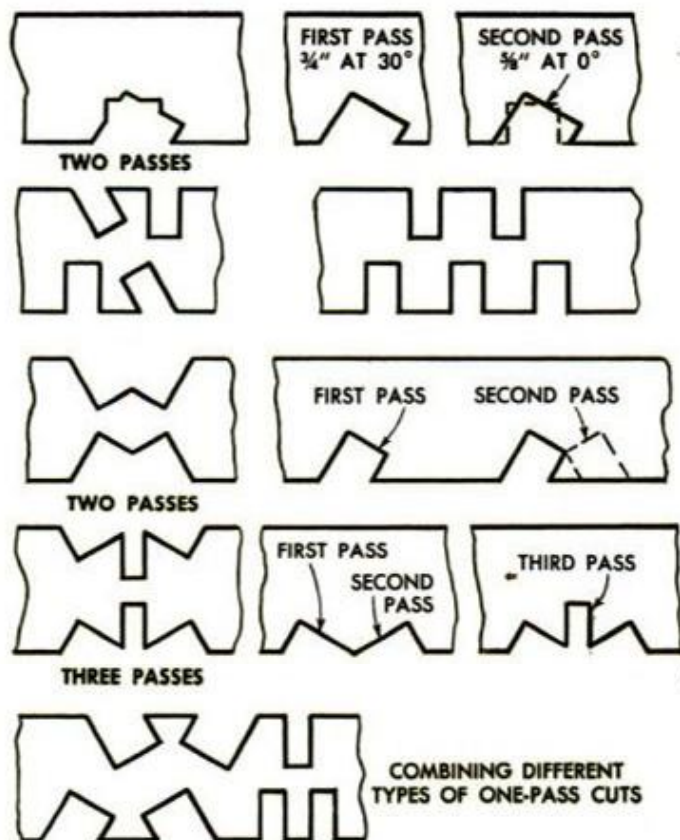


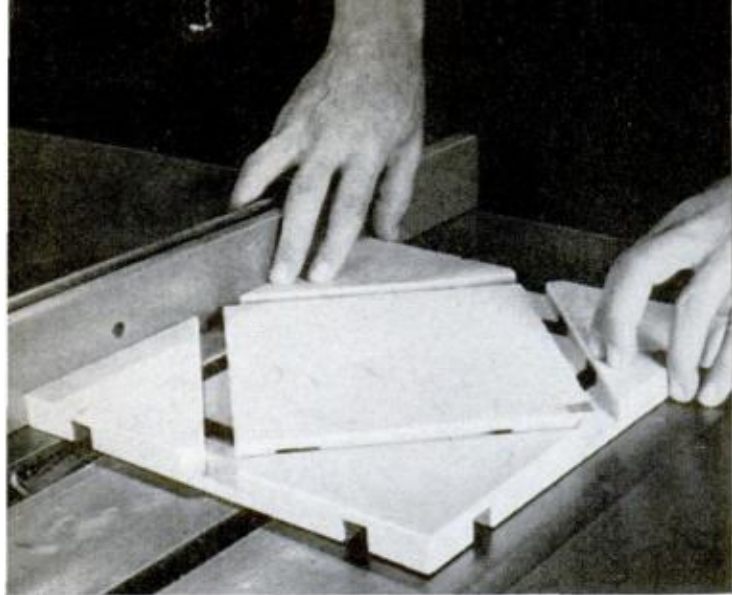
PIERCED PANELS, dentil strips and in-laid or overlaid decorative moldings can be yours for the making. Examples of the work on the opposite page and on a following page show what you can do simply by setting the dado head on your table saw to varying depths, angles and widths of cut on two sides of the stock. The patterns you see at the left are made by assembling thin strips ripped from stock on which dado cuts have been made on both sides as in the photo above, also in the details at the right.

Any type of dado head can be used—a head consisting of assembled cutters and chippers, a wobble saw, or a head having adjustable cutters—but it must be sharp so that it cuts a clean groove with square corners. There are several methods of laying out the work and cutting. You can space simple cuts by eye alone but it is better to lay out the spacings with heavy pencil lines as in the photo above.

As a rule, inclining the dado at an angle of 30 degrees will give about the right pattern characteristics. The dentil cuts are made with the dado at 90 degrees, of course. If you plan to make a number of pierced patterns involving a considerable total area, then it will pay to make a special jig to space the cuts automatically. A jig similar to that used in making box corners will serve the purpose. A hardwood stop,

ANGLE CUTS across the width of the stock on both sides produce pattern you see above. Strips ripped from the edge to a thickness of about $\frac{1}{4}$ in. can be placed edge to edge as pictured on opposite page

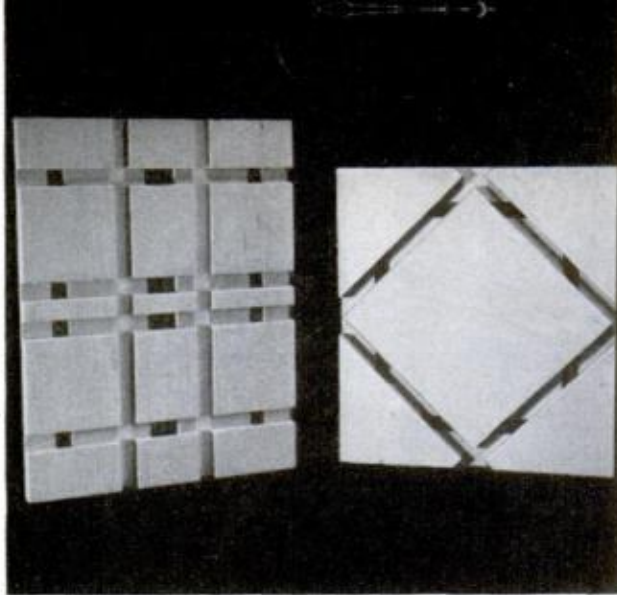




PIERCED WORK in almost innumerable patterns can be made by running cuts on both faces of stock

shaped just like the dado cut in the base piece and inclined at the same angle, is mortised into the edge of a strip screwed to the miter gauge. Once located properly in relation to the dado head, it serves as an accurate stop for the repetitive cuts.

In order to assure symmetry in the final pattern you have to make very sure of the depth setting of the dado. Usually it's a good idea to run test cuts on a piece of waste. Don't attempt to make the cuts on a strip wider than 6 in. A strip 4 in. wide is much easier to handle. If you have a hollow-ground (planer) saw blade use it to rip the thin strips from the base piece. The smooth cut of the planer blade will reduce

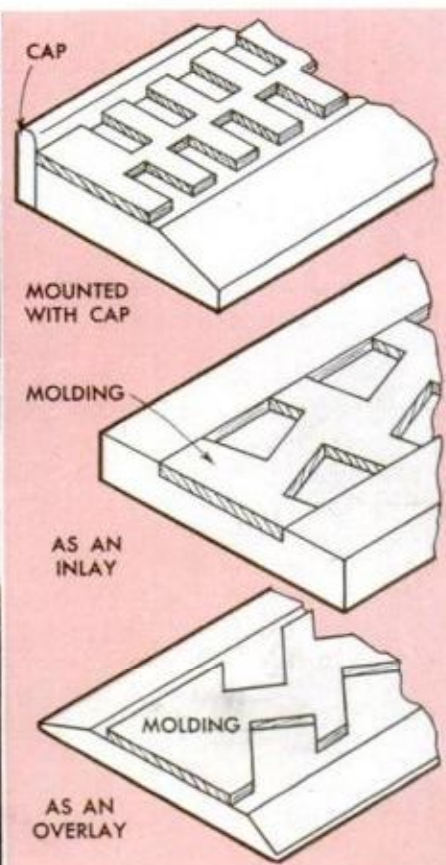
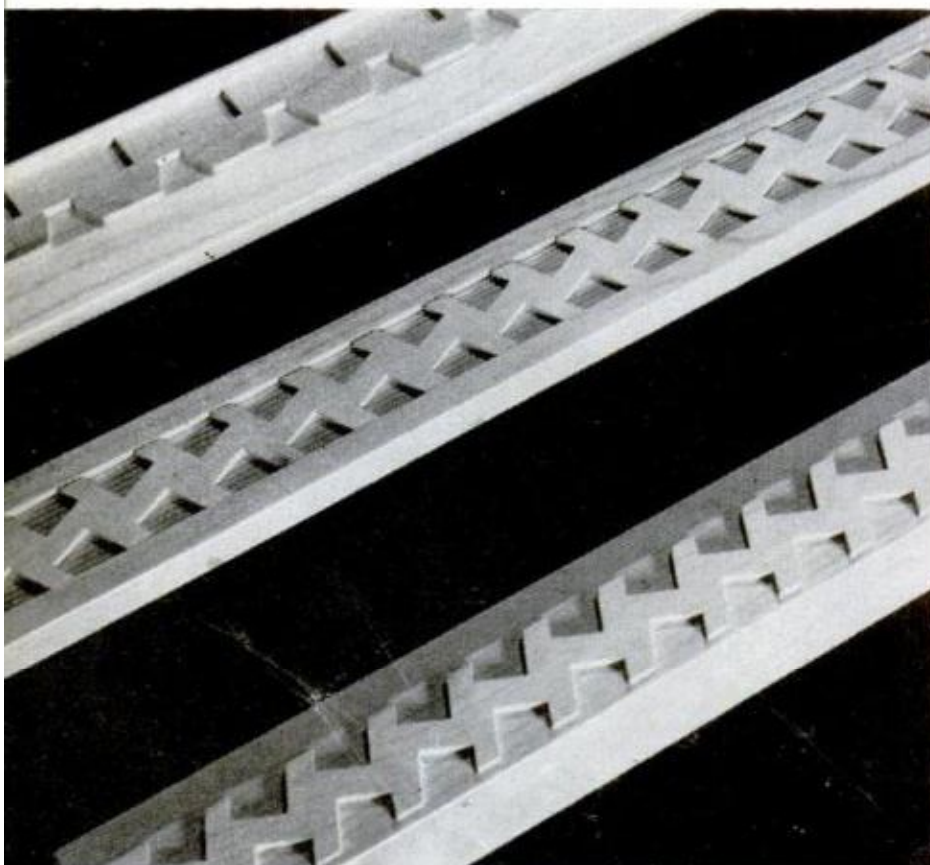


HERE'S ONE example of pierced, or cut-through, work. Dado cuts slightly more than half way through stock

sanding of the strips to the very minimum.

In the type of work pictured above, the dado is set to cut to a depth just slightly more than half the thickness of the solid stock. Then when you turn the material over and run the second groove pattern the dado will cut through into the grooves cut on the opposite face. The design can be almost anything symmetrical.

The photos and details below show how you can build up moldings of attractive design by inlaying and overlaying strips cut from stock already patterned by dadoing. For decorative moldings made by dadoing always use straight-grained woods free from knots and other defects. ★ ★ ★





"Silent" Phono for Youngsters

By Homer L. Davidson

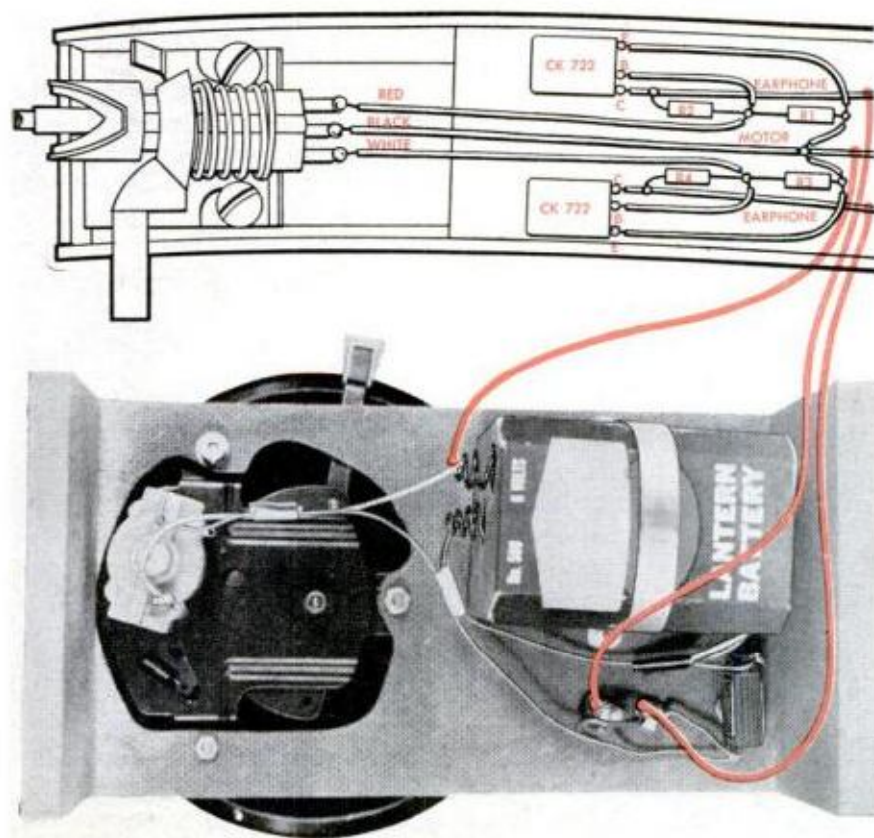
SMALL PHONOGRAPHS keep the youngsters busy but the blare of childish nursery rhymes can cause as much irritation as idle youngsters do!

If you fix the phonograph up with an earphone instead of a speaker, squabbles will develop about who listens to it. In this unit, we use a stereo cartridge, each side having its own transistor amplifier built into the tone arm. Each amplifier feeds a separate

earphone, so two children can listen to the mono records at the same time.

The motor is battery powered, using the same battery that powers the amplifiers, so that there is no danger of electric shock.

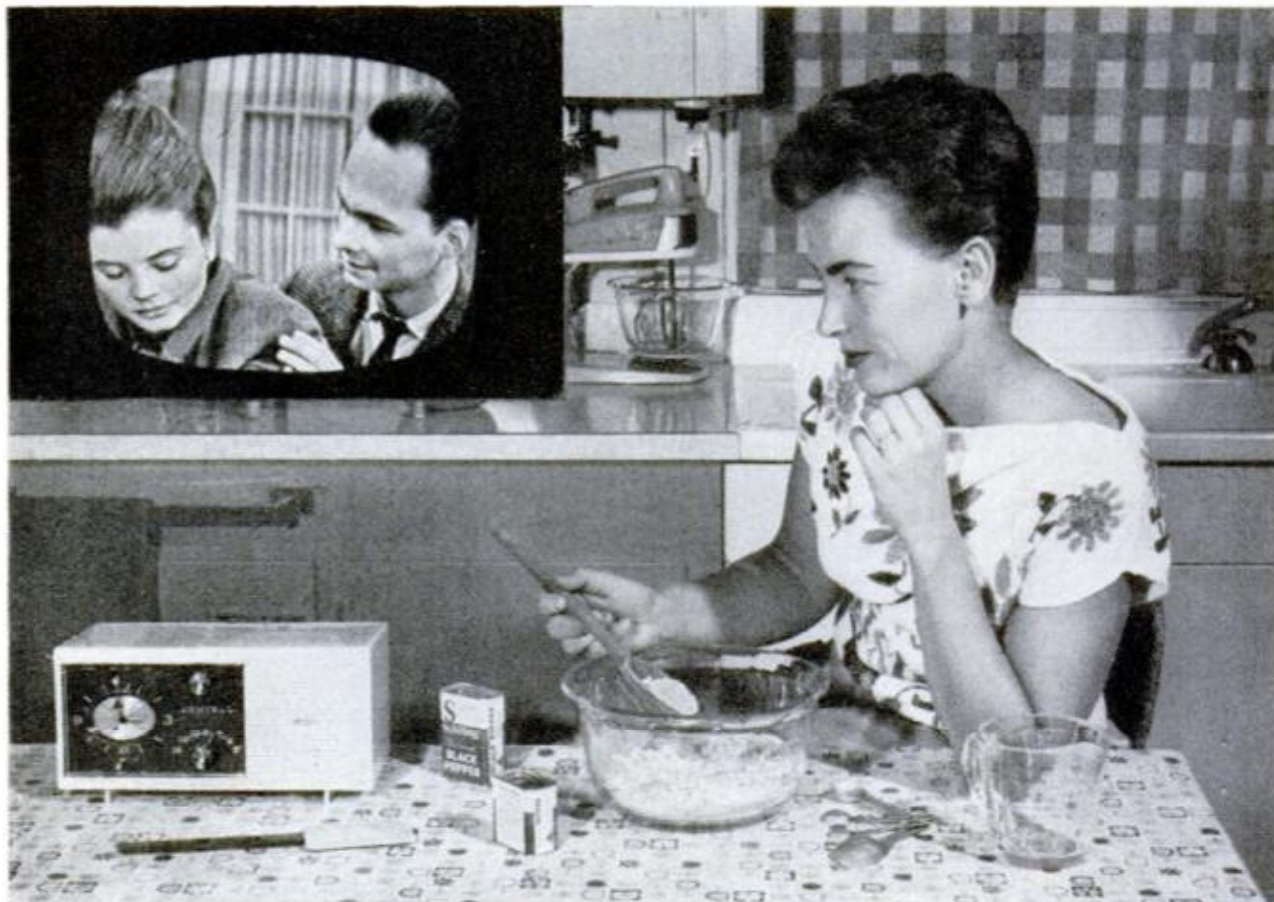
In following the diagram, understand that the colored lines indicated actually run down the length of the tone arm, and through its support post to below the chassis, where the proper connections are made.



PARTS LIST

- R1, R3—10K carbon-fixed 1/8-watt resistor
- R2, R4—470K carbon-fixed 1/8-watt resistor
- CK722—Raytheon transistor
- Battery—6-volt lantern type
- Switch—SPST toggle
- Motor—6-volt d.c. Lafayette ML-9, 3-speed
- Pickup arm—PK-89 or equivalent with stereo cartridge. Electro-Voice Model 66 and Power point Model PT-3 mount
- Phones—2 single 500 to 3000 ohms
- Misc.—8 x 12-in. Masonite board, 2 pieces 1 x 4 x 8-inch soft pine, screws and bolts, etc.

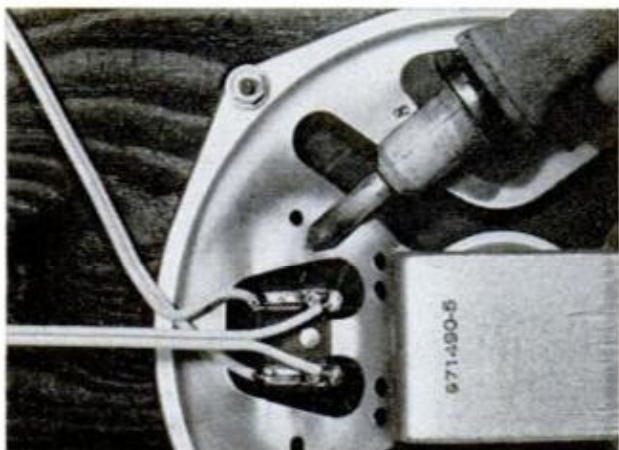
KEEP UP WITH TV



PINKY THE PIRATE OR PURPLE PASSION? You can tell if kids really watch cartoon show or change channels

Are the youngsters really watching that TV cartoon? Maybe they switched over to an "adults only" movie when you left the room. With this setup, it's easy to monitor their TV listening

ANTENNA WIRE from broadcaster is uncoiled and run along baseboard behind TV. Install unit inside TV



WIRELESS BROADCASTERS can make radio receivers serve as one-way intercoms or remote receiving stations for your record player.

With this conversion, a wireless broadcaster may also be used to monitor TV programs through the family radios, either for your own enjoyment or to enable you to keep up with what your youngsters are watching elsewhere in the house.

The wireless broadcaster actually transmits an AM broadcast signal which is of low power and limited range so no FCC license is required.

While any wireless broadcaster will do, we modified an Allied Radio Co. Knight-Kit (Catalog No. 83Y706, \$12.95). The modification consists of removing the input resistor and replacing it with a 50,000-ohm potentiometer, mounted in a $\frac{3}{8}$ -in. hole in the front panel. The center arm of the pot connects to the J2 input jack and the right arm to pin 8 of V1. The equalization capacitor and resistor (C4 and R6) are then removed.

If your TV is an a.c.-d.c. model, (it will be marked on the back) use a neon tester to determine which side of the line is ground

ON YOUR RADIO By Tommy Thomas

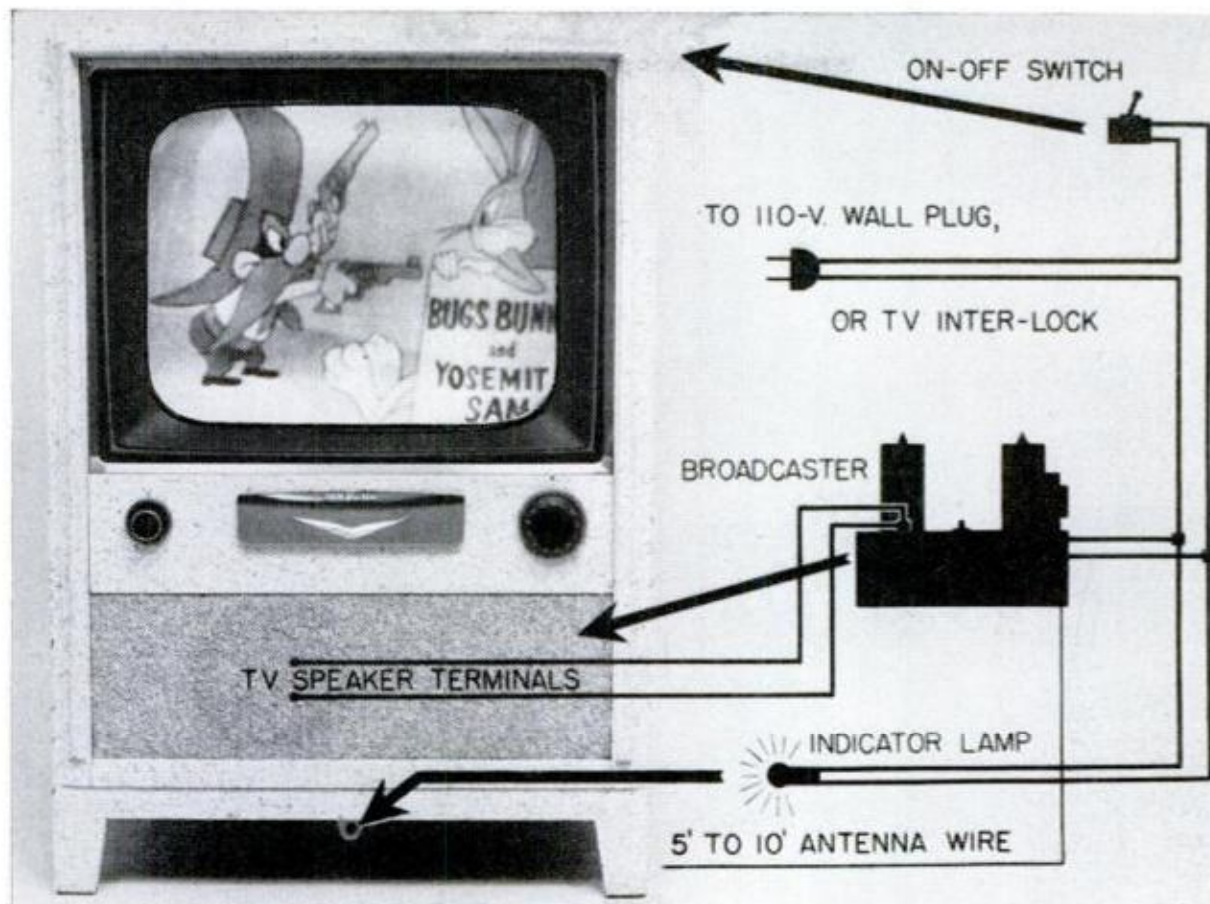


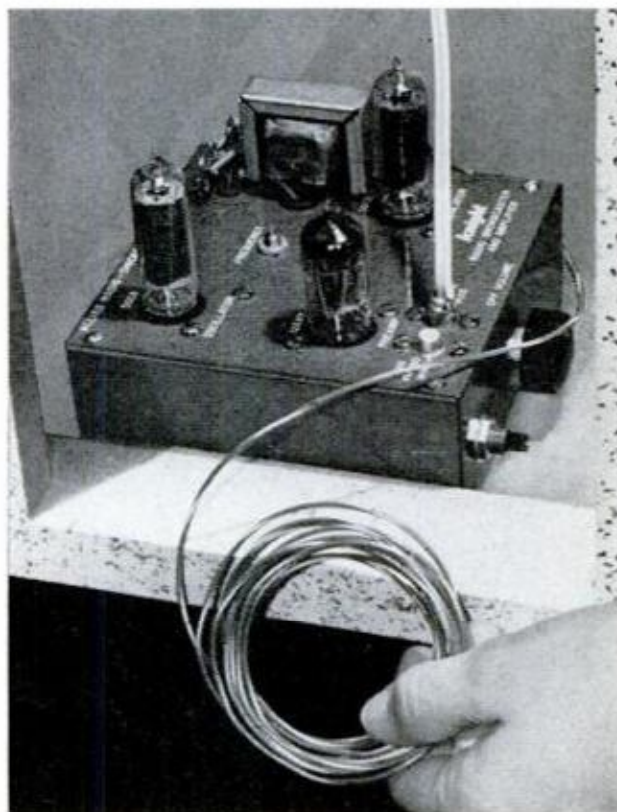
DIAGRAM ABOVE shows how broadcaster is connected to TV set. Unit doesn't hamper normal TV reception

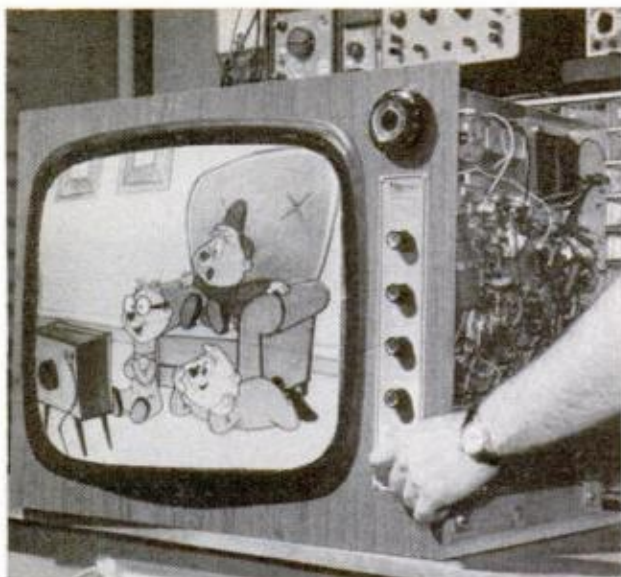
by placing one wire of the tester at the wall plate mounting screw, and the other on either terminal of your line cord. The bulb will not light when touched to the ground side. Be sure that the ground side of the wire from the broadcaster and the one from the TV set are the same, making all connections with the TV set and broadcaster disconnected from the wall outlet. Connect the broadcaster through a switch and neon lamp as per drawing.

Uncoil and extend the antenna wire from the broadcaster to its full length along the baseboard behind the TV set. Solder the ends of a lamp-cord wire to the speaker terminals of the TV set and connect the other end of this lamp-cord wire to a small Phono plug, which connects to the just modified J2 jack on the broadcaster.

Now turn on the broadcaster, the TV set and the radio. Tune the radio to a no-station spot on the dial. Adjust the broadcaster frequency control until you hear the TV audio in the radio, with all volume controls set at normal levels. Adjust controls on broadcaster for maximum volume without distortion. Shortening antenna or substituting unmodified jack may improve reception. ★★★

BROADCASTER INPUT is taken directly from TV speaker terminals. Other end is fitted with a phono plug





Custom TV Kit

COMPLETED SET mounts vertically or horizontally depending on type of panel you choose. Picture comes on locked, with neither rolling nor tearing

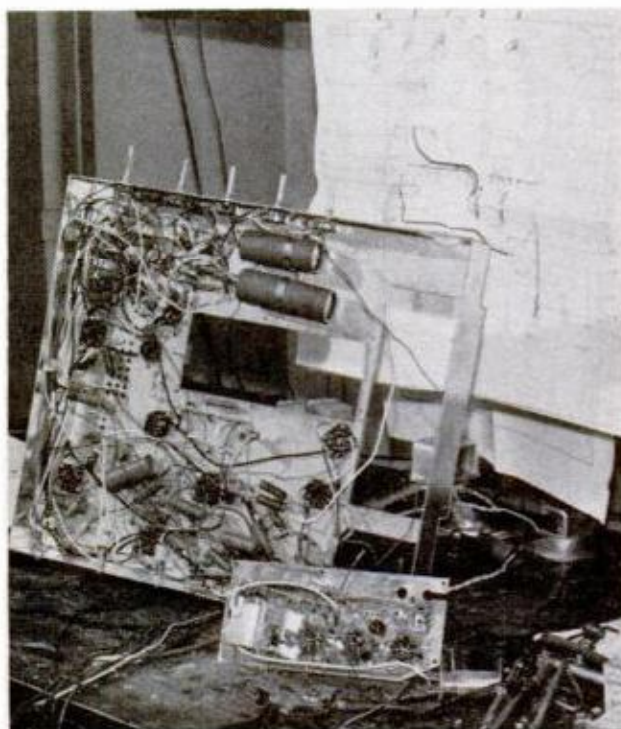
THIS HIGH-FIDELITY SET, originally designed for instructional use in television schools, makes a rewarding educational project for the kit builder.

The critical stages of the set use separate tubes, thereby keeping the horizontal and vertical circuits, for example, from interacting. Many component parts are over-rated (600-volt capacitors, for example, where 150-volt would do) to extend service-free life. Other circuitry refinements rarely found on commercial sets below the #300 range, include: d.c. restoration for blacker blacks, Williamson negative feedback, hi-fi-type amplifier, audio tone control and a woofer-tweeter speaker system. A retrace eliminator removes the slanting white lines that appear on some sets.

The prewired and prealigned i.f. strip solves a critical problem in the construction. All you need do is screw it into place and connect to it.

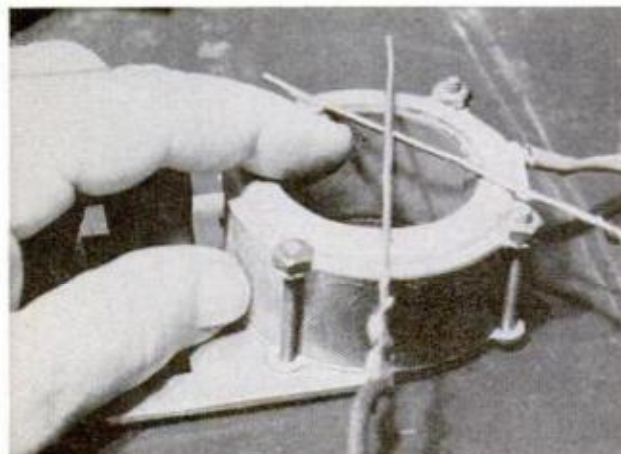
It took an experienced kit builder 25 hours' time to build and test this kit, which comes in a series of subkit packages, each of which is assembled to the chassis in turn. Full-size chassis diagrams accompany the instruction manual to facilitate wiring.

Although these kits are available with picture tube sizes ranging from 17 at \$119 to 27 inches at \$199, and some variations in circuitry. This 23-inch model is \$143 from Transvision, New Rochelle, N. Y.



FULL-SIZE DIAGRAMS of chassis are related to instruction book. Separate diagram is used with each stage of construction. Wiring is in single layers

SAVE THE MAGNETS from those old TV yokes! They're excellent magnetic vises for holding small metal parts while soldering. Magnet can be permanently mounted to bench or carried around for other jobs



NEVER LOSE PIN STRAIGHTENERS. Using epoxy cement, you can mount your seven and nine-pin straighteners directly on the tube tester with which they most often are used. The result is greater convenience





YOU LOVE THE FLAVOR...AND EVERYONE LOVES THE AROMA!

■ When you light up your pipe with HALF AND HALF, the people around you enjoy it almost as much as you do. That's because no other pipe tobacco has such a delightful aroma—and such a distinctive taste.

■ HALF AND HALF is a mixture of choice aromatic tobaccos... specially selected and blended for mild taste and friendly aroma. So, relax and light up—your pipe is welcome everywhere when you smoke HALF AND HALF.

■ Buy and enjoy famous HALF AND HALF in the pocket pouch or vacuum-packed humidor tin today.



CONFIDENTIAL!
 (For married men only.)
**YOUR BETTER HALF
 WILL LOVE THE AROMA
 OF HALF AND HALF!**

A CARGO OF CONTENTMENT IN THE BOWL OF ANY PIPE!

©THE AMERICAN TOBACCO COMPANY

"STUMP-PYRE" distributed by
INDIANA FARM BUREAU COOPERATIVE ASSN. INC.
47 S. PENNSYLVANIA, INDIANAPOLIS, IND.

CLINIC FOR HOMEMAKERS

As a service to our readers in solving the hundreds of problems pertaining to a home — inside or out — editors of Popular Mechanics invite you to present your problems to The Clinic Editor for help and advice. Address your questions to The Clinic Editor, Popular Mechanics Magazine, 200 East Ontario Street, Chicago 11, Ill.

Removing Tree Stumps

Q—Last winter we cut down an old tree in the yard. Only the stump remains. What, in your opinion, is the easiest way of getting rid of it? Everyone we talked with gave us a different answer.—A.G., Mo.

A—Old timers have their own pet methods of removing stumps. Usually you will get a different answer from each of them. If a stump is dead and it's in a lawn area, the following relatively easy method has given some good results.

The stump should be cut off level with the ground. If practical, even remove two or three inches of the wood below ground level. A few holes, bored vertically into the top of the stump, will help speed up the decaying process. Soak the area thoroughly and spread top soil over it. The ground should then be kept wet until it freezes. Fall will generally be the best time for seeding those bare spots which are left.

However, should you intend using the area for gardening, you will want to remove as much of the underground root system as possible. About the easiest way of doing this is to dig a trench around the stump, allowing just enough clearance for operat-



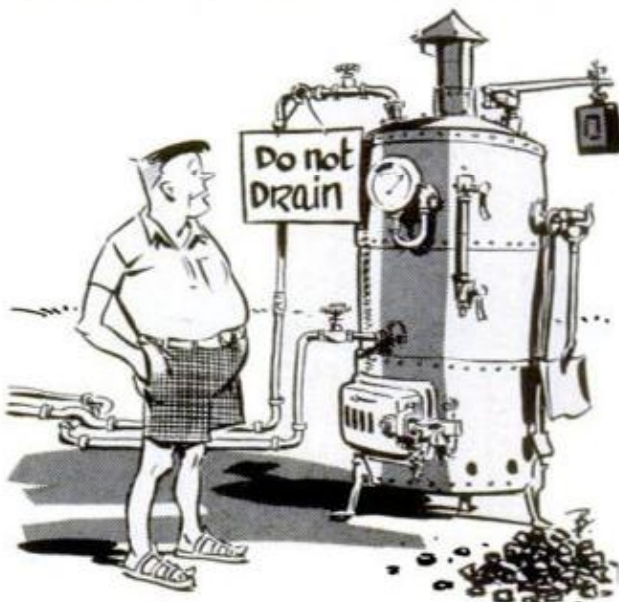
ing a small power saw. With the saw, cut off the main roots. It should then be easy to pry out the stump.

Trying to remove a stump by pouring acid over it is, in our estimation, too much of a safety hazard, especially when children are likely to be playing in the yard. And the results often are unsatisfactory.

Attempting to burn out a stump is frequently discouraging as the fire often requires too much attention in order to keep it going. There are commercial chemicals on the market which may be used for treating stumps so that they can be burned out, roots and all.

Spring Care of Hot-Water Boiler

Q—We heat our house with a gas-fired, hot-water system, and I've been advised not to drain the boiler at the end of the heating season. Is this correct?—W.T., Colo.



A—Yes, you have received good advice. The water remaining in a hot-water system at the end of the heating season should not be changed. Instead, it should be left in the boiler throughout the summer months. Water which has been heated for some time will contain less oxygen than fresh water, so the boiler and pipes will be less likely to rust out than if fresh water is put in at the end of the heating season.

In the fall, when you are ready to start heating again, you can drain off dirty, sediment-laden water (removing no more than necessary) and refill with fresh.

If the boiler water requires frequent cleaning and collects a considerable amount of sediment, you may use one of the commercial boiler cleaning compounds to keep the system in good condition.

When draining, refilling or adding water to a boiler, the manufacturer's instructions should be followed carefully. ★ ★ ★

Harry's Saturday just went up in smoke

Planned a big day out with the wife, kids and ol' Patch. Planned it for weeks, and today's the day . . . weather perfect, lunch packed, birds singing, and family in the starting blocks. But right now Harry's got something else on his mind . . . a lot less fun and a whole lot more expensive. What happened to him could happen to you or me or anybody. Seems that while waiting for things to get rolling, he decided to wheel out the power mower and make a quick pass at the lawn . . . never giving the crankcase oil level a second thought. The sad result is that smoking ruin at Harry's feet. Motor and bearings burned to a crisp. Now he's got the miserable chore of lugging the mower down to the repair shop, listening to the snickers, and shelling out a good piece of change. Unhappily, this story is repeated over and over again, every Saturday of the Summer. Maybe you've had your turn, maybe you're next. Of course, the whole business could have been prevented for Harry, just as it can be prevented for you.

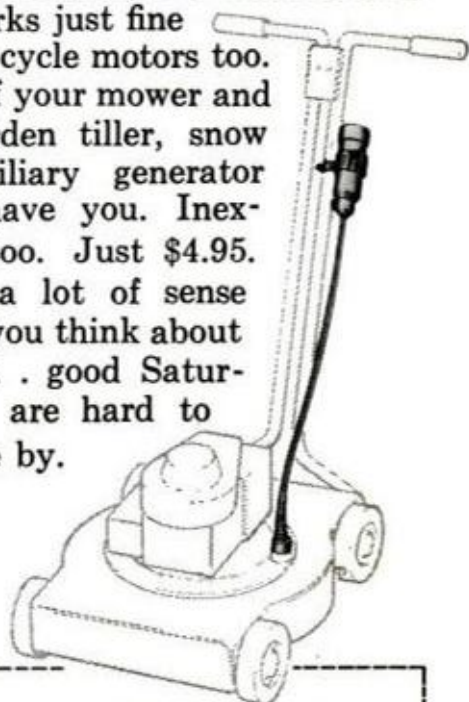
The General Plastics people developed their patented MOT'R SAV'R to do just that. The MOT'R SAV'R provides you with an auxiliary, automatic-feed oil reservoir which, because of its unique construction, lets you know at a glance when it's time to add. Install it on any mower in two minutes and you're set for years. Works just fine on a lot of other 4-cycle motors too. Simply slip it off your mower and onto your garden tiller, snow blower, auxiliary generator or what have you. Inexpensive too. Just \$4.95. Makes a lot of sense when you think about it . . . good Saturdays are hard to come by.

The General Plastics people developed their patented MOT'R SAV'R to do just that. The MOT'R SAV'R provides you with an auxiliary, automatic-feed oil reservoir which, because of its unique construction, lets you know at a glance when it's time to add. Install it on any mower in two minutes and you're set for years. Works just fine

on a lot of other 4-cycle motors too.

Simply slip it off your mower and onto your garden tiller, snow blower, auxiliary generator or what have you. Inexpensive too. Just \$4.95.

Makes a lot of sense when you think about it . . . good Saturdays are hard to come by.



Money-Back Guarantee

GENERAL PLASTICS, INC.

P.O. Box 225 Auburn, Maine

Please rush meMOT'R SAV'R(s)

Check Enclosed C.O.D.* Bill me later*

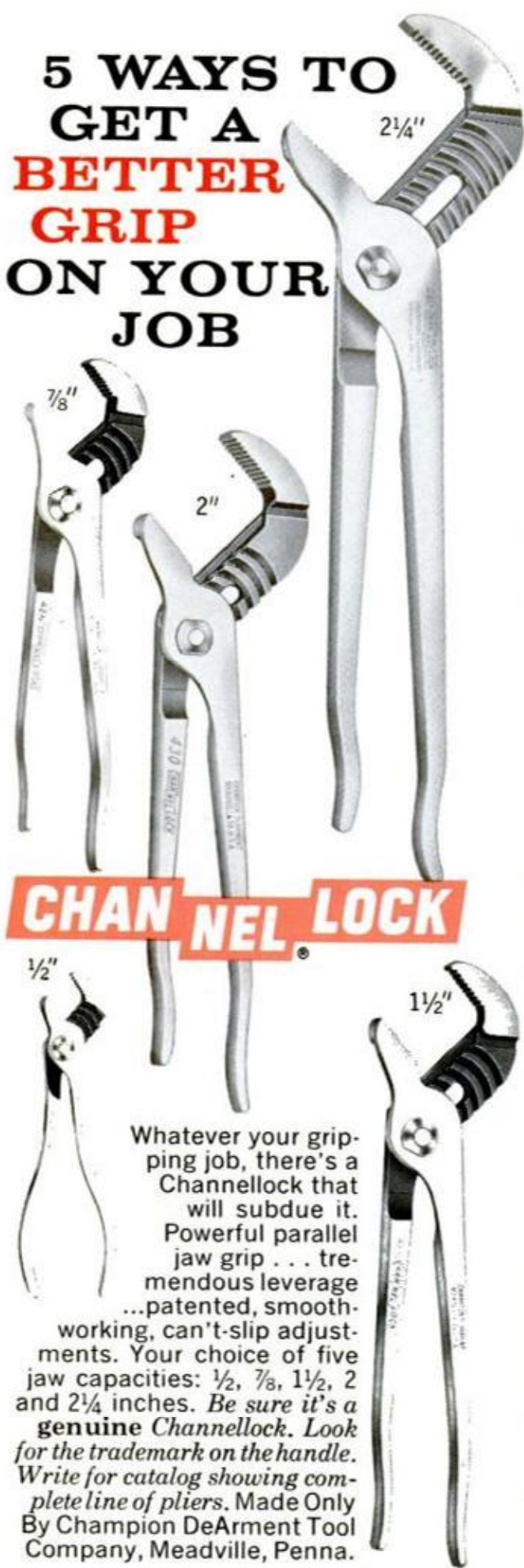
*plus modest mailing and handling charges.

NAME _____

ADDRESS _____

CITY _____ STATE _____

5 WAYS TO GET A BETTER GRIP ON YOUR JOB



Whatever your gripping job, there's a Channellock that will subdue it. Powerful parallel jaw grip . . . tremendous leverage . . . patented, smooth-working, can't-slip adjustments. Your choice of five jaw capacities: $\frac{1}{2}$, $\frac{7}{8}$, $1\frac{1}{2}$, 2 and $2\frac{1}{4}$ inches. **Be sure it's a genuine Channellock.** Look for the trademark on the handle. Write for catalog showing complete line of pliers. Made Only By Champion DeArment Tool Company, Meadville, Penna.

Ignition's the Word for Go

(Continued from page 162)

wire terminals are usually open on one end. Don't remove the eccentric screw used for adjusting point opening.

Present-day condensers rarely fail. The hermetically sealed types now in use are not affected by moisture. Remove the condenser and clean the breaker plate with a solvent-dampened cloth and wipe off. Lubricate the plate at the oil points with a few drops of engine oil. The breaker cam should be wiped off carefully. Then apply just a trace of silicone or special high-temperature lubricant. An important lubrication point is the distributor shaft. It has either a grease fitting, an oil cup or it is of the sealed type having an oil reservoir. The reservoir of the sealed unit should be filled at tune-up time with the specified lubricant. If the distributor points must be replaced, use the factory-assembled type having prealigned points. This unit is quite easy to install. After installing place a tiny drop of light machine oil on the point pivot, and a few on the wick (if present) in the rotor shaft.

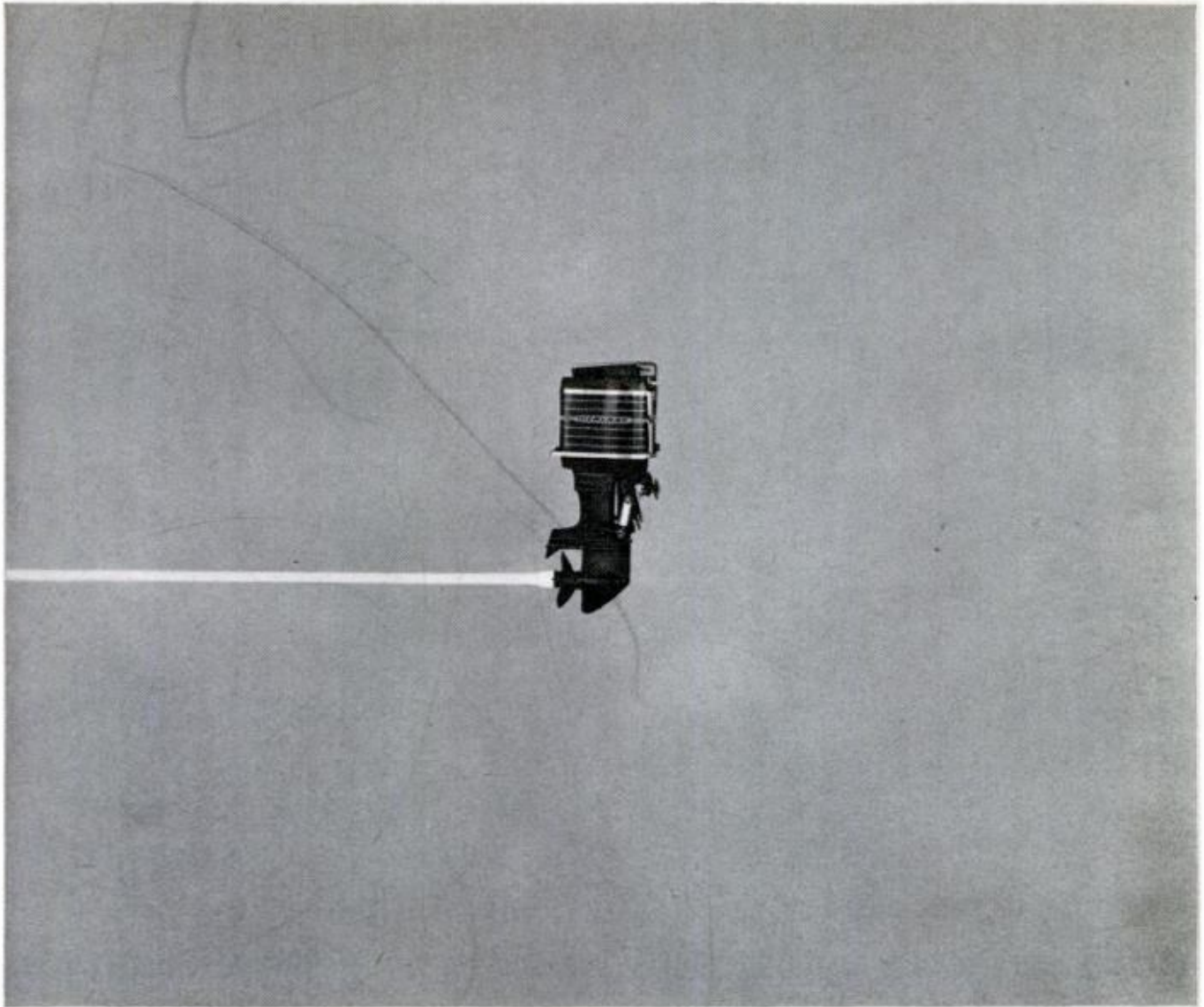
Tension Scale

If you're not replacing the points, then it's a good idea to check with a tension scale as in Fig. 13. Incorrect tension here will result in poor high-speed performance. After tension has been checked any necessary adjustment is made on the breaker arm as in Fig. 12. When replacing the condenser, make sure all surfaces on the condenser mount are clean. Route all wires carefully. Do not tighten the point assembly screws until after they are spaced.

Cam Angle

Cam angle is the number of degrees of a circle through which the points dwell or hold in a closed position. It is not possible to achieve proper dwell time without proper point spacing. All these factors are closely related. Check the factory tune-up specs. Point spacing must be adjusted after disassembly of the distributor. Turn over the motor until the point rubbing block is on top of one of the cam lobes. Insert a feeler gauge between the points and adjust the opening with the eccentric or other screw adjustment. Tighten the screws. Dual points must be adjusted separately. Other types of distributors may have an external point adjustment. Cam angle or dwell time may be adjusted more accurately with the distributor on the car. The mechanical dwell indicator, Fig. 14, works with the engine off while the electrical dwell meter

(Continued to page 178)



MERCURY HAS A NEW SMALL VOICE

One of the problems of building a powerful outboard is to keep it quiet.

There are two sources of noise in an outboard . . . the powerhead and the exhaust. Mercury engineering attacked this problem at its two sources.

Combustion noises have been greatly reduced by the new Power-Dome combustion chambers which squish the fuel-air mixture.

A second step in reducing noise was through the use of Mercury's Jet-Prop which fires the exhaust through the center of the propeller hub, burying it far deeper than other outboards which drag the

exhaust outlet near the surface. Jet-Prop literally drowns exhaust noise and, at the same time, improves the engine's breathing and reduces underwater drag.

Mercury relies not on padding alone, but on creative engineering to give you more powerful outboards with a new small voice . . . to give you more *run* for your money.

MERCURY

*100, 85, 70, 50, 45, 25, 9.8 and
6 horsepower outboards*

© 1962, Kiekhaefer Corporation, Fond du Lac, Wisconsin



they bring home the bacon . . .

WORK-AND-PLAY



VERSATILE RAMPSIDE PICKUP

Talk about workers! Chevrolet's Corvair 95 Rampside pickup is a proved-on-the-job hauler that waltzes away with payloads of up to 1,900 lbs. thanks to four-wheel independent suspension, unitized body-frame construction, Unipack power team and much more. And, when it comes to playtime, this one takes to a camper body like it was made for sports and nothing else! Side gate drops to give an easy-loading ramp or handy camper door.



DOUBLE-DUTY CARRYALL

Hard-working panel-type carrier or crew bus on one hand . . . next thing to a station wagon (or portable camp) on the other. That's the Suburban Carryall—versatility unlimited! Room for 3, 5, 6 or 8 people, supplies and gear, depending on how you arrange seats. And you get a smooth ride with independent front suspension.





then hike out for fun!

CHEVROLETS!

Weekday breadwinners, weekend trail blazers! These Chevrolets are built to lead a double life. They're hard-working savers that sail through giant-sized jobs day in and day out. Then, presto!—they're easygoing fun-lovers rarin' to go all-out on a holiday.

It's the way they're made that makes them work so well both ways. The worth-more, work-more build that makes them top hands on the job also makes them top-notchers on the trail.

Roomy, relaxing cabs, for instance, that even the gals will go for. Rugged good looks and go-anywhere components that can't be beat on tough truck jobs or off the beaten path. With Chevrolet's advanced independent front suspension, you get a road-gentling ride that's as kind to cargoes as it is to people.

And with all this goes camper body equipment of all kinds, ideally suited for Chevrolet

Fleetside, Stepside or Corvair 95 pickups. It's easily available from leading manufacturers all over the country to make the Chevy you pick a versatile quick-change artist at work or play the year around.

Whatever your hauling job, however the outdoors is calling, there's a work-and-play Chevrolet you can tailor to the activity at hand. A Fleetside, Stepside or Rampside pickup with a low, wide pickup box that's just right for camper body installation. Or a Suburban Carryall that looks enough like a station wagon to be one, carries up to 8 people and lots of gear or with rear seats out, even a 12-foot boat.

Before you hit the trail, get on the trail of a work-or-play Chevrolet during the special Fun 'n Sun Days at your Chevrolet dealer's. . . Chevrolet Division of General Motors, Detroit 2, Michigan.

CHEVROLET



U.S. Pat. No. 2,789,872

THIS IS THE RING the experts pick to do a ring job right!

It's Sealed Power's KromeX ring set with the years-ahead Stainless Steel oil ring. This ring controls oil better and longer than any other, bar none. Here's why:

To start with, Stainless Steel is a superior metal. It doesn't corrode, it resists pitting and etching of gases caused by internal combustion. This means carbon doesn't cling, return oil vents don't plug, there's better lubrication with less friction and less wear. Rings last longer.

Stainless Steel retains its tension at operating temperatures, gives you lasting side-sealing, lasting oil control.

And Sealed Power's patented, proven end-abutment design always produces proper tension, regardless of contact with bottom of the groove. No groove depth problems. Chrome-plated side rails seat instantly.

Installation is simple as A-B-C. No gauges, no shims, no springs. No troubles. Period. Sealed Power Corporation, Muskegon, Michigan.



Sealed Power Stainless Steel
oil rings stop oil pumping

(preferred) adjusts with the engine running. With the engine in operation the dwell meter will detect wear in the breaker plate, also the cam and shaft bushing, by showing more than three degrees variation in dwell time between idle speed and approximately 1750 r.p.m. Remember also, that high resistance in the ignition system can cause variations in the readings.

Timing of the spark is the last adjustment on the distributor. To adjust the timing, loosen the clamp screw at the distributor base. Then, using a neon or electronic flash (preferred because of brightness), turn the whole distributor slightly, Fig. 10. The timing mark on the flywheel or harmonic balancer must line up correctly with the pointer. This position is indicated as so many degrees related to TDC (top dead center). For example, three degrees BTDC means the spark will occur three degrees before the piston is at the top of, or flush with, the top of the motor block. While advancing the spark will give somewhat more gas economy, one of the best ways to feel sure the adjustment is correct is to slow down when driving in high gear to about 12 or 15 miles per hour, then step hard on the accelerator. If you hear a light pinging, the adjustment is about right.

Since the ignition coil is part of the secondary high-voltage circuit, the wiring and terminal connections should be bright and clean. The coil may be tested with a meter designed for this purpose or with a volt-ohmmeter (resistance check). Trouble here is quite rare, but you should be able to spot it if necessary. ★ ★ ★

Sun Heats Test Home

Two-thirds of the energy required for heating the rooms and hot water in a three-bedroom suburban house in New England could be supplied by the sun shining on its roof, according to findings released by Massachusetts Institute of Technology.

After three years of testing with a solar house in Lexington, Mass., (cover feature in *PM*, October '57), MIT heating engineers report that modern equipment could supply that amount of heat at a cost justifiable by fuel savings and without an inconvenient amount of heat-storage space.

In the test house, solar energy was collected by a heat-absorbent surface in the roof and south wall. Water, warmed in the wall, went through a heat exchanger and warmed air to heat the house. The regular warm-air heating equipment boosted the solar system on very cold days and filled the gaps created by long cloudy periods, when little solar energy could be utilized.



**FREE
BUILDING
PLANS**

Imagine the pride and excitement of building an attractive patio or deck . . . *plus* a beautiful fence. West Coast Lumber makes it a simple task with two new colorful planning booklets—*Fashions in Fences* and *Patios 'n' Decks*. Both are filled with illustrations and ideas on everything from styling to framework . . . both can help *you* beautify your home. Ask for your **FREE** copies at your Retail Lumber Dealer . . . or mail the coupon below.



**WEST
COAST
LUMBER**



WEST COAST DOUGLAS FIR
WEST COAST HEMLOCK
WESTERN RED CEDAR
SITKA SPRUCE
WHITE FIR

MANUFACTURED IN THE U.S.A. BY COAST REGION
MILLS OF WASHINGTON, OREGON AND CALIFORNIA.

Dept. 305

West Coast Lumbermen's Association
1410 S.W. Morrison Street, Portland 5, Oregon

Please send me the booklets checked below.

Patios 'n' Decks Fashions in Fences

Name _____

Address _____

City _____ State _____



**POWERFUL
EASY
WAY
TO
MOW**

Springfield

Put on the Springfield smile. Put yourself on a Springfield. Powerful enough to pull wide range of attachments, make quick work of mowing. Proved best through use on thousands of lawns. The easy way to complete lawn care. Meets all ASA safety standards. Meets users' high standards, too. Springfield!

Springfield

Quick Mfg., Inc. The House of Power Springfield, Ohio

Why borrow?

Speedy Sprayer

now only **\$34⁹⁵**

Slightly higher Denver Wash.



New! Speedy Sprayer Outfit complete with motor, ready to plug in and spray! Pays for itself on your first big paint job. Does an hour's work in minutes—spray fences, screens, shutters, furniture, rough walls, floors, etc. Smooth, flawless finish. A real professional tool! Ask for "Compact" 404. Write for "How to Spray" and folder.

W. R. BROWN CORP.

Specialists in Portable Sprayers Since 1921

2635 North Normandy Avenue • Chicago 35, Illinois

Sneak Attack!

(Continued from page 133)

procedures are much the same. In homes already built, subterranean termite colonies can be destroyed by chemical treatment of the soil around the foundation and under the basement floor. Photos on page 133 picture methods often used by builders to prevent termite infestation by chemical treatment of the soil around foundations and under slab floors and basement floors in new construction. Careful builders also clean up all wood cuttings and other debris before grading to prevent any wood from being buried either inside or outside the foundation as in the lower detail on page 130. If you're building a new house, be sure to remind your builder of this precaution. Builders also use physical barriers against termites in new construction as in the upper details on page 131, which show approved methods. Woods used in new construction also should be treated.

Soil Treatment

Some of the methods you can use are quite similar. Sketches on page 131 show how you go about eliminating an existing colony, and to a certain extent, preventing a new colony from establishing itself by chemical treatment of the soil around a home with a crawl space, a home with a slab floor or one having a full basement. Trenches around the foundations of homes with a crawl space or slab floor should go down to the footings and trenches around homes with basements should average about 30 in. deep. Of course, digging the trench is rather slow, tedious hand work and unless you do the job entirely yourself, it will likely be cheaper in the long run to engage reputable professional termite exterminators, of which there are several who operate nationwide services in both extermination and prevention. Also, there is available a soil injector which operates as in the upper left-hand detail on page 133. This unit comes as a kit and can be attached to any garden hose.

If you prefer to use the trenching system, then the safest and most practical chemicals to use are those known as water emulsions. These are quite readily available from garden supply dealers and other sources of insecticides and are safe if handled in full accordance with instructions which come with the products. These are chlordane as a 1-percent solution, dieldrin as a 0.5-percent solution, aldrin as a 0.5-percent solution and benzene hexachloride (BHC) as an 0.8-percent solution. None of these solutions will damage shrubbery.

★ ★ ★

OMC Accessories are design-fitted to your Outboard Motor!

OMC accessories and outboard motors belong together. Here's why. Each accessory is developed as an *integral* part of OMC's overall engine design. And that's why it installs so easily, fits so accurately . . . why it offers the same high quality, performance and dependability as the motor itself.

See your dealer today. Look over his complete line of OMC accessories. And when you do, ask him for your free copy of his illustrated booklet that describes how various accessories can add so much to your boating pleasure.

OMC Accessories are designed to make your boating more fun!



OUTBOARD MARINE



For cockpit convenience . . .
REMOTE CONTROLS. Up-front, finger-tip control makes docking, mooring and other handling situations much easier, safer. Practically a "must" for water skiing. Operation is smooth and positive. No lag, no creep, no lost motion. Corrosion-proof. Complete kit fits any boat. Single or dual controls.



GENERATOR KIT. 12-volt generator maintains your battery charge under any normal accessory load. Allows the convenience of electric running and cabin lights, radio, horn, etc. Ends battery worries, frequent re-charging. Current and voltage regulator circuit prevents overcharging. Complete kit is easily installed.



ELECTRIC STARTING KIT. For OMC motors in the middle horsepower range. Just a turn of the key, and your motor is running. Especially desirable if women or young people operate boat. Kit includes all parts (pre-assembled) and easy-to-follow instructions for a quick and complete installation by your dealer.

Get your OMC parts and accessories at: Evinrude, Gale, Johnson, OMC Boat Dealers



For engine performance . . .
PRIMER PUMP KIT. Assures a proper fuel supply when a permanent fuel tank installation is used. Primer Pump and Filter Assembly primes the motor and properly filters the fuel. Illustrated instructions make for a fast, simple installing job.



PROPELLERS. OMC turns out a line of extra propellers to meet every boating need: for high speeds on light boats, or for heavier loads. Your Outboard Marine Dealer can recommend the correct diameter and pitch to give you best performance with your motor.



POWER-TILT. New remote-operated hydraulic unit permits tilting a "75" up or down with the flick of a dashboard switch. A great aid in beaching, mooring or trailer launching. Does not interfere with regular trip-up action. Kit contains all necessary parts for installation.

Is the Indy Race in a Rut?

(Continued from page 93)

is one reason proponents of Grand Prix racing poke fun at the "brickyard," and point out that all Indianapolis drivers have to know is how to negotiate a left-hand curve. At the same time, there are signs that Grand Prix "machinery" ideas are beginning to penetrate Indy's oval. The lighter weight of cars being built for this year's race is an example. So is the fact that both the Zink and Thompson entries use independent wheel suspension.

It's possible, too, that some Grand Prix drivers would not mind getting in on the Indianapolis act. There are problems, though. We talked to one of the best known road racing drivers in the business on this point recently. He pointed out that he was under contract to drive one manufacturer's race cars—cars which rank among the most famous in Grand Prix road racing. Are they planning to race at Indy? we asked. Well, they have a model especially designed for Indianapolis racing, but it won't be entered this year. How about next year, then? He didn't know—it was all up to the Old Man. And if the Old Man did decide to enter it next year, who would drive it? "I would certainly expect to," the racing great snapped back with gusto.

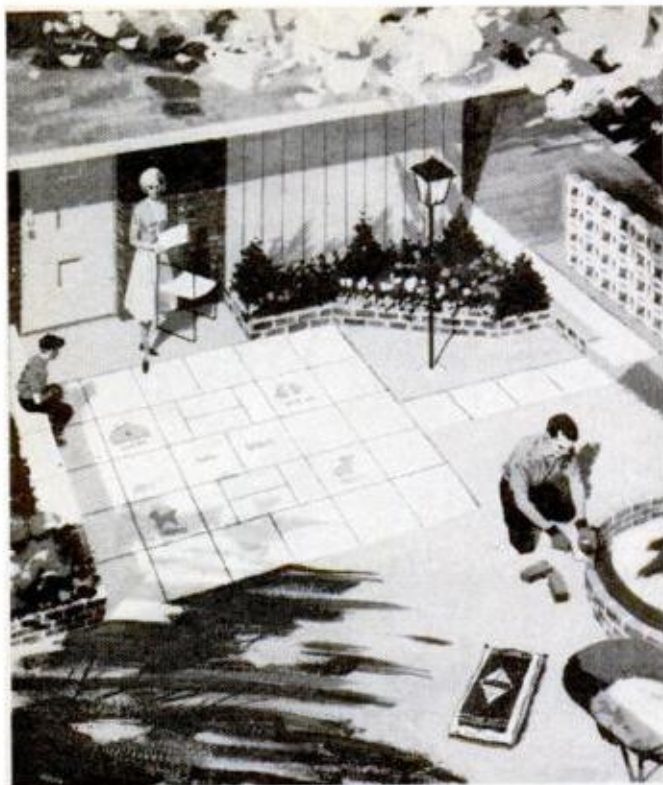
How Many Good Drivers?

This conflicts with statements from some racing-car owners who have planned to enter at Indianapolis—men who claim that no more than six drivers in the country are brave enough to drive at the high speeds necessary to win the 500. They say if an owner doesn't sign up one of these top drivers, he hasn't a chance, barring accidents or a lucky fluke. They believe that if smaller (and presumably slower) engines were required, many more drivers would be fighting for a chance to compete.

Here is another criticism Sam Hanks dismisses with a snort. He says there are plenty of drivers who have the skill to win, although not all of them in the past have had the determination to win. But this is changing, Sam points out. Many who passed their driving test at the track recently are showing signs of greatness.

Whatever their previous racing background, though, the new drivers this year will undoubtedly get the same "lecture" Wilbur Shaw used to give. It concerns the peculiarity of what happens early in the race when 33 closely packed cars all roar into the first turn at about the same time, creating in effect enough of a vacuum to sustain a car's momentum even when the

(Continued to page 184)



Build these **8** patio projects
yourself with **SAKRETE**[®]
... for less than **\$99***

For hours of fun and relaxation all summer long . . . there's nothing like a patio. You can build your own for less than \$99—with SAKRETE Concrete and Mortar Mixes. You'll have fun making your own patio blocks, planter boxes and flower bed edging with pre-mixed SAKRETE. Do a little at a time . . . start and stop any time . . . for SAKRETE stores indefinitely until you add water. High strength, easy to use, economical, no waste. Get SAKRETE today at your lumber, building material or hardware dealer.

*Approximate cost of materials in most areas for this 10' x 12' patio project.



FREE: Project booklet of cement building and repair projects. Ask your dealer for your copy or write Sakrete Inc., Box 1, Cincinnati 17, Ohio.

SAKRETE[®]
concrete and
mortar mixes



© 1962

NEW ROLLER BEARING DRILLS

NEW ROLLER BEARING DRILLS

NEW ROLLER BEARING DRILLS

NEW ROLLER BEARING DRILLS

NEW ROLLER BEARING DRILLS

NEW ROLLER BEARING DRILLS

NEW ROLLER BEARING DRILLS

NEW ROLLER BEARING DRILLS

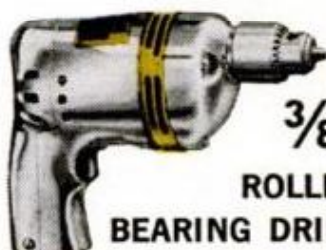
NEW U-300 PROFESSIONAL



1/4"

ROLLER BEARING DRILL

NEW U-320 PROFESSIONAL



3/8"

ROLLER BEARING DRILL

20% MORE GO!

\$5.00 OFF



U-351 PROFESSIONAL Jig Saw



U-66 Decker Finishing Sander



745 Decker Belt Sander



U-44 Decker Finishing Sander

An industry first! 1/4" and 3/8" drills with all roller bearings to give you 20% more useable power—and the most drill for your money. Black & Decker built these new Professional Roller Bearing Drills for professionals and home users who want extra non-stalling power at the spindle for those tough jobs, and cool-running, long-lasting drill performance. UL industrially listed at 2.2 and 2.3 Amps. See them, and the other great Spring Values on display at your Black & Decker retailer's now.

Only 25c! 180 page booklet "How To Choose and Use Power Tools." Write: The Black & Decker Mfg. Co., Dept. D-052, Towson 4, Md.



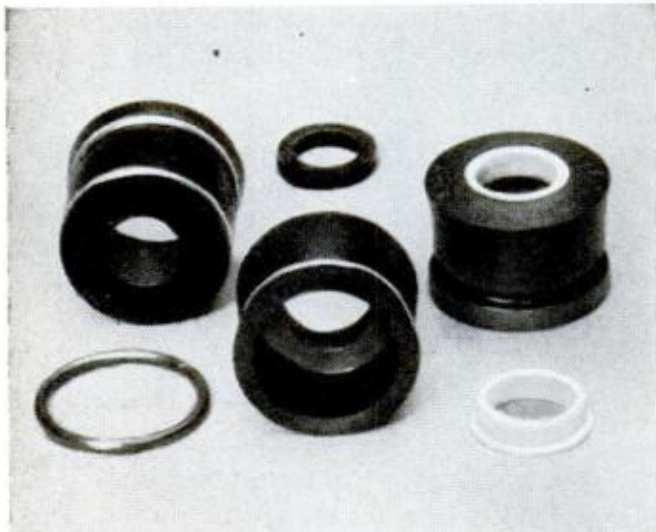
Black & Decker®

THE WORLD'S LEADING MAKER OF POWER TOOLS AND THE WORLD'S FIRST CORDLESS ELECTRIC DRILL



Test your automotive I.Q!

QUICK QUIZ BY QUAKER STATE



1. What is the purpose of these valve stem seals?



2. What does this symbol stand for?

At top, the seals prevent oil loss past the valve guides on overhead-valve engine. At bottom, the life preserver stands for Quaker State Motor Oil—because it is the best engine life preserver. Made from 100% pure Pennsylvania Grade Crude Oil, it keeps your car on the road, out of the repair shop. Insist on Quaker State—the best engine life preserver.



QUAKER STATE OIL REFINING CORP., OIL CITY, PA.

driver's foot is taken off the gas pedal. Quite a shock to a rookie, that.

The claim of the Indianapolis 500 Race to the status of proving ground for the automotive industry has often been rather warmly debated. In Indy's early days, when few passenger car manufacturers had their own proving grounds, they frequently sponsored teams at Indianapolis. Later, manufacturers developed their own proving grounds, and, in general, withdrew from direct sponsorship at Indy.

Certainly Indianapolis has played its part in testing out important automotive developments. Four-wheel hydraulic brakes passed their trial-by-fire at Indy in 1922 when a car equipped with them won. In 1925 a car equipped with balloon tires came in first. The Magnaflux technique for checking components, first introduced around 1936, has become almost universally popular. Tubular shocks similar to those used on passenger cars today, first appeared at Indy in the late 1930s, and eventually took over from the pump type and adjustable rotary-vane-type shocks. But, as Sam Hanks points out, when the modern-type shocks were first tried at Indy, they were good for no more than 10 to 15 minutes. "Today, after a number of design changes," says Hanks, "the modern-type shocks more than last through the race. And the same redesigning improved passenger cars."

Hanks also recalls a more recent case illustrating the value of Indianapolis as a proving ground. "When radiator pressure caps were first adopted for private cars," he says, "they were tried also at Indianapolis and gave nothing but trouble. Company representatives flew back to their factory and came up with a new design that takes higher pressure safely, and this improvement now benefits everyone."

Still another fairly recent example of Indy's value came out of the troublesome experiences Indy drivers were having with radiator hose, even of the best aircraft quality. Then one company developed a corrugated type that proved ideal at Indianapolis and since has become common.

There are some things Indianapolis proves in an unforgettable manner. In this connection, Al Bloemker of the Speedway staff cites Jack Turner's spectacular end-over-end flip in last year's race. He came out of it with only a minor leg injury because he was wearing the seat belt and shoulder harness required of all drivers. What more dramatic proof could you have of the value of these safety devices?

There obviously are some areas where

(Continued to page 186)

Long Life for Paintings

Aluminum "canvas" offers a new—and nearly ageless—surface for painters who are dissatisfied with the life expectancy of the usual materials.

Developed by Leon Messina, a commercial artist, the textured metal surface will take oil, casein, tempera, wash or water colors, and will never stretch, crack or buckle in any condition of humidity or temperature. It is a nonrepellent base, and allows colors to retain their original brilliance. The "canvas" is being made by the Aluminum Canvas Corp., 421 East 101st St., Brooklyn 36, New York. *OUT OF BUSINESS*

Self Starter for Gas Engines

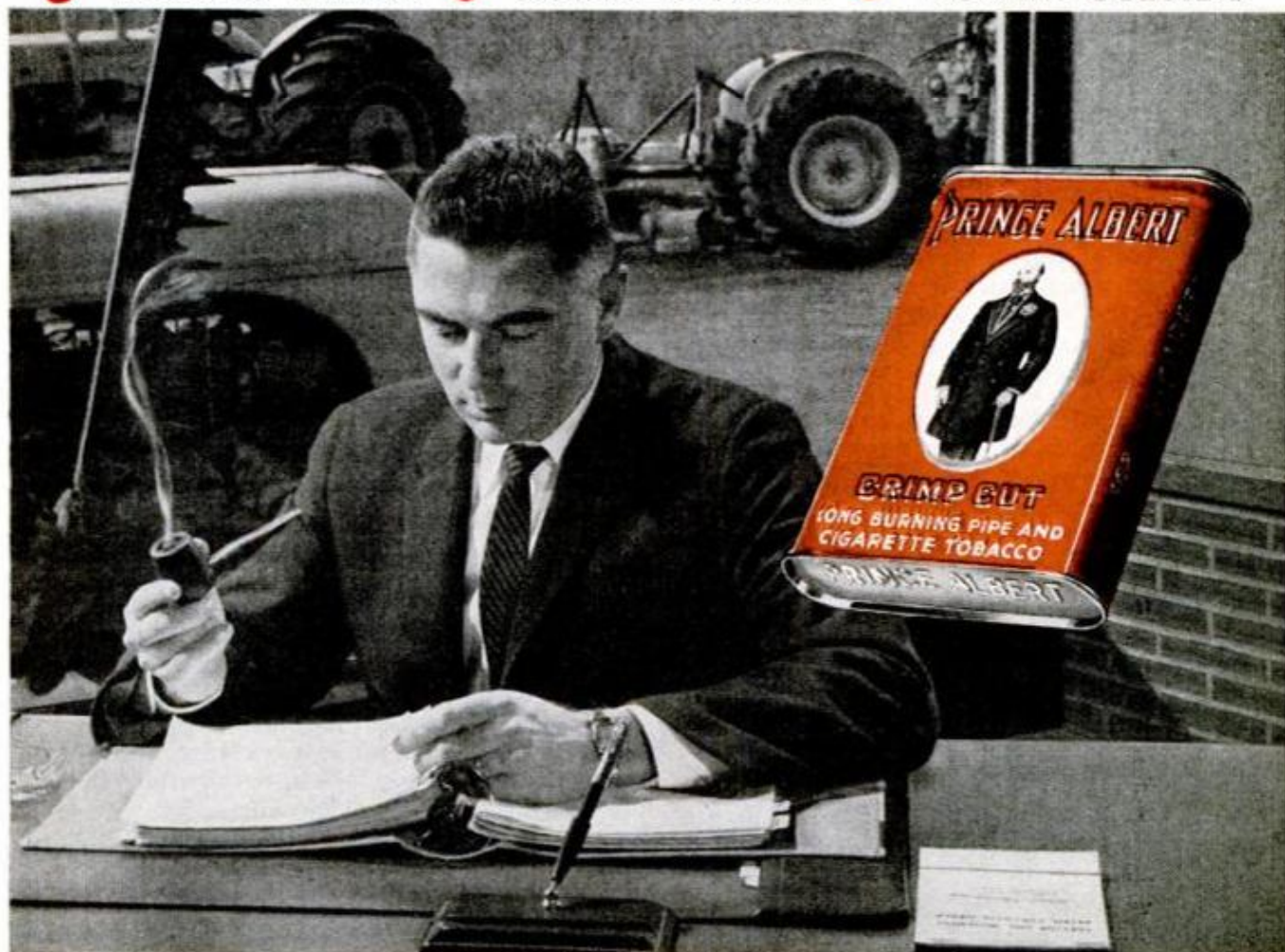
Gasoline engines up to 12 horsepower can be started with a small self starter which operates on a new principle. Power from the engine is used to re-energize the starter for the next operation.

The starter is mounted directly on the engine—lawn mowers, snow blowers, outboard engines, chain saws, karts, etc.—and by moving the start button the full energy of the starter is transferred to the engine shaft. Then the power of the engine can be used to re-energize the starter.

The Action starter is made by Tiffany, Inc., 3333 E. 10th St., Rock Falls, Ill.

The proof is in the puffing!

● TASTES FRESH ● SMOKES COOL ● BURNS STEADY



R. J. Reynolds Tobacco Co., Winston-Salem, N. C.

The flavor most favored in the U.S.A.

PRINCE ALBERT

MAY 1962

185

*Easier to read...
resists stains, rust, wear*

Starrett®

COMBINATION SET



*with SATIN-CHROME BLADE
and PROTRACTOR HEAD*

Starrett No. C434 Combination Set will give you many extra years of quick accuracy, wide utility and time-saving convenience. SATIN-CHROME finish on blade and protractor head ends glare, makes reading easy in any light. Also resists stains, rust and wear.

Other features you'll want include: forged and hardened square and center heads . . . patented reversible lock bolt for quick blade reversal without removing bolt . . . smooth fitting parts with precision ground faces . . . reversible protractor head with direct reading double graduations . . . square and protractor heads with built-in spirit levels . . . scriber right in the square head.

Set No. C434 is available in 12, 18 and 24-inch sizes. Ask your Industrial Supply Distributor . . . or write for Catalog No. 27. Please use the coupon.

STARRETT TOOLS are carried by
leading Industrial Supply Distributors
and Hardware Tool Stores.

THE L. S. STARRETT COMPANY
Dept. AP, Athol, Massachusetts, U. S. A.

Please send my free copy of Catalog No. 27
describing Starrett Combination Squares and
Sets... and over 3000 other fine precision tools.

Name _____

Occupation _____

Address _____

City _____ Zone _____ State _____

the specialized needs of racing contribute little to the development of passenger cars. Most of the race cars use alcohol as a fuel, hence the race has little effect on the development of better gasolines. The fuel injection system which has taken the place of regular carburetion at the Speedway is designed for that kind of operation only. It's method of sucking excess fuel back to the tank instead of using a float valve bears little relationship to the fuel injection systems on American passenger cars.

Tubeless tires were ready for Speedway trial around the mid 1950s, and they would have brought appealing weight savings of four pounds per wheel or a total of 16 pounds unsprung weight per car. But the cast magnesium wheels being used were too porous to hold the air. Someone worked out a way to extract the porosity from the magnesium and then seal it with a plastic compound. But there still was a catch—the plastic compound prevented Magnafluxing.

The rear-view mirror that is so helpful to passenger car owners, and the idiot lights that are so frustrating, also have had their day at Indy. Yet, last year newcomer Brabham was the only one of the Indy drivers to use a rear-view mirror—other drivers preferred to turn their heads—at well over 100 m.p.h.!

Idiot lights appeared on one Indy car one year in place of gauges, but they didn't take the track by storm. The fact is that many veteran drivers scorn any kind of dash instrumentation—and frequently disconnect the gauges or cover them up with a tape, on which is printed some such light-hearted message as, "Relax" or "Go" or "\$."

The Indianapolis 500 is, of course, not the only "proving ground" race course in the world. Many developments such as four-speed synchro gear boxes, independent rear suspensions, and rack-and-pinion steering which have appeared on some American passenger cars have been derived, at least in part, from European road racing experience.

One interesting feature—the weight jacks which permit the torsion bars suspension to be adjusted for changing weight distribution (important because of the effect of taking all those lefthand turns while the fuel load changes), Indy has tested thoroughly. You saw something like this in Packard's 1955 Torsion-Level and you may again see a similar setup featured as an improvement on your car one of these days.

In fact, with all the changes and innovations Indy has seen in the past—and the exciting lineup that is being built for this year's 500, it can safely be said that Indy is in anything but a rut.

Turmoil might be a better word. ★ ★ ★



Now you can paint your house in color and be sure it will last . . . with new "Dutch Boy" Latex House Paint

Now there's a new kind of paint that ends all the old problems of conventional colored paints. It's "Dutch Boy" Latex House Paint. Use it and your house will stay looking bright and fresh for years. Made with "Dutch Boy's" own acrylic resins, tests have shown it to be outstandingly resistant to sunlight and oxidization. In fact, this new paint retains its color so well you can come back and touch it up years afterwards, and not see the difference. When it's time for a new paint job, you'll only have to repaint the weathered side. Keep the same color and you may never have to paint your whole house at one time again!

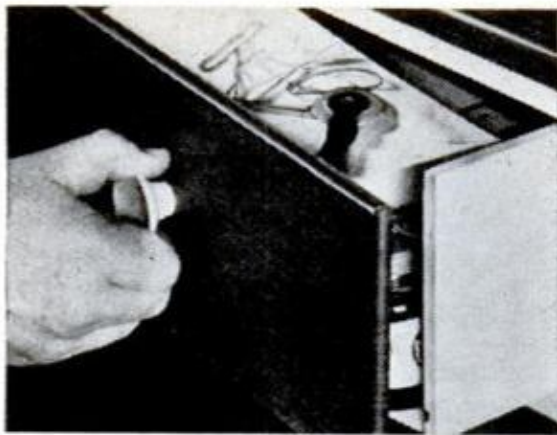
"Dutch Boy" Latex House Paint is probably the most convenient paint ever developed for the weekend painter. You don't have to wait for ideal weather. Use it right after a rainstorm if you like. And you can stop and start anywhere. Lap marks won't show.

It's easier to use, too. "Dutch Boy" Latex House Paint flows off the brush, without paint drag. And this one paint is all you need for almost any surface—wood, stucco, brick and even composition shingles.

More advantages: Brushes and equipment clean up with just soap and water. And you can eliminate most of the blistering and peeling problems that used to be caused by trapped interior moisture. "Dutch Boy" Latex House Paint breathes—allowing moisture to escape, yet sealing out the weather.

If you'd like to find out more about this remarkable paint, check with your nearest "Dutch Boy" dealer, listed in the Yellow Pages. Or write for informative free booklet to: NATIONAL LEAD COMPANY, General Offices, 111 Broadway, New York 6, N. Y.

Dutch Boy
LATEX HOUSE PAINT®



don't say "darn"...buy

DURATITE®

WHITE GLUE



Outstanding bond for paper, wood, fabric, metal, glass, china, tile, more. A great glue for household, hobby, workshop. Dries fast and clear. Handy plastic squeeze bottle. Mend it right with Duratite White Glue.

DURATITE Division, DAP inc., Dayton 31, Ohio

Quality
is more than
skin-deep in...



Beneath the handsome chrome-plated finish you'll find the strength, precision and fist-fitting comfort that set S-K/Lectrolite wrenches apart. Professional mechanics' choice for 38 years.



SEND TODAY for FREE pocket catalog of S-K/LECTROLITE Wrenches.

S-K/Lectrolite Tools—Dept. B
Chicago 32, Illinois

Name _____

Address _____

City _____ State _____

Secret Partner in Defense

(Continued from page 112)

matic pilot to correct the flight. Or it could be put in a highway control center and decide instantly on alternate routes and traffic light patterns to keep cars moving in and out of a city.

• Research into a beetle's eye has paid dividends to the Air Force in the form of a new, highly accurate, ground-speed indicator for its aircraft. The beetle has a compound eye—one actually made up of hundreds of little eyes, and each comparable in most ways to the complete eye of higher animals. Complicated experiments by Air Force scientists found the beetle gets extremely accurate speed information through its compound eye. Technicians succeeded in duplicating the fundamental structure of the eye and this many-celled electronic eye is now being used on test aircraft.

Scientists' Best Friend

Probably the most research on any single type of creature has been done by the Navy with porpoises. The Navy would very much like to find out how these sea mammals swim as fast—up to 45 miles an hour—as they do. There's a theory that the porpoise has a way of reducing water friction. Water flows smoothly around the creature's pointed nose, where its skin is nearly bloodless. Toward the tail, where turbulence builds up, the animal has more skin blood vessels. Scientists say this great blood circulation toward the aft end could produce a smoother flow either through heat transfer to the water or by wrinkling the skin.

If it would add speed, submarines and torpedoes could be given heated plastic skins that ripple.

Just as interesting to the Navy is the porpoise's amazing sonar system. Not long ago, two of the marine mammals were put in a large muddy pool. Visibility in it was only about 20 inches.

The 55-by-70-foot pool was studded with metal poles which, if touched, rang a bell. During their first 20 minutes of swimming through this maze, the two porpoises together brushed the poles only four times, apparently when their horizontal tail flukes touched the poles after their bodies had already passed through.

During the second 20-minute session the porpoises made even fewer contacts with the poles. After that they negotiated the course in test after test without once ringing the bell. Even in total darkness, the porpoises swam all over the pool without hitting the rods.

(Continued to page 190)



GRAVELY
 doesn't give
 up
 when the
 mowing gets
 tough!



When the grass is thick and heavy, the weeds are tall and tough, Gravely gives you the lugging power—the performance—to get the job done . . . right! No pushing, pulling or pampering needed—Gravely POWER does the work!

You ride for the routine jobs, guide for the tough jobs. Have a flexibility of performance, a versatility of tools that will make your place the envy of the neighbors, a source of pride and satisfaction to yourself, without drudgery!



30 TOOLS from which to choose, powered by the one 6.6 hp Gravely Tractor. All-Gear Drive, two speeds forward and reverse . . . designed and built for the tough jobs. Optional electric starter.

Installment Plan Available

Get the facts before you buy—from Gravely's big 24-page "Power Vs. Drudgery" booklet. See how Gravely proves it's best for you before you buy! Write now!



SNOWBLOWER



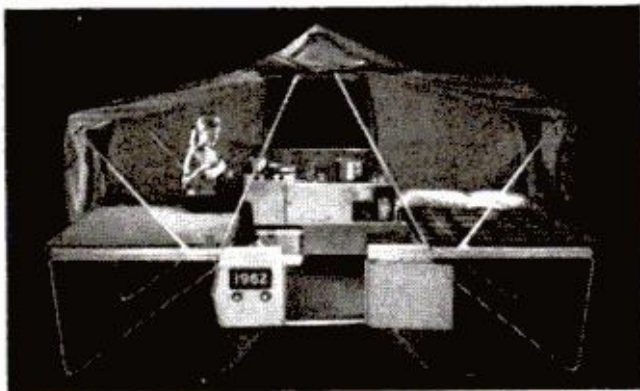
CART

GRAVELY TRACTORS

DIVISION STUDEBAKER-PACKARD CORPORATION
 P. O. BOX 601-E DUNBAR, W. VA.



Sold & Serviced by Authorized **GRAVELY DEALERS**—our 40th year!



The new APACHE EAGLE off-the-ground camper in mocha-tan

THERE'S ROOM FOR REAL LIVIN' IN THE NEW APACHE FOR 1962

Room a'plenty for all your camping gear, on the road and when you're set up. Cook, eat, sleep in spacious comfort. See what real camping is like . . . see APACHE.

FREE color catalog of the full APACHE line available at your nearest APACHE Camping Center or write to:

World's largest manufacturer of aluminum camping trailers

3 GREAT APACHE MODELS

The EAGLE . . . \$645
The CHIEF . . . \$525
The SCOUT . . . \$345

optional equipment extra
—prices f.o.b. Lapeer



VESELY MANUFACTURING CO.
Box 151, Lapeer, Mich. Dept. PM-5

SOME DEALER TERRITORIES AVAILABLE

STOP WATER DAMAGE...



Wood
Plywood
Shingles
Asbestos siding
Concrete blocks
Concrete
Mortar
Stucco
Plaster
Brick
Paint
Wallboard
Tile
Canvas
Leather
Linoleum
Fabrics

Prevents warping, swelling, mildew, mold, water stains, seepage, dampness, rot.

Keeps moisture out 5 years and longer.

Use on all woodworking jobs, boats, patio furniture, planter boxes, shutters, screen doors, window sash, shingle roofs. Stops seepage in basement walls, concrete silos, foundations. Waterproofs canvas, tarps, tents, awnings, leather boots, shoes, outdoor clothing. Won't harden or crack leather or fabrics. Perfect underseal for oil base or alkyd paints. Deep penetrating, colorless. Apply by brush, spray or roller. At paint or hardware stores or order direct. 16 oz. spray can \$1.89, Qt. \$1.75, Gal. \$5.35, 5 Gal. \$25.25, ppd., tax incl. Send check or money order to **E. A. Thompson Co** 1355 Market St., San Francisco 3, Calif. No COD's please. (Since 1929.) Dealer and jobber inquiries invited.

Later experiments showed that a porpoise can use its sonar to judge target sizes quickly and easily. This was shown by dropping six-inch spot fish—a delicacy to the mammal—into the pond along with some 12-inch mullet, which is not quite as tasty. No matter how dark or muddy the water, the porpoise unerringly headed for the smaller fish every time.

The Navy hopes to learn more about marine life with which it shares the sea by strapping radios on sharks, whales, porpoises and turtles and turning them loose in the ocean.

These radios will transmit only when the antenna is above the surface of the water, but tiny instruments will record and store information about the marine creatures' physical actions and about the surrounding water. Then, when the antenna is pushed out of the water during normal movements, the radio will automatically broadcast all this data in one short burst lasting not more than a second or two, to ships and aircraft monitoring the frequency. Navy scientists expect to pick up these signals for detailed analysis. Since the antenna must be above the water to transmit, it can only be carried by surface-swimming fish or mammals which break the surface regularly.

The miniature radio is already being used by scientists probing bird navigation secrets. Carried on a bird's back the radio can track the bird's route and tell how it reacts to changing magnetic fields or whether it uses landmarks or the sun and moon in its navigation.

This research into biological mechanisms doesn't mean that science is necessarily trying to duplicate exactly the components of nature's systems—aerodynamic laws were learned from the birds, but man didn't have to put feathers on airplanes.

Cracking Mother Nature's secrets will be no short-range project, though. "After all," as one scientist said, "she's had millions of years. We've had only a few."

★ ★ ★

QUOTE:

"The whole operation of developing, making and testing weapons and putting the peaceful atom to work in the U.S. has had a remarkable safety record for a fundamentally hazardous business. With well over 200,000 people employed in this general field in the U.S., there have been very few serious injuries and only three deaths due to radiation in 20 years! As a matter of fact, their over-all safety record is several times as good as the average of industry generally."

DR. ROBERT E. WILSON, Commissioner
U.S. Atomic Energy Commission

*To the parents of young men
just beginning to shave regularly*



A very special *graduation* offer from the makers of the Norelco Speedshaver

No doubt your son has already started on his lifetime routine of regular shaving. It *can* become a daily nuisance. But did you know there are millions of men who actually *enjoy* their morning shave? They shave with a Norelco Speedshaver—the electric shaver with rotary blades that give a man the most comfortable shaves he can hope to get.

FACES LOVE IT!

Norelco Speedshavers operate on a revolutionary shaving principle. Other shavers work with a back-and-forth clipping action that can pinch, pull and irritate. Norelco's finely-honed, self-sharpening rotary blades whirl around in one continuous motion to *stroke* off whiskers. Norelco's reputation for bringing comfort to shaving has made it America's Number One Shaver.

We believe that young men just beginning to shave should be started off right... with a Norelco 'flip-top' Speedshaver®. This is the less expensive model and the

largest seller in the world. You owe it to your son to see that he owns one.

A FREE GIFT TO YOUR YOUNG MAN

We at Norelco want to learn about the shaving habits of young men so that we can continue to bring them features they prefer in a shaving instrument. Therefore we have provided our dealers with a simple data card... ask for one when making your purchase. When your son fills it out and sends it to us, we will send him a gift in return: a full-sized, \$1.29 bottle of a wonderful new Norelco pre-shaving lotion called PRELEC that sets up whiskers for a perfect shave. Offer ends June 30. See your dealer soon. Send your young man out to conquer his daily world—high of spirit and fresh of face.

Norelco®
ROTARY BLADE SHAVERS

NORTH AMERICAN PHILIPS COMPANY, INC.,
100 E. 42nd Street, New York 17. Norelco is known as PhiliShave in Canada and throughout the free world.



**NEW FROM
PRATT & LAMBERT**

"6-T-1"

HOUSE PAINT

**GIVES OIL PAINT GLOSS and PROTECTION
PLUS WATER THINNABLE EASE**

Give your home beautiful oil paint luster, and enjoy convenient, easy water clean-up of new P&L "6-T-1" House Paint.

An exclusive Pratt & Lambert formulation with linseed oil in solution, "6-T-1" House Paint brings you all these advantages and more . . .

"6-T-1" House Paint brushes on easier and sets up faster than ordinary oil paint. It can be applied over chalked old paint in otherwise good condition without using a prime coat. "6-T-1" resists blistering . . . can even be applied while surface is damp. "6-T-1" House Paint can be thinned when necessary with plain tap water. And brushes and equipment wash out in a jiffy with ordinary soap and water.

Next time you paint, make it easy on yourself, and give your home that bright new look with "6-T-1" House Paint, from your nearest Pratt & Lambert dealer.

**PRATT &
LAMBERT-Inc.**

NEW YORK • BUFFALO • CHICAGO
FORT ERIE, ONTARIO

*The paint of professionals
for over a century*



They Spy for Industry

(Continued from page 106)

vate purposes is everywhere illegal, yet its use seems to be indicated by the fact that Burns is sometimes called upon to search for both bugs and wiretaps.

Rapid-sequence cameras have been used to good advantage in detecting fraud or espionage. A heavy industry in the Midwest discovered that certain highly-secret statistical information was getting out to a competitor. An industrial protection company, through one of its undercover men, developed a suspect. The firm then arranged to have a concealed rapid-sequence camera installed near the desk in which the information was kept. The camera trigger was electronically hooked up to an electric eye system. Resulting photographs showed the production manager go into the desk and take out some papers one evening—data he had no business handling. Confronted with the photos, he admitted that he had been selling these confidential records to a competitor.

Lie detector (polygraph) tests are rapidly gaining favor in industry. Among a variety of questions, the applicant is asked if he ever stole anything from a previous employer. When a man is to be assigned to a sensitive or dangerous job, as might be the case in a chemical plant, he is closely questioned as to his previous experience.

But, admits an investigator, "An equally important reason for giving polygraph tests is to make sure the new man isn't a 'plant' sent by a competitor."

Ethical?

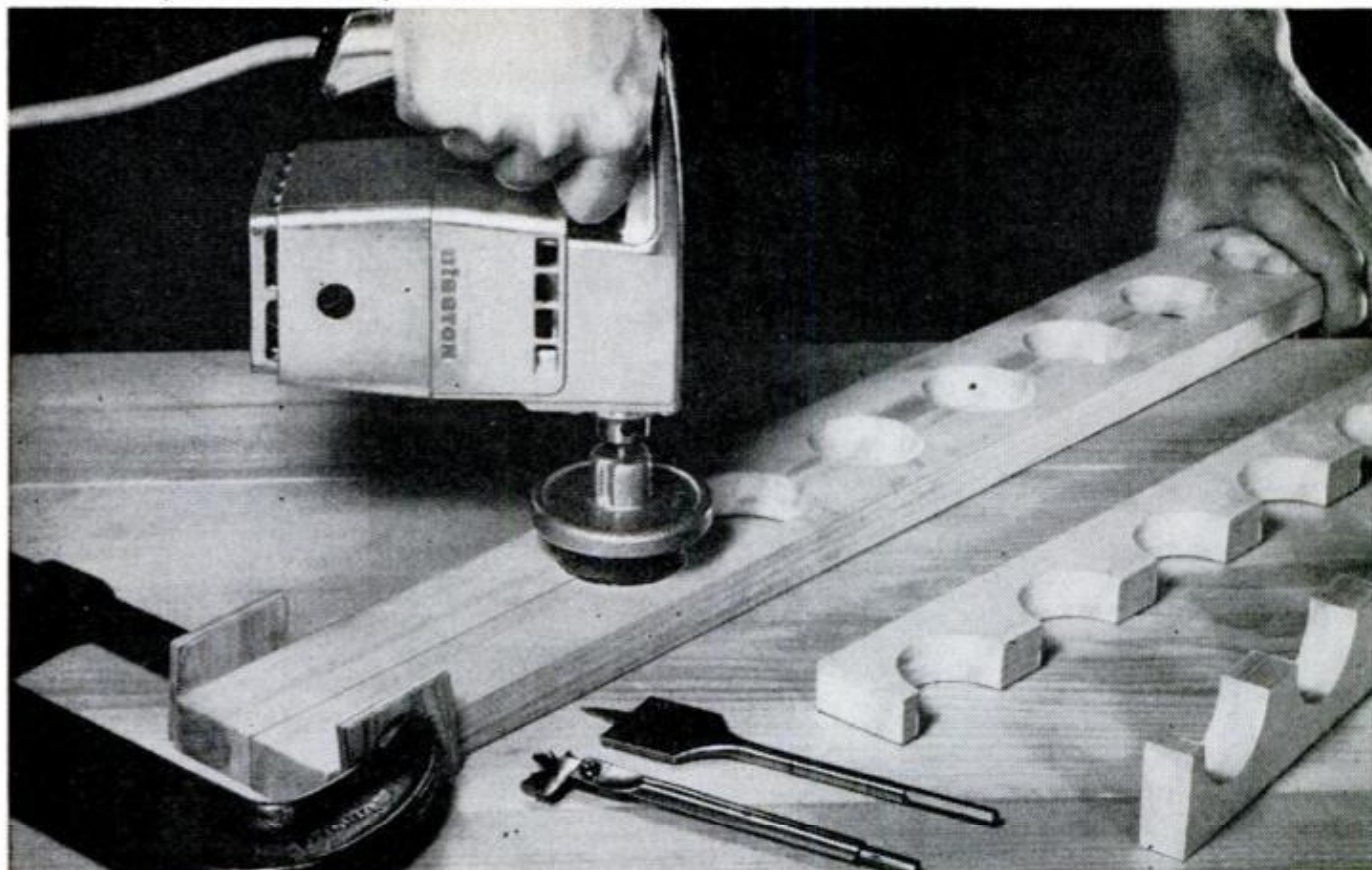
In 1959 the Harvard Business School undertook a thorough examination of industrial espionage. More than 200 business firms were queried, and 100 businessmen personally questioned.

These leaders of industry felt that all was fair in the war against internal dishonesty and employee malingering. And they were unanimous in recognizing their need for competitive intelligence. But when it came to some of the more extreme forms of spying, they differed in their opinions. Many seriously felt that these represent a decline in business ethics.

One executive related these practices directly to the subject of industrial decay when he said, "If you spend too much time finding out what your competitor is doing, you may be spending too little time developing newer products and processes of your own. You become less imaginative, less dynamic, less resourceful."

And these, after all, are the very qualities that have made U.S. industry the giant it is today. ★ ★ ★

Another power tool tip from **DISSTON**



Here's a quick, easy way to decorate moldings

Clamp both pieces of wood together with the good sides up. Then drill on the joint line.

When you finish, each piece is shaped with a series of half-circles. Use a spade or an expansive bit for larger circles or a hole saw.

Try the new Disston $\frac{1}{4}$ " Dirk on heavy-duty jobs like this—it handles them with almost no effort.

In fact, this powerful drill is the toughest in its price class. It has a full 3-amp,

$\frac{1}{4}$ -hp motor (1800 rpm) with Spiroid® gearing.

The Dirk is the only drill with a stand-up base; makes bits easier to change because it's always in an upright position.

It's the only drill with an offset motor and a recessed, geared chuck. You can sneak its slim profile into corners, between joists and closer to floors and ceilings.

See it and try it at your favorite hardware or department store. Suggested price \$30.

DISSTON—Master Toolmaker since 1840. Disston Division, H. K. Porter Company, Inc., Porter Building, Pittsburgh 19, Pa.

See Disston's full line of power tools, including:



D-1 Disston Dot
 $\frac{1}{4}$ " Power Drill



D-20 Disston Dagger
Sabre Saw



D-650 Disston Defender
Circular Saw



D-600 Disston Discus
Circular Saw

PORTER

DISSTON DIVISION
H. K. PORTER COMPANY, INC.

**stays
accurate
longer**

A LUFKIN EXCLUSIVE: 5 to 7 fewer parts than other micrometers . . . less to get out of adjustment! One-piece frame and hub simplifies wear adjustment, assures greater accuracy. Exclusive cam lock prevents reading errors. Ratchet stop top. Easy-to-read markings on nonglare *Chrome Clad*[®] finish.

Leading Industrial Distributors feature Lufkin — the new leader in precision tools.

LUFKIN
SAGINAW, MICHIGAN

Owners Report on the Fairlane

(Continued from page 82)

"Gas mileage for the V8 should be better (14.2 m.p.g. over-all) by quite a bit according to others with 14-inch wheels."—Minnesota Navy man.

"Because of its weak shock system, car hits bottom."—Texas railroad engineer.

"On rough roads the front end hits bottom."—Virginia foreman.

"When hitting some very small bumps in the road traveling at 20 to 25, the front end hits the frame."—Pennsylvania truck driver.

We didn't catch this on either the Six or V8 Fairlanes tested. It could be below-par shocks or substandard coil springs. Either would be the result of a quality control lapse rather than poor design.

"The front springs are too soft; car bottoms easily."—Ohio machine operator.

"The front end hits bottom too easily on rough spots."—North Dakota farmer.

"The speedometer cable busted. It had been put in with too much of a sharp bend in it."—Wisconsin railroader.

Someday we hope to see more accurate speedometers with electronic hookup.

"The speedometer cable broke from abrupt turn in cable housing."—Virginia decorator.

"It doesn't turn short enough; shifting is a little too slow for me."—Minnesota trucker.

"The transmission is a little rough between low and second."—Iowa forester.

"Hard to shift due to safety device on clutch which makes shift catch at times."—Louisiana insurance agent.

Stick shift on Fairlane Six that PM drove was stiff, jerky and unpleasant to use. Detroit keeps dreaming of the day that stick shifts can be eliminated. Most automakers therefore refuse to take 'em seriously enough.

"Shifting is still a little stiff (after 3000 miles)—California engineer.

"There are two horizontal rods in the trunk which have been a constant rattle."—Missouri student.

"Car rattles quite a bit."—Virginia serviceman.

"So far, nothing more than a couple of rattles that are proving hard to eliminate."—New York clerk.

But things aren't too gloomy, as you can see in this list of best-liked features, numbers six through ten, in order of frequency of mention:

"Very smooth comfortable ride for its size and weight."—New Jersey aircraft mechanic.

(Continued to page 196)



Quality Twins

...symbols of the best in replacement parts!

Now, one stop is all it takes to get your pick of the quality twins—FoMoCo and Rotunda Parts. Both of these fine lines are made to the same high quality control standards to fit right and last longer... to help keep maintenance costs at rock bottom, performance at its peak. Like FoMoCo, Rotunda Parts are *first line*, precision-made parts of the same high quality that Ford insists on for original equipment. ■ Rotunda Parts—oil filters, shock absorbers and others—are made for 9 out of 10 cars and trucks now in use, *including all Fords*. ■ The important thing to remember is that anyone offering FoMoCo and Rotunda Parts is in business to service your car better.

**NOW . . . TWO TOP QUALITY LINES OF PARTS AVAILABLE
THROUGH FORD DEALERS AND SELECTED SERVICE OUTLETS**



PRODUCTS OF  MOTOR COMPANY

PM staff testers found Fairlane V8 comfortable, a car that lets you drive relaxed.

"It rides like a big car."—Ohio custodian.

"Rides like higher-priced cars."—Indiana student.

"It has good pickup over 12 m.p.h. in high for a six-cylinder engine."—Colorado mechanic.

"It has plenty of pep and power for a six."—Delaware engineer.

He's easier to please than we are.

"It's very easy to park."—New York insurance agent.

"In making calls I find it easy to park and handle."—Michigan insurance agent.

We agree up to a point—there's a lot of wheel winding necessary.

"Parks like it has power steering."—Connecticut accountant.

"The car has a good, tight feeling."—Tennessee salesman.

"I like the heavy-car feel, although it's not in the large-car class."—California timekeeper.

"I like its sturdy construction."—Ohio clerk.

"Wonderful visibility."—Washington teacher.

Some problems can mean a lot—to owners who have to live with them. Here is the

second group of complaints, six to ten, in their order of mention.

"The trunk is of nice, large size, but too hard to lift things over."—Ohio bookkeeper.

"My carburetor—unable to be adjusted by the dealer—will not idle smoothly. Even resetting the automatic choke and changing the carburetor itself didn't help the trouble."—Kentucky government employee.

An all-too-familiar story. If manufacturers would only check out lower-priced cars before shipping as they do higher-priced cars! There are plenty of people who appreciate quality. The question Detroit asks itself is: If we put in "total quality" would they pay for it?

"The signal lights or sockets in front and rear gave trouble. Water was somehow trapped in the front one and damaged the housing. Had to take the car back to dealer three times to get rear one to give good service."—Virginia teacher.

Turn signals had to be repaired two different times. The front end had to be aligned at my cost."—Indiana boiler inspector.

"There's too much low-speed slippage on automatic transmission."—Michigan salesman.

This two-speed automatic is a depth error on Ford's part. It has been annoying to Ford, Falcon, Mercury, Comet and now Fairlane

FREE



- Citizens Band Transceivers
- Citizens Band Antennas and Accessories
- Amateur and Citizens Band Crystals
- Commercial Crystals
- Transmitters/Modulators
- Frequency Alignment Equipment
- Auto Radio Converters

YOUR 1962 BUYING GUIDE FOR PRECISION MADE RADIO CRYSTALS AND ELECTRONIC EQUIPMENT.

International Crystal Mfg. Co.
18 North Lee, Oklahoma City, Okla.
Rush FREE 1962 Catalog

2

Name _____
Please Print
Address _____
City _____ Zone _____ State _____

NEW JET DRIVEN BOAT KIT
KIT INCLUDES BOAT and JET FOR AUTO ENGINE
FREE CATALOG \$22375 DOWN \$3804 PER MO. CONSTRUCTION DRAWINGS \$2.00
TAFT MARINE WOODCRAFT
DEPT. PM-562 • 636 39th Ave. N. E.
MINNEAPOLIS 21, MINNESOTA

For Perfect Painting

DO IT YOURSELF!



"Pressure Maid"

PORTABLE PAINT SPRAYER

Complete—ready to spray—with gun, hose, compressor, and motor. Gives you the features and performance of more costly units... fast, easy professional results every time. Also useful for inflating toys and tires, all-purpose spraying, etc. Displaces 4.7 CFM... delivers over 2.2 CFM at 40 psi.

Write for Catalog



The Campbell-Hausfeld Co.
1046-Q Railroad Ave., Harrison, Ohio

CAMPBELL-HAUSFELD

owners. Wonder when management will get the message?

"There's a vacuum leak on the transmission."—Wisconsin highway engineer.

"I have owned Fords with Fordomatic and Cruise-O-Matic transmissions, the latter the finest transmission that I've ever driven. New Fordomatic, the low-priced '59-62 automatic not as good as "standard" automatic of 1952-58."—Arkansas salesman.

We feel sure that the few dollars extra that it would cost Ford to put three-speed automatic in a car of Fairlane's price would gladly be paid by owners. Ford would be smart to do it at cost.

"The car is good. However, I would buy a V8 with automatic transmission in preference to this car. It's too slow in traffic and will not idle along in traffic at 12 m.p.h.; you have to run in second gear."—Mississippi foreman.

"Every time you slow down, you have to change gears."—Alabama crane operator.

Closing out the plus side, here are best-liked features, in order of their frequency of mention, numbers 11-14.

"I like its quiet operation, even at highway speeds."—Virginia management trainee.

"It has excellent insulation—low noise level."—Ohio district manager.

This is true on Fairlane "500" only. PM found the "standard" Fairlane full of tinny resonance at speed.

"I like the inner and outer appearance with good appointments, not too flashy for my church."—Florida minister.

"It sticks to road very well."—Iowa furniture dealer.

PM felt, by-and-large, that Fairlane is a roadable car, although its steering was, in our opinion, too slow when manual and too vague, imprecise and "lifeless" when power equipped.

"The car starts immediately in 10-degree-below-zero weather."—Kansas payroll accountant.

"I like the ease of starting even down to minus 25 degrees F."—North Dakota teacher.

And, a last look on the pessimistic side brings out complaints numbering 11 through 17 in order of mention.

"The doors leak air. There are other air leaks which I can't pin down. It is very tinny and badly put together."—Connecticut production manager.

"There's very little power below 30 m.p.h. in high gear."—Mississippi trade association manager.

"I wish I had bought the V8 140-horse-
(Continued to page 198)

HERE'S WHERE THE INDIANAPOLIS "500" BEGINS... ...AND ENDS



It's where the "500's" fine hand tools come from, PROTO'S unique Speedway store

Here at Proto's special Speedway store gleam thousands of the finest hand tools—a whole truckload will be sold to race mechanics before the event begins. You see, the race begins for the mechanics when they buy the tools of their trade.

Just watch the mechanics before the race. Watch them tinker, and listen, and fuss and adjust. And watch them during a pit stop. It's one of the most exciting sights of the race.

In a way, the race ends here in the Proto shop, too. Because winning drivers and mechanics will pay us a last visit to receive valuable prize sets of Proto Tools.

Perhaps you, too, will pay the store a visit. You'll see all together the familiar Proto tool panels and displays found in stores around the world. It's the finest single array of hand tools you're ever likely to see.



OFFICIAL TOOLS INDIANAPOLIS "500"

PROTO TOOLS
PROFESSIONAL QUALITY TOOLS



2202 Santa Fe Ave. 502 Allen St. 1702 Oxford East.
Los Angeles 54, Calif. Jamestown, N. Y. London, Ont., Canada

Send 50¢, your name, address, for forged alloy Keyring Screwdriver and fully illustrated 78-page catalog.

BLACK & DECKER TOOLS REPAIRED

- ✓ FULL GUARANTEE on all recommended repairs
- ✓ NEW PRICE POLICY saves you money
- ✓ FAST REPAIRS in 24 hours or less
- ✓ GENUINE FACTORY PARTS made for your B&D tools
- ✓ ALL REPAIRS MADE by tool experts
- ✓ FREE REPAIR ESTIMATE on request

OVER 100 REPAIR CENTERS. Check the Yellow Pages under "Tools Electric" or write for address of nearest service station.



Black & Decker®

Towson 4, Md.

QUALITY TOOL SERVICE

Lasting
Bargain in
Beauty!



SUPERPLY ENAMEL

APPLY IT YOURSELF

It takes just one coat of this easy-brushing, high-gloss enamel to brighten and protect your kitchen, bathroom and woodwork anywhere! Wonderful, too, for furniture, on any wood or metal surface indoors or out. SUPERPLY Quick-Drying Enamel retains its porcelain-like finish after repeated washings.



ONLY
\$1.79
QUART



sold by **WOOLWORTH'S**
and **NEISNER'S**

for FREE color cards, write:

A. WILHELM CO. • READING, PA.

power engine or the 160-horsepower job. How the Ford engineers ever put a 101-horsepower motor in this body is beyond me."—Michigan miner.

It was the only Six they had that fit. Their big Six (135 b.h.p.) is a little long and a bit heavy, and it would have made 145 hp. V8 redundant.

"When car gets under 20 miles per hour, I have to shift to low gear (6-cylinder)." — Washington retiree.

"It has nicely spaced gear ratios, but the six doesn't have the power to pull at low speeds, which, in the city, causes constant downshifting."—Michigan electrician.

"The six-cylinder engine with automatic is too small; it should be approximately 120 hp."—Delaware airman.

Yes, and if they upped it to 120 it would use a bit more gas and others would complain about that.

"Grillework on the defroster should be turned so heat reaches the corners of the windshield."—Illinois insulator.

Defrosting a wide windshield from this single, central grille is somewhat like trying to heat your home with a pot-bellied stove.

"It's hard to shift gears—even had car adjusted three times, but it's still not right." — Kansas aircraft worker.

"There was a noise in the transmission; dealer replaced reverse idler, cluster gear and main drive bearing." — Minnesota trucker.

"I had to have a new coil and a new generator put in."—Ohio lift truck operator.

"The generator didn't charge the battery as it should, causing trouble starting engine in moderate cold weather."—Illinois poultry inspector.

Complaints like these are old, sad stories that you hear much too often concerning almost every new car. If any man could put out a full production run of flawless automobiles in the U.S. for \$2500 he could be elected president.

"Very poor paint job." — South Dakota student.

"The paint job is lousy. The paint chipped in many spots and the dealer fixed them once. Now there are more paint chips." — New Jersey mail carrier.

"There are noises in the dashboard that no one seems to be able to fix."—Pennsylvania traveling salesman. ★ ★ ★

Valiant opinions from owners of the new Valiants. In the June Popular Mechanics, they reveal what they like and don't like about their cars, based on a million miles of driving.

POPULAR MECHANICS

AConomize on Gasoline

Get more miles per dollar—install an AC ACon-O-Mizer between your fuel pump and carburetor. Reduces flooding and stalling ... tailors fuel pressure—precisely and instantly—to every driving condition from idle to full throttle. The best answer yet to real gasoline economy!

suggested retail price

\$7.95



ACon-O-Mizer

At Your Nearby Service Station, garage or General Motors Dealer

AC SPARK PLUG THE ELECTRONICS DIVISION OF GENERAL MOTORS

UNUSUAL TOOLS BY MAIL



No. 44—COMBINATION MITER BOX AND CORNER CLAMP

Holds the wood and holds your saw. Uses any handsaw for accurate cuts from 0° to 180°. Full 3" capacity. Sides of joints exposed for nailing, gluing.

\$2.75 PPD.

No. 33 Works the same as No. 44 but without saw guide attachment. **\$1.75 ppd.**



SUPER DRILL GRINDER
Sharpens round shank drills like new, using hand or power grinders.

\$2.95 PPD.

Paint Brush Holder
2 for \$1.00 ppd.



JOINT AND SHARPEN ALL SAWS

SUPER FILER NO. 11 joints and sharpens hand and circular saws 6" to 10" with all teeth correct in height, depth, pitch, bevel. When file hits steel roller, teeth are finished. Saw runs true **\$9.95 PPD** with no side pull. Includes 8" file...

"TRU-CIRCLE"

Saw set automatically sets teeth at 10° or more... **\$2.95 PPD**



A. D. McBurney, 5908 Hollywood Blvd., Hollywood 28, Cal., Dept. A-52

SAVE ON WOOD EVERYTHING for the WORKSHOP TOOLS—SUPPLIES



New 140 Page Catalog! Send Today!

Now—discount prices on Stanley Power Tools! Finest kiln-dried domestic and imported woods, wood and metal legs, ornaments. Over 1,500 items! Big values on tools, craftsman hardware, Mosaic Tile, lamp parts, upholstery supplies. Project ideas and plans. Send name ... enclose 25c to help pay the mailing cost. Write to:

CRAFTSMAN WOOD SERVICE
2729 S. Mary Street, Dept. A-5, Chicago 8, Ill.

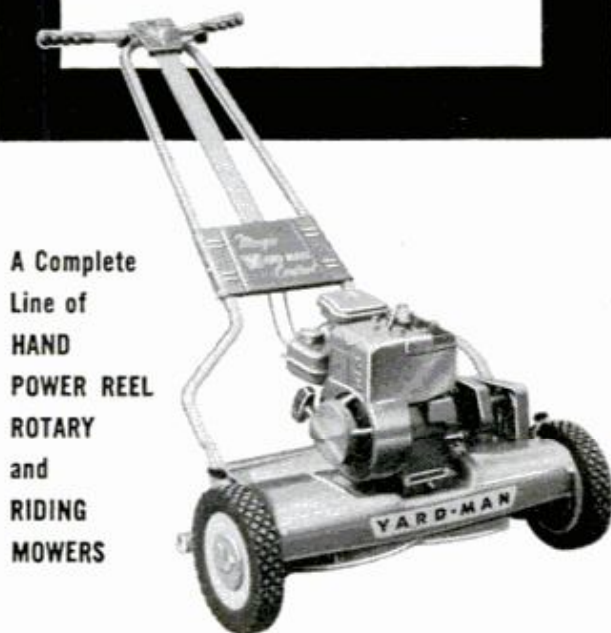
RETARDED CHILDREN CAN BE HELPED



SUPPORT YOUR LOCAL ASSOCIATION FOR RETARDED CHILDREN

MAY 1962

FOR PEOPLE WHO DEMAND PERFORMANCE



A Complete Line of HAND POWER REEL ROTARY and RIDING MOWERS



POWER REEL MOWERS

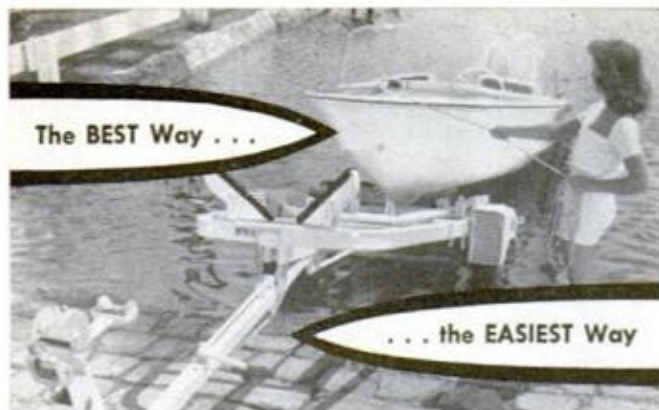
Bring out the true beauty of your lawn with a smooth, clean-cutting YARD-MAN. You'll find more features more people want in a YARD-MAN. Years later, as your YARD-MAN purrs across your lawn, you'll still be enjoying the superior mowing performance and economy only a YARD-MAN can offer. Features like these make mowing so easy with YARD-MAN.

1. FAMOUS "SILENT YARD-MAN" DESIGN
2. FAST-SET CUTTING HEIGHT CONTROL
3. MAGIC-CONTROL HANDLE

See your Yard-Man Dealer today or write for free, full color literature.



1436 W. GANSON ST., JACKSON, MICH.



...is the **GATOR** WAY!

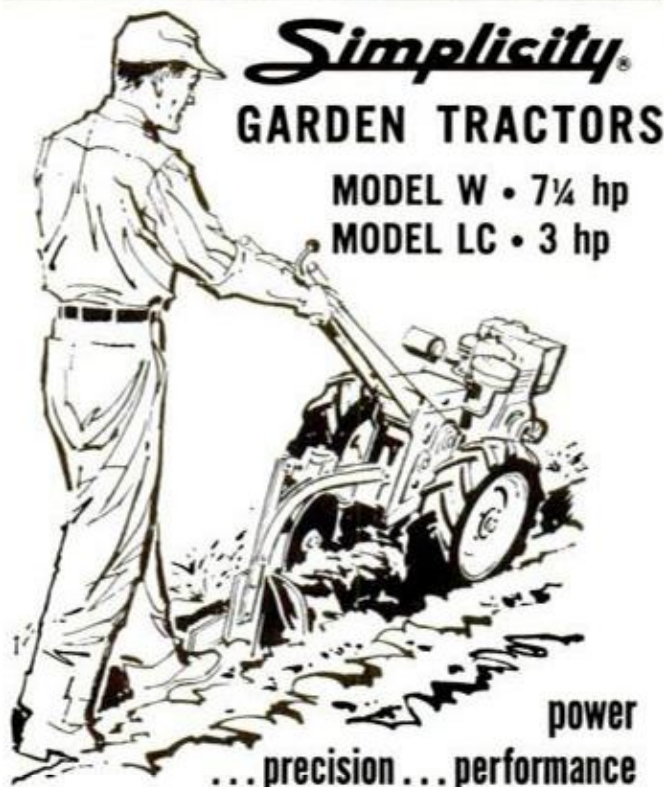
Transporting your boat the safe way is one thing to consider, and **LOADING AND LAUNCHING** is the major thing to consider. We've got both of them licked with our patented Gator Auto-Launch feature. Words can't describe this terrific development . . . you'll have to see for yourself!

Make a date with your Gator-Champ Dealer today — let him demonstrate Gator's Auto-Launch ease — one of many reasons why . . . "Sooner or Later, You'll Go Gator!"

FOR INFORMATION, WRITE DEPT. PM-62-5B

PETERSON BROS., Inc.

1925 East Beaver Street, Box 51, Station G., Jacksonville 6, Florida



for your year-'round garden jobs!

Quick-change attachments mean week-after-week utility. Convenient gear shift for forward or reverse. Controlled traction differential for maximum traction in all soil conditions. Ask your Simplicity dealer.

Simplicity Manufacturing Co. • 6243 Spring St., Port Washington, Wis.

We Fought the Red Guerrillas

(Continued from page 72)

Americans and have seen some examples of this unfortunate breed.

If you read what newspapers say about the fighting in Vietnam, you get the idea that the Viet Cong are brilliant masters of the art of ambush. None of us saw a single well-executed Red ambush. But even an amateurish ambush can result in the slaughter of scores of men if a detachment is clumsy enough to fall into it. Soldiers have to learn that the Viet Cong can even lurk in rice paddies. They dig rat holes in the ground and hide in them, pulling stubble over their heads. After the soldiers have passed, they pop up and start shooting. But this is all second-rate compared to the similar tactics of the Japanese in World War II or the Chinese Reds in Korea.

We instructed the Rangers to be alert for ambushes. When riding in trucks, they were never to close the tail gate. Then (in case they were surprised) they could pile out the rear in a hurry.

"If the enemy shoots from one side," we told them, "get the truck between the fire and you. Don't plunge heedlessly into cover because chances are good that there will be poisoned bamboo stakes waiting for you there. The main thing is to return fire instantly, shooting even at flashes or reports to upset the enemy's aim. You're bound to lose men in an ambush. Fight back hard, and few guerrilla forces will be able to hold. They just don't have the staying power."

Unconventional Weapons

We taught the Rangers how to make shaped charges and mine trails and to make an unconventional use of conventional small arms. It took some doing to convince them that instinctive firing as first practiced by OSS guerrilla fighters in World War II resulted in accurate shooting from the hip, without waiting to take aim. The Rangers learned the trick of swinging their rifles up by bending their knees forward. This kept shots from flying high. We also urged marksmanship. One day three of the American officers got into what appeared to the Vietnamese to be a violent argument.

"I'll show you fellows how to shoot," shouted one.

The three put up seemingly impossible bamboo targets and competed against one another to see who was the best shot while the Vietnamese, who love to gamble, backed their favorites. The competition in the best tradition of the American frontier

(Continued to page 202)

ALL ALUMINUM WATERFRONT EQUIPMENT



- stationary piers
- floating docks
- gangways

ALUMIDOCK

Trouble-free ALUMIDOCK no rust, no rot waterfront equipment can eliminate annoying maintenance and costly repairs. ALUMIDOCK equipment is salt water tested and designed to be installed or removed without the owner getting into the water. ALUMIDOCK lasts a lifetime.

Send 10c in coin for complete catalog.

New
"Do-it-Yourself"
dock kits.

ALUMIDOCK

4 SHELDON STREET, RANDOLPH, N. Y.



GENUINE ALNICO MAGNETS

AMAZING, PERMANENT, NON-ELECTRIC, HIGHLY PRACTICAL. Conduct interesting experiments. Hundreds of uses. Retrieve valuable steel items such as guns, tackle from fresh or salt water; tools from tanks & drains. **GUARANTEED.** Try any magnet one week. Money back if you are not well-pleased.

M-90 (Wt. 5 oz.) Has pull of 15 lbs. on steel block.....	\$ 3.50
M-500 (Wt. 13 oz.) Has pull of 50 lbs. on steel block.....	\$ 5.00
M-575 (Wt. 18 oz.) Has pull of 75 lbs. on steel block.....	\$ 7.00
M-625 (Wt. 70 oz.) Has pull of 125 lbs. on steel block.....	\$10.00
M-710 (Wt. 53 oz.) Has pull of 225 lbs. on steel block.....	\$18.00
M-44 Rod Magnets for Electric Guitars 1/4" Dia. x 1 1/4", 12 for	\$ 4.00
M-47 Hot Pad Magnets, 10 for	\$1.00
M-35 Science Experimenter Kit of 8 magnets.....	\$ 2.00

Send M.O. or check. We pay postage. Sorry no C.O.D.'s.

MIAMI MAGNET COMPANY, 3240 N.W. 27th Ave., Miami 42, Fla.

DO MORE PLANING JOBS WITH LOW COST BELSAW



Exclusive MONEY-MAKING Features: Full 12 1/4" x 6" capacity • Power feeds at 14' to 34' a minute • Provides for Grinding Knives in the Cutter-head • Attachments for Jointing, Rabbeting, Tongue, Matching, Groove. Convert low cost rough lumber into high priced stock. Easy to make flooring and popular patterns. Send Today for FREE Literature and Prices.

Belsaw Machinery Co., 2052 Field Bldg., K.C. 11, Mo

LOW DOWN
PAYMENT
EASY TERMS

Fussy about filtration for your swimming pool? You have reason to be, as the June Popular Mechanics reveals. But the article also shows some sound and simple solutions to the problem.

You have a use for

KRYLON SPRAY PAINT

In Ready-to-Use Aerosol

IF YOU PRIZE IT...KRYLON-IZE IT!

Works in seconds!



Loosens Rusted Bolts
nuts, screws, "frozen" parts!

LIQUID WRENCH

SUPER-PENETRANT

The super-penetrating rust solvent that quickly loosens rust and corrosion.

AT ALL HARDWARE
AND AUTO STORES

RADIATOR SPECIALTY COMPANY
CHARLOTTE, N. C.



LOOK

what you can build
for \$995 plus freight



no money down easy financing

Pre-Planned, Pre-Cut and Packaged! Order it direct from Potlatch's new "Free-Time" Home Plan Idea Book. Included are cabin hide-a-ways, weekend retreats and year around vacation homes. Builder-approved, easy-to-use, engineered blueprints available for all "Free-Time" Homes. For complete information on your own vacation cabin, mail coupon today.

Potlatch

Build now . . . pay later financing. No money down.

Unsecured loans to \$1700. Up to 7 years to pay on easy terms. Application Form in Plan Idea Book.

27 VACATION PLAN IDEAS

Choose from this complete range of ideas illustrated in full color. There's a plan to fit your budget, your site and your dreams. Mail coupon today . . . only 50c.



POTLATCH FORESTS INC.

Lewiston, Idaho



symbol of
quality
since 1908

PM Enclosed is 50c

NAME _____

ADDRESS _____

CITY _____ ZONE _____ STATE _____

Free!

BRAND NEW LAFAYETTE ELECTRONICS

1962 CATALOG 620

It's Bigger and Better
Than Ever!

340 giant-sized page catalog from the world's leading supplier of electronics and stereo hi-fi equipment.



340 PAGES

It's a complete shopping center for audiophiles, technicians, engineers, students, hobbyists, servicemen and dealers. Thousands of items at lowest money-saving prices — featuring LAFAYETTE KITS . . . the best value for your money any day.

SPECIAL! NO MONEY DOWN

with Lafayette's NEW EASY-PAY PLAN.

MAIL THE COUPON TODAY FOR YOUR FREE CATALOG

LAFAYETTE LOCATIONS
JAMAICA • BRONX • NEW YORK CITY
NEWARK • PLAINFIELD • PARAMUS • BOSTON

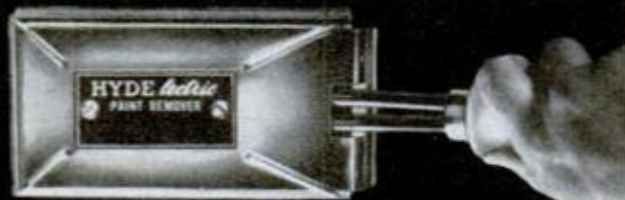
Lafayette Electronics Dept. LE-2
P.O. Box 10, Syosset, L. I., N.Y.
Send me the FREE 340-pg. 1962 catalog 620.

Name

Address

City Zone State

HOW-TO Remove and Apply Paint



ELECTRIC PAINT REMOVER

Removes paint from houses and boats. Easy, fast and safe no matter the number of coats. Down to bare wood in seconds. Hydelectric Paint Remover with heating element like unit in electric range. Retail \$12.95.

NEW SPRAY PAINTER

Applies all kinds of paints, oil, latex, stucco, sand, multi-color right from the mfgs. quart paint can with Hyde Spray Painter. Fastens to vacuum cleaner or Electric Air Blower. Easiest to clean . . . easiest to use. Retail \$12.95.



Write for FREE catalog

HYDE TOOLS

SINCE 1875

SOUTHBRIDGE, MASS., U. S. A.

ended with firing from the hip at objects tossed in the air. After that the Rangers took good marksmanship to their hearts.

People ask me what I remember most about Vietnam. It isn't the jungle, being constantly on the lookout for ambushes or seeking the enemy as we trained the Rangers to protect their people from the Reds. After all, I'm a medic, and I remember most of all a day in a Vietnamese village. I had to repair a man's leg which had been improperly amputated by what he called "a Chinese doctor." It was badly infected and the bone protruded at least an inch through the stump. By the time I finished the villagers had gathered around, impassively watching my knife.

Wounded Boy Becomes Symbol

A wrinkled farmer and his wife carried forward a little boy and placed him at my feet. A water buffalo had gored him viciously in the buttocks. To me the suffering boy seemed a living symbol of his suffering country. I had to help him. Applying an antiseptic, I talked soothingly to him. Then I pushed a needle in and anesthetized a small area close to the wound. When the anesthetic took effect, I dug the needle in deeper and anesthetized even more flesh. I continued the process until I had numbed the child for some six inches. Then I cut away the dead, macerated flesh while the demo man, Sergeant Murphy, cross-trained in medics, put on hemostats to clamp off the bleeding.

The mother screamed with each motion of my knife, but the brave child only trembled. When I had cleaned the wound, there was an incision six inches in length and two inches in width. I sutured the gap in the flesh and gave the boy a shot of penicillin. I'll never forget that mother's face when she got her boy back. In the next several hours I treated scores of Vietnamese villagers suffering from diseases and wounds until all my medicine was gone. Four days later I returned to the village to see how my first patient was doing, and he was making a perfect recovery.

I am convinced that his country will recover just as fully from the Communist attack. Its soldiers have courage and an increasing capacity to fight. They take quickly to Special Forces training. With renewed faith in their leaders, faith in their weapons and faith in themselves, the Vietnamese will turn back the tide of Red conquest. ★★★

Send for your free WHERE-TO-FIND-IT list giving sources of supply or further information on articles in this issue.



"O.K., now. Lillian, you call the plumber. Uncle Charley, you run down to the service station for some more Mac's Sealer and Stop Leak. And Irma...please try to remember it's for car radiators, not sinks."



WORLD'S MOST EXCITING LOWEST PRICED CAR
KING MIDGET FOR 1962
 Drive it for 75c a week.
 Rider Agents Wanted. Send 25c for 32 page book, full details, dealer price. Or send \$1 (refunded first order) for this plus Service and Repair Manual and 16 5x7 photos of car and factory.
MIDGET MOTORS CORP.
 ATHENS 1, OHIO

INVEST 4c IN SAFETY!

FREE! The "Story of the Shoe", tells about safety of this flail-type mower. Proven safe for over 13 years in Industrial and Military use. Now—available for domestic use. Not a reel—not a rotary.

MOTT Hammer-Knife MOWER

Unique flail-type principle combines safety and cutting efficiency to give you the best mower on the market. Before you buy—Find out why you should get MOTT. You owe this to your family and friends. Write for your Free, "Story of the Shoe" today.

MOTT CORPORATION, 507 Shawmut Ave., LaGrange, Ill.

Send for your free WHERE-TO-FIND-IT list giving sources of supply or further information on articles in this issue.

Print Your Own
 Cards, Stationery, Advertising, Circulars, labels, photo and movie titles, church work, tags, etc. Save money. Sold direct from factory only. Raised printing like engraving, too.
Own a Printing Business
 Print for Others, Good Profit. Have home shop. Junior press \$15; Senior \$35 up. We supply everything. Easy rules. Pays for itself in short time. Write now for free details.
KELSEY PRESSES, Z-37 Meriden, Conn.

Fill Flaws In Plywood
 Handles like putty. Hardens like wood.
PLASTIC WOOD
 The Genuine - Accept No Substitute.

A three-way welder is a June issue project for PM readers. Use it as a spot welder, arc welder or voltage booster for extension-line work with power tools. Automatic solenoid switch prevents arcing flash. Parts are readily obtainable.

MFG
 challenges you to . . .

Before you invest in any outboard boat, compare them all . . . feature-by-feature . . . fact-by-fact. Be sure you are buying the boat that's best for you. You'll want the "Challenge Test," a side-by-side comparison guide to outboard boat buying. Ask your MFG dealer for a free copy or write direct. See for yourself how MFG meets the challenge of quality.



COMPARE THEM ALL!

MFG BEST BOAT BUILT . . . *Anywhere*

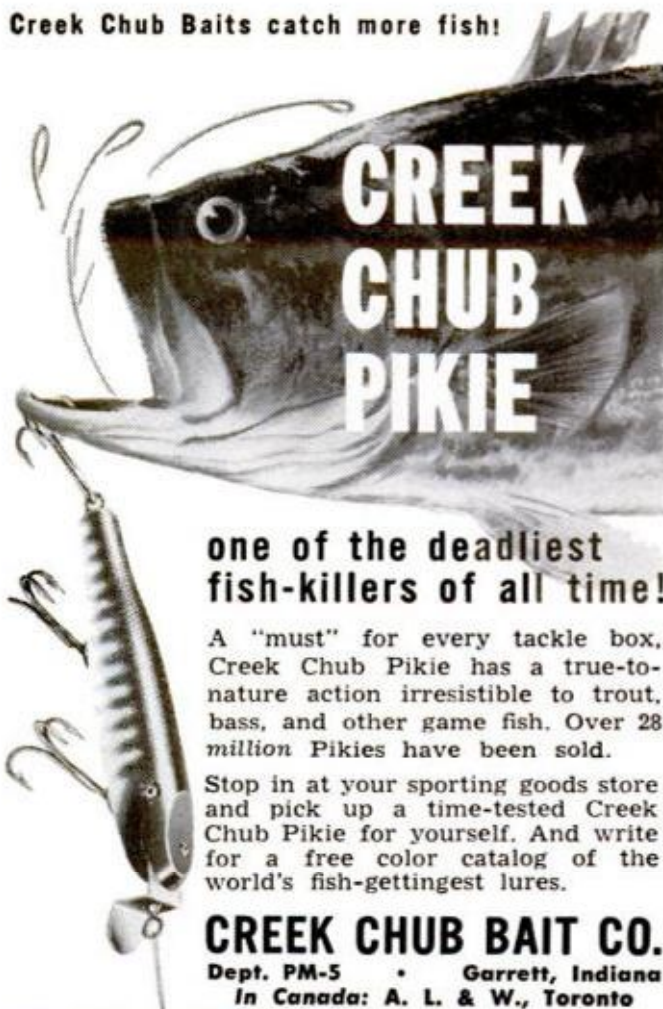
Molded Fiber Glass Boat Co., 71 Fourth Ave., Union City, Pa.

In Canada: Canadian Locomotive Limited, Kingston, Ont.



World's largest producers of fiber glass reinforced plastics

Creek Chub Baits catch more fish!



CREEK CHUB PIKIE

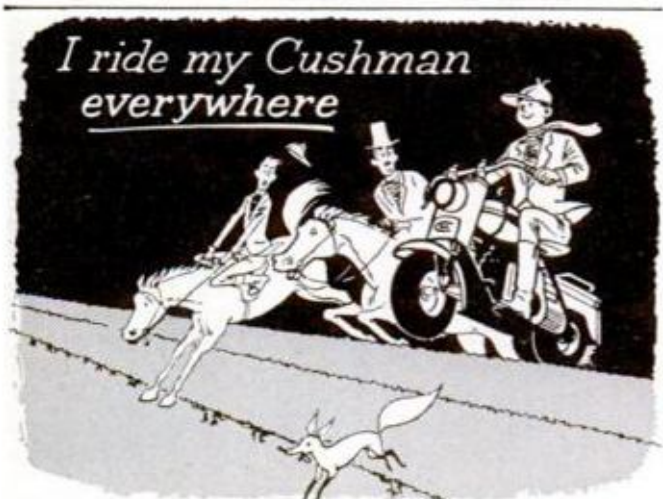
one of the deadliest fish-killers of all time!

A "must" for every tackle box, Creek Chub Pike has a true-to-nature action irresistible to trout, bass, and other game fish. Over 28 million Piekies have been sold.

Stop in at your sporting goods store and pick up a time-tested Creek Chub Pike for yourself. And write for a free color catalog of the world's fish-gettingest lures.

CREEK CHUB BAIT CO.
Dept. PM-5 • Garrett, Indiana
In Canada: A. L. & W., Toronto

I ride my Cushman everywhere

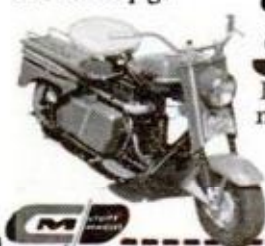


A sleekly styled Cushman Scooter is today's way to get there. It's superbly engineered for dynamic performance. It's economical, too—up to 100 mpg.

CUSHMAN Super Eagle

Famous for rugged roadability, now with new seat suspension, new brake action.

Ask your dealer for free demonstration or write for colorful booklet.



CUSHMAN MOTORS
Division of Outboard Marine Corporation
948 No. 21st
Lincoln, Nebraska

NAME _____
ADDRESS _____
CITY _____ STATE _____

Owners Report on the Buick V6

(Continued from page 78)

"I want to like the Buick very much—but so far it hasn't let me. A very poor factory inspection caused a lot of trouble."—California printer.

With its minor problems ironed out, the V6 will be hard for a lot of buyers to resist, once they try it.

Body trim shows poor workmanship."—California probation officer.

More favorable comments—the second group of five best-liked features, in order of their mention:

Economy is better than any other automatic shift I've had (20.8 m.p.g.)."—Ohio rural mail carrier.

"I like the economy at constant highway speeds; from 70-90 m.p.h. on a 1700-mile trip the gas mileage was 20 miles per gallon."—North Carolina physician.

His carburetor is working just fine!

"I like the happy combination of good performance with reasonable economy."—California airline foreman.

"The performance of the V6 surpasses my expectations, and the mileage on a gallon of gas is truly outstanding—17-20 m.p.g."—Virginia government worker.

"I am 6 ft.-3 in. tall and I find head and legroom excellent."—California salesman.

Similarly-sized, we agree; the Special is roomier than it looks to be.

"It is a compact car, yet has enough room for my four children, ranging in years from 4 to 12, my husband and myself."—Pennsylvania housewife.

"I especially like the ease with which I can park it."—Nebraska secretary.

"I like the visibility. The hood is "shaved" and allows the driver a full view of the road. Also, I like the all-around glass areas; and the way it handles is relaxing."—Washington mechanic.

"The steering is practically like power steering."—North Carolina executive.

Right, except it costs you \$86 less.

Numbers six through ten in the complaint department follow. They appear in the order of their frequency of mention:

"The engine is slightly rough at low speeds and idle due to balance of crankshaft."—California agricultural inspector.

"Rocking of engine when idling vibrates entire car."—California machinist.

This is the one weak spot in V6's design, but most of this vibration can be removed if engine is in perfect tune.

"There's too much engine noise in low range."—Michigan retiree.

"It's got a noisy muffler—sounds like a truck."—Florida airplane pilot.

(Continued to page 206)

**WHY WATCH AND WAIT
'TIL OTHER PAINTS DRY?**

JET-DRI®



paint a floor with JET-DRI
WALK on it
15 minutes later!



paint a chair with JET-DRI
SIT on it
15 minutes later!



paint toys with JET-DRI

In Spray Cans, Qts., or Gallons wherever paints are sold or write for nearest dealer.

**DRIES IN
15
MINUTES**

with superior ...

- abrasion resistance
- acid, alkali, alcohol resistance
- exterior durability

Greatest advance in paint history! Paint anything... concrete, metal, wood or plaster with no effort, leaves no brush marks... and dries to a porcelain-like finish in 15 minutes. Perfect for indoors and outdoors. Non-toxic. Also Rust-Resistant Primer.

For new "Profitable Paint Ideas" booklet, write—

CONSOLIDATED CHEMICAL & PAINT CORPORATION

442 Driggs Ave., Brooklyn 11, N.Y.

Two experienced backpackers reveal the savvy and short cuts they have learned the hard way — tips that give you more time to enjoy the thrills of backpacking. You'll find their story in the June Popular Mechanics.

CRUISERS \$369 UP: 18, 20, 22 FT.



**1/4 Down 2 Years to Pay
CRUISERS EASILY ASSEMBLED
FROM PRE-ASSEMBLED UNITS**

All parts precision-cut and preformed. Assemble easily as small boats. Airy cabins, full length bunks, toilets, galleys; complete for extended cruises.



**HOUSEBOAT-CRUISER
22 FT. \$224 DN.**

Cruiser speed, handling; houseboat comforts, space. Sleeps 6-10

MONEY BACK GUARANTEE ON ALL LUGER KITS

FIBERGLASS \$299 UP: 14, 16 FT.

Assemble in One Evening

Anyone can interlock and bond 3 factory molded sections into 1-piece molded Fiberglass boat in evening. Save to \$500.

PLYWOOD RUNABOUTS

40 MODELS 12-20 FT. \$104 UP EASY PAYMENTS

Equal factory-finished boats in appearance and performance; save 1/2-3/5. Low prices on hardware, trailers, all boating supplies.

**FREE CATALOG
LUGER BOAT KITS**

Dept. B-5, 9200 Access Road, Minneapolis 20, Minn.

WAR SURPLUS ONE DIME BARGAINS SAVE UP TO 90%



U.S. NAVY SEXTANT (AN 5851) Adjustable bubble and nite lite, built-in averaging device. Both artificial and natural horizon. Used with or without bubble. Used by many power squadrons. All units tested for tolerances. Complete with filters, astigmatizer, batteries & instruction book. Approx. GOVT. COST \$586. Like NEW. \$16.50.



CORNELIUS AIR COMPRESSOR Ideal for filling underwater diving tanks, air horn tanks, etc. Three stage USAF air compressor. Has built-in 1/2 HP, 27 V. DC electric motor and adjustable cut-out switch. Develops 1500 PSI or may be reset to 2000 PSI. Delivers .4 CFM. Approx. GOVT. COST \$375. Like NEW. \$29.95.



ELECTRIC STORAGE BATTERY WINCH

New, improved model contains heavy-duty, 2-way drum switch. Fully reversible heavy-duty, two-speed motor, 160 to 1 gear reduction. Ball bearing construction throughout. Drum will handle 70' of 1/4" cable. Can be used on 6 and 12 V. battery. Lift cap. 2000 lbs. plus. Ready to install & operate. 19" long x 9" wide x 8" high. For jeeps, trailers, boats, trucks, etc. Complete with mounting flange, safety load locking brake and leads. Shpg. Wt. 60 lbs. Approx. GOVT. COST \$400. NEW. Model E. \$49.50.

DELUXE MODEL ED Same as above but with extra heavy base & outrigger support bearing. 250' 1/4" cable spool capacity. NEW. \$69.50.



BUILD YOUR OWN ARC WELDER, LIGHT PLANT OR BATTERY CHARGER \$39.50

Kit incl. 1 Navy NEA-5 Gen. combination AC-DC type. AC 115 V. DC 24 V., 200-300 Amps. 2 complete generators in 1, yet no larger than reg. gen. Ideal for home, shop and farm lighting plants. Delivers 1200 Watts AC. DC side for charging batteries, welding and operating war surplus motors. Also in kit: 1 DC Voltage Reg., Reverse Current Relay, 1 Voltmeter, Rheostat, Electrode Holder, Toggle Switch, Welder's Shield, Wiring Diagram for kit. Wt. under 100 lbs. Approx. GOVT. COST \$650. Kit—\$39.50. Navy NEA-5 Gen. as above, purchased separately, \$23.50



11 PIECE CROWFOOT WRENCH SETS

Wrenches snap onto T-bar in 3 different positions. The only wrenches for hard-to-get-to places. Mfd. by Plomb Tool and other leading mfr. Finest case hardened tool steel. No shop mechanic should be without this set. Approx. GOVT. COST \$47. NEW. \$5.95 ppd.



FRESH WATER SYSTEM PUMP — For boats, campers & trailers. Output 10 to 200 gal. an hr. Variable rheostat controls output. 1/2" pipe thread into bronze impeller housing. 12 V.D.C. Radio noise filter. 5.2 amp. draw. Explosion-proof const. Shpg. wt. 11 lbs. Complete with mounting instructions & wiring diagram. Approx. GOVT. COST, \$200. NEW. \$10.95.



225-1 REDUCTION GEAR For beaching boats, winches, hoists. Ideal motor in golf or boy's electric car. DC motor and clutch. Easily reversible wiring diagram furnished. Hi torque. Runs at 47 RPM on 12 V. DC; 105 RPM on 24 V. DC. Approx. 20 RPM on 6 V. DC. All ball bearing const. Shpg. wt. 65 lbs. Approx. GOVT. COST \$300. \$13.50 Matched splined gear — \$3.00 ea.

NEW 1962 CATALOG!

Tremendous catalog — our biggest ever — fully illustrated — 1000s of bargains in war surplus & other items. Send 25c in coin for your copy today or free copy with order. Where ppd. indicated applies to US only. Other prices FOB Culver City, Calif. Send cash, check, money order, 50% deposit for COD.

AIRBORNE SALES CO., INC. DEPT. PM562
8501 Stellar Drive, Culver City, Calif



**Men who know
PAINTERS' CUTLERY
say the BEST are
Red Devil Tools.**



**EASY!
QUIET!**

5 TIMES FASTER THAN A BRUSH

The Sprayit 600 gives you real "master painter" results with smooth, fast delivery. Saves you time and work on all home maintenance painting. Precision quality, modestly priced at \$39.95. Oil-less type compressor with built-in motor. Adjustable all-aluminum spray gun. A versatile outfit—also cleans machinery, sprays insecticides, liquid fertilizers; many other home and farm uses. Full year warranty. Send 10¢ for paint spraying booklet and free literature. Thomas Industries Inc., Sprayit Div., Dept. PMS2, 207 E. Broadway, Louisville, Ky.

SPRAYIT® 600



Best Remover FOR Refinishing Furniture

Low-viscosity Klean-Strip is a free-flowing remover that peels off all furniture finishes without making a gummy mess.

Old finish stays wet and workable, can be wiped off easily. Leaves surface dry, clean, ready for new finish. Non-flammable, safe.

KLEAN-STRIP PAINT REMOVER

THE KLEAN-STRIP CO., INC.
MEMPHIS 6, TENN.—WINNIPEG, MAN.

DYNAMIC INDUSTRIAL TYPE TRANSFORMER WELDER

WELD-CUT-BRAZE-SOLDER-HEAT
IRON-STEEL-BRONZE-BRASS
ALUMINUM AND OTHER METALS



Professional Electric Arc Welder. Ideal for Home, Shop, Farm or Industrial use. The handiest tool in your workshop. Weld, Braze, Solder, Cut, Bend all metals. Do expert work on your first job. Build or repair Boats, Trailers, Auto Bodies, parts, fenders, metal and ornamental iron furniture, fixtures, farm equipment, garden tools, bicycles, toys, etc. Operates on any properly wired 110 V. A.C. line. Complete with helmet, arc torch, electrode holders, flux, rods, cables, instruction book. **FULL YEAR GUARANTEE**, 10 day money back trial. **ONLY \$38.50 f.o.b.**

Only \$38.50 f.o.b. Send only \$6.00 check or m.o. Pay postman balance plus charges. EASY PAY PLAN. Low down payment. Pay as you weld.

DYNAMIC WELDER CO. 1808 SOUTH FEDERAL STREET
Dept. D2-E, CHICAGO 16, ILL.

"It's somewhat noisy (engine) especially in starting up from a dead stop."—New York accountant.

PM's test car had exhaust resonance period in muffler, but oddly enough, we grew to like it!

Manual transmission shift linkage has been rough and sticky."—New York sales engineer.

"The car has very little power in high gear at low speeds—I almost have to change to 2nd if speed drops below 30."—California minister.

His problem sounds like an out-of-tune engine unless he's expecting sensational pickup, which he can get in second.

"It swerves and doesn't seem to want to hold a straight course, and it feels very light on a windy day."—Kentucky steam-fitter.

Could be a combination of a bad shock absorber and unevenly inflated tires.

"The car is much too light in the rear for carefree driving on icy roads."—Michigan assistant cafeteria manager.

"It's hard to hold on the road in strong winds such as we have."—Kansas nurse.

"The rear end is too light when empty, and with Wyoming's strong winds the car is hard to handle. I carry a 150-lb. hunk of iron in the trunk to 'even' the weight."—Wyoming teacher.

PM's test convertible gave no trouble in cross winds, but we needed weight in trunk for traction on snow and ice.

"The dashpot on carburetor had to be adjusted twice to lower idling speed."—Washington editor.

For the full measure of compliments, here is the final group—numbers 11-17, in their order of frequency:

"It holds the road like a big car, at least up to 90 m.p.h., which is as high as I have had it."—Washington carpenter.

"It holds the road with little effort, even at 105 miles an hour—think of that."—California chef.

You think of it, Cookie, we're too scared to drive that fast in the Middle West! But you've got a great testimonial there.

"It starts easily even at 35 degrees below zero!"—Wyoming homemaker, teacher.

"Friends who drive the car think it is a V8 until I tell them it's a six."—Texas maintenance man.

Maybe that's why Buick didn't put a V6 emblem on the hood.

"Buick has done a very good job isolating engine vibration from the body."—Indiana engineering design supervisor.

"I have a convertible; it has no rattles, which are normally expected."—Georgia salesman.

(Continued to page 208)

New standard for power and torque in a compact grinder!

NEW DREMEL NO. 3 INDUSTRIAL MOTO-TOOL



This new industrial type grinder belongs on your workbench! The No. 3 is a compact "powerhouse" developing 27,000 rpm — and sustains high torque under load. It's easy to handle (fits your hand), runs cool, lightweight. Weighs only 17 oz.! Just the ticket for precision grinding, polishing, drilling, sharpening, modelmaking — working in tight corners. Powerful 110 Volt AC or DC motor is housed in a heavy-duty, shockproof Bakelite case. Handy hanger hook keeps it within reach.

DREMEL MFG. CO., Dept. 112-E, Racine, Wisconsin



No. 3 Moto-Tool is complete with 1/8" and 3/32" collets, 3-wire grounding cord with 2-prong adapter, finger grip — in steel case. **Only \$29.95.**

No. 2 Moto-Tool — long time favorite with industry, craftsmen, model makers since 1936 —

No. 2 Moto-Tool with 3-wire grounding cord, **\$19.95.**

No. 2 Moto-Tool with 23 accessories in steel case, **\$29.95.**

See Your Dealer or Write for Complete Power Tool Catalog



USEFUL

DELTA POWERlite



Used *more* often by *more* people in *more* places! Front spotlight throws brilliant beam; top floodlight gives wide-area illumination. Perfect for outdoors, auto, home. Only **\$6.15**, with top red flasher... **\$6.19**, less 6-volt battery.



Delta makes 16 lanterns, from \$2.09. See your dealer or write to us direct.

Delta LIGHTS THE WAY

Delta Electric Co., 323 West 33rd Street, Marion, Indiana

MAY 1962

DRAINS cellars, cisterns, wash tubs; **\$7.95**
IRRIGATES - CIRCULATES - SPRAYS

1,001 uses. Stainless shaft. Won't rust or clog! Use 1/8 HP motor or larger... 3/4 HP for up to 2,400 GPH; 450 GPH 80' high; or 1800 GPH from 25' well. 1" inlet; 3/4" outlet. Coupling included free. **\$7.95.**

HEAVY DUTY BALL-BEARING PUMP. Up to 5,200 GPH; or 3,000 GPH from 25' well. 1 1/4" inlet; 1" outlet. **\$12.95**

Postpaid if cash with order. **MONEY BACK GUARANTEE**

Centrifugal and Gear Pumps in All Sizes
LABAWCO PUMPS, Belle Mead 7, New Jersey

priced from \$109.50...

HAND-HELD, MOBILE, BASE STATION

2-WAY RADIO

VIKING MESSENGERS



Now, 3 feature packed Johnson Messengers...
outperforming everything else in the field!

Compact, hand-held 100 milliwatt or 1 watt "Personal Messengers". Rugged and reliable—11 transistors, 4 diodes! Superheterodyne receiver and exclusive tuned RF amplifier gives twice the sensitivity and 40% more range than similar units with conventional circuitry—more output than similar units with same rated inputs!

For mobile or base stations—performance proved Viking "Messenger" punches your signal across the miles! High efficiency design makes full use of maximum allowable legal power. Excellent receiver sensitivity and selectivity. Automatic "squelch" control—5 channel coverage. Only 5" x 7" x 11", easy to install anywhere!

WRITE TODAY
for
information packed
4 Color Catalog



E. F. JOHNSON COMPANY

1407 10th Ave. S.W., Waseca, Minnesota

Please rush "Messenger" details to:

NAME _____

ADDRESS _____

CITY _____ STATE _____

Manufacturers of the world's most widely used personal communications transmitters.

207

screens, upholstery, carpets...

hundreds of other uses.

You name 'em!



Swingline 101 Staple Gun

Staples practically anything. Exclusive push-button loading and built-in staple extractor. At your stationery, department or hardware store.

only **4⁹⁵**

FREE! New 8-page

SEND FOR YOURS TODAY!

"TIPS FOR TACKING" Booklet

... shows you how to save time, money and effort — with a SWINGLINE AUTOMATIC STAPLE GUN



Swingline INC.

32-00 Skillman Ave., Long Island City 1, New York



NO TOOL SET IS COMPLETE WITHOUT X-ACTO

X-Acto precision knives are used by skilled craftsmen on the job. They—and you, too, will—count on X-Acto's extra sharpness and perfect balance for accuracy and safety. For doing professional jobs, complete your tool set with X-Acto. X-Acto No. 82 Knife Chest contains three X-Acto knives with nine extra assorted blades in a fitted, natural-finish wood chest... \$4.50. See your X-Acto dealer, or write:



X-Acto, Inc.,

48-41 Van Dam St., Dept. R-8, Long Island City 1, N.Y.

PM's test Special was the first nonrattling convertible (excepting Cadillac and Mercedes) that we've ever ridden in.

"I like the interior workmanship compared to other compacts."—New Jersey teacher.

"It has excellent lower gear and passing gear. No worry about gear going out right when you need it."—Illinois teacher.

"Like the smoothness of the automatic transmission."—Ohio carpenter.

We think that Special's automatic is an outstanding design, comparatively simple yet smooth and efficient.

"The V6 gives me the economy of a small car and the feel of a big one."—Pennsylvania oil distributor.

"It's got a solid sound to the doors, trunk, and hood."—New Jersey electrician.

The last batch of gripes, 11-17, follows, listed by frequency of mention.

"Steering should be improved—just isn't sensitive enough without power."—West Virginia research analyst.

"The steering is too slow."—Illinois sales engineer.

One advantage of power steering—and in our opinion the only one on Specials—is that it lowers steering from five wheel turns to four turns, lock to lock.

"The car has an uncommonly large number of rattles."—Missouri secretary.

"Within two days of purchase I had water hose replaced; it had a large hole through which all water and antifreeze drained."—Michigan educational consultant.

"The car has a tendency to lean on corners or on a crowned road because of an uneven load (two adults on the right, one on the left)."—New Jersey Air Force pilot.

"The dual windshield wipers were hooked up wrong; the dealer ordered a new motor and switch; later found the hookup was incorrect."—Maryland retiree.

"We hear excessive noise from air-cooled transmission."—Michigan secretary.

"It has a very noisy automatic transmission when accelerating in low gear."—New York plant manager.

"Buick was skimpy on standard equipment, which I took for granted, such as a sun visor for 2nd front seat and bumper guards."—New York exporter.

Here's a legitimate point. Buick made the necessities into "extras" to get advertised price attractively low. Recently they brought out a deluxe-trim version of V6 in response to demand.

"My complaint is about the omission of small items: Cigarette lighter, only one sun visor, no dome light, door switch, etc. Cheapens the name of 'Buick.'"—Tennessee photographer. ★★★



for metals, glass, china, tile, most plastics, other non-porous materials
It's Elmer's new Epoxy glue—the new wonder-glue—the “stickiest” glue made especially for non-porous surfaces. The molecules of the Epoxy bond with those of the surface to be repaired. Dries clear, strong, and waterproof. Send stamped, self-addressed envelope for your FREE copy of ELMER'S WOOD-GLUING HANDBOOK. Elmer, The Borden Company, Dept. PM-52, 350 Madison Avenue, New York 17, New York. (Available in Canada.)

EVERLITE* World's THRIFTIEST Light Plants

(Item 869-10T)



NEW TRANSISTOR ALTERNATOR REPLACES GENERATOR

Now a Service Free Light Plant built with a transistorized alternator. Offers 30% greater efficiency—more power for less fuel. Terrific service life—no brushes to arc and burn. No more commutator to wear, no collector ring trouble. And best of all it costs no more to “go modern with Everlite.” Thrifty 1000 watt, 115v. AC plant powered by a rugged easy starting 4 cycle engine—leader priced. Model 869-10T. Wt. 65 lbs. as illustrated **\$179.50**

fob factory

*Trade-Mark Registered

All sizes available—can finance. Write for catalog. Special models for public utilities—Approved for Civil Defense. Write.

MASTER MECHANIC MFG. CO., Dept. A-562, Burlington, Wis.
Southern Customers Order from Dept. A-562, Box 65, Sarasota, Fla.

HELP or INFORMATION?

Do you need help or information for any repair or remodeling Idea Projects you are undertaking? A complete list of Lumber Dealers who are cooperating with Popular Mechanics to bring you information and quality products is available. To obtain this list of the dealer nearest you, write:

Service Bureau, Popular Mechanics

200 E. Ontario Street

Chicago 11, Illinois

FREE CATALOG!
TREMENDOUS SAVINGS ON HUNDREDS OF SURPLUS AND NEWLY MANUFACTURED ITEMS!
New 1961 edition contains over 50 pages of tools and equipment for farm, home, workshop, factory. Hydraulic equipment, pumps, motors, construction and diesel equipment and parts! Write for your FREE CATALOG Today.
GROBAN SUPPLY COMPANY
1139 South Wabash Ave., Dept. G-5 Chicago 5, Ill., WEbster 9-3793

Fill Cracks And Holes Better

Handles like putty. Hardens like wood.

PLASTIC WOOD®

The *Genuine*—Accept No Substitute.

MAY 1962

209

What's New in High Fidelity
by Fred Honig
Former Editor of Hi Fi Guide, well-known writer and authority on high fidelity

How Components Save You Money

There's only one way to get the most out of your “sound” investment: component high fidelity! High fidelity components give you the most for your money in flexibility and, most important, in quality. First, you can enjoy the performance of “custom selected” components without paying for expensive cabinetry. Second, you can build or install your components to fit the needs of your home—using existing furniture, bookshelves, closets, etc. Third, you have your choice of equipment: engineered to reproduce music without audible distortion to please your personal preference for quality. You get exactly what you want in an FM/stereo tuner, record player, tape recorder, amplifiers, speakers—selecting each component for the sense it makes in your music system. You can plan ahead and budget your component buying...for quality with economy.



EMPIRE TROUBADOUR
Record Playback System
Turntable with
Dynamic Balance Tone Arm,
Mono-Stereo Cartridge \$200.

Superb record playing components, single play or automatic, must perform silently and without creating distortion. Scientific engineering of turntable, motor and precision-balanced tone arm permits almost miraculous tracking of today's sensitive cartridges. Choose units separately or already integrated (as illustrated).

Whatever the music you prefer on records, tape or radio, your speaker system is the fine instrument you eventually hear and it must be capable of reproducing a full range of natural sound. You may choose from many decorator designed types and sizes, including highly versatile compact speaker systems (as shown).



WHARFEDALE
W60, Achromatic
Compact
2-Speaker System
True wood, \$116.50
Unfinished, \$101.50

For helpful information about high fidelity components, send in the coupon below.

Institute of High Fidelity Manufacturers, Inc.
Dept. E-32 — 516 Fifth Avenue, New York 36

Please send me free booklet—High Fidelity Components.

NAME _____

ADDRESS _____

CITY _____ STATE _____

WELD - BRAZE - SOLDER - CUT

REPAIR MOST EVERYTHING MADE OF METAL



Home Appliances, Auto parts. Make and repair lawn chairs, tables, ornamental iron work, gates, wazons, etc. Solder, heat, bend, and straighten, with terrific heat from arc torch. Cut and weld up to 1/4" steel plate. A million uses for Home, auto, farm, inventors, factories, etc. Works from any home 110 volt plug-in. Complete with dark welder's mask, arc torch, supply of carbon steel welding and brazing rods and complete Welding Instruction Book. 1 year guarantee.

SEND ONLY \$3 (cash, ck. mo.) and pay postman \$11.95 plus COD postage on arrival or send \$14.95 and we will send postpaid. Ideal gift for mechanically minded, relatives, friends. Order now. Available only from:

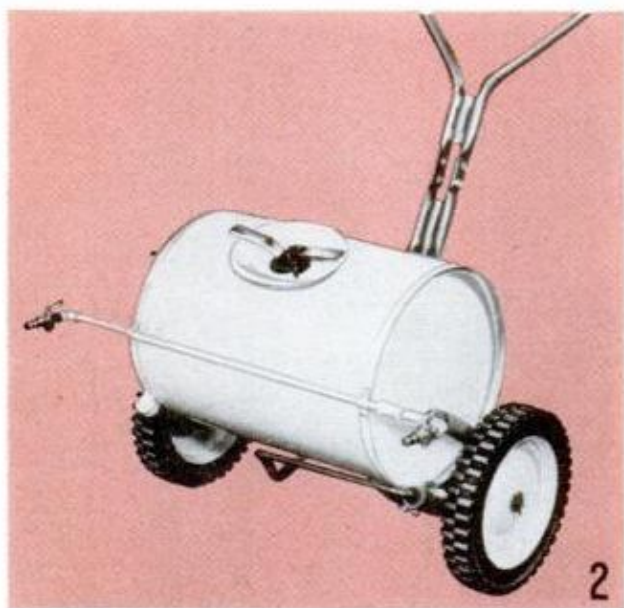
MIDWAY WELDER, Dept. DPM-5, Kearney, Neb.



On the market

1. TO SOLVE THE PROBLEM of finishing those squared ends on gypsum wallboard there's a new panel, said to provide smoother end joints and to reduce joint-finishing time. All four edges of panels come tapered to make joint finishing easier for amateur. Celotex Corp., 120 S. LaSalle St., Chicago 3, Ill.

2. WHEEL-PUMP SPRAYER, designed specifically for turf control, utilizes a pumping tube coupled with drive wheel. Sprayer "milks" measured amount of solution from tank, forcing it out the nozzle. The faster sprayer is pushed the more solution it sprays. Sold by Universal Metal Products Co., Saranac, Mich.



3. MAGNETIC HOLDER provides mounting base for trouble light in almost any position. Nuts, bolts and small tools may be stored on top of magnets. Unit supports flashlight and a variety of tools and equipment. Priced at \$6.98 and \$8.98. Automatic Tripod, Inc., 2337 South Michigan Ave., Chicago 16, Ill.

4. SHATTERPROOF SHOWER DOOR provides watertight enclosure with easy access to tub—may be folded back to either end. Unit combines an aluminum frame with accordion-folding sections made of polyethylene plastic. \$32.50 to \$47.50. Showerfold Door Corp., 5858 N. Pulaski Rd., Chicago 46, Ill.

5. CLEAR PLASTIC COATING is said to be impervious to burns and stains—even a dog scratching on door will seldom mar the finish. Use for wood floors, doors, paneling and furniture—also for boats. Protects metal against weathering and corrosion. Product of the Flecto Co., Inc., Berkeley, Calif.

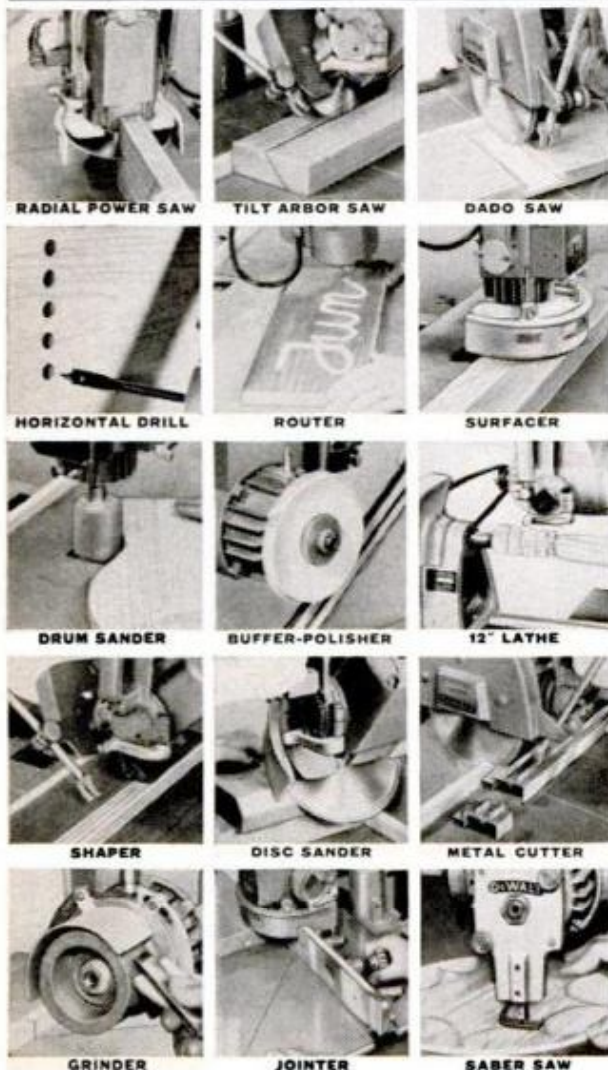


Still the wisest buy
for shopwise men

DeWALT



15 POWER TOOLS IN ONE!



Every shopwise man has always wanted to use and enjoy the all-purpose DEWALT POWER SHOP. This one compact, power-packed machine puts the "expert" touch in everything it makes. DeWalt is unmatched for safety and accuracy.

You're in for a real treat when you see a DeWalt demonstration. Try DeWalt...feel how smoothly and easily it works...and you'll want to own one. Visit your DeWalt dealer and see how easy he makes it for you to own a DeWalt. Mail coupon for more information.



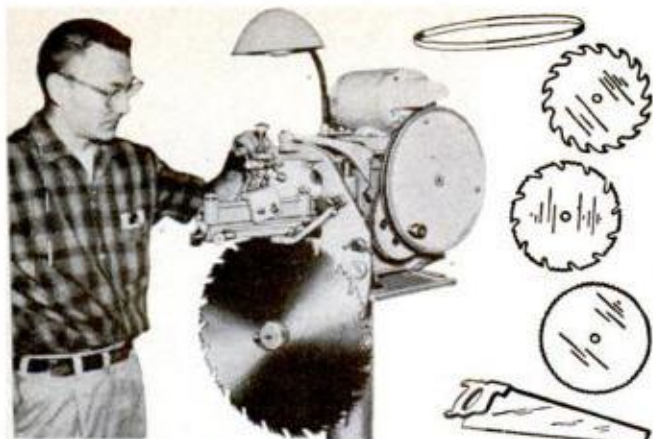
DeWALT, Inc. Dept. PM-562
A *Black & Decker* SUBSIDIARY
Lancaster, Pa.

- Please send me free 20-page CATALOG.
- Please send me name of nearest dealer.

Name _____

Address _____

City _____ State _____



CASH FILING SAWS

Here is a steady repeat CASH business you can start at home. No experience needed—no canvassing—every saw you sharpen will bring new customers. You can make up to \$3 or \$6 an hour—\$20 to \$30 a week in your spare time as a starter. "My spare time saw filing business has made me \$952 these first ten months," says R. T. Chapman.

The new model 200 Foley Saw Filer automatically sharpens combination (rip and crosscut) circular saws, hand saws, band saws and crosscut circular saws.

Free Book—"MONEY MAKING FACTS" shows you how to get into this CASH business. Time Payments if desired. Mail coupon now. No salesman will call.

FOLEY MFG. CO.
543-2 Foley Bldg., Minneapolis 18, Minn.

Send me free book "MONEY MAKING FACTS" and Time Payment Plan.

Name _____

Address _____

City _____ State _____



GO! Really GO!



on the brand new **BSA SPORTSMAN SS-90**

Gives you the quick, easy handling of a light-weight motorcycle, yet is powered by a big, husky 350 cc engine for flashing acceleration, capable highway speeds, and long service life. A beauty champion too, with new metallic enamels, lots of brilliant chrome.

BSA MOTORCYCLES

The most popular motorcycle in the world

Write to the nearest address for a colorfully illustrated free catalog of the new 1962 models.

Catalog offer limited to U. S. residents only.

West:

HAP ALZINA
Dept. P62
3074 Broadway
Oakland, California

East:

BSA INCORPORATED
Dept. P62
639 Passaic Ave.
Nutley, New Jersey

GUNK® removes grease -- scourfully! cleans -- degreases -- freshens



- power mowers • engines
 - cement floors • kitchen walls • ovens • exhaust ducts
 - paint brushes • furnace filters • barbecue grills
 - implements • machinery
- AT AUTO SUPPLY, FARM & HARDWARE STORES!**

GUNK CHICAGO CO., River Forest, Illinois
serving the Midwest and Southwest
RADIATOR SPECIALTY CO., Charlotte, N. C.
serving the East, Southeast and the West

END NUT and BOLT HANGOVERS

DOT Teenuts



Can't Slip ... Steel Threads in Wood
Flush-Mounted ... Strong ... Versatile!

The One Nut That Makes Sense!



Ideal for permanent work or where easy "knock-down" feature is wanted. Available to fit standard thread bolt sizes: 6-32, 8-32, 10-24, 10-32, 1/4-20, 5/16-18, 3/8-16. Available at

hardware dealers. If not, send \$1 for special mail order package and name of nearest distributor. Specify size.

COLUMBIA FASTENER COMPANY
3229 South Ashland Ave. • Dept. PM • Chicago 8, Illinois



Barbecue Grill for Boats

Boaters can have a barbecue afloat with a covered grill that has a gimbal suspension to keep it level. An ash catcher retains sparks. Made by Weber-Stephens Products Co., Wood Dale, Ill., it costs \$34.95.

SURPLUS SALE

GOVT. SURPLUS
EXCESS INVENTORY
BANKRUPT STOCK



ARMY AC GENERATOR

• Item #626. New, all ball bearing heavy duty 115-v 3,000 to 4,000-w, 60-c generator, 1,200 rpm. With voltage control and voltmeter. • Drive with tractor, auto engine, etc. Ready to use for farm, etc. Size 21" x 14" x 20". Wt. 260 lbs.

Govt. cost over \$800.

\$139.50

SALE. Many other Surplus Power Plants and Generators.

SELF PRIMING WATER PUMP



• Item #204. New Govt. Fine for boat, sump etc. Timken bearings, 1 1/2" intake and discharge ports. 3/4" shaft. Size 12" x 10" x 18". Wt. 32 lbs. Cost \$27.50.

\$19.49

AIR COMPRESSOR EQUIPMENT



• Make your own outfit. For painting, tires, shop use, etc. Save to 60%. • Compressor, \$21.50. Gov't Tank, \$10.95. Gauge, \$1.75. Paint Gun, \$11.50. Auto Switch \$4.75. Air Regulator \$3.95.

GOV'T. GEARED BATTERY MOTOR



• ITEM #564. . . Powerful geared-down motor. Runs on 6 or 12-volt battery. Use for golf car, boat or farm winch, etc. Speed 110 to 350 rpm. 24 to 1 gear ratio. Size 17" x 6". Weight

34 lbs. Cost Govt. Over \$250.00

\$18.95

SALE

BATTERY REMOTE CONTROL WINCH

• Item #322. Govt. DC hoist with push-button switch, 20' control cable.

• 35' 4000-lb. cable. High strength rating 1000-lbs. on 12-v. Fine for boats, docks, trucks, jeeps, farms, etc. Electric brake. Wt. 90 lbs. Size 12" x 14" x 8". Govt. cost \$395.

\$68.25

SALE

DIAL TELEPHONE

• Item #716. Std. phone, same used on all phone systems. Use as extension to main phone and on private systems. Directions furnished. Wt. 8 lbs.



\$7.95

Cost \$25.00. SALE

SPECIAL OF THE MONTH!

POWERFUL ARMY AIR HORN

• Item #102. Genuine Army Air Two Tone Horn. Will give powerful loud-clear tone—penetrating signal on moderate air pressure. • Fine for large trucks, sport cars, as factory "whistle", etc. • Use with air tank charged at filling station, or with small air compressor. Marvellous buy. Size 12 3/4" x 7" x 3 3/4". Wt. 3 lbs. Ind. List \$24.95.



\$12.95

EXAMPLE BARGAINS IN 1962 CATALOG

- \$ 40. 6-24 volt DC Gear Motor . . . \$ 5.31
- 55. Finest 7x50 Binoculars . . . 24.15
- 67. Survivors Level, rod, tripod . . . 50.25
- 12. Fish-Worm Shocker . . . 3.49
- 15. Massage Motor unit—110-V . . . 7.69
- 172. Engine Driven Weed Sprayer . . . 109.95
- 80. Army Self Prime 1 1/2" Pump . . . 19.49
- 25. 1-Ton Hand Hoist & Puller . . . 19.95
- 75. Electric Puller—12-V—1000 lb. . . 7.98

ALL ITEMS THIS AD FOB LINCOLN
Write today for large 1962 catalog.

SURPLUS CENTER

DEPT. 807, LINCOLN, NEBR.

INCREASE HOME VALUE—MAKE NEEDED IMPROVEMENTS NOW

NOW!

FOR THE FIRST TIME

THE PUSH-BUTTON IS IN THE ROD—



THE ALL-NEW BRONSON 63

... is the most advanced rod/reel combination, yet so unusually simple anyone can use it. Nothing like it anywhere. No line pinching or twisting. Level wind. Unitized drag control. All metal, heavy duty precision gearing. Reel finished in rich brown anodized aluminum. Perfect-balance 2-piece 6 1/2' Tubular Glass Rod. Comes with 100 yds. 10 lb. test monofilament. Available in left or right hand crank. Combination complete—sold anywhere. **\$32.95**

BRONSON BRONSON REEL COMPANY
ROCHESTER, MICHIGAN
Division of Higbie Manufacturing Co.

Send for Free Full Color Bronson Fishing Handbook



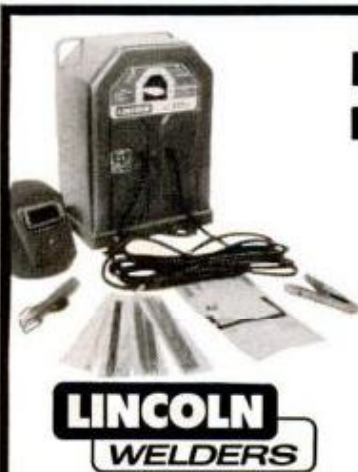
FREE EICO® CATALOG

Build Your Own Hi-Fi, Radios, Ham Gear, Test Instr.,—Save 50%

Get started in ELECTRONICS the easy EICO way. No technical knowledge needed to build EICO kits. Simple, step-by-step "Beginner-Tested" pictorial instructions guide you all the way. 106 beautiful kits to choose from. Mail coupon now!

EICO Electronic Instrument Co., Inc.
3300 Northern Blvd., L. I. C. 1, N. Y. PM-5
Please send free catalog and name of local dealer.

Name.....
Address.....
City..... Zone..... State.....



NEW 225-AMP AC LINCOLN WELDER

DELIVERED, WITH ACCESSORIES, ONLY **\$158⁰⁰**

This amazing buy is the only welder on the market selling for less than \$200 which will burn 3/16-inch electrodes. Does big jobs, fast. Exceptional arc stability allows use of new low-hydrogen electrodes which make strong welds even on steels which tend to crack. Also good for stainless, hardsurfacing and pipe thawing. Write to the World's largest manufacturer of arc welders and electrodes—The Lincoln Electric Company, Dept. 4722, Cleveland 17, Ohio.

**LINCOLN
WELDERS**



Lincwelder 100

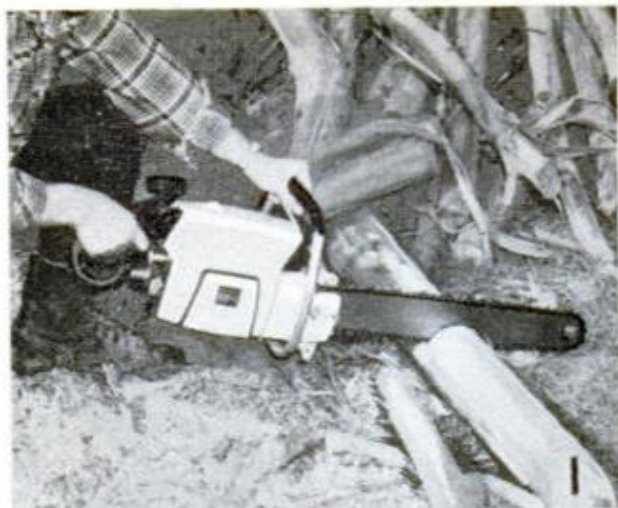
Burns 1/8" electrode. Arc torch for soldering, brazing. Wonderful hobby-shop welder.

AC-180-S

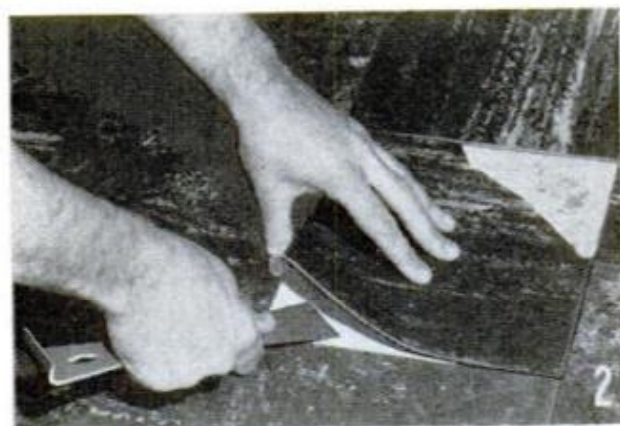
Burns 3/32" electrodes. Uses large arc torch for heating, bending, brazing. Hardsurfaces and thaws frozen water pipes. Ideal for farmers.



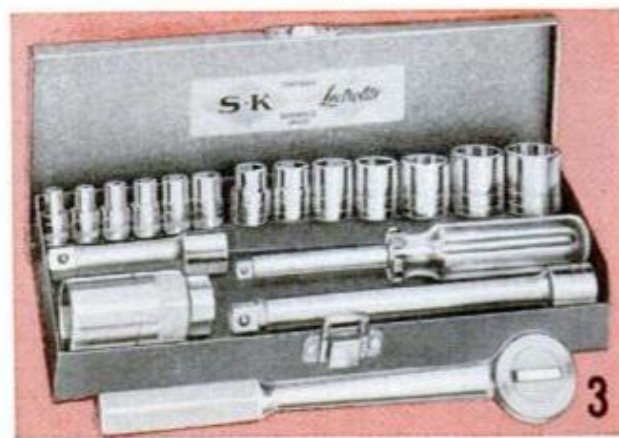
Shopping for tools



1. LIGHTWEIGHT CHAIN SAW features balanced piston engine. Basically, the engine has one power piston counterbalanced by second piston, which does not fire. Design is said to reduce vibration. Built-in grinder automatically sharpens chain. McCulloch Corp., 6101 W. Century Blvd., Los Angeles 45, Calif.



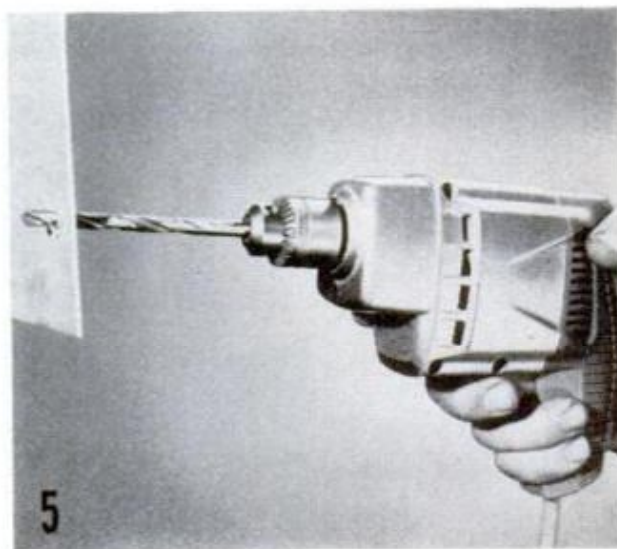
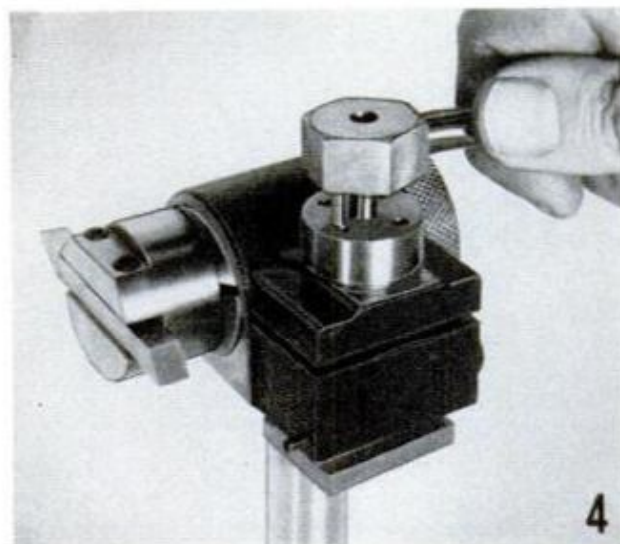
2. COMBINATION CHISEL-and-pry-bar is designed for such jobs as scraping, gouging and opening things. Made of high-carbon tool steel, Li'l Jimmie has a special eyelet in handle which slips over nail heads for fast, easy pulling. Priced at \$1.45. Made by Red Devil Tools, 2400 Vauxhall Rd., Union, N.J.



3. COMBINATION SOCKET-WRENCH SET includes 18 different pieces: Ratchet unit, spark-plug socket with neoprene insert, 2 extensions, 7 standard sockets, plus 6 standard 1/4-in. drive sockets and spinner handle—all in metal box. Priced at \$11.95. Sherman-Klove Co., 3531 W. 47 St., Chicago 32, Ill.

4. THIS 4-POSITION TOOL HOLDER is especially useful on a home workshop lathe. Attachment fits any standard lathe with 6- to 13-in. swing. Using holder, bit can be set higher or lower, tilted up or down, rotated or slid in and out on carriage. \$49.50. Latady Tool Co., Box 3064, Philadelphia 50, Pa.

5. PORTABLE DRILL (1/4-in.) moderately priced, includes bubble level which provides operator with greater accuracy and control in starting holes. Has built-in storage space in heavy-duty plastic handle for extra bits. Sells for \$16.95. Disston Div., H. K. Porter Co., Porter Building, Pittsburgh 19, Pa.



tune-up
you get ACTION with



For sharp springtime performance, pep up your car and mower with new AC Spark Plugs



You'll have more fun driving this spring, cut an easier swath with your mower and get surer-firing power in your garden power equipment by installing new AC Fire-Ring Spark Plugs.

ACs put new pep in winter-worn cars and season-tired implements. They give you fast starting and full-power action with the exclusive Hot Tip that burns off fouling deposits as they form. They give you positive protection against gas leakage and

overheating with heat-bonded inner seals. They give you wear-resisting electrodes and the famous extra-strong Buttress Top that lessens flashover misfiring.

Your car, yard and garden machines will run better *longer* with AC Fire-Ring Spark Plugs. Get set for spring by getting ACs for every engine you own! Remember, you get AC quality only under the AC name.

AC SPARK PLUG  THE ELECTRONICS DIVISION OF GENERAL MOTORS

AC FIRE-RING SPARK PLUGS



Amazing new clear finish dries faster—gives twice the wear!

Flecto Varathane is a remarkable new clear plastic finish

that dries dust-free in minutes, and lasts *twice* as long as varnish.

Flows right on *any* kind of wood, inside or out. Needs no sealer. Put it on siding, floors, kitchen cabinets, furniture, even boats. Comes in glossy or satin finish, regular can or easy-to-use aerosol container for quick touch-ups.

Note to users: Clean brush and equipment with mineral spirits. First coat covers 500 sq. ft. per gallon. Second coat covers 600-800 sq. ft.

If your nearby paint, hardware or building supply dealer doesn't carry it yet — or for free brochure — contact...

The Flecto Company Inc., P.O. Box 84, Berkeley 2, Calif.
Flecto Coatings, Ltd., 8850 Selkirk, Vancouver, B. C.



Three-Minute Color Processor

Amateur photographers may now make their own color prints with a processor that produces them from color negatives in three minutes. It's called the P-100 Printer.

The automatic model, a Pavelle Corp. product priced at about \$200, requires no darkroom and only two solutions, the color developer and bleach-fix, followed by a single wash. It's miniature computer automatically determines the right color balance and exposure. Prints up to 3½ inches square can be produced.

SAVE Clipper-Ship **CATHEAD POWER WINCH**
Attention YACHTSMEN • BOATMEN • FISHERMEN • SKIN DIVERS

Never before at such a low price! NOW... exclusive with Palley's. A light weight, power-brute winch to lift that anchor. Has up to 2000 lb. pull with a rope speed of 130 to 150 ft. per min. Operates on 6, 8 or 12 Volt D.C. current. Weighs only 37 lbs. Also available in a vertical through-the-deck model at \$99.50.

79⁹⁵

SAVE! 1/30HP ELECT. MOTOR
Surplus! Series wound, 28V. DC. Turns at Hi-RPM. Case is 1-5/8" x 2-19/32" long... **29⁵ EA.**

GIRAFFE NECK HOIST
Lifts 1500 lbs. Has 21-1 gear ratio, 40" arm w/pulley. Drum has 12ft. of 3/16" cable. Has winding handle & brake. **49⁹⁵**

HYDRAULIC CYLINDERS
No. H-60 — 1500 PSI Dbl. Action — 5/8" bore, 4-1/8" stroke, 7/16" shaft, 9-5/8" lgh. 1/4" ports. **37⁵**
No. H-84 — 1500 PSI Dbl. Action — 1-1/2" bore, 9/16" shaft, 14 1/2" lgh. adjustable stroke 1-3/16" to 4-3/8". **39⁵**
No. H-70E — 2000 PSI, Dbl. Action — 2-1/2" bore, 30" stroke, 40 1/2" eye-to-eye length, 1 1/2" shaft. Ideal for presses, tail gates, etc. **28⁸⁸**

WORLD'S MOST AMAZING CATALOG
260 PAGES of GOV'T SURPLUS
Factory Closeouts and Hard-to-Find Bargains!

From EVERYWHERE Palley's bring you products of every description and at **lower-than-wholesale 'DISCOUNT' prices.** Here you'll find bargains in Hand & Power Tools, Electric Motors & Generators, Sports & Outdoor Equipment, "Gadgets," Aircraft Instruments & Hardware, Winches & Hoists — PLUS World's largest on-the-shelf stocks of Hydraulic Cylinders, Pumps, Valves, Motors, etc. at **SAVINGS up to 85%.** Order Your Copy TODAY and SAVE!

Only 50c ORDER TODAY Your 50c will be refunded with your first order of \$1.00 or more.
TO COVER HANDLING & MAILING

TO ORDER — Send your Check or Money Order. Enclose 50% deposit with all C.O.D.s. All items are sent freight or postage collect.

palley's 2263 E. VERNON AVE., Dept. PM-52
LOS ANGELES 58, CALIF.

SHOOT

A STAPLE WHEREVER YOU'D DRIVE A NAIL!

Same Machine uses 6 Staple Sizes...

"ONE SQUEEZE AND YOU'VE NAILED IT!"

WITH AN **ARROW** Brooklyn 12, N. Y.

No. T-50 All-Purpose STAPLE GUN

Available at Hardware, Building, Lumber and Stationery Dealers Everywhere.
ARROW FASTENER CO., INC. 1 Junius St., Brooklyn, N. Y.

FROM

STANLEY[®]

FAMOUS FOR RULES,
SQUARES,
LEVELS

NEW

POCKET RULE WITH
LIFE GUARD * **YELLOW**
FINISH

* Stanley black-on-yellow
combination with special
super-tough blade finish
lasts 3 to 10 times longer!



Slim, trim pocket-size tape rules everybody should own! In 6, 8 and 10 foot lengths, 1/4" thin. Priced from only 99¢.

And for the professional craftsman, there are tape and wood folding rules in the Stanley family of LIFE GUARD YELLOW RULES that meet every measuring need. Black numbers and graduations on a yellow background mean easy, accurate readings under all job conditions. Life Guard Yellow finish resists most solvents, oils, alkalies and acids.

FREE OFFER!

Prove to yourself the superior values of Life Guard Yellow Rules. For a free 6-inch stick, write to Stanley Tools, Division of The Stanley Works, 625 Elm Street, New Britain, Conn.



No. X6LG—6 ft. Extension Rule (standard folding rule with 7" brass extension). \$2.69

No. MY312—12-ft. tape rule with Life Guard Yellow Blade, 3/4" wide. Blade is flexible, yet rigid for easy use. \$2.98



No. MY50, MY100—Long Tapes in 50 and 100 foot lengths. Foot and stud markings with 1/8" graduations. \$6.60 and \$9.25.



STANLEY

THE TOOL BOX OF THE WORLD

BIG JOB BOOM FORECAST!

Can You Get Ready in Time?

Right now job opportunities are tight all along the line. Economists now predict a period of mild ups and downs. Look for the "big break" to come in the next three years, they say. That's when good jobs will open up as never before. And men who are preparing themselves *now* will ride the crest of the boom.

DARK OUTLOOK FOR UNSKILLED WORKERS

Those with little or no training will find the going tough. Fewer openings. More competition for existing jobs. The tide is against the unskilled worker. It's getting stronger. Nor will the boom help. The new opportunities will go first to the skilled, next to the semi-skilled.

BIGGEST DEMAND IN THESE FIELDS

What's ahead? According to the best estimates, here are the industries due for the sharpest employment rise: Heavy transportation equipment. Mechanical, electrical, chemical, aeronautical and highway engineering. Industrial electronics.

All metals. Business services. Natural gas and oil. Paper products. On the other end of the scale, employment may lag in agriculture and leather. Check the trends in *your* field. Are you prepared to switch, if necessary?

GETTING YOURSELF READY—NOW

All the experts agree: Education, skill, specialized training will net the greatest rewards in the coming boom. The time you spend improving yourself is perhaps the wisest investment you can make *right now*. Your future success and happiness could hinge on your mastering a certain subject or acquiring a special skill. But there are obstacles. You may have a family to support. Or a job to hold down. You may feel you're too old to learn.

HOW I.C.S. CAN HELP YOU

For the man who can take his training hard and fast—without time off from his job or heavy expense—I.C.S. offers real advantages. A total of 259 courses to choose from (see partial list below). A spare-time

method that lets you progress as rapidly as you're able. Up-to-date, authoritative text material. Thorough, personalized instruction. Industry-recognized diploma to graduates. I.C.S. is the oldest and largest school accredited by the Accrediting Commission of the National Home Study Council. Its long list of successful graduates reads like "Who's Who."

Can you be ready for the next job boom? You can if you act quickly. Your first step: mark and mail the coupon below. What you do right this minute may determine how you make out in the coming boom!

THREE FREE BOOKS TELL HOW TO MEET NEXT JOB BOOM

Get the details on the fields that offer the best jobs in the immediate future. Get these three valuable books free—(1) "How to Succeed"—pocket-size guide to advancement, (2) Sample lesson (Math.) demonstrating the I.C.S. method, (3) Opportunity catalog on the subject you check in the coupon. Just mail the coupon.

For Real Job Security—Get an I. C. S. Diploma! I. C. S., Scranton 15, Penna.

Accredited Member,
National Home Study Council

INTERNATIONAL CORRESPONDENCE SCHOOLS



BOX H5419E, SCRANTON 15, PENNA. (In Hawaii, reply P.O. Box 418, Honolulu) (Partial list of courses)

Without cost or obligation, send me "HOW TO SUCCEED" and the opportunity booklet about the field BEFORE which I have marked X (plus sample lesson):

ARCHITECTURE and BUILDING CONSTRUCTION

- Air Conditioning
- Architecture
- Arch. Drawing and Designing
- Building Contractor
- Building Estimator
- Carpenter Builder
- Carpentry and Millwork
- Heating
- Painting Contractor
- Plumbing
- Reading Arch. Blueprints

ART

- Commercial Art
- Magazine Illus.
- Sign Painting and Design's
- Sketching and Painting

AUTOMOTIVE

- Automobile
- Auto Body Rebuilding and Refinishing
- Auto Engine Tuneup
- Auto Electrical Technician
- Diesel Engines

AVIATION

- Aero-Engineering Technology
- Aviation Engine Mech.
- Reading Aircraft Blueprints

BUSINESS

- Accounting
- Advertising
- Bookkeeping and Cost Accounting
- Business Administration
- Business Management
- Clerk Typist
- Creative Salesmanship
- Managing a Small Business
- Professional Secretary
- Public Accounting
- Purchasing Agent
- Real Estate Salesmanship
- Salesmanship
- Salesmanship and Management
- Traffic Management

CHEMICAL

- Analytical Chemistry
- Chemical Engineering
- Chem. Lab. Technician
- General Chemistry

CIVIL ENGINEERING

- Civil Engineering
- Construction Engineering
- Highway Engineering
- Professional Engineer (Civil)
- Reading Struc. Blueprints
- Sanitary Engineer
- Sewage Plant Operator
- Structural Engineering
- Surveying and Mapping
- Water Works Operator

DRAFTING

- Aircraft Drafting
- Architectural Drafting
- Drafting & Machine Design
- Electrical Drafting
- Electrical Engineer Drafting
- Industrial Piping Drafting
- Mechanical Drafting
- Sheet Metal Drafting

ELECTRICAL

- Electrical Appliance Servicing
- Electrical Engineering

ELECTRIC MOTOR REPAIRMAN

- Elec. Engr. Technician
- Elec. Light and Power
- Practical Electrician
- Practical Lineman
- Professional Engineer

HIGH SCHOOL

- Good English
- High School Diploma
- High School General
- H. S. College Prep. (Eng'g & Science)
- High School Math
- High School Science
- Short Story Writing

LEADERSHIP

- Industrial Foremanship
- Industrial Supervision
- Personnel-Labor Relations
- Supervision

MECHANICAL and SHOP

- Diesel Engines
- Gas-Elec. Welding
- Heating and Air Conditioning
- Industrial Engineering
- Industrial Instrumentation

INDUSTRIAL SAFETY

- Industrial Safety
- Machine Shop Practice
- Mechanical Engineering
- Plumbing and Heating
- Professional Engineer
- Quality Control
- Reading Shop Blueprints
- Refrigeration and Air Conditioning
- Tool Design
- Tool Making

RADIO, TELEVISION

- General Electronics Tech.
- Industrial Electronics
- Practical Radio-TV Eng'r's
- Radio-TV Servicing
- TV Technician

RAILROAD

- General Railroad

STEAM and DIESEL POWER

- Combustion Engineering
- Power Plant Engineer
- Stationary Diesel Eng'r.
- Stationary Steam Engines

TEXTILE

- General

Name _____ Age _____ Home Address _____

City _____ Zone _____ State _____ Working Hours _____ A.M. to P.M. _____

Occupation _____ Canadian residents send coupon to International Correspondence Schools, Canadian, Ltd., Montreal, Canada. . . . Special low monthly tuition rates to members of the U. S. Armed Forces.



This sander leads a double life— it's a paint remover, too

Here's a tool that doesn't stop at finishing jobs on woods, masonry and metals—but lets you handle paint removing, too—without gouging!

This Porter-Cable Disc Sander, equipped with an exclusive *Paint Removing attachment*, works *twice* as fast as any other method. Vertical-horizontal adjustments eliminate gouging or marring—even permit working flush to clapboard overhang.

Get this bonus paint remover feature—plus professional ease on all other

sanding jobs—with Porter-Cable Model 304 PR (illustrated above)—only \$74.50. Your Porter-Cable dealer will gladly demonstrate—he's listed under TOOLS, ELECTRIC in the Yellow Pages.

Write for FREE LITERATURE— Porter-Cable Machine Company, Subsidiary of Rockwell Manufacturing Company, 502E N. Lexington Avenue, Pittsburgh 8, Pa.



Portable Disc Sander is equipped with powerful 4.0 amp. motor, converts with accessories for drilling, buffing, grinding and cutting. Available with regular abrasive or Tungsten Carbide Discs.





28 horses

... you can lead them to water  for less than you think!

Full size fun at a "compact" price! If you own an undersized motor and want more power for skiing or a roomier fishing rig, take a look at Speeditwin's rugged power and reasonable price. If you're still a landlubber looking for the right outfit that's big enough for far-ranging family adventure, yet compact enough for easy trailering and launching... Speeditwin is the ticket for those "million dollar weekends." ■ Speeditwin has the same cushioned power as the most expensive Evinrude models. For economy's sake, we've eliminated thermostat control, fixed-jet carburetion, and automatic choke (luxury features you won't find on most motors at any price). But when it comes to quality, rugged construction and performance, we've made no compromise. Speeditwin was designed to be the standout value in its power class. See it at your Evinrude dealer now.

(In Canada: Peterborough, Ont.) A Division of Outboard Marine Corporation.

Ask for free 1962 Evinrude catalog.
Look for his name in your
phone book, or write:
Evinrude Motors, 4219 N. 27th St.,
Milwaukee 16, Wis.

EVINRUDE

OUTBOARD



MOTORS