

POPULAR MECHANICS®

APRIL 1962
VOL. 117 NO. 4

INTERNATIONAL EDITIONS • SPANISH: Mexico-Caribbean, Southern Hemisphere • FRENCH •

Features of Special Interest

'Sputniks' Orbit the Supermart - - - - -	85
Owners Report on the Falcon - - - - -	92
Owners Report on the Pontiac - - - - -	96
The Celebrated Jumping Frogs - - - - -	104
Don't Let the Cries of Doomsday Panic You - - - - -	113
I Fished the Finest Spot in North America - - - - -	118
Armload of Power - - - - -	128
You Can Win the War on Weeds - - - - -	132
Are These the New Airliners? - - - - -	138
PM Shopping Guide: Tents - - - - -	144

For the Craftsman

Lawn Sweeper Uses Old Mower Parts - - - - -	150
Safe Electric Touring Car - - - - -	156
Animated Easter Egg - - - - -	163
Start Your Vacation Home at Home—Part III - - - - -	166
Regulator and Generator Checks - - - - -	172
Building the PM Jet—Conclusion - - - - -	176
Appliance Fix-It File: Vacuum Cleaner - - - - -	182
Working With Sheet Metal - - - - -	184
Tape Sync for Slide Projector - - - - -	193
Ten Ways to Improve AM Radio Reception - - - - -	194

Address communications to: 200 E. Ontario St., Chicago 11, Illinois. **SUBSCRIPTION SERVICE:** Mail all subscription orders, changes of address, correspondence concerning subscriptions, and Postmaster notices of undeliverable copies to Popular Mechanics, 250 West 55th St., New York 19, N. Y.

Published by Popular Mechanics Company, RICHARD E. BERLIN, *President*

CLIFFORD B. HICKS
Editor

RICHARD E. DEEMS
Executive Vice-President

JOSEPH R. BUELL, JR.
Publisher

Managing Editor: DON DINWIDDIE
Assistant Managing Editor: JOHN A. LINKLETTER
Shop and Crafts Editor: WAYNE C. LECKEY
Eastern Editor: RICHARD F. DEMPEWOLFF
959 Eighth Ave., New York 19, N. Y.
Western Editor: THOMAS E. STIMSON, JR.
Suite 1003, 3460 Wilshire Blvd., Los Angeles 5, Calif.
Art Director: HENRY M. NEHRBASS
Automotive Editor: JAMES R. WHIPPLE
Associate Editors: W. CLYDE LAMMEY, WALLACE MYERS
Electronics Editor: BYRON G. WELS

Assistant Editors: JAMES BIERY, KEVIN V. BROWN
ROBERT L. HERING, R. B. KIRKPATRICK
ARTHUR MIKESSELL, BIL TOMAN, RICHARD WILLIFORD
Assistant Art Director: LEO R. WEEKS
Art Editor: RICHARD A. POTTS
Chief Photographer: FRANK P. FRITZ
International Editor: HEINZ P. SCHLICHTING
Ritterstrasse 26, Karlsruhe/Bd., Germany
Advertising Manager: FRANK R. DUPUY
959 Eighth Ave., New York 19, N. Y.
Advertising Production: DOROTHY M. WINER
Director, Bureau of Information: ALLAN CARPENTER



Only AC Fire-Ring Spark Plugs offer the amazing self-cleaning Hot Tip for all cars!

Here at the business end of an AC Fire-Ring Spark Plug you see the key to AC's self-cleaning action. It's the red-hot recessed insulator in the center of this photograph . . . the famous Hot Tip. It's an AC exclusive and it's the only spark plug that provides self-cleaning action for *all* cars!

This insulator is the thinnest and the toughest made. It heats rapidly, cools rapidly; burns off harmful deposits as fast as they form. What's more, this extra-thin construction allows the white hot com-

bustion gases to swirl around the insulator—actually searing it clean while you drive.

What does this mean to you? Just this: AC's exclusive brand of self-cleaning action, found only under the AC name, can give your engine *longer peak performance* and *better gasoline economy*. So, next time you ask for action . . . ask for AC Fire-Ring Spark Plugs with the amazing self-cleaning Hot Tip.

AC SPARK PLUG  THE ELECTRONICS DIVISION OF GENERAL MOTORS

self-cleaning,
you get **Action** with



**FIRE-RING
SPARK PLUGS**



**moving machine
either side of the line!**

Pontiac Catalina

There's a good deal more to driving than a straight-line quarter-mile, and nobody knows that better than the performance-minded. Which is why Pontiac's Catalina shows up so often among you people.

One of the reasons for this popularity is the choice of engine/transmission teams. Standard equipment is a 215-hp Trophy V-8 hooked up to a three-speed stick, of course. But you can get a storming 405-horse engine and heavy-duty four-speed as extra-cost options. And other extra-cost options blanket the area in between, including automatics.

Wide-Track and Pontiac's own special han-

dling precision come standard with the Catalina, naturally. So does a fat helping of pure luxury.

The great thing is that a new Catalina goes easy on your bankroll—this is Pontiac's lowest-priced full-sized series. Talk it over with your Pontiac dealer first chance you get. Plan to spend some time with him—you could use up a whole day just looking through that list of options, and a happier time you couldn't imagine.

(Oh, and if you'd like to check your Cat against the clocks, feel free. No fair making the Catalina do the pushing while the dragster has all the fun.) Pontiac Motor Division, General Motors Corporation.

If you wish additional sources of information for the articles in this issue, or if you wish the name and address of the manufacturer of a particular product shown here, write to Bureau of Information, Popular Mechanics, 200 E. Ontario St., Chicago 11, Ill. Ask for the free "Where-to-Find-it-List" for this issue.

DANISH • SWEDISH • GERMAN • PORTUGUESE • DUTCH

Departments

Over the Editor's Desk - - - -	8
Tune In on the Inventors - - - -	14
Spotlight on the Citroen Sahara -	16
On the Market - - - - -	22
Items From All Outdoors - - - -	26
Science Overseas - - - - -	30
Worth Writing For - - - - -	42
Science Bulletins - - - - -	52
Sidelights on Aviation - - - - -	78
Shopping for Tools - - - - -	82
Detroit Listening Post - - - - -	89
What's New for Your Home - - -	126
Solving Home Problems - - - -	161
Clinic for Homemakers - - - -	198

Next Month . . .

A master sergeant tells you how the guerilla war in Vietnam looks—through the sights of an M-1 rifle . . . Owners give you their opinions of the new Buick V6 and Ford Fairlane, after driving them over a million miles . . . A racing expert speculates on whether or not the Indianapolis race is in a rut . . . and maintenance-weary homeowners learn how to keep paint from peeling.

ADVERTISING OFFICES—Chicago: 200 E. Ontario St., Whitehall 4-0100; New York: 959 Eighth Ave., Columbus 5-7300; Detroit: General Motors Bldg., TRinity 5-8711; Cleveland: Hanna Bldg., 1422 Euclid Ave., PRospect 1-0456; Los Angeles: 3460 Wilshire Blvd., DUNkirk 2-8458; San Francisco: 111 Sutter St., YUKon 2-0823.

Published monthly by Popular Mechanics Company, 200 E. Ontario St., Chicago 11, Ill. Richard E. Berlin, President; Richard E. Deems, Executive Vice-President; Fred Lewis, Vice-President and General Manager; John R. Miller, Vice-President; Joseph R. Buell, Jr., Vice-President; G. O. Markuson, Treasurer; R. F. McCauley, Secretary. Single copy in the United States and Canada, 35 cents. Subscription prices: United States and Possessions, \$4.00 for one year; \$7.00 for two years; \$9.00 for three years. Canada, add \$0.50 for each year. Pan-American Postal Union countries, add \$1.00 for each year. All other countries, add \$2.00 for each year. If you plan to move, notify us at least 30 days in advance so you will not miss an issue. Give both your old and new addresses. Second-class postage paid at Chicago, Illinois, and at additional mailing offices. Authorized as second class mail by the Post Office Department, Ottawa, and for payment of postage in cash. Registered as Second Class Matter at the Post Office at Mexico, D.F., Mexico, June 20, 1950. © 1962 by Popular Mechanics Company. All rights reserved. Printed in the United States of America.



"Hot Dog"
Tailpipe
page 112



Finest
Fishing
Spot?
page 118



Chopper
Airliners
page 138



Make an Old
Mower Sweep
page 150



Camera
Gun Stock
page 190

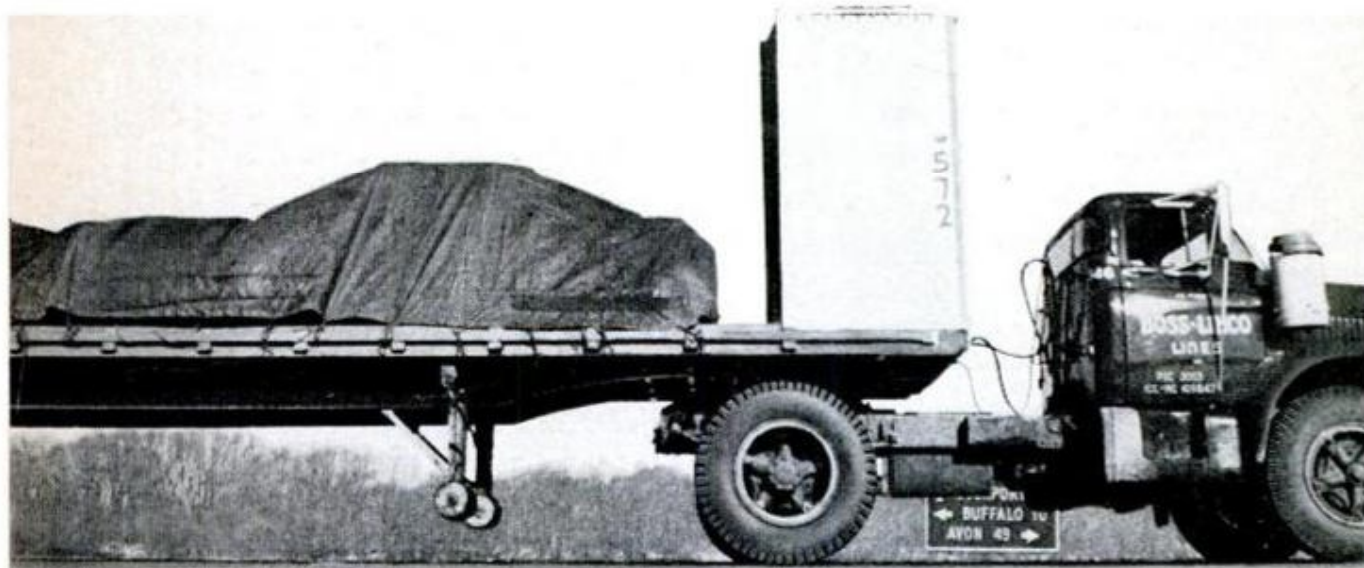
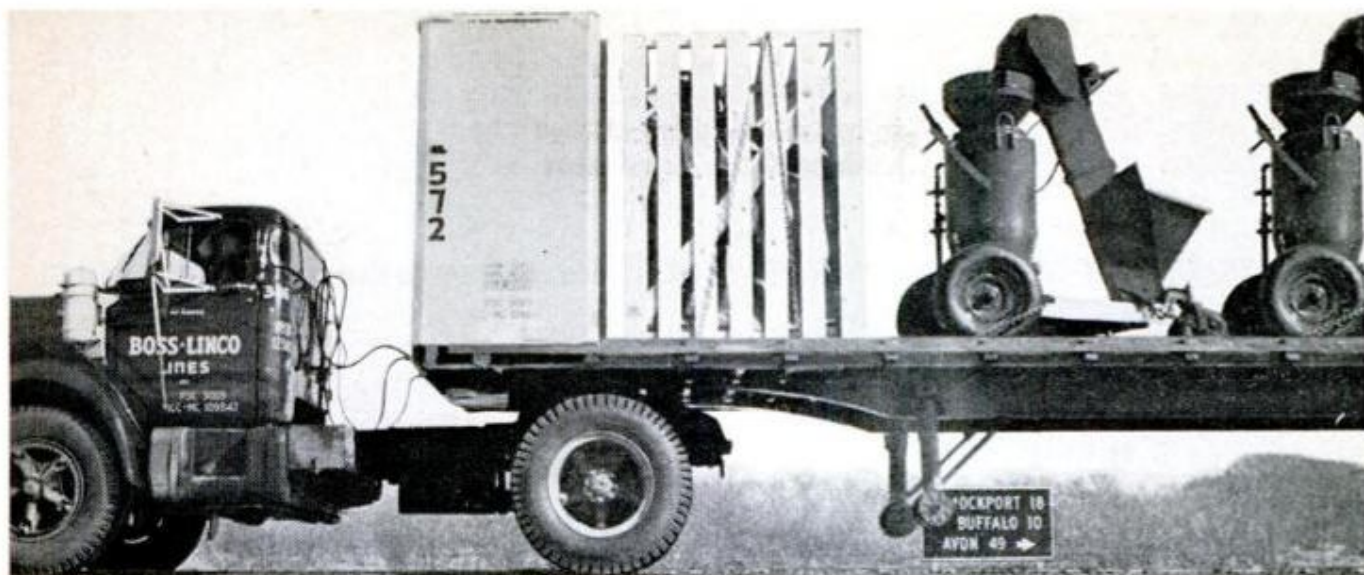

New tire brings you back "free"!

One inescapable thing in trucking is that a "run" means a "round trip."

You have to figure *most any* truck tire will get you there and back. But Goodyear's new Super Cross-Rib truck tires get you back "free"!

How come? Simple. Super Cross-Rib *doubles your drivewheel mileage* over ordinary tires.

Big reason for the bonus: A "dual compounded" tread—actually two treads—up to 60% thicker than

in ordinary tires. The outer tread is super-toughened to run farther. The inner tread is more resilient to restrict flexing and reduce heat buildup—a major cause of tire failure.

So when you think of any "run," think of Super Cross-Rib. The cost of getting there is the same. Super Cross-Rib gets you back "free." See your Goodyear Dealer or Goodyear Service Store today. Goodyear, Akron 16, Ohio.

ANOTHER REASON WHY: MORE TONS ARE HAULED ON GOODYEAR

GOODYEAR

This One



NY5D-1YN-BT2A

If you wish additional sources of information for the articles in this issue, or if you wish the name and address of the manufacturer of a particular product shown here, write to Bureau of Information, Popular Mechanics, 200 E. Ontario St., Chicago 11, Ill. Ask for the free "Where-to-Find-it-List" for this issue.

DANISH • SWEDISH • GERMAN • PORTUGUESE • DUTCH

Departments

Over the Editor's Desk - - - -	8
Tune In on the Inventors - - - -	14
Spotlight on the Citroen Sahara -	16
On the Market - - - - -	22
Items From All Outdoors - - - -	26
Science Overseas - - - - -	30
Worth Writing For - - - - -	42
Science Bulletins - - - - -	52
Sidelights on Aviation - - - - -	78
Shopping for Tools - - - - -	82
Detroit Listening Post - - - - -	89
What's New for Your Home - - -	126
Solving Home Problems - - - - -	161
Clinic for Homemakers - - - - -	198

Next Month . . .

A master sergeant tells you how the guerilla war in Vietnam looks—through the sights of an M-1 rifle . . . Owners give you their opinions of the new Buick V6 and Ford Fairlane, after driving them over a million miles . . . A racing expert speculates on whether or not the Indianapolis race is in a rut . . . and maintenance-weary homeowners learn how to keep paint from peeling.

ADVERTISING OFFICES—Chicago: 200 E. Ontario St., Whitehall 4-0100; New York: 959 Eighth Ave., Columbus 5-7300; Detroit: General Motors Bldg., TRinity 5-8711; Cleveland: Hanna Bldg., 1422 Euclid Ave., PRospect 1-0456; Los Angeles: 3460 Wilshire Blvd., DUNkirk 2-8458; San Francisco: 111 Sutter St., YUKon 2-0823.

Published monthly by Popular Mechanics Company, 200 E. Ontario St., Chicago 11, Ill. Richard E. Berlin, President; Richard E. Deems, Executive Vice-President; Fred Lewis, Vice-President and General Manager; John R. Miller, Vice-President; Joseph R. Buell, Jr., Vice-President; G. O. Markuson, Treasurer; R. F. McCauley, Secretary. Single copy in the United States and Canada, 35 cents. Subscription prices: United States and Possessions, \$4.00 for one year; \$7.00 for two years; \$9.00 for three years. Canada, add \$0.50 for each year. Pan-American Postal Union countries, add \$1.00 for each year. All other countries, add \$2.00 for each year. If you plan to move, notify us at least 30 days in advance so you will not miss an issue. Give both your old and new addresses. Second-class postage paid at Chicago, Illinois, and at additional mailing offices. Authorized as second class mail by the Post Office Department, Ottawa, and for payment of postage in cash. Registered as Second Class Matter at the Post Office at Mexico, D.F., Mexico, June 20, 1950. © 1962 by Popular Mechanics Company. All rights reserved. Printed in the United States of America.



"Hot Dog"
Tailpipe
page 112



Finest
Fishing
Spot?
page 118



Chopper
Airliners
page 138



Make an Old
Mower Sweep
page 150



Camera
Gun Stock
page 190

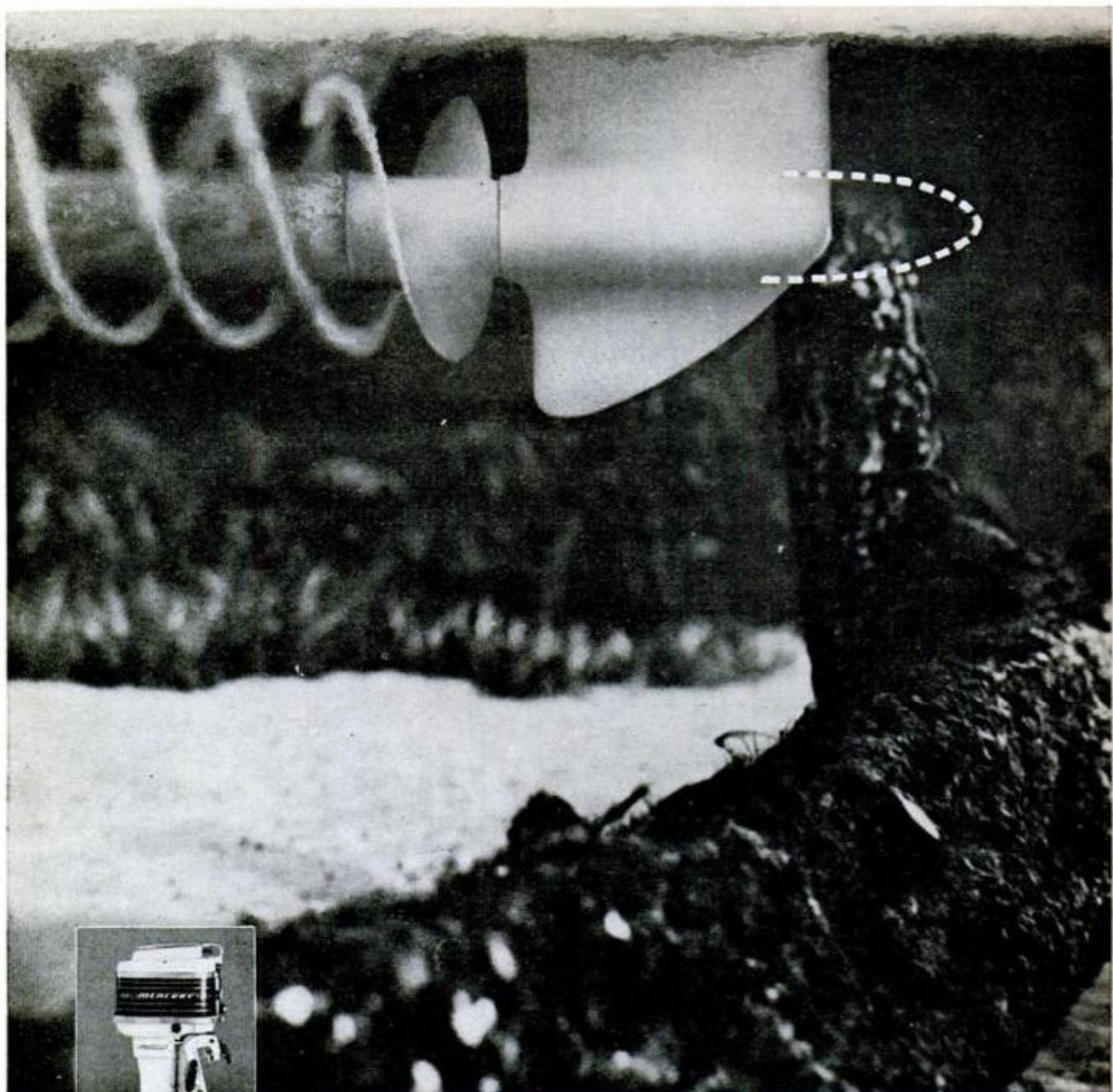

Photographed underwater at Florida's Silver Springs



No Snag, No Drag

Ever take a fish's-eye view of a Mercury? It may give you a new slant on the differences between outboards.

All Mercury outboard motors have a streamlined one-piece lower unit that glides over unseen obstacles. There's no protruding nose to snag on weeds, logs, or trotlines.

And, speaking of lower units, did you know that a driving propeller creates a vacuum behind its hub? It does. And, this vacuum cuts down mph and mpg.

Not so with Merc. Merc's exhaust fires out the center of the prop, destroying the drag, burying the noise and fumes. (We call it "Jet-Prop.")

No snag, no drag with Mercury. Just more RUN for your money!

MERCURY

**100, 85, 70, 50, 45, 25, 9.8, and
6 horsepower outboards**

© 1962, Kiekhaefer Corporation, Fond du Lac, Wis.



When other
truck tires
are
retread bound...

Firestone
TRANSPORT-100's
are still
covering ground!

MONEY SAVING EXTRA MILEAGE WITHOUT PREMIUM PRICE ON FREE ROLLING WHEELS AND GREATLY INCREASED MILEAGE ON DRIVE WHEELS! These are the gains documented by independent fleet owners after millions of miles of ferrying cargo on Firestone Transport-100 tires. Two advances in particular: (1) the Transport-100's new broad center rib that reduces squirming and scuffing, and (2) its wide, flat tread face that strengthens grip and minimizes uneven wear. No premium price, either! Order Transport-100's in nylon or Tyrex® rayon cord, tubeless or tubed, at your Firestone Dealer or Store.

©T. M. of Tyrex, Inc.

Always Specify Firestone Tires on New Trucks and Trailers
Copyright 1962, The Firestone Tire & Rubber Company Transport® T. M. Firestone

MEMBER  AMERICAN TRUCKING INDUSTRY

Over the editor's desk

Metallic Brake Linings

After reading your January article on Velvetouch Metalik brake linings, I decided to put a set on my '60 Falcon. When I went into a local auto-parts store, the owner said he couldn't get the linings and wouldn't recommend them if he could. He said metallic linings would cause undue wear on my brake drums.

Salinas, Calif.

LYNN HETTRICK

A few years ago, your store owner might have been right. But the amount of drum wear caused by Velvetouch Metalik linings is an insignificant .0002 to .0003-inch per thousand miles of vehicle travel. That's equal to or less than the wear caused by quality conventional asbestos linings. As for obtaining the Velvetouch linings, R. C. Bringleb of the S. K. Wellman Co., 200 Egbert Rd., Bedford, Ohio, can tell you where to find them in your area.

Buy Direct From Detroit?

I would like to buy a General Motors automobile from the Detroit factory. This would save me a great deal of money by excluding the dealer's profit.

San Francisco, Calif.

V. L. BUXBAUM

You can take delivery at the factory and save freight but your local dealer still "makes the sale" and gets the profit—there's no way of bypassing him. That profit, incidentally, is what keeps him in business so that when you need a fender, voltage regulator or transmission adjustment in Elk's Knee, Montana, somebody's around with \$500,000 worth of parts and shop equipment and four or five mechanics to serve you.

Won't Roll in the Chop

This Swish, from your March-May 1958 plans, was fun to build with ordinary carpenter's tools and it is more than fun boating with it. With a 40 hp. Mercury and my wife and myself in the boat, we have had



it up to 30 m.p.h. by our boat speedometer, and up to 25 m.p.h. pulling a teen-age skier.

We have come across the often-choppy Chain of Lakes with a strong cross wind and the boat was stable, easy to keep on course and had no tendency to roll.

Brookfield, Ill.

ERNEST V. THOMPSON

Posterity's Dim View

With the cost of iron and steel what it is, I see nothing bright about catapulting junked autos to the bottom of the sea from the deck of a carrier (page 154, Feb. PM). Why aren't the junked cars salvaged for their steel instead? We are a wasteful nation.

Philadelphia, Pa.

ANDY VENA

... Posterity will think little of these generations when it looks back at the record and down into those empty iron mines. Grand Rapids, Mich.

J. R. HARMAN

We're inclined to agree that some promotion man's bright idea for dramatizing the need to get junk autos off the highways was rustier than he realized.

Whoosh!

Under your February picture of the Seattle World's Fair 600-foot Space Needle, you stated it would be served by two 800-foot-per-second elevators. The ride of 600 feet in less than a second would not be too bad but it is going to be hard on people when the elevator stops.

Jackson, Tenn.

JOHN SAWYER

Not as hard as we were on the proof-reader who seconded his minutes.

Quick-Wit Disagreement

I disagree with the answer to situation 9 of your Test Your Quick-Wit Quotient (Jan. '62 PM). Why not open the hood and pull the center wire from the distributor? This will stop the engine. . . .

Villanova, Pa.

JOHN ZUCKER

The idea of pulling out the wire (which many other readers also suggested) would be good were it not for the danger of the child inside the car pulling the automatic-shift lever into Drive while you were in front struggling with the hood latch. People have been pinned and injured by the creep action of an automatic transmission car which is set on a high idle.

Football Offensive

Mr. Foss (Editor's Desk, Feb. PM) states soccer is harder to play and requires more courage and skill than football. I doubt he

(Continued to page 10)

**Stop wasting time in a dead-end job!
Enjoy the big rewards offered the
Law-trained man in business**

EARN A LAW

DEGREE

in your spare time at home



WHATEVER your present position—whatever your previous schooling—you can multiply your opportunities for rapid promotion, big income and prestige through LaSalle Law Training at home.

A knowledge of Law is regarded today as indispensable equipment in every activity of business. The greatly increased role of government in business, the many new problems of Law involving taxes, insurance, contracts, liability, employment, and much more—all require the legally-trained executive who can make day-to-day decisions effectively. That is why leading corporations seek out such men for key positions and reward them with top salaries.

You can master Law easily and enjoyably at home—at remarkably low cost—under the supervision of LaSalle's distinguished Law faculty. You work with actual legal cases, acquiring real experience. Upon completion of your training, you are awarded a Bachelor of Laws degree if qualified. *The famed LaSalle Law Library of 14 volumes is given to you as part of your course.*

Send for this Free Book For 54 years LaSalle has been an acknowledged leader in business training, with more than 1,000,000 students. Send for the free book "Law Training for Leadership" and see how LaSalle can help you move up rapidly in your career. Address: 417 So. Dearborn St., Chicago 5, Ill.

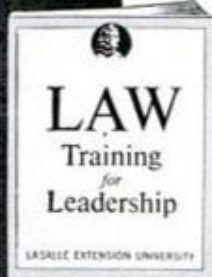

LA SALLE EXTENSION UNIVERSITY

An Accredited Correspondence Institution
417 South Dearborn St., Dept. L04-040, Chicago 5, Ill.

Please send me, free of cost or obligation, your illustrated book "Law Training for Leadership."

Name Age ...

Address County

City &

Zone State

210

has ever put a block on a big defensive lineman or tackled a charging fullback. I have and I have also played soccer and I can say football requires more courage, skill and stamina than any other sport.
 Brooklyn, N.Y. NOEL INZERVILLE

Football is not only a game of brute strength but of brains. A player must try to outwit his opponent and it takes great skill for a football team to work as a unit with perfect timing . . .
 Freeport, Ill. FRED CREMER

Perhaps you football fans would like to engage Mr. Foss in another challenging sport—boxing.

Careful Scot

Our favorite Scotsman is George Blow, the boating specialist in PM's Art Department. Born in Dundee, Scotland, George got his introduction to boating on the River Tay.

We've often wondered how George managed to achieve such a fine record for accuracy in his boat construction drawings. They are more accurate and comprehensive, in fact, than some we've seen produced by naval architects. The other day we learned the answer—when we came



upon George putting the finishing touches on a scale model of the PM Jet boat (page 176). Seems that George builds them before he draws them, to make sure the construction details are correct and clearly shown.

That's not a bad idea, particularly for any project as complex as a boat. Do any of you boat builders "miniaturize" your projects first?

The Editors

LOOKING FOR LONG WEAR IN SERVICE SHOES?

TRY **shaw** SHOES

WITH **NEOPRENE SOLES!**



Style "Chet"

Dress oxford style, work shoe ruggedness, plus the important comfort features that make shoes a joy to wear. Toe-to-heel cushioned insoles, steel arch supports, cushion side arch supports, metatarsal pads. All add up to a combination of features that make SHAW service shoes top sellers with men whose work is tough on shoes.

The long wear you get is no accident. Both soles and heels are of oil-resistant DuPont Neoprene. Rugged and resilient Neoprene resists grease, chemicals and cold-weather cracking as well. You'll find it on many lines of quality service shoes. Write Dept. PM-4-NS, Wilmington 98, Del.



Better Things for Better Living . . . through Chemistry

Ask for Neoprene soles the next time you buy service shoes.

HOW TO MAKE YOUR BOSS SIT UP AND TAKE NOTICE

Best way we know of is to come up with the right answers on the job. Show him you have the drive and ambition it takes to get ahead.

How? By getting the right kind of training... training that enables you to come up with the right answers. Nowadays the crying need in business and industry is for men with special knowledge—skilled technicians, plant and office workers who have more to offer than on-the-job experience.

Without the right training you're just another one of the millions competing for the same, dull routine jobs, the same low salary.

But—when you have the right kind of training your boss can't help but sit up and take notice of you. He can see you're a man who is prepared to move ahead.

Now is the time to act! Choose the kind of training you need to get ahead from success-proven I.C.S. Courses—259 in all. Each I.C.S. Course was developed



by business and industry leaders who know—who can tell you—what you need to go places.

The instruction is practical, down-to-earth. What you learn has immediate "cash value." No waiting to see results. Students report increased earnings within as little as three months.

You get personalized guidance. Study in your spare time—at your own pace. Chances are by the time you get your coveted I.C.S. diploma you're already on your way to a better job, bigger pay.

Don't wait another day. Start this minute to make your boss sit up and take notice of you. Mark and mail the coupon.

For Real Job Security—Get an I. C. S. Diploma!

I. C. S., Scranton 15, Penna.

Accredited Member,
National Home Study Council

INTERNATIONAL CORRESPONDENCE SCHOOLS



BOX B7419D, SCRANTON 15, PENNA.

(In Hawaii, reply P.O. Box 418, Honolulu)

(Partial list of courses)

Without cost or obligation, send me "HOW to SUCCEED" and the opportunity booklet about the field BEFORE which I have marked X (plus sample lesson):

ARCHITECTURE and BUILDING CONSTRUCTION

- Air Conditioning
- Architecture
- Arch. Drawing and Designing
- Building Contractor
- Building Estimator
- Carpenter Builder
- Carpentry and Millwork
- Heating
- Painting Contractor
- Plumbing
- Reading Arch. Blueprints

ART

- Commercial Art
- Magazine Illus.
- Sign Painting and Design'g
- Sketching and Painting

AUTOMOTIVE

- Automobile
- Auto Body Rebuilding and Refinishing
- Auto Engine Tuneup
- Auto Electrical Technician
- Diesel Engines

AVIATION

- Aero-Engineering Technology
- Aviation Engine Mech.
- Reading Aircraft Blueprints

BUSINESS

- Accounting
- Advertising
- Bookkeeping and Cost Accounting
- Business Administration
- Business Management
- Clerk Typist
- Creative Salesmanship
- Managing a Small Business
- Professional Secretary
- Public Accounting
- Purchasing Agent
- Real Estate Salesmanship
- Salesmanship
- Salesmanship and Management
- Traffic Management

CHEMICAL

- Analytical Chemistry
- Chemical Engineering
- Chem. Lab. Technician
- General Chemistry

- Oil Field Technology
- Pulp and Paper Making

CIVIL ENGINEERING

- Civil Engineering
- Construction Engineering
- Highway Engineering
- Professional Engineer (Civil)
- Reading Struc. Blueprints
- Sanitary Engineer
- Sewage Plant Operator
- Structural Engineering
- Surveying and Mapping
- Water Works Operator

DRAFTING

- Aircraft Drafting
- Architectural Drafting
- Drafting & Machine Design
- Electrical Drafting
- Electrical Engineer Drafting
- Industrial Piping Drafting
- Mechanical Drafting
- Sheet Metal Drafting

ELECTRICAL

- Electrical Appliance Servicing
- Electrical Engineering

- Electric Motor Repairman
- Elec. Engr. Technician
- Elec. Light and Power
- Practical Electrician
- Practical Lineman
- Professional Engineer

HIGH SCHOOL

- Good English
- High School Diploma
- High School General
- H. S. College Prep. (Eng'r'g & Science)
- High School Math
- High School Science
- Short Story Writing

LEADERSHIP

- Industrial Foremanship
- Industrial Supervision
- Personnel-Labor Relations
- Supervision

MECHANICAL and SHOP

- Diesel Engines
- Gas-Elec. Welding
- Heating and Air Conditioning
- Industrial Engineering
- Industrial Instrumentation

- Industrial Safety
- Machine Shop Practice
- Mechanical Engineering
- Plumbing and Heating
- Professional Engineer
- Quality Control
- Reading Shop Blueprints
- Refrigeration and Air Conditioning
- Tool Design
- Tool Making

RADIO, TELEVISION

- General Electronics Tech.
- Industrial Electronics
- Practical Radio-TV Eng'r'g
- Radio-TV Servicing
- TV Technician

RAILROAD

- General Railroad

STEAM and DIESEL POWER

- Combustion Engineering
- Power Plant Engineer
- Stationary Diesel Engr.
- Stationary Steam Engines

TEXTILE

- General

Name _____ Age _____ Home Address _____

City _____ Zone _____ State _____ Working Hours _____ A.M. to P.M. _____

Occupation _____

Canadian residents send coupon to International Correspondence Schools, Canadian, Ltd., Montreal, Canada. . . . Special low monthly tuition rates to members of the U. S. Armed Forces.

SAVE **AS MUCH AS 80% ON** POWER TOOLS

GUARANTEED TO DO THE WORK OF \$40, \$60, \$80 UNITS

- SAVE! BUY DIRECT FROM FACTORY
- PROFESSIONAL QUALITY, LIFETIME ENGINEERED
- UNCONDITIONAL 10-YEAR GUARANTEE

REVOLUTIONARY PATENTS DECREASE COSTS, INCREASE EFFICIENCY. Top quality full scale power tools of heavy duty 100% cast iron and steel. Streamlined design features such as perforations on table tops reduce weight, cut material costs, cut polishing and grinding time—reduce production costs. Special patents provide added efficiency, accuracy, savings. Nothing left out but exp've gingerbread. Parts made, assembled, tested and packed in our own factories, shipped direct to you. No retail store handling or profits to add to your cost.

\$995



Exp. Coll.

**8" TILT
ARBOR
POWER
SAW**

Complete as shown, less blade. Incl. precision mitre gauge, ground cast iron table. If desired, RIP FENCE for easier work alignment, \$3.50 add'l.

DOES THE WORK OF \$50 BENCH SAWS!

CROSS-CUTS, RIPS, BEVELS, MITRES, DADOES, CUTS COMPOUND ANGLES. Patented motor mount takes any standard 1/4 to 1/2 h.p. motor . . . keeps belt tight, assures perfect alignment at any angle, transmits full power. Table stays level—blade tilts, locks securely at any angle to 50°, raises, lowers 0"-2 1/4". Patented tilt mechanism has accurate etched scale. Takes standard blade, saw insert removes easily for insertion of any STANDARD dadoe heads, cutters, etc. Accessories, table extensions, when wanted, at factory prices. Versatile, rugged performance proven by almost a half-million users.

UNCONDITIONAL 10 YEAR GUARANTEE

DOES THE WORK OF \$60 UNITS

Now, at little more than a hand tool price, a guaranteed professional quality precision machine which does same work as skilled hand planing . . . much faster, more accurately. Make accurate glue joints; rabbeting cuts for doors, window frames, table drawers; square taper cuts for chair legs; extremely accurate beveling. Helps amateurs produce quality work—with the sweat eliminated.

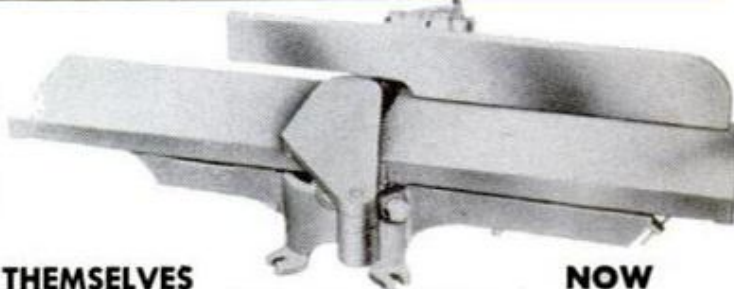

TOP QUALITY FEATURES SPEAK FOR THEMSELVES

- Precision ground cast iron tables, adjustable for depth of cut
- Rigid cast iron base
- New patent-pending design holds clearance between knives and tables at any depth
- Rabbet depth 3/4"
- Hardened, ground high speed steel knives
- Patent-pending fence adjustable to any position, any angle 0°-50°
- Patent pending lift-off guard (nothing to loosen!)
- Balanced steel cutter head. UNCONDITIONAL 10-YEAR GUARANTEE.

FULL 22" LONG, 4 1/2"
JOINTER-PLANER

NOW
\$1995

Complete as shown

100% precision ground cast iron and steel. Exp. Coll.

BENCH DRILL PRESS

DRILLS TO CENTER OF 10" CIRCLE—Rugged, dependable . . . all cast iron and steel. Table to 1/2" handtite chuck: max. 13 1/2". Spindle has combination ball and bronze bearings. Adjustable stop for repetitive drilling. Precision ground cast iron table. Table assembly fully adjustable on column. UNCONDITIONAL 10 YEAR GUARANTEE.

\$1995

Less Belt
Exp. Coll.



6" SWING 3-FT. LATHE

\$985
Exp. Coll.



Complete as shown

DOES THE WORK OF \$40 UNITS—This sturdy all cast iron power tool will turn wood or plastics with the precision and speed of machines selling for 4 times as much. Has tubular steel bed, ball thrust cup center, spur center. T-Rest assembly, lever action tail stock, 2 speed pulley. Fits any motor. Perfect for the home or professional workshop, garage or farm. UNCONDITIONAL 10 YEAR GUARANTEE.

Optional Faceplate for turning bowls, trays, lamp bases, rosettes, etc. **\$250**

Deluxe Ball Bearing WOOD SHAPER KIT



DOES WORK OF \$100 UNITS

Makes decorator edges on furniture, forms beads, coves, moldings, tongue-in-groove joints, etc. A-B-C plans make assembly a breeze. Everything incl. but plywood for table, skirt. Greased-for-life ball bearings in sealed cast iron housing; fully adjustable, easily accessible cutter height control, fence assembly. Precision-machined for smooth, accurate cuts at high speed. Takes 1/4 h.p. or larger motor; standard cutters avail. at Sears, other retailers. UNCONDITIONAL 10-YR. GUARANTEE.

Exp. Coll. **\$1495** Complete less wood parts, motor

MAIL COUPON TODAY!

American Machine & Tool Co., Dept. PM-42 Royersford, Pa.

Please send me the units checked. Payment in full enclosed \$ or \$3 deposit each item enclosed. Balance C.O.D. I must be fully satisfied or will return unit within 10 days for full refund. No questions asked.

8" Saw \$9.95 8" Saw & Rip Fence \$13.45 Drill Press \$19.95

Lathe \$9.85 Lathe & Faceplate \$12.35 Shaper Kit \$14.95

NAME

ADDRESS

CITY ZONE STATE

(please print)

10 DAY MONEY BACK GUARANTEE

You must be satisfied or money refunded, no questions asked.

AMERICAN MACHINE & TOOL COMPANY
Dept. PM-42, Royersford, Pa.

AMAZING NEW HOME TRAINING PLAN IN AIR CONDITIONING AND REFRIGERATION

... the exclusive CTI Learn-and-Practice method which enables many students to earn money in spare time — as they train for a top-pay job or their own business

Important news for the inexperienced man who needs a short cut to a better job, more money and greater security.



You build an operating condensing unit

This Is Your
"Home Training Shop"



25 Kits
20 Shop Projects

Learn by Practicing—Get Experience

The new CTI semi-sealed condensing unit. You build this heavy-duty commercial-type unit from 25 kits that CTI sends without extra cost. You complete 20 Shop Projects. After assembling unit, you may then build an air conditioner, freezer, refrigerator or milk cooler.

Mechanic's Tools

You get wrenches, tube flaring tools, hammer, tubing, fittings, gauges and other items used by the experienced mechanic. Everything is of professional quality. Best of all, CTI trains you to use tools with speed and skill.



"A demand for many thousands of additional mechanics who can install, maintain, and repair air-conditioning and refrigeration equipment is expected in the 1960s," the U.S. Dept. of Labor reports. "The use of air-conditioning in offices, stores, and theatres is increasing tremendously. In homes, the number of centrally installed air conditioning units doubled between 1957 and 1960." The growth of refrigeration in food preservation and in the manufacture of synthetic rubber, oil, high-test gasoline, medicine and drugs is also stressed by the Labor Dept. Want to be a mechanic in this great-growth field? Find out how—by mailing coupon below for complete information! No obligation.

Easy and Interesting Course

CTI's exclusive home study course is expertly written, clearly illustrated, easy to understand. It offers up-to-date knowledge and includes kits of tools and parts that you assemble into a working unit. It provides job experience projects which help you put knowledge to practical use. It's prepared especially for men who've had no previous experience. You'll enjoy CTI lessons.

Make Money as You Train

Many CTI students earn money in spare time. Some handle servicing for food stores, restaurants, taverns, etc., on a monthly fee basis. Others work part time with local dealers. Many make service calls to homes on their own.



Graduates Praise Training

"I started my own business. Earn from \$800 to \$900 a month."—Dale Landsberger, Okla. "Have gone into trucking refrigeration. My wages have tripled."—James Wiest, Minn. "I quit my \$75 a week job and am now making \$120 a week in a refrigeration shop."—Roy Goldsworth, Wyo. "Am a repair man and earn \$200 a month over what I used to."—Albert Baum, Ill.

Go in Business—Be the Boss

Opportunities to go in business are available because air conditioning is one of America's two fastest-growing industries. Start in a small way working from your home, and gradually expand. In time, you may want to add a sales division. Manufacturers offer attractive franchises and aids to ambitious and qualified men. Many CTI graduates report they are starting repair shops.



Over 50,000 Graduates

CTI is one of the nation's largest home study institutes and has graduated over 50,000 men. CTI is the only school in this field that sends parts-kits to build real equipment.



FREE! THREE VALUABLE OPPORTUNITY BOOKLETS

Investigate your opportunities for a better-pay job or your own business in an industry that has grown by 400% the past 12 years. Just fill out and mail coupon and we'll send our school catalog, lesson samples and a booklet of testimonials from grateful graduates. Act today.

CLIP COUPON BEFORE YOU TURN
THIS PAGE—MAIL TO CTI TODAY

COMMERCIAL TRADES INSTITUTE CHICAGO 26, ILLINOIS
A Non-Profit Organization • Accredited by National Home Study Council

COMMERCIAL TRADES INSTITUTE
1400 GREENLEAF AVENUE DEPT. R-76
CHICAGO 26, ILLINOIS

Send me your 3 free booklets, Success in Air Conditioning and Refrigeration, Lesson Samples, and Proof from Graduates. No obligation.

NAME _____ AGE _____

ADDRESS _____

CITY _____ ZONE _____ STATE _____



Tune in on the inventors

Not all inventions are for the good of humanity. A spoil sport named Rollin Armer, of Berkeley, Calif., won patent No. 3,015,208 recently for a device that returns a parking meter to zero when the paying car moves from the parking space. The departing vehicle trips an air tube, canceling any time left on the meter and forcing the next parker to start from scratch.

A new concept for language study won patent No. 3,014,286 for Richard Hricak of Mamaroneck, N. Y. It covers a series of oral guides designed to position the student's lips, teeth and tongue for proper pronunciation. The hollow guides help the student learn to form the sounds of an unfamiliar language, but do not interfere with the user's voice.

Three Indianans, John Dyer, Brooks Short and Walter Parker, won patent No. 3,015,835 for an improved method of controlling the wiper motor and washer pump

on automobiles. The electrical device will keep the wiper from operating in conjunction with the washer if the washer reservoir is empty or the tubes are blocked.

Color in Polaroid photography may not be too far away. Patent No. 3,015,561 was awarded to Howard Rogers, of Weston, Mass., for a system for controlling the speed of coloring chemicals in a Land camera. His invention is an improvement on a process already patented by Edwin Land, and his rights have been assigned to Polaroid Corp.

A new kind of spark plug is currently pending a patent for Joseph Palecek, of Zenia, Ohio. He reports that his invention will provide a maximum of insulation at a minimum cost by replacing the ceramic plug body with a body formed of a structural plastic. By covering the entire external plug body, even the lugged base, his plastic insulation gives a maximum distance from the wire to the base, and is expected to be more durable and less fragile than existing porcelain bodies.

Copies of the original patents may be ordered for 25 cents each from the Commissioner of Patents, Dept. of Commerce, Washington 25, D. C.

STEWART-WARNER "VOLT-GUARD"

New from Stewart-Warner—"Volt Guard"—the gauge that checks the complete electrical system. Warns of impending trouble in battery, generator or voltage regulator. Alerts you against costly and time-consuming breakdowns and electrical system failures. For all cars, trucks, buses and engines with 12-volt ignition systems. Ideal for boats, too. See the Stewart-Warner "Volt-Guard" at your nearby service station, garage or automotive parts store.

*the "look-out" that
helps you prevent trouble!*



Dept. C-42, 1840 Diversey Pkwy., Chicago 14

How high can YOU GO in Electronics?

\$ 18,000
\$ 16,000
\$ 14,000
\$ 12,000
\$ 10,000
\$ 8,000
\$ 6,000



J. E. SMITH
Founder NRI

No school or college can tell you how high you can go—how much you can earn. But we at NRI can tell you that there are NRI graduates in all salary ranges you see above. Some have even gone higher. Among the thousands of NRI graduates there were many who were beginners—men who decided to turn their interest or hobby into a profitable career. Others were already in TV, Radio or Electronics and realized that

by adding to their knowledge they could take quick advantage of new opportunities and move up to higher levels of prestige and pay.

PICK YOUR CAREER Train with the Leader



● Industrial Electronics

Prepares you for a career as an Electronic Technician in industry, business, or military. Covers computers, telemetry, automation, microwave, etc. Training equipment included.

● TV-Radio Servicing

NRI's time-tested course trains you to fix radios, TV sets, hi-fi, etc., shows you how to earn extra money while training, how to start your own business. Training equipment included.

● FCC License

Trains you quickly to take government exams for your FCC First Class Radiotelephone License. Necessary to operate and service TV and Radio broadcasting and other equipment.

● Communications

Prepares you for jobs in AM, FM, TV broadcasting stations, mobile radio, marine, aviation, shipboard radio, etc. Special training equipment included.

Job Counsellors Recommend

As a reader of this magazine, you are well aware of the expanding uses of Electronics in industry, business, broadcasting, the home. Electronics is changing our world, and a school offering training must keep pace with change. That's why the NRI staff of technical writers, teachers, editors and engineers is on the job constantly to keep NRI lessons and training equipment correct and up-to-date.

NRI Equips You to Grow

You read about advances in FM stereo broadcasting, in computers, telemetry, microwave, color TV. NRI not only provides courses which cover these important new subjects, but gives you *experience* working with the circuitry involved. NRI training equipment is not a conglomeration of commercial instruments, but specially designed to blend with course material. You build circuits, perform experiments, work with Electronic test instruments you build yourself.

In short, NRI equips you to *grow* . . . in your new career, in usefulness, in prestige, in monetary gain.



Oldest and Largest School

For nearly 50 years, NRI has earned the confidence and respect of students, graduates, the Electronics Industry. NRI training is recognized by all as an outstanding educational value. That's because NRI is America's oldest and largest Radio-TV Electronics School, drawing on experience gained with hundreds of thousands of students. Mail coupon now. **National Radio Institute, Wash-**

ington 16, D.C.

The Amazing
Field of
Electronics



Mail coupon for
FREE CATALOG

National Radio Institute
Washington 16, D. C.

2DA

Send me your catalog. (Please print. No salesman will call.) I am particularly interested in:

- Industrial Electronics
 Radio-TV Servicing
 FCC License
 Radio-TV Communications

Name _____ Age _____

Address _____

City _____ Zone _____ State _____

Accredited Member National Home Study Council



DOUBLE-THINK is needed when refueling twin-engined Sahara as each engine has its own under-seat tank



Spotlight on the Citroën Sahara

By Heinz Schlichting, PM's International Editor

CITROËN, one of France's *Big Three* automakers, has an interesting "Sahara" version of its beloved ugly duckling, the 2-CV ("deux chevaux"). It may be the cheapest yet most versatile utility car ever built.

The Sahara was created by simply adding a second, identical, two-cylinder engine in the rear, and oversize tires to the familiar front-engined, front-drive, four passenger 2-CV, which is the Model-T of France.

The Sahara appears to be a normal 2-CV but for the air inlet port to the rear engine's cooling fan. The second 13-horsepower engine is placed in the luggage compartment.

Acceleration is boosted considerably with the second engine added, PM found in testing it. The Sahara will hit 25 miles per hour in 10 seconds; 37 in 15 seconds. Top speed is 65 m.p.h. (The standard 2-CV will just about make 50 m.p.h.)

Run by its front engine alone, the Sahara waddles along like a lame duck on its extra-wide Michelin-X tires inflated to only 10 pounds. These low-pressure tires create

SAHARA WAS CREATED from a standard 2-CV by adding identical, flat, two-cylinder engine in rear

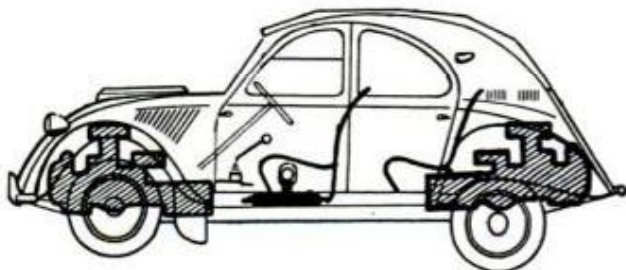

considerable rolling friction but give better traction.

The car virtually glides over goat paths and maintains traction in deep, loose sand—through which it will climb a 40 percent grade. On hard ground, the 1800-lb. vehicle will climb grades up to 50 percent in its first-speed, "creeper" gear.

Thus, with 4-wheel drive, fully independent suspension and low-pressure tires, it runs all day over "impassable" terrain. Like a camel, delicately balancing its weight, it slowly, deliberately picks its way over sand, snow and marshes. In snow it competes with a good skier going up a not-too-steep grade.

In normal on-the-road use, the Sahara, with its 149-inch over-all length and 94-inch wheelbase, lends itself to maneuverable, economical operation in city traffic, yet is capable of long runs at top speed.

One engine squeezes out as much as 39 miles per gallon. With two engines, you can expect about 26 m.p.g. And on a flat-out, off-the-road tour (with both engines), PM got nearly 20 miles to the gallon. Even climbing around tricky passes in the French Alps, a Sahara went 19.5 miles on a gallon, and a 100-mile turnpike run showed 32.5 m.p.g. at 60 miles per hour.

Dual pushbuttons start the Sahara, but it's worth the effort to see the startled expressions on bystanders when they hear the second engine start up.

The power plants are opposed, two-cylinder, air-cooled, four-cycle engines of 26-cubic-inch displacement, each developing

(Continued to page 20)

SENSATIONAL OFFER TO POPULAR MECHANICS' READERS

SAVE
MORE
THAN
EVER

2 COMPLETE 1962 MODEL FISHING OUTFITS 279^{PCS}

PFLUEGER, MUSTAD, DUPONT

SMOOTH POWERFUL DIRECT DRIVE
LEVEL WIND CASTING REEL

FREE! If you order NOW!
LEAKPROOF FLOATING
TACKLE BOX

POWER ACTION
GLASS RODS
STRONGER
THAN STEEL
OR BAMBOO

LIVE BAIT BOX

FOLD-A-WAY
FLOATING
TROUT NET

FISH KNIFE
with SHEATH

FAMOUS
JIGS and FLIES

28 Pc.
POPPING
LURE SET

SAFETY
STAR DRAG
Found only
on best reels

DETACHABLE
HANDLE
FULL CORK
GRIP

COMPARE!
with EXPENSIVE SETS

\$14⁹⁵

**BOTH SETS
FOR THE PRICE OF A
REEL ALONE**

NEW! AUTOMATIC
SUPER "88" REEL

- SMOOTH POWERFUL LIGHTNING FAST FINGERTIP CONTROL
- PUSH BUTTON CASTING ANTI-REVERSE—NO BACKLASH

19 FAMOUS
CRAFTY
LURES

COMPLETE! Nothing else to BUY!

NEWEST! EASIEST WAY TO CATCH FISH!

SELECTED FOR YOU BY EXPERTS. This choice fish-getting tackle, used by experts, contains nationally famous brands. Each item carefully chosen—everything you need for all types of fishing. Deadly lures that are all time favorites. Whether you're a veteran angler or an occasional fisherman, you can be proud of this precision-built kit. Nothing else to buy—you can go fishing at once. Compare! You will not find a bargain like this anywhere.

LOOK! YOU GET EVERYTHING SHOWN. Super "88"—Automatic Spin Cast Reel with line. Comet X3C Bait Casting Reel—5 ft. (2 pc.) Spin Cast Rod—4 ft. Bait Cast Rod, Live Bait Box, Fish Knife and Sheath, 19 Famous Lures, Tackle Box and Removable Tray, Cable Leader, Clincher Sinkers, Assorted Hooks, Snelled Hooks, Fold-Away Trout Net, Stringer, Hook Remover, Hook Guards, Bobbers, Split Shot, Snaps and Swivels, Practice Plug, 28 pc. Popper Lure Set and Complete Instructions.

FREE! "Experts Guide" Over 200 best lakes and streams selected from more than 10,000 FAMOUS FISHING SPOTS IN AMERICA.

NIRESK DISCOUNT SALES Div. of NIRESK IND. • CHICAGO 47

MONEY BACK GUARANTEE!

NIRESK DISCOUNT SALES • Chicago 47, Ill. • Dept. FC-54
ORDER TODAY! We're so sure that you will be pleased that we make this daring offer. If you're not 100% pleased we'll refund your full purchase price promptly. **YOU KEEP FREE TACKLE BOX REGARDLESS!**

Please rush _____ 279 pcs. 2 Complete Fishing Sets

NAME _____

ADDRESS _____

CITY _____ ZONE _____ STATE _____

- I enclose \$14.95 plus \$1.00 for postage & handling
 Ship C.O.D. I will pay C.O.D. charges and postage.

Guaranteed against burn-out

AIROGRATE YELLO-BOLE



1. Smokes sweeter!
Imported briar bowl lined with real honey. Starts caking the instant you light up. Hence, no break-in.

2. Smokes drier and healthier! Metal grate condenses moisture, tars, nicotine. No wet heel.

3. Smokes cooler!
Air-vented chamber draws in fresh air. Aluminum fins and shank throw off heat, cool the smoke.

Famous honey-lining!

\$350

Extra interchangeable bowls—\$1.95 each
Guaranteed against burn-out for life

"Icepak" Set—Airograte Yello-Bole Pipe plus one extra bowl, \$5.45

Other Yello-Bole Pipes, also of imported briar \$1.95 to \$4.95.

Send for FREE FOLDER, YELLO-BOLE PIPES, Inc., Dept. Y55, N.Y. 22

Don't read this UNLESS...

... you want a profitable hobby, a rewarding sideline, or your own full-time business. Perhaps you have seen Ornamental Concrete Items and wondered how they are made. You can make them, and in a professional manner. All you need is Molds and Knowledge. We'll sell you BOTH and you'll know what you are doing even before you start.

We manufacture and sell on a direct basis the industry's best molds. Durable, Dependable, High Quality, and of Aluminum. 96-pg. "How To Turn Concrete Into Gold" includes 29 pgs. of priceless instructions for professional results. Describes and Prices over 300 molds for Bird Baths, Benches and Tables, Flower Urns, Statues, Animals, Religious Items, and many more from 2" to 68" high. It gives the full story. Order yours TODAY—Rushed to you by First Class Mail. It's only \$2.00.



No. 225 Hen
Mold makes 15" high Concrete Hens. Price of Mold only \$40.00. No. 228 Chick, 6 1/2" high. Price of Mold only \$10.50. Over 300 other molds to select from.



Manufacture And Sell Your Own Ornamental Concrete Items OVER 300 DIFFERENT DESIGNS

Concrete Machinery Co., Inc.
839 Lenoir Road, N. W. • Hickory 2, N. C.



SECOND ENGINE drives the car's rear wheels and "breathes" cooling air through port in the trunk door

13 hp. at 4500 r.p.m. These overhead-valve engines have a 2.6-inch bore, a 2.44-inch stroke, and a compression ratio of 7.0:1. Crankshaft-driven fans provide cooling.

Each engine drives the wheels at its end of the car. There's no interconnecting shaft. Engines are linked only by the throttle and a common gear lever connecting the four-speed transmissions. The two clutches are hydraulically operated by a single pedal and master cylinder. A separate lever on the drive-shaft tunnel permits the three-way option of propelling the car with either engine, or both in tandem.

Primitively-styled and uncomfortable looking, the Sahara's sparse elastic and naked-pipe-frame seats dismay people at first glance. But scorn changes to admiration after one discovers the car's comfort.

The Sahara's excellent suspension system gives the little car extremely good roadability at speed on paved roads.

The car's comfort and utility make it a great vehicle for hunters, trappers and those who like to fish in out of the way places.

A favorite with geologists and other explorers, the Sahara is used by U.N. forces and in foreign oil fields. Besides "go-anywhere" traction and good road holding, there's a "spare" engine. And, if one engine won't start, you push or pull it with the other one until it fires up.

PM was lucky to drive the Sahara—in Europe—as it's currently sold only to commercial users. Even Frenchmen stand in line (with \$2200) for this unique car. If public interest grows, production could be upped. The second engine's installation isn't complicated, and in time, we might well find this dauntless compact scurrying up the Rockies. ★ ★ ★

\$1 starts your COUNTDOWN TO PROFITS



in
**FLORIDA'S
FASTEST-
GROWING
AREA!**



Here are
10 GOOD REASONS
why you should invest in
CANAVERAL WEST — NOW!

- 10** IT IS CLOSE TO AMERICA'S BOOMING-EST AREA — BY FAR!
Brevard County (in which Cape Canaveral is located and neighboring county to CANAVERAL WEST) is the fastest-growing in the entire United States! Population has soared an astounding 470% in the last 10 years! The reason for this phenomenal growth? — NASA's selection of the area for project NOVA, America's 20 BILLION DOLLAR effort to put a man on the moon, described as the biggest development ever in the Florida economy!
- 9** IT IS LOCATED CLOSE TO AN AREA WHERE GROWTH IS ASSURED!
The project is a U.S. Government commitment, with funds allocated over coming years. This is a fact — not wishful thinking. Very rarely, if ever, does any area offer this kind of solid, growth-producing foundation.
- 8** IT IS EXCELLENTLY LOCATED TO PROFIT FROM
CAPE CANAVERAL'S FUTURE EXPANSION!
With direct access to two important U.S. Highways — East/West U.S. 192 connecting booming Melbourne with thriving Orlando and North/South highway U.S. 441, which leads to Miami and West Palm Beach. It is 35 miles west of Melbourne, 30 air miles from Cocoa — 45 from Cape Canaveral, 37 from Orlando, and only 10 miles from Florida's beautiful lake country.
- 7** THE LAW OF SUPPLY AND DEMAND WORKS FOR YOU — AS THE
DEMAND FOR LAND KEEPS GROWING... GROWING... GROWING!
Huge project NOVA has attracted over 100 giant industrial firms and smaller sub-contractors! This means thousands of employees and new residents (an estimated 40,000 in the next 2 years!) — and houses, stores, recreation facilities to serve them. This takes land — thousands of acres of it — from an already limited supply. The likely result: higher prices for the land that is still undeveloped!



- 6** MILLIONS OF DOLLARS HAVE BEEN INVESTED IN THIS AREA...
MILLIONS MORE WILL BE!
\$1,700,000,000 has been allocated by Congress for America's race into space. Hundreds of millions of dollars more have been invested by electronic super-firms: RCA, Bell Telephone, General Electric, Remington Rand, Westinghouse, Aerojet, Convair, Northrup, Martin, Fairchild, AVCO, Burroughs, Ford, Douglas, Lockheed, Philco, Chrysler, General Motors.
- 5** IT IS GOOD INVESTMENT LAND!
Average elevation is 64-72'. CANAVERAL WEST may be wet during the rainy season because it is undeveloped acreage and requires clearing, roads and drainage before being usable (none of these improvements are presently planned). Much of the land in the immediate area is now being used for cattle-grazing, farming and orange groves.
- 4** PRICES ARE STILL LOW IN CANAVERAL WEST —
AS LAND VALUES SOAR!
Because Canaveral West is located in the outlying area, prices have not yet skyrocketed. Thus, you can still share in the continuing expansion of the area — without paying a premium for the land. By acting now, your profit-making potential will be greatly increased.
- 3** YOUR INVESTMENT IS GUARANTEED — 6 WAYS!
1) 30-day money back guarantee, if you are not completely satisfied for any reason. 2) Free Warranty Deed*. 3) Free Title Insurance*. 4) No interest. 5) No taxes until you receive full title. 6) No hidden closing costs.
- 2** THIS IS AN INTRODUCTORY OFFER ONLY.
The limited quantity of available land within 45 miles of Cape Canaveral is rapidly decreasing, increasing the value of the remaining supply. We cannot hold the present price line for long. Prices must go up. You can get in on the ground floor — by getting in now.
*includes 50% oil and mineral rights.

\$1 DOWN • 1¼ ACRES (54,450 SQ. FT.)
TOTAL PRICE \$595 • \$10 MONTH
THIS IS YOUR CHANCE TO BUY IN CANAVERAL WEST
AT THIS LOW INTRODUCTORY PRICE! MAIL RESER-
VATION COUPON AND \$1 DOWN PAYMENT — NOW!

**CANAVERAL
WEST** **FLORIDA**

Member: Chambers of Commerce, Miami, Melbourne.

CANAVERAL INVESTMENT LAND CORP., DEPT. PM-1
PALM SPRINGS PROFESSIONAL BUILDING
801 W. 49th ST. • HIALEAH, FLORIDA

Enclosed is my \$1 Down Payment for.....1¼-acre tract(s)
in CANAVERAL WEST. Please rush me complete details, brochure, photos,
maps, etc. I understand that I have a 30-day MONEY BACK GUARANTEE.

NAME.....
ADDRESS.....
CITY.....ZONE.....STATE.....

AD 62016



On the market

1. CREATING PICTURES WITH STAPLES will fascinate children and grownups of all ages. The kit for producing such unusual works of art includes a stapler, Stapl-Art boards, design-transfer sheets, transfer chalk and full information about this new craft. The kits range in price from \$2.98 to \$5.98 ppd. Stapl-Art, Inc., 60 Dedham Ave., Needham 92, Mass.

2. LOW-PRICED REFRACTOR TELESCOPE is a precision-made optical instrument. Color-corrected, two-element objective lens gives full 67-power viewing with sharp, clear definition. This can be increased to 100X and 200X by using a Barlow lens which is included. Priced at \$19.95 ppd., the telescope is available from Edmund Scientific Co., Barrington, N. J.



3. ACCESSORY IMPULSE STARTER permits converting most gasoline-powered lawn and garden units of 4½ hp. or less from recoil to impulse starting. A few turns load spring, then the handle is folded over to start engine. Priced at about \$10.00, it's made by Beaver Products, Inc., Beaver Dam, Wis.

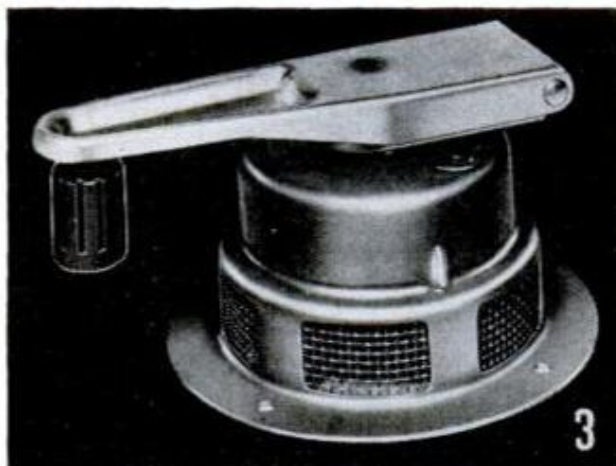

4. LIGHTWEIGHT PRECAST stone material permanently bonded to ½-in. insulation board is available in 14 x 32-in. panels which can be mounted with nails. After mounting, the joints are filled with regular ready-mix mortar. Panels are available in either gray blend or buff. Manufactured by AlSCO Aluminum Building Products, 225 S. Forge St., Akron 8, Ohio

5. PLASTIC-FINISHED random-grooved wall panels are produced in five distinctive wood grains and a wide variety of colors. Finish is laminated to ¼-in. hardboard and never needs waxing. Panels have tongue-and-groove edges and are easily installed with special clips and nails. Made by Woodall Industries, Inc., 3500 Oakton St., Skokie, Illinois



How to Select a Watch

An Easy Way To Recognize A Quality Watch Without Being A Watchmaker

TO BE ABLE to select the best watch of any given price range requires certain specialized knowledge. To make an expert choice without being a watchmaker yourself it is important to know what makes up the essence of quality in a watch. Style and design are important but in no way do they relate to the quality of the movement. The important difference in a good watch is a long-lasting timing center (jewel-lever escapement) . . . and the key to this difference is the Incabloc shock absorber.

Incabloc is the shock protective system that maintains the accuracy and the quality of jewel-lever watches and reduces repair costs to a minimum. Its characteristic, easily recognized lyre-shaped spring can be seen at the center of the moving balance wheel. Manufacturers rely on Incabloc to maintain the quality of their precision timepieces and when you select a watch you can rely on Incabloc to be sure you are getting the best value for your money.

To date over 200 million Incabloc-equipped watches have been sold by the world's leading manufacturers.

Ask your jeweler to certify that the watch he sells you is manufactured with the authentic Incabloc shock protective system. It is your key to a quality watch.

Advertisement

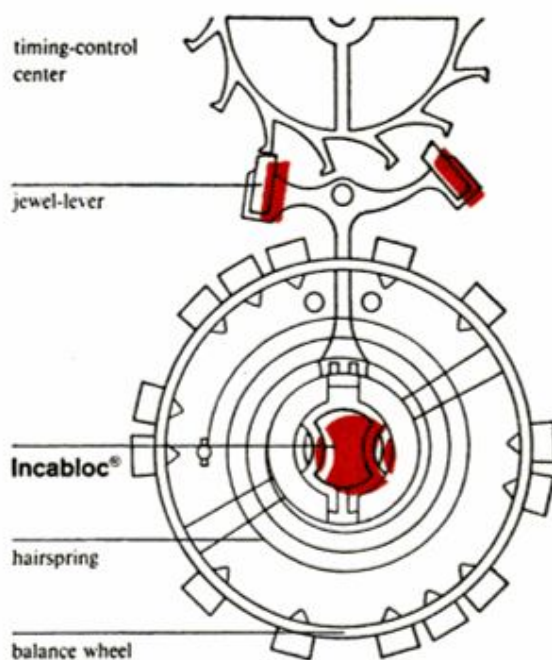

FREE!

TRIAL
LESSON



Trial lesson in DRAFTING

LEARN AT HOME IN SPARE TIME

Check the want ads in any newspaper — SEE the big-pay opportunities open to you as a draftsman. What's more, you can learn this well-paid, prestige profession at home — quickly, easily! No special talent needed! Get complete, step-by-step Chicago Tech lessons in the mail, spend a few pleasant hours studying each week. In a short time you'll be a well-trained draftsman, ready to take your pick of many good jobs. Act now!

FREE INFORMATION—MAIL COUPON TODAY!

Get FREE TRIAL LESSON plus information about C.T.C. practical training. Learn what successful Chicago Tech graduates say about high pay and opportunities in drafting. No charge, or obligation.

Est. 1904 Accredited National Home Study Council

CHICAGO TECHNICAL COLLEGE

D-200 Tech. Bldg., 2000 So. Michigan Ave.
Chicago 16, Illinois

Mail me FREE Lesson with information about big opportunities in DRAFTING.

Name..... Age.....

Address

City..... Zone..... State.....

ENGINEERING SCIENCE MATH

DEGREE IN 27 or 36 MOS.



B.S. degree — 36 mos. • B.E. degree — 27 mos.

ACCELERATED YEAR-ROUND PROGRAM prepares for early employment in fields of **SCIENCE AND ENGINEERING**. Regular 4-year program for B.S. Degree completed in 36 months, special engineering degree program in 27. Classes start — June, July, Sept., Jan., March. **QUALITY EDUCATION**. Graduates employed from coast to coast. Government approved for veteran training. Students from 50 states, 40 countries. 20 buildings; dorms, gym. Campus. **SAVE TIME AND MONEY. EARN BOARD** while studying. Write for catalog and complete information.

INDIANA TECHNICAL COLLEGE

542 E. Washington Boulevard, Fort Wayne 2, Indiana

Please send me free information on Bachelor's Degree Programs in Engineering and Science as checked below:

- | | |
|---|--|
| <input type="checkbox"/> Aeronautical Engineering | <input type="checkbox"/> Mechanical Engineering |
| <input type="checkbox"/> Chemical Engineering | <input type="checkbox"/> Metallurgical Engineering |
| <input type="checkbox"/> Civil Engineering | <input type="checkbox"/> Physics |
| <input type="checkbox"/> Electrical Engineering | <input type="checkbox"/> Chemistry |
| <input type="checkbox"/> Electronic Engineering | <input type="checkbox"/> Mathematics |

Name.....

Address.....

NOW \$1.50 Brings You Most Needed ENGINEERING DATA

Condensed, Concise, Complete
A Bookful On Each Page

For Engineers, Tech workers, Students, Teachers, Essential technical data from 1000 sources. Condensed, accurate. Each book 140 pages material. For reference on the job.

LOOSE LEAF POCKET SIZE BOOKS \$1.50 EA.

- | | | |
|--|--|---|
| <input type="checkbox"/> Architecture | <input type="checkbox"/> Math. Tables | <input type="checkbox"/> Mech. of Materials |
| <input type="checkbox"/> Building Const. | <input type="checkbox"/> Physics | <input type="checkbox"/> Thermo Tbls & Charts |
| <input type="checkbox"/> Survey Data | <input type="checkbox"/> Trig-Log Tables | <input type="checkbox"/> Machinists Data |
| <input type="checkbox"/> Survey Tables | <input type="checkbox"/> Gen'l Chemistry | <input type="checkbox"/> Mech. Drawing |
| <input type="checkbox"/> Highway Eng'g. | <input type="checkbox"/> Chemical Tables | <input type="checkbox"/> Metallurgy |
| <input type="checkbox"/> General Math | <input type="checkbox"/> Analytic Chem. | <input type="checkbox"/> Conversion Tbls. |

WRITE FOR FREE CATALOG (2000 listings). See how helpful Lefax can be to you. Send \$1.50 book, or \$4 for any 3 books to

LEFAX PUBLISHERS Dept. P.M. 42, Phila. 7, Pa.

6-IN-1 ONLY MACHINE OF ITS KIND!

UNIMAT



Compact workshop for all metal, plastic, wood. Precision lathe, milling machine, drill press, surface grinder, polishing/grinding machine, portable drill. Complete basic unit, \$129.50. **WRITE FOR FREE CATALOG.**
AMERICAN EDELSTAAL, INC., DEPT. GD 350 BROADWAY, N.Y. 13, N.Y.

FREE GERMAN HUNTING KNIFE

STEEL 4-INCH BLADE



We give you handiest hunting and fishing knife you've ever had! Has 4-INCH LONG highly tempered steel blade—VERY SHARP! Attractive handle. We send knife FREE to acquaint you with our below-wholesale bargains. Please send 25c for handling. NO LIMIT—but send 25c handling for each knife. Order TODAY!
HUNTING KNIFE, Dept. K-648, Box 881, St. Louis, Mo.

Would You Like to Make **\$1,000 A MONTH?**



That's what Stanley Hyman made selling the amazing new Presto Fire Extinguisher! Many others "cleaning up"—so can you! Amazing tiny new extinguisher ends fires fast at 2 seconds. **Guaranteed for 20 years!** Sells for only \$4.95. Write for Free sales kit.

Merlite Industries, Inc., Presto Div.,
114 E. 32nd St., Dept. P-155, New York 16, N. Y.

RUPTURED

BE FREE FROM TRUSS SLAVERY

Surely you want to **THROW AWAY TRUSSES FOREVER**, be rid of Rupture Worries. Then Why Do you put up with wearing a griping, chafing and unsanitary truss the balance of your life? If you do, it will NOT be through necessity but through choice on your part.

Now there is a new modern Non-Surgical treatment that is designed to permanently correct rupture. These Non-Surgical treatments are so dependable, that a Lifetime Certificate of Assurance is given. Write today for our new **FREE BOOK** that gives facts that may save you painful, expensive surgery. Tells **HOW** and explains **WHY NON-SURGICAL** Methods of Treating Rupture are so successful today. No obligation.

Excelsior Medical Clinic
Dept. H8125, Excelsior Springs, Mo.



IF IT CAN BE MISTAKEN MISLAID MISFILED MISUSED MIS-ANYTHING

DYMO LABELS IT

FREE demonstration of the DYMO Universal Labeling System: Your DYMO representative will call at your place of business and label any six items with the DYMO Tapewriter. See for yourself how easily you can make handsome, raised-letter labels for 1001 ap-

plications. Labels take seconds to make, cost pennies, stick permanently to almost any surface. Vinyl tape in 10 colors, plus five striped tapes. Six metal tapes. Five DYMO Tapewriter models, from \$24.95. Send the coupon for a personal on-the-job demonstration...no obligation to you or your firm, of course.

DYMO
INDUSTRIES, INC.

Prices slightly higher
in Canada.

DYMO INDUSTRIES
Dept. PM, P. O. Box 1030,
Berkeley 1, California

I want a demonstration of the DYMO UNIVERSAL LABELING SYSTEM. Six items will be labeled at no obligation to me or my firm.

NAME _____

TITLE _____ FIRM _____

PROD. OR SERVICE _____ TEL. _____

ADDRESS _____

CITY _____ ZONE _____ STATE _____

Items from all outdoors

Sportsmen are a funny bunch. They are so accustomed to working out double-duty gimmicks in their equipment that they confound even the manufacturer sometimes. Here's a batch of examples from conversation around the recent Sporting Goods Association show:

Plastic worms have become such a big item in tackle shops that one manufacturer, Sportsman's Products of Marion, Ind., made up a batch of giant display worms, 18 inches long and fitted with big 9/0 hooks to match. Always ready to try anything, salt-water fishermen tried them on big-fish trolling tackle. They were such a success (Dan Tessar, operating the charter boat *Uncle Duff* out of Panama City, took barracuda of 40 and 57 pounds) that the company is putting the king-sized "joke" worms into regular production.

West coast fly fishermen have long led the tackle industry in development of tackle for extremely long casts in fast, deep water. Any new product or technique that

looks like it might cast a little farther or sink a little faster is quickly adapted to their salmon and steelhead rivers. Myron Gregory, caster, fisherman and fly tier from Oakland, Calif., reports they're enjoying good results in deep-water fly casting with Gladding's Special Mark Five trolling line instead of ordinary fly line. The new line, which is a plastic-finished nylon braid over a lead wire core, is intended for deep trolling. But its finish is just like that of a good fly line, so it casts like a heavy level line, but sinks like a stone. Gregory reports he can fish flies in 80 feet of water, using a 30-foot shooting head of the lead line backed with monofilament shooting line.

Hunters around the world have used the new .44 Magnum handgun cartridge on almost every big game animal. Its accuracy and knockdown power made it competitive with many rifle cartridges. Soon rifles were being chambered for the .44 Magnum; Sturm, Ruger & Co. are building a short carbine for it. Ammunition manufacturers, recognizing a trend, are now making soft-point ammunition for the rifles which will also work in the handguns. Just the thing for your next buffalo hunt?

Dick Liebpatrick



**Pack the
shaver
that packs
its own power!**

- Runs on two flashlight batteries tucked into its case.
- World-famous rotary blade shaves, 'flip-top' cleaning.
- Easy to pack, pocket-slim.
- Case houses built-in mirror and quick-recoil cord.

- Ask your Norelco dealer about the whole line of rotary blade shavers.

NEW
Norelco®
SPORTSMAN

NORTH AMERICAN PHILIPS COMPANY, INC., 100 East 42nd Street, New York 17, New York.
Norelco is known as PhiloShave in Canada and throughout the rest of the free world.



Earn **HIGH WAGES** as a **HEAVY EQUIPMENT OPERATOR**



**FIELD-TRAIN
AT NATIONAL ON
DIESEL-ENGINE MACHINES**

Learn Operation,
Maintenance and
Safety

RUGGED OUTDOOR MEN

up to 56 years old can qualify!

**NO PREVIOUS
EXPERIENCE NECESSARY**
No Special Education Needed

High wages and security NOW and in the years to come are yours as a trained heavy equipment operator. Your chance is TODAY . . . your opportunity is HERE, if YOU will but take advantage of it! The world's fast-growing multi-billion dollar construction industry needs men NOW for work in this country and overseas — you can be one of them!

As a heavy equipment operator you will "move the earth" on aerospace projects, highway building, and industrial construction. Learn HOW at National, the original school of heavy equipment operation, through actual field training on the same kind of diesel-engined bulldozers, rubber-tired scrapers, motor-graders, and cranes now in use by the industry.

National School is NOT a correspondence school . . . if your application is accepted, you will field-train on its huge proving ground in the beautiful Piedmont area of North Carolina. Full training courses, VA approved, payment plans available. AND, National maintains its own Job Advisory and Counselling Department with a full-time Director for the exclusive use of its graduates!

Make up your mind NOW that you are interested in high wages and security and mail the coupon TODAY for FREE illustrated school catalog . . . you are not obligated in any way.



Even if you are presently taking a "course" in heavy equipment operation, write for our free catalog (there is no obligation), and compare the "training" you are receiving with ours.

MAIL TODAY
For **FREE** Illustrated School
Catalog and complete information

NATIONAL SCHOOL OF HEAVY EQUIPMENT OPERATION
Dept. D-27
P. O. Drawer 1686, Charlotte, N. C.

Please send one **FREE** illustrated school catalog and complete information about how I can become a Heavy Equipment Operator. I understand there's no obligation.

Name _____ Age _____

Address _____

City _____ Zone _____ State _____

6062



THIS VALUABLE BOOK GIVEN

Free

TO PEOPLE WHO WANT TO EARN MONEY IN AN

Accounting Career

LaSalle will train you in your spare time

The demand for trained Accountants far exceeds the supply. Salaries are at an all-time high. Accountancy-trained men move up to big positions in business. LaSalle's distinguished faculty prepares you at home, in your spare time—at remarkably low cost. You work with actual Accounting problems, acquire real experience. Thorough, practical, enjoyable—and quick in results. Many students report up to 56% pay increases even before completing training. Mail coupon for free book and sample lesson.

LA SALLE EXTENSION UNIVERSITY

An Accredited Correspondence Institution

417 S. Dearborn, Dept. 04-041, Chicago 5, Ill.

Please send free book "Opportunities in Accounting" and interesting sample lesson.

Name..... Age.....
 Address.....
 City..... Zone.....
 County..... State.....

Be a Drain Tile Manufacturer

T-5

A manufacturer in Ohio made 167,000 tile in his first year of operation—924,000 in his sixth year. A plant in Wisconsin averages 3 million annually. It's a business where the markets are broad and the profit-potentials truly amazing.



Champion — Superfine Concrete Tile

This can be Your Big Opportunity

Champion concrete drain tile are used for farm drainage—road building—drain fields—building construction. Champion machine makes world's best tile—dense, strong, truly round. Yet at costs so low that Champion manufacturers always have a price advantage. Makes all sizes from 3" to 12". Simple—compact—requires little space—easy to operate. Available on easy payment plan. Write for free Champion Book and other valuable information.

W. E. DUNN MFG. CO.

522 W. 24th St., Holland, Mich.



FREE SAMPLE

NEW WONDER AUTO GLAZE

with Miracle Methyl Silicone Fluids



Given to show how you can make \$55.00 a day profit on your own exclusive route!

GUARANTEED to outshine, outlast and outperform ANY wax polish on the market today—or money back!

FAST REPEAT SELLER! Needed by 45,000,000 car owners. Demonstrates like magic. Just apply, wipe off. No hard rubbing. Keeps car and chrome like new for months!

OVER 175% PROFIT! Retail: \$2.00 pint (year's supply). Your profit can be over \$1.35 pint—more on gallons!

FREE SAMPLE sent to try on your car. Rush name for FREE sample and FREE money-making details. No obligation!

ROYALTONE PRODUCTS CORP., Dept. PM-4
 1035 E. 10th St. • BROOKLYN 30, N.Y.

AIRCRAFT TYPE METAL-TO-METAL AUTO SEAT BELT

Metal-to-Metal
\$6.95
 Postpaid



Aircraft Type
\$4.95
 Postpaid

BUY DIRECT

• Exceeds SAE Standards • Heavy duty 2" Nylon Webbing • Flame Blue, Black, Gray, Green, Beige. • Easy Installation—Fits all cars. • Mail check and order today!!

ROSE AUTO PARTS, Dept. PM, 2129 East Michigan, Kalamazoo, Mich.



get into operating or repairing EARTH MOVING EQUIPMENT

Men needed now for good paying jobs in booming road and construction work. Learn operating or repair-rebuilding of heavy road machinery, cranes, bulldozers, earth carriers, etc. Actual "on the job" training. 5 to 13 1/2 week courses. Classes start every Monday. Reserve your space now. Complete catalog and reservation facts FREE. Approved for veterans. Write

Greer TECHNICAL INSTITUTE
 Attn.: P. D. Hutch, Box 368, Braidwood, Ill.



ALL FAMOUS BRANDS! **FARM TRUCK AUTO TIRES!** AT LESS THAN WHOLESALE

SAVINGS NEVER LESS THAN 50% up to 70% OFF REG. PRICE!
 HEADQUARTERS FOR ALL SPORT CAR TIRE SIZES
 FREE • SEND FOR YOUR FREE CATALOG • FREE!
 RELIABLE TIRE DIST., 730 Morgan Blvd., Camden 4, N. J.

JEEP OWNERS

RE-POWER NOW WITH A V-8 OR 6 CYL. ENGINE — USE FORD—CHEV.—MERCURY—GMC—PONT—STUDE—DODGE OR PLYMOUTH

In Jeeps, Jeepsters, Sta-Wgn, trucks, Kaiser & M. J. cars. Conversion Kits \$45.35 to \$56.90. Want fast action? Give us full information, send \$15.00 Dep. and we will ship correct kit. Bal. COD. Send full amount for prepaid shipment. Wire, phone or write today. Details FREE.

HOOSIER MACHINE PRODUCTS CO.
 312 S. E. 6th St. Phone CR 6-3442 Pendleton, Oregon



STOP FRONT DRIVE DRAG AND WEAR ON 4-WHEEL-DRIVES!

WARN HUBS

Free-wheeling 2-wheel drive with Warn Hubs means big savings in gear, engine, tire wear, gas—plus more pep, performance, power in high, and easier steering. Rugged, dependable, proven, with over 400,000 in use. Iron-clad guarantee. Choose Lock-O-Matics that change drive as you shift, or manual Locking Hubs. Models for all 4-w. ds. at dealers. or write for literature.

WARN MFG. CO. Riverton Box 6064-A
 Seattle 88, Wash.

It's Like Having Auto Factory Experts Right Beside You...



SHOWING YOU

HOW TO FIX ANY PART OF ANY CAR!

NOW—Whether You're a Beginner or an Expert Mechanic—You Can "Breeze Through" ANY Auto Repair Job—QUICKLY — EASILY — RIGHT!

SUPPOSE you had an auto-mobile factory engineer standing right beside you . . . guiding your hands through every step of even the toughest car repair jobs! Think how you'd "whiz through" every job! No wonder, then, that 4,000,000 MOTOR'S Auto Manuals have been sold. No wonder so many thousands of beginner and expert mechanics alike are already using MOTOR'S brand-new AUTO REPAIR MANUAL. It shows you, in step-by-step words and pictures, factory-approved repair procedures for fixing ANY part of ANY car listed here — 1955 through 1962!

No guesswork! MOTOR'S Manual "starts from scratch" — leads you through entire job with easy directions. You CAN'T go wrong!

OVER 1,100 BIG PAGES —
OVER 2800 PICTURES

NEW, REVISED, ENLARGED Edition covers everything you need to know to fix practically any car model from 1955 thru 1962, including all the new compacts. Over 1,100 giant pages, 2,850 "This-is-How" pictures, 195 "Quick-Check" charts — more than 30,000 essential repair specifications. Over 225,000 service and repair facts. Plus a big handy Trouble-Shooting section!

Even a green beginner mechanic can do a good job with this giant manual before him. And if you're a top-notch mechanic, you'll find short-cuts that will amaze you. No wonder this guide is used by the U. S. Army and Navy! No wonder hundreds of thousands of men call it the "Auto Repair Man's Bible"!

Engineers from every automobile plant in America worked out these time-saving procedures for their own motor car line. Now the editors of MOTOR'S have gathered together this wealth of "know-how" from over 176 Official Shop Manuals and "boiled it down" into crystal-clear terms in one handy indexed book!

EVERYTHING YOU NEED TO KNOW

Includes ALL Automatic Transmissions, Overdrives, Power Steering, Power Brakes, Carburetors, Fuel Pumps, Starting Motors, 12-Volt Systems, Generators, Alternators, Voltage Regulators, Distributors, Axles, etc. Factory Specifications and Adjustment Tables. Tune-up Charts, Tables of Measurements and Clearances, Overhauling and Replacement Facts, etc.

Covers These Makes

Buick	Jeep
Buick Special	Lancee
Cadillac	Lark
Chevrolet	Lincoln
Chevy II	Mercury
Chrysler	Metzger
Comet	Oldsmobile
Continental	Olds F-85
Corvair	Plymouth
Corvette	Pontiac
Dart	Pontiac Tempest
De Soto	Rambler
Dodge	Rambler American
Edsel	Studebaker
Fairlane	Thunderbird
Falcon	Valiant
Ford	
Imperial	

MOTOR'S AUTO REPAIR MANUAL

CARBURETOR

GENERATOR

FUEL PUMP

STEERING GEAR

BRAKES

DISTRIBUTOR

AUTOMATIC TRANSMISSIONS

STARTING MOTORS

STARTER SWITCHES

AIR CONDITIONERS

IGNITION

MUCH MUCH MORE!

TRY BOOK **FREE** FOR 10 WHOLE DAYS

SEND NO MONEY

Just mail coupon. (Attach it to postcard, for faster action.) Unless you agree this book is the greatest time- and work-saver you've ever seen — return it in 10 days, pay nothing. Mail coupon to MOTOR BOOK Dept., Desk 214, 250 West 55th St., New York 19, N. Y. (Schools, Bookstores: Write for Discounts).

MAIL COUPON NOW FOR 10-DAY FREE TRIAL
(Attach to Postcard if More Convenient)

MOTOR BOOK DEPT.
Desk 214, 250 W. 55th St., New York 19, N. Y.
Rush to me at once (check box opposite book you want):
 MOTOR'S New AUTO REPAIR MANUAL. If O.K., I will remit \$2 in 10 days, \$2 monthly for 2 months and a final payment of \$2.95 (plus 45¢ delivery charges and sales tax) one month after that. Otherwise I will return the book postpaid in 10 days.
 MOTOR'S New TRUCK REPAIR MANUAL. If O.K., I will remit \$3 in 10 days, \$3 a month later, then \$2 monthly for 2 months, plus 45¢ delivery charges and sales tax with final payment. Otherwise I will return book postpaid in 10 days.

Print Name.....Age.....

Address.....

City.....Zone.....State.....

Check box and save 45¢ shipping charge by enclosing WITH coupon entire payment of \$8.95 for Auto Manual (or \$10 for Truck Manual) plus sales tax. Same 10-day return-refund privilege applies.



Same FREE Offer On MOTOR'S Brand-New Truck Repair Manual

Covers every job on every popular make gasoline and Diesel truck made since 1952! Over 2000 pictures. Over 800 big pages. FREE 10-Day trial. Check proper box in coupon.

AMAZING SCIENCE BUYS

OVER 1000 ITEMS

WAR SURPLUS AMERICAN-MADE 7x50 BINOCULARS

Big savings! Brand new! Crystal clear viewing—7 power. Every optical element is coated. An excellent night glass—the size recommended for satellite viewing. Individual eye focus. Exit pupil 7mm. Approx. field at 1,000 yds. is 376 ft. Carrying case included. American 7 x 50's normally cost \$274.50. Our war surplus price saves you real money.



Stock No. 1544-H. only \$74.80 postpd. (Tax included)
6 x 30 Binoculars—similar to above and a terrific bargain.
Stock No. 963-H. \$33.00 postpd. (Tax included)

LARGE SIZE OPAQUE PROJECTOR

Ideal for photographers, this low-cost unit projects 3 1/2 ft. sq. image at 6 ft.—7 1/3 ft. sq. image at 12 ft. Projects photos, drawings, sketches, clippings, any opaque copy up to 6" x 6"—larger pieces in sections. Lenses are 2 plano-convex, 3 1/2" dia. mounted in 5 1/4" barrel. Projector is 11 1/2" high, 13 1/4" wide, 9" front to back, pressed steel in black wrinkle finish, bakelite handle. Uses two 200 watt bulbs—not included. Complete with side platform to hold illustrations, 6 ft. elec. cord, heat resist. plate glass mirror.



Complete with side platform to hold illustrations, 6 ft. elec. cord, heat resist. plate glass mirror.

Stock No. 80.066-H \$42.00 Postpaid

OPAQUE PROJECTOR



Projects illustrations up to 3" by 3 1/2" and enlarges them to 35" x 30" if screen is 6 1/2 ft. from projector; larger pictures if screen is further away. No film or negatives needed. Projects charts, diagrams, pictures, photos, lettering in full color or black-and-white. Operates on 115 volt, A.C. current. 6-ft. extension cord and plug included. Operates on 60 watt bulb, not included.

Size 12" x 8" x 4 1/2" wide. Weight 1 lb., 2 oz. Plastic case with built-in handle.
Stock No. 70.199-H \$7.95 Postpaid

EXPERIMENT IN PLASTICS WITH NEW PLASTICS ENGINEERING SET



Keep pace with advances in plastics technology. Innumerable profit opportunities. Designed for working knowledge for non-plastics technicians, etc. Teaches how to identify and shows unusual properties and behavior of different plastics. Demonstrates heat forming, heat sealing, cementing. Depicts methods of foam casting, solid casting, rotational casting, slush molding. Make plastic products by injection molding and blow molding. Kit 15" x 6" x 11 3/4". Incl. non-tech. instr. manual.

Stock No. 70.456-H \$25.00 Postpaid

'FISH' WITH A MAGNET

Go Treasure Hunting On the Bottom

Great idea! Fascinating fun and sometimes tremendously profitable! Tie a line to our 5-lb. Magnet—drop it overboard in bay, river, lake or ocean. Trawl it along the bottom—your "treasure" haul can be out board motors, anchors, fishing tackle, all kinds of metal valuables. 5-lb. Magnet is war surplus—Alnico V Type—a terrific bargain. Lifts over 125 lbs. on land—much greater weights under water. Order now and try this new sport.

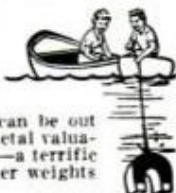

Stock No. 70.183-H. 5-lb. Magnet \$9.95 Postpaid

NEW EMUND STAR FINDER



With this precision made metal instrument, any observer can quickly locate and identify any charted visible star. The view is erect, same size, some brightness. Overall size is 8" x 4" wide x 7 1/4" deep. It is designed for use on any photo tripod or simple mount. (Suggestions for mounting are included). Full directions included.

Stock No. 70.501-H \$9.00 Postpaid

Order by Stock No.—Send Check or M.O.—Money-Back Guarantee
EDMUND SCIENTIFIC CO., Barrington, New Jersey

MAIL COUPON FOR FREE CATALOG "H"

160 Pages! Over 1000 Bargains!

EDMUND SCIENTIFIC CO., Barrington, N. J.

Please rush Free Giant Catalog "H"

Name

Address

City..... Zone..... State.....



Science overseas

By William Kreh

Wasps are now foaming at the mouth in Australia. Because they have been threatening valuable woodlands, foresters are trapping them by setting up glass wasp traps baited with a half pint of beer mixed with water. Wasps, it seems, like a wee nip.



Helium, a vital substance of the space age, has been found in the French Sahara at the natural gas field at In-Salah, about 600 miles south of Algiers. It's an important discovery, for the world's only other known sources are in Texas and Utah.



Nosey British biologists recently dropped microphones into the depths of the North Sea, off Cuxhaven, Germany, for 25 days to record the love call of the herring. The call, they discovered, was "peep, peep."



A salmon may have a keener sense of smell than a bloodhound. Canadian fisheries scientists plugged the nasal sacs of young sockeye salmon held in tanks, and discovered the fish couldn't find food put in the water for them. When the plugs were removed, though, the fish had no trouble.

From this and other experiments, ichthyologists conclude salmon literally smell their way up large rivers like the Fraser, in British Columbia, to spawn in the head-water streams where they, themselves, were spawned.

Their noses are sensitive to certain wet substances in quantities as low as one part in 800,000.



Radioactive grubs are now helping bug exterminators. Scientists at Canada's Biological Control Laboratory now find hidden nests of carpenter ants by treating insect grubs—a delicacy to the destructive ants—with radioactive iodine. Then they spread the "hot" bait around an infested building. Next day, they use Geiger counters to pinpoint locations of nests even though they're hidden behind walls or under floors.



A paint spray gun that works without air, has been developed by a firm in West Germany. A high-powered pump puts paint in the gun at pressures of 120 to 175

atmospheres. Releasing the pressure in the can releases the paint through spray holes that are only a few tenths of a millimeter in diameter. The company says advantages of the system are a softer paint jet with little back splashing, no fog formation, and less wastage of paint.



The Russians claim they are protecting their vineyards by shooting down hailstorms with rockets. Rocket launchers are mounted at 11 places among the peaks surrounding the Alazanskaya Valley in Georgia. Radar sets scan approaching clouds. If hail is detected within them, the rockets are fired. They discharge an undisclosed chemical that causes the clouds to dump their hail on the mountains, rather than on the valley's vineyards. The grapes, which produce some of Russia's best wine, get only rain out of the storm.



King Henry VIII had a lousy regime and experts now can prove it. English archeologist Michael Green has found mummified bodies of fleas on the site of Henry VIII's palace of Whitehall. Fleas were found in remains of cloth and leather in a part of the palace that may have been a court dressmaker's rooms.



Needling sharks has become a specialty of two Australian skindivers. Ben Cropp and Ron Taylor devised a hypodermic needle which is recessed in a rod shot from a regular spear gun. Upon impact, the rod triggers the needle, forcing the point further into the shark. The needles are filled with strychnine nitrate — one jab kills a shark in less than 30 seconds. The men hope their device will help reduce the hazardous shark population in Australian waters.



Atomic engineers in London use a clever method to find bad leaks in buried hot-water heating systems. They drop a pill of irradiated sodium bicarbonate into the pipe and its progress is checked with scintillation counters and rate meters. When the ball stops moving, it means water has stopped and there is the leak.



Tuna fish really travel. Ichthyologists tagged a 350-pound blue tuna, caught off the Bahamas last June, with a small barbed shaft that carried a bright yellow streamer. In October, the streamer was picked up on the dock of a Norwegian fishing town after a boat had unloaded a big catch. Apparently the tuna had traveled a distance of 4500 miles in 133 days. ★ ★ ★

AMAZING SCIENCE BUYS

See the Stars, Moon, Planets Close Up!
3" ASTRONOMICAL REFLECTING TELESCOPE
60 TO 180 POWER
Famous Mt. Palomar Type!
An Unusual Buy!



See the Rings of Saturn, the fascinating planet Mars, huge craters on the Moon. Equatorial Mount with lock on both axes. Aluminized and overcoated 3" diameter high-speed f/10 mirror. Telescope comes equipped with a 60X eyepiece and a mounted Barlow Lens. Optical Finder Telescope included. Hardwood, portable tripod. FREE with Scope: Valuable STAR CHART plus 272-page "HANDBOOK OF HEAVENS" plus "HOW TO USE YOUR TELESCOPE" BOOK.

Stock No. 85,050-H \$29.95 Postpaid
4 1/4" REFLECTING TELESCOPE—Up to 255 Power.
Stock No. 85,105-H \$79.50 F.O.B., Barrington, N. J.

OVER 1000 ITEMS

NEW TAPE RECORDER
AT AN AMAZING \$29.95
American Made—For Business, School or Hobby



Latest type, super-sensitive transistors in place of expensive bulky tubes is secret of low price. Excellent tone and quality. Real handy item for teachers, students, engineers, salesmen, etc. Single, foolproof control changes from rewind, off, play, record. All-transistor circuit sensitive crystal microphone, built-in Alnico V dynamic speaker for clear, loud amplification. Compact, lightweight. 8 1/2" x 9 1/4" x 3 1/8". Operates on 2 size D and one 9 V transistor battery (not included). Two 3" reels and 150 ft. magnetic tape, plus instructions (included).

Stock No. 70,480-H \$29.95 Postpaid

SPECIAL PURCHASE—SAVE \$7 ON THIS
PROFESSIONAL MECHANICAL DRAWING SET
Made to Sell for \$19.95—OUR PRICE ONLY \$12.95. Precision-made for professionals, yet priced within low-budget range. We bought all available stock from one of West Germany's famous instrument makers to bring you this super bargain. Every instrument real chromium on brass—not brass nickel. Wonderful gift for anyone in need of drawing equipment. Set includes: 6" detail (Swede) pen; 6" divider; 6" hinged divider with pen, pencil and extension; two 3 1/4" ruling pens; 4 1/2" bow divider with center wheel, bow pencils with center wheel; and bow pen, all precision type; 4 1/2" drop compass with pencil and pen attachment; spare parts box; screwdriver for adjusting extra lead box; polishing cloth. All metal parts rust free. Two-flap velvet lined case.



Stock No. 70,440-H \$12.95 Postpaid

WOODEN SOLID PUZZLES
12 Different puzzles that will stimulate your ability to think and reason. Here is a fascinating assortment of wood puzzles that will provide hours of pleasure. Twelve different puzzles, animals and geometric forms to take apart and reassemble, give a chance for all the family, young or old, to test skill, patience, and, best of all to stimulate ability to think and reason while having lots of fun. Order yours now.



Stock No. 70,205-H \$3.00 Postpaid

MINIATURE WATER PUMP
Wonderful for experiments, miniature waterfalls, fountains, Christmas gardens, HO gage railroad backdrops, etc. Tiny (2 5/8" x 1 3/4") electric motor and pump ideal for hobbyists, labs, schools. Pumps continuous flow of water at rate of one pint per minute at a 12" head. With 2 D Batteries in series will pump to 24" high. Works in either direction. Stock No. 50,345-H \$2.25 Postpaid



BUILD A SOLAR ENERGY FURNACE
A fascinating new field. Build your own Solar Furnace for experimentation—many practical uses. Easy! Inexpensive! Use scrapwood! We furnish instructions. This sun powered furnace will generate terrific heat—2000° to 3000°. Fuses enamel to metal. Sets paper aflame in seconds. Use our Fresnel Lens—14" diameter . . . f.1. 14". Stock No. 70,130-H \$6.00 Pstpd. 11" Sq. Fresnel Lens F.L. 19" Stock No. 70,533-H \$4.75 Pstpd.



Order by Stock No.—Send Check or M.O.—Money-Back Guarantee
EDMUND SCIENTIFIC CO., Barrington, New Jersey

MAIL COUPON FOR FREE CATALOG "H"

160 Pages! Over 1000 Bargains!
EDMUND SCIENTIFIC CO., Barrington, N. J.
Please rush Free Giant Catalog "H"
Name
Address
City..... Zone.... State.....



Now Easy to Start a Spare Time Business on Small Investment

Warner Home Business Plan gives exact instructions for metalizing in gold, silver or copper-bronze—how to get business without house-to-house selling—how we help finance your start.

A small manufacturing plant has now been developed for operation in the home. The work is so light a woman can do it. It's so easy and pleasant, the whole family will want to help—especially when they see how 58¢ worth of materials can be turned into a product which sells for \$6.95 at retail. Once the product is prepared, a little metalizing machine takes over and turns out the finished product while the owner is at work, asleep, or at a social gathering. The Home Business Plan that goes with the machine shows 11 different ways to get customers without any house-to-house canvassing. And, it is easy to get into the home metalizing business because the machine that does the work is so small it can be set up wherever you have a few square feet of space—even on a kitchen table. The cost of the equipment is easily handled because with our monthly payment plan we help finance men who are serious about making extra money in their spare hours. You can get complete information by mail, free, postage prepaid. No charge, now or at any other time. Just mail the coupon below to WARNER ELECTRIC CO., 1512 Jarvis Avenue, Dept. M2-4, Chicago 26, Illinois.

**WARNER ELECTRIC CO., Dept. M2-4,
1512 Jarvis Avenue, Chicago 26, Ill.**

Please tell me how I can start my own metalizing business at home in my spare time. Everything you send me now is free and I am under no obligation. No salesman will call.

Name _____
Address _____
City _____ Zone _____ State _____

\$6.44 AN HOUR IN YOUR OWN BUSINESS

**STEP INTO THIS BOOMING
\$19 BILLION A YEAR INDUSTRY**



Hundreds of accidents and losses will happen this year in your community.

We'll show you how to investigate and adjust these losses for insurance companies, railroads, government offices. You buy NO tools or equipment. You do NO selling. You need NO prior experience or higher education. And you can operate out of your own home. Right

now independent Accident Investigators average \$6.44 an hour. We'll train you quickly to do the same. Start part-time if now employed. Fill the need for an Accident Investigation specialist in your area. Colorful booklet explains everything. Absolutely no obligation on your part. No salesman will call. Write TODAY for FREE Booklet.

UNIVERSAL SCHOOLS, PM-4, 6801 Hillcrest, Dallas 5, Texas

**SAVE BY MAIL...
DISCOUNTS UP TO 40%!**

1,001 famous U.S. products for workshop, garden, boat, paint jobs—all in our valuable, 68-page Catalog of discounts. Name brands from cover to cover. Satisfaction guaranteed. Send for your copy today, enclosing just 25 cents.

GATES GENERAL CORPORATION
P.O. BOX 355 PM • FARMINGTON, CONNECTICUT

BRONZE FOUNDRY



Since 1935
Schools • Home Workshops • Inventors
Make your own castings of aluminum, copper, bronze, silver. Foundry sets are available in six sizes, capacity 1½ lb. to 48 lb. of red brass. 2400 Deg. F. blast furnace included with each. Write for Free Circular.

KANSAS CITY SPECIALTIES CO. DEPT. P-4
MARYSVILLE, KAN.

LAW FREE BOOK THE LAW TRAINED MAN

Write today for a FREE copy of illustrated law book, "THE LAW TRAINED MAN," which shows how to earn the professional Bachelor of Laws (LL.B.) degree through home study of the famous Blackstone Law Course. All necessary books and lessons provided. Moderate cost; convenient monthly terms. Write for FREE law training book today.

Blackstone School of Law, 307 N. Michigan Ave.
Founded 1890 Dept. 54, Chicago 1, Illinois

DO FALSE TEETH Rock, Slide or Slip?

FASTEETH, an improved powder to be sprinkled on upper or lower plates, holds false teeth more firmly in place. Do not slide, slip or rock. No gummy, gooey, pasty taste or feeling. FASTEETH is alkaline (non-acid). Does not sour. Checks "plate odor" (denture breath). Get FASTEETH at any drug counter.



POPULAR MECHANICS



FOR A BETTER JOB WITH BETTER PAY

LEARN ELECTRONICS AT HOME

Choose from these seven complete up-to-date courses

- Radio and Electronic Fundamentals
- TV Servicing • Color TV
- Communications Electronics
- Automation Electronics
- Computer Programming • Transistors

Each lesson a complete training package! Practical application begins with your first lesson — you get prime quality equipment as required to keep and use on the job. Courses for beginners and advanced students.

Voluntary Tuition Plan — pay for each lesson only when you order it! You never have to pay for the whole course if you don't complete it; courses can be interrupted at any time you wish — resumed later!

Approved for veterans.
SEND FOR THIS FREE BOOK NOW!
64-PAGES OF CAREER IDEAS IN ELECTRONICS!



RCA INSTITUTES, INC.
A Service of Radio Corporation of America
The Most Trusted Name in Electronics

Resident School Courses in New York City and Los Angeles offer comprehensive training in Television and Electronics. Day and Evening classes start four times each year. Detailed information on request.

RCA INSTITUTES, INC. Home Study School, Dept. PM42
350 West Fourth Street, New York 14, N. Y.

Rush me the FREE 64-page illustrated booklet "Your Career in Electronics" describing your electronic home study training program. No salesmen will call.

Name Age.....

Address.....

City..... Zone..... State.....

CANADIANS — Take advantage of these same RCA courses at no additional cost. No postage, no customs, no delay. Send coupon to: RCA Victor Co., Ltd., 5581 Royalmount Ave., Montreal 9, Quebec.



FREE
MUSCLE BUILDING
INFORMATION
Sensational New Methods
Less Time—Less Effort—Better results
BODY-TONE, Box 638, North Miami 61, Fla.

They're off and running in the May issue of Popular Mechanics—those plans you readers have requested for table-top racing layouts. Article includes instructions for building both HO-size and 1/32-inch-scale tracks.

HANDIEST SAW YOU EVER HELD!
Cuts Wood -- Metal -- Plastic -- up to 4 1/4" thickness
with Finger-Tip Control



Just \$14.75 including 6 assorted blades, lubricant and wrench (der). Wt. 2 1/2 lbs. F.O.B. Los Gatos (postage prepaid if cash with order). GRIP-TORC Saw gives YOU control of the blade because of its right angle pivoting on electric drill. Compact 6 1/4" length gets at hard-to-reach places... cuts squares, circles, bevels, and close to wall or floor. Reversible blade for right or left hand use, with push or pull movement. Provides unexcelled cutting speeds. Unconditionally guaranteed. Order today!



tools 17480 SHELburnE WAY
LOS GATOS, CALIFORNIA

AUDELS GUIDES

No. 1	AUTOMOBILE MECHANICS GUIDE. 1132 Pages.....	\$ 6.00
No. 2	HOME APPLIANCE SERVICE GUIDE. 864 Pages.....	6.00
No. 3	TV & RADIO SERVICE LIBRARY. 2 Book Set.....	8.00
No. 4	HANDY BOOK OF ELECTRICITY. 1052 Pages.....	5.00
No. 6	PLUMBERS & STEAMFITTERS GUIDES. 4 Book Set.....	9.00
No. 8	CARPENTERS & BUILDERS GUIDES. 4 Book Set.....	9.00
No. 9	DIESEL ENGINE MANUAL. 640 Pages.....	3.00
No. 10	WELDERS GUIDE. 608 Pages.....	3.00
No. 11	MATHEMATICS MADE EASY. 672 Pages.....	3.00
No. 12	MACHINISTS & TOOLMAKERS HANDBOOK. 1250 Pgs.....	6.00
No. 13	WIRING DIAGRAMS. 304 Pages.....	2.50
No. 14	REFRIGERATION & AIR CONDITIONING. 1360 Pages.....	6.00
No. 15	ELECTRIC LIBRARY. 10 Volume Set.....	22.50
No. 25	BLUE PRINT READING. 448 Pages.....	3.00
No. 26	MASONS & BUILDERS GUIDES. 4 Book Set.....	8.00
No. 27	ELECTRIC MOTOR GUIDE. 1056 Pages.....	5.00
No. 28	OIL BURNER GUIDE. 416 Pages.....	2.50
No. 29	SHEET METAL PATTERN LAYOUTS. 1152 Pages.....	7.50
No. 30	SHEET METAL WORKERS HANDY BOOK. 448 Pages.....	2.50
No. 43	DO-IT-YOURSELF ENCYCLOPEDIA. 2 Book Set.....	8.95
No. 44	NEW MECHANICAL DICTIONARY. 712 Pages.....	6.95

7-DAY FREE EXAMINATION

HERE IS ALL YOU DO

SEND NO MONEY—Pay the postman nothing! We'll send you any of the Audel Guides for FREE examination in your home. If you decide to keep the books you may pay for them under our easy-pay plan of only \$2 a month.

IT'S EASY TO ORDER: In the No-Risk Mail Order Coupon below you need only draw a circle around the number of Audel Guides you want. We will send them to you at once. If you are not completely satisfied, return the books to us.

MAIL THIS COUPON TODAY!

THEO. AUDEL & CO. — Self Improvement Publishers Since 1879
49 W. 23rd Street, New York 10, N. Y.

P4

Please mail me for 7 days' FREE EXAMINATION the books I have circled. I agree to mail \$2 in 7 days on each book or set ordered, and to further mail \$2 a month on each book or set ordered until I have paid the purchase price, plus shipping costs. If I am not completely satisfied with my Audel Guides I may return them.

NAME.....

ADDRESS.....

EMPLOYED BY.....

1 2 3 4 6 8 9 10 11 12 Check Here for Free
13 14 15 25 26 27 28 29 30 43 44 Complete Catalog

SAVE SHIPPING COSTS! Check here if you enclose complete payment with order. We pay postage charges. You have some return privilege.

EARN HIGH SCHOOL DIPLOMA AT HOME AT YOUR OWN SPEED

a program of **ENCYCLOPAEDIA BRITANNICA FILMS**

Learn fast! Earn more! Enter college, professional or technical schools. Take individual courses or full 4 year schooling for high school diploma. Work at home at your own speed under qualified teachers offering personalized instruction. Moderate tuition includes all textbooks. *Please send me latest school catalog.*

ACADEMY FOR ADULTS

a division of Encyclopaedia Britannica Films, Inc.
30 W. Washington, Dept. PM-4 Chicago 2, Ill.

NAME _____
ADDRESS _____
CITY _____ STATE _____

KARATE!

SAMURAI SUICIDE WARRIORS
JUDO **BOXING!** **MUSCLEBUILDING!** **YOGA!**
STRONGMAN STUNTS! **STRENGTH & ENDURANCE!** **HANDBALANCING!** etc.

YOU GET ALL THESE COURSES! *20 illustrated KARATE blows *SAVATE foot fighting *Secret NERVE CENTER and ANATOMY charts *20 lethal JUDO throws *20 terrific STRONGMAN STUNTS *Complete MUSCLE-BUILDING course *Ancient YOGA secrets *HANDBALANCING stunts *Complete BOXING course. Secrets of ENDURANCE. *All picture packed. Super wall charts. (surplus 1961 printing). No C.O.D.'s. Canadian orders 50c.

K-MAN KARATE PRACTICE DUMMY. Life like! Shows attack points 15c with 35c order only. Total 50c

35c you get the lot!

Oxford Studio, 44T Bromfield, Boston, Mass.

...TURN CONCRETE INTO GOLD!

MAKE UP TO \$75 A DAY IN YOUR OWN BUSINESS

If you want to have your own business — to start a business on your own — here's your big opportunity! New high speed, low cost General block machine produces up to 1,000 concrete blocks a day. Sell all you make to builders, supply houses, and others for homes, factories, buildings, garages. Cash in on the building boom! You can make profits of 100% to 150% — up to \$75. a day! General block machine equipped with 1/2 h.p. electric motor — or can be supplied with gasoline engine — works anywhere, in little space, indoors or out. Operates from ordinary house light socket. Simple, foolproof 3 step operation — so easy a child can do it. Makes superior 3 core blocks any size from 4" to 12". Also makes chimney, sash, corner and other types. Blocks meet any building code anywhere in the country. Materials — sand, water, cement, available anywhere. Simple illustrated operating instructions and mixing formulae for cement and cinder blocks supplied with each machine. Write for FREE folder with full information.

MOTOR DRIVEN

R. L. T. of New York City reports: "MY GENERAL BLOCK MACHINE PAID FOR ITSELF IN FIRST 2 WEEKS!" Hundreds now in use the world over! Write for FREE details today!

EXTRA Amazing illustrated book gives floor plans for 6 sensational concrete block bungalows. Tells how to lay blocks, lay out building lines, mix concrete, build steps, porch and concrete floors all at great savings. Written by experts. Can save many times the cost of the machine! Get it now! No strings attached. Send \$1.

BOOK SENT FREE IF YOU BUY MACHINE.
\$1 REFUNDED IF YOU BUY LATER.

GENERAL ENGINES CO.
DEPT. PB-42, ROUTE 130, THOROFARE, N. J.

HOW TO BUILD YOUR OWN CONCRETE BLOCK HOME
Only \$1 Prepaid

TRY THIS AMAZING NEW B-B SHOT! IT SHOOTS BB'S WITH TREMENDOUS POWER AND ACCURACY, YET IS ONLY 2" LONG.

Only 2" long x 1" diameter, this new device has amazing power and accuracy. Scientifically designed to give you the utmost in operating ease, power and safety. Great for targets, hunting and pests.

FREE Order now and get these valuable Extras **FREE:** A handy automatic BB Dispenser, spare Velocity Cone, a generous supply of BBs and a Target... all for only \$1.98 ppd., 3 for \$5.00 ppd. Not sold to N.Y.C. residents or minors. **Guaranteed!** **GRAYSON PROD., INC., Dept. B-91** 210 Fifth Avenue, New York 10, N. Y.

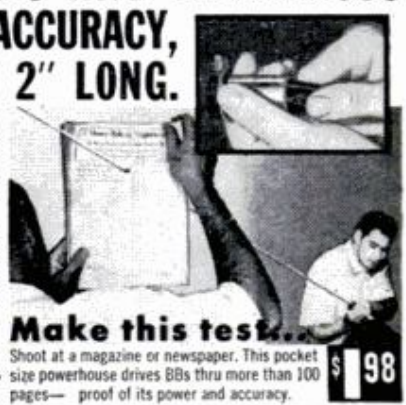

Make this test. Shoot at a magazine or newspaper. This pocket size powerhouse drives BBs thru more than 100 pages — proof of its power and accuracy.

\$1.98

PLAY GUITAR IN 7 DAYS

Or Your Money Back Guaranteed

SURPRISE FRIENDS, RELATIVES, ENJOY POPULARITY AND FUN GALORE!

In this introductory offer you get **TOP RADIO GUITARIST ED SALE'S** famous 66 page secret system worth \$3.00 which positively teaches you to play a beautiful song the first day and any song by ear or note in seven days! Contains 52 photos, 87 finger placing charts, etc. Shows how to tune, keep time, build chords, bass runs, dance chords, swins, etc., plus 110 popular and western songs, words and music; a \$1.00 Chord Finder of all the chords used in popular music; a \$3.00 Guitarist Book of Knowledge—

TOTAL VALUE \$7.00—ALL THREE for only \$2.98. SEND NO MONEY! Just your name and address, pay postman \$2.98 plus C.O.D. postage. (Or send \$3.00 with order and I pay postage.) Same Money-back Guarantee. **ED SALE, Studio 153-G, AVON BY THE SEA, N. J.**

Regular Price of a Slide Rule \$4 and Up

92c and this Ad Add 8c Postage

SLIDE RULE with FREE 28-Page Inst. Book

If you can use a pencil, you can use this Slide Rule

For students, accountants, mechanics, hobbyists, salesmen, everybody. Simplifies mathematics for everybody. Easy to calculate instantly, accurately. Multiplying, proportions, division, roots, etc. "High Vision" Clear View Slide, Full 10" Rule, A, B, C, D, C1 and K Scales. **LARCH, 118 East 28th Street, Dept. 62-C, New York 16, N. Y.**

SONG IDEAS WANTED

SA Songwriters, with publisher contacts, want song ideas. **SHARE ROYALTIES. NO FEES.** Send poems: **SONGWRITERS' ASSOCIATES** Studio PM, 1650 Broadway, New York 19, N. Y.

After the city, Before the state

The ZONE keeps your mail

★ From being late ★

The Post Office has divided 106 cities into postal delivery zones to speed mail delivery. Be sure to include zone number when writing to these cities; be sure to include your zone number in your return address — after the city, before the state.

Learn PACKAGING!

MAKE TO 2500% PROFITS AT HOME
YOU PACKAGE WE DO YOUR SELLING!

HERE'S PROOF
that Packaging means
Big Profits for You!

Item Per Doz.	Bulk Cost	Sells For
Safety Pins	2½¢	15¢
Balloons	3½¢	19¢
Fish Hooks	2¢	50¢

Make profits like these on over 100,000 other products you can package right in your own home. We show you how!

Package products at home for nationwide sales force. You package bulk items in your own home. We do your selling coast-to-coast. FREE 'No Selling Plan' reveals thousands full, spare time big profit opportunities for beginners in self-service packaging, contract packaging, gift wrapping. We guide you step by step. Everything furnished.

Write today for FREE "10-STEP PACKAGING PROFIT PLAN", and full details. No salesman will call.



HOME PACKAGING CO., Dept. R-257
2212 E. Jesse St., Los Angeles 23, Calif.

"\$7,10850 First Year SERVICING RADIATORS!"

— Hank Konter, Newcastle, Wyo.

Make good money servicing auto-truck-tractor radiators with new Inland 1-Piece Radiator Shop. Easy to test-clean-repair radiators. Inland, world's largest radiator equip. mfr., trains you free. Small down payment starts you. Easy-pay plan lets you pay from profits. Proved merchandising assures volume. Profitable dept. for garage or service station. WRITE for Free Book. INLAND MFG. CO., Dept. PM1108 Jackson St., Omaha 2, Nebr.



NEW!



Learn Profitable Profession in few months at Home

MEN AND WOMEN, 18 TO 60

\$4.00 to \$5.00 for 1-hour treatment is the established charge for a skilled operator. Easy to learn and do. Diploma awarded. Open your own office or earn good income from Doctors, Hospitals, Clubs and other health or recreational centers. Wonderful part-time profession. Low monthly payments. Write today for free Anatomy Charts and catalog. No obligation.

ANDERSON SCHOOL OF SCIENTIFIC MASSAGE
Dept. D1, Princeton, Illinois

HALF-FLUSH — WATER SAVER



New—Save Water and Your Cesspool!

Why use 5 gals. when 1 to 2 gals. will flush fluid waste? HALF-FLUSH used at least 6 times to 1 full flush. Flush any amount you want. Pays for itself 1st month. Lasts for years. Full flush works same as always. Put on in 5 minutes. Instructions incl. \$1.50 ppd. Crandall Mfg. Co., Box 284, Dept. C, Sunland, Calif.



Excitement! Security! Good Pay! CRIME DETECTION

LEARN AT HOME IN SPARE TIME—START NOW!

Crime everywhere is on the rise! Learn now, in your own home, the profitable profession that enables you to track down criminals and bring them to justice! Hundreds of Identification Bureaus employ I. A. S. graduates... trained in finger printing, police photography, handwriting identification, firearms and investigation. Our 44th year! FREE "Blue Book of Crime"... packed with crime facts and the full story of famous I. A. S. training. State exact age. No salesman will call. Rush Coupon! A Correspondence School Founded in 1916.

FREE
Blue Book of Crime
MAIL COUPON

INSTITUTE OF APPLIED SCIENCE, Dept. 1354
1920 Sunnyside Avenue, Chicago 40, Ill.
Rush Blue Book of Crime... FREE!

NAME.....Age.....
ADDRESS.....
TOWN.....STATE.....

FREE CAREER BOOKLET



To guide you to a
successful future in

METALLURGY MECHANICAL ENGINEERING AIR CONDITIONING INDUSTRIAL TECHNOLOGY

This interesting pictorial booklet tells you how you can prepare for a dynamic career as a Mechanical Engineer or Engineering Technician in such rewarding fields as:

**DEVELOPMENT • RESEARCH • SELLING
PRODUCT DESIGN • PURCHASING
QUALITY CONTROL • TIME STUDY**

Get all the facts about job opportunities, length of study, courses offered, degrees you can earn, scholarships, part-time work — as well as pictures of the Milwaukee School of Engineering's educational and recreational facilities. No obligation — it's yours free.

MILWAUKEE SCHOOL OF ENGINEERING

MAIL COUPON TODAY!

Milwaukee School of Engineering
Dept. PM-462, 1025 N. Milwaukee St., Milwaukee, Wis.
Please send FREE "Your Career" booklet
I'm interested in Metallurgy Air Conditioning
 Industrial Engineering Mechanical Engineering
 Electrical Engineering.

Name.....Age.....

PLEASE PRINT

Address.....

City.....Zone.....State.....

I'm eligible for veterans education benefits.

Discharge date..... MS-110

Free!

BRAND NEW LAFAYETTE ELECTRONICS

1962 CATALOG 620

It's Bigger and Better
Than Ever!

340 giant-sized page catalog from the world's leading supplier of electronics and stereo hi-fi equipment.



340 PAGES

It's a complete shopping center for audiophiles, technicians, engineers, students, hobbyists, servicemen and dealers. Thousands of items at lowest money-saving prices — featuring LAFAYETTE KITS . . . the best value for your money any day.

SPECIAL! NO MONEY DOWN

with Lafayette's NEW EASY-PAY PLAN.

MAIL THE COUPON TODAY FOR YOUR FREE CATALOG

LAFAYETTE LOCATIONS
JAMAICA • BRONX • NEW YORK CITY
NEWARK • PLAINFIELD • PARAMUS • BOSTON

Lafayette Electronics Dept. LD-2

P.O. Box 190, Jamaica 31, N. Y.

Send me the FREE 340-pg. 1962 catalog 620.

Name

Address

City

Zone

State



WANT MORE MONEY? GET INTO PHOTOGRAPHY

Coast-to-coast, high-paying jobs in photography are waiting for people with the "know-how" to fill them. You can quickly, easily qualify at home with the world-famous NYI Learn-by-Doing Method. Write today for free catalog. Also resident training in N. Y. Our 52nd Year. Approved for Veterans.

NEW YORK INSTITUTE OF PHOTOGRAPHY

Dept. 49

10 West 33 St.

New York 1, N. Y.

YOU CAN OPERATE A GARDENCRETE CENTER

GC-4



New Wayside Enterprise Offers High Income on Low Investment

You can make, display and sell Gardencrete — a line of decorative masonry rich in eye-appeal and use appeal. Many items — traditional and contemporary. Bird baths, lawn seats, flagstones, vases, screen block, brick and stone for building patios, walks, planters, barbecue pits, etc. Large color range. Easy to make; no experience necessary.

This is a franchise opportunity, giving you exclusive privileges in protected territory. Broad markets . . . generous profit potentials. A timely business, with fascination, interest and opportunity to capitalize on personal vision and aggressiveness. We supply all necessary instructions and much sales cooperation. Thousands of good territories now open. Write at once for prospectus "The Gardencrete Center Idea".

COLORCRETE INDUSTRIES, INC.

726 Ottawa Avenue
HOLLAND, MICHIGAN



MADE ON
AMERICAN LASTS

from
Italy

FOR MEN WHO KNOW STYLE

The new—the different—imported footwear, in a handsome variety for street, dress, casual wear. Sizes 5 to 13; A to EEE. From \$12.95 to \$19.95.

2001 Demi-boot slip on with side gores for snug fit.

Eleganza

IMPORTS

192 Freight St.
Brockton, Mass.

Write for FREE catalog TODAY!

A BUSINESS OF YOUR OWN REPAIR HYDRAULIC JACKS



Earn while you learn at home. Millions of jacks in gas and auto-service stations, truckers, body-shops, riggers, factories, farms need servicing. We show you HOW — easy step by step directions and what tools to use. EARN UP TO \$5 an hour, in spare time, in your basement or garage. Start your own business NOW!

Write for folder PM-4 and free bonus offer

INSTITUTE OF HYDRAULIC JACK REPAIR

P. O. BOX 50 • BLOOMFIELD, N. J.

A Correspondence School Licensed by N. J. Bd. of Ed.

Secrets of VENTRILOQUISM Now Revealed!



Easy to learn in 60 to 90 days with our Home Study Course. RESULTS GUARANTEED Make Money! Be Popular! Have Fun! Big Opportunity! Radio, Television, Stage Appearances! For FREE information regarding price and terms WRITE. You must state your age. Dummy Catalog 25c. MAHER HOME COURSE OF VENTRILOQUISM Box 36, Studio PM-4, Kensington Station Detroit 24, Michigan

GET INTO ELECTRONICS

V.T.I. training leads to success as technicians, field engineers, specialists in communications, guided missiles, computers, radar, automation. Basic and advanced courses. Electronic Engineering Technology an ECPD accredited Technical Institute curriculum. Assoc. degree in 29 mos. B.S. obtainable. G.I. approved. Start Sept. Feb. Dorms, campus. H.S. graduate or equivalent. Catalog.

VALPARAISO TECHNICAL INSTITUTE

DEPT. D

VALPARAISO, INDIANA

LEARN TO BE A DENTAL MECHANIC



SECURITY • PRESTIGE • GOOD PAY

Learn at home, in your spare time, to make Crowns, Plates, Bridgework, etc. Dental Mechanics are employed by Dentists, Dental Laboratories or open your own shop, full or spare time. FULL EQUIPMENT OF TOOLS AND MATERIALS INCLUDED WITH COURSE. Low tuition. Easy Terms. Write for FREE BOOK about this money-making profession that's not affected by automation.

McCARRIE SCHOOL OF MECHANICAL DENTISTRY
127 So. 13th St., Dept. 49, Philadelphia 7, Pa.

LEARN
MONEY

Marshall's NEW PHOTO PAINTING PENCILS

Check this easy way to turn free time into extra cash. There's a big money market for hand colored photos, snap shots and Polaroid Land prints. No special talent needed. Send for FREE instructions or \$1.98 for Complete Coloring Kit of 8 Pencils. MARSHALL'S, 149 N. 9th St., B'klyn 11, N. Y. At photo, art, hobby, drug & stationery stores.



MEN! WOMEN!
IMPORT PAYS BIG!

H. L. Mellinger, Jr.
Director

Transistor Radio with battery \$3.92

Derringer Pistol \$5.74

17-Jewel Watch \$2.87

Make big profits. Buy dazzling bargains like these abroad. Sell to friends, stores, mail order. New Drop Ship Plan puts you in direct contact with overseas sources—starts you full or spare time, without product investment or previous experience. FREE details! Airmail reaches us overnight.

MELLINGER CO., Dept. D254
1554 S. Sepulveda, Los Angeles 25, Calif.

Plan shows where you get bargains like these for big profit sales.

DO NOT ORDER FROM US

Close Out! Clinton Engines

65% discount 5½ hp E65 Clinton Engines (right or left). Go-Cart mfg. gone out of business—offering engines at ridiculous prices. Complete with exhaust stack, recoil starter, motor mount, air cleaner, \$34.00 ea. Retail \$96.50. Send check, cash, or money order (no C.O.D.). Add \$3.00 ea. for parcel post, insurance and handling in the U. S.

Box 337 Warrensburg, Mo.



**FOR CARTS
SCOOTERS
AIR BOATS
GRAIN AUGERS
CHAIN SAWS**

LEARN PLASTICS



COMPLETE LOW COST SHOP METHOD HOME TRAINING NOW AVAILABLE

Get in on Big Money opportunities in Plastic molding, casting, forming, carving, etc. Earn as you learn with Interstate's professionally prepared course. All plastic materials furnished.

INTERSTATE TRAINING SERVICE

DEPT. C-3, PORTLAND 12, OREGON

WRITE FOR FREE BOOKLET



Print Your Own

Cards, Stationery, Advertising, Circulars, labels, photo and movie titles, church work, tags, etc. Save money. Sold direct from factory only. Raised printing like engraving, too.

Own a Printing Business

Print for Others, Good Profit. Have home shop. Junior press \$15; Senior \$35 up. We supply everything. Easy rules. Pays for itself in short time. Write now for free details.

KELSEY PRESSES, Z-37 Meriden, Conn.

Kelsey Presses

**Shrinks Hemorrhoids
New Way Without Surgery
Stops Itch - Relieves Pain**

For the first time science has found a new healing substance with the astonishing ability to shrink hemorrhoids and to relieve pain — without surgery.

In case after case, while gently relieving pain, actual reduction (shrinkage) took place.

Most amazing of all — results were so thorough that sufferers made astonishing statements like "Piles have ceased to be a problem!"

The secret is a new healing substance (Bio-Dyne®)—discovery of a world-famous research institute.

This substance is now available in suppository or ointment form under the name Preparation H®. Ask for it at all drug counters.

94.6% OF BAILEY GRADUATES ARE EMPLOYED AT TOP PAY IN THE FIELDS WHICH THEY WERE TRAINED!



DIESEL-AUTO MECHANICS DESPERATELY NEEDED!

We have a far greater demand for our students than we can fill!

We can show you an actual waiting list of leading companies throughout the world who have tried Bailey graduates — found them outstanding, and are coming back for more!

Bailey Graduates are Successful . . . RECEIVE BIG PAY — HAVE SECURE FUTURE!

The Famous Bailey Course prepares you for BOTH Diesel and Gasoline Mechanics.

This is a must—due to the advent of using Diesel principles, such as 'Fuel Injection' on passenger cars . . . use of gasoline engines for starting Diesel engines, etc. You learn all this at Bailey in the amount of time ordinarily required to learn just one of these subjects, **ALL FOR THE PRICE OF ONE.**

Don't be satisfied with a 'futureless', one-type job — learn how you can make big money now! Write today for Free Booklet that takes you on a step-by-step camera tour through our spacious, modern shops — See Bailey students in action as they Learn-by-doing with the Famous Bailey Method of training!

We provide you with housing and part time jobs while in school, plus nation-wide placement service for graduates.

BAILEY Technical SCHOOLS

1634 S. GRAND

ST. LOUIS 4, MO.

MAIL TODAY!

Please mail immediately this free booklet without obligation.

FREE BOOKLET



Name _____

Address _____

City _____ State _____

APPROVED FOR VETERAN . . . NON-VETERAN

FREE! 53 ORIENTALS



Send today for this Spectacular Oriental Collection! More than 50 fabulous genuine postage stamps from Taiwan, Korea, Viet Nam, Japan, Singapore, Burma, Pakistan, Indonesia, Thailand, Hong Kong, Laos, many other strange, remote lands of the mysterious Far East. Sensational stamps picturing weird beasts, birds, ancient ships, queens, kings, beautiful women. Extra! Big Bargain Catalog, exciting offers and other thrilling stamps for your free examination. Send 10c for mailing expense — Double your money back if not delighted!

Jamestown Stamp Co. Dept. C42PM Jamestown, New York
RUSH my Free Collection of 53 Orientals & other offers.
I enclose 10c for mailing costs.
PLEASE PRINT

Name

Address

City & State

AVIATION CAREER

SPECIALIZED EDUCATION / PROFESSIONAL TRAINING... only 16 months to 2 years

Top-pay prestige positions, bright future in aviation. Job opportunities waiting for you as soon as you're ready. Airframe and Powerplant Technician, Aeronautical Engineering degree course, Business or Executive, Pilot. Classes in Miami.

SEND FOR FREE 80-PAGE BOOK

Embry-Riddle Aeronautical Institute
Miami, Florida (Founded 1926)

Name

Address

City.....Zone....State.....

NEW IDEAL 900 LAWNMOWER SHARPENER

with "Two-Way" Grinding Option means big volume and big profit for you!

Unit sharpens any reel-type mower either by "hook" or "straight-line" method—for top versatility. Gravity feed. Screw-type adjustments. 1/2 h.p. motor. 6-inch grinding wheel. Includes: Bed-knife grinder, reconditioner and Tool Tray.



Write today for full details!

The Fale-Roof-Heath Company, Dept. PM-4, Plymouth, Ohio

FREE OUTFIT STARTS YOU IN BIG MONEY SHOE BUSINESS!



Run your own profitable 'shoe store' business from home! Represent fast growing million dollar firm in spare or full time. We give you — FREE — complete Starting Outfit that makes you \$217.00 EXTRA each month for just 2 easy orders a day. You feature 195 fast-selling dress, sport, work shoe styles for men and women. Air-cushion shoes, many other special features! Sizes 2 1/2-15—widths AAAA to EEEE. Draw on 200,000 pair stock. Also horsehide jackets. Start now selling to friends, folks where you work. Rush postcard for FREE Outfit!

MASON SHOE, Dept. H-350, CHIPPEWA FALLS, WIS.

ACCORDIONS UP TO 1/2 OFF



Save up to 1/2 off retail prices of comparable accordions

5-DAY FREE TRIAL

Buy DIRECT from world's Largest Exclusive Dealer! Compare our Importer-to-You prices! See how you save! Over 30 models—finest genuine Italian makes! New, easier terms! 5-Day Free Home Playing Trial with satisfaction 100% assured. Bonus Gifts Free. Rush name and address for FREE Color Catalogs and direct Importer-to-You prices—FREE. Write TODAY!

Accordion Corporation of America
2003 W. Chicago Av., Dept. R-42 Chicago 22

BIG PROFITS FROM FIREPLACE WOOD

Lickity log splitter eliminates the drudgery of splitting logs up to 48" lengths, any diameter. Does splitting with 18 ton hydraulic power. It's fun to operate. Highly profitable for FIREWOOD MERCHANTS, Farmers, Estate Owners, Country Clubs, Parks, Cities. Write for complete details without obligation to:

WACO AIRCRAFT CO., Dept. D, TROY, OHIO

KILLS USING NO CHEMICALS, GASES, ETC.

- MOSQUITOES • MOTHS, MILLERS
- FLIES, GNATS • FISH FLIES, ETC.

OVER 1/4 ACRE HANGS ANYWHERE

No insect recovery. Guaranteed. Beautiful outdoor lighting. Plug into any 110 volt socket.

NO AREA CONTAMINATION

Safe, beautiful. Complete with fly attractor. Dead insect catcher. Cord. Directions, Etc. Low cost.

SING SING BUG CHAIR, INC.
Box #3708, Oak Park 37, MICH.

WEIGHT 12 LBS.
BOX SIZE 15X15X18

DRAINS cellars, cisterns, wash tubs; \$7.95

IRRIGATES - CIRCULATES - SPRAYS

1,001 uses. Stainless shaft. Won't rust or clog! Use 1/6 HP motor or larger . . . 3/4 HP for up to 2,400 GPH; 450 GPH 80' high; or 1800 GPH from 25' well. 1" inlet; 3/4" outlet. Coupling included free. \$7.95.

HEAVY DUTY BALL-BEARING PUMP. Up to 5,200 GPH; or 3,000 GPH from 25' well. 1 1/4" inlet; 1" outlet. \$12.95

Footpaid if cash with order. MONEY BACK GUARANTEE

Centrifugal and Gear Pumps in All Sizes
LABAWCO PUMPS, Belle Mead 7, New Jersey

How would you like to MAKE \$26⁵² in 3 HOURS?

That's what M. R. Stanley of Calif. did with amazing MERLITE FIRE ALARM!

You can make big money, spare or full time, up to \$1,000 in a month, introducing sensational new automatic Fire Alarm. No installation, hangs on wall like picture. When fire starts, Alarm "beeps," can be heard 1 1/2 mile! Astounding "lighted match" demonstration sells alarms fast. **FREE SALES KIT!** Rush name, address for big Sales Kit with everything you need to make big money first day. All FREE. No obligation. Write:

MERLITE, Dept. F-155, Alarm Div., 114 E. 32nd, N.Y. 16, N.Y.

NO JOB WORRIES

PLASTEX INDUSTRY needs manufacturers on small scale for big production of Lamps, Clock Stands, Art Goods, Novelties in Plastic Marble imitation. No Experience necessary. Age material makes regular 10c store sellers. Moulds furnished for fast production. Small investment brings good profit. Big wholesale orders now being placed. Ambitious men have chance for real prosperity and job security. Our NEW FREE booklet will interest and benefit you.

PLASTEX INDUSTRIES, Dept. A
3400 Third Ave. New York 56, N. Y.



Not everyone does as well, but T. N. CODY, who started a business of his own, reports...

For 12 months I've averaged

\$800 PER MONTH INCOME

—most of it clear profit for me!

Many men have discovered how to be independent, to be free of layoffs and bosses. C. G. Naples grossed more than \$200 his first week. A father-son combination grossed \$44,000 their second year. H. Lemon says, "I netted \$133 in one 8-hour day."

How much you make depends largely on you. You need no special skill, no large investment. Start part time if you wish.

NO SHOP NECESSARY • Our Electric Deterger shampoos rugs, carpets right on floor—removes dirt and grime and helps to show their natural color and beauty. So efficient and safe it is used by largest railroads and hotels.

► **This is not a lease proposition.** You own the machine, you work when and where you please and all the money you take in is your own. You take no risk. Machines fully guaranteed.



MAIL COUPON TODAY FOR FREE BOOK

VON SCHRADER MFG. CO.
410 "R" Pl., Racine, Wisconsin

Without obligation send me **FREE** booklet about your RUG DETERGER and tell me how I can start my own permanent, profitable business.

Name _____

Address _____

City _____ Zone _____ State _____

BEAUTIFY YOUR HOME

with Pikes Peak Low Cost Quality Plantings

SEND TODAY FOR SPRING CATALOG

PIKES PEAK Nurseries

801 WATER STREET INDIANA 11, PA.

**GOVERNMENT OIL LEASES
LOW AS \$1 PER ACRE**

You do no drilling, pay no taxes, may realize a king-size profit without ever leaving home. Write for free map and literature.

AMERICAN OIL SCOUTS, Dept. PM
619 Cascade Bldg. Portland 4, Oregon

industry demands degree

Major corporations regularly visit us to interview and employ seniors. **B. S. DEGREE IN 27 MONTHS** in Engineering (five areas). **IN 36 MONTHS B.S. Degree** in Business Administration. Small classes. **Low Costs.** Well-equipped labs. New dorms. Enter quarterly. Write **J. E. McCarthy** for Catalog and "Your Career" Book.

TRI-STATE COLLEGE 442 College Street
Angola, Indiana



EARN BIG MONEY...

*U.S. Pat. Applied For

LEARN AT HOME IN SPARE TIME

You don't need previous training or art ability with the "Famous System of Manual Training!"* With this modern streamlined method, you learn rapidly and easily...start to cartoon immediately, without tedious study or exercises.

Wide Demand for Cartoonists—Earn While You Learn... Magazines, newspapers, movies, television, ad agencies—all are searching for new cartoon ideas and talent. As a successful, Continental-trained Cartoonist, your earnings are not lim-

ited. Many of our students start earning after first few lessons. A wonderful pastime, too.

We Supply Everything... As our student, you receive **FREE** of extra cost a big 15-piece Professional Kit containing all equipment and materials you need, and valuable Articulated Model that helps you draw any human pose.

Get All the Facts FREE... Big, colorful Free catalog gives all details plus pages of useful information. **FREE** for the asking. Use coupon.

Continental Schools, Inc.

4201 S. BROADWAY, LOS ANGELES 37, CALIF.

Continental Schools, Inc.
Dept. E-137, 4201 S. Broadway, Los Angeles 37, Calif.
Please rush me your Free Catalog and other information by return mail. No charge or obligation.

NAME _____

ADDRESS _____

CITY _____ ZONE _____ STATE _____



SEND
COUPON FOR
FREE BOOK

ENGINEERING



Heald's Micro-wave and Radar Laboratory Equipment.

ENROLL NOW FOR NEW TERM

HEALD Engineering College

Van Ness at Post, Dept. PM San Francisco, California

NAME _____
STREET _____
CITY _____ STATE _____

AMERICAN INDUSTRY NEEDS TRAINED ENGINEERS NOW

BACHELOR OF SCIENCE DEGREE, 30 MONTHS

SAVE 2 YEARS' TIME

B.S. Degree Courses:

- | | |
|---|---|
| <input type="checkbox"/> Electronic Engineering | <input type="checkbox"/> Mechanical Engineering |
| <input type="checkbox"/> Electrical Engineering | <input type="checkbox"/> Civil Engineering |
| | <input type="checkbox"/> Architecture |

Diploma Courses:

- | | |
|--|---|
| <input type="checkbox"/> Radio-Television Plus Color | <input type="checkbox"/> Architectural Drafting |
| <input type="checkbox"/> Electronic Technician | <input type="checkbox"/> Mechanical Drafting |
| | <input type="checkbox"/> Structural Drafting |

APPROVED FOR VETERANS

Send for **FREE** Information



Play Right Away!

ANY INSTRUMENT

New it's **EASY** to learn ANY INSTRUMENT—even if you don't know a single note now. No boring exercises. You start playing delightful little pieces **RIGHT AWAY**—from very first lesson! Properly—by note. Simple as A-B-C. You can make amazing progress—at home, in spare time without teacher. Only few cents per lesson. 1,000,000 students all over the world. (Est. 1898—Chartered by N.Y. State Education Dept.)

FREE BOOK Shows how easily you can learn music. Write for it. No obligation. No salesman will call. **U. S. SCHOOL OF MUSIC**, Studio 304, Port Washington, New York.



Test Almost Everything Electrical

TROUBLE-SHOOT:

• motors • batteries • heating elements • radio and TV tubes with this combination multi-range ac/dc voltmeter, ammeter, ohmmeter, wattmeter, and leakage tester.

EICO®

READI-TESTER #540

Kit \$12.95
Wired \$15.95
(add 5% in the West)

Write for free catalog of over 106 electronic kits for stereo hi-fi, ham gear, test instruments, transistor radios, and name of nearest dealer to:

EICO® ELECTRONIC INSTRUMENT CO., INC.
Dept. PM-4 3300 N. Blvd., L.I.C. 1, N.Y.



TOOLS WHOLESALE

\$100 PUTS YOU IN BUSINESS

Start your own business, sell tools to your friends and neighbors, or buy tools for your own use and **SAVE MONEY \$\$\$**

A MILLION DOLLAR INVENTORY AT YOUR FINGERTIPS, NO STOCK TO CARRY, ORDER AS YOU NEED IT.

BUY AT WHOLESALE PRICES. Extra \$25.00 profit on your accumulated purchases. \$1.00 refund on first purchase or refunded if you are not 100% satisfied.

THOUSANDS!! of Nationally Advertised items of Hand Tools, Power Tools, Machinist Tools, Tool Chests, Paint Sprayers, Light Fixtures, Appliances, Guns, Gifts, Toys and other items too numerous to mention.

WE SHIP COAST TO COAST Dept. White. Disc. up to 50% off

SILVO HARDWARE CO., PM-4 107 Walnut St., Phila. 6, Pa.

REAL ESTATE BE A BROKER

PAYS BIG! SEND FOR FREE, BIG, ILLUSTRATED CATALOG NOW! Graduates report making substantial incomes. Start and run your own business quickly. Men, women of all ages. Learn easily. Course covers Sales, Property Management, Appraising, Loans, Mortgages, and related subjects. **STUDY AT HOME** or in classrooms in leading cities. Diploma awarded. Write **TODAY** for free booklet! No obligation.



Approved for World War II and Korean Veterans
WEAVER SCHOOL OF REAL ESTATE (Est. 1936)
3521P Broadway Kansas City, Mo.

PROFIT IN YOUR SPARE TIME

SMALL ENGINE REPAIR PAYS BIG!

Outboard • Powermower • Chain Saw • Tractor
MAKE EXTRA MONEY — or fix your own engines and **SAVE!** Illustrated, easy-to-learn Home Study Course qualifies you as expert. Free information. Write today!



LINCOLN TECHNICAL INSTITUTE
SUITE 4-E, 472 MARKET STREET, NEWARK 5, N. J.

MAKE YOUR FORTUNE

Sell famous Spring-Step Cushion Shoes for all the family. Earn big money daily plus Cash Bonus and Retirement Income with amazing 1-minute demonstration that sells on sight. Big repeat business. Full or spare time. America's biggest selection of shoes. Free outfit given. No investment ever. Fabulous insurance benefits—free to qualified dealers. Write today.



ORTHO-VENT Shoe Co., Inc.
1124 Brand Road Salem, Virginia

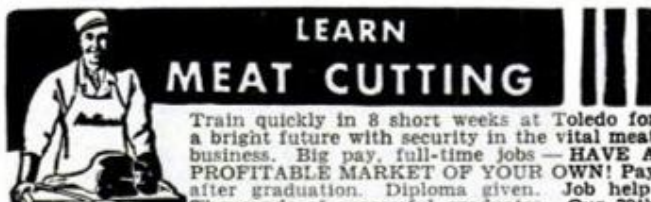

LEARN MEAT CUTTING

Train quickly in 8 short weeks at Toledo for a bright future with security in the vital meat business. Big pay, full-time jobs — **HAVE A PROFITABLE MARKET OF YOUR OWN!** Pay after graduation. Diploma given. Job help. Thousands of successful graduates. Our 39th year! Send **NOW** for **FREE** catalog. No obligation. GI approved.
NATIONAL SCHOOL OF MEAT CUTTING, Dept. 50-D, Toledo 4, Ohio

Order your **FREE** copy of . . .

What You Should Know About Patents

Comprehensive information on patents and how to secure a patent. Write Popular Mechanics, Bureau of Information, 200 E. Ontario, Chicago 11, Ill.

POPULAR MECHANICS

**EARN UP TO
\$1,000 A MONTH**

Car Furnished

Pick Your Locality

**NO SELLING
of Any Kind**

Compare this Interesting Job to the One You Have Now — then if you'd like to switch—I'll show you how to do it!

I'd like to show you how easy it is to get into one of the best paying professions in America today—the business of investigating auto accidents and adjusting accident claims. Here is why employers are glad to pay top salaries to men in this particular field.

25 Million New Claims to Settle This Year!

Every day, throughout the year, 69,000 auto accident claims have to be settled. And there just aren't enough claim investigator-adjustors to handle them. These investigations cannot be put off. The courts demand action! Insurance companies cannot afford to let claims drag on—and mount up! They must be settled, because huge reserves of company money are tied up by law when auto accident claims remain unsettled.

And That Is Where YOU Come In!

Insurance companies everywhere are looking for people who know how to handle this specialized work—and they are prepared to pay a top salary to any man who can fill the bill. In addition, they offer every opportunity for rapid advancement to executive positions and the high bracket incomes that go with them. And because experienced help is so scarce—they offer many fringe benefits



and also other valuable extras practically unheard of in many other kinds of businesses.

But Money Isn't ALL You Get!

And remember that a Claim Investigator's Life is crammed with exciting new experiences. No two cases are alike. You rub shoulders with lawyers and police officers, doctors and judges. You render an important service to your community.

And later on, if you want to set up your own claim adjusting business, we show you how you can begin right in your own home.

Free Employment Help Given

Even if you have only an average education, you can go far in this new profession. All we ask is the ambition to get ahead! And when you have successfully completed the course, we provide a FREE employment service to get you off to a flying start.

Just Mail the Coupon Today

I have prepared a Special Booklet in which I explain carefully to you my "20 Steps to Success" as an Automobile Insurance Claim Adjustor. It tells just what to do to get into this fascinating, fast-growing profession. There is no charge for this Booklet—now or any other time. Here's your big chance to eventually make as much as \$12,000 to \$15,000 a year! Mail the coupon below or send a postcard with your name and address to Eric P. McNair, President, Liberty School of Claim Investigating, Dept. 94, Libertyville, Illinois.



JUST MAIL THE COUPON TODAY

Mr. Eric P. McNair, President Dept. 94
Liberty School of Claim Investigating
Libertyville, Illinois

Please rush me your FREE Booklet explaining how I can quickly qualify as an Automobile Insurance Claim Investigator and Adjustor. It is understood that no salesman will call on me, and that everything you send me now is absolutely FREE, and places me under no obligation whatsoever.

My Age is _____

My Name _____
(Please Print)

Address _____

City _____ Zone _____ State _____
or R.D. _____

make your own Gems 36⁵⁰
The Gem Maker comes complete with all necessary equipment, including a super-charged diamond blade for sawing, and all the wheels for grinding, shaping and polishing; also complete instructions. The complete equipment as shown, less motor and belt for only \$36.50, f.o.b. Burlington, Wisconsin. Write today for information and literature.

B&I MANUFACTURING CO.
Dept. P. Burlington, Wis.

MAKE MORE MONEY

Be in business for yourself year-round. Fast growing company. Travel United States and parts Canada. Paid training. Age 21 or over, pass physical, own or can finance '57 or later 260 cu. in. or larger tractor. Write Mayflower Transit, Box 107, Dept. PM, Indianapolis 6, Ind.

**PELLET FIRING
LUGER AUTOMATIC**

- MAGAZINE LOADING CLIP
- OVER 15 MOVING PARTS
- FULLY AUTOMATIC

Automatic full size model of a Luger Automatic pistol—contains over 15 moving parts. Loads 8 complete rounds which snap into the hard butt simulating a Luger. Fires 8 bullet shaped pellets. Has automatic slide action.

ONLY \$198

MOST AUTHENTIC MODEL GUN WE'VE EVER SEEN
Comes to you with working parts disassembled with cleverly engineered springs, full instructions, supply of pellets and specially designed belt holster. Full Money Back Guarantee. Simply send \$1.98 plus 27¢ shipping charge or order C.O.D. From:
HONOR HOUSE PROD. CORP., Dept. LB-35, Lynbrook, N.Y.

MANUFACTURE THIS BEAUTIFUL CONCRETE OUTDOOR FIREPLACE

Right In Your Own Backyard

\$4.00 Worth of Sand & Cement produces this Attractive Fireplace.

Sells on Sight from \$60. to \$80. Easy to start your own Profitable Business.

The General Fireplace Molds and Process are the most amazing and foolproof ever invented. Simple to operate. Two men can produce five fireplaces a day.

BIG DEMAND!!

Sell all you produce to Department Stores, Homeowners, Parks, Nurseries and Picnic Groves. Fireplaces sell on sight. No experience necessary. We supply full operating instructions and equipment plus the know-how that spells **BIG PROFITS**. This is an outstanding opportunity for men of vision and small capital to get into a busy rich paying field. Don't delay, be the only exclusive manufacturer in your own home town. Mail coupon at once for full details as to how you can reserve your territory. **Molds sold only on exclusive franchise.**

GENERAL ENGINES CO., Inc., Dept. MF-42
ROUTE 130, THOROFARE, N. J.

Mr. Tor of Philadelphia writes:
Sold 250 in first 4 months. Selling to Sears Roebuck, John Wanamaker, and Gimbel Bros. in Philadelphia area.

Name _____
Address _____
City _____ Zone _____
State _____



POPULAR SHOPPING

worth
writing
for . . .



NUMBER PORTRAIT KIT

An improved oil portrait kit to enable you to paint a living image with no patchwork appearance by simply filling numbered spaces. This kit is far superior to prior custom kits (improved pat. pend.) and includes a fine 14" x 20" marked canvas panel; two brushes; 24 cups paint (no mixing); brush cleaner; instructions and color guide photo. SEND ONLY \$9.95 and any photo or color slide for your kit postage paid. Photos returned unharmed. Indicate hair and eye color.

ZAN PRODUCTS INC.
Harbor City 33, California

Storage space, and how to get it, is the subject of free booklet published by the Western Pine Assn., Yeon Building, Portland 4, Ore. It contains a wide variety of practical ideas to help the home craftsman design and build attractive shelves, drawers and cabinets to needs of his home. Send 10 cents for handling and mailing.

Tips for Safer Cruising is the title and subject of a booklet available from Walter Kidde & Co., Industrial and Marine Div., Dept. PM, Belleville 9, N. J. Illustra-

tions point up information on weather signs, storm signals, mooring knots, anchoring, channel markers, rules of the road, distress signals, artificial respiration and fire protection.

Terms used in the interior decoration and design field are compiled and defined in a 25-cent glossary published by the Chicago School of Interior Decoration, 835 Diversey Parkway, Chicago 14, Ill. A handy reference, it introduces to the homemaker the specialized vocabulary of the field—one that abounds in such words as patina, ormolu, marquetry.

THE FLYING JODHPUR

Nothing like it. Benchmade! . . . Comfortable, glove-soft long-wearing leather and fully lined. Black . . . Brown . . . Tan. Sizes 5 to 13. \$3 more for sizes 13½ to 15. \$2 C.O.D. deposit.

1995 PPD #5006

Sold only by mail Fully guaranteed



Write for Free Folder.

NAVARRO BROS.

DEPT. IV • 204 SAN FRANCISCO AVE. • EL PASO, TEXAS

Dramatic photos of space-age goals—the Moon and Mars, for example—and of space-age vehicles highlight the new Space Atlas presented by the American Map Co., Inc., 3 West 61st St., New York 23, N. Y. The text is by the U. S. Naval Institute and gives a complete description of the Universe, Solar System, Earth in space, tide, calendar, time and much other topical data. It contains a detailed moon map. Cost: \$1.25 postpaid.

2



The 250 amp. "BANTAM CHAMP" is highly popular for light to medium fabrication. Permits up to 500 current control steps. Has push button starting, sturdy lifting eye. Ask for data sheet A-108-J.

(D. C. WELDER) (A. C. WELDER)



The 180 amp. "TROJAN" delivers top results in small repair, sheet metal, hobby, plumbing and heating shops, garages. Use it to repair parts, equipment, build railings, furniture, hardsurface tools, braze, solder, cut, and burn holes. Low cost. Meets REA requirements. Accessories included. Ask for data sheet A-520-G.

battery charger
attach
most
optional

LOW COST / EASY-TO-USE / BIG PROFIT-MAKING WELDERS / WRITE FOR DETAILS TODAY!

HOBART BROTHERS COMPANY, BOX M-42, TROY, OHIO, U.S.A., PHONE FE 2-1223

WORLD'S MOST FAMOUS TOOL NOW AT A NEW LOW PRICE! !

SENSATIONAL

PLIERENCH

• Made in U.S.A. • 10 TO 1 GEAR RATIO • 1 TON GRIPPING POWER

A COMPLETE WORKSHOP IN 1 TOOL

• It's a Geared Ratchet Wrench—Securely holds corners, edges as well as flat surfaces. • It's a Wire Cutter—Snips off the heaviest barbed wire.

• It's an Internal-External Wrench and Pipe Extractor—Grips tubes and pipes from the inside where no outside area is exposed.

A fantastic tool for homeowners, farmers, mechanics. Replaces a multitude of ordinary tools including complete sets of wrenches: such as box, lug, ratchet, "S" pipe, open end as well as regular adjustable and monkey wrenches. Eliminates need for all types of pliers. Automatically locks as vise or clamp. Made of select hand-forged tool steel and Hi-Drize heat treated, the 10 to 1 gripping ratio and 100% parallel jaws give the Plierench 5000 lbs. of gripping power. The special gear transmission allows instant adjustment to any size or shape. The Plierench is UNCONDITIONALLY GUARANTEED for 5 years. Comes in handy tool pouch.

ALSO AVAILABLE! **PLIERENCH STANDARD KIT**

Usually \$9.98 NOW ONLY **\$6.98** PLUS 32c PP.

This kit contains universal jaw plus (A) pipe jaw, (B) Giant pipe jaw and (C) giant internal external jaw

FORMERLY \$6.98

NOW ONLY **\$3.98** Plus 32c pp.



Over 3 Million Satisfied Users

SCOTT MITCHELL HOUSE, Inc., Dept. PM-2, 415 So. Broadway, Yonkers, N. Y.

New Table Top Invention Puts You In...
PROFITABLE RUBBER STAMP BUSINESS

Home Operators now make **\$9.20 AN HOUR** in Business once monopolized by a few big companies

Special rubber stamps bring high prices—cost only pennies to make on new, low-cost table top machine. Take 27 cents worth of material, make perfect stamps, the kind businesses and offices now buy by the dozen at \$1.80 each. Make up to \$9.20 an hour. Start in spare time in your own home. Run machine on kitchen table using ordinary electrical outlet. Make any kind of stamp. We'll send you free information without obligation about this established, highly profitable business. **We'll even help finance your start.** For free information send name and address today on a postcard to: Rubber Stamp Div., 1512 Jarvis Ave., Dept. R-2-D, Chicago 26

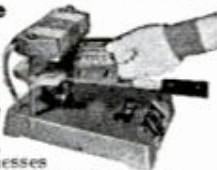

ASSOCIATE IN SCIENCE DEGREE in 90 Weeks



- ARCHITECTURAL DRAFTING
- INDUSTRIAL TECHNOLOGY
- TOOL AND GAUGE DESIGN

Complete training in less than two years. Free placement service for life. Many excellent positions available to graduates. Start any Monday.

LAIN TECHNICAL INSTITUTE

TWO SCHOOLS: 603 N. Delaware St., INDIANAPOLIS, IND. 821 E. Division St., EVANSVILLE, IND.

LIFE INSURANCE

FOR PEOPLE 50 TO 80

Old line legal reserve \$500 or \$1000 policies. Rates guaranteed never to increase. Non-cancellable. 30 DAY MONEY BACK GUARANTEE. No doctor examination if in good health. Write for FREE LIFE EXPECTANCY CHART. Policy owners in every state. No obligation. No salesman.

SECURITY LIFE INSURANCE COMPANY OF AMERICA
 183 E. Grant St., Dept. PM, Minneapolis 3, Minnesota



\$47,983.06 ORDERS FROM 12 WORD CLASSIFIED AD.

Amazing—Startling—but TRUE. Terrific story sent free. Request must be made on business letterhead. F. W. Johnson, Classified Adv. Manager, 200 E. Ontario St., Chicago 11, Ill.

MONEY IN WORMS

Success for you! 5000 of our hybrid red wiggler fishworms produce 5,000,000 in one year using our successful method of worm raising. Read our success story in LIFE MAGAZINE, Dec. 28, 1959 issue. Let us teach you our secrets of success. Write today for FREE INFORMATION on how to raise and sell fishworms and crickets.

Special Today—Hybrid Red Wigglers—3000—\$5.95, 5000—\$8.95, 10,000—\$16.95. Postpaid.

CARTER WORM RANCH, PLAINS, GEORGIA

Processing of KODACHROME (Licensed by Eastman Kodak)

AT DISCOUNT PRICES

- KODACHROME I & II } \$100
- 8mm ROLL OR 35mm 20 EXP. MTD. }
 - 8mm MAGAZINE75
 - 35mm 36 EXP. MTD..... 1.75

SEND FOR FREE MAILERS and our big FREE CATALOG of Processing, Film and Equipment at DISCOUNT PRICES!



SOLAR CINE PRODUCTS 4247 S. Kedzie Chicago 32, Ill. Dept. ME

MEN PAST 40

Afflicted With Bladder Trouble, Pains in Back, Hips, Legs, Nervousness, Tiredness.

If you are a victim of these symptoms, your trouble may be due to Glandular Inflammation. A constitutional Disease that requires special types of medical treatment. Neglect of such Inflammation causes men to grow old prematurely and often leads to Incurable conditions.

Most men, if treatment is taken in time, can be successfully NON-SURGICALLY treated for Glandular Inflammation. If the condition is aggravated by lack of treatment, surgery may be the only chance.

NON-SURGICAL TREATMENTS

The NON-SURGICAL New Type treatments used at the Excelsior Medical Clinic are the result of discoveries in recent years of new techniques and drugs, plus over 20 years research by scientific technologists and doctors.

Men from all walks of life and from over 1,000 communities have been successfully treated here at Excelsior Springs. They found soothing and comforting relief and new health in life.

EXAMINATION AT LOW COST

When you arrive, our Doctors, who are experienced specialists, make a complete examination. You then decide if you will take the treatments needed, which are so mild, hospitalization is not needed—a considerable saving in expense.

RECTAL-COLON DISORDERS

Are often associated with Glandular Inflammation. These disorders, we can treat at the same time we treat Glandular Inflammation.

REDUCIBLE HERNIA

Is also amenable to a painless Non-Surgical treatment that we have developed. Full details of this treatment given in our Free Book.

Write For FREE BOOK

The Excelsior Medical Clinic has published a New FREE Book that deals with diseases peculiar to men. It could prove of utmost importance to your future life. Write today. No obligation.



EXCELSIOR MEDICAL CLINIC
 Dept. B 6151
 Excelsior Springs, Mo.

Gentlemen: Kindly send me at once, your New FREE Book. I am interested in full information. (Please Check Box)

- Glandular Inflammation Hernia
 Rectal-Colon

Name.....
 Address.....
 City..... State.....



ELECTRIC APPLIANCES

PAYS \$3 TO \$5 AN HOUR
Spare Time, Full Time • Learn at Home

FREE BOOK offered below shows how **YOU** can now have a good-paying business of your own, right in your home. No experience needed, just simple tools. Learn to repair Electric Appliances. Pays \$3-\$5 an hour!

FREE BOOK SHOWS HOW FREE LESSON STARTS YOU

ment, garage, even on your kitchen table.

QUICK WAY TO GET STARTED

For less than 20¢ a day our easy, pictured instruction — backed by 45 years of success in home training — prepares you for top earnings in this booming field. Earl Reid of Thompson, Ohio says: "Made \$510 in one month spare time. NRI course is priceless." At no extra charge you even get all parts for your own Appliance Tester, too. Finds trouble-spots, speeds and checks your work.

Get your **FREE Book** and **FREE Sample Lesson!** Mail coupon below, letter or post-card, *now*.

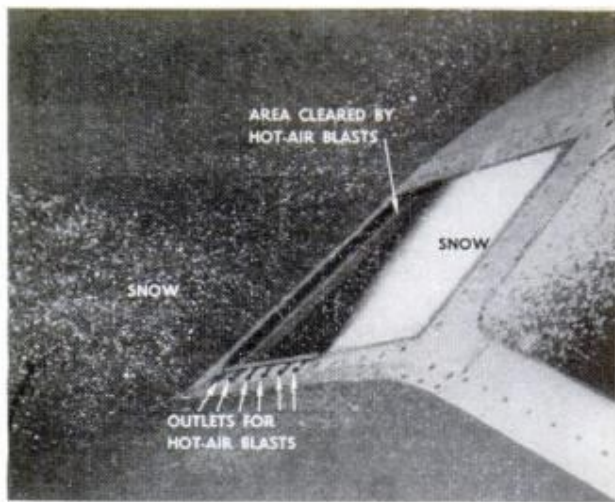

Hot-Air "Wipers" for Airliners

High-velocity hot air vaporizes rain or snow before it hits the windshields of high-flying United Air Lines jets.

Led from the turbine engines via stainless-steel tubes to perforations located parallel to the windshields, the 450-degree F. air shoots out and evaporates the snow and rain, without interfering with visibility.

The system, which replaces windshield wipers, was developed by the Douglas Aircraft Co. for the DC-8 jet. United will also use the method on its 720s and 727s.

FREE BOOK

FREE LESSON

NATIONAL RADIO INSTITUTE, Appliance Division
Dept. AD2, Washington 16, D.C.

Send *Free Book, Free Appliance Repair Course Lesson*. Am interested in:

Spare Time Earnings My Own Business
 Better Job

Name.....
Address.....
City.....Zone...State.....

Accredited Member National Home Study Council

you can always
BE SURE OF A JOB

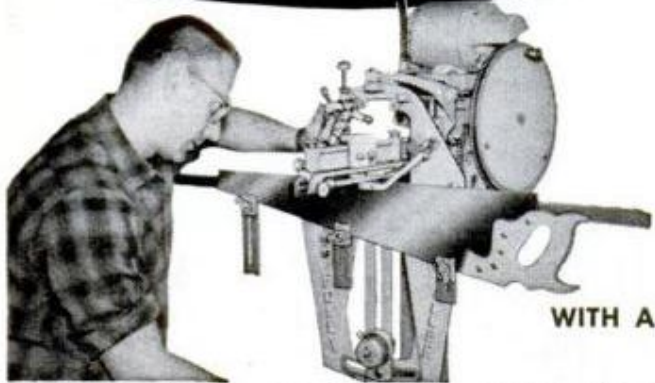

FOLEY SAW FILER

Have you been laid off—or afraid you may be? If you want security, plus a bigger income too—**don't** look for a job—start **your own** spare time business. In his first 2 months J. P. Robitaille earned \$300 with his Foley Saw Filer. From his starting day R. T. Hart made \$600 in 4 months. Frank P. Layne wrote—"In our town of 2,800 instead of 200 to 300 saws I did over 1,500 the first year, averaging about \$1.50 each.

FREE booklet "MONEY MAKING FACTS" shows you how to get business. The new Foley "200" sharpens hand, band and both "combination" and crosscut circular saws. Use our Time Payment Plan—pay for the machine out of your CASH profits. Send coupon today—no obligation, and no salesman will call.

FOLEY MFG. CO., 443-2 Foley Bldg., Minneapolis 18, Minn.
Send *Free Booklet and Time Payment Plan* on Foley Saw Filer.

Name.....
Address.....
City.....State.....



Worship
together
this
week



You need not walk alone!

RELIGION IN AMERICAN LIFE, INC.

Published as a public service in cooperation with The Advertising Council.

Here is Your Opportunity to Build a Successful Business of Your Own

At Home in Your Spare Time

BIG PROFITS IN MOSAIC TILE

MOSAIC TILE

Go into this year around business. Big profits making Serving Trays, Jewel Boxes, Bric-a-Brac Shelves, Sewing Boxes, Table Pieces—customers come to you. Complete Business Outfit tells how to sell to Department Stores, Variety Stores, Gift Shops. Use in homes, for walls, table tops, floor patterns. Finest quality imported Tile, Trivets, Glue, Grout, at Wholesale Prices. No previous experience necessary—with our visual aid training do professional looking work in 2 or 3 hours. Opportunity to start earning right away. Send now for Booklet telling how to get started. **50¢**

STARK'S DISTRIBUTING CORPORATION
1601 S. Canal St., Dept. PM-42, Chicago 16, Illinois

RUPTURE!

An amazing Air-Cushion Invention allows body freedom at work or play. Light, neat, cool, sanitary. Durable, cheap. Day and night protection helps Nature support weakened muscles gently but surely. No risk. Sent on Trial! Write NOW for free Booklet and Proof of Results. All correspondence confidential.



Brooks Company, 143-E State St., Marshall, Mich.

High School Course at Home Many Finish in 2 Years

Go as rapidly as your time and abilities permit. Course equivalent to resident school work—prepares for college entrance exams. Standard H. S. texts supplied. Diploma, Credit for H. S. subjects already completed. Single subjects if desired. High school education is very important for advancement in business and industry and socially. Don't be handicapped all your life. Be a High School graduate. Start your training now. Free Bulletin on request. No obligation.

American School, Dept. H445, Drexel at 58th, Chicago 37

GIANT "WOLF KILLER HUNTING" KNIFE

SHARP, RUGGED, IMPORTED BEAUTY ACCLAIMED WORLD OVER FOR ITS EFFECTIVENESS IN ANY LIFE & DEATH SPORTING EMERGENCY. Blade is of fine carbon steel, guaranteed to stay razor-sharp and open everytime. Not a switch blade knife; no buttons or springs to fob with. Opens lightning-fast.

Note: One Idaho customer claims it saved his life when wolf attacked him.

7 SIZES!
Overall lengths:
5 1/2" — \$4.70;
6 1/4" — \$4.80;
7 1/8" — \$4.95;
8 1/4" — \$5.95; 9" — \$6.95; 11" — \$7.50;
GIANT 13 1/2" — \$7.95. Special! Get both 5 1/2" and 13 1/2" knives (Reg. \$12.65) only \$10.95. Immediate delivery. Send cash, check, or M.O. Sorry, no C.O.D.'s. Calif. res. add 4% state tax. 10-day money back guarantee.

MERCHANTS INC., 1221 S. Grand Ave., Dept. PM-4, Los Angeles 15, Calif.



Especially for **APPLIANCE REPAIRMEN!**

YOU NEED ELECTRIC APPLIANCE SERVICE NEWS

EASN—now in its 12th year—is the Only Publication Serving the ENTIRE Appliance Repair Field.

EASN LISTS sources of supply for parts on all types of household electric appliances, such as washing machines, dryers, ironers, vacuum cleaners, ranges, sewing machines, toasters, irons, mixers, coffeemakers, and so forth.

EASN OFFERS a "Buyers' Guide," listed alphabetically by product name, to help you get the parts you need.

EASN ADVERTISERS send free mailings of catalogs and other pertinent market data to readers from time to time.

EASN BRINGS NEWS of appliance repair schools and clinics in your area.

EASN OFFERS editorial material covering industry news with articles on techniques used by service firms, technical information, and industry trends.

ELECTRIC APPLIANCE Service News

ONLY PUBLICATION SERVING THE ENTIRE APPLIANCE REPAIR FIELD

505 N. LA SALLE ST. CHICAGO 10, ILL.

TRIAL OFFER

ELECTRIC APPLIANCE SERVICE NEWS (Published Monthly)
505 N. La Salle St., Chicago 10, Ill.

GENTLEMEN: Enclosed find Check Money Order Stamps

Cash to cover my subscription as I have indicated below:

\$1.00 for 4 months trial subscription, or

\$2.00 for 1 year \$3.00 for 2 years \$4.00 for 3 years

By (Individual)

Firm Name

Street

City..... Zone..... State.....

(Please enclose your business card or letterhead stationery) PM

Magic Mail Plan—Make up to \$5 an Hour!

THIS MAN ... is taking out of the machine a Plastic Sealing Job—ordered by mail—only 11c in material cost brings back \$2.58 in cash by mail. Capacity of machine: \$25.00 profit per hour of operation.



Get **ORDERS** and **CASH** from your mailman—do work in **SPARE TIME** at home—or expand into **FULL TIME** business. Send coupon for Free facts about the newest and most fascinating of all home operated businesses. For the first time a simplified machine brings the fabulous profits of **Plastic Sealing** and **Plastic Laminating** within the reach of the small operator. Anyone can learn to operate the machine with a few minutes practice—then with our **Magic Mail Plan** can get mail orders pouring in daily with cash in every envelope. **No canvassing—no selling.** We even

Get into PLASTIC LAMINATING at home

WE'LL EVEN HELP FINANCE YOU supply the circulars you mail to bring back cash and orders, financing help, too. Rush name. We'll send you **FREE** and postpaid, pictures, prices, details, finance plan, all the facts you need. Mail coupon or send name on postcard. No charge.

Warner Electric Co., 1512 Jarvis Av., Dept. L-2-D, Chicago 26, Ill.

Make Thousands of Beautiful Art Creations

COSTUME JEWELRY • CIGARETTE BOXES TRAYS • CANDLESTICKS • COASTERS LAMP BASES • BOOK ENDS...ALL IN SPARKLING COLORED PLASTIC



WARNER ELECTRIC CO., 1512 Jarvis Av. Dept. L-2-D, Chicago 26, Ill.

At no cost to me, please rush full details and financing plan, postage prepaid. No obligation.

Name

Address

City..... Zone..... State.....

WHAT DO SMART BIRDS KNOW?



Lots of things. Among them: *It pays to be a Duraclean carpet and furniture cleaning dealer. Here's why:*

- ✓ You're independent. You have the prestige and security that comes with *owning* a business.
- ✓ You make big money. An average of ten dollars an hour.
- ✓ Your services are in demand. Every home and business owner is a prospective customer.
- ✓ You're backed by a big national advertising campaign. Prospects read about your Duraclean service in magazines like Parents', McCall's, and American Home.
- ✓ You can begin part time, full time or hire a crew for the servicing. A few hours with an easy-to-understand training manual and you are ready to start making money.

Are you a smart bird? Send the coupon today.

"OWN A BUSINESS" COUPON

DURACLEAN CO., 2-164 Duraclean Bldg., Deerfield, Illinois
I'm a smart bird. Send me details on Duraclean.

Name

Address

City..... State.....

EARN \$125 A WEEK AND UP

BE AN AUTO DIESEL EXPERT—LEARN A TRADE YOU LIKE

You learn fast in our shops because you learn with tools on real equipment. Students short of money may earn most of their expenses by doing part-time work. Experienced instructors explain WHY and show you HOW, then you DO IT YOURSELF. Many of our graduates earn \$125 a week and up. Approved for veterans. Day and evening classes. Free bulletin-write today.

MAIL THIS COUPON TODAY!

NASHVILLE AUTO-DIESEL COLLEGE
226 7th Ave., No., Dept. 86, Nashville, Tenn.
Please send without obligation free catalog.

NAME _____
(please print or write plainly)

ADDRESS _____

CITY _____ STATE _____

POPULAR MECHANICS

*The Issue You NEED
Is Always*

AT YOUR FINGERTIPS



When You Use Popular Mechanic's FILE BOXES

OH SO HANDY! Each box holds a full volume of Popular Mechanics—6 big issues. Keeps all your back copies in order, and any issue you want is instantly available.

ATTRACTIVE—Blue, grained, washable cover looks and feels like leather. Embossed gold lettering makes your storage boxes suitable for the finest libraries.

ECONOMICAL—Set of two handsome, sturdy Popular Mechanics file boxes only \$1.00—six sets for \$5.00. One set holds and protects and organizes a full year, 12 big issues, of the magazine everybody wants to save for constant reference.

CLIP THE COUPON TODAY and send in your order.

Service Bureau, Popular Mechanics
Department FB, 200 E. Ontario, Chicago 11, Ill.
Please send me . . . sets of storage boxes for Popular
Mechanics, @ \$1.00 per set, six sets for \$5.00, for
which I enclose \$.....

Name.....

Street.....

City.....Zone..... State.....

Now . . . Blessed Relief From ARTHRITIS Without Drugs or Surgery

If you act promptly, an amazing illustrated new FREE book that may change your whole life will be rushed to you by return mail.

Send for it today—and discover why drugs give you only temporary relief. How to avoid needless agony and crippling deformities. How a specialized drugless, non-surgical treatment may eliminate causes of your pains. This treatment is given only at the BALL CLINIC. Over 70,000 people have benefited from these wonderful non-surgical treatments. 96% were delighted with the blessed relief from pain they found at the Clinic.

You owe it to yourself to send for this valuable FREE book without delay. No obligation. No agent will call. Write: The Ball Clinic, Dept. 756A, Excelsior Springs, Missouri.

FREE CATALOG!

TREMENDOUS SAVINGS ON HUNDREDS OF SURPLUS AND NEWLY MANUFACTURED ITEMS!

New 1961 edition contains over 50 pages of tools and equipment for farm, home, workshop, factory. Hydraulic equipment, pumps, motors, construction and diesel equipment and parts! Write for your FREE CATALOG Today.

GROBAN SUPPLY COMPANY
1139 South Wabash Ave., Dept. 64 Chicago 5, Ill., WEbster 9-3793

Traveler's enlarger, including built-in timer and exposure meter, tucks into a tiny 3 x 7½ x 8½-inch carrying case. Ideal for enlarging 35-mm. prints. You'll find plans for it in the May Popular Mechanics.



You can make money in
WATCH REPAIR

Learn at home the low cost Sweazey Way

Watch repairing pays up to \$6 an hour, part time watch makers report on survey. Unique and modern Sweazey home study System starts you making repairs right away on Swiss and American watches. Professionally prepared training. No previous experience needed. Special tools provided for practice. Tuition only \$5 a month. Diploma Awarded. Free sample lesson and opportunity book give all facts. Write today. No obligation.

CHICAGO SCHOOL OF WATCHMAKING
2330 N. Milwaukee Avenue, Dept. 142, Chicago 47, Illinois

FREE BOOK and SAMPLE LESSON

CHICAGO SCHOOL OF WATCHMAKING
2330 N. Milwaukee Ave., Dept. 142, Chicago 47, Illinois
Please rush FREE BOOK and Sample Home Study Lesson.

Name _____ Age _____
Address _____
City _____ Zone _____ State _____

APRIL 1962

MY SPARE TIME HOBBY MAKES ME \$5⁰⁰ an hour CASH PROFIT

—Grover Squires



START YOUR OWN SPARE TIME BUSINESS

You can turn your spare time into Big Cash Profits with your own COMPLETE SHARPENING SHOP . . . Grind saws, knives, scissors, skates, lawn mower blades . . . all cutting edges. Your Own Cash Business with no inventory . . . right at home . . . no experience needed.

FREE BOOK tells how you can start your own spare time business while you are still working at your regular job. Low Cost — time payments only \$15.00 a month. Send coupon today.

FREE BOOK

BELSAW SHARP-ALL CO., 712 Field Bldg., Kansas City 11, Mo.
Send Free Book "LIFETIME SECURITY". No obligation.

Name _____

Address _____

City _____ State _____

MAKE YOUR HOME WORKSHOP PAY OFF in spare time or full time income ELECTRICAL APPLIANCE REPAIR



Turn spare hours into cash profits. Millions of Home Appliances need fixing. Every home is your market for Full-Time Career or Spare Time "Second" Income.

Costs Less Than \$1.50 A Week. All you need is a workbench, spare time and N.T.S. Home-Training in Electrical Appliance Repair. You get a professional appliance tester, tools, and easy-to-learn, practical instructions, fully illustrated. Start earning early in course. Mail coupon now. No obligation. No salesman will call.

NATIONAL TECHNICAL SCHOOLS

WORLD-WIDE TRAINING SINCE 1909

4000 So. Figueroa Street
Los Angeles 37, Calif., U.S.A.

FREE BOOK and ACTUAL LESSON

NATIONAL TECHNICAL SCHOOLS
Los Angeles 37, California

HB-42

Name _____ Age _____

Address _____

City _____ Zone _____ State _____

“ANCHORMEN” OF INDUSTRY

Machining workers have been called the “anchormen” of our industrial team. Here are the reasons for their importance.

by B. Richard

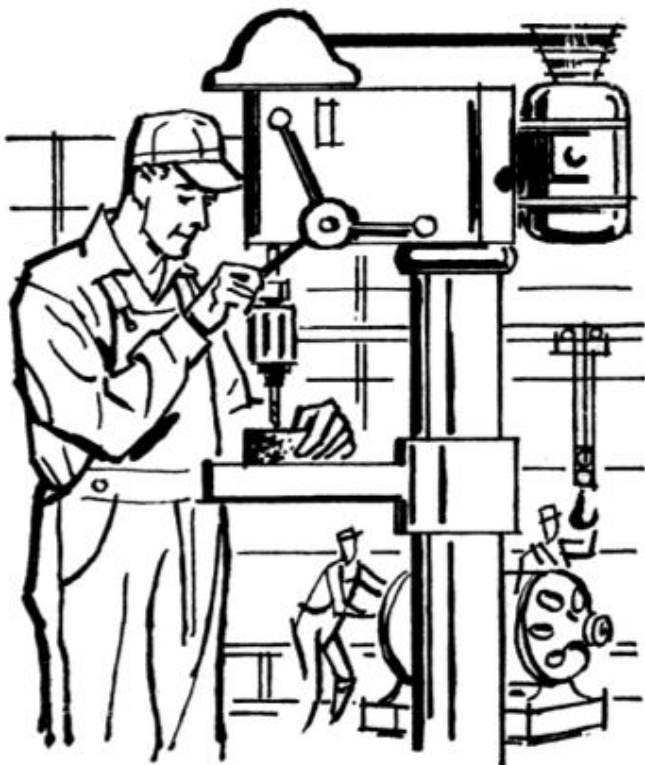

Machining workers are craftsmen whose specialized skills are essential to American industry. They make most of the metal parts contained in manufactured products; and, even more important, they make the metal parts for the machines on our modern production lines.

Machine tool operators, tool and die makers and all-around machinists shape metal parts with precision accuracy, sometimes allowing for tolerances of only one ten-thousandth of an inch, and these parts are so important to industry that machining workers have been termed the “anchormen” of America’s industrial team by the National Association of Manufacturers.

In 1958, over one million workers were employed in skilled or semi-skilled machining occupations, and the United States Department of Labor predicts that there will be thousands of opportunities for new workers during the 1960’s.

Our growing population is expected to bring about a continuing increase in demand for metal consumer products such as cars, refrigerators, washing machines, heating equipment, stoves, freezers, etc. In addition, American industry is expected to increase its expenditures for new equipment, new plants and industrial machinery.

All of these products contain the results of the skilled machinist’s labors; and, as the demand for these products grows, the demand for machinists, the highly-trained “anchormen” of industry, will also grow.

Of the utmost importance to the strength of America is the contribution made by skilled machining workers to our national defense projects. The great use of metal in virtually all of our defensive weapons and the fact that this country will most likely be forced to expand the defense program, will increase even further employment opportunities in machining.

It is the job of a machinist to operate power-driven equipment which either cuts, shaves, grinds, or drills metal. The most common types of machine tools are lathes, grinding machines, boring mills, drilling machines, milling and broaching machines, shapers and planers.

As an example, a machine operator preparing a metal part for an automobile engine must be so accurate in his work that the parts he makes are interchangeable for fast, easy mass production. This makes the margin for error in his work very small, and he must be experienced in the use of such measuring instruments as the micrometer.

An all-round machinist is experienced in operating many different types of machine tools and is expected to plan and execute all operations required in turning out a machined product or part. A thorough knowledge of the strength and machining characteristics of metals and a complete background in the mathematics used in planning his work are required.

(Continued to page 50)



Build Your Own TOP QUALITY TV SET

Anyone can build it—no technical knowledge or skill needed. The "Custom 70" is *Performance Guaranteed* by NRI—top name in Electronic training for nearly 50 years. 206 sq. in. picture tube. All-American parts. Quality "slim-line" cabinet. Everything at one low price. For pictures and facts, tear out this ad, write your name and address in margin and mail to: Conar, 3939 Wisconsin Ave., Washington 16, D. C.

CONAR instruments

A Division of National Radio Institute DH2C

SEW LEATHER AND TOUGH MATERIALS EASILY

COMPLETE, EASY-TO-USE, HEAVY DUTY
STITCHER KIT IN ONE COMPACT TOOL

Not sold in stores

\$1.98

Postpaid

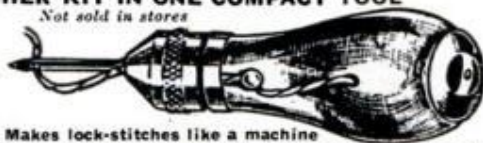

Makes lock-stitches like a machine

SAVE MONEY with **HEAVY-DUTY STITCHER**. It's easy to sew or repair anything made of Leather, Canvas, Nylon, Plastic, or other heavy materials. Quick "push-pull" action makes firm, even lock-stitches like a machine. Gets into hard-to-get-at places. Just the tool needed for repairing Luggage, Footwear, Convertible Tops, Awnings, Seat Covers, Sportsgear, Rugs, Saddlery, etc. Comes complete with 3 different needles (fine, heavy, curved) and bobbin of strong waxed thread (10 yds) all self-contained in **HEAVY-DUTY STITCHER**. Easy-to-follow directions included. Extra needles and thread always available. Send \$1.98 money order or check, and we pay postage. If C.O.D. \$1.98 plus postal charges. Money back Guarantee. Sportsman's Post, 366 Madison Ave., Dept. A-86, New York 17

New Catalog of 2900 Novelties



Send 10c for amazing catalog of novelties, live animals, scientific supplies, hobbies, funmakers, planes & boats, looms, magic tricks, joke articles, unusual seeds, gadget timesavers, cameras, optical goods, projectors, movies, lucky jewelry, religious novelties, disguises, musical instruments, stamps, coins, puzzles, fortune tellers, radios, auto & bike accessories, telescopes, magnifiers, compasses, banks, smokers' gadgets, artists' supplies, printing sets, engines, motors, shockers, knives, billfolds, guns, rifles, sports, books, games, plants etc. Send 10c.

JOHNSON SMITH COMPANY Dept. 562 Detroit 7, Mich.

MOTORIZED YOUR BICYCLE



Complete Kit — Fits All Bikes

● V-Belt Drive — Up to 30 M.P.H.

● 2 1/2 H.P. Two Cycle Engine

\$79.95
P.P.D.

MONEY BACK GUARANTEE
GO-BYK INDUSTRIES
Fergus Falls, Minn.

How Treyco Servicemaster Turns Your Time Into Money

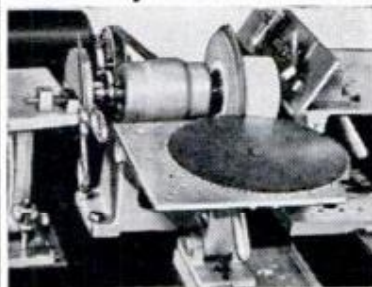

Now make up to \$6.00 per hour spare or full time in your home or shop. **TREYCO** grinding units turn out professional sharpening work on scissors, saws, tools, cutters, barber and beauty shop shears, medical and dental tools, home, butcher and restaurant knives, etc. Easy to start, add equipment as your profits grow. Send for Free Manual.

MAIL COUPON for Free Money Making Plan RIGHT NOW, No Obligation

TREYCO PRODUCTS
375 Old Falls Blvd.
N. Tonawanda,
New York

Please send Free Manual about Making Money With Treyco

Name
Street
City State

Superior's New Model 82A

A professional, emission-type TUBE TESTER

TEST ANY TUBE IN 10 SECONDS FLAT!



- 1 Turn the filament selector switch to position specified.
- 2 Insert it into a numbered socket as designated on our chart (over 850 types included.)
- 3 Press down the quality button—

THAT'S ALL! Read emission quality direct on bad-good meter scale.

SPECIFICATIONS:

- Tests over 850 tube types.
- Tests OZ4 and other gas-filled tubes.
- Employs new 4" meter with sealed air-damping chamber resulting in accurate vibrationless readings.
- Use of 22 sockets permits testing all popular tube types.
- Dual Scale meter permits testing of low current tubes.
- 7 and 9 pin straighteners mounted on panel.
- All sections of multi-element tubes tested simultaneously.
- Ultra-sensitive leakage test circuit will indicate leakage up to 5 megohms.

Model 82A comes housed in handsome, portable Saddle-Stitched Texon case, Only **\$36.50**

(Picture Tube Adapter available for \$5.50 additional)

SHIPPED ON APPROVAL
NO MONEY WITH ORDER — NO C. O. D.

Try it for 10 days before you buy. If completely satisfied then send \$6.50 and pay balance at rate of \$6.00 per month for 3 months — **No Interest or FINANCE CHARGES Added!** If not completely satisfied, return to us, no explanation necessary.

MOSS ELECTRONIC, INC.
DEPT. D-926, 2849 Tenth Ave., New York 34, N.Y.
Please rush Model 82A. If satisfactory, I will pay on terms specified. Otherwise I will return tester.

Include Picture Tube Adapter \$95.50

Name
Address
City Zone State
All prices net, F.O.B., N.Y.C.

"I Upped My Earnings \$200 A Month"

Says **TEDDY RYAN, Norfolk, Va.**

"I have always liked working with my hands, and locksmithing seems to be what I've been looking for. I've increased my monthly earnings by \$200 just during my training period!"



Be a LOCKSMITH

Add 50%-100% to **YOUR INCOME** with easy spare time earnings. Cash in on nationwide shortage — trained locksmiths in demand! Quickly step into a big-pay opportunity job — high-profit shop of your own.

Earn Extra Money RIGHT AWAY! All Special Tools, Supplies Furnished FREE.

Age, education, minor physical handicaps don't matter in this growing trade. You can quickly qualify as a skilled locksmith. Study at home as little as one hour a week. Gain practical experience through well-illustrated lessons. Do real jobs on car locks, house locks, padlocks and safe locks, under the guidance of experts.

FREE ILLUSTRATED BOOK

For a future as your own boss or in a high-pay job, send for **FREE** book and sample lesson pages. Only school of its kind. Lic. State of N. J., Acc'd NHSC. **LOCKSMITHING INSTITUTE** (Div. Tech. H. S. Schools) **APPROVED for VET.** Dept. 104-2, Little Falls, New Jersey

MAIL COUPON NOW!

Please send for **FREE** Book on Locksmithing "Big Money in Locksmithing," Equipment Folder and Sample Lesson Pages. No Salesman will call.

LOCKSMITHING INSTITUTE,
Dept. 104-2, Little Falls, New Jersey

Name
(Print here)

Address

City Zone State

Check if Veteran

FREE INTERNATIONAL

CATALOG



- Citizens Band Transceivers
- Citizens Band Antennas and Accessories
- Amateur and Citizens Band Crystals
- Commercial Crystals
- Transmitters/Modulators
- Frequency Alignment Equipment
- Auto Radio Converters

YOUR 1962 BUYING GUIDE FOR PRECISION MADE RADIO CRYSTALS AND ELECTRONIC EQUIPMENT.

International Crystal Mfg. Co.
18 North Lee, Oklahoma City, Okla.
Rush FREE 1962 Catalog

2

Name _____
Please Print
Address _____
City _____ Zone _____ State _____

GO! Really GO!



on the brand new BSA SPORTSMAN SS-90

Gives you the quick, easy handling of a light-weight motorcycle, yet is powered by a big, husky 350 cc engine for flashing acceleration, capable highway speeds, and long service life. A beauty champion too, with new metallic enamels, lots of brilliant chrome.

BSA MOTORCYCLES

The most popular motorcycle in the world

Write to the nearest address for a colorfully illustrated free catalog of the new 1962 models.

Catalog offer limited to U. S. residents only.

West:

HAP ALZINA
Dept. P62
3074 Broadway
Oakland, California

East:

BSA INCORPORATED
Dept. P62
639 Passaic Ave.
Nutley, New Jersey

Even more specialized and skillful are the tool and die makers who produce the jigs and fixtures needed to hold a piece of work for machining and the metal forms used in shaping metal by the stamping, forging or punching methods. Not only is it essential that these craftsmen be top machinists, but it is also necessary that they have a sound knowledge of mathematics, basic science, electronics and hydraulics to help them in their work.

As is the case in many skilled occupations, the machining trades require a certain formal, supervised period of training. This involves an apprenticeship during which the worker learns all the aspects of his trade while he is on the job.

Most employers prefer to select men with trade school training for their apprenticeship programs. Resident or home-study trade school courses in metal working are highly recommended for those who wish to enter into apprenticeship for the machining field.

Most experienced all-round machinists and tool and die makers have started as machinists working with only one or two metal-forming tools. Experience and know-how picked up on the job have qualified these men for their present highly skilled positions. Many have helped themselves qualify for higher-paying jobs by taking correspondence or trade school courses in blueprint reading and mathematics.

Skilled machining workers have many possibilities for advancement. Some become foremen and others become tool designers or advance to other more highly technical jobs. Many skilled machining workers have found it profitable to open their own tool and die or machine shops, and in this way these workers capitalize on the knowledge and experience they have gained through the years with larger industrial concerns.

If you like mechanical work, like to use tools, take pride in craftsmanship and want to get into a creative occupation with good pay and excellent future opportunity, you should consider the machining trades.

Machinists make an important contribution to our national economy and are needed to help keep America strong. They work in every state and in almost every city in the country.

For information on correspondence and resident training courses in the machining trade and other important occupations, write for your free SKILLS for AMERICA booklet. Write Popular Mechanics Magazine, Dept. SFA, 200 East Ontario Street, Chicago 11, Illinois.

If You Want to Make \$1,000 a Month
 Mail this Certificate NOW with name and address
Get FREE Details of Amazing Light Bulb with No-Time-Limit Free Replacement Guarantee
 Tear out this certificate, mail with name, address to learn how you can make up to \$50 and more in a day, spare or full time, introducing sensational longer-burning Merlite Light Bulbs in your area. Simply say . . . "Once you buy Merlite Bulbs, you never again have to buy light bulbs." Friends, neighbors, others order 12 to 24 and more at a time on astounding Free Replacement Guarantee without time limit! **FREE SALES KIT!** Everything you need to start making good money first day. Rush your name and address with this Certificate—TODAY!
MERLITE INDUSTRIES, Bulb Div., 114 E. 32nd., N.Y. 16, Dept. C-15S
 In Canada: Mopa Co., Ltd., 371 Dowd St., Montreal 1, P. Q.

SOARS BEHIND YOUR BOAT AT 10 MPH
TAFT FLYING BOAT KIT
 Send for special supplement, or complete boat kit catalog.
COMPLETE KIT \$425.00 ONLY 1/2 DOWN
TAFT MARINE WOODCRAFT
 Dept. PM 462, 636 39th Ave. N. E. Minneapolis, Minn.

BE A MAGICIAN!
 Get started today! Become a popular man of mystery. Earn and learn in spare time. Magic is fun and profitable too. Be the Life of the Party. Astonish your friends!
RUSH 25¢ now for PROFESSIONAL MAGIC CATALOG
 160 pages thick • 800 illus. • 1000 Mysteries Also Jokes, Puzzles, Secrets, Illusions.
FREE MAGIC TRICK INCLUDED
 HOUSE OF 1000 MYSTERIES • DEPT. PM4-62 • TRUMBULL, CONN.

NEW OLYMPIC STAMPS
NEW COMPLETE SET OF 10 VALUES:
 With diamond-shapes, colorfully featuring Gold-Medal Olympic winners at Melbourne & Rome. This valuable complete used set (costing \$2.50 mint) is absolutely **FREE to ADULTS ONLY** to introduce our bargain approvals.
STAMPEX CO., Box 47-FM, White Plains, N. Y.

RETARDED CHILDREN CAN BE HELPED



SUPPORT YOUR LOCAL ASSOCIATION FOR RETARDED CHILDREN

EARN MORE - LEARN AUTO DIESEL MECHANICS

OR TRAIN WITH OTHER GREER DIPLOMA COURSES

<input type="checkbox"/> AUTO MECHANICS	<input type="checkbox"/> REFRIGERATION
<input type="checkbox"/> DIESEL MECHANICS	<input type="checkbox"/> AIR CONDITIONING
<input type="checkbox"/> BODY & FENDER REPAIR	<input type="checkbox"/> MACHINIST-TOOL & DIE
<input type="checkbox"/> GAS, ARC WELDING	<input type="checkbox"/> AUTOMATIC TRANSMISSIONS
<input type="checkbox"/> HELIARC WELDING	<input type="checkbox"/> MOTOR TUNE-UP
<input type="checkbox"/> DRAFTING	

Civ. or G.I.

Skilled men are needed in every part of the country. Earn top pay in established shops or start your own business. Greer's expert instruction and actual shop training teaches you how. You learn by doing—quick, easy courses using the latest tools and equipment. Day, evening and part time instructions available.

Job placement aid and convenient living accommodations are yours while training. Contact GREER'S FREE JOB PLACEMENT SERVICE when you enroll if you wish part time or full time employment assistance.

TECHNICIAN COURSES

<input type="checkbox"/> DIESEL AUTOMOTIVE TECHNICIAN—21 MONTHS
<input type="checkbox"/> REFRIGERATION & AIR COND. TECHNICIAN—17 MONTHS
<input type="checkbox"/> WELDING TECHNICIAN—14 MONTHS

Please rush me free literature on the trade indicated at no obligation.

NAME _____ AGE _____
 STREET _____
 TOWN _____ ZONE _____ STATE _____

Established 1902
GREER SHOP TRAINING
 Box D, 2236 S. Michigan Ave. Chicago 16, Ill.

ELECTRONICS
 Train in the new shop-labs of the world famous **COYNE ELECTRICAL SCHOOL** on a quarter of a million dollars worth of equipment. Est. 1899—Non-Profit Institute.
 Courses: Electronics • Electricity • TV-Radio.

Use this coupon to get our free book "GUIDE TO CAREERS"
COYNE ELECTRICAL SCHOOL Educ. Serv. Dept. 42-S
 1501 W. Congress Parkway, Chicago 7, Ill.

NAME _____
 ADDRESS _____
 CITY _____ STATE _____
Unlike most other schools, we do not employ salesmen.

BIG MONEY and FUN IN A PROFITABLE HOBBY!

PLUSH FINISH SPRAYS ON ANY SURFACE

NO EXPERIENCE NEEDED

HOME BUSINESS For You—full or spare time

Why not spend a postage stamp to discover a wonderful hobby that others have turned into a big-profit home business starting spare-time.

Write: **COAST INDUSTRIES Dept. 24**
 15133 S. Broadway, Los Angeles 61, Calif.

Send for FREE SAMPLES



"WE PAY HIM \$150 A WEEK"

"He's worth every cent of it. Came here several years ago asking for a job. He got just that—a small job at a small salary.

"Then I forgot about him—hardly knew he was on the payroll until I got a letter from International Correspondence Schools telling me he'd enrolled for spare-time study.

"It's remarkable the progress he's made. We pay him \$150 a week now—and it won't be long before he gets another raise."

How do you stand with your employers? Do they think of you when they're looking for men to promote? A few hours a week with I.C.S. can equip you for advancement and more money in the work you like best. Hundreds of thousands of success stories prove the I.C.S. method brings results.

Mail coupon for 3 valuable booklets — FREE!

INTERNATIONAL CORRESPONDENCE SCHOOLS



Box U0419D, Scranton 15, Pa.

(In Canada: I.C.S. Canadian, Ltd., Montreal. In Hawaii, P. O. Box 418, Honolulu)

Without cost or obligation, send me "How to Succeed," the opportunity booklet for the field I've checked, and a sample study lesson.

- | | |
|---|---|
| <input type="checkbox"/> Architecture & Building Trades | <input type="checkbox"/> Eng'r'g Drawing |
| <input type="checkbox"/> Automobiles | <input type="checkbox"/> High School |
| <input type="checkbox"/> Art | <input type="checkbox"/> Interior Decorating |
| <input type="checkbox"/> Business | <input type="checkbox"/> Math & Physics |
| <input type="checkbox"/> Chemical Eng'r'g | <input type="checkbox"/> Mechanical Eng'r'g |
| <input type="checkbox"/> Civil Eng'r'g | <input type="checkbox"/> Professional Eng'r'g |
| <input type="checkbox"/> Electrical Eng'r'g | <input type="checkbox"/> Shop Practice |
| <input type="checkbox"/> Electronics-TV-Radio | <input type="checkbox"/> Textiles |
| | <input type="checkbox"/> Other _____ |

Name _____

Age _____ Home Address _____

City _____ Zone _____ State _____

Working hrs. _____ Employed by _____

Special low rates to members of U. S. Armed Forces

Science bulletins

Rainmaking is a bust in Arizona. Four years of seeding clouds with silver iodide produced the same amount of rain, statistically, on seeded as on nonseeded days.

One of a pair of days having suitable clouds was seeded on a random basis, and measurements on both days were made with rain gauges, radar and aerial cameras.

Dr. Louis Battan of Arizona University says the experiment indicates that small-scale atmospheric processes are not as important in governing amounts of rainfall as once suspected.

That warts are stubborn has just been confirmed by a 10-year study. Dr. Philip Anderson of the U. of Michigan's Department of Dermatology says warts frequently return at intervals ranging from 7 weeks to 10 years "despite caustics, curetting, electrosurgery, excisional surgery and cryotherapy (freezing)."

One bright spot: Warts which "recurred after one year were readily cured."

The most powerful siren in the world is roaring like a freight train in the Rocky Mountains near Denver. It is shooting 172 decibels of sound (1,000,000 times the level that causes ear pain) at components of space vehicles, testing their ability to survive the roar of giant rocket engines which can set up destructive vibrations.

Three researchers at Armour Research Foundation have tickled life into a tired question that has intrigued scientists (and magazine writers) for years: "Is there life on Mars?"

Could be. They subjected two kinds of bacteria—*Klebsiella pneumoniae* and *Clostridium botulinum* to a Martian environment: Placed in test tubes of crushed lava, they were subjected to varying temperatures and atmospheres. They survived.

Whether life with these bacteria would be worth living is another question. *Klebsiella* causes lobar pneumonia and *Clostridium* causes food poisoning.

James Biery

POPULAR MECHANICS

WORLD'S
BEST
WANT-AD
MEDIUM

CLASSIFIED ADVERTISEMENTS



Advertisements in this section \$1.35 per word, each insertion, minimum 10 words, payable in advance.
To be inserted under proper classification, copy must be in our office the
18th of the second month preceding date of issue
F. W. Johnson, Manager, Classified Advertising
Popular Mechanics, 200 East Ontario Street, Chicago 11, Illinois

YOU'LL PROFIT

By reading and answering the classified ads in this section. Hundreds of opportunities for you to make and save money

AUTOMOBILES, MIDGET CARS

RESTORE A Model T Ford. Send 20¢ for illustrated booklet. Syverson Cabinets, 3036 Orchard Place, Des Plaines, Ill.

GO-KARTS \$29.95 full price less motor. Details 10¢. Sportsmobile, 4210 Paul Street, Philadelphia 24, Penn.

AUTOMOBILE Catalogs, photos, manuals; hobby club, monthly bulletin. Free information. Auto Enthusiasts, Box 451H, Mount Clemens, Michigan.

GAS Station owners: Reduce operating costs in your station up to 80% with new fluorescent pump lites in your pumps. Write for brochure. Pump-Lite Corporation, 467 N.E. 42nd Street, Ft. Lauderdale, Florida.

AUTO SUPPLIES AND EQUIPMENT

NEW And used parts at savings. Complete guaranteed parts service for all models cars and trucks. Largest in the West. Jeep and army parts specialists. Newest type shifting hubs for all jeep and all military and latest production front end drive vehicles. \$27.50 and up. Also, foreign car parts. Write, Pioneer Auto and Truck Parts Co., 734 W. 13th Avenue, Denver 17, Colo.

PARTS, Model "A." List 25¢. (Refundable) Matco, Box 135, San Pedro, Calif.

1909-1934 FORD Parts illustrated catalogs 75¢. Mark Auto, Layton, N. J.

RING-Valve job while driving, \$6.00 postpaid. Guaranteed! Nothing like it! Lasts 100,000 miles! Motaloy, Grantham, Penna.

A Powr-Grip valve grinder grips better. Free circular. Wood's Powr-Grip, Wolf Point, Montana.

JEOP Owners. Four Wheeler magazine. Road tests, V-8 conversions, back country trips, technical articles. \$4.50 year. Box 95P, Tarzana, California.

WILLYS Jeep tops, \$87.50. Mor-Nan, Box 141, Beverly, Mass.

NEW! Auto window curtains. Privacy in parking, picnicking, camping beach. Covers all windows. Only \$3.00 per set. Satisfaction guaranteed. Monroe Auto Products, Box 434, Monroe, Michigan.

FORD Model "A" owners! Restore new carburetor performance with proven Viton fuel inlet needle valve and seat assembly. Resilient tip of tough Viton assures positive sealing of valve and seat. Send order with \$3.50 to Viton, Box "A," Warren, Michigan. Michigan orders at 4% sales tax.

HYDRAULIC Jack repair kits. Free catalog. Free "Silent-Salesmen" with each kit. Hydraulic Jack Packing & Tool Co., P.O. Box 50, Bloomfield, N. J.

AUTO Shop welding repair training in world's largest non-profit welding school. Low tuition. Free booklet. Hobart Welders, Box M-421, Troy, Ohio.

JEOP Owners — V8 conversions. Read Jeep Owners ad, page 28.

AUTO Testing equipment direct from factory. Generator regulator tester, \$19.95. Cam angle dwell meter, \$19.95. Ignition wire tester, \$15.95. Precision instruments, fully guaranteed. Write for free illustrated literature. Fraser-Lubbers, 11300 E. McNichols, Detroit 34, Michigan.

JUST Out! New 324-page, illustrated catalog offering savings up to 50% on over 100,000 auto parts and accessories, everything to renew, rebuild, renovate '28-'31 Model "A" Fords. All makes (1920 to 1962 models) trucks, foreign and sports cars. Hollywood accessories, custom styling, hi-speed equipment. Send 25¢ for postage, packing—refundable on first order. Whitney, 1919 PM-4 Archer, Chicago 16, Ill.

SAVE \$25.00. Tune up your own engine. Car owner's easy tune-up manual \$1.00. Hove Engineering, Box 5406, Minneapolis 8, Minn.

AIR Conditioner for your car. Build it yourself for \$37.50. This is new. Not an evaporator, but real refrigerated air. Use in your car and sell them. Easy plans, \$1.00. Box 1196, Sioux City, Iowa.

CRANKSHAFT Grinder. Hand operated. Makes bearings fit without taking engine apart, \$5.00. Literature, L. D. McGee, 719 Cascade, Wenatchee, Wash.

INCREASE Gas mileage 18 to 26%, \$3.00 postpaid. Recent tests proved linkage device effective. Guaranteed. Japmets, Box 809, Iowa City, Ia.

AUTO TRAILERS

VACATION Rentals. Brand new 15- and 16-ft. travel trailers. Sleeps 6 people. Hitch, insurance and hookup included. If you are going to Seattle World's Fair, Yellowstone, or anywhere in the Rocky Mtn. area, make arrangements to pick your trailer up in Denver. Write for full details. Mobile Trailer Leasing, Inc., 4101 W. Colfax, Ch. 4-7782, Denver 4, Colo.

TRAVEL Trailer plans. Easy to follow blueprints, using available materials. 7x8 closed. 14x8 open. \$2.00 postpaid. John Vance, Van-Don Products, Box 4013, Trotwood, Ohio.

BUILD Expanding eight foot trailer. Accommodates five. Literature 10¢. Framar Company, Wilmington, Mass.

MOTORCYCLES, BICYCLES, MOTORSCOOTERS AND SUPPLIES

GO Cart \$10. Crosley chassis \$20, Micro-midget \$18, less engines. Engines \$4 up. Cushman motorscooter \$20. Ridging tractor \$45, Isetta \$225. Mailorder only. Send 25¢ (35¢ for first class mailing) for 32 page directory-catalogue Number 106 listing these and hundreds of other bargains in midget cars, motorscooters, homebuilders parts, plans, etc. Midget Motors Directory, Athens, Ohio.

BMW Motorcycles, shaftdrive. U. S. distributor Butler & Smith, Inc., 160 West 83rd St., New York 24, New York.

HARLEY-Davidsons — Used bargains. New, used parts, accessories, all models. Bulletin 25¢. Knuth's (Factory Dealer), 1753 Muskego, Milwaukee, Wis.

RECONDITIONED Motorcycle motors. Large stock Indian Cushman Vespa Mustang NSU parts. Indian Motorcycle Sales, Kansas City 27, Missouri.

MOTORCYCLE Parts. New, used. List 25¢. Ballak, 811 N. 9th, St. Louis 1, Mo.

UNICYCLE. Plans to build and how to ride. \$3.00. Dan Benner, Pedro, Ohio.

VINCENT Motorcycle parts. Aucutt, 6204 Wissahickon Ave., Philadelphia, Penna. Parts, books \$5.00 new issue.

BUILD Motor scooter from bicycle frame. Plans, parts list \$1.50. Refundable. Gilliom Manufacturing, St. Charles, Mo.

1962 ITALIAN Scooters. 2 seats. 150 m.p.g. 45 m.p.h. 4 cycle engine \$295.00. Jolly Jerry's, Atlantic City, N. J.

WINDSHIELDS Unused Harley Davidson surplus. Fit most motorcycles, scooters, motorbikes. Handlebar clamps included. \$9.95 postpaid. Halik, 143-39 Rose Ave., Flushing, N. Y.

AVIATION

AUTOGYRO Blades for gyroscopiers. Solid aircraft spruce. Terrific! Vancraft, 7246 North Mohawk, Portland 3, Oregon.

PROPELLERS, Plans, supplies for airboats, snowplanes. 125 h.p. Lycoming engines \$135.00. Prompt delivery. Catalog 25¢. Banks-Maxwell Propeller Co., Box 3301E, Ft. Worth 5, Texas.

GYROSCOPE Rotor blades, marine plywood or aircraft spruce \$29.95. Steel spars and other accessories available. Free brochure. Roto-Float Co., Box 451, Winston-Salem, N. C.

SMALL Helicopters theory and guide manual. Drawings. Construction data. \$2.00. Greater Plains Industries, Box 482A, O'Neill, Nebraska.

HOMEBUILT Helicopter handbook \$1.00. Directory \$1.00. Urshanair, Box 250, Santee, California.

BATTERIES, GENERATORS

LEARN Battery repair! Complete manual \$3.00. Hydraulic jack repair manual \$3.00. Chrysler Corp. alternator guide \$3.00. C. O. D. accepted. Bayer Publications, 938AB Betty Avenue, Neenah, Wis.

BATTERY Corrosion stopped permanently. Amazing new discovery attached easily. Eliminates corrosion nuisance immediately. Send \$1.00 postpaid to Help Enterprises, 890 S. Rosemead Blvd., Pasadena, Calif.

ELECTRICAL SUPPLIES

WASHING Machine, dryer parts! Illustrated catalog. All makes, models. Save order direct—pumps, kits, agitator, gears, etc., at discounts; Free "trouble diagnosis chart" included. 25¢ refundable on first order. Jonsai Co., Dept. PM4, 291 Atlantic Ave., Massapequa Park, New York.

LAMP, Electrical parts, wholesale. Thousands of items for repairing, converting. Catalog 35¢. Brown Lamp, Box 305, Clayton 5, Missouri.

LAMPS—Parts handbook with instructions for wiring. 50¢ refunded first order. Gyro, 5208P N.W. 35th Ave., Miami 42, Florida.

APPLIANCE, Lamp, vacuum parts wholesale. Catalogue 25¢. Seco, 112 South 20th Street, Birmingham 3, Alabama.

GARAGE Door operator kits—Edwards KR-50 kit. Available with or without remote car control. Priced from \$59.95. Edward T. Fink Co., Inc., 284 Nepperhan Ave., Yonkers, N. Y., Dept. PM.

WELDING, SOLDERING, PLATING

WELD, Solder, cut, braze, $\frac{1}{8}$ " welder complete \$9.95. Flame-torch \$3.95. Postage 50¢. 75 ampere $\frac{1}{2}$ " transformer welder \$29.95 complete. F.O.B. Essay Mfg. Co., Dept. C, Quincy 69, Mass.

ELECTRIC Motor repairing simplified! Details free! Modern, Box 8715, Kansas City 14, Mo.

ARC Welder manual, only 50¢. Regular \$1.00 value. Tells how to weld every job. Emerson Electric, 8100 Florissant, Dept. PM-4, St. Louis, Missouri.

FREE Catalog, welders, kits. Build 350-ampere welder using aircraft generator, plans 25¢. Dunbar, Minneapolis 8, Minn.

BUILD Yourself. Pickup wire roller for approximately \$5.00. Plans \$1.00. Carson Industries, Faxon 1, Oklahoma.

PLATING Equipment and supplies. Save 50% and more on new fiberglass tanks. DC power units. 50 amp, 6 volt DC power supply \$97.50; 100 amp, 6 volt \$145; other sizes from 5 amps to 250 amps. Easy terms. Mix your own solution and save. Send \$1 for newest formulas and operating data for all types of plating, equipment guide and catalog. HBS Equipment Division, Dept. L5, 3445 Union Pacific, Los Angeles 23, Calif.

FREE Welder catalog. Kits, build 350-ampere welder using aircraft generator, plans. 25¢. LeJay, Minneapolis 20, Minn.

WELDERS, 110/220, \$39.50. Morris, 1070 Inner Drive, Schenectady 3, New York.

ACETYLENE Outfits \$59.50; arcwelders \$69.50. Eagle Welding, Dept. PM, 5085 Broadway, Chicago 40, Ill.

MACHINERY, TOOLS, SUPPLIES

FREE New catalog showing only complete line of work holding tools available anywhere. Drill press vises, angle and swivel machine vises, rotary tables, production and heavy duty angle vises. 68 different models, fully described with prices. Palmgren Products Co., 8365 South Chicago Ave., Chicago 17, Illinois.

40 NEW Machinist, draftsmen tools. Campbell Tools, M-1, 1424 Barclay, Springfield, Ohio.

ENGINES, MOTORS, DYNAMOS

10 AND 20 KW AC generators, 60 cycle, 110/220 volts, belt drive. Diesel engines, generators, parts. Rent, sell. New, used, government surplus. Save 50%! Guaranteed. Portable power is our business. Midwest Diesel Power, Inc., 4120 Belmont, Chicago 41, Illinois.

INSTALL Your 220V 3-phase motor on 220V 1-phase line. Information available for \$2.50 by return mail. No gimmicks, ballasts, condensers, rewinding, or reconnecting. Just technical know-how. Strang Elec. & Eng. Co., P.O. Box 555, Hawthorne, Calif.

ENGINES, Parts bought, sold. Atlantic Engines, 741 Ocean, Freeport, N. Y.

DIESEL Injector parts and fuel pumps wanted. GM51-71-110. Bares, 2093 East 19 Street, Cleveland 15, Ohio.

REWIND Motors yourself. Complete instructions, \$1.00. Lewis Manufacturing, Howell, Michigan.

WINDING Data. 275 motors, single and three phase \$1.10. Data Company, 512 Kensington, Kansas City 24, Mo.

GOVERNMENT SURPLUS

JEEPS \$278, airplanes \$159, boats \$7.88, generators \$2.68, typewriters \$8.79 are typical government surplus sale prices. Buy 10,001 items wholesale, direct. Full details, 627 locations and procedure only \$1.00. Surplus, Box 789-C94, York, Penna.

JEEPS, Boats, airplanes, helicopters, walkie-talkies, radar, tents, typewriters, tires, tools, cameras. Individuals can buy now direct from government. "U.S. Depot Directory & Procedure" \$1.00. Brody, Box 425-PM, Nanuet, N. Y.

BUY Surplus direct from government. Complete guide—25¢. Janacek, 373 East 135th Street, New York 55, N. Y.

TENTS, Government surplus. Hexagonal, Pyramidal. Cost \$140. Our price \$39.50. \$225 paint spray unit, \$44.50. Free folder. Imcco, 1829 S. State, Chicago, Ill.

GOV'T Surplus. How and where to buy in your area. Send \$1.00. Surplus Information, PM, Headquarters Building, Washington 6, D. C.

U.S. Government surplus—Jeeps, \$264.00; radios, \$2.53; guns; typewriters; cameras; tools; thousands of items. Fabulously low surplus prices. Complete information sent immediately. Send \$1.00 to: Surplus, Box 512-E, New Orleans 12, Louisiana.

GOVERNMENT Surplus, radios, jeeps, walkie talkies, guns, etc. Buy direct. Locations & procedures. 50¢. Why pay more? Satisfaction guaranteed. Delta, Box 2262-M, Dallas 21, Texas.

GOVERNMENT Surplus boats. Jeeps, radios, binoculars, tents, etc. Detailed procedure \$1.00. Terrific bargains. Broobs, 560-A Chestnut, Meadville, Penna.

BOATS, OUTBOARD MOTORS

BUILD Your own boat from our large-scale blueprints. Books of plans give how-to-build help. Hundreds of professional designs—motor, sail or auxiliary—for amateur builders. Free catalog. MoToR Boat-in-G, 959 Eighth Ave., New York 22, N. Y.

FISHERMEN. Boating enthusiasts, build convertible top for your utility, pram, runabout. Plans \$1.00. Whiteway Products, Box 312, Webster City, Iowa.

FULL Size, cut-to-shape boat patterns, blueprints, 7 $\frac{1}{2}$ -38 feet. Big new 88-page illustrated "Build a Boat" catalog of naval architect-designed catamarans, cruisers, runabouts, skiffs, outboard boats, sailing, racing, houseboats, 50¢. "How to Build a Boat" booklet, \$2.50. Cleveland Boat Blueprint Co., Box 1651, Cleveland, Ohio.

NEW. Used, rebuilt marine motors. Marine conversions, fittings. Free catalog. Stokes Marine Supply, Dept. 24, Coldwater, Michigan.

MARINE Conversions. Ford, Chevrolet, Jeep engines. Catalog 25¢. Lehman Manufacturing Company, 800 Elizabeth Avenue, Linden 4, N. J.

FIBERGLAS Your old wooden boat. Make it waterproof. Repaint over fiberglass, wood, or metal with new Poly-Aqua Epoxy paint. Free literature. Ajax Plastic Co., Dept. 6, P.O. Box 1323, Ft. Worth, Texas.

MARINE Conversions and gears for all popular automotive engines. Send 25¢ coin for complete catalogue. Barr Marine, 2706A Castor Ave., Philadelphia, Penna.

HOW To build floating docks from inertubes. Send \$1.00 for blueprint. Jagiel Research, 3106 Algonquin, Toledo 6, Ohio.

FREE Literature on how to stabilize your outboard motor. Eliminates pounding and cavitating. Jagiel Research, 3106 Algonquin, Toledo 6, Ohio.

FREE. 32 page 4-color catalog of Klepper foldaway boats and tents custom built by Europe's foremost craftsmen since 1907. Sail, motor, paddle; Klepper boats are guaranteed unsinkable. Amazingly compact. Pack down to fit any car trunk. Carried like luggage. Smallest storage space. Snap-lock fittings speed assembly (16 minutes) without tools. Built-in air tubes; ideal family boat. Economical, no dockage, no trailer, lowest maintenance. Kleppers merited 4 world championships, won all international slalom awards, performed 2 Atlantic crossings. Many new models, kayaks to sloops. New tent section. For free catalog write to Hans Klepper, Dept. PM1, 820 Greenwich Street, New York City 14.

BOAT Plans, frame kits, full-size patterns prepared specially for amateurs. Send 50¢ for new 80-page catalog illustrating over 40 build-it-yourself power boats from 7' to 28'. Glen Designs, 9152 Rosecrans, Bellflower, Calif.

BOAT Docks, build yourself or for profit. Complete plans, specifications, instructions for six different models. Send \$1.00. National Floating Dock Co., 1717 Gent, Indianapolis 2, Ind.

PLYWOOD Boats. 21 plans book, \$1.95; Plans and book catalog, 35¢. Rudder, Dept. P., 575 Lexington Ave., New York 22, N. Y.

FIBERGLASS Boat covering, wholesale prices. Free literature and sample. Seifert's, Box 1206-M, Green Bay, Wis.

DISTINCTIVE Clothing and superior equipment for boating. Guaranteed outstanding value and quality. Dress right, be right while boating. Free catalog. Write: Captain Bill, 462 Mechanics Street, Longbranch, Washington.

200 BOAT Plans, patterns, kits. Catalogs: Powerboat 75¢, sailboat 25¢. Marinecraft, Box 161-M, Brighton 35, Mass.

1962 BOAT Hardware kit 50% off. Includes Perko wheel, 37' cable, 4 pulleys, 2 clamps, 2 transom handles, 2 cleats, 2 deck chocks, bow handle, bow cleat. All northwood chrome plated. Net \$19.95. Satisfaction guaranteed or money refunded. Complete line of canoes, fishing boats, runabouts 11' to 16', tops and windshields, available from mfr. at distributor prices. Send 10¢ for brochures. Queen City Canoes, 6100 Sandlewood Drive, Charlotte 9, N. C.

I want to send you proof of the wonderful pulling power of Popular Mechanics classified pages. What's your proposition? Write me today. Include literature if possible. F. W. Johnson, Manager Classified Advertising, Popular Mechanics Magazine, 200 E. Ontario St., Chicago 11, Ill.

ATHLETIC EQUIPMENT, BODY BUILDING COURSES

BARBELL Dynamics! Proven. Train like champions. Complete course, \$1.00. Washington Health Club, Dept. D, Box 4708, Washington 20, D. C.

FREE—Bigger, stronger, muscle information! Centuck, 37 Station, Yonkers 4, N. Y.

BEAUTIFUL Bodies for males, females. Amazing new exercises. Easy. Guaranteed. \$1.00. Jack James, Box 262, Brooklyn 17, N. Y.

PHYSICAL Perfection. Reducing, gaining, muscles, longevity. Mail 25¢ for all 4 courses, (Guaranteed) to Sids System, PM-2, 8421-C Evergreen, Southgate, California.

"GIANT Arms." Dr. Young's, D.C. revolutionary discovery. \$2. Satisfaction or refund. Gaucho, Box 9309-S7, Chicago 90.

OUTSTANDING Physical development! Any age. New guaranteed discovery uses only a rope! Strength, health, muscles. Gain—reduce. Free booklet. Roperise, 4834 Art, San Diego 15, California.

BECOME Taller. New scientific method will add inches to your present height even after maturity. Visible results in weeks. Send for free information and trial offer. Height Increase Institute, Dept. PM-4, GPO Box 1902, New York 1, N. Y.

SPORTING GOODS, GUNS, FISHING, SKIN DIVING, ARCHERY

JAP Rifle altering to 30-06, \$6.00. Jap-shells, \$3.95. Catalog 10¢. T. P. Shop, West Branch 11, Mich.

MOLDS—For casting your own fishing sinkers. Free illustrated booklet. Reading Instrument Co., Box PM78, Reading, Penna.

FREE—Wholesale catalog. Beads. Spinners. Lure parts. Sinkers molds. Jigs. Reels. Finnsports (ME), Toledo 14, Ohio.

BIG Money raising crickets and 12 inch African fishworms. Free literature. Carter Ranch, Plains, Georgia.

MOLDS For fisherman's sinkers, jigs, squids, casting and spinning lures. Free catalog. Sweet's Molds, Tonawanda 1, New York.

SPORTING Goods. Wholesale. Information. \$1.00 refundable. Berkshire Wholesale Sporting Goods, Six Lakes, Michigan.

ANIMAL And fish baits and lures. Guaranteed. Catalogs 10¢. Myers Lures, Marquand, Mo.

MITCHELL Spinning reels 300 type imported \$6.00. Spin casting reels \$3.25. Plastic lure bodies complete resale. Free circular. Quaker City Mfg., 3514-24 N. Lawrence, Philadelphia 40, Penna.

WORLD'S Smallest real Derringer. Caliber .22 short. Replica of very scarce Ethan Allen "hide-away" pistol made almost 100 years ago. Hides in palm of hand. Weight 3 oz. Rifled barrel. Genuine steel and bronze, no slush metal or aluminum. Fine little gun for collector or tackle box. Only \$12.95. A-B Distributor, 4243 North Harlem, Chicago 34, Illinois.

154 PAGE Catalog—A real dream book for fishermen. It's free. Netcraft Company, Dept. B-4, Toledo 13, Ohio.

GUNS. Buy wholesale. Become a dealer. Complete instructions \$1.00. Gunsco, Box 34 PM-4, Fulton, Calif.

FREE! Introductory offer. 5 hand tied flies. 25¢ postage-handling. Flies, Chapell, Nebraska.

RIFLES. Modern military surplus \$5.95. New revolvers \$9.95. Wholesale catalog \$1.00. Refundable. Mailmart, Box 191, PM-4, Sebastopol, Calif.

25 ASSORTED Dry and wet flies plus 8 insect lures, \$3.95 postpaid. The Petro-sky Co., Box 89, College Point 56, N. Y.

REEL Oil the perfect oil for fishing reels \$1.00 post paid. Mail-It, 292 Park Ave., Paterson, N. J.

POPPERS. Assorted. Ten for \$1.00. Sanders, 7581 Edgemont, Cincinnati 37, Ohio.

ARCHERS Save money. Aluminum shafts for making your own arrows, \$7.50 doz. Velloco Products, 500 E. 41 St., Paterson 4, N. J.

CAMPING EQUIPMENT AND TENTS

FREE Full-color brochure on compact new fold-out camping trailer, "cartop" camper, camp kitchen. Nation's pioneer manufacturer. Heilite Trailers, 1475 South Sacramento, Lodi, California.

CAMPING Equipment, tents, world's largest selection. Send 25¢ for new giant catalogue-handbook-camp site directory (print name-address). Morsan Tents, 10-21R 50th Ave., Long Island City 1, New York.

PORTABLE Kitchen-pantry. Approved by university camping clinics, outdoor writers and veteran campers. Plywood construction. Plans \$1.00. Specify station wagon or sedan. Literature 10¢. Campers Kitchen Company, Box 6062, San Antonio 9, Texas.

PICKUP Campers. Pre-cut kits. Blueprints. Supplies. Literature 10¢. Comstock Trailers, Parsons, Kansas.

EARTHWORMS, CRICKETS, FROGS

\$1,000 MONTHLY Possible, raising earthworms—African giants! Backyard, garage, basement. Complete illustrated booklet, explains raising, feeding, packing, marketing. Send 25¢! Ozark Worm Farm-J, Willow Springs, Missouri.

HYBRED Redworms 1000, \$3.00; 2000, \$5.00; 5000, \$8.00 postpaid with raising instructions. Brazos Bait Farm, 60 Lincoln, Waco, Texas.

EARN Money raising fishworms for us! Exciting details free! Oakhaven—56, Cedar Hill, Texas.

BIG Money raising fishworms and crickets. We teach you how to raise and where to sell. Free literature. Medium redworms, 3000, \$5.95; 10,000, \$16.95. Carter Redworms, Plains, Georgia.

WORM Your way to wealth. Raising red worms is profitable. Information. Earlybird Worm Hatchery, 273, Moylan, Penna.

YOUNG Jumbo frogs and giant breeders. Stock your lakes and ponds. Nu-Tex Frog Farm, P. O. Box 4029, Corpus Christi, Tex.

RAISE Nightcrawlers, redworms. Soil-less method. Three Oaks Ranch, Dresden, Tenn.

HYBRID Redworms. Money back guarantee. 1,000—\$3.50, 5,000—\$16.50. Medium 2,500—\$4.95, 5,000—\$8.95, 10,000—\$16.50. Postpaid. Free literature. Hall Farm, Hilton, Georgia.

BINOCULARS, TELESCOPES, MICROSCOPES, MAGNIFIERS

BUILD Your own reflector telescopes. Complete kits: mirrors, eyepieces, tripods, all other accessories. Request free illustrated literature. Criterion Manufacturing, Dept. KPM-87, Hartford 1, Conn.

BINOCULARS. Telescopes, microscopes and accessories. Profusely illustrated brochure. Wolbers, Portage, Mich.

TELESCOPES, Microscopes, Binoculars. \$1.49 to \$99.99. Free catalog! Quality Optics, 13571 Kentucky, Detroit 38, Mich.

DYNASCOPE. Amazing world-famous reflector telescope. Request free brochure. Criterion, Dept. DP-90, Hartford 1, Conn.

TELESCOPE Kits—Direct from manufacturer. Other optical hobby kits. Large selection. Free booklet. Esco Products, Oak Ridge, N. J.

AMAZING New Zoom binoculars! Telescopes! Microscopes! Riflescopes! Free catalog. Adventure Company, Box 2133, San Diego 12, California.

REFLECTING Telescope, 60X, completely assembled. Guaranteed observatory clearness. Free information. Skyscope, P.O. Box 55, Brooklyn 28, N. Y.

SCIENCE Bargains! Lenses, telescopes, binoculars, microscopes, kits, parts, war surplus. Send \$1.00 for beginner's 10-lens kit with instruction booklet. Order Stock 2-CH. Request free 144-page Catalog CH. Edmund Scientific Co., Barrington, New Jersey.

PLANTS, SEEDS, BULBS, NURSERY SUPPLIES

SHADE Trees, evergreens, azaleas. Low-est prices on earth. Bill Wentzell, Elmer, New Jersey.

10 GEORGEUS Low growing hardy Chrysanthemum plants. \$2.00 postpaid. Five colors. Kern Nursery, New Castle, Indiana.

GINSENG Bringing \$14 pound. Have seeds, plants. Goldenseal. Full information. K. Collins, Viola, Iowa.

COMPLETE Line of insect eating plants and supplies; unusual and atomic mutated seeds. Peter Pauls Nurseries, Bldg. 2, Canandaigua, New York.

MING Trees! Seeds, instructions, 35¢, U.S. only. "Specialties," 1439-E Sabraton Ave., Morgantown, W. Va.

PETS—DOGS, BIRDS, HAMSTERS, ETC.

UNUSUAL Pets—Animals, birds, reptiles. Catalog 10¢. Ray Singleton, Interbay Station, Tampa, Florida.

PIGEONS. Sale. Breeders, exhibitor. Marian, 785 Losson Rd., Buffalo 25, N. Y.

BABY Raccoons, monkeys, skunks, snakes, lizards, turtles, birds. Catalogue 10¢. Thompson Zoo, Clewiston, Fla.

BEAUTIFUL Pure white pedigree German Shepherds. Ansonia Kennels, McHenry, N. Dak.

LIVE Seahorses: For \$3.50 moneyorder you can receive mated pair, plus salt, feed, instructions, guaranteed live arrival, all postpaid. (Our 28th year), Box 100, Kendall, Florida.

TRAIN Dogs. Obedience, show, movie tricks. Using shortcuts, secrets of experts. Unlimited opportunities. For detailed know-how send only \$1.00. Hurry! Canine Center, 3232 West Central, Franklin 8, Wisconsin.

MONKEYS: Small type; active, interesting, comical. \$19.95 moneyorder FOB Miami. (You pay express upon arrival.) 2 for \$35. Collars 50¢, leashes \$1.00. Box 100, Kendall, Florida.

SKUNK Kittens, pen raised, deodorized. \$10.00. Ferrets \$6.00. June-July delivery. Ruby Fur Farm, New Sharon, Iowa.

PETS—Hamsters, mice, rabbits, squirrels, chipmunks, guinea pigs, skunks, raccoons. Pricelist dime. Picture catalog twenty five cents. Moore's Hamster Ranch, Shepherdstown 25, West Virginia.

HAWKS, Reptiles, raccoons, skunks, squirrels. Catalogue 25¢. Trails End Zoo, St. Stephen, S. C.

MAKE Money raising chinchillas, mink, rabbits, cavies for us. Free catalog. Keeney Brothers, New Freedom 2, Penna.

HAMSTERS—Ideal pets, \$2.95 pair. Free booklet. Jer-fre's Hamstery, 1447 Apple, Muskegon 13, Michigan.

INTERESTED In pets? Send 15¢ for fascinating list. Mammals, birds, reptiles. 4529 West Pico Blvd, Los Angeles, Calif.

RABBITS—FUR BEARING ANIMALS

RAISE Rabbits. Make money. Information and prices sent free. Write Johnson, 683, Kansas City, Missouri.

MINK Raising information free. Complete. Lake Superior Mink Farm, Superior. EEL, Wisconsin.

RAISE Rabbits successfully by knowing facts. 48 page book. 38 illustrations describing 25 breeds. Housing. Breeding. Feeding. Markets and Marketing. Bulletin etc. 25 cents. American Rabbit Association, 36 ARBA Building, Pittsburgh, Penna.

RAISE Rabbits. Details. Rabbit Enterprises, 548 River Road, Ludlow, Ky.

EARN \$10,000 Yearly raising Angora rabbit wool for us. Information 25¢ coin. American Angora Company, Malta 12, Montana.

RAISE Rabbits on \$500 month plan. Free details. White's Rabbitry, Mt. Vernon, Ohio.

FARMS, FARM LANDS, REAL ESTATE

NUMEROUS Unique features. Only \$20 an acre and low down payment buys versatile 1,400-acre Lake of the Ozarks area ranch featuring private 8-acre spring-fed lake stocked with fish, 1 1/4 miles creek frontage, 18 stocked minnow ponds, large springs, deep wells! Owner estimates \$10,000 annual income from minnow hatchery alone! Pasture for grazing about 100 mother cows plus calves, woven and barb wire, marketable timber. Electric-lighted 5-room 3-bedroom house, running water, knoll setting commands gorgeous view of surrounding countryside. Big barn, poultry buildings, combined garage and work shop. One of most outstanding values on market today at \$28,000, only \$7,000 down. Big free illustrated Spring catalog, bargains coast to coast! United Farm Agency, 2825-PM Main St., Kansas City 41, Mo.

OPPORTUNITY In Brazil. You can own virgin timber and ranch lands in Brazil's golden west for as little as \$10 down and \$10 monthly. A fabulous new empire is now opening up in Brazil as in America's golden west 100 years ago. Fortunes may be made by those with the foresight to take advantage of this unparalleled speculative land investment opportunity, in undeveloped Brazilian acreage. Get the full, exciting story, without obligation. Write Interbaz, Dept. P4, 4211 Ninth St., N.W., Washington 11, D. C.

CANADIAN Lands. seized and sold for taxes. Our 45th annual series of lists, just begun, describe many choice properties, situated from coast to coast, acquired by us through tax sale. Priced as low as five dollars per acre, guaranteed perfect title, small monthly payments, no mortgage. Beautifully situated hunting and fishing camps, where there is real sport; summer cottage sites, heavily wooded acreages. Now is the time to invest in Canada's minerals, forests and farms. Write today for free twenty page booklet with full explanation. Tax Sale Service, Room 411-D, 1173 Bay St., Toronto 5, Canada.

FLORIDA Special. Big, beautifully wooded tracts on prominent highway. Extra-wide highway frontage. Write today for free maps, pictures, etc. Wendell Wood, Fountain, Florida. AD62005 (Q-O)

FLORIDA: 2 1/4 Acres. Gulf Coast area: 50 ft. elevation. \$795.00, \$15.00 down and month. Russell Hancock, Realtor, Brooksville, Florida.

OZARKIAN Contentment! Improved acreage \$15 monthly. Descriptions free. Armstrongs, Wappapello, Mo.

\$5 MONTHLY Buys 5 acres—near clear-water lake. Price \$125. Excellent fishing, good cabin sites. Free list. Box 425-P, Carthage, Mo.

FREE Strout catalog! Farms, homes, businesses, resorts, retirement properties. Over 3000 values coast to coast. 61 years experience. World's largest! Write Strout Realty, 7-CJ S. Dearborn, Chicago 3, Ill.

CANADIAN Vacation lands: Full price \$385.00. 40 acres. \$10 month. Suitable cottage sites, hunting, fishing, investment. Free information. Land Corporation, 3768-C Bathurst, Downsview, Ontario, Canada.

FLORIDA Hillside lots restricted at Ocala National Forest, three miles from Saint John's River. \$495. \$10 monthly. Write Victor Roepke, Route 3, DeLand, Florida.

FARM MACHINERY AND SUPPLIES

3 H.P. Hoeing machine. No other like it. Uproots all weeds in row and between plants. Very simple. Very sturdy. Women operate easily. Also tills. Depth adjustable 0-6". Self propelled. Buy direct at discount. 30 day trial. One year warranty. Write Autohoe, West De Pere 22, Wis.

PROFITABLE OCCUPATIONS

INVESTIGATE Accidents. Earn \$750 to \$1,000 monthly. Men urgently needed. Car furnished. Business expenses paid. No selling. No college education necessary. Pick own job location. Investigate full time. Or earn \$6.44 hour spare time. Write for free literature. No obligation. Universal, CPM-4, 6801 Hillcrest, Dallas 5, Texas.

INVESTIGATE Auto accidents. Earn up to \$750 monthly. Investigators needed in every state. No selling required. Car furnished; expenses paid. Or start a business of your own. Associate with interesting, important people. We train you at home. You hold present job until ready to switch. Get free information. No obligation. Write Liberty School, Dept. C-94, 1139 West Park, Libertyville, Illinois.

BUY Below wholesale! Thousands of nationally advertised products. Drugs, clothing, housewares, cameras, jewelry, hardware, sporting goods, etc. Postcard brings price list showing actual factory cost. Buy-Rite, 310 Main, Bennington 1, Vermont.

AUCTIONEERING—Home study course. Diploma granted. Auction School, Ft. Smith, Ark.

VENDING Machines. No selling. Operate a route of coin machines and earn amazing profits. 32-page catalogue free. Parkway Machine Corporation, Dept. #25, 715 Ensor Street, Baltimore 2, Maryland.

BAKE New greaseless doughnuts in kitchen. Sell stores. Free recipes. Michael, 3605 South 15th, Minneapolis 7, Minn.

BIG Money raising fishworms and crickets. Free literature. Carter Wormery, Plains, Georgia.

BECOME Independent with your own franchise business. Thousands earning handsome incomes. Request interesting facts today. National Franchise Reports, PM-528, 333 North Michigan, Chicago 1.

HOME Mailorder business. Simple, enjoyable. Net \$15,000 year. Write: Mail-order, Box 512-E, New Orleans 1, La.

SAVE Those boxtops! They're worth money! Inquire: "Boxtops-MA," Cedar Hill, Texas.

EARN \$240.00 A month at home, spare time, doing only two \$5.00 invisible mending jobs a day. Big money paid for service that makes cuts, tears disappear from fabrics. Steady demand. Details free. Fabricon, 1586 Howard, Chicago 26, Ill.

EARN Money raising fishworms for us! Write: Oakhaven—58, Cedar Hill, Texas.

SHARPEN Scissors, pinkers, clippers. Inexpensive machines, supplies. Black-hawks, Sheldahl, Iowa.

FOR Real earning security learn to straighten crank shafts, sharpen, repair, and service lawn mowers. Wirt's, 1419 Gnahn, Burlington, Iowa.

FREE Report: "609 Unusual, Successful Businesses." Box 1001-PT, Evanston, Ill.

FREE Book "990 Successful, Little-Known Businesses." Work home! Plymouth-57A, Brooklyn 4, New York.

WHOLESALE Magazine subscriptions. Highest commissions. Bonus! Qualified Agencies, 451NA Kingston, Brooklyn 25, N. Y.

BOOKS, PERIODICALS, PICTURES, POSTCARDS

ANY Book located! Books-On-File, Dept. PM, Union City, New Jersey.

BOOKS Located! You name it—we find it. Book Mart, 51A Walnut, Mt. Clemens, Mich.

100,000 BOOKS! Bargains! Catalog—5c. Treasure-Site, 6990 Aberdeen, Upper Darby, Penna.

SAVE To 83% on books. Free catalogue. Discount Reader's Service, MD-5435 Upland Way, Philadelphia 31.

TRANVESTIA Magazine, other interesting books available. Free descriptive folder. Chevalier D'eon Publications, Box 36091P, Los Angeles 36, Calif.

NEW ENGLAND Legends and lore, local history, genealogy. Catalogue 10". Box 4, Cambridge 40, Mass.

WRITE For free sample copy, "The Presbyterian Journal." Weaverville, North Carolina.

"DICTIONARY OF Your Dreams" 50¢. Book catalog free. Write: Reynolds, 62 Grove, Morris Plains, New Jersey.

FREE Catalog. Self-help books. Write Wilshire, 8721 Sunset, Los Angeles 46P.

BOOKFINDERS! All subjects. Send wants! Jaher Book Service, 183 Hazelwood Drive, Westbury, N. Y.

NATIONAL Geographic magazines, 1888-1960, any issue. Periodical Service, Box 465-PM, Wilmington, Delaware.

BOOKHUNTERS! Scarce, miscellaneous books supplied! Atlantic Book Service, Cedar Street, Charlestown 29, Mass.

BRITISH Book bargains—Any subject. Catalogues free. Transatbooks, Wantagh, N. Y.

PROPHET Elijah coming before Christ. Wonderful book free. E. Megiddo Mission, Rochester 19, New York.

OUT-Of-print books at lowest prices! You name it, we find it! Fast service. No obligation. International Bookfinders, Box 3003-PM, Beverly Hills, Calif.

JOIN The Novel Club—\$2.50 per year. Self-addressed, stamped envelope brings details. Novel Club, Box 4207-PM, Bakersfield, California.

GAMES, TOYS, NOVELTIES

POKADOMETER. Exciting, thrilling game. Keeps children busy on long auto trips. Moneyback guarantee. Circular free. Hamburg Game, 132 Woodland Dr., Hamburg, N. Y.

PARTY Games! Adults'. Children's. Two 64-page books 50¢ postpaid! Sharon, Box 5114A, Kansas City 32, Missouri.

MAGIC TRICKS, PUZZLES, JOKER NOVELTIES

WORLD Of wonders! Get big jumbo surprise catalog! 1000 world's best jokes, tricks and professional magic. Rush 10¢. House of 1000 Mysteries, Dept. PM4C-62, Trumbull, Conn.

FLARE! Monthly magic news, tricks, patter. Sample 50¢. 1658 W. Magnolia, Fort Worth, Texas.

SEND Dime for magic catalogue. Zombie, 15217 Grovewood, Cleveland 10, Ohio.

LEARN Ventriloquism. Easiest method. Copyrighted. Details free. Johnson, 2023 West Forest Hill Ave., Peoria, Illinois.

FUNNY Cards—50 samples 25¢. Wholesale joke catalog. Dohn-RM-Marks, Broadview, Illinois.

JOKERS! Invisible ink. Amazing! \$1.00. Hobby, Box 63, Hillside, N. J.

PUZZLE PAK. Five colorful puzzles selected after world-wide search for the unusual. Fun for all ages. Ideal for patients. \$2.98 postpaid. Semler Crafts, 9345 Atlantic, South Gate, Calif.

84 PAGES, Completely illustrated catalogs, 25¢. Manhattan Magic, Box 334-P, New York City 11.

MATCH Tricks! Ten for all occasions, one dollar. Box 726, San Fernando, Calif.

BE A Magician! Introductory catalog with free trick, only 35¢. Ireland, 109-F North Dearborn, Chicago 2.

WORLD'S Finest professional magic. Joker novelties. Giant illustrated catalog 10¢. Top Hat, Evanston 12, Illinois.

3000 TRICKS. Pocket, parlor, stage. World's finest magic catalog (408 pages), \$2.50. Kanter's, M-1311 Walnut, Philadelphia 7.

2700 NOVELTIES, Jokes, tricks, fun-makers, hobbies. World's biggest gadget catalog 10¢. Johnson-Smith, D-549, Detroit 7.

500 TRICKS, New 1962 edition, famous Douglas catalog of magicians tricks and supplies now available just 10¢. Fastest service. Douglas Magicland, Dept. 61, Dallas, Texas.

400 LAUGH Lines plus professional comedy catalog. \$1. Orben Publications, Hewlett, N. Y.

CATALOG. Free trick, 25¢. (1,500,399 tricks, jokes). Magico, Box 4373-P, San Antonio 7, Texas.

COINS, TOKENS, CURRENCY

SELL Me coins. Highest prices by grading. Book teaches. \$1.00. Shay Coins, 33-44 91st St., Long Island 72, N. Y.

FANTASTIC Profits in new coins. Small investments. No risk. Free details. How Publications, 1612-M Sterling, Brooklyn 33, New York.

ANY Four Roosevelt dimes \$1.00. Any three Whitman coin folders \$1.00. Trayce, 25 Quinlan, Staten Island 14, New York.

MAILING List coin and supply. Box 276F, Mooresville, N. C.

TOPS! Fascinating coin collection from Camerouns, Formosa, Vatican, etc., and foreign banknote. Catalog price over \$1.50! Only 10¢ with exciting coin approvals! Littleton Coin Company, Littleton T1, New Hampshire.

ELEVEN Types silver and bronze Mexican coins. Fine to brilliant uncirculated, \$1.25. Burkett, T-25180 6th St., Ft. Bliss, Texas.

\$18,000 FOR 1913 Liberty head nickel. Uncirculated dollars 1804-1839, 1893-S, 1895-P, 1903-O pay \$200.00-\$15,000.00. Certain dates—Lincoln cents before 1932, \$250.00; Flying eagle cents, \$950.00; Indian cents, \$1,750.00; Dimes before 1943, \$5,250.00; Quarters before 1924, \$5,250.00; Half dollars before 1929, \$7,500.00; 2¢ pieces, \$200.00; 3¢ pieces, \$200.00; half-dimes, \$3,250.00. Hundreds of others worth \$10.00-\$10,000.00. Canadian coins, 1921, 5¢ Silver, \$300.00. 1875 quarter, \$500.00. 1921, 50¢, \$2,000.00. Wanted 20¢ pieces, gold coins, paper money, etc. Our large illustrated guaranteed buying-selling catalogue, giving complete allcoin information. Send \$1.00. Purchase catalogue before sending coins. Worthycoin Corporation (K-528-C), Boston 8, Massachusetts.

U. S. Coin value guide, \$1.00. Refundable. Griffin's, 322 West State, Ithaca, New York.

WANTED! United States, Canadian. Catalog 50¢. Williams, Box 481, Oshkosh, Wisconsin.

INDIANS For sale 20¢ each: 1898, 1899, 1900, 1901, 1902, 1903, 1904, 1905, 1906, 1907. John Gardner, Box 408, Colorado Springs, Colorado.

STATEHOOD Medals. New series of finely sculptured medals commemorating each state. Historic, educational, appreciable value. Unmatched quality. Start collection with first-in-a-series Ohio medal. Ideal as a keepsake or gift for both adults and students. Write for free brochure: Presidential Art Medals, Inc., P.O. Box 187A, Englewood, Ohio.

FREE Silver dollar price list. Apelman, Box 505F, Whiting, Indiana.

HIGHEST Prices paid for United States coins. Send 25¢ for our buying lists. Wilmot's, 1067-A Bridge, Grand Rapids 4, Michigan.

LINCOLNS 100 Different in Whitmans \$7.00. Houdelette, 10011 Arden, Tampa 12, Fla.

GUARANTEED Profit on uncirculated bags cents. Carolina Coin Company, Box 1338, Charlotte, N. C.

COINS. Closeout prices. List 15¢. Lee's, 525 Mt. Curve, St. Paul 16, Minn.

CANADIAN Coins worth plenty! Just released 1962 catalogue prices, illustrates thousands! Almost 300 pages. \$2 postpaid: "Coin Books," 1636 West 4th, Vancouver, Canada.

3¢ NICKEL 95¢, 2¢ piece \$1.25. Large cent \$1.75. Half dime \$1.25. Half cent \$3.75. Vaccino, Box 10, Richmond 1, Va.

JEFFERSON Nickels. Complete set, fine, \$9.50. Prepaid. List included. Stroud's Coins, Kinston, N. C.

BRILLIANT Proof sets, 1957 \$4.95; 1961 \$2.95. Lacheen, Box 1355, Philadelphia, Penna.

FREE Coin bulletin listing coins for sale at bargain prices. Send self-addressed, stamped envelope to: Ben's Coin Company, 31 North Clark, Chicago 2.

INTRODUCTORY: Free confederate dime, foreign coin, coin and medal catalog; send 25¢ postage, handling. Collectors Club, Box 71-C, Rockaway 94, New York.

FREE Coin supplies! Giant coin list 10¢ (refundable). Economy Sales, Mansfield, Massachusetts.

INDIAN Pennies, 5 for \$1.00, or Liberty nickels, 6 for \$1.00. Joseph Gaidar, 6615 So. Ashland, Chicago, Ill.

FREE Bargain lists. The RJR Coin Company, Astoria 1, Oregon.

COINS & supplies, Lincoln cents our specialty. Catalogue free. Hyles Sales, Box 9566, Dallas 14, Texas.

UNCIRCULATED 1935 silver pony express commemorative medal \$1.00. Coin lists free. Sayers, 1000 Unaka, Johnson City, Tennessee.

LARGEST Coin magazine. 288 pages, 50¢. Scrapbook, 7320-J Milwaukee, Chicago 31.

NUMISMATICS Largest newspaper. Semi-monthly. Sample 25¢. \$2.00 yearly. Numismatic News Box 452, Iola, Wis.

RARE 1878 CC mint dollar uncirculated \$5.00. 100pg. catalogue 50¢. Shultz, Salt Lake City 10, Utah.

BARGAIN List! U. S. coins, accessories. Stamp please. Hugh's, Hickory, N. C.

40 PAGE Illustrated United States and Canadian coin list 10¢. Stoney, 260 Washington, Boston 8, Mass.

25 BEAUTIFUL Coins from 25 countries. Mostly uncirculated. Terrific assortment. \$1.00. Hindley, Box 708, Aurora, Illinois.

RARE Unc. 1899 Philadelphia silver dollar, \$5.00. Butts, Torrington, Wyo.

COIN Collector's magazine. On your newsstand or direct. Sample 35¢. \$3.00 yearly. Coins Magazine, Box 274, Iola, Wis.

TWENTY-Four page 1962 retail price list of USA and Canadian coins 10¢. Our selling prices on thousands of coins and coin collectors' supplies. Bryson Incorporated, 612A White, Toledo 5, Ohio.

SIX Different Indian cents with lists. \$1.00. Hutchinson's, Box 6256, Philadelphia, Penna.

COINS Bought. Illustrated catalog 25¢. Hutchinson's, Box 6256, Philadelphia, Penna.

15 DIFFERENT Lincolns before 1921. \$1.00. Gene Carlton, Box 336, Chandler, Oklahoma.

LINCOLN Cents 23-S, 21-S-P, 24-S, 16-S-D, 18-S-D, 19-S-D, 20-S-D, 55-S, 34-D, 28-S-D, 27-S-D, 38-S-D, 29-S-D, 25-S-D, 09-P, 30-S-D, 32-D, 33-P, 39-S-D, 31-P. Good to fine complete lot \$7.25. Rolls of 55-S Lincoln cents fine to A.U. \$6.50. Berry, Box 306, Westminster, Calif.

LINCOLNS 40 Different 1909-1940 plus 1960D small date, \$1.95. 25 different "S," including rare 1955S \$1.50. Harris, Box 611P, Cupertino, California.

WORLD'S Greatest coin magazine and wooden nickel 10¢. Lawrences, Anamosa, Iowa.

PROOF Sets 1961-\$4.00. 1960, 1959 \$5.00 each, postpaid. A. Kern, 542 So. 25th, New Castle, Indiana.

PRIMITIVE Monies — African bronze ring \$2.95; Cowry shell \$1.00; Siam silver bullet \$2.75; Siam porcelain (4) \$1.50. All seven \$6.95. Brilliant proof sets—1957 \$4.25; 1959 \$4.75; 1960 \$3.75; 1961 \$2.85; Ghana \$10.50; Pakistan \$4.75; So. Africa \$6.95. 1961 Canada "proof-like" \$4.85. "Red" guidebook \$1.75. Bebee's, 4514 North 30th, Omaha 11, Nebraska.

NUMISMATISTS. Price list valuable gift, 40¢. Coin Investment—unprecedented, invaluable to small investor—booklet \$1.00. Vanderman, Box 9161, Suitland, Maryland.

STAMP COLLECTING

U.S.-Foreign pricelists free. Somith, Box 83-PM (Rugby), Brooklyn 3, N. Y.

508 DIFFERENT World-wide from Formosa, Morocco, Indonesia, etc., cataloging over \$15, only 35¢. Offer to adults only. Approvals. Littleton Stamp Co., Littleton Q1, New Hampshire.

GIGANTIC Collection free. Includes triangles, early United States, animals, commemoratives, British Colonies, high value pictorials, etc. Complete collection plus big illustrated magazine all free. Send 5¢ for postage. Gray Stamp Company, Dept. PM, Toronto, Canada.

105 DIVERSIFIED British Empire 10¢. Approvals included. Linstamps, St. Catharines 401, Ontario.

AMERICAN Historical collection! Enormous George Washington beauty, F. D. Roosevelt diamond, giant Abe Lincoln U.S.A. flag commemorative, plus midget soldier. Latin orchid issue, old IFNI overprint, etc. 10¢ with approvals. Roseland Stamps, Spring Lake 2A, Mich.

WILL Rogers air! Helicopter triangle! Plus Monte Carlo dove triangle! Stamp printed in solid gold! New York Empire State Bldg. airmail, lovely Congo orchids in full color, etc. 10¢ with approvals. Sunny Stamps, Apopka 24, Florida.

BATHING Beauty, spacemen packet, approvals, 10¢. Nugget, 2408 Gillen, Racine, Wisconsin.

FREE: Two U. S. \$5 stamps with U. S. mixture—500 stamps \$1.00 (U.S.A.). Wessbecher, 7116 Oakland, St. Louis 17, Mo.

FREE—Gigantic collection of 103 different stamps including triangles, air's, bi-colors! Also fascinating approvals. Rush 10¢ for handling to "Stamps," Box 336, Alameda, California.

OVER \$20.00 Catalog value for just \$1.00. 1000 different worldwide. Approvals included to adults only. Universal, Box 6, Kenosha 5, Wisconsin.

FREE 400 Genuine postage stamps! Worth \$10.00 at catalogue prices. Africa, Europe, Asia, British Emp.—a fascinating, valuable mixture from foreign convents, banks, etc. Who knows what you will find. Also free valuable booklet. Adults only. Approvals enclosed. Frasek Co., PM-4, White Plains, N. Y.

MINT FN Complete 1937 Army-Navy set 50¢. Approvals. Taylor, Box 91, Brooklyn 23, N. Y.

HOLY Stamp depicting Christ and cross! Plus triangle discus thrower, enormous multi-colored Balkans Diamond issue, wonderful map collection from Timor, Macao and Angola. Extra! Brilliant flag set, etc. only 10¢ with approvals. Capital Stamp Co., Ferrysburg 2C, Michigan.

MAYFLOWER Stamp album 10¢. 407 illustrations, 64 pages. Approvals accompanying. Niagara Stamps, St. Catharines 701, Ontario.

FIRST Day cover approvals. Included free. Valuable airmail cover. Myers, Coopersburg, Penna.

AMERICAN Astronaut Alan Shepard: Complete mint postage set from Paraguay, absolutely free to adults requesting our bargain approvals. Stampex, Box 47-HM, White Plains, N. Y.

SURPRISE Collection! Exotic mint British colonials, absolutely free with approvals. Viking, Great Neck 8, N. Y.

200 DIFFERENT U.S. stamps \$1.00. Approvals included. Shelron, Box 907-K, New York 8, N. Y.

FREE! Giant bargain catalog. New edition listing thousands of bargains including U.S. and B.N.A. stamps, packets, mixtures, albums, accessories and supplies; sent with beautiful approvals. Jamestown Stamp, E42PM, Jamestown, N. Y.

FREE Niger Republic birds. Approvals. Bacon, 405 Main, Rolla, Missouri.

100 DIFFERENT U. S. commemoratives \$1.00. 125 different Canada \$1.00. 200 different British Empire \$1.00. 1000 worldwide \$1.00. Approvals on request. Confederation Stamp, Box 65P, Charlotte-town, P. E. Island, Canada.

PHILATELIC Jungle 10¢. Fifteen zoological specimens. Approvals included. Free watermark detector. Crown Stamps, Virgil 301, Ontario.

500 FINE Mixed U. S. 15¢. Wright, 201M Mealey, Hagerstown, Maryland.

DISCONTINUING Stamp business. Tremendous values! \$2.00. Conglomeration includes mixtures, packets, sheets. Norge, Ho-Ho-Kus, N. J.

PICTORIAL Commemorative collection Togo, Monaco, Congo, Oceania, many more. Mounted with stories. Send 10¢ mailing cost. Approvals. Morgan Self, 621 Shakespeare, Oshawa, Canada.

10 DIFFERENT Civil War United States and representative Confederate states stamps plus pricelist 10¢. Minuteman, 127 Lincoln, Lexington 73, Mass.

25 DIFFERENT U. S. commemoratives, 1893 up, 10¢ approvals. K & B Stamp Co., Box 70, Brooklyn 23, N. Y.

115 DIFFERENT 10¢. 1000—\$2.25. 1000 mixed 80¢. Pop Harris, Oklawaha, Florida.

FREE. Over 1500 stamps to approval buyers. For details and approvals write: Egert, Marysville, Michigan.

FREE 1963 Scott's combined catalog. Details 25¢. Superior, Grafton, Ohio.

EXOTIC Vietnam fish cat. \$2.50, 25¢ to serious approval applicants. Down to earth prices. Fred Easley, Sterling, Alaska.

SEND Two dimes, 100 different stamps. Receive 150 different. Gilcraft, Box 313, Lorain, Ohio.

12 BEAUTIFUL Triangles 10¢. Approvals. Marshall, Box 553-PL, Pacific Grove, Calif.

WOW! 110 All different Germany 10¢. Zeppelins, semi-postals, airmails, high values, etc. Giant catalog, bargain lists included with beautiful approvals. Jamestown Stamp, Dept. A42PM, Jamestown, N. Y.

AIRMAILS. \$6.00 catalogue, only \$1.00 with approvals. Stamparee, Sierra Madre, Calif.

U. S. Stamps. Giant discount catalog—25¢. Raymax, 37-VZ Maidenlane, New York City 38.

FREE 100 Worldwide with penny approvals. 10¢ handling. Skytop, Box 1022-PM, Binghamton, N. Y.

500 DIFFERENT. Includes pictorials. 35¢. Knopp, Box 1381, Bristol, Conn.

NEW Zealand. 25 beautiful 10¢ with world approvals. Terrace, Box 718, El Cerrito, Calif.

INDONESIA Set free. Approvals. Spangenberg, 4619 Gary Dr., Bristol, Penna.

BEAUTIFUL Laos elephants free. Approvals accompany. Fred Easley, Sterling, Alaska.

50 DIFFERENT Central and South America, 10¢ with worldwide approvals. Cole, Box 223-A, Buffalo 21, N. Y.

21,000 ALL Different, only pennies a day using our systematic payment plan. Details free. Sjoquist. 1435 Cherrydale, San Jose 25, California.

50, LATIN, British, Orient: 10¢. Approvals. These, 9320-M San Juan, South Gate, California.

U.S. Fully illustrated catalog 10¢ deductible. Simmy's, 45 Bromfield, Boston 8, Massachusetts.

U.S. Approvals. Low prices. Eagle Stamps, Romine Ave., Pittsburgh 26, Penna.

FREE! 25 Different Portuguese; colorful, inexpensive approvals. Elkhart, Box 33, Elkhart, Indiana.

FREE Mint Africa set with approvals. Lithor, Box 51, Canoga Park, Calif.

300 DIFFERENT Given free with approvals. Particulars. Windsor Stamps, P.O. Box 735, Santa Clara, California.

STAMP Collecting outfit, includes packet worldwide stamps, package hinges, watermark detector, millimeter gauge. Everything 10¢ with approvals. Loraine Brown, Marion, Michigan.

FREE 30 Large U. S. commemoratives with approvals. 10¢ handling. Jack Clancy, Box 2187, Portland 14, Oregon.

FREE Sample. Interesting, informative, illustrated. National Stamp News, Anderson, South Carolina.

FREE! 25 Egypt, 10¢ handling. Approvals. Bellet, Mapledale, Hazel Park, Michigan.

200 STAMPS. 25¢ With approvals. Smith, 508A Brooks, College Station, Texas.

FREE! 222 worldwide. 10¢ handling. Penny approvals. Jung, 1601 North Stanley, Los Angeles 46.

TERRIFIC Value. Eight complete mint sets 10¢ with approvals. Beatties, Box 4503, Fort Lauderdale, Florida.

U.S., U.N., Confederate states catalog free. Stone, 260 Washington, Boston 8, Mass.

U.S. Mint specials! Flag set, complete \$1.00; 1¢, 2¢, 3¢ famous Americans (21 different), \$1.00. Free list. Brooks, 2323 Avenue X, Brooklyn 35, New York.

TWO \$5.00 United States stamps, 20 others 10¢ with United States approvals. Irwin, Box 1105, Brooklyn 30, New York.

80 DIFF. U. S. stamps includes 19th Century commemorative. High values. Plus 1943 flag stamp of occupied nations. All for only 25¢. Approvals included. Willett Co., Box 338-C, Yorktown Heights, N. Y.

UNITED Nations 15th anniversary sheet with first day cancel, as commemorated by Russia. Free! While they last, with approvals. Philatelics, R-J, New Paltz, N. Y.

25 COLUMBIA 10¢. Approvals included. Reed, Box 980, Chicago 90, Illinois.

INTRODUCING Our better United States approvals we offer 15 United States stamps including Columbian, Bi-Centennials, famous American, airmails, others; only 10¢. Ocean Stamps, Box 64-PM, Brooklyn 29, New York.

PENNY Approvals. Thousands. Bargains for pennies. Gifts with purchases. Penny Stamps, Orange, California.

GIANT Approvals, thousands different. 1¢ and 2¢ each. Wahl's Stamp Exchange, 7008P Farragut, Chicago 31, Ill.

UNITED States commemorative collection containing 33 different—10¢. Approvals. White, 516-A Avenue L, Brooklyn 30, New York.

SELL Your surplus good grade stamps. Write, describing fully what you have. Vanroy Shirk, Lebanon, Pennsylvania.

AMAZING OFFER! 200 United States stamps — including commemoratives, airmails, high denominations to \$1.00. Only 10¢ to approval applicants! Illustrated bargain lists free. Mystic Stamp Co., Dept. 80, Camden, New York.

100 OLD United States between 1861 and 1935. \$1.00. Roush Stamps, 51 Chestnut, Mansfield, Ohio.

UNITED States price list, 116 pages, price 25¢. Mark Hanna, 335 Fifth Ave., Pittsburgh 22, Penna.

FREE Monaco nudes. Approvals. Stamp Ranch, 902 Addison, Chicago 13, Ill.

PENNY Approvals! Regardless catalogue! Kloster, 4164—52nd St., San Diego 5, Calif.

60 DIFFERENT U. S. (30 commemoratives) 25¢. No approvals. Seidenberg, Appleton, Wisconsin.

225 STAMPS For only 10¢! This mammoth value includes airmails, pictorials; stamps from strange countries cataloging up to 25¢ each! Also approvals. Mystic Stamp Company, Camden 80, New York.

FREE 50 Worldwide, mailed with inexpensive approvals. University Stamps, P.O. Box 44-592, Miami 44, Florida.

FREE Mint set! Approvals accompany. Stampco, Box 737, Memphis 1, Tenn.

111 WORLDWIDE. Includes airm, midgets, triangles, 10¢. Approvals. Premiums. Faith, 20½ Bushnell, Alhambra, Calif.

100 DIFFERENT United States commemoratives, ½¢ to 10¢ values—used \$1.00; Mint \$4.95. No approvals. Gil's, Box 12BA, Brooklyn 29, N. Y.

FREE—All volumes Scott's International albums. Scott's 1962 catalogues—even master global albums free—when you buy our sensational foreign approvals. Bargain Stamps, Redlands, California.

701 U.S.A.—25¢. Plenty commemoratives. Request approvals. Horace Gatewood, Winston-Salem, N. C.

FREE Macao mint set, approvals. Coretta, G.P.O. Box 1546, New York 1.

215 DIFFERENT Worldwide 25¢. Flume, Korea, Laos, Russia, Transvaal. Approvals. Bobb's, Box 3045, Saint Louis 30, Missouri.

FREE! World's largest! Strange, valuable 7"x14" beauty. Send 15¢ handling now! Norrisco, Milwaukee 7, Wis.

PENNY Approvals, 1,000 foreign stamps mounted in Scott order. No assorting! Bullost Approvals, 1359 Coney Is. Ave., Brooklyn 30, N. Y.

FREE—When you buy our foreign approvals, you receive absolutely free stamps equaling your purchases. Coast, 1609 S. Park, Santa Ana, California.

MINIATURE Collection Queen Elizabeth mint sets (Antigua, Caymans, Mauritius, Montserrat, Virgins, St. Kitts)! 21 lovely pictorials, only 25¢! Attractive approvals! Gannon Stamps, Box 931, Canton 1, Ohio.

UNIQUE Collection 51 all different world wide religious stamps 10¢! Includes cathedrals, shrines, temples, saints, plus religious dancers, nativity issues and scarce mint Goya Holy Family painting. Wonderful approvals. Darling Co., Ridgway 1, Penna.

MILLION Foreign stamps! 2¢ each! Send for thrilling, giant approvals! ABC Stamps, Box 6000-MB, San Francisco 1, Calif.

14,000 DIFFERENT! Amazing new plan builds your collection systematically, country by country. Only 50¢ weekly. Free details. L. G. Ware, Monroe 75, Conn.

STANDARD Cachets. Next 4¢ release 10¢. Stanets, 1548, Highland, Indiana.

GAMBLER'S Packet, 25¢ with approvals. Lee Kennedy, Box 9497, San Diego 9, Calif.

FREE! North America plus 87 foreign flag stamps. Big valuable collection of all-different, genuine stamps from Greenland (North Pole), St. Pierre, Newfoundland, Canada—picturing Eskimos, Indians, scarce 1867 Confederation, Northern Territories, Nova Scotia, United Nations, U.S.—Ancient 19th Century; first ship and plane; rare whooping crane; pony express; etc. Also, complete set Colonial and Civil War commemoratives. Plus colorful flag stamps of 87 foreign countries. Extra! Big bargain catalog. Approvals. Send 10¢ for mailing. Kenmore, Milford EF-306, New Hamp.

FREE Surprise set with approvals. Way-out Peachtree, Box 9875, Atlanta 19, Ga.

100 FOREIGN Stamps only 10¢ with approvals. Rorry Stamps, 7521-A Mason, Canoga Park, California.

SENSATIONAL Penny approvals! Pictorials, topicals, etc. Write today! Schmidt, Box 1128, Richmond, Calif.

SPRING Offer, 1000 worldwide stamps \$1.00, 3500, \$3.00. No approvals follow. Harrison's Stamps, 1435 First Ave., Oakland 6, Calif.

900,000 STAMPS Sellout! Bargain lot: packets, sets, rare stamps \$1. Giant sellout assortment \$5. High value packet \$3. Persile, 436 N. Y. Ave., Brooklyn 25, N. Y.

U.S. Bargain. 100 different 25¢, with approvals. Stamps, Kennebunk, Maine.

PAPUA Free with 20 Netherlands at 10¢. Adanac, 6884 Briand, Montreal 20.

CHOICE U.S.A.! 50 different commemoratives 20¢. Approvals. Kingsbury, Groton 2, Vt.

SCREWBALL Fish in natural colors; Pan, the Goat Man; Egypt, Mothers' Day; Crawley Bugs set; Jets; Somaliland flower garden; French model; U.S. Revolutionary War; Others free while purchasing approvals. Stamp Farm, MS-43, Oxford, Wis.

MUSCAT, Bahrain, Qatar, Kuwait free with approvals. Delual, Box 142, Palmyra, N. Jersey.

100 DIFFERENT Norway 25¢! Worldwide approvals. Carling, 462-A, Howard City, Michigan.

AIRMAILS 25 Different 5¢ with approvals. Howard Davison, Suncook 4, N. H.

ICELAND, 50 Different, \$1.00! Bill Evenden, Box 5001, Eugene, Oregon.

CENTENARIES: Wales, Queensland, Melbourne cup. Commemoratives: post office, guiding, flying doctor. 25 dif. Australian. 10¢. Amazing approvals. Reinhardt's, Box 93MD, Troy, Michigan.

300 DIFFERENT Stamps 20¢. Approvals. Lake, Box 922, Lake Charles 62, Louisiana.

CLEARING House for collectors. Trade idle duplicates. Get what you need. Write for details. Stamp Collectors Exchange, 462 Baltic Street, Brooklyn 17, N. Y.

110 DIFFERENT World-wide stamps, 10¢. Bargain lists, special offers, sent with beautiful approvals. Galaxy Stamp, P.O. Box 641, Miami (Tamiami Station), Florida.

SEND Nine 4¢ or twelve 3¢ plate blocks, receive in exchange \$10.00 catalog value (10¢ up), foreign stamps, all different. Alexander 215P Coleridge Street, Brooklyn 35, N. Y.

U. S. Commemoratives; 150 dif. \$1.00! Money saving list free! Ewing, 2133 Lunt, Chicago 45.

SAN MARINO, Latest antique automobiles, free with approvals. William Deems, 226x Race, Ravenswood, West Va.

COMPLETE Vatican, Israel, United Nations. Pricelists. Zampino, 2055 West Tenth, Brooklyn 23.

1¢ EACH Over face value mint United States commemoratives #922 to date. Beautiful United States catalog 10¢ handling. Hille, 51 Lake, Orlington 74, Mass.

EXTRAORDINARY! Free! 20 different Finland to those requesting approvals. Rosenberg, Box 1303, Chicago 90.

ANIMALS, Butterflies, emblems 10¢. Approvals. Pugh, Box 2051, Arlington 2, Virginia.

UNCOMMON Old U.S. seconds 1/6 Scott. K. Swartz, Malden Bridge, New York.

HUNDREDS Of free commemoratives and bi-colored stamps to buyers from our 1/2¢, 1¢ and 2¢ approvals. Orana, Box 424, Tustin, California.

FREE 10 Japan war stamps. Approvals. Schroeder, 1486 1/2 Sherburne, St. Paul 4, Minn.

ARTCRAFT Engraved astronaut Glenn historic first day cover 30¢. Limit two. Washington Stamp, Maplewood, N. J.

FREE 1963 Scott's combined catalog. Details 25¢. Superior, Grafton, Ohio.

CANADA Totem dollar 10 cents. Approvals. Daleti, Box 832, Moncton, New Brunswick.

GREEK Nudes! Fairy tales, rockets, Russia sports diamonds! 10¢, approvals. Paul's, 24-I Lime Street, Boston 8, Mass.

LINCOLN 1¢ plate block 15¢. Prins, 1325 Broadway, Watervliet, N. Y.

STAMP Grab bag featuring exclusively animals, trains, flags, ships, triangles, maps, planes. Send dime. Stampliner, 283 Lakeside Drive, North Bay, Ontario.

AFRICA Independent nations. Fascinating collection 11 sets 9 countries 36 stamps only 25¢. Approvals. Berchtold, Troy, Ohio.

FREE! Surprise packet. Approvals. Premiums given. Dancer, 75-P32, Mansfield, Ohio.

TRADE Your duplicates toward our approvals! (Foreign only.) Complete information, 10¢. Variety Stamps, Box 98-P, Newton Highlands 61, Mass.

FREE! 33 Greenland, Congo, Ruanda, India. Approvals. Keating, 2520-P Boulevard, Jersey City 4, New Jersey.

GIGANTIC Surprise packet, contains hundreds, catalog to 30¢ each, 15¢ with approvals. Dresel, Box 128-M, West Englewood, New Jersey.

ICELANDIC Stamps. Free list. Handling 25¢. Ardal, Keflavik Airport, Iceland.

MINT Pairs 27-50¢; 52-1.00; 204-\$4.00. 100 pipe cleaners 50¢. 19 Christmas seals 50¢. King, 330 Alexander, Kamloops, B.C., Canada.

FREE! From world "hotspot"—new Congo triangle set plus first U.S. astronaut, gold Japan stamp, San Marino triangle, Monaco wedding, Spanish diamond, Negri-Sembilan, Scout issue, Kenya—with approvals. Postmark, Box 542-P, Great Neck, N. Y.

MAKE \$5,000-\$10,000 year. Start a profitable approval business from your own collection. One dollar brings details. Universal, Box 33117, Houston 33, Texas.

2500 U. S. stamps \$1.00. Cozatt, 1916 West Okla, Enid, Okla.

HAWAII—Old stamp. Free. Approvals. W. B. Stamps, Wilkes Barre, Penna.

LUCKY Dollar packet 25¢ with approvals. Richer, 901P, Schenectady 1, N. Y.

FREE! Beautiful pictorial packet! Approvals. Conklin, Box 388-PM, Osage, Iowa.

SELL Stamps to our readers. Your ad in this space will be read by thousands of stamp buyers. I'll prove that to you. Write now for Folder "S." P. W. Johnson, Classified Advertising Manager, Popular Mechanics, 200 E. Ontario St., Chicago 11, Ill.

HOBBIES AND COLLECTIONS

BASEBALL Cards 4¢ each. 50¢ minimum order. Send 25¢ for price list of all types of cards. Card Collectors' Co., Dept. PM, Box 293, Franklin Square, N. Y.

GENUINE Atlantic driftwood for lamps, floral decorating, etc., \$5. NRAS, Box 462, Aquebogue, New York.

AMERICAN Newspaper, complete, original, dated before 1860, \$1.50. 25¢ stamps brings catalogue. D. R. Spaight, Book-seller, Tall Timbers 1, Maryland.

BUY! Sell! Exchange! All kinds antiques, handicrafts, relics, coins, stamps—anything! Nearly 50 classifications in "Collectors News" make it easy! Sample copy 25¢. Box 566-A, Columbus, Nebraska.

50 **ORIENTAL** Butterflies, 25 gemstones, each \$2.00. Free pricelists. P. Haas, Box 2468, New York 8, N. Y.

ANTIQUES, RELICS, INDIAN GOODS, CURIOS

BIRDPOINTS: \$18.00 per hundred. Satisfaction guaranteed. Trading Post, Pottsville, Ark.

6 **ARROWHEADS**, Archaic knife, scraper, \$2.00. Smith, 841 N. Tacoma, Indianapolis 1, Indiana.

SELLING 20,000 Ancient arrowheads, spearheads, etc. List free. Lear's, Glenwood, Arkansas.

ESKIMO Harpoons \$1.00. 7 African, Comanche, Tenn. artifacts \$2.00. 5 fossilized shark teeth \$1.00. 7 imported butterflies \$1.00. List 25¢. All \$4.00. Tervo's, 14 Nassau, Garden City South, New York.

PRECIOUS STONES, MINERALS

SEMI-Precious uncut gems. Ten different for \$1.00. Request list 28. Prospectors Shop, 201 San Francisco, Santa Fe, New Mexico.

AMETHYST-Quartz clusters; Whole geodes; 3 rock crystal points, 3 gold, uranium, magnetite ore; 3 unakite, mariposite, tourmaline specimen. 1 unit \$1.00. Lists 25¢. All \$5.00. Tervo's, 14 Nassau, Garden City South, New York.

GOLD Nuggets, \$2.00. Lester Lea, Box 1125-PM, Mt. Shasta, California.

GET Free catalog no serious rockhound, gem cutter, jewelry maker, hobbyist or craftsman can be without. Full of bargains, exclusive items, low prices from largest suppliers and authorities in the field. Free new catalog just off the press, yours for the asking! Write Grieger's, Dept. C-12, 1633 E. Walnut, Pasadena, California.

EARTH Science. Rockhound's National Magazine. Subscription \$2.50. Sample 35¢. Box 1357-PM, Chicago 90, Ill.

U.S. And foreign mineral specimens, lists 10¢. Minerals, Winston, New Mexico.

PHOTOGRAPHY, CAMERAS, PHOTO SUPPLIES

FREE Catalog. Cameras below wholesale. Gibson's, 188 King, East Aurora 1, N. Y.

DEVELOP Professionally any temperature \$1.00. Toth's, 20 Doerr Street, Pittsburgh 33, Penna.

FREE! Send now for 64-page book of new and used photographic bargains. Dept. 1-AR-4 Central Camera Company, 230 So. Wabash Ave., Chicago, Illinois.

PHOTO FINISHING

"MAKE Money! Save money! Film & photo finishing at wholesale prices. Details free. Economy Film Labs, GPO Box 2081, New York 1, N. Y.

KODACOLOR Film 120-127-620, including processing and prints, \$2.95. MBG Photo, Box 537, Toledo 1, Ohio.

COLOR Movie fans! Low cost—high quality processing our specialty, 8mm. just \$1 (or \$3 with fresh film). Mailed back next day. Craftsmanship guaranteed. Send exposed reel or request free mailers and price list of complete photo-finishing services. Direct Mail Photo, Box 8832-PM, Pittsburgh 21, Penna.

A **FREE** Kodak roll returned with each black and white or Kodacolor developed and printed, fast service, lowest prices, guaranteed quality send for free mailers. Economy Photo Service, Dept. P. M., Box 1111, Albany 1, N. Y.

FAST, Hi-quality finishing. Kodacolor rolls: eight jumbo prints \$1.98. Twelve \$2.49. Twenty \$3.49. Reprints 15¢. Also low B&W prices. Custom Quality Studio, Box 4838, Chicago 80.

EKTACHROME-Ansochrome 35mm. 20 exp. 620, 120, 127, developed, mounted, \$1.00. Kodachrome 8mm. and 35mm., low prices, prompt service. Complete price list—free mailers. Write Tricolor, P.O. Box 123, So. Windsor, Conn.

MOTION PICTURES AND SOUND EQUIPMENT

"TITLES" 8MM Kodachrome. Special sample assortment \$2.00. Movie Title Service, 10128 Frankstown Road, Pittsburgh 35, Pennsylvania.

FEATURE Movies 8mm., 16mm. Film Classic, 1926 South Vermont, Los Angeles 7, Calif.

BARGAINS 16M.M. sound films, list. Bedner, 5300 So. Talman, Chicago.

SAVE Money on B&W, color, 8mm., 16mm. film and supplies. Send 10¢ for bargain catalog. Superior, 448 N. Wells, Chicago 10

5,000 8-16 MM. Movie films. Free catalogues. International, Greenvale, N. Y.

MOVIE Camera film: 8mm. roll \$1.50. 16mm. 100' \$3.00. Free processing. Better Films, 742 New Lots, Brooklyn, N. Y.

MOVIE Film! Free catalog! ESO-R, 47th Holly, Kansas City 12, Missouri.

16MM. Sound, projectors, films. Sale, rental, exchange. Visit store or write for catalog. National Cinema, 71 Dey St., New York City.

LADY Wrestling. Movies, photos. Free list. Peerless, Box 171-M, New York 13, N. Y.

16MM SOUND—8mm films. New, used. Free list. Entertainment Films, 236 W. 55, New York City.

8MM. Valentino, Fairbanks, Keaton, others. 16mm. sound features, shorts, silent classics. Large assortment. Entertainment Films Co., 236 W. 55th, New York City.

8MM. Home movies. Free catalog. Midwest Enterprises, P.O. Box 2062, Milwaukee, Wisconsin.

COLOR SLIDES

COPY Your color slides by attaching slide duplicator to your camera. Information free. Electron Development Co., Box 11152, Indianapolis, Indiana.

8MM., 16MM. Movie subjects. Silent, sound. New, used. 2"x2" color slides. Biggest selection anywhere! Free each month, big 24-page newspaper-size catalog. Blackhawk Films, Davenport 14, Iowa.

TRANSPARENCIES Wanted. Up to \$500.00 each. For information write American Color, P.O. Box 46372, Hollywood 46, Calif.

LINCOLN Story in 500 color slides: Hogdenville, Knob Creek, Gentryville, Rockport, New Salem, Springfield, Washington, Gettysburg, statues, memorials, etc. Sample slide 35¢. Catalogue free. Willems, Box 1515-A, Chicago 90.

MUSIC & MUSICAL INSTRUMENTS

VIOLINMAKERS, Repairers. Fine tone woods and supplies. Also headquarters for violins, guitars (regular and electric) double basses. Send for wholesale price lists. International Violin Co., 414-MPM E. Baltimore Street, Baltimore 2, Maryland.

SONGPOEMS Wanted! Collaborate with professional songwriters on equal basis. Share royalties. Songwriters Contact Co., 1619-D Broadway, New York 19.

PIANO Tuning pays. Learn at home in 30 days. Diploma granted. American Tuning School, Gilroy, Calif.

30% OFF On all instruments. State instrument. Music Sales, Box 385, Silver Spring, Maryland.

PLAY guitar. Teach yourself. \$1.00. Ernie Ball Guitars, Box 308PM, Tarzana, Calif.

ACCORDIONS, Chord organs, guitars! Buy direct—save to 1/2. Famous makes. Free home trial. Easy terms. Trades. Free catalogs. Mention instrument. International Music Mart, Dept. R, 2003 Chicago Avenue, Chicago 22.

ELECTRIC Guitars, amplifiers, wholesale. Free catalog. Carvin, PMM, Covina, Calif.

LOW Quotes: Stereo tapes, components, recorders. HiFi, Roslyn 6, Penna.

SONGS, Poems, offer, details. Newart Publications, Box 693, Syracuse, N. Y.

"HOW To Write, How to Sell Songs," including a practical rhyming dictionary. Complete book—\$2.95 postpaid. Send check or money order to: Belmont Press, 200-A 23rd Ave. N., Nashville 5, Tenn.

SONGPOEMS And songs wanted! Mail to: Tin Pan Alley, Inc., Box 405, Radio City Station, New York 19, N. Y.

POEMS Wanted for musical setting and recording. Send poems. Free examination. Crown Music Company, 49-C West 32 Street, New York 1.

POEMS Needed immediately for new songs and records. Free examination and appraisal. Send poems: Songcrafters, Acklen Station, Nashville, Tenn.

GUITAR Making books, plans, imported woods, tools. List 10¢. Satinwood, 510 East 11th Street, New York 9, N. Y.

SONGS Wanted. Pays royalties. Enclose postage. Olenik Records, Mount Morris, Michigan.

POEMS Wanted for songs and records by America's original oldest and largest song studio. Established 20 years. Avoid imitators. We have helped many. We can help you with your songs. Send poems for free examination. Immediate consideration guaranteed. Five Star Music Masters, 620 Beacon Bldg., Boston.

GUITAR Self-instruction books, all chords, melodies. Special \$1.00. Guitar Co., Box 950, Chicago 90.

ACCORDIANS Piano, chromatics, button-type, concertinas. Wholesale catalogs free. Italian Accordion Mfg. Co., 7600-C Cottage Grove, Chicago 19, Illinois.

IMPORTED Direct to you. All transistor tape recorder only \$27.95. Guaranteed. Eastcoast Enterprise, 4111 Colonial Ave., Norfolk 8, Va.

EUROPEAN Market wants: Poems, music, songs. Our world-wide organization: Promote, publish, record, royalty basis. French, Italian versions supplied. Free examination. Rush airmail material to: Benedetto, P. O. Box 1737, Milan, Italy, Europe.

ACCORDIONS All sizes. Free home trial. Color catalog. Save 1/2. Terms. Accordion Import Center, 7120 Galli Dr., San Jose 29, Calif.

PIANO Tuning instructions, \$3.00. Parts, tools retail. Blyther's, Camden, S. C.

RADIO, TELEVISION AND ELECTRONICS

RADIO Course only \$14.95. Includes all tubes, parts, tools, instructions. Write for full information. Progressive "EduKits" Inc., Dept. 570B, Hewlett, N. Y.

RECORDING Tape wholesale bargain list. West Pacific Distributing, 1301 N. W. Glisan, Portland, Oregon.

TRANSISTORIZED Products dealers catalog, \$1. Intercontinental, CPO 1717, Tokyo, Japan.

RECORDING Tapes. Lowest prices. Free literature. Towers, Box 3095, Philadelphia 50.

SILENCE Annoying TV commercials. Inexpensive method revealed for \$1.00. Norm's 1135 W. Arrow, Claremont, Calif.

LEARN While asleep with amazing "Electronic Educator" endless tape recorder. Details free. Research Association, Box 24-PX, Olympia, Wash.

RECORDERS, Hi-fi. Free wholesale catalogue. Carston, 125-Y East 88, N. Y. C. 28.

GOVERNMENT Surplus radios, parts. Picture catalog 10¢. Meshna, Malden 48, Mass.

FIX Your own TV. Save 80%! Send for free illustrated chart showing how! We'll include giant electronics catalog. Zalytron, 220-M West 42 St., New York City.

TAPE Recorders hi-fi components. Sleep learning equipment, tapes. Unusual values. Free catalog. Dressner, 1523M Jericho Tpke, New Hyde Park, N. Y.

SAVE Dollars on radio, TV-tubes, parts at less than manufacturer's cost. 100% guaranteed! No rebrands, pulls. Request bargain bulletin. United Radio, 1000-M, Newark, N. J.

DON'T Buy hi-fi components, kits, tape, tape recorders until you get our low, low return mail quotes. "We guarantee not to be undersold." Wholesale catalog free. Easy time payment plan. 10% down—up to 24 months to pay. Send 10¢ to: Hi-Fidelity Center, 230-M E. 23 St., New York 10, N. Y.

CRYSTAL Radio kit \$1.00. Amplifier and speaker for same \$4.95. Catalogue. Clearco, Box 1638, Stuart, Florida.

OPERATE Car radios from 110 volts! Build battery eliminator for \$15.00. Complete plans \$1.00. Astro Electronics, 5212 Wea Dr., Kokomo, Indiana.

IONS. Do they improve well being? Facts, plans for building negative ionizer \$1.00. Tusp, Box 4114G, Cleveland 23, Ohio.

RADIO Troubles? Illustrated symptoms chart 20¢. Millett, PM, 5208 Longton, Cleveland 24, Ohio.

TRANSISTOR Radios repaired. \$5.00 covers parts, labor, return postage. Mail radio and \$5.00 to Mannington TV, 23 Pyles Ave., Mannington, W. Va. Guaranteed.

BUSINESS OPPORTUNITIES

\$50-\$100 WEEKLY With your camera. Information: Camera Artists, Rt. 1, Box 365, Grass Valley, California.

EXPORT-Import opportunity, profitable, world-wide, mail-order business from home, without capital; or travel abroad. Established world trader ships instructions for no-risk examination. Experience unnecessary. Free details. Mellinger, D704, Los Angeles 25.

DOLLS! Dolls! Dolls! We teach you to make, repair, dress and sell. Study at home. Earn while learning. Free booklet. Doll Hospital School, Studio MC-42, 11826 San Vicente Blvd., Los Angeles 49, Calif.

BECOME Tax consultant. Graduates earn \$1,000-\$3,000 every tax season preparing returns evenings. State approved. Union Institute, Lakewood K-2, N. J.

LOOKING For new ways to make money? Idea Press, exciting 8-page newspaper, outlines money-making ideas for everyone. Copy, \$1. Idea House, 46 Asnuntuck, Thompsonville, Conn.

FANTASTIC Profits in new coins. Small investments. No risk. Free details. How Publications, 1612-N Sterling, Brooklyn 33, New York.

CLIP Newspaper items for plastic laminating. Exclusive territory. Details. Marlow, Holbrook, N. Y.

BIG Profits operating amazing mail-order method. \$2.00. Money-back guarantee. Barber, 1823 Augusta Dr., Lexington, Ky.

AUTO Mechanics—be your own boss. Grind crankshaft journals with Sunnen portable crankshaft grinder right in the car. Many Sunnen grinder operators earn over \$50 a day. Why not get into this profitable business? Write for details. Sunnen Products Company, 7954 Manchester Avenue, St. Louis 17, Missouri.

MOTEL Supply mailorder business. Excellent opportunity. Complete setup. Hermes Advertising, 152 West 42, New York City 36.

10,000 PROFITABLE Formulas, recipes, trade secrets. Details free. Colen, 7731-M4 Yates, Chicago 49.

MAKE Extra money—Big cash commission plus premiums for you and your customers. Sell advertising book matches. Sensational new tenor, glamour girls, hill billies; dozens others. All sizes. Quick daily sales; big repeat business. Free master kit makes selling easy. No experience necessary. Superior Match, Dept. MX 462, 7530 Greenwood, Chicago 19.

FORTUNES Made prospecting! Are you walking over money when hunting, fishing, or hiking? Learn how to locate, identify, sell, stake claims on valuable ore and minerals. New comprehensive approved correspondence course. Free revealing information! Modern Prospector, 1038 So. La Brea, Dept. HC174, Los Angeles, Calif.

START Your own business on credit. U.S. only. Your own boss. 1344 dealers sold \$5,000 to \$25,500 in 1960. We supply stocks, equipment on credit. 200 home necessities. Sales experience unnecessary. Pleasant, profitable business backed by world-wide industry. Write Rawleigh's, Dept. D-U-PPM, Freeport, Ill.

READ "Mailorder Laws and Regulations." Explains licenses, taxes and legal preparations necessary before starting business. \$2.00. Recommended especially for beginners. Neil H. Tasker, Shamokin, Pennsylvania.

MUSHROOM Spawn first class, (seed) to plant 50 square feet \$10.50, to plant 100 square feet \$16.00. Free instructions and suggested market where to sell your mushrooms at highest prices are furnished with each order. Send full cash payment with order for prompt prepaid shipment. Thomas Company, 1019—6th North, Seattle, Wash.

OPERATE Paying mail order business from home. Eye opening details. Kukitz, 369 Spruce St., Coplay, Penna.

MAILORDER. America's most unique no cost beginner's plan. Armstrong's, 154-A Darrington S.W., Washington 24, D. C.

RE-REFINE Used oil. Drawings, instructions, \$3.00. Pacific, Box 311, Gresham, Oregon.

FREE Sample for magic beautiful green lawn growth. Free catalog showing how to make big money at home business. Sure-grow Company, 1019—6th North, Seattle, Wash.

SECRETS! Secrets! Mail order success revealed by internationally famous expert who discovered how to make home business fortunes. Beginners: Get free copy "How to Make Money in Mail Order." Disclosed free advertising, profitable products, everything! No obligation. Write Malco, 1554 Sepulveda, Dept. D704, Los Angeles 25.

\$34.70 TWO Hours manufacturing concrete products. No selling. Castings #3. Box 1721, Rapid City, South Dakota.

DICTAGRAPH Fire alarm systems. Freds, 735 North Fourth, Coeur d Alene, Idaho.

\$400 PER Week profit possible with amazing 5 pound invention that prints on cloth, wood, glass, plastics, felt, metal, ceramics; flat, curved surfaces. Free facts and samples. Screen Print, Los Angeles 61-2C4.

LEARN Landscaping and the growing of plants. Start a profitable business part or full time. Free information without obligation. National Landscape Institute, Dept. MC-42, 11826 San Vicente Blvd., Los Angeles 49, Calif.

NEW Products and ideas. 100 dropship dealer names and addresses. Just send \$1.00 to Aden Sales Co., P.O. Box 875, Philadelphia 5, Penna.

BIG Money—Operate your own fix-it shop. Service all household appliances: irons, fans, refrigerators, automatic washer-dryers, etc. Do house wiring, commercial writing. Rewind motors of all sizes. Sharpen mowers, skates, saws. Buy needed spare parts wholesale. Free book. Christy Trades School, A-2403, 3214 W. Lawrence, Chicago 25.

NEW Swiss watches \$2.95. Illustrated bargain catalog free. Cosmos, New York 35. Dept. 814.

EXCLUSIVE Kits for manufacturing square concrete bird baths. Details 10¢. Forms, 11621 Lee Rd., Alsip 58, Ill.

YOUR Own baby shoe bronzing business. Instructions, equipment, supplies. Metalizing, glassing, Pearl-Kote. We finance. Free booklet. Dept. A, Box 5036, Inglewood, Calif.

PACKAGE At home for profit! We supply everything. No selling. Free home business details. HPC, 2212BJ Jesse Street, Los Angeles 25.

MANUFACTURE Products 400% profit. Catalogue free. International, 6347 Par-nell, Chicago 21, Illinois.

EVERYBODY Likes fine candy and popcorn specialties. Make professionally home. (Our 50th year.) Ragsdale Candies, B107 East Orange, New Jersey.

WORK At home packaging merchandise. Very profitable. No selling. Everything supplied. Details free. D'Amico, 5711 W. Chicago, Chicago 51.

HIGH Earnings cleaning, repairing, watches! Illustrated instructions. Kester, Deckerville, Michigan.

FREE Book "990 Successful, Little-Known Businesses." Work home! Plymouth-572A, Brooklyn 4, New York.

CATALOGS, Your name imprinted. \$1.00. Sample 25¢. Stars, Box 3155, Pensacola, Florida.

FREE! "39 Easy Home Business Ideas." Merkins, 30 Ontario, Terryville, N. Y.

MOLD Statuary, pottery, tiles, novelties—5¢ materials makes dollar sellers! Particulars free. Marbleizing Service, Edwardsville, Illinois.

OPERATE Profitable home mailorder business. Details free. Alto Distributors, Box 253, Palo Alto, California.

CAN You enjoy independence and high income? Obtain a guaranteed program for business planning. \$5.00. Business Advisors, P.O. Box 91, LaSalle Station, Niagara Falls, N. Y.

SAWDUST 112 uses. Tin-cans 63. Newspapers 27. Rubber 67. Glass 20. Rags 35. Instructions \$1.00 each. Any three \$2.00. All six \$3.00. Charles Company, 42-AG, Norwood, Ohio.

SHARPIT \$39.50. Precision knife, instrument, scissors, tool sharpening machine 98% profit! Clean, light, profitable route or home business. Free circular. Snellenberger, 1100 Cleveland, East St. Louis, Illinois.

TERRIFIC Profits! Sells itself! Golden brass social security card. 3-Color U.S. flags and eagle. Rush \$1.00 (agent's price) for your engraved Perma-Card. Print name, address and Social Security number. Free carrying case and complete sales kit. Perma-Card, P.O. Box 704-CA, North Miami Beach 62, Florida.

YOUR Home mailorder business. Permanent repeat income. Supplies free. Bibles, Dayton 9, Va.

I Want a man who wants a business of his own. I will train you, supply the equipment, help finance you, start you rolling. This is not a risky get-rich-quick scheme. It is a legitimate business, a selected franchise, proved successful by hundreds throughout the country. Send name, address and phone number to Marion Wade, 2117 North Wayne, Dept. 609, Chicago 14, Ill.

STOP Looking, start earning! Learn of opportunities to have your own franchised business. Write immediately for free information. National Franchise Reports, Dept. PB-528, 333 North Michigan, Chicago 1.

MAILORDER Certificates worth \$1.00. Absolutely free. Neil H. Tasker, Shamokin, Pennsylvania.

PARTS Bins. Quart capacity. Unbreakable! 25¢ hundred. Tommy Lynch, 2330 Springlake, Dallas 34, Texas.

\$100.00 WEEKLY. Sparetime home mail order business. Successful beginners plan. L & D, 109 W. 42nd, New York City 36.

OWN And operate a collection agency. Complete instructions \$5. Janeczek, 373 East 115th Street, New York 55, N. Y.

EARN \$5,000 To \$15,000 in spare time with newest, most unique food franchise. "Capn's Galley"—floating self-powered boat-in restaurant—serves big, fast-growing boating public. Enjoy the fun of boating as you earn. Minimum investment. Write for details: Leisure Enterprises, Inc., P.O. Box 1860, Peoria, Illinois.

START Profitable mailorder business. Easy way! Merkins, 30 Ontario, Terryville, N. Y.

\$70.00 WEEKLY—Home, spare time. Simplified mail bookkeeping. Immediate income—easy. Auditax, 34741A, Los Angeles 34.

RAISE Rabbits on \$500 month plan. Free details. White's Rabbitry, Mt. Vernon, Ohio.

BUY Direct from factories. Appliances, cameras, watches! Free details! Cam Co., 436 P.M. Bloomfield Ave., Verona, N. J.

\$200.00 MONTHLY. Spare time. With table saw, bandsaw or jigsaw. Write. Holiday House, A3800 Harney, Vancouver, Washington.

SHARPEN Saws and lawnmowers the profitable way. Send for free literature. Max Manufacturing Company, 138 Stockton Avenue, San Jose 26, California.

FRANCHISES Make profits! Operate your own exclusive franchised business. Write today for free interesting details. National Franchise Reports, W-528, 333 North Michigan, Chicago 1.

SELL Champion, AC, Autolite spark plugs. Reconditioned, electroplated, guaranteed 10,000 miles, 100% profit. Free sample. Lee Plugs, 1608-A Roberts, Houston 3, Texas.

VENDING Machines. No selling. Operate a route of coin machines and earn amazing profits. 32-page catalogue free. Parkway Machine Corporation, Dept. #27, 715 Ensor Street, Baltimore 2, Maryland.

BUSINESSES, Resorts, motels, investment property, ranches. Our special service dept. at your disposal. No obligation. World's largest, 58 years' service. Strout Realty, 7-MB S. Dearborn, Chicago 3, Ill.

BIG Money raising fishworms and crickets. Free literature. Carter Farms, Plains, Georgia.

TO \$100.00 Weekly. Sparetime, home operated mailorder business. Successful beginner's plan. Everything supplied. Lynn, 10420-M National, Los Angeles 34.

PIANO Tuning learned quickly at home. Tremendous field! Musical knowledge unnecessary. Information free. Empire School of Piano Tuning, Champaign, Ill. (Founded 1935).

COPUBLISH Mail Sale Advertiser, leading mail order paper. Details, latest copy, dime. Vanroy Shirk, Lebanon, Penna.

OPERATE Profitable mail order business. Write Walter Service, 4159A East 112th, Cleveland 5, Ohio.

BAKE New greaseless doughnuts in kitchen. Sell stores. Free recipes. Montgomery, 3605 South 15th, Minneapolis 7, Minnesota.

MAKE \$46 From square foot plywood: jigsaw necessary. Free details. Woodart, Bridgewater, Mass.

\$400.00 MONTHLY Raising giant fishworms. Soilless method. Charlie Morgan, Bushnell, Florida.

HOW And where to obtain capital. Write: Reliable Service, Rome City, Ind.

SELL Books by mail. 400% profit. Royal, Box 368-X, Cleveland 27, Ohio.

PLASTERCRAFT Molds, liquid rubber, plasters, flocks, candle supplies. Catalog and manual free. Blue Rapids Supply, Blue Rapids, Kansas.

WORLD'S Largest wholesale supply. Buy from 679 American, European, Japanese wholesalers. Tailormade suits from Hongkong. 123 dropship catalogs. Rock-bottom prices. Free details. International Buyers, 216-MM Jackson, Chicago 6, Ill.

EARN \$3 hourly, spare, full time, looking up information at your local library. Operate research bureau. Details free. Service, 81C Knickerbocker Station, New York.

RE-CAST Junk batteries into new. Latest achievements. Battery Laboratories, Bayou LaBatre, Alabama.

11,000 NEW Prospects daily. Baby record books, shoes, albums. Sell mailorder. Use our literature. Write: No-Co-Ro, Capitola, Calif.

SIGNS. Sell restaurants, bars, etc. Samples \$1.00. Box 9563, Jackson, Miss.

INTERNATIONAL Mailorder business made easy. Complete setup service, not just instructions. Hermes, 152 West 42, New York City 36.

OPERATE Home mailorder business. Vosacek Printing, 4444AI Ute, San Diego, 17, Calif.

MAILORDER: Extra income, spare time. Easy. Write: American Distributors, Box 409, Niles, Michigan.

COLORGLAZED Concrete pottery made without molds. Patented method. Cemetery products, novelties, tiles. Basement leak-sealing. Money-making projects. Booklet, details free. Men only. National Potteries Company, Grand Rapids, Minnesota.

MUSHROOMS Quicker, easier, cheaper. Spawn (seed) plus newest manureless growing, various processes, marketing. \$1. Free literature. Luxur, 641 South 19th, Newark 3, N. J.

CANDIED Popcorn and potato chip equipment. Eakins, Box 933-A2, Springfield, Ohio.

MAKE Money making leathers. 1148 ideas. Free information. Tandy Leather Co., Box 791-F2, Fort Worth, Texas.

WANT To make big money at home? \$10.00 profit in an hour possible with invisible mending. Make tears, holes disappear from clothing, fabrics. Steady year-round demand from cleaners, laundries, homes. Details free. Fabricon, 1585 Howard, Chicago 26, Ill.

LEARN Sewing machine repairing. To \$125 weekly. Sparetime. Supplies. Add to present business. Write today! Taylor Service, Box 484, Cupertino, Calif.

EARN Money raising fishworms for us! Write: Oakhaven—36, Cedar Hill, Texas.

MAKE Money from old tires. Operators clearing \$400 weekly. Equipment costs \$800. Get facts. S & S Patents, Inc., 3511 N. Lincoln, Chicago 13.

BRONZE Baby shoes: Instructions, equipment and mountings for genuine electroplating process. Largest supplier of all plating equipment, supplies. Free catalog. Hollywood Bronze Supply, Dept. B-3, 3445 Union Pacific, Los Angeles 23, Calif.

LIFETIME Home business bottling fabric softener. Details. Morgan's, Coldspring Street, Norwalk, Conn.

DRIED Mushrooms \$4.50 pound for large canning company. Receiving warehouse in United States. Growers wanted on contract, everything supplied. Dehydrated Products & Chemicals, No. 548, Calgary, Alberta, Canada.

GARDEN Golf. Start amusement center. Invest now. Brockway, Box 3762, Portland 8, Oregon.

AMAZING Profits in exterminating. Full time, part time. Free details. Baylab 21-M, Cambridge, Maryland.

OPERATE Profitable mailorder business. Free details. Coats, Box 1247-A, Ontario, California.

OPERATE Thrilling mailorder business. Amazing profits. Write: Sax, Milan 1, Ohio.

GOOD Earnings showing, installing inter-communication systems for businesses, homes. Hold private inter-departmental, house to garage, etc. phone conversations. Requires only household tools. Telephone Repairs, 1760-A Lunt, Chicago 26.

NEW Imports. New American products. Largest selection. Wholesale only. Exclusive Reviews, 1186 Broadway, New York 1, N. Y.

PROFITABLE Mail order businesses directory, 25¢. Mail Dealers Headquarters, Box 64, Rego Park 74, N. Y.

HAVE Worthwhile mailorder business. Write Rocky Service, N6740 Waterworks Rd., Norfolk 2, Va.

OPERATE Profitable mail-order business. Write Wayne's Service, 3016-J Channing, Washington 18, D. C.

JOIN Dollars unlimited club. Huge profits. Box 2766B, Kalamazoo, Mich.

HANDSOME Profits. Instructions on how to make and sell this hot item in your spare time. \$3 to Pritchard, Box 10274, Fort Worth, Texas.

VENDING Machine catalog. Rakes, 609F Spring Garden, Philadelphia 23, Penna.

FREE Moneymaker. "Successful Home Formulas." Informat, 2644-PF No. Western, Chicago 47.

"MAILORDER Methods." Your own imprinted brochure, containing 72 luxury gifts, drop-shipped to your customers, while you operate from home! Details, sample, wholesale price list. "Methods," Lafayette Hill 63, Pennsylvania.

\$15.00 AN Hour possible in new home manufacturing business. Spare or full time. Amazing velvet-spray transforms hundreds of old items into money-making products. Write for samples, free "50 Business Opportunities Booklet." Coast Industries, Los Angeles 61-BC4.

MONEYMAKING OPPORTUNITIES

MAKE Plastic novelties for extra income. Low cost home training now available. Write for free booklet. Interstate Training Service, Dept. D-3, Portland 12, Oregon.

"HOME Businesses" (U.S. Government reprint) 25¢. Dittofax, 5815-PM Compass, Los Angeles 45.

\$35-\$65 WEEKLY Assembling artificial lures at home for stores. Materials supplied free. Write: Lures, Box 1280, Fort Walton Beach, Fla.

BAKE New greasless doughnuts in kitchen. Sell stores. Free recipes. Melvin, 3605 South 15th, Minneapolis 7, Minn.

FABULOUS Profits raising earthworms. Picture folder free. Excello, Kosciuszko 6, Mississippi.

ATTENTION—Aluminum concrete yard ornament molds—donkey cart planters, beautiful bird baths, urns, etc. Prices slashed. Write for information. Knapp's, 4257 Josephine Street, Denver 16, Colorado.

CIGARETTES—Make 20 plain or filter-top for 9¢. Facts free. Moberly, Box 4012, Owensboro, Kentucky.

MINK Raising information free. Complete. Lake Superior Mink Farm, Superior, EE1, Wisconsin.

EARN Money evenings copying and duplicating comic cartoons for advertisers. Adservice, Argyle 1, Wisconsin.

VENDING Machines. No selling. Operate a route of coin machines and earn amazing profits. 32-page catalogue free. Parkway Machine Corporation, Dept. #26, 715 Ensor Street, Baltimore 2, Maryland.

EARN Money raising fishworms for us! Write: Oakhaven—59, Cedar Hill, Texas.

YOUR Own, easy-to-start, home mail-order business, sparetime. Fascinating; profitable! Information free. Alfano, 19-PM Pine, Closter, N. J.

BIG Money raising fishworms and crickets. Free literature. Carter Hatchery, Plains, Georgia.

READ "Progressive Mailtrade," the magazine that tells how to make money by mail. Quarter brings sample and special offer. Progressive Mailtrade, Box 357, Sheboygan, Wisconsin.

AMAZING Successes through franchises! Become exclusive franchise holder your territory. Information rushed. National Franchise Reports, MP-528, 333 North Michigan, Chicago 1.

LEARN The secrets of repairing junk batteries, generators, starters, profitable, easy, at home. Free particulars. Battery-man, 3465 Forrest, Santa Clara, Calif.

\$25-\$50 WEEKLY Possible, re-writing news items, jokes, poems, recipes, for publishers. Some worth \$10 each. Details free. Service, 81-D, Knickerbocker Station, N.Y.C.

MAILORDER Business learned easily. Write: Easco, Box 323, Grand Rapids 1, Michigan.

"LUCKY Day Adpak" is loaded with money making opportunities. Order yours today, 25¢. Arcane, Box 117, Plant City, Florida.

MAKE Up to \$8,500 a year sparetime. Complete data \$1, refundable. Janeczek, 373 East 155th Street, New York 55, N. Y.

PROFITABLE Income. Leveling sidewalks. Small investment. Instructions \$1.00. Business Enterprises, 1505 Prather, St. Louis 10, Mo.

PROFITABLE Mail-work, evenings. Literature 25¢, refundable. Interstate, 37-1 Besch, Albany 9, N. Y.

LEARN Jewelry making at home. Inexpensive art metalcraft course teaches how to make all types cuff links, earrings, tableware, etc. of silver, gold, copper. Send postcard for free booklet. Interstate Training Service, Dept. L-3, Portland 12, Oregon.

MAKE \$5,000 Yearly sparetime raising mink, chinchillas, nutria, etc. Free booklet reveals proved plans. Write: Furs, 588 Mt. Pleasant Road, Toronto 1, Canada.

MONEYMAKING Formulas trade secrets. Hooton, 1398 Monserate Ave., Chula Vista, Calif.

MAKE Money by making jewelry. Send 25¢ in coin for instructive catalogs. Jay-Cee Jewelry Inc., 618 Carew St., Springfield, Mass.

MEN—Women! Start money-making plastic laminating business at home in spare time. Material that costs 11¢ brings back \$2.58. No canvassing or selling but mail orders brings in \$20 a day. Write for full particulars free. Rush name on postcard to Warner, Room CL-2-D, 1512 Jarvis, Chicago 26, Ill.

\$100 WEEKLY selling "Alarmobile"—"Doorscope." Carco, 115 Madeira, Salinas, California.

FREE! Directory extraordinary money-making home businesses! Southern Specialty Supply, 1912-PM, Corpus Christi, Texas.

WANTED—Cartoonists. Amateurs, professionals. Over 200 markets. Information free. Cartoon Markets-M4PM, 11620 Lansdowne, Detroit 24, Michigan.

MAKE Up to \$200 a week or more. Set your own pace! Get paid top rates every day for each name on lists of past due accounts you send in to us for our firm to collect. General Finance Company, 304X Pickwick Bldg., Kansas City 6, Mo.

EASY To start rubber stamp business at home in spare time. Make up to \$9.80 an hour without experience. Facts free. Write Roberts, 1512 Jarvis, Room CR-2-D, Chicago 26.

MAKE Money with any camera, learn photography; amazing results quick. Proved instruction card starts you, earns cash, only \$2.00, money-back guarantee. Experience not necessary, work at home, anywhere. Order today! Drop card for c.o.d. Photoway, Box 1066E, Richmond, Calif.

MAKE Big extra money with herbs. Grow inside-outside or gather wild. Free details. Whitlow, Dept. A-4, 726 Fairwood, Dallas 32, Texas.

"TIMELESS-Treasures" offer weekly spare-time income \$50.00 and over to men and women without leaving home. Establish steady, profitable, dignified business. Limited to first applicants. P. O. Box 1652-M, Wichita, Kansas.

SAVE And make hundreds of dollars. Money-making ideas, wholesale sources. Bonanza of information only \$1.00. Nickerson, 4818 Reno, Sarasota, Fla.

SUGGESTIONS. 100 ways to make money through your plant suggestion plan. Booklet with sketches and examples, \$1.00. Suggestions, P.O. Box 2541, Mansfield, Ohio.

MAKE Money with your car. Quarter brings plans. Dennis, 954 W. 70th Place, Hialeah, Fla.

EXPORT — IMPORT

NEWEST Products, fabulous bargains in direct importing. 475 worldwide firms, classified—\$1.00. Henderson, 2620 Rio Vista, Tampa 3, Florida

JAPAN: Direct mail-order 26 page catalogue: dolls, novelties, business information, manufacturers' names, addresses, \$1.00; Japan's Trade Directory, 3000 companies, \$3.00. Send cash. Clarence Yamagata, 814 Toginbiru, Marunouchi, Tokyo.

WORLDWIDE Dropship and import directory \$1. Janeczek, 373 East 155th Street, New York 55, N. Y.

"FOREIGN Bargains Directory." \$1.00. L. J. Finn Company, 140 Virginia Park, Detroit 2, Michigan.

WATCHES! Airmailed from Switzerland. 152-page catalog 35¢. K-P Imports, 511 Glenwood, Buffalo 8, N. Y.

RECEIVE—Import catalogs! Circulars! Foreign business opportunities! Get listed, 25¢. Importico, Enka, N. C.

SCIENCE & CHEMISTRY

AMAZING New book of science experiments, formulas, and catalogue of laboratory supplies. Only 35¢. National Scientific Co., 13 S. Park Avenue, Dept. PM-4, Lombard, Illinois.

RADIATION Detector kit of instructions together with calibrated scale and diagrams for simple assembly. Send \$1.00 to Bre-Ton, Inc., 1000 North Lyndale Avenue, Minneapolis, Minnesota.

SPECTROSCOPE \$3.00. Speeds chemical analysis. Book 200 electric stunts \$1.00. Kuttingson, 875 Arastradero, Palo Alto, Calif.

ATOMIC Fall out laboratory. See fall out radiations, for the first time. Kit \$3.95. Laboratory \$4.95 complete. Florida Radiations Co. PM. Green Cove Springs, Florida.

ROCKETS: New illustrated catalog 25¢. Single and multistage kits, cones, engines, launchers, trackers, technical information, etc. Fast service. Estes Industries, Penrose 7, Colorado.

ROCKETS Available now: Powerful new 2-stage model spacecraft! Kits, cones, engines, chemicals. Bigger 1962 catalog 25¢. Central Rocket Company, Waupaca, Wis.

CHEMICALS And apparatus for industrial, analytical, and private laboratories. Catalog 35¢. Dept. M-50, Biological Supply Co., 1176 Mt. Hope Ave., Rochester 20, N. Y.

232 PAGE Catalog \$2.00. Laboratory Materials, 7319 Vincennes, Chicago, Ill.

ILLUSTRATED Catalog: Chemistry, mineralogy, biology 25¢. Tracey Laboratories, Evanston, Illinois.

UNUSUAL Chemistry books, courses, kits! Rare chemicals, cheap! Catalog 25¢. NSC, Box 11133, Palo Alto, Calif.

LABORATORY Conversion charts with bigger catalogue—25¢. Hagenow Laboratories, Manitowoc, Wisconsin.

DEEP Sea experiments conducted from your home. Interesting details 10¢. Johnson Exploration, Berth 78, San Pedro, California.

FORMULAS, PLANS, ETC.

PROFESSIONAL Formula books. Information free. Directory Service, Box 964, Philadelphia 5.

FORMULAS—All kinds. Amazing big catalog, 10¢. Kemixal, Park Ridge, Ill.

LATE, Modern manufacturing formulas. List free. Moon Chemical, Martville, New York.

FORMULAS For latest money-making discoveries. New! Good! Valuable literature free! Miller, Chemist, 1517-D, Tampa, Florida.

10,000 PROFITABLE Formulas, recipes, trade secrets. Details free. Colen, 7731-MD Yates, Chicago 49.

PLASTICS

NEW Liquid casting plastic, clear, colors. Embed real flowers, butterflies, photos, coins. Send 25¢ for two handbooks "How to Cast Liquid Plastics" and "How to Make Extra Money at Home." Castolite, Dept. D-101, Woodstock, Illinois.

NOW! Plastic vacuum forming machines. Hobby. Easy. Profitable. Details. Burr, 330 East Center, Kalamazoo, Mich.

PLASTIC Embedding and molding made easy with new instruction manual, \$1.00. Catalog 25¢. Castcraft Corp., Dept. M-462, P.O. Box 555, Palo Alto, Calif.

MAKE, Sell plastic signs. Sample 25¢. Refundable. Dixie Plastic, Lakeland, Fla.

BOXES, Plastic. 200 sizes. Free list. Althor, 170 Bay 23 Street, Brooklyn, N. Y.

PROFITS! Vacuum form plastic! Easy! Box 1971, San Diego 12, Calif.

AGENTS WANTED

MAKE Most extra cash with world's biggest line everyday greeting card assortments, gifts. Introduce friends, neighbors, to over 150 assortments, 500 big money-makers. Pocket up to 100% profit plus big cash bonus. Free giant color catalog; samples on approval. Write Arrow Greetings, 513 Fourth Ave., S., Dept. 83-M, Minneapolis, Minn.

BE The Popular Mechanics representative in your neighborhood and earn big profits in your spare time. Write Popular Mechanics, Room 4-A, 250 West 55th St., New York 19, N. Y.

MEN-Women agents: Sensational new money-makers—beautifully hand-painted, plastic personalized photo enlargements, compacts, rings, bracelets, lockets, etc. Simply take orders pocket 40% commission. We deliver and collect. Sales outfit free. Noveico, 3343 North Ave., Chicago 47.

AGENTS—300% Profit selling genuine gold window letters; stores and offices. Free samples. Metallic Sign Letter Co., 1217-D West Newport, Chicago.

ENGLISH Chamois—low tannery prices. Good profits. Chantana, Lakeland, Florida.

MEN—Women agents: Generous commissions, repeat business, selling educational filmstrips to schools and churches. For full particulars write to: Eye Gate House, Inc., 146-01 Archer Ave., Jamaica 35, N. Y.

AUTO Safety belts. Tremendous profits! Imperial, 150-26 Hillside, Jamaica 32, N. Y.

WHOLESALE Fishing tackle, transistors, jewelry. Lindback Distributing, Woodside, Muskegon, Michigan.

BIG Money in year's best selling book. Robbins-3, Box 1673, Escondido, Calif.

MAKE \$55 A day clear profit! Sell nationally advertised Royaltone Auto Glaze to car owners, dealers, jobbers. Exclusive territories. Rush name for free sample, details. Royaltone, Brooklyn 30, N. Y.

RUN A spare-time greeting card and gift shop at home. Show friends samples of our wonderful new 1962 all-occasion greeting cards and gifts. Take their orders and earn up to 100% profit. No experience necessary. Costs nothing to try. Write today for samples on approval. Regal Greetings, Dept. 67, Ferndale, Michigan.

SELL Champion, AC, Autolite spark plugs. Reconditioned, electroplated, guaranteed 10,000 miles. 100% profit. Free sample. Lee Plugs, 1608-E Roberts, Houston 3, Texas.

FREE Sample. Beautiful curios! Sell on sight! Apartado 9036, Mexico City.

PRINTING. Advertising salesmen—Excellent moneymaking sideline selling decalcomania name plates, small quantities. Automobile initials, sign letters. Free samples. Ralco, XL, Boston 19, Mass.

YOUR Own business—Used suits \$1.50; overcoats 65¢; mackinaws 35¢; shoes 12½¢; ladies' coats 30¢; dresses 15¢. Enormous profits. Catalog free. Nathan Portnoy Associates, 2109-AA Roosevelt Road, Chicago 8, Ill.

MAKE Up to \$50.00 a day soliciting delinquent accounts. Terrific commissions. Write today. National Credit, 304Y Pickwick Bldg., Kansas City 6, Mo.

BIG Profits. Stamp social security plates, key protectors. Sample 50¢. Catalog free. General Products, 11 No. Pearl St., Albany 7, N. Y.

\$20.00 FIRST Day introducing distinctive personalized doorplate assortment. Complete sales kit free. Reeves, Attleboro 7, Mass.

SPARETIME Profit (men or women) taking orders for small Hoot Gibson California Ranchos. Literature on request. Tracy Wiley, 440 So. Atlantic, Monterey Park, California.

YOUR Ad in this space will get some good agents for you. Yes, I'll prove it. Write for Folder "A" right now. F. W. Johnson, Classified Advertising Manager, Popular Mechanics Magazine, 200 E. Ontario St., Chicago 11, Ill.

BUY IT WHOLESALE

EVERYDAY Necessities. Everything guaranteed. Free illustrated wholesale catalog packed with bargains. Free offer. Southland Enterprises, Forest City 1, Fla.

MERCHANDISE For the auction trade: tarpaulins, fishing equipment, tools, miscellaneous items. Write for prices. Patterson Tool Co., 1013 D, Lawton, Okla.

BULOVA. Benrus watches like new \$5.95 up. Hundreds of other bargains, 30 page illustrated catalog free. Cosmos, New York 35, Dept. 810.

NEW Deluxe below wholesale catalog. Automobile catalog and others. Furniture, clothing, housewares, appliances, refrigerators, freezers, washers, dryers, television, radios, luggage, binoculars, hi-fi, stereo, phonographs, recorders, cameras, projectors, musical instruments, sporting goods, toys, tools, typewriters, watches, jewelry. Huge discounts on thousands of name brand items. For free specimen list of actual factory prices—postcard: Selbyco, Decatur 15, Illinois.

ALL Famous brands. Lowest prices. Arkay, 380-C Highland, Somerville 44, Mass.

REAL Wholesale prices. General merchandise. Free list. Ateep, Box 66, Teaneck, N. J.

WHOLESALE Bargains. Guaranteed. Special catalog \$1. Loeber, 224-AC Wyatt, Lincoln, Ill.

BELOW Wholesale! Tools, housewares, watches, etc. Postcard: Lant Distributors, 718 Myrtle, Albany 8, New York.

BUY Below wholesale! 1962 automobiles, appliances, drugs, vitamins, cameras, furniture, sporting goods, jewelry, tools, etc. Free price list. Consumers Digest, 1102 Third, Des Plaines, Illinois.

WHOLESALE Bargains. Send postcard for catalog. Tod, Box 101, Mountainville, N. Y.

100,000 PRODUCTS Wholesale! Terrific bargains! United Wholesalers, 1265-M Broadway, New York 1, N. Y.

FREE! Name brands catalog! Your own high profit business. Sell name brands, full or part time. No inventory, no investment. More than 2,000 name brand items; lowest wholesale prices. Watches, jewelry, cameras, hi-fi, stereo radios-phonos, appliances, housewares, hardware, power tools, luggage, musical instruments, garden equipment, sporting goods, toys, many others. 8 floors of name brands. Million dollar inventory. Orders shipped complete in 24 hours! Send for free, beautifully illustrated catalog now! Separate wholesale price list. H. B. Davis Corp., Dept. PM, 145 W. 15 St., New York 11, N. Y.

BUY Below wholesale! Thousands of nationally advertised products. Drugs, clothing, housewares, cameras, jewelry, hardware, sporting goods, etc. Postcard brings price list showing actual factory cost. Buy-Rite, 310 Main, Bennington 2, Vermont.

WORLD'S Largest wholesale supply. Buy from 679 American, European, Japanese wholesalers. Tailormade suits from Hongkong. 123 dropship catalogs. Rockbottom prices. Free details. International Buyers, 216-M Jackson, Chicago 6, Illinois.

USED And new watches \$2 up. Free list. Southern Watches, 5-PM So. Wabash, Chicago 3.

LARGEST Wholesale supply source in U.S.! 15 free catalogs. Furniture, clothing, appliances, housewares, automobiles and accessories, tools, sporting goods, hobby supplies, farm equipment, imports, new products, bargain merchandise. Free details. Associated, Box 108-DD, Lincoln 1, Nebr.

GENUINE Wholesale prices. Catalog 25¢. Watonga Company, Box 6792-B, Portland 66, Oregon.

ELECTRIC Guitars, amplifiers, wholesale. Free catalog. Carvin PMW, Covina, Calif.

NATIONALLY Advertised products wholesale. Send products name-model for quotation. Coats, Box 1247-A, Ontario, California.

2,000 PAGES Wholesale catalogs! Write: Mosaser, Box 47-B, Newark, Ohio.

FINEST Swedish stainless razor blades. 50¢ dozen. "Closeouts," 3931 Washington, Boston 31, Mass. Pricelists 10¢.

SALESMEN—DISTRIBUTORS

MAKE Extra money—Big cash commissions plus premium for you and your customers. Sell advertising book matches. Sensational new tenor glamour girls, hillbillies; dozens others. All sizes. Quick daily sale; big repeat business. Free master kit makes selling easy. No experience necessary. Superior Match, Dept. M462, 7530 Greenwood, Chicago 19.

START Your own business, selling the "World's Most Usable Bible." Sales quick, easy, and profitable. Extra bonuses; free insurance; other benefits. Write International Book Company, Department M-4, Box 118, Wichita 1, Kansas.

\$1,000.00 A Month for making dramatic 3-second demonstration of amazing lightweight Presto fire extinguisher. New chemical used by airforce snuffs out fires instantly. Only \$4.95. Terrific commissions. Millions want it. Free kit. Merlite, 114 E. 32nd, Dept. P-66S, New York 16.

REDHOT Seller. Nothing else like it. "Antenna Pet" will amaze you. Biggest moneymaker in centuries. No competition. Ground floor opportunity. Exciting free proof. Astro Distributors, Inc., 121 N.E. 9th St., Miami 32, Fla.

HIGH Commission and bonus. Earn \$100 to \$300 weekly. 30 year old company has openings. List delinquent accounts for collection. Experience not necessary. Permanent. Write Merchants Protective Agency, 1015A Walnut, Kansas City, Mo.

STORES, Offices, factories, institutions pay you big profits when you introduce sensational guaranteed longer-life light bulbs, fluorescent tubes. Astounding guarantee assures bulbs last 5,000 hours, tubes up to 18,000 hours—more than 7 times life of ordinary lights—or free replacement. Show firms how they save big money, cut replacement cost. Get automatic repeat orders. Free money-making sales manual. Grenada, 114 East 32nd, Dept. E-6651, New York 16.

BUSINESS Card cigarette lighters reproduced photographically. Send card and \$3.00 for sample. Boat Specialties, Dept. PM4, 4043 St. Clair Avenue, Cleveland 3, Ohio.

AMAZING Opportunity. New low priced fire alarm protects homes, farms, offices, factories, etc. No wiring—hangs like picture. Pays up to \$1,100 a month. Free kit. Merlite (Alarm Div.), 114 E. 32nd St., Dept. F-66S, New York 16, N. Y.

MAKE 90% Sale. Free sample. New-ricon, Box 2213f, Waco, Texas.

UNIQUE Animal pins wholesale or retail. Details. Norm Meyer, Box 683, Boca Raton, Florida.

MAKE Money selling advertising specialties, ballpens, calendars, etc. If willing to work, write Sales Manager, Box 330, Syracuse, N. Y.

BIG Profits. Repeat sales. Selling corrosion inhibitors to service stations, auto dealers, stores. Prevents power wasting corrosion from forming on auto batteries, cables. Free details. Aldo Company, 4275—10th Ave. North., Lake Worth, Fla.

SENSATIONAL New longer-burning light bulb. Amazing free replacement guarantee—never again buy light bulbs. No competition. Multi-million dollar market yours alone. Make small fortune even spare time. Incredibly quick sales. Free sales kit. Merlite (Bulb Div.), 114 E. 32nd, Dept. C-74S, New York 16.

MAKE Extra money selling advertising matchbooks. Free catalog and sales outfit. Matchcorp, Dept. PM-42, Chicago 32.

STOP Looking, start earning! Learn of opportunities to have your own franchised business. Write immediately for free information. National Franchise Reports, Dept. PT-528, 333 North Michigan, Chicago 1.

SPARE Time business, full time earnings with vitamin route. Wide selection popular priced formulas cover everyone's needs. Steady repeats, 150% profit. Hussey Vitamins, 115 Broad, Atlanta 3, Georgia.

EARN Big commission full or part time. Build profitable business of your own selling America's largest line low priced business printing and advertising specialties. 360 page catalog samples hundreds of items used daily by business people. Imprinted ball pens low as \$7.95 for 100. Big line low priced union label political printing included. Free sales kit. National Press, Dept. 8, North Chicago, Illinois.

EXPERIENCED Magazine men, no turn in. Cars, crews furnished. Apply Mark Steele (Magazine King), Steele, Missouri.

MAKE Big money taking orders Campbell's Gro-Green Liquid and 100% soluble crystal fertilizer concentrates. Saves time, money, labor. Feeds foliage, soil. Field proven over 10 years. Increases protein, mineral content grains, forage. Free sample. Selling outfit. Credit given. Ideal for corn and feed men. Campbell Co. (Est. 1928), Rochelle 52, Illinois.

MAKE Up to \$50.00 a day soliciting delinquent accounts. Terrific commissions. Write today. General Finance, 304V Pickwick Bldg., Kansas City 6, Mo.

IF You're interested in making money in selling, see the hundreds of exceptional opportunities in Salesmen's Opportunity Magazine. Send name for your copy, absolutely free. Tell us what you're selling now. Opportunity, 848 N. Dearborn, Dept. 17, Chicago 10, Illinois.

EMPLOYMENT INFORMATION

BASIC Facts on Southern California living. Valuable advice on planning and trip, opportunities, living, living costs. Save \$20.00 to \$600.00. Send \$1.00 to California Information, 13809 Janetdale, LaPuente, California.

MERCHANT Marine jobs. Men and women. Top wages. Travel. Helimco, 234 Broadway, Pendleton 1, Indiana.

TREMENDOUS Opportunities. U.S.A., overseas. Choose your job, your location. Bonuses. Free transportation. Free details. International Occupations, International Airport, Box 100C-5, Jamaica 30, N. Y.

WORK in Sunny Arizona. Information and job listings, \$1.00. Thompson Enterprises, Box 6561, Phoenix 5, Ariz.

JOBS Galore. Big classifieds \$1.00. Gart, Box 18333, Dallas 18, Texas.

GOVERNMENT Jobs open! Now! Everywhere! Every occupation! Amazing new book tells how to get them and succeed! Good pay! Security! Retirement! Details free or will rush postpaid copy for \$2.00. C.O.D.s accepted. Wicks, Topping, Va.

EXCELLENT Employment. Immediate openings. All occupations. High wages. United States, Canada, Alaska, Hawaii. Foreign. Free information. Employment Surveys, 2908-A Gawthorne, Oroville, California.

U. S. A. And foreign jobs, up to \$1600.00 monthly. Construction, clerical, supervisory, etc. Skilled, unskilled. Free transportation. Unusual opportunities. Complete information plus worldwide project reports. Only \$2.00 (\$2.50 airmail). Satisfaction guaranteed. International Opportunities, Dept. 16E, 109 W. 42, New York 36, N. Y.

CALIFORNIA Jobs. Aircraft, missiles, sales. Many others. Send \$2.00 for latest listings. California Opportunity, Box 2463, San Bernardino, Calif.

BOSTON Massachusetts area. Hundreds varied opportunities. Large classifieds \$1.00. Personal, Box 575, Lowell, Mass.

THOUSANDS Of jobs paying \$7,000 to \$35,000 available. U.S.A.-overseas. Most require college training. Get free report. National Employment Reports, 105 W. Adams, G-1, Chicago 3.

LATEST 1962 Information lists. Many attractive new selections covering all occupations, U.S. and overseas. Travel, romance, adventure, security. Full information with proper application forms only \$2.00. Mailed same day. Universal, Box 1117, Sandusky, Ohio.

HOLLYWOOD, Los Angeles employment information 2 weeklys, \$2.00. H.E.I., Box 492, Hollywood, Calif.

DIRECTORY Reports. Construction, aviation, shipping, oilfields, government, manufacturing, trucking, etc. Foreign-stateside. Helpful information plus job-getting tips on preparing application letters. Unconditional money-back guarantee of satisfaction. Act today. Only \$2.00 (\$2.25 airmail). (C.O.D.'s accepted). Research Services, Meramec Building, St. Louis 5-PM, Missouri.

FOREIGN Employment information. Europe, Alaska, Africa, Asia, Canada. Travel, adventure. Up to \$1,600 monthly. Construction workers, truck drivers, clerks, teachers, professionals, etc. Sensational opportunities—most complete information, application form sent immediately by return mail. Send \$2.00 to: Jobs, Box 512-E, New Orleans 12, Louisiana.

MERCHANT Marine jobs. Men and women. Top wages. Travel. Captain, Box 501-P, Reading, Massachusetts.

JOB-Getting resumes easily prepared. "Effective Resume Guide" shows you how, makes it simple, step by step. Sample resumes included. Send \$3.00. Richton Company, Dept. A, 1020 Broad, Newark, New Jersey.

FOREIGN Employment. Construction, other work projects. Good paying overseas jobs with extras, travel expenses. Write only: Foreign Service Bureau, Dept. PM, Bradenton Beach, Florida.

JOBS On ships. Employment directory \$1. Janeczek, 373 East 155th Street, New York 55, N. Y.

FLORIDA Booming! Classified job advertisements Miami or Fort Lauderdale 50¢ each. Cards, letters remailed, 25¢ each. Errands performed. Goldcoaster, Box 477, Ft. Lauderdale, Florida.

SPECIAL SERVICES

RESEARCH Service. Any subject! Product information. Jake Barraco, 478 Gardner, South Beloit, Illinois.

INFORMATION On anything. Ferguson Research Specialists, 59 Lent Ave., Hempstead, N. Y.

EDUCATIONAL AND INSTRUCTION

BE A Real Estate Broker. Insure security for yourself and your family. Study at home. Prepare for state examination. GI approved. Write for free book today. Weaver School of Real Estate, 3519P Broadway, Kansas City, Missouri.

OVER 75 Million watches in U.S. waiting repair. Urgent need for watchmakers. Get the facts. Write Kansas City School of Watchmaking, 1228PM Admiral Blvd., Kansas City 6, Missouri.

SWEDISH Massage. Foot technique. Post graduate. Home study. Residential. Diploma. Dr. Swanson's Illinois Licensed School, 3809-PL Alta Vista, Chicago 13.

PROFITABLE National Camera Repair School training at home! 174PM, Englewood, Colorado.

LEARN Realistic oil painting by correspondence. Amateur and advanced. Walker School of Art, Box 486, Montrose 4, Colo.

BARGAINS! Used correspondence courses and instruction books bought, sold, exchanged. List 10¢. Smith's, 124 Marlborough, Salem, Mass.

BE A memory machine. Earn \$3700.00 yearly extra. Research Center, Box 7192-H, El Paso 22, Texas.

ENGINEERING And Art degrees earned through home study. Electronics, Mechanical, Liberal Arts. When writing specify course desired. Pacific International College of Arts & Sciences, primarily a correspondence school. Resident classes also available. 5719-B Santa Monica Blvd., Hollywood 38, California.

LEARN Chinese fast. New method. Earn \$4,100 yearly extra. Interpreters' Center, Box 67, El Paso, Texas.

BACCALAUREATE Degree correspondence course directory: \$2.00. College Research, North Highlands 1, California.

USED Correspondence courses and books sold and rented. Money back guarantee. Catalog free. (Courses bought.) Lee Mountain, Pisgah, Alabama.

WOODWORKING And cabinetmaking course for beginning and advanced home craftsmen. Only complete low-cost home training program available. Write for free booklet. Interstate Training Service, Dept. G-3, Portland 12, Ore.

WANT A diesel job? Higher pay? Advancement? We can help you qualify! Complete diesel, tractor and heavy equipment and Cummins Diesel Engine Shop-method home-training courses available. Write today. Interstate Training Service, Dept. B-3, Portland 12, Ore.

HIGH School diploma at home. Licensed teachers. Approved materials. Southern States Academy, Station E-16, Atlanta, Ga.

BOOKKEEPERS. Operate your own "Dollar-A-Week" system. Ellis, Box 200, Cedar Grove, North Carolina.

LEARN Asleep or awake! Records, tapes, equipment! Free catalog! Drawer PM-697, Ruidoso, New Mexico.

MEN Wanted. Earn \$125 a week and up. Master a trade with a future. Learn auto diesel mechanics in our shops. You learn with tools on real equipment. Earn while you learn. Many of our graduates earn \$125 a week and up. Write for free bulletin: Dept. 256, Auto Diesel College, Nashville 3, Tenn.

PIANO Tuning pays. Learned easily at home. GI approved. 59th year. Free booklet. Niles Bryant School, Dept. P, 3731 Stockton, Sacramento 20, Calif.

SWEDISH Massage, physical culture and weight reduction pay big profits. Men and women. Learn at home. Diploma course. Free catalog. National Institute, Desk 4, 165 E. Ontario, Chicago 11, Illinois.

INVESTIGATORS Course. Credentials, diploma. Free information. Southwestern Institute Criminology, 510-A Iowa, Geronimo, Okla.

PENMANSHIP Corrector. Improve poor penmanship quickly. Details free. Ozment, Box 665-34, St. Louis 88, Mo.

FINGERPRINTING And identification taught at home. Diploma. Details free. Alabama School of Fingerprinting, Fairfield, Alabama.

LEARN Auctioneering. Free catalog. Missouri Auction School, 1330 Linwood, Kansas City 9-X3, Mo.

LEARN Ventriloquism. Amazing-entertaining! Easy! Details free. B. Davis, B-38, Safety Harbor, Florida.

SECRET Investigations. Experience unnecessary. Investigators particulars free. George Wagner, M125 West 86th, New York City 24.

DENTAL Technician's home study kit!! Instruments, plastic, etc. Write for free illustrated instructions. Grant Laboratory, Haas Bldg., Los Angeles 14, Calif.

LEARN While asleep with your recorder, phono. Details, catalog free. Sleep-Learning, Box 24-PX, Olympia, Wash.

PROFESSIONAL Investigator. Home study. Lapel pin, certificate, future. Box 41197-F, Los Angeles 41, California.

PIANO Tuning pays. Big money in spare time. Learn at home in 30 days. No musical knowledge necessary. Phonograph, records, tools and instructions furnished. Electronic tuning also taught. Free catalog. Capital Tuning School, 3160 S.W. 16th Court, Ft. Lauderdale, Fla.

EARN \$150 Weekly Mechanical, Electronic Drafting. Send \$2 first lesson, \$25 complete home study course. Prior, Inc., 23-09 169 Street, Whitestone 57, New York.

INVESTIGATE Accidents. Earn \$750 to \$1,000 monthly. More investigators urgently needed. Car furnished; business expenses paid. No college education necessary. No selling of any kind. Pick your own job locality. We train you at home spare time. You keep present job until ready to switch. Write for free book. No obligation. Universal Schools, CPM-41, 6801 Hillcrest, Dallas 5, Texas.

NEW Self-teaching course in memory helps you achieve greater success in business and social world. Free booklet. Memory Studies, 835 Diversey Parkway, Dept. 3434, Chicago 14.

DRAFTING Pays big money. Leads to position in automotive, aeronautical, construction, mechanical fields. Learn at home in spare time. All equipment supplied. Pay later plan. Free book. Christy Trades School, D-5803, 3214 Lawrence, Chicago 25.

SLIDE-RULE. Home study. \$29.00. Patsco, Marion, Texas.

GOOD Paying jobs open! Operate, repair heavy earth moving equipment! Learn "on the job" operating latest cranes, bulldozers, earth carriers! V.A. approved. Free catalog. Write T. D. Hutch, Greer Technical Institute, Braidwood, Illinois.

MASTER Watch making at home. Free sample lesson. Chicago School, 2328-YD Milwaukee, Chicago 47.

LEARN Civil and criminal investigation at home. Earn steady, good pay. State age. Institute Applied Science, 1920 Sunny-side, Department 164, Chicago 40, Illinois.

LEARN Scientific Swedish massage in few months at home. Skilled operators earn \$4.00 to \$5.00 an hour. Open your own office or earn good income at health and recreational centers. Wonderful part-time profession. Free anatomy charts and catalog. Anderson School of Scientific Massage, Dept. XD1, Princeton, Illinois.

HIGH School at home in spare time with 65-year-old school. No classes. Standard high school texts supplied. Single subjects if desired. Credit for subjects already completed. Progress at own speed. Diploma awarded. Information booklet free—write today! American School, Dept. X445, Drexel at 58th, Chicago 37.

FINISH High School at home. Better jobs, more pay for high school graduates. Get your diploma through simplified home study course. Personal attention. Write for free book, read about our "Guarantee of Success." Wayne School, Dept. 04-558, 417 S. Dearborn, Chicago 5, Illinois.

INVESTIGATOR Training. Career for young and old, men and women. Write to: Phillips Secret Service, 1917-PM North Kenneth, Chicago 39, Illinois.

OPERATE Collection agency. Little gold mine. Franklin Credit, Roanoke, Virginia.

BOOKS. Free general catalog, 100 pages. Text, vocational, educational, instructional subjects. Millions of volumes, new and used. Bargain prices. Books bought. Est. 1902. Long's College Book Co., Dept. PM, Columbus 1, Ohio.

IBM Key punch. Teletype. TTS. Computer. Home training. Teletype School, 251 W. 42 St., New York City.

52 COLLEGES Offer high school, college, correspondence courses! Course Directory \$1.00. Alex Soave, Box 518, Mount Vernon, New York.

SPEAK. Sing with power. Self-training records. Amazing! Canfield, 2018-A Fifth Avenue South, Minneapolis 4, Minn.

ARITHMETIC Made easy. Home-study course for everyone. Full price \$3.00. Guaranteed. "American Tech," P.O. Box 6241, Atlanta 8, Georgia.

HOLLYWOOD Correspondence School of Bartending. Information free. Box 492, Hollywood, Cal.

LEARN Real Estate business fast. Economical homestudy. Literature free. Howard Schools, Box 8394-A, Kansas City 5, Missouri.

ADVERTISING AGENCIES, ADV. SERVICE, MAILING LISTS

MAILORDER Copy. Pulling! Effective! Low priced. Merkins Advertising, 30 Ontario, Terryville, N. Y.

FREE! Red-hot book, "More Profit From Your Advertising." Lists—best mail order magazine, newspapers. Adservice, 516 Cornelia, Chicago 13.

Free Radio advertising! Nationwide. Complete procedure \$5. Janacek, 373 East 155th Street, New York 55, N. Y.

ADVERTISE: 24 Words, 75 Canadian newspapers, \$5.50. Lists free. Advertising Bureau, 10511-C Springfield, Chicago 55.

ADVERTISING Ratebook leading newspapers, magazines, free. Chicago Advertising Agency, 28-E Jackson, Chicago 4.

MAILING Lists most all kinds 1000 \$5.00. Free folder. Your circulars mailed \$4.00 1000. Dixie Mailers, King, N. C.

NOW Ready: New, amazing Classified Advertising Record Book—prepared especially for classified advertisers. Here is a book that tells you instantly whether or not your advertising in any publication is paying you real results. You can tell immediately how many inquiries each publication produced—how much cash received from every ad. Spaces are provided for the name and address of the publication, date of issue, space used, rate, cost of ad, key number, etc. You have a complete record of each publication right before your eyes. Plenty of space to keep accurate record of 28 separate publications. You can have a copy by sending only 10¢ to cover postage and handling. Send for your copy now. W. F. Johnson, Classified Adv. Mgr., Popular Mechanics Magazine, 204 E. Ontario Street, Chicago 11, Illinois.

AMAZING New Book—"Profits From Classified Advertising." Tells how and what to advertise. Be sure to read this book before you invest one cent in advertising. Write for your copy now. F. W. Johnson, Classified Advertising Manager, 202-210 East Ontario Street, Chicago 11, Illinois.

PLAYS, STORIES, MANUSCRIPTS

WRITERS! Free list of top-notch U.S.A. markets for short stories, articles, books and plays. Write for your free copy today! Literary Agent Mead, 915 Broadway, New York 10.

WANT Your book published? Learn how we publish, advertise, promote, distribute. Many successes. Free booklet PM. Vantage, 120 West 31, New York City. Or 6253 Hollywood Blvd., Hollywood 28, Calif.

TYPEWRITERS, DUPLICATORS, OFFICE DEVICES

RECONDITIONED Typewriters, mimeograph, printing presses \$25.00 up. Write Dixigraph, King, N. C.

LITTLE Wonder duplicator. With supplies. Guaranteed. F-tax paid. Prints 1 to 5 colors on postcards or circulars \$16.95 U.S.A. Full size \$48.25. A simplified book-keeping system keep your records free. N. Collins, Cayuta, N. Y. Rt. 1.-2.

RUBBER STAMPS AND OFFICE SUPPLIES

STAMP Makers' supplies. Lowest prices. O'Brien's, 421 Jackson, Toledo 4, Ohio.

3 LINES \$1.00. Extra lines 25¢. Cushioned mount, knob handle. One day service. Wallace, Box 146, Hanover, Penna.

FREE 32-Page rubber stamp catalog. Stock stamps, pads, ink. Signature stamps \$3.50. Free label brochure. Youngers Stamp Shop, Princeton, Iowa.

RUBBER Stamps, 4 line \$1.50. Kays, 172 W 34 St., Riviera Beach, Fla.

SIGNATURE Stamp specialist \$2.95. 3 lines \$1.00. O. Linneman, 84 Harding Avenue, Runnemede, New Jersey.

CATALOG: Rubber stamps, daters, printing, business cards. Martin, 1425 Major, Jefferson City, Missouri.

THREE Line self-inking pocket stamp 50¢. Meese, Dept. B, 42 "E," Keyser, W. Va.

POCKET Rubber Stamp. Self-inking case. 3 lines 85¢ postpaid. James Beal, 4260 Piedmont Ave., Oakland 11, Calif.

POCKET, 3 lines \$1.00. Guaranteed. Specialty, 8464 Manhattan, Detroit 11, Michigan.

FACTORY Prices. Rubber stamp catalog 10¢. Adirondack Printers, Saranac Lake, New York.

CARTOONING, COMMERCIAL ART, SHOWCARD & SIGN PAINTING, TATTOOING

LEARN Profitable magazine cartooning. Free details. Hartman, Box 3097, Lincoln 10, Nebraska.

YOU Can entertain with chalk talks. Catalog 10¢. Balda the Cartoonist, Oshkosh, Wis.

LEARN Sign painting at home. Free talent test. Ben Kerns, Box 812-PM, Greenville, S.C.

LEARN Sign painting with fascinating system. Straley, 410 S. Western, Springfield, Ohio.

"HOW To Make Money with Simple Cartoons." A book everyone who likes to draw should have. It is free; no obligation. Simply address Cartoonists' Exchange, Dept. 94, Pleasant Hill, Ohio.

LEARN Profitable, fascinating tattooing. Illustrated information \$1. Zeis, 728-C Leslie, Rockford, Illinois.

CARTOONERAMA Teaches you cartooning in a new 24 lesson course. Free brochure. CFA, Box 263-D6, Branford, Conn.

ART—Learn at home. Earn big money. Learn commercial art, cartooning, lettering, figure drawing, painting, TV art, in spare time. All for 20¢ a day. Send for free 36-page book. No obligation. Washington School of Art, Studio 144X, Port Washington, N. Y. Tear this out as reminder.

WANTED—Cartoonists, Amateurs, professionals. Over 200 markets. Information free. Cartoon Markets-4PM, 11620 Lansdowne, Detroit 24, Michigan.

COMPLETE Set sign lettering patterns \$2.00. Stamp brings details. Anderson Studio, 1420 Logan, Denver 3, Colorado.

SIGN Painting outfit, paint, brushes, book, \$9.50! Profits first day! We sell oil-board, hardboard, plywood letter patterns. Paulow Signs, Crystal Falls, Michigan.

LEARN To draw for cash. Illustrated booklet. Proven system. Complete. \$1.00. Woods Art Studios, Box 87, Sturgis, Michigan.

SIGN Painting—simplified, quick, easy. Learn home. Ramey, 19 So. Martin, Waukegan, Illinois.

SIGN Painting. Easy method. Ellis, 10533 121 Ave., Largo, Florida.

PRINTING, MULTIGRAPHING, MIMEOGRAPHING, GUMMED LABELS

OFFSET Printing. Free prices, samples. Harrison Litho, 248 South Hackett, So. Beloit, Illinois.

OVERNITE Offset printing 1000 8½" x 11"—\$6.50. Postage extra. Evergreen, 9420 Trumbull, Chicago 42.

FREE Descriptive label literature. Name and address, stock, photographers, religious, record and comic labels. Youngers, Princeton, Iowa.

PERSONALIZED Boxed stationery, letterheads, envelopes, printed scratch pads. Details free. Tobin's, 1114 Marine, El Cajon, California.

MIMEOGRAPHING, Offset printing. Free samples. Pennway, Drawer 1340, Scranton, Penna.

AMAZING Business printing values. Samples. Print Shop, Box 576, Greenville, R. I.

FREE Catalogs postpaid printing. Rubber stamps. DM Press, Sebastopol, Calif.

BUSINESS Cards \$2.75 thousand postpaid. Free samples. Kavanagh, 607 Knickerbocker Ave., Brooklyn 21, N. Y.

1000 BUSINESS Cards \$3.95. Embossed. Samples. Joseph's, 20935 Harper, Harper Woods 36, Mich.

FREE Catalog and samples, quality printing. S. D. Walker, 408 Ventura Ave., Orlando, Florida.

OFFSET, 8 1/2 x 11, 16 lb. White, line copy! 1000, \$7.00; 5000, \$19.50; 10,000, \$35.00. F.O.B. Cash with order. Free samples, pricelists. Napco, 1744 Bath Avenue, Brooklyn 14.

OFFSET Printing. Reasonable. Samples. Varga Company, 36, Farbridge, Rochester, N. Y.

1000 NAME. Address labels 88¢. Rubber pocket stamp 88¢. Labels, printing, business cards, rubber stamp, catalogs. Jordan's, 552 West O'Connor, Lima, Ohio.

LETTERHEADS, Billheads, envelopes, statements. Super special. Free details. OKayprint, Martins Ferry, Ohio.

1000 STATIONERY Assortments \$7.50. Samples 5¢. Kormoczy, 1822 1/2 Broadway, Seattle 12, Washington.

OUTSTANDING Printing. Free estimates, samples. Elanem, 1116 Inwood, Plainfield, N. J.

FREE Printing catalog. Low postpaid prices. Musselman, Box 2766F, Kalamazoo, Mich.

PERSONALIZED Stationery. A gift for everyone. Prices. Printing, Box 931, Rochester, N. Y.

1000 BUSINESS Cards, raised letters. \$3.75 postpaid. Samples. Routh, PM-4, 2633 Randleman, Greensboro, N. C.

OFFSET Printing: 500 — 8 1/2 x 11 illustrated circulars, forms \$5.95. Barney Barsketis, 6540 So. Western, Chicago 36.

ADS Running under this heading sell printing. Ask me for proof. I'll gladly send you amazing facts. Ask for Folder "P." F. W. Johnson, 200 E. Ontario St., Chicago 11, Ill.

PRINTING OUTFITS AND SUPPLIES

BARGAIN New mimeograph duplicator machines. Write. Caryb Sales, Inverness, Fla.

HARD Type for rubber stamp making, printing. Introductory offer 10 or 12 pt. 20th Century Medium caps or L.C. \$2.50. Free catalog. Barco Type, 232 Evergreen, Bensenville, Ill.

RUBBER Stamp presses, hydraulic operated, electrically heated. Sizes 5"x8", 8"x12", 10"x15". Starting outfits, supplies. Printing presses. Custom Manufacturing, 1464-P East Commercial, Springfield, Missouri.

NEW Type catalog from world's largest printers' supply house. 9" x 12" book illustrating hundreds of type styles including foundry type, brass type, steel type, wood type. Send \$1 to cover mailing. Refund with first order. Huge inventory of thousands of printers' supply items always on hand. American Printing Equipment & Supply Co., Dept. PM, 42-25 Ninth Street, Long Island City 1, N. Y.

MAKE Your own self-molding rubber stamps and printing cuts. Plexirubber. Argyle 1, Wisconsin.

DO Your own printing. Save money. Simple rules. We supply everything. Print for others; good profit. Raised printing like engraving too. Have home shop. Details free. Kelsey Presses, V-11, Meriden, Connecticut.

RUBBER Stamp outfits, supplies. Kiewit, 2025 Barney Road, Kalamazoo, Mich.

PRINTING Presses, type, supplies. Lists 4¢. Turnbaugh Service, Mechanicsburg, Penna.

FOR INVENTORS

INVENTIONS Needed immediately for manufacturers. For additional information write Kessler Corporation, C-54-F1, Fremont, Ohio.

TRADEMARK Register. Over 500 pages. Patent Searching Service, 437 Washington Building, Washington 5, D. C.

PATENT Drawings made according to Patent Office specifications. H. & P. Drawing Service, 1726 McClintock Drive, Belleville, Ill.

INVENTORS Seeking cash or royalties for patented or unpatented inventions. Write New Products Co., 734 15th Street, N.W., Washington 5, D. C.

FREE "Vital Information Every Inventor Needs Before Selling Invention." Adams, 15 Park Row, New York City, N. Y.

BEGINNERS: What to invent. How to secure a patent and sell your invention. Get facts I learned the hard way. \$2 postpaid. Chester Archer, 2216 Grantland, Nashville 4, Tenn.

PATENT Searches, prompt complete \$6.00. Patent office copies of related patents airmailed. For free "Protection Forms" and "Patent Information" write to Anne Hamilton, 711 14th Street N. W., Suite 507, Washington 5, D. C.

IDEAS—10 Ideas for exceptional, marketable products. Send \$1.00 to: Ideas, Box 39794, Los Angeles 39, California.

PRODUCT Ideas make money. Manufacturers, ready buyers waiting. Write Inventors Creative Service, PM354 South Spring, Los Angeles 13, California.

WRITE For information about our new concept in developing and promoting ideas and inventions. Taylor-Garner Corporation, 1113 Healey Bldg., Atlanta 3, Georgia.

LEARN How to get free government assistance in marketing your idea! Patent Info Service, P.O. Box 1971, San Diego 12, Calif.

PATENT Searches, \$6.00, including official patent office copies of related U. S. patents. Certified, airmailed! For free "Invention Record" and "Patent Information," write: United States Inventors Service Company, 1311 "G" Street NW, Washington 5, D. C.

SAVE High fees! Prepare your patent application yourself! New "do-it-yourself" patent kit now makes it easy. Free "Registration Form." Miss Blaine, 306 Carry Building, Washington 5, D. C.

PATENT Searches, professional patent development of inventions by licensed professional patent engineer and U.S. Patent Office former examiner with staff of engineering specialists in all fields of inventions. Expert searches performed in the U.S. Patent Office. Your inventions and ideas engineered for maximum patent protection and greatest commercial value. Inventions developed by us negotiated for cash or royalties with our nationwide contacts. Send for free protection "Invention Certificates" and further interesting, valuable patent information. George Spector, Licensed Professional Patent Engineer, U.S. Patent Office Former Examiner, Woolworth Building, New York.

PATENT Searches, including copies of related U.S. Patents, \$6.00. Inventors, attorneys, manufacturers use my "Worldwide" airmail service. "Invention Record" form and "Information Every Inventor Needs," sent free! Miss Hayward, 1029 Vermont Ave. NW, Washington 5, D. C.

PROFESSIONAL Patent searches, \$6.00, including official copies of related U.S. patents. Prompt, dependable airmail service! For free "Invention Record Folio" and "Information Every Inventor Should Have," write: Congress Invention Institute, 210 McKim Building, Washington 5, D. C.

FAST Airmail service on all patent searches; \$6.00, including copies of related U.S. Patents! For free Record Form and vital information, write: Washington Inventors Service, 422 Washington Building, Washington 5, D. C.

PROFESSIONAL Searches of the Patent Office. Dependable—reliable \$6.00 including airmail report and related patents. For free protection forms and patent information write Trans-World Patent Service, 500 Walker Building, Washington 5, D. C.

PATENT Searches including full, airmail report and closest patent copies, \$6.00. Quality searches, expertly administered. Free protection forms and patent information. Write Professional Patent Office Search Bureau, 709 Albee Building, Washington 5, D. C.

INVENTORS! Outright cash sale or royalties for your inventions. Patented. Unpatented. Constant demand from our client manufacturers. Write: United States Invention Brokerage, 78 Wall Street, New York 5, N. Y.

INVENTORS! Consider our offer first before selling or licensing your invention on a cash or royalty basis. Patented. Unpatented. Write: Inventions on Demand, 79 Wall Street, New York 5, N. Y.

PATENT Searches, including copies of nearest patents, \$6.00. Reports airmailed within 48 hours. More than 200 registered patent attorneys have used my service. For free invention protection forms, write Miss Ann Hastings, P. O. Box 176, Washington 4, D. C.

WE Have the markets if you have the ideas. Harvey Engineers, Cambridge 1 Maryland.

INVENTORS: Test the commercial value of your patented or unpatented inventions, quickly and inexpensively. Write for free information. Institute of American Inventors, Dept. 40-B, 635-F St., N.W., Washington 4, D. C.

INVENTORS! Searches of the Patent Office administered professionally. \$6.00 including airmailed comprehensive report and related patent copies. For free invention protection forms, dependable service, write Washington Patent Office Search Bureau, 1426 G Street N.W., Washington 5, D. C.

INVENTORS! Sell your invention for cash or royalties! Our manufacturers constantly seeking new items. Patented. Unpatented. For free information write Gilbert Adams, Patent Broker, 80 Wall Street, Financial District, New York, N. Y.

PATENTS Skillfully prepared for maximum commercial value, with useful product development. High record of success in proving and claiming patentability. Valuable market service. Patent prepared for a fee as low as \$200.00. Send for self-protecting record of invention forms free. Patent search with valuable engineering report \$15.00. Foreign patents filed at low cost. Thirty years established. Joseph O'Brien, Patent and Development Engineer, 132 Nassau St., New York 38, N. Y.

CASH Or Royalties for inventions! Consider our offer first before licensing or selling your patented or unpatented invention. Write Aladdin Industries, 80 Wall St., New York 5, N. Y.

PATENTS Professionally prepared for maximum commercial value. Patent searches including report \$6.00. Patents prepared as low as \$195.00. Valuable market service with cash or royalty sales. 10 years dependable service. For free self-protecting Record of Invention forms write: H. Lawrence Blasius, Patent and Development Engineer, 19 Park Row, New York 38, N. Y.

U.S. Patent office searches—\$5.00. Free invention record. Patents engineered. Patent Office Searchers, 233 Broadway, Room 3615, New York.

INVENTORS: Save time and money. Prepare and file your own patent application. Our complete "Patent Kit" makes it easy. Includes detailed instructions and all necessary material. Only \$8.95. Money back guarantee. Don't delay. Send check or money order today to National Inventors Service, Box 88, Benjamin Franklin Station, Washington, D.C.

INVENTIONS WANTED

INVENTORS: If you have an invention for sale, patented or unpatented, write for free brochure outlining manufacturers requirements, royalty rates. Kessler Corporation, C-54-IW, Fremont, Ohio.

INVENTORS Seeking cash or royalties for patented or unpatented inventions, write New Products Co., 734 15th Street, N.W., Washington 5, D. C.

WANTED Inventions, patented or unpatented. Unusual services. Professional Engineer, Box 113-A, Hampton, N. H.

INVENTIONS Sold, licensed. Cash-royalty basis. Inventions International, Box 560, Wall Street, New York 5, N. Y.

INVENTIONS Wanted. Patented; unpatented. Tremendous manufacturers lists. Global Marketing Service, 2420 77th, Oakland 5, California.

INVENTORS: Hundreds of manufacturers have requested our assistance in locating marketable new products. Complete information free. Institute of American Inventors, Dept. 40-D, 635-F St. N.W., Washington 4, D. C.

ARE You interested in offers from reliable manufacturers for your invention? Patented, unpatented. Harvey Engineers, Cambridge, Maryland.

INVENTORS! Outright cash sale or royalties for your inventions. Patented. Unpatented. Constant demand from our client manufacturers. Write: United States Invention Brokerage, 78 Wall Street, New York 5, N. Y.

INVENTORS! Consider our offer first before selling or licensing your invention on a cash or royalty basis. Patented. Unpatented. Write: Inventions on Demand, 79 Wall Street, New York 5, N. Y.

INVENTORS Needing help with any problem, financial, development, securing manufacturer, obtaining patent. Write the organization that delivers action and results—not promises. Pioneer Invention Institute, 150 Broadway, New York 38, N. Y.

INVENTORS! Sell your invention for cash or royalties! Our manufacturers constantly seeking new items. Patented. Unpatented. For free information write Gilbert Adams, Patent Broker, 80 Wall Street, Financial District, New York, N. Y.

INVENTIONS Promoted-for cash-royalty sales with manufacturer contacts. George Spector, Licensed Invention Engineer, Woolworth Building, New York.

SELL Your invention for cash. No commissions. Milburn, Burlington, Kentucky.

CASH Or Royalties for inventions! Consider our offer first before licensing or selling your patented or unpatented invention. Write Aladdin Industries, 80 Wall St., New York 5, N. Y.

INVENTORS! Don't sell your invention, patented or unpatented, until you receive our offer. Write Universal Inventions, Box 298, Marion, Ohio.

MODELS—SHIPS, TRAINS, PLANES, ETC.

ROCKETS: New illustrated catalog 25¢. Single and multistage kits, cones, engines, launchers, trackers, technical information, etc. For service. Estes Industries, Penrose 2, Colorado.

ROCKET Kit, complete solid fuel flying model plus new catalog; everything for rocketeers. Immediate shipment. \$1.00. Astrocraft, Box 45, Stevens Point, Wis.

ROCKETS! Five blueprints. Plus instrumentation, fuels, electronic firing, parachute systems. \$1.00. Amazing 2-stage missile, \$1.50. 7 mile altitude. Officially designed by United States altitude champion. Both publications, \$2.00. Rocketry, Dept. D, Box 4708, Washington 20, D. C.

MODEL Hobbyists! Send 10¢ for catalog. Our 70 powered model plane and boat kits, many radio-control operated, also accessories. Sterling-M, 501 Wister, Philadelphia 44, Penna.

FASTENINGS! Model hexagon head bolts, nuts, washers. Miniature rivets, socket head screws, taper, cotter, es-cutechon pins. Huge stock engines, boilers. Comprehensive 100-page catalog #18, \$1.00. Chas. Cole, Ventura, Calif.

LIONEL Trains. Big discounts bulletin 10¢. Catalog 25¢. Mack-Bros., 2043P, Chicago Ave., Chicago 22.

SHIP Models. Kits, fittings, plans, books, tools, engines, motors. Big illustrated catalog 50¢. James Bliss & Co., Dept. SM, 342 Atlantic Avenue, Boston 10, Massachusetts.

LIVE Steam engine castings kits, boilers, variety. Model maker's lathe, low priced, compact, motorized. Illustrated catalog 35¢. HPK Models, P.O. Box 34, Centuck Station, Yonkers, N. Y.

MINIATURE Gasoline and steam engines—easily machined using our castings and blueprints. Fascinating hobby. Illustrated catalog 35¢. Octura Models, 8148-PM Milwaukee, Niles 48, Ill.

SHIP Model kits and fittings: clippers, frigates, etc. Catalog paint-tool list, book list, 35¢. Model Shipways, Box 85, Bogota, N. J.

SAVINGS To 50%. Lionel, Gilbert, Althearn, etc. New trains accessories. Hobby Surplus, P.O. Box 1106, New Britain, Connecticut.

SHIP And yacht model fittings; blueprints. Send 40¢ for illustrated catalog listing hundreds of items. A. J. Fisher, Inc., 1002-1 Etowah Ave., Royal Oak, Mich.

"POWER Drives Handbook"—36 pages illustrating many types motor drives for model autos, boats, displays, turntables, etc. Mail 25 cents cash, returnable first order \$3.00 or more. Wilson's of Cleveland, Dept. PM, P.O. Box 8995, Ft. Lauderdale, Fla.

MANUFACTURING

MODELS—Small lot manufacturing. Metals, plastics, etc. Milburn, Burlington, Kentucky.

LATHE And drill press work. Single or multipliable parts made to specification. Henry A. Meunier, 18022 Hubbell, Detroit 35, Michigan.

HOME CRAFTSMEN

EASTER Bunny craft kits. Complete instructions and materials. \$1.00 each postpaid. Roberts, Box 38-1356, Miami 38, Fla.

VENEERS, 1/28" Thick. Send \$1.50 for two square feet each of cherry, mahogany, maple, oak and walnut. Catalog of wood working supplies 10¢. Barap Specialties, P.O. Box 2044, Dept. P-15, Chicago 9.

UNIQUE! "Logicalectric," the Binary puzzle: Fun for the whole family! Build easily with full plans, step-by-step instructions—\$2.00. Logica, Box 15063, San Diego 15, California.

SHINGLE Shelters for wrens. They're new. They're different. Low cost easy construction. Illustrated plans for 3 models \$1.00. D. Goltry, Macedonia, Iowa.

101 PATTERNS Of smart gifts, novelties, shelves, action windmills plus "Make Money Jig Sawing." \$1.00. Mastercraft, 45M, 7041 Olcott, Chicago 31.

FREE Necklace kit with new jewelry supply catalog, 25¢. Designs, kits, instructions. Big profits! Easy to make! Modern Craft, Box 11088-R24, Saint Petersburg 33, Florida.

KNOCKDOWN Cedar chests and lumber. Catalog 25¢. Bedford Lumber Company, Dept. A-3, Shelbyville, Tennessee.

KNOCKDOWN Cedar chests, also over fifty kits. Catalog 25¢. Giles Kendall Co., Huntsville 2, Alabama.

SKIL-CRAFTS New 62-63 catalog. Largest and finest selection of leathercraft, artist, hobbycraft supplies in the world. Free gift with first order. Send 50¢. Refundable with first order. Skil-Crafts, Box 167-P, Joplin, Missouri.

FREE! Leathercraft catalog. Hundreds of new items. Write MacPherson Bros. Leather Company, Dept. E, 730 Mission St., San Francisco 3, Calif.

PICTURE Frame moulding, squares and lumber. Kiln dried walnut, cherry, silver maple. Midland Lumber Company, Box 262, Savannah, Mo.

FREE, New catalog. 2447 plans, patterns. World's greatest selection things to do, make. Fun. Profit. Craftplans, 1322-A Wabash, Chicago 5.

FREE "Do-it-yourself" leathercraft catalog. Tandy Leather Company, Box 791-042, Fort Worth, Texas.

DO IT YOURSELF

FALLOUT Shelter, 1000 Factor protection, class A, concrete, O.C.D.M. approved for 7 persons. Build for \$500.00. Engineers calcs., material list, blueprints, complete details, \$5.00. Plans, Box 451, Stanton, Calif.

RESILVER Mirrors; plate. Literature catalog 25¢. Mirrocraft, 18518 Winthrop, Detroit 35.

BUILD Bongo drums. Complete plans \$1.25. R. Cormier, Box 297, So. Swansea, Massachusetts.

HOW To lay cement block houses, cellars, camps, porch, steps, explained in booklet \$1.00. Chestnut Store, Mahoning, Penna.

ADOBE Builds hut or hacienda, all regions, to any masonry building plan at fractional cost. Spanish-Indian adobe making details—soil types, binders, mixing, molding, curing. Drawings, building tips, \$1.00. Steele, Box 403, San Angelo, Texas.

BEAUTIFY Your home with genuine cypress knees. Ornaments, lamps, planters, etc. Easy to make. Details free. Cypress Lumber Co., Fairfield, N. C.

"DRIP-STOPRS" Seal worn faucets. Long life guaranteed. Six \$1.00 postpaid. House of Ideas, Box 992-D, Racine 20, Wisconsin.

MAKE Hydrogen, inflate balloons. Make your own generator. Plans \$1.00. Box 1196, Sioux City, Iowa.

FALL-OUT Shelter equipment—Fresh air blowers, hand-operated, 100 CFM., \$21.95. Hoods for vent pipes \$8.95. Both non-rusting, cast aluminum. Fits standard 3" steel vent pipes. Money-back 10 day guarantee. Ppd. U.S.A. only. No c.o.d.'s. Free literature. Kloppenborg Fan Co., 211 Marquette, Davenport, Iowa.

FREE Check-list covering more than 500 classifications of projects, plans, instructions, service and repair information detailed in Popular Mechanics famous series of instructional booklets, books, patterns, and blueprints. List covers an extremely wide variety of do-it-yourself data on home remodeling, repair and improvement, hobbies, crafts, boating, games, lawn and garden, and hundreds of others. For your free copy of this helpful list, write: Service Bureau, Popular Mechanics, Room 520, 200 East Ontario, Chicago 11, Ill.

WATCHES, OLD GOLD, JEWELRY

CASH Immediately for old gold, jewelry, gold teeth, watches, diamonds, silverware, spectacles, platinum, mercury. Free information. Rose Industries, Heyworth Building, Chicago 2.

HIGHEST Cash for gold, teeth, jewelry, rings, diamonds, watches, silver, platinum. Mail articles today. Free gift with information. Chicago Gold & Precious Metals, 6 E. Monroe, Dept. 3858, Chicago 3.

WATCH And clock repairing books. Free catalog. North American, 2320-AR Milwaukee, Chicago 47, Illinois.

SELL Them to us! Gold, silver, platinum articles. Electro Company, 1042 Highland Avenue, Buffalo 23, New York.

ARIZONA Apache tear earrings, legend, description and pocket piece, \$2. Desert Gems, Box 9334, Phoenix 20, Arizona. Catalog included.

FOR THE HOME

MARVELOUS Jar opener. Copper finish. \$1.25 postpaid. Audvis-Tronics Co., Box 823, Clark, New Jersey.

UNIQUE Useful items for home, everyone. Low prices. Illustrated catalog free. Tom's Products, 536 Fourth, San Diego 1, Calif.

OF INTEREST TO WOMEN

PERSONALIZED Home study. Doll Hospital School, Studio MC-42A, Los Angeles 49, Calif.

LEARN Expert candle decorating, candlemaking. Free details on home instruction method. Candle Institute, Dept. X-668, Fallbrook, Calif.

KILL The hair root! With the famous Mahler Hair Removal Epilator, you can destroy unwanted hair permanently in the privacy of your own home. Send 10¢ for "New Radiant Beauty" booklet to Mahler's Inc., Dept. 252D, Providence 15, Rhode Island.

DELIGHTFULLY Different birth announcement cards 20 for \$1.00. Samples 25¢. Martinson, 3226 East 26th Street, Tucson, Arizona.

\$25.00 WEEKLY Making jewelry, flowers. Catalog 10¢. Flocraft, Farrell, Penna.

SELL Fine fabrics. Get yours wholesale. Box 863, Norwalk, Conn.

STOP Throwing away boxtops! They're worth money! Some, 25¢! Inquire: "Box-tops-M," Cedar Hill, Texas.

"SUCCESS" 1/2 oz. French perfume \$2.95. Harold Watkins, 6 North Duke, Topeka, Kansas.

WHY Be fat? Liquid diet formula. Make money recommending to friends. Free circular. Monarch Company, Box 319, Roanoke, Virginia.

PERSONAL

STAMMERING. Corrected myself. Could help you. R.H.D., 103 Church, Detroit 3.

MAIL Loans, \$100 to \$1,000. Private. Fast service. Reliable company. Write now for free information. World Finance Co., Dept. 32-H, 620 Symes Bldg., Denver 2, Colo.

INVESTIGATORS. Free brochure latest subminiature electronic listening devices. Dept. 4P, 11500 N.W. 7th Ave., Miami 50, Fla.

BORROW \$100 To \$1,000 by mail. Quick, easy, private. No co-signers. Repay in 24 small monthly payments. For the amount you want write today to Dial Finance Co., 410 Kilpatrick Bldg., Dept. D-1, Omaha 2, Nebraska.

MARRIAGE Certificate, two color, 8 1/2 x 10 1/2, suitable framing, mailed flat, stamped personal, \$1.00. Coswell Store, Frankstown Road, Altoona, Penna.

INVESTIGATIONS. Tracing, write: National Investigations Associates, Box 353, Altadena, California.

AMAZING! Frank! ESP deep character analysis from your photo and signature. \$5.00. Isis, Box 75628-M, Los Angeles 5, California.

BIBLE Questions answered. Stamped envelope. Bylon, 17167 Bentler, Detroit 19, Michigan.

LOANS By mail, \$100-\$600. Anywhere. Confidential. Write Union Finance, Dept. PM, 323 E. Camelback, Phoenix, Arizona.

LOANS By Air Mail, \$100-\$600. Anywhere. Confidential. Easy payments. Write Security Finance Co., 898 Van Ness Ave., Dept. PM, San Francisco 9, Calif.

NEW! Borrow \$800. Anywhere. Increased loan limit. Air mail service. Postal Finance, 374 New Brotherhood Building, Dept. 17-C, Kansas City, Kansas.

DEVELOP Mind power, personality while asleep. Details free. Research Association, Box 24-N, Olympia, Washington.

REMAILING SERVICE

SECRET Mail address. Receiving and forwarding. Free information. Henry Labrie, 380 Elgin Street, Room 7, Ottawa 4, Ont., Canada.

YUKON Territory postcards, 4 for \$1.00. Write message and return to us for re-mailing. Monthly forwarding service \$3.00. Other remails, 25¢. Yarter, Box 177, Watson Lake, Yukon Territory, Canada.

SECRET Mail receiving-forwarding system. Hedgpath, Box 830, Alhambra 23, California.

LETTERS Retailed 25¢. Confidential. Robert Carter, Box 742, Los Angeles 53, Calif.

SECRET Mail address. \$3 month. Wolfe, 7604 Mack, Detroit 14, Mich.

REMAILING — 25¢. Seattle, "World's Fair City." Waltco, 1049 7th, Edmonds, Washington.

REMAIL-Forwarding service. Free details. Olson, Box 205, Tujunga, Calif.

MILWAUKEE, Wis. Confidential, secret, remailing, forwarding service. 25¢, \$3.00 monthly. Paul's 2526-A, W. Greenfield.

LOS Angeles, Hollywood, San Fernando Valley 25¢ single, \$3.00 monthly. Confidential, 10437 Lanark, Sun Valley 3, Calif.

CONNECTICUT Remails 25¢. Monthly \$3.00. Details free. Roman, Box 584, New Haven.

CANADA'S Capital postcards, 4 for \$1.00. Complete and return for free re-mailing. Others 25¢. Box 3044, Station "C," Ottawa 3, Canada.

HAWAII Secret address 25¢, \$3.00 month. Coe, Box 984, Kailua, Hawaii.

CONFIDENTIAL New York City mailing, receiving, forwarding address. Business personal mail \$3.00 month. Remails 25¢. Details free. Birnhan, 152 West 42, New York City 36.

ASHEVILLE, N. C. Letters, 25¢ each. Bill Deusser, 68 Providence Road.

SECRET, Personal, business, 25¢. \$3.00 month. De Graff, Box 14156M, San Diego, California.

CHICAGO Forwarding service, \$3.00 monthly. Foremail, Box 5209, Chicago, Ill.

ATLANTA 19, Ga.: Letter 25¢, month \$3.00. Evans, 1171 Clearview Dr. N.E.

MASSACHUSETTS Remailing 25¢ each. Business details. Write: Seabury Co., Box 133, Arlington 74, Mass.

TREASURE FINDERS

FUN & Profit finding buried treasure, relics with transistor M-Scope. Known worldwide for supersensitivity, dependability. Guaranteed. From \$59.50. Easy terms. Send for free literature, fascinating user experiences. Fisher Research, Dept. AZ, Palo Alto, Calif.

METAL Locator kits and assembled models from \$39.90. Terms. Transistorized and underwater models available. Free catalog. Electronic Applications, Dept. M, Box 8, Arlington 10, Virginia.

GOLD, Silver, coins, Civil War relics, treasures. Choice 5 locators. Established 1933. Free literature. Write The Goldak Company, 1541 W. Glenoaks Blvd., Glendale 1, California.

TREASURE, Gold, silver, relics. Find them with new Detectron instruments. Free information. Raytech, Box 715, North Hollywood, California.

WANTED—MISCELLANEOUS

GUNS. Old rifles, muskets, revolvers. Describe price. Murphy, Macungie, Penna.

CASH For used tennis, golf balls. Write American Company, Merrick 7, N. Y.

STAMP Collections, accumulations. Eagle Stamp Co., 2221 Romine, Pittsburgh 26, Penna.

QUICKSILVER, Platinum, silver, gold. Ores analyzed. Wholesale Terminal, Norwood, Mass.

FOR SALE—MISCELLANEOUS

CANNIBALISTIC Plant! Venus's Fly-trap. Catches, devours insects. One bulb, \$1.00. Three, \$2.00. Plants, Dept. D, Box 4708, Washington 20, D. C.

FREE Money-saving catalog. Surplus and newly manufactured equipment and tools for workshop, home, boats, farm, factory. Write: Groban, 1139 So. Wabash, Chicago 5, Ill.

WAR Surplus bargains! New government releases arrive constantly. Save up to 80%. Blankets, boots, coats, tents, wearing apparel, etc. Send for free war surplus catalog. Sioux Falls Surplus Store, Sioux Falls, South Dakota.

HEARING Aid batteries wholesale. Free list. Habs, Box 51, York, Penna.

MISCELLANEOUS

LET Us tell you how to turn the reading habits of your friends into profit for you. \$10.00, \$25.00 or \$50.00 can easily and quickly be made under our Popular Mechanics subscription plan. No experience needed. Write Popular Mechanics, Room 4M, 250 West 55th St., New York 19, N. Y.

ILLUSTRATED Gifts galore catalog 10¢. 16-pages household, automotive and novelty items. Arch Enterprises, 1733 E. 5th, Keweenaw, Ill.

ADULTS, Teenagers personalized jewelry, stationery, book matches, etc. Dime brings catalogue. Hallows, 14 Drexel, Dept. M, Cahokia, Illinois.

BIG Mail. Terrific offers. Get listed with 1000 mailers. 25¢. Logan, 8-288 Charles, Winnipeg 4, Manitoba.

NEW Process. Letters come up, when you write. Free details. S. Sidella, Pottsville, Penna.

BLACK Forest cuckoo clock, hand carved, walnut finish. Cuckoos every 15 minutes. Mailed direct from Germany. \$3.95. Stringers Mail Order, 715 N. Dewitt, Bay City, Mich.

TRAVELOGUE. Save hundreds! Where and how to save on gas, food, and motels wherever you go. Send \$1.00 to Travelogue, P.O. Box 183, Alma, Michigan.

FIND Lost treasures. Locations of lost mines, buried treasures, sunken ships, etc. Send \$1.00 to Box 1551, Alamogordo, New Mexico.

HAVE You made your will? Two will forms and copy of U.S. Supreme Court Chief Justice White's will \$1. Globe Publishers, Box 814-X, Macon, Georgia.

SKOOTBOARD. Unique portable drawing board with T-square, triangles for students, engineers, handymen; \$4.98. Salesmen and retailers inquiries also welcomed. Swescot Co., Box 41, Boston 52, Mass.

HEARING Aids, only \$29.95 up. Free trial. Terms. Write CaryB Hearing Aids, Inverness, Fla. Agents inquire.

EARN Money raising fishworms for us! Write: Oakhaven-60, Cedar Hill, Texas.

BOOKS On antiques and their prices. Free circular! P. Warman Publishers, Uniontown, Penna.

CIGARETTES—Make 20 plain or filter-tips for 9¢. Facts free. Moberly, Box 785, Owensboro, Kentucky.

SUPER Memory overnight! Success guaranteed! Bijou, Box 1727-M, Hollywood 28, California.

WANT Your name with 1000 mailers? 25¢ lists your name year with our mailings every month. Dixie Mailers, King, N. C.

100,000 PRODUCTS Wholesale — Free catalog! Send postcard: Econ-O-Mart, Whippany 15, New Jersey.

SEND Us wool for blankets. Write El-Dorado Woolens, Eldorado, Texas.

STAMMER, Stutter, no more. (Dr. Young.) Write: Gaucho, Box 9309-S7, Chicago 90.

SEPTIC Tanks, cesspools, root clogged drains restored to newness by powerful crystal chemicals. Pumping and rodding unnecessary. Details. Testimonials. Chemical Cesspool Cleaning Co., Allston 34, Mass.

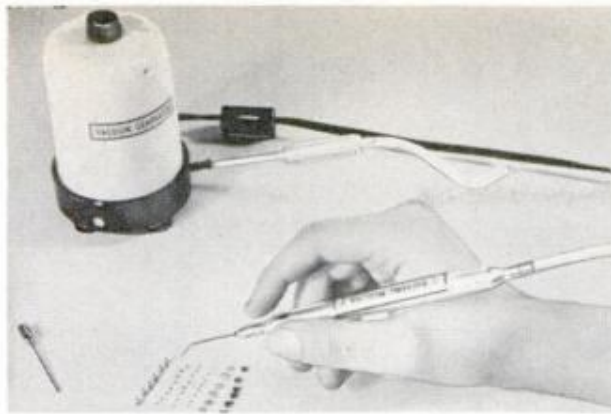

Wheezer Tweezer

Using a finger-controlled vacuum probe is the answer to picking up and assembling small parts. The table-top vacuum unit plugs into any standard a.c. line, and pressure is regulated by the index finger, over a hole in the probe. Price of the unit is \$39.95; manufacturer is ANCO Products, Box 100, Collingswood, N. J.

GIGANTIC PROFITS

New Tarnish-Proof Wonder Metal! Guaranteed not to tarnish! Full of life and brilliancy! In natural Gold Color—or White!



1/2 Ct. Simulated Diamond	\$7.20
Minimum order 1 Gross	Gross
Also same ring in	\$9.00
1 Ct. center	Gross

Complete line of other tarnish-proof rings, including birthstones!

Send \$2.00 for complete Sample Line and Catalog.

Please State Your Business.

Sorry, no samples shipped C.O.D.

STERLING JEWELERS, INC.

1975 E. Main St. Dept. PM Columbus, Ohio

BRANDS of BATTERIES by SCRANTON CELLOMATIC CORP.

6 volts	4 year	\$29.20	12 volts	4 year	\$37.00
	3 year	23.40		3 year	29.30
	2 year	16.62		2 year	22.11

Marine, with wing nuts—case painted silver
Services 50 horsepower—\$29.30

All prices f.o.b. Archbald, Pa.



BARBELLS

140-Pound. CHROME DELUXE Barbell-Dumbbell set only \$19.80. This is our feature set and is the finest ever manufactured.

Training with adjustable weight is the BEST way to keep fit; the ONLY way to develop great strength and a perfect body. As the oldest and best equipped barbell company, BUR gives value and prices no one can equal.

SEND FOR FREE CATALOG

BUR BARBELL CO.
Lyndhurst 9, New Jersey

NEW BENSEN GYRO-COPTER

Plans and kits for one-man "Spirit of Kitty Hawk" now available. Easy to build and fly. 3-view drawings, specs, photo \$2 or simpler Copter Glider \$1. Order today!

BENSEN AIRCRAFT CORP., Dept. PM-42
Raleigh-Durham Airport, Raleigh, N. C.

NAME _____
ADDRESS _____

EARN WHILE YOU LEARN CUSTOM UPHOLSTERY & SLIP COVERS



Make Big Money In Spare Time

You can earn right off, in your own home, while learning Custom Furniture Upholstery and Professional Slip-Cover making. Enjoy steady work, well-paid job, big profits as your own boss. Booming fields also offer ideal opportunity for husband-and-wife. YOU GET ALL MATERIALS AND SUPPLIES with UTS complete easy home study training—make beautiful chairs, lovely slip-covers, to keep or sell. Send for Big Free Illustrated Book. At home become skilled, professional custom upholsterer, make slip-covers like professional decorator. Also training in N.Y. School.

Vet. Approved. Accredited by N.H.S.C. Mail coupon today. No obligation. No salesman.

**EARN
BIG
MONEY**

Upholstery Trades School
Dept. TD318, 721 Broadway, N.Y. 3, N.Y.

Please send me Big FREE Book about

Upholstery & Slip Covers Slip Covers Only

I am interested in

Home Study

Training in N.Y. School

Name _____

Address _____

City _____ Zone _____ State _____

check if Korean Veteran

WELD - BRAZE - SOLDER - CUT

REPAIR MOST EVERYTHING MADE OF METAL



Home Appliances, Auto parts, Make and repair lawn chairs, tables, ornamental iron work, gates, wagons, etc. Solder, heat, bend, and straighten, with terrific heat from arc torch. Cut and weld up to 1/4" steel plate. A million uses for Home, auto, farm, inventors, factories, etc. Works

from any home 110 volt plug-in. Complete with dark welder's mask, arc torch, supply of carbon steel welding and brazing rods and complete Welding Instruction Book. 1 year guarantee.

SEND ONLY \$3 (cash, ck. mo.) and pay postman \$11.95 plus COD postage on arrival or send \$14.95 and we will send postpaid. Ideal gift for mechanically minded, relatives, friends. Order now. Available only from:

MIDWAY WELDER, Dept. DPM-4, Kearney, Neb.

CIVIL DEFENSE APPROVED PLANS for fallout shelters, plus expert advice on survival, in handy booklet. Only 25c from Popular Mechanics Service Bureau, Dept. RSB, 200 E. Ontario, Chicago 11, Ill.

A BIG BUSINESS OF YOUR OWN!



MAKE UP TO \$10 AN HOUR

Earn \$100, \$250, \$500 in spare time and more full time. Work when you want—you're the boss! Supply homes, stores, offices, factories with Sunmaster's guaranteed 5-year light bulb—outlasts 10 to 13 ordinary bulbs—saves your customer at least \$2.00 per bulb on replacement costs. That's why sales come easy—profits come fast—up to 108% on each sale! Write today for FREE Sales Outfit and 30-Day No-Risk Offer.

**IT'S
GUARANTEED
FOR 5 YEARS**

Sunmaster Electric Products Dept. PM-42
366 Fifth Ave., New York 1, N.Y.

Send FREE Sales Kit and No-Risk Profit Plan.

Name _____

Address _____

City _____ Zone _____ State _____

(In Canada, 539 King St. W., Toronto, Ont.)

NOW YOU CAN BUY A BIG VACATION HOUSE FOR ONLY \$1850

All the space
you need for
real fun and
rest . . .

The ARCH-SPAN® house is 32 x 20 feet, provides 640 square feet of interior space free of supports, so that living quarters can be arranged as you like. Modern window-wall visibility is built into both front and rear sections. Time-tested, climate-proven ARCH-SPAN® design withstands high winds, sheds heavy snow . . . fabricated from weather-tested, exterior grade, cross-laminated, resin-bonded, fir plywood . . . one of the strongest, longest lasting building materials available.

The ARCH-SPAN house is constructed in 4' x 8' modular sections. Easy to nail together. Lap construction assures strong, square, air tight joints between sections. Any handy man with one helper can erect the ARCH-SPAN house in one day with only a hammer and nails. No sawing, no fitting, no measuring.

Our price of only \$1850.00 (fob Akron, Ohio), includes all the precut, assembled modulars, for erecting the entire 32 x 20 house. Exterior surfaces primed, interior panels ready to paint. Easy terms to responsible parties. \$555.00 down and as long as 22 months to pay balance. Write for details.



EASY TERMS!
as little as \$555.00
down payment
and as long as
22 months
to pay



ARCH-SPAN BUILDING CORP.

21 WEST NORTH ST.
AKRON, OHIO

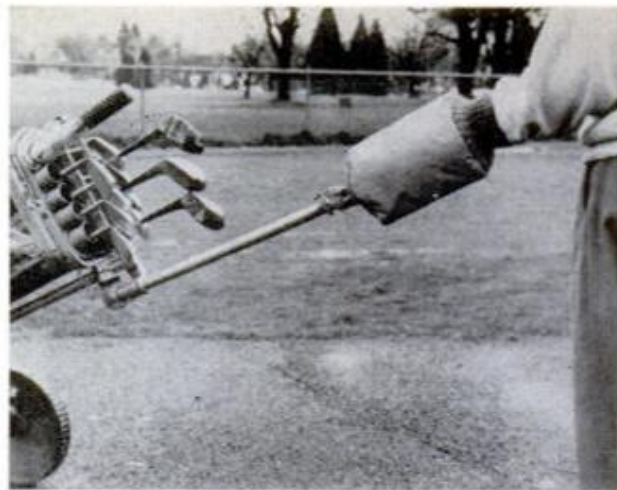

Warm Hand, Cold Cart

Cold-weather golfers can keep a hand warm while pulling a cart in cold, wet weather with a new golfcart hand warmer.

The warmer fits over the hand grip of any golf cart; and an elastic band holds it in place. Knit cuffs fit the wrist snugly to keep out wind and rain; a tightly woven nylon cover sheds water. Unsnapped, it may be used as muff for both hands. The warmer costs \$2.95 from Fairway Specialties Co., 5335 NE Sandy Blvd., Portland 13, Ore.



**"I'm Looking For
People Who Like to Use
Their Off-Time
Constructively"**

Let me show you how you can turn your "off hours" into cash profits by getting started in a fascinating and profitable activity . . . Modern Leatherwork!

I'm looking for people who want "to make" a successful living. If you like to work with your hands, then you have the first requisite for starting in Modern Leatherwork.

Imagine the fun of having a hobby that pays for itself! You can put the experience you gain through this hobby to work — making extra profits for you right in your own home — while you learn!

ANYBODY can get started in Leatherwork! I would personally testify that you could never find a more rewarding, satisfying experience than Leatherwork!

Dave Tandy

FREE

blueprints \$1.00

INSTRUCTIONS

How to Lace and Curve Leather.
How to make Tables, TV Bench,
Leather Garments, plus 23 others.

LEATHER with *Style*

SPECIAL OFFER

To Readers of POPULAR MECHANICS:
Let us send you a FREE copy of our amazing new book. **BLUEPRINTS TO LEATHER**, with instructions, patterns for making 29 items for home or resale. A \$1.00 VALUE. Write today for your free copy, plus Tandy's new 112 page Catalog.

TANDY LEATHER COMPANY (Since 1919)
P. O. Box 791-MZ Fort Worth 1, Texas



"I wonder how long it will take for them to find out that it's not a real Snowman."

Master builder paints all
metal surfaces with DERUSTO...
made with aluminum pigments

from *ALCOA*

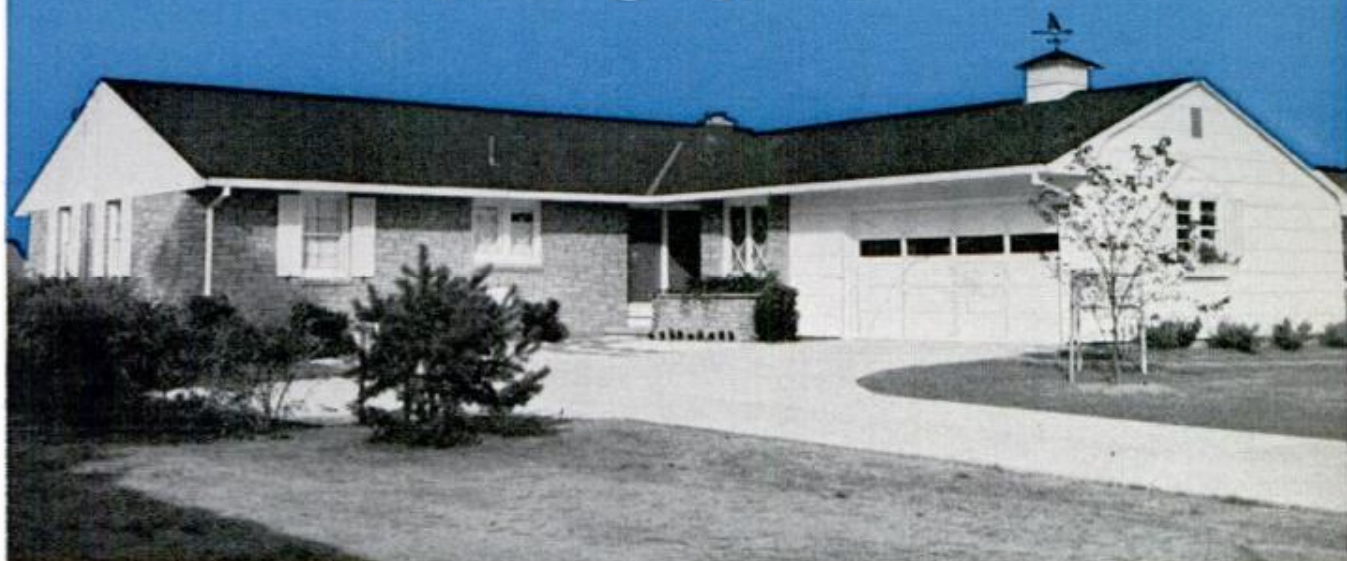

Intelligent design and choice of materials won first honors in a 1961 nationwide home contest for this airy, 6-room ranch model by Green Acres, Inc., Bloomfield, Conn.

One touch of quality: All metal surfaces are protected with Derusto Colored Aluminum Paint, made with Alcoa® Pigments by Master Bronze Powder Co., Inc., Calumet City, Ill.

Louis M. Beckenstein, president of Green Acres, writes, "Derusto helps us maintain our reputation as quality builders. We wouldn't finish a home without it."

Take a tip from a master builder. Durable colored aluminum paints like Derusto are ideal for sprucing up any property, old or new. There's no better way to protect and decorate metal surfaces such as porch railings, basement casement windows, exposed pipes, air conditioning units, ornamental iron, etc. Quick drying . . . easy to apply. Ask your local dealer.

Alcoa does not make colored aluminum paint, but we'll be happy to refer you to reputable manufacturers who do. Send coupon today for our informative booklets.

Entertainment at Its Best
ALCOA PREMIERE with Fred Astaire as Host
Tuesday Evenings, ABC-TV



Aluminum Company of America
1743-D Alcoa Building, Pittsburgh 19, Pa.
Please send your free booklets:
 Painting With Aluminum In Color
 Aluminum Roof Coatings Make Time Stand Still
Name _____
Company _____
Address _____
City _____ Zone _____ State _____

Sworn statement from CHAS. LEMMING reads:

"After starting my own business"



I've averaged \$100 A DAY —most of it clear profit!"

• If you want to be independent—free from layoffs, bosses—start profitable, year 'round business of your own. Ours is NOT a lease proposition. You own the machine, you work when and where you please, and all the money you take in is your own. FREE book tells you how.

MAIL COUPON TODAY FOR FREE BOOK

VON SCHRADER MFG. CO.
410 "D" Pl., Racine, Wisconsin

Without obligation rush your FREE booklet about how I can start my own permanent, profitable electric Upholstery Cleaning business.

Name _____

Address _____

City _____ Zone _____ State _____

Not everyone does as well...

Mr. Lemming owns two machines

In city of less than 50,000, Mr. Lemming started his own business after filling in coupon like one below. He averaged \$100 a day during first year, some days \$200. F. E. Doran grossed \$1050 in single month. Geo. Held grossed \$300 in one week.

How much you earn depends largely on you. No special skill, no large investment required for our electric upholstery cleaning machine. Start spare time until full time justified. Hire helpers as needed.

NO SHOP NECESSARY • You clean upholstered furniture on customers' premises—homes, hotels, motels, etc. Auto upholstery, too. No hauling; operate from your home. Watch business grow as satisfied customers tell friends. Supplies cost little, profits high.

FIX LEAKS YOURSELF!



Why pay a \$10 repair bill?
39¢ gets you

NEW HERCULES TAPE DOPE!

Stop leaks fast in shower heads, sink traps, radiators, valves, water lines, hose connections—any threaded joint—with cleaner, faster Hercules all-purpose Tape Dope, the modern pipe joint compound in easy to use tape form. Made of DuPont Teflon, Hercules Tape Dope eliminates old-fashioned messy pastes, gloppy brushes, soiled hands; it never runs or drips. Tape Dope permits easy assembly and disassembly and does a permanent leakproof job on all household plumbing connections. Only 39¢ for the 30" roll (seals 20-1/2" joints) at your hardware store or wherever plumbing supplies are sold. For free literature write to:

Hercules Chemical Co., Inc., 416 Broadway, New York 13

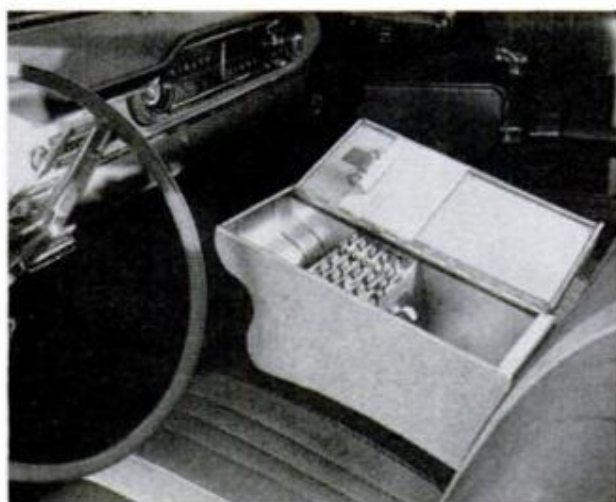

Have File, Will Travel

Traveling businessmen and salesmen can keep important data at their fingertips in a new portable travel file.

Shaped to fit the seat of a car, the file has a padded top so that it can also serve as an arm rest, seat divider or child's seat. Made of steel, the unit has a vinyl cover in a choice of five colors.

The file will hold 300 account cards. With 100 cards, 50 folders and an index, it sells for \$12.95. The manufacturer is Kay Tool & Die, Inc., Union City, Tenn.



NEW HI-FI PERFORMANCE

The Exciting NEW **MODEL 422 BENJAMIN**
CO₂ 10-SHOT SEMI-AUTOMATIC
.22 PELLET PISTOL

\$24.00

EFFICIENT—SAFE—DEPENDABLE—CONVENIENT
 Famous BENJAMIN Quality

AT LAST—an Amazing New Handgun that Incorporates the Characteristics Wanted for Serious Training, Plinking and Match Competition—Indoors and Outdoors—at **LOWEST SHOOTING COSTS!** Handsome, Dynamic, Mechanically Reliable, MODEL 422 combines Traditional BENJAMIN PEAK POWER and ACCURACY with Incredible Firing Speed—Smooth JAM-PROOF ACTION (no ramrod for cleaning pistol bore required)

WITH **EXTRA MARGIN**
 BENJAMIN'S Unique **DOUBLE SAFETIES**



KEEPS SHOOTING & SHOOTING & SHOOTING & SHOOTING
 AS FAST AS YOU CAN SQUEEZE THE TRIGGER!

FREE Write today! Complete Catalog Benjamin Rifles & Pistols—Single Shot & Repeaters—BB or 177 or 22. Also, Special Offer on Hunting Knives. **BENJAMIN AIR RIFLE CO. 896 MARION ST., ST. LOUIS 4, MO.**



Live Longer And Better in NEW MEXICO



THE HEALTHIEST SUNNIEST CLIMATE in All America

The fortunate people who live in New Mexico wake up to sunshine 355 days out of each year. They don't know what it is to be oppressed by humid heat in the summer or by winter's cold, damp clutch. They know that in New Mexico the rate of cancer and heart disease is only half of what the Nation as a whole faces. They work and play in a climate called **America's healthiest!**

Deming, New Mexico is in the southwest corner of the state, away from the rigors of winter. A boom has begun here and Deming's present 9,000 population will be 25,000 in the next 2-3 years. And **DEMING RANCHETTES** is only 5 minutes from downtown. It is rich with fertile soil, pure water and gorgeous mountains. Yet a half-acre Ranchette is only **\$199 complete, \$5 down, \$5 a month.** Write for **FREE** color portfolio. No salesman will call.

DEMING RANCHETTES Dept. N-6B
 112 West Pine St., Deming, N. M.
 Please send your **FREE** portfolio in full color including maps and story.

Name _____
 Address _____
 City _____ Zone _____ State _____

APRIL 1962

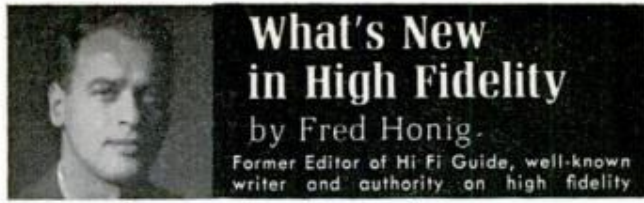

What's New in High Fidelity

by Fred Honig
 Former Editor of Hi-Fi Guide, well-known writer and authority on high fidelity

Ingenuity in Cabinetry

You don't need cabinetry for high fidelity components—they're self-contained and can be put almost anywhere. However, if you do want to house your components in a cabinet, you don't have to buy an expensive piece of furniture. You can build it yourself without starting from scratch. Many of the old, ready-to-be-discarded china cabinets, end tables, old TV consoles, etc., can, with a little ingenuity, be rebuilt into handsome, functional component cabinets that will house your FM stereo tuner, amplifier and record or tape player. Today's speaker systems, of course, already come in beautiful woods and in a variety of sizes to match any room's decor and acoustics.



GARRARD
 Type A Automatic Turntable (Dynamically-Balanced Tone Arm)
 \$79.50

Playback of up-to-date stereo and monaural records in your collection requires sensitive cartridges. Fine record-playing mechanisms...precision motors, turntables and tone arms...are scientifically engineered to reproduce dramatic qualities without creating mechanical distortion. Single play or automatic units (as shown) are available.

The modern stereo pre-amplifiers (example shown) give you a flexible control center for your entire high fidelity component music system. Whether you "build-it" yourself or buy it pre-assembled and tested, this key component—with all controls on one unit—permits expansion or replacement of stereo or monaural units whenever you wish.



DYNACO
 PAS-2 Stereo-Preamplifier
 \$59.95 kit
 \$99.95 assembled and tested



ALTEC-LANSING
 Model 605A "Duplex" Speaker
 \$177.50

You can take your choice of precisely engineered speakers of the type illustrated that will meet individual room characteristics. Fine speaker systems reproduce the full range of sound realistically. You can incorporate them into any room in suitable areas, enclosures or cabinets which you can buy complete or build yourself.

For information about high fidelity components, send the coupon below for free booklet.

Institute of High Fidelity Manufacturers, Inc.
 Dept. D-32 — 516 Fifth Avenue, New York 36
 Please send me free booklet—High Fidelity Components.

NAME _____
 ADDRESS _____
 CITY _____ STATE _____

**Hottest News
in Motorcycling**



**The World's Fastest* Motorcycle
T120 BONNEVILLE**

This 40 cu. in. (650 c.c.) OHV Twin with dual carburetors is the top model in the complete Triumph line. New performance, mechanical advances and breath-taking maneuverability are built into the new models. See the Triumph dealer in your neighborhood for details and easy terms.

**RIDE THE WORLD'S BEST —
PUT YOURSELF
ON A TRIUMPH**

***A.M.A. approved absolute speed record, Bonneville, Utah, 214.47 m.p.h.**

Johnson Motors, Inc.

267 W. Colorado St.
Pasadena 1, Calif.

THE TRIUMPH

Corporation
Towson, Baltimore 4, Maryland

Please send **FREE** full-color, full-line 1962 Triumph catalog to:

NAME AGE
Please Print

STREET

CITY OR TOWN STATE

TELEPHONE Dept. P

JOURNALISM at Home

"Nearly 3 jobs waiting for every Journalism graduate," reports EDITOR & PUBLISHER!

Exciting, well paid jobs—fulltime, freelance, spare-time—waiting for trained journalists in over 9,750 Newspapers and Radio and TV Newsrooms, general, trade and professional magazines. Now you can prepare at home in spare time through famed Newspaper Institute training—the Journalism course American Newspaper Publishers' Assn. calls the only one of its kind in the world. Send **TODAY** for Editor & Publisher Article describing career opportunities for writers in Journalism and NIA's time-proven confidential Writing Aptitude Test. **NO COST, NO OBLIGATION,**

NIA

NO SALESMAN! Newspaper Institute of America, Inc., Dept. 5592-D, Two Park Ave., N.Y. 16, N.Y. (Founded 1925.) Licensed by N.Y. State Dept. of Education, NHSC Accredited. Appr'd for Veteran Rehab. Trg.

**Cover Glamourizes
Unsightly Tubs!**

Cover
Removes
For
Cleaning



Easy To
Build
Sets Off
Floor

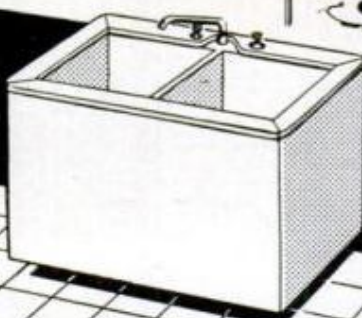

AT LAST a modern, Practical Designed Plan to match your appliances and improve appearance of a drudgery laundry room.

For your "TUB COVER PLAN" Send
Only \$1.00 M. O. or check to:

BROWN DESIGNS
P. O. BOX 7514
CLEVELAND 30, OHIO

**A MAN'S IDEA OF
COMFORT**

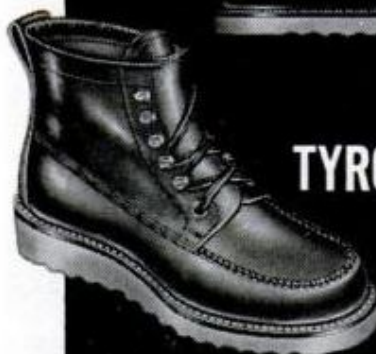

**GENUINE
DUNHAM'S
TYROLEANS®**

Write for
name of
nearest
dealer

DUNHAM'S — BRATTLEBORO, VERMONT
IN CANADA: GREB SHOES LTD., KITCHENER, ONT.

**NEW 225-AMP AC
LINCOLN WELDER**

DELIVERED, WITH ACCESSORIES, ONLY **\$158⁰⁰**

This amazing buy is the only welder on the market selling for less than \$200 which will burn 3/16-inch electrodes. Does big jobs, fast. Exceptional arc stability allows use of new low-hydrogen electrodes which make strong welds even on steels which tend to crack. Also good for stainless, hardsurfacing and pipe thawing. Write to the World's largest manufacturer of arc welders and electrodes—The Lincoln Electric Company, Dept. 4712, Cleveland 17, Ohio.



**LINCOLN
WELDERS**



Lincwelder 100

Burns 1/8" electrode. Arc torch for soldering, brazing hobby-shop welder.

AC-180-S

Burns 5/32" electrodes. Uses large arc torch for heating, bending, brazing. Hardsurfaces and thaws frozen water pipes. Ideal for farmers.



SPECIAL OFFER!



AVAILABLE NOW!

DETAILED BUILDING BOOKLET for

POPULAR MECHANICS

VACATION HOME

HERE IT IS—complete in one book—step-by-step construction information on the Popular Mechanics Vacation Home. It includes the full story on the Vacation Home, plus many more how-to-do it pictures and construction suggestions.

- ★ When used in conjunction with the plans for the PM Vacation Home, the Construction Aid Manual simplifies the completion of your home.
- ★ Included in the Manual is an extensive source list of companies and associations who offer plans and/or further information on other types of vacation homes.
- ★ The entire Manual is printed on heavy, waterproof paper. You can use it in your shop, at the construction site of your home—even drop it in water—without serious damage.
- ★ Popular Mechanics will see that you are provided with information from manufacturers concerning many, many ideas on minimum maintenance features, conveniences, and new products!
- ★ If you should decide to buy the plans for the Vacation Home from Popular Mechanics, the cost of the Construction Aid Manual will be deducted from the cost of the plans!

MAKE SURE you get your copy of the PM Vacation Home Construction Aid Manual early! Fill in and mail the coupon below today!

POPULAR MECHANICS
Dept. VHM, 200 East Ontario
Chicago 11, Illinois

Enclosed is \$1.00 for my copy of the PM Vacation Home Construction Aid Manual. Please rush it to me postpaid as soon as it is available.

(Please Print)

Name.....

Address.....

City and State.....

APRIL 1962

REPLACE OR REPAIR YOUR HOLLEY CARBURETOR AT NEW LOW COST!

BRAND NEW HOLLEY PEP® CARBURETORS AT PRICES COMPETITIVE WITH REBUILTS

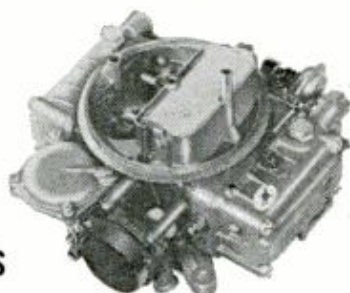

You can give your car new power and pep at low cost with a *genuine* Holley PEP Carburetor. These inexpensive PEP Carburetors are brand-new, factory built to exacting original equipment specifications. They are simple to install . . . complete, easy-to-follow instructions are furnished. PEP Carburetors are available for Ford, American Motors, and Chrysler-built cars.

GENUINE PEP KITS FOR NEW-CAR PERFORMANCE IN OLDER CARBURETORS



These **low-cost** PEP Kits include complete instructions, and all parts necessary to restore new *power, economy and performance* to a mileage-worn carburetor. PEP Kits are available for Ford, American Motors, and Chrysler-built cars. See your Holley Distributor or Dealer today.

★ ★ ★

When you make your own carburetor or ignition repairs and parts are required, be sure to use *genuine* Holley parts. Your Authorized Holley Distributor or Dealer, listed in the Yellow Pages, has a complete stock of Holley carburetor minor overhaul kits, tune-up kits, ignition parts, and brand-new replacement carburetors. All are engineered and built to exacting *original equipment* standards. **BE SATISFIED . . . BUY HOLLEY!**



ORIGINAL EQUIPMENT MANUFACTURERS OF CARBURETION AND IGNITION PRODUCTS FOR 56 YEARS

C-2A

Dept. A • 11955 E. Nine Mile Road • Warren, Michigan

® Registered Trademark

EARN MORE on INSURED SAVINGS

5%

PER YEAR
Compounded
Semi-Annually



EACH ACCOUNT INSURED TO \$20,000
BY SECURITY FINANCIAL INSURANCE CORP.
Baltimore, Maryland

THE WEST'S OLDEST SAVINGS FIRM PAYING A HIGHER RATE!

- ASSETS OVER \$18 MILLION
- 43 YEARS OF CONTINUOUS SERVICE
- STATE GOVERNMENT SUPERVISION

FREE GIFTS

FOR NEW ACCOUNTS AND ADD-ONS

- \$ 100 TO \$ 249 — Six-Piece Manicure Set
- \$ 250 TO \$ 499 — Shaeffer Pen and Pencil Set
- \$ 500 TO \$ 999 — Leatherette Travel Clock
- \$1,000 TO \$1,499 — Dormeyer Hair Dryer
- \$1,500 TO \$2,499 — 52-Piece Stainless Steel Set
- \$2,500 TO \$4,999 — \$59.95 Benrus Wrist Watch
- \$5,000 TO \$9,999 — Westinghouse Elect. Blanket
- \$10,000 AND UP \$71.50 Gruen Wrist Watch

(GIFT OFFER VOID IN STATES WHERE PROHIBITED)

*Savings Postmarked by Jan. 31st
Earn From The First of The Year!*

UTAH SAVINGS

and Loan Association

65 North University Avenue, Provo, Utah

PLEASE SEND FURTHER DETAILS **M**

ENCLOSED IS REMITTANCE OF

\$..... TO OPEN MY ACCOUNT

NAME.....

ADDRESS.....

CITY..... STATE.....

Gift Choice:.....

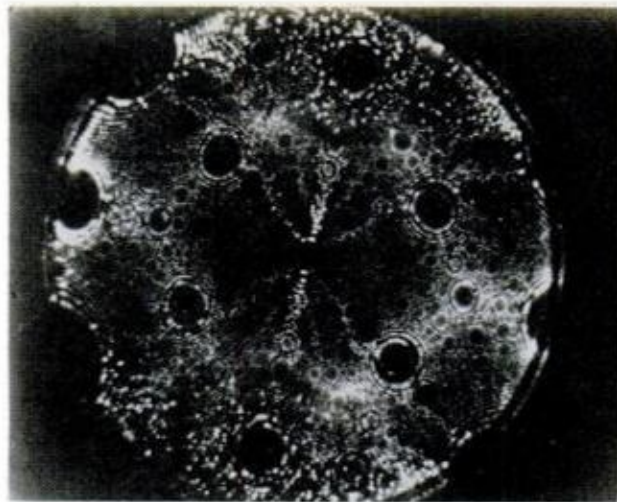

Microscope Shows Atoms

Capable of magnifying atoms two million times, a field ionization microscope (one of six in existence) enables Union Carbide Corp. scientists to see how atoms are positioned in matter. They use the 'scope to study action of catalysts.

A needle of tungsten, two-millionths-of-an-inch thick, for example, is placed in a container of helium. Electrical fields are generated from the tip of the tungsten by charging it with 500 million volts. Electrons are stripped from helium atoms, leaving them with positive charges.

Ionization takes place at the various tungsten atoms; helium ions so formed strike a phosphorescent screen, giving off dots of light. These display the geometric pattern of the metal crystal, allowing the key atoms to show on the screen.

The 'scope is not expensive, but is difficult to assemble.

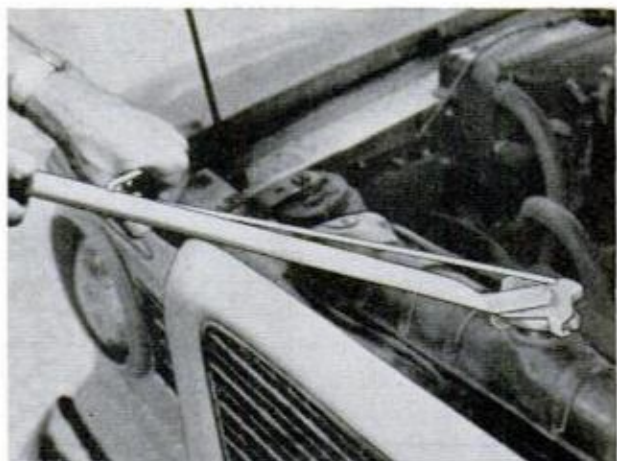

Cool Tool for Hot Caps

Pressure on a lever bar turns the radiator cap of a car, allowing steam to escape while the operator stands at a safe distance. The tool fits all caps, whether two or four prong. Priced at \$2.98, it's available from Cool Tool Co., P.O. Drawer 527, Waco, Tex.

ALMOST 80% OF THE LAST 34 INDIANAPOLIS "500" RACES HAVE BEEN WON WITH PERFECT CIRCLE EQUIPPED ENGINES, AS WELL AS MOST OTHER MAJOR USAC AND NASCAR RACES

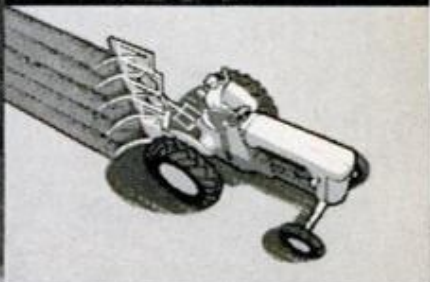
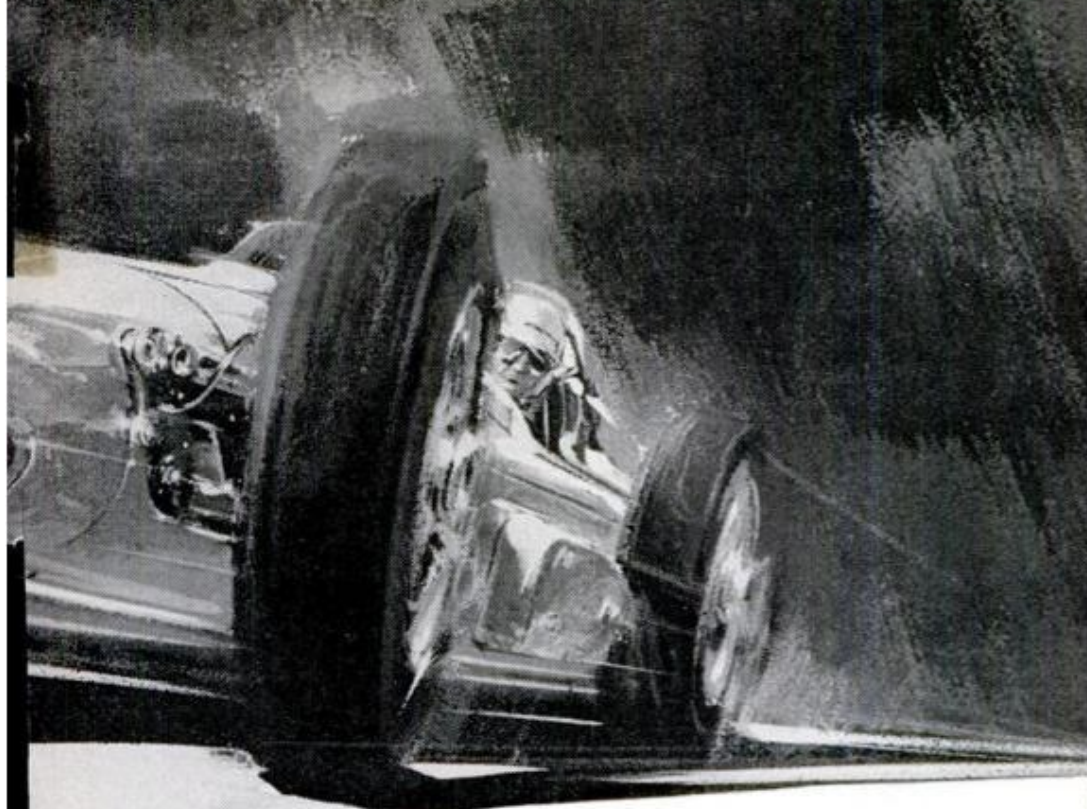

PERFECT CIRCLE PISTON RINGS ARE INSTALLED AS ORIGINAL FACTORY EQUIPMENT IN 94 BRANDS OF VEHICLES AND ENGINES

WHY THE "PROS" PREFER PERFECT CIRCLE PISTON RINGS

No other piston rings—and few products of any kind—are made with greater care and precision than Perfect Circles.

Each ring set is custom engineered to the engine. Radial pressures are held within exacting limits to assure compression seal and positive oil control. Special alloys are chosen for their ability to resist heat, corrosion, wear and fatigue. The extra-thick, solid chrome plating is finished with watchmaking precision to assure truest fit and eliminate tedious break-in.

As a result, Perfect Circle rings deliver the long life and superior performance that engine "pros" recognize and demand.

To restore like-new power and oil control to your engine, see your Doctor of Motors—your skilled mechanic. He'll respect your judgment when you ask for Perfect Circle—the rings preferred by so many leading vehicle and engine manufacturers, race drivers, fleet operators and mechanics.



THE DOCTOR OF MOTORS—

your skilled mechanic—is the "pro" to see to get superior Perfect Circle performance

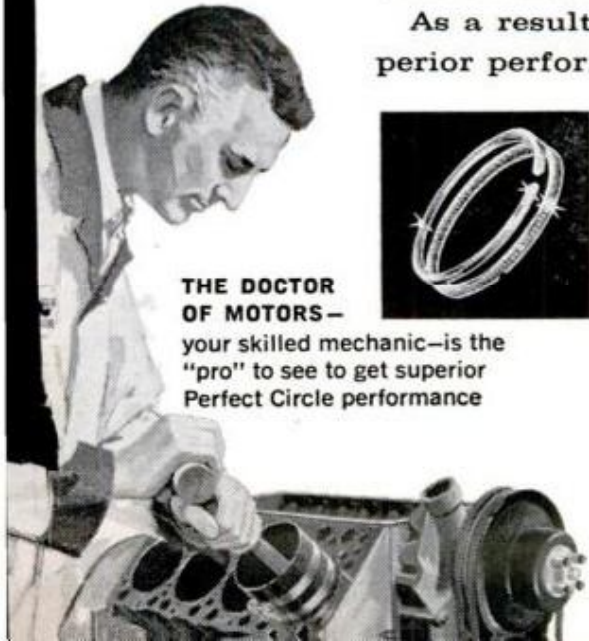

PERFECT CIRCLE

PISTON RINGS · PRECISION CASTINGS · SPEEDOSTAT · ELECTRONIC PROGRAMING EQUIPMENT

Hagerstown, Indiana • Don Mills, Ontario, Canada

SEND TODAY
FOR YOUR

ALLIED

MONEY-SAVING 1962 ELECTRONICS CATALOG

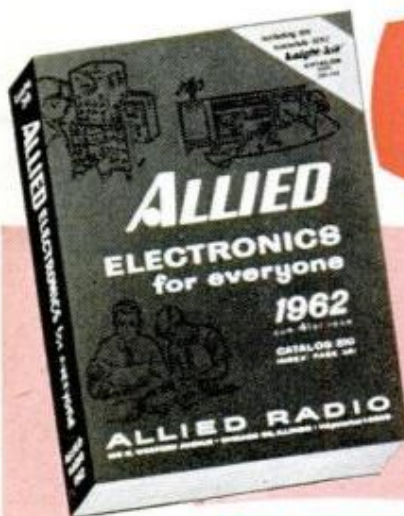

Free

444 PAGES
World's Biggest
Most Complete!

**NO MONEY
DOWN**
New Credit Plan
Gives You 50%
More Buying
Power!

SAVE MOST ON EVERYTHING IN ELECTRONICS

- Everything in Stereo High-Fidelity
- New Multiplex Stereo FM
- **KNIGHT®** Super-Value Stereo Hi-Fi
- Tape Recorders & Tape
- Transistor & FM-AM Radios
- Phonographs and Records
- Citizens Band 2-Way Radios
- TV Tubes, Antennas, Accessories
- Parts, Tubes, Transistors, Books
- Ham Station Equipment
- Latest Test & Lab Instruments

SPACE AGE HOBBY!

the excitement of electronics is in
Knight-Kits like these



Famous
"Span Master"
world-wide
radio kit



Multiplex
adapter for
Stereo FM



Transistorized
Electronic
Tachometer



SEE MORE
THAN 100
GREAT KNIGHT-KITS!

Satisfaction guaranteed or your money back

TOP TOOL VALUES



See the widest selection of quality tools at unbeatable money-saving prices—everything you need for your home workshop!

**FREE
CATALOG**



ALLIED RADIO, Dept. 5-D2
100 N. Western Ave., Chicago 80, Ill.

Rush FREE 1962 ALLIED Catalog.

Name _____
PLEASE PRINT

Address _____

City _____ Zone _____ State _____

Sidelights on aviation

Flotation rigs which prevent the sinking of Mercury spacecraft are discussed in *The Celebrated Jumping Frogs*, an article beginning on page 104. Still one more emergency flotation device has now been accepted for use with the capsule.

On the second suborbital flight the capsule sank after the hatch blew open prematurely and water poured in. Now, if this happens and the helicopter has to drop the spacecraft because it is too heavy to lift, an inflatable bag attached to the lifting cable will automatically drop from the helicopter when the cable is disengaged. As it separates, a static cord actuates a CO₂ gas cylinder which immediately inflates the bag.

Even though the capsule sinks, it is still attached to the pear-shaped bag via the cable. The bag has a buoyancy of more than 2500 pounds, more than enough to support the capsule. It will continue to float until another recovery attempt can be made.

Random comparisons show that air traffic in the United States is far ahead of Europe.

London, the busiest in Europe with 146,506 plane movements in 1961, is behind Indianapolis, Ind., which had 148,595 and was well down on the U. S. list.

Chicago's Midway, last year the world's busiest with 315,487 movements, may finally lose its title this year. Almost all the major airlines have moved their entire operations to Midway's neighbor field, Chicago-O'Hare, because O'Hare has longer runways for jet traffic. In size, O'Hare is already far larger than any airport anywhere. It covers more than 6500 acres. Midway has 640.

Amateur aircraft builders may now get all the rules necessary to comply with civil-air regulations for certification and operation of homemade aircraft in one booklet, *Flight Standards Service Release No. 456*. It is available free from any Federal Aviation Agency office.

"Hands off" helicopter flights may now be possible with an automatic-pilot system developed for the Army. It gives the helicopter pilot a stable platform and frees him for other duties such as aiming missiles.

Kevin V. Brown

POPULAR MECHANICS



SELF-SCRUBBER

WHAT YOU SHOULD KNOW ABOUT THE SPARK PLUG THAT CLEANS ITSELF WHILE YOU DRIVE.

First off, it cleans itself with the heat of your engine. Autolite Power Tip spark plugs extend a bit deeper into your combustion chamber. Not much deeper. Just enough so that potentially

harmful deposits get little chance to accumulate. They're burned right up and out the tailpipe. That's why your Autolite spark plugs stay cleaner.

That is why your car runs better. That is also why you don't have to buy so much gasoline.

One other point you should know about the

spark plug that cleans itself while you drive. Ford Motor Company now installs Autolite Power Tip spark plugs as original equipment on every new car it builds. Other manufacturers use them too.

Next time you change spark plugs, stick in some self-scrubbers . . . some Autolite spark plugs.

SPARK PLUGS • BATTERIES • SERVICE PARTS

 **AUTOLITE**

THE NAME TO REMEMBER WHEN YOU CARE FOR YOUR CAR



World-Famous York Testing Laboratory Proves:

YOU CAN SAVE UP TO **400** MILES OF ENGINE WEAR EVERY **1000** MILES YOU DRIVE!

Whether you use premium motor oil or economy oil in your car, the addition of BARD AHL can reduce engine wear by 10 to 40 per cent and make your car run smoother and quieter—so proved York Research Corporation, Stamford, Connecticut, after exhaustive six-month test.

“Frankly, gentlemen, we didn’t believe Bardahl could make that difference!” Those were the opening words of the famous York research engineers when they finished testing the country’s best-known motor oil additive. For 180 days engineers put BARD AHL to the most exacting laboratory test.

On a delicate *jeweler’s lathe*, the researchers mounted two finely honed engine valves facing each other. By rotating one valve and pressing the two metal surfaces together, they simulated a friction condition that occurs thousands of times each minute in today’s automobile engine.

Day after day, hour after hour, tiny drops of oil—premium grade oil, low grade oil, contaminated oil, and oil samples with BARD AHL added—were placed between the two rubbing valves. Thousands of test runs were recorded.

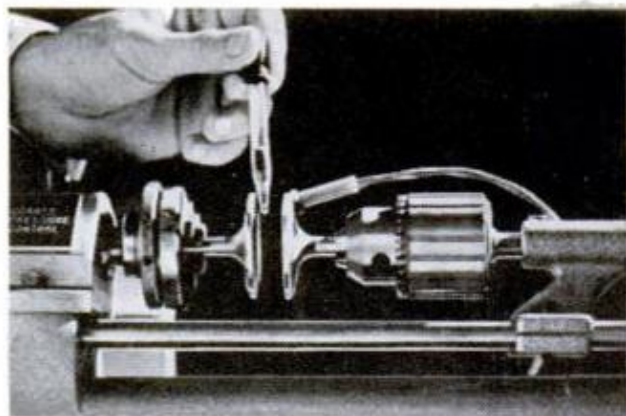

Thousands of oil samples were tested on this delicate jeweler’s lathe

The valves were cleaned and re-cleaned. The instruments checked and re-checked. Finally, the York engineers were satisfied they had eliminated every chance of error. The results were uncontestable.

When added to regular crankcase oil, Bardahl will reduce wear 10 to 40 per cent. (Research technicians say the average motorist, taking normal care of his car, should expect at least a 20% saving.)

POPULAR MECHANICS

Does This Mean a Substantial Savings in Dollars and Cents?

Yes. When you put BARD AHL in your crankcase, you put dollars back in your pocket. These are dollars you would otherwise pay out for more frequent repairs and overhauls. Let's assume you buy a new car and begin adding BARD AHL to your oil with every oil change. If you travel 10,000 miles each year for the next four years, your speedometer may read 40,000 miles but, thanks to BARD AHL, the actual wear age of your engine may be only 30,000 miles.

Your car will also be peppier, run smoother, be free of many irritating engine noises. BARD AHL helps remove sludge and gum which foul up valves and hydraulic lifters, and make your engine sluggish. You'll feel more power and get more mileage.

York Engineers Reported:

"York has been able to produce evidence that BARD AHL Additive Motor Oil, when used with various regular and premium grade motor oils, is able to effectively reduce friction and temperature and in this way ultimately reduce wear in an automobile engine between 10% and 40% on such critical area parts as rocker arm and shaft, valves and guides, hydraulic lifters, tappets and cams, fuel pump arm and eccentric and oil pump drive gear; as well as reduce wear on other parts, such as main bearings, rod bearings, piston rings, pins, connecting rod bearings and cylinder walls."

December 11, 1961



What is this magic additive called BARD AHL?

There is nothing so magical about the idea that new chemical compounds can improve ordinary hydrocarbon oils taken from the earth. BARD AHL happens to be an unusual blend of such chemicals and fine oil. It carries an S.A.E. viscosity rating and you could use it "straight" in your crankcase. Fortunately you need only a 20% mixture, or one quart of BARD AHL with each four quarts of your normal oil.

But the real secret of BARD AHL is its "polar attraction" formula. Leading scientists, studying the reaction of metals to friction, discovered that certain substances have a molecular attraction for metal. These substances cling to metal surfaces, stubbornly refuse to get squeezed out or burn off. BARD AHL is this type of extreme-pressure lubricant.

So, if you're one of the millions of motorists who still treasure a finely tuned engine—who still wince at the thought of unnecessary wear—one answer is BARD AHL. Add one quart of BARD AHL to your crankcase with each oil change. And don't forget to add BARD AHL TOP OIL to your gas tank with each 10 gallons of gas. BARD AHL TOP OIL lubricates the oil-starved upper cylinders, reduces carbon deposits, and frees sticky valves.

FOR MORE TECHNICAL DATA ON BARD AHL TEST, WRITE YORK RESEARCH CORPORATION, 1 RESEARCH DRIVE, STAMFORD, CONNECTICUT, U.S.A.

Shopping for tools



1. LONG STEEL TAPES in butt-end cases permit you to make accurate inside-outside measurements up to 100 ft. Additional features include attached belt clip and self-adjusting end hook which automatically compensates for its own thickness. The 50-ft. tape sells for \$3.99; a larger 100-ft. size for \$5.99. Evans Rule Co., 400 Trumbull St., Elizabeth, N. J.

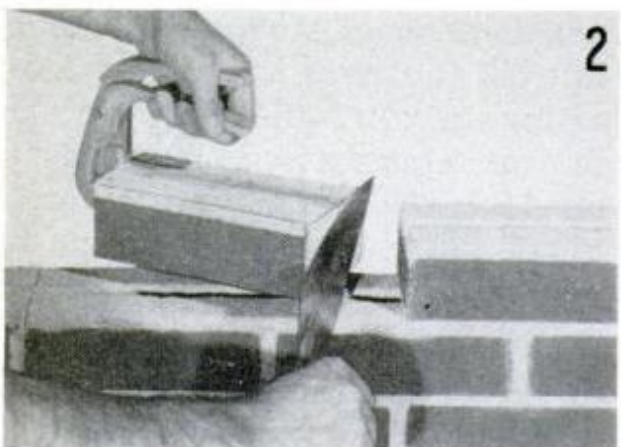

2. BRICKLAYER'S TOOL allows you to lay bricks without touching them, and makes perfectly spaced, even joints. Called "Automason," the tool makes it possible to butter bricks uniformly without mortar waste. Tool designed for regular bricks costs \$4.80; for special Roman size, price is \$5.20 ppd. Made by Port Austin Level & Tool Mfg. Co., Port Austin, Mich.



3. BALL-BEARING 9-IN. ARBOR SAW comes complete in one compact package which includes a 1-hp. electric motor, belt, pulley, cord, plug, switch and a rugged all-steel stand plus two cast-iron table extensions. The complete unit, ready to plug in and operate, sells for \$191.85. Saw is manufactured by Toolkraft Corp., 700 Plainfield St., Springfield, Mass.

4. TRIPLE-BLADED GRASS SHEARS enable you to trim grass in half the time. With three blades, both side blades work against the center blade making it possible to cut an area twice the size of that cut with normal shears. Featuring soft vinyl grips, it's priced at \$3.50 and marketed by Hardware and Industrial Tool Co., 20th & Oxford St., Philadelphia, Pa.

5. HIGH-SPEED HAND GRINDER develops 27,000 r.p.m. and can sustain a high torque under load. Industrially rated, the unit is designed to cover a wide range of applications including grinding, drilling, carving, polishing, routing, sanding, etc. It includes a 3-wire ground cord for safety and sells for \$29.95 with steel case. Dremel Manufacturing Co., Racine, Wis.

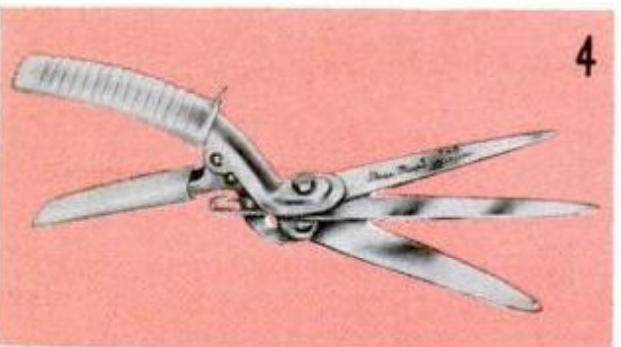

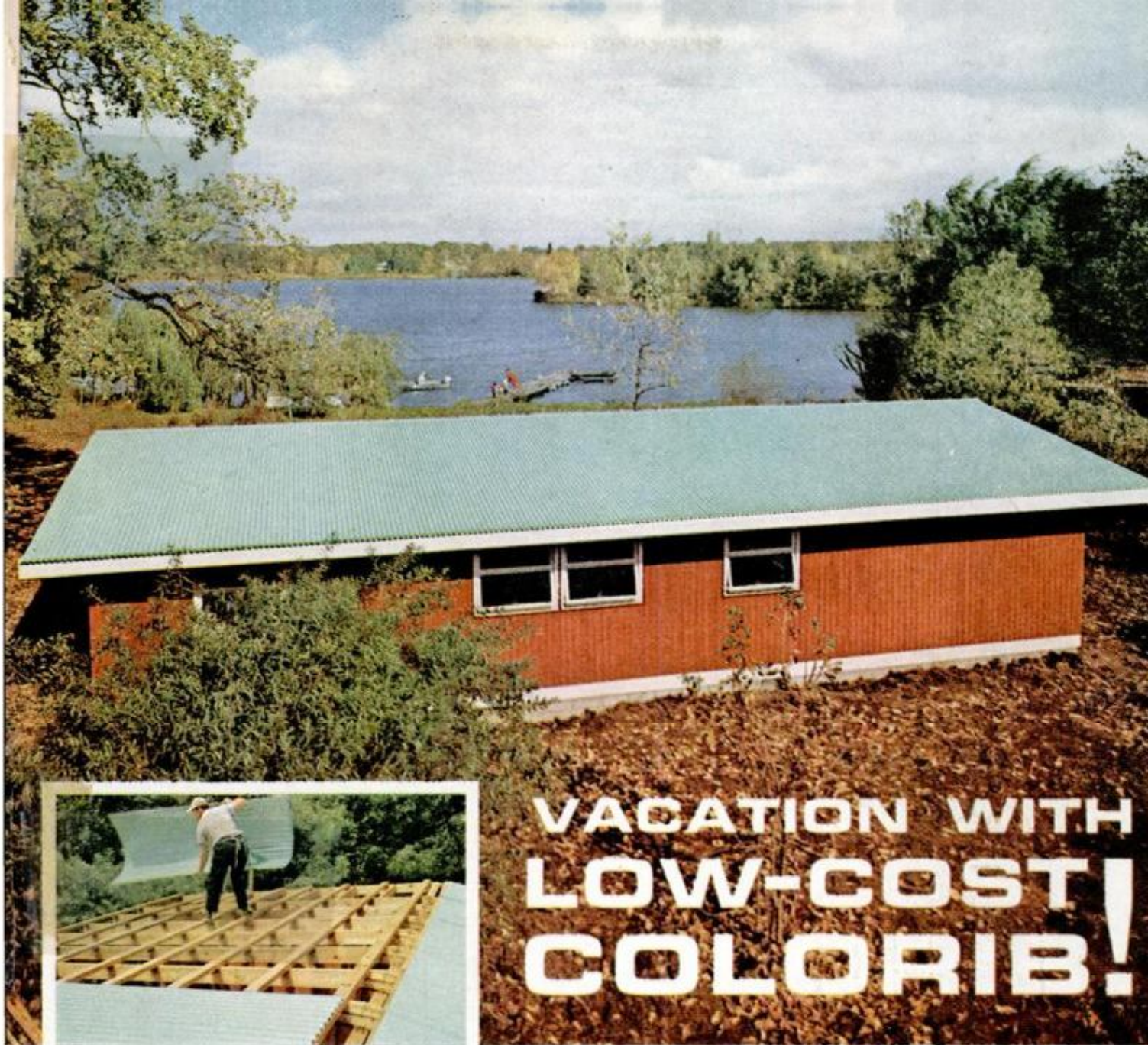

VACATION WITH LOW-COST! COLORIB!

BUILD patios, fences, boathouses and vacation homes with Alcoa® Aluminum Colorib® Panels.

GOES UP FAST AND EASY—Use simple hand tools. Heavy-gage yet lightweight, covers fast.

ONCE UP, NO UPKEEP—Won't rust, rot or warp.

TOUGH AND HANDSOME—Finish won't chip, crack, flake, peel or blister. Baked enamel Colorib Panels stand up to wind, rain and snow.

WRITE IN TODAY—for Colorib Panel Idea Folder and where you can get **FREE PROJECT PLANS**. Clip and mail Coupon, or write: Aluminum Company of America, 891-D Alcoa Building, Pittsburgh 19, Pa.



ALCOA PANELS IN 7 BRIGHT COLORS

Entertainment at Its Best . . . **ALCOA PREMIERE**
with **Fred Astaire** as host Tuesday Evenings, ABC-TV

ALCOA COLORIB PANELS
ALUMINUM COMPANY OF AMERICA
891-D ALCOA BUILDING
PITTSBURGH 19, PA.

Please send me a free copy of Alcoa's idea folder showing how to use Alcoa COLORIB Panels, and the name of my nearest dealer where I can get my free Project Plans.

NAME _____

ADDRESS _____

CITY _____ ZONE _____ STATE _____



Pleasure is a Chesterfield



IF YOU SMOKE FOR PLEASURE and not just from habit, get to know the satisfaction of Chesterfield King. Your pleasure is long and true and filter-free. For Chesterfield is 21 vintage tobaccos grown mild, aged mild, blended mild —not filtered mild. Millions of pleasure smokers say . . . **“THEY SATISFY.”**

21 GREAT TOBACCOS make 20 WONDERFUL SMOKES!!

THE SAME GREAT TOBACCOS ARE IN BOTH REGULAR CHESTERFIELD AND CHESTERFIELD KING.

'Sputniks' Orbit the Supermart

Your wife might be paying more money for less groceries because they come in overblown, underweight and deceptive packages

"BRING HOME a loaf of bread," my wife called out and, at the supermarket, I grabbed a big sandwich loaf at 29 cents, six cents cheaper than the others.

But it seemed lighter than usual. I hunted for the net-weight declaration and couldn't find it. I took off my bifocals and squinted and turned the loaf over and over. Ah, there it was! Could have used a magnifying glass. Fifteen ounces, it said. But the other, smaller loaves on the shelf weighed 22 ounces. The cheap loaf was the most expensive per ounce.

"It's a 'sputnik'," the grocer commented. "The bakery puts enough dough for a standard loaf into a large pan, then blows it up to fit."

Another time I wanted some real Swiss cheese and I hunted through the cheese counter and thought I found it. When I got

By Thomas E. Stimson, Jr.



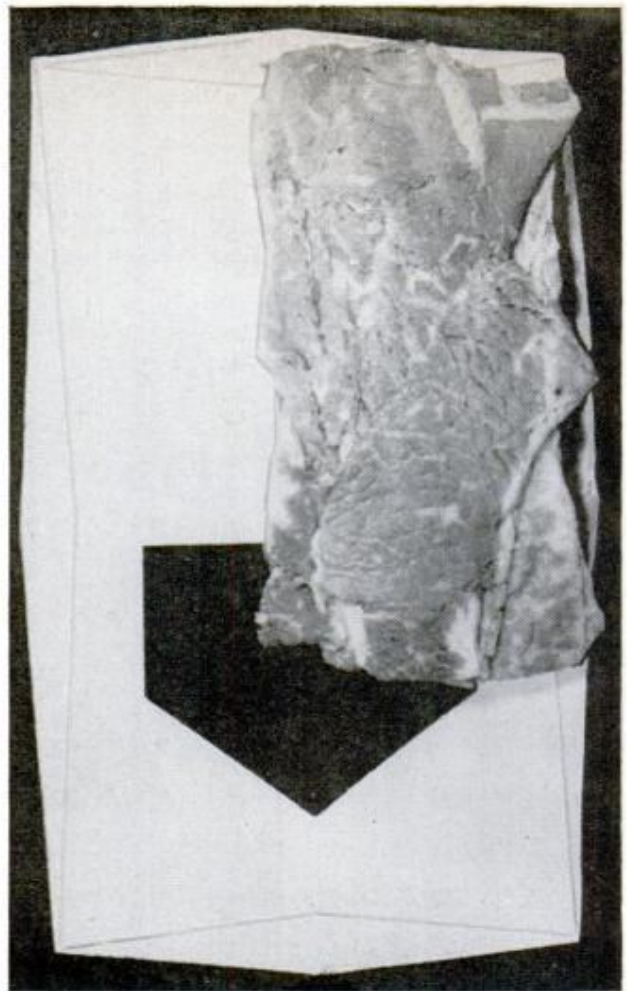
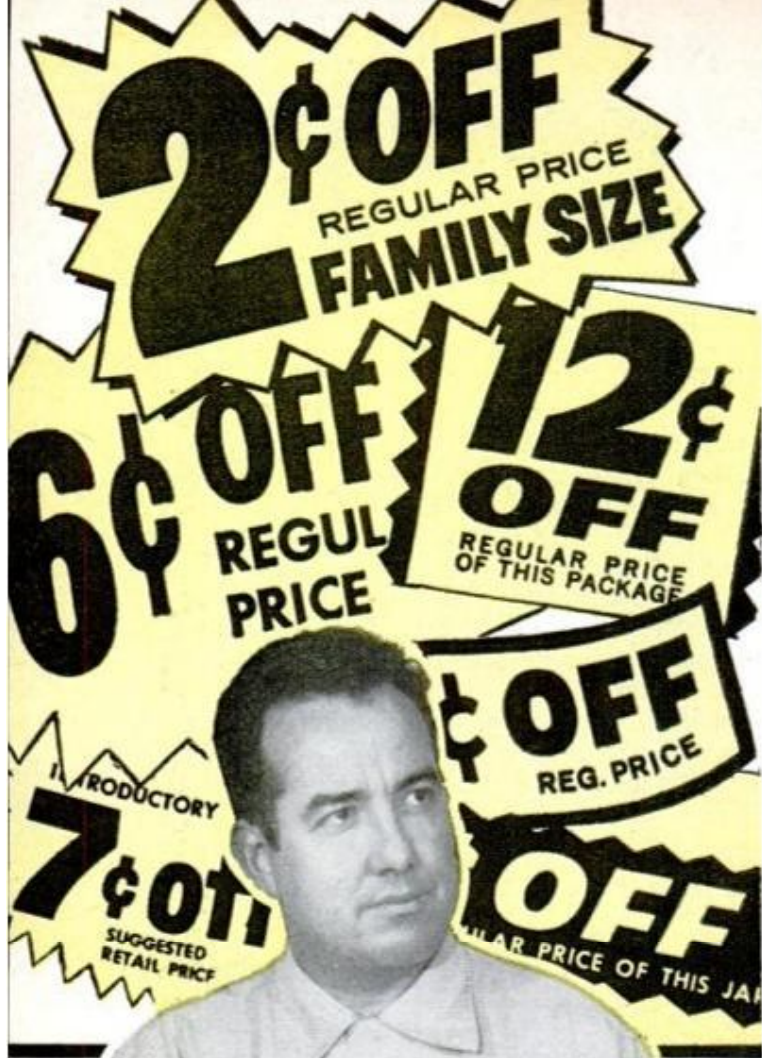

DECEPTIVE PACKAGE of corned beef, when opened, shows that beef occupied less than half the packet

home, I saw the wrapper said, in tiny print, "Imported from Denmark."

"Sucker!" I told myself.

That same week, my wife brought home a package of "Large Fancy Walnuts." Most of them were small and many of them were wormy. The worms may have been fancy, but we didn't try them.

I bought a candy bar, and it was mostly cardboard wrapper. I bought a packet of smoked salmon and it contained just enough salmon to fill the small plastic window. I bought some sliced bacon and it was all white fat except for a thin ridge of meat.

What's going on, anyway? Is everyone out to gyp me? I complained to an official and he said, "Ali Baba's Forty Thieves were pikers compared to some people in the food-packaging business. There are lots of honest packagers, of course. And there are others who stay awake nights thinking up new ways to trick you!"

Once upon a time you asked your grocer for half a pound of this and three pounds of that and he filled your order while you waited. Today, most items in food stores are prepacked. An estimate is that more than 6000 kinds of packages confront the shopper, counting all the different foods,

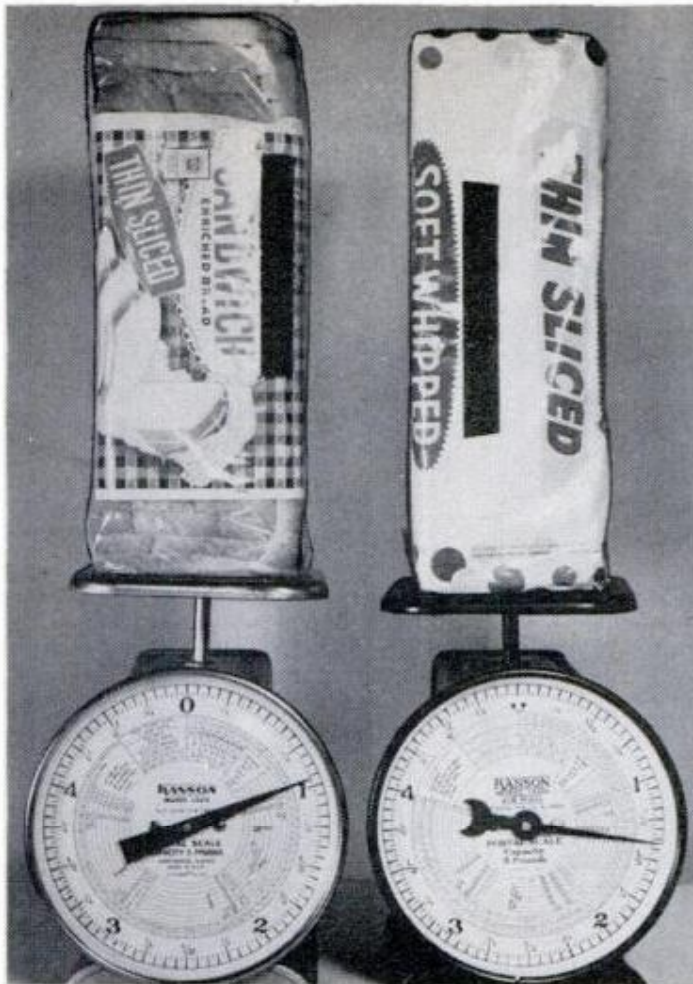

DECEPTIVE SIZE of bread shows one loaf, as large as other, actually weighs nearly a half-pound less

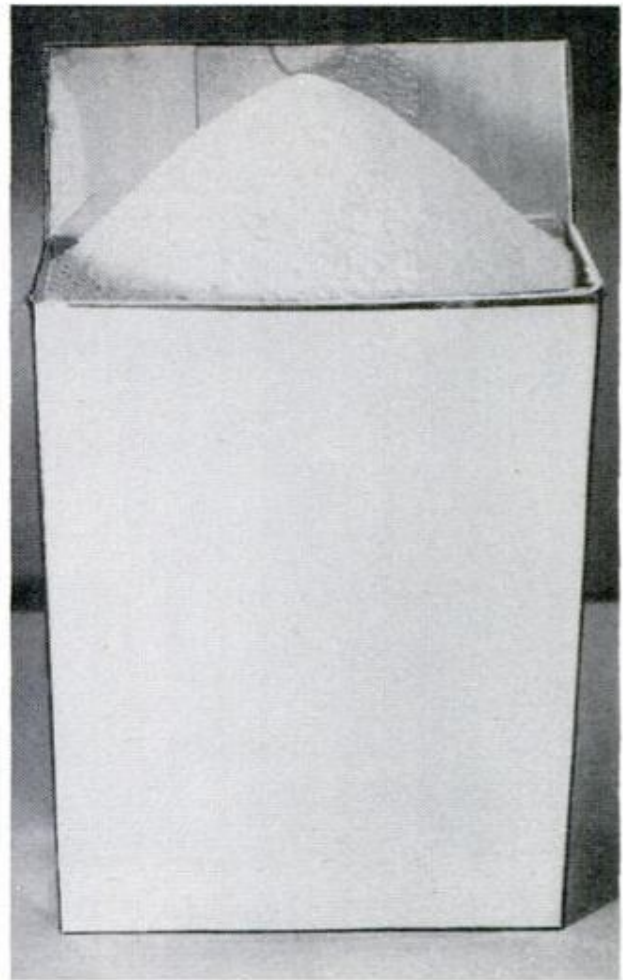

HONEST SLACK results from vibration during shipment. Soap powder overfills box, but settles in transit

brands and sizes. Each package is a silent salesman that fights for the customer's attention. Sometimes very dubious tactics are used.

Well over a year ago an opinion survey reported that housewives had two major complaints about packaging. One was that the manufacturers were trying to fool them by packing a small amount of product into an oversize package, and the other was that there was altogether too much advertising on packages, taking up space that could be better used for directions and descriptions.

So many people have been complaining about deceptive packaging that the government has taken notice of it. A subcommittee of the U. S. Senate under Sen. Philip A. Hart of Michigan has been holding hearings to investigate the way that the labeling and packaging of food and household products affect the consumer.

One common complaint to the subcommittee was that shoppers are bewildered by such claims as "Jumbo Half-Quart" and "Big Two Ounce" amounts. Ordinary horse sense tells one that a jumbo half-quart is, after all, only a pint, and that two ounces don't weigh any more just because they are called "big."

"Small, medium and large are becoming things of the past," one witness said in essence. "Today it's large, super and giant. Large is the smallest you can get!"

Another kind of exaggeration can be found among frozen foods. One package of a frozen vegetable weighing 12 ounces may have a reasonable "two servings" printed on it, while another that weighs only nine ounces may state "feeds four." Feeds four what, midgets?

A big complaint was that you don't get as much for the same amount of money as you used to. A can of baby food contains a quarter ounce less than before, with no reduction in price. A box of cake mix is down one ounce, and a cereal box that used to contain 12 ounces now holds 10¼ ounces. What was once a pint of vinegar is down to 12 or 14 ounces, and so on.

Every story has two sides and in this case the packager's side certainly has some merit. A company that is faced with rising costs is going to raise its prices, that's sure. One way is to raise the price of its standard package. Another way is to reduce the quantity in the package and continue to sell it at the old price. Obviously, a company that raises its price is at a disadvan-

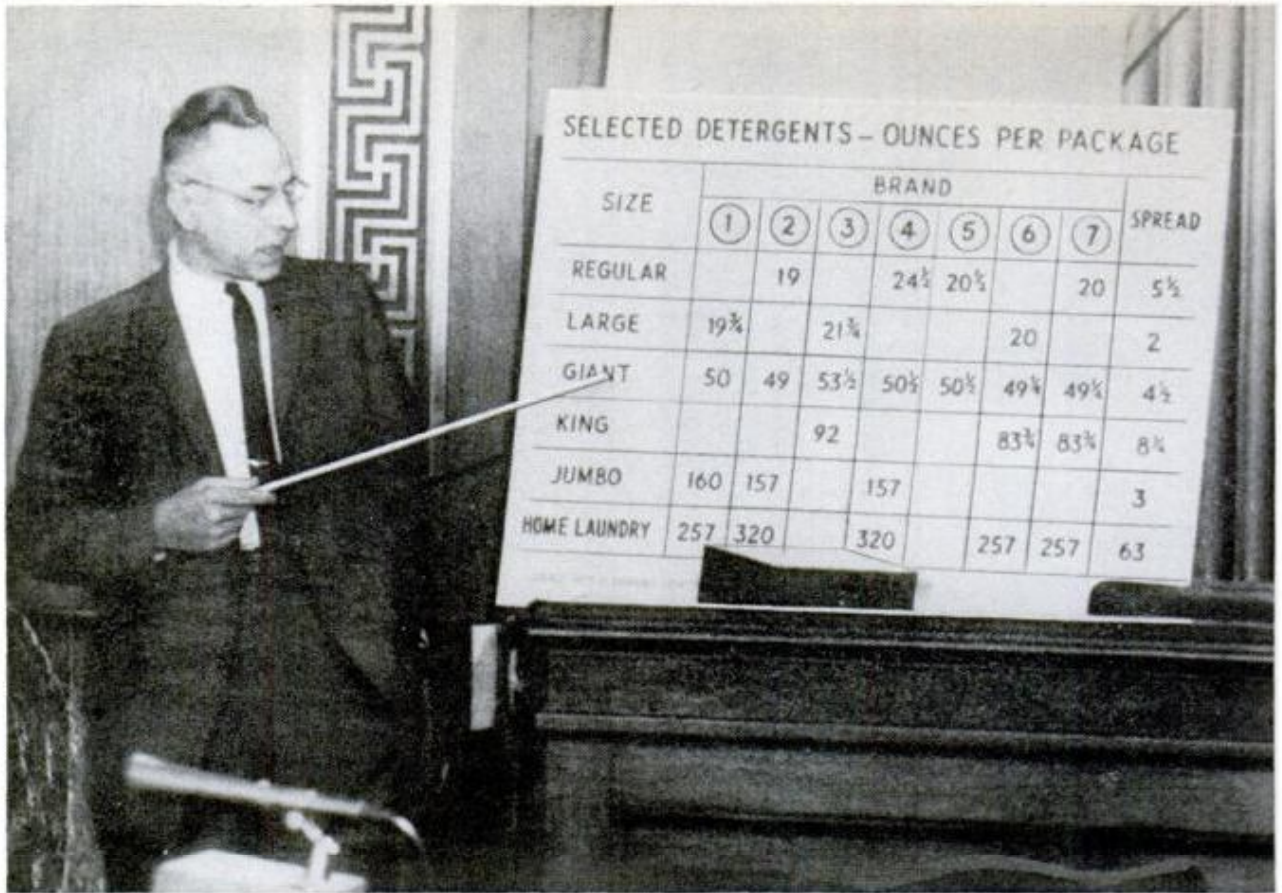

DECEPTIVE NAMES mean different things to different manufacturers. "Giant," "King," "Jumbo" vary in weight

tage if its competitors decide to "package to the old price." So, almost without exception, packagers have chosen the latter path.

Senator Hart made it clear that the subcommittee is not denying a manufacturer the right to adjust his prices.

Other witnesses took exception to the trend toward packaging in odd amounts. In

some commodities it's impossible to buy by the pound any more.

"The giant size of this brand is 3 lb.-1¼ oz. for 79 cents. King size is 5 lb.-3¾ oz. for \$1.31. Home-laundry size is 16 lb.-1 oz. for \$3.99," one witness testified. "How do you compare them, pricewise?"

(Continued to page 238)

Which one is the best buy?

COMPLICATED WEIGHTS can be compared on handy "consumer's computer" which shows which costs least

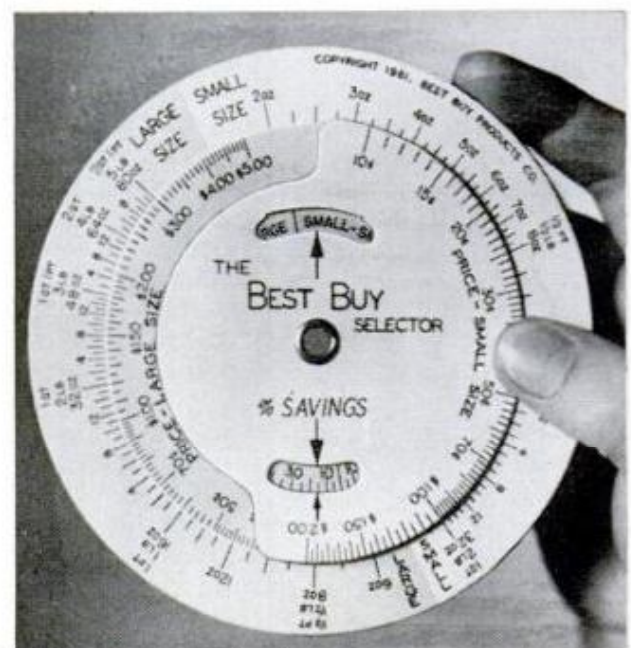
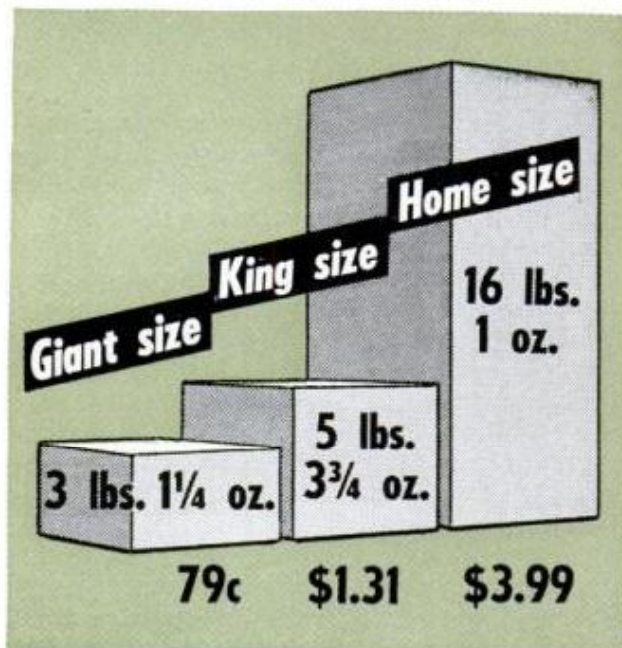



By Jim Whipple



Horsepower Hikeup—Any Number Can Play. What Provokes Detroit's Loudest Silence?

First reports from Ford show an upbeat takeoff for the **Fairlane**. Reported as of February 1st were 62,000 sales since the October '61 introduction. That's pretty good going for a car that is offered only in two and four-door sedans.

Unofficial word from a Ford executive—“We'll have **Fairlane** station wagons by late summer.” They certainly should, because the **Fairlane** itself is aimed at the medium income family, \$7000 to \$10,000-a-year folks, and these are the very people who go for wagons priced below \$3000.

Incidentally, **Fairlane** buyers are voting heavily for the V8 engine, as sales are running 80 percent as of now. According to Ford Division's head man Lee Iacocca, this was a surprise. They had expected not much more than 50-60 percent. Mr. Iacocca admitted that the **Fairlane's** standard 101-horsepower Six might “leave something to be desired in the way of performance.” Just in case some people feel that way about the 143-horsepower V8, Ford has hastened to add one with 39 more cubic inches displacement as an option.

This gives the **Fairlane** buyer 164 horsepower to play with, which takes us back about seven years to the 1954 Ford, a similar-to-**Fairlane**-sized car which started with a new, 130-horsepower V8 which promptly jumped to 162 on the '55 model. (Isn't this where we came in?)

This 260-cubic-inch engine was scheduled for the '63 **Fairlane**, but public interest spurred Ford to action this spring.

Whatever Ford does it's a cinch that Chevrolet isn't far behind. In this matter they're ahead as they've made the 327-cubic-inch V8 available in the **Chevy II** just as Ed Cole promised (**PM** November '61, p. 110). This rig makes up a living bomb which will reach 60 m.p.h. in about 6.5 seconds.

Chrysler Corporation is also hip deep in horsepower with a dual four-barrel carbureted job with a new aluminum intake manifold built in one piece and embodying 15-inch ram tubes tuned for high output.

This beautiful brute is rated at 410 horsepower from 413 cubic inches with 11-to-1 compression ratio burning superpremium

gasoline. Dodge calls it the Ram Charger, while on **Plymouths** it's the Super Stock 413.

This engine is a factory option available in May. As far as we know it will not fit under the hood of a **Valiant** or **Lancer**.

Over at Buick, however, there's a refreshing (to us, anyway) trend away from the complexities of hyped horsepower. The buyer demand for the **Buick Special** with V6 engine has the plant scrambling to catch up, while there are plenty of aluminum V8s for all.

The loudest silence around Detroit these days comes when you ask about two-ply tires. These light, flexible shoes were going on all the 13-inch rims of compacts and even headed for, so the industry spokesmen said last year, some not-so-compact cars.

A recent check by **PM** of brand-new compacts revealed no visible letters or ciphers on their casings indicating how many plies they had. Formerly these were two-ply marked “4-ply rating.”

Word from a top executive in tire marketing (not connected with a rubber company) is that there were problems. It seems that when tires were overloaded the sidewalls weakened at just above the bead and too many failures occurred.

So, to play safe, everybody went to four plies. According to our source, the two-ply 13-inch tires offered a slightly softer ride and a saving of less than 50 cents each in cost for the automakers. Replacement tires sold by the rubber companies for compacts were always 4-ply.

Dolling up the compacts, seems to be a sweeping trend as American Motors adds simulated wood trim to a **Rambler** station wagon while Ford presents us with the ultimate **Falcon**, (price not available at press time), the **Futura Sports**, a two-door job with leatherlike vinyl-covered **Thunderbird**-styled roof, four-speed floor shift and, sakes alive, honest-to-Pete knockoff wire wheels.

The four-speed box comes from Ford of England's **Zephyr** and, says a Ford executive, should be reasonably priced at around \$75. What a happy thought! ★ ★ ★

Lift-off Hardtop

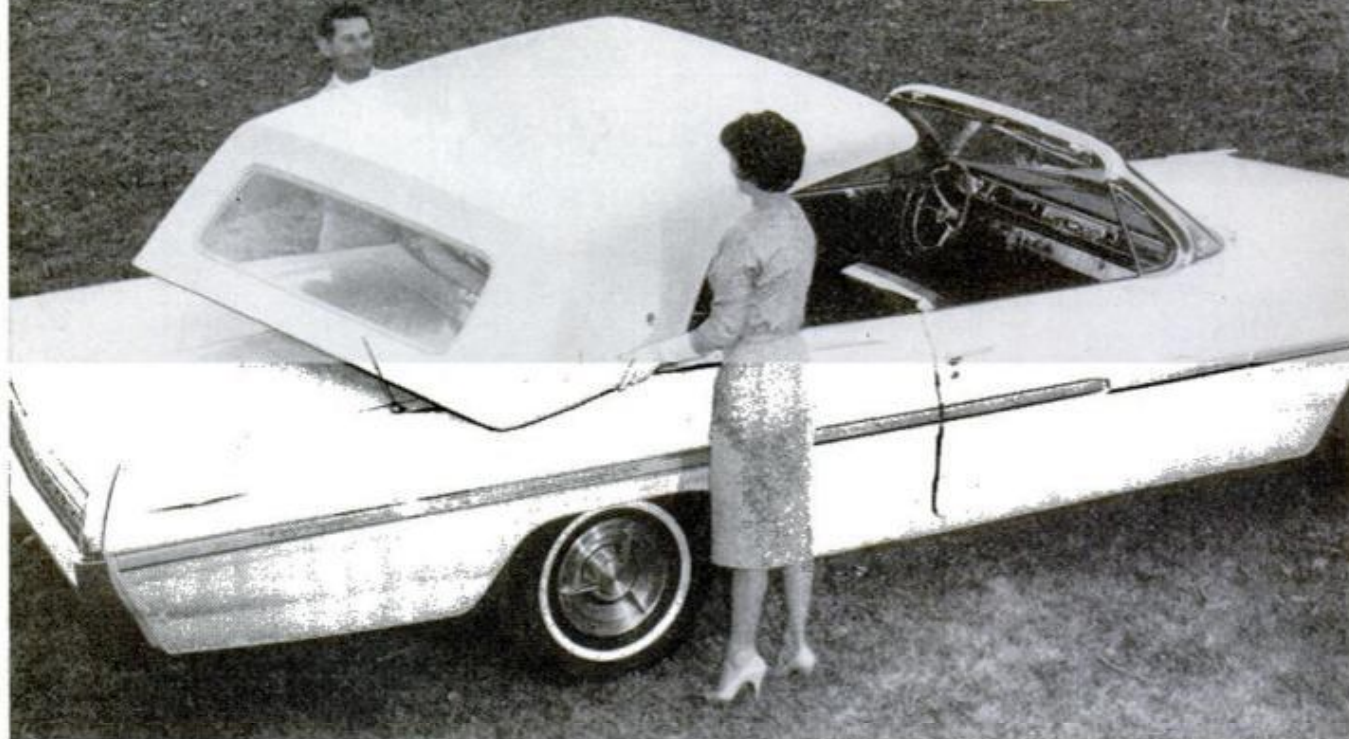

IN LESS THAN A MINUTE, the Le Mans fiberglass top changes a convertible to a snug, weatherproof hardtop



TIGHT FIT, good seal on Pontiac convertible, left, gives watertight comfort like sister hardtop, at right

FRONT LATCHES use ordinary soft top hook fittings supplied with car to fasten top to windshield frame

REAR IS CLAMPED with two spring-loaded hooks. Top was tested at speed with these unhooked

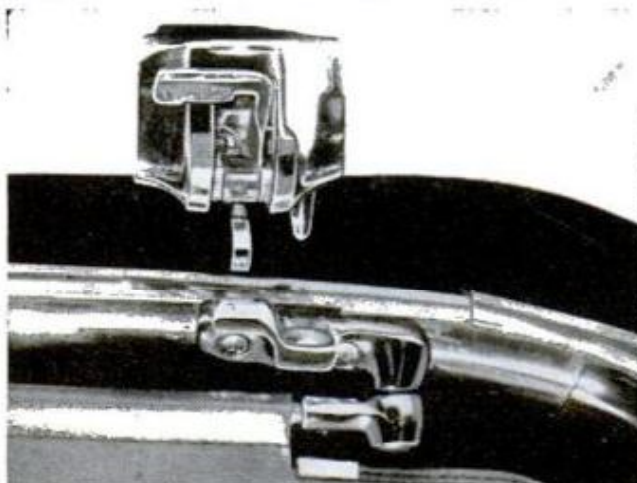



TOP HAS GRAINED exterior surfaces and a white rubber edge molding. Rear window uses laminated safety glass **ONE-PIECE CONSTRUCTION** will support a ski rack, several hundred pounds of luggage or a light boat



CONVERTIBLE OWNERS can now give their cars a "dual personality" treatment that used to be enjoyed only by drivers of certain personal cars and imports. Le Mans, Inc., a San Diego firm, has engineered a light-weight fiberglass hardtop that turns full-size convertibles into snug, closed cars.

No drilling or modification of any kind is required to adapt the top and as it weighs but 80 lb., two persons can easily lift it into place. At the first sign of bad weather, it can be buckled on in less than a minute to banish drafts and help keep the interior warmer than usual in winter.

The Le Mans top is made of multilayers of fiberglass and its precise molding creates a fit and weatherproof seal the maker claims will allow a car fitted with it to come through a mechanical car wash bone-dry.

The limousine-style rear window is made of laminated safety glass and cranking one of the doors or quarter windows down suddenly won't blow it out. Both the interior and exterior are scratch-resistant, grained surfaces that are not affected by the elements and will not discolor.

Two models (at \$395, and \$435) fit all Chevrolet, Pontiac, Buick, Oldsmobile and Cadillac full-size convertibles. The maker plans to offer a top for convertibles in the Ford family, beginning with the '63 line, as well as for many of the American compacts.

Le Mans, Inc. plans to have GM dealers sell the top in a choice of black or white (or prime coat), with a matching or contrasting underside. It would be ordered as any other accessory right with the purchase of a new car.—*Dick Williford*

Falcon's Easy Driving, High Gas Mileage Please Owners

Marginal and boldface comments by Jim Whipple, PM's Auto Editor



STATUS SYMBOLS went compact when Falcon introduced the handsome yet practical Squire wagon with the imitation wood paneling like its Galaxie big brother. Like owners, PM found Falcon a great go-in-snow car

Falcon's success over Corvair was due to more interior room, conventional engineering. It outsold → Valiant partly because of latter's off-beat styling. A greater number of dealers helps it trump Rambler's ace

PM's test Squire bore a highly "uncompact" → sticker price of \$3200!

Somehow these dooded-up economy cars like → Falcon remind us of nice little girls wearing Mom's dress, shoes and lipstick on Halloween

HAS SUCCESS SPOILED Ford's Falcon? Because there's no doubt that 1,100,000 copies sold since this practical compact first appeared, spell just that . . . success of the highest order. Falcon has outsold Rambler, itself the father of compacts, as well as more recent arrivals, Corvair and Valiant.

For a look at the facts we compared results of this current owners report with one from owners of the 1960 Falcon (PM, April, 1960, p. 98). In passing, it's worth noting differences in the car itself.

The current Falcon is a far more sophisticated product than the version of just 24 months ago. That early Falcon was available as a two or four-door sedan (wagons came later in the year) with a single 85-hp. engine and choice of either manual or automatic transmission.

Today, there are the same sedans, conventional two and four-door wagons, a camper-type wagon and the luxurious Squire wagon—a four-door with simulated wood paneling, roof rack, bucket seats and luxury carpet which PM used as a test car to backstop this report. There's even a cute little pickup truck called the Ranchero, plus the elegant, newly roofed bucket-seated sports coupe, Futura.

But beneath this latter day finery we find much the same sensible simplicity and efficiency that marked the car from the start. There's still neither power steering nor power brakes; you must unlatch doors for summer ventilation and regulate the warmup via a manual choke.

Not tinkering with the basic formula has kept public acceptance high, as owners still like their Falcons.

A solid 62.8 percent of owners rated their car Excellent; 31.0 percent said it was Good; 5.3 percent rated it Fair, and

BASED ON 1,306,208 OWNER-DRIVEN MILES

FALCON OWNERS LIKE . . .

Ease of driving, parking
Low-cost operation
Comfortable ride

DISLIKE . . .

Awkward entry, exit
Carb and brake woes
Disappointing gas mileage

POPULAR MECHANICS

OWNERS
REPORT

A NATIONWIDE SURVEY

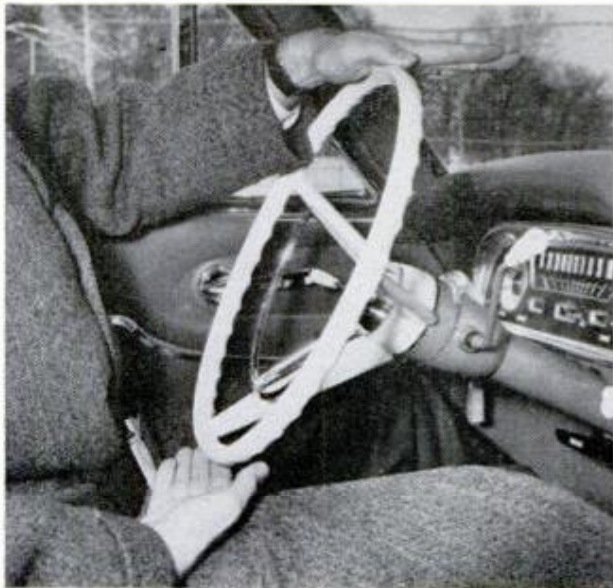

WHEEL sits high up and far back, close to your tummy in bucket-seat Squire. But owners didn't object

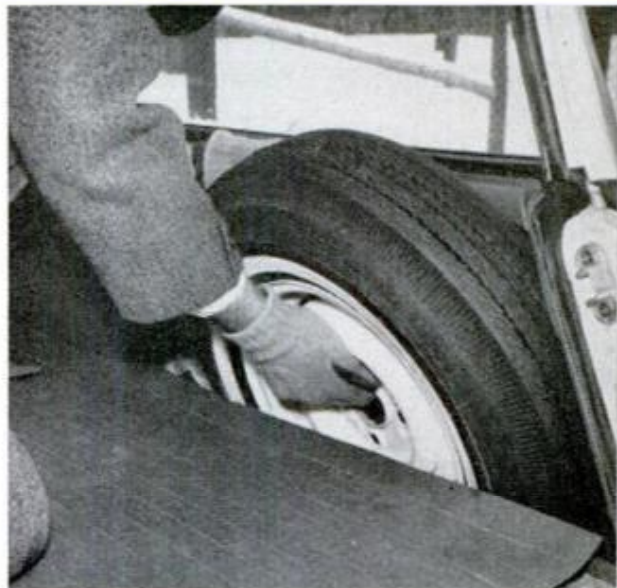

SNUG IN WELL, where it rides beneath plastic cover, spare tire demands you get inside to take it out

only a tiny minority of 0.9 percent turned thumbs down calling it Poor.

However, there have been a couple of changes that were reflected very strongly in the reports.

When Falcon was first marketed it had one engine (144-cubic-inch six) rated at 85 horsepower and propelling the car through a 3.10 to 1 rear-axle ratio.

The result was fuel mileage comparable with some of the smaller four-cylinder imports and notably tepid performance. So much so, in fact, that the factory changed the standard ratio to 3.50 to 1, and hustled a 170-cubic-inch (101 horsepower) version of the engine into production for the '61 model, in response to public demand which was evidenced in PM's '60 reports by the leading complaint: "Not Enough Power," 18.2 percent.

Today though, with 56 percent buying the 101-horsepower engine, these complaints are down to 3.1 percent.

Inexorable laws of physics apply here as everywhere. So when power goes up, mileage must come down and fewer owners are now satisfied with fuel economy—72.1 percent as against 89.0 for the 1960 car.

PM's test car, a well-equipped Squire with 101-horsepower engine and automatic transmission, run in cold snowy weather with over-the-road and traffic driving, turned in 17.75 miles per gallon over-all. Fuel meter results at constant speeds were as follows:

22.8 miles per gallon at 30 m.p.h.
22.1 miles per gallon at 40 m.p.h.
20.3 miles per gallon at 50 m.p.h.
16.6 miles per gallon at 60 m.p.h.
14.4 miles per gallon at 70 m.p.h.

← *That '60 job with automatic was a real wet noodle. It couldn't pull the lid off a stew pot in a high wind!*

← *What we need is a multicylinder engine that would use only four cylinders in traffic for economy yet enable you to switch to six or eight when you needed power. (The French are trying it, see page 16 this issue)*

← *Test Squire weighed about 3000 lb. with driver on board*

SUMMARY OF OWNERS REPORT:

EXCELLENT	GOOD	FAIR	POOR
66.9%	30.1%	2.4%	0.6%
62.8	31.0	5.3	0.9

Satisfied with automatic economy?	Had mechanical trouble?	Least-liked interior features
About as expected.....51.4%	No trouble.....72.4%	Glove compartment.....11.0%
Better.....10.4	Some trouble.....24.5	Step-down floor wells.....7.6
Not as good.....38.2	Considerable trouble.....3.1	Ash tray (too close to radio)...3.7
Satisfied with manual economy?	What was trouble?	Lack of legroom (mostly in rear) 3.7
About as expected.....62.2	Carburetor ills.....5.2	Carpeting.....3.1
Better.....17.7	Starter.....3.1	Dashboard.....3.1
Not as good.....20.1	Automatic transmission.....2.4	Did consider buying another compact?55.0
Best-liked features	Brakes.....2.4	Corvair.....29.1
Handling ease.....60.3	Best-liked exterior features	Rambler.....15.0
Economy.....37.6	Simple, clean styling.....12.2	Comet.....12.8
Riding comfort.....22.0	Grille.....5.5	Did not consider buying an import79.2
Ease of parking.....21.7	Taillights.....4.9	Did consider buying an import16.5
Size.....16.8	Just enough brightwork.....4.6	Volkswagen.....70.4
Roominess.....16.5	Wood paneling (Squire).....4.0	Renault.....14.8
Power, performance.....13.1	Luggage rack (Wagons).....3.1	Falcon is only car in family63.6
Styling.....12.0	Least-liked exterior features	Decision to buy Falcon based on:
Visibility.....11.6	Grille.....4.6	Economy.....68.3
Starting ease (zero weather)...9.8	Bumpers.....2.4	Price.....47.1
Good traction in winter.....8.6	Parking lights in bumper.....2.4	Styling.....46.8
Most frequent complaints	Single headlights.....2.1	Size.....44.3
Difficult entry/exit.....5.5	Best-liked interior features	Previous ownership.....3.4
Squeaky brakes.....5.2	Upholstery.....22.3	How is dealer service?
Carburetor.....5.2	Comfortable seats.....11.9	Excellent.....51.4
Poor gas mileage.....4.6	Dashboard.....9.5	Average.....37.2
13-inch tires.....4.3	Bucket seats.....9.2	Poor.....11.4
Light weight.....4.3	Heater/defroster.....5.5	Would buy another Falcon?
Gas filler spout.....4.0	Carpeting.....4.3	Yes, would buy.....87.5
Squeaks and rattles.....3.7	Manual choke.....4.0	No, would not buy.....5.2
Starter.....3.1		Undecided, no answer.....7.3

Now let's get down to cases with the first five best-liked features as rated in their order of mention by Falcon owners.

"The car is easy to handle—I'm a new driver and am glad about this."—Rhode Island social worker.

"Ease of handling: As most of my driving is intricacy, I notice this most of all."—New Mexico maintenance supervisor.

"I like the ease of handling in town and on the road."—Georgia aircraft inspector.

"It's the best handling car I ever had, and I have owned nine new ones so far."—Montana salesman.

"I use my Falcon in taxi service. It has cut my operating expense 50 percent, and driving doesn't tire me out as it does with big cars."—Tennessee taxi driver.

"I traded a '58 Fairlane for a '60 Falcon; then traded the '60 for a '61; the '61 for a '62. I spent \$5 each for upkeep on the '60 and '61 Falcons. The '62 drives and performs better all around."—Texas plant guard.

"My '62 has the 101-hp. engine. Since October, 1961, it has 15,000 miles, averaging 4000 miles per month at 21 miles per gallon driving from one farm to another."—Idaho veterinarian.

"There is no question that the best feature is economy of operation; this is my second Falcon."—New Jersey insurance man.

"I like the over-all economy: Fuel, license tags, insurance."—Oklahoma salesman.

"It uses half the gas our Chevrolet used."—New Mexico oil field worker.

"It is very economical. I save over \$200 a year on gas alone—my second Falcon."—Colorado florist.

"The Falcon is most comfortable on rough roads."—New York physician.

"I find it very comfortable (driving about 40,000 miles per year)."—Kentucky animal husbandryman.

"I like the fact that it is an economy car, and still doesn't ride like a puddle-jumper."—Maryland auto upholsterer.

This kind of testimony is hard to argue with →

The 101-horsepower engine is best for all-around, one-car family use, and this mileage is quite satisfactory →

Good point, there's more to economy than just good mileage →

This is one of the big reasons import sales have leveled off →



ILL FITTING doors drew complaints from some owners, let snow sift into PM's Falcon Squire

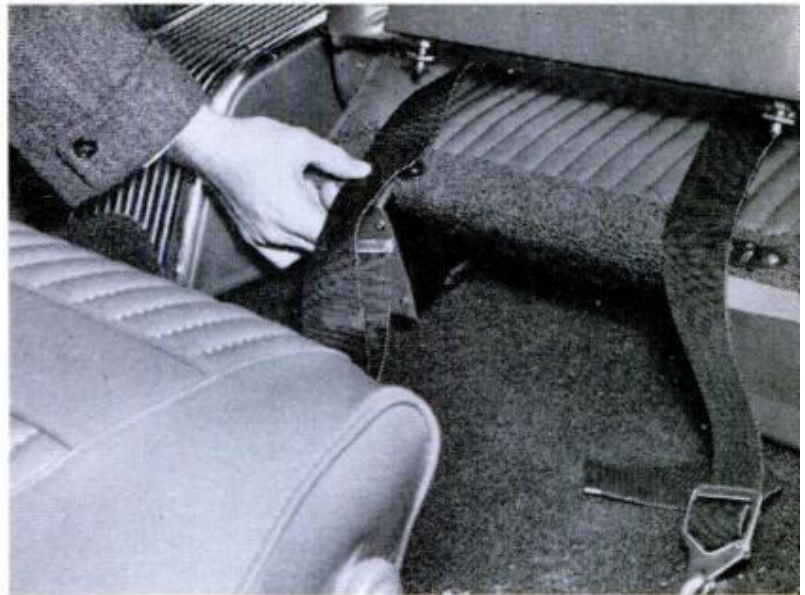

A GOOD IDEA gone wrong. Spikes on pivoting seat back stick in sockets to prevent tilting but could stab seat belts

"It is about the easiest car to park I know of. Steering is free—almost like power steering—and it is fun to drive."—Illinois retail store manager.

"I like the convenience of its size when parallel parking."—Nebraska teacher.

"It's compact, yet not too small."—North Carolina license examiner.

Complaints roll in, too. Here are the first five in order of their frequency of mention.

"I also own a '62 Club Wagon. My only complaint, and a serious one, is the terrible inconvenience of entering and getting out of both front seats. The front cab should be enlarged so that a person can step in or out with ease."—New York postal supervisor.

"The door sill's in the way getting out or in."—Maine retiree.

"Getting in and out is a bit awkward."—Rhode Island clerk.

"Glazed brake lining caused squeaking brakes."—Rhode Island rubber worker.

(Continued to page 230)

← **Falcon, and some other compacts, have shown Americans that it's not only smart to be thrifty but that it can be fun, too**

← **Falcon's Club Wagon, basically a box on wheels, is one of several of this special type of vehicle which must compromise between ease of entry and added cargo capacity**

EXCLUDED are mileages of 85-hp. automatics and 101-hp. manual-shift Falcons, as few owners ordered them

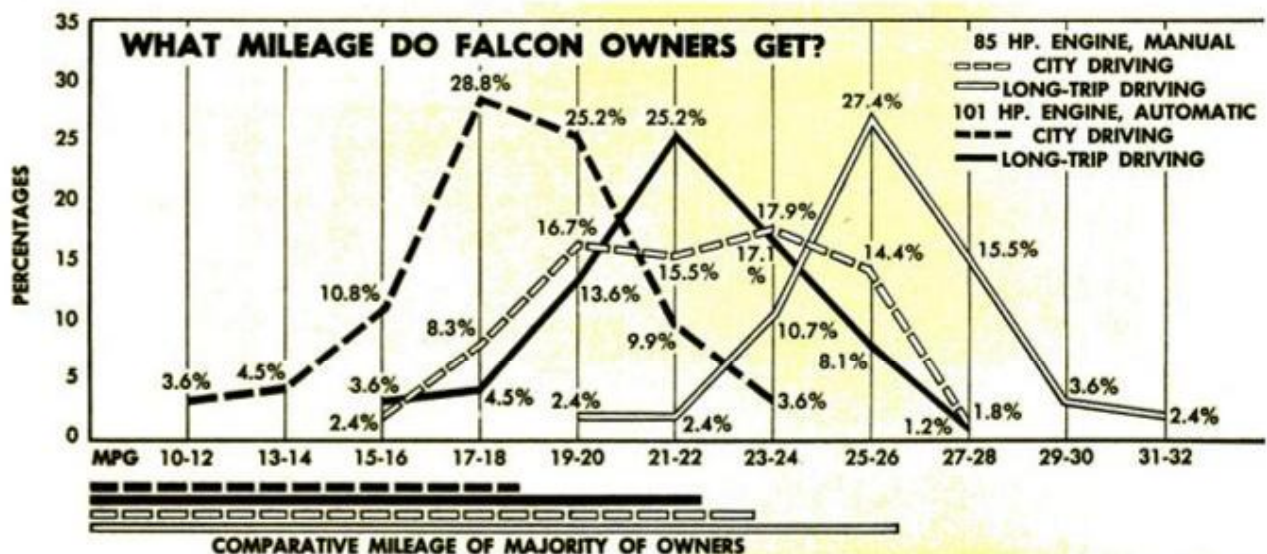

Pontiac's Plush and Power Delight, But Gas Mileage Disappoints Owners

Marginal and boldface comments by Jim Whipple, PM's Auto Editor



SOFT SPRINGS (for comfort) let Pontiac heel on curve but wide track (low center of gravity) helps hug road

As a matter of fact, in February it edged out Rambler for third place in national sales →

Just take a look at a '56 Pontiac standing next to a '62 and you'll begin to understand what Bunky has done with the car →

CURRENTLY PONTIAC IS the hottest car in the medium-priced field, keeping the sales lead established during the past year over Olds, Buick, Dodge, Mercury and Chrysler.

According to a cross section of new owners, the reason for success seems to be that Pontiacs give more of what medium-price buyers are looking for, at prices equal to or lower than the competition's.

High on the list of desirable characteristics owners mentioned were the handling ease, riding comfort, power and performance and styling.

Performance was the number one factor cited by owners (68.8 percent) for buying their new Pontiacs, with styling a close second (63.7 percent). That should please S. E. Knudsen, as these were the major factors he emphasized during his five years as Pontiac's General Manager. (He recently moved over to head up Chevrolet.)

Pontiac owners seem to be a loyal group. A hard core of 45.2 percent traded another Pontiac in on their '62. All of them did not find perfection, however. Some 27.9 percent reported some mechanical troubles with their new cars. And

OWNERS
REPORT

A NATIONWIDE SURVEY

BASED ON 1,427,804 OWNER-DRIVEN MILES**OWNERS LIKE . . .**

All-around handling
Smooth, luxury ride
Powerful pickup

OWNERS DISLIKE . . .

Thirst for gas
Sluggish automatic shift
Sloppy, chipping paint

**OWNERS PRAISE** good vision but dislike glare at top of high windshield

33.2 percent of the reporting owners indicated that their fuel mileage was less than they had expected.

As a check, PM ran constant-speed tests with its fuel meter on a Catalina sedan with two-barrel carburetor and automatic transmission. Here are the results:

21.1 miles per gallon at 30 m.p.h.
17.8 miles per gallon at 40 m.p.h.
16.4 miles per gallon at 50 m.p.h.
15.1 miles per gallon at 60 m.p.h.
14.2 miles per gallon at 70 m.p.h.

Those mileages were obtained with favorable steady-speed operation, but in unfavorable winter weather.

Fuel consumption notwithstanding, Pontiac owners were generally very well pleased with their choice. Some 66.9 percent said the car was Excellent, 30.1 percent Good, just 2.1 Fair and only .6 percent labeled it Poor. And a whopping 90.3 percent said that they would buy another Pontiac.

Starting with the credit side of the ledger, here, in order of frequency of mention, are Pontiac owners' five best-liked features.

"It's very easy to handle and you don't feel like you have

Remember, folks, this is no
← **compact. PM's test car**
had full power equipment,
weighed over 4000
pounds at the curb

This '62 Pontiac had lowest
percentage of Poor ratings
← **of any PM report in**
past two years. No
wonder Chief Engineer
Estes was promoted to VP

SUMMARY OF OWNERS REPORT:

EXCELLENT	GOOD	FAIR	POOR
62.8%	31.0%	5.3%	0.9%
66.9	30.1	2.4	0.6

Satisfied with automatic economy?		Best-liked exterior features?		Did consider another car in	
About as expected.....	50.5%	Grille.....	12.7%	Pontiac's price range?.....	48.8%
Better.....	16.3	Clean, simple styling.....	9.8	Oldsmobile.....	37.9
Not as good.....	33.2	Rear-end styling.....	5.1	Buick.....	16.1
Best-liked features		Roof line.....	3.6	Chevrolet.....	11.2
Handling ease.....	53.0	Front-end treatment.....	3.0	Ford.....	8.1
Riding comfort.....	35.1	Taillights.....	3.0	Mercury.....	8.1
Power, performance.....	33.9	Absence of fins, frills.....	3.0	Chrysler.....	6.2
Styling.....	29.3	Lowness.....	2.7	Thunderbird.....	2.5
Roadability.....	9.1	Least-liked exterior features		Dodge.....	2.5
Visibility.....	8.7	Grille.....	3.9	Cadillac.....	1.9
Wide track.....	8.1	Taillights.....	3.0	Is Pontiac only car in family?	
Roominess.....	8.1	Rear-end styling.....	2.7	Yes, it is.....	56.1
Most-frequent complaints		Large windshield.....	2.4	No, it is not.....	43.9
Poor gas mileage.....	12.3	Side fender gas filler.....	2.1	Decision to buy Pontiac based on:	
Automatic transmission.....	5.2	Best-liked interior features		Performance.....	68.8
Voltage regulator.....	4.2	Upholstery.....	23.6	Styling.....	63.7
Inferior paint job.....	3.9	Dashboard, instrument panel.....	18.5	Size.....	34.3
Rattles and squeaks.....	3.9	Comfortable seats.....	12.4	Previous ownership.....	10.6
Had mechanical trouble?		Colors.....	6.0	Economy.....	10.3
No trouble.....	72.1	Headroom.....	4.2	Price, trade-in deal.....	3.9
Some trouble.....	26.4	Large trunk, storage space.....	3.9	Dealer.....	3.9
Considerable trouble.....	1.5	Heater, heater controls.....	3.6	How is dealer service?	
What was trouble?		Least-liked interior features		Excellent.....	60.0
Automatic transmission.....	5.2	Ash tray.....	4.5	Average.....	33.2
Voltage regulator.....	4.2	Transmission hump.....	3.3	Poor.....	6.8
Carburetor.....	2.7	Step-down floor wells.....	2.7	Would buy another Pontiac?	
Speedometer.....	2.1	Indicator lights.....	2.7	Yes, would buy.....	90.3
Generator.....	1.8	Uncomfortable seats.....	2.1	No, would not buy.....	3.0
Automatic choke.....	1.5	Spare tire location, position.....	2.1	Undecided, no answer.....	6.7

This is why Pontiac's a favorite with the stock-car racing boys →

If the '62 Pontiac isn't comfortable enough for you, about all you can do is stay at home on a feather bed →

Here's a realist. He knows better than to expect mini-car economy and hot performance from the same engine in a big car →

He's hit on one of the three practical reasons for plus power; the others—climbing hills, passing →

Yep, and they've even taken the Indian off the hood! →

And who knows this better than a man driving those hilly, winding roads of the Nutmeg state →

to fight the traffic—it's a real pleasure to drive."—Kentucky electrical worker.

"You can drive this car a hundred miles an hour and it handles like you were going thirty."—Minnesota foreman.

"It handles so well on the highway and in city traffic."—South Carolina insurance man.

"You hardly feel the car going over depressions or bumps in the road."—New Jersey designer.

"It has a wonderful ride."—Alabama salesman.

"Riding comfort has been vastly improved."—Nevada clergyman.

"I like its riding comfort—I am a disabled veteran and this car, with its slightly higher front seat, enables me to drive with ease."—Arkansas teacher.

"This car has been very good on the road, the best I ever owned. It is hard on gas, but makes up for it in performance."—Arizona entertainer.

"It likes to GO, GO, GO!"—Minnesota highway construction worker.

"There's power when needed to enter traffic."—Georgia executive.

"I like its slimmed-down lines, streamlined look."—Alabama teacher.

"Like the beautiful appearance—no fins, no frills, no tinsel."—Ohio realtor.

"I like the simplified styling (very little chrome, thank goodness)."—Arkansas public relations man.

"I like the way it holds the road on curves, especially in a high wind."—Arizona miner.

"Holds the road beautifully."—Connecticut manufacturer's representative.

A bed of roses can be turned into a warpath, though. Here are the complaints—the first five in order of mention.

"I'd buy another Pontiac only if they do something about poor gas mileage."—Pennsylvania foreman.

"I was told that I could expect much better mileage than on my '59. This has not proven true."—Ohio salesman.

"Gas mileage is very poor compared to the '56 Pontiac we own."—Nebraska civil engineer.

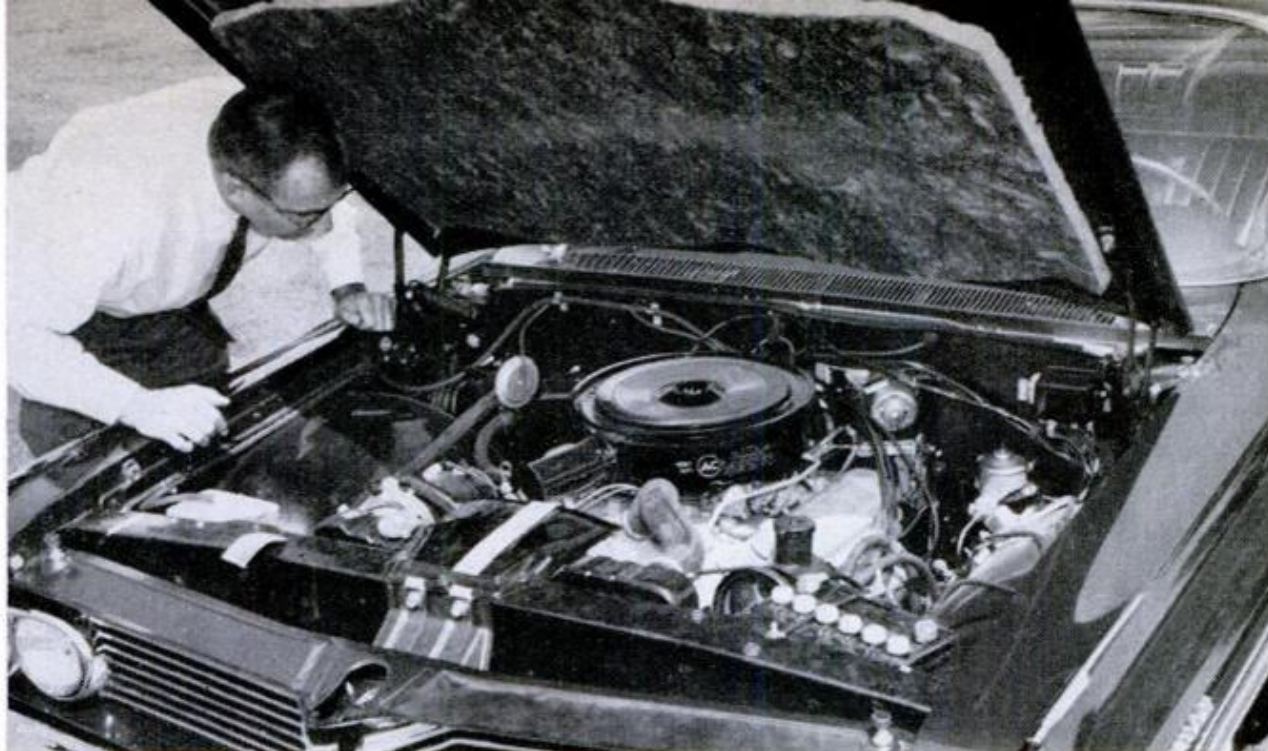

POWERFUL ENGINE looks lost under Pontiac's wide hood, but there's plenty of space for servicing or replacing such items as faulty generators and voltage regulators which caused problems for a number of the owners

"The automatic transmission is not too smooth."—Washington retiree.

"All I have against the car is that the transmission doesn't change from 1st to 2nd fast enough."—Arkansas auto trimmer.

"I have had quite a lot of trouble with the voltage regulator, and it still has not been taken care of."—South Dakota packing house worker.

"The voltage regulator stuck but my dealer repaired it at no charge."—Wisconsin salesman.

"Trim doesn't fit and the paint job is runny—both very bad."—Mississippi businessman.

"Paint chips off very easily."—Louisiana grocer.

"Paint job is not good. The roof top is dull, and rubbing it out (by the dealer) did not help much."—Illinois sales engineer.

"More rattles than usual; original assembly should be improved."—Texas airline captain.

For more peans of praise, here are the best-liked features

(Continued to page 240)

← *Maybe it's the way he drives it. Automatic on PM's test Catalina worked smoothly except in full throttle takeoff*

← *They should check these things like a chicken farmer candles eggs*

← *This is pretty much true of many cars' finishes when banged by carelessly opened doors. We need either guard strips or much tougher paint*

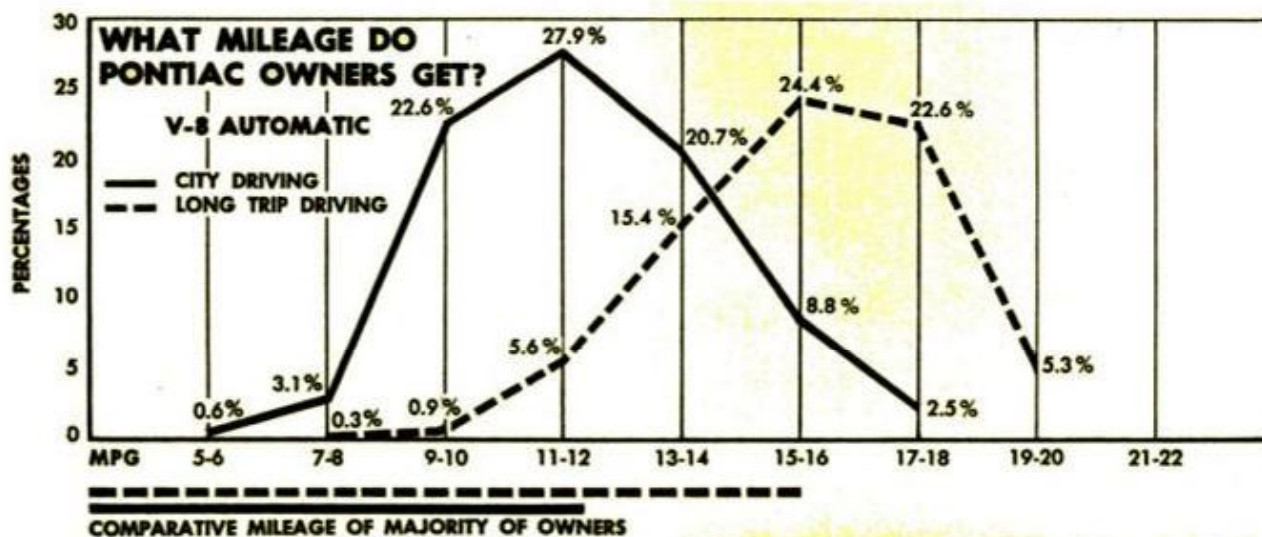



Electric Monorail

Patterned after the monorail used in Disney land, a model toy made in West Germany includes overpasses, switches, and grades of up to 30 degrees.

Many individual parts make it flexible enough to be erected in almost any arrangement. The pillars can be varied in height and, because of the small space needed, the monorail can be erected above any size model city.

Transformers of up to 16 volts can be used. The monorail is distributed in the United States by Schuco Toy Co., 1107 Broadway, New York 10, N.Y.



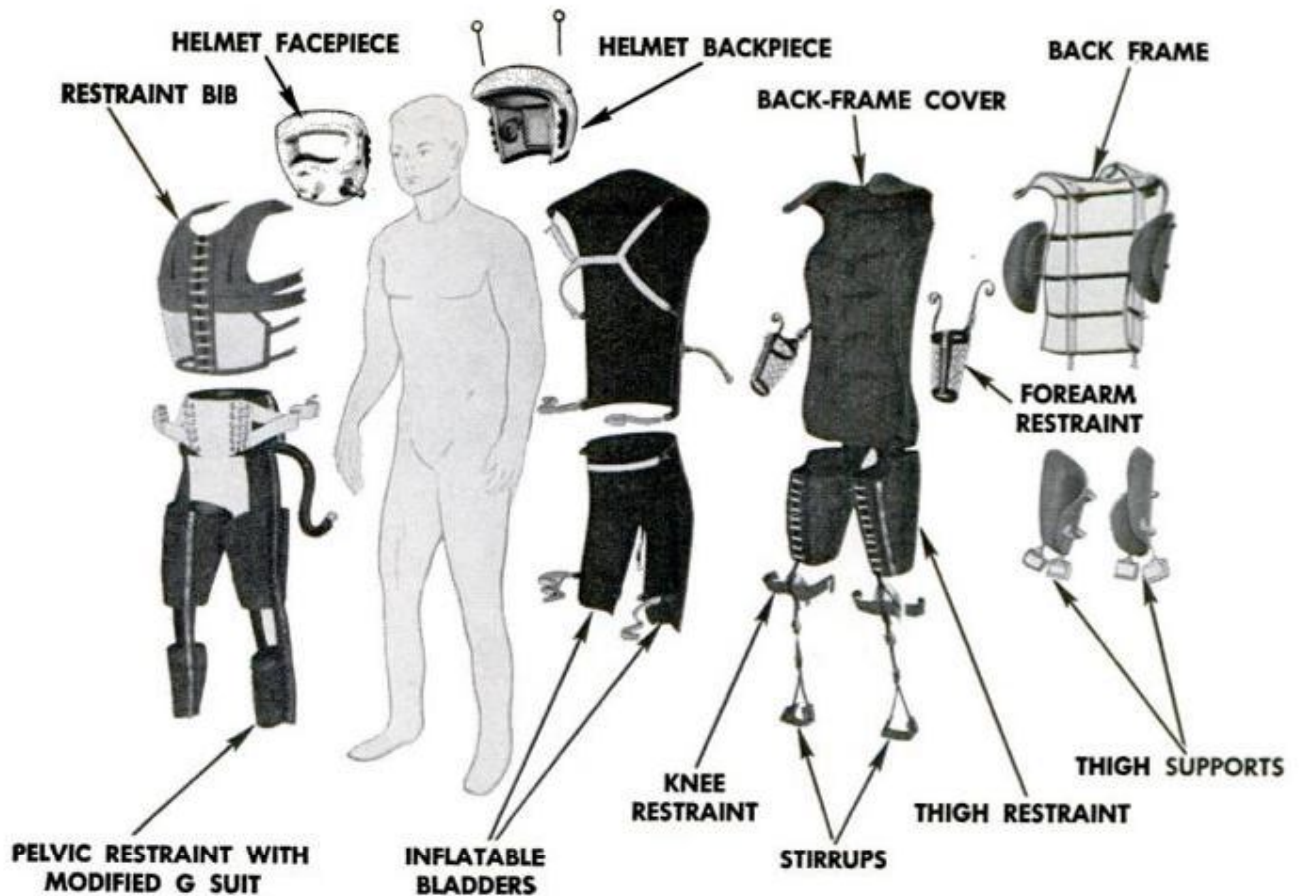

ASTRONAUT ALAN SHEPARD, left, models space suit made to protect pilot from effects of high gravity forces

Astronauts Get Ready-to-Wear Space Suits Right Off the Racks

WHEN THE FIRST American steps out for an evening on the moon, he may be wearing a ready-to-wear space suit rather than the custom-made jobs so much in fashion with contemporary astronauts.

Scientists at the National Aeronautics and Space Administration Center, Ames, Calif., have developed a suit which they call an "interchangeable, mobile pilot restraint system, designed for use in high sustained acceleration force fields." All parts except the face mask, which has to be custom-made, can be taken from stock.

The new space suit is mobile and has a bladder back support which eliminates the need for the individually contoured couch of the Mercury astronaut. Back frame of the suit is built of aluminum plate. The pilot wears a bladder between the nylon-covered frame and himself.

Inflatable bladders appear elsewhere in the suit; for example, one is used to support the buttocks. A series of stays is incorporated over the frontal area of the girdle, and a broad belt there serves as a safety belt.

FACE MASK, shaped by making a plaster cast impression of the pilot's face, provides a sealed compartment



KNIGHTS OF THE RIVER SEINE

1 EN GARDE! At signal, boats rush forward, lancers lower their poles

2 A L'ATTAQUE! As boats close in, combatants screw their courage to sticking place and brace themselves for teeth-rattling crash



FRACTURED FRENCH may have originated on the River Seine, just outside Paris. There some intrepid Gauls have revived the ancient, and bone-breaking, sport of *Jouette Layonnaise*—water jousting.

Based on the equally ancient and dangerous sport of jousting from horseback, the lancers mount the sterns of long boats powered by eight broad-shouldered oarsmen. On a signal, the boats—separated by 200 feet—start toward one another from a dead stop. The boat that accelerates the most has a better chance of retaining its lancer. The lancers, armed only with wooden shields and 12-foot poles, brace themselves for the crash. Sort of a head-on drag race.

The secret is to get a good solid blow at the opponent's shield, with the full force of the braced body and moving boat behind it. It's not hard to pick the winner. The loser is in the water.

You have to admit, it's different. And, as they say in France, *vive la difference!*





3 **TOUCHE!** And double touché! Each lancer hits his target *exactement*

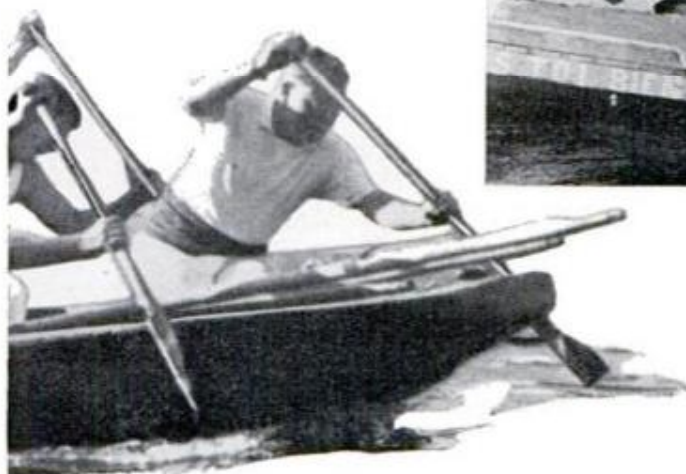

4 **SACREBLEU!** One loses footing, match and dignity, and receives loser's reward—a bath. Dry winner will be wetted down at local bistro

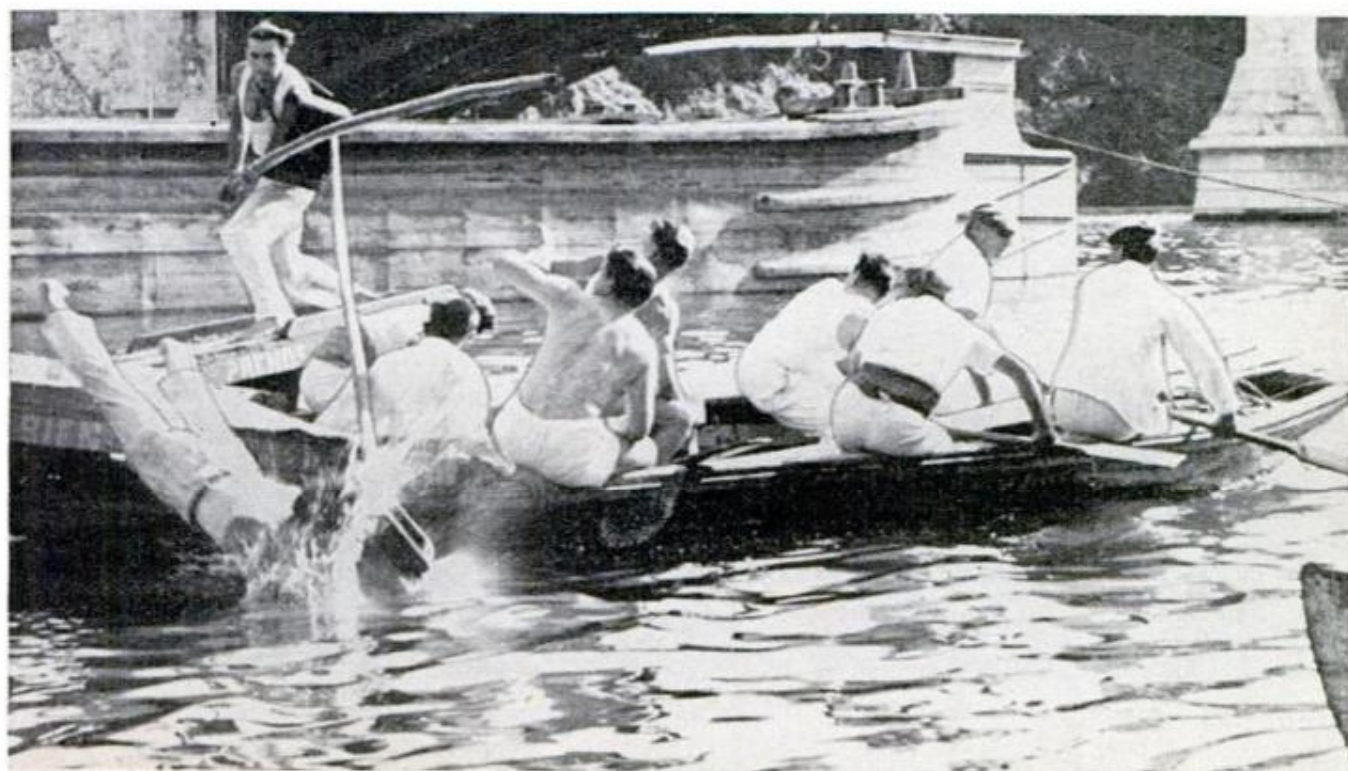

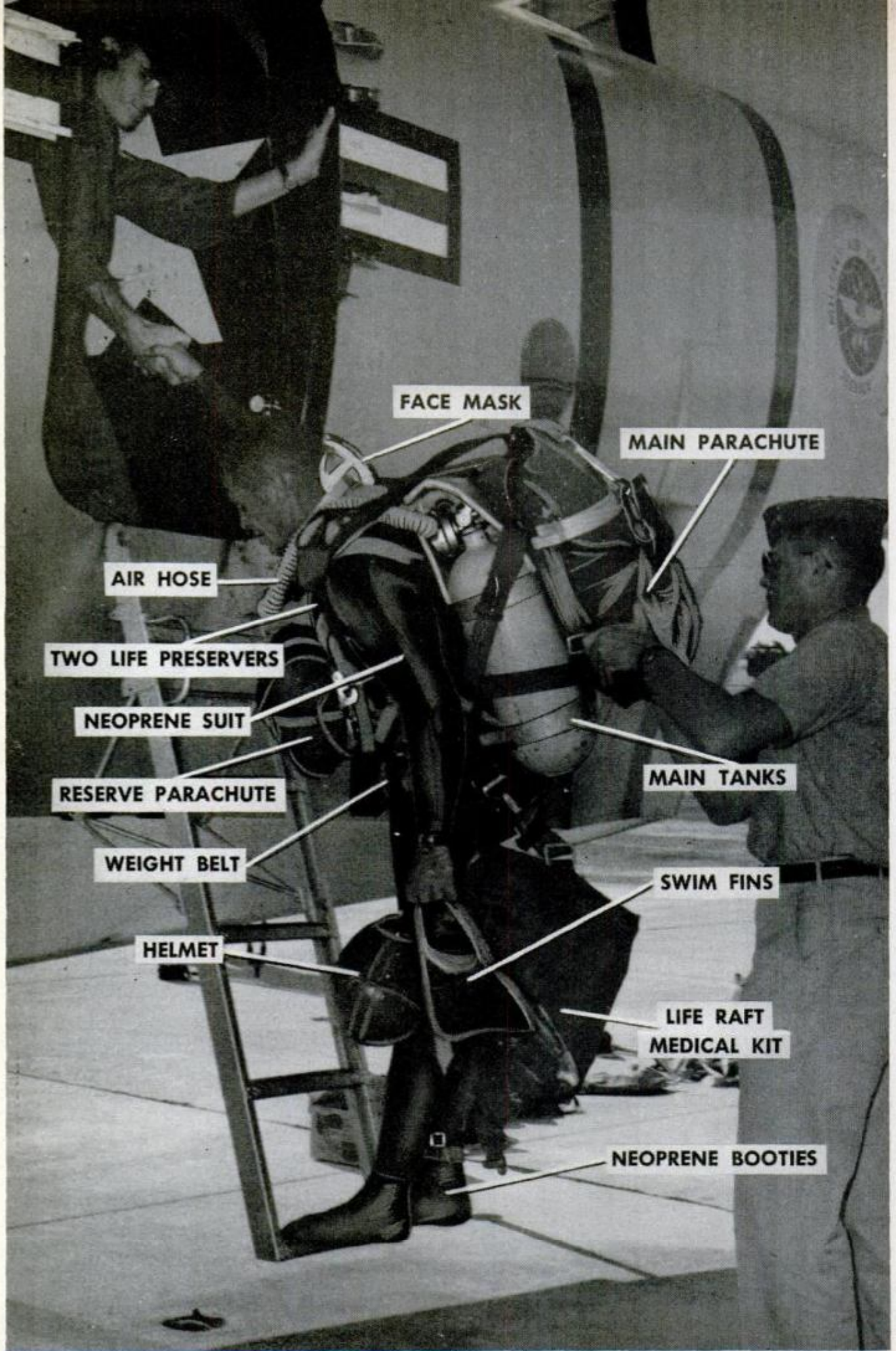

JUMPING FROG, loaded down with 180 pounds of gear, is equipped to parachute into ocean, swim underwater

The Celebrated Jumping Frogs

... parachute from planes in scuba gear to save satellites and astronauts. They are part of the Air Rescue Service which has made some of the most dramatic rescues in the annals of disaster

By
Kevin V. Brown



IN THE BRILLIANT glare of publicity surrounding the on-again-off-again attempt to orbit a man around the earth early this year, some of the light spilled over onto a new group of rescue artists, who have developed new techniques in the old craft of saving people.

Combining the skills of underwater swimmers and

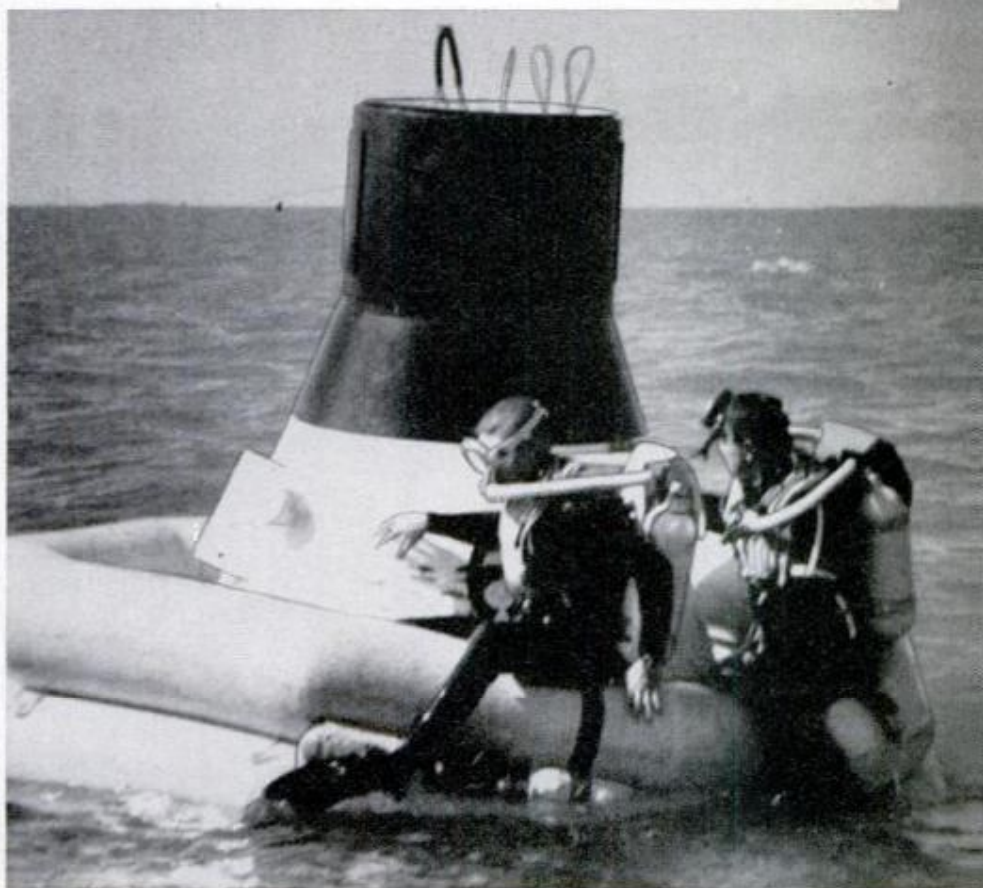

PARARESCUE TEAM, after securing spacecraft, awaits pickup



PARARESCUEMAN deploys life raft on dropline as he floats down to save Discoverer satellite

ALONGSIDE SATELLITE, frogman awaits drop of large life raft. These pictures were shot during actual recovery

DISCOVERER XXIX is now secure (in black tarpaulin) aboard life raft. Rescue was made last year in Pacific

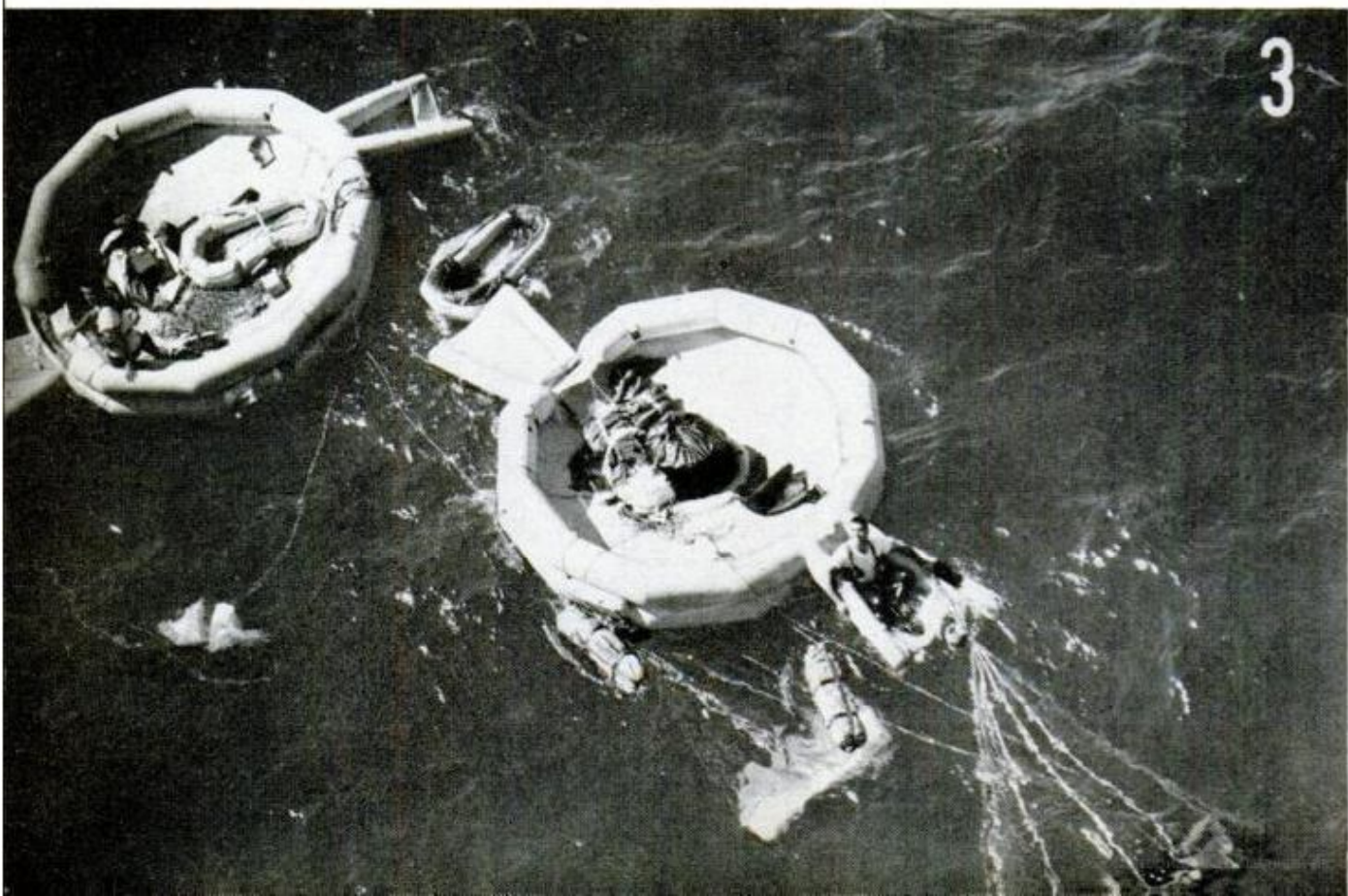

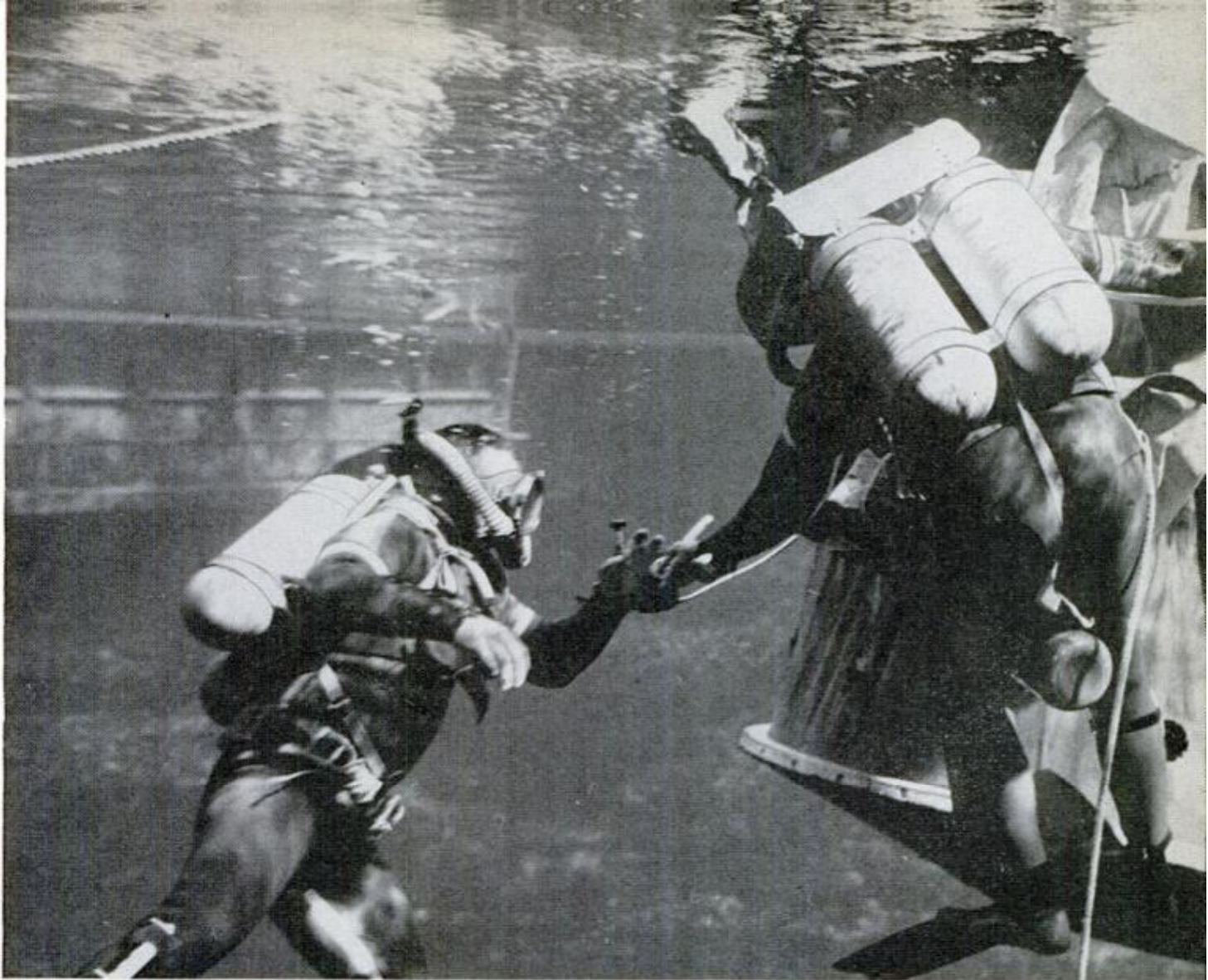

SPACECRAFT RECOVERY is similar. Two-man team attaches floatation device to capsule before inflating it

paratroopers, these flying frogmen were assigned the emergency task of recovering the astronaut if he landed anywhere outside the planned impact areas. The system they have perfected is to parachute near a floating spacecraft, swim to it underwater, secure it to a huge liferaft and, if necessary, render first aid to the occupant.

The idea of putting parachutes on frogmen and flying them to the scene of a rescue is the latest development in techniques used by the U. S. Air Force's much-decorated Air Rescue Service. And these pararescuemen, as the airborne scuba divers are called, are probably the most renowned jumping frogs since Mark Twain's fictional friend failed to get off the ground some years ago in his story of "The Celebrated Jumping Frog of Calaveras County."

Pararescuemen are, in fact, all things to all men in trouble—precision parachutists, gifted underwater swimmers, skilled medics and experts in survival.

Equipped for action, a pararescueman can easily double his normal weight. Ready to jump, he carries as much as 180 pounds of gear. Over his rubber scuba suit, helmet

and boots he wears: Oxygen equipment, including two tanks, hose and face mask; two parachutes, one for emergency use in case the first fails; two life preservers to help him float, and 20 pounds of weights to help him sink (for underwater swimming); swim fins and a surface snorkel; a life raft; a diver's knife; a medical kit; and a tool belt, which includes all the instruments he needs to secure a satellite or spacecraft.

Pararescuemen have made the transition from parachutist to frogman in as little as 90 seconds. In training, they have jumped from planes and secured simulated spacecraft in less than five minutes.

The pararescuemen who specialize in recovering satellites operate out of Hickam Air Force Base, Hawaii. At this writing, fourteen Discoverer satellites have been recovered after orbiting the earth, sometimes by mid-air snatches by Air Force planes and sometimes by jumping the frogmen. If the snatch fails, the frogs jump.

The flying frogmen who are trained to recover Mercury astronauts and their spacecraft have done most of their training in the Gulf of Mexico. They were, however,

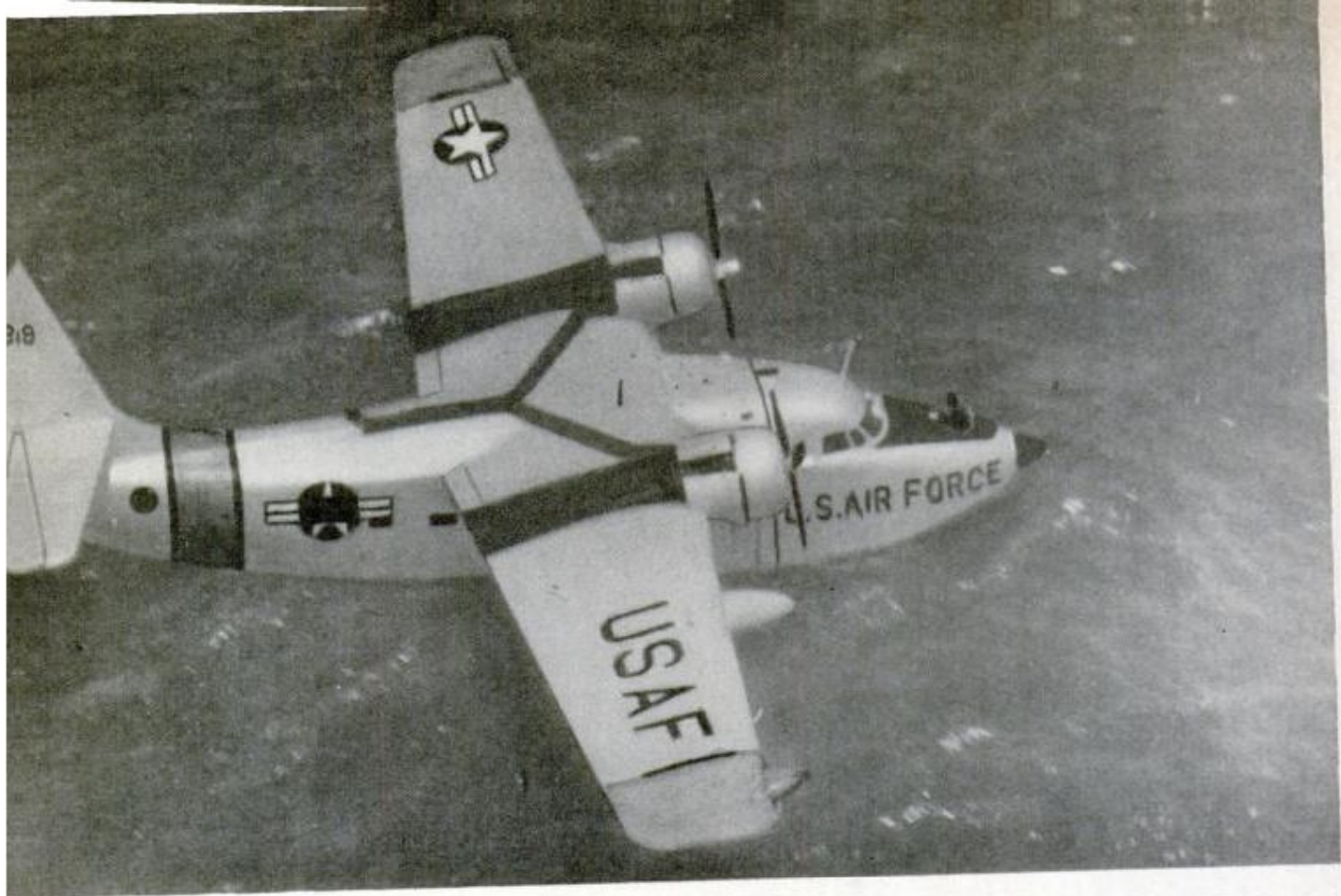



DRAMATIC RESCUE of survivors of airliner shot down by Chinese Reds is made by Air Rescue plane



FACES OF SURVIVORS of another airliner ditched at sea tell story of another dramatic rescue by ARS

←**ARS HELICOPTER** hoists to safety crewman from foundering ship off coast of Okinawa. Other crewmen cling to railings. Pounding surf drove ship onto reef and forced open her watertight door, flooding her

deployed in the Atlantic Ocean for the suborbital flights of both Lt. Comdr. Alan Shepard and Capt. Virgil Grissom, as well as for the full-orbital attempt by Col. Glenn.

Their techniques for recovering both satellites and spacecraft are similar.

Here is the sequence for spacecraft:

When the spacecraft is located, a smoke bomb is dropped to check wind direction, then the aircraft (usually a Douglas SC-54 *Rescuemaster*) flies into the wind at an altitude of about 1200 feet. When it is over the spacecraft, it drops a spotter chute which always drifts downwind. The chute is weighted to approximate the weight of a fully equipped pararescueman.

On the next pass, also upwind, the crew clocks the time it takes the airplane to fly from the chute to the spacecraft and, when the plane has flown the same number of seconds on the opposite side of the capsule, two frogmen jump.

Using this system, they have landed as close as 10 feet from the capsule.

When his main chute opens, each pararescueman discards his spare chute while still airborne and deploys his small rescue raft and first-aid kit at the end of 10-foot droplines. The raft automatically inflates on the way down. Just as his feet touch the water, the pararescueman releases his

chute which billows away in the wind, and he is now a full-fledged frogman.

Next, the two-man team joins up, orients itself on the spacecraft and swims to it, dragging their rafts behind them. (The rafts, kept only for emergencies, are seldom used. Or as one Air Rescue wag put it, "They're for frogmen who are afraid of the water.") If the sea is calm, they swim on the surface. If not, they can make better time underwater. Since they have been breathing oxygen from the time they jump, the transition is no problem.

Meanwhile, their aircraft has circled the scene and, when the two of them have reached the capsule, the plane makes a low pass and free drops (without parachute) a special floatation device for the capsule.

If the astronaut is believed to be in serious need of medical attention, the plane will also drop an MA-1 kit, a more sophisticated medical first-aid kit which includes two large-size life rafts connected by a long, floating cable. Dropped upwind of the capsule, the MA-1 kit—the two rafts with the cable between them—floats down to the capsule and, like a South American cowboy's *bola*, wraps itself around the capsule where the pararescuemen can get at it.

When the special floatation device hits

(Continued to page 234)



PREFAB FIREPLACE— OF BRICK

INSTALLING A FIREPLACE, either in a new home or as an add-on to a finished house, is greatly simplified with a new prefabricated-fireplace unit designed to be installed in a single day. Basic unit in the prefab kit is a heavy steel form which provides the smoke dome, downdraft shelf, damper, throat and firebox in the proper positions and proportions to insure efficient, smoke-free operation. Slip-fitting intermediate chimney sections fit on the form and connect to a prefabricated exterior housing that looks like a brick chimney.

Installation is simple (see cutaway at right). After pouring an eight-inch concrete pad (over suitable foundation unless the fireplace will rest on a slab), the steel form is placed on a firebrick hearth and surrounded with concrete block on three sides. Face brick is laid on the exposed face. The intermediate sections are fitted together and extended through a hole cut in the roof, then connected with the exterior housing through a prefabricated chimney flashing. The entire job can be finished in as little as 10 man-hours on a one-story home. Forms are available for either front-opening or corner fireplaces; the corner style is shown.

Cost of this do-it-yourself installation was \$273 for the prefab unit, five feet of chimney sections and a six-foot chimney housing. Materials for installation—masonry and lumber—cost another \$78, for a total cost of \$351. The cost on simpler fireplaces can be as low as \$235.

The unit shown is the Heatilator, 500 Series, made by Vega Industries, Inc., Syracuse 5, N. Y.



LIVING ROOM before, above left, and after, above right, corner fireplace installation

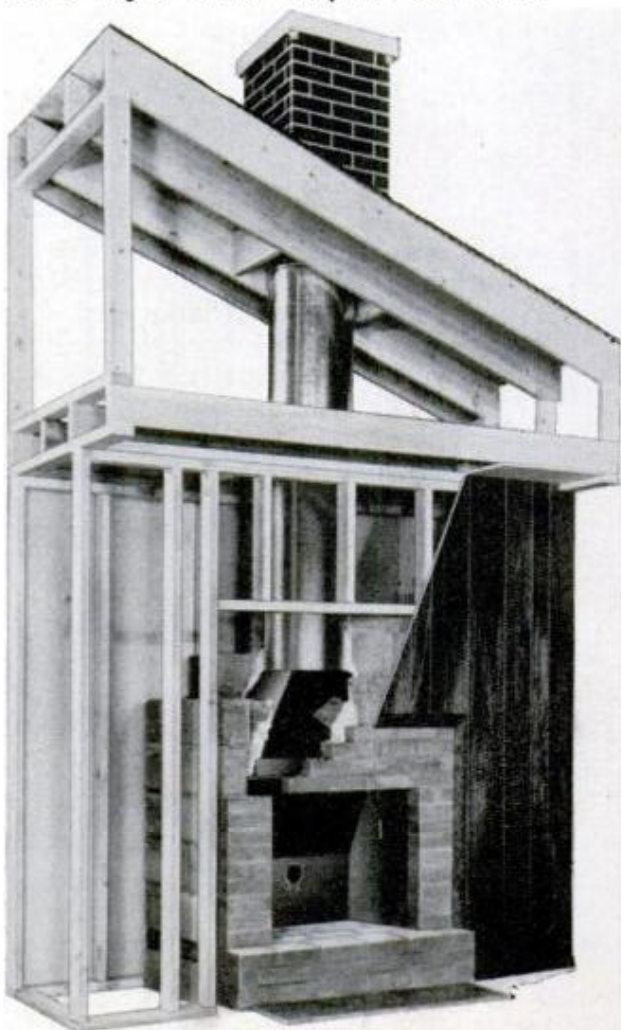



FINISHED FIREPLACE, with masonry and paneling concealing prefab, passes easily for original equipment
WITH FOUNDATION laid through basement, base form goes in place, below left. Right, frame for paneling



APRIL 1962



111



SILENCING SYSTEM installed on T-Bird (top) has no conventional mufflers. Cutaway above shows resonators

Exhaust Pipe "Hot Dogs" Replace Muffler

LOOKING LIKE king-sized hot dogs, hollow resonators, located inside the exhaust pipe itself, may well replace conventional tube-and-baffle mufflers on one or more 1963 cars.

The new silencing system, called ArviNode, consists of an oversized exhaust pipe 2¼ inches in diameter containing 1½-inch-diameter resonators welded to the top. Most such systems require five or six resonators of varying lengths.

Here's how the systems work: As sound

waves reach the resonators, (which have small openings in one end), the resonators are in turn activated and create sound waves of their own which pulsate back against the original sound pressures, causing them to diminish or fade out completely.

The novel "hot dog" system is said to last 2½ times longer than a conventional muffler, because the bottom of the exhaust pipe is clear throughout its length. This permits a direct flow of hot gases, reducing the accumulation of dirt and corrosive liquids.

COMPACT PIPES containing resonators, shown next to frame members in the cross sections below, will enable designers of future cars to lower floors due to elimination of bulky mufflers (dotted lines)

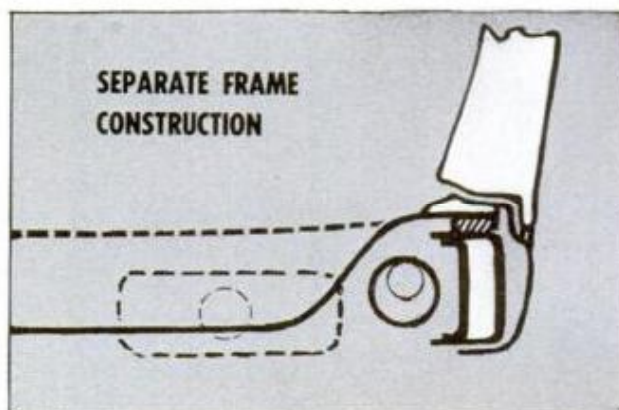
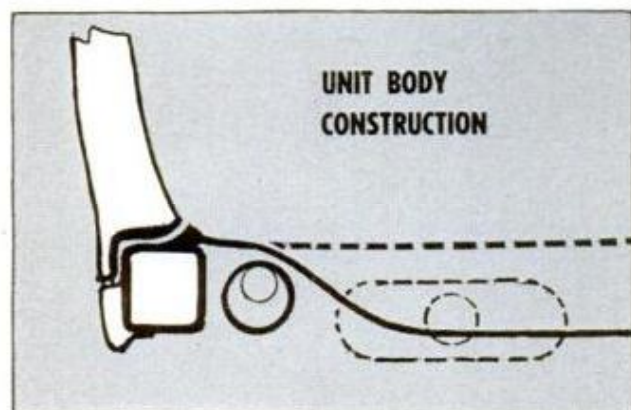

Don't Let the Cries of Doomsday Panic You...

Despite some muddy emotionalism over the value of shelters, research studies show that life unquestionably would go on after the bomb. Here are the facts and figures

By Richard F. Dempewolff

IT WAS TYPICAL fall weather on the day that 263 nuclear weapons struck 224 targets inside the United States. We had been blasted with 1446 megatons of explosive. Before the day was out, an additional 2500 megatons would soil the heavens over U. S. overseas bases and in retaliation against the enemy homeland.

The enemy had hit us with the most destructive punch he could throw—and that's just the way we had planned it.

For this was a theoretical attack, plotted by scientific and military experts to determine the extent of death and destruction which would result from a nuclear war. All weapons had hydrogen warheads. In power they ranged up to 10 megatons (huge bombs like Russia's threatened 50 to 100-megaton monsters would militarily be wasteful and inefficient). All were detonated with the fireball kissing the earth's surface to suck up maximum material, to produce maximum destruction around point zero and maximum fallout at vast distances. Actual weather patterns were used to determine long-term fallout effects.

And what were the results of this theoretical but nonetheless horrifying attack? That 50 million *unsheltered* Americans would die. But the U. S. Congressional subcommittee on radiation, in reporting on these findings, put the matter this way:

"The most significant finding," said they, "was that civil defense preparedness could reduce the casualties from approximately 30 percent of the population to about three percent."

Even if this were to bring the terror within the bounds of comprehension, though, it still does not answer the nagging questions about what happens after the attack is over. Thousands of Americans—debating in their own minds the value of shelters, have wondered: What kind of hunger- and horror-ridden world would we find after such an attack? What would we do for food, water and shelter? How would we support ourselves and families? Who'd care for the sick and dying?

What would life be like? Would survival be worthwhile?

Shadows hidden from the killing

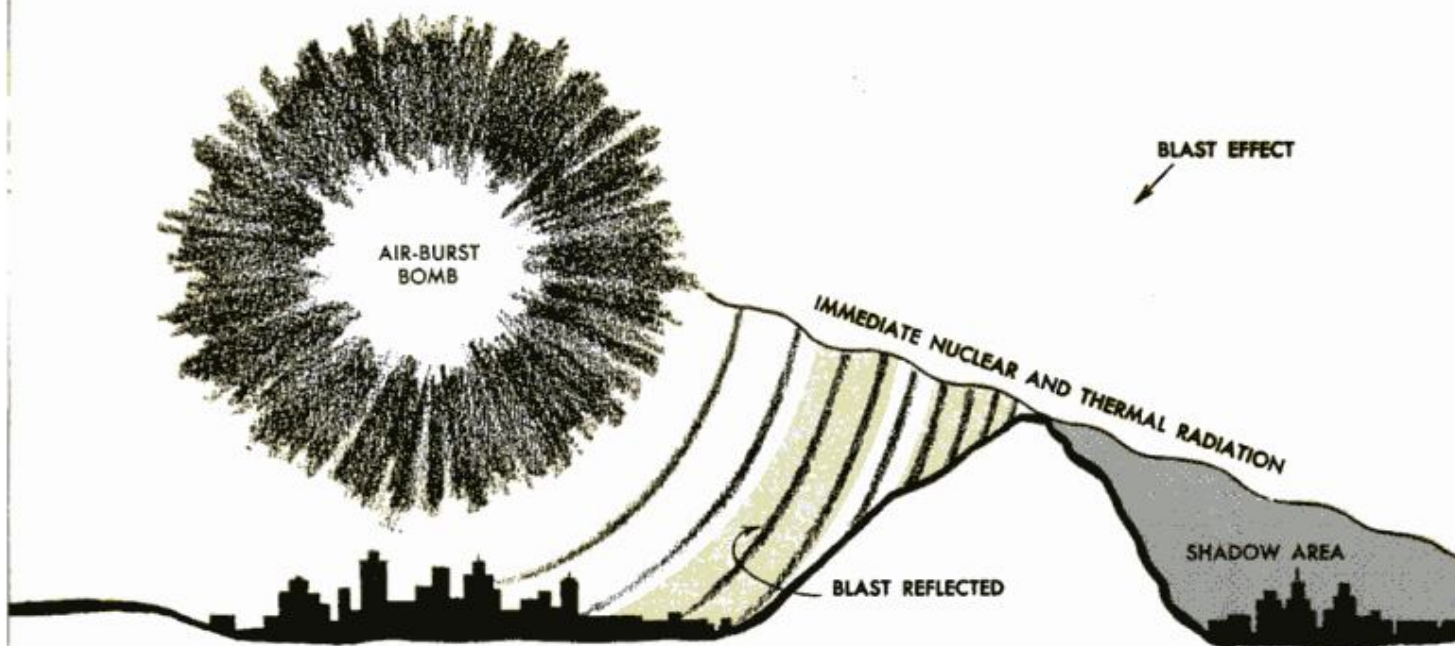

To find answers, *Popular Mechanics* sent me on a tour of government agencies involved in a whole new flurry of post-attack planning.

Here's what I found.

Even after a devastating assault as bad or worse than the one you just read about, some 96 percent of our land area would be virtually unchanged! If you live anywhere in that broad territory and, after two weeks or so in a shelter Conelrad advised safe radiation levels, you would emerge to find your town looking about the same as ever. Some things would be different. No birds would be singing. Evergreen trees and shrubs—highly sensitive to radiation—might be brown or browning. Some small vegetation may have wilted. There probably would be no animals in evidence. But it would be far from the silent world of hot rubble often conjured up. In most places there would be considerable human activity.

Make no mistake; the picture wouldn't be all that pretty. There's the other four percent of the country. It would total 144,600 square miles of wreckage.

"We are dealing with twin national problems," explained an official at the President's Office of Emergency Planning. "There are the scattered areas of heavy damage filled with refugee and sick, mountains of rubble and no housing. This is a rebuilding job. A survivor here, when he comes out, better forget everything and run. Little immediate help can be rendered for these areas. They will be awful.

"But on the peripheries of blast areas and beyond are vast undamaged rural

lands, thousands of villages, towns and cities, intact except for temporary fallout. These areas can and must function to carry on the nation's work. We start with them."

That's nice to hear. But who's going to start what?

Chances are that for the first few weeks you'll shift for yourself. Neighbors will band together to prevent looting and help each other. Volunteer organizations will take over any emergency situation until State and Federal plans get under way. Will there be any food available? Food and farmers, according to Department of Agricultural spokesmen, will be in good shape.

Why won't food be radioactive? Officials point out that an astounding number of people have a grossly mistaken idea about fallout. There's nothing spooky about it. It is a substance like dust or dirt. It falls to Earth like dust. It can be washed away or swept up and removed, like dust. Unlike ordinary dust, it gives off X rays that can damage living tissue, which is why people must hide from it behind dense material that stops the rays. But fallout radiation decays fast. In two days it is less than one percent of what it was at one hour.

One thing many people don't realize is that in most places they will be able to leave their shelters for short periods—to replenish food stocks or dispose of wastes—within a day or two of any attack. The point is that the rays are not injurious to inanimate material, nor can they contaminate anything. The dust is the contaminant. If it gets into food and if you eat the radiating dust particles, you will be irradiated.

In even the heaviest fallout areas, many

sun can provide safety

ENTIRE COMMUNITIES could survive a bomb blast unscathed if they sit in deep valleys, behind hills, or if they are blocked from thermal and blast radiation by massive brick and concrete buildings. The people would have to protect themselves against fallout. The point is illustrated by this loaded propane tank which survived a multikiloton blast less than a mile from ground zero in a Nevada test. It was shielded by bulk of damaged house



OVERPRESSURE FROM BLAST
IS MINIMIZED HERE



packaged foods in markets will be safe to eat immediately after an attack. All they'll need is a washing off (on outside of package). Other things, such as vegetables, can be scrubbed clean and consumed. Water from covered wells will be useable. So will surface water, once particles have settled out—probably in a month, studies from Emergency Planning show. (Geiger counter check required.)

Plans are in the works for special government-directed teams that will redistribute ready foodstocks so everyone will have enough. Measures are going before Congress for moving grain stockpiles to fallout-protected silos, located just beyond blast diameters around probable target cities that would become obvious distress areas.

What about replenishing food stockpiles? Studies show the average farmer faring better than anyone else. Most of our farm and range land lies in what planners call "white areas," where fallout in any attack pattern useful to the enemy would seldom exceed $\frac{1}{10}$ roentgen per hour.

"Many farmers," says the Department of Agriculture, "have already provided some fallout protection for their livestock. A barn with slate roof that could be hosed down would be adequate. Most farmers, except those downwind of a detonation, could be feeding and milking within a day of attack under fair to good conditions.

"Truck gardeners will have no more trouble with fresh vegetables than they do in handling them after use of poison sprays. They'll have to be washed clean. Some young plants and legumes (peas and beans) will have to be monitored since they like

calcium, and tend to pick up from the soil its insidious fallout cousins, strontium 90 and cesium 137."

Long-term radiation effects on foodstuff aren't too accurately known, so a number of conclusive experiments are now going on to find out. One thing the physicists have learned, however, is that seafood rejects radioactive strontium 90 and cesium 137—longlived and serious health hazards that are by-products of nuclear fission—and sea life is highly protected by its element from other fallout products. So fish diets would undoubtedly find a place on far more menus following any nuclear attack.

Department of Agriculture scientists say fallout radioactivity can be removed from fields by scraping away the top few inches of soil. Further, they've found heavily limed fields pass to crops less strontium 90 than do unlimed.

Other reports, covering long-range effects, and developments to minimize effects of radiation are emerging from other labs. Two biologists from New Mexico Highlands University, for example, have found that nuclear blasts at the Nevada test site (where more atmospheric detonations of nuclear weapons have been made than at any other location in the free world) although immediately destructive to plants, appear to have little effect on the return of hardy, pioneer-type vegetation. They found that plants within a range of one-half mile were eradicated by heat and shock of blast, but with the next growing period, the plants were springing up within the central

For radiation patterns, see next page →
(Story [continued on page 222](#))

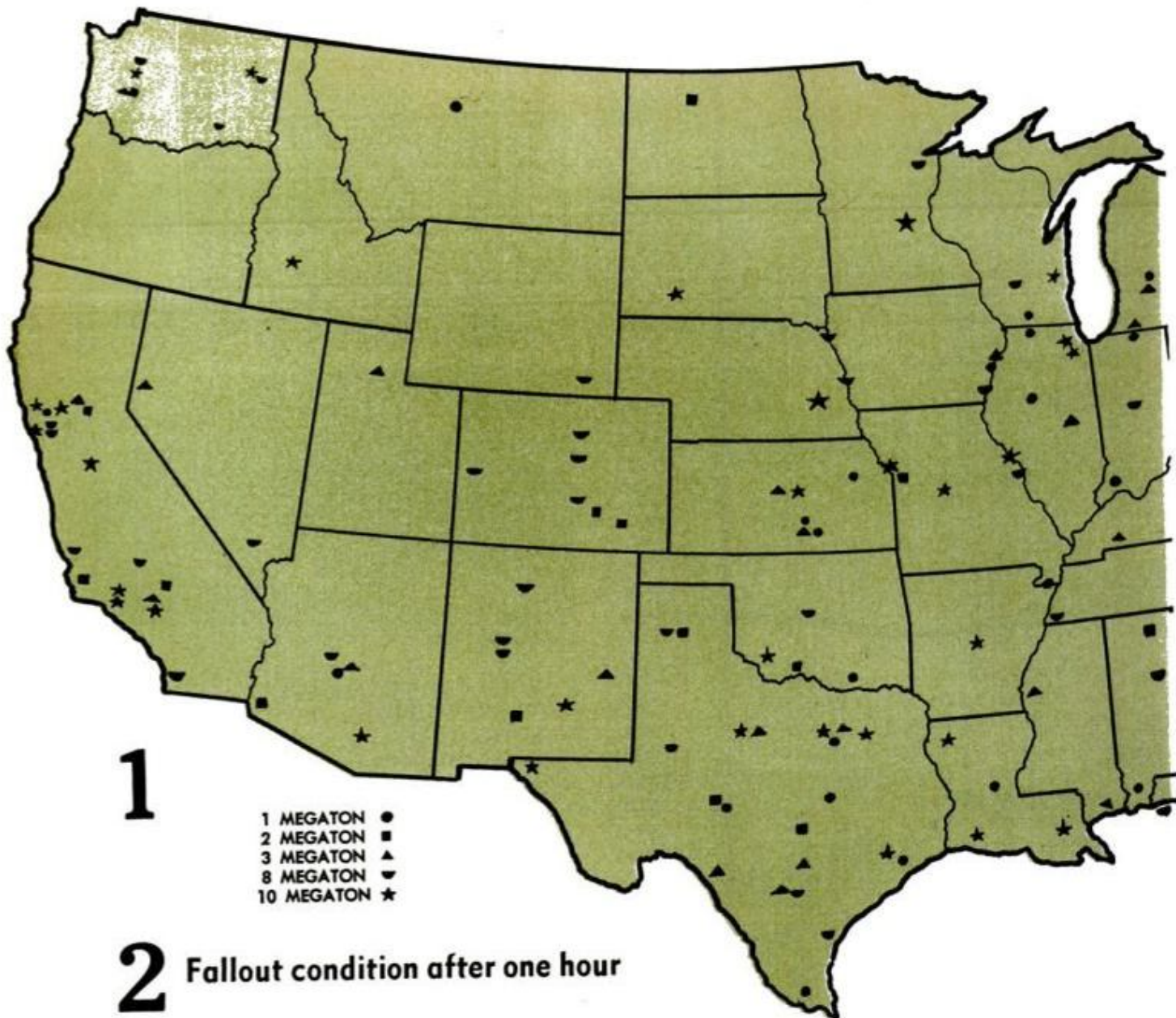

Pattern of Fallout in a Hypothetical War In Which 1400 Megatons Hit U. S. in One Day

NUCLEAR RADIATION is measured in roentgens or rems (roentgen-equivalent-mammal). One rem effects living tissue the same degree as does one roentgen of X ray. Two hundred rem in one day will cause nausea in half of any group; few would die. All would be sick, half would die within 30 days after 450 rem. A 600-rem dose would kill most of any exposed in hours. In the hypothetical attack described, instant radiation up to 700 rem two miles from each 10-megaton burst, and 1.5 miles from 1-megaton bursts were recorded. One hour after attack some 10 percent of country lay under fallout drizzle exceeding 3000 roentgens per hour in some places. In seven hours, some radioactive cloud patterns from single blasts stretched 150 miles downwind, emitting 450 roentgens per hour at edges, 3000 at the core. After two days, half of nation was blanketed but due to natural decay, intensities were down to maximums of 30 roentgens per hour. Two weeks after attack, only a few pockets exceeding 1/10 roentgen per hour were left.

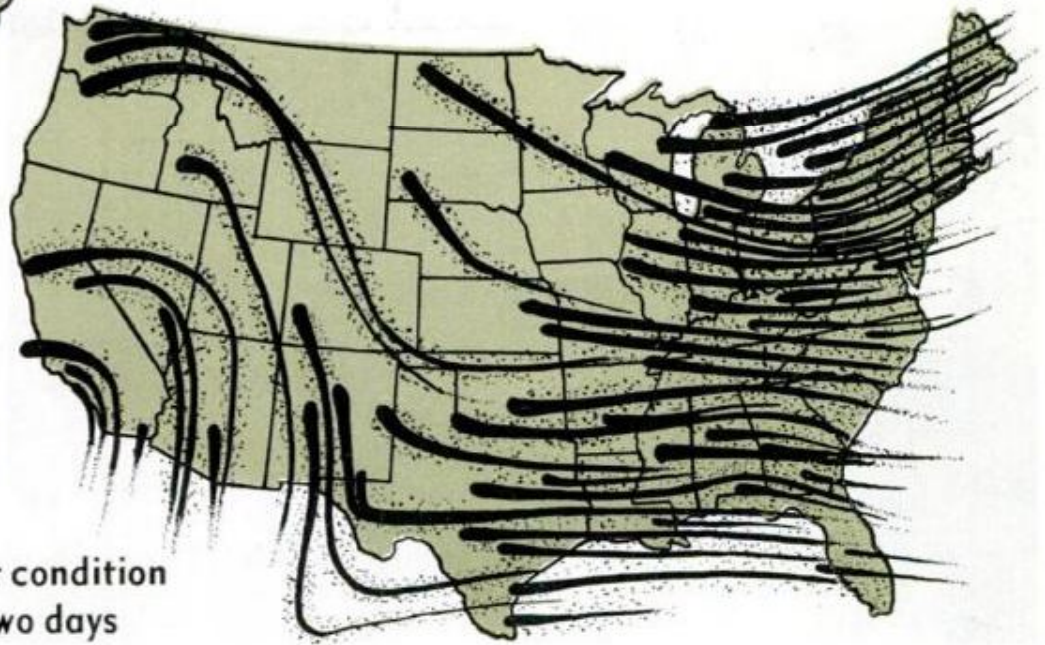

3 Fallout condition
after two days



4 Fallout condition
after two weeks

I Fished the Finest Spot in North America

IT WAS A DREAM ASSIGNMENT. The boss asked, "What's the best fishing spot in North America?" While I mulled over the legendary waters from Mexico to Alaska, he went on, "When you've made up your mind, go there and prove it." Any fisherman would have jumped at the chance, and I did. Three days later I wished I had never been asked.

What makes a good fishing spot? Lots of fish? Big fish? Good action every day, all season? A variety of species? Comfortable accommodations? Easy access? There are a dozen factors to be considered, and your ideas might not agree with your neighbor's. Add to



**WORLD'S FINEST
AIRPORT WAITING ROOM**

By Dick Kirkpatrick
PM's Outdoors Editor

TAZIN LAKE trout at the awkward stage—too big to eat for lunch and too small to keep. Taken near the surface on spinning tackle, this 16-pounder put up a fight to belie the laker's reputation

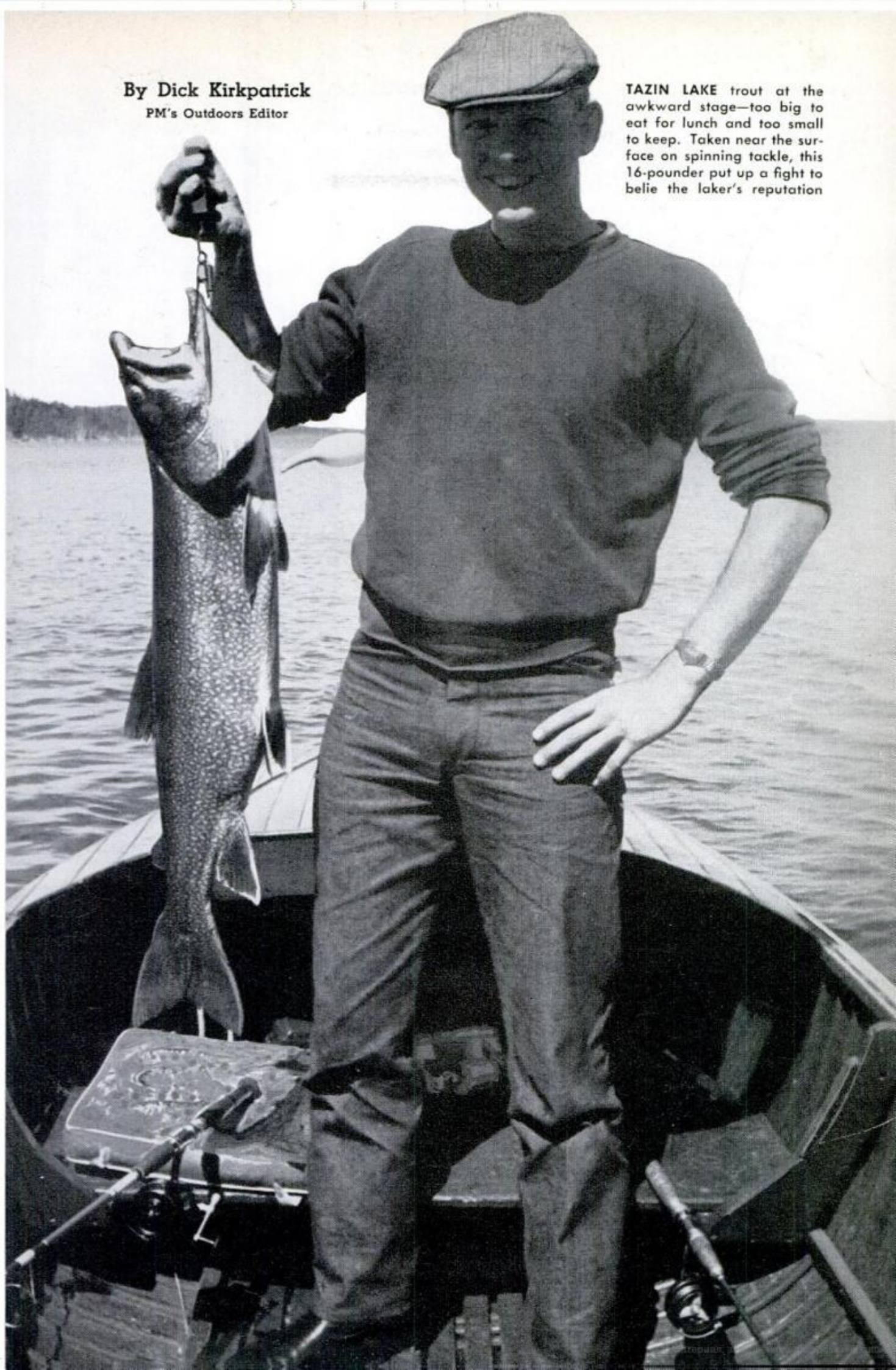

Keepers!

that the fact that, to mean much to a nationwide audience, the location should be a freshwater spot centrally-enough located to be fairly easy to reach from anywhere in the United States.

After considerable research, the pattern became apparent. For really big fish, I had to find lake trout or muskies. Lakers are a lot more reliable when you're fishing in a limited time—as most of us must—and they usually cohabit with other good sporting species such as northern pike, other trout and walleyes. And to get away from the beaten path, the over-fished waters I had to go north—a long way north—but still stay in an area that anyone could reach.

As I interviewed fishermen, sportswriters, bush pilots and resort people, a new name began to crop up—Tazin Lake. Several people had heard of it, but nobody knew for sure where it was. It was a newly opened lake. Only 26 men had fished it the year before, and two had put lake trout in the top ten of a national fishing contest; one 44½ and one 41½ pounds. Two for 26 is an unheard-of average.

Tazin Lake turned out to be almost hidden in the extreme northwest corner of Saskatchewan, north of Lake Athabaska and south of Great Slave Lake, on the Slave-Mackenzie watershed. That country is famous for monstrous lakers—Athabaska yielded a 101-pounder to a commercial fisherman last year—but is neither too far north for northern pike and walleyes, nor too far south for greyling. Despite its remote location and unfished reputation, the lake turned out to be only 20 miles or so from Uranium City, Sask., a bustling mining town named for its main industry and a regular stop on a scheduled airline. That fulfilled the access requirement.

Even Rejects are Impressive



A KEEPER, this trout just made the 25-pound mark to qualify for the ice house and a trip home in one piece

SIGHT TO BRING TEARS to the eyes of a prairie fisherman—guide Chummy Heron puts an 18-pounder over the side to grow up. After the initial shock the visiting fisherman becomes accustomed to this sort of thing; some even manage to smile as he swims away



HAPPY FISHERMAN with a pair. Twenty-pounder is a mite light, but could you have watched it go back in?



THREE from the ice house. Vince Pullar shows off three trout in the 30-pound class on their way out to taxidermists. This batch of six (three more in truck) stopped traffic even in Uranium City

Getting up there isn't as hard as it looks; there are two alternatives. At least one Canadian air service, Parsons Airways, Ltd., of Kenora, Ont., makes weekly trips to Tazin Lake, flying in fishermen on a seven-day package deal. Or you can make your arrangements separately with Tazin Lake Lodge and fly in commercially to Uranium City. The hop to the lake is no more trouble than grabbing a taxi across town; a local air service covers the area nicely with several float planes.

A lot more trouble than actually making the trip was packing for it, and keeping my gear somewhere near the 40-pound weight limit, which pertains whether you fly commercial or charter. (Canadian airlines, however, usually allow 44 pounds.)

By using a salmon bag instead of a tackle box, making tackle do double duty, carrying rods in a cloth bag instead of a metal one, and keeping accessory gear to a minimum, I managed to leave home right on the nose at 40 pounds. I made light clothing do heavy duty by combining down-insulated shirt and pants with a nylon-and-rubber two-piece rain suit in place of heavy foul-weather gear. A couple of pairs of fishing slacks and a couple of warm shirts filled out the necessary wardrobe nicely. They don't dress for dinner at Tazin Lake Lodge.

I flew from Chicago to Uranium City by way of Edmonton, Alberta, a two-day trip if your reservations work out. At the McMurray Air Service base, waiting for the hop into Tazin Lake, I made one discovery



CANADA'S most gracious custom, the shore lunch. Fishermen watch while guides cook fillets on an island

—the world's finest airline waiting room. The small lake that serves as a landing field was alive with northerns, and they were as hungry at the end of the air service dock as they were anywhere. The natives, spoiled on Tazin and Athabaska lakers, scoff at the "snakes," but they beat sitting around any air terminal I've seen.

As I arrived at the airline office, I met a party of 10 fishermen on their way out after a week at Tazin Lake. The fishing had been great, they reported; six of them were taking out lakers over 30 pounds for mounting. Things were looking up.

A sudden batch of wind kept us from flying to Tazin Lake that afternoon, but next morning we made the short hop over the rocky hills to Tazin Lake Lodge, which sits on an island alone in the middle of the 25-by-10-mile lake. Flying in over the lake, you understand how it got its name, which means "black water"—the water is so clear and so deep that it looks like clear coal.

Tazin Lake Lodge is an orderly collection of log buildings—cabins, dining hall, out-buildings and, so help me, a steam bath—built mostly of native materials, since everything else must come in by float plane. Built by former Ontario outfitter Bill Pullar with his wife, Agnes, and son Vince, the place isn't fancy, but it's comfortable, and has a staff of 15 to handle 20 fishermen.

My host was Vince Pullar. He introduced himself, led me to a cabin, introduced my guide and fishing partner, Richard "Chummy" Heron, and suggested I go fishing. I did.

Chummy and I started fishing after a half-hour run across the lake (fishermen *always* go across the lake, no matter how good the fishing is off the end of the dock), casting a rocky shore line with wobbling spoons. After fifteen minutes with no

strikes, I asked what happened if we didn't catch a lunch fish. Chummy admitted that, while he'd been there since the camp was started, that had never happened. At eleven o'clock you started looking for a lunch fish, a nice three or four-pound laker, and by noon you'd found one to suit your taste. Ten minutes later we had two to pick from. They were excellent.

I insisted on casting with light tackle and half-ounce lures most of the first day, looking for big lakers on the surface, since Tazin's surface water is cold enough that they need never go deep. We caught enough trout—and an occasional northern—to make a great day anywhere else, but nothing over six or eight pounds. Lunch fish, Chummy called them. After a wild furry two days before, during which the party of 10 had taken their trophies, the bigger lakers had disappeared from the surface waters. Switching to heavier tackle and big wobbling spoons as we trolled toward the lodge for dinner, we found better trout in the middle depths—20 to 30 feet down produced an occasional 10 and 12-pounder.

Don't let any southern bass fisherman knock the laker as a game fish. Dredged up from 120 feet of temperate-zone water, as in this country, they're pretty tame compared to sportier surface-feeders. But taken near the surface on bass-and-lighter tackle, they're tough. They won't jump like a rainbow, but they fight as hard and last twice as long. Their fight is mostly vertical as they dive toward the rocky bottom. Given enough line, they'll rub off a lure or tear off a light line easily. And on six-pound spinning tackle, an eight-pounder can take it down against your will pretty easily; a 12-pounder is a real handful; better than a lot of big northerns and as well as most still-water trouts.

(Continued to page 200)



Miners Dig Cavern in Granite to Store Gas

After 13 months of mining, engineers recently hewed out a cavern from the granite 380 feet below the Sun Oil Co. refinery at Marcus Hook, Pa. They then faced the problem of removing the air from that mammoth cave—it embraced 2.2-million cubic feet—since the hole was

for storage of propane, and air would make the atmosphere explosive.

Some 112 tons of carbon dioxide were pumped in by the Chemetron Corp., forcing the air out the exit. Eventually 400,000 barrels of propane were pumped into the hole, displacing the carbon dioxide.

Primitive Weapons Guard Our Jets



PRIMITIVE NEGRITOS, Asian pygmies, guard supersonic jets at Clark Air Force Base in Philippines

NEGRITO NATIVES lived in the Philippine Islands long before Magellan.

Today, relatively unchanged, they guard the supersonic jets of the United States' Air Force—with poisoned darts and arrows.

This strange juxtaposition of aborigines and a modern fighting force is the product of recent history. During World War II, the Negritos—whose pygmy ancestors settled there 30,000 years ago—fought bravely with American guerrillas against the Japanese, and won the undying gratitude of the U.S. government. Usually they would ambush Japanese patrols with their poisoned weapons, but some accounts credit them with stealing into Japanese camps at night and beheading the sleeping soldiers. The Japs offered a reward of 1000 pesos (about \$500) for the capture of any Negrito.

After the war, the Negritos were offered jobs at Clark Air Force Base and other strategic locations. They patrol Clark's 23-mile-long perimeter, moving silently through the man-high grass that surrounds the field and, with weapons used centuries ago, protect America's modern air might.

NEGRITO GUARDS, who seldom reach five feet tall, work closely with much bigger American air police



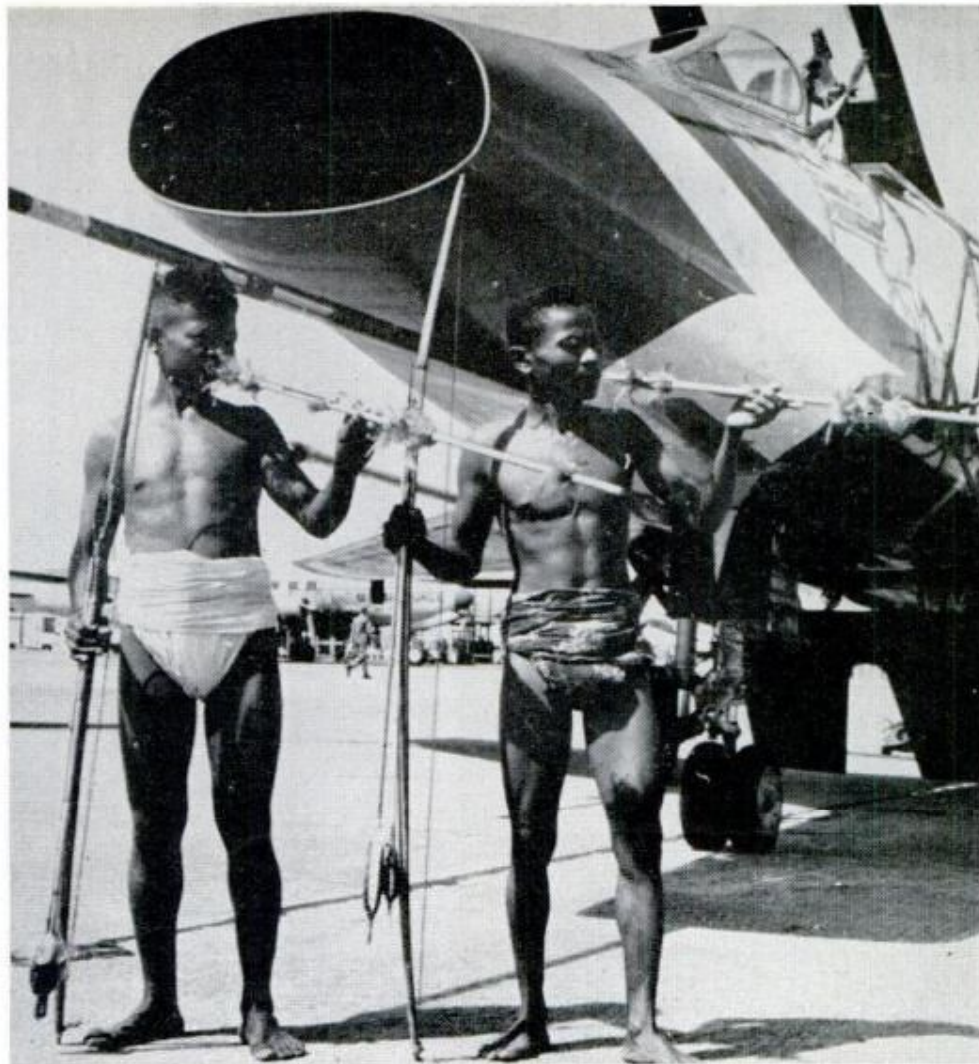

YOUNG NEGRITOS pose before F-100 jet and display their primitive weapons—bows, arrows and blow guns

ARROW TIPS, ground from scrap metal, are dipped in poison made from garlic, roots and snake venom

STANDING UP in cockpit of modern fighter, young aborigine holds up blow gun, centuries-old weapon

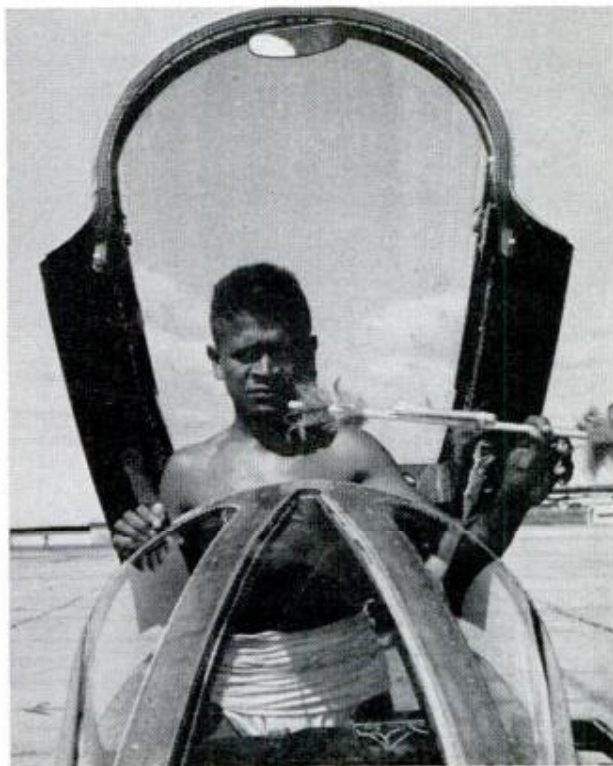



BARBECUING NEEDN'T STOP when summer ends. Steaks, hamburger, chicken and other foods can go right on sizzling with Manesco's (Manhasset, N.Y.) Charco-Broiler—a stainless, gas-fired kitchen unit that evenly distributes heat from a bed of ceramic coals that don't deteriorate

WHAT'S NEW FOR Your Home



A WALL HAT RACK without screws or nails, this adhesive-backed plastic rack sells three for \$2. Cornelia Sales, Cornelia, Ga.

HANDY DOLLY, a wheel and spring with dual hooks, slips under a can or barrel which can then be wheeled easily. \$2.98 ppd. from Pocket Dolly, 1216 S. Lorena St., Los Angeles 23, Calif.



QUICK FASTENER applies snaps to clothing you make or for repair jobs. Also handy for matching socks on washday. \$4.95 with a pack of snaps—from Zip Co., 600 Pleasant Ave., St. Paul, Minn.



ELECTRIC, PORTABLE and smokeless, Rival's Broil-O-Mat uses "Air Space" design to turn out tasty tableside food with a cook-out flavor. It's available at retailers for \$9.95 complete



MISSILE RESEARCH developed tungsten carbide plating that Robeson Cutlery (Perry, N. Y.) coats Flame Edge knives with, to make a super-hard cutting tool that stays sharper longer. From \$2.25, depending on size, at retailers

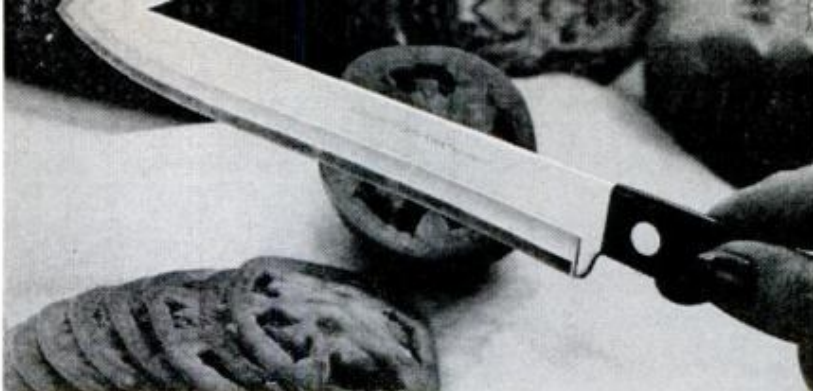

SPACE-SAVING GARDEN CART is an easy-to-handle yard helper with a six-cubic-foot capacity. With a flexible steel bottom and fabric sides, the cart collapses for storage in a small space or for hanging on a wall. If the canvas fabric tears or becomes soiled, replacements are available. The cart weighs 18 pounds. The Snap-Flat cart is available for \$14.45 ppd. from the manufacturer, Zik Mfg. Co., Box 525, Lancaster, Pa.

BUSY MOTHERS need not stop to give baby a bottle. Nurse E-Z bottle holder by Nel-King Prods., 811 Wyandotte, Kansas City 5, is flexible, adjustable and attaches to a crib or high chair. \$9.95 ppd.



JUST SKEWER FOOD, lift, squeeze the handle, and the pusher ejects the food. This Hand-E-Fork is a new stainless spring-steel serving fork to aid in serving hot and cold meats, fowl and baked potatoes. It needs no polishing to keep it from tarnishing. Packed in a plastic gift box, Hand-E-Fork is 8½ inches long and has no breakable parts. It's \$1.98 ppd. from Hand-E-Fork, P.O. Box L23, Calabasas, Calif.

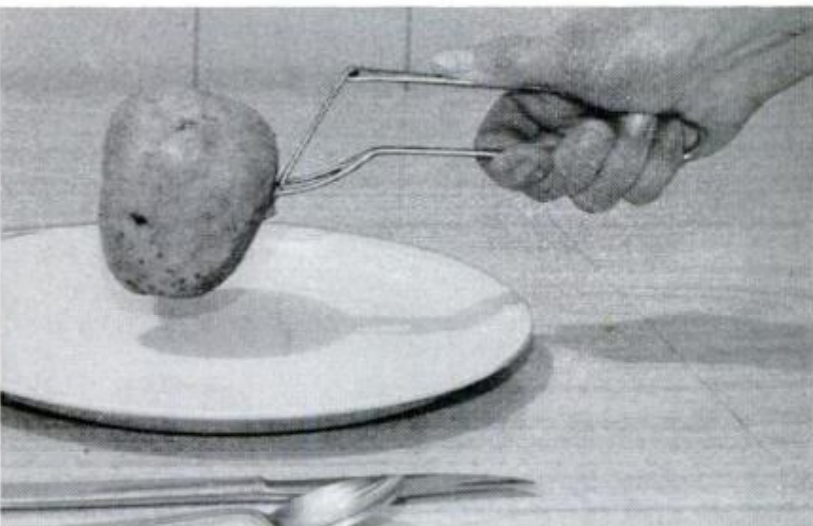

ARMLOAD OF POWER

*Pigmy power plant
charges batteries,
is handyman for
boaters, campers*

By James Joseph

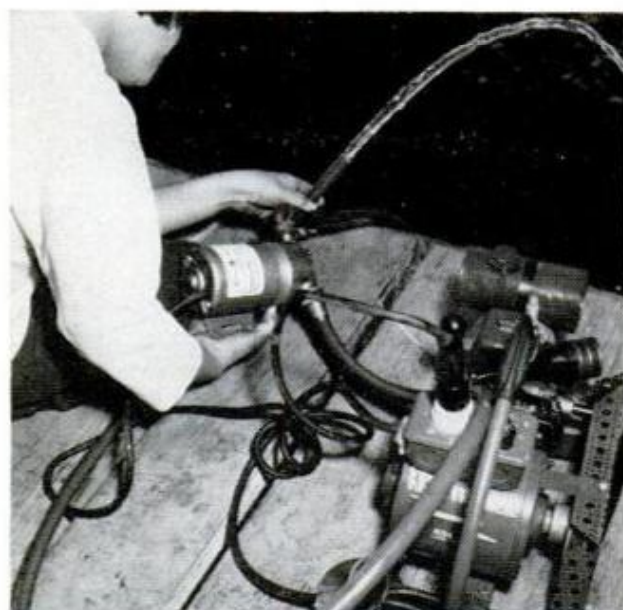
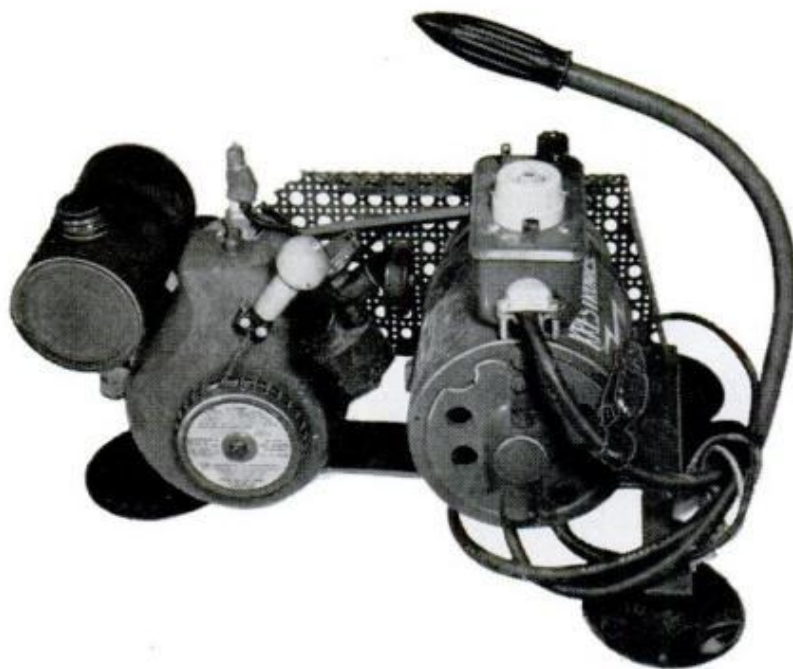

TINY PLANT, teamed with pump, moves 250 gallons of water an hour. Marina operator swabs pier, decks



CAMP LIGHT is powered handily by 200-watt plant. In use, it would be stashed in woods out of hearing

IN THIS AGE of miniaturization, good things keep coming in smaller packages. One exciting new result of thinking small is a 22-pound power plant that can generate both 110-volt, 60-cycle alternating current, and 6 to 12-volt direct current.

It can recharge a car battery, pump dry a flooded basement, power a boat transmitter, or perform hundreds of other chores around home or campsite.

Called Charge-R-Lite, the 200-watt unit teams a 3¼-pound, ¾-horsepower gasoline engine to an a.c./d.c. generator using 8 silicon diodes in place of armature and commutator windings to save weight.

128

Teamed together, they make a package 9 inches wide, 11 inches high and 16 inches long.

Exclusively field-tested by the author during a rugged 150-mile cruise of the lower Colorado River, the power team proved amazingly versatile both afloat and ashore:

- **Afloat**, it powered a searchlight, an electronic megaphone, and provided 110-volt a.c. electricity for predawn shaving; switched to d.c., it twice revitalized anemic boat batteries.

- **Ashore**, it simultaneously ran a 100-watt light and a phonograph, turning our

POPULAR MECHANICS

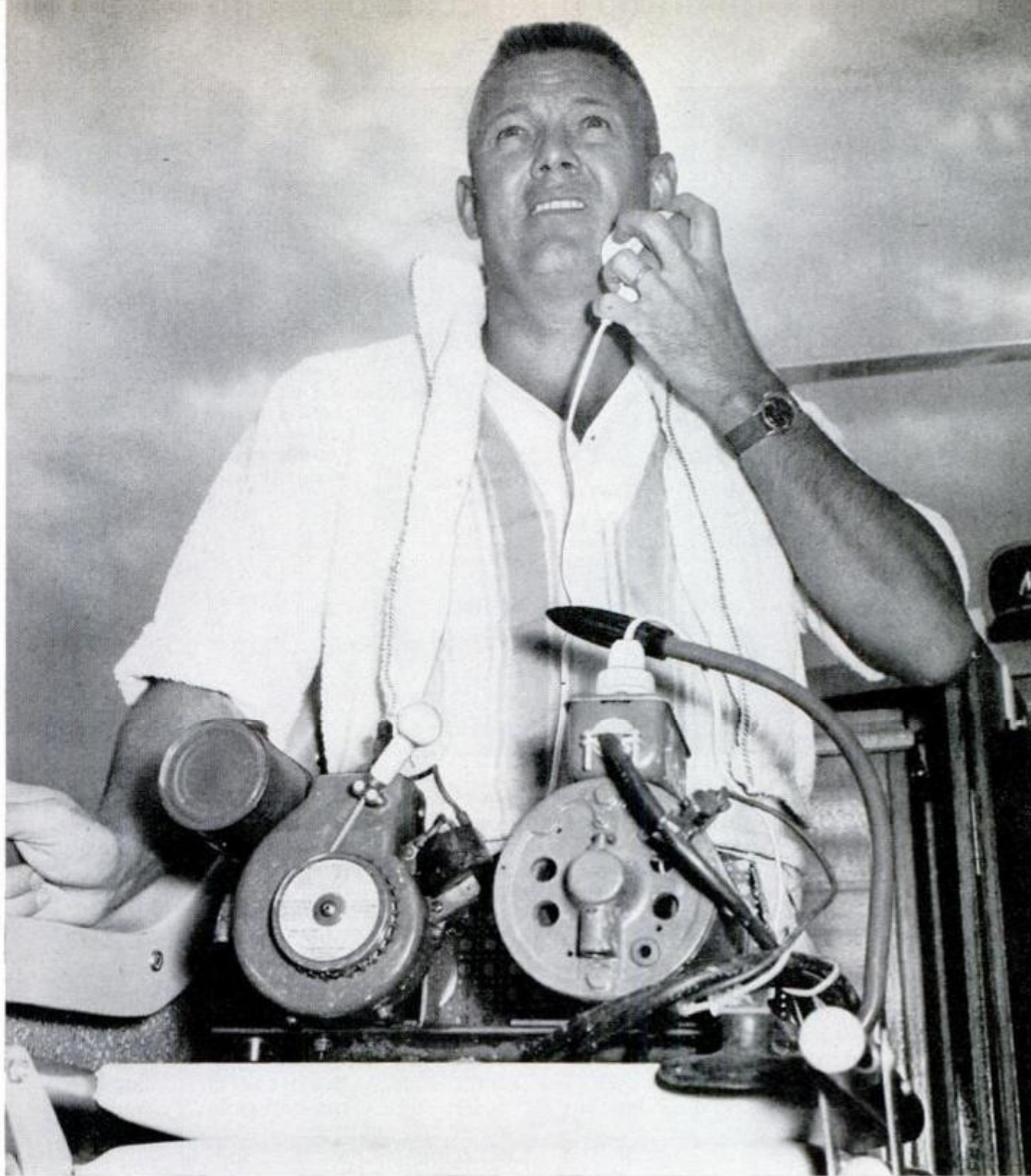

MORNING SHAVING aboard boat is no problem: Pull the two-cycle midget motor's starter cord, open the choke and it revs up to 6300 r.p.m., belt-driving a.c./d.c. alternator, supplying 110-volts a.c. for razor

sand-bar camp both bright and light-hearted.

It's also easy to use. Pull the starter cord on the two-cycle, air-cooled, single-cylindered engine, open the choke and it revs up to 6300 r.p.m., belt-driving the alternator at 3600 r.p.m. Plug a cord into the a.c. receptacle, or attach the two d.c. clamps to your battery's terminals and, with a flick of the a.c./d.c. toggle switch, you have lots of power to do lots of things.

This power plant will quick-charge boat batteries in less than 15 minutes, provide direct current for testing TV or be an electrical standby in a home shelter. Or it will

man a midget pump for draining basement sumps, filling house-trailer water tanks, or emptying the washing machine should it go on the blink. It uses only 1¼ pints of fuel (regular outboard motor oil-gas mix) an hour while performing such tasks.

While the tiny plant cannot run high-wattage appliances such as hot plates, coffee makers or portable tools (unless they're equipped with small brush-type motors), it has a surprisingly wide range of application, thanks to the recent spate of miniaturization.

"We'd no more than announced our power source than half-a-dozen manufac-



TO RECHARGE car battery, merely attach the power plant's d.c. alligator clamps to proper battery terminals (the positive clamp to battery's positive terminal), crank motor to start, then flick control switch to d.c.

turers hit the market with items which, being low-wattage, were just made for it," says the powerplant designer, Bernie King, president of Krestronics, Inc., El Segundo, Calif. Typical of the items is a \$29.50 pump, the Pony, made by Proven Pumps. It consumes only 115 watts, pumps four gallons a minute.

Pump and power plant can fill stock-watering tanks, irrigate garden patches, push descaling compounds through air-conditioning piping, pump out a boat's bilge, circulate fresh water in bait tanks or transfer most noncorrosive liquids (but hydrocarbon derivatives such as gasoline, benzene and methane may attack the pump's synthetic-rubber impellers).

The midget accessories, of course, are not designed for sustained operation. Says one engineer, "They are tools and, like other hand tools around the shop, they're meant for intermittent use, not for long, uninterrupted chores."

Charge-R-Lite, itself, is an example of such limitation. It does not have power enough to operate air blowers in a bomb shelter, but, on the other hand, it will provide power for lighting for a shelter. To keep fumes and noise out, however, the engine would probably need to be outside and an a.c. extension cord could be run to the shelter.

Although Charge-R-Lite is small, it is rugged—right down to its generator's fuse-sized diodes. They weigh, altogether, less

than two ounces but do double duty. Grouped in two tiny bridge circuits, they both self-excite the alternator's field coils and rectify a.c. to d.c.

Magneto Ignition

The engine (designed by Ohlsson & Rice, longtime makers of model-airplane engines) boasts magneto ignition. It has a tiny spark coil, condenser and standard 10-mm. spark plug; a governor which holds engine speed to a maximum of 6300 r.p.m.; carburetor, and drive shaft. Big in everything but size, it is 5¾ inches long and is 5¼ by 6 inches wide, fitting neatly into a fishing tackle box. Limited by its pint-sized fuel tank to runs of about 45 to 60 minutes, it goes six to seven hours on a gallon of fuel. Moreover its relatively high noise level can be hushed with a \$2.30 muffler. Since engine power is reduced by the muffler, King suggests stashing the engine out of sight and sound and bringing the power to camp with an extension cord. You can similarly isolate the unit afloat by planting it near the bow. Its three suction cups, which serve as shock suspension, hold fast to any flat, smooth surface. Simply run an extension cord to the cabin.

Priced at \$149.50, this carry-it-with-you power plant hands the boater a full-fledged auxiliary, the camper a back-packable a.c./d.c. supply, and the home-owner a portable tool as versatile as any in his shop.

★★★

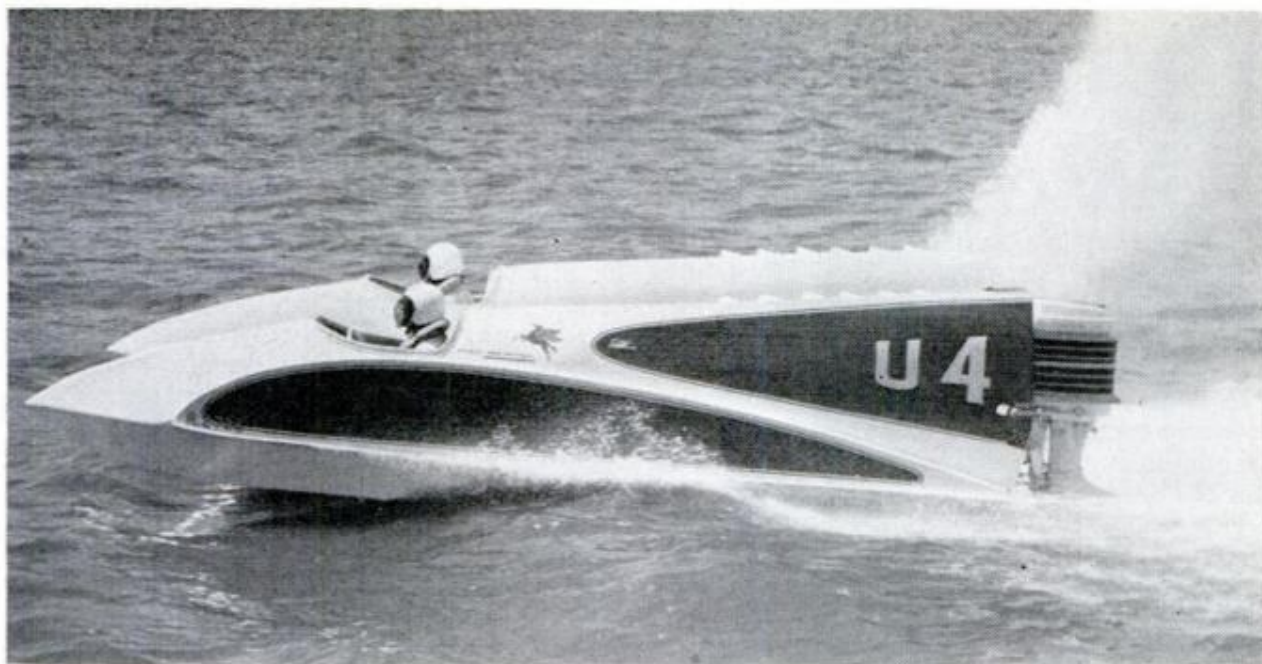

New Breed of "Cat" Features Four-Step Hull

Combined in a radical outboard "cat" are the stability and power tolerance of a catamaran with the speed of a stepped hydroplane. Powered by twin 80-horsepower outboards, the boat averaged 67.13 miles per hour over a choppy 65-mile course when it swept the pleasure-craft division of the WinnebagoLand Marathon in Wisconsin.

Built of marine plywood over foamed plastic for light weight, the 18½-foot, 8-foot-wide craft weighs 950 pounds, and planes high on four steps, two amidships, two aft. With the driver and passenger seated in twin cockpits in the main hulls, the deck between the hulls forms a thin airfoil section, and the craft takes on lines more similar to a true catamaran than the current run of powered cats. Lift from the airfoil, coupled with an air compression effect in the venturi between the hulls and under the center deck, gives the boat a very high planing attitude at speed, with a resultant

reduction in drag. At the same time, the four-step hull feature keeps the hull stable, and the design places the center of lift astern of the center of gravity to prevent "kiting"—the boat won't lift itself out of the water and flip.

Twin plywood fins cover the tall outboards to reduce air resistance, but air-scoops in the fins insure plenty of air for the motors. The fins prevent the motors from tilting forward, however; they're locked in position for racing.

Driver for the Marathon was Bob Switzer, of Crystal Lake, Ill.; passenger was brother Dave Switzer, who designed the craft. Their Switzer-Craft company will build the Hydro-Cat to order through their dealers; price will be \$2995 ready for motors. Tests are under way on another version, designed for a single 100-horsepower motor and expected to sell at approximately the same price.

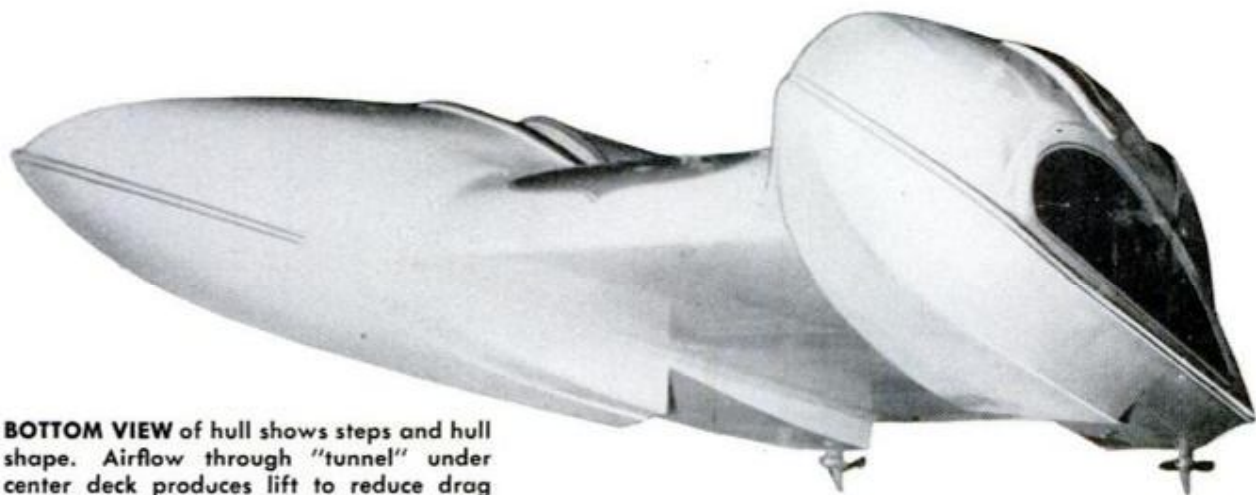

BOTTOM VIEW of hull shows steps and hull shape. Airflow through "tunnel" under center deck produces lift to reduce drag

You Can Win the War on Weeds

By
James N. Miller

WHEN YOU LAUNCH your offensive against weeds this spring, there'll be eight new killing chemicals that may help you win the war.

In addition to this arsenal, new and more effective tactics have been found for using chemicals and sprays that have been on the market before.

This good news for embattled homeowners and farmers—whose weed problems cost them about \$5 billion last year—comes from the government center for agricultural research at Beltsville, Md. There, an eight-man scientific task force, led by Dr.

W. B. Ennis, Jr., has proved that homeowners and farmers can keep their lawns and crops almost entirely weed-free by spraying these recently developed herbicides at recommended rates and times.

To combat crabgrass, the researchers recommend a pre-emergence treatment in spring before crabgrass germinates, using dacthal, calcium arsenate or zytron, which still are a fine trio for heading off crabgrass. One application of any one of the three gives good control for a full season. But don't apply them on soil that is to be seeded or that has recently been seeded.



Meet Some New Killers Science Has Discovered

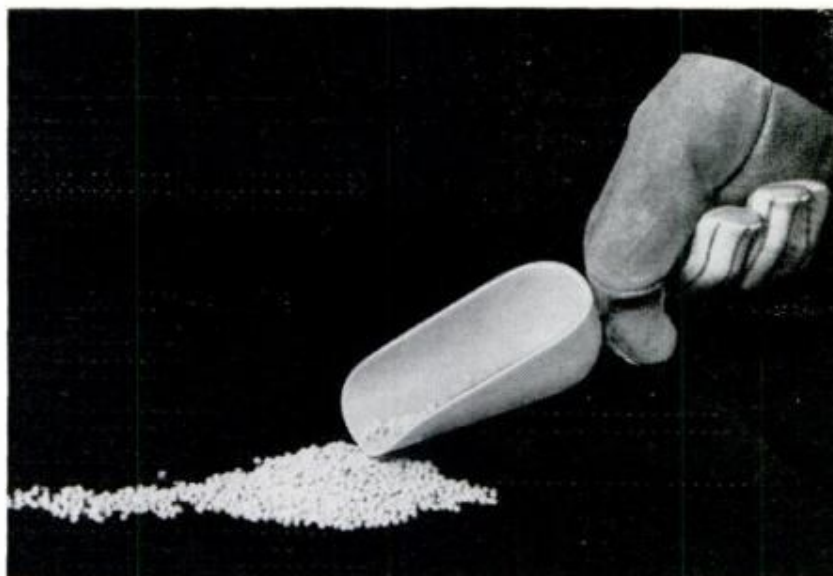

PILLS KILL TREES. Used primarily to rid large areas of unwanted trees, these fenuron compound pills (trade name: **Dybar**) attack root systems

*(E. I. du Pont de Nemours
Wilmington, Del)*



DMA (disodium menometheyl arsenate) or PMA (phenyl mercury acetate)—two of the eight new killer chemicals—give good post-emergence control of crabgrass. Starting soon after the crabgrass emerges, make three applications of one of these herbicides at 7 to 10-day intervals.

You'll need about 8 to 10 gallons of PMA or DMA spray for the average size front lawn of 50 x 100 feet. Total cost shouldn't exceed \$5. Where grass is quite short (as on a putting green) use PMA at half the usual rate and avoid its use on Merion bluegrass which it sometimes will injure. Apply DMA only to moist soil and keep it moist for a few days after each application.

For keeping strawberry plants weed-free, the newly-proven sesone (2, 4-dichlorophenoxyethyl sulfate) is the bright hope. Remove any existing weeds first, as sesone is effective only when applied to the soil, where microorganisms convert it from an inactive to an active form which is absorbed by the root systems of germinating weed-grasses and broadleaved weeds. Sesone should be applied at the rate of about three pounds to 10 to 20 gallons of water per acre.

To control plantain, dandelion and other broad-leaved weeds in lawns, the old fighter 2, 4-D (dichlorophenoxyacetic acid) is still good. Use one ounce or two tablespoons of an amine salt of 2, 4-D per gallon of concentrate in two gallons of water per 1000 square feet.

To fight chickweed and its broadleaf cousins that plague your lawn, there is another new chemical killer called silvex (2, 4, 5-trichlorophenoxy-propionic acid). Use one ounce of silvex in two gallons of water per 1000 square feet. The scientists also suggest a half-and-half mixture of silvex and 2, 4-D for use on the other broadleaf weeds.

To combat quackgrass and other weedy grasses (Bermuda, Johnsongrass, etc.) a promising new weed killer is dalapon (dichloropropionic acid) applied as foliage spray. The sodium salt of dalapon is, in this instance, the widely used compound, although ammonium salts are also used. Dalapon has shown promise for Southern farmers in controlling weeds in sugar cane, sugar beets and for spot-treatment control of Johnsongrass and other grasses in

NAMES OF WEED KILLERS AND

CHEMICAL	TRADE NAME	MANUFACTURER
Sesome	Scuti (Phenyl mercuric salt)	Amchem Products, Inc.
NPA	Alanap-3 (Sodium salt)	O. M. Scott
	Alanap-3	U.S. Rubber Co.
	Alanap-3	Chipman Chemical Co.
	Alanap-3	Allied Chemical Corp.
	Alanap-3	California Chemical Co.
	Alanap-3	Stauffer Chemical Co.
	Alanap-3	Woodbury Chemical Co.
	Alanap-10-G	Allied Chemical Co.
	Alanap-10	California Chemical Co.
Dacthal	Chip-Cal	Diamond Alkali Co.
Calcium Arsonate	Crab-E-Rad	Chipman Chemical Co.
	No-Gro	Vineland Chemical Co.
	Turf-Sel-Pe	Vineland Chemical Co.
	Unico Crabgrass Granules	Doggett-Pfeil Co.
Zytron		United Co-Operative, Inc.
Silvex		Allied Chemical Corp.
		Dow Chemical Co.
		Chipman Chemical Co.
		Miller Products Co.
TCA	Chickweed & Clover Killer	California Chemical Co.
	ACP Grass Killer	Dow Chemical Co.
		Chipman Chemical Co.
		Sherwin-Williams Co.
	Quackil	Parsons Chemical Works
	Rite-O-Way	Allied Chemical Corp.
	Stantox	Standard Agricultural Chemicals
	STCA	H. P. Rossifer & Co.
	T-H	Thompson-Hayward Chemical Co.
	Unico—Grass Killer	United Cooperatives, Inc.
Dalapon		Dow Chemical Co.
Simazine	4G	Geigy Chemical Corp.
	80W	Geigy Chemical Corp.
TBA	"Trysben" 200 Weed Killer	E. I. duPont de Nemours & Co., Inc.
EPTC	Eptam	Stauffer Chemical Co.



TEST FIELD at Beltsville includes 4224 separate plots for testing chemicals on fruits, vegetables and weeds

cotton. It has been effective in controlling cattails and phragmites on irrigation and drainage canals.

Another new quackgrass killer is TCA (trichloroacetic acid), although test results with it have varied in effectiveness. It is also somewhat caustic and does corrode spray equipment.

Chickweed in alfalfa has been a serious problem to farmers in the northeastern United States. For controlling this weed, the Beltsville R and D men recommend another new killer, DNBP, a dinitro com-

pound. They suggest a spray made of $\frac{1}{2}$ to $\frac{3}{4}$ pounds per acre in 20 to 40 gallons of water placed on the weed when it first appears in the fall.

To keep squash, snapbeans and cucumbers free of broadleaf, annual grassy weeds, researchers recommend another new herbicide called NPA (n-1 naphthylphthalamic acid), and that gardeners follow the instructions on the labels of commercial compounds containing this chemical.

Farmers still use over 30 million pounds of 2, 4-D each year on crop lands, because

WHAT THEY ARE CALLED IN STORE

CHEMICAL	TRADE NAME	MANUFACTURER	
DMTT	Crag Mylone	Union Carbide Corp.	
SMDC	VPM Soil Fumigant	E. I. duPont de Nemours & Co., Inc.	
MCP	Vapam	Stauffer Chemical Co.	
	MCP Amine Weed Killer	Agasco, Inc.	
	Crop Rider MCP Amine	Diamond Alkali Co.	
	MCP Amine Weed Killer	Dow Chemical Co.	
	MCP Amine Weed Killer	Allied Chemical Corp.	
	MCP Amine Weed Killer	Sherwin-Williams Co.	
	Methoxone	Chipman Chemical Co.	
	MCP Amine 4	Monsanto Chemical Co.	
	Stantox MCP Weed Killer	Standard Agric. Chem.	
	MCP Amine	Stauffer Chemical Co.	
	Sure Death MCP Amine	Woodbury Chemical Co.	
	Ded-Weed MCP	Thompson-Hayward Chemical Co.	
	Weedar MCP	Amchem Products, Inc.	
	PMA	PM2, 4-D	W. A. Cleary Corp.
	DMA	"Oust" Crabgrass Killer (DSMA)	E. I. duPont de Nemours & Co., Inc.
		Hose-It-On Crabgrass Killer	Acme Quality Paints
		Liquid Disomar	Bonide Chemical Co.
		Crabgrass Killer	Breck's
		Crabgrass Killer	Chemical Formulators, Inc.
		Clout	O. M. Scott
Crab-E-Rad		Vineland Chemical Co.	
Crabgrass Fix		Thompson Chemical Corp.	
Crabgrass Destroyer		Lebanon Chemical Co.	
Di-Met		O. E. Linck Co.	
Methar		W. A. Cleary Corp.	
Crabgrass Killer		Miller Chemical Corp.	
Artox Sodar Crabgrass Killer		Nott Manufacturing Co.	
Crabgrass Killer		Pearson-Ferguson Chemical Co.	
		Samincorp	
Ded-Weed Crabgrass Killer		Thompson-Hayward Chemical Co.	
Unico Crabgrass Killer		United Co-Op., Inc.	
Weedone Crabgrass Killer		Amchem Products, Inc.	

2, 4-D is supplied by a great number of manufacturers.



FIELD TRIALS also include use of experimental spraying equipment such as this vehicle. Air tank forces spray

the compound kills many broadleaved weeds, especially those found in pastures, in wheat, corn and other grains. Ordinarily, less than a pound of 2, 4-D per acre is required when it is mixed into a liquid spray.

Herbicides are sold under a number of trade names and some, especially the new ones, are not always available from local garden-supply dealers. But they usually are available from agricultural chemical dealers.

Six other new herbicides have shown promise in tests conducted by the Beltsville

agricultural research scientists. Since all have long chemical formulas and are in short supply for purchasers this year, only their nicknames or initials will be cited: Simazine, TBA, EPTC, DMTT, SMDC and MCPB.

Simazine is a wettable powder with low solubility in water and organic solvents. It is being tested for pre-emergence weed control in corn, transplanted tomatoes and fruit crops. As a soil sterilant, Simazine has been effective when applied at heavy rates.

(Continued to page 228)

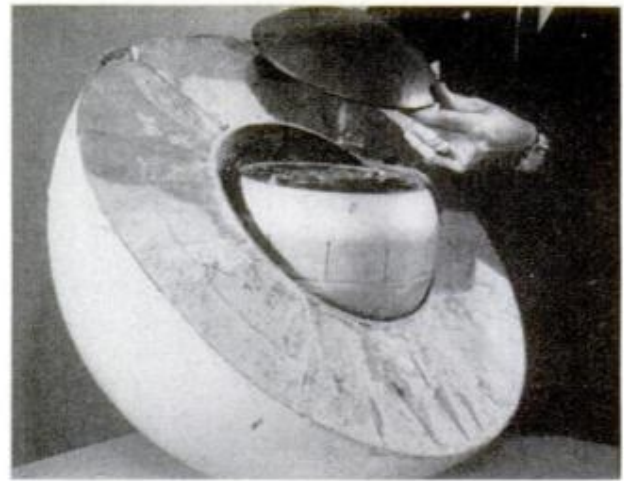

Ball of Balsa for the Moon

Here's the type of instrument-laden ball scheduled to be landed on the moon at a speed of about 150 m.p.h. this year.

Measuring 25 inches in diameter and weighing 325 pounds, the ball contains a seismometer to measure moonquakes, temperature-recording devices and radio equipment to send information to Earth.

The ball is designed to be ejected from a Ranger spacecraft some 25 miles from the surface of the moon.

MOON SPHERE, upper left, is attached to a retrorocket which slows it down; ball and rocket are shrouded in aluminum for Ranger rocket ride from Earth. Instruments ride in smaller ball floating inside balsa

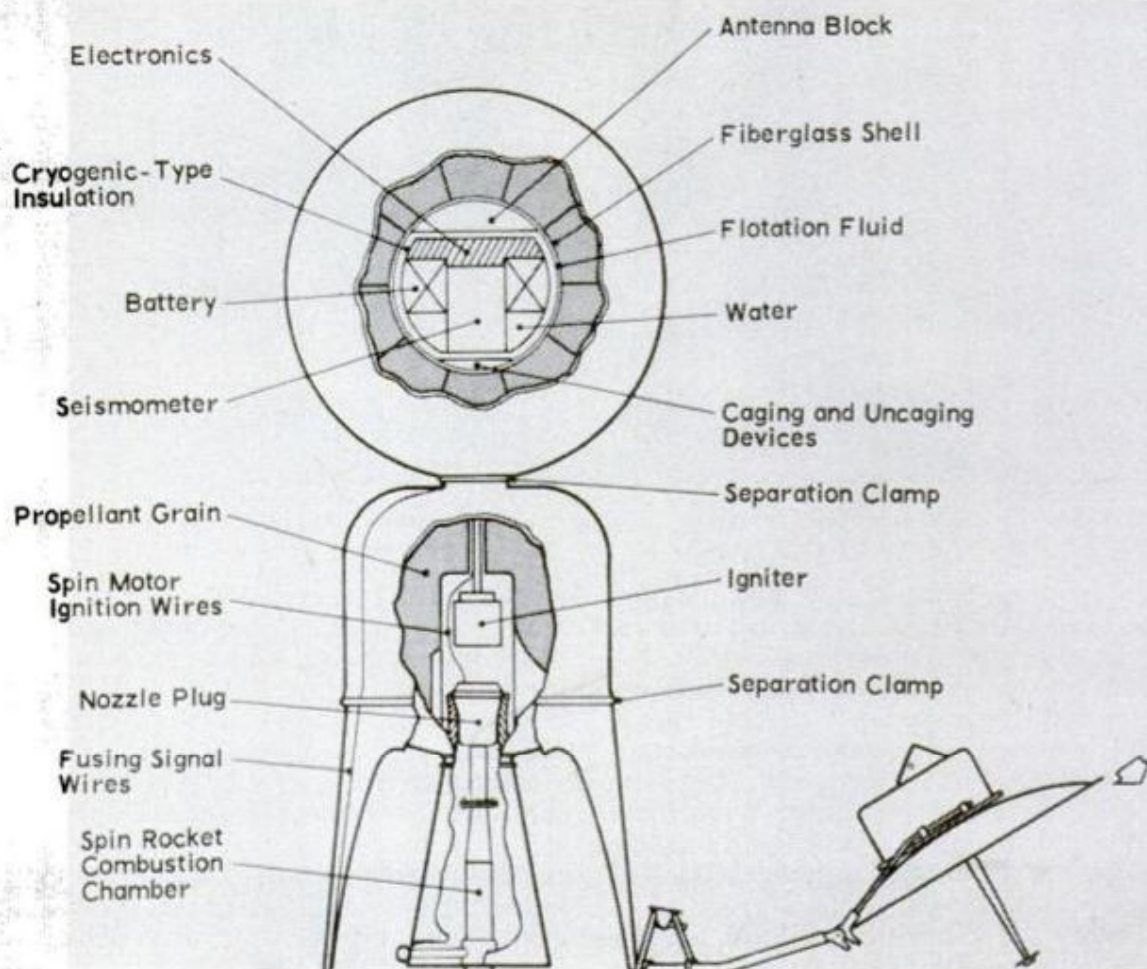

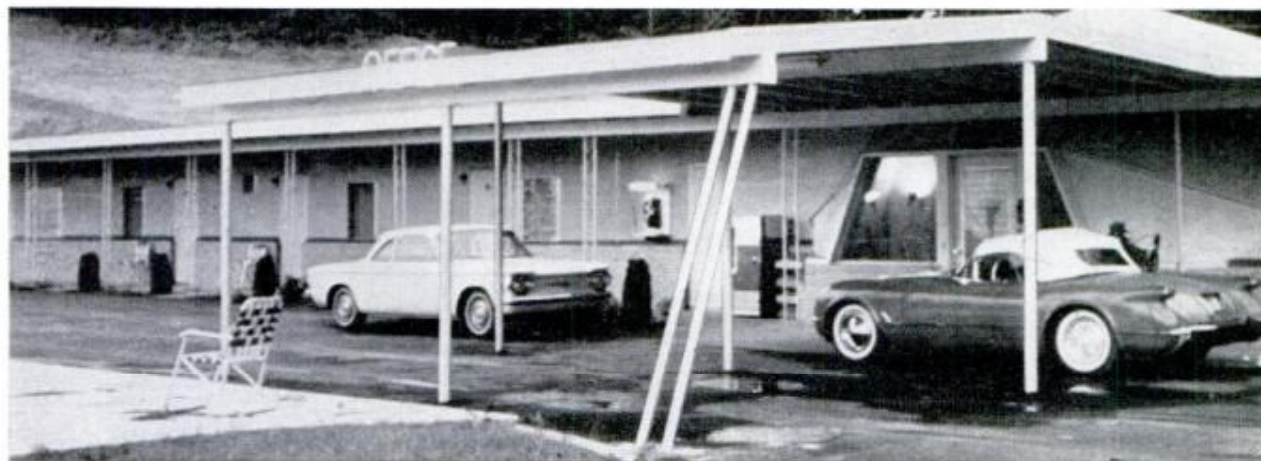

Motels are Rolling Down the Highways

To meet a booming demand for motel rooms, an Indiana manufacturer is putting two, three and four rooms in a section which, much like a house trailer, is towed to the installation site. The motel owner

just puts sheets on the bed, towels on the rack, hooks up the gas, lights, water and sewer, and the rooms are ready. Hart Industries, Elkhart, says its motels can be installed for less than \$2500 per room.

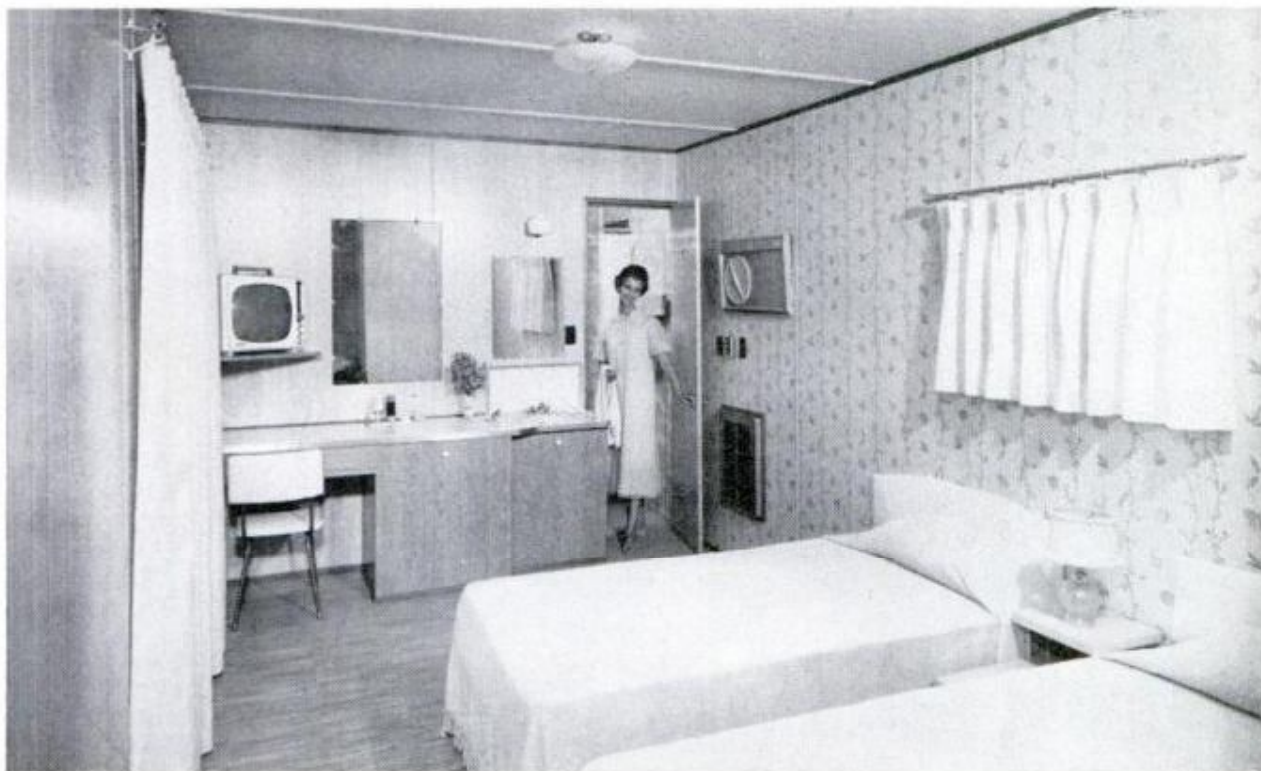

ARE THESE THE

By
**Chris
Edwards**

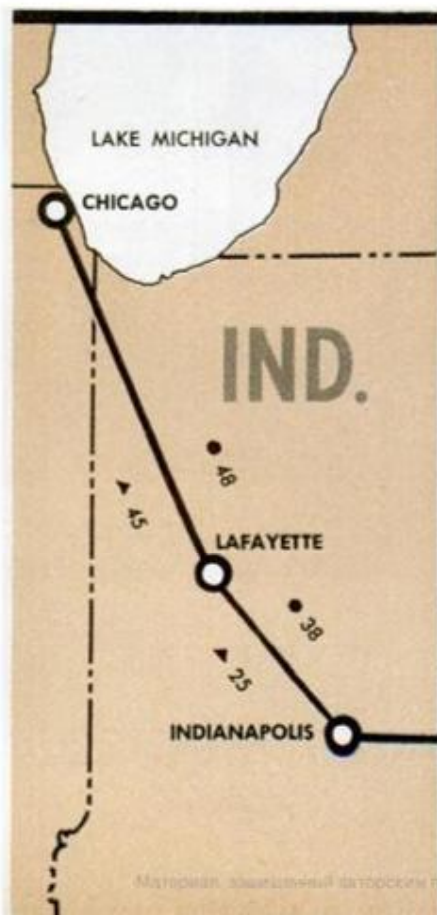
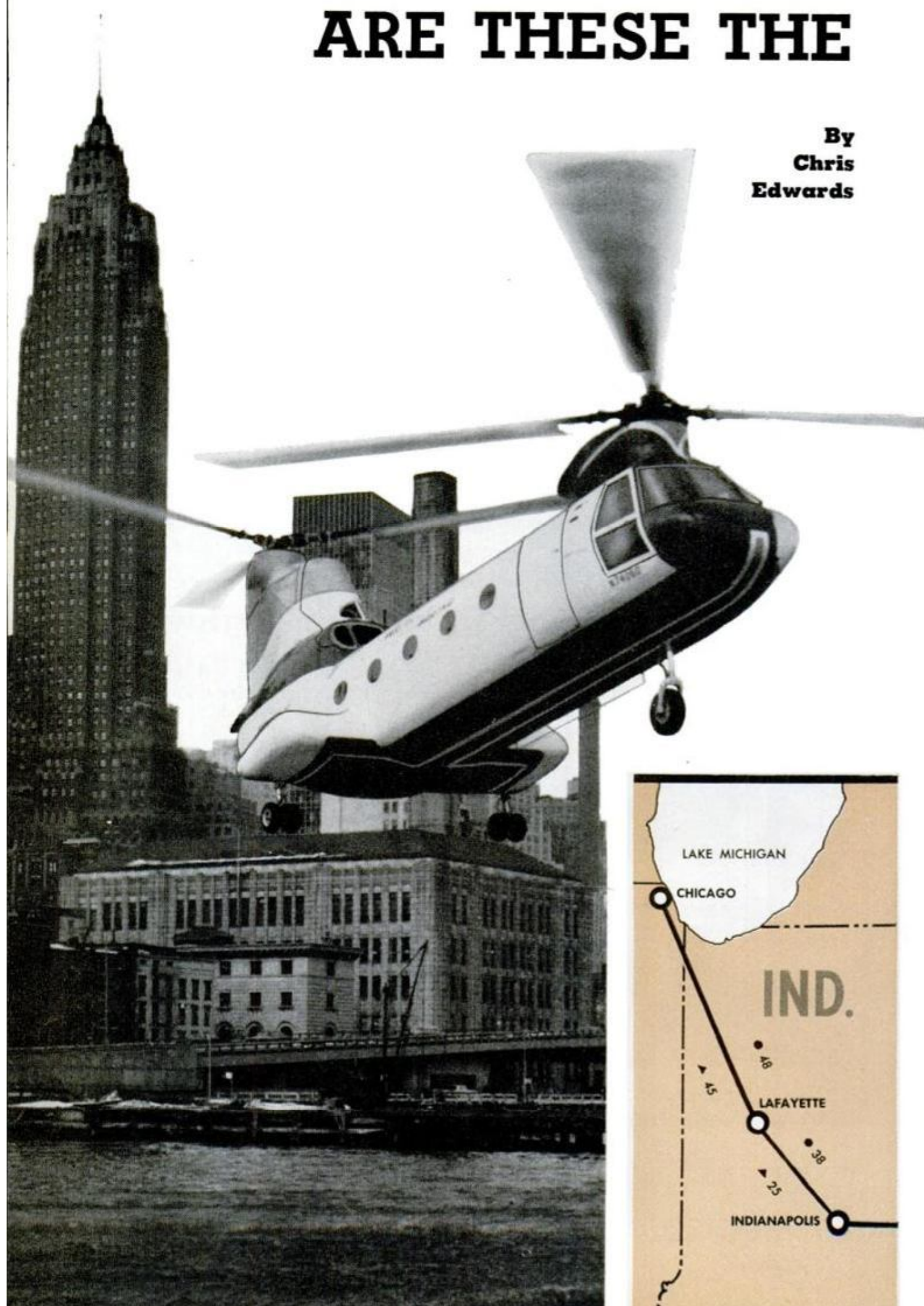

NEW AIRLINERS?

Already flying from downtown to airport, giant rotary aircraft may now take off cross-country, carrying passengers from the heart of one city to another, slashing total trip times

HELICOPTERS ARE ON THE VERGE of changing short-range air travel the way the big 707 and DC-8 jets changed long-range air travel—by slashing trip times.

Airline passengers on short air hops now spend up to two thirds of their total travel time on the ground. Even on long trips, time on the ground is still the big bottleneck. Cruising close to the speed of sound, a jetliner covers the distance between Chicago and New York in about two hours. But, if you are an average passenger, you still spend more time on the ground getting to and from the airports at each city than you spend in the air. Not until you fly more than 1200 miles does the jetliner portion of a trip exceed the average ground time. And, as more and more jetports move farther into open country, where space for long runways is available and the noise bothers fewer people, ground travel times will continue to grow longer—not shorter.

Where does this leave the air traveler who flies from Los Angeles to San Diego, from New York to Washington or from Chicago to Podunk? Mostly on the ground.

But new twin-engine helicopters recently certificated for com-

HELICOPTER AIRLINERS, like the new Vertol 107 (left), can equal or better trip times of regular airliners on short routes, as shown in map below. Big advantage, however, is their ability to land in center of town

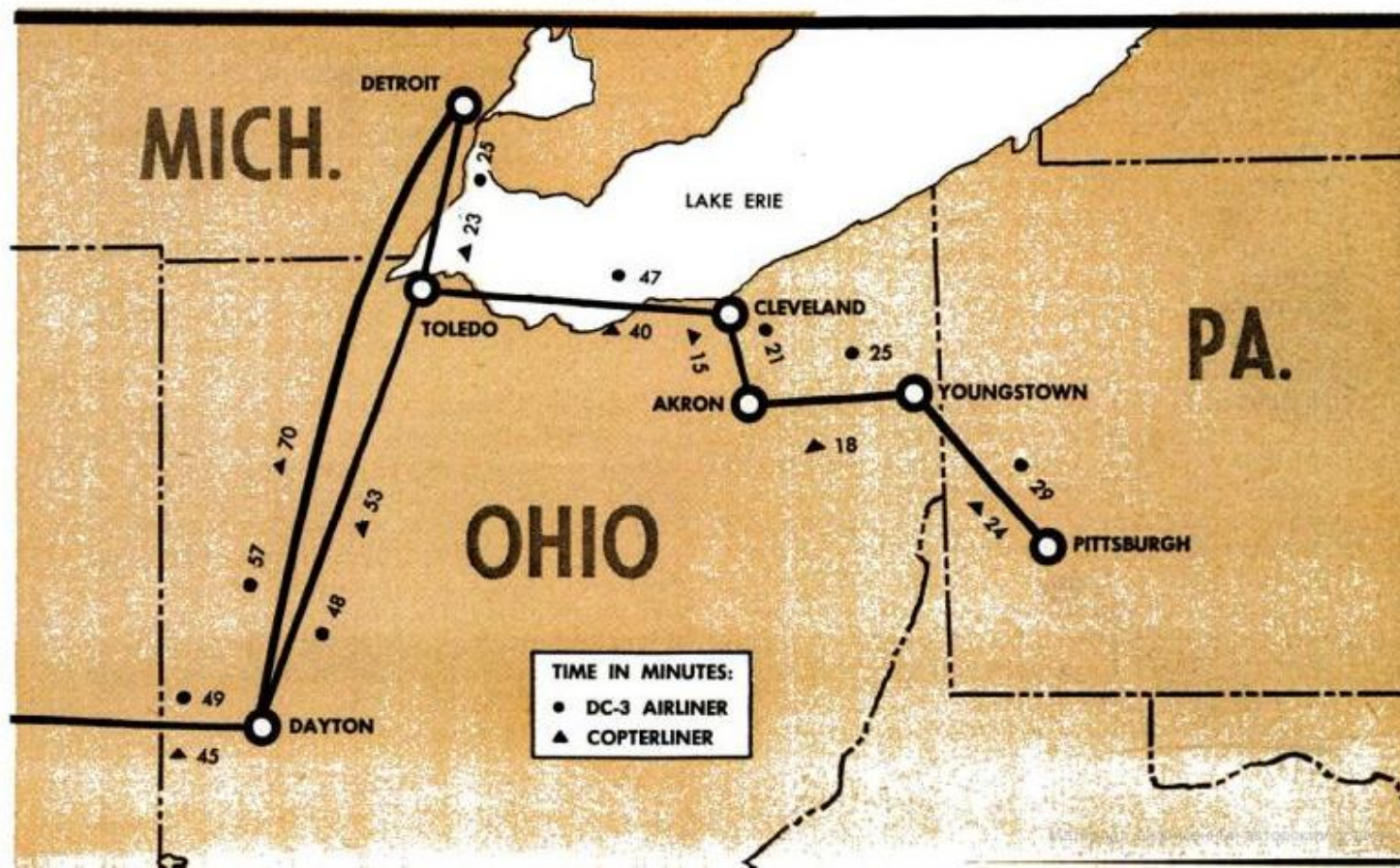

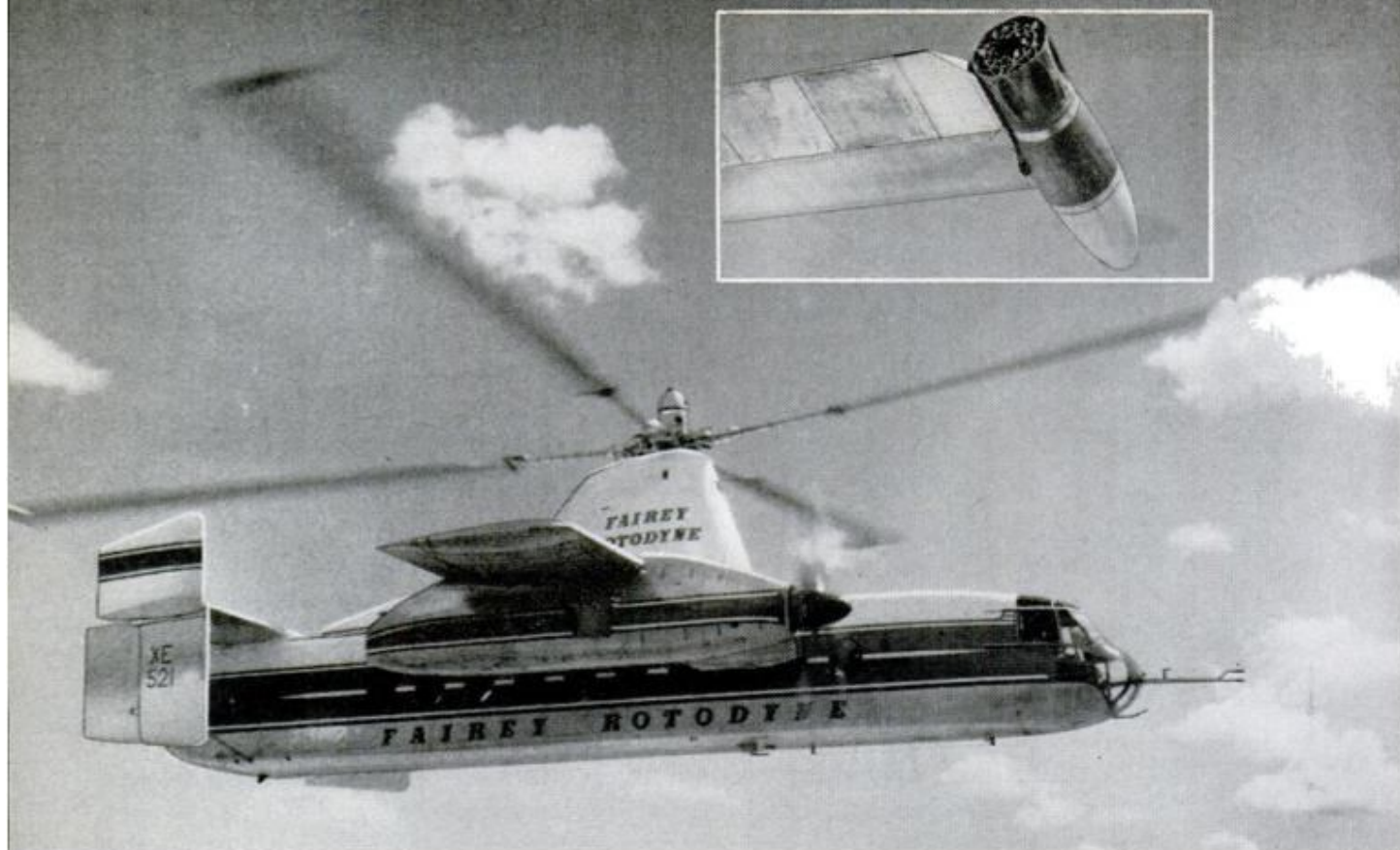

FAIREY "ROTODYNE," British autogyro, uses turboprops for forward speed, jet-tipped rotor for vertical flight

mercial flights make trips up to 200 miles practical between city centers. Two big helicopters, the Boeing Vertol 107 and the Sikorsky S-61, boost flight speeds to 150 m.p.h.

Recently, a Vertol 107 spent nine days simulating operations between cities along part of Lake Central Airlines' routes. The map on pages 138-139 charts current airliner flight times between airports along some of Lake Central's air routes and, for comparison, Vertol 107 flight times along the same routes. On flights up to about one hour, the 107 'copter equaled or bettered Lake Central's presently scheduled flight times. On longer flights the higher speed of conventional fixed-wing transports edged out the slightly slower helicopter.

But actual time in the air over these routes is only part of the story.

Take the trip between Chicago and Lafayette, Ind., for example. Air distance is about 120 miles. If you flew Lake Central's Flight 153, you could board a limousine at a Chicago Loop hotel at 9:45 a.m. bound for Midway Airport on Chicago's southwest side. You would arrive at the airport about 45 minutes later. At 11 a.m. you would board a DC-3, and 48 minutes later the door would open at Lafayette. After another 43 minutes, including baggage claim and pick-up time, you could be in downtown Lafayette. Total time between city centers—nearly three hours!

On a helicopter, the same trip would take

just over an hour — including time for checking in and for handling baggage. By leaving from a heliport on the lake front just outside Chicago's Loop, or from a building-top heliport, you could be in downtown Lafayette before you would have taken off from Midway on Flight 153.

Until the twin-engine Vertol 107 and Sikorsky S-61 transport helicopters appeared, true vertical takeoffs and landings were not permitted with passengers aboard. In contrast, single-engine helicopters are required to lift a few feet off the ground, then accelerate in a flight path close to the ground until they reach a safe airspeed for climbing. So short runways are necessary when carrying passengers. These operations are required because a failure of the single engine close to the ground would allow autorotation of the overhead rotor could slow the descent to a safe sink rate.

With two turbine engines, both the Vertol 107 and S-61 can take off and land vertically. In case one engine fails, the helicopters continue to fly on the second engine or gently descend to the takeoff point. Either or both engines drive the two tandem rotors on the Vertol 107 through an ingenious gearbox. Twin engines also provide all-weather capability under civil-air regulations and permit passenger flights to and from heliports on top of buildings or from built-up congested areas.

Local-service airlines, such as Lake Cen-

CUTAWAY OF ROTODYNE

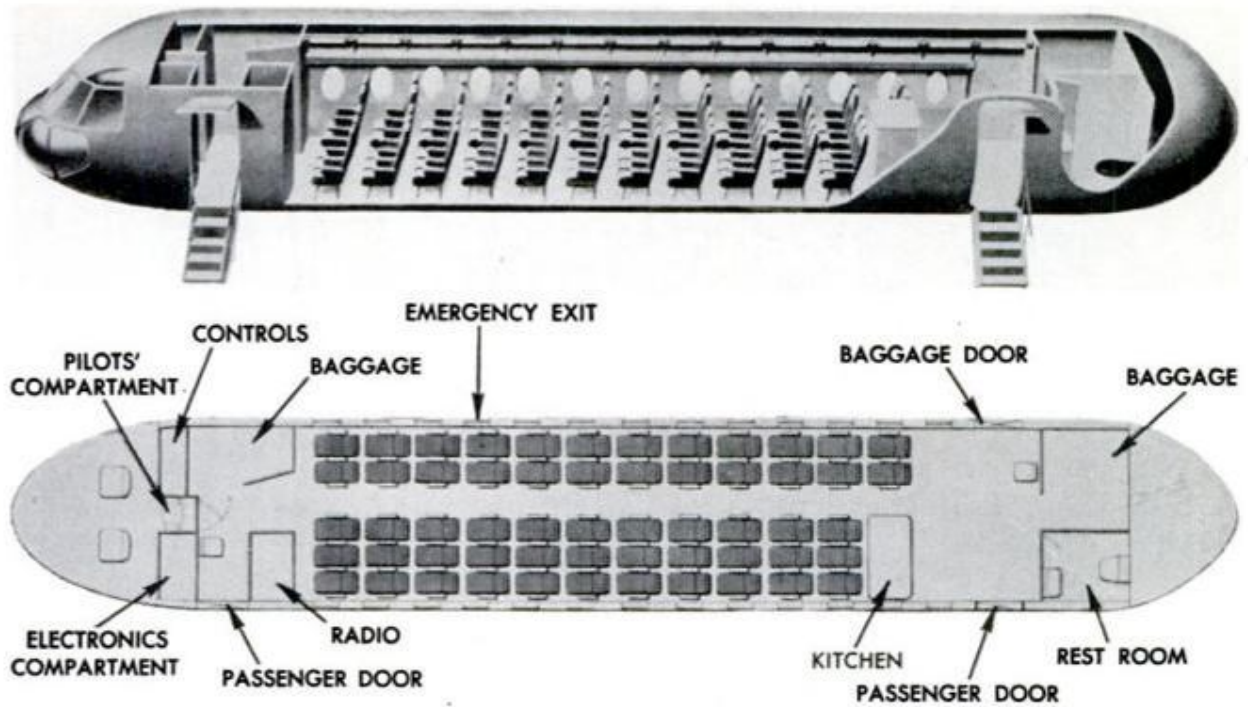

SPACIOUS INTERIOR seats 57 passengers, many more than most short-haul airliners. Venerable DC-3 seats 21

TRAVEL TIME BETWEEN CITY CENTERS BY ROTODYNE

	Rotodyne	Airline limousine	Time saved by Rotodyne
New York-Washington	1:27	2:33	1:06
Detroit-Chicago	1:38	3:36	1:58
Boston-New York	1:21	2:54	1:33
Syracuse-New York	1:23	3:00	1:37
Los Angeles-San Diego	0:42	2:30	1:48
Chicago-St. Louis	1:45	3:48	2:03

IT FLOATS! Although not intended as normal routine, 107's amphibious ability might be used in emergency





SIKORSKY S-61 also uses twin turbine engines, but they drive single large rotor and small tail rotor. Turbine engines make the new helicopters not only more powerful, but less noisy

HELICOPTER INTERIOR can be as plush as airliner. Seating in both 107 and S-61 can be arranged to accommodate 28 people

tral, are not required to compete with other airlines because of the low-traffic density. In fact, all local carriers now receive subsidy payments from the federal government so smaller cities can enjoy the benefits of fast air mail service and air connections to large jetports for longer trips. However, local-service carriers must now actively compete with bus and rail lines that connect city-center areas directly. Between some cities, actual travel times between downtown areas are less by bus than the combined ground-and-air time when using airliners such as the DC-3 or even the new F-27 turboprop. Only by offering direct air service between downtown areas can travel times be cut sharply. The new generation of twin-engine helicopters are a giant breakthrough toward this goal of cutting total travel time.

Will the new helicopters be able to compete on fares for intercity trips? To get a clear picture on this point, let's take the Chicago-Lafayette trip again. Lake Central's current air fare between the airports

at these two cities is \$10.05 plus 10 percent Federal tax or \$11.06. But limousine fare from Chicago's Loop to Midway Airport is \$1.45 and at Lafayette, about \$1.25 for a total of \$2.70 for ground transportation—nearly 25 percent of the air fare. (Taxi fares would be higher.) On a shorter hop, say between Cleveland and Akron, Ohio, limousine fares would total about 50 percent of the air fare.

In contrast, although intercity helicopter fares have not been set at this writing, it is known that the direct operating costs of a Vertol 107 helicopter are about double the costs for a Fairchild F-27 turboprop (6½ cents per seat mile versus 3⅓ cents per seat mile over a 100-mile flight). Projecting these figures, 'copter fares would still exceed the combined air travel-ground travel costs of using a conventional airliner. Either some subsidy or passenger willingness to pay extra for the time gained would be needed at the present time for longer flights from city center to city center.

(Continued to page 220)



PRECISION LEVELING is permitted with the new indicator built into the top of this stereophonic record changer. Compensating for uneven floors, tables, extends record life. Admiral Corp., Chicago, 47, Ill.



GETTING ALL YOU PAY FOR? This meter plugs into a wall outlet, continuously monitors line voltage delivered to your home. If certain appliances act up, low voltage could be blamed. RCA, Camden, N.J.



Electronically New

RADIO PRIVACY is assured by this voice scrambler. Normal speech is converted to gibberish over the air. A matching scrambler at receiver unscrambles the confidential talk. Delcon Corp., Palo Alto, Calif.



CONVENIENT INSTALLATION of TV antenna wire is obtained by using this package. Line is fed out as you need it, balance is maintained tangle-free on the inside. Saxton Products, 4320 Park Ave., Bronx, N.Y.

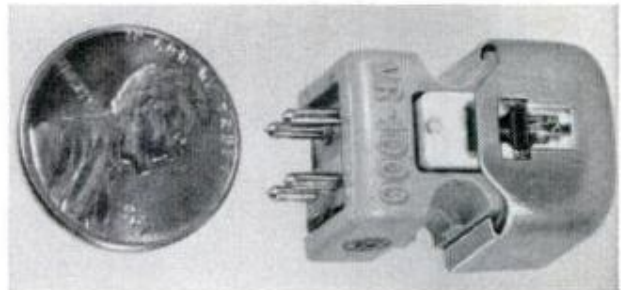

STEREOPHONIC CARTRIDGE designated "Orthonetic" by manufacturer, comes in two styles. One for changers one for manual machines. Universal mount fits all type arms. General Electric Co., Syracuse, N.Y.

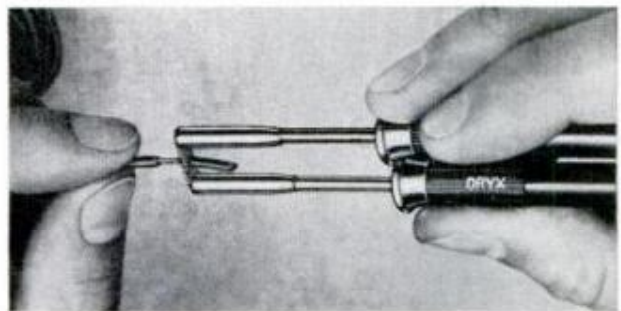

HOT LITTLE STRIPPER really takes it off! Insulation, that is. Unit connects to transformer, heat and pressure strip insulation. Features replaceable tips. West Manufacturing Co., 5979 West 3 St., Los Angeles, Calif.

PM Shopping Guide



TENT FABRICS vary greatly in weight and thread count. Text identifies each of these fabrics



TELESCOPING aluminum poles are light and handy, especially if they're adjustable so you can raise or lower the pole to compensate for stretching or shrinking of the material

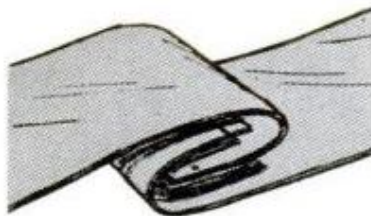

LAP-FELLED or French seams fold four layers of material together to make a stronger, more water-tight seam with no edges

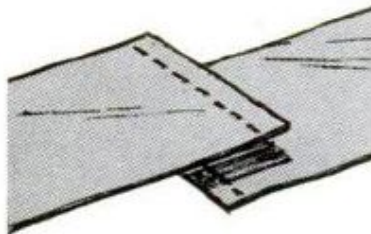

FLAT SEAMS, less costly but less desirable, are common on budget-priced tents. Be sure they're sewed with the flap downward

THE SIZE AND STYLE of the tent you buy will depend on the number of persons who'll be sleeping in it and the time you'll spend inside while awake. Figure a clear floor area of at least $2\frac{1}{2}$ by $6\frac{1}{2}$ feet per person, and add 50 percent to that figure if you'll be sleeping on cots. And remember that you'll want some room left between sleepers for getting in and out while others sleep.

Height of your tent is up to you. If you think you'll spend much waking time inside, you'll want a style with full headroom. But if the tent is only for sleeping, you can get along with a low-ceilinged model that's less expensive, lighter, and easier to pitch. Remember, though, that it'll be uncomfortable to sit in while waiting out a rainstorm.

The fabric in your tent is as important as its size and style, and your choice of materials will affect the tent's weight, water repellent qualities, mildew resistance, life expectancy, care and maintenance, and, most important, cost. As with most consumer goods, the most desirable materials cost the most, and give the best service, but if your needs are simple, you can get along nicely with less expensive fabric.

Tents



WATCH STRESS POINTS closely, especially where guy ropes attach. Look for backing and strong grommets or rings; avoid tapes

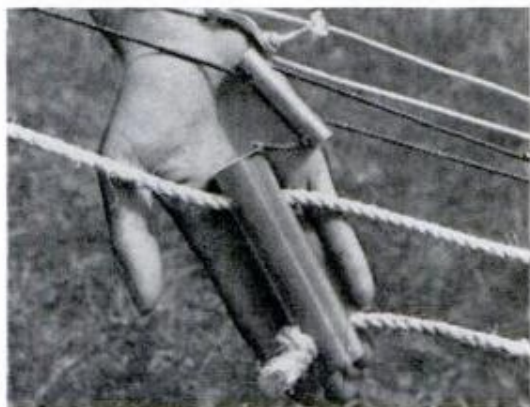

HEAVY LINES and big slides, bottom, don't do any better than light nylon lines and small slides which are lighter and easier to handle

Tent fabrics are rated by weight and thread count. A "six-ounce fabric with a thread count of 130" means that a square yard of the material weighs six ounces, and it has 130 threads to the square inch. Generally speaking, the higher the thread count and the lighter the weight, the better the material. Seven of the most popular fabrics are shown on page 144. They are:

1. **Suma cloth**, a two-ply twill; 5.5 ounces, 400 threads; an excellent light fabric that is "dry" water repellent (chemically treated like a raincoat).

2. **Poplin**; 7.5 ounces, 160 threads; a good, durable single-ply fabric, also "dry" water repellent.

3. **Palina cloth**, rated with poplin.

4. **Drill**; 7.6 ounces, 130 threads; a sturdy, medium-priced fabric, oil treated for water and mildew repellence; adequate for occasional and vacation campers.

FIVE DIFFERENT STYLES



UMBRELLA STYLE gives good head and floor space; is easy to erect with frame



WALL STYLE is roomy but heavy and slow to erect; best for long stays in one camp



EXPLORER STYLE is light, easy to erect; has headroom at one end; needs no pole



MOUNTAIN STYLE is a refined "pup" type; ultra-light protection for two sleepers

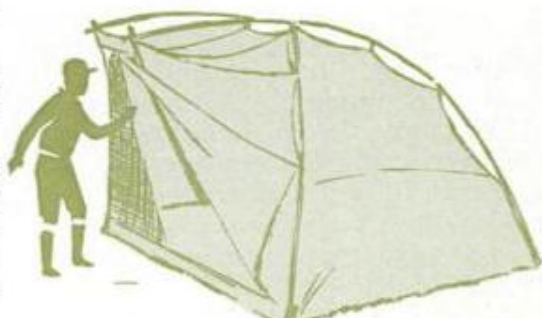

NEW "SAFARI" STYLE uses stressed outside frame, no stakes, but is almost windproof

5. **Medium twill**; 5 ounces, 100 threads; a light, fairly coarse fabric, oil treated.

6. **Twill**; 5.5 ounces, 100 threads; a stiffer twill treated with both oil and wax for better water resistance.

7. **Army duck**, another two-ply fabric; 8.7 ounces, 180 threads; oil treated. Heavy and stiff, but good for tents to be pitched and left for a long time. Can weigh up to 13 ounces.

Watch the tags and literature, and don't hesitate to ask questions about the fabric in your tent. It makes a big difference.

Quality of construction goes hand in hand with quality of materials in a tent. Look for good, lap-felled seams, heavy stitching all around, and reinforcing at stress points like top ridges, front flaps, floor-wall seams, and reinforced metal grommets or rings where guy ropes and poles attach. Look for tight seams and joints and heavy-duty zippers.

If you live in a warm climate, be sure your tent has enough openings to give good ventilation. But make equally sure that the openings can be battened down for wet or cold weather. Flaps should overlap the opening by at least an inch; tents with a fly or awning should have separate door flaps to allow closing the front without dismantling the awning structure.

A sewed-in floor and mosquito door are always a good investment; the deluxe treated-nylon floors that come on the better tents are best. They're lighter and easier to fold and store than heavier, coated materials. And if you're concerned about insects (and who isn't?) be sure all the openings are tightly covered with netting with bugproof zipper closures.

On tents with sloping walls, the better models will have extra tie loops or rings on the sidewalls to allow the walls to be guyed out to give extra room inside on long stays.

Weight and pitching time of the tent are best judged by the man who will have to do the work, but be careful to keep size and weight to a minimum, especially if you're planning to carry the tent far. For back-packing or canoeing, 14 pounds is maximum;

experienced campers try to stay under eight pounds. But if you'll be camping out of a station wagon, weight and bulk are no great problem.

If you'll be pitching your tent in one spot for your two week vacation, there's nothing wrong with a tent that takes an hour to pitch or strike. But if you're likely to be moving daily, as on a driving-camping vacation, you'd better settle for a model that you can get up or down in a few minutes; some of the new external-frame models are ideal for that type of camping.

While accessories shouldn't be the key factor in your tent-buying decision, they're certainly something to think about. Every accessory you have to buy later is adding to the actual cost of your tent. Look for good metal stakes—aluminum if you're packing the tent very far—and lightweight, easy-to-handle lines and slides. Lightweight takedown or telescoping poles save time and weight; there are models that need no pole at all, again for back-packers.

A carrying case for the tent is not only a convenience, but will add to the life of the tent by minimizing damage and wear during storage and transportation. Be sure the poles and stakes have a carrying case—they should never be rolled up inside the tent.

Your choice of materials, conveniences and extra features will make all the difference in the price of your tent. For example, one company offers five tents in the same 5-by-7 or "pup" style, beginning with a basic oiled twill model for \$6.50, and working up through models at \$13.95, \$16.50, and \$17.50 to the deluxe model, with Suma cloth fabric, custom workmanship, double guys, nylon floor, external framework, steel stakes, and a window that opens from the inside—for \$36. It's still a 5-by-7 pup tent, but that deluxe model is the best you can buy, and with all its goodies, weighs two pounds less than the basic model.

Most tents are good—but some are better than others for your purpose. Shop carefully and get all you can for the price you can pay.

—Patrick K. Snook



LOOK FOR good flaps over netting-covered openings; best if they can be opened and closed from inside

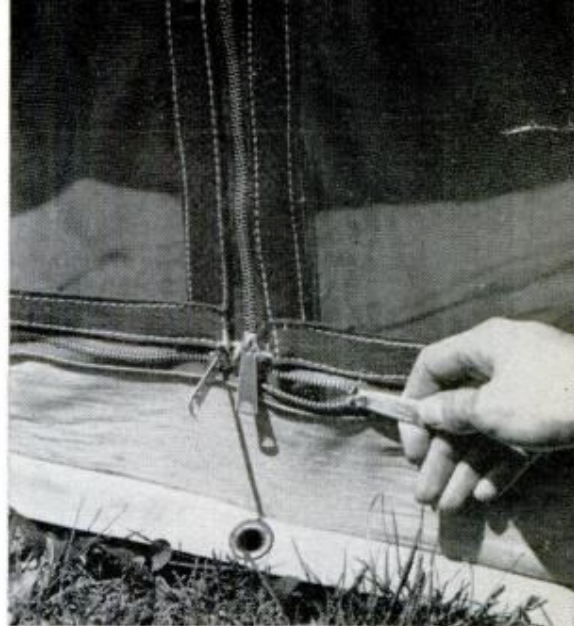

ONLY ZIPPERS will keep bugs out around netting; should close bottom, too

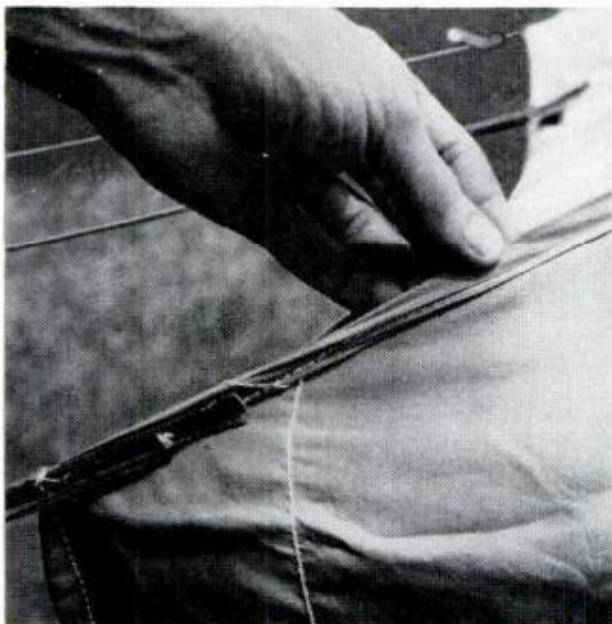

LOOK FOR additional reinforcing strip on eaves and main corner seams, also on flaps and floor-wall seams

LOOK FOR reinforced backing and heavy webbed tape around areas where ropes and poles attach

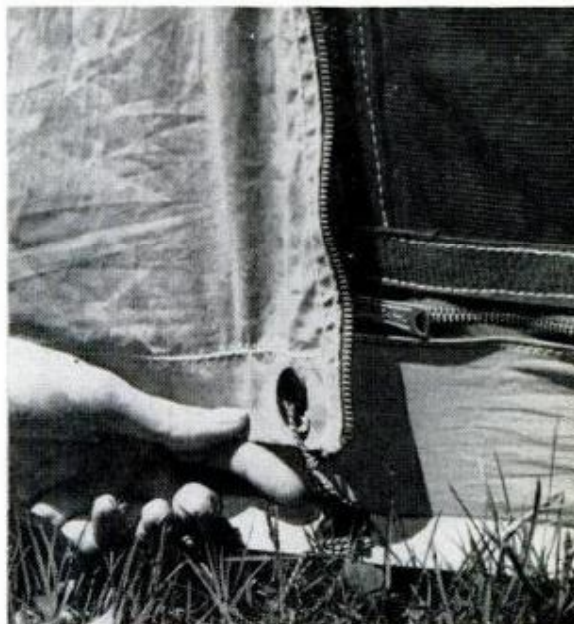

DOOR FLAPS should overlap at least an inch and tie down for wind protection

GOOD VENTILATION demands tie-back flaps and at least one window in rear





KENYA GAME WARDEN D. H. McCabe cocks crossbow for a test. Weapon is quiet, accurate to 100 yards



AIMING for weak spot just below rhino's shoulder, McCabe brings the beast down with one shot, below



African Game Saved by a Crossbow

Working to save game trapped on islands formed by the filling of Lake Kariba in Africa, game wardens have developed a stunning technique using one of man's most ancient weapons, the crossbow. Rhinoceroses and other big, nervous and dangerous animals are cornered and shot with an

arrow tipped with a hypodermic needle. A hit drives the needle home and automatically injects a drug which anesthetizes even a big rhino in 15 minutes. The prostrate animal is given an antidote, then a tranquilizer, then moved by sledge and raft to the mainland, revived, and released.

Bees Set New Cotton Boll Records

Government scientists are using bees to pollinate cotton—and are producing larger crops per acre. Cotton is a self-pollinating plant, but cross-pollination with honeybees increases yields up to 80 percent, according to experimenters at the U. S. Department of Agriculture's Southwestern Bee Culture Lab in Tucson, Ariz.

Researchers keep track of the bees' work by marking them with quick-drying paint for individual study. In addition, they can determine the bees' range of pollination by using distinctive crinkle-leaf control plants that produce ordinary seeds if pollinated by a bee carrying pollen from an ordinary plant.

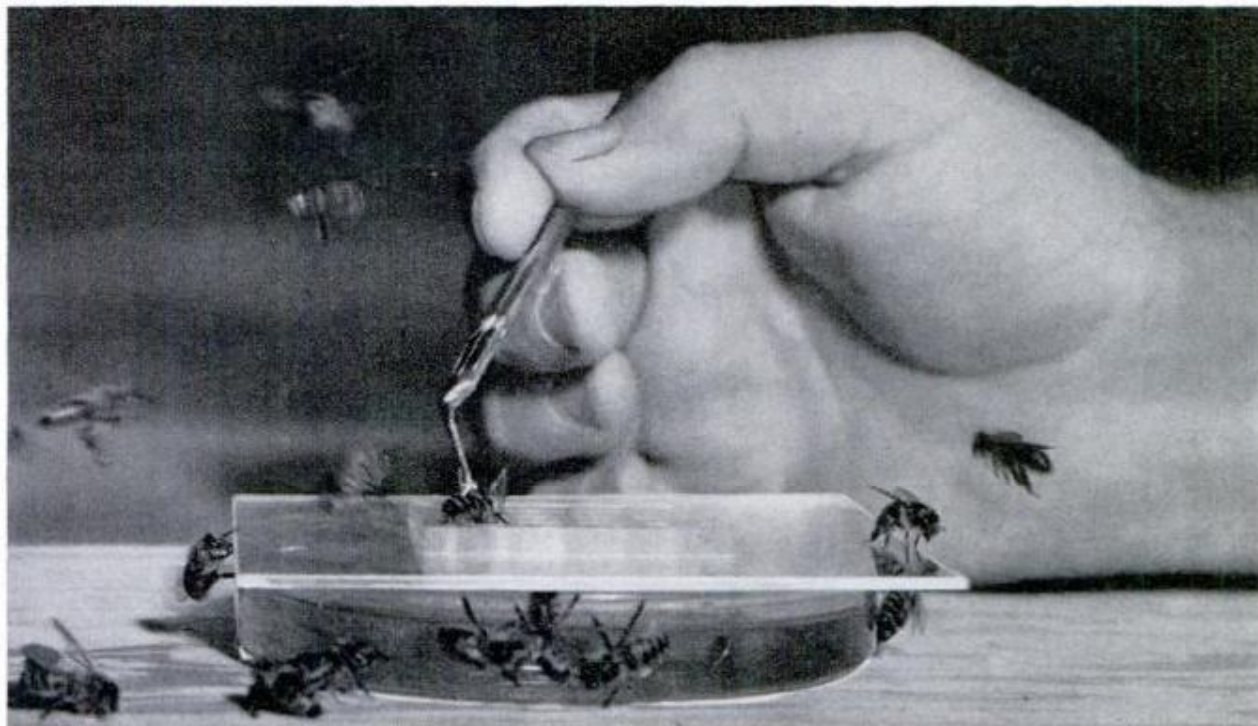

NUMBERING BEE as it feeds on sugar solution in artificial flower enables researchers to keep track of flights

DOTTED WITH POLLEN, bee emerges from cotton flower. It will cross-pollinate other plants it visits next

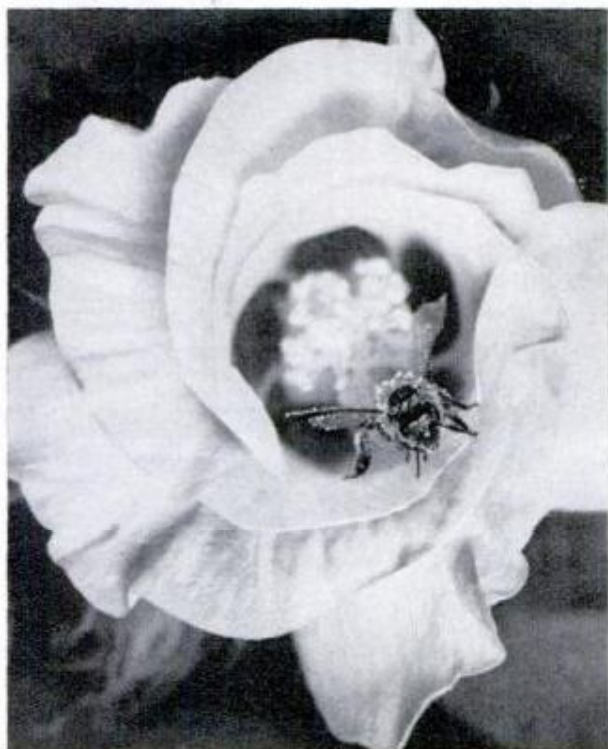

CROSS SECTION of cotton flower, opening at 8 a.m. Bees can only cross-pollinate between 8 a.m. and noon



SHOP AND CRAFTS

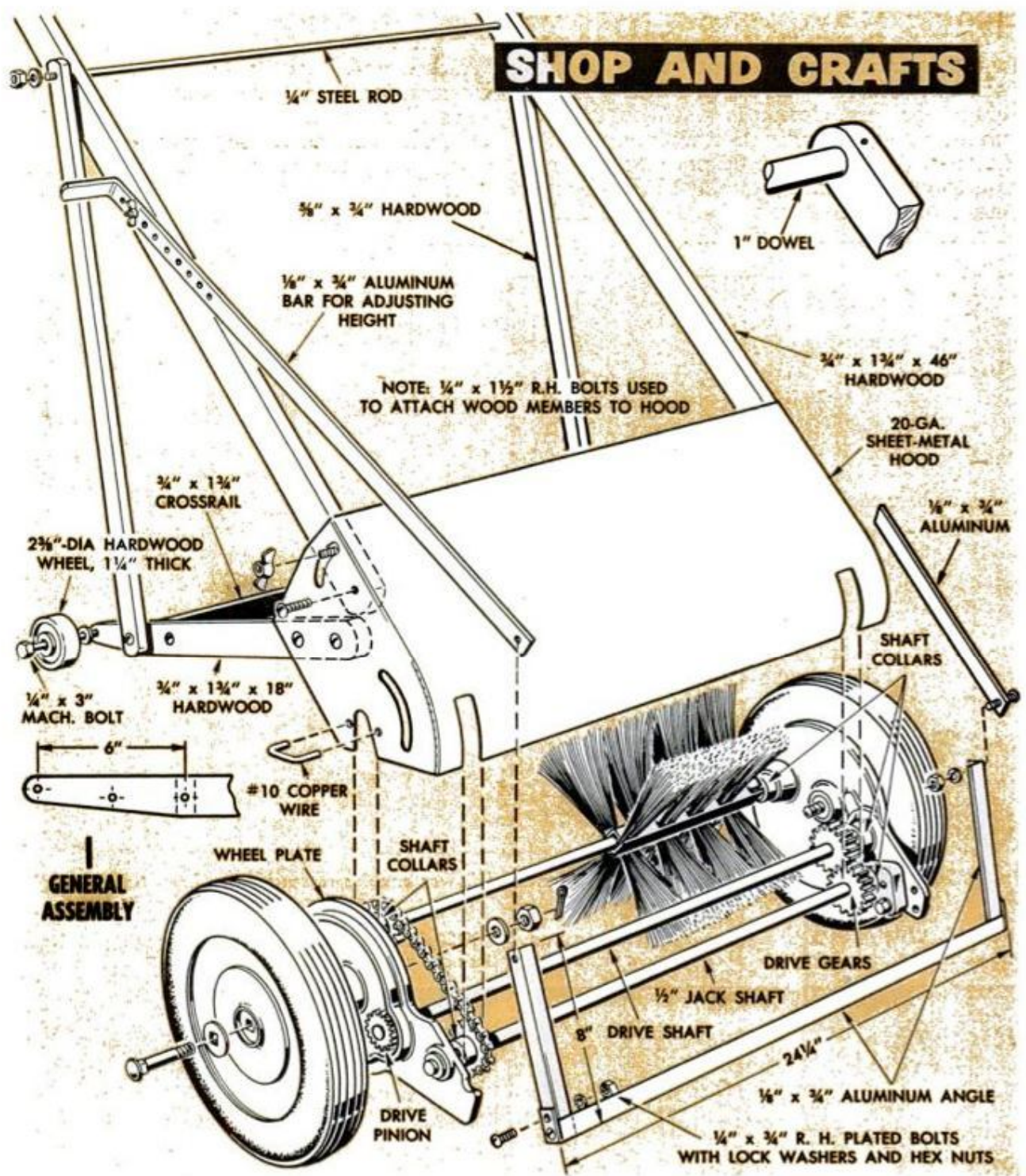

ORIGINAL MOWER wheel, wheel plate with spur gears, brush shaft, jackshaft and drive shaft in place

OPPOSITE MOWER WHEEL showing roller-chain drive to the brush shaft. This drive reverses brush rotation

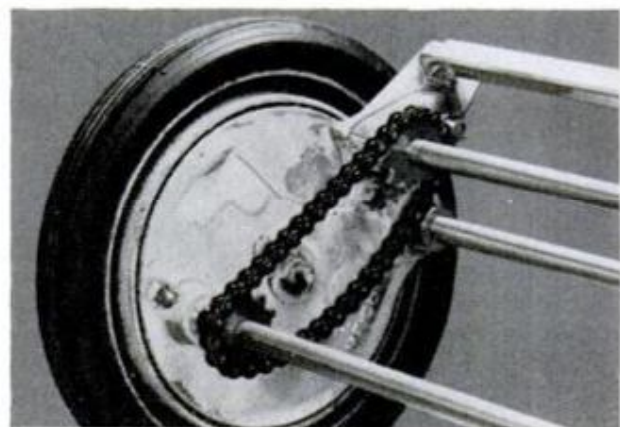
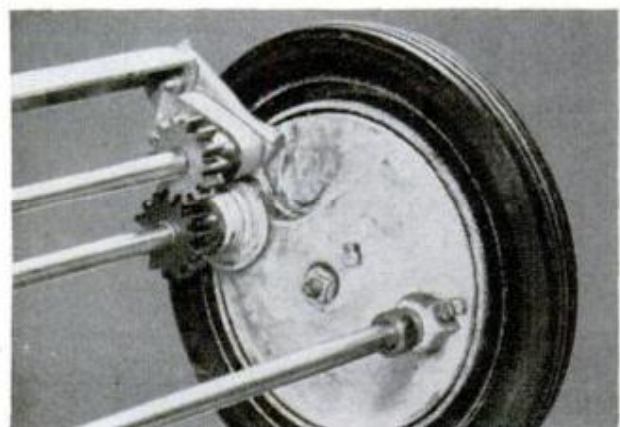

LAWN SWEEPER

USES OLD MOWER PARTS

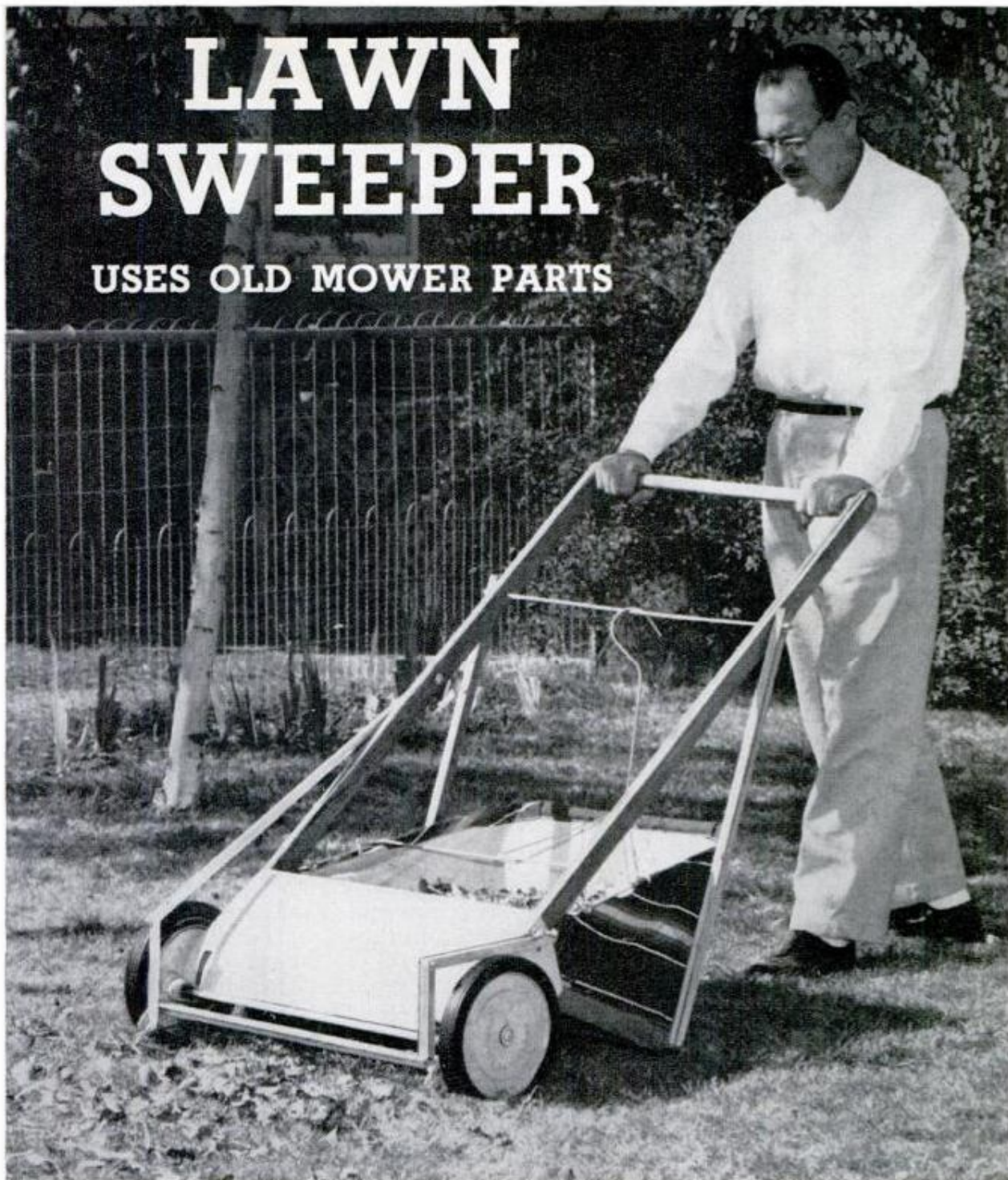

By Manly Banister

MAYBE YOU hadn't thought of it but the parts from that old hand mower you've been ready to toss out since you bought a new power mower can be used to make an excellent lawn sweeper. You dismantle the mower and throw away everything but the wheels, wheel plates (in older hand mowers these are castings) the pinions and clutch pins and the bolts and retainers that hold the wheels on the spindles, and in some cases the reel bearings. Clean these parts thoroughly in a solvent to remove accumulations of grime and lubricant.

APRIL 1962

The brush which picks up leaves and trash must run in a direction opposite to that of the grass-cutting reel. This is accomplished by reversing the normal position of the wheel plates and driving the brush through spur gears and a roller chain as in Figs. 1 and 3. The former detail of the assembly and the photos directly below on the opposite page show how the mower is altered and reassembled with a new drive shaft, a jackshaft, to give the brush shaft a reverse rotation to the direction of travel. The bosses on the wheel plates which nor-

151

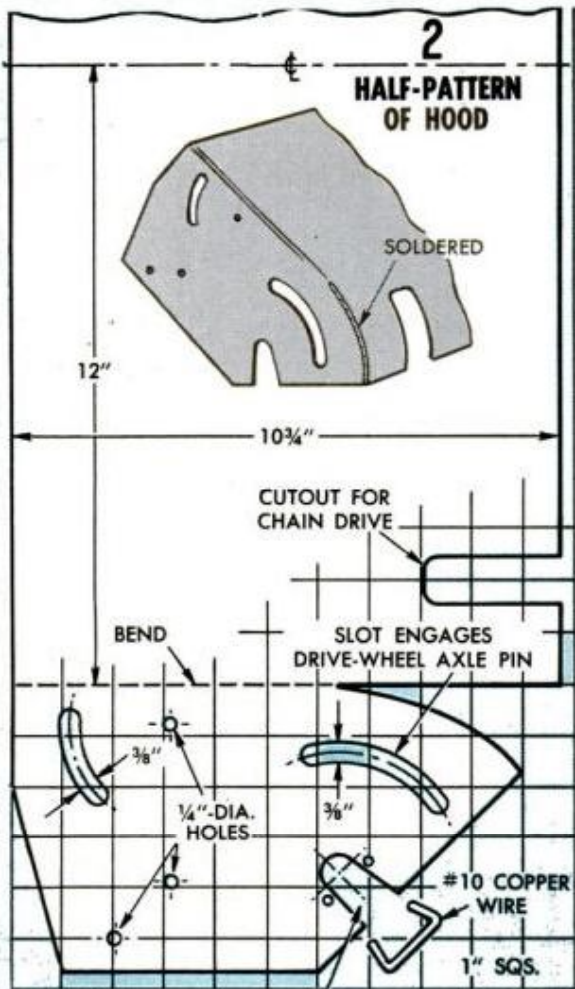

FITS OVER
BRUSH-SHAFT BEARING

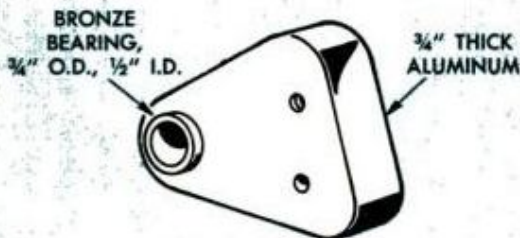

JACK-SHAFT BEARING BLOCK

HANDLE HEIGHT
ADJUSTMENT
40°-45°

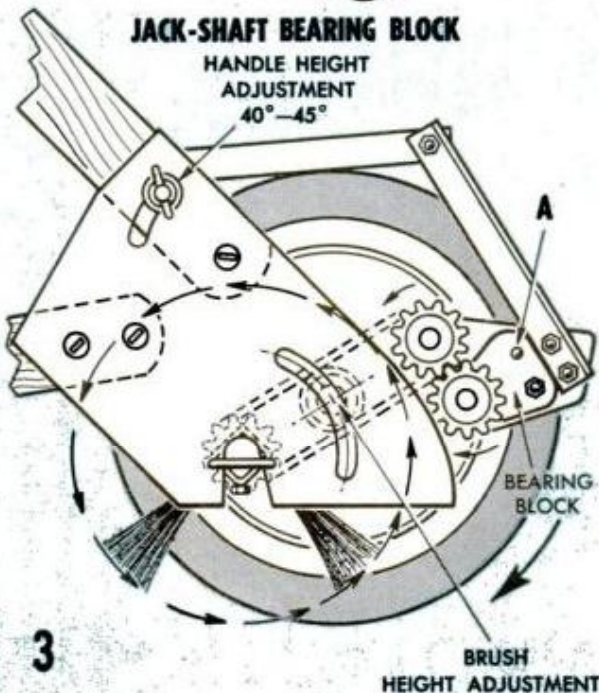

3

BRUSH
HEIGHT ADJUSTMENT

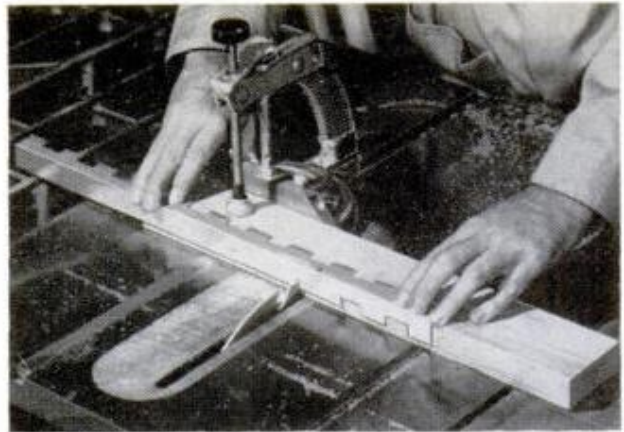

ALUMINUM ANGLES which hold brush sections in place are notched on table saw. Note backing strip

mally take the ends of the shrub bar are utilized as seats for bronze sleeve bearings in which the brush shaft rotates.

Now, from the mower you use you will have to determine the diameter of the drive shaft and the brush shaft. Of course, these are longer than the originals, that is, if the original mower was, say, a 16-in. cut, you can open it out to 24 in. or slightly more in sweeper width, and the 18-in. mower in proportion. The jackshaft can be 1/2 in. diameter as in Fig. 1. But the diameters of the other two shafts will be governed by the size of the sleeve bushings you can seat (by reaming) in the shrub-bar bosses and also by what size bushing can be seated in the drive-shaft bores. On some old mowers the reel is carried on self-aligning ball bearings and it may be that these can be utilized in the conversion. The clutch mechanism of the mower is retained; only the shaft is replaced by a longer one.

Note closely in Fig. 1, the photos below Fig. 1, and also the detail A, Fig. 3, that the jackshaft is carried in pivoting bearing blocks. In the first stage of the assembly these blocks are attached with only one bolt through the mower plates. This permits you to adjust the spur gears for proper running clearance. Once this has been determined—with all parts in position in a trial assembly—the blocks and plates are drilled and tapped for small capscrews, labeled A in Fig. 3. The spur gears were taken from an old mower, the clutch collars, or hubs, machined flush and the body of each drilled between adjacent teeth and tapped for a hollow setscrew. Normally, these gears are 1 1/2 to 1 3/4 in. in diameter, an average being 1 5/8 in. Of course, any pair of spur gears near these sizes can be used. Chain sprockets are 3/8-in pitch, 1 5/8 in. total diameter and have 11 teeth.

Next you make the hood, or brush housing. Fig. 2 shows the development of one half of the hood from a center line and



BROOM STRAWS are bundled in jig, then taped and sewed. Keep bundles as nearly uniform as possible

indicates where and how to bend the metal to obtain the necessary shape. Mowers differ in construction so before you make the cuts and slots indicated, run a check on all parts of the assembly, just to make sure you get them properly located. Don't solder, slot, cut, or drill holes until you're sure of location. Note the relationship of parts in Fig. 3, also the positions they assume when the unit is in operation. Compare also with the pulled-apart detail, Fig. 1. You might also correlate these views with the photo of the finished sweeper on page 151. The adjusting bar, Fig. 1, raises and lowers the brush, the assembly pivoting on the wheel retaining pin. In some mowers this is a bolt and in this case the hex nut can be replaced with a wing nut which is more easily loosened when adjustment is made. Note also in Fig. 3 that when assembled the tips of the four-section brush are trimmed so that they just clear the hood. The clearance can be $\frac{1}{16}$ to $\frac{1}{8}$ in. but no more for leaf sweeping. For some mowers you may have to make a full-size drawing of one wheel and wheel plate in order to determine the locations of the bearing and axle center. By projecting the shape of the hood on the drawing you can then determine the clearances needed for gears, bearing bosses and locations of the brush shaft and wheel-spindle slots.

The length of the brush is determined by the distance between the wheel plates (unit assembled) less the space on the brush shaft required for the two shaft collars and the sprocket. For leaf sweeping and ordinary lawn grooming regular broom straws will do for the brush sections. If there's a broom factory near you then your supply problem is solved. If not, the straws from a couple of old brooms will do. To make the individual brushes you first make a jig, Fig. 4. Then clamp the jig

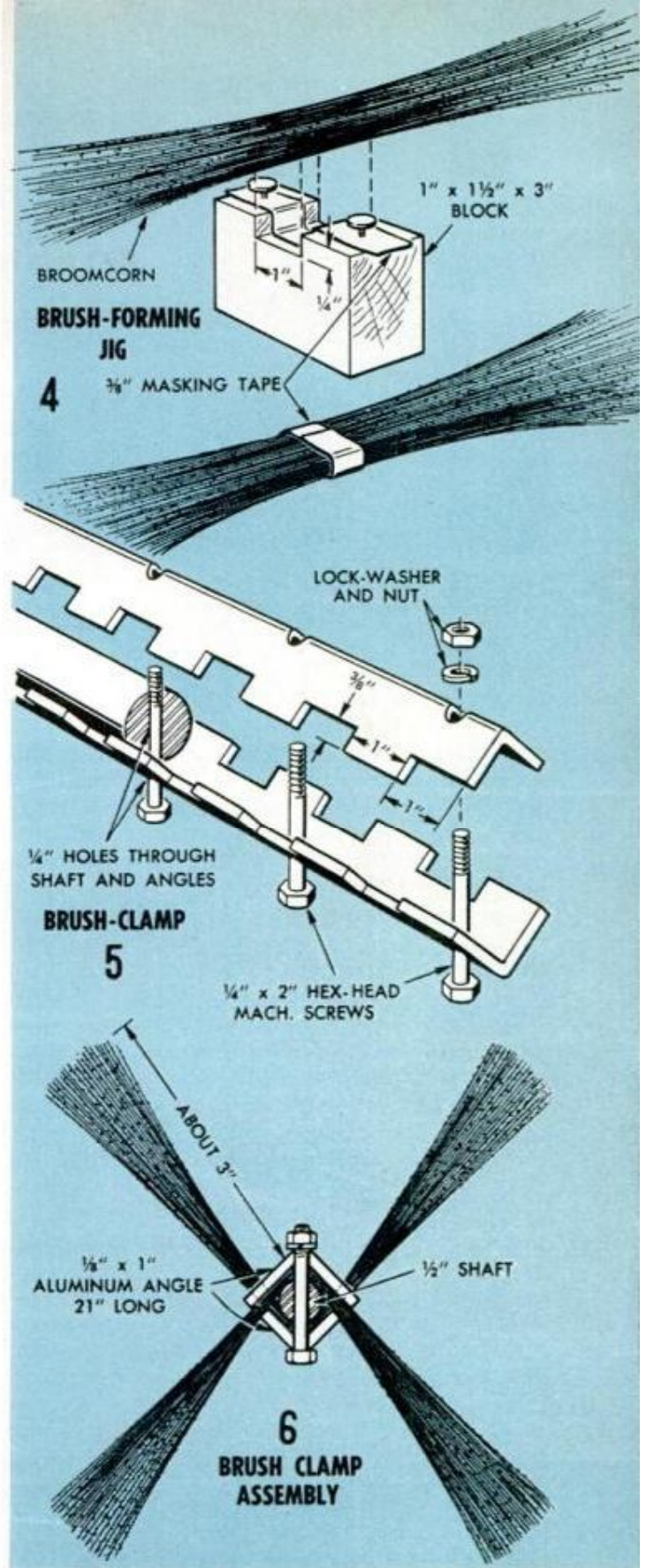
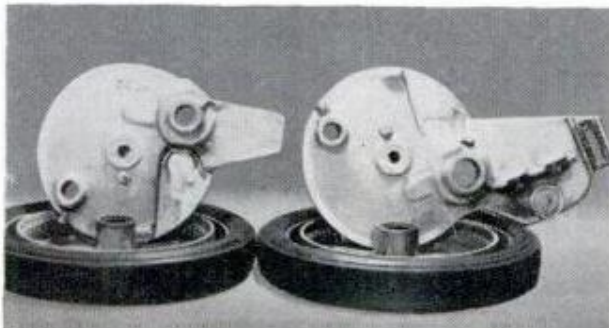

ONLY WHEELS and wheel plates of original mower are used, as pictured at the left. Below, partially assembled brush with all bundles in place ready for placing the second angle which forms complete hub



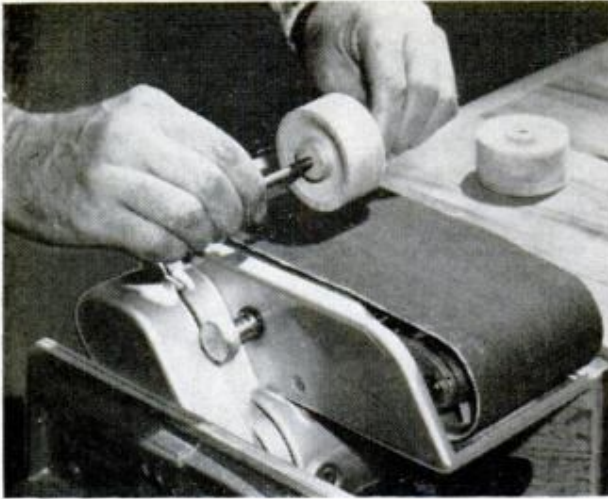

TRUE UP dolly, or trailer, wheel treads on belt sander. Hex-head machine bolts serve as wheel spindles

in a vise, lay a 3-in. length of $\frac{3}{8}$ -in. tape across the groove and thumbtack the ends. Then make uniform bundles of broom straws by pressing them tightly into the groove as in the photo at the left of Fig. 4 and taping them tightly together as indicated. Sew each bundle of broom straws along the center line of the tape, using a heavy linen thread and a backstitch. The purpose of taping is to hold the bundle in shape for sewing; the sewing holds it in shape until it can be clamped in the hub.

The brush hub, or holder, is made as in Figs. 5 and 6. Notches are cut in both webs of each of the two aluminum angles, each notch $\frac{3}{8}$ in. deep and offset 1 in. Notching can be done on a table saw as in the photo on page 152. Place the angles over the brush shaft (it should be removed from the assembly, of course) and drill $\frac{1}{4}$ -in. holes through both angles and the shaft for hex-head bolts, the holes equally spaced.

Bundles of broom straw won't take the bend required without breaking, so you coat them lightly with No. 10 motor oil and place them in the kitchen-range oven at about 250 degrees for an hour or so. The

HOLD WOOD PARTS against sheet-metal parts and drill through both. Method locates holes accurately

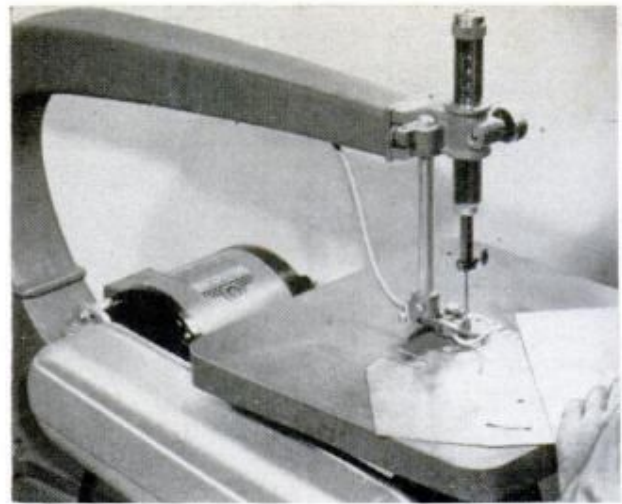
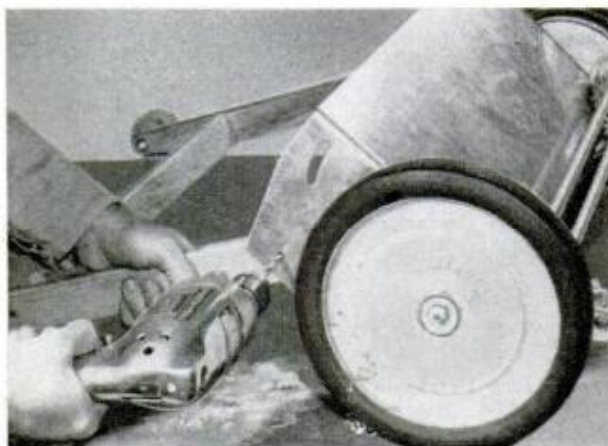

MUCH OF THE WORK of cutting out sheet-metal hood can be done on jigsaw with metal-cutting blade

heat drives the oil into the straws, making the bundles sufficiently flexible to take the bend. Hex-head machine bolts, $\frac{1}{4} \times 2$ in., are about the right length to draw the brush assembly tight, but in the first step in assembly you'll need two longer $\frac{1}{4}$ -in. bolts at the ends of the steel angles so you can draw the angles down sufficiently to permit use of one shorter bolt at the center of the assembly. Once the shorter 2-in. bolt is in place and drawn down, the two longer bolts at the ends can be removed and the 2-in. bolts substituted.

The brush is a little tricky to assemble but perhaps the best way to go about it is to attach the end of one angle loosely to the shaft with one of the longer bolts. Then support the ends of the shaft on blocks (or wooden V-blocks) and place one row of brush bundles, pulling each one under the shaft and pressing into the notches in the angle. Lay the alternate bundles on top of the shaft and the assembly will appear as in the lower right-hand photo on page 153. Now, place the second angle, insert the bolts at the ends and draw down the nuts

(Continued to page 212)

UNDERSIDE VIEW of the finished sweeper showing trailing dolly that supports the hopper and push bar

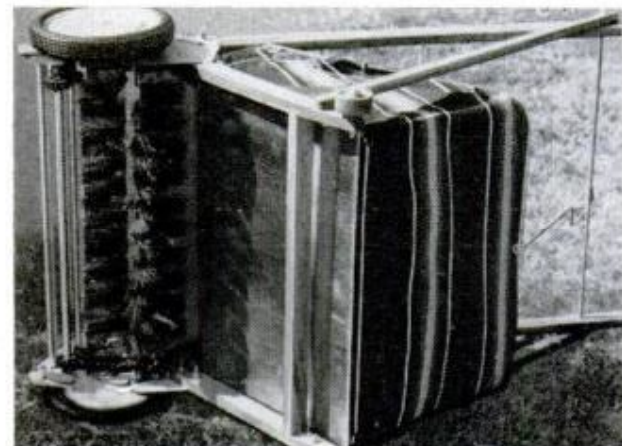



Block Wall Has Built-In Shadow Pattern

When you plan to use concrete blocks for a patio wall, keep in mind the usual shadow patterns that can be obtained simply by offsetting alternate blocks. A three-dimensional pattern is possible with as little as $\frac{1}{2}$ in. of offset per block. The pattern in the wall pictured above was made by offsetting, or corbeling, alternate blocks as each course was laid.

Such a wall can be made even more attractive by judicious use of colored ma-

sonry paints. The color, or colors, can be selected to match the house or provide a colorful background for shrubbery or flowers. With a pattern already built into the wall the surface offers much greater flexibility in the use of color. For example, on alternate sections of the wall the offset blocks can be painted one color and the rest of the blocks a second harmonizing color. Or, paint the wall one color, as you choose.

—John M. White

Cotton Swabs Sub for Paintbrush

Some small touch-up jobs around the home seem almost too minor to bother dipping a paintbrush. The next time you run into a chipped window sash or scratched table leg, forget about the brush and try using a cotton swab, such as a Q-Tip. These throwaways from the nursery are fine for dabbing a drop of paint over a small scratch or even touching up painted toys. Even on big jobs, a cotton swab will come in handy for reaching those hard-to-get corners and recesses which defy most brushes.

Many hand sprayers have small glass jars with threads which correspond to those of quart jars containing mayonnaise or other food products. These larger jars make excellent substitutes for the regular jar if you slip a short length of rubber tubing over the intake tube of the sprayer so that it reaches to the bottom of the container. You can store spray liquids the year round in the same container and simply substitute jars when you wish to use a different spray.—James V. Huffman



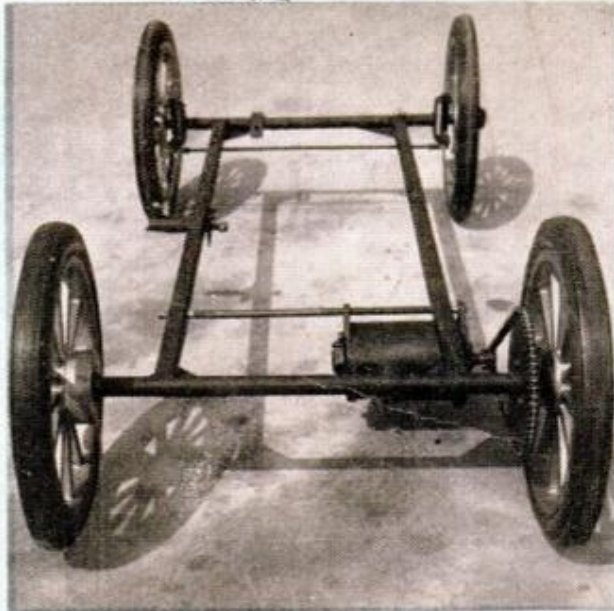

1. FRAME AND AXLES are constructed of steel tubing, both square and round. Motor is mounted in the rear



2. CHAIN DRIVE transmits power from the motor to the large sprocket mounted inside the right rear wheel

3. BRAKE DRUM bolts to inside of left rear wheel, and brake shoe assembly is mounted on the axle itself



Safe Electric

JUST ABOUT THE sharpest little sidewalk car you've ever set eyes on—that's this approximate half-scale replica of an old-time open touring car. It's powered by a 12-volt battery and can buzz around the neighborhood with a full load of passengers—moppet size—all day on one charge. Has everything, headlights, taillights, internal expanding brakes, forward and reverse gear and a loud klaxon to warn people in plenty of time. Top speed is a safe seven miles per hour which should hold Junior until he graduates from the sidewalk set.

You can buy the little car complete, ready to run, or you can purchase the hard-to-make parts with motor and take it from there yourself, making the sheet-metal seats from stock materials and assembling the running gear. This way it makes the perfect father-son project.

The units require a minimum of welding, and the subassemblies can be joined with spotwelds, rivets, or sheet-metal screws. Construction begins with the frame, Figs.

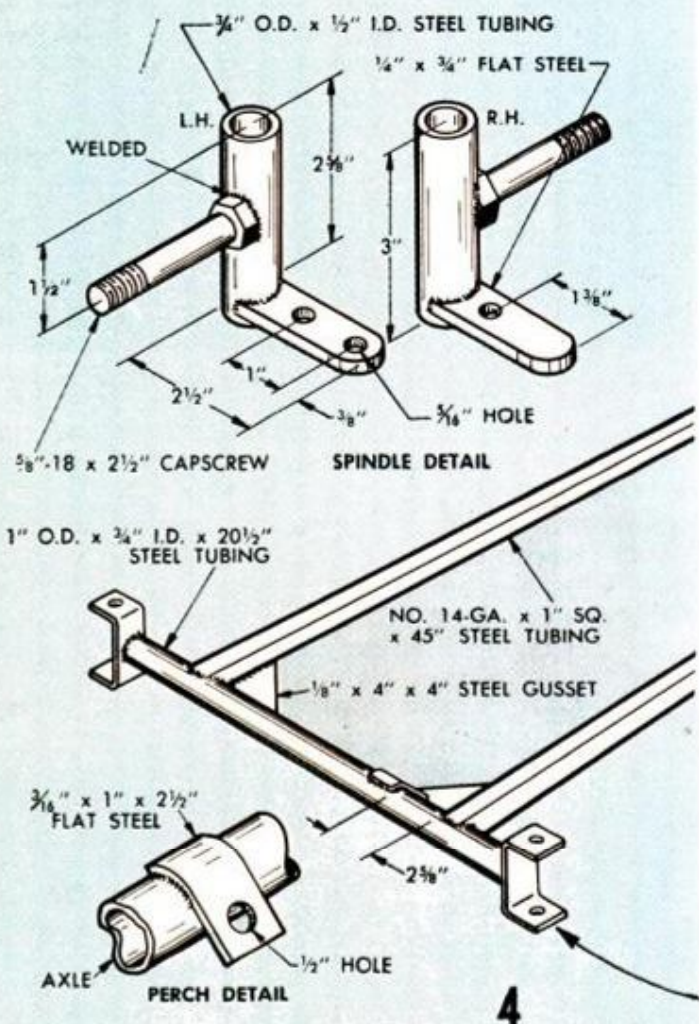

Touring Car

By George E. Jones

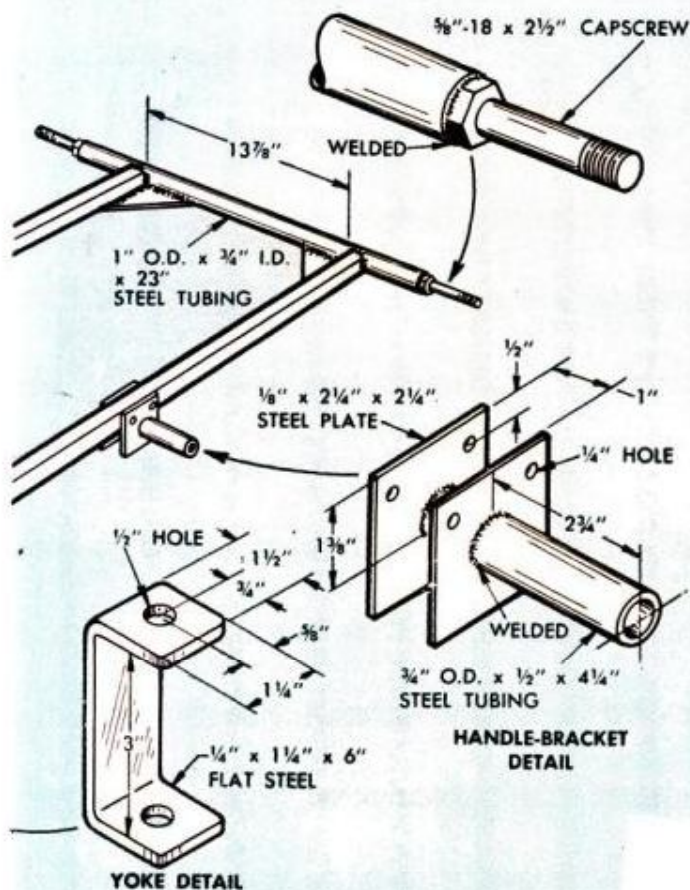

1 and 4, which is made from 14 ga. x 1-in.-square steel tubing. Cut the two side rails to length and file curved notches in the ends for the tubular axles. To make the front axle, cut spindle yokes to length, bend them to the correct shape in a vise and drill holes for 1/2-in. king bolts in the ends. Then cut the axle from 1-in. steel tubing and weld the yokes to it so they are centered on the ends, parallel to each other.

5. **READY TO ROLL**, the half-size touring car will appeal to even most modern, space-minded youngster

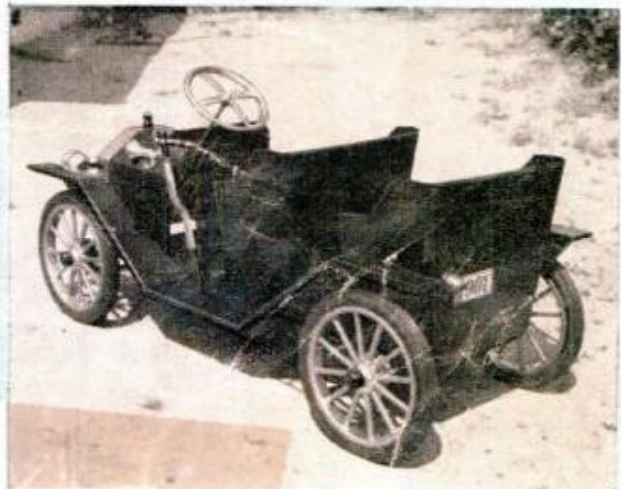

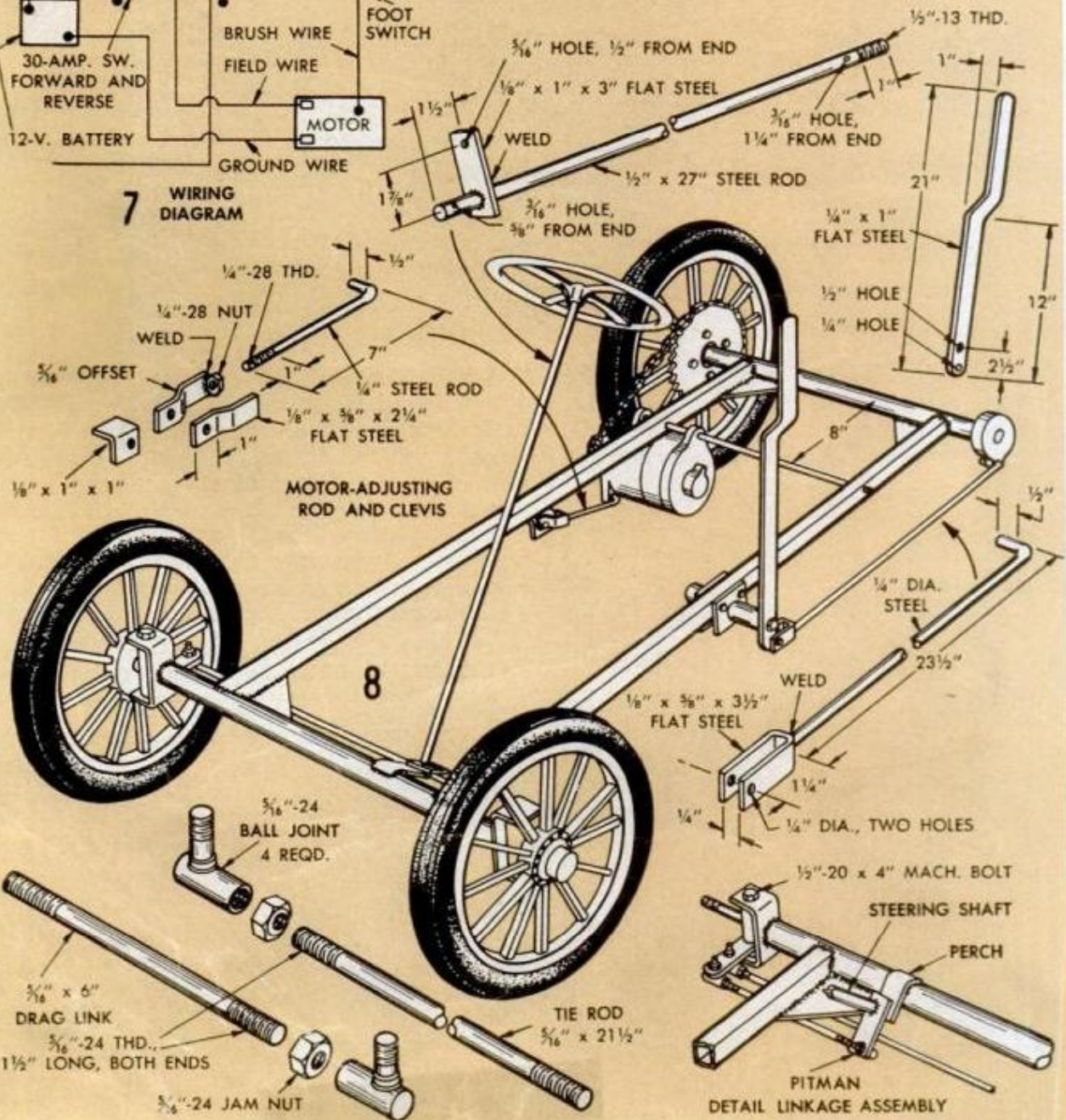
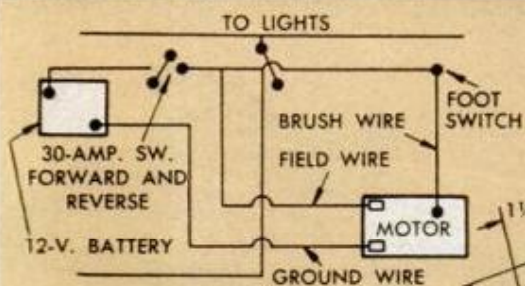
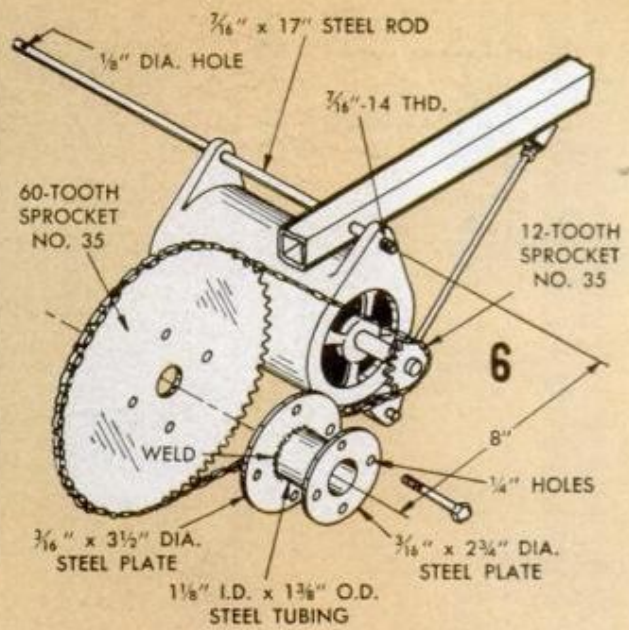

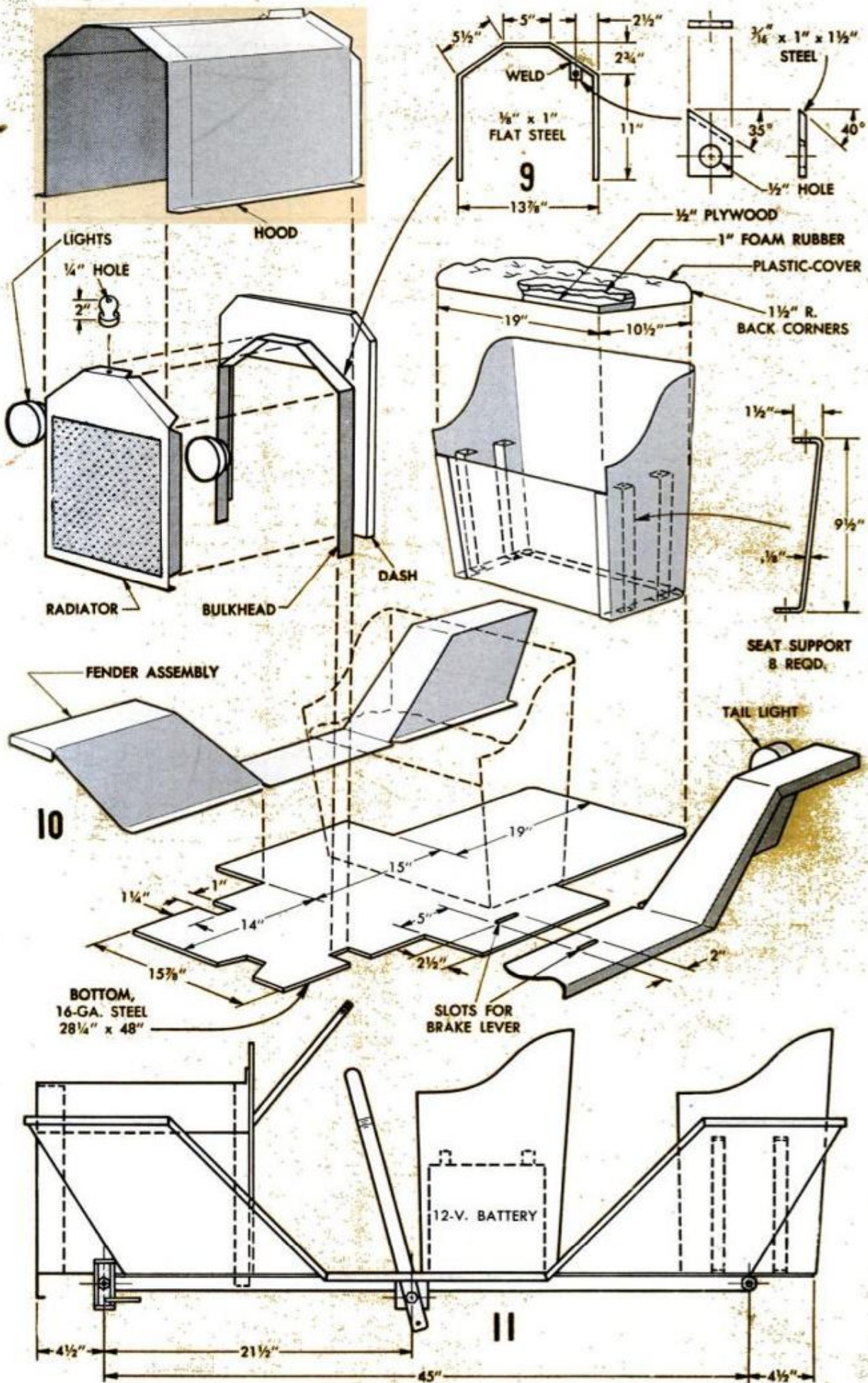

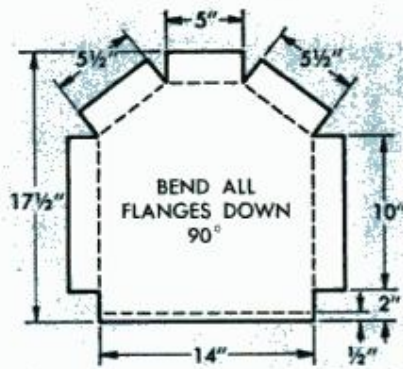

RADIATOR

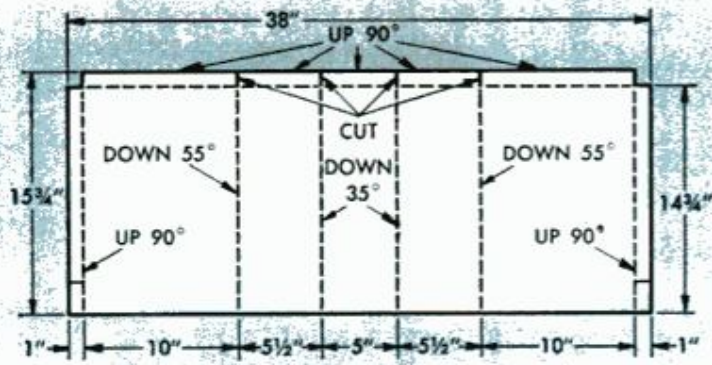

HOOD

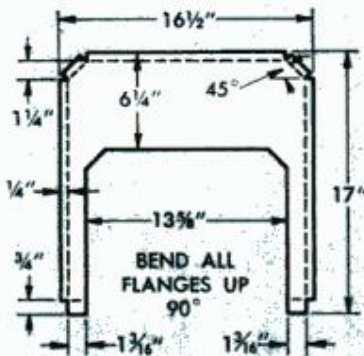

DASH PANEL

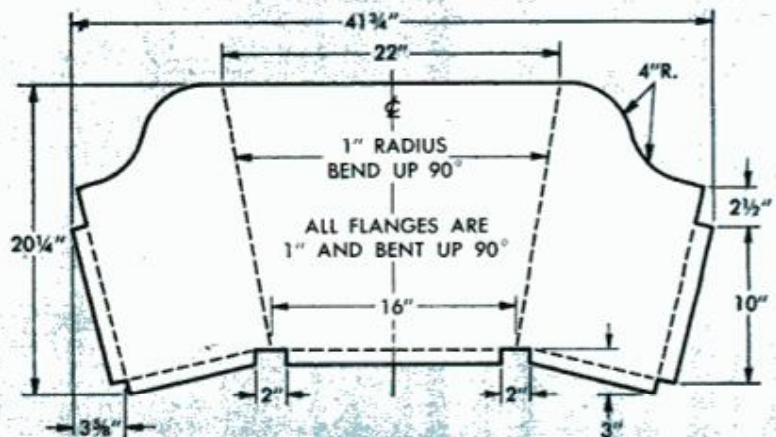

SEAT AND BACK

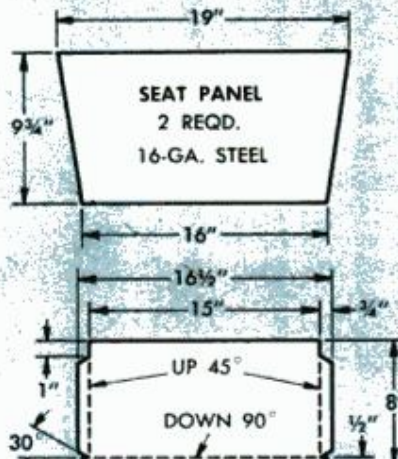

SEAT PANEL
2 REQD.
16-GA. STEEL

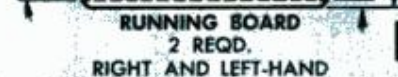

RUNNING BOARD
2 REQD.
RIGHT AND LEFT-HAND

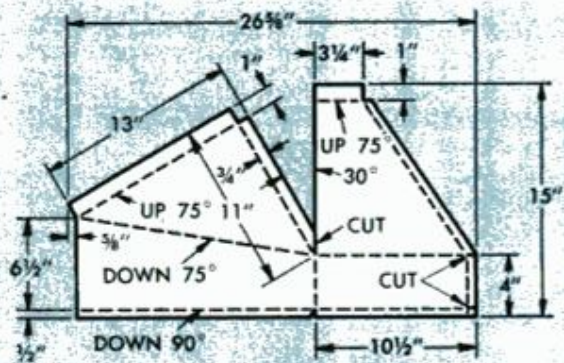

FENDER
4 REQD.
RIGHT AND LEFT-HAND

12 BODY PATTERNS

Weld the front axle in the notches on the ends of the side rails with the yokes at a 90-deg. angle to the side rails. After cutting the steering perch, Fig. 4, drill a 1/2-in. hole in it and weld it to the axle. The rear axle is made by butt-welding capscrews to the ends of 1-in. steel tubing. Weld this in the side-rail notches and complete the frame by welding a gusset in each corner.

To make the front-wheel spindle assemblies, Fig. 4, first drill and mount the arms, then weld capscrews to the tubular bodies at a 90-deg. angle to the arms. Assemble the brake handle bracket, Fig. 4, and mount it on the left frame rail.

Now is a good time to cut all rods to length and thread them. Weld the pitman arm to the steering shaft, Fig. 8, and as-

semble the ball joints on the tie rod and drag link. Bolt the ball joints to the spindle arms and complete the sprocket coupling, then clean the frame and give it one coat each of metal primer and flat black enamel. When the frame has dried, mount the front wheels with castle nuts held in place with 1-in. cotter pins. The wheels will revolve freely if you back the nuts off 1/4 turn from the snug position.

Adjust the ball joints for about 1/16-in. toe-in and tap the hub caps in place. The brake drum, Fig. 3, is bolted on the left rear wheel, and the brake shoe assembly is mounted on the axle itself with setscrews. Snug up the wheel with a castle nut held in place with a cotter pin, and add the hub.

(Continued to page 226)

Solving HOME PROBLEMS

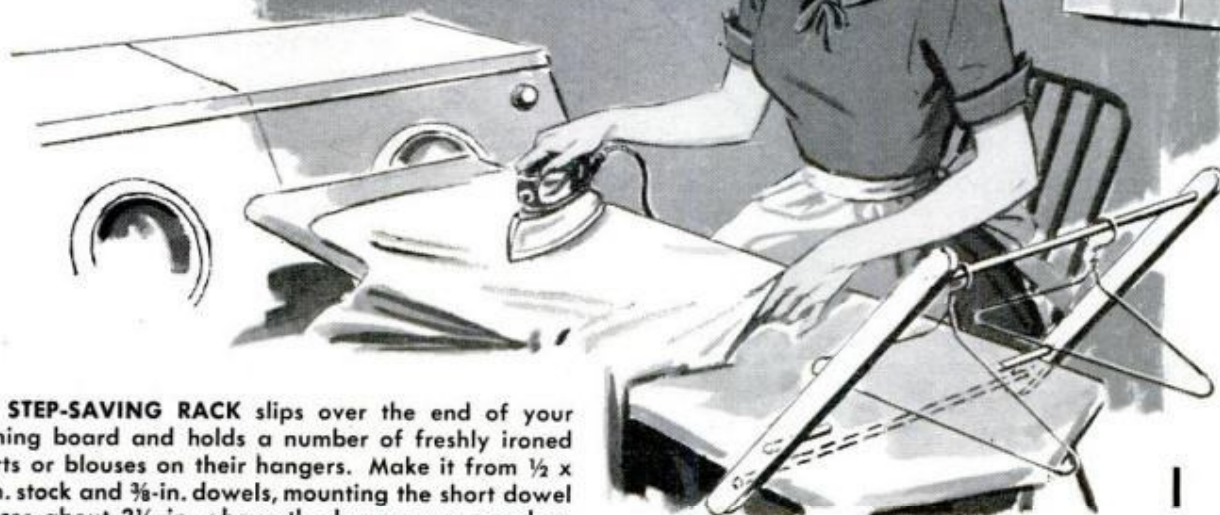

1. STEP-SAVING RACK slips over the end of your ironing board and holds a number of freshly ironed shirts or blouses on their hangers. Make it from $\frac{1}{2}$ x 1-in. stock and $\frac{3}{8}$ -in. dowels, mounting the short dowel braces about $3\frac{1}{2}$ in. above the lower cross member. The side pieces should be approximately 2 ft. long

2. REMOVABLE SHELVES are easily installed between the exposed studs of your garage or workshop if you use short sections of discarded flat curtain rod as shelf slides. Tack the sections of curtain rod to the studs, making sure that they are level, and slide $\frac{1}{4}$ -in. or $\frac{3}{8}$ -in. plywood shelves into the grooves

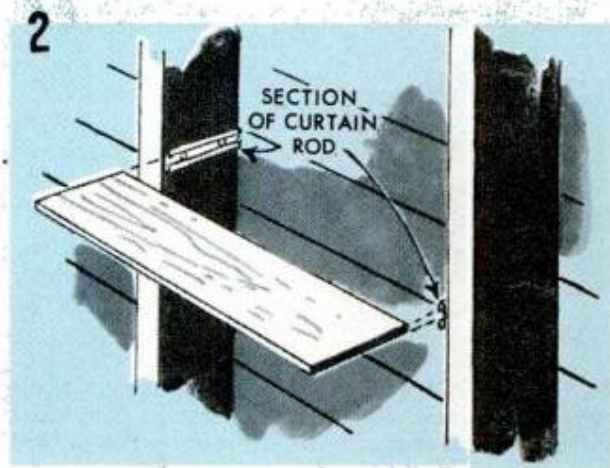

3. ELECTRICAL APPLIANCE cords often trail loosely on the floor when the appliance is not in use. Each time the plug is accidentally stepped on there is a risk of damaging the prongs and increasing the danger of short circuits. To protect plug, slip the prongs into an older-type threaded connector.

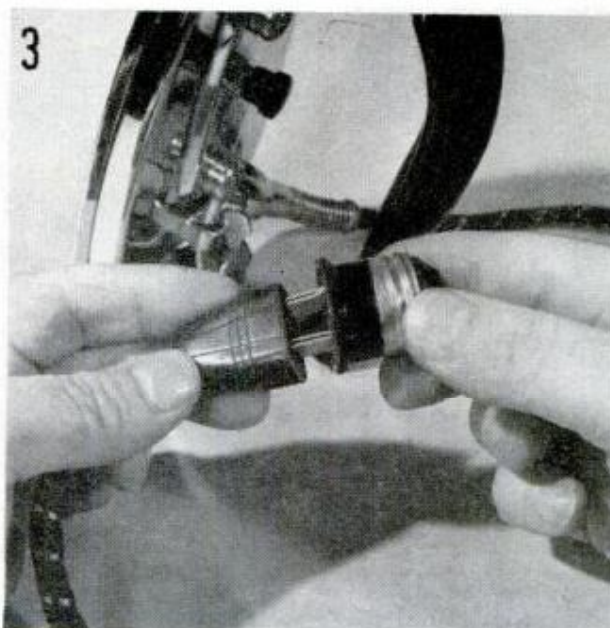

4. SCRUB BRUSHES are made from very hard wood, and their sharp edges often mar woodwork and furniture. To prevent such damage, drive rubber-headed tacks near the ends or corners of the brush to act as bumpers. The tacks will be easier to drive if you first drill slightly undersized pilot holes for them

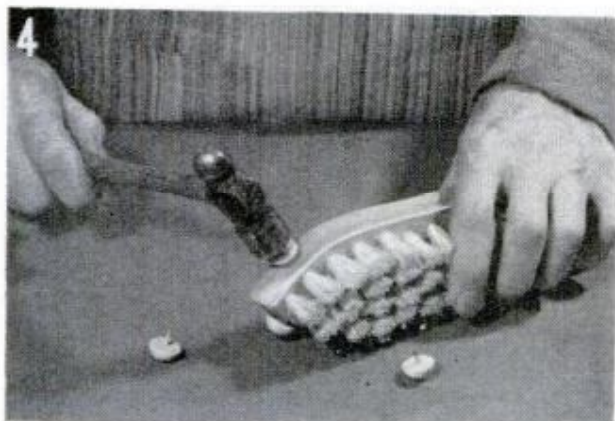

SOLVING HOME PROBLEMS



5. DISCARDED DRAWER can be converted to a useful shelf unit simply by standing the drawer on end and adding one or more shelves. Mount the shelves by nailing into them through the sides of the drawer

7. CHILDREN'S SHOELACES receive hard wear, and the metal tips on the ends are soon either damaged or lost. The next time you have to thread one of these tipless laces, use bobby pin as a threading needle

7



9. CHILDPROOF A DRAWER by installing an elbow catch on the inside of the front panel and a matching striker on the underside of the center guide. Drill a 1-in. hole in the front about 2 in. below catch

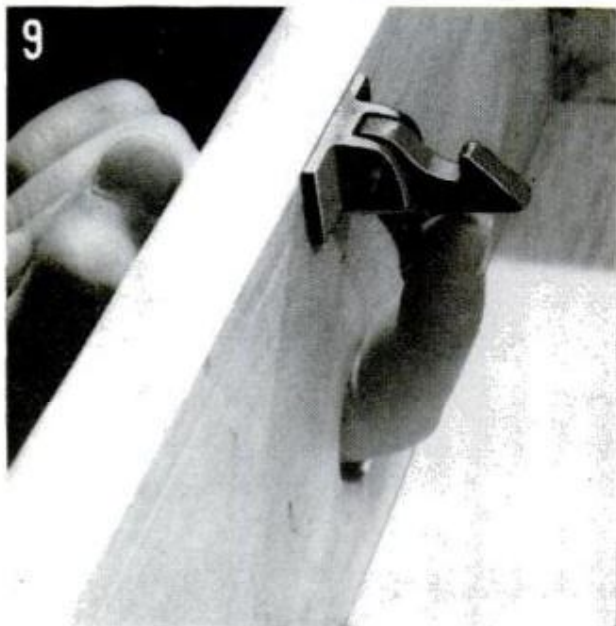

6

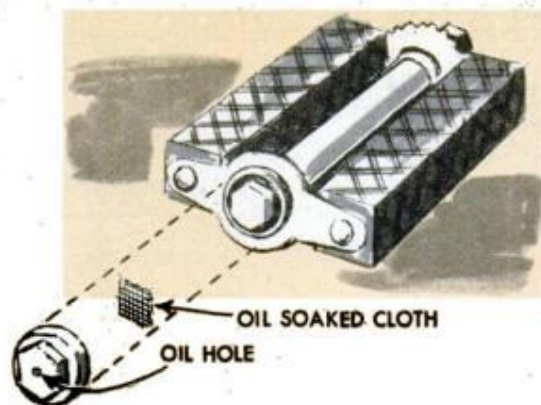

6. BICYCLE PEDALS will wear much longer and require less maintenance if you pack a small, oil-soaked piece of cloth into the cap to lubricate the shaft and prevent dirt from working its way into the bearings

8. JAR OPENERS have always been popular kitchen tools, and here's a Y-shaped plywood model you can make for the purpose. Line the inside of the legs with emery cloth to provide a rough surface for gripping

8



10. TRANSPLANTING can be accomplished without disturbing the delicate root system if you line the starting container with a plastic bag. Don't forget to punch a few drainage holes in the bottom of bag

10



ANIMATED EASTER EGG



By Willard and Elma Waltner

YOUNGSTERS WILL BE sure that they are special friends of the Easter Bunny when they discover this thrilling surprise egg on Easter morning. Long an old-world favorite, the originals were made by constructing tiny scenes inside real egg shells. This giant-sized version is formed of papier-maché over a balloon, and contains an animated scene with three bunnies chasing each other in and out of their house. The viewer makes it work by a concealed crank which is turned by pushing a dowel handle in and out.

Begin by preparing a creamy flour paste and a quantity of irregular paper strips. Any kind of paper will do, but since the strips are applied in layers they should differ in appearance so that you can tell at a glance when one layer is complete.

Blow up the balloon until it is about 20 in. in circumference and tie the stem. At this size, it will be egg-shaped instead of round. Next brush paste on one side of the paper strips and cover the balloon with a single layer of paper, leaving a 2-in. circle around the stem for the viewing hole and a 4-in. hole at the top to admit light. Continue building up the shell until at least six layers of paper have been applied, then brush a coating of paste over the last layer and put the balloon aside to dry for a day or two. Once the shell has dried, you can deflate the balloon and pull it out.

Before cutting the shell in half, trim the edges of the two openings to make them even. Cut the shell lengthwise, beginning



COVER THE BALLOON with strips of paper coated with paste, but leave openings at top and around stem

IN AND OUT they race, and the delighted viewer can control the speed of the rabbits as he turns the crank



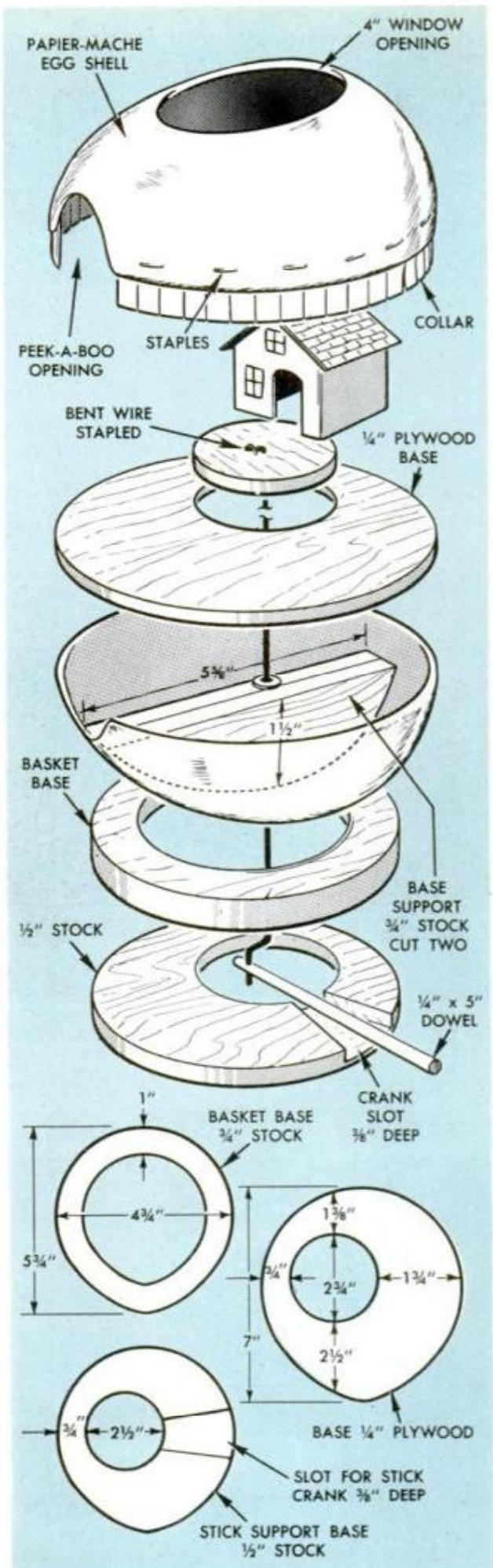

at one edge of the viewing hole and cutting all the way around to the opposite edge of this opening. Make sure that the 4-in. window is centered in the top half of the shell. To make the collar which holds the two halves in position, cut a 1/2-in. strip of posterboard long enough to fit around the inside of the egg and make 1/4-in. slashes in this strip at 1/4-in. intervals. Glue and staple this collar inside the edge of the upper half of the shell. Because of the forming method used, the dimensions and shape of each shell will vary slightly from those given in the diagram. Be sure that you shape the base, base support, basket base, etc., to fit your particular shell.

The base support which is mounted inside the bottom half of the shell is made by cutting two pieces of 3/4-in. stock to fit the curve of the shell and nailing them together. For a closer fit, bevel the outer edges of the support slightly. Before fastening the support in place, cut the 1/4-in. plywood base to the approximate shape and dimensions given in the diagram, and locate a 2 3/4-in. circle as shown. When cutting out this circle use a coarse blade so that the saw kerf will be wide enough to permit the disk to turn freely inside the hole.

Drill a hole in the center of the disk large enough for a coat-hanger wire, then cut a 4-in. length of the wire, bend one end to a right angle and slip the wire through the hole. Use a staple to fasten the short bent portion of the wire to the disk. Now place the base on the base support in the bottom of the shell and locate the point where the wire axle of the small disk should pass through the support. Drill a hole through the support at this point, making it slightly oversize to allow the axle to turn freely. Once this hole has been drilled, you may glue the base and its support in place.

(Continued to page 206)

BASE SUPPORT is made of two pieces of 3/4-in. stock cut and beveled to fit the curvature of the egg shell



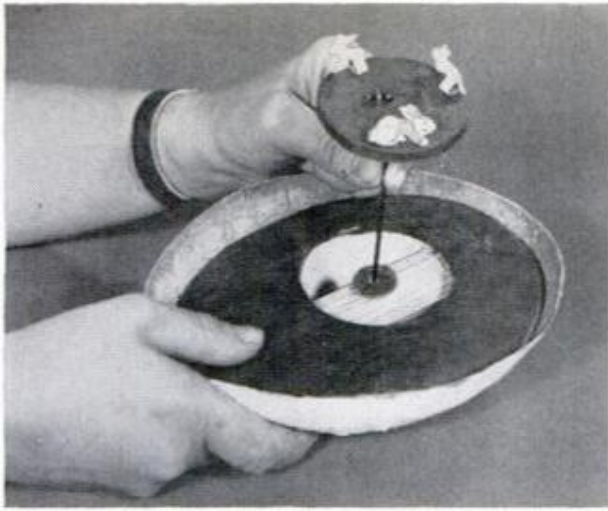

ROTATING DISK is connected to dowel crank by a length of heavy wire which passes through the support



PAPER COLLAR attached to the inside edge of the top part of the shell helps align the two halves of egg



DOWEL CRANK has a hole drilled in one end to hold the bent end of the wire axle which turns the disk



DECORATIONS for the egg are limited only by the materials at hand and the amount of imagination used

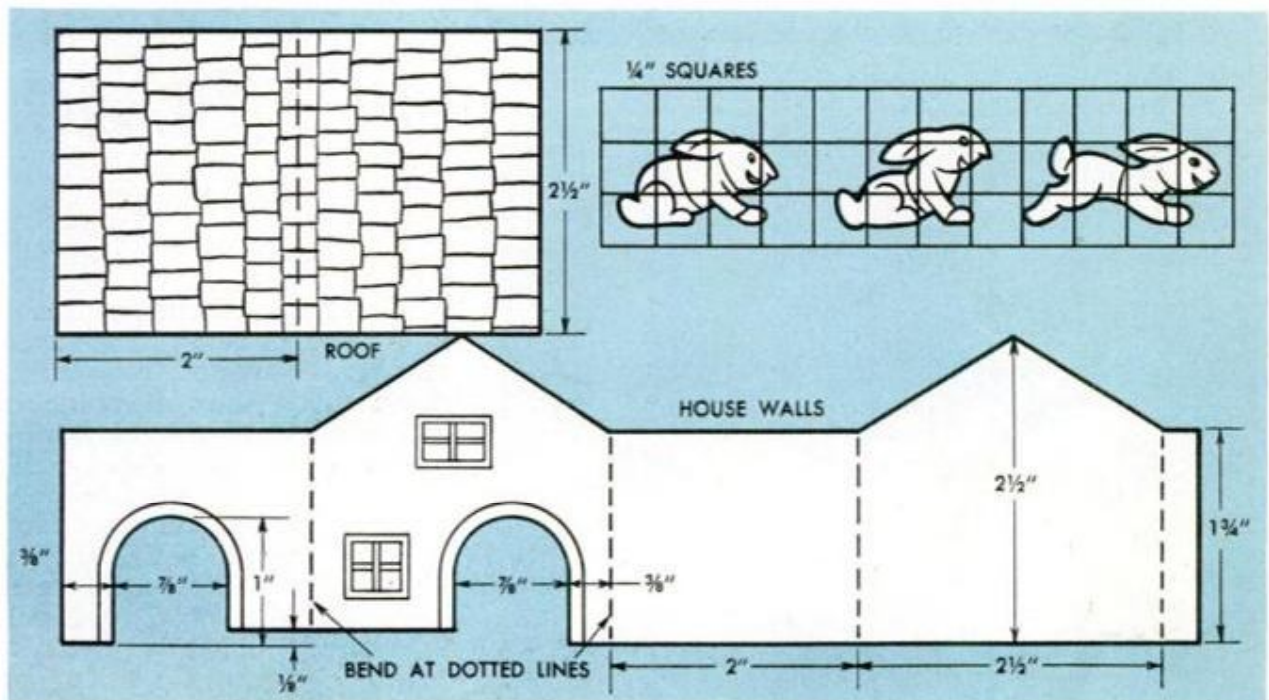

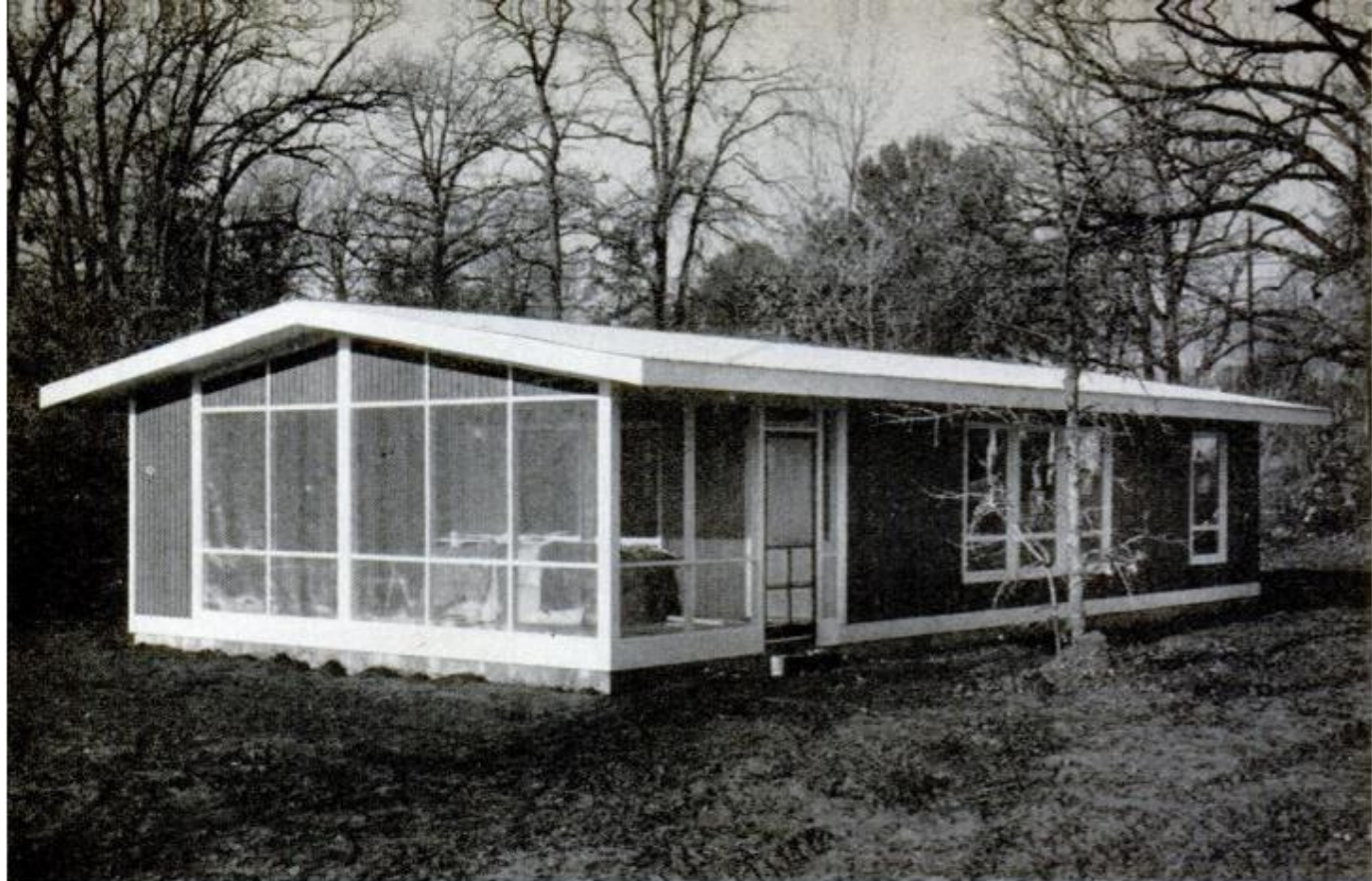

PILOT HOME has roof of colorful corrugated aluminum supported by 2 x 4 purlins nailed to rafters and spaced approx. 24 in. apart



START YOUR VACATION HOME at Home

PART III

NOW THAT the floor sections and the exterior and interior walls of your PM vacation home have been prefabricated, there's little else you can do at home to save time at the building site. While the rafters could be pre-cut, it is more advantageous from a standpoint of transportation to have the rafters, along with other dimensional lumber you'll need, delivered to the site from a nearby lumber dealer and make the plate and ridge cuts on the

POPULAR MECHANICS



WHILE YOUR FUTURE PLANS may not include the bedroom addition, you may someday plan to add the screened porch. Pouring the slab for it now will not only provide a patio you'll enjoy in the meantime but a dry landing outside the door to help keep mud out of the house. Here gravel fill is brought even with footing



HERE VERTICAL-GROOVE plywood of pilot home is being finished with two coats of redwood stain to contrast with white trim



BEFORE FOUNDATION is back-filled, concrete blocks should be waterproofed with asphalt coating. Below, stock panels of vented soffit board come ready for nailing to roof rafters



COMPLETE PLANS

including a material list, are available for the PM Vacation Home. Each set contains 14 sheets which detail the basic home as well as the add-on units. Floor alternates are included for the builder who may wish to follow conventional joist construction rather than pre-fabricating sections. The cost of the plans is \$20.00 for one set, \$35.00 for four sets. Each additional set is \$5.00 when ordered with the initial set. Order from Plans Department, Popular Mechanics Magazine, 200 East Ontario Street, Chicago 11, Illinois.

job. The time saved in cutting them at home hardly would offset the problem of carting such long members (16 ft.) any great distance.

While waiting for the balmy days of spring, a thorough understanding of the general construction of the basic home will allow you to proceed without delay at the site. The sectional view from foundation to roof in Part II, plus accompanying details, will orient you on how the floor sections rest on 2 x 8 plates bolted to the foundation wall and on two laminated beams supported on piers in the crawl space. By hiring someone in the area to put the foundation in for you, you'll be way ahead timewise and can start setting beams and adding the plates the day you arrive. The sectional view also shows how the exterior wall sections hook over the floor sections and how the top of the walls are aligned and tied with a second top plate all around. You'll see how the lower edges of the wall sections are finished off with a drip cap and a 1 x 8 skirt board applied over tarpaper flashing. Also, how the overhang is finished off with a 1 x 8 fascia board, a 36-in. vented soffit board and a 1 x 3 trim board, plus quarter round.

A total of 26 rafters are required for the basic house, eight of which are used to form the rake, or overhang, panels at the gable ends. The rake panels can be made up as separate units assembled on the ground and raised in position, or they can be framed in place on the roof. The pattern for the rafters was given last month in

(Continued to page 214)



KNOCKDOWN WINDOW UNITS are assembled on the job prior to installing in openings in prefabricated walls

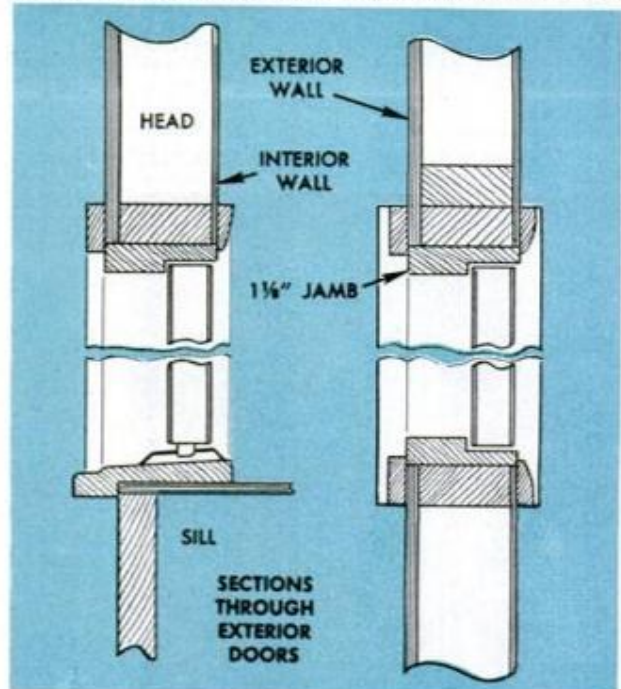

WHEN WIRING is in place in exterior walls, blanket insulation is installed and stapled to the studs



ROOF-FRAMING OF BASIC UNIT

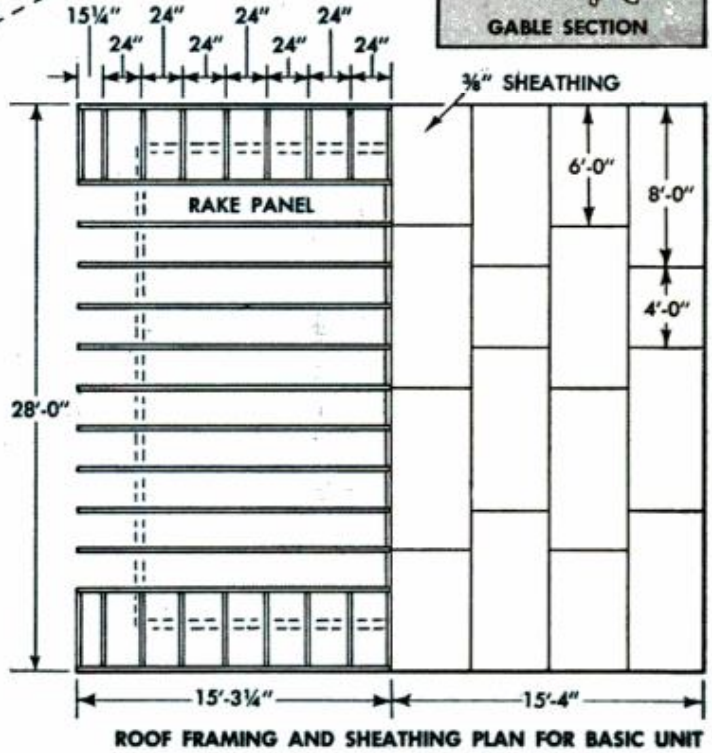
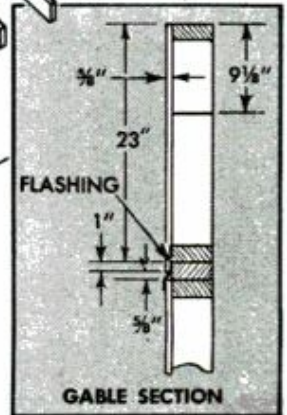
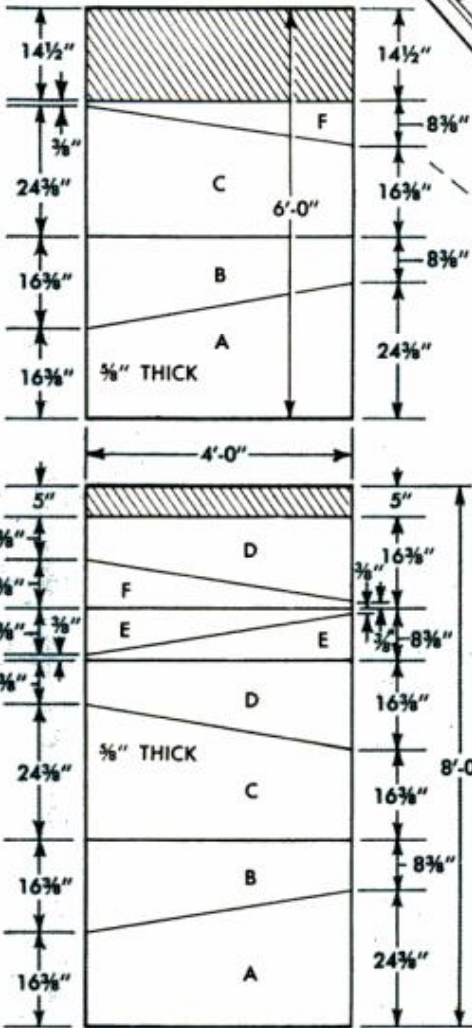
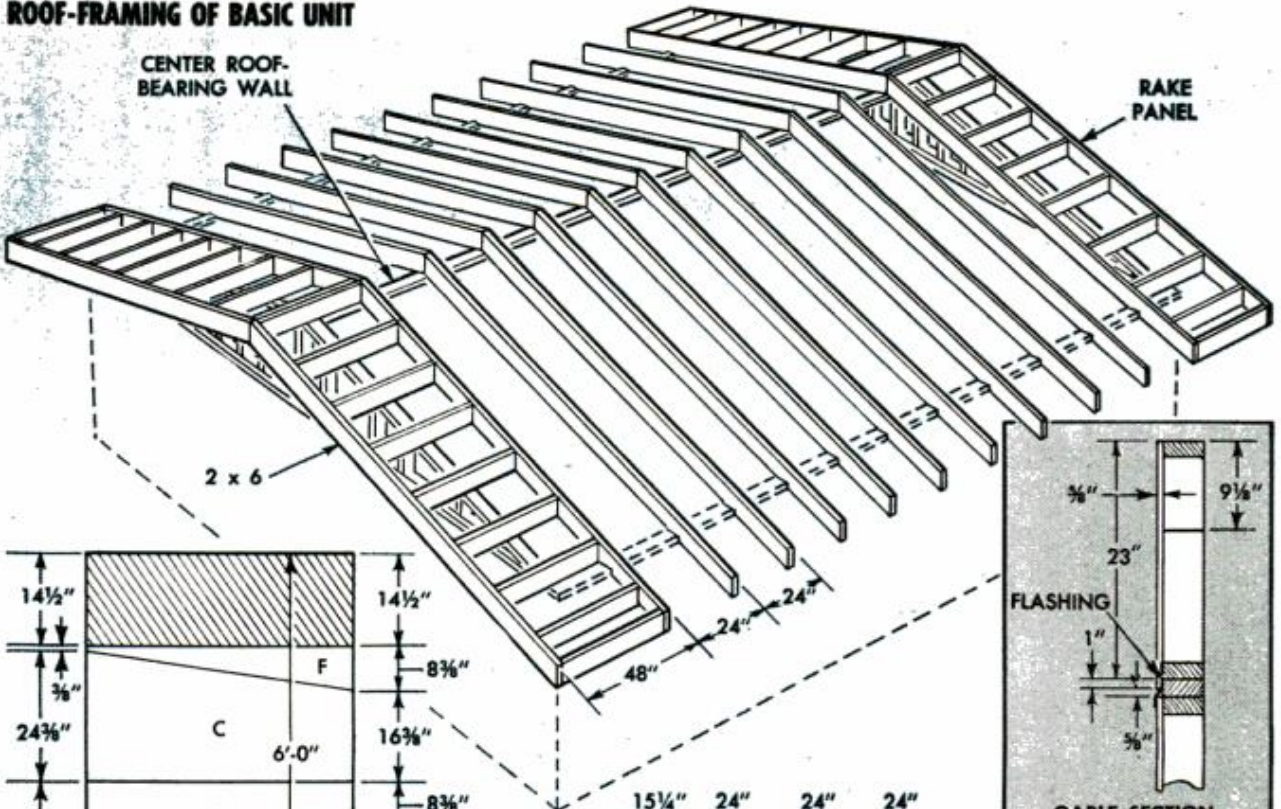

CUTTING PLAN FOR GABLE SHEATHING



ORDER IN WHICH SHEATHING IS APPLIED TO GABLE ENDS

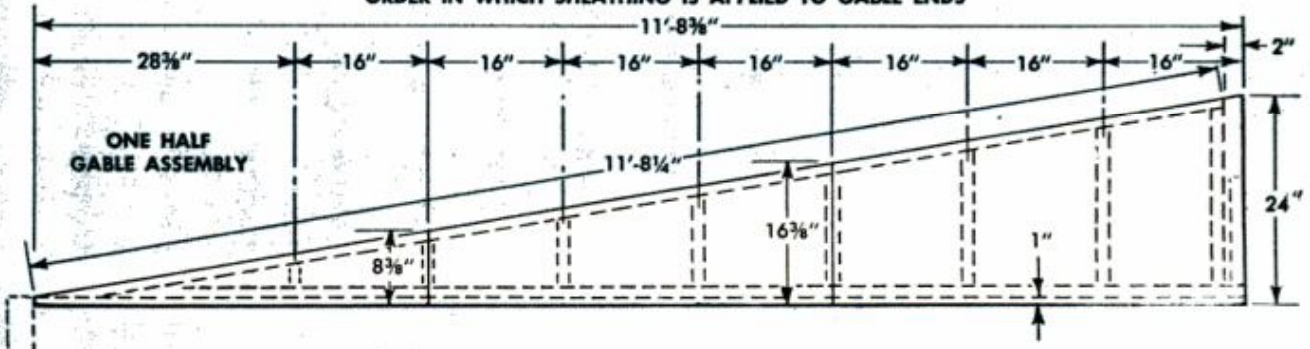



SOLAR HOT-DOG COOKER

WHILE IT'S too small to keep up with the appetites of a hungry Cub Scout pack, this solar cooker is sure to be a successful conversation piece at your next backyard barbecue—even if there's snow on the ground! It costs less than \$10.

The cooker uses a 14-in.-dia. Fresnel flat plastic lens which can be purchased for about \$6. from Edmund Scientific Co., Barrington, N.J. The only other materials needed are a 6 x 8-in. sheet of aluminum, a 1/4-in. rod, two machine screws with wing nuts.

The two-piece frame for the lens should be approximately 14 in. square and is made by sandwiching the lens between two identical wooden frames mitered at the corners. The side pieces of the main frame are about 20 in. long. When attaching the lens frame, locate it so that the center of the lens is in line with the upper edge of the main frame as in the detail.

Form the reflector by rolling the sheet of aluminum into a half cylinder and nailing it to the reflector brace which will be mounted on the main frame later. To make the spit, bend a handle in one end of the metal rod and point the other end. Make the two legs and fasten them to the main frame with machine screws and wing nuts.

You'll need some sun and a hot dog to find the correct locations for the spit and reflector. Drive two small nails for the spit about 14 in. back from the surface of the lens, and temporarily mount the reflector base in such a position that the forward edges of the reflector are approximately in line with the spit. To make a test, aim the cooker at the sun, put a hot dog on the spit and see what happens. You may have to shift the spit or reflector so that the spot of focused sunlight is neither so large that it won't provide enough heat nor so small that it will burn a hole right through the hot dog. ★ ★ ★

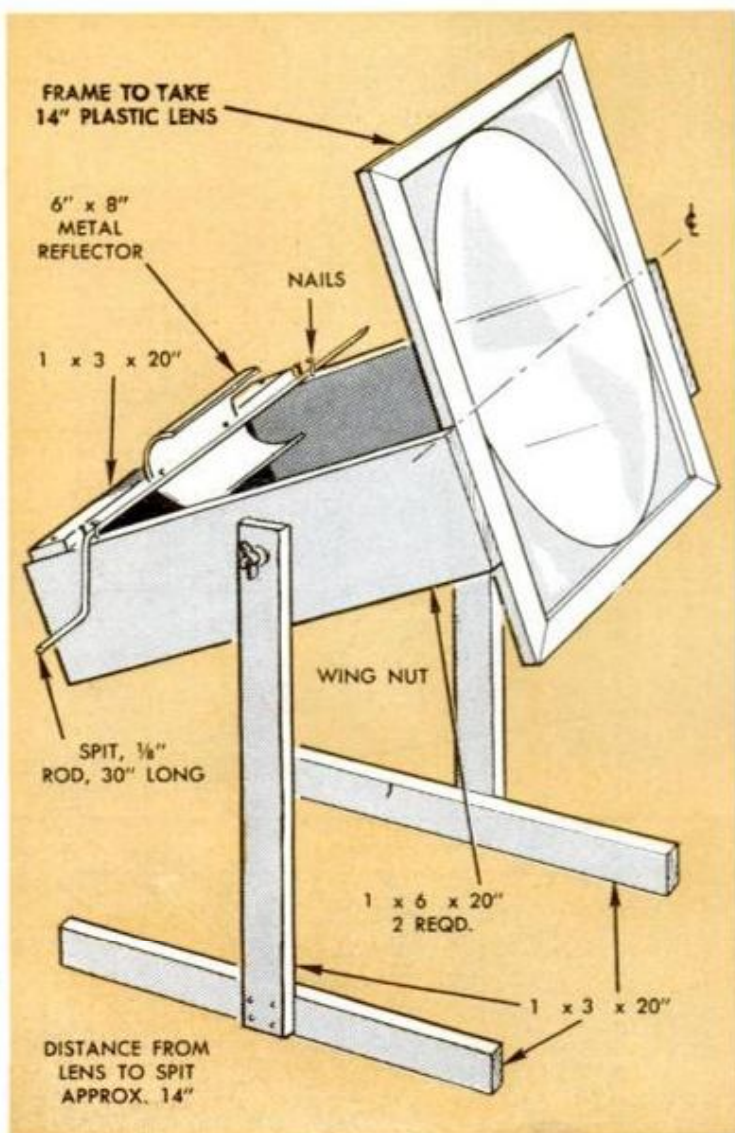

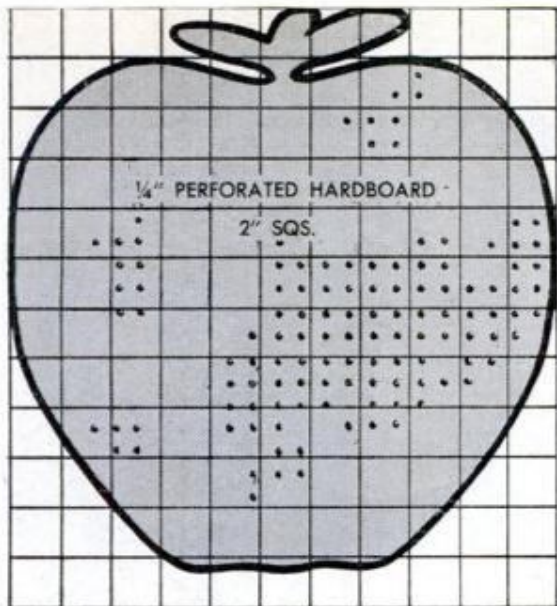

An Apple for the Kitchen

Keeping kitchen tools handy is easy when they are hung within arm's reach on this big harvest apple. It's jigsawed from $\frac{1}{4}$ -in. perforated hardboard and is held out from the wall with a couple of $\frac{3}{4}$ -in. cleats

applied to the back so that regular wire hooks can be used in the holes. If you prefer, a regular hanging rack can be attached to the apple and used in addition to the wire hooks as shown.—J. G. Wisler

Hang It All

Picking bits of glass from countless screws, tacks, nails, etc. kept in jars stored on a shelf may make you eager to find another way of storing glass jars safely in your workshop. Some crafters fasten the jar covers to the overhead joists and screw the jars in them. This method has its drawback in that the jar is without a cover when making repairs outside the shop. A better way of storing the jars, and one which also conserves shelf space, is to attach regular metal corner brackets to the covers so they can be hung from nail hooks.



Gas Chamber for Moles

Want to rid your lawn of moles? Gas them with your power mower. Lawn-mower engineers at Minneapolis have found that the exhaust from gas-powered mowers will effectively put an end to their destructive burrowing habits. Simply attach a length of rubber hose to the mower exhaust, start the mower and insert the hose into the tunnel. The gas fumes will soon spread through the myriad of tunnels, quickly putting an end to Mr. Mole.

Next best thing to a projection stand is an adjustable ironing board. Provides ample table surface for slides, reels, etc.



MOWER MADE BY: TORO MFG. CORP., 3016 SNEILING AVE., MINNEAPOLIS, MINN.

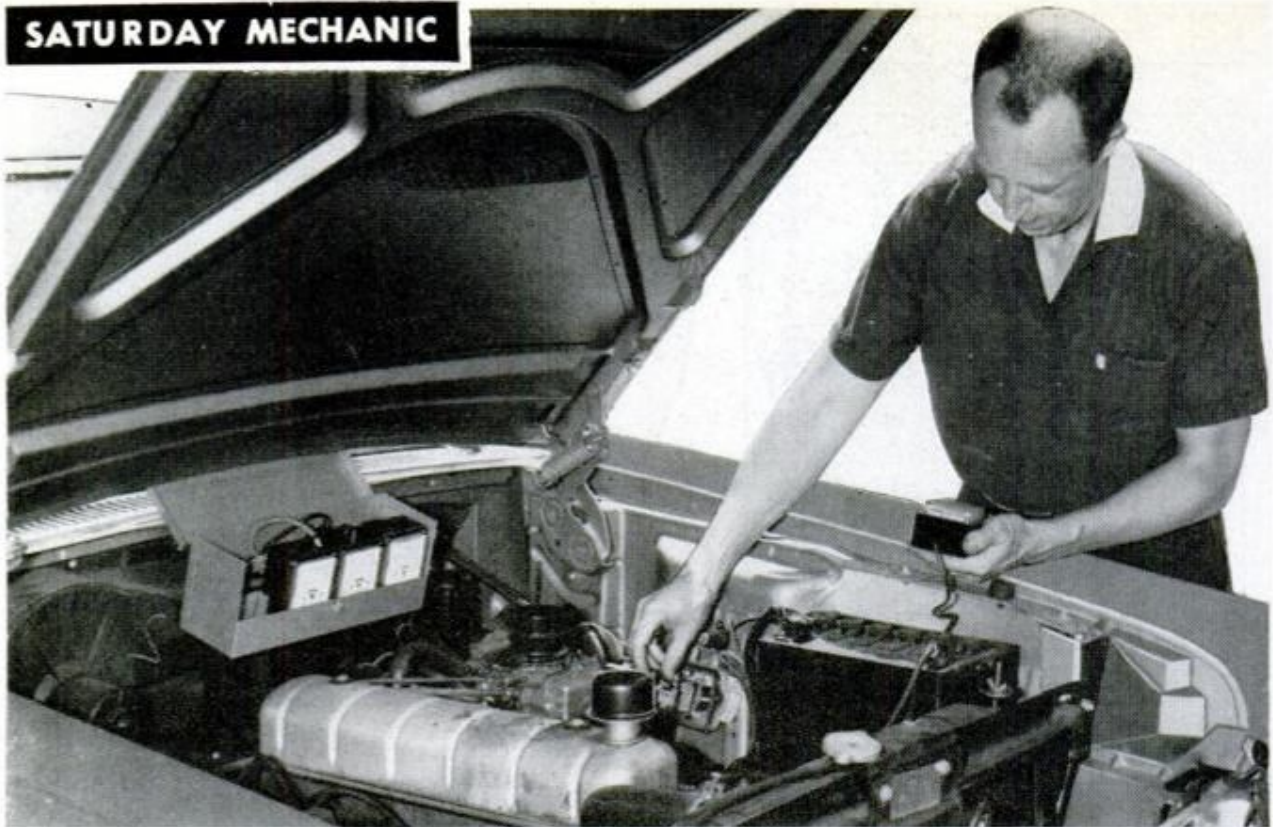

1. TEST INSTRUMENTS should always be located within easy reach from any point about engine compartment

Regulator – Generator Checks

Keep the electrical system of your car at peak efficiency

By William J. Hector

BATTERY RUNNING DOWN more often than normal lately? Headlight bulbs burning out more frequently? If you must answer yes, then you have a warning that something is wrong with the generator-regulator system in your car. If you decide to take care of the chore of checking out the system yourself to localize the trouble, make a few simple visual checks first.

Press inward on the fan belt with your thumb at a point about halfway between the pulleys. Most manufacturer's instructions say that the belt should depress for about $\frac{3}{4}$ in. before tending to resist further movement. As a rule this indicates about the right amount of tension. If you get an inch or more flex in the belt, it may be slipping and this could be the cause of trouble. Tighten the belt to the recommended tension by loosening the bolt holding the generator on its mount and moving the generator back until the correct amount of belt tension is indicated, Fig. 13. Be sure to tighten the bolt.

On cars that have been in service for a year or more nearly every part in front of the fire wall takes on a coating of oil and

grease spatters, road grime and dust. This can even accumulate to the point where it forms a current path across terminals, or results in resistances, possible shorts and

2. BEFORE MAKING any tests polarize the generator and then be sure to observe polarity when testing

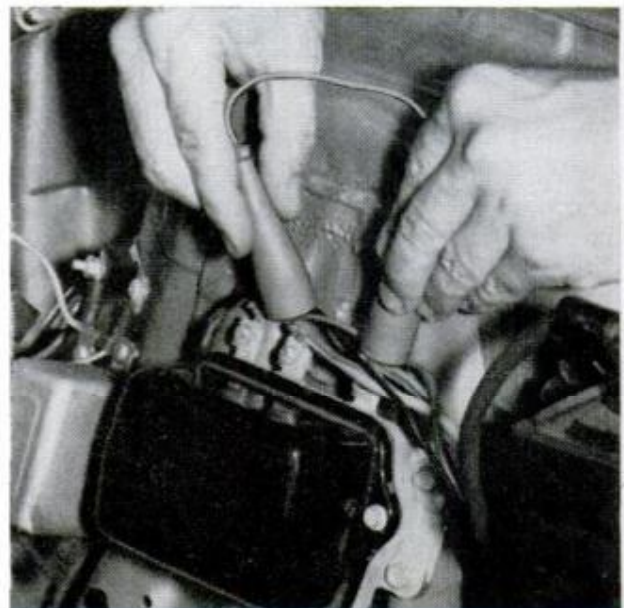

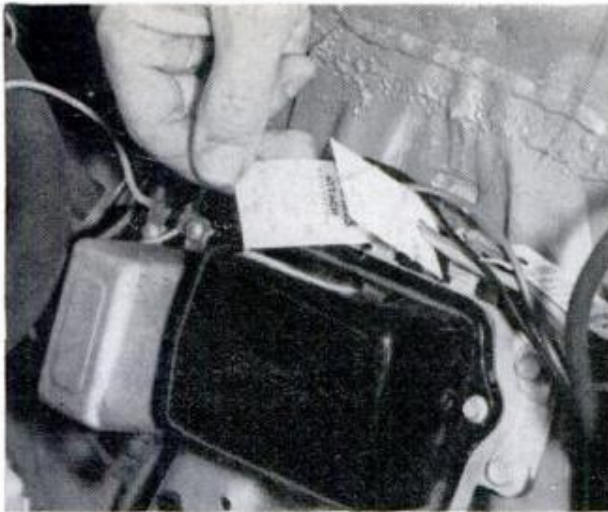

3. BEFORE TESTING tag each wire to be removed from terminals. Reconnecting incorrectly can cause damage

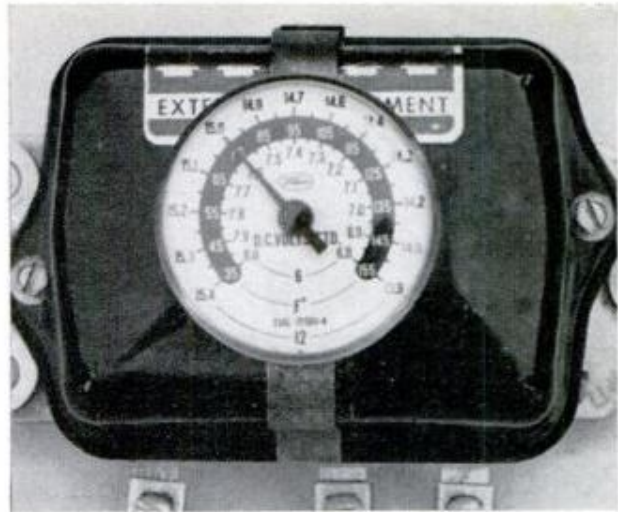

4. REGULATOR THERMOMETER indicates temperature and average setting for voltage limiter, or regulator

REGULATOR GENERATING AND STARTING SYSTEM

Current Rating (Amperes)	25	30*	Maximum Reverse Current to Open (Amperes)	8	8
Current Regulation (Amperes)	23-27	28-32*	Voltage Regulation @ 75°F.	14.6-15.4	
Cut-In Voltage	12.4-13.2	12.0-12.8*	*R.P.O.		

VOLTAGE REGULATION SETTING VERSUS AMBIENT AIR TEMPERATURE

Ambient Temperature °F.	Voltage Regulation Setting (Volts)	Ambient Temperature °F.	Voltage Regulation Setting (Volts)
25	15.1-15.9	95	14.3-15.1
35	15.0-15.8	105	14.2-15.0
45	14.9-15.7	115	14.1-14.9
55	14.8-15.6	125	13.9-14.7
65	14.7-15.5	135	13.8-14.6
75	14.6-15.4	145	13.6-14.4

STARTER MOTOR

Normal Engine Cranking rpm	Min. Torque @ 5 Volts		Maximum Commutator Runout (Inches)	No Load Amperage @ 12 v
	Ft.-Pounds (Min.)	Amp. Load (Max.)		
250-290	15.5	670	0.002	70

Current Draw under load (Engine at operating temp.) 100-150 Amperes.

STARTER MOTOR BRUSHES

Mfg. Length (Min.) (Inches)	Wear Limit (Inches)	Brush Spring Tension (Ounces)	No. Used
0.43-0.46	1/16	48-56	4

GENERATOR Part Number	Field Current Draw Amperes @ 12 v		Watts	Gen. rpm Charge Starts*	Maximum Rate		Pulley			Brushes		
	Hot	Cold			Amps.	Gen. rpm*	Drive Ratio	Belt Width (In.)	Pitch Diameter (Inches)	No.	Original Length (Inches)	Spring Tension (Oz.)
	CODF-10000-C	1.2-1.8			1.7-2.0	375	1400	25	2450	2.00:1	3/8	2.7
CODF-10000-D	1.2-1.8	1.7-2.0	450	1300	30	2550	2.00:1	3/8	2.7	2	0.86	32-40

External Circuit Resistance (generator armature terminal to battery positive terminal): 0.6 Volt Maximum @ 25 Amperes). Maximum Commutator Runout: 0.002 inch.

5. THERMOMETER covering engine temperature range will do in a pinch. An insulated mount is necessary

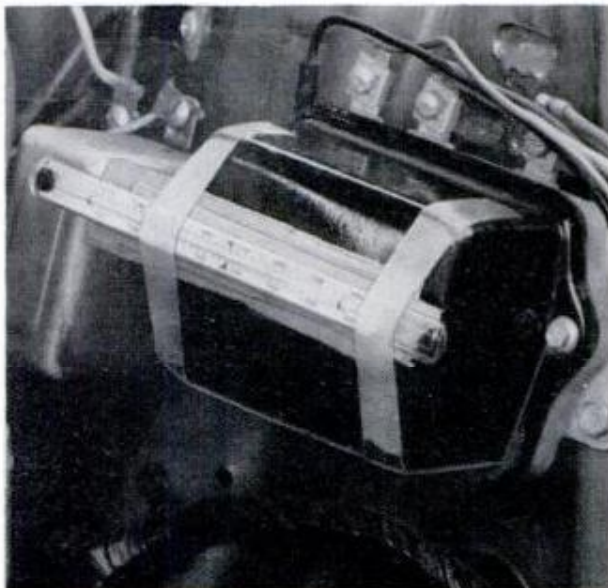

6. RESISTOR of 1/4-ohm capacity assures correct regulator adjustment when used with test equipment



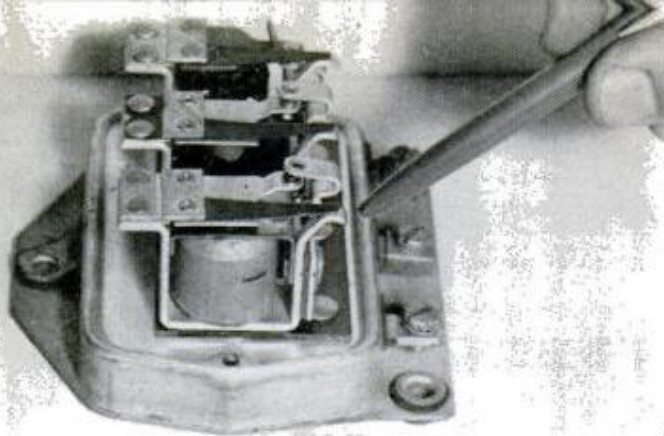

7. REGULATOR of riveted construction is adjusted by bending brackets (pointer). There are no screws

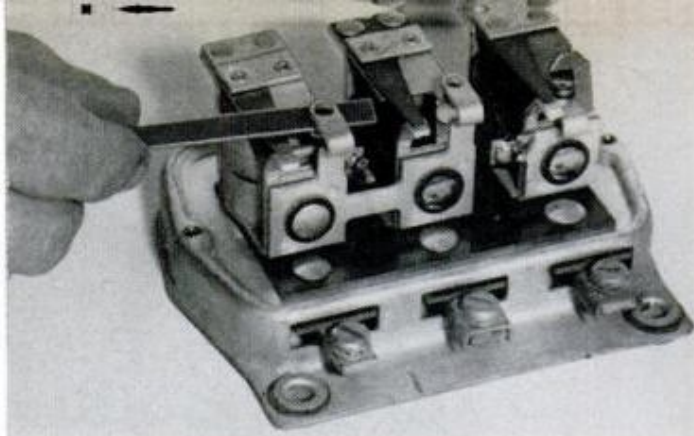

8. THIS METHOD of filing points on riveted regulators is permissible but is not generally approved

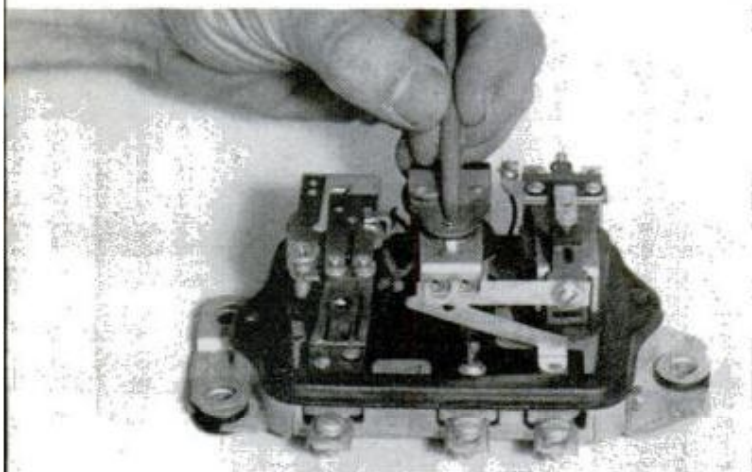

9. CORRECT METHOD of filing points on most regulators. Special file forms required concave surface



10. CLEAN ELECTRICAL CONNECTIONS are critical in wiring. Take time to do a thorough job of cleaning

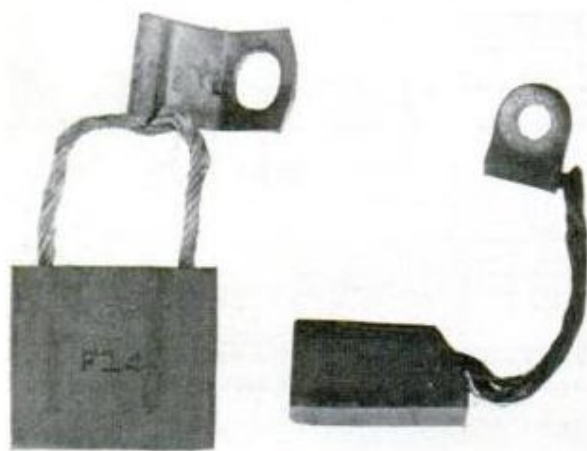

11. COMPARE OLD and new generator brushes, above. Below, be sure brushes are correctly seated

leaks that reduce electrical efficiency. First disconnect the battery cable and then use a small wire brush (a suede shoe brush is just the thing) to get rid of dirt accumulations. To do a good job you likely will have to disconnect each terminal in the generator-regulator system to get at the dirt. Before disconnecting, at any time, identify each wire or cable as in Fig. 3, with a mark or tag.

Assuming that you've checked out the battery as has been previously described, polarize the generator, Fig. 2. This should be done each time before starting a test. Then start the engine and allow it to warm

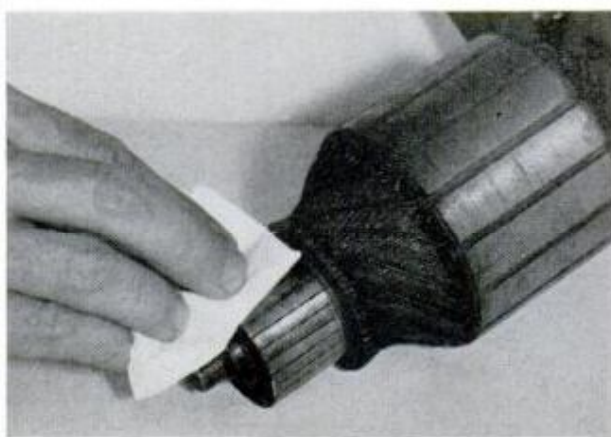
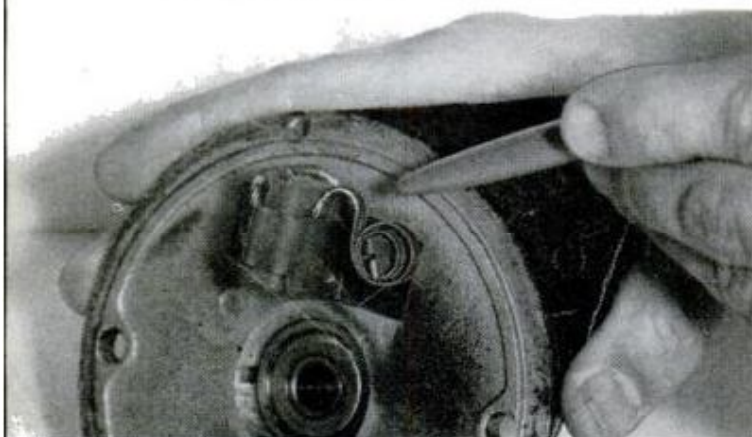

12. A COMMUTATOR in good condition can be cleaned with a soft cloth. Very fine sandpaper also is used



13. WHEN TIGHTENING fan belt you may need a pry bar to hold generator while you tighten the bolt

to operating temperature. Rev it up to fast idle, about 1500 r.p.m. Connect a wire from a clean ground to a cleaned spot on the regulator base. If the charge indicator light goes out, or if the indicator rises, a poor ground exists. With the engine still at 1500 r.p.m. connect a wire from the battery terminal (usually it's marked "BAT.") on the regulator to the armature or generator terminal (ARM. or GEN. markings). If this corrects the trouble, the regulator should be replaced. Or, with the engine still at about 1500 r.p.m., disconnect the F, or FLD. (field) terminal of the regulator and touch it to the generator or armature (GEN. or ARM.) terminal. If this corrects the trouble, replace the regulator.

(Continued to page 208)

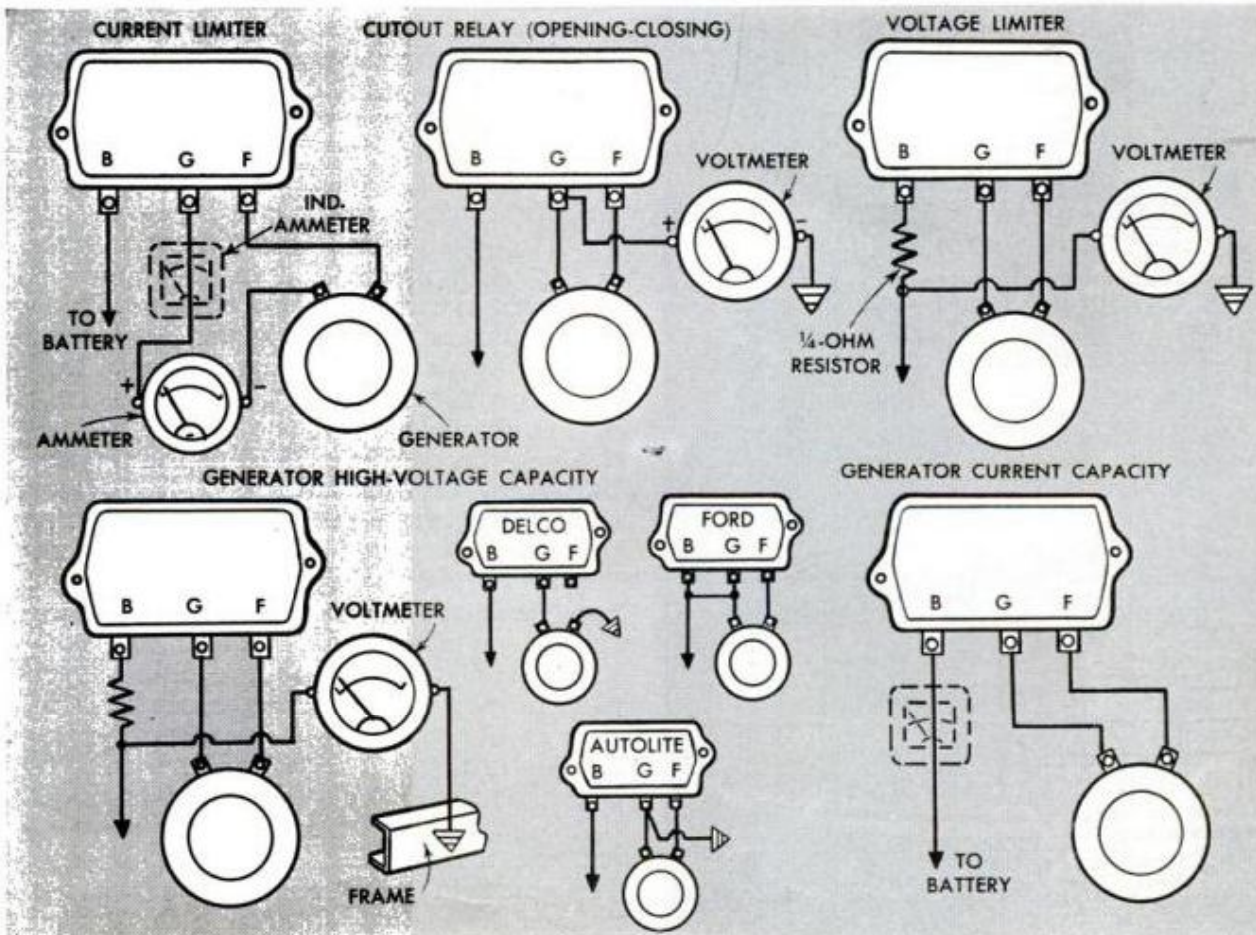
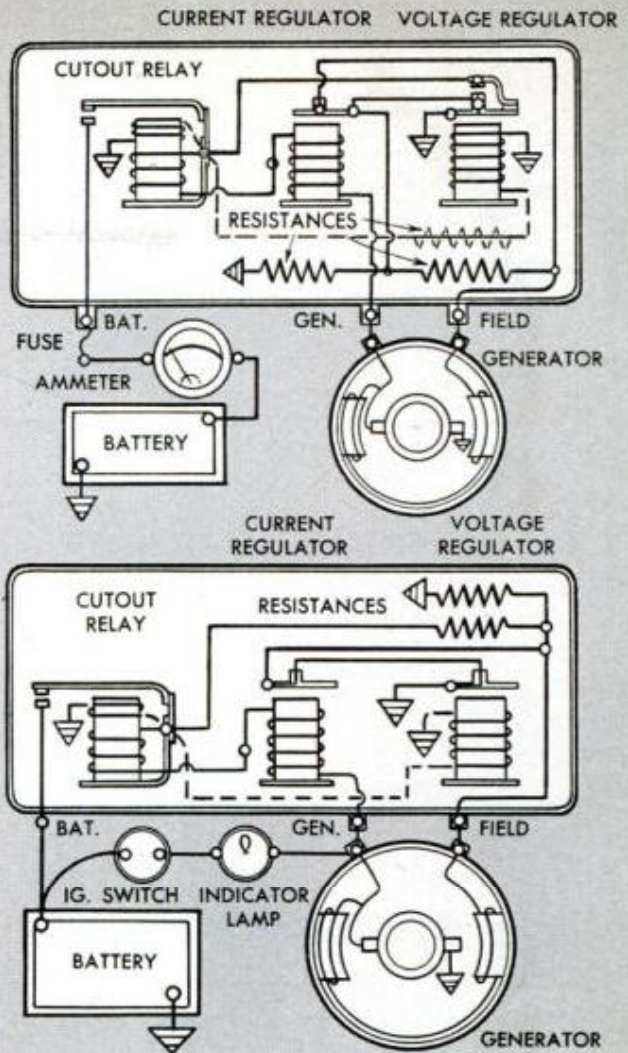

By Arthur Mikesell

Conclusion

THE CONTROL STAND, Fig 21, may be mounted either port or starboard, depending on your preference. First, cut the $\frac{3}{4}$ -in.-plywood mounting panel for the steering blocks and secure this to the inside of the side planking in the proper position. If you plan to use a throttle lever rather than the aircraft-type throttle (which is mounted on the dash), cut and mount a block for this in the position indicated in Fig. 9, Part I.

Secure the $\frac{1}{2}$ -in.-plywood leg to the in-board stringer and attach the dash panel to this leg, the underside of the sheer shelf and the steering-block mount. After installing the forward panel to give the stand rigidity, use a hole saw or saber saw to cut holes in the dash for the wheel, steering cables, instruments and controls. Later, after the coaming has been installed, deck the stand with $\frac{3}{8}$ -in. plywood and add a narrow rim of quarter round or scrap square stock to hold cigarettes, sunglasses, etc., on the stand. Since the top of the stand will be varnished to match the coaming, countersink all fastenings and plug the holes with wood putty.

The seat bottom and forward seat bulkhead, Fig. 21, are cut from $\frac{1}{2}$ -in. plywood. The underseat dividers, which also serve as seat supports, should be $\frac{3}{4}$ -in. plywood notched for the cleats mounted on the seat back and forward seat bulkhead. The ends of the seat are supported by cleats attached to the side planking. Before securing the forward seat bulkhead, treat all underseat surfaces with a good wood preservative (Penta or similiar) and floor the outer storage compartments with $\frac{1}{4}$ -in. plywood. The center compartment, which will hold the battery box, is not floored. After securing the cleats, dividers and forward bulkhead, install the seat bottom using a length of piano hinge.

Since the floorboards will receive extra-hard wear, they are cut from $\frac{1}{2}$ -in. plywood surfaced with a resin-impregnated fiber permanently fused to the wood (Harborite, Duraply or similar). You will have to take the floorboards up later, so use flatheaded screws to install them. Outer floorboard panels will reach from the chine to the center of the inboard stringer, center panels cover the space between the inboard stringers just aft and forward of the seat. The outer forward panels, Fig. 22, must be cut to fit the curve of the hull, but shouldn't come in contact with the bottom planking. The panel under the control stand must be notched in order to fit around the leg, and

BUILDING THE PM

JET

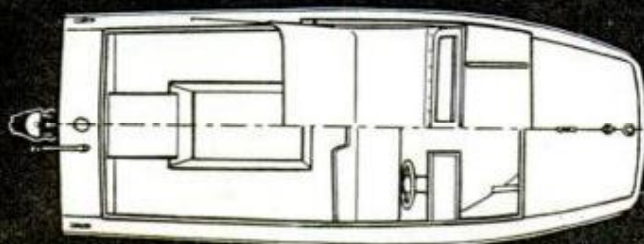

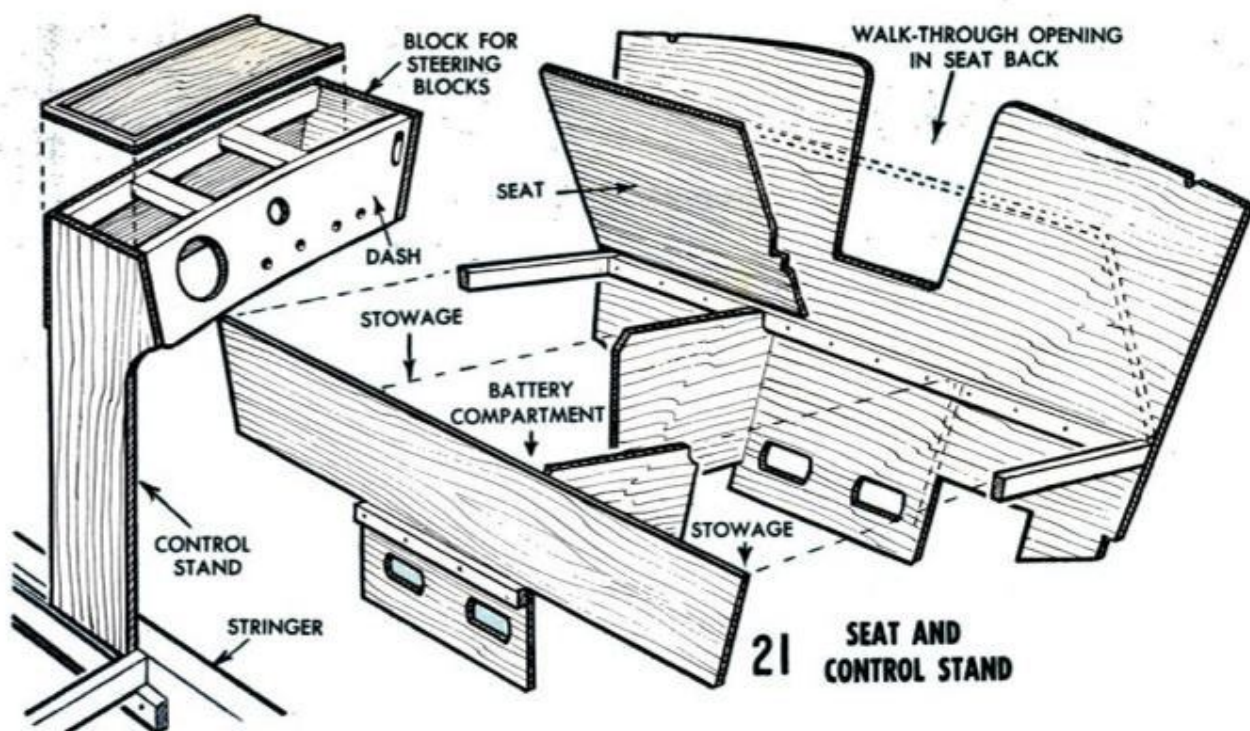

21 SEAT AND CONTROL STAND

a cutout added to this notch to allow clearance for the power cable which runs down the inside of the leg. Use two short panels to floor the center section ahead of the seat so that the shift lever, Fig. 26, can be mounted on a small, well-braced panel for extra rigidity.

You are now ready to make the transom cutout for the jet unit. As mentioned last month in Part I, the unit used in the *PM Jet* is a two-stage model manufactured by Buehler Turbocraft, of Indianapolis, Ind. Since jet units are *not* standardized, all details in this article pertaining to the jet installation apply to *this unit only*. If you are considering another unit, consult the manufacturer before you start to build the *PM Jet* so that the necessary modifications can be made.

Measuring up the centerline on the outer surface of the transom, locate a point $6\frac{1}{2}$ in. from the outside of the bottom planking and bore a 2-in. hole. Now set the jet unit on the intake block so that it is hard against the transom with the drive shaft at the aft end protruding through the hole. Place the point of a compass on the center of the drive shaft and scribe a circle for the jet exhaust to the dimensions given by the manufacturer. Remove the jet unit and cut out this circle with a saber saw, then replace the unit and mark centers of the mounting-base holes



FORWARD FLOORBOARD panels must be cut to follow the curve of the hull but shouldn't come in contact with the planking

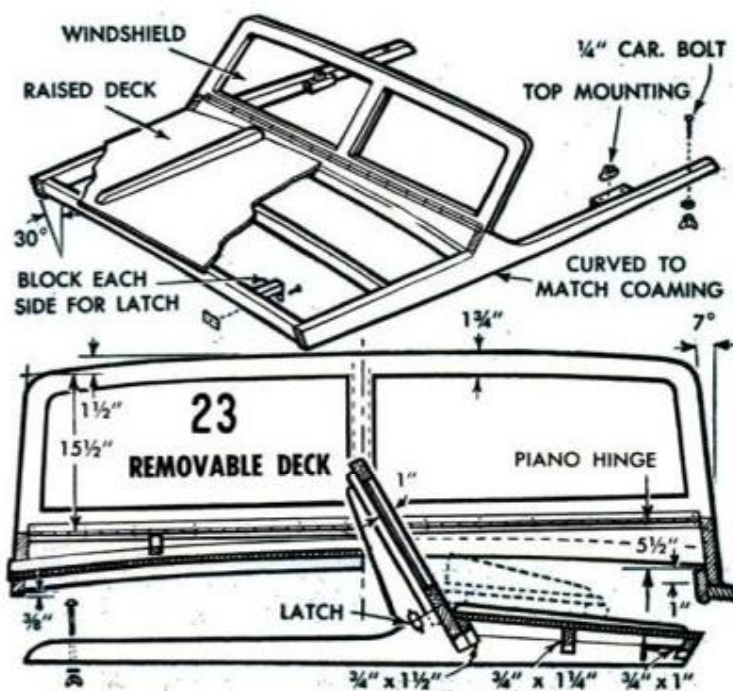

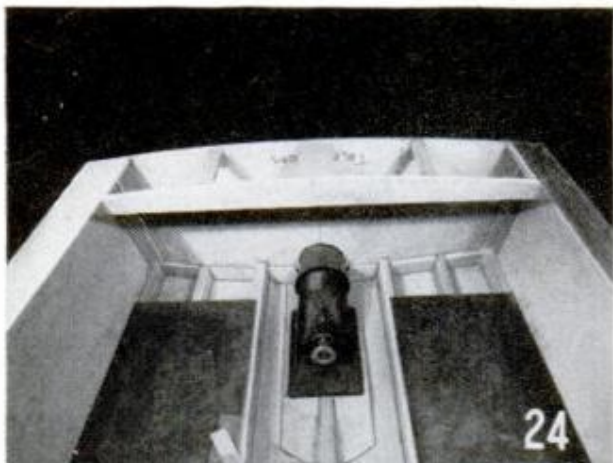

TRANSOM CUTOUT for the jet exhaust should be cut and tested for fit before installing the gas tank

for drilling. After locating and drilling these holes, Fig. 24, put the jet unit aside and complete the transom.

If you plan to purchase a gas tank rather than build the tank detailed in Part I, Fig. 2, make sure that it will fit inside the transom or you will have to extend the transom to cover the tank. Before installing the tank, brace the transom with 1 x 3 stiffeners cut to fit snugly between the longitudinal frame members. The long upper stiffener must be cut to match the curve of the transom top. The gas tank is held in place with metal straps and sits on two legs which are mounted to the outer sides of the inboard stringers. Two short 1 x 3 deck beams help to brace it laterally.

After installing the gas tank, measure 11½ in. forward from the inner face of the plywood transom and construct a frame for the false transom. The two lower members of this frame sit on top of the stringers. The upper member is notched for the sheer shelves and curved to follow the rear deck crown. If you wish to use the two side compartments for storage, seal them off from the jet-unit tunnel, floor them and cut

SMALL-DIAMETER PIPE running just inside the inboard stringer connects the shift lever to the jet unit

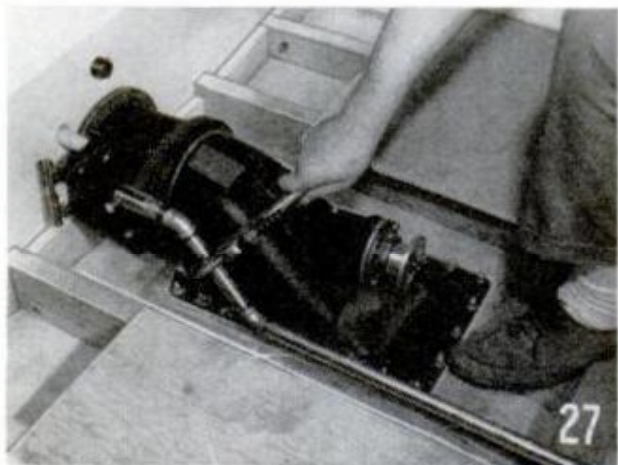

BEDDING COMPOUND must be used when installing the jet unit and at all other through-hull fastenings

access holes in the perforated-hardboard transom cover. The transom decking shouldn't be installed until you have completed the next step, fiberglassing the sheer shelf.

Bring the edge of the cloth about ¾ in. down the side of the sheer mold and just over the inside edge of the sheer shelf. The outer edge of the cloth will be covered by aluminum "J" mold, and the inner edge will be masked by the coaming. Once you have completed the fiberglassing, the fore deck and transom deck may be installed.

Shape the coamings as shown in Fig. 5, Part I, and use countersunk screws to fasten them in place. End coamings should be sawed to match the crown of the deck as this curve is a bit difficult to achieve by bending. Since the coamings are to be varnished, plug the screw holes with wooden plugs.

Before installing the engine, jet unit and controls, Figs. 24-28, remove the floorboards and treat all surfaces below the floorboard line with wood preservative (Penta or similar). Follow the manufacturers' installation instructions for each unit, making

DRIVE SHAFT, motor exhaust tubing, water hose and jet unit all fit under the low-profile walkover cover

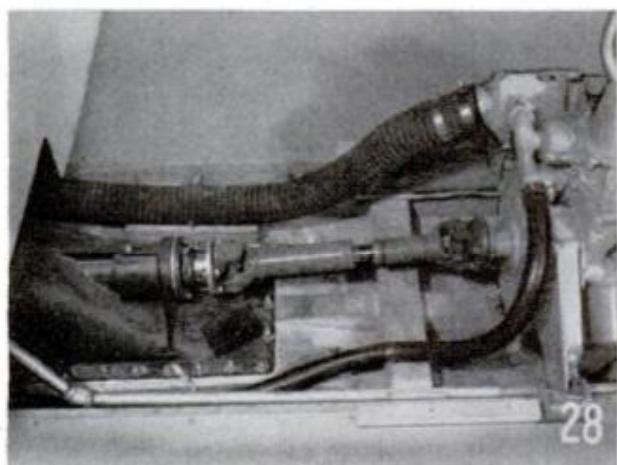

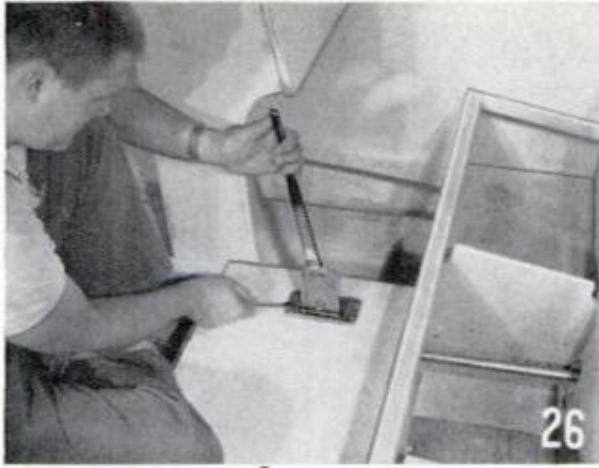

SHIFT LEVER mounts on a small, rigid floorboard panel outside and slightly aft of the control stand

cutouts as necessary in bulkheads and transom. Be sure to use bedding compound on all through-hull fittings, Fig. 25, (i.e., jet intake, motor exhaust, jet exhaust, etc.). Mount steering blocks to lead the cable from the quadrant across the inside surface of the transom to the corner and under the sheer shelf to the control stand. Once the position of the control cables has been established, the knees can be installed. Make a cutout in one knee for the control cables, then secure both by nailing through the side planking and toenailing into the bottom of the sheer shelf.

The quarter fenders, Fig. 29, can now be shaped and mounted. Use plenty of bedding compound at these through-hull fastenings since the quarter fenders are mounted close to the water line. Don't install the half-round aluminum molding on the fenders until the boat has been painted.

The motor cover, Fig. 30, is simply a vented box with slanted ends and a removable top. After constructing the frame and attaching the $\frac{3}{8}$ -in. plywood sides and ends, cut cleats to fit snugly between the side members of the upper frame. Bevel one of these cleats to match the angle of the rear of the box and mount it on the underside of the top so that the beveled side fits flat against the rear frame member when the top is centered. Attach the other cleat toward the front of the top and add a hold-down clamp to the front of the box to lock the top in position. Two other clamps mounted on the inside of the bottom frame members will hold the cover to the inboard stringers. This engine cover is designed for use with an Interceptor 100 marine inboard. If you plan to use any other engine, check the dimensions before you make the cover so that it can be enlarged if necessary.

The walkover cover for the jet unit, Fig. 30, sits on the inboard stringers between the edges of the floorboards. Make sure

(Continued to page 202)

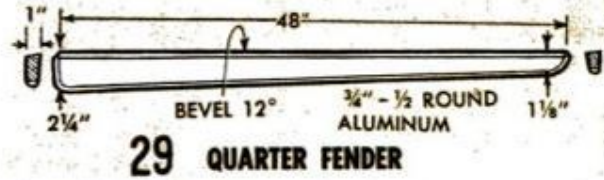

29 QUARTER FENDER

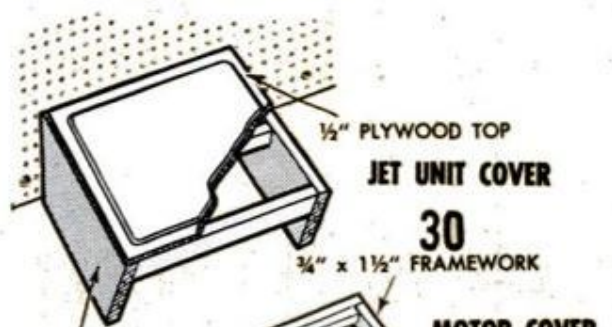

JET UNIT COVER

30

FRAMEWORK

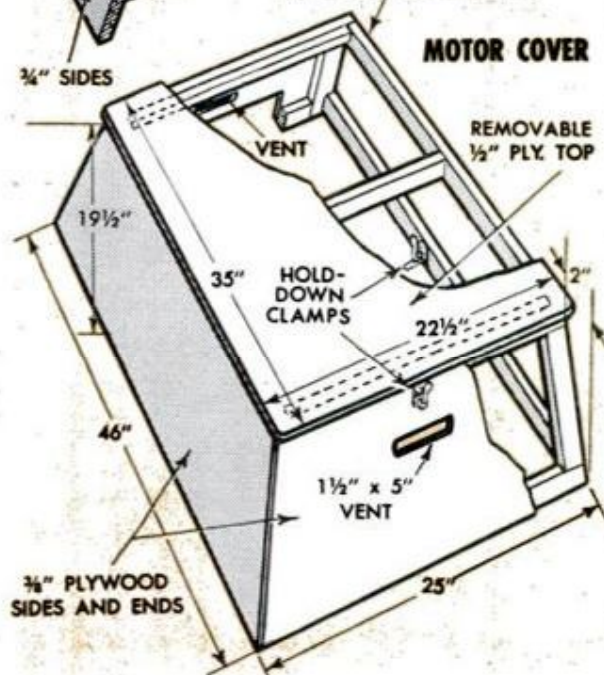

MOTOR COVER

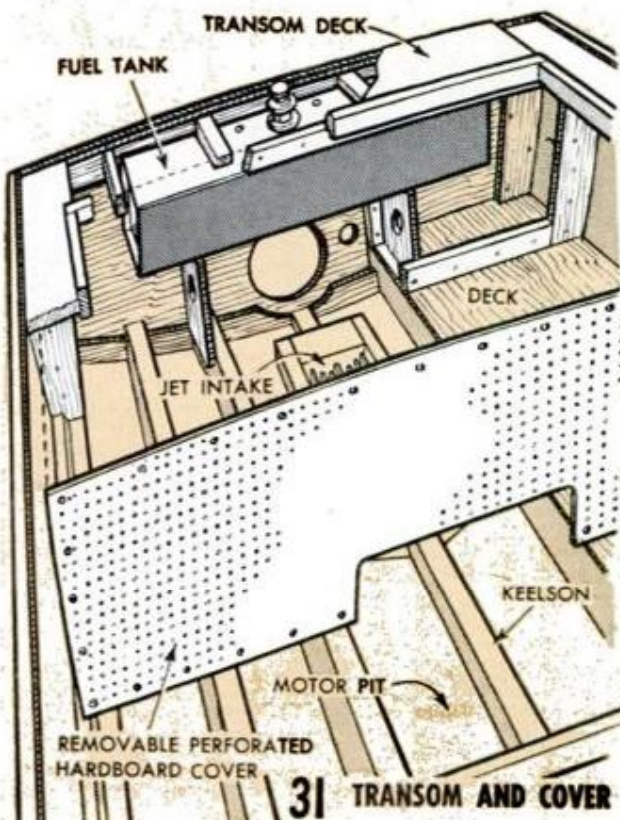

TRANSOM DECK

FUEL TANK

DECK

JET INTAKE

KEELSON

MOTOR PIT

REMOVABLE PERFORATED HARDBOARD COVER

31 TRANSOM AND COVER



Coming Up Next . . .

TERMITES! You can have termites working in your home for years and never know it. No, the walls are not likely to collapse or the foundation cave in, but the structure may be extensively damaged before you discover the pests—unless you read the article in May PM telling what signs to look for, where and when. Termites are quite easy to locate, and eradicate, if you know how to go about it.

WHEN PAINT PEELS. You put paint on the outside walls of your home and it peels off, leaving unsightly patches of bare wood. Why? There are several reasons and in next month's PM we're going into the whys—not only why paint blisters, peels and alligators, but how to repair the damage and prevent it from recurring. That's a large order, you may say, but wait until you read the article.

TRAVELER'S ELECTRONIC ENLARGER. Sound like something different from the mine run of photo-studio equipment? It is different—packs into a carrying case only 3 x 7½ x 8½ in., has a built-in electronic timer and electronic exposure meter. Practically automates the process of making blow-ups from 35-mm. film. The parts you buy to build it cost about \$30.00. Coming in PM's May issue.

DECORATIVE DADO CUTS. Ordinarily you use a dado head for cutting grooves in cabinet joinery, but try setting it up to cut a groove diagonally across one face of a panel and slightly more than half way through the thickness. Turn the panel over, cut another groove on the opposite diagonal and then look at what you have. Get the idea? Decorative dadoing is PM's shop feature for May.



Easter Tree

Why not a tree for Easter? To make one utilize an existing shrub, indoors or out. Punch holes in both ends of eggs and blow the contents into a pan. Then place the shells in egg dyes. When dry, place the shells on the twigs of the shrub as pictured.

—John Krill

Plant Cap

If an unexpected spring frost warning catches you with prized transplants in the open row, protect them with paper bags or cartons anchored with "sticks" made from coat hangers. One coat hanger makes two anchors, each having a hook which is inserted in a hole in the bag.

—Earl C. Hillhouse



KEEP THESE IN MIND

Reseating Old-Type Faucet

In many older-type bathtub faucets the seats are difficult to reach with a standard reseater, especially those having integral, or nonremovable, seats. One plumber improvises the reseater detailed and powers it with his small portable drill. It renews the seats in a jiffy.—*Robert L. Sargisson*

You don't need a special centering punch to center screw holes accurately when fitting hinges or other hardware having countersunk holes. The shank ends of most twist drills are beveled to a point, making them self-centering. Therefore, choose a drill having the same diameter as the holes, apply the shank end of the drill to each hole and tap the cutting end with a mallet or block of soft wood.—*Ken Murray*

V-Block That Stays Put

If you have been wanting to make a V-block for your drill press, here's one designed so it won't slide off the table. An anchoring pin protruding from the underside fits the hole in the center of the table to hold it in place. To make this V-block you'll need a piece of flat steel and a piece of steel angle about 8 in. long. Before welding both together, a hole is drilled and reamed in the center of the flat-steel part for a shouldered pin turned from drill rod. The pin is made to fit the table hole with slight clearance and shouldered for a distance of $\frac{1}{2}$ in. so the V-block can be shifted slightly in all directions for precise alignment of the work with the drill bit.—*H. J. Gerber*

Mailing Tube Assures Even Legs

When shortening or evening up chair or table legs, you'll find that a slotted mailing tube will prevent you from winding up with a footstool. Measure the distance from the lower end of any leg to the first cross member rung and subtract the amount you wish to cut off. Transfer this measurement to the mailing tube and cut a slot in the wall of the tube. Then slip the tube over each leg in turn, place the saw in the slot and make a few strokes to mark the correct length. When evening up legs, find the shortest leg and use the distance between the end of this leg and the cross member to locate the slot in the tube.—*Bil Toman*

Frequent retempering of mortar to keep it moist will not be necessary if the mortar board is painted. The painted surface will keep the wood from absorbing the water from the mortar.

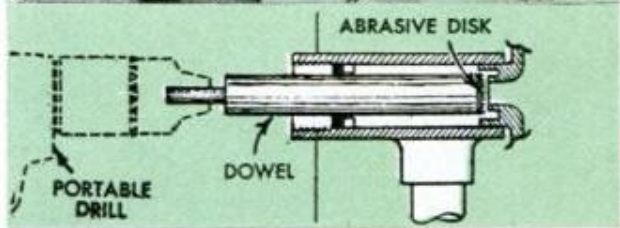

VACUUM CLEANER

Household

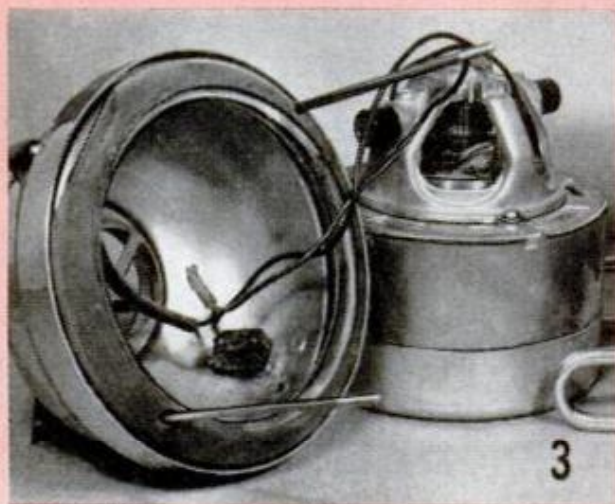
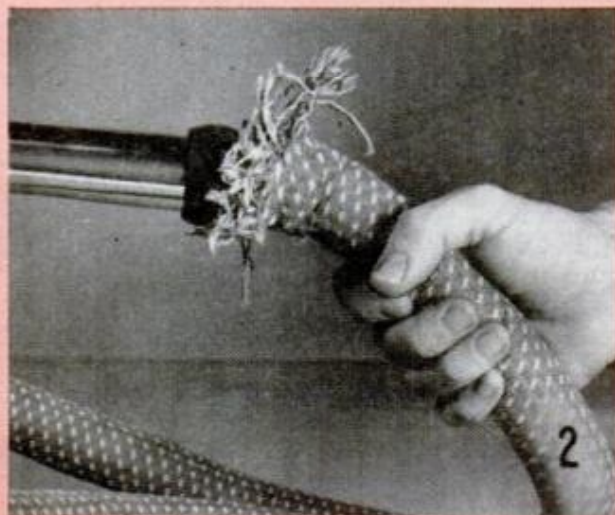
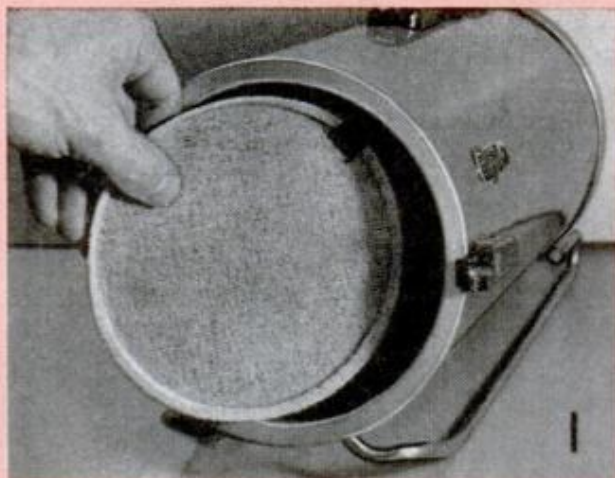

MOST FAMILIES have had a vacuum cleaner in the house as long as the older members can remember. About all that's ever been done to it in the way of servicing has been to change the dust bag when it gets full of dirt. A cleaner averages once-or-twice-a-week use, it gets knocked about, the cord and hose may have been stepped on and it may even have tumbled downstairs once or twice. But when you plug in the cord, or what's left of it, and kick the switch you expect it to run. And usually it does.

As a rule the hose goes first—gets to looking something like the one in Fig. 2. Nothing to do but replace it. A hose that leaks is practically useless.

Tank-type cleaners like the one pictured, also those tank cleaners, sometimes called canister cleaners, that operate standing upright, are fitted with a screen, or filter, between the dust bag and the motor, Fig. 1. This should be cleaned occasionally and each time it is removed for cleaning, it should be examined closely for tiny breaks. If any holes show up, replace the filter. Purpose of this filter is to catch and retain dust that may escape the regular dust bag and prevent it from getting into the motor.

The next step in general servicing is to remove the end cap, Fig. 4, or whatever is necessary to permit the motor to be removed from the unit. Check the switch, visible in Fig. 3, for looseness. Tighten if necessary, or, if it seems at all unreliable, replace. Retape the connections. The motor

Appliance Fix-It File

pictured in Figs. 3, 5 and 6 is typical, although all vacuum-cleaner motors are not of the same size and appearance. Nearly all are of the universal a.c./d.c. (series) type, having carbon brushes which wear down in time to the point where they no longer make full contact with the commutator. Remove the brushes by unscrewing the retaining caps, Fig. 5, making sure that you keep them in order so that they can be returned to the holders in the same position as they were originally. If the brushes are worn badly (as a rule $\frac{3}{8}$ in. is too short) and especially if they are chipped at the edges of the concavity which contacts the commutator, they should be replaced.

The commutator brush track should be examined closely. If it is smooth and shows no wear groove where the brushes ride, wipe it with a dry cloth and let it go at that. If it is slightly rough to the touch, it is permissible to smooth it lightly with very fine sandpaper. Don't use emery cloth or any kind of solvent. If on the other hand, the commutator is grooved, remove, take it to your electric shop and have it turned down and the mica separators undercut. Brush dust from the armature and coils before re-assembling the motor. When you reassemble the cleaner, Fig. 4, be sure that parts are returned to their respective positions and that all screws and bolts are tightened to a uniform tension. If the power cord shows breaks at points where it flexes when in use, it should be replaced.

—John Pennington

P.O. Box 475

Pueblo, Colorado

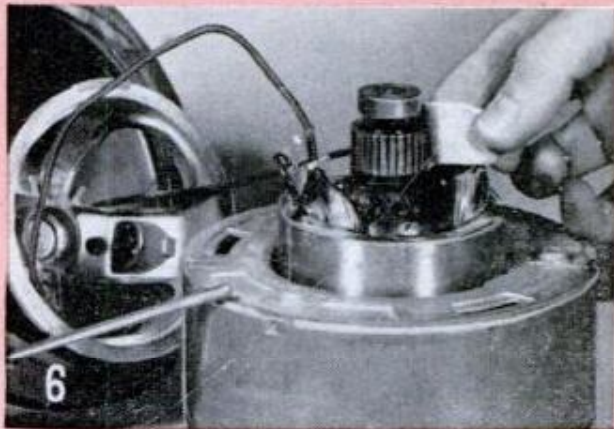
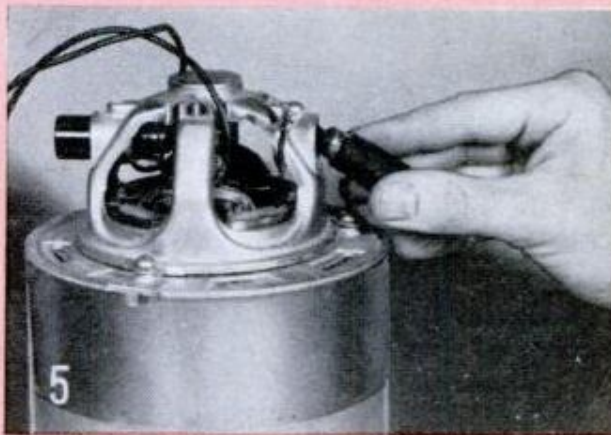

WORKING WITH SHEET METAL

By C. W. Woodson



1. CUTTING SHEET METALS can be done with a portable jigsaw with metal-cutting blade as pictured above, with a squaring shear as in Fig. 2, or with various types of tin snips, several of which are shown in Fig. 25. Sheet metals of 22 gauge or thinner are easily cut with tin snips. For accurate work in cutting to pattern, lines should be scored on surface of metal so that they are easily visible and readily followed with snips. For smooth work cutting edges of snips should be very sharp

Here's the how of working sheet metal from the simplest operation to the broader field of development and forming with machines

WITH SUITABLE metal shears, or snips, to cut the material to size, a hammer and a squared hardwood block or two over which to make angle bends, you can do basic sheet-metal work. Go beyond simple projects and you'll need more tools, more shaping devices, also anvils and bench stakes on which to make seams and radius bends. Beyond this point one enters the field of professional work involving the use of hand and power-operated machines and advanced methods used in the development of sheet-metal shapes.

Three basic methods of developing a given shape are shown in representative form in Figs. 3 through 6. These by no means cover the field of development, but do indicate methods of procedure. The shortcut, rollation method originated by R. W. Poe, Canton, Ill., is quite widely used in the development of the more simple forms. Figs. 12 and 14 through 16 show how the method, Fig. 3, is carried out when making the top of a funnel or similar bell shape. The joint in the funnel top, or bell, can be seamed as in detail A, Fig. 11, and hammered flat as in Fig. 12, or can be sweat-soldered before soldering on the neck, Fig. 11, B. For procedure in laying down a conical shape (or what is to become a conical shape) note the right-hand detail in Fig. 3 and compare with Fig. 14. The cutout in Fig. 14 is then bent as in Fig. 15 and the edges chalked. The final step in the rollation method is pictured in Fig. 16. The other development methods such as parallel-line development, Fig. 4, radial-line development, Fig. 5 and development by

FOOT-OPERATED SQUARING SHEARS are regular equipment in sheet-metal shops, in large school shops

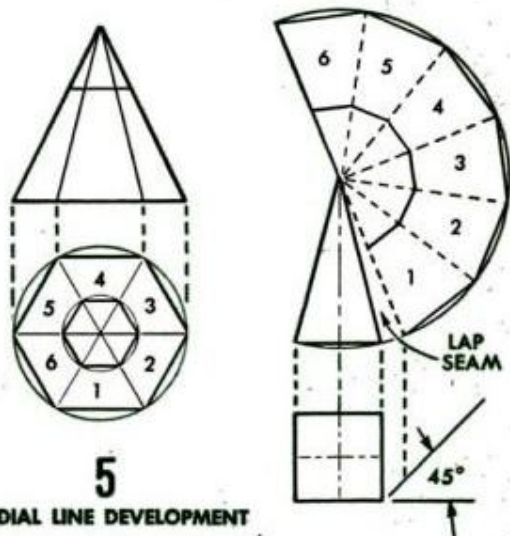
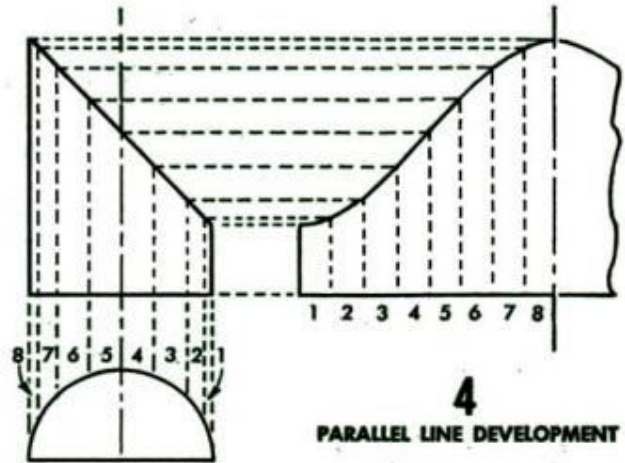
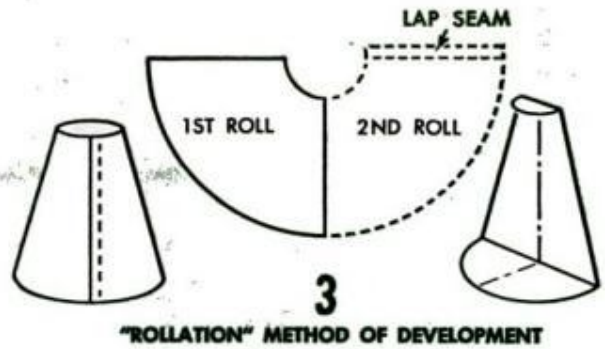

5
RADIAL LINE DEVELOPMENT

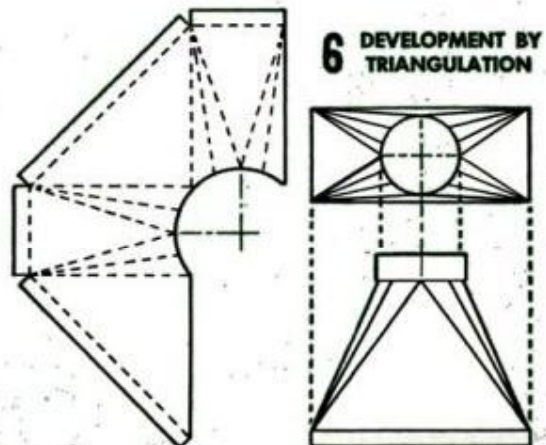

6
DEVELOPMENT BY TRIANGULATION

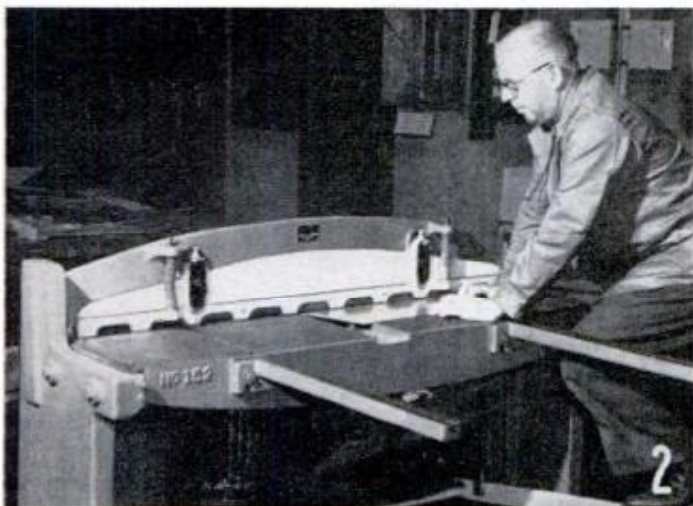

APRIL 1962

185

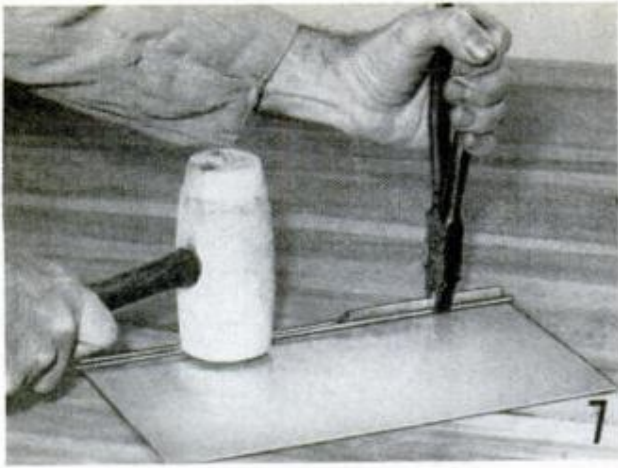

7

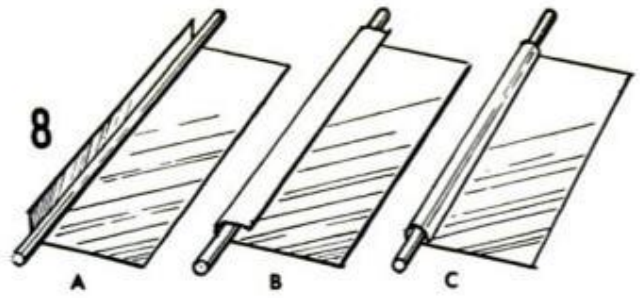

8

WIRING AN EDGE by hand methods is a good test of skill. Details above show the three basic steps and photo at the left shows how mallet and pliers are used to bend edge. Or, use a seaming tool, Fig. 25

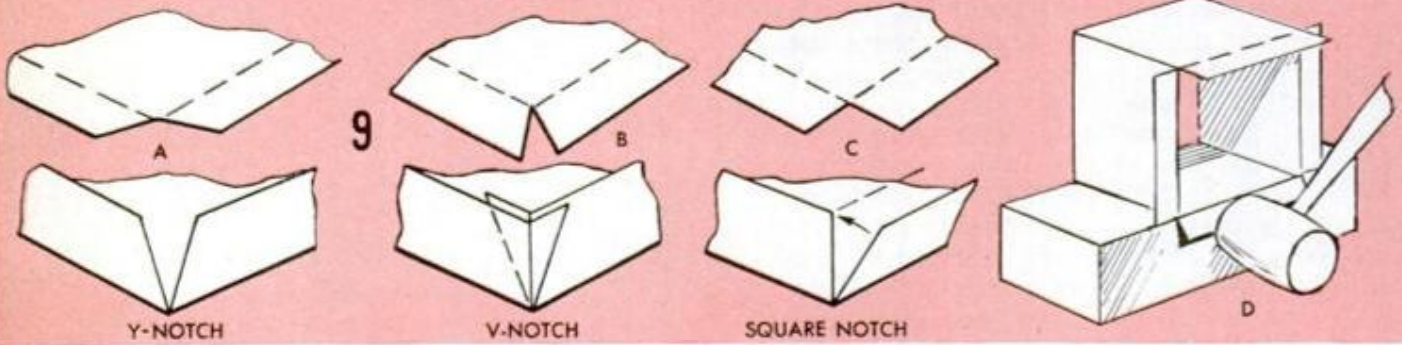

Y-NOTCH

V-NOTCH

SQUARE NOTCH

10

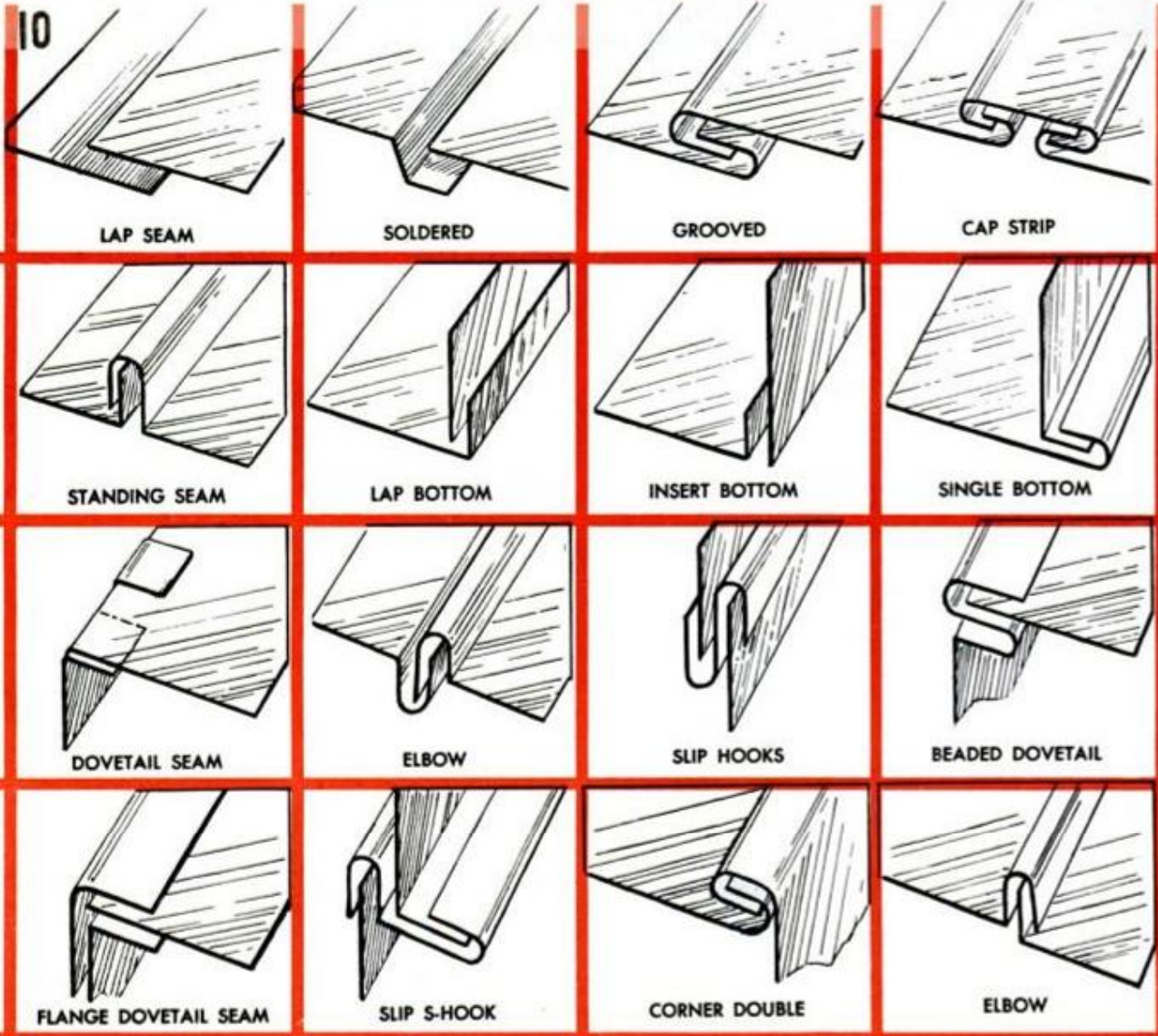

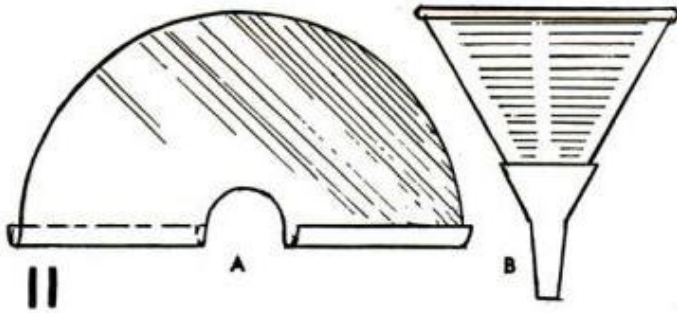

FUNNEL TOP, or bell, is laid out by the rollation method, Figs. 3 and 14 through 16. Note that in detail A the locks are formed for the joining seam which is being hammered down on a stake as in Fig. 12

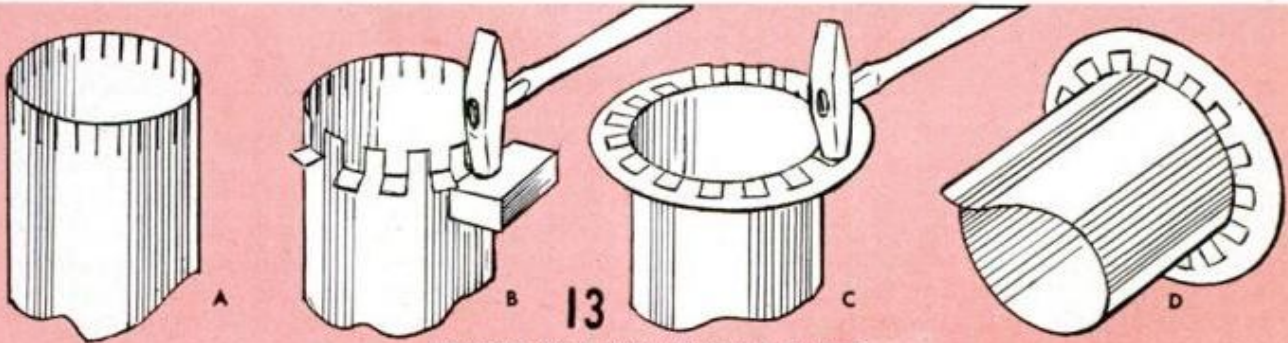
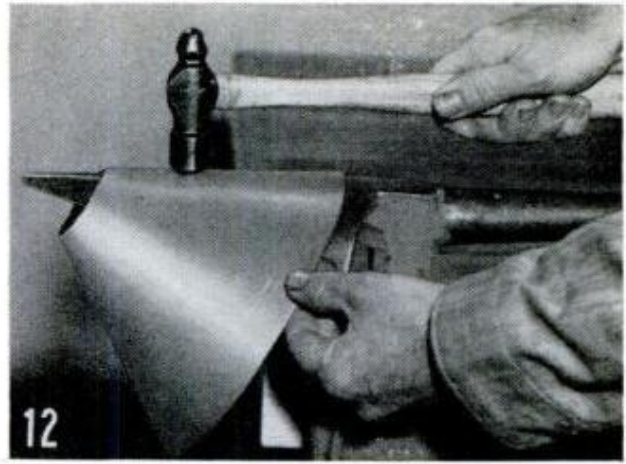

DOVETAIL SEAM FOR ATTACHING FLANGE

triangulation, Fig. 6, are methods used in advanced work in the laying down of large and involved shapes.

Nearly all sheet metals, both ferrous and nonferrous, of 22-gauge or thinner can be cut easily with ordinary tinner's snips, Figs. 14 and 25. Heavier gauges are best cut with compound-lever shears, or with a hacksaw with a blade having not less than 24 teeth per inch. You also can use a portable jigsaw, Fig. 1, fitted with a metal-cutting blade. Many sheet-metal shops and some school shops are equipped with a squaring shear, Fig. 2. Foot-operated units of this latter type usually have a capacity in mild steel of 16 gauge and a nominal cutting width of 30 in. or more.

Hand-wiring an edge, Fig. 8, is a good test of one's skill as a tinsmith. Of course, in shops this job usually is done on a machine, Fig. 17, but you can do a creditable job by hand as in details A, B and C in Fig. 8, using a wood mallet and a pair of pliers, as in the accompanying photo, Fig. 7. Start with a right-angle bend in the sheet as in detail A. Turn it back on itself with the wire inside as in detail B, using the mallet and the pliers in conjunction to make a smooth bend. Wiring usually is done before the part is formed. You'll find wired edges on such commonplace items as pails, pans, funnels, garden carts—almost any open-top container made from sheet metal. The wired edge adds greatly to the strength and durability of any sheet-metal container and improves appearance.

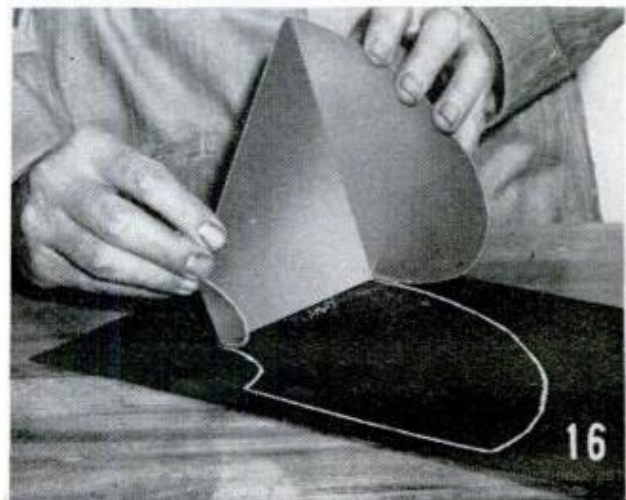
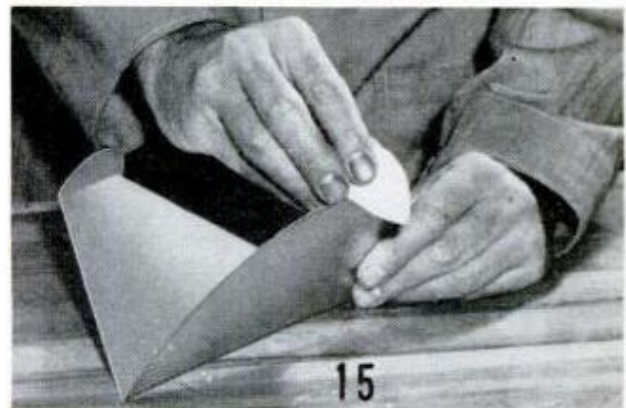
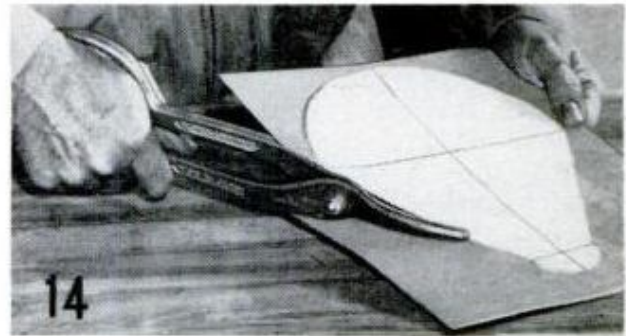



STANDARD ROTARY MACHINE is regular equipment in most sheet-metal shops. Here an edge is wired

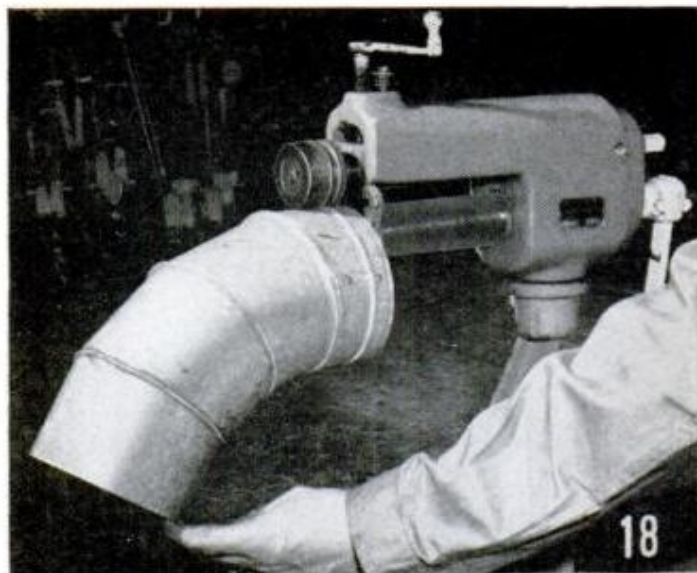

ROTARY MACHINE with deep throat. See also Fig. 20. Here a bead is being rolled on a smoke-pipe elbow

Another step in simple forming which one should be familiar with before tackling any type of corner joining is the method of notching and clipping at corners to produce neat, attractive work. The square notch, used on simple boxlike forms, permits corners to be fitted tightly, details C and D, Fig. 9. The V-notch can be cut as in detail B, producing an overlap for riveting or soldering, or can be cut as in detail A to form a neat corner without an overlap. It also is used for double seaming on work having inside flanges. Bend the flanges against a solid hardwood block as in detail E, using a wood mallet or a soft hammer to prevent denting or scoring the metal.

Progressive steps in making a dovetail seam of one type are shown in Fig. 13. This method is often used when joining a flange to a cylindrical shape. The latter is scribed near the end with a visible line and is then clipped at spaced intervals as in detail A,

the cuts stopping at the scribed line. Next the alternate tabs are bent out and at right-angles as in detail B. Now the flange is cut and slipped over the remaining vertical tabs, which are finally bent outward over the flange as in detail C. The finished job is shown in detail D. For added strength the tabs may be sweat-soldered.

Fig. 10 details various types of locking seams and typical soldered seams that are commonly used in joining sheet metals. Most of these can be formed on a bar folder, Fig. 21. Of course, the seams are not shown as they will appear when completed, as they are shown open, or unlocked, to indicate the relationship of the folded edges. Some of the seams must be sweat-soldered, of course. While most of these bends are made by machine, some can be made easily by hand with the simplest tools. You will find these seams on various

(Continued to page 216)

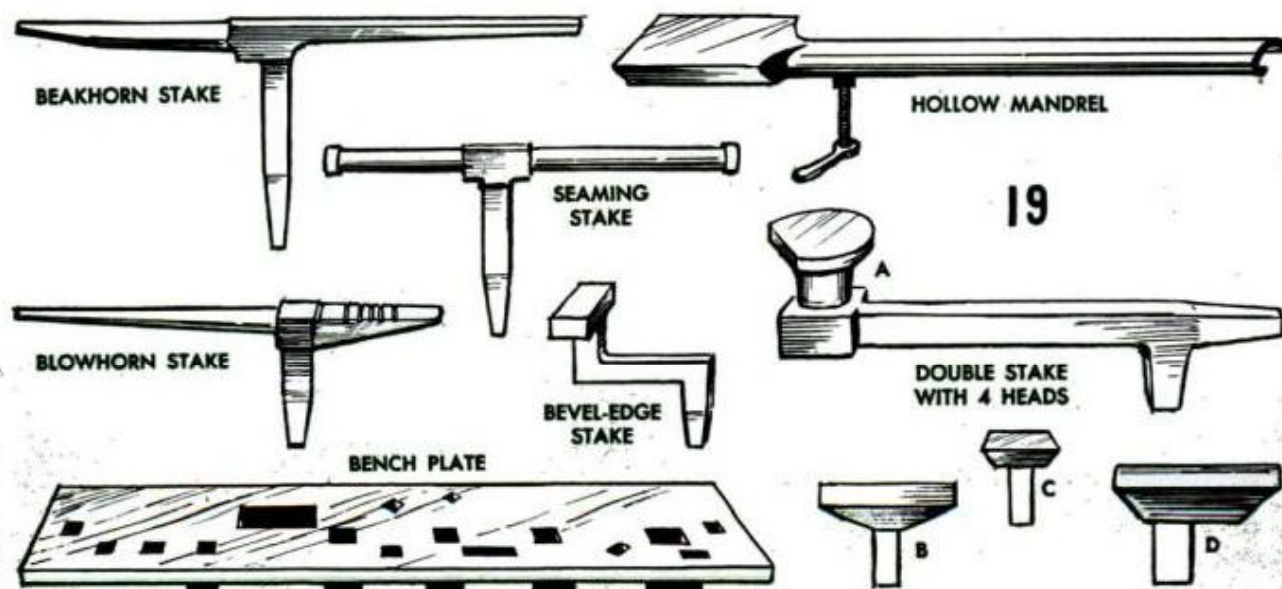

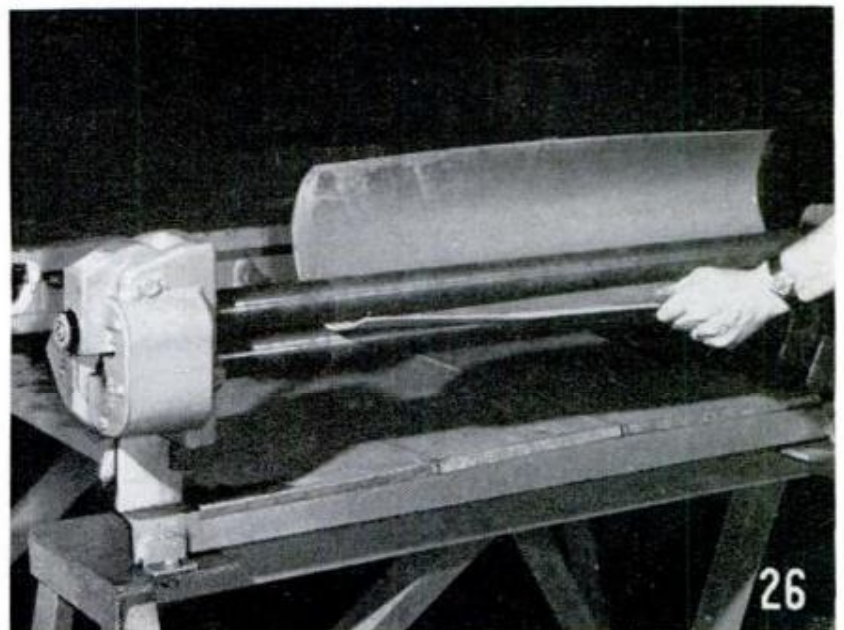
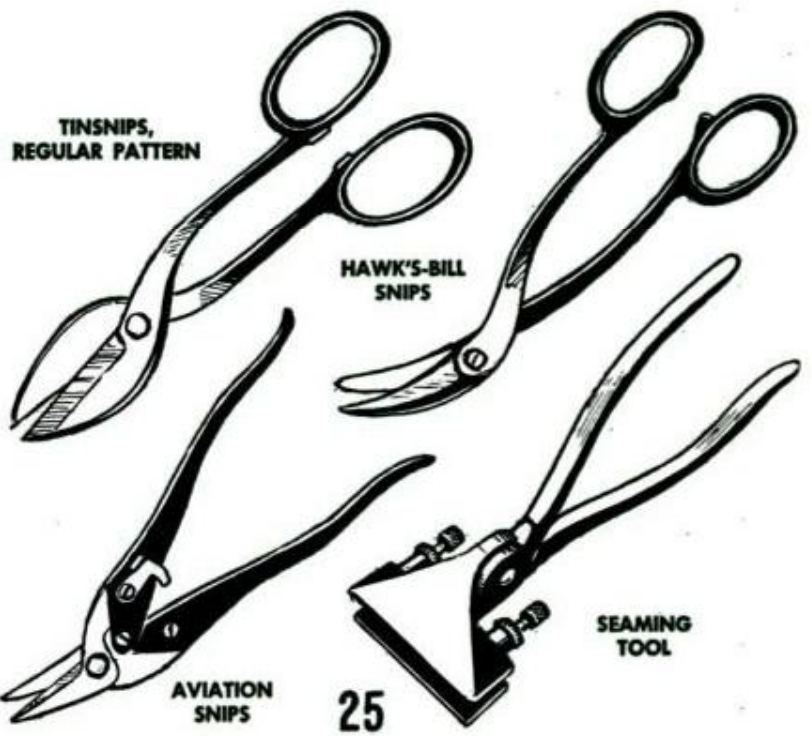
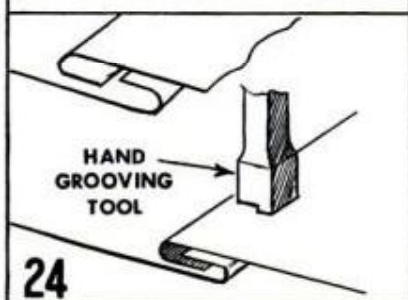
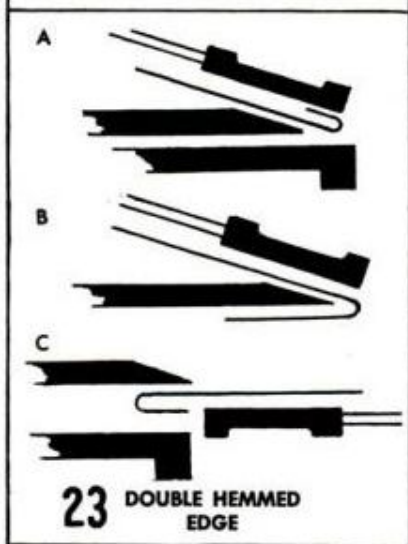
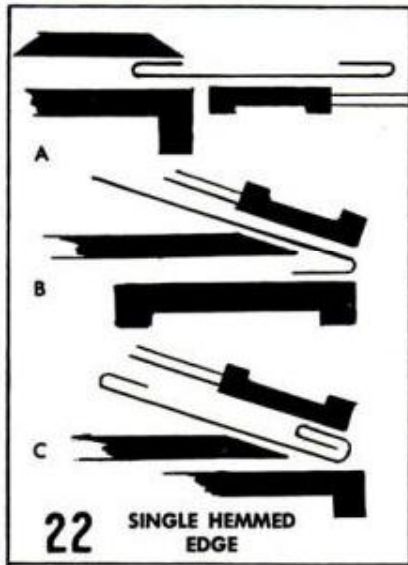
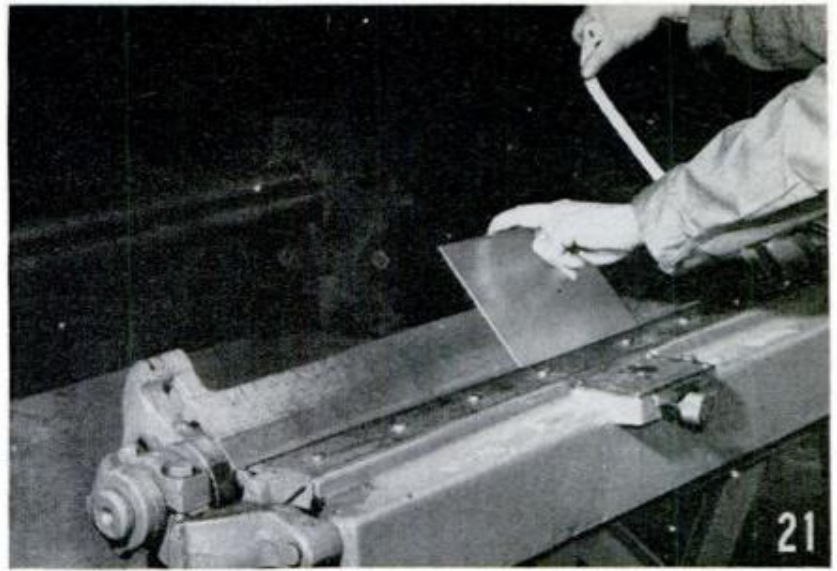
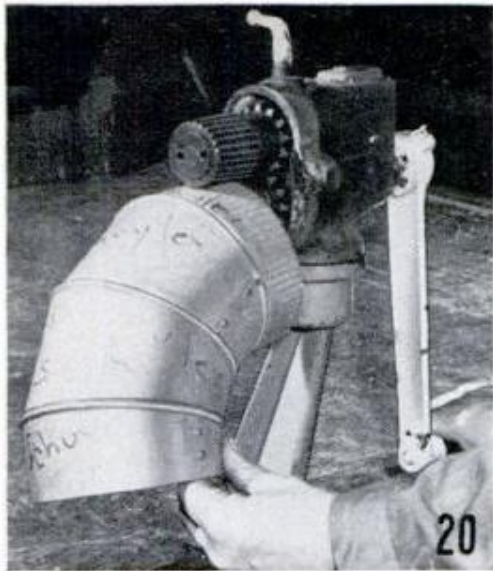

AIM AND FIRE

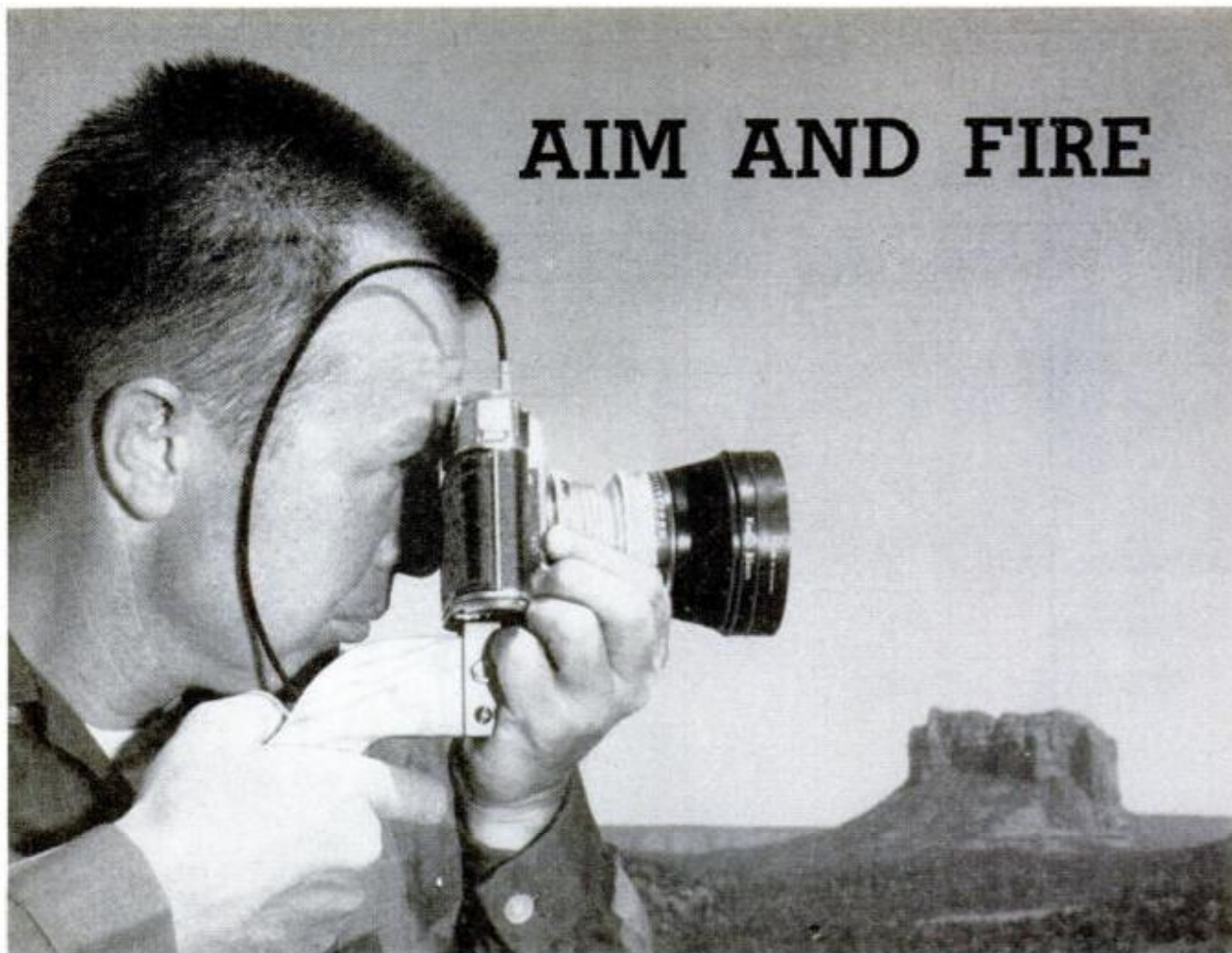

ALTERNATE MOUNTING shows how a bolt inserted through hole in top of the gunstock is used to attach 400-mm. camera

ANGLE BRACKET on the side of the gunstock provides universal mounting for nearly all 35-mm. cameras. Note cable release

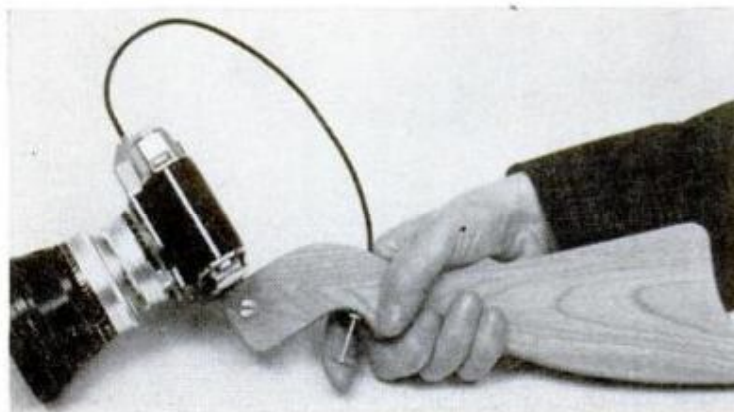

MOUNTED on a gunstock and triggered by a built-in cable release your camera is aimed and fired like a gun. You're ready for instant action and the gunstock provides the steady tripod support needed for those long-range telephoto shots and fast-action pictures. The photo at the top of the page shows how the left hand in focusing the camera also helps to steady the gunstock, assuring those sharp trigger-action shots every time.

Since arm reach will vary with the individual, the gunstock should be custom fitted. Here it might be wise to cut a stock from cardboard first and try it for size. It may be that you will have to increase the size of the squares when enlarging the magazine pattern or simply increase the length an inch or so. The pattern given will suit an average-size person. Select a choice piece of cabinet wood, such as walnut or mahogany, so it can be finished nicely like a gunstock and look like a part of your camera equipment. Tape your final paper pattern onto the wood and saw

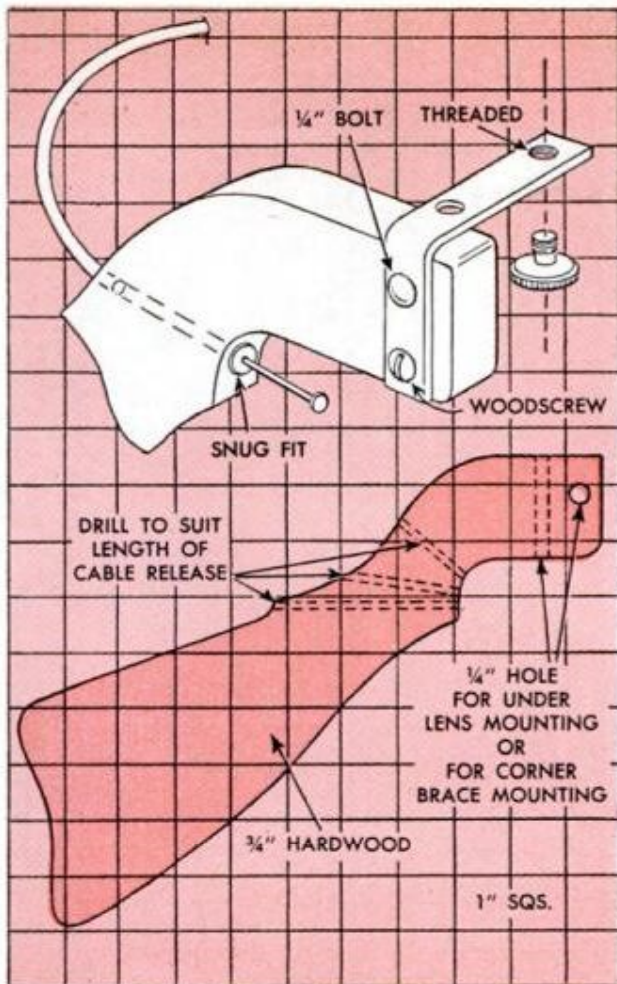

along the outlines with a jigsaw or band-saw. Then sand and round the edges.

Since most 35-mm. cameras have an off-center tripod mounting socket, a metal bracket is used to attach and center the camera on the stock. A regular 2½-in. corner bracket is perfect for this, one leg being shortened and a new hole drilled. The detail shows how the bracket is held to the gunstock with a bolt and wood screw and how it is tapped at the outboard end for a knurled camera-mounting screw.

Just where you drill the stock for the cable release is determined by where it connects to the camera. Some cameras will require a longer release than others. The right length will require a "trial" fit at the store. Select one long enough to avoid kinking. The hole for the release should be just large enough to pass the threaded end. A cable with a swivel end makes it easier to connect to the camera rather than one which has a fixed tip. In actual use, the stock is rested against the upper part of the chest (not against the shoulder as in holding a rifle) due to the fact that sighting must be done with the eye level even with the view finder at the top of the camera. Learning how to hold the camera for a quick shot will require a bit of practice.

—Thomas C. Thomas

FOR CAMERA BUGS



Easy Print Spotting

Spotting prints is much easier and they are not as likely to pick up annoying glare if they are held at an angle rather than on a flat surface. Lay them on a slightly larger piece of corrugated cardboard and use two rubber bands to hold them flat. The cardboard is light and easy to handle and making it larger than the print will give you an edge by which you can handle it without touching the work. This will also give you an area to remove excess toner from the brush.—Wayne Floyd

Double Time

After you have the gang in the view finder you release the self-timer and dash to get in the picture yourself, sometimes with amusing results. You'll have plenty of time to include yourself and pose if you use an auxiliary timer attached to the cable release. Cock both timers and when you're ready, release only the auxiliary timer. The built-in timer will not begin to function until after the first completes its cycle, which gives you that much more time to get yourself set in the picture.

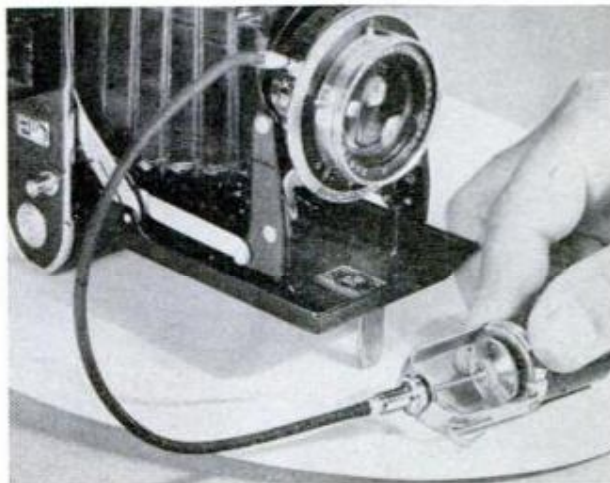

FARM TIMESAVERS



High Lift

By adding a 12-in. nipple of 2-in. pipe, fitted with reducers and a plug, to the hydraulic tractor unit, a trailer bed can be boosted 1½ ft. higher for faster unloading of small grain and ear corn. The pipe adds about 3½ quarts to the normal capacity of the hydraulic unit.—A. M. Wettach

All-Welded Feeder

Available commercially, this all-steel roughage rack can save its cost in a feeding season by greatly lessening feedlot losses of such roughages as hay and the various fodders which are a part of the daily ration of livestock on feed.

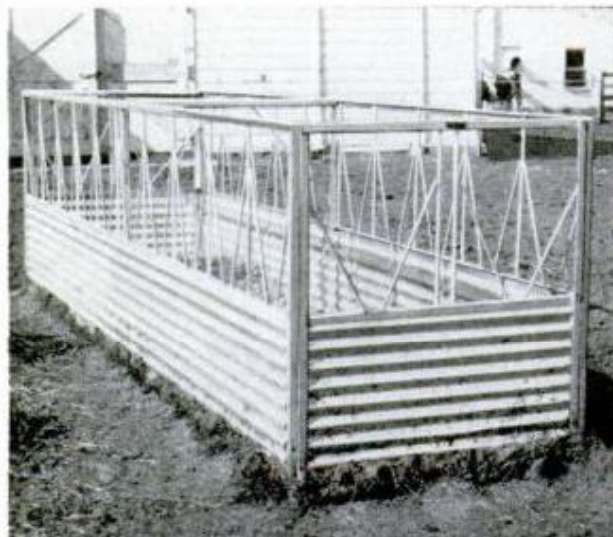

192

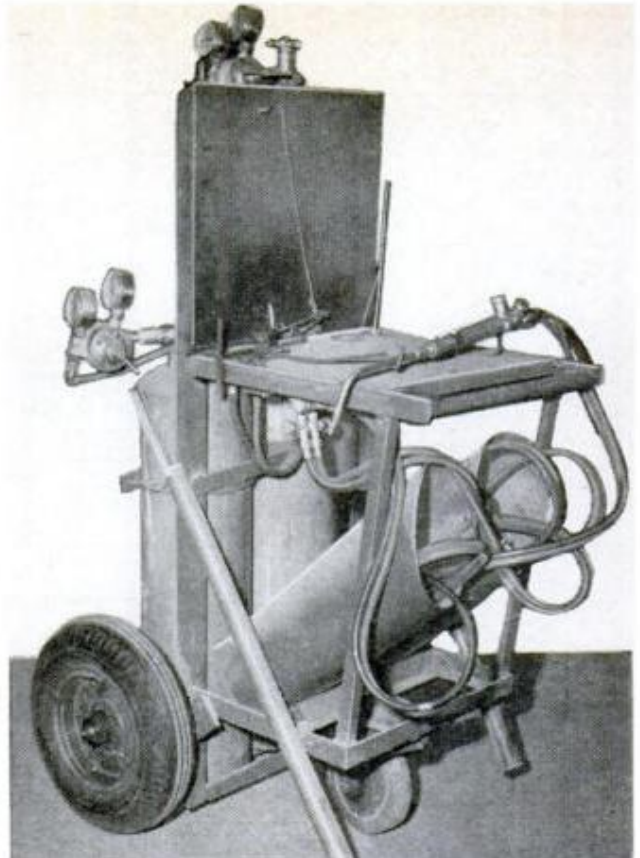

Automatic Snuffer

Designed and built by the Department of Agricultural Engineering, Iowa State University, this gas-welding cart has a wind-shield for outdoor use, hose bins, tank racks, pilot light and automatic snuffer which controls the hose-line valves. Torch goes out when placed on a control cradle.

Extra Gas

A tank holding 50 gallons of extra tractor fuel mounted on the field nurse truck can save an hour or more of time on a big farm when a tractor runs out of gas. Tank should be mounted high enough to transfer fuel by gravity alone.



POPULAR MECHANICS

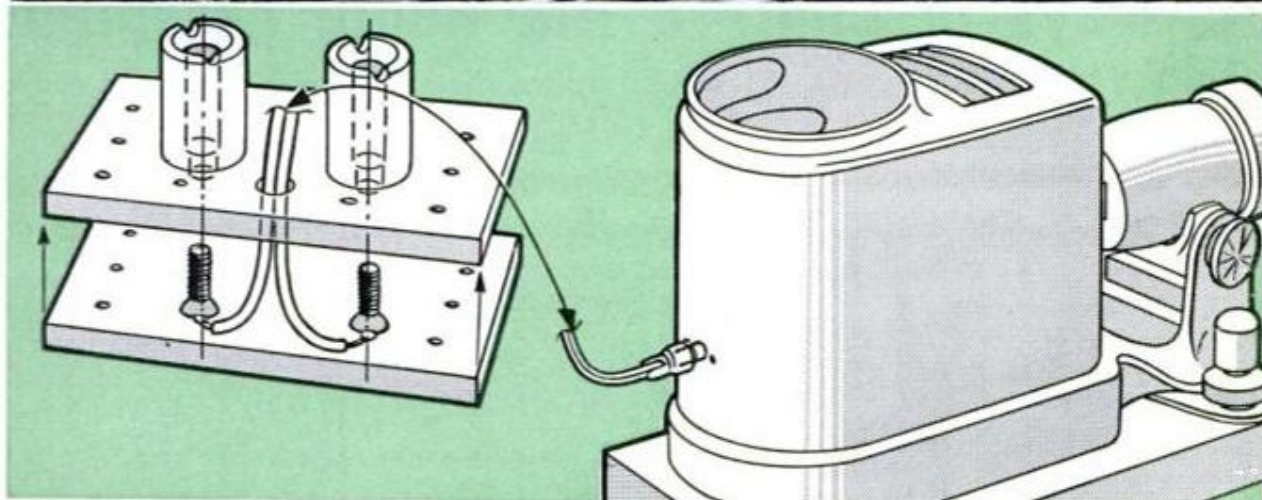
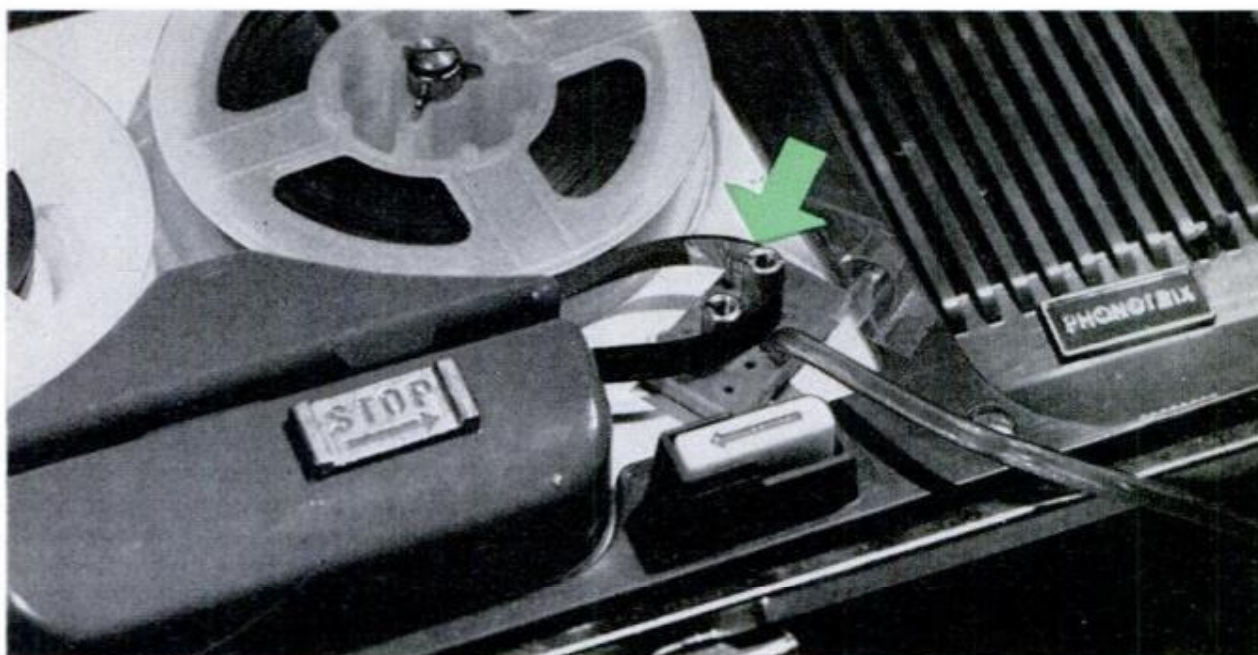

Tape Sync for Slide Projector

TURN THE LIGHTS DOWN, turn on the tape recorder, and your first slide is projected on the screen. From there on, you sit back and enjoy the show with your guests. Slides change automatically, timed with a prerecorded tape narration and background music.

The key to such a system is a small plastic "sandwich" on which two brass spacers, $\frac{1}{4}$ inch by $\frac{3}{8}$ inch long, are mounted as shown above. Connect these spacers to the switch circuit of an automatic slide projector as in the drawing.

With your slides in proper sequence for projecting, add the narration and music to

a tape recording. Whenever you want to change a slide, apply a strip of aluminum foil tape (arrow in photo) to the *shiny* uncoated side of your recorded tape. Then, with the switch mechanism connected to the slide projector, when you play the tape the aluminum "cue" strips close the circuit and change the slide.

The brass spacers and the 2 x 3-inch perforated phenolic sheet from which you cut the base pieces are available from Lafayette Radio, New York; the miniature zip cord from Saxton Products Co., New York; and the aluminum foil tape from local stores or Minnesota Mining.—Byron G. Wels

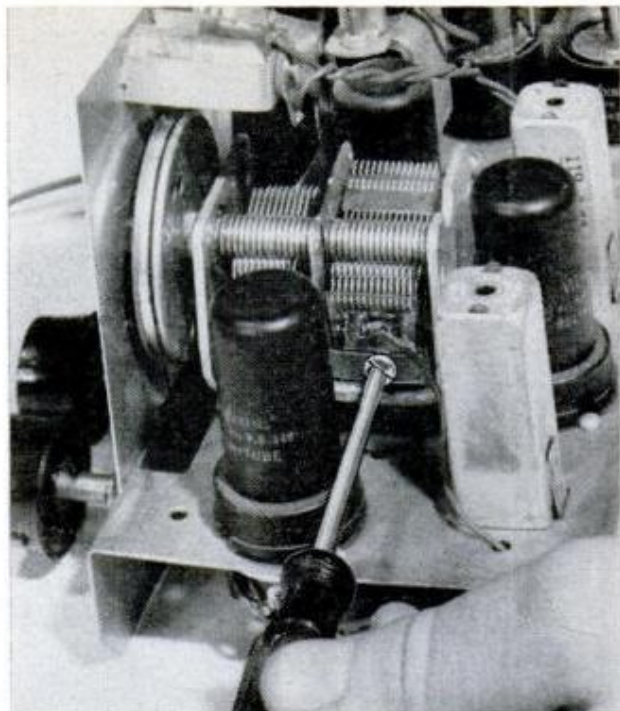
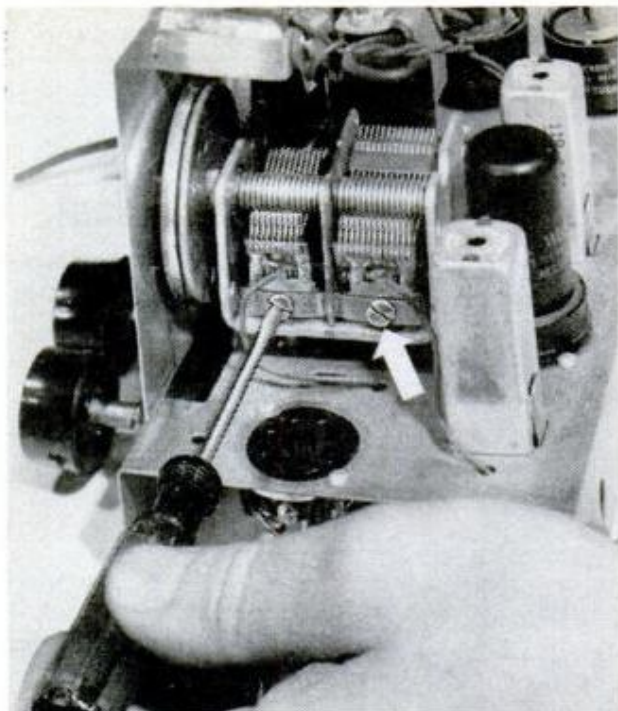

LOCATE TRIMMERS on sides of capacitors. Set dial at station whose kilocycle frequency is known (check newspaper listings). Then adjust front trimmer (left above) until station is strongest at correct dial setting. (Tube was removed here for photo purposes only). Repeat for several stations for best compromise. Repeat with rear trimmer (right above) adjusting for best volume, checking a few stations

10 Ways to Improve AM Radio Reception

COMES A TIME when your a.c.-d.c. table radio may not sound as perky as it used to. The reception may be too weak and the static too strong. Buzzes, rattles or hisses may emanate from the speaker. Just turning the volume control may create scratchy sounds and the dial may seem casual about pinpointing the station you want. When this day comes, your set is obviously overdue for a "tuneup."

Remove the radio from its cabinet and

replace the knobs on their proper shafts. It's wise to eliminate any question of weak or dead tubes by pulling all and testing them at the local radio shop or drug store. With sound tubes, you are ready for the ten-step tuneup that will restore the set to almost new performance. Whenever you test with power on, use an insulated screwdriver. Oldtimers may have their arms calibrated in volts, but play it safe by keeping one hand in your pocket!

TUNING SLUGS are at top and bottom (under chassis) of two IF transformers. Turn carefully one at a time listening for maximum volume. Turn lightly; forcing will hurt transformer. Right, if pilot lamp doesn't work, rectifier tube will burn out faster. Lamp holder snaps out with slight squeezing of fingers

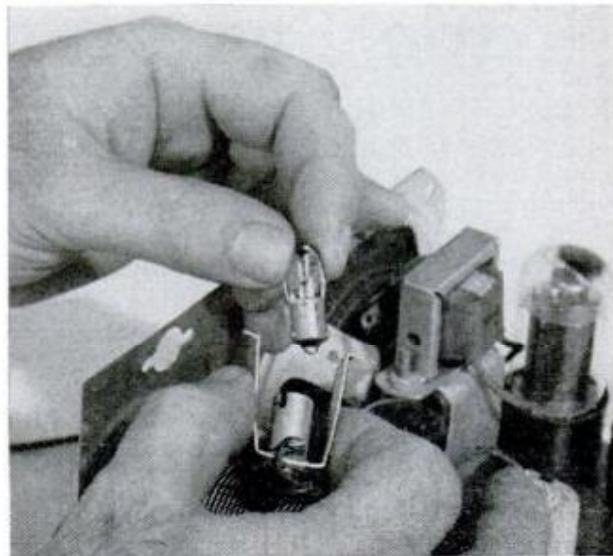
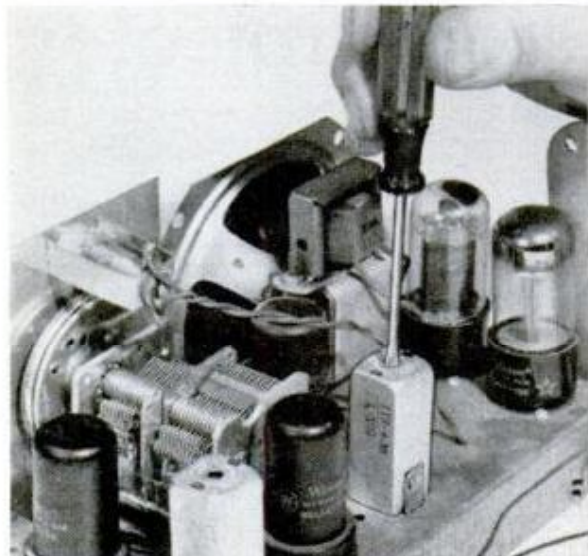

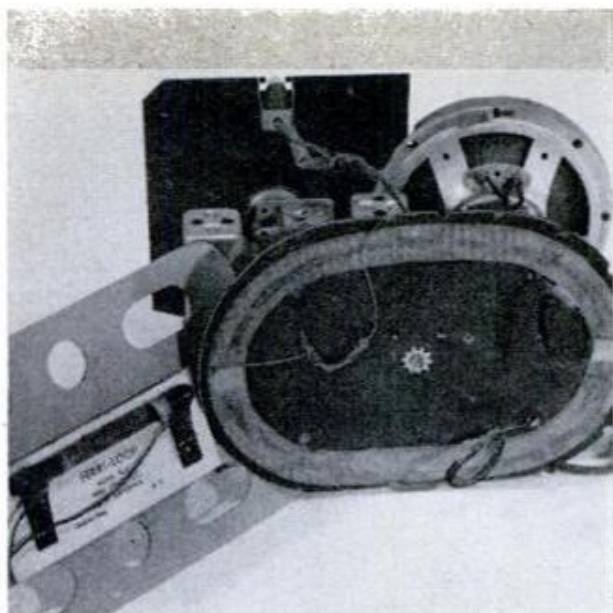

IF SET USES wire loop antenna (above right), substitute ferrite antenna (left) to improve reception. Longer ferrite rods provide the best performance

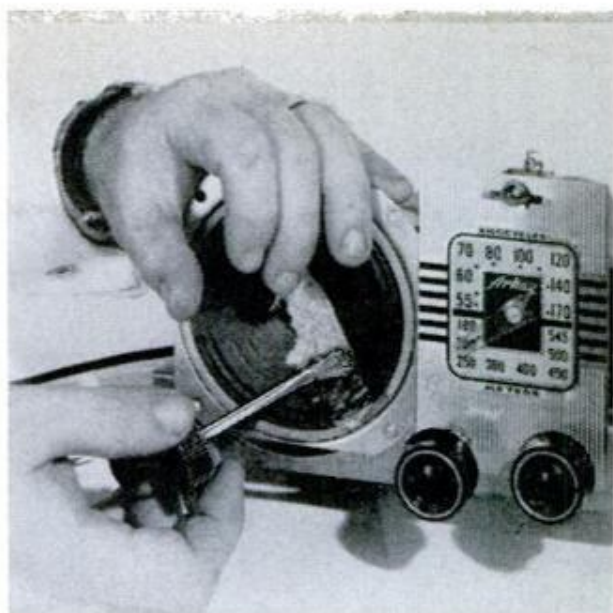

MINOR TEARS produce scratchy sound in loudspeaker. Patch cracks with several layers of tissue paper using household cement or loudspeaker cone cement

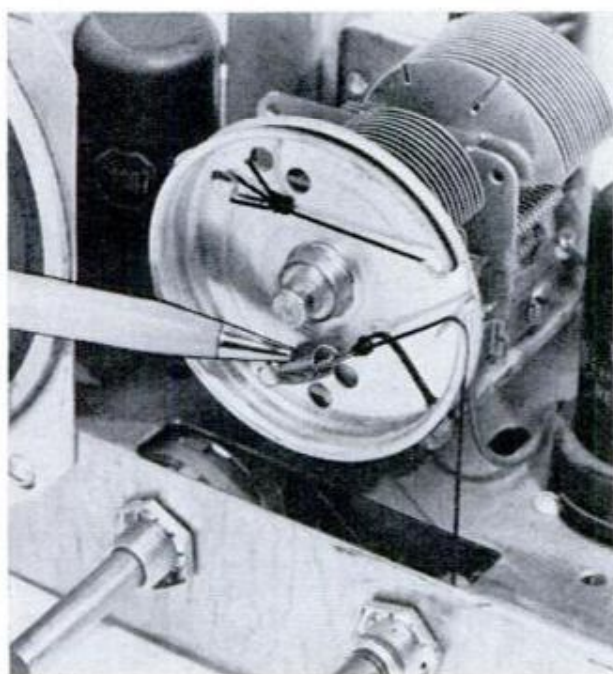

FOR ACCURATE TUNING, dial-cord tension should extend spring slightly. Loose cord causes pointer jumping. Cord slippage is corrected with dial-cord dressing

USE PIPE CLEANER and spray-can contact cleaner to remove resistance-causing dust particles. Unmesh capacitor plates for more room. Don't deform plates

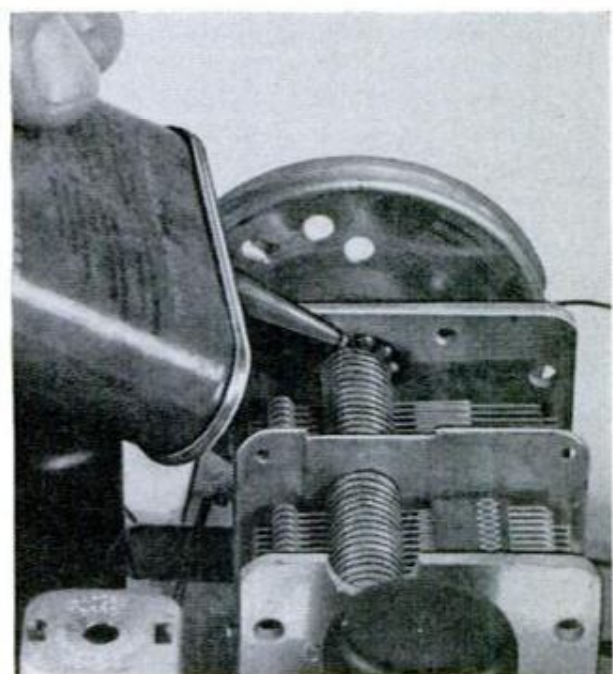

TO LUBRICATE capacitor for smoother tuning, use a light machine oil on bearings front and rear and all moving control shafts. Don't get oil on wires

IF SPECIAL INJECTOR is available, use liquid contact cleaner to provide smoother noise-free action on controls. Some solutions have eyedropper syringe

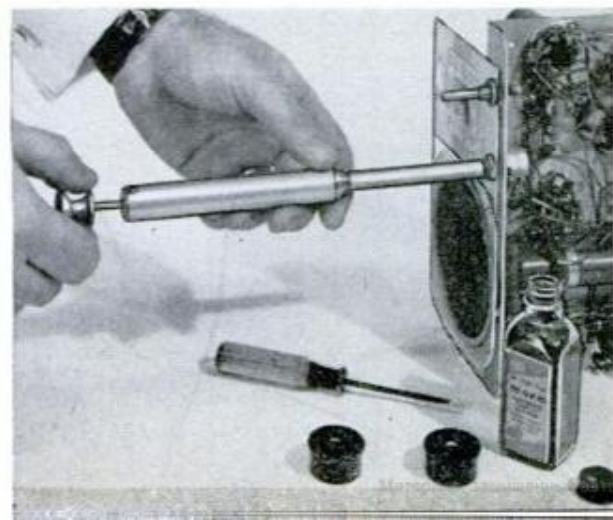



WIRING a twist-lock plug on a soldering iron and a mating receptacle on the end of a retractile reel gives you a handy retractible soldering iron. For portable use away from the workbench, make up one cheater cord with a female socket and an a.c. plug



YOU CAN SIMPLIFY removal of tape boxes from storage files by using index tabs such as are used for office filing systems. These not only make convenient handles, but you can mark the contents of the box on the exposed portion of the plastic index tab

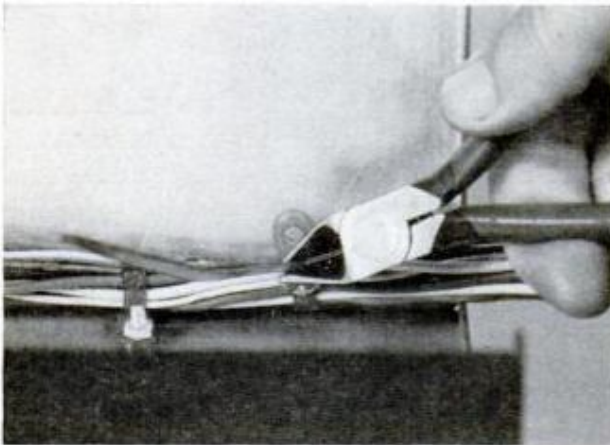

Electronic Tips

PLASTIC CABLE TIES serve a double purpose. In addition to keeping wire cables neatly in place, each is provided with a convenient screw lug which mounts the tie and the cable to the chassis. Tie is wrapped around cable, pulled through slot, and excess cut

HOT RECORDS make racks. To make a unique record rack, run the center of a record through a candle flame a few times. When you feel the disc start to "give," bend it over a sharp table edge. When it cools, you have a novel rack for record, book storage





GRAVELY
 doesn't give
 up
 when the
 mowing gets
 tough!



When the grass is thick and heavy, the weeds are tall and tough, Gravely gives you the lugging power—the performance—to get the job done . . . right! No pushing, pulling or pampering needed—Gravely POWER does the work!

You ride for the routine jobs, guide for the tough jobs. Have a flexibility of performance, a versatility of tools that will make your place the envy of the neighbors, a source of pride and satisfaction to yourself, without drudgery!

30 TOOLS from which to choose, powered by the one 6.6 hp Gravely Tractor. All-Gear Drive, two speeds forward and reverse . . . designed and built for the tough jobs. Optional electric starter.

Installment Plan Available

Get the facts before you buy—from Gravely's big 24-page "Power Vs. Drudgery" booklet. See how Gravely *proves* it's best for you before you buy! Write now!

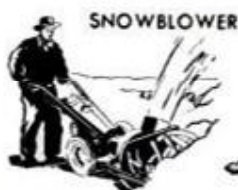

GRAVELY TRACTORS

DIVISION STUDEBAKER-PACKARD CORPORATION
 P. O. BOX 601-D
 DUNBAR, W. VA.



Sold & Serviced by Authorized **GRAVELY DEALERS**—our 40th year!

CLINIC FOR HOMEMAKERS



As a service to our readers in solving the hundreds of problems pertaining to a home—inside or out—editors of Popular Mechanics invite you to present your problems to The Clinic Editor for help and advice. Address your questions to The Clinic Editor, Popular Mechanics Magazine, 200 East Ontario Street, Chicago 11, Ill.

Restoring Appliance Finishes

Q—The white finish on our refrigerator is chipped in a few places. Is there any way I can patch up these spots without having them show and without refinishing the entire appliance?

A—If you're willing to spend a little extra time doing a careful job, you can refinish damaged spots so they won't show, except under close inspection. First, clean up areas with fine sandpaper, removing all rust and wax; then, wash with soap and water.

After removing the rust and wax, work all around the damaged areas with 220-grit silicon carbide paper, feathering the edges so finish slopes towards the middle of damaged areas. To the bare metal, a coat of metal primer is applied. Once this finish is dry, smooth it lightly and rough edges of the old finish to bond subsequent coats.

A finishing coat of lacquer or enamel is sprayed or brushed on. If enamel is used, allow at least 48 hours drying time before proceeding. A 400-grit silicon carbide paper is used to sand areas until edges are practically invisible. During the final operation, the sandpaper should be dipped frequently in soapy water, which acts as a sanding lubricant.



Termite Damage

Q—We've found a small mound of insect wings near the foundation of our house. A neighbor says they are termite wings. Now we're afraid termites may be in the house. How can we tell?

A—It's often difficult, since subterranean termites stay hidden except during the spring mating season and again in the fall. Then you may see flying insects which look something like flying ants. If you see these, you can be sure termites are at least in the neighborhood, and you will want to check for possible damage.

Clear indications of their presence are crooked tubes of mud extending up masonry walls in a basement or up concrete piers under a basementless house. These shelters reach to the wooden sections of a building, where worker termites go for their food. Once the workers establish a path to the



wooden structure of a house, they will eat their way along the grain of the lumber, never once exposing themselves. At worst, the first signs may be sagging floors and settling walls. Wood attacked by termites reveals a honeycombed structure. If severe damage has occurred, a professional exterminator should be called in immediately.

Termite damage can easily be controlled today by using proper construction methods and chemically treating the earth around a house. Topping foundations with rust-proof metal shields and treating understructures with pentachlorophenol will keep termites from entering by these paths.

Using a chlordane insecticide (mixed according to instructions), solution is poured or brushed into foundation cracks. Afterwards, seal these openings with a concrete mix. For soil treatment, a trench is dug two feet deep around the foundation and half the insecticide poured into it. The rest is poured over the soil as it is replaced.

★ ★ ★

GET READY FOR ALL THE SUMMER'S JOBS

Set up a Weldwood Wood Finishes shelf in your workshop



Prime outdoor furniture with Weldwood Firzite.® Seals, prevents wild grain. Reduces checking. Makes paint go farther, flow evenly. Also excellent base for stains when tinted with colors-in-oil.



Repair wooden screens with Weldwood Waterproof Resorcinol Glue. Forms permanent bond that withstands weather, fungus, rot, heat and cold. Ideal for outdoor furniture, boats, sporting goods, toys.



Stain wooden fences with a Weldwood Exterior Stain: Redwood, Driftwood, Sierra Brown, or Cascade Green. Deep-penetrating, hard-drying oils that resist weather, wear, and sunlight. Easy to use.

How handy to have supplies at your fingertips when you need them! It's easy. Keep these Weldwood® adhesives and finishes on your workshop shelf, and you're set for practically every job, indoors or out: Firzite, Exterior Stain, Spar Varnish, Resorcinol Glue, Wood Preservative. Total cost: only a few dollars. And you save yourself time and trouble! Shop your lumber yard or paint and hardware stores this week.

WELDWOOD
WOOD FINISHES

Products of United States Plywood

I Fished the Finest Spot

(Continued from page 122)

The lakers broke a long-standing tradition of the Canadian north country that week by a lack of enthusiasm for metal spoons, their usual staple. On the second day I switched to my ace-in-the-tackle-box, an import from the Puget Sound salmon country called a Lucky Louie. The big plug, one of the greatest lures for big salmon and trout, is almost unknown east of Idaho's Lake Pend Orielle, but those Tazin Lake trout fell all over them, and we began taking bigger fish. On the second day Chummy and I took perhaps forty trout. On the third day, though, we broke Chummy's record. We took good fish all morning, started looking for a lunch fish at eleven o'clock, and at two-thirty we had not taken a trout small enough to kill. Plenty of fish, but bread, butter, bacon and beans for lunch, and broad grins all around.

Northerns in Shallows

I asked Chummy about the northern pike, so we ran into a bay and he showed me where they lived. A government project put a dam on Tazin Lake a couple of years before, raising the water level eight feet. The shallows moved up around the feet of the pine trees along the shore line, and the pike moved along with it, holing up around the stumps and down timber. That was the toughest fishing I have ever seen, but the pike were back there, and there were a lot of big ones.

That "someday fish"—the over-40-pound laker that you know is down there somewhere—is the ruination of fishermen who go up there looking for a little of everything. You end up forgetting the other fish and going after that big fellow; I don't think anyone ever took a walleye up there intentionally, and the greyling are considered a tourist attraction. You get record fever and that's that.

In the long north-country twilight after dinner, the fishermen usually go out again for a couple of hours, often in the middle of a doughnut-shaped flooded island near camp where the pike are thick as blackflies. They call it "The Snake Pit," and happily rattle big pike and pine trees as long as daylight, line and lures hold out. But that's the day's dessert. From breakfast to dinner you fish for trout.

This wouldn't be much of a story without a big one that got away, but *my* big one not only got away, but was so big that I'm ashamed to talk about him in print. He hit a trolled Lucky Louie, took it to the bottom, and stayed there, making short, bullish runs occasionally. Using a tough boat-and-

MINSEER TACKLE CO.
ROUTE 1, BOX 621
PORT ANGELES, WASH.

jetty spinning rod designed to cast four-ounce lures, a big salt-water reel and twenty-pound line, I couldn't move him. I reeled the boat slowly over him. Four times he came up, once within 10 feet of the surface. Four times he went back down, into 40 feet of black water, and 20 minutes later he snagged bottom and broke off. Well, as I said, it wouldn't be much of a story without a big one that got away.

Best Lake Trout Fishing

Was it the best fishing in North America? I don't know—what's *your* definition? It is certainly the finest lake trout fishing in the business; I'll match its record of pounds-per-fisherman or big-fish-per-fisherman with any body of water. They don't keep fish under 25 pounds, and don't get excited at less than 35. That, plus the great lure of record-sized fish, is enough to get it my nomination. (The hook-and-line record laker was only three inches longer than Tazin's record, a skinny spawner far short of that weight but back in there, growing and waiting.)

What's more, it's a beautiful place. The water is so pure that you dip your drinking water over the side of the boat or off the end of the dock. You can see moose along the shoreline and eagles nest in the trees. The lake is big enough to hold big fish, and broad enough that you needn't see another fisherman all day. Yet it's also small and irregular enough that it doesn't kick up in a blow like the bigger trout lakes; there's always a lee shore to fish along.

The tab for the trip is a good big one, but not unreasonable for a once-in-a-lifetime trip; the tourist air fare from Chicago was \$260, round trip, including the charter flight in to the lodge. The rates, all-inclusive from the minute you step off the plane except for your license, smokes and refreshments, are \$275 a week per person. That's guide, boat, meals for a king or a logger—everything. The Parsons Airways seven-day trip costs \$650 a head, and gives you five days at Tazin Lake, two at Snowdrift on Great Slave Lake, and a lot less time lost around airfields. Other airlines are planning similar trip deals. The season runs from mid-June to middle or late September, with the best fishing early and late. You can bring back fillets at a special reduced rate, or you can take advantage of a trophy-handling service out of Uranium City if you get a really big one.

You can get the full story by addressing Mr. Vince Pullar, Tazin Lake Lodge, Uranium City, Saskatchewan, Canada. Tell him I sent you, and have a nice trip. *But don't catch my trout!* I'm going back after him myself. ★ ★ ★

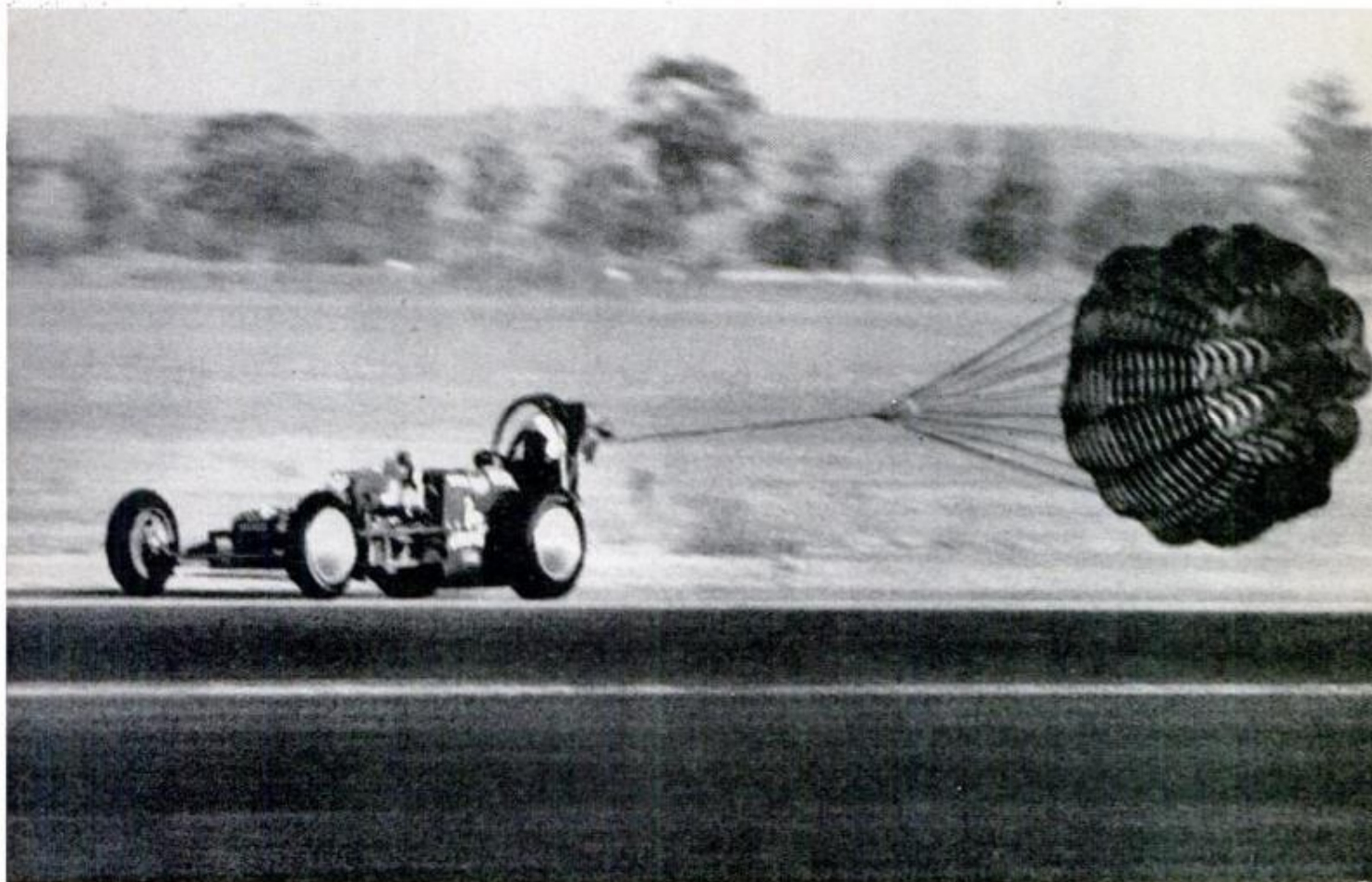

Thompson pops his braking chute after a record run! His spark plugs: new silvery-plated Champions!

Mickey Thompson -- world's fastest driver -- set 14 new national and international records in one morning! Like winners of 9 out of 10 major races, he insists on Champion spark plugs...because Champions have no equal for performance! Why settle for less in your car?



CHAMPION

OUTGRIPS

'EM
ALL...

BIG



SMALL



IN TIGHT
PLACES

CHAN NEL LOCK

Easy does it on every gripping job with a Channellock Plier in your hands. Powerful parallel-jaw grip . . . tremendous leverage . . . patented, smooth-working, can't-slip adjustments. Your choice of five jaw capacities: $\frac{1}{2}$, $\frac{7}{8}$, $1\frac{1}{2}$, 2 and $2\frac{1}{4}$ inches. *Be sure it's a genuine Channellock. Look for the trademark on the handle. Write for catalog showing complete line of pliers. Made Only By Champion DeArment Tool Company, Meadville, Penna.*

Building the PM Jet

(Continued from page 179)

that the three stiffeners clear the drive shaft and jet unit. When finishing the top of this cover, be sure to add nonskid compound to the epoxy paint to avoid accidents.

The removable transom cover, Fig. 31, is made of perforated hardboard and fits under the coaming. Use screws with cup washers to attach this cover to the frame of the false transom. If you have added storage compartments on either side of the jet unit tunnel, cut access holes in the cover and line these holes with half-round molding rabbeted for the hardboard.

Before painting the boat, use surfacing compound (Duratite, Lakerfill or similar) to mask all outside through-hull fastenings. Complete the varnishing first (transom deck, top of motor cover, coamings, top of control stand and fore deck), then prime all exposed wood surfaces above the floorboard line and finish the side planking and interior with at least three coats of epoxy paint. If you are using a spray gun, cover the jet unit, engine and exposed steering blocks. Epoxy paint will give a smooth glossy surface which becomes extremely slippery when wet, so if this is used on the floorboards you should add nonskid compound to the paint.

Once the finish dries, you may mount the aluminum molding on the quarter fenders and sheer. If you wish to use the boat before building the lift-off deck and windshield, the hardware, instruments, controls, seat cushions and intake screen may now be installed. In the prototype, we used two back cushions with snap fasteners located on heavy strips along the top. These snap on the male portion of the fasteners which are mounted on the back of the seat.

Intake Screen

The intake screen, Fig. 3, Part I, should be the last thing installed before putting the boat in the water. While this may be purchased as an accessory to the jet unit, you may also build it at home or have it built in a local shop. All parts are of $\frac{1}{8}$ -in. mild steel except the skeg which is made of heavier, $\frac{3}{16}$ -in. stock. After all parts are welded in place, the whole unit should be galvanized. Use bronze or galvanized flat-headed bolts to mount the screen, and remember to set them in bedding compound. Drill the keelson for the $\frac{1}{2}$ x 3" bolt which is welded near the head of the skeg, and use plenty of bedding compound here, also. Be careful not to overtighten any of these bolts.

You will note that the aft end of the skeg

(Continued to page 204)

END NUT and BOLT HANGOVERS

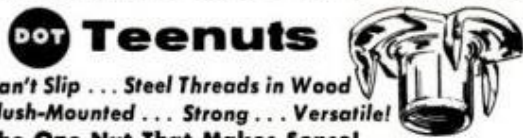

DOT Teenuts
 Can't Slip ... Steel Threads in Wood
 Flush-Mounted ... Strong ... Versatile!
 The **One Nut That Makes Sense!**



Ideal for permanent work or where easy "knock-down" feature is wanted. Available to fit standard thread bolt sizes: 6-32, 8-32, 10-24, 10-32, 1/4-20, 5/16-18, 3/8-16. Available at hardware dealers. If not, send \$1 for special mail order package and name of nearest distributor. Specify size.

COLUMBIA FASTENER COMPANY
 3229 South Ashland Ave. • Dept. PM • Chicago 8, Illinois



G E A R S

In Stock - Immediate Delivery
 Gears, speed reducers, sprockets, thrust bearings, flexible couplings, pulleys, etc. A complete line is carried in our Chicago stock. Can also quote on special gears of any kind. Send in your blueprints and inquiries.

Send for Complete Catalog No. 10 CHICAGO GEAR WORKS
 440-50 N. Oakley Blvd., CHICAGO 12, ILL.



You have a use for

SPRAY PAINT

In Ready-to-Use Aerosol

IF YOU PRIZE IT...KRYLON-IZE IT!

NEED HELP WITH YOUR HOME?

Send for your copy of our **FREE FOLDER**

TIPS FOR HOMEOWNERS

Loads of helpful suggestions and ideas on improving, repairing, and maintaining your home inside and out. Folder contains sources of further information to help you make your home look better and have greater value.

SERVICE BUREAU, POPULAR MECHANICS,
 200 E. Ontario, Chicago 11, Illinois

Please send me my free copy of your TIPS for HOMEOWNERS folder.

Name.....

Street.....

City.....Zone....State.....

South Bend

10" LATHES

with new welded steel floor legs

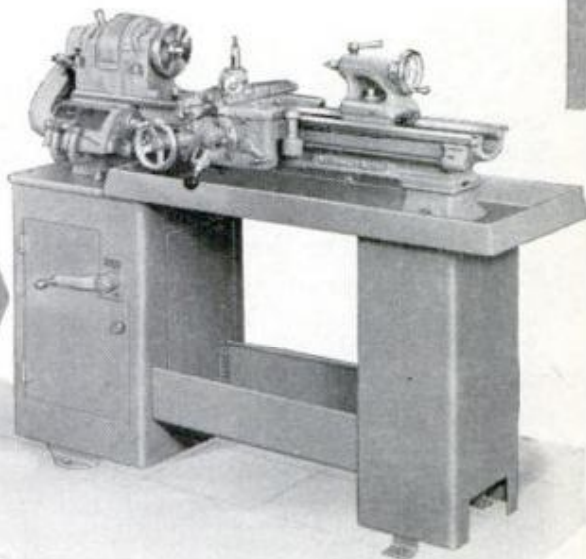

- New, trim floor legs ... reinforced construction of welded, heavy gauge steel ... maximum rigidity with minimum weight ... no increase in price!
- Famous South Bend dependability.
- Superfinished spindles and bearings for uniform accuracy and fine finishes.
- 70 screw threads (4 to 480 per in.) ... 70 longitudinal feeds ... 70 cross feeds.
- Tool room and Engine Lathe models ... prices start at \$1346 f.o.b. factory.

WRITE FOR CATALOG

of South Bend Lathes, Milling Machines, Shapers, Drill Presses and Pedestal Grinders

SOUTH BEND LATHE, INC.

South Bend 22, Indiana

Building Better Tools Since 1906

Time payment plan available. Up to 36 months to pay.



is not welded for a distance of about 3 in. If you have made a slight error in building the boat or installing the jet unit, this section of the skeg can be used as a trim tab and bent slightly to offset any tendency of the boat to pull to one side. Most boats won't require such an adjustment, so make sure that pulling isn't due to a poorly balanced load before you bend the tab.

The lift-off deck, Fig. 23, fits over the coamings with its inside edge hard against the outside edge of the coaming. The fore edge should be raked 30 deg. and crowned to match the fore deck. Legs of the lift-off deck follow the outside of the coaming and are fairings of the windshield legs. This "outer coaming" can be cut from 1 x 2 stock and should follow the curve of the regular coaming except at the seat back. If you make the curve a bit wider here so that the legs spring in slightly, you can be sure of a snug fit to the coaming.

Mounting the Lift-Off Deck

Carriage bolts with large wing nuts are used to attach the aft ends of the legs to the sheer shelf. To hold the fore end in place, fasten blocks to the rear face of the forward crossbeam so that you can mount one half of a hold-down clamp on each block and the other half on the coaming. For a heavier fastening, drill and tap one hole in a common flat mending plate for a $\frac{3}{8}$ " x 1" thumbscrew and mount this on the inner face of the coaming. On the block, mount a corner iron with one hole drilled slightly oversize for the thumbscrew.

Since the removable deck is to be varnished, countersink all fastenings and plug the holes with wood plugs or wood putty. The windshield frame is made of $1\frac{1}{4}$ -in. mahogany and mounted with a piano hinge so that it can be folded down flat on the lift-off deck. Hold-down clamps on the windshield legs hold it in an upright position. The forward surface is decked with $\frac{1}{4}$ -in. mahogany plywood, and two runners are mounted on this so that their upper edges are level with the centerline of the deck to provide support for the windshield when it is in the down position. If you plan to do much running with the windshield folded down, it might be well to pad these runners and add small hold-down clamps to secure the windshield to the deck.

Use simple mortise and tenon joints when assembling the windshield frame, but don't glue those joints where the upper part of the frame attaches to the long lower leg. These should be fastened with oval-head screws and bedding compound so that the frame can be dismantled in case of glass breakage. After varnishing the whole unit, cover the underside of all edges with a

good quality weather stripping. This not only eliminates rattles, but protects the deck finish and makes a watertight seal.

If you wish to make a convertible top for the *PM Jet*, basic bow dimensions and mounting points can be obtained from Figs. 9, 10 and 11, Part I. The longest leg of the top bow is 33 in., the shorter leg mounted at right angles to it is 16 in. These dimensions will permit the top to fold over the windshield and lay flat on the deck. In order to provide sufficient surface for mounting the top fittings, you'll have to cut out a short section of coaming and replace it with a wider mounting block. Shape the upper edge of the block to match the coaming and varnish it.

Any awning maker should be able to make the top for you from the dimensions given here. Fit the forward edge with snap fittings and mount the male parts of the snaps on the front of the windshield frame. Eye straps mounted on the sheer shelf aft will take the snap fittings of the back strap. The top should be set with tension, but be careful not to make it too tight for it will tighten even further when wet and have a tendency to spring the windshield frame.

PLANS AVAILABLE

If you plan to build the *PM Jet* and would prefer to work from larger drawings than those included here, a complete set of plans on $2\frac{1}{2}$ ' x 3' sheets is available. To obtain these plans, plus a booklet containing the text and photos, send \$7.50 to Popular Mechanics Blueprint Dept., 200 E. Ontario St., Chicago 11, Ill.

Once you have completed the boat and are ready to put it on a trailer, the rear keel rollers must be adjusted to provide clearance for the skeg. One method is to make a deep wedge cut in the center of the roller so that the hull rests on the edges on the roller. If you can't provide sufficient clearance by cutting the roller, either substitute oversize rollers to hold the skeg or remove the rear roller altogether and substitute a pair of rollers mounted on the rear cross-member of the trailer as close to the keel as possible.

Don't think that the job is complete just because the boat is ready to be put in the water. The minute you pull up to the launching ramp with the *PM Jet*, curious bystanders will begin to close in and the questions will start. Try to be patient with these people. After all, you've got a versatile, exciting boat, and very likely it's the first jet many of them have seen. You'll just have to get used to being the center of attention. ★ ★ ★

SAVE MONEY ON WOOD

POWER TOOLS
WORKSHOP SUPPLIES



**NEW 140 PAGE
CATALOG
Send Today!**

World's Largest Selection, Rare, Fancy and Imported Woods, Mosaic Tile, Lamp and Upholstery Supplies, Tools and Hardware! All at Money Saving Prices!

Send for this complete new wood buying guide and project book. Craftsman is your best, most complete source of finest kiln-dried domestic and rare imported woods, beautiful wood inlays, colorful bandings, matched plywoods, furniture legs, embossed mouldings, carved ornaments, newest wood-working tools, "hard to find" cabinet hardware and fittings... more than 1,500 items! Packed with new patterns, project ideas and money making plans. Enclose 25c to help pay mailing and handling cost. Write:

CRAFTSMAN WOOD SERVICE CO.
2729 S. Mary St., Dept. A-4, Chicago 8, Ill.

SAVE MILES • DOLLARS HULL AUTO COMPASS

One wrong turn means wasted hours and mileage, lost dollars, lost appointments. Eliminate guesswork with a famous, dependable HULL AUTO COMPASS. \$5.95 to \$7.50. At your dealer's or write for literature.

BOAT OWNERS NEED 'EM, TOO!

HULL MFG. CO. • P.O. Box 246-D-4 • Warren, O.



EXCLUSIVE DOUBLE-BEARING HEAVY DUTY PUMPS

IRRIGATE • DRAIN • CIRCULATE • SPRAY
Use 1/2 HP motor or larger... 1 HP for up to 5,200 GPH; 1,000 GPH 60" high; or 3,000 GPH from 25" well, 1 1/4" inlet; 1" outlet. Stainless shaft.

TYPE X—2 oil-less bronze bearings. **\$10.95**
Won't rust... Best for belt drives... **\$12.95**

Postpaid if cash with order.

Don't delay—send for yours today!

MONEY BACK GUARANTEE

Centrifugal and Gear Pumps in All Sizes

LABAWCO PUMPS, Belle Mead 2, N. J.



SHELTERS AND SURVIVAL BOOKLET—

The latest information on building both blast and fallout shelters, plus expert advice on survival. Send 25c to Popular Mechanics Service Bureau, Dept. RSB, 200 E. Ontario, Chicago 11, Ill.



New ALVA ALLEN Power Punch Press HANDBOOK Catalog

100 pages. Shows 1 to 25 Ton Capacity Punch Presses in hundreds of different model combinations. Full of general detail information on Punch Presses. Gives information on accessories as—Feeds, Punch Units, etc. Most complete Punch Press and Accessories Handbook Catalog. \$1.00 postpaid. Alva Allen Industries, Dept PM, Clinton, Mo.

GUNK® removes grease
-- scourfully!
cleans -- degreases -- freshens



- power mowers • engines
- cement floors • kitchen walls • ovens • exhaust ducts
- paint brushes • furnace filters • barbecue grills
- implements • machinery

AT AUTO SUPPLY, FARM & HARDWARE STORES!

GUNK CHICAGO CO., River Forest, Illinois
serving the Midwest and Southeast
RADIATOR SPECIALTY CO., Charlotte, N.C.
serving the East, Southeast and the West

Use Weldwood Spar Varnish



... when it'll be out in the rain



... scorched by the hot sun



... attacked by salt!

Rain. Ice. Sunlight. Salt air. Weldwood® Spar Varnish beats them all. It's unexcelled for toughness and durability, by actual lab tests. Resists yellowing, discoloration, checking and cracking—even under the severest conditions. And it also resists fungus and mold! For sidings, boats, outdoor furniture, sports equipment—use Weldwood Exterior Clear Spar Varnish—it protects as it beautifies.



Products of United States Plywood





Old paint in the heel of a brush prevents bristles from flexing fully—makes it harder to spread paint evenly. Imperial Brush Cleaner is the answer. Cleans away hard-caked paint and other finishes quickly, thoroughly. Leaves bristles as springy as when new. Ready for instant use. No long soaking needed.

Dull and clean glossy surfaces with WIL-BOND

Just apply this unique surface conditioner with a rag. Removes dirt, grease, wax and dulls the gloss. Makes new finish spread evenly, bond tightly; helps prevent chipping.

Get Imperial Brush Cleaner and Wil-Bond at paint and hardware stores... Write for free literature.

● Send 25¢ for illustrated Refinishing Manual.

Wilson-Imperial Co., 118 Chestnut St., Newark 5, N. J.

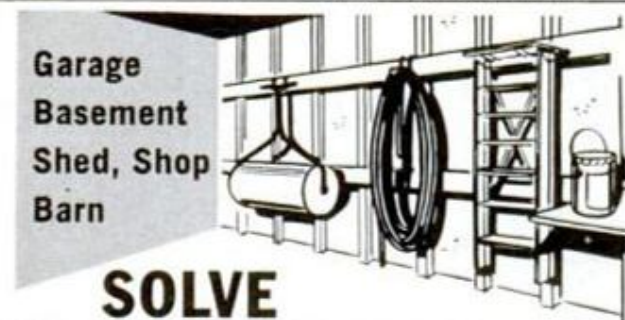

SOLVE STORAGE PROBLEMS

startling
NEW

HERCULES HOOKS

Patent applied for

obsoletes every other method of
HEAVY DUTY WALL STORAGE

These giant steel hooks are approx. 1/4" thick. They fit over the common 1" x 4" wood board. Simple to put up. NO perforated wallboard is used.

Hold the heaviest tools, equipment, shelves, etc. HOLDS EVERYTHING. Ask for them by name at your dealer. HERCULES HOOKS!

Sample hook sent direct to you. Enclose 10¢ for mailing.

Literature FREE!

K THE KERR WIRE PRODUCTS CO.
937 N. Cicero Avenue • Chicago 51, Illinois



8 DIFFERENT STYLES

Animated Easter Egg

(Continued from page 164)

To mount the moving disk, slip a plastic or cardboard washer over the axle wire and push the wire through the hole in the support so that it comes out the bottom of the shell. Using a pair of long-nosed pliers, make a right-angle bend in the wire as close to the outer surface of the shell as possible. Then make a second right-angle bend about 1/2 in. from the first so that it forms a crank.

Cutting the Base

Cut the basket base from 3/4-in. stock, shaping the inner cutout to fit the bottom of the egg and allow clearance for the crank. The stick support base has the same shape but should be cut from 1/2-in. stock. Locate the 2 1/2-in. cutout in the stick support base so that it will allow the crank to turn with approximately 1/2 in. clearance, and cut the slot for the dowel crank as indicated in the diagram, making it about 3/8 in. deep.

Make the dowel crank from a 5-in. length of 1/4-in. dowel, drilling a hole about 1/8 in. from one end for the wire crank. This hole should be large enough so the wire won't bind. Now fasten the basket and stick-support bases together with screws, slip the dowel crank into the slot and glue the base assembly to the shell with the end of the wire in the hole in the dowel crank. To complete the base assembly, glue a piece of light cardboard over the opening in the bottom.

Decorating the Interior

Before mounting the bunnies and house, paint the base and rotating disk green to represent grass. The inside of the upper half should be sky blue, with a horizon of trees and a few clouds added for extra realism. Cut the bunnies from heavy poster-board and the house from a slightly lighter cardboard. After coloring in the details, mount the bunnies with strips of cardboard folded to form triangular supports which hold them upright. Note that the corner of the house which extends over the rotating disk is cut about 1/8 in. shorter to assure clearance. Add trees or bushes of model-railway shrubbery or green-dyed sponge.

To assemble the egg, fit the collar of the upper portion inside the edge of the lower half and fasten the two halves with gummed tape. Cover the window at the top with a piece of transparent plastic cut from a refrigerator bag. Let your imagination run wild when decorating the egg. Use colored crepe paper, paints, fancy braids, felt flowers, beads, sequins—anything goes! ★ ★ ★

CRESCENT WRENCHES

5 WAYS BETTER

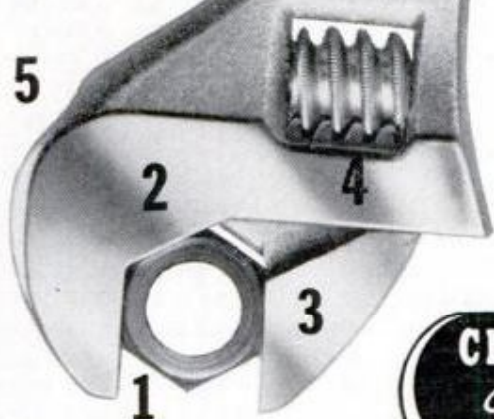

1 CRESCENT wrenches grip hex nut and bolt heads on at least three sides.

2 More solid metal reinforcement at points of maximum strain.

3 Jaws are matched early in manufacturing process to insure uniform hardness and to stay parallel at all times.

4 Precision machining of all parts assure firm hold on nuts and bolts, eliminates slack, lets the wrench open and close freely without a hitch.

5 Special alloy steel, electronically hardened, makes a stronger, thinner wrench... easier to work with, better balanced.

CRESCENT wrenches are made in two styles—CRESTOLOY, full chrome plated and CRESCENT, black with polished head. When you buy wrenches, pliers, and other hand tools... always ask for CRESCENT by name! Sold through leading hardware dealers everywhere.

CRESCENT TOOLS

Give Wings to Work

Jamestown
New York



Regulator and Generator Checks

(Continued from page 175)

Now, to check for overcharged battery or high-charging rate, first be sure the regulator is grounded to the chassis then, with the engine at 1500 r.p.m., disconnect the FLD. terminal from the regulator. If the charging rate drops, the regulator should be replaced. If there is no change, the generator field is grounded in the wiring or in the generator itself.

Generator High-Voltage Capacity

Now to check the generator high-voltage capacity, refer to the diagrams on page 175. Disconnect the regulator from the system and use a jumper wire to eliminate the regulator from the circuit. One thing about markings and position of terminals on regulators: Usually you'll see A, ARM or GEN on the terminal connected to the generator armature. B, BAT or AMM will be found on the car ammeter or battery connected terminal. But the positions and markings vary and one should make connections to the terminals by proper identification and not necessarily by duplication of the positions indicated in the diagrams on page 175. Now rev up the engine to give readings not exceeding 7.8 or 15.5, depending on whether you are checking a 6 or 12-volt system. Be careful not to exceed these readings as it is possible to send the voltage sky-high without the regulator in the circuit. In this test you are only making sure you have a basic minimum voltage. It's important when running tests to have parts at the correct temperature. Use either a standard regulator thermometer, Fig. 4, or improvise by taping a thermometer to the housing as in Fig. 5. Note the recommended temperatures in the table of specifications.

Generator Current Capacity

Generator current capacity can be determined initially by noting the generator amp. rating in the specifications for your car. But it is well to check to see if the generator is delivering the rated amperage. Use the jumper in the same manner as in the previous test. With the engine running turn on all lights, heater, radio and any other accessories. Then using an induction ammeter, Fig. 1, place the yoke over the wire running from regulator to battery. Now, increase the engine speed until the amp. reading just exceeds the generator rating. If the reading does not come up to the required level, then the chances are the commutator is glazed and must be cleaned.

Disassembly of a generator is quite simple and once you get it apart check the

condition of the brushes. Fig. 11 and the photo of brushes directly above Fig. 11 show what the brushes look like. If the brushes are badly worn (half their original length or less) and the commutator appears rough and burned, it will pay well to replace with a rebuilt generator. Otherwise, clean the brushes and holders, Fig. 11 and wipe the commutator with a dry cloth, Fig. 12.

If there is a need for regulator adjustment, use this sequence procedure: Run the engine for 15 minutes or so to bring the regulator to operating temperature. Have the thermometer attached at the time of starting the engine. When the temperature stabilizes take the reading, compare with the chart and note voltage settings in that temperature range.

Voltage Limiter

Stop the engine, disconnect the wire from the BAT(battery) terminal and insert a $\frac{1}{4}$ -ohm resistor, Fig. 6, between the BAT lug and the wire. Remember this wire is hot. Next, polarize the generator and hook up the voltmeter, observing polarity. Use either 8-v. or 16-v. range depending on battery voltage. Start the engine again and run at fast idle. The reading in the voltmeter should be within the range for the ambient temperature if no trouble exists.

If the battery uses water at a rather rapid rate, the voltage limit should be lowered somewhat. The meter reading will change when you remove the cover of the regulator. So, you compensate by taking the reading with the cover on and the cover off. Say, for example, the cover-on reading is 14.2 and the cover-off reading is 14.4 volts. By adjusting the regulator (there is a screw or lever for this purpose) you drop the cover-off voltage to a reading of 14.2. Then when the cover is replaced the voltage reading will be 14.0, a drop of 0.2 volt, which should normally achieve the desired result. When hooking in test instruments and making adjustments it is always best to remove the ground lead from the battery.

Cutout Relay

It's important to know when the cutout relay closes, switching the generator into the circuit. Start the engine and increase its speed gradually. The meter reading should increase, flatten out, then drop off slightly. The highest value reached just before the reading flattens out is the closing voltage. With the same hookup and with the engine not running a zero reading indicates the relay points are open, as they should be.

(Continued to page 210)

EASIEST WAY TO GET THAT HAND RUBBED LOOK

First non-pigmented semi-gloss finish ever developed. Accentuates all grain patterns, colors and wood tones. No primer needed. The most luxurious "hand rubbed" finish ever seen! Won't darken or discolor. Easiest to use. For all interior wood surfaces, old work or new. At Paint, Hardware, Lumber Stores. Pierce & Stevens Chemical Corp., Buffalo 3, N.Y.

In Canada: LEPAGE'S LIMITED, Toronto 18.

Made by the makers of famous FABULON

WOOD LORE

SEMI-GLOSS NATURAL WOOD FINISH

BOAT TRAILER KIT Only \$74.50

620 POUND CAPACITY—FOR BOATS TO 16 FT.
OTHER MODELS FOR ALL BOATS TO 850 POUNDS

You can really save on these rugged, perfectly engineered Kits. Guaranteed highest quality parts ready to assemble into a boat trailer with more features and better performance than high priced trailers.

NEW! CAMPING TRAILER KITS NOW
AVAILABLE AT TREMENDOUS SAVINGS!

Write for 1962 illustrated catalog showing all models and prices. Please enclose 10c for postage and handling.

Dealer inquiries also invited!

TRAILER PRODUCTS, INC. Dept. PM-42, P.O. Box 176
Kingsport, Tennessee



Decorative dadoes make distinct custom moldings or pierced panels. But there's a knack to making them, as you will see if you study Popular Mechanic's May article on the subject.

**My Daddy
Buys
HYDE
Tools**

Most daddies do . . . when they see this beautiful display of handy HYDE fix-up and paint-up tools in leading paint, hardware, building supply and lumberyard stores.

Write for FREE catalog

HYDE TOOLS
SINCE 1875
SOUTHBRIDGE, MASS., U. S. A.

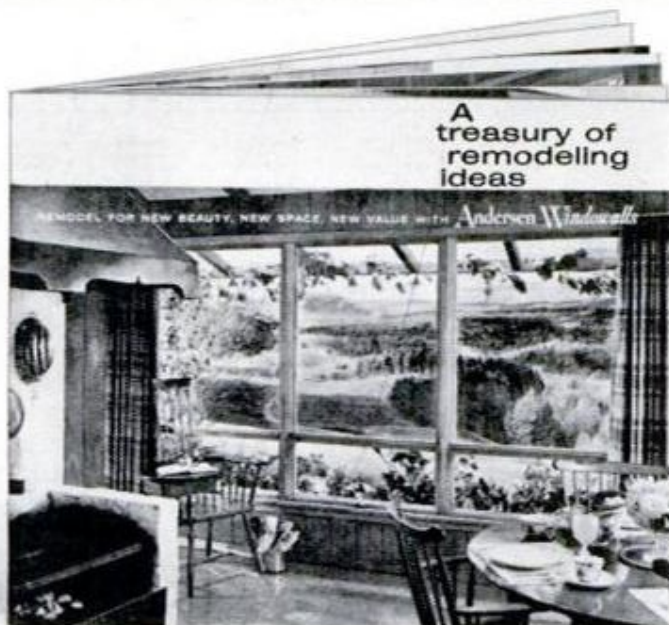

FREE!
REMODELING IDEAS

New 28-page booklet packed with illustrated ideas for making your home more beautiful, more livable, more valuable.

Andersen
Windowalls TRADEMARK OF ANDERSEN CORPORATION

NAME _____

ADDRESS _____

CITY _____

ZONE STATE _____

Andersen Corporation
Bayport, Minnesota PM-42



WHY TOY AROUND

WHEN YOU CAN ENJOY

THE ECONOMY OF

100% PENNSYLVANIA

KENDALL QUALITY

PLUS

PEAK LEVEL ENGINE PERFORMANCE



KENDALL REFINING COMPANY • BRADFORD, PENNA.
Lubrication Specialists since 1881

Current Limiter

This vibrating switch which opens and closes several times per second can be checked with the induction ammeter by holding the latter over any regulator wire except the field (FLD) wire. Drain the battery somewhat by operating lights, radio and other accessories for 5 minutes, start the engine and increase speed until the reading levels off. The highest reading will be the limit of the generator. If the voltage and limiter readings fluctuate, the regulator points may be oxidized, resulting in high resistance and reduced generator output.

Cleaning Points

It's permissible to file the points, Figs. 7 through 10, but be sure to note the specs and use the correct file. Work carefully or you may damage parts. Remove any residues with crocus cloth, or a strip of linen dipped in carbon tetrachloride. ★ ★ ★

ADDRESSES of manufacturers and persons mentioned in this issue are published in the monthly Where-to-Find-It list, available free from Service Bureau, 200 E. Ontario St., Chicago 11, Ill. Send a stamped, self-addressed envelope.

Army Unveils VTOL Aircraft

Due to roll out of the hanger this month is the Army's—and the United States'—first vertical-takeoff-and-landing (VTOL) aircraft. It will be able to rise or descend from small areas and fly in excess of 500 miles per hour.

The unusual aircraft has a system of ejector-mixing chambers buried in its fuselage. Two jet engines, mounted in pods along either side of the fuselage, furnish thrust for forward speed. For vertical operations, the high-velocity exhausts are diverted from the engines and fed to the mixing chambers where they are directed downward through jet nozzles. After take-off, bomb-bay-type doors that cover the top and bottom of the mixing chambers are closed flush with the fuselage. For landing they are opened again and the process is reversed.

The Hummingbird, named because of its ability to hover, will be a two-place mid-wing monoplane. It is intended to aid the Army's combat capabilities on the battlefield.

How to be a **WRECK-LESS** driver... by *Vip*



A more practical way to safeguard your life is with good shock absorbers. Wornout shocks cause dangerous swaying . . . loss of braking and control by allowing your tires to leave the road. Have your shocks checked regularly. For the safest, most comfortable ride of all . . . insist on Gabriel Shock Absorbers.



**CHECK UP BEFORE
YOU CRACK UP...
see your Gabriel
dealer now!**

Gabriel
SHOCK ABSORBERS
LOAD ABSORBERS



BUY GREAT NECK HAND TOOLS
... for long-lasting performance



GREAT NECK SAW MFRS., Inc.
MINEOLA, N. Y. — SEE YOUR LOCAL STORE

WORLD'S MOST EXCITING LOWEST PRICED CAR

KING MIDGET FOR 1962

Drive it for 75c a week.

Rider Agents Wanted. Send 25c for 32 page book, full details, dealer price. Or send \$1 (refunded first order) for this plus Service and Repair Manual and 16 5x7 photos of car and factory.

MIDGET MOTORS CORP.
ATHENS 1, OHIO



**The 'All-Purpose' Oil
For Home Workshops**
Cleans • Lubricates • Prevents Rust
3-IN-ONE® OIL
REGULAR—OIL SPRAY—ELECTRIC MOTOR

APRIL 1962

LAUNCHING'S a Breeze



with
**AUTO-
LAUNCH
EASE!**

Exclusive in Gator Boat Trailers!

And before you buy . . . Compare these work-saving GATOR Features with any other trailer on the market . . .

- **AUTO-LAUNCH** . . . a system of rollers and cradles that give your boat maximum protection in transit and automatic launching at the ramp.
- **LOADING GUIDE** . . . overcomes boat drift caused by wind and water current . . . makes loading a cinch.
- **3-SPEED HEAVY-DUTY WINCH** . . . designed to let you "shift" gears to handle loads up to 2500 lbs. Three gear ratios that take the work out of trailer loading.

Gator is the trailer choice of veteran and novice boatmen everywhere. **SOONER OR LATER YOU'LL GO GATOR** . . . the trailer with features designed by boatmen.

See a full line of economy Champ trailers at your **GATOR-CHAMP DEALER.**

FOR INFORMATION, WRITE DEPT. PM-62-4B

PETERSON BROS., INC.

1925 East Beaver Street, Box 51, Station G, Jacksonville 6, Florida



TILLS
easy
TILLS
close
TILLS
right!

Scientific tilling action breaks toughest soils evenly *without* breaking down soil structure ... with non-winding, self-sharpening tines that are guaranteed against breakage. For quality tilling and cultivating at its best, go **ROTICUL!** Two models: Super 4 hp/ Deluxe 3 hp.

Makers of Simplicity Garden Tractors, Simplicity '725' Riding Tractors, Wonder-Boy Riding Lawn Mowers

Simplicity

SUPER ROTICUL[®] tiller-cultivator

Simplicity Manufacturing Co., 6242 Spring St., Port Washington, Wisconsin



Why borrow?

Speedy Sprayer

now only **\$34⁹⁵**

Slightly higher Denver West



New! Speedy Sprayer Outfit complete with motor, ready to plug in and spray! Pays for itself on your first big paint job. Does an hour's work in minutes—spray fences, screens, shutters, furniture, rough walls, floors, etc. Smooth, flawless finish. A real professional tool! Ask for "Compact" 404. Write for "How to Spray" and folder.

W. R. BROWN CORP.

Specialists in Portable Sprayers Since 1921

2635 North Normandy Avenue • Chicago 35, Illinois

Lawn Sweeper

(Continued from page 154)

just enough to permit inserting a shorter bolt at the center. Draw this bolt down but not so tightly that the angles are bent. Now, insert the shorter bolts each way from the center (you'll have to drill through the broomstraws blocking the holes) and draw the bolts tight by stages until the brush bundles assume the form shown in Fig. 6. Replace the unit in the assembly.

Height Adjustment

Now back to Fig. 1. The aluminum angle bar you see across the front of the pulled-apart unit is fitted with uprights of the same material. The lower ends of these are bolted to the ends of the wheel plates and the upper ends are joined to a locking bar on the left side (looked at from the rear) and to an adjusting bar on the right. The end of the locking bar is simply clamped under the washer on the handle-adjustment bolt, or it can be slotted $\frac{5}{16} \times 2\frac{1}{2}$ in. The upper end of the adjusting bar is bent at right angles to form a handle and is drilled just below the handle with spaced $\frac{1}{4}$ -in. holes for a bolt and wing nut. This arrangement provides for height adjustment of the brush.

Handle Bars

The handle bars, handle-bar supports and the trailing members which carry the dolly wheels are cut from hardwood such as oak. The handle bars are cut 46 to 48 in. long, ends are rounded and the corners are softened by sanding. The push bar is a 1-in. dowel and a $\frac{1}{4}$ -in. steel tie rod, threaded at both ends, joins the supports to the handle bars. A crossrail, or spreader, joins the trailing members. The dolly wheels are turned from hardwood. Machine bolts, with washers to protect the wooden hubs, serve as spindles. As detailed the push bar is about average height. It will not raise or lower. If you wish it to raise or lower then slot the upper ends of the handle-bar supports so that the push bar can be adjusted to any desired height.

And that's it, except that the grass catcher pictured in use with the unit on page 151 is inadequate for leaf sweeping. You'll need to make a much larger fabric hopper for leaf gathering. Attach the leading edge to the forward ends of the trailing bars with wire hooks and screw-eyes. ★ ★ ★

Send for your free WHERE-TO-FIND-IT list giving sources of supply or further information on articles in this issue.

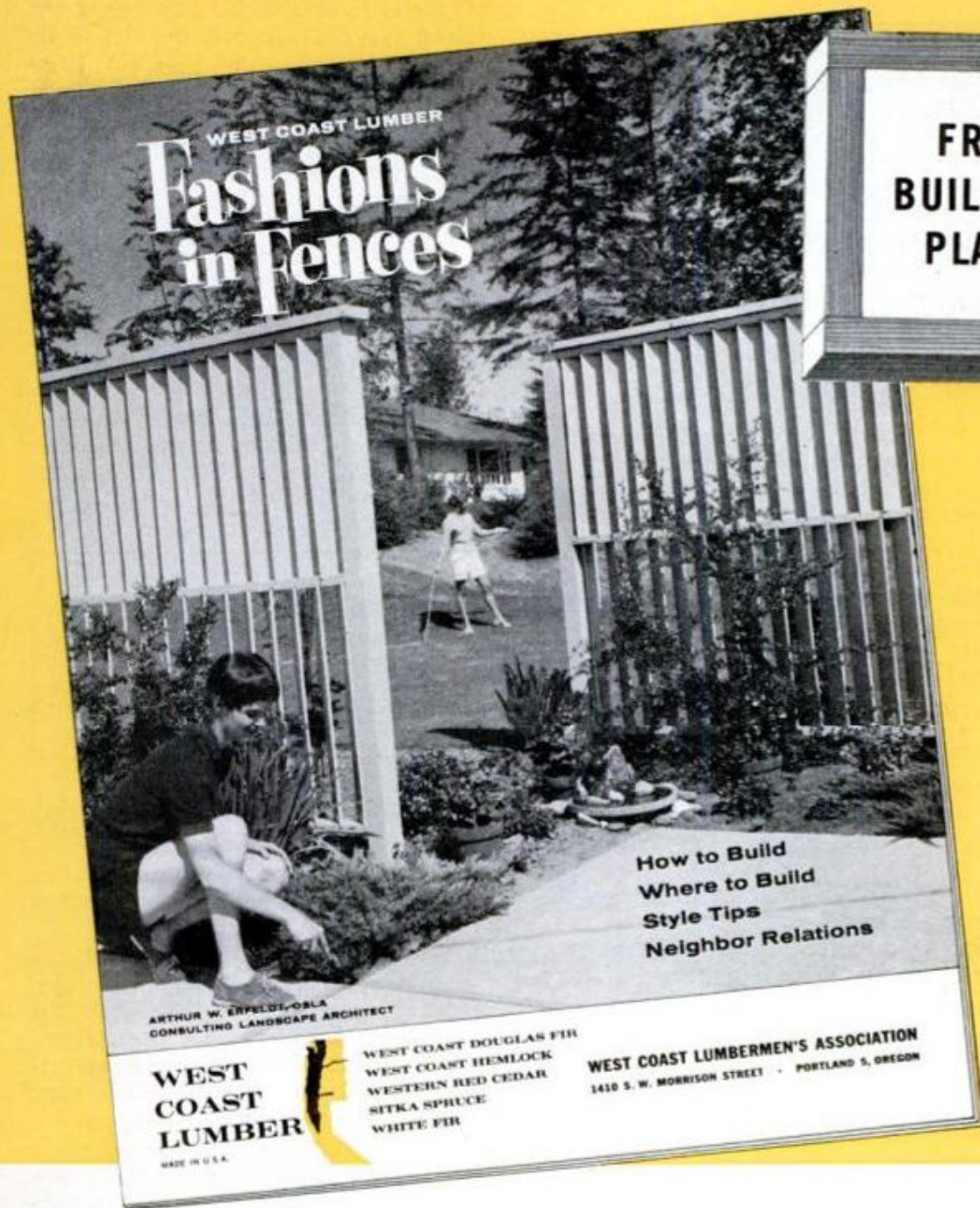

**FREE
BUILDING
PLANS**

You can build an attractive fence yourself with West Coast Lumber.* *Fashions in Fences* is designed to help the do-it-yourself expert solve such problems as styling . . . where to build . . . neighbor relations . . . wind deflection . . . individual designs . . . finishing . . . fence heights . . . and basic framework. Colorful illustrations give you ideas and pointers on how to make a fence enhance the beauty of your home. Your Retail Lumber Dealer has your FREE copy of *West Coast Lumber Fashions in Fences* ready for you . . . ask for it. Or write:

Dept. 204, West Coast Lumbermen's Association, 1410 S. W. Morrison Street, Portland 5, Oregon.

WEST COAST LUMBER

*Manufactured in the U.S.A. by Coast Region Mills of Washington, Oregon and California.

WEST COAST DOUGLAS FIR • WEST COAST HEMLOCK • WESTERN RED CEDAR • SITKA SPRUCE • WHITE FIR

Start Your Vacation Home

(Continued from page 168)

Part II. Cutting them involves notching for the wall tie plates and sawing at an angle to form the ridge cut. You'll notice that no ridge board is used. Pairs of rafters simply butt endwise and are held in line with $\frac{3}{4}$ -in. plywood gussets placed on each side of the joint. Here, as with the rake panels, the 2 x 6 rafters can be assembled in pairs on the ground and lifted to the roof, or the plywood gussets can be added as the rafters are set 24 in. on centers and are toenailed to the tie plates of the outside walls and the central roof-bearing wall.

Prefabbing the Gables

Before all this can be done, four triangular sections which form the gable ends of the structure must be prefabbed. These are identical, each measuring 11 ft.- $8\frac{3}{8}$ in., or half the total span of the end walls. In studying the framing of the rake panels detailed on page 169, you'll see that long bevel cuts are required at one end and that a short fill-in stud is added at the opposite end to form a pocket for the 2 x 8 built-up beam which is a part of the roof-bearing wall. The cutting plan for the gable sheathing shows how two sheets (4 x 6 and 4 x 8) can be cut economically to cover all four gable sections. These are keyed to show where they go, three pieces being used in each case. Notice that the sheathing is applied so it overhangs the bottom edge 1 in. This is done so it laps the top wall plate and also to form a waterproof joint when backed with a strip of metal flashing. Spikes driven through and into the top plate anchor the gable sections securely. The roof rake assemblies are supported by the gable sections, the former being centered over the latter and toenailed to it at each cross header.

Decking the roof can be done in the conventional manner, using roof boards or 4 x 8-ft. sheets and covering with asphalt shingles. Or you can add a roof of corrugated aluminum, fiberglass or other material. Here roof sheathing is omitted and 2 x 4 purlins (2 x 4 furring) are applied to the rafters 24 in. apart and lengthwise of the roof. Some difficulty may be encountered in providing adequate flashing around vent pipes and a chimney with a corrugated roof but it can be done.

To get your dwelling fully under cover you'll want to get the windows and doors installed as soon as possible. The openings in the prefabbed sections accept standard window units. Identical full-length windows are installed in the front and left elevations of the basic unit, whereas shorter half windows are used in the rear wall

of the house. The full-length units have fixed upper sash and a tilt-out casement sash at the bottom. The others are conventional double-hung sash. The two door openings are framed with standard jambs and headers and eventually trimmed with conventional casing, inside and out.

Whether you plan on adding the porch at some future date or not, you'll be wise to pour a 12-ft. slab if for nothing more than a patio for cookouts. Then if you should decide to add the screened porch, the floor will be ready for it. In studying the detail of the porch slab in Part II you'll note how a course of 12-in. block in the foundation wall provides a ledge to support the poured concrete. Besides being reinforced with welded-wire fabric, the slab is supported all around by concrete blocks resting on poured footings.

(To be concluded next month)

IF YOU WOULD LIKE TO KNOW

what the material cost will be to build this economy vacation home in your locality, the name and address of the lumber and building-supply dealer nearest you is listed on page 218. He is prepared to provide you with costs and further information on building the PM vacation home.

Man Warms Up This Cold World

Widespread use of fires, cultivation of the soil and the population explosion have warmed the earth's climate during the last 11,000 years, a scientist reports.

Dr. William Stokes of the University of Utah says these factors increased the amounts of carbon dioxide released into the atmosphere, saturating it and transforming it into something like a greenhouse which traps the warmth of the sun.

Fires, he said, apparently were set by primitive men and allowed to spread with no attempt made to put them out. Huge areas of Europe, Africa and North America often burned out of control.

GI Joe Eating Too Much Fat

Military medics have warned that too many soldiers are getting heart attacks, probably from eating a high-fat diet. They recommend cutting fatty foods in mess-hall menus.

Hardening of the arteries is the leading cause of death in the Army, and most evidence indicates a high-fat diet is a contributing factor.

Surveys of Army training camps showed that total intake was well above the recommended minimum, and that fatty foods—including butter, whole milk, cream, beef, pork and chocolate—made up more than 40 percent of the calories in the GI's diet.



Quality Twins

...two fine names to remember when you need the best in replacement parts!

Whatever make car or truck you own, chances are when you need replacement parts you'll find exactly what you want at your Ford Dealer's or selected service outlet. Now, one stop is all it takes to get your pick of the quality twins—FoMoCo and Rotunda Parts.

■ Both of these fine lines are as alike in quality as two perfect peas in a pod. They're made to the highest quality control standards to fit right and last longer . . . help keep maintenance costs at rock bottom . . . help keep performance at its peak. ■ If you need Ford parts, you'll be right at home with FoMoCo Genuine Parts . . . if you need parts for almost any other make car or truck, specify Rotunda—designed for use on most other-make vehicles. In either case, you'll be money ahead in the long run!

NOW . . . TWO TOP QUALITY LINES OF PARTS AVAILABLE THROUGH FORD DEALERS AND SELECTED SERVICE OUTLETS



PRODUCTS OF  MOTOR COMPANY

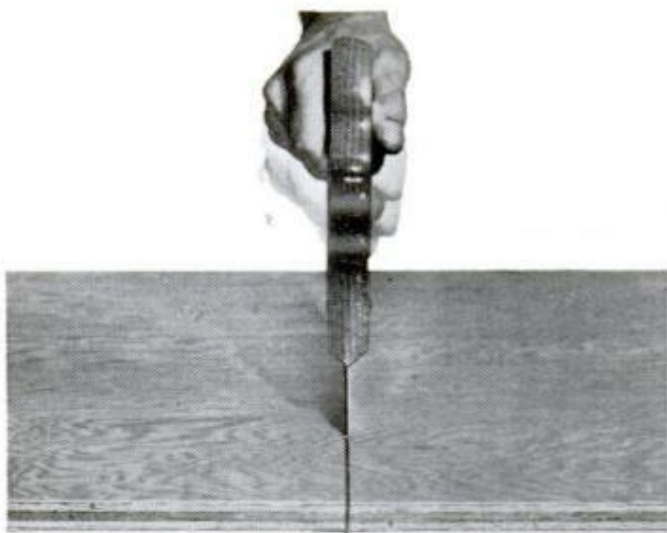

TRUE CUT!

You never saw a saw saw like a Disston saw saws

Line up its tough steel blade on the mark and start sawing. You'll never make a straighter cut, because nobody tempers, smiths and grinds steel like Disston. That's why Disston saws hold their set, can be depended on for day-in, day-out service. Here's a saw beautifully balanced, built for long rugged use—the result of more than 120 years of crafting *the saws most carpenters use*. Disston—Master Toolmaker since 1840.



TRY THE DISSTON D-8. It's a medium weight, skew-back handsaw. Weather-proofed hardwood handle. Available in 20", 22", 26" lengths; 5½, 8 and 10 points. Suggested retail price: \$8.75. Ask your Dad about Disston saws.

Disston also manufactures a full line of circular and sabre saws.

Disston Division, H. K. Porter Company, Inc., Porter Building, Pittsburgh 19, Pa.

PORTER

**DISSTON DIVISION
H. K. PORTER COMPANY, INC.**

Working With Sheet Metal

(Continued from page 188)

types of metal containers, in sheet-metal duct work, furnace plenums—anywhere sheet-metal parts are to be corner-joined or in some cases, joined end to end.

Figs. 17, 18 and 20 picture a hand-powered unit known in tinshops as a rotary machine. It is supplied with interchangeable rolls and can be set up quickly to do crimping, beading, wiring, burring, and a number of other related operations. The machines generally are of two types, the standard unit, Fig. 17 and the deep-throated unit, Figs. 18 and 20. A wiring operation is pictured in Fig. 17 and beading and crimping operations in Figs. 18 and 20.

Bench Stakes

In the well-equipped commercial shops and also in school shops you'll probably find an assortment of stakes and a bench plate, Fig. 19, which illustrates only a few of the many types of stakes available for various types of sheet-metal work at the bench. One which is quite common is the double stake, Fig. 19, which is supplied with at least four heads, A, B, C, and D. Light sheet metals are worked on stakes and hollow mandrels, Fig. 19.

Fig. 22, details A, B and C, show how the single hemmed edge is formed on a bar-type folding machine, Fig. 21. Fig. 23, details A, B and C, show the forming of a double-hemmed edge. In one method of making a grooved seam by hand, the locks on the two pieces of metal are folded and hooked together and the seam closed with a hand grooving tool, Fig. 24. The seam is then flattened with a wood mallet. The seaming tool, Fig. 25, enables one to do a better job of working a seam. It comes in widths up to 6 in. or more and facilitates making a sharp, clean bend. It is adjustable for depth, or reach, which determines the distance from the edge the bend is made.

Cylindrical Forms

Cylindrical forms can be made by working the metal over a hollow mandrel with a mallet, Fig. 19, or with a slip-roll former, Fig. 26. Straight cuts in the light sheet metals of 22 gauge and thinner are easily made with tin snips of the regular pattern, Fig. 25. For making short-radius circular cuts in from an edge you'll need the hawk's-bill snips. For intricate patterns involving curved cuts of medium radius you use what are known as pocket circular snips (not illustrated). Aviation snips, Fig. 25, come right and left and in combination and are designed for intricate work on light sheet metals. ★ ★ ★

CRUISERS \$369 UP: 18, 20, 22 FT.



1/4 Down 2 Years to Pay
CRUISERS EASILY ASSEMBLED
 FROM PRE-ASSEMBLED UNITS
 All parts precision-cut and preformed.
 Assemble easily as small boats. Airy
 cabins, full length bunks, toilets, gal-
 leys; complete for extended cruises.

HOUSEBOAT-CRUISER 22 FT. \$699

Cruiser speed, handling; house-
 boat comforts, space. Sleeps 6-10

MONEY BACK GUARANTEE ON ALL LUGER KITS

FIBERGLASS \$299 UP: 14, 16 FT.

Assemble in One Evening

Anyone can interlock and bond 3
 factory molded sections into 1-piece
 molded Fiberglass boat in evening.
 Save to \$500.



PLYWOOD RUNABOUTS EASY 40 MODELS 12-20 FT. \$104 UP PAYMENTS

Equal factory-finished boats in appearance and performance; save
 1/2-3/5. Low prices on hardware, trailers, all boating supplies.

FREE CATALOG LUGER BOAT **KITS**

Dept. B-4, 9200 Access Road, Minneapolis 20, Minn.



Before You Buy a Power Tool ...

SEND FOR 180 PG. FACT-PACKED BOOK
 ... "HOW TO CHOOSE AND USE POWER
 TOOLS." One quarter invested now can
 pay big dividends. Let an expert show you
 how to get the best results at the least
 cost. Send 25c today: The Black & Decker
 Mfg. Co., Dept. D-042, Towson 4, Md.

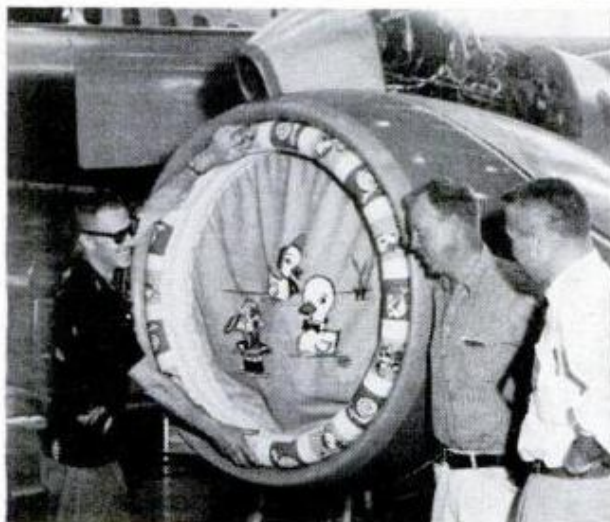

Tots' Pool Corks Up Jet

When he saw some toddlers playing in a
 plastic pool, an aircraft-factory superin-
 tendent got an idea.

The pool, when deflated, formed a small
 neat package. When inflated, it filled the
 intake in the nacelle of a huge jet en-
 gine tightly and precisely. It also cut the
 cost and labor of the company's previous
 method of using plastic covers to keep out
 the dust and prevent damage.

**HERE'S
 ALL
 YOU
 NEED
 TO
 ENJOY**

INSTANT LIVING

**IN A
 NEW MOON HOME**

Imagine! Just dishes, linens, and silverware ... and you're
 ready to set up housekeeping in a completely furnished
 New Moon mobile home.

Everything else ... sparkling range and refrigerator ...
 living room furniture ... dinette furniture ... beds with
 mattresses and box springs ... **everything**, even the color-
 ful drapes in each delightfully decorated room, is furnished
AT NO EXTRA COST.

Here's instant, ready-to-go living. Comfortable, big family
 living ... for **LESS** than the cost of furnishings
 alone in the average home.

And, you can take it with
 you, wherever you go.



Send me free literature
 on instant living in a
NEW MOON HOME



NAME _____
 ADDRESS _____
 CITY _____ STATE _____

NEW MOON HOMES, INC.

Dpt. 22/7808 Carpenter Fwy., Dallas, Texas

6210

IDEA PROJECT INFORMATION CENTERS

CHECK THIS LIST FOR THE ONE NEAREST YOU

LOOK FOR THIS SYMBOL
on their door or window

IDEA PROJECT

MINIMUM MAINTENANCE
FOR MAXIMUM LIVING

POPULAR MECHANICS

CENTER

The lumber and building supply dealers listed below, who display the Idea Project symbol, are the best sources in your area for further product and cost information on the PM Vacation Home. We highly recommend their services to you for this and other Idea Projects you'll see in Popular Mechanics during the coming year.

ALABAMA

Jasper
North Alabama Lumber Co.
201 West 22nd St.

ALASKA

Anchorage
Spensard Builders Supply, Inc.
4412 Lois Drive

ARIZONA

Scottsdale
Hamman McFarland Lumber Co.
6425 East Thomas Road

ARKANSAS

Crossett
Pierce-Grassl Lumber Co., Inc.
503 West 1st Avenue

CALIFORNIA

Bell
Atlantic Lumber Co.
6327 S. Atlantic Blvd.

Culver City
Betts-Sine Lumber Co.
8770 Washington Blvd.

Marysville
Speckert Building Supplies, Inc.

Montebello
Willis Cashway Lumber Co.
1919 Whittier Blvd.

San Bernardino
Gibson Lumber Co.

COLORADO

Durango
Federal Lumber Co.

Grand Junction
Harbert Lumber Co.
204 North Avenue

Littleton
Littleton Lumber Co.
5250 South Santa Fe

Sterling
Broadway Lumber Co.
101 Broadway

Wheatridge
Wheatridge Lumber Co.
8995 West 44th

CONNECTICUT

Hamden
Centerville Lumber Inc.
2308 Whitney Ave.

FLORIDA

Sarasota
Shepard Lumber Co.

IDAHO

Caldwell
McNeel's
1024 Arthur St.

Idaho Falls
Bonnevillie Lumber Co.

ILLINOIS

Belleville
Signal Hill Lumber & Hardware
9300 West Main

Bloomington
Schwulst Lumber & Coal Co.
416 S. Robinson St.

West Side Coal & Lumber Co.
1111 West Market St.

Blue Island
Mathieu Building Center, Inc.
14300 South Western Ave.

Blue Mound
Blue Mound Lumber Co.

Cambridge
Clifford & Clifford

Caseyville
Steck Lumber Co.
10505 Lincoln Trail

Chicago
Gee Lumber Company
2600 West 79th St.

Joseph Lumber Co.
2001 N. Narragansett

Republic Lumber Co.
5584 Northwest Highway

Star Lumber Co.
201 W. 87th St.

Evanston
Evanston Builders Lumber Co.
1001 Sherman Ave.

Fulton
Brinkman & Pessman Lumber Co.
R. R. 1

Harrisburg
Harrisburg Lumber Co.
Vine St.

Jacksonville
Henry Nelch and Son, Co.
725 East College

Joliet
I. N. R. Beatty Lumber Co.
North Broadway & Chaney

Cash & Carry Lumber Co.
816 South Gardner St.

Kankakee
Troup's Building Center
111 East Oak St.

Marseilles
I. N. R. Beatty Lumber Co.
322 Main St.

Morris
I. N. R. Beatty Lumber Co.
824 Liberty Street

Mossville
Hunter Lumber Co.

Mt. Olive
Ervin J. Niemann Lumber Co.
500 East 1st South Street

Oak Lawn
I. N. R. Beatty Lumber Co.
9537 South 52nd Avenue

Orland Park
I. N. R. Beatty Lumber Co.
9730 143rd Street

Peoria Heights
Peoria Heights Lumber Co.
838 East Glen

Pontiac
I. N. R. Beatty Lumber Co.
703 East Howard Street

Rock Falls
Cashway Lumber Co.
405 Emmons Ave.

South Holland
Wausau Lumber & Coal Co.
236 East 161st Place

Tinley Park
I. N. R. Beatty Lumber Co.
6721 North Street

Tuscola
F. H. Jones Lumber Co.
100 N. Parke

Waukegan
Mackemer & McBroom
123 West Walnut

Wilmington
I. N. R. Beatty Lumber Co.
Kankakee Street

INDIANA

Aurora
The Wright Lumber Yard
Third St. & B & O R.R.

Chesterton
Dunes Lumber & Supply Co.

Columbia City
Columbia City Builders Supply Co.
414 South Line St.

Columbus
Wendel's, Inc.
1416 Sycamore St.

Decatur
Arnold Lumber Co., Inc.
425 South Winchester St.

East Chicago
Indiana Harbor Lumber & Coal Co., Inc.
3440 Watling Street

Frankfort
Kramer Brothers Lumber Co.
608 West Washington St.

Ft. Wayne
South Side Lumber Co.
4928 South Hanna

Gary
Grant Street Lumber & Supply Co.
3883 Grant Street

Greentown
Hamer Lumber Co.

Indianapolis
Builders Lumber Co.
1560 Massachusetts Ave.

Lowell
Lowell Lumber Co.

Michigan City
Frey Bros. Lbr. Co.

Middletown
Middletown Lumber & Builders Supply
107 South 8

Morgantown
Stockton Co. Inc.

Portage
Willow Creek Lumber Co.

Rensselaer
The Lumber Co. of Rensselaer, Inc.
Cullen & Vine

St. John
Standard Lumber Co. of St. John, Inc.

South Bend
Eckler Lumber Co.
1406 South Franklin St.

Valparaiso
Smith-Nuppenau Company
360 Indiana Avenue

IOWA

Algona
Ready Mix Concrete & Lumber Co.

Carroll
Kanne Lumber & Supply Co.
814 West Ninth

Marshalltown
Marshall Lumber
312 South 1 Avenue

Waterloo
Shepherd Lumber Co.
1162 East Fourth

KANSAS

Abilene
Central Lumber Co.
511 N.W. 2nd

Argonia
Mack-Welling Lumber & Supply Co.

Axtell
Meyer Lumber & Hardware Co.

Bogue
Mack-Welling Lumber & Supply

Collyer
Mack-Welling Lumber & Supply Co.

Garnett
Star Grain & Lumber Co.

Horton
Horton Lumber Co., Inc.

Hutchinson
Kightlinger's
1301 East Fourth

Kansas City
Logan-Moore Lumber Co.
47th & Mission Road

Mack Lumber Co., Inc.
26th & Metropolitan Ave.

Lawrence
Logan-Moore Lumber Co.

Lucas
Mack-Welling Lumber & Supply Co.

Luray
Mack-Welling Lumber & Supply Co.

Marion
Mack-Welling Lumber & Supply Co.

Natoma
Mack-Welling Lumber & Supply Co.

Palco
Mack-Welling Lumber & Supply Co.

Plainville
Mack-Welling Lumber & Supply Co.

Pratt
W. R. Green Lumber Co.
803 North Main St.

Quinter
Mack-Welling Lumber & Supply Co.

Russell
Mack-Welling Lumber & Supply Co.
122 East Seventh Street

(Continued to page 223)

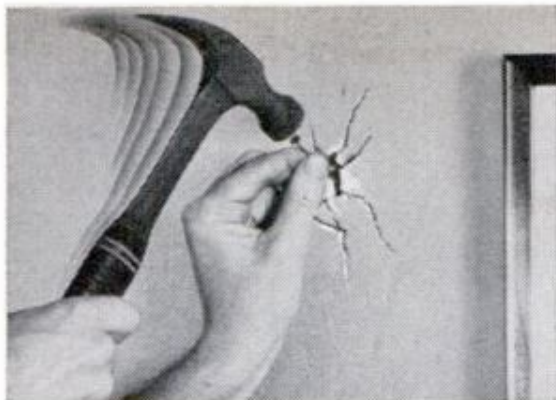

don't say "darn"...say

DAP[®]

Vinyl Paste

SPACKLING



Fast, easy way to patch plaster—fill cracks, holes, dry wall panel joints. Ready to use. No mixing. Smooth spreading. Easy sanding. Fast drying. Needs no primer when you paint. Dry powder patching can't match it!

DAP inc. • Dayton 31, Ohio



Brand New 2½ hp Gas Engine Sale!

Regular price \$49.50
Once in a Lifetime Sale.

\$29.95

Item
1002

1 year factory warranty free service

Unbelievable but true! Chance of a lifetime to buy a brand new Clinton Model A400 2½ hp Engine at nearly half price. Perfect for Go Carts — Scooters — Tractors — Mowers — Generators — Pumps, etc. Built-in throttle control and recoil starter — ready to go. We bailed out a manufacturer who needed cash—his loss is your gain—act fast! 1 for \$29.95, 2 for \$57.50, 6 for \$149.99 quantity limited.

BRIGGS & STRATTON 2hp, 4 cycle engine, Model 60100. New, standard, horizontal shaft engine with rope starter. Act fast—quantity limited—less than ½ price.

Item 1050 B&S engine, wt. 30 lbs. **\$29.75**

MASTER MECHANIC MFG. CO., Dept. A-462, Burlington, Wis.

Southern Customers Order from Dept. A-462, Box 65, Sarasota, Florida

Shop PM Ads for Exciting
Direct-Mail Offers



Works
in
seconds!

**Loosens Rusted Bolts
nuts, screws, "frozen" parts!**

**LIQUID
WRENCH**[®]
SUPER-PENETRANT

The super-penetrating rust solvent that quickly loosens rust and corrosion.

**AT ALL HARDWARE
AND AUTO STORES**

RADIATOR SPECIALTY COMPANY
CHARLOTTE, N. C.



APRIL 1962

Brand New...and the Best Yet!

RIGID[®]
**FLARING
TOOLS**



One integral unit
... parts can't be lost
or separated!

Don't take our word for it—try a new **RIGID** Flaring Tool! See if you don't get smoother, stronger, more uniform flares . . . in less time and with less effort than ever before!

Then, compare this new **RIGID** Flaring Tool, feature-by-feature, with any flaring tool you've ever seen or owned:

- Feed releases automatically when flare is fully formed.
- Reversing feed screw burnishes flare.
- Hardened steel die bars are precision-machined.
- Large, comfort-grip feed screw handle turns easily.
- Precision-ground, hardened steel flaring cone, eccentrically mounted in precision bearings, produces rolling action for even metal flow . . . gives uniform flare walls without galling.
- Tubing hole sizes are clearly marked.
- Easy sliding rugged malleable yoke serves as stop for tubing to give correct flare size.
- Yoke clamp screw fits into centering hole . . . locks bars, yoke and tubing into perfect alignment.
- Stop pins keep yoke on die bars at all times . . . yoke can't slide off.

3 MODELS

RIGID No. 457 for 45° flares, ¼" to ¾" O.D. (7 sizes)

RIGID No. 459 for 45° flares, ⅜" to ¾" O.D. (9 sizes)

RIGID No. 376 for 37° flares, ¼" to ¾" O.D. (6 sizes)

See and try these new **RIGID** Flaring Tools
at Your Hardware and Building Supply Dealer's

RIGID[®]

The Ridge Tool Company • Elyria, Ohio, U.S.A.

219

Are These the New Airliners?

(Continued from page 142)

As helicopters with larger carrying capacities—such as the 65-passenger *Rotodyne*—become generally available, however, direct 'copter service between city centers 300-miles apart would become profitable.

Just as in the development of a practical 600-m.p.h. jetliner, the breakthrough in helicopters had to wait for a reliable gas-turbine engine. With their extremely high power-to-weight ratio, turbine engines develop the "oomph" to lift a loaded helicopter straight up without adding excessively to the load. Two General Electric CT58-110 engines, each producing 1250 shaft hp., drive the fore and aft rotors on the Vertol 107 and the main and auxiliary rotors on the Sikorsky S-61 helicopter.

Two Rotors Help Control

The 107's tandem rotors help maintain control during takeoff and landing in gusty winds. A pilot can use the dual rotors to compensate for the effects of wind drift during ascent or descent without turning into the wind. High winds with gusts up to 60 m.p.h. and the turbulence that swirls in and around Chicago's lake shore skyscrapers did not interfere with the 107's operations during the Lake Central test runs.

Instrument flights in foggy or cloudy weather are routine with a twin-engine helicopter. The Vertol 107, for example, is equipped with a dual "stability-augmentation system" that gives the twin-rotor aircraft handling characteristics equal to a fixed-wing airplane. Both the 107 and the S-61 include anti-icing equipment for flights under the most severe weather conditions.

Airborne navigation aids now provide the helicopter pilot with information to fly by night or in poor weather. These instruments are not basically new, but they have been adapted to the low speeds or hover, low altitudes during cruise, and vertical takeoff and landing flight paths. Once a foolproof altitude instrument is proved, helicopters will be able to land or take off on a vertical or steep-angle beam in weather that keeps the birds walking.

Already on the horizon is the compound VTOL (Vertical Take Off and Landing) transport. A number of designs are in the mill and are being tested, but the machine far ahead of the others in actual flight experience is the Westland (Fairey) *Rotodyne*. Kaman Aircraft Corp. holds a license to build and service the *Rotodyne* in the United States. It is scheduled for delivery beginning in 1964. Until Sikorsky produces its proposed 60-passenger helicopter, the

S-65, this British-made autogyro will be the largest of the new vertical-flight airliners.

The *Rotodyne* jumps VTOL aircraft into a bigger bracket by producing cruise speeds of 200 m.p.h. and a range of 300 miles carrying up to 65 passengers. Despite this increased performance, the *Rotodyne* will operate from heliports 200 feet square.

Combined Helicopter-Plane

With both fixed wings and a rotor, the *Rotodyne* combines the features of a helicopter and a regular airplane. The Rolls-Royce turbine engines drive air compressors through a fluid coupling and two propellers through mechanical transmissions. During vertical or hover flight, the air compressors feed pressurized air to small jet engines mounted at the tips of each rotor blade. There, fuel is injected and burned to develop thrust, much the same as turbojet engines powering 707s and DC-8s. Instead of being driven from the huge hub, the rotor is turned by the tip engines.

After takeoff, the rotor accelerates the *Rotodyne* into cruise. At a transition speed, the compressors are gradually declutched and the engines begin powering the regulation props. As more forward speed is attained, the rotor tip engines are extinguished and the props drive the aircraft in cruise. For landing, the reverse sequence returns power to the rotor.

Major trunk-line airlines have long known that trip lengths under about 300 miles are money losers when flying jetliners. With the *Rotodyne's* 65-passenger capacity available, the airlines could shift short-hop operations away from the big outlying jetports to downtown heliports and relieve jetport traffic congestion while providing time-saving convenience for intercity travelers. For example, a trip from the center of Chicago to the center of Detroit now takes three hours and 36 minutes. The same trip by *Rotodyne* would take only one hour and 38 minutes allowing the same time for boarding and picking up baggage. (See table on page 141.)

Air-taxi runs and short hops by helicopter over the traffic-crowded streets that strangle our cities are routine today. With the Vertol 107 and the S-61 available, helicopters will expand to the suburban-population cities up to 200 miles from major jetports. When the *Rotodyne* appears in quantity in 1964, city center to city center traffic between metropolitan areas up to 300 miles apart will become routine—with travel times slashed in half. Just as the jetliners have made the world 40 percent smaller, big, fast helicopters will shrink countries within the world. ★★



Plans!

*cabins • cottages •
homes for vacation
and retirement*

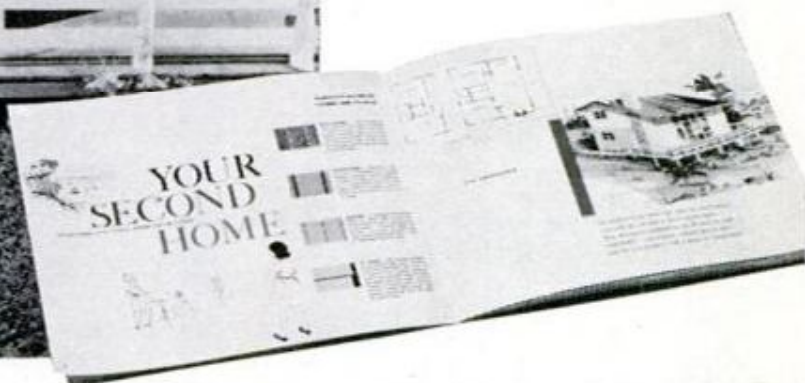

"Some day we'll build a little place 'way off..."

Why not start it now? Enjoy that home away from home as a vacation retreat before your retirement years. It's sensible, practical and economical with the plans and products Masonite offers you.

Vacation house plans that give you full flexibility of design: bi-levels, ranches, rustic cabins; you can vary them to suit your individual needs.

With Masonite products, your vacation home lasts for years. Durable, dent resistant

sidings in a variety of styles and textures will add grace to your exteriors. No paint checking here...no splits, splinters or cracks, either.

Inside, too, Masonite Royalcote wood-grained panels bring you luxury walls at plain wall prices. Choose beautiful cherry- or walnut-grained patterns in delightful color tones. No finishing needed with Royalcote panels. Once they're in place, the job's done. A damp cloth keeps them clean. And so inexpensive: an 8' x 12' wall for less than \$30.00.

Send for free
PLANS Booklet
and Literature



MASONITE *shows the way*

Royalcote and Masonite are registered trademarks of Masonite Corporation

Masonite Corporation, Dept. PM-4, Box 777, Chicago 90, Ill.

Send me vacation house plans booklets and literature

Name _____

Address _____

City _____ Zone _____ State _____



Cries of Doomsday

(Continued from page 115)

area, and the intermediate area beyond.

Agronomists at the University of Minnesota are trying to develop varieties of wheat, barley and soybeans that could be grown and eaten safely despite a fallout.

General Electric says its scientists believe a new refrigerator-sized unit under development for salt-water conversion will make drinkable water from any contaminated supply.

In Beltsville, Md., the U. S. Department of Agriculture says it has removed up to 98 percent of strontium 90 from milk and is perfecting the method on pilot-plant scale.

Already emergency plans for agricultural problems have been organized down to county levels. Slaughtering, sugar making, oil-seed crushing, canning and other processing industries are fortunately located out near the farms today.

There will be distribution delays. Land line communications will be out. Many rail terminals and airports will have been demolished and so will rolling stock in city yards. Oil fields and refineries may add to the "denial time," as the experts call it. But they insist there will be enough surviving transportation equipment and fuel stocks to meet emergency conditions. Interstate transport will recover in a hurry since much overland trackage and highway will remain intact. Probably one of the first outside things you'll see in your town will be a government interview trailer from one of 2000 state employment services set up to put people back to work.

How will these plans be carried out? Suppose Washington is wiped out?

Second Government

A second U. S. government is already in existence and operating with a skeleton staff in a hardened underground control center. Seven more such centers scattered across the country are planned. More than 1000 government agency relocation and safe record sites have been completed in an area stretching for 300 miles west of Washington. Also deep underground, tied in with foolproof communications links with all major centers around the country, is the national damage assessment system. This monster is a high-speed computer that swiftly locates and identifies surviving resources and computes casualty estimates based on the weapons and attack pattern.

Chances are that if nuclear war came, the President, or one of his 12 successors, would establish martial law. More than 26

(Continued to page 224)

KENTUCKY

Ashland
Patton Lumber Co.
53rd Winchester Avenue

Burlington
Burlington Lumber &
Building Supply, Inc.
#2 East Park Drive

Pikeville
Pauley Lumber Co.

LOUISIANA

New Orleans
Simon Streiffer Co.
2026 Metairie Road

MICHIGAN

Adrian
Fridt Lumber Co.
402 College Ave.

Ann Arbor
Fingerle Lumber Co.
617 South Fifth Ave.

Battle Creek
Troxel Lumber Co.
18 Angell St.

Birmingham
Erb-Restrack Lumber Co.
425 South Eton

Boysen Falls
Boysen Falls Log Homes

Cheboygan
Cheboygan Lumber Co.
892 North Huron St.

Coldwater
Woodward Building
Materials
120 West Chicago St.

Detroit
Atlas Lumber Co.
10300 West Fort

Mohawk Lumber &
Supply Co.
East Side Yard
11500 East Eight Mile Rd.

Mohawk Lumber &
Supply Co.
West Side Yard
14525 West Chicago Ave.

Escanaba
Stegath Lumber Co.
1812 Ludington Street

Gaylord
The Otsego Lumber Co.
123 S. Indiana

Gladstone
Sterling Building
Supplies
1122 Delta Ave.

Jasper
Jasper Lumber & Supply
M S 2

Lincoln Park
Mohawk Lumber & Sup-
ply Co.
2172 Dix Avenue

Livonia
Mohawk Lumber & Sup-
ply Co.
33600 Plymouth Road

Merrill
Boutin Lumber Co.

Muskegon
Keene Lumber Co.
346 W. Laketon Ave.

Ontonagon
Hawley Lumber Co.

Port Huron
Foster Builders Supply
Co.
951 Water St.

Rochester
Nowels Lumber &
Coal Co.
412 Water Street

Roseville
Mohawk Lumber & Sup-
ply Co.
26640 Gratiot Ave.

Royal Oak
Erb-Restrack Lumber Co.
803 South Main

Tecumseh
Tecumseh Lumber Co.
2800 E. Monroe Road

Unionville
Unionville Lumber Co.

Wyandotte
Williamson Lumber Co.
651 Vinewood

MINNESOTA

Barnesville
J. H. Fisch Co.

Bigfork
Westby Lumber Co.

Butterfield
W. E. Schrader Lumber
Co.

Hastings
Hastings Lumber Mart,
Inc.
3rd & Bailey Sts.

Hopkins
Justus Lumber Co.
2 Excelsior Avenue, East

Kasson
Kasson Lumber Co.

Litchfield
Ideal Lumber Co.

Madelia
S. Hage Lumber Co.
24 Center Ave., N.

Minneapolis
Crystal Lumber & Mill-
work Co.
5353 Lakeland Ave.

Lowry Lumber Co.
111 Lowry Avenue

Stewart
Stewart Lumber Co.

St. Paul
S. Berglund Lumber Co.
1171 North Snelling Ave.

South St. Paul
Farmers Supply Company
1030 North Concord

Wells
Wells Lumber Co.

MISSOURI

Butler
Logan-Moore Building
Material Co.

Carrollton
J. E. Waddill Lumber Co.
110 East Benton

Kirksville
Adair Lumber Co.
122 South Elson

La Belle
La Belle Lumber Co.

La Plata
La Plata Lumber Co.

Lewiston
Lewiston Lumber Co.

Maryville
Maryville Lumber Co.
315 North Market

Milan
Charles Rice Lumber Co.

Monett
Wilks Lumber Co.

Salisbury
Logan-Moore Lumber Co.

Slater
Sallor Lumber Co.
164 West Front St.

St. Louis
Melcher-Schene Hard-
ware & Lumber Co.
4800 Natural Bridge

Tarkio
Atchison County Lumber
Co.
1st & Main Street

Vandalia
White Lumber Co.
310 South Main

MONTANA

Missoula
Wright Lumber Co.
Hiway #10 West

NEBRASKA

Burwell
Burwell Lumber Co.

Lincoln
Johnson Cashway
Lumber Co.
1820 "R" St.

Millard
Millard Lumber & Grain
Co.
305 South Fifth

North Platte
Field-Birge Co.
101 West Front Street

Waltemath Lumber Co.
800 East Front

NEW JERSEY

Belmar
Sternor Coal &
Lumber Co.
12th & R.R. Aves.

Flemington
C. Tereshko Lumber Co.,
Inc.
Copper Hill

Fords
Fords Coal & Lumber Co.
922 King George Rd.

Hackensack
Fairmount Coal &
Lumber Co., Inc.
Johnson Ave. &
Lawton St.

Old Bridge
Discount Building Mate-
rial Center
Route 9, Madison Twnshp.

Plainfield
Plainfield Lumber &
Supply Co.
403 Berckman St.

(Continued to page 225)



**NEW FROM
PRATT & LAMBERT**

"6-T-1"

HOUSE PAINT

**GIVES OIL PAINT GLOSS and PROTECTION
PLUS WATER THINNABLE EASE**

Give your home beautiful oil paint luster, and enjoy convenient, easy water clean-up of new P&L "6-T-1" House Paint.

An exclusive Pratt & Lambert formulation with linseed oil in solution, "6-T-1" House Paint brings you all these advantages and more . . .

"6-T-1" House Paint brushes on easier and sets up faster than ordinary oil paint. It can be applied over chalked old paint in otherwise good condition without using a prime coat. "6-T-1" resists blistering . . . can even be applied while surface is damp. "6-T-1" House Paint can be thinned when necessary with plain tap water. And brushes and equipment wash out in a jiffy with ordinary soap and water.

Next time you paint, make it easy on yourself, and give your home that bright new look with "6-T-1" House Paint, from your nearest Pratt & Lambert dealer.

**PRATT &
LAMBERT-Inc.**

**NEW YORK • BUFFALO • CHICAGO
FORT ERIE, ONTARIO**

*The paint of professionals
for over a century*



states also have alternate government plans and more are following suit.

The hard fact is that it takes time to put big national—or even state—machinery in motion. For the first month or so after an all-out nuclear attack, you'd be out there (fallout permitting) helping the town fathers ration food, restore utilities and services, care for the sick and dying, curb looters, house refugees—or doing whatever job your talents qualify you for.

All told it would be a busy life for awhile. If the retaliation effort forestalled invasion, most experts estimate it would take 10 or more years to clean up the mess. Whether it would all be worth surviving depends on you.

Islands of Protection

The fact is that, with good fallout protection, even millions of people located inside bombed cities could survive the entire ordeal, due to natural islands of protection. Thermal radiation and immediate radiation from a blast travel in a straight line. Even some buildings close in, but shielded from direct line of sight to the fireball by intervening hills or other buildings, could remain relatively undamaged. During Nevada Flats tests, a loaded propane tank less than half a mile from ground zero re-

mained intact because it lay in the shadow of a concrete block building. In Hiroshima, thermal radiation burned patterns in the streets around shadows cast by stone fences and steel stanchions.

"If I lived in New York's heart, I wouldn't write myself off," says a Department of Agriculture expert. "No one can predict accurately the targets an enemy would pick. He might just need all those harbors—or think he did. We do know that certain military bases—not cities—would be the really prime targets. And no one knows what the pattern of hits and misses will be. In some places the suburbs might get the full brunt of what was meant for downtown. And if it turned out that all you had really needed to save yourself and your entire family for a few days or weeks, was a concrete umbrella to keep radioactive rain off you—you might be pretty sorry."

Even without major cities, rural areas would be able to survive, an OEP executive points out. "Russia's greatest effort would fail if we decide we *want* to survive," he says. "People would be our greatest asset. Comeback would be no worse than the job that faced our forefathers in carving this nation out of the wilderness.

"In fact, we're way ahead of that in *any* post-attack situation you can dream up."

★ ★ ★

Buy Your **WINCH** as Carefully as You Buy Your **TRUCK!**

Buy the *right* winch for the *right* truck. Buy a BRADEN Winch and be sure. BRADEN... considered the leader in winch manufacturing... has pioneered more improvements in winch design than any other company. BRADEN'S Oil Cooled, Fully Automatic Safety Brake, for example, has never been equalled for quality and safety. If you buy your winch as carefully as you buy your truck, you'll insist on BRADEN.



Look in the Yellow Pages for name of your BRADEN Winch distributor, or write direct to the factory for complete information.

Nation-wide Service Available on all BRADEN Winch Products

BRADEN WINCH DIVISION OF
NAUTEC CORPORATION
LYNN LANE AND DALLAS AVE. • BROKEN ARROW, OKLAHOMA

BRADEN

Your BEST Winch Buy



UPRIGHT MODELS — Designed for behind cab mounting. Capacities from 8,000 to 100,000 lbs.

UNDERSLUNG MODELS — Range from 8,000 to 30,000 lbs. capacity. For front end mounting.

FRICTION CLUTCH MODELS — Capacities range from 5,000 to 16,000 lbs. Ideal for small trucks.

SPECIAL MODELS — Constant load, constant speed model specially designed for electric utility and telephone industry application.

Trenton
De Graaf Roofing & Engineering Co., Inc.
1240 Princeton Ave.

Wayne
Circle Building Supply Co., Inc.
Route #23

West New York
West New York Lumber & Supply Co.
Park Ave. & 52nd St.

NEW MEXICO

Carlsbad
D & B Lumber, Inc.

Hobbs
Hobbs Lumber & Supply Co., Inc.
706 West Marland

Hollywood
C & L Lumber & Supply

NEW YORK

Baldwinsville
Tappan Lumber Corp.
East Genesee St.

Bronx
Square Lumber Supply Co., Inc.
115 Westchester Square

Brooklyn
Alco Lumber Co.
5815 Bay Parkway

Gem Lumber Co.
286 Ninth Street

John J. Doody & Son Inc.
Ave. Y & East 17th St.

Elmont
Village Lumber
1 Elmont Road

Medina
Lake Shore Lumber Co. of New York, Inc.
222 Commercial Street

NORTH CAROLINA

Carrboro
Fitch Lumber Co.
309 Greensboro Street

Dunn
Nu-Home Builders Supply Co., Inc.

Greensboro
Hodgin Roofing & Supply Co.
923 West Lee St.

Kinston
Grady's Building Supply & Hardware, Inc.
512-514 East Vernon Ave.

Rose Hill
Herring Supply Co.

NORTH DAKOTA

Anamoose
Heringer Lumber Co.

Bismarck
W. T. Jennings Lumber Co., Inc.

Grand Forks
Ireland's Lumber Yard
123 North Sixth Street

Jamestown
M. Mooney Lumber Co.

OHIO

Canton
The DeVille Lumber Co.
1225 Gross Avenue, N. E.

Cleveland
The West End Lumber Co.
7517 Lorain Ave.

The West End Lumber Co.
4123 Pearl Road

The West End Lumber Co.
4520 West 130th Street

Conneaut
Lake Shore Lumber Co. of Ohio, Inc.
360 Sandusky St.

Coshocton
Muskingum Valley Lumber Co.
1247 East Main Street

Hamler
Panning Lumber Co.
625 Belton Street

Maumee
Maumee Lumber & Supply Co.
707-717 Conant St.

Painesville
Lake Shore Lumber Co. of Ohio, Inc.
284 Richmond St.

Uniopolis
Shaw Lumber Co.

Willoughby
Lake Shore Lumber Co. of Ohio, Inc.
3884 Church St.

OKLAHOMA

Enid
Bank Lumber Co.
302 East Maine

Tulsa
Dale Carter Lumber Co.
4459 South Sheridan Rd.

Dickason Goodman Lumber Co.
2712 West 40th St.

Robert W. Dickson
5249 South Peoria

OREGON

Baker
Builders' Supply
2701 Court St.

Klamath Falls
Swan Lake Molding Co.

Milton-Freewater
J. E. Olinger & Sons
216 S. Columbia

Pendleton
Van Petten Lumber Co.
604 S.W. Dorion

Portland
King Building Supply
4310 S.W. Beaverton-Hillsdale Highway

PENNSYLVANIA

Cecil
Desmet Lumber & Supply Co.

East Stroudsburg
R. C. Cramer Lumber Co.
320 North Courtland St.

Erie
Lake Shore Lumber Co. of Pa., Inc.
21st and East Ave.

North East
Lake Shore Lumber Co. of Pa., Inc.
45 Smedley St.

Sharon
Johnson-Sizer Co.
369 South Dock Ave.

Union City
Mullen's
5 Market St.

TEXAS

Amarillo
Lumber & Supply Co.
2601 East Third

Seale Amerson Lumber & Building Co.
4201 N.E. 8th Street

Austin
Texas Lumber Co.
1313 East 6th St.

Bridge City
Fields Lumber Co.
355 West Round Bunch Road

Ft. Worth
Chickasaw Lumber Co.
2701 West Vickery

Jefson Lumber Co.
3300 West Seminary Drive

Sabine Valley Lumber Co.
4329 East Belknap St.

Houston
Maynor Lumber Co.
6316 Mykawa Road

Olshan Lumber Co.
2600 Canal

Midland
Andy's Lumber Co.
1801 West Industrial

New Braunfels
Richards & Krueger Co.
674-686 S. Seguin Ave.

Orange
West End Lumber Co.
McArthur Drive

Port Arthur
Wyde Lumber Corp.
1205 Ft. Worth Ave.

Wyde Lumber Co.
3333 25th St.

San Angelo
Armstrong Brothers Lumber Co.
801 South Oakes

San Marcos
Tuttle Lumber Co.
228 South Guadalupe St.

Shepherd
Beeson's Builders Supply Co.

UTAH

Salt Lake City
Lillywhite Building Supply, Inc.
3025 E. 33rd St.
(Continued to page 227)

WISS CUTS BEST



ALL NEW Hy-Power Anvil Pruners #708. Completely new design for easier cutting of heaviest branches. New, unique two position latch. Comfortable grips. \$3.25 wherever fine garden tools are sold.

OTHER FINE WISS CUTTING TOOLS

GRASS SHEARS
No. 701
\$2.75

TIN SNIPS
No. V-13
\$2.50

Easiest cutting, fastest cutting grass shears you've ever used, with molded vinyl handle grips and special closing latch. Others from \$1.49 to \$5.50.

Only seven inches long, these "mighty midget" snips cut metal, vinyl, rubber, leather. Others 10" to 17" in aviation, combination and solid steel styles.

J. WISS & SONS CO., NEWARK 7, N. J.
World's Largest Manufacturer of Shears, Scissors, Pinking Shears, Skalloping Shears, Metal Cutting Snips and Garden Shears



Amazing new clear finish dries faster—gives twice the wear!

Flecto Varathane is a remarkable new clear plastic finish

that dries dust-free in minutes, and lasts *twice* as long as varnish.

Flows right on *any* kind of wood, inside or out. Needs no sealer. Put it on siding, floors, kitchen cabinets, furniture, even boats. Comes in glossy or satin finish, regular can or easy-to-use aerosol container for quick touch-ups.

Note to users: Clean brush and equipment with mineral spirits. First coat covers 500 sq. ft. per gallon. Second coat covers 600-800 sq. ft.

If your nearby paint, hardware or building supply dealer doesn't carry it yet — or for free brochure — contact . . .

The Flecto Company Inc., P.O. Box 84, Berkeley 2, Calif.
Flecto Coatings, Ltd., 8850 Selkirk, Vancouver, B. C.

SHOOT A STAPLE WHEREVER YOU'D DRIVE A NAIL!

Same Machine
uses 6
Staple
Sizes . . .



"ONE
SQUEEZE
AND YOU'VE
NAILED IT!"

WITH
AN

ARROW

Brooklyn 12, N. Y.

No. T-50 All-Purpose STAPLE GUN

Available at Hardware, Building, Lumber and Stationery Dealers Everywhere.
ARROW FASTENER CO., INC. 1 Junius St., Brooklyn, N. Y.

Electric Touring Car

(Continued from page 160)

The drive assembly, Figs. 2 and 6, works off the right rear wheel. Mount the sprocket coupling concentric with the outside diameter of the wheel and attach the sprocket. Use the procedure mentioned above to mount the wheel.

The power plant for this little electric car can be either a converted government-surplus electric gear motor (\$16-\$20) or a converted 6-v. automobile generator having either two or three brushes. To convert the generator, remove the third brush, if one is present. Leave the grounded wire intact. Likewise, the other brush wire (running outside or to a terminal on the case) should be left intact. The fields are connected by soldering, and the two field wires run outside or to terminals on case.

Position the motor on the hanger rod which is inserted in holes in the frame, and make sure the sprockets are in line before installing the chain. Mount the motor adjusting rod to the motor and frame, allowing 1/2-in. of slack in the chain (measuring half-way between the sprockets).

Forming Body

All the body parts, Figs. 9 through 12, are cut from 22-ga. sheet metal using a pair of heavy tin snips or a hacksaw. To bend the flanges, clamp a 2 x 4 along each bending line and use a rubber mallet to make a neat even angle. The dash panel should be spot-welded or riveted to the hood. Fasten the seat-panel enclosures to the fronts of the formed seats, and mount the eight seat supports inside to serve as braces for the cushions. These cushions, Fig. 9, are made by cutting two plywood bases, padding them with 1-in. foam rubber and covering them with plastic fabric.

Assemble the radiator, hood, dash panel and bulkhead as one unit. Next, assemble the seats and either rivet or spot-weld the fenders in position. Paint all the body sub-assemblies with one coat of metal primer topped with a coat of glossy black enamel. The wheels can be painted gold or red.

Now comes the final assembly. Place the floor pan in position on the frame and install the hood unit, seats, fenders and steering shaft. Mount the brake handle through the elongated slot and adjust it to the brake rod. The battery sits under the front seat and is held in place with angle brackets. To complete the car, wire motor, lights and accelerator button to the battery, Fig. 7.

Individual parts, complete kits and large-scale plans for this sidewalk car are available from Ma Jo Lektri Kars, Box 3134, Glencoe Station, Burbank, Calif. ★ ★ ★

no longer available

VIRGINIA

Abingdon
Miller & Bradley, Inc.
Chatham
McLaughlin Supply Co.
Main Street
Harrisonburg
R. S. Monger & Sons,
Inc.
265 Chesapeake Ave.
Virginia Beach
Virginia Beach Lumber &
Supply
Birdneck Road

WASHINGTON

Mt. Vernon
J. W. Copeland Lumber
Co.
Olympia
Lumbermens Mercantile
Co.
502 Custer Way
Sunnyside
Home Lumber Inc.
213 State Highway
Yakima
Sears Lumber Market
2318 South 1st St.

WEST VIRGINIA

Charleston
Wright-Bachman Lumber
Co. of W. Va.
South Charleston
Evans Lumber Co.

Weirton
The Weirton Lumber Co.
914 Cove Road

WISCONSIN

Beaver Dam
Roedl-Jacobs Lumber Co.
114 East Third Street
Fort Atkinson
The Hoffman Lumber Co.
10 Madison Ave.
Kenosha
Andrews Lumber Co., Inc.
4800 75 Street
Racine
Wecks Lumber Co.
2000 Douglas Ave.
Sheboygan
Ebenreiter Lumber Co.
1221 Erie Ave.
Wabeno
Twin City Lumber & Fuel
Co.
Wausau
Schuette Builders Co.
1330 South 11th Ave.

WYOMING

Lusk
Frontier Lumber Co.
Powell
Powell Lumber Co.
206 South Absaroka
Sheridan
Vickere Lumber Co.
135 North Gould

THE EASIEST WAY IN THE WORLD TO DRIVE AND REMOVE SCREWS

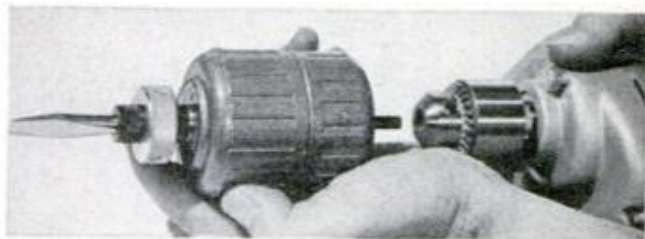

1. After drilling pilot holes simply attach a Versamatic to electric drill. Fits any make.

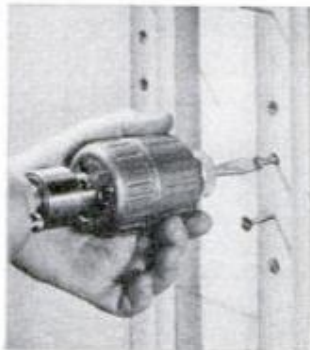

2. Place screw in hole; drive it easily with slight forward pressure . . . hold housing in fingertips.

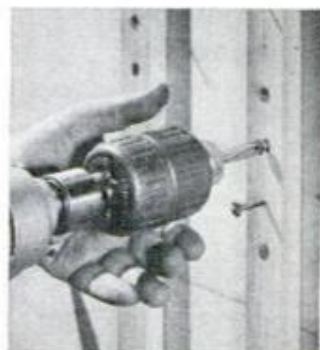

3. Your fingers act as a clutch . . . starting, stopping action instantly. Simple and safe . . . no blisters.

Versamatic puts your power drill into low gear . . .

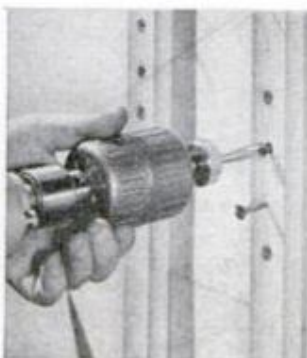

4. Versamatic runs in reverse for removing screws. You won't believe how easy it is until you try it.

by means of 7 to 1
speed reduction.
Gives your drill 7
times more power.

Supreme Versamatic

MADE BY THE MAKERS OF
SUPREME BRAND CHUCKS

SUPREME PRODUCTS
CORPORATION
2222 S. CALUMET, CHICAGO

Sold by leading tool dealers...\$14.95 list

Also . . . ask to see the Supreme Versamate . . .
the non-reversing speed reducer . . . just \$9.95

KILL TERMITES yourself

with Arab[®]
U-DO-IT

PROFESSIONAL TERMITE
PRODUCT FOR HOMEOWNERS

\$9.95 Treats Avg. 5-Room Home
Save as much as \$100 or
more. Do the job yourself
with this professional Chlor-
dane formulation (govern-
ment tests still effective after 12 years). Easy to apply.
Thousands of satisfied customers. 5 yr. chemical re-
placement GUARANTEE available. If your lumber
dealer can't supply you, send for further information
to ARAB U-DO-IT, 2707 Winthrop, Indianapolis 5, Ind.



FREE "HOW-TO" HANDBOOK ON GLUING



NEW 12-page Elmer's Wood-Gluing handbook gives you details on gluing for heavy construction, home improvements, cabinets and furniture, models and toys, sports equipment. Contains hints, tips, and shortcuts. Includes drawings, as well. Tells you what glue to use indoors and out. Send stamped, self-addressed envelope for your free copy. Elmer, The Borden Company, Dept. PM-42, 350 Madison Ave., New York 17, N. Y. (Available in Canada.)



**EASY!
QUIET!**

5 TIMES FASTER THAN A BRUSH

The Sprayit 600 gives you real "master painter" results with smooth, fast delivery. Saves you time and work on all home maintenance painting. Precision quality, modestly priced at \$39.95. Oil-less type compressor with built-in motor. Adjustable all-aluminum spray gun. A versatile outfit—also cleans machinery, sprays insecticides, liquid fertilizers; many other home and farm uses. Full year warranty. Send 10¢ for paint spraying booklet and free literature. Thomas Industries Inc., Sprayit Div., Dept. PMS1, 207 E. Broadway, Louisville, Ky.

⊕ SPRAYIT® 600 ⊕

**Make
\$20 to \$30 a Week
EXTRA MONEY!**

With the high prices of food, clothing and everything else, just think what you could do with extra money every week! Turn your spare time into CASH—sharpening saws with a Foley Automatic

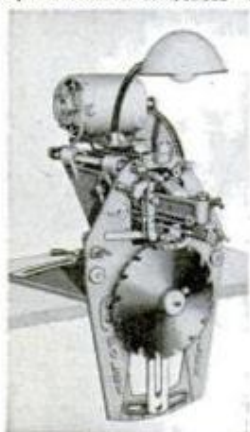

Saw Filer pays from \$3 to \$6 an hour. Start in your basement or garage—no experience necessary. "The first saw I sharpened with my Foley Filer came out 100%"—writes Clarence E. Parsons. No canvassing—"I advertised in our local paper and got in 93 saws—says M. L. Thompson. With a new model 200 Foley you can file all hand saws, also band and both combination and crosscut circular saws.

FREE BOOK Shows How to Start

It explains how you can get business from home owners, farmers, carpenters, schools, factories, etc. "I get work from 20 and 30 miles away"—says Charles H. Smith. Free Book, "Money Making Facts," tells how to start. **Time Payment Plan.** Send coupon today—no salesman will call.

Send Coupon for **FREE BOOK**

FOLEY MFG. CO.
416-2 Foley Bldg., Minneapolis 18, Minn.

Send **FREE BOOK**—"Money Making Facts," and Time Payment Plan.

Name

Address



Win the War on Weeds

(Continued from page 135)

Tests show it may remain active in the soil for long periods.

TBA is effective against a number of weeds that other herbicides have failed to control. It has been used with some success as a pre-emergence spray for wild garlic, annual weed brome grasses, quackgrass, some species of brush and perennial weeds.

EPTC has been tried successfully as a pre-emergence herbicide to control annual grassy weeds and many broadleaved weeds in forage legume seedlings.

DMTT is a volatile soil sterilant that can be applied without the use of airtight cover over the soil for weed control, soil fungi and nematodes. It may be applied as a dry powder or as a spray.

SMDC is basically the same type of soil sterilant as DMTT. If used in liquid form, it can be sprayed onto the soil surface, then soaked into the soil with water. Or it can be mixed with the surface six-inch layer of soil, thoroughly wetting the surface to provide a gas seal. Allow 7 to 14 days after applying SMDC before planting crops.

MCPB has shown promise for post-emergence control of broadleaved weeds in cereals underseeded with certain forage legumes, on forage legume seed production fields, in establishing pure stands of forage legumes, and on flax crops.

To develop new weapons against weeds, the Beltsville scientists conduct dozens of physiological tests. For example, one scientist used a Warburg respirator to determine what effects new herbicides had on the respiration process of a wheat plant. When a herbicide slowed down the plant's "breathing," it was tagged at once as unfit for use.

Right now, in cooperation with equipment manufacturers, the researchers are working on novel vehicles designed to destroy weeds on experimental plots. One of these, a hand-operated sprayer, uses a compressed air storage tank to supply pressure. It shows promise for weed control of food crops, specifically for eliminating ragweed, crabgrass and mustard.

The scientists take pains to point out that the new herbicides can work no magic on lawns which are improperly cared for. A weedy lawn is a starved lawn, they explain, and good plant food is needed to get good grass.

Readers desiring more complete information on the herbicides described in this article are urged to write the Agricultural Research Service, U.S. Department of Agriculture, Beltsville, Md., and ask for a copy of ARS 22-46, "Suggested Guide for Chemical Control of Weeds." ★ ★ ★

MIGHTY GRIP

12" or 15"
CHAIN
WRENCH



DIAMALLOY



Grips any shape, and holds. Made only by makers of famous Diamond Wrenches and Pliers. "There is nothing finer than a DIAMOND."

Write for Free Tool Catalog

DIAMOND TOOL
and Horseshoe Co.

DULUTH, MINNESOTA EST. 1908 TORONTO, ONTARIO

Send for your free WHERE-TO-FIND-IT list giving sources of supply or further information on articles in this issue.

EVERLITE* World's THRIFTIEST Light Plants

(Item 869-107)



NEW TRANSISTOR ALTERNATOR REPLACES GENERATOR

Now a Service Free Light Plant built with a transistorized alternator. Offers 30% greater efficiency—more power for less fuel. Terrific service life—no brushes to arc and burn. No more commutator to wear, no collector ring trouble. And best of all it costs no more to "go modern with Everlite." Thrifty 1000 watt, 115v. AC plant powered by a rugged easy starting 4 cycle engine—leader priced. Model 869-107. Wt. 65 lbs. **\$179.50** as illustrated..... job factory

*Trade-Mark Registered

All sizes available—can finance. Write for catalog. Special models for public utilities—Approved for Civil Defense. Write.

MASTER MECHANIC MFG. CO., Dept. A-462, Burlington, Wis.

Southern Customers Order from Dept. A-462, Box 65, Sarasota, Fla.

TURFMASTER

ROTARY LAWN MOWER



and it's quiet, too!

The new Quiet Turfmaster is the latest addition to our Turfmaster family of fine rotary mowers. It's handsome. Sturdy. Well behaved. And quiet as can be. That good-looking engine cover keeps the engine noise 'way down. So does the extra large muffler of heavy gauge steel. You need no tools to adjust the wheels to any of five cutting heights. And those 8" steel wheels with semi-pneumatic tires roll at a touch. And it's quiet, too. "The World's Standard Mower Since 1874."

Dille & McGuire

MANUFACTURING COMPANY RICHMOND, INDIANA

Keep Tools in Tip-Top Condition

Lubricate • Clean • Prevent Rust

3-IN-ONE® OIL

REGULAR—OIL SPRAY—ELECTRIC MOTOR



Backyard Blues?



Good News!



AMERICA'S FINEST
BASEMENT DOOR

Here's the way to add amazing new beauty and convenience to your home. Replace that troublesome wood door with a modern Bilco. All steel, permanent, watertight, opens and closes at a touch. A new Bilco Door will do wonders for your home . . . and for you!

The Bilco Co., Dept. R-64, New Haven 5, Conn. Please send me your free illustrated folder and name of local dealer.

Name _____

Address _____

City _____ Zone _____ State _____

Owners Report on the Falcon

(Continued from page 95)

"The brakes are squeaking."—Louisiana oil-field worker.

"I'm having trouble with my carburetor. It doesn't take the gas when I step on it."—New Hampshire allowance specialist.

"The only trouble I have had with my Falcon is the carburetor. The Ford people are going to replace it."—West Virginia mechanic.

Over the years, faulty carburetion has been the biggest problem with new cars. Conscientious dealers like his seem to be the only answer.

"I am very disappointed in the gas mileage. My 101-hp. station wagon averages just over 15 miles per gallon."—Vermont painter.

"We think we should get more mileage; salesman used *that* as a sales pitch (he said up to 26 miles per gallon)."—Iowa building contractor.

A salesman's talk of such exceptional fuel mileage should be taken like a politician's pie-in-the-sky campaign promises.

"I think they should put 14 or 15-inch wheels on it for better tire wear."—Maryland cheesemaker.

We doubt his concern because none of the many multiple-Falcon owners have reported undue tire wear.

"The 13-inch tires are too small for hot desert highway driving."—Nevada engineer.

Back on the positive side, the second group of best-liked features, numbers six through ten, is listed by frequency of mention.

"Being tall, I was not supposed to be able to sit inside with my hat on, but I can do so nicely. I couldn't do so in expensive models."—Pennsylvania bank employee.

"It has plenty of room for my family and serves our needs."—Oklahoma rancher.

It's a bit scant on rear seat legroom, but that's where the kids sit, so it's OK.

"I'm 6 feet 3½ inches tall, and I don't have to remove my hat."—D.C. pharmacist.

"I also like my bigger engine for passing and quick takeoff."—Indiana housewife.

"The 85-hp. motor is adequate for normal driving."—Wisconsin foreman.

His "normal" is pretty conservative.

"It cruises at 60-65 m.p.h. smoothly and easily."—California telephone worker.

"Like plain styling; it's not a spaceship."—Massachusetts electrical worker.

"Heaven help us if we get cars that look like Friendship 7!"

"I like the beauty of appearance of my Squire."—Vermont lawyer.

"Like the over-all shape of the Ford Falcon. It is a little car that has the lines of bigger models."—Arizona bookkeeper.

That's the secret of success—think big but cost small.

"I like the sweeping view allowed by the windshield and back window."—Florida nurse.

"The damned thing starts in cold weather!"—New Hampshire retiree.

"For cold-climate owners, the hand choke is most efficient. Please leave it on."—Massachusetts mechanical engineer.

We second the motion!

Here are complaints, numbers six through ten, in their order of mention, making up the second group on the negative side.

"The Falcon is hard to control in the wind."—New Mexico electronics technician.

"Wind has a great swaying effect on the car."—New Jersey aviation electrician.

This seems to be the price one must pay for the light weight that gives economy and happy handling.

"Gas tank filler pipe should be moved to a straight position, as gas spills over both car and chrome."—Rhode Island printer.

Too true, but filler pipes on fender side (behind a door) hog trunk space.

"There are a few squeaks that should not be in it."—Missouri farmer.

"Like all Fords I have driven and owned, it rattles. Why can't Ford make a tight car like GM?"—Texas student.

Wonder why he keeps on buying Ford products?

"There are too many rattles in dash panel area."—Michigan engineer.

"The starter grinds when released."—Colorado clerk.

"A little sluggish on hills when on a long pull (101-hp. station wagon)."—Nevada restaurant owner.

"I would like to see the ratio changed on my 101-hp. Falcon because it roars at 80 m.p.h."—California serviceman.

Overdrive, if only it were offered, would solve your problem as well as that of the Nevadan above.

Tossing a final bouquet or two, here is the last group of best-liked features, eleven through fifteen, in order of their mention.

"Falcon handles better than any other car we have ever owned, and we've had over 30 years of experience in rugged New

(Continued to page 232)



FORD STYLESIDE PICKUP—available in choice of one-piece or separate cab and body designs. Wide range of options including 5 transmissions, Six or V-8 power, 4-wheel drive.

Ford's full-time economy only starts with low price!

'62 Ford Pickups
save gas, oil, tires
-cut upkeep costs
with special
reliability features

Low price is only the start of your savings on '62 Ford pickup trucks.

Ford savings are long-term savings. Modern Ford Six and V-8 engines squeeze every mile from every gallon of gas. Full-Flow oil filter gives you 4,000 miles between changes. Rugged I-beam front suspension keeps tires tracking true—extends tire life.

Moreover, Ford's outstanding reliability gives you more lasting protec-

tion against breakdown and repair costs . . . cuts the "hidden costs" of interrupted schedules, lost man-hours and disappointed customers.

Why settle for anything less—when you can get full-time economy as smart, smooth-riding and dependable as the '62 Ford. Stop in at your Ford Dealer's soon. Get all the facts. Check out Ford's low prices. See how easy it is to start saving money—full time!

**FORD TRUCKS
COST LESS**

SAVE NOW... SAVE FROM NOW ON!

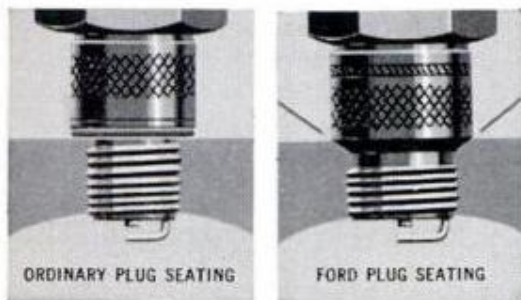

TAPERED-SEAT PLUGS RUN COOLER, RESIST FOULING. They wedge so tightly that no gasket is needed. Thus, heat is transferred easier, plugs run cooler, resist fouling two to three times longer. It's just one of the many reliability details in Ford Trucks—details that are seldom seen, but nevertheless help keep your truck out of the shop!

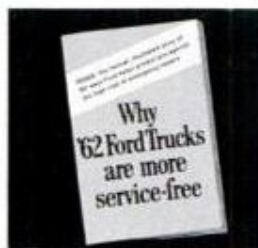

"WHY FORD TRUCKS ARE MORE SERVICE-FREE" a highly readable new booklet pictures 60 ways Ford engineers have countered the most common causes of road failure. Send for your free copy now!

PRODUCTS OF  MOTOR COMPANY

SEND FOR YOUR COPY TODAY!

Department M, Ford Division, Ford Motor Co.
P.O. Box 1000, Plymouth, Mich.

Gentlemen: Please send me, at no cost, one copy of "Why Ford Trucks are more service-free."

Name _____

Address _____

City _____ Zone _____ State _____

Planer·Molder·Saw!

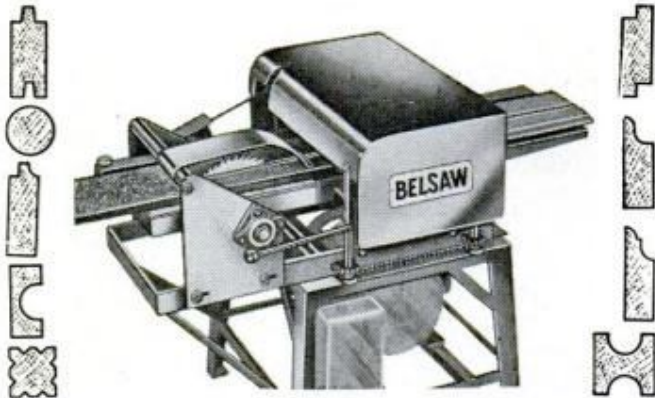

Now you can use this ONE power feed shop to turn rough lumber into high-value moldings, trim, flooring, furniture... ALL popular patterns.

RIP...PLANE...MOLD... separately or all at once by power feed... with a one horsepower motor. Use 3 to 5 HP for high speed commercial output.

LOW COST... You can own this MONEY MAKING POWER TOOL for only **\$3000** down payment

Send coupon today

BELSAW POWER TOOLS 902 Field Bldg., Kansas City 11, Mo.
Send me complete facts on the MULTI-DUTY Power Tool.
No obligation.

Name _____
Address _____
City _____ State _____

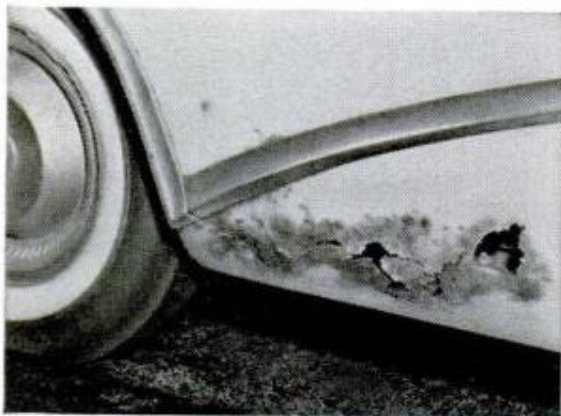

don't say "darn"...buy

DURATITE®

AUTO-MARINE PLASTIC FILLER



Amazing new product makes metal and fiberglass repairs almost invisible. Just fill, sand and paint to get rid of ugly rust holes in your car—restore smooth boat surfaces. Strong, long lasting, professional results.

DURATITE Division, DAP inc., Dayton 31, Ohio

England winter driving."—Vermont teacher.

"It is the greatest on snow or ice—better than any big car I have ever owned."—New Jersey housewife.

According to many owners, Falcon's the next best thing to a pair of snowshoes.

"It holds the road beautifully at 70 m.p.h. and hugs the road on curves."—New Mexico executive.

"My Falcon holds the road well at 80 m.p.h. in turnpike driving."—Ohio teacher.

"Very easy accessibility to motor as regards repairs!"—Massachusetts airline worker.

"I like the 6000-mile oil change and 3000-mile lube change."—Michigan die setter.

We still think that you should change oil more frequently in winter.

The final group of complaints follows—eleven through sixteen—in their order of mention by owners.

"I don't like the glare on the windshield above the dash at night."—Kansas minister.

SOURCES OF SUPPLY and information on articles are published in the free WHERE-TO-FIND-IT list. Send stamped, self-addressed envelope to SERVICE BUREAU, 200 E. Ontario, Chicago 11, Illinois.

"I would like to see different gears in the automatic transmission for faster takeoff."—Georgia mechanic.

So would we. What Falcon needs most is an automatic box with an intermediate gear for acceleration and hill climbing.

"The starter motor failed, and the vacuum line to the transmission broke."—Wyoming airman.

Vacuum-line broke on PM's test car, too. We would fix it with a short length of rubber hose to soak up vibration.

"I had to replace the generator and also the brakes, which are bad again."—Ohio judicial secretary.

"Brakes grab at slow speed when they're wet."—Pennsylvania machinist.

"In city driving it is tiresome to shift from high to second at 15 to 25 miles per hour."—Alabama hospital worker.

"All four shock absorbers had to be replaced!"—Wisconsin agricultural inspector.

A grand slam maybe?

"The windshield leaks very badly."—Mississippi farmer. ★★

Lasting
Bargain in
Beauty!



SUPERPLY ENAMEL

APPLY IT YOURSELF

It takes just one coat of this easy-brushing, high-gloss enamel to brighten and protect your kitchen, bathroom and woodwork anywhere! Wonderful, too, for furniture and toys, on any wood or metal surface indoors or out. SUPERPLY Quick-Drying Enamel retains its porcelain-like finish after repeated washings.



ONLY
\$1.79
QUART



sold by **WOOLWORTH'S**
and **NEISNER'S**
for FREE color cards, write:
A. WILHELM CO. • READING, PA.

SAVE ON HOME-WORK SHOP LAMPS...

Now you can have perfect illumination at a price you can afford. Ideal for the work bench, drafting table, office desk, drafting table, student, sewing, etc. Designed to swing the reflector to light any area on the desk or table up to 6 feet long and 3 feet wide. Extension arms are fully universal and are spring counterbalanced for easy movement. Comes in KIT form to SAVE you money. Balance arms are pre-assembled, just hook-up wire and attach the lamp hood - assembly takes only minutes. Choose from three styles - please specify...

No. ID-118 - MECH-LYTE - Ideal for work bench, shop, etc. Gives concentrated light. Gray finish only.

No. ID-118A - DEN-LYTE - Gives wide area of light for home or office desk, etc. Finished in gray, brown or black enamel (specify).

No. ID-118B - COOL-LYTE - Has insulated lamp hood to reduce lamp heat, ideal for artist, draftsman, etc. Specify gray, brown or black finish.



Only
9.95
each

Adapted from a Swedish design... You've seen it, assembled, priced as much as \$39.00

WORLD'S MOST AMAZING CATALOG

260 PAGES of GOV'T SURPLUS

Factory Closeouts and Hard-to-Find Bargains!

From EVERYWHERE Palley's bring you products of every description and at lower-than-wholesale "DISCOUNT" prices. Here you'll find bargains in Hand & Power Tools, Electric Motors & Generators, Sports & Outdoor Equipment, "Gadgets," Aircraft Instruments & Hardware, Winches & Hoists - PLUS World's largest on-the-shelf stocks of Hydraulic Cylinders, Pumps, Valves, Motors, etc. at SAVINGS up to 85%. Order Your Copy TODAY and SAVE!

Only 50c Your 50c will be refunded with your first order of \$1.00 or more.

TO COVER HANDLING & MAILING

TO ORDER - Send your Check or Money Order. Enclose 50% deposit with all C.O.D.s. All items are sent freight or postage collect.

palley's

2263 E. VERNON AVE., Dept. PM-42
LOS ANGELES 58, CALIF.

screens, upholstery, carpets...
hundreds of other uses.

You name 'em!



Swingline 101 Staple Gun

Staples practically anything. Exclusive push-button loading and built-in staple extractor. At your stationery, department or hardware store.

only **4⁹⁵**

FREE! New 8-page

SEND FOR YOURS TODAY! "TIPS FOR TACKING" Booklet... shows you how to save time, money and effort - with a SWINGLINE AUTOMATIC STAPLE GUN



Swingline INC.

32-00 Skillman Ave., Long Island City 1, New York

ROBERTS STEREO TAPE RECORDERS



LAWRENCE WELK:
"My Roberts 1040 tape recorder is the closest to recording studio equipment that I have seen."

ONLY THE ROBERTS 1040 4-TRACK STEREO TAPE RECORDER

Combines these Advanced Features:

Unique "listen-to-yourself" feature • Records new FM MULTIPLEX STEREO CASTS • 4-track stereo and monaural record/play • 2-track stereo and monaural play • Sound-with-sound, using either track as basic track • Dual, self contained power stereo amplifiers • Dual, built-in extended range stereo speakers • Automatic shut-off. **\$299⁵⁰**

ROBERTS ELECTRONICS, INC. Dept. PM-4-L
5920 Bowcroft Ave., Los Angeles 16, Calif. • Please send me:
 Roberts Stereo Tape Instruction Manual containing stereo and monaural applications. I enclose 25c (cash, stamps) for postage and handling. The name of my nearest dealer.

Name _____
Address _____
City _____ Zone _____ State _____

This point lets you bore holes up to 1½" with small electric drill

It's hollow ground to bore cleaner, faster at any angle

NOW YOU CAN increase the boring range of your small electric drill or drill press. New Irwin Speedbor "88" bits bore faster, cleaner holes up to 1½" in any wood. ¼" shank chucks perfectly. No wobble, no run-out. Sharp cutting edges on Irwin exclusive hollow ground point start holes faster, permit spade-type cutters to bore up to 5 times faster. All Irwin Speedbor "88" wood bits are forged from single bar of special bit steel, tempered full length and machine-sharpened for extra accuracy, longest life. 17 sizes, ¼" to 1½". Buy individually or in sets from your Irwin hardware or building supply dealer.

Only 75c each, sizes ¼" to 1"
Only \$1.25 each, sizes 1 1/8" to 1 1/2"

IRWIN SPEEDBOR "88" WOOD BITS
 at Wilmington, Ohio, since 1885

STOP WATER DAMAGE...

Wood
 Plywood
 Shingles
 Asbestos siding
 Concrete blocks
 Concrete
 Mortar
 Stucco
 Plaster
 Brick
 Paint
 Wallboard
 Tile
 Canvas
 Leather
 Linoleum
 Fabrics

Prevents warping, swelling, mildew, mold, water stains, seepage, dampness, rot.
Keeps moisture out 5 years and longer.

Use on all woodworking jobs, boats, patio furniture, planter boxes, shutters, screen doors, window sash, shingle roofs. Stops seepage in basement walls, concrete silos, foundations. Waterproofs canvas, tarps, tents, awnings, leather boots, shoes, outdoor clothing. Won't harden or crack leather or fabrics. Perfect underseal for oil base or alkyd paints. Deep penetrating, colorless. Apply by brush, spray or roller. At paint or hardware stores or order direct. 16 oz. spray can \$1.89, Qt. \$1.75, Gal. \$5.35, 5 Gal. \$25.25, ppd., tax incl. Send check or money order to **E. A. Thompson Co 1355 Market St., San Francisco 3, Calif.** No COD's please. (Since 1929.) Dealer and jobber inquiries invited.

The Celebrated Jumping Frogs

(Continued from page 109)

the water, one of the parascuemen swims out to retrieve it. Then, together, they position it under the spacecraft, securing it firmly in place and, when all the kinks are out, inflating it. With the capsule now safe from sinking, they get the astronaut out and render whatever aid seems necessary.

If undamaged, the capsule could probably float indefinitely. However, once the hatch is opened to get the astronaut out, water can flood it and sink it. This happened to Capt. Grissom's capsule. So the parascuemen use the extra floatation device.

All of which raises a question. Why wasn't this system used on the Grissom shoot? A frogman gave the wallflower's perennial answer, "Nobody asked us."

The Mercury space program is under the direction of the National Aeronautics and Space Administration, a civilian agency. In all of the space shots so far, it has assigned the Navy the task of recovering the capsule in the primary impact areas (areas about 50 miles wide and 100 miles long), and it has assigned the Air Force the task of recovering the capsule anywhere else.

The original Navy system, using Marine helicopters and crews, lifted both the astronaut and capsule directly out of the water without any extra floatation gear. It worked to perfection after Comdr. Shepard's flight but, following the loss of Grissom's capsule, the Navy apparently abandoned the system and deployed both surface vessels and frogmen into the impact areas for Col. Glenn.

It's still interesting to speculate, however, whether the Grissom capsule could have been saved if the frogman system—of putting a float under the capsule first, then getting the astronaut out—had been used.

Wallflowers or not, the parascuemen believe they're on the right track for perfecting a system that will recover almost any future spaceman or spacecraft.

Meanwhile, they are only one element of the Air Force's celebrated Air Rescue Service (ARS), which has its headquarters in Orlando, Fla., and units scattered—on 24-hour call—throughout the world. While part of its present assignment is obviously wrapped up in the future (space), ARS is justly proud of its past which has made it one of the most highly decorated and widely respected units in the world.

Conceived in the tragedies of World War II—the tragedies of downed airmen and others caught behind the lines who could not be rescued because there was no really consistent system developed for doing so—the Air Rescue Service was actually born

(Continued to page 236)

SURPLUS SALE

GOVT. SURPLUS
EXCESS INVENTORY
BANKRUPT STOCK



STORAGE BATTERY WINCHES—HOISTS

• Item #311. 12-v Gov't reversible, ball bearing 2000-lb. capacity winch. Holds 4' 1/4" cable. For trucks, docks, boats, etc. 55 lbs. Cost over \$250. SALE. **\$49.95**
Many other types battery winches-hoists.

GOV'T AIR COMPRESSOR

• Item #453. Expensive Gov't Compressor. G.E. motor 115-v. 60-c. Built-in air filter, relief valve, etc. Very compact and efficient.
• For paint spraying, insecticides, air brush, etc. A "Super Buy." Wt. 55 lbs. Gov't cost over \$250 SALE **\$29.88**
Many other bargains in Air Compressors, Tanks.

HYDRAULIC SURPLUS BARGAINS

• Great savings. Build loaders, diggers, presses, etc. Brand new equipment.
• 895 Pump, 1000 lb., 14 gpm. **\$41.60**
• 12-v Battery Hyd. Pump **18.49**
• Hand Hyd. Pump and Cylinder **27.95**
• 839 Hyd. Cyl. 3x8" 2-way **19.70**
• Hyd. 2-way 1000-lb. Valve **18.00**



GENERATOR—3000W—115V

• Item #633. D.C. ball bearing compound-wound Delco unit 1" dia. shaft. 2800 RPM. Ideal for portable tools, lights, boats, etc. Will run any 115-v DC-AC tool. 100 lbs. Gov't cost over \$175. SALE. **\$54.75**
Many other Surplus Power Plants and Generators.

FISH AND WORM SHOCKER

• Item #670. Harvest worms, clear private ponds of coarse fish. Powerful 110-v. AC hand geared generator creates powerful electrical field in ground or water. Amazing results. Also fascinating for experimental uses, fun at parties, etc. Super Alnico magnets. 3 lbs. Cost Gov't Over \$12.00. SALE. **\$3.49**

DIAL TELEPHONE

• Item #716. Std. phone, same used on all phone systems. Use as extension to main phone and on private systems. Directions furnished. Wt. 8 lbs. Cost \$25.00. SALE. **\$7.95**

SPECIAL OF THE MONTH!

ARMY JEEP CAPSTAN WINCH

• Item #325. Just rec'd Gov't award limited quantity Brand New Army worm gear Jeep Capstan Winches. Designed for front end mtg. on Army Trucks & Jeeps. Ideal for boats.
• Has input shaft which can be driven thru flexible coupling to fan pulley shaft. Also easily adapts to 12-volt battery motor drive. Size 14"x12"x9". Wt. 39 lbs. Gov't cost over \$100.00 Sale. **\$39.50**
• With 12-volt motor drive. 76 lbs. List \$225.00 SALE. **\$89.50**

EXAMPLE BARGAINS IN 1962 CATALOG

• \$175 Gov't 12-Line Tel. Sw. Board. **\$13.29**
• \$90 Two Station Phone Inter-Com. **26.95**
• \$150 Prismatic Air Force Adv. Lite **11.95**
• \$85 Fire-Burglar Alarm System. **12.95**
• \$275 Battery Gear Motor, 6-12 v. **19.25**
• \$16 AC-Volt meter -0-300V. **7.95**
• \$52 Cathode Ray Exp. 5" Tube. **4.91**
• \$75 1 1/2" Bronze Water Pump. **19.95**
• \$40 Transformer 115 to 230 Volts-1KW. **15.61**

ALL ITEMS THIS AD FOB LINCOLN
Write today for large 1962 catalog.

SURPLUS CENTER

DEPT. 806, LINCOLN, NEBR.

True Natural Wood Beauty

WOOD FINISH



No artificial plastic look

Roll it, brush it, spray it. Deft interior clear is easy to use, fast dry and trouble-free, the complete finish in one can. Free 6-step finish chart folder.

wherever paints are sold, or write—
DESMOND BROS., P. O. Box 2216 Dept. PM,
Torrance, Calif.



4-WAY WELDER \$14.95

WELD-BRAZE-SOLDER-CUT Complete

NO OTHER WELDER AT THIS PRICE Complete with SAFETY FOOT SWITCH, FULL FACE SHIELD, twin carbon arc torch, welding rod holder, clamp, carbons, welding & brazing rods, flux, fuses, instruction book. FULL YEAR GUARANTEE. More than a quarter million in use in homes, garages, farms, shops, factories. NOW anyone can weld, braze, solder, cut, heat, without experience. Does 1001 jobs on all metals. Save & earn money. Make & repair auto bodies, parts, fenders, trailers, boats, metal furniture, fixtures, ornamental iron, farm equipment, garden tools, bicycles, toys, etc. Operate on any properly wired 110 V AC line. SEND ONLY \$2. Pay postman \$12.95 plus C.O.D. charges. Ideal lifetime gift for hobbyist, mechanic, hot rodder, homeowner. Order on 10-day money-back guarantee. **FOUR WAY WELDER CO. DEPT. F2-D, 1810 S. FEDERAL ST. CHICAGO 16, ILL.**

priced from \$109.50...
HAND-HELD, MOBILE, BASE STATION

2-WAY RADIO

VIKING MESSENGERS



Now, 3 feature packed Johnson Messengers...
outperforming everything else in the field!

Compact, hand-held 100 milliwatt or 1 watt "Personal Messengers". Rugged and reliable—11 transistors, 4 diodes! Superheterodyne receiver and exclusive tuned RF amplifier gives twice the sensitivity and 40% more range than similar units with conventional circuitry—more output than similar units with same rated inputs!

For mobile or base stations—performance proved Viking "Messenger" punches your signal across the miles! High efficiency design makes full use of maximum allowable legal power. Excellent receiver sensitivity and selectivity. Automatic "squelch" control—5 channel coverage. Only 5 1/2" x 7" x 1 1/2", easy to install anywhere!

WRITE TODAY
for
information packed
4 Color Catalog



E. F. JOHNSON COMPANY
1407 10th Ave. S.W., Waseca, Minnesota
Please rush "Messenger" details to:
NAME _____
ADDRESS _____
CITY _____ STATE _____

Manufacturers of the world's most widely used personal communications transmitters.

UNUSUAL TOOLS BY MAIL



No. 44—COMBINATION MITER BOX AND CORNER CLAMP

Holds the wood and holds your saw. Uses any handsaw for accurate cuts from 0° to 180°. Full 13" capacity. Sides of joints exposed for nailing, gluing. **\$2.75 PPD.**



SUPER DRILL GRINDER
Sharpens round shank drills like new, using hand or power grinders. **\$2.95 PPD.**

Point Brush Holder
2 for \$1.00 ppd.



JOINT AND SHARPEN ALL SAWS

SUPER FILE NO. 11 joints and sharpens hand and circular saws 6" to 10" with all teeth correct in height, depth, pitch, bevel. When file hits steel roller, teeth are finished. Saw runs true **\$9.95 PPD** with no side pull. Includes 8" file. . .

"TRU-CIRCLE"
Saw set automatically sets teeth at 10° or more... **\$2.95 PPD**



A. D. McBurney, 5908 Hollywood Blvd., Hollywood 28, Cal., Dept. A-42

following the war in 1946. Its primary duty was, and is, the recovery of downed combat airmen, and its primary piece of equipment was the then recently developed helicopter. It still has helicopters (the Sikorsky H-19, Boeing H-21 *Workhorse* and Kamam H-43 *Huskie*), but has since added amphibians (the Grumman SA-16 *Albatross*) and, of course, the jumping frogs.

It has also added many other duties.

To put it in its simplest terms, the Air Rescue Service flies whenever and wherever it is needed—in peace or war. In its 16 years of existence it has answered distress calls—airlifting survivors or dropping medical supplies and equipment—during and after such natural disasters as floods, earthquakes, hurricanes, typhoons, air crashes and shipwrecks, and such man-made disasters as the Korean conflict.

It has rescued from certain death more than 8000 persons, many of them non-Americans, and has aided more than 50,000 while flying nearly 45,000 missions. Individually and collectively, Air Rescue Servicemen have probably created more good will abroad than any other Americans.

As early as February, 1947, ARS men established an emergency airlift when the Mamore River in Bolivia flooded, wiping out native villages in a mountainous region covering an area of more than 100 square miles. Under these hazardous conditions, they evacuated hundreds of natives. When it was over, their commanding officer was awarded Bolivia's highest decoration, the Condor of the Andes, the equivalent of our own Congressional Medal of Honor.

In 1953, thousands of persons were saved by ARS men in the disastrous floods in the Netherlands and England. Dutch Queen Juliana and Prince Bernhard were flown over the stricken areas by ARS aircraft and, in England, probably the greatest single act of heroism was performed by Airman 3/C Reis Leming who, in spite of the fact he couldn't swim, pushed a rubber life-raft into the swirling waters and, in three trips, rescued 27 persons unaided. He collapsed after the third trip. Queen Elizabeth granted him the George Cross, the first foreigner in history to receive it.

Snatched From the Rigging

ARS men rescued stranded Japanese seamen following a typhoon. In one of these rescues, the helicopters just managed to save the crewmen who were clinging to the rigging of their sinking ship. The hull had already sunk from sight.

Perhaps the outstanding sea rescue occurred in 1954 off the coast of Red China. A British airliner, bound for Hong Kong, had been shot down without warning by

Communist jets. Nine of the people aboard were killed, and the survivors were afloat in a lift raft within the 12-mile limit set by the Communists as their international boundary. Red China radios warned that all "war planes" which entered the area would be fired on.

An Air Rescue *Albatross*, stationed at Clark Air Force Base in the Philippines, flew to the rescue. The pilot, Capt. Jack Woodyard, ignored the warnings and, after locating the raft, set down in the water and taxied alongside it where his crew gathered the survivors aboard. One of them, a young Chinese girl, died on the flight back.

All of the above rescues, remember, were of non-Americans and outside of the normal line of duty of the Air Rescue Service. Most of its work, in addition to salvaging satellites and spacecraft, is directed toward rescuing survivors of U. S. military and civilian air crashes and assisting in rescue operations after domestic disasters such as the spring floods in the Middle West and the summer hurricanes on the East Coast.

Its finest work of all, perhaps, was done during the Korean War. No other unit was cited for bravery as often. Perhaps the most outstanding example was the night rescue of an F-51 pilot who had been shot down and had parachuted into the Taedong River in enemy territory.

Blind Rescue Under Fire

Knowing only the approximate position of the downed airman and under continual enemy fire, Lieut. John Najarian landed his *Albatross* on the river without lights and with only a vague idea of the Taedong's depth and width. Taxiing through the dark, he saw a blinking pinpoint of light and headed toward it. It was the downed pilot, using his emergency flashlight. The pilot was gathered aboard and while the shore batteries continued their fire, the takeoff was made in total darkness. Najarian could see neither the water nor the horizon in the blackness. It was successful, however, and, after clearing some high-tension wires at a bend in the river, with the flak still bursting around his plane, Najarian headed for home. For his heroic effort, he was awarded the Distinguished Service Cross, this nation's second highest medal.

As the wise man said, the past is but prologue. The Air Rescue Service has a noble past, but perhaps it's only a prologue to what it might now accomplish as it trains itself for the space age. These rescue artists, who don't always get the glory but take a perverse pride in saving those who do, will now be waiting around to welcome travelers from space and carry them safely home. ★ ★ ★



"So there I was
with my trusty..."

Lucky fisherman: compact car . . . compact sailfish . . . new compact Sea-Horse motor.

NEW JOHNSON COMPACTS

Lighter...leaner...same famous Sea-Horse dependability

Smaller, sleeker, slimmer and trimmer. It's a '62 Johnson Compact! Designed for function, not for flash. Shown above is the 18 hp model. Below and to the right are the 10 and 5½.

And dependability is their middle name. A cushion hub prop that protects against stump bumping. Thermostatic cooling for smoother any-weather performance. Add a super silencing system, full gearshift, plus corrosion proofing and you've got the best fishing news this side of a bass bed.

Your Johnson dealer's in the Yellow Pages. '62 Sea-Horse motors include: Electramatic 75's and 40's; a budget-bomb 28; and a 3 that thinks it's a 5½. Send for free '62 catalog.

Johnson Motors, 1294 Pershing Rd., Waukegan, Ill. Division of Outboard Marine Corp.

Well over two million quiet Sea-Horse motors prove **JOHNSON DEPENDability**



'Sputniks' Orbit the Supermart

(Continued from page 88)

"We asked a salesman for a \$1000 calculating machine if there was a simple way of comparing such amounts on his machine . . . he went away shaking his head."

"What is the price per ounce of this 6½-oz. can of tuna at two for 63 cents, compared to this 9¼-oz. can at 43 cents?" a woman wanted to know. "Only an expert with a slide rule or abacus can figure out comparative costs."

"Most of us are too busy to take a computer, a slide rule and an MIT graduate to market and figure out what we are buying," another witness remarked. (Recently a simplified supermarket calculator that figures out the cost per unit was put on the market by Best Buy Products Co., P.O. Box 82, Decatur, Ill.) — *D/EE PUSTPAID*

Several people touched on the use of "bargain labels" that claim "5 Cents Off Regular Price" or "Special Offer, 30 Cents Off." When such labels are printed by the hundreds of thousands it's silly to think that a special bargain is being offered. The "special" price becomes the regular price, even though the original price had been increased just to permit the reduction.

Chemicals or Foods

One witness testified that some packages contain far more chemicals than foods. He cited a brand of "Clear Chicken Instant Soup" that listed its contents: Salt, dextrose, monosodium glutamate, dehydrated onions, chicken fat (which is not chicken meat), starch, dehydrated vegetables, spices, tricalcium phosphate, butylated hydroxyanisole, propyl gallate, plus citric acid in propylene glycol.

"A correct name for this product," he said, "if one assumes that its sale should be permitted at all, would refer to it as an imitation soup mix."

One of the most common complaints was the difficulty in finding and reading the net weight declaration on many packages. Some declarations appear in tiny print, others are virtually concealed by other means. Instances were cited of labels that used to show the net weight in large print on the front of the package, and that have been replaced by "modern" labels in which the statement of contents is printed in small type and in an inconspicuous place on a side or the back of the package.

Sometimes the declaration blends in with fancy artwork, sometimes it is blended into the background. "Here's an example of a package that has its contents marked in yellow on shiny gold foil that glares in your eyes," one witness declared while holding

up the package. "I would dare the committee to find the ounces on that package. It is there."

Is this sort of thing against the law? The federal Food, Drug and Cosmetic Act requires that the label of a package carry an accurate statement of the amount of the contents, prominently and conspicuously placed. Somehow that part of the law has been stretched out of all recognition.

Another complaint was about slack filling. A housewife said she is always disappointed when she finds an inch or so of air space in the top of a box, even though the contents lives up to its stated weight. She figures that the packager is trying to fool her with an oversize box.

There are exceptions to this, as I learned myself. I opened a box of powdered soap and found more than an inch of air space inside, then I poured the contents into a large pan and back into the box again. I had a lot of soap left over when the box was full and had to cram in the rest of it. In this case it was apparent that the contents had jiggled into smaller space during shipment.

Instances like these are some of the reasons for Senator Hart's hearings on packages and labels. After reviewing all the testimony, his subcommittee will decide whether present laws need to be strengthened or left as they are, or whether some entirely new laws are needed.

Tougher Laws

Senator Hart favors tougher laws. "I felt that there were exhibits that we saw that were within the law and wrong," he said. "It follows that additional legislation is desirable."

Some of the food companies are not waiting for new laws. Running scared, they have already made adjustments in their packaging. One large company sent a memorandum to its various divisions ordering net-content statements to be "clearly, prominently and conspicuously shown on the main display panel," and that no type below a certain size be used.

Another supermarket chain announced it is changing the position and increasing the type size of markings on its own private brands "wherever there is a possibility of a question being raised."

Meanwhile, is there anything you can do about all this yourself? Of course there is! You can complain to your grocer about packages that you believe to be deceptive and ask him to pass on your complaint to the manufacturer. You can write directly to the manufacturer as well. And you can stop buying a particular brand and shop for others. ★ ★ ★



SPECIAL OFFER

**Father's Day • Graduation • Birthday
3/8" DRIVE ALLOY STARTER SET**

Lots of space for keeping other tools in the heavy duty hip roof box. Removable tote tray with exclusive tool organizer. Tools are American made genuine alloy steel, for a lifetime of use. Complete

\$1995

Fleet TOOLS

Special certificate included for **FREE SPARK PLUG SOCKET WRENCH**
Retail value \$1.85
at volume outlets
offer expires July 31, 1962

SCHILLER PARK, ILLINOIS

That sunburned look? If the peeling paint job on your house has it, there are ways to find and correct the moisture conditions which make the paint peel. The May issue of Popular Mechanics contains a trouble-shooting guide on this subject.

ROCK HOUNDS THUMLER'S TUMBLER

- Imparts gem-like polish to 3 to 10 lb. rocks.
- Simple—guaranteed—no better at any price.
- If your dealer can't supply, order direct \$18.95 postpaid. (Set of 2 grits, 1 polish, \$1.20 additional.)



TRU-SQUARE METAL PRODUCTS, INC.

(CHECK OR MONEY ORDER ONLY)
P.O. BOX 375, AUBURN, WASH.

WAR SURPLUS AND OTHER BARGAINS SAVE UP TO 90%

DC JET GENERATOR ARC WELDING KIT Complete with GE Type CM-77 Generator (30 volts D.C., 400 Amp., 3000 RPM up; ampere rating is for continuous duty, intermittent amperage is 500 to 600 amps.), also 2 rheostats, 1 voltage reg., 1 voltmeter, 1 electrode holder, 1 welder's mask, 1 toggle switch, 10 lb. vacuum packed 1/8 in. welding rods, pair welder's gloves & spline coupling. All units guaranteed pre-tested. Wt. 110 lbs. Approx. GOVT. COST \$700. All items, now only **\$64.50**.

*G.E. Generator noted above can be purchased separately. Makes deluxe heavy-duty welder comparable to the finest commercial welders available. Wt. 90 lbs. Approx. GOVT. COST \$600. Gen. alone—**\$49.50**.



ELECTRIC STORAGE BATTERY WINCH

New, improved model contains heavy-duty, 2-way drum switch. Fully reversible heavy-duty, two-speed motor, 160 to 1 gear reduction. Ball bearing construction throughout. Drum will handle 70' of 1/4" cable. Can be used on 6, 12, 24 V. battery. Lift cap. 2000 lbs. plus. Ready to install & operate. 19" long x 9" wide x 8" high. For jeeps, trailers, boats, trucks, etc. Complete with mounting flange safety load locking brake. Shpg. Wt. 60 lbs. Approx. GOVT. COST \$400. NEW. Model E. **\$49.50**.

DELUXE MODEL ED Same as above but with extra heavy base & outrigger support bearing. 200' 1/4" cable spool capacity. NEW. **\$69.50**.

"SUPER 9" 200 AMP WELDING KIT With Deluxe accessories consisting of one 200 AMP. Gen., adjustable helmet, electrode holder, ammeter and shunt, rheostat, toggle switch, voltmeter, voltage reg., 1 pr. heavy-duty welder's gloves and 30' cable. All units guaranteed pre-tested. Approx. GOVT. COST \$500. Most items new—all perfect. **\$27.50**.



HEAVY-DUTY WELDING CABLE—Size No. 1/0. Use as positive and negative electrode cables for arc welder. Rubber jacketed copper cable. Handles up to 300 Amps. Extra flexible, multi-stranded. Terrific value. 50' lengths. **\$24.95**

FRESH WATER SYSTEM PUMP—For boats, campers & trailers. Output 10 to 200 gal. an hr. Variable rheostat controls output. 1/2" pipe thread into bronze impeller housing. 12 V.D.C. Radio noise filter. 5.2 amp. draw. Explosion-proof const. Shpg. wt. 11 lbs. Complete with mounting instructions & wiring diagram. Approx. GOVT. COST, \$200. NEW. **\$10.95**.

225-1 REDUCTION GEAR For beaching boats, winches, hoists. Ideal motor in golf or boy's electric car. DC motor and clutch. Easily reversible wiring diagram furnished. Hi torque. Runs at 47 RPM on 12 V. DC; 105 RPM on 24 V. DC. Approx. 20 RPM on 6 V. DC. All ball bearing const. Shpg. wt. 65 lbs. Approx. GOVT. COST \$300. **\$13.50** Matched splined gear—**\$3.00 ea.**

NEW 1962 CATALOG! Tremendous catalog—our biggest ever—fully illustrated—1000s of bargains in war surplus & other items. Send 25c in coin for your copy today or free copy with order. Where ppd. indicated applies to US only. Other prices FOB Culver City, Calif. Send cash, check, money order, 50% deposit for COD.

AIRBORNE SALES CO., INC. DEPT. PM462
8501 Stellar Drive, Culver City, Calif.

MAKE HOME IMPROVEMENTS NOW

POWERFUL

10,000 cutting strokes per minute

WRIGHT POWER BLADE SAW

The most useful gasoline-powered saw you can own. Rugged power for felling 20" trees, smooth cut for carpentry or pruning, perfect for firewood. Safe to use, even on a ladder. Send coupon today for free plans, literature and the name of your nearest dealer.

SAFE!

FREE PLANS

Plans for log cabin also shows how to build duck blind, rustic furniture, boat dock, fences, etc.

HOW TO BUILD A LOG CABIN

THOMAS INDUSTRIES INC., Wright Saw Div.
Dept. PM-3, 207 E. Broadway, Louisville 2, Ky.

Name _____

Address _____

City _____ Zone _____ State _____

Owners Report on the Pontiac

(Continued from page 99)

six through ten in the order of frequency mentioned.

"I like the full-vision windshield with its effective washers and wipers."—Texas retiree.

"Low sloping hood permits clear vision of the road ahead."—Iowa warehouseman.

"I like the wide-track stability."—Montana electronics specialist.

Wider tread does help stability yet costs little or nothing extra. Pontiac has widest tread in the industry.

"This wide-track car stays on the road better."—Missouri salesman.

"It's comfortable on trips and we are both tall."—New Jersey machinist.

"Everything inside is real comfy. There is plenty of room."—Nebraska secretary.

"It looks smaller than the '59 Catalina I owned."—Missouri salesman.

It is smaller; two inches shorter, two inches narrower, one inch lower, two inches shorter wheelbase but roomier inside. That's progress.

"Very well satisfied with the performance and mileage of this car."—Oklahoma auto repair man.

Back to complaints, with numbers six through ten, in their order of frequency.

"Workmanship in fit of body parts could be better, but Pontiac is as good as any or better."—North Dakota insurance man.

He's right, Pontiac is as well-built—maybe better—as any car in its price range, but there's still room for improvement.

"Sloppy assembly job—many small items aren't put together properly."—Mississippi personnel director.

"I don't like the heating system. It has a center outlet and keeps the driver's right foot hot in highway driving. Also very uncomfortable for middle passenger in the front seat."—Virginia hosiery mill worker.

"The heater fan motor should have separate switch."—Maryland salesman.

Definitely. You can only defrost Pontiacs with full blower speed.

"The heater should be under the seat—people in the rear seat freeze their feet."—Indiana maintenance supervisor.

Pontiac used to have this excellent feature but trend to lower cars in recent years left no room. Perhaps hot air could be piped back through transmission tunnel.

"The speedometer does not register correctly. It's about 15 m.p.h. ahead of the car's actual speed.

"I'm sick of having the sun visor hitting my hat all the time. I read once about a man in Detroit whose life's dream was to make American cars longer and lower. I'd like to bury him deep."—Vermont art dealer.

I think that dreamer is buried lower than his car by now. Over-all heights are holding at about 54 inches. Stylists are now struggling to make 'em look lower but not be lower—a neat trick.

Here's the final group of best-liked features, eleven through sixteen, in the order Pontiac owners mentioned them.

"The power steering is the best I've used."—Utah professor.

"Interior decor is well above average."—Arizona mortgage broker.

"It's easy to park."—Wyoming housewife.

"Very easy to park."—South Carolina secretary.

"I like its ability to move in snow."—Minnesota painting contractor.

"After putting 11,235 miles on the car, over all types of road conditions, it is still tight."—California salesman.

His comment really counts. Most cars manage to stay squeakfree 'till after 1000-mile checkup; when they're solid at 11,000, you've got something.

"I have never driven a smoother auto."—Iowa auto body repairman.

Let's close the debit side with the final group of gripes, numbers eleven through sixteen listed in their order of mention.

"Windshield runs up too high, which does not suit me."—Illinois bank examiner.

"Too much front and rear exposure to the sun inside, but extra visibility compensates for this."—Iowa welder.

He's got a sensible attitude—it's pretty hard to have shade and vision from the same window at the same time. But, there is room for a better sun visor—perhaps a different type.

"Shorted generator armature was replaced at no charge."—Pennsylvania electrical engineer.

"Engine noises aren't adequately insulated from the passengers."—Vermont plant superintendent.

"I had some trouble with the choke."—Kentucky retiree.

"The small (Catalina, Grand Prix) transmission is slow in starting which makes the engine over-rev until a certain speed."—Pennsylvania carpenter.

This is quite true. This new medium-sized HydraMatic is less complicated, less expensive and less effective (see below).

"I dislike the three-speed automatic transmission; I have no passing gear above 55 m.p.h. I would prefer to have the four-speed automatic that's used in the Star Chief and Bonneville."—West Virginia lawyer.

"Wheels are set too close to fenders for chains."—North Carolina mason. ★ ★ ★

That's the price of "wide track" wheels in a standard body width—you can't have everything.



TAIL DRAGGING?

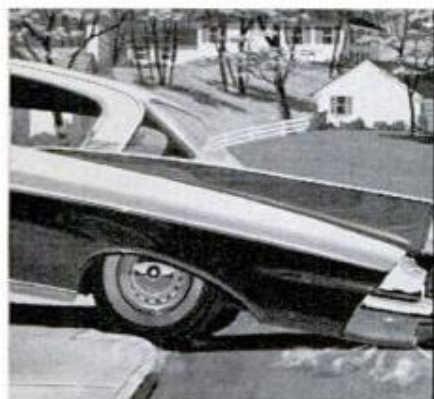

SCRAPING ON DRIVEWAYS? This common annoyance, the result of soft springing, heavy weight and the longer, lower design of today's cars, is eliminated when you install Monroe Super Load-Leveler® stabilizing units. Gone is the problem of scraping rear bumper or tailpipe on any incline.

SWAYING ON CURVES? Side sway is dangerous, throws passengers from side to side, causes uneven tire wear. Give your car that sure-footed "sports car feel" with Monroe Super Load-Leveler stabilizing units.

"BOTTOMING" ON BUMPS? End this danger with Super Load-Leveler stabilizing units. They prevent jarring jolts that can cause car damage and injury. For a safer, more comfortable ride, have a set installed today where you have your car serviced. Ask about Monroe's 60-day free ride.

LOOK FOR THE YELLOW AND BLUE



MONROE DEMONSTRATOR BARREL



MONROE AUTO EQUIPMENT COMPANY • MONROE, MICHIGAN • In Canada, MONROE-ACME LTD. Toronto, Ontario • In Mexico, MEX-PAR, Box 28154, Mexico City • World's Largest Maker of Ride Control Products, including MONRO-MATIC® Shock Absorbers

NEW! PORTABLE NO-CLAMP VISE



Pat. Applied for.

For the repairman, the workshop, kitchen, boat, garage . . . anywhere! Needs no clamps, no screws. The Super Vacuum base holds firmly . . . in any position on any smooth, non-porous surface. 2½" jaws with "V" grooves. Made in USA. Weight: 4½ lbs.

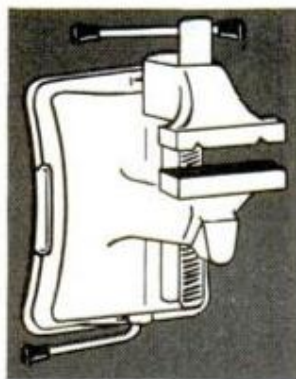

Now you can take the vise to the job!

For the "Do It Yourself", the Repairman, the Man Who Needs a Third Hand. Amazing — holds firmly even in an upright position.

You saw the Vacu Vise on coast-to-coast television.

VACU VISE®

AT BETTER STORES EVERYWHERE, OR WRITE TO:

GENERAL SLICING MACHINE CO., INC.

Dept. PM

Walden, New York

Machine Sings Simple Songs

When an electronic computer of the future feels it is being overworked, it might just speak up and say, "Take it easy, boss, my transistors are aching something awful."

Three scientists at Massachusetts Institute of Technology have developed a synthetic speech machine that can sing simple songs or say a few sentences. One use for such a synthesizer, they say, will be in communications between man and machines such as computers.

The synthesizer electronically simulates the sound pathways of the human vocal tract and nasal cavities. Control circuits are given detailed instructions on what to do—and could be controlled, for instance, by a computer. These instructions were determined by analyzing natural speech sounds, studying X-ray motion picture films of persons speaking and incorporating the scientists' knowledge of speech acoustics and phonetics. The men who made the machine are Drs. M. H. L. Hecker, A. S. House and K. N. Stevens.

QUOTE:

"The good scientist-to-be should be a non-conformist. He must be willing to get off well-traveled mental highways and strike out for himself. The brief history of atomic science is the story of men and women who had the intellectual courage of their convictions."

LAWRENCE R. HAFSTAD
Vice-President, Research
General Motors Corp.

False Tooth Holds Hearing Aid

Installed in a hollow false tooth, a tiny receiver picks up radio signals from a microphone and transmitter worn on a deaf person's wrist and relays the signal into the body's nervous system and brain—and the wearer hears.

The receiver is imbedded partly in tissues of the gum, partly in a tooth attached to a dental bridge and placed between live teeth that have a metal filling. The metal relays the signal to the vital pulp of the teeth and thence to the brain.

The device functions even with the mouth closed, according to the inventors, a New York dentist and a California doctor.

Dr. Joseph L. Lawrence and Dr. Henry K. Puharich say patients report the reception of a clear sound with almost imperceptible background noise.

They are working with engineers to make the entire oral device fit within space of a single missing tooth.

Like a breath of tomorrow

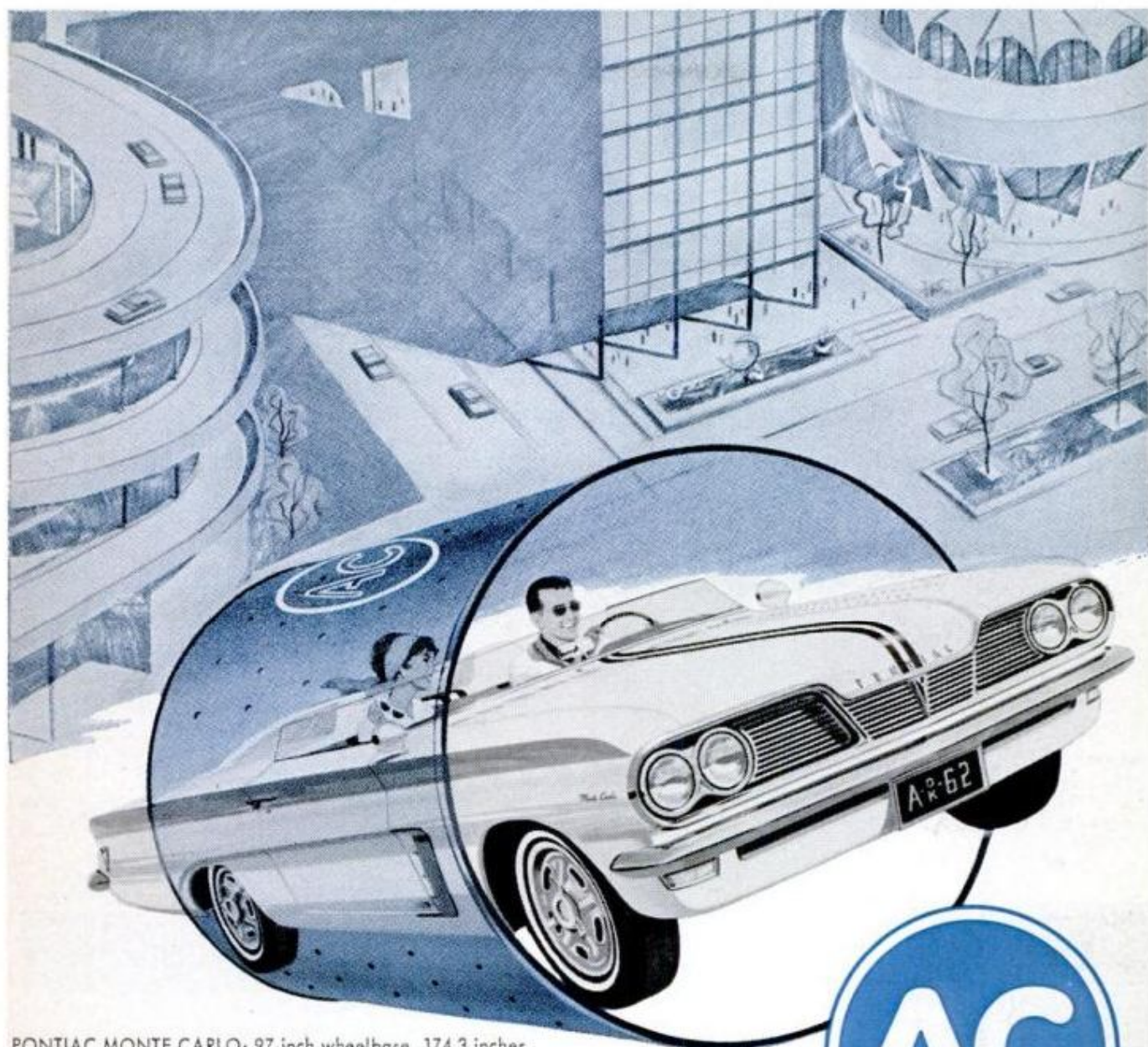

PONTIAC MONTE CARLO: 97-inch wheelbase, 174.3 inches over-all; 4-cylinder Tempest engine; 194.5-cubic-inch displacement; 8.25 to 1 compression ratio; Supercharger is positive displacement blower; 300 h.p. at 5600 r.p.m.

... **protected by**

Engineers specify AC Filters . . . for experimental cars of the most advanced design, as well as today's maximum performance beauties. Shown here is the Monte Carlo, an experimental Pontiac now being put to the test over the fastest highways and toughest proving grounds.

Its vital filtration system is AC throughout—with today's AC Filters, designed and built to meet the rigorous performance demands of *tomorrow*. An AC Oil Filter traps damaging dust, dirt and condensation to keep your oil clean and prevent the formation of power-killing sludge. AC Air and Fuel Filters protect your gasoline from airborne impurities that clog your carburetor and downgrade operating efficiency.

Ask your AC Dealer about Full Filtration by AC. He's a filtration specialist, equipped to give your car the finest protection money can buy. Ask for ACTION . . . ask for AC.

APRIL 1962



**OIL AIR FUEL
FILTERS**

AC SPARK PLUG  THE ELECTRONICS
DIVISION OF GENERAL MOTORS

Are you a guy who didn't MARRY THE BOSS'S DAUGHTER?



They tell us it's a good way to get ahead. The tough part is... there aren't enough bosses' daughters to go around. But there's another way to call your shots.

How? Look at the want ads! Business and industry are crying for men with special training. 60,000 Engineers—Industrial Supervisors, Communications and Traffic Specialists are urgently needed. Demand has never been greater—or salaries higher—for trained people.

With the right kind of training you can step into one of these jobs — write your own ticket. Without it you must compete with a few million other guys who are in the same boat. And, if times get tough, it's not going to be a good boat to be in.

So act now! Choose the education for men who want to get ahead fast. Pick your future from success-proven I.C.S. courses. Whichever field you choose it will be *right* because all I.C.S. courses are developed by business and industry leaders who know what *you* need to know to go places.

You get *personalized* guidance. Earn as you learn. Study in your spare time — at your own pace. And when you get the coveted I.C.S. diploma, it's the frosting on the cake. Chances are by that time you've already been snapped up for a bigger job with a bigger price tag.

Don't wait another day! Choose your course and send for the free career booklets offered below.

For Real Job Security—Get an I. C. S. Diploma!

I. C. S., Scranton 15, Penna.

Accredited Member,
National Home Study Council

INTERNATIONAL CORRESPONDENCE SCHOOLS



BOX F5419D, SCRANTON 15, PENNA.

(In Hawaii, reply P.O. Box 418, Honolulu)

(Partial list of courses)

Without cost or obligation, send me "HOW TO SUCCEED" and the opportunity booklet about the field BEFORE which I have marked X (plus sample lesson):

ARCHITECTURE and BUILDING CONSTRUCTION

- Air Conditioning
- Architecture
- Arch. Drawing and Designing
- Building Contractor
- Building Estimator
- Carpenter Builder
- Carpentry and Millwork
- Heating
- Painting Contractor
- Plumbing
- Reading Arch. Blueprints

ART

- Commercial Art
- Magazine Illus.
- Sign Painting and Design'g
- Sketching and Painting

AUTOMOTIVE

- Automobile
- Auto Body Rebuilding and Refinishing
- Auto Engine Tuneup
- Auto Electrical Technician
- Diesel Engines

AVIATION

- Aero-Engineering Technology
- Aviation Engine Mech.
- Reading Aircraft Blueprints

BUSINESS

- Accounting
- Advertising
- Bookkeeping and Cost Accounting
- Business Administration
- Business Management
- Clerk Typist
- Creative Salesmanship
- Managing a Small Business
- Professional Secretary
- Public Accounting
- Purchasing Agent
- Real Estate Salesmanship
- Salesmanship
- Salesmanship and Management
- Traffic Management

CHEMICAL

- Analytical Chemistry
- Chemical Engineering
- Chem. Lab. Technician
- General Chemistry

- Oil Field Technology
- Pulp and Paper Making

CIVIL ENGINEERING

- Civil Engineering
- Construction Engineering
- Highway Engineering
- Professional Engineer (Civil)
- Reading Struc. Blueprints
- Sanitary Engineer
- Sewage Plant Operator
- Structural Engineering
- Surveying and Mapping
- Water Works Operator

DRAFTING

- Aircraft Drafting
- Architectural Drafting
- Drafting & Machine Design
- Electrical Drafting
- Electrical Engineer Drafting
- Industrial Piping Drafting
- Mechanical Drafting
- Sheet Metal Drafting

ELECTRICAL

- Electrical Appliance Servicing
- Electrical Engineering

- Electric Motor Repairman
- Elec. Engr. Technician
- Elec. Light and Power
- Practical Electrician
- Practical Lineman
- Professional Engineer

HIGH SCHOOL

- Good English
- High School Diploma
- High School General
- H. S. College Prep. (Eng'r'g & Science)
- High School Math
- High School Science
- Short Story Writing

LEADERSHIP

- Industrial Foremanship
- Industrial Supervision
- Personnel-Labor Relations
- Supervision

MECHANICAL and SHOP

- Diesel Engines
- Gas-Elec. Welding
- Heating and Air Conditioning
- Industrial Engineering
- Industrial Instrumentation

- Industrial Safety
- Machine Shop Practice
- Mechanical Engineering
- Plumbing and Heating
- Professional Engineer
- Quality Control
- Reading Shop Blueprints
- Refrigeration and Air Conditioning
- Tool Design
- Tool Making

RADIO, TELEVISION

- General Electronics Tech.
- Industrial Electronics
- Practical Radio-TV Eng'r'g
- Radio-TV Servicing
- TV Technician

RAILROAD

- General Railroad

STEAM and DIESEL POWER

- Combustion Engineering
- Power Plant Engineer
- Stationary Diesel Engr.
- Stationary Steam Engines

TEXTILE

- General

Name _____ Age _____ Home Address _____

City _____ Zone _____ State _____ Working Hours _____ A.M. to P.M. _____

Occupation _____

Canadian residents send coupon to International Correspondence Schools, Canadian, Ltd., Montreal, Canada. . . . Special low monthly tuition rates to members of the U. S. Armed Forces.

NEW



Ready for a radial?

If you haven't already added that radial saw you've been thinking about, you're lucky. Now you can own the **BRAND NEW DELTA SUPER 990!** It backs up horsepower with *cutting* power. It gives you *useful* features, not gadgets. And it's a versatile, one-tool workshop you'll want to see for yourself. So see your Delta Dealer (listed under **MACHINERY** in the Yellow Pages)—you'll like his deal.

Rockwell Manufacturing Co., Delta Power Tool Division
502D N. Lexington Ave., Pittsburgh 8, Pa.

Please send me **FREE FOLDER** with all the facts on
Delta's new **SUPER 990** Radial Saw.

Name

Address

City Zone State

DELTA POWER TOOLS

another fine product by

ROCKWELL



Материал, защищенный авторским правом



It's what's up front that counts

FILTER-BLEND up front, ahead of a pure white, modern filter — that's Winston's flavor secret. Mild, flavorful tobaccos specially selected *and* specially processed for good filter smoking. Your first pack will convince you that Winston *has* it up front where it counts! Smoke Winston.

R. J. REYNOLDS TOBACCO CO., WINSTON-SALEM, N. C.

WINSTON TASTES GOOD *like a cigarette should!*